

AUGUST 30, 1979

WESCON: A TECHNOLOGICAL PREVIEW OF THE EIGHTIES/170

Signal-processing chip boosts microsystem speed to real time/ 131

Optical triac offers direct control of ac power/ 145



FOUR DOLLARS A MCGRAW-HILL PUBLICATION

Electronics®

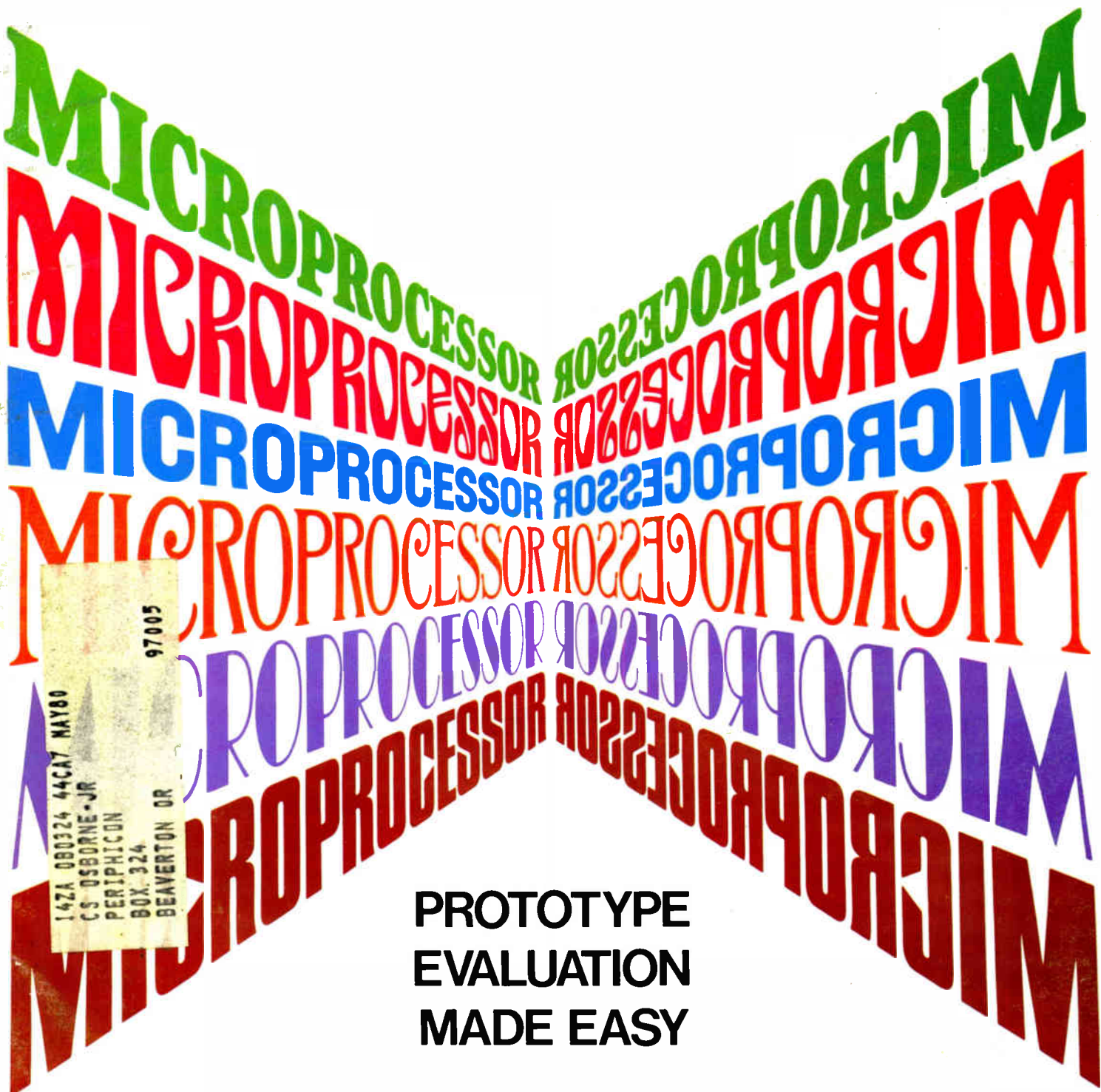

147A 080324 44CA7 MAY80
CS OSBORNE -JR
PERIPHICON
BOX 324
BEAVERTON OR 97005

**PROTOTYPE
EVALUATION
MADE EASY**

Bourns® DIP Pulse Transformers ...

When you
need quality and quantity.

Unlimited Capacity — Custom or standard, Bourns can provide high quality 14 and 16 pin DIP pulse transformers in the quantities you require. Our production capabilities offer virtually unlimited capacity for producing high volume quantities to your specifications.

Technological Leadership — Fully qualified Bourns design engineering personnel can aid you in developing the proper specifications for your applications. Care is taken to assure that all customer requirements are fully met prior to beginning production.

High Quality & Low Cost — There's no need to sacrifice quality for price. The Bourns reputation for high quality at cost-effective prices is well earned. Typical pricing for annual usage of 25,000 is under \$1.00*. All Bourns DIP pulse transformers are totally encapsulated to withstand industrial cleaning processes and high humidity conditions.

Auto-Insertion — Bulk packaged for machine insertion, Bourns DIP pulse transformers can dramatically reduce production costs and increase productivity in high volume applications.

Quick Delivery — Bourns offers realistic delivery dates and . . . we deliver when we say we will! No matter where you're located, Bourns offers worldwide availability.

DIP pulse transformers built by Bourns! For your special or standard applications, call or write today. Or, see us in EEM, Volume 2, page 4194.

MAGNETICS DIVISION, BOURNS, INC., 28151 Highway 74, Romoland, CA 92380. Phone: 714 657-5195. TWX: 910 332-1304. Telex: 67-6446.

European Headquarters: Bourns AG, Zugerstrasse 74 6340 Baar, Switzerland. Phone: 042 33 33 33. Telex: 78722.

*Domestic U.S.A. price only.



BOURNS
MAGNETICS DIVISION

For Immediate Application—Circle 120 For Future Application—Circle 220

EXPANDABILITY

PLUG-INS

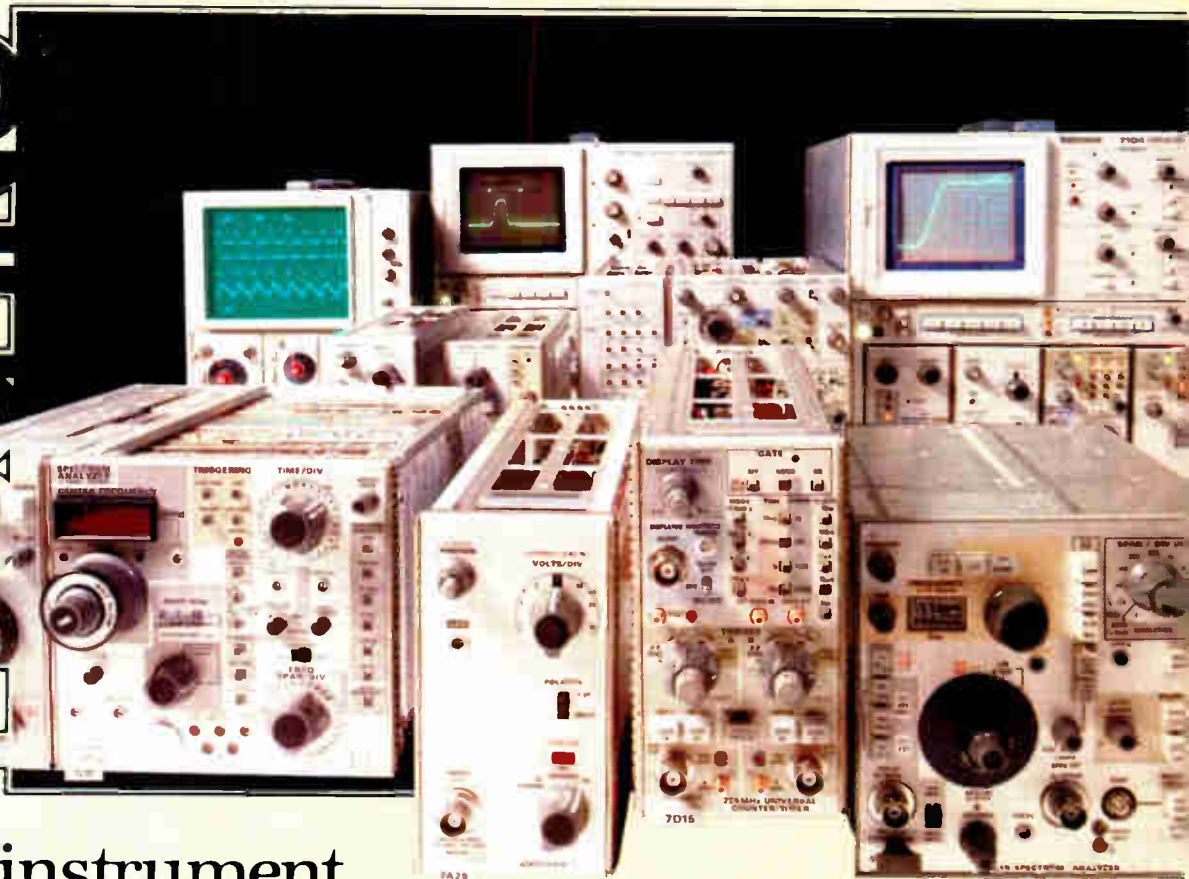

An instrument
for today...and beyond.

Tektronix has made a commitment that gives you a systematic pathway into tomorrow's technology. Here's how. As more advanced measurement techniques are developed, each is adapted to the Tektronix Plug-In oscilloscope you own today.

So, the plug-in units you are using now will fit the mainframes we build tomorrow. Compatibility is assured.

Currently our Plug-In scopes family includes 14 mainframes and 21 plug-in units in the 5000-Series, and 19 mainframes and 35 plug-ins in the 7000-Series. (With them, you can use compatible logic and spectrum analyzers and other special purpose plug-ins.) Among the newer arrivals: a logic analyzer with 16 digital acquisition and display channels. A calibrated 60 GHz spectrum analyzer that's transportable. And the newest: A 1 GHz real time oscilloscope

with 10 mV/div sensitivity and 20 cm/ns photographic writing rate. Plus more milestones just ahead.

Our commitment to superior research and engineering and to performance and reliability extends to each new 5000 and 7000 Plug-In scope we produce.

Tektronix Plug-In scopes meet your critical measurement demands. From circuit design to plasma physics research. From balancing rotating machinery to measuring the accuracy of D to A converters.

What measurement challenges are on your horizon? Contact us. We can help you plan to meet them successfully with our Plug-In scopes. At Tektronix, our commitment goes with our name.

Tektronix
COMMITTED TO EXCELLENCE

For literature, call (800) 547-1512 toll free.

75% of our real-time computers go to OEMs. No wonder we give them such good support!

Or is it the other way round? We give such good support that OEMs buy 75 percent of our HP 1000 computers.

Either way, you can't lose with Hewlett-Packard. If you're building systems for the high-technology, engineering or manufacturing marketplace, talk to us. We've been heavily involved in these fields for the past 40 years. And that experience has helped us develop the hardware and software tools necessary to get your customer the right system at the right price.

Just look at the software you can get with an HP 1000. An upward-compatible, real-time, multi-

user operating system spanning three series of HP1000 computers. Graphics/1000 for simple, device-independent data plotting. DS/1000, our field-proven networking software. And IMAGE/1000, our award-winning data base management package that's extremely useful in developing application software to fit your customer's specific needs.

Last but not least, we have competitive discount rates, as well as discounts on demonstration/development systems. Our shipment, installation and 90-day warranty policies are designed to assure a smooth

start-up. And we offer support before and after the sale, including service, customer training and documentation.

Why don't you explore all the advantages of doing business with us? To start the ball rolling, write to Roger Ueltzen, Marketing Manager, Hewlett-Packard Data Systems Division, Dept. 650, 11000 Wolfe Road, Cupertino CA 95014. Or contact your local HP Sales Office listed in the White Pages.

HEWLETT  PACKARD



39 Electronics Review

MEMORIES: New scaled process pumps life into bipolar devices, 39
 DATA COMMUNICATIONS: Link controller handles more of protocol, 40
 INSTRUMENTS: Plug-in software keys new design approach, 41
 SATELLITES: C-MOS microprocessor to control attitude, 42
 AUTOMOTIVE: Accelerating need seen for chips, 44
 COMMERCIAL: Image processors tackle bank checks, 46
 NEWS BRIEFS: 48
 COMMUNICATIONS: K-band antennas slated for rooftops, 50
 MICROWAVES: IEEE disputes radiation scare, 50

63 Electronics International

GREAT BRITAIN: Optical fiber keeps polarization constant, 67
 Measuring voltage and current optoelectronically, 67
 WEST GERMANY: On-board multiplexing system checks car's lights, 68
 FRANCE: Thomson-CSF to develop low-cost fax unit for PTT, 70
 AROUND THE WORLD: 72

81 Probing the News

COMPUTERS: New minis push into power area, 81
 ABROAD: Tokyo's solid-state meeting glows with importance, 85
 COMPUTERS: IBM delay underscores new rules, 88
 IEEE: Candidates offer choice of paths, 90
 ELECTRONIC INTELLIGENCE: Study foresees 10-year boom, 94

121 Technical Articles

MICROSYSTEMS: Microprocessor development tool cuts delays, 121
 COMMUNICATIONS: Digital PLL finds clock signal in bit stream, 126
 SOLID STATE: V-MOS chip handles signals in real time, 131
 DESIGNER'S CASEBOOK: C-MOS pair sets divider's modulus, 140
 Maximum-length shift register generates white noise, 141
 Instantaneous-frequency meter measures biomedical variables, 143
 COMPONENTS: Optically coupled triac driver chip interfaces logic, 145
 DATA ACQUISITION: A-d converter links with microprocessors, 149
 ENGINEER'S NOTEBOOK: Anemometer has diode wind-sensor, 156
 Teleprinter option unites PROM programmer with MC6800, 157
 WESCON/79: Show hums with news of technology of the 1980s, 170

185 New Products

WESCON PRODUCT PREVIEW:
 5-MHz a-d unit converts 12 bits, 185
 Units make medium-resolution color video affordable, 186
 16-bit d-a converter settles to within 0.003% in 10 μ s, 188
 Interprocessor interfaces link computer buses at DMA speeds, 190
 Emulator uses multiprocessor, multiple-bus approach, 192
 System speeds digital-board checks by 'testing if possible,' 194
 5-MHz computer with disk drive works on S-100 bus, 198
 Single-board development tool for 3870 sells for \$499, 200
 RCA adds prototyping system for single-board computers, 203
 Power meters span 1 GHz, 206

IN THE SPOTLIGHT: 50-W amplifier covers 1 to 400 MHz, 217
 DATA ACQUISITION: Hybrid unit tracks and holds at 100 MHz, 218
 MICROCOMPUTERS & SYSTEMS: Developing micros with minis, 226
 INSTRUMENTS: Portable printers offer flexibility, 238
 COMPUTERS & PERIPHERALS: Tektronix 4054 gets refreshed, 242
 POWER SUPPLIES: Switcher module supplies 3 A at 5 V dc, 246
 COMPONENTS: Fast liquid-crystal display shows any color, 252
 INDUSTRIAL: LED panel meter gets on the bus, 262
 MATERIALS: 270

Departments

Publisher's letter, 4	International newsletter, 63
Readers' comments, 6	Engineer's newsletter, 160
News update, 8	Products newsletter, 267
People, 14	New literature, 272
Editorial, 24	
Meetings, 26	Services
Electronics newsletter, 33	Reprints available, 228
Washington newsletter, 57	Employment opportunities, 276
Washington commentary, 58	Reader service card, 305

Highlights

Cover: Microprocessor development shortcut, 121
 A low-cost universal development tool allows evaluation of a new microprocessor before the device maker's support equipment is ready. It stands alone or hooks to a cassette store or a host development system.

Cover is by Art Director Fred Sklenar.

Why is the System/38 late? 88

IBM's record of on-time delivery is suffering as the company irons the bugs out of its ambitious all-new architecture and software package. Observers feel IBM's troubles may foreshadow similar problems throughout the industry.

Fast V-MOS chip processes audio signals, 131

Linked to a microprocessor, this number-crunching chip is powerful enough to do digital processing or filtering of audio-frequency signals in real time. It offers lower chip count, power consumption, and cost than its competitors.

Wescon/79 to focus on the 1980s, 170

San Francisco will host an expected 35,000 engineers and electronics managers during September 18-20. More than 120 technical presentations will be given, many of them concerned with microprocessors. New products will abound at the 780-plus booths.

... and in the next issue

A special report on new large-scale integration processes . . . a monolithic 8-bit sampled-data analog-to-digital converter . . . a comparison of the capabilities of logic analyzers and microprocessor development systems.

EDITOR-IN-CHIEF: Kemp Anderson

EXECUTIVE EDITOR: Samuel Weber

MANAGING EDITORS: Arthur Erikson,
Gerald M. Walker

ASSISTANT MANAGING EDITORS: Howard Wolff,
Alfred Rosenblatt

SENIOR EDITORS: William F. Arnold,
Ray Connolly

ART DIRECTOR: Fred Sklenar

ASSOCIATE EDITOR: Michael J. Riezenman

DEPARTMENT EDITORS

Aerospace/Military: Ray Connolly

Circuit Design: Vincent Biancomano

Communications & Microwave:

Harvey J. Hindin

Computers & Peripherals: Anthony Durniak

Consumer & Industrial: John Javetski

Test, Measurement & Control:

Richard W. Comerford

Microsystems & Software: John G. Posa

New Products: Michael J. Riezenman,

Pamela Hamilton

Packaging & Production: Jerry Lyman

Solid State: Raymond P. Capece

CHIEF COPY EDITOR: Margaret Eastman

COPY EDITORS: Mike Robinson,
Charlotte Wiggers, Jeremy Young

ART: Charles D. Ciatto, *Associate Director*
Paula Piazza, *Assistant Director*

EDITORIAL SECRETARIES: Janet Noto,
Maryann Tusa

EDITORIAL ASSISTANTS: Penny Reitman,
Marilyn B. Steinberg

REGIONAL EDITORS

New York: Benjamin A. Mason (212) 997-2645

Boston: James B. Brinton (617) 262-1160

Chicago: Larry Marion (312) 751-3805

Dallas: Wesley R. Iversen (214) 742-1747

Los Angeles: Larry Waller (213) 487-1160

Palo Alto: William F. Arnold, *Manager;*

Bruce LeBoss, *Computers & Instruments*
(415) 968-2712

Washington: Ray Connolly (202) 624-7592

Frankfurt: John Gosch 72-5566

London: Kevin Smith 493-1451

Paris: Arthur Erikson,

Kenneth Dreyfack 720-20-70

Tokyo: Charles Cohen 581-9816

McGRAW-HILL WORLD NEWS

Editor: Michael Johnson

Brussels: James Smith

Milan: Jeff Ryser

Moscow: Peter Hann

Stockholm: Robert Skole

Tokyo: Robert E. Lee

PUBLISHER: Paul W. Reiss

GENERAL MANAGER, DIRECT MARKETING
OPERATIONS: Horace T. Howland

CIRCULATION MANAGER: Herbert A. Hunter

RESEARCH MANAGER: Margery D. Sholes

MARKETING ADMINISTRATION MANAGER:

Frances M. Vallone

BOOKS & SPECIAL PROJECTS MANAGER:

Janet Eyer

Although Wescon sometimes seems to be more product promotion than high technology, the program for this year's show at San Francisco's Brooks Hall and Civic Auditorium (see p. 170) will have a prime spot reserved for one of the best and the brightest in electronics technology. That will be the luncheon keynote address on Monday, Sept. 17, by John A. Pierce of the California Institute of Technology.

Dr. Pierce is a widely recognized and much honored pioneer in microwave development. While at Bell Laboratories, working in research on electron tubes and microwaves, he formulated the first concrete proposals for satellite communications; those ideas became part of the Echo and Telstar satellites.

Dr. Pierce has done other groundbreaking work, of course. Just a partial list of his honors and awards indicates somewhat the magnitude of his accomplishments. He has won the Institute of Electrical and Electronics Engineers' Medal of Honor, the Marconi Award, the Stuart Ballantine and John Scott awards of the Franklin Institute, the Edison Medal, and the Valdemar Poulsen Gold Medal.

In his address, "One World of Communications—All Digital," Dr. Pierce will open the doors to a future in communications where "we will have one digital world in which transmission, processing, computing, storage, and switching of voice, pictures, and data will be inextricably intertwined both in communication facilities and in their use."

It happens more and more frequently

Electronics (ISSN 0013-5070). Published every other Thursday by McGraw-Hill, Inc. Founder: James H. McGraw 1860-1948. Publication office 1221 Avenue of the Americas, N.Y., N.Y. 10020; second class postage paid at New York, N.Y., and additional mailing offices. Executive, editorial, circulation and advertising addresses: Electronics, McGraw-Hill Building, 1221 Avenue of the Americas, New York, N.Y. 10020. Telephone (212) 507-1221. Teletype 12-7950 TWX 710-581-4879. Cable address: MCGRAW HILL NEW YORK.

Subscriptions limited to professional persons with active responsibility in electronics technology. No subscriptions accepted without complete identification of subscriber name, title or job function, company or organization, and product manufactured or services performed. Based on information supplied, the publisher reserves the right to reject non-qualified requests. Subscription rates: in the United States and possessions \$17 one year, \$29 two years, \$43 three years; company addressed and company libraries \$23 one year, \$41 two years, \$58 three years; APO/FPO addressed \$35 one year only; Canada and Mexico \$19 one year, \$32 two years, \$47 three years; Europe \$45 one year, \$78 two years, \$110 three years; Japan, Israel and Brazil \$70 one year, \$115 two years, \$165 three years; Australia and New Zealand \$95 one year, \$170 two years, \$240 three years, including air freight; all other countries \$50 one year, \$85 two years, \$125 three years. Limited quota of subscriptions available at higher-than-basic rate for persons allied to field served. Check with publisher for these rates. Single copies \$4.00. Please allow four to eight weeks for shipment.

Officers of McGraw-Hill Publications Company: Gordon L. Jones, President; Group Vice-President: Daniel A. McMillan, James E. Boddorf, Senior Vice President-Editorial, Ralph R. Schutz; Vice-Presidents: Robert

these days since the advent of the microprocessor. A company runs into a problem in designing with processors and, while solving its own needs, comes up with a product that has a market among other microprocessor users.

That was part of the story behind the design and development of the Micro System Designer by Millennium Systems Inc., Cupertino, Calif., which is described in this issue's cover article (p. 121). "The first goal was to develop a tool for us," recalls coauthor Chris Bailey, marketing manager, "and the second was to make that tool appeal to others."

A primary concern for coauthor Tracy Kahl, who spearheaded the design project, was producing a universal tool—one that could cover the range of 8-bit and 16-bit processors available today or about to become available. It also had to handle two levels of microprocessor users. On the one hand, there are those who want to evaluate and program numerous different microprocessors or single-chip microcomputers from different vendors. On the other, there are experienced users who want a full-performance development tool for serious design.

Says Bailey, "We were looking ahead to a family of microprocessor solutions covering the full spectrum from design to development to production to field-service instruments."



August 30, 1979 Volume 52, Number 18 102,751 copies of this issue printed

B. Doll, Circulation; James E. Heckelt, Controller; William H. Hammond, Communications; Thomas H. King, Manufacturing; John W. Patten, Sales; Edward E. Schirmer, International.

Officers of the Corporation: Harold W. McGraw, Jr., President, Chief Executive Officer, and Chairman of the Board; Robert N. Landes, Senior Vice President and Secretary; Ralph J. Webb, Treasurer.

Title registered in U.S. Patent Office; Copyright © 1979 by McGraw-Hill, Inc. All rights reserved. The contents of this publication may not be reproduced in whole or in part without the consent of copyright owner.

Where necessary, permission is granted by the copyright owner for libraries and others registered with the Copyright Clearance Center (CCC) to photocopy any article herein for the base fee of \$0.50 per copy of the article plus \$0.25 per page. Payment should be sent directly to the CCC. Copying done for other than personal or internal reference use without the express permission of McGraw-Hill is prohibited. Requests for special permission or bulk orders should be addressed to the publisher. ISSN 0013-5070/79\$0.50+.25.

Subscribers: The publisher, upon written request to our New York office from any subscriber, agrees to refund that part of the subscription price applying to copies not yet mailed. Please send change-of-address notices or complaints to Fulfillment Manager; subscription orders to Circulation Manager, Electronics, at address below. Change-of-address notices should provide old as well as new address, including zip codes. Attach address label from recent issue. Allow one month for change to become effective. Subscriber Service: call (609) 448-8110, 9 a.m. to 4 p.m. EST.

Postmaster: Please send form 3579 to Fulfillment Manager, Electronics, P.O. Box 430, Hightstown, N.J. 08520.

smart power for ATE!

PROGRAMMABLE POWER FOR YOUR AUTOMATIC TEST EQUIPMENT

KEPCO

series

ATE

power supplies

- programmable from IEEE-488 bus with Kepco digital interfaces
- automatic crossover voltage and current stabilization
- 0.001% stabilization (load effect)
- 0.0005% stabilization (source effect)
- programmable over-voltage crowbar with flag
- fast programming capability
- five groups, 50 Watts to 1000 Watts



50 & 100 WATT MODELS

250 WATT MODEL

KEPCO®

For complete specifications, write Dept. COF-14

KEPCO, INC. • 131-38 SANFORD AVENUE • FLUSHING, N.Y. 11352 U.S.A. • (212) 461-7000 • TWX # 710-582-2631 • Cable: KEPCOPOWER NEWYORK

Circle 5 on reader service card

SIGNAL GENERATOR AMPLIFIER

Our Model 603L is the ultimate in RF signal generator amplifiers. Just plug this low cost unit into any signal or sweep generator in its 0.8 to 1000 MHz range and this completely solid state unit will provide you with the maximum in power flexibility.



With a flat frequency response and 3 watts of linear Class A output (up to 5 watts saturated), the 603L will provide constant forward power, making it ideal for driving reactive or resistive loads.

Priced at \$1895*, the versatility and usefulness of this outstanding power amplifier can best be demonstrated in your own applications.

For detailed specifications or a demonstration, please contact:

ENI
3000 Winton Road South
Rochester, New York 14623
Call: 716-473-6900 or
Telex: 97-8283 ENI ROC

* U.S.A.

ENI

The World's Leader
in Power Amplifiers

Readers' comments

Not as bad as figured

To the Editor: I would like to point out a misleading comment on page 126 of the April 26 issue, in "Watch out for Super C-MOS," which accompanied the special report "The race heats up in fast static RAMs." In discussing our 6147 4-K part, you say that "the absolute worst-case dissipation is likely to climb to more than half a watt and could be as high as the 2147's 900 mw."

However, power dissipation at a 55-ns cycle time is typically less than 100 mw; in the worst case, it is about 220 mw. The fact is that only a small part of the current drawn is frequency-dependent.

H. Miyamoto
Hitachi Ltd.
Tokyo, Japan

Speaking up for TFTs . . .

To the Editor: In your June 21 issue, p. 69 ["Amorphous silicon shows promise for flat-panel TV display"], you describe current work on amorphous-silicon thin-film transistors (TFTs) for a liquid-crystal display by a Dundee University group under W. E. Spear. Since my work at Westinghouse was referred to, permit me to make a few remarks.

First, we actually built a 6-by-6-inch liquid-crystal TV display and reported on it at the 1978 Society for Information Display International Symposium. No problems whatsoever were experienced with "controlling two-component thin-film materials," and very high-performance transistors were consistently obtained with such materials.

Second, the commercial objective of the Westinghouse work was an electroluminescent, TFT-driven panel, not an LCD. The reasons for the termination of this program were complex but in no way related to unsatisfactory TFT performance.

Third, amorphous silicon has an extremely low carrier mobility (about 0.1 cm²/V-s); hence high-performance TFTs cannot be built with it. A high switching ratio, supposedly obtainable with amorphous Si, is quite insufficient for a flat-panel TV application if the cutoff frequency of the device is in

the low kilohertz region, which it has to be for the dimensions reported. This extremely poor frequency response was one of the main reasons that led a French research group at Thomson-CSF to abandon amorphous silicon in favor of cadmium selenide, which has a carrier mobility approximately 1,000 times that of amorphous Si, with correspondingly higher frequency response.

I have formed a company in order to commercialize the Westinghouse CdSe active matrix display technology, and our first product, a high-resolution, very low-power LCD has been announced.

T. P. Brody
Panelvision Inc.
Pittsburgh, Pa.

. . . against solar-power satellites

To the Editor: I would like to make a "reasoned, factual argument" against solar-power satellites, rather than for them as proposed by Jon D. Rolands in a letter in the June 7 issue, p. 6.

As a radio astronomer, I am deeply worried about the radio-frequency interference problems associated with the satellite's power transmitter. Unless the spurious emissions can be kept more than 150 dB below a likely gigawatt power level (extremely unlikely), the satellites will be the strongest "radio sources" in the sky.

For reference, radio astronomers routinely observe sources with spectral power densities of less than 10⁻²⁶ W-m⁻²-Hz⁻¹ and can easily detect signals at power levels of -170 dBm. Planetary spacecraft missions are tracked at similar levels. These two scientific endeavors could easily be wiped out by the power satellites. Satellite communications systems may well be affected, too.

I find it hard to believe that solar cells in orbit could really be economically better than the additional redundancy and power-storage systems required for ground-based solar-power systems.

David B. Shaffer
Green Bank, W. Va.

Three ways that pre-owned instruments are better than new.

If you're troubled by the long lead times and high cost of buying new instruments, USIR has some pleasant news for you. Used instruments are better than new three ways—price, delivery and reliability (yes, reliability). As a supplier of rental and leased instruments, USIR stays in business by keeping every one of our instruments in top shape, so when you buy from US you know the instrument has received expert attention.

1 Pre-owned instruments cost 10-40% less than new. At a time when instrument costs are skyrocketing, you can keep your acquisition budget in line by purchasing previously owned gear.

You can usually purchase top quality, current model instruments for 10-20% less than

new, less current instruments for 20-40%. But each instrument is in top shape, no cats and dogs here.

2 You can get immediate delivery on your instrument.

If you've been listening to new instrument suppliers quoting 12-16 week deliveries, listen to this. Our entire catalog of instruments is ready for sale and immediate delivery off-the-shelf. As fast as a truck or airplane can reach you, you can have the instrument you need.

3 Pre-owned means well field-tested—not used up (no infant mortality here).

The greatest risk of failure in any solid state item is the first hundred hours. These instruments, most of which are two to three years old, have proven themselves in day-to-day use. And, because they have been maintained by USIR's own technicians, we can assure you that they are functionally, and usually cosmetically, indistinguishable from new.

No-risk warranty.

Every pre-owned instrument we sell comes with a 90-day parts and labor warranty.* If anything goes wrong, ship it back, we'll fix it or replace it at our expense.

Take a look at what's available, send for a catalog today.

Our 24-page illustrated catalog will show you the seventy-five lines and hundreds of models of instruments that are available now. It includes prices and information on the variety of acquisition options you can choose from. And, since new items are added to our pre-owned inventory every day, you can get an immediate update on the availability of any instrument by calling any USIR sales office.

*Except BWOs, TWTs, and YIGs.



US INSTRUMENT RENTALS

Pre-Owned Equipment
Sales Department
2121 S. El Camino Real
San Mateo, California 94403
(415) 574-6006

New possibilities for your Printed Circuit Board

WIMA Miniature Capacitors

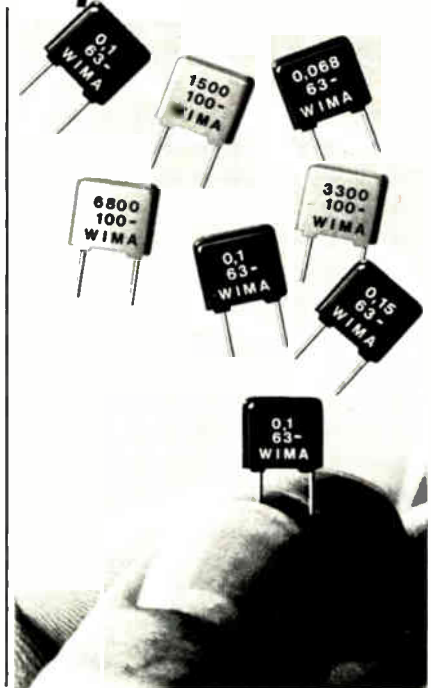

WIMA MKS 2 with a PCM of 5 mm

The new miniatures from WIMA help you to save space on your Printed Circuit Boards and can be utilised everywhere. They are the smallest plastic cased, metallised polyester Capacitors available.

Capacitance values 0.01 — 0.47 μ F (1 μ F with 7.5 mm PCM.)

WIMA FKS 2 from 1000 pF.

All capacitors are resistant to moisture.

Please ask for our special catalogue.



WILH. WESTERMANN

Spezialvertrieb elektron. Bauelemente
P. O. Box 2345 · D-6800 Mannheim 1
Fed. Rep. of Germany

U.S. Sales Offices:
BOSL & ROUNDY · 3333, Delray Drive
Ft. Wayne · Indiana 46815
(219) 483-3378

THE INTER-TECHNICAL GROUP INC.
North Dearman Street · P. O. Box 23
Irvington · New York 10533
(914) 591-8822

TAW ELECTRONICS CO.
4215 W. Burbank Blvd., Burbank
California 91505 · (213) 846-3911

8 Circle 8 on reader service card

News update

■ The reports are coming in now on Seasat—the ill-fated satellite with a microwave instrumentation payload that went down 105 days after launch [*Electronics*, Dec. 7, 1978, p. 36]. During its short but active life, Seasat collected a unique set of data on ocean winds, waves, temperature, and topography. All indications from a preliminary analysis are that most of the mission's objective—microwave surveillance of the world's oceans under almost all weather conditions—was met and that similar instruments can be used in the future.

For example, analysis of radar altimeter data shows that the instrument met its specifications (to within ± 10 centimeters) for measuring the height of the spacecraft above the ocean surface and wave height (to within ± 0.5 meter). It seems clear to the researchers that the altimeter, having undergone development through three earth-orbit missions, can be used for practical quantitative oceanographic investigations.

The Seasat microwave scatterometer was another success. It was designed to measure wind speed to an accuracy of within ± 2 m per second and wind direction to $\pm 20^\circ$ in two swaths 500 kilometers wide on either side of the spacecraft; it appears to have done so successfully.

A preliminary assessment has also been made of the capability of the Seasat synthetic aperture radar to detect ocean waves. Comparison with surface and aircraft measurements from five passes of the satellite over the Gulf of Alaska indicates agreement to within about $\pm 15\%$ in wave length and about $\pm 25^\circ$ in wave direction.

Finally, visual and infrared images produced by the Seasat visible and infrared radiometers were shown to be adequate for identifying cloud, land, and water features. A statistical comparison of such sea-surface temperatures in a cloud-free region, with a National Oceanic and Atmospheric Administration analysis based on various surface measurements taken in the same region, showed substantial agreement.

—Harvey J. Hindin

50 ps RISETIME GENERATOR



Model TD-50PA (shown above) and Model P5A (250 ps risetime) are intended for precision measurement and testing of high-speed circuits and systems and for TDR applications. They are also ideal sources to drive amplifiers because they exhibit low transient aberrations and excellent pulse flatness. The TD-50PA has a separate pretrigger (85 ns) and a normal trigger output. Both units come with their own power supply so they can be used with any oscilloscope system. The TD-50PA is priced at \$449, the P5A at \$149.

COLBY INSTRUMENTS, INC.,
P.O. Box 84379, VA Branch (E),
Los Angeles, CA 90073.
(213) 476-6139.

Circle 12 on reader service card



Waiting for an outbreak of HOPE

Give to:
PROJECT HOPE

Department A, Washington, D.C. 20007

Electronics / August 30, 1979

ANOTHER FIRST FROM



MILLION DOLLAR \$ \$ \$ SALE \$ \$ \$



Here's a "ONE IN A MILLION" opportunity to buy

LSI-11/2 CPU's at 30% OFF...

First's MILLION DOLLAR September SALE
Selling One Million Dollars worth of LSI-11/2® CPU'S
at 30% OFF. . . During SEPTEMBER ONLY!

Don't let this "ONE IN A MILLION" opportunity pass you buy!

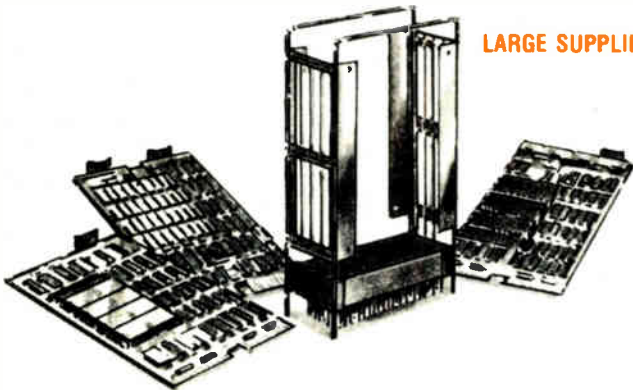

LARGE SUPPLIES "IN STOCK" FOR IMMEDIATE DELIVERY

DEC® List
Price

Our
Price

KD11-HA LSI11/2 Microcomputer	\$695	\$487
KD11-HB KD11-HA Plus 8K Word RAM Memory	1290	903
KD11-HC KD11-HA Plus 16K Word RAM Memory	1490	1043
KD11-HD KD11-HA Plus 32K Word RAM Memory	1690	1183

MD-1



TWX NUMBER 910-651-1916

computer corporation

corporate square / 825 north cass avenue / westmont, illinois 60559 / (312) 920-1050

® Registered trademark of Digital Equipment Corporation, Maynard, Mass.

™ Registered trademark of First Computer Corporation

Circle 9 on reader service card

\$21!

Advanced Micro Devices just cut the price of the Am2903 by 30%, and you can get it right now.

If you like the price, you'll love the slice.

The Am2903 is a 4-bit CPU slice with 16 internal working registers, multi-function arithmetic, shifting logic, expandable register file and two-address architecture.

To reduce the MSI and SSI, we put all

the extra hardware to do 2's complement multiply and divide right inside the chip.

But enough on the Am2903. For our next number, the Am2910:

\$18.95!

Advanced Micro Devices announces another 30% off on another super part—the Am2910 microprogram sequencer.

The Am2910 provides the ability to step sequentially through memory locations. It

**Superslice.TM
Super price.**

can branch on a single cycle to any of the several externally specified addresses. It allows you to jump to or return from sub-

routines up to five levels deep. It provides a 12-bit address field all in one chip. And like the Am2903, it's available right now.

Call Advanced Micro Devices for all the facts on the Am2903 and Am2910.

They're both 30% off. And 100% super.

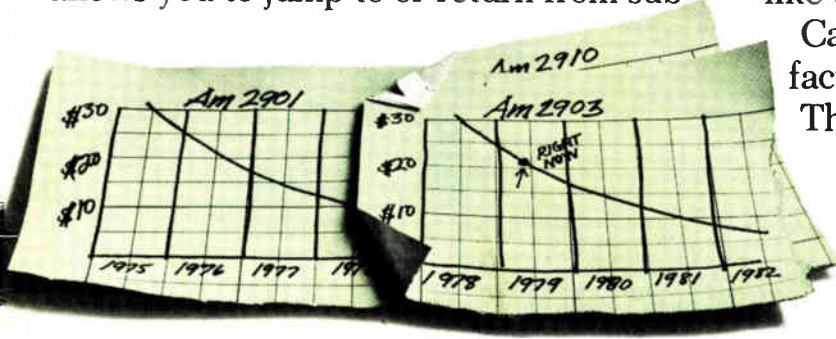

In '75 the Am2901 was \$30. Now it's under \$10.
Just like we said. Here we go again with the Am2903.

Advanced Micro Devices

901 Thompson Place, Sunnyvale, CA 94086 · Telephone: (408) 732-2400, Ext. 2905



OUR CUSTOMERS' REACTION TO THE NEW NOVA 4 DIDN'T SURPRISE US.

After the success we've had with the Data General NOVA computer line over the last 10 years, who could blame them? But what really counts is your reaction to your latest NOVA—NOVA 4.

The new NOVA 4 gives you three ways to sell. It's the one computer that will give you so wide a range of capability and options it will meet the price and capability needs of all your customers.

NOVA 4/C. The component OEM's dream.

The speed and performance you get in the NOVA 4/C—for \$3500* (complete)—is the best deal ever offered a customer needing a basic computer to integrate in his terminals, test instruments or similar applications. And it includes a unique self-diagnostic capability that lets the computer trouble-shoot itself to cut service time and cost.

NOVA 4/S. An important part of your process.

Whatever data your customers process now—from blood analysis to pipeline flow—the new NOVA 4/S can cut processing time in half. Outstanding processing throughput comes from its new high speed floating point and character manipulation capabilities. Plus, it includes NOVA 4 self-diagnostic features.

NOVA 4/X. The business end of the line.

For the business computer customer, or the technical one, the 4/X will do the job. All the capabilities of the 4/S with memory up to 256K bytes, with self-diagnostic capability.

NOVA 4. The multi-customer mini.

4/C, 4/S, 4/X—all three are fully compatible with the NOVA 3 computers now in use. And there's one that's right for your customer's application.

And they match the 10 year NOVA tradition of increasingly high performance (NOVA 4 achieves up to twice the speed of competitive systems as well as the NOVA 3), newsworthy price (lower than competitive units; 43% lower than NOVA 3) and reliability and maintainability features unheard of in competitive systems.

The all new NOVA 4. It's the brand new computer with 10 years of proven performance that will leave your customers smiling. Mail the coupon for full information.



*NOVA 4/C with 64K bytes of MOS Memory, asynchronous interface, automatic program load, power fail/auto restart, and 5-slot chassis with power supply. Domestic U.S. price, quantity one. OEM and quantity discounts available.

Mail to: Data General Corporation
Westboro, MA 01581

Send me full information on the NOVA 4.

Name _____

Title _____

Company _____

Address _____ Tel. _____

City _____ State _____ Zip _____

E830

 Data General

We make computers that make sense.



NEW TEXTOOL ECONO ZIP PRODUCTION SOCKETS

New TEXTOOL inexpensive ECONO ZIP socket series features easy, safe zero insertion and extraction pressure for "end-user" production requirements.

TEXTOOL's new low cost ECONO ZIP series of production sockets are especially designed for those applications where initial loading and field replacement of expensive IC's are a necessity and socketry is an absolute requirement.

ECONO ZIP sockets are available in 16, 24 and 40 pin models. They are designed for mounting on standard .100" centers on either axis.

The ECONO ZIP socket is designed for the most simple mechanical action. A device can literally be dropped into the socket. Rotation of the cam to a built-in stop firmly retains the device with exceptionally good electrical contact. Counter rotation of the cam releases the device, thus providing zero pressure during both insertion and extraction.

These economical (U.L. approved plastic) production sockets offer additional device protection features including wide entry holes to accept bent or distorted leads that don't have to be reformed prior to insertion, a screw driver operated plastic cam for easy operation and prevention of accidental unloading, and extremely long life (hundreds of actuations).

Detailed technical information on new low cost ECONO ZIP production sockets is available from your nearest TEXTOOL sales representative or the factory direct.



PRODUCTS, INC.

1410 W. Pioneer Drive • Irving, Texas 75061
214/259-2676

People

GTE International's Empey sees U. S. losing edge

Charles H. Empey thinks the U. S. free enterprise system may have more fans abroad than at home, especially as a result of recent Government policies. Empey is the new marketing vice president of GTE International Systems Corp., Waltham, Mass. In his line of work he competes with other U. S. firms, as well as European and Japanese companies, for a share of the world market in telecommunications equipment, especially microwave point-to-point and ground-station equipment. But every now and then, Empey, an electrical engineer who joined GTE as a field engineer for its Sylvania operation in 1958, has the feeling he is also competing with his own Government.

"There is a lack of official understanding on a couple of points: first, foreign competition is heating up worldwide—there are no safe markets left; second, U. S. technology has less of a lead than it did—the old two-year cushion isn't there anymore," he says. He moves to his new post after being manager of marketing for his company's Pacific division since 1977.

While markets become tougher, he notes, U. S. firms appear to be facing more governmental flak. "U. S. policy today is contradictory and self-defeating. On the one hand, we are supposed to expand exports. On the other, lack of positive Government action, along with new regulations and restrictions, makes it increasingly hard for us to penetrate third-world markets."

Policies. Empey proposes three policy changes to help put Government force behind U. S. exports. "I'd like to see us give more financial help to third-world countries," he says. He does not mean passing money to U. S. firms via other governments, but the creation of well-founded, growing industrial bases in developing nations.

Next, "the Government must realize that ambiguous regulations regarding the transfer of technology,

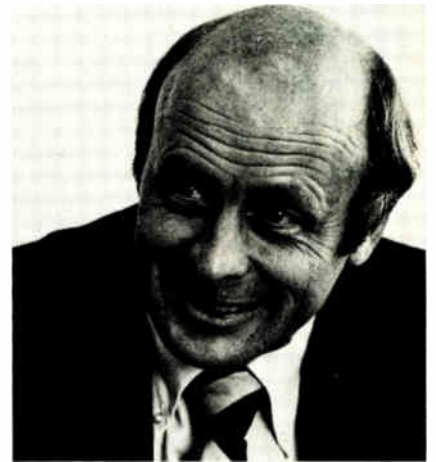

Funds needed. More long-term R&D is needed to restore U. S. edge, says Empey.

for example, put U. S. firms at a disadvantage in competing against companies from Europe and Japan."

Finally, to restore some of the U. S.'s technological edge, Empey "would like to see more Government-sponsored R&D—long-term research is underfunded now. But it is this sort of work that got us out front in the first place, and if we aren't going to fall behind, we need to get back to the labs."

Nitron's Tang to develop potential of MNOS memory

No one would expect an executive to refer to his seven-year-old semiconductor company as a start-up opportunity, but Edward Y. Tang, the new executive vice president and chief operating officer of Nitron Inc., is doing just that. What's more, he is happy about it. "There aren't too many semiconductor start-ups left, and I have the background for it," he says. He is referring to his help in founding integrated-circuit makers Eurosil GmbH in Munich, West Germany, and Intersil Memories Inc., in Cupertino, Calif.

Nitron, also in Cupertino, was one of the pioneers in nonvolatile memories using the tricky metal-nitride-oxide-silicon technology initiated by McDonnell Douglas Corp. in 1972. But Nitron was unable to capitalize on MNOS, even after it was sold to

Vector graphics. OEM prices.

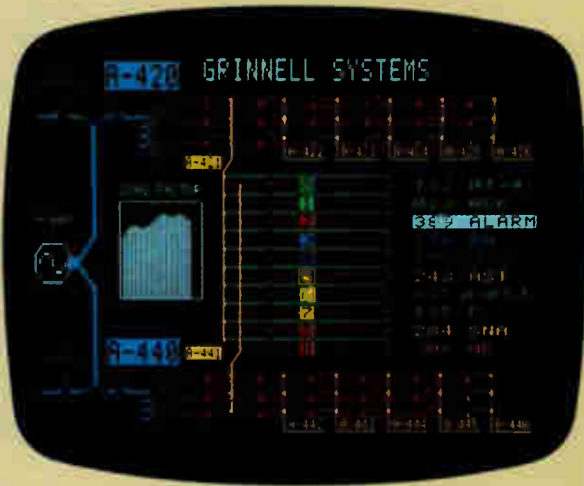

Now, with Grinnell's GMR-37 graphic display systems, you can have the resolution and input advantages of dot matrix television for about the same price as more limited character-based systems.

And, every GMR-37 display is a complete operating system: display generator, MOS refresh memory, vector and rectilinear graphics, alphanumeric in 4 sizes, bi-directional RS-232 computer interface and RS-170 video interface. Systems, including power supplies, are housed in a 7", rack-mountable chassis and drive standard closed circuit monitors.

Four basic GMR-37 models can be tailored to fit into almost any computer-based system. Here are just a few examples. (Prices are F.O.B. San Jose, and quantity discounts are available. TV monitors are extra.):

GMR 37-20: \$3700

256 x 512 resolution, one channel RGB color plus blink. (Two channels: \$4500)

GMR 37-30: \$4500

512 x 512 resolution, one channel RGB color plus blink.

GMR 37-60: \$4700

1024 x 1024 resolution, one channel B/W.

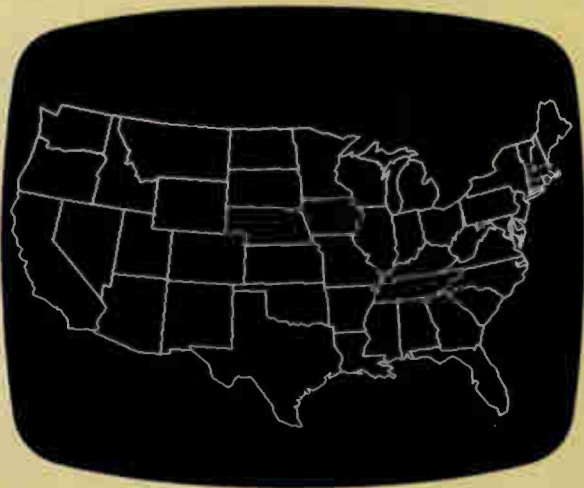

In addition, you can also have several economical options: independent cursors, joysticks, keyboards, special character sets and 16 bit, plug-compatible parallel minicomputer interfaces.

Further, if you ever want to move up, Grinnell has a complete line of larger systems—all software compatible with the GMR-37—to do things like animation, image processing and real-time frame grabbing.

So, if quality graphic displays are important to your product, look at the GMR-37 line. For a quotation on the system that meets your specific requirements, call or write.

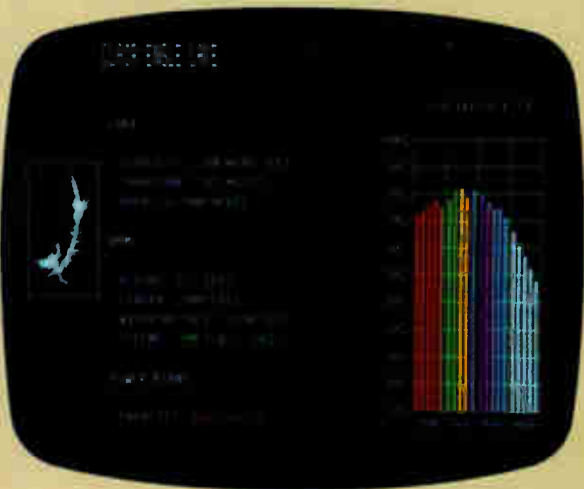

GRINNELL SYSTEMS

2159 Bering Drive, San Jose, California 95131 (408) 263-9920

At last...
a switching power supply
as dependable as a linear.

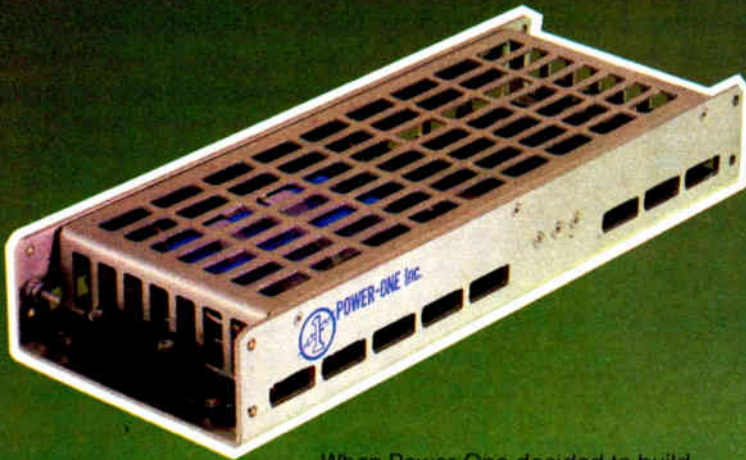

When Power-One decided to build a switching power supply, we issued one simple mandate: it must be as dependable as our linears or we would never produce it.

After a considerable R&D effort, we accomplished our goal. The new SK5-40/OVP performs with maximum dependability... thanks to several innovative ideas that really work. Ideas such as direct drive switching, volt-second regulation, digital feedback, and others.

But get the whole story. Send for complete details. See for yourself why Power-One's new switcher is as dependable as our linears.

- Model SK5-40/OVP, 5V @ 40A
- \$250 Single Quantity
- Smaller Size, Lighter Weight
- 2.0" x 4.88" x 13.0"; 3 lbs., 14 oz.
- Simple Dependable Design
- Convection Cooled
- High Efficiency — 75%
- Made in USA

 **POWER-ONE** INC.
D.C. POWER SUPPLIES

Power One Drive • Camarillo, California 93010 • (805) 484-2806 • TWX 910-336-1297

Circle 16 on reader service card

1979 Electronics Buyers' Guide



The only book of its kind in the field. If you haven't got it, you're not in the market.

To insure prompt delivery
enclose your check with
this coupon.

1979 edition available
in June.

Electronic Buyers Guide
1221 Ave. of the Americas
New York, N.Y. 10020

Yes, please send me _____ copy(ies) of 1979 EBG.
 I've enclosed \$30 per copy delivered in the USA or Canada.
 I've enclosed \$52 per copy for delivery elsewhere

Name _____
Company _____
Street _____
City _____ State _____ Zip _____

People



Booster. Edward Tang hopes to boost MNOS with new products and processes.

Nanon Electronics Inc. in late 1977. Tang, whose 14 years in the semiconductor business includes being vice president of research and development for Micro Power Systems Inc., plans to change that.

"There's a tremendous untapped potential here," he says. Facing design and process problems, McDonnell Douglas "never really got off the ground" and did not bring a broad product line to market.

Tang is out to do just that. He will be continuing projects he has been working on since he joined Nitron as R&D director earlier this year. Next year will come 2-K-by-8-bit memories to complement the 2-K-by-4-bit devices Nitron is selling now.

He is also developing a static 256-by-4-bit part that will be used on a 16-K memory board for the LSI-11 minicomputer. It will fit a variety of applications, according to Tang, including a scrambler system for community antenna TV.

Tang has other MNOS irons in the fire as well. One is a faster n-channel design that also operates at lower voltage than present p-channel devices. And he is looking at a double-polysilicon approach "to get away from the nitride problem, but it doesn't have the endurance of MNOS."

Nitron will be growing in other areas, says Tang. It will soon be running n-channel and complementary-MOS lines, with a firm eye on the telecommunications market.

IMAGINE

More features than you'd expect—for less than you'd expect—on a single-board 16K byte microcomputer.

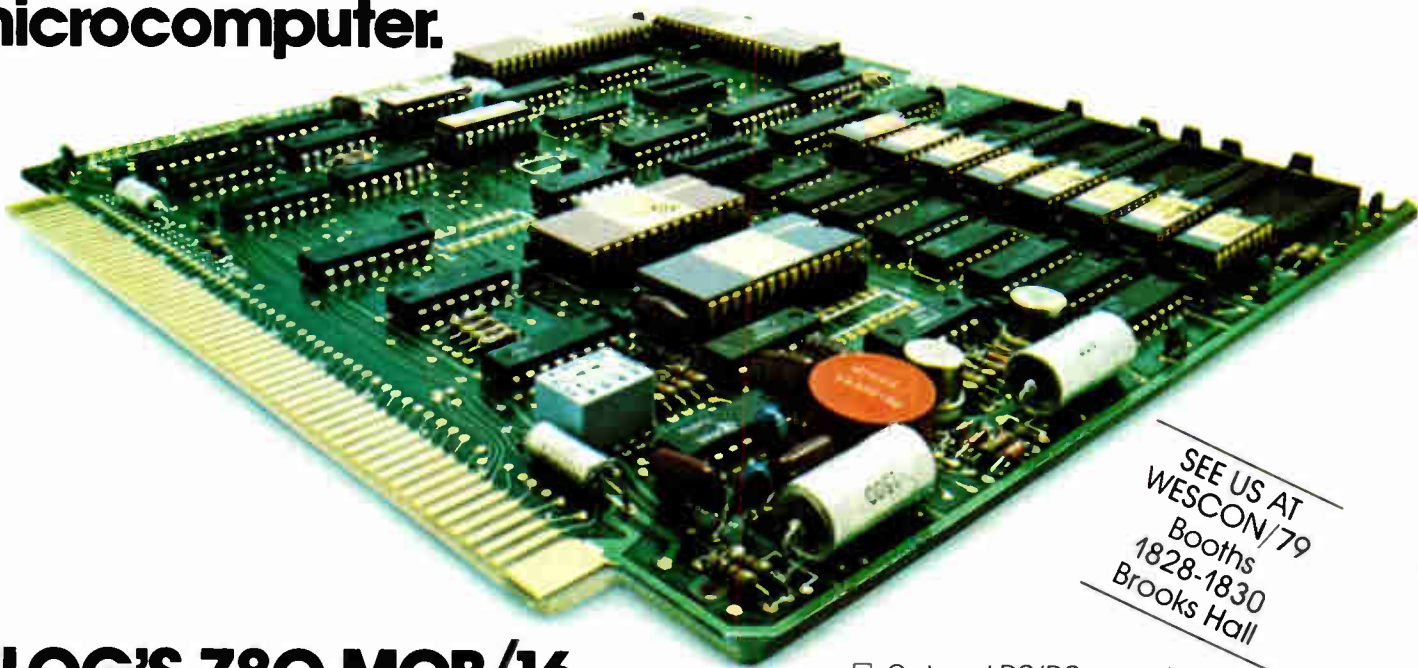

SEE US AT
WESCON/79
Booths
1828-1830
Brooks Hall

ZILOG'S Z80 MCB/16.

Need maximum performance?
In minimum space? With
minimum power? Nothing
comes close to Zilog's Z80
MCB/16 in capabilities—or
low price. Look at what you
get for just \$795.00*

- 16K bytes of RAM.
- 5V operation.
- Z80 CPU with 158 instructions.
- Compact 7.5 x 7.7 inch board.
- 16 parallel I/O lines.

- Serial I/O.
- RS232 or 20ma interface.
- Programmable baud rates.
- Synchronous or asynchronous protocol.
- 4K bytes of PROM memory space.
- Complete buffering of address data and control lines.
- Four 8 bit counter-timer channels.
- Vectored interrupt capability.
- Instruction execution speed of 1.6 μ sec.

- On board DC/DC converter.
- Also available as the Z80 MCB/4 with 4K bytes of RAM for \$595.00*

For complete specifications and the name of your nearest Zilog distributor write:
Zilog, 10340 Bubb Road, Cupertino, CA 95014.



Zilog

An affiliate of
EXXON ENTERPRISES INC.

Circle 17 on reader service card

*Suggested Domestic U.S. prices only. OEM quantity discounts available.

The fireworks have just begun!

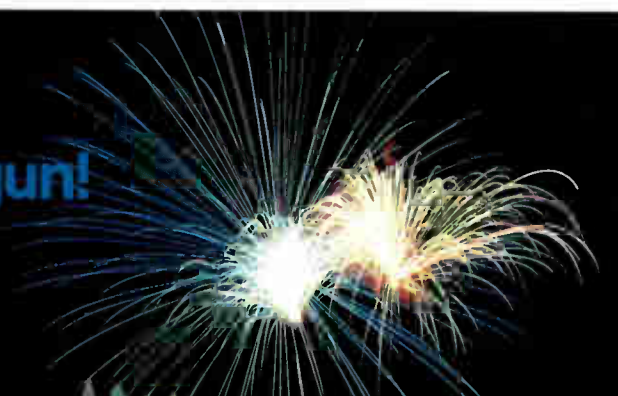

MONSANTO OPTOELECTRONICS

MONSANTO OPTOELECTRONICS

GENERAL INSTRUMENT OPTOELECTRONICS

GENERAL INSTRUMENT OPTO

It's a name that is already well known in semiconductor products as well as in data systems, cable TV products, and industrial components. Now, we're taking it into another area of high technology.

In June, General Instrument acquired the total optoelectronics operations of Monsanto. Their broad product line. Their experienced people. Their modern production facilities. And most important . . . an outstanding expertise in optoelectronics.

*We are the
new name
in optoelectronics...*

**TEN YEARS OF EXPERIENCE IS
A GOOD PLACE TO START**

Since 1969, the major thrust has been to apply high technological capability to product development. Result—a continuing series of “firsts” in LED lamps, displays and optoisolators. Today, you can select from over 150 high performance devices in our product line. And you are assured of high quality and top performance because of vertically integrated production . . . from LED crystal to finished LED product.

**NO BREAK IN CONTINUITY OF
CUSTOMER SERVICE**

The same conscientious and dedicated people will continue to back up our product line.

With the same prompt product and technical assistance, order processing and after-sale service.

Even the product



LECTRONICS

designations remain the same. The only change you will notice is a more aggressive attitude. General Instrument is committed to providing total resources to become the leader in optoelectronics.

OUR FIELD ORGANIZATION IS THE SAME TOP TEAM

Over 50 of the most competent distributors throughout the world will continue to provide our customers with immediate availability of our wide variety of optoelectronic products. And our sales representatives are strategically located to give on-the-spot assistance in design and product selection.

THE FUTURE IS EVEN BRIGHTER

During the past year we "enlightened" the industry with better ways to use alphanumeric, new approaches to panel design and how to get bigger, brighter digits in less space. And that's just the beginning. You'll soon see the result of constant research and development as we announce a number of creative new products in the months to come. As the "oldtimer-newcomer" in optoelectronics, we'll continue to design, produce and improve the products that best fill your design needs. That's a promise.

General Instrument Optoelectronics Division,
3400 Hillview Avenue, Palo Alto, California
94304, Telephone (415) 493-0400

GENERAL INSTRUMENT

and we will continue to make a name for ourselves.

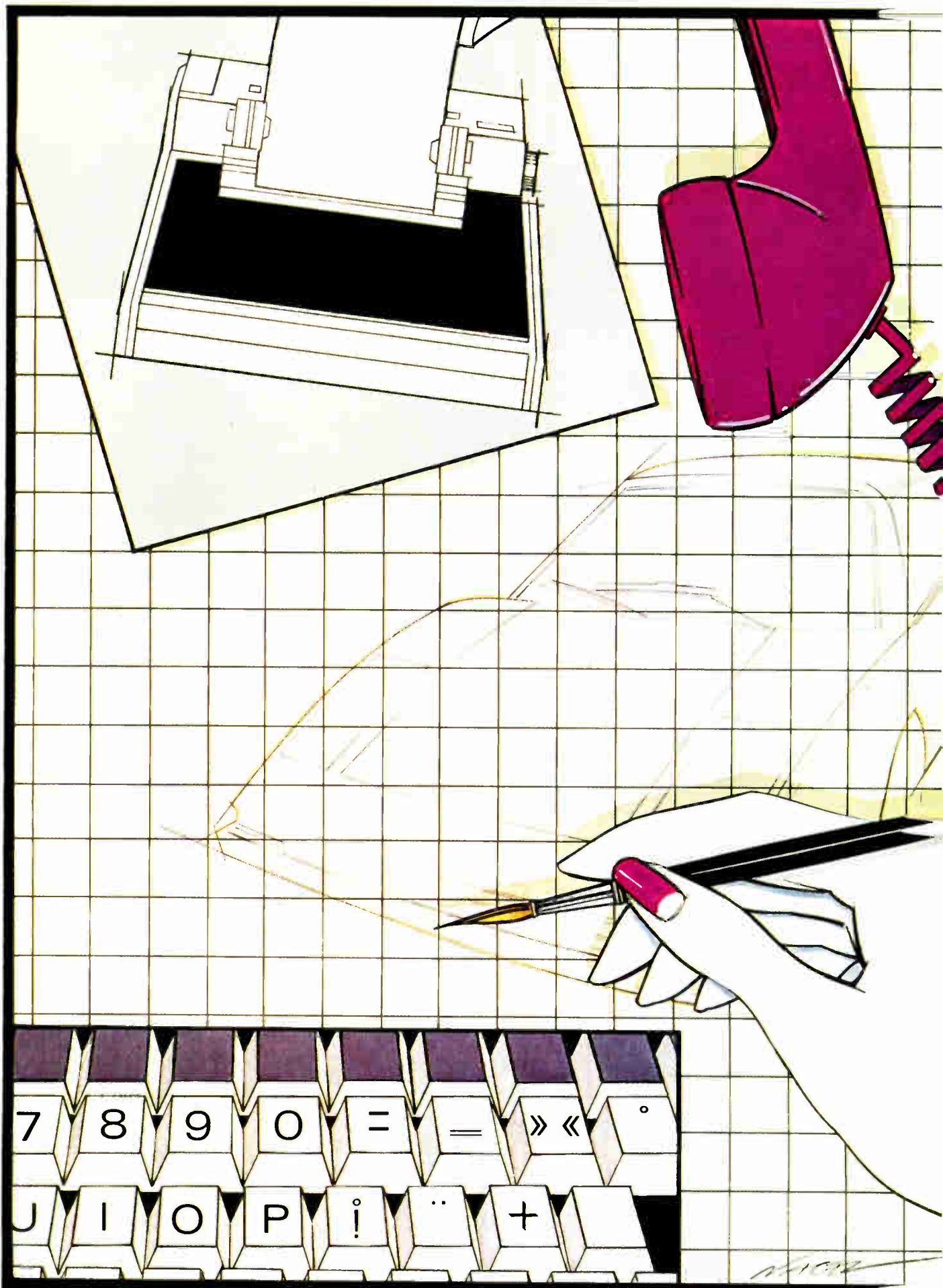

Microcontroller Masterpieces

Create yours using any of Intel's seven single-chip microcomputers and Intellec® development system

It starts with an idea—your inspiration to add the power of microcomputer intelligence to create a new product, revitalize an existing one, add features or reduce manufacturing costs. What's the next step? Do you choose a computer-on-a-chip for performance, for capabilities, for economy... Or, should you first evaluate program development tools that can shorten the design cycle, reduce product development costs and simplify the whole process?

The answer: Intel. Because your success depends on choosing the right microcontroller and the right development support.

That's why our 8048 family of microcontrollers has set industry-wide standards for performance, features and economy. And our Intellec system is far and away the most advanced approach to program development in microcomputer history.

A full spectrum of solutions

A microcontroller is a remarkable device—a complete computer-on-a-chip, with program storage, data memory, input/output circuitry and CPU, all etched on a single chip of silicon. Such integration, though, makes it important to choose the right family of microcontrollers with the right combination of features for your growing application needs.

Intel makes that easy by putting the industry's broadest selection on your palette. The foundation of the family is the 8048, the microcontroller that won industry acceptance for the computer-on-a-chip concept. Then there's the world's easiest to use microcontroller, the 8748. It's an 8048 with on-chip program memory

the user can erase and reprogram over and over, during development or when customizing products.

For sheer performance, nothing can match the 8049, with twice the program and data memory of the 8048—and twice the speed.

The 8021 provides full 8-bit power for cost-sensitive applications. And our newest family member, the 8022, offers a unique extra for control applications—an on-chip analog-to-digital converter.

All seven existing (see chart) and future Intel® microcontrollers provide software compatibility to permit easy upgrade flexibility. All operate from a single +5V supply and are fully supported by the Intellec development system.



Color yourself successful— with the Intellec® System

There's no quicker way to go from inspiration to completed masterpieces than our Intellec development system. From design through production, the Intellec system manages, cuts and compresses the development cycle. For new users, the Intellec system's sophisticated simplicity ensures a smooth transition to microcomputer technology.

At the Intellec console, you write programs using 8048 family assembly language, and let the system automatically translate them into appropriate machine code for your system application.

8048 Microcomputer Family

Model	Program Memory (Bytes)	Data Memory (Bytes)	I/O Lines
8021	1K ROM	64	21
8022	2K ROM	64	28
8048	1K ROM	64	27
8748	1K EPROM	64	27
8035	(External)	64	27
8049	2K ROM	128	27
8039	(External)	128	27

The ICE-49™ emulator brings a new standard of in-circuit emulation to the Intellec system, ending the frustration and time lost trying to merge hardware and software. From the beginning of your development cycle, the ICE-49 module provides you with a "diagnostic window" into the 8048 microcomputer family. And with the Intellec Development System you can emulate on-chip functions inaccessible by other approaches.

Get started today

Find out more about Intel microcontrollers and the Intellec system. Call your local Intel sales office or distributor for more information about our next MCS-48™ microcontroller workshop in your area. Or write for our complete Success Manual for Single-Chip Users. Intel Corporation, Literature Dept., 3065 Bowers Avenue, Santa Clara, CA 95051. 408/987-8080.

intel delivers.

Europe: Intel International, Brussels, Belgium. Japan: Intel Japan, Tokyo. United States and Canadian distributors: Arrow Electronics, Alliance, Almac/Stroum, Component Specialties, Cramer, Hamilton/Avnet, Harvey, Industrial Components, Pioneer, Wyle/Elmar, Wyle/Liberty, L.A. Varah and Zentronics.

Nicolet EXPLORERS

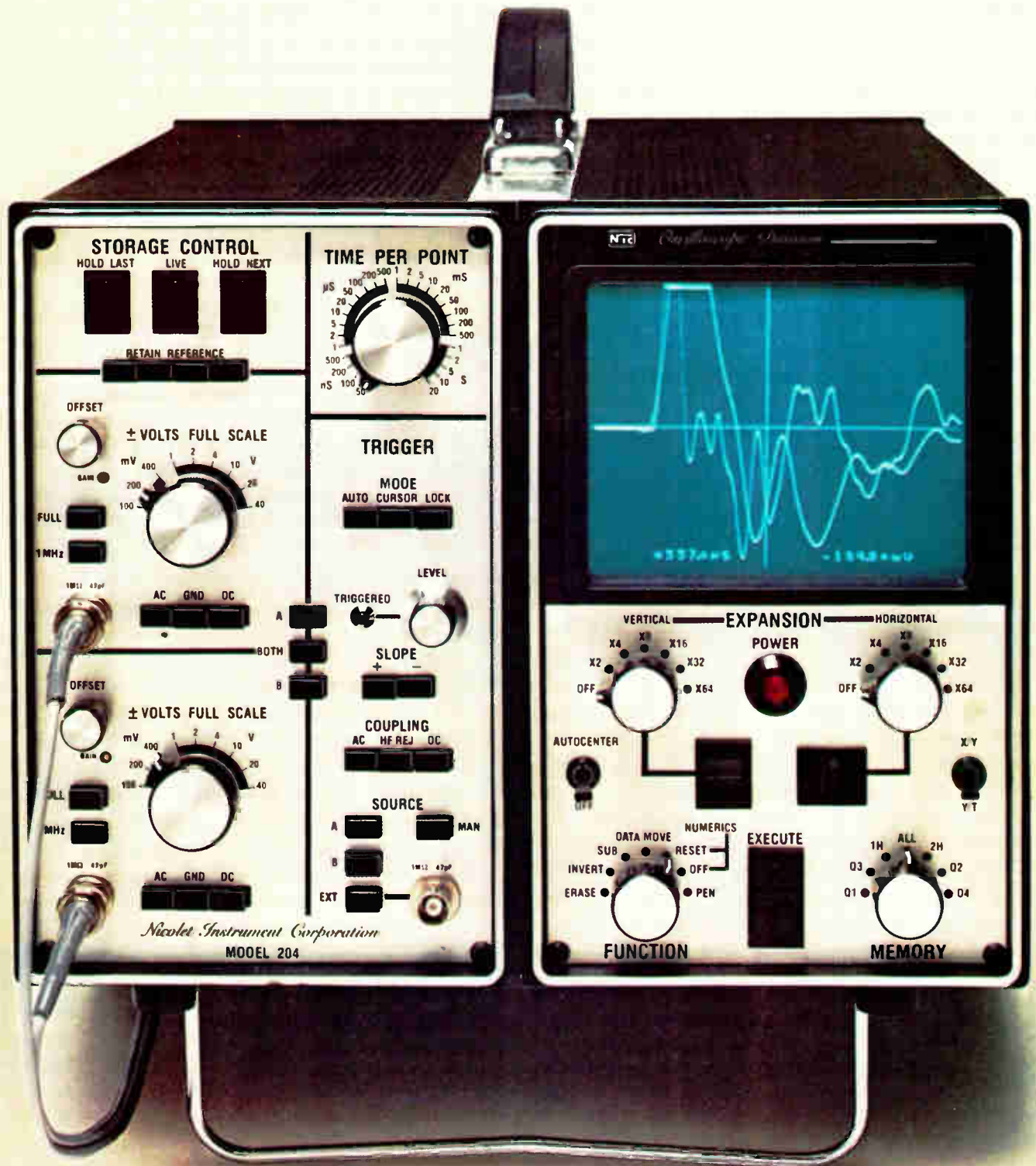

... as easy as I, II, III

Three precise, high resolution digital oscilloscopes for analog signals

- Easy operation—storage at the touch of a button
- High precision
- Clear, concise display with no bloom, fade or flicker
- Excellent hard-copy graphics
- Optional digital records via internal disk recorder
- Retroactive sweep trigger
- XY or YT operation
- 20 times better resolution
- Display expansion to 64X, both axes
- Superimposed stored & live, stored & stored or live & live waveforms
- Optional parallel 12 bit, RS-232C and IEEE-488-GPIB interfaces



**NICOLET
INSTRUMENT
CORPORATION**

OSCILLOSCOPE DIVISION

5225 Verona Road, Madison, Wisconsin 53711
Telephone: 608/271-3333
TWX: 910-286-2737

EXPLORERS OUTPERFORM:

- Low frequency analog scopes
- Low frequency storage scopes
- Transient recorders
- XY recorders
- Strip chart recorders
- Light beam recorders
- Other digital oscilloscopes

EXPLORER I is priced at \$3,990 (U.S. domestic list price).

NICOLET, WHO'S NICOLET?

Nicolet is a leading manufacturer of digital electronic measurement instruments (signal averagers and FFT spectrum analyzers), analytical instruments (FT-IR and FT-NMR spectrometers), biomedical computers and digital graphic plotters. Nicolet's expertise in high technology digital instrumentation led to the first digital oscilloscope in 1973.

To learn how the EXPLORERS can help you, call toll free, **1-800/835-2246** (in Kansas, **1-800/362-2421**) and request our new brochure. To discuss your application or to arrange a demonstration, call **608/271-3333**.

SALES AND SERVICE OFFICES WORLDWIDE

WESCON BOOTHS 1155-1157

The globe continues to shrink

Some six years ago, *Electronics* published a special issue that was perhaps the first salute to the pervasiveness of electronic technology. Its theme was "The Great Takeover." The writers and editors of that seminal examination of the astounding growth of electronics also emphasized the increasing universality of the technology: the world, they said, was shrinking. Electronic advancement was inevitably going to become less and less a respecter of conventional national borders and chauvinistic instincts, they predicted.

That prediction has proved to be correct in the years since then. The shrinking of the once-awesome technological chasm between the U. S. and the rest of the world is proceeding apace. As a further narrowing the gap, now about to take its place alongside the premier solid-state technology conferences held in America each year is a Japanese meeting: the International Conference on Solid State Devices. The ICSSD is ready to stand beside the ISSCC (International Solid State Circuits Conference) and the IEDM (International Electron Devices Meeting) as initials of consequence, another weathervane for the hot technologies, the new directions, and the future leaders in solid-state electronics. On page 85, there is a look at this year's conference. And by next year, the ICSSD will be even more a force to be reckoned with.

Let electronics do the thinking

The respected research firm Arthur D. Little Inc. has issued from its headquarters in Cambridge, Mass., the nine-volume result

of a two-year study of intelligent electronics. Entitled "Strategic Impact of Intelligent Electronics in the United States and Europe—1977 to 1987," it foresees a market in 1987 adding up to \$40 billion worth of hardware—and that does not include the ordinary computers and associated machinery that usually come to mind when the subject of electronic intelligence is brought up. Rather, the hardware will consist of microprocessors and other intelligent chips, including some yet to be developed.

Although that figure is cause for optimism, ADL's Jerry Wasserman, the project director, tempers it a little. "Opportunities will occur in selected areas and the pace of acceptance of intelligent electronics will vary in different industries and will differ in the United States and Europe."

He notes, for example, that the volatile consumer market might be very responsive to economic pressures, whereas the more conservative industrial-controls sector would tend to grow slowly but surely. In short, some areas are going to boom soon and be mature or in decline by 1987; others will still be gathering momentum.

To sum up the ADL study, there is cause to be optimistic about the future of intelligent electronics and about the opportunities for the makers of electronic hardware. In the best-case scenario, the \$40-billion total-market forecast could turn out to be a very conservative one. But for business survival in a selling arena that barely exists at this moment, worst-case planning is what's needed—the people who are going to make it in a big way are the ones already identifying the pitfalls inherent in so massive a market, with its hundreds of submarkets.

EASY DESIGN

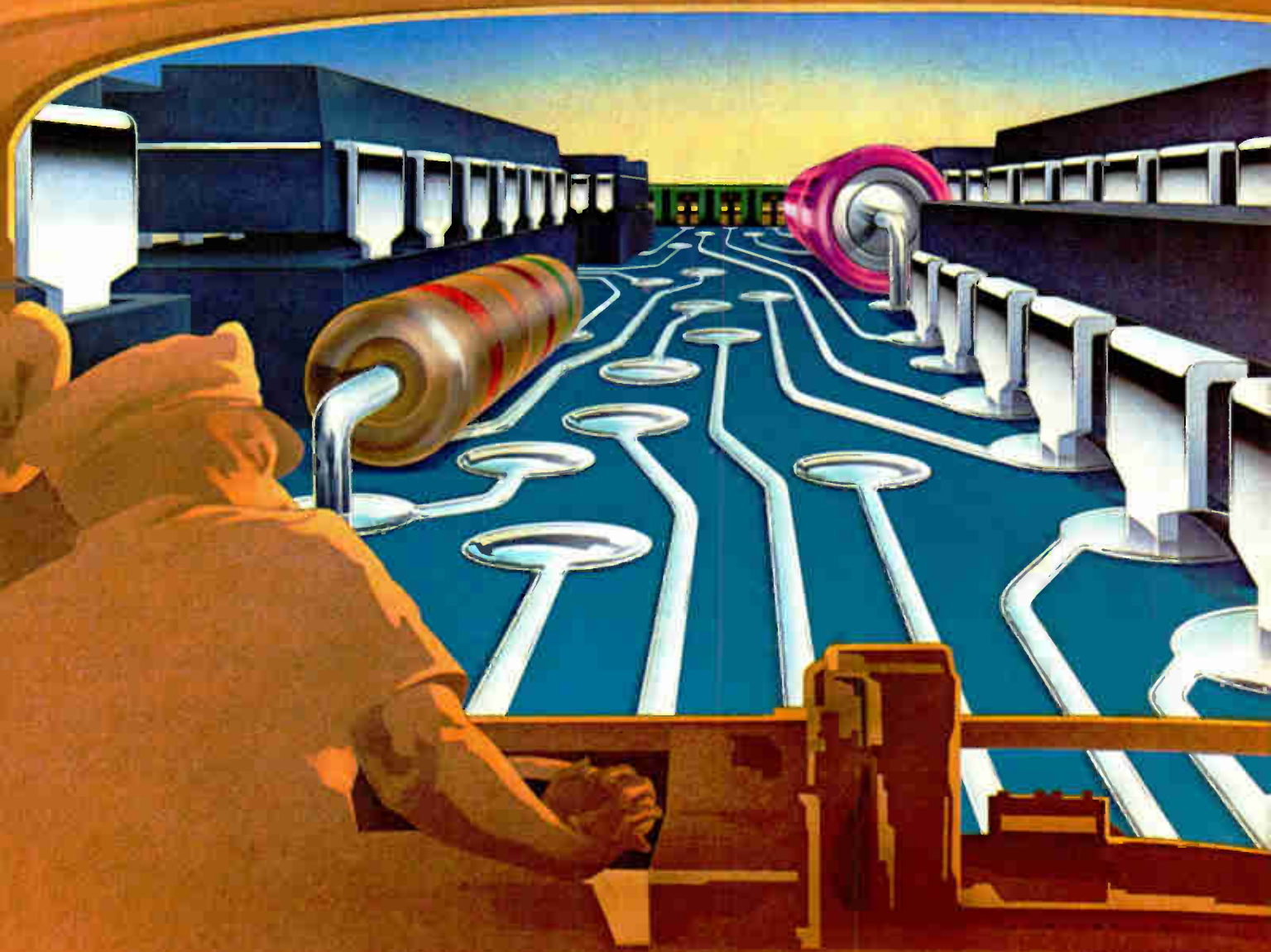

Pro-Log maps the STD BUS route to easy microprocessor design.

First checkpoint, our STD BUS Information Packet.

It explains the basics of the new STD BUS and Pro-Log's Series 7000 cards. With these, you can build 8-bit microprocessor systems around a standard bused motherboard. You can choose the functions in your system, the memory type, even the microprocessor type by simply selecting from among Series 7000 cards. The STD BUS is 56 lines wide, compatible with Pro-Log's standard 4-1/2 inch by 6-1/2 inch edge-connected cards, supported by other manufacturers, and freely available to the industry.

Second checkpoint, our STD BUS Technical Manual.

It contains detailed electrical and mechanical specifications for the STD BUS and Pro-Log's Series 7000 cards.

Third checkpoint, our microprocessor design course.

Where we teach you how to design and document an STD BUS microprocessor system independent of any development system. Write for a schedule of courses in your locale.

Your destination: easy, cost-effective, fast design.

Contact Pro-Log Corporation, 2411 Garden Road, Monterey, CA 93940, phone (408) 372-4693.

SERIES 7000 CARDS AVAILABLE

Z-80; 6800; AND 8085 PROCESSOR

16K BYTE STATIC RAM; 16K BYTE 2716 EPROM

TTL INPUT; TTL OUTPUT; AND TTL I/O PORTS
UNIVERSAL TTL I/O

TRIAC OUTPUTS; SP/ST RELAY OUTPUTS
AC/DC OPTOISOLATED INPUTS
MEDIUM POWER DC DRIVERS

RS 232 AND TTY DRIVER/RECEIVER
KEYBOARD/ALPHANUMERIC DISPLAY

1/8; 1/4; AND 1/2 STD BUS RACKS

CARD EXTENDER; GENERAL UTILITY
UTILITY DIP; DECODED UTILITY



PRO-LOG
CORPORATION

Microprocessors at your fingertips.

Circle 25 on reader service card

Visit our booth #1631 at WESCON

"THE
AmZ8000
IS BETTER."



The AmZ8000 has more addressing modes, more general-purpose registers, larger addressing spaces, better capability and more powerful instructions than the 8086.

Call Advanced Micro Devices and get all the facts on the AmZ8000. It's the best 16-bit CPU there is.

**Advanced
Micro
Devices**



901 Thompson Place,
Sunnyvale, CA 94086
Tel: (408) 732-2400

Meetings

Fall Conference, USE Inc. (the organization for those who use Spery Univac's series 1100 computers, Bladensburg, Md.), Diplomat Hotel, Miami, Fla., Sept. 10-14.

Ninth European Microwave Conference, Institution of Electrical Engineers (London), The Brighton Centre, Brighton, England, Sept. 17-21.

Impact of Improved Clocks and Oscillators on Communication and Navigation, National Bureau of Standards, NBS headquarters, Gaithersburg, Md., Sept. 18-20.

Wescon/79 Show and Convention, IEEE and Electronic Conventions Inc. (El Segundo, Calif.), Brooks Hall, San Francisco, Sept. 18-20.

Autotestcon—Automatic Support System for Advanced Maintainability Conference, IEEE, Radisson Hotel, Minneapolis, Sept. 19-21.

29th Annual Broadcast Symposium, IEEE, The Washington Hotel, Washington, D. C., Sept. 19-21.

Telecom '79—Third World Telecommunications Exhibition, ITU, Palais des Expositions, Geneva, Sept. 20-26.

IPC Fall Meeting, The Institute for Interconnecting and Packaging Electronic Circuits (Evanston, Ill.), Sheraton Palace Hotel, San Francisco, Sept. 23-27.

Electrical Overstress/Electrostatic Discharge Symposium, ITT Research Institute (c/o RADC/RBRAC, Griffiss Air Force Base, N. Y. 13441), Stouffer's Denver Inn, Denver, Colo., Sept. 25-27.

Military Electronics and Defense Exposition, Industrial and Scientific Conference Management Inc. (Chicago), Rhein-Main Halle, Wiesbaden, West Germany, Sept. 25-27.

Mini/Micro Computer Conference and Exposition, sponsored by the organization of the same name (Anaheim, Calif.), Convention Cen-

ter, Anaheim, Sept. 25-27.

Second International Conference on Electrical Variable Speed Drives, Institution of Electrical Engineers, at the IEE headquarters, London, Sept. 25-27.

Ultrasonics Symposium, IEEE, Monteleone Hotel, New Orleans, Sept. 26-27.

Gallium Arsenide Integrated Circuit Symposium, IEEE, Sahara Tahoe Hotel, Lake Tahoe, Nev., Sept. 28-29.

Northeast Personal and Business Computer Show, Northeast Expositions (Brookline Village, Mass.), Hynes Auditorium, Boston, Sept. 28-30.

Annual Meeting of the Industry Applications Society, IEEE, Bond Court, Cleveland, Sept. 30-Oct. 4.

International Electrical and Electronics Conference and Exposition, IEEE, Exhibition Palace, Toronto, Oct. 2-4.

ATFA/79—Advanced Techniques in Failure Analysis Symposium and Exposition, International Society for Testing and Failure Analysis (Rondo Beach, Calif.), Airport Marriott Hotel, Los Angeles, Oct. 8-11.

Annual Meeting of the Optical Society of America (Washington, D. C.), Genesee Plaza Holiday Inn and Americana of Rochester, Rochester, N. Y., Oct. 8-12.

International Symposium on Electromagnetic Compatibility, IEEE, Town & Country Hotel, San Diego, Calif., Oct. 9-11.

12th Annual Connector Symposium, Electronic Connector Study Group (Box 1428, Camden, N. J. 08101), Cherry Hill Hyatt House, Cherry Hill, N. J., Oct. 17-18.

Semiconductor Test Conference, IEEE, Cherry Hill Hyatt House, Cherry Hill, N. J., Oct. 23-25.



The keyboard switch with a heart of gold

...keeps your product WORKING year after year... after year.

In your keyboard or ours, Cherry key switches just don't fail. The knife-edge contact area is so small (9 millionths of a square inch)... the contact pressure so great (about 5,000 psi) ... the gold alloy so pure and film-free ... that you are assured of positive contact every time. For 50 million operations and beyond. (Which is probably beyond the life expectancy of your product!)

Cherry "heart of gold" keyboard switches are available individually or with two-shot molded keycaps. Hopefully, you want keycaps. Because, we *have* keycaps ... in more legends, sizes, type faces than you're likely to find anywhere else. Sculptured keycaps? We've got 'em. Gloss or matte finish? We've got *both*. Colors? Lighted? Specials? Sure! Some "off the shelf" ... all at prices that make it obvious why the *Cherry* way is the *economical* way to put a heart of gold in any keyboard.

See Us At
WESCON
Sept. 18-20, 1979
San Francisco
CHERRY BOOTHS: 1534-38

For free test sample switch
and catalog, just
TWX 910-235-1572 ...
or PHONE 312-689-7700.

CHERRY



CHERRY ELECTRICAL PRODUCTS CORP., 3608 Sunset Avenue, Waukegan, IL 60085

Cherry switches now
available locally from distributors.

Circle 27 on reader service card



NASA was willing to bet a billion dollars on our switches.

The planet Mars has long been the object of Man's curiosity. Perhaps because it is the most likely of all planets to have life on it.

After traveling over 400 million miles, and after rejecting three sites as too dangerous, the Viking I spacecraft set down safely in the northern hemisphere. Its search for life began when it reached out a mechanical arm for samples of Martian soil.

That arm depended on two of our limit switches.

Three years earlier, project technicians came to us in search of switches that could survive the long trip, the rough landing, and the intensely cold Martian nights.

Working together, we found a way to make two of our miniature hermetically-sealed limit switches do the job. And to make the trip that Man has made so many times in science fiction.

That's no easy task when you consider what those switches had to go through, even before they helped control the movement of that mechanical arm.

Earlier, Mariner space probes took long-distance shots that revealed a terrain with towering volcanoes, some perhaps still active. At least one three times as high as Mount Everest.

And a gigantic canyon system nearly four miles deep, 150 miles wide, and as long as the United States is wide.

A rugged landing could put a fragile switch out of commission. Then there was the orange-red dust that covered the entire planet. A hermetic seal kept our switches clean.

So they survived the trip. And they worked. When no one could afford a failure.

Helping to make the Mars mission a success is only one of the ways we've helped our customers.

We've been working with medical specialists who are designing and testing an artificial heart. One of our sensors makes it beat.

We're also working with leading auto manufacturers in the development of the computerized car engine.

Working with customers early in their design process nearly always results in a better product. For them, and for us. That's one of the reasons why we have the widest variety of switches and sensors in the world. And, if we don't already have one that solves your problem, chances are we can design a solution together.

For information about how we can help you get your project off the ground, write MICRO SWITCH, The Sensor Consultants, Freeport, Illinois 61032. Or call 815-235-6600.

MICRO SWITCH products are available worldwide through Honeywell International.

MICRO SWITCH
Can you afford anything less?

See us at the Wescon Show
Booth #309,311,313

ALCAR
ENTERPRISES INC.
RT. 252 - 1 MILE NORTH OF
PAOLI

**We've accepted
of cost**

Low cost...high reliability...and quick interconnection! Tough for any connector. A tougher challenge yet for demanding automotive specs. TRW Cinch engineering met the cost effective challenge with the New Cinch Plastic Polarized Subminiature Connector.

Originally designed for cost-conscious automotive systems, the quick PCB snap-mounting device makes the new high contact density connector a logical choice for a wide range of applications including computer peripheral equipment, test equipment and telecommunications.

Check these other outstanding Cinch features...25-pin polarized arrangement...compact all-plastic shock and vibration resistant design...interchangeable, intermatable, intermountable with all standard "D" subminiature connectors.

Meeting all of your interconnection needs is the challenge of the NEW Cinch. Just as we worked with this automotive manufacturer, we'll work with you to solve your connector problems with a highly reliable pro-

duct and prompt delivery schedule. Need a connector?

Challenge Us!

For all the facts on the Plastic Polarized Subminiature and the full line of Cinch connectors, contact your local TRW Electronic Components Sales Office...listed in EEM.

TRW Cinch Connectors,
A Division of TRW, Inc.,
1501 Morse Avenue,
Elk Grove Village, IL 60007
(312) 439-8800.



the challenge effectiveness.

See us at Wescon. Booth No. 110 thru 118

TRW CINCH CONNECTORS

Circle 31 on reader service card

Sharpen your competitive edge with A-B resistive components.

When you specify Allen-Bradley components, you put greater assurance of reliability into your products. You also share in A-B's nationwide reputation for high quality. In addition, our in-depth factory and distributor stocks (at competitive prices) make it easier for you to meet your delivery commitments. In short, our competitive edge can add to your competitive edge.

Fixed resistors hot-molded composition and cermet.

Resistor networks thick film (cermet) and thin film (precision).

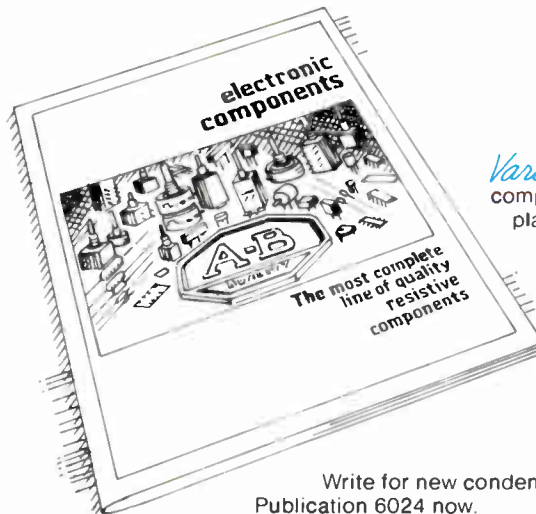

Variable resistors hot-molded composition, cermet and conductive plastic.

Trimmers hot-molded composition and cermet.

Write for new condensed catalog, Publication 6024 now.



Quality in the best tradition.



ALLEN-BRADLEY
Milwaukee, Wisconsin 53204

Bell comes up with one-chip microcomputer

Researchers at Bell Laboratories, Murray Hill, N. J., have developed a single-chip microcomputer called the MAC-4. The device, to be described Sept. 5 at the Comcon conference in Washington, D. C., is geared for versatility: **34 of its 40 pins are dedicated to input and output**, and its 40-plus instructions are heavy on bit manipulation. Though the device has a 4-bit-wide data bus, it can also process 8-, 12- and 16-bit operands. Also, because its some 10,000 transistors are built from complementary-MOS, power dissipation is a low 200 mw and can be further reduced with a special halt instruction. The microcomputer consists of five functional sections—internal control, arithmetic and logic, special registers and an address-arithmetic unit, memories, and input/output circuits. Read-only memory capacity can be varied from 1,024 to 3,840 4-bit nibbles, random-access memory can vary from 80 to 192 nibbles, and coding will use an assembly language compatible with C programming language.

TI starts push in board-level bubble products

Look for a new marketing thrust from Texas Instruments Inc. involving board-level magnetic-bubble memory products. The move is made possible in part by emerging availability of peripheral chips necessary to drive the Dallas company's 256-kilobit bubble device—the TIB0303. Within recent weeks, TI has begun shipping samples of three direct 256-kilobit bubble peripheral chips, the SN75385 coil driver, the SN75384 function driver, and the SN75282 sense amplifier. Also waiting in the wings is the TMS9922, a bubble-controller chip **that integrates many of the functions done with small- and medium-scale-integrated devices** on the controller board in TI's two-board 256-kilobit evaluation set that the firm began shipping last April. Among other things, TI is expected to announce an improved version of the two-board set—which in its original version was expandable to an 8-megabit system—that will be offered as a subsystem aligned for use with the firm's TM990 microcomputer module family. The availability of new bubble peripheral chips will also be important in TI's plans, which call for introduction this year of a 1-megabit device.

'Micro-Winnie' disk-head pack called next twist

The latest twist in the peripheral-device industry's attempts to meet the demands of users of small-business computer word-processing and micro-computer systems will be the so-called micro-Winnie, say market researchers at Creative Strategies Inc. Based on the increasingly popular Winchester technology that integrates the disks and their recording heads into a hermetically sealed unit, **the new units will package disks 4 to 6 inches in diameter with thin-film recording heads** into a removable unit about the size of an eight-track tape cartridge. The San Jose, Calif., firm predicts that these units will be introduced later this year in 1-megabyte versions, with shipments to reach the 40,000-unit level by next year and grow at a 106% compounded annual growth rate to 350,000 units by 1983.

Digital version of GenRad 1731 IC tester due

GenRad Inc. is expected to introduce in September its 1732, the digital equivalent of its 1731 analog integrated-circuit tester. The new benchtop digital IC tester, selling for less than \$50,000, would perform almost all tests now done only by machines costing from \$80,000 to \$600,000. **The firm feels it has found a gap in the market similar to that spotted for the 1731 analog tester** which, since its introduction [*Electronics*, March 29, p. 136], is said to have captured more than 30% of the benchtop analog IC

test market. Its success surprised GenRad; a company source calls it the most successful product introduction in the Concord, Mass., firm's 60-year history. GenRad hopes for similar success with the microprocessor-controlled 1732, which is said to test "all digital devices from small-scale IC's to VLSI and memories."

Motorola's 16-bit processor now set for September bow

The long-awaited MC6800 microprocessor from Motorola Inc. has gone through two silicon passes, with the second iteration being sent in sample quantities on a serialized basis to selected customers that have signed nondisclosure agreements. According to word out of Motorola's Austin, Texas, integrated-circuit operation—where the 16-bit machine will be produced—formal announcement of the part is now scheduled for mid-September.

Teleprinter handles three major U. S. communications services

A universal teleprinter that can be used on the three main telecommunications networks in the U. S. will be sold by Toshiba Corp. to Cal Data Com Corp. of Santa Ana, Calif., on a private-label basis. The contract, worth \$55 million, calls for delivery of 30,000 units over six years. With microprocessor control built around Toshiba's TMP8085AP, the teleprinter supports four interfaces to match Western Union Telex and TWX services and AT&T's Direct Distance Dialing. (The fourth could be used to connect a paper-tape reader, a cathode-ray-tube display, or a floppy disk, but Toshiba has no present plans to support these devices.) The teleprinter comes with a basic 4-kilobyte memory expandable to 20 kilobytes and operates at 30 or 96 characters a second in semi- or full-duplex modes. Toshiba claims the machine will be the first on the market to operate on all three networks. Yet it is small enough to mount on a stand or table and weighs only 16 kg.

Ballantine wins tester contract for Mecca system

Ballantine Laboratories Inc. of Boonton, N. J., has won a \$694,000 contract from the Navy to design, develop, and build 90 programmable oscilloscope calibrators for the second generation of the Mecca system. The ruggedized portable instrument, to be named the Ballantine 6127M calibrator, is to be fully compatible with the IEEE-488 bus. It is based on Ballantine's 6125C time and amplitude calibrator, an off-the-shelf tester.

The instrument is to provide calibrated precision amplitudes from 40 μV to 200 v; crystal-controlled time-calibration markers from 0.5 ns to 5 s; a fast-rise calibration pulse with a rise time of 200 ps; and a means for checking amplitude calibrators built into oscilloscopes. The contract was awarded by the Navy's Metrology Engineering Center in Pomona, Calif.

Largest photovoltaic plant operating Air Force radar

Photovoltaic power took another step forward in August when the Army's Mobility Equipment Research and Development Command brought on line a 60-kw power plant—the world's largest—at the Air Force radar station near Mt. Laguna, Calif., some 60 miles east of San Diego. The new \$1.6 million installation using 97,000 solar cells can supply about 10% of the station's daytime electricity requirements. It is more than twice as large as the Department of Energy's 25-kw system used in a Mead, Neb., irrigation program. The Air Force system is expected to save annually about 11,500 gallons of diesel fuel now used by power generators.

NEW! LOW COST CRT DISPLAY MODULE

MOST-REQUESTED FEATURES

Motorola's new 12-inch CRT display module offers low unit cost while maintaining the features most requested in volume OEM applications. Features such as 800-line resolution, excellent linearity and geometry, video response to 15 MHz—features that contribute to the module's capability of providing sharp, clean characters in a full 80 x 24 format. TTL-compatible direct drive operation and single 12V dc input requirement further simplify your design considerations.

CHASSIS OR KIT

The new module is available with sheet metal chassis as Model M3570, or with-

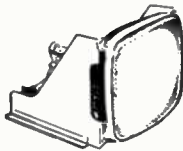

out the chassis in "kit" form as Model M3970, pictured below. Model M3970 offers superior economy—and has no metal boundaries to inhibit your own layout.

PRICED TO HELP HOLD DOWN YOUR PRODUCT COSTS

In addition to the already low unit price, maximum cost savings can be achieved by ordering either model packaged in bulk (subject to minimum purchase volume and shipping restrictions). These cost savings at the component level can have a noticeable impact on the price of your final product. Without compromising performance!

CALL TODAY

Call today for more information about the new, low-cost display from Motorola ■ Santa Clara, CA (408) 988-3422 ■ Tustin, CA (714) 838-5621 ■ West Chicago, IL (312) 231-4400 ■ Richardson, TX (214) 231-9901 ■ Windham, NH (603) 898-5921 ■ Shrewsbury, NJ (201) 544-9541 ■ Baltimore, MD (301) 821-0062 ■ Overseas and Canada call West Chicago, IL (312) 231-4400 ■ TWX: 910-230-3117



MOTOROLA INC.

Display Systems

1155 Harvester Rd.
West Chicago, IL 60185

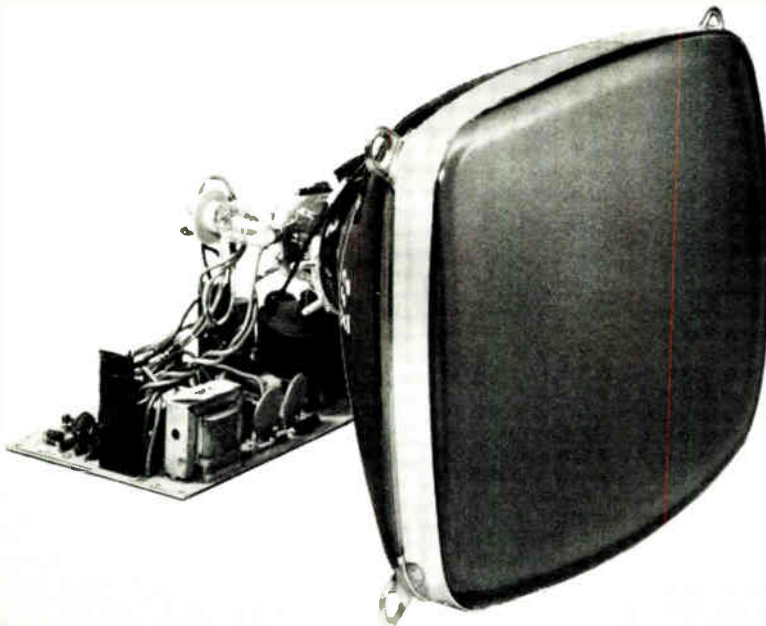

**In Custom
it's not just what
who you know.**

MOS/LSI, you know, it's

For a long time now, National has enjoyed an enviable reputation in the Custom business. And for several very good reasons. One is that our Custom group has some of the sharpest design specialists in the field. In fact, many of them have been at it for eight and nine years.

But on top of having so much of their own knowledge to call upon, National's Custom people have something else: the opportunity to call on other National specialists in integrated design and application in other departments.

Since we are one of the world's largest and broadest suppliers of semiconductor products, we can draw on a wealth of experience in linear, digital, opto, memory, etc.

Which means, that when we design Custom MOS/LSI, it's easy for us to anticipate all the potential requirements of a unique system. Will it drive an op amp? Light an opto display? Operate a relay? Talk to a microprocessor? Such close coordination between departments often leads to cost-saving alternatives.

We're also constantly coming up with creative solutions to unusual problems. For instance, four years ago, it wasn't common to put linear and digital on the same chip. Now we do it all the time. And in large volumes.

Then, too, you can take advantage of our versatility in fabrication. We have, for example, capabilities for eight different MOS processes.

And finally there's our production power.

NSC has a line of over 6,000 standard circuits produced in a dozen plants across the globe. We've developed a manufacturing muscle second to none. When your volume grows, we'll be right there with you to supply the increase. Regardless of size.

So if you're considering a new Custom MOS/LSI application, give us a call. We've got the contacts.

National Semiconductor
2900 Semiconductor Drive M/S 16250
Santa Clara, California 95051

Gentlemen: I want to hear about Custom from the specialists who've got the insiders on the inside. Send me more information.

Name _____ Title _____

Company _____ Phone _____

Address _____

City _____ State _____ Zip _____

E8/30 9-19

 **National Semiconductor**

The sensible solution to an efficient ATE system.

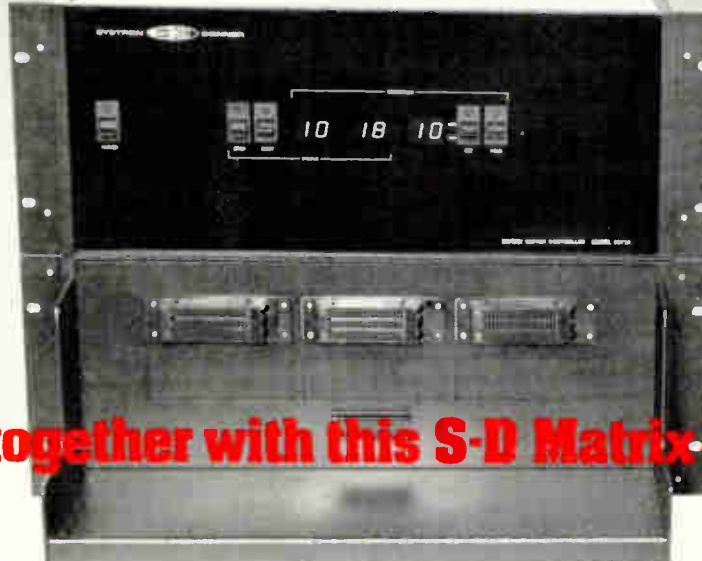
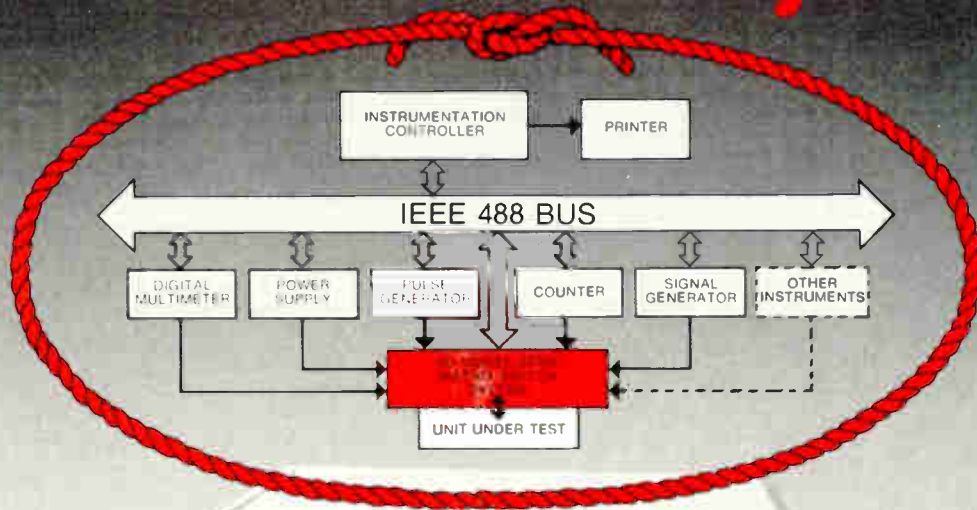

Key features of model 3570A Matrix Switching System

- IEEE-488 bus interface standard
- RS232C communications interface standard
- Error detection firmware
- Label assignment firmware; no costly software
- Clock with error display
- Full 16 x 64 signal matrix module; 10 MHz bandwidth
- 4 x 8 power matrix module; 5 amp current carrying capability.

Tie it together with this S-D Matrix Switch

The Systron-Donner Matrix Switch completes the picture of a flexible, automated test system.

Specifically, the Model 3570A automates the **interconnect** of your IEEE-488 compatible test instruments with the unit under test. Note that all signals and power may be routed through the Matrix Switch to tie the whole system together.

With your interconnect automated, you have further reduced costly, time consuming operator interface, creating a highly efficient and cost effective system for dedicated and

non-dedicated applications.

Let Systron-Donner help you with your test system requirements. Our extensive line of standard, off-the-shelf IEEE-488 compatible instruments includes signal generators, frequency counters, DVMs, pulse generators, power supplies and instrument controllers. All may be used separately as well as in your system. That's really making your hardware dollars work!

To find out more, call Systron-Donner, 10 Systron Drive, Concord, CA 94518. Telephone (415) 676-5000, Ext. 273.



PUT OUR PERFORMANCE
TO THE TEST

SYSTRON DONNER

Scaled process adds new life to bipolar RAMs

by Raymond P. Capece, Solid State Editor

Static random-access chips made with new process hold off fastest MOS parts; 16-K density is next target

Just when bipolar memory manufacturers seemed to have yielded in the face of the new, faster MOS processes, a long overdue overhaul by Fairchild Camera and Instrument Corp. promises to reinstate the bipolar device as king of speedy random-access memories. Still, the battle is far from over; what is now a contest over speed will soon shift to one over price and density.

Fairchild's process make-over is called Isoplanar S. The Isoplanar name was coined by the Mountain View, Calif., company eight years ago when it first used oxide-isolated transistors in a planar process to build a 256-bit RAM. The new S nomenclature stands for scaling, and it is reducing the access time of Fairchild's 1-K RAM to 20 nanoseconds.

Smaller. The most dramatic evidence of the new process is the reduction in die size (see figure) afforded by the new fine-line lithography. Isoplanar used 5-to-6 micrometer metal lines for a 4-K RAM with an area of 23,300 square mils; the 4-K RAM built with Isoplanar S uses 3-to-4- μm lines and is 47%

smaller at 12,400 mil². The process also will build faster, smaller logic devices and other memory types.

Scaling down is just one aspect of the Isoplanar S program, explains Devereaux Rice, strategic marketing manager for bipolar devices at Fairchild. "It actually involves a continuing process development in three areas—lithography, metal systems, and power dissipation."

Metal systems, he says, include not only the alloys used for interconnecting devices, but also techniques for depositing them on silicon. The third effort—to reduce power by changing device structures and developing higher-value resistors—is important in some markets, says

1977

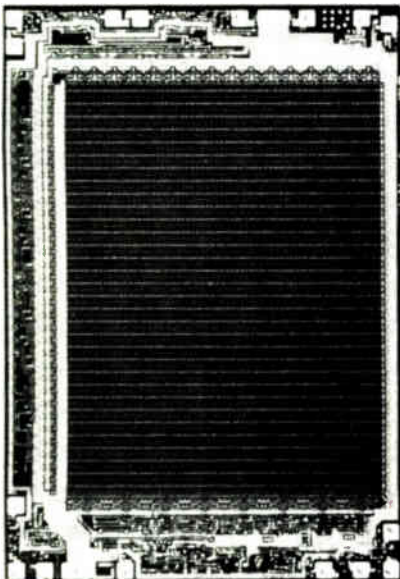

23,300 MIL²

1978

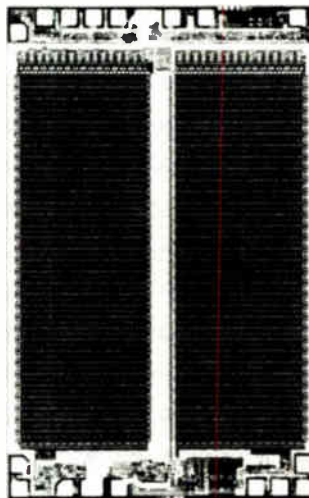

17,200 MIL²

1979

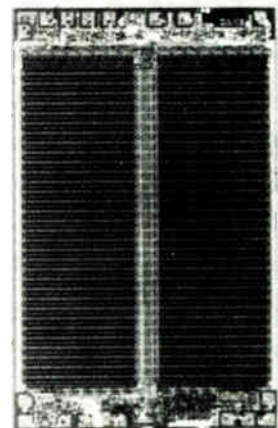

12,400 MIL²

Shrinking bipolar memories. When the 93471 4-K RAM (left) came on the scene in 1977, it was 23,300 mil². Last year it shrank 35% (middle). Now Fairchild's Isoplanar S process will reduce the RAM to 12,400 mil²—about half the original size (right).

Rice, "but our interest now—and our customers'—is primarily speed."

It was Intel Corp. that put Fairchild up against the wall with its high-performance HMOS II process. The Santa Clara, Calif., company's 1-K and 4-K n-channel RAMs undercut the access time of existing bipolar devices.

Intel's 1-K 2125H-1 has a maximum address-access time of 20 ns, whereas the pin-compatible TTL 1-K 93425 from Fairchild is specified at 30 ns, worst-case. Similarly, Intel's 4-K 2147H-1 is a 35-ns part, beating out Fairchild's 45-ns 93471. But Fairchild's new 93F425 has a 20-ns access time, and the forthcoming 93F471 will offer 30-ns access.

Academic. Though the competition for fastest RAM may be important now, in a year or so speed will be academic. The high capacitance of the interconnecting wires limits the ability to handle the 0-to-5-volt swings between logic level 0 and level 1 at high speed.

"We expect TTL memories to bottom out at 20 ns," says Lou Williams, Fairchild's marketing manager for bipolar RAMs. "To go any faster, emitter-coupled logic must be used." Still, TTL design will be around a long time, he maintains, but the focus will shift from speed to density.

Next generation. Intel and Fairchild are developing their next-generation 16-K parts, which will be introduced by both early next year. The way it looks now, Intel's part will be organized as 16-K by 1 bit and will be built with the tighter-dimension polysilicon-load cells on a 38,000-mil² die using HMOS II (2- μ m active regions). Fairchild's first 16-K part, also organized as 16-K by 1 bit, will use 4- μ m metallization (2- μ m active regions), and will have a die of less than 18,000 mil². "The 16-K RAM will be the first part to really use all the aspects of Isoplanar S," says Rice. The two devices should go head to head in speed—perhaps around 45-ns access, but they should be closer in cost than bipolar and MOS devices have been.

The other bonus of shrinking die size is, of course, cheaper parts due

to more dice per wafer. Even though Fairchild's new 4-K RAM is 42% smaller than Intel's (12,400 mil² as against 21,200 mil²), the bipolar process is regarded as inherently more expensive. The yield factors further muddy the picture, and just who can produce the cheaper device is not clear.

"The primary motives for pricing are still market considerations," Fairchild's Williams contends. With only Fairchild and Intel currently driving high-speed technology, prices are not likely to fall quickly—both are asking more than \$30 for premium-speed 4-K RAMs.

What will change that picture are the dozens of other MOS manufacturers and the handful of other bipo-

lar firms nailing down high-speed processes and getting ready to start a real price war. "But that's going to take a long time," says Williams. "Intel has a two-year jump on all other MOS manufacturers. We believe that right now our cost structure is equal to, if not less than, Intel's—and we haven't begun to use the new equipment yet."

The new equipment to which he refers is a direct wafer-stepping projection system for finer-line lithography. Though such equipment will also be a boon to next-generation MOS processing, Fairchild has great expectations for it: within three years, a fast 64-K static RAM with 1 μ m active-device dimensions that will fit on a 25,000-mil² chip.

Data communications

IC packs in circuitry that implements protocol for packet-switching networks

As data-communications protocols become more sophisticated, the hardware needed to implement these procedures governing information interchange becomes more complex. This unsatisfactory state of affairs attracts the attention of semiconductor houses, and the specialized large-scale integrated circuits they are beginning to turn out can hold much of the circuitry.

A case in point is the new WD2501 IC from Western Digital Corp. in Newport Beach, Calif.

[*Electronics*, Aug. 2, p. 35]. It is intended for the versatile and increasingly popular packet-switching networks that use the complex X.25 protocol. Such chips could dramatically lower the cost of interfacing with these nets, thereby helping make them accessible to small-business users and possibly even to home computing systems.

Level 2. The 2501 implements X.25's second level, for link control (see "Protocols aid data communications," opposite). Its designer, Geary

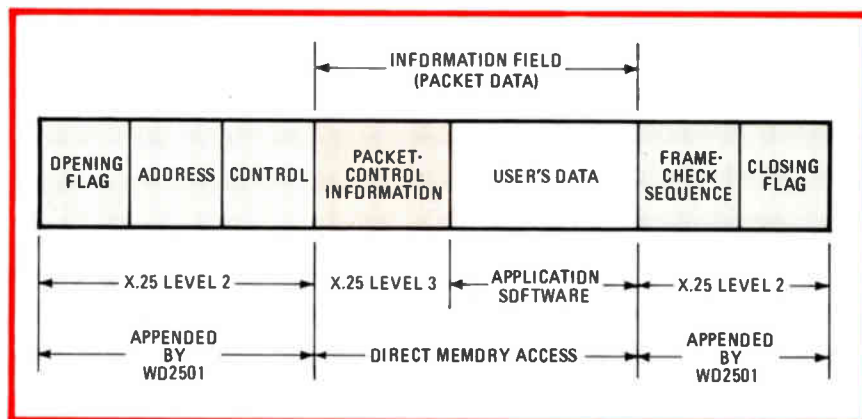

Integrated solution. The WD2501 data-link controller chip integrates the hardware and software necessary to generate link-control data for packet-switching networks.

Protocols aid data communications

In data communications, a protocol ensures orderly information exchange by defining the rules for physical, electrical, and functional characteristics of the communications link. X.25 is the standard for interfacing with public packet-switching networks, adopted by CCITT, the Consultative Committee on International Telephony and Telegraphy. It consists of three levels corresponding closely to the first three of the standardized seven-level protocol hierarchy that has been proposed by ISO, the International Standards Organization, and ANSI, the American National Standards Institute [*Electronics*, Dec. 7, 1978, p. 120].

Level 1 deals with the physical link. It specifies the mechanical, electrical, and functional characteristics required to connect, maintain, and disconnect a linking circuit.

Level 2 provides control between two nodes in a network. It adds addresses to outgoing messages and decodes them on incoming ones. It also provides the ability to detect and correct errors and otherwise control the flow of data.

Level 3 in the ISO-ANSI hierarchy controls the path between nodes. It specifies network addressing and routing through the net, controls errors, and accounts for services rendered. In X.25, essentially, it specifies packet-switching procedures.

Leger, notes that "there are a lot of other popular chips that handle Level 2's frame structure." He is referring to the numerous protocol controllers [*Electronics*, June 8, 1978, p. 112]. If these data-link control chips are bit-oriented, they can work in packet-switching nets because X.25's Level 2 is a subset of the bit-oriented HDLC protocol (HDLC stands for high-level data link control).

"But there's more to Level 2," notes Leger. The 2501 goes beyond other chips to integrate these added functions:

- Setting up and disconnecting the communications link.
- Retransmitting as many as seven frames after errors are detected at the other end of the link.
- Generating and testing unnumbered and supervisory frames, the two additional types specified by X.25 besides the information frame shown in the diagram.

More of protocol. In effect, the Western chip uses its real estate to hold as much of the X.25 protocol as possible, whereas other recent data-link control chips use it to handle more subsets of different protocols. "This chip's range is narrower, but it does more work in its area of application," Leger says.

It does go beyond X.25 in one

respect. Whereas the protocol defines only communications between terminal and circuit-terminating equipment, the 2501 chip recognizes address sequences that permit terminal-to-terminal communications, multiple destinations, and loop-back testing.

As well as the hardware and software implementing the added Level 2 functions, the 2501 has a built-in direct-memory-access controller and counting logic. Thus it supplants "a bit-oriented protocol controller chip, a dual-channel DMA controller, along with any address latches it may need for its operation, and a counter chip," Leger says.

Level 3. The third and highest level in X.25 (tinted in the diagram) holds the packet-switching procedures. Level 3 is the next data-communications mountain for an LSI chip to shrink.

"Level 3 is software-intensive," says Leger. Moreover, "it is defined to the point where it's workable, but there remain significant problems—in the area of data-packet flow control, for one." Given a satisfactory resolution, "I could see a future product including some of level 3, such as control of the header information and possible channel status."

Western's chip, in a 48-pin package with 16 pins for output address-

ing and 8 for a bidirectional data bus, operates at from 0 to 1.6 megabits per second, with higher rates available on special order. It will be available in samples by the end of the year, but it has no final price yet. However, Leger figures it will cost on the order of \$120 each in 1,000-piece lots. "We've had a number of semiconductor companies talking to us about second-sourcing the 2501," he adds.

-John G. Posa

Instruments

Plug-in software keys new design approach

As if traditional instrument manufacturers are not straining enough simply competing with each other, they will soon be under additional pressure from a relative newcomer to the field. Three-year-old Paratronics Inc., heretofore a manufacturer of logic analyzers, is taking a fresh approach to the design of instruments—one that may ultimately replace conventional units.

Systems. Rather than approaching design in terms of dedicated instruments, engineers at the San Jose, Calif., firm have developed what they call a data system, which can combine several related instruments in one compact package. The concept, president Ira H. Spector says, "may change the way instrument users and manufacturers keep pace with technological advances."

According to Spector, a 34-year-old co-founder of Paratronics, the data-system approach lets a manufacturer create an entirely new instrument by changing its probe and plugging in a card with front-end electronics and program memory. What's more, he notes, a user can choose to have functions operate interactively as a total data system or as independent analytical units.

The first model of a planned series of such instruments is the model 540 analyzer that the company will unveil at next month's Wescon/79 show in San Francisco. It combines functions ordinarily found in two or



Multipurpose. Paratronics' new analyzer (right) can perform several functions, thanks to a plug-in cards holding front-end electronics and a program read-only memory.

three instruments: it works not only as a logic analyzer capable of both timing and state measurements, but as a waveform analyzer as well.

Choices. A user will be able to buy the basic model 540 with either a timing- or state-analysis function for about \$5,000. Approximately \$8,000 buys a three-domain instrument with input/output capabilities that include RS-232-C, IEEE-488, and floppy-disk interfaces. Bought individually, these instruments cost anywhere from \$4,000 to \$7,000 each. The 29-pound Paratronics analyzer—called “the paralyzer” by its engineers because it captures data, waveform, status, and timing information, freezing it for later display—will be available in December of this year.

At the center of the analyzer's versatility is Paratronics' system 5000. It consists of a 9-inch-diagonal cathode-ray tube, a keyboard, an 8-K data memory, a power supply, and an Intel 8085 8-bit microprocessor and associated memory.

The functions to be performed are determined by the plug-in applications board and as much as 16 K of

associated program in a custom read-only memory. “You trade dedicated hardware for software that is implemented by a relatively low-cost microprocessor and increasingly less-expensive memory chips,” Spector points out. “Whether you make the instrument perform one function or another depends on the programming in the front end. You have, as it were, a virtual instrument.”

Beyond. The next logical step in Paratronics' data-system approach, Spector says, is to put in one package a reasonable number of related instruments to analyze problems that may cross over between different measurement domains—timing, state, and analog, for example. “End-user systems are complex and it takes more than one instrument to solve a problem,” he says. But independent instruments such as digital voltmeters, oscilloscopes, and logic analyzers could all be contained in one instrument. Paratronics is working on offering such functionally linked systems but will disclose no timetable for their availability.

With hardware functions transferred to firmware, Spector notes

that both instrument makers and users will be less susceptible to advances in, for example, microprocessor technology. “The user is less likely to see his instrument made obsolete,” he says.

Previously, users who designed systems using, for example, the 8080 8-bit microprocessor likely bought a \$7,000 logic analyzer that “couldn't be used the following year with the newer 8086 and Z8000 16-bit microprocessors that came out,” he explains. Using Paratronics' concept, these processors could be accommodated by changing the front-end electronics and software.

Spector points out that the concept, if adopted by other manufacturers, would give them the ability to diversify their future products into different areas of application, with consequent lower cost of entry and lower risk. “It can cut in half the development cycle for sophisticated products,” he adds. —**Bruce L. LeBoss**

Satellites

C-MOS processor to control attitude

The planned October launch of Magsat, a small U. S. satellite that will study the earth's magnetic fields, will mark the first use of a complementary-MOS microprocessor in space. The processor will monitor and control the space vehicle's pitch, roll, and yaw.

Watching carefully will be Johns Hopkins University's Applied Physics Laboratory, which designed and built Magsat, and RCA Corp.'s Solid State division, which supplied its 1802 8-bit processor to APL to serve as the heart of the attitude-control system.

The C-MOS chip was chosen “because we needed low power on such a small spacecraft, and n-channel MOS just didn't make it,” says Glenn H. Fountain, APL program leader in Laurel, Md. The 1½-pound processor package requires only 1 watt of power, which the satellite's solar panel provides. The processor can

THIS IS KONTRON

LOGIC ANALYZERS

NEW

48-Channel Model LAM 4850 Intelligent
Logic Analyzer from Dolch.



**Introducing . . .
the world's first 48-channel
logic analyzer.**

Kontron offers you the complete line of Dolch logic analyzers ranging from 16 channels to 48. The new 48-channel LAM 4850 was designed to debug systems

built around the new 16-bit microprocessors. It has 6 independent 8-channel inputs which can be organized 7 ways for sequential and parallel recording. Our standard features include:

- 1024 bits recording and reference memory per channel

- Sampling rates—DC to 50 MHz
- 5 ns glitch latch capability
- 3-level simultaneous synch/asynch clocking
- 4-level sequential triggering

Write or call
Kontron Electronic Inc.,
700 South Claremont Street,
San Mateo, California 94402

LOGIC ANALYZERS:

FOR DATA ON KONTRON® MULTIMETERS, COUNTERS, PROM PROGRAMMERS
AND PRINTERS, CALL (800) 227-6845. IN CALIFORNIA CALL (415) 348-7291.



Circle 43 on reader service card

aid the accuracy of magnetic-field measurements by providing ground observers with the axis of the spacecraft within 14 seconds of arc. Thus the observers know more exactly where the measurement package aboard the satellite is aimed.

The application is a milestone of sorts for C-MOS parts, indicating their rising acceptance as users become more familiar with their reliability histories. Radiation sensitivity, sometimes a C-MOS question mark, does not arise, for the orbit is not subject to radiation.

Magsat is small as satellites go, but its mission is expected to provide precise data which will aid in the discovery of new deposits of oil and minerals. Designed for launching aboard a small Scout rocket, the spacecraft is just 62 inches long with a 26-in. diameter and a 402-lb launch weight.

During the expected 90-day life of the satellite, its elliptical polar orbit will take it as close as 340 kilometers from earth or as far as 570 km. After achieving orbit, it will extend a boom 6.02 meters aft with a sensor platform containing highly accurate scalar and vector magnetometers, a precision sun sensor, and mirrors that use an optical system to define the orientation of the sensor platform to the instrument module at the base of the boom.

That module, Fountain explains, contains a pair of star cameras for precise determination of the spacecraft's attitude. "The control system must maintain attitude so that the magnetometers, sun sensors, star cameras, and solar panels are properly oriented," he says.

Data. "Magsat flies like an airplane relative to earth, with one side facing downward and another oriented toward the normal of the orbit," he explains. The attitude-control system built around the 1802 receives roll and pitch data from a combination of sensors. One is an infrared detector that scans the earth's horizons and is linked via the microprocessor to an electrically driven reaction wheel; the wheel's voltage can be varied to provide torque and thus alter the satellite's

roll and pitch. Also feeding into the processor control system are a pitch-axis gyroscope and magnetometers separate from those in the instrument module.

The only ground control necessary is an update, approximately once a week, of registers that store the changes in orbital position and attitude. Using input from the sensors,

the control system activates appropriate torque coils to make attitude corrections. Should any of the sensors show abnormal output, indicating a malfunction, the microprocessor can shift it off or bypass it in making corrections. Magsat's system is also equipped to correct spacecraft nutation, commonly referred to as jitter, Fountain adds. **-Ray Connolly**

Automotive

Accelerating need for chips seen approaching \$4 billion by 1990

Any doubts semiconductor manufacturers may have about the size of the automotive engine-control marketplace should be blown away by a forthcoming Gnostic Concepts Inc. analysis. The conclusion, in short, is that it will be huge.

The value of electronics systems for engine control in cars and light-duty trucks made in North America will rise from \$1.2 billion in the 1980 model year, at an average annual compound growth rate of 27%, to reach \$3 billion in 1984. Then that market will begin to flatten out to a 2.6% growth rate to hit \$3.9 billion, probably including sales of electron-

ic transmission controls, in 1990, estimates John Hutchison, manager of the automotive electronics program for the Menlo Park, Calif., market-research company.

These figures represent the estimated manufacturing costs of the systems and include components, printed-circuit boards, labor, and the like. The report is due to be published by the end of this month, with another on heavy-duty trucks and off-road vehicles in planning.

Totals. It all adds up to a staggering number of circuits, Hutchison says. For engine-control systems in the 1981 model year, for example, he

Economy, emissions are the spurs

Driving car makers toward electronic engine controls are the increasingly tough Federal standards on fuel economy and emissions. In fact, the more precise digital controls are supplanting analog designs because the standards are becoming so strict.

The mandated company economy average for gasoline-powered cars will jump from 20 miles per gallon in the 1980 model year by 2 miles per gallon for each of the next three model years. For emissions, the allowable grams-per-mile figures for hydrocarbons and carbon monoxide drop in the 1980 model year to 0.41 and 7 from 1.5 and 15, respectively. In 1981, the carbon monoxide figure will drop to 3.4 and the nitrogen oxide limit will drop to 1 from the current 2.

Car makers can apply for extensions of the 1980 carbon monoxide figure in 1981 and 1982, and for an nitrogen oxide limit of 1.5 through 1984. The Federal government has not yet published any mandate beyond 1985, so any new lower limits could inflate the flatter 2.6% growth rate that Gnostic Concepts anticipates beyond 1984.

The smaller auto is another way to meet the economy standards in particular, but Hutchison notes that cars can only grow so small and that further weight reduction can get prohibitively expensive. "You reach a point of diminishing returns with downsizing: you reach a point where you'll have to start downsizing the driving," he quips.

-W. F. A.

The Intelligent Alternative...



MINI-480

MAXI-64

MINI-320

MAXI-1X32

**flat
panel
displays!**

We invite you to compare IEE's ARGUS to any other display around!

No matter what your needs in alphanumeric displays, IEE's ARGUS is the answer. Choose from a variety of single through 24-line displays available with 16, 32, or 40 characters per line. These minimum-depth display panels offer fields of 32 through 960-characters—most types available from stock.

ARGUS gives you sharp, readable 5x7 characters in .21", .25" and .33" heights and your choice of orange, red or green display color. These low power, compact modules interface easily with your processor or other data source. All ARGUS models feature a standard TTL ASCII interface, optional font sets, and an addressable cursor.

Add up the outstanding features of our many models plus our proven reliability, and **you** make the choice!

We are the intelligent alternative!



The Display Maker

Industrial Electronic Engineers, Inc.
7740 Lemona Ave., Van Nuys, CA 91405
(213) 787-0311 • TWX 910-495-1753

Yes, I'm interested in ARGUS displays!

My application is: _____
 Please have your sales representative contact me:
 Name: _____
 Company: _____
 Address: _____
 City: _____ State: _____ Zip: _____
 Area Code _____ Phone Number _____ Ext. _____

EL75

estimates that North American car makers will need more than 150 million integrated circuits, including microprocessors, analog-to-digital converters, and memory chips. General Motors Corp., which currently accounts for about 58% of the U. S. auto market, estimates that its integrated-circuit requirements for all electronic functions, including entertainment systems and dashboard controls, will rise from 20 million in 1979 to 200 million in 1981. More than half of the 1981 requirement will be for engine-control systems, Hutchison says.

Moreover, "there's a lot of discrettes still in the automobile," he declares. To handle all the electronic functions for the 5.4 million cars GM expects to make in the 1981 model year, the company will need roughly 1 billion capacitors, 1 billion resistors, 800 million diodes, and more than 250 million transistors, he says.

The Semiconductor Industry Association estimates that the 1979 worldwide shipments of U. S.-based chip makers will total 4.4 billion ICs and 11.4 billion discrete devices. Meeting the automobile demand could pose capacity problems.

Parts count. Detroit's needs may seem high, but the number of parts in engine-control systems can be considerable. Hutchison points out that the computer-controlled catalytic converter system in GM's recently launched small X cars contains more than 250 components, such as 80 resistors and 33 ICs, including a Motorola 8-bit microprocessor. Ford Motor Co.'s EEC-2 electronic engine-control system has 14 ICs, of which 5 are Toshiba large-scale-integrated chips, he says.

The big question, of course, is where the auto makers will find all the devices they desperately need. Hutchison concedes it is a tough one to answer. The problem is compounded because some chip makers are not interested in supplying the car market directly and some will limit the number of parts they will supply, he observes.

Several scenarios are possible, he says: car makers may turn to offshore suppliers (GM's Delco divi-

sion already buys about 50% of its electronic parts offshore); other auto electronic systems may take a back seat to the crucial engine-control systems; car makers may have to continue using the less efficient analog parts for a while; and further integration of functions into large-scale or very large-scale integrated chips may reduce the parts counts of various systems. -William F. Arnold

Commercial

Image processors tackle bank checks

A number of companies expert in optical-character recognition have been working recently on developing image-processing techniques, with an eye on the growing bank-check-processing market. Among them is Recognition Equipment Inc., a 17-year-old Irving, Texas, firm that markets a variety of products and systems employing OCR techniques. At the recent American Bankers Association National Operations and Automation Conference

in Anaheim, Calif., the company introduced a system billed as the first to bring image-processing technologies to automated check-clearing operations.

Add-on unit. Depending on the configuration, REI's new TRIM (for trace image) system sells for between \$700,000 and \$850,000. It is designed to work as an optional module with the company's \$600,000 to \$700,000 Trace automated check-processing system.

At a rate of 200,000 checks per minute, the TRIM system optically captures and digitizes the image of each check's face, which is then stored on disk. Reduced images of the checks can then be printed using the system's 5,200-line-per-minute high-speed laser printer. The output is an 8½-by-11-inch page that can hold as many as 21 check images.

For a typical account, says REI, a monthly activity statement and an image of all checks written—instead of the original checks—can be printed on two sheets of paper weighing less than 2 ounces. Mailings to account holders will thus take less postage.

The TRIM system's separate pro-

Coping with the check blizzard

As the number of bank checks written by Americans rises to a projected 36 billion next year, the nation's banks are under continuing pressure to reduce the handling involved. As long as checks are used, the ultimate goal will be truncation, or storage, of a check at the bank that first processes it, states the chairman of an American Bankers Association task force assigned to look into "check safekeeping" activities.

The ABA group is talking with companies interested in supplying software and hardware requirements for a planned prototype truncation system that will allow electronic clearing and paying of some checks by participating banks. The prototype system is planned to be operating by the second quarter of 1980 and could involve a network of 30 to 35 U. S. banks, reports Joseph Coriacci, a senior vice president at the Continental Illinois Bank, Chicago, and chairman of the ABA task force. The pilot system will be used initially to clear the checks that are written by corporate account holders. Such businesses are less inclined than are individual account holders to require actual returned checks to accompany their statements.

Initially, the pilot system may involve the digital transmission of data lifted from the MICR (magnetic ink character recognition) line on each check, eliminating the need for physical presentation of the check for payment by one bank to another, ABA officials indicate. But the association has also been interested in emerging image-processing technologies, which are viewed by some as a promising approach for further reducing check-handling requirements in the future by cutting the number of passes necessary during sorting and processing, among other things.

-W. R. I.

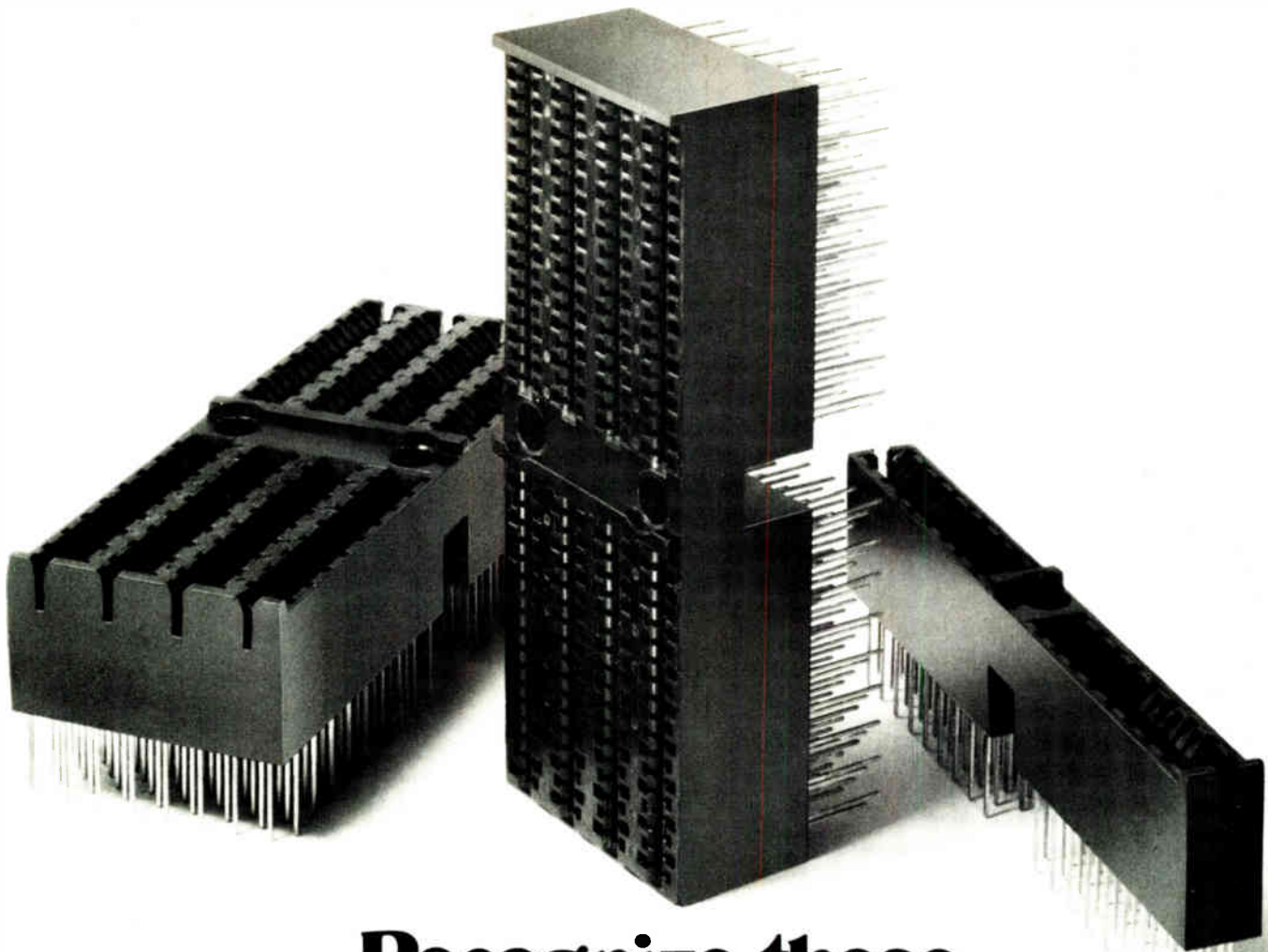

Recognize these without their name tag?

If you do, then we'd like you to know that you now have a new, direct source for these 72 and 288 pin connector blocks.

The connectors meet exactly and fully the specs you'd expect them to: .125" center-to-center spacing of staggered contact rows, the unique deep-wiping action with .450" card slot depth — and all the rest.

In fact, the only thing about these connector blocks that will catch you by surprise is the price.

Get the details. Call us direct: (213) 341-4330.

 **Viking**
CONNECTORS

21001 Nordhoff Street / Chatsworth, CA 91311, U.S.A. / TWX 910-494-2094



Just checking. Recognition Equipment's Trace system can read up to 2,000 checks per minute, put them into disk storage, and copy them for statements.

cessor makes use of data-compression algorithms that reduce the memory space required for storing each check's image from about 19 to 8 kilobytes per check, explains REI vice president John Erickson. Depending on check volume and number of monthly billing cycles, a bank using the TRIM system might require anywhere from 200 to 800 megabytes of system disk-storage capacity, he adds.

Expectations. The firm has had no orders for a TRIM system since the product's introduction. However, there are about 100 Trace systems already in the field, and there is the recent American Banking Association study activity relating to check storage and truncation techniques (see "Coping with the check blizzard," p. 46). So the company expects a strong image-processor market to develop.

Agreeing with REI's bullish analysis of the potential for such systems is Tom LeBrun, executive vice president for development of BancTec Inc., a Dallas manufacturer of check-processing equipment. Though his company has made no formal product announcement, LeBrun says that it "expects to make [initial] installations early next year" of a new image-processing system for checks. He says the firm is discussing it with a "handful" of potential customers.

Currently referred to as the DSC

News briefs

Mostek trade-secrets case against Inmos dismissed

A federal judge in Dallas has dismissed a trade-secrets suit filed by Mostek Corp. last year against Inmos Ltd. and several of its principals [*Electronics*, Aug. 31, 1978, p. 42]. Under terms of a final judgment agreed to by all parties, all charges have been dismissed. Mostek retains the right to bring action in the future if Inmos uses or discloses technical information that Mostek alleges to be a trade secret or confidential. The Carrollton, Texas, firm brought the suit after several employees resigned to join the newly formed Inmos, which is backed financially by Britain's National Enterprise Board. Inmos now has its U. S. headquarters in Colorado Springs, Colo.

Intel plans to open VLSI design center in Japan

Intel Corp., Santa Clara, Calif., has decided to open a VLSI design center next March at a yet-to-be-chosen site near Tokyo. It will be the company's fifth design center and the second outside the U. S., after one in Israel. The center will develop very large-scale integrated products for the world markets, not just for Japanese consumption. General manager for the new center is Masatoshi Shima, who recently returned to Intel after a four-year stint at Zilog Inc. Shima is the designer of Zilog's Z8000 processor and worked on the design of Intel's 4004 and 8080 microprocessors.

Motorola rearranges top management

Motorola Inc. has switched around some of its top management. Earl Gomersall, formerly vice president for manufacturing of the Semiconductor Group, now has a corporate post that includes responsibility for all manufacturing facilities, quality control, and several staff functions. James Lincicome, assistant general manager for the Government Electronics division, has been promoted to general manager. Ralph Elsner, GED general manager, has been reassigned as deputy to William Weisz, the president.

Gene Amdahl resigns as head of Amdahl Corp.

In the midst of merger negotiations with Memorex Corp., Amdahl Corp.'s chairman and founder, Gene M. Amdahl, has decided to resign from the helm of the large-computer manufacturer. Amdahl, who will become chairman emeritus of the Sunnyvale, Calif., firm, will be replaced Sept. 1 by Eugene R. White, currently deputy chairman. Citing a desire to devote more time to outside interests, Amdahl said the move is part of a continuing separation from the firm that will end with retirement on Jan. 1, 1981.

3M to get into video disk business

3M Co., Minneapolis, is entering the video disk business as a supplier of masters and copies. The first deal was with Thomson-CSF of France, but 3M officials say they will make disks for all "viable" video formats. Initially, 3M will supply only low-volume copies of disks for the institutional market, with no move to the consumer market yet contemplated. Officials would not comment on whether they were negotiating with MCA-Philips, RCA, or other potential makers of video disk players.

R. C. Sanders plans word processor, sells stock

The company formed four years ago by Royden C. Sanders Jr. is working on its second product and has sold 23% of its stock in a public offering. R. C. Sanders Technology Systems Inc.'s new stand-alone word processor will use the company's innovative impact printer [*Electronics*, April 13, 1978, p. 48]. The processor is being developed for Sanders' European distributor, Fleischauer Datentraeger GmbH, a Pelikan AG subsidiary. Working through the investment bankers Laidlaw, Adams and Peck Inc., Sanders has raised some \$3.6 million by selling stock and will use about half of the proceeds to buy production equipment. It expects to increase printer production from sample quantities to 1,000 a month in 1980. In the past 18 months, the printer's software and hardware has undergone considerable development.

Digital's RAMpart 64 micro memory.

The price just keeps getting better.

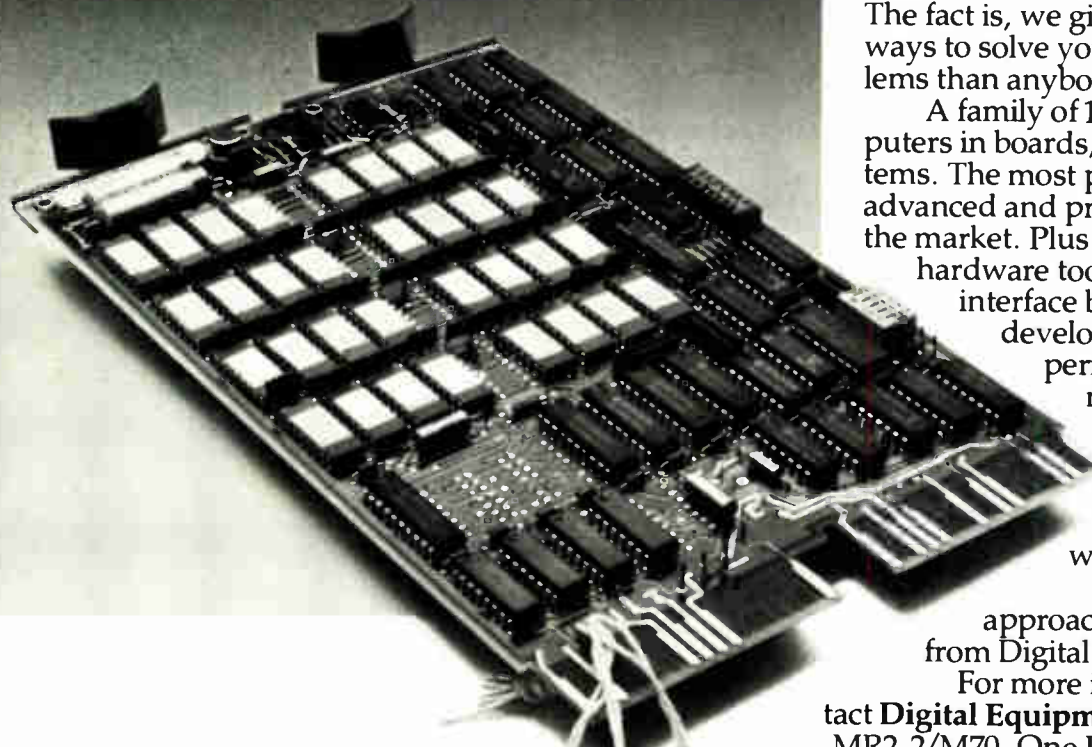

For the second time this year, we've cut the price on our 64Kb RAMpart 64 memory. Just \$582 in 100's when purchased with similar quantities of LSI-11/2 CPUs.

So with every 16-bit LSI-11/2 microcomputer, you can get the memory that was made for it. With Digital's quality and reliability built right in — we actually burn-in and schmoo every board we ship.

Our RAMpart 64 memory gives you on-board refresh, selectable I/O page boundary, and a typical access time of just 210ns.

All on a 5.2" x 8.9" (13.2 cm x 22.8 cm) board.

Price is just one way we're committed to the micro market. The fact is, we give you more ways to solve your design problems than anybody.

A family of 16-bit microcomputers in boards, boxes and systems. The most powerful, advanced and proven software on the market. Plus hundreds of hardware tools — memory and interface boards, complete development systems, peripherals and terminals. And we back it all with over 11,000 support people worldwide.

It's the total approach to micros, only from Digital.

For more information, contact **Digital Equipment Corporation**, MR2-2/M70, One Iron Way, Marlborough, MA 01752. Or call toll-free 800-225-9220. (In MA, HA, AL, and Canada, call 617-481-7400, ext. 5144.) Or contact your local

Hamilton/Avnet distributor. In Europe: 12 av. des Morgines, 1213 Petit-Lancy/Geneva.

In Canada: Digital Equipment of Canada, Ltd.

It took the minicomputer company to make micros this easy.



digital

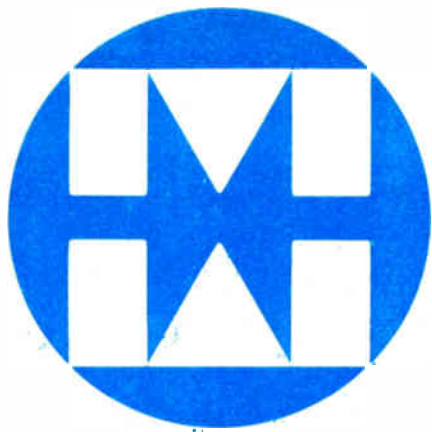

MITEL

CMOS/LSI LIQUID-CRYSTAL- DISPLAY DRIVER/LATCHES

MD4330 • MD4331 • MD4332
30 & 32-BIT REGISTER DRIVERS

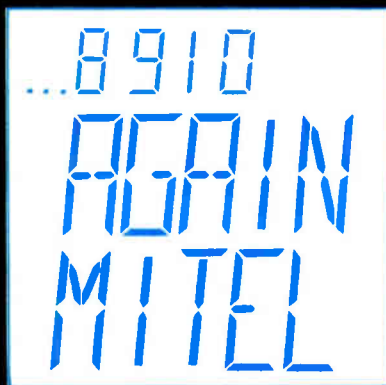

DRIVES UP TO FOUR 7-SEGMENT OR TWO 16-SEGMENT LCD READOUTS DIRECTLY. THE LATCHED DATA CAN BE CHANGED BY SERIALLY SHIFTING NEW DATA INTO THE REGISTER AT SPEEDS OVER 3MHz. Low-Power (1 μ A) Consumption with High-Power Performance.

FEATURING:

- 3 to 18 VOLT OPERATION
- SYNCHRONOUS OR ASYNCHRONOUS RESET
- INPUTS WAVE-SHAPED ON-CHIP
- FULL PARALLEL TRUE/COMPLEMENT OUTPUTS
- STD. 40-PIN DUAL-IN-LINE PACKAGES

For more information write or phone:

1745 JEFFERSON DAVIS HWY
SUITE 611
ARLINGTON, VA. 22202
TEL 703-243-1600



MITEL

Semiconductor

Electronics review

Fax, Banctec's system will probably sell for between \$1 million and \$2 million, according to LeBrun. He adds, "We think right now that there are more banks interested in doing this [image processing] than we can accommodate."

Filming. Unlike REI's new unit, Banctec's system is not initially aimed at producing check images for return to bank depositors. Instead it is designed to introduce image processing "at the very front, when a check leaves the teller's cage," LeBrun says.

This approach will save the bank labor and check-processing equipment time without disturbing depositors who are accustomed to receiving actual returned checks each month. The new Banctec unit will store captured check images on disk, later generating them on microfiche by an electron-beam recorder, according to LeBrun.

-Wesley R. Iversen

Communications

K-band antennas slated for rooftops

K-band frequencies continue to show promise as the microwaves of the future in satellite communications. For example, experimenters at the GTE Laboratories Inc., Waltham, Mass., are investigating the promise and problems of propagation at 12 to 14 and at 19 to 29 gigahertz.

At these frequencies, as opposed to today's common up- and down-link frequencies of between 4 and 6 GHz, an antenna of given gain can be smaller and lighter, thus becoming rooftop-sized. There are other benefits. Beam widths can be very narrow and are already less than one half a degree wide at the -3-decibel points, even with today's antennas. Finally, because of high K-band operating frequencies, transmission would be free of most terrestrial interference.

But there are still problems with these frequencies. They are attenuated by rainfall: a storm passing over a ground station site can cut the amount of power in the link dramatically—by 30 dB or more, depending on the intensity of the rainfall.

Showers. To determine how much trouble rain causes, GTE set up three ground stations in a worst-case location in Tampa, Fla. The site was picked because the Gulf Coast has the highest incidence of thunderstorms and heavy rain in the U. S.—averaging 89 thunderstorms a year.

New antennas were specially designed for the experiments and may be a foretaste of small future rooftop antennas. They are somewhat similar to the 7.6-meter elliptical ground-station antenna for lower-frequency operation, to be introduced by a sister company, GTE International Systems Corp. [*Electronics*, Aug. 16, p. 39] in that they use a folded, Gregorian feed. Unlike the larger, lower-frequency antenna,

IEEE disputes radiation scare

It's taken almost a year, but the Institute of Electrical and Electronics Engineers' Committee on Man and Radiation (Comar) has challenged a microwave radiation report contained in an article in the Boston Globe last September. A staff writer, Andrew Blake, had taken a Narda model 8616 field-strength meter into Boston and other communities and had taken very high power-density readings—some as high as 170 milliwatts per square centimeter, well above U. S. exposure safety levels.

The article touched off strong public reactions. But Donald R. Justesen, chairman of Comar and director of the Neuropsychology and Behavioral Radiology Laboratories at the Kansas City, Mo., Veterans Administration Hospital, challenged the findings. He proposed a new survey with the Globe, with many additional participants.

Sure enough, the latest readings were far lower than those in the Blake survey, typically in the nanowatt-per-square-centimeter range. For instance, in locations where the Globe story reported readings of 20 mW/cm², Comar found 1 to 63 nW/cm².

-James B. Brinton

TIME after TIME

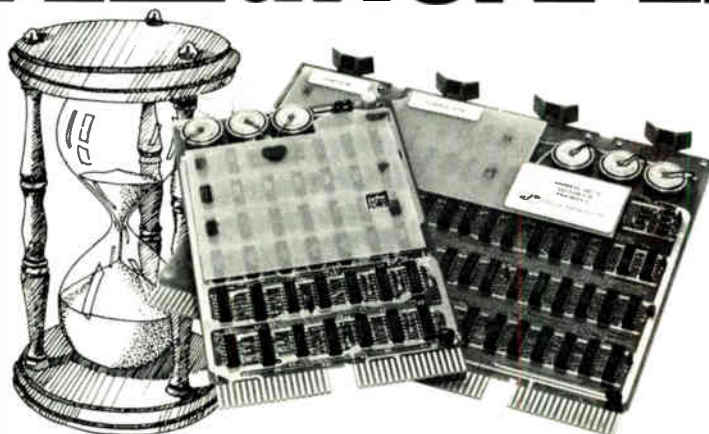

BATTERY SUPPORTED CALENDAR CLOCKS

PDP-11*

TCU-100 • \$495

- Provides month, day, hour, minute and second.
- Can interrupt on date/time, or periodic intervals.

TCU-150 • \$430

- Provides year, month, day, hour, minute and second.
- Automatic leap year.
- Patches for RSX-11M, RT-11 FB/SJ VO2, VO3 and UNIX.

LSI-11/2*

TCU-50D • \$295

- Provides month, day, hour, minute and second.
- Dual size board.
- Patches for RT-11 SJ/FB VO2, VO3B.

Lockheed SUE

TCU-200 • \$550

- Provides year, month, day, hour, minute, second and milli-second.
- Interval interrupts between 1/1024 seconds and 64 seconds.

Computer Automation (Naked Mini)

TCU-310 • \$385

- Provides year, month, day, hour, minute and second.

Multi-Bus**

TCU-410 • \$325

- Provides year, month, day, hour, minute and second.
- SBC/BLC compatible.

HP 2100

TCU-2100 • \$395

- Correct time restored after power failure.
- Compatible with the HP TBG card.

Serial Clock (RS 232 or 20 mA)

SLC-1 • \$575

- Connects between any terminal and host computer.
- Provides date, time and more!

All Digital Pathways TCUs have on board NICAD batteries to maintain time and date during power down. Timing is provided by a crystal controlled oscillator. Prices are U.S. domestic single piece. Quantity discounts available.

*For more information on these products, contact:
Digital Pathways Inc.
4151 Middlefield Road
Palo Alto, CA 94306
Phone: (415) 493-5544*

*Trademark of Digital Equipment Corporation



**Trademark of Intel Corporation

DIGITAL PATHWAYS

NOW! A NEW SOLID-STATE MICRO RELAY FROM ELEC-TROL

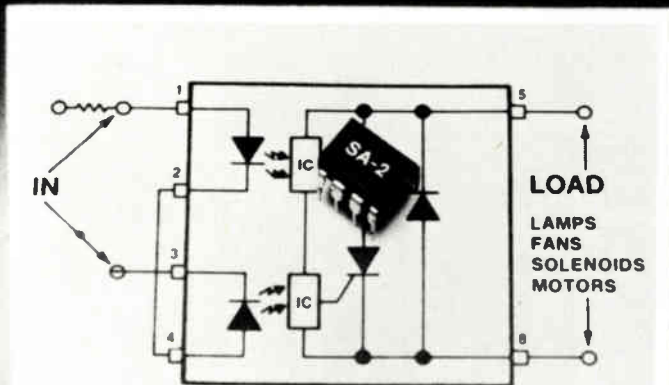

Elec-Trol has introduced a new solid-state micro relay, Model SA-2, that comes in an 8-lead dual in-line epoxy package and measures only .335" L by .250" W. This new relay features inverse parallel SCR output, high built-in transient immunity, optical isolation, zero volt switching, and very low leakage current.

The input is DTL/TTL compatible and is composed of two light emitting diodes that can be connected externally in either series or parallel. The output is composed of two back-to-back SCR's driven by high technology IC circuits optically coupled to the input LED's. The unit is designed to handle 0.5 amperes steady-state current and is guaranteed to 2500 VAC minimum breakdown voltage between output and input.

This tiny new relay is especially useful wherever high-density assembly is desired. It can be used directly as a micro relay in low current applications, or it can be used as a driver to drive power back-to-back SCR's or triacs. Potential driver applications include fans, computer peripheral equipment, microwave ovens, and motor controls.

For more information, use the reader service card. For sample or off-the-shelf delivery, contact your Elec-Trol distributor.

Elec-Trol, Inc., 26477 N. Golden Valley Road, Saugus, Calif. 91350. Phone: (213) 788-7292, (805) 252-8330. TELEX 18-1151.

ELEC-TROL

Circle 52 on reader service card

Leaders in Electronics

The only reference devoted solely to biographies of the most influential people in electronics

- corporate executives • technical managers • designers and developers • government and military officials • academics • editors/publishers • securities analysts • trade/professional group directors • consultants . . . plus an 80-page index of biographees by affiliation.

Prepared by the staff of Electronics magazine. 5,240 biographies. 651 pages, clothbound. \$39.50

Electronics Magazine Books
P.O. Box 669, Hightstown, NJ 08520
(609) 448-1700, ext. 5494

Send me _____ copies of *Leaders in Electronics* @ \$39.50 plus applicable sales tax. McGraw-Hill pays regular shipping and handling charges on pre-paid orders.

Payment enclosed Bill firm Bill me

Name _____

Company _____

Street _____

City _____ State _____ Zip _____

Signature _____

Electronics review

though, they need little in the way of microwave-energy-absorbing material, since there is little use for K-band signals at ground level and thus little interference.

The small antennas' parabolic reflectors are about 2.5 m in diameter and face a 1.3-m flat-plate subreflector, which bounces energy between the parabola and the feed. The feed, tucked behind the main reflector, is protected from the elements, making the design a good candidate for foul-weather applications. It offers both dual-frequency and dual-polarization capabilities.

Researchers installed the antennas atop two local telephone offices and one at the University of South Florida. Full operation of the three ground stations began in March 1978. The three sites formed a triangle with sides 11.3, 16.1, and 20.3 kilometers long. The university site had the task of logging attenuation data for all three locations. The satellites used for the study were Comstar repeaters, with K-band beacon facilities that were designed by Bell Laboratories.

Clearing. The real test of the system was its ability to receive K-band beacon signals, and the results have been encouraging, according to GTE. Thunderstorm "cells" appear to be very tightly localized, and those large enough to cover more than one ground station site proved rare. Statistics for one month of heavy rain showed that for the university site the 10-dB attenuation point was reached only about 0.1% of the time; with two stations working as a spatial diversity pair, the -10-dB outage rate fell to about 0.005%; and with all three in simultaneous use, the outage was "vanishingly small."

According to GTE researchers, this data proves that the K-band, with its advantages of small antennas, tight beams, and lack of interference, can be applied after all to telephone-systems interconnection applications. Not only is low cost expected from such compact installations, but also there is now less fear of downlink attenuation that could result from rainfall.

-James B. Brinton

THIS IS KONTRON

Model 6001 Autoranging Counter/Timer
with a programming option.

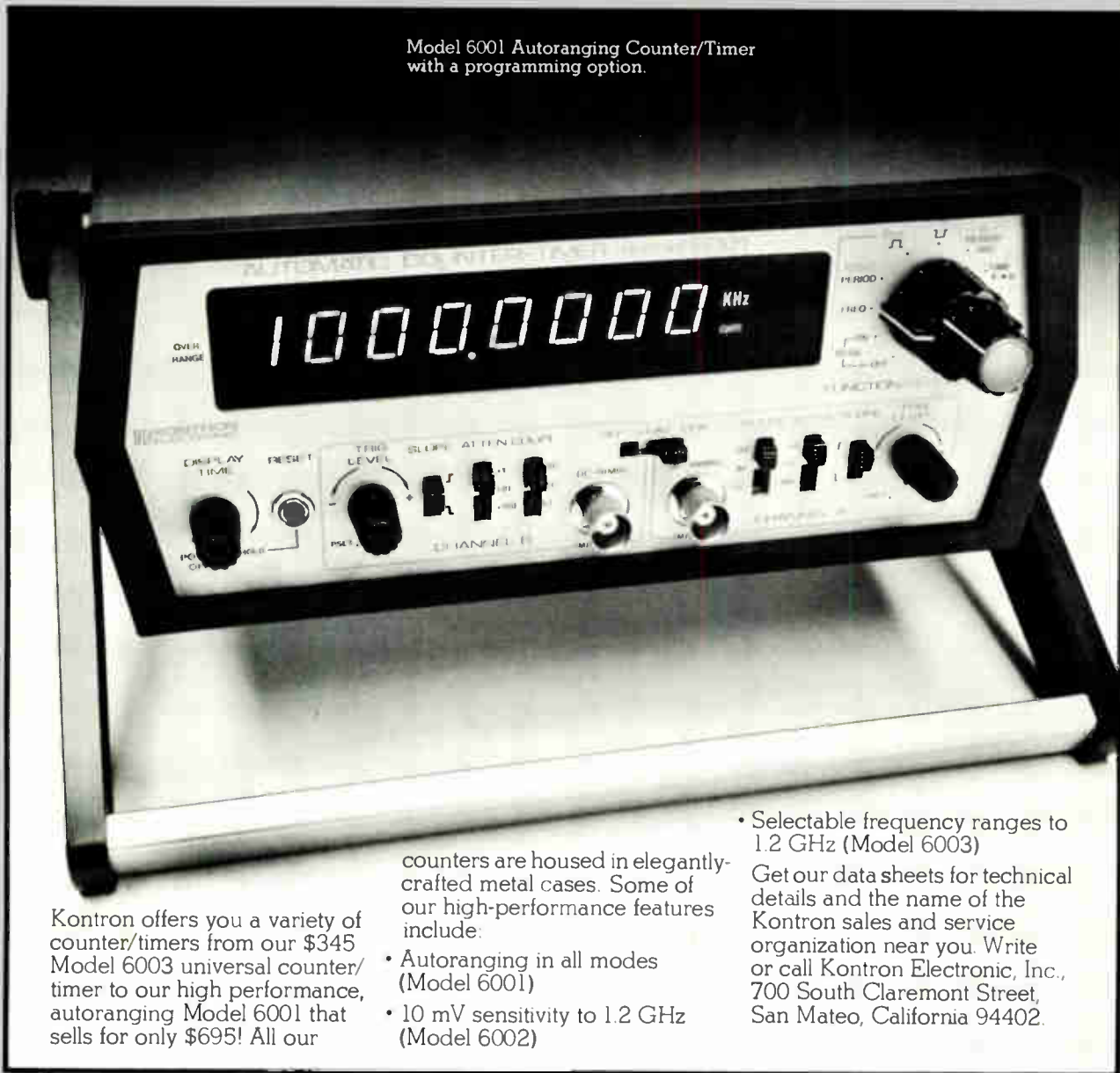

Kontron offers you a variety of counter/timers from our \$345 Model 6003 universal counter/timer to our high performance, autoranging Model 6001 that sells for only \$695! All our

counters are housed in elegantly-crafted metal cases. Some of our high-performance features include:

- Autoranging in all modes (Model 6001)
- 10 mV sensitivity to 1.2 GHz (Model 6002)

- Selectable frequency ranges to 1.2 GHz (Model 6003)
- Get our data sheets for technical details and the name of the Kontron sales and service organization near you. Write or call Kontron Electronic, Inc., 700 South Claremont Street, San Mateo, California 94402.

COUNTERS

COUNTERS:

FOR DATA ON KONTRON® MULTIMETERS, COUNTERS, PROM PROGRAMMERS
AND PRINTERS, CALL (800) 227-6854. IN CALIFORNIA CALL (415) 348-7291.



Circle 53 on reader service card

AND NOW, VMOS POWER

**YOU KNOW WHAT IT IS.
NOW, YOU KNOW WHERE TO GET IT.**

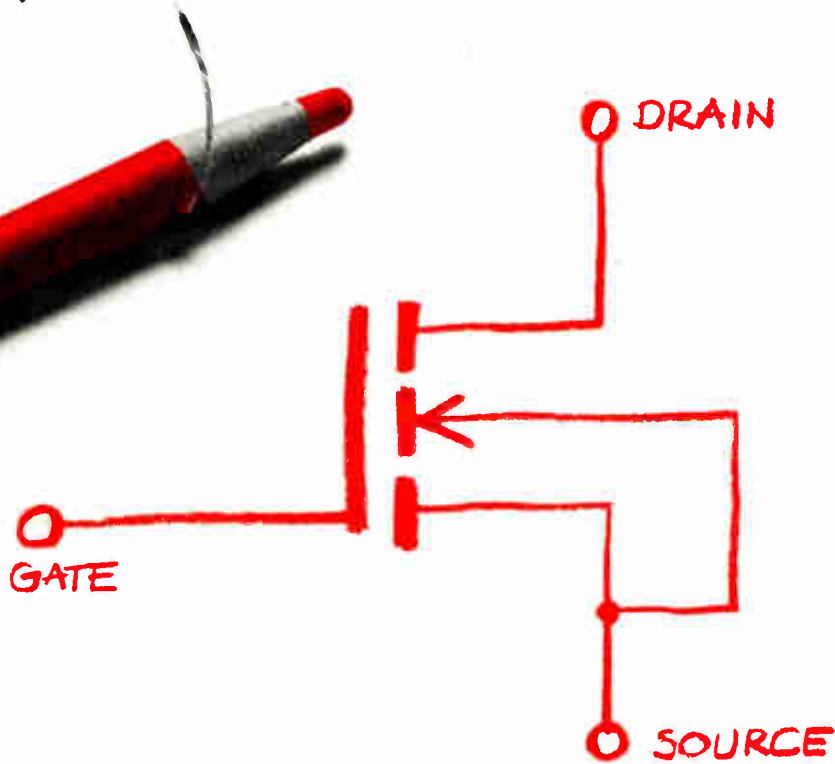

THE IVN5200 FAMILY. PLUS.

Part Number Series	$R_{DS(on)}$ Range	BV_{DSS} Range	$I_{D(on)}$ Range	$t_{(on)}/t_{(off)}$ Switching	Packages Available
IVN5200/5201 Series	0.5 ohms maximum	40-60-80 Volts minimum	4.0-5.0 Amps continuous, 10-12 Amps peak	4 nsec typical	TO-3, TO-39, TO-66*, TO-220*
IVN5000/5001/6657 Series	2.2 ohms, typ. 2.5-4.0 ohms maximum	40-60-80-90 Volts minimum	0.7-2.4 Amps continuous, 2.0-3.0 Amps peak	2 nsec typical	TO-3, TO-39, TO-52, TO-237*
Siliconix VN Series	2.5-5.0 ohms maximum	35-40-60-80-90 Volts minimum	1.2-2.4 Amps continuous, 3.0 Amps peak	2 nsec typical	TO-3, TO-39, TO-202

*Available soon

FETS. FROM INTERSIL.

THE WORLD'S GOING VMOS.

The VMOS power FET is so superior to the bipolar devices you're using now that nobody's arguing. Here are just a few of the reasons why:

- Super high speed switching.
- Extremely high power gain.
- Greatly extended safe operating area.
- Reduced system component count.
- Plus availability from Intersil, and, the reliability of our silicon gate, flat-bottom groove process.

THREE VMOS FAMILIES.

Here's what you get in our new IVN5200 family of VMOS power FETs: 80V BV_{DSS} , 5A $I_{D(on)}$, $0.5\Omega R_{DS(on)}$ Max. Ideal for high frequency switching power supplies, servo amplifiers, motor controls, high level analog switches... you name it. And the IVN5000 series of 2.5Ω to 4.0Ω devices. IVN5000 specs: 80V BV_{DSS} , $2.5\Omega R_{DS(on)}$ Max. Logic compatible thresholds guaranteed. Choice of packages including TO-52 and TO-237. Great in applications such as peripheral interfaces and RF amplifiers. Plus, an alternate source for the Siliconix VN series.

A BETTER TECHNOLOGY.

Intersil's flat-bottom groove, silicon gate technology offers more efficient production... and better delivery...with the great specs we mentioned above.

WITH SOLID SPECS.

Maximum ratings fully characterized. Our data sheets give you everything you need to know about Intersil's IVN5200, IVN5000 and VN second-source devices.

AVAILABLE. NOW.

Intersil's entry into the VMOS power FET market means there's another major source. We've got them. We're delivering them now. And, there are more on the way. With even better specs. In Intersil's flat-bottom groove silicon gate technology. If you'd like complete information on the IVN5200, IVN5000 and Siliconix VN series of VMOS power FETs, contact your Intersil Sales Office, Intersil Distributor, or, return the coupon below.

INTERSIL SALES OFFICES:

CALIFORNIA: Sunnyvale (408) 744-0618, Long Beach (213) 436-9261 • COLORADO: Aurora (303) 750-7004 • FLORIDA: Fort Lauderdale (305) 772-4122 • ILLINOIS: Hinsdale (312) 986-5303 • MASSACHUSETTS: Lexington (617) 861-6220 • MINNESOTA: Minneapolis (612) 925-1844 • NEW JERSEY: Englewood Cliffs (201) 567-5585 • OHIO: Dayton (513) 866-7328 • TEXAS: Dallas (214) 387-0539 • CANADA: Brampton, Ontario (416) 457-1014

INTERSIL FRANCHISED DISTRIBUTORS:

Advent/Indiana • Alliance Electronics • Arrow Electronics • Bell Industries/Century Electronic Division • CESCO • Component Specialties Inc. • Components Plus • Diplomat Electronics Inc., (FLA) • Diplomat Electronics Inc., (NJ) • Harvey Electronics • Intermark Electronics • Kierulff Electronics • LCOMP • Parrott Electronics • R.A.E. Ind. Elect. Ltd. • RESCO/Raleigh • Schweber Electronics • Sheridan Associates • Summit Distributors Inc. • Wyle Distribution Group • Zentronics Ltd.

INTERSIL

Analog Products—VMOS Power FETs
10710 No. Tantau Ave., Cupertino, CA 95014
Tel: (408) 996-5000 TWX: 910-338-0171
(800) 538-7930 (outside California)

Gentlemen:

If you're delivering VMOS power FETs,
I need your data sheets on:

- ___ the IVN5200 family.
- ___ the IVN5000 family.
- ___ the Siliconix VN series.

___ Please include your 20"x24" Benjamin Franklin poster.

"Never confuse motion with action."



Name _____

Company _____

Address _____

City _____ State _____ Zip _____

Raytheon Linear ICs give you more . . .

Raytheon Linear ICs offer you more . . .

We've been supplying high reliability linear ICs for commercial, industrial, military and aerospace use with a constant emphasis on quality.

Op Amps with a bonus

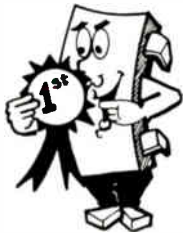

Raytheon was the first to offer guaranteed AC performance and the first to have a true 741 type quad op amp—the 4136.

Audio requirements are no problem with Raytheon high speed, low noise, op amps. In single, dual or quad, we can meet your toughest requirements.

The Analog Wizard

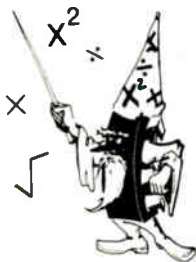

Our RC4200 Analog Multiplier is a multi-function high-accuracy device with complete compensation for non-linearity, the primary source of error and distortion.

The RC4200 can be used to multiply, divide, square, square root and in applications like RMS-to-DC conversion, AGC and to modulate or demodulate.

VFCs for all occasions



The 4151 was the first multi-function VFC offered by Raytheon.

The 4152 has expanded capability, and the 4153 put LSI technology to work, making precision analog-to-digital interfacing an economic reality.

38510 QPL Parts from stock



Our on-going 38510 program and our new facility make us one of the most modern and capable sources for your Hi-Rel needs.

We have the only QPL's for the LH2111DM dual precision comparator and the RM4156DC high-performance quad op amp.

Make the move to quality

Specify Raytheon Linear ICs on your next project. We deliver quality and reliability, making your product last longer and perform better.

Linear Products

Op Amps	74
Comparators	12
Voltage Regulators	10
Voltage References	8
Line Drivers & Receivers	4
VFCs	3
Timers	2
Wideband Amplifier	1
VCOs	1
FSK Demodulator	1
Tone Decoder	1
Analog Multiplier	1
X-Point Array	1

Volume Availability

Get the facts for yourself. Give us a call today. Raytheon Company, Semiconductor Division, 350 Ellis Street, Mountain View, CA 94042. (415) 968-9211.



Semiconductor Division

Electronics / August 30, 1979

First VHSIC awards from 15 proposals due in September

The Defense Department is impressed with "the very good quality" of the 15 responses now being evaluated for beginning research and development on very high-speed integrated circuits (VHSIC) and expects to award three or more Phase Zero contracts with available funds before the Sept. 30 end of the fiscal year. The request for proposals, which went to 63 companies earlier this summer [*Electronics*, July 5, p. 61], has elements oriented toward each of the three military services, even though the responses and awards are being handled by the Naval Electronic Systems Command.

How much the Pentagon spends on VHSIC this year still depends on **how much, if any, money a House-Senate conference committee votes for fiscal 1979-80**, the first year of VHSIC's proposed six-year \$200 million effort. The Senate still favors the program, but the House subcommittees on armed services authorizations and defense appropriations have voted down the \$30.4 million VHSIC request. A conference committee resolution of that conflict is expected in September. Meanwhile, sources indicate the Pentagon is lowering its funding sights to about \$25 million and will put some segments, like Phase Three, off until fiscal year 1980-81.

Local governments, utilities seek 50 channels

The Federal Communications Commission wants to earmark 50 of its remaining 250 land-mobile radio channels in the 800-MHz band for large "slow-growth" systems. These would have 200 vehicles used by local governments, public-safety organizations, and utilities that require long lead times for planning, financing, and installation. The FCC proposal, on which comments must be filed by Nov. 1, comes in response to fears of public safety and utilities telecommunications groups **that rapid growth of land-mobile systems in business and industry might not leave any channels available** for large police and fire departments and public utilities.

The FCC wants 40 of the new channels set aside for trunked systems of five or more channels in which automatic assignment of available channels to individual users is done by computer. The remaining 10 would be for conventional systems. All of the 150 channels initially allocated for conventional use in 1976 and 1978 have already been assigned in the New York, Chicago, and Los Angeles areas, the FCC notes. Allocations of the 200 channels first assigned for trunked systems that began this year are following a similar pattern, with a large share of licenses again being assigned to business users.

Weapons' lasers exempted from safety rules

Protection from a possible 2 to 5 mW of radiation from laser-guided firearms may not be high among the priorities of those about to die in gun battles. It appears that the Department of Health, Education and Welfare's Bureau of Radiological Health is thinking along those lines in **granting a five-year waiver of laser safety requirements** for built-in helium-neon laser target designators used exclusively for law enforcement and military purposes. Revolvers, riot shotguns, assault rifles, and submachine guns with built-in target designators running parallel to the weapon's bore will not have remote-control connectors, key controls, emission indicators, or beam attenuators. These features, the bureau notes, could add to a weapon's bulk and cause "a delay in functioning" that "could be hazardous to the operator in tactical situations." The variance was granted by the agency to California's Newport Research Corp., Fountain Valley, for firearms, and Lase-Aim Inc., Santa Cruz, for designators.

Intelsat: big at 15 and still growing

Fifteen years ago last month, representatives of 11 nations met in Washington, D.C., and created the International Telecommunications Satellite Organization. Less than eight months later, on April 6, 1965, Intelsat had placed in orbit its first satellite—Early Bird, or Intelsat I—with a capacity of one television channel or 240 simultaneous telephone calls.

Today 102 nations, from Afghanistan to Zambia, are members of Intelsat. Its space segment consists of 10 satellites in synchronous orbit, with a capacity of several TV channels plus some 20,000 telephone circuits that handle about two thirds of the world's intercontinental communications. Intelsat shows that some Washington projects do work well.

Separating technology and politics

Intelsat, involved in maintaining a commercially viable global satellite network, has a political structure almost as complex as the technology it employs. Since February 1973 it has consisted of four parts: an Assembly of Parties made up of all 102 governments that are parties to the Intelsat agreement, a smaller Meeting of Signatories comprising governments or their designated telecommunications entities that have signed the operating agreement, a 27-member Board of Governors representing 84 signatories, and an executive group headed by director general Santiago Astrain. The key to the success of that complex structure is that the Board of Governors, relying heavily on the expertise of Astrain's staff, is responsible for decisions on design, development, construction, establishment, operations, and maintenance of the space segment, whereas the larger assemblies meet only occasionally to decide policy issues. Ground stations, meanwhile, are owned and operated by the telecommunications entities in the countries in which they are located, with Intelsat providing standards for compatibility.

As demand has grown for Intelsat services—it already has 19 users that are not members, including Bahrain, Togo, and the USSR—so has its spacecraft investment. Whereas the Intelsat IV and IV-A each have two TV channels and 4,000 and 6,000 voice circuits, respectively, the

planned Intelsat V will have 12,000 voice circuits and two TV channels.

R&D goals

Nevertheless, there is still room for improvement, in the opinion of Dharmendra K. Sachdev, Intelsat's research and development manager. "If you look at the global satellite network as a jigsaw puzzle, I would say that the use of intersatellite links is the last missing piece," he says. "Intersatellite links will allow satellites to talk to each other, permitting a signal to be beamed from an earth station to a satellite and routed through any number of satellites before being beamed back to earth."

Technologies that need to be perfected before intersatellite links can pay off commercially include wideband fm modems, traveling-wave tubes, on-board tracking antennas, and low-noise receivers. Sachdev sees parts of this technology coming into use in the latter part of the next decade, but he believes that "it will take longer before it is in use on a worldwide basis."

Intelsat's R&D plan for 1980 calls for studies of intersatellite links for use near the end of the decade, as well as work on multiple-beam antennas for more extensive use of the available spectrum and the development of larger satellites that could be accommodated by increased launching capabilities. "But the technology of the near future, say, the next five to ten years," Sachdev believes, "is the all-digital network." Intelsat is already working on both space and ground systems "to adapt the existing networks to time-division multiple access and eventually to satellite-switched TDMA."

Making Intelsat a success for the last decade and a half are in large part the efforts of the initial 11 signatories, the U.S. among them. The technology behind Intelsat is still largely an American product, even though the U.S. has been unable during that period to establish a domestic communications satellite network of its own. To be sure, Intelsat has not been free of political problems, but its working system is to its credit. There is a message here for America's telecommunications industry and those who regulate it.

-Ray Connolly

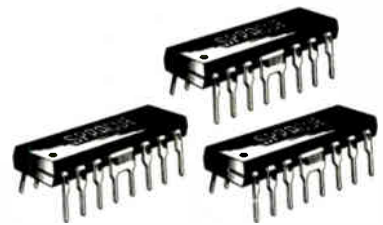

Solve design problems simply with 1.5 Amp Interface ICs for Negative Supply Applications.

You can use Sprague Electric's new Series UDN-2840B 1.5 amp monolithic quad power drivers in three basic versions to solve your circuit needs for (1) sink applications, (2) source applications, and (3) com-

bination sink-and-source applications.

You can get this versatile IC family with either 5V logic compatibility or 12-15V MOS compatibility. Make your choice from these six types:

TYPE	I _{OUT}	V _{OUT(OFF)}	OUTPUTS	V _{SUPPLY (TYP)}	COMPATIBILITY	TYPICAL APPLICATIONS
UDN-2841B	1.5 A	-50 V	Sink (4)	0 V to 5 V	5 V Logic	electrosensitive printer interface
UDN-2842B	1.5 A	-50 V	Sink (4)	0 V to 12 V	PMOS, CMOS	
UDN-2843B	-1.5 A	-50 V	Source (4)	5 V	5 V Logic	solenoid, LED, or relay drive
UDN-2844B	-1.5 A	-50 V	Source (4)	5 V to 12 V	PMOS, CMOS	
UDN-2845B	1.5 A / -1.5 A	-50 V	Sink (2) Source (2)	5 V	5 V Logic	bridge motor drives
UDN-2846B	1.5 A / -1.5 A	-50 V	Sink (2) Source (2)	5 V	PMOS, CMOS	

All Series UDN-2840B power driver ICs include input current limiting, level translation, and sufficient amplification to operate high current Darlington out-

puts. The Sprague-originated 16-lead webbed dual in-line package is used for maximum power dissipation.

For application engineering assistance on these or other interface circuits, standard or custom, write or call George Tully or Paul Emerald, Semiconductor Division, Sprague Electric Co., 115 Northeast Cutoff, Worcester, Mass. 01606. Telephone 617/853-5000.

For Engineering Bulletin 29314 and a 'Quick Guide to Interface Circuits', write to: Technical Literature Service, Sprague Electric Company, 35 Marshall Street, North Adams, Mass. 01247.

For the name of your nearest Sprague Semiconductor Distributor, write or call Roger Lemere, Sprague Products Co., North Adams, Mass. 01247. Telephone 413/664-4481.

FOR FAST INFORMATION, CALL YOUR NEAREST SPRAGUE SALES OFFICE:

ALABAMA, Sprague Electric Co. 205-883-0520 • ARIZONA, Sprague Electric Co. 602-279-5435 • CALIFORNIA, Sprague Electric Co. 213-649-2600; Sprague Electric Co. 714-549-9913; Wm. J. Purdy Co. 415-347-7701 • COLORADO, Wm. J. Purdy Co. 303-777-1411 • CONNECTICUT, Sprague Electric Co. 203-261-2551; Ray Perron & Co. Inc. 203-268-9631 • DIST. OF COLUMBIA, Sprague Electric Co. (Govt. sales only). 202-337-7820 • FLORIDA, Sprague Electric Co. 305-831-3636 • ILLINOIS, Sprague Electric Co. 312-296-6620 • INDIANA, Sprague Electric Co. 317-253-4247 • MASSACHUSETTS, Sprague Electric Co. 617-899-9100; Sprague Electric Co. 413-664-4411 • MICHIGAN, Sprague Electric Co. 517-787-3934 • MINNESOTA, HMR, Inc. 612-831-7400 • MISSOURI, Sprague Electric Co. 314-781-2420 • NEW HAMPSHIRE, Ray Perron & Co. Inc. 603-742-2321 • NEW JERSEY, Sprague Electric Co. 201-696-8200; Sprague Electric Co. 609-795-2299; Trinkle Sales Inc. 609-795-4200 • NEW MEXICO, Wm. J. Purdy Co. 505-266-7959 • NEW YORK, Sprague Electric Co. 516-549-4141; Wm. Rutt, Inc. 914-834-8555; Sprague Electric Co. 315-437-7311; Mar-Corn Associates. 315-437-2843 • NORTH CAROLINA, Electronic Marketing Associates, 919-722-5151 • OHIO, Sprague Electric Co. 513-866-2170; Electronic Salesmasters, Inc. 800-362-2616 • PENNSYLVANIA, Sprague Electric Co. 215-467-5252; Trinkle Sales Inc. 215-922-2080 • TEXAS, Sprague Electric Co. 214-235-1256 • VERMONT, Ray Perron & Co. Inc. 617-782-8114 • VIRGINIA, Sprague Electric Co. 703-463-9161 • WASHINGTON, Sprague Electric Co. 206-632-7761 • CANADA, Sprague Electric of Canada Ltd. 416-766-6123 or 613-238-2542

4SS-9101R1



a subsidiary of **GK Technologies**
Incorporated

Circle 59 on reader service card

NEW!

From McGraw-Hill Publications and **Electronics Magazine**



"Critical information that helps **YOU** focus on global markets with the greatest profit potential"

NEVER BEFORE PUBLISHED!

344 pages of official U.S. Government intelligence reports

International Marketing Opportunities ELECTRONICS

- Contains 102 reports that identify the best *future* markets for electronic products around the world.
- Compiled by McGraw-Hill editors from more than 1,500 pages of official U.S. government intelligence reports. (prepared by U.S. Commerce Department attaches)
- Reports cover 44 countries and six types of electronic products. Provide details on market growth, competition, investment opportunities, promotion opportunities, and government development policies in each country.
- Organized by major product category.
- Available now for marketing, corporate planning, and manufacturing executives in the electronics industries.

Extracted From Official U.S. Government Intelligence Reports

102 REPORTS COVER SIX PRODUCT CATEGORIES:

- Computers and peripherals
- Electronic components
- Production and test equipment
- Communications equipment and systems
- Office and business machines
- Security systems

TYPICAL MARKET REPORT . . .

- Predicts future market growth
- Analyzes existing and potential competition
- Pinpoints specific high potential equipment needs
- Identifies trade and investment opportunities
- Shows market growth over last three years
- Reveals government development policies (and other factors) that will affect future demand in each country.

Money-Back Guarantee

To: McGraw-Hill Publications
International Marketing Opportunities/ELECTRONICS
457 National Press Building Dept 48
Washington, D.C. 20045

YES, please rush me ____ copy(ies) of **International Marketing Opportunities/ELECTRONICS**, a compilation of official U.S. government reports that identify the most profitable future markets for electronic products around the world. I understand that I have 10 days to examine it and can return it within that time for a full refund. Price per copy: \$157.00 (\$174.00 for orders outside the U.S.). Price includes postage and handling. Orders outside the U.S. shipped airmail.

My check is enclosed Bill my company Bill me.

Name _____

Company _____

Address _____

City, State (Country), Zip _____

(Please allow 6 to 8 weeks for delivery.)

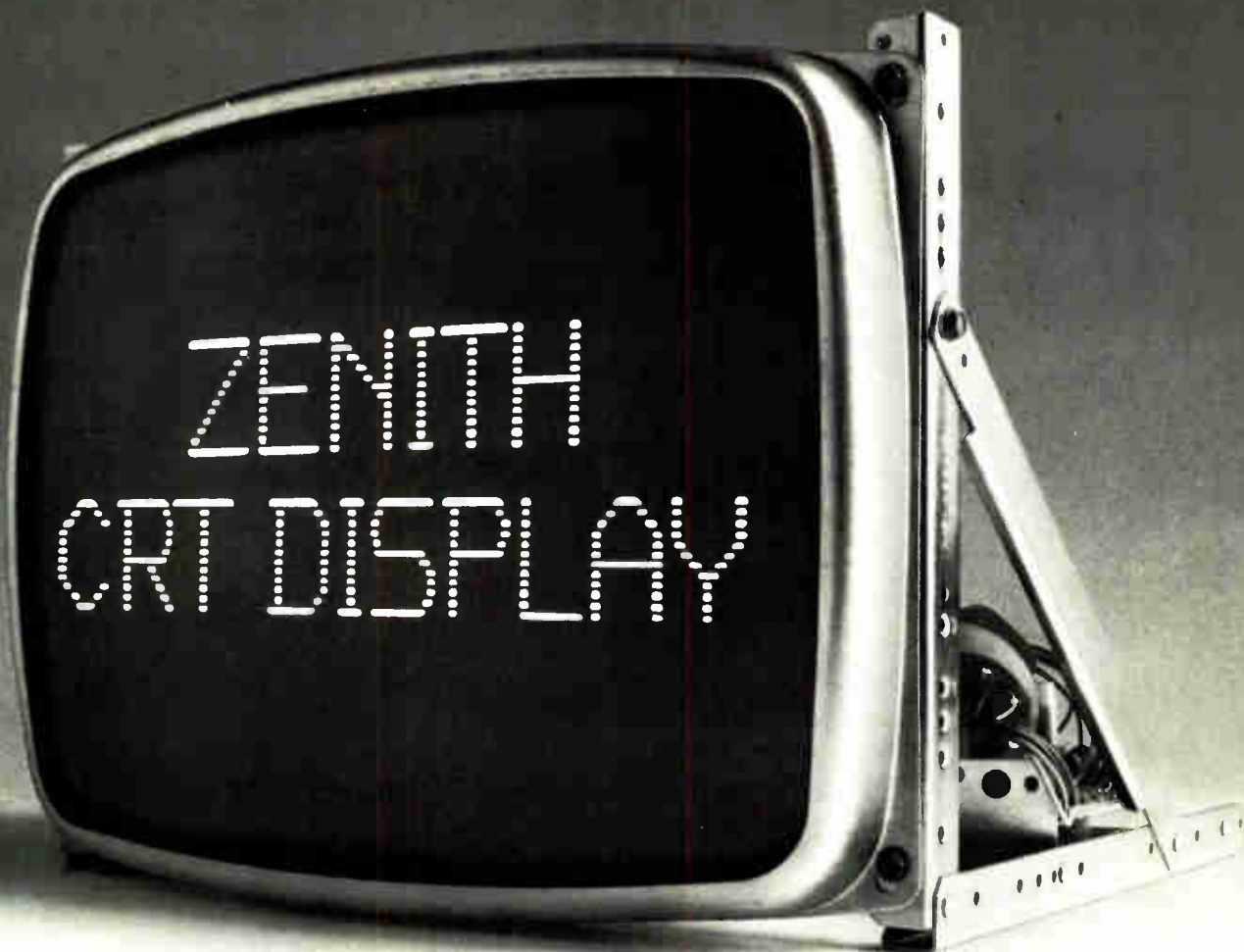

The read-out is quality.

Quality is what has made Zenith famous for over sixty years and number one in the television industry. It's that quality, that commitment to excellence — that insures the reliability of every product we make.

Our manufacturing facilities, laboratories, equipment, procedures, experience and know-how give you the quality and reliability that you look for in a CRT Display. A CRT Display that will hold up under really tough operating conditions.

And to all this, our people add the personal service and special attention you want from your CRT Display source.

Exhaustive testing

Our testing insures that every component operates to exacting Zenith standards. Exhaustive computer analysis, electron microscope and thermograph scan tests are only a sample of what we do.

Our environmental lab tests Zenith CRT Displays for thousands of hours under extreme humidity, vibration, altitude and temperature conditions.

Zenith CRT Displays are designed not only to meet our exhaustive testing requirements, but your demanding specifications as well.

Application engineering

Every CRT Display we design has our customers in mind. Before our engineers even begin new circuit layouts, we'll meet with you and find out what your exact needs and specifications are.

Advanced componentry

Components in the CRT Display are designed with reserve capacity for low maintenance and continued reliability.

The Zenith CRT Display is equipped with a Zenith designed and built deflection transformer. It not only gives a consistent scan, but it is also embedded in epoxy for long-term reliability and the elimination of high frequency squeal.

Important Zenith Features

The Zenith CRT Display is precision engineered. No linearity controls are required and the CRT Display's

vertical and horizontal synchronization is automatic.

The Zenith CRT Display frame can be adjusted to virtually any angle you want. This will satisfy many customer requirements without having a frame custom designed.

But we do welcome the opportunity to meet all your special requirements.

Zenith tradition

At Zenith we'll make sure you get the same service, quality and reliability in your CRT Display that we've been giving our customers for over sixty years.

For further information and specifications, write CRT Display Engineering Division, Zenith Radio Corporation, 1000 Milwaukee Avenue, Glenview, Illinois 60025, or call 312-773-0074.

The quality goes in before the name goes on.™

Circle 61 on reader service card

This coupon is the first step to circuit design perfection.

Send in this coupon and get a look at the E&L method of circuit design and testing. It's your headstart to circuit design perfection.

A big step indeed. This coupon will get you our catalog on the ADAM and ELITE breadboarding systems. Four circuit design and test instruments from E&L, the people who cover the entire spectrum of electronic design technology.

The ADAM mainframe and modular plug-in systems provide total capability for signal generation, control and measurement at an attractively low cost per function. A system that can be expanded in-house to meet your unique requirements.

ELITE circuit design systems let you build, test and finalize your new circuit design in hours because it's compact and completely solderless. No more coaxial cables, clip leads or power cables. Power, control, signal and indicator devices are terminated in BP-22 pins that accept standard 22 gage solid wire.

This catalog is the second.

Send me the ADAM and ELITE catalog with information on your cost effective, self-contained circuit design instruments.

Name _____

Position _____

Company _____

Street _____

City _____ State ____ Zip _____



**E&L Instruments
Incorporated**

61 First Street
Derby, CT 06418



**From the Teachings
of the Modern Masters.**

International newsletter_____

Japanese build subnanosecond CML chips

Using a bipolar master-slice approach, two types of 1,200-gate subnanosecond integrated circuits have been fabricated for the Musachino Electrical Communication Laboratory of Nippon Telegraph and Telephone Public Corp. by Nippon Electric Co. An error-correcting-code circuit has a data width of 2 bytes and a microprogram sequencer has one of 4 bits. The chips will be used in DIPS-11 computers designed for NTT's on-line distributed information-processing service. Applications will include mainframes and controllers for file memories, including magnetic disks, and for communications.

NTT's low-energy current-mode logic technology puts the 1,200 gates on a 39,400-mil² chip (5 by 5 mm). The internal gates have a power dissipation of 1 mW and a propagation delay of 0.9 ns; the 40 gates that interface with external circuits draw 5 mA, though, for high drive capability. Total dissipation is 1.7 w.

European giants reported considering closer cooperation

Will Europe's two biggest consumer electronics producers, NV Philips Gloeilampenfabrieken in the Netherlands and West Germany's Grundig AG, link up financially? Both companies emphatically deny such a prospect, but speculation among West German industry observers is mounting that some sort of mutual stock purchase is in the making. A more immediate prospect, however, is expanded cooperation in developing products. A Grundig spokesman does confirm that "loose exploratory talks" aimed at closer cooperation are being held. Both firms have been working together for some time in certain areas, notably in video cassette recorders [*Electronics*, July 5, p. 72]. A new accord, though, would encompass much more, possibly the whole spectrum of entertainment electronics equipment. The motive is not hard to guess: to put up a united front against the Japanese onslaught on European markets.

Plessey targets bubble-memory boards at System 80 users

Aiming to be among the first with an Intel Multibus-compatible bubble-memory board, Plessey Microsystems Ltd. in Towcester, Northants., will be hawking a half-million-bit card with a 100-kilobyte/data-transfer rate, the PBM 80S, at Wescon. Fast, 12-week delivery and a competitive board price of under \$3,000, says the company, come from good yields on its 64-kilobit bubble devices. Plessey will follow with a 2-megabit Multibus-compatible board using Rockwell Microelectronics 256-kilobit bubble memories, as availability improves. It will also use its own 256-kilobit parts, pin-compatible with the Rockwell memory, when they become available in about one year. Also new at Wescon will be a rugged PBM 90M 8-megabit board.

Development system from the Netherlands emulates in real time

The Scientific and Industrial Equipment division of NV Philips Gloeilampenfabrieken in the Netherlands will unveil in early September a microcomputer development system that, in contrast to many other such systems on the market, features true real-time emulation for the fastest microprocessors on the market today and has a separate emulation memory with up to 256-K bytes per emulator. Based on a 16-bit concept, Philips' Universal Microcomputer Development System, or UMDS, is an integrated unit for hardware, software, and system development, as well as for debugging and for programmable read-only memory loading. The initial version will support the 8085, the Z80, and the 6500 family; next year the system will

also handle the 8086, the 2650, and the 6800 and 8048 families and will gain a Pascal language option. It will be capable of supporting the coming generation of 16-bit microprocessors. The UMDS will first go to market in Europe; later, Philips will consider the U. S. market. Complete with peripherals, it will sell for between \$30,000 and \$40,000.

Hall-effect device could replace relay sensors

Targeting applications where an accurately set drift-free operating threshold must be combined with a high degree of circuit isolation, Standard Telecommunications Laboratories Ltd. in Harlow, Essex, has come up with a Hall-effect sensor having high sensitivity and temperature stability. An 8-mm hermetic package with a magnetic lid results in an efficient magnetic circuit and a threshold sensitivity of 24 ampere-turns, compared with 10 for a telegraph relay. The device, which is **smaller, needs no maintenance, and is potentially cheaper than its electromechanical counterpart**, could replace the latter in telephone terminal equipment used to sense line conditions. It also has applications in the TXE4A semielectronic reed-relay exchange from sister company Standard Telephones & Cables Ltd. Sample quantities are now available from ITT Components Group, Europe Ltd.

C-MOS on sapphire for UK aircraft data bus gets alternative source

The British Ministry of Defence has placed a contract with Smiths Industries Aerospace and Defense Systems Co. to ensure two sources for large-scale integrated circuits to be used in future military aircraft. The award parallels an earlier one to GEC Semiconductors Ltd. [*Electronics*, June 7, p. 70]. The ICs are needed to interface avionics payloads with a shared high-speed data bus. The U. S. is already moving to a dual data bus (for redundancy) as defined in MIL-STD-1553B, and the UK is adopting this standard. GEC plans a four-chip complementary-MOS hybrid version initially before integrating to one or two chips using its still-evolving C-MOS-on-sapphire process. But Smiths, in Cheltenham, will go directly to very large-scale integration. **It has adopted relaxed design rules so that a single set of masks can be used with either Mitel Corp's Iso C-MOS or Hughes Aircraft Co.'s C-MOS-on-sapphire process.**

BASF AG to enter VCR market with fixed-head unit

Look for West Germany's BASF AG, a chemical firm active in data-storage devices, to enter the consumer video cassette recorder market with a machine that uses a single fixed head. It is introducing its Longitudinal Video Recording (LVR) unit at the current International Radio and Television Exhibition in West Berlin. The use of a fixed head is in contrast to the rotating head drums of all but one recorder—a continuous-loop system from Toshiba Corp. [*Electronics*, March 15, p. 72] that is not yet available. Besides greatly simplifying the mechanical design, the fixed head facilitates service, as it can be replaced easily and quickly. In longitudinal—as opposed to helical scan—recording, the tracks run parallel along the length of the tape. The 8-mm-wide, 8.5- μ m-thick chromium-dioxide tape has 72 tracks and moves past the head at a rate of 4 m/s. Switching tracks at the two tape ends takes only 100 ms. With the tape 600 m long, the cassette plays for three hours. The LVR system, developed at BASF Video Corp., a subsidiary in Newport Beach, Calif., **will go on sale in Europe and the U. S. in mid-1980 for about \$1,000.**

CANNON. THE SOURCE.



Cannon KJL/KJ Connectors.

Your ITT Cannon Electric distributor has an in-store supply of Cannon® KJL Series I and KJ Series II connectors for your MIL-C-38999 requirements.

High-reliability connectors with superior contact stability secured by the Super Caesar™ rear release contact retention assembly.

A design variety for temperature environments from -85°F to +392°F with nine shell sizes each series. Fifty-nine contact arrangements from 3 to 128 contacts. All contacts adaptable to AWG wire sizes 16-28 and easily installed by simple and fast customer tooling to lower your total installed cost.

So when you need KJL and KJ connectors, remember the source. ITT Cannon.

For more information contact your local distributor. Or write to: Product Manager, Circular Division, ITT Cannon Electric, 666 East Dyer Road, Santa Ana, California 92702. For 24-hour service, call toll-free (800) 854-3573; in California (800) 432-7063.

For all your Cannon connector needs see the EEM directory.

Six decades on the leading edge of interconnect technology.

CANNON ITT

Relax!

We can get HP's 9845S Desktop Computer on its way to you in minutes.

Whether your requirement is for a week, a month, a year or longer, there's one way to get HP's 9845S desktop computer without waiting. Rent it from Leasametric.

Instantly, our nationwide on-line computerized inventory system will check our dozens of regional inventory centers to pinpoint the unit closest to you. Within minutes, your order will be processed and moving on its way. In most cases, your desktop computer will be in your hands in less than 24 hours.

Need other computers? Don't waste time and energy calling everyone in the book.

One phone call to Leasametric is the fast, simple way to end your equipment worries and start relaxing. And, rental means more than immediate possession. It's the one effective way to get the new equipment you

need without going back to management for more money. There's no major capital investment with a Leasametric rental.

Leasametric, of course, means more than desktop computers. We stock the latest terminals, acoustic couplers, modems, development systems, general-purpose and communications test equipment . . . just about anything you might conceivably need.

Our growing inventory includes over 23,000 items from 500 of the top electronic manufacturers — including almost the entire HP catalog.

Need it now? Why wait? To order, or for our latest rental catalog, pick up the phone and call one of the relaxing, nationwide numbers shown below. They're toll free. Or call your local Leasametric office. There's one in every major city.

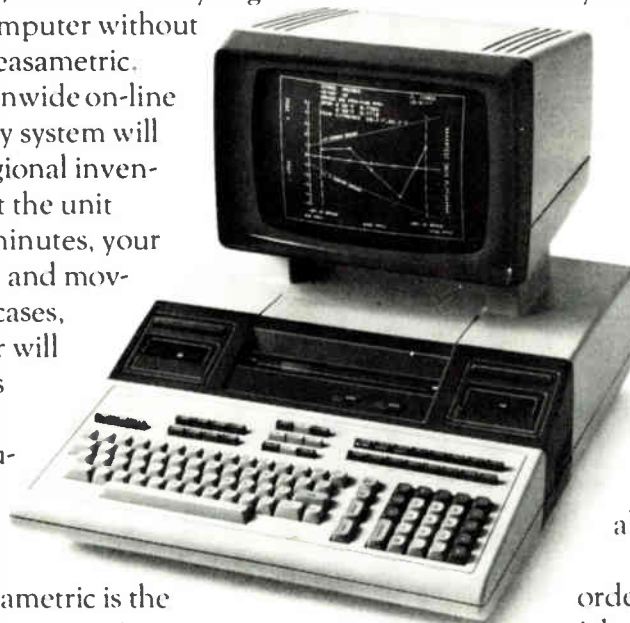

Rent it and relax.

In the West

Call 800-227-0280

In California, call (415) 574-4441

In the Central U. S.

Call 800-323-2513

In Illinois, call (312) 595-2700

In the East

Call 800-638-4009

In Maryland, call (301) 948-9700

Leasametric

1164 Triton Drive, Foster City, CA 94404

A Trans Union Company

Optical fiber keeps polarization constant

by Kevin Smith, London bureau manager

Elliptical shape aids single-mode propagation; uses seen for optoelectronic instruments, communications

A new kind of optical fiber that can preserve the polarization of laser light by virtue of its elliptical cross section is on the way. Developed at Britain's Imperial College, London, in collaboration with the Andrew Corp., Orland Park, Ill., the fiber could have a role to play in future long-haul optic communication systems. More immediately, its developer, Richard B. Dyott, sees uses in instruments exploiting light-polarization effects.

Britain's Central Electricity Research Laboratories, for example, has developed a laser-based instrument to measure lightning- and fault-induced current transients on Britain's grid system, and a further development of the instrument for metering applications could use the new fiber (see "Measuring current, voltage optoelectronically"). The fiber could also find use in aircraft laser-gyro systems now being developed. Although single-mode optic telecommunications systems are further off, Dyott says that polarization effects in fiber-optic systems are already a hot research topic, and he sees an immediate research market for his fibers.

At present he is producing fibers that are single-moded at the helium-neon laser wavelength of 0.63 micrometer. The Andrew Corp., which took Dyott's advice on getting into the fiber-optics business as a late

starter, is now scaling up the production process and could be delivering first samples in 12 to 18 months.

Impractical. "The potential advantages of a single-mode fiber waveguide able to preserve polarization are well known," Dyott says. Elliptically cross-sectioned fibers have this property but, he says, were discounted because the fiber dimen-

sions would have been impossibly small and because no suitable production technique existed.

Now, the shift to longer wavelengths of 1.3 and 1.5 μm proposed for long-distance communications brings the fiber dimensions within the range of present-day joining techniques. Dyott estimates that the core dimensions for a step-index

Measuring current, voltage optoelectronically

Britain's Central Electricity Research Laboratories in Leatherhead, Surrey, is developing optoelectronic alternatives to conventional transformers for measuring voltage and current on power networks. The alternatives use lasers and two types of optical fibers. Conventional transformers, says A. J. Rogers, who heads up the team developing the new devices, are bulky, expensive to insulate, and limited in their transient response, whereas optical devices for the same purpose can be compact, cheap, and very fast.

The new current-measuring devices exploit an effect discovered by Michael Faraday in 1845 whereby a magnetic field can rotate the plane of polarization of a light beam traveling through an otherwise isotropic medium. In one version now being tested by the labs on a metal-clad generator bus bar at Fawley power station, a single-mode fiber is looped several times around the cladding and acts as both a light guide and a transducer. A helium-neon laser supplies the light, and at the other end a polarization analyzer followed by a photodetector senses the plane of polarization. In a production version, which is the next stage, a semiconductor laser will be used instead.

For the system to work, the fiber loop around the bus bar's cladding must be free from stresses introduced during manufacturing that result in an unwanted birefringence. Birefringence is a property of materials in which the velocity of light is dependent on its state of polarization. As a linearly polarized beam traverses a birefringent fiber, it becomes elliptically polarized, corkscrewing through the fiber and reducing the detector's sensitivity to rotation. To solve this problem, Rogers' group went to Southampton University's fiber-optic group, which came up with an accurately rounded stress-relieved fiber, and this is used in their prototype instrument.

However, the laser and sensing elements still have to be located close to the fiber-optic transducer as long fiber-cable runs can reintroduce stress during laying. Rogers therefore plans to use elliptical-section fibers developed at Imperial College to preserve linear polarization in the laser feed and to act as a polarization analyzer in the return path. As a result, he says, "the electronics could be sited several kilometers away." His group is also working on optical techniques for measuring voltage. **-K. S.**

fiber operating at a wavelength of $1.5\ \mu\text{m}$ will be $5.07\ \mu\text{m}$ for the major and $2.03\ \mu\text{m}$ for the minor axis.

"The Andrew Corp. liked the idea," says Dyott, "because they already produce elliptical metal waveguides to preserve polarization in antenna power feeds."

Process. Dyott's production process is based on the modified controlled-vapor-deposition process used to make graded-index fiber. Germanium and phosphorus vapor dopants are introduced into the hollow core of the glass stock together with silicon tetrachloride and deposited in a single operation to produce a step-index fiber having a large refractive index between core and cladding.

To overcome the thermal stress problems on cooling due to the large index difference, Dyott devised a rig in which fiber pulling follows deposition at the same high temperature. Though he is reluctant to release details, he says the process promises easily controlled production of low-cost step-index fiber.

According to Dyott, polarization-holding fibers will be needed when integrated optic repeater and switching systems become available. By locking the polarization plane in the elliptically cored fiber, radiant energy can be efficiently coupled from the fiber into the planar-constructed integrated optic device and back again. In conventional long-distance optic telecommunications links, too, such fibers would avoid polarization effects that are now seen as a potential noise problem in high-performance systems.

Skeptics. However, though accepting the place of elliptical fiber in instruments, some workers in fiber optics are reserved about their applicability to long-distance telecommunications. They point out the extreme difficulty of joining elliptical fibers and suggest that for the 100-kilometer distances now becoming possible, there may be easier ways of overcoming the bandwidth limitations when two orthogonal modes exit from a fiber. They also suggest that integrated optic devices are still a long way off.

The ability of a fiber to propagate light in two or more modes simultaneously limits the bandwidth and is a source of polarization-induced noise because the path difference between modes causes pulse spreading and narrows the tradeoff between fiber length and data rate.

Dyott says future single-mode optic systems will use polarized laser light sources with the plane of polarization aligned with the major axis

of the fiber. As a double safeguard, he has shown that there is a range of ellipticity values at which the group velocities in the two modes are made equal despite a substantial difference in phase velocities. That means, he says, that "for long-distance communication it may be possible to make a fiber in which any accidental coupling into the unwanted polarization would be unimportant as far as group delay is concerned."

West Germany

On-board multiplexing system checks car's lights automatically

A West German company has taken a big step toward the full multiplexing network for cars envisioned by auto engineers for the late 1980s [*Electronics*, Sept. 29, 1977, p. 83]. Kabelwerke Reinshagen GmbH, an affiliate of NV Philips Gloeilampenfabrieken in the Netherlands, is about to introduce its microprocessor-based, multiplexing Automatic Check and Control System that continuously monitors the car's lights and, by means of a display on the dashboard, tells the driver which one is malfunctioning.

The system automatically checks the lights even while the car is barreling down the road, regardless of whether they are on or off, a feature that should appeal to safety-conscious drivers. Auto engineers will welcome the system because it

provides a savings in space, especially behind the dashboard, which now conceals a maze of wires. It also checks the oil-pressure and brake-fluid sensors and can easily be upgraded to check others.

Will such a system pay off in increased safety? "Indeed it will," insists Reinhard Gereth, head of the Electronic Systems division at Wuppertal-based Reinshagen and a former associate of transistor co-inventor William Shockley. As evidence, he cites a recent check of 3 million cars in the U. S. that showed that every fifth vehicle had at least one defective light.

On display. Car makers in West Germany, including subsidiaries of U. S. firms, have reacted "extremely positively" to the system, Gereth says. It will be publicly demonstrated for the first time at the Sept. 13-23 International Automobile Exhibition in Frankfurt and will also be discussed at the Second International Conference on Automotive Electronics in London, Oct. 29-Nov. 2.

At its heart is an 8-bit microprocessor whose prime functions are giving instructions for activating the lamps, monitoring the signals from the lights and sensors, and informing the driver of any failures via the dashboard indicator. The microprocessor is contained, along with peripheral components, in a small unit behind the dashboard.

In the basic configuration for one

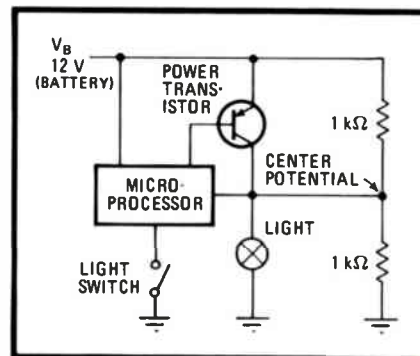

Checker. Fully automatic multiplexing system from Kabelwerke Reinshagen uses microprocessor to check car's lights. Shown here is basic circuit for one lamp.

Hamlin is many things

... all of them dependable!

You may know Hamlin as the world's leading manufacturer of reed switches. You may know Hamlin as the leading manufacturer of reed and solid state relays ... or mercury-wetted relays ... or liquid crystal displays. The point is, you know Hamlin as the leader in the industry.

This position of leadership is due to over thirty years of engineering experience, almost totally integrated manufacture, and unsurpassed quality control. That means **DEPENDABILITY!**

Reed Switches and Sensors

Switches available from local stock as small as $\frac{1}{4}$ inch to switch :1 watt and as large as the giant of the industry that handles 15,000 volts. Models include single and double throw units, mercury-wetted, and a new any position mercury switch. Sensors operate without physical contact, mechanical tripping or exposed arcing. For AC switching to $1\frac{1}{2}$ A, 250V. DC to 10W, 200V.

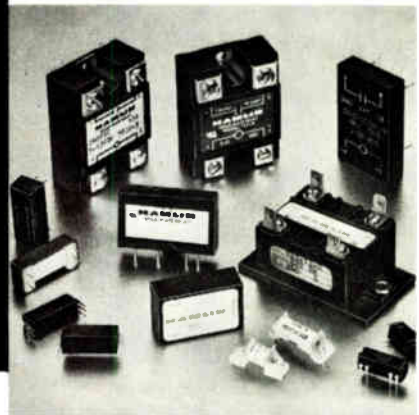
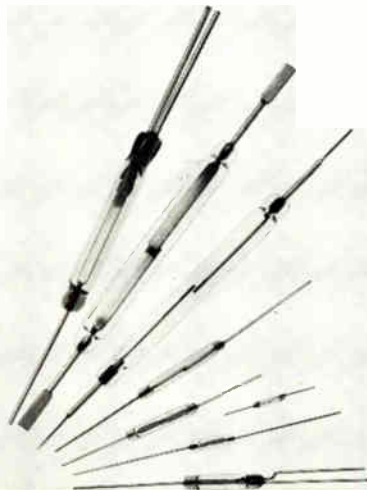

Reed and Solid State Relays

Reed form A, B, or C contacts, hermetically sealed. Choice of terminations. Contacts with ratings of 50W, dry, to 100 VA, mercury-wetted. Solid state are PCB and surface mounted to switch inductive, capacitive, or resistive loads up to 40 amps. DC or AC inputs, 120 or 240 Vac outputs, 1500 Vac isolation, zero voltage switching, 2-40 amp ratings.



Mercury-Wetted Relays

For billions of bounce-free operations. A hermetically sealed glass capsule contains Form A, B or C contacts and a small pool of mercury. While most mercury-wetted relays are position sensitive (30° from vertical), one Hamlin unit operates in any position ... A Hamlin First!

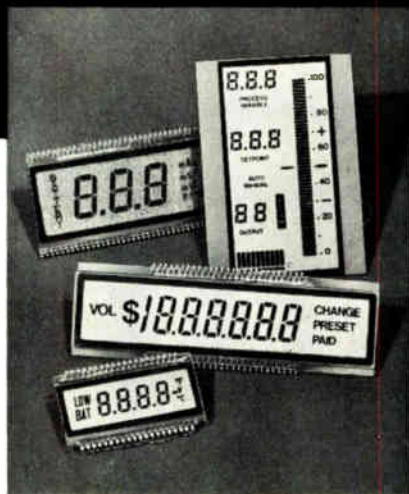

Liquid Crystal Displays

Stock units include 12 and 24 hour clock ... 2, $3\frac{1}{2}$, $4\frac{1}{2}$, 5, 6 and 8 digit instrument and numeric ... plus alphanumeric 1, 4 and 8 characters. Complete design and production service for custom displays.

HAMLIN

INCORPORATED

Lake & Grove Sts., Lake Mills, WI 53551 414/648-2361

Write or call for complete specifications and technical literature.

1625

lamp (see figure), the power transistor connects the light to the car battery. Parallel to the transistor-light combination is a high-resistance voltage divider whose center potential serves as one criterion in checking lamp conditions.

In operation, the microprocessor checks the value of the divider's center potential every 10 milliseconds. When the light is on, that potential is 12 volts; when off, 0 v. However, if there is a short in the light circuit, it will be 0 v in both cases.

To obtain positive indications for all combinations of possible failures and light modes, the test must be supplemented to include the off mode when the light is turned on and the on mode when it is turned off. Therefore, if a lamp is on, the system turns it off once every second for about 100 microseconds; if it is off, the system periodically turns it on every 40 seconds for about 100 μ s.

Prolonged. The light's turn-on and turn-off cycles are triggered by signals stored in a 512-bit random-access memory. These signals apply the proper base current to the power transistor, which, acting as a switch, activates the light. The test starts right after the car's ignition is turned on and lasts until 100 seconds after it is turned off. This prolonged operation ensures that lamp failures are also detected during the filament's cooling-off period.

The power transistors also act as reversible electronic fuses. For example, when a short is detected in the light circuitry, a transistor automatically turns off the lamp within 10 ms. Thus the need for fuses in the car's electrical system is eliminated.

To monitor all car lights, the basic control circuit configuration must be expanded. For this, Reinshagen uses time-division multiplexing. An 8-K programmable read-only memory on the microprocessor chip stores the logic sequence of the transistors' turn-on and turn-off times. Its access time of about 3 μ s guarantees that as many as 32 lamps or sensors can be tested within 10 ms.

A two-digit light-emitting-diode display whose number combination indicates which light or sensor has

failed alerts the driver to a malfunctioning light. If more than one failure exists, the most crucial one is indicated first; then, when that is fixed, the display indicates the next most crucial one.

With the system, the light switches no longer handle power-level current; they only switch low-voltage logic currents. To do so, thin wires suffice to connect the switches to the electronic unit behind the

dashboard, thus saving space.

What's more, there is no need for the mechanical interlocking schemes on today's cars that prevent, for instance, the fog lights from coming on as long as the high beams of the headlights are on. In the new system, interlocking is handled by logic circuitry. Not only does that, too, save space, but it also reduces the parts count and simplifies the design of the car's wiring. **-John Gosch**

France

Thomson-CSF wins government contract to develop low-cost facsimile transceiver

Thomson-CSF hopes to become one of the world's biggest copycats with its low-cost facsimile transceiver. The Telecommunications division of the huge Paris-based electronics group was selected this month from among four companies by the French Ministry of Posts and Telecommunications to continue development of a digital facsimile device that will transmit an 8½-by-11-inch sheet of copy over regular telephone lines in about 2 minutes and sell for less than \$500, once large-scale

production gets under way in late 1981 [*Electronics*, July 5, p. 85].

The \$3 million contract calls for delivery of two prototypes next year, to be followed by delivery of 50 preproduction models early in 1981.

Capable. The unit can receive facsimiles when unattended, can be used to create hard copies of videotext transmissions, and can also serve as simple photocopier. The key to keeping the cost down, according to Michel Sitterlin, director of the graphic communications service for

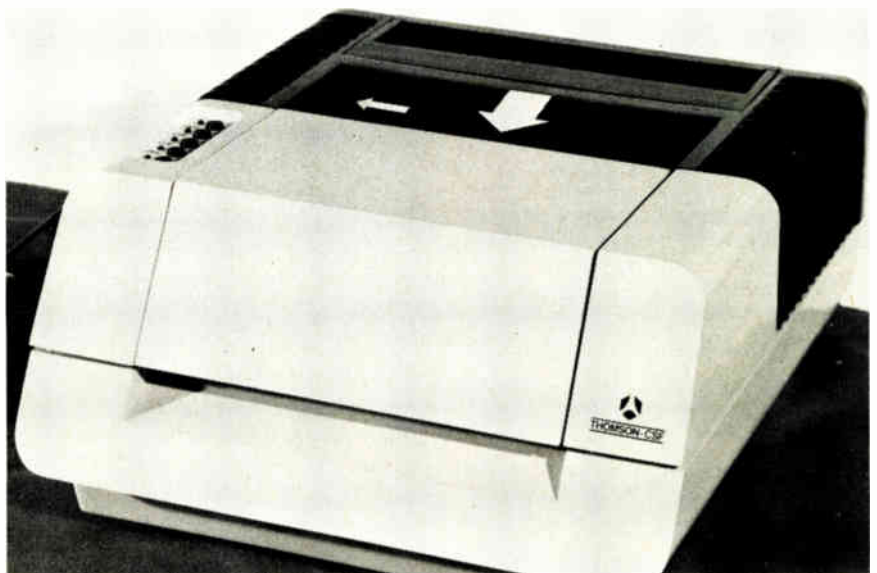

Just the fax, ma'am. Thomson-CSF has been chosen by France's Ministry of Posts and Telecommunications to develop and supply preproduction models of a low-cost facsimile transceiver. Shown here is a prototype submitted as part of Thomson's bid.

Your products will do more and do it better with a Sharp SM-4 or SM-5.



4-bit 1-chip C-MOS microcomputers for direct interface with LCDs

Sharp gives your products a boost in reliability and performance with these two low power consuming microcomputers. They provide direct interfacing with LCDs (accurate time control with crystal oscillator). They can be practically incorporated for the controller of telephone dialers, for programmable digital timers, cash registers,

vending machines, calculators and countless other products. They come with high ROM/RAM capacity, static shift register, 15-stage divider with reset, and other peripheral circuits on 1 chip. And, best of all, Sharp mass produces these tiny chips with a system that provides a substantial reduction in cost. So look over the specs below, take your pick and order today. Then watch your products do more and do it better.

SM-4

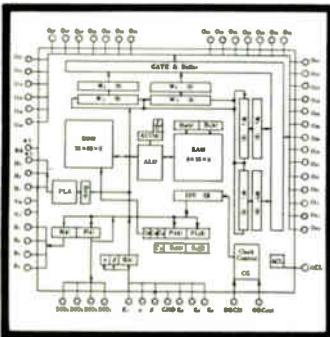

1K RAM

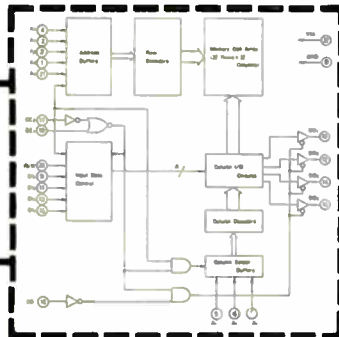

SM-5

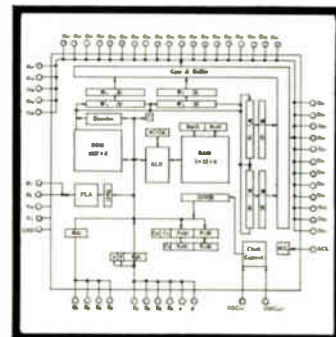

C-MOS SM Series (4-Bit 1-Chip Microcomputers)

	Cycle time (Typ)	Vcc	Pd (Typ)	Instructions	ROM (bit)	RAM (bit)	Package
SM-4	62.5 sec.	-3V	0.06mW	54	2268 × 8	96 × 4	60 Flat
SM-5	62.5 sec.	-3V	0.06mW	51	1827 × 8	65 × 4	60 Flat

C-MOS Static Random Access Memories

Model No.	Constitution (bit)	Access time (Max.)	Cycle time (Min.)	Supply volt.	Package	Remark
LH-5101S	256 × 4	300 nsec	300 nsec	3V	22 Dip	Expansion RAM for SM-4
LH-5101W	256 × 4	800 nsec	800 nsec	5V	22 Dip	
LH-5102	512 × 4	1200 nsec	1200 nsec	5V	22 Dip	

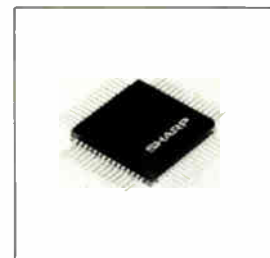

SM-4 applications

Auto telephone dialers, AM/FM digital display units, home health equipment, clock-calculators, programmable remote controls, programmable digital timers, etc.

SM-5 applications

Pocket bells, thermometers and pulse counters, cash registers, POS terminals, vending machines, controllers for home appliances and audio equipment, etc.

SHARP

For further information, write to:
Mr. Nobukazu Yagi, Sales Representative
SHARP ELECTRONICS CORPORATION
10 Keystone Place
Paramus, New Jersey 07652

the company's Telecommunications division in Gennevilliers, outside of Paris, is the use of a microprocessor plus as few moving parts as possible.

The transceiver, which conforms to the requirements for group 3 digital facsimile devices as set by the Consultative Committee on International Telephony and Telegraphy (CCITT), uses 1,728 phototransistors to scan each line of copy to be transmitted. A line is 240 micrometers wide and 216 millimeters long, and the scanning time for a single line is 10 milliseconds. The output from the phototransistors is fed directly to a register of 1,728 charge-coupled devices that serializes the data. Since the phototransistors are responsive to a wide optic band, transmitting color documents poses no special problems, but currently all data is recorded only as black or white, with no shades of gray.

Once it has been serialized, the data is coded by the microprocessor. Thomson used a Motorola 6800 for the prototypes it submitted and will probably go to a 6801 or a 6803 for its production version, says Sitterlin, noting that the company's Sescosem subsidiary is a second source for the Motorola 6800 family.

Modem. Researchers at Thomson's Telecommunications Laboratories developed a single-chip modem capable of handling 2,400 bits per second especially for the facsimile transceiver. The devices are to be produced by the group's integrated-circuit subsidiary, Société pour l'Etude de la Fabrication de Circuits Intégrés Spéciaux (Efcis). Transmission is accomplished through four-stage phase modulation of an 1,800-hertz signal at 1,200 bauds.

Sitterlin notes that it is the image-impression system on the receiving end of the device that accounts for nearly one third of the overall cost, and he believes that thermal printing makes Thomson's device superior to those of its competitors for the government contract. The other companies opted for electrocatalytic or photosensitive impression systems. Sitterlin says the advantages of thermal printing include well-defined images, no noise or other environ-

Around the world

Israel moves toward color television

Israel has decided to stop erasing color from imported programs in the first step toward introducing color television. Communications Minister Yitchak Modai said that within two months Israelis who now have color sets will be able to view imported shows in color. Local color programs are expected to get under way in a year's time. The government has tried to prevent the introduction of color TV for economic reasons: it wanted to keep people from rushing to buy new sets, thereby further heating up the economy and causing the balance of payments to deteriorate even more. Despite the high price of about \$2,000, Israelis have already purchased 180,000 color sets, out of a total of 850,000 sets bought in the country; most of them can pick up color programs from neighboring Jordan. Israel will use the PAL transmission system.

Danes look for shortcut in testing

A Danish team is trying to find out if the usual 168-hour burn-in time for components testing is longer than necessary. Drawn mainly from the Danish Engineering Academy, with a sprinkling of industry representatives, the group will try to determine if much of the work can be eliminated by using a probability distribution curve. Jorgen Moltoft, team leader, says that most—or even all—of the likely component failures will have been discovered by the time the curve flattens out. In some cases, he says, this may mean cutting the burn-in testing time to 10 hours. The \$100,000 project is to run for a year.

West German firm makes C-MOS alarm circuit for analog clocks

West Germany's Munich-based Eurosil GmbH has developed a complementary-MOS circuit for analog clocks with an unusual feature: its logic circuitry produces a series of pulses that are fed to an external transducer to generate an alarm sounding as gong tones. The 1,024-hertz 1-second tones come at decreasing intervals: 16 seconds, 8 seconds, 4 seconds, 2 seconds, and then every second until the alarm is shut off. Designated the 1400 and being marketed now in Europe (and eventually in the U. S.), the C-MOS device incorporates a 4-megahertz oscillator, binary divider stages, output drivers, and the pulse-sequence logic circuitry. Besides providing an alarm, a test, and a reset function, it also checks the status of its 1.5-volt battery. It consumes only 30 microamperes.

mental problems, and low paper cost (about 3½ cents per page).

The actual impression is created on heat-sensitive paper by a bank of resistors. The final production model will have either a stationary bank of 1,728 resistive points, to reproduce the 1,728 points per transmitted line, or a movable bank of 576 resistors, which would reproduce one line in three steps. Sitterlin says the final decision will depend on which system turns out to be most economical. In either case, the maximum printing time for a line would be 40 ms.

One more. Although the ministry's telecommunications division has chosen the Thomson unit, it wants two companies to supply the devices and has invited the three other companies in the bidding to submit

revised versions by the end of the year. Almost certainly, one of the three will receive a similar preproduction contract, and both it and Thomson will then supply the ministry with production models.

Sales of the devices to the public will be handled by the company or companies themselves, says Jean Syrota, director of industrial and international affairs for the ministry's telecommunications branch. He sees a \$5 billion market for the facsimile transceivers in France over the next 10 to 12 years, as well as considerable export possibilities, especially in the U. S. Thomson officials say that their device could easily be adapted for American use and that the 3M Co. is negotiating to do just that. **-Kenneth Dreyfack**



Gain huge savings—in dollars and inches—by replacing bulky conventional oscillators with tiny IC circuits.

WHILE CONVENTIONAL OSCILLATORS (FUNCTION GENERATORS, WAVEFORM GENERATORS, VCO'S, ETC.) COST UP TO SEVERAL HUNDRED DOLLARS, A SINGLE-CHIP IC OSCILLATOR CAN LITERALLY DO THE SAME JOB...AND FOR AS LITTLE AS \$1.72. All you give up for this tremendous reduction in cost and size is a certain degree of regulation in the output, and a variety of knobs and controls. But let's be realistic—for most applications, the IC oscillator is perfectly adequate. Its small size and low price makes the alternate approach quite impractical.

Nothing left out in the process.

Despite its small size, an IC chip really does contain every operating section of a traditional function generator. Consider a typical semiconductor oscillator, the XR-2206. On-chip you find the oscillator circuit (to generate the basic periodic waveform); the wave shaper to give you a clean sine wave; the modulator section (for AM capability); and an output drive amplifier. Basically the selfsame circuitry you'd receive if you bought a standard oscillator or benchtop function generator hundreds, even thousands of times as big as the IC.

But the real payoff comes in the outputs of these oscillators, and here too you lose nothing by going solid-state. The IC

oscillator will generate a combination of eight different types of output waveforms: triangle, ramp, sawtooth, squarewave, sinewave, pulse and FSK (frequency-shift keying) outputs, each with its own appropriate range of applications.

Just the item for sweep generators and sweep modulators.

The sweep generator, with its output hodgepodge of frequencies, can be a complex device. Yet it's a circuit easily built with ICs. A triangle-, ramp- or sawtooth-wave generator (XR-2207) modulates another oscillator (XR-2206) set up for voltage-to-frequency conversions. And presto! You have a functioning pocket-size sweeper.

Digital test equipment and stable phase-locked loop design.

Where space is at a premium, the solid-state precision voltage-controlled oscillator (XR-2209) comes to the rescue with banners flying. It more than meets the functional accuracies required, saves pounds and inches, and shaves dollars too.

Audio test equipment too.

Low cost is the prime requisite here, and once again the IC oscillator comes through for the design engineer. Solid-state sinewave generators (XR-2206 or XR-8038) are ideal, low-cost, simple solutions that often can offer a size and power advantage perfect for the test or hobby market.

Digital communications, including data-interface or acoustical-coupled MODEMS.

The FSK oscillator is tailor made to solve this design dilemma. Modern designers, particularly those dealing with computer and data-processing systems, are continually put upon to squeeze more capability into ever decreasing amounts of space. Where board space is tight, the IC FSK oscillator (XR-2206 or XR-2207) is magnificently effective in compressing a complex function into a nutshell. You wind up with inches of real estate for really important things such as more memory.

Digital testers, logic circuits, on/off gating.

Naturally, there's an IC oscillator for the purpose. This time one with a pulse output (XR-

2206 or XR-2207). All the same advantages you find in other applications—size, cost, low power requirements—apply here as well. In short, regardless of where you need to use an oscillator or function generator, there's an outstanding chance you can find a solid-state device to do the job and make you a hero in the bargain.

Beware. Only one company produces a complete line of IC oscillators.

With a stable of five different circuits, Exar boasts by far the industry's broadest choice of IC oscillators. From low cost, easy-to-use devices to high performance function generators, the line is summarized in Table 1. Check them out, find the one best suited for your use, then make the shrewd move to solid state.

Exar's Function Generator Data Book contains technical articles and application notes. To request your copy, write on your company letterhead to your nearest Exar representative or to Exar, 750 Palomar Avenue, Sunnyvale, California 94086.

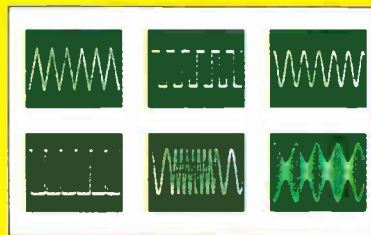

Electrical Characteristics	EXAR Device Type				
	205	8038	2206	2207	2209
Output Waveforms	Triangle, Square, Sine			Triangle, Square	
Upper freq. limit (MHz)	4	1	1	1	1
Sweep range	1	1000	2000	2000	2000
Typ. amp. drive (PPM/10)	300	50	30	30	30
Typ. sinewave distortion	2.5	0.5	0.5	—	—

Table 1. Exar's line of IC Oscillators.

FOR THE EXAR DISTRIBUTOR OR REP NEAREST YOU, CALL EXAR AT (408) 732-7970.

**Can you deliver
components
from stock?**

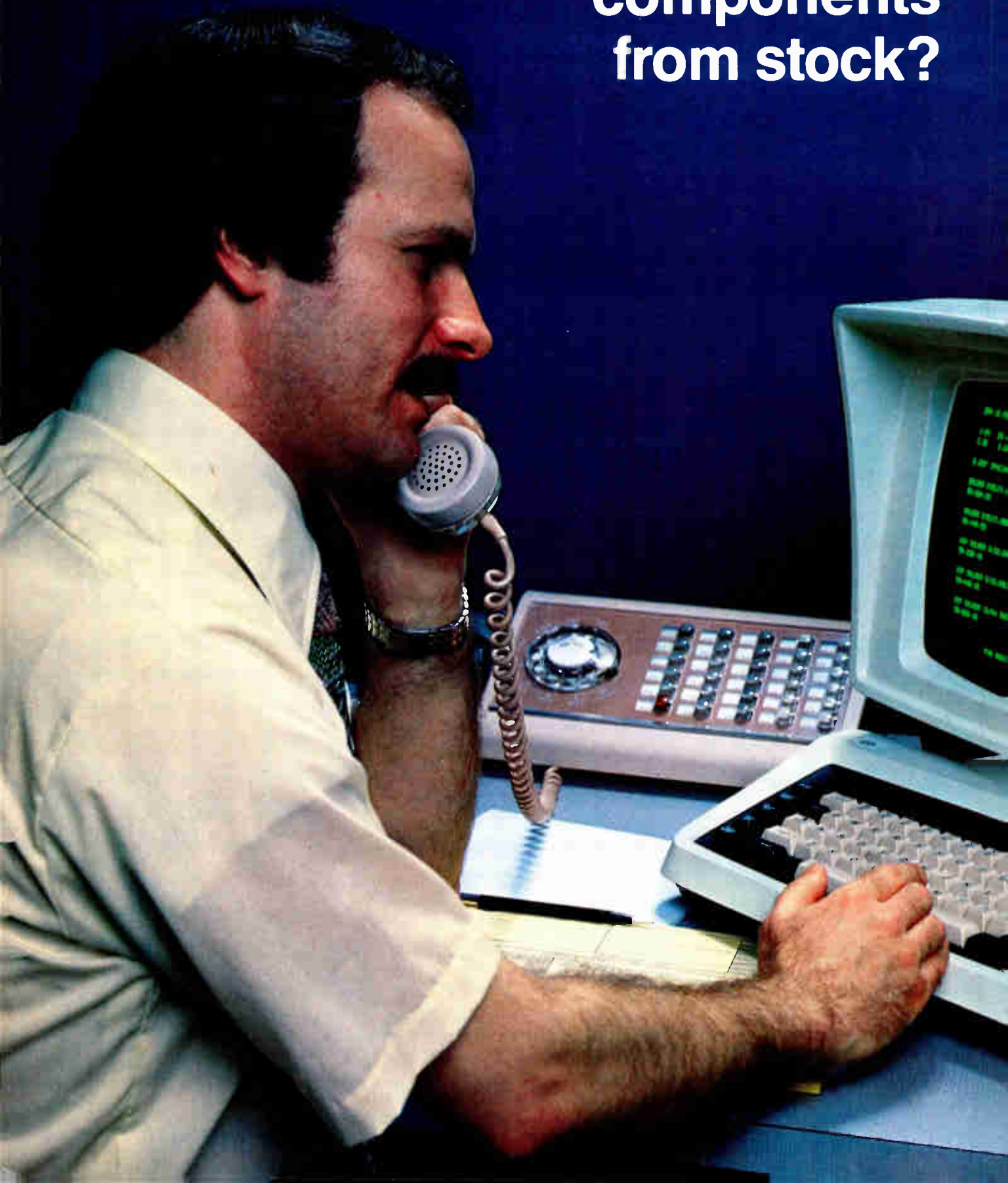

When it's TRW, the answer is yes.



Maintaining the availability of its standard products is essential to service and that's why there is a world-wide network of TRW/ECD distributors with large stocks on hand, plus in-depth, back-up inventories at the TRW factories.

TRW distributors are selected for their positive attitudes toward customer service and their ability to stock TRW products in large enough quantities to satisfy customer needs.

TRW factory-trained distributors

know our products and can recommend the best one for your application—or they can work with our field staffs (250 people in 50 offices) or factory people to adapt to your unusual requirements.

When you want yes for an answer, call your TRW distributor, TRW/ECD sales office or Renfrew Electronics in Canada. You'll find them listed in EEM, Gold Book, Electronics Buyers' Guide, Who's Who in Electronics, the Electronic Industry Telephone Directory and the Electronic Buyers' Handbook.

TRW CAPACITORS
TRW CINCH CONNECTORS
TRW CINCH-GRAFIK
TRW CINCH-MONADNOCK
TRW ELECTRONIC FUNCTIONS
TRW GLOBE MOTORS
TRW HOLYOKE WIRE & CABLE

TRW INDUCTIVE PRODUCTS
TRW IRC NETWORKS
TRW IRC RESISTORS
TRW LSI PRODUCTS
TRW OPTRON
TRW POWER SEMICONDUCTORS
TRW RF SEMICONDUCTORS

TRW ELECTRONIC COMPONENTS

DIVISIONS OF TRW INC.

If you're waiting for tubeaxial fans...

Can you find an “extra inch”?

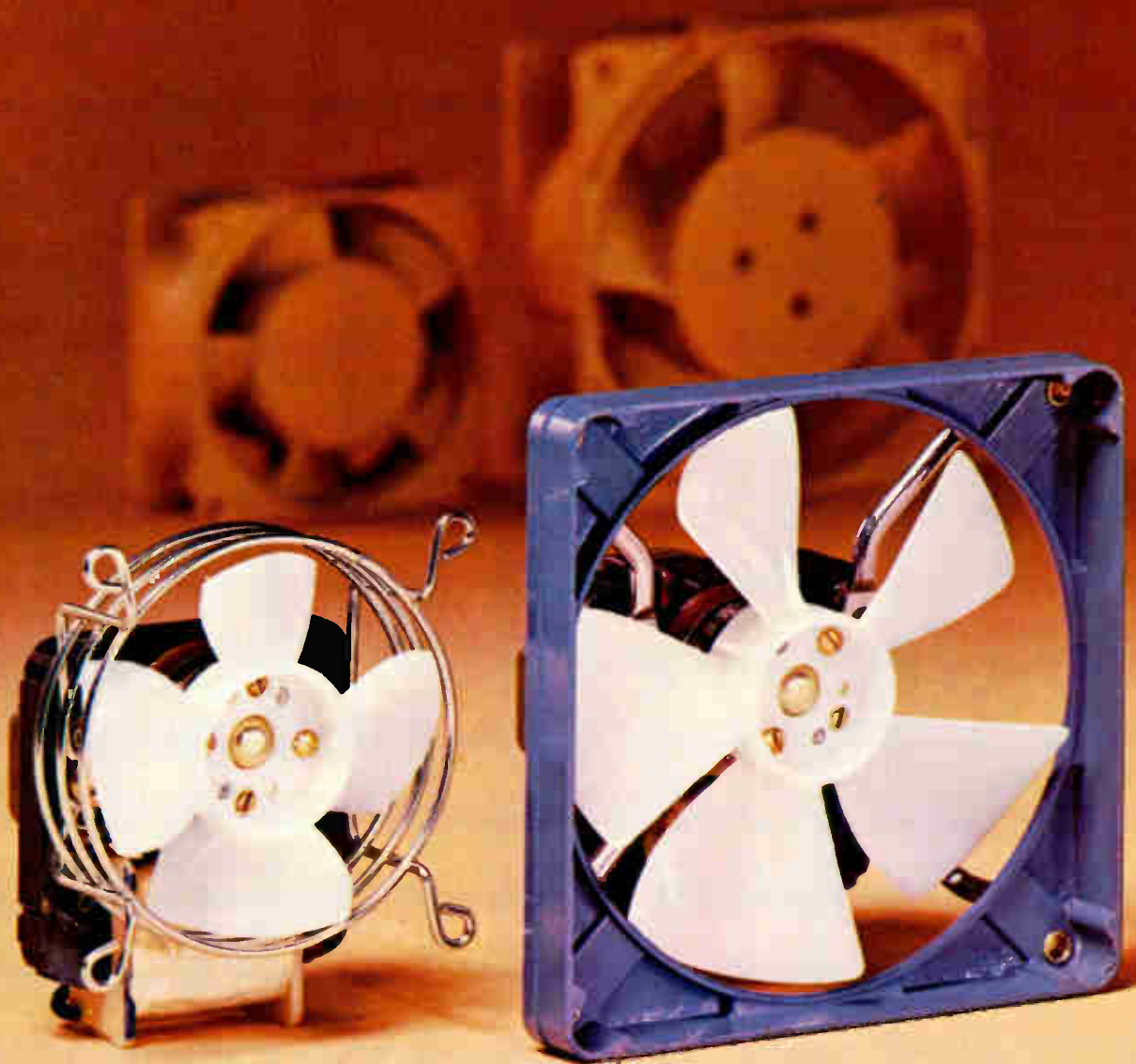

If you've got an "extra inch" these Howard fans can cut costs 30% to 50% ...and you'll get 12-week delivery!

If you can find an extra .694" to 1.43" of space for cooling — these Howard open fans can deliver the same CFM of cooling air as hard-to-find tubeaxial fans. And Howard can deliver them in a short 12 weeks! (Oh yes, they fit the same mounting centers as tubeaxial fans.)

Another plus! These easy-to-get Howard fans cost from 30% to 50% less than comparable tubeaxial fans.

These Howard-Powered fans offer what no others can . . .

non-stop lubrication

Patented* sealed tube system in Howard Unit Bearing Motors delivers 10 full years of trouble-free service . . . compare that with ordinary fan motors!

Because oil circulates continuously in a patented sealed system, this fan motor never needs attention. It remains properly lubricated for the life of the motor.

* U.S. Patent No. 3844920

COMPARE SIZES—they need just a little extra depth.

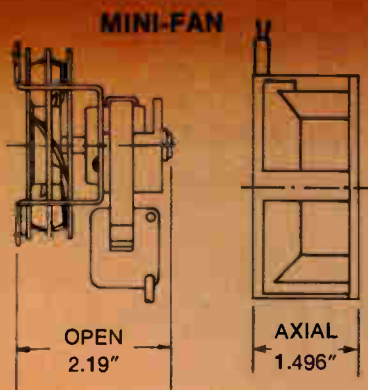

— takes just .694" more space

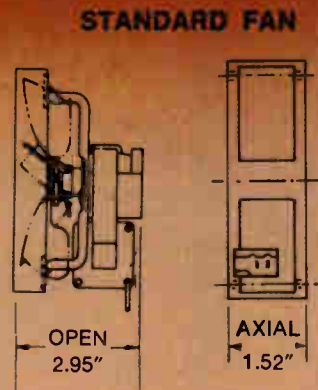

— takes just 1.43" more space



WRITE TODAY for full specifications on these available fans. You'll save lots of time — and money.

HOWARD® POWERED

HOWARD INDUSTRIES — One North Dixie Highway, Milford, Illinois 60953 — Phone: (815) 889-4105

Circle 77 on reader service card

Our JANs outnumber and outrank everybody in the field.

Fairchild is unquestionably in command when it comes to supplying Linear Hi-Rel products to the aerospace and defense industries. We carry more JAN qualified parts than all the other suppliers combined. In fact, our growing Linear JAN line numbers more than 150 products, including op amps, regulators, comparators and interface, while our closest competitor is miles away with less than 15.

You'll salute our quality.

Our Linear JAN program offers you four-star quality and proven reliability. That's why we've had parts enlisted in key military systems for many years. We design our products to meet the stiff requirements demanded of MIL-M-38510 JAN devices. And because of our strict standards and controls, we also have the capability to service your "Class S" business. So it's no wonder designers of missiles, satellites and communication systems are depending on us more and more.

Our delivery has a good service record.

All of our JAN products are competitively priced, currently available, and ready to be recruited. And when you order, you can count on us to deliver. With no snafus.

Join the Fairchild corps.

When your military or high-reliability systems need a Hi-Rel supplier, follow the leader. For more information on our JAN products, or a copy of our JAN brochure, call us direct at (415) 962-4942 to reach our Linear Aerospace and Defense troops. Or write Fairchild Camera and Instrument Corporation, P.O. Box 880A, Mountain View, California 94042.

FAIRCHILD

Call us on it.

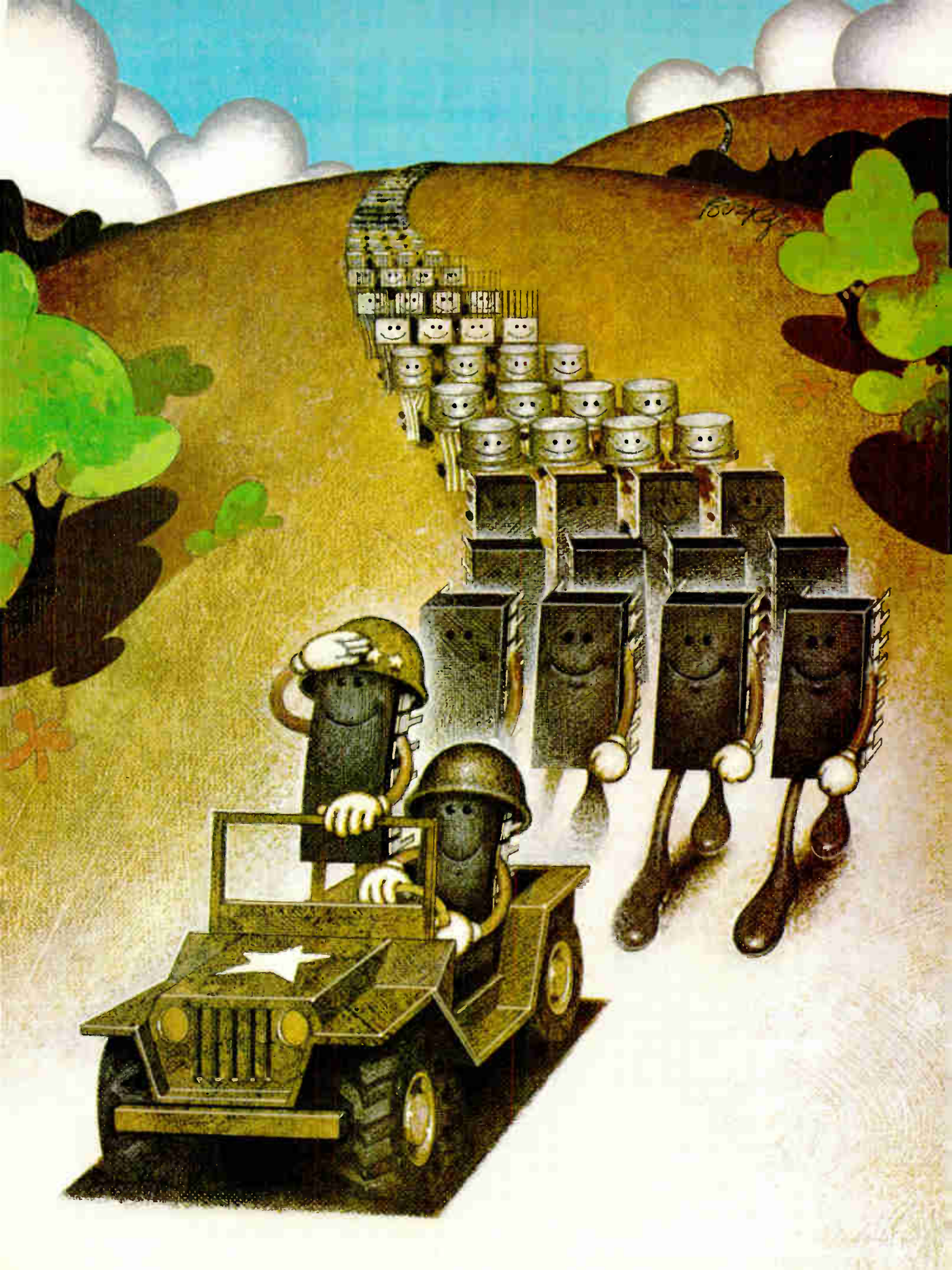

*Teradyne finds the practical solution.
No. 11 in a series.*

The self-programming board tester

Just give it a dozen good boards.

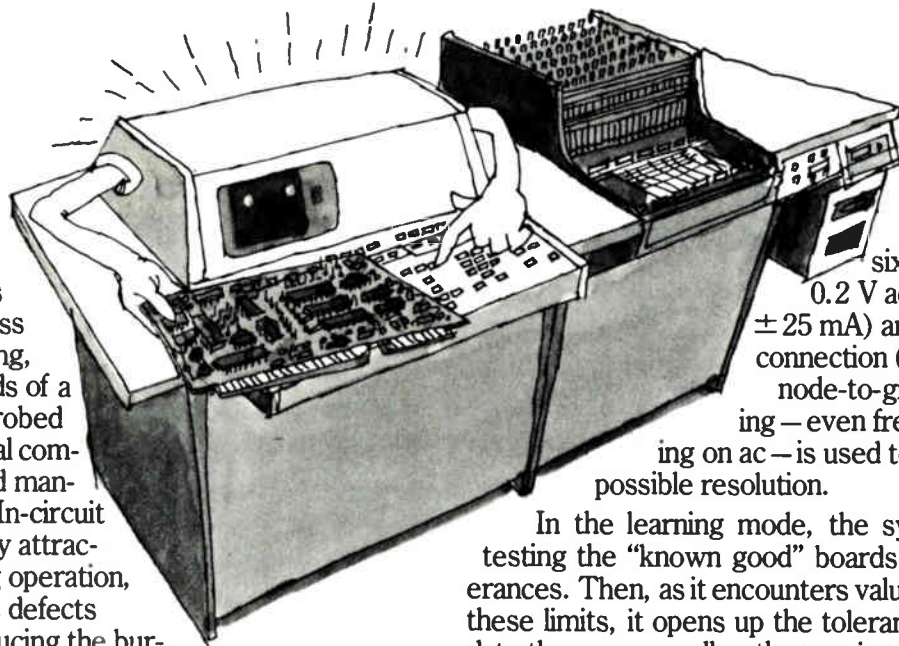

One of the fastest growing segments of the ATE business is "in-circuit" testing, in which the innards of a circuit board are probed and tested to reveal component defects and manufacturing errors. In-circuit testing is especially attractive as a screening operation, weeding out gross defects early and thus reducing the burden on the more expensive functional test systems.

As many people are finding out, however, the heaviest burden of all has less to do with testing than with test programming. Thus, if the in-circuit tester is to pay off as a screening device, it should not consume programming time more urgently needed somewhere downstream.

Teradyne's solution to this problem is an in-circuit tester (the L529) that writes its own test program while examining a small sample of "known good" boards. The human contribution to the process consists of telling the tester what kind of component (resistor, capacitor, semiconductor, etc.) appears at each node. This is a button-pushing exercise requiring not a semester's worth of electronics, but to make things even simpler the buttons are keyed to the user's own component designators (e.g., Q for transistors, R for resistors, etc.).

To develop the tests required for each type of component, the system employs various combinations of

six stimuli (0.2 V dc, 0.2 V ac, ± 2.5 V dc, and ± 25 mA) and two methods of connection (node-to-node and node-to-ground). Autoranging — even frequency autoranging on ac — is used to achieve the best possible resolution.

In the learning mode, the system first starts testing the "known good" boards to fairly tight tolerances. Then, as it encounters values that fall outside these limits, it opens up the tolerances to accommodate the new as well as the previous values. The ideal limits will of course be just outside the range of actual values measured on the sample of good boards, and the system automatically settles in on these tolerances. After about a dozen boards have been examined, the test system has a very good idea of what constitutes a "good board." The system, in other words, has been programmed — without tears.

The self-programming in-circuit tester is only the latest round in a full-scale Teradyne attack on test programming costs. Some years ago, we began offering industry's first self-programming backplane testers, and more recently we mounted a massive effort to develop an automatic test-generation system for functional board testers.

It's not that we don't like programmers. But when it starts costing more to program testers than to buy them, it's time to realize that we need automatic programming equipment no less than we need automatic test equipment. It's time for the ATE industry to go APE.

TERADYNE

New minis push into power area

Systems Engineering's VPS line features number-crunching capability and speed suitable for scientific applications

by James B. Brinton, Boston bureau manager

Sales literature will call them "mini vector processors," but Systems Engineering Laboratories Inc. calls them "mini Crays." They are the VPS (for vector processor system) computers due next month from the Fort Lauderdale, Fla., company, and they may have more number-crunching power and speed than any mini-computer system yet—so much that they may even encroach upon applications now filled by large machines from Cray Research Inc. and Control Data Corp.

The results of SEL's announcement could be multifold. Not only do the VPS machines accelerate the trend toward hanging array processors on systems, but they might chip away at traditional large mainframe markets like scientific time-sharing

or shared-resource applications. What's more, like the minicomputers of the 1960s, their mere presence might broaden scientific computer applications. They will be available in four to six months, and their prices are relatively low—\$79,000 to \$215,000.

The scientific market isn't peanuts. According to a study by Donaldson, Lufkin & Jenrette Securities Corp., New York, the scientific computer market, now almost totally large mainframes, was worth \$800 million in the past five years and could exceed \$1.4 billion in the next five based on sales of 150 to 200 large systems.

The report's writer, analyst Michael J. Geran, feels that there may be a big future for VPS-type

machines for several reasons. "The market is a logical extension [of SEL's] traditional market; the customers (unlike commercial customers) will buy on the basis of technical excellence—they're knowledgeable; finally, there is quite an opportunity here at the low end of the scientific and engineering market, especially if a system is adequately interactive."

Senior consultant Frederic G. Withington of Arthur D. Little Inc., Cambridge, Mass., tends to agree, calling the VPS approach a new idea in the marketplace. "Nobody has done this before, although the idea has been discussed. It's difficult to predict its effect on the market, though I would expect it to enlarge the low end of the scientific engineering sector. Applications that came to mind include speech and pattern recognition, robotic control, and such."

He adds, "In some applications, such as earth resources, astronomical, and some seismic data processing, data bases are getting so large that it's becoming easier to bring the computer to the data. Time-sharing can be a very tough environment in which to manipulate large data bases, and the time may be ripe for a mini number cruncher small enough to be installed near the data base." The VPS computer would seem to fit that description.

Problems. But the road to riches is not all smooth. According to ADL senior consultant Norman S. Zimbel, head of the firm's distributed

Systems' system. SEL expects its VPS (for vector processor system) to challenge the big number-crunching mainframes for a place in the scientific-computer market.



Probing the news

systems unit, "Applying an array processor to date has been something of an art; you have to visualize and structure problems differently than with standard computer systems."

SEL spokesmen agree to a point. According to SEL's product manager, Darrel McGinnis, only about 4% to 5% of array processor customers are capable of fully integrating an outboard processor. Another 20% could do it but are a little shy about taking on the task, he says. "Well, for that 25% we have done just about all the systems integration that needs doing." There is another 50% of the market in which array-processor systems would be used in specialized applications, like a specified type of structural analysis. "We will sell our VPS systems to OEMs, who in turn would supply highly specialized software for these applications," McGinnis says; thus SEL would make available the equivalent of applications packages via a middleman.

Zimbel thinks that VPS might first find its way into three major areas: scientific and engineering applications, pattern recognition, and perhaps robotics. Scientific applicatons

are a natural; that's where (along with seismic data processing) array processors have been selling for years. Zimbel feels that if VPS is successful, "the proportion of minis with array-processing capabilities could very well increase, especially as prices of array-processing hardware drop."

Pattern recognition and robotics go hand in hand, and McGinnis already speaks of interesting applications that hint of robotics, or at least sophisticated control. "We already have had inquiries from a bottler who wanted to use video input to inspect empty bottles before filling and to check liquid level afterward. A researcher wants to use a video-input system to record the activities of rats during drug tests—where the computer would track the centroid of the rat and record its rate and frequency of movement. Activity recording now is done by humans and there's a lot of potential for error and lost information."

ADL's Zimbel remarks that if SEL is successful, the pattern of growth established by the minicomputer in the 1960s might repeat itself—"first scientific and engineering uses, then infiltration of the mass market." Miniature vector processors may already be reaching the mass-market

stage if McGinnis' applications projections are accurate.

What's more, SEL's new machines are viewed by some computer-industry observers as the possible hallmark of a growing trend toward more massive processing power in small packages. Data General Corp.'s augmented Eclipse S/250 with 8661 array processor, Prime Computer Inc.'s 50-series 32-bit machines, and Digital Equipment Corp.'s VAX are now viewed as limited steps in this direction. But SEL appears to be going all out.

SEL, which last year grossed about \$65 million, expects VPS to add \$10 million or more to sales in the coming year. Ignoring growth in other markets, the VPS system alone would increase the firm's income by more than 15% if projections are correct. "This is an untapped market," says a SEL source, "and the customers are waiting to be sold."

Marriage. The VPS weds two corporate technologies. The bulk of a system consists of a Systems 32/77 high-speed 32-bit computer [*Electronics*, April 3, 1975, p. 134], a machine known for its mammoth input-output data rates and applicability to real-time data reduction and control applications. Although wrapped in SEL sheet metal, the other part of any VPS system will consist of a 32- or 64-bit vector and array processor from Computer Signal Processors Inc., Burlington, Mass. (see "The hardware story").

McGinnis has his own ideas about the market. "When you cut the entry fee for fast 64-bit computation from about \$8 million [for a Cray] to \$217,000 for a 4-bit processor [SEL's price], the market is going to expand," says McGinnis. "We expect to take some tasks away from Control Data, Cray, and IBM," he says. "We won't displace their machines, but we will be selling to guys who now buy time on their machines."

According to SEL's James T. Holley, sales manager for VPS systems, "Now you can buy a complete system for about \$80,000 to a couple of hundred thousand bucks and it will sit in your office, doing your work. A Cray may be faster, but you won't have to wait to get aboard a VPS." □

The hardware story

Systems Engineering Laboratories Inc.'s new VPS system will be sold in three models, all based on the company's Systems 32/77, a 32-bit processor. The smallest would be the VPS 3200; at \$79,000 it would include a 32-bit array processor. The middle-sized unit would be the VPS 3300, again using a somewhat more sophisticated 32-bit array processor and priced at \$85,000. Largest in the present line of VPS systems would be the VPS 6400, with a 64-bit array processor and a price of \$137,000. These prices reflect minimal hardware; for example, a high-speed data interface with the array processor and minimal peripheral equipment. Delivery would take 120 to 150 days.

SEL will also offer a VPS "package system" based on the 6400. It would include 500 kilobytes of 600-nanosecond MOS main memory expandable to 4 megabytes, 80 megabytes of disk storage, a 75-inch-per-second tape drive, a 600-line-per-minute printer, a 300-character-per-minute auxiliary printer, a cathode-ray-tube console, and software, including Fortran. The 64-bit array processor would be equipped with 16 kilobytes of 32-bit program memory, 32 kilobytes of 64-bit data memory, and all necessary software and interfacing circuitry. The package would sell for \$215,000.

All VPS machines will be offered with the user's choice of three array-processor memory speeds—full cycle times would be 170, 300, or 500 ns.

The speed of the system, by minicomputer standards, would be blinding. A matrix-to-matrix multiplication of 100 by 100 numbers—each with 16-decimal-digital resolution and an exponent of $10^{\pm 76}$ or $10^{\pm 77}$ —would take 1 second; a 1,024-point fast Fourier transform, with each point a 64-bit binary number, would run less than 25 milliseconds.



The Model 935
the world's most accurate hand-held 3 1/2 digit portable \$149.



The Model 3400
the world's most accurate 4 1/2 digit lab and systems multimeter \$795.



The Model 7500
the world's most accurate high speed 5 1/2 digit systems multimeter \$2995. base



The Model 245
the world's most accurate 4 1/2 digit portable \$295.

**When
you want
the world's
most accurate
multimeters...**

**you want
Data Precision
multimeters.**

For a demonstration or a copy of our comprehensive Digital Instrumentation catalog contact Data Precision Corporation, Electronics Avenue, Danvers, MA 01923, USA

Phone (617) 246-1600 Telex (0650) 921819

DATA PRECISION[®]
...years ahead

FOR A DEMONSTRATION CIRCLE 82.
FOR ADDITIONAL INFORMATION CIRCLE 83.
VISIT US AT WESCON, BOOTHS 1041-1045.

```

PROGRAM Reduce_Software_Costs;
  BEGIN
    IF Choose_MICROPROCESSOR_PASCAL
      THEN CASE (Benefits) OF
        A : Software_Costs := Lower;
        B : Redesign := Easier;
        C : Design_Cycle := Shorter;
        D : 16-Bit_Avail. := Now;
      END;
    FOR microprocessors TO minicomputers
      DO MICROPROCESSOR_PASCAL;
    END[Happy].
  
```

The program to reduce software costs. Microprocessor Pascal System. New. From Texas Instruments.

Learnability. Transportability. Maintainability.

The features of Pascal, plus the benefits of TI's learning curve experience, are offered in the new Microprocessor Pascal system.

A system designed for microprocessor applications.

A system developed for the 16-bit 9900 Family, including the TM990 microcomputer modules, and 990 minicomputers.

A system to effectively lower your software costs today. And keep them low tomorrow.

At TI, Pascal is the first and only corporate-wide approved high-level programming language. For a lot of good reasons.

Pascal lets you solve your application without getting involved in the intricacies of machine architecture. And, Pascal's block structure results in fewer

programming errors, because the code is easier to write, read and modify.

TI's Microprocessor Pascal system consists of six parts and provides the most Pascal capability ever offered:

- Source Editor — specifically designed to create/edit Pascal programs and check program syntax.
- Compiler — compiles conventional Pascal programs as well as TI's Pascal concurrent extensions into interpretive code, which can then be executed directly, or converted into 9900 native machine code.
- Host Debugger — over fifteen options for tracing variables and modifying data.
- Configurator — enables the target system to retain only the parts of the runtime support necessary for program execution.
- Native-Code Generator — converts

Pascal interpretive code into 9900 native machine code.

- Run-Time Support — both interpretive and native-code execution provide a speed/memory trade-off.

TI's continuing commitment to innovative, cost-effective 16-bit microprocessor software means an increased applications capability and decreased development time for you.

Find out how you can reduce your present and future software costs. Put the new TI Microprocessor Pascal system to work for you, today.

For more information, call your nearest TI field sales office or authorized distributor, or write to Texas Instruments, P.O. Box 1443, M/S 6404, Houston, Texas 77001.

**TEXAS INSTRUMENTS
MOVING AHEAD
IN MICROCOMPUTERS**



TEXAS INSTRUMENTS
INCORPORATED

Electronics abroad

Tokyo meeting gains stature

ICSSD features solid-state heavy hitters from Japan, U. S., and Europe, with VLSI the most popular topic

Charles Cohen, Tokyo bureau manager

In only its third year as an international conference, the 1979 International Conference on Solid State Devices in Tokyo has attracted a sparkling collection of papers to emerge as one of the major meetings on the subject. Approximately 100 papers were selected; a list of the invited papers reads like a veritable technology guide to the semiconductor industry.

Despite its name, the Aug. 27-29 meeting features many more papers on basic technology than on devices, with very large-scale integration the most discussed subject. Of the 18 most important papers, 4 (on static-induction transistors, electron-beam lithography, basic technology for VLSI, and recent progress in semiconductor lasers) constitute the entire opening session. The other 14 set the tone of their sessions.

Compound semiconductor devices and optoelectronics perhaps get less than their fair share of papers because there are special conferences dealing with these subjects. On the other hand, a session on solar cells and amorphous devices brought forth papers from Venezuela, India, the Republic of China, and Australia. This seems fitting, as those devices may benefit developing nations more than VLSI will.

Perhaps most likely to wind up on the average engineer's workbench are memory devices now being developed. Hitachi Ltd. and Toshiba Corp. talk about variations of Hitachi's metal-nitride-oxide-semiconductor transistor that can be used in an erasable programmable read-only memory (EE-PROM) or in a dynamic random-access memory with MNOS backup for power-supply failure.

Toshiba uses MNOS capacitors to back up a static RAM [*Electronics*, Aug. 16, p. 68]. Hitachi also describes an experimental 16-K static RAM featuring smaller cells than previously announced.

VLSI. Most of the silicon sessions include work directly or indirectly driven by Japan's national VLSI project and a related project at the Nippon Telegraph and Telephone Public Corp. (NTT). But except when the tie-in is obvious, as with a reducing electron-beam projection

system developed at the VLSI cooperative lab, no mention is made of the connection. In the same session there are also papers on X-ray lithography by NTT, electron image projection by Philips of the Netherlands, and electron-beam mask fabrication for ROMs using design rules of 1 to 1.5 micrometers by Hitachi, giving a fair roundup of advanced lithography.

A session on basic aspects of MOS devices is largely devoted to problems that are apt to crop up in VLSI.

A look at some sessions

- The opening session includes papers on the progress and potential of static-induction transistor (SIT) technology, electron-beam fabrication of MOS devices, technology for VLSI, and progress in semiconductor lasers.
- Session A-1, advanced lithography, features a paper on a reducing electron projection system.
- Session B-1, gallium-arsenide integrated circuits, discusses low-power and high-speed GaAs MOS field-effect transistors, high-speed enhancement-mode GaAs metalized semiconductor FETs, an integrated GaAs enhancement FET, and power GaAs MES FETs with a graded-recess structure.
- Session C-2, Josephson devices, includes fabrication of Josephson weak links using electron-beam lithography and ion etching and a proposal for a new single-flux quantum logic.
- Session A-3, laser annealing and complementary-MOS-on-sapphire devices, presents papers on the mechanism of laser annealing, short-channel MOS FETs, and "Is SOS ready for VLSI?"
- Session B-3, lasers, covers mode control in semiconductor lasers and heteroepitaxial devices for optoelectronics.
- Session A-5, memory devices, features a bipolar dynamic random-access memory, analysis and design of the taper-isolated dynamic-threshold transistor for VLSI dynamic RAMs, and a fast nonvolatile C-MOS-MNOS RAM.
- Session A-4, LSI devices, discusses a high-speed Schottky 4-K programmable read-only memory using a diffused eutectic aluminum process (DEAP), a new transistor structure for high-speed bipolar LSI, a single-chip speech synthesizer for the Parcor codec, adaptive wafer-scale integration, and a 3,000-gate C-MOS master slice LSI.
- Session B-6, solar cells and amorphous devices, includes MOS solar cells on polycrystalline silicon, a new type of amorphous-silicon high-voltage photovoltaic cell, amorphous-silicon image-pickup devices, and high-density video-signal recording in a new amorphous-chalcogenide thin film [*Electronics*, July 19, p. 68].

SMALL PACKAGE

DIP HERMETICALLY SEALED SINEWAVE OSCILLATOR

NEW!



MODEL DPS1

FREQUENCIES AVAILABLE

Any fixed frequency from 1 kHz to 100 kHz

FREQUENCY STABILITY:

±.01% over temperature range -25°C to +75°C

OUTPUT WAVEFORM: Sine wave

total harmonic distortion ≤ 5%

OUTPUT AMPLITUDE:

1 Vrms minimum into a 10 kΩ Load, DC coupled

SUPPLY VOLTAGE: 5Vdc ± 10%

SUPPLY CURRENT: 50 MA maximum

LOW FREQUENCY
< 1 Hz >
LOW PROFILE



MODEL
S14P5

DIP CRYSTAL OSCILLATOR

LSTTL COMPATIBLE

FREQUENCIES AVAILABLE:

Any fixed frequency from 0.5Hz to 10 MHz

FREQUENCY TOLERANCE:

±.005% over temperature range -25°C to +75°C

OUTPUT WAVEFORM: Squarewave, fanout

10 LSTTL loads, LOG ≥ 2.4V, LOG 0 ≤ 0.4V

SUPPLY VOLTAGE: 5 Vdc ± 5%

SUPPLY CURRENT: 50MA Maximum

NEW! MODEL
(< 1 ma) L22R



24 PIN DIP
**CMOS
CRYSTAL
OSCILLATOR**

THE OUTPUT OF THIS HYBRID CRYSTAL OSCILLATOR CONSISTS OF A FUNDAMENTAL FREQUENCY AND ALL TWELVE BINARY DIVISIONS OF THE FUNDAMENTAL FREQUENCY. THE FUNDAMENTAL FREQUENCY IS AVAILABLE IN THE RANGE OF 500 Hz to 8MHz.

FREQUENCY TOLERANCE

MODELS

L22R1K, L22R3K ±.001%	+20 to +40
L22R1R, L22R3R ±.0025%	0 to +50
L22R1M, L22R3M ±.005%	-40 to +85
L22R1B, L22R3B ±.005%	0 to +50
L22R1W, L22R3W ±0.2%	-40 to +85
L22R1V, L22R3V ±.05%	-55 to +125

SUPPLY VOLTAGE 5Vdc to 15Vdc

SUPPLY CURRENT < 1ma at 5Vdc, 5ma at 15Vdc

Dimensions 0.2" H x 0.8" W x 1.37" L

THE CONNOR-WINFIELD CORP.



West Chicago, IL 60185, USA

Phone: (312) 231-5270

TWX: 910-230-3231

Cable: CONWINWCGO

86 Circle 86 on reader service card

Probing the news

Included are an invited paper on short-channel effects by Hewlett-Packard Co. and one on nonthermal carrier generation by Toshiba. Also covered are device limitations due to substrate currents and the secondary impact of electrons ionized in n-channel MOS LSI devices.

The session on laser annealing and complementary-MOS-on-sapphire devices lumps together two very different techniques that may play important roles in future VLSI. Two papers set the stage. One by Bell Laboratories describes the mechanism of laser annealing; another, from Stanford University, describes applications of scanning continuous-wave laser and electron beams in semiconductor processing. A Japanese group from Hitachi describes short-channel MOS field-effect transistors fabricated by self-aligned ion implantation and laser annealing, and a group from Toshiba tells how to use laser annealing to reduce the resistivity of polycrystalline silicon films to about one fourth of their usual value.

The C-MOS-on-sapphire portion of the session starts with a paper from France's Laboratoire d'Electronique et de Technologie Informatique asking if the technique is ready for VLSI. Then an NTT team describes a high-speed C-MOS integrated circuit fabricated with a technique that provides the dielectric isolation of C-MOS-on-sapphire without the lattice-matching and autodoping problems. After implantation of oxygen, epitaxial silicon is grown on the surface, and the islands are completely surrounded by the buried and thermally created silicon dioxide. In the charge-pumping memory with C-MOS-on-sapphire transistors described by Fujitsu Ltd., charge pumped into individual cells raises the potential of their substrates to store information.

The large and small. A session on LSI includes an odd couple from Fujitsu. One device is a high-speed Schottky TTL programmable ROM using a diffused eutectic aluminum process to provide short circuits in cells that are written. They are smaller than the blown-fuse devices.

At the other extreme is a 3,000-gate C-MOS master slice with an extremely low power dissipation of only 50 milliwatts at 10 megahertz on a chip that is relatively large at 9.72 by 9.72 millimeters. One application is a disk-drive controller. Also in this session is a single-chip speech synthesizer by NTT that features a fast 200-nanosecond instruction cycle time and a low power dissipation of 450 mW [*Electronics*, May 24, p. 69]. Mitsubishi Electric Corp. describes a new transistor structure for bipolar LSI with low base and collector series resistance and low storage capacitance—making for a high gain-bandwidth product.

Multipurpose SIT. A real question mark at the conference is the static-induction transistor developed by Prof. Jun-ichi Nishizawa at Tohoku University. It spans the range of applications from femtojoule logic and memory to multihundred-watt devices operating at microwave frequencies. Although originally developed as a short-channel junction FET that does not saturate, it can take at least two bipolar forms—one similar to integrated injection logic and one similar to a thyristor. In one version, drain current increases by 8 to 10 orders of magnitude for a 2-millivolt change in gate voltage. It may become difficult to tell what is a SIT because Nishizawa says as the channel length decreases, short-channel FETs degenerate into SIT devices.

The microwave SITs described at the conference are a Toshiba 2.1-gigahertz device with an output of about 10 watts and a Mitsubishi 1-GHz device with an output of 100 W. These devices have applications in their present form and are also a step toward a 400-W device operating at 2.45 GHz—which would enable them to replace the magnetrons in microwave ovens.

The session on gallium-arsenide ICs kicks off with a paper from McDonnell Douglas Corp. pushing planar GaAs for the gigabit logic of the future. Succeeding papers from Rockwell International, Fujitsu, NTT, and the University of Southern California tout the different approaches of each. The largest scale in a GaAs device is an eight-input data multiplexer from Rockwell with 64 gates. □



Has your power supply vendor left you with your back against the wall?

For one reason or another, your power supply vendor can't deliver. He can't meet specs. Or he's out of stock. Or maybe he's even pulled up stakes.

What to do? Call Powercube®.

Powercube Cirkitblock® power supply modules are not only readily available from stock, but you can use these miniature modules to design systems that fit — or retrofit — almost anywhere you want them. You can also count on them to do what you want done. Used for over a decade in major Military, Space, and Industrial programs, these proven 1" x 1" x 2" modules meet the toughest specs for size, weight, performance and environment.

If you have a power supply problem — or want to avoid one — check your requirements with Powercube. Just call us at (617) 667-9500 or circle the reader response card.



 **POWERCUBE**
A SUBSIDIARY OF UNITRODE CORPORATION

POWERCUBE CORPORATION
EIGHT SUBURBAN PARK DRIVE
BILLERICA, MASSACHUSETTS 01821
(617) 667-9500

Computers

IBM delay underscores new rules

System/38's lateness is further evidence that software complexity means changes in the development and marketing of computers

by Anthony Durniak, *Computers & Peripherals Editor*

The decision of International Business Machines Corp. to delay first-shipments of its new System/38 small business computer because of problems with software is convincing evidence that the rules of the product-development game are changing.

Product delays are nothing new to the computer industry—but they are unusual coming from IBM. And whereas most delays have resulted from hardware problems, the System/38's is one of the first attributed solely to software.

As manufacturers try to make computers easier to use, the so-called systems software—for operations, communications, and data management—represents a larger and more important portion of the machine than the hardware. At the same time, it is becoming more complex and difficult to develop. These factors, along with more and increasingly sophisticated customers,

may force computer manufacturers to change their product-development and marketing practices.

IBM revealed the problems when it announced earlier this month that its System/38 would be six to nine months late [*Electronics*, Aug. 16, p. 155]. The extra time “is needed to integrate and test the system's programming elements to achieve planned performance levels,” it said.

Although the Armonk, N.Y.-based company will not go into details, it apparently is having trouble with its new Control Program Facility, Interactive Data Base Utilities, and RPG III programming language compilers (see figure). These formed the basis of an ambitious new architecture—IBM's first entirely new architecture and operating system since the System/360 was introduced on April 7, 1964. It promises a single-level memory-addressing scheme with an object-

oriented memory-reference technique; up to 280 trillion bytes of virtual memory; and a single control language for use in all applications by all programmers, operators, or terminal users [*Electronics*, March 15, p. 105].

Working with two layers of micro-code, this software will offer what System/38 project manager Brian G. Utley has called a high-level architecture that “capitalizes on the rapid evolution of technology and yet minimizes the impact of hardware changes on the user's software.”

Getting together. Reading between the lines of IBM's statement, industry observers say that the company is having trouble making the different kinds of the software work efficiently together. “The way they worded the statement, [it appears] they're close to achieving the functionality they desired but haven't reached the performance,” says Nicholas M. DiCianni, director of strategic planning for Sperry Univac, Blue Bell, Pa. One problem IBM is having with the virtual memory system, the observers conjecture, is “thrashing”—that is, the constant swapping of data between the peripheral memories and the main memory. Furthermore, the software is loaded with bugs and is achieving only 4½ hours mean time between failures, according to some reports.

Although this is the first time most observers can remember IBM holding off delivery of a product, the delay does not surprise them. “There's nothing in recent memory as ambitious as the 38,” says Gideon Gartner, president of the Gartner Group, a New York consulting firm. “I don't think anyone else has tried a



Not quite ready. IBM has put off shipment of the first of its System 38 computer systems because it has run into trouble making the different types of software work together.

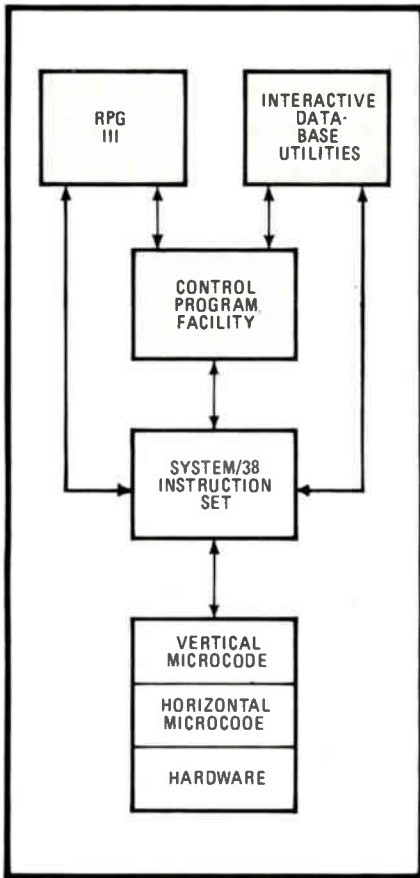

Stubborn. IBM apparently is having difficulty getting its Control Program Facility operating system to work with RPG III programming language and data-base utilities.

soup-to-nuts rewrite of an architecture or operating system, at least not to this extent."

Robert T. Bond, marketing manager for the HP-3000 series at Hewlett-Packard Co.'s General Systems division, sympathizes with IBM. "Any time you push the state of the art it's going to take longer than expected." Bond recalls what he terms the painful period following the introduction of the HP-3000 in November 1971. Problems with the operating system delayed its delivery, forcing the Cupertino, Calif., company to withdraw the product from marketing and reintroduce it in November 1973. "You can't give birth to a major new operating system without problems."

Previous trouble. In fact, many point to the fact that IBM also had trouble with its last completely new operating system, the OS/360, designed for the System/360. The company initially delivered only a fraction of the functional it prom-

ised, and the system required several versions and several years of field repairs before it was complete.

But Bond says the size of today's market does not allow IBM, or any other company, to deliver the software and then fix it in the field. "There are an estimated 35,000 System/38s on order. Supporting that number of machines in the field will eat you alive." And the increased use of microcode to hold the systems software makes the job tougher. "It's one thing to send out a new release of software on a floppy disk or magnetic tape, but it's another to send out a field-service engineer to change 16 read-only memory chips," Bond says.

Sperry Univac's DiCianni says software development will continue to pose problems for all manufacturers because as it becomes more complex, "the bottlenecks become more subtle and difficult to anticipate." Making the job tougher, he adds, is the fact that "we don't have as sophisticated tools for software development as we do for hardware, and we're not making rapid advances in the way of tools."

These technical concerns "are forcing manufacturers to take a harder look at product release procedures," notes Bond. In fact, some feel the System/38's problem was not the software. "The System/38's delay has more to do with IBM's aggressive announcement strategy than with technical issues," says Steven Gaal, director of software development for Data General Corp., Westboro, Mass.

"With a new architecture you have to be careful how you introduce it," agrees Andrew Knowles, marketing vice-president for Digital Equipment Corp., Maynard, Mass. Knowles points with pride to DEC's experience with its VAX 11/780 32-bit computer, which offered a new architecture and operating system [*Electronics*, Nov. 10, 1977, p. 36; July 6, 1978, p. 98]. He says the company announced the product in stages so that it could deliver the software it promised each time.

Companies will have to continue "to be conservative," Knowles says, because the more sophisticated computer users today understand the promises and expect a lot. □

matrox SBC-80 MULTIBUS

displays

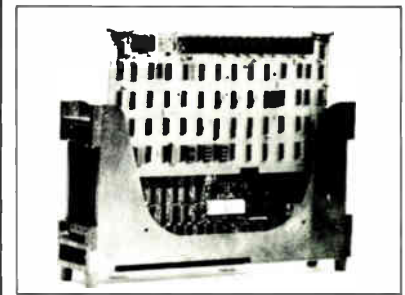
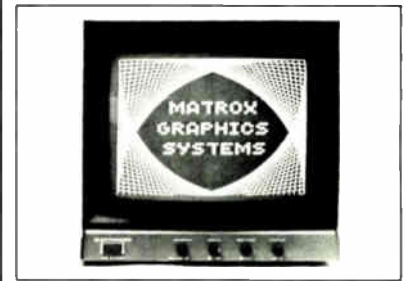

MATROX has the most complete line of CRT display boards for Intel's/NSC Multibus in the industry. We have alphanumeric; graphics; color; black and white; variable resolution; external/internal sync; 50/60 Hz; software and much, much more. Just plug the board in any Multibus chassis connect video to any standard TV monitor, and presto, you have added a complete display to your system at a surprisingly low cost.

MSBC-2480	24 lines x 80 character alphanumeric
MSBC-256	256 x 256 dot graphics
MSBC-512x256	512 x 256 graphics
MSBC-512	512 x 512 graphics
MSBC-1024	1024 x 256 graphics
MSBC-24/320	24 x 80 alpha; 320 x 240 graphics combined
RGB-256	256 x 256 x 4; 16 color or grey graphics

And we have other uP displays and display controllers. These include state of the art OEM alphanumeric LED displays, alphanumeric video RAM's and CRT graphics controllers. They come as complete, ready to use sub-systems (single chips, modules, PCB's). Many of them are plug-in compatible with other buses PDP-11/LSI-11, S-100, Exorciser, STD as well as custom design capability.

matrox electronic systems

The Visible Solutions Company

5800 ANDOVER AVENUE, T.M.R. MONTREAL, QUE H4T 1H4
TEL (514) 735-1182 TELEX 05-825651
U.S. ONLY, TRIMEX BUILDING, MOORE'S, N.Y. 12958

IEEE

Candidates offer choice of paths

Young wants U. S. Activities Board to work more in area of member-related matters, whereas Schneider favors public affairs

by Benjamin A. Mason, New York bureau manager

What may be the most significant IEEE presidential election in years is entering its crucial phase as ballots go out. Members of the Institute of Electrical and Electronics Engineers will be choosing between two candidates who see very different priorities for the organization.

There are, in fact, substantial areas of agreement between Burkhard H. Schneider, the candidate chosen by the institute's board of directors and currently IEEE executive vice president, and Leo Young, the petition candidate. Their chief areas of disagreement, however, go to the heart of the dispute about the

By petition. Leo Young, petition candidate for presidency, was a founder of the USAB. He is IEEE executive vice president and a staff consultant for the Naval Research Lab.

IEEE's direction. A decade ago some of the institute's members began to push for action on issues affecting individual EEs, such as employment and pensions, and on public-affairs issues that are technology-related or that affect the electronics industries. The rubric was professional affairs, and the mechanism was what is now known as the U. S. Activities Board.

Gathering momentum and funds, the USAB began to emphasize issues related to members, a tilt many of them disliked. But as the national mood has become more conservative the pendulum has swung to the public affairs side, with activist EEs seeking redress.

Fee splitting. Both Schneider and Young think there should be more USAB member-related activities, but Young wants more than Schneider does; he talks of funding them roughly 2:1. "Polls of the members always produce results favoring a 50:50 balance, but the more meaningful question is how much money to put into each category," he says. "When a not-too-scientific IEEE poll asked U. S. members how they would like their \$10 USAB fee [assessed only on U. S. members] spent, the results were \$6.50 for member-oriented activities, \$2.89 for public affairs, and \$0.61 for other activities." Young was an early USAB chairman, and he says funding then was a better reflection of the members' wishes.

Schneider talks of balance between the two types of USAB activities. "We need a program that addresses both types of issues as far as possible and satisfies most members," he says. "So we should concentrate on high-priority items—

that's another criticism heard of the USAB, that it's spread too thin."

Both candidates, who have impressively long records of IEEE participation, say the strong technical program must continue, that it is the lifeblood of the institute.

Career support. Members who oppose the USAB and the activist stance that it could bring to the IEEE have long argued that its activities detract from the technical activities. Schneider's statement comes close to embracing that position. Consider, in contrast, one of Young's campaign statements:

"Without first-rate publications

Board nominee. Selected to run by the directors, Burkhard H. Schneider has served on that board as well as the USAB. He is vice president for divisions at Detroit Edison.



THE COOL ONE DOES EVERYTHING THE 2147 RAM DOES BUT ON 1/5TH THE POWER!



OUR 6147 IS A SURE THING.

The Cool One is the industry standard HM6147LP. This high-speed static CMOS RAM offers total function compatibility with the standard 2147, 4K x 1, 18 pin RAM, but with one very important advantage... it operates on one-fifth the power. Just 75mW active and 10 μ W standby to be exact. It runs cooler to let your system run cooler.

You get direct TTL compatibility in all areas. Including input, output and operation on a single +5V power

supply. Cycle times equal access times—55ns/70ns maximum. Plus automatic power down and completely static operation.

The Cool One, the HM6147, is ready for immediate delivery in either plastic or ceramic package. If low-power consumption is one of your system needs... invest in a sure thing. Call us and start cutting your cooling and power supply costs today.

For further information call, (312) 593-7660

Hitachi. The sure thing.

Electronic Devices Sales and Service Division

707 W. Algonquin Road, Arlington Heights, IL 60005 (312) 593-7660 • TLX: 20-6825

Representatives:

AL, Tech. Mktg. Assoc., (205) 883-7893
CA, Irvine, Bestronics, (714) 979-9910
Culver City, Bestronics, (213) 870-9191
San Diego, Littlefield & Smith,
(714) 455-0055
Sunnyvale, Quadrep, (408) 733-7300
CO, Parker Webster Co., (303) 751-2600
FL, Orlando, TMA, (305) 857-3760
Pompano, TMA, (305) 942-0774
IA, PMA Corp., (319) 362-9177
IL, Sumer, (312) 991-8500

IN, ES&E, (317) 849-4260
KS, PMA Corp., (913) 381-0004
PMA Corp., (316) 684-4141
MA, TSI, (617) 862-1306
MD, Rob't., Elect. Sales, (301) 766-6374
MI, O-M Sales, (313) 973-9450
MN, Northport Eng., (612) 854-5556
MO, PMA Corp., (314) 569-1220
NJ, ABC Elect., (201) 568-2354
NY, S.F. Foster, (315) 637-5427
S.F. Foster, (716) 265-2072
ABC Elect., (516) 747-6610
ABC Elect., (914) 769-8808

OH, Bear Mktg., (216) 659-3131
PA, Campbell Assoc., (215) 322-6630
TX, Delta Comp., (214) 358-4288
Delta Comp., (713) 783-6848
UT, Parker Webster Co., (801) 487-5911
WI, Sumer, (414) 259-9060
Canada: Ontario, RFQ, Ltd., (416) 626-1445
Quebec, RFQ, Ltd., (514) 694-5724



HITACHI
Hitachi, Ltd. Tokyo, Japan

Stocking Distributors: Bell • Future • Jaco • Marshall • RM Electronics • Time

PRECISION MAGNETIC MEASUREMENT

by LDJ ELECTRONICS, INC.
WORLD LEADER IN MAGNETIC
MEASURING INSTRUMENTS

GAUSSMETERS



DIGITAL MODEL 511

- 3½ Digit display
- Range 10-100,000 Gauss
- High accuracy
- DC and AC measurement
- Peak Reading or Classifier options

ANALOG MODEL 101

- Versatile
- Range 100-30,000 Gauss
- Light weight
- Economical

DIGITAL-BATTERY OPERATED 101B

- Handheld - Portable
- 4 Ranges—100, 1K, 10K, 100K
- 3½ Digit LCD display
- 1% Accuracy w/Reference Magnet

FLUXMETERS



MODEL 702

- Digital display
- Broad range: 100° maxwell turns to 1.999 x 10⁸ maxwell turns
- High stability
- Scale factor for flux density
- Peak reading or classifier options

MODEL 710

- Zero drift
- 4½ digit display
- Completely digital
- Auto reset

ANALOG MODEL 601

- Versatile and economical
- Ranges of 30,000 to 10⁷ maxwell-turns
- Go No-Go option

**“WE SELL APPLICATIONS —
NOT JUST INSTRUMENTATION”**

OUR FULL RANGE MAGNETIC INSTRUMENTATION ALSO INCLUDES:
Permeameters; BH Meters - Thin Films, Tapes, etc.; Magnetizers;
Demagnetizers; Calibrators; Fixtures - Made to Order; Magnetic Standards;
Coercimeters



LDJ ELECTRONICS, INC.

Specialists in Magnetic Measuring Equipment

1064 Naughton • Troy, Michigan 48084

TEL. (313) 689-3623

TWX 810-232-1509 LDJ TRMI

Probing the news

and technical activities, the institute is nothing. But man does not live by bread alone, and engineers don't live by technology alone. The IEEE must provide more than technical sustenance: it must provide support for the career needs of its members.”

Of course Schneider is hardly abandoning the USAB. In fact, he is proposing a major new program, a computerized job and skills bank that would attempt to meld job-seeking EEs with suitable openings.

Job support. Another hot USAB issue is how far the institute should go in supporting members who run into age discrimination or are fired after they have compromised their employers' interests on grounds of conscience. Schneider believes that advice of a general nature should be available to members, but that IEEE activity should be confined to entering the case as an *amicus curiae*, or friend of the court, as it is now.

Young thinks that the IEEE should look into more direct action on job discrimination and should provide research assistance for members fighting ethics cases. Such policies could improve the institute's standing, he says. “It would show that our responsibilities go beyond designing the product. If we do this and do a good job, the IEEE will gain.”

The other principal area in which the two candidates disagree concerns the governing structure of the institute, and it reflects a split in the membership. The argument is whether the governing hierarchy is organized according to the membership's wishes or is meant to operate as a kind of self-chosen elite.

Vote for N&A. Crystallizing the issue is a constitutional amendment appearing on this fall's ballot, promoted by Robert Bruce of the Long Island section's professional activities committee. It would provide for membership election of the Nominations and Appointments Committee, which has a major say in choosing the top officials in the volunteer hierarchy. At present, its members are chosen by the board of directors.

Schneider firmly opposes direct election of the committee's members, whereas Young supports it. □

New Military Intelligence

Here's the G-2 for systems designers on all three of Intel's advanced military microprocessors.

It's no secret that Intel invented the microprocessor. Or that our 8080A was the first microprocessor to receive JAN approval. Today, Intel offers a broader range of military microprocessors than any other supplier.

M8080A, M8085A and M8048 are mil-spec versions of three proven, industry standard 8-bit microprocessors. They're part of Intel's plan to continue upgrading the world's highest performance LSI microcircuits to military standards.

Strength in numbers with JAN-approved 8080A

When you're designing with advanced LSI technology, there's strength in numbers—and experience. Our 8080A is a good example. It's the most widely used microprocessor ever. And best supported by hardware and software. No wonder its military equivalent was the first QPL Part I listed microprocessor (M38510/42001BQB). We've already delivered thousands to military users.

For even higher performance: M8085A

Our M8085A is the world's highest performing military 8-bit microprocessor. It gives you 50%

faster processing than the M8080A with 66% fewer components in a basic system. For a complete high performance 5V military microprocessor system, build with our M8155 256-byte RAM with I/O and timer, our M8212 8-bit I/O port and M2716 EPROM.

First military computer-on-a-chip: our M8048

For designers developing military controller solutions, Intel's new 8-bit M8048 microcomputer

is ideal. It gives you CPU, RAM, ROM and I/O ports all on a single chip. For prototyping, you can even use our user-programmable M8748 EPROM version of the M8048. A companion single-chip microcomputer, the M8035L, gives you M8048 performance using external memory.

Our military support strategy

We support our three military microprocessors with a full range of mil-spec RAMs, EPROMs, bipolar PROMs and peripherals. All are processed to full level B requirements of MIL-STD-883B, Method 5004 and quality conformance procedures of Method 5005. To ensure a smooth, cost-effective design, use our Intellect® Development System for both hardware and software development.

For more information on Intel's complete family of military microprocessor devices, contact your local Intel distributor or write Intel Corporation, 3065 Bowers Avenue, Santa Clara, CA 95051. Or call (408) 987-8080.



intel delivers.

Europe: Intel International, Brussels, Belgium. Japan: Intel Japan, Tokyo. United States and Canadian distributors: Arrow Electronics, Alliance, Almac/Strom, Component Specialties, Cramer, Hamilton/Avnet, Harvey, Industrial Components, Pioneer, Wyle/Elmar, Wyle/Liberty, L.A. Varah and Zenronics.

Intelligent electronics

Study foresees 10-year boom

A. D. Little report says market for all types of devices should reach \$40 billion by 1987

by James D. Brinton, Boston bureau manager

It is begging the question to say that electronic intelligence will change the face of business. The real problem lies in predicting how much and in what areas. Executives need some idea of what sort of change to expect, and that's where Arthur D. Little Inc. comes in.

The Cambridge, Mass., firm has spent two years and \$1.5 million on a study entitled "Strategic Impact of Intelligent Electronics in the United States and Europe—1977 to 1987."

In broad outline, the nine-volume report predicts growth and a lot of it, projecting a market for intelligent electronic devices of all types—but largely excluding traditional data-processing hardware—exceeding \$40 billion by 1987 in 1978 dollars.

But ADL adds that the input/output problem will decide the future of many markets. Sensors, actuators, and peripheral devices already account for most of the cost of intelligent electronic products, it is said,

and the pace at which these ancillary components develop is going to be critical to the rate of acceptance of electronic intelligence in certain markets.

The study divides the intelligent electronics market into four major sectors—automotive, business/communications, consumer, and industrial. It breaks each of these into subareas and plots forcing factors or constraints peculiar to each, attempts to chart each area's market

General Purpose Relays

No one delivers
like P&B

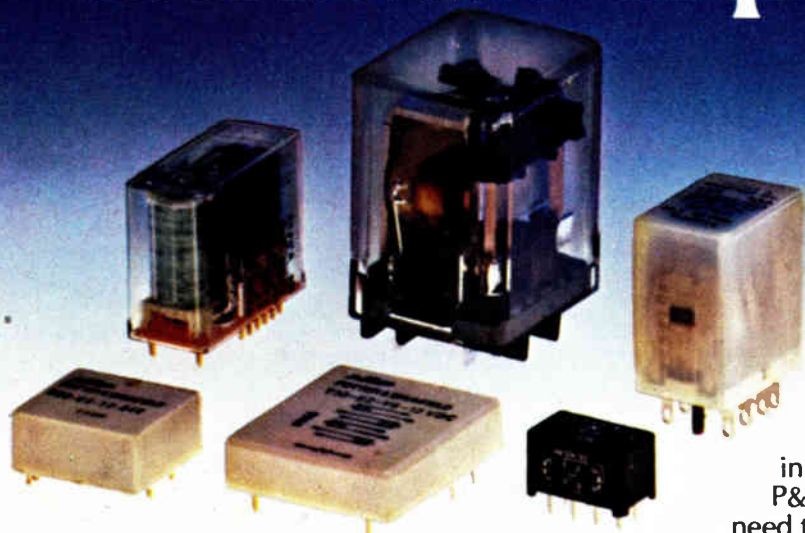

P&B is the largest manufacturer of general purpose relays in North America. We have the broadest line and the greatest number of design options in standard models or specials. With 45 years experience, we pioneered relays that are now industry standards...like our KH and PR series. We also have seven plants and the broadest distributor network in the business. This means you can rely on P&B to deliver the relays you need when you need them.

Potter & Brumfield Division AMF Incorporated, 200
Richland Creek Dr., Princeton, IN 47671. 812/386-1000.

Potter & Brumfield

life cycle, and finally illustrates the differences in each market when viewed from a U.S. or European perspective.

Automotive. According to the study, the automotive market in the U.S. and Western Europe will exceed \$7 billion (uninflated) in 1987 and will probably still be growing. Immediate forcing factors include Federal fuel-economy and pollution regulations in the U.S.; these are already affecting design and will continue to do so during the 1980s. Similar regulation only affects European exports today, but will become effective in domestic markets by the mid-1980s. Thus, although the European automotive electronics market will lag behind that of the U.S. by a few years, it still could be a third to one half its size by 1987. ADL translates this estimate into overall growth factors of 20 to 40 in the next nine years—with the rates that high because some markets are starting from almost nothing. However, some markets may grow only 10% to 30% in that time.

How the consumer market shapes up

No electronics market is more volatile than the consumer sector, and Arthur D. Little study says that intelligent electronics will be no exception. The study divides the sector into the home entertainment and education center, the telephone and other communication systems, and games.

The first area's common denominator is the interactive video console—and whether it is a computer or a terminal is unimportant, according to ADL, as both will eventually tie into communications systems, perhaps providing access to remote processors or data bases. ADL foresees more than 20 million interactive consoles in homes by 1987.

Near-term telephone and communications system applications would include extensions of existing services. Beyond that point, entrepreneurial imagination will rule with such advances as electronic mail, teletext, electronic shopping, and interactive television systems reaching into 15 times as many households in 1987 as in 1977. The toy and game market will expand by 600% to 700% in the next nine years.

Business/communications. There already are markets and products in this area almost beyond counting, and by 1987 electronic intelligence will have penetrated most of them and added new ones until it will account for more than \$13 billion in sales in 1978 dollars.

The U.S. leads Europe in this sector, too, with obvious driving

forces like the need for more effective use of management time, for faster transmission of information from collector to user, and especially in America, for increased productivity.

According to the study team, the “integrated office” could be available off-the-shelf by the mid-1980s and would feature multimedia com-

...and other solutions to your tough design problems are found in P&B's growing product line.



Low-cost S87R Industrial Relay. UL recognized. Contacts rated to 20 amps, 277V AC, 50,000 operations at rated load. Contact forms to DPDT. Ideal for vending machines, HVAC, home appliances and machine tool controls.

Circle 95



EOM Opto-coupled Solid State Relays. Long life interface between the logic output of TTL, HTL, or MOS circuitry and AC loads to 20 amps. Medium power, 120/240V. AC 50/60Hz. Zero voltage turn-on. Zero current turn-off.

Circle 146

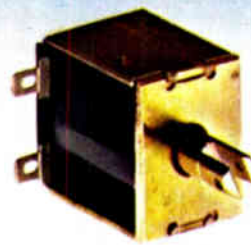

NEW S28 Box-Frame Solenoid. New compact, general purpose solenoid has enclosed coil for extra protection. Pull-on operate 6, 12, 24, 120 and 240V AC; and 6, 12, 24, 110 and 220V DC coils. Approximate coil power is 5.5 watts or 8 VA at continuous duty and 11.5 watts or 16.5 VA at 25% duty. UL recognized materials.

Circle 147



NEW Industrial Screw Terminal Sockets. UL recognized. Molded of rugged glass filled polyester with a compact unibody structure. Spring-action pin retainers assure positive electrical contact. Formed bus connections within socket for maximum trouble-free life. Can be used in track mounting systems.

Circle 148

AMF
Potter & Brumfield

Probing the news

munications, as well as the descendants of available products like word-processing systems, facsimile and copying systems, electronic telephones and private business exchanges, private communications systems, micrographics equipment, and calculators. The heavy rate of new-product introductions of the late

1960s and 1970s should continue through the next decade.

On the whole, the view is bright. Even taking declining submarkets into account, the 1987 market for intelligent business systems of all types will be 140% to 250% in constant dollars over that of 1977.

Consumer. "More than 400 million intelligent-electronic modules will be sold in the consumer market in 1987. At an estimated average

selling price of \$50, this implies a potential market (in constant dollars) of more than \$20 billion," says the study, for a decade's growth of more than 1,000%.

The consumer market will be in ferment throughout the 1980s, the report predicts. Markets will appear and disappear quickly, making it, then as now, a field for the adroit and well-capitalized. But the ADL team sees the consumer market as a fertile field for small companies with new ideas because it will not be controlled by large computer and common-carrier firms as the business/communications market will continue to be (see "How the consumer market shapes up," p. 95).

Overall, consumer consumption of microprocessors in the coming decade will increase almost in proportion to the market as a whole, nearing 1,000% in 1987 compared with sales of a decade earlier.

Industrial. "Industrial products using intelligent electronics will have a market value of more than \$10 billion by 1987," according to the study. ADL has broken the industrial sector into process control, automated manufacturing, analytical instruments, automated test equipment, and building automation systems. Of these, process control is the most mature.

Automated manufacturing will be a less apparent market for electronic intelligence. The ADL team feels that machine intelligence as such will mean less to users than the features and cost reductions it makes possible. These will enlarge markets for numerical control systems, robots, and materials-handling systems. Competition in this market, says the report, will be hard-nosed, based on the number of functions per dollar, because of the capital-intensive nature of automation.

Because of the outlays involved in automating production, infant markets in computer-aided design and production-equipment diagnostics will also grow.

The very size of the electronic intelligence market, regardless of market category, and the consequent need to test, maintain, and repair products will trigger a fivefold growth in automated test gear sales by 1987, according to the study. □

Tall, handsome and Optima.



With open frame installation of electronics for faster cabling and checkout, our new Vertical Cabinets could well be the most economical you've ever used. With the long list of options, everything from sliding drawers and retractable writing surfaces to louvered doors and air moving devices, certainly they're the most flexible. Get our catalog for the tall story.

We make you look better

OPTIMA[®]
Scientific-Atlanta

2166 Mountain Industrial Blvd., Tucker, Ga. • Tel: (404) 939-6340
Europe: McKeltrick-Agnew, Macmerry, East Lothian, Scotland, EH33 1EX • Telex: 72623

Sweden for high-technology electronics



Hadar Cars
Swedish Secretary of Commerce

Sweden's high-technology electronics are well known for quality and reliability.

And Swedish manufacturers of innovative cost-cutting electronic systems and advanced electronic instruments and equipment are rapidly filling the demands of worldwide markets.

The business of electronics is a prime example of the importance of two-way international hardware and software trading.

There are more than 500 Swedish companies engaged in high-technology electronics and related fields. We are delighted to welcome you to the following pages describing the know-how and capabilities of some of these Swedish companies.

We don't wait for the technics of tomorrow.

SATT ELEKTRONIK is a Swedish company which develops and manufactures advanced systems in electronics and electric techniques.

We build the systems today.

We want to solve your electronic engineering problems. We work in 4 special areas.

- Remote Control for example lighthouses or power stations.
- Telecommunication, e.g. Special Telephones or Portable Studio Mixer.
- Military electronics, e.g. radar warning systems.
- Industrial electronics, e.g. Micro-, Mini-computers and programable controllers (PC Systems) for among other, process and material handling.

Our name is

SATT Elektronik AB.

SV 30 is a proof

SATT ELEKTRONIK's welding timer, SV-30, is a highly developed and advanced microcomputer based system for resistance welding. This system has been developed in cooperating with the Swedish Volvo Company.

The SV-30 system produced a super quality weld and a 100% control of the high power current. It is a complete system with one or more units which can store up to 30x16 programs.

The SV-30 can be equipped with an electric guard that can supervise the main supply net, - temperature, insulation, etc.

We can help you, too.

- A varier of, installations around the world to choose from
- standard and custom made units
- know-how on process and control system

Contact us - we can solve your problem

SATT
Elektronik

SATT Elektronik AB

Telephone-international - 46 8 81 01 00
P.O. Box 32 006
S-126 11 Stockholm, Sweden
Telex: 10884. Cable: SATTEL S

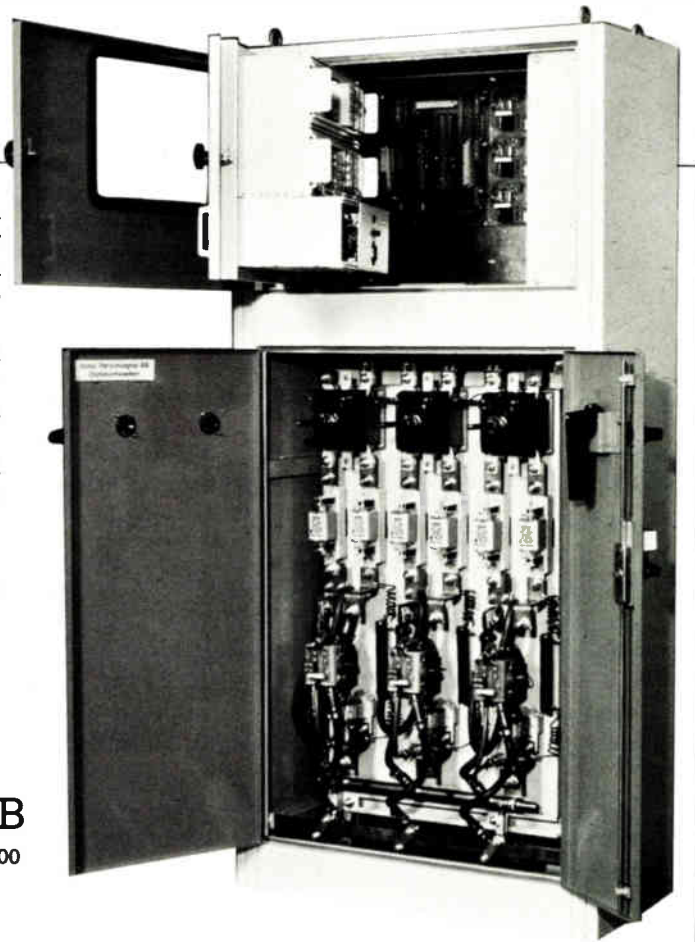

ATEW has many ideas for computer and control systems

As a young company that is still growing, ATEW is full of ideas. In fact, it can develop electronic ideas from frame specifications or block diagrams to a finished prototype geared for rational production. At its new premises outside Flen, the company makes control equipment and alarm systems for industrial and

marine applications, products based on microcomputer technology, and medical X-ray equipment.

ATEW's new microcontroller, the μC , is just one example of many. Based on analog control techniques, it is simple to use and, being programmable, is highly adaptable to a variety of control tasks.

Bejting transfers technology, focuses on information retrieval

Now one of the oldest electronics firms in Stockholm, M. Bejting AB has been doing consulting and developing work since 1946. As a specialist in the Swedish PTT/Datavision system, it also provides terminals for information retrieval systems. Products aimed at foreign markets include special-purpose transformers,

light dimmers, optoelectrical and microcomputer-based equipment, and medical and military electronics.

A promising upcoming product is a pocket-sized pen-controlled TV-Computer. It will convert a TV set equipped with a Viewdata module into an information supply terminal at a cost of only tens

Eloptricon looks ahead in optics and semiconductors

For a rather small company, Eloptricon AB covers a rather large product area, including the development, construction, and manufacture of instruments and apparatus within the areas of electronics, optics, and fine mechanics. In addition, Eloptricon manufactures and programs microcomputers.

The electronics division develops and manufactures both analog and digital circuits and has experience with TTL, C-MOS, and CCD techniques. Eloptricon's personnel keep abreast of the newest innovations in the fast-moving field of electronics.

The optics division develops, con-

Facit Data Products zeroes in on minicomputer peripherals

Though typewriters and calculators first made Facit famous, many of its star performers today are products of the data age. Facit Data Products is an independent division within the Swedish Facit Group. The division's 1978 turnover was over \$50 million, while the group's was about \$300 million.

The division produces and markets peripheral data products and has been especially successful with minicomputer peripherals. The Facit 4540 serial matrix printer has a completely new print head, in which print hammers are mounted on flexible arms held back by electromagnets. For each impact the current is shut

off, allowing the hammer to snap forward. The small, tight head is guaranteed to produce 500 million clear characters. With hammer travel minimized, no adjustments or lubrication are required and there is virtually no wear. The Facit 4570 tape punch is known to have set the standard for the industry.

of U.S. dollars. The unique design is patented worldwide.

On offer for the past few years has been a custom integrated-circuit service that includes everything from finding the external components needed to complete an IC as a module to investigating the patent situation and filing patent applications.

As a result, Bejting is also marketing as a turnkey "commodity" the know-how it has gained in the use of computers for market surveys and patent investigations, according to president Lars Wern.

structs, and mounts complete optical instruments. Moreover, the last few years have seen a closer cooperation between the optical and electronics industries, and Eloptricon has developed a number of components that combine electronic and optical techniques.

As a considerable number of the electronic instruments of the 1980s contain one or more microcomputers, Eloptricon's computer section can offer customers electronic constructions along these lines for the optimal solution to many problems.

Facit is the only peripheral manufacturer in Sweden, one of the few in Europe, and has 50% of the U.S. market for one of its key products. It has sales and service companies in 16 countries, including the U.S., Canada, and Japan.

INOR has won a name for transmitters and alarm systems

Founded in 1940, INOR AB has won a strong reputation in the European market as a supplier of high-quality transmitters and alarm systems. It now supplies products to nearly all of the large electronics industries in Europe. All INOR products will be exhibited at the October, 1979, ISA Fair in Chicago by INOR's U. S. sales

organization ADEFECO (c/o Noral Inc., 23600 Mercantile Road, Beachwood Commerce Park, Cleveland, Ohio).

A recent introduction from INOR is a two-wire temperature transmitter that mounts directly on the connection heads of temperature bulbs. It is designed to accept inputs from resistance tempera-

ture detectors (RTDs) and thermocouples. In the first case, it is compensated for the nonlinear response of the RTD platinum 100-ohm resistance, and in the second it is provided with integral cold junction compensation from 32° to 212° F with very low drift. The unit can work with guaranteed specifications in the ambient temperature range of -4° to +212° F. For operation in hazardous areas, the transmitter is available in an intrinsically safe version tested according to Factory Mutual and Underwriters Laboratories specifications.

LM Ericsson Telemateriel makes components for advanced technology

The name LM Ericsson needs no introduction. But the LM Ericsson Group is of course only as good as the sum of its "components," one of which is LME Telemateriel.

The company makes a great variety of electronic components, ranging from rocker switches and pulse counters to

terminal banks and multipole, multiway, and multipoint connectors.

Among its products is the 19-inch distribution rack NBF 110 03, a quick, easy, and flexible means of housing a telesignaling network in an IDF room or cable duct. A high-technology product is a dry-reed relay that is monostable and

designed for mounting on printed-circuit boards equipped with injection-molded plastic forms for dry-reed contact.

LME Telemateriel also makes sophisticated rotary stepping selectors, including the RVF type 30-step selector with two, four, or six contact banks. In each of these, two adjacent contacts are closed on every step by a rotating set of wipers driven by a stepping mechanism.

Also available is a series of modular components designed for mounting on printed-board assemblies, in holders, and on panels.



Swedish Sunrise

- the new dynamic marketing organization for a group of Swedish electronic companies
- stands for the most modern electronic components and systems of high technology and quality

Examples of products:

- EASYMESSAGE — the new outstanding computer terminal for stationary or mobile use
- DC-DC converters, power supply
- SODAR — acoustic radar, a new tool for atmospheric monitoring
- Raingauge
- PDS — position determination system
- TRANSREX — system for control of transport and production

Contact us

Headoffice: Swedish Sunrise AB, Svartmangatan 27, S-111 29 STOCKHOLM, Sweden. Phone: (08)238770.

Aff: Swedish Sunrise Inc, 10880 Wilshire Blvd, Suite 914, Los Angeles, California 90024, USA. Phone: (213)475-4501.

NDC Netzler and Dahlgren produce watchdogs for industry

Founded in 1962 by Göran Netzler, NDC Co. AB makes sophisticated electronics for the marine and industrial sectors. NDC has three divisions: R&D, Test and Quality, and Production. There are also three product groups: monitoring systems for industrial and naval applications; carrier systems; and OEM products.

Like many other electronics firms in Sweden, NDC uses subcontractors for production, so as to concentrate on development and quality control and on only small production runs. Its activities are paying off—its turnover last year was over 7.5 million Skr.

When it comes to moving things, NDC

is right up front with a comprehensive range of induction-steered automatic carriers with electronics from its new Mobicon program. For its carrier systems NDC cooperates with Tellus Machinery Corp., which has outlets in the U. S. and many other countries.

But one of NDC's fastest-growing markets is for its industrial "watchdogs." NDC has taken its highly developed monitoring systems for ships and adapted them to a host of industrial uses. These alarm systems are all low-priced and easy to install and maintain.

Ossi Carlson specializes in custom connectors

Ossi Carlson AB began making high-quality, mostly custom-designed connectors for the electronics industry in 1974. Since the firm is small (it was bought last year by Eldon AB), production is flexible. And Carlson does the whole job—designing the connector, making the molds for plastic injection, molding the parts, and

turning them out on its own machines.

One of Carlson's latest products is the super connector that is going into Data-saab's new computer terminal S. 41. Since this connector had to be well shielded against electromagnetic interference and easy to use both in the field and in production, two and six poles

were required. The cable connector of six poles has four contacts for wire wrap and two for crimp.

One internal connector was also made for the Datasaab project: a stackable printed-circuit power connector designed for a seven-pole ribbon cable and for a feed-through pin-socket contact that is installed with a press technique.

With Carlson, the time from idea to product is short. This year the company expects a turnover of over 3 million Skr., and the picture for next year looks even brighter.

High quality — high technology components: you have our word on it 4,000,000 times a week.

RIFA is Scandinavia's largest manufacturer of electronic components. Our sales exceed \$50 million a year. We have nine manufacturing facilities capable of producing over 4,000,000 components a week. High quality capacitors for every conceivable application and custom designed ICs — a RIFA specialty.

Advanced technology in the design of capacitors has made us a world leader in the area of RFI interference suppression capacitors, pulse application capacitors, and precision capacitors.

Our large monolithic-hybrid facility is equipped with extensive research laboratories, and our design teams are assisted by an advanced computer aided design system.

The hybrid manufacturing plant, which is among the largest and best equipped in Europe, includes facilities for laser trimming, automatic printing, component mounting, and wire bonding.

By investing in automated production and a quality control system continually monitored by on line computers we are able to offer you high quality components at reasonable prices.

For assistance in the U.S.A., contact our well stocked distributor:



RIFA Division, 19678 8th St. East, Sonoma, CA 95476.

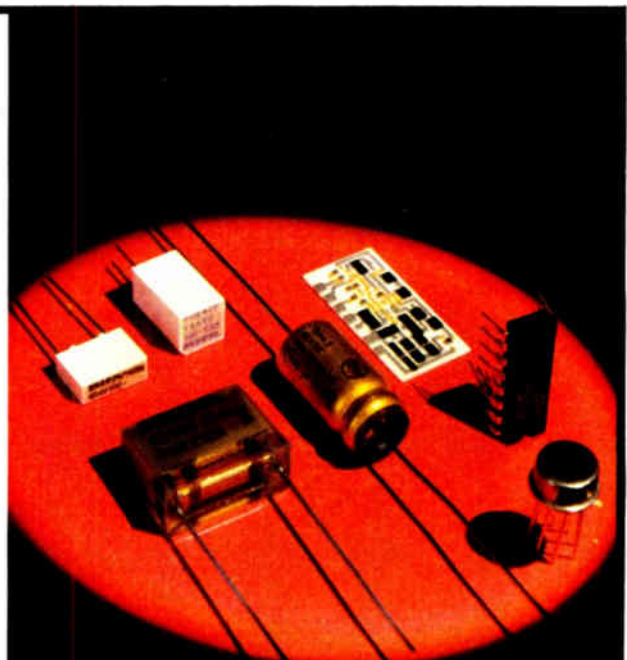

RIFA

Powerbox is a powerhouse of innovation

Powerbox AB began in 1974 by importing and reselling power supplies. But that picture soon changed. Karl Fredmark, founder of the company, hit on a new idea—building power boxes incorporating some unique design features to hold electronic gear. The idea caught on. Powerbox now makes 50 standard

cases, "but we can also very easily build cases of any size," says Fredmark.

Known as the Flexibox line, the company's instrument cases are attractive to look at as well as rugged, easy to use and service, and, as the name implies, extremely flexible. All have guide channels for printed-circuit cards or

mounting plates; grooves for cover plates; grooves for skinplate, plexiglass, or other material; drawn holes for mounting screws; grooves for mounting extra panels, for cover plates for transistors, and for tapped strip.

Just last year the company introduced its new Powerbox 3000, a power supply designed for microcomputers and similar equipment. Five-hundred units have already been sold in Sweden for only \$400 each. It's no wonder that Powerbox had a turnover last year of over \$1 million.

RIFA supplies the world with components

AB RIFA, founded in 1943, is now the largest manufacturer of electronic components in Scandinavia. An independent subsidiary of LM Ericsson, it develops and manufactures integrated circuits and passive components. While its main IC focus is custom monolithic and hybrid devices, RIFA also manufactures a range of stan-

dard monolithic circuits, including ICs for electronic telephones. Most of its passive components are capacitors, which will account for two thirds of the company's 250 million Skr. turnover this year.

As the prime supplier of high-quality components to one of the largest telecommunication companies in the world,

RIFA has very high standards of reliability.

At Wescon 79, RIFA will exhibit aluminum electrolytic, polystyrene, metalized polypropylene, metalized paper, and motor capacitors. It will also be displaying semicustom circuits for the electronic telephone, including monolithic DTMF generators for push-button models.

RIFA's metalized paper capacitors are especially interesting in that they are vacuum-impregnated with epoxy and have three unique features—excellent self-healing properties, ionization durability, and pulse durability (2,000 V/μs).

Everybody's talking about AXE components

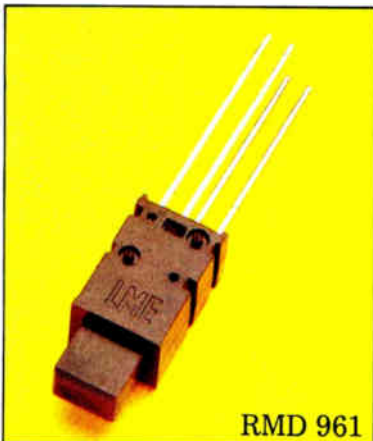

RMD 961

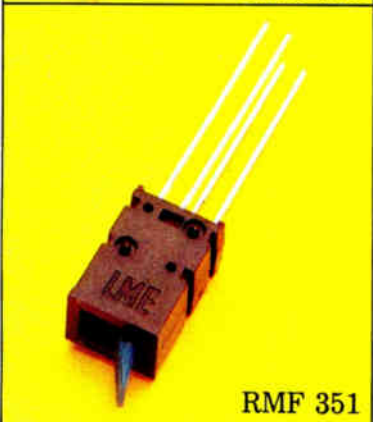

RMF 351

Because the AXE components are so versatile. They are of uniform design, based on a modular system where $M = .1$ ". Dimensions: $.3 \times .4 \times .6$ ". These components are intended for front assembly on PCB but can also be assembled vertically. They are manufactured of dark-coloured thermoplastic.

New proximity switches
Type RMD 961 push button switch and type RMF 351 toggle switch with Hall element for 5–12 V nominal voltage and a transistor outlet with an open collector.

New type of trimming potentiometer
A multi-turn trimming potentiometer, REL 279, provided with a plastic collar as a protection against accidentally moving the trimming screw. Resistance values from 100 ohms to 1 Mohm in E3 standard series.

LM ERICSSON *Ericsson*
TELEMATERIEL AB

Components Department
Box 401, S-135 24 TYRESÖ, Sweden
Telex: 10920 LMSBO S

Please contact: World Products Inc.
19678 Eighth St. East, Sonoma, Ca. 95476

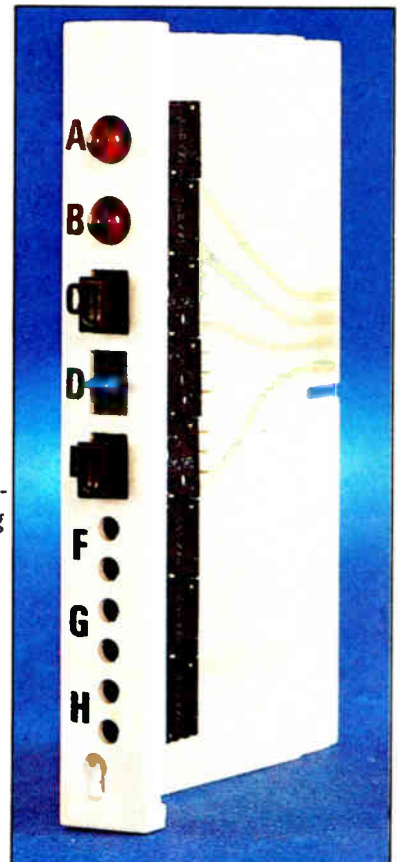

ATEW CASSETTE INTERFACE

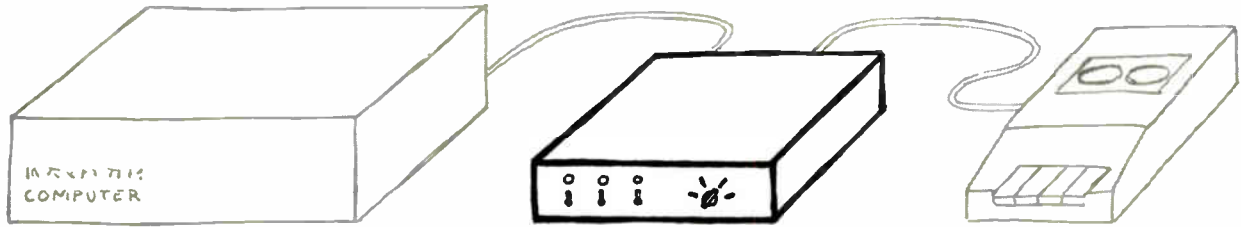

ANY CASSETTE RECORDER CAN BE USED FOR PROGRAM AND DATA STORAGE

ATEW'S CASSETTE INTERFACE PROVIDES THE MOST RELIABLE RECORDINGS EVER

- KANSAS CITY STANDARD RECORDING FORMAT 300 BAUD
- ADDITIONAL BAUD RATES 600, 1 200 AND 2 400
- FREQUENCY VARIATION TOLERANCE $\pm 30\%$
- INPUT VOLTAGE RANGE 150 mV TO 10 V

ATEW'S CASSETTE INTERFACE WILL READ CORRECTLY ALSO FROM VERY BAD RECORDINGS

- COMPUTER CONNECTION RS 232
- 1 OR 2 STOP BITS SELECTABLE
- DOUBLE BAUD RATE TO COMPUTER SELECTABLE

AB **ATEW**

P.O. BOX 125

642 00 FLEN

SWEDEN

Circle 103 on reader service card

Optocator™ The Swedish optoelectronic system that simplifies high-precision non-contact measurement.

Optocator produces precision measurement data—for position, dimensions, contour, vibration, thickness, etc.—on almost any material regardless of its texture, temperature, or color. It can measure extruded parts and moving webs, gauge formed or machined parts, and add visual capabilities to robots.

Unlike other non-contact systems, OPTOCATOR does not have to be close to the surface being measured. It has no mirrors, prisms, video imaging devices, or isotope radiation sources. And it is ruggedly built, for demanding environments.

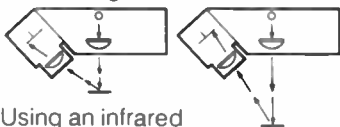

Using an infrared light source—LED or a laser diode—OPTOCATOR projects a spot of light on the surface to be measured and its detector "sees" an

™ Trademark of Selective Electronic, Inc



image of the spot in the same manner that an image would be focused in the human eye.

The detector is a new photosensitive device which responds to the location of the center of the light image and generates output signals which are converted into precise position information.

Available as a complete system with one or more non-contact gauging probes, or use the probes alone.



Selective Electronic Inc.
P.O. Box 100, Valdese, N.C. 28690 U.S.A.
Telephone (704) 874-2289
Telex 510-936-5403

Selcom
Selective Electronic Co AB
Box 250 S-433 01 Partille 1, Sweden
Telephone 031-447440, Telex 27304

Selcom Messsysteme GmbH
Postfach 977, Sandersbeek 21
3400 GÖTTINGEN, West Germany
Telephone 0551/79 40 66, Telex 96792

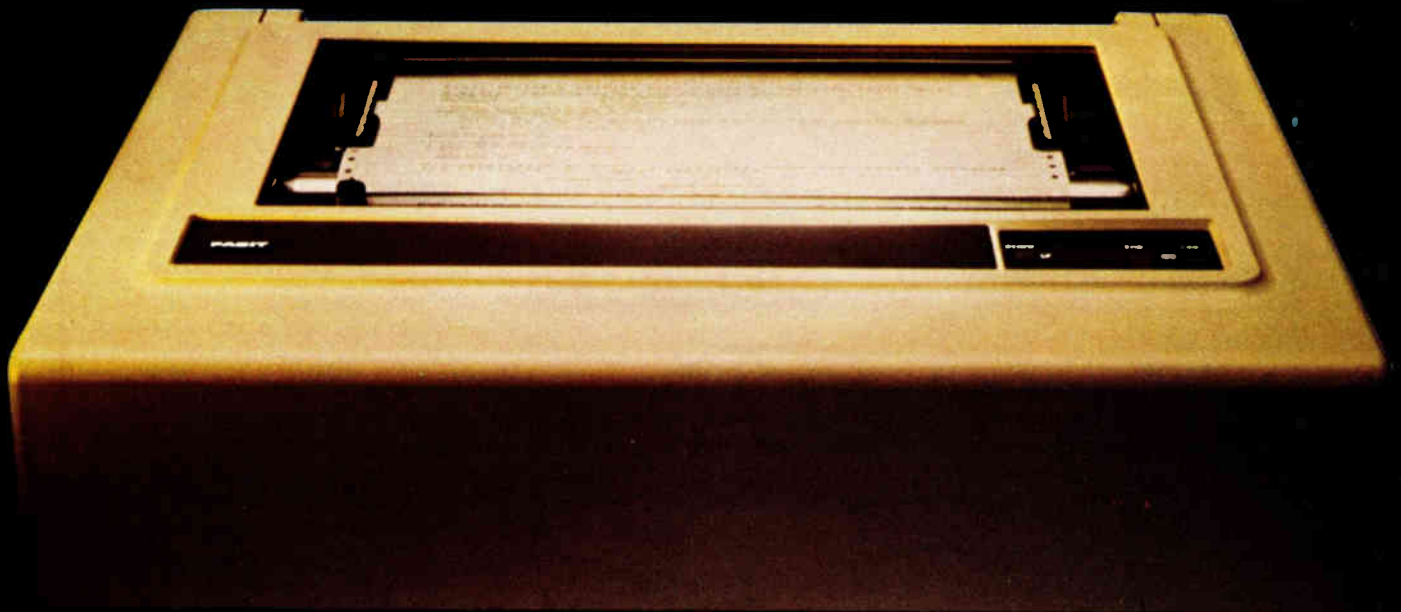

THE FACIT 4540 PRINTER REALLY USES ITS HEAD.

The printhead on the Facit 4540 Serial Matrix Printer is so advanced, it practically thinks for itself.

A new concept of printhead design uses 9 stored force flexible hammers to print a 9 x 9 dot matrix pattern bi-directionally at 250 cps.

The printhead movements have been reduced to a minimum. The printing principle assures extraordinarily long printhead life. With no adjustment, no lubrication and practically no wear. In fact, outstanding sharp and consistent printing results are guaranteed for more than a minimum of 500 million characters before any service might be required on the printhead.

The Facit 4540 is a prime example of the integration of mechanics and electronics which has made Facit peripheral data products world famous.



Our revolutionary printhead makes Facit 4540 a matrix printer with line printer speed.

Write for more detailed information on how the 4540 Printer can get the most out of your system.

Facit, Inc., 66 Field Point Road,
Greenwich, CT 06830



FACIT
DATA
PRODUCTS

SATT Elektronik has seen half a century of growth

SATT Elektronik AB had a modest beginning back in 1921 as a sales company for AEG-Telefunken Products. Today it is one of the major electronics firms in Europe, with an expected turnover this year of about \$31 million.

SATT produces sophisticated telecommunications, defense, and industrial

equipment, remote control and test systems, and also components.

Its telecommunications and industrial sectors are expanding rapidly. It designs and produces a wide range of advanced systems for telephony and telegraphy, video engineering, and teletransmission, including 3-to-10-kW fm transmitters for

the 87.5-to-108-MHz frequency range, cable video amplifier systems, and monitoring centers and substations for television and broadcasting. Its industrial electronics branch produces computerized remote control and monitoring systems, among other equipment.

Every year the company invests heavily in R&D, generating such products as the Programmable Binary Control System (PBS), for handling materials in production lines, and the SAM 82, perhaps the world's most compact and portable professional sound mixer.

Selcom measures up in optoelectronics

Selcom (Selective Electronic Co. AB) is a relative newcomer in the electronics business. The company was founded in 1970 for the purpose of producing and marketing a single-channel electrocardiographic telemetry system—the Selcom Pace Control.

As the name implies, Selcom is selec-

tive in what it makes. Today it produces a few highly sophisticated and innovative products, such as the Selspot, an optoelectronic movement-monitoring system.

Work began on the Selspot in 1973, and by 1975 the first production run of the successful digital version was started. Developed with assistance from the

Swedish Board for Technical Development and the Department of Applied Electronics at Chalmers, the Selspot is based on a highly linear position-sensitive photodetector that is now patented in a number of industrialized countries around the world.

Selcom's latest development is the revolutionary Optocator, a high-technology device using light pulses for noncontact measurement of dimensions. Both products are being marketed through Selcom's own subsidiaries in the U.S. and West Germany.

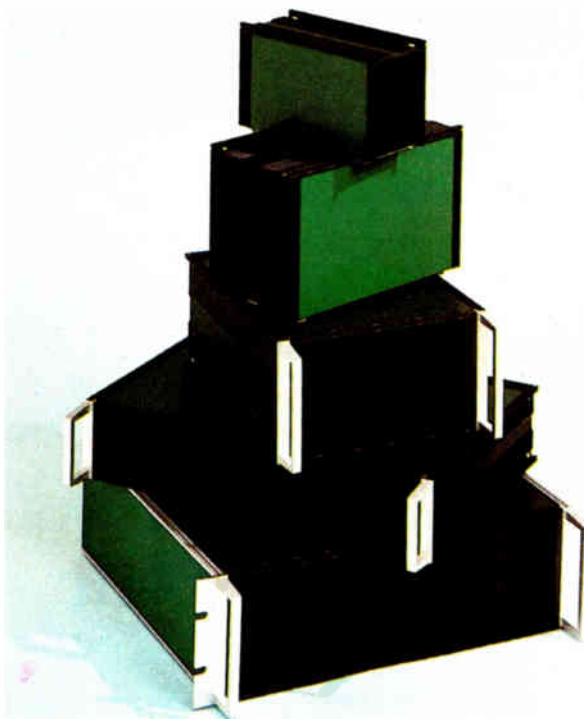

Flexibox® is a modular instrument case system, developed for applications where you don't expect thousands and thousands of units to be sold, but a few units, up to a couple of hundreds.

The case consist of black anodized extruded aluminium-profiles, with top- and bottom-cover plates of skin-plate, (PVC-coated aluminium).

In our standard range you can find instrument-cases especially designed for small power supplies, our MINI range, micro and mini computer-applications our MIDI-box. The MAXI-box is ideal for inverters, amplifiers, DC/DC-converters, CB-radios and other tough products, where maximum heatradiation must be achieved. The MULTI-box is mainly developed for stereo-amplifiers and audioequipment.

Flexibox is delivered in a kit form. All parts: profiles, cover-plates, handles, cover-angles or rack-angles plus screws and rubber-feet are packed in a suitable container.

Write or call us for our 16 page catalogue, you will be surprised at the low price and the flexibility.

powerbox

Box 159, S-150 10 Gnesta, Sweden.
Phone: 0158/119 20, Telex: 11502.

SRA Communications tells where the action is—in color and real time

Founded in 1919, SRA AB began by making marine radio transmitters but soon entered the domestic radio market as well. Now the largest Swedish company in radio communications and part of the LM Ericsson Group, it makes an impressive variety of communication devices—mobile radios, marine and mili-

tary radios, personal paging systems, radio links, and traffic control systems.

In addition, SRA supplies the Swedish air force with electronic displays for its fighter aircraft and has also supplied sophisticated communications gear for international satellite projects.

As a spinoff from its military activities,

SRA has launched a line of graphic color terminals. The latest of these, developed just last year, is the Semigraf 240. It gives its operator a true 50-Hz, flicker-free picture of exactly what is happening where. It consists of an interactive (if need be) color TV display, a keyboard, and a control unit—a microprocessor with memory—that is connected to a real-time computer capable of storing 300 to 400 pictures.

SRA's turnover in 1978 was 448 million Skr. It and its subsidiaries export about a third of their total production.

Swedish Sunrise coordinates the designers with the markets

Like so many of its electronic products, Swedish Sunrise is also a new idea. Formed last year by Krister Karlström, the group already consists of three electronics companies. By the end of this year it will include 5 and at the end of 1980, 10 different companies. But Swedish Sunrise is not a holding company—rather, it is

wholly owned by the group and functions as a "common marketing" company for the members.

All the companies are inventors and designers specializing in different fields. All of the actual production work is carried out by subcontractors, and all the products are marketed under one organ-

izational umbrella by Swedish Sunrise.

Present members of the group include Karlström's own company, Teknisk Assistent AB in Södertälje, which specializes in microcomputer designs, both hardware and software. Polyamp AB, the second member, makes dc-dc converters and power supplies (small to large), while Sensitron AB concentrates on sonar radar and meteorological equipment. Sensitron's Sodar (acoustic radar) system is a new tool for atmospheric monitoring. The group has a turnover of about \$2,000,000 last year.



**teleCOURIER
system 800**

THE TOTAL PAGING CONCEPT

TATECO AB
THE INCENTIVE GROUP

Box 8783

**S-402 76 GÖTEBORG 8
SWEDEN**

Data Input – Voltage Output

The key to the Xelex Power Supply unit is in reality – data input – voltage output. For example the XL 157 and XL 175 have voltage output ranges of
 $\pm 256 \text{ V} \pm 0,5 \text{ A}$ and
 $\pm 51,2 \text{ V} \pm 3 \text{ A}$ respectively.

All are conservatively rated and extremely easy to maintain. Most importantly, XL Power Supply Units are clearly

micro second speed units – demonstrably faster than other switching units from known manufacturers the world over. Test the XL in your own operations. See how it will substantially cut your testing costs. Another electronic product from Sweden's leading manufacturer of High Power Amplifiers.

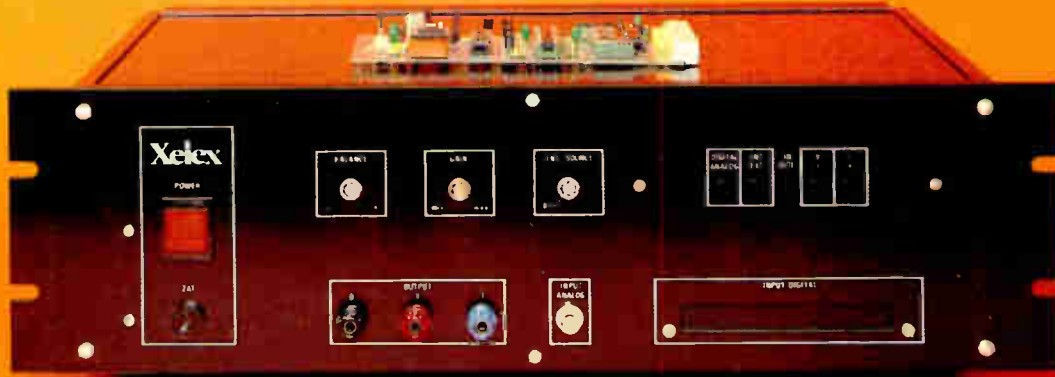

Xelex

AB S-124 44 Bandhagen, Sweden Tel. 08/86 00 50

Circle 107 on reader service card

Cable crimp connectors

Stackable power connector

PC direct solder in

CUSTOM DESIGN CONNECTORS

OSSI CARLSON AB design and produce connectors for special needs, also in small series. Many solutions are available to-day.

OSSI CARLSON AB

Box 201 S-571 00 NÄSSJÖ SWEDEN

A member of the ELDON group.

Tateco leaves nothing to chance in paging and building management

Tateco AB, part of the Incentive group of companies, has been in the paging business for over 20 years and is known as an innovator in the field of building automation and security. Its latest development in the paging field, called teleCOURIER System 800, makes use of several human senses—hearing, sight and even

feeling—to get the message across.

In a hospital, an industrial complex, or a small company, the operator at the System 800's paging keyboard sends a message that is immediately picked up by the elegantly designed pocket transceiver both acoustically (voice or bleep) and visually (light signal). In addition,

Tateco is the first company in the world to offer a digital display for foolproof identification of the message. For especially noisy environments, there is a vibrating transceiver.

TeleCOURIER 800 allows for 20 simultaneous pagings, simultaneous speaking and bleeping with no interference, and many options, including one- or two-way speech. It can be connected with the company's Digilarm personal alarm system and teleCONTAL building management system to produce a single unified control system.

Xelex pushes ahead with sophisticated converters

Xelex AB is a very high-technology company with an advanced engineering department. The man behind it is Bengt Olsson, who founded the company in 1964 and also cofounded the U.S. company Data Device Corp. (DDC). "We make anything in the power and analog component field," Olsson says.

"And we have an advanced research lab so we can develop products from the idea to the finished item."

Xelex produces transistorized power amplifiers of up to 1 kW (and even higher) on special order. It has an extensive line of low-noise operational modules in small sizes like VCA, moving-coil cart-

ridge amplifiers, and so on. Xelex also produces a line of broadcast studio units such as 10-octave band equalizers, compressors and noise-reduction systems, as well as public address amplifiers and FET power amplifiers for hi-fi.

Xelex engineers have come up with a new converter generation: switching dc/ac sinewave output converters that range from 0.5 to 2.5 kVA. Up to five units can operate in parallel to increase the output power. Such converters have immediate applicability in emergency power supply systems.

Eloptricon AB of Sweden -your key into Europe



Whether you're planning to expand or whether you're just getting established in Europe, talk to Eloptricon AB first. It could be profitable for you. Eloptricon is a privately-owned company fully experienced in the fields of electronics, optics, precision engineering and computer technology.

We possess some of the most advanced machines and measuring equipment available today and our people are thoroughly familiar with the extreme demands imposed on, for example, military equipment.

- We undertake the development, and contract and licence manufacture of your electronic, optical and mechanical components, and equipment.
- We will gladly act as agents for the marketing of your technically complex appliances and systems.
- We will gladly undertake to act as your company's service organization in Europe.
- You can be assured of Swedish quality and reliable delivery.
- We know the European market and the standards that have to be met for manufacturing and sales. We'll even help you adapt your products to European standards and safety requirements.

Getting established on a new market is oftentimes a gamble and the odds against success are formidable. So why not let Eloptricon be the key to your successful operations in Europe.

Get in touch with us for further details.

ELOPTRICON AB

Norrbölegatan 66, S-931 37 Skellefteå, Sweden Tel: 0910-173 00 Telex 65031

Alarm Annunciators

*a new range of highly reliable
low cost compacts . . .*

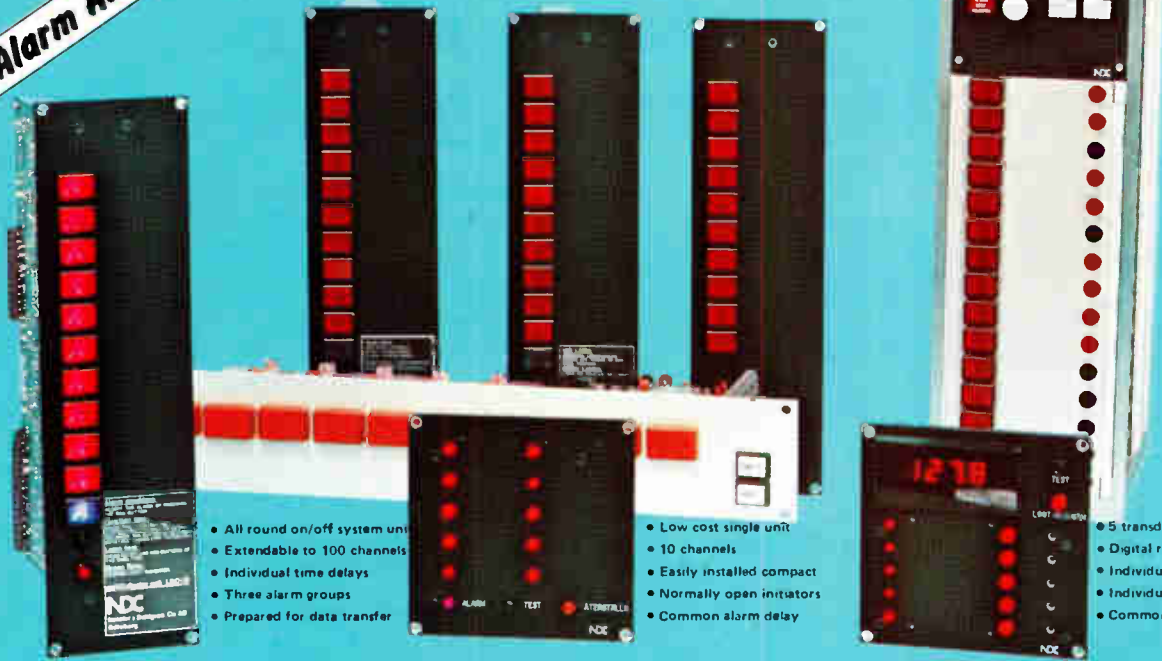

- All round on/off system unit
- Extendable to 100 channels
- Individual time delays
- Three alarm groups
- Prepared for data transfer

- Low cost single unit
- 10 channels
- Easily installed compact
- Normally open initiators
- Common alarm delay

- 5 transducer signals
- Digital read-out
- Individual setpoints
- Individual tripping relays
- Common alarm output

NDC Netzler & Dahlgren Co AB

Address: S-430 40 Särö Sweden
Phone: 031/70 60 20
Telex: 2460 ENDECE S

Circle 109 on reader service card

M. BEJTING AB Stockholm, Sweden



See separate article for further information

M. BEJTING AB

Markvardsgat. 11, S-11353 Stockholm, Sweden
Member of Swedish Association of Electronics Industries





It takes a TRA to report accurately in ambient temperatures up to 212° F.

The TRA is our new 2-wire temperature transmitter. Components are potted with epoxy to make one solid, encapsulated unit that's protected against radio frequency and electromagnetic interference. It's also temperature-proof, vibration-proof, dust-proof, moisture-proof, and explosion-proof. Using our remarkable range of adapters, you can install the TRA on any temperature bulb connecting head. If we don't have the adapter you need, we can make it. In thermocouple applications, the TRA uses ordinary copper wire, not expensive thermocouple extension wire. Therefore, it's an inexpensive way to modernize and centralize your plant equipment, and it's the right way to begin in new plant applications. Other TRA features: patented RTD linearization; 15-50V DC operations; 4-20mA outputs; one year warranty on all Adefco products.

ADEFKO

Learn more about the new TRA today.
Call or write for literature.

23600 Mercantile Road • Cleveland, Ohio 44122 • 216-831-5525

Circle 110 on reader service card

You'll be surprised!



The picture is a presentation on the eight colour screen of Semigraf 240, a new system in a series of CRT data display terminals by SRA of Sweden.

A close study may suggest the multitude of possibilities offered by Semigraf 240. Its limitations are few, its versatility tremendous. And the value you'll get for your money will be a surprise.

Write, call or telex and we will provide you with details and, most likely, more surprises.

SEMIGRAF 240

REGISTERED TRADE MARK

SRA

SRA Communications AB. Mail: Fack, S-163 00 Stockholm-Spanga, Sweden.
Telephone: (08) 752 10 00. Telex: 135 45 SRA S.

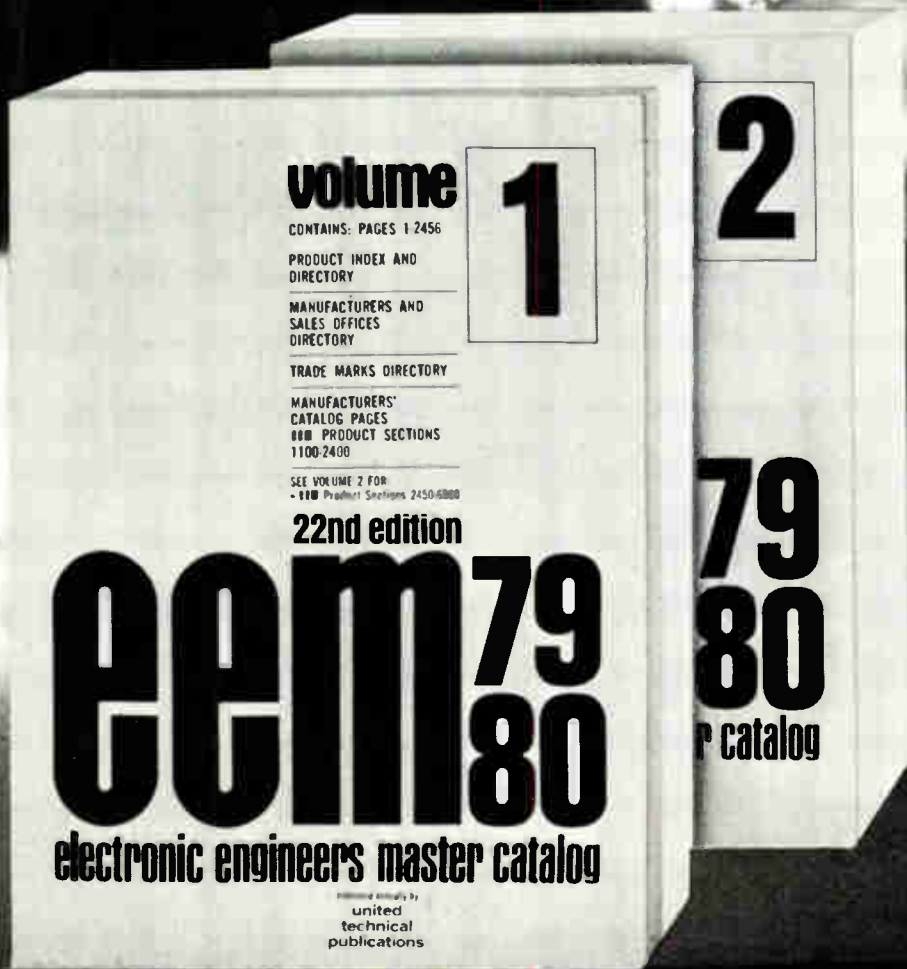

volume

1

CONTAINS: PAGES 1-2456

PRODUCT INDEX AND
DIRECTORY

MANUFACTURERS AND
SALES OFFICES
DIRECTORY

TRADE MARKS DIRECTORY

MANUFACTURERS'
CATALOG PAGES
888 PRODUCT SECTIONS
1100-2400

SEE VOLUME 2 FOR
- 818 Product Sections 2450-6000

22nd edition

eem⁷⁹₈₀

electronic engineers master catalog

introduced annually by
**united
technical
publications**

2

**79
80
P catalog**

is here!



Danny Anthony needs an electrical engineer...who can also handle the Vikings at 3° F.

Danny, BSEE, Cal Polytech (Pomona) '70, was a lifelong Southern Californian until he joined Honeywell in Minneapolis several cold seasons ago. He was slow to shift loyalty from the Rams to the Vikings but cross-country skiing grabbed him immediately. Alas, just as he was up-to-speed in applied cold-weather sybaritics, spring came and there he was back at tennis, swimming, camping, picnicking by the lakeshore, and such familiar, California-like pursuits. Our four distinctive seasons boggled Danny temporarily, but nighttimes provided continuity with a never-ending flow of exciting theater and rock concerts.

At Honeywell, where Danny is a principal systems engineer at the leading edge of defense technology, he could use an experienced logic designer or microcode designer at his side, as well as any number

of BS/MS colleagues in EE, ME-small mechanisms, Physics, Computer Science, Math, Hydrodynamics or Ocean Engineering. As for company to share away-from-work diversions, that's really an ongoing, four-season invitation. We mentioned winter only so we could brag. It's the season the truly enlightened know is Minnesota's greatest. For prompt, confidential consideration, call George Bills collect at 612-931-6713 or send resume to:

Mr. George Bills, Engineering Manager, MN 11-1020 (XX), Honeywell Inc., Defense Systems Division, 600 Second Street N.E., Hopkins, Minnesota 55343.

Honeywell

Equal Opportunity Employer M/F

What is a Stackpole?

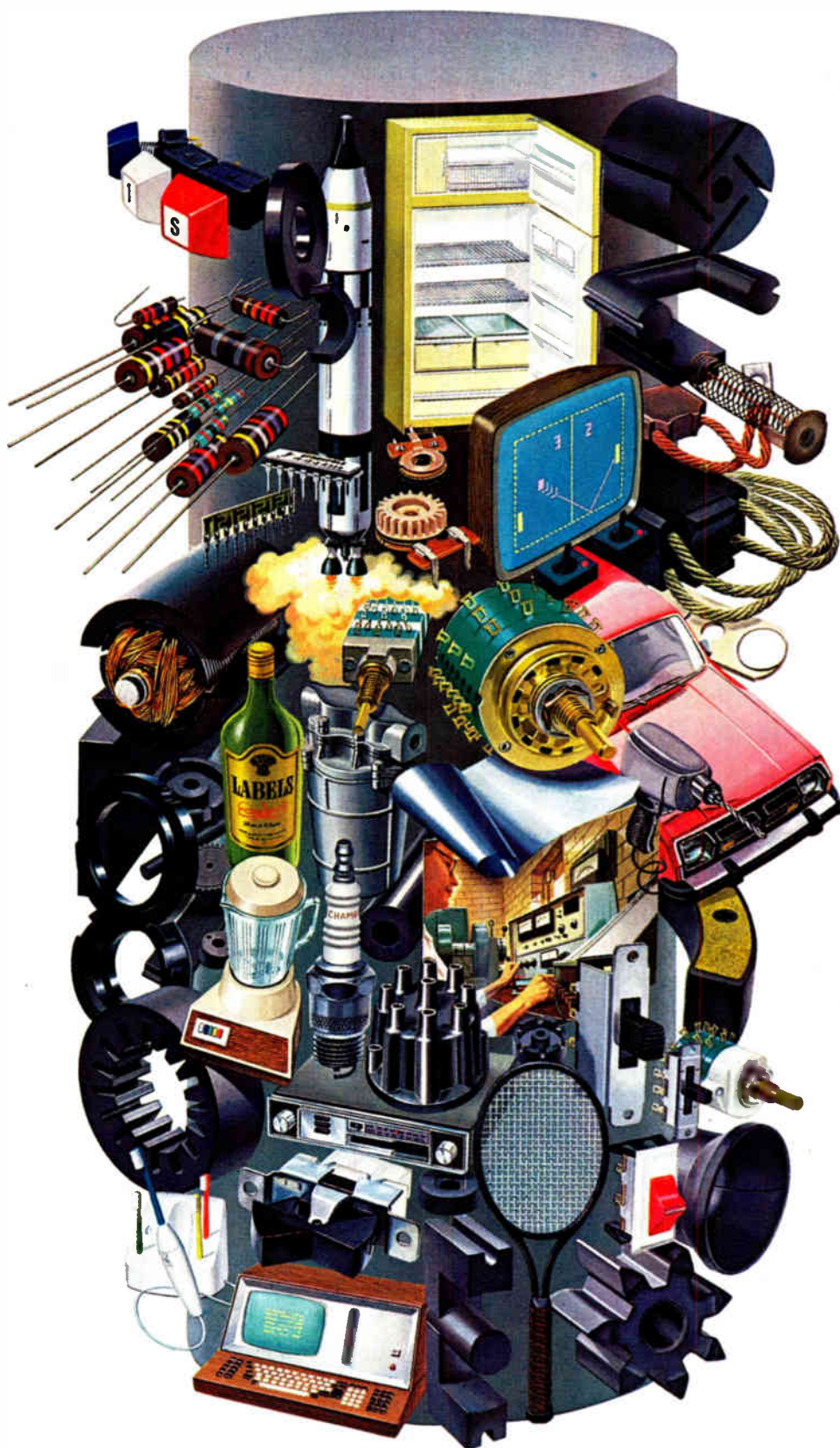

"Most important is how well your component fits in with our overall design. Can you help?"

We can. Because at Stackpole we understand the concerns of electronic design engineers. And we can help by supplying a variety of standard as well as custom components that are flexible and adaptable, for more specialized jobs.

More than just an electronics company

A half-century of component manufacturing experience has made us the world's largest producer of slide switches for commercial applications. And we produce millions of rotary, rocker and key switches annually.

Stackpole soft ferrite cores have helped electronic design engineers upgrade the quality and performance of TV sets, radios and a wide range of power supplies.

Our carbon-comp, carbon-film, industrial and special-purpose resistors, as well as our resistor networks, are integral parts of the electrical and electronic products we all use every day.

Ceramic magnetizable powders and permanent magnet materials, used in a wide variety of automotive, appliance and industrial applications, are produced by our Magnet Division.

More than just another source.

As a result of our manufacturing expertise and electronics know-how, we're capable of meeting your specific design needs. Whether your concern is switching, resistance or ferromagnetics, Stackpole has both the products and a special willingness to help solve your component and materials problems.

To learn more, call or write: Mr. Daur Stackpole, Corporate Marketing Manager, Stackpole Carbon Company, Sr. Marys, Pa. 15857. Phone: (814) 781-1234.

 **STACKPOLE**
Get to know us. We can help.

This is a Stackpole.

Circle Reader's Service Card No. 90.



Store Recorders have made



Flick a single switch on a dual standard recorder in the new Racal Store DS range, and you've changed instantly from Intermediate Band to Wideband operation on FM. A single switch that selects either recording standard—without the need to interchange plug-in modules. A single switch changes all the signal channels (four to fourteen) on all seven speeds.

FM Capability

The Store range of instrumentation recorders, well-renowned for research in the scientific, automobile, aerospace and medical fields, now offers an FM capability over the entire band DC to 40 kHz, and up to 300 kHz on Direct Recording.

Greater Flexibility

And even greater flexibility. Switch any channel to unipolar, and the full dynamic range becomes available to either positive or negative going signals. Switch any channel to offset, and you can record a 100 mV peak-to-peak signal on a 20 V step—without losing any dynamic range.

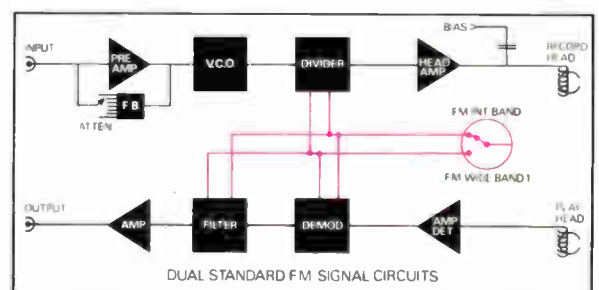



a quick switch to wideband.

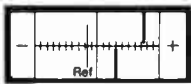

Proven Success

All these outstanding new advantages have been added to the host of features which have made the existing range such a success—like single switch seven-speed selection, full servo operation, dual peak-indicating meters, full remote control of all functions, portability, and operation from AC or battery power sources.

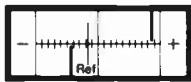
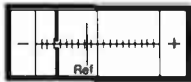

That's why, by switching to the Racal Recorders' new Store DS range, you can make a quick switch to a whole new wideband world.

Racal Recorders Limited Hardley Industrial Estate,
Hythe Southampton Hampshire SO4 6ZH England.
Telephone: 0703-843265 Telex: 47600.

Racal Recorders Inc 5 Research Place,
Rockville Maryland 20850.
Telephone: (301) 948 3085.

Racal Recorders Inc, 1109 West San Bernardino Road,
Suite 110 Covina California 91722
Telephone: (213) 967 2869.



Racal Recorders Always on the right track

Electronics / August 30, 1979

RACAL

Circle 115 on reader service card 115

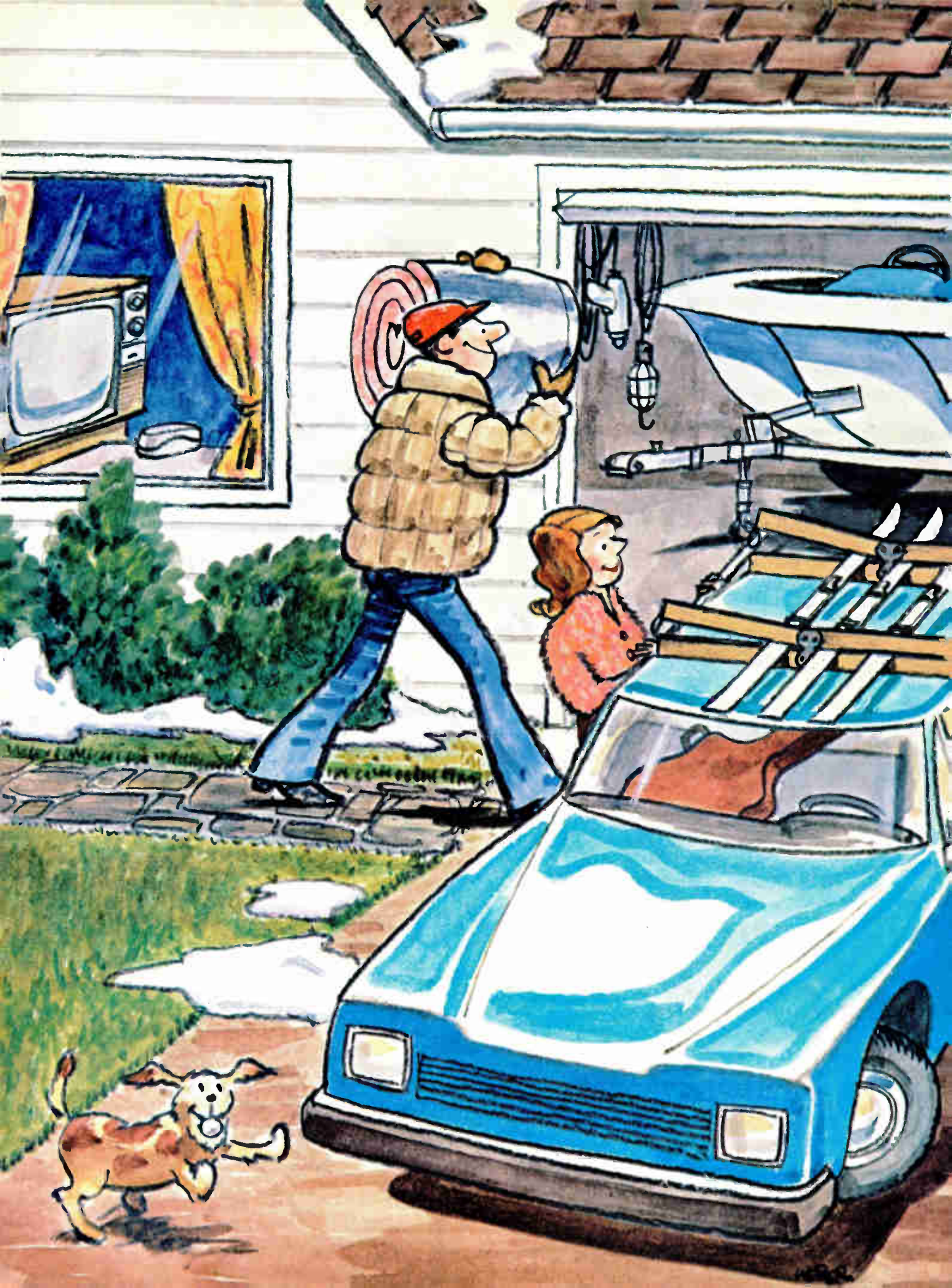

CAN YOU FIND THE 14 WAYS ONE PRODUCT IMPROVED THIS PICTURE?

The items you're looking for all had one thing in common: at some point in their manufacture an organic polymer had to be combined with an inorganic filler.

In every case, the product that brought them together was a silane coupling agent.

These remarkable agents improved processability through reduced viscosity, faster wetting and better dispersion. And helped improve moisture resistance, barrier properties and everything from better physicals to better dielectrics.

Our key will give you some idea of our coupling agents' application versatility. They

improve a wide range of plastic, rubber and fiberglass products as well as foundry sands, electrical and electronic components and circuitry.

To learn about hundreds more, please write to us at Dept. JSW, 270 Park Avenue, New York, N.Y. 10017. Just describe your system and the properties you want. We'll be glad to recommend the correct silane coupling agent as well as practical formulations.

Get the picture?

PEOPLE PLANNING THE FUTURE.

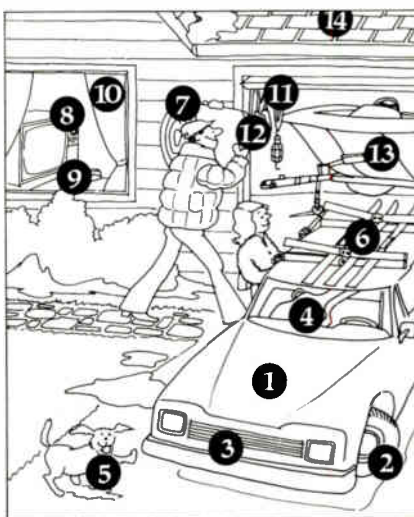

1. Foundry-cast engine block. 2. Tires. 3. Grill-opening, header panels. 4. Electric guitar case. 5. Golf-ball core. 6. Fiberglass skis. 7. Home insulation. 8. TV circuit board. 9. Telephone circuit board. 10. Fiberglass curtains. 11. Trouble-light EPDM insulation. 12. Hand-drill housing. 13. Fiberglass boat. 14. Roof shingles.



Silicones

VAX Performance. Ask any user.

"VAX simply ran over the competition. In cost/productivity ratios, nothing even came close."

*Lou Crain, Mgr. of Software Products
Prototype Development Associates
Santa Ana, California*

PDA is an employee-owned engineering concern whose business ranges from fundamental research in structural analysis to the manufacture of critical aerospace components.

The VAX-11/780 is PDA's first in-house computer. Lou Crain, Manager of Software Products, tells us, "We've been doing all our computing through utilities using CDC 6600, Cyber 74 and Univac 1108 mainframes. The key elements in our decision to acquire the VAX-11/780 were cost and capability — compared to service bureaus, mainframes and competitive minis."

From the standpoint of capability, PDA considered traditional superminis like the Data General Eclipse and the Prime 400 and 500 Series, plus a used 1108 mainframe. Lou Crain says, "Our benchmark showed VAX to be very powerful against the competition — up to a 2:1 performance advantage over both the Eclipse and the 1108."

"After installation," Crain concludes, "VAX has lived up to our expectations and has performed impressively. It's resulted in better

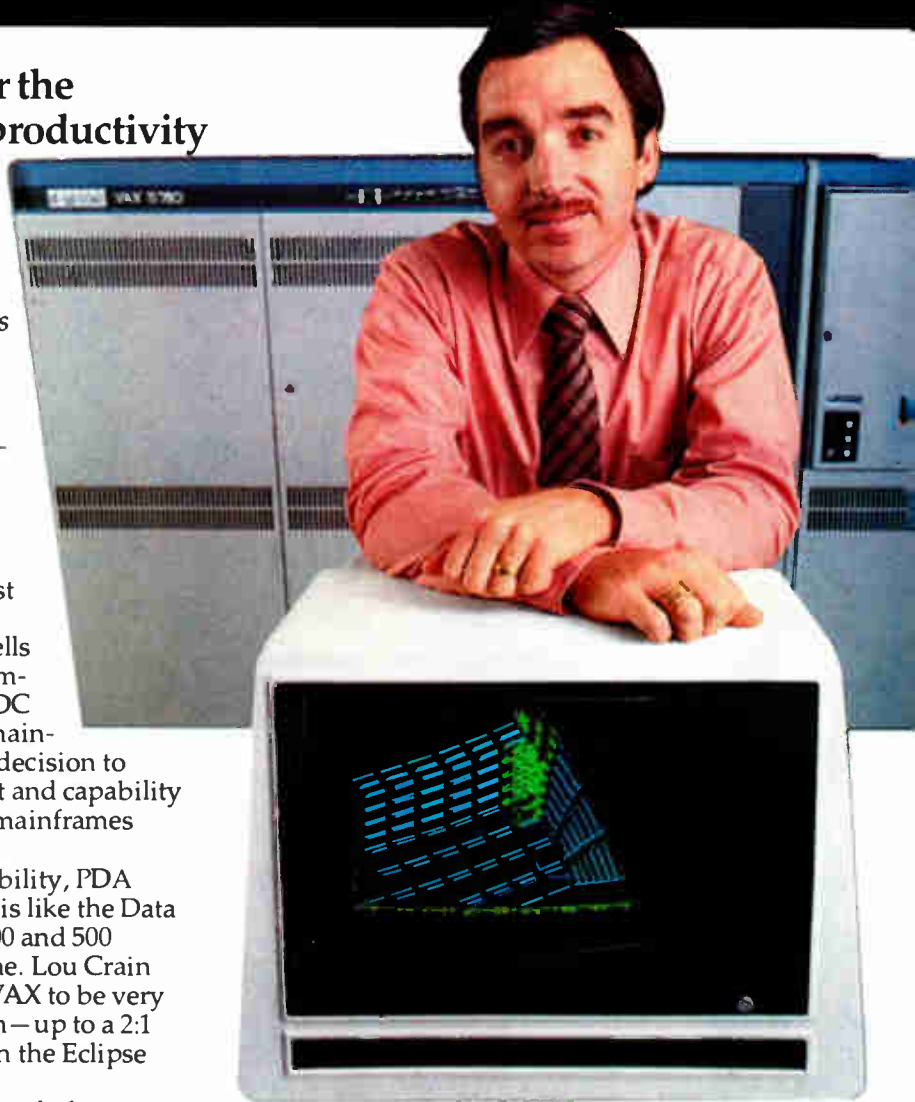

products for our customers, as well as improved cost-effectiveness. Having our own interactive capability in-house has meant an increase in engineering productivity of up to 300%."

"VAX turns out to be twice the machine for the same amount of money."

*Roger Vossler,
Section Manager and Systems Engineer
TRW Defense and Space Systems Group
Redondo Beach, California*

Sensor data processing and distributed processing systems in support of real-time embedded applications are among the specialties of TRW's Defense and Space Systems Group.

To find the right computer, TRW continues to evaluate numerous machines—including Digital's VAX-11/780. They've also conducted numerous FORTRAN and PASCAL benchmarks.

In every test, VAX stands out as a clear winner.

Roger Vossler, Section Manager and Systems Engineer, says, "VAX is one of the best implementations we've seen of a successful integrated hardware and software system."

Since TRW's sensor data processing applications require enormous memories—over a million bytes to store a single image, for example—VAX's true 32-bit address space is vitally important. In addition, says Vossler, "VAX's I/O bandwidth capabilities are extremely important for effectively moving large quantities of real-time data at very high data rates."

Because TRW already had an investment in Digital technology, Vossler is particularly impressed with the relative ease of moving PDP-11 series programs onto VAX.

"But," says Vossler, "Even if I were starting all over again—without our Digital experience—I would still pick VAX, on the basis of its architecture, both hardware and software, and its impressive performance."

"Implementation was faster on VAX than on 25 other machines."

*Brian Ford, Director
Numerical Algorithms Group
Oxford, England/
Downers Grove, Illinois*

The Numerical Algorithms Group develops and maintains mathematical and statistical software libraries for customers in industry, science and academia.



Before VAX, NAG had implemented their complex Mark 6 Library on 25 major machines, including the Burroughs 6700, CDC 7600, Univac 1100, and the IBM 370. The average implementation time was 13 man-weeks.

VAX took five.

In Dr. Ford's words, "A successful implementation requires the correct functioning of the 345 library routines to a prescribed accuracy and efficiency in execution of NAG's suite of 620 test programs. Whilst the activity is a significant examination of a machine's conformity to the ANSI standard of the FORTRAN compiler, its main technical features are file creation, file comparison, file manipulation and file maintenance."

And implementation performance was just the start. Dr. Ford comments on VAX's impressive record of reliability after the program was up and running: "No problems were encountered in the VAX/VMS software even though approximately 3000 files were being handled. The operational availability time for the machine was close to 100%, an outstanding statistic for new hardware and a new operating system.

"VAX," Dr. Ford concludes, "is an implementor's dream."

Digital's VAX-11/780 has re-defined the level of performance you can expect from computers in its price range.

If your application requires large number crunching capability, high floating point accuracy, or lots of high-speed real-time calculations, there is simply no better system.

But don't take our word for it. Send for our new brochure. And listen to our customers.

- Please send me the new "VAX—Ask Any User" brochure and detailed Technical Summary.
 Please contact me.

Name _____ Title _____

Company _____

Address _____

City _____ State _____ Zip _____

Phone _____

My application is: Education Medical Laboratory
 Engineering Government Resale Other

Send to: Digital Equipment Corporation, 146 Main Street, Maynard, MA 01754, Attn: Communication Services, NR-2/2, Tel. 617-481-9511, ext. 6885.

Digital Equipment Corporation International, 12 av. des Morgines, 1213 Petit-Lancy, Geneva, Switzerland

In Canada: Digital Equipment of Canada, Ltd.

N 8-30-9

digital

SABRE X. The lab recorder/reproducer your lab won't outgrow.



You know how your projects can expand and change. And a limited capability magnetic tape recorder won't always have the necessary capacity, and versatility to meet your new requirements.

Enter the Sabre X.

This is the largest, most versatile lab recorder we offer. It comes complete with microprocessor control and full capacity for up to 88 hours of recording time on a single tape. In addition, it has features you won't find on any other recording system.

For example, the Sabre X offers 10 bi-directional electrically switchable tape speeds from 15/32 ips, fast forward and fast rewind speeds of 320 ips in phase lock, a high density PCM, wide band servo and vacuum tape tensioning system. At 240 ips, Sabre X provides full 4MHz direct record/reproduce bandwidth or an 8 Mb/s per track HDR data rate.

The microprocessor-controlled tape transport features a programmable end-of-tape and shuttle. It also has a built-in diagnostic/alarm system that constantly monitors crystal reference, vacuum level, AC line voltage variation, all DC power supplies and heat sink temperatures of the reel drive and capstan power amplifiers.

Don't get stuck with a lab recorder you'll outgrow; specify the Sabre X. For a free copy of our new, illustrated SABRE X catalog and complete specifications, contact Ron Johnson at (813) 371-0811. Or simply circle the number on the reader service card.



Sangamo Data Recorders P. O. Box 3041
Sarasota, FL 33578 Telephone: (813) 371-0811

SANGAMO WESTON

Schlumberger

Evaluation delay cut by low-cost microprocessor development tool

Universal prototyping instrument standardizes command and data entry; data ports allow expansion to include development system, cassette storage

by Chris Bailey and Tracy Kahl
Millennium Systems Inc., Cupertino, Calif.

□ Competitive design engineers have an ongoing hunger for the latest microprocessors. But when they are presented with a tempting new chip, the pangs of frustration hit all the harder. It is six months before development-system support arrives to allow device evaluation and integration into the contemplated system. And when the support finally shows up, the accompanying bill can ruin the best of appetites.

The Micro System Designer is a development tool that trims both the wait for support and the price paid for it. Its streamlined design makes the most of the minimal number of powerful components that it contains. With it, numerous different microprocessors and single-chip microcomputers from different vendors may be evaluated and programmed long before the chip makers get their development-system acts together. Moreover, the instrument can be married through a serial link to an existing development system or general-purpose computer for more serious design work.

Useful for training

Functioning both as a universal prototyping station and as a training tool, the instrument is useful to both the neophyte microprocessor user and the seasoned engineer. It will support the evaluation of several microprocessors, including the 8085A, 8088, 8086, Z80A and Z8000, this year; personality modules will be provided early in 1980 for the 68000 microprocessor and the 8049, 6801, and Z8 single-chip microcomputers. Command- and data-entry formats have been standard-

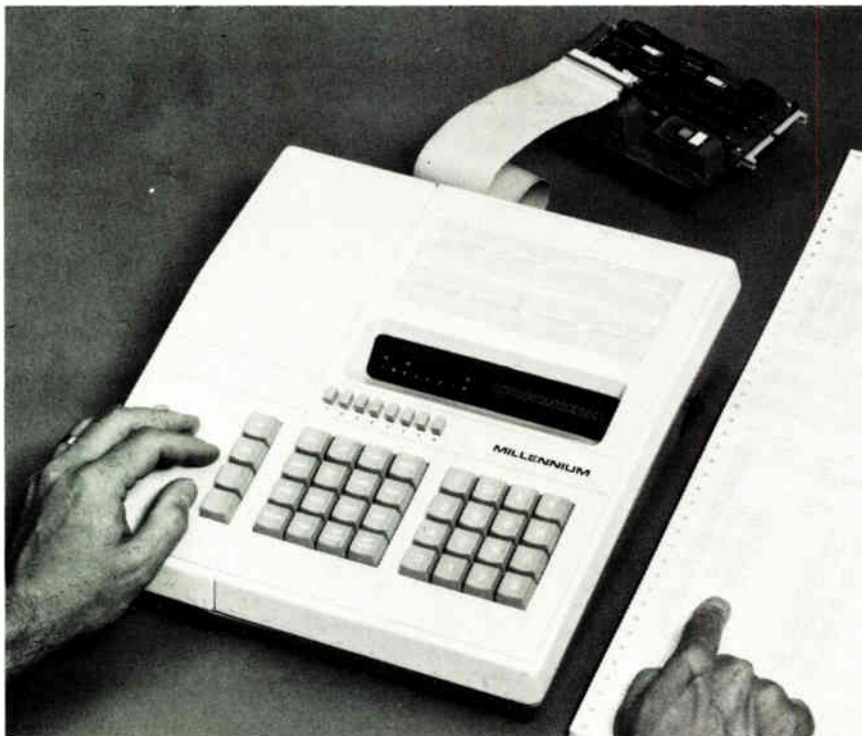

1. Hands on. The Micro System Designer is broken into two parts, logically and physically. The user's left hand rests on the processor-dependent personality module; the cable connecting it to the prototype system is driven by a copy of the microprocessor that is being investigated.

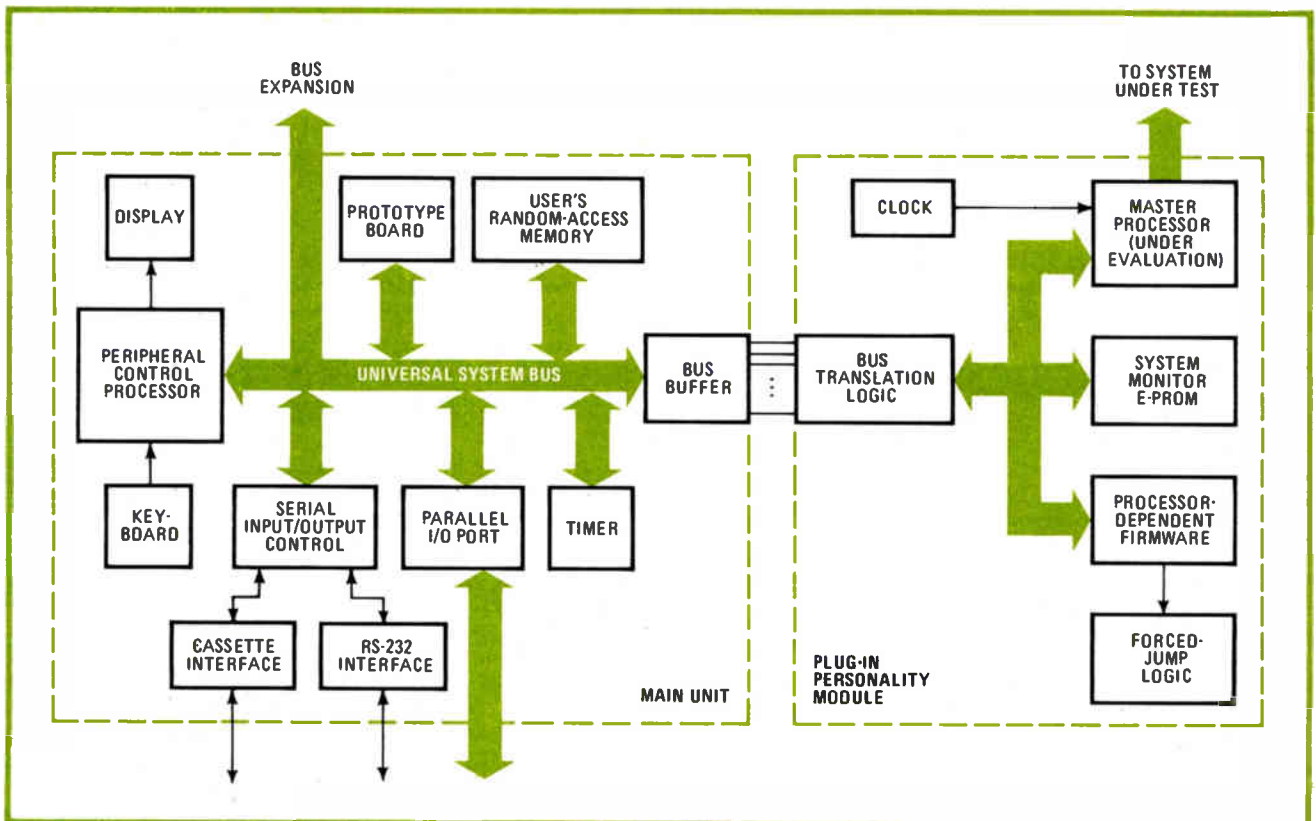

2. Plug-ins. The logic in the main unit is constant from processor to processor while the personality module is changed for each device. The unique aspect of the Micro System Designer is that the master processor under evaluation also runs the entire instrument.

ized to be identical for all processor types and to permit fast mastery of the unit.

Design engineers who want to become familiar with the so-called workhorse microprocessors—the 8080, 6800, and Z80—are most often forced to employ a microprocessor development system from one of the major semiconductor companies. These systems support only one microprocessor family, locking designers into a single vendor. One way to avoid such entrapment is to select a universal development system, one that can be configured for several popular microprocessors.

Lackluster alternatives

Whether universal or dedicated, the development system has many advantages, including the availability of a complete software and hardware station (if in-circuit emulation is available) for complete system integration. The cost, however, is very high. Another disadvantage is the fact that only one user can operate the system at a time. But the lag time of six months to a year between the availability of a new microprocessor chip and the delivery of a suitable development system is the most frustrating aspect. Increasing chip complexities that compound emulation difficulties can only increase that delay. If software is cross-assembled or reworked from existing libraries, this delay may be permissible. But in hardware design efforts, a six-month lag can easily spell the difference between a timely, successful product and a "me too" design that becomes lost in a forest of competition.

Microprocessor vendors have attempted to expedite

development time by offering evaluation boards to rapidly acquaint the design engineer with a new microprocessor. This is a good solution, except that a semiconductor vendor may have little interest in supporting the product over time and so may shift focus to newer, more profitable products like bus-oriented boards and boxed systems. As a result, the evaluation boards are used for a brief period and then fall into disuse. The boards are useful for evaluating only one processor and are usually expensive.

The Micro System Designer, which is shown in Fig. 1, is a desktop instrument with an internal power supply. The user interface includes a simple hexadecimal keypad, an 18-key function keypad, input and output light-emitting diodes, and a 16-digit alphanumeric vacuum fluorescent display.

The microprocessor under test resides in the personality module. The processor's signals are brought out over a flat cable unique to each personality module—the plug on the end of the cable matches the pinout of the processor. It can be used in the solderless prototyping area above the display or plugged into the socket the processor would occupy in the user's prototype system, as shown. This also makes the signals easily accessible for analysis with an oscilloscope or logic analyzer.

The function keys allow automatic input/output reading and writing, single-stepping a program, setting hardware breakpoints, timing of the user's routines, as well as memory moving, loading, and dumping. The load and dump keys are used with the simple audio cassette interface; they also allow a serial RS-232 hookup to a

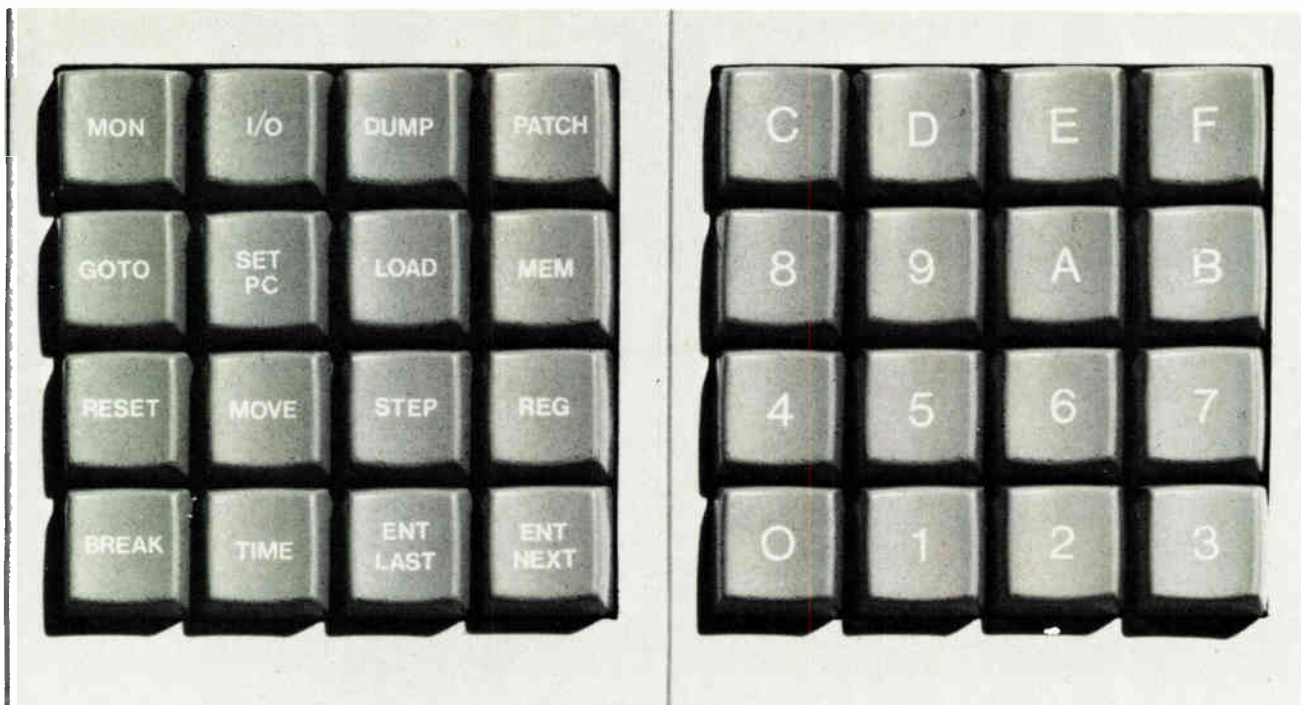

3. In key. The keyboard includes 16 keys for the standardized commands, through which different types of processors are controlled and evaluated, and a hexadecimal pad for entry of addresses and data. Keys on the personality module (not shown) initiate interrupts.

host computer or development system to be established.

When the Designer is used in conjunction with an 8-bit microprocessor development system, the development system is in effect transformed into a prototyping and debugging station for other 8-bit chips—and more importantly, 16-bit microprocessors. Though not as complete as a true 16-bit development system, the Designer does provide an easy, inexpensive avenue for exploiting existing equipment to gain experience with new microprocessors in the laboratory.

The user has complete control over the system's operational environment. Communication with I/O devices is provided, and interrupts can be generated manually or by means of a real-time system clock.

In practice, a program is manually entered through the hexadecimal keyboard. Once loaded, the operator uses monitoring commands to examine and change memory and registers, set breakpoints, and single-step the program. When a program is successful, it may be saved on an audio cassette using a modified Kansas-City-standard interface built into the unit. Optionally, if the user has access to a computer system, the RS-232 serial port can be employed as an up-load or down-load line. As mentioned earlier, this is a great boon to those who already possess a development system or home computer or who have access to a minicomputer or timeshared computer.

The hardware

As is shown in Fig. 2, the main unit contains a universal system bus that connects an 8041 peripheral control processor (for the keyboard and display), random-access memory, a serial input/output port, RS-232 and cassette interfaces, a parallel I/O port, a timer, and a prototyping board. This bus also interfaces with a

bidirectional expansion cable that allows extension of the allowed system I/O and memory space. Within this universal part of the design lab, commands and formats remain constant from processor to processor.

The processor-dependent plug-in personality module that contains the microprocessor under evaluation (the master processor) also houses the processor's clock and electrically programmable read-only memory (E-PROM) that contains the system monitor. It also contains bus-translation logic and forced-jump logic for hardware entry into the monitor routines. This separate plug-in personality module connects to the main unit via an 86-pin connector.

The peripheral control processor performs the function of controlling the system display and scanning the keyboard. This frees the master processor so that it can be programmed completely by the user, but the master processor can also access the parallel and serial I/O ports directly. In fact, the peripheral control processor is itself treated as a peripheral device by the master processor, with port DE_{16} set aside for status and control, and with DC_{16} reserved for data transfer.

A total of 1,024 bytes of static RAM located at address 0000_{16} is common to all personality modules. Sockets internal to the main unit are provided for expansion up to 4,096 bytes or 16-bit words. This memory is intended for the user's programs and data. In addition, there are 128 bytes of RAM located at address $FF80_{16}$ that are used as a scratchpad and system stack. Off-board memory can be expanded to 64 kilobytes.

The system-monitor E-PROM, a 2716, resides at a processor-dependent location (for example, at $C000_{16}$ for the Z80A) in the plug-in personality module and contains machine-dependent software routines that control the instrument. The forced-jump logic provides

TABLE 1: AN 8-BY-8-BIT UNSIGNED MULTIPLICATION

Z80		8086	
B register contains multiplicand C register contains multiplier HL register contains result		AL register contains multiplicand BL register contains multiplier AX register contains result	
0020	1E 08	BEGIN:	LD E,8 ; Load bit shift counter
0022	21 00 00		LD HL,0000 ; Clear result register
0025	79	LOOP:	LD A,C ; Start shift loop
0026	1F		RRA
0027	4F		LD C,A
0028	7C		LD A,H
0029	30 01		JR NC
002B	80		ADD B
002C	1F	SHFT:	RRA
002D	67		LD H,A
002E	7D		LD A,L
002F	1F		RRA
0030	6F		LD L,A
0031	1D		DEC E ; Decrement counter
0032	20 F1		JR NZ ; Loop if not Zero
			END
Instructions:	15		1
Bytes:	20		2
Execution time (at 4 megahertz):	133 microseconds		27 microseconds

automatic entry into the monitor after power-up or after the monitor key is pushed; it also provides for return from a breakpoint or single-step.

The breakpoint key allows the user to set and examine hardware breakpoints. Breakpoint comparison is detected with a 16-bit register, loaded by the master processor, and clocked with its memory-read and -write signals. A comparison sets the register, which enables a forced-jump sequencer. This in turn forces the master processor into the monitor when the next instruction is fetched.

The single-step function activated by the step key is accomplished using a forced jump to the monitor in a manner similar to the breakpoint function. The address to be executed is set in the breakpoint register, a jump is made to this address, and the logic returns control to the monitor after the one instruction. A continuous single-step feature can trigger the execution of the next instruction after a time delay of from 20 milliseconds to 6 seconds. The delay can be set by the user; its default value is 1/2 second.

The system's serial I/O uses a universal asynchronous receiver/transmitter chip, with the Designer configured as an RS-232 modem. The transmission rate is selected by a dual-in-line switch and can be set from 110 to 9,600 bits per second. The instrument also has a parallel port wired to eight toggle switches and the eight front-panel LEDs. This is useful in a training environment where intimate interaction with the microprocessor under program control is desired.

Because of the different timing of the various microprocessors supported, each personality module contains its own clock. This means that each processor is able to run at full speed.

Figure 3 gives a closer look at the keypads. The go key

requests a starting address; program execution begins at that address. Execution continues after the address is entered until a breakpoint is encountered, or until the user pushes the reset or monitor key. The Designer automatically times the execution of the user's code. After execution of a single step, the system returns to the monitor mode and displays the address of the next instruction and the last referenced register or memory location. Upon return to the monitor mode, depressing the time key will display the elapsed time of execution in microseconds.

Key functions

The memory key allows the user's memory to be displayed and altered. When an address location is specified, the data stored there is displayed. With the enter-next key, new data can be entered into that location and the next sequential address is displayed. With the enter-last key, data in the previous location can be examined and verified.

Rapid entry of a string of data is accomplished through a patch key. Upon a single patch command, data is entered in 4-bit nibbles. If an error has occurred, hitting the patch key again backs up the sequence to display the last address loaded.

The dump key mentioned previously sends a block of code to the serial port and out a cassette jack in a standard hexadecimal format. The data rate defaults to 300 b/s in accordance with the Kansas City standard, but, as mentioned earlier, it can be pushed up to 9,600 b/s for computer communication. This does not require a driver or handler routine to be resident on a Tektronix development system; the load key transfers data from the cassette or RS-232 port into the Designer's memory in a format compatible with Tektronix systems.

TABLE 2: A 256-BYTE BLOCK MOVE

Z80		8086	
11 00 02	LD DE, 0200 ; Load destination into DE	B9 FF 00	MOV C, 00FF ; Load byte count into C
21 00 03	LD HL, 0300 ; Load source into HL	BE 00 03	MOV SI, 0300 ; Load source into SI
01 FF 00	LD BC, 00FF ; Load byte count into BC	BF 00 02	MOV DI, 0200 ; Load destination into DI
ED B0	LDIR ; Block move	F2	REP ; Repeat primitive
	END	A4	MOVB ; Move instruction
			END
Instructions:	4		5
Bytes:	11		11
Execution time (at 4 megahertz):	1,347 microseconds		1,313 microseconds

It often happens that the prototype system and the program, though carefully assembled, do not work as intended. Suppose that, in the editing of the program on a software development system, a jump to a subroutine has inadvertently been left out. Even though the program is near perfect, a problem results that could be attributed to an I/O hardware fault, a system-bus problem, an addressing problem, or any number of software errors. Days could be spent tracking down such a problem, but the Micro System Designer can help trim debugging time to minutes.

Spotting program bugs

By plugging the microprocessor cable from the personality module into the system under development, the Designer can be used to stalk hardware and software difficulties alike. Once it is thus plugged in, the Designer's commands may be invoked. The I/O key allows quick manual examination of the I/O to confirm the integrity of the system hardware. If it checks out, breakpoints may be set in the program (even if it already resides in read-only memory) and it may be stepped through. After setting several breakpoints, the problem area can usually be localized and mended.

The engineer must be mindful of two very important limitations, however: first, the master processor in the instrument must drive the cable as well as the system under test; this loading may impair speed. Secondly, since the personality module uses some I/O space and memory locations for the monitor, the system under development cannot occupy those locations at the same time. The system under test must be small enough to conform to these memory and I/O restrictions.

Comparing microprocessors

Another use of the Micro System Designer is to compare the relative merits of the instruction sets of different microprocessors. For example, if a contemplated design requires mathematical computations, the designer might pose this question: how much of an advantage would the 8086 have (with its built-in multiplication and division instructions) over the Z80A microprocessor? In this example, a Z80A routine will execute an 8-by-8-bit unsigned multiplication using 15 instructions and 20 bytes of memory. By comparison, the 8086 requires only a single instruction and two bytes of memory for the same operation, as can be seen in Table 1.

To use the instrument in such an evaluation role, the personality module of the Z80A is installed and the code entered and debugged. When the program is ready to be executed, the timer is cleared and a breakpoint set at the routine's last address. Since the multiplicand resides in register B and the multiplier is in register C, the register key is used and the numbers to be multiplied are entered. The program is executed via the go key; it runs, the breakpoint is encountered, and control passes to the monitor.

When the time key is pressed, the execution time of the routine is shown on the display (133 microseconds). An identical sequence of events using an 8086 personality module gives the 8086's time (27 μ s). The user has a clear record of actual execution times and can make a decision on what processor to use for a given application based on empirical evidence. (This experiment and the one to follow both used a 4-megahertz system clock.)

Suppose an engineer wants to compare block moves performed by the Z80A and 8086. Using the 8086 personality module, a simple program to move 256 bytes of data from address 0300₁₆ is entered (see Table 2). A hardware analysis can be made using the microprocessor cable and an oscilloscope to watch the signals of the processor as it executes the program. And once again, timing analysis can be made by using the time key. As it happens, the 16-bit 8086 requires 5 instructions and 11 bytes of memory to perform a block move of 256 bytes, and it takes 1,313 μ s to do so. But the 8-bit Z80A requires only 4 instructions, 11 bytes of memory, and 1,347 μ s to move the same 256-byte block.

These examples show that determining the best processor for a given application really depends upon the type of operations involved. Sometimes it may be obvious which microprocessor is superior, but it often requires an actual trial to make a clear determination.

The Micro System Designer provides the design engineer with a flexible tool to make thorough examinations of the hardware and software differences of the various processors on the market. With the inherent benefits of universality, the powerful breakpoint and single-step commands, prototyping area, microprocessor cable, interrupt control features, internal peripheral control processor, built-in addressable I/O and communications link, the instrument offers many development-system tools at a fraction of the price: no other development aid for under \$2,000 offers comparable features. \square

Digital phase-locked loop finds clock signal in bit stream

A new MOS chip can extract the original data rate even from a demodulated or encoded input

by John Snyder, Comsat Laboratories, Clarksburg, Md.

□ In digital data transmission, the clock signal is generally inherent in the bit stream. Extracting it therefore is usually a complex and costly business. Either all the circuitry associated with analog phase-locked loops must be used or else, if the goal is a totally digital system with the fewest possible sources of bit error, a custom digital circuit must be designed.

For data rates up to 64 kilobits a second, these approaches are no longer necessary. The timing information can instead be recovered by a single MOS integrated circuit (Fig. 1). Dubbed the digital bit-timing recovery (DBTR) chip, it can do the job even when a clock rate is changed by the insertion of timing information or parity checks in the bit stream.

The source

The MOS circuit is based on a TTL version developed at Comsat Laboratories. The goal of that device was to enhance the capabilities of the single-channel-per-carrier pulse-code-modulation multiple-access demand-assignment (Spade) equipment of the International Telecom-

munications Satellite Organization. But as will shortly become apparent, the MOS chip can be applied to other systems as well.

The approximate frequency of the timing signal of a bit stream is most often known from system considerations. The major problem is its phase, which is completely unknown and must be determined from the digital bit stream alone. Once recovered, the signal is usually employed to relock the data for further processing.

Where to look

All timing information is contained in the data pulse edges. No such information is provided by their amplitudes; obviously, a continuous string of either 0s or 1s produced by one clock is as flat and undifferentiated as a similar string produced by a clock of entirely different frequency and phase.

The fact that the pulse edges are crucial establishes two important requirements for the design of the timing recovery circuit. First, the average transition rate of the bit stream must be high enough to enable the circuit to

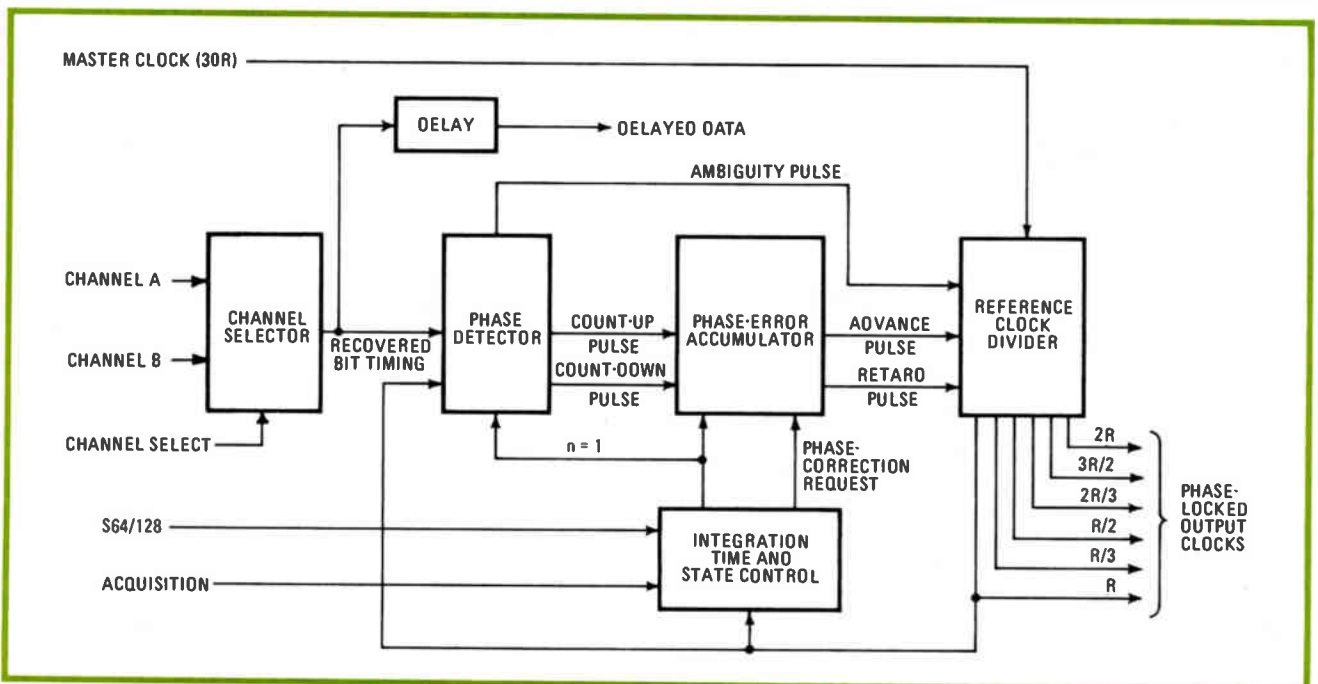

1. All in one. The digital bit-timing recovery (DBTR) chip is a 24-pin complementary-MOS device that requires only one 5-volt supply for operation. It can pull clock signals out of either of two parallel bit streams at data rates of up to 64 kilobits per second.

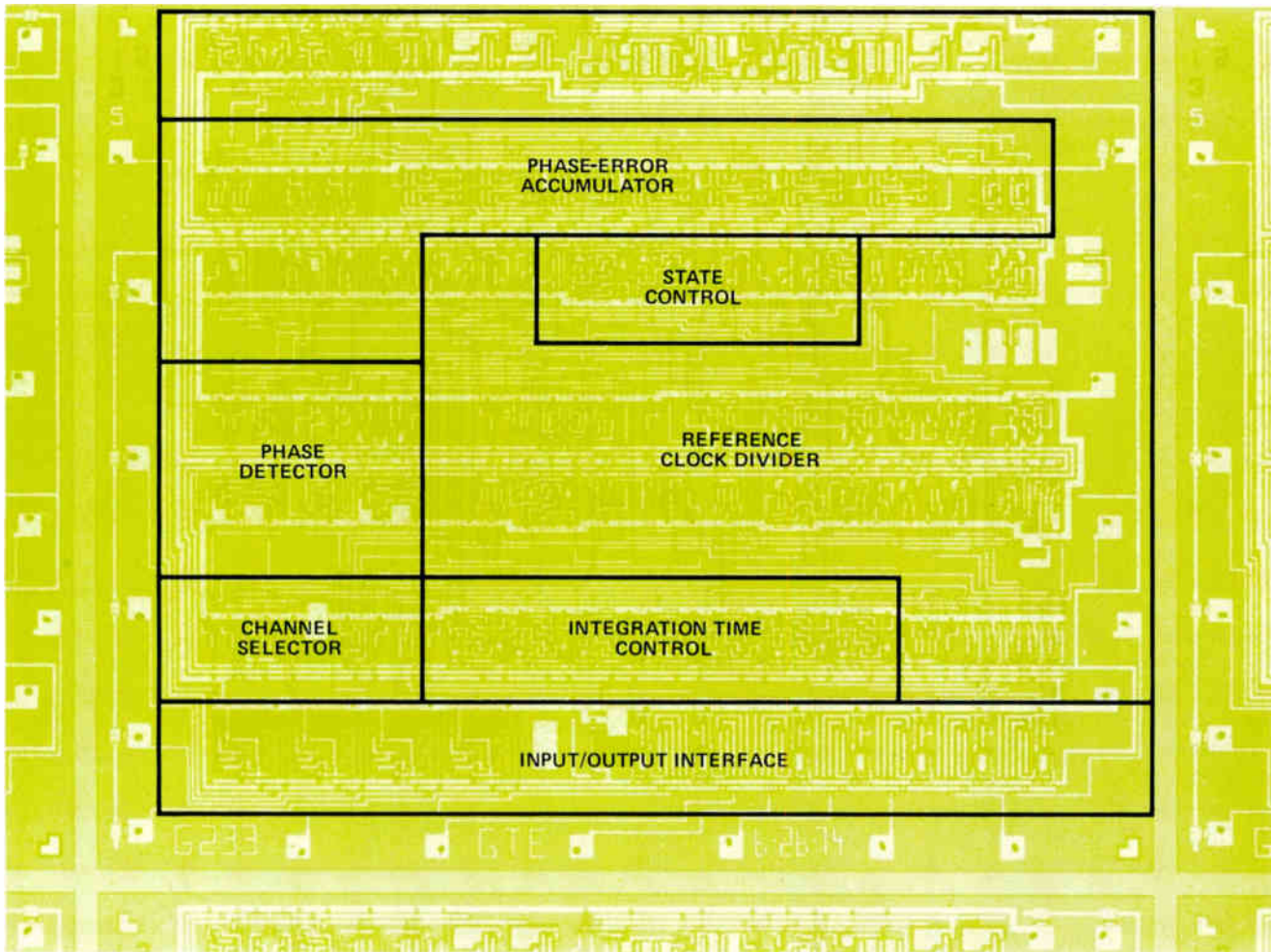

2. The layout. The DBTR circuit is an all-digital phase-locked loop. It not only recovers a coherent clock from a random binary data signal but also can generate other synchronous clocks at multiples and submultiples of the data rate of the recovered signal.

function within specifications. If it is not high enough, it may be increased by passing the data through a randomizing scrambler at the transmitting end; then at the receiving end, after the bit timing has been ascertained, an inverse descrambling operation is performed. Second, the timing recovery circuit must be capable of “coasting”—in other words, the longest possible data interval containing no transition must not create excessive drift in the derived clock.

The DBTR chip is capable not only of recovering a coherent clock signal from random binary data, but also of using it to generate other synchronous clocks at multiples and submultiples of the recovered rate. As will be seen, such a capability is of use in dealing with coding and decoding circuits.

Simply put, the chip divides an externally furnished master oscillator to obtain the recovered output clock, generating the division ratio itself on the basis of constant sampling of the edges of the input data stream. What is more, it regularly alters the division ratio to advance or retard the phase of the recovered output. It even varies the rate of phase correction in such a way as to acquire the initial synchronization rapidly and then average the phase corrections over a longer period to enhance steady-state performance.

The DBTR circuit is implemented as a state-of-the-art digital phase-locked loop (Fig. 2). The channel select input selects either the channel A or channel B input signal from which to derive the recovered clock. (This two-channel capability enlarges the range of the chip's applications.)

In operation

The phase detector samples the recovered bit timing (RBT) waveform on every amplitude transition of the bit stream selected. If a sampled value is a binary 1, a count-up (CUP) pulse is generated. Similarly a binary 0 produces a count-down (CDN) pulse. These pulses are used to increment or decrement a 7-bit counter, which functions as a phase error accumulator.

Phase-correction requests (PCRs) occur at intervals and will generate a command to advance (ADV) the phase of the RBT waveform if the average phase error is positive (more CUP than CDN pulses have been produced) or retard (RETP) the phase when the accumulated phase error is negative. Neither command is present for an average phase error of zero.

The advance and retard lines correct the phase of the RBT waveform by altering the ratio of the programmable reference clock divider, which nominally reproduces the

The inside story

The digital bit-timing recovery (DTBR) chip was originally developed as a custom circuit by GTE Laboratories for the International Telecommunications Satellite Organization (Intelsat). It was part of a Comsat-conducted research and development program aimed at enhancing the effectiveness of Intelsat's single-channel-per-carrier pulse-code-modulation multiple-access demand-assignment (Spade) equipment.

Under the same program, GTE Laboratories also developed integrated circuits for A-law pulse-code-modulation (PCM) encoding, PCM decoding, rate $\frac{3}{4}$ convolutional encoding for error correction, and rate $\frac{3}{4}$ threshold decoding [*Electronics*, March 29, 1979, p. 91]. In addition, RCA Corp. produced large-scale integrated transmit and receive synchronizer circuits to perform timing, buffering, and framing operations.

The Intelsat board of governors decided to make the technology developed under the program available to interested parties on a royalty-free basis without restric-

tion. As part of a technology transfer program, comprehensive data packages are available that document extensively the operation and application of the LSI circuits. These packages, which contain chip operating descriptions and specifications, manufacturer's LSI device schematics, application information, Comsat engineering drawings for subsystems utilizing the chips, and test results, are available for a nominal fee to defray costs.

Those wishing to participate in the DTBR chip technology transfer program are referred to John H. Heck at Communications Satellite Corp., 950 L'Enfant Plaza, S.W., Washington, D.C. 20024; telephone (202) 554-6705. Technical questions may be addressed to author John S. Snyder at Comsat Laboratories, 22300 Comsat Dr., Clarksburg, Md. 20734; telephone (301) 428-4574. As for commercial information, details on price and availability may be obtained from Harry M. Luhrs of GTE at 40 Sylvan Rd., Waltham, Mass. 02154; telephone (617) 890-8460, ext. 218.

data rate R by dividing a $30R$ master input clock by 30. However, the circuit will divide by 29 for one RBT cycle with an advance signal and by 31 in response to another cycle with a retard command.

The programmable divider is implemented by a five-state counter that is cascaded with additional circuitry for dividing by six. This produces the overall divide-by-30 ratio. To reduce this ratio, the counter divides by 4 once in the cycle, producing an overall ratio of $4 + (5 \times 5)$, or 29. Similarly, the counter may count to 6 for division by 31, or $6 + (5 \times 5)$.

Phase-correction requests

The phase-correction request (PCR) signal is generated by the integration time and state control circuit, which in turn is driven either by the acquisition control or by the S64/128 input signal. The first provides for rapid phase lock at the start of a digital bit stream, while the second produces a PCR signal on a periodic basis.

When the acquisition control line is set high, the integration time and state control section enters state one ($n = 1$). In this state, it requests a phase correction for each transition of the input data. It also bypasses the phase error accumulator and gates the CUP and CDN pulses directly onto the advance and retard lines, respectively. The $n = 1$ state lasts for nine corrections, after which state two ($n = 2$) begins.

In the second state, the accumulator is switched in, and phase corrections are requested every fourth cycle of the RBT. This state is maintained for 32 RBT cycles. Then the final ($n = 3$) state is entered.

In state three, PCR signals are generated either every 64 or every 128 cycles, depending on the state of input S64/128. Thus, by using all three states the loop can rapidly acquire a phase lock and then automatically switch to a long integration time so as to improve steady-state performance.

The DTBR circuit is designed so that the recovered clock's negative-going edges coincide with data transitions. On initial acquisition, therefore, an ambiguous

situation may arise if the data transitions occur near the positive-going edge of the RBT. What might happen here is that if the transitions were to occur after the positive-going edge, the phase of RBT would be advanced, while if they occurred prior to the positive-going edge, the phase would be retarded.

The ambiguity window

To prevent this from occurring and, at the same time, to accelerate the acquisition of phase lock, an ambiguity window with a duration of 10 counts of the master ($30R$) clock is generated. This is centered on the positive-going RBT edge. If a data transition should happen to occur within the ambiguity window during state one, an ambiguity pulse (ΔMBP) is produced and is used to effect a 180° phase change in RBT.

In addition to the primary recovered clock at the data rate, R , output clocks are supplied at frequencies of $\frac{1}{3} R$, $\frac{1}{2} R$, $\frac{2}{3} R$, $\frac{3}{2} R$, and $2 R$. These are produced by simple multiplication and division circuits and locked to the primary clock.

And finally, the delayed data output is merely the selected data channel delayed by approximately 1.75 microseconds. It is used in some applications for alignment with the recovered clock.

Doing the job

Since the phase detector operates in response to input transitions, its performance is a function of how often amplitude levels change in the input bit stream. In fact, the duration of the $n = 1$ state is directly proportional to the transition rate because this state persists for nine data transitions.

In the $n = 2$ and steady-state modes, jitter in the recovered clock is minimized if data transitions are frequent. This is because more phase comparisons are made in the interval between PCRs. In such a situation then, phase corrections are based on a more accurate measure of average phase error.

For any given master clock frequency, variation in the

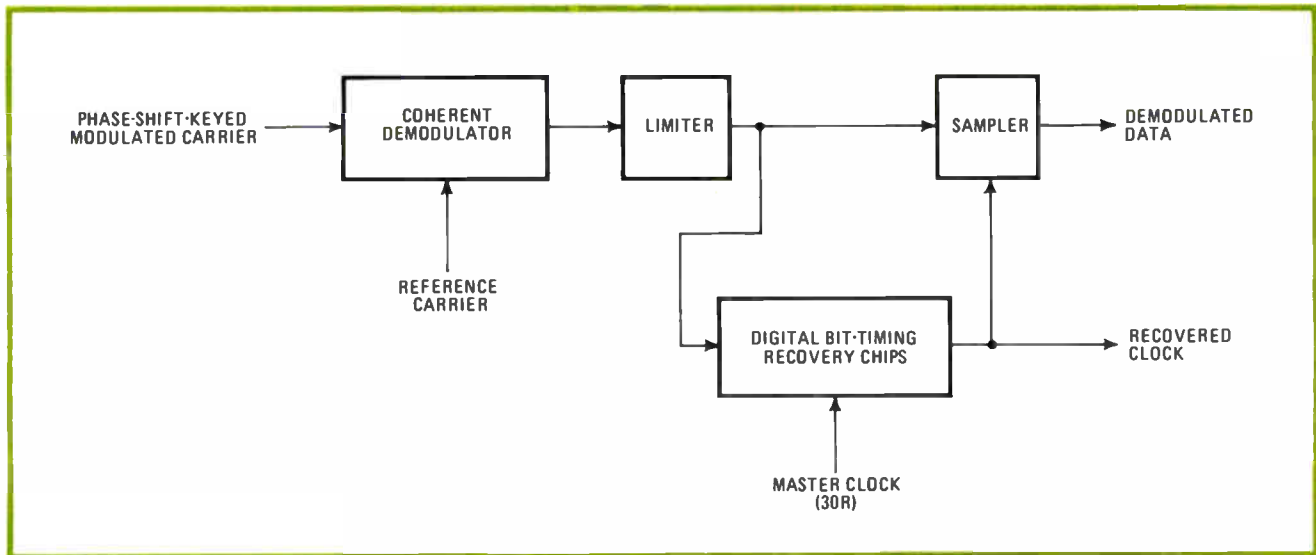

3. Find the clock. Clock recovery from a demodulated data signal presents its own problems. Here the limiter squares up the demodulated signal into binary form for the DBTR chip to sample. This sampling is done at mid-bit, to minimize the influence of noise on the bit-error rate.

input data rate will be tracked over a range that is a function of the size of the correction and the number of clock cycles per correction. Since the size of a correction in the DTBR chip is $\pm 1/30$ of a clock period, this function may be expressed as a normalized frequency offset given by $\Delta R/R = \pm 1/30N$, where R is the frequency of the recovered clock, ΔR is the tracking range, and N is the number of clock cycles per correction (64 or 128). For $N = 64$, this comes down to $\Delta R/R = \pm 5.2 \times 10^{-4}$ and for $N = 128$, $\Delta R/R = \pm 2.6 \times 10^{-4}$.

This performance was confirmed by tests conducted under noise-free conditions. It also held up under tests employing a filtered and regenerated analog data waveform containing sufficient additive Gaussian noise to produce a 10^{-3} bit-error rate.

Digital data is frequently transmitted by means of a phase-shift-keyed (PSK) carrier [*Electronics*, March 29, 1979, p. 91]. Demodulation of such a waveform requires the received carrier to be compared with a reference carrier (Fig. 3).

The demodulated waveform resulting from this process is then applied to a limiter that squares up the signal into binary form. To achieve a minimum bit-error rate in the presence of the noise inevitable in a real system, it is necessary to sample the output of the limiter at approximately mid-bit. Signal power at the output of the coherent demodulator's filter is then maximum and so is the receiver signal-to-noise ratio.

Dealing with jitter

The DBTR can be used as shown in the figure to simplify the recovery of both the demodulated data and the hidden clock signal. But a certain amount of jitter in the recovered clock is unavoidable since corrections are made in fixed increments of $\pm 1/30$ of its period, T .

In addition to this $\pm T/30$ jitter, noise that has been added to the PSK carrier during transmission and reception produces additional jitter by causing improper corrections. This latter effect is minimized by averaging phase corrections over intervals of 64 or 128 bits. This is

equivalent to filtering the noise, but is done automatically without additional circuitry.

The effect of timing jitter is to make sampling the limiter nonoptimal. This in turn results in an increase in the bit-error rate over that theoretically obtainable with a perfectly phased clock. But the increase is very small in a practical system, to judge from tests conducted on an experimental, high-performance 32-kb/s binary PSK modulator and demodulator constructed using the DBTR circuit. To simulate optimum clock recovery, the transmit clock of this system was hardwired to its receive side. Then when normal clock recovery was substituted using the DBTR chip at one correction per 128 clock periods, the degradation observed was only about 0.1 dB—not noticeable in practice.

Error-correction coding

Data may be encoded before transmission by inserting parity bits that permit errors to be detected and corrected at the receiving end. However, the presence of these additional bits means that transmission must take place at a speed higher than the input data rate. What is more, the correction coding and decoding devices usually require additional timing signals synchronized to the input data or received signal rate. Both the clock rate change signals and the additional timing signals may be provided by the DBTR chip.

Consider, for example, a so-called convolutional encoder that functions by accepting serial input data and converting it into parallel information sequences. These sequences are shifted through registers that are tapped in accordance with the chosen encoding algorithm.

The contents of the tapped stages are added in exclusive-OR circuits to form a single parity sequence, which is then combined with the original information sequences to generate the output data streams.

In the example in Fig. 4, the addition of a parity bit to each group of 3 input bits results in 4 output bits. Therefore, this is known as a rate $3/4$ code.

While data enters the encoder at a clock rate R , the

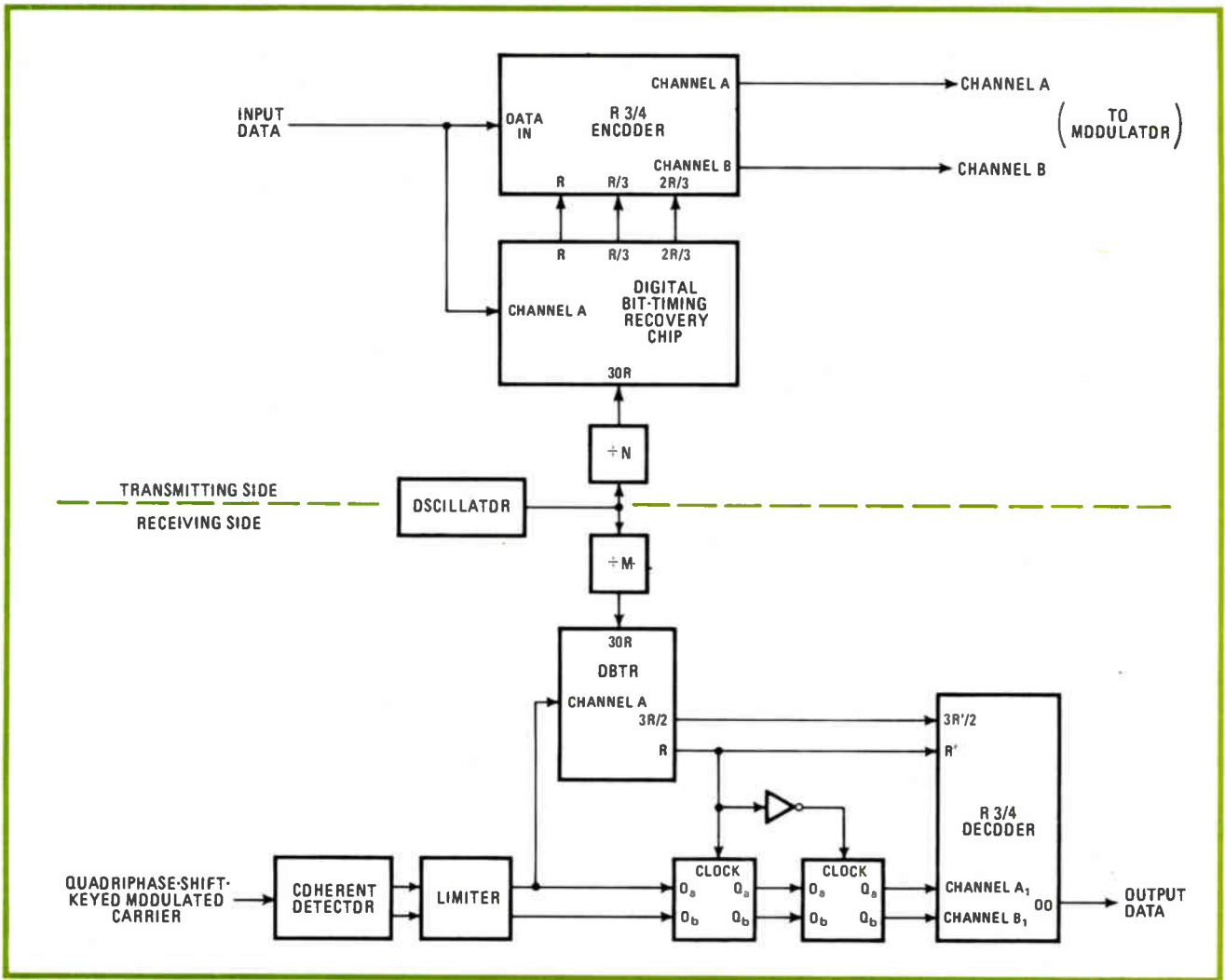

4. New rate. When parity bits are inserted into a data-transmission system for error correction, the effective data rate is changed. The DBTR chip finds application at both the transmitting and receiving ends to provide timing recovery and all the necessary timing clocks.

coded output exits in parallel streams with a clock of rate $2R/3$. This results in composite transmitted-bit rate of $4R/3$ —higher than the original data rate, as mentioned above.

To operate in this mode, the convolutional encoder requires clocks at rates R , $R/3$, and $2R/3$. These are readily furnished by the DTBR chip.

At the receiver

The corresponding rate $3/4$ threshold decoder at the receiver puts out serial output data at the bit rate at which the raw data originally entered the coder. Typically, when there is a channel bit-error probability of 10^{-4} , the bit-error rate of the decoded output works out at less than 10^{-7} .

With coded data arriving in two parallel streams of rate R' , the decoder requires both the R' clock and a $3R'/2$ clock. Of course, $3R'/2$ must be equal to R , the rate at which the original uncoded data entered the encoder.

As shown in the figure, the encoder and decoder may obtain all necessary clock signals from separate DBTR circuits. In this system, the encoded data appears in two

parallel bit streams suitable for interfacing with a quadriphase-shift-keyed (QPSK) modulator. There, each pair of bits defines one out of four possible phases of the modulated carrier.

The corresponding pair of output channels from the demodulator's limiter may be sampled in mid-bit for a low bit-error rate by the first D-type flip-flop pair. Data is then clocked on the opposite phase of the recovered clock in order to regain the proper decoder input timing relationships.

In practice, the flip-flops may be eliminated and the output of the limiter fed directly into the decoder. All that is required of the decoder is that it accomplish the necessary mid-bit sampling of its input. Since each channel contains the same timing information, the data clock may be recovered from either.

It is important to remember that while the $30R$ input to the encoder DBTR is a clock at 30 times the input data rate, the decoder DBTR requires a master clock of 30 times the demodulator symbol rate. This is 20 times the input data rate. If desired, both clocks may be derived from the same oscillator by choosing appropriate division ratios N and M such that $N/M = 2/3$. □

V-MOS chip joins microprocessor to handle signals in real time

By performing millions of operations a second, this device enables a standard microprocessor to rival bit-slice systems

by Richard W. Blasco, *American Microsystems Inc., Santa Clara, Calif.*

□ Versatility, easy programming, and low cost make standard microprocessors heavy hitters in many leagues. But they do tend to strike out when it comes to real-time signal processing, with its number-crunching throughputs of several million arithmetic operations each second, its need for external synchronization at minimal software overhead, and so on. However, help is at hand.

A powerful microcomputer

A new large-scale integrated chip gives a microprocessor system the processing clout required to handle real-time signals. Dubbed the S2811 signal-processing peripheral (SPP), this powerful chip gives the system a signal-processing capability rivaling the capability of bipolar bit slices and dedicated multipliers—at consider-

ably lower chip count, cost, and power consumption.

The SPP is actually a powerful microcomputer in its own right, packing 30,500 devices on a die measuring only 198 by 205 mils. This density was achieved with the proprietary V-MOS process, in which vertical devices are fabricated by etching a V groove through an epitaxial layer. Like a microcomputer, the part is programmable for digital processing of signals in voice-grade communications systems and other audio-frequency applications. The architecture is optimized for the processing of audio signals (Fig. 1).

Linking instruction memory, data memory, a hardware multiplier, and an adder/subtractor unit with a parallel multiple-bus structure, the SPP can fetch two operands, multiply them, and accumulate and store the

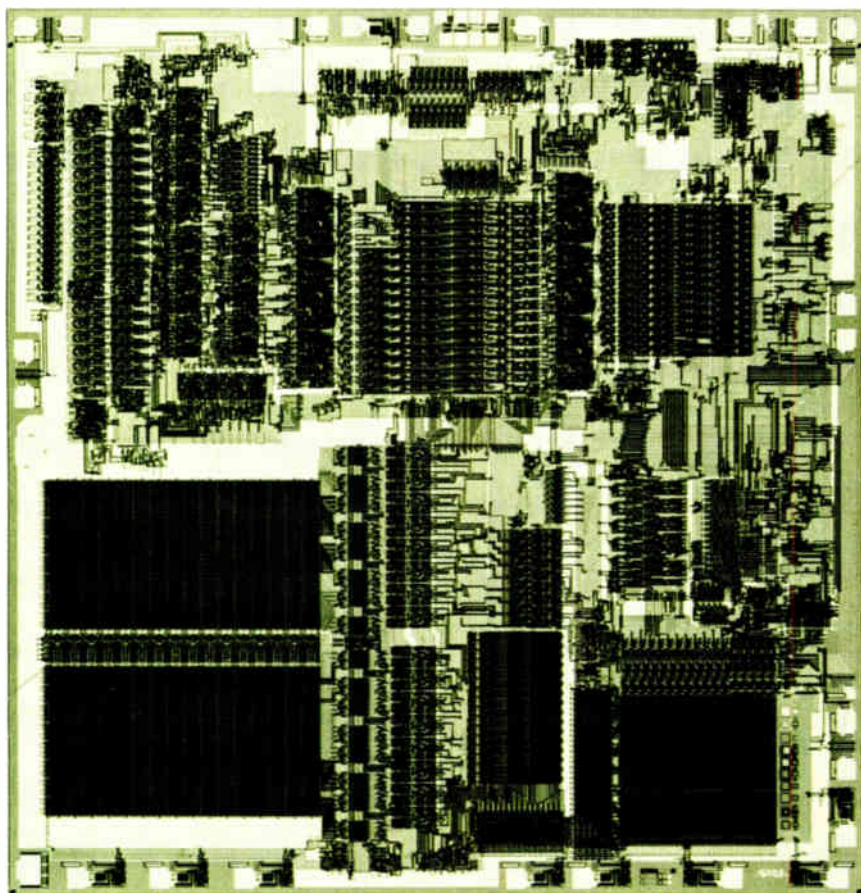

Signal processor. Actually a 16-bit microcomputer, this peripheral chip uses V-MOS technology to achieve the density necessary for handling voice communications digitally in real time.

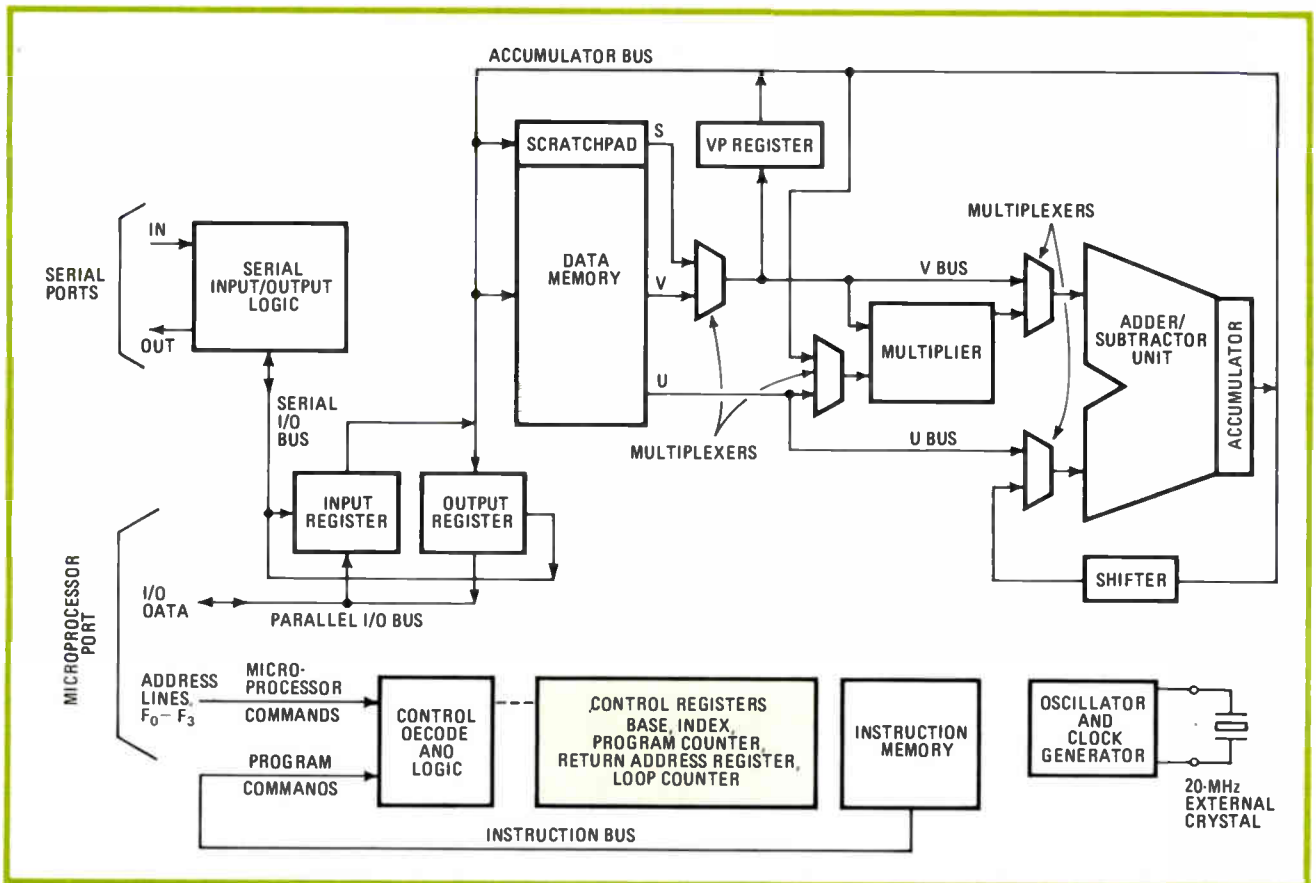

1. Built for speed. Architecture of the S2811 signal-processing peripheral device features multiple buses and special-purpose registers to provide processing throughput that is comparable to that of bipolar bit slices; yet the new device is a single chip.

TABLE 1: S2811 SIGNAL-PROCESSING PERIPHERAL CHIP BENCHMARKS

Operation	Number of instructions	Execution time
Biquad filter section	7	2.1 μ s
Dual-tone multifrequency decoder	51	54 μ s/sample
μ -law/linear conversion	15	6.6 μ s
Sine and cosine of angle	19	5.7 μ s
Fixed to floating-point conversion	18	15.9 μ s
Floating-point to fixed conversion	3	5.1 μ s
V.27 (4,800-bit/s) modem	248	497.7 μ s/ baud
32-point complex fast Fourier transform (expandable)	190	1.5 ms/32 points
Audio-spectrum analyzer	34	21.7 μ s/sample

result in a single 300-nanosecond instruction cycle. Its architecture also includes several special-purpose registers to facilitate throughput.

The result is processing capability equivalent to some 35 bipolar bit-slice devices packed into a 28-pin dual in-line package. Clocking is provided by connecting a 20-megahertz series-resonant crystal across two pins. Power dissipation of the device is less than 1 watt from a single 5-volt supply.

The S2811's processing capability should make it a practical solution in many applications, as the benchmarks in Table 1 suggest. The part was designed for telecommunications applications, but prospective users

also have proposed it for radar image processing, speech compression and recognition, process control, and pattern classification. The small size and low power dissipation of SPP-based systems are particularly advantageous in mobile applications. For complex tasks a number of the chips may be linked together in an array; for specialized jobs, several standard, factory-programmed parts will be available.

Control by microprocessor

The SPP teams with a microprocessor to provide a flexible and powerful signal-processing arrangement. It is coded using an internal mask-programmable read-only memory. The coding results in a collection of processing sequences, or "hardware subroutines," called up by the microprocessor to process signals. By providing parametric data during the callup or by changing the sequence of routine calls, the processor can modify program flow.

For example, a universal filter routine may be coded in the SPP, with key filter parameters (order of filter, pole and zero locations, and so on) supplied by the control processor at execution time. So the same mask pattern is usable for several different applications. Similarly, a single mask pattern can provide both forward and inverse Fourier transform operations, depending on the sequence of calls from the control processor.

The SPP may be coded to provide an interrupt upon completion of its task, freeing the control processor to perform other tasks until then. The instruction set is

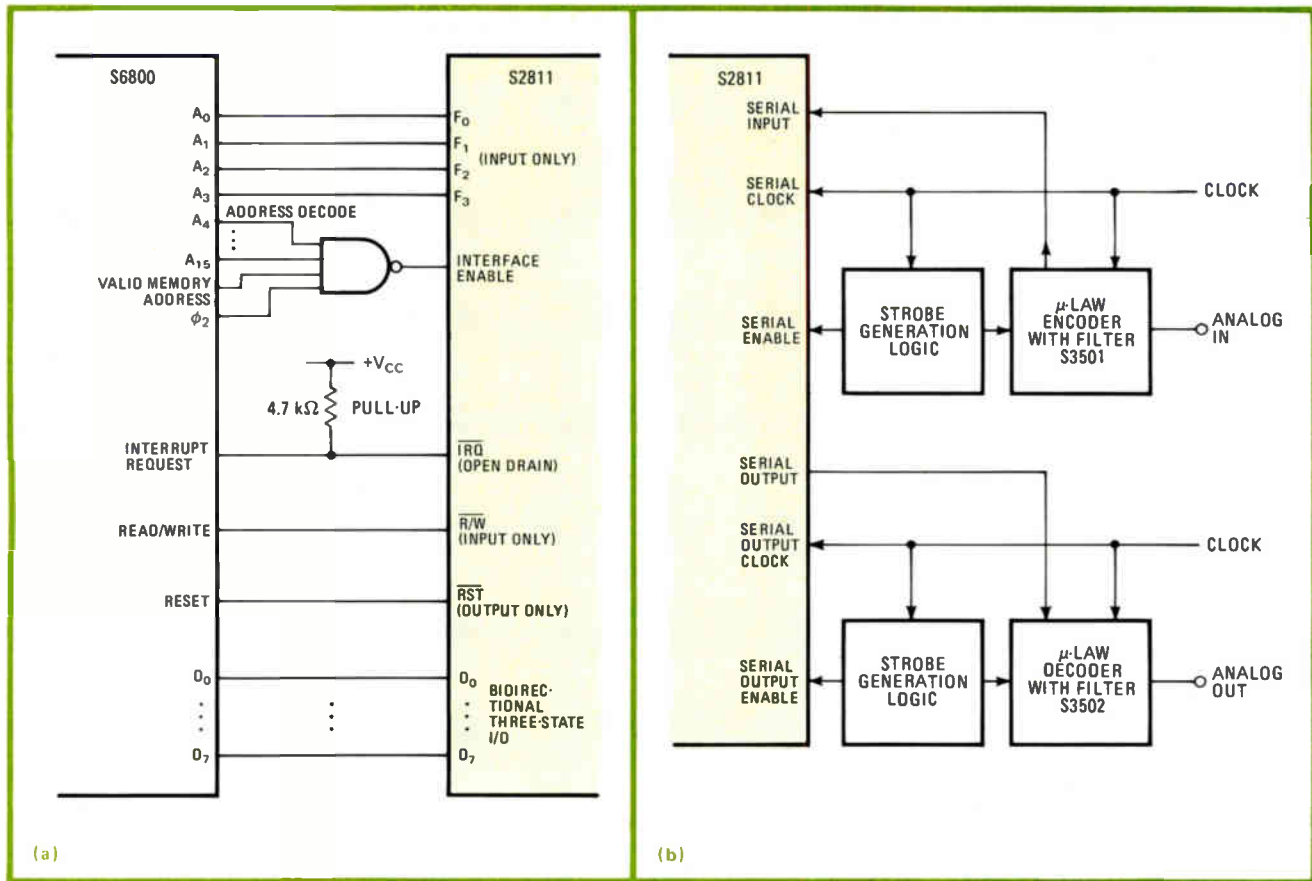

2. **Straightforward.** Microprocessor port (a) and serial ports (b) provide straightforward and simple interfacing. The serial input and output ports are independent, and each can interface up to 10 coders/decoders thanks to the time-division-multiplexed format.

powerful enough to permit operation for several hundred microseconds between microprocessor calls. This permits use of any standard processor to control the part.

While capable of operating without a control processor (see "It stands alone for simple jobs," p. 134), the SPP is intended to fit into a microprocessor environment. Its interface was designed to be both simple and flexible, with two input/output ports: one to the microprocessor, and a serial port to the outside world.

Data may be routed via the microprocessor or serial port under software control. The multiple-bus architecture permits a serial input and output, either a parallel input or output, and internal number crunching all to take place simultaneously. All necessary control logic is handled by hardware in the S2811, minimizing software overhead. This sophistication makes the interface as simple and straightforward as possible (Fig. 2).

The microprocessor port, for device control and data I/O, is directly compatible with the 6800 and 9900 bus format. Addition of a few medium-scale integrated devices provides compatibility with any of the popular microprocessors.

The serial port, for signal I/O, is directly compatible with the interfaces of the American Microsystems S3501/S3502 coder/decoder. Low-cost codecs may be used for analog-to-digital and d-a access because the S2811 software can be written to include conversion from companded to noncompanded code and vice versa.

The serial port may be directly connected to a stan-

dard telecommunications highway for processing of pulse-code-modulated signals without leaving the digital domain. It will handle word lengths from 1 to 16 bits at a shift rate up to 5 MHz. The part can service as many as 10 transmit and 10 receive PCM channels simultaneously at a 2.048-MHz shift rate. The transmit and receive channels are asynchronous and independent.

Synchronization of data

Input and output flags, along with double buffering of the serial port, permit the SPP to operate in synchronous sampled-data systems with a minimum of software overhead. Signal processing usually involves sampling the input signal at regular intervals and passing these samples to the processor. The sampling must occur at precise intervals, with essentially no phase jitter on the sampling strobe. The signal processor must acquire the samples at precise points in the program execution cycle for proper operation. Some means of synchronization is therefore required.

Synchronization can be achieved in two ways. Sampling strobes may be generated by the processor by fixing the program length and providing special sampling instructions. Alternatively, the processor may be synchronized to an external sampling strobe by somehow adjusting the program length to equal the sample period. Both methods are to be found implemented in signal-processing chips.

The first method requires minimal hardware, since no

It stands alone for simple jobs

For simple tasks like Touch-Tone decoding, the S2811 can operate without a control processor, as shown above. The resistor and capacitor on the RST input generate a start pulse to initialize the part and begin execution at location 00. Use of jump tables and the special MODE instruction allows the part to provide its own program control and setup information.

Generating a strobe for the codecs and SPP requires only the 4024 seven-stage ripple counter and a quarter of a 4081 AND gate. The S3501/2 codec chips contain the aliasing filters required by the sampling arrangement. The unused S2811 parallel inputs may be connected to provide program options or with a transistor-transistor-logic patch to provide more outputs.

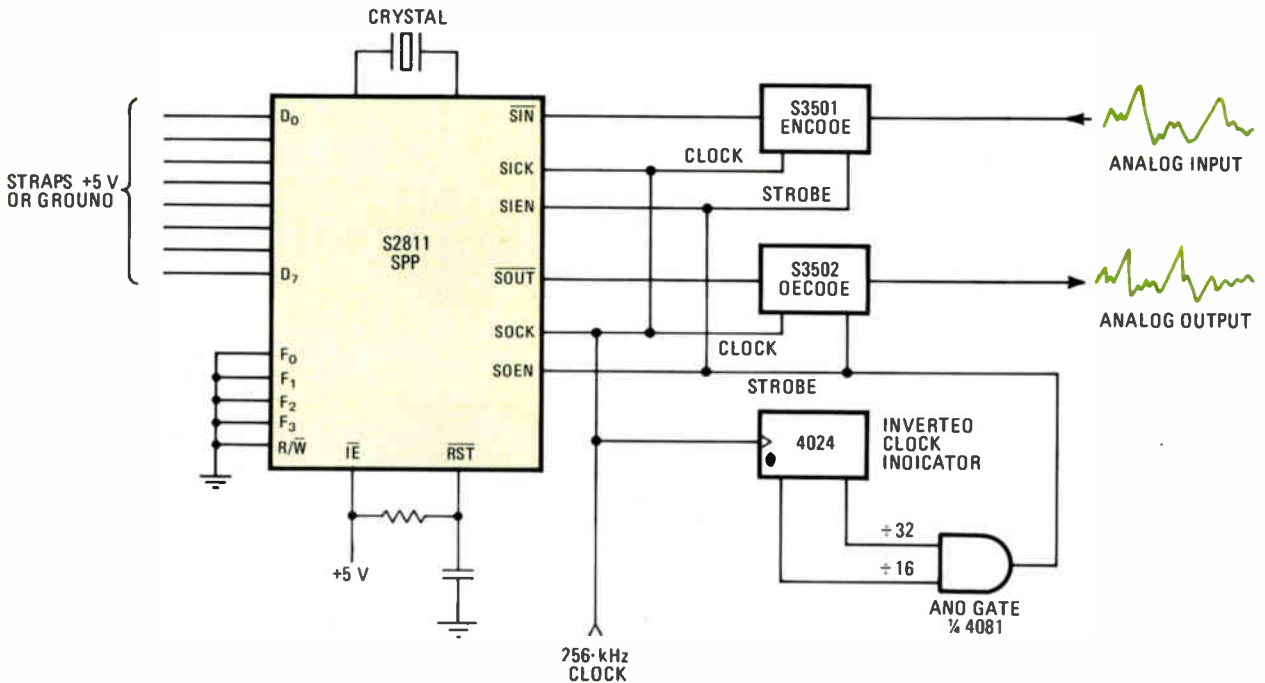

adjustments for program length are needed. However, strobe accuracy requirements are now imposed on the processor clock. Program jumps and loops are all but excluded, since they would make maintaining a constant program length excessively difficult. The limitations of this approach become unacceptable as the processing algorithm gains complexity.

The S2811 uses the second, more common approach. The fixed program length is slightly less than the sampling interval, and wait loops extend the length to equal the sample period. One or more buffer registers provide elastic storage with samples remaining there for a period equaling the difference between the sampling period and the instantaneous program length. Elastic storage permits synchronization to be maintained despite small variations in program length, so long as the average program length is no longer than the sample period.

Hardware resources

As the signal-processing element in a microprocessor-based system, the SPP is designed to be flexible and easy to use for most audio-signal tasks. The architecture will look familiar to those who assemble signal-processing units from medium- or small-scale integrated circuits; on a single chip are the hardware features of the typical bipolar bit-slice solution.

The user's code is stored in a 256-by-17-bit ROM. Six

of the 17-bit instruction words are reserved for production-line testing; the remaining 250 words are available to the user. The limited size of the instruction memory is not as much of a constraint as it might seem, because of the power of the instruction set itself (as later discussion of the set will make clear). Experience suggests that available processing time is exhausted slightly before code space is depleted in most applications.

The data memory stores 256 16-bit data words. The arrangement of Fig. 3 permits simultaneous access of two operands with a single fetch command. The memory is organized as 32 "base" groups of eight "displacement" words each. All eight displacement words are accessed in parallel, over lines 0-7, and the two displacement multiplexers select two of the words for processing. For convenience of reference, one multiplexer and the associated lines are identified as the U circuit, the other multiplexer and lines as the V circuit.

To conserve die area, the data memory is split between a random-access memory and a ROM. In most applications this partitioning is ideal, since coefficients, lookup tables, and other fixed data conveniently reside in the four ROM displacements—and there is no need to load coefficients into the SPP upon power-up. Those applications requiring additional RAM may utilize the block-transfer mode to expand the apparent memory size.

An eight-word scratchpad can replace the V output.

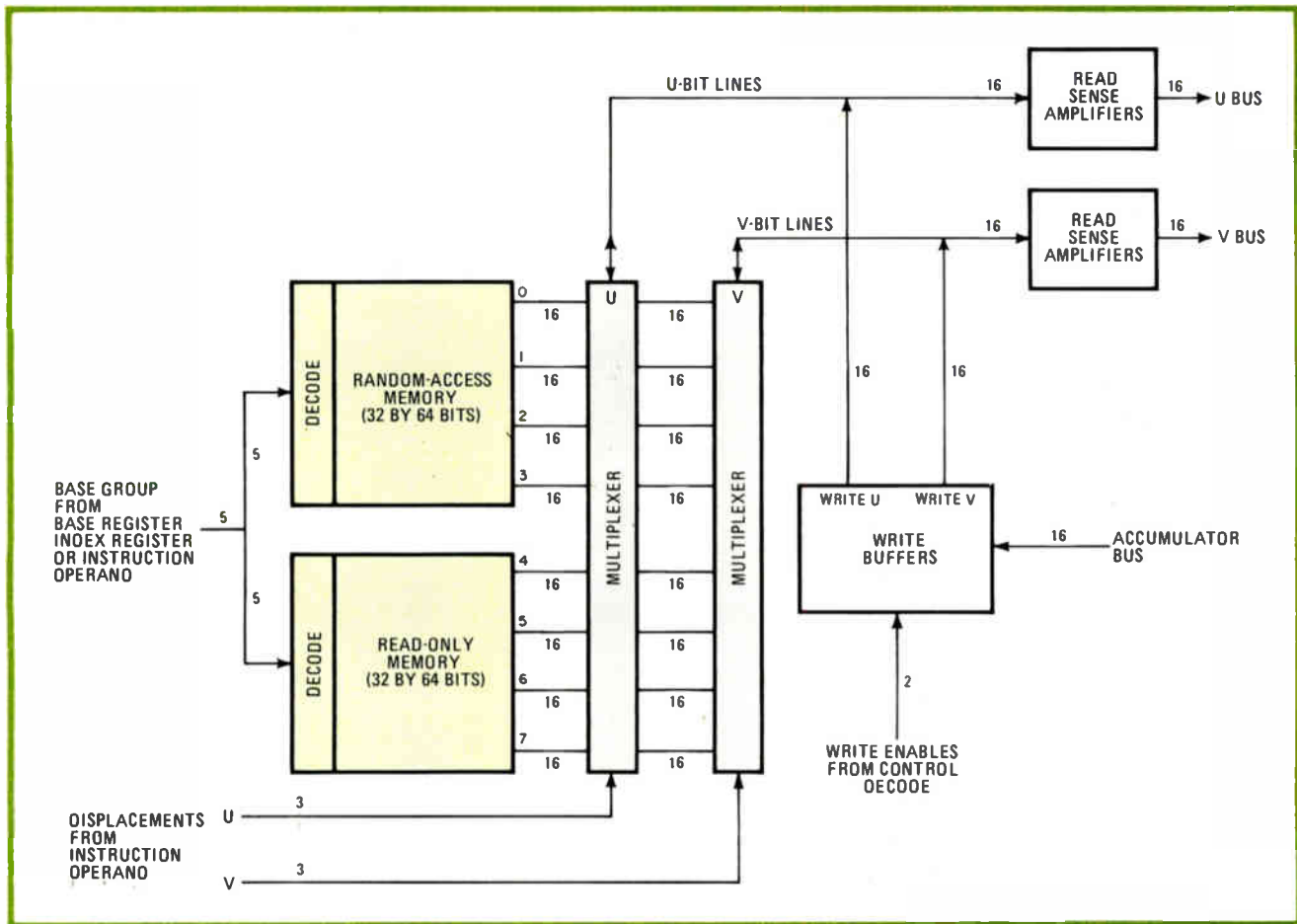

3. Two for the price of one. The base-displacement organization of the 256-word data memory coupled with the output multiplexers, provides two memory words with a single fetch. One word comes on the U-bit lines, and the other on the V-bit lines.

All in RAM, the scratchpad data is available independently of the base-group selection (each base consists of four words in RAM and four in ROM). It stores the constants and parameters common to several groups of data and also is handy for temporary storage of intermediate results.

A fully parallel modified Booth algorithm multiplier forms the product of two 12-bit inputs and rounds off the result to 16 bits. The round-off scheme used is accurate to $15\frac{3}{4}$ bits and has zero mean error.

Multiply time is 300 ns and overlaps the 300-ns instruction cycle so that the product of two operands fetched during instruction N is available during instruction N + 1. This pipelining maximizes throughput and is fairly easy to handle when programming the SPP.

The adder/subtractor unit (ASU) calculates the sum or difference of two 16-bit members. Circuitry is provided to detect zero, negative, and overflow outputs, with special jump instructions providing program branching on these conditions. Overflow protect circuitry provides the saturation arithmetic already discussed. A 1-bit arithmetic shifter scales numbers in the ASU by a factor of two.

Digital filtering algorithms require implementation of a delay of one sample period (Z^{-1}). The VP register makes the V operand accessed during instruction N available during instruction N + 1 for storage. This

simplifies filtering routines (see "Filters are easy," p. 136) by eliminating the overhead otherwise required to implement the Z^{-1} delays.

Control logic interprets the commands from the the control microprocessor or from the internal instruction memory and sets up data paths in the SPP. (Several macroinstructions are provided to minimize code for commonly used routines.) Programmable logic arrays implement all decoding, making it relatively easy to modify the basic instruction set.

Several counters and registers assist in controlling the SPP. These are:

- The base register, which is a 5-bit presettable up/down counter providing base-group address information to the data memory.
- The index register, an 8-bit presettable up counter providing addressing during the block-transfer mode and serving as an alternative base register (using only 5 bits) for table-lookup and dual-base addressing operations.
- The program counter, an 8-bit presettable up counter providing the instruction memory address. Extensive jump instructions allow program branches and loops.
- The return address register, an 8-bit register storing the program return address when a subroutine is called. One level of subroutine nesting is available.
- The loop counter, a presettable 5-bit down counter controlling iteration loops. Several jump instructions are

Filters are easy

The S2811 architecture is optimized for implementation of digital filters. Consequently, implementation of filters is both straightforward and efficient. For example, the finite impulse response transversal filter is implemented with the following equation:

$$Y_n = \sum_{i=0}^N W_i X_{(n-i)}$$

where

$Y_{(n)}$ = the output

$X_{(n)}$ = the input

N = the number of stages

i = the stage number

W_i = the weight associated with stage i

$X_{(n-i)}$ = the present input sample delayed by i samples.

Data samples are shifted following each $Y_{(n)}$ calculation.

The following six-instruction routine implements this filter, including setup of required control registers. The new sample $X_{(n)}$ is placed into location 00.0.

Use of the REPT command provides high efficiency, since each additional tap requires only 300 nanoseconds to process. The power of the S2811 instruction set is illustrated in line 54, where an accumulation, VP-register-to-RAM transfer, base-register increment, multiplier setup, loop-counter decrement, and loop-counter test are all implemented in a single 300-ns macroinstruction, including all necessary overhead.

Adaptive transversal filters are implemented using similar routines, with coefficients stored in random-access memory. Tap update routines modify the coefficients to make the filter adaptive.

LINE	OP1	OP2	OPERAND	COMMENTS
50	NOP	CLAC	-	Clears accumulator
51	-	LLTI	L(09F)	Loads base, loop counter set up to input register
52	AVZ	LIBL	D(00.4)	Sets base = 1, loop ctr = 31, loads W0 in accumulator, and starts multiply of W0 x (ASU) = 0
53	APZ	REPT	D(00.0)	Sets up first multiply, loads zero product into accumulator (next line to be repeated 31 times)
54	APA	TVIB	UV(4,0)	Accumulates product from previous tap, starts multiply for new tap, and shifts data using VP register, incrementing base register
55	APA	TACV	D(0E.2)	Accumulates last term and stores Y sample in address 0E.2

TABLE 2: S2811 SIGNAL-PROCESSING PERIPHERAL CHIP'S OP1 (ASU) INSTRUCTIONS

Type	Mnemonic	Operation
No operation	NOP	No operation
Accumulator operations	ABS	Absolute value
	NEG	Negate ASU contents
	SHR	Arithmetic shift right
	SGV	Negate ASU contents if different polarity from RAM-V contents
Addition operations	AUZ	Load RAM-U contents in ASU
	AVZ	Load RAM-V contents in ASU
	AVA	Add RAM-V and ASU contents
	AUV	Add RAM-U and RAM-V contents
Subtraction operations	SVA	Subtract ASU from RAM-V contents
	SVU	Subtract RAM-U from RAM-V contents
Multiply/add operations	APZ	Load product in ASU
	APA	Add product to ASU contents
	APU	Add product and RAM-U contents
Multiply/subtract operations	SPA	Subtract ASU contents from product
	SPU	Subtract RAM-U contents from product

conditioned on this counter, which is automatically decremented each time it is tested. Gating logic is provided to prevent underflow when the loop counter counts down to zero.

Control codes

The microprocessor controls the SPP over the four address lines designated F_0 - F_3 in Fig. 2. When the interface-enable (\overline{TE}) line is brought low, the command is transmitted over these lines to set a latch in the chip. The user maps his processing codes into 16 contiguous addresses of the microprocessor's memory space by assigning the F lines to the four least significant address lines. Then reading or writing to the appropriate memory address will activate the desired SPP command.

The DUH/DLH commands (data-upper half byte and data-lower half byte) will transfer 16-bit data into or out of the SPP. Since DUH terminates a word transfer, the most significant bits are always transferred last. Using the DUH command alone is enough to transfer 8-bit data at full efficiency.

The basic routine call from the microprocessor is XEQ: start execution at location D_0 - D_7 . Execution will start at the SPP code location corresponding to the D_0 - D_7 data inputs. In addition, either hardware or software reset will start execution at location 00, providing boot-strap start-up when a control processor is not used.

The remaining control codes set latches to provide special modes of operation. These special modes are set

up by first clearing the control latches using the CLR command and then calling out the desired modes with the appropriate commands.

In addition, these control latches can be set with a special operating instruction (MODE) to provide its own control commands. At the time he is developing his program, the user is free to specify which of the control commands are to be fixed in the code and which of them will be selected by the control processor later on, at the execution time.

Control options for flexibility

The remaining eight commands in the control code provide I/O format and source options to maximize flexibility. The S2811 usually operates with all data transferred via the parallel microprocessor port, one byte at a time. The SRI and SRO commands (enable serial input or output) will route data samples via the serial input and output ports, respectively. With the serial port selected, data may be presented in sign-magnitude form rather than the normal 2's complement format. The SMI and SMO commands (sign-magnitude serial input or output) enable the appropriate conversion logic.

Blocks of data may be moved using the BLK mode. Repeated DLH/DUH access commands will transfer data words while automatically incrementing the index register to access the next word. With an appropriate direct-memory-access controller, data may be transferred into and out of the SPP at a 4-megabyte-per-second rate. Thus the block-transfer capability permits virtual techniques to expand the apparent memory size of the chip.

An external ROM mode (XRM) permits control of the SPP from an external code source. It was included primarily for testing of the part, allowing a standard test pattern to exercise the chip independently of the user's code. With 10 MSI packages, however, users may run the chip from an external programmable ROM, but it operates at half speed (600-ns cycle) in this mode.

The external ROM mode may be used for program development or to provide patches or additions to existing code. The limitations of this mode militate against its use for general program development, where tight timing constraints probably will exist.

The SOP and COP commands determine whether saturation arithmetic (SOP) or overflow arithmetic (COP) is performed in the adder/subtractor unit. With overflow protection enabled, the ASU output will saturate to the maximum positive or negative value, corresponding to the direction of the overflow.

Expandable options

The block-transfer capabilities, microprocessor control, and dual I/O ports provide SPP-based systems with degrees of expandability. Using the block-transfer mode, a single chip may be used to process several sets of data on a time-sharing basis. Under direction of the microprocessor, higher throughput may be achieved by dividing the processing tasks among several parts.

Using the serial ports, two SPPs can pass data directly to each other. Array processor architectures are easily implemented in this manner. The time-division-multiplexed format of the serial ports permits selective inter-

TABLE 3: S2811 SIGNAL-PROCESSING PERIPHERAL CHIP'S OP2 (TRANSFER/CONTROL) INSTRUCTIONS

Type	Mnemonic	Operation
No operation	NOOP	No operation
Load instructions	LLTI	Load literal in input register
	LIBL	Load input register contents into base and loop counters
	LACO	Load ASU contents in output register (sets interrupt request)
	LAXV	Load ASU contents in index register and RAM-V
	LALV	Load ASU contents in loop counter and RAM-V
	LABV	Load ASU contents in base register and RAM-V
Data transfer instructions	TACU	Transfer ASU contents to RAM-U
	TACV	Transfer ASU contents to RAM-V
	TIRV	Transfer input register contents to RAM-V
	TVPV	Transfer VP register contents to RAM-V
	TAUI	Transfer ASU contents to RAM-U using index contents as base
Adder/subtractor unit operations	CLAC	Clear ASU and overflow, SWAP latches
Register manipulation instructions	INIX	Increment index register
	INCB	Increment base register
	DECB	Decrement base register
	SWAP	Interchange roles of base, index registers
Unconditional jump instructions	JMUD	Jump unconditionally direct
	JMUI	Jump unconditionally indirect (index points to jump table)
Conditional jump instructions	JMCD	Jump direct, conditioned on loop counter (jumps if LC ≠ 0, LC auto-decrements)
	JMPZ	Jump direct if ASU contents = 0
	JMPN	Jump direct if ASU contents are negative
	JMPO	Jump direct if ASU overflow latch is set (resets overflow latch)
	JMIF	Jump direct if input flag is low (input register empty)
	JMOF	Jump direct if output flag is high (output register full)
Subroutine instructions	JMSR	Jump to subroutine
	RETN	Return to main program
Macro-instructions	JCDT	Jump conditionally dual-tracking (increments base and index registers)
	JCDI	Jump conditionally direct and increment base register
	TVIB	Transfer VP contents to RAM-V and increment base register
	REPT	Repeat next instruction until LC = 0 (LC decrements with each iteration)
	MODE	Force OP1 to NOP and use OP1 bits to provide control code (Table 1)

TABLE 4: S2811 SIGNAL-PROCESSING PERIPHERAL CHIP'S ADDRESS MODES/MULTIPLIER SETUP

Mode	Description	Multiplier inputs
UV	Offset addressing using base and two displacements provided in operand; data located in RAM-U and RAM-V	RAM-U X RAM-V
US	Offset addressing; data located in RAM-U and scratchpad	RAM-U X scratchpad
DA	Direct addressing using address provided in operand; data is RAM-V only	ASU X RAM-V
LT	Literal; data located in operand	None — previous inputs are held
DT	Direct transfer; jump address provided in operand	None — previous inputs are held

connection of the array elements by generating input and output strobes during the appropriate time slots.

To harness the processing power of this architecture, a potent instruction set comes with it. The 17-bit instruction word, partitioned into two op codes and an operand, are stored in the SPP's ROM. They are the vehicle by which the user customizes the chip's functions for his application. In general, this code is independent of the control microprocessor's program. The two are linked via the F lines.

Instruction set details

The 4-bit OP_1 code controls the ASU, while the 5-bit OP_2 commands set up data transfer and program flow. The 8-bit operand provides literal data or address information (3 bits each for displacement selection as shown bottom left of Fig. 3).

The 16 OP_1 instructions (Table 2) and 32 OP_2 instructions (Table 3) provide 388 valid instruction combinations. Benchmarks indicate that this arrangement permits the user to command an average of 3.3 operations per line of code executed.

The large number of instruction possibilities, coupled with the branching and looping capabilities of the SPP, maximize program efficiency. Also, subroutines allow code to be used several times in a program. This ability allows the chip to operate with minimal direction from the control microprocessor and makes the maximum 250 lines of code more than adequate for the majority of applications.

The last 2 bits of the operand identify the addressing mode. Data may be directly addressed, offset addressed, or indirectly addressed. Direct addressing allows access of data in displacements 2, 4, or 6 of Fig. 3, independent of the base register and the index registers. It allows

access of only a single word at a time.

Offset addressing makes use of either the base or the index register to point to the base group, while the U and V displacements are specified by the operand. It permits the simultaneous access of two words, one of which may be a scratchpad word.

An offset variant

Dual-base addressing is a variation of offset addressing in which the base and index registers alternately supply the base-group information, under the direction of the swap command. JCDT (jump conditionally, dual tracking) increments the base and index together, providing a tracking arrangement. This address mode is useful in computing kernel functions in which data becomes separated in memory by a fixed offset, as in the fast Fourier transform. It allows the base and index registers to be set up to accommodate this offset with negligible loss of program efficiency.

Indirect addressing allows use of lookup and jump tables stored in the data memory. The index register points to the base group whose contents may be loaded into the ASU for table lookup or into the program counter for jump-table implementation.

Specifying an address automatically sets up the SPP multiplier, as detailed in Table 4. The last two modes in the table serve to inhibit the update of the multiplier inputs, causing a product to be held while executing jump or literal instructions.

The multiplier runs constantly. Access to a product takes only specification of the proper OP_1 code to load it into the accumulator. Products not used are simply overwritten by new products.

Programming support

The assembly-language format has been defined to make SPP code readable, and users may submit their programs in this format to the manufacturer. A low-cost in-circuit emulator that is designed to run at a reduced speed will be available soon, and a software simulator and a real-time in-circuit emulator will be available somewhat later on a limited basis.

Moreover, several SPP-based standard products, programmed for specific tasks, will be introduced. The first such product is the S2814 fast Fourier transformer. Users of these parts need only be concerned with proper interface to the SPP.

A bright future

Technology in the area of signal processing is developing rapidly, and the SPP approach is not the only possible approach. Other chips will be coming for microprocessor-based systems. Also, further development of bipolar bit slices, switched-capacitor analog technology, and even analog microprocessors will provide many options for signal-processing systems.

Products like the SPP make the message clear: signal-processing technology is in the midst of a revolution. Techniques previously thought impractical are easily implemented with newly available integrated components. Whichever technologies emerge, the outcome will be easier, more flexible, faster signal processing. □

Add-on quality, Add-in quality with OEM memory from Control Data.

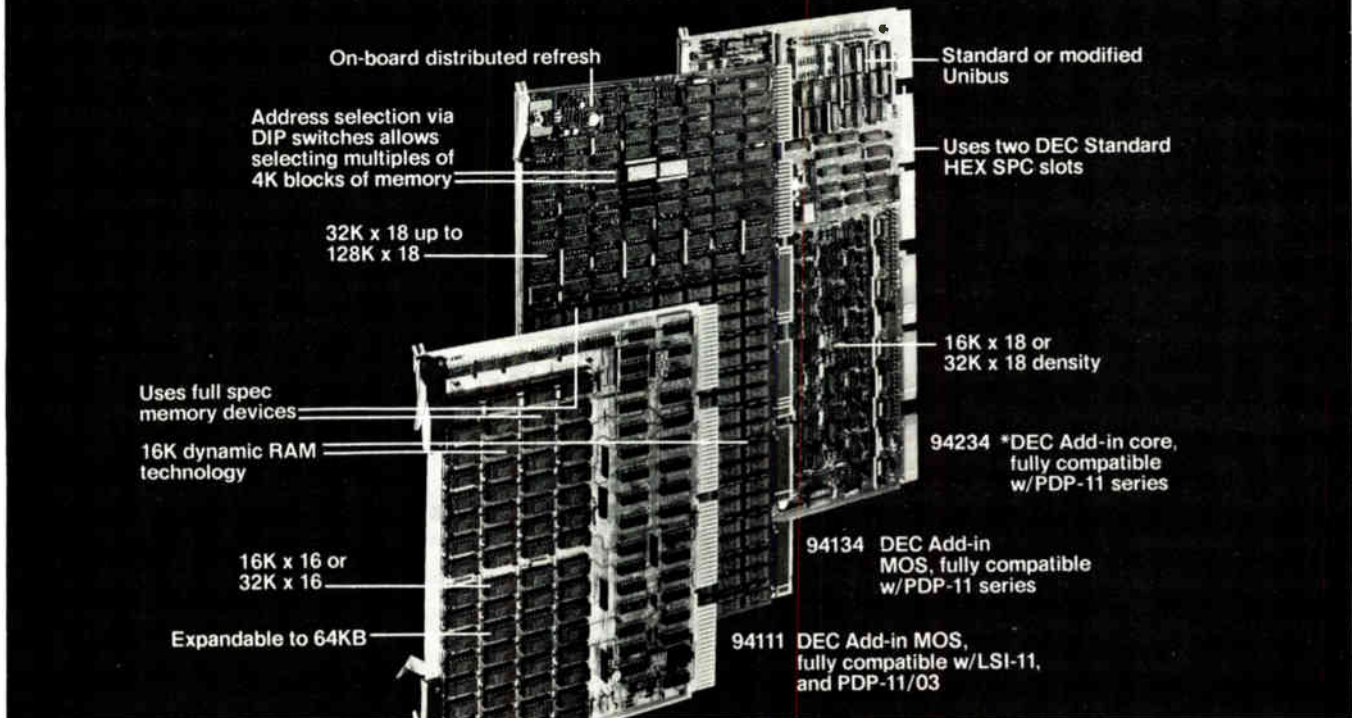

Control Data offers a complete line of semiconductor and core memory that's fully compatible with today's processors. Enclosures, too. And all are built with the same concern for quality that goes into every product we manufacture.

You see, Control Data believes in improving upon basic design when we make memory for mini-computer processors. All chips in our semiconductor memory are "full-goods." So you get all the quality and density you pay for. We use IC sockets instead of hardwiring our chips, so servicing is easier.

When your *PDP-11 needs more memory...

Add-in our 94234 Core Memory Module. It's fully compatible, of course, but you also get the inherent reliability and non-volatility of core memory technology.



94270

Our Add-on core is fully compatible too, and fits into your PDP-11/70 rack. It gives you up to 512 Kbytes in a 10½ inch enclosure housing two power supplies, one

back plane, one controller circuit board, two to eight memory modules (in pairs), four interconnect cables and four terminator circuit boards.

And when you need better semiconductor memory...

Our 94134 MOS RAM module is fully compatible with your PDP-11/34 and uses either the standard

or the modified unibus connector. Maximum configuration is 128K x 18, but smaller densities are also available. Refresh is automatic.

Our 94111 MOS RAM has block address selection via switches for the standard configuration of 16K or 32K x 16. It is pin-to-pin, voltage, signal, hardware and software compatible with *LSI-11 and PDP-11/03 systems.

Put quality behind your nameplate. Call us at 612/830-6018 or send us the coupon below.

*DEC, LSI and PDP are registered trademarks of Digital Equipment Corporation.

Jack Middlestaedt, Product Sales Manager E-8-30
Control Data Corporation, Computer Memory Division
8001 East Bloomington Freeway, Bloomington, MN 55420

Please tell me more about memory for my _____ processor.

Name _____ Phone _____

Company _____ Title _____

Address _____

City _____ State _____ Zip _____

CD CONTROL DATA CORPORATION

More than a computer company

C-MOS counter-decoder pair sets divider's modulus

by Bradley Albing
Hickok Electrical Instrument Co., Cleveland, Ohio

The availability of one-chip complementary-MOS counters and decoders makes it possible to construct this low-power, variable-modulo divider with only two integrated circuits and a single-pole, multiple-position switch. Divider ratios of from 1 to 16 can be ordered.

A_1 , a synchronous binary counter having a parallel-load feature, is stepped by an input signal of frequency f_{in} , as shown. Advancing from zero, its output is introduced to A_2 , a 4-to-16 line decoder.

A_2 serves as a hexadecimal decoder, where each output port n (of m total ports) moves high sequentially after n cycles of f_{in} . Switch S_1 selects the desired port from which the output signal (\overline{TC}) is fed back to reset A_1 . Thus it is seen that $f_{out} = f_{in}/n$.

It is easy to display the value of the divisor if a binary-coded-decimal-to-seven-segment decoder (that is, a 74C48) and a suitable seven-segment display are available. Here, the output of A_1 drives the decoder as well as the corresponding inputs of A_2 . Note that A_1 may be reset to 1 or any other number as required.

A 10-part CD4028 decoder may be used in place of a 74C154 if a divisor of 10 or less is desired. In this case, an inverter will be needed between the TC line and the \overline{PE} port of the 74C161 counter. □

Designer's casebook is a regular feature in *Electronics*. We invite readers to submit original and unpublished circuit ideas and solutions to design problems. Explain briefly but thoroughly the circuit's operating principle and purpose. We'll pay \$50 for each item published.

Decimal divider. Binary counter (A_1) and one-of-sixteen decoder (A_2) form variable-modulo divider. Ratios are selected with multiposition switch. CD4028 can replace 74C154 if a divisor of 10 or less is required. C-MOS circuit draws low power — typically a few milliamperes.

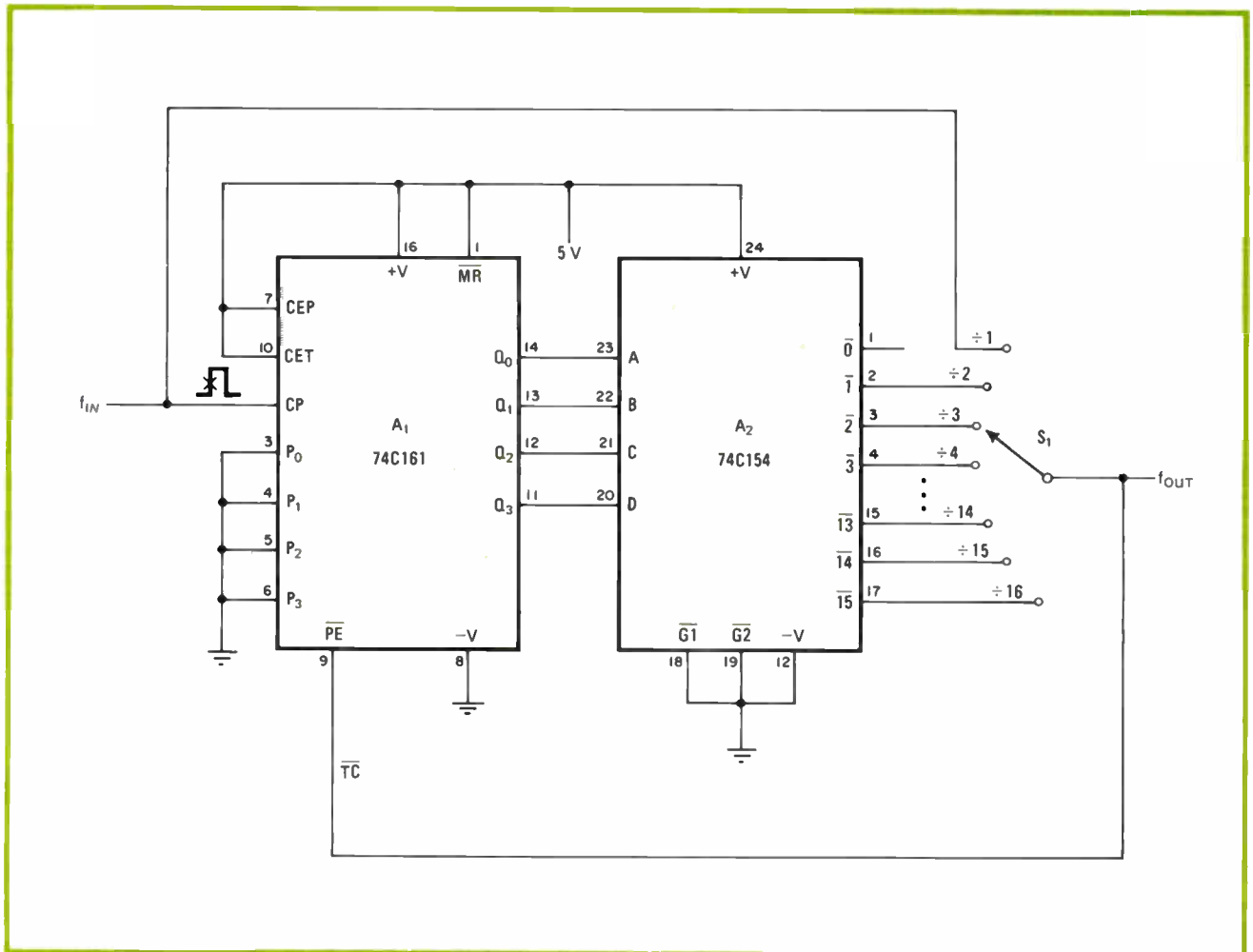

Maximum-length shift register generates white noise

by Henrique Sarmiento Malvar
 Department of Electrical Engineering, University of Brasilia, Brazil

Using a circuit based on a maximum length sequence generator,¹ this simple unit inexpensively provides a source of white noise over a range of up to 200 kHz. It is far superior to generators that use a reverse-biased base-to-emitter transistor junction, which provides quasi-white noise over a very limited portion of the spectrum. Using two integrated circuits comprising a 25-stage shift register, it can be built for less than \$6.

A₁ and A₂ form the n-stage shift register driven by clock G₁-G₂, with A₁ an 18-stage device and A₂ being eight stages in length. A₁ and A₂ are driven simultaneously but out of phase with respect to each other.

The output from stage 7 of A₁ and the last stage of A₂ is applied to G₃ in the feedback loop G₃-G₄, so that a register sequence length of 2ⁿ⁻¹ clock periods is obtained.

Note that G₄ provides signal inversion, so that on power up (the all-zero output state of A₁ and A₂), the noise generator will be self-starting.

It can be shown that the spectrum of the signal at the output of A₂ will contain several discrete frequencies, separated by f_c/(2ⁿ⁻¹), where f_c is the clock frequency, in this case 200 kHz. Because n is large, the separations between the discrete frequencies become so close (here, it will be 0.006 Hz with a sequence period of 150 seconds), that the spectrum may be considered continuous. So although the noise is pseudorandom because of the method used to produce it, the difference in the spectral properties of the noise as compared with the ideal is minimal.

As for the amplitude of the output envelope, it will vary with frequency as (x⁻¹ sin x)², where x = f/f_c. Here, the -3-dB point will occur at f = 0.45 f_c, as shown in the curve at the lower left of the figure.

Q₁ serves as a buffer. The network R₁R₂C₂ is a low-pass filter that has been added for an application requiring noise to be confined (bandlimited) to the audio frequencies. Its -3 dB point occurs at 25 kHz. □

References

1. I. H. Witten and P. H. C. Madams, "The Chatterbox-2," *Wireless World*, Jan. 1979, p. 77.

Spectrum spread. 25-stage shift register creates closely spaced signals of discrete frequency for generating pseudorandom white noise over wide range. Spectral response of source (bottom left) is flat from dc to 0.45 f_c, where f_c is the clock frequency.

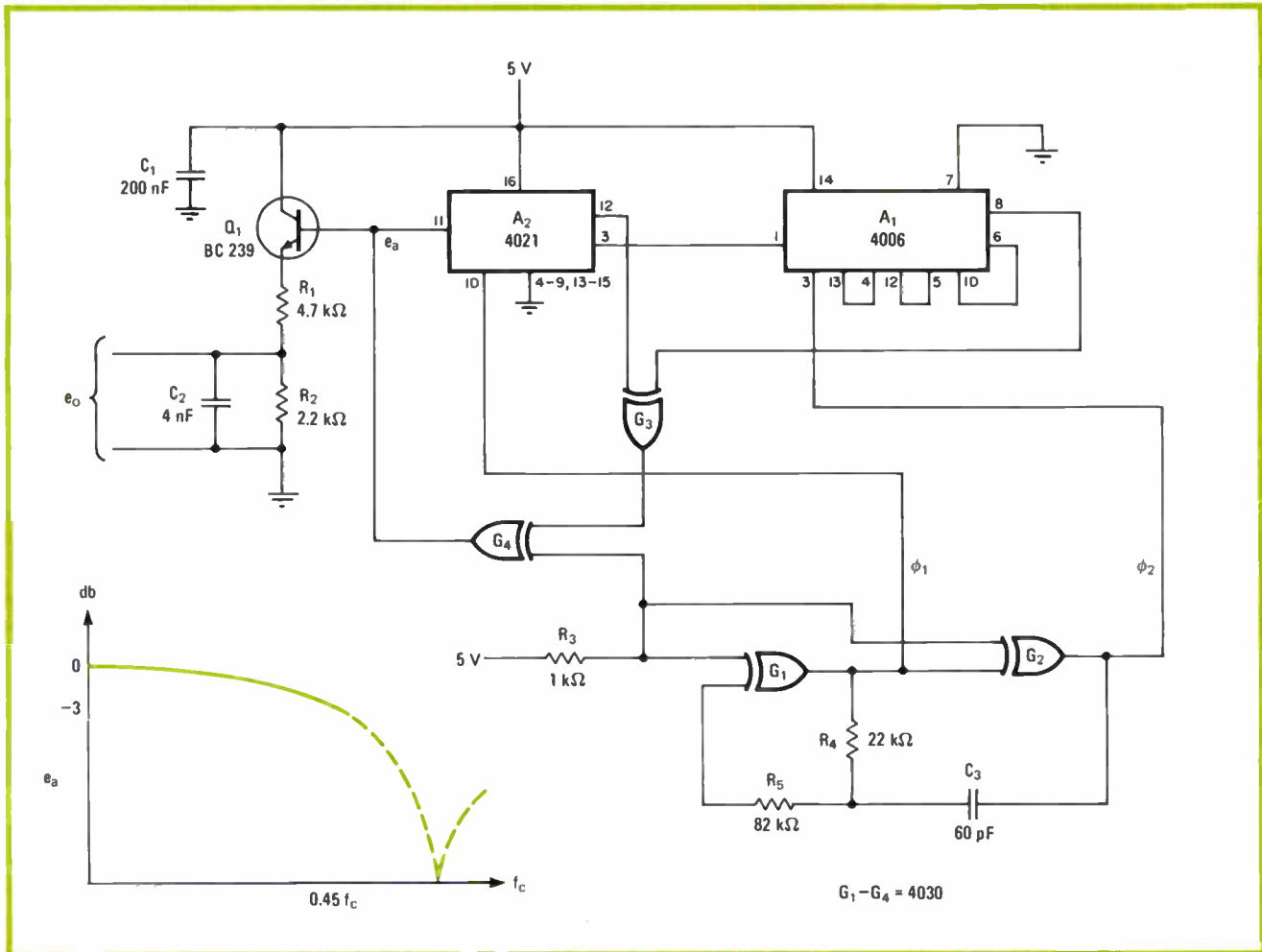

Making the Grade with Codecs.

Per-channel PCM codecs and their associated filters are among the first analog LSI devices to be produced in volume.

From a testing standpoint, they differ from most other "new" LSI devices in that the standards for quality and compatibility of codecs and filters are already well established.

The specifications are spelled out in detail in the D3 and Digital Channel Bank Compatibility Specifications and those recommended by the International Telegraph and Telephone Consultative Committee (CCITT). These present a range of ac tests ensuring that the devices will function properly in a telecommunications system.

Not that having established specifications makes the testing job any easier. The standards are rigid, calling for a sizable number of complex tests on devices that operate at their theoretical limits.

The testing situation is further complicated by the need for high throughput in a production environment, the increasing need for detailed device characterization, and the existence of both μ -255 and A-Law devices.

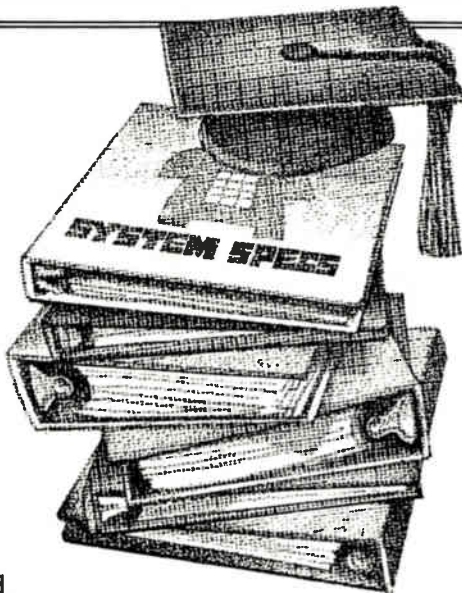

Moreover, packaging combinations for the encoders, decoders, and filters are becoming increasingly varied, with all three elements destined to appear on a single chip in the near future.

For those reasons, Teradyne has developed its Telecommunications Test Package for use on the new A300 family of analog LSI test systems.

Now a device manufacturer or user can perform fast, thorough testing to the industry standards on μ -255 and A-Law encoders, decoders, and filters. Individually or in any combination, even when they are all packaged on one chip.

The Package performs both ac and dc tests, so it satisfies the industry needs for such ac testing as gain tracking, frequency response, and signal to total distortion, as well as providing

valuable characterization information for analyzing device design.

The Package can generate programmable PCM digital code for decoders and convert the code to the analog domain for encoders. It also provides programmable digital control logic to eliminate the need for customized logic for each device type. And its bit rate range well exceeds the requirements of today's devices.

Such thoroughness in testing was once assumed to require too much time — 30 to 60 seconds. But the Teradyne Telecommunications Test Package cuts test time to just a few seconds, meaning that high throughput *and* complete testing are now both possible.

The Teradyne Telecommunications Test Package is designed for use on the new A300 Analog LSI Test Systems, and is adaptable to the hundreds of J273 Linear Test Systems already in the field.

For more information, write Teradyne, 183 Essex Street, Boston, MA 02111.

TERADYNE

Instantaneous-frequency meter measures biomedical variables

by T. G. Barnett and J. Millar
 Department of Physiology, The London Hospital Medical College, England

Providing immediate feedback on respiration, heart rate, and other biomedical parameters, this device generates an output proportional to instantaneous frequency ($1/\text{interpulse interval}$) at 100 hertz and less. The meter is simple and inexpensive and uses readily available components.

As shown in the diagram, an input spike generated by the variable being measured fires monostable A_1 , whose timing components $R_c C_c$ are selected to provide an output pulse of 500 microseconds. A_1 's output initializes A_2 , an 8-bit digital-to-analog converter, which begins to count up at a rate determined by clock A_3 .

Thus A_2 generates a precision ramp whose slope is controlled by the clock frequency $f = 1.44/(R_a + R_b)C_a$. After passing through buffer A_4 , the ramp is introduced to a transmission gate, A_5 , which passes the ramp to a sample-and-hold amplifier A_6 until A_1 times out. The

value of the ramp is stored at this time in capacitor C_H . One-shot A_7 , triggered by the falling edge of A_1 , then resets the d-a converter to zero, initiating generation of a new ramp.

One problem with an earlier version of this circuit lay in handling too long a pulse interval, in which case A_2 would reach a maximum and reset, giving an erroneously small output voltage. To remedy this situation, comparator A_8 has been added. When the ramp rises above the user-selected reference voltage, the comparator goes high and turns oscillator A_3 off. Thus the maximum ramp voltage can be set to any level.

If a voltage proportional to the pulse interval is required, it may be tapped from the output of the sample-and-hold directly. For securing a voltage proportional to $1/\text{pulse interval}$, the output may be taken from analog divider A_9 , which generates an output equal to $10z/x$, where x is the input voltage and z is a reference (in this case, 0.1 volt).

Although the frequency response of the circuit is affected by the choice of monostable pulse widths and by the oscillation frequency, the factor limiting the response is determined by the minimum voltage A_9 can detect. The voltage will be nominally 100 millivolts, yielding a maximum countable frequency of 100 Hz. More expensive analog dividers may improve on this figure. □

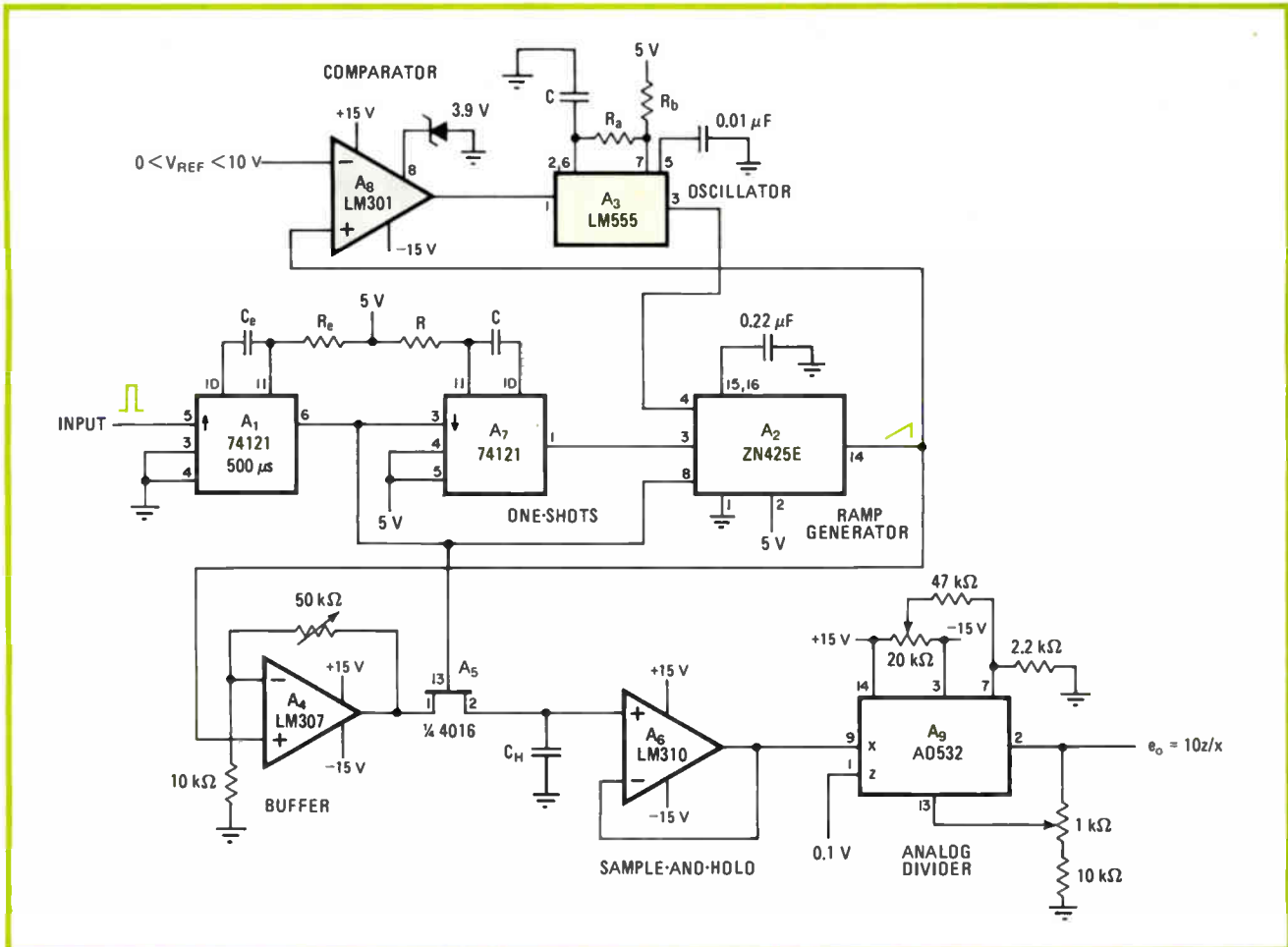

Spot frequency. Precision ramp generator and associated control circuitry generate analog voltage both directly and in inverse proportion to instantaneous input frequency. Providing maximum countable frequency of 100 Hz, meter is useful in biomedical applications.

DAK ANTI-STATIC KEYLOCK SWITCH

**Static discharge protection
up to 20,000 volts**



**Your body can develop
a static charge
of up to 20 kv—high
enough to cause
system errors and
even destroy
logic circuits.**

The Oak Anti-Static Keylock Switch provides complete equipment security. For all ratings to 3 amps @ 120 VAC. Long life, UL and CSA recognized. Only 2¹/₁₆" long, fits standard lock panel cutout. Wide range of key options available.

In Europe: OAK Holland BV
Sales Department: P.O. Box 201
3640 AE Mijdrecht-Holland
TEL: 31-02979-2111 TELEX: 18183

DAK Industries Inc.

SWITCH DIVISION/CRYSTAL LAKE, ILLINOIS 60014

TELEPHONE: 815 • 459 • 5000 ■ TWX: 910 • 634 • 3353 ■ TELEX: 72 • 2447

Optically coupled triac driver chip interfaces logic to ac load

High isolation combines with control flexibility in a zero-crossing monolithic circuit

by Pat O'Neill,

Motorola Semiconductor Products Inc., Phoenix, Ariz.

□ The high isolation between load and logic that is provided by optical coupling cannot be matched by any other technique. The elimination of ground loop problems and the protection against high-voltage transients that result from the total lack of a common electrical connection (Fig. 1) are ideal for handling the low-level signals encountered in logic-to-logic coupling between equipment, data transmission over twisted pairs, and telephone coupling. Just as often, optocouplers are used to interface logic to alternating-current loads.

Before the development of a monolithic zero-crossing triac driver, this interface was a complicated and expensive proposition. Typically the output device supplied with an optocoupler is an npn transistor or a silicon controlled rectifier, neither of which is suitable for driving an ac line directly. It has therefore been customary to add the circuitry shown in Fig. 2. Any monolithic alternative to this circuitry must of course be capable of handling the same problems.

Three hurdles

An optical coupler that must drive a 115-volt ac load has three obstacles to circumvent. First, the peak voltage seen on the 115-v ac rms line is over 180 v. To provide a suitable safety margin, the photosensitive output device must be capable of blocking a voltage of 250 v or greater of either polarity.

Second, the gain of a transistor photocoupler is not very great—current transfer ratios of unity are typical—yet up to 100 milliamperes of gate current may be required by a triac driving an ac load. To provide a suitable drive for a triac, the 115-v ac coupler should therefore be able to handle load currents much greater than its input excitation current.

Third, the output device must be able to handle current flowing through the detector in either direction to trigger the triac in its most sensitive quadrants.

Couplers built with phototransistors or silicon controlled rectifiers do not succeed in meeting all three of these needs.

Requirements for the output device of the 115-v ac coupler are similar to those for a triac, so an obvious solution is to try to couple a triac optically to a light-emitting diode. Unfortunately, the structure of a standard vertically diffused triac requires a shorted junction

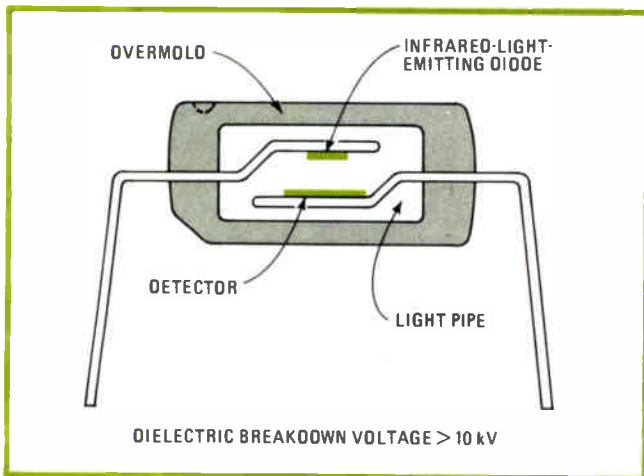

1. Optocoupler. An optocoupler has no electrical connection between the input (light-emitting-diode) side and the output (detector) side. Components of this type have found extensive use in low-level interface circuits in data processing and telephony.

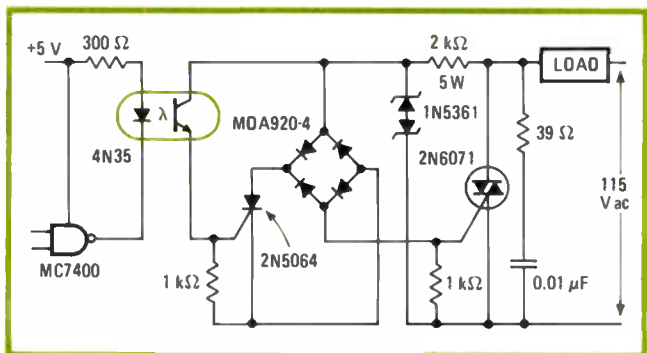

2. Logic-to-ac interface. An optically isolated interface between a standard TTL gate and a triac driving an ac load requires this large group of components, interconnections, and circuitry. A monolithic device has been developed that simplifies this interface.

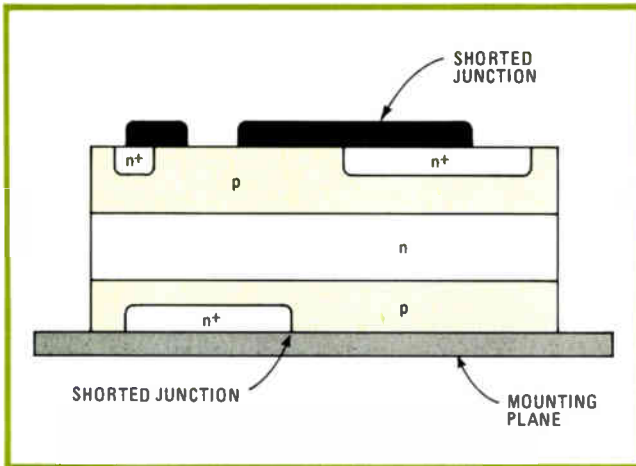

3. Vertical triac. The shorted junctions and deep diffusions of the standard, vertically structured, triac greatly reduce its sensitivity to incident light, making it unsuitable for use as the detector in an optical coupler. This situation led to the design of the integrated triac.

that greatly reduces the sensitivity of the device to incident photons (Fig. 3). Also, the diffusions are so deep as to absorb incident photons before they reach the active region of the device, reducing its sensitivity even more. For these reasons, a standard triac structure is unsuited for use in an optical coupler.

One solution is to make the detector chip a monolithic structure equivalent to a triac (Fig. 4a). Such a triac driver chip can be fabricated by planar diffusions, each of which forms more than one element, so that the layout is very clean and simple.

The cross section of this synthesized structure (Fig. 4b) illustrates how the various regions interact to act like a triac. Introduced in 1977 as the MOC3011, this simple driver works very well in most applications (Fig. 5) and has achieved a considerable degree of popularity in a short time.

An improved driver

Although the MOC3011 met all of the original goals for the optically isolated triac driver, customer feedback indicated that several features could be added that would greatly increase the utility of the part. One of these was a better resistance to unwanted turn-on because of the occurrence of dv/dt triggering.

Such triggering occurs when a fast rising voltage induces a capacitive current in the collector-base junction of the phototransistors. This current appears to the rest of the circuit to be identical to the photon-induced current that turns the device on.

The unwanted triggering explains the presence of the triac driver snubbing network shown in Fig. 5. The network filters fast transients that might accidentally turn on the triac driver. Without it, the triac driver cannot control an inductive load, since inductive turnoff generates dv/dt values greater than the rating of the triac driver.

The triac driver turns off as soon as it has turned on the triac because the voltage from terminal MT_2 to the gate of the triac is not enough to keep the triac driver on. This condition allows the triac driver to be off most of

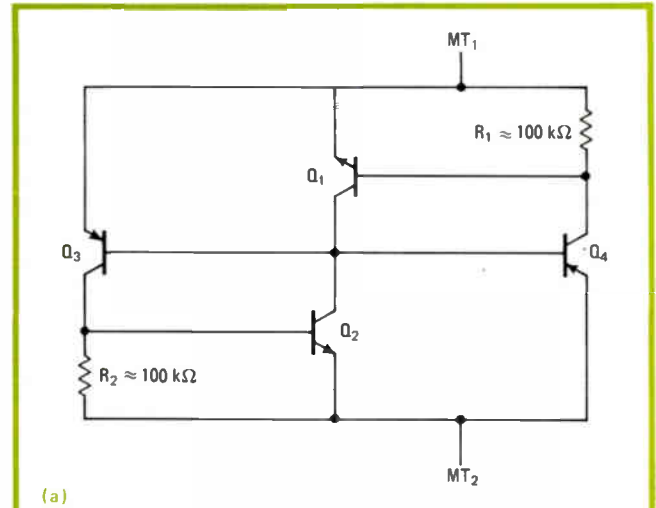

(a)

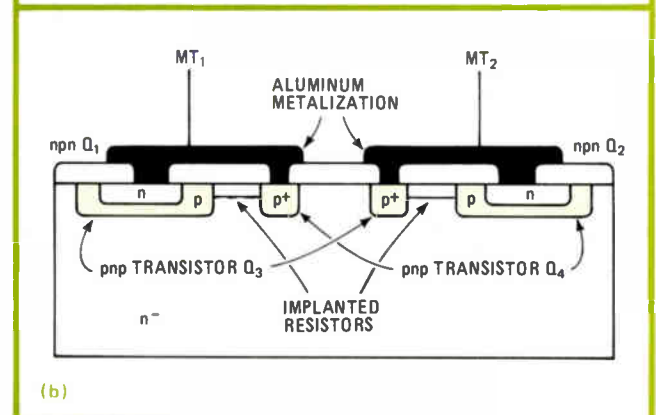

(b)

4. Planar triac driver. Planar triac driver (a) has structure equivalent to that of a triac circuit. Cross section of the actual chip (b), fabricated by planar diffusions, has two ion-implanted 100-k Ω resistors joining base to emitter in each transistor.

the time, reducing its power dissipation and allowing it to be limited only by its "static" (device turned off) dv/dt , which is higher than that for "commutating" (device turned on).

The driven triac is in the commutating dv/dt mode. Consequently, if it is possible to make the static dv/dt of the triac driver greater in value than the commutating dv/dt of the triac, then the triac driver will not compromise the dv/dt of the total circuit.

A new approach

This procedure was not feasible in the original device, because to have done so would have meant reducing the value of R_1 and R_2 (Fig. 4a) so much as to approach the low values of the original shorted junctions, making the device no longer light-sensitive. Clearly a new approach was required.

Another desirable feature to implement in any new design was to make the triac driver sensitive to turn-on only when applied line voltage is near zero. Many advantages are gained by this mode of operation:

- The triac is protected from high in-rush currents and dv/dt damage.
- The generation of electromagnetic interference (emi) by large in-rush currents is greatly reduced.

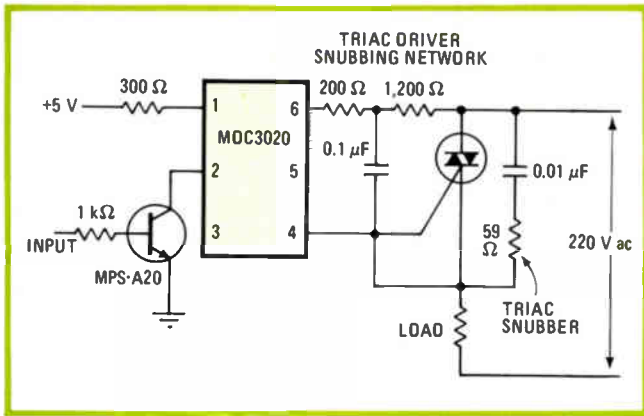

5. Snubbed. In a typical application circuit for a monolithic non-zero-crossing triac driver, snubber networks across the input and output of the triac protect it from dv/dt effects. Total component count is quite small in comparison with a discrete implementation.

■ The operating life of some loads, such as incandescent bulbs, is extended.

This zero-crossing function is built into most solid-state relays, but posed some difficulties for the MOC3011 when the problem was first encountered. For although the function is relatively easy to implement in hybrids, it is more difficult for monolithic devices. A certain amount of logic is necessary to perform the zero-crossing function, and the majority of logic devices are not compatible with the 300-v ratings of the triac driver.

A monolithic zero-crossing triac driver

In the implementation shown in Fig. 6a, two n-MOS enhancement field-effect transistors were added to the original triac driver with their gates tied to the n^- substrate. When the voltage from one main terminal to the other exceeds the threshold value of a FET, then the FET turns on, reducing the current gain of the triac to such a low value that the photocurrent generated by the photons from the LED is no longer able to switch the device into the on state. On the other hand, if the device is already in the on state, there will never be enough voltage across the device to turn the FET on, so the FET is incapable of turning the device off once it has been turned on.

This FET action is exactly what is needed to implement the zero-crossing function. At the same time, the dv/dt immunity of the device is extended to much higher values than earlier devices. Because the FETs can turn on very rapidly, they can shunt dv/dt induced currents around the bipolar portion of the circuitry without allowing the triac driver to switch into its on state.

The typical static dv/dt rating of the MOC3030 is 100 v per microsecond as compared to 2 $v/\mu s$ for the MOC3010 non-zero-crossing device. Since the typical commutating dv/dt rating of triacs is about 5 or 10 $v/\mu s$, the triac driver no longer limits the dv/dt immunity of the complete circuit.

Unlike most zero-crossing circuits, the FETs used in this device consume practically no power, so that the leakage through the load in the off state is basically the triac leakage current and primary photocurrents. Other

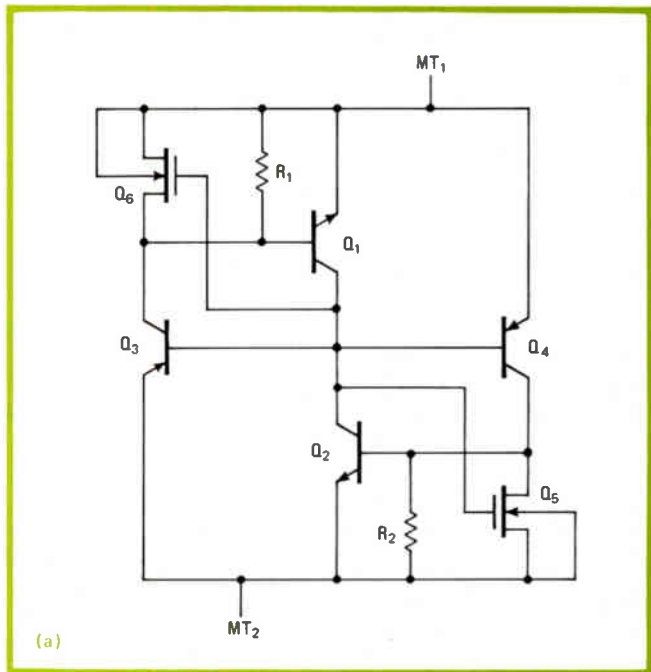

(a)

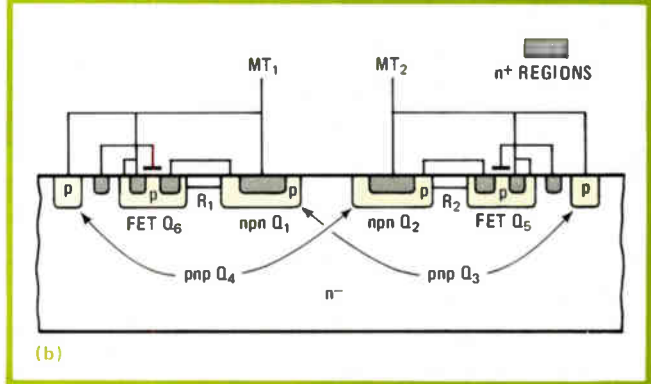

(b)

6. Zero-crossing triac driver. Addition of n-MOS FETs to the integrated triac (a) provides the zero-crossing function and makes the device insensitive to voltage transients. Structure of the zero-crossing triac driver may be further simplified (b).

zero-crossing circuits pass currents of tens of milliamperes in the off state.

A simplified cross section of the new device is shown in Fig. 6b. Both FETs are located in the p-type tub diffused into the n substrate.

Chip design and processing

The FETs have some rather special requirements. In particular, their gate rupture voltage has to be greater than the blocking voltage of the triac driver. So long as this is true, the triac driver breakdown voltage will protect the FET gates by clamping the applied voltage before the gate ruptures.

However, this means the FETs must each have a very thick dielectric, making them relatively low transconductance devices, which in turn are more sensitive to contamination problems than FETs with a thin gate oxide. The FETs are produced by ion-implanting each p tub and by using a deposited oxide in order to form the gate dielectrics.

The breakdown voltage of the bipolar devices is aided

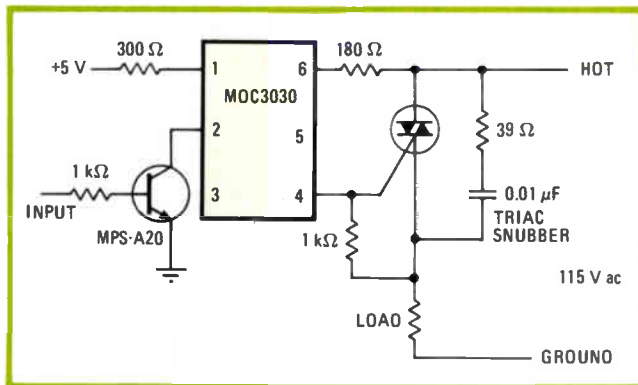

7. dv/dt immunity. Typical zero-crossing optocoupled triac driver has no need of snubbing because of its high static dv/dt immunity. To prevent shock hazards, the load is tied to the ground side of the ac line, which would be costly if pulse transformers were used.

8. Microprocessor control. In a microprocessor-based system, the optically coupled triac driver simplifies the interface of 115-V ac powered peripherals. The triac driver can provide the zero-crossing triggering function as well as all the necessary drive to the triac.

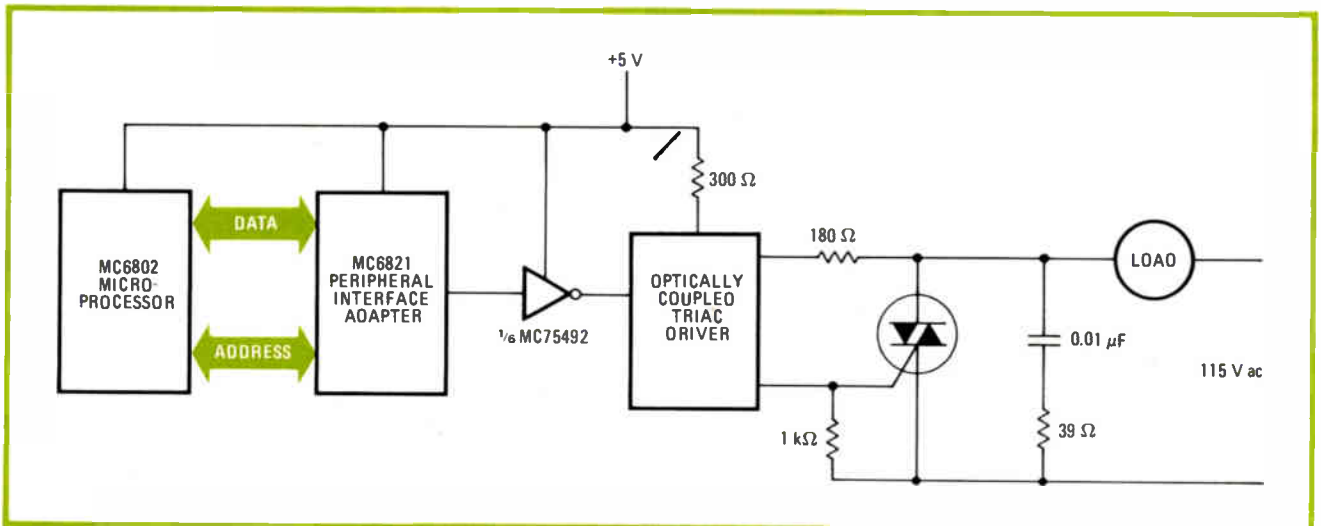

by field plates that extend beyond the junction where necessary to relieve fields concentrated by the relatively shallow diffusions used throughout the device. The 100-kilohm resistors (R^1 , R^2 in Fig. 2) help prevent the device from being turned on by dv/dt or leakage currents at low voltages when the FETs are inoperative. These passive components are ion-implanted before the emitter diffusion and protected with deposited oxide to preserve their original value during subsequent processing.

The finished chips are assembled together with gallium-arsenide liquid-epitaxial LEDs in a dual-molded coupler package. The dual-molding technique yields much higher isolation voltages than glass dielectric or die coating techniques. Devices are tested to data sheet specifications and to guarantee product uniformity and reliability.

In the driver's seat

In general, the zero-crossing triac is very easy to use. Figure 7 shows one circuit application that adds two input resistors to the triac driver and triac. The triac driver cannot turn on when the voltage is high. But as the primary photocurrents generated when the LED is illuminated are still present, a 1-k Ω resistor is tied from MT_1 to the gate of the external triac in order to bypass this small current (less than 200 microamperes). (In many applications, this component is not needed because the triac itself is insensitive to the passage of such low currents through the gate.)

The 180-ohm resistor limits the peak current through the MOC3030 to less than 1 ampere to protect the chip and its wire bonds.

The circuit of Fig. 7 has the load located in the "cold" side of the line. This is much to be preferred in many applications to a location on the hot side of the line as it prevents a shock hazard. Optical isolation makes this possible at lower cost than is the case when pulse transformers are used.

Microprocessor-controlled drivers

Probably the greatest field of application of zero-crossing triac driver will be in interfacing microprocessors to peripheral devices. Peripherals in these microprocessor-based applications must be taken to include not only teletypewriters and cathode-ray-tube displays, but also refrigerators, air conditioners, ovens, and heaters.

Although the output ports of most microprocessors will not provide the 15 mA necessary to actuate the triac driver, very inexpensive buffers such as the MC75492 are available to do the job (Fig. 8).

The zero-crossing triac driver described above seems to offer nearly everything the designer could want in working with 115-v ac power. An obvious area of improvement to expect will be to raise the blocking voltage high enough for use on 220-v ac power lines. It might also be useful to raise the current rating of zero-crossing device to allow driving a high-power triac or heavier loads. \square

Low-cost a-d converter links easily with microprocessors

In the guise of a memory, economical unit delivers 8 bits in 15 μ s to a variety of popular processors

by M. Tuthill and D. P. Burton, *Analog Devices Inc., Woburn, Mass.*

□ With the 8-bit microprocessor a standard element in many designs today, much attention is being paid to using it as economically and effectively as possible. For data-acquisition and process-control applications, that means employing an analog-to-digital converter that can interface easily with the processor, operate quickly and efficiently, and not weigh heavily on the product's overall budget.

Such were the design goals of the AD7574. A monolithic a-d converter built using a complementary-MOS process, it comes in an 18-pin dual in-line package and is priced at \$5 each in large quantities. At its three-state buffered outputs, it can provide the 8-bit digital result of a conversion in just 15 microseconds. Furthermore, over its operating temperature range, that result has no missing codes. In addition, the various interfacing options available make the AD7574 an excellent candidate for use with a variety of popular processors.

Clocking the device is the most critical factor for proper operation with a microprocessor. A clear understanding of the converter's timing circuitry is therefore called for.

Short cuts

The successive-approximation logic of the AD7574 is implemented by a Johnson counter and R-S latches (Fig. 1). This approach not only is particularly amenable to being realized in C-MOS, but also results in a small die size. The logic is arranged so that the most significant bit is continually being compared with the input signal while the device is not performing a conversion. On receipt of a conversion command, the device's asynchronous clock starts, the first falling edge of the clock signal sets the MSB, and the converter moves quickly to the next bit comparison. This method eliminates the setup time usually required to obtain the MSB, thereby allowing the

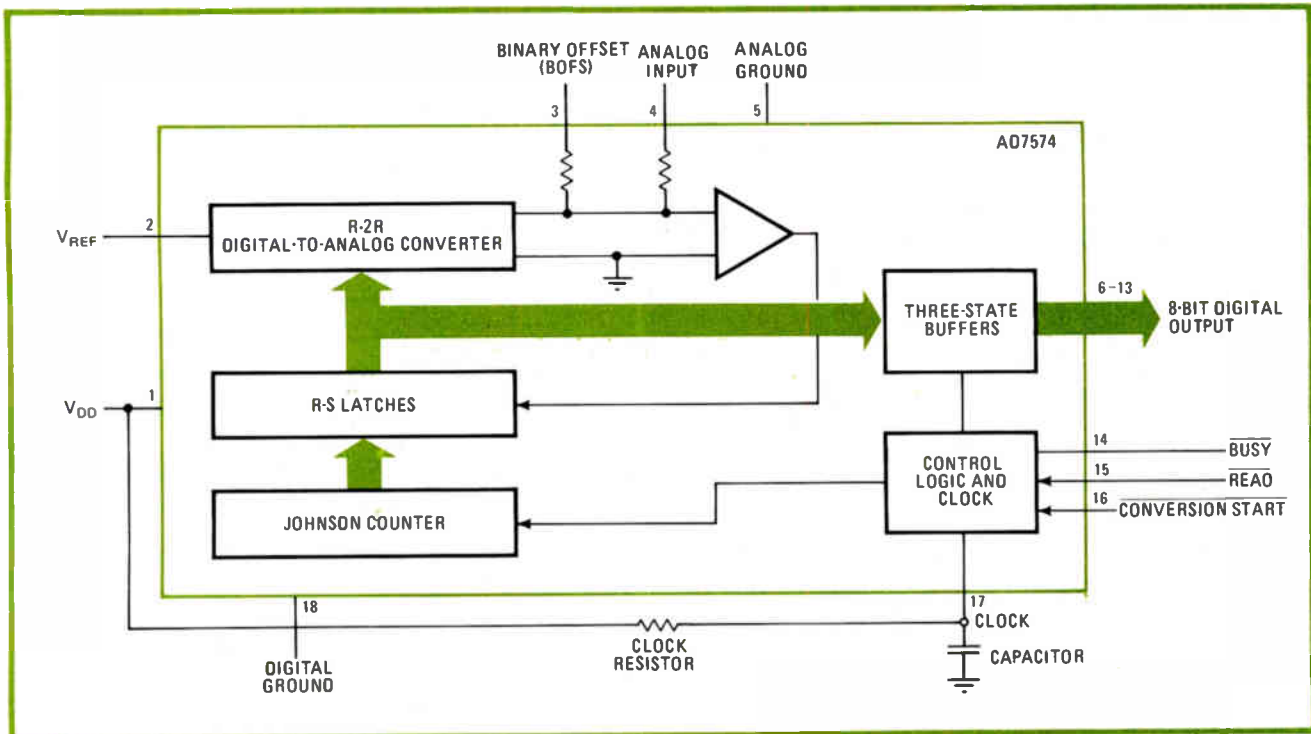

1. Quick conversion. Inside the AD7574 analog-to-digital converter, the analog input from pin 3 is compared continually with the output of the R-S latches until a conversion-start signal is received. Thus, the most significant bit can be set without the usual wait for settling.

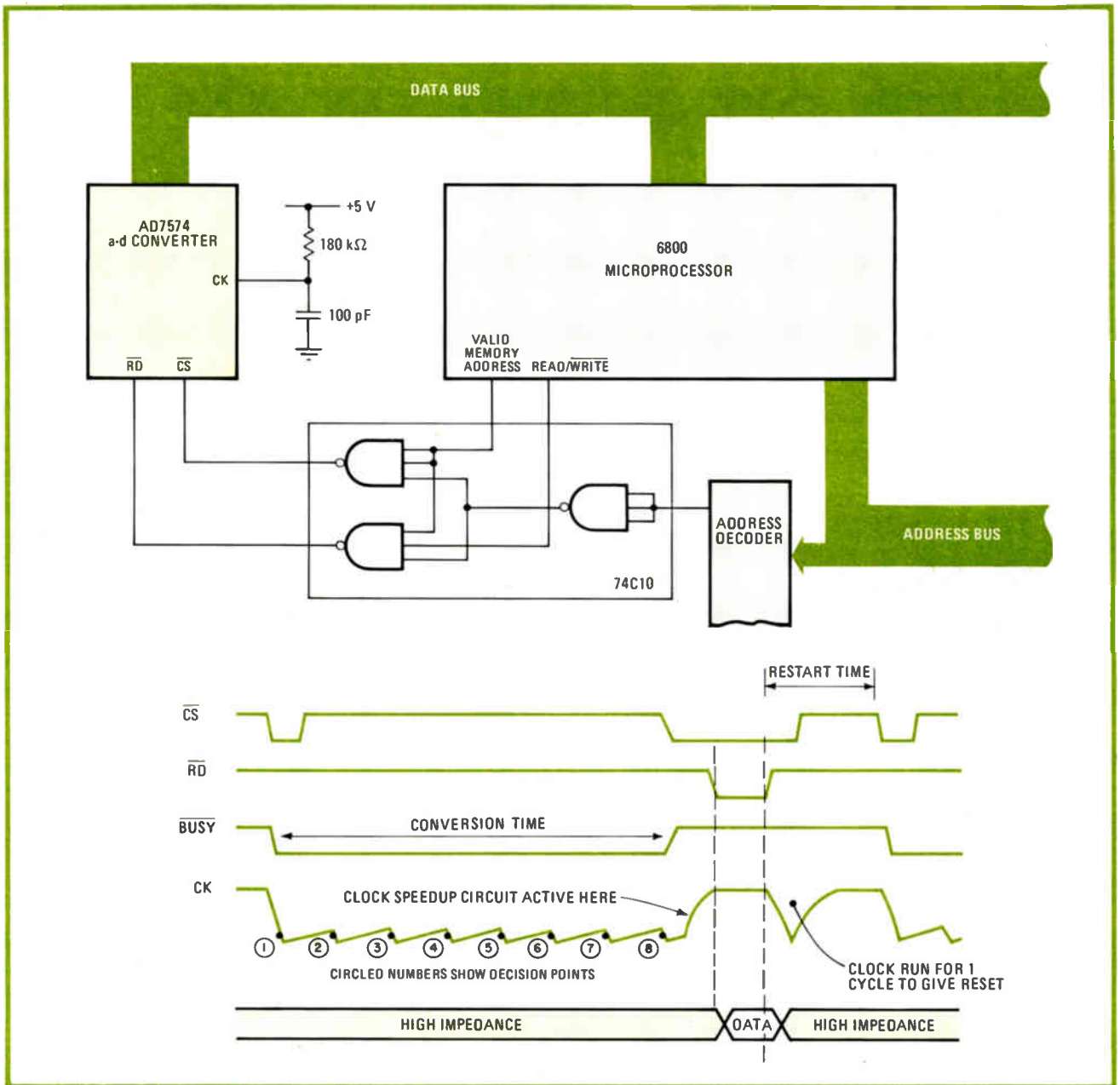

2. RAM seen. By virtue of three triple-input NAND gates between its address decoder and the converter, a 6800 processor sees the addressed configuration as a RAM that must be written into before it is read. The wait needed for conversion can be clocked by software.

AD7574 to perform a full 8-bit conversion in only $7\frac{1}{2}$ clock cycles, rather than the 8 cycles most other a-d converters require.

To further hasten the conversion process, the clock circuit generates a signal with a grossly asymmetrical ratio of the time mark to space and uses a speedup circuit to reduce the space after the eighth mark. Since the latch for the least significant bit is set at the start of the last space and the conversion is then, in effect, complete, this space should be as short as possible.

In addition to conversion, the internal clock controls resetting. One of the operating modes, to be discussed below, calls for continuous conversion, and in this instance the reset time serves as a delay period in which the MSB is allowed to settle between conversions. Given

the complex nature of the clock waveforms, an internal clock was considered necessary for successful operation of the device.

The operating frequency of the clock (500 kilohertz at maximum) can be determined by an external RC network. Alternatively, the clock circuit can be driven by an external clock, as will be discussed later.

Memorable events

In considering the in-circuit operation of the converter, it is convenient to regard the AD7574 as if it were a memory. Using this analogy, three distinct modes of operation can be readily described.

The first is dubbed the RAM mode because, to the microprocessor, the AD7574 appears as an 8-bit

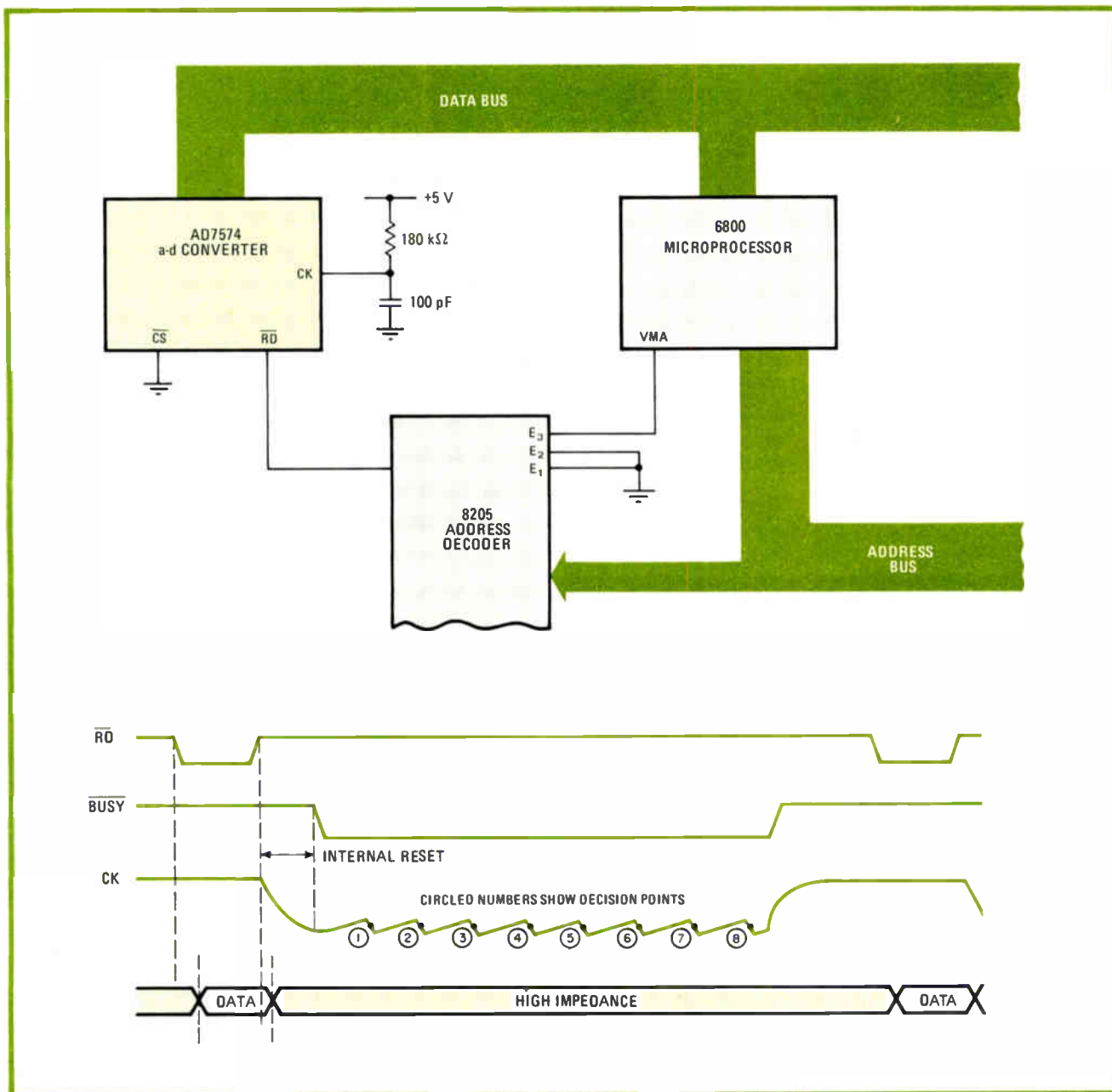

3. ROM-ish. Keeping the converter's \overline{CS} pin strapped to ground allows the processor to gather data as if from a read-only memory: the device address is gated to the 7574 by the VMA signal. Since the data read must first be stored, its freshness must be considered.

random-access memory that must be written into before it can be read. The microcomputer's memory-write command is used to start a conversion, and its memory-read command is used to obtain the converted information after the conversion is completed.

In the second mode, the converter acts as a single-location read-only memory. In this, the ROM mode, one read command automatically reads the result of the preceding conversion, resets the converter, and initiates a new conversion.

The third is called the slow-memory mode. In this case, the converter begins the conversion when addressed and sends a busy signal. The busy signal indicates to the microcomputer that it must wait until data is available for reading.

Although each operating mode (implemented by appropriate connections of the read, conversion-start, and busy lines to the microcomputer) has its particular benefits and restrictions, timing considerations are critical to all. If they are not properly observed, one mode may be inadvertently changed to another and data lost or misread.

RAM mode

In the RAM mode, conversion is initiated by taking the converter's conversion-start (\overline{CS}) pin low while its read (\overline{RD}) pin is kept high. When conversion is complete, the \overline{CS} and \overline{RD} pins are driven low together so that the output impedance is lowered and the data can be read. Thus there are two distinct operations for each conversion: a

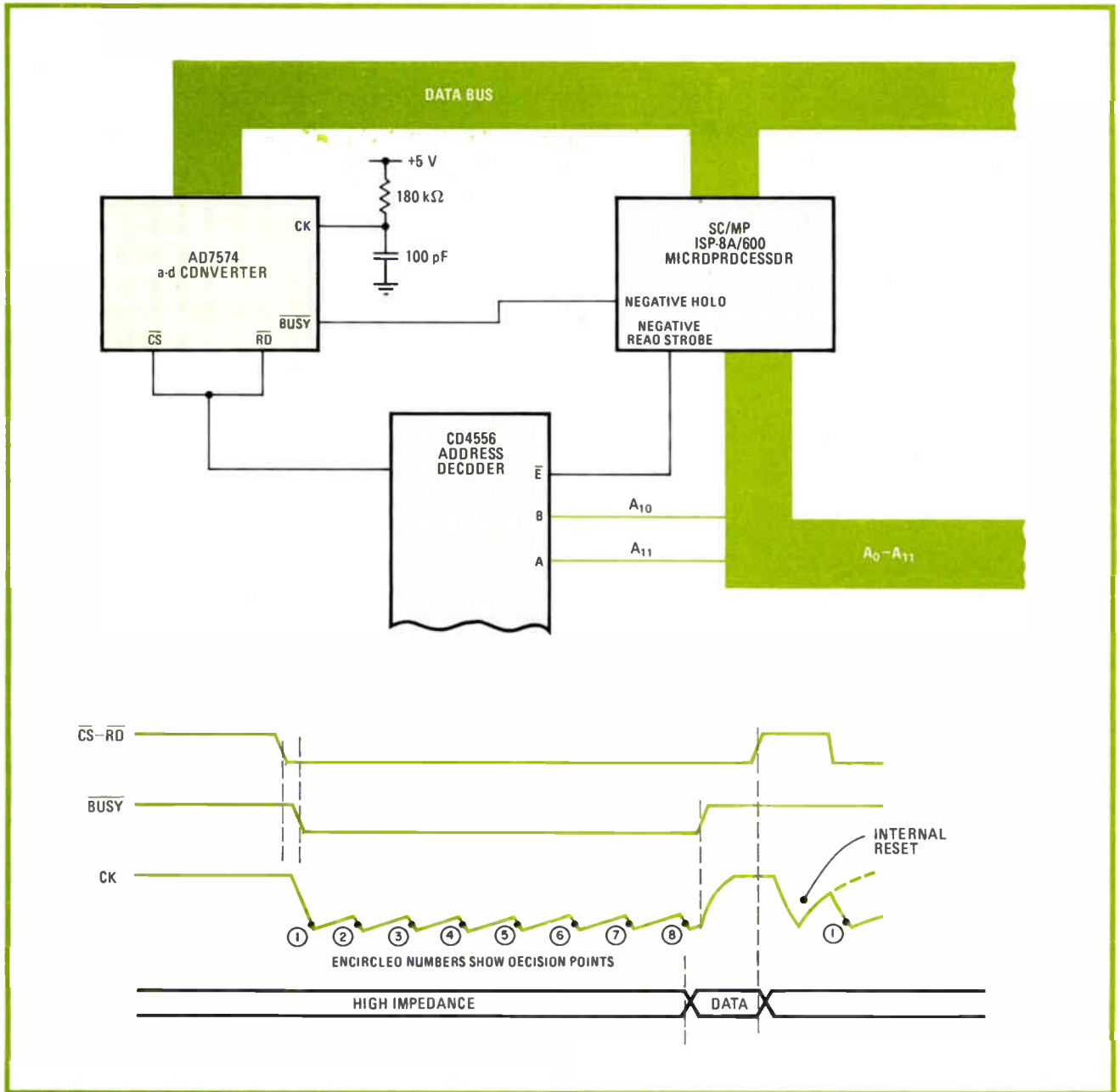

4. Elegantly queried. When configured to appear as a slow memory to the SC/MP, the 7574 runs from start of conversion to digital output at the behest of a single command. Its $\overline{\text{BUSY}}$ signal tells the processor to wait until data is ready for reading.

start command and a read command.

At the end of the read command, the rising edge of the $\overline{\text{RD}}$ signal initiates an internal reset by running the internal clock for one cycle. Though reading can be started before a conversion is actually complete, at no time during the conversion can $\overline{\text{RD}}$ be allowed to return high; failure to observe this restriction can cause erroneous data to be read.

Used in this mode with a 6800 processor, the AD7574 is addressed as a RAM through an address decoder and three three-input NAND gates (Fig. 2). When the 6800 addresses the converter and issues a write command, however, the 6800 must wait until the conversion is complete. It can mark this time in software, either by running through a series of no-op codes or by performing

instructions of fixed, known execution times, until the data is ready to be read with a read command.

When configured to appear as a read-only memory, the AD7574 has its $\overline{\text{CS}}$ pin strapped low, allowing the entire conversion process to be controlled by the $\overline{\text{RD}}$ pin. After data has been read, the rising edge of the $\overline{\text{RD}}$ signal initiates a new conversion. Consequently, at any time after the conversion period, data is immediately available to the processor when it sends a read command to the converter's address.

ROM mode

As shown in Fig. 3, this scheme has the advantage of being simple to implement. Without any additional hardware, the converter appears to the 6800 micropro-

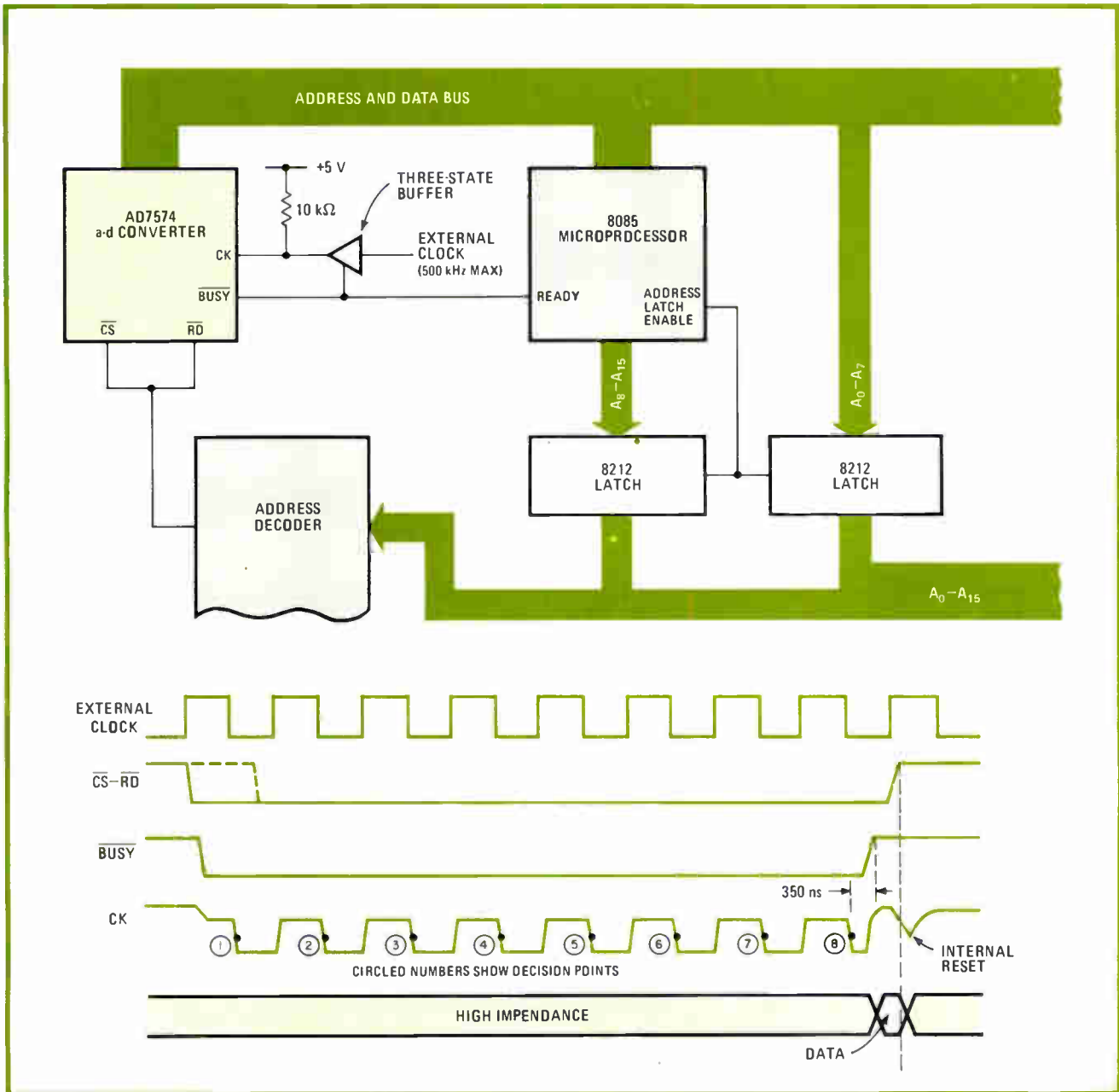

5. On guard. By latching the address of 7574 with the ALE signal, the 8085 uses the slow-memory mode while guarding against errors that can be induced by address-related glitches. An external clock is used to provide a reference having higher temperature stability.

cessor as an ordinary ROM. However, this scheme raises the question of the data's age. What is actually read at any time is an analog value that existed some time between the end of the last read command and the start of the next. When the time reference of the data sample point is not critical, the fact that the start of conversion is ill-defined with respect to software operation can be ignored and in such a case this method's easy implementation is a definite advantage.

If the time reference is important, however, a conversion can be forced to take place at any given time by using two read commands separated by a known, software-implemented delay that is slightly longer than the conversion time. In either instance, a read signal should never make a positive-going transition during conversion,

since that will reset the converter and any data read will be invalid.

During conversion, the $\overline{\text{BUSY}}$ line will indicate the ongoing process with a logic low. For a continuous-conversion scheme, that signal can be used to trigger a one-shot multivibrator whose output initiates a short read cycle. Then, at the end of the read cycle, the rising edge of the read signal will restart the conversion cycle and the process will be repeated indefinitely.

When using the circuit shown in Fig. 3, the software should never try to cause data to be written into the location occupied by the converter, because bus conflicts result. To ensure that that does not occur, the processor's valid-memory-address (VMA) signal can be ANDed with the $\text{RD}/\overline{\text{WR}}$ signal. The gate output can then enable the

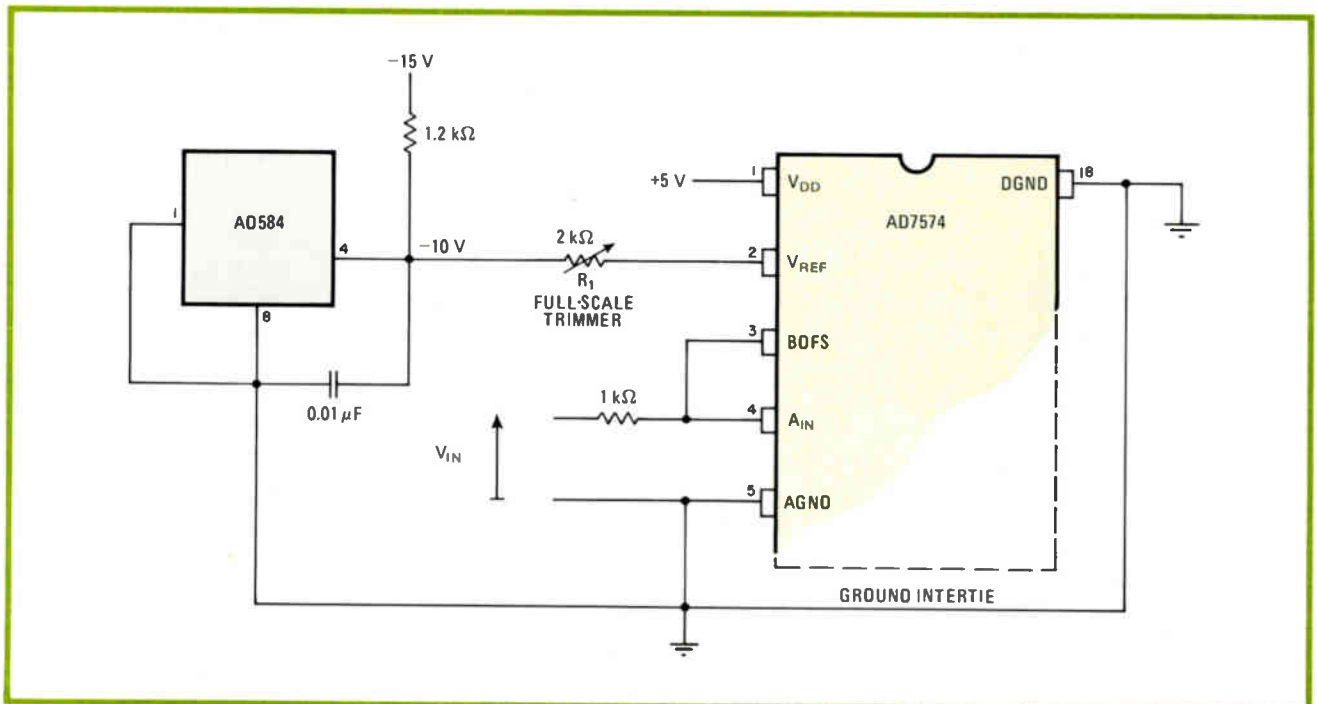

6. Unipolar input. Positive input signals of up to 10 V produce straight binary outputs with the configuration shown. Trimming potentiometer R_1 adjusts the full-scale range of the converter; software that permits a display of the output while making adjustments eases system setup.

address decoder controlling converter operation.

Of the three modes, the slow-memory mode is probably the most elegant: with just one instruction, the microprocessor can initiate conversion, wait until it is done, and read the resultant data.

Slow-memory mode

When the AD7574 is used in this way, its \overline{CS} and \overline{RD} pins are tied together and the \overline{BUSY} pin connected to a microprocessor's ready/wait line. Driving the united \overline{CS} and \overline{RD} lines low and holding them there with an instruction starts the conversion and makes the \overline{BUSY} line go low. That in turn makes the processor wait until the conversion is complete. At that time, the \overline{BUSY} line goes high and the read operation is completed by the processor, just as if it had been waiting to get information from a slow memory.

This mode can only be used with processors that are able to remain in the wait state for at least 15 μs —the SC/MP processor, for example (Fig. 4).

Keep glitches out

As is clear from the preceding discussion, timing considerations for all modes mandate that the \overline{RD} and \overline{CS} lines remain relatively glitch-free. Although glitches of 20 nanoseconds or less will not affect the operation of the AD7574, longer glitches (caused by unspecified address states, for example) could start unwanted conversions or resets.

The best way to avoid address-related glitches is by gating the address-decoding logic with a relevant microprocessor signal. For the 6800, this gating can be done with the VMA signal; for the 8085, the \overline{RD} or \overline{WR} lines can do the job.

An alternative means of deglitching is possible with

the 8085. This device has an address-latch-enable (ALE) line that can be employed to latch the more significant address bits. Using the line in that way prevents unspecified addresses (which occur during operating-code fetch cycles) from causing glitch-induced malfunctions of the converter.

For slow-memory schemes, this latching approach (Fig. 5) is preferable. In addition to deglitching the signals, it makes the joint \overline{CS} - \overline{RD} signal available sooner and gives the AD7574 more time to respond with a \overline{BUSY} signal than in the \overline{RD} -gated address design. With the latter design, the 8085 must be restricted to a lower clock frequency to permit the AD7574 to respond with a \overline{BUSY} signal.

Time in or time out

The temperature stability of the AD7574's control logic and clock circuitry have been optimized for internal clock operation. In some instances, though, it may be desirable to use a more stable external clock, as in the slow-memory circuit of Fig. 5.

In this circuit, the external clock signal is gated by the converter's \overline{BUSY} line through a three-state drive, thus providing the AD7574 with the eight negative-going edges it needs for each conversion. The reset timing, with its special speedup process, is still performed by the converter's internal logic and does not require an external clock pulse. For maximum settling time of the MSB, \overline{CS} should not go low until the positive edge of the first clock pulse. But if the AD7574 has been in the reset mode for 3 μs or more, \overline{CS} can go low at any time.

The maximum external clock frequency recommended is 500 kHz, basically the same as that for the internal clock. However, for applications in which conversions must be performed in less than 15 μs , the resistor that

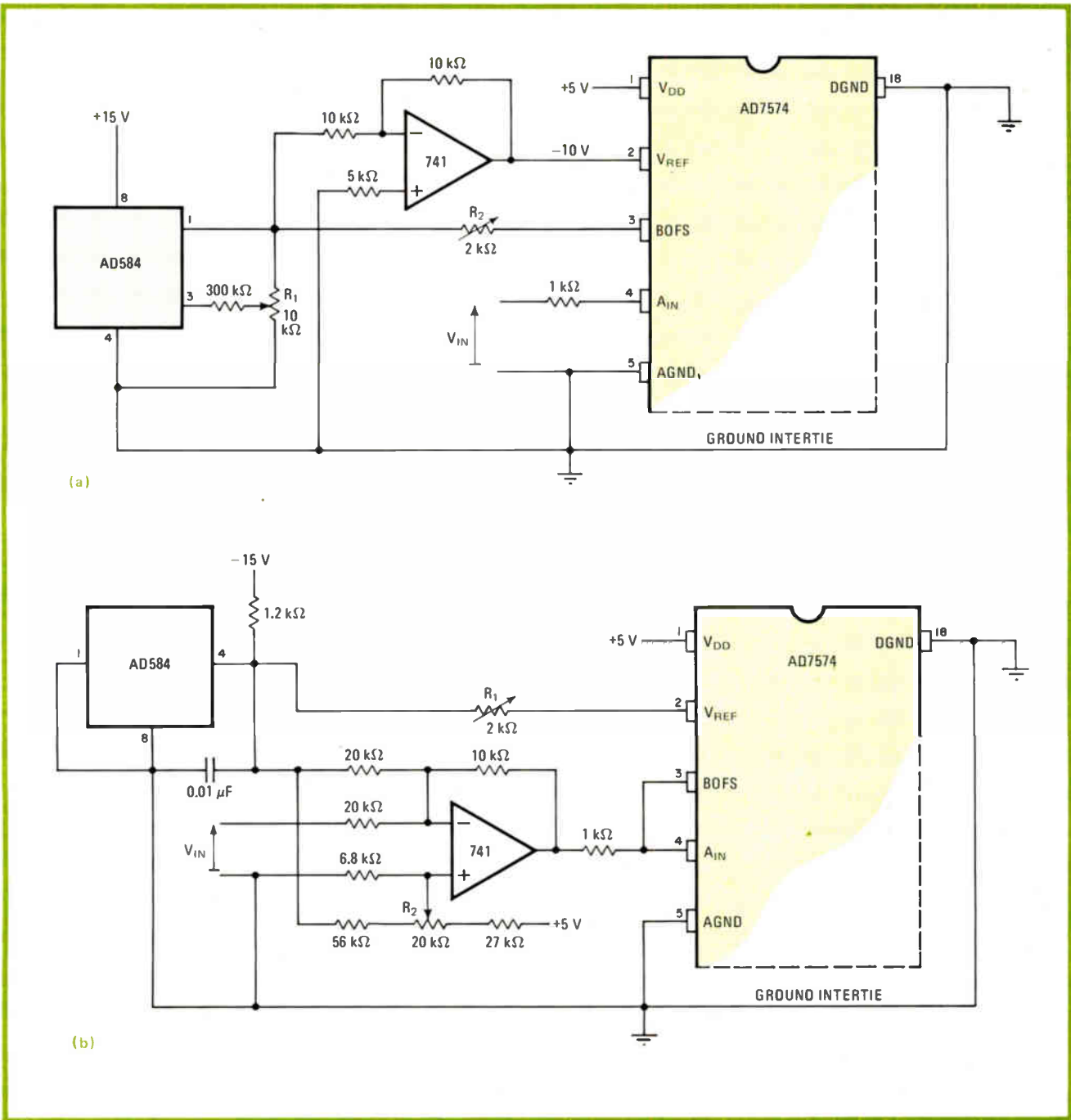

7. Bipolar response. The AD584's +10-V, pin 1 output offsets the input range in (a), so inputs of -10 to +10 V are converted into offset-binary-coded outputs. Adding resistors, an amplifier, and a 5-V source to the circuit of Fig. 6 results in (b), with complementary outputs.

controls the internal clock circuit can be variable. Usually then, the internal clock can be trimmed to provide conversions times of as little as 13 μ s. At lower conversion times, missing codes occur; below 15 μ s, the first code missed is typically 1011111.

As with many other converters, the format and the full-scale error of the AD7574 are determined at its analog input. Since some adjustment will be done just before the system is put into operation, it is useful to include some software that will display the converter's digital output directly, in order to facilitate trimming.

In Fig. 6, the converter is configured for direct binary

output from a unipolar input. Variable resistor R_1 allows the user to trim the reference input for the desired full-scale output.

To interpret bipolar inputs, the AD7574 can be used with bipolar reference voltages, as shown in Fig. 7a; or its analog input may be offset so that it falls into a unipolar range, as in Fig. 7b. In the former, the digital output is in offset binary code; in the latter, it is in complementary offset binary. In both circuits, R_1 serves to adjust full-scale error and R_2 compensates for any mismatch between the internal resistors of the analog signal and binary offset inputs. □

Cupless anemometer has diode wind-sensor

by J. P. Scoseria
Montevideo, Uruguay

Working well as a differential thermometer, this simple circuit can also be used to find wind speed by detecting the difference in junction voltage between two forward-biased diodes. Here, one junction is heated to a fixed temperature, and the other's temperature-dependent junction potential is made to vary with the cooling effect of the wind. Being totally solid-state, the unit eliminates all mechanical difficulties. The unit can also function as a psychrometer, or humidity indicator, if the heated junction is wetted down instead.

Diode D_1 and a resistor are situated within the confines of a small one-of-a-kind aluminum enclosure built for this circuit. D_1 is heated by the power dissipated by the resistor. The enclosure maintains a constant temperature throughout, independent of environmental changes, as in an oven. Although the absolute temperature reached by the diode junction is of little importance in this circuit, it will be a direct function of the power supplied to the block, the area of the block available for heat transfer, and its heat transfer coefficient.

The same general considerations exist for the stream-temperature sensor, D_2 , which is placed in a similar

aluminum block to reduce temperature variations due to changes in wind speed (settling time ≈ 2 minutes). Here, however, the power supplied to the block is small, being about 1 milliwatt to activate D_2 , and heat variations reach the junction from the outside.

Generally, the output from the 741 op amp is $e_o = K(V_1 - V_2)$, where K is a constant and V_1 and V_2 are functions of the temperature associated respectively with the heated block sensor and the wind speed. The voltages across both D_1 and D_2 drop by 2.5 millivolt for each degree Celsius rise, and so $V_{d1} \approx 0.7 - 2.5(10^{-3})T_f$, and $V_{d2} \approx 0.7 - 2.5(10^{-3})T_w$, where temperature T_f corresponds to V_1 and T_w to V_2 . As a result, $e_o = K(-2.5)(10^{-3})(T_f - T_w)$, and so the output of the op amp will be proportional to the temperature difference. The current that flows through ammeter M will thus vary linearly with temperature.

The relation between the wind's cooling factor and temperature is nonlinear, however, and because the initial zero-wind current in meter M is a function of the block temperature (and thus block size), and because the sensor temperature, and D_1 and D_2 are not driven from true constant-current sources, the calibration will not be uniform for any two units.

Although it would be ideal to have access to a wind tunnel for calibration, good results can be obtained with the aid of an automobile. Placing the sensor on the auto's antenna, with the meter set at maximum for zero wind speed, the unit can be calibrated satisfactorily on a windless day by noting M 's output as a function of the car's speed. \square

Ceaseless wind. Temperature difference between heat oven surrounding diode junction D_1 and stream sensor D_2 , whose junction temperature varies with wind speed, is reflected as a change in current at M . Unit can be satisfactorily calibrated with auto's speedometer on a calm day.

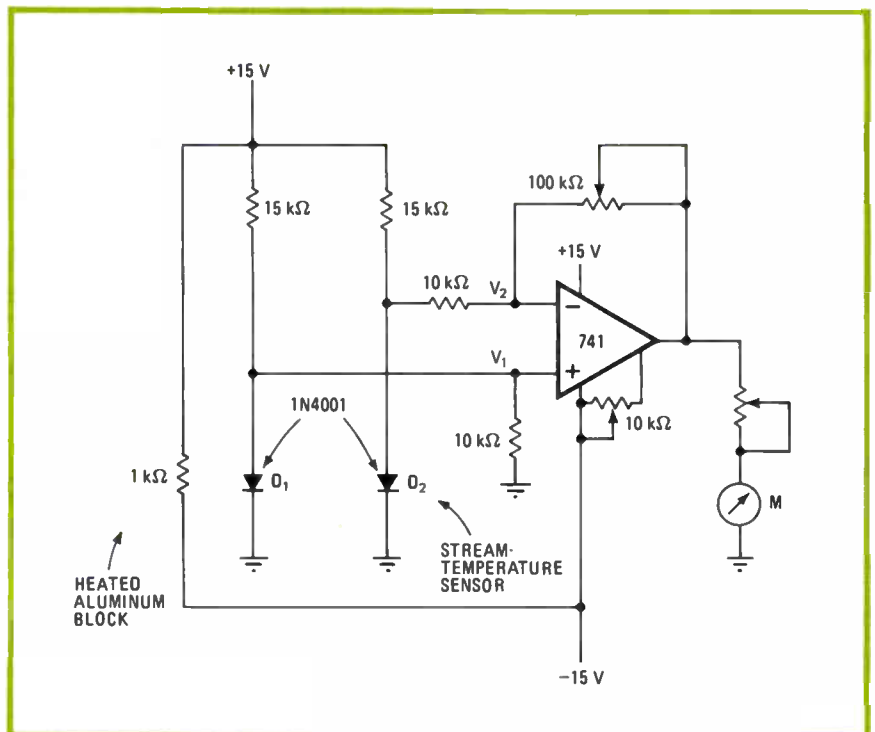

Teleprinter option unites PROM programmer to MC6800

by J. Padmanabhan and M. S. Swaminathan
O/E/N India Ltd., Mulanthuruthy, Cochin, India

Offering a simple way to unite the often-used MC6800 microprocessor system to the popular Prolog Series 90 PROM programmer, this modified teleprinter option and appropriate software provide an economical way to transfer large blocks of data rapidly. Here, what is essentially the modified 9102 teleprinter interface and interactive software for supervising data flow between microprocessor and PROM programmer do the basic job of the more expensive 9104 computer interface normally used to do the task.

The 9102 option was designed to link the computer bus to a teleprinter through a 20-milliampere current loop, as shown in (a). In cases where it is used, it will offer an operator at a teleprinter console a convenient way to enter spot commands or data into a microprocessor or other device. But manual loading of 2 kilobytes of data or program, for example, is impractical because of the time required and the errors that may be generated because of human interaction.

On the other hand, the transferring of data stored in memory to the programmable read-only memories (PROMs) by means of the PROM programmer's "duplicate" facility can only be done if the master PROMs are of the same word size as the PROMs to be programmed. These problems are overcome by transferring the data from the 6800 to the programmer through the teletypewriter interface via an asynchronous communications interface adapter. The data transfer is controlled by the user at a console with the aid of suitable software.

Adding three open-collector inverters between the ACIA and the teletypewriter interface going to the PROM programmer (b) constitutes the hardware modification. Note that the teletypewriter console, not shown, would be connected to the 6800 bus through a separate ACIA and unmodified teletypewriter interface, also not shown.

Inverter A₁ connects the normally high ACIA output to a logic 0, which simulates the active-high teletypewriter signal that the PROM programmer requires. Note that the interconnecting loop now operates on voltage levels, not on a current mode. A₂ and A₃, acting in a similar role, provide buffering action in the reverse direction.

The software operates in an interactive mode and is transparent to both the operator and the PROM programmer. It can handle any console device besides the teleprinter (such as a video terminal or hex keyboard) operating at any baud rate and may be easily modified to accommodate any PROM size. As shown in the figure,

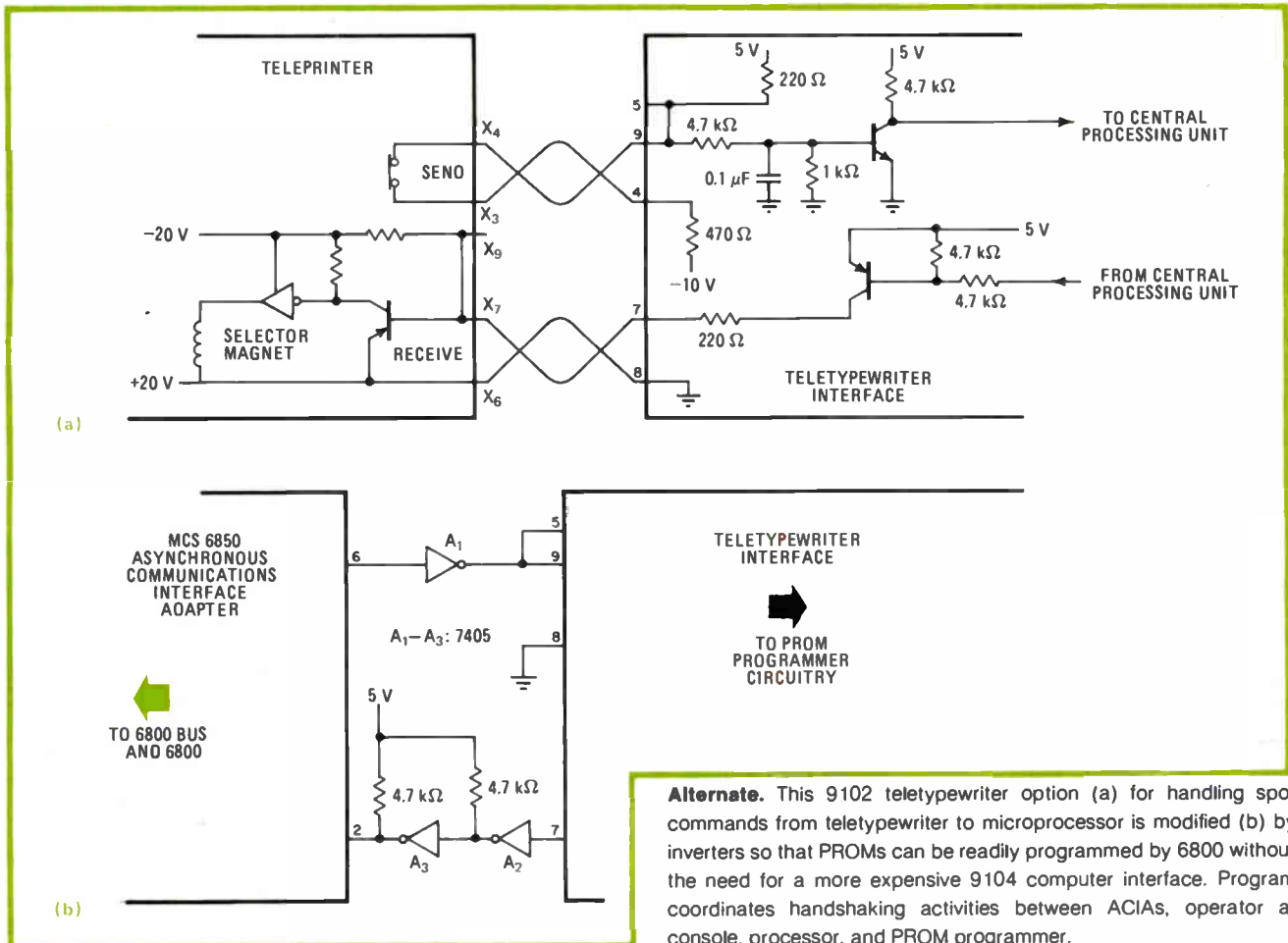

Alternate. This 9102 teletypewriter option (a) for handling spot commands from teletypewriter to microprocessor is modified (b) by inverters so that PROMs can be readily programmed by 6800 without the need for a more expensive 9104 computer interface. Program coordinates handshaking activities between ACIAs, operator at console, processor, and PROM programmer.

FLUKE'S MICROPROCESSOR-BASED SCANNER IS COMPATIBLE WITH EITHER IEEE 488 OR RS232.

Or scans automatically without a controller!

That's right — the new Fluke 2204A scanner is so flexible you can use it for R&D applications like component research, life-cycle and environmental testing, quick-change production line test set-ups, and even precise process monitoring jobs that demand the highest possible reliability.

System building block

When you build your system around the 2204A, you have a mainframe capacity up to 100 channels, and scan speeds up to 125 channels/second. Whatever capacity you need up to 1000 total channels is easily provided by chassis extenders.

Choose from either general purpose (2-wire) or low thermal ($<1 \mu\text{V}$, 3-wire) relay scanner cards. Both switch up to 170 VDC and have excellent high frequency AC response. We provided for convenient four-terminal ohms measurements, and high-accuracy temperature measurements through an exclusive isothermal

input connector.

When it comes to checking out or trouble-shooting your system, you can do it conveniently and quickly in the manual mode right from the front panel of the 2204A. The whole system can be synchronized by using the scanner's output trigger pulse.

Now, about what voltmeter to use.

The 2204A and our 8502A 6½-digit voltmeter make an ideal pair that we call the 7600A system. The combination of these two precision instruments gives some unique system advantages that no other scanner/DVM combination can provide:

- Utilization of the maximum speed potential of the scanner on the bus, afforded by the 8502A's high speed.
- Excellent noise rejection due to the 8502A's unique digital filtering characteristics.
- Scanner data that can be massaged without a controller. The 8502A's strong math capabilities plus scal-

ing, offsetting, peak reading, and "hi-pass-lo" decisions give you immediately useful information, with no additional computation necessary.

• Time and money savings, because the 7600A system comes factory tested and shipped together, with all the cables and connectors you need. And at no increase in cost over individual instrument prices!

CALL (800) 426-0361, TOLL FREE* or contact any of the 100 Fluke offices and representatives, worldwide. In the U.S. and countries outside Europe write: John Fluke Mfg. Co., Inc., P.O. Box 43210, Mountlake Terrace, WA 98043, U.S.A.

In Europe, contact: Fluke (Nederland) B.V., P.O. Box 5053, Tilburg, The Netherlands. Telephone: (013) 673973 Telex: 52237.

* Alaska, Hawaii, Washington residents — please call (206) 774-2481.



The Fluke 2204A IEEE-compatible scanner (top) — a perfect match for the Fluke 8502A DVM.

Ad number 6110-8003

For Technical Data Circle 158

158

For Demonstration Circle 159

Electronics / August 30, 1979

6800 ROUTINE: PROM PROGRAMMER TO PROCESSOR TELETYPEWRITER INTERFACE

LOCATION	MNEMONIC	COMMENTS
0001	CNTRG1 EQU 00C7	CONTROL REGISTER OF ACIA1
0002	CNTRG2 EQU 00C6	CONTROL REGISTER OF ACIA2
0003	DATRG1 EQU 0087	DATA REGISTER OF ACIA1
0004	DATRG2 EQU 0086	DATA REGISTER OF ACIA2
0005	START LDA A#03	ACIA INITIALIZATION
0006	STA A CNTRG2	
0007	STA A CNTRG1	
0008	LDA A#05	
0009	STA A CNTRG2	
0010	STA A CNTRG1	
0011	LDX ADDBUF	STARTING ADDRESS IN X
0012	LDA B#01	
0013	JSR 1NECHO	INPUT*
0014	LDA B#02	
0015	JSR PGRTTY	OUTPUT CR, LF
0016	LDA B#01	
0017	JSR INECHO	INPUT P
0018	LDA B#02	
0019	JSR PGRTTY	OUTPUT CR, LF
0020	LDA B#06	
0021	JSR INECHO	INPUT ADDRESS FIELD
0022	LDA B#07	
0023	JSR PGRTTY	OUTPUT CR, LF, LF, ADD, SPACE
0024	NXTDTA LDA B#02	
0025	JSR MPPGR	DATA TO PROGRAMMER
0026	LDA B#03	
0027	JSR PGRTTY	OUTPUT CR, LF & ONE CHARACTER
0028	COM A#0A	CHECK FOR LF
0029	BEQ ERROR	TO ERROR HANDLING
0030	COM A#0D	CHECK CR
0031	BEQ END	TO END OF PROGRAMMING
0032	LDA B#02	TWO MORE DIGITS OF ADDRESS
0033	JSR PGRTTY	
0034	BRA NXTDTA	GO FOR NEXT DATA
0035	END LDA B#04	
0036	JSR PGRTTY	OUTPUT LF, /, CR, LF
0037	BRA RETURN	RETURN FROM PROGRAM
0038	ERROR LDA B#03	ERROR HANDLING
0039	JSR PGRTTY	OUTPUT TWO DIGIT ADDRESS & SPACE
0040	RETURN RTS	END OF PROGRAMMING

the program handles data transfer between the user and PROM programmer and vice versa, from the microprocessor to the PROM programmer and between the two ACIA ports.

In transferring information from the console to the PROM, the user initializes the program and defines the mode of operation and the address field. For full-duplex operation, these data characters have to be accepted from the user and transmitted to the PROM programmer, whereupon a data-valid signal will be sent back to the console. Because the number of characters for a given word of information varies, a loop-counter subroutine must be contained in the program.

When the PROM programmer is ready to accept the next data, it transmits CR, LF, and the address of the next location. When transferring information from the microprocessor to the programmer, data is transferred as required, provided the operating mode and the address field has been previously defined. The data is available in computer memory in binary form, and the processor

transmits it to the programmer as two hexadecimal ASCII characters for each byte sent. A data-valid command is then sent back to the user terminal at the completion of a data-transfer cycle.

The program identifies any error condition as well as the completion of programming by checking the third character transmitted to the console by the PROM programmer. If there are data errors, the programmer transmits CR, LF, LF, and the address of the current location (instead of CR, LF, and the address, which is the normal condition). The system then waits for user intervention. At the completion of programming (all good data), the programmer sends back CR, LF, CR, LF, /, CR, LF.

Note that the subroutines INECHO, PGRTTY, and MPPGR are all well-known teleprinter handling routines. In the interest of space, they are not listed here. □

Engineer's notebook is a regular feature in *Electronics*. We invite readers to submit original design shortcuts, calculation aids, measurement and test techniques, and other ideas for saving engineering time or cost. We'll pay \$50 for each item published.

System tames the avalanche of information

Engineering is one of those disciplines in which endless stacks of information accumulate in such a way as to frustrate anyone searching for a particular item. Robert M. Gordon of Indexing Services Ltd. has invented a system to help those inundated by information to determine whether needed material was saved, and if it was, to find it. His simple system, called Mnemodex, **requires only a pencil, the appropriate forms, and a loose-leaf notebook.** In spite of Mnemodex's simplicity, it is powerful enough to manage large collections of information for organizations or individuals. Work is under way to implement the system on a computer using Basic. Write Gordon at 14533 Kazan St., Irvine, Calif. 92714, or call (714) 559-4947.

Test kit aids in avoiding solder mixups

The proportion of tin in solder has serious consequences for the processing of electronic circuit boards and in other metalworking industries, as the tin content affects the solder's application temperature, corrosion resistance, and mechanical properties. The Tin-in-solder ID Kit is handy for making **quick color spot tests to distinguish between solders of differing tin content.** This test kit is designed for use by untrained personnel on solder of any shape. Instructions and materials for 200 tests are included. Details on kit #1550 are available from Ralf H. Koslow of Koslow Scientific Co., 7800 River Rd., North Bergen, N. J. 07047; (201) 861-2266.

Chart shows Canadian rules on radio spectrum

Communications is a vital technology to the widely dispersed population of so expansive a country as Canada; anyone involved in the radio, television, satellite, or short-wave equipment business should therefore bear the Canadian market in mind. To aid in keeping track of the electromagnetic situation in that country, a full-color chart has been put together that shows at a glance what frequencies are used for what. A brief description in French and English of **the allocation of each color-coded band is given for the entire spectrum between 3 kilohertz and 300 gigahertz.** The chart is available free if you write to the Government of Canada, Department of Communications, Information Services, 300 Slater Street, Ottawa K1A 0C8. The words "spectrum chart" should appear on the envelope. Only one chart will be sent to each addressee, but groups and associations may arrange to order more through Paul Villeneuve, distribution officer. He may be reached at (613) 995-8185.

School to examine sputtering, metalization, and plasma etching

Engineers involved in production of semiconductors and hybrid circuits should note that the sputtering, metalization, and plasma etching processes used in making these devices will be the subjects of the **24th Sputter School and Conference sponsored by Materials Research Corp.** The event, scheduled for Dec. 10-12, will begin with a basic review of the processes; the latest techniques will then be covered by authorities in their fields from leading integrated-circuit houses. Lectures will be followed by panel discussions. Further information on and registration forms for the three-day program, to be held in Pebble Beach, Calif., can be obtained from conference secretary Rosemary McPhillips, Materials Research Corp., Orangeburg, N. Y. 10962; (914) 358-2002. **-Harvey J. Hindin**

An Elgar AC Power Source lets you tap into all kinds of unusual powers—from 120 VA to 27 KVA. A single model lets you choose from 50 available plug-in oscillators for variable or fixed frequencies from 15 Hz to 10 KHz. Anything they can't provide, our programmable oscillator can. You

can even order Elgar Power Sources with two- and three-phase outputs. So if you're in the market for power, come right to the source. Elgar is also a leading producer of High Isolation Transformers, AC Line Conditioners, and Uninterruptible Power Systems.

ELGAR

8225 Mercury Ct., San Diego,
CA 92111. Phone (714) 565-1155.

See us at Wescon Booth #1855/1857

You can have all the power in the world.

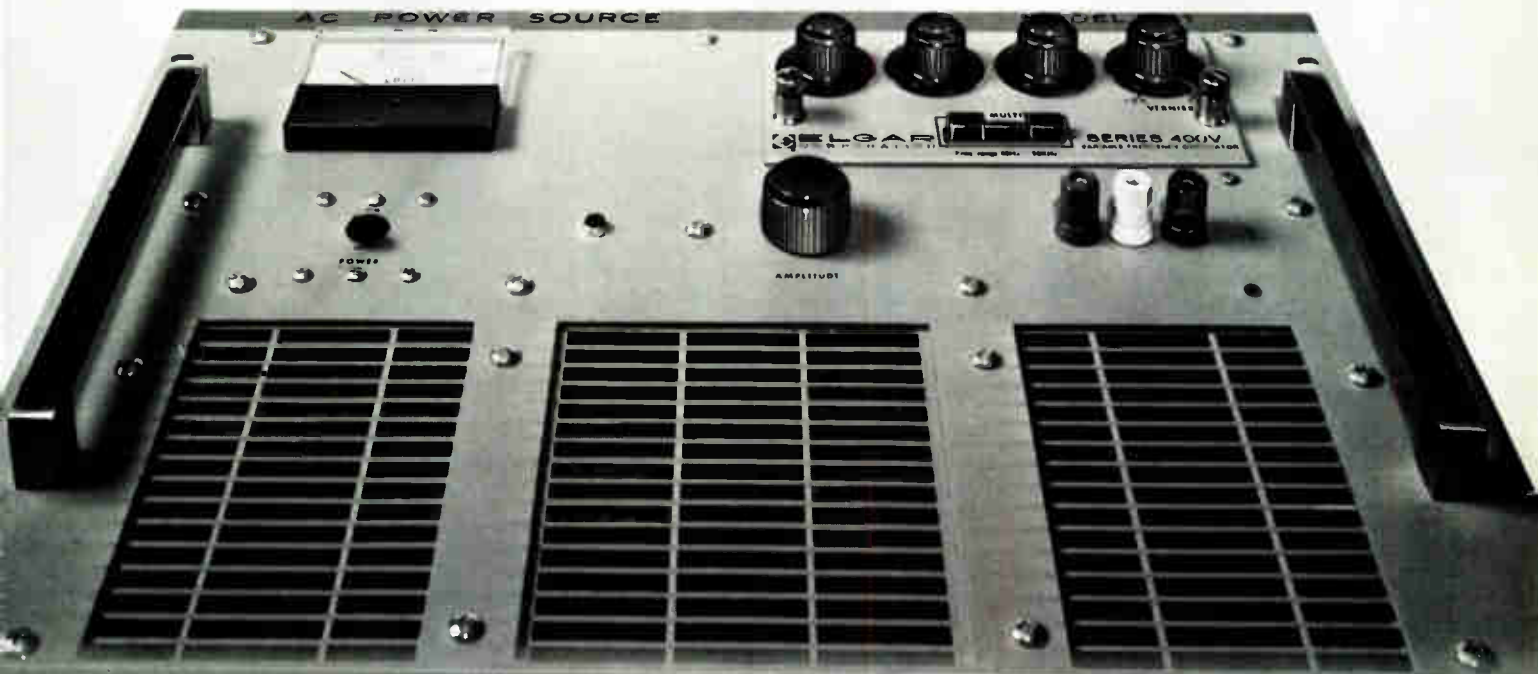

Right from the source.

Circle 161 on reader service card

**POWER
TO THE
PROGRAMMER.**



INTRODUCING A POTENT TEST PROGRAMMING COMBINATION FOR LSI BOARDS.

You shall overcome.

The once insoluble test programming problems presented by LSI boards are problems no more.

Because Teradyne has combined LASAR, our most powerful test program generation software, with an awesome piece of hardware. A DEC VAX 11/780 computer.

Result: unprecedented programming power to generate higher quality board test programs faster than any system in the world.

You can use this new-found power to achieve formerly unattainable levels of productivity with Teradyne's L135 or any other board test system.

POWER HAS ITS REWARDS.

Teradyne's programming power offers some powerful benefits.

For starters, the VAX/LASAR combination can minimize your startup time. Enabling you to test and ship your product in short order.

Since even complex LSI programs can now be generated quickly, you can use your most important resource (your engineers) more efficiently.

And because VAX and LASAR provides a more thorough test program, you get more complete testing at the board test stage. System test yields, therefore, will climb to new heights.

LASAR[®] AND VAX.

Sounds like the cast of "Star Wars," but this is no fantasy.

LASAR is an extensive software system capable of slashing the total time it takes to test pro-

gram complex digital PC boards. Particularly LSI.

LASAR excels at revealing formerly hidden testability problems. Moreover, its automatic program generation can cope with much of the most difficult circuitry an engineer faces.

Then there's VAX. The first affordable computer with sufficient power to utilize the LASAR software's full capability.

Made by DEC, the VAX 11/780 is technically a minicomputer. However, its 32-bit architecture gives it the kind of computing power normally available from only large mainframe systems.

Together, VAX and LASAR can handle boards with up to 100,000 gates. As many as 25 programmers can be kept busily at work. Immediate program verification and Teradyne's extensive LSI modelling library are two additional benefits.

And for the first time, your costs for all this programming power become fixed and predictable.

LASAR and VAX add unequalled programming power to the already formidable test capabilities of Teradyne's L135 Board Test System. Power to make the L135 even more productive.

That's something you should learn more about. Because productivity is the bottom line.

Contact your local Teradyne Sales Office at the number listed below.

PRODUCTIVITY IS THE BOTTOM LINE.

BOSTON (617) 969-6300 / CHICAGO (312) 298-8610 / LOS ANGELES (714) 979-4590
LONDON 932-51431 / MUNICH 089-335061 / PARIS 073-1698 / TOKYO (03) 406-4021

TERADYNE

The AD that transit

brings rapid to the bus.

Introducing an 8-bit A/D converter that gets you a lot more accuracy on any bus for a lot less money and time.

It's called the "Naked-8." So pegged because it performs with no costume at all. It is so completely compatible with microprocessors (i.e., signals, protocol and timing) that no external support chips are needed.

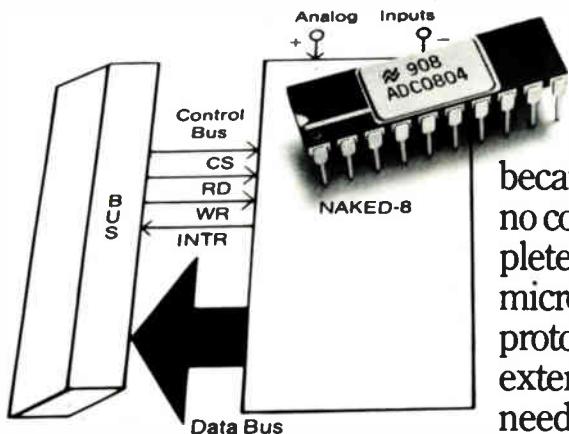

Combine this virtue with a 100 μ sec conversion time, an accuracy as good as $\pm 1/4$ LSB, a power need of 5V at 1 mA, and a cost as low as \$2.95. There's no easier or better way to get to the bus.

The "Naked-8" opens up a whole new world of A/D design applications. Drop us the coupon below and get the complete story on the ADC0801 family.

And start taking the fast route.

National Semiconductor
2900 Semiconductor Drive M/S 16250
Santa Clara, CA 95051

Sure, I'd like to be exposed to the "Naked-8." Please send me the facts on ADC0801, ADC0802, ADC0803, and ADC0804.

Name _____ Title _____

Company _____ Phone _____

Address _____

City _____ State _____ Zip _____

E 8/30 9-3

 National Semiconductor

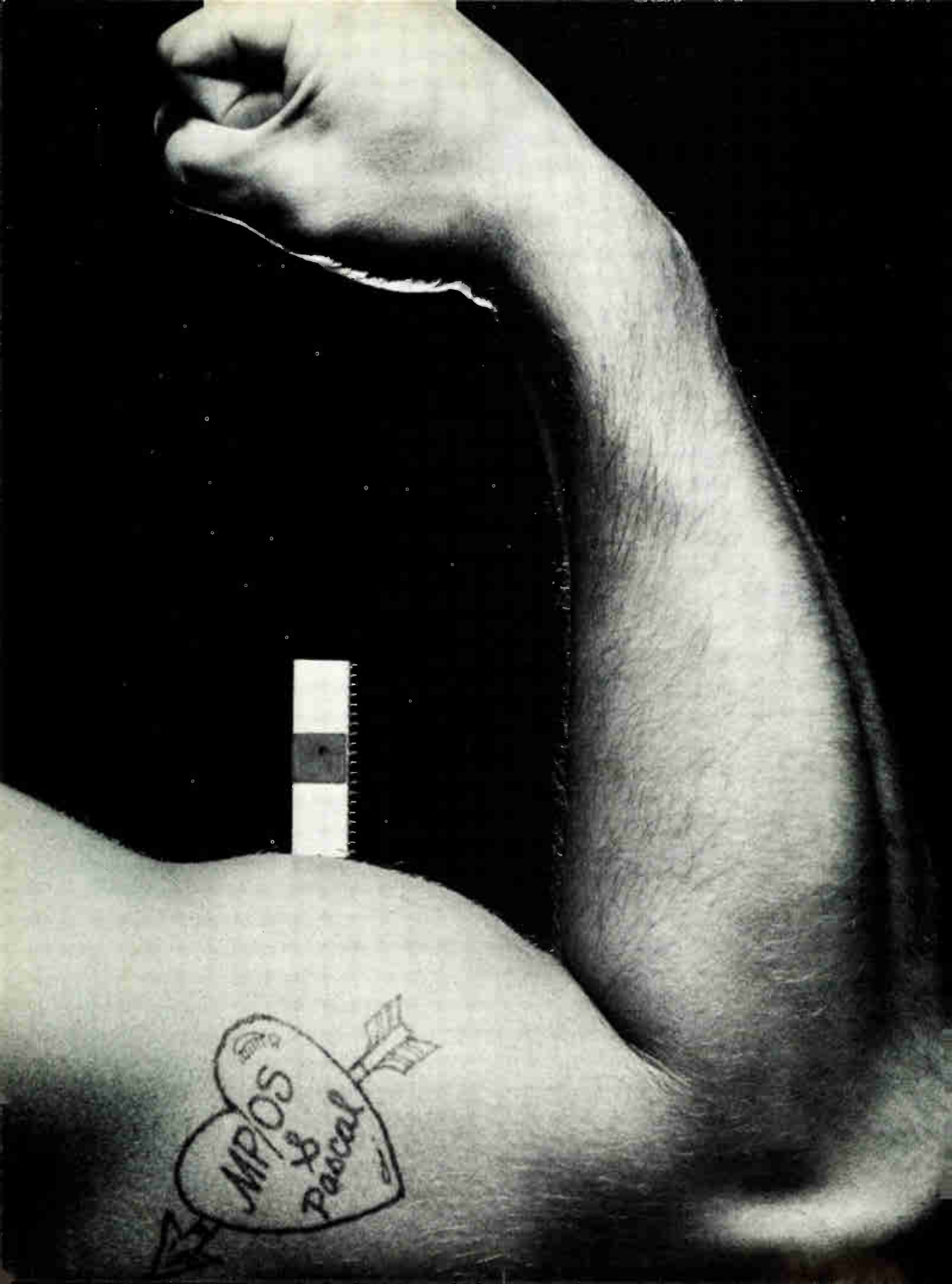

MIPOS
&
Pascal

MICRO GOES MACHO

Introducing MP/OS. The most powerful microcomputer operating system, ever.

Watch out. Here's MP/OS. The most powerful, most advanced operating system ever developed for a microcomputer. Only from Data General.

More Muscle for microNOVA.®

Recently we announced two powerful new families of 16 bit microNOVA computers – the low cost MP/100 and the high performance MP/200.

Now we're backing them up with MP/OS. And with this tough new operating system you get two tough new programming languages – MP/PASCAL and MP/FORTRAN IV. Now your microNOVA packs a punch like never before.

MP/OS. Software That Works Hard.

With MP/OS you get a complete range of powerful features. Multitasking, unpended I/O, software engineered reliability and, you can configure systems from PROM based board level, through disc/diskette systems up to the ECLIPSE® Advanced Operating System (AOS).

The MP/OS advanced disk file design combines reliability, high performance and dynamic allocation flexibility that can't be beat. Interactive development tools for MP/OS based microNOVAs include interactive editor, macro-assembler, binder, symbolic debugger and more for easy use and fast application knockouts.

MP/PASCAL and MP/FORTRAN IV. Two Fisted Punch for MP/OS.

MP/PASCAL is a high-level, structured programming language that comes with modular pro-

gramming extensions, comprehensive data representation, high programmer productivity, and lowered development and maintenance costs. And you get an impressive range of features from a comprehensive file structure to complete compatibility with Data General's AOS operating systems.

MP/FORTRAN IV comes with several important real-time extensions like multitasking and re-entrant coding for high performance in a real-time environment. And just like our MP/PASCAL it's AOS compatible.

Now Get Tough with your Software Costs.

If you're tired of taking it on the chin every time your computer takes a fall, move up to Data General's hard working microNOVA computer systems and the MP/OS operating system.

Find out more about the computers that make sense.



**The Computer of the
U.S. Olympic Sports
Medicine Committee**

I'm tired of taking it on the chin. Show me how to get macho with MP/OS.

Name _____

Title _____

Company _____ Tel. _____

Address _____

City _____ State _____ Zip _____

E830

 **Data General**
We make computers that make sense.

The biographies of 5,240 of your colleagues...

Profiles the Top Management of Major Electronics Firms throughout the World —and more

McGraw-Hill's

Leaders in Electronics

Prepared by the Staff of Electronics

651 pages

This is the only reference devoted solely to biographies of the most influential people in electronics: corporate executives... technical managers... designers and developers of important products and processes... government and military officials... academics... editors and publishers... securities analysts... directors of trade and professional groups... and consultants.

As easy to read as any professional publication in electronics

With LEADERS IN ELECTRONICS on your bookshelf, you no longer have to search through many different sources for biographical data on your colleagues. What's more, you don't have to strain your eyes reading minuscule type, nor do you have to waste valuable time trying to decipher seemingly endless paragraphs of abbreviations. Boldface type spotlights the various information categories so that you can scan entries rapidly to pinpoint what you need.

Unique convenience feature... Index of biographees by affiliation

A special 80-page index lists individual organizations alphabetically, complete with the names and titles of top employees. By looking up the names in the general biography listing, you can get a complete profile of the organization's top management in a matter of minutes. Plus an easy-access listing of independent consultants in every electronics specialty.

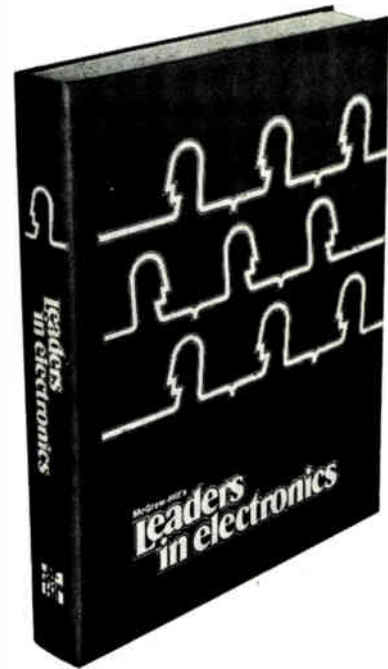

Sample Listing

Jones, John J

Chmn & CEO, Microprocessor Div of Computers Inc, 1023 W Warner Ave, Dayton, OH 45479, Tel (513) 555-2000. Born: Mar 26, 1926, Philadelphia, PA. Education: MBA, Harvard Business School, 1950; BSEE, Univ of Ill., 1946; PhD (Hon), Yale Univ, 1977. Professional Experience: Natl Bur of Standards, 1956-74, Adm Eng; Litton Ind, 1954-56, Sr Eng; NCR Corp, 1950-54, Eng. Directorships: Computers Inc since 1975. Organizations: IEEE since 1946, Sec Head 1972-73; AAAS since 1971; Midwest Ind Mgt Assn since 1974. Awards: Fellow, IEEE, 1977; Public Service Award, City of Dayton, 1976. Patents Held: 8 in computer circuits, incl Special Circuit for Microcomputer Chip Design 1975. Achievements: founded Microprocessor Inc 1974; project manager of first application of microprocessors for standard interfaces 1975. Books: 4 incl *Small Circuits and Their Applications* (editor), McGraw-Hill, New York, 1975. Personal: married 1950 to Mary (Smith), children John Jr, Jane Anne, Kevin. Residence: 344 W 34th St, Dayton, OH 45403, Tel (513) 555-4343.

Order today using this coupon!

Return coupon to:
Leaders in Electronics
P.O. Box 669
Hightstown, New Jersey 08520
(609) 448-1700, ext. 5494



Send me _____ copy (copies) of *Leaders in Electronics* on a 10-day money-back guarantee. I understand that if I am not absolutely satisfied, I may return the book(s) within ten days at no further obligation. Otherwise, McGraw-Hill will bill me \$39.50 for each copy, plus applicable sales tax, shipping and handling charges.

Name _____
Title _____
Company _____
Address _____
City _____ State _____ Zip _____

SAVE MONEY! Enclose payment in full, plus local sales tax, and McGraw-Hill pays all regular shipping and handling charges. Ten-day money-back guarantee still applies.

_____ Check enclosed _____ Bill me _____ Bill my company _____ Company purchase order # _____

This offer subject to acceptance by McGraw-Hill.

EL1

Seven Reasons Why PDP*-11 Computer Users Prefer MDB Interface Products:

1. Superior Performance
2. Quality Workmanship
3. Comprehensive Product Mix
4. Competitive Pricing
5. Better Delivery
6. One-Year Unconditional Warranty
7. Worldwide Sales

Find your reason here!

■ PERIPHERAL DEVICE CONTROLLERS

- MDB-LP11 Line Printer Controller (high speed)
- MDB-LS11 Line Printer Controller (slower speed) These will accommodate most major manufacturers' models
- New! MDB-LV11 High Speed Electrostatic Printer/Plotter Controller
- MDB-CR11 Card Reader Controller (most popular models)
- MDB-PC11 Paper Tape Reader/Punch Controller (controllers above include 15 foot cable)
- MDB-XY11 Incremental Plotter Controller

■ SYSTEMS MODULES

- MDB-DR11B Direct Memory Access Module (single quad board)
- MDB-DR11C General Purpose Interface Module
- MDB-TA528 Digital I/O Module
- MDB-UT/930 Unibus Terminator
- MDB-DT1711 Data Acquisition I/O Subsystem

■ COMMUNICATIONS/TERMINAL MODULES

- MDB-MDL11 Asynchronous Serial Line Adapter
- MDB-MDL11W Same, with Line Frequency Clock
- MDB-MDU11 Synchronous Serial Line Adapter
- New! MDB-DUP11 Synchronous Serial Line Adapter for bit or byte oriented protocols (quad board) (modules above include choice of cable)
- New! MDB-DZ11AC Eight Line Asynchronous Multiplexor
- New! MDB-PDI-11 Byte Parallel DMA Terminal Interface

■ INTERPROCESSOR LINK SUBSYSTEMS

- New! MDB-DA11BJ Parallel DMA Interprocessor Link between two PDP-11 computers; with differential receivers & drivers
- New! MDB-DA11BOI Parallel DMA Interprocessor Link between two PDP-11 computers; with differential drivers, optically isolated receivers
- New! MDB/MLSI-DA11BOI Parallel DMA Interprocessor Link between PDP-11 and LSI-11 computers, differential drivers and optically isolated receivers
- New! MDB-DA528 Programmable Buffered Parallel Interprocessor Link between PDP-11 computers (subsystems above include 50 foot cables)

■ (P)ROM MEMORY MODULES

- New! MDB-MR11A (P)ROM Bootstrap Loader/Restart Module (quad board)
- ROM Modules, no memory:**
- New! MDB-MR-004 For 2716 or 2758 PROMS with on-board PROM programmer
- New! MDB-MR-005 For 2704, 2708, 3624, 2716, 2732, 2758 or similar devices

■ GENERAL PURPOSE/FOUNDATION MODULES

- MDB-11B General Purpose DMA Foundation Module; 12 user IC positions
- MDB-11C General Purpose Bus Foundation Module, 16 bit input and output registers; 20 user IC positions
- MDB-1710 General Purpose Bus Foundation Module; 40 user IC positions, sockets optional
- MDB-11WWB Quad Wire Wrap Module; 70 user IC positions, sockets optional
- New! MDB-W9501 Universal Quad Wire Wrap Module
- New! MDB-9500 Universal Hex Wire Wrap Module; sockets optional
- MDB-WWB1 Dual Wire Wrap Module
- New! MDB-M91WW Dual Wire Wrap I/O Coupler Module (all modules above have pins inserted in the wire wrap portion)

MDB interface products always equal or exceed the host computer manufacturer's specifications and performance for a similar product. MDB interfaces are completely hardware compatible and software transparent to the host computer. MDB products are competitively priced, delivery is 30 days ARO or sooner. MDB places an unconditional one-year warranty on its controllers and tested products.

MDB also supplies similar interface modules for DEC LSI*-11, Data General**, Perkin-Elmer (Interdata) and IBM Series/1 computers. Product literature kits are complete with data sheets, pricing and discount schedules.

MDB
SYSTEMS INC. 1995 N. Batavia Street
Orange, California 92665
714-998-6900
TWX: 910-593-1339

* TM Digital Equipment Corp. ** Data General is a computer manufacturer not related to MDB

Northern California 408/733-3950 □ Mid-Atlantic: 301/652-2173 □ New England: 617/444-1800 □ Mid-Western: 312/266-1032 □ Southeastern: 305/254-2511
Southwestern: 713/438-1238 □ Australia & New Zealand: (03) 543 2077 □ Belgium & Luxembourg: 02-720.90.38 □ Canada: 416/625-1907 □ France: 956.81.42
Greece: 9514.944 9520.589 □ Hawaii: (808)524-8633 □ Hong Kong: 5-771768 □ India: 234343 □ Japan: 03-437-5371 □ Malaysia: 944 404 □ Netherlands: 03404-21344
Philippines: 89-10-96 □ Singapore: 295-2381-2389 □ Sweden, Norway & Finland: 06/94 04 90 □ Switzerland & Liechtenstein: 01/730 48 48 W. Germany: 0 89/80 60 61-62



Wescon hums with news of the technology of the 1980s

by Howard Wolff, *Associate Managing Editor*

□ These days electronics exhibitions are setting records for both attendance and numbers of exhibitors, and next month's Western Electronics Show and Convention will continue the streak. The numbers are truly dazzling for the San Francisco fixture: there will be 439 exhibitors occupying 808 booths, compared to 383 and 687, respectively, in San Francisco in 1977, and the show organizers are preparing to play host to some 35,000 engineers, designers, marketers, and managers.

Wescon will be held from Sept. 18 to 20, with professional sessions at the St. Francis and Hyatt on Union Square Hotels and exhibits at the Civic Auditorium and Brooks Hall. Its theme is "Gateway to the Eighties," and the exhibits and technical sessions will certainly focus attention on the decade to come. Continuing the trend of the last several years of the 1970s, microprocessors lead the parade into the next decade. Every facet of the omnipresent little chips will be examined, with papers on memories for microprocessors, on single-chip types, on aiding the handicapped with microcomputers, and on their application in conservation efforts. Other topics almost as popular are personal computers, satellites for television relays and communications, analog and digital large-scale integration, integrated-circuit arrays, medical electronics, digital image processing, large-scale



computer-assisted design, and radar.

As a fillip for the footsore Wescon-goer, there will be a panel discussion of more than passing interest called "Super Solutions to Super Problems"—problems of vehicular safety, energy, pollution, and mass transit, among others.

Instruments and LSI

The IEEE-488 bus will touch the working life of every engineer in the foreseeable future, whether he is designing advanced microprocessors or taking ordinary measurements. How the definition of that bus is evolving and affecting instrumentation, where bus controllers are headed, what users will have to do to assemble and access bus systems—these and other topics will be addressed in a Wescon session organized and chaired by James Geisman of Tektronix Inc., Beaverton, Ore.

Maris Graube, also of Tektronix, is a member of the IEEE committee that has been wrestling with proposed changes to the standard. As the lead-off speaker, he will give an overview of the committee's work on a specification for codes and formats. He will also discuss some of Tektronix's internal bus standards.

Taking a look at some of the problems with present bus controllers, Bob Hallissy of Hewlett-Packard Co.,

Fort Collins, Colo., will identify those likely to be solved in the next few years. "Nobody yet knows how to fully specify a controller," Hallissy observes. He cites as an example the case of a user who buys a controller with a bus rate specified at 100 kilohertz. Although he plugs it into a system with 100-kHz instruments, he finds the communication rate is only 50 kHz because interchange protocols have an unspecified effect on bus rates.

Much of the change in instrumentation has come with LSI, and Bruce Gould of Wavetek Inc., San Diego, will examine the impact of microprocessors now and the part they will play in the future. In so doing, he will take a look at "virtual instrumentation," which he defines as devices able to "perform a measurement that is only possible because of software; for example, taking a nonlinear circuit and making it appear linear." Also, he will discuss the free-formatting possibilities made possible by processors.

Closing the formal session will be a glimpse of an advanced automated testing system that employs the bus in the testing of space craft and other devices, a view provided by Donald Leavitt and Thomas Thorpe of TRW-DSSG in Redondo Beach, Calif.

The analog and digital chip

One of the hot topics at Wescon's technical sessions is the art of combining analog and digital functions on a single chip. Session 16 addresses the problems forthcoming in such large-scale integrated circuits. Microprocessors with built-in analog-to-digital converters and the various coder-decoder (codec) chips are only the beginning of things to come, says session chairman Robert Walker of Intel Corp., Santa Clara, Calif. Which technology best meets both analog and digital requirements will be argued among the session speakers.

Bruce E. Amazeen, senior design engineer at Analog Devices Inc., Woburn, Mass., will proffer integrated injection logic (I^2L) as the do-all process. While he concedes that MOS transistors are more nearly ideal for high-density logic, the drawback is poor linear performance. Standard bipolar devices, he says, are incomparable for linear circuits, and the compatible I^2L process handles the dense logic. Versatility is really the issue, Amazeen says: what other process offers the designer so many tools—lateral and vertical transistors, resistors, capacitors, zener and band-gap references, and current sources—as I^2L ?

Intersil Inc.'s Jerry Zis says complementary-MOS is the only process for combining analog and digital functions. C-MOS is already recognized for its low-power performance in digital circuits, and Zis cites his Cupertino, Calif., company's operational amplifiers and 12-bit a-d converter as proof that C-MOS fills the analog bill, too. Early C-MOS amplifiers may have been noisy and transistors for them difficult to match—but now op amps competitive in ac performance with the popular 741 bipolar devices are available that dissipate only

microwatts of power, Zis contends.

Putting in a word for n-channel MOS as a linear technology is Roger Mao from American Microsystems Inc., Santa Clara, Calif., who discusses cost and performance tradeoffs between n-MOS and C-MOS circuits from his perspective as Telecommunications group manager. Mao stresses that the particular function being realized must first be partitioned into analog and digital sections—and that is not always a straightforward procedure. While something like a keyboard input is unquestionably digital and amplitude-modulated audio information is clearly analog, some functions, like filtering, should sometimes be performed in the analog domain with switched-capacitor filters and at other times lend themselves better to digital work.

Tagged onto session 16 is a discussion by Marcian E. (Ted) Hoff of Intel's 2920 signal-processing microcomputer chip, which provides a different all-digital solution to the a-d conversion questions. The device relies on programming its on-board erasable programmable read-only memory (E-PROM) to carry out real-time digital-signal processing to build filters, modulators, mixers, limiters, and other analog circuits.

Development systems to the fore

The topic of two sessions is the development system, that much-needed instrument for microcomputer design. Number 11, chaired by Jeff Krawitz, a marketing manager at Solid State Scientific Inc., Montgomeryville, Pa., compares universal systems with those dedicated to a single processor or family. And session 17 examines what effect, if any, the latest, most complex processors will have on development-system and emulator design.

Dave West, chairman of the latter session, has drawn speakers from Hewlett-Packard Co., Zilog Inc., Intel Corp., Tektronix Inc., and his own firm, Millennium Systems Inc., Cupertino, Calif., where he is in charge of business development.

Sam Lee, product manager at HP in Colorado Springs, Colo., will deliver a paper entitled, "Is there such a thing as a development system?" However, the question could just as easily be, "Will semiconductor manufacturers ever build chips with emulation in mind?" His topics are such issues as the emulation of 16-bit devices, the problems with emulating single-chip microcomputers (especially those with analog inputs and/or outputs), the effect of the increasing software development burden, and possibly ways in which HP approached some of these considerations for its upcoming development systems [*Electronics*, July 19, p. 33].

Another dilemma is what Lee calls the "pipeline issue," which, he says, is exhibited by Intel's 8086; the 16-bit CPU has an internal instruction queue so it is difficult to tell when a particular instruction is being executed. For instance, when a jump is taken, the 8086's internal queue is flushed out and refilled with the codes located at the new destination address. This means that

the emulator must have a buffer and flush the queue when it sees that the jump has been taken.

Tektronix will undoubtedly be interested in answers to the same types of questions, and the represented chip-makers, Intel and Zilog, may explain how they circumvented such problems in the design of their own dedicated systems. Intel may introduce at this session a hard-disk subsystem for its Intellec line of development systems.

Session 11 has gathered four system manufacturers: Tektronix, Futuredata Computer Corp. of Los Angeles, Diversified Technology Inc. of Ridgeland, Miss., and Intel. Because the session pits universal against dedicated units, it may seem likely to be Intel versus the other three. But, says chairman Krawitz, with the microprocessor families of companies like Intel growing so large, "there will ultimately be so much overlap that all development systems will be universal, in a way."

Diversified Technology's μ -MOS development system attacks universality from a unique angle. Software is first written in the high-level language Forth, regardless of the processor to be used in the design. Then, cross compilers and assemblers generate code for various target machines. This allows roughly 80% of the original code to be salvaged when upgrading or changing to a new processor.

Futuredata has introduced some bold distributed architectures for its systems, and it will be speaking about its latest invention, the slave emulator control unit [*Electronics*, April 26, p. 40]. The concept disjoins emulator and control buses, thus bunching the emulator-specific hardware together and making the unit truly universal. It lets the processor that is under scrutiny run all out, and eight of the slaves can be chained together through a single master development system.

The semicustom route

Session 13 will answer every question about semicustom linear and digital circuits, such as when to use gate arrays, which technology to choose, and when a full custom circuit is right. Of the five papers in the session, one is devoted entirely to analog semicustom circuits. James H. Feit, engineering manager at Interdesign Inc., Sunnyvale, Calif., will first discuss the tradeoffs among standard-chip, semicustom, and fully custom implementations of an analog circuit; he backs the semicustom approach, since Interdesign makes such a device. Called the MOF, it contains more than 400 components—mainly npn transistors, but also pnp devices and resistor arrays.

George N. Krautner of Exar Integrated Systems Inc., Sunnyvale, Calif., addresses the subject of combined analog and digital circuit design with 1^2L gate arrays, which can meet the needs of linear circuits with inherent bipolar devices.

The remaining papers in the session are devoted mainly to the digital end, all three covering gate arrays. The first is by Allan M. Cox and Stephen P. Blater of

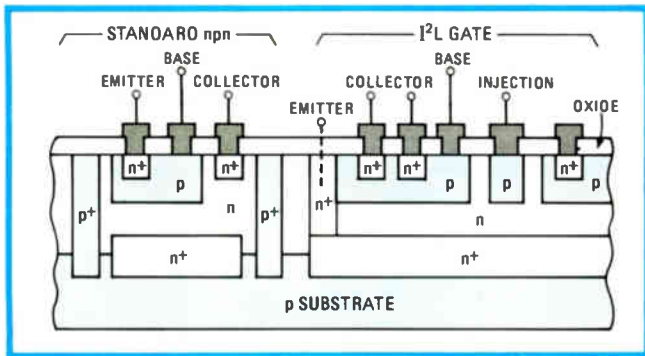

Side by side. This comparison, in Session 16, by Analog Devices Semiconductor of a standard npn transistor and an I²L gate shows the similarity between them. The most important difference is that the npn structure is upside down in the I²L gate.

Ferranti Computer Systems Ltd. in Manchester and Ferranti Electronics Ltd. in Oldham, England, respectively. Ferranti's gate array uses bipolar devices built by a process called collector diffusion isolation (CDI), which lends itself well to arrays because the power supplies are delivered within the bulk silicon and do not get in the way of metalization routing. The CDI process builds good current-mode logic (CML) devices, says Ferranti, but is more versatile than that. It has been used in low-power arrays as well, even in one that mixes precision linear circuits. Special interface circuits allow high-performance amplifiers, comparators, oscillators, and analog switches.

From Signetics Corp. is a high-performance 1,200-gate array built with integrated Schottky logic (ISL) pioneered by NV Philips Gloeilampenfabrieken, Eindhoven, the Netherlands [*Electronics*, June 8, 1978, p. 41]. Stephen Y. Lau discusses the new technology and the array organization. ISL outspeeds I²L with a typical gate delay of 3.5 nanoseconds against I²L's 15 ns. Most impressive is the power-delay product of 0.88 picojoule—less than 1/20 that of low-power Schottky (LS) logic.

Medical matters

Electronics faces some of its greatest challenges—technical, legal, moral, and economic—in the field of medicine. Some of the technical and economic answers, and plans for finding others, will be covered in several Wescon sessions.

A meeting called "Microcomputers Help the Handicapped," organized by Andrew Sekey of the University of California at Santa Clara and chaired by both him and colleague Robert Hanson, will be devoted to systems that permit the disabled to enter the industrial and educational mainstream. Papers will cover a variety of microcomputer applications: its use in computer conferencing to break down communication and transportation barriers, optimizing interfaces and control systems, and in aural output systems for the speech-impaired and the

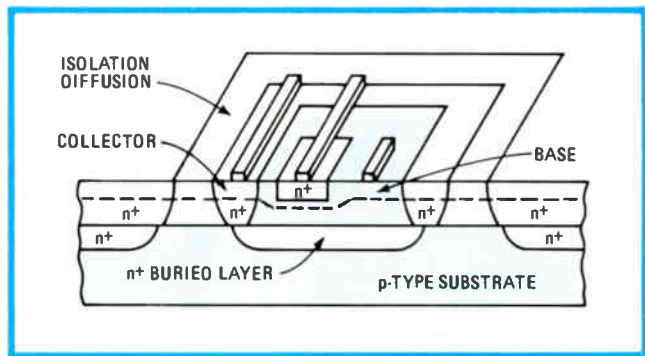

From Britain. From Ferranti comes a description of gate arrays using bipolar devices built with a process called collector diffusion isolation. It is said to yield densities in the order of those produced by n-channel MOS, I²L, and complementary-MOS on sapphire.

blind. For such aids to become truly affordable, greater integration of effort is needed. At present, Sekey points out, funding for research comes from several Government agencies, and as a result, efforts are often duplicated.

Advances in imaging technologies have had a major impact on medicine in the last few years. Two sessions at Wescon will touch on medical applications.

Coming first is the "Topics in Digital Image Processing." Organized and chaired by William Bisignani of Mitre Corp. in McLean, Va., it calls attention to dramatic strides being made in array processing, algorithms, and two-dimensional transforms permitting images to be processed faster and better than they ever were before.

"The CAT scanner is a big victory for digital image-processing people," claims Ken Castleman of Caltech's Jet Propulsion Laboratory (JPL) at Pasadena, who will present a paper on biomedical image processing. CAT—computerized axial tomographic—scanners have been accepted because of the diagnostic image they provide, possible only through digital processing.

Terminals for consumers

The next hot product for the technically competent consumer will be satellite receive-only terminals, and Wescon's Session 25, chaired by H. Paul Shuch of Microcomm in San Jose, Calif., will discuss how such broadcasts are received and what happens when they are. There are many legal questions concerning private reception of common-carrier-originated signals as opposed to those broadcast. These will be addressed by a panel composed of all the authors delivering technical papers in this session.

The technical papers themselves will describe the programming that is available in "Those Great Repeaters in the Sky—a Summary of Domsat Video Programming," organized by Richard Campbell of Homesat Inc. in Atlanta, Ga., and how to set up to receive them. Included will be such necessary goodies as antennas and

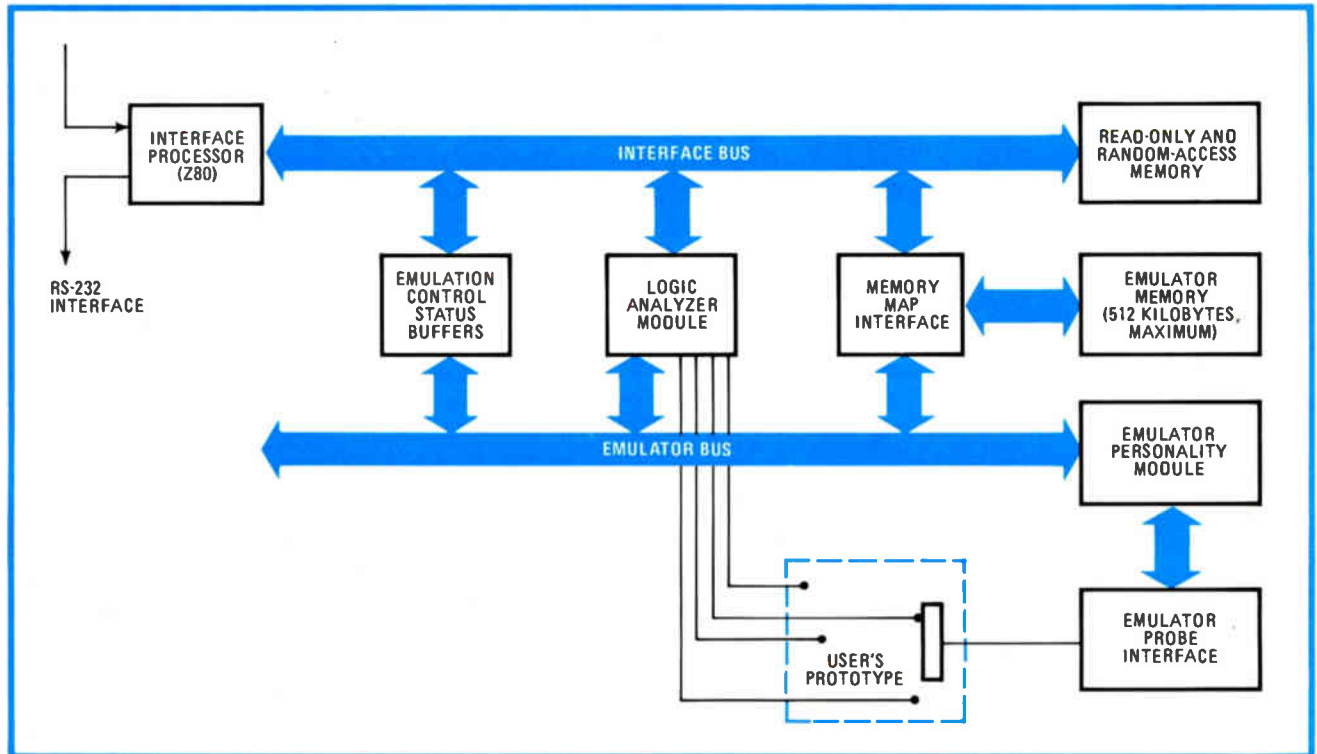

Slave labor. Futuredata's slave-emulator control unit employs two separate buses: one for an interface to the host system, and one for emulator control. With this arrangement, processors under test can run at top speed without having to relinquish any address space.

feeds (John Kinik of Ford Aerospace and Communications Corp. in Palo Alto, Calif.), low-noise amplifiers (George Vendelin and Mike Fornaciari of Dexcel Corp. in Santa Clara, Calif.), receivers (session chairman Shuch), and how to put the whole system together and make it work (H. T. Howard of Stanford University).

Stopping the data thief

Concern for the safe handling of data, especially that generated by computers, continues to grow at a rapid rate and Wescon Session 14 is designed to provide an overview of the ramifications of this controversial topic [*Electronics*, June 21, p. 107]. One of the major questions is just what kind of encoding scheme should be used. This issue will be addressed by Martin Hellman and Ralph Merkle of Stanford University. They advocate the public-key system in which the transmitting algorithms are public information but the receiving algorithms are secret, and the two are related by a complex mathematical procedure. The issue is how secure it is compared with the National Bureau of Standards data encryption standard.

The session, chaired by Mitre Corp.'s William T. Bisignani, will not ignore other aspects of the computer security problem. For example, the concept of an unauthorized act will be discussed in "Fraud, Theft and Unauthorized Acts" by Robert P. Abbott of EDP Audit Controls Inc. of Oakland, Calif. How to find the risks

users take with each system will be covered by speakers from Computer Resource Controls in Rockville, Md., and the U. S. Railroad Retirement Board in Chicago.

The state of the art in radar

Radar systems have been with us for a long time and the typical engineer may think there is not much new to say about them. The papers in Session 20 prove the contrary. Chaired by John Q. Adams of ITT Gilfillan in Van Nuys, Calif., the papers concentrate on new radars that are an outgrowth of the latest semiconductor technology and on the need for increased cost effectiveness.

"Digital Processing Trends in Radar Systems" by Gerald Rosen of the same company is typical. Rosen says that his paper is "not comprehensive but does reveal the state of the art for current production radars." He discusses the application of digital processing to beam steering, timing control, built-in testing, and display processing, among others.

Taking the original radar concept of 1930—where the transmitter and receiver are physically separate—as his jumping-off point, Russell J. Lefevre of Technology Service Corp. in Santa Monica, Calif., shows how this bistatic radar can be applied to new programs such as the "Sanctuary" radar testbed. This is a feasibility study for defense radars.

Other papers in this session will cover "The Future of Microprocessors in Radar Systems" and solid-state

transmitters. There is even that perennial favorite—"Millimeter Waves—an Emerging Technology."

Session 5, chaired by S. H. Durrani of the National Aeronautics and Space Administration in Greenbelt, Md., is an overview of what to expect from the satellite systems that will be going up in the next decade. Subjects such as post-Intelsat-5 planning, the newly emerging Inmarsat, and the Landsat-D system will be discussed. The papers will be given at the system level and should be of interest even to nonspecialists.

The EE and the programmable calculator

The relevance of Session 24, "The Programmable Calculator: an Engineer's Computer," to the original-equipment manufacturer and end user is emphasized by its organizer, Richard J. Nelson of the Statek Corp., Orange, Calif., and the HP-67 Users' Club. He notes that the capability of the machines is expanding daily and that all segments of the electronics industries are finding an increasing number of uses for the powerful

devices. Chairman Rudy Panholzer of the Naval Postgraduate School, Monterey, Calif., also draws attention to the virtual certainty of integration of such calculators into the general academic engineering curriculum.

In "The Development of an OEM Market for Hand-held Programmables," Richard D. Cuthbert of Texas Instruments Inc. in Dallas will discuss TI's entry into a relatively new phase of programmable-calculator activity—supplying custom software to the users of its scientific machines through its Solid State Software modules.

David Conklin and Bernard E. Musch of Hewlett-Packard Co., Corvallis, Ore., then present "Present and Future Trends in Hand-held Calculator Systems," which will focus attention on the new HP-41C system and its alphanumeric display in particular and show in general how products introduced by TI, Sharp, and Casio over the past 18 months have provided great advances in performance. Conklin and Musch point to the advantages gained by the alphanumerics, including a plain-English display of the functions ordered up, such as COS



Making a muscle. To be described in a medical session at Wescon is this system from Caltech's Jet Propulsion Laboratory. With its assistance, an operator can locate and measure muscle fibers under the microscope.

for cosine function. They discuss how other features fast becoming standard—complementary-MOS memories and nonvolatility, the use of liquid-crystal displays, the ability to display a complete list of machine functions (cataloging), larger user memory, partitioning options for program and data space, and the provision for connecting external devices—can make it possible for the calculator to attack problems previously tackled only by full-fledged computers.

Rex H. Shudde next discusses the field use of the calculator in antisubmarine warfare and officer training in the five-year program at the Naval Postgraduate School. The paper (“Naval Applications of Programmable Hand-held Calculators”) provides a good overview of some activity in the Navy, which has assumed a position of leadership in the field among the armed forces because of its involvement since 1965.

Organizer Nelson then closes the session by presenting an overview of four major scientific calculators—the TI-59, the HP-67, Casio’s FX502P, and Sharp’s EL5100—and of several down-the-line models in his paper “Today’s PPCs: An Engineer User’s View.” In addition to discussing what have become the five basic calculator topics—logic systems, program writing, hardware, software configuration, and user’s organization—Nelson will display photographs of each calculator’s internal interface and provide suggestions and details for each instrument’s use.

Computer-aided design news

Considering the application of computer-aided design (CAD) programs to four segments of the electronics industries—consumer products, computers, integrated circuits, and education in the electrical engineering curriculum—Session 26, “Large-Scale CAD Programs: Present and Future,” provides insight into the design aids for users of complex programmable ICs, programs for circuit design, the significance of thermal analysis and graphics input/output optimization, and the specialized very large-scale task of chip verification.

Ed W. Nowak of Zenith Co., Glenview, Ill., opens up the session with “Consumer Electronics and CAD Programs,” a discussion of the considerations and difficulties encountered implementing a version of the Spice system for several chips in Zenith’s line of TV, radios, and games. The talk, on a general level, will give users practical information for device modeling and optimization using many of the popular programs, such as SLIC, SINC, and Cornap.

Norbert Santoski of Sperry Univac Co., St. Paul, Minn., will then present “On the Use of Large-Scale Circuit and Thermal Programs,” focusing on the capabilities of Spice 2, Circuit, Sinda, and Thermal in the related areas of circuit analysis, component/device modeling, thermal analysis, and graphics. Santoski will discuss program tradeoffs and applications (including inter disciplinary considerations) and the verification of

model and analysis results that the large-scale systems can be used intelligently and to their greatest advantage. Closing out the talk is session organizer and chairman Carl R. Zimmer of Arizona State University, who discusses “Some Aspects of CAD in Electrical Engineering Education.”

Problems in the outside world

Turning on Tuesday morning from the orderly world of electronics to the more disorderly world around it, the aforementioned panel, “Super Solutions to Super Problems,” will consider vehicular safety, mass transit, pollution control, and the electrical energy crisis.

“What I really hope this session will do is create controversy,” says its organizer, Robert E. McMillan, associate professor of electrical engineering at the New Jersey Institute of Technology, Newark. “I would like to jar our technical people into recognizing the need for a well-thought-out technological commitment. . . . We, the engineers, should be thinking about how to prevent chaos in our environment.”

Such a commitment to finding solutions is necessary, he says. Not all of the papers will offer “super solutions”—but they will all certainly pose “super problems.” The chairman for the session will be Rep. Harold C. Hollenbeck (R., N. J.), ranking minority member of the House subcommittee on science, research, and technology.

McMillan will give the paper on vehicular safety, which, like the other three, will begin with the dimensions of the problem. He will propose an accident-prevention approach where the car and the highway are seen as a system. It will include such features as a sensing system (radar, infrared, laser, or sonar) and an onboard computer so sophisticated that it can evaluate almost anything the sensors pick up. All in all, development and realization would take an effort comparable to that it took to put a man on the moon, McMillan says.

Getting people out of automobiles and around cities via mass transit will be the topic of a paper by George Jernstadt, president of his own consulting firm, Cityscope and Mobility, Boliver, Pa. He calls his solution the horizontal elevator, basing it on concepts developed during his many years at Westinghouse Corp.’s mass transit operations.

Jernstadt says airport transportation systems in Tampa, Fla., and Seattle-Tacoma, Wash., are examples of the horizontal elevator, which is much like a regular building elevator, except that it runs outdoors on a suspended track. The idea is to link related buildings in a reasonably compact urban area with parking lots on the outskirts.

Horizontal elevators could certainly sweeten the air on city streets, but what about the many other sources of air and water pollution, asks Edward Schroeder, chairman of the civil engineering department at the University of California, Davis. Public concern about pollution is now



One day, the pencil factory started producing pencils with erasers at both ends, because the machine that put the erasers on went haywire, because the computer gave it the wrong message, because one of its printed circuit boards malfunctioned, because one of the I.C.s was in backwards, because the DIP insertion machine made an error, because there was no DIP verifier to catch the mistake, because the DIP insertion machine wasn't a Dyna/Pert.

Announcing Dyna/Pert's new DIP verifier, DCV-A. Even with automatic DIP insertion, there's such a thing as human error. But the DCV-A guarantees that the correct DIP with the correct polarity goes into the correct PCB position, every time. It tests both digital and analog I.C.s without slowing down the insertion cycle one bit, and without requiring any extra labor investment. Tremendous cost savings and no human error: that's the whole point.

We help you do it right the first time.

DYNA/PERT®

Division of USM Corporation, Elliott Street, Beverly, Massachusetts 01915





focused on industrial sources, and people want to know how to control them, he says.

"The current situation is that we simply cannot control [this pollution]," he says. Neither the industries involved nor government bodies have performed effectively: "Clearly the system is not functioning as it should, so there will have to be changes." Schroeder admits that the cupboard seems bare when it comes to ready solutions, but he hopes to offer some encouragement in the final draft of his paper.

A similarly gloomy outlook on electrical power will come from Donald Hodel, president of the National Electrical Reliability Council, Lake Oswego, Ore. As part of the worldwide energy crisis, the U. S. demand for electrical power is about to outstrip the supply of power sources for the immediate future.

"The energy problem of this country has become highly complex. It will require imaginative and complex solutions," says Hodel, former administrator of the Bonneville Power Administration. "Solutions are available, just as assuredly as energy resources in abundance are available if we decide to set about converting them to a usable form."

What the U. S. must do, he says, is to fashion a multiple-path solution, developing every possible source of energy from nuclear to solar (while paying close attention to conservation and similar measures). All of these solutions are technologically feasible, says Hodel, but he nevertheless worries that the national will to bring them about is lacking.

Picoseconds and processors

Computer designers are forever trying for faster and faster systems. But they are rapidly approaching the operating limitations of the silicon integrated circuits that are the basic components in digital equipment. Session 15 will examine current research at development of new semiconductor technologies capable of operating in the subnanosecond range.

For example, a paper to be presented by Paul T. Greiling of Hughes Research Laboratory, Malibu, Calif., discusses the use of gallium-arsenide devices that can operate up to six times faster than their silicon counterparts. Such devices have demonstrated logic gate delays of 33 picoseconds with 1.4-picojoule speed-power products, he notes. Experimental circuits currently being built in GaAs, he explains, are based on depletion-mode field-effect transistors, Schottky-diode FETs, and enhancement-mode FETs. Although it is the faster of the circuit types and now the most widely used, Greiling does not expect depletion-mode FETs to be used in large-scale-integrated GaAs circuits because of their high power dissipation. Offering lower power is the Schottky diode FET logic, which combines depletion-mode FETs with Schottky diodes for decision functions. Greiling calls the enhancement-mode FETs very promising because of their substantially reduced power consump-

tion. Inherently simpler than the other two types of circuits, they can also be packed more closely together on the chip, he notes.

More bits from bipolars

A number of new bipolar devices for designers of microprogrammed computer systems will be explained in Session 2. Advanced Micro Devices Inc., Sunnyvale, Calif., will unveil its Am29116 16-bit microprocessor in a paper by designers William J. Harmon Jr. and Warren K. Miller.

Employing emitter-coupled logic internally, it has converters on its input and output pins to make it compatible with transistor-transistor-logic circuitry. The use of the ECL circuits lets the 29116 operate at 100 nanosecond cycle times, somewhat faster than the rest of the TTL-based members of the 2900 family. With a powerful instruction set, the 16-bit unit is designed primarily for use in controllers, Harmon points out, and many of the members of the 2900 family can be used with it to complete the design of such a microprogrammed controller.

Among the architectural features of the AMD device are a 16-bit barrel shifter that can rotate data in 15 positions, 32 working registers, and the ability to perform immediate instructions. This facilitates the entry of constants into the system's microprogram. Fabricated with a new oxide isolated process, samples of the device will be available within nine months after Wescon, the company estimates.

Paul Chu will be explaining Fairchild Camera and Instruments' recently introduced family of 8-bit slice ECL microprocessors [*Electronics*, Feb. 15, p. 125; Aug. 2, p. 120]. Operating on 8 bits of data and a ninth parity bit, the devices can substantially reduce the interchip delays that rob ECL circuits of their speed advantage, Chu notes. The four members of the family are the F100200 address and data interface unit, the F100221 multiple-function network, the F100222 dual-access stack, and the F100223 programmable interface unit. Together these parts can be used to build a microprogrammed central processing unit with a cycle time on the order of 40 nanoseconds for a 64-bit data path. Next to come, Chu says, will be a F100224 microprogram sequencer chip.

Another relatively new family of large-scale integrated ECL circuits is Motorola's M10800 family, to be discussed by William R. Blood Jr. [*Electronics*, Feb. 1, p. 99; Feb. 15, p. 113.] A 4-bit-slice family, it now consists of nine parts, including the MC10800 arithmetic and logic unit, the MC10801 microprogram control unit, the MC10803 memory interface unit and the MC10806 dual-access stack. Motorola has also used the same production techniques with its Macrocell array—integrated circuits that contain 48 functional logic areas, to be interconnected as the user desires through the use of a computer-aided system for custom designs. □

New PANDUIT™ MAS-CON™

Mass Termination Assembly System

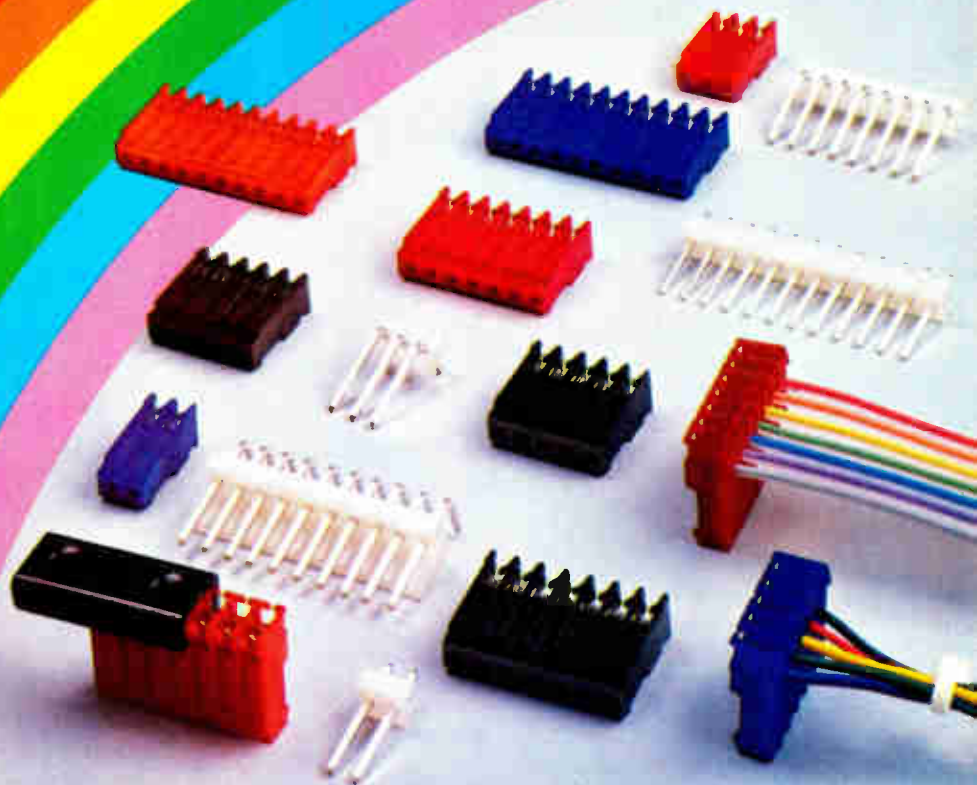

Unique Wire Retention Design Speeds Installation and Reduces Installed Costs

Now you can mass-terminate both discrete wire and notched flat cable without insulation stripping.

- Wires snap quickly into unique wire retainers in each connector. These retainers hold wires securely prior to termination.
- Compact, inexpensive, easy-to-use bench press quickly terminates both through-circuit and end-circuit connectors.
- System includes: Insulation displacement connectors, header assemblies, harness board accessories, polarizing keys, manual and pneumatic hand tools and bench presses.
- MAS-CON is the mass termination system with the flexibility you've been looking for.

Ask for Free Demonstration
and Cost Analysis

FREE SAMPLES

Visit PANDUIT at WESCON, Booth 1715-1717

Circle 178 on reader service card

The Reliable... Wherever Electricity Is Used



ELECTRONIC PRODUCTS GROUP
Tinley Park, IL 60477 • Phone (312) 532-1800
In Canada: Panduit (Canada) Limited

THE AD DAC80. NOW WHO'S

TAKE A CLOSER LOOK. WHO DOES IT WITH 8 FEWER CHIPS?

Check the arithmetic. With the Analog Devices AD DAC80, a big decrease in the number of chips buys you a big increase in performance and reliability. The AD DAC80, a pin-compatible, economy 12-bit DAC outperforms the old industry-standard DAC80. Whatever way you want to look at it. Number of chips, size, reliability, power consumption, drift, power supply rejection or reference current capability. What it all adds up to is that now the AD DAC80 gives you a convenient way to upgrade system performance without expensive redesign.

By packing these significant improvements in performance on just three chips we've greatly improved the inherent reliability. Compared to other DAC80's, the AD DAC80 has half the number of bond wires,

one-third the number of internal attached components, no substrate and significantly reduced power consumption.

WHO HAS THE SPECS TO PROVE IT?

Check the specs. The new AD DAC80, a pin-for-pin replacement for competitive DAC80's, features an on-board output amplifier that settles to $\pm 0.01\%$ in $3 \mu\text{Sec.}$ (voltage models); guaranteed monotonicity over the temperature range of 0 to $+70^\circ\text{C}$; low profile, ceramic, dual-in-line package with welded leads.

The laser-trimmed AD DAC80 also includes a high-stability precision buried zener reference which can supply up to 2.5mA for use externally in the application. Maximum nonlinearity error is $\pm 0.012\%$ with $\pm 30 \text{ppm}/^\circ\text{C}$ maximum gain drift and total accuracy drift in bipolar configuration of $\pm 20 \text{ppm}/^\circ\text{C}$ maximum.

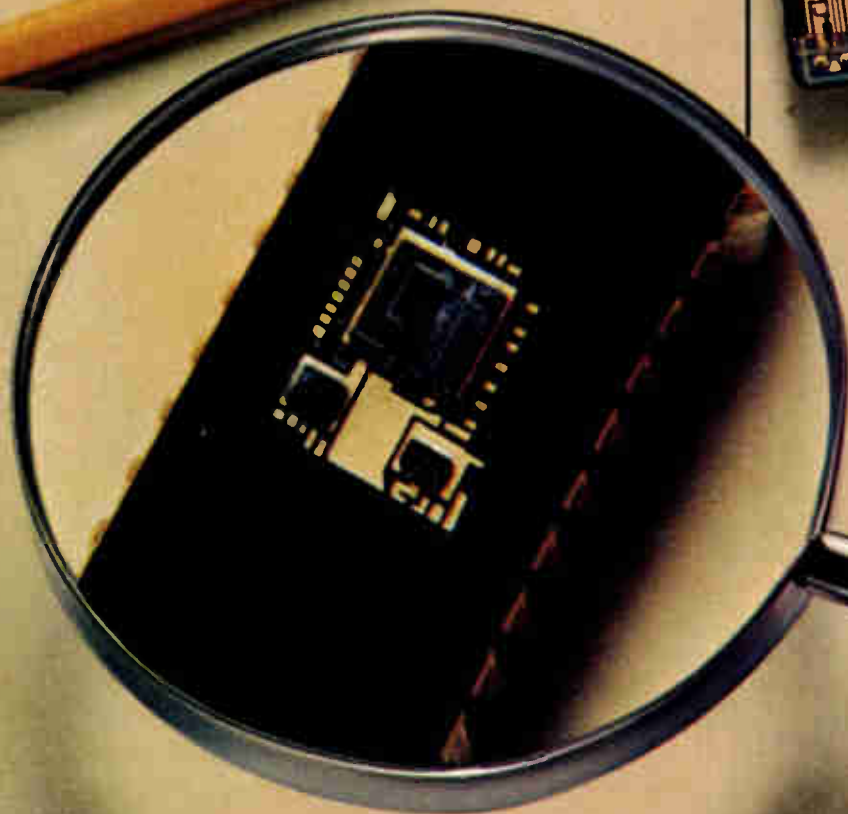
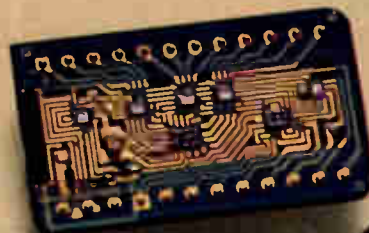
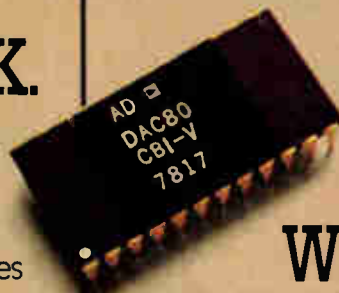

THE SECOND SOURCE?

	AD DAC 80	BB DAC 80
Number of Chips	3	11
MTBF (failures/million hrs.)*	9.3	23.0
Max. Total Bipolar Drift	± 20 ppm/ $^{\circ}$ C	± 25 ppm/ $^{\circ}$ C
Max. Reference Output Current	± 2.5 mA	± 200 μ A
Max. Power Dissipation	925mW	1200mW

Input codes may be BCD or binary and output ranges are ± 2.5 V, ± 5 V, ± 10 V, 0 to $+5$ V or 0 to $+10$ V on voltage output models or ± 1 mA or 0 to 2mA on current output models.

The AD DAC80 not only has the specs, the reliability and the performance, but also the price. Starting at \$18.50 in 100s, available immediately from stock.

WHO'S YOUR FIRST SOURCE FOR ALL THIS AND MORE?

Just because the AD DAC80 is the first, it is by no means the last "second sourced" converter that we've succeeded in improving the performance and reliability of while lowering the price. We have a whole series of devices that are pin compatible with other industry standards but offer much better everything at much lower prices.

- **AD DAC85** – A premium 12-bit IC digital-to-analog converter that replaces standard DAC 85 devices with considerable improvements in reliability, size and price. The AD DAC85 offers maximum nonlinearity

*Calculated per MIL-HNBK-217B.

error of $\pm 1/2$ LSB, ± 20 ppm/ $^{\circ}$ C maximum gain drift, and a total accuracy drift in bipolar configuration of ± 10 ppm/ $^{\circ}$ C maximum.

■ **AD DAC87** – For wider temperatures, the AD DAC87 offers similar performance specifications over the full MIL temperature range, -55° C to $+125^{\circ}$ C, and is available to full MIL-STD-883B processing.

■ **AD ADC80** – A complete, self-contained 12-bit successive approximation analog-to-digital converter that directly replaces standard ADC80s. Reduced chip count and MSI digital and linear construction greatly increase the performance and reliability of the AD ADC80. The AD ADC80 offers fast conversion time of 22 μ s, typical low power dissipation of 800 mW, maximum linearity error of $\pm 0.012\%$ at 25° , and maximum gain T.C. of 30 ppm/ $^{\circ}$ C.

For more information on the AD DAC80, the new industry, or any of the other "second sourced" converters, call Doug Grant or Don Travers at (617) 935-5565. Or write Analog Devices, Inc., P.O. Box 280, Norwood, MA 02062.



**ANALOG
DEVICES**

WAY OUT IN FRONT.

BERYLLIUM COPPER,



COPPER ALLOY,



OR GOLD INLAY.



NOW YOU GET AUGAT QUALITY, LOWER PRICES AND A CHOICE OF CONTACTS.

Which 200 Series socket best fits your application?

Beryllium Copper. The original 200 Series socket. It proved you don't have to sacrifice high performance for low cost. The 2xx-AG39D features beryllium

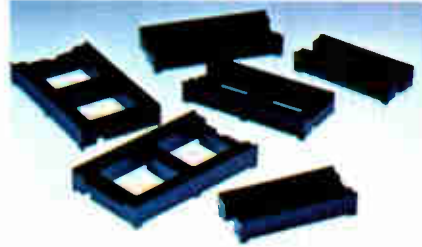

copper side-wipe contacts for maximum mechanical and gas-tight electrical performance. MIL-S-83734 approved.

Copper Alloy. The lowest-cost 200 Series socket you can buy. It features copper alloy tin-plated contacts to provide excellent performance for maximum economy. Yet the 2xx-AG29D has all the design innovations that made the 200 Series an overnight success.

Gold Inlay. Now true gold contacts are available in a low-cost socket.

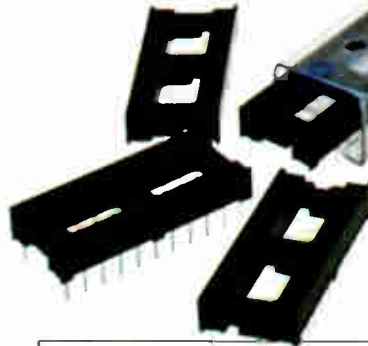

Augat Series 2xx-AG49D sockets establish a new gold standard for dependability and economy.

And no matter which contact material you choose, you still get Augat's low-profile construction with end and side stackability to save valuable board space. Insulators with molded standoffs to provide clearance for proper cleaning. Closed bottoms to eliminate solder wicking. And all 200 Series sockets—beryllium copper, copper alloy, or gold inlay—are available in all popular sizes from 8 to 40 pins. All are packaged in tubes, at no extra cost, compatible with automatic insertion equipment.

So if you're looking for low-cost sockets,

look to your Augat representative or distributor. He can help you make the right choice.

For the name of the nearest Augat representative or distributor, write Augat, Inc., 33 Perry Avenue, P.O. Box 779, Attleboro, Mass. 02703. Tel. (617) 222-2202. In Europe—Augat SA-France: (Z.I. Sofilic) B.P. 440 Cedex/94263 Fresnes, France. Tel: 668.30.90. Telex: 201.227 AUGSAF.

TEST DATA

Insertion Force	230 grams when measured with a .015" x .023" rectangular lead.
Withdrawal Force	88 grams when measured with a .088" x .015" rectangular lead.
Initial Contact Resistance Per MIL-STD-1344, Method 3002	Low-signal level contact resistance at 20 mv open circuit measured at 6.79 milliohms, before corrosive atmosphere.
Socket Durability 50 Cycles with .014" x .021" Gauge	5.4 milliohms measured before durability and 6.15 milliohms after 50 cycles.
Corrosive Atmosphere per MIL-S-83734 Para. 4.7-16	No evidence of porous plating or exposure of base metal. Contact resistance averaged 6.64 milliohms indicating gas-tight performance. Low-signal level 100 ma at 20 mv.

Your contacts are on the next page, too. Look for Augat's complete distribution listing.

Send for detailed Augat test report #178

AUGAT®

Augat interconnection products, isotronics microcircuit packaging, and Alco subminiature switches.

Circle 183 on reader service card

YOU HAVE THE CONTACTS.



Whether you're looking for Beryllium Copper, Copper Alloy or Gold Inlay contacts, your Augat Distributor has the 200 Series sockets you need—in stock—at the right price.

ACK Semiconductors	Radarc Electronics
Arrow Electronics	Radio Supply
A.S.I.	Richey Electronics
Car-Lac Electronics	Standard Supply
Cramer Electronics	Sterling Electronics
Deeco Inc.	Summit
Empire Electronics	Thompson Electronics
Fort Wayne Electronics	Walters Radio Supply
Genesis	Wedemeyer Electronics
Gopher Electronics	Wyle Dist. Group (Elmar/Liberty)
Graham Electronics	Canada:
Hamilton/Avnet Electronics	Cam Gard
Ideal Electronics	Cardinal
Kierulff Electronics	Future
Kirkman Electronics	Hamilton/Avnet
Lectronix	RAE
Milgray Electronics	Saynor
Newark Electronics	LA Varah
Pattison Supply	Wackid
Pioneer Electronics	

AUGAT®

See 200 Series Advertisement on preceding page.

LYTRON'S compact heat exchangers fit where others wont.

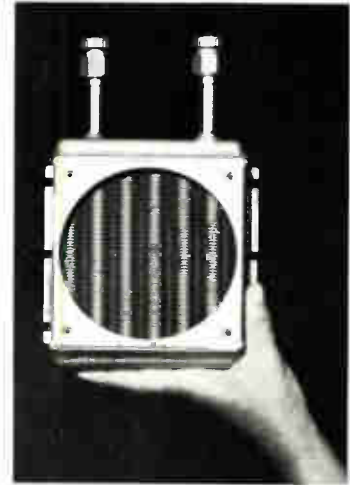

Compact Lytron heat exchangers fit tight spaces . . . pump heat out, efficiently.

Solve heat buildup problems with these compact, space-saving Lytron heat exchangers. Choose from 24 standard models, aluminum or copper.

Exclusive INNER-FIN® construction increases internal cooling surface and saves up to 50% of ordinary coil space.

Ideal for cooling electronic cabinets, lasers, machine tools, computer systems, X-ray machines, space vehicles, airborne and mobile equipment . . . and a variety of electronic or mechanical equipment where unwanted heat builds up in tight quarters.

Compact Lytron heat exchangers—they fit where others won't. All standard models delivered from stock. Special designs for special problems also available. As well as applications engineering assistance.

For compact size, minimum weight, proven reliability, prompt service and fast delivery at low cost, contact Lytron Incorporated

2 Dragon Court
Woburn, Massachusetts 01801
Phone: (617) 933-7300

 **LYTRON**
INCORPORATED



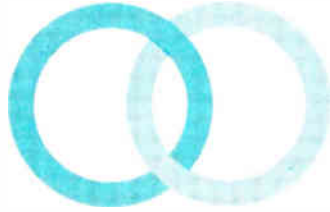

Wescon/79

Microcomputers, especially development systems, will get most of the play when the doors open on this year's show, Sept. 18-20, in San Francisco

5-MHz a-d unit converts 12 bits

At \$3,495 and 11 cubic inches, the MOD-1205 is about a third the cost and one seventieth the size of its nearest competitor; it could be that the new analog-to-digital converter from the Computer Labs division of Analog Devices Inc. is a bargain.

That's the way marketing manager Edward L. Graves feels. "Nobody else sells a 12-bit, 5-MHz analog-to-digital converter at anything near this price," he claims, adding that the nearest competition is another Computer Labs product, its rack-mountable CLB-1205 at about \$11,000. By contrast, the MOD-1205 is contained on a single 5-by-5-in. printed-circuit board and is designed for video digitization in precision radar, instrumentation, and digital communications applications requiring a compact package.

One of the few companies to specify a converter's dynamic characteristics, Computer Labs is not bashful about the ac linearity of the MOD-1205; spurious signals are more than 70 dB below full scale, worst case, between dc and 1 MHz, and more than 65 dB down between 1 and 2.5 MHz. Conversion (word) rate is user-variable from near zero to 5 MHz. Aperture uncertainty time (jitter) is ± 25 ps maximum. Root-mean-square signal-to-noise ratio is a minimum of 66 dB, and the rarely quoted noise-power ratio is a mini-

mum of 56 dB. Transient response of the MOD-1205 is such that the converter yields 12-bit accuracy within 200 ns.

Dc inaccuracy, including nonlinearity, is no more than $\pm 0.0125\%$ of full scale, $\pm 1/2$ least significant bit. Monotonicity is guaranteed. Maximum nonlinearity versus temperature is 0.0005% of full scale per $^{\circ}\text{C}$; gain change versus temperature is 0.005% of full scale maximum and typically 0.002%.

The unit's analog input-voltage range is ± 2.048 v for full-scale output and ± 4 v maximum. The input impedance is user-selectable at either 400 or 50 Ω while bias current is no more than 1 nA. Offset voltage can be zeroed by an on-board potentiometer; it drifts with temperature no more than 0.005% of full scale per $^{\circ}\text{C}$ and typically only 0.002%.

Correcting. The MOD-1205 uses a proprietary, and perhaps unique, conversion scheme to reach this

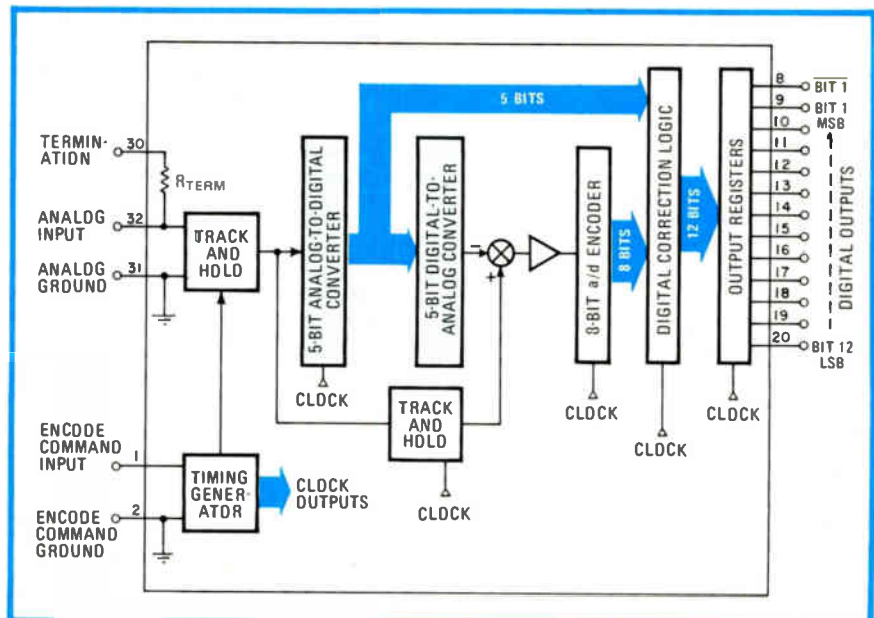

Precise. The performance of the 12-bit MOD-1205 is set by its 5-bit a-d converter and its 5-bit d-a converter, both of which are trimmed to 13-bit absolute accuracy.

COMPUTER AIDED DRAFTING—ADVANCED STATE OF THE ART

Between \$18,000 to \$45,000
Simply input ideas
with Joystick or
Graphic tablet



Computer does work,
you do the thinking



Instant Recall: Add or delete
entire blocks of drawings with
one command



Plotter gives camera ready
art in minutes

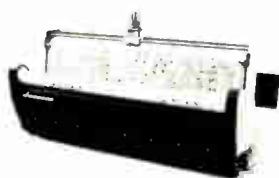

Only at I Corporation
Order yours today!

- * PC Layout
- * Schematic
- * Mechanical
- * Hybrid

(415) 848-6600

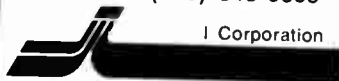

835 Addison Street
Berkeley, CA 94710

New products

performance. Computer Labs calls it digital correcting subranging. Subranging converters are not new, but the concept of correction during conversion may be.

In the MOD-1205, the equivalent of two parallel conversion paths are established side by side. One is 5 and the other 8 bits wide for a total of 13 bits; thus, in gross terms, the converter "overresolves." But the key is elsewhere, according to Graves.

The input converter is a 5-bit parallel (flash) 50-ns device; its output is sent both to a precision 5-bit digital-to-analog converter and to what is called digital correction logic. The d-a converter puts it back into analog form; it is then subtracted from the original input. The resulting difference is sent to an 8-bit parallel a-d converter, the output of which also goes to the correction logic subsystem.

According to Graves, "accuracy is set by the first flash encoder and the subsequent d-a converter; though

rated at 5 bits, they are trimmed to 13-bit absolute accuracy. This, coupled with the overresolution of the second (8-bit) encoder makes basic accuracy quite high. Finally, the error-correcting signal is applied to the least significant bits."

There is more art in preventing discontinuities where one converter takes over for another, but Graves has even less to say about that than about the basic design.

Making a system run this fast meant using specially designed fast-settling op amps, circuits with fast (4-GHz cutoff frequency) transistors, plus a lot of parts selection and laser trimming of resistor networks. Thus the price tag, which, when compared to the size of the board, looks large: \$3,495 each. But, says Graves, "we didn't design to price, but to a market requirement."

The MOD-1205 is available from stock.

Computer Labs, a division of Analog Devices Inc., 505 Edwardia Dr., Greensboro, N. C. 27409. Phone (919) 292-6427 [401]

Units make medium-resolution color video affordable

For displaying information, it is hard to hold a candle to high-resolution color graphics. Although widely desirable, color video systems have been prohibitively costly in the past, as they still are for very high-resolution applications. But at least one company, Matrox Electronic Systems Ltd., is helping to bring medium-resolution color video and graphics into the price range necessary for broad usage.

At Wescon, the Canadian company will be showing three video components: a color television monitor (the MCTV-15), a 256-by-256-dot color graphics generator (the RGB-256), and a video digitizer (the FG-01). Each of these components may be used separately or in combination with one or more of the others.

The color TV monitor provides superior-quality 256-by-256-dot

images and good-quality graphics at resolutions approaching 512 by 512 bits. And at \$1,195, Matrox claims that this monitor is the lowest-priced color monitor to have separate gun controls. The unit employs a 15-in. television manufactured by Sony Corp. and functions in three modes: RGB, composite-video, or normal color television. Optimal performance is realized in the RGB mode, where each color gun is driven independently while composite-synchronization information is provided separately. By contrast, in the composite-video mode, a single 75-Ω coaxial line allows the MCTV-15 to be positioned several hundred feet away from the controller.

In all modes of operation, composite video is brought out to daisy-chain other color or black-and-white monitors. The composite video signal is derived from the station chosen by

Hipotronics inc.

HIGH VOLTAGE DC POWER SUPPLIES AND POWER PACKS

Standard supplies from 1 kW to 50 kW



1 kW supply provides 120 kV @ 8 mA

Power Supplies

Complete range of unregulated high voltage dc supplies with voltage outputs from 1 kV to 1000 kV and current outputs from 10 mA to 50 Amps available in standard designs at economical prices. Fully instrumented and protected, these supplies are ideal for:

- Laboratory use
- Capacitor charging
- Laser supplies
- CRT supplies
- Marx generators
- Many more

5, 7.5 & 10 kV @ 5 mA OEM Power Packs



Power Packs

Miniaturized, oil-filled steel cans for OEM use. Voltages from 2.5 kV to 100 kV at 2, 5 & 10 mA. Low cost, high reliability.

Metered Power Packs

Same miniature power packs available with simplified or deluxe controls for rack-mounting. Short circuit current limit option makes these ideal for cap charging applications.

Write or call for complete details.

HIPOTRONICS

HIPOTRONICS, INC.

P O Drawer A, Brewster, NY 10509
(914) 279-8031 Tlx 710-574-2420
Amex Symbol HIP

New products

the channel selector and can be fed to the RGB-256 and the FG-01 boards to digitize, display, and/or store broadcast-video frames.

The RGB-256 color graphics driver board requires +5- and +12-v power supplies and Intel's Multibus. The card delivers a dense, 256-by-256-dot resolution and has built-in NTSC (American) or PAL (European) encoders that provide up to 16 colors or shades of gray. The module also incorporates a phase-locked loop that permits the output to be synchronized with external video sources like cameras.

RGB-256 cards can be combined to yield more bits of resolution per pixel. For example, with two cards and no additional hardware, up to 256 colors or gray levels can be applied to any dot on the screen.

Intended for use with RGB-256 boards is the FG-01 video digitizer. It incorporates a high-speed analog-to-digital converter and, like the RGB-256, is Multibus-compatible. On-board logic also allows the digitizer to be interfaced with other buses, giving a large variety of microprocessors and minicomputers a low-cost "eye."



Under program control, one of four sources is selected and fed to the a-d converter. This quantizes the selected video signal and forms a 256-by-256-dot digital image. This output, at TTL voltage levels, can then be fed to one or more RGB-256 boards. With this combination of boards, digitized video may either be displayed continuously or frozen and grabbed to be read, modified, or compared with other digital data or previous frames.

Prices for the RGB-256 begin at \$1,395 and for the FG-01 at \$800. Quantity discounts are available.

Matrox Electronic Systems Ltd., 5800 An-dover Ave., Montreal, Quebec H4T 1H4, Canada. Phone (514) 735-1182 [402]

16-bit d-a converter settles to within 0.003% in 10 μ s

A 16-bit digital-to-analog converter with 14-bit accuracy, a $\pm 0.003\%$ linearity error, and a 10- μ s conversion time may not be new. But Burr Brown believes that those features, when combined with a \$47 price tag (in 100 quantities), will lure new users into the high-resolution d-a converter market.

Operating over the temperature range from -25°C to $+85^{\circ}\text{C}$, the DAC72 is a companion converter to the earlier, commercial version DAC71 [*Electronics*, March 29, p. 145]. The company has improved on that earlier model by locating all major resistors on a single chip. "All critical resistors have been put onto one chip in a single resistor-ladder network," notes Joseph R. Santen, product marketing manager for

data-conversion products. "Therefore the resistors are all at the same tracking temperature, with the result that the converter has good temperature performance," he adds. This thin-film resistor network is laser-trimmed at the wafer level. Also key to the d-a converter's reliability is laser-trimming the resistor associated with the in-circuit zener diode, while varying the temperature of that diode. Fast-settling switches contribute to the converter's operation as well.

The hybrid unit comes in three differently coded models: complementary-coded-decimal, complementary-straight-binary, and complementary-offset-binary. The user may also opt for either a voltage- or a current-output model. The CCD

calcumeter

the only low cost way
to intelligent
measurement
processing

plus low cost data logging

Accessory data printer—
microprocessor controlled—
combined with Calcumeter to
make automatic data logging
system. (Variable printout
intervals up to 3 hours)

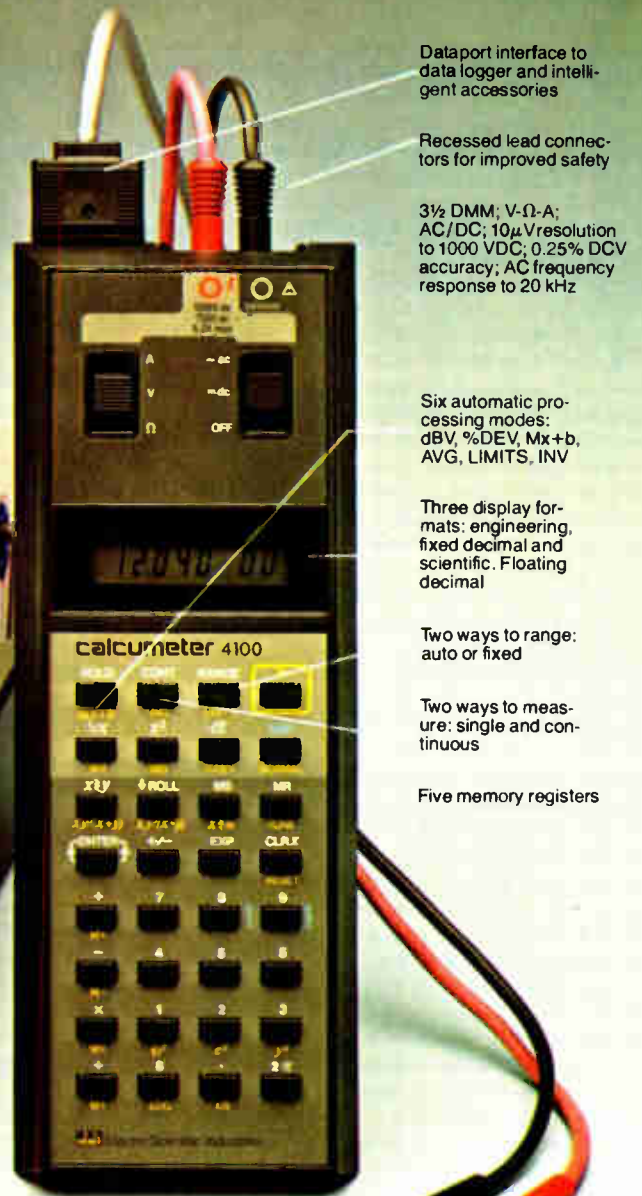

Dataport interface to
data logger and intelli-
gent accessories

Recessed lead connec-
tors for improved safety

3½ DMM; V-Ω-A;
AC/DC; 10μV resolution
to 1000 VDC; 0.25% DC
accuracy; AC frequency
response to 20 kHz

Six automatic pro-
cessing modes:
dBV, %DEV, Mx+b,
AVG, LIMITS, INV

Three display for-
mats: engineering,
fixed decimal and
scientific. Floating
decimal

Two ways to range:
auto or fixed

Two ways to meas-
ure: single and con-
tinuous

Five memory registers

Scientific RPN cal-
culator: 2π, 10^x, y^x,
LOG, LN, e^x, xy/x+y

One million meas-
urements on a 9V
battery



Free yourself for more creative tasks... the intelligent Calcumeter way.

Our custom CMOS microcomputer turns a handheld 3½-digit DMM into an automatic measurement processor... At the touch of a button you program the battery-powered Calcumeter™ to perform complex chores that can save you hours every week!

- Convert transducer signals automatically to engineering units of temperature, pressure, 20mA current loops, etc. (Mx + b key).
- Measure current without breaking into the circuit (Mx + b key), $I = (1/R)V + 0$.
- Average away noise (AVG key).
- Sort components, using the HI-LO LIMITS mode (both "analog" display and audible alarm!).
- Use the LIMITS mode as a universal logic probe.
- Read out audio signals and amplifier gain in dB (dBV key).
- Test % tolerance or power supply regulation (% DEV key).
- Determine parallel or shunt resistance (xy/x + y key; xy/x-y key).

The Calcumeter offers you escape from much of the chore work connected with design, testing and maintenance, enabling you to spend more time in creative tasks. It pays for itself in a few months, often on the basis of one application alone. They are now available from regional distributors at the same low price.

calcumeter \$389 (USA)

The intelligent new way to measure V-Ω-A.

Call toll free for nearest distributor — 800-547-5637
or send for 12-page full color brochure

esi
ELECTRO
SCIENTIFIC

Electro Scientific Industries, Inc.
13900 NW Science Park Dr.
Portland, Oregon, USA 97229
Telex 36-0273 · Telephone (503) 641-4141

Circle 189 on reader service card

Incredible,
but true!

10 Watts
1 to 1000 MHz

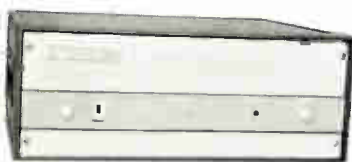

ULTRA-WIDEBAND AMPLIFIER

Amplifier Research again leads the way with its new Model 10W1000, an ultra-wideband amplifier that delivers 10 watts of linear power from 1 to 1000 MHz—more power and bandwidth than any other amplifier of its kind. In fact, as the "next generation" in ultra-wideband amplifiers, Model 10W1000 offers you 2½ times the power of its predecessor, the Model 4W1000.

Versatile and unconditionally stable, this high-performance amplifier can be used with frequency synthesizers or swept signal sources to provide high-level outputs for RFI susceptibility testing, NMR spectroscopy, antenna and component testing, general lab applications, and other uses.

For complete information on our 10W1000 and other W Series amplifiers, write or call:

Amplifier Research
160 School House Road
Souderton, PA 18964
Phone: 215-723-8181
TWX 510-661-6094

 **AMPLIFIER
RESEARCH**

New products

model has a resolution of 4-digits. The CSB and CCD both have a voltage output range of 0 to ± 10 v, while the COB has a bipolar output of ± 10 v. Current output ranges for these respective units are 0 to -2 mA and ± 1 mA. Maximum linearity error at 25° C for CCD version is $\pm 0.005\%$ of full scale; for the COB and CSB models, it is the lower $\pm 0.003\%$. Gain drift for the voltage version is ± 5 ppm/° C, and for the current, ± 35 ppm/° C.

The voltage units settle to within $\pm 0.003\%$ of full scale with a 20-v step in 5 μ s typically and 10 μ s maximum. For current units, with a 2-mA step and a 10- Ω to 100- Ω load, the settling time is a maximum 1 μ s to within $\pm 0.003\%$. Monotonicity is maintained over the 0° to 70° C temperature range. Both differential nonlinearity and linearity error over temperature is ± 1 ppm of full scale/° C.

Santen points out three major application areas for the DAC72, noting that "people are happy with converters that can settle in 50 μ s now, but they'll find ways to take advantage of the 72's speed." Analytical instrumentation, such as blood analyzers or gas chromatographs, and photo typesetting or photo composition, where resolution is important, are both new and growing

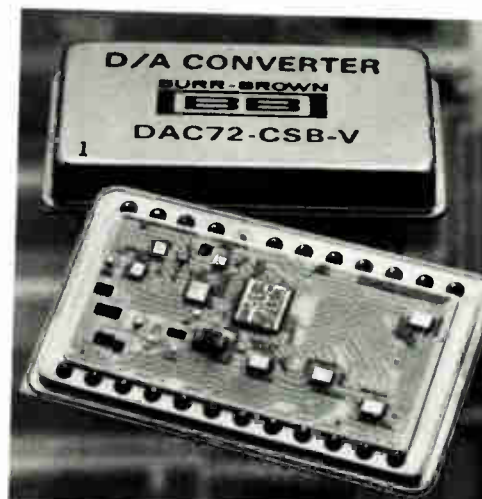

markets for this kind of converter. But the DAC72 will find its greatest applicability in military environments using closed-loop servo systems, such as long-distance radar tracking systems.

Packaged in a 24-pin, nickel-plated Kovar case measuring 1.375 in. by 0.75 in. by 0.25 in., the DAC72 is hermetically sealed using welded connections. Input power needed is ± 15 v dc and +5 v dc. The unit has an on-board 6.3-v reference.

Burr-Brown Research Corp., International Airport Industrial Park, P. O. Box 11400, Tucson, Ariz. 85734. Phone Herman Loopeker at (602) 746-1111 [403]

Interprocessor interfaces link computer buses at DMA speeds

Computer systems designers often desire to tie two central processing units together so they can share data, thereby creating systems that are more flexible and less sensitive to failure. To make this easier for users of Digital Equipment Corp.'s popular PDP-11 minicomputers and LSI-11 microcomputers, MDB Systems Inc. is introducing four parallel interprocessor links that will allow the buses of two computers to be linked in a high-speed, direct-memory-access manner.

Until now, DEC users have had to create their own interprocessor links

by adding logic to a DEC DR11B DMA interface board, or they have had to settle for a lower-speed serial data-communications link, according to Don Perkins, vice president for product development at MDB. "And in addition to coupling the Unibus-based PDP-11 computers, we have units capable of coupling a PDP-11 to either the LSI-11/2 or LSI-11/23," he adds.

Based on MDB's DA11B DMA interface board, the new interprocessor interfaces add the interprocessor interlock and timing logic important for directly connecting the buses of

Why Wait for SOLID STATE? *Magnecraft*[®]

HAS 26 DIFFERENT RELAYS IN STOCK FOR IMMEDIATE DELIVERY.



MAGNECRAFT'S SOLID STATE RELAYS FEATURE:

- —
- Output current ratings from 2.5 to 40 amps . . . IN STOCK
- Output voltage ratings to 480VAC . . . IN STOCK
- A.C. & D.C. input . . . IN STOCK
- Zero voltage switching . . . IN STOCK
- Opto isolation between input and output . . . IN STOCK
- P.C. terminals, screw terminals and quick connect types. . . IN STOCK
- Matching heat sinks . . . IN STOCK



Designers guide for applying and specifying our Solid State Relays.

This catalog outlines the surge current and thermal characteristics that must be considered in order to derive the best performance vs costs for many types of circuit conditions and loads.

MAKE A LOCAL CALL

206-883-3550	303-841-3435	316-788-0621	602-894-2345
213-641-4255	305-831-8233	317-259-4431	609-933-2600
214-631-9450	312-963-6400	414-784-3390	612-933-2594
216-238-0300	313-398-5556	415-592-8333	617-969-8100
301-465-5944	315-472-5273	516-364-0310	803-233-4637

CALL OR SEND
FOR YOUR
FREE CATALOG

Magnecraft[®]
ELECTRIC COMPANY

5575 NORTH LYNCH AVE., CHGO., ILL. 60630
312/282-5500

Boschert's 3T Switching Regulator



3T-12AP-1001

Size: 5" x 4.1" x 1.7" max.
 Input Voltage: 10 to 40VDC (60 Hz bulk source or battery)
 Output Voltage: 4.5 to 30VDC (adjustable)
 Output Current: 0 to 12A
 Efficiency: 80% typical
 Regulation: $\pm 1\%$ (15 to 40VDC),
 2% (10 to 40VDC)
 Current Limit: 5A to 20A (adjustable)
 Price: \$30 in quantities of 100
 Available from stock

3T-5AN-1001

Size: 5" x 5.4" x 1.7" max.
 Input Voltage: 10 to 40VDC (60 Hz bulk source or battery)
 Output Voltage: 4.5 to 30VDC
 Output Current: 0 to 5A
 Efficiency: 80% typical
 Regulation: $\pm 1\%$
 Current Limit: 1A to 10A (adjustable)
 Price: \$35 in quantities of 100
 Available from stock

Boschert Representatives

Northeast

BGR Assoc.
 Willow Grove, PA
 (215) 657-3301

Neville & Vespo Corp.
 Bogota, NJ
 (201) 487-1505

Datcom, Inc.
 Waltham, MA
 (617) 891-4600

Bob Dean, Inc.
 Ithaca, NY
 (607) 272-2187

Mid-Atlantic

Glen White Assoc.
 Timonium, MD
 (301) 252-6360

Southeast

Glen White Assoc.
 Lynchburg, VA
 (804) 384-6920

EIR, Incorporated
 Casselberry, FL
 (305) 830-9600

Midwest

Stan Clothier Co.
 Minneapolis, MN
 (612) 944-3456

SAI Marketing Corp.
 Brighton, MI
 (313) 227-1786
 Dayton, OH
 (513) 435-3181

Sumer. Inc.

Rolling Meadows, IL
 (312) 991-8500

West

Electrodyne, Inc.
 Denver, CO
 (303) 759-4409

Salt Lake City, UT
 (801) 486-3801

Mycrosystems
 Mktg., Inc.
 Dallas, TX
 (214) 238-7157

Houston, TX
 (713) 783-2900

Criterion, Inc.
 Santa Clara, CA
 (408) 988-6300

ES/Chase Company
 Beaverton, OR
 (503) 641-4111

Seattle, WA
 (206) 762-4824

Fred Board Assoc.
 Scottsdale, AZ
 (602) 994-9388

The Powerhouse
 Mission Viejo, CA
 (714) 830-5666



New products

two computers. And three of the new models also feature optically isolated receivers and drivers, providing voltage isolation up to 3 kv and eliminating the need for a common ground loop between the two computers. Since the interprocessor interfaces can connect computers up to 1,000 ft apart, the computers may be in different buildings with completely independent power supplies.

The interfaces can provide data transfers at rates up to 500,000 words—1 megabyte—per second in a half-duplex mode, with both computers transferring data, via DMA control, in blocks of 32 kilowords.

To tie only PDP-11 computers together, without optical isolation, the MDB-DA11BJ, priced at \$4,875, is used. The MDB-DA11BOI adds the optical isolators and sells for \$5,275.

For coupling two LSI-11 computers together, the optically isolated MLSI-DA11BOI, which has a price tag of \$3,295 is used. Integrating a

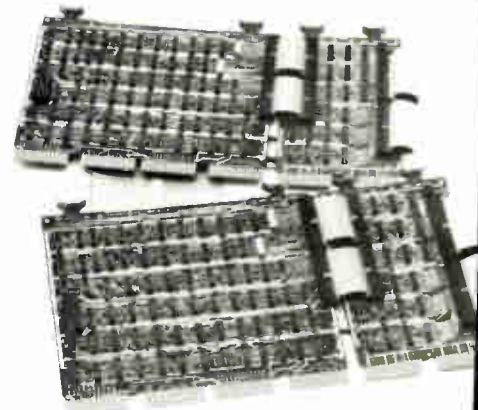

PDP-11 and an LSI-11 into the same system calls for the MDB/MLSI-DA11BOI—an optically isolated DMA interprocessor interface—that sells for \$4,050.

The units occupy either one quad slot on the standard LSI-11 backplane or one hex slot on the PDP-11 backplane.

MDB Systems Inc., 1995 N. Batavia St., Orange, Calif. 92665 [404]

Emulator uses multiprocessor, multiple-bus approach

In-circuit emulation is perhaps the most effective method of bringing a microprocessor-based system to market, yet most emulators are less than ideal. For example, often the processor under test is restrained from running at top speed, or some of its memory is tied up for the emulator's use, or the system under test must be halted to conduct debugging operations. These limitations are solved with the 2302 Slave Emulator Control Unit (SECU) from GenRad/Futuredata. Rather than using a single bus, the SECU employs a multiprocessor, multiple-bus setup that permits nonstop, full-speed emulation of 8- or 16-bit microprocessors from different manufacturers.

The SECU is designed to mate with Futuredata's 2300 Series of Advanced Development Systems. Communication takes place over a 19.2-kb/s RS-232-C serial interface, and up to eight SECUs may be daisy-

chained to a single development system. Each slave emulator includes a 4-MHz, Z80-based interface module to process debugging requests from the host, a read-only memory or programmable-ROM simulator memory, a power supply, an eight-slot card cage, and a case.

Every SECU has a personality module containing, on board, the processor to be emulated. The user can also add other 9-by-12-in. boards, for additional memory or for a universal logic analyzer. Each SECU may use a different personality module. An 8086 personality card will be shown at Wescon, and others, for the 6502 and 6809, will be announced later this year. Support modules for the 16-bit Z8000 and the 68000 microprocessors are scheduled for release during the first half of 1980. Each personality package contains the emulator interface card that plugs into the SECU and a

Our 3-terminal switching regulator gets OEMs over the toughest hurdle.

Introducing Boschert's new 12A submodule. It gives you the jump on building switching power supplies in-house.

Manufacturing your own switching power supply can be a big money saver. But designing it can be risky and time-consuming.

Today Boschert solves the most difficult problem of building your own hybrid switching power supplies with our new low cost 3-terminal switching regulator. It gives you a perfectly matched set of magnetics, logic and power circuits to 12 amps — all on a single 4" x 5" board. The 3T switching regulator is bound to save you design time and production cost. It will get your systems to market sooner — without the risk.

For designers working with microprocessor systems or battery backups, this regulator is ideal. (See specs left) If needed, DC voltage can be distributed to various 3T submodules throughout a system to eliminate voltage drop problems. And since hybrid power supplies have built-in isolation and low leakage, the 3T regulator is perfect for medical equipment, too.

At Boschert, we've been building off-line switching power supplies for nearly a decade. Over 100,000 of our multiple output power systems are now in operation. For any power requirement between 25-400 watts, at any volume

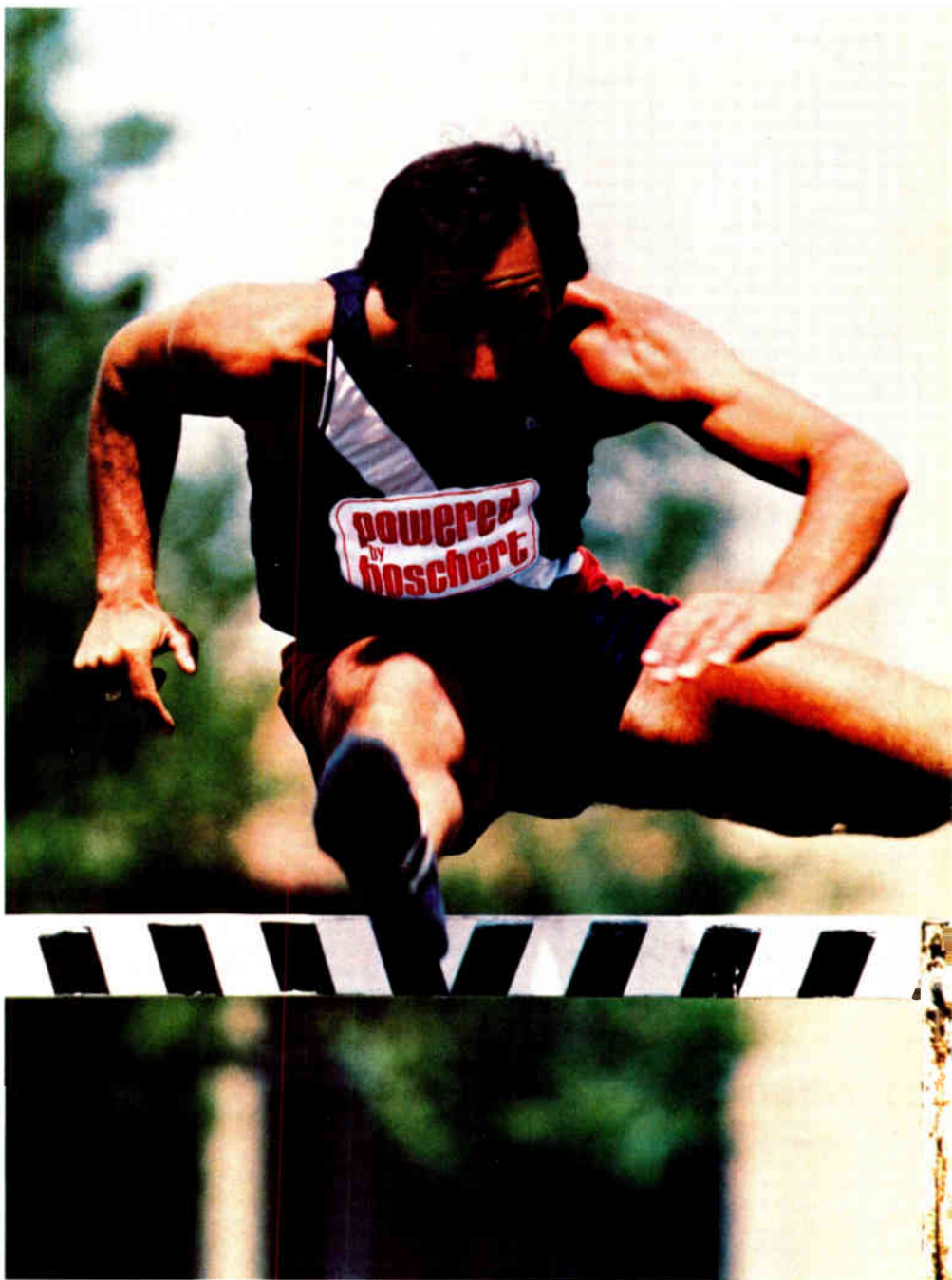

level between 1 and 1000 a month, Boschert sticks with you. Today Boschert also sticks with OEMs who want to produce their own.

For more information on how our new 3T Switching Regulator takes the guesswork out of hybrid switching power supplies, contact your local Boschert

representative. Or write Boschert, Inc., 384 Santa Trinita Avenue, Sunnyvale, CA 94086. Or call (408) 732-2440.

boschert SWITCHING
POWER
SUPPLIES

ANOTHER
SCHADOW EXCLUSIVE
...presenting...

the
PUSH
toward
miniaturization

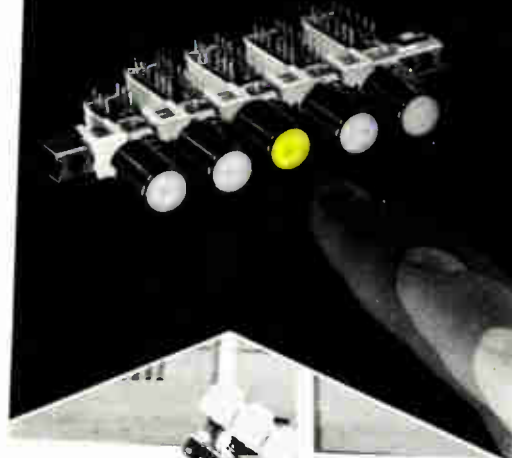

SCHADOW SERIES MP PUSH BUTTON SWITCH

25% smaller than comparable multi-position push button switches. Featuring a shorter stroke and the standard 10, 12.5, 15 and 20mm button centers, *plus exclusive 8mm!* Interlocking push push and momentary mechanical functions. L.E.D. illumination, double bank and piano key, optional. Large assortment of button styles in black, white, red, grey and chrome.

Fast service on samples, specs and price quotations.

Ask for switches by our first name
...Schadow

ITT Schadow Inc.
8081 Wallace Road, Eden Prairie, MN 55344
612/944-1820 TWX 910-576-2469

ITT Schadow

New products



probe that places critical components close to the user's prototype.

ROM/PROM simulator memory modules are available with either 32 kilobytes of static random-access memory or 128 kilobytes of dynamic RAM. The memory automatically reconfigures itself to be either 8 or 16 bits wide, depending upon the type of processor under test. Using the latest devices, the static memory boards provide full-speed emulation to 10 MHz.

The logic analyzer provides three breakpoints to nest events and timing measurements. And breakpoint conditions can be complex;

they can be set for specific cycles, memory-address ranges, data values, etc. Trace memory is 64 bits wide and will store 256 events. The debugging software provided is able to show register and memory contents in both ASCII and hexadecimal.

The SECU costs \$3,500 with 16-kilobytes of static RAM. Personality packages range from \$1,500 to \$2,000, and the slave logic analyzer is priced at \$2,500. A 32-kilobyte high-speed static RAM module goes for \$2,300.

GenRad/Futuredata, 6151 W. Century Blvd., Suite 1124, Los Angeles, Calif. 90045. Phone (213) 641-7200 [405]

System speeds digital-board checks by 'testing if possible'

A buyer paying more than \$100,000 for a digital-circuit-board tester should expect its operation to be fairly hassle-free. At any rate, that has been the goal of the designers of the new 2270D Digital In-Circuit Test System, according to GenRad Inc. spokesmen. To minimize hassle, the Concord, Mass., firm has added some features said to be unique in the field:

- A "test-if-possible" strategy to

boost throughput by continuing testing even when faults are found.

- "Scratch probing" to speed integrated-circuit pin diagnostics.

- Memory-based parallel input/output hardware at each pin.

- Automatic test generation (ATG) software.

- Learn-mode library data generation.

The 2270D includes an LSI-11 computer with floating-point pack-

← Circle 194 on reader service card

Electronics / August 30, 1979

When your design calls for SCR's or triacs...no one gives you the choice that Teccor does.

And — our electrically isolated packages are U.L. recognized.



Teccor is a name you can specify with confidence. It's the company that pioneered electrically isolated SCR and triac packages. Teccor was well ahead of the times in development of thyristors for use in energy efficient applications — long before energy became a major design consideration.

Glass passivated device junctions insure long-term reliability. Devices are available with current ratings from 800 mA to 40 amps and voltage ratings up to 1000 volts.

And, when you specify Teccor, you know

the products will be readily available when it's time for production runs. About one out of every three triacs made this year . . . will be made by Teccor.

So, no matter what case style best fits your design — chances are Teccor has it. Get your free copy of the Teccor catalog. It'll make it quick and easy to get the device you want in the package you need to fit your design.

How about SSR's in your choice of "normally open" or "normally closed" configurations? You'll find those in your Teccor catalog too.



U.L. File #E71639

TECCOR
TECCOR ELECTRONICS, INC.
P.O. Box 61447 Dallas, Texas 75261
214/252-7651

Circle 195 on reader service card

Leaders in Electronics

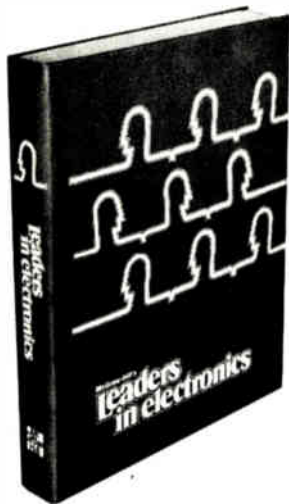

The only reference devoted solely to biographies of the most influential people in electronics

- corporate executives • technical managers • designers/developers • government and military officials • academics • consultants • editors/publishers • trade/professional group directors • securities analysts

Plus an 80-page index of biographies by affiliation, including independent consultants in every electronics specialty.

Prepared by the staff of Electronics magazine. 5,240 biographies. 651 pages, clothbound. \$39.50

Electronics Magazine Books
P.O. Box 669, Hightstown, NJ 08520

Send me...

_____ copies of *Leaders in Electronics* @ \$39.50 plus applicable sales tax. McGraw-Hill pays regular shipping and handling charges on pre-paid orders.

I must be fully satisfied or you will refund full payment if the book is returned after ten-day trial examination.

Payment enclosed Bill firm Bill me
Charge to my credit card: American Express
 Diners Club Visa Master Charge
Acct. No. _____ Date Exp. _____

On Master Charge only,
first numbers above name

Name _____

Company _____

Street _____

City _____ State _____ Zip _____

Signature _____

New products

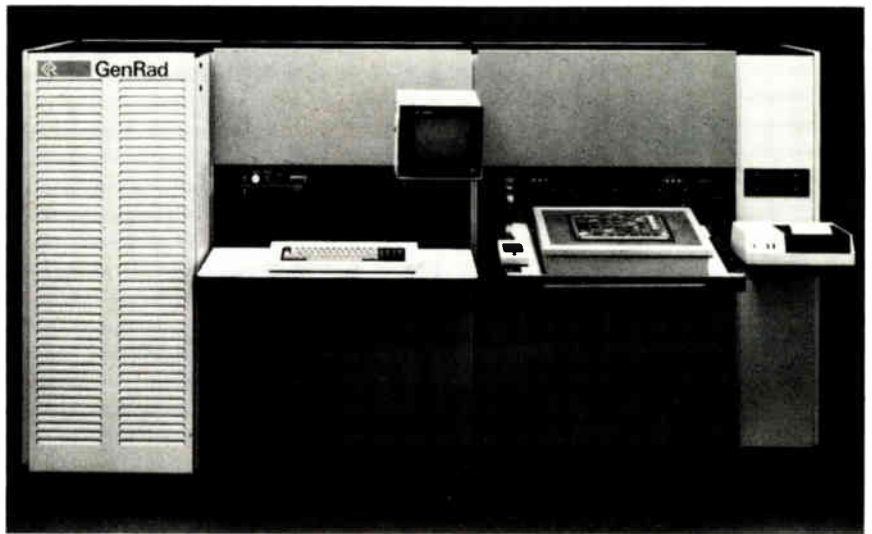

age, automatic bootstrap loader, and 32-K-by-16-bit memory. Mass memory consists of a fixed disk and a removable disk cartridge with a total capacity of 10 megabytes. There is a full-ASCII strip printer for data-logging or fault-repair printouts. A cathode-ray-tube display presents alignment patterns used in presetting adjustable components. Finally, there are two keyboards, one standard-sized for programming purposes and the other a movable operator's control pad, much like a calculator's, for use during test. The test fixture is of the common vacuum-operated bed-of-nails type.

Statistically, according to GenRad, most faults originate in assembly. So the 2270D first checks for shorts, open circuits, wrong parts, missing ones, or parts inserted backward or incorrectly seated. If any are found, the fact is printed out.

But what follows, according to spokesmen, is unique. To spot the most faults on a pass, testing continues even though flaws like shorts are found; the 2270D simply avoids testing components associated with shorted pins. Other ICs are tested for functional operation, with each pin exercised at least once to be sure the circuit is properly installed and functioning.

Sometimes there is doubt whether a failure is due to a bad IC, an open circuit, or a bad nail in the test fixture. The usual answer is to probe each IC pin to check continuity.

Instead of this slow and sometimes faulty process, GenRad has developed scratch probing, in which a test probe is quickly run along the pins of a suspect device. With this probe, the 2270D verifies that there is continuity between the device pins and system drivers in a fraction of a second. And there is no chance of counting pins and making a mistake.

At the pin. All in-circuit testing is controlled through dynamic bursts from a local 1,024-bit memory at each pin; associated with the memory are individual drivers and sensors so that parallel-data-bit patterns can be either written or read back in a programmed sequence. GenRad spokesmen feel this gives users the flexibility needed to tackle bus-structured boards of large- and medium-scale ICs.

Memory bursts consist of functional test steps. Each step might include selection of a pin as either "drive" or "sense," the desired drive or sense state, the sensed logic state, and a switch to detect whether or not sensed errors should be ignored. This makes it possible for parallel bit patterns to be written into and read out of a device. These parallel patterns may alternate with other synchronous or asynchronous control bits.

The bottom line is speed—more thorough testing performed faster, say GenRad spokesmen. For added flexibility, the 2270D includes independently programmable drive and



Yes, it's glass

...for the superior reliability required by the computer industry.

In the highly competitive computer industry, one of the biggest goals is to reduce the storage and retrieval costs per bit of information to the end user. In recent years, the evolution of the Winchester disk drive technology has achieved just that—more information packed on the same size disk.

The narrower and higher density information tracks on the disk, made the precision of the read/write head an extremely critical factor. So the choice of slider material was critical as well. The solution was Fotoceram® glass-ceramic by Corning.

Fotoceram glass-ceramic had already been established as one of the most reliable slider materials available. It is known for superior wear characteristics during start and stop contact conditions. Surface smoothness of less than a micro-inch. Superior homogeneous structure. Compatibility with ferrites and sealing glasses. Precision tolerances to .001". And the bonus of low tooling costs. In addition, designers found that Fotoceram could be configured to smaller and more complex shapes required for this application.

What can Fotoceram glass-ceramic do for you? Use your imagination. With Fotoceram material, we can photo-etch holes, slots or channels in any shape or configuration you



Actual size of the Fotoceram® slider shown above.

choose. Dimensions can be as small as .002", with tolerances as tight as .001". And you can pack up to 50,000 holes per square inch into sheets as thin as .010".

Fotoceram glass-ceramic is rigid, strong and dimensionally stable. It can easily handle heat to 750°C and stress to 3,000 psi. Electrical stability is excellent and moisture absorption is zero. And Fotoceram glass-ceramic is just one of three photo-etchable materials by Corning. The other two are Fotoform glass and Fotoform Opal glass-ceramic. Although all three are derived from the same photo-sensitive glass, each has its own distinct properties.

The uses for these materials are endless. They're being used for dot matrix printer wire guides, flat panel display cell sheets, fluidic devices, dielectric spacers and more. If you've got a possible application, we've got all the specs in our technical package "Materials for the Design Engineer." Just write. We're the Fotoform Products Group, part of the Materials Business, MS 123A, Corning Glass Works, Corning, New York 14830.

Fotoceram and Fotoform are registered trademarks of Corning Glass Works.

CORNING

**MODEL 535 DIGITAL COLOR
MONOSCOPE SIGNAL GENERATOR**

WORLD'S FIRST

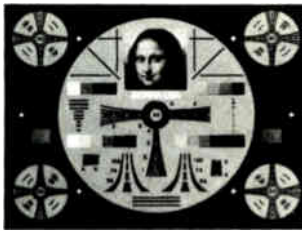

- o Simple, perfect measurement signal.
- o Mona Lisa face eliminates the need for the conventional flying spot, and eliminates erroneous color and permits unchanging correct evaluation. This picture does not contain the noise generated by the camera and flying spot.
- o Y, I, and Q channel characteristics can be measured at once (Model 535N)
- o Color resolution can be measured by wedge-shape color signal.
- o Built-in I, Q system broadcasting standards encoder (Model 535N)
- o Perfect broadcasting standards encoder at other color systems is also available.
- o Since the signals are generated electronically, there is no deflection distortion and instability such as that of the conventional camera.
- o DRC (Digital Rise time Controller) system generates pictures of the same quality as the camera. (Applicable to circle, 300 circle, vertical resolution, letters)
- o One source generation system assures accurate horizontal resolution.
- o APC system with constant picture size generates a perfect measurement signal.
- o Masterpiece that will remain unchanged in the future. This pattern can be selected with confidence.
- o Plug-in system is extremely easy to service.
- o The excellence of the conventional digital monoscope signal generator (MODEL 525 series)
- o Built-in sync signal generator.
- o Gen-lock and color lock possible when "L" is appended to the end of the model number.
- o Grating, flashing-dot and dot are also displayed
- o Overscan scale can be turned ON and OFF.
- o Mona Lisa face can be changed to the desired reflection. (Option 1)
- o The Letters "MONA LISA" can be changed to the desired letters. (Option 2)

**525 SERIES DIGITAL MONOSCOPE
SIGNAL GENERATOR**

Models 525A12 and 525C12 picture

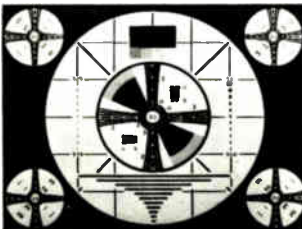

Model 525A11 Picture (Models 525A11H, and 525C11H picture is the same, except for the resolution.)

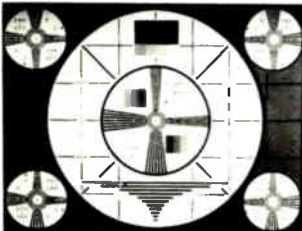

- o Since the signal is generated electronically, there is no deflection distortion or instability such as that of the conventional monoscope camera.
- o DRC (Digital Rise time Control) system generates the same picture quality as a camera.
- o One-source generation system assure accurate horizontal resolution.
- o APC system in the same, constant picture size generates a perfect measurement signal.
- o Masterpiece that will not change in the future. You can select this pattern with confidence.
- o Simple maintenance plug-in unit system.
- o Same Picture as a conventional monoscope up to letters, DRC system picture. (Applicable to Models A12, C12)
- o Checkered contrast pattern which is in good reputation.
- o Built-in sync signal generator.
- o Grating and overscan scale can be turned ON and OFF.

New products

sense logic thresholds, programmable delay for logic sensing, drive-level verification, and fast solid-state drive and sense switching.

But it is all under software control, and to make this aspect of testing less costly, GenRad has designed in what it calls Automatic Test Generation software. The package not only includes IC library elements but also compensates for component interconnect wiring to save program preparation and debugging time. Software generation begins with a circuit description of the board to be tested; the ATG software system combines its library data with the description to create what GenRad claims will be a fully documented IC-by-IC test program. Impossible or inappropriate tests, which would otherwise have de-

manded debugging, are eliminated automatically by the ATG software package.

GenRad claims a 70% to 80% reduction in program preparation time compared to manual writing of test programs.

Finally, to help keep the ATG system's library up to date, there is a learn mode for generating new library data. An operator simply specifies an IC's inputs, but notes that its output pins' expected states are unknown. The IC is tested, and the resulting output states are then stored in the library.

Average price of a 2270D system will be between \$100,000 and \$120,000. Delivery will take about 16 weeks.

GenRad Inc., 300 Baker Ave., Concord, Mass. 01742. Phone (617) 369-4400 [410]

**5-MHz computer with disk
drives works on S-100 bus**

In purchasing a computer system, small businesses usually have two options: trying to upgrade a low-cost but limited personal computer or investing in a relatively expensive business computer with perhaps too

much capability. That middle ground is where Artec Electronics Inc. is aiming its Centurion line of computers.

The Centurion is designed to meet the needs of countless small compa-

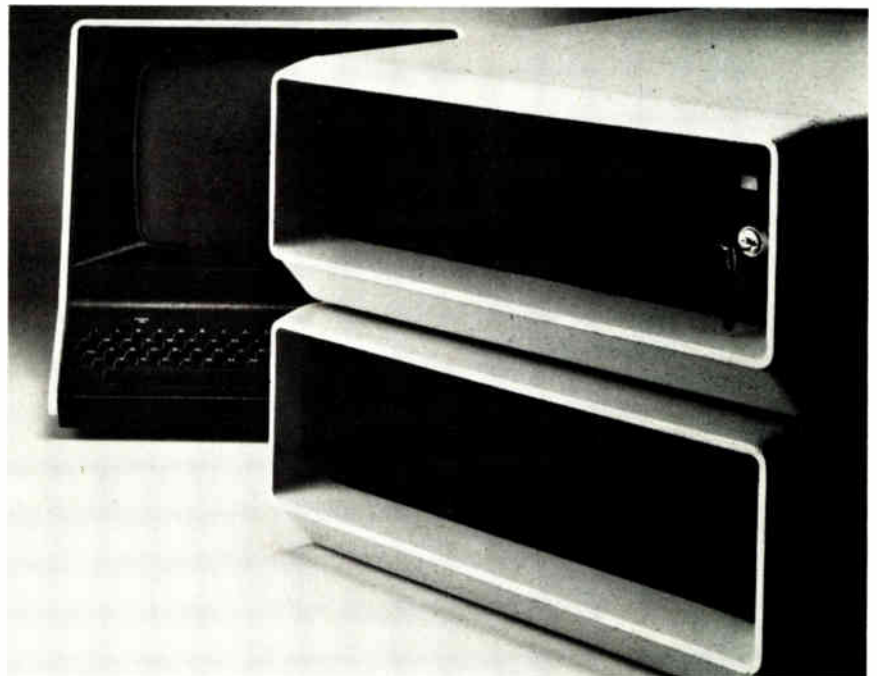

NTIA NTI America, Inc.
TAPT BUILDING SUITE 202
1580 NORTH VINE STREET LOS ANGELES CALIFORNIA 90028
PHONE 213-482-8045 TELEEX 230874230

NTI NIPPON TELEVISION INDUSTRY CO.
26-2-302 Nishigotanda 1 Chome Shinagawa Ku Tokyo 141 JAPAN
PHONE (03) 494-0121 TELEEX 246-8276 NTV J

Make your readouts outstanding with the latest Itron innovations.

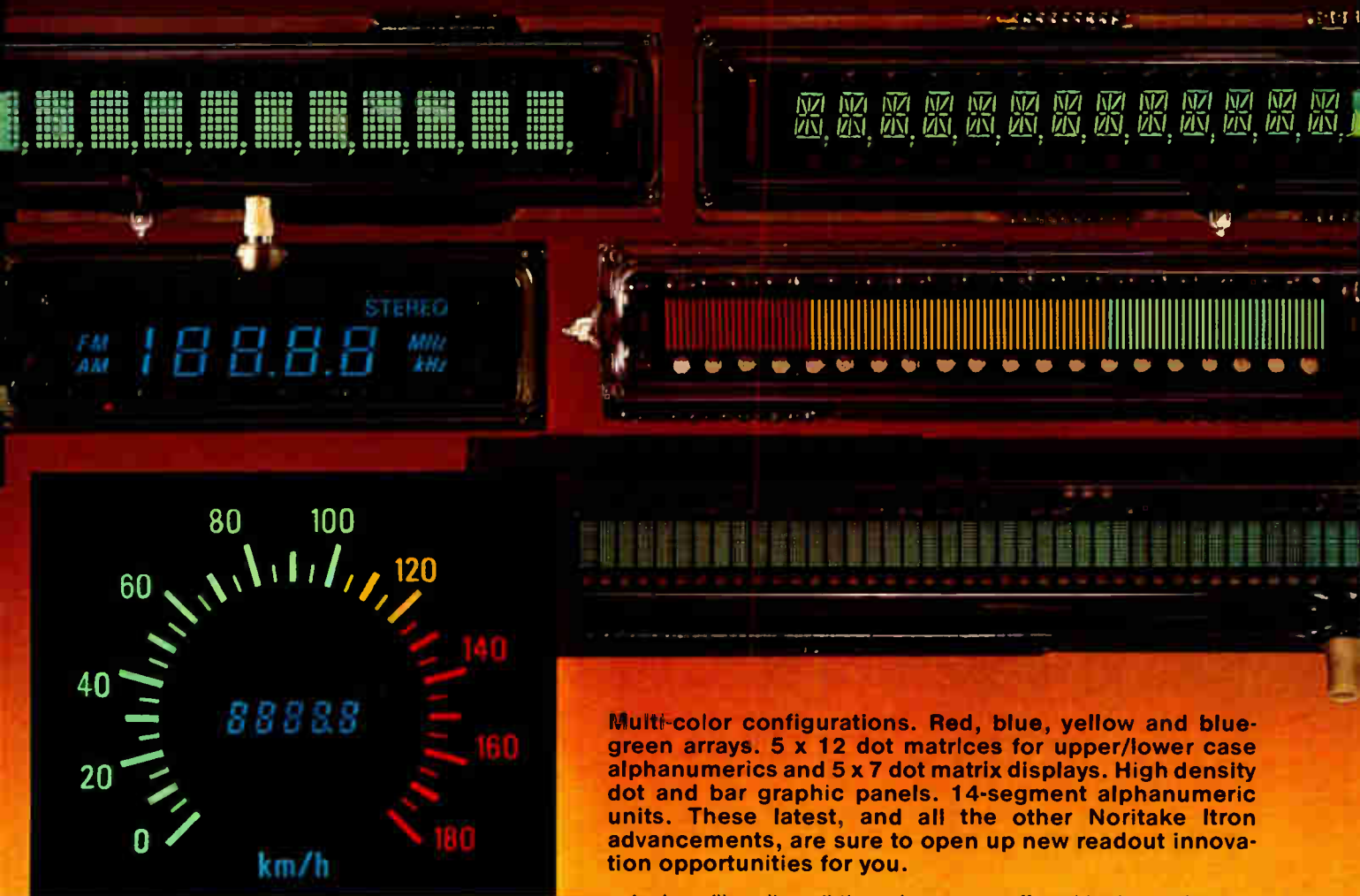

Multi-color configurations. Red, blue, yellow and blue-green arrays. 5 x 12 dot matrices for upper/lower case alphanumeric and 5 x 7 dot matrix displays. High density dot and bar graphic panels. 14-segment alphanumeric units. These latest, and all the other Noritake Itron advancements, are sure to open up new readout innovation opportunities for you.

And you'll realize all the advantages offered by Itron Fluorescent units over ordinary digital displays. Their cost-effective pricing and simple, fast installation will save you time and trouble, as well as a great deal of money. Interfacing with peripheral circuits is easy too; further reducing costs. They operate at low voltage and consume little power. Their bright fluorescent output and flat-glass packages make for easy readability, at a distance and at wide viewing angles, even under high ambient light conditions.

What's more, Itron displays have a proven long-life track record for reliable performance under stringent conditions. And we can quickly and economically fabricate custom configurations. Since there's much more you should know to make an optimum display selection, contact us for all the particulars.

itron[®]

**FLUORESCENT
DISPLAYS**

Patented and manufactured by
ISE ELECTRONICS CORP.

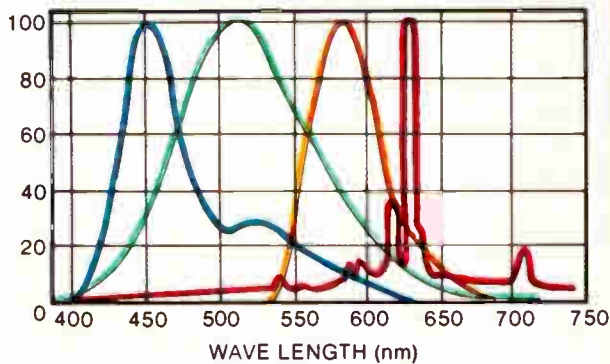

INTERNATIONAL REPRESENTATIVES

WEST GERMANY: Neumuller GmbH, Eschenstr 2, 8021, Taufkirchen, Munich Phone: 089/6118-245 Telex: 522106

FRANCE: Europavia, France, 5 Avenue Leon Harmel 92167 Antony Cedex Phone: 666-21-10 Telex: 42204381

UNITED KINGDOM: ITT Meridian, West Road, Harlow, Essex CM20 2BP Phone: 0279-35351 Telex: 817202

SWEDEN: AB Nordqvist & Berg, Box 9145 S-10272, Stockholm Phone: 08-690400 Telex: 10407

HONG KONG: Phone: 5-232420 TAIPEI: Phone: 351-0293

NORITAKE ELECTRONICS, INC.

L.A. OFFICE: 22410 Hawthorne Boulevard, Torrance, CA 90505, (213) 373-6704, Telex: 67-4910
N.Y. OFFICE: 41 Madison Avenue, New York, NY 10010, (212) 481-3440, Telex: 12-5469

NORITAKE COMPANY, LIMITED

JAPAN: 1 - 1 Noritake Shinmachi, Nishiku, Nagoya-Shi, (052) 561-7111, Telex: J59738
EUROPE: Burotel Belgium SA, Rue de la Presse 3-5, 1000 Bruxelles, (02) 217-83-60, Telex: 4626962

Circle 192 for Sales Contact

Circle 199 for Literature Only

New products

nies or manufacturers who require fairly powerful computing systems for business or process-control operations at a reasonable cost, according to president Robert L. Jones. Moreover, it comes in three basic models—variations depend on the size and number of disk drives and the inclusion of a Hazeltine 1500 cathode-ray-tube terminal.

The top-of-the-line, \$10,825 Centurion has the Hazeltine CRT terminal, a separate enclosure for two 8-in. double-density, dual-sided disk drives, and another enclosure for the central processing unit and buffer memory. Each rack-mountable enclosure has its own power supply. The middle-range system comes without a CRT terminal, but puts the central processing unit, memory, and the 8-in. disk drives into a single 10-in.-high enclosure. The third family member also comes in one enclosure, but has room only for two 5.25-in. disks. The CRT terminal is an option for these last two.

Responsible for the power of the Centurion is Artec's recently developed single-board computer based on a 5-MHz Intel 8085A-2 microprocessor. Also on board is an Advanced Micro Devices 9511 arithmetic processing unit chip for fast number crunching. With this chip, the CPU

board can perform additions and multiplications four times faster than other microcomputers. For example, an addition can be done in 175 μ s, and a floating-point multiplication in 168 μ s. This computing power helps to save software cost and time.

The board also has three Intel 2708 1-kilobyte, erasable programmable read-only memories, used to store programs, files, or other data, as well as 1 kilobyte of scratchpad random-access memory. Included are two switch-selectable input/output ports to cover any baud rate from 75 to 9,600 for use with either a keyboard or an RS-232-C terminal, vectored interrupts, and a variable clock frequency to slow the system down to 2 MHz, letting it work with slower memory. The whole computer family will operate on a S-100 bus.

The Centurion CPU board is complemented by two 32-kilobyte cards containing Texas Instruments' 4044 (a 250-ns, 4-kilobyte static RAM), a disk controller card, a 16-kilobyte 2708-type E-PROM card addressable in four 4-kilobyte groups, and a parallel I/O card.

Artec Electronics Inc., 605 Old County Rd., San Carlos, Calif., 94070. Phone (415) 592-2740 [408]

Single-board development tool for 3870 sells for \$499

In a move aimed at broadening the customer base for its MK3870 family of single-chip microcomputers, Mostek Corp. will be showing a new low-cost, single-board development tool called the Eval-70 at this year's Wescon show.

With a \$499 sticker price, the Eval-70 will be the economy model in Mostek's 3870 development system line, equipped with everything needed for full in-circuit emulation of 3870 family devices. Designed as an introductory, or low-end, microcomputer evaluation and prototyping tool, the Eval-70 is aimed at potential customers whose low-volume

applications do not require a mask read-only-memory version of the 3870 or who cannot afford a full-blown floppy-disk-based development system like Mostek's Aid-80F, the company says.

Included on the 8.5-by-12-in. board are a keypad and seven-segment address and data display, as well as a DDT-70 operating system with a debugging monitor contained in 2 kilobytes of ROM. Programs can be entered directly from the keyboard and debugged in random-access memory before being loaded into programmable ROMs for final circuit checkout. A PROM program-

Call your Amphenol® Connector Distributor

ARIZONA
Cetec Moltronics
Phoenix
(602) 272-7951
Wyle Distribution Group
Phoenix
(602) 249-2232

CALIFORNIA
Bell Industries
Sunnyvale
(408) 734-8570
Kierulff Electronics
Los Angeles
(213) 725-0325
San Diego
(714) 278-2112

Wyle Distribution Group
Santa Clara
(408) 727-2500
Wyle Distribution Group
El Segundo
(213) 322-8100
San Diego
(714) 565-9171
Cetec Moltronics
San Diego
(714) 278-5020

South Gate
(213) 773-6521
Sterling Electronics
Santa Clara
(408) 985-7411

COLORADO
Newark Electronics
Denver
(303) 757-3351
Wyle Distribution Group
Commerce City
(303) 287-9611

CONNECTICUT
Connector Co.
New Haven
(203) 624-0127
Wilshire Electronics
Hamden
(203) 281-1166

FLORIDA
Arrow Electronics
Palm Bay
(305) 725-1480

Kierulff Electronics
St. Petersburg
(813) 576-1966
Schweber Electronics
Hollywood
(305) 927-0511

GEORGIA
Arrow Electronics
Doraville
(404) 455-4054

ILLINOIS
Bell Industries
Chicago
(312) 982-9210
Klaus Radio, Inc.
Peoria
(309) 691-4840
Newark Electronics
Chicago
(312) 638-4411
Ohm Electronics, Inc.
Palatine
(312) 359-5500
Schweber Electronics
Elk Grove
(312) 593-2740

INDIANA
Genesis Electronics
South Bend
(219) 287-2911
Graham Electronics
Indianapolis
(317) 634-8202

KANSAS
Wichita Aircraft
Wichita
(316) 838-1421

MARYLAND
Arrow Electronics
Baltimore
(301) 247-5200
Cramer Electronics
Gaithersburg
(301) 948-0110
Pioneer Electronics
Gaithersburg
(301) 948-0710

MASSACHUSETTS
Cramer Electronics
Newton
(617) 969-7700
Industrial Components Corp.
North Wilbraham
(413) 596-3854
Kierulff Electronics
Billerica
(617) 935-5134
Schweber Electronics
Bedford
(617) 890-8484
Wilshire Electronics
Burlington
(617) 272-8200

MICHIGAN
RS Electronics
Livonia
(313) 525-1155
Wedemeyer Electronic Co.
Ann Arbor
(313) 665-8611

MINNESOTA
Arrow Electronics
Edina
(612) 830-1800
Newark Electronics
Minneapolis
(612) 331-6350

MISSOURI
Olive Electronics, Inc.
St. Louis
(314) 426-4500
Walters Radio Supply
Kansas City
(816) 531-7015

NEW JERSEY
Radio Electric Service Co.
Pennsauken
(215) 925-6900
Schweber Electronics
Fairfield
(201) 227-7880
Wilshire Electronics
Clifton
(201) 340-1900

NEW YORK
Arrow Electronics
Farmingdale
(516) 694-6800
Genesee Radio Parts Co.
Buffalo
(716) 873-9661

Harvey Electronics
Binghamton
(607) 748-8211
Progress Electronics
Plainview
(516) 433-1700
Schweber Electronics
Westbury
(516) 334-7474
Simcona Electronics
Rochester
(716) 328-3230
Summit Distributors
Buffalo
(716) 884-3450

NORTH CAROLINA
Cramer Electronics
Winston-Salem
(919) 725-8711

OHIO
Pioneer Electronics
Cleveland
(216) 587-3600
Dayton
(513) 236-9900
Schuster Electric Co.
Cincinnati
(513) 984-1600
Schweber Electronics
Beachwood
(216) 464-2970

OKLAHOMA
Electro Enterprises
Oklahoma City
(405) 478-1752

PENNSYLVANIA
Almo Electronics
Philadelphia
(215) 698-4000
CAM/RPC Indus. Electron
Pittsburgh
(412) 782-3770
Pytronic Industries
Montgomeryville
(215) 643-2850

TENNESSEE
Electra Distributing Co.
Nashville
(615) 329-3971

TEXAS
Allied Electronics
Ft. Worth
(817) 336-5401
Hamilton/Avnet
Dallas
(214) 661-8661
Sterling Electronics
Dallas
(214) 357-9131
Houston
(713) 627-9800
Texas Instrument Supply Co.
Dallas
(214) 238-6821

UTAH
Diplomat/Alta
Salt Lake City
(801) 486-4134
Standard Supply Co.
Salt Lake City
(801) 486-3371

WASHINGTON
Bell Industries
Bellevue
(206) 747-1515
Wyle Distribution Group
Seattle
(206) 453-8300

WISCONSIN
Electronic Expeditors
Milwaukee
(414) 228-8100

CANADA:
Distributors in major cities

Stays dry. Saves big.



Amphenol® 44 Series connector.
It costs only a little to withstand a lot.
Like water, oil, ozone, fuel...

There's no entry for liquids in this environmentally sealed, low-cost connector. What's more, the unique one-piece insulator is molded of an extremely durable resilient material. It resists harmful liquids (including lubricants, fuels, and salt spray), while it withstands ozone, abrasion and shock.

So the 44 Series is just what you need for rough-and-tumble jobs—truck or marine disconnects, auto system connectors, RV interconnects.

Even a fumblefingers can't mismatch a 44 Series connector. It's simply push to mate, pull to unmate.

Our crimp Poke-Home® contacts are supported by a complete line of semi-automatic crimping and contact insertion equipment providing for low installation cost.

Inexpensive hand crimp and contact insertion/removal tools enable easy field servicing thus keeping maintenance costs minimal. These are added values beyond the low cost of the 44 Series connectors.

Your choice of 1 through 6 contact arrangements. Panel mounting, too.

For complete information, technical data, dimensions and prices, contact your nearest Amphenol North America sales office or distributor.



Typical 44 Series connector, actual size.



AMPHENOL NORTH AMERICA

A Division of Bunker Ramo Corporation

Circle 201 on reader service card

Amphenol North America Division Headquarters: Oak Brook, Illinois 60521

Sales Offices: Atlanta (404) 394-6298 • Boston (617) 475-7055 • Chicago (312) 986-2330 • Dallas (214) 235-8318 • Dayton (513) 294-0461
Denver (303) 752-4114 • Detroit (313) 722-1431 • Greensboro (919) 292-9273 • Houston (713) 444-4096 • Indianapolis (317) 842-3245
Kansas City (816) 737-3937 • Knoxville (615) 690-6765 • Los Angeles (213) 649-5015 • Minneapolis (612) 835-4595 • New York (516) 364-2270
Orlando (305) 647-5504 • Philadelphia (215) 653-8750 • Phoenix (602) 265-3227 • St. Louis (314) 569-2277 • San Diego (714) 272-5451
San Francisco (408) 732-8990 • Seattle (206) 455-2525 • Syracuse (315) 455-5786 • Washington, DC (703) 524-8700
Canada: Montreal (514) 482-5520 • Toronto (416) 291-4401 • Vancouver (604) 278-7636 • International: Oak Brook, Illinois TELEX 206-054

When you're searching
for component solutions...

Add
the touch of innovation
to your
product

(as Spectral
Dynamics did)

with
Centralab
MONOPANEL...

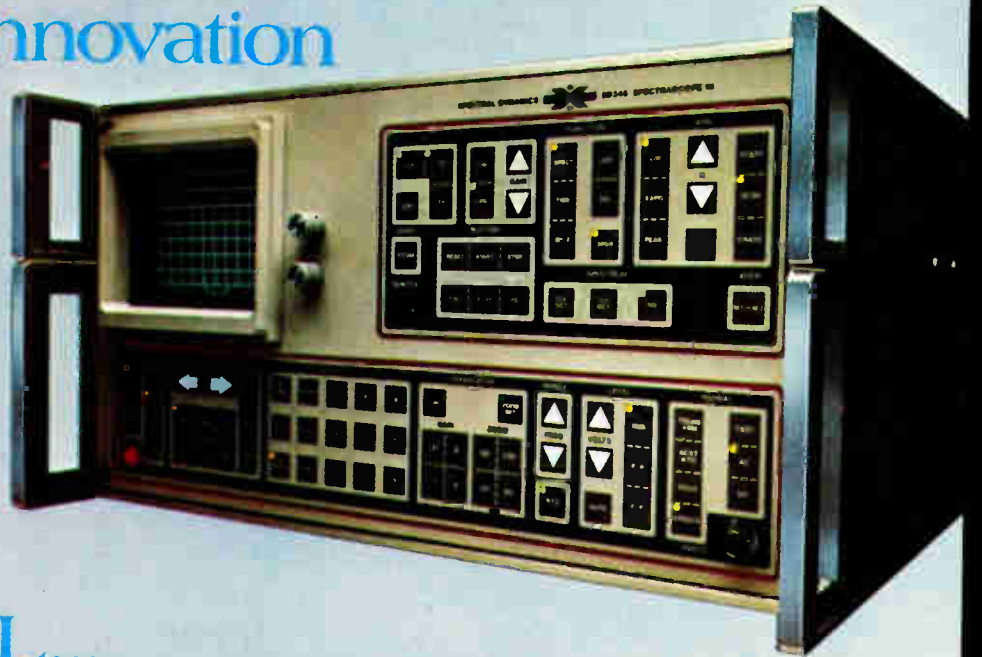

Spectral Dynamics (a Scientific-Atlanta subsidiary), a leader in spectrum analysis, selected Centralab's Monopanel touch switch system for their new SD345 FFT signal analyzer because they demanded:

- Ultra dependable life for millions of failure free switching cycles.
- Unlimited choice of graphics for maximum flexibility of functional panel design and esthetic appeal.
- High density, custom designed front panel complete with switches and graphics for simplified installation.

Monopanel gives them all of that and cost effectiveness too! We've done the same for scores of

other manufacturers. Monopanel is the proven touch switch in test and measurement instruments, medical apparatus, communications equipment, computers and a wide variety of industrial equipment. That's why more and more manufacturers are choosing Monopanel touch switches. They know that they can rely on Centralab's 50 years of experience in switch design, manufacture and application.

Your Centralab representative listed on the opposite page is your best source of design and application assistance. Ask him for a demonstration to see how you can add the touch of innovation to your product.

Products you need from people who care.



CENTRALAB

ELECTRONICS DIVISION
GLOBE-UNION INC.

5757 North Green Bay Avenue
Milwaukee, Wisconsin 53201

CERAMIC CAPACITORS • POTENTIOMETERS • SWITCHES • THICK FILM CIRCUITS

Circle 202 on reader service card

... call your Centralab
Sales Representative

ALABAMA
Huntsville
Cartwright & Bean, Inc.
(205) 533-3509

ARIZONA
Phoenix
Clemick-Neenan &
Assoc.
(602) 279-7649

CALIFORNIA
Palo Alto
Brooks Technical
Group
(415) 328-3232
Sherman Oaks
Clemick-Neenan &
Assoc.
(213) 990-3150
Tustin
Clemick-Neenan &
Assoc.
(714) 547-0966

COLORADO
Denver
Electro-Rep. Inc.
(303) 744-2821

CONNECTICUT
Meridian
Centralab
(203) 235-0770

FLORIDA
Ft. Lauderdale
Cartwright & Bean, Inc.
(305) 735-4900
Orlando
Cartwright & Bean, Inc.
(305) 422-4531

GEORGIA
Atlanta
Cartwright & Bean, Inc.
(404) 255-5262

HAWAII
Honolulu
Oougherty Enterprises
(808) 847-4144

ILLINOIS
Oes Plaines
Centralab
(312) 827-4487

INDIANA
Indianapolis
Les M. DeVoe Co.
(317) 842-3245

IOWA
Cedar Rapids
Jerry Vrbik Co.
(319) 366-8733

KANSAS
Shawnee Mission
Lowell-Kangas &
Assoc.
(913) 631-3515

LOUISIANA
Metairie
Cartwright & Bean, Inc.
(504) 835-6220

MARYLAND
Columbia
Bresson Assoc. Inc.
(215) 664-6460

MASSACHUSETTS
Needham
Centralab
(617) 444-4781

MICHIGAN
Lathrup Village
Centralab
(313) 559-9095
St. Joseph
Centralab
(616) 983-0233

MINNESOTA
Minneapolis
Centralab
(612) 831-5212

MISSISSIPPI
Jackson
Cartwright & Bean, Inc.
(601) 981-1368

MISSOURI
St. Louis
Lowell-Kangas
(314) 821-4050

NEW JERSEY
Paramus
Centralab
(201) 262-6716

NEW YORK
Albany
Reagan/Compar Albany
(518) 489-7408
Endwell
Reagan/Compar Albany
(607) 723-8743
Fairport
Reagan/Compar Albany
(716) 271-2230
New Hartford
Reagan/Compar Albany
(315) 732-3775

NORTH CAROLINA
Charlotte
Cartwright & Bean, Inc.
(704) 377-5673
Raleigh
Cartwright & Bean, Inc.
(919) 781-6560

OHIO
Cleveland
Centralab
(216) 526-1205
Columbus
Centralab
(614) 888-2150

OREGON
Portland
Centralab
(503) 620-1611

PENNSYLVANIA
Narberth
Bresson Assoc. Inc.
(215) 664-6460

TENNESSEE
Knoxville
Cartwright & Bean, Inc.
(615) 693-7450
Memphis
Cartwright & Bean, Inc.
(901) 276-4442

TEXAS
Austin
Centralab
(512) 454-9529

El Paso
Centralab
(915) 779-3961
Farmers Branch
Centralab
(214) 243-8791

VIRGINIA
Lynchburg
Bresson Assoc. Inc.
(215) 664-6460

WASHINGTON
Bellevue
Centralab
(206) 454-7754

WISCONSIN
Milwaukee
Centralab
(414) 228-2122

PUERTO RICO
Hato-Rey
M. Anderson Co., Inc.
(809) 751-2026

CANADA
BRITISH COLUMBIA
North Vancouver
Arwin Tech Sales Ltd.
(604) 980-4346

ONTARIO
Ajax
McHugh Electronics
(416) 683-1540

QUEBEC
Ste. Oorothee Laval
Harnett Enterprises
(514) 689-4184

New products

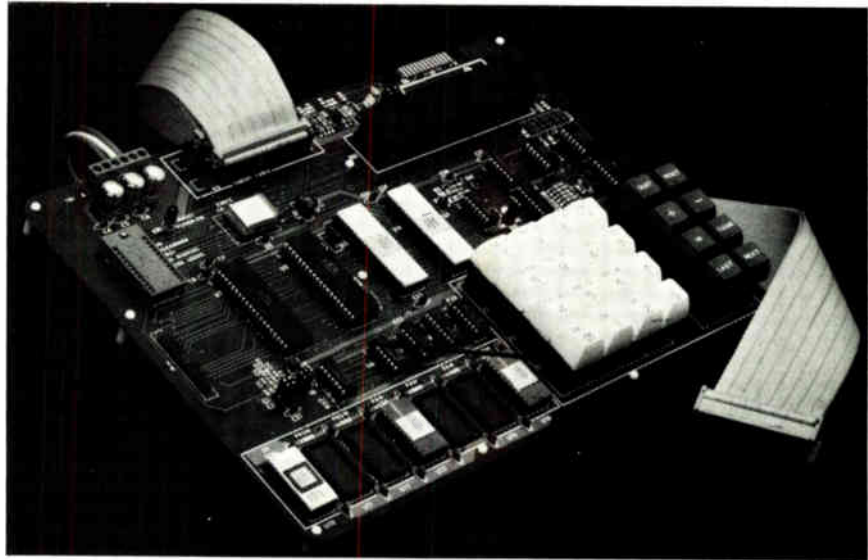

ming socket is also included on the board.

The standard board comes with 2 kilobytes of MK4118 static RAM, but 4 kilobytes is optional for users wishing to emulate Mostek's 3872 single-chip device with its 4 kilobytes of RAM. In addition to a PROM programming socket, the Eval-70 also contains sockets for plugging in up to 4 kilobytes of 2716-type PROM, enabling field testing of programs in PROM not generated on the Eval-70. Programs in PROM may be loaded into RAM for easier debugging.

The Eval-70 will come complete with a cable that plugs into a 40-pin 3870 family system socket for real-time emulation. Two power supplies—+5 v and +12 v—are required for normal operation, though a 25-v supply is needed for PROM programming, notes Mike Miller, the Mostek senior design engineer who developed the unit and

its associated software.

As an added feature, the Eval-70 is designed with a hardware connector that will allow programs to be loaded into the unit's RAM from current-loop interface devices like a teletypewriter or from machines that use a standard RS-232 serial interface. An extension of the DDT-70 operating system is required to use the Eval-70 in this mode, which the user can key into RAM and then transfer to reuseable PROM by following instructions in the operating manual. This feature will allow the Eval-70 to be used as a low-cost debugging station for programs generated on other machines such as the Aid-80F, Miller explains.

The Eval-70 is scheduled to be available from Mostek during the month of October.

Mostek Corp., 1215 West Crosby Rd., Mail Station 535, Carrollton, Texas, 75006. Phone (214) 242-0444 [407]

RCA adds prototyping system for single-board computers

With its family of Microboard single-board computers well launched at this year's Electro show, RCA Corp.'s Solid State division will use Wescon to show off the prototyping system for the CDP18S600 series.

Also bowing in the RCA complementary MOS family are two more random-access-memory boards and a combined memory and input/output expansion board.

"The CDP18S691 prototyping system is one step down from a

ON THE MOVE...



The Suffolk Incentive

- Confidential assistance in site selection, labor analysis and transportation studies.
- Special County and local tax benefits to qualified industries.
- Additional state tax deductions for creating new jobs.
- A skilled and non-skilled work force.
- Organizations, such as IDA, JDA, SBA, and others cooperating with local Banking establishments to meet your financing requirements.
- A County government dedicated to serving the needs of its business and residential community.
- Superior housing, educational and medical facilities.
- An ideal location to carry out your business of everyday living.

Suffolk County—Not Just Another Pretty Place!



For Information write:
SUFFOLK COUNTY DEPARTMENT OF ECONOMIC DEVELOPMENT
William J. Sheridan, Commissioner
Veterans Memorial Highway • Hauppauge, New York 11787
(516) 979-2929
John V.N. Klein, County Executive

New products

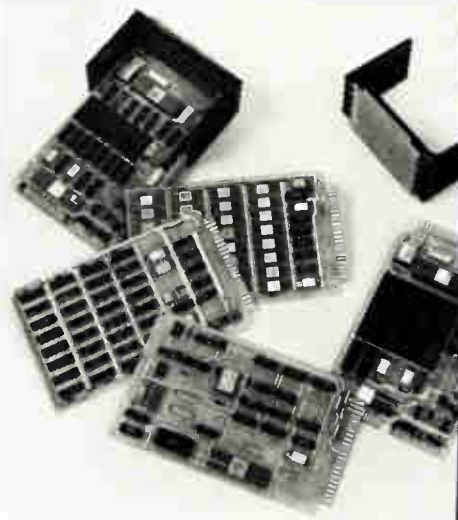

development system," says Michael Caterina, product marketing manager for micro-processor systems. "For \$990, it makes it possible to do assembly-level software development."

The 691 prototyping system uses the 601 Microboard computer [*Electronics*, April 12, p. 179] and the 640 control and display module. These boards occupy two slots in the family's five-card chassis that features a universal printed backplane allowing insertion of the cards in any order.

Also included are the 659 Microboard breadboard module and the 023 power converter. The control card comes with a six-digit hexadecimal display and has serial I/O ports to hook the prototyping system to any terminal; there are both RS-232-C and 20-mA current-loop connections on this card.

The system has eight MWS5114 RAMs, made in RCA's C-MOS-on-sapphire technology, for a total of 4 kilobytes of read/write memory. Four sockets provide the space for 4 or 8 kilobytes of read-only memory or erasable programmable ROM.

Contained in ROM is the system's UT60 utility program, which allows the program developer to insert, display, move, fill, and substitute memory values and to run his program.

After calling in the utility program, the user can choose full- or half-duplex operation, which will calculate the time constant to match

Your Guardian Angel invites you to

CHECK HER MEASUREMENTS

of these two "half-size" 13 amp relays.

These two small relays are about half the size of competitive relays that do the same job. The cost? About the same as those big competitive units. In many cases, a few cents less.

Choice of dual type (solder lug or 3/16" QC) or printed circuit termination. Choice of solder lug, printed circuit or screw mount sockets.

I380

4 Form C (4PDT)
contact arrangement.

I390

2 Form C (2PDT)
contact arrangement.



Get all the facts on both these "half-size" relays. Send today for special technical bulletins that are yours free for the asking.

GUARDIAN

GUARDIAN ELECTRIC MANUFACTURING COMPANY—1550 W. Carroll Avenue, Chicago, IL 60607—312/243-1100

See Us At
WESCON
Booths: 1521-25

Circle 205 on reader service card

Plenco and Prestolite ...good under the hood

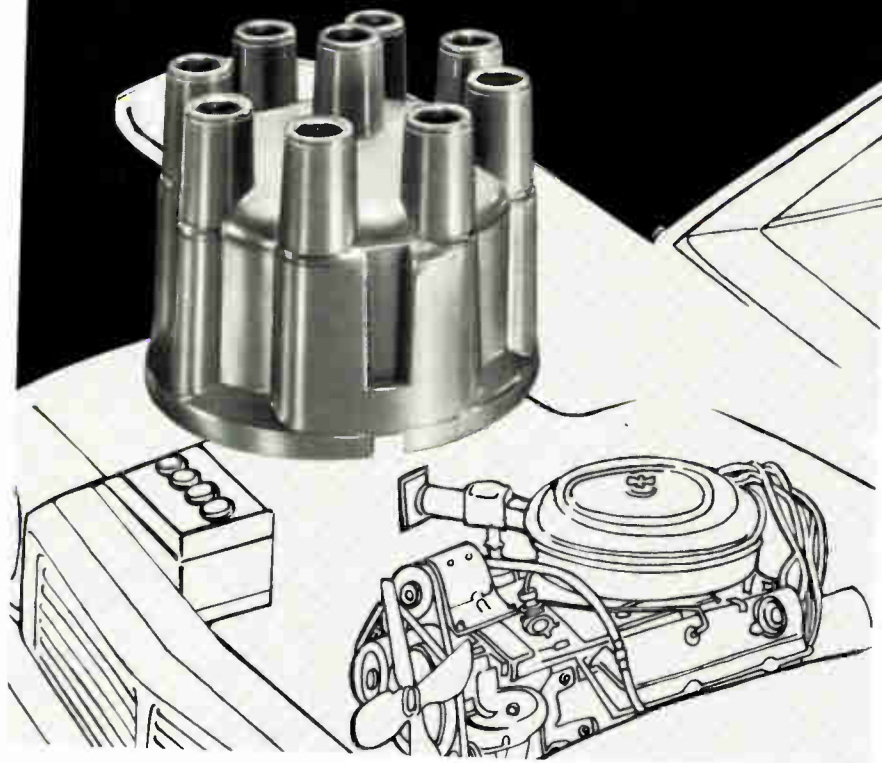

... distributor caps, molded of our 1510 alkyd.
To help things get going.

Caps like this are used in automotive ignition systems, an application requiring a high degree of arc and track resistance. Manufactured by the Prestolite Electrical Division of Eltra Corporation, Toledo, OH, the caps are molded of a thermosetting compound formulated with polyester resins: Plenco 1510 Electrical-Grade Alkyd Molding Compound.

Laboratory tests, according to Prestolite, showed this material to have an excellent combination of electrical properties, dimen-

sional stability, and resistance to water absorption.

Why not get going on your own molding needs? Give Plenco a call at (414) 458-2121, and more than likely our wide selections, experienced counsel and service can get you started right.

PLENCO
THERMOSET PLASTICS

PLASTICS ENGINEERING COMPANY
Sheboygan, WI 53081

Through Plenco research... a wide range of ready-made or custom-formulated phenolic, melamine-phenolic and alkyd thermoset molding compounds, and industrial resins.

206 Circle 206 on reader service card

New products

the baud rate of the data terminal. For limited debugging capability, some register contents can be saved and displayed.

Four control switches enable the operator to clear the system and hold it in the reset state, to initialize and start the program under development, to initialize and start the utility program, and to operate the system in either single-step or continuous mode.

The six-digit hexadecimal display uses four digits for current memory address and two for current data-bus content. For complete software and hardware debugging, the 691 may be combined with the \$1,995 Micro-monitor, Caterina says.

The RAM boards being introduced are the 623, a \$650 8-kilobyte board, and the 624, a \$515 4-kilobyte board with battery backup. Both are half-capacity versions of RAM boards introduced last spring and use the MWS5114 chip, which is 1,024 by 4 bits.

In addition to fitting into CDP18S600-based systems, all the RAM boards may serve as add-ons to the CDP18S005 Cosmac development system.

Caterina reports that users are substituting the battery-powered RAM boards for E-PROMs in systems under development. There are three advantages, he says: no erasing lag (speeding program changes), no special voltage requirements, and greater availability.

Also to be shown at Wescon is the 660 board, a combined memory and I/O expansion board that costs \$450. It holds 2 kilobytes of 5114 RAMs and has sockets for 2 kilobytes of ROM or E-PROM. It also has 40 programmable parallel I/O lines.

RCA Solid State Division, Route 202, Somerville, N. J. 08876. Phone Michael Caterina at (201) 685-6599 [409]

Power meters span 1 GHz

Among the several surprises that Rcal Dana has in store for Wescon

Electronics / August 30, 1979

Half-size **Amber** R Relays

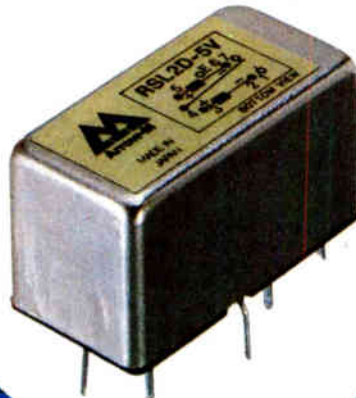

Thanks for the memory.

Latching function acts as a memory to protect the integrity of your program.

Half-size Amber R Relays latching types operate on alternate application of reversed polarity voltage. The stability of the memory is dependable at all times, retaining program integrity even during power failures.

- Power types will switch 1 Ampere 20 watts for over 1 million operations, and they will not weld even when carrying high inrush currents.
- The unique construction permits true Form C contacts in a reed type relay.
- High sensitivity: Minimum operating power. Latching type 40mW/Standard type 80mW
- Totally encapsulated for automatic wave soldering and cleaning.

More than 26 million R Relays in service around the world.



Relays for Advanced Technology



Member of Matsushita Group

**Contact Your
Aromat Representative
or Distributor Today.**

Aromat Corporation:
250 Sheffield Street
Mountainside, NJ 07092
(201) 232-4260

Mid-Western Office:
311 Lively Blvd.
Suite 1
Elk Grove Village, IL 60007
(312) 593-8535

Western Office:
10400 North Tantau Avenue
Cupertino, CA 95014
(408) 446-5000

To stay on top . . . be prepared!

ICE will help you put together a winning integrated circuit implementation program to get your product to market

IMPLEMENTATION SEMINARS

- Technology trends and applications
- What the microprocessor can and cannot do
- Cost and time for IC design cycles
- Forming winning development teams
- Economics of bringing processing in-house
- Contracting for design and manufacturing
- Successful and unsuccessful case histories.

\$475 (Domestic USA only)
Phoenix, Arizona October 17-18, 1979
Bordeaux, France November 28-30, 1979
(Sponsored by ADERA)
Washington, DC January 30-31, 1980
Phoenix, Arizona February 26-27, 1980

For further information
contact Integrated Circuit
Engineering Corporation
Seminar and Publication
Division, Department E
6710 E. Camelback Rd.
Scottsdale, AZ 85251
602-945-4564



Circle 208 on reader service card

College dollars need
time to grow.

Take stock in America.

With higher paying U.S. Savings Bonds.



New products

attendees this year is the 9100 series of absorption power meters, a new but natural adjunct to its line of other instruments. The three portable models and the bench-top unit that comprise the series all cover the wide range of 1 MHz to 1 GHz. Each provides an attenuated output that the company hopes users will plug into its existing frequency counters



digital voltmeters, or modulation meters.

The three portable units are "one third the size and about half the weight of existing portable power meters," according to Norbert Laengrich, international marketing manager for the Irvine, Calif., company. Designated the 9101, 2, and 3, the dual-range meters differ in their maximum power-measuring capability and price.



The 9101 has 1- and 3-w ranges and sells for \$349; the 9102 jumps a decade higher in each range and has a \$480 price tag. The 9103 has 30-

Norplex consistency is as certain as the sun and the tide.

Major fabricators and users of printed circuitry specify Norplex® laminates because of complete confidence in the uniform quality of our product.

Norplex is dedicated to quality. We adhere to self-imposed standards of excellence, from careful scrutiny of raw materials to final inspection before shipping. During processing, every lot is monitored, analyzed and documented by quality control personnel.

No other manufacturer of base materials can offer you the combination of Norplex services that includes research/engineering experience, technical resources and quality assurance.

This reservoir of talent, expertise and dedication is available to you through your Norplex Technical Service Representative, a qualified consultant closely supported by the full research and development facilities of both Norplex Division and the UOP Corporate Research Center.

At Norplex, our watchword is quality. We will never compromise.

Norplex Division, UOP Inc. U.S. Operations: LaCrosse, WI (World Headquarters); Black River Falls, WI; Franklin, IN; Postville, IA. European Headquarters: Wipperfürth, West Germany. Pacific Headquarters: Kowloon, Hong Kong.



Norplex laminates
by UOP

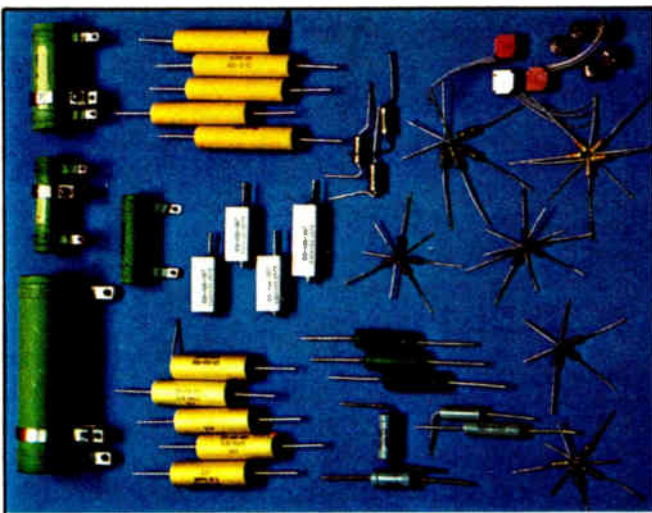

NEED RELIABLE CIRCUITRY? ELORG RESISTORS WILL DO THEIR BIT!

With their specifications that meet IEC standards for dimensions, ratings and tolerances.

Some 50 types of fixed, variable, wirewound and non-wire resistors include

- S2-33i miniature metal film resistors for 0.25W and 0.5W power dissipation ratings; maximum temperature coefficient $500 \times 10^{-6}/^{\circ}\text{C}$; packed in adhesive tape or placed on tape reels; color code markings;
- S1-4M carbon resistors for 0.25W power dissipation ratings, average temperature coefficient $800 \times 10^{-6}/^{\circ}\text{C}$; packed in adhesive tape or placed on tape reels; color code markings;
- precision non-wire fixed resistors S2-29 for 0.125, 0.25, 0.5, 1.0 and 2.0W power dissipation ratings, temperature coefficient $\pm 25 - \pm 300 \times 10^{-6}/^{\circ}\text{C}$; resistance tolerance ± 0.1 ; ± 0.25 , ± 0.5 and ± 1.0 percent;
- thermal resistors;
- photoresistors;
- varistors.

Sole exporter -



32/34 Smolenskaya-Sennaya
121200 Moscow
USSR
Telephone 251-39-46, Telex 7586

New products

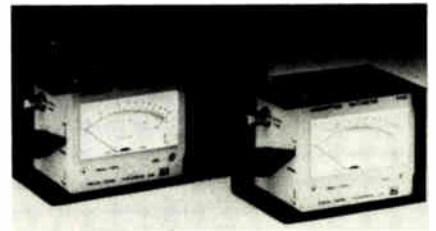

and 100-w ranges and costs \$699. Each of the meters has a 50- Ω input impedance and a total measurement uncertainty of $\pm 6\%$ of full scale at 30 MHz. The units can act as 50- Ω loads even at dc levels, and their voltage standing wave ratio is better than 1.2:1 up to 1 GHz.

For benchtop measurements, the true-root-mean-square model 9104 lets users choose any of seven ranges with full-scale markings of 300 mW to 300W. Power readings are calculated by a squaring circuit followed by an averaging amplifier, a scheme that not only allows users to measure the true rms power of modulated signals directly, but also permits the use of a linear scale, more convenient than a logarithmic one for making high-end readings.

Another convenience is the 9104's fast-responding detector, which enables a user to tune the system in real time. Still another is its overload protection, which consists of a pair of relay contacts. These are brought out to the front panel so that they can be used to shut down another instrument or the power source. Maximum permitted overload is 600 w for 1 min. in a 15-min. period.

The \$2,470 meter also comes with a dc output directly proportional to the measured true rms value, so it could be used as part of an automated test system. Overall measurement uncertainty, including mismatch errors, at load temperatures between 20° and 30°C has a base of $\pm 3\%$ regardless of frequency; frequencies from 1 to 500 MHz inject $\pm 7\%$ of the power reading into that base and those from 500 MHz to 1 GHz add $\pm 12\%$ of reading. All four power meters will be available from stock to 30 days.

Racal-Dana Instruments Inc., 18912 Von Karman Ave., Irvine, Calif. 92714. Phone (714) 833-1234 [415]

2¢ a byte!

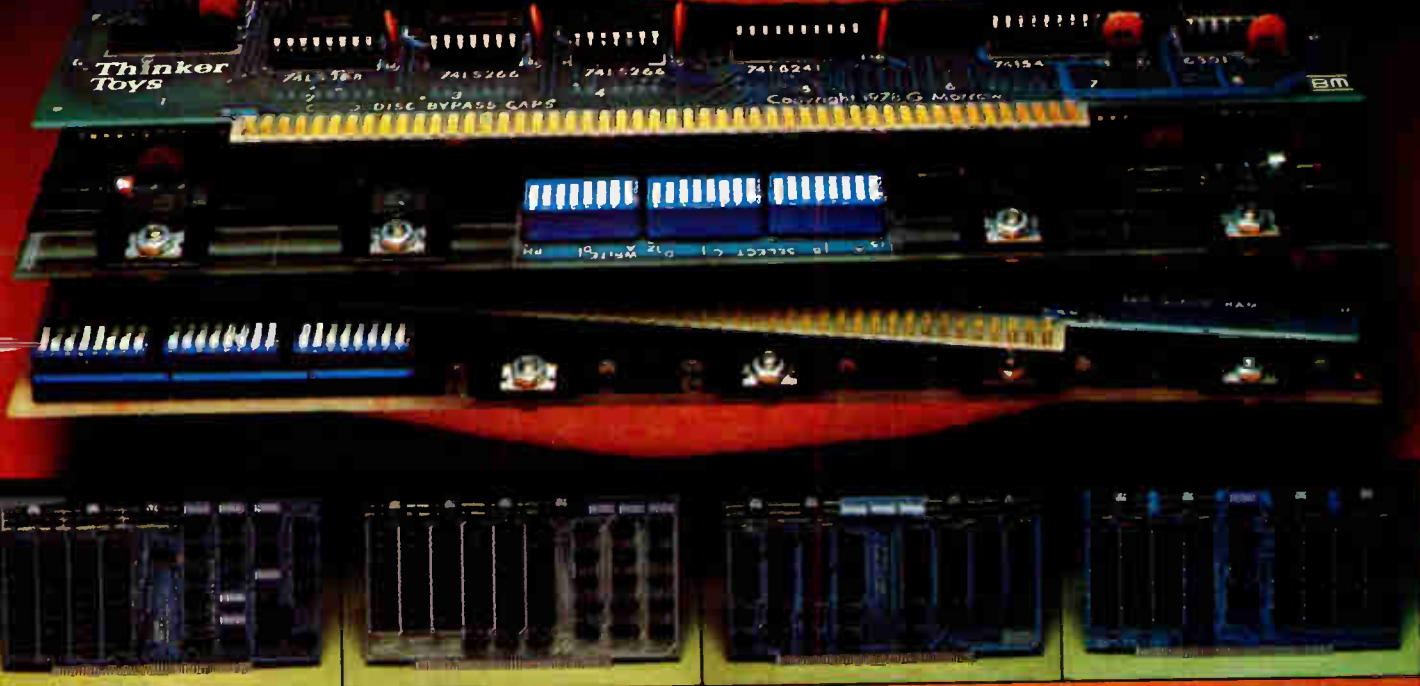

MM16K/\$349 = 2.1¢

MM24K/\$499 = 2¢

SR16K/\$299 = 1.8¢

SR32K/\$649 = 2¢

Now you can afford to sink your teeth into some big, feature-packed static memories. Because George Morrow's ultra-efficient designs have brought S-100 memory down to 2¢ a byte.

Introducing Morrow's new "MemoryMaster" Bank Select Logic memories, the top of the SuperRam™ line.

The SuperRam™ MemoryMaster 16K Static may be the most sophisticated S-100 memory at any price. The MM16K is switch-programmable to write-protect any of the four 4K blocks ... or to open invisible 1K "windows" to accommodate VDM's or disk controllers. An on-board I/O device and jumper block allow you to use the memory-extending Bank Select Logic features of your software.

Yet, the SuperRam™ MemoryMaster 16K kit is just 2.1¢ a byte at \$349. Assembled and tested, \$399.

The SuperRam™ MemoryMaster is also available in 24K configuration: 3 individually write-protectable 8K blocks with Bank Select Logic capability. MM24K Kit, \$499. Assembled and tested, \$549.

Or, get your memory at a rock-bottom 1.8¢ a byte with the SuperRam™ 16K Static. It gives you 4 individual 4K blocks ... plus the ability to switch-enable the Phantom Line for power-up sequencing. Kit, \$299. Assembled and tested, \$349.

But if you really need a big helping of memory, the SuperRam™ 32K Static serves up two individual 16K blocks for 2¢ a byte: \$649 in kit. Assembled and tested, \$699.

Whichever Morrow memory suits your taste, it will run perfectly in 2 MHz 8080, 4 MHz Z-80 or 5 MHz 8085 systems. And meets the Proposed IEEE S-100 Standard.

2¢ a byte! That's food for thought. And they're ready to take out at your local computer shop. Or if not, we deliver. Write Thinker Toys™, 5221 Central Ave., Richmond CA 94804. Or call 415-524-2101 (10-4 Pacific Time any weekday).



Morrow Designs

Thinker Toys™

Circle 211 on reader service card

Productivity. Hysol Epoxies mean more of it. And you can prove it.

You can prove, on your own existing equipment, that you can mold more units per shift than with competing products.

That's increased productivity *without* increased capital investment.

You won't be sacrificing quality or reliability.

You'll be adding to them—significantly. As you

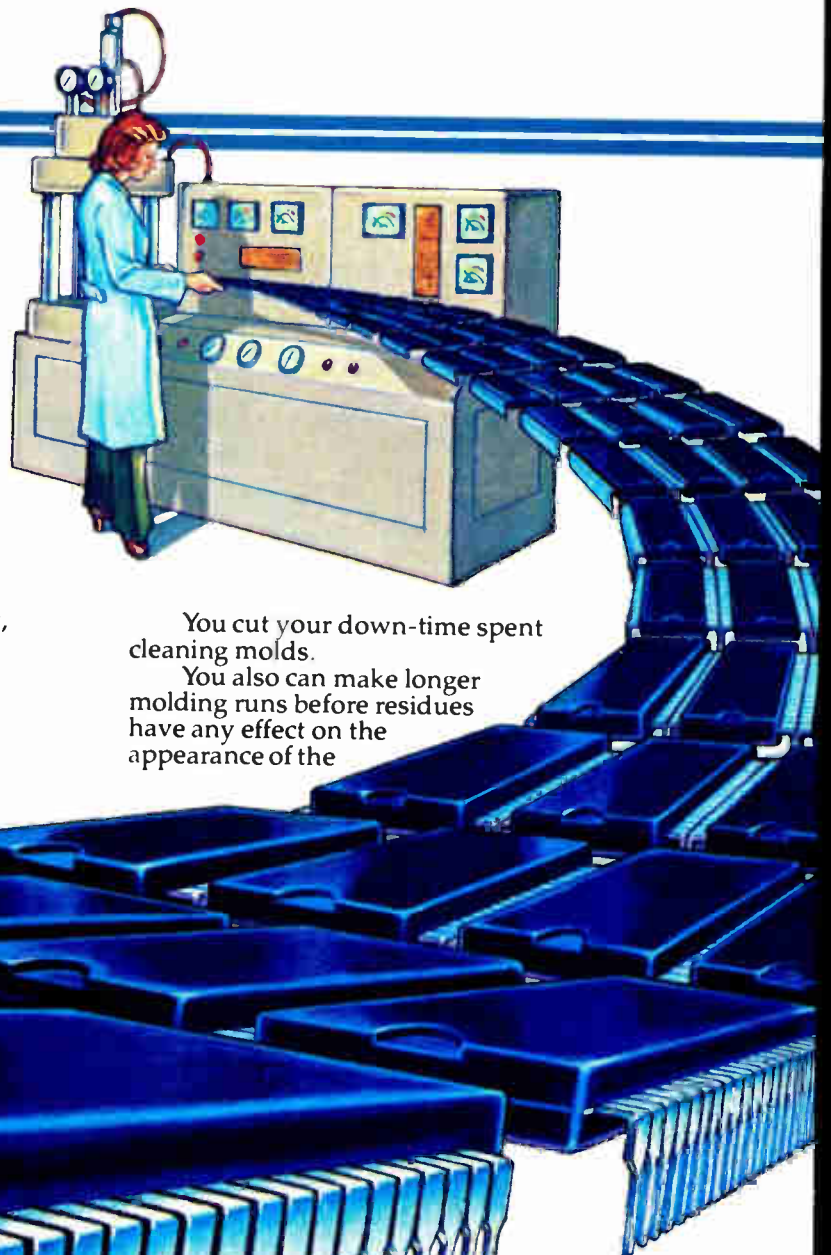

You cut your down-time spent cleaning molds.

You also can make longer molding runs before residues have any effect on the appearance of the

product.
(A lot of competitor's products require mold cleaning at least once

a shift.)

How much more production time per press can you get from Hysol?

Many Hysol users are comfortable cleaning every other shift. Or once every three shifts.

Some are molding for a solid week with no down-time for cleaning. That's productivity!

increase your productivity.

That's because

Hysol epoxy molding compounds bring you performance characteristics you just won't find in competitive brands.

Reduced cleaning frequency means more productivity.

Hysol epoxies leave molds cleaner than competitive products.

And Hysol leaves those molds cleaner much longer. More than twice as long!

Higher hot hardness means more productivity.

Hysol epoxies develop a higher hot hardness than competitive products.

And they develop it in less time.

The average close-to-close time for molding is about three minutes.

Hysol customers achieve a close-to-close time as low as two minutes.

Your molding press operators can make more 'shots' per shift.

And the more shots per shift, the better your productivity.

Far less flash means more productivity.

Hysol epoxies are *lowest* in flash by an enormous amount.

In fact, for some products, you don't need a de-flashing step at all.

With Hysol you either completely eliminate the cost of deflashing, or you reduce it significantly.

Short post-cure means more productivity.

The typical post-cure for semiconductor grade epoxies is specified as six hours.

Many Hysol users safely cut that time to two hours.

Post-cure time this short means faster throughput—more productivity—for you. Plus significant energy savings.

Other epoxies take a lot longer to cure. And no matter how long they take, they wind up with a lower

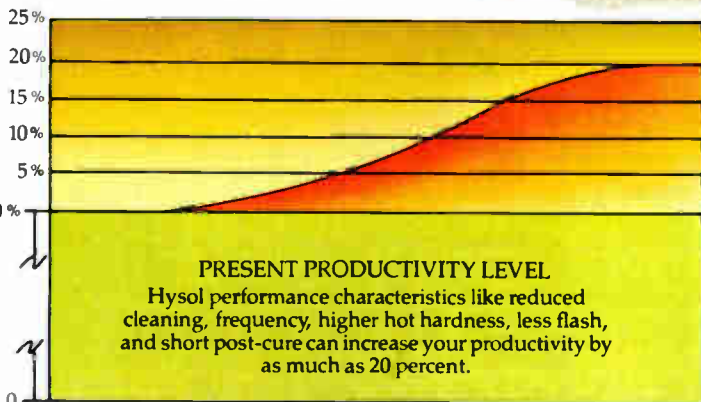

glass transition temperature (T_g).

Hysol's higher T_g means that their epoxy has a lower temperature coefficient of expansion over a wider temperature. This reduces thermal intermittents. And increases reliability.

To these three performance characteristics which contribute to productivity, add Hysol's better thermal stability and moisture resistance—which contribute to higher reliability.

Just more reasons why Hysol is the epoxy to be preferred in the semiconductor industry!

Prove it first-hand

Why not see how Hysol can mean more productivity on your own production floor, using your own mold, and press?

We'll arrange it for you. And we'll supply, at no cost to you, the epoxy and a qualified field sales engineer to assist in the trial and discuss potential productivity improvements in terms of your existing equipment and procedures.

You keep all the samples so your own engineering and R & QA people can evaluate them.

OR...

Send your own engineer to our testing lab and we'll run our samples side-by-side with yours—or any others you specify.

To get things rolling—either at your place or ours—just call Ron Benham, our Product Marketing Manager, Semiconductor Molding Compounds at (213) 968-6511.



THANKS!

I'm not quite ready (yet) for an in-plant demonstration of Hysol Productivity.

But I would like to see your new brochure on molding productivity, quality and reliability with Hysol.

NAME _____

TITLE _____

COMPANY _____

ADDRESS _____

CITY _____

STATE _____

ZIP _____

Mail to: Hysol Division, The Dexter Corporation, 15051 East Don Julian Road, Industry, California 91749.

HYSOL EPOXIES

THE DEXTER CORPORATION

Circle 213 on reader service card

NEC introduces The College Board.

Our educational TK-80A—the first complete 8080A based single board computer.

Here's the perfect system for all levels of computer education—from basic computing to advanced programming techniques.

It's a complete 8080A based computer on a single board. With a 25-key pad, 8-digit display, 1-8K byte EEPROM monitor, 1-4K byte RAM, and three 8-bit programmable I/O ports.

And it's fully expandable. Memory can be increased off-board to a total of 64K bytes. And a standard Kansas City interface lets you hook up a cassette for additional storage. If you need a terminal, a TTY or RS 232 interface can be easily attached.

What's more, 2 or 3 TK-80A boards can be connected for instruction in sophisticated programming techniques—such as distributed processing, parallel processing, and peripheral control.

And once students have mastered the TK-80A, they can easily apply what they've learned to process control, energy control systems, and environmental control and monitoring.

The TK-80A is not only supported by our thorough documentation, it's backed by our 90-day warranty on the entire board and one year warranty on the components.

And the price is only \$299.

At NEC Microcomputers, we've already built a reputation as one of the most reliable component suppliers in the industry. Now we're putting our reputation behind the first complete 8080A based computer on a board.

For more information on NEC's new college board, send in the coupon.

NEC
NEC Microcomputers, Inc.

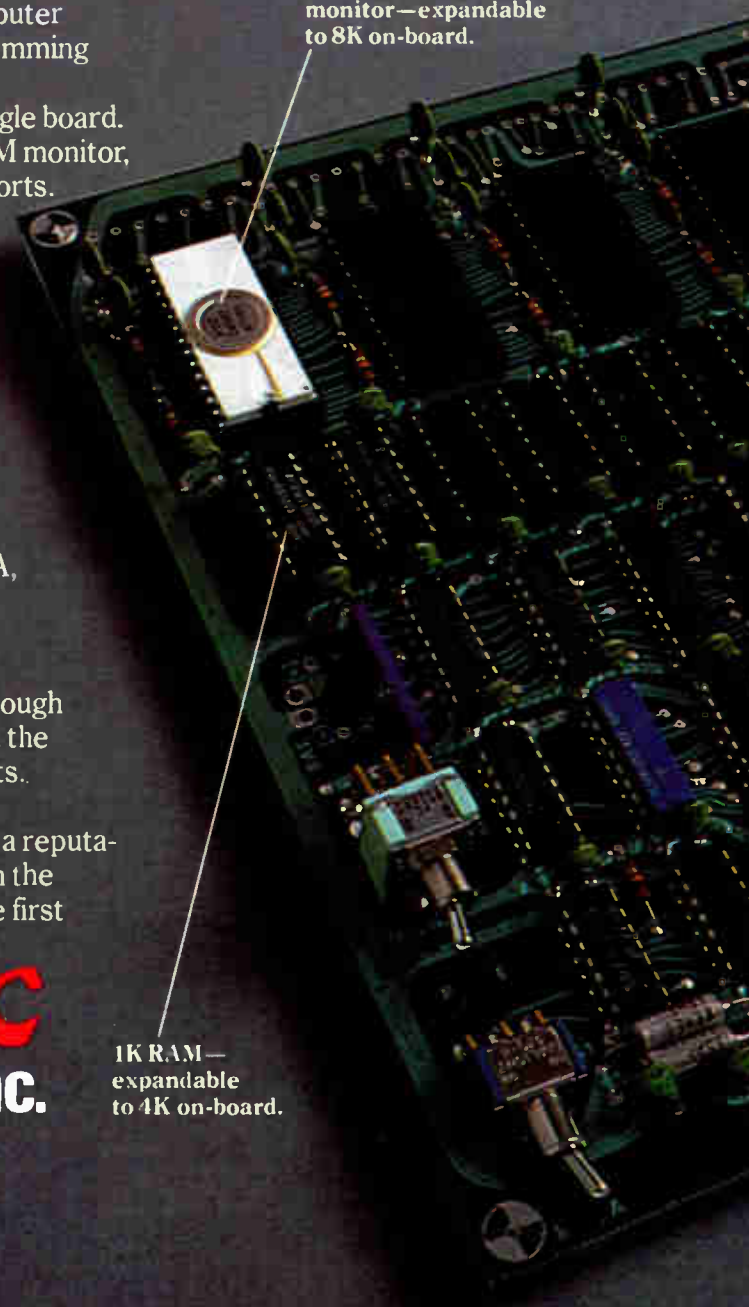

1K Electrically Erasable PROM monitor—expandable to 8K on-board.

1K RAM—expandable to 4K on-board.

WESTERN REGION OFFICE: Orange, CA at (714) 633-2980; EASTERN REGION OFFICE: Melville, NY at (516) 293-5660; MIDWESTERN REGION OFFICE: Des Plaines, IL at (312) 298-7081; SOUTHERN REGION OFFICE: Dallas, TX.

REPS: Action Unlimited, Arlington, TX; Spring, TX; Cerco, San Diego, CA; Contact Sales, Inc., Burlington, MA; D/Z Associates, Inc., Denver, CO; Electronics Innovators, Inc., Minneapolis, MN; Eltron, Phoenix, AZ; Kaytronics Limited, Ville St. Pierre, QUEBEC, Concord, ONTARIO, Surrey, BRITISH COLUMBIA; Santana Sales, Costa Mesa, CA; Trident Associates, Inc., Sunnyvale, CA; Tri-Tronix, Albuquerque, NM; Tri-Tronix, NW, Mercer Island, WA.

DISTRIBUTORS: Almo Electronics Corp., Philadelphia, PA; Baltimore, MD; Bell Industries, Bellevue, WA; Century Electronics, Albuquerque, NM; Wheatridge, CO; Salt Lake City, UT; Diplomat/Westland, Inc., Sunnyvale, CA; Diplomat/Southland, Inc., Clearwater, FL; Diplomat/Lakeland, Inc., Elk Grove Village, IL; Diplomat/IPC of Mass., Chicopee Falls, MA; Diplomat, Holliston, MA; Diplomat/Northland, Inc., Farmington, MI; Diplomat/Electro-Com Corp., Minneapolis, MN; Diplomat/St. Louis, Inc., St. Louis.

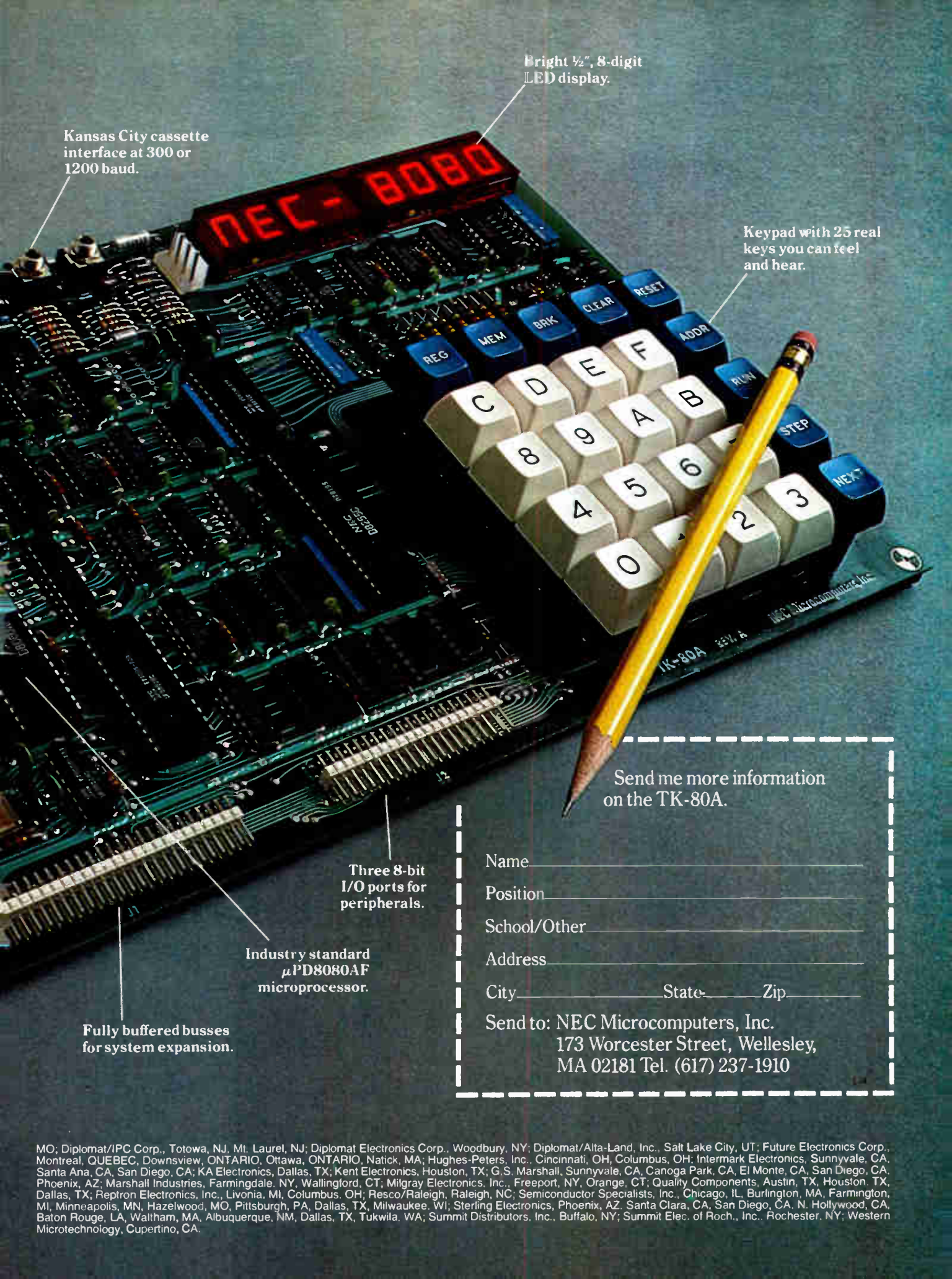

Kansas City cassette interface at 300 or 1200 baud.

Bright 1/2", 8-digit LED display.

Keypad with 25 real keys you can feel and hear.

Three 8-bit I/O ports for peripherals.

Industry standard μ PD8080AF microprocessor.

Fully buffered busses for system expansion.

Send me more information on the TK-80A.

Name _____

Position _____

School/Other _____

Address _____

City _____ State _____ Zip _____

Send to: NEC Microcomputers, Inc.
173 Worcester Street, Wellesley,
MA 02181 Tel. (617) 237-1910

MO: Diplomat/IPC Corp., Totowa, NJ. Mt. Laurel, NJ; Diplomat Electronics Corp., Woodbury, NY; Diplomat/Alta-Land, Inc., Salt Lake City, UT; Future Electronics Corp., Montreal, QUEBEC, Downsview, ONTARIO, Ottawa, ONTARIO, Natick, MA; Hughes-Peters, Inc., Cincinnati, OH, Columbus, OH; Intermark Electronics, Sunnyvale, CA, Santa Ana, CA, San Diego, CA; KA Electronics, Dallas, TX; Kent Electronics, Houston, TX; G.S. Marshall, Sunnyvale, CA, Canoga Park, CA, El Monte, CA, San Diego, CA, Phoenix, AZ; Marshall Industries, Farmingdale, NY, Wallingford, CT; Milgray Electronics, Inc., Freeport, NY, Orange, CT; Quality Components, Austin, TX, Houston, TX, Dallas, TX; Reptron Electronics, Inc., Livonia, MI, Columbus, OH; Resco/Raleigh, Raleigh, NC; Semiconductor Specialists, Inc., Chicago, IL, Burlington, MA, Farmington, MI, Minneapolis, MN, Hazelwood, MO, Pittsburgh, PA, Dallas, TX, Milwaukee, WI; Sterling Electronics, Phoenix, AZ, Santa Clara, CA, San Diego, CA, N. Hollywood, CA, Baton Rouge, LA, Waltham, MA, Albuquerque, NM, Dallas, TX, Tukwila, WA; Summit Distributors, Inc., Buffalo, NY; Summit Elec. of Roch., Inc., Rochester, NY; Western Microtechnology, Cupertino, CA.

**Performs like cermet.
Costs like carbon.
Stands up like steel.**

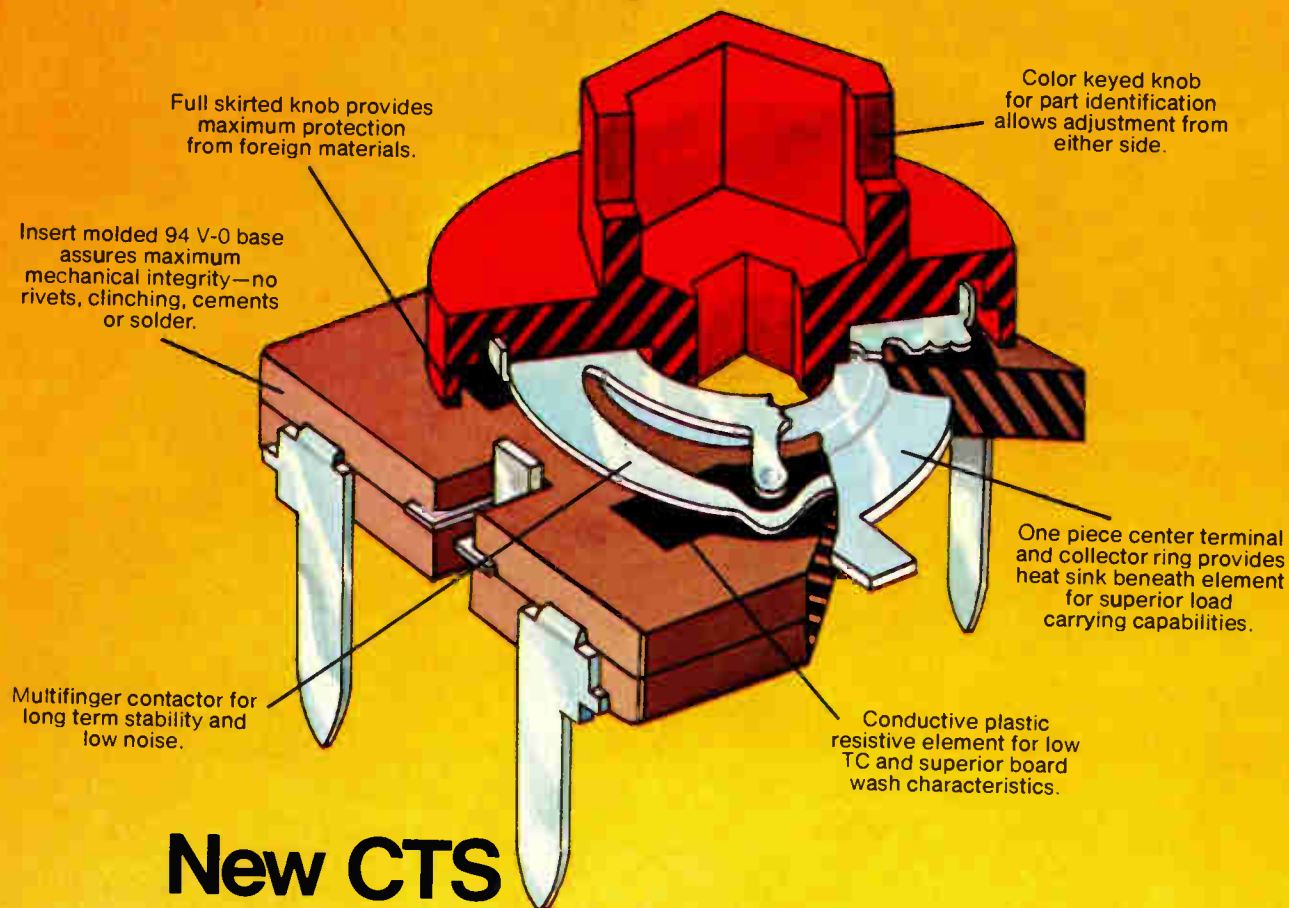

New CTS Consertrim™ 10mm resistors.

These high performance CTS trimmers feature a conductive plastic element on a UL-94 V-0 rated fire retardant, molded substrate; stability and load carrying characteristics approaching cermet; at a price close to carbon. Add to this a mechanical integrity that can withstand forces best described as brutal. Insert-molded terminations provide solid mechanical anchoring and double as an effective heat sink.

CTS series 268 Consertrim resistors are adjustable from both the top/front and bottom/rear; adjustment axis may be either parallel with, or perpendicular to, the PC board. A wide resistance range is available in a new standard of reliability and performance... with superior board wash characteristics.

Resistance Range:
500 ohms—5 megohms.
Power Rating, Watts:
½ watt @ 70°C.
TC: <400 ppm/°C typical.
Stability: 0.05%
Noise: <1% CRV initial.
Operating Temperature Range: -55°C to +125°C.

Consertrim resistors have performance characteristics exceeding most carbonaceous trimmers, yet are competitively priced. For complete series 268 catalog literature, write or call CTS of Elkhart, Inc., 1142 West Beardsley Avenue, Elkhart, Indiana 46514. Phone: (219) 295-3575.



CTS CORPORATION
ELKHART, INDIANA



Circle 216 on reader service card

50-W amplifier covers 1 to 400 MHz

High-gain linear unit will operate without damage or oscillation under any combination of source and load impedances

by Michael J. Riezenman, New Products Editor

Just as computers often seem to need just a bit more memory than they have, so signal generators and sweepers are frequently called upon to supply somewhat more power than they can deliver. Made many years ago, this observation has resulted in the design and manufacture of many linear power amplifiers intended mainly to boost the output powers of laboratory instruments. These amplifiers have tended to be either high-power units with fairly narrow bandwidths or reasonably wideband instruments capable of delivering only a few watts.

Now Electronic Navigation Industries Inc., long a major factor in this field, has developed an extremely wideband solid-state amplifier capable of delivering more than 50 W over its range of 1.5 to 400 MHz. If highly linear operation is not essential, the model 550L can deliver more than 100 W of continuous-wave power from 1.5 to 220 MHz.

Stable. Enhancing the usefulness of its power rating is the 550L's unconditional stability. It will not oscillate or be damaged under any combination of source and load impedance, regardless of magnitude or phase, including open and short circuits. The unit is thus extremely well suited for such tasks as driving ultrasonic transducers and laser modulators, which typically do not present a constant impedance when the frequency or amplitude of the driving signal is varied.

Because the amplifier's nominal gain of 50 dB varies by no more than ± 1.5 dB from 1.5 to 400 MHz, the instrument is also expected to find wide applicability in the testing of electronic equipment for susceptibili-

ty to electromagnetic interference. In this application, the 550L is connected between a signal source, such as a broadband sweeper, and an antenna, which is used to irradiate the device under test.

The amplifier can also be used as a broadcast transmitter. It is sufficiently linear to faithfully reproduce such complex waveforms as those associated with television, single-sideband, pulse, and other complex modulations. All harmonics are at least 25 dB below the fundamental at full output power and lower at reduced power. The typical third-order-intermodulation intercept point is +59 dBm.

Both input and output impedances are 50 Ω . The input standing-wave ratio is no more than 1.8 : 1 over the full frequency range, and the output SWR is a maximum of 2.5 : 1.

Since the amplifier is a 50- Ω

system with a gain of 50 dB and a maximum output of 50 W, it requires only 500 μ W, which corresponds to about 158 mV rms, to drive it to full power. Nevertheless, the unit can withstand 16 dB of overdrive—that is, 1 V rms—under any output load condition without sustaining any damage.

Other key specifications of the 550L include a typical noise figure of 12 dB and an operating temperature range of 0° to 45°C. The 59-lb unit contains its own power supply and cooling system and requires either 12 A at 115 V ac or 6 A at 230 V ac. Its compact case measures 15.5 by 19.75 by 8.5 in.

The 550L sells for \$4,925 and is available from stock to 60 days.

Electronic Navigation Industries Inc., 3000 Winton Rd. South, Rochester, N. Y. 14623. Phone Leon Salmen at (716) 473-6900 [338]

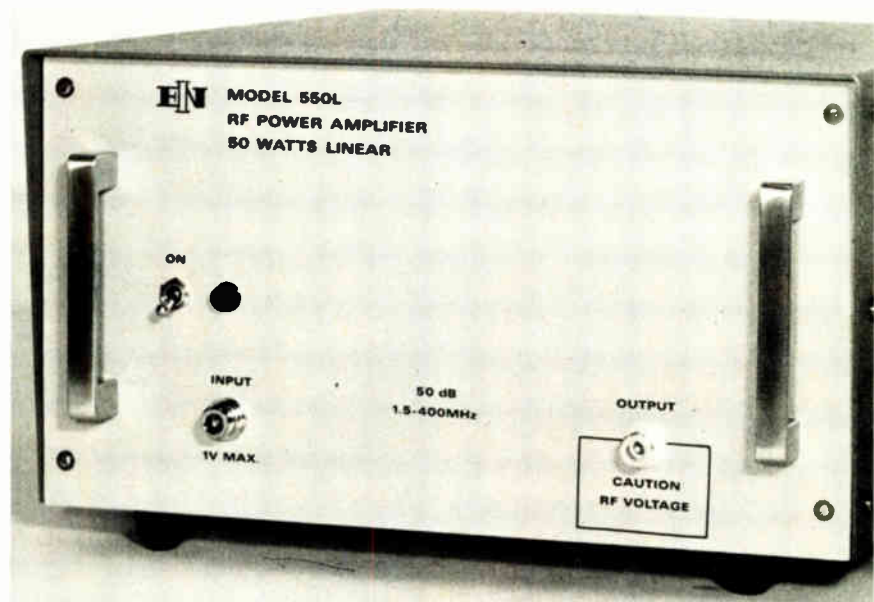

CRYSTAL CLOCK OSCILLATORS

by MOTOROLA ...



K1135A, B
BAUD RATE
GENERATORS

K1152A
CMOS/NMOS
COMPATIBLE



K1150A
CMOS
8041/8741
DRIVER

LOCO II



K1100A



TTL
COMPATIBLE
CRYSTAL
CLOCK
OSCILLATORS

K1091A



are the
industry standard!
HERE'S WHY:

- ✓ the widest line of thick film crystal clock oscillators available anywhere.
- ✓ frequency stability to match your application.
- ✓ frequencies as low as 25 kHz, as high as 70 MHz.
- ✓ logic outputs for TTL, CMOS, ECL, NMOS, dual complementary TTL.
- ✓ volume production capability, fast prototype delivery.
- ✓ DIP packaging saves board space, assembly time.
- ✓ in-house control, from quartz growing through thick-film processing.

Send today for more information on the clock oscillator to fit your application.



COMPONENT PRODUCTS
2553 N. Edgington
Franklin Park, IL 60131

New products

Data acquisition

Unit tracks and holds at 100 MHz

Hybrid circuit features a 35-ps jitter and a 50-mA transient current capability

A hybrid track-and-hold amplifier with a 100-MHz input bandwidth and a 10-ns acquisition time, developed by ILC Data Device Corp., is mainly for use with parallel (flash) analog-to-digital converters. The wideband amplifier eliminates skew errors and allows conversions at rates of up to 50 MHz. Nearly 75 active and passive chip components are used in the multilayer model DDC-8530, which packs all of its circuitry into a 24-pin double dual in-line package. Included in the circuit are a holding capacitor, a FET amplifier to buffer the holding capacitor, an input buffer amplifier, and an emitter-coupled-logic-compatible gate input.

Featuring a 20-ps typical (35-ps maximum) aperture time uncertainty—or jitter—the 8530 has a typical acquisition time of 10 ns and a maximum acquisition time of 15 ns to within 0.1% of final value, for a

± 2 -v input change. With a 0.2-v input change those numbers fall to 5 ns typically and 8 ns maximum. "Ten nanoseconds [for an acquisition time] is about twice as fast as anything else on market now," notes Peter Scholl, sales engineer for hybrids at the company. The aperture time delay is clocked in at 3.5 ns typically and 5 ns at most. Settling time to 0.1% of final value is 5 ns typically and 10 ns maximum.

The droop rate at 25°C is 1 mV/ μ s typically or 10 mV/ μ s maximum. Measured against temperature, it doubles for every 10°C increase. An optional external holding capacitor to parallel the internal capacitor is provided for, with the benefit that droop is reduced and longer holding times are possible; acquisition time is increased, however.

The 8530 circuit displays a temperature coefficient of gain of 25 parts per million/°C, typically, or 50 ppm/°C, maximum. Dc offset voltage (trimmable to zero) is 25 mV typically and 100 mV maximum, with a dc offset temperature coefficient of 40 μ V/°C typically and 100 μ V/°C maximum.

With an output voltage range of ± 1 v maximum, the 8530 has a steady-state current capability of ± 5 mA maximum. A ± 50 -mA transient current capability enables the 8530 to work well with parallel converters. "The unit has the ability

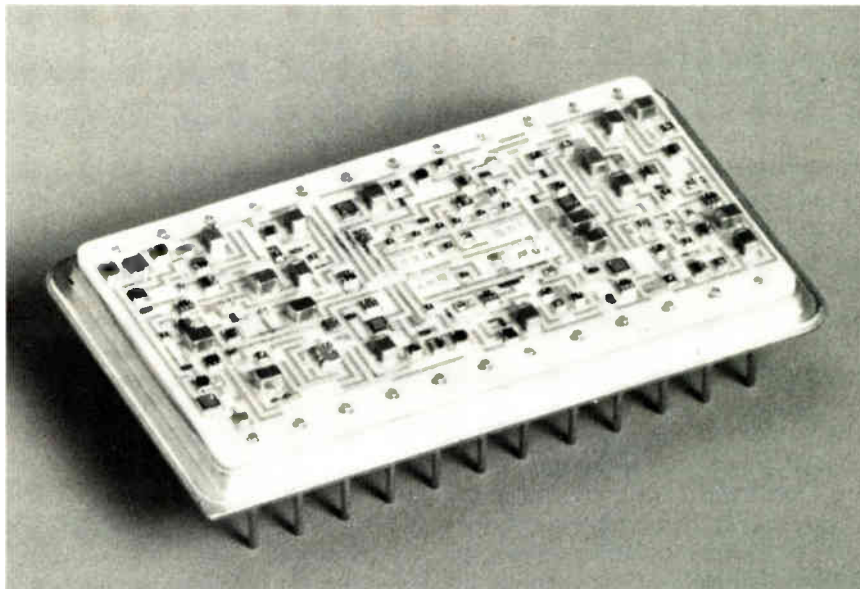



samtec

SAMTEC 'SUDDEN SERVICE'

keeps customers coming back for more

We know it's old-fashioned to be as concerned about your order as you are—but that's the way we do it at SAMTEC. Our samples, catalogs and quotes go out pronto. We know you need to know where your order is now—so our "expediting crew" does its darndest to keep you informed. And Samtec

delivers when promised, with never a gold surcharge. Guaranteed pricing (without surprises) is a way of life for us.

Give Samtec a try. You'll discover Samtec "sudden service" can make buying Electronic Hardware truly trouble-free.

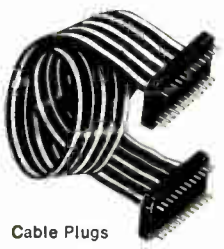

Cable Plugs

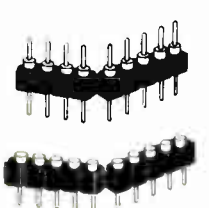

Socket/Terminal Strips



Adaptors



TO Sockets

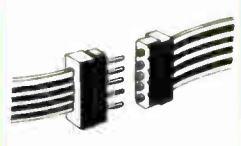

Cable Strip Connectors



DIP Sockets

Get our New 32-page catalog today—complete with all specs and ordering data.

See what a difference personalized service can make!



© 1979 Samtec, Inc.

samtec

810 PROGRESS BOULEVARD, NEW ALBANY, INDIANA 47150
PHONE (812) 944-6733

Circle 219 on reader service card

Bud's New Horizon

The electronic components cabinet with unlimited versatility.

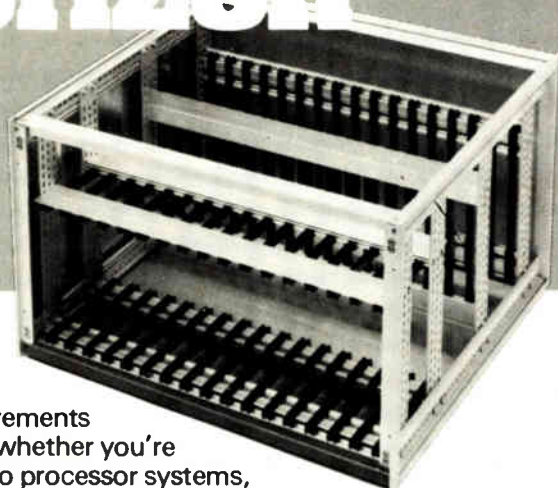

Design requirements change, but whether you're housing micro processor systems, micro computers, PC boards, mother boards, power supplies or plug-in modules, Horizon is the only cabinet you'll ever need.

All exterior panels of its sturdy extruded frame slide out for full interior access. Options include: snap-in guides for perfect component alignment; an accessory chassis that mounts vertically or horizontally and adjustable mounting rails, connector rails and horizontal frame members.

For more information on Horizon, the cabinet that lets you create the electronic package to fit your design requirements, send for our 4-page brochure. Write: Bud Industries, Inc., 4605 East 355th Street, Willoughby, Ohio 44094, or Bud West, Inc., 3838 North 36th Avenue, Phoenix, Arizona 85019.



**BUY
BUD**
First...of all.

Circle 118 on reader service card

New products

to drive a heavy capacitance load. It eliminates the time-skew errors of flash converters or parallel converters," observes Scholl. An internal voltage offset of +1 v or -1 v, offered as an option, provides unipolar output voltage ranges of 0 to +2 v or 0 to -2 v.

According to Scholl, the 8530 will have its strongest use in video data-acquisition systems, especially in radar-pulse processing at upward of 100 MHz, video-imaging systems, and some high-speed television applications.

In single quantities, the 8530 will sell in the \$400 to \$500 range, with deliveries within four to eight weeks. Shipments are scheduled to begin in September.

ILC Data Device Corp., Airport International Plaza, Bohemia, N. Y. 11716. Phone Peter Scholl at (516) 567-5600 [381]

Frequency converters span 10 Hz to 100 kHz accurately

The 4780 family of voltage-to-frequency and frequency-to-voltage converters combine bipolar and complementary-MOS technology on the same substrate, with all five members in the series offering a range of 10 Hz to 100 kHz.

With a nonlinearity of $\pm 0.05\%$ of full scale between 10 Hz and 10 kHz, and $\pm 0.025\%$ from 10 kHz to 100 kHz, the 4780 operates over a 0° to 70°C temperature range. Its companion, the 4780-02, with identical nonlinearity specifications, operates from -40°C to $+85^\circ\text{C}$. Across these respective temperature ranges, the 4781 and 4781-02 boast a $\pm 0.01\%$ maximum nonlinearity between 10 Hz and 10 kHz and $\pm 0.08\%$ between 10 kHz and 100 kHz. The 4782 has a $\pm 0.25\%$ nonlinearity at 10 kHz and $\pm 0.50\%$ at 100 kHz when operating between 0° and 70°C . The first four converters have temperature coefficients of ± 40 parts per million/ $^\circ\text{C}$, while the last has a tempco of ± 100 ppm/ $^\circ\text{C}$. Each unit comes in a 14-pin dual in-line package.

In all the converters, MOS transis-

HOPE The project a ship launched.

First there was the hospital ship S.S. HOPE, now retired. Today HOPE is an established project which has carried its goal of improving health through education to 24 developing countries of the world and the United States.

Give to:

**PROJECT
HOPE**

Department A
Washington, D. C. 20007



Why is the Digitec Datalogger 3000 already the most popular logger in the world?



most powerful & easiest to use

The Datalogger 3000 puts more power in your hands than any other datalogger.

MORE DATA ACQUISITION. The 3000 handles the widest variety of inputs: ac and dc voltages, ac and dc currents, resistances, *all* thermocouples, RTD's, thermistors, digital and contact closures — *all standard*.

MORE COMPUTATION.

The 3000 opens up the power of mathematical computation. It can determine an Average, Difference, Deviation from a Mean, extract Square-Roots and more. You can easily convert to engineering units with 30 programmable offset and scale factors. That's 900 different $m \times + b$ equations. Two unique tables feature the exclusive "U-*PLOT*" function (User-Programmable Linearization Tables). This powerful feature provides linearization for any transducer or transmitter.

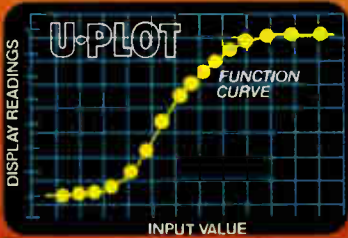

MORE DECISIONS. The 3000 offers 100 programmable set-points for alarm detection. You can assign up to 4 different limits, with priority levels, to each channel for "High," "Low," or "Equal to" decisions. You can Alarm on rate of change or alarm transition. Ten unmasked Alarm Relays provide outputs for annunciation and control. And, only Digitec Dataloggers verbally spell out alarm messages on a built-in CRT. Behind all these standard features is 32K of memory. That's enough power to support a system of up to 1000 points.

The Datalogger 3000... more powerful than any other datalogger.

The Datalogger 3000 is as easy to use as it is powerful. All communication is in everyday English. We spent many years developing programming innovations so you can program your system in minutes.

PROGRAM PROMPTING.

A built-in CRT display provides prompting to guide you through each step of your program. The Datalogger asks you simple questions in plain English and supplies multiple-choice answers. This interactive prompting assures quick and accurate program entry. Programming is further simplified by utilization of conventional data acquisition terms, no need for complex, computer languages.



CASSETTE LIBRARY. Once your program requirements have been defined, they can be saved on the built-in cassette. This lets you create a library of application tapes. Simply drop in a cassette and the Datalogger will completely program itself. Changing programs, therefore, is as easy as changing cassettes. The same cassette deck can be used to record measured data for future reference.

COMPLETE COMMUNICATION. The built-in CRT provides more information than possible with conventional datalogger displays. You can see 10 channels of system information at a single glance. For hard copy, a standard, built-in alphanumeric printer quietly records data. To communicate with peripheral devices, the 3000 offers the widest variety of interfaces: ASCII outputs, both serial and parallel, relay outputs, external condition input, and composite video output are all standard.

The Datalogger 3000... easier to use than any other datalogger.

For a free brochure or "hands-on" demonstration, just call Daryl Barnaby collect, (513) 254-6251



UNITED SYSTEMS CORPORATION

Information Only circle #217

Demonstration Only circle #221

Yes! There is a Stator Yoke for 110° CRT's!

The Syntronic *Data 110* Stator Core Yoke will produce clean, clear dot/matrix or stroke-written characters anywhere on a 110° CRT . . . over 6000 of them on a 15" diag. screen.

This is achieved using a precision-tooled ferrite stator core, built-in geometry correction, complementary coil turns distribution, and interlocking components for repeatability in volume production.

If a saddle yoke doesn't do the job . . . evaluate the *Data 110* Yoke. Ask for Bulletin # 033.



Data 110 Stator Yoke

syntronic

Syntronic Instruments, Inc.
100 Industrial Road
Addison, IL 60101
Phone: (312) 543-6444

New products

tors at the inputs reduce offset and bias currents, while bipolar transistors in the op amp and at all outputs provide excellent current-driving capabilities. C-MOS logic throughout the circuit minimizes power consumption. By adding two capacitors, three resistors, and a reference voltage, the user has a complete system.

In quantities of one to nine, the 4780 sells for \$7.40, the 4780-02 for \$11.50, the 4781 for \$9.25, the 4781-02 for \$13.95 and the 4782 for \$3.45. Delivery is from stock.

Teledyne Philbrick, Allied Drive at Rte. 128, Dedham, Mass. 02026. Phone (617) 329-1600 [383]

12-bit d-a converters

offer $\pm 1/2$ -LSB linearity error

Featuring double-layer metal interconnections, the 8640 and 8641 12-bit complementary-MOS digital-to-analog converters are the first in a series from Teledyne Semiconductor. The company has used a uniform thin-film deposition technique, in conjunction with keeping resistor size ratios tightly specified, to eliminate the need for laser trimming. This obviates altering actual resistor sizes—a process that may introduce long-term drift. Compensating FET switches in the feedback-resistor circuit and at the end of the ladder chain reduces the gain error temperature coefficient to 2 parts per million/°C maximum.

The 8641 has a linearity error of $\pm 1/2$ least significant bit, while the 8640 has a ± 1 LSB error. The converters come in three temperature ranges: 0° to 70° C, -25° to +85° C, and -55° to +125° C. Each converter uses only 2 mA of current, and both feature a 1 μ s settling time to within $\pm 1/2$ LSB.

Prices for the units, in 100s, are \$15.95 (8640CJ) and \$17.70 (8641CJ) for the commercial versions, \$21.95 (8640CN) and \$23.50 (8641CN) for the industrial units, and \$62.00 (8640BN) and \$68.00 (8641BN) for the military models.

Teledyne Semiconductor, 1300 Terra Bella Ave., Mountain View, Calif. 94022 [385]

THE INTERRUPTION YOU'VE BEEN WAITING FOR.



Most design engineers don't mind an interruption that offers a low-cost, high-volume design alternative. Like Spectronics' line of optical interrupter switches.

In fact, our SPX 1870 series has been so successful as a replacement for mechanical switch headaches like corrosion, contact bounce, and fatigue, that it's become the industry standard optical sensor.

And we're one of the largest volume producers, offering a variety of types and package designs. All microprocessor compatible with -55°C to 100°C operation and switching speeds as fast as 10 microseconds.

Already our sensors and encoders have turned up in applications ranging from cameras, servo systems, computer peripherals, and disc drives to automo-

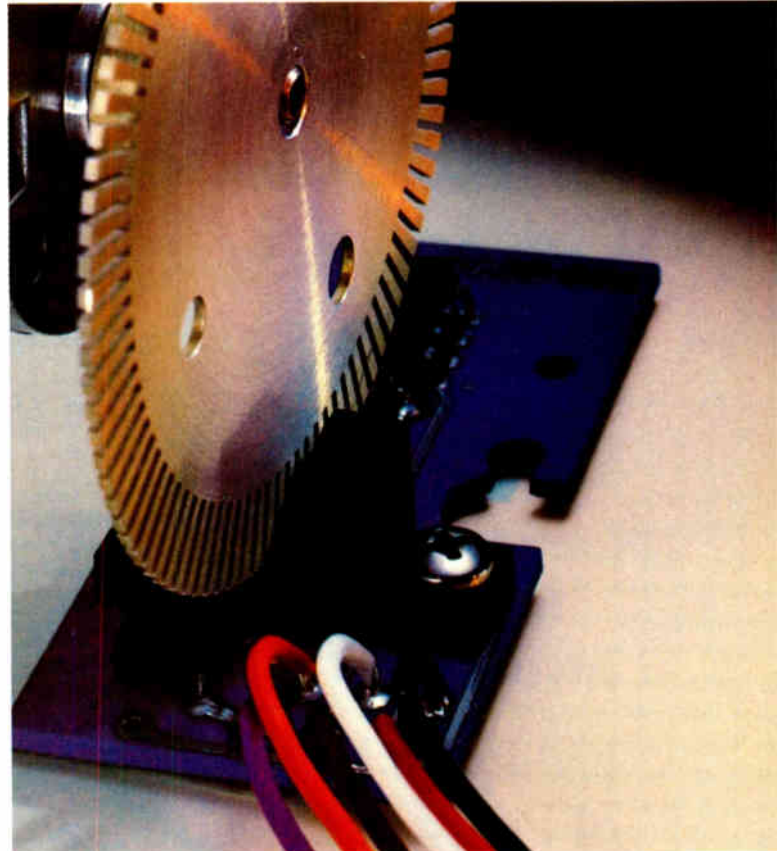

bile cruise controls, copy machines, printers and stepping motors.

We also provide the industry's leading opto isolators, infra-red components, and fiber optic products.

So if you're into optoelectronics, give us a call. That's one interruption that could save you time and money.

Give us a call at 214/234-4271. Or write us at 830 East Arapaho Road, Richardson, Texas 75081.

Spectronics
A Division of Honeywell

PLUG INTO THE RIGHT CIRCUIT.

You'll be in good company in Georgia... in the midst of a growing electronics community. Complete with a full range of support services from manufacturers in allied areas.

Your company will be able to take advantage of the engineering schools at Georgia Tech. For higher education. For research. For high quality engineering talent.

And Georgia's Quick Start training program will be working for you, too. With labor specifically trained for your operation. At our expense.

For more information, including confidential site selection assistance, call or write: W. Milton Folds, Commissioner, Georgia Department of Industry & Trade, 404/656-3556, P.O. Box 1776, Atlanta, Georgia 30301, Dept. EL-021.



Circle 224 on reader service card

Invitation

**Exhibition
of industrial electronics
and electrical engineering**

October 9-13, 1979

Basle / Switzerland

in the halls of the
Swiss Industries Fair

Information and catalogue:
Ineltec 79

CH-4021 Basle/Switzerland

Telephone 061 26 20 20

Telex 62685 fairs ch

**79
ineltec**

224 Circle 42 on reader service card

Electronics / August 30, 1979

Need 24 or 40-pin DIP's off the shelf?

We're your source.

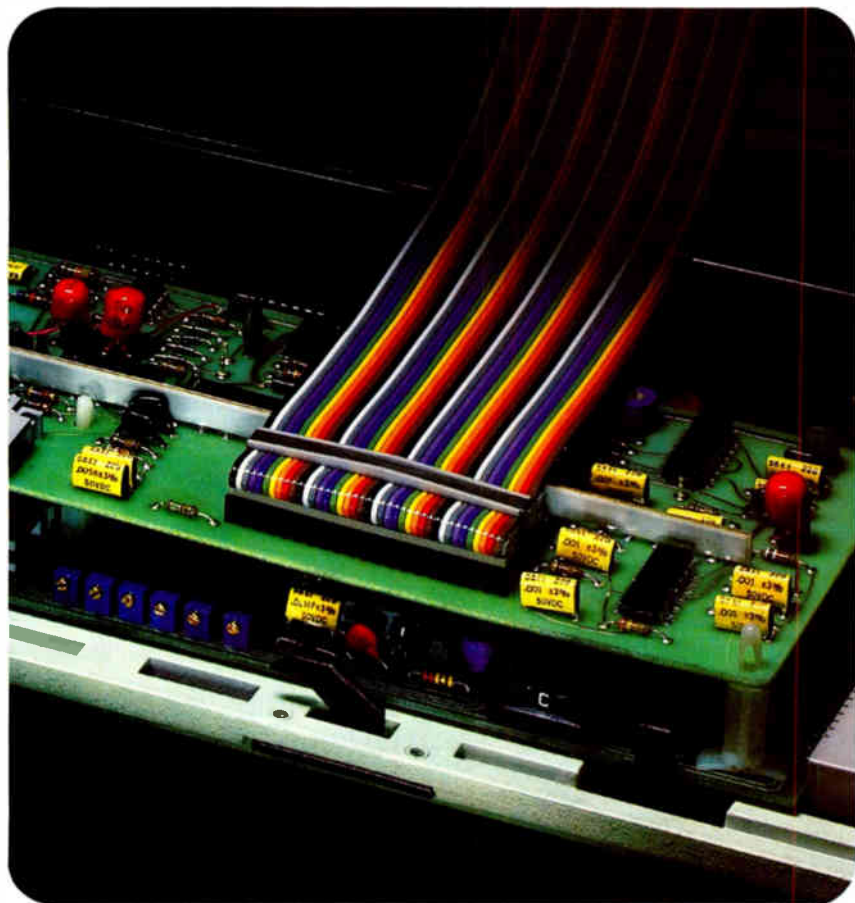

Want the speed, savings and reliability of mass termination with larger size D.I.P. connectors? Come to 3M. Our Scotchflex brand D.I.P. connectors in 24 and 40-contact sizes let you design quick, easy interboard jumpering with readily available parts. Their space-saving low-profile design makes them ideal for microprocessor applications. They also speed and simplify test jumpering or checkout of I.C. sockets.

Both connectors have .100" x .600" grid spacing and are available with either rectangular legs for use with standard I.C. sockets or round legs for use with high density packaging panels. They may be used with Scotchflex shielded, non-shielded or color-coded flat cable or with twisted pair or parallel lay woven cable.

Where frequent plugging and unplugging is necessary, strain relief bars and pull

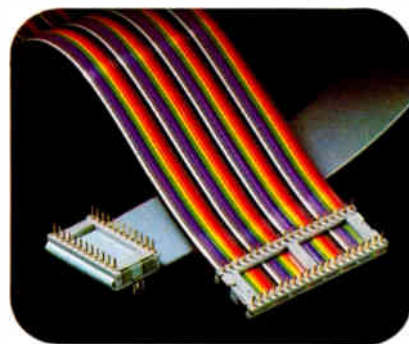

tabs are available for all Scotchflex D.I.P. connectors including 14 and 16-pin sizes.

Need some more ways to simplify wiring and increase circuit density? 3M's Scotchflex line offers you the widest choice of mass terminating cable, connectors and system components to accommodate your design packages. Plus proven reliability. Off-the-shelf availability. And the unmatched experience of the people who pioneered the concept of electronic mass termination.

Scotchflex connectors are recognized under the component program of Underwriter's Laboratories, Inc. 

"Scotchflex" is a registered trademark of 3M Co.

Scotchflex® systems from 3M.

The source.

3M

World's most popular —



MONOBLOC® Ceramic Capacitors



Temperature Compensating Stable and General Purpose

ERIE Red Cap Monobloc® Ceramic Capacitors are in a quality class by themselves and today represent a standard of excellence unequalled in the industry.

Monobloc capacitor elements, solid structures of fused ceramic, are produced in a wide range of capacitance values, characteristics and sizes. They offer inherent stability with conservative voltage ratings for long, trouble-free life.

The combination of Monobloc and "Weecon" capacitors, under the famous Red Cap name, provide circuit engineers with unlimited design flexibility.

Best delivery in the industry for these popular Z5U values . . .

.1 .47 .68 1.0 2.2 4.7 μ F.

- Capacitance range 100 pF. thru 7.5 μ F.
- 25, 50, 100, 200, 500 Volts
- Broadest range of TC materials and tolerances

Write for catalog 8100

ERIE

ERIE TECHNOLOGICAL PRODUCTS, INC.
State College, Pa. 16802
814-237-1431

New products

Microcomputers & systems Systems develop micros with minis

Universal development systems come in versions that handle from one to eight users

With the cost of microprocessor development systems soaring, it is only logical to ask, "Why not use a minicomputer?" Well, the Boston Systems Office has already thought of that. Its Universal Microprocessor Development System (UMDS) series offers all those features that designers have been awaiting from the microprocessor manufacturers. This combination allows concurrent development for as many microprocessors as there are users, at speeds from 20 to 70 times faster than any microprocessor-based system.

Three typical UMDS configurations are shown in the table, but components can also be mixed and matched for special requirements. Installed systems can be readily expanded in the field to permit more users and terminal stations, greater disk storage, and additional RS-

232-compatible peripherals, including programmable read-only memory (PROM) programmers and in-circuit emulators.

All PROM burners and in-circuit emulators (like those in Intel Corp.'s ICE family) can be directly downloaded from any UMDS. The BSO systems can also produce object files that are already compatible with Tektronix Inc.'s 8001 and 8002 microprocessor labs. Numerous cross-assemblers and compilers are also available from BSO to run on the UMDS series, to support just about all the popular microprocessors from different manufacturers.

The Boston Systems Office, 469 Moody St., Waltham, Mass. 02154. Phone (617) 894-7800 [361]

Trace cuts bit-slice firmware development time in half

The design of development tools and systems for MOS microprocessors has been awarded ample attention. But bit-slice and bipolar microprocessors need the same kind of support, and Step Engineering has been active in delivering it. Many development tools are already available via the Step-2 firmware integration and test system, including a writable control

BSO UNIVERSAL MICROPROCESSOR DEVELOPMENT SYSTEMS			
System	UMDS-10	UMDS-20	UMDS-40
Users	1	2 - 6	4 - 8
CPU	LSI-11/2		PDP-11/34A
RAM	32-K words		128-K words
Mass storage	dual 512-kilobit diskettes	dual 5-megabyte RLO1 removable hard disks, RX02 backup diskettes	
I/O link	quad RS-232 EIA interface		eight-line EIA multiplexer
Peripherals	hard-copy or CRT terminals		
	LA180 high-speed printer		
Operating system	RT-11	RT-11 or time-shared	RSX-11M RSTS-E
Other software	utilities, cross-assemblers (optional: simulator/debugger, BSO Pascal, and BSO Fortran)		
Price	\$13,500	\$29,650	\$46,800*

*also includes real-time clock, parity control, programmer's console, and memory management

There are solid engineering reasons why you should have Cambion on board.

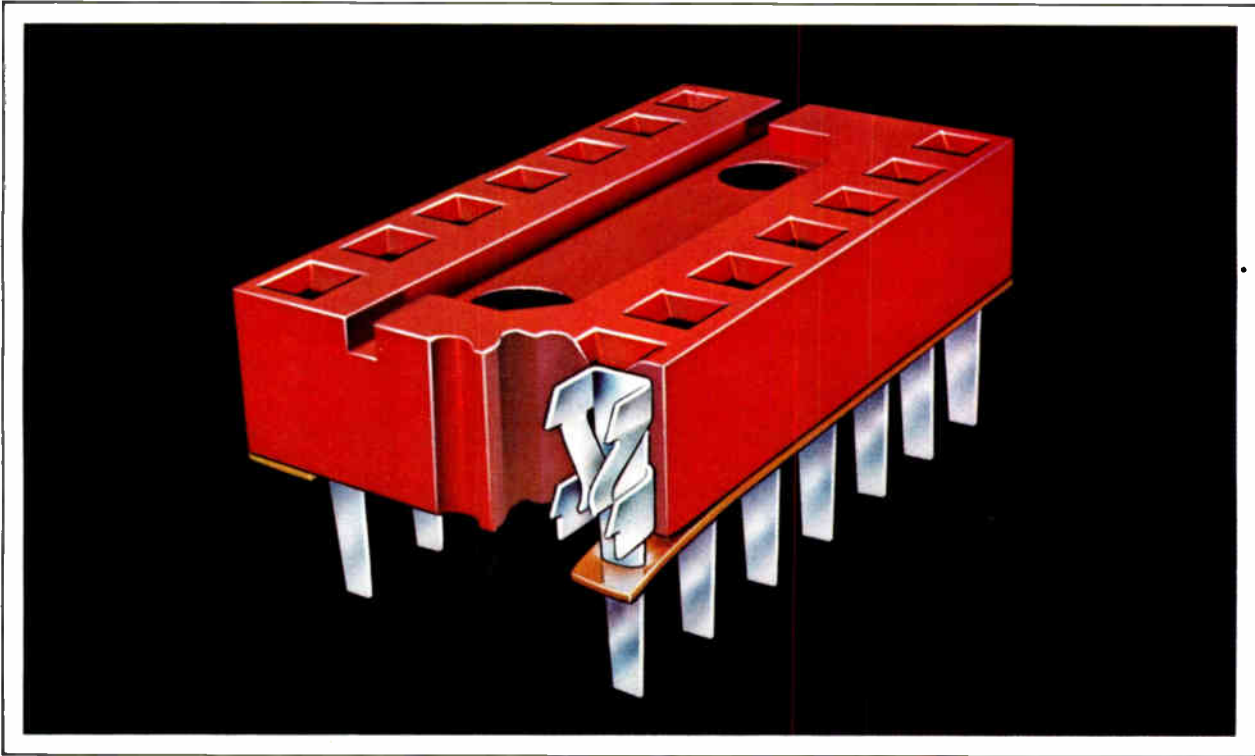

Four Times the Reliability With Dual-Leaf Inverted Contacts

Low profile solder tab sockets are now made by scores of manufacturers around the world. *But there's only one CAMBION – with Kapton film.*

- Unique inverted spring design overcomes insertion force resistance
- Dual leaf spring for redundancy of contacts – reliability increases as the square of number of contacts
- Excellent DIP retention (low insertion, high extraction forces)
- Long guided lead-in delivers DIP tail directly into contact throat and prevents lead bending and hang-up
- Buttable end to end and side to side

Kapton™ Secured

- All contacts sealed tightly on board side with Kapton – DuPont's polyimide film which inhibits solder or flux entry. Kapton withstands temperatures of -269°C to $+400^{\circ}\text{C}$, is flame retardant, resists organic solvents
- All popular types in tin or gold plating: 8, 14, 16, 18, 22, 24, 28, 40 and 64-pin

And massive availability, too!

Send for our latest Socket Brochure and Catalog 121 for the straight engineering story.

Cambridge Thermionic Corporation,
445 Concord Avenue, Cambridge,
Massachusetts 02238. (617) 491-5400.

CAMBION®
The Right Connection.

KAPTON – Trade Mark of DuPont Corp.

REPRINTS AVAILABLE FROM *ELECTRONICS*

No. of
copies
wanted

Charts

- ___ R-823 Communications satellites \$3.00
- ___ R-516 Electronic symbols \$2.00
- ___ R-213 Electromagnetic spectrum (updated 1976) \$3.00
- ___ R-326 Optical spectrum (6-page report and chart) \$3.00

Articles

All articles are \$3.00 each. Quantities of 5 or more in any combination are \$2.00 each.

- ___ R-923 A burst of energy in photovoltaics 18 pp
- ___ R-921 LSI-based data encryption discourages the data thief 14 pp
- ___ R-919 Special report—VLSI shakes the foundations of computer architecture 24 pp
- ___ R-917 Memory products 20 pp
- ___ R-915 The race heats up in fast static RAMs 12 pp
- ___ R-913 Lithography chases the incredible shrinking line 12 pp
- ___ R-911 Transmitting data by satellite calls for special signal handling 8 pp
- ___ R-909 Special market series—Electronics abroad 8 pp
- ___ R-907 Touch-tone decoder chip mates analog filters with digital logic 8 pp
- ___ R-901 1979 world market survey and forecast 24 pp
- ___ R-829 Special report: New networks tie down distributed processing concepts 16 pp
- ___ R-827 Tackling the very large-scale problems of VLSI: a special report 15 pp
- ___ R-821 Codecs answer the call 18 pp
- ___ R-817 How bit-slice families compare 18 pp
- ___ R-816 Packaging technology responds to the demand for higher densities 9 pp
- ___ R-815 Higher power ratings extend V-MOS FETs' dominion 8 pp
- ___ R-813 Data-link control chips: bringing order to data protocols 10 pp

- ___ R-811 Multiplexing liquid-crystal displays 10 pp
- ___ R-809 New methods and materials stir up printed wiring 10 pp

Books

- ___ R-903 Personal Computing: Hardware and Software Basics—Electronics Book Series 266 pp \$11.95
- ___ R-803 New Product Trends in Electronics 1977—Electronics Book Series 333 pp \$14.95
- ___ R-732 Memory Design: Microcomputers to Mainframes—Electronics Book Series 180 pp \$12.95
- ___ R-726 Design Techniques for Electronics Engineers: 293 time-saving ideas in 48 chapters—Electronics Book Series 370 pp \$15.95
- ___ R-711 Circuits for Electronics Engineers: 306 circuits in 51 functional groups—Electronics Book Series 396 pp \$15.95
- ___ R-31D Designer's Casebook Number 1 106 pp \$5.50
- ___ R-704 Thermal Design in Electronics 52 pp \$5.00
- ___ R-701 Applying Microprocessors—Electronics Book Series 191 pp \$9.95
- ___ R-608 Basics of Data Communications—Electronics Book Series 303 pp \$12.95
- ___ R-602 Large Scale Integration—Electronics Book Series 208 pp \$9.95
- ___ R-520 Microprocessors—Electronics Book Series 154 pp \$8.95
- ___ R-011 Computer-aided Design 135 pp \$4.00

Payment must accompany your order

Make check or money order payable to Electronics Reprints. All orders are shipped prepaid by parcel post. Allow two to three weeks for delivery. We will make any editorial reprint to order in quantities of 500 or more. For price list and additional information call (609) 448-1700 ext. 5494.

USE THIS PAGE AS YOUR ORDER FORM

Cost of orders \$ _____
 Plus 10% handling charge \$ _____
 TOTAL AMOUNT ENCLOSED \$ _____

Mail your order to:
 Janice Austin
 ELECTRONICS REPRINTS
 P.O. Box 669
 Hightstown, N.J. 08520

SEND REPRINTS TO

Name _____
 Company _____ Dept. _____
 Street _____
 City _____ State _____ Zip _____

228

New products

```
MON HLT ARR1 01KX32 SA=0000
```

```
SOURCE1 = 12
0 OR CR=NO CHANGE 1=RUN ALWAYS
2=TB1 3=TB2 4=TQ1 5=TQ2 6=UAC
7=TB1*TQ1 8=TQ1*TQ2 9=TB2*TQ2
10=TB1*TQ1*TQ2 11=TB1+TQ1+TQ2
12=TB1+TB2+TQ1
```

```
MON HLT ARR1 01KX32 SA=0000
```

```
RUN
B1:027F B2:NONE B3:NONE
```

```
TRACE STATUS= ARMED
TRIG= TB1+TB2+TQ1 THEN 25 UAC
```

```
MON HLT ARR1 01KX32 SA=0000
```

```
238 D0D0 0001 1101 0000 0100
239 7171 0000 0110 0000 0000
240 F1F0 0001 1101 0000 0000
241 70F1 0010 1101 0000 0001
242 66D0 0100 0101 0000 0000
```

Trace. Menu (top) allows user to select trigger terms. Breakpoint equation (center) results in trace shown at bottom.

store for real-time emulation, diagnostic tools, a word-oriented editor, and loading and dumping programs. Now Step has taken the next step by adding a trace module that can cut firmware development time in half, over and above the savings already possible with the host instrument.

Tracing a bit-slice microprocessor's path of execution means following the address sequence of the machine and keeping a record of successive accesses to its microcoded control store, usually programmed into bipolar read-only memory. In real-time development work today, logic analyzers are usually called upon to do the tracing. The cost of the Step trace is one half to one third that of most logic analyzers.

Like the Step 2, the trace is optimized for bit-slice and bipolar devices such as 9405/10, 2900,

Meet the Analyst.

An improved version of an old friend.

Since its introduction, the Fluke 8020A has virtually become the industry standard for value in hand-held digital multimeters. And now the 8020A boasts a new set of features making it an even better buy—and a more powerful performer. So powerful, we call it the Analyst.

Now 0.1% benchtop DMM accuracy in a hand-held instrument. A crystal-controlled A/D converter insures accurate, steady, noise free measurements and a basic dc accuracy of 0.1%. That's 25 times better than you'll find in most analog VOM's.

Here's something new that won't shock you. The Analyst boasts a new Fluke-designed test lead system with finger guards on the probe and shrouded contacts on the connectors to discourage accidental contact with circuit voltages.

We prove our reliability with a two-year confidence warranty. With well over 100,000 8020A's in the field, we know the Analyst is rugged and reliable. So we now back the Analyst with an exclusive limited two-year warranty and NBS traceable calibration with prompt service from over 45 factory authorized service centers worldwide.

There's more to the price than you might expect. You'd expect to

pay more money for the Analyst's added features. After all, the 8020A already boasts 26 ranges for seven functions including conductance. This capability is a unique way to measure high resistance—a must for checking leakage in capacitors, pcb's, cables and insulators, and general use above 20 MΩ. High and low-power ohms functions, easy one-hand push button operation and full over-voltage and over-current protection are all included. In fact, over 20% of the instrument's components are devoted to input protection.

But the price is still \$169*. And it now includes a deluxe carrying case and an improved operator's manual. The kind of value in performance, features, and accessories that only the industry leader can provide.

Here's how to get your hands on one. Contact the Fluke office,

representative, or authorized distributor in your area. In the U.S., CALL TOLL FREE (800) 426-0361. (For residents of Alaska, Hawaii, and

Washington, the number is (206) 774-2481.)

In Europe, contact: Fluke (Holland) B.V., P.O. Box 5053, 5004 EB Tilburg, The Netherlands. Telephone (013) 7673973. Telex: 52237.

For immediate response, fill out the attached coupon.



John Fluke Mfg. Co., Inc.
P.O. Box 43210 MS #2B
Mountlake Terrace, WA 98043

- Please have a salesman call.
 Please send 8020A Analyst data.

Name _____

Title _____ Mail Stop _____

Company _____

Address _____

City _____ State _____ Zip _____

Telephone () _____ Ext. _____

E3 8/79

POWER LINE DISTURBANCES?

SPIKES/SAGS/SURGES/BROWN-OUTS/DROP-OUTS



ANALYZE & TEST

Power-Science[®]



MODEL LSM
Spike Monitor w/Memory



MODEL LVA
Line Analyzer w/Memory



MODEL LTG
1KW Transient Generator



MODEL SPG
60KW Spike Generator

SOLUTIONS



Power-Matic[®]

Patented Multi-Primary Switching Line Regulators and Conditioners for Brown-Out, wide input range and overvoltage.

- 1/2 Cycle Response Time
- 99% Efficiency
- 45-70Hz Operation
- Any Power Factor
- No Distortion
- No Spikes
- Small Size
- Low Cost

The largest selection of over 400 standard models from 250VA to 15KVA single phase.

MODELS

- MPS-3003
- MPS-3150
- MPS-5005
- OEM-3150
- LC-3003
- LC-3150
- LC-5005

For complete information call or write:

Power-Science, Inc. *Power-Matic, Inc.*
(714) 292-4322 (714) 292-4422
7667 Vickers St., San Diego, CA 92111

Circle 230 on reader service card

New products

8X300, 8X02, and S481. Also like the host, the trace is architecture-independent and will support MOS processors as well. Running at synchronous speeds up to 11 MHz, the trace allows the capture of 250 32-bit successive events (16 address bits and 16 data bits).

To set up the trace, the user selects from menus of trigger terms, as shown in the top photo. Choices include the breakpoint addresses, external qualifiers, and user address clocks, as well as combinations of these. The completed equation (bottom line in middle picture) takes many forms; here it uses breakpoint addresses shown in the fourth line of the display (027F₁₆). The resulting path of execution of the processor consists of line numbers (e.g., 238), addresses (e.g., D0D₁₆), and binary data collected by probes, as in the bottom photo.

The trace allows the actions of the microprocessor being designed to be tracked as the microcode is edited. And plain-English commands make the trace features quick to learn and easy to use. Available 75 days after receipt of order, the trace add-on costs \$2,750, complete with data and address cables.

Step Engineering, P. O. Box 61166, Sunnyvale, Calif. 94088 [362]

Small microcomputer tester simplifies field service

Eliminating the need for an expensive control panel in every microcomputer-based product is a handheld microcomputer analyzer, the Patuck model T-8 field tester. Interfaces capable of accommodating most common 8-bit microcomputers, including the 6501, 6502, 6505, 8080, 8085, and Z80, are available for use with the analyzer.

A simple printed-circuit-board strap option or a rocker switch activates the diagnostic routine in the microcomputer. The tester, connected to the microcomputer by a 40-pin chip clip, then analyzes the results of the diagnostic tests. Set to the breakpoint at preselected diagnostic ad-



HOPE

The project a ship launched.

First there was the hospital ship S.S. HOPE, now retired. Today HOPE is an established project which has carried its goal of improving health through education to 24 developing countries of the world and the United States.

Give to:



Department A
Washington, D.C. 20007

THE NEW SPECTRUM ANALYZER FROM AILTECH

Its Superior Performance Gives You Confidence in Your Measurements



Now with ■ Internal Frequency and Amplitude Calibration ■ Digital Storage ■ CRT Display of Control Settings ■ Normalized Display ■ Uncal Warning Light ■ LED Switch Indicators. And, the 757 has retained all of the features of the Ailtech 727 Spectrum Analyzer: ■ 100 dB on Screen Displays ■ Built-in Preselection ■ -125 dBm/Hz Sensitivity ■ Highly Selective Filters and Automatic Features.

The 757 Spectrum Analyzer, another of the finest instruments you have come to depend upon from Ailtech... is a complete instrument—no modules to add!

With special features for Communications, Radar, rfi/emi and Production Test, the 757 is the easiest Analyzer to use.

Send for your specific application information, and ask for a demonstration in your own lab.

AILTECH

PRODUCT OF:

LONG ISLAND OPERATION • 2070 Fifth Avenue • Ronkonkoma, N.Y. 11779 • Telephone: (516) 588-3630 • Telex: (510) 228-6507

CITY OF INDUSTRY OPERATION • 19535 East Walnut Drive • City of Industry, Ca. 91748 • Telephone: (213) 965-4911 • Telex: (910) 584-1811

LOS ANGELES OPERATION • 5340 Alla Road • Los Angeles, Ca. 90066 • Telephone: (213) 822-3061 • Telex: (910) 343-6969

FRANCE • La Garenne — Colombes • Telephone: (01) 780-73-73 • Telex: 620821

UNITED KINGDOM • Crowthorne • Telephone: Crowthorne 5777 (Area 3446) • Telex: 847238

GERMANY • Munich • Telephone: (089) 5233023-24 • Telex: 529420

HOLLAND • Rozenburg N-H • Telephone: (02977) 29376 • Telex: 18399

LOOK! programmable microvolts dc calibrator/standard

EDC model 501 Series J

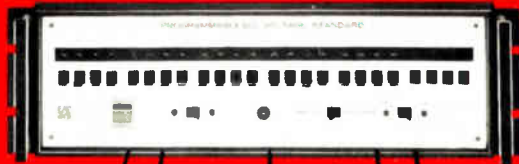

Programming
IEEE 488 (GP/IB).
or
Binary
or
Parallel/Serial

Range Control
 $\pm 0.1 \mu\text{V}$ to $\pm 1000\text{Vdc}$
 $\pm 10\text{nA}$ to 10 Amps dc

Resolution (1ppm)
24 Bits (BCD)
or
20 Bits (Binary)

Local/Remote
Program lines
remain connected.
Uninterrupted
program up-date.

Prices* start at
\$1895

Output Specifications

Range: $10 \mu\text{V}$ to 10Vdc
Accuracy: $\pm 0.005\%$
Speed: $50 \mu\text{S}$
Isolation: $10^9 \Omega$, 130pf , 500 Vdc
Stability: $\pm 0.0005\%$

Optional Functions

100 mV Range: $0.1 \mu\text{V}$ to 100 mVdc
200 V Range: $10 \mu\text{V}$ to 200 Vdc
1000 V Range: $10 \mu\text{V}$ to 1000 Vdc
100 mA Range: $10 \mu\text{A}$ to 100 mA
10 Amp Range: $10 \mu\text{A}$ to 10 Amps dc

Programming Options

BCD or Binary, Parallel or Serial entry,
ASC II Code, IEEE 488 (GP/IB)

*U.S. Basic Price, Options, Accessories and
Auxiliary Instruments additional.

Call Bob Ross for additional information.



**ELECTRONIC
DEVELOPMENT
CORPORATION**

11 Hamlin St., Boston, MA 02127, Tel: (617) 268-9696

See us at Wescon Show Booth #1050

New products



addresses, the T-8 displays error messages from the 63-byte history memory on an $8\frac{1}{2}$ -digit display. To analyze indicated malfunctions, the tester can single-step the microprocessor through the test, or it can let it run freely to a previously chosen error-vector trap address. Internal tracing allows the user to examine the 63 machine cycles preceding the breakpoint.

The T-8 sells for \$695, with the microprocessor interfaces carrying a price tag of \$50 each. Shipments are from stock.

Patuck Inc., 537 Russell Ave., Pensauken, N. J. 08109. Phone (609) 662-0677 [363]

Desktop microcomputer uses APL language

The APL language can be used in a new desktop microcomputer. The APL/DTC is a hardware-software package that includes a 4-MHz Z80-based central processor, two quad-density minidisk drives, a video terminal, an APL character generator, an object-code disk, and documentation. With 24 kilobytes of usable APL workspace, the system allows standard APL arithmetic functions, plus Boolean, relational, selectional, structural, and general functions to be used. The computer can handle many languages besides APL—optional software packages are available for Basic, Fortran, Cobol, and Pascal. A Z80 assembler and word-processing software are also on the option list.

The standard APL/DTC system

MEET THE GANG!



Data I/O's new gang module programs eight NMOS EPROMS at once! (Now that's an offer you can't refuse.)

Our new Gang Module fits neatly into the Data I/O System 19 and System 17 to give you production programming capability at surprisingly low cost.

With the Data I/O Gang Module you can program all 2704, 2708, 2716 (both 1V and 3V), 2732, 2758, 2508, 2516 and 2532 devices. But instead of changing the entire module every-time you program a different device, you simply change the device "characterizer." Seven characterizers are available for the Gang Module.

Worry free programming. Before any devices are programmed, the module conducts a blank check and an illegal bit check. After programming, the unit verifies the data in each device against the data in the RAM. If any test

fails, the LED below the affected device lights up.

And with the Data I/O gang module, you can verify the data in all eight devices at once after burn in — an advantage not available on some programmers.

No matter what your production needs, talk to Data I/O. Besides our new Gang Module, we offer the unique Model 16 — a sophisticated, high production unit for MOS devices.

You haven't shopped around until you've looked at Data I/O. Let us show you the difference. Circle the reader service number or contact Data I/O, P.O. Box 308, Issaquah, WA 98027. **For answers fast, call toll free: 800-426-9016.**

Good idea!

DATA I/O
Programming systems for tomorrow...today

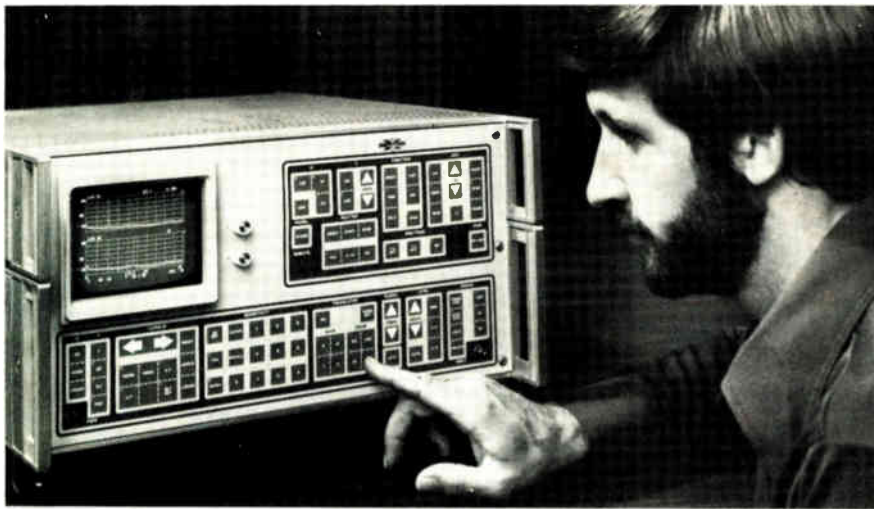

Spectrum analysis at a mere touch

The SD345 FFT Signal Analyzer looks different and *is* different, and although the differences start right up front with a revolutionary new fingertip control panel, the features built into it are more than just cosmetic. They provide capabilities no other analyzer on the market can match. Here are some of the highlights:

- 400-line spectrum analysis to 100 kHz
- 70 dB dynamic range shown on a crisp (raster scan) video
- Time-signal averaging *plus* synchronous spectrum averaging for maximum signal-to-noise enhancement
- 1/3-octave and octave analysis from continuous or transient signals (*optional*)
- Selectable A or B acoustic weighting
- Digital input-output for complete computer control via IEEE 488/RS 232 interfaces (*optional*)
- Digital translator for expansion of specific spectrum areas by as much as 100X (*optional*)

Fingertip convenience . . . digital accuracy . . . clear, easy-to-read instant results—that's the new SD345. Send for the complete story so you can analyze the real difference in a really different spectrum analyzer.



contact has been made.

No knobs or switches. Just fingertip pressure actuates the function shown, and a LED plus a light tone tells you

No guesswork! Complete X and Y grids, alpha-numeric annotation and data scaling gives immediate, accurate spectral information.

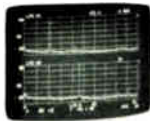

Spectral Dynamics

Scientific-Atlanta

P.O. Box 671 • San Diego, CA 92112 • (714) 268-7100

Circle 234 on reader service card

College dollars need time to grow.

Take stock in America.

With higher paying U.S. Savings Bonds.



New products



includes one auxiliary processor for interfacing input/output ports and another to implement an index file system. Three additional auxiliary processors are available as options: one for data communications, one for high-resolution graphics manipulation, and one for analog-to-digital conversion in control applications.

The standard hardware-software APL/DTC package is priced at \$6,495, with delivery between 30 and 60 days.

Vanguard Systems Corp., 6812 San Pedro, San Antonio, Texas 78216. Phone Gary Dawkins at (512) 828-0554 [364]

Miniature printer weighs in at 1½ lb. and costs \$42.95

A miniature impact dot-matrix printer that costs only \$42.95 in 1,000-unit quantities can be used with microcomputers and in equipment like electronic cash registers. Model DP-822 has an easily replaceable seven-by-five-dot-matrix printing head with a life expectancy of 15 million characters and provides up to 21 columns of hard copy at a speed of 2.5 lines per second. The 1.5-lb. printer uses just one 12-v dc motor to control the printing head, paper feed, and ribbon.

The DP-822 uses standard adding-machine tape and, despite its small size (approximately 2 by 4 by 5.7 in.), provides an impact that is strong enough to be used with carbonless tapes to make two copies simultaneously. The printing head can reproduce any alphanumeric type font.

Star Micronics Inc., Pan Am Building (Suite 2308), 200 Park Ave., New York, N.Y. 10017. Phone Arnie Peters at (212) 986-6770 [365]

WHEN QUALITY AND RELIABILITY COUNT. . .

COUNT ON SIMPSON METERS & METER RELAYS

Analog, digital or Ana-Led® . . . Simpson meters and meter relays are the choice of design engineers everywhere. Our self-shielding movements provide optimum sensitivity and are immune to stray magnetic fields. Simpson taut-band and pivot-and-jewel mechanisms withstand shock

and vibration and stay accurate. When you need a meter fast, get fast delivery on over 1500 stock ranges, types and sizes . . . or order custom ranges, scales, damping, tracking, accuracy. See your Simpson distributor or write for full line catalog.



SIMPSON ELECTRIC COMPANY

853 Dundee Avenue, Elgin, IL 60120
(312) 697-2260 • Telex 72-2416 • Cable SIMELCO

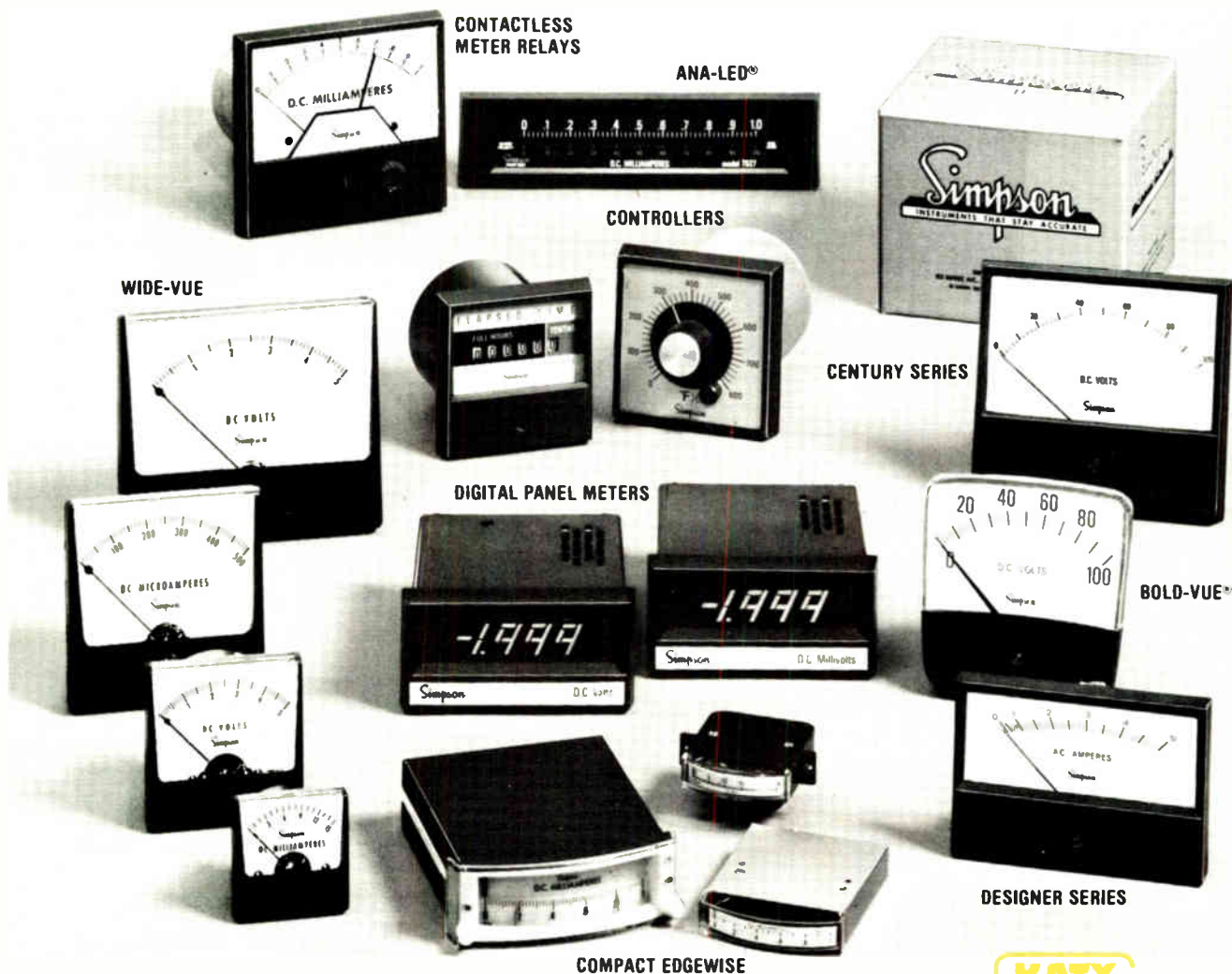

Announcing a proven solution to today's shortage of design engineers.

ENGINEERS WANTED

... San Diego ...

A world leader in the design of integrated and solid state memories and systems has immediate requirements for innovative engineers to fill the following positions

ANALOG DESIGN and DIGITAL DESIGN ENGINEERS

Both positions require a BSEE and a minimum of five years experience. MSEE would be a plus. ANALOG position requires active background in linear and non-linear circuit design, and familiarity with high frequency systems and techniques desirable. DIGITAL position requires strength in logic design plus interface background and peripheral controller experience. Should be knowledgeable in mini-computer systems theory, both hardware organization and assembly level language software.

Superb living conditions in America's Finest City. Excellent compensation and benefit package within a high-technology state-of-the-art environment.

Professional Employment

It is now estimated that there is a nationwide shortage of 15,000 design engineers.*

If your company isn't feeling the pinch, chances are you soon will.

Which means you and your staff will have to do more work with the same number of people.

Unless you talk to Information Handling Services.

Because we can help make your entire engineering department more productive by reducing the amount of time they have to spend finding important technical information.

The solution is an IHS information system commonly known as VSMF that allows your engineers to identify product vendors, check specifications, and locate all pertinent infor-

mation on Industry Standards or Mil Specs—in about one-sixth the normal time.

Which means they spend a far greater percentage of their time doing what they do best, designing, instead of acting as file clerks.

But our system doesn't just save time.

It is so complete, with information on over 10,000,000 products from more than 22,000 different manufacturers, that your engineers can use it to help locate alternate vendors. Or to find less expensive parts and components. Or newer and more efficient products. And you'll know your information will be current, because we automatically update it for you as frequently as every 15 days.

*Dun's Review, June 1979

Finding information the IHS way: It can increase your productivity at a fraction of the cost of a new employee.

How can IHS help your engineers find the information they need so quickly?

Let's suppose, for example, that one of your people needs to specify a non-lighted, push-pull switch. Our system can deliver data from all 85 primary manufacturers of this device. So you can

be sure he'll get precisely the one he needs, when he needs it, at the right price. Along with all the information required on Industry Standards or Mil Specs. And here's how simple the IHS system is to use...

He checks the IHS Product/Subject Master Index to locate the appropriate product category.
Time required: :45 seconds



2 Next, he uses the IHS Locator Index to identify the appropriate cartridge.
Time required: :45 seconds

The correct cartridge is located and loaded.
Time required: :20 seconds



3 Then, he reviews the catalog data sheets of all 85 possible vendors. He selects 4 that specifically meet his product requirements.
Time required: 8:00 minutes

4 He pushes the print button to obtain copies of the selected catalog data sheets.
Time required: 1:45 minutes
TOTAL ELAPSED TIME: 11:35 minutes



Should you require Domestic or International Industry Standards or Mil Specs your people can use this same system and this same procedure in about the same amount of time! Or even less!

To get complete details on our IHS system, and

to see what our customers themselves have to say about it, please call our toll-free number below: TWX 910-935-0715; or write: Information Handling Services, Dept. 450, 15 Inverness Way East, Englewood, Colorado 80150.



Information Handling Services

An Indian Head Company

**For information, call toll-free, night or day, 7 days a week:
1-800-821-2280, ext. 288. (In Missouri: 1-816-358-8850, ext 288.)**

Circle 237 on reader service card

Instruments

Printers offer flexibility

Portable 20-column units process, print, and plot data in many modes

The questions an engineer has had to answer when choosing a printer to automatically record measured data have been many and varied. In what form will the data appear? Will measurements be made in the lab, on the bench, or in the field? Should the raw data be recorded or should it first be processed to present a graphic display or a derived parameter?

Now, rather than making these decisions before purchase, the engineer can turn to two 20-column thermal printers that provide the functional flexibility needed for a variety of tasks. Made by the John Fluke Manufacturing Co., both units adhere to the company's portable test

instrument (PTI) concept. This means not only that they can be stacked with and latched to digital multimeters, counters, and other instruments in the PTI family, but that they also easily accept inputs from these other family members via a PTI interface. Furthermore, one of the printers, the model 2020A, is easily configured to take data in a number of formats.

Five interface cards are offered as options for the 2020A; any of them can be installed in the field in as little as five minutes with nothing but a screwdriver. The cards configure the printer for parallel ASCII, RS-232, IEEE-488, PTI, or BCD interfaces. The same printer can therefore be used at different times with an intelligent terminal (at baud rates of 110 to 1,200 b/s), remotely with up to nine other PTI instruments, and as a system printer responding to an IEEE-488 controller or other IEEE-488 instrument.

When the desired data must be derived from several measured parameters, the model 2030A can be used to manipulate measurements. At its front panel, a user can select

multipliers that will linearly scale readings into more relevant units. He can also set it to calculate the difference or percentage difference between readings or between readings and a constant.

Any of seven recording modes may be selected by the user. He may initiate a one-time print by pressing a button, or he may have the 2030A print three readings per second continually. He may also have it print at programmed intervals and, if he wishes, monitor for alarms between readings. He may have data plotted between limits rather than printed, and plots may also be made at programmed intervals. Finally, he may control printing from a remote location while monitoring the device or system under test with the alarm output that the printer provides.

Like the 2020A, the 2030A can scan up to nine other PTI instruments at present. (The 2300 scanner, to be introduced later this year, will increase this capability to 100 channels.) Special addresses can designate one PTI instrument's readings for mathematical transformation, another's for unit scaling, yet another's for alarms, and still another's for graphical presentation. To keep track of all this information, printouts can be annotated with a variety of user-selectable designations, giving a permanent record of tests.

Both printers can work off a 12-v source such as a car battery as well as a 120-v ac line. The 2020A has a basic price of \$570, with interface cards ranging in price from \$75 for a parallel ASCII to \$225 for an IEEE-488. The 2030A computing printer is priced at \$945. Deliveries of both units will commence next January.

John Fluke Manufacturing Co., P. O. Box 43210, Mountlake Terrace, Wash. 98043 [351]



Digital scopes resolve

1 part in 4,096

The Explorer series of digital oscilloscopes displays signals in greater detail than other low-frequency instruments, whether they be analog

THE DSW WAFER STEPPER.™

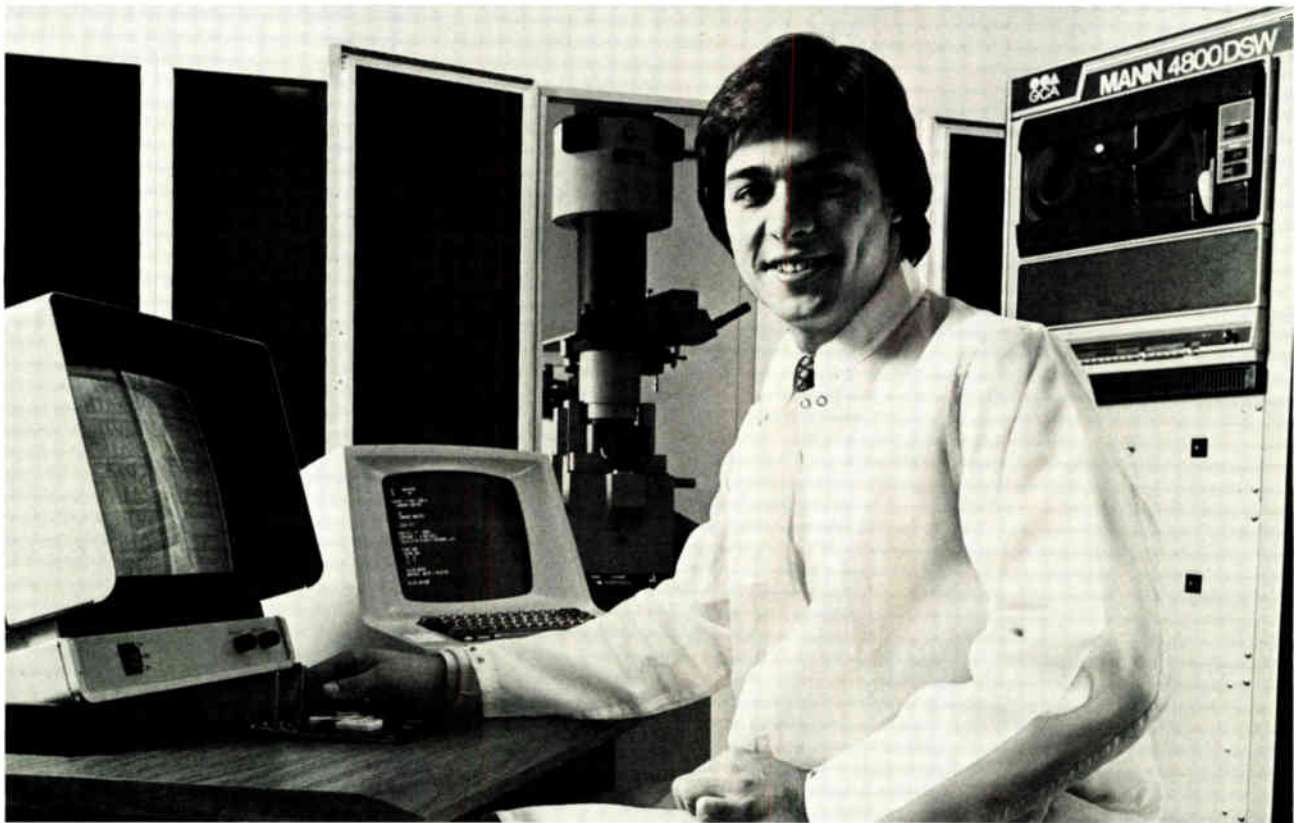

Funny thing about micro-imaging systems. A lot of them need daily adjustments. Which tend to be a daily pain.

But the DSW is painless. Once it's set to go, you can forget about daily adjustments. And because wafer handling is automatic, you can forget about that, too.

The DSW is a complex, state-of-the-art system. But for all its sophistication, it's a high throughput, high yield, day-in and day-out production tool.

It's also simple to operate and easy to

maintain. We can give you immediate, on-the-spot service, no matter where you're located. Or we can train your own people to maintain it.

Over fifty systems have already been ordered by over twenty-five IC manufacturers. If you'd like to know why, ask us for literature. If you'd like to see why, ask for a demonstration. Write Bill Tobey at GCA/Burlington, 174 Middlesex Turnpike, Burlington, Massachusetts 01803. Or call him at 272-5600. Telex: 94-9352.



**GCA CORPORATION
Burlington Division**

174 Middlesex Turnpike
Burlington, Mass. 01803
(617) 272-5600
Telex: 94-9352

*Part of the
GCA/IC Systems Group*

ONCE YOU ADJUST IT, IT JUST WON'T STOP

When you need rockers & toggles or more than rockers & toggles...



Come to the people who've always been specialists in having more good ways to solve problems: Dialight. What we've done in indicator lights, illuminated switches, readouts and LEDs, we're doing now in miniature rockers and toggles.

This new Dialight family of switches, which comes in a full range of sizes is, we're proud to point out, all-American made.

When you consider all the configurations of styles, sizes, life and safety ratings, colors and mountings, you'll find there are literally hundreds of thousands of design combinations. Such a number of possibilities

can in itself be a problem, except that the new Dialight catalog is specifically designed to prevent confusion and help you quickly and easily find the most advantageous combination of features for your applications.

If you'd like to see what Dialight quality rockers and toggles can do for the looks, durability and economics of your products, contact us today for the Dialight "Meets Your Need" Book. Your free copy will include a list of stocking distributors in the U.S. and Canada.

DIALIGHT
A North American Philips Company

Made in the U.S.A. by DIALIGHT

Dialight meets your needs.

Dialight, 203 Harrison Place, Brooklyn, N.Y. 11237 (212) 497-7600

Circle 240 on reader service card

New products

and storage scopes, XY and strip chart recorders, transient and light-beam recorders or other digital scopes.

Unlike their analog counterparts, the Explorer scopes offer resolution to 0.025% (12-bit memory words resolving 1 part in 4,096), linearity to $\pm 0.05\%$ of full scale, and rise times as fast as 50 ns. The two input channels operate simultaneously. A mid-signal trigger mode makes it possible to see the causes as well as the consequences of events.

Plug-in modules let the user measure slow signals with great precision as readily as he can capture transients speeding by. In fact, without him present, the scopes can automatically capture many signals in quick succession or sporadic signals in slow succession.

Complete standard digital interfaces include IEEE-488, RS-232-C, and parallel 12-bit binary. A built-in magnetic-disk recorder is optional. Prices start at \$3,990 for Explorer 1. Nicolet Instrument Corp., Oscilloscope Division, 5225 Verona Rd., Madison, Wis. 53711. Phone (608) 271-3333 [353]

Solid-state supply serves precision pot circuits

Intended as a replacement for the wet-cell batteries that commonly drive precision potentiometer circuits, the Trancell PPPS-6/35 solid-state power supply has to be calibrated no oftener than once a day.

The unit replaces any 6.3-v $\pm 5\%$ type battery requiring a 0-to-35-mA load current. It also has a second output level at 10 v $\pm 0.005\%$.

At the 6.3-v output, stability ranges from 1 to 2 ppm over 8 hours and from 20 to 50 ppm over a year. At the 10-v output, comparable figures are 2 ppm and 50 to 100 ppm. Inputs of 120 v at 60 Hz or 240 v at 50Hz are available.

Versions rated for the higher and lower stabilities have unit prices of \$520 and \$390, respectively. Delivery is from stock to six weeks.

Standard Reference Labs Inc., Pollitt Drive South, Fair Lawn, N. J. 07410 [357]

Dialight rockers & toggles

ROCKER AND TOGGLE SWITCHES FOR ALL APPLICATIONS

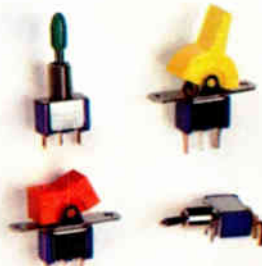

Contact Rating Information

1. Low Level: 0.4 Volt Amps Max @ 20 VAC or DC.
2. Standard: 5 Amps @ 120 VAC and 28 VDC, or 2 Amps @ 250 VAC.
3. Standard/Low Level Combination: 5 Amps @ 120 VAC/28 VDC, 0.4 VA Max. @ 20 VAC or DC.

573 SERIES PC MOUNTED TOGGLE SWITCHES



PC Mounted Toggle Switches Easy to mount . . . terminals bent at a 90° angle. Available with and without epoxy sealing . . . and with 7 types of actuators available for low, standard or low/standard levels . . . Low cost . . . Fast delivery.

PC MOUNTED ROCKER/TOGGLE SWITCHES WITH SUPPORT BRACKETS

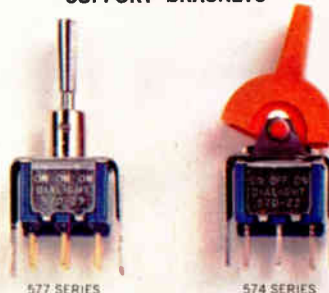

Support brackets take strain off the PC terminals . . . various types available . . . Available in all toggle, rocker and lever actuators. Available in low, standard or low/standard level ratings . . . all these variations competitively priced.

Dialight meets your needs. So talk to the specialists at Dialight, first. Send for your free copy of Dialight's current catalog today.

DIALIGHT

Dialight, A North American Philips Company
203 Harrison Place, Brooklyn, N. Y. 11237
(212) 497-7600

MINIATURE LOW COST 4½-Digit DPM



PM-450 \$114
0.02% Accuracy

- 2V/20V/200V or 1000V range
- Range-change capability.
- Automatic polarity and over-load indication.
- Programmable decimal.
- Input voltage protection.
- Less than 1" high.
- Power usage: 260 mA.

NLS products are available from Nationwide Electronic Distributors. Send for our brochure today!



Non-Linear Systems, Inc.

Originator of the digital voltmeter.
Box N, Del Mar, California 92014
Telephone (714) 755-1134 TWX 910-322-1132

Circle 242 on reader service card

Check

- Transistors
- Capacitors
- Diodes
- IC's

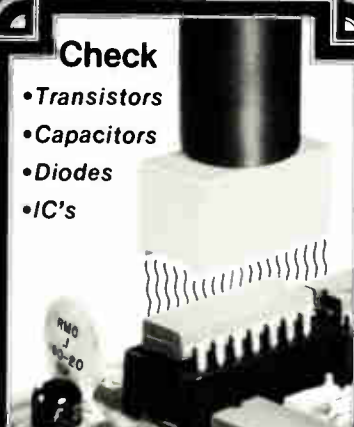

**CONTROLLED HEATING
... where it counts
THERMO-PROBE**

Heat any Integrated circuit or electronic component to its rated temperature with a heat probe. Accuracy $\pm 3^{\circ}\text{C}$ or better. Or check the component's temperature with a thermo-couple probe. Model 810 Thermo-Probe does both. Reads out directly in $^{\circ}\text{C}$ and $^{\circ}\text{F}$ on a large 4½-inch meter.

**MTI MICRO-TECHNICAL
INDUSTRIES**

P.O. Box 287 South Laguna, CA 92677
TELEPHONE (714) 545-3734
TWX 910 596-1325 MICROTECH LBEN

242 Circle 44 on reader service card

New products

Computers & peripherals

Tektronix 4054 gets refreshed

Graphics option lets users
create "objects" for
subsequent manipulation

Among the increasingly popular desktop computers, the five-month-old Tektronix 4054 is one of the most appealing for engineers and scientists because of its high-resolution graphics capability [*Electronics*, March 29, p. 125]. Now the 4054 can handle dynamically refreshed graphics as well.

The new dynamic graphics option lets users create so-called objects—any combination of lines and alphanumerics—and then manipulate them either under control of a program or interactively with the user. These objects are not stored on the 4054's 19-inch direct-view storage tube, but rather are refreshed at a rate of 37.5 Hz.

The secret to this capability is a separate circuit board containing a Signetics microprocessor and some 32 kilobytes of random-access mem-

ory, which stores the dynamic object and handles its refresh. Refresh is achieved in Tektronix' two-gun storage cathode-ray tube by moving the writing electron beam three times faster than normal to write an image intense enough to be seen but not stored. This technique is similar to that used with some of the company's other tubes.

As many as 1,000 vectors averaging one-half centimeter in length or up to 180 characters can be displayed flicker-free, the company says, but the refresh board can hold twice as many objects in its memory, providing a library of images. Extra instructions added to the Basic programming language offered with the 4054 control the operation of the refresh board.

Tektronix' 4050 series product line manager Miki Tokola says the graphics option will particularly enhance the 4054 for engineering design applications. Many design problems, he notes, involve configuring standard components, such as circuit elements, in a schematic diagram.

"With the dynamic graphics option the 4054 packs a lot of power on a desktop," he says.

The Dynamic Graphics option is priced at \$2,500, while the basic 4054 with 32 kilobytes of random-

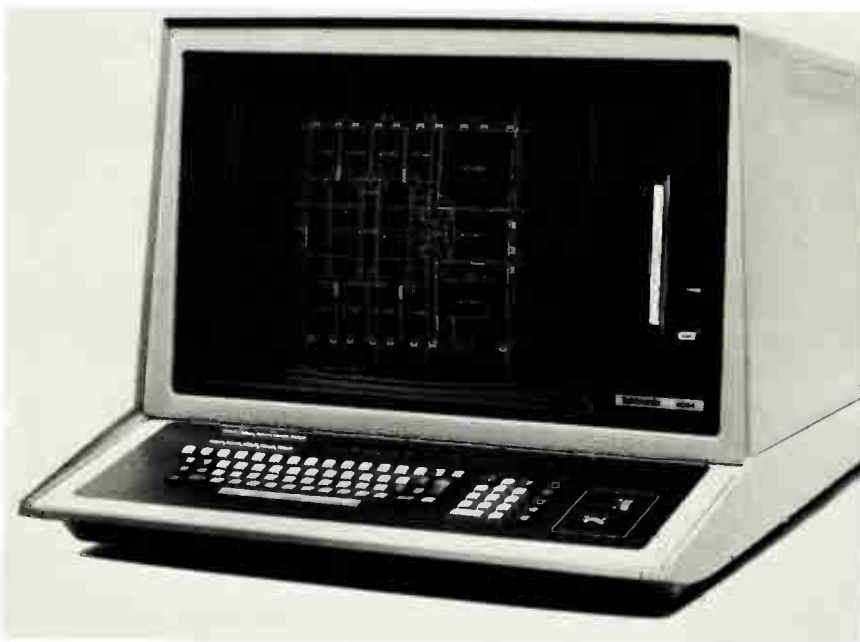

Electronics / August 30, 1979

Keep every one under your thumb.

C & K gives you an unqualified "thumbs-up" to design and function with a full line of front or rear mounted thumbwheel switches. Each thumbwheel is a switch unto itself or the sections may be mounted side by side to meet your most complex switching needs. They're available in single and double pole versions with seven different color wheels to choose from.

The latest additions to our thumbwheel line include a "16 position; Binary Coded Hexadecimal" and a "BCD w/separate Common-to not true bits."

Write to us today! We'll send a catalog to thumb through that is sure to keep you switching our way.



The Primary Source Worldwide.

C&K Components, Inc.

15 Riverdale Avenue, Newton, MA 02158

Tel: (617) 964-6400, TELEX: 92-2546, TWX: 710-335-1163



ML-10 MINILOGGER

LOW COST, LOW POWER PORTABLE DATALOGGER WITH LARGE SYSTEM CAPABILITY



- 10 Analog Channels
- 32 Digital Inputs
- Digital Clock
- Digital Readout
- Datasheet Recording
- RS232 Output
- Battery Operation
- Printer Option

WESCON booth #1347

A. D. DATA SYSTEMS, INC.
200 COMMERCE DR. • ROCHESTER, N.Y. 14623
PHONE 716-334-9649 • TWX 510-253-3246

Circle 244 on reader service card

New products

access memory sells for \$16,500.

Tektronix Inc., Information Display Division,
P. O. Box 500, Beaverton, Ore. 97077.
Phone (503) 682-3411 [411]

Structured Fortran grows from ANSI 77 standard

Increasingly, minicomputer vendors are beefing up their software offerings to meet the needs of systems builders and original-equipment manufacturers. The latest of these is Systems Engineering Laboratories Inc., which has introduced a software family intended to "provide better tools to reduce the software development costs of our users," says Michael Resnikow, software product manager.

Most interesting among the new software packages is the Fortran 77+ compiler, said to surpass the recent ANSI 77 standard [*Electronics*, Aug. 16, p. 155]. The compiler is one of the first to employ the so-called structured programming features of the new standard, offering the program techniques that are popular in new structured languages such as Pascal.

Operating with these compilers are two scientific run-time libraries containing often-used—but complex—mathematical routines already programmed into more efficient assembly language. The second of these, the scientific accelerator, further improves system performance by programming the most frequently used routines into micro-code, which is then held in an add-in control-store board.

One-time, single-system license fees for object-code copies of the software packages are: \$5,700 for the new Fortran 77+ compiler; \$1,700 for the scientific run-time library; and \$2,700 for the scientific accelerator, which requires either read-only-memory control-store hardware, priced at \$4,500, or a writeable control-store board, selling for \$8,000.

Systems Engineering Laboratories, 6901 W. Sunrise Blvd., Fort Lauderdale, Fla. 33313.
Phone (305) 587-2900 [412]



Fantastic!

5V AND 12V Resistor LED'S In Red, Yellow, Green

Xciton's Resistor LED Lamps, 5 and 12 Volt series, incorporate an internal current limiting resistor. Available in the popular T-1 and T-1 3/4 packages, these devices provide savings in PC Board space, assembly costs, and parts inventories.

Operating directly from a 12V supply, the 12V series provides easy interface to CMOS and finds wide application in the computer, automotive, and marine accessory market. This series may also be used at reduced voltages to provide low current (2.5mA @ 5V), high readability status and fault indicators.

The 5V series is designed to operate directly from 5 Volts D.C. and provide interface to TTL.

What About Price and Delivery?

Try Us. An integrated quality assurance and engineering support program assures timely delivery of product with an average 8 week lead time. Prompt quotations, competitive pricing, accessible technical assistance, plus unmatched product service with a one year warranty — is what Xciton is all about. Catalog, spec sheet, and free samples are available from the factory direct. Let Xciton make your Resistor LED Lamps.

Xciting
Xciton

Call Cliff Jurus
Xciton Corporation
Shaker Park, 5 Hemlock Street
Latham, New York 12110
(518) 783-7726, TWX: 710-444-4962

244 Circle 45 on reader service card

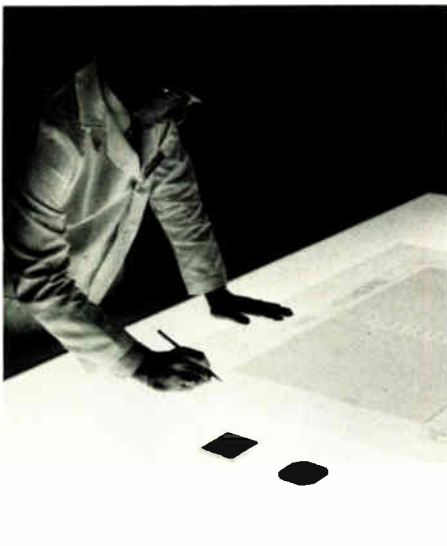

Ultratech counts on Culligan ultrapure R/O water for precision manufacturing

Water purity is an absolute must for Ultratech of Santa Clara, California. Their only business is the manufacturing of photo masks for integrated circuit production. Even the smallest impurity in the emulsion can cause rejection of the end product.

So Ultratech relies on a Culligan-designed system to prevent any impurities from endangering this precise manufacturing process. Included is filtration, softening, deionization, reverse osmosis, ultraviolet light sterilization and submicron filtration.

The importance of this system is pointed out by Ultratech's emulsion production manager, David Lee. "Any serious problem with the quality of our water could possibly cause us to lose a valuable customer, not just a few rejects."

Culligan even installed conductivity monitors to make sure quality water standards are maintained. And a Culligan dealer is always nearby to handle emergencies at once.

Culligan Offers 2 Types of "State of the Art" Reverse Osmosis Membranes — cellulose acetate and hollow fiber.

Culligan's patented COR-FLO™ module solves previous size limitations for spiral wound cellulose acetate membranes—produces more high quality water in the available space. Removes up to 95% of total dissolved solids, organics, even most bacteria.

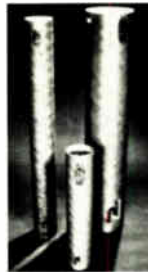

The DuPont PERMASEP® hollow fiber modules, for large applications produce quality water with up to 95% of the total dissolved solids, and most organics and bacteria removed. Proven design simplicity.



Culligan Aqua-Clear® S Series. Low cost, fully automatic ultra-filtration at 20, 50, 100, 200 and 300 gallons per day.



Aqua-Clear® M, MC, MD Series. Quality water—high bacteria and organic rejection, at 500 to 6000 gallons daily.



Aqua-Clear® KD Series. For high volume applications requiring ultra-filtration at 8000 to 140,000 gallons a day.

Your Inquiry is Welcome—To find out how Culligan can add precision to your manufacturing process, call your local authorized Culligan dealer. Or contact Greg Montgomery at Culligan USA. Phone 312/498-2000. Or mail the coupon.

Greg Montgomery, Culligan USA

9A21

Northbrook, Illinois 60062

I would like to know more about Culligan water treatment.

Have representative call Send literature

NAME

TITLE

COMPANY

PHONE

ADDRESS

CITY, STATE, ZIP

Water Treatment Application



Culligan®

WE TREAT WATER SERIOUSLY™

Circle 245 on reader service card

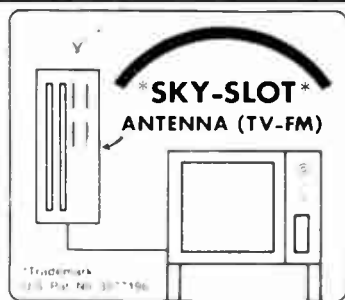

COLOR TELEVISION AND RADIO FM ANTENNA

Patented rollable slotted array design with PERFECT COLOR BAND-WIDTH. Uses no masts, no dangerous Rabbit Ears or plugging to AC lines; and NO SIGNAL SPLITTERS, since the UHF-VHF-FM terminals are available (AND USABLE) at the same time. CAN BE USED OUTSIDE IF YOU GUNK TO SURFACE FACING BROADCASTING STATION'S ANTENNA. Made of heavy decorative plastic burflap (metal slots not seen) rugged enough for YACHT or RV. OPTIONAL plain plastic or with acrylic painting of a GALAXY by artist. Antenna size is 18" x 48" (long side hangs vertically). Standard TV twin-line (300 ohm) furnished. NOTHING ELSE TO BUY OR NEEDED TO INSTALL, just hang on wall and you have a 40 mi. range (6 db. above dipole) antenna. ORDER POSTPAID BY CO., insured, airmail, GUARANTEED, for \$24 for plain model or \$44 for antenna with hand-made GALAXY OR LANDSCAPE OR HANDING BRANCH. Send check or M.O. to:

30-DAY MONEY—BACK GUARANTEE!
WE ACCEPT MASTER CHARGE, VISA

NAME _____
ADDRESS _____
CITY _____ STATE _____ ZIP _____
TEL # _____ AMOUNT _____
CHECK MASTER CHARGE VISA
CARD NO. _____ EXP. DATE _____
SIGNATURE _____

SKY-SLOT ANTENNA DESIGN CO.

11621 Hughes Ave. NE
Albuquerque, NM 87112

PS: Antenna can be DC grounded for SAFETY!!!

"TURN-KEY"

Test Generation Services

offers you many advantages

- No capital investment.
- Economical rates
- Accurate accounting of Test Generation costs
- Eases internal manpower requirements.
- Firm fixed price quotations (Easy to budget/forecast).
- Fast turn around
- Test programs are easily updated
- Complete documentation of test program quality and content
- Processed in a format to be compatible with your ATE (in most cases)
- Produced to your test requirements.

With minimal information supplied by you

Accurate circuit schematics
Parts list/identification
ATE which test program will reside.
ROM Data or Custom LSI Data.
Test Requirements (i.e., percent detention, etc.)

SMC will provide you with a comprehensive S-LASAR test program. Write or call us for further details.

SMC

SCIENTIFIC MACHINES CORPORATION

2636 Walnut Hill, Suite 200
Dallas, Texas 75229
(214) 357-9343 - Telex 73 2662

New products

Power supplies

Module supplies 3 A at 5 V dc

Switching power supply
delivers 15 W from line
input at 80% efficiency

Efficiency in a small package is the name of the game in switching power supplies today. And Datel/Intersil of Mansfield, Mass., has recently unveiled a supply that may have the highest guaranteed efficiency in the market—a minimum of 80%. Typically a switcher with 75% to 80% efficiency is good, but the USM-5/3 appears to take up where others leave off.

The switcher is a 15-w, line-operated module yielding 5 v dc at 3 A. It is fully encapsulated in a standard potting cup measuring 2.5 by 3.5 by 1.25 in. At 80% efficiency, only 3.75 w is dissipated as heat, and according to Datel spokesmen, case temperature does not exceed 28° C under full load. In order to achieve this level of efficiency, the module utilizes Schottky rectifiers, a mono-

lithic switching regulator, and also inductors that are designed to minimize iron losses. The circuit uses a push-pull, pulse-width-modulation approach and a switching frequency of 20 kHz minimum.

Line-voltage inputs can vary from 90 v to 130 v ac between 47 Hz and 450 Hz. Worst-case output ripple is 50 mV peak to peak maximum—about 14 mV rms—and can easily be removed with a small capacitor to ground. Output voltage is within 1% of 5 v, with overvoltage protection that cuts in at 6.5 v through a silicon-controlled-rectifier crowbar circuit. There is also current limiting over an indefinite period. Turn-on and turn-off are "soft"—there is no voltage or current overshoot, either of which might harm logic circuitry.

Regulation is 0.05% line and 0.1% load, and because of low internal heat dissipation and careful parts selection, the voltage temperature coefficient is only 0.02%/°C.

Normal operating temperature range is -25° to +71° C, with power output derating at 2%/°C above 55° C.

The unit's transient response is also worthy of note: the output voltage will vary less than ±200 mV for a 100% load change and it will typically recover to within 1% of the

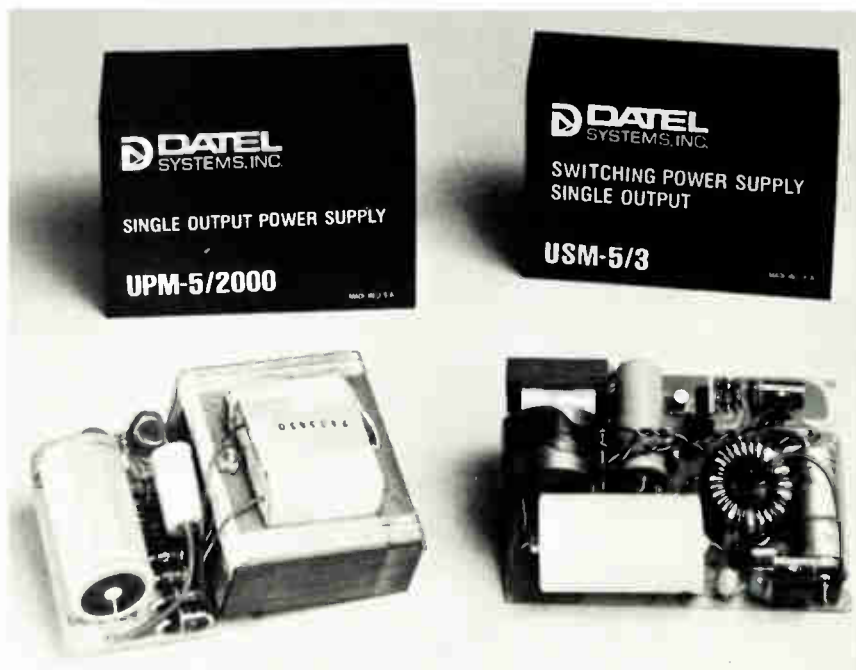

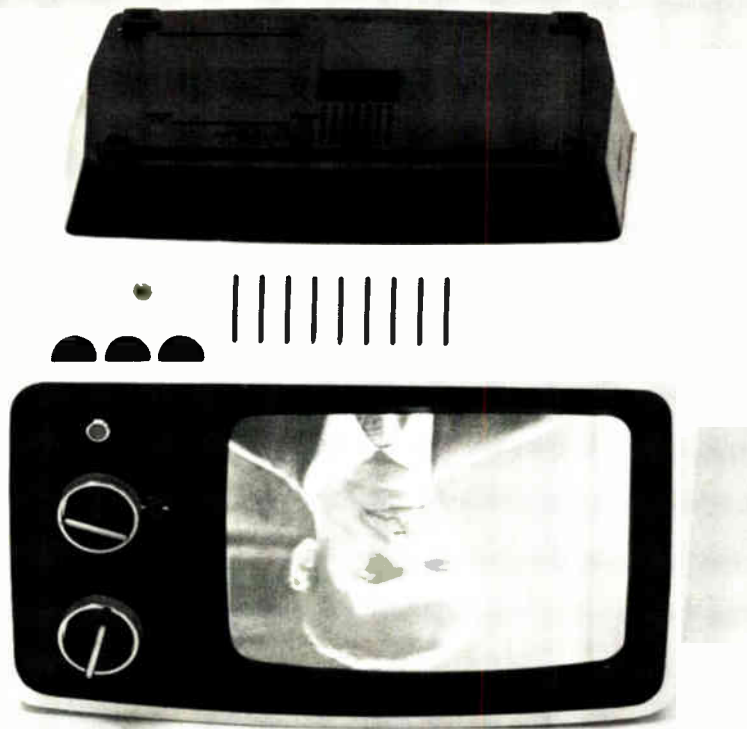

WHO IN HIS RIGHT MIND WOULD PUT A LEAD-ACID BATTERY IN A TV?

Lead-acid batteries leak. And gas. And corrode. And, traditionally, have all sorts of bad habits.

So, who'd ever design one into a portable television, or any other critical application, where it could do its worst?

Designers who know about Gates Energy, that's who. Because we've developed the sealed lead-acid cell to the point where it's almost faultlessly safe and reliable.

Our cells operate in any position without leaking. They're safe and predictable in temperatures ranging from -65°C to $+65^{\circ}\text{C}$.

Performance, frankly, is outstanding.

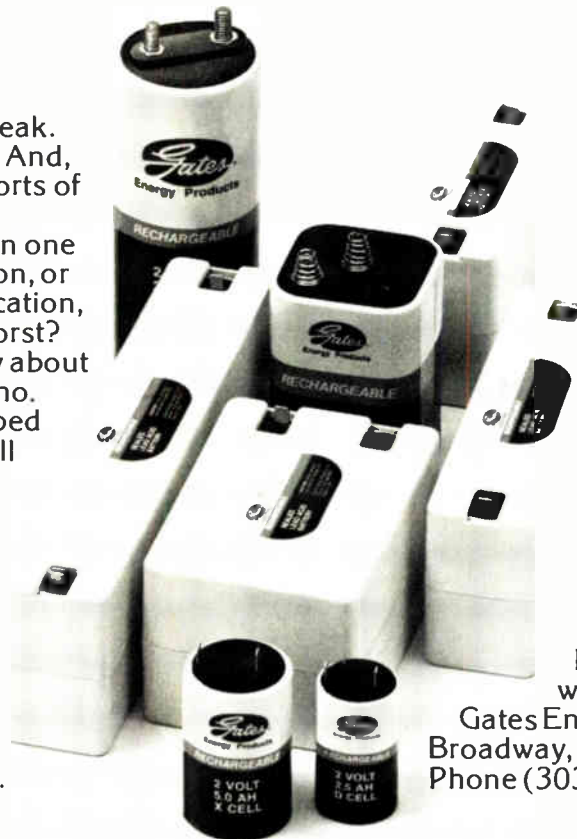

Expect hundreds of discharge cycles. Dependable, simple charging for both float and cyclic applications. No memory problems.

It all adds up to overall product reliability.

Just what every designer in his right mind has in mind when he tackles a new product's design.

Learn more about Gates Energy cells and batteries. Send for our comprehensive information packet full of design data, spec sheets and application notes. Circle our Reader Service number, or write us directly.

Gates Energy Products, Inc., 1050 South Broadway, Denver, CO 80217.
Phone (303) 744-4806.

GATES ENERGY

HAVE ENGINEER CALL 247
SEND LITERATURE 250

If it has to do with heat dissipation, it has to do with us.

EG & G Wakefield Engineering is your source for heat sinks and thermal products. We have the largest inventory of off-the-shelf heat sinks including extrusions and stampings as well as proven custom-design capabilities. Our extensive distributor network, east and west coast manufacturing facilities, reliable service and competitive prices are second to none.



That's why . . . if it has to do with heat dissipation . . . people throughout the electronics industry call EG & G Wakefield Engineering.

EG&G WAKEFIELD ENGINEERING
60 Audubon Rd., Wakefield, MA 01880 (617) 245-5900

Circle 67 on reader service card

New products

nominal value in 300 μ s.

The price of the USM-5/3 is \$98.50, in quantities of one to nine. Delivery is from stock.

Datel/Intersil, 11 Cabot Blvd., Mansfield, Mass. 02048. Phone (617) 828-8000 [391]

Switchers provide high currents at low voltages

Two switching regulator power sources that provide up to three dc-output channels are specifically designed for high-speed emitter-coupled-logic (ECL) systems, which require low voltages at high currents. Models PM2677A and PM2678A offer typical ECL main channel outputs of -2 v at 200 A or -5.2 v at 150 A. The second channel has characteristic ratings of -2 v or -5.2 v, either at 30 A, with the third channel having outputs between 5 and 28 v at either 5 or 7 A.

The PM2677A has a maximum

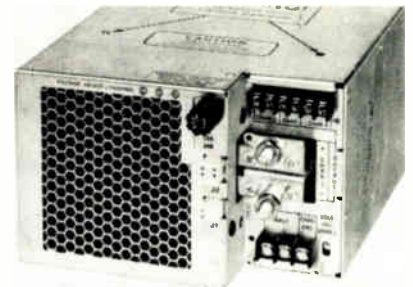

power level of 750 w, whereas the PM2678A is rated at 850 w. The Underwriters-Laboratories-recognized power sources supply outputs regulated to within 2% at full load over input voltage ranges of 92 to 138 v rms or 184 to 250 v rms. Extreme brownout protection is featured by both models, which operate efficiently for extended periods at inputs as low as 80 v ac or 160 v ac, depending on input voltage. Paralleling capability and protection from overvoltage are among the standard features. Operating temperature ranges from 0° to 50°C at full load with derating to 80% to 70°C.

Price is \$793.00 for the PM2677A and \$866.00 for the PM2678A in quantities of 1 to 24. Delivery time

NJE



Send For Catalog 578

All Products Completely Mfrd. In The U.S.A.

A Division Of Technology Development Corp.

POWER SUPPLIES

STANDARD & CUSTOM

- FERRORESONANT •
- SWITCHER-REGULATED •
- SERIES-REGULATED •

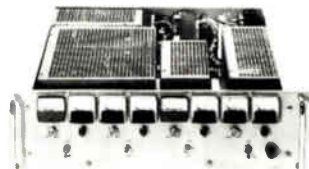

- POWER SYSTEMS •

NJE

P.O. BOX 50 E
DAYTON, NJ - 08810
(201) 329-4611 • TWX 710-480-5674

Climb to new heights in performance

Switch to Semikron's quality/precision-built power semiconductors

Semikron has the product and power range to meet your application — and of course on-time delivery.

Twenty-eight years of innovative design and manufacturing of power semiconductors has pivoted us to the number one position in Europe. Presently our new plants in Hudson, New Hampshire, and Inglewood, California are gearing for full production to assure you of on-time delivery.

Semikron's product line comprises: discrete semiconductors (thyristors and diodes) from 1 to 2000A to frequencies of 10 KHz and 3000V — including high speed fast recovery diodes and thyristors • controlled and non-controlled power modules (SEMIPACK®) •

avalanche and high voltage diodes • controlled avalanche bridges • single and three phase bridge modules, triacs, rectifier assemblies, and heat sinks. •

Write or call today on your specific requirement/ brochure.

SEMIKRON

INTERNATIONAL INC.

In North America SEMIKRON INTERNATIONAL, INC.
11 Executive Drive / Hudson, NH 03051 / U.S.A. / Tel: 603 883-8102

In Europe SEMIKRON INTERNATIONAL / Dr. Fritz Martin GmbH & Co. KG
Sigmundstrasse 200 / Postfach 61 / D-8500 Nurnberg 113 / Germany
Tel: (0911) 6559-1

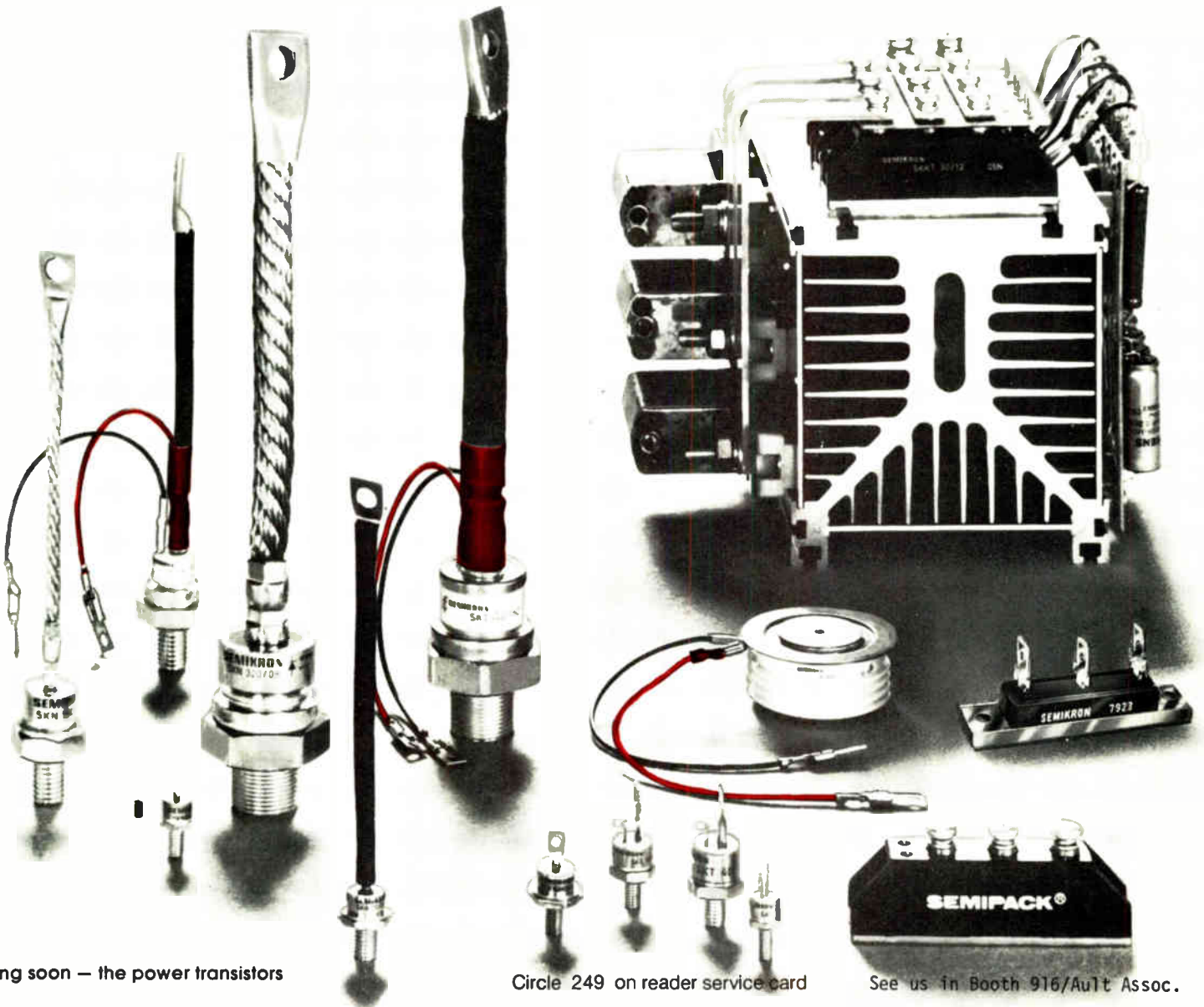

Coming soon — the power transistors

Circle 249 on reader service card

See us in Booth 916/Ault Assoc.

Electronics Magazine Books Offers You:



- 1. Microprocessors** What you must know about available microprocessor technology, devices, information, 4th printing. \$8.95
- 2. Applying Microprocessors** 2nd and 3rd generation technology. 26 detailed applications from data networks to video games. \$9.95
- 3. Large Scale Integration** Covers the basic technology, new LSI devices, LSI testing procedures, plus system design and applications. \$9.95
- 4. Basics of Data Communications** Includes 47 articles from Data Communications magazine covering more than 11 key areas. \$12.95
- 5. Circuits for Electronics Engineers** Contains 306 circuits arranged by 51 functions from Amplifiers to Voltage Regulating Circuits. Saves design drudgery. \$15.95
- 6. Design Techniques for Electronics Engineers** Nearly 300 articles drawn from "Engineer's Notebook." A storehouse of design problem solutions. \$15.95
- 7. Memory Design: Microcomputers to Mainframes** The technology, devices, and applications that link memory components and system design. \$12.95
- 8. Personal Computing: Hardware and Software Basics** More than 50 articles from leading publications, including specifications, helpful hints, subject index. \$11.95

Electronics Magazine Books P.O. Box 669, Hightstown, NJ 08520
I must be fully satisfied or you will refund full payment if the book is returned after ten-day trial examination. Send me:

- _____ copies of 1. *Microprocessors* @ \$8.95
- _____ copies of 2. *Applying Microprocessors* @ \$9.95
- _____ copies of 3. *Large Scale Integration* @ \$9.95
- _____ copies of 4. *Basics of Data Communications* @ \$12.95
- _____ copies of 5. *Circuits for Electronics Engineers* @ \$15.95
- _____ copies of 6. *Design Techniques for Electronics Engineers* @ \$15.95
- _____ copies of 7. *Memory Design: Microcomputers to Mainframes* @ \$12.95
- _____ copies of 8. *Personal Computing: Hardware and Software Basics* @ \$11.95

Discounts of 40% on orders of 10 or more of each book.

Payment enclosed Bill firm Bill me

Charge to my credit card:

American Express Diners Club
 Visa Master Charge

Acct. No. _____ Date Exp. _____

On Master Charge only, first numbers above name _____

Name _____ Title _____

Company _____

Street _____

City _____ State _____ Zip _____

Signature _____

New products

for both supplies is about 12 weeks. Pioneer Magnetics Inc., 1745 Berkeley St., Santa Monica, Calif. 90404. Phone Bob Friedman at (213) 829-6751 [393]

50-W switching power supply has 70% minimum efficiency

A switched-mode power source supplies the user with 50 w (5 v at 10 A) of regulated dc power and achieves a minimum efficiency of 70%. The SR1.5.10's load regulation is $\pm 0.1\%$ for a 10% to 100% load change at constant line. Line regulation is $\pm 0.1\%$ for 95 to 130 v or 190 to 260 v line change at constant load. Ripple is 50 mv p-p (from 0 to 30 MHz).

The unit features soft-start circuitry and overvoltage protection set to limit at 6.8 to 7 v. The output is current-limited at about 120% of full load current. The SR1.5.10 is priced at \$149.00.

Calex Manufacturing Co., 3355 Vincent Rd., Pleasant Hill, Calif. 94523. Phone Ron Kreps or Nick Stephens at (415) 932-3911 [394]

76-87% efficiency reported in 200-W power supplies

Two versions of a 200-w, ac-to-dc single-output power supply have an efficiency of 76% to 87%. One version is for commercial, the other for military applications. There are five models in each series, ranging from 5 to 48 v dc output. The commercial units are designed for a single-phase input with 115 v ac, 47 to 440 Hz; the military versions are for three-phase 115 v ac, 400 Hz.

Line regulation is $\pm 0.1\%$ maximum for a $\pm 10\%$ change in line voltage. Load regulation is 0.1% maximum. Ripple and noise are either 100 mv or 1% peak to peak, whichever is greater. The commercial version sells for \$645.00, the military type for \$825.00, with delivery in 10 to 12 weeks.

Century Electronics, 5965 Washington Blvd., Culver City, Calif. 90230. Phone (213) 838-1806 [395]

MICRO POWER

Microcomputer with printer - \$375. That's Rockwell Micropower.

For learning, designing, work or just fun, Rockwell's AIM 65 microcomputer gives you an easy, inexpensive head start.



- 20-Column Printer and Display
- Dual Cassette, TTY and General-Purpose I/Os
- R6502 NMOS Microprocessor
- System Expansion Bus
- Read/Write RAM Memory
- PROM/ROM Expansion Sockets
- Advanced Interactive Monitor Firmware
- Big Terminal-Style Keyboard

For more on AIM-65 and how you can develop programs in assembly language or BASIC, write Microelectronic Devices, Rockwell International, D-727-F4, P.O. Box 17479, Irvine, CA 92713 or phone (714) 632-3729, or contact your local Hamilton-Avnet office.



Rockwell International

...where science gets down to business

New!! 30 MHz!! MINISCOPE

From



MS-230 **\$559**

- 30-megahertz bandwidth.
- External & internal trigger.
- Line synchronization mode.
- Power usage: less than 50W.
- Rechargeable batteries and charger unit included.
- 2.9" H x 6.4" W x 8.5" D.

NLS products are available from Nationwide Electronic Distributors. Send for our brochure today!



Non-Linear Systems, Inc.

Originator of the digital voltmeter.
Box N, Del Mar, California 92014
Telephone (714) 755-1134 TWX 910-322-1132

Circle 252 on reader service card

MOVING?

Please give us 4 weeks advance notice. Attach the label for your old address, write in your new address below, and send to Fulfillment Manager, Electronics, P.O. Box 430, Hightstown, N.J. 08520.

OLD
ADDRESS
LABEL

NEW ADDRESS

Name _____

Address _____

City _____

State/Province _____

Zip/Postcode _____

Country _____

New products

Components

LCD shows any color

Fast-switching dichroic dye display uses no polarizers, can be viewed over 180°

Conventional liquid-crystal displays, which are based upon twisted nematic materials, suffer from several problems: their polarizers limit their viewing angles and make them sensitive to humidity, they are fairly slow, and they do not lend themselves readily to multicolor displays. A new dichroic dye LCD from Integrated Display Systems Inc. overcomes these problems because it operates on an absorption, rather than a polarization, principle. As Derick Jones, IDSI's manager of the LCD operation puts it, "The new display, essentially, is a light valve. It is opaque in the off state, appearing black when exposed to incident light.

With an applied field, the LCD becomes transmitting, showing the color [or colors] of the reflector."

According to Jones, although others have produced dichroic dye LCDs before, IDSI's is the first that is truly opaque in the off state. The others, he explains, were colored and were therefore limited in the background colors they could accommodate. The new display, being black, can mask any color and may therefore be used with any color reflector. An example of the usefulness of this property is illustrated by a speedometer dial his company is trying to sell to auto makers. It shows speeds up to 55 mph in white, speeds from 55 to 65 in amber, and speeds above that in red.

The operation of the dichroic dye display involves a phase change from the cholesteric state, in which the dye absorbs light, to the nonabsorbing nematic state. Because no polarizers are needed, the viewing angle is essentially 180°. Eliminating the polarizers brings an additional bonus—freedom from humidity problems.

The display's turn-on and turn-off

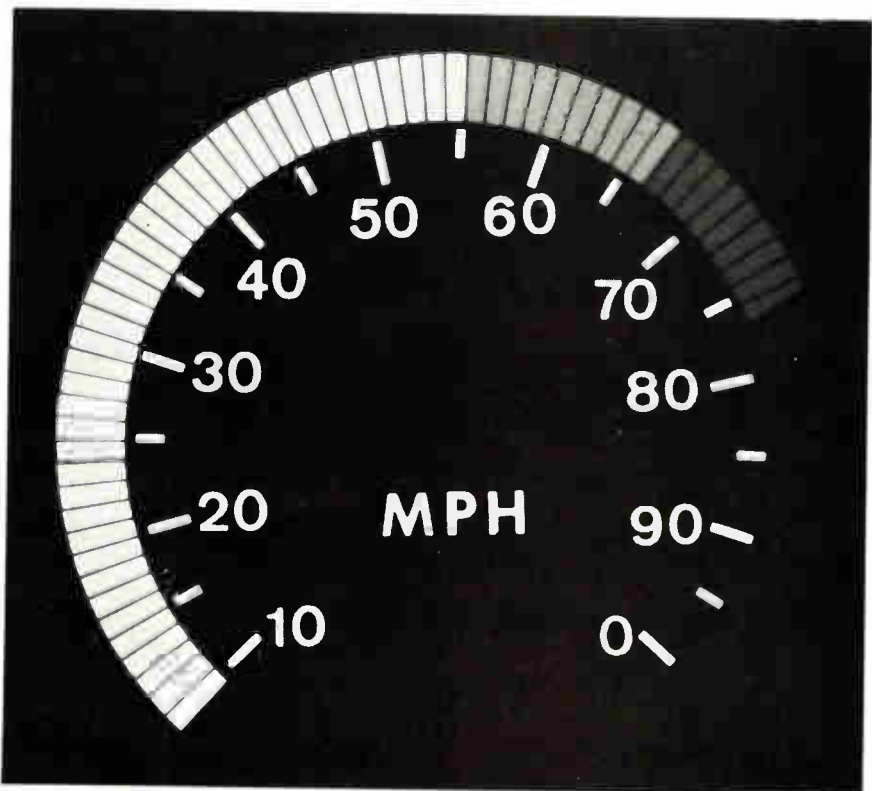

Everything you need to know about flat cable/ connector systems.

To save space. To increase circuit flexibility and reliability. To lower total installed cost. To profit from the state-of-the-art in mass termination.

T&B/Ansley offers you the industry's broadest line of flat cable/connector systems. That's because we've been flat cable specialists for decades, and we were pioneers in the development of cost effective mass-termination techniques for volume production and ease of assembly.

Now we're also offering an engineering specification bible that tells you everything you need to know about mass-termination cable/connector systems.

That includes connectors, headers, mounting hardware. It includes round and flat conductor flat cable, as well as jacketed and shielded jacketed cable. It includes our MICRO-PITCH line, which is ideal for mass termination in high density, controlled impedance applications. And our FLEXSTRIP® Jumpers, the most flexible, reliable components available for interconnecting one circuit board to another.

It includes a complete line of hand and bench tools for volume installations, small production runs, or field service applications.

And a great deal more. And it's free. So you'll never get a better offer. Call or write today.

T&B / Ansley

The mass termination company.

T&B/Ansley Corporation
Subsidiary of Thomas & Betts Corporation
3208 Humboldt St. • Los Angeles, CA 90031
Tel. (213) 223-2331 • TELEX 68-6109
TWX 910-321-3938

Stocked and Sold through Authorized
Ansley Distributors.

Circle 253 on reader service card



Send for your free copy today!

International T&B/Ansley Offices: AUSTRALIA, Brookvale, (02) 938-1713 • AUSTRIA, Vienna, (222) 645206 • CANADA, Iberville, Quebec, (514) 347-1014 • ENGLAND, Luton, (0582) 597-271 • FRANCE, Rungis, 687-23-85 • HOLLAND, Zoetermeer, (79) 214688 • ITALY, Milano, 02-4986451 • JAPAN, Tokyo, 03-354-9661 • SINGAPORE (65) 2923711 • SOUTH AFRICA, Benrose 24-8134 • SPAIN, Barcelona, (93) 212-8607 • SWEDEN, Upplands Vasby, 0760-86140 • SWITZERLAND, Hombrechtikon, (04155) 422791 • WEST GERMANY, Dreieich bei Frankfurt, 06103-8 20 21

$T_{R10}^{90} \approx 2.2 (R_s + R_L) (C_J + C_{MOS} + C_{PKG} + C_{EXT})$

$T_R < 10 \text{ nSec}$

$T_{RC} = 2.2 (R_s + R_L) (C_J + C_{MOS} + C_{PKG} + C_{EXT})$

$T_{diff} = (D \cdot A) / d = 0.35 \sqrt{pn} (V_0 + V_B) 10^{-4} \cdot 2$

$T_{R10}^{90} \approx 0.35 \sqrt{pn} (V_0 + V_B) 10^{-4} \cdot 2$

$T_{R10}^{90} \approx 0.35 \sqrt{pn} (V_0 + V_B) 10^{-4} \cdot 2$

HIGH-SPEED SILICON PHOTODIODES

HIGH RELIABILITY, EXCELLENT LINEAR RESPONSE, AND DELIVERY FROM STOCK.

High-speed silicon planar diffused photodiodes from Applied Solar Energy Corporation offer the engineer 10 nS rise times, 9 decades of linearity, NEPs to $8 \times 10^{-14} \text{ W/Hz}^{1/2}$, and a choice of six active areas. They are ideal for use with fiber optics or as instrument detectors.

For complete information contact Optoelectronics Group, Applied Solar Energy Corporation, (formerly OCLI Photoelectronics Division), 15251 East Don Julian Road, City of Industry, CA 91746. Telephone (213) 968-6581. TWX (910) 584-4890.

Applied Solar Energy Corp.

Circle 254 on reader service card

MANAGER:

NEW PROGRAM

THIN FILM METALIZATION REQUIREMENT?

Engineering/Development
Process/Product
Prototype/Production

TimAu **CrCu**

Sapphire **TiCu**

TiAu **TnMoAu**

CrCu **Plastics**

BeO **Custom**

MoAu **Vitrium**

Quartz **Iron Garnet**

If your upcoming program is as complex as most in this day and age, and if that program requires THIN FILM metalized materials of any kind—then our 17 years in the microelectronics business, with many man/years of accumulated Managerial and Engineering experience could add confidence that one element of your project is resolvable to a high probability of success. Our management experience has shown that the earlier our professional team develops a working relationship with the program and design professionals of our customer, the higher the degree of success at the outcome.

Thus, if your program is now in the concept stage and the need for THIN FILM technology has been identified or is being considered, then call us and delete one risk from that complex program.

Best Regards,
Don Gortney
Don Gortney
Division Manager

The THIN FILM Leaders

Mii **MICROPAC INDUSTRIES, INC.** **Mii**
Thin Film Microelectronics Division

905 E. Walnut St.
Garland, Texas 75040

214/272-3571
TWX 910-860-5186

254 Circle 143 on reader service card

New products

times are fast—about 50 ms at room temperature and less than one second at -30°C . The display will operate at temperatures as high as 85°C .

Integrated Display Systems Inc., Montgomeryville, Pa. 18936. Phone Derick Jones at (215) 368-8050 [341]

Crystal-clock oscillators cover 250 kHz to 25 MHz

A new series of hybrid crystal-clock oscillators come in frequencies ranging from 250 kHz to 25 MHz. The VF 150 series oscillators have a resistance-welded miniature dual in-line package configuration that combines thick-film hybrid technology with a quartz crystal element for a frequency stability of 0.01% per year on a lifetime basis.

The TTL output of the oscillator has a symmetry of better than 60/40 with rise and fall times of less than 10 ns. It can drive as many as 10 TTL gates while operating with a power supply of $+5 \text{ v dc} \pm 10\%$. Depending on the frequency, the price for 100 pieces ranges from \$8.45 to



\$11.75. Delivery is currently four to six weeks.

Valpey-Fisher Division of Valtec Corp., 75 South St., Hopkinton, Mass. 01748. Phone Neil Bernstein at (617) 435-6831 [343]

10-segment LCD bar graph highlights trends

A liquid-crystal-display bar graph that translates analog inputs into digital form numbers its 10 segments with the numerals 1 through

Electronics / August 30, 1979

Electronic Film Materials:

Engelhard produces more kinds of film materials than anyone else in the world... and we've been doing it for a long time.

Precious Metal Powders — Gold, Platinum, Palladium and Silver. Available in pure form, or as alloys and sub-micron mixtures with wide ranging capabilities in selection and control of surface area. Average particle size in the one to five micron range.

Electronic Inks — Used in Hybrid Microelectronics and stacked ceramic capacitors. They

include gold platinum, silver platinum, silver palladium, palladium, platinum and gold conductors; zero-flow multi-layer and overglaze inks; rely-ohm high stability resistor inks and organic coatings.

Metallo-Organics — This remarkable *thin film* is obtained by using thick film processing suitable for the screen printing, spraying, or brushing of all precious metals and their alloys. Flat surfaces, porous internal surfaces or even gauze can be coated.

Industrial Silver Inks — Used in products as diversified as *bronze baby shoes and automobiles!* Available in very large or very small volumes for room temperature curing or high temperature sintering.

Next time *you're* involved in electronic film application, make the one call that gets results. Call (201) 589-5000.

ENGELHARD

We're the only one!

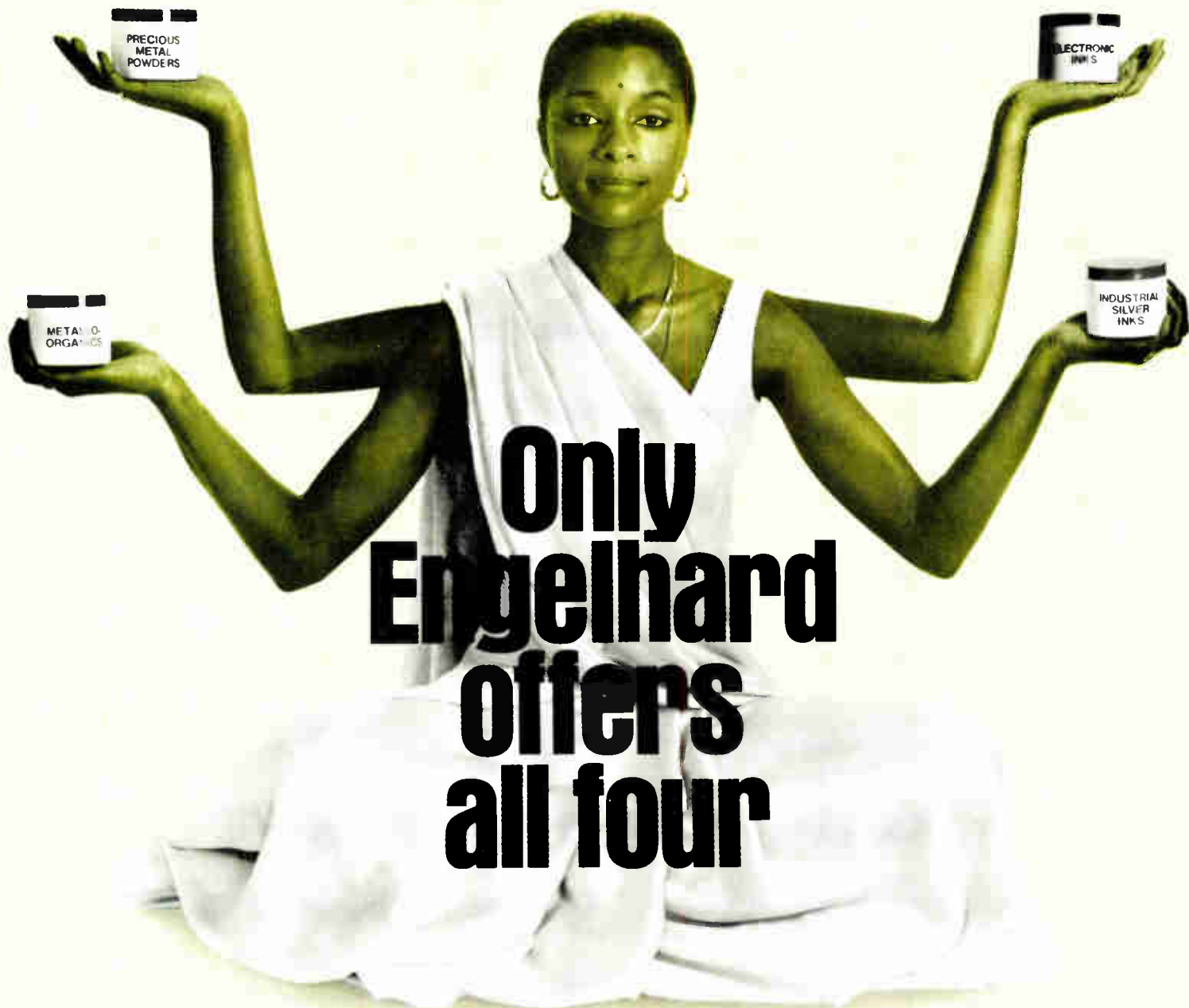

Only
Engelhard
offers
all four

ENGELHARD

HANOVIA THICK FILM
ENGELHARD INDUSTRIES DIVISION
ENGELHARD MINERALS & CHEMICALS CORPORATION
1 WEST CENTRAL AVENUE, EAST NEWARK, N. J. 07029

An Equal Opportunity Employer

Circle 255 on reader service card



More
than
just a
tool box.

Snap-on superbly crafted chests and roll cabs are professional quality throughout—with plenty of space, rugged strength, good locks for security. Features include full length piano hinges; easy glide drawer runners; double side walls; all welded construction; extra heavy gauge steel. Wide range of sizes and types. Ask your Snap-on man. Snap-on Tools Corporation, 8051-H 28th Avenue, Kenosha, Wisconsin 53140.

421

Snap-on Tools

Circle 256 on reader service card

About mailing lists... an important notice to our subscribers.

In recent years we have made the list of subscribers to McGraw-Hill publications (names and mailing addresses only) available to carefully screened companies whose products or services might be of interest to you.

These companies enter into an agreement that permits them to mail information to you without placing you under any obligation.

We have always considered such direct marketing activities to be legitimate and important in the American system of free trade—and we're confident that the majority of subscribers share this position.

However, we respect the interests of those who for some reason may wish to have their names restricted from such use by companies either affiliated or not affiliated with McGraw-Hill, Inc.

If you wish to delete your name from lists we make available to other firms, please fill in the information requested below exactly as it appears on your mailing label on the cover of this issue. Or, if you prefer, attach the label itself to the coupon and return.

McGraw-Hill, Inc.

P.O. Box 555, Hightstown, N.J. 08520

Attn: Mailing List Dept.



Please remove my name from your mailing lists.

Title of this publication _____

Name _____

Address _____
(exactly as shown as mailing label, please)

City State Zip _____

New products

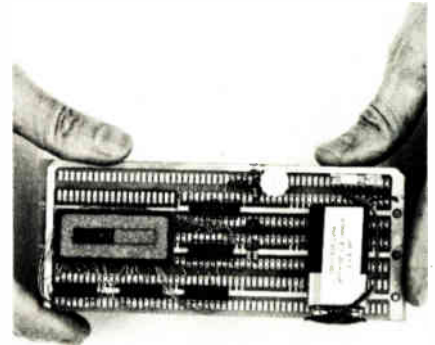

10. When linked with a compatible integrated drive circuit and (for instance) a National LM3914N, it displays analog voltage levels as either a number cursor or a continuous string of digits. Amid a large information display, it therefore shows trends more clearly than would a single seven-segment digit, although it is also available in combination with such devices.

Normally mounted horizontally, the model 2210AN is 2 in. wide and has connections on 0.1-in. centers on a single edge. The numerals are black on a pewter ground or white on a clear one, for backlighting with color filters or for use with reflectors.

The price is \$6.27 in quantities of 10,000 and delivery takes three to five weeks.

UCE Inc., 20 North Main, Norwalk, Conn. 06854. Phone (203) 838-7509 [344]

Insert-molded trimmer resistors gain stability

An insert-molding manufacturing process yields a conductive-plastic trimmer resistor that approximates cermet in its stability and power rating. The Series 268 Consertrim 10-mm trimmer consists of a one-piece center terminal and collector ring, molded within a UL-94 V-0-rated fire-retardant thermoplastic base. The manufacturer believes that this is probably the first time a trimmer resistor has been manufactured using the insert-molding technique, which reduces the

New
product,
lower cost

Seitz

Seitz, c'est sûr !

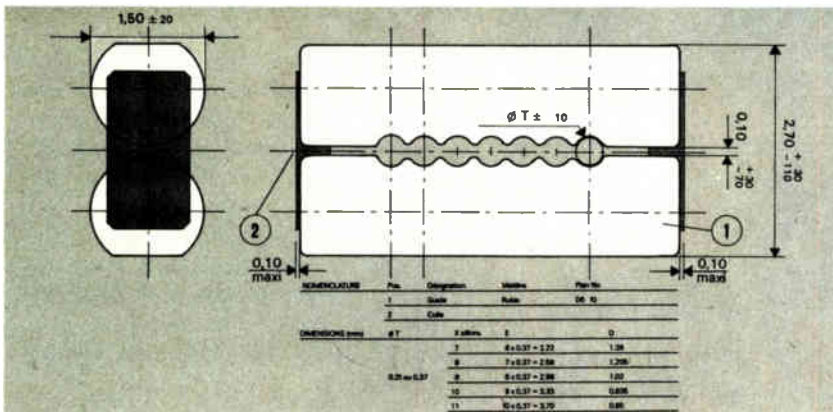

Wire-guide bars for printing heads

All kinds of material have been tried out for the manufacture of wire-guide bars. The corundum in single crystal structure ($Al^2 O^3$) still remains the best one. Seitz knows it and uses it in an economic and intelligent way.

The form: a cylindrical bar, which means reduction of friction, improvement of the ribbon guiding, elimination of the wear of the head. Application: in every type of head, thanks to the rigorously respected dimensions and tolerances.

Seitz is the pioneer of wire-guides and is furthermore the most important manufacturer of this product. Seitz has created and fixed its norms.

Seitz wire-guide bars: A technical and economic solution.

Seitz wire-guide bars: A technical and economic solution.



Choose the power supplies the experts choose.

Tecnetics Incorporated is one of the leading suppliers of DC to DC power conversion units to military and aerospace markets.

Those experts come to us because of our expertise in the technology of high efficiency and reliability.

Because we design, build and test according to their highest standards. And because our products are proven under their toughest applications.

So send for the catalog the experts use—the 1979 Tecnetics Catalog. And choose from over 800 quality DC to DC supplies.

tecnetics

INCORPORATED

The DC-DC Expert

1625 Range St., P.O. Box 910, Boulder, CO 80302
(303) 442-3837 TWX 910-940-3246

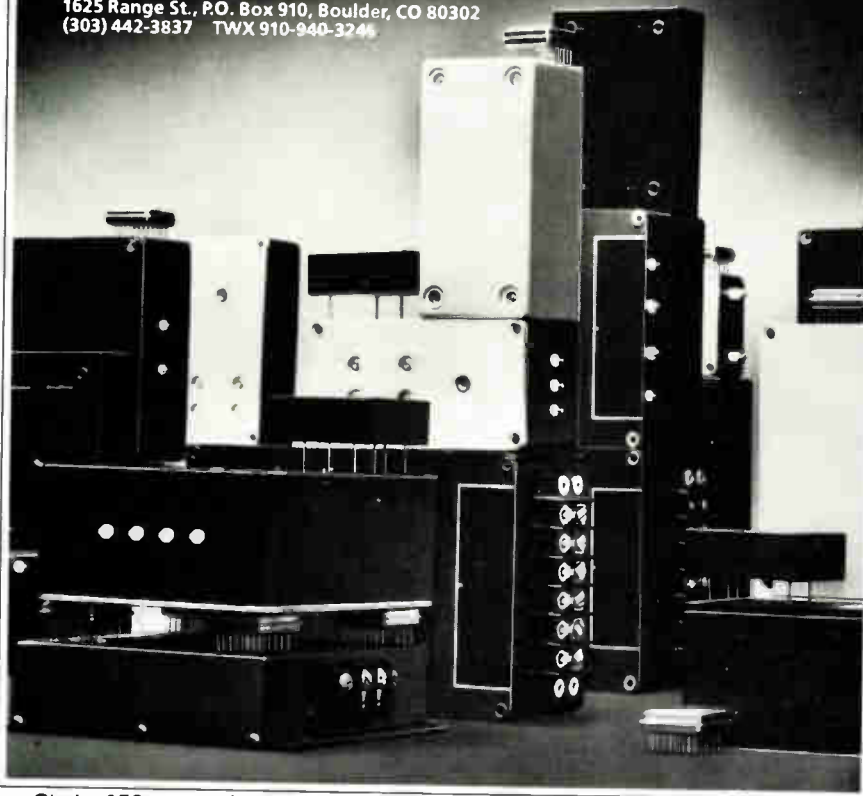

Circle 258 on reader service card

The magazine you're reading now, could be your own.

Drop off the routing list. Get your own fresh, unclipped copy mailed to your home or office. Turn to the subscription card in the back of the magazine. If somebody has beat you to it, write: Electronics, P.O. Box 430, Hightstown, N.J. 08520.

258

New products

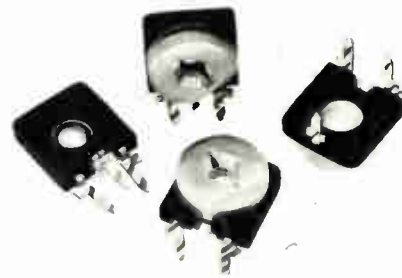

likelihood of solder leaking into the element.

The voltage rating of the Consertrim is an operating maximum of 500 v dc, with the load not to exceed a wattage rating of $\frac{1}{3}$ w at 70°C, derated to no load at 125°C. The temperature coefficient is -450 ± 150 ppm/°C; the setting stability is typically less than 0.2% of full scale. Price of the 268 Consertrim is under 10¢ each in production quantities.

CTS of Elkhart Inc., 1142 West Beardsley Ave., Elkhart, Ind. 46514. Phone Ray McCuddy at (219) 295-3575 [345]

Stainless-steel mechanism expands life of switches

Series 30 interlock switches use a stainless-steel instead of plastic slide mechanism for a minimum mechanical life of one half million operations. The switches are designed for use in instrumentation and control panel applications and are available with seven different mechanical interlock systems that can be assembled in multiple combinations of 2 to 20 separate switch or indicator units. The seven systems are: no mechanical interlock, mutual blocking, mutual release, mutual release and blocking, individual operation with master release, sequential operation with master release and blocking, and key lock. The bezel of each switch is 24 mm wide and 18 mm high.

The switches can be used in EAO interlock systems, which can be assembled with a choice of three switching elements: a one- to four-pole snap-acting switch element, a

Now you can sound off
right from your
printed circuit boards.

The Mallory Sonalert® Signal.

This new Sonalert design gives you a choice of three medium loud sounds — continuous, fast pulse, or slow pulse at 2900 Hz. It will even give you pulsing or continuous sound in the same package. You can spec it into just about anything in which you need sound. And its pin mounting makes it easy to insert and solder into printed circuit boards. Units may be hand or wave soldered.

Mallory Sonalert Electronic Signals are available direct, or through authorized Mallory distributors in U.S., Canada and overseas. Give us a hearing. Write or call.
P. R. Mallory & Co. Inc.,
Box 1284, Indianapolis,
Indiana 46206.
(317) 856-3731.



MALLORY

Circle 122 on reader service card

★ ★ ★ 5 DAY ★ ★ ★ DELIVERY ★ ★ ★ Microcomputer Analog I/O Systems



For:

DEC LSI-11 & LSI-11/2 (FORTRAN SUBROUTINES AVAILABLE FOR RT-11)
DEC PDP-11 UNIBUS
INTEL SBC-80 Series & NATIONAL BLC-80 Series
ZILOG MCB Series (Z-80)
MOSTEK/PROLOG STD BUS
COMPUTER AUTOMATION LSI 2, 3, & 4 Series

Precise Analog I/O for any micro.

Data Translation manufactures the largest array of analog I/O modules and systems in the industry.

Standard interfaces for every major micro-computer.

From isolated inputs to extremely high-speed inputs. Designed to meet your most stringent data acquisition needs in a wide range of measurement and control applications.

Highly reliable systems in only 5 days.

Our goal is to ship the most reliable analog I/O systems available anywhere. That's why we go to such great lengths to ensure the highest reliability.

Delivery? We doubt that you'll find any company faster than Data Translation.

We assure five-day delivery. When you order on Monday, we deliver by the next Monday. No excuses. No delays.

SEND for Full Technical Data or Call us.
GSA Contract No. GS-00S-64219

DATA TRANSLATION

INC

4 Strathmore Rd., Natick MA 01760
(617) 655-5300 Telex 948474

Circle 259 on reader service card

METER CALIBRATION

from A to Ω

The industry's broadest line of calibrators for digital/analog meters

Series 600 Wideband Calibrators

Unprecedented speed and flexibility in meter calibration. Frequencies from DC to 50 kHz; voltages to 1000V; currents to 50 A; resistance values to 10 Meg. Highest accuracies (0.002% DC, 0.025% AC); fully programmable.

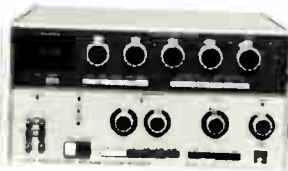

Series 3900 Calibration Group

Seven superbly-engineered, stand-alone calibrators, designed to fit a broad range of calibration budgets. Domestic prices start at \$3195, f.o.b. Waltham, Mass.

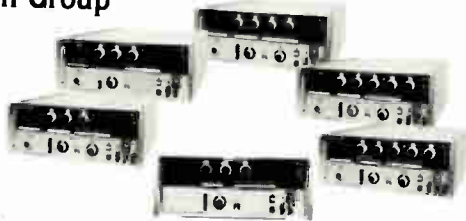

PAMC-100 Automatic Calibration System

A fully-automated system for rapid, high-precision, high-volume meter calibration. Complete with easy-to-use software. High throughput; hard-copy calibration records; expandable via IEEE 488 bus.

STANDS ALONE TO TEST DMM's—With Rotek equipment, there is never a need to pay for extra booster amplifiers for higher-voltage calibrations.

Send for complete data & specifications.

ROTEK INSTRUMENT CORP.

220 GROVE STREET, BOX 504, WALTHAM, MASS. 02154 — TEL. (617) 899-4611

Circle 260 on reader service card

1979 Electronics Buyers' Guide

The only book of its kind in the field. If you haven't got it, you're not in the market.

To insure prompt delivery enclose your check with this coupon.

1979 edition available in June.

260

Electronic Buyers Guide
1221 Ave. of the Americas
New York, N.Y. 10020

Yes, please send me _____ copy(ies) of 1979 EBG.
 I've enclosed \$30 per copy delivered in the USA or Canada.
 I've enclosed \$52 per copy for delivery elsewhere

Name _____
Company _____
Street _____
City _____ State _____ Zip _____



New products

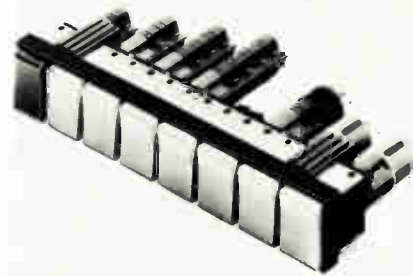

low-level switch element with two contacts in any combination of make/break, and a solid-state Hall-effect switch element.

The systems, which will be displayed at Wescon, start at \$25.00 in quantities of 100 for a six-position interlock.

EAO Switch Corp., 255 Cherry St., Milford, Conn. 06460. Phone (203) 877-4577 [346]

Imaging particle detector

spots single particle

An imaging particle detector with high quantum efficiency can detect a single particle or photon and reconstruct its position in fluxes of up to 10^5 events per second, with a dead time of about 7 μ s. The detector, with a spatial resolution of more than 100 pairs of lines per inch, may be used with electron and mass spectrometers, with ultraviolet or x-ray imaging systems, and in particle physics experiments.

The detector is 2 in. in diameter and 1.5 in. thick and consists of electron multiplier plates that produce a pulse of about 10^6 electrons when struck by a single particle or photon. This charge is collected by four electrodes on a resistive anode beneath the multiplier plates and transmitted to position-computer electronics. The X-Y position of the particle or photon is computed from the charge division among the four electrodes and then relayed as digital or analog outputs to the user's cathode-ray-tube or computer.

The detector sells for \$9,500 in single quantities, with deliveries in 60 days.

Surface Science Laboratories, 4151 Middlefield Rd., Palo Alto, Calif. 94303. Phone Mike Kelly at (415) 493-0229 [374]

You are Invited!!!

to Examine the Prestigious,
Portable Voltmeter Collection.

- Greatest selection. • Smallest size. • Low prices. • Greatest portability. • Excellent performance. • Dependability. • Reliable.

- VDC, VAC, Ohms, Low Ohms, DCmA & ACmA.
- Three & one-half digits.
- Automatic zero.
- Automatic polarity.
- Battery operation.*

Circle 151



LM-353
With LCD Readout
& 100 Hr. Battery Life



LM-4A
With LED Readout

- Measures VDC, VAC, Ohms, DCmA & ACmA.
- Full four digits.
- Automatic zero.
- Automatic polarity.
- Battery powered with charger unit included.

Circle 152

- VDC, DCmA, Ohms and RMS VAC & ACmA.
- Three & one-half digits.
- Automatic zero.
- Automatic polarity.
- Battery or AC line operation.*

Circle 123



RMS-350
With LCD Readout

Size: 1.9"H x 2.7"W x 4.0"D/Weight: 9.2 oz

SPECIFICATIONS

MODEL	RANGES	DC ACCURACY	RESOLUTION	DIGITS	PRICES
LM-3A	VDC, VAC, DCmA & ACmA	±1% Rdg	1 mV	3	\$134
LM-300	1, 10, 100 & 1000. *100% over-range - 1000 VDC or peak AC & IA maximum.	±1% Rdg	1 mV	3	\$114
LM-3.5A*		±0.5% Rdg	1 mV	3-1/2	\$155
LM-350*	RMS-350 displays true RMS in VAC and ACmA modes.	±0.5% Rdg	1 mV	3-1/2	\$144
LM-353*		±0.5% Rdg	1 mV	3-1/2	\$149.50
RMS-350*	OHMS	±0.5% Rdg	1 mV	3-1/2	\$208
LM-40A	1 kΩ, 10 kΩ, 100 kΩ, 1 MΩ & 10 MΩ	±0.1% Rdg	100 μV	4	\$309
LM-4A	LM-353 also has 0.1 kΩ range.	±0.05% Rdg	100 μV	4	\$250

LM "A" Series display - LED's; LM-300, LM-350, LM-353 & RMS-350 - LCD's.

*LED-display models—NiCad batteries and charger unit included.
LCD-display models—batteries and charger unit *not* included.

NLS products are available from Nationwide Electronic Distributors. Send for our brochure today!



Non-Linear Systems, Inc.

Originator of the digital voltmeter.

Box N, Del Mar, California 92014 Telephone (714) 755-1134

So Much Multibus Analog I/O...

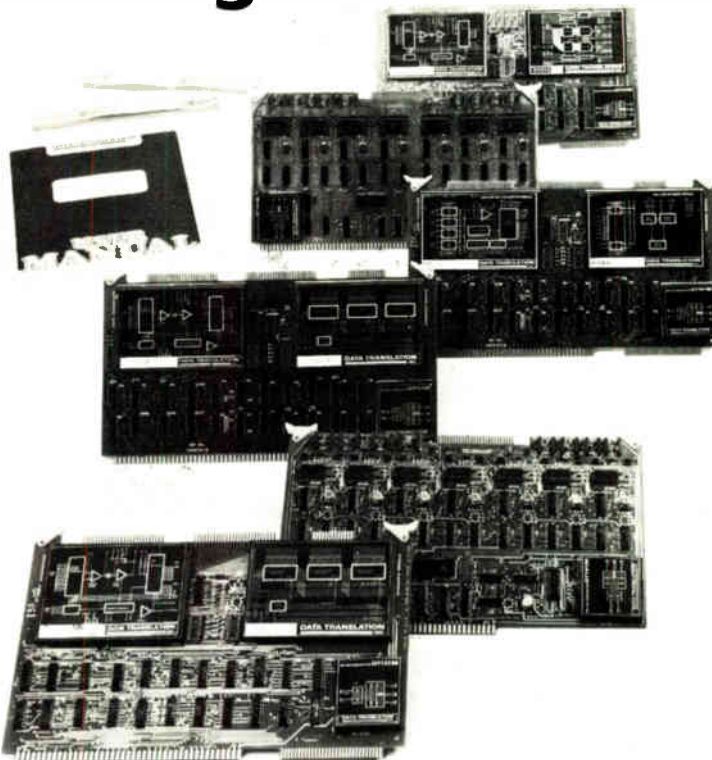

You'd Think We were Intel.

Achieve all common analog environments from laboratory to industrial control...choose from a selection of more than 10 systems for Intel and National micros.

High speed, high performance 12-bit analog I/O. Or 14-bit, if high resolution and accuracy is what you need. Complete system board solutions to analog measurement problems. If noise is your problem, our isolated systems measure signals of a few microvolts despite peak noise levels to 500V. More Multibus compatible data acquisition system boards than you can get from Intel or National. At lower prices.

A/D systems include: up to 64 channel analog inputs, 125KHz throughput, programmable gain amplifier, low level inputs of inputs of 10mV FSR, 14-bit accuracy and resolution, 4-20mA current loop inputs, isolated low level inputs, and full Multibus compatibility.

D/A systems include: up to 8 analog outputs per slot, with DC/DC converter on-board, fast settling of 3usec to 12-bit accuracy, 20mA outputs for guaranteed cable driving, point plotting capability, and 4 to 20mA current loop outputs.

DELIVERY? We doubt that you'll find any company faster than **DATA TRANSLATION**. We assure five-day delivery. When you order on Monday, we deliver by the next Monday. No excuses. No delays. GSA Contract. **SEND** for Full Technical Data or Call us.

DATA TRANSLATION
INC

4 Strathmore Rd., Natick MA 01760
(617) 655-5300 Telex 948474

Industrial**LED panel meter gets on the bus**

Unit turns 7-bit TTL or C-MOS signals into bar graphs or point displays in 2.5 ms

Microprocessor compatibility is a key feature for a growing number of products, and the latest light-emitting-diode analog panel meter from Bowmar/ALI is no exception. The APM-110 accepts 7-bit binary signals—either TTL or 5-v C-MOS—to yield either a bar graph or a point display of selected data. It is directly compatible with most popular microprocessors, including the Z80.

The APM-110 uses 128 LEDs to illuminate a 3-in. linear scale, thereby achieving a resolution of slightly better than 1%. Its response time is 2.5 ms full scale, and it has a flashing overrange indicator. There is a wide variety of scale types, ranging from volume units (VU) and linear scales to zero-center scales displaying deviation about a selected level. All the drive circuitry needed for the display is included.

Applications include process monitoring, medical instrumentation, and portable test equipment. The ruggedized unit meets various MIL-specifications—MIL-STD-167 for vibration, MIL-S-901C for shock, and MIL-E-16400 for temperature and humidity—so that it is not unreasonable to expect to find these displays in military environments.

The meter operates from two supply voltages—5 and 15 v dc. The 15-v supply typically has to deliver about 3 mA. For the 5-v supply, the figure is about 50 mA, although it can reach about 380 mA when all diodes are illuminated.

The unit will tolerate up to 7 v at its 5-v supply pin and up to 40 v at its 15-v pin. Its input signal voltage may range between -0.3 v and +5 v. The input impedance is 100 k Ω to ground and purely resistive.

The standard markings available, either vertically or horizontally arranged, include linear scales from 0 to 10, 50, or 100 and -100 to 0 to +100, with custom scales available on request. The user can select either a bar graph or a point display through one of the pins on the back of the small unit; brightness may be varied by replacing a jumper with either a fixed or variable resistor of up to 15 k Ω .

Options include single and dual setpoints, simulated mechanical damping, a flashing alarm display, and a visual single setpoint.

The APM-110 measures 0.54 in. by 3.75 in. by 3.27 in. and is priced at \$110 each, with the first deliveries beginning in October.

Bowmar/ALI Inc., 531 Main St., Acton, Mass. 01720. Phone (617) 263-8365 [371]

Trend monitor warns of trouble 24 hours in advance

The M746 trend monitor warns operators when preset operating limits of critical rotating machinery have been exceeded or if trends indicate they are likely to be exceeded in the next 24 hours. The monitor continuously scans 40 separate channels (expandable to 64) for vibration, speed, position, temperature, voltage, and percent information. The single compact cabinet provides both a large digital display of operating parameters and a permanent paper-tape log of current machinery conditions, as well as the rate at which these conditions are changing. Readouts require no further calculations since they are in direct engineering units (mils, in./s, etc.).

Inputs can come from already installed machinery-protection systems or directly from transducers. A memory backup battery, continuously recharged, protects against loss of data in a power failure. Because the monitor is housed in a single enclosure, it may be used as either portable or permanent instrumentation.

The M746 costs \$13,500. Delivery time is six to eight weeks.

Dymac Division of Spectral Dynamics, P. O. Box 671, San Diego, Calif. 92112. [373]

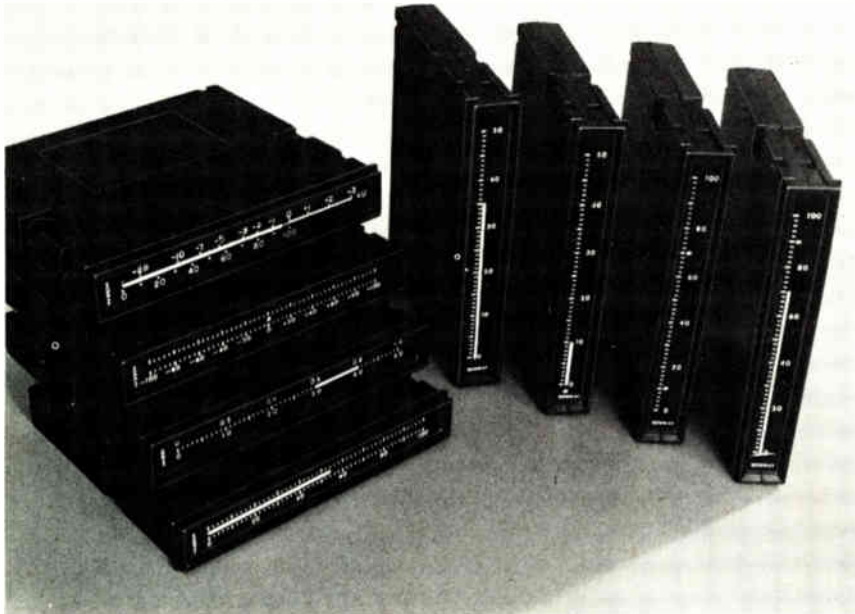

Choose from two new piezo ceramic Audio Indicators. Get softer, more comfortable sound on low power with high reliability. The new, more compact AI-380 operates from 3 to 30 VDC with a 2.7 KHz tone, 83 to 103 dbA at 1.0 ft. The new AI-385 delivers a softer, less shrill 2.0 KHz tone on 3 to 20 VDC, with an 80 to 95 dbA. Low current drain and panel mounting make these ideal for low power usage. For details and full line catalog, write Projects Unlimited, Inc., 3680 Wyse Road, Dayton, Ohio 45414. Phone: (513) 890-1918. TWX: 810-450-2523.



WARNINGS YOU CAN LIVE WITH.



Circle 124 on reader service card



Volume Eprom Erasing in 6.7 Minutes!

Introducing two new members in UVP's growing family of MEMORASE® Eprom Erasing Systems. Both offer speed, reliability and outstanding performance.

For large capacity requirements, the C-90 will erase a 600 chip batch in under 7 minutes. No preoperative adjustments or tuning are needed. Simply load it, set the timer, and forget it. It's that easy.

Model C-91 is geared for small systems users and delivers fast, efficient operation at an affordable price. It provides complete, thorough erasure of up to 96 chips in one cycle in less than 7 minutes.

Like all UVP products, each MEMORASE System is quality built, and backed by nearly 50 years of UV experience and technology.

Why settle for less? Call or write today for more information.

New ... from the research labs at UVP.

ULTRA-VIOLET PRODUCTS, INC.
5100 Walnut Grove Avenue, San Gabriel, CA 91778 U.S.A.

Circle 125 on reader service card

So Much LSI-11 & PDP-11 Analog I/O...

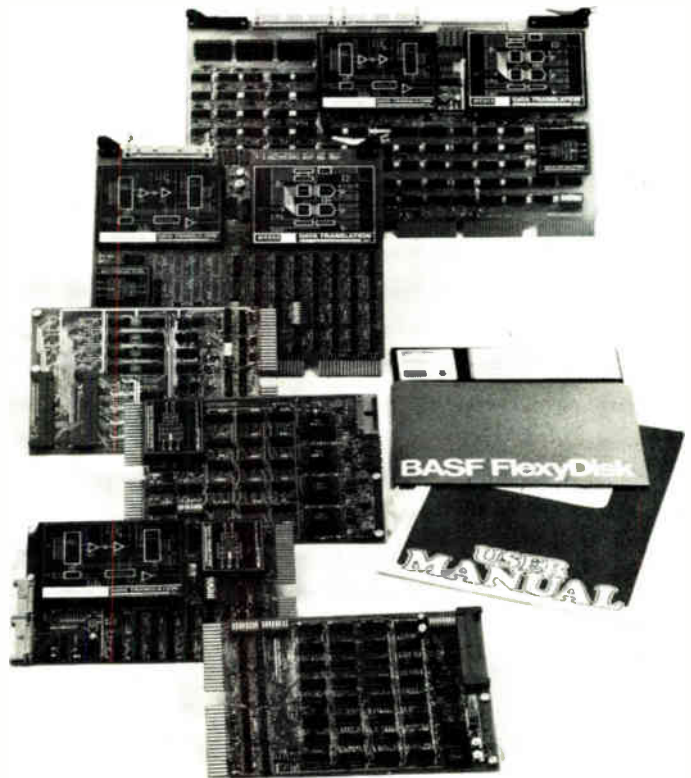

You'd Think We were DEC.

Choose from over twenty-nine analog I/O systems. Dual height systems for LSI-11, LSI-11/2, and LSI-11/23 designed to save valuable backplane space and lower costs. Quad size systems with features no one else offers. Hex height PDP-11 Unibus® systems with unmatched performance.

High-speed, high-performance 12-bit I/O. Or 14-bit, if high resolution and accuracy is what you need. In addition hard-to-get-DEC equivalents. Digital I/O. Programmable real-time clock. Interfaces with FORTRAN subroutines that reduce your programming time. PLUS, guaranteed bus and software compatibility. More LSI-11 and PDP-11 data acquisition system boards than you can get from DEC. At lower prices.

A/D systems include: up to 64 channel analog inputs, 125KHz throughput, DMA interface, programmable gain amplifier, low level inputs of 10mV FSR, 14-bit accuracy and resolution, 4-20mA current loop inputs, isolated low level inputs, and full DEC compatibility.

D/A systems include: up to 8 analog outputs per slot, fast settling of 3usec to 12-bit accuracy, 25mA outputs for guaranteed cable driving, point plotting capability, DMA interface and read/write byte addressable registers.

Digital boards include: Digital I/O, Isolated Digital I/O, and programmable real-time clock.

DELIVERY? We doubt that you'll find any company faster than **DATA TRANSLATION**. We assure five-day delivery. When you order on Monday, we deliver by the next Monday. No excuses. No delays. GSA Contract. SEND for Full Technical Data or Call us.

DATA TRANSLATION INC
4 Strathmore Rd., Natick MA 01760
(617) 655-5300 Telex 948474

*UNIBUS, LSI-11 & PDP-11 are Trademarks of Digital Equipment Corp

Circle 263 on reader service card

We'll do it your way...

There's a TT Series slide in your future.

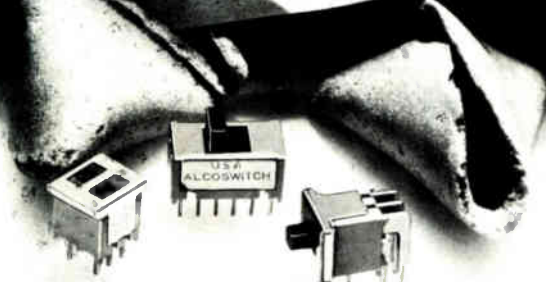

SWITCHING ACTION
SPDT, DPDT, 4PDT
or Dual SPDT.

ACTUATOR HEIGHT
Flush: Single or Dual.
.110": Single or Dual.

TERMINALS
Wired, PC, Right Angle Wirewrap,
Right Angle PC, Extended PC.

CONTACTS **CASE SIZE**
Choice of One, two or
Gold or Silver. four pole.

Switches shown are typical of our new TT Slide Switch Series & are actual size. Mating pushbuttons and toggles also available.

Our engineering and production groups can provide customized switch designs promptly and economically. Choose from a wide variety of standard TT Series actuator styles, terminal configurations and switching functions to meet your specific application.

TT Series made in U.S.A. Patented worldwide.
See us at Wescon '79: Booth No. 208 12.

ALCOSWITCH®

ALCO ELECTRONIC PRODUCTS, INC. a subsidiary of Augat®
1551 Osgood St., No. Andover, MA. 01845 USA
Tel: (617) 685-4371 TWX: 710 342-0552

Circle 126 on reader service card

if you use precious metals

(gold, silver, platinum and palladium)

You need this free booklet



Prepared by the most experienced (and helpful) people in precious metals reclamation since 1907

Wildberg Bros.

349 Oyster Point Blvd.
South San Francisco, CA 94080
(415) 588-1120

Write or call

Circle 127 on reader service card

Symbols of the World's Most Precious Elements

Pt, Au, Ag, Gs



The last symbol in our list stands for **GUARANTEED SPECIFICATION**. To us at **TELEDYNE PHILBRICK**, it's every bit as precious as platinum, gold, or silver. That's because our customers know that when we guarantee a performance parameter, the guarantee is as good as gold.

SEE US AT WESCON BOOTH #1403

Circle 264 on reader service card

TELEDYNE PHILBRICK

DATA CONVERTERS, V/F/V CONVERTERS, LINEARS, NONLINEARS, POWER SUPPLIES
Allied Drive at Route 128, Dedham, Massachusetts 02026
Tel: (617) 329-1600 TWX: (710) 348-6726 Telex: 92-4439

abbott

POWER SUPPLIES

Our standard products meet MIL specs

Why order "specials" and pay for "options" when you can get an Abbott militarized power module virtually off-the-shelf for fewer dollars per watt? Take our Model C's and W's, for example. They're hermetically sealed, feature superior tracking accuracy for *all* rated conditions, and come in package sizes as small as 2½" x 3¼" x 3¼". (The units we put on SKYLAB, except for some special components and testing, were "standard".)



28 VDC to DC Power Modules (Model "C") — feature smaller volume, lower weight, and higher performance. Low peak-to-peak ripple and close regulation meet even the most demanding specs. The standard Model "C" line converts 24-30 volts DC to any output between 5 and 100 volts DC.

For Catalog Circle Card Number 100



400 Hz to DC Power Modules (Model "W") — feature close line and load regulation, low output ripple, and are built to meet the EMI requirements of MIL-STD-461. The Model "W" family provides output voltages from 5 to 100 VDC with current levels from 0.3 to 20 amps. Why waste time and money designing a "special" power supply?

For Catalog Circle Card Number 101



Dual Output Versions — both the C and the W series are available in hermetically sealed, dual output models that feature 1% tracking accuracy, 0.2% regulation, low peak to peak ripple, +100°C operation . . . and we offer CC's and WW's as standards, not "specials."

For Catalog Circle Card Number 102

See Power Supply Section 4000, and Transformer Section 5600, Vol. 2, of your EEM catalog; or Power Supply Section 4500, and Transformer Section 0400, Vol. 2, of your GOLD BOOK for complete information on Abbott products.

abbott

transistor

LABORATORIES, INCORPORATED

General Offices
5200 W. Jefferson Blvd., Los Angeles 90016
(213) 936-8185 Telex: 69-1398

Eastern Office
1224 Anderson Ave., Fort Lee, N.J. 07024
(201) 224-6900 Telex: 13-5332

PL-20E Thermal Printer

The PL-20E is a quality, high-speed thermal line printer designed for quiet, economical, and continuous operation in the most demanding environments. A rigid frame, high torque stepper motor, and fixed head assure a long and reliable lifetime for the printing mechanism.

Key features include:

- Microprocessor-controlled printing
- 2½ lines per second (50 characters per second) printing speed
- 5 x 8 dot matrix ASCII character set with upper case, lower case and underline capability
- Quiet, clean operation — no ink or ribbons
- 8 bit parallel interface
- Self-test mode
- Invert mode (panel mountable)
- Paper-out provision
- Automatic carriage return and line feed
- Requires simply 5 volts at 150 mA and 20 volts at 500 mA
- Uses inexpensive and readily available 2½" wide thermographic paper

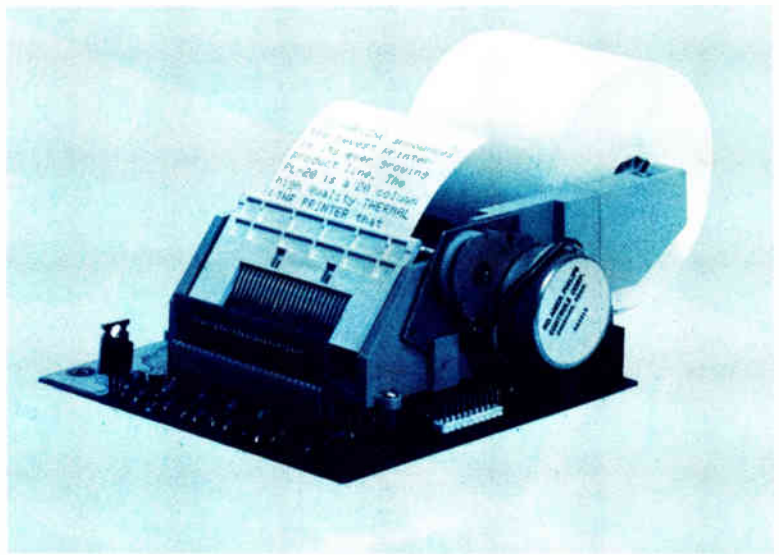

In quantities of 100 \$249.00
 Single quantities \$297.00

telpar, inc.

For more information contact Telpar, (214) 233-6631
 4132 Billy Mitchell Road, Box 796, Addison, Texas 75001
 Telex: 73-7561 (TELSERV) DAL.

Circle 266 on reader service card

You get a great deal from LFE



A **♠** DIGITAL PANEL METERS (UL Recognized) CIRCLE READER NO 128

A **♥** METER-RELAYS (UL Recognized) CIRCLE READER NO 129

A **♣** ANALOG PANEL METERS CIRCLE READER NO 130

A **♦** TEMPERATURE CONTROLLERS (UL Recognized) CIRCLE READER NO 131

2 **♥** PRESSURE INSTRUMENTATION CIRCLE READER NO 132

LFE has instruments to meet all of your measurement and control needs — at competitive prices.

LFE CORPORATION Process Control Division
 1601 Trapelo Road
 Waltham, Massachusetts 02154 Tel. (617) 890-2000

Circle the applicable Reader Service Number, for our product catalogs, or call or write LFE Corporation.

See LFE at Wescon Booth 1154.

Products newsletter

Z80, 8085 hop on STD bus prototyping system at Wescon

Two new bus-prototyping systems, one for the Z80 and the other for the 8085, will be introduced at Wescon by Pro-Log Corp., Monterey, Calif. **Priced at \$4,995 each, the systems contain STD bus hardware, test equipment, applications and debugging software based on programmable read-only memory, and complete documentation.** Included in the hardware are a central processing unit card with 1 kilobyte of random-access memory and room for 8 kilobytes of 2716 erasable PROMs, and STD-bus-compatible cards, including ones for power supply, keyboard display, and TTL input/output. The test equipment contains a PROM programmer with a personality module, an ultraviolet erasing light, a logic analyzer, and a microprocessor analyzer.

Keithley to offer reduced bus fare at Wescon

Getting onto the IEEE-488 bus will cost about a third less when Keithley Instruments Inc. of Cleveland, Ohio unveils its model 1793 at Wescon next month. Built around a 6802 processor, the \$295 bus interface can be installed in the company's low-cost 4½-digit digital multimeter (models 177, 179, and 179-20A) or its model 480 picoammeter in the field or factory. To demonstrate how users can put together a basic, complete system for about \$1,600, **Keithley will put a DMM-installed interface through its paces at the show with a PET 2001 home computer.**

Mostek joins firm in Midwest to make temperature monitors

Mostek Corp. has teamed up with Barber Colman Co., a small Midwestern manufacturer of industrial heat controllers located in Rockford, Ill., to make a \$382 single-loop controller. **A key advantage over existing controllers: the digital circuitry offers accuracy of up to 0.25% of setpoint, or ±1 digit of the display, compared to a 2° variation common to most analog hardware.** The Mostek 3872 microcomputer, together with additional ROM, RAM, and E-PROM, can maintain one or two temperature setpoints through connections with a triac switch or direct current control.

Backup power system keeps computers up and running

With brown- and blackouts becoming quite regular and expected occurrences, Data General Corp., Westboro, Mass., has announced a backup power system for its MP/100 and MP/200 microcomputer boards. **Consisting of a model 4315 battery-backup board and a model 4316, 2.5-A-hr battery pack—or two user-supplied 12-v auto batteries—the \$500 package cuts in the batteries when the ac line is interrupted.** Though the system cannot supply power to peripherals, it will power a 64-kilobyte MP/100 for 16 minutes, and a similar MP/200 for 7 minutes, including fans. That should be more than enough time to save stored data through most outages and even to finish most runs.

SBC-80 users can now store more data in bubbles

Adding to its family of bubble memory systems, Bubbl-Tec, a division of PC/M Inc. in San Ramon, Calif., has developed the MBB-80 board, a bubble memory add-in that is compatible with SBC-80 microcomputers. **Users of SBC-80s can now store large amounts of data since the MBB-80 board provides 92,304 8-bit bytes of storage.** Maximum seek time is 6.4 ms, and maximum access time is 7.27 ms to the first byte. The MBB-80 is priced at \$1,695 in single quantities. Earlier this year Bubbl-Tec introduced an LSI-11-compatible bubble memory add-in module and controller [*Electronics*, June 7, p. 184].

An Introduction to Microcomputers:



Volume 0 — The Beginner's Book

This is a book for the complete beginner in the field of microcomputers. **The Beginner's Book** describes the component parts of a microcomputer system, and relates them to the world of the individual computer hobbyist. It introduces basic microcomputer terminology and discusses the general concepts behind microcomputer functioning (which will prepare you for the next book in the series, **Volume 1**).

Volume 0 will help you understand why microcomputers are coming to pervade society. Numerous illustrations and photographs combine with a clear, easy-to-follow text to provide the reader with an elementary but broad-based background.

Table of Contents: The Parts that Make the Whole; Use a Microcomputer and Watch it Grow; Microcomputer System Components—What You See is Not Always What You Get; Inside a Microcomputer; Getting Down to Basics—Numbers and Logic.



Volume 1 — Basic Concepts

Long our best-seller, **Basic Concepts** presents a framework of ideas concerning the design and use of microcomputers. It leads the reader from elementary logic and simple binary arithmetic through concepts that are characteristic of all microcomputers. It tells how to take ideas and create final products from them through the use of microcomputers.

All aspects of microcomputers are covered: the logic devices that constitute a microcomputer system; numeric characteristics of instruction sets; communicating with external logic via interrupts, direct memory access, and serial or parallel I/O; microprogramming and macroprogramming; assemblers and assembler directives; linking and relocation—in short, virtually everything you should know before applying a microcomputer to any given problem.

Table of Contents: What is a Microcomputer?; Some Fundamental Concepts; The Makings of a Microcomputer; The Microcomputer Central Processing Unit; Logic Beyond the CPU; Programming Microcomputers; An Instruction Set.

Order Form

Title	Price	Quantity	Amount
Vol. 0 Beginner's Book	\$7.95		
Vol. 1 Basic Concepts	\$9.50		

Calif. residents tax	Calif. residents tax
6 1/2% BART, 6% others	
Shipping—allow 4 weeks	Shipping
45¢ per book USA, \$4.00 foreign	TOTAL

Name: _____
 Address: _____
 City: _____ State: _____
 Zip: _____ Phone: _____

OSBORNE/McGraw-Hill, Inc.
 630 Bancroft Way, Dept. E8
 Berkeley, CA 94710



For faster shipment or credit card, phone (415) 548-2805

S1053

The Personal Computing Book



Take the computer revolution into your own hands!

More than 50 articles are presented from leading publications in the field to give you this up-to-date guide that answers all your questions on personal computing precisely and reliably.

Hardware • Software • Theory
 • Applications • Helpful Hints

Order today, and don't forget the other valuable Electronics Magazine Books listed in the coupon below.

Electronics Magazine Books
 P.O. Box 669, Hightstown, NJ 08520



Send me...

- _____ copies of *Microprocessors* @ \$8.95
- _____ copies of *Applying Microprocessors* @ \$9.95
- _____ copies of *Large Scale Integration* @ \$9.95
- _____ copies of *Basics of Data Communications* @ \$12.95
- _____ copies of *Circuits for Electronics Engineers* @ \$15.95
- _____ copies of *Design Techniques for Electronics Engineers* @ \$15.95
- _____ copies of *Memory Design: Microcomputers to Mainframes* @ \$12.95
- _____ copies of *New Product Trends in Electronics, No. 1* @ \$14.95
- _____ copies of *Personal Computing: Hardware and Software Basics* @ \$11.95

Discounts of 40% on orders of 10 or more copies of each book.

I must be fully satisfied or you will refund full payment if the book is returned after ten-day trial examination.

Payment enclosed Bill firm Bill me
 Charge to my credit card: American Express
 Diners Club Visa Master Charge
 Acct. No. _____ Date Exp. _____

On Master Charge only, first numbers above name _____

Name _____ Title _____

Company _____

Street _____

City _____ State _____ Zip _____

Signature _____

Low-leakage, tantalum-like performance at 40% off the cost. With extremely fast delivery.



We go to extremes for you.

Quality performance at way below the cost of tantalum capacitors?

Not only does Nichicon deliver it, but we go a step further.

Now Nichicon has developed an exclusive advanced etching technology for its Low Leakage LL Miniature Aluminum Electrolytic Series to give you more capacitance and lower leakage. In other words, tantalum-like performance for critical applications — with up to 40% savings.

So why continue to live with long lead times and pay the extra money for tantalum or film capacitors?

Especially when we can give you prompt delivery of axial and radial lead

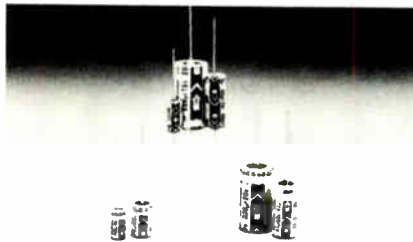

nichicon
goes to extremes for you.

space-saving designs in a capacitance range of 0.1 μ F to 100 μ F.

Especially when you can now get performance like a maximum leakage of .002CV or 0.4 μ A (whichever is greater) over the recommended operating temperature range of -40° C through $+85^{\circ}$ C.

And why wait for tantalum capacitors when we give you that kind of performance in both axial and radial lead styles.

Instead, call your local Nichicon representative or distributor. Or write us for data sheet NAC-LL038.

And start saving an extremely sizable amount of money.

Nichicon (America) Corporation • 927 East State Parkway • Schaumburg, IL 60195 • (312) 843-7500

Division of Nichicon Capacitor Ltd., Kyoto, Japan

Miniature and can-type aluminum electrolytics. Ceramic. Reduced titanite. Polyester and metallized polyester film capacitors.

WHEN μ S COUNT, YOU CAN COUNT ON FTS.

We've pushed the state of the art in Cesium Beam technology a long way. High performance FTS units are on airborne, shipboard and mobile platforms and in the laboratory with frequency accuracy of $\pm 7 \times 10^{-12}$, and frequency stability exceeding 1×10^{-13} . And FTS's unique 5-year cesium tube warranty, and no charge instrument loan program (if warranty repairs will take >30 days) will cut down time and costs at your end.

FTS offers all three configurations: Modular (FTS 4000), Instrument (FTS 4050), and Portable (FTS 4010).

Delivery for all units is 90 days or better. We have a complete line of low noise, high stability quartz crystal oscillators and standards.

We're also into Time and Frequency Systems and special products.

WE THOUGHT IT WAS TIME YOU KNEW.



Circle 270 on reader service card



FTS · FREQUENCY AND TIME SYSTEMS, INC.
182 CONANT ST. DANVERS, MA 01923
(617) 777-1255

Call or write T.J. Parelo, Director of Marketing for complete information.

Leaders in Electronics

The only reference devoted solely to biographies of the most influential people in electronics

- corporate executives • technical managers • designers and developers • government and military officials • academics • editors/publishers • securities analysts • trade/professional group directors • consultants ... plus an 80-page index of biographees by affiliation.

Prepared by the staff of Electronics magazine. 5,240 biographies. 651 pages, clothbound. \$39.50

Electronics Magazine Books
P.O. Box 669, Hightstown, NJ 08520
(609) 448-1700, ext. 5494

Send me _____ copies of *Leaders in Electronics* @ \$39.50 plus applicable sales tax. McGraw-Hill pays regular shipping and handling charges on pre-paid orders.

Payment enclosed Bill firm Bill me

Name _____

Company _____

Street _____

City _____ State _____ Zip _____

Signature _____

New products/materials

An immersion gold solution, producing a beautiful, lustrous finish on tin-nickel-plated printed-circuit boards, allows a chemical deposition of gold at room temperature. The procedure is accomplished in approximately 5 to 10 minutes and results in a gold plate of roughly 10 millionths of an inch. The solution, which contains no cyanides, eliminates the problems and expenses associated with electrolytic gold plating and avoids passivation difficulties, as well as the need for costly plating equipment and even costlier gold inventories.

Lectrokem Inc., 13635 Alondra Blvd., Santa Fe Springs, Calif. 90670 [476]

Silver conductive compositions and Mylar polyester have been produced by Du Pont's Electronic Materials division for the manufacture of flexible membrane switches. The two new silver conductors are the 4198 and 4226. The 4198 silver is curable at low temperatures, while the 4226 offers cost-saving benefits. Mylar film provides both a flexible substrate for the printed circuitry and a surface for switch graphics. It is available in a wide variety of types and gauges with a variety of combinations of excellent surface, electrical, mechanical, and appearance characteristics. The 4198 and 4226 compositions are priced at \$.29 and \$.16 per gram for 150 kg. Prices vary with the silver metals market and the shipment quantity. Mylar film prices vary according to the type, gauge, and quantity ordered.

Du Pont Co., Public Affairs Department, Wilmington, Del. 19898 [477]

A noncyanide, alkaline stripper, Enstrip EN-79, dissolves high-phosphorous (8 to 14%) electroless nickel deposits up to 5 mils thick from steel, copper, and copper alloys. Enstrip EN-79 is supplied as two components: Enstrip EN-79A, a liquid, and Enstrip EN-79B, a powder. Both components are mixed with sodium hydroxide and water to make up and replenish the operating solution.

Enthone Inc., Box 1900, New Haven, Conn. 06508 [480]

MPP 80S—Field service PROM
Programmer from \$1995.

We've got universal PROM programmers for your designers, field service technicians and production people. And they're extremely easy to use. Our MPP 80S, a completely self-contained service system, does it all. You've got to see it to appreciate it. A few salient features:

- μ P controlled (Z80)
- Compact, easy-to-use personality modules
- Extra storage space for modules, master PROMs and power cord
- Built-in UV lamp

Get our data sheets for technical details and the name of a Kontron sales and service organization near you. Write or call Kontron Electronic Inc. 700 South Claremont Street, San Mateo, California 94402.



PROM PROGRAMMERS

FOR DATA ON KONTRON® MULTIMETERS, COUNTERS, PROM PROGRAMMERS
AND PRINTERS, CALL (800) 227-6854. IN CALIFORNIA CALL (415) 348-7291.



Circle 271 on reader service card

Introducing...

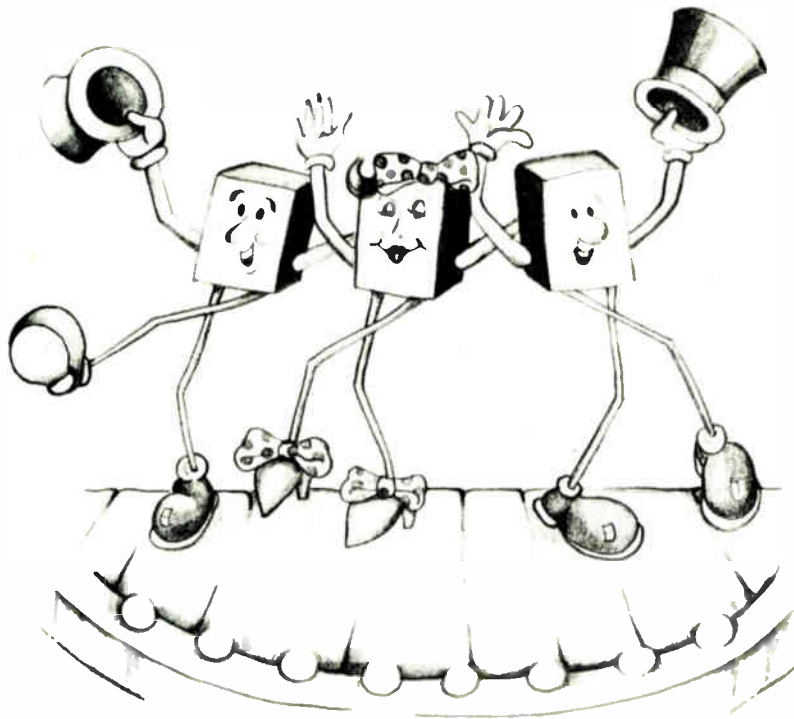

new line of toroidal inductors

The new Series 2020 incorporate the stability of a toroidal winding on an iron core in a small size. All molded package configuration. The shielded design conforms to MS Spec #21422. Ruggedly constructed with heavy tinned copper radial leads, they are ideal for P.C. and all designs when stable inductive performance is essential. Available in 25 inductance values from .10 to 10.00 microhenries. Prototype quantities with current ratings up to 2200 milliamps are available for prompt delivery. Bulletin 2020-C has all the facts. Ask for your copy.

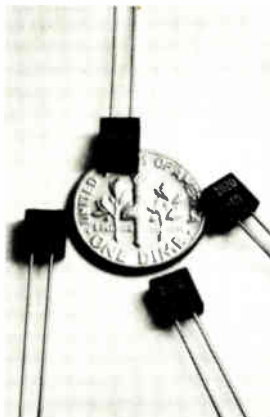

Delevan
Division



AMERICAN
PRECISION
INDUSTRIES INC.

270 QUAKER RD., EAST AURORA, N.Y. 14052
TELEPHONE 716/652/3600 TELEX 91-293

OTHER DIVISIONS & SUBSIDIARIES INCLUDE:
APITRON, BASCO, DUSTEX, AMERICAN PRECISION
INDUSTRIES (U.K.) LTD., DUSTEX OF CANADA, INC.

New literature

Printed-circuit boards. "Factors Affecting Insulation Resistance (IR) Performance of Printed Boards" describes how the insulation resistance of a laminate might be degraded in the manufacturing process and how that degradation can affect both maker and user of the printed-wiring boards. The 68-page report defines the insulation resistance failure mechanism; recommends limits and solutions; specifies cleaning methods; and provides helpful conclusions. A copy of IPC-TR-468 can be obtained for \$5.00 by members and \$10.00 by others from IPC Headquarters, 1717 Howard St., Evanston, Ill. 60202.

Microwave components. The 1979-80 edition of "Coaxial and Waveguide Catalog and Microwave Measurement Handbook" gives information on more than 350 microwave components used in coaxial and waveguide measurements. Some of the products discussed are attenuators, detectors, couplers, filters, power sensors, slotted lines, and a selection of 75-ohm items. The 96-page catalog summarizes common scalar measurement techniques of attenuation, standing-wave ratio, power, frequency, and noise figure. For a copy of publication No. 5952-8207 write to Hewlett-Packard Co., 1507 Page Mill Rd., Palo Alto, Calif. 94304. Circle reader service number 423.

Packaging equipment. Augat's Short Form Catalog S100 covers integrated-circuit panels and accessories, packaging systems, the Holtite product family, sockets, and fiberoptic systems. Product illustrations and photographs of Augat's various products are also contained in the 28-page catalog. Augat Inc., Interconnection Products Division, 33 Perry Ave., P. O. Box 779, Attleboro, Mass. 02703 [425]

Rectifiers. Proper specification of output rectifiers in the design of linear, ferro-resonant, and switching power supplies is discussed in a technical application note titled "Considerations in Selecting Rectifiers for

Winners Circle



EMM Wins the Megabyte Memory Race

with higher speed and lower maintenance than rotating disks and drums.

A Real Thoroughbred

Our tough EMM/SESCO inspector has a real winner in our Megabyte Memory, which, for fast throughput and low maintenance, beats rotating disks and drums hands down!

A real thoroughbred, Megabyte gives you one million 8-bit bytes of dependable, non-volatile core storage on a single pluggable module. As an entry, a 4-megabyte system, including interface, takes up only 17.5 inches of chassis space.

A New Track Record

This all-electronic mass memory is orders of magnitude faster than disks and drums. And by interleaving Megabyte memories, a data transfer rate of greater than 16 million bits per second can be achieved.

Speed AND Dependability

Maintenance on disks and drums is complicated and expensive. With our megabyte core memory, however, service downtime is virtually eliminated since there are no moving parts to wear out. And if maintenance is ever needed, our modular design makes it simple. This all adds up to higher system performance at a lower total life cycle cost.

Plenty of Memories

There are plenty of memories in store for you at EMM/SESCO. Up to 256K bytes of semiconductor memory on a single card for the commercial user. A complete line of ruggedized memories for military and industrial applications. Even a ruggedized version of Intel's popular iSBC* 80/10A microcomputer. And a severe environment version of Megabyte is in development.

So when you're looking for winning memories... Buy SESCO... they work!

EMM SESCO

A Subsidiary of Electronic Memories & Magnetics Corporation

20630 Plummer Street • P.O. Box 668 • Chatsworth, California 91311
Telephone: (213) 998-9090 • Telex: 69-1404



*Trademark of Intel Corporation

Circle 273 on reader service card

When Quality Counts!

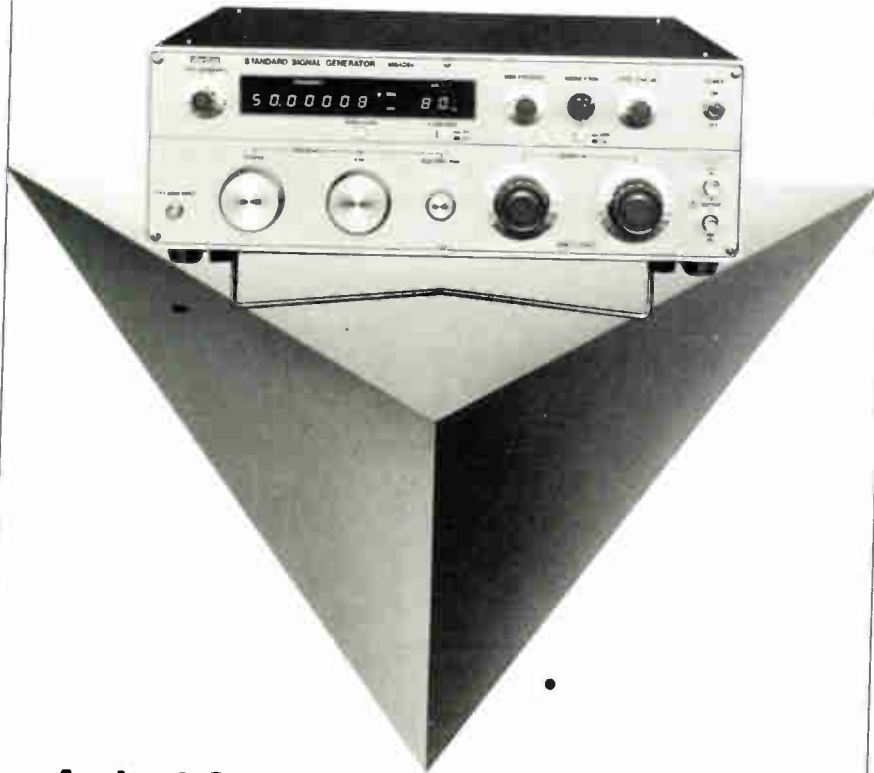

Anritsu's Standard Signal Generator MG439A

The standard signal generator is one of the most basic test instruments on any radio technician's workbench and one of the most important. The new Anritsu MG439A reflects the latest thinking about how a reliable test instrument should work. It is designed for the manufacturer or maintenance facility that deals with AM and SSB receivers on a day in day out basis. This is the signal generator to consider when only the best will do. Special consideration has been given to easy operation, high stability, high output and superb signal purity. What kind of specifications are we talking about? Consider the following:

- Frequency range 50kHz to 50MHz in 9 bands, 7 digits
- Stability $\leq 30\text{Hz}/30\text{min. at } 50\text{MHz}$
- SSB AM noise $\leq -130\text{dBc}/\text{Hz, } 1\text{kHz offset}$
- Output level -24 to $132\text{dB}\mu$, and -137 to $+19\text{dBm}$ at 50Ω
 -24 to $132\text{dB}\mu$ at 75Ω
- Source impedance 50Ω and 75Ω , BNC connector
- Modulation Up to 100% AM at $130\text{dB}\mu$ output
- Internal modulation frequency 0.3, 0.4, 1, 2, 3kHz,
 accuracy: $\pm 2\%$

For comprehensive literature on the
Standard Signal Generator MG439A, contact—

Anritsu

ANRITSU ELECTRIC CO., LTD
MEASURING INSTRUMENTS DIVISION

SALES DEPARTMENT:
10-27, Minamiazabu 5 chome, Minato-ku, Tokyo 106, Japan
Phone: 03-446-1111/Telex: 0-242-2353
Cable: ANRITDENKI TOKYO

• U.S.A. Anritsu America, Inc. Tel: (201) 569-4474 • West Germany Knott Elektronik GmbH Tel: (08178) 4085
 • U.K. Dynair Electronics Limited Tel: Watford 37321 • France Tekelis Airtronic Tel: (1) 946 96 48
 • Italy Vianello S.p.A. Tel: (02) 94 40 41 • Spain Unintronic S.A. Tel: 242 52 04 • Holland C.N. Rood B.V. Tel: 070-99 63 60
 • Belgium C.N. Rood S.A. Tel: 02 35 21 35 • Sweden Teleinstrument AB Tel: 08 38 03 70
 • Singapore O'Connor's (Pte.) Ltd. Tel: 637944 • Australia NEC Avitralia Pty Ltd. Tel: Melbourne 560 5233
 • Malaysia O'Connor's (Malaysia) SDN. BHD. Tel: 51563/5 • Brazil Anritsu Eletrônica Comércio Ltda. Tel: Rio 221 6086

New literature

Power Supplies. The 12-page guide provides information on different types of power supplies and rectifiers to help ensure peak conversion efficiency, provide system cost savings, and avoid performance problems resulting from misapplication. Four types of rectifiers—standard, fast-recovery, superfast recovery, and Schottky—as well as key performance parameters such as forward voltage drop, turn-off time, and reverse blocking voltage are also discussed in the guide. FMC Corp., Semiconductor Products Division, 800 Hoyt St., Broomfield, Colo. 80020 [426]

Transmitters. "Freeze Protection of Transmitters" lists several methods of preventing transmitter freeze or cooking incidents. These methods include sealing liquid, purging, piping for gas flow and pressure, mechanical (diaphragm) seals, and electric and steam heating. An appendix on steam temperature and pressure describes precautions required to prevent overheating with low-pressure steam derived from high-pressure supplies. Honeywell Process Control Division, Dept. MS 436, 1100 Virginia Dr., Fort Washington, Pa. 19034 [427]

Interconnecting devices. Patching, connectors, cable assemblies, and electro-optics are discussed in a 40-page catalog. The products are illustrated in standard, miniature, and subminiature coaxial, twinax, triax, and quadax. For a copy of T12 write to Trompeter Electronics Inc., 8936 Comanche Ave., Chatsworth, Calif. 91311 [428]

Power-signal sources. Specifications and application information on radio-frequency power-signal sources and high-power broadband amplifiers are discussed in a 12-page brochure. Described are rf power-signal sources in the 10-kilohertz range with power outputs up to 100 watts, and high-power linear amplifiers covering the frequency range of 10 kHz to 1 gigahertz. Ailtech, 19525 East Walnut Dr., City of Industry, Calif. 91748 [429]

Up-front backup.

Now Bussmann brings products and technical backup right to your front door.

If you've been going to an electronics distributor for Bussmann products, here's great news.

The Bussmann representative who brings new product information and application help to your distributor will now do the same for you.

He is likely to be the same sales representative who's kept you stocked with a variety of other electronics products. But now that he'll be bringing you Bussmann too, you

stand to gain a lot more than just single-source convenience.

For one thing, you'll get dependable technical help whenever you need it. As an experienced electronics professional, your Bussmann representative is a prime source of application advice. And he has the full backup of Bussmann in-plant application specialists.

Your Bussmann representative will also give you faster, more direct access to Bussmann products. Product literature. Tech-

nical bulletins. And more.

Working with your distributor, your Bussmann representative puts our total capability at your disposal. This new service team is just one more way we've strengthened and reaffirmed our commitment to you.

After all, when you specify the best electrical protection devices money can buy, you expect equally good service.

And now Bussmann gives you both.

Bussmann Manufacturing Division
McGraw-Edison Company
P.O. Box 14460
St. Louis, Missouri 63178

McGRAW-EDISON

**Bussmann.
The Protection
Experts.**

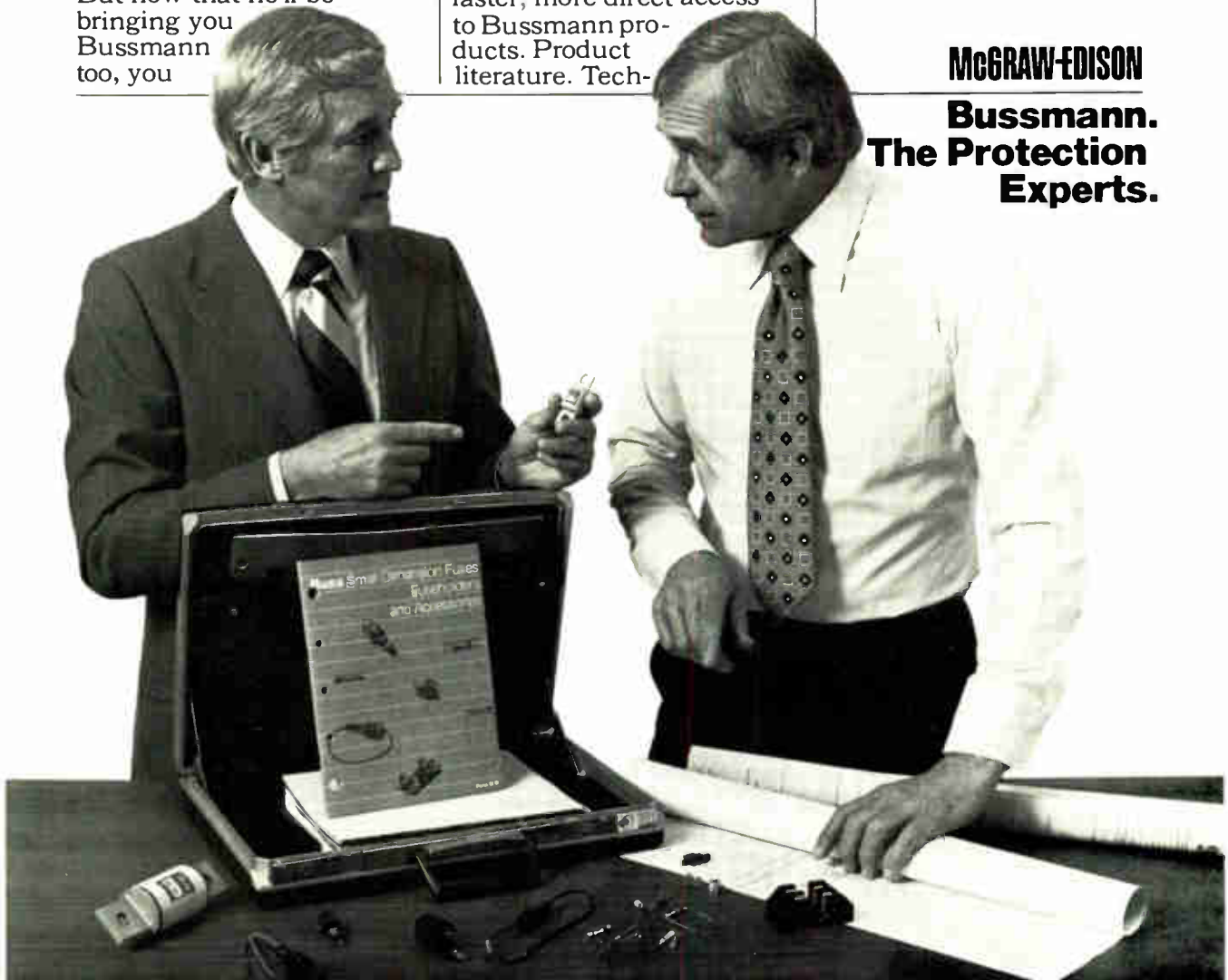

Classified section FOR ENGINEERING/TECHNICAL EMPLOYMENT OPPORTUNITIES

CLASSIFIED SALES REPRESENTATIVES

Atlanta . Maggie McClelland 404/892-2868
 Boston . Jim McClure 617/262-1160
 Chicago . Bill Higgins 312/751-3733

Chicago Linda Nocella 312/751-3770
 Cleveland Mac Huestis. 216/781-7000
 Dallas Mike Taylor . 214/742-1747
 Denver Shirley Klotz 303/837-1010

Sales Manager—Mary Ellen Kearns—212/997-3306

Detroit Mac Huestis 313/873-7410
 Houston Mike Taylor 713/659-8381
 Los Angeles Ana Galaz . 213/487-1160
 New York Larry Kelly . 212/997-3594
 Philadelphia Dan Ferro . . . 215/568-6161
 Pittsburgh Jack Gardner 412/227-3658
 San Francisco Peter McGraw 415/362-4600
 Stamford William Eydt . 203/359-2860

PCB FABRICATION MANAGER

The Boeing Company in Seattle, Washington has an immediate opening for a qualified person to manage our Printed Wire Board fabrication shop.

You'll be responsible for projects in both our commercial airplane and aerospace divisions, including the 727, 737, 747, 757 and 767, and the Inertial Upper Stage, ACLM and Sentry E-3A.

Requirements include knowledge of single-sided, two-sided and multilayer circuit board fabrication, chemical processes, drilling, laminating, imaging, electroless and electrolytic plating, material and process control. And you must have a minimum of five years current experience managing a production facility, plus a knowledge of MII-Specs.

We're offering an excellent salary and benefits package.

Plus the chance to enjoy the clean air, abundant recreation and relaxed lifestyle of Seattle and the Pacific Northwest.

If this sounds good to you send your résumé to The Boeing Company, P.O. Box 3707-LTZ, Seattle, WA 98124.

An equal opportunity employer.

BOEING
GETTING PEOPLE TOGETHER

SENIOR ENGINEERING POSITION ROBOT SYSTEMS DEVELOPMENT

A program is being pursued for the development of robot systems for advanced automotive manufacturing applications. Development of fully automated robotized paint booths is in progress, using new computer based robot programming and editing systems that control spray gun motions. Smart interactive links will control robots via a host computer. The most advanced industrial implementation of state-of-the-art robot technology is planned.

POSITION: We are seeking a senior development engineer to provide leadership for advanced development of robot hardware and software systems.

REQUIREMENTS: The successful candidate must have a record of accomplishments, innovation and demonstrated ability to lead independent applied research and development of computer interface hardware/software system and electro-mechanical machinery. Must have a strong interest in robotics development. Strong support groups are available in mechanical design, control systems engineering, computer science, and machinery development.

Educational/Experience requirements: An MS or Ph.D. in Mechanical Electrical Engineering, Computer Sciences, Engineering Mechanics or equivalent plus experience in development of computer controlled equipment.

Salary commensurate with experience. Excellent benefits program and opportunity for advancement.

Please submit detailed resume to:



Engineering & Research Staff

Salaried Personnel MFG 79-069
Room E-1141 Sci. Rsch. Labs. Bldg.,
Dearborn, Michigan 48121

An Equal Opportunity Employer

ELECTRICAL ENGINEERING CAREER OPPORTUNITIES BELL AEROSPACE TEXTRON

ARE YOU A DOER? . . . A MOVER AND AN INNOVATOR?

Then, here's your chance to earn full satisfaction as an achiever—with a company which is a front-runner in both innovation and performance. If you're ready for a challenge and a real career opportunity in the following fields:

SENIOR INERTIAL SYSTEMS ANALYST

Experience in modern control and filtering theory as it relates to inertial systems. Will perform detailed error analyses of complex shipboard electronic system. A BSEE degree is required with MSEE or Ph.D. desired.

SENIOR COMPUTER ENGINEER

Must be experienced in computer software development for complex military systems. Will derive computational needs from system requirements and direct programmers to arrive at complete system software package. BS in electrical engineering with a minor in computer science required with MS desired.

SENIOR SYSTEMS ENGINEERS

Must have experience in directing the development of computer-based electronic systems. Experience in design, integration and test of military systems is required. Will direct the efforts of a number of engineers in systems design. BSEE required with MSEE or Ph.D. desired.

DESIGN ENGINEER

Design, develop and test of analog and digital circuits. Ability to troubleshoot and diagnostic test a must. BSEE required, MSEE a plus.

Then submit resumes including recent salary history to Howard D. Butler, Employment Supervisor, Bell Aerospace Textron, P.O. Box 1, Buffalo, NY 14240.

Bell Aerospace **TEXTRON**

Division of Textron Inc.

An Equal Opportunity Employer M/F/H



Our Roots Are In Riverside, California But Our Influence Is Worldwide.

Over 30 years' of solid expansion and diversification has moved Bourns into world wide prominence in the manufacture and design of electro-mechanical precision instruments and related electronic components. We are continuing to build, with new facilities in Arizona and throughout Utah. Join us at our Corporate Headquarters in Riverside as

- Mechanical Engineers
- Electronic Engineers
- Manufacturing Engineers
- Machine Design Engineers
- Applications Engineers
- Q/C Engineers

Our Riverside location offers housing at a cost much more reasonable than other Southern California areas. For an excellent salary, a comprehensive benefits portfolio and plenty of room for professional advancement, send your resume to **Professional Employment, Bourns, Inc., 1200 Columbia Avenue, Riverside, California 92507.** We are an equal opportunity employer M/F/H

BOURNS, INC.

Semiconductor Technologist

Sperry Univac, a leader in the computer industry, has an immediate requirement for a semiconductor technologist. The successful candidate will be a member of an aggressive research group investigating technologies for the design of very large scale integrated circuits for use in future computing systems.

Applicants should have previous experience in I.C. layout, modeling and simulation. Responsibilities will include definition of design rules for advanced processes, formulation of VLSI design techniques, and the definition and implementation of research projects in VLSI design.

Technology disciplines will include: Silicon, Silicon on Sapphire, and Gallium Arsenide materials, operation at cryogenic temperatures, submicron lithography, and design automation considerations.

Applicants possessing a related M.S. degree or equivalent industrial experience in semiconductors should forward their resume to: **R. A. Pagano, Research Staffing, Sperry Univac, a division of Sperry Rand Corporation, P.O. Box 500, Blue Bell, PA. 19424.**

An equal opportunity employer, M/F/V/H.

SPERRY  UNIVAC

ENGINEERS

Our continued expansion in commercial and military avionics markets has created some outstanding openings. This is your opportunity to join a rapidly growing avionics manufacturing company with projected growth of 25% in the next 2 years! If you are qualified, please call us today.

ELECTRONIC PROJECT ENGINEER

Will primarily be involved in MICROPROCESSOR hardware and software design with additional assignment in ANALOG and DIGITAL CIRCUIT design.

ELECTRONIC ENGINEER

Will perform SYMBOL GENERATOR and general DIGITAL DESIGN for CRT presentations. Initial assignment will be new HUD program for commercial jet application.

NAVIGATION SYSTEMS ENGINEER

Minimum of 5 years experience with VOR DME R-NAV systems or other R-NAV systems. Experience must include specifying performance and program management through flight test.

FLIGHT CONTROLS ENGINEERS

Minimum of 5 years experience in specifying and certifying flight control systems. Experience in general or commercial aviation desirable.

GYRO PROJECT ENGINEER

Will coordinate GYRO DESIGN and prototype build and evaluation programs. Will interface with Quality Control, Manufacturing Engineering, Purchasing, and related group to assume that design specs will be met.

Call now toll-free to apply! (800) 253-9525

Or send resume for immediate confidential consideration to:

G.E. Brooks
Director Industrial Relations

5353 52nd Street
Grand Rapids, Michigan 49508



An Equal Opportunity Employer M/F

ENGINEERS

**OPPORTUNITY . . .
CHALLENGE . . .**

ENGINEERING career openings exist NOW at Boeing Wichita Company on a number of long range programs involving advanced aircraft systems. Staffing is underway for the early phases of a range of projects relating to Air Force bombers and tankers.

Air Launched Cruise Missiles Integration... Offensive and Defensive Avionics Systems... Countermeasures Systems... Electronic Agile Radar Systems... Electronic Steerable Antenna Systems... Weapon System Trainers... Aircraft Winglets.. and Automated Test Equipment. Join these high technology programs now while program assignments are growing.

DESIGN YOUR FUTURE AT BOEING

IMMEDIATE REQUIREMENTS include the following which require U.S. Citizenship and BS or higher degree in Engineering, Physics, Computer Science or Math

- **STRUCTURAL DESIGN**
- **STRESS ANALYSIS**
- **PRODUCT SYSTEMS ENGINEER**
- **ELECTRICAL/ELECTRONIC INSTALLATION DESIGN**
- **GROUND SUPPORT REQUIREMENTS ELECTRICAL/ELECTRONICS**
- **INSTRUMENTATION DESIGN**
- **TECH WRITER - ELECTRONICS/MECHANICAL**
- **ELECTRONICS/ ELECTRICAL TESTING**
- **FLIGHT SYSTEM TESTING**
- **INSTRUMENTATION TEST**
- **TEST PLANNING**
- **CONTROL SYSTEM ANALYSIS**
- **ELECTRONIC SYSTEM ANALYSIS**
- **SYSTEM SAFETY**
- **POWER DISTRIBUTION ANALYSIS**
- **FACILITIES ENGINEERS - ELECTRICAL/MECHANICAL**
- **MANUFACTURING RESEARCH & DEVELOPMENT ENGINEERS**
- **TOOL ENGINEERS**

Ask us today just how your experience and background can match our many requirements. We think you'll be pleasantly surprised at what we have to talk about.

DISCOVER MIDWEST LIVING. You'll find a friendly neighborhood environment in a Metropolitan area that other big cities just can't equal. For growing families and families-to-be, Wichita has a lot to offer. With a population of 383,312, close-to-work living, excellent schools including three universities, smog-free four season climate and plenty of recreational activities, Wichita is waiting to provide you with an informal yet challenging atmosphere in which to design your future.

Send resume to: Jim Snelling, Boeing Wichita Company 4300 E. MacArthur Road, Dept E8
Wichita, Kansas 67210 or Call Collect (316) 687-3057

BOEING

WICHITA COMPANY

An Equal Opportunity Employer M/F

MANAGER OF COMPONENT ENGINEERING

Are you an outstanding Component Specialist?

Are you an experienced Manager?

Can you assume complete component engineering responsibility for a \$100 million product line?

Would you enjoy the challenge of upgrading an existing organization?

Are you prepared to handle over 100 products in 7 product lines, including a complete micro-computer line?

If your answers are yes, you are a very special person and you should contact us immediately about this exciting opportunity and your professional future

Our modern Facilities are located on the shores of Lake Michigan in a pleasant community which offers ample recreation and low cost of living

Sound good?

Why don't you send your resume with salary requirements to:

J. K. Bartley
HEATH COMPANY
 St. Joseph, Michigan 49085
 Equal Opportunity Employer M/F

HEATH

Schlumberger



★★ ENGINEERS ★★

- Computer Design
- Pwr. Supplies
- Controllers
- Missile Sys.
- Radar
- Management
- Sales

★★ TECHNICIANS ★★

- Missile Sys.
 - Instructors
 - Writers
 - Radar Sys.
- 127 Client Companies with Nationwide Openings. Send resumes to:
 Key Assoc. Inc.
 Suite 205
 6296 Rivers Ave.
 No. Chas., SC 29406

ENGINEERS/ MANAGERS

ELECTRONICS ENGINEERS, \$15K-\$40K. Immediate west coast & national positions entry level thru mgmt in commercial, aerospace & communications industries. We will put you in contact with large, medium or small prestigious cos desiring backgrounds in analog, digital, microprocessor, instrumentation, microwave technology & related areas. For immediate confidential response, call or send resume w/salary history to Glenn English, President, GLENN ENGLISH AGENCY, 7840 Mission Center Ct., San Diego, CA 92108 (714/291-9220).

ELECTRONICS ENGINEERS, \$18,000-\$50,000. Choice entry level to management positions immediately available in Pennsylvania & national locations. Reply in strict confidence to J. G. Weir, President, WEIR PERSONNEL SERVICES, 535 Court St., Reading, PA 19603 (215/376-8486).

DESIGN ENGINEERS to \$38K. Central Penna. Design connectors/terminals, micro-processors. Outstanding relocation packages. Prompt confidential reply. MECK ASSOC. PERSONNEL, 1517 Cedar Cliff, Camp Hill, PA 17011 (717/761-4777).

all positions fee-paid

npc NATIONAL PERSONNEL CONSULTANTS

Administrative Executive

Our requirements are simple:

- Administrative skills a must.
- Financial planning background.
- Financial analysis background.
- High technology sales background.
- Manufacturing/production knowledge in the electronics or computer industry.
- MBA

Please send resume with salary history, principals only.

P-9849, Electronics

Class Adv Dept., P.O. Box 900, N.Y., N.Y. 10020
 Equal Opportunity Employer M/F

Electrical Engineer

We're looking for someone who is looking for . . .

**Consumer Product Design and Development
 Microprocessor Technology
 Project Engineering Approach**

Be part of the product development of the electrical systems for Johnson and Evinrude Outboard Motors. Interest in boating and engines is a plus. BSEE required. Call or send resume:

Contact: Roger Gallentine

(312) 689-5289



OUTBOARD MARINE CORP.

100 Sea Horse Drive Waukegan, Ill. 60085

An Equal Opportunity Employer M/F

Engineers—SE Locations, Process, Power Light, Software, Hardware, Systems, Instrumentation, Facilities Fee Paid, No Contracts, 12 yrs experience. Send resume to Ted McCulloch.

**Beall Associates
 P.O. Box 5042
 Spartanburg, S.C. 29304**

**SUN BELT MGRS. & ENGRS.
 Electronic & Electrical**

Enjoy living in the energy rich South/South west. Confidential representation. 25 years' industry experience

JOHN WYLIE ASSOCIATES, INC.
 Professional Recruitment Consultants
 522 S. Boston, Tulsa, OK 74103
 (918) 585-3166

Staff Engineer Microprocessors

We are a leading Fortune 200 corporation who have recently formed a new corporate electronics laboratory. We are looking for an experienced degreed engineer to design, develop and implement cost-effective programs utilizing single chip microprocessors in a high volume consumer products environment

This position is located in **ST. LOUIS** and reports to the Corporate Manager, Electronics Lab. We offer a superior opportunity for advancement plus a very progressive compensation and benefits package. For consideration, send detailed resume with salary history, in confidence to:

P-9850, Electronics

Class. Adv. Dept., P.O. Box 900, N.Y., N.Y. 10020
 An equal opportunity employer m/f

AT GRUMMAN ENGINEERS WORK WITH GREAT FACILITY



Take Our Fly-By-Wire Labs For Instance

Our fly-by-wire laboratories were set up to speed the development of potential fly-by-wire (FBW) system configurations through hardware and software analysis. Much of the work performed in these labs is aimed at validating FBW system configurations; other tasks include the testing of in-line and skewed sensor redundancy management techniques and investigations of digital control mechanization methods.

The FBW facility actually consists of two laboratories: the actuator lab, devoted to the test of actuator hardware, and the systems lab, in which overall FBW systems studies are performed.

The Fly-By-Wire lab is just one of many advanced facilities available to our engineers. Others include the anechoic chamber, multi-plexing/data bus, laboratory electro/optics facility, micro-electronics facility,

high temperature hydropneumatic test facility, environmental control lab. We could go on...

One of the pleasures of working at Grumman is the extensive up-to-the-minute facilities at the professional's fingertips. Encompassing the broadest range of activity, the facilities permit the widest latitude of use including outright experiment, verification, prototype development and manufacture. They are a major element of the high-performance environment that is Grumman. The facility doesn't stop with bricks and mortar and machines. It extends to the work itself. Challenging, of course, difficult, to be sure, but nothing that can't be done with great facility.

The work areas shown will give you some indication. If you're qualified, we have immediate openings and would like to hear from you.

■ R.F. EQUIPMENT DESIGN AND DEVELOPMENT

BS in E.E., Physics, or Electrophysics. Experience should include design, development, test, analysis and integration of microwave components, transmission lines, Antennas and Radomes; aircraft and spacecraft communication, navigation and identification (CNI) equipment; Radar systems and Electronic Counter-Counter Measures techniques; state of the art ECM equipment and excitors of airborne vehicles including active and passive ECM technology, ELINT and digitally integrated ECM equipment.

■ SOFTWARE DEVELOPMENT

Software Development Engineers. Design and implement real time software systems. Applications include military avionics and automate list system development. Programming experience should include assembler and higher order languages, developmental tools and operating systems.

■ SYSTEMS DESIGN AND ANALYSIS

B.S. Electrical Engineering, Applied Math, Computer Science or Physics. Experience should include airborne avionics involving areas such as design of digital and computer based systems, real time software requirements and Algorithm development, EW systems performance analysis, weapon systems performance analysis and mission effectiveness and cost performance analysis involving complex combinations of radar, ECM and weapon systems.

■ SOFTWARE DESIGN AND ANALYSIS

Software Systems Engineers. Develop and expand program requirements and architecture to satisfy operational objectives. Perform trade studies, performance analysis and computing resource budgeting. Tasks involve working with complex real time systems having high speed processing and massive data control challenges.

For prompt consideration, send resume in strict confidence to: Mr. Dan Nettuno, Grumman Aerospace Corporation, Bethpage, New York 11714.

AN EQUAL OPPORTUNITY EMPLOYER M/F



The reliable source

If you currently earn between \$20,000-\$45,000 we've got a better job for you . . . NOW!

Several new contract awards have created numerous, immediate, long term career opportunities for degreed, technical professionals. We are only interested in top caliber, creative individuals with proven records of success in engineering, management & consulting. Locations are nationwide.

Opportunities include technical/management consulting, project management, R&D, test and systems evaluation. Major contract areas include Communications, Satellites, Weapons, Intelligence, Computer, Energy and Aerospace systems. All positions require U.S. CITIZENSHIP, MINIMUM OF A BS degree (MS/Ph.D preferred), and a minimum of one year experience in one or more of the specific areas listed below.

- Minicomputers
- Microprocessors
- Software development
- Signal processing
- Digital systems
- Command & Control
- Radar Systems
- Communication Systems
- EW/SIGINT/ELINT
- Microwave Systems
- Electromagnetics
- Fire Control Systems

If you want to join one of the fastest growing firms in the country, call Robert Beach, Vice President, collect at (301) 762-1100 or, if you prefer, send your detailed resume, in confidence. We'll make you an offer you can't refuse.

WALLACH Your career connection
Equal Opportunity Employer Agcy

WALLACH
associates, inc.

1010 Rockville Pike
Box 6016
Rockville, Maryland 20852
(301) 762-1100

Job-seekers... be the first to know with McGraw-Hill's Advance Job Listings

By having our weekly ADVANCE JOB LISTINGS sent to your home every Monday you can be the first to know about openings both in and out of your field. AJL will enable you to contact anxious recruitment managers BEFORE their ads appear in upcoming issues of 21 McGraw-Hill publications. To receive a free sample copy, plus information about our low subscription rates, fill out and return the coupon below.

ADVANCE JOB LISTINGS / P.O. BOX 900 / NY 10020

PLEASE SEND A SAMPLE COPY
OF ADVANCE JOB LISTINGS TO

NAME _____ ADDRESS _____
CITY _____ STATE ZIP _____

POSITIONS VACANT

Electronics Test Engineer (ATE) National Bureau of Standards. The NBS Center for Electronics and Electrical Engineering, ElectroSystems Division, is developing a program on metrology for the improved characterization of complex systems and automatic test equipment (ATE). A program manager is needed who has expertise in the areas of metrology, test equipment standards, and automatic testing practices for electronic components (including RF and microwave devices), subassemblies, and complete functional units. Experience or familiarity with design for testability concepts and optimization methods which utilize the tools of operations research and the mathematics of probability and statistics is also desired. This position allows opportunity to interact widely with the test equipment industry in order to establish needed improvements in metrology support. Preference will be shown to candidates with experience in program planning and implementation together with demonstrated ability to interact effectively with technical, administrative, and managerial personnel. Depending on individual experience, the salary level is at grade GS-14 (\$32,442-\$42,171) or GS-15 (\$38,160-\$47,500). To be considered, send your resume or Personal Qualifications Statement (SF-171) to: Deborah Raisher, National Bureau of Standards, Administration Building, Room A-123, Washington, D.C. 20234. An Equal Employment Opportunity/Affirmative Action Employer.

Applications are invited for an Instrumentation Engineer position for appointment on or before November 1, 1979. Duties include design, fabrication and modification of electronic, electro-optical and electro-mechanical instruments used in biological research and attending to the data processing needs of the staff. B.S. Electrical Engineering and a strong interest in instrumentation are required, and 1-2 years of experience would be helpful. The salary is competitive. Please reply with full particulars including experience, salary expectations, curriculum vitae, references and date of availability to Dr. William L. Pak, Department of Biological Sciences, Purdue University, West Lafayette, Indiana 47907. Equal Access/Equal.

EMPLOYMENT SERVICES

Electronic engineering growth positions with clients located nationally. Our service is enhanced by the fact that I am an EE with 20 years in industry and over 10 years in placing professionals on an employer fee paid basis. Send your resume to Joe Torcassi, Director, J. Anthony & Associates, PO Drawer AD, Lynchburg, OH 45142. 513/364-2305.

POSITIONS VACANT

Radio Network Director of Engineering Six-station interconnected FM radio network in Minnesota seeks engineer with AM, FM, audio, microwave and satellite experience, plus administrative skills, to be responsible for engineering activity as Director of Engineering. Send resume, salary requirements, letter of interest and references to Tom Kigin, Minnesota Public Radio, Box A, 400 Sibley St., St. Paul MN 55101 AA/EOE.

Radio Audio Engineer - Six-station interconnected FM radio network in Minnesota seeks engineer strong in audio, with some RF background, to help design and build new studio-office complex (with seven control rooms and studios), and remain as Chief Audio Engineer with responsibility to evaluate, specify, design and construct audio equipment to ensure high standards of quality throughout network. Send resume, salary requirements, letter of interest and references to Tom Kigin, Box B, Minnesota Public Radio 400 Sibley St., St. Paul MN 55101.

BUSINESS OPPORTUNITIES

Get paid for telling others what you already know. Speakers can make over \$100 per hour. Learn how to cash in on your skills. 22-page practical guide, \$5.95 (CA Res. add \$0.24 tax). Rosenau Consulting, Suite 202B, 1003 Wilshire Bl., Santa Monica, CA 90401.

FACULTY POSITIONS VACANT

Engineering Technology - Faculty position available at the Wilkes-Barre Campus of The Pennsylvania State University: Biomedical Equipment Technology, Master's degree in appropriate field required. Practical experience highly desirable. Send resume by December 1, 1979 to: Nils Parr, Wilkes-Barre Campus, P.O. Box 1830, Wilkes-Barre, PA 18708. Phone: 717-675-2171. An Equal Opportunity/Affirmative Action Employer.

SYSTEMS ENGINEERS: You're the Vital Link in Data Communications

If challenge and increased responsibility appeal to you, there are exciting opportunities molding our high performance, high speed data communications products to our customers' specific needs. You'll design special hardware, create special software, and face off against all of the challenges inherent in managing the implementation of major data communications networks. You're the link that helps get the information through, and our reputation sits squarely on your shoulders.

Senior Design Engineers

We're seeking engineers to design hardware and software to meet our customer specifications. For hardware design, you'll need a BSEE and 5 years of experience in digital and/or analog in a hardware design environment; microprocessor experience is a plus. Software designers will work with IBM, Honeywell and Burroughs protocols. You'll need a computer science degree and 3-5 years of minicomputer, real-time systems, and programming experience.

Let us know you are ready for action by dropping us a line or sending your resume to Art Buliung, CODEX CORPORATION, 20 Cabot Boulevard, Mansfield, MA 02048.

codex
corporation

A Subsidiary of MOTOROLA INC

An Equal Opportunity/Affirmative Action Employer

MOS/LSI Design Engineers: Take A Close Look At Honeywell... And Find Your Future In Systems.

The future of IC technology is at the systems level. For years, Honeywell's been working on that future. It's a future that's key to your career.

Now's the time for you to investigate our efforts. And discover the challenge, recognition, and rewards that are waiting for you.

At Honeywell's Small/Medium Information Systems Division (S/MISD), we are expanding our advanced state-of-the-art design center to focus on the future of our overwhelmingly successful minicomputer and terminal products. We're looking for experienced MOS/LSI design engineers to join us.

Our S/MISD design center is located in suburban Billerica, Massachusetts. Adjacent to the famed Route 128 electronics belt, and just 30 minutes west of Boston, Billerica provides easy access to the cultural, educational, and recreational resources of New England. And pleasant, affordable living.

LSI Circuit Design Engineers

Positions are available for both individual contributors and project leaders to assume responsibility for logic and circuit implementation of complex LSI circuits, including central processors and peripheral controllers. You should have a BSEE and ability and interest to make significant contributions to immediate and long-term programs.

Don't pass up this opportunity to take a close look at Honeywell and discover what a future in systems could mean to you.

For more information, call Jerry Haynesworth at (617) 667-3111 ext. 2894. If unable to call, send your resume, in confidence, to: J. Haynesworth, HONEYWELL S/MISD, 300 Concord Road, Billerica, MA 01821.

An Equal Opportunity Employer M/F.

Honeywell

People.
Our Competitive
Edge

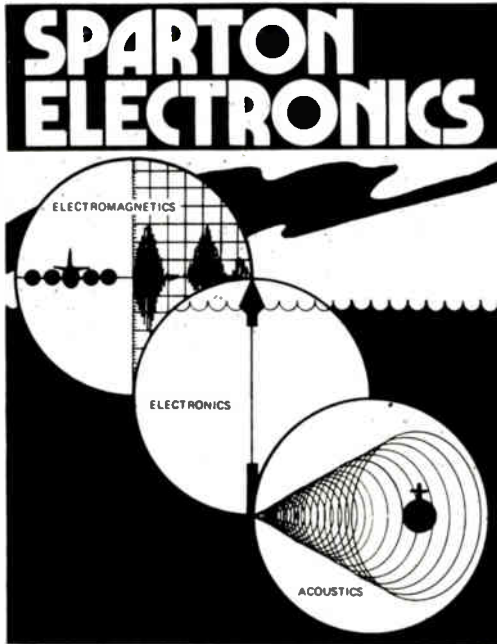

Sparton Electronics -- Our approach has always been a little different. It's our nature to experiment and innovate -- you see it in everything we do. But it's not just the innovation, it's the testing and research behind it. That's why we place such importance on you -- the engineer -- and that's why we have so much to offer. If you are an experienced EE or ME looking for more challenge and responsibility or maybe you just enjoy a small town atmosphere with easy access to almost any kind of recreation, check out Sparton Electronics.

IMMEDIATE OPENINGS:

Electronic Design Engineers - Responsible for the design of VHF-UHF receivers and transmitters, sonar receivers and transmitters, and various analog and digital circuits. Experience applicable to one or more of these areas required.

Mechanical Design Engineers - Responsible for the mechanical design of low-cost, high-quantity electromechanical and electronic equipment. Experience should include the design of injection moldings and die castings. Responsibilities consist of conceptual design, prototype build and qualification, and production support.

Call or send resume and salary requirements to:
Gary Whitworth, Employee Relations Manager



sparton electronics

2400 E. Ganson St
Jackson, Michigan 49202
Phone (517) 787-8600

AN EQUAL OPPORTUNITY EMPLOYER M/F

Move to the State-of-the-Art in IC Engineering.

Our rapid growth and financial success has created these challenging opportunities for state-of-the-art IC engineers.

Product Design Engineers:

Experience in CMOS Random Logic mask design, BSEE a must.

Senior Process Engineers:

Responsibility for day-to-day sustaining of CMOS photo-resist area. Background in negative/positive resists, projection aligners, plasma etching. Heavy people interface.

Design Engineers:

Involved in product development MOS memories from initial concept through initial manufacturing. Including: concept design, coordination of layout and circuit evaluations. 3-5 years experience in MOS memory design or development.

Lead Product Engineer:

Product engineering on manufacturing programs, wafer fabrication process, and device design on new

circuit development. Technologies of programs assigned include high performance silicon gate CMOS, metal gate CMOS, PMOS and radiation hardenings. 1-5 years experience in design fabrication of MOS or bipolar silicon monolithic IC devices.

Reliability Engineers:

Reliability prove-in with failure analysis of digital memory products, layout/design review. Accelerated stress evaluation and worst-case stress/application, with process and failure mechanism familiarity.

If you're looking for a professional environment that encourages and rewards contribution, and a beautiful, affordable lifestyle on the sunny Florida shoreline, come to Harris.

Send resume with salary history to:

Ken Judson, Staffing Supervisor,
Harris Semiconductor Group, Dept. 35,
P.O. Box 883, Melbourne, Florida 32901.
Or Call Collect (305) 724-7782.

Harris in Florida, the good life.



An Equal Opportunity Employer M/F

PERFECT TIMING

You're at the right place at the right time - Litton Data Systems in beautiful suburban Southern California. NOW... DSD is recruiting for top professional engineers, and the challenge has never been greater.

We are developing advanced realtime information processing systems for domestic and foreign military applications. Long-term programs have created new opportunities for Systems and Product Development Engineers at all levels of experience to join our professional staff.

SIGNAL PROCESSING TECHNOLOGY

● CUSTOM LSI DESIGN

Develop custom LSI devices for applications in military communications and signal processing. Includes cell definition and design, logic and circuit analysis from cell level to total chip, and generation of logic simulation and test specifications for procurement of processed chips.

● SIGNAL PROCESSING ENGINEERS

Develop signal processing systems that use advanced circuitry and firmware in distributed and array processors. These systems perform radar and IFF target detection, automatic clutter mapping, radar-IFF correlation, automatic target tracking, communications processing, and radar and IFF combat environment simulation. Creative engineers at all experience levels are needed to perform system, hardware, and firmware design.

ADVANCED DISPLAY SYSTEMS

● HARDWARE/LOGIC DESIGN

Opportunities for individuals with digital design experience. Knowledge of microprocessor applications, LSI logic, IC memory and data handling circuitry useful.

● FIRMWARE DESIGN

Develop machine-language programs and logic for our dedicated applications. Knowledge of PROM and PLA technology, computer science and software experience useful.

● SR. DISPLAY SYSTEMS ENGINEERS

Excellent opportunity for an individual with a broad background in designing military command and control display systems. The individual must have a working knowledge of display systems, architecture, display processing techniques, display circuits, and various display medias (CRT, Plasma Panel, LED's).

AIR DEFENSE SYSTEMS

● SYSTEMS ENGINEERS

New and exciting opportunities exist in the areas of integration of surveillance radars, large scale data processing, and/or communications design. Background in military command and control systems and equipment is desirable.

COMMUNICATIONS TECHNOLOGY

● COMMUNICATIONS SYSTEMS ENGINEERS

Expanding markets for Litton's Command and Control Systems technology has created openings for systems engineers to specify and design communication systems. A BS/MS EE degree and practical experience in HF, VHF and UHF communication systems implementation is desirable.

● DIGITAL COMMUNICATIONS ENGINEERS

These openings require senior level engineers with practical experience in system design involving digital multiplexers, switching and transmission equipment. Experience with front-end processing and concentrators, as well as traffic and throughput analysis is desirable. Familiarity with military and international telecommunication standards is required.

● COMMUNICATIONS TERMINAL ENGINEERS

New designs in subscriber terminals with internal processing capability have created openings for system engineers experienced in the definition and application of hard copy and interactive terminals for communication networks to analyze intelligent terminals and their interaction with common link protocols such as X25 and BISYNC. You will have the opportunity of full design, follow-through, implementation and sell-off.

● COMMUNICATIONS CONTROL ENGINEERS

The application of microprocessors in system control has created openings in the development of advanced methods of communications management. Experience required in the analysis of operational requirements of telecommunication systems, their traffic patterns and volumes. You will develop computerized control techniques and integrate with signaling schemes for switching and network control.

● DATA TRANSMISSION ENGINEERS

Develop fiber optic data busses, digital t6K bit/sec modems and programmable voice band terminals using advanced techniques for error detection and correction, digital demodulation of FSK, nonrecursive digital filtering, and digital phase locked loops. Hybrid and custom LSI technologies are used when required.

● MESSAGE SWITCHING ENGINEERS

Apply multiprocessing architecture using microprocessors and custom LSI. Develop diphas modems, high speed forward error correcting encoders/decoders, and cryptographic controllers. This hardware will support multiprocessing software that has specific line protocols, message routing policies and system control concepts.

● CIRCUIT SWITCHING ENGINEERS

Develop a family of low power, high performance circuit switches. PCM and CVSD voice digitization techniques are used with the latest LSI technology to produce a modularly expandable switch. These switches will go into systems ranging from 64 subscriber tactical intercoms to 2000 line all-digital centrals.

RADAR TECHNOLOGY

● RADAR SYSTEMS ENGINEERS

These positions will enable you to lead proposal efforts, studies and system design related to tactical systems using radar and electro-optical technologies. Your background must include previous systems engineering.

SOFTWARE APPLICATIONS

● SOFTWARE SYSTEMS ENGINEERS

Assignments exist for senior level systems engineers with experience in hardware and/or software associated with large scale realtime systems to formulate command and control system requirements and provide specifications for implementation.

POWER SUPPLY

● SR. POWER SUPPLY ENGINEERS

Will develop switching mode power conversion hardware and power distribution networks for large military communications, computer and display systems.

COMPUTER/MEMORY SYSTEMS

● LOGIC/FIRMWARE DESIGNERS

These positions are open for various levels of experienced engineers interested in developing sophisticated special purpose processing hardware, utilizing the latest LSI and Bit/Slice technologies.

● MEMORY DESIGN ENGINEERS

Openings exist for Memory Designers to work on interesting and challenging digital and analog circuit design, including semi-conductor and bubble memory assignments.

Take advantage of these exciting career opportunities...and an appealing new lifestyle in an attractive, uncongested area of Southern California. We offer excellent salaries, and an outstanding benefits package. For consideration, please submit your resume, complete with salary history, or call COLLECT:

Jim Wolhowe or Peter Herrera
(213) 781-8211, Ext. 2727



DATA SYSTEMS
Litton 8000 Woodley Avenue
Van Nuys, CA 91409

U.S. Citizenship and/or
Permanent Visa Required
Equal Opportunity Employer M/F/H

Engineers

Aerojet ElectroSystems

is looking for professionals . . . the type of engineers considered the best in the industry to participate in the growth of this expanding technology with specialities or related experience in . . .

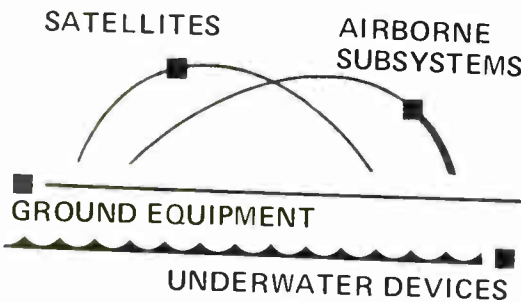

ELECTRONIC DESIGN

- Analog and digital circuits
- Signal processing systems
- Solid state sub-systems
- Digital test equipment

OPTICS DESIGN

- Infrared, laser and visible optics systems
- Advanced optics systems
- Laser countermeasures

MECHANICAL DESIGN

- Structural mechanics
- Engineering mechanics

QUALITY ASSURANCE

- Quality engineers
- Supplier reps

SCIENTIFIC PROGRAMMERS

- E/O simulation
- E/O data reduction

BS/MS/PhD levels

Submit resume to:

Mary Ehrlich, Employment Manager

**Aerojet
ElectroSystems**

P.O. Box 296-W . . . Azusa, Calif. 91702

an affirmative action employer

MARKETING REPS

An excellent opportunity for you to expand into all areas of automatic test generation with a leading manufacturer and service company. Scientific Machines Corporation is well-established in the military market and is planning its entry into commercial activity. Distributors with expertise in the digital manufacturing industry are needed now in San Francisco, Los Angeles, Chicago, Boston and Florida to develop viable leads. Direct support will be provided by the company. Please forward a brief resume to Keith Wolski, Vice President.

SMC
SCIENTIFIC MACHINES CORPORATION
2636 Walnut Hill, Suite 200
Dallas, Texas 75229
(214) 357-9343 - Telex 73 2662

ENGINEERS

ELECTRONIC ENGINEERS, \$18,000-\$45,000. For the electronics engineer, New England offers the widest diversity of positions available anywhere. As one of the largest, long established (15 years) technical placement organizations in the area, we can represent you with a wide variety of clients, large and small, for positions ranging from entry level to senior management. Nationwide representation is also part of our service. Contact Bob McNamara, E. P. REARDON ASSOCIATES, 888 Washington St., Dedham, MA 02026 (617/329-2660).

ENGINEERS / MANAGERS to \$70K. Nationwide exclusive opportunities exist for creative, innovative engineers. Confidential. Contact John Ruck, CAREER ASSOCIATES, 583 State Rd., P.O. Box 86, N. Dartmouth, MA 02747 (617/997-3311) COLLECT.

BSEE / ELECTRONIC DESIGN ENGINEERS, \$15,000-\$35,000. Immediate, desirable upstate New York & nationwide. Junior to senior project management. In confidence send resume or call James F. Corby, President, NORMILE PERSONNEL ASSOC., INC., 5 Leroy St., Box 110 Westview Station, Binghamton, NY 13905 (607/723-5377).

NEW JERSEY / NATIONAL, \$18K-\$33K. Numerous positions in telecommunications, point of sale terminals & electronic power systems. Call or send resume to Jim Mann, ARTHUR PERSONNEL, 8 Forest Ave., Caldwell, NJ 07006 (201/226-4555).

all positions fee-paid

npc NATIONAL PERSONNEL CONSULTANTS



**Would
you hire
an engineer
who
couldn't
understand
this
magazine?**

Of course not. ELECTRONICS is the technical publication for technical people. If they can't understand it, they can't receive it. That's why, when you're looking for qualified engineers, you should consider our Classified Section.

For only \$46.00 per inch your recruitment advertising will reach 46,000 pre-screened engineers—that's just \$1 per thousand!—as they're reading to combat job obsolescence, while they're thinking about their future and bettering themselves.

There's no charge for typesetting and free layout service is provided.

For more information call or write:

ELECTRONICS

Post Office Box 900
New York, N.Y. 10020
Phone: 212/997-2556

McDonnell Douglas Corporation, Industrial Control Products, a leader in the application of Microcomputers to Numerical Control, has openings for:



SENIOR ELECTRONIC ENGINEERS

Will perform applications of high speed microprocessors to Industrial Equipment. Requires recent experience in Logic Design/Microcomputers.

SENIOR MECHANICAL ENGINEERS

Will be responsible for packaging complex micro-computer components into custom electronics cabinets for Industrial applications.

APPLICATIONS ENGINEERS

Will be working closely with customers' technical staff to design interfaces between CNC control and machine tools. Will also support Marketing/Sales Managers in developing new customers. Requires 2-5 years experience in design or applications.

If you are interested in joining a growing, dynamic organization, please call or send resume to:

Glenn Schmitt, Director-Engineering • (213) 359-8216

MCDONNELL DOUGLAS CORPORATION

Industrial Control Products
700 Royal Oaks Drive Monrovia, CA 91016

MCDONNELL DOUGLAS
CORPORATION

An Equal Opportunity Employer

SOFTWARE ENGINEERS



TRW VIDAR
on the
SAN FRANCISCO PENINSULA
continues to broaden
its scope of activities
in the telephony industry
with controlled but
outstanding growth
in the development
of its digital
switching systems.

You have exciting and rewarding opportunities awaiting you with TRW Vidar, as one of the leading companies in the industry. Our current needs in our Switching Product Assurance group require individuals interested in continuing their professional development in such a challenging, dynamic environment.

Working as a Switching System Test & Evaluation Engineer, you will have responsibility for planning, designing, documenting, introducing & supporting programs for Product Assurance testing of our digital switching systems. In addition to a degree in CS or EE, your background should include experience in microprocessor programming with real time operating systems. Familiarity with current hardware technology and prior telephone switching systems experience are a plus.

Professional opportunities at TRW Vidar are excellent. Our outstanding benefits program and attractive work environment make our company the right one to explore.

Call 415/961-1000 for Dick Duncan in our Professional Placement department to discuss your background, or send him a resume outlining your experience. (You'll receive prompt consideration.) TRW Vidar, 77 Ortega Ave., Mt. View, CA 94040. An equal opportunity employer M/F.

TRW VIDAR

SEMICONDUCTOR PROCESS SPECIALIST

We have an excellent opportunity in our Research group for a semiconductor specialist with extensive experience in process development, who is familiar with state-of-the-art wafer processing equipment and techniques.

You will be part of a highly select group of specialists who are investigating semiconductor processes for advanced high performance VLSI applications in computing equipment.

Processing disciplines will include: Silicon, Silicon on Sapphire, and Gallium Arsenide materials; high resolution multilayer metalization, dry processing techniques, and submicron lithography.

Applicants possessing a related M.S. degree or equivalent industrial experience should forward their resume to: **R. A. Pagano, Research and Technology Staffing, Sperry Univac, a division of Sperry Rand Corporation, P.O. Box 500, Blue Bell, PA. 19424.** An equal opportunity employer. M/F/V/H.

SPERRY UNIVAC
COMPUTER SYSTEMS

FREE Your dream job.

We hope you're happy in your current position, but there's always that ideal job you'd prefer if you knew about it.

That's why it makes sense to have your resume on file in the Electronics Manpower Register, a computerized data bank containing the qualifications of career-conscious ELECTRONICS readers just like yourself.

You'll benefit from nation-wide exposure to industry firms privileged to search the system, and since the computer never forgets, if you match up with their job requirements you'll be brought together in confidence.

To take advantage of this free service, mail your resume to the address below.

ELECTRONICS MANPOWER REGISTER
Post Office Box 900/New York, N.Y. 10020

“Want a reason to join Hughes? We’ll give you a dozen of them.”

- 1.** Challenges creative minds thrive on. From research and development to electro-optical systems applications and manufacturing, we'll give it to you as easy or as tough as you want it.
- 2.** Career opportunities that knock again and again. And when we promote, it's almost always from within.
- 3.** Job security. With over 1500 programs, it's no wonder people who work with us tend to stay with us. Right now, the average is 9.3 years.

- 4.** Our future. The business forecast has never been brighter.
- 5.** Space age facilities that are down to earth. Our new 143 acre complex will be completed in 1981.
- 6.** Plenty of sunshine. And tennis and boating and beaches and...
- 7.** Good people to work with. In a people-oriented company.
- 8.** The world's third largest credit union. We typically pay 7%.
- 9.** Education. You provide the mind, we'll provide the tuition, 100% of it.

- 10.** Lots of benefits. Company funded health, dental, major medical, life insurance and more.
- 11.** An employees' association that's jumping. For runners, skiers, stamp collectors, musicians and more.
- 12.** Pride in the place you work. Besides being a good, big company, Hughes has become the leader in Electro-Optical Systems — with a whole lot of help from our friends.

Engineers for Manufacturing Division, El Segundo

- Electronics
- Senior Project
- Electro-Optical
- Microprocessor
- Control Systems
- Test Equipment
- Process
- Quality Assurance
- Production
- Industrial
- Facility

Call us at (213) 641-5510 or send your resumé to Hughes Professional Employment, Electro-Optical & Data Systems Group, Manufacturing Division, P.O. Box 92746, Airport Station, Dept. EL, Los Angeles, California 90009.

Engineers for Research & Development, Culver City:

Components & Materials

- Material/Process Development
- Device Design/Application
- Test/Reliability
- Failure Analysis
- Product Evaluation
- Problem Solution

Space Sensors

- Missions Analysis
- Systems Engineering
- Signal/Data Processing
- E-O Sensor Systems
- Cryogenics
- Optics/Holographics
- Control/Imaging Systems

Lasers Systems

- Gas/Solid State Lasers
- Electrical/Chemical Lasers
- Image Processors
- IR Sensors
- Control Systems
- Circuits/Servos
- Rangefinders/Target Designators

Electro-Optical Systems

- IR Sensors/Imaging Systems
- Microprocessors/Computers
- Analog/Digital Design
- Circuit Analysis/Servos
- Electronic Packaging
- Structural Dynamics
- Signal Enhancement/Processing

Call us at (213) 391-0543 or send your resumé to: Professional Employment, Hughes Electro-Optical & Data Systems Group, Research and Development, 11940 W. Jefferson Blvd., Dept. EL, Culver City, CA 90230.

Call us. You'll like what you hear.

All positions require an appropriate engineering or technical degree from an accredited university. U.S. Citizenship Required. Equal Opportunity M/F/H/C Employer.

HUGHES

ELECTRO-OPTICAL AND DATA SYSTEMS GROUP

ROCKWELL INTERNATIONAL OFFERS MORE...MUCH, MUCH MORE!

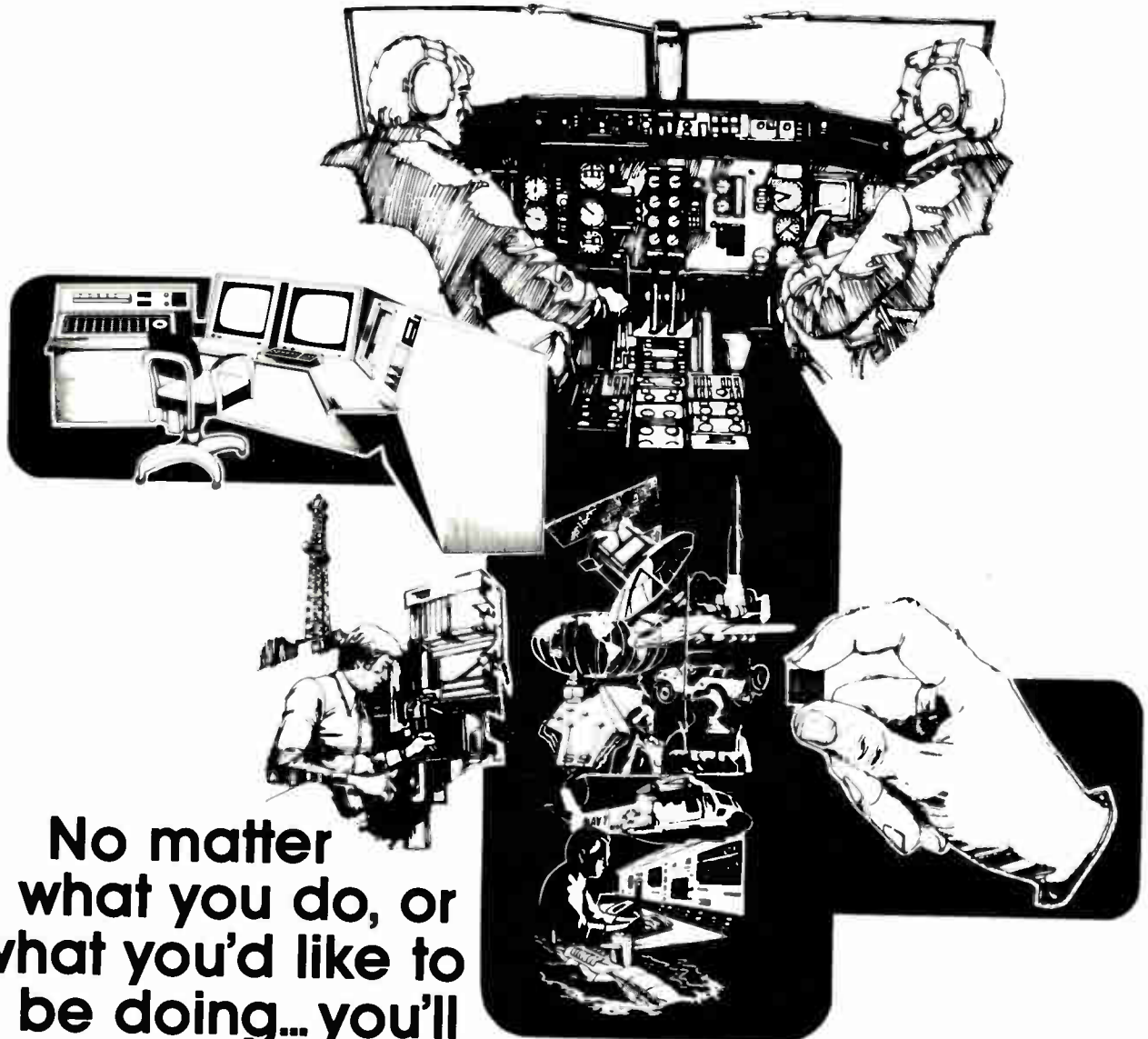

No matter
what you do, or
what you'd like to
be doing... you'll
find more of what you're looking
for on the following pages.

We are an equal opportunity employer.
Minorities, women and handicapped are
encouraged to apply.



**Rockwell
International**

...where science gets down to business

AVIONICS

Rockwell International's Avionics and Missiles Group is a world leader in the design, development and production of communication, navigation, flight control and flight instrument products and systems for air transport and general aviation, as well as military and government aircraft. Also, we offer precision guidance and weapon systems for the U.S. armed services and international customers.

Located in scenic Cedar Rapids, Iowa, a city that proudly boasts of being comparatively free of pollution, noise, and crime. Cedar Rapids has all the advantages of city life, but in a pastoral setting. In this combination of urban and rural life, our Avionics divisions—the Collins Air Transport Division, the Collins General Aviation Division and the Collins Government Avionics Division—continue the Rockwell tradition of designing and producing quality products through the proper application of state-of-the-art, cost-effective technologies and engineering principles.

Our engineers are engaged in advanced experimental programs on emerging technologies related to all areas required to product design. These areas include: avionics systems, analog/digital circuits, digital computers, software, microwave circuits, sensors and display. As well as developing new products and technologies, Rockwell is the established industry leader in quality and reliability for aviation products.

COLLINS AIR TRANSPORT DIVISION

The airline market, truly a world market, is treated as such by our people in the Collins Air Transport Division. As a leader in supplying quality avionics products, systems and services to airlines and airframe companies, this division addresses itself to these markets with a broad array of products that stay abreast or ahead of advancements in aircraft design. As a matter of fact, our Digital Flight Control System will be aboard the all new Boeing Model 767/757 airliners.

COLLINS GENERAL AVIATION DIVISION

Not to be outdone, the Collins General Aviation Division is also a leading supplier of avionics systems, products, and services to a broad range of customers in business and private aviation. Our

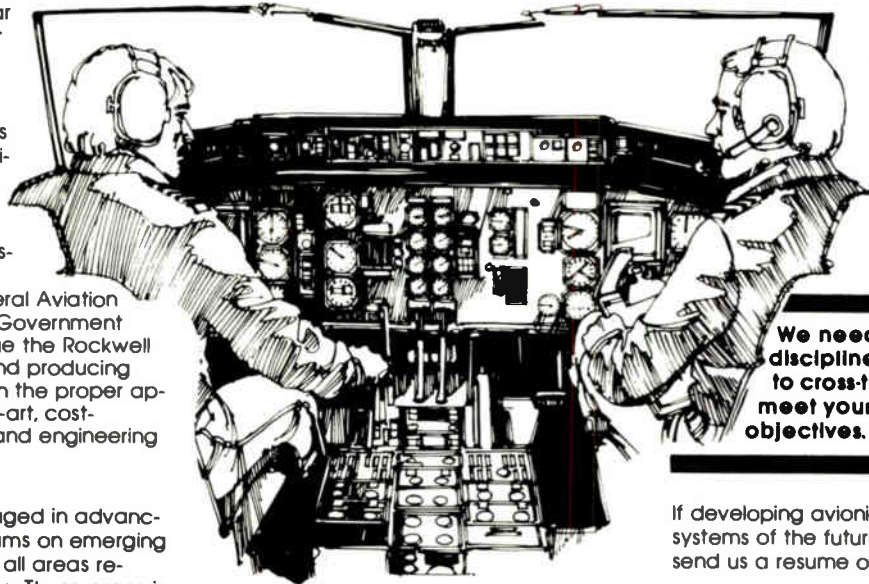

engineers in this division supply these varied and ever growing markets with innovative and distinctive products that help to increase the safety of general aviation customers in a cost-efficient manner.

COLLINS GOVERNMENT AVIONICS DIVISION

Our Collins Government Avionics Division is a dedicated group of people that specialize in supplying high-technology avionics and automated test equipment to the U.S. military and other governments throughout the free world. Our engineers not only supply the world with the most up-to-date equipment for military aircraft, but are also hard at work developing the next generation of navigation systems. Recently, they were awarded a contract to help develop the Navstar

Global Positioning System (GPS), which is the first navigation system that provides the user with accurate position, velocity, and time with 24-hour coverage. Also, they will be the avionics system integrator for the Coast Guard's Short Range Recovery Helicopter (SRR).

The Avionics and Missiles Group's reputation for quality products and advanced technologies began in the 1930's, and we plan to continue and enhance that

reputation through the year 2000 and beyond. Because of this commitment to excellence, we are always looking for talented, ambitious, imaginative people who share our hopes, dreams and desire for excellence.

We need engineers in all the disciplines, and we are willing to cross-train you in order to meet your career goals and objectives.

If developing avionics products and systems of the future interests you, then send us a resume or call us COLLECT:

**Loren Wells, Manager,
Professional Employment
Avionics & Missiles Group
Rockwell International
400 Collins Road N.E.
M/S 120-145
Cedar Rapids, Iowa 52406
(319) 395-2351**

We are an equal opportunity employer. Minorities, women and handicapped are encouraged to apply.



**Rockwell
International**

...where science gets down to business

MISSILE X (MX)

The Autonetics Strategic Systems Division in Anaheim, California is involved in the development of guidance and control systems, and advanced electronics for missiles, space vehicles and aircraft.

ASSD has been selected to play a major role in the full scale development of the nation's newest generation of land-based ICBM's-MISSILE X. The division will have responsibility for the MX guidance and control system, and for the critical operational support equipment. In addition, they are involved in ongoing programs for the Minuteman and a new, light-weight, highly accurate strapdown navigator which employs electro-statically supported gyro technology.

MISSILE X will introduce state-of-the-art technology that calls for the nation's highest levels of scientific and engineering skills. For instance: Accuracy-3 times better than Minuteman III; Hardness-10 times Minuteman III requirements; Device Technology-Bipolar MSI circuits based upon Trident parts...plated-wire memory...potential alternate memory using hardened MNOS/SOS technology.

Career opportunities are immediately available for engineers and scientists with degrees in EE, ME, Physics, and Computer Science, whose experience and/or interests lie in the following technologies:

- DIGITAL FLIGHT CONTROL ELECTRONICS
- NUCLEAR-HARDENED FLIGHT COMPUTER DESIGN
- NUCLEAR-HARDENED GUIDANCE AND CONTROL COMPONENTS DEVELOPMENT
- ADVANCED BOOST CONTROL AND FLIGHT PROGRAMMING DESIGN
- SOFTWARE FOR PRECISION INERTIAL SYSTEMS CALIBRATION
- HIGHER ORDER LANGUAGE SOFTWARE

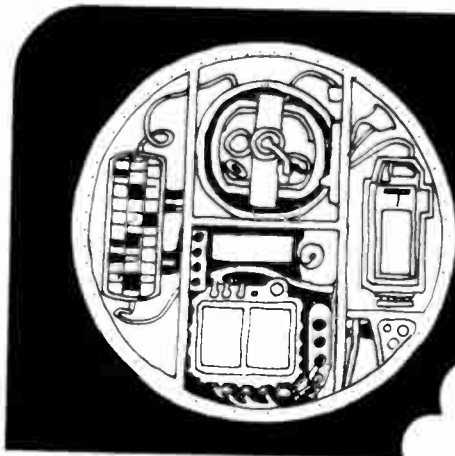

- SOFTWARE TECHNIQUES FOR ACCURACY AND RELIABILITY
- ADVANCED SYSTEMS INTEGRATION TECHNIQUES
- ADVANCED TESTING SYSTEMS DEVELOPMENT

A majority of the available positions are for engineers with less than six years experience, including many opportunities for recent college graduates.

The MISSILE X (MX) high priority contract calls for team effort by the nation's finest scientists and

engineers, and staffing for the program is underway. If you would be interested in participating in this effort, ACT NOW. We will be selecting qualified candidates as rapidly as possible, and we invite you to explore opportunities on Rockwell International's MISSILE X Team.

**CALL COLLECT:
(714) 632-1001**

or send resume to:

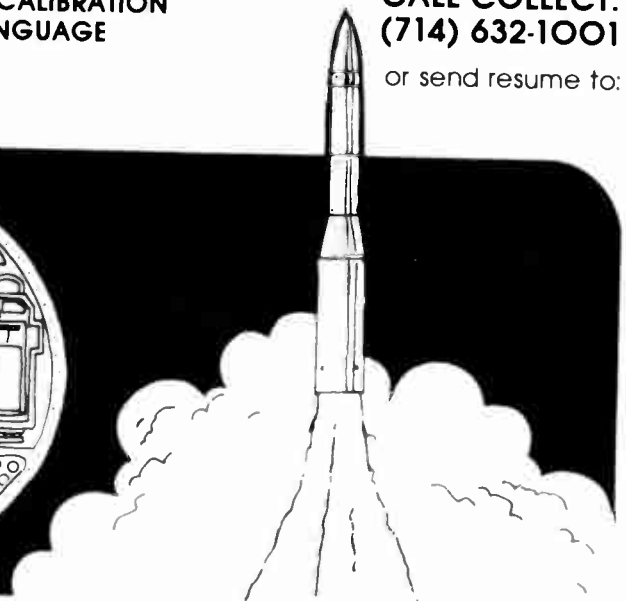

**Autonetics Strategic
Systems Division
Rockwell International
3370 Miraloma Avenue
Anaheim, Ca. 92803
Attn: Dept. E9-AA39**

We are an equal opportunity employer. Minorities, women and handicapped are encouraged to apply.



**Rockwell
International**

...where science gets down to business

MARINE SYSTEMS

Autonetics Marine Systems Division (AMSD) in Anaheim, California is a leader in research and development involving ships inertial navigation systems, ships signal processing, sonar processing equipment, shipboard data multiplex systems, shipboard command and control systems, and a state-of-the-art electrostatically supported gyro monitor.

The Navy has recently awarded AMSD a contract to design, develop, manufacture and test an Advanced Mobile Acoustic Torpedo Target (ADMATT), to simulate evasive actions taken by an enemy submarine.

The Division's submarine systems experience encompasses detailed analytical studies ... hardware design and production...operational and interface software design...system integration...computerized systems simulation and evaluation...and design and production of training equipment.

AMSD's efforts in acoustic signal processing, beamforming and automatic tracking have been supported by Navy contracts as well as substantial independent and development funds.

A significant breakthrough in ship design and construction methodology, developed by AMSD, involves the use of multiplexing for shipboard data transfer, which replaces the traditional massive amounts of cabling, junction boxes, switchboards, etc.

Autonetics Marine Systems Division has a dedicated, secure hardware/software integration capability for developing and testing a full range of software for the effective integration of increasingly complex electronics systems such as communications, navigation, radar, sonar, and fire control systems.

Graduate engineers with experience, and new college graduates, will be interested in a variety of positions available in Anaheim, California; Arlington, Virginia; and Groton, Connecticut. If your experience and/or

- **SHIPBOARD INERTIAL NAVIGATION SYSTEMS ENGINEERING**

- **ACOUSTICAL ENGINEERING**

- **TRAINING REQUIREMENTS**

- **SYSTEMS MAINTAINABILITY**

- **FIELD ENGINEERING**

- **TECHNICAL WRITING**

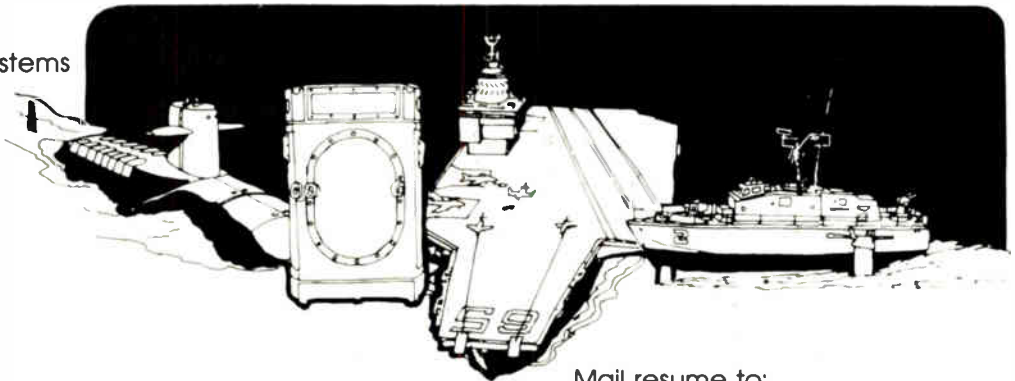

Mail resume to:

**Autonetics Marine
Systems Division
Rockwell International
3370 Miraloma Avenue
Anaheim, CA. 92803**

Attn: Dept. E830-AA39

We are an equal opportunity employer. Minorities, women and handicapped are encouraged to apply.

interests lie in any of the following areas, we would like to hear from you!

- **NAVAL TACTICAL DATA SYSTEMS ENGINEERING**

- **SONAR SYSTEMS ENGINEERING**

- **SUBMARINE COMBAT SYSTEMS ENGINEERING**

- **SHIPBOARD COMBAT SYSTEMS ENGINEERING**



**Rockwell
International**

...where science gets down to business

TELECOMMU-

SPACE & SECURE TELECOMMUNICATIONS SYSTEMS

Rockwell's Space and Secure Telecommunications Systems Division is one of the world's leading suppliers of satellite communication terminals and tactical and strategic data communications equipment.

Products range from microminiature components to large scale systems, and cover the entire frequency spectrum from very low frequency to light.

The Division is a leading supplier of satellite communication systems and products to military and government agencies around the world in the UHF, SHF and EHF ranges, and of space-qualified electronic products for use in satellites.

We are also a leader in secure communication systems, provide strategic and tactical communication and surveillance systems and cryptographic devices for submarine, shipboard, airborne, and shorebased applications.

Our engineers and scientists provide the base for the Division's continued technological leadership in the fields of satellite communications, real-time signal processing, software systems and electro-optical imaging. Some of the positions currently available include:

SIGNAL PROCESSING ENGINEERS: Enter the challenging world of real-time signal processing using bit-slice microprocessors imbedded in state-of-the-art modems for VLF, HF and UHF communications systems.

ANALOG CIRCUIT DESIGNERS: Immediate openings for engineers in all facets of analog design, with particular emphasis on special techniques for controlling EMI and TEMPEST hazards.

DIGITAL CIRCUIT DESIGNERS: Perform conceptual design and implement state-of-the-art military communications hardware.

Successful candidate will perform system and equipment design, breadboard and prototype testing and hardware-software integration.

SOFTWARE SYSTEMS PROGRAMMERS: Perform systems design through all of the development stages, including design, code, test, and system integration. Hardware background with

microprocessor development desirable. You should have strong assembly language programming skills related to microprocessor development systems.

SENIOR SATCOM SYSTEM ENGINEER: Immediate opportunity for senior engineer with an MS or PhD and 10 years analytical and design experience.

COMPONENT/RELIABILITY ENGINEERS: Opportunities exist for engineers with a thorough knowledge of passive and/or active devices including connectors, materials and processes.

If our careers sound interesting to you, send a resume or call us COLLECT:

Jeff Dwhyte

Mgr. Personnel Resources

Space & Secure

Telecommunications

Systems Division

Rockwell International

P.O. Box "C"

Newport Beach, Calif. 92660

(714) 833-4442

TELECOMMUNICATIONS PRODUCTS

The Collins Telecommunications Products Division of Rockwell International is located in Cedar Rapids, Iowa and produces a wide and diverse range of advanced communications equipment for airborne, shipboard, vehicular, manpack, and fixed-station applications.

As one of the world's largest communications equipment suppliers, we manufacture many of the traditional Collins products that have established industry standards for excellence in quality and reliability. Our capabilities extend throughout the communications spectrum with products that are sold worldwide to government, industrial, and individual customers.

Major new programs in advanced tactical communications represent an unusual opportunity for degreed engineers who can bring fresh thinking and innovative approaches to these growing business areas.

HF COMMUNICATIONS: Experience in HF technologies such as skywave propagation, channel characterization, and communication equipment design.

MICROPROCESSOR SOFTWARE/FIRMWARE: Beginning and intermediate

positions in our Advanced Technology department. Experience with soft/firmware desirable.

AUTOMATIC TEST EQUIPMENT: Software support and hardware design. Analysis, design, development and integration of special test instrumentation and adaptor utilizing microprocessors, calculators and HP MS21 minicomputers. Knowledge of Fortran-IV, Basic and HP RTE III/IV Operating systems required.

RF ENGINEERS: Application of fiber optics for control and communication in EM environment. EMI/EMC engineering and use of large computer/analysis tool. Knowledge of EM coupling or propagation and antennas required.

Send Resume or call COLLECT:

Nelson Brown, Professional Staffing

Collins Telecommunications

Products Division

Rockwell International

855 35th Street, N.E. M/S 137-157

Cedar Rapids, Iowa 52406

(319) 395-2381

TELECOMMUNICATIONS SYSTEMS

The Collins Telecommunications Systems Division of Rockwell International's Electronic Systems Group-Dallas is a major supplier of telecommunications systems for tactical, strategic, and national networks. Spanning the entire communications frequency spectrum and all modes of operation, these systems have been supplied to military and government agencies in more than 40 countries and are the backbone of many U.S. military networks.

One of the division's major programs is the Navy's TACAMO Communication System. This airborne system provides the only around-the-clock communication link that allows the President to relay messages to deployed strategic submarines. For the Air Force, the division supplies numerous types of systems including communication shelters, such as the TSC-60 which can be transported by air or truck to new sites as needed. The division also provides various communications systems to international government and military customers.

To maintain our leadership position in

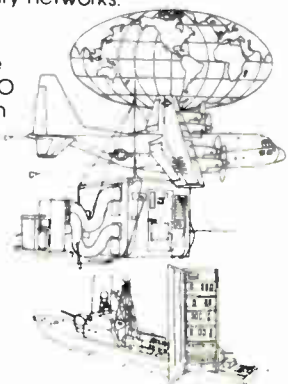
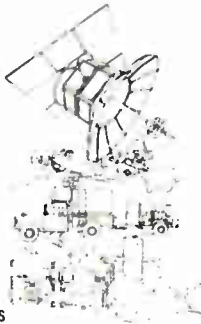

COMMUNICATIONS

these markets, we are continually investing in the development of new technologies and systems capabilities. Because of the commitment to improvement, we are looking for:

MECHANICAL ENGINEERS who can develop and implement communications systems, thermal and stress analysis, mechanical design, and electronic packaging.

ELECTRICAL ENGINEERS who will participate in the design of communication systems, and should be familiar with military communications.

SOFTWARE ENGINEERS with experience in the design, use, testing, and documentation of real-time software-systems.

Interested and qualified candidates are invited to submit resume or call collect:

Alan Leverett,
Mgr. Salaried Resources
Collins Telecommunications
Systems Division
Rockwell International
P.O. Box 10462, Dallas, Texas 75207
(214) 996-7021

SWITCHING SYSTEMS

Voice and Data Switching Systems, Fingerprint Identification Systems, and Energy Management Systems...that's what the Collins Communication Switching Systems Division is all about. We solve communications problems for a wide diversity of industries. Banks use our switching systems to handle their transactions. Most major airlines have turned to our voice switching systems to handle reservations. Electric Utilities are depending upon our Energy Management Systems to permit them to continue to provide power at a profit to an increasing number of customers despite inflation and fuel shortages. And our Fingerprint Identification Systems should soon provide the solution to numerous security problems by replacing the commonly used "lock & key" with the touch of a finger.

The Division has an immediate need for the following individuals.

SOFTWARE SYSTEMS PROGRAMMERS: PL-1 or Pascal with DEC POP-11 experience

DATA BASE MANAGEMENT SYSTEM DEVELOPERS: CODASYL level DBMS experience as applied to digital switching product lines

COMPILER DEVELOPERS: Compiler organization experience coupled with knowledge of Fortran and global optimizers code/generators

OPERATING SYSTEM SPECIALISTS: Knowledge of DEC POP-11 RSX-11 operating system

PROTOCOL SPECIALISTS: Experienced in Bisynch protocol

SOFTWARE SUPPORT ENGINEERS: Experience in real-time environment, large scale operating system. Knowledge of Fortran, assembly, design, coding, documentation and integration on a Xerox Sigma mainframe

SYSTEMS ENGINEERS: Knowledge of system design engineering, network planning, transmission performance specification, T-Carrier technology

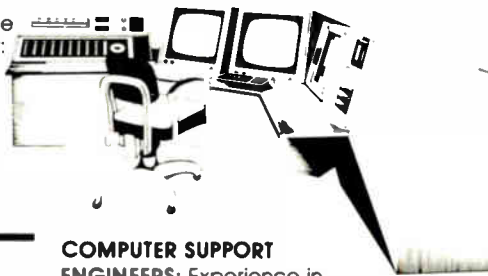

COMPUTER SUPPORT

ENGINEERS: Experience in support and maintenance of mini-computers

Qualified candidates are invited to submit a resume or call collect:

Mr. William McKinney
Collins Communication
Switching Systems Division
Rockwell International
3330 Miraloma Avenue
Anahem, California 92803
Div. 090, SA-01
(714) 632-1841

TRANSMISSION SYSTEMS

The Collins Transmission Systems Division designs, develops,

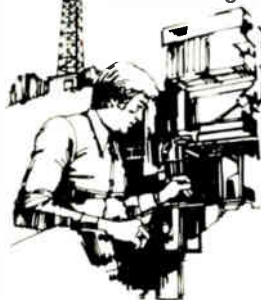

and manufactures microwave systems (primarily used by telephone companies and railroads), satellite communications (design and install earth station systems), and commercial broadcast products (everything needed to put an

AM/FM station on the air).

Microwave transmission provides multi-channel voice, data and video as primary communication for long haul,

inter-city and intra-city interconnections. The bulk of these communications is between central office switching centers where communications are concentrated, processed and distributed.

Satellite transmission provides point-to-multipoint communications for television, radio and news services, as well as point-to-point telecommunications for voice, data and facsimile.

Broadcast provides electronic equipment for commercial and educational AM and FM radio stations.

Opportunities exist for recent graduates and experienced candidates at the BS, MS and PhD levels in the following areas:

SATELLITE SYSTEMS ENGINEERS: Perform analysis, design and test of satellite communication systems for domestic and international applications.

MECHANICAL ENGINEERS: To design and document electronic packaging for microwave and multiplex subsystems and modules.

FIELD SUPPORT ENGINEERS: To assume responsibilities for installation, test and alignment of microwave systems or satellite ground stations throughout the world.

ANALOG/DIGITAL/LOGIC DESIGN ENGINEERS: Circuit design and product development engineering for communications systems.

MULTIPLEX DESIGN ENGINEERS: To assume hardware design and development responsibilities for multiplex and sub-system units.

UHF/MICROWAVE DESIGN ENGINEERS: To assume hardware design and development responsibilities for microwave radio-relay communications equipment.

INDUSTRIAL ENGINEERS: To develop basic manufacturing, fabrication, and inspection methods, processes, labor cost, standards, performance and assembly line write-ups.

Interested and qualified candidates are invited to submit resume or call collect:

Don Elder, Employment Manager
Collins Transmission Systems Division
Rockwell International
1200 North Alma Road
Richardson, Texas 75080
(214) 996-7189

We are an equal opportunity employer. Minorities, women and handicapped are encouraged to apply.



**Rockwell
International**

...where science gets down to business

MICROELECTRONICS

The best electronic brains are still human

In the ever advancing world of microelectronics, leadership belongs to companies which prize the value of human resources. This is the source of Rockwell's power in microelectronics.

Rockwell's Electronic Devices Division supplies components and devices to the company's billion-dollar-plus electronic control, guidance and communications operations. We're also a major microelectronic supplier to key firms worldwide.

Rockwell's commitment to leadership in microelectronic research, design and production is also a commitment to providing professionally satisfying careers for our engineers and scientists. Rockwell's current activities document this:

- Rockwell is the first company to demonstrate a megabit bubble domain memory device, and the first to put a 256K-bit device into production. Volume production of megabit devices begins in 1980 while Rockwell scientists work on 4 megabit and larger devices.
- Rockwell, a leader in high speed LSI modems, is the first company to design and market a modular 2400 bps modem capable of low-cost integration into systems of communications and computer related equipment.
- Rockwell is volume producing NMOS, third generation R6500 microprocessor devices, and is phasing into VLSI production. In our laboratories, we've fabricated NMOS transistors with 1/4-micron gate lengths in a ring oscillator that's achieved switching speeds of 80 picoseconds.
- We're leaders in developing CMOS-SOS-LSI technology. We've demonstrated an 8,000-FET device with two micron gate lengths operating at 70 megahertz. We're transferring CMOS-SOS-LSI technology into production. Rockwell also leads in developing gallium arsenide (GaAs) technology.

Career opportunities at Electronic Devices Division

If you're interested in enlarging your career in the fields of bubble memories, data modems, VLSI and VRSIC, SOS-LSI, GaAs, or other long-term technologies, arrange a confidential interview now. Call collect or write:

**Dan Frownfelter or
Jerry Laveroni**
Professional Staffing
Electronic Devices Division
Rockwell International
D/703WN, P.O. Box 3669
Anaheim, California 92803
714-632-4757

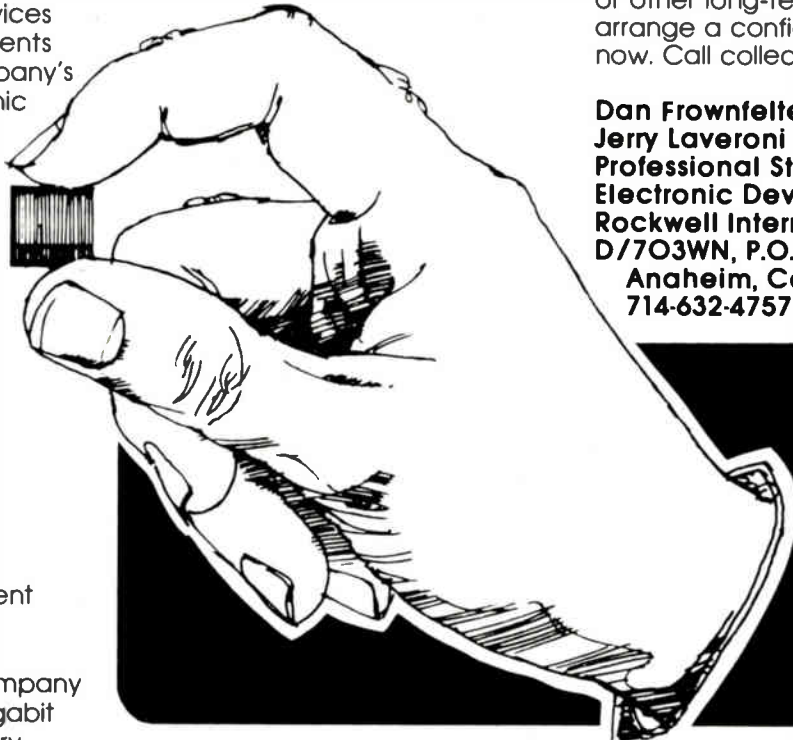

We are an equal opportunity employer. Minorities, women and handicapped are encouraged to apply.



**Rockwell
International**

...where science gets down to business

ROCKWELL INTERNATIONAL OFFERS MORE...MUCH, MUCH MORE!

You have just seen a sampling of the outstanding opportunities available with Rockwell International's Electronics Operations.

Rockwell International's total sales for 1978 were \$5.67 billion yielding record profits. Our net income for 1978 was \$176.6 million, generating a record setting \$5.02 per share. The timing couldn't be better for you to make your move to Rockwell.

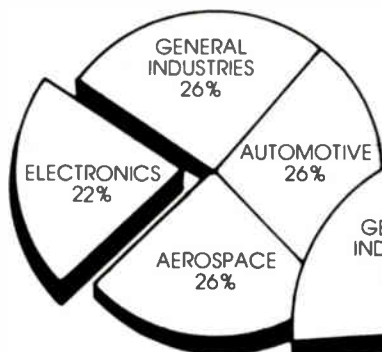

1978 total sales

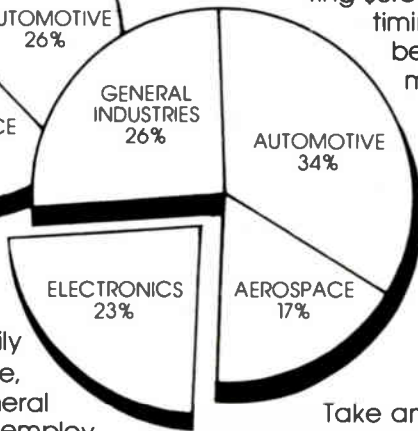

1978 operating income

Rockwell is also heavily involved in Aerospace, Automotive and General Industries. In fact, we employ over 14,300 scientists and engineers...or approximately one percent of America's total scientific-engineering community. If the ideal position for you doesn't exist within our organization, chances are that it just doesn't exist.

Take another look over this section. Call or write the representative immediately following the position of most interest to you. Feel free to contact as many of our people as you desire. Everyone from recent college graduates to seasoned professionals are welcome.

Earnings per share

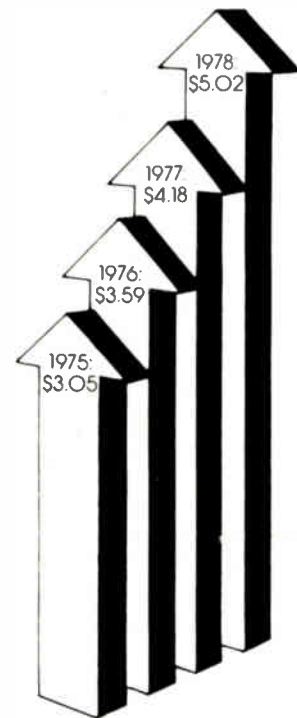

We are an equal opportunity employer. Minorities, women and handicapped are encouraged to apply.



Rockwell International

...where science gets down to business

COMPUTER SYSTEMS PROFESSIONALS

We Have Room For Your Imagination and Innovation!

At National we are making an investment to change computer design through semiconductor technology. This is part of our commitment to making computers accessible to a broader market at more effective price and performance, than is available today.

Areas of experience should include major mainframe manufacturer's mini-computer manufacturer's and microprocessor manufacturer's. 3 to 5 years working experience with CPU's, peripherals, operating systems, traditional languages, and systems configuration or integration knowledge, plus a technical education is required.

INVEST IN YOUR FUTURE BY JOINING NATIONAL'S COMPUTER PRODUCTS GROUP

Computer systems professionals with areas of specialties that include: Mini, Micro, Mainframe, and Memories...the following positions are currently open:

- Software Development
- Mechanical Packaging
- Software Support
- Manufacturing Engineering
- Analog Design
- Digital Designers
- Design Drafting
- Field Service
- Product Management
- Micro Code Specialists
- Test Engineers
- Software/Hardware Training Specialists
- Technical Support
- Quality Engineering
- Material Production Control Planners

For information, call Jim Rook COLLECT (408) 737-5000, or send your resume to him at: National Semiconductor, 2900 Semiconductor Drive, Santa Clara, California, 95051. An equal opportunity employer m/f/h.

National — A Company Making Technology Tools For People

 **National Semiconductor**
Computer Products Group

MAKE YOUR MOVE — ARIZONA

Motorola's Government Electronics Division - Scottsdale and Tempe, Arizona - is seeking design and development engineers for our communications, radar, and tactical electronics operations. GED is over 4000 people strong, setting records in sales and bookings, and has opportunities in a wide range of disciplines.

RF SYSTEMS AND HARDWARE

- ★ Frequency Synthesizers - Circuit design experience at 1 GHz and below including VCO's, filters, mixers, and phase locked loops.
- ★ Space Data Systems - RF experience including OP amps, stable oscillators, and low noise detection of signals.
- ★ Wideband Receiver Systems
- ★ Microwave Synthesizers - experience with UHF band, wide tuning ranges, low phase noise.
- ★ FM Telemetry/Pulse Amplifiers - knowledge of fast pulse and spread spectrum techniques.
- ★ Microwave Circuit Design - 5 to 10 years experience in solid state circuits built in a variety of transmission lines operating at frequencies from 1-20 GHz.
- ★ S/X Band Transponders - design and test

DIGITAL SYSTEMS AND HARDWARE

- ★ Satellite Communications Systems - A/D converters, microprocessors, control circuitry.
- ★ Digital Circuits - radar applications, micro-processor design, some tempest design.
- ★ Design and test of MOS LSI and TTL devices.

ANTENNA DEVELOPMENT

- ★ Project engineers experienced in tracking antennas, active phased antennas with knowledge of stripline and millimeter wave techniques.
- ★ Analog/Servo Mechanisms - antennas, servo amps, and analysis.

LOGIC DESIGN

- ★ Broadband high speed (1-1000 MHz) logic design and hardware implementation.
- ★ Senior Logic Designer/Task Leader - TTL, CMOS, and ECL, MPU hardware and software.
- ★ Wideband Sampled Data Systems - high data rates (100 Mbps).

EW SYSTEMS

- ★ Subsystem development to include antenna, acquisition, set-on receivers, processors, and repeater loops. ECM configuration.

FUZE SYSTEMS

- ★ Radar Fuze Design - High G environment.
- ★ Microwave Experience - microstrip RF head design in high G environment.
- ★ PCM and FM telemetry

MECHANICAL ENGINEERS

- ★ High density packaging - RF and microwave
- ★ Airborne and Ground TTL packaging
- ★ Space-borne equipment

HP 21 MX

- ★ Design and programming of distributed systems - Assembly Language and Fortran

TRANSFORMER, INDUCTOR, POWER SUPPLY DESIGN

EMI/TEMPEST DESIGN

RELIABILITY ENGINEERING/ PROJECT COORDINATORS

ENVIRONMENTAL TEST - ELECTRICAL AND MECHANICAL

MANUFACTURING

- ★ Manufacturing Engineers - Labor control systems, electro-mechanical assembly, assembly process development, work factor training and measurement.
- ★ Industrial Engineers - tool engineering, mechanization, floor layouts, work flows.
- ★ Project Managers - project planning and control, budget, and scheduling.

Accept our challenge. It is your opportunity to join a very successful electronics team in an environment conducive to your professional growth. If you are interested in joining our team, please apply in person or forward resume to:

Rich Moran, Dept. 476

MOTOROLA
Government Electronics Division

8201 E. McDowell Road, Scottsdale, Arizona 85257

An Equal Opportunity Employer



Electronics advertisers

August 30, 1979

Abbott Translator Labs	265	* Data Display	53	FRINI ANTENNE	194
■ A. D. Data Systems Inc.	244	Data General Corporation	12,13,166,167	* Fujitsu Limited	2E
Advanced Micro Devices	26,10,11,	Data I/O Corporation	233	Gates Energy Products, Inc.	247
■ Alltech	231	* Data Modul Modul GmbH	179	GCA Burlington	239
■ Alco Electronic Products	264	■ Data Precision	83	General Instrument Optoelectronics Div.	18,19
■ Allen-Bradley	32	■ Data Translation	259,261,263	‡ Georgia Department of Industry & Trade	224
Allied Trading Co. Ltd.	8	■ Delevan Div. American Precision Indust.	92	■ Gould Inc./Instruments Oscilloscopes	301
AMF Potter and Brumfield	94,95	■ Dialight	240,241	Grinnell Systems	15
■ Amphenol North America Bunker Ramo Corp.	200,201	Digital Equip. Accessories & Supplies Group	118,119	Guardian Electric Mfg. Co.	205
Amplifier Research	190	Digital Equipment Components	49	■ Hamlin	69
Analog Devices	180,181	Digital Pathways Inc.	51	■ Hewlett-Packard	2
Anritsu Electric Co. Ltd.	274	* Ducati Elettrotecnica Microfarad	207	■ Hipotronics Inc.	188
■ Ansley (Thomas & Betts)	253	Dyna/Part Div. USM Corporation	177	‡ Hitachi America	91
Applied Solar Energy Corporation	254	E.G.&G. Wakefield	248	■ Howard Industries	76,77
‡ Aromat	207	■ Electro Scientific Industries	187,189	Hysol	212,213
■ Augat, Inc.	182,183,184	Elec-Trol Inc.	52	I Corporation	186
* Bayer AG	71	Electronic Development Corporation	232	IEE Industrial Electronic Engineers, Inc.	45
Boechert	192,193	Electronic Measurements	303	Information Handling Services	236,237
■ Bourns, Inc.	2nd C.	■ Electronic Navigation Industries	6	Integrated Circuits Engineering	208
■ Bud Industries	220	Elevam Electronic Tube Co. Ltd.	304	Intel International	9
■ Busmann Mfg. Div., McGraw Edison Co.	275	■ Elgar Corporation	161	Intel Microcomputer components	20,21
■ Cambridge Thermionic Corp.	227	EL Instruments	62	Intel Military	93
‡ Centralab Electronics Div.	202,203	Elorg Electronorgtechica	210	Interface Technology	301
■ Cherry Electrical Products	27	■ EMM BESCO	273	Intersil	54,55
■ C & K Components	243	* Enertec Schlumberger	1E,8E	‡ ITT Canon Electric	65
■ Clairex Electronics	4th C.	Englehard/Thick Film	255	■ ITT Schadow Inc.	194
Colby Instruments Inc.	8	■ Erie Technological Products	226	* Iwatsu Electric Co. Ltd.	6E
■ Conner Winfield Corporation	86	EXAR	73	■ Kepco Inc.	5
Control Data Corporation	139	Fairchild Semiconductor Operations Div.	78,79	‡ Kontron Electronic Inc.	43,53,271
Corning Glass Works Fototorm Dept.	197	‡ First Computer Corporation	9	LDJ	272
‡ CTS Corporation	216	Fluke, John Mfg. Co.	158,229	Leasametric	66
Culligan USA	245	Frequency & Time Systems Inc.	270	LFE Corporation	266

NEW, FLEXIBLE, GOULD 60 MHz SCOPE.



Under \$2,000

GOULD

An Electrical/Electronics Company

The Gould OS3500 provides the latest in oscilloscope operating features. The 6 ns risetime combines with a third channel trigger view and holdoff to make the instrument ideal for the digital engineer.

- DC — 60 MHz at 2mV/cm (100 MHz trigger)
- 8 cm x 10 CRT operating at 12 kV
- Composite trigger, 3rd channel trigger view and holdoff
- Alternate timebase mode displays both delayed and intensified sweeps simultaneously
- Add-on, retrofitable, DM3010 digital measuring option increases accuracy in amplitude, time and frequency measurements
- Unique two-year warranty covers all parts and labor (exclusive of fuses, calibration and minor maintenance)

For a demonstration or answers to any questions on the OS3500, call (216) 361-3315. Gould Inc., Instruments Division, 3631 Perkins Ave., Cleveland, Ohio 44114.

Call free for brochure: (800) 325-6400. In Missouri (800) 342-6600.

Circle 133 on reader service card

Peel off
... press
it's on to
stay!

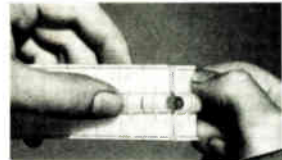

**MOLDED
NYLON
PRESS
CLIPS**

Adhesive-backed press clips now in tough, durable nylon. Fastest way yet to install clips. Comes in easy-to-use strips . . . merely peel clip off of backing strip and press into place — it's on to stay. Four sizes for bundles or cables from 1/8" to 1/2" diameter

Weckesser Company Inc.

4444 West Irving Park Road • Chicago, Illinois 60641

Circle 134 on reader service card

The biggest problem with your IEEE bus...

So your new equipment conforms to IEEE standards. Great. But your system doesn't work. Not so great. Either your interface or your software isn't compatible. But which one?

Look no further. This is Model 488. The IEEE Bus Monitor/Analyzer from Interface Technology.

It records, analyzes, and controls. It stimulates, calibrates, tests, and verifies. In short, it does the thinking — and the searching — for you.

Call today for a demonstration of this remarkable time saver. Now that you're on the bus, you don't want to miss the boat.



...is finding why
your bus has a problem.



interface
TECHNOLOGY

852 North Cummings Road • Covina, California 91724 U.S.A. • (213) 966-1718

France MB Electronique • Switzerland/Spain Instrumatic AG • W. Germany Kontron Elektronik GmbH • UK Wavetek Electronics Ltd. • Japan Tokyo Electronics Trading Co., Ltd.

Circle 135 on reader service card

Lytron	184	■ Projects Unlimited	263	Teradyne, Inc.	80,142,162,163
■ Magnecraft Electric Company	191	Pro-Log	25	Texas Instruments Semiconductor	84
Mallory Capacitor Co.	259	Racal Dana Instruments Ltd.	214,215	Textool Products Inc.	14
■ Matrox Electronic Systems	89	Racal Recorders Ltd.	114,115	Thinker Toys	211
* Matsushita Electric Trading Company	7	Raytheon Co.	56	■ TRW Cinch Connectors	30,31
MDB Systems	169	Rockwell Microelectronic Device Div.	250,251	■ TRW Electric Components	74,75
* Micro Networks Corporation	43	* Rohde & Schwarz	7E,65	■ Ultra Violet Products	263
Micro Pek	254	Roim Corporation	64A-64D	Union Carbide	116,117
■ Microswitch Div of Honeywell	28,29	Rotek Instrument Corporation	260	US Instrument Rentals	7
Microtechnical Industries	242	Samtec	219	United Systems Corporation	221
Mitel Semiconductor Inc.	50	Sangamo Weston	120	United Technical Publications	111
■ 3M Co. Electronics Div.	225	* Schweizer Mustermesse	224	Universal Instruments	3rd C.
* Molex Inc.	4E,5E	Scientific Machines Corporation	246	■ Viking Industries	47
Motorola Inc. Component Products	218	Seltz SA	257	Weckesser Company Inc.	301
Motorola Semiconductor Products	35	Semikron International Inc.	249	Wilhelm Westermann	8
■ National Semiconductor Corp.	36,37,164,165	‡ Sharp Corporation	71	Wildberg Brothers	264
NEC Microcomputers	214,215	Siemens AG Munich	60	Xcliton	244
Nichicon America Corporation	269	Simpson Electric	235	* Zeltron	216
■ Nicolet Instrument Corporation	22,23	Snap-on Tools Corporation	256	Zenith Radio Corporation	61
■ Nippon Television Industry Co. Ltd.	198	Spectral Dynamics Corporation	234	Zilog	17
■ NJE	248	Spectronics	223		
■ Non-Linear Systems, Inc.	242,252,261,304	Sprague Electric	59		
Noritake Electronics, Inc.	199	■ Stackpole	113		
Norplex Div. UOP Inc.	209	Suffolk County Dept. of Economic Development	204		
Oak Industries Inc.	144	Swedish Advertising Section	97-112		
Optima Div. of Scientific Atlanta	96	■ Syntonic Instruments Inc.	222		
Osborne & Associates	268	Systron-donner Data Products Div.	38		
‡ Panduit Corporation	179	Teccor Electronics Inc.	195		
Plastics Engineering Company	206	Tecnetics	258		
Power One Inc.	16	Tektronix	1		
■ Powercube Corporation	81	Teledyne Philbrick	264		
Power-Matic	230	Telesensory Systems Inc.	304		
		Telpar	266		

Classified and employment advertising
F. J. Eberle, Manager 212-997-2557

Aerojet Electro System..	286
Beall Associates..	280
Bell Aerospace Textron..	277
Boeing Co.,	276
Boeing Wichita Company	279
Bourns Inc.,	278
Codex Corp.,	283
Ford Motor Co.,	277
Grumman Aerospace..	281
Harris Semiconductor Group..	284
Heath Co.,	280
Honeywell..	283
Hughes Electro-Optical & Data..	289
Key Associates Inc.,	280
Jet Electronics..	278
Litton Data Systems..	285
McDonnell Douglas..	287
National Personnel Cons.,	280,286
National Semiconductor..	298
Outboard Marine Corp.,	280
Rockwell Int'l.,	290-297
Scientific Machine Corp.,	286
Sparton Corp.,	284
Sperry Univac.,	278,288
TRW Vidor	288
Wallach Associates.,	282
Wylie Associates., John.,	280

■ For more information of complete product line see advertisement in the latest Electronics Buyers Guide
* Advertisers in Electronics International
‡ Advertisers in Electronics domestic edition

Advertising Sales Staff

Advertising sales manager: Paul W. Reiss

1221 Avenue of the Americas, New York, N.Y. 10020
[212] 997-4371

Atlanta, Ga. 30309: Michael Charlton
100 Colony Square, 1175 Peachtree St., N.E.
[404] 892-2868

Boston, Mass. 02116: Frank Mitchell
607 Boylston St.
[617] 262-1160

Chicago, Ill. 60611
645 North Michigan Avenue
Jack Anderson [312] 751-3739
Robert M. Denmead [312] 751-3738

Cleveland, Ohio 44113: William J. Boyle
[716] 248-5620

Costa Mesa, Calif. 92626: Robert E. Boedicker
3001 Red Hill Ave. Bldg. #1 Suite 222
[714] 557-6292

Dallas, Texas 75201: John J. Uphues
2001 Bryan Tower, Suite 1070
[214] 742-1747

Denver, Colo. 80203: Harry B. Doyle, Jr.
123 Speer Blvd. #400
[303] 837-1010

Detroit, Michigan 48202: Jack Anderson
1400 Fisher Bldg.
[313] 873-7410

Fort Lauderdale, Fla. 33306: Michael Charlton
3000 N.E. 30th Place, Suite #400
[305] 563-9111

Houston, Texas 77002: John J. Uphues
601 Jefferson Street, Dresser Tower
[713] 659-8381

Los Angeles, Calif. 90010: Robert J. Riely
3200 Wilshire Blvd., South Tower
[213] 487-1160

Minneapolis, Minn. 55435: Robert M. Denmead
4015 W. 65th St.
[312] 751-3738

New York, N.Y. 10020
1221 Avenue of the Americas
John Gallie [212] 997-3616
Matthew T. Reseska [212] 997-3617

Philadelphia, Pa. 19102: Matthew T. Reseska
Three Parkway
[212] 997-3617

Pittsburgh, Pa. 15222: Matthew T. Reseska
4 Gateway Center
[212] 997-3617

Rochester, N.Y. 14534: William J. Boyle
Powder Mill Office Park, 1163 Pittsford-Mendon Rd.,
Pittsford, N.Y. 14534
[716] 248-5620

San Francisco, Calif. 94111: Don Farris
Dean Genge, 425 Battery Street.
[415] 362-4600

Paris: Patrick Mouillard
17 Rue-Georges Bizet, 75116 Paris, France
Tel: 720-73-01

United Kingdom & Scandinavia: Simon Smith
34 Dover Street, London W1
Tel: 01-493-1451

Scandinavia: Andrew Karnig and Assoc.
Kungsholmsgatan 10
112 27 Stockholm, Sweden
Tel: 08 51 68 70 Telex: 179 51

Milan: Ferruccio Silvera
1 via Baracchini, Italy
Phone 86-90-656

Brussels:
23 Chaussee de Wavre
Brussels 1040, Belgium
Tel: 513-73-95

Frankfurt/Main: Fritz Krusebecker
Liebigstrasse 27c, Germany
Phone 72 01 81

Tokyo: Akio Saijo, McGraw-Hill
Publications Overseas Corporation,
Kasumigaseki Building 2-5, 3-chome,
Kasumigaseki, Chiyoda-Ku, Tokyo, Japan
[581] 9811

Business Department

Thomas M. Egan
Production Director
[212] 997-3140

Carol Gallagher
Production Manager International
[212] 997-2045

Betty Preis
Production Manager Domestic
[212] 997-2908

Thomas Kazich
Production Manager Related Products
[212] 997-2044

Marianne Meissner, Production Assistant
[212] 997-2843

Frances Vallone
Reader Service Manager
[212] 997-6057

Electronics Buyers' Guide

H.T. Howland, General Manager
[212] 997-6642

Regina Hera, Directory Manager
[212] 997-2544

Thomas Kazich, Production Manager
[212] 997-2044

Marianne Meissner, Production Assistant
[212] 997-2843

Frances Vallone, Reader Service Manager
[212] 997-6057

Classified and Employment Advertising

Frank Eberle, Manager

[212] 997-2557

Mary Ellen Kearns, Sales Manager (212) 997-3306

economy

We became the world's largest manufacturer of SCR power supplies by offering higher quality at lower prices.

In a word: economy. In another word: value.

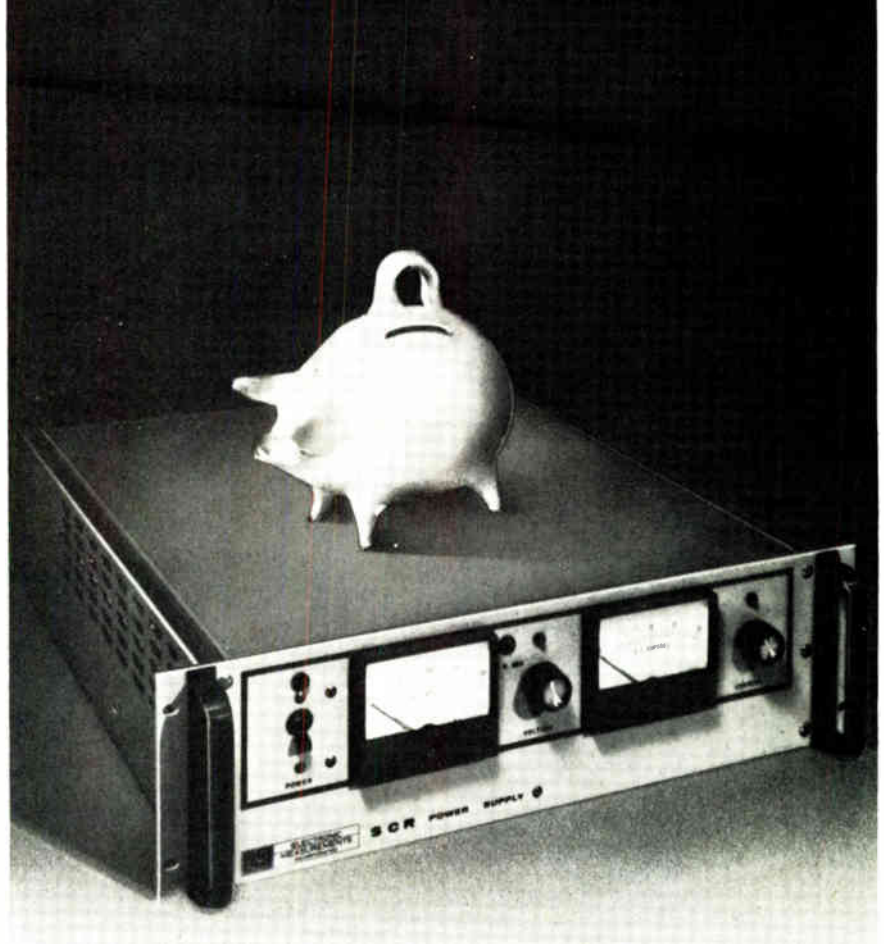

One- and three-phase rack-mounted power supplies from 500 to 10,000 watts. Call TOLL FREE 800-631-4298 for complete information and prices, or write for our catalog.



ELECTRONIC MEASUREMENTS INC.

405 Essex Road, Neptune, N.J. 07753

Phone: (NJ, HI, AK) 201-922-9300. TOLL FREE 800-631-4298

Specialists in Power Conversion Equipment

MUNIFICENT MINISCOPES!!

- For electronic professionals on the go.
- Prices that please.
- Greatest selection.
- Now!! 30-MHz bandwidth in the new dual-trace Model MS-230.



MS-15 \$318
15 MHz — Single-Trace

- External & internal trigger.
- Line synchronization mode.
- Power usage—<15 W.
- Battery or line operation.
- 2.9" H x 6.4" W x 8.0" D.

Circle 136 on reader service card

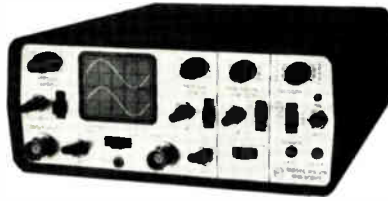

MS-215 \$435
15 MHz — Dual-Trace

- External & internal trigger.
- Line synchronization mode.
- Power usage—<15 W.
- Battery or line operation.
- 2.9" H x 6.4" W x 8.0" D.

Circle 140 on reader service card

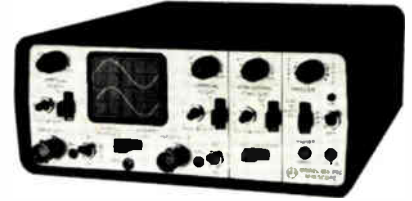

MS-230 \$559
30 MHz — Dual-Trace

- External & internal trigger.
- Line synchronization mode.
- Power usage—<40 W.
- Battery or line operation.
- 2.9" H x 6.4" W x 8.6" D.

Circle 141 on reader service card

NLS products are available from Nationwide Electronic Distributors.
Send for our brochure today!



Non-Linear Systems, Inc.

Originator of the digital voltmeter.

Box N, Del Mar, California 92014 Telephone (714) 755-1134

SUPER MINIATURE

Neon Glow Lamps

Circuits Volts.....AC 105-125
Series Resistance.....150KΩ
Nominal Current.....0.3mA
Total Flux.....20mlm MIN.
Average Life Hours...30,000

Dimension:mm

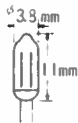

NL-8S

CLEAR-GREEN

Fluorescent Glow Lamps

Circuit Volts.....AC or DC 105-125
Series Resistance.....33KΩ
Nominal Current.....1.6mA
Total Flux(MIN.).....AC:120mlm,DC:130mlm
Avg. Life Hours.....AC:30,000 DC:40,000

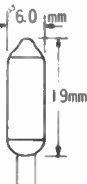

NL-35 G

Circuit Volts.....AC 105-125
Series Resistance.....27KΩ
Nominal Current.....1.5mA
Total Flux.....90mlm MIN.
Avg. Life Hours.....20,000



NL-21 G

● MAIN PRODUCT

NEON GLOW LAMP, XENON FLASH LAMP,
RARE GAS, DISCHARGE LAMP.
MINIATURE : BLACK-LIGHT, UV-LIGHT,
FLUORESCENT COLOR-LIGHT.

ELEVAM ELECTRONIC TUBE CO., LTD.

EXPORT DIVISION

NO. 17-8CHUO 2-CHOME OTA-KU, TOKYO JAPAN.
TELEPHONE : 03 774 1231-5 TELEX : 246-8855 ELEVAM

Speech Synthesizer

Invented by Forrest Mozer

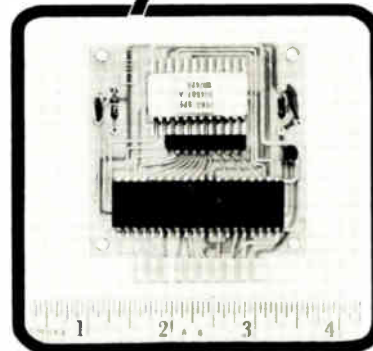

NEW, LOW-COST, FIXED VOCABULARY SPEECH SYNTHESIZERS FOR OEM USE

- Two 64 word vocabularies available
 - Full spoken numerals plus a variety of measurement words
 - ASCII characters numerals, alphabet, punctuation
- Clear, highly intelligible male voice
- All MOS LSI circuitry
- 6 bit parallel strobed input
- No external clocks required
- Inputs are TTL compatible
- Analog Speech output signal

\$179⁰⁰

Boards with numbers & calculator functions... only \$95.00*

*Plus state sales taxes where applicable

Custom Vocabularies can be produced for your particular application.



TELESENSORY SYSTEMS, INC.

3408 Hillview Ave., P.O. Box 10099
Palo Alto, California 94304
Telephone (415) 493-2626

Who said choosing the best electronic assembly machines is a game of chance?

Improved
Model 6295
dual head VCD
with new high
speed cycle
rate of 25,000
an hour.

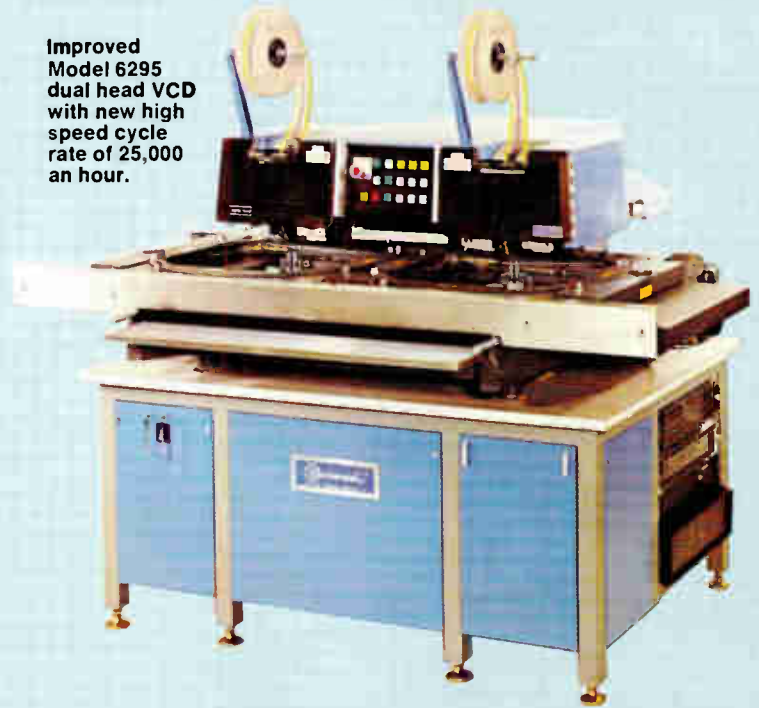

There is only one basis for selecting component sequencing and insertion equipment—and that's *system productivity*. Universal has maintained its strong leadership in automation for electronic assembly by designing and building reliable systems that are responsive to the growing production needs of our customers.

And now, Universal announces a 30% increase in sequencing and component insertion rates.

Again, as always in the past, Universal leads the way for obtaining the lowest unit cost to produce your product.

Don't gamble with your profits—call Universal for a demonstration of these new systems. Seeing is believing.

Improved Model
2596 Sequencer
with up to 160
input stations
and new cycle
rate of 25,000
an hour.

Patent Pending



 **Universal**[®]

Universal Instruments Corporation
Kirkwood Industrial Park
Box 825, Binghamton, New York 13902
Tel: 607/772/7522 TWX: 510/252/1990

Circle 901 on reader service card

Switch from the old to the new!

Low-cost OPTICAL SWITCHES from Clairex

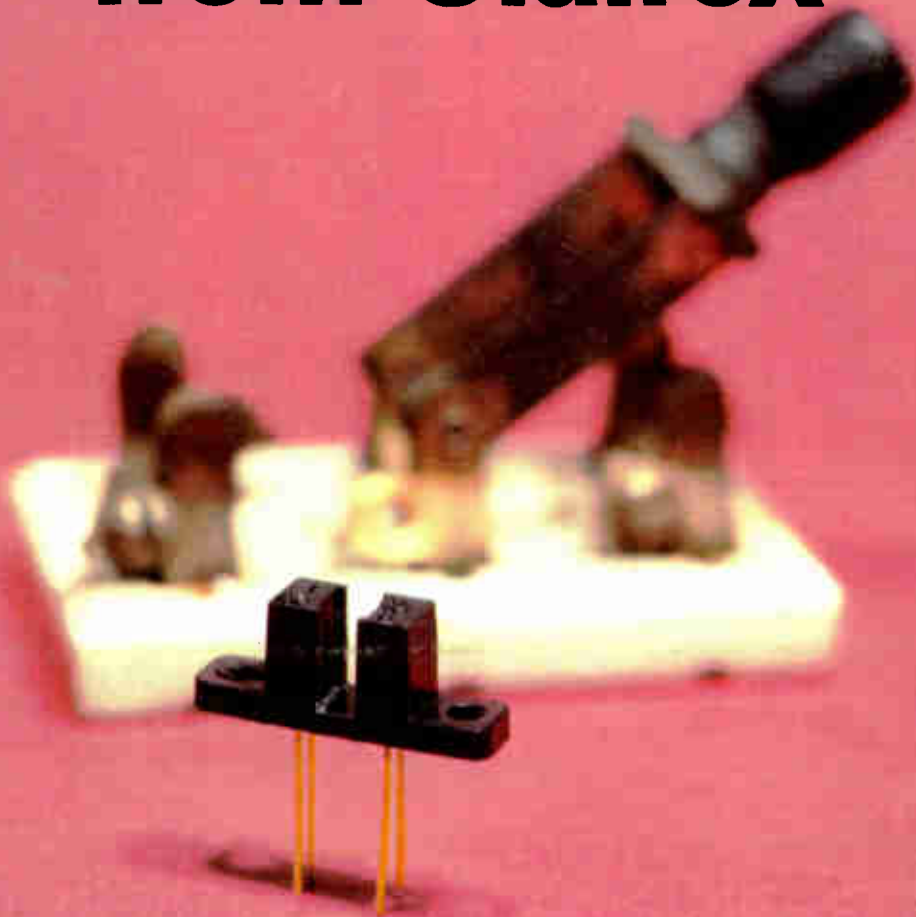

Switch from slow switching, moving parts and arcing problems to fast switching, solid-state, low-cost optical switches from Clairex.

Seventeen optical switches in the CLI 800 series lets you choose from: a wide range of sensor currents; phototransistor

and photodarlington outputs; and two voltage ranges, 30 and 55 volts. Each series features a model with a ten-mil slit over the sensor for applications necessitating stringent target resolution.

Clairex also offers the CLI 200 and CLI 300 series

that are designed for harsh environmental applications.

For details on the full line of Clairex Optical Switches, call (914) 664-6602 or write Clairex®, 560 South Third Avenue, Mount Vernon, New York 10550.

CLAIREX ELECTRONICS

A Division of Clairex Corporation

Circle 902 on reader service card