

FEBRUARY 1, 1979

CARTER'S SECOND BUDGET: HOW MUCH FOR ELECTRONICS?/83

Silicon-on-sapphire goes to work for high-performance minicomputer / 108

High-level microprocessor languages, part 2: optimization / 121

FOUR DOLLARS A MCGRAW-HILL PUBLICATION

Electronics®

SE SAHICKI
DATA ACQUISITION SYSTEMS
105 N CHAPEL ST
TORRINGTON CT 06790

- VLSI
- LSI
- MSI
- SSI

ECL

GROWING UP FAST



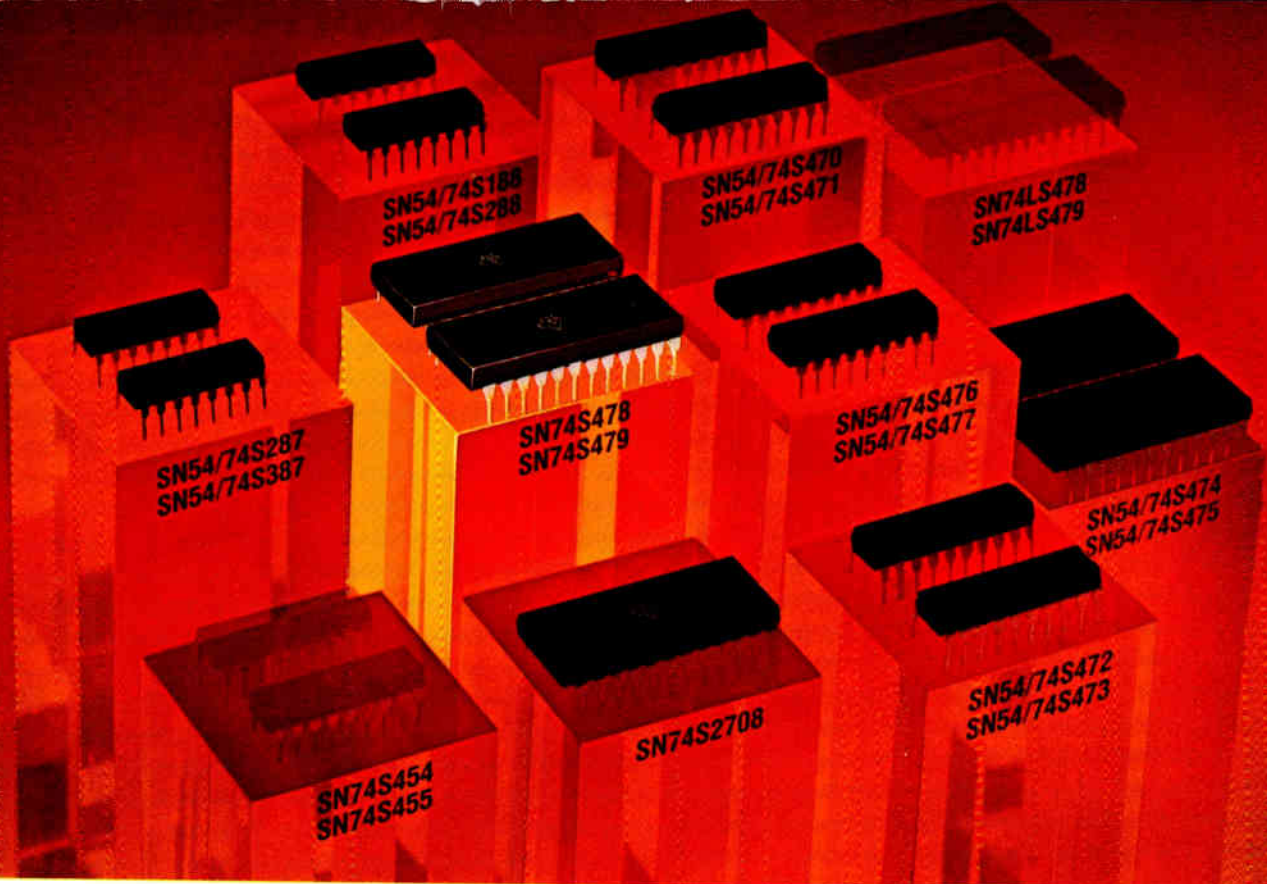

Check 'em out: TI's new 8K Schottky PROMs. Greater density. Greater performance.

You double memory capacity. To 8K. And get a speedy 45 ns typical access time. With the new SN74S478 and SN74S479 Schottky PROMs from Texas Instruments. Available now for evaluation.

Yet, power dissipation is about half that of two 4Ks—630 mW typical.

These new high performance PROMs are organized by 8—especially attractive for microprocessor-based designs. They offer socket compatibility with TI's 24-pin S474 and S475 4K PROMs. And you can upgrade from other 4K configurations with minimum design changes. Price: only \$19.35 each in 100-piece quantities in plastic DIPs. Outputs can be either three-state (S478) or open-collector (S479).

Another family addition

Now available is TI's new 8K SN74S2708 PROM. Switch to it for

production after you've programmed with TI's TMS2708 EPROM. You'll gain faster throughput, greater stability, higher temperature capability.

TI's growing choice

The new S478, S479 and S2708 further expand TI's leadership in memories. You now have a choice of 15 PROMs. In 18, 20 and 24-pin

plastic or ceramic packages. With by 4 and by 8 organizations.

Proven programming techniques are available for all. Low current pnp inputs permit interfacing with MOS and bipolar microprocessors. Titanium-tungsten fuse links speed programming, improve reliability.

More PROMs coming: On the way are low-power versions of the S478 and S479—the LS478 and LS479. Also, two 8K PROMs organized 2K by 4 in 18-pin packages—S454 and S455.

To check out the new S478 and S479, call your nearest TI distributor or TI field sales office. For a copy of TI's Schottky Memory brochure, write Texas Instruments Incorporated, P.O. Box 225012, M/S 308, Dallas, Texas 75265.

TI'S BROAD PROM FAMILY

Device	Description
SN74S478	1024 W x 8B, 3-S, 24 Pins
SN74S479	1024 W x 8B, 0-C, 24 Pins
SN74S2708	1024 W x 8B, 3-S, 24 Pins
SN54/SN74S476	1024 W x 4B, 3-S, 18 Pins
SN54/SN74S477	1024 W x 4B, 0-C, 18 Pins
SN54/SN74S474	512 W x 8B, 3-S, 24 Pins
SN54/SN74S475	512 W x 8B, 0-C, 24 Pins
SN54/SN74S472	512 W x 8B, 3-S, 20 Pins
SN54/SN74S473	512 W x 8B, 0-C, 20 Pins
SN54/SN74S470	256 W x 8B, 0-C, 20 Pins
SN54/SN74S471	256 W x 8B, 3-S, 20 Pins
SN54/SN74S287	256 W x 4B, 3-S, 16 Pins
SN54/SN74S387	256 W x 4B, 0-C, 16 Pins
SN54/SN74S188	32 W x 8B, 0-C, 16 Pins
SN54/SN74S288	32 W x 8B, 3-S, 16 Pins

**TEXAS INSTRUMENTS
MOVING AHEAD
IN MEMORIES**



TEXAS INSTRUMENTS
INCORPORATED



The keyboard switch with a heart of gold

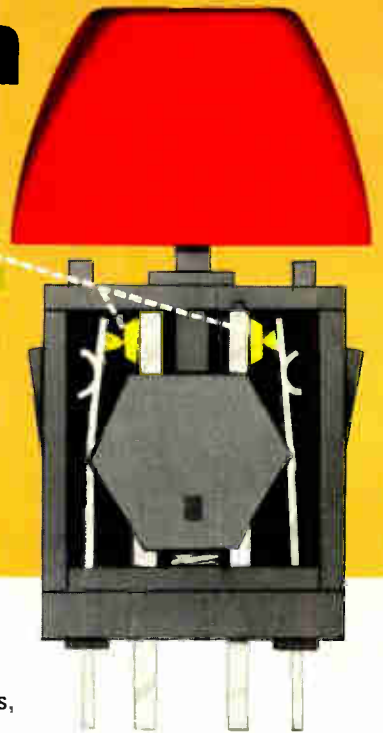

...keeps your product **WORKING** year after year...after year.

In your keyboard or ours, Cherry key switches just don't fail. The knife-edge contact area is so small (9 millionths of a square inch) ... the contact pressure so great (about 5,000 psi) ... the gold alloy so pure and film-free ... that you are assured of positive contact every time. For 50 million operations and beyond. (Which is probably beyond the life expectancy of your product!)

Cherry "heart of gold" keyboard switches are available individually or with two-shot molded keycaps. Hopefully, you want keycaps. Because, *we have keycaps* ... in more legends, sizes, type faces than you're likely to find anywhere else. Sculptured keycaps? We've got 'em. Gloss or matte finish? We've got *both*. Colors? Lighted? Specials? Sure! Some "off the shelf" ... all at prices that make it obvious why the *Cherry way* is the *economical way* to put a heart of gold in any keyboard.

For free test sample switch
and catalog, just
TWX 910-235-1572 ...
or PHONE 312-689-7700

CHERRY



CHERRY ELECTRICAL PRODUCTS CORP., 3608 Sunset Avenue, Waukegan, IL 60085

Cherry switches now
available locally from distributors.

Circle 1 on reader service card



Here's how you can be fully computerized for so much less than you thought

BUSINESS — EDUCATION — ENGINEERING — MANUFACTURING

We are pleased to announce the first professional time-sharing system in the microcomputer field.

Naturally, it's from Cromemco.

This new multi-user system will do all of the tasks you usually associate with much more expensive time-sharing computers. Yet it's priced at an almost unbelievably low figure.

Look at these features:

- You can have up to 7 terminals plus a fast, 132-column line printer
- You can have a large system RAM memory that's expandable to 1/2 megabyte using the Bank Select feature
- Each user has an independent bank of RAM
- You can have floppy disk storage of up to 1 megabyte
- You have confidentiality between most stations
- And, make no mistake, the system is fast and powerful. You'll want to try its fast execution time yourself.



PROGRAMMERS LOVE OUR BASIC

This new system is based on Cromemco's well-known System Three Computer and our new Multi-User BASIC software package.

Programmers tell us that Cromemco Multi-User BASIC is the best in the field. Here are some of its attractions:

- You can use long variable names and labels up to 31 characters long — names like "material on order" or "calculate speed reduction."
- You get many unusual and helpful commands that simplify programs and execution — commands such as PROTECT, LIST VARIABLES, NOLIST, and many more.

- No round-off error in financial work (because our BASIC uses binary-coded decimal rather than binary operation). And we've still been able to make it FAST.
- Terminals and printer are interrupt-driven — no additional overhead until key is pressed.
- The conveniences in this Multi-User BASIC make it much easier to write your own application software.
- A line editor simplifies changes.

BENCHMARK IT — NOW

In the final analysis, the thing to do is see this beautiful new system at your dealer. See its rugged professional quality. Evaluate it. Benchmark it for speed with your own routine (you'll be agreeably surprised, we guarantee you).

Find out, too, about Cromemco's reputation for quality and engineering.

Look into it now because you can have the capabilities of a fully computerized operation much quicker and for much less than you ever thought.

 **Cromemco**
i n c o r p o r a t e d
Microcomputer Systems

Circle 2 on reader service card

280 BERNARDO AVE., MOUNTAIN VIEW, CA 94040 • (415) 964-7400

41 Electronics Review

PACKAGING & PRODUCTION: Thin films shrink inductors to chips, 41
SUPERCOMPUTERS: CDC unveils new big computer, 42
CONSUMER: Low-cost home security systems head for market, 43
POINT-OF-SALE: Terminal makers try creative maintenance, 44
LASERS: Exxon gets 18 mW from solid-state unit, 44
COMPANIES: Inmos Ltd. adds four top executives, 46
COMMUNICATIONS: White House seeks automation, 48
NEWS BRIEFS: 48
COMPUTERS: Harris designs speedier processor, 50
MICROWAVES: Ovens compete for spectrum space, 52

69 Electronics International

WEST GERMANY: TV tube and yoke align automatically, 69
JAPAN: Ink-jet printer jumps speed, 70
GREAT BRITAIN: Programmable filter fits 256 points, 72
FRANCE: Wiring method rivals multilayer, Multiwire, 74

83 Probing the News

GOVERNMENT: Federal budget stresses austerity, 83
ABROAD: Italians hope for a miracle, 87
SOLID STATE: Faster, lower-powered TTL looks for work, 88

99 Technical Articles

SOLID STATE: High density raises sights of ECL design, 99
COMPUTERS: C-MOS on sapphire sparks small unit's performance, 108
DESIGNER'S CASEBOOK: Coordinate converter aligns tilt elements, 114
Acoustic protector damps telephone-line transients, 115
Time-shared counters simplify multiplexed display, 117
MICROPROCESSOR SOFTWARE: Optimizing high-level languages, 121
COMMUNICATIONS: Chips, processes unite in per-channel codec, 126
ENGINEER'S NOTEBOOK: Interfacing microprocessor to calculator, 132
CALCULATOR NOTES: HP 25 aids short-vertical antenna design, 135

147 New Products

IN THE SPOTLIGHT: 12-MHz scope fits in briefcase, 147
Rugged 3½-digit DMM sells for \$149, 150
MICROCOMPUTERS & SYSTEMS: School board gives course, 153
COMMUNICATIONS: PCM system tester is easy to use, 159
MATERIALS: Strong, thin tape slices costs, 162
PACKAGING & PRODUCTION: Two-layer board goes to 500 MHz, 168
COMPONENTS: Swiss switch lives long, 172
INSTRUMENTS: Oscilloscope covers dc to 1 gigahertz, 179

Departments

Publisher's letter, 4
Readers' comments, 6
Editorial, 12
People, 14
Meetings, 28
Electronics newsletter, 35
Washington newsletter, 57
Washington commentary, 58
International newsletter, 65
Engineer's newsletter, 138
Products newsletter, 183
New literature, 184

Services

Employment opportunities, 186
Reprints available, 182
Reader service card, 195

Highlights

Cover: Higher integration aids ECL design, 99

When a very fast microprocessor is needed, emitter-coupled logic is the technology of choice—a choice made all the easier by the availability of a family of standard bit-slice parts whose latest members achieve new highs in ECL density.

Cover is by Art Director Fred Sklenar.

'Standard' TTL diversifies again, 88

Several major chip makers are either launching or preparing to launch high-performance, extra-low-power versions of transistor-transistor logic, further splintering the market in so-called standard bipolar logic.

Small computer moves in on big machines, 108

Advances in three areas contribute to performance exceptional for the HP 300's size—complementary-MOS-on-sapphire logic chips, functional partitioning of the central processing unit, and a virtual-memory operating system.

Putting the squeeze on bulky programs, 121

If a microcomputer program is written entirely in a high-level language, it may overflow the limited memory space available. To make it fit, the most cumbersome parts should be rewritten in terser assembly code, says the second article in a series on using high-level languages for microcomputers.

And in the next issue . . .

Analog filters meet digital logic on single chip . . . a self-refreshing 64-K random-access memory . . . more about high-speed large-scale integration: emitter-coupled-logic arrays.

EDITOR-IN-CHIEF: Kemp Anderson

EXECUTIVE EDITOR: Samuel Weber

MANAGING EDITORS: Arthur Erikson,
Gerald M. Walker

ASSISTANT MANAGING EDITORS: Howard Wolff,
Alfred Rosenblatt

SENIOR EDITORS: William F. Arnold,
Ray Connolly

ART DIRECTOR: Fred Sklenar

DEPARTMENT EDITORS

Aerospace/Military: Ray Connolly
Circuit Design: Vincent Biancomano
Communications & Microwave:

Harvey J. Hindin

Components: Nicolas Mokhoff

Computers: Anthony Durniak

Consumer and Industrial: John Javetski

Microsystems and Software: John G. Posa

Instrumentation: Albert F. Shackil

New Products: Michael J. Riezenman,

Richard W. Comerford

Packaging & Production: Jerry Lyman

Solid State: Raymond P. Capece

CHIEF COPY EDITOR: Margaret Eastman

COPY EDITORS: Mike Robinson,
Steven Weitzner

ART: Charles D. Ciatto, *Associate Director*
Paula Piazza, *Assistant Director*

EDITORIAL SECRETARIES: Janet Noto,
Penny Reitman, Maryann Tusa

EDITORIAL ASSISTANT: Marilyn B. Steinberg

REGIONAL EDITORS

New York: Ben Mason (212) 997-2245

Boston: Pamela Hamilton (617) 262-1160

Chicago: Larry Marion (312) 751-3805

Dallas: Wesley R. Iversen (214) 742-1747

Los Angeles: Larry Waller (213) 487-1160

Palo Alto: William F. Arnold

Robert Brownstein (415) 968-2712

Washington: Ray Connolly (202) 624-7592

Frankfurt: John Gosch

London: Kevin Smith

Paris: Arthur Erikson

Tokyo: Charles Cohen

McGRAW-HILL WORLD NEWS

Editor: Michael Johnson

Brussels: James Smith

Milan: Andrew Heath

Moscow: Peter Hann

Paris: Andrew Lloyd

Stockholm: Robert Skole

Tokyo: Robert E. Lee

PUBLISHER: Dan McMillan

ADVERTISING SALES MANAGER:

Paul W. Reiss

MARKETING ADMINISTRATION MANAGER:

Wallis Clarke

CIRCULATION MANAGER: Karl Peterson

MARKETING SERVICES MANAGER:

Tomlinson Howland

RESEARCH MANAGER: Margery D. Sholes

There's bound to be a great amount of satisfaction for William Blood in seeing emitter-coupled logic take on a leadership role. Now manager of bipolar systems engineering for Motorola's Integrated Circuits division in Mesa, Ariz., he has been working on the technology since 1969.

He points out that today the demand for high-speed large-scale integration has moved ECL circuits to the forefront for some applications. In the first of his two-part article (p. 99), Bill describes the design and application of one of these out-front products—a high-speed bit-slice family. "This family represents an advanced architecture built around ECL," he states.

The 38-year-old engineer is also pleased with the development of the ECL-based Macrocell array that will be featured in the second part of his article. This device permits the designer to define functions for a very high-speed circuit, in effect making the array a semicustom building block.

"What happens to the array in actual use will largely influence what we do next," Bill observes. "We're at the limits of the technology now, so it's difficult to say where we will go—but we'll keep pushing ECL technology."

Last year it was a snow storm and this year an ice storm that greeted the press on the day that the Carter Administration released its fiscal 1980 Federal budget. But neither rain, nor sleet, nor documents weighing several pounds can stay Washington bureau manager Ray Connol-

ly from getting the annual budget story (p. 83).

Aided by managing editor Jerry Walker and assistant managing editor Howard Wolff, Ray slipped and slid his way through a day of briefings at various Government agencies in order to see how electronics will fare in the spending plans. He found that electronics equipment purchases will come out well, despite what the Administration is calling an austerity budget.

It's hard to think of a \$531.6 billion total proposal as austere, but in Washington circles this kind of spending is considered tight. The budget as submitted represents a 7.7% increase over fiscal 1979, which is just about level with today's inflation. However, within this framework, outlays for research and development in which electronics figures prominently will increase by almost 13% in the coming year. The Department of Defense, the biggest R&D spender, wants to bump up its outlays in this category by over 10%. Basic research sponsored by Uncle Sam will increase 9%.

"The outlook for electronics is pretty good," comments Ray. "If spending for electronics can swim against the stream in an 'austere' budget, it should do even better next year, when the Carter Administration is expected to use the budget to stimulate the economy in time for the presidential election."



February 1, 1979 Volume 52, Number 3 98,081 copies of this issue printed

Published every other Thursday by McGraw-Hill, Inc. Founder: James H. McGraw 1860-1948. Publication office 1221 Avenue of the Americas, N.Y., N.Y. 10020; second class postage paid at New York, N.Y., and additional mailing offices. L# 172400.

Executive, editorial, circulation and advertising addresses: Electronics, McGraw-Hill Building, 1221 Avenue of the Americas, New York, N.Y. 10020. Telephone (212) 997-1221. Teletype 12-7960 TWX 710-581-4879. Cable address: MCGRAW HILL NEW YORK.

Subscriptions limited to professional persons with active responsibility in electronics technology. No subscriptions accepted without complete identification of subscriber name, title or job function, company or organization, and product manufactured or services performed. Based on information supplied, the publisher reserves the right to reject non-qualified requests. Subscription rates: in the United States and possessions \$17 one year, \$29 two years, \$43 three years; company addressed and company libraries \$23 one year, \$41 two years, \$58 three years; APO/FPO addressed \$35 one year only; Canada and Mexico \$19 one year, \$32 two years, \$47 three years; Europe \$46 one year, \$78 two years, \$110 three years; Japan, Israel and Brazil \$70 one year, \$115 two years, \$165 three years; Australia and New Zealand \$95 one year, \$170 two years, \$240 three years, including air freight; all other countries \$50 one year, \$85 two years, \$125 three years. Limited quota of subscriptions available at higher-than-basic rate for persons allied to field served. Check with publisher for these rates. Single copies: \$4.00. Please allow four to eight weeks for shipment.

Officers of McGraw-Hill Publications Company: Gordon L. Jones, President; Paul F. McPherson, Executive Vice-President; Group Vice-President: Gene W. Simpson; Senior Vice-Presidents: Russell F. Ander-

son; James E. Boddorf, Planning & Development; Ralph R. Schulz, Editorial; Vice-Presidents: James E. Hackett, Controller; Thomas H. King, Manufacturing; Robert L. Leyburn, Circulation; John W. Patten, Sales; Edward E. Schirmer, International.

Officers of the Corporation: Harold W. McGraw, Jr., President, Chief Executive Officer, and Chairman of the Board; Robert N. Landes, Senior Vice President and Secretary; Ralph J. Webb, Treasurer.

Title registered in U.S. Patent Office. Copyright © 1979 by McGraw-Hill, Inc. All rights reserved. The contents of this publication may not be reproduced in whole or in part without the consent of copyright owner.

Where necessary, permission is granted by the copyright owner for libraries and others registered with the Copyright Clearance Center (CCC) to photocopy any article herein for the base fee of \$0.50 per copy of the article plus \$0.25 per page. Payment should be sent directly to the CCC. Copying done for other than personal or internal reference use without the express permission of McGraw-Hill is prohibited. Requests for special permission or bulk orders should be addressed to the publisher, ISSN 0013-5070/79\$0.50+.25.

Subscribers: The publisher, upon written request to our New York office from any subscriber, agrees to refund that part of the subscription price applying to copies not yet mailed. Please send change-of-address notices or complaints to Fulfillment Manager; subscription orders to Circulation Manager, Electronics, at address below. Change-of-address notices should provide old as well as new address, including postal zip code number. If possible, attach address label from recent issue. Allow one month for change to become effective.

Postmaster: Please send form 3579 to Fulfillment Manager, Electronics, P.O. Box 430, Hightstown, N.J. 08520.

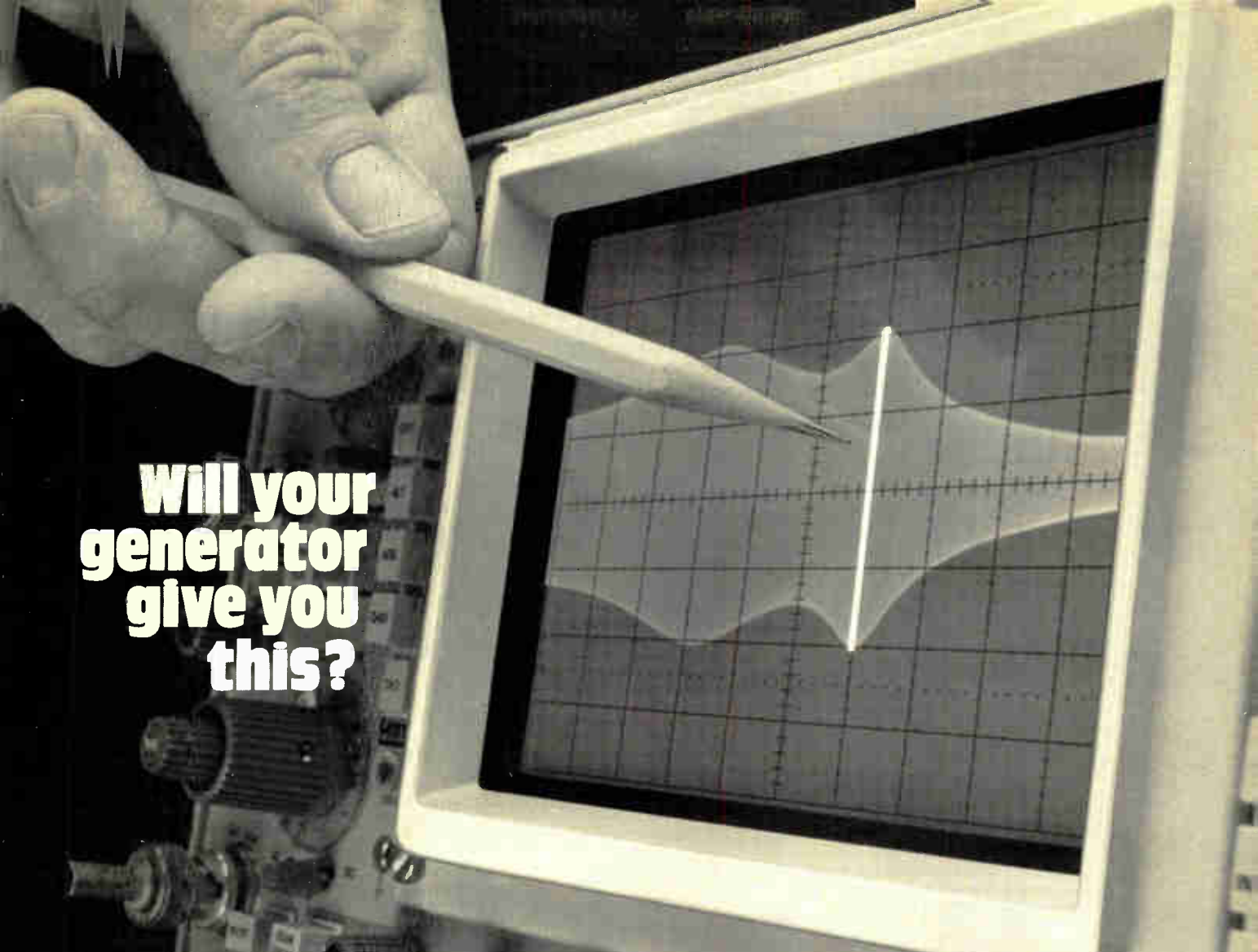

**Will your
generator
give you
this?**

Krohn-Hite's 2200 lin/log sweep function generator with frequency marker will!

Krohn-Hite's new generator delivers more flexibility than any other generator ever offered, including:

- Choice of sine, square, triangle, ramp and pulsed waveforms
- Lin/log sweep, up and down
- Unique frequency marker
- Nine operating modes: continuous, gate, trigger, burst, pulse, sweep, triggered sweep, triggered sweep burst, external VC
- Frequency range .003 Hz to 30 MHz

The exclusive marker/pause feature lets you interrupt the sweep for any duration from 0.1 ms upward, and gives you a bright marker blip at the marked frequency.



These plus numerous other convenience features make the Model 2200 an ideal choice for amplifier gain/response checks, network and filter evaluation, communications equipment testing and many other recurring requirements. Pushbutton operation shortens test time in production operations.

Priced at only \$1295, Model 2200 is available today.

Circle reader service number or contact

**KH KROHN-HITE
CORPORATION**

Avon Industrial Park, Avon, MA 02322 • (617) 580-1660 TWX 710 345 0831

Circle 5 on reader service card

AL, Huntsville (205) 534-9771; AZ, Phoenix (602) 279-1531; CA, Inglewood (213) 674-6850, San Jose (408) 292-3220; CO, Denver (303) 773-1218; CT, Canton Center (203) 693-0719; FL, Orlando (305) 894-4401; GA, Atlanta (404) 455-1206; HI, Honolulu (808) 941-4574; IL, Chicago (312) 283-0713; IN, Carmel (317) 844-0114; KS, Overland Park (913) 649-6996; LA, Gretna (504) 367-3975; MD, Towson (301) 321-1411; MA, Wakefield (617) 245-5940; MI, Detroit (313) 961-3042; MN, Minneapolis (612) 835-4818; MO, St. Louis (314) 569-1406; NM, Albuquerque (505) 255-2330; NJ, Cherry Hill (609) 482-0059; Englewood (201) 871-3916; NY, Rochester (716) 473-5720, Syracuse (315) 437-6666, Vestal (607) 785-9947; NC, Burlington (919) 227-3639; OH, Chesterland (216) 729-2222, Dayton (513) 294-2476; OK, Jenks (918) 299-2636; OR, Portland (503) 297-2248; TX, Dallas (214) 661-0400, Houston (713) 688-1431; UT, Salt Lake City (801) 466-8729; VA, Falls Church (703) 573-8787; WA, Bellevue (206) 454-3400; WI, Milwaukee (414) 545-8400; CANADA, Montreal, Quebec (514) 341-7630, Ottawa, Ontario (613) 235-5121, Toronto, Ontario (416) 445-9900, Vancouver, British Columbia (604) 253-5555, Halifax, Nova Scotia (902) 454-8321, St. John's Newfoundland (709) 726-2422.

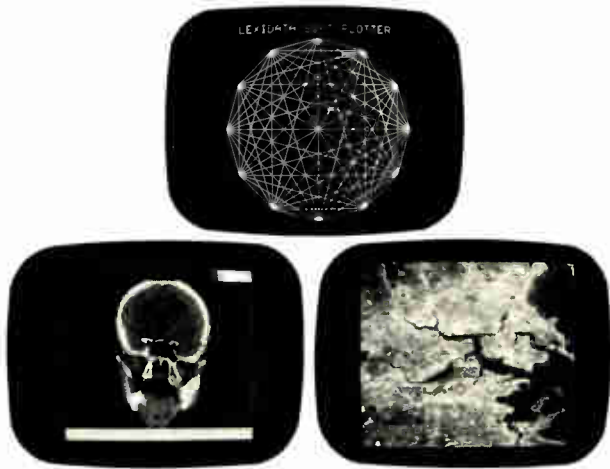

Raster scan high resolution refresh graphics

at a price you can't ignore

Now you can have a system
to meet your unique computer-graphics applications

System-sophistication made practical for the OEM and end-user

- Full refresh, flicker-free, raster scan display
 - up to 1280 x 1024 pixels in 16-levels of grayscale
 - display 1024 simultaneous colors from color look-up table
 - up to 16 bits of intensity or overlay data per pixel
- Interfaces for most minicomputers
- Gamma-corrected and composite video output
- High-speed, variable image processing
 - pixel update as fast as 45 nsec per pixel
 - random and sequential update
 - dynamic memory allocation
 - writeable control store
- User can program the alphanumeric generator and define the cursor
- Nondestructive functions to highlight image displayed
 - vector and alphanumeric overlays on image
 - zoom with continuous 4-directional scrolling
- Command I/O and DMA to host computer
- Peripheral options

A versatile graphics-system to meet your widely diverse needs that you'll want to know more about. Just write Lexidata Corporation, 215 Middlesex Turnpike, Burlington, MA 01803 or faster yet, call us at 617 273-2700, and ask for Martin Duhms.



Best in graphics, year after year

215 Middlesex Turnpike, Burlington, MA 01803
617 273-2700 • TWX 710-332-1381

Readers' comments

Explanation offered

To the Editor: I read Richard Tax's letter [Dec. 7, 1978, p. 6] with sympathy and interest—that is, sympathy for his desire to move the IEEE faster on professional activities, and interest because not enough members communicate their frustrations. I have frequently been critical of the IEEE's progress in professional activities, but in this instance the criticism is misdirected.

The primary objectives of Professional Activities Committee workshops are to keep PAC representatives informed, to provide feedback to the United States Activities Board, and to recruit volunteer workers for USAB task forces. I have seen workshops operate effectively in 1978 and before.

Not every PAC workshop covers the full range of activities, which depends on the availability of busy volunteer leaders. Thus, although pension activities were not fully covered in Los Angeles, successful pension workshops were held earlier in the year, in Washington in April and in Dallas in December.

As 1978 chairman of the Pension Task Force, I received full support from the USAB in 1978. I intend to see to it that the new Pension Task Force chairman, Bob Barden, will receive full support in 1979.

Leo Young
1979 Executive Vice President
Institute of Electrical and
Electronics Engineers

Old stuff

To the Editor: Ten or so years ago, when I was a member of the board of editors of the Review of Scientific Instruments, we decided that papers submitted on the subject of liquid-nitrogen- or helium-level controls would be printed only if there was something truly unique in their design. The reason was the astonishing number of articles that had already appeared.

I can assure you that Tom McGuire's idea ["Carbon resistor doubles as low-temp switch," Engineer's Newsletter, Dec. 21, 1978, p. 122] is no more than 20 to 25 years old and that there are no more

A Place for Life



Work in a place where your family can live, where there's more to life than your work. A place where you can enjoy sailing and the symphony, the opera and the great outdoors. Where your life-at-work is everything you can make it. Find a place for life, in Oregon. Where we've been for thirty-two years. If you have the research, engineering, marketing or software development skills that could become part of the life of a Fortune 500 leader in electronic test and measurement, and computer graphics, write to Bill Eppick Professional Placement. He'll answer your letter. Send you a color print of this Oregon scene if you request it. No obligation. Professional Placement, Tektronix, Inc., P.O. Box 500, 13-E, Beaverton, Oregon 97077. An Equal Opportunity Employer (M, F, H).

Tektronix
COMMITTED TO EXCELLENCE

Circle 7 on reader service card

Choose a
TELEQUIPMENT
Oscilloscope
for:
Performance.

Like the performance you'll find in the 25-MHz D67A. A real bench-top work horse with dual trace, calibrated delayed sweep, 10 mV/div sensitivity, and a big 8 x 10 cm crt display. All for only \$1,660.* Ideal for the researcher, engineer, educator, or service technician.

There are eight other TELEQUIPMENT Instruments combining the performance you'd expect from a division of Tektronix with the high value you demand in low-cost instrumentation. Storage models, battery powered portables, low-cost basic oscilloscopes, and even an inexpensive curve tracer. Priced from \$495* to \$1,995*.

And TELEQUIPMENT Instruments are now sold through stocking distributors offering local availability, service, warranty repairs and models previously not sold in the United States.

For proof of Telequipment's performance and the name of the Teleequipment Distributor nearest you, write: Teleequipment U.S. Sales, (43/000), P.O. Box 500, Beaverton, OR 97077 or call: (503) 644-0143.

*Suggested U.S. list price.

TELEQUIPMENT 
A division of Tektronix U.K. Ltd. a subsidiary of Tektronix, Inc.

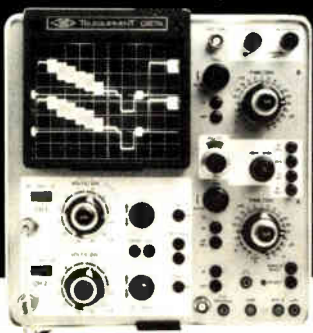

8 For Technical Data circle #8 on Reader Service Card
For Demonstration circle #192 on Reader Service Card

Readers' comments

than a dozen companies who manufacture such a device (system).

Lawrence G. Rubin
Cambridge, Mass.

A question of accuracy

To the Editor: In a recent Engineer's Notebook, "Measuring picoamperes with extreme accuracy" [Nov. 23, 1978, p. 156], the title was contradicted by the last paragraph, as the article referred to the more accurate estimation of nanoampere currents using a digital voltmeter.

Also, for the 100-pA range, precise measurement can be accomplished if the input resistance, R_{in} , and the internal equivalent of the circuit under test are sufficiently well known. However, the measurement of picoamperes is conveniently accomplished with a picoammeter!

R. J. Gardner
Edmonton, Alberta
Canada

■ *Agreed, "picoamperes" would have been best replaced by "nanoamperes." Also, a picoammeter admittedly does the job of measuring picoamperes, but the point of the article was to show how to improve the accuracy of an earlier technique while using the same inexpensive equipment on hand. — ED.*

Dropped but not shaken

To the Editor: The Dec. 21 editorial, "Light at the end of the fiber" [p. 16], quoted Siecor as "going to quit marketing ready-to-go links and concentrate on what we know best—the production of fiber." Though we have dropped our transmitter-receiver sets, we don't look at this as a shakeout.

Several years ago we marketed transmitter-receiver sets to fill what was then a void in the market; we are pleased with the progress of optoelectronic interfaces in the fiber optics market, and as your survey shows, there are several such products commercially available.

We will now concentrate on what we do know best—passive transmission subsystems, optical cables, ancillary hardware and equipment.

James A. Cole
Siecor Optical Cables Inc.
Horseheads, N. Y.

NEW PRODUCT

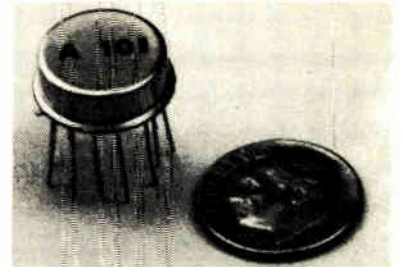

CHARGE SENSITIVE PREAMPLIFIER- DISCRIMINATOR

Model A-101 is a charge sensitive preamplifier-discriminator and pulse shaper developed especially for instrumentation employing photomultipliers, channel electron multipliers and other charge producing detectors in the pulse counting mode. Its small size (TO-8 package) allows mounting close to the collector of the multiplier. Power is typically 15 milliwatts and output interfaces directly with C-MOS and TTL logic. Input threshold and output pulse width are externally adjustable.

AMPTEK

6 DeAngelo Drive, Bedford, Mass 01730
Tel: (617) 275-2242

Circle 195 on reader service card

TRIPLE TESTED THRIFTMETERS

Now with lower prices
—AND plug-in components
—AND unichip electronics



PM-349 \$52
Lowest priced Thriftmeter.
PM-350 \$65
With plug-in components.

Features Include:

- 3-1/2 digits.
- Accuracy is $\pm(0.05\%$ Rdg. + 0.05% F.S.).
- $\pm 0.2V$, $\pm 2V$, $\pm 20V$, $\pm 200V$ or $\pm 1000V$ range.
- Auto zero and auto polarity.
- 5 vdc power @ 1 W.
- Large 0.3" LEDs.
- Small size: 1" H x 2.5" W x 3.25" D.
- Protected input.
- Unichip construction.



Non-Linear Systems, Inc.

Originator of the digital voltmeter.

Box N, Del Mar, California 92014

Telephone (714) 755-1134 TWX 910-322-1132

Circle 196 on reader service card

Whatever you need in an IC socket... **RN has 'em all!**

—and with “side wipe” reliability

PRODUCTION SOCKETS

NEW! ICL Series

26% lower profile—.150"
Ideal for high density, high
volume configurations,
provides maximum vibration
resistance. Solder type; single leaf
“side-wipe” contacts. 8 to 40 contacts.



ICN Series high reliability general-
purpose sockets. Low insertion
force allows automatic IC insertion.
In solder or wire-wrap. 6 to 64
contacts. Dual leaf
“side-wipe” contacts.

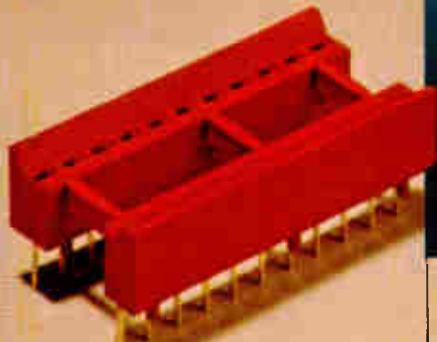

ICA Series

high reliability pin
socket contacts. Low
profile in solder
or wire-wrap.
8 to 40 contacts.

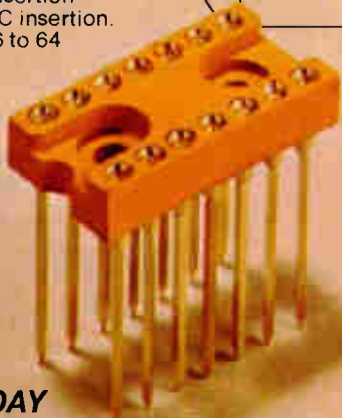

WRITE TODAY
for latest R-N “Short Form” Catalog...

BURN-IN, TEST SOCKETS

TS Series

very long contact
life. Very low insertion
force. Ideal for in-
coming inspection. With
14 to 40 contacts. Also
strip sockets up to
21 positions.

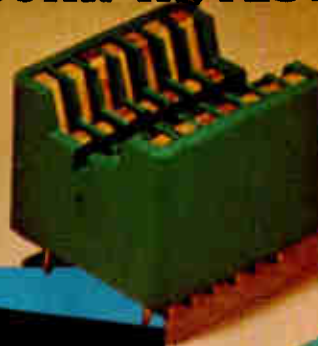

IC Series

moderate cost, long life.
Designed for general test and
burn-in up to 350°C.
With 14 to 40
contacts.

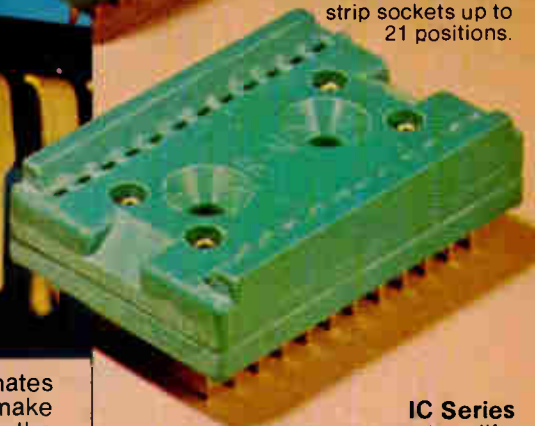

ICN/S2 Series

lowest cost burn-in
socket available.
Designed to accept IC
extraction tool. With 8 to 40
contacts, with strip sockets
up to 25 positions.



RN HIGH RELIABILITY eliminates
trouble. “Side-wipe” contacts make
100% greater surface contact with the
wide, flat sides of your IC leads for
positive electrical connection.



... of R-N production DIP sockets. Contains
full specs, dimensions and material data.
Get yours now.

RN ROBINSON NUGENT, INC.

ROBINSON-NUGENT, INC. • 800 East Eighth Street • New Albany, Indiana 47150 • Phone: (812) 945-0211

Circle 9 on reader service card

How Intel's codec cut PCM

The switchover to an all digital telephone network just took a great leap forward. Introducing Intel's 2912 transmit/receive filter. It's the first and only one-chip LSI filter. And it's the only filter with a companion one-chip codec, our 2910 (μ Law) and 2911 (A Law).

Since we introduced the 2910/2911, line card designers have had the capability to code and decode digital signals with a single, reliable component. Now our 2912 goes a step further. Like our codec, the 2912 replaces multiple devices with a monolithic solution. And it meets the stringent digital Class 5 Central Office requirements for both D3/D4 and CCITT Transmission Standards, with necessary voiceband flatness and stop band rejection. The 2912 also has a 50-60 Hz notch to filter AC line noise, and permits gain adjustments of voice signals.

We designed our codec and filter to work together. And neither one

requires precision external components. The 2912 provides a direct interface to line or trunk circuits that use either transformers or electronic hybrids.

**Meeting in the middle
of the digital highway**

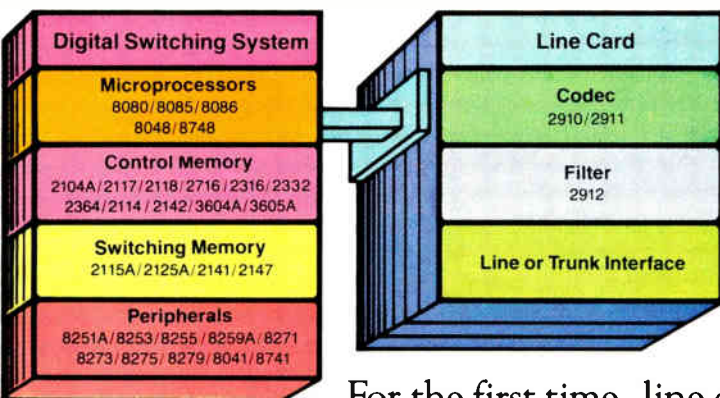

For the first time, line card design can dramatically reduce PCM switching costs in most TDM systems. That's because our codec has a built-in microcomputer interface that allows switching directly on the PCM highway, eliminating or greatly reducing the size of the time-slot interchange memory and allowing greater flexibility in the level of blocking selected for the system.

So when line card designers select Intel's filter and codec, the systems savings and design simplicity extend beyond the entrance to the digital highway. System

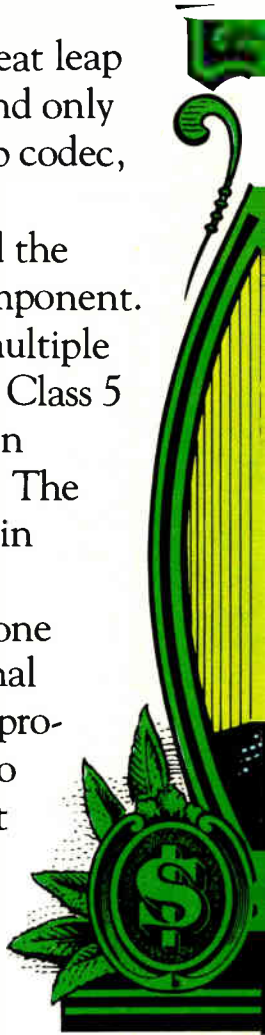

new filter and system costs.



engineers benefit, too, with important economies in hardware and common control overhead.

How Intel gives you a head start in digital technology

We've long been a supplier to the telecommunications industry, at the forefront of each new step in the evolving digital network. Today we supply microprocessors, memory components and peripheral support circuits, as well as our codec and filter.

All our telecommunications products use the same NMOS process we use to manufacture tens of millions of semiconductor components each year. And every Intel telecommunications product undergoes extensive testing before it's shipped.

Best of all, the 2912 filter, as well as our codec, is in volume

production and available for delivery now. To order, or to obtain additional information, contact: Intel Corporation, 3065 Bowers Avenue, Santa Clara, CA 95051, or telephone (408) 987-6475.

Europe: Intel International, Rue du Moulin a Papier, 51 Boite 1, B-1160, Brussels, Belgium. Tel: (32-2) 660 30 10

intel® delivers.

'Lean' takes on a new meaning . . .

How fat is thin? The Federal budget for the 1979–1980 fiscal year offers what may be a novel answer. With President Carter leading the way, officials on every level of the bureaucracy are passing the words for this year: lean and austere. Asking for expenditures of \$531.6 billion, the document seems to reflect the conservative mood of the new Congress and back up the Administration's vows to do something about inflation. The argument of some critics that it does this at the expense of social programs designed to help the cities, the poor, and the unemployed appears to cut no ice in the White House and its Office of Management and Budget; the Administration seems eager to avoid the appearance of profligacy.

. . . in the light of an optimistic outlook

Along the line of what the budget means in terms of inflation and contracts, a recent dinner in Palo Alto, Calif., of the American Electronics Association offers some fascinating insights. Discussing the question whether 1979 will see a glitch in the electronics growth curve were John A. Young, president of Hewlett-Packard Co., William J. Weisz, president of Motorola Inc., and Robert H. B. Baldwin, president of Morgan Stanley and Co., the New York investment firm. Young said he believes that "U. S. electronics should weather a recession or slowdown very well, with only a mild deceleration from the 13% to 15% growth in 1978," with the international nature of the electronics industries helping considerably. Also, he pointed out, "many parts of electronics are correlated with Government and capital spending programs, which are growing."

Weisz was also optimistic—with an "if." A glitch in the upward curve? "No, not necessarily," he said, "if the general slowdown is not severe. But in any event, the long-term

But that's only one side of the definition. On the other, there is the Department of Defense, with which electronics suppliers annually do a great deal of business. There, the lean look sports rosy cheeks and not a little hint of bulging muscles. The good news for electronics people is that spending for weapon systems will increase 14.5% to some \$25.7 billion if the Pentagon's requests are approved. In the same vein, defense officials want to increase their spending for research and development by 10% to \$13 billion.

Thus it would seem that, for suppliers of electronics to the military at least, less is more: the lean and austere budget is actually a satisfying one, with good news for some important programs and the electronics in them.

outlook for the electronics industries seems to have become more positive than it has looked in the past." He sees rising sales in automotive electronics, in semiconductors, in radio and data communications, and to the Government. "All areas should return to normal growth rates after any slowdown is over," Weisz predicted confidently.

But it was Baldwin who perhaps got to the heart of Carter's budget and its political implications when he said, "When the first primaries are a little over six months away, were the economy to show signs of weakness at that point, [Carter] wouldn't be the first President to opt for a stimulative fiscal policy to see him through an election year." Overall, though, Baldwin told the members of the association, "I would be very optimistic about the nation's economy and your industry in the 1980s."

So the scenario seems straightforward: leanness in the budget now except for the military, but with a Federal spending injection at the first sign of softness.

The Microcomputers you should take seriously.

The C3 Series is the microcomputer family with the hardware features, high level software and application programs that serious users in business and industry demand from a computer system, no matter what its size.

Since its introduction in August, 1977, the C3 has become one of the most successful microcomputer systems in small business, educational and industrial development applications. Thousands of C3's have been delivered and today hundreds of demonstrator units are set up at systems dealers around the country.

Now the C3 systems offer features which make their performance comparable with today's most powerful mini-based systems. Some of these features are:

Three processors today, more tomorrow.

The C3 Series is the only computer system with the three most popular processors—the 6502A, 68B00 and Z-80. This allows you to take maximum advantage of the Ohio Scientific software library and the tremendous number of programs offered by independent suppliers and publishers. And all C3's have provisions for the next generation of 16 bit micros via their 16 bit data BUS, 20 address bits, and unused processor select codes. This means you'll be able to plug a CPU expander card with two or more 16 bit micros right in to your existing C3 computer.

Systems Software for three processors.

Five DOS options including development, end user, and virtual data file single user systems, real time, time share, and networkable multi-user systems.

The three most popular computer languages including three types of BASIC

Circle 13 on reader service card

plus FORTRAN and COBOL with more languages on the way. And, of course, complete assembler, editor, debugger and run time packages for each of the system's microprocessors.

Applications Software for Small Business Users.

Ready made factory supported small business software including Accounts Receivable, Payables, Cash Receipts, Disbursements, General Ledger, Balance Sheet, P & L Statements, Payroll, Personnel files, Inventory and Order Entry as stand alone packages or integrated systems. A complete word processor system with full editing and output formatting including justification, proportional spacing and hyphenation that can compete directly with dedicated word processor systems.

There are specialized applications packages for specific businesses, plus the vast general library of standard BASIC, FORTRAN and COBOL software.

OS-DMS, the new software star.

Ohio Scientific has developed a remarkable new Information Management system which provides end user

intelligence far beyond what you would expect from even the most powerful mini-systems. Basically, it allows end users to store any collection of information under a Data Base Manager and then instantly obtain information, lists, reports, statistical analysis and even answers to conventional "English" questions pertinent to information in the Data Base. OS-DMS allows many applications to be computerized without any programming!

The new "GT" option heralds the new era of sub-microsecond microcomputers.

Ohio Scientific now offers the 6502C microprocessor with 150 nanosecond main memory as the GT option on all C3 Series products. This system performs a memory to register ADD in 600 nanoseconds and a JUMP (65K byte range) in 900 nanoseconds. The system performs an average of 1.5 million instructions per second executing typical end user applications software (and that's a mix of 8, 16 and 24 bit instructions!).

Mini-system Expansion Ability.

C3 systems offer the greatest expansion capability in the microcomputer industry, including a full line of over 40 expansion accessories. The maximum configuration is 768K bytes RAM, four 80 million byte Winchester hard disks, 16 communications ports, real time clock, line printer, word processing printer and numerous control interfaces.

Prices you have to take seriously.

The C3 systems have phenomenal performance-to-cost ratios. The C3-S1 with 32K static RAM, dual 8" floppies, RS-232 port, BASIC and DOS has a suggested retail price of under \$3600. 80 megabyte disk based systems start at under \$12,000. Our OS-CP/M software package with BASIC, FORTRAN and COBOL is only \$600. The OS-DMS nucleus package has a suggested retail price of only \$300, and other options are comparably priced.

To get the full story on the C3 systems and what they can do for you, contact your local Ohio Scientific dealer or call the factory at (216) 562-3101.

C3-B wins Award of Merit at WESCON '78 as the outstanding microcomputer application for Small Business

The C3 Series from Ohio Scientific.



C3-B



C3-S1



C3-OEM

OHIO SCIENTIFIC

1333 S. Chillicothe Road • Aurora, Ohio 44202



OPTICALLY COUPLED INTERRUPTER MODULES

OPTRON OFFERS IMMEDIATE DELIVERY OF NEW, LOW COST SERIES

OPTRON's new, low cost optically coupled interrupter module series combines non-contact switching and solid state reliability for applications requiring sensing of position or motion of an opaque object such as motion limit, paper edge or shaft encoding.

The new OPB 813, OPB 814 and OPB 815 consist of a gallium arsenide infrared LED coupled with a silicon phototransistor in an economical molded plastic housing. With a LED input of 20 mA, the OPB 813 and OPB 815 have typical unblocked current outputs of 2.0 mA and 3.0 mA, respectively. Typical output of the OPB 814 is 3.0 mA with a 10 mA input. The entire series is available from stock.

Background illumination noise is eliminated by a built-in infrared transmitting filter and dust cover in each device type. The OPB 813 also is available with a 0.010 inch aperture for high resolution applications.

New OPTRON optically coupled interrupter modules are interchangeable with similar products as follows:

OPTRON	GE
OPB 813	H13A1
OPB 813	H13A2
OPB 814	H13B1
OPB 814	H13B2

Detailed technical information on these and other OPTRON standard interrupter and reflective modules, as well as versions for specific applications is available on request.



OPTRON, INC.

1201 Tappan Circle
Carrollton, Texas 75006, U.S.A.
TWX-910-860-5958
214/242-6571

People

Computers to help surgeons gauge their work, Mann says

Robert W. Mann is a visionary of sorts, providing the link between what is and what could be. Working 20 years in a field that was only accepted as such in the last 10, the 54-year-old professor at Massachusetts Institute of Technology has pioneered much of the technology being used in rehabilitative aids for the handicapped today.

He has worked on such projects as flexible canes and computer-based braille translators for the blind and electronically controlled leg and arm prostheses to replace purely mechanical artificial limbs. Last month the Institute of Electrical and Electronics Engineers recognized these endeavors, and elected Mann a fellow.

With a Ph.D. in mechanical engineering, Mann has certainly been involved with the mechanics of rehabilitative devices. However, computer-aided design has played a major role in his work, as he readily points out: "Computer interactive simulation goes to the heart of a design problem. It allows you to brainstorm freely, without collapsing a cornucopia of possibilities."

He adds, "You don't have the nagging problem of 'did I pick the right design' because you aren't committing man or machine [to a specific design]."

Inside. One of Mann's current projects uses implantable instrumentation in a hip prosthesis to help determine the causes of osteoarthritis. Using ultrasonic devices surgically implanted within the artificial hip joint, pressure profiles and distribution data across the joint are collected and analysed by a PDP-11/40 computer.

"We'll be getting novel information on how a hip joint operates in real life," says Mann. "This is different from traditional [medical] techniques that estimate the force vectors across a joint from the outside."

Taking this type of medical investigation one step further, Mann one day envisions what he calls computer-aided surgery. With this technique, a surgeon could "operate"



Possibility. According to Mann, surgical problems could be solved first on a CRT.

without ever touching scalpel to flesh, to determine the effects of corrective surgery.

For example, a stylized data model of a knee would be stored in computer memory. Using this model as a base, specific information about a particular patient could be fed into the computer. Electrode sensors attached around the knee, for example, could feed in position and movement information.

The doctor would then operate on the computer model, Mann explains. He would feed instructions, such as "shorten this ligament" or "turn this muscle," into the computer. In effect, the computer would perform the operation and project an image on a cathode-ray tube that shows how the patient would then walk.

"With computer-aided surgery, a doctor could sit down in front of a console and get a solution to a surgical problem without operating," Mann says.

WARC's Robinson looks

forward to next September

Is the U.S. going to be ready to protect its interests at the World Administrative Radio Conference next September? Glen O. Robinson, chairman of the U.S. delegation, says yes, and has told critics that their criticism of his committee for not doing its job is wrong.

"The U.S. effort in preparing for

HOW COULD THE INDUSTRY STANDARD 5½-DIGIT DMM BE IMPROVED?



It's specified for one year! You know how much money you can save by eliminating the time and expense of shorter re-cal cycles. And this kind of long-term stability is just what you'd expect from Fluke.

So now, in addition to the industry standard 8800A, you have your choice of application-oriented and cost-saving configurations of the new 8810A, choices you'd expect only from Fluke.



The problem was, what could be improved? The 8800A already has made its reputation by providing the accuracy, stability and resolution usually found only in big, expensive lab instruments. And it has four-terminal ohms, 1000 MΩDC input resistance, and full guarding thrown in for good measure.

Combine all this with autoranging, extensive overload protection, and a cost effective price, and it's no wonder the 8800A is the industry's most popular bench/portable 5½-digit DMM.

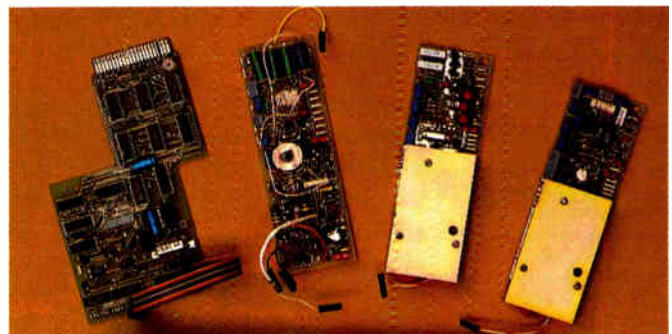

Field-installable options snap-in when you need them.

Now look at the 8810A.

It's modular! You can buy the lab-performance DC mainframe for only \$695. Add the six-range ohms converter for \$175 any time you wish.

It's got true rms ac! Actually you can choose either the true RMS converter module for accurate measurements of most waveforms at \$275, or the average-responding AC converter module at \$150. Both are spec'd to 100 kHz.

For data recording, there's a data output option.

CALL (800) 426-0361*, TOLL FREE. Or, contact one of the more than 100 Fluke offices or representatives, worldwide. In the U.S. and all countries outside of Europe, contact: John Fluke Mfg. Co., Inc., P.O. Box 43210, Mountlake Terrace, WA 98043, U.S.A. Telex: 32-0013.

In Europe, contact: Fluke (Nederland) B.V., P.O. Box 5053, Tilburg, The Netherlands. Tel.: (013) 673973. Telex: 52237.

Prices U.S. only.

*Alaska, Hawaii, Washington residents please call (206) 774-2481.

COMMAND PERFORMANCE: DEMAND FLUKE DMMs.



2505-8019

Circle 199 for literature
Circle 15 for demonstration

**Your best salesman
never says a word.**

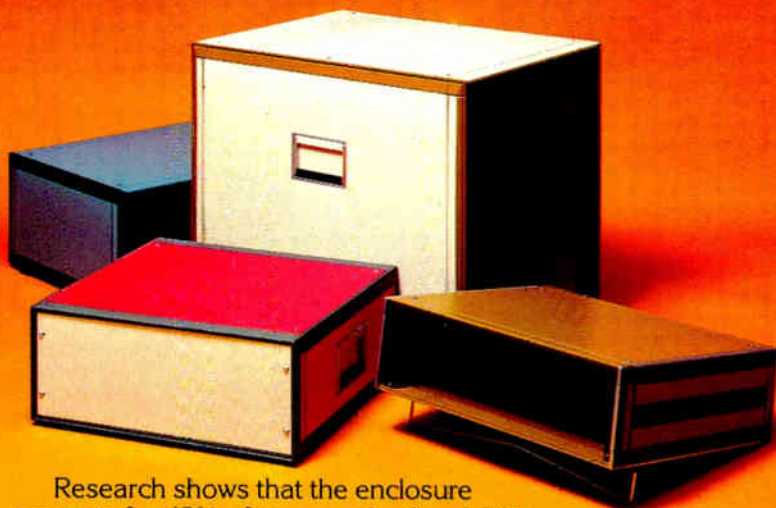

Research shows that the enclosure accounts for 48% of your product's salability. People buy looks. And they buy quality.

The VIP Series 19 is the perfect combination of functional design and precision engineering. It gives your product a custom quality appearance. And the rugged strength that lets you know the quality doesn't stop at appearances.

There is complete accessibility from top, bottom, front and rear. All 10 sizes accept standard EIA panels in heights from 5 1/4" to 28". You can choose from a variety of decorator colors, or we'll paint to match yours.

Despite the versatility and custom look, standardized components mean two-week delivery and off-the-shelf prices.

Hire the best salesman you can get for your product. VIP Series 19. It says the nicest things about you.

ZERO

We make you look good.

Zero Corporation • Burbank, CA 213/846-4191 • Monson, MA 413/267-5561

#16 Call Me, I'm Interested

#200 Mail Catalog

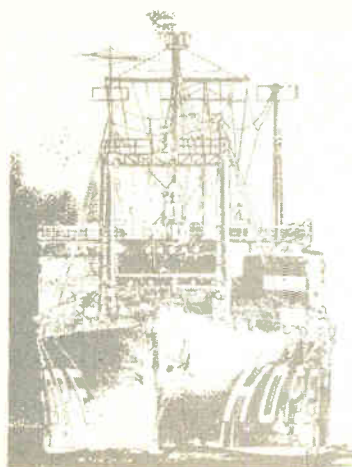

HOPE

The project a ship launched.

First there was the hospital ship S.S. HOPE, now retired. Today HOPE is an established project which has carried its goal of improving health through education to 24 developing countries of the world and the United States.

Give to:

**PROJECT
HOPE**

Department A
Washington, D. C. 20007

WARC—though not perfect—is going well,” Robinson said at a meeting in Washington last month of the Armed Forces Communications and Electronics Association. “It started over five years ago with various interested groups, and our position will be finalized by early February in a consensus document representing both Federal and private interests.” He has had inputs, he notes, “from everyone from girl scouts to radio astronomers.”

WARC will be tackling the international review of frequency allocations that takes place every 10 years. Decisions are governed by a one-nation, one-vote rule. This has caused concern to be expressed that the U. S. and other Western nations will be undone by bloc voting on the part of the technologically underdeveloped nations.

Robinson—a law professor at the University of Virginia and a former Federal Communications Commission commissioner—minimizes the possibility. Rather, he believes most of the real difficulties in getting spectrum allocations favorable to the U. S. will come from Canada and other allies.

For example, he points out that “there is fierce competition for the limited number of synchronous orbit slots and repeater channels that are available.” It also turns out that the U. S. military wants the same spectrum regions used by international broadcasters.

What for? Another problem could hinge on the fact that some regions, like Africa, want frequencies allocated solely for their own countries. Robinson generally opposes this but concedes that it may be suitable “in a few special cases.”

Indeed, he seems to be looking forward to what he hopes will be give-and-take negotiations next September. The U. S. delegation has been engaging in bilateral discussions with many of the 154 members of the International Telecommunications Union, sponsor of the conference, “The U. S. is not taking a hard line,” he says. “There are no bottom-line proposals, although there are certain needs.”

hp MEASUREMENT COMPUTATION NEWS

product advances from Hewlett-Packard

FEBRUARY 1979

Solve tough board test production problems fast with HP's new board tester

HP's introduction of the 3060A Board Test System establishes a new dimension in PCB testing efficiency, to help you increase your PCB yield, achieve higher product turn-on rates, and make capital equipment savings. In a single console system, the 3060A combines advanced in-circuit test techniques and a wide range of board-level functional tools that enable testing of analog, hybrid, or digital boards with a high degree of confidence.

Accuracy and Consistency

In-circuit testing with the 3060A permits optimum coverage over an expanded set of components, values, and tolerances. That, coupled with consistency and accuracy results in significantly higher PCB yield. This means more of your final products turn on the first time, reducing your troubleshooting costs. Once shorts and in-circuit testing is completed by the 3060A, the environment of the finished product can be simulated by applying power to the PCB and performing the stimulus/response tests. The 3060A provides a full set of analog and digital functional testing tools, including two digital test capabilities—static pattern testing and signature analysis.

Easy Programming

The 3060A also features impressive programming power without sacrificing the programming convenience. This allows an operator with no technical training to quickly generate complete test programs and easily perform editing and debugging.

Check item **B** on the HP Reply Card for all the details.



Adding extra capabilities to the HP-IB compatible 3060A is simple since no factory modification or software is required.

IN THIS ISSUE

New 1800 cm/ μ s scope • 10 kHz-1280 MHz signal generator • Two new computers with SOS

HP-67/97 calculator software support makes the difference

Software support for the HP-67 and HP-97 offers an unequalled and powerful asset to programmable calculator users—it makes solutions happen. HP's software support includes:

10 Comprehensive Application Pacs - Prewritten, thoroughly tested software that covers a myriad of specific disciplines: Electrical, Mechanical, or Civil Engineering, Business, Math, Statistics, Clinical Lab, Navigation, Surveying, and Games—each typically contains over 6000 stored keystrokes pre-recorded on easy-to-use magnetic cards.

40 Users' Library Solutions Books - Representing HP's best Users' Library programs in 39 areas, these Solutions Books provide the user with prewritten software in a wide range of specialized subjects. Industrial Engineering, Filter Design, Antennas, Control Systems, plus High-Level Math, Energy Conservation, Photo Dark Room and more. Each book contains full user instructions and program listings ready to be keystroked into the calculator and recorded on magnetic cards for future use.



HP-67/97 Users' Library Collection -

Over 3000 user-developed programs available to you from the growing Users' Library. Perhaps the very program you

need has already been written and documented in the Users' Library!

Check **A** on the HP Reply Card if you'd like more information.

Choose from two intelligent, high-performance sources for your bench and automatic test

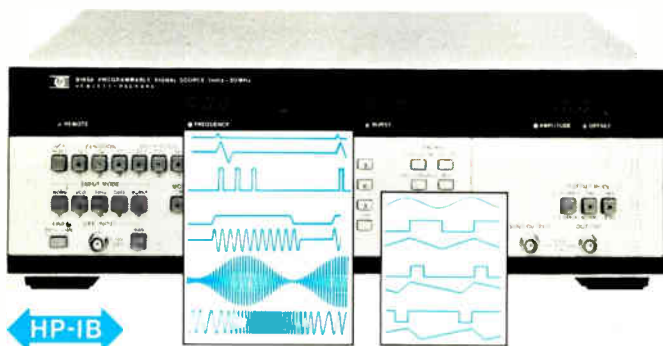

Whether you require precision pulses or multi-waveforms with synthesizer stability, the benefits of rapid integration, easy HP-IB programming and micro-processor control are yours with HP's 8160A Programmable Pulse Generator and 8165A Programmable Pulse Generator Signal Source. Non-volatile parameter and mode storage, LED indication of parameter and value, identical remote and front panel programming sequences, and automatic indication of incompatible settings are

among the many operating conveniences which save time in integration, training and use. Accurate programming obviates the need for monitoring and therefore saves you hardware.

The 8165A provides sine, square, pulse, triangle and ramp. Linear circuits can be tested with VCO, FM, and optional AM and Sweep modes. The instrument's fast 5 ns pulses are excellent for MOS and TTL.

The 8160A breaks precedent with a new, radical approach to pulse source

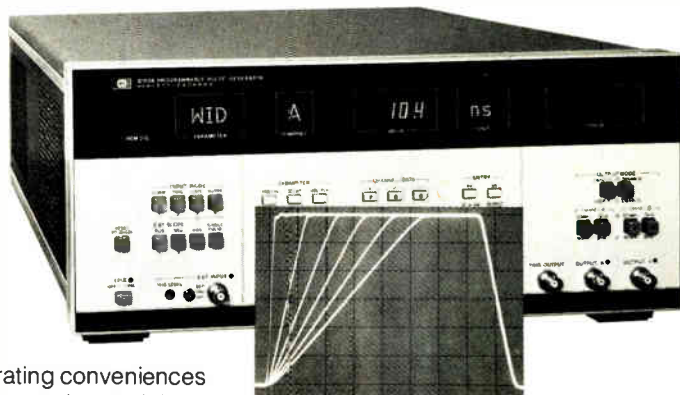

design. For the first time, all pulse parameters including delay or double pulse delay can be set to a 1-3% accuracy with 3-digit resolution, without monitoring the output.

For further information, check **C** on the HP Reply Card.

HP's SOS yields more innovations in business computers

Continuing the tradition of bringing customers more computer power for less money and in less space, Hewlett-Packard recently introduced two new computers for business data processing—the HP 300 and the HP 3000 Series 33. Key to the compactness of each system is an overall infusion of SOS technology. Six different HP SOS chip designs are used—the most impressive being that of the processor. Nearly all the CPU logic and circuitry have been condensed to fit on a mere three CMOS/SOS chips.

A new kind of computer—HP 300

Thanks to this SOS technology, the HP 300 is a brand new kind of business computer. The name of its operating system—Amigo*/300 gives a clue to its personality. A list of features, previously available only on larger, expensive machines, attests to the HP 300's enormous power: multiprogramming, multitasking, multiterminal, priority scheduling, virtual memory, file and data base management, BASIC, and RPGII.

The HP 300's approach to basic software development is quite innovative. As you may know, all BASIC programs pass through several stages before they are executable. Traditionally, a programmer had to know each of the intermediate forms, and also how to invoke processing at each stage. On the HP 300, when you depress the program "text" key, your program automatically begins to run. Another innovative aspect of the HP 300 is its microprocessor-based integrated display system (IDS)—a screen/keyboard combination.

Windowing—32 mini displays

The Amigo display screen can become up to 32 mini displays, each with its own input and output capabilities. Moreover, any one "window" can scroll vertically or horizontally to display information in your files. Eight special user definable keys are also available. Used in combination, the soft keys, windows, scrolling, and screen-display enhancements can create a lively, interactive, push key, menu selection environment. A user is conveniently guided through what might otherwise be a complex interaction. In applications, the screen literally comes alive with the guiding interplay of windows and soft keys. Only a live demo can bring this concept to reality for you. We'd be happy to arrange one for you.

For a demo or brochure, check **D** on the HP Reply Card.

*Amigo-Spanish for friend

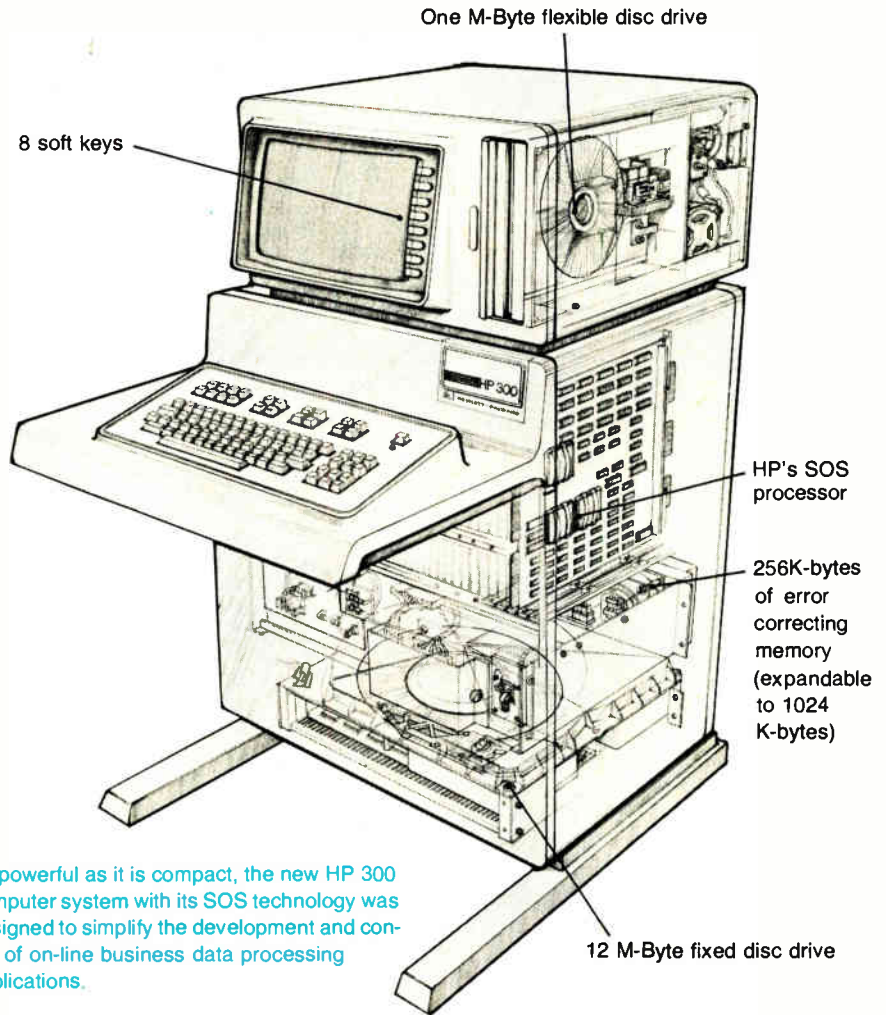

As powerful as it is compact, the new HP 300 computer system with its SOS technology was designed to simplify the development and control of on-line business data processing applications.

New Series 33 enhances HP 3000 family

With the advent of the SOS infused Series 33, HP now offers a compatible family of HP 3000s with different prices, reflecting different performance capabilities and designs.

The Series 33 is the low-cost, entry level HP 3000 designed for transaction processing environments. It has many features commonly found only on large mainframe systems—an MPE III multiprogramming executive operating system, COBOL, BASIC, FORTRAN, RPG, SPL, and IMAGE/QUERY data base management/inquiry system, and a complete VIEW data entry facility. HP supported Series 33 software and application programs can be run on the Series II and III without any recompilation or coding changes.

Hewlett-Packard has made an effort to reduce expenses through a high-level, self-test diagnostic program and a remote system verification program. Each turns the system console into a powerful stand-alone maintenance computer.

Should the self-test not locate your trouble, you can utilize the Series 33's innovative remote system verification program (RSVP). Via your own asynchronous telephone modem, it is possible to give complete interactive control of all the system's maintenance capabilities to an HP customer engineer located at any HP office.

For more information, please check **E** on the HP Reply Card.

New bus extender makes remote operation of HP-IB systems a reality



Lowest cost ever for an HP Universal Counter

Electronic counter users on a small budget no longer need settle for less than a full complement of measurement functions and input signal conditioning controls. HP's new Model 5314A Universal Counter offers them all at the lowest price we've ever had for so much capability, thanks to a new IC chip that performs all counting functions, and HP packaging innovations.

The 5314A measures frequency to 100 MHz with 25 mV sensitivity all the way, period, period average, time interval with 100 ns resolution, frequency ratio, and totalizing.

Options include a built-in, sealed, lead-acid battery with deep discharge protection and charger, and a temperature-compensated crystal oscillator (TCXO) for higher stability and longer time between calibrations. Full capability signal conditioning for time interval measurement is normally not found in such low priced models, but the 5314A provides full control of trigger amplitude and slope for two input channels. A separate-common switch lets you measure pulse widths or time between events on one or two input channels.

The display is an easy-to-read, seven-digit, amber LED unit.

For details, check **F** on the HP Reply Card.



Despite its low price, HP's 5314A offers a full complement of universal counter measurement functions and input signal conditioning controls.

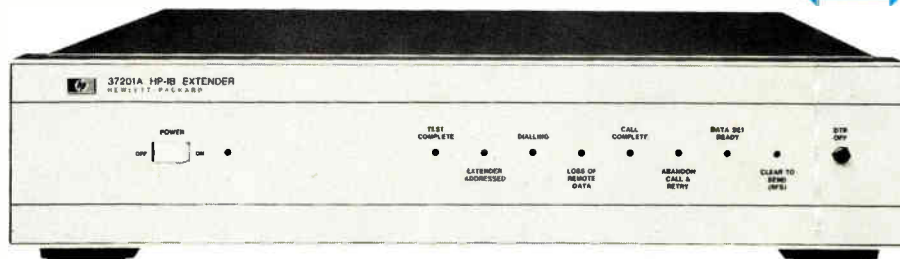

Serial communication between two 37201A HP-IB Extenders, via modems or twin-pair cable, allows two distant groups of HP-IB devices to operate as one.

The new, easy-to-use 37201A HP-IB Extender enables users to connect HP-IB compatible devices at distances up to 1000 metres using low-cost, twin-pair cables. In addition, a modem interface is provided which allows connections, via the telephone network, for even longer hauls. The extended link is transparent, so a pair of 37201A's can be incorporated in a system without special programming. Another important feature is the ability of the HP-IB Extender to detect transmission errors and correct them automatically by retransmission.

The 37201A will work with suitable

full-duplex modems in point-to-point or multi-point configurations, and up to 14 HP-IB devices can be connected to each extender. The modem interface is compatible with RS232C and V24 standards, and the transmission rates are 150, 300, 600 and 1200 bit/s asynchronous or up to 20 kbit/s synchronous. An RS366/V25 auto-dialler interface enables hands-off operation; telephone connections being made automatically under program control.

Check **G** on the HP Reply Card for full information.

Expanded coverage, new convenience in swept-frequency testing

Capability of the time-proven HP 8755 Frequency Response Test Set, normally covering 10 MHz to 18 GHz, has now been expanded with optional new detectors that measure to 26.5 GHz. In addition, the system is now offered with the HP 8750A digital storage/normalizer unit included. This gives you flicker-free displays plus the ability to normalize out system frequency response variations.

The 8755S system's range, accuracy, and ease of operation make it an excellent choice for swept-frequency testing of microwave components and systems. The 8755 has two measurement channels (for simultaneous transmission and reflection measurements); each has 60 dB dynamic range. In some applications the dynamic range can be extended to more than 100 dB.

For more information, check **H** on the HP Reply Card.

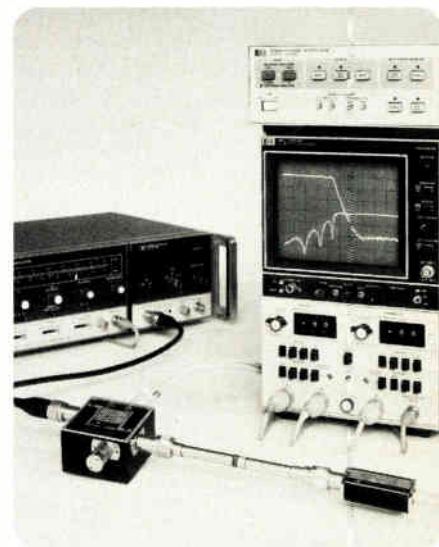

Microwave component testing is fast, thorough, and accurate with the HP 8755A.

Exceptional spectral purity offered by new 10 kHz-1280 MHz synthesized generator



HP-IB

Many modern microwave applications require signal sources with exceptionally low phase noise. Typical of these would be satellite ranging work or as the starting signal in communications multiplier chains and up-converters.

Synthesized signal generators have often been preferred for such applications because of their inherent frequency accuracy, high resolution, long term stability and, sometimes, their frequency programmability. But their spectral purity characteristics usually could not measure up to other oscillator types such as cavities or special filtered equipment.

HP now introduces the 8662A, a 10 kHz to 1280 MHz synthesized signal generator, with exceptionally low phase noise performance. For example, at 160 MHz, SSB noise is < -144 dBc/Hz at 10 kHz offset, and -113 dBc/Hz at 10 Hz offset, with a broadband noise floor of -150 dBc/Hz. Non-harmonic spurious signals are >100 dB below the carrier.

Novel Design

The key to this spectral purity is a new switched-inductance oscillator of novel design which exhibits a quiet, free-running signal even before disciplining with a reference signal which has two separate spectral clean-up crystal filter sections. The result is excellent spectral purity close-in to the carrier, important in multiplier applications, as well as at offsets like 20 kHz so important in mobile

FM receiver testing.

Full signal generator capability is provided with high performance AM and FM modulation. AM rates to 40 kHz are possible depending on modulation depth and carrier frequency. FM deviations to 200 kHz and rates to 100 kHz are available with external inputs. A 400 or 1000 Hz internal source can be selected.

Output level ranges from +13 to -139.9 dBm with a resolution of 0.1 dB. Taking advantage of the microprocessor control, the output signal is automatically corrected from a data look-up table to achieve ± 1 dB level accuracy from +13 to -120 dBm.

Measurement Efficiency

A major design objective of the front panel layout was measurement efficiency, enabling engineers and production test personnel to improve their productivity. The internal microprocessor provides semi-automatic test sequences able to store 9 complete sets of front panel settings and call these back individually or in a sequence of up to 10 steps.

Powerful "sweep" capability is also available since the stability, resolution, and accuracy of the synthesizer are preserved. This makes it an excellent choice for characterizing high stability components like crystal filters. Start/stop or span sweeps can be selected with five key-set markers. Linear or log sweep is available.

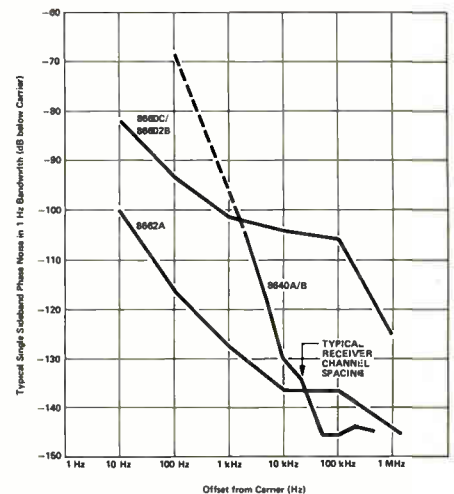

This chart shows SSB noise performance of the new 8662A compared to the Model 8640B cavity-tuned generator and an older Model 8660C Synthesizer.

Multiple alternate sweeps can be viewed on a scope simultaneously.

All 8662A functions are HP-IB programmable. Switching time (to be within 100 Hz) is typically 12 ms with RF settling time = 0.5 ms. For applications of testing frequency-agile receivers, a special "learn" mode drives frequencies directly and reduces switching time to 500 μ s.

Check 1 on the HP Reply Card for further information.

New thermal line printer delivers very fast printing and versatile plotting for a multitude of applications

HP-IB

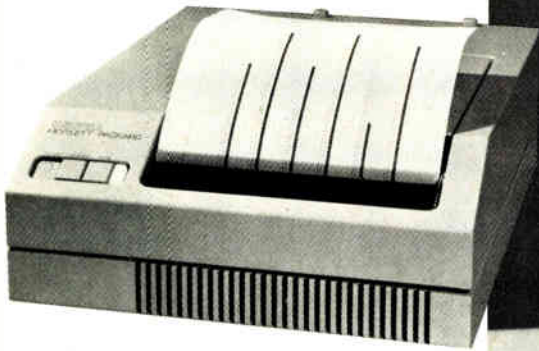

HP's new thermal graphics printer is also available in a caseless version (11479A) to facilitate integration into OEM systems.

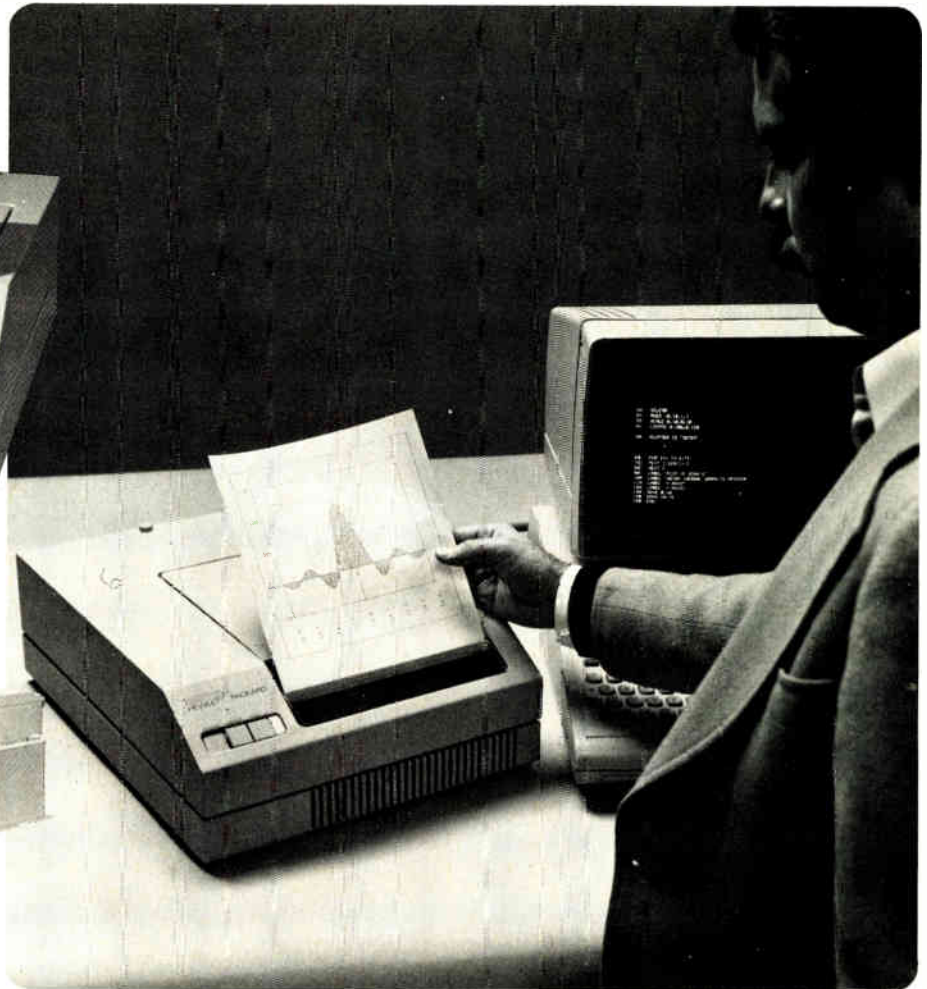
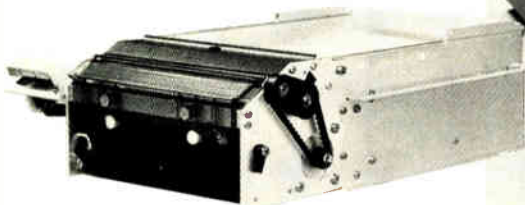

HP has just introduced an exceptionally fast, quiet and easy-to-operate thermal line printer that delivers sophisticated graphics output in addition to alphanumeric printing. Its reliable, high-resolution performance, coupled with HP-IB and 8-bit parallel interfaces, makes the 9876A an outstanding companion for a wide variety of computers and terminals from HP as well as other manufacturers.

Fast Printing

Printing 80-character lines at speeds up to 480 lines per minute, the 9876A is very well suited for office or laboratory applications, requiring high speed listings and frequent work reports. The standard ASCII character set is in 5x7 dot matrix format with additional dots available for ascenders and descenders, oversized characters, underlining, overbars,

and any other character or symbols you may wish to create for various special applications.

Versatile Graphics Output

Plotting speeds, over an 18.5 cm wide plotting field, range from 0.38 cm/s to 2.5 cm/s in two modes. The strip-chart mode allows you to do plots as long as you need. The CRT-dump mode allows you to reproduce plots from a graphics CRT, dot-for-dot usually in less time than it took to do the plot on the screen. You can edit a soft plot on the CRT until you get exactly what you need and then get a hard copy from the 9876 in just a few seconds.

Choice of Papers

An internal tray holds 330 sheets of perforated fan-fold paper, eliminating the curl of roll paper. High-contrast paper is

available for black as well as blue printing, both in 8½ inch and 21 cm widths. The black paper is fade resistant and copies easily. It is also easy to load. Simply feed the first sheet into the rollers and push the feed button. The rest is automatic. There are no sprockets to align, no messy ribbons to insert.

Fast, Easy Servicing

HP has a reputation for reliability of its thermal printers and the 9876A is no exception. Sophisticated, built-in, self-test features assure that the printer is working correctly or help indicate the nature of the problem so it can be back on line in the shortest possible time.

For more information, check J on the HP Reply Card.

The latest Fiber Optics-Optoelectronics technology presented in an HP seminar

Here's your opportunity to learn about the newest and fastest growing technology today! HP's **Fiber Optics-Optoelectronics Application Seminar** will be held in 66 different cities around the world beginning in California, end of March, 1979.

The seminar will include:

- Fiber optics from fundamental to advanced applications with schematics and lightwave communication methods.

- Digital transmission using optocouplers to expand designer's choices.
- CTR degradation of optocouplers.
- Optical scanning and encoding systems
- Contrast enhancement for LED displays for viewing in direct sunlight
- Backlighting techniques for illuminating legends, indicators, bar graphics, and lighted switches.
- Alphanumeric display systems using microprocessors.

The seminar will be presented by HP's Application Engineers, who help designers solve problems with fiber optics and optoelectronics. Why not plan to attend? For a modest tuition and registration fee you can participate in this in-depth seminar with our experienced Applications Engineers.

You will also receive the McGraw-Hill **Optoelectronics Manual**, a 100-plus page supplement, HP's designer catalog, and more.

For more information, check **K** on the *HP Reply Card*.

World's first packaged 0.5 μm GaAs FET with low noise and high gain

No one has offered a packaged microwave GaAs FET like this before. HP's new HFET-2201 is characterized to 18 GHz. The typical noise figure at 14 GHz is 3.1 dB; associated gain is 8 dB.

It comes in a newly introduced, easy-to-handle, hermetic, microstrip package

that is unaffected by harsh operating environments. And, since it's a packaged GaAs FET, it can be tested before you commit it to your circuit.

Partial pre-tuning in the package facilitates broadband designs. Performance is consistent, and variance between typical and guaranteed maximum noise figure is only 0.4 dB at 10 GHz.

For more information on this state-of-the-art 0.5 micrometer GaAs FET, check **M** on the *HP Reply Card*.

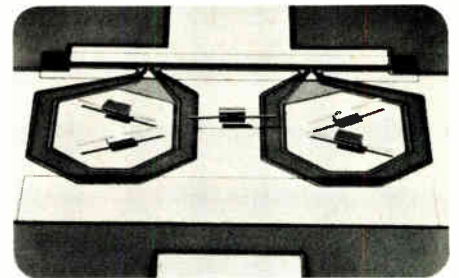

The new low noise 0.5 micrometer GaAs FET in its unique package designed with very low parasitics is displayed on its chip.

Two new bipolar transistors for lower microwave frequencies

Two new small signal NPN bipolar transistors, the HXTR-2102 and the HXTR-6106, are now available from Hewlett-Packard.

Optimized for designs at 2 GHz, the HXTR-2102 is a general purpose transistor with minimum tuned gain (guaranteed) of 13 dB. In addition, its typical linear output power of 100 mW (20 dBm) makes this versatile transistor suitable for use in driver or output amplifier stages.

The economical HXTR-6106 is a low noise device with a guaranteed noise fi-

gure of 2.7 dB maximum at 2 GHz. With an associated gain of 11.5 dB typical at 2 GHz and characterization from 500 MHz to 6 GHz, this transistor can be used in a wide variety of low noise communications, radar, and ECM applications.

Both of these transistors are offered in a rugged, hermetic 70-mil diameter alumina package with a grounded top. The small size of the package insures that the loss in gain due to package parasitics is minimal and the reduced physical size is consistent with efforts to utilize space efficiently in circuit designs.

For more information, check **L** on the *HP Reply Card*.

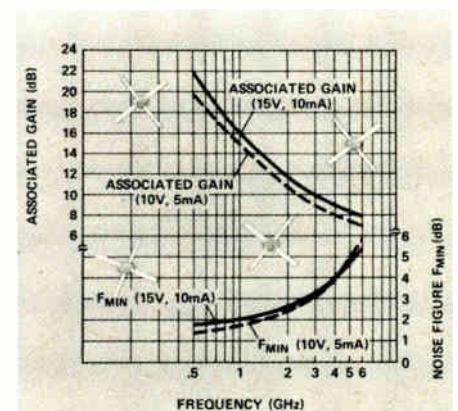

Shown above is the new HXTR-6106 low noise microwave transistor with a guaranteed noise figure of 2.7 dB maximum at 2 GHz.

New technique advances writing speed for HP's variable persistence storage scope to 1800 cm/ μ s

A new advanced variable persistence storage CRT, used for the first time in HP's new 100 MHz 1744A oscilloscope, has a 1800 cm/ μ s, single-shot writing speed for the capture of fast transient signals. This fast writing speed is achieved with a new technique called expansion storage.

Expansion Storage

Expansion storage technology combines a small storage mesh (about the size of a postage stamp) and an expansion lens system. This arrangement permits a writing speed of 1800 cm/ μ s with a fine spot size without requiring reduced scan operation. Combining variable persistence storage with high-speed writing speed fills measurement applications requiring integration and light amplification capabilities, along with single-shot measurements at 100 MHz bandwidth.

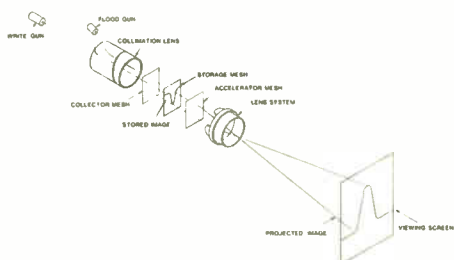

Expansion Storage CRT

Auto/Erase, Auto/Store

Any input signal within bandwidth specifications is displayed with the sharpness needed for detailed evaluation

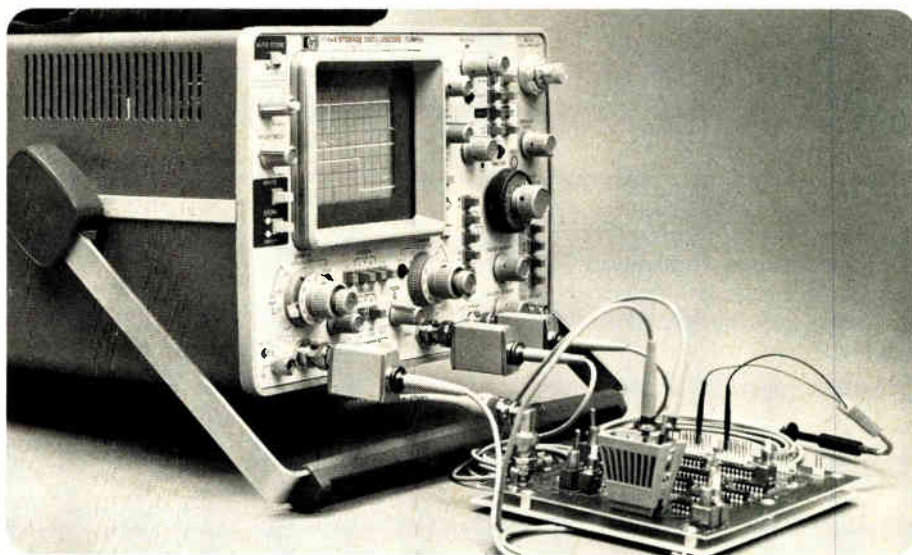

HP's 1744A captures fast, single-shot and low rep-rate events over a large display area. Any input signal within the bandwidth specifications will be displayed with the clarity and sharpness needed for detailed evaluations of hard-to-catch waveforms.

tion of hard-to-catch waveforms. Auto Erase/Auto Store modes simplify the capture of transients. Auto Erase provides hands-off operation while Auto Store captures the transient when it occurs. Both modes are powerful capabilities for capturing those spurious spikes that disrupt digital circuit operation.

Convenience Features

The 1744A also includes pushbutton selection of third channel trigger view. Now measurements of timing relationships between the trigger signal and the

two vertical channels can be made simultaneously. Other capabilities to achieve convenient measurements include Easy-IC-Probes for connecting to closely spaced test points and eliminating shorting hazards; selectable input impedance (1 M Ω /50 Ω) for general purpose probing or 50 Ω matching; and dual channel measurements as low as 1 mV/div to 30 MHz without cascading.

For more information, check **N** on the HP Reply Card.

East-4 Choke Cherry Road, Rockville, MD 20850.
Ph. (301) 948-6370.

South-P.O. Box 10505, 450 Interstate North Pkwy.,
Atlanta, GA 30348, Ph. (404) 434-4000.

Midwest-5201 Tollview Dr., Rolling Meadows, IL 60008,
Ph. (312) 255-9800.

West-3939 Lankershim Blvd, North Hollywood, CA
91604, Ph. (213) 877-1282.

Europe-Central Mailing Depot, P.O. Box 529,
Amstelveen-1134, Netherlands,
Ph. (020) 47 20 21.

Japan-Yokogawa-Hewlett-Packard Ltd., Ohashi
29-21 Takaido-Higashi 3-chome
Suginami-ku, Tokyo 168, Ph. 03-331-6111.

HEWLETT  PACKARD

 MEASUREMENT **news**
COMPUTATION
product advances from Hewlett-Packard

January/February 1979

New product information from

HEWLETT-PACKARD

Editor:

Bojana Fazarinc-Bitencourt

Editorial Offices:

1507 Page Mill Road
Palo Alto, California, 94304 U.S.A.

Berg's TLC* connector terminates transmission line cable without a paddleboard.

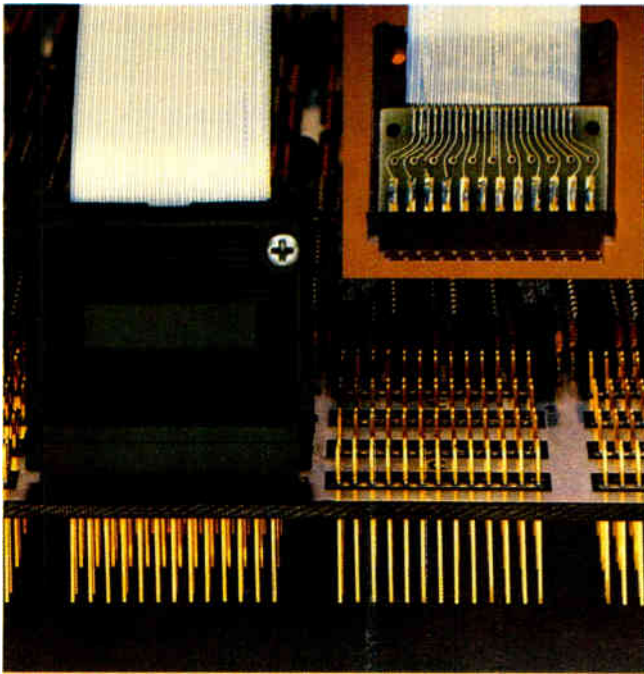

Paddleboard assembly—the slow way.

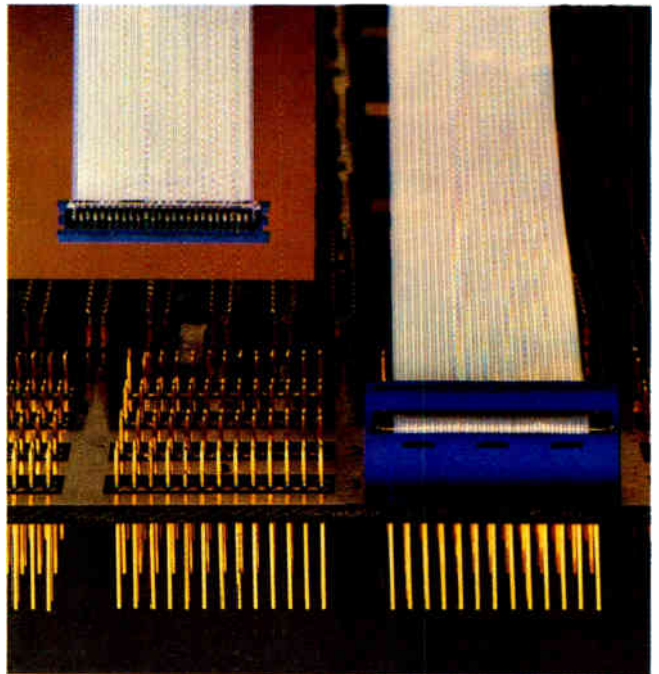

"TLC" connector—the fast way.

Assembly time and the cost of terminating transmission line cable are significantly reduced with Berg's unique "TLC" connector system. Completely eliminating the need for a paddleboard, the "TLC" connector reduces cable assembly time to seconds.

The connector's compact size provides greater signal fidelity and facilitates high-density packaging.

"TLC" connectors terminate any cable with signals on 0.050" centers. The ground wires are commoned on the buss bar allowing use of a wide range of cable designs with a variety of ground centers and diameters. Pre-deposited solder on the buss bar and signal tabs allow for mass reflow. This produces higher yields and further reduces assembly cost.

The "TLC" design uses Berg's proprietary PV* receptacle, a connector of proven reliability for over a decade in data processing applications. The dual-metal construction of the "PV" provides a high

normal force to assure highly reliable mechanical and electrical performance.

"TLC" connectors mate with 0.025" pins or standard Berg headers on 0.100" grid to form a complete interconnection system.

Look to Berg for innovative research and development to meet your connector needs, today and in the future. For a brochure describing the "TLC" system, write or call:

The Du Pont Company, Berg Electronics Division,
New Cumberland, Pennsylvania 17070.

Telephone: (717) 938-6711.



REG. U.S. PAT. & TM. OFF.

BERG
ELECTRONICS

*Du Pont Trademark

\$24.95

...AND HOLDING

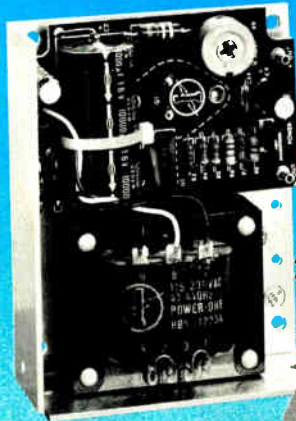

Model HB5-3/OVP

5V at 3A with Built-in OVP

Power One's B Case models started at \$24.95. Over 100,000 models and five years later, they're *still* only \$24.95!

- 115/230 VAC Input
- OVP Built-in
- .05% Regulation
- 2-Year Warranty
- 2-Hour Burn-in
- UL Recognized
- CSA Certified

Get all the details on our 84 standard open frames in our new 1978 catalog.



IN-STOCK NATIONWIDE... FOR IMMEDIATE DELIVERY

ARIZ.: Scottsdale, PLS Assoc. (602) 994-5461 CAL.: Pasadena, A-F Sls Engr. (213) 681-5631; San Jose, Richards Assoc. (408) 246-5860 COL.: Denver, PLS Assoc. (303) 773-1218 CT.: Litchfield, Digital Sls. Assoc. (203) 567-9776 FLA.: Orlando, Gra-Mar (305) 894-3351 ILL.: Chicago, Coombs Assoc. (312) 298-4830 IND.: Indianapolis, Coombs Assoc. (317) 897-5424 MD.: Lanham, Brimberg Sls. Assoc. (301) 946-2670; Baltimore, Brimberg Sls. Assoc. (301) 792-8661 MASS.: Waltham, Digital Sls. Assoc. (617) 899-4300 MINN.: Minneapolis, Engr. Prod. Assoc. (612) 925-1883 N.J.: Whippany, Livera-Polk Assoc. (201) 377-3220 N.M.: Albuquerque, PLS Assoc. (505) 255-2330 N.Y.: Roslyn Hts., Livera-Polk Assoc. (516) 484-1276; Syracuse, C.W. Beach (315) 446-9587 ORE.: Portland, Jas. J. Backer (503) 297-3776; Salem, Jas. J. Backer (503) 362-0717 TEX.: Dallas, Advance Technical Sls. (214) 361-8584; Solid State Electr. (214) 352-2601; Houston, Advance Technical Sls. (713) 469-6668; Solid State Electr. (713) 785-5436 WASH.: Seattle, Jas. J. Backer (206) 285-1300; Radar Elec. Co. (206) 282-2511 WIS.: Milwaukee, Coombs Assoc. (414) 671-1945 EUROPE: Hanex, L.A., CA (213) 556-3807 CANADA: Duncan Instr. Weston, Ontario (416) 742-4448

"Think about

POWER-ONE INC.
D.C. POWER SUPPLIES

Power One Drive • Camarillo, CA 93010 • Phone: 805/484-2806 • TWX: 910-336-1297

SEE OUR COMPLETE PRODUCT LISTING IN EEM & GOLDBOOK

Circle 28 on reader service card

The magazine you're reading now, could be your own.

Drop off the routing list. Get your own fresh, unclipped copy mailed to your home or office. Turn to the subscription card in the back of the magazine. If somebody has beat you to it, write: Electronics, P.O. Box 430, Hightstown, N.J. 08520.

Meetings

Future Trends in Fiber-Optic Markets and Technology, Information Gatekeepers Inc. (Brookline, Mass.), New York Sheraton, New York, Feb. 14-15.

International Solid-State Circuits Conference, IEEE, Sheraton Hotel, Philadelphia, Feb. 14-16.

1979 SAE Congress and Exposition, Society of Automotive Engineers (Warrendale, Pa.), Cobo Hall, Detroit, Feb. 25-March 2.

Sixth Energy Technology Conference and Exposition, Electric Power Research Institute (Palo Alto, Calif.), Sheraton Park Hotel, Washington, D. C., Feb. 26-28.

Recent Advances in High-Frequency Communications, Institute of Electrical Engineers (London), Savoy Place, London, Feb. 26-28.

Comcon Spring '79-18th IEEE Computer Society International Conference, IEEE, Jack Tar Hotel, San Francisco, Feb. 26-March 1.

Digital Microwave Transmission Seminar, IEEE and Princeton University, at Princeton University, Princeton, N. J., Feb. 27.

Digital Encoding and Processing of Voice and Video Seminar, George Washington University, Washington, D. C., Feb. 27-March 1.

Nepcon West '79, Industrial and Scientific Conference Management Inc. (Chicago), Anaheim Convention Center, Anaheim, Calif., Feb. 27-March 1.

ICE '79-International Computer Exposition, Marcom International Inc. (Tokyo) and Golden Gate Enterprises Inc. (Sunnyvale, Calif.), Tokyo Harumi Fairgrounds, Tokyo, Feb. 28-March 2.

Optical Fiber Communication Meeting, the IEEE and the Optical Society of America, Shoreham Americana Hotel, Washington, D. C., March 6-8.

Telecommunications, memories and microcomputers...

The Mostek System Solution

 Only Mostek offers a complete system for your telecommunication applications. Innovative design techniques give Mostek the edge in telecommunication product features. High density RAMs, ROMs, PROMs and versatile microcomputers complete the picture. Total compatibility from a single source—that's why we call it the system solution.

Designed by the leader

Mostek made its commitment to telecommunication products in 1974 when we built our first tone dialer. During the past year, we've shipped over three million circuits and earned a reputation as industry's most dependable source for reliable products. Products like tone receivers, tone dialers, pulse dialers, repertory dialers and CODECs are available in volume now. Monolithic filters are coming soon, followed by 2-4 wire converters.

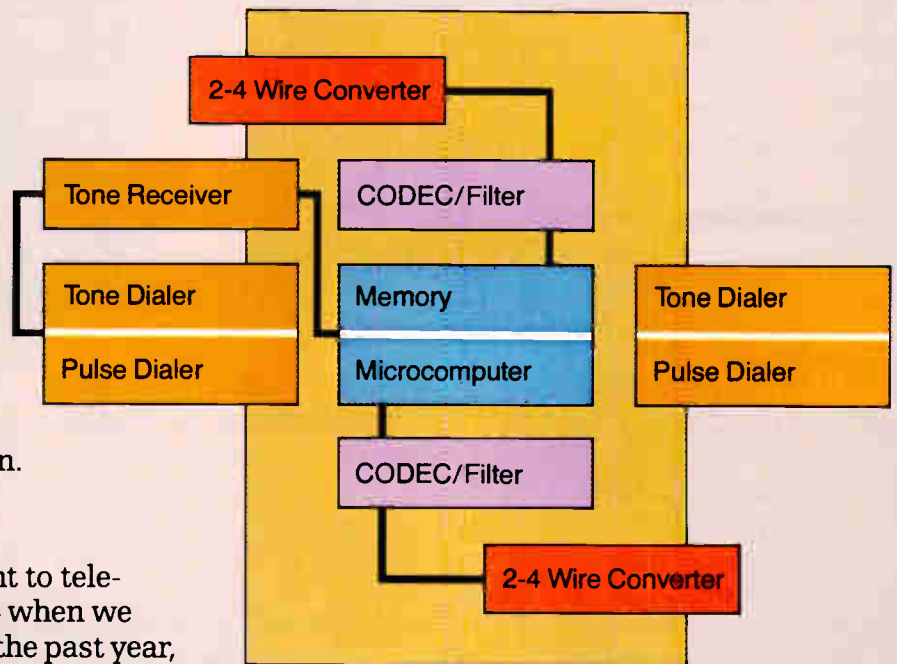

Designed for tough applications

The Mostek System Solution will meet your toughest specifications. Whether you're designing central office switching systems, key telephone systems, PABX, remote concentrators, channel banks, or automatic call distributors, contact Mostek for the solution, 1215 West Crosby Road, Carrollton, Texas 75006; phone 214/242-0444. In Europe, contact Mostek Brussels; phone (32)02/660.25.68.

MOSTEK®

Circle 29 on reader service card

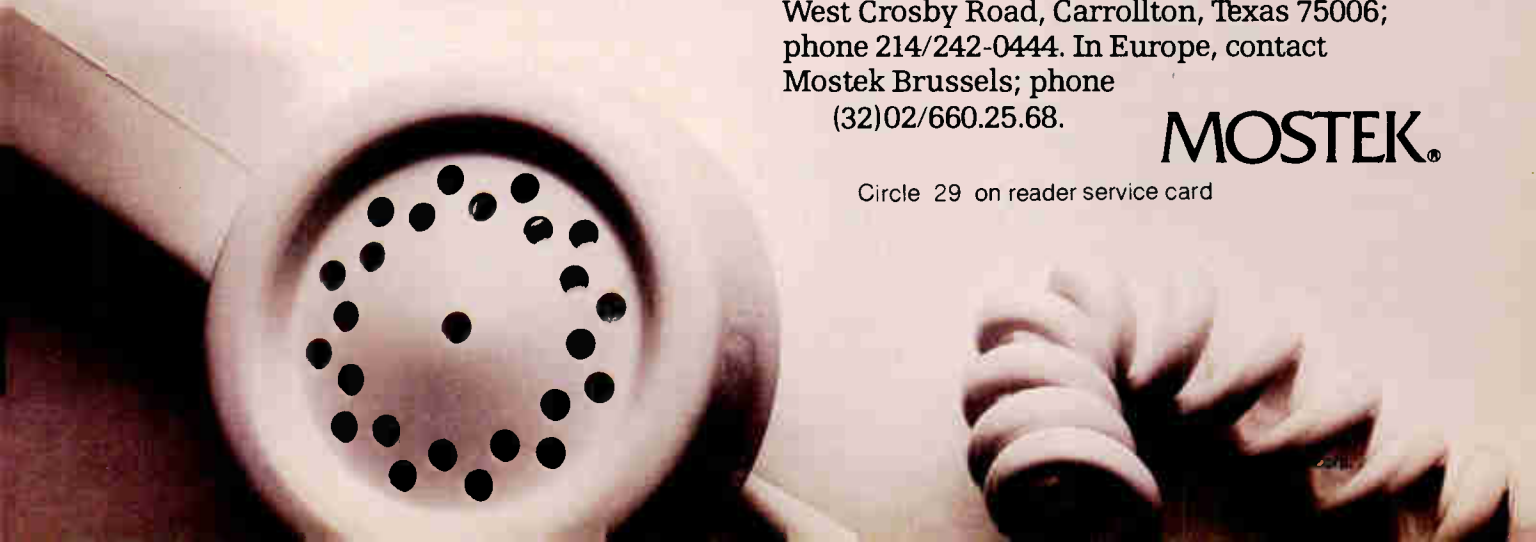

Design your 64K system now.

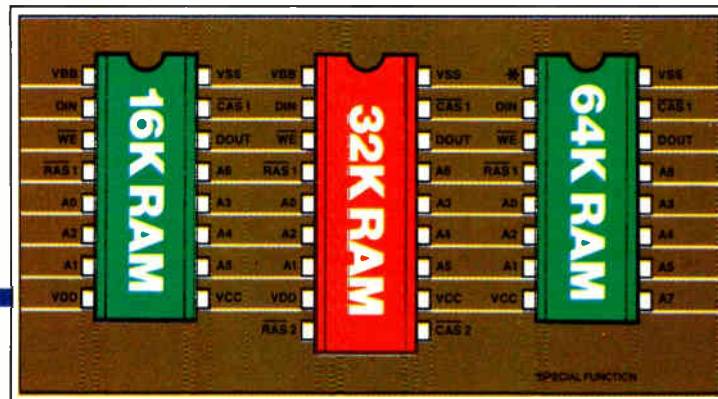

 Design now. Start production now. You don't have to wait for the 64K RAM.

Mostek's new 32K RAM is available and offers twice the density of 16K RAMs.

When 64K RAMs are available, your 32K system can be totally compatible.

Design in flexibility.

You can design memory systems that interchange 4K, 16K, 32K and 64K dynamic RAMs. The MK4332, organized as 32K x 1, mounts two 4116s in leadless chip carriers connected to a standard 18-pin dual-in-line package. The two chips share common Address, Data In, Data Out, Write Enable and power pins. Separate $\overline{\text{RAS}}$ and $\overline{\text{CAS}}$ clocks for each 4116 are provided for easy device selection and control. The arrangement of all other pins is identical to the indus-

try standard 16-pin configuration for 4K and 16K RAMs. The pin configuration is also compatible with Mostek's soon-to-be-announced 64K RAM, the MK4164.

Design in high performance.

Access time for the high density 4332 is a fast 200ns with a cycle time of just 375ns. Because both 16Ks feature an Edge-Activated™ selection mode, one chip remains in standby while the other is activated. This means the 4332 dissipates just 482mW while active and 40mW during standby. It allows a $\pm 10\%$ tolerance on all power supplies (+12V, $\pm 5\text{V}$).

Design with confidence.

With 16K RAMs in high volume production, you can be certain of 32K RAM availability. And alternate sourcing will soon be an-

nounced. You can count on Mostek's reliability. Mostek's 4116 quality standards set the pace for the industry. Every 16K RAM we ship is thoroughly tested to rigorous screens and stresses. With the same package dimensions as an 18-pin cerdip, the 4332 is compatible with your automatic handling and test equipment.

For more information on Mostek's 32K RAM, call your local Mostek representative or 214/245-0266 for location of the nearest sales office. Mostek Corporation, 1215 W. Crosby Road, Carrollton, Texas 75006. In Europe, contact Mostek Brussels; phone (32)02/660.25.68.

MOSTEK®

With our 32K RAM.

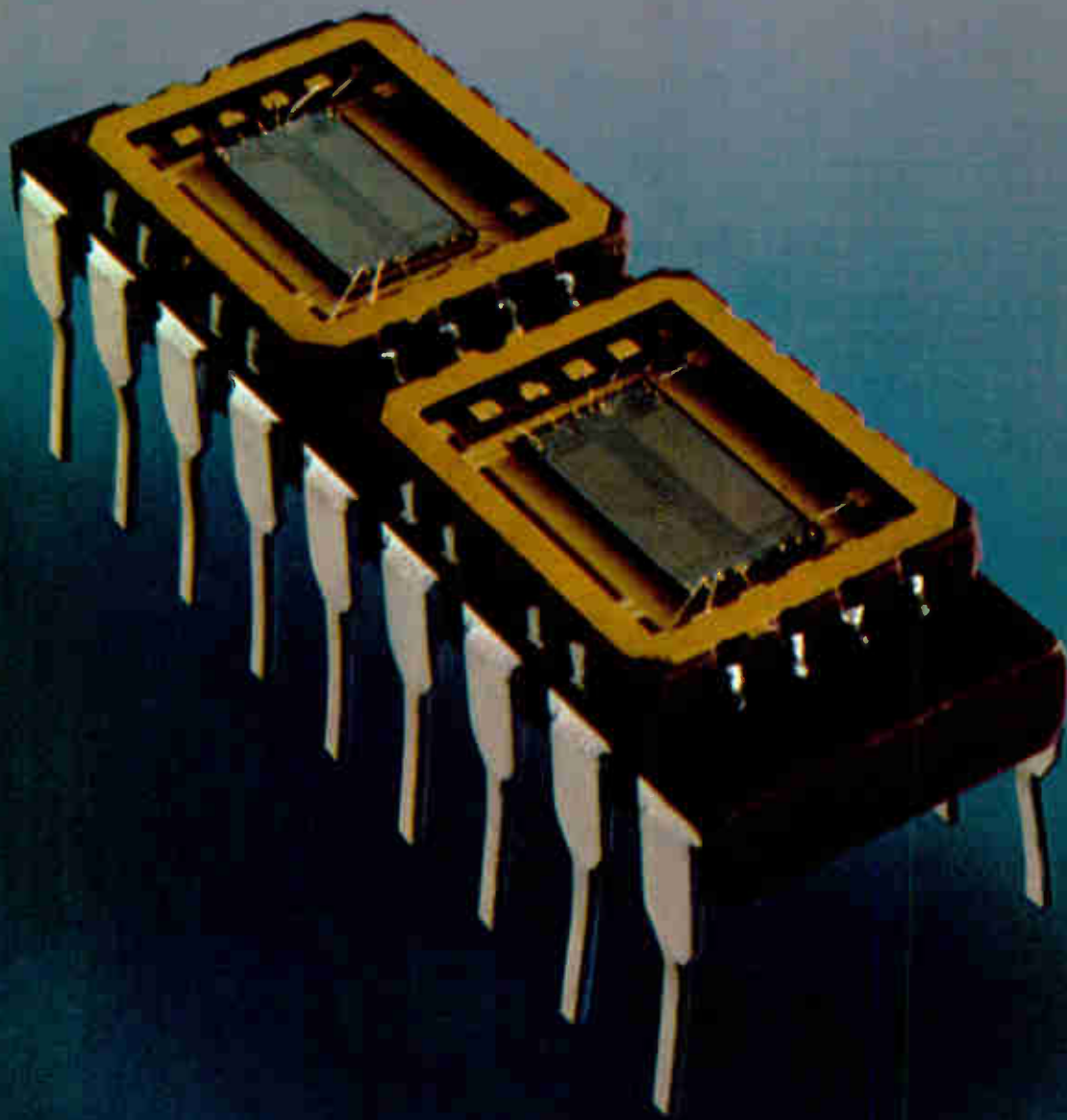

THE MOSTEK

Because even engineers

When was the last time you had the "perfect" hardware design only to learn it now needs three serial I/O ports?

Our new Micro Design Series minimizes these problems and lets you quickly respond to changing product definition and market conditions. Here's how:

Any Card. Any Slot. Any Time.

First, decide what functions your system needs. Match the Z80-based, MDX functional modules to your design. Plug

those modules into an MDX card cage. Then start writing your software.

Need to modify your system? Simply exchange, add or delete MDX modules at any time. The small 4.5" x 6.5" board size makes system packaging easier. And both 2.5 and 4.0 MHz versions are available.

You get this versatility because all MDX modules are STD-Z80 BUS compatible. This second-sourced, motherboard

MDX-SIO \$171*

MDX-DRAM 8K, 16K, 32K \$410* (32K)

MDX-CPU1 \$171*

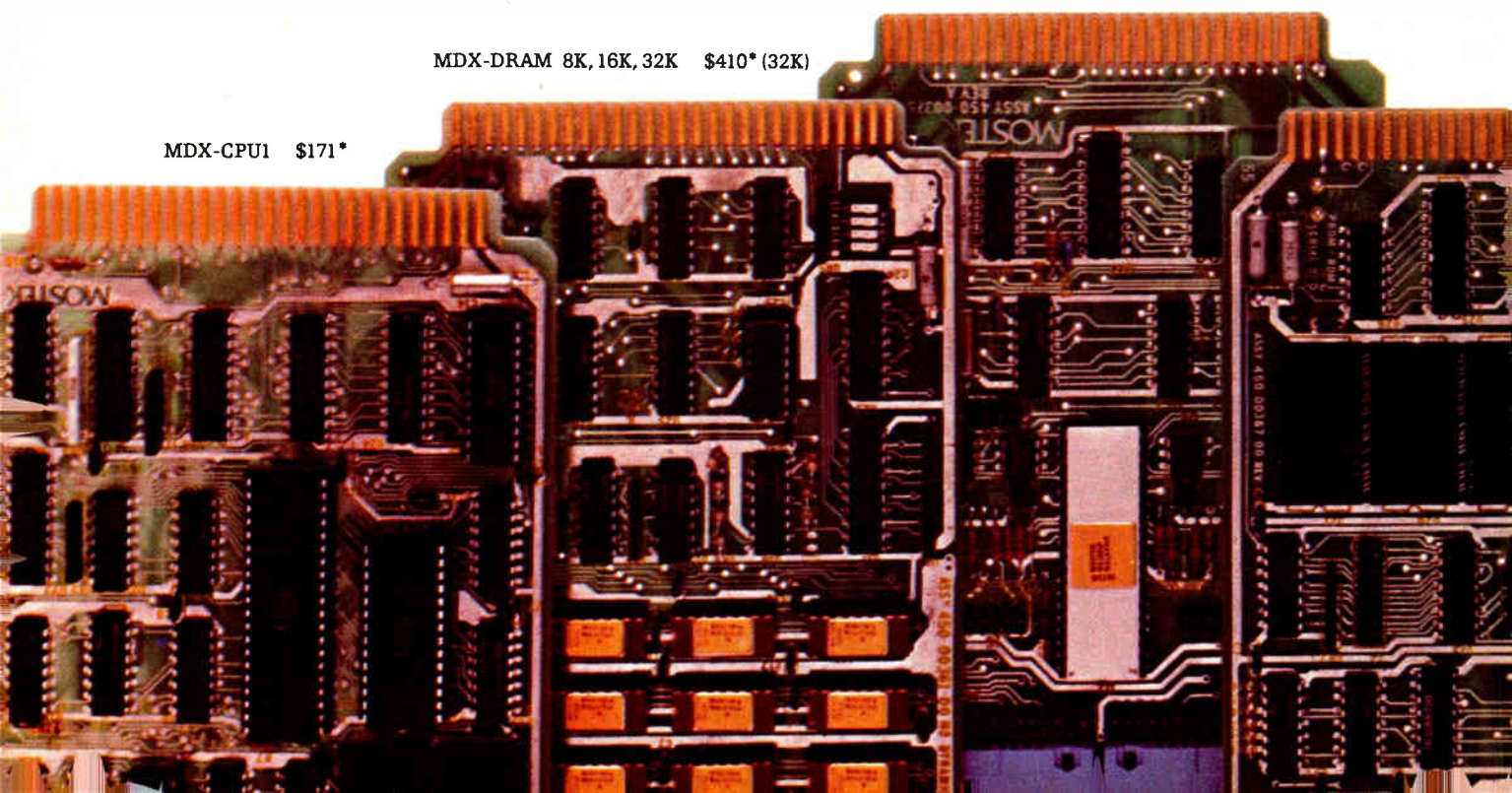

MD SERIES™

can't predict the future.

interconnect system lowers system cost two ways: you buy only what you need, and you reduce hardware development time.

A Wide Choice of Z80-Based Systems.

Need a small but powerful single-board computer? In addition to the broad family of MDX modules, Mostek's MD Series includes a separate family of stand-alone boards designated MD. The MD single-board computers are also Mostek Z80-based and the same small size as the MDX modules.

MDX-EPROM/UART \$148*

MDX-PIO \$164*

More Coming in '79.

For even greater design flexibility, the MD Series will expand to include a hardware single-step module, 2-channel programmable serial I/O module, 32-bit programmable parallel I/O module, floppy-disk controller module, plus more MD single-board computers.

Start designing your MDX system with the MDX-PROTO kit. This powerful evaluation/prototyping kit is available now for only \$1095.

Call or write us today for more information. Mostek, 1215 West Crosby Road, Carrollton, Texas 75006; phone 214/242-0444. In Europe, contact Mostek Brussels; phone (32)02/660.25.68.

MD-SBC1 \$171*

Circle 33 on reader service card

*100 lot quantities
MDX-DEBUG \$279*

MOSTEK®

Once you compare our new 191 digital multimeter to ordinary 5½-digit DMMs, we think you'll readily agree that it outclasses its class. For good reason.

The 191 is a ±200,000-count DMM capable of 0.004% accuracy and 1μV/1mΩ sensitivity. It delivers unsurpassed accuracy, faster, because firmware in the 6802-based μcomputer has replaced slower, less precise analog circuitry.

Displayed data is updated at the fastest rate of digit change readable by the human eye—4 conversions per second. Settling time of 0.5 seconds is easily half that of the 191's nearest competitor.

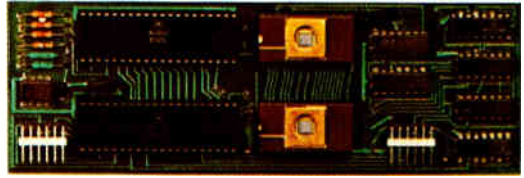

The μP combines both charge-balance and single-slope conversion techniques. Every displayed reading is automatically corrected for zero and gain drift.

If you've ever had to contend with the frustration of potentiometer zeroing, you'll appreciate the 191's null function. Automatic arithmetical correction of residual error is standard. With a touch of the button

you can buck out any in-range signal, large or small.

A year from now you'll own one or wish you did. You don't need low-level noise either. So the 191 automatically suppresses it. The 191's non-linear digital filter is entirely free of dielectric absorption and leakage problems associated with analog techniques. On the 200mV and 200Ω ranges, the filter effectively attenuates noise by displaying a running average of the 8 previous readings. Yet it instantly displays input changes of 10 digits or more.

Another exclusive of the 191 is 2 and 4-terminal measurement from 1mΩ to 20MΩ across six ranges. Simply adding two more sense leads automatically enables Kelvin measurements. No changing input terminal links or even pushbutton settings.

And, finally, since μP design reduces component count, the 191 requires less servicing and calibration, increasing reliability and stability.

At \$499 without plug-in ACV, the 191 is today's performance/value leader in 5½-digit DMMs. A year from now most people will agree.

KEITHLEY

But you probably don't need that much time to make up your mind. And we're ready to help you with a demonstration or additional information. Call 800-321-0560. In Ohio, 216-248-0400.

Next year you'll be glad you did.

Circle #34 for literature

Circle #35 for demonstration

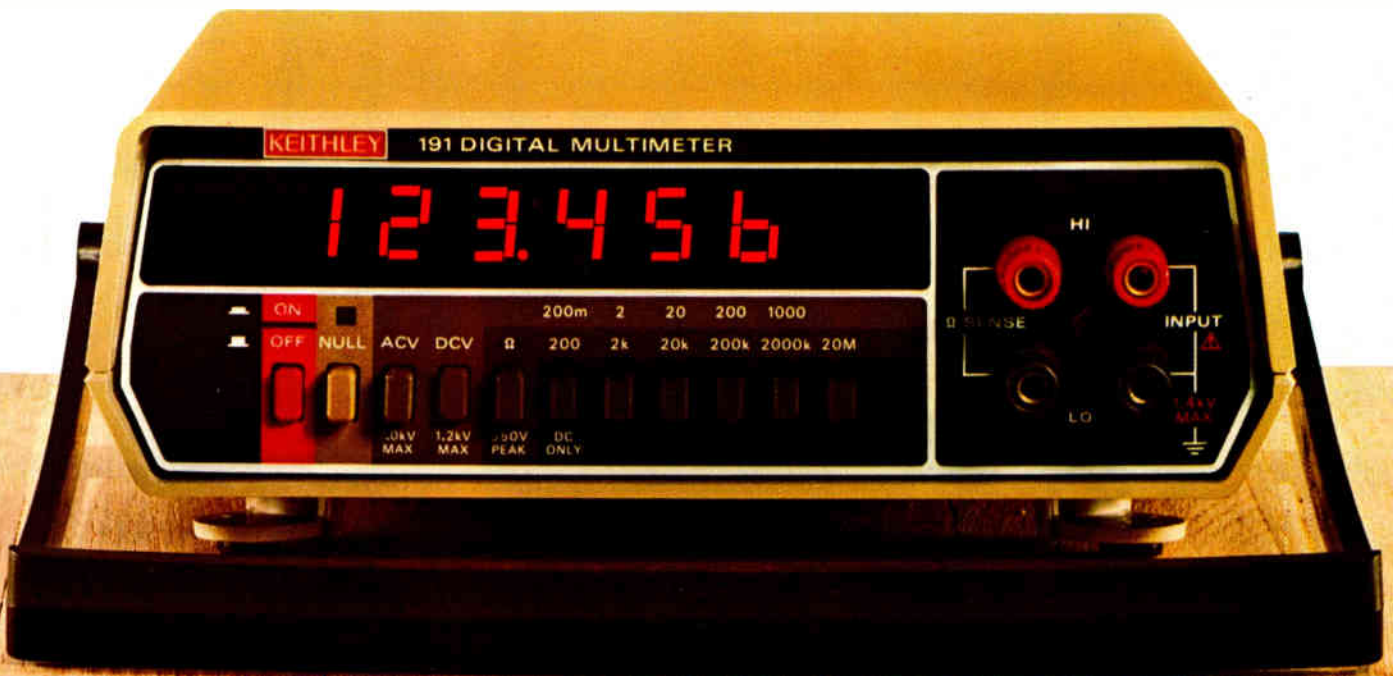

National lists single 5-V 16-K and 64-K RAMs

As National Semiconductor Corp. prepares to contest Texas Instruments Inc., Motorola Inc., and others this year by bringing out a 65,536-bit dynamic random-access memory with a single 5-v power supply, **the Santa Clara, Calif., company is expected to have a surprise for Intel Corp. as well:** a 16,384-bit dynamic RAM with a single 5-v supply to compete with Intel's 2118 [*Electronics*, Sept. 14, 1978, p. 206]. National's triple polysilicon, stacked-capacitor cell structure, which occupies only 0.3 mil² on the 64-K part, would yield a 16-K die measuring about 11,000 mil² and a chip whose power-dissipation specifications would be better than the 64-K's 4 mA standby and 40 mA active. Target access time matches Intel's 16-K at 80 ns versus 120 ns for the 64-K. To be provided in samples late this year, the device is aimed as an immediate cost-effective upgrade for high-performance minicomputer users forsaking conventional 16-K RAMs with three power supplies. Volume production of 64-K devices will not be starting in the near term.

Harris terminals to be installable by customers

Terminals that customers themselves can install will be introduced in coming product generations from Harris Corp.'s Data Communications division in Dallas. The approach, which has been pioneered by IBM Corp., is one of several techniques planned by Harris **as a way to meet increasing service and maintenance requirements imposed by the growth of distributed processing**, says Elliott D. James, division vice president and general manager. Increased use of self-diagnostics made possible by technological advances in components and by learning-curve cost reductions is also in the works for Harris machines.

New competitor in desktop market shows computer

Yet another foray is being made into the intelligent terminal–desktop computer market. This time it's by a company new to the game, Solid State Technology Inc. of Woburn, Mass., introducing a product new to the marketplace, the Athena. A typical system will consist of an enhanced Athena (microprocessor-based controller modules are added to the basic central processor), 64 kilobytes of random-access memory, a keyboard, a cathode-ray-tube display, two floppy disks, two mini-cassettes and an impact dot-matrix printer, all for less than \$10,000.

The Athena will function as part of a low-end networking system at 9,600 baud with an RS-232 or current-loop interface, or as a high-end networking system at 500 kilobaud. The computer has Cobol, APL, Pascal, Basic, and Fortran compilers, or it can work in assembler language. Full production of the Athena will begin in late April or early May.

HP cuts prices on big computers

Hewlett-Packard Co. is honing the edge it has over competitors in business-oriented minicomputer systems by dropping prices for its top-of-the-line 3000 Series III and its recently announced complementary-MOS-on-sapphire-based Series 33 computers. Series III prices fall from a base of \$115,000 to \$105,000; the cost of the 33 plummets from \$70,000 to \$58,500. Edward R. McCracken, general manager of HP's General Systems division, explains the changes by saying that **innovations in system power supplies reduced production costs**. Moreover, he says, the new power supplies run cooler than the ones they are designed to replace, making the whole system more reliable.

AMI controller features on-chip converters

Drawing a bead on microcontroller competitors, American Microsystems Inc. of Santa Clara, Calif., is adding two parts to its four-bit S2000 family with unique features: **on-chip analog-to-digital and digital-to-analog conversion**. Other unique features of AMI's S2200 and S2400 chips are expandable read-only memory, power-failure detection, 8-bit programmable internal timer, eight multiplexed inputs, and touch-control capability. The S2200, with 2,048 bytes of integral random-access memory, is due in sample quantities this summer, followed by the S2400, with 4,096 on-chip bytes of RAM, which will be made in a complementary-MOS version early next year. Slated for growing low-end appliance, automobile, and industrial applications, the parts will be priced by AMD at less than \$5 each in volume.

IBM to unveil new technologies and processors

IBM Corp.'s General Systems division is getting ready to ship the first System/34 small business computer containing its new disk technology. The Atlanta-based division won't talk about the disk drive until the first customer receives the unit, but the disk is reported to store 63.9 megabytes on an 8-in. platter using thin-film recording-head technology to achieve the higher bit and track densities.

Meanwhile, the computer industry is buzzing with reports that the Data Processing division in White Plains, N. Y., is **about to unveil its long awaited E-Series computers** [*Electronics*, Aug. 17, 1978, p. 44]. The new mainframes are expected to replace the low end of the System/370 line by offering 2½ to 3 times the performance per dollar of the models 115, 125, 138, and 148, according to Robert Fertig, vice president of Advanced Computer Techniques' Technology Analysis group. He spoke at last month's Future System Forum sponsored by his company and the International Information Technology Institute.

Addenda

After more than 30 years of development work on superconductors, the Westinghouse Electric Corp. has received a contract to build **the world's first 300,000 kilovolt-ampere superconducting generator** for delivery to a utility. The Electric Power Research Institute—the research arm of the electric utility industry—will share costs of the five-year program. . . . Improved propagation conditions because of sunspot activity have induced the National Bureau of Standards to **resume broadcasting time and frequency information at 20 MHz**—the most reliable U. S. East Coast transmission frequency. . . . Prompted by interest of oil-well loggers, Micro Networks Corp. of Worcester, Mass., is designing a 12-bit analog-to-digital converter that will be able to sustain **higher temperatures than the 125°C specified by the military**. It will be able to operate for at least 100 hours at 200°C. The converter, accurate to 10 bits, is to be introduced within the next six months. . . . **A kitchen range that uses magnetic induction for cool-surface cooking** will be introduced in the spring by Chambers Corp., a subsidiary of Rangaire Corp. of Cleburne, Texas. Called Magnawave, it operates at a frequency above 20 kHz and uses inductor coils under each of its four heating areas, silicon-controlled rectifiers for power generation, and a standard 30-A circuit. It also sports a Motorola 3870 8-bit microprocessor for logic control, input/output, display, and timing functions.

5 DAY DELIVERY

Microcomputer Analog I/O Systems



For:

DEC LSI-11 & LSI-11/2

DEC PDP-11 UNIBUS

INTEL SBC-80 Series & NATIONAL BLC-80 Series

ZILOG MCB Series (Z-80)

MOSTEK/PROLOG STD BUS

COMPUTER AUTOMATION LSI 2, 3, & 4 Series

Precise analog I/O for any micro.

Data Translation manufactures the largest array of analog I/O modules and systems in the industry.

Standard interfaces for every major micro-computer. From isolated inputs to extremely high-speed inputs. Designed to meet your most stringent data acquisition needs in a wide range of measurement and control applications.

Highly reliable systems in only 5 days.

Our goal is to ship the most reliable analog I/O

systems available anywhere. That's why we go to such great lengths to ensure the highest reliability.

Delivery? We doubt that you'll find any company faster than **DATA TRANSLATION**.

We assure five-day delivery. When you order on Monday, we deliver by the next Monday. No excuses. No delays.

SEND for Full Technical Data or Call us.

GSA Contract No. GS-00S-64219

DATA TRANSLATION

INC
4 Strathmore Rd., Natick MA 01760
(617) 655-5300 Telex 948474

U.S. SALES OFFICES: AL (404) 455-7222; AZ (602) 944-5400; CA (408) 244-5508; (213) 681-5631; CO (303) 371-2422; CT (203) 622-9191; DC (301) 636-1151; FL (305) 274-4899; (813) 725-2201; GA (404) 455-7222; ID (801) 466-6522; IL (312) 297-2616; LA (713) 780-2511; MD (301) 636-1151; MN (612) 488-1129; NC (919) 723-8102; NJ (516) 488-2100; (609) 428-6060; NM (505) 292-1212; (505) 523-6061; NY (516) 488-2100; OK (405) 528-6071; PA (609) 428-6060; (412) 327-8979; SC (803) 233-1469; TN (404) 455-7222; TX (512) 451-5174; (214) 661-0300; (505) 532-0601; (713) 780-2511; (512) 828-2251; UT (801) 466-6522; WI (414) 567-0444; CANADA (416) 625-1907.
Authorized Distributor - First Computer, Chicago (312) 920-1050.

Circle 37 on reader service card

BIFET OP AMPS

Fairchild proudly introduces lower standards.

The company you look to for industry standards has just reached an all-time low: A second generation of BIFET Op Amps that combine the lowest cost and the lowest noise in the industry.

These monolithic BIFET operational amplifiers come in your choice of single μ AF771, dual μ AF772 or quad μ AF774.

With matched ion-implanted JFET inputs on the same chip.

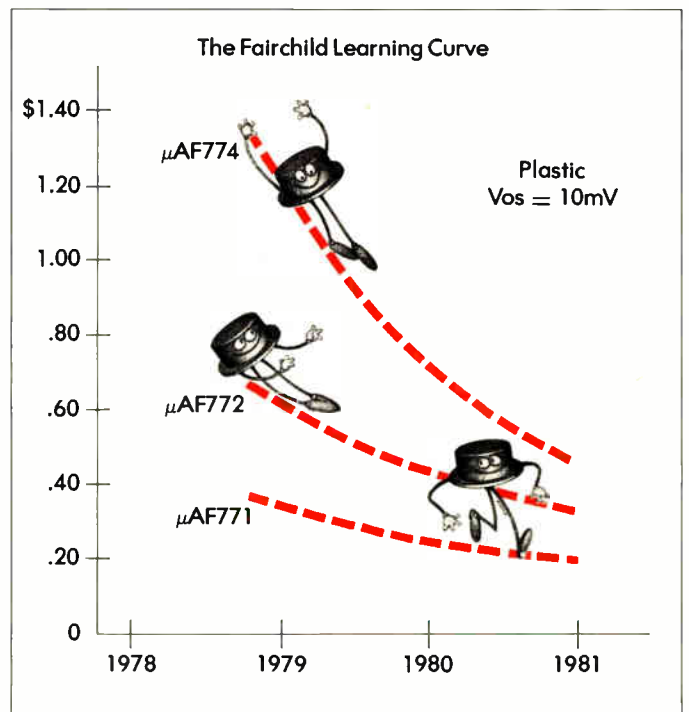

The Industry standard bearer.

Fairchild has been in the Op Amp spotlight for 14 years. We were establishing "learning curves" and creating "miracles" in Silicon Gulch long before the industry started talking about them. A list of Fairchild firsts includes:

- | | |
|------------------|---|
| 1964 μ A702 | world's first monolithic Op Amp |
| 1965 μ A709 | first industry standard Op Amp |
| 1968 μ A741 | first internally compensated Op Amp |
| 1969 μ A725 | first quad input instrumentation Op Amp |
| 1970 μ A740 | first monolithic FET Op Amp |
| 1976 μ AF356 | first BIFET in plastic |
| 1977 μ A714 | first low-cost precision Op Amp |



In short, we know our way around an Op Amp. It's no accident that our second generation BIFET Op Amps are the best you can buy.

Quadruple the benefits.

All our BIFETs — single, dual and quad alike — have quadded JFET inputs. This substantially improves the matching of input devices which results in improved input offset voltage distribution and yield. And in dual and quad Op Amps, quadding improves channel separation by reducing the effects of thermal gradients on the chips. All of which means a more cost-effective Op Amp.

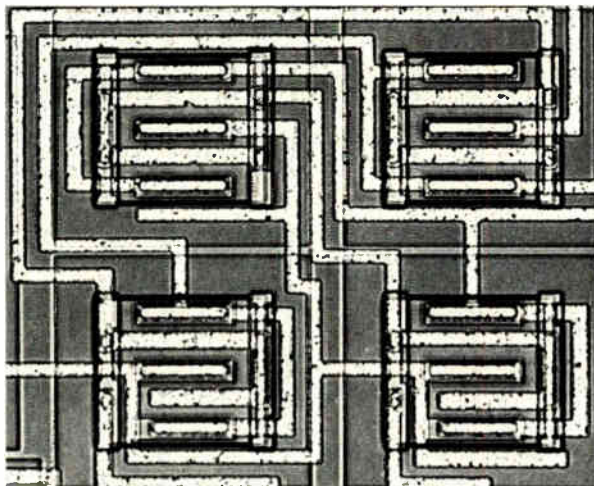

Specs speak louder than words.

Our second generation Op Amps feature typical performance specs like 50 pA input bias current. 25 pA offset current. 13 V/ μ s slew rate. And 3.0 MHz bandwidth.

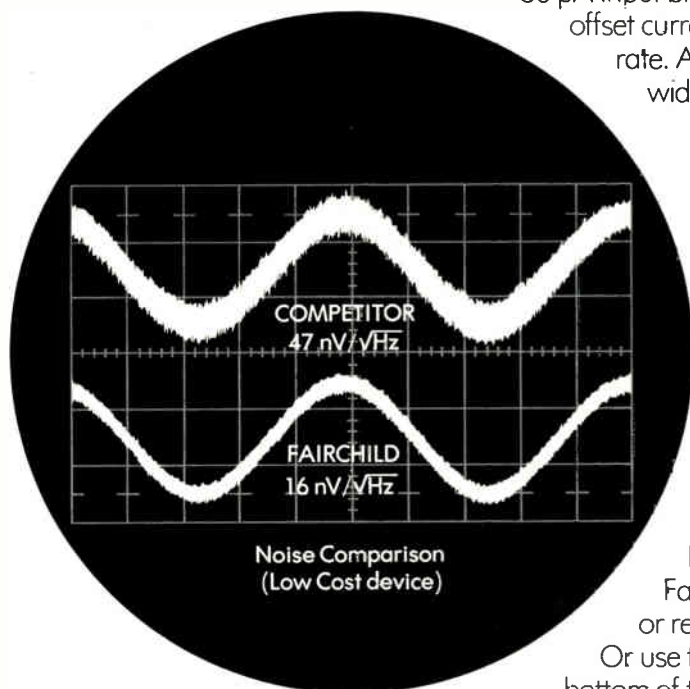

Maximum ratings include ± 18 V supply voltage. ± 30 V differential input voltage. And operation over the full military temperature range when required.

For the complete lowdown on our new μ AF771, μ AF772 or μ AF774 BIFETs, contact your Fairchild distributor or representative today.

Or use the direct line at the bottom of this ad to reach our Linear Division direct. Fairchild

Camera and Instrument Corporation, Box 880A, Mountain View, California 94042. Tel: (415) 962-4903. TWX: 910-379-6435.

FAIRCHILD

**Call us on it.
(415) 962-4903**

Duncan hybrid pots have a proven track record

Duncan hybrids have proven themselves where it counts. In reliability, accuracy, durability and economy. In countless applications, especially in multi-turn configurations, these pots do the job best.

That's because Duncan hybrid pots combine the outstanding environmental characteristics and low temperature coefficient of wirewound pots, with the exceptionally long life and virtually infinite resolution of conductive plastic.

Hybrid pots are made with Duncan's exclusive RESOLON[®] conductive plastic. Rotational life of 50 million revolutions and more can be expected with this superior type of material.

Techniques have been developed which allow for automatic application of the RESOLON conductive plastic to the wirewound element. That means you can replace any wirewound pot, be it rectilinear, or rotary, single-turn or multi-turn, with a Duncan hybrid version . . . and all of these with either linear or non-linear functions.

So, whatever your potentiometer needs, Duncan can deliver a hybrid that has the inside track to getting the job done.

Why not let us prove it? Send for literature or call us direct for engineering assistance.



DUNCAN ELECTRONICS
SUBSIDIARY

SYSTRON  **DONNER**

2865 Fairview Road • Costa Mesa, California 92626
PHONE: (714) 545-8261 □ TWX 910-595-1128

Circle 40 on reader service card

Thin-film layers shrink rf inductors to chip size

Thinco division of Hull Corp. has built capacitors as well; goal is to fabricate an entire passive filter on a chip

Getting a lot of turns of "wire" into a thin-film inductor is not easy, especially if the part is to remain small. More turns—and inductance—usually means more surface area, but not when the inductor is made with a new technique developed by the Thinco division of Hull Corp., Hatboro, Pa.

Instead of adding turns by depositing film on a flat surface, Thinco fabricates the turns vertically, depositing alternate layers of metal and silicon-dioxide dielectric on an alumina substrate. Furthermore, the components—Thinco has produced capacitors, too—are batch-produced in a vacuum chamber during only a single vacuum pump-down.

Harold de Palma, Thinco's general manager, calls his company's "picominaturization" of passive components "a great advance." But he does not think that Thinco, organized some five years ago to develop the production process, will stop there. "Ultimately, we will build passive filters on a chip."

Two types. Presently, Thinco sells two types of inductors designed to be included in hybrid radio-frequency circuitry. The XL-30 can be made with inductances specified between 3 and 56 nanohenries. It has a self-resonant frequency of about 2 gigahertz and measures 85 by 50 mils. The XL-55, with inductances between 15 and 210 nH and a self-

resonant frequency of about 700 megahertz is somewhat larger at 67 by 67 mils.

Chip inductors in these ranges are currently available, but they are made with thick-film materials in cubic packages about 100 mils on a side. Both of the new inductors are, at most, only 2 mils high, and are about the same size as a transistor chip. The quality coefficient, or Q, for both units are up in the 40 to 50 range at 400 MHz.

Thinco's engineers use substrates about 8 to 10 mils thick, sturdy enough to be handled in a production environment. Thus, the volume of an inductor is only about 4% of that of the commercial thick-film type. Using an electron-beam gun in a vacuum chamber, the thin-film materials are deposited through precision masks onto the substrate. The gun beam vaporizes material stored in any of four crucibles contained in a

"lazy susan" arrangement within the chamber. The chamber also has a library of masks and a mask changer and indexer.

Each mask pattern is stepped and repeated in a grid, enabling thousands of identical components to be put down on a 2-by-2-in. substrate. Thinco will soon add a mask-changing mechanism that can accommodate a 6-by-6-in. substrate, enough for 6,000 XL-55-size inductors in a single pump-down.

Capacitors, too. Thinco has also built capacitors using the technique. One prototype, measuring 30 by 50 mils and 2 mils high has been made with capacitances between 2.7 and 100 picofarads. "With higher dielectric constant materials, we expect to obtain capacitances up to 1,000 pF in a 1-mil-high structure measuring 40 by 50 mils," says de Palma.

Film thicknesses, which range between 5,000 and 50,000 ang-

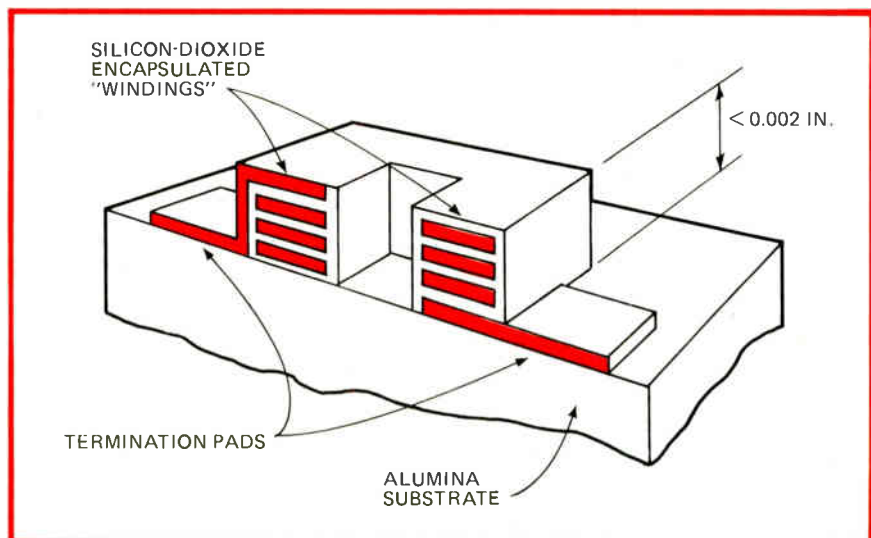

On a chip. Radio-frequency inductors built of vacuum-deposited thin films have ranged as large as 210 nanohenries. Two chip types are about 4,250 and 4,490 mil².

Electronics review

stroms, can be controlled to several hundred angstroms, according to de Palma. Lot-to-lot repeatability is high because of this close film control, as well as the precision mask indexing that is possible, he says. A computer program helps calculate layer thicknesses to tailor inductances, capacitances, and self-resonant frequencies.

Future plans call for the fabrication of passive filter networks incorporating combinations of inductor, capacitor, and resistor elements. A

preliminary design of a very high-frequency pass-band filter has dimensions of 295 by 60 mils by 12 mils high; another is 160 by 110 mils by 12 mils high.

Samples of the new inductors are already being evaluated by companies including Raytheon, General Electric, TRW, and Watkins-Johnson, de Palma says. The parts sell for between 70 and 90 cents each and de Palma hopes that further automation of the process could bring this down to 50 cents. □

Supercomputers

CDC unveils new big computer with bipolar memories and 100K ECL logic

The exclusive club of supercomputers—those high-speed number crunchers aimed primarily at scientific applications—will soon have a new member. Control Data Corp. last month announced it was one year away from delivering its new Cyber 203 and showed Cray Research Inc. and Burroughs Corp., its challengers in the supercomputer arena, that it was applying some of

the newest technologies.

No newcomer to the supercomputer, CDC says its new machine is essentially an upgrade of its current Star 100. But the Minneapolis firm packs the new unit with features the Star lacks. These include some already available on Cray's Cray-1 machine, like semiconductor bipolar memory instead of core and single-bit error correction and double-bit

error detection on memory.

The Cyber 203 also has an unusually large register file of 256 registers that are fast enough to handle two read and one write operations in a 20-nanosecond clock cycle. In addition, it is CDC's first use of a new version of the extremely fast emitter-coupled-logic 100K family, jointly developed with Fairchild Camera and Instrument Corp., Mountain View, Calif. (Fairchild markets the version commercially as the F200K family.)

Each large-scale integrated chip contains 168 gates and has an average loaded gate delay of 800 picoseconds. With computer-aided design, CDC created 14 logic types that it uses as building blocks for the system, says Anthony Vacca, CDC's manager of electronics technology.

New processor. The ECL implements a new scalar processor that, with the bipolar memory, operates with the same vector processor used in the Star 100. (Vector processors handle the arrays so useful in scientific and engineering computations.) CDC says the new scalar processor is some six times faster than the scalar portion of the Star.

The scalar processor, which uses 2,700 chips, has a cycle time of 20 ns and performs 50 million floating-point operations per second—so-called megaflops—according to Lloyd M. Thorndyke, CDC's senior vice president for supercomputer operations. The vector processor has a cycle time of 40 ns and a peak speed of 100 megaflops, he adds. Up to 16 megabytes of bipolar memory can be attached to these processors. It has an access time of 80 ns with 64-way interleaving and can transfer 100 billion bits per second. Up to 12 input/output channels can be used, each capable of a transfer rate of 5 megabytes per second.

CDC says that it has also improved the Star-compatible software. It has reduced operating system overhead, and the Fortran compiler now has an automatic vectorization procedure that finds not-so-obvious operations that can be performed more efficiently with vector instructions. The machine also has a virtual-memory

Coming soon. First models of the Cyber 203, the most powerful computer ever built by Control Data Corp., will start to be delivered in about a year to the Air Force.



system based on a 48-bit address that can handle several trillion bytes of virtual-address space.

Among supercomputers, the Cray-1 has a 12.5 ns cycle time and up to 8 megabytes of bipolar memory. The Burroughs Scientific Processor, announced over two years ago [*Electronics*, Oct. 28, 1976, p. 32] but not yet delivered nor even benchmarked, operates at 50 megaflops, with some 40 megabytes of main memory. By comparison, a commercial top-of-the-line computer like the IBM 3033 has a cycle time of 58 ns and up to 16 megabytes of eight-way interleaved main memory with an access time of about 340 ns. It is estimated to perform some 5 megaflops.

Prices of the Cyber 203 range from \$5.8 million to \$11.7 million. CDC says it has already received a \$25 million order to install three of them at Kirtland Air Force Base near Albuquerque, N. M. The unit has already been benchmarked.

According to Thorndyke, more is yet to come. "Our next objective is to design and check out a new vector processor based on the same family of LSI circuits, making it a full LSI supercomputer." Already in the works is a machine with four to eight times the performance of the Cyber 203, to be available in the early 1980s, CDC says. □

Consumer

Home security heads to market

At about \$3,000, custom-designed home security systems are much too costly for the average consumer. But the price is coming down—way down—and a broad range of electronic install-it-yourself systems to protect doors and windows are expected to appear this year. In fact, more than a half dozen systems were either on display or talked about at the National Housewares Show in Chicago last month, prompting Frank A. Lopez, manager of the Home Security division of North American Philips Corp. (Norelco) to

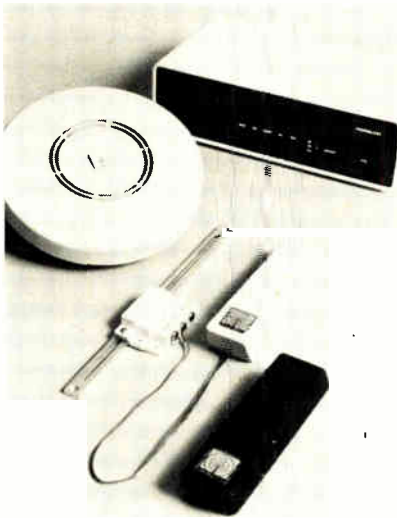

Alarmer. Norelco's \$299.95 system consists of a controller-receiver (rear), three magnetic window switches and a door transmitter (white units), and a smoke detector (circle). Black transmitter for a car is optional.

say that "1979 will be the kick-off year for home security."

In the forefront, with new systems retailing for \$300 and under, are companies like Norelco, Statitrol division of Emerson Electric, Universal Security Instruments, and Pittway—all of which had been selling residential smoke detectors and may have been burned in the process as prices and profits eroded sharply. Now they hope to capitalize on that consumer marketing experience and get back into the home by selling security.

Norelco has already introduced a wireless system—tagged at \$299.95 but frequently discounted to \$199.95—using radio-frequency links from magnetic switch sensors attached to doors and windows. The controller, built by Fyrnetics Inc., Elgin, Ill., with two custom complementary-metal-oxide-semiconductor chips, can also receive a 1-second digital pulse at 375 megahertz from smoke detectors. Other devices, such as an automobile monitor that sends a signal to the controller and portable signal generators with a range of 200 feet, are available as options.

Going up. Lopez says that the domestic market for home security systems will hit 1.5 million to 2 million units annually by 1980, with

gross revenues in 1981 approaching the \$300 million that smoke detectors currently ring up. Others say the figures could go higher.

Unveiled at the housewares show was Statitrol's system, which relies on a proprietary infrared heat sensor. An off-the-shelf integrated circuit and discrete components combine to form a logic center that automatically ignores stationary heat sources but reacts to moving sources. The system will retail for about \$100.

Also introduced at the show was Universal Security Instruments Inc.'s hardwired Kojak. The \$79.95 unit includes magnetic contacts and a light-emitting-diode doorway light that alerts residents to a break-in. A 12-volt battery powers the base unit, which is built with standard off-the-shelf discrete components. A wireless system with a microprocessor for less than \$200 will be unveiled in May, and will include an outdoor perimeter monitor option, says Thomas D. Regney, sales and marketing director at Universal in Owings Mills, Md.

At the edge. Perimeter monitoring will also be a key feature in the under-\$200 wireless system to be unveiled this spring by Pittway Corp.'s BRK Electronics, Aurora, Ill., and in one from the Pyrotronics division of Baker Industries.

Security systems are also being eyed by nonelectronics companies as a lucrative new growth opportunity. Regal Ware Inc., Kewaskum, Wis.; the Westclox division of Talley Industries, LaSalle, Ill.; and Teledyne Water Pik division, Teledyne Industries, Fort Collins, Colo., are introducing security devices and systems as they try to expand beyond kitchen pots, clocks, and electric toothbrushes.

In the wings, though, are a couple of electronics giants that could step in and dominate the new market with costly advertising campaigns and price cutting beyond the resources of small companies—General Electric Co. and Honeywell Inc. James T. Thompson, national sales manager for consumer products at Honeywell, says a wireless system

Electronics review

may be released this year, backed by a "tremendous merchandising investment." If so, a price war for the infant market could come in late 1980, Norelco's Lopez concedes. □

Point-of-sale

Terminal makers try creative maintenance

After several years of using micro-processors and denser semiconductor memories to add functions to electronic cash registers and point-of-sale terminals, manufacturers are turning to a new problem—how to service their increasingly complex units. And the solutions the POS vendors are proposing will have an impact on components suppliers and test-equipment makers.

Admittedly the question of how to support units in the field is not a new one. But the POS manufacturers discussing the issue at the National Retail Merchants Association's (NRMA) annual convention in New York last month say several trends have driven the service question into the spotlight over the past year.

Reciting the common litany of

declining hardware costs but increasing labor costs, the makers explain that field service now costs them and their customers more and is a much larger portion of the cost of ownership. In fact, Dan Barnes, vice president and general manager of TRW Inc.'s Retail Systems division, Hawthorne, Calif., says "the cost of maintenance could get to the point where it's higher than the amount of depreciation the customer can take on the machine." And he adds that service contract fees traditionally bundled into rental and lease prices are more noticeable now that more and more customers are buying the equipment outright and paying for service separately.

Creativity. Dean Liles, industry manager of marketing support for distribution industry and store systems at IBM Corp.'s Data Processing division, White Plains, N. Y., agrees that "service is one area where we still need to be creative."

The creativity is showing up in both how the products are designed and built and how they are installed and serviced in the field. Emilio Fontana, vice president for marketing and product planning at Litton Industries Inc.'s Sweda division, Pine Brook, N. J., comes down on

the side of machine design. "The use of component sockets, for example, adds to our cost of building the machine, but it allows more chip-level repairs at field offices, rather than shipping the boards to repair depots." In addition, Sweda gives servicemen a memory system, built in house, that stores the terminal's program while repairs are made and reloads it afterwards.

NCR Corp., the Dayton, Ohio, leader in the electronic POS market, is turning to parts standardization throughout its line, according to John Marmen, director of industry marketing for the retail systems division. For example, a variety of POS terminals and cash registers now use the same dot-matrix printer.

Self-help. Vendors are also looking at having the customer do more maintenance, thereby saving the travel costs of a service call and lowering service contract prices. General Instrument Corp.'s Business Systems division has just started testing what it calls a participatory maintenance system. According to Michael J. McHale, vice president and general manager of retail systems, several key customers are having personnel trained to perform what he calls "first-level maintenance—checking for jammed paper, changing ribbons and burnt-out light bulbs, making sure the unit is plugged in, things people used to call a service man for."

And IBM's new 3680 stand-alone terminal, unveiled at the NRMA show, is installed by the customer thanks to a design that makes the procedure similar to setting up a stereo system, says Liles. □

Creativity. Dean Liles, in charge of marketing support for store systems, IBM Data Processing division, says that POS servicing calls for creative solutions.



Lasers

Exxon gets 18 mW from solid-state unit

Exxon's got a laser in its tank—and a double-heterostructure aluminum gallium arsenide semiconductor one at that. Unveiled late last month, the new laser is produced by the corporation's Optical Information Sys-

The margin of difference . . .

ACCURACY

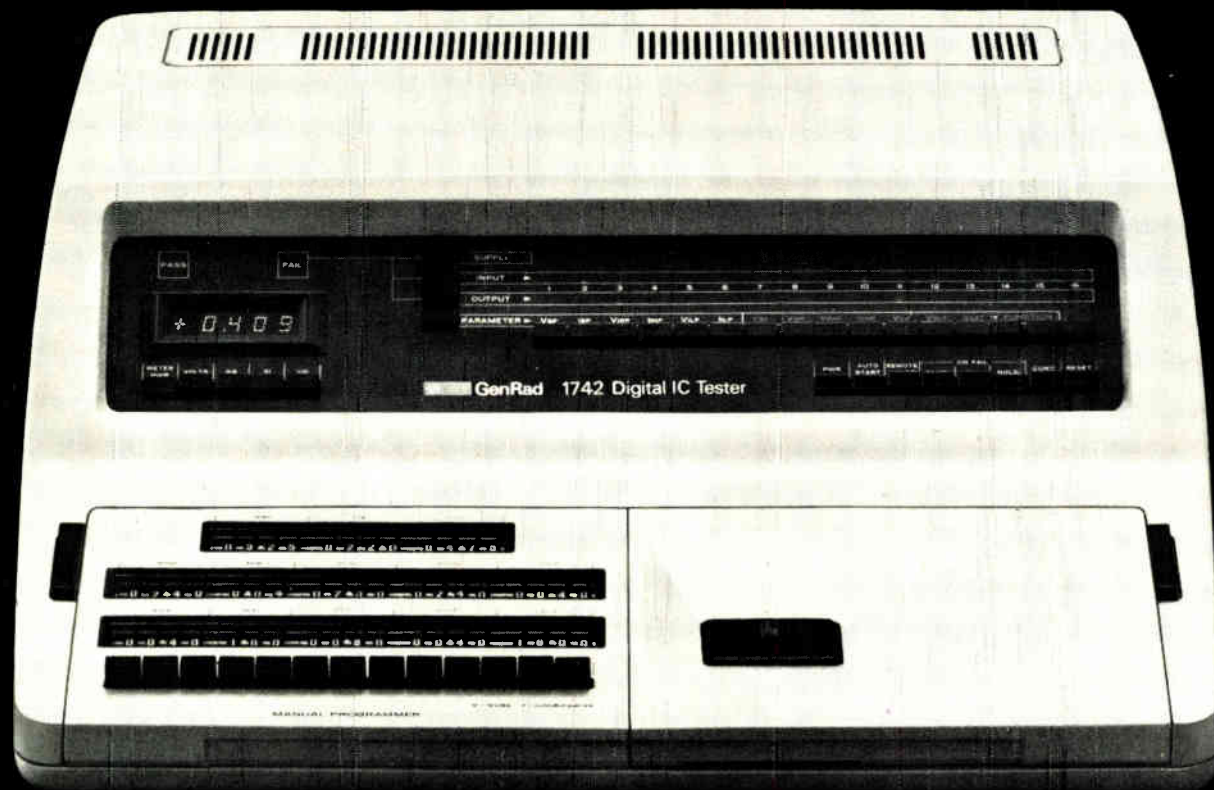

The GR 1742 Digital IC Tester

For

- incoming inspection
- quality control
- failure analysis
- reliability and burn-in
- component engineering

There's more than 1% accuracy that makes the GR 1742 the best digital IC tester to buy. There's the ability to change forcing functions and measurement parameters; the ability to measure a failed parameter and to relate it to the device pin; the ability to test a wide variety of IC families; the ability to test complex 28 pin ICs; and the ability to test CMOS up to 20 Vdc.

With typical industry rejection rates on digital ICs ranging from 0.5% to 5%, you can reduce PC board failures significantly.

The GR 1742 is simple to use. Just plug in a program card and start testing. The PASS/FAIL display provides

the operator with the test results. For high-volume requirements, the 1742 can be interfaced to almost any autohandler.

Accurate parametric tests to vendor specs eliminate marginal devices. The rigorous functional sequence with a pseudo-random gray code assures you of good devices.

A wide variety of devices can be tested with universal program cards to keep the on-going cost of ownership down. You'll be surprised how low your total investment will be.

With all these features and many more, you can see why the GenRad 1742 is the digital IC tester to select. Find out more about the GenRad difference. Call our sales office.



GenRad

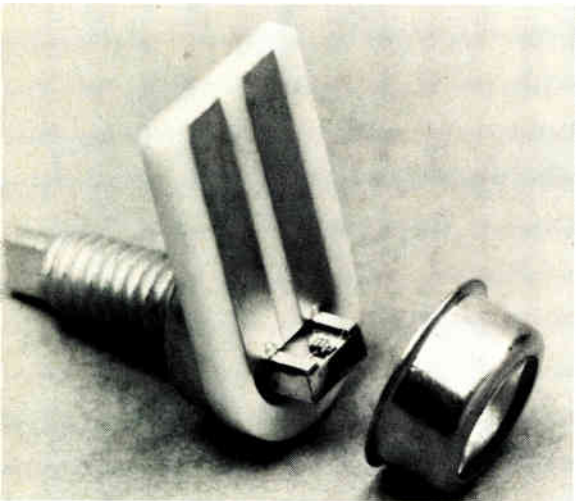

Easy mount. Threaded stud simplifies mounting of semiconductor laser developed by Exxon's Optical Information System.

tems division, the latest addition to its growing stable of electronics companies.

Intended for sophisticated applications such as long-distance fiber-optic communications, optical data storage, or laser computer-output printers, the laser chips have surprisingly high output power. They can operate in electro-optically linear modes to either 8 or 18 milliwatts of optical power or in a fundamental transverse mode to 18 milliwatts. With a typical threshold of 100 milliamperes, the chips produce beams with either 800 or 835 nanometer wavelengths—especially good for long distance fiber-optic applications, since these wavelengths experience the least attenuation with current fibers. Also unique is an optional integrated photodetector for feedback control. The resonant cavities of the units, which provide their maximum power at about 130 milliamperes, are defined using proprietary masking techniques.

To make the lasers even more appealing, two standard packages are offered; a stud-mounted version and one that fits 14-pin dual-in-line connectors. A variety of fiber-optic connectors are offered for coupling the output to the outside world.

Currently available for delivery, the lasers range in price from \$1,000 to \$3,950—significantly more than

light-emitting diodes. But LED's have much less power, and it is produced at a frequency that is not optimum for fiber optics. Hence, the Exxon device is suitable for much longer links. But operating at 1.5 volts means extra circuits are needed to interface them with common transistor-transistor logic.

Michael H. Coden, manager of the Elmsford, N.Y.-based division says it has "reduced the art of making semiconductor lasers to a manufacturing science." Some 24 proprietary techniques were developed for growing, cleaving, and processing gallium arsenide crystals to achieve what Coden says is an unusually high degree of uniformity. He hopes to patent the techniques.

Exxon Enterprises, the Exxon subsidiary that has provided venture capital for a number of high-flying electronics firms including Zilog, Vydec, Qwip, Qyx and Qume [*Electronics*, April 27, 1978, p. 88] has similar high hopes for Optical Information Systems.

Coden says his company "will build both components and complete information-processing systems," implying that it will make optical data storage units or non-impact printers. And in addition to lasers it is already developing high-speed switching transistors that may have potential use in computer logic. □

Companies

Inmos adds four top executives

Despite the trade secrets suit filed against it, Inmos Ltd., the British-backed entry in the arena of large-scale integrated circuits, continues to get its act together. It will have almost filled out its top management team by the end of this month, when four new people join managing director Richard Petritz and his deputy, Paul Schroeder. Also, it has selected scenic sites for its first two plants—Colorado Springs, Colo., where corporate headquarters will also be located, and Bristol, near the

seacoast of southwest England.

Among the new managers is John D. Heightley, formerly IC design manager for Sandia Laboratories in Albuquerque, N. M., where he worked with metal-oxide-semiconductor, bipolar, and microwave technologies, as well as computer-aided design. As Inmos's director of memory component development, Heightley replaces Ward Parkinson.

Together with two other Inmos employees, Parkinson suddenly resigned his post with the fledgling firm last Oct. 1 in the wake of the trade secrets suit filed by his former employer, Mostek Corp., and now scheduled for an Aug. 20 trial. Petritz, Schroeder, and others remain as defendants. Parkinson and the two others who left Inmos have settled their differences with Mostek. What's more, they have formed a company to do design work exclusively for their former employer.

Heightley once worked with Schroeder at Bell Laboratories. So did Alfred P. Gnadinger, another new Inmos official. Formerly in charge of research and development activities for Faselec Corp., the Zurich-based subsidiary of N V Philips Gloeilampenfabrieken, Gnadinger becomes director of technology. He will be responsible for process development, an area in which outsiders judge the Inmos team has been weak. Joining as vice president and manager of production is Thomas Hartman, former manager of Intel Corp.'s Portland, Ore., production facility, while Michael Burton, former controller of TI France in Nice, will serve as Inmos's manager of planning and control. Yet to be hired are a financial director and a sales and marketing official.

64-K RAM. On the production side, the Inmos business plan, bolstered by \$45 million in start-up funds from the British government [*Electronics*, Aug. 3, p. 42], calls for first samples of several memory parts to be ready in 12 to 18 months. A 64-K random-access memory will be one of the first devices produced in Colorado Springs, which will start up as a prototype production facility, says Schroeder. The company will also

YOURS FREE

Everything that's New and Exciting
in Electronics...All in the
NEW, Hot-Off-The Press

HEATHKIT® CATALOG



Read about nearly 400 exciting do-it-yourself kits including Amateur Radio Equipment, Personal Computers, Home Improvement Products, Stereo Hi-Fi, Programmable Color TV, Automotive, Aircraft and Marine Accessories, Test Instruments, R/C Modeling, Self-Learning Programs and lots more! Something for everyone, and everything is easy to build and fun to use — it's the Heathkit way!



**Send for your
FREE Catalog Today!** 

Heathkit products are displayed, sold and serviced at Heathkit Electronic Centers coast to coast. (Units of Schlumberger Products Corporation). See the white pages of your phone book. If coupon is missing, write Heath Company, Dept. 510-500, Benton Harbor, Michigan 49022

HEATH	
Schlumberger	Heath Company, Dept. 510-500 Benton Harbor, Michigan 49022 FREE!
Please send me my FREE Heathkit Catalog. I am not currently receiving your catalog.	
Name _____	
Address _____	
City _____	State _____
CL-676	Zip _____

produce high-speed static RAMs, read-only memories, and programmable ROMs, he adds. Within five years, Inmos hopes to have 1,000 U. S. employees, most of them in the planned 100,000-square-foot Colorado Springs plant.

Though the memories will be designed largely in the U. S., Inmos also has established a UK technology center in Bristol. Headed by Iann Barron—a third principal founder together with Petritz and Schroeder—the Bristol center will initially be charged with design and development of a new microcomputer family. Process development for both the memory product line and the microcomputer family, which will follow the memory products to market, will take place at first in the U. S., Petritz says. But within two years, the Bristol facility is also expected to begin wafer processing. Inmos will establish up to four UK production centers, to be built as “modules” limited to 1,000 employees each. The first center should be running at full capacity within three years. □

Communications

White House seeks automation

The White House may become an automation showcase for computer and business-equipment makers. The reason: the Executive Office of the President has in the works a sweeping program to pull together the data-processing and communications and other office operations of the President's staff. The program is part of President Carter's plan to make White House operations more efficient and speed up the decision-making process by making information available more quickly.

The new information-processing system will go by the awkward initials EOP/IPS and will be made up of two separate systems—one involving office automation, the other data processing—according to Jarrell L. Elmquist, who oversees the project. Proposals for the office automation

News briefs

Top role splits at Tektronix

In moving William D. Walker, 48, formerly group vice president of test and measurement at Tektronix Inc., to a new slot—executive vice president and chief operating officer—the Beaverton, Ore., instrument giant's board of directors has taken some of the management heat off Earl Wantland, 47, president and chief executive officer. However, the balance that existed in the two separate marketing groups has been upset and further repercussions are expected. Until now, both Walker and Lawrence L. Mayhew, group vice president for information and displays, had separate marketing managers reporting to them. They, in turn, reported to Wantland. Now Mayhew will head up both marketing groups and report to Walker. The fate of marketing managers Peter Strong (test and measurement) and Jon Reed (information and display) is uncertain, but according to a Tektronix spokesman, their jobs ultimately will be performed by one person.

1978 color TV sales set record, as radio sales decline

Color TV sales to dealers set a U. S. record in 1978, rising to more than 10.2 million units, a 12.4% gain on 1977's total of 9.1 million. Monochrome receivers rose 7.1% to more than 6 million units, the highest sales year since 1973, to make the 16.3 million TV sales total for the year the second highest in history, just under the 1972 record of 16.5 million units. The Electronic Industries Association's figures also show video cassette recorder sales totaled 401,930 units in 1978, the first year in which EIA compiled data.

Home and auto radio sales to dealers declined to 45.1 million units, the EIA reports, down 17.5% from 1977's total of nearly 54.7 million. Home radios bore the brunt of the downturn, dropping 22.3% from the 1977 level to 32.4 million units, and auto radios slipped by 1.7% to 12.6 million units.

Bunker Ramo data-exchange controllers to operate at 6.3 Mb/s

Two prototype data-exchange controllers able to transmit data at speeds of 6.3 million bits per second for Satellite Business System Inc.'s network will be designed, developed, and tested by Bunker Ramo Corp., Westlake Village, Calif., under a new contract. Dollar value of the award was withheld. The prototypes will be demonstrated by the end of 1979. Bunker Ramo says it will begin marketing production units in the third quarter of 1980.

Satellite communications to hit \$1.4 billion in 1983

Although uncertainties cloud the outlook, U. S. suppliers of satellite communications should see their market grow from \$840 million last year to \$1.4 billion in 1983, according to Creative Strategies International, a San Jose, Calif., market research firm. Pacing the forecast is the services segment, which provides communications over voice and digital networks. It will soar two and a half times to about \$1.1 billion. Small earth terminals should triple to \$60 million, whereas new satellite construction will tail off a bit to \$300 million in 1983 from \$380 million in 1978. Among the potential problems the report notes are frequency allocations, limited slots open to new satellites, and regulatory battles highlighted by the struggle between AT&T, IBM, and a variety of common carriers.

Fernandez is new Zilog VP

Manuel Fernandez, who has been group vice president at Fairchild Camera and Instrument Corp., is now at Zilog Inc., Cupertino, Calif., as group vice president, a newly created position. He fills the duties vacated by Ralph K. Ungermann, former executive vice president and chief operating officer, who left Zilog after a dispute with president Federico Faggini, now also chief executive officer. Fernandez, who had been president of Emdex, an Exxon Enterprises division, will be responsible for Zilog's systems, components, tester, and corporate marketing operations. Michael M. Clair, formerly product marketing manager at Tymshare Inc., is the new marketing manager for microcomputer systems reporting to Jim Gibbons, manager of corporate marketing. Clair replaces Robert Field, who left the company.

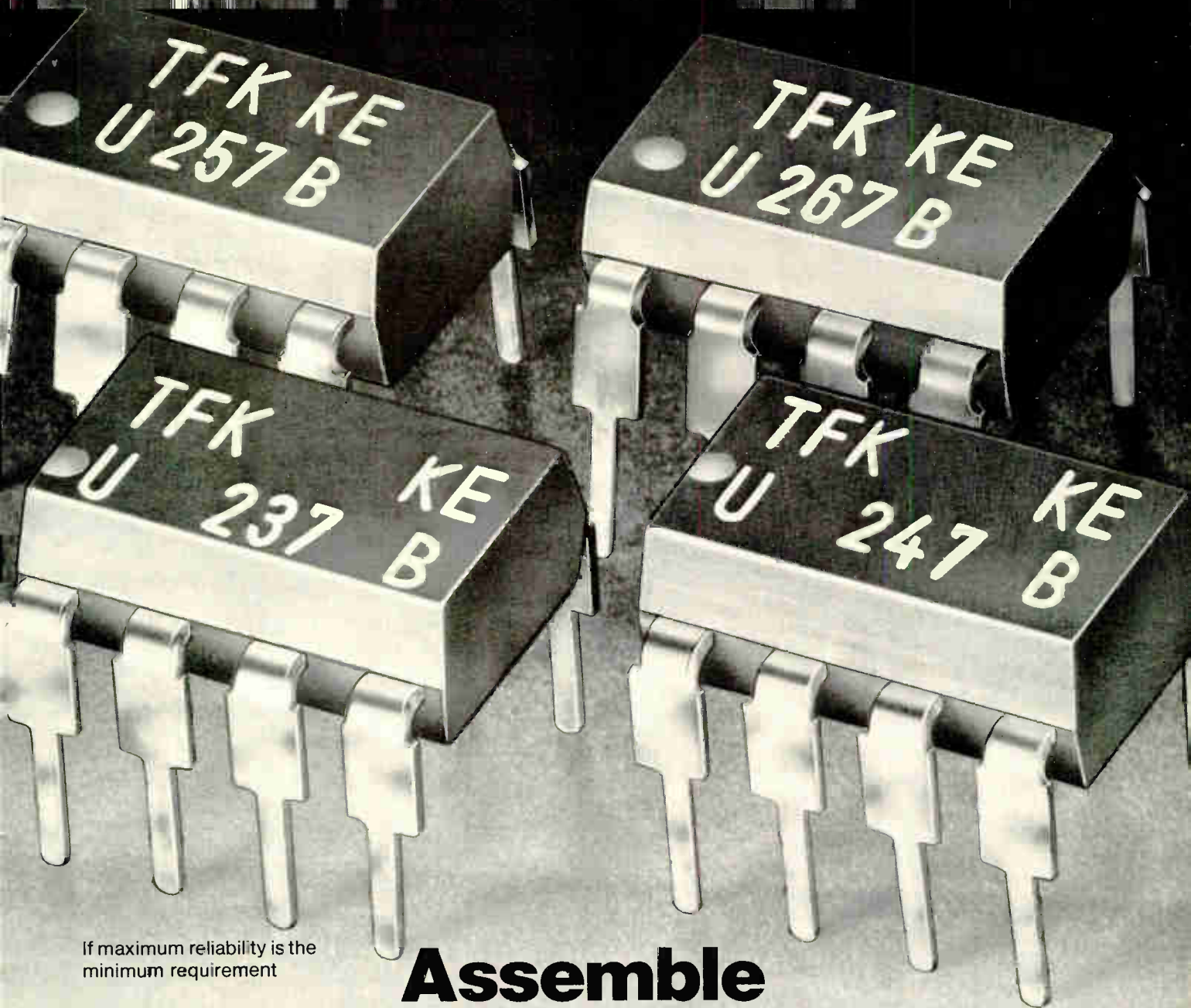

If maximum reliability is the minimum requirement

Assemble and forget it.

Wherever LED displays are used, they should function reliably, regardless of whether they are in a simple alarm clock or in a Mach-3 aircraft. However, this can be guaranteed only by absolutely reliable control circuits.

We build such circuits. Our ICs **U 237 B** and **U 247 B** are designed for linear scales, while **U 257 B** and **U 267 B** are for logarithmic LED scales. The table shows the operating points:

	1st	2nd	3rd	4th	5th
U 237 B	0,2	0,4	0,6	0,8	1,0 V
U 247 B	0,1	0,3	0,5	0,7	0,9 V
U 257 B	0,18/-15	0,5/-6	0,84/-1,5	1,19/+1,5	2,0/+6 V/dB
U 267 B	0,1/-20	0,32/-10	0,71/-3	1,0/0	1,41/+3 V/dB

Each of these circuits can control a five-position LED strip display.

Interconnection of the control circuits permits ten-position strip displays to be implemented - 100 mV to 1000 mV for linear displays and -20 dB to +6 dB for logarithmic displays.

The output current is 20 mA. The supply voltage may lie in the range 12-25 V, with a typical current consumption of 25 mA.

Please ask for information material. A telephone call is sufficient. Information is available from:

AEG-TELEFUNKEN Corporation
Route 22 - Orr Drive
Sommerville/New Jersey
New Jersey 08876



AEG-TELEFUNKEN
Integrated Circuits

Circle 49 on reader service card

system are due March 5, with April 1 the date for submitting proposals for the data-processing system.

Integration of the two systems with a communications network will come later, after installation. A cable-based network, possibly using fiber optics, will link the offices and data centers.

In a separate action last month, White House technology specialists and an estimated 200 potential Government users attended a demonstration of the British Viewdata/Teletext information display system. Among other things, this system can transfer computer programs to a user's intelligent cathode-ray-tube terminal or small computer [*Electronics*, Nov. 9, 1978, p. 58]. Edward Zimmerman, White House systems planner, says any incorporation of such a system into the EOP/IPS is still "some years away."

Image maker. Competitors for the information-processing and office-automation packages of the EOP/IPS are almost as excited about the image-building aspects of a winning proposal as they are about the dollars to be made. "Imagine being able to say that your company's system is the one bought by the White House in competition for the best!" exclaims one bidder's man. And the estimated price tag of upwards of \$20 million, he adds, "is nothing to sneeze at."

The White House plan to use a single prime contractor for the information-processing system is a major departure from the multisource approach now used. Each part of the Executive Office is responsible for meeting its own needs.

The Office of Management and Budget will be the agency most immediately affected by the new program: it now accounts for well over half of the EOP's information systems activity, supported by its IBM 370/155 with 2 million bytes of memory, plus another 1.8 billion bytes of disk storage.

The proposed data-processing system will initially handle up to 75 users. It will be expanded over five years to 160 users, including simultaneous access to 12 billion on-line

characters for 110 users.

As for office automation, the planners want an internal electronic mail capability, including document reproduction and storage, a bibliographic system for retrieving documents using key words, and maintenance of staff files ranging from daily "to do" calendars to office diaries.

To interconnect with the new EOP/IPS data base, the White House initially wants a communications capability of at least 75 asynchronous ports able to handle half- and full-duplex modes, with six speeds ranging from 110 to 9,600 bits per second. This system would expand in five years from an initial 200 users to 1,000 users, with simultaneous access for 250 and on-line storage of 4 billion bytes.

The EOP/IPS designers stress that they tried to "put people before technology." As one explains: "Most of the people using this system know nothing about electronics, but they want a system that 'speaks English.' We have to get a system that people will want to use, one that doesn't intimidate them." □

Computers

Harris designs speedier processor

More powerful minicomputers are the name of the game among makers of data-processing systems, and Harris Corp. is in there pitching with an advanced-architecture 16-bit machine developed in house for its 1600 systems. However, the 1600-02 model II bucks the trend toward more compact processors: it is a three-board unit replacing the two-board 1600-00 machine.

The model II, which is compatible with existing 1600 software and peripherals, is three to four times faster than the 1600-00, Harris says. Though some of that speed comes from fast bipolar and Schottky transistor-transistor logic, architectural sophistication is the primary reason for the increased throughput, says

James R. Oyler, product marketing manager at the Data Communications division in Dallas.

The new unit uses pipelining to decode an instruction while executing the previous one, and a look-ahead memory-address control system allows up to eight half words to be fetched ahead of the instruction being executed. The result is an average execution time of 200 nanoseconds for a microcode cycle, compared with 750 ns in the old processor, Oyler says. Also improving the speed is the unit's double-width bit-memory transfer, which can simultaneously transfer two 16-bit words from memory.

Three reasons. A number of Harris's competitors are opting for single-board computers in new data-processing systems, but Oyler says his firm rejected that approach for three reasons. For one, the three-board mini fits right into the existing cabinet, whereas a single-board unit might not.

For another, the Harris approach strikes a favorable balance between the cost of making the denser circuitry for a single-board unit and the cost of incorporating two more boards. Finally, maintenance and support is easier, a prime concern because the company leases most of the 1600 systems it produces.

The model II uses hardware memory mapping for the main memory and a virtual-memory scheme that permits disk-held data to be treated like main memory. Its main memory, using 16-kilobit metal-oxide-semiconductor chips on one board, stores 192,608 bytes, up from 96 kilobytes in its predecessor.

Moreover, the main memory board can be expanded to 256 kilobytes. With the addition of another board, refined addressing techniques, and an expanded algorithm, memory capacity could be boosted to 512 kilobytes in the future.

The product of nearly three year's in-house development, the model II replaces the two-board Interdata 7/16, which Harris has used since the first 1600-series deliveries began in 1976. The company began volume manufacturing the model II in

SUPER SCHOTTKY

We made Schottky faster-acting and easier to take.

Until now, to get Schottky speed, you had to live with certain design headaches. Heavy power consumption and noise sensitivity, to name a couple.

But those days are over. Fairchild has made a whole Schottky TTL logic family called Fairchild Advanced Schottky TTL. Or, FAST. It delivers up to 75% more speed than Low Power Schottky. Up to 20% more speed than Schottky. With only 25% of Schottky's power requirement.

High-potency logic.

So now you can drive more circuits with less power. And put the power you save to work somewhere else. But the best part is, FAST extends the life of your TTL logic designs and equipment by cutting

the difference between Schottky and 10K ECL to almost nothing. And with FAST, there's no need to learn a new logic system.

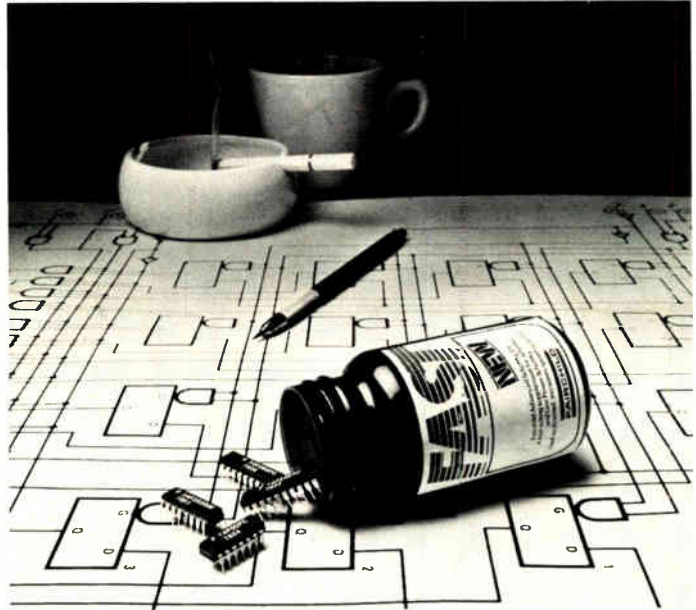

Part#	t _{PHL} (ns)	t _{PLH} (ns)
74F00PC	2.6	2.9
74F02PC	2.6	3.5
74F04PC	2.5	2.7
74F08PC	3.6	4.1
74F10PC	2.7	2.9
74F11PC	3.7	4.2
74F20PC	2.8	2.9
74F32PC	3.5	3.9
74F64PC	2.8	3.6
Typical 15 pF Gate Delays FAST		

FAST gives you external gate delays of 4-4.5 ns over the full commercial and military temperature and voltage ranges while driving 50 pF load capacitance. Internal gate delays are 1.5 ns and power consumption is typically 4 mW per gate function. Input thresholds are 1.5 V and output drive is identical to 20 mA Schottky.

Yet, as revolutionary as FAST is, it's proven. It's manufactured using Fairchild's patented, time-honored Isoplanar process. You can depend on it.

The basic ingredients.

These nine FAST parts are available now, with many more familiar functions coming soon. To get FAST facts, call (415) 962-3716. Or, contact your Fairchild sales office, distributor or representative. Fairchild Camera and Instrument Corporation, P.O. Box 880A, Mountain View, CA 94042. TWX: 910-379-6435.

FAIRCHILD

**Call us on it.
(415) 962-3716**

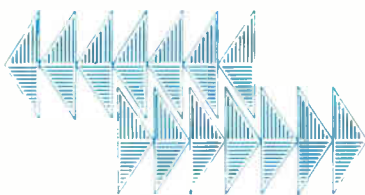

BI-DIRECTIONAL OCTAL BUS TRANSCIVERS WITH 3-STATE OUTPUT DRIVERS

MITEL's ISO-CMOS™ 54C245/74C245
vs
THE TTL 54LS245/74LS245

SAVE on Power Supply Requirements

- Wider operating voltage range—
3V to 6.5V **VS** 5V $\pm 10\%$
- Lower current drain—
1 mA **VS** 100 mA

REDUCE Generated Noise

- Controlled output rise and fall times—
>15nS **VS** <15nS

REDUCE dc Loading of Bus Lines

- Lower Input/Output leakages—
10 μ A **VS** 100 μ A

NO LOSS in System Performance

- Propagation delays—
15nS **VS** 12nS

SAME 20-Pin Packages

Contact the leader in CMOS technology
for more information:



1745 JEFFERSON DAVIS HWY
SUITE 611
ARLINGTON, VA. 22202
TEL 703-243-1600

MITEL
Semiconductor

Electronics review

Dallas last September.

All Harris 1600 remote batch-processing and distributed data-processing systems are being sold with the new processor as standard equipment, says Oyler. In most cases, there is no price increase for the new processor, he says, though a remote-batch user might be charged about a \$75 monthly premium. □

Microwaves

Ovens compete for spectrum space

When Litton Industries' Microwave Cooking Products operation applied for permission to operate microwave ovens in the little used 10.5-to-10.7-gigahertz range two years ago, it had no idea how involved it would get with spectrum allocation problems. Compared with the currently used 2.45 GHz, the higher frequencies cook food more uniformly and brown it better—not unsubstantial advantages in the fiercely competitive microwave oven industry.

Now Litton, in Minneapolis, finds that the much heralded "office of the future" may cook the goose of their better browned chickens. Xerox Corp. wants the same frequencies and has filed for them with the Federal Communications Commission. It wants them for its proposed XTEN system, which will speed data communications by microwave carrier from office to office [*Electronics*, Dec. 7, 1978, p. 83].

The XTEN system is Xerox's bid to compete with systems like AT&T's Advanced Communications Systems in the estimated multibillion-dollar office communications market. But microwave cooking is no small thing either. In 1978, retail sales of ovens and ranges reached \$1.1 billion, says Litton, which has sold more than 2 million of the 9 million ovens now in use. And, adds Litton, this market will grow to about 50 million units in 5 to 10 years.

Two-year wait. Litton senior vice president for technology Verle Blaha is particularly miffed that he has

had to wait more than two years "without an answer either way." This is a costly delay, for developing a magnetron to generate the 10.6-GHz radiation takes time.

Blaha finally went to Minnesota Senator David Durenberger, who found out that the FCC will probably turn down the request. Though the FCC agrees that "the portion of the spectrum requested by Litton is relatively unused at the present time in this country," it noted, in a letter to Durenberger, that "there are more important considerations."

"I'm afraid those more important considerations are spelled 'Xerox,'" says Blaha. But he disagrees that communications is more important. "A lot of people stand to benefit by improved cooking performance. And there are energy savings to be had at the higher frequencies."

Litton had asked the FCC to include its request in the proposals being prepared for next September's World Administrative Radio Conference (WARC) sponsored by the International Telecommunications Union. But the FCC is not doing this.

Another frequency. The FCC's WARC proposal will suggest 61 GHz as another microwave cooking frequency. However, Litton thinks this is impractical, given the state of the art in that region of the spectrum.

The FCC notes that if the band Litton wants were allocated unilaterally, which is possible, the U.S. would have to eliminate any interference with radio stations operating in this band in Canada or Mexico. Raymond E. Spence, chief engineer of the FCC, says this could be extremely difficult because of the widespread use of microwave ovens. Nor does he deem it feasible for Litton to share this band with other users like high-speed data services because of the ovens' wide bandwidth and radiation levels.

Litton takes exception, noting that present 2.45-GHz ovens share spectrum with other services and do not cause harmful interference. Besides, notes the firm, "all microwave ovens are built to exceed the Government radiation [emission] standards during their entire useful lifetime." □

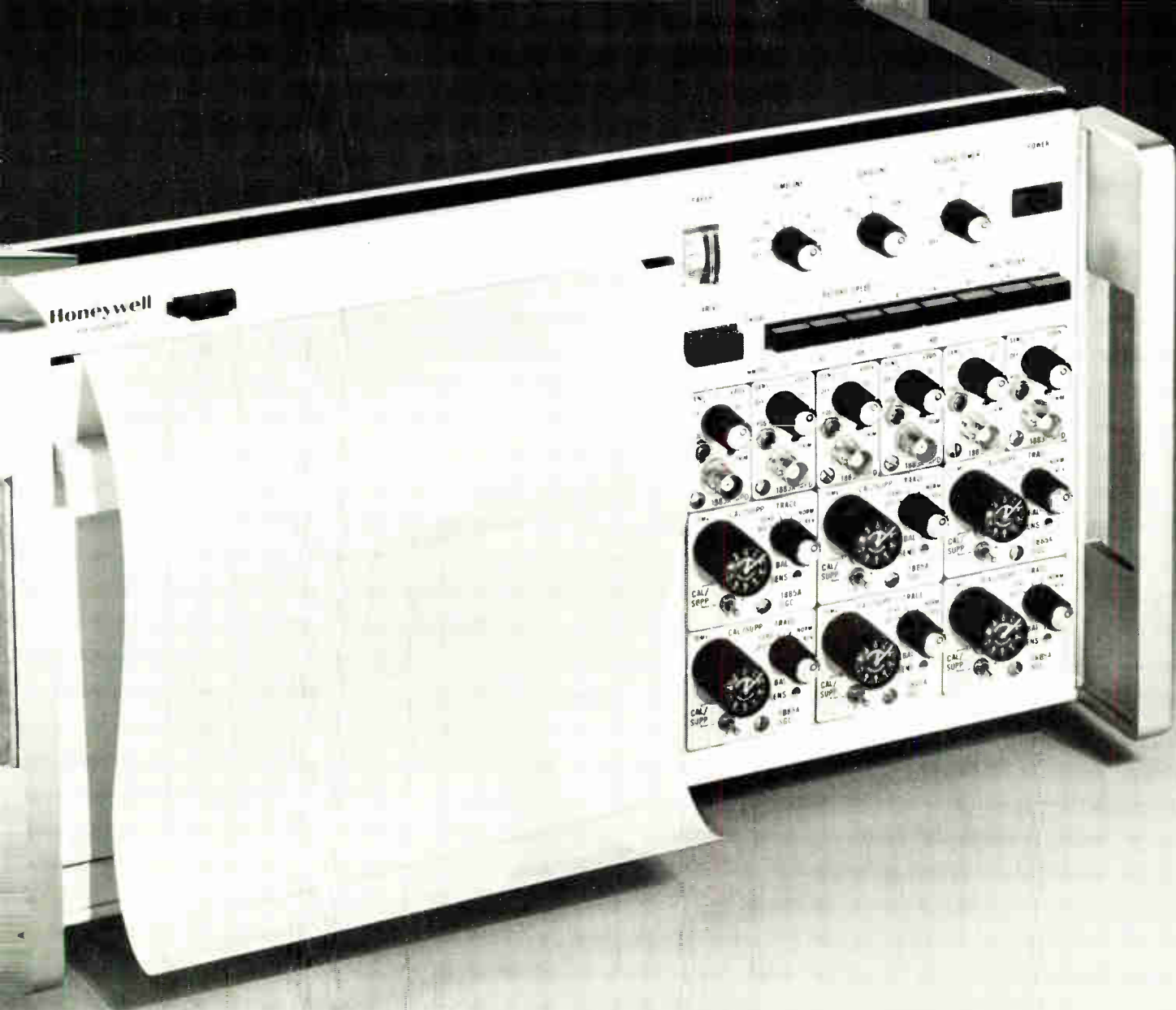

HERE'S EVERYTHING YOU NEED FOR HIGH-PERFORMANCE RECORDING. EVERYTHING.

Pick up the Visicorder Model 1858 and you have a complete system—up to 18 channels including signal conditioning—in a package less than nine inches high. Since it's self-contained, you simply plug in the power cord, connect your signal input cables and start recording. There are no separate cases to mount; no interconnect cables to hook up; and no powders, inks, chemicals or heaters to fool with.

And if you should need more channel capacity, an auxiliary housing quickly expands your system to 32 channels, each with dc to 5 kHz response.

Whether you record in the lab or field, the Model 1858 quickly adapts to your changing requirements. Wide changes of input levels for different recording applications are easily accommodated, often with a mere

change of the sensitivity setting on the front panel. Even a complete change of type of measurements is just a matter of inserting different plug-in modules in the appropriate channels. And you have a complete family of these signal conditioning modules to choose from, for strain gages, thermocouples, flowmeters, tachometers or voltage sources.

For detailed information on how the Model 1858 might meet your recording needs, call Lloyd Moyer at (303) 771-4700. Or write for technical data sheets on the Model 1858 and our illustrated brochure that describes all of Honeywell's oscillographic recorders, magnetic tape systems and signal conditioning modules. Honeywell Test Instruments Division, Box 5227, Denver, CO 80217.

WE'LL SHOW YOU A BETTER WAY.

Honeywell

Circle 53 on reader service card

“...And for higher performance,
we'll specify Harris Data Acquisition
components.”

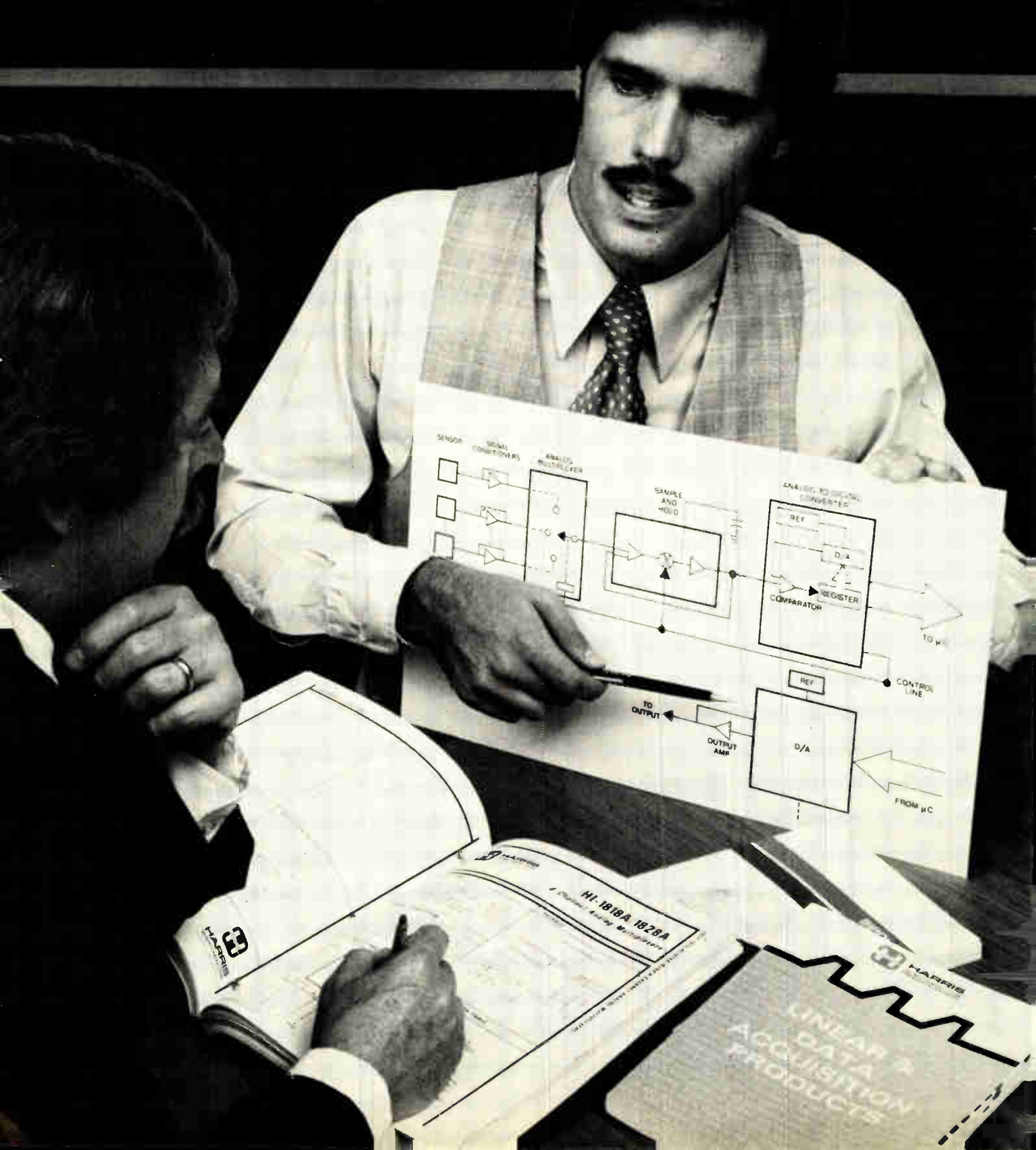

Harris high performance components assure superior speed and accuracy.

Now Harris can provide you with a complete selection of data acquisition products—from op amps to digital-to-analog converters—with the highest performance available anywhere.

It's what you expect from Harris—the leading supplier of monolithic sample-and-hold, high performance multiplexers and switches. And producer of the first 12-bit monolithic D/A converter... which has led to the most advanced family of DACs in the industry.

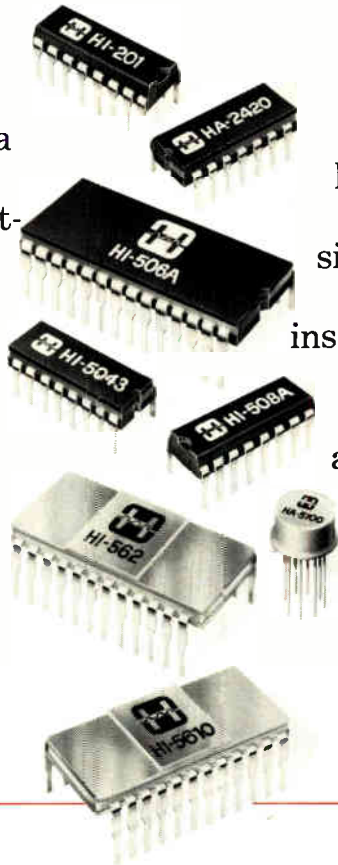

Harris data acquisition components provide the high speed, high accuracy and high throughput you need for processing fast signals in all types of applications—military, aerospace/ avionic, instrumentation, industrial process control, and others. To get top performance in your data acquisition systems, all you have to know is Harris. For fast facts, call the Harris Hot Line, or write: **Harris Semiconductor Products Division, Box 883, Melbourne, Florida 32901.**

HARRIS DATA ACQUISITION PRODUCTS

DIGITAL-TO-ANALOG CONVERTERS

The fastest, most accurate monolithic DACs available. Monotonic over temperature. Designed for minimum glitches.

- HI-562 — 12-bit, 200 ns to 0.01%
- HI-5612 — 12-bit, 150 ns to 0.01%
- HI-5610 — 10-bit, 85 ns to 0.05%
- HI-5608 — 8-bit, 50 ns to 0.19%*

ANALOG-TO-DIGITAL CONVERTERS

12-bit ADCs soon to be introduced will offer precisions and conversion speeds in microprocessor-compatible versions.

- HI-5712 — 12-bit, 6 μ s conversion*
- HI-5812 — 12-bit, precision*

CMOS ANALOG MULTIPLEXERS

Latch-proof, Single/Differential, 8/16 channel. Overvoltage protected versions can withstand transients up to 1000 volts and inputs of ± 20 volts greater than either supply.

- HI-506A/7A — 16-channel, overvoltage protected
- HI-506/7 — 16-channel
- HI-508A/9A — 8-channel, overvoltage protected
- HI-1818A/28A — 8-channel
- HI-1840 — 16-channel, high Z, overvoltage protected

CMOS ANALOG SWITCHES

Two popular series feature several latch-proof configurations with high-speed, low-on-resistance, and low-power versions.

- HI-200/201 — Dual/Quad, 180 ns, 55 ohms, 15 mW
- HI-5040 series—370 ns, 25 ohms, 1.5 mW

MONOLITHIC SAMPLE-AND-HOLD

Low droop rate coupled with fast acquisition time furnishes the speed and precision needed for 12-bit systems.

- HA-2420—4 μ s to 0.01% acquisition, 5 pA drift current

VOLTAGE REFERENCES

Two new laser trimmed ± 10 volt references offer industry milestones in precision and stability.

- HA-1600— ± 10 volt, ± 1 ppm/ $^{\circ}$ C
- HA-1610— ± 10 volt, ± 5 ppm/ $^{\circ}$ C

SIGNAL CONDITIONERS

New precision BIFET op amps to complement the Harris high-performance line. Laser trimmed for low offset voltage.

- HA-5100/5110—Wide band BIFET
- HA-5150/5160—High slew BIFET*

FAST-SETTLING OP AMP

The fastest monolithic true op amp in the world has superior settling times for voltage output DACs.

- HA-5190—100 ns to 0.01%, 200 V/ μ s Slew

COMPARATORS

A family of fast quad comparators is coupled with a soon-to-be-introduced, high-speed precision single comparator for use in ADCs. The 4950 will give true 12-bit accuracy with no sacrifice in throughput.

- HA-4950—35 ns response, with 100 μ V resolution*

*To be introduced

HARRIS HOT LINE!
1-800-528-6050, Ext. 455

Call toll-free (except Hawaii & Alaska) for phone number of your nearby Harris sales office, authorized distributor or expedited literature service.

Harris Technology
... Your Competitive Edge



HARRIS
SEMICONDUCTOR
PRODUCTS DIVISION
A DIVISION OF HARRIS CORPORATION

Circle 55 on reader service card

TEAC MT-2: THE VALUE-PACKED CASSETTE DATA PACK.

MORE PERFORMANCE FOR LOWER PRICE.

The case for digital cassette

An all-round winner, digital cassette is easier to handle, lower in cost and smaller than floppy disk. Data transfer rate is approximately 40 times faster than Kansas City Standard audio cassettes. And operating cost is considerably lower than conventional data cartridges.

Maximum reliability

Small size is no detriment to this unit's reliability and precision. Soft error rate is better than 1×10^{-9} bits. MTBF is 10,000 hours—real durability, and tape-life spans an outstanding 1000 passes or more thanks to superior transport design.

Easier maintenance

The uncomplicated structure of the MT-2 is another big plus. Two reel motors and a disc encoder are the only moving parts—fewer servicing problems, less spare-parts storage and lower maintenance cost.

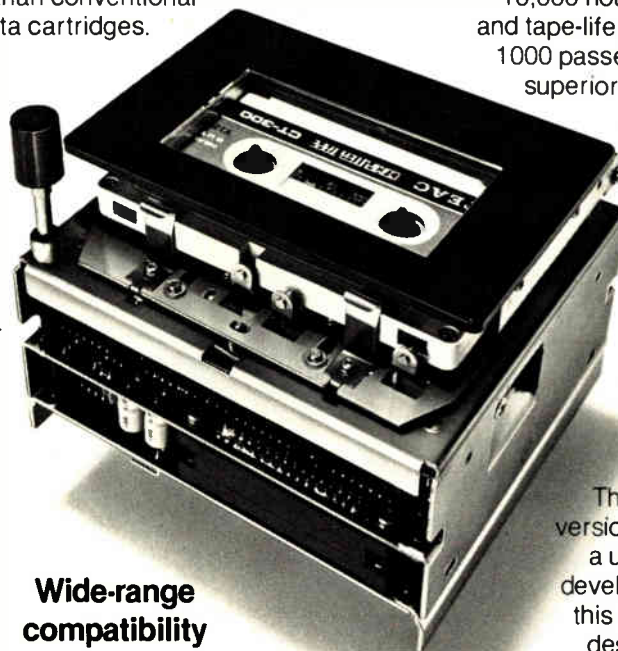

Easy microprocessor interface

The MT-2 is available in four versions, two of which incorporate a unique interface controller developed by TEAC especially for this unit. It features a simplified design, and lets you connect the MT-2 to the bus lines of 8080, 6800 and Z-80 or equivalent series microprocessors for greater flexibility and convenience than conventional, high-priced outboard devices.

Wide-range compatibility

The MT-2 is totally compatible with ISO, ANSI, JIS and ECMA phase encoding standards. You can read tapes recorded on other machines complying to these standards, and vice versa.

U.S.A. Triple I, 4605 N. Stiles, P.O. Box 18209, Oklahoma City, Oklahoma 73118 Tel: (405) 521-9000 **Canada** R.H. NICHOLS CO., LTD., 214 Dolomite Dr., Downsview, Ont. M3J2P8 Tel: (416) 661-3190 **Hongkong** Dah Chong Hong Ltd., Hang Seng Bank Bldg., 77 Des Voeux Road, Central Tel: 5-261111, 5-226258 **Australia & New Zealand** JACOBY MITCHELL LTD., P.O. Box 70, Kingsgrove N.S.W. 2208, Australia Tel: 6307400 **South Africa** Mayfair Sales (Pty) Ltd., Marshalltown 2107, Transvaal Tel: 011-834-2131 **Belgium & Luxembourg** Simac Electronics S.P.R.L., Triomfiaan 148 1160 Brussel **Denmark** Danbit, Plantagevej 23 DK-2680 Solrod, Strand Tel: (03) 141515 **France** TEKELEC AIRTRONIC S.A.,

TEAC

Cite des Bruyeres, Rue Carle-Vernet 92 Sevres Tel: (027) 7536 **Holland** Simac Electronics B.V., Veenstraat 20, Veldhoven Tel: 040-533725 **Italy** A.E.S.E. S.R.L., Corso Lodi, 47 20139 Milano Tel: 54.64.741-2-3 **Norway** R and Data, Gladengveien 3A Oslo 6 Tel: (472) 674950 **Spain** Ataio Ingenieros S.A., Madrid-16, Enrique Larreta 12 Tel: (215) 3543 **Sweden** Scantel AB, Tengdahlsgatan 24, 116, 41 Stockholm Tel: 08-24 58 25 **United Kingdom** International Instruments Ltd., 92 High Street, Berkhosted, Herts, HP4, 2BL Tel: 044275959 **West Germany & Austria** nbn ELECTRONIK STARBERG, 813 Starnberg, Max-Emanuel-Str. 8, West Germany Tel: (08151) 13036

TEAC CORPORATION: 3-7-3 Naka-cho, Musashino, Tokyo, Japan Tel: (0422) 53-1111

Circle 56 on reader service card

Japanese TV dumping could sour trade pact, White House fears

The White House is increasingly worried that Congress "could blow our trade agreement out of the water," says one staff specialist, after allegations that **at least four Japanese TV makers dumped their receivers in the U. S.** below Japanese market prices by paying kickbacks to major American retailers. President Carter had notified Congress when it convened last month that "we are now in sight of a successful conclusion to these negotiations" on the multilateral trade negotiations with other nations of the General Agreement on Tariffs and Trade, including Japan.

But Carter's notification came before Justice and Treasury Department sources confirmed that at least three Federal grand juries are investigating allegations that U. S. retailers importing Japanese television sets committed fraud by failing to report kickbacks to the Treasury's U. S. Customs Service and pay offsetting penalties.

U. S.-Japanese trade relations began to sour late last year with Japan's refusal to open the country's telecommunications system, Nippon Telegraph and Telephone Public Corp., to American products [*Electronics*, Dec. 21, 1978, p. 49], but the alleged TV dumping conspiracy "could make it much harder," says a U. S. official, to get congressional approval for a new trade agreement. Companies reportedly involved in the Customs investigation include Matsushita Electric Industrial Co., Sanyo Electric Co., Sharp Corp., and Toshiba Corp., and importers like Montgomery Ward & Co., J.C. Penney Co., and Sears, Roebuck & Co.

NASA discovers new alloys for superconductivity

A new method of casting previously incompatible materials like aluminum and lead has been discovered by Government space researchers that **could lead to superconducting alloys operating at room temperature.** "This is of major technical significance," says Robert Schwinghamer, director of the materials and processes laboratory at the National Aeronautics and Space Administration's Marshall Space Flight Center in Huntsville, Ala., where the discovery was made by Mary Helen Johnston and Richard A. Parr. The controlled structure casting process adds a small amount of impurities to the alloy materials during melting and then applies rapid cooling from one end of the cast. In the case of aluminum and lead, the impurities cause the aluminum to form a hexagonal cell structure as it cools, and the lead finds its way into valleys formed by the hexagons, dispersing uniformly throughout the casting. With many possible combinations having unique and desirable electrical characteristics, Johnston says, "our problem now is choosing the way to go from here."

Stiff penalties for computer crimes sought by Senate

The new Congress is being asked to approve prison terms of up to 15 years and heavy fines for "electronic burglars" who use computers and their technology to steal or manipulate data, financial instruments like checks, and other property. The penalties are listed in a bill by Sen. Abraham Ribicoff (D., Conn.) and 10 other sponsors. **Ribicoff's hearings last year valued thefts involving computers as high as \$3 billion annually,** with crimes against corporations averaging \$621,000 each. Without new laws, however, Ribicoff estimates chances of being caught at 1-in-100; of being convicted at 1-in-500.

TI's Bucy calls for U. S. policy on technology trade

The issue of technology trade between the U. S. and Warsaw Pact powers continues to intensify in the absence of any clear national policy, says J. Fred Bucy, president of Texas Instruments Inc. of Dallas. Bucy believes the issue can only be resolved if the Congress, Executive Branch, and industry agree on a definition of what is meant by technology, determine how much of it is critical to U. S. security, and modernize U. S. export controls accordingly. These highlights from Bucy's presentation last month before a Washington symposium of the Armed Forces Communications and Electronics Association deserve a wider audience than they received.

—Ray Connolly

The debate regarding export controls for technology of military significance to Communist countries has intensified over the past five years. Unfortunately, throughout the period, there has been minimal progress by the Executive Branch in either specifically defining critical technologies or making any discernible changes in the implementation of present controls. This intransigency by the administrative bureaucracy has further aroused the anxieties of industry and heightens the suspicion that their intent is only to pursue a "zero risk" policy and overcontrol exports to Communist countries.

Products are not technology

The definition of technology must be used in a specific sense, if these issues are to be clarified. Technology is the application of science to the design and manufacture of products and services. These products are the end result of technology. Products are not technology. Neither is science. Science is directed to obtaining knowledge. Scientific information is exchanged around the world and adds to man's understanding. It should continue to flow freely.

On the other hand, technology is specific know-how required for design and manufacture. It is usually privately owned and closely guarded. In this technology-intensive industry, economic survival is dependent on gaining market share in worldwide markets, which can only be realized by the timely application of technology to products for these markets.

The need for controls on the export of technology should be on those commercial trade mechanisms which most effectively "transfer" know-how. The "reverse engineering" of products—dissection and analysis—is not an effective technique for transferring technology. Effective mechanisms for transferring technology to state-controlled enterprises include sales of

"turnkey" factories, sales of manufacturing and technical data, licenses with extensive teaching, consulting agreements, and the training of technical personnel.

The control of critical technologies does not need to be absolute in order to be effective. Its objective is to delay their rapid acquisition by the Soviets and other controlled countries.

As is often the case when major policy changes are proposed, objections arise because there is uncertainty about their implementation, or because of ignorance and distortion of the need for the policy. Objections by individuals in the Federal Government ignore the negative impact of present case-by-case reviews with their delays, ambiguities, and resulting low credibility of the process held by segments of industry and some of our allies. This practice is an unnecessary interference in the commercial trade of many products. Without a policy framework, case-by-case reviews based on the precedents of history offer no opportunity to develop a cohesive policy, and a defocused policy is no policy at all.

A clear definition of critical technologies is necessary to win support from our allies. As for neutral nations, if we cannot control reexportation of critical technologies, then there should be no serious question as to why it is transferred to them at all.

Need for judgment

As to the objection that no basis exists for policy formulation since the critical technologies lack a data base and in fact cannot be quantified or measured, [let me say] not all logical deductions can be quantified. Where it is attempted, data is often subjective or poorly defined. The lack of quantitative measures places greater reliance on the involvement and judgment of senior personnel for definition and implementation.

The challenge that we face is to implement a policy that will allow the U. S. an effective means of meeting two conflicting goals: enhancement of East-West trade, particularly in the products of "high technology," while at the same time protecting the technology itself to provide a qualitative advantage for U. S. military systems. The immediate task requires a realistic definition of critical technologies by the Defense Department and the implementation of strategies for effectively controlling them by the U. S. and its allies. Without this definition, only generalities exist which further fuel the controversy over export controls.

For film capacitors in volume . . .

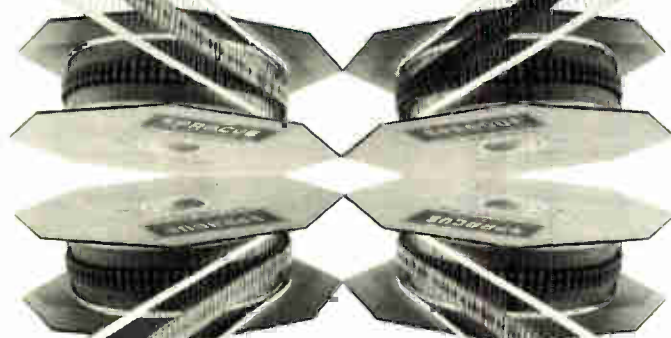

talk to the reel people.

SPRAGUE TYPE 192P

Plastic-sleeved
PACER® Capacitors

Polyester film. Unique construction . . . extended foil sections terminated in metal end caps to which leads are attached . . . outer protection is tough plastic sleeve. Capacitance values from .0001 to .39 μ F. Voltage ratings from 80 to 600 WVDC.

Write for Bulletin 2066C
or circle number 202

SPRAGUE TYPE 413P

Epoxy-coated
FILMITE® 'E' Capacitors

Polyester film. Conformal epoxy coating and excellent lead concentricity permit automatic insertion. Preferred where size and cost are important. Capacitance values from .001 to .1 μ F. Voltage ratings of both 100 and 200 WVDC.

Write for Bulletin 2061B
or circle number 203

SPRAGUE TYPE 416P

Film-wrapped
YELLOW JACKET® Capacitors

Polyester film. Extended foil sections protected against moisture by outer wrap of polyester or polyolefin film. Plastic resin end seals. This construction results in weight/space advantages. Capacitance values from .001 to 1 μ F. Voltage ratings, 50 to 600 WVDC.

Write for Bulletin 2063C
or circle number 204

SPRAGUE TYPE 433P

Epoxy-coated
METFILM® 'E' Capacitors

Closely-controlled metallized polyester film. Superior conformal epoxy coating. Low cost for use in entertainment electronics, yet dependable enough for industrial applications. Capacitance values from .027 to 1.0 μ F. Voltage ratings from 100 to 400 WVDC.

Write for Bulletin 2060A
or circle number 59

For complete technical data on the capacitor type(s) in which you are interested, write for appropriate engineering bulletin(s) as shown above, to: Technical Literature Service, Sprague Electric Co., 35 Marshall St., North Adams, Mass. 01247.

THE BROAD-LINE PRODUCER OF ELECTRONIC PARTS

SPRAGUE
THE MARK OF RELIABILITY

Sprague and ® are registered trademarks of the Sprague Electric Co.

a
**General
Cable**
subsidiary

RCA STEPS UP THE PACE IN LINEAR IC'S.



We're making LICs at a faster rate than ever. And we've loaded distributors' shelves with the types you use most. That means you can get as much as you want. As fast as you want. At the right price! As always, RCA gives you high quality in every unit. Plus some options you won't find anywhere else.

We've rushed plenty of product to distributors.

They're the most popular industry standards. Including 301 family, 307 family, 3240 family, 339 family, 723, 741, 747, 748, 1458, 1558 family, 3046, 3068, 3401.

Priced to move fast.

RCA is committed to strong competitive pricing. So there's no need to accept anything less than RCA quality.

Gold CHIP: step-up in reliability at little cost.

An RCA exclusive that gives you gold metalization and a hermetically sealed chip in a plastic package. At plastic prices. Over 25 Gold CHIP types include 301A, 307, 324, 339, 555, 741, 748, 1458, 3401, 3724, 3725.

BiMOS op amps: big step-up in performance.

Featuring better-than-bipolar characteristics at lower-than-Bifet prices, this RCA innovation is sweeping the field. And second sourcing is on the way. Our challenge: Compare the 3140 vs. the 741. The 3240 vs. the 747. Or the 3130 vs. just about anything.

More popular choices, all winners.

Variable op amps, A/D converters, and an array of arrays. All of them do specific jobs better.

For more information, contact your local RCA Solid State distributor. Or contact RCA Solid State headquarters in Somerville, NJ; 1130 Brussels, Belgium; Sunbury-on-Thames, Middlesex, England; Quickborn 2085, W. Germany; Ste.-Anne-de-Bellevue, Quebec, Canada; Sao Paulo, Brazil; Tokyo, Japan.

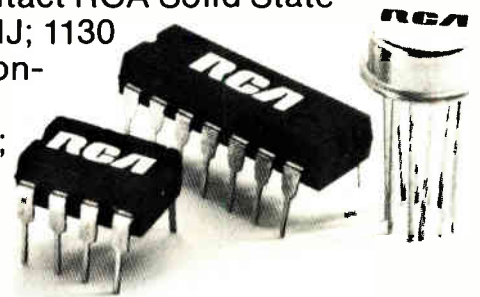

RCA

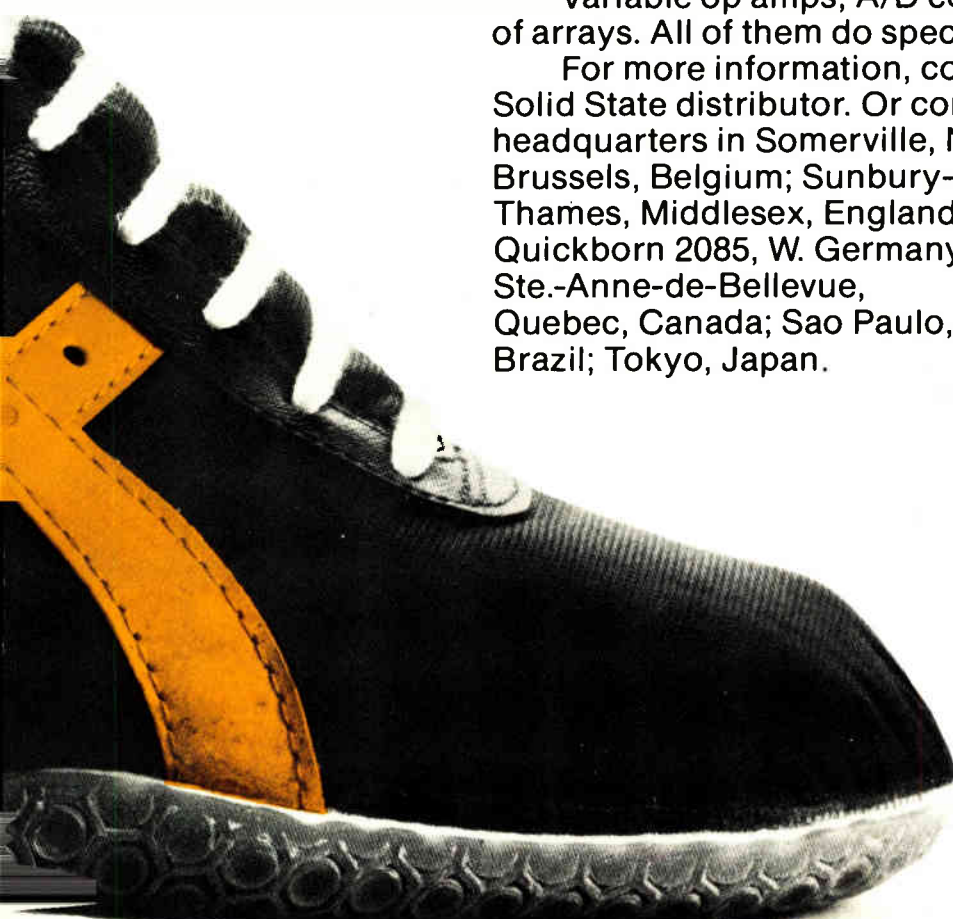

Who do you think of
for a complete line of 8-bit microprocessors?

Next time,



If you haven't checked into our 8-bit line recently, take a look at what you've been missing.

Our 8-bit Families

μ PD 8080AF	μ PD 8085A	μ PD 8048	μ PD 780
μ PD 8080AF	μ PD 8085A	μ PD 8048	μ PD 780
μ PD 8080AF-2	μ PD 8085A-2	μ PD 8049	μ PD 780-1
μ PD 8080AF-1		μ PD 8039	
		μ PD 8035	
μ PD 8041			
	μ PD 8155		
	μ PD 8156		
μ PB 8212			
μ PB 8214			
μ PB 8216/26			
μ PB 8224			
μ PB 8228/38			
		μ PD 8243	
μ PD 8251/A			
μ PD 8253			
μ PD 8255/A-5			
μ PD 8257			
μ PD 8259			
μ PD 8279-5			
	μ PD 8355		
μ PD 765			

We've got everything you need in 8-bit

processors—plus a full assortment of industry standard peripherals and memories. And we've got them all in volume, ready to ship.

Not only do we support the entire 8080A family; we also offer the lower-cost single-chip 8048 family and the higher-performance 8085A series.

And for those with applications that require the capability of a Z80™, we have

the fully compatible μ PD780—supported by the full family of 8080 peripherals.

TM Zilog

REPS: Action Unlimited, Arlington, TX; Spring, TX. Burton-Medley Associates, Grandview, MO. Cerco, San Diego, CA. Contact Sales, Inc. Burlington, MA. D/Z Associates, Inc., Denver, CO. Electronic Innovators, Inc., Minneapolis, MN. Eltron, Phoenix, AZ. HLM Assoc., Northport, NY; Parsippany, NJ. Imtech, Inc., Cleveland, OH; Dayton, OH. Kaytronics Limited, Ville St. Pierre, Quebec; Downsview, Ontario; Surrey, British Columbia. L & M Associates, Pikesville, MD; Montpelier, VA. Harry Nash Associates, Willow Grove, PA. R.C. Nordstrom & Company, Lathrup Village, MI. Perrott Associates, Inc., Fort Lauderdale, FL; Clearwater, FL; Orlando, FL. Santana Sales, Costa Mesa, CA. Stone Component Sales, Waltham, MA. Technology Sales, Inc., Palatine, IL. Trident Associates, Inc., Sunnyvale, CA. Tri-Tronix, Albuquerque, NM. Tri-Tronix, NW., Mercer Island, WA. 20th Century Marketing, Inc., Huntsville, AL; Greenville, TN. Wolff's Sales Service Company, Raleigh, NC.

DISTRIBUTORS: Almo Electronics Corp., Philadelphia, PA, Baltimore, MD. Bell Industries, Bellevue, WA. Century Electronics, Albuquerque, NM; Wheatridge, CO; Salt Lake City, UT. Norman Davis Electronics, South Euclid, OH. Diplomat/Westland, Inc., Sunnyvale, CA. Diplomat/Southland, Inc., Clearwater, FL. Diplomat/Lakeland, Inc., Elk Grove Village, IL. Diplomat/IPC of Mass., Chicopee Falls, MA. Diplomat, Holliston, MA. Diplomat/Northland, Inc., Farmington, MI. Diplomat/Electro-Com

think NEC.

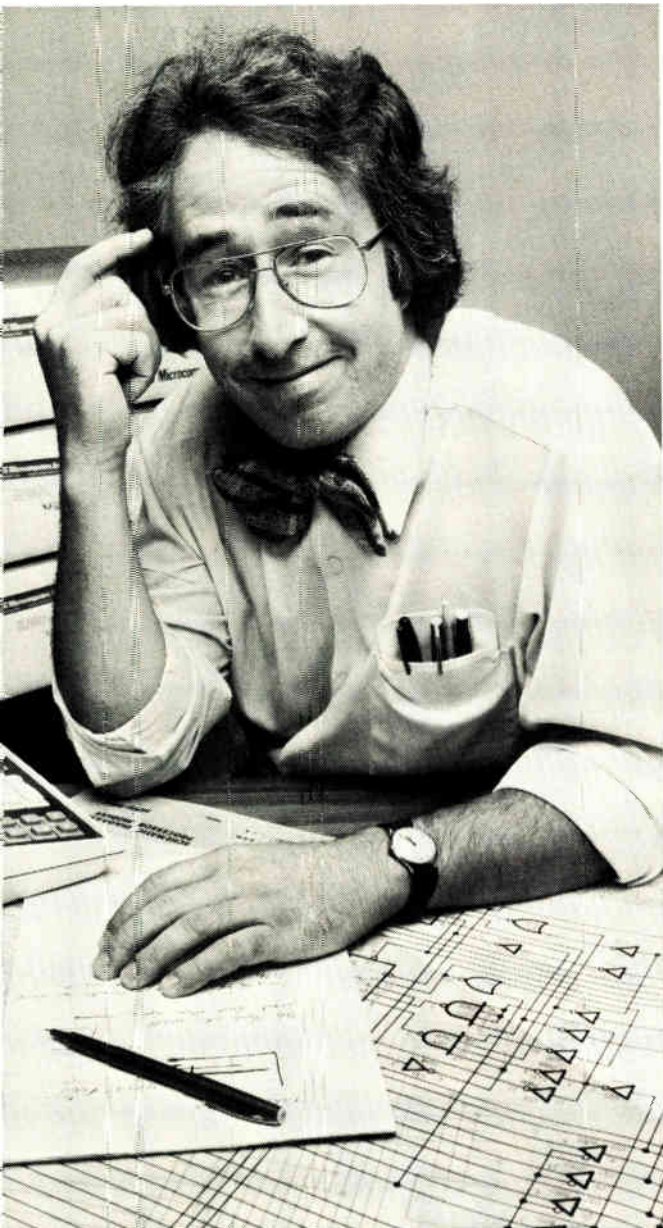

We can also fill your needs for a wide range of high-performance peripherals, including our IBM-compatible, double-density, double-sided floppy disc controller, the μ PD765.

NEC not only means advanced technology and volume delivery; we also offer remarkable product reliability—thanks to experienced designers and meticulous manufacturing techniques, backed up by 100% burn-in and testing with MIL-STD-883 methods.

What's more, we give you thorough support—including documentation, design assistance, and product development services. And our engineers are always available to help with specific application problems.

Our new catalog will give you a better idea of just how much we can do for you, not just in 8-bit products, but also in 4-bit single-chip processors and 1K, 4K and 16K memories.

For your free copy, clip your business card or letterhead stationery to this page and send to:

NEC Microcomputers, Inc.,
173 Worcester Street, Wellesley, MA 02181.

If you haven't thought of NEC before, you will.

Next time.

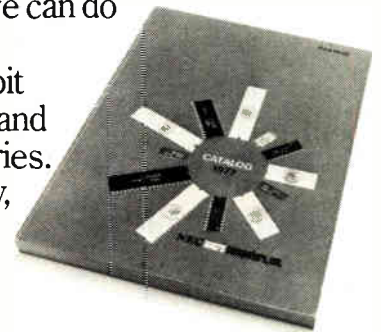

NEC Microcomputers, Inc.

Corp., Minneapolis, MN. Diplomat/St. Louis, Inc., St. Louis, MO. Diplomat/IPC Corp., Totowa, NJ; Mt. Laurel, NJ. Diplomat Electronics Corp., Woodbury, NY. Diplomat/Alta-Land, Inc., Salt Lake City, UT. Future Electronics Corp., Montreal, Quebec; Rexdale, Ontario; Ottawa, Ontario. Hughes-Peters, Inc., Cincinnati, OH; Columbus, OH. Intermark Electronics, Sunnyvale, CA; Santa Ana, CA; San Diego, CA. Kent Electronics, Houston, TX. G.S. Marshall, Sunnyvale, CA; Irvine, CA; El Monte, CA; San Diego, CA; Phoenix, AZ. Milgray Electronics, Inc., Freeport, NY; Orange, CT. Repron Electronics, Inc., Livonia, MI. Resco/Raleigh, Raleigh, NC. Semiconductor Specialists, Inc., Chicago, IL; Burlington, MA; Farmington, MI; Minneapolis, MN; Hazelwood, MO; Pittsburgh, PA; Dallas, TX; Milwaukee, WI. Sterling Electronics, Phoenix, AZ; Sun Valley, CA; San Diego, CA; Baton Rouge, LA; Waltham, MA; Albuquerque, NM; Dallas, TX; Houston TX; Seattle, WA. Summit Distributors, Inc., Buffalo, NY. Summit Elec. of Roch., Inc., Rochester, NY. Technico, Inc., Columbia, MD; Roanoke, VA. Western Microtechnology Sales, Sunnyvale, CA.

REGIONAL SALES OFFICES: Western Region, NEC Microcomputers, Orange, CA (714) 633-2980. Eastern Region, NEC Microcomputers, Melville, NY (516) 293-5660.

E1-4

The Newport family circle of DPVMs.

Circle your choice on the reader service card—take your pick of resolution, display, case, output, and price. Join the growing family of Newport DPVM users.



MODEL 203A • ± 1999 counts • .56" orange LED display • Parallel BCD outputs standard • DIN or NEMA case • Auto zero and polarity • Ratio standard • 100 μV resolution • Power 100/115/230 VAC or 5VDC • OEM price from \$71/100



MODEL 204A • ± 3999 or ± 5999 • .56" orange LED display • Auto zero and polarity • Parallel BCD standard • Offset and scaling • RMS converter (option) • Buffered, isolated, gated & stored BCD • Screw terminal barrier strip • Non-functional extra zero (option) • OEM prices from \$105/100

MODEL 2003A • ± 1999 counts • .56" orange LED display • Parallel BCD output • Buffered, isolated, gated & stored BCD (option) • DIN or NEMA case • Auto zero and polarity • Ratio standard • 10 μV resolution • Power 100/115/230 VAC or 5 VDC • OEM price from \$140/100



MODEL 216 • ± 5999 counts • True differential input • Orange or red LED display • Auto zero and polarity • 10 μV resolution • 3 or 4 wire ratio • Bit parallel, character serial BCD (option) • Power 5VDC • Small DIN size case • OEM price from \$87/100



MODEL 258 • ± 1999 counts • 0.55" gas discharge display • Up to 32 readings/second • Auto zero and polarity • Parallel BCD output standard • Buffered, isolated, gated & stored BCD (option) • Linearized analog output (option) • Single limit set point (option) • DIN or NEMA case • 100 μV resolution • Power 100/115/230 VAC • Ratio standard • OEM price from \$99/100



MODEL 214 • ± 1999 counts • 1/2" red LED display • True differential input • 5VDC powered • Range change from connector • OEM price from \$36.50/100

Corporate Office
630 East Young St.
Santa Ana, CA 92705
Telephone: (714) 540-4914
TWX: 910-595-1787
Cable: Newlab, Santa Ana
CA 92705

Newport BV
P.O. Box 7759
Schiphol East
The Netherlands
Telephone: (20) 45-20-52
Telex: 844-16347

Newport Laboratories GmbH
6072 Dreieich 1
Max-Planck-Strasse 13
Postfach 102163
German Federal Republic
Telephone: (06103) 3741/3742
Telex: 417908 (NEWPT D)

Available through Distributors Nationwide

NEWPORT

International newsletter

Matsushita says its CCD TV camera offers best resolution

Matsushita Electronics Corp. is readying a black-and-white CCD video camera that it claims has the highest resolution of any solid-state model available. The charge-coupled-device array has 512 pixels (picture elements) vertically by 486 horizontally, for a total of 248,832. **Resolution, the firm says, is 360 horizontal TV lines by 350 vertical.** The chip itself is a mammoth 700 by 540 mils, of which 360 by 460 mils is occupied by the sensing region. The camera will be produced initially in small quantities, with price ranging from \$3,000 to \$5,000.

France to institute bank network

The French postal and telecommunications authority is reinforcing its entry into the network services market. It will set up a message-switching center to handle transactions between banks by September 1980. One aim is to avoid banks' having to pass purely national transactions through the Brussels-based Swift system. The center will use CII-Honeywell Bull Mini 6 minicomputers. **The authority also plans an electronic funds transfer network called Mercure.** The network will use Transpac technology, the French version of packet switching; it will link more than 20 clearing centers and transmit check images instead of the checks themselves.

Computer system gives telephone callers train information

Telephone users in Frankfurt will soon be able to obtain information on train departures and ticket costs from a voice-output data-processing system simply by dialing a certain number. The system asks the caller to dial the zip code numbers of the destination and the desired departure time. **Then it picks out the appropriate train and gives the caller the requested information in synthetic speech.** It also tells him or her where to change trains, if necessary. Funded by the ministry for research and technology and developed at the West German aerospace firm Dornier GmbH, the system is scheduled to start a two-month trial on June 1 and then enter regular service. Initially it will supply information on 300 domestic and foreign destinations.

British Post Office to establish national paging service

The British Post Office will establish a **national paging service by late 1980 or early 1981 at a cost of about \$300 million.** The successful London-area paging scheme, now serving 20,000 subscribers, will be extended through 1979, with wide-area trials first in Birmingham and then in the Manchester area. **Initial orders totaling \$2 million have been placed with Multitone Electric Co. and Motorola Electronics Ltd. for 15,000 pagers and terminal equipment.** About 500 vhf dual-frequency paging transmitters will be supplied by Redifon Telecommunications Ltd. in a \$1.5 million order. Paging calls for the full national service, established by dialing a 10-digit number, will be automatically acknowledged and routed through to the paging transmitters by a national network of 16 dual-processor 4070s from General Electric Co. Ltd.

Jaeger goes with electrolytic displays for dashboards

Jaeger, the leading French supplier of automobile dashboards and a major producer of electronic clocks, continues to back its belief that electrolytic displays—rather than light-emitting diodes or liquid crystals—will one day prevail for dashboards. The company, based in the Paris suburb of Levallois, now expects first versions of a clock display with seven-segment digits to be ready around mid-February at its research laboratory and

pilot production in June, according to Jaeger president-director general Pierre Picard. The firm is using a concept worked out by the French atomic energy agency's Laboratoire d'Electronique et de Technologie de l'Informatique (LETI) in Grenoble. The electrolytic display's **normally transparent segments turn opaque when a 1-v pulse of between 50 and 300 ms is applied** to them [*Electronics*, April 28, 1977, p. 68].

Digital switch and fiber optics simulate distributed PABX

The Norwegian air force is testing a digital switch and fiber-optic cable combination that functions much like a distributed private automatic branch exchange and **provides pulse-code modulation communications between 150 subscribers at seven different sites**. The microprocessor-controlled system accommodates already in-place analog telephones.

Two of the network switches are linked by a fiber-optic cable mounted on a pole and 1,800 meters long. Conventional radio hooks up the others. Standard Telefon og Kabelfabrik AS of Norway made the installation, which is being run primarily to gain operating experience, compare the fiber and radio links, and check the analog-telephone-digital-transmission mode of operation.

Wafer-stepping method promises throughput to 50 wafers/hour

Thomson-CSF has tested an automatic optical alignment process for wafer stepping that should be capable of processing 50 3-inch wafers per hour (one alignment per hour), with an alignment tolerance of 0.1 μm . **The new method employs direct photorepetition at a 10- or 5-to-1 scale, rather than the usual 1-to-1**. Alignment time is less than 200 ms per mark per axis when initial misalignment is 1 μm ; for a 3-in. wafer and 100-mm² circuits using chip-by-chip reindexing, total alignment time is about 10 seconds. The automatic search field is 20 by 20 μm . So far, only a bench version with manual wafer feeding exists, but Thomson hopes for government aid to develop the process further as part of France's plans for very large-scale integration.

Simple two-way divider keeps output phase constant

A two-way electronically variable microwave power divider that keeps the phase angle between the two output ports the same regardless of the power division chosen has been tested by researchers at Chalmers University of Technology in Gothenburg, Sweden. Unlike previously available dividers, **the new strip-line component does not require an internal phase shifter**, so its construction is relatively simple. The dividers, which were tested in the L band (1.4 to 1.8 GHz), are used in satellite antenna feeds.

Yugoslavian microcomputer on its way

Without fanfare, Yugoslavia's electronics industry has launched itself into the microcomputer age. It plans to start volume production of a device this year. Behind the effort is the Ljubljana-based firm Iskra, which developed its first microcomputer last year together with the city's technical university—and **without any know-how from abroad**, according to company sources in West Germany, who released no technical information. Plans call for a production volume valued at nearly \$12 million this year, increasing to about \$63 million in 1982. The microcomputers are intended primarily for use in communications equipment and other professional gear that the company makes.

Best design. Best buy.



The designs Philips threw out years ago live on. Unfortunately. Scopes abound with controls scattered around the CRT, probes popping out everywhere. Trigger some scopes and your hand gets in the way of the display. It took Philips to bring logic and human engineering into the scope design picture. But we're more than just a pretty face. Go behind the face of the PM3214 25MHz 2mV dual trace oscilloscope and you'll find the only and most comprehensive alternate time base scope in the world that's priced under \$1500.*

In the field or the lab, the PM3214 gives instant and unambiguous measurements comparable to more expensive scopes. You will see both main and delayed time bases at the same time-eliminating confusing switching back and forth to find delayed time base position. The calibrated delayed

time base has a completely separate control section which includes full trigger source selection. The large and bright display reads easily even under adverse light conditions. Triggering facilities include AC, DC, TV and an Auto position that derives its trigger from the peak to peak value of the incoming signal. Trigger selection is available from either channel, as well as from line or external source.

The PM3214 is the best design in its class. It's your best buy. Because no one gives you more for your money than Philips. For More Facts or a Convincing Hands-On Demonstration, use our toll-free number, 800-631-7172 in the continental U.S. In New Jersey, call collect. (201) 529-3800. Or contact Philips Test & Measuring Instruments, Inc., 85 McKee Drive, Mahwah, New Jersey 07430.

* U.S. Domestic price only



Test & Measuring
Instruments

PHILIPS

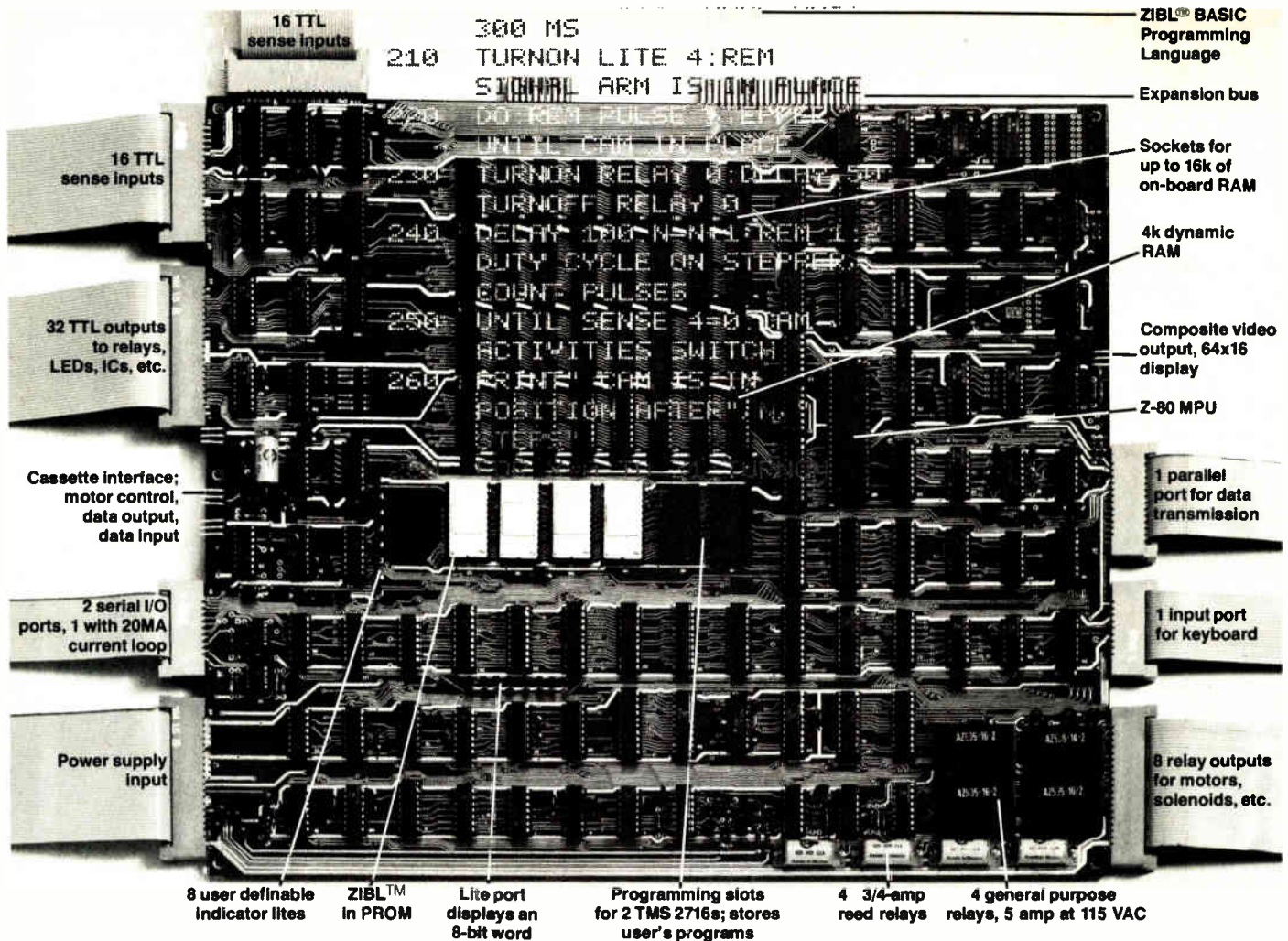

WHAT CAN “CONVERSATIONAL FLEXIBILITY” DO FOR YOU?

SOLVE A COSTLY PROBLEM.

That's why we created the DYNABYTE BASIC CONTROLLER™. Up to now, you've had good reason for not taking full advantage of microcomputers. Inflexible interface and the lack of suitable, *simple* programming languages have left your control applications neglected and expensive to handle.

Writing and debugging software has been difficult. Great effort has gone into learning new languages. Special control circuits had to be constructed.

Microcomputers have been neither conversational nor flexible. And, you have been paying the price—with inadequate hardware or no hardware at all.

THE SOLUTION.

The new DYNABYTE BASIC CONTROLLER™ is designed for you. Now you can have a controller that gives you *flexible interface* and *conversational programming*.

Circle 68 on reader service card

It's a self-contained, single-board computer that is oriented toward control applications. You will have everything you need—relays, lites, video display, flag outputs, sense inputs, tape cassette interface, communication interfaces, EPROM programmer and much more.

Its enhanced version of BASIC and ease of interface makes the DYNABYTE BASIC CONTROLLER™ ideal for a variety of control applications. You will get results easily and efficiently, even if you have little or no experience with computers.

Finally, you will have Conversational Flexibility.

WHERE TO USE IT.

Just about anywhere. Some of the applications in which the BASIC CONTROLLER™ is now solving problems are electronic equipment testing . . . medical instrumentation . . . temperature and PH control in chemical labs . . . animation . . . solar power system management . . . psychological experiments . . .

discotheque lighting . . . agricultural control . . . pollution monitoring and control . . . satellite earth station control . . . and many more.

WHO USES IT.

Hundreds of BASIC CONTROLLERS™ are being used by organizations like Honeywell, Johns Hopkins, Motorola, NOAA, Signetics, Johnson Control, Mission Bell Telephone, EPA and numerous universities.

They're solving problems and getting results with Conversational Flexibility, with the DYNABYTE BASIC CONTROLLER™.

Call and ask for Rick Mehrlich. He'll tell you more.

1005 Elwell Ct., Palo Alto, CA 94303 (415) 965-1010

DYNABYTE

Reference system automatically aligns TV tube and yoke

By streamlining the mating of the two units, Philips' 30AX achieves lower costs; it also provides a sharper picture

A quick glance at the back of NV Philips' Gloeilampenfabrieken's new 30AX color TV picture tube discloses three bumps molded into the glass. They are half of what is called a boss-to-boss reference system, for they match three cavities on the inside of the deflection unit. With this simple system, Philips achieves a self-aligning picture tube.

Self-alignment means lower costs because it eliminates adjustments of the match between tube and deflection unit that set makers (or repairmen) must make in order to achieve proper performance. Moreover, the new 110° in-line tube also has a sharper picture than its 20AX predecessor, which the Dutch conglomerate has supplied to most of Europe's set makers.

Precise. With this precision self-alignment, it is simply a matter of snapping the proper size of deflection yoke into the bosses on the 20-, 22-, or 26-inch-diagonal tube. This ensures the proper axial positioning of the two units, which means the optimum raster orientation is automatically achieved.

Moreover, the boss-to-boss reference system combines with closer manufacturing tolerances in the yoke, neck, and cone to give dynamic convergence automatically. Such self-convergence is a feature of other modern TV tubes, but the more precise setup of the 30AX gives

more precise self-convergence.

To eliminate production-line adjustments for static convergence and color purity, the Philips designers have replaced multipole magnetic focusing rings around the neck of the tube with a simple wire ring built into the electron gun. This ring is magnetized during tube manufacture to provide the two-, four-, or six-pole fields that direct the electron beams, optimizing static convergence and color purity. In conventional tubes with multipole units, the set maker must perform production-line adjustments to achieve the optimum characteristics.

Sharper. Yet another big selling point for the 30AX should be its sharper picture. The Philips engineers reduced the size of each color spot by about 30%, thus improving the resolution. They also eliminated the characteristic coma problem that distorts the beam spot on the edges of the screen into a comet shape.

In a color TV tube, coma can cause the green beam emitting from the center gun to misconverge with respect to the red and blue side beams. It may be eliminated by correction field shapers, which are some form of curved metallic plates.

The new Philips tube has its shapers in the deflection coils, rather than in the electron gun, thereby giving a coma-free deflection field. This maintains good spot quality and identical focusing for the three color beams, either or both of which are hard for other shapers to achieve. Longer deflection coils and more turns on the field coil improve deflection sensitivity (the distance the beam moves in response to a certain amount of current), resulting in less power consumption, less heat, and greater reliability.

Now in pilot production at the firm's Eindhoven headquarters, the new tube will soon go into volume production at various Philips tube-

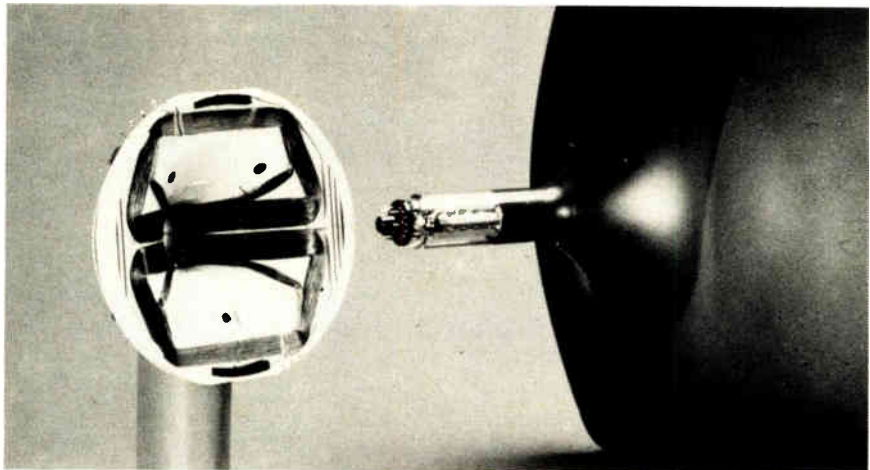

Yes, boss. For automatic alignment of picture tube and deflection yoke, the 30AX has a boss-to-boss reference system: yoke indentations match glass bumps on the tube. A sharper picture results from a smaller color-spot size and elimination of coma.

manufacturing plants in Europe. The first sets using the 30AX should be on the market around midyear. □

Japan

Printer jumps speed with modified matrix

Hitachi Ltd. is completing development of an ink-jet printer that is two to several times faster than other units and offers good character fidelity, especially for the speed.

The company uses what it calls an "anomalous modified" dot matrix to achieve a printing speed of 1,090 characters per second with good quality and 530 c/s with sufficient quality for letters and reports.

Sharp Corp.'s machine, for example, has a speed of 500 c/s for a five-by-seven-dot matrix and 250 c/s for characters with greater defini-

tion. West Germany's Siemens AG offers a 270-c/s printer. In the U. S., IBM Corp. has a high-quality unit that prints 92 c/s.

The higher speed is fast enough for many impact line-printer applications. The typewriter quality of the lower-speed mode qualifies the printer for use in word processors and as a computer terminal.

Like other ink-jet printers, Hitachi's has a nozzle that shoots droplets of ink at a rate synchronized with the information rate (see figure). Individual droplets are given a charge proportional to the height at which they are to be printed and then pass between deflection plates with a several-kilovolt potential difference that deflect the droplets according to charge. Uncharged droplets strike the edge of a gutter that returns them to a reservoir for reuse.

Through careful attention to detail, the new machine produces drop-

lets at 103 kilohertz. Hitachi says that is faster than other ink-jet units.

What's more, deflection occurs along a line 23.2° from the vertical. The resultant matrix allows a dot to be used any place along the slant line it can reach. This requires careful character design for efficient use of the droplets and optimum character shape.

Less waste. The high-speed mode uses up to 47 droplets, and the high-quality mode up to 97. Actually, there are 47 horizontal positions and 145 vertical in the former mode and 97 and 177, respectively, in the latter. The large number of points available makes possible much greater character fidelity than conventional matrixes. Slanting the vertical line wastes fewer droplets on the space between characters, thus increasing the printer's speed.

Hitachi's version of the 6800 microprocessor is the basis of the printer's control electronics. The

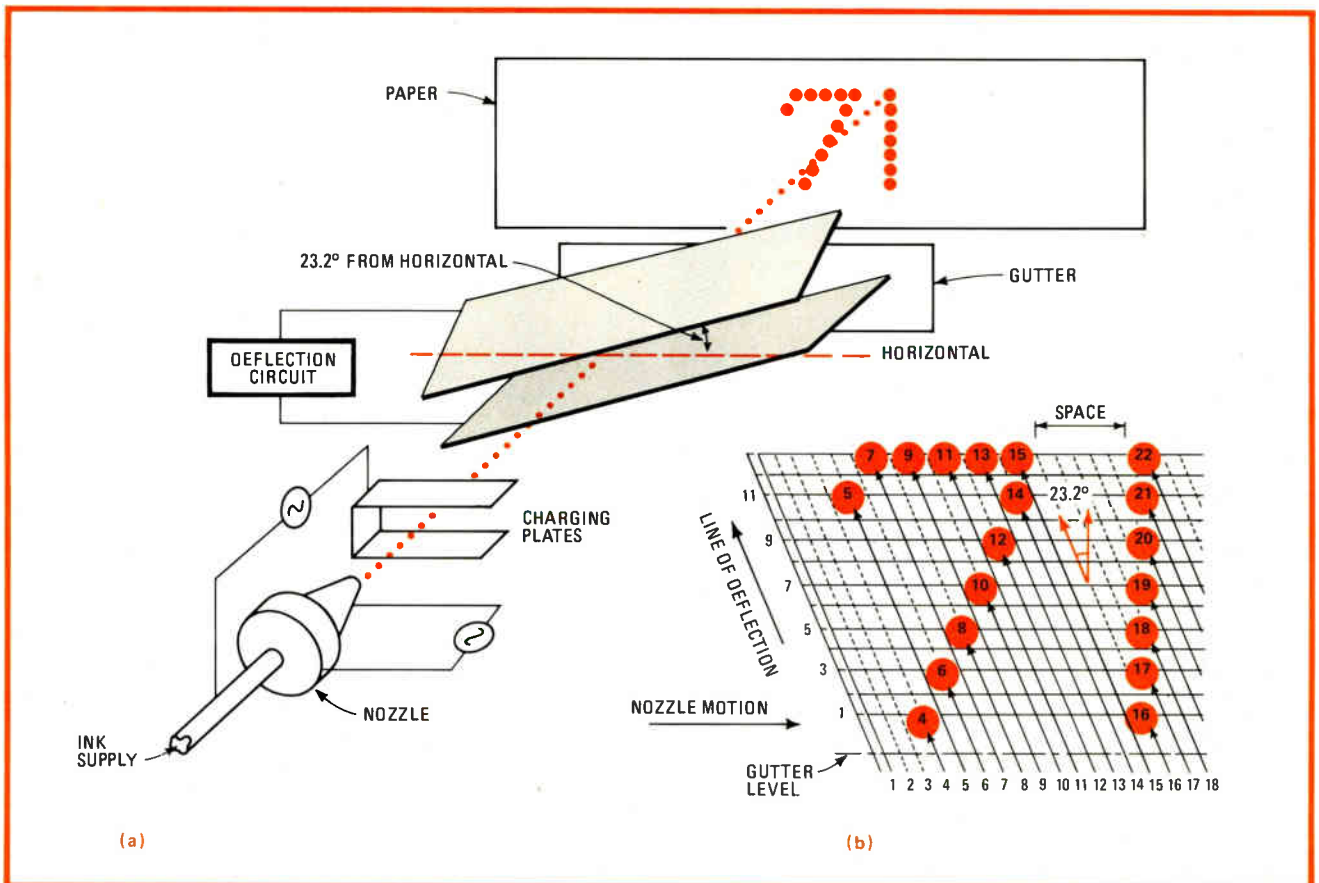

A new slant. Hitachi's new ink-jet printer deflects ink droplets along a line 23.2° from the vertical (a). Its "anomalous modified" matrix, greatly simplified here (b), contains both 47 and 97 horizontal by 145 and 177 vertical positions, respectively.

Centronics. The Band Leader.



We're the leading OEM supplier of band printers. Over 100 OEM's have selected Centronics' 6000 Series Band Printers for use with their computer systems. That makes us the world's biggest supplier of band printers to the OEM market.

You can't beat the band for value. The reason we're the band leader is simple. In a word, it's value. Centronics' band printers cost up to 40% less than comparable printers. Yet they offer immediate availability, unsurpassed reliability, simple serviceability and over 85% spare parts commonality.

End users are hopping on our bandwagon. Another reason we're so big with OEM's is

customer choice. More and more end users select the Centronics' 6000 Series Band Printers for their systems. Small wonder, really. Centronics' 6000 Series Band Printers are unmatched for operational flexibility, print quality, upward compatibility, easy economical operation. And, Centronics offers more service capability worldwide than any other printer manufacturer.

Strike up the band. Price. Performance. Availability. And service. That's a combination that's hard to beat. Isn't it time you joined the bandwagon? For information, write or call: Centronics Data Computer Corp., Hudson, NH 03051, (603) 883-0111.

CENTRONICS®
The Band Leader

position of each droplet is controlled by an 8-bit data byte. Since the machine can print at either 47 or 97 such positions for each of the 96 characters in the type font, nearly 14 kilobytes of read-only memory are required.

Commercial versions should be available later this year. Hitachi says prices will be competitive but may be slightly higher because of improved performance. □

Great Britain

Programmable filter fits 256 points

Design engineers could soon be buying single-chip 256-point programmable transversal filters capable of greatly enhancing signal-to-noise ratio, if pioneering work at Wolfson Microelectronics Institute at the University of Edinburgh lives up to expectations.

There, a group of research workers led by John Mavor and Peter Denyer is completing the layout of a transversal filter incorporating a 256-stage charge-coupled-device tapped delay line and 256 two-quadrant multipliers, each a single metal-oxide-semiconductor transistor, on a single chip.

In operation, input samples are successively delayed and multiplied by a set of weighting coefficients programmed in by the user, and all the products are summed between each 2-megahertz clock pulse.

The industry's first commercially available programmable transversal filter was a 64-point device using a bucket-brigade delay line introduced by Reticon Corp. [*Electronics*, Dec. 8, 1977, p. 34]. The work at Edinburgh takes that technology a stage further. In particular, use of a CCD delay line promises a greater charge-transfer efficiency and improved frequency performance, and the greater number of filter points widens the range of signal-processing applications.

The incoming signal is shifted through a 256-stage CCD delay line

by a three-phase clock structure. At each stage in the delay line, the trapped charge is sensed by a floating gate connected via a buffer amplifier to an MOS capacitor (see figure). This unit serves as a voltage memory and its output is applied to one of the inputs of a two-quadrant multiplier.

The reference voltage, representing a weighting factor, is applied to the second input over a digitally multiplexed analog input bus. These reference levels are sequentially read out of a dedicated off-chip store and switched to each stage in the delay line. Of course, only one coefficient can be changed in any one cycle, but that is sufficient for just about any application.

"The programmable transversal filter is the analog equivalent of the microprocessor because it can be programmed externally to perform number-crunching tasks directly on an analog signal," says John Mavor. At its stated 2-MHz clock rate it will

perform 512 million multiplications per second.

He adds: "It can be programmed as a matched filter or as an adaptive filter, it can be used in spectrum analysis using the chirp Z transform function, and it can be used as a miniature single-chip frequency filter. Teamed with a read-only memory, it can be programmed as a dedicated transversal filter for on-off applications."

Spur for the device's development came from the Admiralty Underwater Weapons Research Establishment, Portland, which is interested in its use as a miniature matched filter to extract sonar echoes from background clutter.

Add-on. In such matched filter applications, up to eight 256-point filters can be cascaded together to give a 1,024-point correlation between the expected and received signals. Moreover, says Mavor, the technology can be stretched even

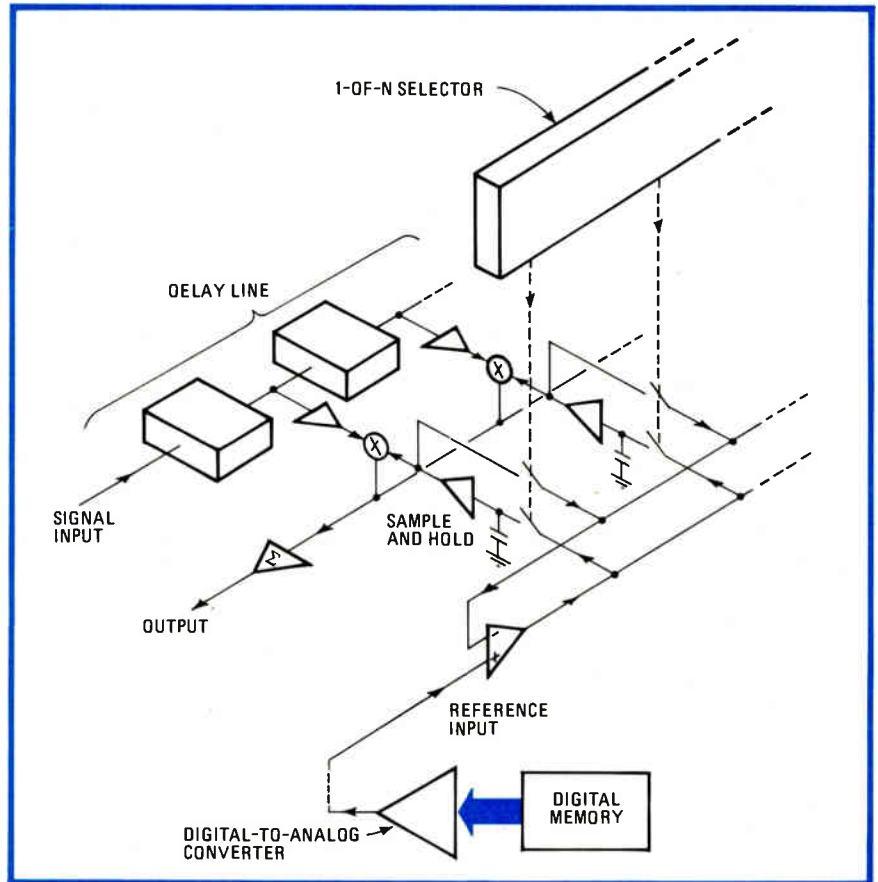

Good points. Programmable transversal filter puts a 256-stage CCD delay line and 256 two-quadrant multipliers, each a single MOS transistor, on one chip. Clock rate is 2 MHz.

Here is absolutely the best PC connector catalog you can get your hands on.



There's no point in being modest about the thing. This is the clearest, most straight forward, easy-to-use PC connector catalog in the business.

It helps that it is also your guide to one of the broadest lines of PC connectors offered by a single manufacturer. We have more basic designs in more depth, with more options than anyone.

But our line is only as good as your ability to get to it. And so we've spent time and effort to make sure our catalog lets you do just that.

It's logically organized — first by contact centers and then by type of terminations.

Everything on each connector series is shown on a single spread. No flipping back and forth.

You spend your time solving your design problem — instead of trying to solve our catalog.

Use the coupon and get your free copy.

Quick delivery of connectors Our distributors keep a large inventory of standard Viking connectors. If you need connectors in a hurry, chances are they're only a phone call away.

O.K. Send me

- your latest PC connector catalog.
- the name of your nearest rep./distributor.

NAME: _____ TITLE: _____

COMPANY: _____ PHONE: _____ EXT: _____

ADDRESS: _____

CITY: _____ STATE: _____ ZIP: _____



Viking Industries, Inc.

21001 Nordhoff Street, Chatsworth, CA 91311, U.S.A. / (213) 341-4330/TWX 910-494-2094

further. The present 2-MHz clock rate could be pushed to 5 MHz in custom devices, which according to the Nyquist criterion would allow 2.5-MHz signals to be handled.

"Some very exciting possibilities then begin to open up—like video processing. At these speeds competitive digital techniques start to get very watty," says Mavor.

To produce the 256-point filter the Edinburgh group is going to a high-density MOS process for large-scale integration under development at Plessey's Allan Clark Research Center, Caswell, instead of the metal-gate process used in the earlier 64-point device. The double-polysilicon n-channel ion-implantation process is already producing high yields on prototype tapped-delay-line CCD circuits that have been processed. Combining CCDs and MOS transistors and capacitors on the same chip calls for just one extra masking stage.

One reason for the high circuit densities achieved is a newly developed two- or four-quadrant multiplier using a single MOS transistor, says Mavor. "We time-multiplex the transistor over two clock periods. The reference sample is applied to the drain for both periods, and the signal offset is applied to the gate for one period and the signal plus offset for the second period." Current from all multiplier transistors is summed on a common busbar.

The transistor can be operated in the two- or four-quadrant mode. In this application, it is operated in the two-quadrant mode.

The researchers have already obtained performance figures and experience with programmable transversal filters using their 64-point device, which has been available for about nine months. In particular, they have teamed the device with a Z80 microprocessor to demonstrate its use as an adaptive filter.

The group hopes to have the first 256-point circuits developed in the third quarter of 1979 and available to selected research organizations as experimental devices. Once the technology has been proved feasible, semiconductor firms could follow with commercial devices. □

France

Wiring system rivals multilayer, Multiwire

Circuit boards wired automatically by a new process are now going out to clients of France's Laboratoire d'Electronique et de Technologie. The Grenoble-based electronic research division of the French atomic energy agency says the system, dubbed K6, is often cheaper than other methods of wiring, including multilayering and Multiwire.

"For a double-sided card, we are cheaper only in quantities of 100 to 200," says Denis Randet, head of LETI's laboratory for new electronic components. "But once we start using the K6 process to replace multilayer boards, we can go to higher quantities and save money." For example, he estimates that with a six-layer board the K6 process is less expensive for quantities of 500 to 1,000. "Once we're into 10-layer boards, we're always cheaper," he continues.

What's more, he claims the process is faster than Multiwire: though the soldering step employed requires extra time, the K6 system saves time overall, as well as money, by eliminating plating and drilling. "We can do 300 to 400 points an hour with one head," says Gérard Nicolas, the engineer responsible for K6. He also says the K6 hardware is less expensive than a Multiwire system, though he will not come up with a specific figure.

The conventional Multiwire method starts with a base material, such as an epoxy resin, and coats it with a thermosetting adhesive. The wire pattern is formed using a numerically controlled machine, and the card is then pressed and baked. Finally, holes are drilled and metalized to form the hole-to-wire joint.

Comparison. The K6 approach, which has evolved over several years, uses standard printed-circuit boards with metalized holes and their pads. These are covered by electrodeposi-

tion with a 1-mil layer of solder. Next, a thermosetting adhesive is screen-deposited over the entire board except for the pads and holes. Then, the numerically controlled K6 machine forms the wire pattern using conventional enameled wire 100 to 120 micrometers (about 4 mils) thick.

The machine takes the wire in a pincer, strips it, places it on a pad, solders it with a miniature soldering iron, and cuts it. Dual in-line packages are wave-soldered. Finally, a second layer of adhesive is applied to protect the card, and the whole is baked to polymerize the adhesives.

The hardware consists of a control bay run from paper tape and an X-Y table controlled by two motors. The table is large enough to handle the biggest commonly used cards (400 by 500 millimeters). The system can have from one to four wiring heads controlled electromechanically and hydraulically. Each head can unwind or attach wires, and all follow the same program.

In between. The system is aimed to fall between simple wire-wrapping processes and complex, Multiwire systems. One prime application is backpanel wiring, as in the intricate examples often found in telecommunications gear. Randet hopes that once the method is seen to work for such complicated circuits as those, clients will accept it as economical for simpler applications.

A state agency, LETI does not intend to produce the machine. Instead, it is looking for firms to manufacture and use the K6 under license. "We have several potential French customers," Randet says, "and CIT-Alcatel is already building K6 systems to produce circuit boards for telecommunications."

But "we are not looking just for French partners," he continues. "French firms are not necessarily well placed to sell or use this equipment in terms of world markets. We hope to find at least one manufacturing partner in the U. S."

LETI is now working to wire very high-density circuits. The aim is to handle wires with diameters of less than 50 micrometers (2 mils). □

As fast as you can say "downtime" your production, test or repair people can activate an AMP Latch Easy Release Header with one hand. Just squeeze and the cable half is disengaged. No wrenching on the cable. No wiggling. And no damaged contacts. An important matter when

We sure do. AMP Latch.

neither your production costs nor your on-board costs can take a back seat to one another. And one of many reasons why AMP Latch has drawn the attention of designers in the data processing, instrument and communications industries. Yet AMP Latch offers a unique feature that extends far beyond what other ribbon cable connectors can offer. It offers precision registration built into the tooling which minimizes rejection rates. Unquestioned reliability. That's what AMP Latch is about, too. You get a four-point electrical contact and mechanical grip for each conductor. Built-in inspection ports make test simpler than ever. The fact is, nobody today has a wider range of easy-to-apply no-strip, no-solder, round conductor flat cable connectors than AMP. For more details, see the opposite page and the page overleaf.

AMP has a better way.

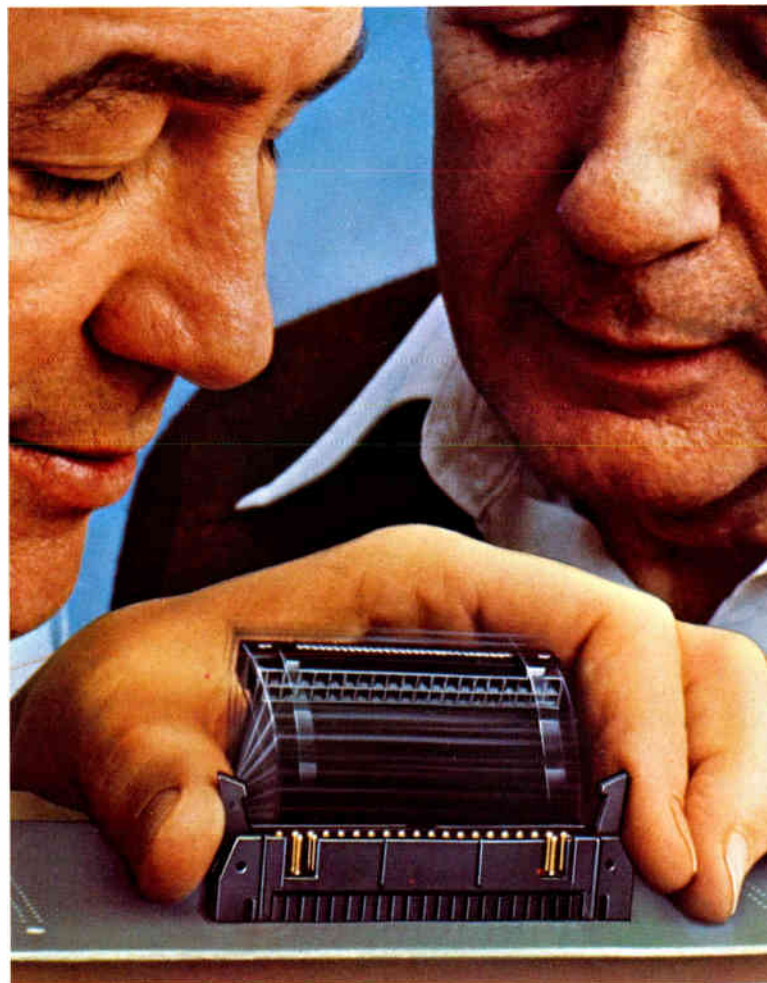

Some facts worth knowing about AMP Latch Connectors

Function: Simultaneous mass termination of all conductors without cable stripping.
Wire types: Small gauge solid or stranded discrete wires as well as flat ribbon, woven ribbon and other types flat cable with round conductors on .050" centers.
No. of positions: 10 to 60.
Connector types: Wide variety of cable-to-cable, card edge, DIP and receptacle connectors available.
Mates with: Full range of AMPMODU headers and pcb posts.

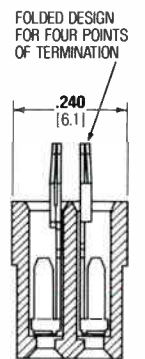
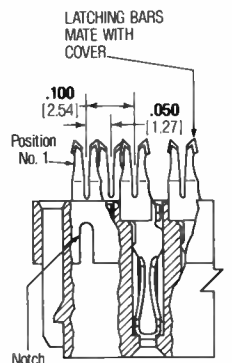
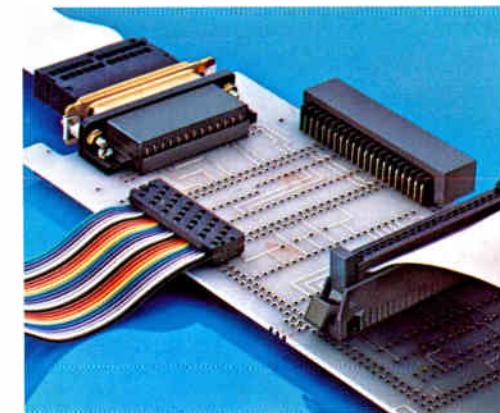

Electrical Current Rating:
1 Ampere (Continuous).
Operating Temperature Range:
-55°C to +105°C.
Dielectric Withstanding Voltage:
500 Volts, RMS.
Tooling available: Pneumatic and Manual Bench Mounted Models and a Hand Tool, each with interchangeable die sets.
Who to contact: Call AMP Latch Information Desk at (717) 564-0100. Ext. 8400. Or write AMP Incorporated, Harrisburg, PA 17105.
Product Information: Check Reader Service Number 99.

“Look, I’ve got two challenges for my ribbon cable interconnects—to reduce manufacturing rejection rates and prevent contact damage during testing. Got any solutions?”



And cost effective tooling.

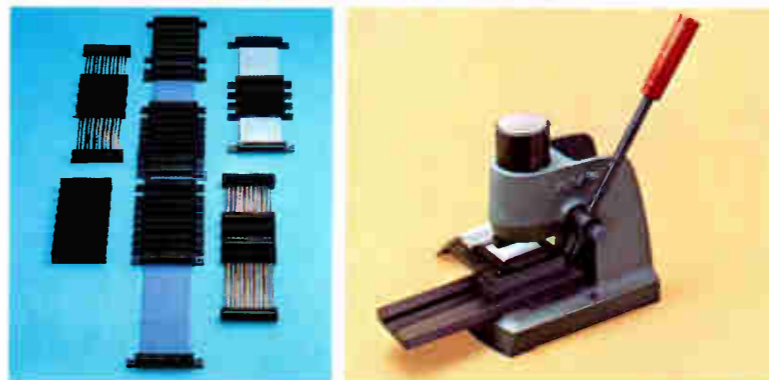
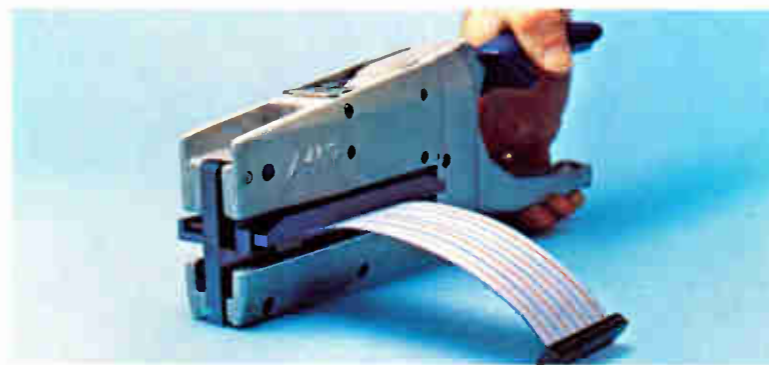

With AMP Latch Tooling the terminations are made quickly, easily and simultaneously. No need for pre-stripping the insulation. One tool will terminate virtually all popular round conductor flexible cable, including those with flat side down or ribbed side down.

Two basic bench-mounted AMP Latch tools include: a heavy-duty pneumatically powered unit and a manually operated unit. Both are reliable. Both are easy to load. And precision cable registration is built in. Alignment is automatic and positive. Six different precision die sets are available for terminating receptacle, plug, card edge, paddle board and pin connectors as well as discrete wire.

Also available is equipment for daisy chain terminations, and a hand tool with interchangeable dies.

For the complete story on AMP Latch Connectors, AMP Latch Tooling, and the AMP Technical Support that goes with them, call AMP Latch Information Desk at (717) 564-0100. Ext. 8400. Or write AMP Incorporated, Harrisburg, PA 17105.

AMP and AMPMODU are trademarks of AMP Incorporated

AMP

**“Show me a truly
flexible packaging
system...something
we can grow on
right into the 80’s.”**

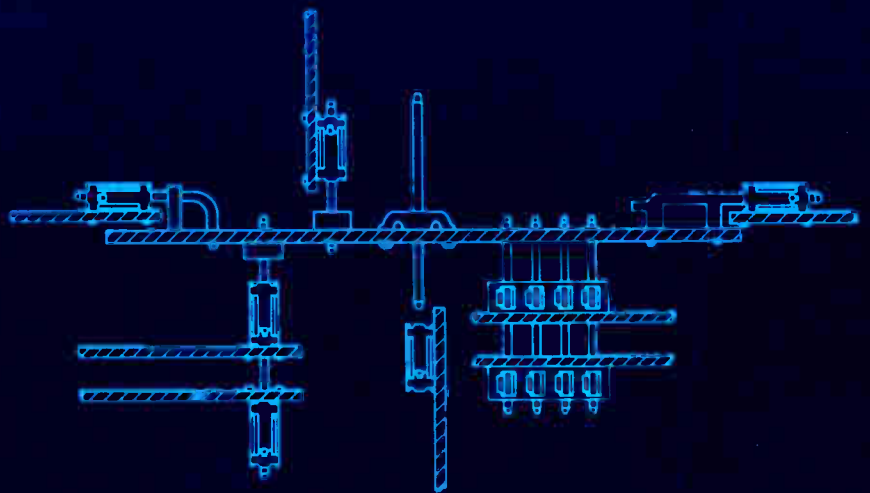

The AMPMODU Interconnection System offers you both .100 centerline or larger packaging. It is a truly universal board-to-board and wire-to-board system that lets you expand your capabilities without obsolescence.

Take the receptacles. They offer a high degree of flexibility with electronic packaging schemes of all kinds. Board mount receptacles are available for both vertical use as well as for horizontal board stacking applications. Two classes of posts, five types of receptacles and 10 polarized header styles, in fact, make several thousand connection variations possible—now and in the future.

It's yours now. The

Headers mate with coaxial ribbon cable connectors, flat cable connectors, round conductor ribbon cable connectors, and AMPMODU Connectors for discrete wire and webbed cables.

With this kind of potential it is easy to switch, say, from "round" wires to flat wires by using the appropriate AMP Connector. Yet all this versatility is possible with a three-dimensional design that saves board real estate like never before.

At the front of the unique header receptacle is a dual cantilever spring beam design with a very forgiving nature and positive anti-overstress for unequalled contact protection. It assures a uniform, positive electrical contact with mating posts every time.

If you need a packaging system that can grow with your equipment design evolution, you need AMPMODU connectors...the interconnection system that lets you go board-to-board, wire-to-board and wire-to-wire—any time. Want more information?

See the opposite page and the page overleaf for complete tooling details.

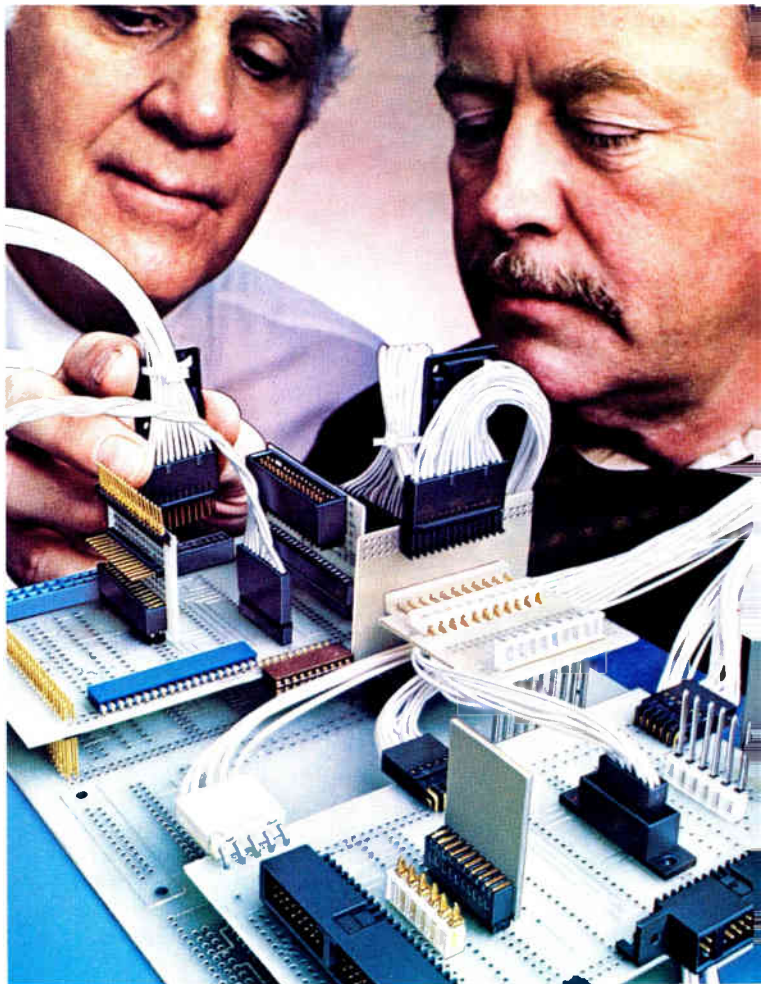

AMP has a better way.

AMPMODU System.

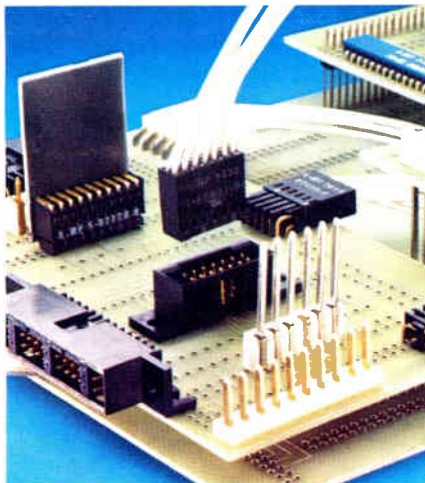

Some facts worth knowing about AMPMODU connectors

Function: The AMPMODU Interconnection System is a reliable, inexpensive way to provide three dimensional interconnections through a unique modular technique employing two mating members (posts) and female members (receptacles). The posts and receptacles fall into two general classifications:

.031" x .062" posts and mating receptacles and multicircuit housings. These are generally used in memory boards, power supplies and rugged interconnection systems.

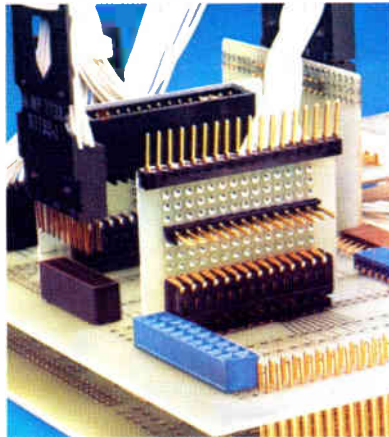

.025" x .025" posts and mating receptacles incorporating standard, intermediate and high pressure receptacles for individual and multicircuit interconnections in a wide variety of sizes, styles and geometries to accommodate the higher density of sophisticated interconnection systems.

Where to telephone: Call AMPMODU Information Desk (717) 564-0100, Ext. 8400

Where to write: AMP Incorporated, Harrisburg, PA 17105

Product Information: Check Reader Service Card No. 100.

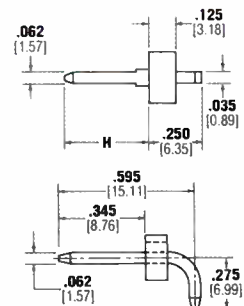

1. Headers for .031" x .062" technology

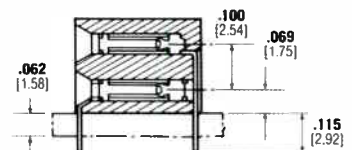
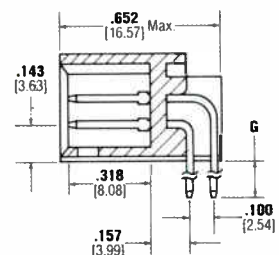

2. Headers for .025" x .025" technology

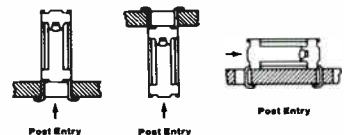

3. Board mount receptacle configurations

...and with cost effective tooling.

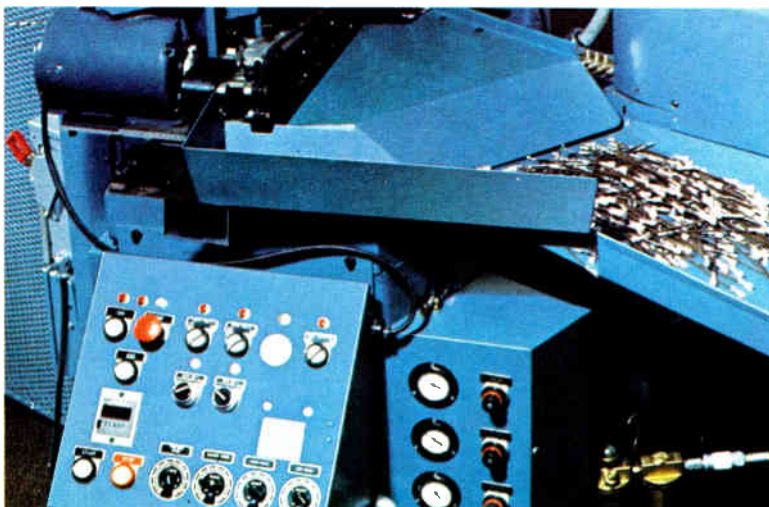
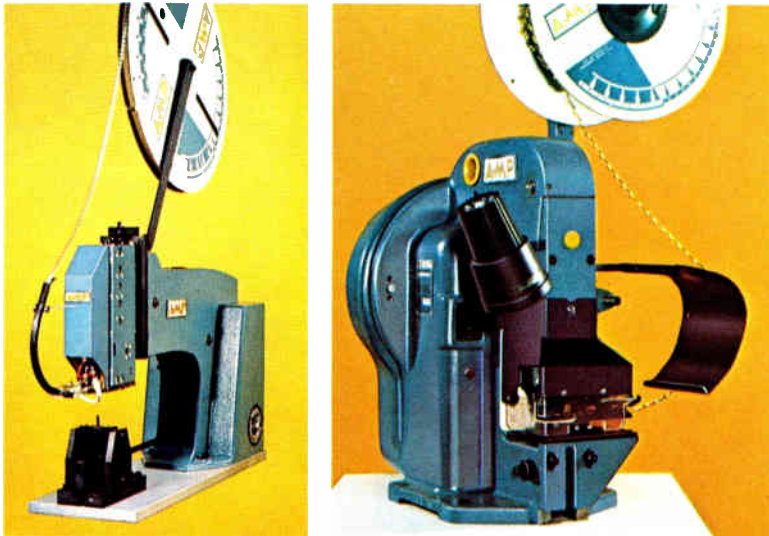

Quick staking, rapid terminations and low on-board costs are the hallmarks of AMPMODU Application Tooling.

The AMP Pantograph Machine, for instance, is a strip feed machine which stakes up to 12,000 posts and/or receptacles an hour. And it can do it with remarkable accuracy.

The production rate on the AMP Printed Circuit Board Insertion Machine can be as high as 2000 insertions per hour, depending on the operator. Styles are available for both the .031" x .062" and .025" x .025" components.

AMP also offers a complete range of wire terminating equipment, including bench machines, and high volume automatic lead making machines capable of terminating several thousand leads per hour.

Need more information about AMPMODU Tooling? Call the AMPMODU Information Desk at (717) 564-0100, Ext. 8400.

Or write AMP Incorporated,
Harrisburg, PA 17105.

AMP, AMPMODU are trademarks of AMP Incorporated.

AMP

Budget signals battle with Congress

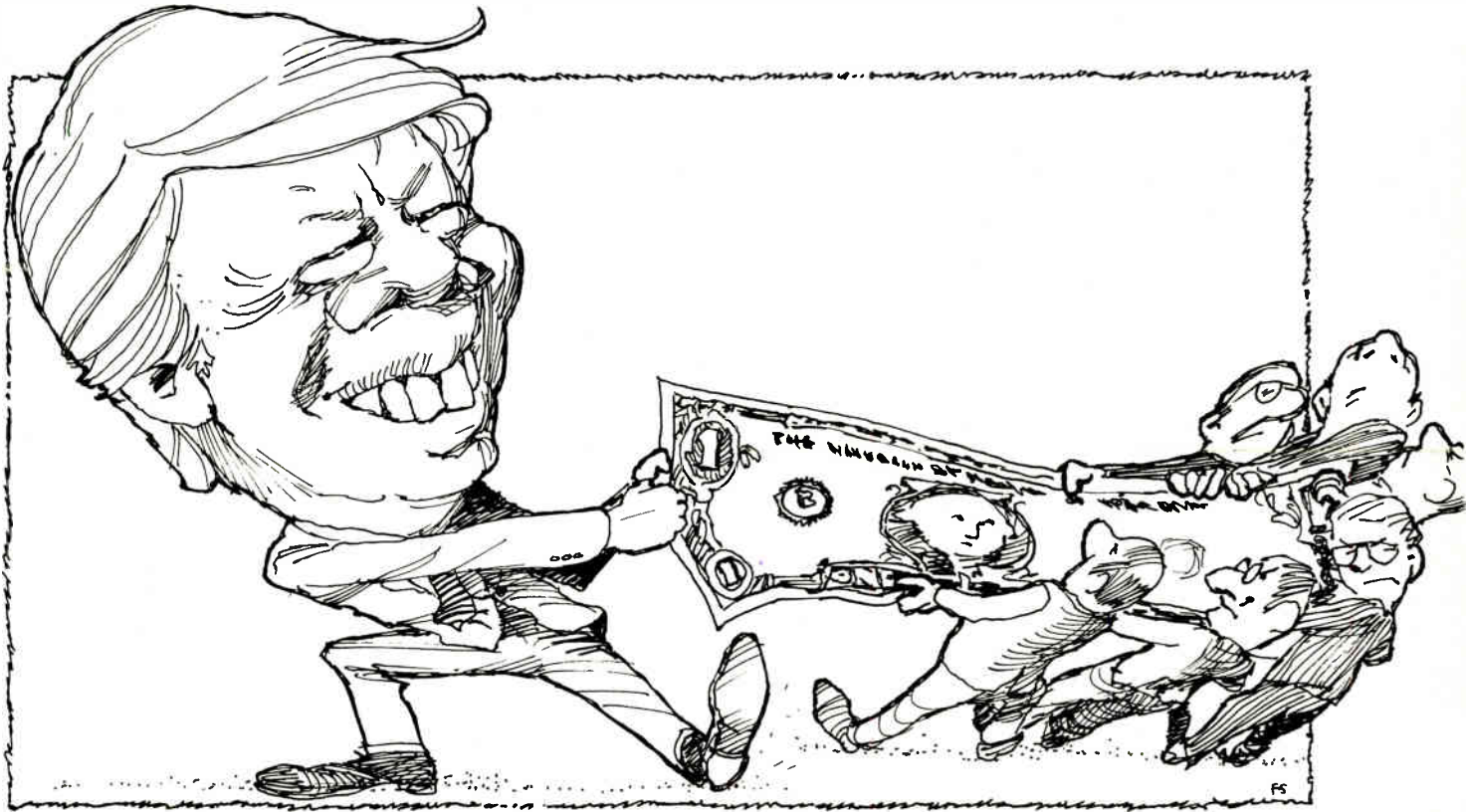

Military electronics contractors have a rosy outlook with 14.5% increase in weapons system purchases sought

by Ray Connolly, Washington bureau manager

Not everyone agrees with President Jimmy Carter that his \$531.6 billion budget for 1980 is lean and austere. Military electronics contractors, for example, express quiet satisfaction with the Carter plan to boost weapons systems buys by 14.5% to \$25.7 billion in the fiscal year that begins Oct. 1. They are also pleased with Pentagon plans to lay out more than \$13 billion for research and development—a 10% increase over this fiscal year's total.

The Department of Defense estimates that its expanding program, which is already creating a shortage of electronics engineers, will increase the number of defense industry jobs by 80,000 from September 1978 to September 1979 and add 120,000

more in the following 12 months for a total of 1.85 million workers.

Beyond military outlays, however, the Government electronics market outlined in the President's budget message to Congress is relatively tight, showing little change from fiscal 1979 spending levels for space, transportation, and solar energy.

Struggle. Those constraints on nonmilitary technology, coupled with cutbacks in several social programs, guarantee the President a fight with Congress to get his budget passed without significant amendments. "There are just too many guns and not enough of anything else," says one House Appropriations Committee staffer, and notes that the Pentagon will have a harder

time justifying its programs before the Defense Appropriations subcommittee's new chairman, New York Democrat Joseph P. Addabbo. "George Mahon is gone now," the staffer points out, "and Addabbo can be expected to ask a lot more questions; he is going to want specific justification of these outlays." Addabbo is seen as maintaining an arms-length relationship with the Department of Defense and its military services, taking a more cautious approach than his predecessor.

Carter's principal justification for the increased outlays is to provide a real growth of 3% after inflation in U.S. military support of the North Atlantic Treaty Organization. America's NATO allies have agreed

Probing the news

to follow the U.S. spending lead, and Carter says, "They are meeting the goal that we agreed upon. We must and will do our share." The President also wants R&D spending hikes "to meet future challenges."

In that context, the Defense Research & Engineering (DRE) office got White House support for \$32 million to begin developing very high-speed integrated circuits [*Electronics*, Sept. 14, 1978, p. 81]. "It's not quite as much as the \$36 million we asked for," says Leonard Weisberg, DRE's electronics and physical sciences chief, "but it will get us off to a good start. Industry response is very favorable." The six-year program is expected to cost about \$200 million.

Military R&D overall will jump almost 11% in fiscal 1980 to more than \$13 billion, or about 5% in real growth after discounting inflation. That increase is equivalent to this year's rise from 1978. It is a plan that delights military electronics researchers as much as it distresses nonmilitary contractors, who see funds for their programs in other agencies being sacrificed to the Pentagon's priorities (see "R&D also feels the pinch").

At the National Aeronautics and Space Administration, for example, R&D spending would rise a mere 2.8% from this year's budget, while NASA's proposed total outlays of less than \$4.6 billion reflect a rise of just 4.3% from the present level. The budget "falls short of the inflation rate," says Administrator Robert Frosch, "and does not accommodate new programs."

Compared to NASA's 20 space vehicle launches last calendar year, the agency is down to 14 in 1979—with nine of those pegged as "reimbursables," satellites launched for other agencies or corporations. NASA's single big number this year will be its first orbital flight of the space shuttle, the reusable transportation vehicle, now scheduled for Sept. 28.

While photovoltaics R&D gets a significant 25% boost in fiscal 1980 outlays to \$11.7 million from this year's \$9.3 million level, the Depart-

MAJOR REQUESTS FOR WEAPONS PROCUREMENT

(in millions of dollars, quantities in parentheses)

	FY 1979	FY 1980	Contractor
ARMY AIRCRAFT			
AH-1S Cobra/Tow	\$202.2 (137)	\$264.3 (160)	Bell
UH-60A	391.9 (129)	380.2 (145)	
NAVY AIRCRAFT			
A-6E Intruder	181.8 (12)	72.5	Grumman
A-7E Corsair II	120.2 (12)	15.0	Vought
CH-53E Sea Stallion	183.2 (14)	202.0 (15)	Sikorsky
E-2C Hawkeye	212.7 (6)	215.0 (6)	Grumman
EA-6B Prowler	172.2 (6)	179.3 (6)	Grumman
EC-1300 Hercules	32.5 (1)	99.0 (3)	Lockheed
F-4 modifications	107.0	85.5	Grumman
F-14A Tomcat	884.4 (36)	666.1 (24)	Grumman
F/A-18 Hornet	1,038.0 (9)	1,044.0 (15)	McDonnell
P-3C Orion	342.2 (12)	366.4 (12)	Lockheed
S-3A Viking	1.0	9.6	Lockheed
AIR FORCE AIRCRAFT			
A-10	840.6 (144)	903.9 (144)	Fairchild
B-52G/H missile and avionics	204.9 (8)	490.4 (48)	Boeing
E-3A Awacs	301.4 (3)	406.9 (3)	Boeing
EF-111A modifications	160.1	62.0	Grumman
F-15 Eagle	1,443.2 (78)	989.5 (60)	McDonnell
F-16 Multimission fighter	1,578.9 (145)	1,699.6 (175)	General Dynamics
NATO Awacs (U.S. share)	95.1	250.2	---
ARMY MISSILES			
Chaparral, air defense	34.8 (850)	9.3	Ford
GSRS Rocket Launcher System	62.8	134.6 (1,764)	---
Hawk, air defense	75.4 (608)	46.6 (187)	Raytheon
Patriot, air defense	295.7	569.4 (155)	Raytheon
Roland, air defense	190.3 (75)	308.2 (410)	Hughes/Boeing
Stinger, air defense (1)	147.7 (2,678)	108.7 (2,654)	GD
Tow, antitank (2)	66.3 (10,920)	103.2 (16,805)	Hughes
NAVY MISSILES			
Harm, air-surface	44.2	109.3 (80)	TI
Harpoon, antiship	139.0 (240)	154.7 (240)	McDonnell
Phoenix, air-air	116.0 (210)	148.1 (180)	Hughes
Poseidon, strategic	24.2	25.9	Lockheed
Sidewinder, air-air (3)	144.9 (3,150)	119.3 (2,370)	Raytheon/Ford
Sparrow, air-air (3)	202.3 (1,910)	223.3 (1,560)	Raytheon/GD
Standard ER/MR, air defense	217.5 (520)	255.7 (565)	GD
Tomahawk, cruise weapon system	152.1	107.2	---
Trident I, strategic	1,096.7 (86)	831.6 (82)	Lockheed
AIR FORCE MISSILES			
ALCM Air Launched Cruise Missile	431.1 (24)	475.4 (225)	Lockheed
GLCM Ground Launched Cruise Missile	53.2	74.1	GD
Minuteman II/III, strategic	122.0	135.4	multiple
NAVY VESSELS			
CVV, aircraft carrier	19.6	1,624.0 (1)	not selected
DDG-2, guided missile destroyer modernization	132.0	225.8 (1)	not selected
DDG-47, destroyer (Aegis)	10.2	825.4 (1)	---
FFG, guided missile frigate	1,710.6 (9)	1,261.5 (6)	not selected
SSN 688, nuclear attack sub	720.2 (1)	522.9 (1)	Newport News/GD
Trident, ballistic missile sub	667.6	1,502.6 (1)	GD
T-AGOS, ocean surveillance ship	71.8 (2)	154.2 (5)	not selected
OTHER PROCUREMENT			
MK-15, Phalanx close-in weapon system	86.3 (27)	135.3 (61)	GD
FLTSATCOM, fleet satellite communications	26.0	35.8	GD
AFSATCOM, Air Force satellite communications system	27.4	70.8	not selected
DMSP, Defense Meteorological Satellite Program	56.7	43.7	not selected
DSCS, Defense Satellite Communications System	48.1	101.2	not selected
Space shuttle	373.6	400.0	not selected

(1) includes Marine Corps Procurement (2) includes Navy/Marine Corps Procurement

(3) includes Army/Naval requirements

Source: DOD

ment of Energy budget is distressing to a number of industry specialists who looked for a move to production quantity purchases in the year ahead as a means of perfecting production techniques and lowering unit costs. Yet money for the Federal photovoltaic demonstration program is down 23% to \$1.2 million in the coming

budget, much of it coming from unspent funds to be carried over from this year.

"Admittedly, it is frustrating to be unable to move more quickly into production," says one Energy Department specialist, "but there are still a lot of people who believe we have to explore the alternatives to

R&D also feels the pinch

If further proof is needed that the Carter Administration isn't just whistling "Dixie" when it calls its budget tight, take a look at research and development. While the \$29.7 billion requested for all R&D is \$2.1 billion more than the fiscal 1979 figure, the increase is only about 7.6%, and inflation will more than eat that up. By comparison, basic research fares a bit better with a 9% increase to \$379 million.

As usual, the Defense Department is top dog—its expenditures will account for more than 45% of all the Federal R&D support—with outlays totaling \$13 billion, some 10% over this year's figure. But the Pentagon wants to spend 16% more on basic research, including a start on the very high-speed integrated circuits (VHSI) program. In second place is

the Department of Energy, which seeks \$4.6 billion, only a slight increase, because the new National Energy Act is designed to increase incentive for private investment in R&D. Like the Pentagon, the DOE seeks to increase funding for basic research, by 17%.

R&D requests in dollar billions:

	FISCAL YEAR	
	1979	1980
Military (DOD)	\$11.7	\$13.0
Energy (DOE)	4.5	4.6
Aerospace (NASA)	3.5	3.6
Health/Education (HEW)	3.5	3.6
Science (NSF)	0.8	0.9
Transportation (DOT)	0.4	0.3
Commerce (DOC)	0.3	0.3
All others	2.9	3.4
TOTAL	\$27.6	\$29.7

silicon and gallium arsenide further." Specifically, interest in high efficiency low-cost sulfides of cadmium and copper is believed to need further exploration [*Electronics*, June 2, 1978, p. 42].

Getting there. Not far away from the DOE, the Department of Transportation is also talking austerity, but electronics spending comes out relatively well in the DOT's \$15.8 billion budget.

For instance, air traffic safety is one of secretary Brock Adams' top priorities in the coming year, which means that funding in the Federal Aviation Administration's budget for collision avoidance radar equipment will increase despite the slight drop in the FAA's total request. Congress will probably not be inclined to reduce the \$25.6 million requested by the FAA for facilities and equipment devoted to air traffic control.

This amount comes on top of a \$17.1 million supplemental appropriation requested for fiscal year 1979 specifically for collision avoidance equipment. In addition, the FAA has asked for \$107 million for research and development to support programs such as microwave landing systems and discrete-address radar beacons. The FAA budget also seeks \$10 million for procurement of Remote Center Air/Ground com-

munications equipment.

The Coast Guard has requested \$284.4 million for capital improvements that will include three cutters, three aircraft, and 17 short-range helicopters. In addition, funds will cover completion of five new all-weather airborne tracking systems using radar, ultraviolet, and infrared technologies.

DOT will probably make another indirect contribution to increasing

electronics in automobiles. Stating that the car makers are not responding adequately to fuel economy standards, Adams has decided to hold a conference in Washington this spring "to plan an intensive research effort to develop a new automobile." He hopes to get representatives from industry and universities plus "anyone else with an idea" to attend. It's too soon to tell what might come out of this effort, but to get what Adams calls "a socially responsible automobile" will most likely lead to tougher fuel economy, safety, and emission-control standards in for auto makers to shoot for coming years.

The General Services Administration's (GSA) market for non-military computer hardware and software shows a significant growth potential in the new Carter budget. GSA's automatic data-processing fund, built on income from charges to computer-using agencies, has grown to a point where money available for commercial computer purchases and leases is substantial. A 22% rise in computer costs and leases for fiscal 1980 is forecast with a \$151.6 million total. This comes on top of a 73% increase in this fiscal year from 1978. By far the largest share of this total, nearly \$135 million in 1980, will finance a range of commercial services from local and remote processing, including teleprocessing

WEAPONS R&D FUNDS

(in millions of dollars)

	FY 1979	FY 1980	Contractor
ARMY			
Advanced Attack Helicopter (AAH)	\$177.4	\$176.2	Hughes
Ballistic Missile Defense Program	227.5	228.5	multiple
Remotely Piloted Vehicles	18.2	49.4	not selected
NAVY			
Aegis, surface-air missile	62.6	53.1	RCA
Advanced ASW torpedo	44.3	60.1	multiple
LAMPS III, helicopter	92.9	177.0	multiple
TACTAS, Tactical Towed Array Sonar	28.7	27.8	not selected
Trident II	25.0	40.6	Lockheed
AIR FORCE			
AMRAAM, Advanced Medium Range Air-Air Missile	36.7	54.7	not selected
ASALM, Air Surface Launch Missile	48.5	25.0	not selected
HEL, High Energy Laser	90.3	97.1	not selected
M-X, strategic missile	423.2	675.4	not selected
NAVSTAR, global positioning system	139.7	230.3	GD/Rockwell
PLSS, Precision Location Strike System	86.8	24.9	Lockheed
QSR, Quick Strike Reconnaissance	—	10.1	not selected

Source: DOD

Probing the news

service contracts, to management consultant, performance, and evaluation services.

DOD's draw. With the biggest gains for technologists in military spending programs, however, the Pentagon's potential is the greatest by far for new spending. Major aircraft programs with large electronics segments include Boeing Co.'s E-4A Airborne Warning and Control System (Awacs), which calls for three more planes in fiscal 1980, same as this year, although the price tag is up by one-third to \$314 million, plus another \$74 million for research, development, test, and evaluation (RDT&E), reflecting improvements in the radar, computers, and other subsystems. Additionally, the Air Force has set aside another \$250 million in fiscal 1980 and another \$95.1 million for the fiscal 1979 supplemental spending program now before Congress for the U. S. share of 19 Awacs planes to be acquired and operated by NATO. The U. S. share of the program through fiscal 1984 is projected to reach \$1.3 billion, the DOD says, for the force that will be complemented by 11 Nimrod planes to be ordered from the United Kingdom.

Another Air Force old faithful, the B-52 heavy bomber (models G and H), will accelerate its avionics modernization program following last year's cancellation of the B-1 follow-on. The \$397 million proposed for 29 planes is more than four times the \$97 million set aside this year. Additionally, the B-52G will get another \$93 million to modify 19 planes to carry the air-launched cruise missile (ALCM) after completion of R&D to be accomplished with 1979 funds.

The ALCM itself is set to move to large-scale production in the new budget, with 225 missiles to cost \$364 million, plus another \$90 million for RDT&E. Principal beneficiaries will be prime contractors Boeing, General Dynamics, McDonnell Douglas, and Williams Research. The same contractors also will share most of the 30% increase, most of it in R&D, for the ground-launched cruise missile variant of

New kid on the block

Putting together its first budget, the year-old Department of Energy has decided to strike a blow for practicality, not a bad idea in a capital where the watchwords all have to do with trimming fat. In the words of Secretary James D. Schlesinger, "We are attempting to bring together R&D and commercialization—we want to avoid R&D with no end."

For the electronics community, the energy program of greatest interest is solar energy. The importance of that area is underlined by George McIsaac, the DOE's assistant secretary for resource applications. He points out that while long-term spending for research in other technologies is steady or up just a bit, the requested outlay for research into solar alternatives would increase by 25%. At the same time, for fiscal 1980, the department seeks \$597 million for development and deployment of solar energy systems, 13% more than the \$528 million in this year's budget. Photovoltaic R&D, however, would receive a 25% increase to \$11.7 million from \$9.3 million. Another \$8 million is earmarked for the Solar Powered Satellite.

Looking at the department's overall spending requests for fiscal 1980, outlays total \$10.2 billion with about a third of that—\$3.5 billion—earmarked for energy technology. The next largest expenditure, some \$3 billion, would be used for defense activities. This covers mostly the broad area of atomic energy, and includes such things as reactors and surface ship propulsion systems. For basic energy sciences, the figure is \$253 million compared to this year's \$208 million.

The department wants to increase slightly its expenditure for electric and hybrid vehicle R&D to \$41 million from \$37.5 million. The three-year congressional mandate calls for 1,700 vehicles to be bought this year, but Paul Brown, who heads the program, says the DOE will seek to cut that number to 700. Of these 200 would be improved with the three types of batteries being nickel-zinc, and nickel-iron. Brown says the department will push hard to get approval of the change.

the air-launched missile.

The biggest single Air Force outlay for planes, however, will continue to be the General Dynamics F-16 fighter with the proposal for another 175 planes, bringing the three-year order total to 425. Money for the latest purchase totals \$1.699 million, including nearly \$28 million for RDT&E.

The Navy's billion-dollar deal continues to be the McDonnell Douglas F/A-18 Hornet fighter and attack aircraft as a replacement for the F-4 and A-7. The program topped the billion-dollar mark this fiscal year with money for the first nine planes totaling \$539 million plus a nearly equal amount for RDT&E. Fiscal 1980 calls for \$1.044 billion, with 70% of that going for 15 more planes and the rest to be spent for RDT&E.

At the same time, the Navy will continue tapering off on Grumman Aerospace Corp.'s F-14A Tomcat, ordering just 24 of the sweep-wing fighters, one-third fewer than this year. Money sought for fiscal 1980 is

\$666 million, down 25%. However, RDT&E for the plane is 85% higher at nearly \$28 million, and Navy officials say a significant portion of this will be used to upgrade the Tomcat's avionics.

One of the Navy's biggest aircraft electronics potentials lies with the Sikorsky Lamps III ship-based anti-submarine and surveillance helicopter. Proposed funding for the RDT&E project rises by 85% to nearly \$179 million from the present level. International Business Machines Corp. is principal electronic systems contractor for the craft.

For tactical missiles, the big new starter in the Carter budget is the Texas Instruments Inc.'s HARM air-to-surface missile that homes on radar emissions. Money sought more than doubles to nearly \$110 million for the joint program being managed by the Navy for itself and the Air Force. The proposed funds are about equally split between purchasing the first 80 missiles and the continuation of the work on RDT&E for the new weapon. □

Electronics abroad

Italy looks for a miracle

That's what it will take on the part of the government to repeat 1978's modest increase in prosperity

by Arthur Erikson, Managing Editor International, and Jeff Ryser, McGraw-Hill World News

Italians managed to achieve a fragile prosperity last year despite considerable distraction—two new popes, a new president, and the tidal wave of emotion touched off by the assassination of Aldo Moro, perhaps the country's most respected politician. To consolidate that prosperity this year, Prime Minister Giulio Andreotti must develop a miracle mortar, and it won't be easy to find the right mix.

If Andreotti's alchemy works, chances are that the economy will show reasonable growth this year. Economists at the 24-nation Organization for Economic Cooperation and Development peg 1979 growth for Italy at 3.5% in real terms. Some Italian forecasters say that the growth rate could be running as high as 4.5% by the end of the year.

Nonetheless, it does not look like a particularly buoyant year for electronics equipment and components markets in Italy. *Electronics'* survey, made last fall, led to a forecast of \$3.957 billion for equipment markets in 1979. That works out to a gain of 12.1% over the estimated \$3.531 billion for 1978. Under the right conditions, a rise of 12.1% wouldn't be too bad. But conditions are not right. For one thing, the nominal rise dwindles to almost nothing when discounted for inflation. For another, the forecast 1979 rise falls well below the nominal gain logged last year—15.7%.

Charted. A quick look at the markets chart shows the main cause. Sales of consumer electronics equipment, propelled strongly upward last year by a spurt in color television, will slow. Market watchers at the Associazione Nazionale Industrie

Elettrotecniche ed Elettroniche (AMIE) figure that Italian consumers bought 870,000 color sets in 1977 when colorcasting officially started in the country, and 1.25 million last year. But for this year AMIE foresees a lot less bustle with its prediction of a rise of at least 10%. At factory prices, the market will edge up some 15% to just over \$730 million, according to *Electronics'* forecast.

The government-controlled telephone agency Società Italiana per l'Escercizio Telefonico (SIP) has kept its investment spending almost constant in real terms for the past few years. What is more, SIP is not switching to electronic switching as fast as originally planned, although it has cut over the first of the Italian-designed Proteo electronic exchanges. So communications-equipment makers face a lackluster home

market this year. The survey suggests markets totaling \$595 million, up from an estimated \$535 million last year. However, there is substantial growth in sight for suppliers of military electronics gear. The Italian army, navy, and air force all have big budgets for long-term equipment programs.

The government has telecommunications makers on the list for a \$115 million share of the \$605 million it earmarked last summer to bolster research and development in advanced technology [*Electronics*, Aug. 3, 1978, p. 84]. What is more, SIP, which is part of the telecommunications holding STET, in turn controlled by the government holding agency Istituto per Ricostruzione Italiana (IRI) has been pushing for a tariff increase to finance investments in a new plant. □

ITALIAN ELECTRONICS MARKETS FORECAST
(IN MILLIONS OF DOLLARS)

	1977	1978	1979
Total assembled equipment	3,046	3,513	3,957
Consumer electronics	1,092	1,257	1,410
Communications equipment	481	535	595
Computers and related hardware	976	1,177	1,351
Industrial electronics	343	373	415
Medical electronics	75	83	91
Test and measurement equipment	50	57	63
Power supplies	29	31	32
Total components	578	668	735
Passive and electromechanical	282	321	354
Discrete semiconductors	72	78	85
Integrated circuits	77	89	104
Tubes	147	180	192

(Exchange rate: \$1 = 855 lire)

Note: Estimates in this chart are consensus estimates of consumption of electronic equipment obtained from a survey made by *Electronics* in September and October 1978. Domestic hardware is valued at factory sales prices and imports at landed costs.

Solid state

Faster, lower-power TTL looks for work

New Schottky logic families are entering marketplace even though potential users are not clamoring for them

by Raymond P. Capece, Solid State Editor

High-density metal-oxide-semiconductor processing technology is not the only place where capability is ahead of demand—it's also happening in transistor-transistor logic (TTL), the random-logic parts that build minicomputers and mainframes and hold together microprocessor-based systems. Here, the solution in search of a problem is know-how that enables several bipolar manufacturers to produce TTL that is faster and that draws less power than ever before. The problem: who needs the improved performance, and how much is needed?

A market of nearly a half-billion dollars that is already segmented into four permutations of speed and power dissipation, TTL is on the verge of being splintered by a shotgun blast of new speed and power offerings from four manufacturers. In the last few months, Fairchild Camera and Instrument Corp. and Raytheon Co., both of Mountain View, Calif., National Semiconductor Corp. of Santa Clara, Calif., and Texas Instruments Inc., Dallas, have announced or discussed with customers high-performance and low-low-power TTL designs that each hopes

will capture market share from existing families.

TI's offerings are the latest—two new families to be added to the much-used 7400 series. The advanced Schottky (AS) line, SN54/74AS, is twice as fast as current Schottky (54/74S) parts, yet draws the same amount of power. The advanced low-power Schottky (ALS) line, SN54/74ALS, not only uses half the power of today's low-power Schottky parts (54/74LS), but is more than twice as fast.

In terms of functions, TI has two different paths in mind for the families. Bob Stehlin, design development manager, says ALS will duplicate 72 functions of its predecessor, the LS family. Eventually, all members of the LS family will be duplicated in ALS. The AS line, on the other hand, will concentrate on improved functionality, over the S-family parts. Although no exact duplicates are planned, some parts will be very similar. Altogether, as many as 22 different functions will be offered as samples during 1979.

History. The attack on what is supposed to be a standard logic family essentially began in the fall of 1977, when two of IBM Corp.'s divisions independently issued requests for quotes on enhanced TTL. One was looking for some parts with higher speed—twice as fast as Schottky TTL—while the other wanted half the power of low-power Schottky at the same speed. The bidding was open to almost all manufacturers of TTL, including Motorola Semiconductor Group's bipolar operation in Mesa, Ariz., and Advanced Micro Devices Inc. and Signetics Corp., both in Sunnyvale,

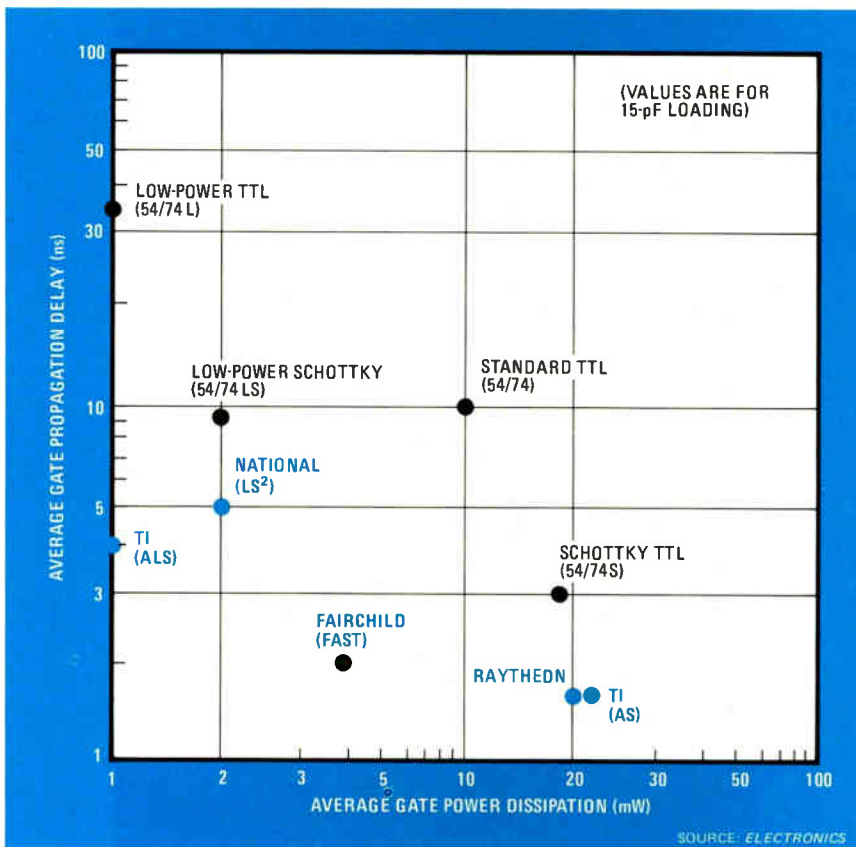

NEW TRANSISTOR-TRANSISTOR-LOGIC FAMILIES

Manufacturer	Family	Typical power per gate (mW)	Typical propagation delay per gate (ns)		Typical maximum toggle frequency (MHz)	Part types to be built initially	Initial price premium	Features
			15-pF load	50-pF load				
Fairchild Camera and Instrument Corp.	FAST	4	2	3	130	50 most popular standard-Schottky parts: 11 small-scale, the rest medium- and large-scale integrated	20% above Schottky	Isoplanar II process, current-mirrored outputs for higher drive capability, Schottky-clamped inputs, short-circuit protection, three-gain-stage gate designs
National Semiconductor Corp.	LS ²	2	5 - 6	7 - 8	32	all low-power Schottky	20% above low-power Schottky	higher noise immunity (800 mV)
Raytheon Co.	Advanced Schottky (54/74 AS)	20	1.5	2.2	200	gates, flip-flops, and MSI or standard Schottky	25% to 30% above Schottky	higher output drive capability
Texas Instruments Inc.	Advanced Schottky (54/74 AS)	22	1.5	2.8	200	no exact duplication of standard Schottky - 20 to 22 new arithmetic functions	15% to 30% above Schottky	output current sink boosted to 40 mA in many parts, new 300-mil, 24-pin DIP, ion-implant, no diffusion, low temperature coefficient
	Advanced low-power Schottky (54/74 ALS)	1	4	6	50	25 popular SSI and MSI low-power Schottky parts	15% to 30% above low-power Schottky	plug-compatible with LS, new 300-mil, 24-pin DIP, all ion-implant

SOURCE: ELECTRONICS

Calif., as well as the four chip makers already mentioned.

AMD and Signetics, neither of which is supplying enhanced TTL parts to IBM, are evaluating their positions, but sitting tight. Rick Goerner, marketing manager for Signetics' logic division, points out that from a business standpoint it is hard for him to rationalize another small-scale integration family when Signetics is pursuing LSI gate arrays as an alternative to lots of random TTL packages. "I wonder if users want another single-sourced TTL family," he adds.

The issue of an alternate source of parts is a critical one. "Our customers just won't buy parts from a sole source," acknowledges Bill Kean, marketing manager for TI's ALS program. Although TI has no second source yet for either of its new product lines, Kean is confident that it will have no less than two within a few months: "If anyone wants to stay in the TTL business, he's going to have to make our parts."

TI's ploy is clearly to outperform the competition. While National's LS² family, for example, carries the

speed and power along the lines of the original IBM request for quotes—5-nanosecond delay and 2-milliwatt power consumption per gate—TI's ALS boasts 4 ns and 1 mW.

TI says it was developing its ALS family before it heard from IBM. Its AS line, however, was in response to an IBM request—but TI has since backed out of the contract. The only firms supplying IBM are Raytheon, Fairchild, and Motorola.

Big splash. Motorola's entry into low-power Schottky occurred almost overnight, late in 1976, when it gave Fairchild rights to its 6800 micro-processor in exchange for TTL masks. Motorola turned around the entire 7400 family—then about 85 parts—in a few months.

So where is Motorola's super-Schottky entry? "We just don't feel that the markets are clearly enough defined," explains Henri Jarrat, a vice president and the director of bipolar operations. "Until we get a better feel for what the customer wants, we can't act," he says, although industry sources expect Motorola's decision is imminent.

Apparently, Motorola is caught

between loyalty to Fairchild, which already has its FAST parts available, and interest in TI's devices, which carry clout plus better specifications. But the question of customer demand is valid—IBM's contract is not large enough to keep any chip maker producing a new product line. "It's the Burroughses, Univacs, and DECS that we're waiting to hear from," Jarrat explains. "They're not giving us a clear indication of the performance they'll be needing."

One design engineer from Digital Equipment Corp. in Maynard, Mass., admits that a clear answer is difficult: "It's hard to say, 'Yes, we'll start using a new family in an existing product,' because the parts can't just be plugged in. And for new designs, a logic, or gate-array approach might be better."

No matter which new TTL families are adopted, those parts will go into new designs; the families that have been around for years will not disappear overnight. The four- to six-year product life cycle is evidenced by the large sales of standard TTL—LS family shipments will pass standard parts near the end of this year. □

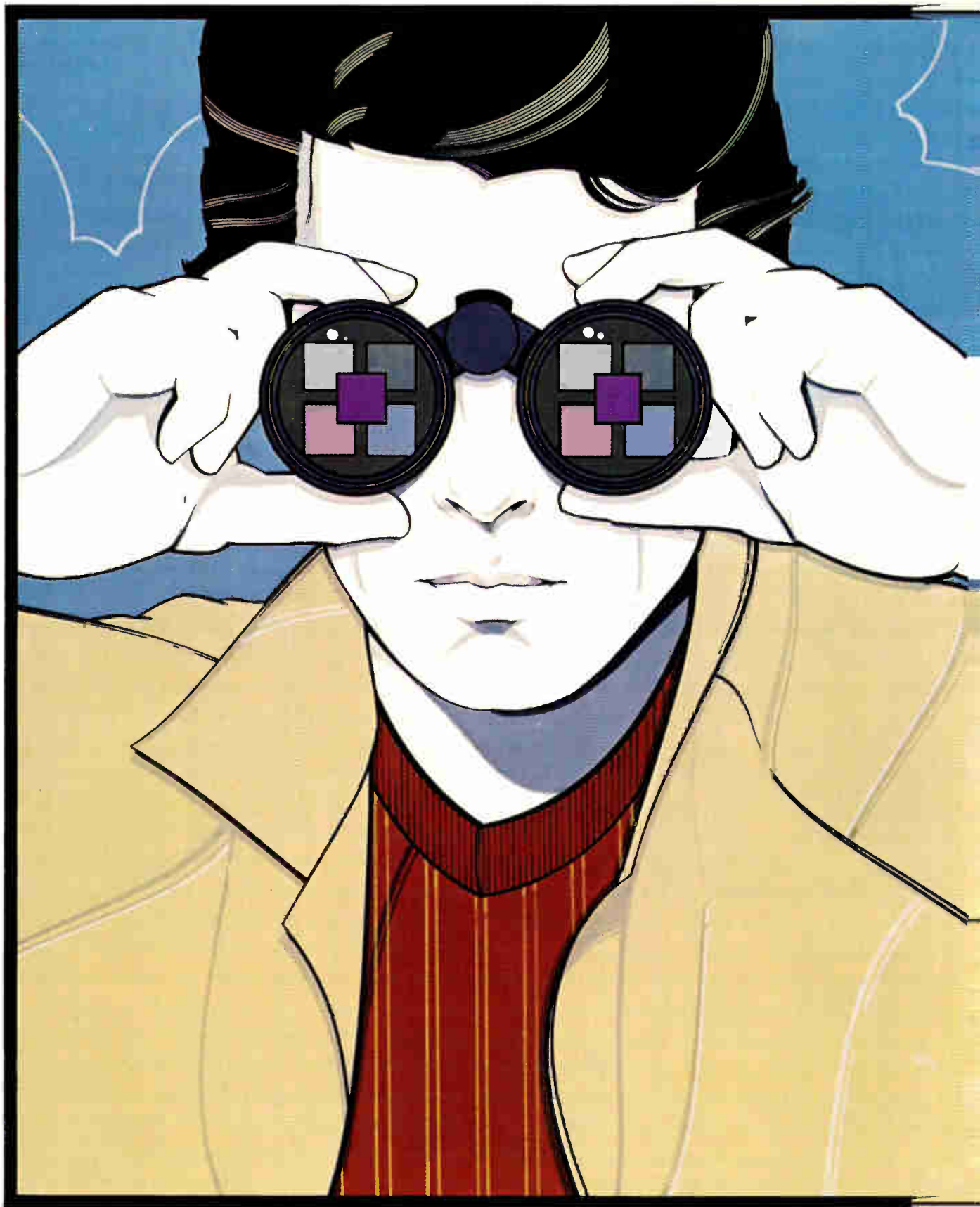

The Future Has Arrived.

Intel delivers the 8086. Powerful. Practical. And the Architecture of the Future. Here today.

We have seen the Future and it is called 8086.

Even better, it's here today. Our new 16-bit microcomputer is an architectural triumph, introducing designers to a new world of system expansion capability, high-level language programming and dramatically increased system thrupt.

Why we call it "The Future"

To deliver the Future, we designed the 8086 with a totally new architecture, super-efficient for implementing high-level, block-structured languages such as Pascal and PL/M-86.

The 8086 addresses up to a full megabyte of system memory with new addressing modes and efficient register utilization that totally support such minicomputer-like capabilities as relocatable and re-entrant code and instruction look ahead.

And the 8086's powerful new instruction set includes both 8-bit and 16-bit multiply and divide in hardware, with efficient byte string operations and improved bit manipulation.

We're committed to delivering the industry's highest performance, today and into the future. The 8086's architecture maximizes system thrupt today by delivering ten times the processing power of its 8-bit predecessors. Planned expansion promises another order of magnitude increase in performance through the addition of

I/O processors, special instruction set extension processors, memory management and distributed intelligence configurations.

System components for expanded multiprocessor applications are available right now, supporting the Multibus™ architecture in timing, control and drive levels. They include 8288 Bus Controller, 8282/8283 Octal Latches and 8286/8287 Octal Transceivers.

Get a jump on the future.

8086 is the most successful new microcomputer ever. The list of major market leaders who have evaluated 16-bit machines and chosen the 8086 is staggering.

One reason for the 8086's success is our commitment to *your* success. We've made the 8086 the industry's best-supported microcomputer. The cpu, interrupt controller and six additional support circuits are on distributors shelves, with more on the way. You can take advantage of the 28 existing Intel peripheral interfaces. Our 2716 (16K) and 2732 (32K) EPROMS provide programming

flexibility and unique features for 8086 users, including protection against bus contention.

And we complete your system with a variety of off-the-shelf +5 volt MOS RAMs.

You can begin hardware/software development today, using the Intellec® Microcomputer Development system with ICE-86 in-circuit emulation, PL/M-86 and ASM-86 for assembly language programming and 8080/8085 software conversion.

SDK-86, a complete system design kit including all essential components, makes it easy to begin prototyping without delay.

For an additional head start, iSBC 86/12 single board computer brings the power of the 8086 to the Multibus with a fully assembled and tested 16-bit system.

The Future belongs to you.

Get to market first and capture a piece of the future for your product. You can order the complete 8086 family from your distributor. Or, for more information, contact your local Intel sales office or write: Intel Corporation, Literature Dept., 3065 Bowers Avenue, Santa Clara, CA 95051.

intel® delivers.

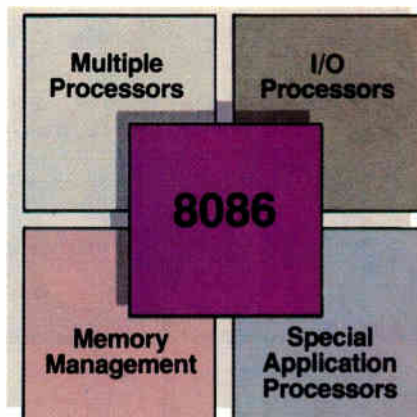

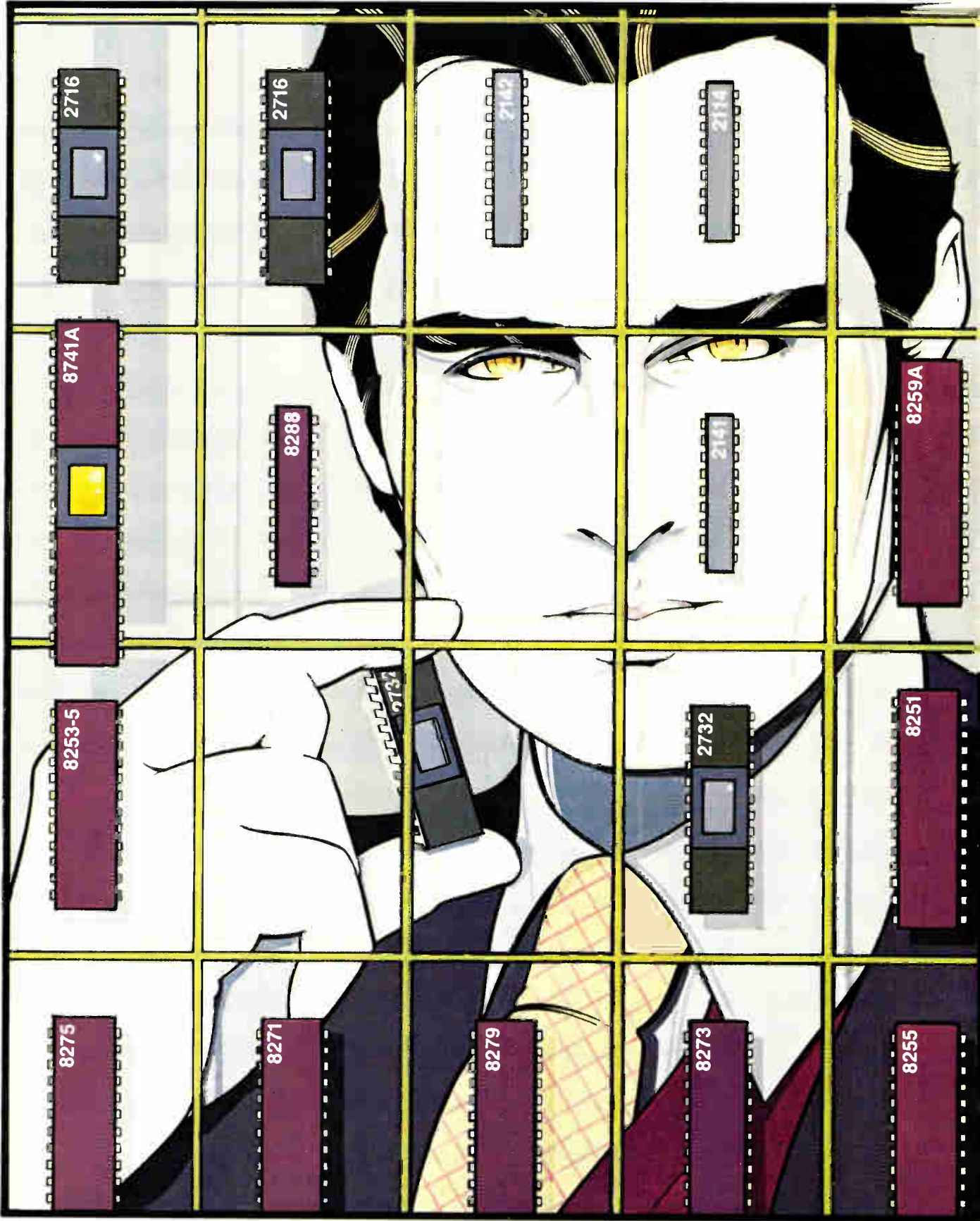

8275

8271

8279

8273

8255

8253-5

8288

2732

8251

8259A

8741A

2716

2142

2141

2141

2716

2716

2142

2141

2141

8086 System Success.

Intel delivers EPROMs, RAMs and peripherals you need to start building on the Architecture of the Future.

Intel's powerful microprocessor, the 16-bit 8086, gives designers the architectural foundation to create a new generation of microcomputer solutions. The success of these system designs, though, depends on the performance and availability of compatible support components.

We understood this interdependence when, seven years ago, we invented the first microcomputer. At each step since then, our achievements in data memory, program memory and peripherals have anticipated the demands of higher performance microprocessors. Today's 8086 designs can take advantage of our full complement of compatible components to start building the systems of the future without delay.

Our EPROMs exist to support microprocessors

Key to practical microcomputer design is the EPROM. We invented these erasable and reprogrammable memories to make system prototyping faster and simpler. Now that the 8086 has extended the use of microprocessors to more complex data processing, the program flexibility of EPROMs is more important than ever.

Two Intel EPROMs, the 2716 16K and 2732 32K, are ideal devices for 8086 systems. Both were designed with high speed, 5-volt microprocessors in mind. And they're the only EPROMs that give designers two independent control

lines to eliminate the possibility of bus contention in multiplexed and multiprocessor systems.

A RAM for every purpose

Intel delivers a variety of components to meet the data memory requirements of 8086 systems. Whether you're working in shared or multiple memory environments, Intel's family of 5-volt static RAMs gives you a full range of speed and power solutions.

Intel's 2142 (1K x 4), for example, is an ideal RAM for high performance systems. Because it has the same two-line control as our 2716 and 2732 EPROMs, the 2142 also simplifies design in high throughput, multiprocessor systems. With announced second sources, the 2142 is the new 20-pin

industry standard. In an 18-pin format, Intel delivers the industry standard 2114, with access times to 200 ns and the proven performance of the most popular 4K RAM ever. For even higher speed and lower

power, use our 2141. It's the 4K x 1 bit, high performance HMOS RAM that has speed versions to 120 ns, operating current as low as 40 mA active and standby current of 5 mA.

Building on 16-bit architecture

To get started quickly with 8086 designs, you can take advantage of the family of 28 interface and control components we've developed for Intel industry standard microprocessors. They include intelligent peripheral interfaces for keyboard display, communications devices and general purpose I/O peripherals. Intel controllers give you programmable command over floppy disks, SDLC/HDLC protocol and CRTs.

Start today

The surest path to system success with the 8086 is to specify Intel EPROMs, RAMs and peripherals. They're all here now. For detailed information on any of the above products, contact your local distributor. Or write Intel Corporation, Literature

Dept., 3065 Bowers Avenue, Santa Clara, CA 95051.

intel delivers.

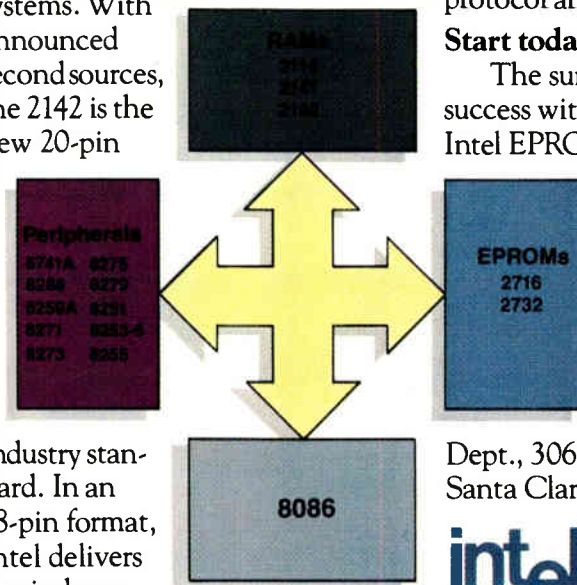



Shortcut to Success.

Introducing iSBC 86/12, the single board computer that brings the power of the 8086 to the Multibus standard.

There's no quicker way to implement designs with the new 8086 16-bit microprocessor than our new iSBC 86/12. It's dramatic evidence of the architectural capability of the 8086, with unprecedented computing power, memory and I/O capacity on a single board.

Multibus architecture ensures success.

The Multibus standard is your path to success with the iSBC 86/12 board. Since we introduced it in 1976 it has become the industry standard micro-computer bus. Even then we were looking forward to the 8086 and designed the Multibus architecture to support both 8- and 16-bit computers in single or multibus systems, and a full megabyte of directly addressable memory.

That gives you unlimited design flexibility, with immediate access to the complete iSBC family of 8-bit computers, memory boards, analog and digital I/O, peripheral control and communications boards.

Plus over 100 additional expansion boards from more than 40 independent suppliers. And Multibus compatibility means you can preserve your design investment as your application requirements grow from 8 to 16 bits.

iSBC 86/12 designed from experience.

We drew upon all our design experience to make the iSBC 86/12 board the most advanced 16-bit single board computer available.

At its heart is our 8086 CPU that gives the iSBC 86/12 board ten times the processing power of our 8-bit single board computers. We added 32K bytes of dual port RAM, fully accessible by all Multibus masters in shared memory designs. There are sockets for up to 16K bytes of EPROM. And the advanced architecture of the 8086 addresses up to a full megabyte of system memory.

The iSBC 86/12 board has a flexible I/O structure, with 24 programmable parallel I/O lines and a programmable synchronous/asynchronous communications channel with RS232C interface and programmable baud rate generator. In addition, the iSBC 86/12 architecture provides nine levels of vectored interrupt control and two programmable interval timers.

More than a shortcut.

The iSBC 86/12 board is a fully assembled and tested computer, dramatically reducing development time compared to component level design. More important, lower hardware costs enable you to incorporate the iSBC 86/12 board in hundreds of performance-dependent applications where the size and cost of larger computer systems would be prohibitive.

And, with Intel, there's no penalty for success. When volume makes it more economical for you to build instead of buy your boards, we'll provide manufacturing drawings, pc artwork and a volume source for all the essential LSI components.

The same Intel[®] Microcomputer Development System used with all Intel[®] microcomputers supports the iSBC 86/12 board with features such as ASM 86 assembler and PL/M 86 block-structured high level system programming language. You can debug your software right on your prototype system with ICE-86 In-Circuit Emulator or with the iSBC 957 Interface and Execution package.

Attend an iSBC seminar in your area.

The best way to get started with this new-generation Single Board Computer is to attend the Intel iSBC seminar in your area.

You'll learn about the iSBC 86/12 board and the rest of the iSBC product line. And we'll take you through the configuration and design cycle for several applications. For a seminar schedule and detailed information contact one of the Intel regional offices listed below.

And, for a free copy of our iSBC Configuration Planning Kit, or for on-site configuration or pricing assistance, write: Intel Corporation, Dept. 4-903, 3065 Bowers Avenue, Santa Clara, CA 95051.

intel[®] delivers.

Intel Regional Offices
Santa Ana, CA: (714) 835-9642 Boston, MA: (617) 667-8126
Chicago, IL: (312) 325-9510 Dayton, OH: (513) 890-5350

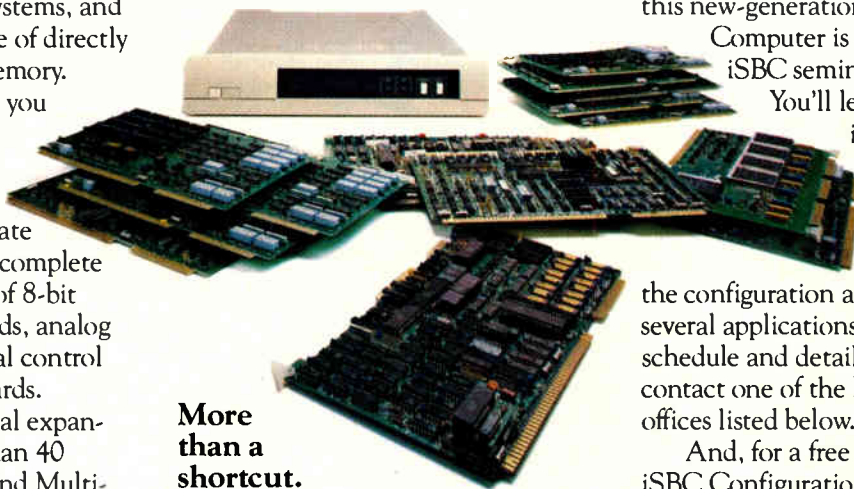

Recalibrate.

(Your thinking and your budget)

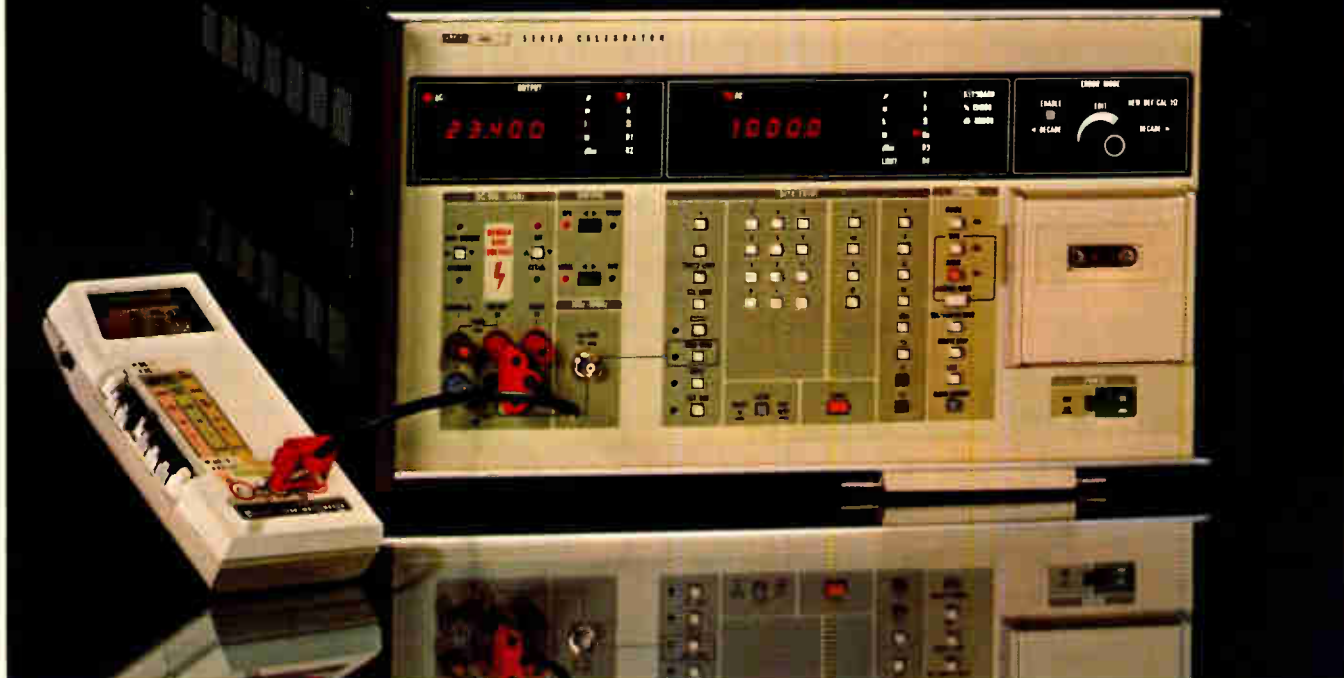

Our new 5100/5101A calibrators can calibrate VTVMs, VOMs, 3½-, 4½- and most 5½-digit DMMs around, in a fraction of the time it takes you now! (It's a cal lab in a box! All at an average price under \$9,000.)

For \$10,000 to \$15,000, you could invest in an intricate maze of instruments that takes a wizard to operate. Or, you could fill a room with computer-based hardware and expensive talent. About \$100,000 worth.

The Fluke μ P-controlled alternative.

We've designed the new 5100A and 5101A for production test, QA and cal lab applications that need large system flexibility at a fraction of large system cost.

The heart of our new meter calibrators is a microprocessor that eliminates mechanical switches—the largest contributor to failure in conventional calibrators.

And, you can enter your tolerances

in dB, volts or percent. The μ P converts for you! For safety, store current or voltage limits and protect both your operator and the meter being calibrated.

Microprocessor control also facilitates scaling (for linearity checking), and makes your calibrator a *rangeless* instrument, always selecting the proper range for maximum resolution, *automatically!*

Automation or economy? Fluke has both.

The 5100A is perfect for manual bench operation or integration into your existing cal system to upgrade it to Fluke standards of calibration



excellence. Priced at \$6,995, you save dollars but don't sacrifice accuracy or overall performance.

For perfection in automated calibration, you'll want the 5101A with its *mini-tape cassette reader*, a unique new feature that allows you to store up to 58 calibration settings, including limits and tolerances. Only \$9,495.

Both models have a friendly calculator-type keyboard. And, both have the RS232 or IEEE 488 system options you want for remote operation or hard-copy printouts of results.

Call (800) 426-0361*, toll free. Ask for complete technical specs or the location of your local Fluke office or representative. Or, write: John Fluke Mfg. Co., Inc., P.O. Box 43210, Mountlake Terrace, WA 98043. In Europe: Fluke (Nederland) B.V., P.O. Box 5053, Tilburg, The Netherlands. (013) 673973. Telex: 52237.

Prices U.S. only.

*Alaska, Hawaii, Washington residents please call (206) 774-2481.

Command Performance: Demand Fluke Calibrators.



6101-5100

Circle 98 for literature

98

Circle 205 for demonstration

Electronics/February 1, 1979

—— VLSI

—— LSI

—— MSI

—— SSI

HIGH DENSITY RAISES SIGHTS OF

ECL DESIGN

by William R. Blood, Jr. *Motorola Inc., Integrated Circuits Division, Mesa, Ariz.*

□ In the realm of microprocessors, bipolar large-scale integrated circuitry has evolved very differently from the metal-oxide-semiconductor LSI technologies. Its big selling point is its speed, which can only be optimized for any given microprocessor application if the designer has control of the processor's bus structure, word size, and instruction set. The need for such control has led to the bit-slice approach in bipolar LSI circuits, which is quite unlike the more general-purpose byte orientation of slower MOS microprocessors.

The fastest bipolar technology is emitter-coupled logic, and ECL is the basis for the M10800 family of standard bit-slice parts.

The 10800 family

There are nine members in the 10800 ECL bit-slice family. Each handles 4-bit-wide data paths, but since each is designed around the slice concept, it can parallel itself to build a processor of any given word width. Moreover, each contains data ports for easy interconnection to other LSI circuits. The family includes:

- The MC10800 basic 4-bit arithmetic-and-logic unit.
- The MC10801 microprogram-control circuit.
- The MC10802 timing controller.

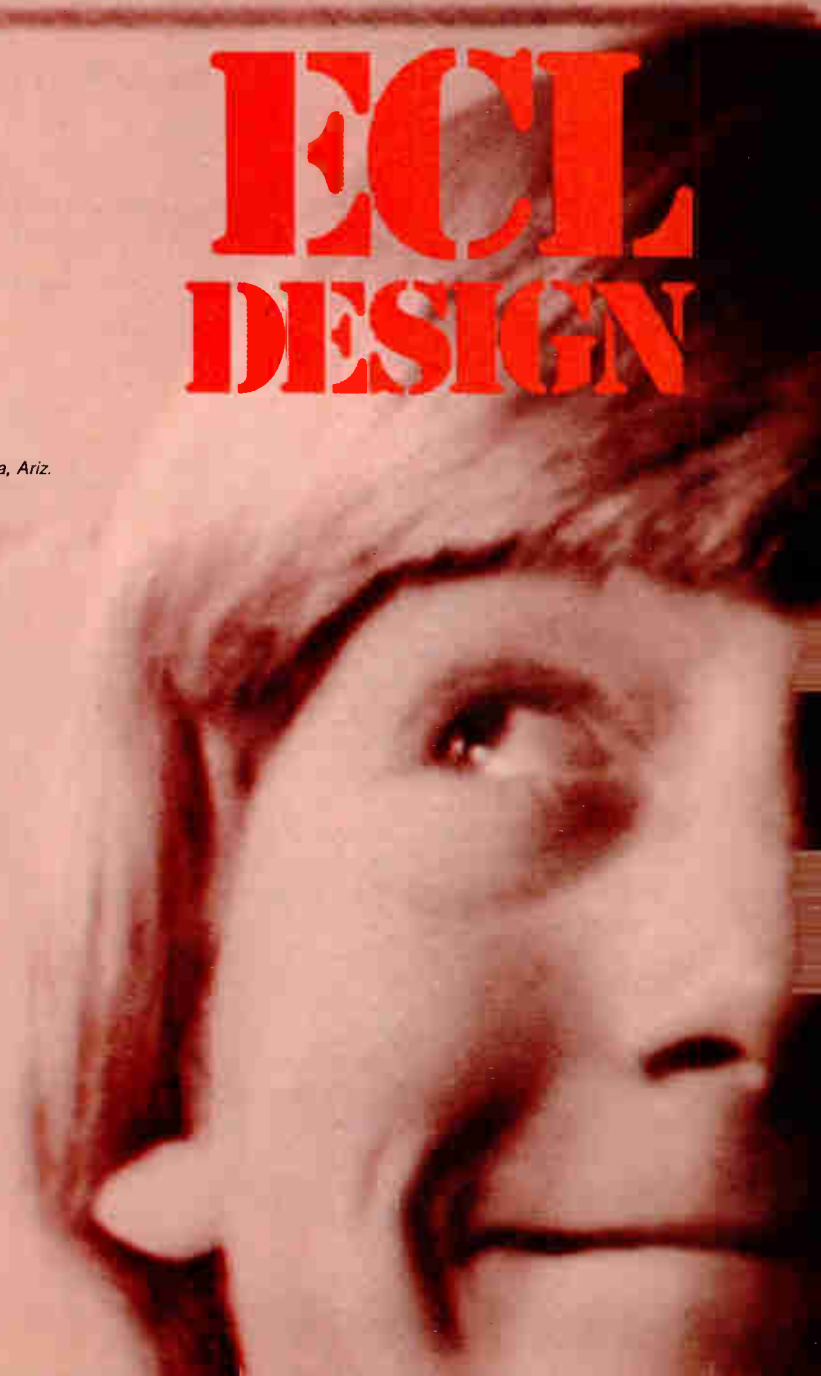

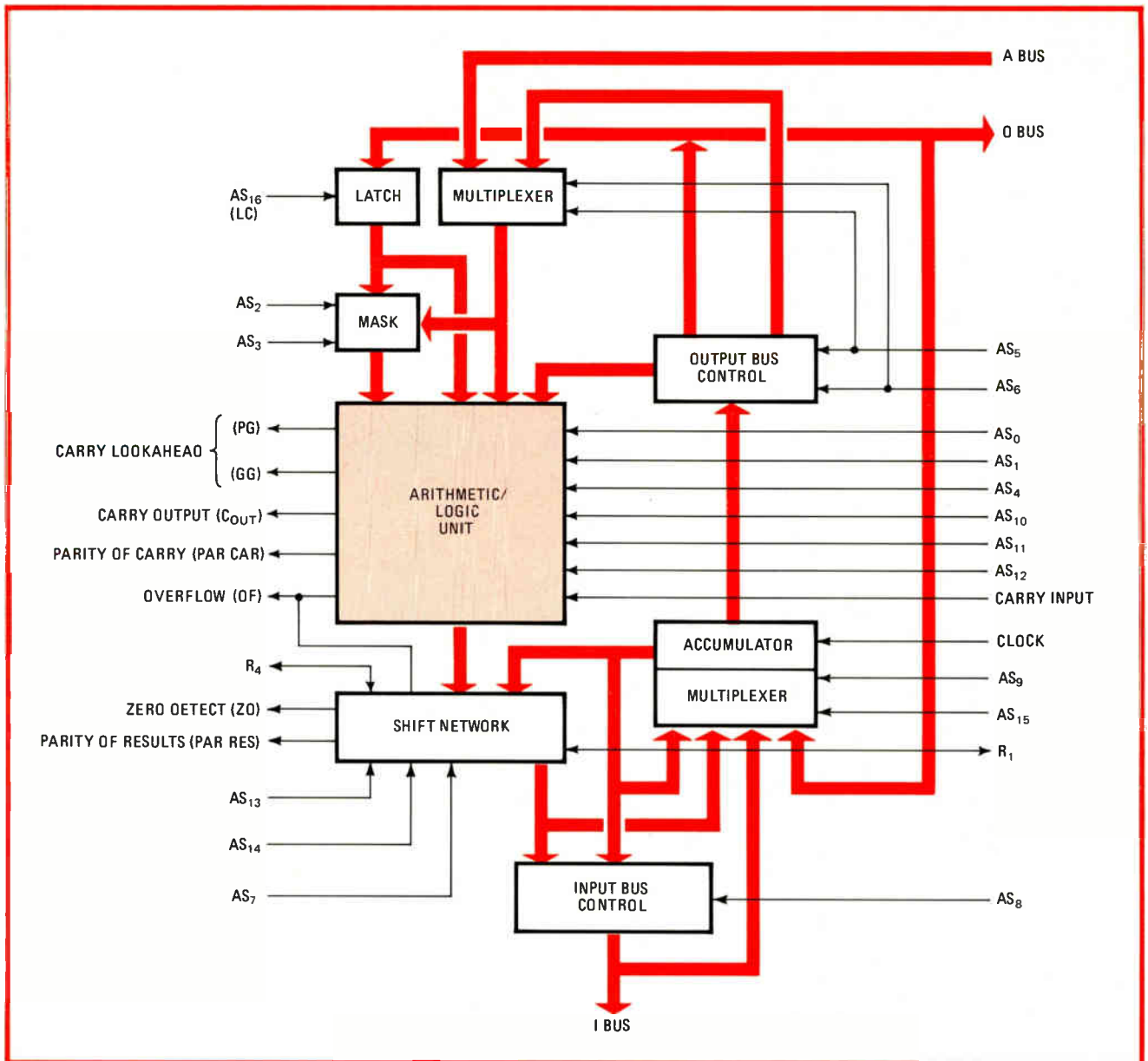

1. Processor element. The MC10800 4-bit arithmetic-and-logic unit slice is the heart of Motorola's family of high-speed emitter-coupled-logic circuits. Structured around three buses, two of which are bidirectional, the chip is capable of handling binary and binary-coded-decimal data.

- The MC10803 memory-interface circuit.
- The MC10804 and MC10805, which are 4- and 5-bit level translators for hooking ECL to TTL.
- The MC10806, a dual-access buffer memory.
- The MC10807 5-bit bus transceiver.
- The MC10808 programmable multibit shifter.

The parts also hook onto compatible ECL memories, such as the MCM10146 1,024-bit random-access memory.

The speed of the family is mainly attributable to new circuit design techniques, rather than any breakthrough in integrated-circuit processing. An example is the internal logic that operates off a -2-volt supply, which is better suited than a 5-v supply to the operation of multiplexers, registers, and some other commonly used logic elements. Those elements can thus be easily integrated with those circuit elements like adders that are better built with the series-gated ECL structures powered

by the conventional -5.2-v supply. Further, since the 10800 family of parts employs the same fabrication process as the MCM10146 high-speed 1,024-by-1-bit ECL RAM, they enjoy all the benefits of long-established, high-volume production.

The ALU chip

At the heart of the family is the MC10800 4-bit arithmetic-and-logic-unit (ALU) slice, which was the first in the family of standard ECL products to be developed. The chip performs the logic, arithmetic, and shift functions required to execute various machine instructions. Because the part was the first built with the new -2-v logic design, circuit complexity was held to the equivalent of a conservative 350 gates. The area of the chip, which employs standard design rules and double-layer metalization, is less than 15,000 square mils.

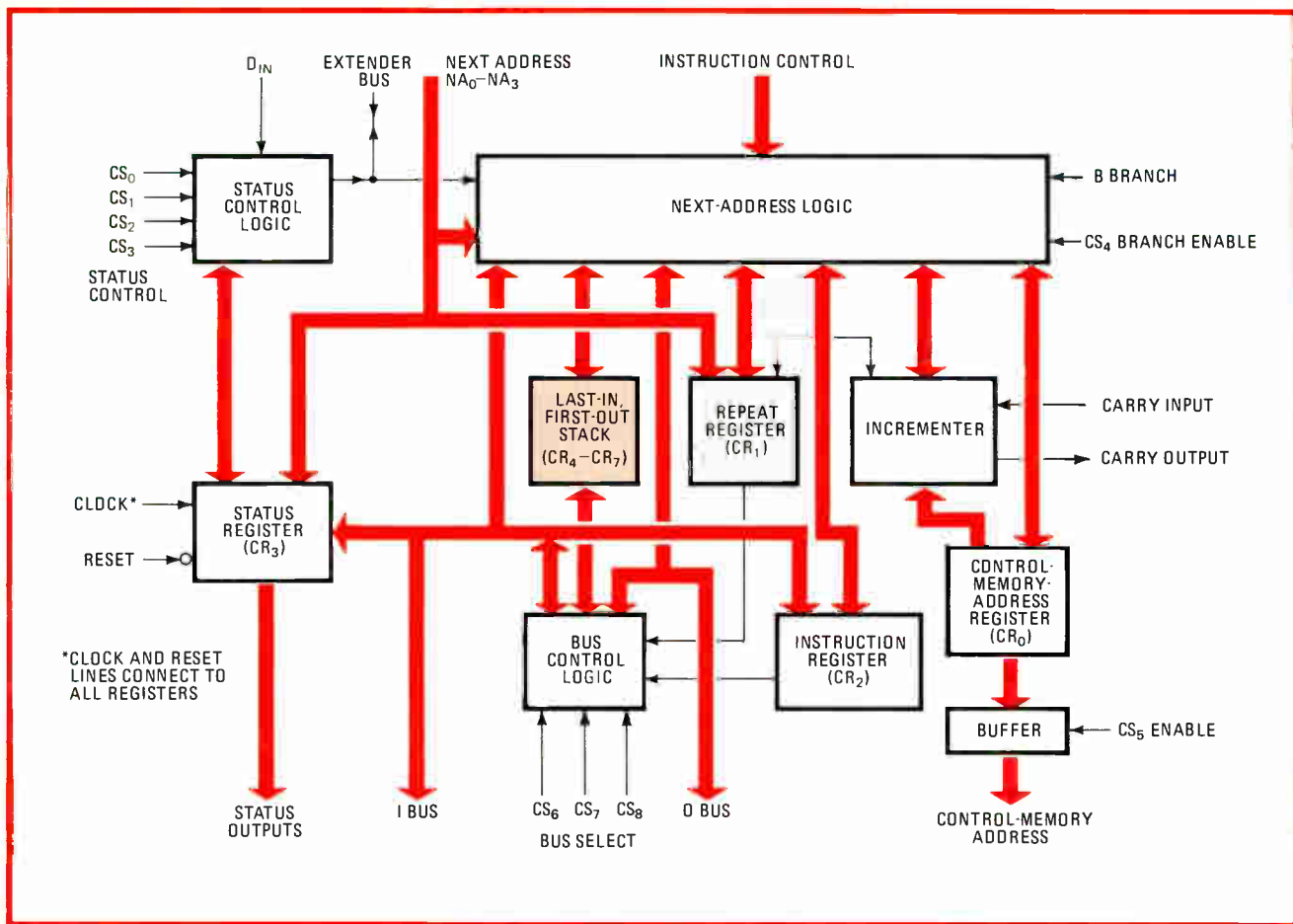

2. Controller. The MC10801 microprogram-control chip, which is also a 4-bit-wide slice, generates the microprogram address and provides the logic for complete sequence control. Five address buses interface to microprogram memory, to other parts and to external test points.

The 10800 operates with three data ports, as shown in Fig. 1. The I and the O buses are both 4 bits wide and bidirectional. The third, the A bus, is a 4-bit-wide input-only port. Control of the ALU is by 17 select lines, AS_0 through AS_{16} . The select lines control all circuit functions and determine the source and destination for ALU data. A full set of condition-code outputs, which include parity, carry, overflow, and zero-detect, simplify branch testing. Unique among bit-slice processor elements is the 10800's ability to perform both binary and binary-coded-decimal (BCD) arithmetic with equal ease and speed. Direct BCD arithmetic is gaining in popularity in business computers, process controllers, and test systems where human interface is most often in a BCD format. The chip also features a signal overflow shift network that indicates when an arithmetic left shift has prompted a sign-bit change.

The MC10801 microprogram-control chip is the companion part to the processor element and carries out the sequencing of operations. The development of the 10801, which packs 550 equivalent gates onto a 25,000-square-mil chip, proceeded all the more confidently because of the high yields already obtained with the less complex 10800 part.

The 10801, also a 4-bit-wide slice, is shown in Fig. 2. The control-memory-address register CR_0 holds the microprogram memory address, while the remaining

blocks in the figure provide logic for the sequencing operation. Register CR_1 , called the repeat register, is a special feature that adds greatly to the 10801's speed and flexibility. Aside from its usefulness as a cycle counter, which allows single instructions or subroutines to be executed a specific number of times by automatically keeping track of loop count, testing for end count, and remaining in or leaving the loop on test result, register CR_1 further provides a return destination for microprogram interrupts.

Register CR_2 is set up to hold a machine instruction starting address or an interrupt vector. Register CR_3 , however, is unique to the 10801 in that it interfaces microprogram control to external test points. The register can be loaded with any given bits of status information, whereupon it will test those bits for conditional microprogram jumps. Moreover, its contents can be set or cleared under program control to signal the processor's status. Finally, CR_3 can hold the page address in a word- or page-organized microprogram. In that case, memory address register CR_0 would hold only the microprogram word address.

Registers CR_4 - CR_7 form a four-word last-in, first-out (LIFO) stack for nesting subroutines within a program. With the logic built into the 10801, operation of the LIFO is completely automatic. If needed, however, the LIFO can be extended or tested for full stack through the I bus

TABLE 1: 10801 INSTRUCTION SET

INC	— Increment
JMP	— Jump to next-address inputs
JIB	— Jump to I bus
JIN	— Jump to I bus and load CR ₂
JPI	— Jump to primary instruction (CR ₂)
JEP	— Jump to external port (O bus)
JL2	— Jump to next-address inputs and load CR ₂
JLA	— Jump to next-address inputs and load address into CR ₁
JSR	— Jump to subroutine
RTN	— Return from subroutine
RSR	— Repeat subroutine (load CR ₁ from next-address inputs)
RPI	— Repeat instruction
BRC	— Branch to next-address inputs on condition; otherwise increment
BSR	— Branch to subroutine on condition; otherwise increment
ROC	— Return from subroutine on condition; otherwise jump to next-address inputs
BRM	— Branch and modify address with branch inputs (multiway branch)

or the O bus ports. Two branch inputs—the branch (B) and extended branch (\overline{XB})—supply status for conditional microprogram jumps.

The whole part is tied together with 16 instructions that are built into the next-address logic block. These instructions, listed in Table 1, control the source for each new microprogram word address and have been designed to save both microprogram memory size and development time. For example, an 8-bit shift in the ALU can be done with only two microprogram words—a repeat-subroutine instruction (RSR) to load the repeat number (8) into register CR₁, and a repeat instruction (RPI) to perform the eight shifts.

Control of timing

Clock control, often one of the most complex segments of processor design, is implemented with a single chip—the MC10802. As shown in Fig. 3, the chip contains the logic to generate multiple phases, simplify system start and stop, and provide some diagnostic capability.

The 10802 takes a clock input, usually from a crystal oscillator, and splits the signal into separate phases with its four-phase shifter block. The number of different phases can be programmed for two, three, or four phases. The go/halt, run/maintenance, and start inputs control system start and stop operations. The single-cycle/single-phase input helps with diagnostics by advancing the system one clock phase or a complete cycle for each starting signal input. Finally, a synchronizer network built into the part eases interfacing to the start input.

Hooking the bit-slice processor to slower memory and peripherals calls for the MC10803 interface chip. The part is designed for maximum speed: it can simultaneously route data while addressing the memory or peripherals. With 600 equivalent gates packed into a

21,000-square-mil area, the 10803 is actually denser than the 10801 microcontroller. The difference is due to a less complex metalization pattern used in the memory interface chip.

The 10803 has its own ALU. Also organized as 4-bit slices, several 10803s may be connected in parallel to meet any particular system data and address requirements. As shown in Fig. 4, the circuit has data and address ports for interfacing to peripheral equipment, plus the I bus and O bus for connecting directly to other 10800 parts. In addition, a fifth port with pointer inputs to the ALU can be used as a source of address modifiers or constants for memory addressing.

A memory-address register holds the memory address while a memory-data register buffers incoming or outgoing data. A separate four-word register file stores information that is needed in the course of memory addressing, such as the page addresses or the value of the program counter, index register, or stack pointer.

Some select inputs to the data-interface logic have control of a total of 17 data-transfer operations between buses and registers. Other select inputs control the function of the ALU and determine the source and destination of data through microfunctions and destination-decoding logic. Although the ALU is normally used for memory addressing, it can perform seven basic functions—add, subtract, OR, AND, exclusive-OR, shift-left, and shift-right—on a wide variety of data sources.

Certain systems can take advantage of the 10803 to reduce parts count. A peripheral controller, for example, transfers and formats data and usually requires little arithmetic capability. Such a system uses the 10803 both for input/output (I/O) control and as its main ALU, eliminating the need for a 10800.

Tying the parts into a system

The simplicity with which the parts of the 10800 bit-slice family can be assembled into a microprogrammable 16-bit minicomputer or signal processor is evident from Fig. 5. Although structures will vary depending on the application, the example illustrates several key features. Eleven LSI chips, together with a few medium-scale integrated parts and supporting high-speed memory devices, are all that is required.

Bus ports on the 10800, 10801, and 10803 directly interconnect. The 10801 microprogram controller supplies an address to microprogram memory, selecting one microprogram word. Each word is divided into groups of bits called fields (represented by the broad arrows at bottom). Each field independently controls a system section. Since all fields are present at the same time in each microprogram word, the various system sections can operate simultaneously for maximum system speed.

A system function performed by all the fields in one microprogram word is called a microinstruction. Several microinstructions may be required for one machine instruction. System performance, therefore, is determined by the number of microinstructions in a system and the speed of each microinstruction. Microinstruction cycle time for a 16-bit 10800-family-based system is about 100 nanoseconds.

The operation of the system in Fig. 5 can be explained

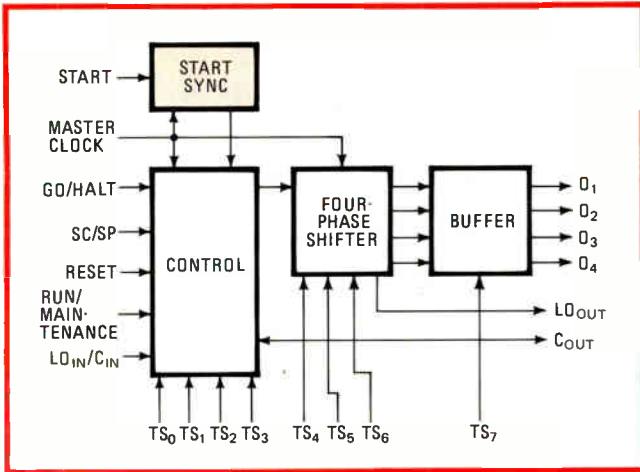

3. Timer. Many of the usual timing problems in bit-slice processor design are handled by the MC10802 timing function chip, including system start, stop, and clock control for diagnostics. A start synchronizer input simplifies interfacing to front-panel switches.

in terms of the relationship of microprogram fields to the LSI blocks. Two fields controlling the 10801 generate each new microprogram address. An instruction field selects one of the 16 program-flow instructions given in Table 1, and once selected, all logic needed to execute the instruction is contained in the 10801. However, some

instructions require additional information. For example, a jump-to-next-address or jump-to-subroutine instruction requires a destination, which is supplied by the next-address microprogram field. An important feature of the 10801 is the ability to route next-address data through the O-bus port for ALU or memory interface constants, bit-mask patterns, and offsets when the field is not required for microprogram flow.

Branch control is a third field associated with microprogram addressing. Most programs have to make a large number of flow decisions either from ALU condition codes, such as zero-detection, overflow, and sign bit, or from external test points. Under command of the control field, those status signals are multiplexed into the 10801 branch inputs through control logic. Branch instructions that have been built into the 10801 include branch on condition, branch to subroutine, and branch and modify.

The 10800 performs arithmetic, logic, and shift operations on data within its ALU, register file, and/or memory interface. The bus structure of the processor in Fig. 5 also allows the ALU to generate microprogram addresses through the I bus, if required. Moreover, the ALU will operate in either binary or BCD data formats as controlled by the ALU microprogram field.

Unlike most other bipolar bit-slice families, the 10800 family leaves the register file as a separate block. The

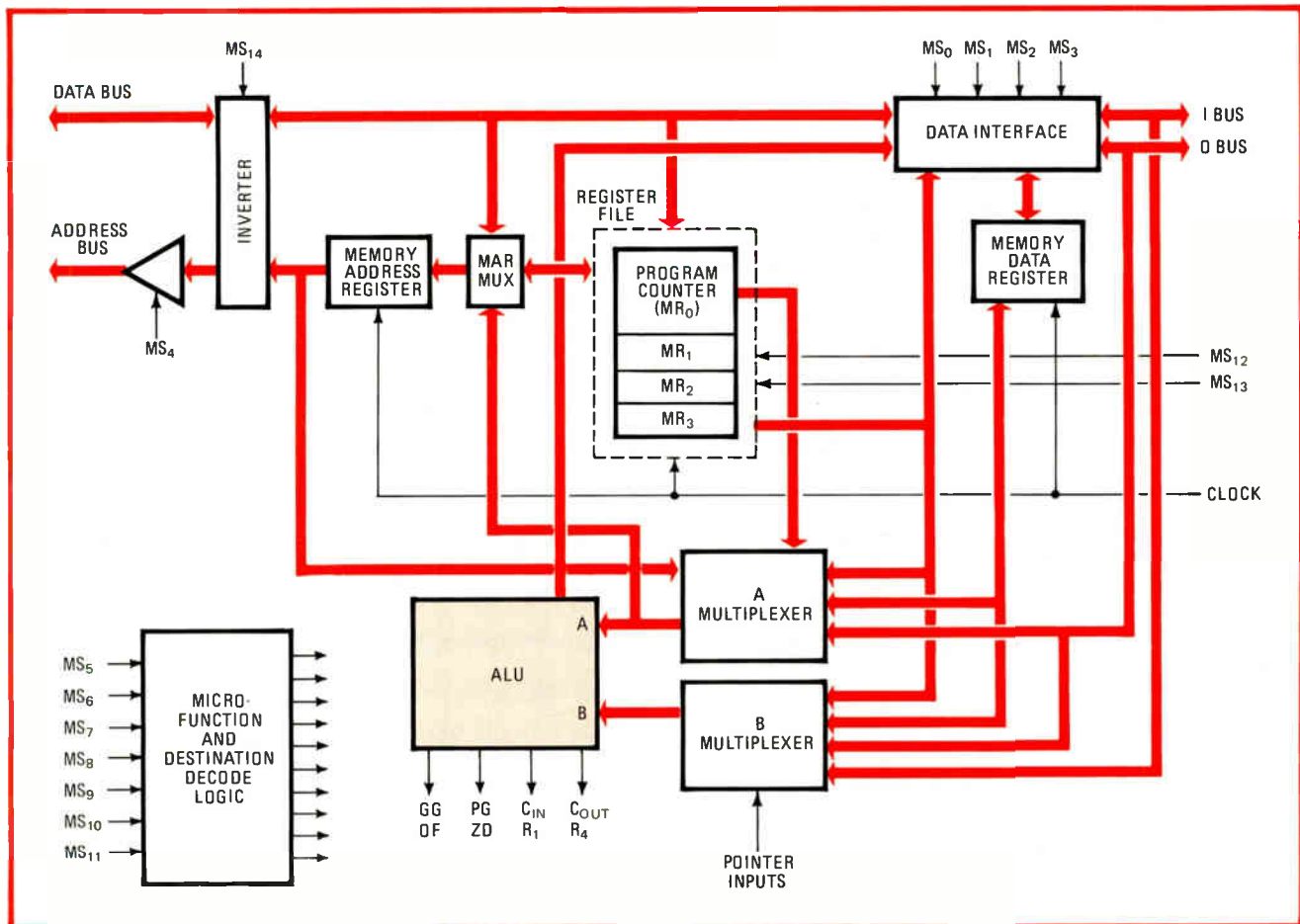

4. Interface. Interfacing the bit-slice processor to peripheral equipment through data and address buses, the MC10803 has separate select lines and provides for parallel data transfer and address generation within one microprogram cycle. It is expandable as necessary.

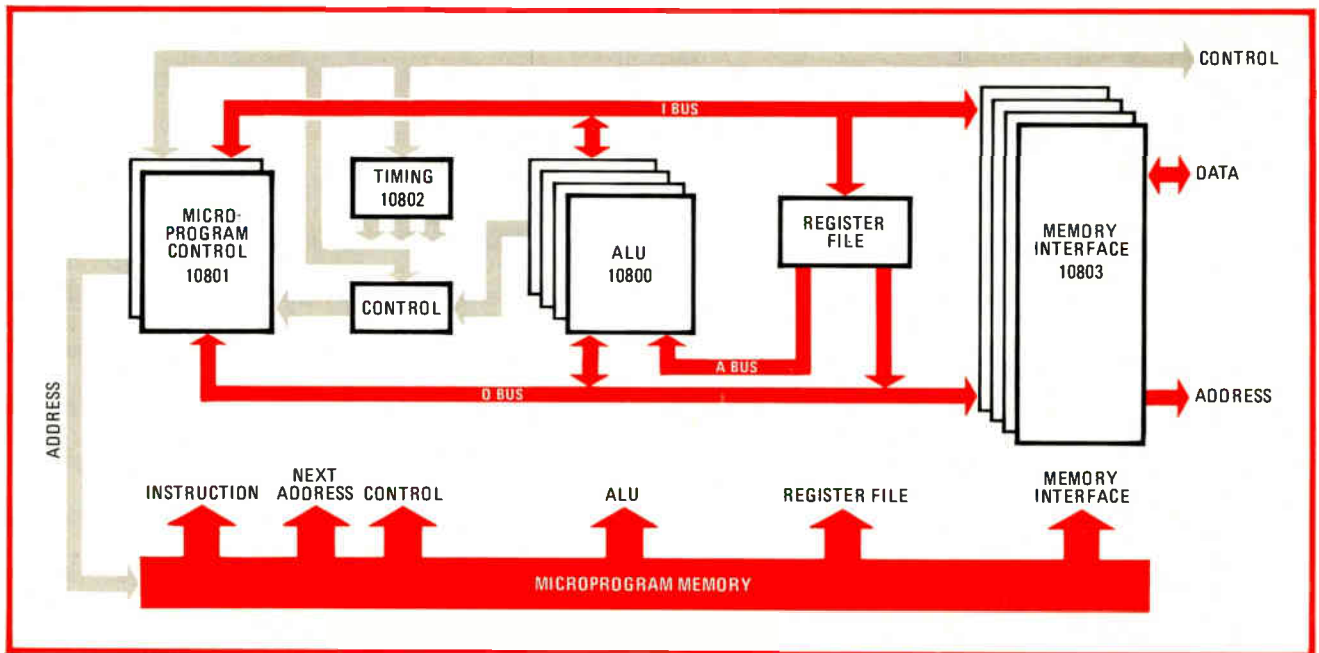

5. Tying it together. This design for a 16-bit minicomputer or signal processor uses only 11 LSI parts from the 10800 all-ECL family plus some ECL MSI parts and memories. Microcode for the processor is a wide word, shown at bottom; broad arrows indicate control fields.

advantages of that are the possibility of file expansion to any size and the flexibility of organization. But most important is the ability of the ALU and memory-interface circuits to share the register file without tying each other up. Some of the devices that may be used for the register-file block include MC10145 16-by-4-bit RAMs and the MC10806 dual-address stack.

The 10803 interfaces to peripheral equipment through data and address ports. The I and O buses can route I/O information directly to or from the required internal processor circuits. An architectural strength of the family is the 10803's ability to transfer data and to generate memory addresses independent of ALU operation. When not used for I/O control, the ALU in the 10803 can even be paralleled with the main ALU for double-precision arithmetic.

Beyond the main components already discussed that are required for processor design, bus-interface parts as well as special-purpose LSI circuits are needed to solve additional system problems. The MC10804 through MC10808 fall into those categories.

More circuits

The 10804 and 10805 are bidirectional level translators for hooking ECL buses to transistor-transistor logic. Many high-speed ECL processors will need to interface to TTL-compatible peripherals. Other translators, such as the 10124 and 10125, handle the interfacing of individual address and control lines. The 10804 and 10805 offer complete interfacing with translation of bidirectional data buses. The 10804 is a 4-bit-wide part in a 16-pin package, while the 10805 handles 5 bits in a 20-pin package. The two can also be combined to permit efficient translation of 9-bit data bytes. Figure 6 shows the internal logic used by both types for each bit.

A MECL/TTL select line controls the direction of data through the circuit. That combines with an output

disable to force the TTL side into a three-state mode and ECL to an equivalent low-logic-level output. An internal latch holds data in either direction. The latch-bypass input routes data around the latch for faster translation time or to transfer data while holding information in the latch. The 10805 is also designed to drive a heavy capacitive load and, as such, can interface an ECL processor directly to MOS main memory with high speed and a minimum of parts.

A useful variation

The MC10807 5-bit transceiver was produced when the demand arose for an ECL circuit with 10805 functionality, but without TTL-level translators. This circuit, shown in Fig. 7, is identical with the 10805 but has ECL signals on both ports. The buffered bidirectional ECL driver/receivers allow complex ECL bus networks to maintain a full transmission-line environment.

The MC10806 dual-address stack represents a milestone in standard ECL LSI products. Although equivalent gate count is not entirely pertinent as a description of a memory-type part, circuit complexity can be judged from the chip's large 35,500-mil-square area. Again, experience gained with the 10800 family has allowed circuit complexity so to increase that the 10806 is almost two and a half times larger than the 10800.

The 10806 is intended primarily as a data buffer between the high-speed ECL processor and slower peripherals; however, a versatile dual read/write bus structure also allows the circuit to function as a last-in, first-out or first-in, first-out stack, or as a 10800-system register file. The 10806 has two bidirectional data buses, the A and the B bus, each with access to a 32-by-9-bit memory (Fig. 8). Having output register latches in series with both data buses gives the circuit a master-slave appearance where the memory cells are master stages and the latches are slaves.

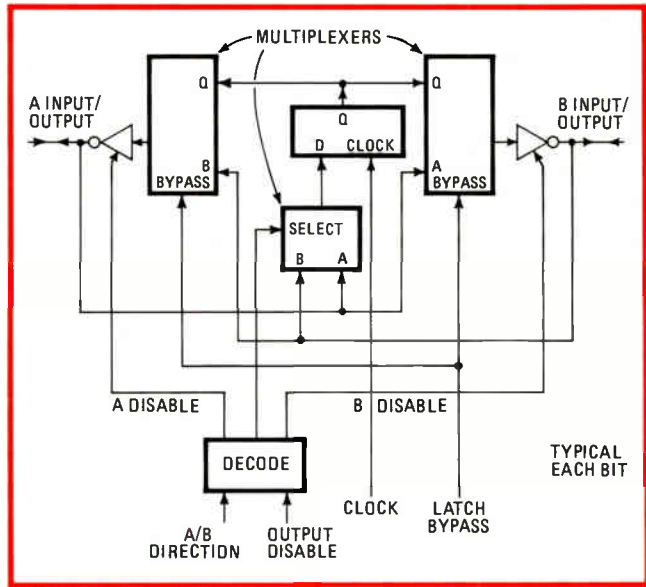
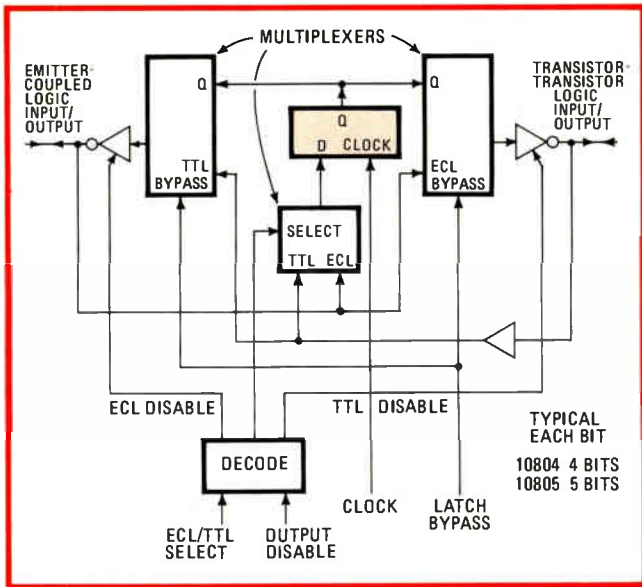

6. Translators. The MC10804 and 10805 bidirectional level translators interface ECL and TTL circuits. The circuit for a single bit is shown; the internal latch can be used to compensate for an ECL bus, which may be much faster than the TTL side.

7. Transceiver. Basically the same logic used in the 10805 level translator, the MC10807 5-bit transceiver has all-ECL inputs and outputs. Having a transceiver in a single package and not several greatly reduces fanout problems and chip count.

The A- and B-address inputs each select a memory word for the corresponding buses. Separate clocks and write- and data-enable lines control read and write operations for each side. Parity checking is automatic on the 9-bit data word and optional on the address inputs. When parity is used, the write operation is prohibited on any address with incorrect parity. Parity can be bypassed in those systems not requiring it.

A sign-bit input controls the sign-bit polarity and thus allows the circuit to operate in either positive or negative logic formats.

The ability to write from both data ports could lead to priority problems: writing different data on the A and B data buses into the same word address could cause loss of one or both data words. In order to avoid such an occurrence, address-contention logic in the 10806 looks at write-enables and addresses to detect and indicate address conflicts.

With the additional 10800 chips, the extremely high-performance processor of Fig. 10 can be built. Translators at interface points give the processor TTL-compatible inputs and outputs. A 10806 data buffer holds 32 data words, allowing the TTL bus to be slower than the ECL system microinstruction cycle time. The 10806 dual-bus structure easily adapts to the bidirectional data bus, so that both incoming and outgoing data can be stored.

Multibit shifter

Obtaining higher performance

The MC10808 programmable multiple-bit shifter is another example of standard LSI that solves a system problem. Using ALU circuits, which shift data only 1 or 2 bits per microinstruction, becomes time-consuming when data must be shifted many places for such jobs as formatting, bit testing, or normalizing floating-point numbers. The 10808 shifts data any number of bits in a single 10-ns pass.

The data bus following the 10806 buffer is routed directly to the microprogram control. Compared to Fig. 6, this bus structure saves instruction-execution time since a starting address need not go through memory interface, but the ALU no longer has a direct path to microprogram control.

Each circuit is a 16-bit shifter organized as shown in Fig. 9. The algorithm used can be combined with the ECL wired-OR feature for unlimited expansion—4 chips for a 32-bit shifter, 16 for a 64-bit shifter, and so on. Since expansion is in a horizontal manner, only the delay of a single part results, regardless of shifter size.

The system also uses the 10806 for a register file. The first half of a microinstruction reads a register file via the O bus, and then the second microinstruction half routes ALU results to memory interface or back to register file with the I bus. O bus latch, internal to the 10800 holds the O bus input during the second to eliminate race conditions within the ALU. The other register file port routes data through the shifter to the ALU A bus, to memory interface, or to microprogram control. The 10808 shifter is placed in front of the ALU for single-pass shift and test. Data shifting through the part only takes about 10 ns, and therefore the series arrangement has little effect on microinstruction cycle time. Moreover, the same microprogram ALU field can control both the 10808 and 10800 for a very powerful ALU function set.

The number of bits shifted is programmed through scale-factor inputs. Data-shift inputs select one of the eight possible shift types or output controls listed in Table 2. Two of the shift-right and -left instructions (SRC and SLC) program the scale factor as a 2's complement number, controlling both direction and distance of

A pipeline register is placed between microprogram memory and the data-handling LSI circuits to reduce microinstruction cycle time. The register permits parallel

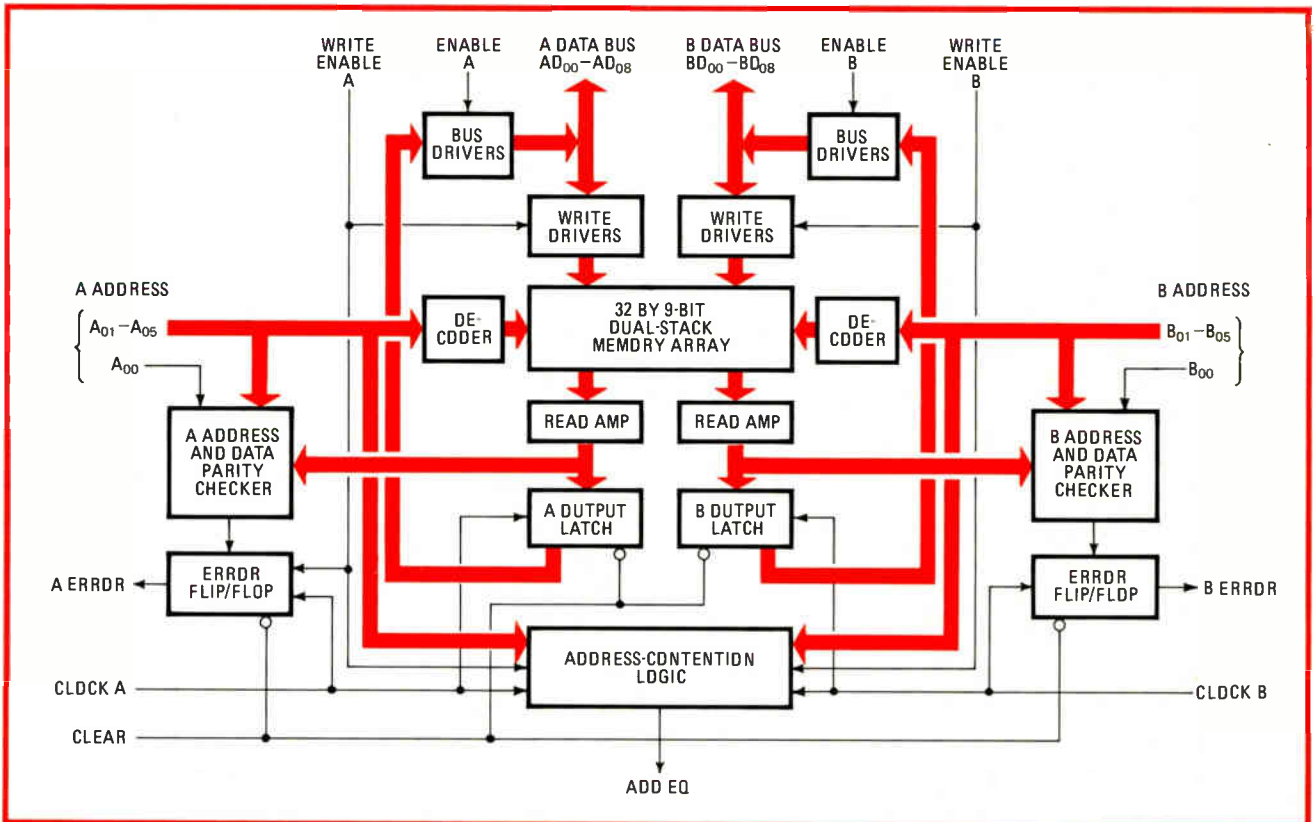

8. Stacked. The MC10806 dual-address stack has a 32-by-9-bit memory array with two independent read/write data ports. The dual-port structure combines with internal parity checking (which may be bypassed if unneeded) and solves many buffer-memory design problems.

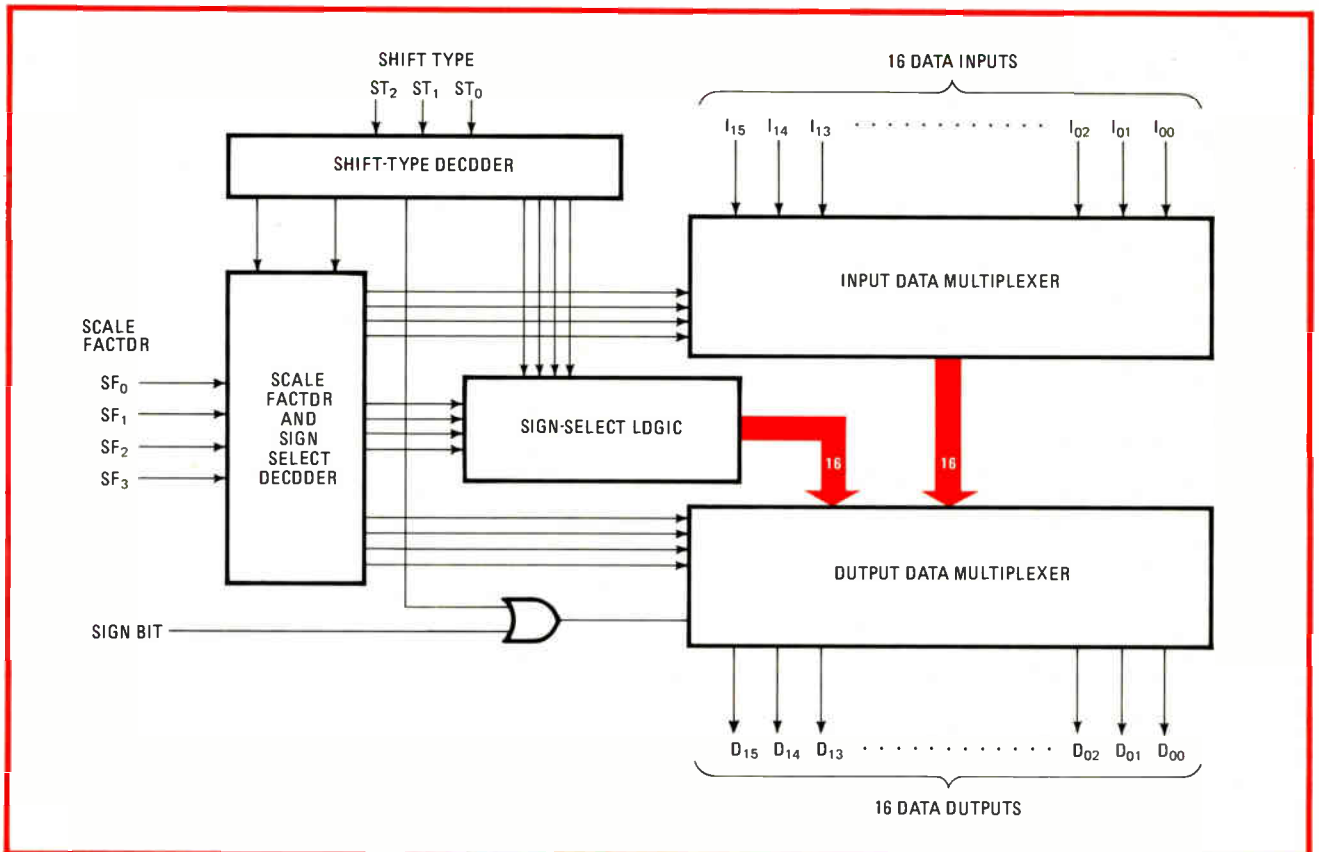

9. Shifter. A programmable multiple-bit shifter, the MC10808 shifts 16 input bits from 0 to 15 places to the left, to the right, or in rotation. Cascadable like the other bit-slice parts, the circuit can be easily expanded to larger word sizes at no sacrifice in speed.

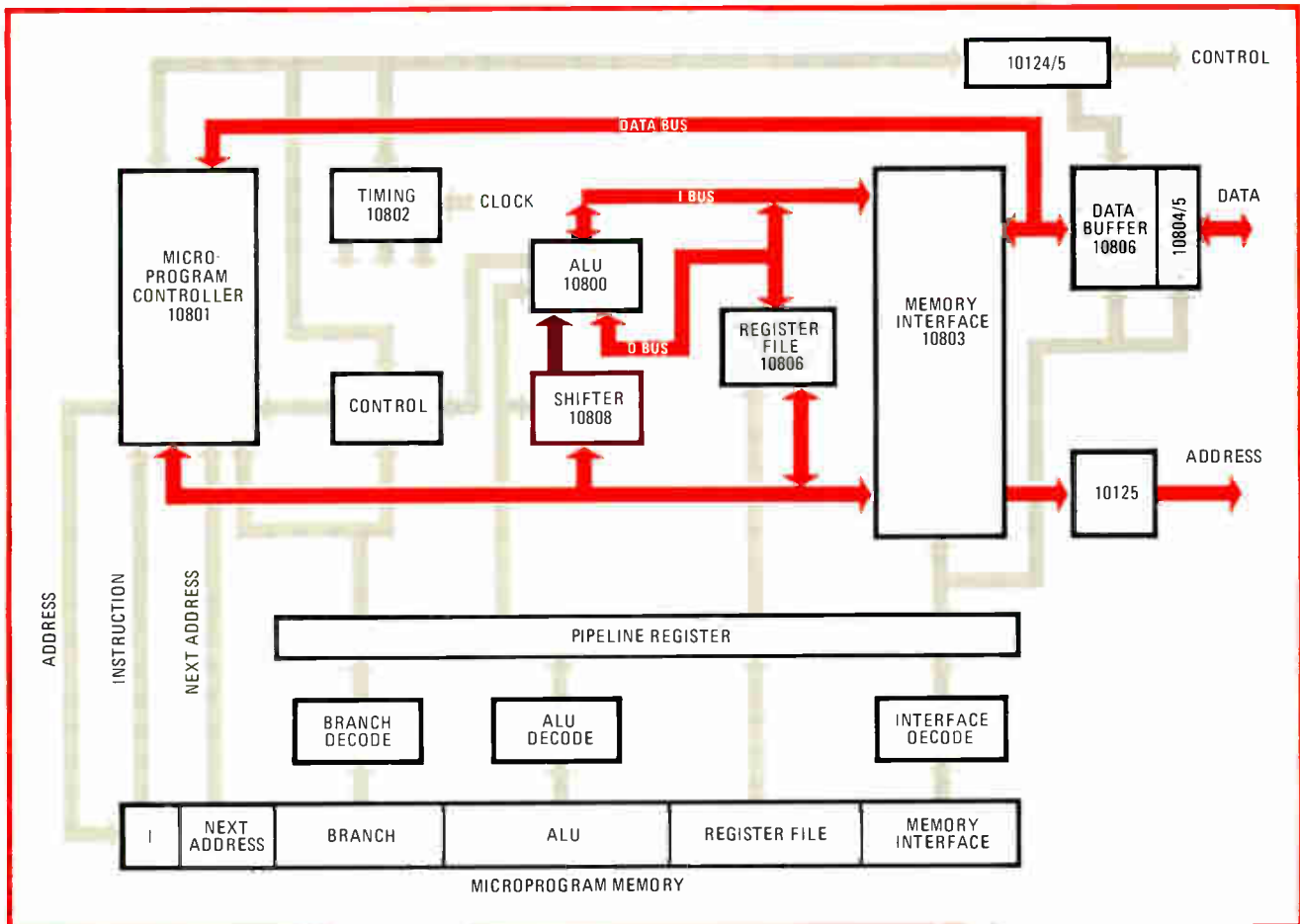

10. Superprocessor. Hooking the 10808 in series with the 10800 and supporting the 10806 with TTL translators creates an extremely powerful processor. The design also has a pipeline register to reduce cycle time, plus microprogram field decoding to cut word length.

TABLE 2: 10808 INSTRUCTION SET

ALS	—	ARITHMETIC SHIFT LEFT
ARS	—	ARITHMETIC SHIFT RIGHT
RLT	—	ROTATE LEFT
RRT	—	ROTATE RIGHT
SRC	—	SHIFT RIGHT - 2'S COMPLEMENT
SLC	—	SHIFT LEFT - 2'S COMPLEMENT
ODA	—	OUTPUT DISABLE
SBO	—	SIGN BIT AT ALL OUTPUTS

operation between microprogram control and the rest of the processor. While the ALU, register file, and memory interface are executing one microinstruction, the 10801 is generating a new microprogram memory address. Pipelining is optional in a system built with the 10800 family—the 10801 interfaces directly to the microprogram in either case.

A final feature of the high-performance processor of Fig. 10 is the use of branch, ALU, and interface-decoding logic. Those blocks allow a relatively wide pipeline register feeding a large number of LSI control inputs to be driven from a narrow microprogram word. For example, a 6-bit microprogram field can select 1 of 64 ALU instructions. The ALU logic, however, may require 12 to

20 control inputs. The fanout is performed in decode logic commonly built with fast 10139 programmable read-only memories (PROMs). In addition to reducing microprogram size for cost reasons, decoding logic allows microprogram fields to be structured for easier programming. The decoding logic does not slow system performance since it is possible to go from clock to the 10801's address output through microprogrammed RAM or PROM and from decoding logic to pipeline register, all within the cycle time of one microinstruction.

Future ECL LSI

Motorola has developed a MECL 10,000 Macrocell-array integrated circuit that is compatible with the 10800 parts and allows rapid development of high-speed LSI circuits with complexities of up to 750 equivalent gates. Although the Macrocell array will be used to develop specialized circuits for specific customers and systems, the advantages of this LSI concept will also lead to new standard products in the 10800 family.

The plans are thus to use new circuit developments to build on the 10800 family rather than around it. New functions under consideration include an advanced 8-bit arithmetic-and-logic and a very high-speed, expandable LSI array multiplier. These circuits, plus the Macrocell array concept, will be featured in an article on ECL LSI in the next issue. □

C-MOS on sapphire sparks small computer's performance

Functionally partitioned three-chip CPU resolves architectural challenge, packs big machine power into a small package

by Jake Jacobs

Hewlett-Packard Co., General Systems Division, Santa Clara, Calif.

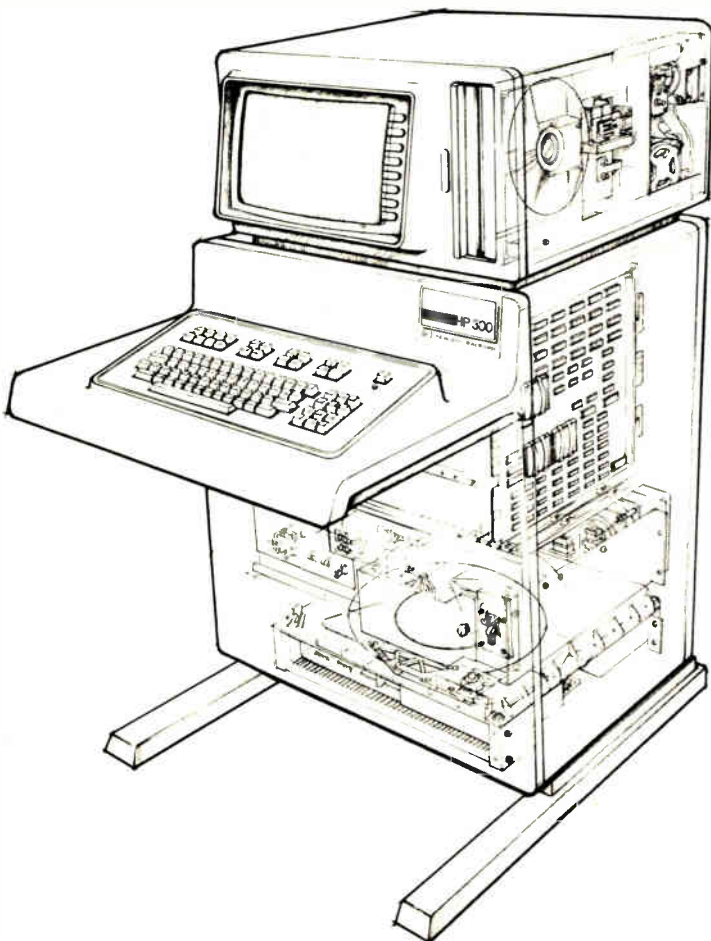

□ Recent advances in semiconductor technology, computer architecture, and software techniques are carrying small computer systems to a level of performance previously achieved only by larger machines. Along with the many advantages these new technologies bring come challenges and restrictions for the computer designer.

One successful resolution of this conflict is the recently introduced Hewlett-Packard HP 300 computer [*Electronics*, Oct. 12, p. 39], which melds complementary-metal-oxide-semiconductor-on-sapphire logic chips, 16-K random-access memories, Winchester disk-drive technology, and a virtual-memory operating system. The system packs into a single pedestal-style cabinet (Fig. 1) 1 megabyte of main memory, a 12-megabyte fixed-disk drive, a 1-megabyte double-sided, double-density floppy-disk drive, and input/output channels.

In addition, the I/O channels can support up to 16 additional cathode-ray-tube terminals and as much as 248 megabytes of external disk drives. Under control of the Amigo 300 virtual-memory operating system, the computer handles Business Basic and RPG II programming languages.

Shrinking CPU

To a large degree, the use of state-of-the-art semiconductor devices is responsible for the compact size of the computer. For example, large-scale integration fits 90% of the central processing unit's logic onto three custom C-MOS-on-sapphire chips (Fig. 2). An earlier HP processor, very similar in architecture to the HP 300, required eight printed-circuit boards the size of the two that now carry the complete CPU. With so much of the machine's architecture on so few chips, however, the computer designer faces semiconductor design issues he could previously ignore, in particular the question of how to partition the machine's structure among the chips.

When design of the CPU was started in 1974, various partitioning approaches were investigated. Bit-, nibble-, and byte-slice processors were examined, and two-, three-, four- and six-chip designs proposed. Rather than use one of the traditional slice approaches, HP chose a functional partitioning to minimize the effects of inter-chip propagation delays. It was further decided that no more than three different chips could be designed with the number of people available to do the job.

One main reason for choosing the C-MOS-on-sapphire semiconductors was their good speed-power product. Moreover, designing a C-MOS chip is much like designing with static flip-flops—unlike designs using dynamic n-channel MOS devices, where charge storage and timing are primary concerns. This gave C-MOS a distinct advantage because the computer designers on the project had never designed an integrated circuit before and felt much more comfortable with the familiar flip-flop schemes. When the design was first started, the team had yet to see a single circuit from HP's fledgling IC labs,

1. Mild-mannered exterior. Through the use of state-of-the-art semiconductors, computer architecture, and peripherals, Hewlett-Packard has been able to package a complete computer system with 1 megabyte of main memory and a 12-megabyte fixed-disk drive into what appears to be a CRT terminal on a pedestal.

so work on the process was proceeding in parallel with the development of the three-chip CPU.

Rather than computer-simulate the three chips, a transistor-transistor-logic functional breadboard of each chip was built, using wire-wrapping techniques. As each chip was manufactured and packaged, it was substituted for the TTL breadboard equivalent until all three LSI chips had replaced the breadboards. Only 60 pins on each chip could be used, since the commercial die-and-chip testers HP owned at the time could only accommodate that many pins. To overcome the limitation in one case, two signals had to be multiplexed on one pin.

The resulting microprogrammed processor consists of a processor control unit (PCU) chip; a register, address, skip, and special chip (RASS), and a register and arithmetic-and-logic unit chip (RALU). Together, the RALU and RASS form the data paths and manipulation portions of the CPU (Fig. 3). The RALU contains the arithmetic-and-logic unit, the shifter, and the working and bounds registers in the A-bus block. It measures 194 mils square and has 49 pins.

The RASS contains copies of some of the working and bounds registers in its B-bus block as well as bounds-checking logic and the pre-adder that is used to generate part of the address: the displacement from the current instruction and indexing if needed. The RASS also contains the microprocessor skip and special logic, measures about 176 by 204 mils, and has 58 pins.

The PCU is the microprogrammable control portion of the processor and contains the ROM address register, which holds the current microinstruction address, and the next-microinstruction-address calculation logic, which includes the microprocessor subroutine address-save register stack. It also contains the mapper, which maps the current instruction to an address in the microcode jump table and generates 16-bit constants for microcode immediate operations. The PCU measures 207 by 140 mils and has 60 pins. Because of pin limitations, it was necessary to multiplex the stack bit and right stack operand signals on one pin of the PCU. Each chip also has a ROM instruction register (RIR), which holds the microinstruction currently being executed.

Associated with the PCU are 6,000 words of microinstruction control store, made up of 8-K bipolar ROMs with a 100-nanosecond cycle time. The logic circuitry not on the three chips resides on the second CPU board. It contains the small- and medium-scale integration logic used to implement the intermodule-bus handshake logic, including the memory address, bus data, interrupt status, next instruction registers, and RIR.

The CPU clock runs at about 90 nanoseconds and can execute a microinstruction in between 270 and 720 nanoseconds, depending on the type.

Paralleling the chip creation effort was the microcode development—firmware that bridges the gap between the hardware processor and the software instructions. Each word of microcode is 32 bits long and is divided into seven sections: one each to control the A- and B-bus blocks, a store section to determine the destination registers, one to select which function is to be performed by the ALU, one that indicates on which conditions to skip to the next microinstruction, one to control the shifter,

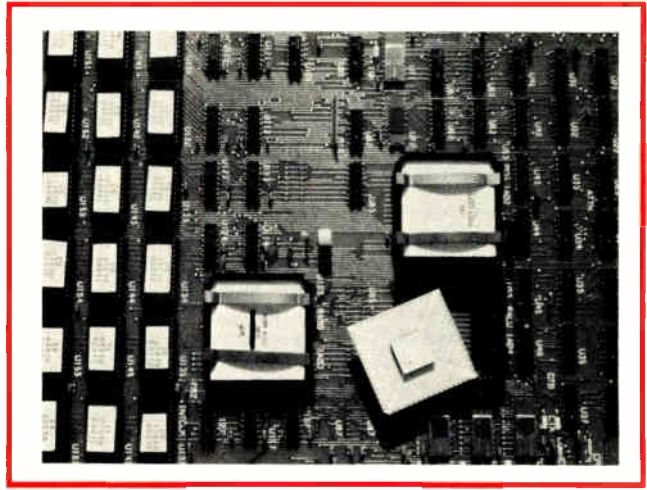

2. Heart of sapphire. A C-MOS-on-sapphire three logic-chip set is the heart of the HP 300. Shown here with their circuit board, they contain some 90% of the central processing unit's logic, reducing what used to be an eight-board CPU to two. The second board has the intermodule bus interface and the remaining logic.

and a section to indicate special functions not designated in another area, such as read and write.

Of the 6,000 words of microcode, 3,000 words are needed to implement the 170 instructions and the general I/O-channel code interpreter. The decimal arithmetic instructions require 700 words, 32-bit and 64-bit floating-point arithmetic requires 600 words, self-test is allocated another 1,200 words, cold-load and memory dump requires some 300 words. The remaining 200 words are allocated for future use.

The main memory system, too, is affected by semiconductor technology, consisting of 16-K RAMs that allow 128 kilobytes to fit on one board. The system has a cycle time of 500 ns and an access time of 430 ns. A 22-bit word is used for redundancy, allowing correction of all 1-bit errors and 2-bit error detection.

When a 1-bit error occurs, the error is also logged in a special error-log RAM on the memory controller. One bit in the error-log RAM corresponds to each 16-K main memory chip, making it easier for a customer service engineer to determine which chip, if any, has failed and replace it.

Virtual memory on a low-cost machine

This hardware and microcode form the basis for a powerful and versatile virtual-memory computer system. Virtual-memory software, which controls both the main memory and peripheral disk storage, exchanges information—be it data or program instructions—between disk and main memory. Information currently being used resides in main memory, while other unused portions are stored on the disk. This gives the user a memory capacity that appears larger than the physical amount of main memory contained in the computer.

Rather than the switching schemes based on fixed page or bank sizes generally used by minicomputers, the HP 300's Amigo operating system uses segmentation techniques. The processor hardware has a virtual-memory address space of over 130 million words, or 260

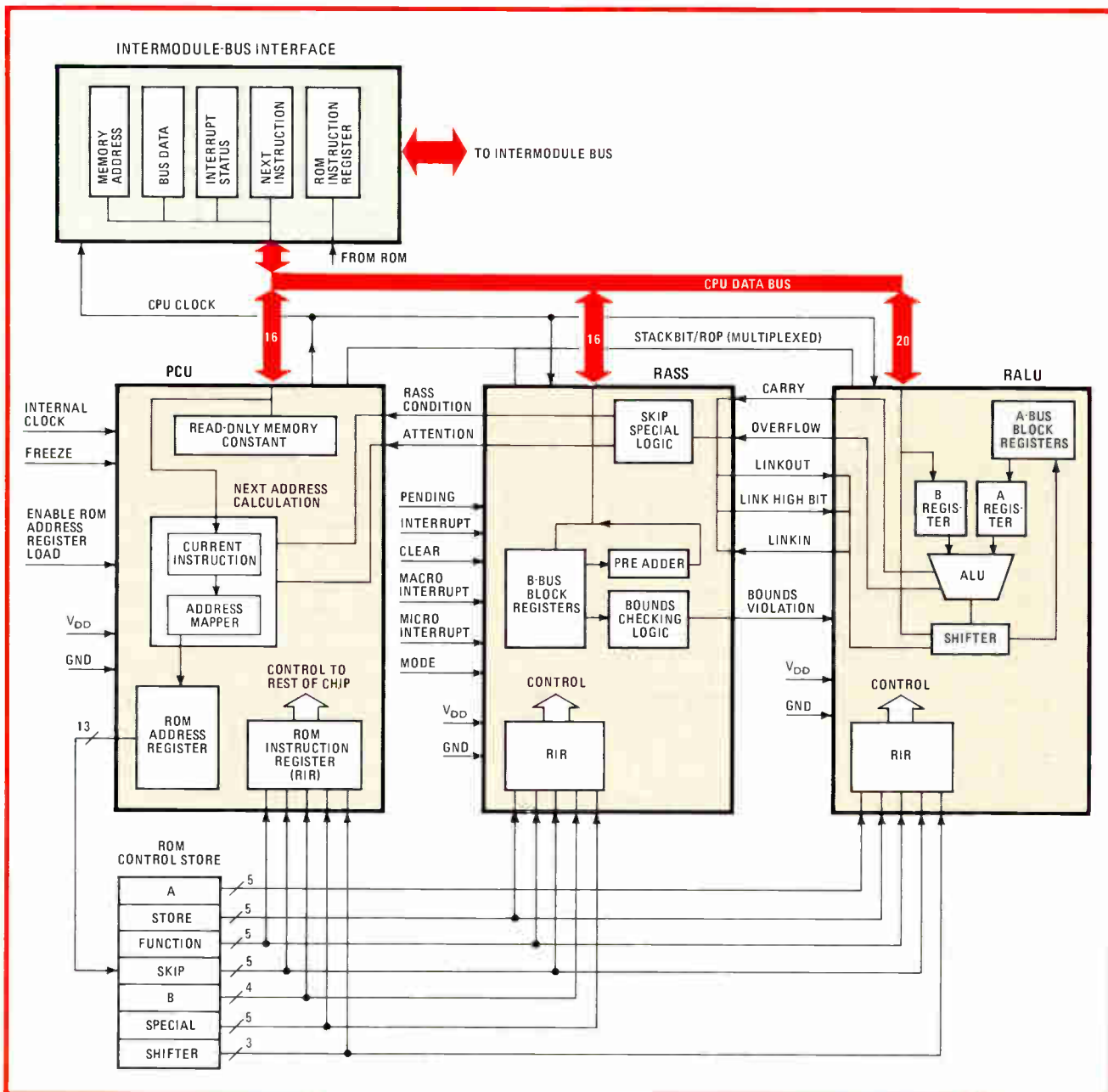

3. Functional partitioning. The use of large-scale integration poses new partitioning problems for the computer designer. Rather than a slice approach, HP functionally partitioned the computer architecture. The processor control unit generates addresses for the microinstruction control store, which provides the control for the register, address, skip, and special and the register and arithmetic-and-logic unit chips.

megabytes, available and the operating system currently allows each user's program to address up to 10 megabytes. The variable-length segments free the user from concerns about bank boundaries or page sizes.

Under the segmentation scheme, data and program instructions or code are stored separately. Only data can be modified during execution of a program, never code. Thus each user must have a copy of his own data. A user always has a stack, a global data area, and as many as 4,000 data segments, each with a maximum length of 32,000 16-bit words. But currently the operating system limits these segments to 1,000 words each.

All code segments therefore are "pure" executable code. Because the code can never be modified during

execution, it can be shared among many users running the same application program or compiler. Another advantage of pure code is that since it cannot be modified during execution, the copy on the disk is always identical to copy in main memory. This eliminates the need to "swap" it back to the disk before overlaying the main memory with new code or data, thus increasing operating efficiency.

Code segmentation provides up to 63 code segments of up to 16,000 words each for each user on the system. An additional 191 code segments are reserved for the operating system to reside in. A code segment can contain one or more code procedures. The user's main program, then, is merely a code procedure called by the operating

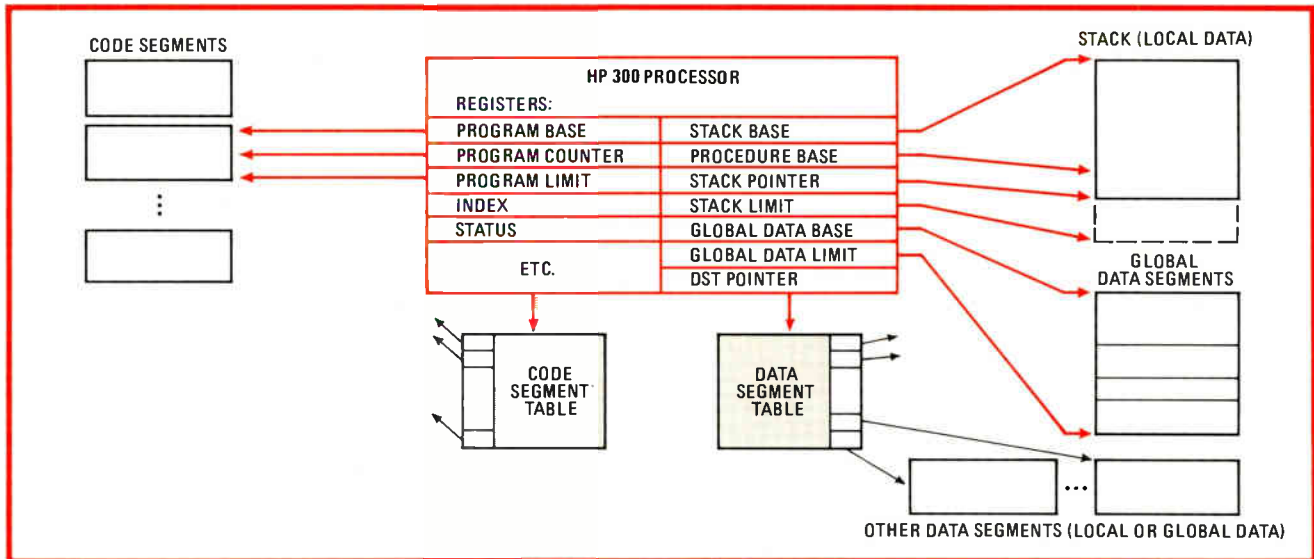

4. Hardware for software. Special registers in the HP 300 CPU make the virtual-memory software's addressing job easier. The logical addresses for programs are translated by the code segment table into actual physical addresses that are then stored in the registers. Data is manipulated in the stack, and can be stored in either the global data segment or in data segments referenced by the data segment table.

system. A procedure in any code segment may call another procedure in the same code segment currently in use or in another external code segment that is either resident in main memory or absent and therefore stored on the disk.

The user need not be concerned where in the physical memory the code or data segment happens to be at that moment. The microcode locates it and, should the segment be absent from main memory, informs the software operating system, which schedules a disk transfer to bring the segment into memory. The segment may be brought into any place in memory without requiring any addresses in the code to be modified. Thus all addresses in the virtual memory's code and data spaces are called logical addresses—the user never sees an absolute or actual physical address.

Although virtual memory is primarily handled by software, hardware registers in the HP 300's CPU assist the operating system in more efficiently managing the virtual-memory space (Fig. 4). For example, addresses in the code segment are either relative to the beginning of the code segment stored in the program base register or relative to the CPU's program counter register.

Another pair of base registers in the CPU point to both ends of a global data area; any reference outside these bounds registers results in an address or bounds violation. Thus the user is protected against accidental or malicious programming bugs made by himself or other users running on the same system. All absolute code segment addresses are kept in a code segment table in memory which is managed by the operating system and the microcode. The user cannot access this table.

A stack architecture

To understand the virtual addressing of the data segments, it must be pointed out that all operations in the HP 300 are performed on its stack. The stack, depicted in Fig. 5, is actually contained in main memory and grows downward towards higher memory addresses.

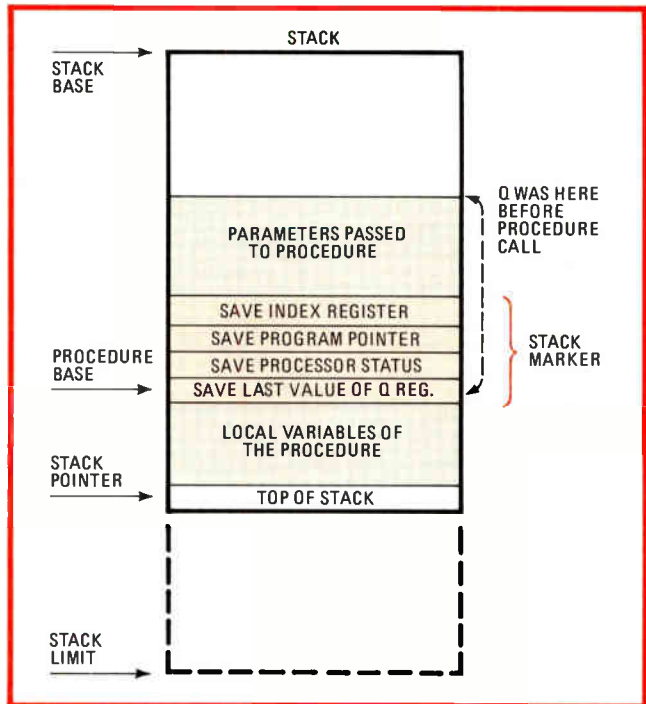

5. Stackable. Each time a procedure is called, a stack marker is put into the stack. The stack pointer is then moved to make room for the procedure's local variables. These and parameters passed to the procedure are addressed by referencing the procedure base pointer.

Again, hardware registers in the CPU help keep track of the stack, as well as the virtual-memory storage of segments. The stack-base register in the CPU defines its beginning location, while the stack-limit register holds its limit, the stack pointer indicates the "top" of stack, and the procedure base register is called the Q-register.

Every time a procedure call instruction is executed, a four-word stack marker containing return address information is pushed onto the stack. Then the CPU Q-register is changed to point to the top of the stack,

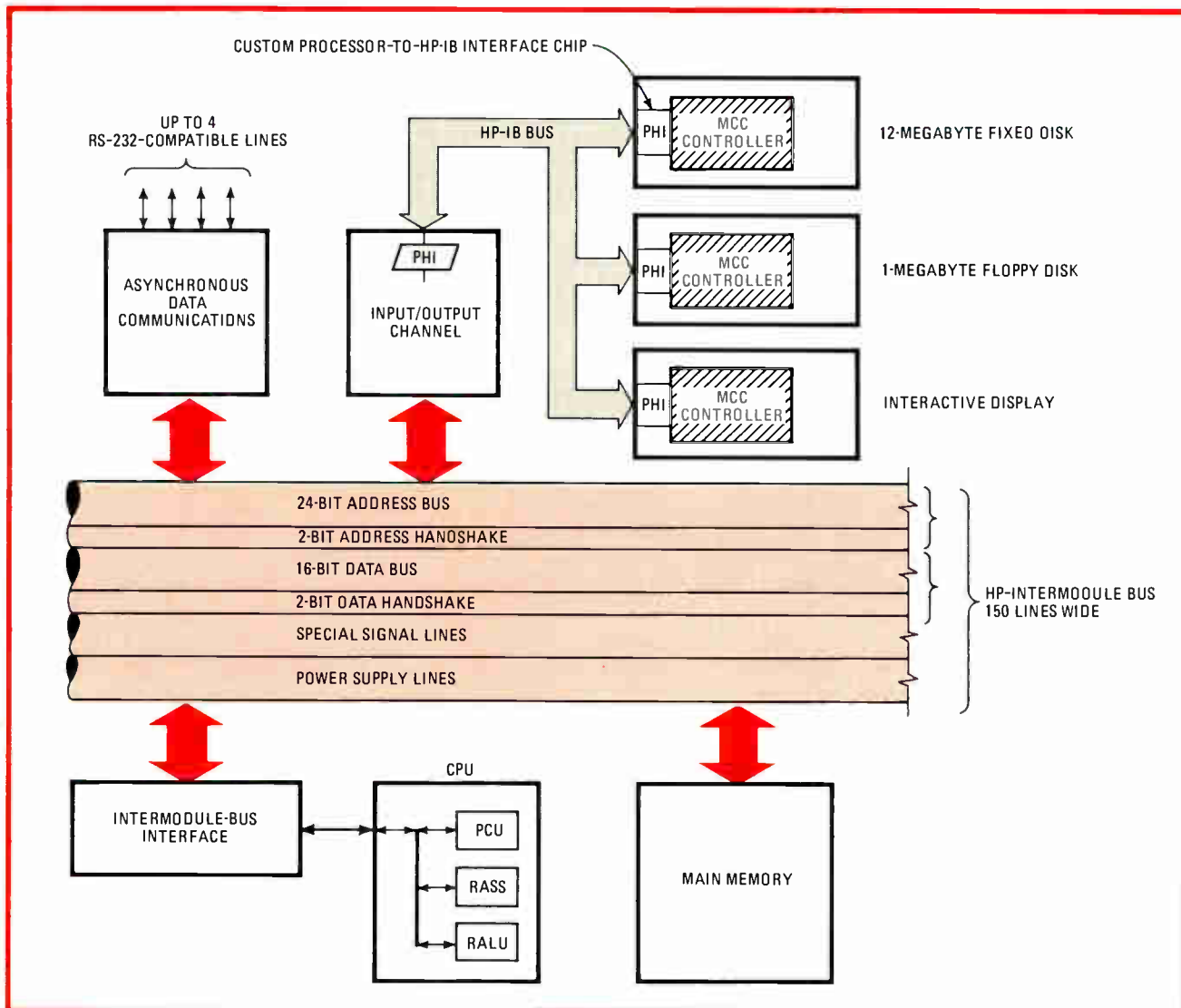

6. Two better than one. Instead of the peripherals and processor elements sharing one bus, the intermodule bus connects the processor elements while the HP-interface bus connects the peripherals to the channels. The 150-line-wide intermodule bus features separate 2-bit address- and data-handshake lines, allowing these handshakes to occur concurrently and thus increasing the CPU's throughput.

thereby establishing a new, local base register for accessing parameters passed to the procedure as well as for accessing variables declared locally to the procedure. Upon exiting the procedure, the Q-register is moved back to its previous position—from information contained in the stack marker—thereby deallocating the temporary storage used by the procedure. This stack is used for all arithmetic and logical operations except decimal, which are done entirely in main memory.

In addition to the stack, each user has a global data area, which contains all globally defined variables and some arrays. As mentioned, the global area is delimited by the CPU's data base and the data limit registers. The third data entity is the data segment. As already noted, each user can have up to 4,000 data segments in addition to the 4,000 data segments reserved for the operating system's use. Indirect access to the stack, global area, or data segments is through a data label. A data segment label in one of four formats contains an index into a system-maintained data segment table (DST). A one-

word DST label points to the start of the data segment; a two-word DST points to a word within the segment.

Note that as with code segments, the data label never contains an absolute address. All addresses are relative to the start of the data segment. Only the operating system knows the absolute address of any data segment. Any stack, global area, or data segment may be relocated in memory at any time by the operating system with no knowledge on the user's part. As can be seen, this capability to move code and data dynamically was designed into the system hardware, not added on.

On the bus

Unlike the single-bus architecture used on many mini-computers that has the processor elements and peripherals share the same bus, the HP 300 has separate processor and I/O buses. The CPU, memory, and I/O channels attach to the high-speed internal intermodule bus. The I/O channels, in turn, provide for the attachment of peripherals using the Hewlett-Packard Interface Bus

(HP-IB), HP's version of what is now called the IEEE-488 standard (see Fig. 6).

The intermodule bus consists of 150 parallel lines, operates at a transfer rate of 6 megabytes per second, and provides a variety of paths. Included are a 24-bit bidirectional address bus, a 16-bit bidirectional data bus, and numerous power and special signal paths. A unique feature of the intermodule bus is the use of two pairs of special handshake lines, one each with the address and data buses. By decoupling the address handshake from the data handshake, these address and data handshakes can overlap, increasing the throughput of the CPU.

Each I/O channel provides a 1-megabyte/second HP-IB cable to which up to eight peripheral devices can be attached. The architecture allows for up to 15 I/O channels although currently only one is supported. Most peripherals have HP-IB-compatible interfaces. Hence, peripherals such as disks, diskettes, printers, and interactive display systems can be connected to the HP 300 on this simple, low-cost, 16-signal bus rather than having to connect to the larger, more costly intermodule bus. Furthermore, the HP-IB can be strung from one external peripheral to the next, or from instrument to instrument. An external line printer, for example, does not require a special interface board in the mainframe. To add a printer, the user need only extend the HP-IB from the last device in the daisy-chain to the newly added printer.

Peripherals advance, too

The peripherals used with the HP 300 system also make use of new semiconductor technology. Each, for example, is controlled by a C-MOS-on-sapphire microprocessor, HP's MCC [*Electronics*, May 26, 1977, p. 99]. The 12-megabyte hard-disk controller has 4 kilobytes of ROM and 512 bytes of scratchpad RAM, while the floppy-disk controller has 8 kilobytes of ROM and 512 bytes of RAM. The interactive-display-system controller has 16 kilobytes of ROM and 2 kilobytes of RAM, not including the display memory needed to refresh the image on the cathode-ray-tube display.

In addition, each type of peripheral device is permanently assigned an identifying code at manufacture. It supplies this code to the host HP 300 upon demand. For example, when the system is powered up, the operating system software interrogates all devices on each I/O channel. Any devices that have been added since the last time the system was powered up can be automatically configured into the system tables and be immediately available to the user. No manual system build procedure would be required.

Each active device on an I/O channel has associated with it an I/O channel program in main memory. These channel programs provide each device with a sequence of instructions to be executed to carry out an I/O action. Thus the channel, not the CPU, is responsible for executing these I/O channel programs. In fact, the channel program instruction set is completely different from the CPU instruction set.

The I/O channel instruction set provides for multiplexed or block read-and-write operations, conditional jumps within the channel program, main CPU interrupt generation, command and status transfer, and device



7. Versatile. The three-chip central processing unit used in the HP-300 can also be used in the HP 3000 series 33 processor shown here. Changing the voltage on the mode pin of the register, address, skip, and special chip (RASS) alters its operation.

self-test initialization. Devices cannot directly interrupt the CPU; rather, a channel program is retrieved and started. One of the I/O channel instructions is the wait operation. When the channel executes the wait instruction for a device, nothing further happens in the I/O channel for that device until the device signals the channel by responding to an HP-IB parallel poll command. At that time the I/O channel program continues execution, starting at the instruction following the wait instruction. The next instruction might be an interrupt instruction, which would then cause a CPU interrupt. Or it might be a block read instruction, for example. A very powerful instruction is the device-specified jump, which will cause a forward jump within the channel program by the number of words specified by a byte returned to the channel from the device.

The extensive use of C-MOS-on-sapphire technology is proving to offer many advantages. For example, the HP 300's three-chip CPU is versatile enough to also be used on the new HP 3000 series 33 processor (Fig. 7). Changing the voltage on the mode pin of the RASS chip selects CPU operation for one of the two models. Looking ahead, HP hopes to use the silicon-on-sapphire technology in all of its computer families. □

Coordinate converter aligns piezoelectric positioner

by Lawrence E. Schmutz
Adaptive Optics Associates, Cambridge, Mass.

Piezoelectric tilt elements of the kind used to position laser beams and optical scanners can be aligned with the help of this circuit, which converts the transducer's high input driving voltages, normally resolved in X-Y coordinates, into corresponding coordinates (a, b, c) in a nonorthogonal three-axis system. Only one quad operational amplifier and two resistor-array packages are used for the transformation.

The geometry of many popular piezoelectric positioning elements (a), as for example the Burleigh Instruments' PZ-80, is such that:

$$x = c - a \quad y = b - \frac{1}{2}(a + c) \quad 0 = a + b + c$$

Solving these equations simultaneously for a, b, and c

yields:

$$a = \frac{1}{2}x - \frac{1}{2}y \quad b = \frac{2}{3}y \quad c = -\frac{1}{2}x - \frac{1}{3}y$$

Simplifying further:

$$a = c + x \quad b = -(a + c) \quad c = -(x/2 + y/3)$$

The last set of equations is easily implemented by using precision resistors to set the gain of several op amps (b).

Resistor arrays in dual in-line packages will perform the transformation accurately, for their elements have a tolerance of $\pm 0.5\%$. The overall circuit uncertainty becomes $\pm 1\%$ when two arrays are configured as shown. To ensure that the circuit occupies no more space than that taken by three dual in-line packages, the resistors are grouped in their respective arrays as shown by the dotted lines.

The TL084 op amp is more than adequate for the circuit accuracy desired, since in most applications the piezoelectric devices operate in the lower audio-frequency range. \square

Designer's casebook is a regular feature in *Electronics*. We invite readers to submit original and unpublished circuit ideas and solutions to design problems. Explain briefly but thoroughly the circuit's operating principle and purpose. We'll pay \$50 for each item published.

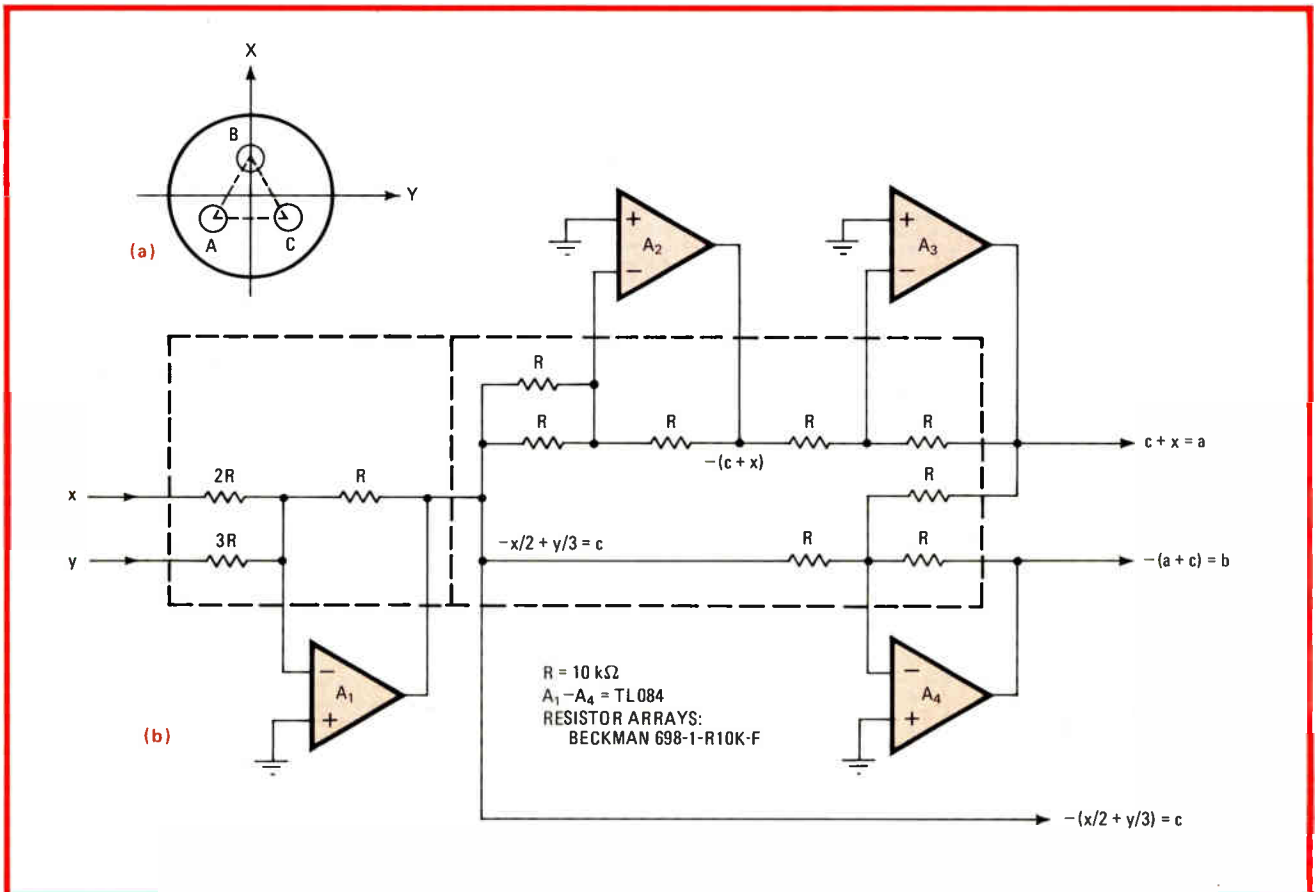

Beaming true. Input information for positioning laser beam, normally presented in X-Y coordinates, must be converted into three-axis coordinates for many piezoelectric transducers (a). One op amp and two precision resistor arrays perform the transformation (b).



YOURS FREE
 when you subscribe
 to Electronics.
**This Designers
 Casebook—
 Number 2**

PLEASE ENTER MY SUBSCRIPTION TO ELECTRONICS FOR:

ONE YEAR AT \$17 TWO YEARS AT \$29 THREE YEARS AT \$43

Payment Enclosed Bill My Company Bill Me

CHARGE MY
 SUBSCRIPTION
 TO...

American Express Diners Club Visa
 Master Charge _____ Interbank No. _____
 Acct. No. _____
 Date Card Expires _____
 Signature _____

Mr.
 NAME Mrs. _____ TITLE _____ 53690-F
 Ms. _____
 COMPANY _____ DIV. or DEPT _____

COMPANY ADDRESS _____

CITY _____ STATE _____ ZIP _____

Check here if you wish publication to be sent to home address
 STREET _____ CITY _____ STATE _____ ZIP _____

Qualification for above rates is based on answers to all questions listed below. Those not qualifying may pay higher than basic price of \$30 one year or \$75 for three years.

Signature _____

2. 1 PLANT 2 DEPARTMENT

- A. Large computers
- B. Mini-computers
- C. Computer peripheral equipment
- D. Data Processing Systems (systems integration)
- E. Office and business machines
- F. Test and measuring equipment
- G. Communications systems and equipment
- H. Navigation and guidance or control systems
- I. Consumer entertainment electronic equipment
- J. Other consumer electronic equip. (appliances, autos, hand tools)

Indicate the primary product manufactured or service performed at your plant (Box 1) and in your department (Box 2). Be sure to indicate applicable letter in each of the two boxes even if they are the same letter.

- K. Industrial controls, systems and equipment
- L. Sub-assemblies
- M. Passive electronic components
- N. Active electronic components
- O. Materials and Hardware
- P. Aircraft, Missiles, space and ground support equipment
- Q. Oceanography and support equipment
- R. Medical electronics
- S. Industrial equipment containing electronic components or products
- T. Independent R&D laboratory and consultant
- U. Research and development organizations which are a part of an educational institution
- V. Government Agency and military
- W. Industrial companies using and/or incorporating electronic products in their mfg., research or development activities
- X. Utilities
- Y. Broadcasting, sound and motion pictures and recording studios
- Z. Commercial users of electronic equipment (railroads, pipelines, police, airlines)
- 9. College, University

3. Indicate your principal job function (place applicable number in box. If numbers 9, 10, or 11 are used, fill in name of college or university)

- 1. General and corporate management
- 2. Design and development engineering
- 3. Engineering services (evaluation, quality control, reliability, standards, test)
- 4. Basic research
- 5. Manufacturing and production
- 6. Engineering support (lab assistant, technician)
- 7. Purchasing and procurement
- 8. Marketing and sales
- 9. Professor at _____
- 10. Senior student at _____
- 11. Graduate student at _____

Senior and graduate students are eligible for professional rate for one year subscription only.

4. Indicate your principal job responsibility (place applicable number in box)

- 1. Management
- 2. Engineering

5. Your design function: (Insert each letter that applies)

- A. I do electronic design or development engineering work
- B. I supervise electronic design or development engineering work
- C. I set standards for, or evaluate electronic design components, systems and materials

6. Estimated number of employees at this location. (check one)

- 1 to 49
- 50 to 249
- 250 to 999
- over 1,000



NO POSTAGE
NECESSARY
IF MAILED
IN THE
UNITED STATES

BUSINESS REPLY MAIL

FIRST CLASS PERMIT NO. 42 HIGHTSTOWN, N.J. 08520

POSTAGE WILL BE PAID BY ADDRESSEE

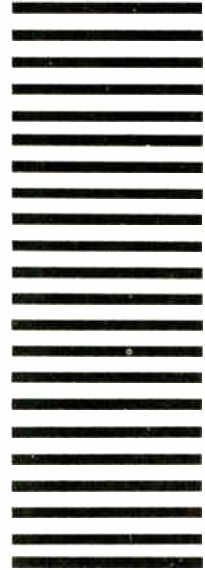

Electronics

McGRAW-HILL Inc.
Subscription Department
P.O. Box 514
Hightstown, N.J. 08520

Acoustic protector damps telephone-line transients

by Gil Marosi
Intech Function Modules Inc., Santa Clara, Calif.

By limiting the transients on telephone lines, this acoustic shock protector prevents those sudden high sound levels that can damage the ear badly enough to cause loss of hearing. It holds the maximum peak-to-peak voltage at the receiver of a telephone headset to 50 millivolts.

A four-terminal device, the shock protector is inserted between the receiver side of the telephone hybrid and the receiver proper. A block diagram of the circuit, which operates from a single 5-volt supply, is shown in (a). Input signals are amplified by a factor of 5 and applied to a voltage-controlled, variable-gain stage. Because this stage also attenuates the signal to the degree indicated by the actual level of a feedback signal, further amplification may be needed, and is available, to retain the loop's gain margin. A voltage doubler then converts the

amplifier signal to a dc voltage. This voltage is compared with a preset reference at the inputs of an averaging amplifier.

The output of the averager, which is essentially an integrating network, is connected to the variable-gain stage. As the input voltage from the hybrid becomes greater, so does the feedback voltage, and thus still more attenuation is provided for the variable-gain stage.

As for the actual circuit (b), transformers T_1 and T_2 isolate the protector from the floating telephone line, so that the circuit operates from a 5-v supply referred to ground. A_{1a} , one half of an LM358 operational amplifier, provides the required amplification of the input signal. D_1 and D_2 clamp A_{1a} 's output to 0.7 v and introduce the signal to buffer Q_1 . This transistor, along with R_4 - R_7 , R_{14} , D_4 , A_{1b} , and C_3 , make up the variable-gain stage.

Zeners Z_1 and Z_2 and op amp A_{2a} bias A_{1a} and A_{1b} so that input signals to those stages swing about a quiescent point of 2 v. The circuit thus provides maximum dynamic range. Note that most op amps require a 12-v supply to achieve a comparable range.

Q_1 's output is converted to a current with the aid of R_{14} . Current flows through D_4 , which operates as a current-controlled variable resistor. D_4 is biased through

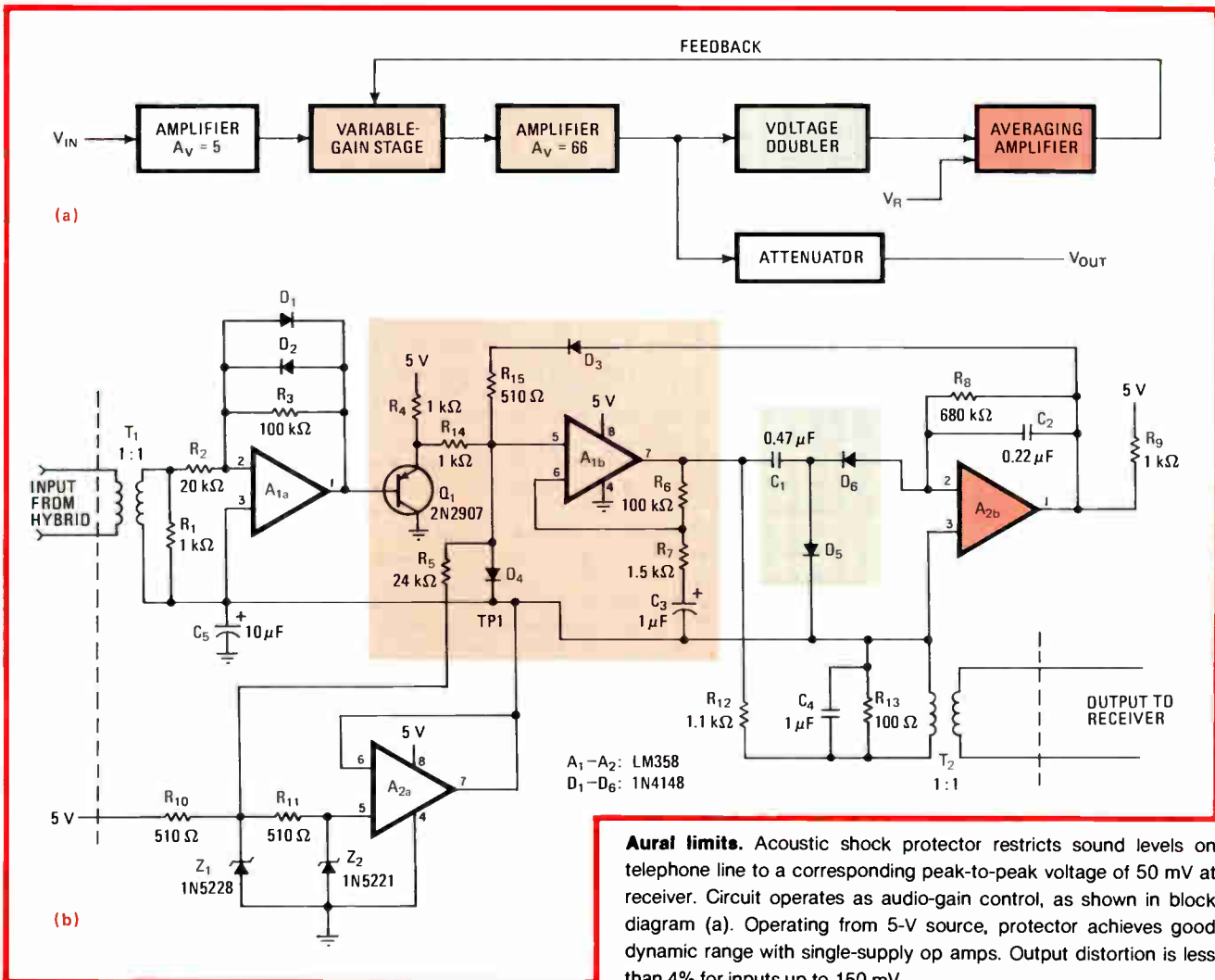

Aural limits. Acoustic shock protector restricts sound levels on telephone line to a corresponding peak-to-peak voltage of 50 mV at receiver. Circuit operates as audio-gain control, as shown in block diagram (a). Operating from 5-V source, protector achieves good dynamic range with single-supply op amps. Output distortion is less than 4% for inputs up to 150 mV.

Even a quick glance at the face of our new Model 3003 tells you it's no ordinary signal generator.

Right away you can see the unique internal and external modulation features, such as the provision for complex or simultaneous modulations with AM-AM, AM-FM or FM-FM.

The 3003 gives you twice as many modulation frequencies as most other generators. Besides the standard frequencies of 400 Hz and 1 KHz, you can choose and pre-set two more frequencies between 100 Hz and 10 KHz. And like other models in the 3000 Series, this one is



accurate to 0.001% over the entire 1 MHz to 520 MHz range. (We also have a unit that goes down to 1 KHz.)

But the main thing you'll notice is how convenient the Model 3003 is to use: internal or external FM deviation and AM modulation are easily set on the big front-panel

meter. For extra readability and accuracy, you get two AM scales and four FM scales. Everything is so clearly labeled that learning to operate the instrument takes only a matter of minutes.

One thing you can't see on the face of the 3003 is the price. At a low \$3,350, we're really hiding one of its most attractive features.

Wavetek Indiana, Inc.,
66 N. First Ave., P.O. Box 190, Beech Grove, Indiana 46107. Telephone (317) 783-3221, TWX 810-341-3226.

WAVETEK®

Circle 116 on reader service card



**Performance
is written
all over our face.**

R_5 such that its nominal resistance is 500 ohms.

The voltage at the noninverting input of A_{1b} is amplified and applied to the voltage doubler (C_1 , D_5 , and D_6). A_{2b} and its associated circuit perform the averaging function that provides a feedback current to the variable-gain stage. The gain from input to output is unity until the amplifier's input threshold—set at 50 mV—is exceeded. The acoustic shock protector then operates as an automatic gain control for inputs up to 150 mV. The

output distortion up to that point does not exceed 4%. Beyond 150 mV, however, the protector simply clamps the output to 50 mV p-p without regard to distortion.

Because the phone receiver is an inductive device, its impedance increases with frequency. C_4 is placed across R_{14} to compensate for this rise in impedance. The overall gain of the acoustic shock protector is thus held flat to within 1 decibel from 300 hertz to 3 kilohertz so long as the output of A_{1b} is below 600 mV or so. □

Time-shared counters simplify multiplexed display

by Darryl Morris

Northeast Electronics, Concord, N. H.

Although multiplexed display circuits reduce the number of components otherwise required for decoding on a per-digit basis, additional hardware is then needed to select and multiplex various lines to the display. But if a display is driven by a frequency counter, as is often the case, the counter itself can be made to perform the multiplexing with only minimal extra circuitry.

Multiplexing is done by using a master clock having several times the frequency of the normal clock, depending on the number of digits to be multiplexed, and by

time-sharing the counters between the count and display mode. In the count mode, the \overline{LOAD} and enable-P (EP) inputs of the counters shown are high and A_1 – A_5 function as a conventional cascaded counter circuit under control of the enable-T (ET) input of A_1 . The counter circuit advances one count for each clock period during which the count control line is high.

During the display mode, the control line and \overline{LOAD} input of A_1 – A_5 move low. The counters now accept data at their preload inputs, P_A – P_D . Because the preload inputs are connected to each preceding set of a counter's outputs, A_1 – A_5 operates as a 4-bit-wide recirculating shift register when clocked. Thus, the contents of each counter is rotated past the seven-segment decoder (A_6) during its display interval, and the appropriate digit in the display is strobed by the mode controller, A_7 and A_8 .

This technique offers the best saving in chip count when the count rate is slow or numbers are to be displayed only after the counted event has terminated. □

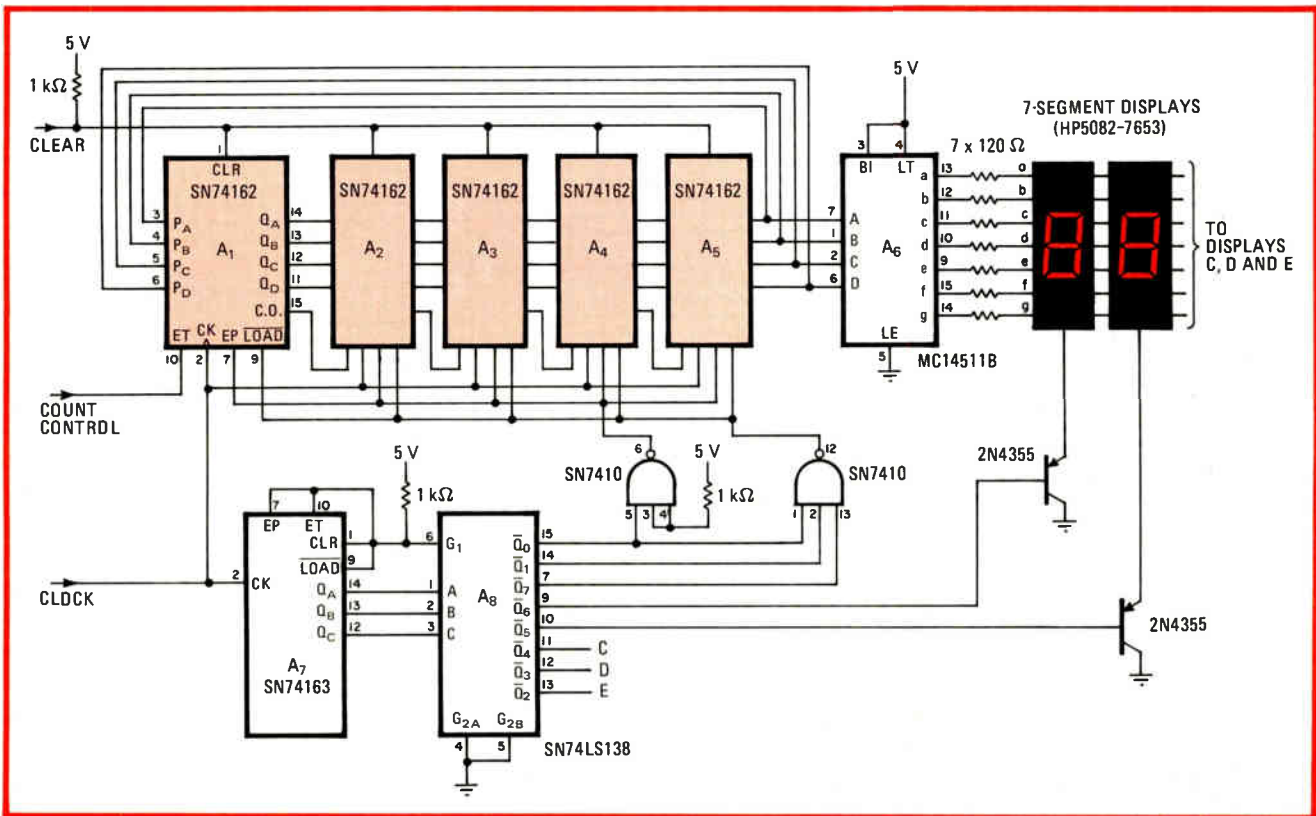

Time-shared. Counter circuit switches between count and display modes without selector devices. Counter operates as 4-bit-wide recirculating shift register. Master clock frequency is assumed to be several times that used for the counting circuits.

A great computer system



Our DEC® equivalent:

In small business systems, DEC is a standout. So when we introduced our own system, we made certain that anything you can do on a DEC 322®, 324® or 325® you can do on a Plessey Datasystem 1. Using the same people, programs and procedures.

Plessey Datasystems are available in three configurations: our Datasystem 1A comes with a 512K byte floppy, while our 1B uses a 5 Mbyte cartridge disc system and our 1C uses a 10 Mbyte cartridge system.

Any version will run any of your existing DIBOL® programs.

And Plessey Datasystems cost about 30% less than the DEC equivalents.

®Registered trademark of Digital Equipment Corporation

made a great deal better



So that anything you can do on a DEC system, you can do faster and for less with Plessey. And add a few things that your DEC system can't do at all.

Product enhancements like this have made us the largest independent supplier of DEC-compatible peripherals and systems. We're the only real alternative to DEC for all your mini-computer needs, a complete single source.

For the rest of the details, please contact the nearest Plessey sales office or call (714) 540-9945 today.

Peripheral Systems

California 92714 (714) 540-9945

real alternative.

Circle 119 on reader service card

Need receiver

NOISE

measurements?

**Ailtech has the box
that can do it!**

Ailtech's 75 Precision Automatic Noise Figure Indicator (PANFI) can **MEASURE** amplifier and receiver noise figure with accuracy (± 0.15 dB) and precision (0.05 dB resolution). To **MONITOR** repeated measurements, there's the 7300 System Noise Monitors. They're available in analog and digital configurations and are ideal for amplifier production tests *including simultaneous gain measurements* and on-line radar receiver noise monitoring. Ailtech can **GENERATE**, with a comprehensive line of broadband solid state and gas-discharge devices for laboratory or system requirements; and can **CALIBRATE** RF and microwaves noise sources with the Ailtech 82 Noise Calibration System.

Measure, Monitor, Generate, Calibrate — Ailtech knows the whole story. And we'd like to tell you that story. Write today, we'll send it to you.



"Now available
with 488 buss
interface option."



AILTECH 
DIVISION CUTLER-HAMMER CONTROL

WEST COAST • CITY OF INDUSTRY, CA. 91748 • (213) 965-4911
EAST COAST • RONKONKOMA, NEW YORK 14779 • (516) 588-3600
FRANCE • LA GARENNE-COLOMBES • TELEPHONE 7807373
UNITED KINGDOM • CROFTHORNE • TELEPHONE 5777
GERMANY • MUNICH • TELEPHONE (089) 5233023
NEDERLANDS • ROTTERDAM • TELEPHONE (010) 81 4466

MEMBER OF CUTLER-HAMMER INSTRUMENTS & SYSTEMS GROUP
Circle 206 on reader service card

LASERMARK MEANS

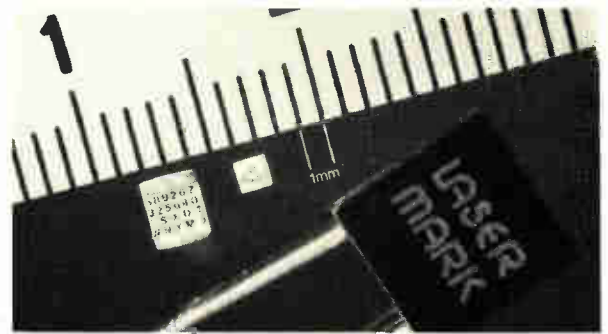

CHARACTER HEIGHT AS SMALL AS .012"

Problems marking small components? Lasermark will put a clear image on any shape or sized product right down to tiny capsules and electronic chip components. If desired, a mark can be made that is visible only through a microscope. Even on this minute scale, every detail will be clean and sharp, because there is no physical contact. Why not let us lighten up your marking problems! To get the full story on these unique, inkless, non-contact coding and marking systems, contact:

**LASER
MARK** A DIVISION OF
LUMONICS RESEARCH LIMITED
105 SCHNEIDER ROAD,
KANATA, (OTTAWA), ONTARIO
CANADA K2K 1Y3
(613) 592-1460

Bringing marking and coding out of the Dark Ages

Circle 207 on reader service card



Using assembly coding to optimize high-level language programs

Coding critical sections by hand can trim microcomputers' storage needs and execution time

by Pat Caudill, Tektronix Inc., Beaverton, Ore.

□ The increasing capabilities of microprocessors demand increasingly complicated programs. At the same time, per-hour programming costs continue to rise sharply. These factors have spurred the adaptation of high-level languages to microprocessors.

In general, these languages make programming easier and quicker than with assembly language, but they almost always require longer execution times and greater memory space. Therefore optimizing a high-level language program for a microprocessor-based system

This is the second part of series on using high-level languages for microprocessor-based systems. The first article appeared in the Jan. 18 issue, page 105.

often is not merely desirable, but in fact essential.

Optimization frequently involves manually converting parts of a program into assembly language. The decision of when and where to do so when developing a microprocessor-based system, however, depends mainly on the high-level language selected. Some of the ones currently used in designing these systems are supported by efficient compilers, but others are not. For the latter, optimizing with assembly language may be the only way to save memory space and execution time.

In general, assembly language can be useful when programming machine-dependent features (for example, interrupt-driven input/output devices), functions in which time is at a premium, and critical loops. (A

```

FORTRAN-80 VER 2 01 COPYRIGHT 1978 MICROSOFTE -
1 SUBROUTINE PDSH
2 BYTE BUFFER(128)
3 COMMON BUFFER
4 DO 20 I = 1, 128, 2
5 C-- ONE LEVEL OF LOOP UNWINDING
6 10 IF (INF*8) AND 1=60 TO 10
7 ***** LDI H,0001 2.50
8 ***** SHLD I 4.00
9 ***** LDI H,I 2.50
10 ***** CALL INF 4.15
11 ***** ANI 01 2.75
12 ***** STX T,000002 3.25
13 ***** BUFFER(I) = INF*10+
14 ***** OFH A 1.00
15 ***** THL L 2.50
16 ***** BUFFER(I+1) = INF*10+
17 20 CONTINUE
18 ***** LHLD I 4.00
19 ***** SHLD T,000000 4.00
20 ***** LDI D,BUFFER-0001 2.50
21 ***** DAD D 2.75
22 ***** SHLD T,010000 4.00
23 ***** LDI H,I 00 2.50
24 ***** CALL INF 4.25
25 ***** LHLD T,010000 4.00
26 ***** MOV B,H 1.75
27 ***** LHLD T,000000 4.00
28 ***** LDI D,BUFFER 2.50
29 ***** DAD D 2.75
30 ***** SHLD T,020000 4.00
31 ***** LDI H,I 00 2.50
32 ***** CALL INF 4.15
33 ***** LHLD T,020000 4.00
34 ***** MOV B,H 1.75
35 ***** RETURN
36 ***** LHLD I 4.00
37 ***** INX H 1.50
38 ***** INX H 1.50
39 ***** MVI A,80 1.75
40 ***** SUB L 1.00
41 ***** MVI A,80 1.75
42 ***** SBB H 1.00
43 ***** JP 0005 1.50
44 ***** RET 1.50
45 ***** ENC 13.25

```

```

LD HL,BUFFER ; Buffer address
LD BC,0000AH ; B = BYTE COUNT
                ; C = STATUS PORT
2.75 LPI IN A,(B) ; Get status
1.00 RRA ; Wait loop until status
1.75 JR NC,LPI ; Shows data byte ready
4.00 INI ; Get byte and store it
3.00 JR NE,LPI ; Go back for next byte
12.50 μs RET

```

1. Quicker loop. This example illustrates that a human can often do better than a compiler. The 11 Fortran statements on the left resulted in 34 8080 assembly-language instructions. At a clock speed of 4 MHz, these are executed in 93.25 microseconds. On the right is the hand-optimized version, taking only 12.50 μs.

IF • END • UNTIL • DO • WHILE • END • ELSE • FOR • NEX

```

PL/M-80 COMPILER

1515-11 PL/M-80 V3 0 COMPILATION OF MODULE SWAPPER
NO OBJECT MODULE REQUESTED
COMPILER INVOKED BY: PL/M80 F1 SBL PLM PRINT LP 1 CODE NOOBJECT

1 SWAPPER DO
2 1 SWAPPER PROCEDURE ( WORD, POINTER )
    PROC SWAPPER
    0000 218200 LXI H, POINTER+1H
    0003 72 MOV M,D
    0004 2B DCR H
    0005 72 MOV M,E
    0006 2B DCR H
    0007 70 MOV M,B
    0008 2B DCR H
    0009 71 MOV M,C
    /* NAME SWAPPER */
    /* PURPOSE TO STORE AN ADDRESS VALUE INTO MAIN MEMOR WITH IT'S BYTES
    IN REVERSE ORDER SO THEY MAY BE ACCESSED BY AN 8080 */
    /* PARAMETERS
    WORD = ADDRESS VALUE TO HAVE IT'S BYTES SWAPPED
    POINTER = MEMORY LOCATION WHERE THE DATA IS TO BE STORED
    /* RETURNED VALUE NONE

3 2 DECLARE
    WORD ADDRESS, /* DATA WORD TO BE SWAPPED
    POINTER ADDRESS, /* LOCATION WHERE DATA IS TO BE STORED
    POINTER BASED POINTER BYTE, /* WHERE DATA IS TO BE STORED

4 2 POINTEE = HIGH(WORD) /* STORE HIGH BYTE FIRST
    STATEMENT # 4
    000F 290000 MLD WORD
    0010 7C MOV M,H
    0011 290200 MLD POINTER
    0012 77 MOV M,A
    STATEMENT # 5
    0013 290200 MLD POINTER
    0014 23 INR H
    0015 290200 MLD POINTER
    STATEMENT # 6
    0016 290000 MLD WORD
    0017 70 MOV M,L
    0018 290200 MLD POINTER
    0019 77 MOV M,A
    STATEMENT # 7
    0020 77 MOV M,A
    /* THATS ALL THERE IS
    STATEMENT # 7

0021 C9 RET
END SWAPPER
STATEMENT # 8

9 1 END SWAPPER
    
```

critical loop is one that is small in terms of memory needs, but requires a disproportionately large amount of execution time.)

For this discussion, an interpreter is defined as a program that executes a high-level language directly, and a compiler as one that converts a high-level language program to the processor's native code for execution. A compiler generates more efficient code than an interpreter. There is therefore less need to include assembly-language sections with a compiler than with an interpreter. It is also easier to insert assembly-language segments into a high-level language program when a compiler is used as the translator program.

A number of high-level languages are available for

```

AS800 F1 SBL ASM PRINT LP 1 NOOBJECT

1515-11 8000 8005 AS800 ASSEMBLER V2 0 MODULE PAGE 1

LOC OBJ SEQ SOURCE STATEMENT
-----
1
2 NAME SWAPPER
3
4 PURPOSE TO STORE THE BYTES OF A DATA WORD IN MEMORY IN REVERSE
5 ORDER SO THAT THEY MAY BE ACCESSED BY AN 8080 PROCESSOR
6
7 PARAMETERS
8 B C = WORD TO BE SWAPPED
9 D E = POINTER TO LOCATION WHERE THEY ARE TO BE STORED
10
11 RETURNS NOTHING
12
13 CSEG
14 PUBLIC SWAPPER
15 SWAPPER XCHG MOV M,B
16 70 MOV M,L
17 23 INR H
18 70 MOV M,L
19 C9 RET
20 END

PUBLIC SYMBOLS
SWAPPER C 0000

EXTERNAL SYMBOLS

USER SYMBOLS
SWAPPER C 0000

ASSEMBLY COMPLETE. NO ERRORS
    
```

2. Swapper. The 8080 stores a word with the least followed by the most significant byte. The order is reversed in the 6800. High-level PL/M was not designed for this operation (left). Assembly-language coding reduced the number of lines from 20 to 8 (right).

microprocessor-based systems. The list includes Pascal, Basic, Intel's PL/M, Bell Laboratories' C, Motorola's MPL, and Signetics' PL μ S. In addition, several leading semiconductor manufacturers are promising microprocessor-compatible Fortran and Cobol.

High-level languages

Pascal was originally designed to support structured programming in a learning environment. It has two basic implementations: a compiled version and an interpretive one. The language itself is relatively new. It has been used extensively with microprocessor-based systems, but not in a compiled fashion. With minor language extensions, though, compiled Pascal could be linked with assembly-language routines.

The interpretive version has been in use longer than the compiled version. It requires a lot of memory (48 kilobytes) and does not allow assembly-language calls.

Standard Pascal does not support interrupts, but a compiled version known as Concurrent Pascal (developed by Per Brinch-Hansen, a professor of computer science at the University of Southern California) does. However, this version has not yet been implemented on a microprocessor-based system.

Basic is ordinarily used interpretively and is therefore very seldom configured with the capability of linking to assembly-code sections. It, too, was designed as a teaching tool and has been widely adapted for microprocessors. It is best for small, single-task programs that a programmer can sit down to and type out.

PROCEDURE • BEGIN • REPEAT • FUNCTION • IF • THEN • CASE

Several Basic interpreters allow calling of assembly routines. Calling can be accomplished if the interpreter is instructed to reserve an area of memory for a routine when first loaded. Typically, Basic does not handle interrupts, rendering it unsuitable for interrupt coding.

The C language was originated by Bell Laboratories for use with PDP-11s and PDP-10s. Versions of C are being developed by several companies for microprocessor use, and at least one generates 8080 code.

C is basically a structured language. It is not highly typed—that is, a programmer has leeway in choosing a variable's usage (unlike Pascal, which is very restricted in what it can do with a given variable). C was designed to allow its users, who do not ordinarily want to work in assembly language, to write successful programs.

Forth is a stack-oriented, interpretive language developed for Digital Equipment Corp.'s minicomputers. It has been modified to run on many microprocessors and has been used extensively in process-control applications. It is very concise, but rather cryptic to read. Some versions supply their own assembler for definitions of machine-language functions.

Although optimization usually means using assembly language, remember that better code can often be written in a high-level language rather than in assembly language when the object code is supplied by a really good compiler. However, such compilers require a great deal of main memory.

Tighten up

Optimizing with assembly language requires focusing on small sections of the program. A good high-level language optimizing compiler can look at the whole program and keep track of all the variables over a long period of time much better than a human; consequently, it does much better over a large area. On the other hand, a person can take a small section, recode it, and do a really good job. Individuals coding in assembly language tend to do better on small sections because, for example, knowing that they will use a variable again, they do not put it back into memory.

Computer programs tend to obey the 80/20 rule. That is, 80% of the time is spent executing 20% of the code. To speed up a program, find that 20% and hand-code it. Often a very significant improvement in performance will result.

A good place to look for that 20% is the inner-loop portions of the program. For instance, when Tektronix was developing the 8002 Microprocessor Lab, the assembler was squeezed by recoding selected subroutines in assembly language. Recoding 10% cut the running time approximately in half.

As another example, consider reading a section of a

3. New CPU. The PL/M compiler generated this 8080 code. However, the 8080 was replaced with a Z80. Although the Z80 is able to execute 8080 instructions, it also has enhanced capabilities that should be taken advantage of through manual recoding.

```
ISIS-11 PL/M-88 VS 2 COMPILATION OF MODULE SHFTXNPL
NO OBJECT MODULE REQUESTED
COMPILER INVOKED BY: PLM88 F1.SR1.PLN PRINT(L.P.) CODE NOOBJECT

1          SHFTXNPL DO ;
2 1        DECLARE
           AOP STRUCTURE (
           A$TYPE BYTE,
           A$VALUE ADDRESS,
           B$TYPE BYTE,
           B$VALUE ADDRESS) ;
3 1        SHRF PROCEDURE ;
           ; STATEMENT # 3
           ; PROC SHRF
4 2        AOP A$VALUE = SHR( AOP, A$VALUE, AOP, B$VALUE) ;
           ; STATEMENT # 4
           0014 2A0400  LJLD  AOP+4H
           0017 4D      MOV  C,L
           0018 210100  LXI  H,AOP+1H
           001B CD2400  CALL @P0091
           001E EB      XCHG
           001F 2B      DCX  H
           0020 73      MOV  M,E
           0021 23      INX  H
           0022 72      MOV  M,D
5 2        RETURN ;
           ; STATEMENT # 5
           0023 C9      RET
6 2        END SHRF ;
           ; STATEMENT # 6
7 1        AOP A$VALUE = 1 ;
           ; STATEMENT # 7
           0000 310000  LXI  SP,@STACK$ORIGIN
           0003 210100  LXI  H,1H
           0006 220100  SHLD AOP+1H
8 1        AOP B$VALUE = 2 ;
           ; STATEMENT # 8
           0009 210200  LXI  H,2H
           000C 220400  SHLD AOP+4H
9 1        CALL SHRF ;
           ; STATEMENT # 9
           000F CD1400  CALL SHRF
10 1       END SHFTXNPL ;
           ; STATEMENT # 10
           0012 FB      EI
           0013 76      HLT
           @P0091
           0024 5E      MOV  E,M
           0025 23      INX  H
           0026 56      MOV  D,M
           @P0092
           0027 EB      XCHG
           @P0093
           0028 7C      MOV  A,H
           0029 B7      ORA  A
           002A 1F      RAR
           002B 67      MOV  H,A
           002C 7D      MOV  A,L
           002D 1F      RAR
           002E 6F      MOV  L,A
           002F 00      DCR  C
           0030 C22800  JNZ  $-8H
           0033 C9      RET

MODULE INFORMATION:
CODE AREA SIZE = 0034H 52D
VARIABLE AREA SIZE = 0006H 6D
MAXIMUM STACK SIZE = 0004H 4D
15 LINES READ
0 PROGRAM ERROR(S)

END OF PL/M-88 COMPILATION
```

IF·END·UNTIL·DO·WHILE·END·ELSE·FOR·NEXT

```

Tektronix          Z80 ASM V3.1                      Page      1

00001                NAME      SHRXMFL
00002                GLOBAL   LSR+ AOP
00003          0001  >  AVALUE EQU      AOP+1  ; OFFSET TO AOP, A$VALUE
00004          0004  >  BVALUE EQU      AOP+4  ; OFFSET TO AOP, B$VALUE
00005  0000  2A0100  >  LSR   LD      HL,(AVALUE)  ; GET THE VALUE TO BE SHIFTED.
00006  0003  3E04  >  LD    LD      A,BVALUE     ; GET THE SHIFT COUNT.
00007  0005  47                LD    LD      B,A           ; PUT IT IN B FOR A COUNTER.
00008  0006  B7                OR   OR      A           ; BUT FIRST TEST FOR ZERO COUNT
00009  0007  C8                RET  RET                     ; IF NO SHIFT THEN WERE DONE
00010  0008  CB3C          LSR    SRL   R          ; SHIFT THE HIGH BYTE AND
00011  000A  CR1B          RR    RR    R          ; THEN THE LOW ONE WITH CARRY IN.
00012  000E  10FA          DJNZ DJNZ  LSR    ; LOOP IF NECESSARY.
00013  000E  220100  >  LD    LD      (AVALUE),HL  ; SAVE THE NEW RESULT.
00014  0011  C9                RET  RET
00015

```

4. Upgraded. The instructions in Fig. 3 were reworked by hand to take advantage of the Z80. Because multiple shift operators were needed, Z80 assembly code yielded much better results. The Z80 has the instruction SRL (shift register or memory) but the 8080 does not.

floppy-disk in a time-critical loop in which a disk is presenting data very fast. The program in Fig. 1 must read bursts of 128 bytes, with each byte lasting 32 microseconds. At 4 megahertz, the Fortran routine takes 93.25 μ s to do this, compared with 12.5 μ s for the assembly-level coding. This is a case where a human coder can generate better code than a compiler, as noted earlier, because the coder knows when variables will be reused (the variable I in the figure). Moreover, the use of assembly language in this case makes possible a software loop that cannot be realized with a high-level language.

Perhaps the most common instance in which assembly language is needed is when a programmer wants to do something the high-level language was not designed to do. For example, in one of the first routines written at Tektronix for the 8002's assembler, the 8080 stored data in memory with the least followed by the most significant byte. But the data was transmitted to another processor (a 6800) that stores them in reverse order. It took something like 20 separate statements in the high-level language used to swap the bytes around so that they were in the right order.

As illustrated in Fig. 2, rewriting that PL/M subroutine in assembly language made it possible to derive source code that was much smaller than the original program, with accompanying reductions in the amount of object code required.

On another occasion, memory requirements were cut when upgrading processors from Intel's 8080 to Zilog's Z80. Some of the routines, originally written in PL/M, were rewritten in Z80 assembly language to take advantage of capabilities not found in the 8080. In this case, multiple shifts had to be performed. The original PL/M program compiled into 32 lines of 8080 code, as shown in Fig. 3. It turned out the Z80 could do the shifting with just 17 instructions (Fig. 4).

Such dramatic improvements are not always forthcoming, however. In an instance of converting PL/M to assembly language, the most obvious candidates for savings reduced memory requirements by approximately

67%. However, these reductions were possible for only a small number of routines, and the savings dropped to about 33% for other routines.

To facilitate the isolation of program sections as targets for assembly-language optimization, the linking loader supplied with some development systems can break programs into as many sections as desired and assign them as specified. For example, sections may begin at a 256-byte boundary and not cross over the next one. The program could therefore be indirectly optimized because if no more than 256 bytes of memory will be indexed, the least significant byte of a register pair used for indexing could be left alone.

Many people write code to conform with the underlying structure of the processor they are writing for. In that case, the program is much more efficient when compiled. However, such programs are of course not as portable between processors as programs written with a more general code.

Three options

Development systems that support a high-level language can be used in three different ways to optimize code. First, using the real-time trace, a programmer can see what code the high-level language generated and how it is executed. Second, using breakpoints, programmers can determine how assembly-language portions of the program interface with the high-level language portions. Third, segments of the program can be timed and the programmer can determine which portions of the program are being called most often by scanning real-time traces.

High-level language programming will become more common for microprocessor-based systems in the future as compilers for microprocessors proliferate. At the same time, compilers will generate more efficient code. But the need to optimize portions of a program by hand will remain as long as microprocessor system designers operate under memory constraints or are required to push the speed of execution in their designs. □

Why limit your application opportunities? Go with Noritake's optimized Itron displays!

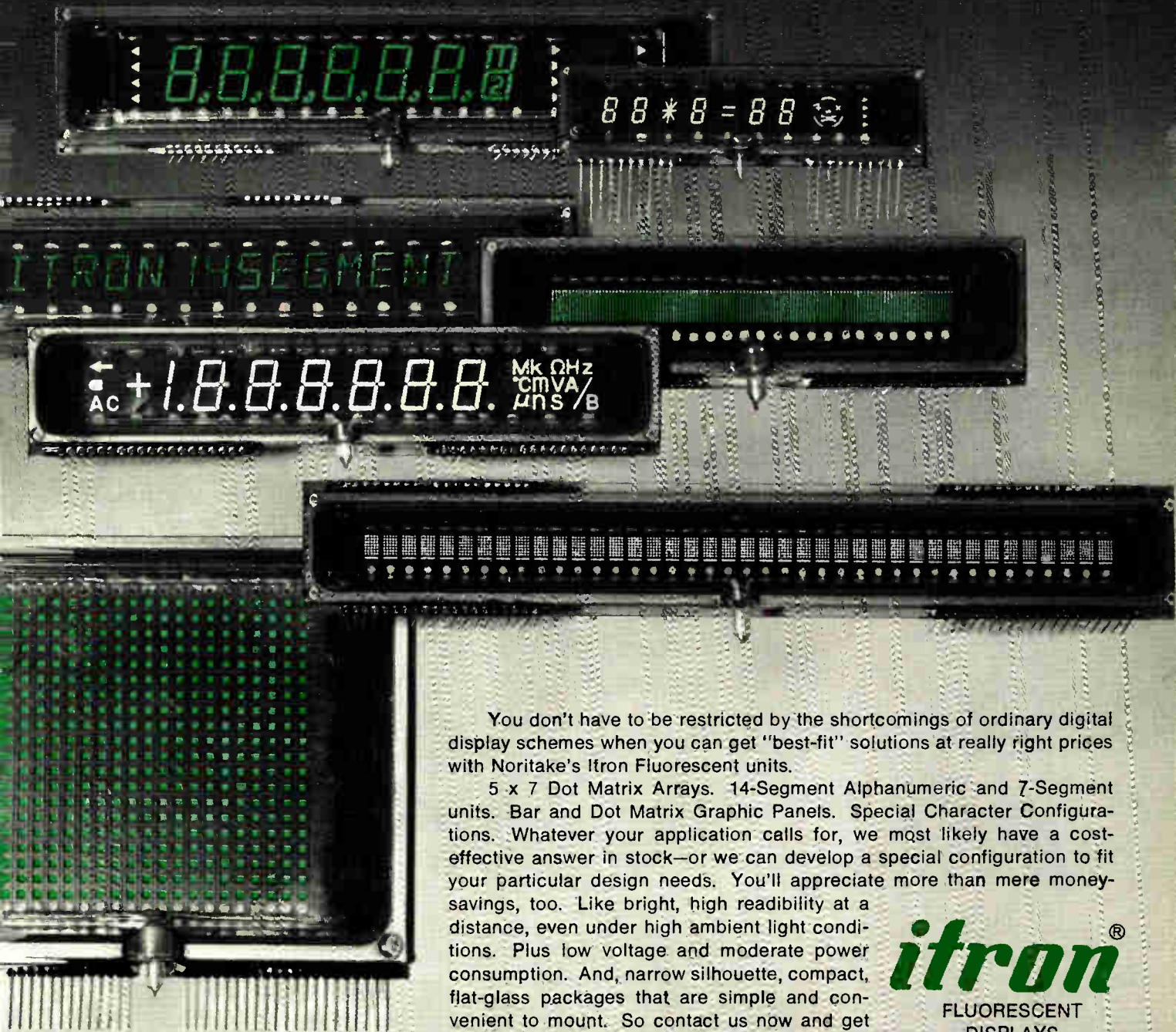

You don't have to be restricted by the shortcomings of ordinary digital display schemes when you can get "best-fit" solutions at really right prices with Noritake's Itron Fluorescent units.

5 x 7 Dot Matrix Arrays. 14-Segment Alphanumeric and 7-Segment units. Bar and Dot Matrix Graphic Panels. Special Character Configurations. Whatever your application calls for, we most likely have a cost-effective answer in stock—or we can develop a special configuration to fit your particular design needs. You'll appreciate more than mere money-savings, too. Like bright, high readability at a distance, even under high ambient light conditions. Plus low voltage and moderate power consumption. And, narrow silhouette, compact, flat-glass packages that are simple and convenient to mount. So contact us now and get your optimized display designs going fast with Noritake's Itron Fluorescent units.

itron[®]

FLUORESCENT
DISPLAYS

Patented and manufactured by
ISE ELECTRONICS CORP.

INTERNATIONAL REPRESENTATIVES

WEST GERMANY: Neumüller GMBH, 8 Monchen 2,
Karlstrasse 55, Phone: (089) 599-1230, Telex: 522106.

FRANCE: Europavia France, 5 Ave. Leon Harmel,
Antony Cedex 92167, Phone: 666-21-10, Telex: 42204381

UNITED KINGDOM: ITT Component Service, West Road,
Harlow, Essex CM20 2BP U.K., Phone: 027-35351, Telex: 817202

HONG KONG: Phone: 5-232420 TAIPEI Phone: 351-0293

NORITAKE ELECTRONICS, INC.

L. A. OFFICE: 22410 Hawthorne Boulevard, Torrance, CA 90505, (213) 373-6704, Telex: 67-4910

N.Y. OFFICE: 41 Madison Avenue, New York, NY 10010, (212) 481-3440, Telex: 12-5469

NORITAKE COMPANY, LIMITED

JAPAN: 1-1 Noritake Shinmachi, Nishi-ku, Nagoya-Shi, (052) 561-7111, Telex: J59738

EUROPE: Burotel Belgium SA, Rue de la Presse 3-5, 1000 Bruxelles, (02) 217-83-60, Telex: 4626962

Circle 124 for Literature Only

Circle 125 for Demonstration

Two chips, two processes combine in per-channel coder-decoder

Codec takes advantage of each technology's strengths in its bi-FET linear and C-MOS digital chips

by James W. Smith, *National Semiconductor Corp., Santa Clara, Calif.*

□ Just as a quarterback and a wide receiver combine their disparate talents for an 80-yard touchdown, two chips, each of a different semiconductor process, combine to produce a coder-decoder for individual telephone lines. This per-channel codec exploits the strengths of the two processes for its integrated circuits, one linear and one digital.

The TP3000 series has a bipolar-field-effect-transistor linear chip and two versions of a complementary-metal-oxide-semiconductor digital chip. The bi-FET device includes a stable voltage reference; the C-MOS chip has a reliable, monotonic digital-to-analog converter—as well as a coding-interrupt mode and five control inputs, two features that contribute to the versatility and flexibility of the series.

The two-chip, two-process approach is one of several explored for codecs by semiconductor makers [*Electronics*, Sept. 14, 1978, p. 105]. It results in many advantages for the designer of communications systems.

Why two processes?

Since the signal-processing functions determine codec performance and long-term stability, it is essential to design the linear chip with a proven process. Thus National opted for its process trademarked BI-FET. On the other hand, adopting C-MOS technology for the digital logic gives a triumvirate of advantages. The device combines good performance with low power dissipation, while allowing flexible system interfaces due to its wide tolerance of signal voltages.

There are two members of the series: the TP3001 for the North American coding scheme called the μ -255 law and the TP3002 for the European coding scheme called the A law. The TP3001 suits the μ -law setup of 24 multiplexed channels, and the TP3002 can operate in the A-law 32-channel setup; both will operate in the single-channel mode or with any number of multiplexed channels up to 32. Moreover, these channels may be controlled by a hardware setup, or they may be configured for microprocessor control.

All this is accomplished with two ICs (Fig. 1). The linear input-and-output, sample-and-hold, and automatic-zeroing circuitry, the successive-approximation comparator, and the voltage reference and its polarity switch are contained in the 20-pin LF3700 bi-FET device. The successive-approximation register, control logic, I/O

pulse-code-modulation buffers, and the digital-to-analog conversion networks are in the C-MOS package. For μ -law systems, this is the 28-pin MM58100; for the A-law, it is the 22-pin MM58150.

The combination of technologies gives highly usable performance. The bi-FET voltage reference minimizes distortion and crosstalk, yet assures long-term stability. The signal-to-distortion ratio is at least 3 decibels above any applicable standard, while the harmonic-distortion crosstalk ratio exceeds the European recommendations.

No gain adjustments

The gain tracking error is ± 0.25 dB maximum. Moreover, no external gain adjustments are necessary, yet time and temperature have so minimal an effect on the stability that drift is less than $\pm 1\%$ over 20 years.

Operating power is low—250 milliwatts—and there is a power-shutdown mode for additional savings. The two-chip arrangement also lends itself to high-speed testing: every functional block on each chip is accessible through package pins, for testing as a discrete function.

Many different elements control the accuracy and stability of a codec, but the voltage reference is a major contributor. The TP3000 makes use of a proven band-gap bipolar reference technique for the overall system's excellent long-term stability.

Unlike devices such as the zener diode that develop a reference by surface-charge breakdown, the band-gap circuit develops its reference by taking the difference of the voltages across two forward-biased base-emitter junctions. Forward biasing means that subsurface charge injection controls the voltage drops of the junctions. Surface contamination and irregularities, therefore, minimally affect the output.

Two variables

In fact, only two major variables control the output of the band-gap reference: the area ratio of the two base-emitter junctions and the circuit's temperature. Area geometry is easily controlled by careful circuit layout, while a reverse temperature coefficient introduced by a resistor network can null the temperature coefficient.

Used to convert digital words into analog voltages or to serve as feedback in a successive-approximation coding loop, the digital-to-analog converter has ultimate control of the codec's transfer characteristic. The

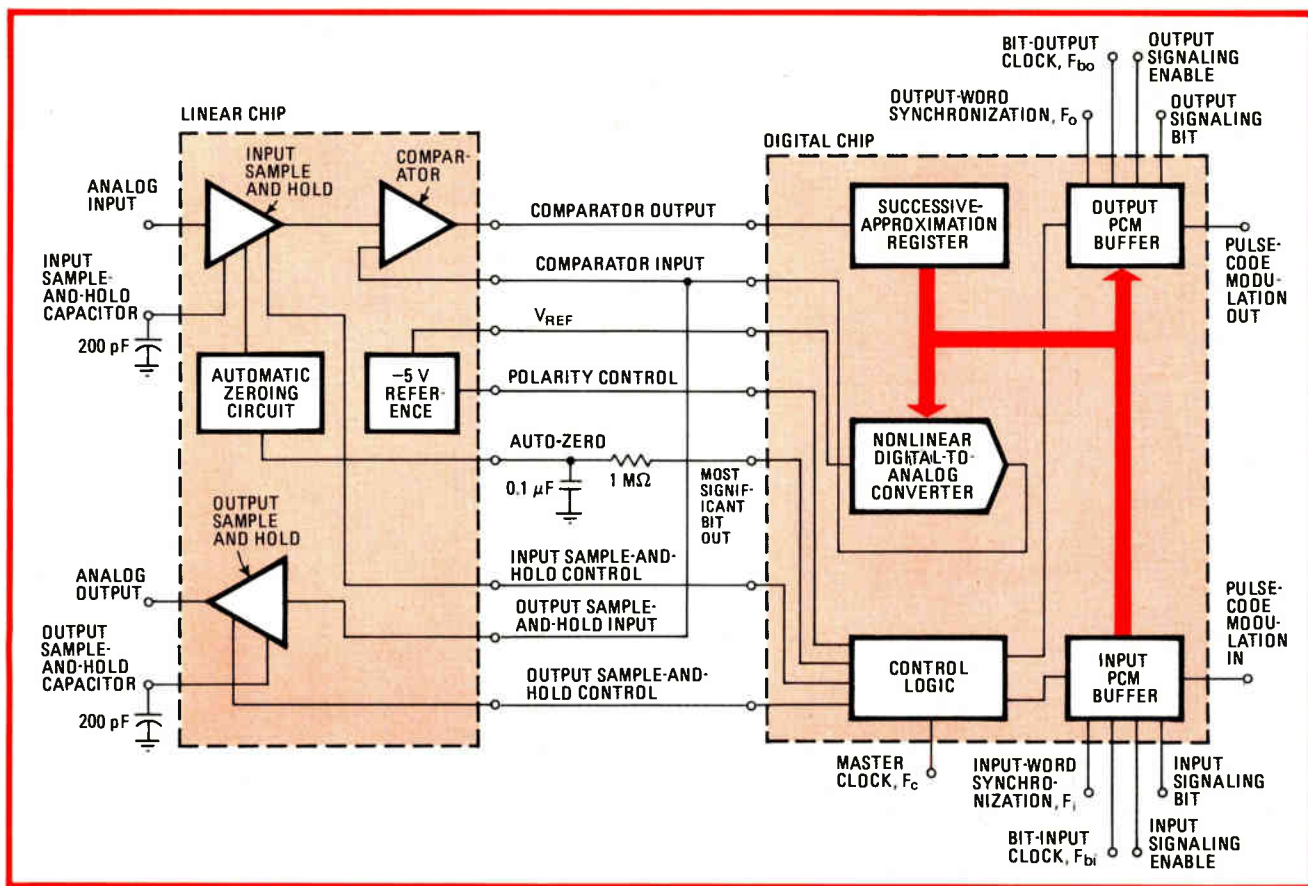

1. Two integrated circuits. A complete μ -law system, the TP3001, needs one linear LF3700 plus the digital MM58100. An A-law system, the TP3002, uses the same linear part plus the MM58150. Only ± 12 volts are needed to power both—the same as in most telephone systems.

TP3000's d-a converter uses C-MOS technology and p^+ diffused resistor elements. The resistor network's R/2R ladder structure has digital-to-analog conversion characteristics that conform exactly to the curve specified in the A law. With slight metalization modifications, it matches the μ -law curve.

To achieve the piecewise linear approximation recommended as an a-d conversion technique by the telephone industry, 16 equally spaced taps on each R element in the ladder are brought out. This structure is diffused with taps at each R/2R and R/16 node. The resulting ladder structure has few metal contacts and is easily multiplexed with C-MOS analog switches.

The ladder structure is grounded, so that the most accurate codes are developed near the ground potential where the lowest ac signals are referenced. This configuration requires a voltage reference with nearly equal positive and negative potential. So the TP3000 uses a highly accurate polarity switch on the output of its band-gap reference.

The voltage sensitivity of a diffused MOS resistor would usually make the device unattractive for codec use. However, the R/2R structure results in a network that divides the ladder current equally at the endpoints of each linear segment of the piecewise approximation. This setup yields voltage coefficients with first-order effects that cancel. The resulting overall coefficient is far less than the least significant bit of the linear segments of the transfer characteristic.

The coding and decoding conversions, each requiring use of the d-a converter, must take place within the 125 microseconds that each analog signal is sampled and held. Since coding takes about 70 μ s and decoding only 15 to 20 μ s, both operations can be performed within the 125- μ s time limit—so long as operation is synchronous.

Asynchronous data

But the TP3000 must also accept asynchronous digital data, as in the typical telephone conversation. Here a coding cycle may have to be terminated to allow a decoding operation. Yet if it has to begin anew after the decoding, it may not be completed at the end of the 125- μ s cycle. Therefore, the codec's C-MOS chip incorporates a decoding-interrupt feature.

In spite of its name, this feature interrupts the coding operation, doing so when decoding is required simultaneously. The contents of the successive-approximation register are temporarily held while the d-a converter decodes the received data. After the 15-to-20- μ s decoding, the converter is reconnected into the successive-approximation loop. The coding resumes where it left off, ensuring that the total operation will take place within the 125- μ s time constraint.

Flexible operation results from the TP3000's five control inputs, or clocks, for standard asynchronous operation. The μ -law system requires two more clocks for insertion and extraction of signaling information.

A 128-kilohertz master clock, F_c , clocks the codec

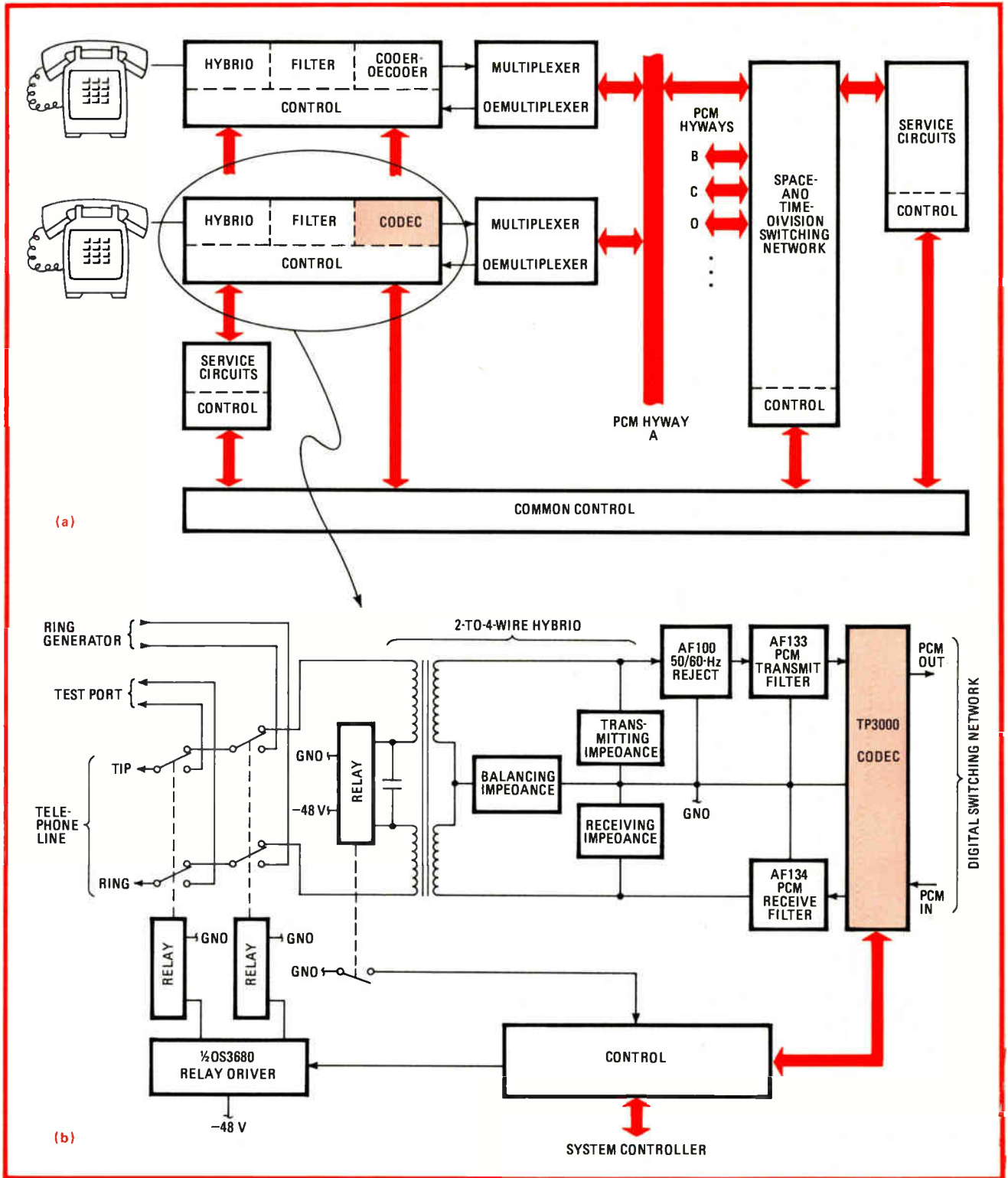

2. In the central office. The typical telephone-line interface circuit at a digital central office can house single-channel codecs in the overall system (a). Many interconnections with hybrids, filters, and other control circuitry (b) are required before any multiplexing operation.

control functions, allowing digital data to be clocked in and out at various rates without affecting typical codec timing. The rate for this data clocking may be anything between the 64-kilobit-per-second single-channel rate and the 2,048-kb/s 32-channel European rate. The two signals associated with this clocking are F_{bo} , the output-

bit clock, and F_{bi} , the input-bit clock.

The last two standard clock signals identify the transmit and receive time slots in multichannel operation. They are called F_o , for output-word synchronization, and F_i , for input-word synchronization. In a synchronous system, F_{bo} and F_{bi} usually have a common source, and in

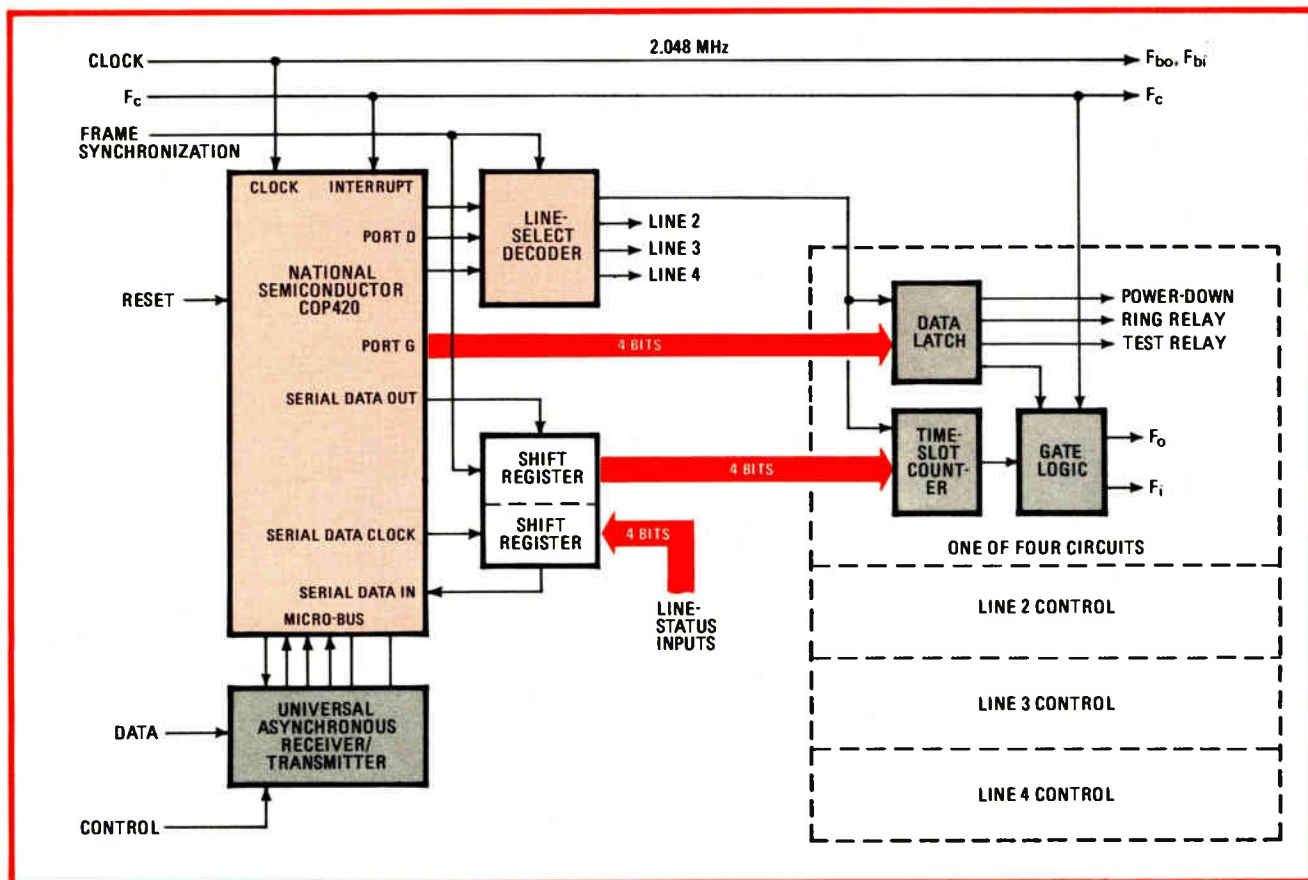

3. Quad card. Multiplexing time-slot assignments for as many as four codecs on a printed-circuit board can be automatically assigned with a microprocessor. For four subscribers, a 4-bit, single-chip microcomputer is useful, although other hardware or bit sizes may be used.

some cases F_o and F_i may have a common source or may be related for derivation from common logic.

The TP3000 samples, at an 8-kilohertz rate, an analog signal that has been filtered to a bandwidth of 300 hertz to 3.4 kHz. It converts this sampled voltage into an 8-bit companded digital code (either μ - or A-law) and stores the code in a high-speed serial buffer. External control logic then directs the shifting of the 8-bit code onto a time-shared pulse-code-modulated bus. The codec then acquires a new analog signal and begins a new digital coding cycle.

At the same time the codec is transmitting its 8-bit data, it can accept incoming data either synchronously or asynchronously. It decodes this incoming data into the equivalent analog voltage level and stores it in the output sample-and-hold amplifier. After off-chip filtering to remove the effects of sampling, the analog signal closely matches the initial filtered analog source.

In operation

The TP3000 can operate in a digital telephone-exchange office, inserted into the interface circuit for an individual telephone line (Fig. 2a). Its digital input and output may be time-multiplexed onto a bus with as many as 31 other codecs.

The telephone line itself is connected to the terminal marked TIP and RING in Fig. 2b. Two relays test or ring the line, and a hybrid device separates the voice signals according to the direction of flow (transmit or receive).

Low-pass filtering and elimination of any 50- or 60-Hz hum are performed before the analog or digital signal goes to the codec for conversion. All these parts make up what is called the subscriber-line interface circuit.

Typical setup

Probably the typical central-office setup would combine every four codecs and related interface circuits with a common controller on a circuit board. The controller organizes the bus time-slot assignments, controls the relays, and collects signaling information from the telephone. It also can power-down unused circuits and can perform routine troubleshooting.

A configuration for this controller uses a 4-bit, single-chip microcomputer (Fig. 3). A common system control provides each controller with the time-slot assignments for the codecs. This time slot is twice the standard time needed for F_o or F_i alone, because each codec will send data during the first half of the time slot and receive it during the second half while the codec at the other end of the line reverses the procedure.

Since the codec's internal timing is independent of the data control clocks, a single unit can be used readily for such a full-duplex single channel because of the sharing of the time slot with the unit at the other end of the line. The data moves at 128 kHz, the same frequency as the TP3000 master clock. □

This article is the fourth in a series exploring the different approaches to codec design. Earlier stories appeared in the issues of Sept. 14 and Sept. 28, 1978.

All Electronic Cleaning Problems Are Not Alike...

That's why we offer 7 different product answers.

Safely, quickly cleans electronic components



MS-180 Freon® TF Solvent

Safely, quickly cleans electronic components and circuits, precision instruments, switches, motors, film equipment and tools. Low surface tension – penetrates minute openings. Non-conductive – safe to use on working electrical equipment. Evaporates quickly – leaves no film.

Fast cleaning action removes all types of organic flux



MS-190 Freon TMC Solvent

Fast cleaning action removes all types of organic flux. Excellent for spot flux removal. Avoids down-time, ideal for field service. Convenient for production and prototype work.

Flux removal and critical cleaning of printed circuit boards



MS-160 Freon T-P35 Solvent

Flux removal and critical cleaning of printed circuit boards, and their components, relays, switches, servo-mechanisms and instruments. Absorption and removal of water films.





EXCLUSIVE CLEANING SYSTEM

MS-226 Cobra® Solvent Spray Brush

Miller-Stephenson's exclusive Cobra Extension Brush will convert any M-S aerosol cleaner into an efficient metered spray with scrubbing action. Insures maximum cleaning accuracy with minimum solvent waste.

® Registered trademark of Miller-Stephenson



Outstanding particulate matter removal



MS-165 Freon TMS Solvent

Outstanding particulate matter removal. It is well suited for cleaning ionic soils from complex assemblies containing plastics and elastomers. Specifically formulated for activated rosin flux removal.

MS-175 Freon TE Solvent

Removes flux residue from solvent-sensitive components such as printed circuit board assemblies, hybrid micro-circuits, capacitors, telephone assemblies and also cleans precision timing devices.



Write for our **FREE** Catalog. Discover the answers to all your cleaning problems.

miller-stephenson chemical co.,inc.

LOS ANGELES • CHICAGO • DANBURY, CT. • TORONTO

Purity...it's something we never forget

Offers improved, long term compatibility with metals



MS-176 Freon TES Solvent

Offers improved, long term compatibility with reactive metals, such as aluminum, magnesium and zinc. Used with plastics, elastomers, films, foil and most other solvent-sensitive materials. Ideal for cleaning electronic components. Will not harm printed circuit boards, containing reactive metals.

Critical cleaning of printed circuit boards

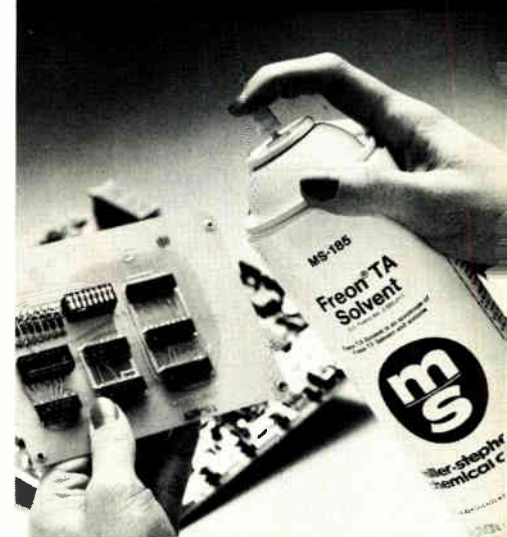

MS-185 Freon TA Solvent

Critical cleaning of printed circuit boards, electrical relays, missile guidance systems, potentiometers, precision capacitors, hearing aids, micro-modules, electrical meters, timers and semiconductors.



miller-stephenson chemical co.,inc.

George Washington Highway, Danbury, CT 06810 / (203) 743-4447

EM-2-X

- Please send **FREE** catalog and prices on the complete line of MS Cleaners for Electronics.
- Enclosed is \$2.00 (each), please send trial unit of MS MS, MS, MS, MS
- Enclosed is \$5.00, please send trial units of MS and Cobra Solvent Spray Brush (MS-226).

Intended Use

Name Dept./Title

Company

Address

For Industrial Use only. Trial Unit must be sent to company address.

Circle 131 on reader service card

TTL and C-MOS interface unites microprocessor with calculator

by Bert K. Erickson
Fayetteville, N. Y.

This interface combines a general-purpose scientific calculator, which performs rapid arithmetic operations, with the extensive memory of 8-bit microprocessor-based systems into a system that has the advantages of both. Here, the calculator can program or be programmed exclusively by the microprocessor; ultimately, of course, it is programmed by software residing in system memory. Alternatively, the calculator can be used for its

normal purpose. Using transistor-transistor-logic and complementary-metal-oxide-semiconductor devices, the interface costs less than \$20 dollars.

Virtually any microprocessor can be united with any calculator, assuming the calculator's keyboard can be accessed. In general, the keyboard scanning lines will be connected to the calculator's corresponding display driver pins and to the microprocessor system through appropriate circuitry. A two-key roll-over feature that inhibits data entry when two keys are depressed simultaneously should be included. Several lines from the microprocessor will be connected to the keyboard so that microprocessor instructions can be entered into the calculator.

Figure 1 shows how a typical calculator (MOS Technology's two-chip MCS2525/2526) was initially modified to interface with a microprocessor. A set of buffers (4050) serves as the link between the strobe lines and the

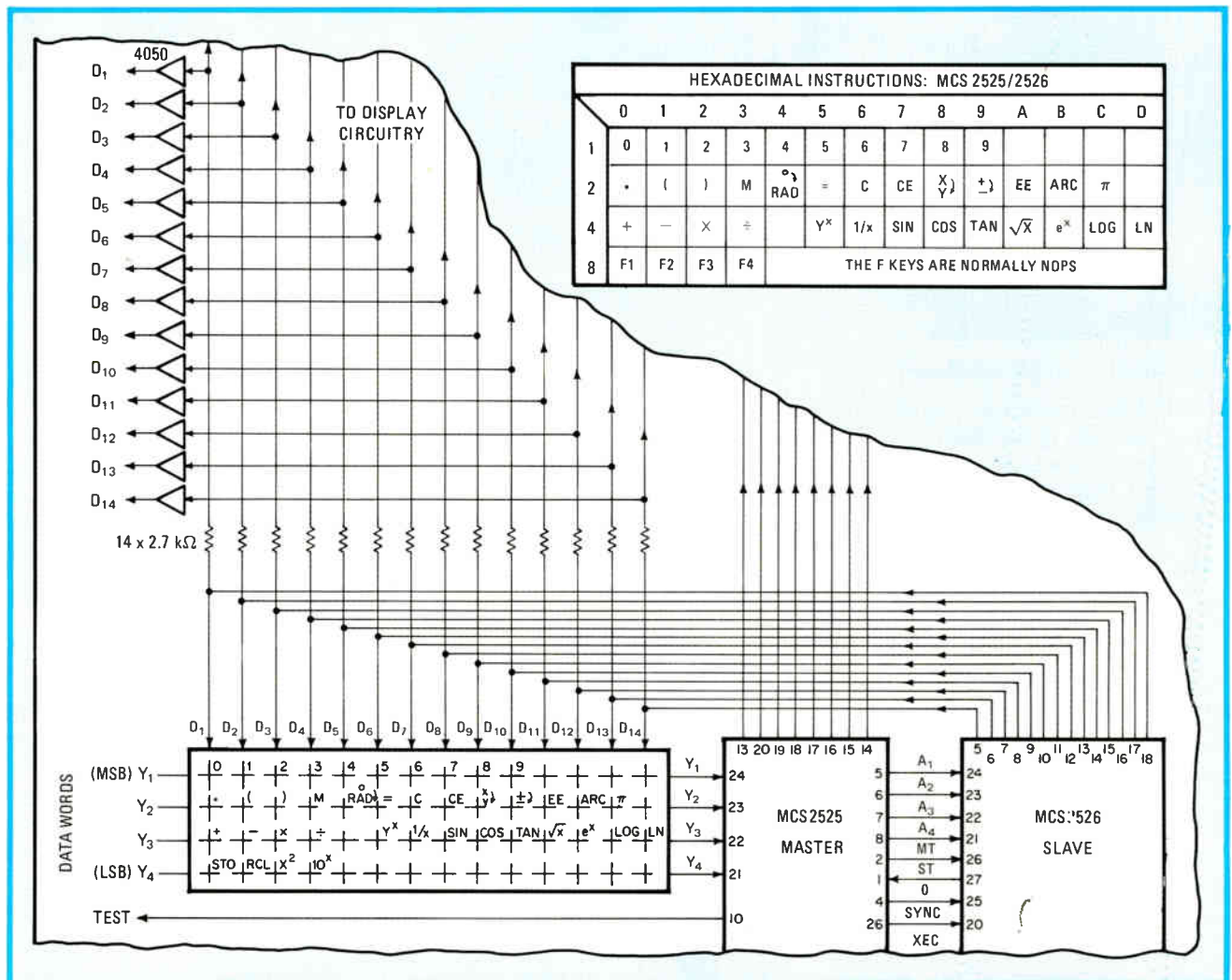

1. Lines of command. MCS2525/2526 calculator chip pair sends instructions to 8000 microprocessor through appropriate 4050 buffers when corresponding key is depressed. Alternatively, microprocessor can program calculator when half of data word is introduced at Y₁-Y₄; other half of data word and calculator's strobe circuits generate D₁-D₁₄ signals at keypad, so that key closures are simulated.

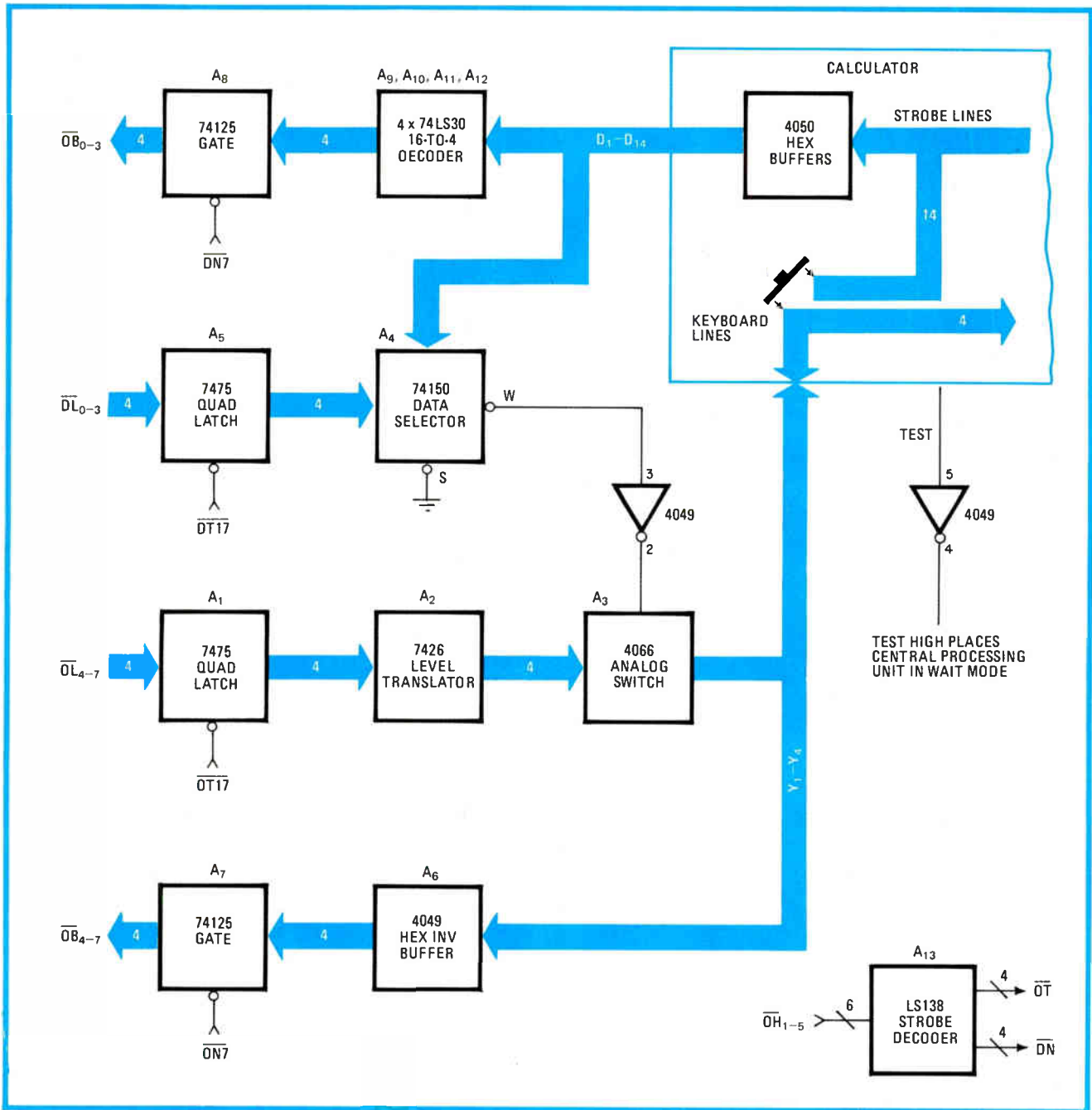

2. Control. Interface transmits keypad instructions to 8000 processor and also aids in simulating key closure for calculator programming by 8000. Accompanying sample program for displaying digits sequentially has built-in delay instructions to slow input-data rate, so that a keyboard scan can be completed for each word entered at the calculator. Two-key roll-over protection is also provided.

input to the microprocessor for programming by the MCS2525/2526. The 2.7-kilohm resistors are used to decouple the calculator from the buffer input in order to minimize loading of the MCS2525/2526. Decoupling resistors should also be placed in series with the calculator's input lines, Y_1 - Y_4 , where microprocessor instructions (data words) to the 2525/2526 are entered.

The MCS2525/2526 automatically scans the calculator's keyed pins, D_1 - D_{14} , with a 7-volt strobe. To enter an instruction from the microprocessor, a keypad closure is simulated from the data entered at lines Y_1 - Y_4 and on lines D_1 - D_{14} . By applying the first 4 bits of the 8-bit data

word at the Y lines and by introducing the last four bits at the D lines, key closure is simulated. For example, to enter digit 5, line Y_1 must be brought high while D_6 is being strobed (an instruction corresponding to hexadecimal number 15, as shown in the particular instruction set for this microprocessor-calculator). Alternatively, the microprocessor can be programmed by depressing the appropriate key on the keypad.

The hardware used to implement the keypad-line coding is shown in Fig. 2. For generating calculator instructions, the upper 4 bits of the data word, which are eventually applied to Y_1 - Y_4 , is latched into A_1 . The



WIRE FOR WIRE-WRAPPING



CUT TO LENGTH AND PRE-STRIPPED ON BOTH ENDS

LENGTH "L" INCH	AWG 30 (0.25MM) KYNAR WIRE INSULATION DIAMETER .0195 INCH (0.50MM) STRIP-OFF LENGTH BOTH ENDS 1 INCH (25MM) 500 WIRES PER PACKAGE				AWG 28 (0.32MM) KYNAR WIRE INSULATION DIAMETER .023 INCH (0.59MM) STRIP-OFF LENGTH BOTH ENDS 1 INCH (25MM) 500 WIRES PER PACKAGE				AWG 26 (0.40MM) KYNAR WIRE INSULATION DIAMETER .027 INCH (0.69MM) STRIP-OFF LENGTH BOTH ENDS 1 INCH (25MM) 500 WIRES PER PACKAGE			
	BLUE PART NO.	WHITE PART NO.	YELLOW PART NO.	PRICE PER 500	BLUE PART NO.	WHITE PART NO.	YELLOW PART NO.	PRICE PER 500	BLUE PART NO.	WHITE PART NO.	YELLOW PART NO.	PRICE PER 500
1	30B-010	30W-010	30Y-010	\$4.88	28B-010	28W-010	28Y-010	\$5.25	26B-010	26W-010	26Y-010	\$5.75
1.5	30B-015	30W-015	30Y-015	5.19	28B-015	28W-015	28Y-015	5.63	26B-015	26W-015	26Y-015	6.23
2	30B-020	30W-020	30Y-020	5.50	28B-020	28W-020	28Y-020	6.00	26B-020	26W-020	26Y-020	6.68
2.5	30B-025	30W-025	30Y-025	5.82	28B-025	28W-025	28Y-025	6.38	26B-025	26W-025	26Y-025	7.13
3	30B-030	30W-030	30Y-030	6.13	28B-030	28W-030	28Y-030	6.75	26B-030	26W-030	26Y-030	7.60
3.5	30B-035	30W-035	30Y-035	6.44	28B-035	28W-035	28Y-035	7.13	26B-035	26W-035	26Y-035	8.05
4	30B-040	30W-040	30Y-040	6.75	28B-040	28W-040	28Y-040	7.50	26B-040	26W-040	26Y-040	8.50
4.5	30B-045	30W-045	30Y-045	7.07	28B-045	28W-045	28Y-045	7.87	26B-045	26W-045	26Y-045	8.98
5	30B-050	30W-050	30Y-050	7.38	28B-050	28W-050	28Y-050	8.25	26B-050	26W-050	26Y-050	9.43
6	30B-060	30W-060	30Y-060	8.00	28B-060	28W-060	28Y-060	9.00	26B-060	26W-060	26Y-060	10.35
7	30B-070	30W-070	30Y-070	8.63	28B-070	28W-070	28Y-070	9.75	26B-070	26W-070	26Y-070	11.25
8	30B-080	30W-080	30Y-080	9.25	28B-080	28W-080	28Y-080	10.50	26B-080	26W-080	26Y-080	12.18
9	30B-090	30W-090	30Y-090	9.88	28B-090	28W-090	28Y-090	11.25	26B-090	26W-090	26Y-090	13.55
10	30B-100	30W-100	30Y-100	10.50	28B-100	28W-100	28Y-100	12.00	26B-100	26W-100	26Y-100	14.00

ROLLS OF WIRE

100 ft. roll	R30B-0100	R30W-0100	R30Y-0100	\$3.65	R28B-0100	R28W-0100	R28Y-0100	\$4.05	R26B-0100	R26W-0100	R26Y-0100	\$4.35
500 ft. roll	R30B-0500	R30W-0500	R30Y-0500	10.40	R28B-0500	R28W-0500	R28Y-0500	12.85	R26B-0500	R26W-0500	R26Y-0500	13.80
1000 ft. roll	R30B-1000	R30W-1000	R30Y-1000	16.82	R28B-1000	R28W-1000	R28Y-1000	21.10	R26B-1000	R26W-1000	R26Y-1000	23.15

© KYNAR PENWALT

MINIMUM BILLING \$25.00. ADD SHIPPING CHARGE \$1.00. NEW YORK RESIDENTS ADD APPLICABLE TAX.

OK MACHINE & TOOL CORPORATION

3455 CONNER STREET, BRONX, N.Y. 10475 (212) 994-6600 Telex 125091

Circle 134 on reader service card

Electronics Magazine Book Series.



- 1. Microprocessors** What you must know about available micro-processor technology, devices, information, 4th printing. \$8.95
- 2. Applying Microprocessors** 2nd and 3rd generation technology. 26 detailed applications from data networks to video games. \$9.95
- 3. Large Scale Integration** Covers the basic technology, new LSI devices, LSI testing procedures, plus system design and applications. \$9.95
- 4. Basics of Data Communications** Includes 47 articles from Data Communications magazine covering more than 11 key areas. \$12.95



- 5. Circuits for Electronics Engineers** Contains 306 circuits arranged by 51 functions from Amplifiers to Voltage Regulating Circuits. Saves design drudgery. \$15.95
- 6. Design Techniques for Electronics Engineers** Nearly 300 articles drawn from "Engineer's Notebook." A storehouse of design problem solutions. \$15.95
- 7. Memory Design: Microcomputers to Mainframes** The technology, devices, and applications that link memory components and system design. \$12.95
- 8. New Product Trends in Electronics, Number One** From "New Products," state-of-the-art materials and equipment, arranged according to function. \$14.95

Electronics Book Series P.O. Box 669, Hightstown, N.J. 08520

1. Send me _____ copies of "Microprocessors" at \$8.95 per copy.
2. Send me _____ copies of "Applying Microprocessors" at \$9.95 per copy.
3. Send me _____ copies of "Large Scale Integration" at \$9.95 per copy.
4. Send me _____ copies of "Basics of Data Communications" at \$12.95 per copy.
5. Send me _____ copies of "Circuits for Electronics Engineers" at \$15.95 per copy.
6. Send me _____ copies of "Design Techniques for Electronics Engineers" at \$15.95 per copy.
7. Send me _____ copies of "Memory Design: Microprocessors to Mainframes" at \$12.95 per copy.
8. Send me _____ copies of "New Product Trends in Electronics" at \$14.95 per copy.

Discounts of 40% on orders of 10 or more copies of each book.

I must be fully satisfied or you will refund full payment if the book is returned after ten-day trial examination.

Payment enclosed Bill firm Bill me

Charge to my credit card:

American Express Diners Club
 BankAmericard/Visa Master Charge

Acc't No. _____ Date exp. _____

On Master Charge only,
first numbers above name _____

Name _____ Title _____

Company _____

Street _____

City _____ State _____ Zip _____

Signature _____



output of A₁ is shifted in level by open-collector gate A₂, and the 7-V strobe is applied to the keyboard lines by analog switch A₃.

A₃ is switched on by selector A₄ through the 4050 buffers, and A₄ is scanned in the same sequence as the columns of the keypad. The input line selected for enabling A₃ at the proper time is determined by the lower 4 bits of the data word stored in A₅. Information stored in the microprocessor can now be processed by the calculator, providing the instructions are applied to Y₁–Y₄ at a slow rate (the time it takes to depress a key manually). Time delays are therefore required, since the microprocessor can generate instructions much faster than the calculator can scan the keypad. The delays are provided by the program itself.

If the microprocessor is to be controlled by the calculator, its keypad rows are interrogated by A₆ and applied to the input port of A₇. The keyboard columns are scanned and applied to the input port of A₈.

As for the actual programming of the calculator by the microprocessor (in this case an 8000), a sample program is shown in the table. This program generates the digits 1 through 9 on the calculator's display in succession. When all digits are displayed, they blink three times. The sequence then repeats. Though this subroutine has little practical value, it demonstrates several characteristics of the software required for programming.

The program, stored in random-access memory, is switched to the starting address on page 0, and the restart address is entered on the keypad. The program is then initiated with an interrupt request to the microprocessor, which may be entered from the keypad if one of the unused function keys is wired appropriately for the interrupt code required.

The RST 6 branch instruction provides the calculator with ample time to complete a keypad scan between program steps. To absolutely prevent instructions from arriving at the calculator's input while an instruction is being executed, the test pin of the MCS2525/2526 can be connected to the microprocessor's wait input. Instructions A8, 35 simulate the two-key roll-over feature mentioned earlier. □

MICROPROCESSOR / CALCULATOR TEST PROGRAM: SEQUENTIAL DIGIT DISPLAY					
Label	DH register	DL register	Op code	Mnemonic	Comments
RST 6	01	30	5F	OUT 17	Keyboard scan delay
		31	10	INR C	
		32	48	JNZ	
		33	31	31	
		34	01	01	
		35	07	RET	
		·	·	·	
RST 7	01	38	0E	MVI B	Set first digit
		39	11	11	Set digit count
		3A	26	MVI E	
		3B	1D	1D	
		3C	C1	MOV AB	Set display time
		3D	1E	MVI D	
		3E	E0	E0	
		3F	35	RST 6	Display sequence
		40	18	INR D	
		41	48	JNZ	
		42	3F	3F	
		43	01	01	Release digit
		44	A8	XRA A	
		45	35	RST 6	} Enter and display next digit if zero is not set
46	0B	INR B			
47	C1	MOV AB			
48	BC	CMP E			
49	48	JNZ			
4A	3D	3D			
4B	01	01	Enter clear		
4C	06	MVI A			
4D	26	26	Release clear		
4E	35	RST 6			
4F	A8	XRA A	Repeat subroutine		
50	35	RST 6			
51	3D	RST 7			

Engineer's notebook is a regular feature in *Electronics*. We invite readers to submit original design shortcuts, calculation aids, measurement and test techniques, and other ideas for saving engineering time or cost. We'll pay \$50 for each item published.

Calculator notes

HP-25/HP-33E aids design of short-vertical antennas

by Walter J. Schulz Jr.
Philadelphia, Pa.

Space restrictions and other considerations often limit the height of a vertical antenna that should be one-quarter wavelength at the desired frequency of operation, and in those cases, a capacitive hat is required to extend the antenna's electrical length. This program,

which works with either the HP-25 or HP-33E calculator, will aid in the design of short verticals by finding the top-loading disk radius of the top hat. In addition, the radiation resistance of the antenna is also found, so that it can be fed by an appropriately matching transmission line.

The program treats the vertical as an open-ended transmission line, first finding its characteristic impedance with:

$$Z_0 = 60 \left[\ln \frac{2h}{a} - 1 \right]$$

where h is the actual electrical height of the antenna and a is the mast radius. Both parameters are expressed in

YOUR FLAT CABLE CONNECTION NEEDS ARE SUMMED UP IN ONE WORD. AUGAT.



We have everything it takes to make the right connections. And we mean everything. What's more, all our connectors offer the advanced technology and high quality you've come to expect from Augat.

Take our unique crossover header. Its special mirror-image pin design inside the connector lets you mate cable-to-cable with direct line continuity. This eliminates translator boards and lets you make

make "T" connections for special programming, testing, or daisy chaining.

Of course, if you need standard flat cable and



bulkhead connections without polarization problems.

Yet our new crossover header isn't the only thing that's new. We also offer a new intra-switch and intra-connector. They make it easy to isolate or select any combination of circuits individually or in a group. What's more, they let you

connectors, we have those, too. In fact, we have a wide range of female socket connectors, DIP plugs, and header assemblies. We can even supply complete assemblies to your specifications.



When you add Augat's line of mass termination connectors to our complete line of DIP sockets, packaging panels, and Wire-Wrap* services, you get the single source for all your interconnection needs.

So if you've been having a hard time making ends meet, call your nearest Augat distributor, or write Augat, Inc., 33 Perry Avenue, P.O. Box 779, Attleboro, Mass. 02703. Tel. (617) 222-2202.

*Registered Trademark Gardner-Denver Company

AUGAT[®]

Augat interconnection products, Isotronics microcircuit packaging, and Alco subminiature switches.

Circle 136 on reader service card

degrees with respect to one wavelength. Next, using Z_0 , the radius of the top hat required is found by:

$$r = (7.5 \lambda \tan H_b) / Z_0$$

where r is expressed in degrees, $\lambda = 360^\circ$, and H_b is the degree of top loading equal to $90^\circ - h$. Note that there is no need to find the amount of capacitance required to resonate the antenna for operation at one-quarter wavelength, as the capacitance of a disk of given radius r is known and is expressed directly in this equation.

Radiation resistance, or the resistance seen by the transmission line feeding the base of the vertical is then found with:

$$R_r = 40(1 - 0.085 \sin^2 h) \sin^2 h$$

This equation, which is not widely known, has been derived by Dome using the method of moments, whereby an antenna with a height of 90° and with a radiation resistance of 36.6 ohms is compared with the antenna under study.

As an example of the program's usefulness, consider a short vertical designed for an electrical height of 60° (30° top loading) and having a mast of radius 0.6383° . Keying in the appropriate data as directed in the instructions (the program pauses at steps 2, 6, and 16 to allow for data entry) yields $Z_0 = 254.1863 \Omega$, $r = 6.1327^\circ$, and $R_r = 28.2202 \Omega$. □

HP-33E PROGRAM FOR SHORT VERTICAL ANTENNAS

Line	Code	Key
001	01 31	ENTER ↑
002	02 74	R/S
003	03 23 0	STO 0
004	04 2	2
005	05 61	X
006	06 74	R/S
007	07 71	÷
008	08 14 1	f ln
009	09 1	1
010	10 41	—
011	11 24 1	RCL 1
012	12 24 61	X
013	13 14 74	f PAUSE
014	14 23 2	STO 2
015	15 15 21	g DEG
016	16 74	R/S
017	17 14 9	f tan
018	18 24 3	RCL 3
019	19 24 4	RCL 4
020	20 61	X
021	21 61	X
022	22 24 2	RCL 2
023	23 71	÷
024	24 74	R/S
025	25 34	CLX
026	26 1	1
027	27 31	ENTER ↑
028	28 24 7	RCL 7
029	29 24 0	RCL 0
030	30 14 7	f sin
031	31 23 5	STO 5
032	32 24 6	RCL 6
033	33 14 3	f y ^x
034	34 61	X
035	35 41	—
036	36 24 5	RCL 5
037	37 15 0	g x ²
038	38 61	X
039	39 4	4
040	40 0	0
041	41 61	X
042	42 74	R/S
043	43 13 01	GTO 01

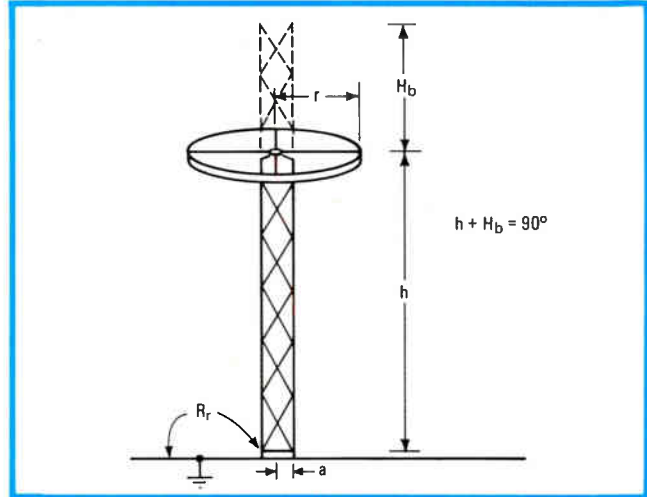

On top. HP-25/HP-33E program finds two antenna parameters: radius of capacitive hat required to resonate short verticals at one-quarter wavelength, and vertical's radiation resistance. Variables h , H_b , and a must be expressed in electrical degrees. Top-hat radius, r , is given in same units. Amount of top loading, H_b , is defined as difference between one-quarter wavelength (90°) and h .

Registers	
R ₀	h
R ₁	60
R ₂	Z_0
R ₃	7.5
R ₄	360
R ₅	$\sin h$
R ₆	2.5
R ₇	0.085

Instructions

- Key in program
- Enter RUN mode and initialize
- Key in antenna height, mast radius and top loading value as program proceeds:
(h), R/S, (a), R/S, (H_b), R/S
(all variables must be expressed in electrical degrees)
- Antenna's characteristic impedance (Z_0) is displayed, followed by the disk radius (r); pressing R/S displays the radiation resistance (R_r)

A latch in time saves a line

Most single-chip microprocessors have fewer input/output lines than system designers would like. A popular input use for these software-programmable lines is to detect asynchronous pulses and perform some function on them. But often the external pulses are short and must be latched by external logic—which then must be reset by another I/O line.

Jim Edrington of Texas Instruments Inc., Austin, Texas, has therefore designed a circuit that enables just one microprocessor I/O pin to handle both the logic detection and the reset function. In this circuit, the pulse input line is tied to one of the inputs of a dual open-collector gate (7401); the output of this gate is in turn tied to a pull-up resistor, the I/O line, and the input of an inverter; and the inverter output is then tied back to the other input of the dual gate, forming a latch.

Normally the I/O pin is programmed as an input and polled by software. Whenever a logic 1 is detected at the latch output, the specified function is performed and then the pin is programmed as an output (logic 0) and restored to an input function. Logic 0 on the output line resets the latch to a logic 0. Use of an open collector gate and a pull-up resistor permits the latch output to be tied to the processor output.

Darlington plus Schottky equals high efficiency

Engineers involved with power processing circuits now have two relatively new specialized power semiconductors to work with—the power Darlington transistor and the Schottky diode. The “Darlington/Schottky Blue Book on High-Frequency Power Switching” from TRW describes various techniques for designing high-efficiency switching regulators and motor controllers. Six switching regulators and shunt motor controls are covered in the booklet. Copies are available free from TRW Power Semiconductors, 14520 Aviation Blvd., Lawndale, Calif. 90260.

Polyester bundle saves a bundle

To his dismay, a minicomputer manufacturer recently found his wiring shop posed a health hazard to his employees—but the cure actually saved him money. Workers were experiencing an allergic reaction to the nylon and glass sleeving being used to protect the company's harnesses. Replacing the original materials with Bentley-Harris's braided-polyester Expando protective sleeving cleared up the problem, since polyester is chemically stable and inert. The beneficial side-effect was a drop in harnessing costs. As the new jackets accepted a wide range of wire bundles, the company was able to standardize on two sizes of Expando jackets, whereas many sizes of sleeving had formerly to be stocked. The address of Bentley-Harris Manufacturing Co. is 241 Welsh Pool Rd., Lionville, Pa. 19353.

Revising the IEEE bus

Since its publication in 1975, IEEE STD 488 has played an important part in the design of instrumentation interfaces, and now the Institute of Electrical and Electronics Engineers has just published a revised edition of it. The technical concepts defined in the original standard remain the same, but new information has been provided on system controllers, devices powered off and on, serial-poll and parallel-poll configurations, interface function capability identification, and data-rate considerations. Copies of the new standard are available at \$10 each from the IEEE Service Center, 445 Hoes Lane, Piscataway, N. J. 08854. **Jerry Lyman**

Now you can have a broader scope of capabilities in a TM 500 package...

from Tektronix.

You can judge an oscilloscope by the company it keeps, and the company that makes it. When Tektronix builds a new scope, reliability and technology are designed in. Along with a wide range of performance to match our scopes to your toughest application.

We've built two NEW TM 500 Scopes to prove it. The only thing small about these new scopes is their size. They're big on performance, 80 MHz bandwidth with one and 10 MHz bistable storage with the other.

You can slip these scopes into a TM 500 Mainframe, select the other instruments you need—from over 40 in our TM 500 line—and create your own test set.

The new 80 MHz TM 500 Scope features dual trace enhanced automatic triggering, true X-Y capability and maximum sensitivity of 5 mV/div. And, the new 10 MHz bistable storage scope features dual trace and true X-Y capability plus auto-erase and variable enhancement for increased writing speed.

And when you add the versatile capabilities of our dual trace, 15 MHz oscilloscope and our compact 5 MHz scope, you've got a TM 500 scope for virtually every application. From the company that knows oscilloscopes best. Tektronix.



Make the most of your TM 500 test set . . . call the Tektronix Field Office nearest you today for details on TM 500 Oscilloscopes. To request a copy of the TM 500 catalog, call Tektronix's toll free automatic answering service: 1-800-547-1512. In Oregon, call collect: 644-9051. In Europe: Tektronix Limited, P.O. Box 36, St. Peter Port, Guernsey, Channel Islands.

TM 500
Designed for
Configurability

Tektronix[®]
COMMITTED TO EXCELLENCE

For Technical Data Circle #138 on Reader Service Card
For demonstration Circle #139 on Reader Service Card
For immediate action, dial our toll free automatic answering service 1-800-547-1512



Welcome to Connectorland.

Answers to your design problems lie in Amphenol® connectors. We know the territory.

Find the connector you want right here. These are just a few of our problem-solvers. (There are lots more where these come from.)



Amphenol 48 Series Miniature Circular Connectors. Qualified to MIL-C-26500. Full performance in extreme environments. Lightweight. Easy-to-assemble with crimp-removable contacts. Front release. Bayonet or threaded coupling.

Reader Service Number 209



Amphenol FCP-type BNC Plugs and Jacks. Assemble faster, easier than standard BNC's. Only three parts (not six) to assemble. No special tools. Trim coax, solder center contacts, and slide parts together. For RG-58/59U cable.

Reader Service Number 210



Amphenol 97 Series Standard Circular Connectors. Time-tested, highly reliable. Non-rotating, pre-aligned contacts. Rugged, with diallyl phthalate inserts and molded barriers between each contact.

Reader Service Number 212



Amphenol 225 Series Printed Circuit Connectors. Low contact resistance. Slotted bellows or folded-ribbon solder-type contacts. Low-friction mating for repeated insertion and withdrawals. Rugged, one-piece bodies. Wide range of contact positions and terminations.

Reader Service Number 213



Amphenol 223 Series Tiny Tim® Connectors. For potted-in or surface-mounted circuits, or for microminiature rack-and-panel, cable-to-cable, or cable-to-panel. 5 to 33 contacts, polycarbonate or nylon bodies.

Reader Service Number 211

Amphenol 57 Series Micro-Ribbon® Connectors. For telephony and EDP. High-contact density (14 to 64). Protective polarized shell.

Reader Service Number 215



Amphenol 221 Series Strip Connectors. Low-cost miniatures. High contact density. And you can cut and/or stack them to almost any shape.

Reader Service Number 214



Amphenol 285 Series Modular Telephone Jacks. Direct mounting on PC boards without adapters. Keyed or non-keyed, 6-position (4 or 6 contacts) or 8-position. Ring or spade lugs. PC tails or stripped ends.

Reader Service Number 216



Amphenol 157 Series Micro-Pierce® Connectors. Fast, solderless termination in factory or field. Portable, easy-to-use termination tools. Intermateable with currently used connectors in telephony or EDP.

Reader Service Number 141

**BUNKER
RAMO**

AMPHENOL NORTH AMERICA

General Offices: Oak Brook, Illinois 60521

Sales Offices: Atlanta (404) 394-6298 • Boston (617) 475-7055 • Chicago (312) 449-1880
 Dallas (214) 235-8318 • Dayton (513) 294-0461 • Denver (303) 758-8033 • Detroit (313) 722-1431
 Greensboro (919) 275-8644 • Houston (713) 444-4096 • Indianapolis (317) 842-3245
 Kansas City (913) 764-1541 • Knoxville (615) 690-6765 • Los Angeles (213) 649-5015
 Minneapolis (612) 835-4595 • New York (516) 364-2270 • Orlando (305) 647-5504
 Philadelphia (215) 657-5170 • Phoenix (602) 265-3227 • St. Louis (314) 569-2277
 San Diego (714) 272-5451 • San Francisco (408) 732-8990 • Seattle (206) 455-2525
 Syracuse (315) 455-5786 • Washington, DC (703) 524-8700
 Canada: Montreal (514) 482-5520 • Toronto (416) 291-4401 • Vancouver (604) 278-7636
 International: Oak Brook, Illinois TELEX 206-054

Call your Amphenol North America Distributor

ARIZONA
 Liberty Electronics
 Phoenix
 (602) 249-2232
 Cetec Moltronics
 Phoenix
 (602) 272-7951

CALIFORNIA
 Bell Industries
 Sunnyvale
 (408) 734-8570
 Cramer Electronics
 Irvine
 (714) 979-3000
 (213) 771-8300
 Elmar Electronics
 Mountain View
 (415) 961-3611
 Kierulf Electronics
 Los Angeles
 (213) 725-0325
 San Diego
 (714) 278-2112
 Liberty Electronics
 El Segundo
 (213) 322-8100
 San Diego
 (714) 565-9171

Cetec Moltronics
 San Diego
 (714) 278-5020
 South Gate
 (213) 773-6521
 Sterling Electronics
 Santa Clara
 (408) 985-7411

COLORADO
 Elmar Electronics
 Commerce City
 (303) 287-9611
 Newark Electronics
 Denver
 (303) 757-3351

CONNECTICUT
 Connector Co.
 New Haven
 (203) 624-0127
 Wilshire Electronics
 Hamden
 (203) 281-1166

FLORIDA
 Cramer Electronics
 Orlando
 (305) 894-1511
 Schweber Electronics
 Hollywood
 (305) 927-0511

GEORGIA
 Arrow Electronics
 Doraville
 (404) 455-4054
 Cramer Electronics
 Norcross
 (404) 448-9050

ILLINOIS
 Bell Industries
 Chicago
 (312) 982-9210
 Klaus Radio, Inc.
 Peoria
 (309) 691-4840
 Newark Electronics
 Chicago
 (312) 638-4411

Ohm Electronics, Inc.
 Palatine
 (312) 359-5500
 Schweber Electronics
 Elk Grove
 (312) 593-2740

INDIANA
 Graham Electronics
 Indianapolis
 (317) 634-8202
 Genesis Electronics
 South Bend
 (219) 287-2911

KANSAS
 Interstate Electronic
 Wichita
 (316) 264-6317
 Wichita Aircraft
 Wichita
 (316) 838-1421

MARYLAND
 Arrow Electronics
 Baltimore
 (301) 247-5200
 Cramer Electronics
 Gaithersburg
 (301) 948-0110
 Pioneer Electronics
 Gaithersburg
 (301) 948-0710

MASSACHUSETTS
 Cramer Electronics
 Newton
 (617) 969-7700

Industrial Components Corp.
 No. Wilbraham
 (413) 596-3854
 Kierulf Electronics
 Billerica
 (617) 935-5134

Schweber Electronics
 Waltham
 (617) 890-8434
 Wilshire Electronics
 Burlington
 (617) 272-8200

MICHIGAN
 RS Electronics
 Livonia
 (313) 525-1155
 Wedemeyer Electronic Co.
 Ann Arbor
 (313) 665-8611

MINNESOTA
 Arrow Electronics
 Edina
 (612) 987-6400
 Cramer/Bonn Co.
 Edina
 (612) 835-7811
 Newark Electronics
 Minneapolis
 (612) 331-6350

MISSOURI
 LCOMP Electronics
 Kansas City
 (816) 221-2400
 Maryland Hts.
 (314) 291-6200
 Olive Electronics, Inc.
 St. Louis
 (314) 426-4500
 Walters Radio Supply
 Kansas City
 (816) 531-7015

NEW JERSEY
 Radio Electric Service Co.
 Pennsauken
 (215) 925-6900
 Schweber Electronics
 Somerset
 (201) 469-6008
 Wilshire Electronics
 Clifton
 (201) 340-1900

NEW YORK
 DRW Electronic Corp.
 Farmingdale
 (516) 249-2660
 Genesee Radio Parts Co.
 Buffalo
 (716) 873-9661

Harvey Electronics
 Binghamton
 (607) 748-8211
 Progress Electronics
 Plainville
 (516) 433-1700

Schweber Electronics
 Westbury
 (516) 334-7474
 Simcona Electronics
 Rochester
 (716) 328-3230
 Summit Distributors
 Buffalo
 (716) 884-3450

NORTH CAROLINA
 Cramer Electronics
 Winston-Salem
 (919) 725-8711

OHIO
 Pioneer Electronics
 Cleveland
 (216) 587-3600
 Dayton
 (513) 236-9900
 Schuster Electric Co.
 Cincinnati
 (513) 984-1600

Schweber Electronics
 Beachwood
 (216) 464-2970

OKLAHOMA
 Electro Enterprises
 Oklahoma City
 (405) 478-1752

PENNSYLVANIA
 Almo Electronics
 Philadelphia
 (215) 698-4000
 CAM-RPC Indus. Electronics
 Pittsburgh
 (412) 782-3770
 Pyttronic Industries
 Montgomeryville
 (215) 643-2850

TENNESSEE
 Electra Distributing Co.
 Nashville
 (615) 329-3971

TEXAS
 Allied Electronics
 Ft. Worth
 (817) 336-5401
 Hamilton/Avnet
 Dallas
 (214) 661-8661

Sterling Electronics
 Dallas
 (214) 357-9131
 Houston
 (713) 627-9800
 Texas Instrument Supply Co.
 Dallas
 (214) 238-6862

UTAH
 Diplomat/Alta
 Salt Lake City
 (801) 486-4134
 Standard Supply Co.
 Salt Lake City
 (801) 486-3371

WASHINGTON
 Bell Industries
 Bellevue
 (206) 747-1515
 Liberty Electronics
 Seattle
 (206) 453-8300

WISCONSIN
 Electronic Expeditors
 Milwaukee
 (414) 228-8100

CANADA: Distributors in major cities

VAX.
The fastest 32-bit OEM computer on earth.





Amphenol 285 Series Modular Telephone Jacks. Direct mounting on PC boards without adapters. Keyed or non-keyed, 6-position (4 or 6 contacts) or 8-position. Ring or spade lugs. PC tails or stripped ends.

Reader Service Number 216



Amphenol 157 Series Micro-Pierce® Connectors. Fast, solderless termination in factory or field. Portable, easy-to-use termination tools. Intermateable with currently used connectors in telephony or EDP.

Reader Service Number 141



AMPHENOL NORTH AMERICA

General Offices: Oak Brook, Illinois 60521

Sales Offices: Atlanta (404) 394-6298 • Boston (617) 475-7055 • Chicago (312) 449-1880
 Dallas (214) 235-8318 • Dayton (513) 294-0461 • Denver (303) 758-8033 • Detroit (313) 722-1431
 Greensboro (919) 275-8644 • Houston (713) 444-4096 • Indianapolis (317) 842-3245
 Kansas City (913) 764-1541 • Knoxville (615) 690-6765 • Los Angeles (213) 649-5015
 Minneapolis (612) 835-4595 • New York (516) 364-2270 • Orlando (305) 647-5504
 Philadelphia (215) 657-5170 • Phoenix (602) 265-3227 • St. Louis (314) 569-2277
 San Diego (714) 272-5451 • San Francisco (408) 732-8990 • Seattle (206) 455-2525
 Syracuse (315) 455-5786 • Washington, DC (703) 524-8700
 Canada: Montreal (514) 482-5520 • Toronto (416) 291-4401 • Vancouver (604) 278-7636
 International: Oak Brook, Illinois TELEX 206-054

Call your Amphenol North America Distributor

- ARIZONA**
 Liberty Electronics
 Phoenix
 (602) 249-2232
 Celtec Moltronic
 Phoenix
 (602) 272-7951
- CALIFORNIA**
 Bell Industries
 Sunnyvale
 (408) 734-8570
 Cramer Electronics
 Irvine
 (714) 979-3000
 (213) 771-8300
 Elmar Electronics
 Mountain View
 (415) 961-3611
 Kieruff Electronics
 Los Angeles
 (213) 725-0325
 San Diego
 (714) 278-2112
 Liberty Electronics
 El Segundo
 (213) 322-8100
 San Diego
 (714) 565-9171
 Celtec Moltronic
 San Diego
 (714) 278-5020
 South Gate
 (213) 773-6521
 Sterling Electronics
 Santa Clara
 (408) 985-7411
- COLORADO**
 Elmar Electronics
 Commerce City
 (303) 287-9611
 Newark Electronics
 Denver
 (303) 757-3351
- CONNECTICUT**
 Connector Co.
 New Haven
 (203) 624-0127
 Wilshire Electronics
 Hamden
 (203) 281-1166
- FLORIDA**
 Cramer Electronics
 Orlando
 (305) 894-1511
 Schweber Electronics
 Hollywood
 (305) 927-0511
- GEORGIA**
 Arrow Electronics
 Dorville
 (404) 455-4054
 Cramer Electronics
 Norcross
 (404) 448-9050
- ILLINOIS**
 Bell Industries
 Chicago
 (312) 982-9210
 Klaus Radio, Inc.
 Peoria
 (309) 691-4840
 Newark Electronics
 Chicago
 (312) 638-4411
 Ohm Electronics, Inc.
 Palatine
 (312) 359-5500
 Schweber Electronics
 Elk Grove
 (312) 593-2740
- INDIANA**
 Graham Electronics
 Indianapolis
 (317) 634-8202
 Genesis Electronics
 South Bend
 (219) 287-2911
- KANSAS**
 Interstate Electronic
 Wichita
 (316) 264-6317
 Wichita Aircraft
 Wichita
 (316) 838-1421
- MARYLAND**
 Arrow Electronics
 Baltimore
 (301) 247-5200
 Cramer Electronics
 Gaithersburg
 (301) 948-0110
 Pioneer Electronics
 Gaithersburg
 (301) 948-0710
- MASSACHUSETTS**
 Cramer Electronics
 Newton
 (617) 969-7700
 Industrial Components Corp.
 No. Wilbraham
 (413) 596-3854
 Kieruff Electronics
 Billerica
 (617) 935-5134
 Schweber Electronics
 Waltham
 (617) 890-8484
 Wilshire Electronics
 Burlington
 (617) 272-8200
- MICHIGAN**
 RS Electronics
 Livonia
 (313) 525-1155
 Wedemeyer Electronic Co.
 Ann Arbor
 (313) 665-8611
- MINNESOTA**
 Arrow Electronics
 Edina
 (612) 887-6400
 Cramer/Bonn Co.
 Edina
 (612) 835-7811
 Newark Electronics
 Minneapolis
 (612) 331-6350
- MISSOURI**
 LCOMP Electronics
 Kansas City
 (816) 221-2400
 Maryland Hts.
 (314) 291-6200
 Olive Electronics, Inc.
 St. Louis
 (314) 426-4500
 Walters Radio Supply
 Kansas City
 (816) 531-7015
- NEW JERSEY**
 Radio Electric Service Co.
 Pennsauken
 (215) 925-6900
 Schweber Electronics
 Somerset
 (201) 469-5008
 Wilshire Electronics
 Clifton
 (201) 340-1900
- NEW YORK**
 DRW Electronic Corp.
 Farmingdale
 (516) 249-2660
 Genesee Radio Parts Co.
 Buffalo
 (716) 873-9661
 Harvey Electronics
 Binghamton
 (607) 748-8211
 Progress Electronics
 Plainview
 (516) 433-1700
 Schweber Electronics
 Westbury
 (516) 334-7474
 Simcona Electronics
 Rochester
 (716) 328-3230
 Summit Distributors
 Buffalo
 (716) 884-3450
- NORTH CAROLINA**
 Cramer Electronics
 Winston-Salem
 (919) 725-8711
- OHIO**
 Pioneer Electronics
 Cleveland
 (216) 587-3600
 Dayton
 (513) 236-9900
 Schuster Electric Co.
 Cincinnati
 (513) 984-1600
 Schweber Electronics
 Beachwood
 (216) 464-2970
- OKLAHOMA**
 Electro Enterprises
 Oklahoma City
 (405) 478-1752
- PENNSYLVANIA**
 Almo Electronics
 Philadelphia
 (215) 698-4000
 CAM-RPC Indus. Electronics
 Pittsburgh
 (412) 752-3770
 Pyttronic Industries
 Montgomeryville
 (215) 643-2850
- TENNESSEE**
 Electra Distributing Co.
 Nashville
 (615) 329-3971
- TEXAS**
 Allied Electronics
 Ft. Worth
 (817) 336-5401
 Hamilton/Avnet
 Dallas
 (214) 661-8661
 Sterling Electronics
 Dallas
 (214) 357-9131
 Houston
 (713) 627-9800
 Texas Instrument Supply Co.
 Dallas
 (214) 238-6862
- UTAH**
 Diplomat/Alta
 Salt Lake City
 (801) 486-4134
 Standard Supply Co.
 Salt Lake City
 (801) 486-3371
- WASHINGTON**
 Bell Industries
 Bellevue
 (206) 747-1515
 Liberty Electronics
 Seattle
 (206) 453-8300
- WISCONSIN**
 Electronic Expeditors
 Milwaukee
 (414) 228-8100

CANADA: Distributors in major cities

Introducing the 50¢

Siliconix' VMOS is here with volume economy.

Now you can really afford the switch from complicated bipolar designs — even in volume applications. Ever since we introduced VMOS technology in 1976, Siliconix power FET prices have been moving steadily downward. Now our new VN10KM, with scaled down die size and new packaging, gives designers the lowest base price ever.* And even better, production is in full swing to support volume requirements.

But component price is just the start of the VMOS economy story. Because VMOS devices so dramatically reduce component count and simplify designs, your big savings will be in overall system cost.

Using Siliconix power FETs instead of bipolar transistors eliminates the need for input current limiting, biasing, leakage compensation networks or switching time speed up components. Nor will you need input resistors, current buffers or preamplifier stages. Count on saving two components if you're replacing a darlington, and up to five or more in most other bipolar applications.

Now you can kiss

VMOS power FET

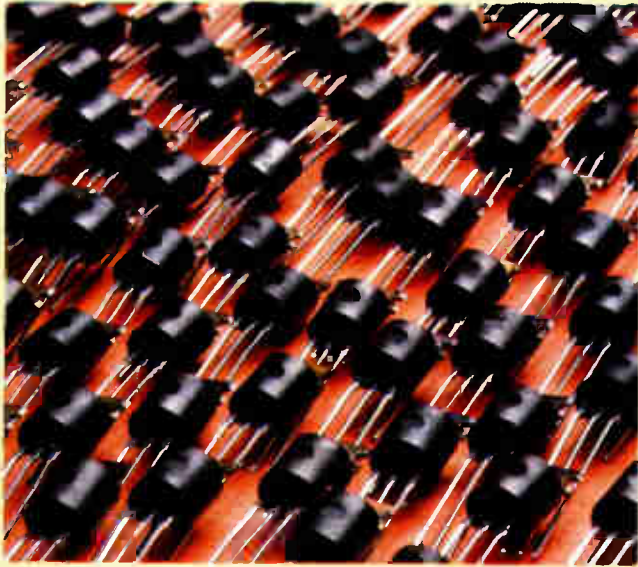

Available now in dealer stock.

VN10KM is available off the shelf and in volume from your local distributor. For immediate delivery, contact our franchised distributors:

Alliance • Bell/Century • Cadence • Components Plus • Wyle/Elmar • Wyle/Liberty • Future • Hamilton/Avnet • Industrial Components • Pioneer • Quality Components • R.A.E. and Wilshire.

For more information, call (408) 988-4110. Or write Siliconix, Inc., 2201 Laurelwood Rd., Santa Clara, CA 95054.

Siliconix

High performance comes in smaller packages. Faster switching, high gain, high input impedance, linear operation, no thermal runaway, no current hogging and blow-out proof operation. They're all part of the performance and reliability advantages that come with VMOS. Now our VN10KM gives designers a 60 volt, 5 ohm, 1 watt device with 500 mA switching in 7 ns. VGS threshold is only 2.5 volts.

VN10KM Specifications

 TO-237	BV_{DSS}	60 volts
	$I_{D(on)}$	0.5 amp
	$R_{DS(on)}$	5.0 ohms
	P_D	1 watt
	$t_{(on)}, t_{(off)}$	7 ns.

Finally, we've put all this high performance in a plastic TO-237 (TO-92 plus) package to minimize size and price.

*10,000 piece price, U.S. only, 50¢ each.

bipolars goodbye

VAX.
The fastest 32-bit OEM computer on earth.



Your benchmark will prove it.

When speed is an important measure of an OEM computer, nothing measures up to VAX.

In benchmark after benchmark, Digital's VAX-11/780 has beaten the competition cold. In a full range of demanding real-time, interactive, and multi-user batch applications.

Along with the fastest speed you can buy, VAX offers a long list of other unique performance advantages—features that are even more amazing when you consider that VAX is priced like a super-mini.

For example:

True 32-bit addressing, for a virtual address capacity of 4 billion bytes.

Our powerful easy-to-use VAX/VMS operating system, with a complete set of comprehensive software tools to speed your development time.

A rich, efficient instruction set to maximize FORTRAN performance.

Five I/O adaptors, providing an aggregate data rate of 9.5 megabytes.

A tunable real-time scheduler that locks critical programs and service routines in memory. Plus a variety of real-time interfaces.

What's more, VAX is available with all the peripherals you're likely to need.

Of course, the only way you'll truly appreciate VAX's winning performance is to try it with one of your toughest programs—and benchmark it against the challenger of your choice.

If our past record is any indication, there's no doubt about who'll be faster.

The only question is, by how much.

For more information, send the coupon or contact: Digital Equipment Corporation, 129 Parker Street, PK3/M-56, Maynard, MA 01754. 617-493-9797.

I'd like to benchmark my program on VAX—please contact me.

Please send your new VAX OEM brochure.

Name _____ Title _____

Company _____

Address _____

City _____ State _____ Zip _____

Telephone _____

Send to: Digital Equipment Corporation,
129 Parker St., PK3/M-56, Maynard, MA 01754. Or
call: (617) 493-9797. In Europe: 12 av. des Morgines,
1213 Petit-Lancy/Geneva. Tel. 93 33 11. In Canada:
Digital Equipment of Canada, Ltd.

N-2-1-9

digital

PLUG OUR SOLUTION INTO YOUR TOUGH MEASUREMENT PROBLEM.

Only Gould offers a complete range of plug-in signal conditioners to handle your toughest measurement problems. Three of our plug-ins are exclusive.

Our high voltage DC amplifier measures voltages up to 1500 volts. With 100% calibrated zero suppression, you can examine complex wave forms with much better resolution and measure millivolt level signals that are up to 1500 volts DC off-ground.

True RMS is critical for fast rise time AC measurements. So only

Gould gives you a true RMS plug-in amplifier with calibrated zero suppression. You measure both voltage and current wave forms at crest factors as high as 10 to 1.

A unique frequency deviation converter allows you to select center frequencies of 50, 60 and 400 Hz. Four measurement ranges for each center frequency are front panel accessible. With this plug-in you can measure frequency deviations as small as 0.01 Hz.

But no matter how

specialized or how simple your measurement problem, count on Gould to plug in the right solution. Contact Gould Inc., Instruments Division, 3631 Perkins Ave. Cleveland, OH 44114. Or Gould Alco S.A., 57 rue St. Sauveur, 91160 Ballainvilliers, France. For brochure call toll-free: 800-325-6400, ext. 77. In Missouri: 800-342-6600.

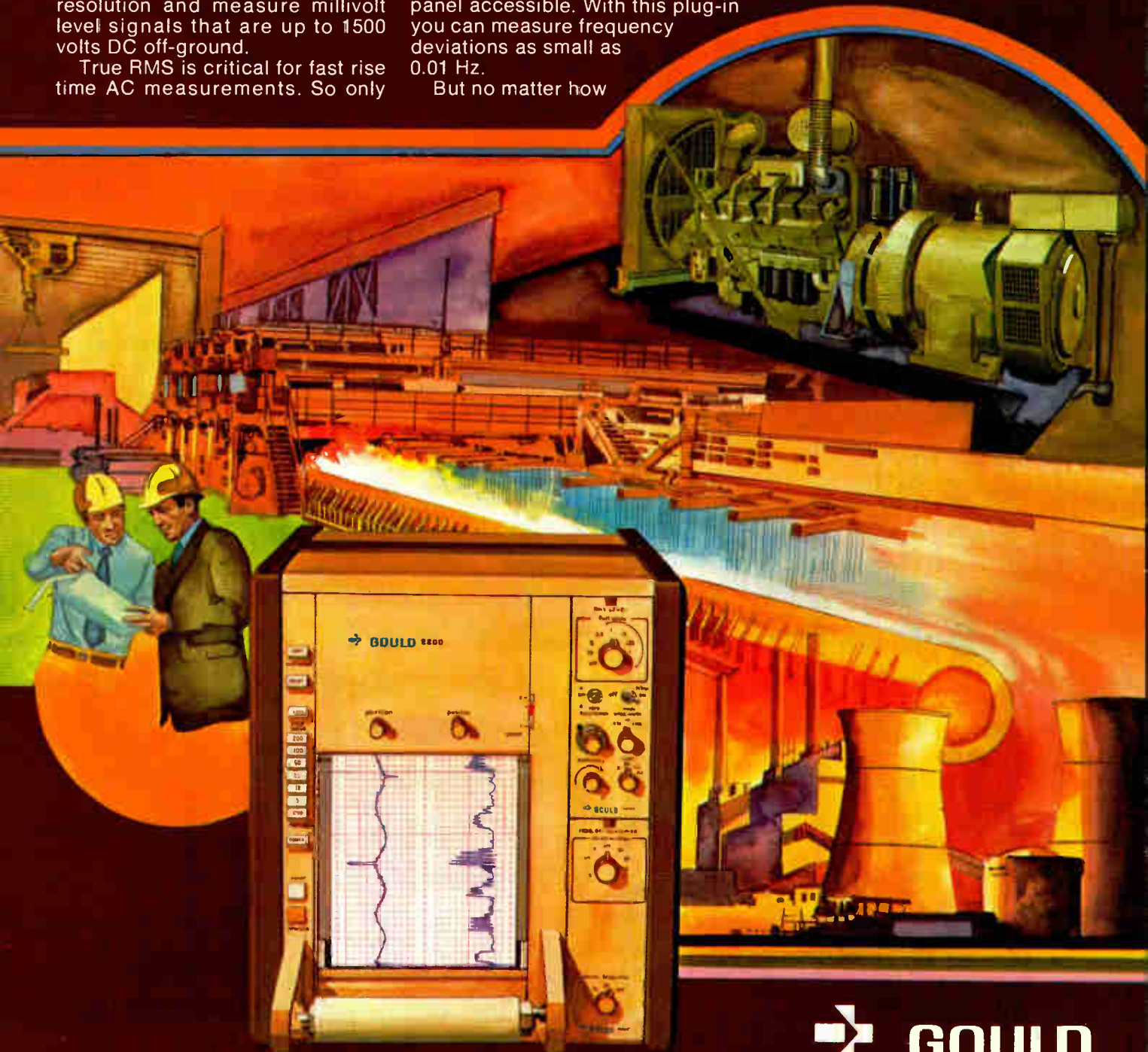

Circle 146 on reader service card

 **GOULD**

12-MHz scope fits in briefcase

Rugged dual-trace instrument with 3-inch screen measures only 3.5 by 8 by 7.375 inches, weighs less than 5 lb, and sells for \$795

by Al Shackil, Instrumentation Editor

"We've done for the portable oscilloscope what others did for the portable DMM," says Fred Katzmann, president of Ballantine Laboratories, referring to the way his company has exploited modern integrated-circuit technology to miniaturize the formerly bulky oscilloscope. The result of its efforts is a 12-MHz dual-trace scope that weighs less than 5 lb and measures a mere 3.5 by 8 by 7.375 inches—small enough to fit into a briefcase. The model 1022A has a 3-in. screen (measured diagonally) and a modest \$795 price tag.

But the 1022A is not just light and small. It's also tough. Its metalized plastic case is sealed against dust, dirt, and radio-frequency interference. Splashproof, hence operable in the rain, the 1022A can be operated in the immediate vicinity of transmitting antennas with ease. And because the instrument's cathode-ray tube is a low-voltage device, the problems associated with high altitude and humidity—corona and arcing—are eliminated. Thus the new scope is well suited for, among other things, outdoor and industrial field servicing.

Obviously, though, a well sealed oscilloscope must do without a fan. Therefore a key consideration in its design was the minimization of power dissipation. One step in this direction was the use of complementary metal-oxide-semiconductor circuitry in all those areas in which high speed was not essential. A second step was the use of a high-efficiency, high-frequency dc-to-dc converter fed by an external 10-to-16-v dc source. This move keeps the total internal power dissipation down to 10 w by moving the power trans-

former and rectifier assembly out of the main unit and leaving it at the wall outlet along with line voltage and noise. (The assembly requires $117\text{ v} \pm 10\%$ at 50 to 400 Hz.)

Dc power enters the scope through a filter, which prevents conducted interference from affecting its operation. The dc-dc converter's ability to accept a wide range of input voltage not only permits operation from many different sources, but also lets the scope keep going when it is being powered by a 12-v battery that's running out of juice.

Looking backwards. Ballantine looked to the past when it selected a blown, rather than a cast, CRT with a low-voltage (1-kv) monoaccelerator. This stubby CRT with its curved face eliminates astigmatism, while its thin-walled construction and screened-on graticule minimize parallax errors. As a bonus, the tube is

stronger than CRTs with welded-on flat faceplates.

The monoaccelerator design has some distinct advantages and disadvantages. On the plus side, in addition to low accelerator voltage, the tube provides a sharp, bright, uniform spot. On the minus side, it requires a relatively high beam current, typically 10 times as high as that of a 3-kv tube, and is relatively insensitive—that is, it takes a large signal to deflect and blank the beam. The vertical, horizontal, and blanking circuits, therefore, employ high-gain amplifiers whose outputs can swing over $\pm 200\text{ v}$. To minimize the power demanded by these circuits, the 1022A employs video network compensation, to reduce the current in the sweep circuits.

When these pluses and minuses are balanced out one finds a 12-MHz scope with a corresponding 30-ns

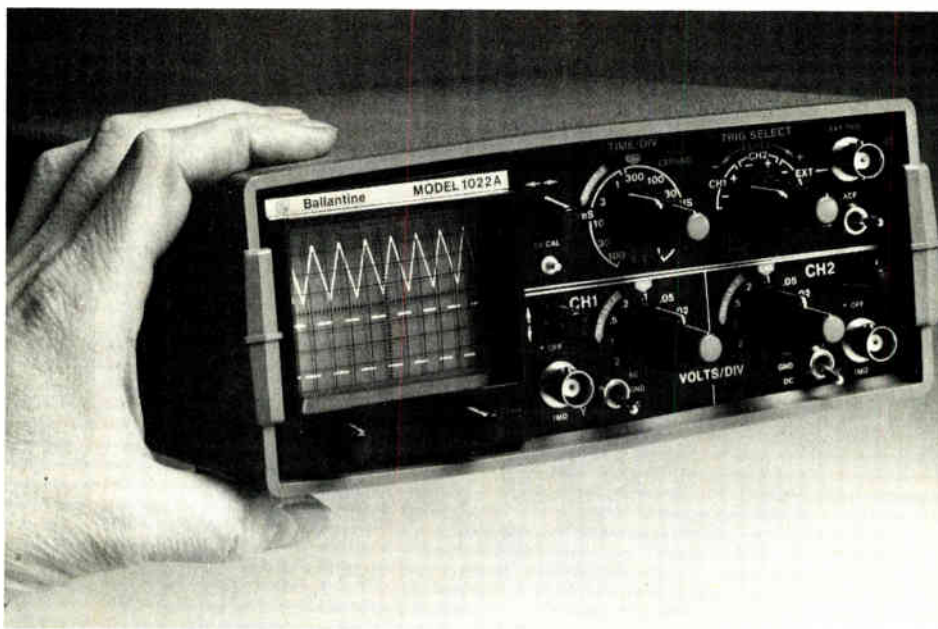

New products

rise time—suitable for troubleshooting most logic and switching circuits. Sensitivity is 5 mV/division. Minimum calibrated sensitivity is 2 v/div for a direct connection (20 v/div with a 10× attenuator). A 2.5:1 vernier extends the sensitivity to 5 v/div (50 v/div with the attenuator).

The dc drift is so low that no front-panel zeroing control is provided. Total temperature-induced drift is less than a tenth of a division over the scope's full 0° to 50°C operating range.

Like any full-blown modern scope, the 1022A has an automatic trigger circuit that provides a bright line in the absence of an input signal, thus eliminating both beam searching and the possibility of burning a hole in the phosphor. The miniscope has the usual selection of trigger modes: ±channel A, ±channel B, and ±external. Each may be ac or dc coupled. Triggering sensitivity is one-quarter division from dc to 5 MHz and half a division from 5 to 10 MHz, for internal triggering. For external trigger signals, the sensitivity is 100 mV from dc to 5 MHz and 150 mV from 5 to 10 MHz.

Sweep speeds range from 100 ms per division up to 1 μs/div. Cutting in a 10× sweep multiplier increases the maximum rate to 100 ns/div. The 1022A, like other dual-channel scopes, offers a choice of display modes: channel A only, channel B only, alternate, and chopped. In addition, it can be used as an X-Y display with channel A on the vertical axis and channel B on the horizontal. Switching between the chopped and alternate modes is performed automatically: for sweep speeds up to 1 ms/div the signal is chopped; above that speed the alternate mode is used.

Accessories for the scope include the usual assortment of probes, a carrying case, a battery pack, and a special harness that permits the miniscope to be carried on the chest for easy viewing. Delivery time for the 1022A is 60 days.

Ballantine Laboratories Inc., P. O. Box 97, Boonton, N. J. 07005. Phone (201) 335-0900 [338]



BUCKEYE KNOBS

Enter a new dimension in equipment design with the visual harmony of Buckeye matching instrument knobs round, bar, concentric, pointer or skirted. Two set screws and aluminum

bushings assure concentricity. The finest markings are available either not-stamped or silk-screened.

the BUCKEYE stamping co.

555 Marion Rd., Columbus, Ohio 43207 614/445-8433

Circle 148 on reader service card

the NO CREEP heat sink compound

ideal for circuit applications requiring a highly conductive, silicone-free thermal compound

Est. 1895

AOS

NEWARK • BUFFALO • NEW ORLEANS

Specially formulated and proven for use in electronic assemblies where excessive heat can substantially reduce service life, new PQ HEAT SINK COMPOUND contains heat-conductive, inorganic oxides that prevent creeping. And PQ's excellent lubricity permits easy, efficient application to sensitive circuit board components. Meets Western Electric spec. KS 21343

Packed in 1 lb. cans & 4 oz. tubes

American Oil and Supply Co.
238B Wilson Ave., Newark, N. J. 07105.
(201) 589-0250 • TWX 710-995-4462



148

Circle 217 on reader service card

abbott

POWER SUPPLIES

**2,685 answers
to power supply questions.**

Answers to better power and thermal efficiency. Answers to size and weight reductions. Answers to available off-the-shelf covered/open frame power supplies and transformers. And price and delivery answers.

These and many more answers can be found in our three product catalogs. And they're yours. Free. Just circle reader card number. Better yet, write or call Abbott. The Power Supply Specialist.

Power Supply Catalog — Comprehensive 60-pager describes our full line of 1,573 hi-efficiency, hermetically sealed, single and dual output power supplies and switcher modules. Inputs of 60 and 400Hz and DC are available with outputs from 3VDC to 740VDC, 1 to 250 Watts. Prices start as low as \$174 for 2-4 units.

Circle Card Number 100

Industrial Power Supply Catalog — Some 279 of our low cost, high quality OEM power modules are detailed in this 16-pager. Includes covered/open frame, AC to DC single, dual and triple output versions, with outputs from 5 to 36VDC, 0.5 to 320 Watts. Plus DC to AC converters with 50 and 60Hz outputs. Priced as low as \$35 for up to 24 units.

Circle Card Number 101

Transformer Catalog — We specialize in custom transformers, and this 20-pager gives you detailed information on how to specify for your exact requirements. It also covers over 800 standard military, industrial and miniature pcb transformers, including 60 and 400Hz, single phase input units. Prices for standards start as low as \$5.10 for up to 9 pieces.

Circle Card Number 102

See Power Supply Section 4000, and Transformer Section 5600, Vol. 2, of your EEM catalog; or Power Supply Section 4500, and Transformer Section 0400, Vol. 2, of your GOLD BOOK for complete information on Abbott products.

abbott transistor

LABORATORIES, INCORPORATED

General Offices
5200 W. Jefferson Blvd., Los Angeles 90016
(213) 936-8185 Telex: 69-1398

Eastern Office
1224 Anderson Ave., Fort Lee, N.J. 07024
(201) 224-6900 Telex: 13-5332

Rugged DMM sells for \$149

Compact 3½-digit multimeter weighs only 9.5 ounces, can withstand 500 V rms or dc on its resistance ranges

by Pam Hamilton, Boston bureau

What's so small it will easily fit in your hand, so tough it can be dropped onto a concrete floor without damage, and sells for a mere \$149? The answer: a full-function 3½-digit multimeter from Data Precision Corp. Called the model 935, the 9.5-oz instrument will measure ac and dc voltage and current and will also measure resistance with both high (2.8-v) and low (250-mv) excitation voltages. All three parameters—function, range, and excitation voltage—are selected by using push-button switches on the side of the meter. Measurements, complete

with polarity sign and decimal point, are presented on a liquid-crystal display with characters that are 0.5-inch high.

Full-scale ranges for dc voltage measurements go from 100 mV to 1,000 V with an uncertainty of $\pm(0.1\%$ of input + 1 count) for one year at $23^{\circ}\text{C} \pm 5^{\circ}\text{C}$. Input resistance for all five ranges is $10\text{ M}\Omega$. Dc current is measured in four ranges, from 1 mA full scale to 1,000 mA. Maximum error for these ranges is $\pm(0.5\%$ of input + 1 count).

Ac voltage can be measured over the same ranges as dc voltage. Maxi-

imum error is $\pm(1\%$ of input + 6 counts) at 30 Hz; from 50 Hz to 500 Hz the figure drops to $\pm(0.5\%$ of input + 4 counts). The input impedance is $10\text{ M}\Omega$ shunted by 100 pF. Ac current ranges are also the same as those for dc. Maximum error for the 10-, 100-, and 1,000-mA ranges is $\pm(1.5\% + 5\text{ counts})$ at 30 Hz, dropping to $\pm(0.75\% + 4\text{ counts})$ from 50 to 500 Hz. For the 1-mA range the figures are the same, except that the upper frequency limit is reduced to 100 Hz. At 500 Hz the error increases to a maximum of $\pm(2.5\%$ of input + 4 counts). The ac scales use an ac-coupled average-responding circuit calibrated in the root-mean-square value of a sinusoid.

As anyone who has ever been responsible for the maintenance of a company's test equipment can testify, overload protection—particularly on the resistance ranges—is one of the most important multimeter specifications. All too many meters have been destroyed by the accidental application of ac line voltage to their resistance-measuring terminals. The model 935 should make this sort of accident a thing of the past, since its ohms ranges can tolerate an applied voltage of 500 V rms or dc with no loss of accuracy. The dc voltage ranges can all withstand 1,000 V and the ac ranges 700 V—also with no degradation in their specifications. The current ranges are protected by a 2-A fuse.

The model 935 sells for \$149 in small quantities. Delivery is from stock.

Data Precision Corp., Electronics Avenue, Danvers, Mass. 01923. Phone John Wilder at (617) 246-1600 [339]



The dawn of a new generation of product performance.

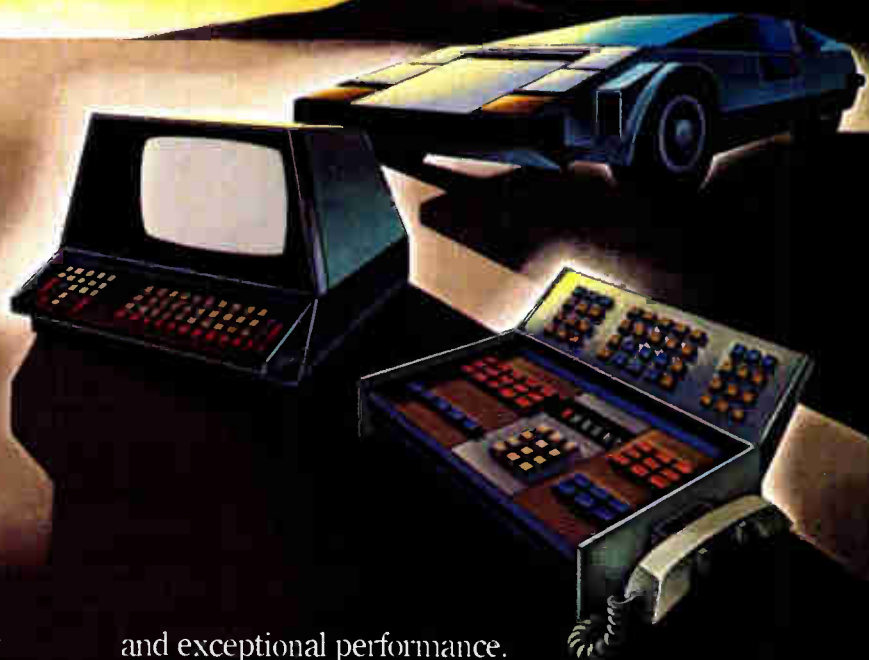

A little over a year ago, Dow Corning quietly changed the state-of-the-art of the electronics industry.

We changed it with a product so unique, so totally outstanding, that it overshadowed all existing technology. The product was Dow Corning 631 silicone/epoxy molding compound. And it marked the dawn of a new generation of product performance.

We looked at the advantages of silicone. We looked at the advantages of epoxy. And brought them together to make the world's first successful silicone/epoxy molding compound.

Dow Corning 631 gives semiconductor device manufacturers the compatibility, moisture resistance, and ease of molding of silicone, coupled with the strength, strong lead seal, and salt-spray resistance of epoxy. What it means to semiconductor devices is unmatched reliability

and exceptional performance.

In almost any electronic product. Computers. Telecommunications equipment. Auto electronic devices. Almost anything.

For the past year, almost every major semiconductor manufacturer in the country has been testing Dow Corning 631. And the initial reports indicate that 631 is everything we designed it to be: strong, compatible, reliable.

Experience the dawn of the new generation of product performance for yourself. For more information about what Dow Corning 631 silicone/epoxy molding compound can do for your products, write Dow Corning Corporation, Department B-8578, Midland, Michigan 48640.

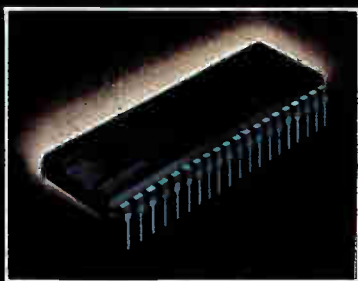

DOW CORNING



© Copyright Dow Corning Corporation 1979.

Circle 151 on reader service card

When you're searching
for component solutions . . .

Add
the touch of innovation
to your
product

*(as Spectral
Dynamics did)*

with
Centralab
MONOPANEL...

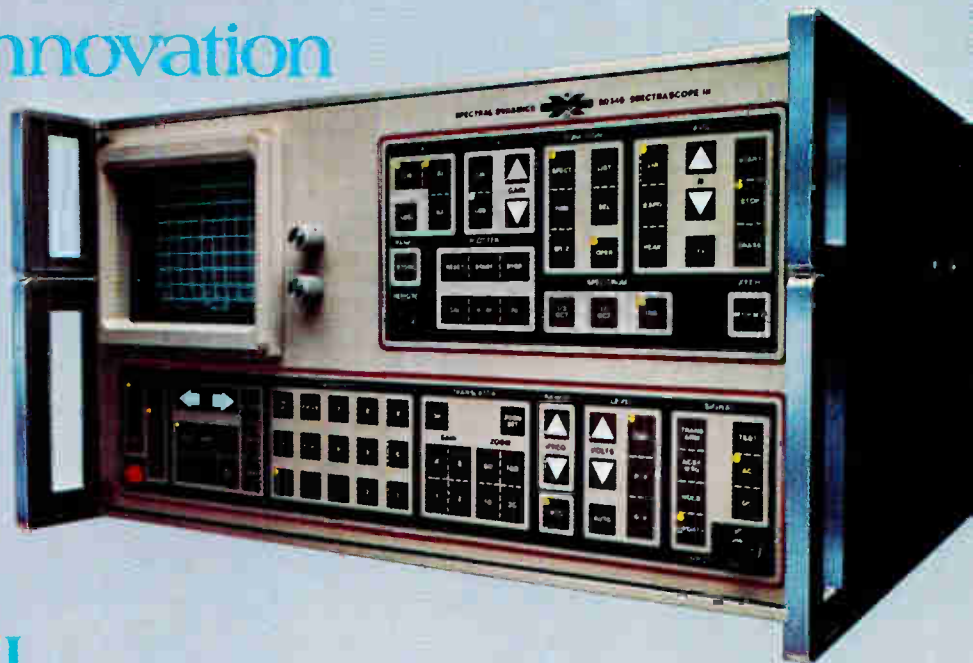

Spectral Dynamics (a Scientific-Atlanta subsidiary), a leader in spectrum analysis, selected Centralab's Monopanel touch switch system for their new SD345 FFT signal analyzer because they demanded:

- Ultra dependable life for millions of failure free switching cycles.
- Unlimited choice of graphics for maximum flexibility of functional panel design and esthetic appeal.
- High density, custom designed front panel complete with switches and graphics for simplified installation.

Monopanel gives them all of that and cost effectiveness too! We've done the same for scores of

other manufacturers. Monopanel is the proven touch switch in test and measurement instruments, medical apparatus, communications equipment, computers and a wide variety of industrial equipment. That's why more and more manufacturers are choosing Monopanel touch switches. They know that they can rely on Centralab's 50 years of experience in switch design, manufacture and application.

Your Centralab representative listed on the opposite page is your best source of design and application assistance. Ask him for a demonstration to see how you can add the touch of innovation to your product.

Products you need from people who care.



CENTRALAB

ELECTRONICS DIVISION
GLOBE-UNION INC.

5757 North Green Bay Avenue
Milwaukee, Wisconsin 53201

CERAMIC CAPACITORS • EMI/RFI FILTERS • POTENTIOMETERS • SWITCHES • THICK FILM CIRCUITS • TRIMMER RESISTORS

Circle 152 on reader service card

... call your Centralab
Sales Representative

ALABAMA

Huntsville
Cartwright & Bean, Inc.
(205) 533-3509

ARIZONA

Phoenix
Clemick-Neenan &
Assoc.
(602) 279-7649

CALIFORNIA

Palo Alto
Brooks Technical Group
(415) 328-3232
Sherman Oaks
Clemick-Neenan &
Assoc.
(213) 990-3150

Tustin
Clemick-Neenan &
Assoc.
(714) 547-0966

COLORADO

Denver
Electro-Rep. Inc.
(303) 744-2821

CONNECTICUT

Meriden
Centralab
(203) 235-0766

FLORIDA

Ft. Lauderdale
Cartwright & Bean, Inc.
(305) 735-4900

Orlando
Cartwright & Bean, Inc.
(305) 422-4531

GEORGIA

Atlanta
Cartwright & Bean, Inc.
(404) 255-5262

HAWAII

Honolulu
Dougherty Enterprises
(808) 847-4144

ILLINOIS

Des Plaines
Centralab
(312) 694-4870

INDIANA

Indianapolis
Las M. DeVoe Co.
(317) 842-3245

IOWA

Cedar Rapids
Jerry Vrbik Co.
(319) 366-8733

KANSAS

Shawnee Mission
Lowell-Kangas &
Assoc.
(913) 631-3515

LOUISIANA

Metairie
Cartwright & Bean, Inc.
(504) 834-2350

MARYLAND

Columbia
Bresson Assoc. Inc.
(215) 664-6460

Towson
Bresson Assoc. Inc.
(215) 664-6460

MASSACHUSETTS

Needham
Centrelab
(617) 444-4781

MICHIGAN

Lathrup Village
Centrelab
(313) 559-9095

St. Joseph
Centralab
(616) 983-0233

MINNESOTA

Minneapolis
Centrelab
(612) 831-5212

MISSISSIPPI

Jackson
Cartwright & Bean, Inc.
(601) 981-1368

MISSOURI

St. Louis
Lowell-Kangas &
Assoc.
(314) 821-4050

NEW JERSEY

Paramus
Centralab
(201) 262-6716

NEW YORK

Albany
Reagan/Comper Albany
(518) 489-7408

Endwell
Reagan/Comper Albany
(607) 723-8743

Fairport
Reagan/Comper Albany
(716) 271-2230

New Hartford
Reagan/Comper Albany
(315) 732-3775

NORTH CAROLINA

Charlotte
Cartwright & Bean, Inc.
(704) 377-5673

Raleigh
Cartwright & Bean, Inc.
(919) 781-6560

OHIO

Cleveland
Centralab
(216) 526-1205

Columbus
Centralab
(614) 888-2150

OREGON

Portland
Centralab
(503) 620-1611

PENNSYLVANIA

McMurray
Centralab
(412) 941-7440

Narberth
Bresson Assoc. Inc.
(215) 664-6460

TENNESSEE

Knoxville
Cartwright & Bean, Inc.
(615) 693-7450

Memphis
Cartwright & Bean, Inc.
(901) 276-4442

TEXAS

Austin
Centralab
(512) 454-9529

El Paso
Centrelab
(915) 779-3961

Farmers Branch
Centrelab
(214) 243-8791

VIRGINIA

Lynchburg
Bresson Assoc. Inc.
(215) 664-6460

WASHINGTON

Bellevue
Centrelab
(206) 454-7754

WISCONSIN

Milwaukee
Centrelab
(414) 228-2122

PUERTO RICO

Santurce
E. Franceschini Assoc.
(809) 726-0225

CANADA

BRITISH COLUMBIA
North Vancouver
Arwin Tech Sales Ltd.
(604) 980-4346

ONTARIO

Ajex
McHugh Electronics
Ltd.
(416) 683-1540

QUEBEC

Ste. Dorothee Leval
Harnett Enterprises
(514) 689-4184

New products

Microcomputers & systems

**School board
gives course**

Latest TM990 family member
teaches tyros programming
as well as interfacing

It looks like a single-board computer with a pocket calculator glued to it—and it is, in fact, the newest member of Texas Instruments' TM990 board-computer family, the TM990/189M. But it does more than compute—designed as a low-cost learning aid, the /189 gives hands-on experience and training in microcomputer fundamentals and interfacing, as well as in assembly- and machine-language programming of the 16-bit 9900 family.

To enhance its portability, the board is totally self-contained. It has 1 kilobyte of read-write memory, expandable on board to 2 kilobytes. The module also has 4 kilobytes of read-only memory with space for an additional 2 kilobytes. The 4 kilobytes of ROM contain a symbolic assembler and a system monitor called Unibug.

The calculator-like object provides the operator interface through a 45-key alphanumeric keyboard and a 10-digit, seven-segment display. The display uses a 32-character buffer. Any 10 of the 32 digits may be seen on the display by shifting left or right.

At the heart of the TM990/189 board is the TMS 9980 16-bit central processing unit. The other two 40-pin chips are TMS 9901 programmable systems-interface integrated circuits that supply interrupts and input/output ports. Provisions are on the board to support an external EIA-standard terminal or a teletypewriter interface. The board can also make use of off-board memory: through a cassette interface, mass memory can be attached. "It's got some connectors which can be used for external RAM or ROM,"

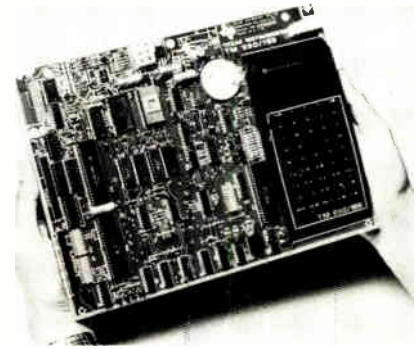

says Jim Huffines, marketing manager for MOS microprocessors at TI. "It can handle another 8 to 12 kilobytes to fill up the 9980's 16-kilobyte address space."

Other features of the /189 module are a series of light-emitting diodes and a piezoelectric speaker for audio signals. When the microcomputer is powered up, the group of LEDs flashes, the speaker sounds, and the 10-digit display shows "CPU ready." This assures the user that the system is in working order. The same LEDs indicate the status of the cassette, CPU, and keyboard.

The board also comes with a comprehensive user's guide and a complete applications textbook. The textbook can be used as a learning guide by college or university students taking a class on 16-bit microcomputers. The TM990/189M is punched for insertion into a three-ring binder.

The TM990/189M is now available and sells for \$299. A power supply, the TM990/519, is available as an option for \$65.

Texas Instruments Inc., Inquiry Answering Service, 8600 Commerce Park Dr., Houston, Texas 77036 [371]

Language lets board solve
floating-point problems

Fortran-80, a language and compiler for microcomputers that more than meets the requirements of American National Standards Institute standard X.3.9-78, is now available with additional capabilities. Designated Version 2.0, the improved language allows greater input/output flexibility.

Switch Access From Racked PC Boards

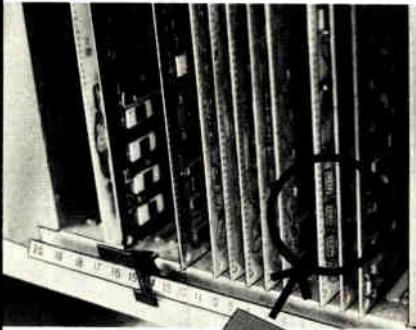

Grayhill Piano-DIP™ Side-Actuated Rocker DIP Switches

SPST circuitry under each rocker... Dimensionally compatible with SPST, SPDT, and DPDT Rocker DIP switches and standard sockets.

- Positive identification of rocker position from the side of the mounted switch.
- Low profile... can be readily edge mounted on racked PC boards.
- Grayhill's reliable spring loaded, sliding ball contact system... life rated at 50,000 operations with positive wiping action and immunity to normal shock and vibration.

Here's the latest entry to the comprehensive and innovative Grayhill DIP switch line... a new switch that can be actuated without removing the PC board from its rack. Because of its distinctive shape and side actuation, Grayhill calls this the PIANO-DIP[®]. It's ideal for mounting on the exposed edge of a racked PC board, allowing engineer or technician easy programming access. PIANO-DIP[™] switches are offered with 4 to 10 switch stations. Complete information is contained in Bulletin 276, available free on request from Grayhill, Inc., 561 Hillgrove Avenue, La Grange, Illinois 60525; phone: (312) 354-1040.



New products

ty and faster floating-point calculations. Additionally, it can work with another language—Basic-80.

A high-level language well suited to engineering problems, Fortran-80 has been used to develop program modules for linking with modules written in PL/M-80 and ASM 80/85 assembly language. Now it can also be linked to programs written in Basic-80, a version of the popular and easy-to-learn language based on Standard ANSI 78 Basic. Mixing modules allows the programmer to choose the most efficient means for handling a given operation within a program.

With Version 2.0, programs can now be configured with wider range I/O drivers—small programs that control external devices or execute larger programs. In addition to ISIS-II and RMX-80 I/O support, user-supplied drivers can be used with Fortran-80.

For savings in code size, programs can take advantage of the internally formatted input/output facilities along with user-supplied PL/M-80 drivers, for instance. To take advantage of Fortran-80's full capabilities, on the other hand, drivers can be record oriented and interface with Fortran statements such as READ and OPEN.

For problems encoded using Version 2.0, floating-point calculations can be performed by either software routines or a mathematics board, such as the iSBC-310. (This board can provide solutions 5 to 10 times faster than the software routines provided in the Fortran-80 floating-point library.) Further enhancing the appeal of Version 2.0, the choice of method need not be made until it is time to link a program to the library.

Both Fortran-80 and Basic-80 are available now on either single- or double-density diskettes, and both are accompanied by manuals. The package for the former language is priced at \$1,750 in single quantities, while that for the latter has a price tag of \$750.

Intel Corp., 3065 Bowers Ave., Santa Clara, Calif. 95051. Phone Rob Walker at (408) 987-8080 [375]

Board uses less power for floating-point math

Compatible with the SBC 80 series and the MDS 800 development series, the AMC 95/6011 is a math board that can add, subtract, multiply, and divide in single- or double-precision fixed-point format, or in 32-bit floating-point. Not only can it perform those functions, but it also juggles trigonometric, inverse trig, and log functions in floating point.

The board pulls approximately 3 W, about 10% of the power required by competitive boards. Deliveries of the board, which costs \$595, will be 30 days after receipt of order. Also available is a \$30 applications program to evaluate the board or its Am9511 arithmetic processing unit. The program runs under ISIS-II.

Advanced Micro Computers, 3340 Scott Blvd., Santa Clara, Calif. 95051. [377]

Terminal takes on whole 2-MHz family

The EXORterm 220 display terminal was specifically built to support development of all 2-MHz members of the M6800 family of microprocessors and single-chip computers, including the MC6800, MC68A00, MC68B00, and second-source versions.

The terminal consists of a cathode-ray-tube display, a keyboard, an isolated motherboard, an MPU II module, a DEbug II module, and two 16-kilobyte random-access-memory (RAM) modules. In addition, it contains a relocatable macro assembler and linking loader, plus a CRT editor, all on diskette. Special keys on the console invoke functions unique to the development system in each of its command levels: EXbug and DOS.

Configured with dynamic RAMs, the system is priced at \$8,600; an extra \$600 buys static memory. Motorola Microsystems, P. O. Box 20912, Phoenix, Ariz. 85036 [376]

PCB Simplicity with Bendix Brush Connectors.

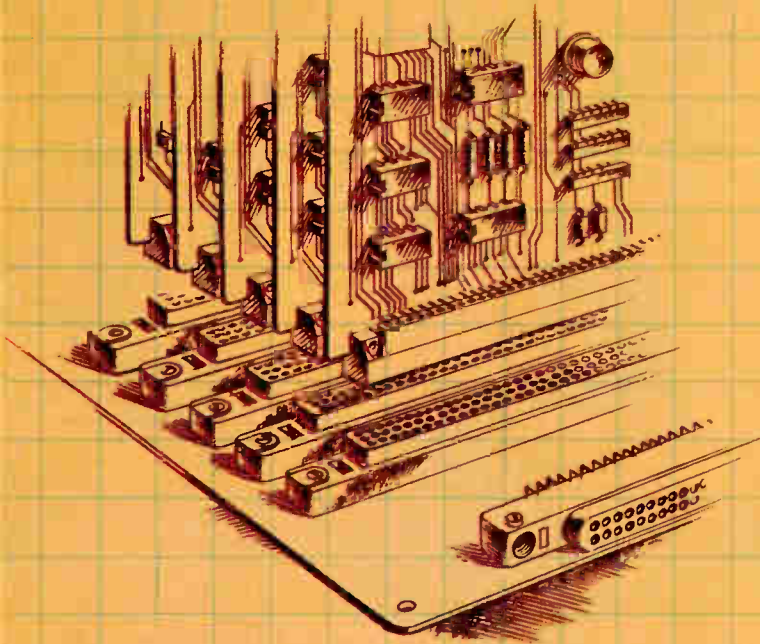

Bendix Brush Connectors can streamline your printed circuit board designs. They don't require the extra board support necessary with conventional, higher mating force connectors and they eliminate the need for secondary actuation systems or procedures used with zero-insertion force connectors. Here's how:

Bendix Brush Connectors increase circuit count per board.

- Reduce number of boards by allowing more circuits per board.
- Greater board effectiveness by providing exact circuit counts up to 400 contacts in only one connector!

Bendix Brush Connectors reduce mating force 70% to 90%.

- Less complex board supports.
- Secondary actuators eliminated.
- Extended mechanical life. Up to 20,000 mates/unmates.

- Fewer damaged boards.
- One connector instead of multiple, fixture-mounted connectors.

Bendix Brush Connectors—a broad product line.

- Mother Board, Daughter Board, Input/Output, PC receptacle body styles.
- 2, 3 and 4 row configurations.
- 90° and straight PC, solderless wrap, crimp removable terminations with multiple lengths and plating options.

Bendix Brush contacts improve electrical characteristics.

- Highly redundant contact sites with multiple electrical paths and wiping action.
- Gold plated wire bristles mesh together intimately with gas-tight junctions.
- Stable contact resistance even after extreme mechanical durability abuse to 20,000 matings.

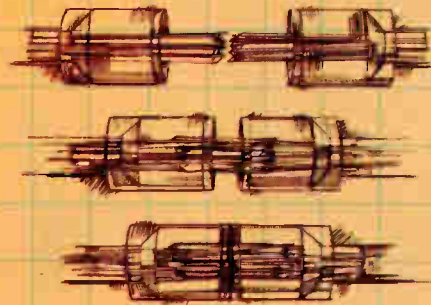

For full information, call (607) 563-5302, or write The Bendix Corporation, Electrical Components Division, Sidney, New York 13838.



We speak connectors.

Circle 155 on reader service card

**"OUR \$2000 FAMILY RUNS
END MICROCOMPUTERS. I'VE**



RINGS AROUND THE OTHER LOW-GOT THE PROOF RIGHT HERE."

Our first 4-bit computer-on-a-chip was a smash hit. Designers found the S2000 ideal for all kinds of appliances, process and industrial controls and automotive applications.

But that was just the beginning. We're now expanding the family to give you a variety of system options. The S2150 is the first new arrival, increasing the on-board ROM to 1.5K bytes (from 1K) and the scratchpad RAM to 80 4-bit nibbles (up from 64). Coming down the pike are the S2200, with 2K-byte ROM and the S2400, with 4K ROM. Both of these parts have 512 bits of RAM, A/D or D/A converters, programmable 8-bit counter/timers and three interrupts.

These new wrinkles are in addition to all those features that make the S2000 such a hot number. The powerful set of computer instructions, direct SCR or triac drive, zero voltage crossover detection, 4.5 microsecond execution cycle, inputs for mechanical or touch switching, 50/60 Hz power monitor option, three-level subroutine stack, a choice of LED or fluorescent display drive and much, much more, all designed to reduce your systems cost.

Couple these outstanding features with AMI's advanced floppy-disc based CRT development system, logic analyzer and circuit emulator and you've got the answer to your design problems. In fact, there's so much going for us that we decided to compare the S2000 with all the major low-end microcomputers. The results may surprise you.

OUR WALL CHART WILL SET YOU STRAIGHT.

We've put together a detailed chart comparing offerings from AMI, Motorola, National, Texas Instruments, Mostek, Intel and Rockwell.

It covers specs on each low-end circuit in more than two dozen different categories. All the significant features are included. (We didn't have to skip any to make ours look better.)

Obviously, we wouldn't have published these findings if they didn't show clearly that the S2000 family rises head and shoulders above the others.

But don't take our word for it. Send us the coupon and we'll send you a copy of our comparison chart. (It's printed as a handsome poster.) Or call us at (408) 246-0330. Pretty soon, you'll be designing some new products that run rings round your competition.

Yes, I'd like to see your proof! Send me a copy of ^{E2/1/9} the comparison chart right away. No obligation, of course.

Name _____

Title _____

Company _____

Address _____

City/State/Zip _____

Phone _____

AMI
AMERICAN MICROSYSTEMS, INC.

Mail to: AMI, 3800 Homestead Road,
Santa Clara CA 95051

IMPROVED PERFORMANCE

The "INTELLIGENT" DVM's from Guildline



MODEL 9575—5½ digit (shown above)
 MODEL 9576—6½ digit
 Similar measurement functions
 Different performance capabilities

Guildline's two new voltmeters measure DC voltage, AC voltage and resistance PLUS they use their measured results as a data base for processing information on a real time basis.

MEASUREMENT

Conventional measurements can be displayed, processed and displayed, and recalled at the end of each run. Accuracy ± 0.0009% • Stability—7ppm/6 months • Resolution—1uV • Scale length—3½ digits to 6½ digits • Ranging—auto and manual • 400 high speed readings/second

PLUS

Microprocessor Controlled Features include automatic calibration balance, 9 built-in programs—21 individual calculations. Full math capabilities: $Y = Ax + B$ or $Y = A(x + B)$

PLUS

Special Processing Power
DATA REDUCTION—scaling, offset, ratio, logarithmic,

squaring, and thermocouple linearization
STATISTICAL—% deviation, rolling average, updated variance, updated standard deviation, RMS, min., max., peak to peak
CONTROL—high-low limits, real time programmable clock, full internal time control: start, stop, interval between measurements and run time

PLUS

Data Systems Options
 IEEE—488/1975, RS-232, Binary, BCD
 Independent connectors offer time sharing between GP-IB and RS-232. 10 nanovolt resolution with any interface option to 6½ digits

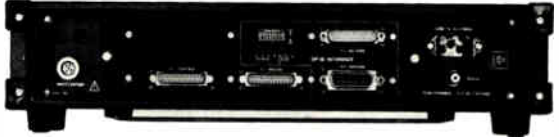

To get a wealth of information at your fingertips, call or write

 **Guildline Instruments, Inc.**
 2 Westchester Plaza, Elmsford, NY 10523 (914) 592-9101 • TELEX—GUILDLINEMFD145487

Communications

PCM tester is easy to use

Microprocessor-based analyzer makes end-to-end and partial checks

Chipmakers are lining up to supply coder-decoder chips to domestic and European telephone companies for building pulse-code-modulated channel-bank networks [*Electronics*, Sept. 14, 1978, P. 15] and Hewlett-Packard is taking the lead in developing instruments to analyze equipment built with these PCM circuits. HP's first offering is a smart instrument no larger than an average oscilloscope that can replace the racks of instruments formerly needed to make the same measurements.

Called a primary multiplex analyzer, HP's model 3779 features a proprietary 16-bit silicon-on-sapphire microprocessor plus a combination of read-only memory, read-write memory, and even magnetic-core memory—all aimed at making the operating task an easy one. Its primary application is analyzing PCM and frequency-division multiplexed terminals, according to Stan B. Jones, marketing support man-

ager for telecommunications products in the U.S. "HP's design goal was to make the instrument as easy to operate as a calculator," he says.

System software, measurement configuration data, sets of default measurement parameters, and self-test programs are stored in semiconductor ROM (32 K by 16 bits wide). A 1-K-by-16-bit read-write memory acts as a scratch-pad in which users can manipulate and execute measurement variables. The same amount of core memory is used to store user-defined measurement limit masks and sequence information.

As a result, no special skills are required to operate the 3779 and measurement variables are easily entered and changed using the front-panel keyboard. Specific settings or groups of variables may be changed without having to rewrite an entire test program while a numeric-code security lock entered from the keyboard prevents altering the measurement sequence either by accident or by unauthorized access.

Codecs, in concert with filters, convert radio signals to digital representations after some non-linear compression. Then, after transmission, they reconvert the digital codes back into analog signals and expand them to nearly their original form [*Electronics*, Sept. 14, 1978, p. 108]. The primary multiplex analyzer can measure the performance of a network from end-to-end that is

analog-to-analog by looping the digital inputs and outputs internally or it can be used to examine the intermediate conversions (analog-to-digital and the reverse).

Inside the 3779 is a 16-bit microprocessor control section and a pair of digital and analog receivers and transmitters. Using conventional analog hardware—a frequency synthesizer, selectable filters, and ac averaging or rms detectors—the 3779 can make up to 21 different analog-to-analog measurements. Analog-to-digital and digital-to-analog analysis is performed by the 3779 in conformance with either the American Telephone and Telegraph μ -law standards or the CCITT A-law standards.

HP is making two versions: the 3779A is for users who conform to CCITT recommendations G.711 and G.732 (which is for 30 voice channels in 32 time slots using A-law encoding and time-division multiplexing at a rate of 2,048 kilobits per second). For users who use the Bell technique (24 voice channels in 24 time slots using μ -law encoding and time-division multiplexing in a 1,544-kilobit-per-second digital stream), HP has the 3779B.

Each version has an integral cathode-ray-tube display screen and allows hard copies to be made by joining a 3779 to a printer via its IEEE-488 interface bus. The bus also allows for remote control and control of associated channel selectors. First deliveries of these systems are expected in February, according to Jones. Each system will cost \$20,530.

Hewlett-Packard Co., 1507 Page Mill Rd., Palo Alto, Calif. 94304 [401]

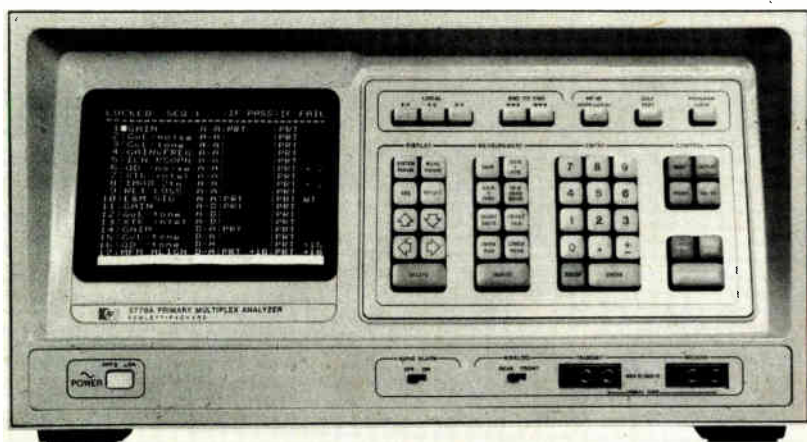

DIP-to-DIP optic link costs less than \$100 in 100's

Where high-speed, cabinet-to-cabinet data communications are endangered by noisy environments, the Dip-Link-1 system can provide the required immunity. Consisting of an optical transmitter and receiver, each of which is packaged in a 24-

Hipotronics inc.

HIGH VOLTAGE DC POWER SUPPLIES AND POWER PACKS

Standard supplies from 1 kW to 50 kW



1 kW supply provides 120 kV @ 8 mA

Power Supplies

Complete range of unregulated high voltage dc supplies with voltage outputs from 1 kV to 1000 kV and current outputs from 10 mA to 50 Amps available in standard designs at economical prices. Fully instrumented and protected, these supplies are ideal for:

- Laboratory use
- Capacitor charging
- Laser supplies
- CRT supplies
- Marx generators
- Many more

5, 7.5 & 10 kV @ 5 mA OEM Power Packs



Power Packs

Miniaturized, oil-filled steel cans for OEM use. Voltages from 2.5 kV to 100 kV at 2, 5 & 10 mA. Low cost, high reliability.

Metered Power Packs

Same miniature power packs available with simplified or deluxe controls for rack-mounting. Short circuit current limit option makes these ideal for cap charging applications.

Write or call for complete details.

HIPOTRONICS
HIPOTRONICS, INC.

P O Drawer A. Brewster, NY 10509
(914) 279-8031 Twx 710-574-2420
Amex Symbol HIP

New products

pin dual in-line package that stands only 0.4 in. high, the set sells for only \$99.50 in 100-piece quantities.

Data rates from dc to 1 megabit/s (return-to-zero) can be obtained, without the necessity of encoding, over distances of up to 17 meters. In standard form, both transmitter and receiver come with half-meter pig-tails of PFX-P140 plastic-core optical fiber to which AMP's Optimate connectors can easily be added. Thus configured, transmission lengths of up to 15 m are attainable. However, the units can also be configured with longer pig-tails that provide a 17-m transmission path with a single splice.

The transmitter's light-emitting diode generates a visible, 670-nm output from either transistor-transistor-logic (TTL) or complementary-metal-oxide-semiconductor (C-MOS) inputs. Both receiver and transmitter require 12-v power to provide high-immunity transmission with C-MOS systems.

For use with TTL devices, the receiver requires 12- and 5-v supplies and the transmitter needs only a single 5-v supply. Individual units can operate from the appropriate supply or supplies to provide C-MOS-to-TTL or TTL-to-C-MOS conversion. Delivery of the system takes two to four weeks.

Radiation Devices Inc., P.O. Box 8450, Baltimore, Md. 21234. Phone Frank Ryback at (301) 628-2240 [404]

9,600 bit/s modem can multiplex, too

Using digitally implemented vestigial sideband modulation, the DM 9600 modem can transmit and receive at rates up to 9,600 bits/s on 3002-type private lines with or without C2 conditioning. When optionally configured for multiplexing, the unit can operate with two 4,800- or four 2,400-bit/s inputs.

The multiplexing option, which employs elastic buffering, requires the addition of three to five boards (depending on desired output) to the basic eight-board system. The unit

comes with built-in diagnostics, and light-emitting diodes on its front panel indicate transmission-error rates and the condition of the transmission lines.

The DM 9600, which measures 8¾ by 11 by 15¾ in., has a basic price of \$6,500; with full multiplexing capability it costs \$8,220.

Penril Corp., 5520 Randolph Rd., Rockville, Md. 20852. Phone Harry Worsley at (301) 881-8151 [405]

I & Q networks can be ordered to specification

Designers of radar systems for, say, fire control can now purchase I & Q networks made to their specifications rather than build their own. The networks work in the high-,

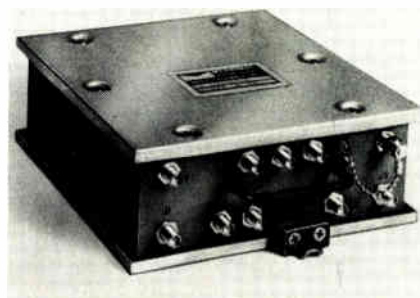

very-high-, and ultra-high-frequency bands and basically consist of two balanced mixers, an in-phase power divider, and a quadrature coupler.

Typical of the networks which can be supplied are units that accept i-f and coherent oscillator inputs with center frequencies of 30, 60, or 130 MHz. I-f 0.5-dB bandwidths and video output 3-dB bandwidths can be 0.5, 1.0, 5, or 20 MHz. With a video output of ± 0.25 v, phase and amplitude balance between I and Q signals can be $90^\circ \pm 2^\circ$ to 0.1° , and ± 1.0 to 0.25 dB, respectively. Third order intermodulation distortion for two 0-dBm inputs can be 60 dB below the desired output. Input to output isolation is a minimum of 60 dB at 30 MHz.

Merrimac Industries Inc., 41 Fairfield Pl., West Caldwell, N.J. 07006. Phone Dan Brodow at (201) 575-1300 [406]

THINK BAUSCH & LOMB RELIABILITY

BAUSCH & LOMB introduced the first zooming microscope in 1959, more and more people all over the world selected and used StereoZoom® over any other instruments of their kind. StereoZoom® offers an optimum balance of depth of field from precision optics and mechanical components; unmatched ergonomics; stands, and accessories; automatic micrographic exposure capabilities; as well as dependable, time-tested construction. The StereoZoom microscope is the one instrument you can rely on to help you do your job better year after year. Find out which StereoZoom microscope is best suited to handle the job for you. Write or call BAUSCH & LOMB for a detailed StereoZoom microscope catalog or a personal demonstration. THINK BAUSCH & LOMB . . . the name in reliable microscopes since 1874.

BAUSCH & LOMB
StereoZoom
microscopes
20
ANNIVERSARY



BAUSCH & LOMB 
Scientific Optical Products Division

In CANADA: BAUSCH & LOMB Canada Ltd.
2001 Leslie St.
Don Mills, M3B2M3, Ontario, Canada
(416) 447-9101

ROCHESTER, NEW YORK 14602 USA
716-338-6000, TWX 510-253-6189
TELEX 97-8231, CABLE BAUSCH & LOMB

Circle 161 on reader service card

Introducing wireless warning . . . the new AI-126 Audio Indicator from Projects Unlimited, available now with P.C. mount. Wave Solderable, the AI-126 features include: Electronic/Mechanical transducer • 375 Hz frequency • Voltage Ranges 1.5 to 16 Vdc • Economical price. For full catalog information on the AI-126, and our entire line of audio indicators write Projects Unlimited, Inc., 3680 Wyse Road, Dayton, Ohio 45414. Phone (513) 890-1918 TWX 810-450-2523.



WARNING WITHOUT WIRING.



WE'RE WARNING YOU . . .

Circle 222 on reader service card

ALCOLITE

MINIATURE INDICATORS
WITH BUILT-IN LEDs.

Contemporary styling adds color and vitality to your equipment appearance. High quality indicators are made in two basic styles for panel mounting. The extended LED provides 90° viewing angle, the recessed type for high ambient locations.

Four basic sizes fit into panel holes ranging from 7/32" to 3/8" diameter. All models are provided with choice of red, green or two-color red/green LEDs.

Use of black housing enhances contrast ratio or your choice of bright nickel to match other panel components. Supplied without internal resistor to maximize usefulness in meeting your custom needs.

We urge you to call Customer Service at (617) 685-4371.

Our sales people would like to discuss further details on this line.

P.S. Don't forget to ask for our 100-page catalog and free sample, too!



ALCO ELECTRONIC PRODUCTS, INC.
1551 OSGOOD ST., NO. ANDOVER, MA. 01845 USA

Tel: (617) 685-4371

TWX 710 342-0552

A SUBSIDIARY OF

AUGAT INC.

Circle 223 on reader service card 161



**Frequency
Devices
INC.**

ACTIVE FILTERS

Low Pass • High Pass
Band Pass • Band Reject
0.001 Hz to 50 kHz

**FIXED FREQUENCY
RESISTIVE TUNEABLE**

F.D.I. also manufactures
Sinewave Oscillators, Tone Encoders,
Tone Detectors and other
Communications Products

Frequency Devices Inc.
25 Locust Street
Haverhill, Mass. 01830

(617) 374-0761/TWX 710-347-0314

Circle 162 on reader service card

Lab Accuracy Volkmmeters



LM-4A \$250
0.03% Accuracy

LM-40A \$209
0.1% Accuracy

- Measures VDC, VAC, Ohms, DCmA & ACmA.
- Auto zero & Polarity.
- Battery powered with charger unit included.
- 1.9"H x 2.7"W x 4.0"D.
- Large 0.3" LED display.



Non-Linear Systems, Inc.
Originator of the digital voltmeter.
Box N, Del Mar, California 92014
Telephone (714) 755-1134 TWX 911-322-1132

162 Circle 224 on reader service card

New products

Materials

Thin tape slices costs

Flame-retardant film
has high dielectric
and tensile strengths

Often taken for granted by the electronics industry, electrical insulating tape performs many holding, fastening, insulating, identifying, and protecting functions such as coil covering, anchoring, transformer banding, and strapping for small motors and wire harnesses. 3M's latest product in this field can cut tape inventories and thus costs because it incorporates a combination of critical properties not previously available in a single tape. The new no. 10 tape is a flame-retardant, reinforced epoxy film with a coating of thermosetting rubber resin pressure-sensitive adhesive. The 5.5-mil tape has a tensile

strength of 40 lb/in. resist breaking and stretching applied under tension. It has 6,500-v dielectric strength, thus provides more dielectric strength per layer than woven materials. For instance, in one application, 4.25 layers of insulation on a coil could be cut to 1.5 layers of no. 10 tape.

Because of its unique combination of properties, the new tape is particularly suitable for coil manufacturing. Its conformability allows it to follow the contours of irregularly shaped coils without wrinkling, and its handling properties allow it to be positioned quickly and easily. The material's electrolytic corrosion factor of 1.0 provides resistance to corrosion in fine wire coils. Finally, all tests with the product indicate that it is compatible with magnet-wire enamels.

The tape, which has a 45 oz/in. adhesion to steel, will retain its unwinding and adhesion characteristics during relatively long storage periods. It is being sold through distributors and sales representatives

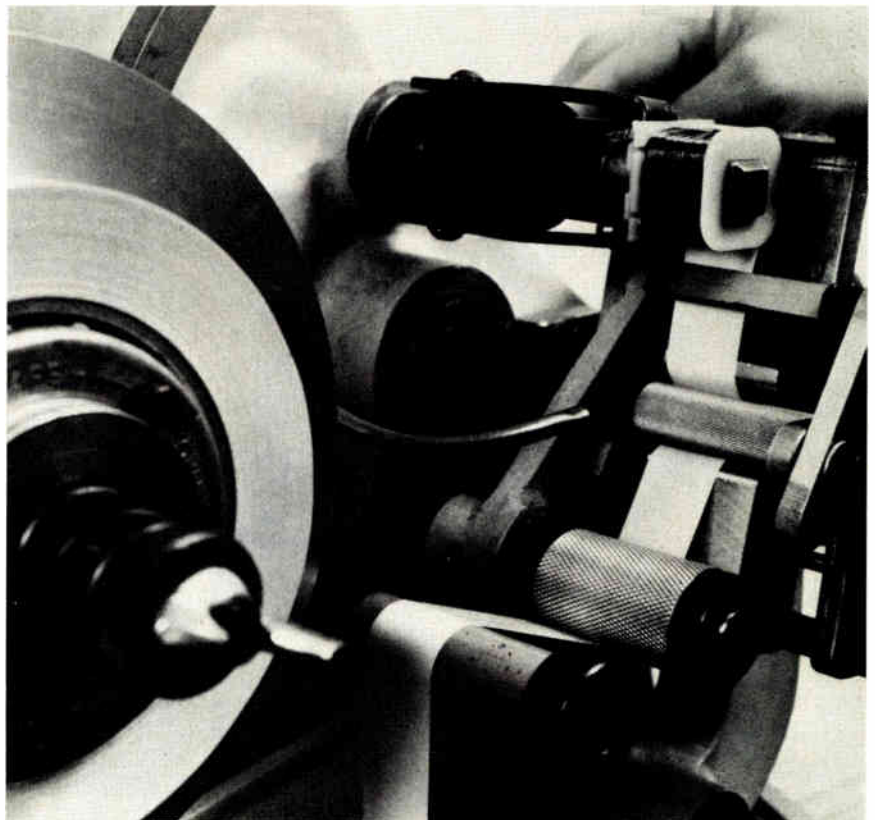

MPU SERIES MICROPROCESSOR POWER SUPPLIES

△ Lambda's triple output MPU-1 and MPU-2 are compatible to power any microprocessor and its associated clock, ROM's, FEPROM's, RAM's, PROM's, memories and I/O chips.

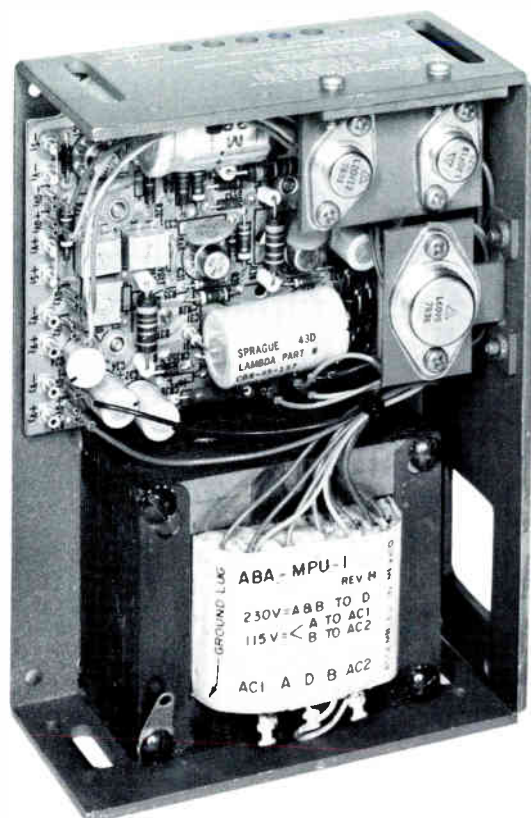

MPU-1

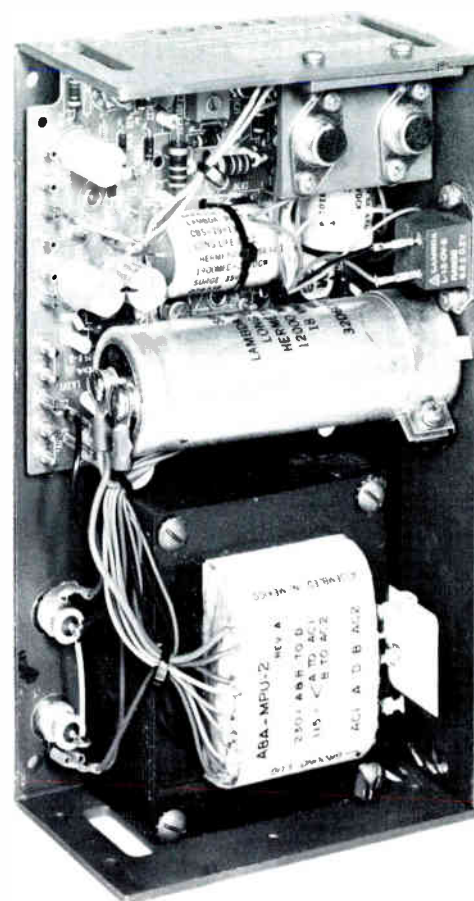

MPU-2

FEATURES

MPU-1 and MPU-2 are designed to be used for laboratory, bread-board, engineering prototype and pilot production as well as production systems.

1. All MPU power supplies contain three Lambda built-in overvoltage protectors, the only overvoltage protector that can maintain trip voltage tolerance over 71°C temperature range to protect microprocessors; clocks, memories, RAMs, ROMs, PROMs, FEPROMs and I/O chips from destruction.
2. Dual input voltage for domestic and overseas use in both MPU supplies: 105-125 or 210-250 VAC.
3. Sprague electrolytic capacitors used exclusively for improved reliability.
4. All hermetically sealed regulators used exclusively.
5. Modern design Darlington silicon power transistors.
6. All hermetically sealed semi-conductors.
7. No overshoot under conditions of power turn-off or power failure.

SPECIFICATIONS OF MPU-1 AND MPU-2 POWER SUPPLIES

Voltage and Current Ratings For Triple Output MPU-1 and MPU-2 Power Supplies

Model	VDC	Max Current (Amps) at			Price	
		40° C	50° C	60° C	Qty 1	Qty 25
MPU-1	5 ± 5% Adj.	3.0	2.5	2.0	\$100	\$ 80
	12 ± 5% Adj.	0.6	0.5	0.4		
	9-12V Adj.	0.6	0.5	0.4		
	or 5V*	0.38	0.38	0.38		
MPU-2	5 ± 5% Adj.	7.0	6.0	5.0	\$135	\$108
	12 ± 5% Adj.	1.0	0.9	0.8		
	9V	1.2	1.1	1.0		
	or 5V*	0.75	0.65	0.55		

(*)Customer selectable

DC output

voltage ranges shown in table above

Regulated voltage

regulation, line 0.15% for input variations from 105-125, 125-105, 210-250 or 250-210 VAC

regulation, load 0.15% for load variations from no load to full load or full load to no load.

ripple and noise 1.5mV rms, 5 mV pk-pk

temperature coefficient 0.03% per °C

remote programming 200 ohms/volt, nominal. resistance (5V output only)

remote programming volt per volt. voltage (5V output only)

AC input

line 105-125 VAC/210-250 VAC at 47-440 Hz (derate 10% at 50 Hz). Units are factory prewired for 105-125 VAC. Consult factory for operation at frequencies other than 47 to 63 Hz.

input power MPU-1 75 watts, MPU-2 145 watts.

line current MPU-1 1.0A, MPU-2 1.7A.

Overshoot

no overshoot on turn-on, turn-off or power failure

Ambient operating range

continuous duty from 0° to 60°C

Storage temperature range

-20°C to +85°C

Overload protection

automatic electronic current limiting circuit, limits output current to a safe value, protecting load and power supply when overload and direct shorts occur.

Overvoltage protection

all outputs include fixed built-in overvoltage protection circuits which prevent damage to the load caused by excessive power supply output voltage. Overvoltage protection firing range—see table below:

Output	Overvoltage Trip range (volts)
5V	6.5 ± .2
12V	13.8 ± .5
9-12V or 5V (MPU-1)	13.8 ± .5
9V or 5V (MPU-2)	10.5 ± .5

Cooling

convection cooled, no heat sinks or forced air required

Controls

DC output control. Simple screwdriver voltage adjustment over voltage range.

Remote sensing

Provision is made for remote sensing, on 5V output only, to minimize the effect of power output lead resistance on DC regulation.

Input and Output Connections

AC input and Ground—thru terminals on transformer DC output and Sensing—thru turret terminal on P-C boards

Finish

Gray, Fed. Std. 595 No. 26081

Mounting

Three surfaces, each with clearance mounting holes, can be utilized for mounting this unit.

Physical Data

Model	Weight		Size (inches)
	Lbs net	Lbs ship,	
MPU-1	5 1/2	6	7 x 4 7/8 x 2 3/4
MPU-2	7 3/4	8 1/2	9 x 4 7/8 x 2 3/4

Guaranteed

60 day guarantee includes labor as well as parts. Guarantee applies to operation at full published specifications at end of 60 days.

LN SERIES 5-YEAR GUARANTEED LOW-COST MPU SYSTEM COMPATIBLE POWER SUPPLIES



USED WITH COVER

5 Year Guarantee

USED WITHOUT COVER

CONDENSED SPECIFICATIONS OF LN SERIES

DC Output Dual Output
5 VOLTS ± 5% ADJ, 9V-12V ADJ

MODEL	VOLT. VDC.	(1) MAX CURRENT AMPS AT				PRICE
		40°C	50°C	60°C	71°C	
LND-X-MPU (2)	5±5%	7.0 (5.95)	6.0 (5.11)	4.7 (4.0)	3.2 (2.72)	\$172
	9-12	1.2 (1.02)	1.1 (0.94)	1.0 (0.85)	0.8 (0.68)	
LND-P-MPU (2)	5±5%	14.0 (13.3)	12.2 (11.59)	10.0 (9.5)	7.5 (7.13)	245
	9-12	2.5 (2.38)	2.2 (2.09)	1.8 (1.71)	1.35 (1.28)	

NOTES: 1. Rating in Parenthesis for LN Series when cover is used
2. Includes OV protection on both outputs (5 OV trip point is 6.6±.2V fixed; 9-12V OV trip points is 13.7±.4V fixed)

Regulated Voltage

regulation, line 0.1%
regulation, load 0.1%
ripple and noise 1.5mV RMS, 5mV pk-pk with either positive or negative terminal grounded.
temperature coefficient 0.03%/°C

AC Input

line 105-127 VAC, 210-254 VAC (by transformer tap change) 47-440 Hz. Consult factory for operation at frequencies other than 57-63 Hz.

Overload Protection

Electrical
External overload protection, automatic electronic current limiting circuit limits the output current to a preset value, thereby providing protection for the load as well as the power supply.

Thermal

Thermostat — automatically reset when over temperature condition is eliminated.

Overshoot

No overshoot on turn-on, turn-off or power failure.

Overvoltage Protection

Overvoltage protection module crowbars output when trip level is exceeded.

Ambient Operating Temperature Range

Continuous duty from 0° to + 71°C

Convection Cooled

No external heatsinks or blowers necessary

Fungus Proof

No fungus nutrient material used

Military Specifications

The LN series has passed the following tests in accordance with MIL-STD-810C:

- 1) Low Pressure — Method 500.1, Procedure I.
 - 2) High Temperature — Method 501.1, Procedure I & II.
 - 3) Low Temperature — Method 502.1, Procedure I.
 - 4) Temperature Shock — Method 503.0, Procedure I.
 - 5) Temperature — Altitude — Method 504.1, Procedure I. Class 2 (0°C operating)
 - 6) Humidity — Method 507.1, Procedures I & II.
 - 7) Fungus — Method 508.1, Procedure I.
 - 8) Vibration — Method 514.2, Procedures X & XI.
 - 9) Shock — Method 516.2, Procedures I & III.
- MIL-I-6181D — Conducted and radiated EMI with one output terminal grounded.

Physical Data

Weight

Package Model	Lbs. Net	Lbs. Ship	Size Inches
LND-X	7-3/4	8-1/4	7 x 4-7/8 x 2-7/8 (w/cover) 7 x 4-7/8 x 2-3/4 (w/o cover)
LND-P	15-1/2	17	11 x 4-7/8 x 4-13/32 (w & w/o cover)

Finish

Gray, Fed. Std. 595 No. 26081.

VDE/CSA

Listed in UL Recognized Components Index.
Designed for listing in VDE Index.
CSA certified

LAMBDA CUTS PRICES 20%

ON MICROPROCESSOR SYSTEM
POWER SUPPLIES

MPU-1 QTY 25

~~\$100~~
80

MPU-2 QTY 25

~~\$135~~
108

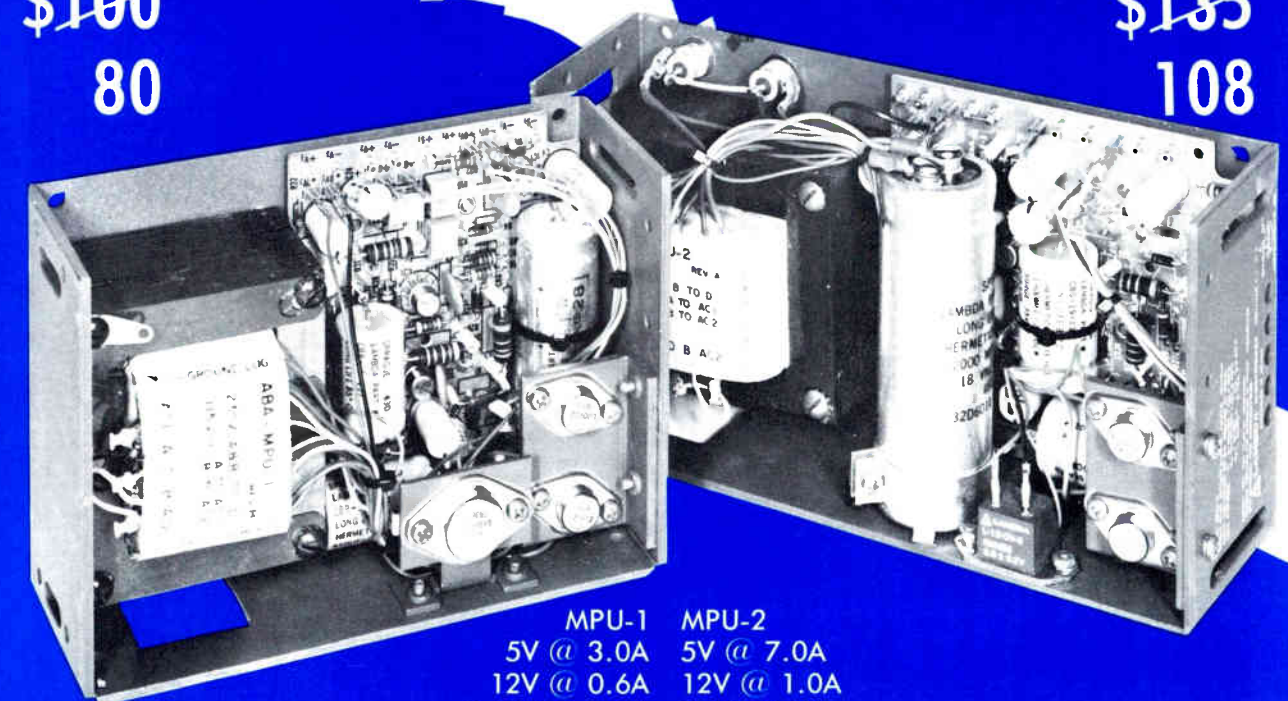

MPU-1	MPU-2
5V @ 3.0A	5V @ 7.0A
12V @ 0.6A	12V @ 1.0A
9-12V @ 0.6A	9V @ 1.2A
or 5V @ 0.38A	or 5V @ 0.38A

THE INDUSTRIES BROADEST LINE OF μ P SYSTEM POWER SUPPLIES

Complete details on 5 year guaranteed dual output models inside

BUY DIRECT FROM LAMBDA-ONE DAY DELIVERY

LAMBDA ELECTRONICS

Lambda staffed sales and service offices

ATLANTIC REGION Melville, New York 11747 515 Broad Hollow Road Tel. 516-694-4200 TWX: 510-224-6484	MID-WESTERN REGION Arlington Heights, Ill. 60005 2420 East Oakton St., Unit O Tel. 312-593-2550 TWX: 910-222-2856	SOUTH-WESTERN REGION Dallas, Texas 75231 6950 Winchester Tel. 214-341-5130 TWX: 910-861-9048	CANADA Veeco Lambda Ltd. 100C Hymus Blvd. Pointe-Claire, Quebec-H9R 1E4 Tel. 514-697-6520 TWX: 610-422-3029
NORTH-EASTERN REGION Lexington, Massachusetts 02173 2 Milita Drive Tel. 617-861-8585 TWX: 710-326-7558	FAR-WESTERN REGION Cerritos, Ca 90701 12607 Hidden Creek Way Suite J Tel. 213-926-0562 TWX: 910-346-7649	NORTH-WESTERN REGION Sunnyvale, California 94086 599 N. Mathilda Ave. Tel. 408-738-2541 TWX: 910-339-9243	Veeco Lambda Ltd. P.O. Box 501, Postal Station K Toronto, Ont., M4P 2G9 Tel. 416-486-0794 TWX: 610-422-3029



New products

of 3M's Industrial Electrical Products division.

3M Co., Industrial Electrical Products Division, P. O. Box 33600, 3M Center, St. Paul, Minn. 55133 [340]

Rotating transformer rings replace slip rings

Ferrite rotating-transformer sets designed to couple ac power to rotating platforms can be used as replacements for slip rings in oceanographic and geophysical data-logging appli-

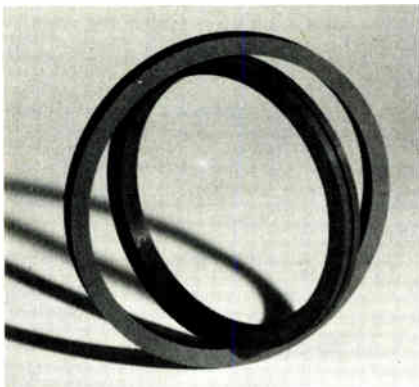

cations. The ferrite pieces are available with outer diameters from 0.5 to 10 inches. Machining tolerances are within ± 0.1 mil in both prototype and production quantities. The materials can be used at frequencies from 10 kHz to 100 MHz.

Ceramic Magnetics Inc., 87 Fairfield Rd., Fairfield, N. J. 07006. Phone (201) 227-4222 [479]

Knitted-wire tape shields wires and cables

A knitted-wire tape wraps around wires, cables, and harnesses to shield them against electromagnetic interference. Metex Shield Wrap tape is an inch-wide double layer of tin-plated copper-clad knitted steel wire.

The tape can be fabricated from almost any metal wire and its width can be varied. Standard wire diameters range from 3.5 to 6.0 mils (0.09 to 0.15 mm). The shielding effectiveness of the standard tape is 52 dB at

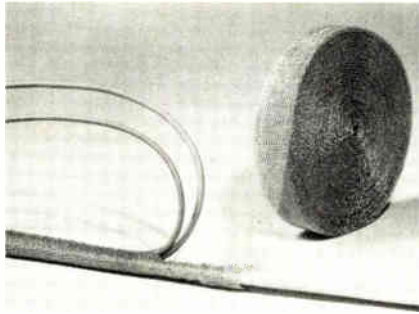

14 kHz, 75 dB at 18 MHz, and 55 dB at 1 GHz.

Metex Electronic Shielding Group, 970 New Durham Rd., Edison, N. J. 08817. Phone Peter G. Novak at (201) 287-0800 [478]

Thick-film conductor adheres well after multiple firings

A thick-film conductor dubbed Multifire claims double the strength of conventional frit-bonded conductors even after many firings. This is particularly important in building multilayer hybrid circuits in which the first conductor is usually fired at least twice and often 8 to 10 times.

After multiple firings, the 8-to-15-lb peel strength of a conventional conductor would usually drop to between 5 and 9 lb. When the Multifire bonding technique is used, the adhesion of 100-mil² pads remains in the range of 22 to 25 lb after 10 refirings at 850°C. Production prices are \$0.70 a gram for palladium-silver, \$1.65 a gram for platinum-palladium-silver, and \$8.10 a gram for platinum-gold.

Thick Film Systems Inc., 324 Palm Ave., Santa Barbara, Calif. 93101 [476]

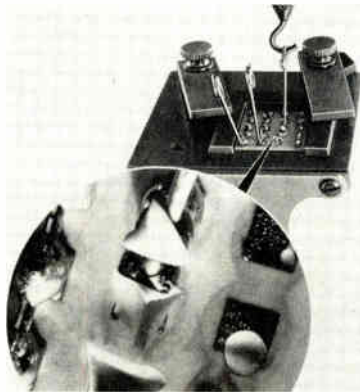

Incredible, but true!

10 Watts 1 to 1000 MHz

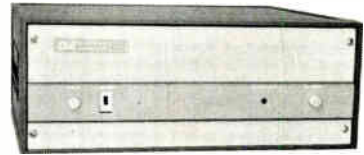

ULTRA-WIDEBAND AMPLIFIER

Amplifier Research again leads the way with its new Model 10W1000, an ultra-wideband amplifier that delivers 10 watts of linear power from 1 to 1000 MHz—more power and bandwidth than any other amplifier of its kind. In fact, as the "next generation" in ultra-wideband amplifiers, Model 10W1000 offers you 2½ times the power of its predecessor, the Model 4W1000.

Versatile and unconditionally stable, this high-performance amplifier can be used with frequency synthesizers or swept signal sources to provide high-level outputs for RFI susceptibility testing, NMR spectroscopy, antenna and component testing, general lab applications, and other uses.

For complete information on our 10W1000 and other W Series amplifiers, write or call:

Amplifier Research
160 School House Road
Souderton, PA 18964
Phone: 215-723-8181
TWX 510-661-6094

AR **AMPLIFIER
RESEARCH**

Packaging & production

Two-layer board goes to 500 MHz

Wrapped-wire panel for analog and digital applications has five power buses

Multilayer wire-wrapped boards are going to be a thing of the past, according to Hybricon Corp., which has designed a board for applications up to 500 MHz. Designated the 700-VHF, the board can be used for a wide variety of analog and digital applications, including emitter-coupled logic and very high-frequency radio circuitry.

The key to the board's design is that it only uses two layers of tin-plated copper, each of which acts as

a ground plane, separated by 0.0625 in. of glass-epoxy. Plated-through holes, on a 0.1-inch grid 36 columns long by 52 rows wide, connect the two planes through the glass-epoxy layer.

"What we've tried to do is generate a wire-wrapped board that has an extended frequency response and low noise characteristics," says C. Michael Hayward, vice president for engineering. "Our two-layer board can easily accommodate high-density digital circuitry—both integrated circuits and discrete components," he adds.

The wiring side of the board acts as a large ground plane, as does the component side, where the five separate power buses are located. Hayward points out that one of the advantages of this design is that it allows logic and analog circuitry to be combined on one board. "Our board has very good shielding, so noise between the circuits isn't a

problem," he explains. The continuous ground plane also lets hard-soldered bypass capacitors be placed where they are needed.

The board will accommodate ICs housed in 0.3-, 0.4-, 0.6-, and 0.9-in. dual in-line packages. There are also a 120-finger edge-connector and mating holes for a 50-pin flat-cable connector. The fingers of the edge connector are plated with 50 micro-inches of gold over 150 μ m. of nickel. The board is prepinned at input/output, power, and ground locations. Using two optional accessories—a plated-brass washer and a twin-holed jumper—pins can be soldered to the ground plane (with the washer) or connected to each other (with the jumper).

A pair of component pins soldered to the board has a typical thermal resistance to ambient of 40°C/w. The maximum safe operating voltage between holes and ground and between adjacent connector fingers is 50 v dc or peak. Current-carrying capacity for the fingers and connectors, using No. 30 Kynar wire, is 3 A. Typical insulation resistance between holes and ground, and between pairs of holes, is 10⁶ M Ω .

The board can be used over the frequency range from dc to approximately 500 MHz. The exact upper frequency limit depends on layout and other factors.

Prices for the 700-VHF start at \$74.95 in single quantities. Delivery is from stock.

Hybricon Corp., 410 Great Rd., P. O. Box 513, Littleton, Mass. 01460. Phone John Richards at (617) 486-3174 [391]



Unit inserts pins individually into printed-circuit boards

The AD-1350 pin-setting machine inserts 0.025- or 0.045-in. pins individually into printed-circuit boards with grids as dense as 0.100 in. by 0.100 in. To load the machine, the operator dumps about 1,000 pins into the bowl of the AD-1350. From here the pins move, one at a time, to the vertical magazine and on to the rotary driver head. The operator

Coming through...

with better ways
to interface

NEW "GPIB" CABLES

Interface computer power with test and measurement hardware—without lots of time-consuming patchwork wiring.

Belden's new "General Purpose Interface Bus" cable assemblies will become essential tools for you in R/D, quality control and on-the-job trouble-shooting.

Interconnect up to 15 programmable instruments at once. In star or daisy chain networks. Cables work with counters, signal generators, calculators, digital multimeters—in fact, they can be used with any instrument equipped with standard IEEE 488 interfaces. That means hundreds of compatible products today and the hundreds more coming on-stream soon.

These new 24 conductor cables are built to last, too. Semi-rigid PVC insulation and PVC jacket offer good flex life. U.L. recognized self-extinguishing plastic connectors are designed to withstand constant make/break cycling. Contact pins featuring gold over nickel-plated beryllium copper deliver far better conductivity than designs using plain copper. Belden U.L. approved "GPIB" cable assemblies (with metric cadmium plated screws) are available right now in five standard lengths up to 16 m (52.5'). U.L. approved and CSA certified bulk put-ups are also available. Let Belden come through for you. Contact your local Belden distributor or Belden Corporation, Electronic Division, P. O. Box 1327, Richmond, Indiana 47374; 317-966-6661.

BELDEN

Coming through...

with new ideas for moving electrical energy



SUPER MINIATURE Neon Glow Lamps

Circuits Volts..... AC 105-125
Series Resistance..... 150K Ω
Nominal Current..... 0.3mA
Total Flux 20mlm MIN.
Average Life Hours... 30,000

Dimension: mm



NL-8S

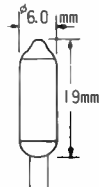

NL-35/G

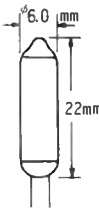

NL-21/G

CLEAR-GREEN

Fluorescent Glow Lamps

Circuit Volts..... AC cr DC 105-125
Series Resistance..... 33K Ω
Nominal Current..... 1.6mA
Total Flux (MIN.) AC: 120mlm, DC: 130mlm
Avg. Life Hours AC: 30,000 DC: 40,000

Circuit Volts..... AC 105-125
Series Resistance 27K Ω
Nominal Current..... 1.5mA
Total Flux 90mlm MIN.
Avg. Life Hours 20,000

● MAIN PRODUCT

NEON GLOW LAMP, XENON FLASH LAMP,
RARE GAS, DISCHARGE LAMP.
MINIATURE : BLACK-LIGHT, UV-LIGHT,
FLUORESCENT COLOR-LIGHT.

ELEVAM ELECTRONIC TUBE CO., LTD.

NO. 17-8 CHUO 2-CHOME OTA-KU, TOKYO JAPAN
TELEPHONE : 03 (774) 1231~5

EXPORT DIVISION : JAPAN NANOTRONIX CO., LTD.
OTA-KU TOKYO, TELEPHONE. (03)775-4811 TELEX 246-6583 JNANOX

Circle 170 on reader service card

New products



positions the pc board where he wants the pin inserted and steps on the pedal to complete the job. For each pin to be inserted, the operator must manually move the board to the desired location. Up to 6,000 pins an hour can be placed, and the machine can handle pin lengths from 0.4 to 1 in. The AD-1350 requires 115 V ac at 5 A, 80 pounds pressure per square inch of air, and only 30 by 30 in. of floor space.

The base price of the machine is \$10,000, and several options can be added.

Methode Electronics Inc., Interconnect Products Division, 1700 Hicks Rd., Rolling Meadows, Ill. 60008. Phone (312) 392-3500 [394]

Tool inserts 14- and 16-pin ICs into sockets or boards

The MOS1416 DIP insertion tool inserts both 14- and 16-pin dual in-line packages into sockets or pre-drilled boards. The tool is conductive, which reduces static electricity. A ground strap may be attached for highly sensitive metal-oxide-semiconductor and complementary-MOS integrated circuits. In using the tool, an IC is inserted into it and rocked on the straightening saddle; the IC is then ready for insertion into the pc board. The MOS-1416 sells for \$7.95 each.

O. K. Machine and Tool Corp., 34-5 Conner St., Bronx, N.Y. 10474. Phone (212) 994-6600 [397]

Tri-State LED

RED —
GREEN —
OFF —



Xciton's unique Tri-State LED lamp provides red and green lighted color from the same T-1 1/2 plastic package—saving PC board space and assembly time.

Advanced manufacturing techniques provide an equal color brightness of the red and green at the same drive current of 10mA.

Available at popular pricing, the Tri-State is ideal in Level Sensors, Null Indicators, Alarms, Consumer Appliances and Instrumentation.

Custom built LEDs, accessible technical assistance, plus unmatched product service—with a 6-8 week lead time—is what Xciton is all about.

Catalog, spec sheet, and free Tri-State sample—are available from your Xciton sales representative or the factory direct—call

Cliff Jurus at

Xciton Corp.

5 Hemlock St., Latham, N.Y. 12110
(518) 783-7726, TWX: 710-444-4962

BY POPULAR DEMAND!

MS-215 Dual Trace Miniscope



With Rechargeable
Batteries & Charger Unit. **\$435**

- 15-megahertz bandwidth.
- External & internal trigger.
- Auto or line sync modes.
- Power usage — < 15 W.
- Battery or line operation.
- 2.9" H x 6.4" W x 8.0" D.



Non-Linear Systems, Inc.

Originator of the digital voltmeter.
Box N, Del Mar, California 92014
Telephone (714) 755-1134 TWX 910-322-1132

170 Circle 225 on reader service card Circle 226 on reader service card

Electronics / February 1, 1979

Half-size Amber R Relays

More than 26 million R Relays
in service around the world.



Remember us?
... we used to
be known as Arrow-M.

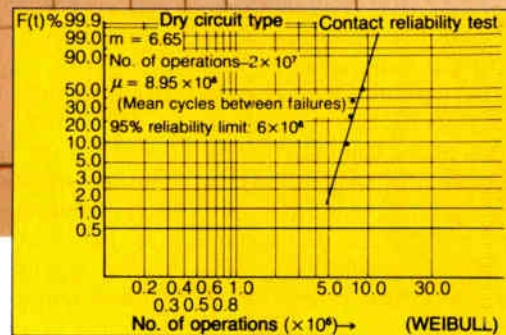

High reliability: 8,000,000 operations at low level switching...without a failure!

The Weibull chart proves this high contact reliability. Mean cycles between failures is 8.95×10^6 operations at 100 uA switching.

- The minimum operating power for a single side stable type is 80mw, for a latching type 40mw.
- Aromat R Relays are available in 1 Form C contacts which can carry a high current capacity of 1 Ampere 20 watts, and are capable of resisting welding at higher inrush currents. A dry circuit type, which can switch current as low-level as 10uA, is available in addition to the power type.
- In addition to the standard, there are 1 coil and 2 coil latching types, which are useful for logic circuit design as a memory component.
- Not only can they be automatically wave soldered on PC boards with a high density of electronic parts, but they are simple to clean with most degreasers and detergents without affecting maximum contact reliability.

Relays for Advanced Technology



Contact Your
Aromat Representative
or Distributor Today.

Aromat Corporation:
250 Sheffield Street
Mountainside, NJ 07092
(201) 232-4260

Mid-Western Office:
311 Lively Blvd.
Suite 1
Elk Grove Village, IL 60007
(312) 593-8535

Western Office:
10400 North Tantau Avenue
Cupertino, CA 95014
(408) 446-5000

Components

Swiss switch lives long

Made for low-level uses, push-button unit is rated for 5 million operations

Lifetime, a most critical switch parameter, depends on quality. Consequently, when EAO Switch Corp. introduced both itself and the series 99 switch to the American marketplace, it was careful to emphasize that the underlying factor, both in the formation of the company and in the creation of the switch, was to ensure that quality would be provided. This is reflected in the fact that the circuit-mountable push-button switches are rated for 5 million operations with currents of 50 mA.

Intended primarily for low-level switching applications, the one-make-one-break devices can handle currents ranging up to 100 mA at 50 v. The resistance of the 99's contacts is down at about 10 m Ω and contact bounce is less than 100 μ s.

Switches are available that operate in either momentary-action or step-action mode. In both versions, the user can choose between a concave surface, which is preferable for any switch that is pushed frequently (as any typist can tell you), and a flat service, which gives a greater angle of readability to legends printed on the switches.

Red, yellow, green, or blue color films can be inserted into the switch's screen at the purchaser's request to provide functional coding. They can also be supplied with T-1 lamps. The concave or flat screens measure 18.6 mm on each side and are 15 mm high. The total height of the push button is 28 mm.

The switches, which are manufactured by the Swiss parent company (Electro-Apparatebau Olten) using highly automated production lines, are being stocked by the wholly owned subsidiary at levels based on 90-day requirements of distributors and customers. According to Robert W. Maier, vice-president, marketing, "it is EAO's goal to ship 90% of material within 48 hours after receipt of order." In quantities of 1,000, prices for Series 99 units begin at \$2 each.

EAO Switch Corp., 255 Cherry St., Milford, Conn. 06460. Phone (203) 877-4577 [341]

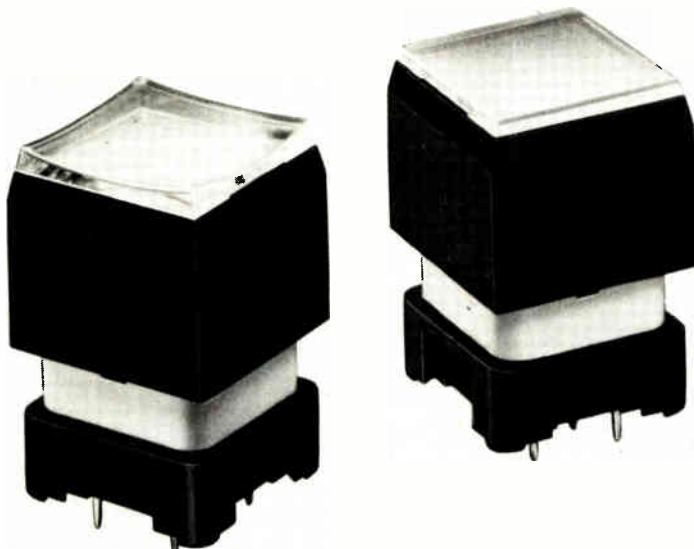

Capacitors withstand heat thanks to outside contacts

Capacitors that provide high-frequency filtering in computer-grade switching power supplies must operate at high voltages and temperatures for extended periods—and they



must do so reliably. The type 125 series, which is intended for such applications, consists of aluminum electrolytic capacitors that are tested for 2,000 hours at rated voltage and at a temperature of 125°C. Based on such testing, the units have a projected rated lifetime of over 20 years at 65°C and rated voltage.

According to the manufacturer, the reliability of the capacitors is attributable to their unique construction. Called Thermal Pack, it allows the conducting cathode foil to come in contact with the aluminum case bottom, thus providing a thermally conductive path. Furthermore the wound capacitive element is mechanically secured to the case, eliminating the need for potting compound and permitting greater internal volume for gas expansion.

Units within the series range from 1,400 to 72,000 μ F and have maximum voltage ratings from 5 to 40 v dc. Standard tolerance is -10%, +75%. At 85°C, units can handle 10-kHz ripple currents of up to 35 A, and at that frequency the equivalent

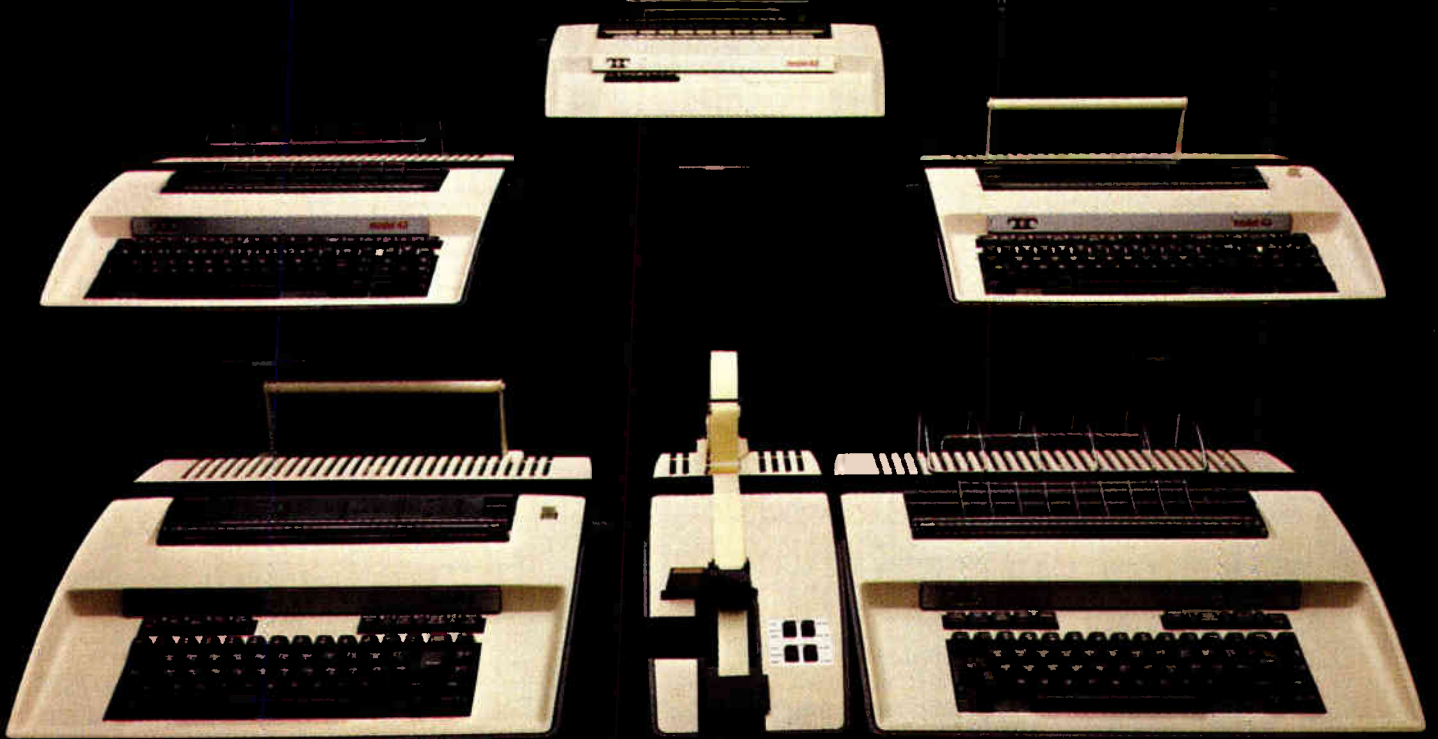

OUR MODEL 43 TELEPRINTER FAMILY IS THE BEGINNING OF A NEW LEGEND.

When we introduced it just a year ago, the basic idea behind the Teletype* model 43 proved so sound and flexible that today it's grown into a comprehensive terminal family with extensive capabilities for message communications.

Model 43's come in a variety of configurations with either 80 column friction-feed or 132 column pin-feed printers. Some units are designed for use on the switched network, others for point-to-point private-line systems. (There's also a new generation of 5-level buffered teleprinters for Telex applications.)

The basic model 43 series operates on-line at 10 or 30 cps in either the half- or full-duplex mode and prints multiple copies using the 96 character ASCII code set. A wide choice of interfaces, including EIA RS232C and DC 20-60ma, are available for easy system integration.

With the automatic send-receive configuration, messages can be prepared off-line via the paper tape punch, edited, combined with

a master tape, then sent at maximum terminal speed—automatically and unattended—when line rates are lowest.

Buffered 43's operate on-line at speeds ranging from 10 to 180 cps and provide up to 20,000 characters of storage for sending, receiving and editing. These terminals send and receive automatically via the buffer while messages are simultaneously being prepared for future transmission. They also include full forms control, the automatic answer capability and answer back.

Just like its predecessor, the legendary model 33, our model 43 family is designed for extreme reliability. The reason is simple: simplicity. Our model 43's use only five major pluggable components (six, counting the paper tape module on the ASR), along with extensive use of LSI circuitry.

So when you think of our model 43 family, think of it as the beginning of a new legend.



THE TELETYPE MODEL 43 FAMILY.

Teletype Corporation, 5555 Touhy Avenue, Dept. 3185, Skokie, IL 60076. Tel. (312) 982-2000.

*Teletype is a trademark and service mark of the Teletype Corporation.

Circle 173 on reader service card

Dialight LEDs

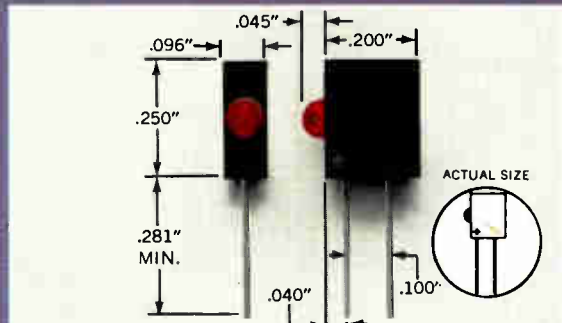

555 SERIES LED logic state indicators available in 14 models with voltage ratings from 1.7 to 14. Suitable for dense packaging on printed circuit boards—up to 10 units to the inch—IC compatible. With built-in resistor. Polarity identified. Low power consumption. With pricing as low as .57¢ (1000 lot quantity).

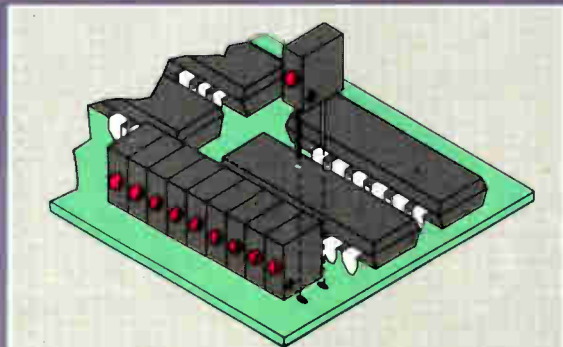

These low cost LED logic state indicators are extremely versatile devices and lend themselves to a wide range of applications. Digital status indicators and circuit fault indicators are typical applications.

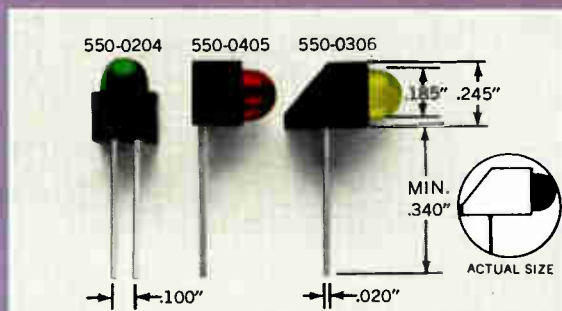

550 SERIES Mix 'em or match 'em. LED logic state indicators are available in red, yellow and green, in a variety of shapes, some with a built-in resistor. Can be driven from DTL and TTL logic. Designed for easy alignment on PC boards. Also available with high brightness LEDs. With pricing as low as .32¢ (1000 lot quantity).

Dialight meets your needs. So talk to the specialists at Dialight, first. Send for your free copy of Dialight's current catalog today.

DIALIGHT

Dialight, A North American Philips Company
203 Harrison Place, Brooklyn, N. Y. 11237
(212) 497-7600

Circle 174 on readerservice card

New products

series resistance ranges from 0.004 to 0.040 Ω depending on capacitance value.

Type 125 capacitors come in cases with an outside diameter of 1.375 in. and they range in height from 1.625 to 5.625 in., depending on value. In 1,000-piece quantities, individual units range in price from \$6.50 to \$10. Units are available for delivery from stock.

Sangamo Capacitor Division, Sangamo Weston, Box 128, Pickens, South Carolina 29671 [343]

General-purpose preamplifier has sensitivity of 5 μ V

Designed for use in both the field and the laboratory, Series 1220 preamplifiers have an input sensitivity of 5 μ V referred to input. In its standard configuration, a 1220 unit

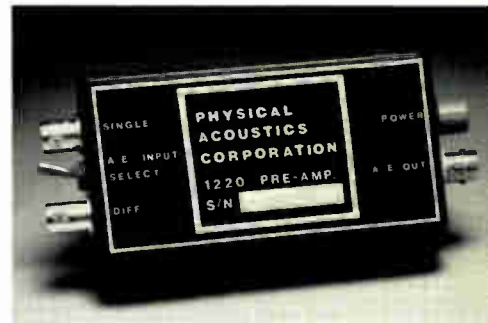

works in the 100-kHz-to-2.0-MHz band, but this range can be modified for a particular purpose using field-replaceable high-pass and low-pass filter modules.

Either single or differential inputs can be applied to the preamp depending on the setting of the input-mode toggle switch. Units are available with either 40 to 60 dB gain, or they can be purchased with a switch that allows selection of either gain, as required.

Series 1220 preamplifiers provide an output voltage of 20 v peak-to-peak and input protection of 110 v peak. Prices begin at \$250.

Physical Acoustic Corp., P. O. Box 3135, 743 Alexander Rd., Princeton, N. J. 08540. Phone Michael Cuozzo at (609) 452-2510 [344]

**FAMOUS
FIRSTS.**

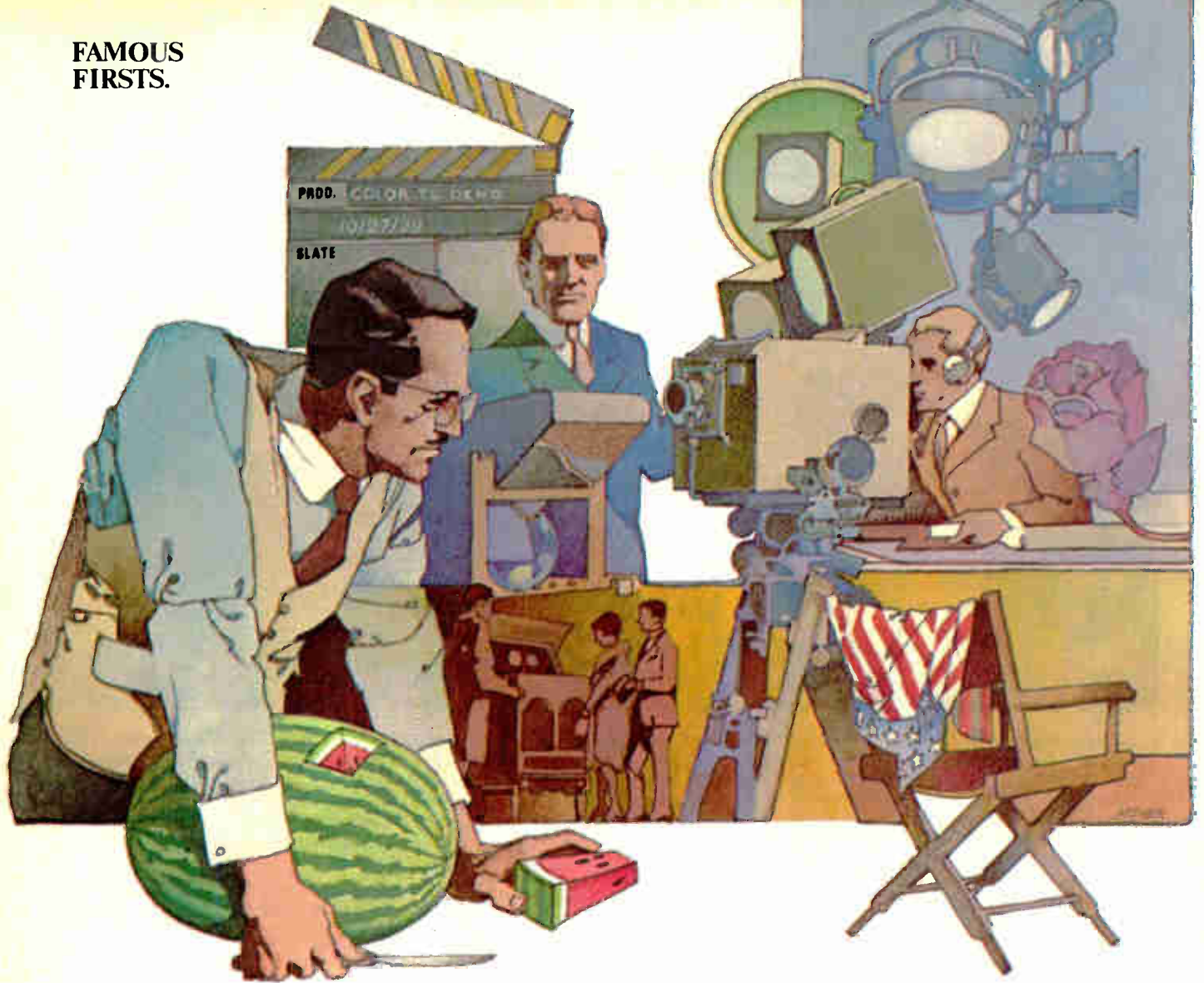

On an October day in '29, a watermelon was plugged as a TV star.

It, an American flag and a bunch of roses shared top billing in the first public color television demonstration in New York City, October 27, 1929. It was primitive, but it was a beginning. And as Bud has proven since its founding in 1928, small beginnings based on good ideas trigger growth.

In fact, today Bud holds the prime spot in offering, and making immediately available, the industry's largest selection of enclosures. And whichever of the over 2,500 styles and sizes you specify, that Bud enclosure will add to your product's value, function, styling -- add to its marketability. That's why we're in business, to help you in yours. And that's why we've grown.

Bud Industries, Inc., 4605 East 355th Street, Willoughby, Ohio 44094. Bud West, Inc., 3838 North 36th Avenue, Phoenix, Arizona 85019.

BUY BUD

FAMOUS...AND FIRST.

For Complete Information, circle number 175

For information,
phone toll free: (800) 321-1764;
in Ohio, (800) 362-2265.



*Choose your enclosures from over
2,500 styles and sizes, all immediately
available from Bud.*

To have salesman call, circle number 228

Engineers . . . Isn't it about time you had one more moving experience?



Instead of sitting around just wondering what it would be like to join the nation's number one avionics team you owe it to yourself to find out. Over 80 longterm sub-contracts and millions more in diversified R&D business have created exciting and secure career opportunities for top engineers with Honeywell-in-Florida. A higher after-tax take-home pay, a lower cost of living, a more exciting career challenge, and a new life in one of America's "most liveable" cities where vacation begins every day after work. It all adds up to Honeywell-in-Florida.

You'll appreciate Honeywell-in-Florida's commitment to engineering excellence. And the freedom you'll have to realize your full career potential in a company which recognizes and rewards achievement.

Welcome To The Good Life!

Living on Florida's famous Suncoast is more than just sun and sand and fun.

Sure, there's a 98.9041 per cent chance of sunshine every day and you can swim in the middle of winter. But equally as important, you can watch a Broadway show or Las Vegas headliner talent, catch major league NFL football or NASL Soccer, enjoy first class opera and symphony concerts, or tour one of the many art museums in the area. Or you can take the whole family to nearby Disney World, Circus World, or Busch Gardens. Whatever you want to do is here for you. On Florida's famous Suncoast. The family place.

If being involved with something really significant is important to you, then we're your

Avionics Division
Honeywell
in Florida A place in the sun for you!

Honeywell is an equal opportunity employer actively seeking applicants under its Affirmative Action Program.

kind of company. And if you and your family like the idea of moving to Florida's Suncoast, where your new salary with Honeywell-in-Florida will be worth thousands more a year, rush us the "Instant Application" in complete confidence, of course.

Honeywell-in-Florida has immediate and long term needs for Engineers in the following disciplines:

- Mechanical Design
- Software Engineering
- Systems Engineering
- Computer Systems
- Digital Design
- Analog Circuit Design
- Reliability Engineering
- Analog Design
- Production Test
- Production Build
- Electronics Design

*Christian Science Monitor.

"INSTANT APPLICATION"

Name _____
Address _____
City _____ State _____
Zip _____
Home Phone _____
Business Phone _____
Job Applying for _____
Present Employer _____
Salary requirements _____
Present salary _____
Dates Employed _____
Job title _____

Duties _____
Previous Employer _____
Dates Employed _____
Job title _____

Mail to: G Manthos
Avionics Division,
Honeywell-in-Florida
13350 U.S. Hwy 19
Pinellas County, Florida 33733

Avionics Division
Honeywell
in Florida A place in the sun for you!

Duties _____
Previous Employer _____
Dates Employed _____
Job title _____
Duties _____
Education _____
Other Experience _____

The Quiet Printer Telpar's 48-Column PS-48E... \$380.00*

KEY FEATURES INCLUDE:

- Microprocessor controlled
- Versatile interface (no added charge)
 - Serial: RS-232C, 20 mil loop, or TTL
 - Parallel: TTL interactive
- Upper/lower case, 96 ASCII characters
- Throughput rate — 24 characters per second
- Signalling rates
 - Serial mode: 110 or 300 Baud
 - Parallel mode: up to 960 cps
- Automatic carriage return and line feed
- Thermal printing, no ribbons or ink

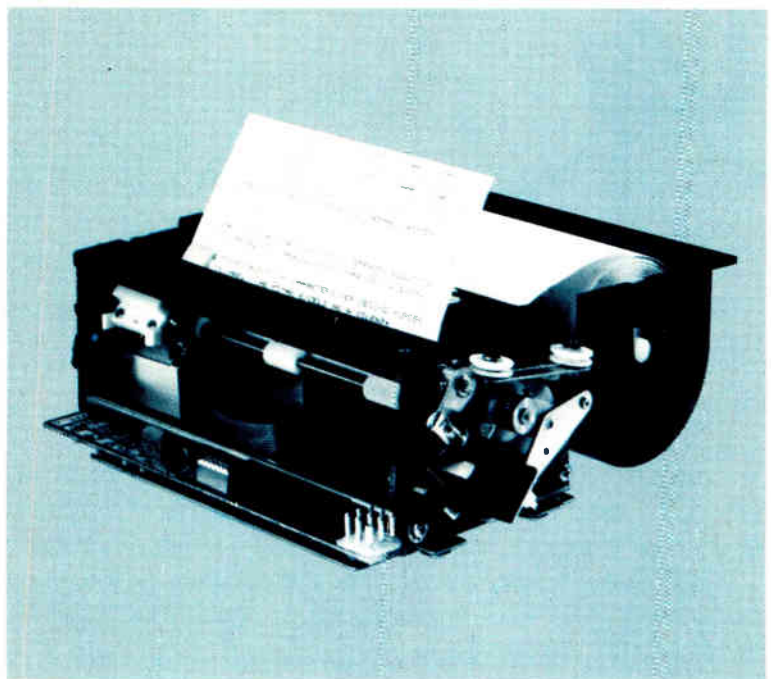

*** In quantities of 100 \$380.00**
 Single quantity \$465.00

telpar, inc.

For more information contact Telpar, (214) 233-6631,
 4132 Billy Mitchell Road, Box 796, Addison, Texas 75001.
 Telex: 73-7561 (TELESERV) DAL.

Circle 177 on reader service card

MOVING?

Please give us 4 weeks advance notice. Attach the label for your old address, write in your new address below, and send to Fulfillment Manager, Electronics, P.O. Box 430, Hightstown, N.J. 08520.

**OLD
ADDRESS
LABEL**

NEW ADDRESS

Name _____
 Address _____
 City _____
 State/Province _____
 Zip/Postcode _____
 Country _____

Get a BUZZZZ.



Sound transducers, solid state electronic micro-buzzers or piezo ceramics. Count on Citizen for reliability, competitive pricing, and immediate delivery whenever you need a buzz.

- SMB 1.5, 6, 12, 24 VDC
- RMB 3, 6, 12, 24 VDC
- IMB (Intermittent) 6, 12 VDC
- PMB 3, 6, 12, 24 VDC
- MMB 1.5 VDC
- PCB (Piezo Ceramic) 1.5-9 VDC, 3-20 VDC
- CB-12A (Transducer) 1.5 VDC

CITIZEN CITIZEN AMERICA CORPORATION

1710-22nd Street, Santa Monica, California 90404
 (213) 829-3541 TWX: (910) 343-6450

Circle 230 on reader service card 177

VACTEC DOES MORE

(than make photoconductors, phototransistors, photodiodes, photovoltaic cells, photocouplers)

We design and process CMOS and bipolar I-C's. One of our designs can be found in the Kodak EK4 & EK6 Instant Cameras and Tele Instamatic 708 Pocket camera. (A) This I-C requires no outboard components and has photodiode on the CMOS chip—digital and linear circuitry—times the shutter—sets the aperture—flasher circuit for LOW light signal (battery check available) (write for copy of I-C facilities brochure)



(A)

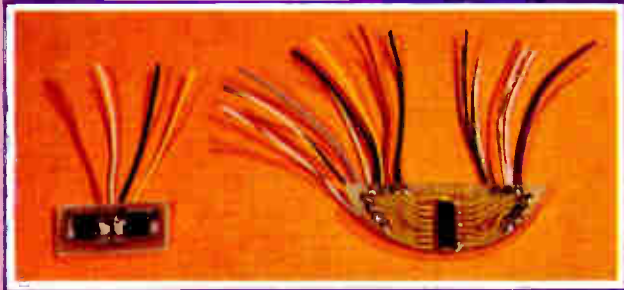

(B)



(C)

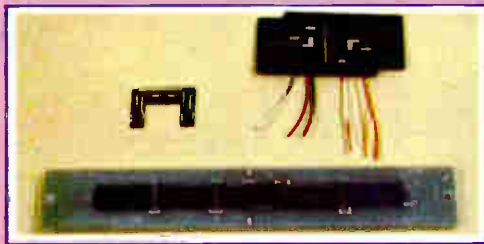

(E)



(F)

Complete subassemblies using our photodetectors for:

- B. Photodiode arrays for linear or rotary position shaft encoders.
- C. Phototransistor/LED coupled arrays for Medical densitometric tests.
- D. Miniature Photodiode arrays for battery charging.
- E. Surveying by laser.
- F. Microfilm readers—detect code on film strip for high speed location.



(D)

Custom detector chips, such as dual element phototransistors, special geometry photodiode (single or multiple) can be developed for reasonable engineering plus mask generation charges.

Can we assist in your custom requirements
Please write attn: Marketing Dept.—Custom

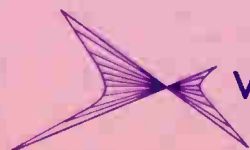

Vactec, Inc.

2423 Northline Industrial Blvd. • Maryland Heights, Mo. 63043 U.S.A.
314-872-8300 • TWX 910-764-0811

Circle 178 on reader service card

New products

Instruments

Scope covers dc to 1 GHz

Real-time instrument has 10-mV/div sensitivity, sweeps at 200 ps/div

The state of the art in general-purpose oscilloscopes was advanced by a factor of two with the introduction by Tektronix Inc. of its model 7104—a plug-in lab scope with a bandwidth of 1 GHz, twice that of its predecessor's. The speed and bright trace of this instrument allow users to observe extremely fast single-event pulses in real time, under normal lighting, with no need to resort to cumbersome photographic techniques.

In addition to its bandwidth and brightness, the 7104 features a rise time of 350 ps, calibrated vertical sensitivities from 10 mV/division to 1 V/div, and full sweep-triggering capability out to 1 GHz. The horizontal system is just as impressive with its 350-MHz bandwidth and calibrated sweep speeds to 200 ps/div. The display is 10 divisions wide by 8 divisions high; each division is 0.85 cm. The scope's photographic writing rate is 20 cm/ns.

Developing a general-purpose 1-GHz scope that is compatible with the rest of the 7000 series required technological innovation at just about every turn. Much of the design, of course, consisted of the application of microwave technology to an unusual set of problems. To solve them Tektronix developed special high-speed integrated circuits using its own proprietary processes, microstripline layout techniques, and an interconnection system with metalized-elastomer contacts to reduce reflection losses and mismatches.

The heart of the scope, however, is its cathode-ray tube—a totally new design with a distributed horizontal-

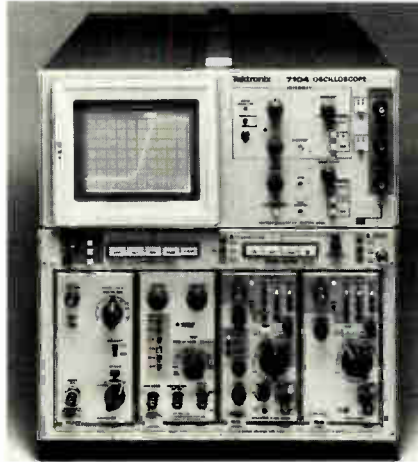

deflection system to achieve the necessary bandwidth, a meshless expansion lens for full-screen waveform projection, and a microchannel-plate electron multiplier to provide a bright image. The CRT is what makes possible the accurate and easy viewing of fast one-shot events. Earlier, and far more expensive, oscilloscope systems designed for this purpose had to use photographic means to capture fast signals because the traces were too weak to be seen with the naked eye.

The model 7104 mainframe sells for \$14,400. With a 7A29 vertical amplifier plug-in, a 7B10 time-base plug-in, and a 7B15 delaying time-base plug-in, the total instrument price rises to \$19,485. The oscilloscope is available from stock.

Tektronix Inc., P. O. Box 500, Beaverton, Ore. 97077. Phone Eric Lane toll-free at (800) 547-1572 [351]

Probe lets standard DMM take temperature readings

Plugged into any digital multimeter with a measuring range of 0 to 200 mV, the T-10 universal temperature probe lets users take temperature readings over a range of -50° to $+150^{\circ}\text{C}$ that are accurate to within $\pm 3^{\circ}\text{C}$.

The probe, which uses a bridge circuit powered by a disposable 9-v battery, has an output voltage of 1 mV/ $^{\circ}\text{C}$ with 0 mV corresponding to 0°C . Thus, readings in millivolts

If this is what you're looking for

HIGH TEMPERATURE CAPACITORS



Performance Data

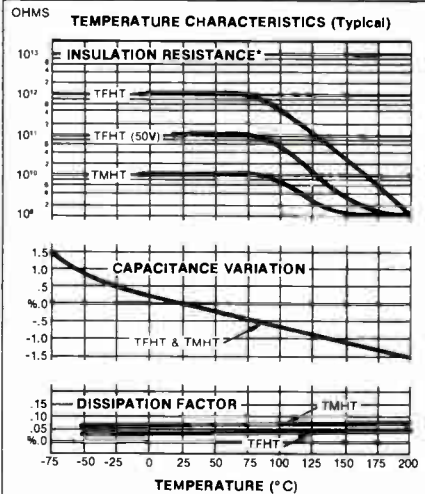

Specify Standard T Series Custom Capacitors, made with DuPont TEFLON® — for temperatures to 200°C . and beyond.

- Insulation Resistance up to 10^{12} ohms
- Dissipation factor down to .02%
- Temperature Coefficient down to -90 ± 40 ppm/ $^{\circ}\text{C}$.

For complete data and FREE TechniTip, please fill out coupon and mail today.

Also available: C Series Mica for energy storage, and K Series Mica for maximum volumetric efficiency.

Name _____
Title _____
Company _____
City _____
State _____ Zip _____

Please send FREE TechniTip on Custom T Series Film Capacitors.



CUSTOM ELECTRONICS, INC.
12 Browne St., Oneonta, NY 13820
PH: 607-432-3880 TWX: 510-241-8292

INTERNATIONAL

OE CRYSTAL OSCILLATOR ELEMENTS

International's OE series of Crystal Oscillator Elements provide a complete crystal controlled signal source. The OE units cover the range 2000 KHz to 160 MHz. The standard OE unit is designed to mount direct on a printed circuit board. Also available is printed circuit board plug-in type.

The various OE units are divided into groups by frequency and by temperature stability. Models OE-20 and OE-30 are temperature compensated units. The listed "Overall Accuracy" includes room temperature or 25° C tolerance and may be considered a maximum value rather than nominal.

All OE units are designed for 9.5 to 15 volts dc operation. The OE-20 and OE-30 require a regulated source to maintain the listed tolerance with input supply less than 12 vdc.

Prices listed include oscillator and crystal. For the plug-in type add the suffix "P" after the OE number; eg OE-1P.

OE-1, 5 and 10 can be supplied to operate at 5 vdc with reduced rf output. Specify 5 vdc when ordering.

Output — 10 dbm min. All oscillators over 66 MHz do not have frequency adjust trimmers.



Catalog	Oscillator Element Type	2000 KHz to 66 MHz	67 MHz to 139 MHz	140 MHz to 160 MHz	Overall Accuracy	25°C Tolerance
035213	OE-1	\$13.50			± .01% -30° to +60°C	± .005%
035214	OE-1		\$15.50			
035215	OE-1			\$19.50		
035216	OE-5	\$16.75			± .002% -10° to +60°C	± .0005% 2 - 66MHz ± .001% 67 to 139 MHz ± .0025% 140 to 160 MHz
035217	OE-5		\$19.75			
035218	OE-5			\$26.00		
Catalog Number	Oscillator Element Type	4000 KHz to 20000 KHz			Overall Accuracy	25°C Tolerance
035219	OE-10	\$19.75			± .0005% -10° to +60°C	Zero trimmer
035220	OE-20	\$29.00			± .0005% -30° to +60°C	Zero trimmer
035221	OE-30	\$60.00			± .0002% -30° to +60°C	Zero trimmer



INTERNATIONAL CRYSTAL MFG. CO., INC.
10 North Lee, Oklahoma City, Oklahoma 73102
405/236-3741

New products

correspond directly to readings in °C, including sign. Measurements made with the probe are accurate to within

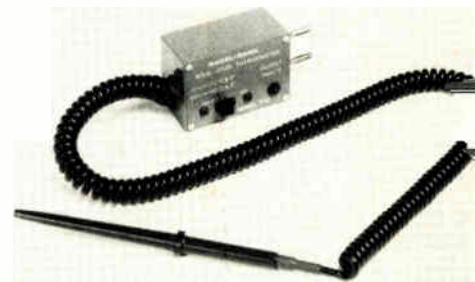

±2°C over the range from 0° to 100°C. In single quantities, it costs \$99.

Racal-Dana Instruments, 18912 Von Karman Ave., Irvine, Calif. 92715 [355]

Strip chart recorder plots data from computer or GPIB

Strip chart recorders in the 47-TR series take data from a computer or from an IEEE-488 general-purpose interface bus (GPIB) and plot it as a smooth analog curve, writing as fast as 75 cm/s. When no pen lifts are required, the recorders can accept data at up to 2,400 baud. Paper advance and pen lift, as well as pen position, are digitally controlled.

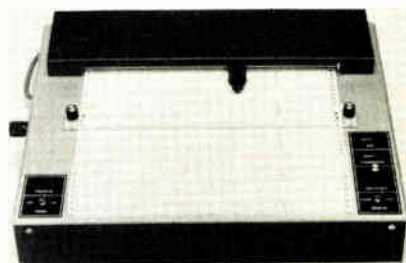

The model 47-TRS computer plotter and 47-TRP GPIB plotter, which accept inputs in serial and parallel form, respectively, have maximum chart-advance speeds of 20 in./min. They can move their fiber-tip pens across the full 10-in. paper width in 400 ms and lift them 10 times per second. The recorders

ABOUT MAILING LISTS . . .

an important notice to our subscribers.

In recent years we have made the list of subscribers to McGraw-Hill publications (names and mailing addresses only) available to carefully screened companies whose products or services might be of interest to you.

These companies enter into an agreement that permits them to mail information to you without placing you under any obligation.

We have always considered such direct marketing activities to be legitimate and important in the American system of free trade—and we're confident that the majority of subscribers share this position.

However, we respect the interests of those who for some reason may wish to have their names restricted from such use by companies either affiliated or not affiliated with McGraw-Hill, Inc.

If you wish to delete your name from lists we make available to other firms, please fill in the information requested below exactly as it appears on your mailing label on the cover of this issue. Or, if you prefer, attach the label itself to the coupon and return.

McGraw-Hill, Inc.
P.O. Box 555
Hightstown, N.J. 08520
Attn: Mailing List Dept.



Please remove my name from your mailing lists.

Title of this publication _____

Name _____

Address (exactly as shown on mailing label, please) _____

City/State/Zip _____

New products

have a price of \$785 apiece for small-quantity orders.

Pedersen Instruments, 2772 Camino Diablo, Walnut Creek, Calif. 94596 [356]

System extends length of GPIB to 300 meters

The start of 1979 has seen dramatic changes in the applicability of the general-purpose interface bus, which is variously known as IEEE-488, HP-IB, GPIB, and ANSI MC1.1, to name but a few of its titles. At almost the same time that an extender using a parallel-to-serial conversion scheme to transmit data over long distances was being introduced [*Electronics*, Jan. 18, p. 158], another extender was becoming available.

Known as the GPIB-100 extender system, the second entry is a fully parallel scheme that allows devices to be separated by up to 300 meters. Consisting of two extender boxes, the GPIB-100 is a transparent system whose only effects on the system (besides lengthening it) are to slow down the handshaking process by the two-way propagation time of the signals between the two extenders and to make parallel-poll responses lag by one poll.

The system can be used in single- or multiple-controller systems with controllers located on either or both ends of the cable connecting the two extenders. Instruments may be located at multiple stations with several extenders connected in series. For systems that do not need a controller, the GPIB-100 provides a talk-only mode.

The price of a pair of extenders is \$1,600. Each extender measures 8.54 by 3.48 by 13 in. and uses 115- or 230-v power. The interconnection cable, which consists of 24 twisted pairs, an overall shield, and connectors at each end, is available in several standard lengths from 20 meters (\$225) to 100 m (\$900). Custom lengths can also be provided. Delivery is from stock.

National Instruments, P. O. Box 9922, Austin, Texas 78766. Phone Kim Harrison at (512) 837-9546 [357]

VOLTEK



Only 60g (2.1 OZ.)

Mini Switching Modules

Model	Output	Size
2011	5V·0.5A	51W×19H ×41Dmm (2" W×0.75" H ×1.63" D)
2031	12V·0.25A	
2061	±12V·0.1A	
2071	±15V·0.1A	

Source Voltage : 115Vac ±10%
Output Voltage Variation : ±5%
(combined)

Mini DC~DC Converters

Model	Output	Size
6211	5V·250mA	51W×19H ×41Dmm (2" W×0.75" H ×1.63" D)
6231	12V·150mA	
6261	±12V·50mA	
6271	±15V·50mA	

Source Voltage : dc5V or 12V or 24V
Output Voltage Variation : ±5%
(combined)

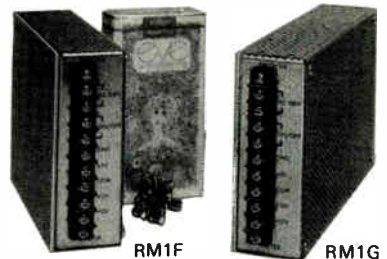

Triple Output Switchers

Model	Output
RM1F-104	+5V·2A, ±12V·0.2A
RM1F-106	+5V·2A, ±15V·0.2A
RM1G-104	+5V·3A, ±12V·0.3A
RM1G-106	+5V·3A, ±15V·0.3A

Source Voltage: 115Vac ±10%
Regulation(line): ±0.1%
Regulation(load): 0.5%
Ripple & Noise: 50mVpp
Overvoltage Protection: provided at +5V

VOLTEK CORP.

6-2-18, Nakanobu, Shinagawa-ku,
Tokyo, Japan 142

Perfection comes
to an imperfect world.



Racal-Dana Instruments Inc.
18912 Von Karman Avenue, Irvine, CA 92715. Telephone: 714/833-1234.

*With true rms from 10Hz to 1.5GHz,
you can now make accurate RF
millivolt measurements no matter
what the shape of your wave form.*

Only the Racal-Dana 9301A gives you true rms measuring capability for RF signals. With less than 20 microvolt residual noise levels, it assures you maximum accuracy to -60dBm .

You get direct, accurate read-outs without the need for calculations. And a read-and-hold probe circuit allows you to capture and store readings up to 3 minutes.

In addition, the 9301A is fully programmable for systems applications. Don't settle for less than the 9301A. At \$1295, it's the perfect solution. Call or write today.

RACAL-DANA

RACAL

Circle 182 for Literature Only.

Circle 231 for Product Demonstration.

When nobody's got
just what you need in
Magnetic Materials

**PERMAG'S
Got It!**

In stock. Off-the-shelf. 24-hour delivery. Grinding to your prints. Engineering assistance. Fabricating facilities. In addition, PERMAG has exotic, exclusive hard-to-get items. Complete facilities for measuring, testing, and producing special materials. 8 modern plants stocked, staffed, and equipped to meet your every requirement.

Write for new catalog.

**IN THE MAGNETIC FIELD
PERMAG IS NO. 1.**

YOUR NO. 1 SOURCE
FOR ALL MAGNETIC MATERIALS



Consult your Yellow Pages for
address and telephone number
of Permug near you.



No Frills Color. Just the basics. If you're a black and white terminal manufacturer, the Intecolor 813 is all you need to upgrade your terminals to color.

It consists of an 8-color, 13" CRT, plus a special Analog Module System with all the circuitry necessary to perform deflection and video drive functions for the CRT. The completely self-contained circuitry is on a single printed wiring board which also generates the low voltage, high voltage and CRT bias, mounted on a sturdy aluminum frame for heat sinking the power transistors needed for the circuitry.

With our Nine Sector Convergence System, perfect color registration takes only three to five minutes. And this convenient control panel can be located anywhere for easy access.

Available in standard 262 Raster line or 400 Raster line high scan versions. If you're ready to upgrade to a color line, call 800/241-9699 toll-free for a demonstration. (In Georgia, call 404/449-5961.)

Color Communicates Better

Intelligent Systems Corp.



5965 Peachtree Corners East/Norcross, Georgia 30071
Telephone 404/449-5961 TWX: 810-766-1581

182 Circle 232 on reader service card

Circle 233 on reader service card

Products newsletter

Thyristors handle up to 400 kVA

Two very large thyristors can together control up to 400 kVA. Developed by Japan's Mitsubishi Electric Corp., the devices should **simplify the design of power systems, especially constant-voltage, constant-frequency inverters** of the kind found in large uninterruptible power supplies for hospitals, computer rooms, and communications facilities. The FT1500EY-24 has reverse- and forward-voltage ratings of 1,200 v, an average conducting current of 1,500 A, and a turn-off time of less than 15 μ s. The FT1000CX-36, needed for commutation, has forward- and reverse-voltage ratings of 1,800 v, a peak repetitive current rating of 10,000 A, and a turn-off time of less than 30 μ s. The commutating device has an average conducting current rating of 800 A.

FMC to make Schottky low-power rectifiers

FMC Corp.'s Semiconductor Products division, Broomfield, Colo., has signed a cross-licensing agreement with TRW Semiconductor, Lawndale, Calif., under the terms of which **FMC may use TRW's proprietary die-manufacturing process to produce a full line of low-power Schottky rectifiers.** As part of the agreement, any future technological advances or improvements in the process will be shared by both companies. FMC will package the devices in its TO-3, DO-4, and DO-5 cases.

Fluke Trendar adds analog capability to digital tester

Add the hybrid option to a Fluke Trendar model 3040A Logic tester, and the digital-board tester is converted into a unit that can also make analog voltage and timing measurements on up to 32 parallel pins. The CWC (for complex waveform conformance) hardware is a comparison tester that **uses a reference signal and a window comparator with a programmable window to examine the signal under test.** Applications for the hybrid tester include the checking of boards for computer peripherals, appliances, and telecommunications equipment, according to the Mountain View, Calif., company.

National slashes prices of adjustable voltage regulators

National Semiconductor Corp., Santa Clara, Calif., has slashed prices by up to 50% on its entire line of adjustable voltage regulators. **In making adjustable-regulator pricing more competitive with that of fixed-output-voltage devices, National will be offering higher-performance devices at a lower price,** since the adjustable regulators exhibit superior electrical characteristics.

The company's 3-A adjustable regulator in a TO-3 can, model LM350, has been reduced to \$4 apiece from the earlier \$6 list price for 100 pieces. For negative-voltage applications, the LM337T, a 1.5-A⁺ adjustable unit, is being reduced from \$2.80 to \$1.35 each for 100.

Thermistor-duplicating service available

Fenwal Electronics, Framingham, Mass., has expanded its material development department so that it can now produce disk thermistors whose resistance-temperature characteristics duplicate those of virtually any thermistor offered by other manufacturers. The low-cost disk units are especially well suited for applications in which **medium power dissipation is a requirement and space is not a problem.** The devices are available with standard lead configurations as well as in custom packages.

New literature

Switching SCRs. Intended for both inexperienced and experienced users of silicon controlled rectifiers, the "Westinghouse Fast Switching SCR

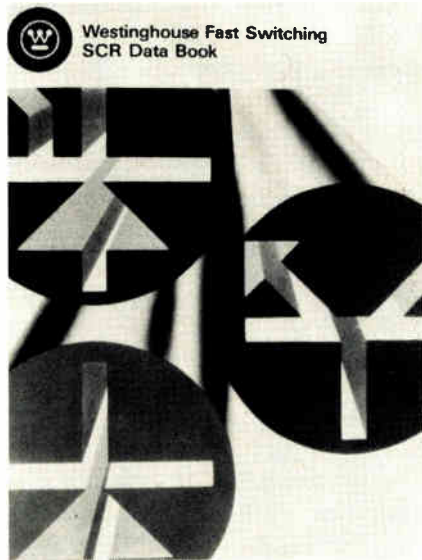

Data Book" describes in detail a complete line of fast switching thyristors. Packaged in different styles, including stud, disk, integral heat-sink, and flat-base, the SCRs have a variety of uses: chopper controls for the transportation industry, inverters for uninterruptible power supplies, induction heating, melting, and ac motor controls. The data book contains frequency ratings for the entire line and presents sinusoidal and trapezoidal waveform current-rating and pulse-loss curves as functions of peak current and pulse width. Parametric characteristics are given. Westinghouse Electric Corp., Semiconductor Division, Youngwood, Pa. 15697. Circle reader service number 421.

Phosphine. Used in low-pressure chemical-vapor-deposition reactors for the production of phosphorous-

doped oxides, Tech/Brief 158 provides information on the physical and chemical properties and toxicity of phosphine. Suggested procedures for using the gas safely are also supplied. "Safe Handling of Phosphine in Low Pressure Reactors" is available from Matheson, 1275 Valley Brook Ave., P. O. Box E, Lyndhurst, N. J. 07071 [422]

CATV coaxial cable. Selection and use of a broad line of community-access TV coaxial cables, including flooded, dual, and messengered types, are discussed in a 20-page guide. Cataloged are 60 styles of 59/U and 6/U drop cable and converter and accessory cable. A number of shields are described: bonded foil, foil-film laminate, copper and aluminum braid, and combinations of these materials. In addition to providing technical data, the

E-H International gives you 18 channels and 50 MHz to work with in our new LA-1850 . . .

18-Bit-Logic Analyzer

When you're working with 16-bit words in the time or data domain, it's important to have a couple of spare channels for the extra flags or interrupts that are essential trigger qualifiers.

Reason enough to use our hotline to set up a demo of our new LA-1850.

What's in it for you?

Built-in display formatter gives you timing diagram, data domain (binary, hex or octal) and mapping.

Full memory depth comparison lets you load in 510 known good words and compare that data block with up to 510 words of incoming data. Gives you a fast "good board, bad board" look.

Trigger delays let you set your trigger point after 1 to 9,999 trigger events or delay triggering 10 to 99,990 clock

counts. You can specify the perfect pre- and post-trigger envelope.

Three-state bus analysis is easy with the LA-1850 because you set it to trigger only on data wider than 1, 2, or 3 clock periods, ignoring spikes . . . or you can **trigger on spikes**.

For only \$6100* you get a whole lot more with the LA-1850, as you can see by eyeballing the front panel. This is the logic analyzer that will do your job for a good long time. Return the coupon for the data sheet and a copy of "State versus Timing Analysis . . . What's the Difference?" For immediate information or a demo, please use our hotline, (415) 834-3030. Ask for Tina Bilhorn.

*U.S. domestic price only





Coming through...
with a guide to the
selection and use of
CATV coaxial cable

guide describes the development and applications of SEED, Belden's shielding-effectiveness evaluation device. It can be obtained from Belden Corp., 2000 S. Batavia Ave., Geneva, Ill. 60134. [423]

Dual in-line package switches. The series 206 dual in-line package switch is described in catalog publication 4206. Included are electrical and mechanical specifications for single-pole, single-throw; single-pole, double-throw; double-pole, single-throw; and double-pole, double-throw versions. CTS Corp., 905 N. West Boulevard, Elkhart, Ind. 46514 [425]

Special-purpose alloys. The properties and size ranges for all alloys produced in wire, flat-wire, and strip form are listed in a product guide. It covers five categories: alloys for heating and other resistive elements, alloys for thermocouples, controlled expansion alloys, and magnetic alloys. The nominal composition and resistivity in metric and English units are also given. W. B. Driver Co., Marketing Department, 1875

McCarter Hwy., Newark, N. J. 07104 [426]

Fused silica properties. Nine grades of optical fused silica are described in a 14-page brochure, "Electro-Quartz." It gives the transmission, purity, inclusions, homogeneity, typical applications, sizes and weights, striations, and granularity for each of the products. Quartz Products Corp., 688 Somerset St., P. O. Box 628, Plainfield, N. J. 07061 [424]

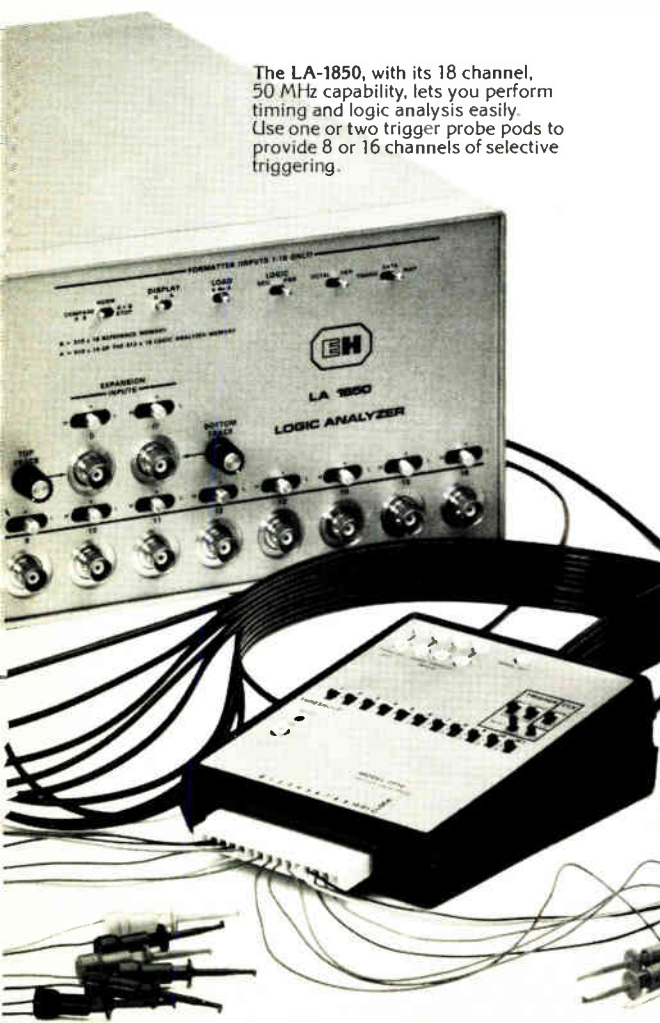

The LA-1850, with its 18 channel, 50 MHz capability, lets you perform timing and logic analysis easily. Use one or two trigger probe pods to provide 8 or 16 channels of selective triggering.

E-H International, Inc., 515 Eleventh Street, Oakland, CA 94607.
TWX (910) 366 7258

Sirs: Please send me complete info on the new E-H LA-1850 18-Bit-Logic Analyzer. Also send me your FREE booklet, "State Versus Timing Analysis . . . What's the Difference?"

Name _____ Title _____
 Company _____
 Address _____
 City, State/Zip _____
 I'm in something of a hurry. Please have one of your sales offices
 phone me at (_____) _____

Our LM-218 provides a convenient display companion for the LA-1850. The 6 1/2-inch screen is an excellent size for studying timing, logic, or map mode digrams.

Classified section FOR ENGINEERING/TECHNICAL EMPLOYMENT OPPORTUNITIES

CLASSIFIED SALES REPRESENTATIVES

Atlanta 404/892-2868
 Boston Jim McClure 617/262-1160
 Chicago Bill Higgins 312/751-3733

Cleveland Mac Huestis 216/781-7000
 Dallas Mike Taylor 214/742-1747
 Denver Shirley Klotz 303/837-1010
 Detroit Mac Huestis 313/873-7410

Sales Manager—Mary Ellen Kearns—212/997-3306

Houston Mike Taylor 713/659-8381
 Los Angeles Ana Galaz 213/487-1160
 New York Larry Kelly 212/997-3594

Philadelphia Dan Ferro 215/568-6161
 Pittsburgh Dan Ferro 412/391-1314
 San Francisco Peter McGraw 415/362-4600
 Stamford William Eydtt 203/359-2860

ELECTRONIC ENGINEERS

ENGINEERS to \$50,000. New England/Metro NY is our market. Openings at all levels within the nation's highest demand area for electronic pros in design, application, systems. ACCESS GROUP, 111 High Ridge Road, Stamford, CT 06905 (203/356-1166).

ELECTRONICS ENGINEERS, \$15,000-\$45,000. Choice entry-level to management positions immediately available in Pennsylvania & national locations. Reply in strict confidence to J. G. Weir, President, WEIR PERSONNEL SERVICES, 535 Court St., Reading, PA 19603 (215/376-8486).

BSEE / ELECTRONIC DESIGN ENGINEERS, \$15,000-\$35,000. Immediate, desirable upstate New York & nationwide. Junior to senior project management. In confidence send resume or call James F. Corby, President, NORMILE PERSONNEL ASSOC., INC., 5 Leroy St., Box 110 Westview Station, Binghamton, NY 13905 (607/723-5377).

DESIGN ENGINEERS to \$30K. Central Penna. Design connectors/terminals, E/M components. Outstanding relocation package. Prompt confidential reply. MECK ASSOC. PERSONNEL, 1517 Cedar Cliff, Camp Hill, PA 17011 (717/761-4777).

ENGINEERS. We specialize nationally in the electronics industry at the 0-5 yrs experience level. If you are worth more than you are making or your career is stagnated, send your resume. CAREER ASSOC., 583 State Rd., N. Dartmouth, MA 02747 (617/997-3311).



NATIONAL PERSONNEL CONSULTANTS

DIVISION MANAGEMENT

NYSE listed Corporation seeks a seasoned manager to assume total P & L responsibility for an operating division engaged in the development and manufacturing of electronic systems and products.

Position requires very strong business development and technical leadership abilities.

Your background should include a technical degree, business training, and at least 10 years general management experience with specific involvement in engineering, marketing, manufacturing and finance.

Compensation package includes a very attractive base salary and bonus based on profitability. Please send resume and compensation history to:

P-8604, Electronics

Class. Adv. Dept., P.O. Box 900, NY, NY 10020



Systems Engrs. Data Processing Electronics

Salaries to \$46,000
 Manufacturing Engrs.
 ECM Engrs.
 Tool Design Engrs.
 Air Traffic Contrl. Syst. Engrs.
 Rotating Devices Engrs.
 Thermometric Engrs.
 Digital CKT Design Engrs.
 Power Systems Engrs.
 Sr. Military Systems Engrs.
 Field Engrs. (Electronic Equip.)
 Digital Systems Engrs.
 Production Control
 Programmers/Mgrs.
 QA and/or QC Engrs.
 Technicians
 Companies Assume Our Fees.
 Submit Resume, Call or Visit:
THE ENGINEER'S INDEX
 133 Federal Street, Suite 701
 Boston, Massachusetts 02110
 Telephone (617)482-2800

BIOMEDICAL ELECTRONICS DESIGN ENGINEER

Move to sunny south Florida. One of the largest and fastest growing pharmaceutical firms in the nation, seeks a Biomedical Electronics Design Engineer experienced in designing implantable electronics and electrodes. The ideal prospect should also possess expertise in biomedical electronics, hybridization, microprocessors, and some manufacturing experience. The successful candidate will be one who is able to take a project from the idea stage through production. Must be willing to relocate. Excellent potential and salary. Please call or write:

EDI
 16500 NW 15th Avenue
 Miami, FL 33169
 (800) 327-7106

NOW IS THE TIME ... TO HIRE A STUDENT THIS SUMMER.

First, it's later than you think, with schools closing on different semester schedules, and students torn between lining-up "sure" jobs now or gambling that something in their chosen field will come along later.

Second, and most important, it's in our industry's best interest to encourage and hold its life-blood by providing practical experience in their future profession.

And, since there'll always be more applicants than openings, you'll be able to select the cream of the crop, then evaluate them

with an eye towards hiring, when as coveted graduates, the job market might be in their favor.

Because we believe this program is of mutual benefit to both employer and employee alike, we again offer our services as a clearing-house.

Just fill out and return the coupon below, and we'll include your organization in a free listing to be sent to Placement Directors and Department Heads at leading colleges and universities across the nation. They'll post it, and the students will contact you directly.

Free summer help listing

MAIL TO: ELECTRONICS/POST OFFICE BOX 900/NEW YORK/NY 10020

NAME/TITLE (of individual to be contacted) _____

ADDRESS: (Mailing address of your personnel office) _____

ORGANIZATION: (Firm, Company, Government Agency or Institution) _____

TYPE AND NUMBER OF STUDENTS SOUGHT: Electronics Avionics _____

Technician _____ Other: (Draftsman, etc.) _____

2/1/79

Note: Last date coupons can be accepted for this year's student mailings is 4/6/79

ELECTRONICS ENGINEERS

Specializing in the placement of Electrical Engineers Nationally. All fees company paid. This is only a partial listing. Send resume.

Project Mgr.	30K Power Eng.	23K
Design E.E.	21K Controls Eng.	23K
Instrumentation	22K Systems Eng.	22K
Sr. Systems	25K Facilities	25K
Project Eng.	22K Mechanical Des.	24K

COREY ASSOCIATES
 Suite 230, 105 Wolf Rd., Albany, NY 12205

ENGINEERS—MANUFACTURING SUPERVISORS—SCIENTISTS

A Nationwide Placement Service. Our clients pay all fees and interview expenses. All transactions conducted in strict confidence. Send resume to:

E. J. Stephen

EXECUTIVE SEARCH AND PLACEMENT
 TRI STATE MALL • CLAYMONT, DE 1903
 (302) 798 6861

SOUTHEAST OPPORTUNITIES

We have immediate openings with the most progressive clients in the Southeast and nationally for E.E.'s with Data Processing background involved in the computer field. Send resume to: Continental Personnel, Inc., P.O. Box 11321, Charlotte, NC 28220. (704) 525-2160.

ELECTRONIC ENGINEERS

Nationwide opportunities are available to talented & degreed Electronic Engineers looking for a career. Reply in confidence to Stu Hopard for prompt & confidential service.

TAFT Personnel Agency
521 5th/43St, NYC 10017
212-697-0100

POSITIONS VACANT

Electronics Shop Supervisor—Department of Chemistry, The University of Chicago. Opening for experienced person to head our 3-man electronics shop. Knowledge of magnetic resonance, mass spectrophotometers preferred. Should be familiar with RF techniques (through microwaves), mechanical design, analog and digital I.C.s and a broad range of vacuum tube and solid state circuits. Send resume to: Dr. G. L. Boshart, Department of Chemistry, The University of Chicago, 5735 S. Ellis Ave., Chicago, Illinois 60637. An Affirmative Action Equal Opportunity Employer.

Sales Manager Electronic Tools, \$100,000.—A New Line of Patented Tools for the electronics industry to be introduced nationwide. Test marketing successfully finished. Product is consumable item. Need is for a highly qualified sales manager experienced in that market. Sales thru distribution and direct. Write to: McGraw-Hill Publications Company, Liebigstrasse 27C D-6 Frankfurt/Main 1, Germany. Tel. (0611) 720181.

Radio Engineer—Minnesota Public Radio seeks engineer to provide network engineering support for six-station public radio network. Report to Director of Network Engineering. Evaluation, specification, design and construction of RF and audio equipment to ensure high standard of audio and transmission quality throughout network including extensive field work. \$14,000 to \$22,000. FCC 1st or equivalent. Strong experience. Resume, references and letter of interest immediately to Dan Rieder, Director of Engineering, MPR 400 Sibley Street, St. Paul, MN 55101. AA/EOE.

Electronics Technical Associate—The University of Texas McDonald Observatory has an opening for a skilled Research Engineer Associate II in electronics primarily for maintenance of telescope control and drive systems, computers, and computer interfaces and peripherals. Trouble-shooting and repair of both analog and digital circuits is required. Some electronic construction and installation work is involved. Requires Master's degree in Electronics Engineering and no experience or a Bachelor's degree and two years related experience. Residence at McDonald Observatory, P.O. Box 1337, Fort Davis, Texas 79734 or apply: Office of Personnel Services, The University of Texas at Austin P.O. Drawer V, Austin, Texas 78712. An Equal Opportunity/Affirmative Action Employer.

At AMECOM... innovation starts with your ideas.



And ideas are what we're all about.

We've earned international recognition for our breakthroughs in state-of-the-art electronic warfare and advanced telecommunications. If you're a creative professional who thrives on fresh ideas, take time now and start a professional conversation with us.

We're looking for people who like to think, and we give them time to develop productive thoughts to their fullest potential. We specialize in solutions to hard problems, the kind of solutions that come from innovative ideas.

Positions of uncommon potential exist now in these areas:

ANALOG OR DIGITAL PROCESSING

- LSI application
- High speed data conversion
- Power supplies

TELECOMMUNICATIONS SYSTEMS DESIGN

- Advanced digital subsystems including TDM
- RF and analog subsystems including frequency synthesis and FDM techniques
- Microprocessors and related real-time operating systems software
- Voice switching systems

ELECTRONIC WARFARE SYSTEMS

- State-of-the-art ESM/ECM
- Signal processing

ELECTRONIC WARFARE PROCESSING — HARDWARE

- Microwave subsystem design
- Circuit design — RF, video, analog, high speed A/D converters
- EW digital subsystem design — signal sorting, microprocessors/microcontroller design, computer interfacing

RF

- Microwave communications and receiving systems
- High sensitivity DF receivers
- Solid state microwave component design

Besides excellent compensation, benefits and a creative professional environment, we're located in a pleasant Maryland suburb with your choice of city, mountain or water living and recreation.

Call or write Bill McAmis (301) 864-5600

Amecom Division, LITTON SYSTEMS, INC.

5115 Calvert Road, College Park, MD 20740

An equal opportunity employer M/F/H.

 **Amecom Division
LITTON
SYSTEMS, INC.**

DESIGN DEVELOPMENT ENGINEERS HARDWARE SOFTWARE

Join This Constantly Expanding
World Leader in Automatic Test Equipment
as We Advance New Programs

PRD Electronics a Division of Harris, a corporation with a record of most impressive growth and expansion now at the \$800 plus million level, again has many openings. They reflect existing programs and brand new ones, both with favorable outlook for years to come.

These Are Among Present Opportunities To Give Your Future Security and Potential PROJECT ENGINEERS (Software)

Lead technical teams to define hardware and interface requirements with advanced ATE systems as well as computer based processing and control systems. Familiar with the disciplines of software development, language standardization, compiler throughput and on system operating systems capable of conceptual design. BS Engr. Physics Comp. Sci.. Adv. Degree desirable.

SENIOR ENGINEER (Software)

Responsible for detail design of programs and subsequent systems integration. Capable of working from overall software specifications into systems analysis and subsequent coding conversions. Experience with mini-base systems as well as microprocessor designs and applications. Familiar with circuit analysis techniques. BS Engr. Comp. Sci.. Adv. Degree desirable.

PROGRAMMER ANALYST

Capable of working from conceptual specifications to the establishment of design to software specifications. Primary area is the expansion of computer systems technology to automatic programming aspects as well as program aspects as well as program validation. BS Comp. Sci. required.

TEST PROGRAM ENGINEERS

Translate circuit operation in computer programs for automatic fault detection and isolation. Experience in design and analysis, digital/analog, R/F and micro-processor applications with BSEE or Equivalent desirable.

PROJECT ENGINEERS

SENIOR ENGINEERS (Analog, Video)

BSEE. 3-10 years with hands-on design experience in current Analog and Video signal processing technologies. Heavy emphasis on phase lock loop, synthesizer and wide band op amp applications.

PROJECT ENGINEERS

SENIOR ENGINEERS (Digital Design)

BSEE. 3-10 years hands-on experience in LSI and micro-processor technology, with leadership capability.

Please forward your resume
with salary history in confidence to:
Mr. Tom Castoro, Harris Corporation,
PRD Electronics Division,
6801 Jericho Turnpike, Syosset, New York 11791



HARRIS
COMMUNICATIONS AND
INFORMATION HANDLING

An Equal Opportunity Employer — Male and Female

ELECTRONIC ENGINEER

RF Equipment Design

Grumman Aerospace Corporation has an immediate opening for an Electronic Engineer with a B.S.M.S. in Electrical Engineering, Physics or Electro-physics. Two to five years experience in the design, development, test and integration of various types of antenna and related microwave components into aircraft and space vehicles is also required.

In addition to an excellent facility with mathematics and computer programming, ability and experience should include the theoretical analysis of diffraction and scattering of electromagnetic waves from metal or non-metallic objects.

Qualified applicants should send their resumes in strictest confidence to: **Mr. Dan R.F. Nettuno**, Manager, Professional Employment.

**GRUMMAN AEROSPACE
CORPORATION**
BETHPAGE, NEW YORK 11714

AN EQUAL OPPORTUNITY EMPLOYER M/F U.S. CITIZENSHIP REQUIRED

SUPERVISING ENGINEER

BONNEVILLE PRODUCTIONS has an immediate opening for an electronic engineer to supervise technical operations of our tape duplication operation. Qualifications necessary include a BSEE (or equivalent training plus experience), thorough experience in magnetic tape theory and recording techniques (professional systems), an excellent troubleshooting background and the ability to supervise a staff of four engineers and technicians. Experience with Cetec/Gauss tape duplication equipment is preferred. Tape production and engineering areas are designated no-smoking. Please reply with resume, references and salary requirements to:

Lorna van Komen
Bonneville Productions
130 Social Hall Ave.
Salt Lake City, Utah 84111



F-14 A TOMCAT

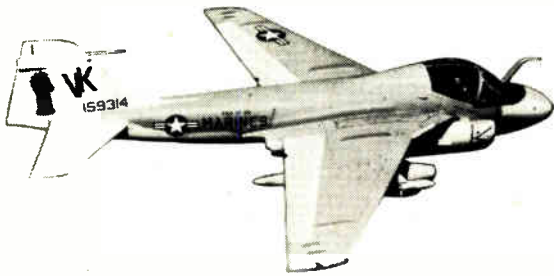

A-6E INTRUDER

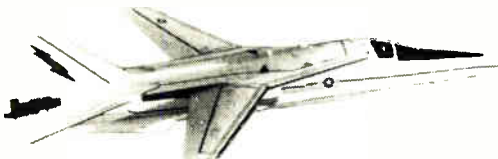

EF-111A

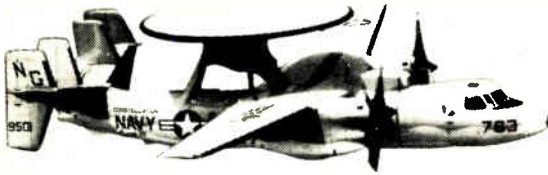

E-2C HAWKEYE



MOHAWK ALL-WEATHER
ARMED SURVEILLANCE AIRCRAFT



EA-6B PROWLER

A NEW YEAR AND A NEW CAREER AWAIT YOU AT GRUMMAN

The Integrated Logistics Support Department of Grumman Aerospace Corporation has current and long term needs on its Training Devices and Ground Support Equipment Product Lines for engineers with capability in design associated with computer (mini-micro) based simulators and automatic test equipment. Opportunities exist for growth-conscious engineers in the following areas:

■ **SYSTEMS DESIGN:**

BS/MS in Electrical Engineering; Computer Science; Physics. Minimum experience should include two years in simulator or ATE design.

■ **MATH MODELING:**

BS/MS in Electrical Engineering; Physics; Applied Mathematics. Modeling experience should include development of dynamic models involving rigid and flexible bodies, operational systems and tactical situations.

■ **AUTOMATIC TEST GENERATION:**

BS/MS in Electrical Engineering; Physics; Mathematics. Experience should include use/development of ATG's.

■ **HARDWARE/FIRMWARE:**

BS/MS in Electrical Engineering; Physics. Experience should include three to five years in design of microprocessor based devices/systems.

In addition to an excellent fringe benefit package (100% Company paid), Grumman offers the excitement of Long Island living. Situated 30 miles East of New York City, you're close enough for its cultural attractions. You're a 30 minute drive from the beaches of the Atlantic Ocean or Long Island Sound and there are numerous Universities and Colleges for continuing your education. So why not consider what Grumman and Long Island have to offer you?

Interested individuals are encouraged to send their resumes in strictest confidence to **Mr. E.M. Nettuno**, Manager Professional Employment.

GRUMMAN AEROSPACE CORPORATION
BETHPAGE, NEW YORK 11714

AN EQUAL OPPORTUNITY EMPLOYER M/F

U.S. CITIZENSHIP REQUIRED

Design Personal Business Terminals

An ambitious digital business system which includes low-cost terminals and utilizes the latest keyboard, display and packaging technologies is being developed. We require a senior electronics engineer, M.S. preferred, with experience in terminal design, and with knowledge of digital and analog electronics, logic design, and manufacturing techniques.

Our attractive Connecticut location offers a quiet New England environment with abundant recreational opportunities and large metropolitan areas within easy reach.

If you can see the career potential of being responsible for the design of an important component of a major new business system, send your resume to:

**Manager,
Professional Employment
Department E-118
Burroughs Corporation
105 Newtown Road
Danbury, Connecticut 06810**
An Equal Opportunity Employer M/F

Burroughs



ENGINEERS

- Connecticut Living
- Advanced Technology
- International Travel
- Personal Development

Combine at General Electric's Circuit Protective Devices Dept. near Hartford. Leading the industry in personal Ground Fault Protection and Industrial Power Circuit Devices requires a continuing effort in solid state technology. These careers are at the leading edge of the business.



MATERIALS AND PROCESSES ENGINEER

Select and specify processes, materials and standards used for manufacture of printed wiring board assemblies, thick film substrates, photo-resist processing, solid state materials and structural plastics.

Requires BS Che. Eng. or CHEM or equivalent with materials processing experience in circuit board manufacturing technology.



ELECTRONIC COMPONENTS RELIABILITY ENGINEERING

Selection, evaluation and specifying discrete electronic components, Direct and monitor reliability and environmental testing procedures. Requires BSEE or Physics and two years' reliability or components design engineering. Knowledge of circuit design and failure analysis useful. Excellent communications skills required.



PRODUCTION ENGINEER

Directs new product introductions. Designs improvements in product costs and quality. International travel necessary to coordinate activities with satellite plants.

Requires BSME or EE with working knowledge of high-speed mechanisms and electro-mechanical devices. Strong communications skills required for interface with vendors, manufacturing staff, and regulatory agencies.

We offer an outstanding package of salary, benefits and stable, long-range growth.

Apply by mail with resume to—

**R. Butler
CPD—41 Woodford Avenue
Plainville, Connecticut 06062**

GENERAL  ELECTRIC

An equal opportunity employer M/F

Your February could look like this.

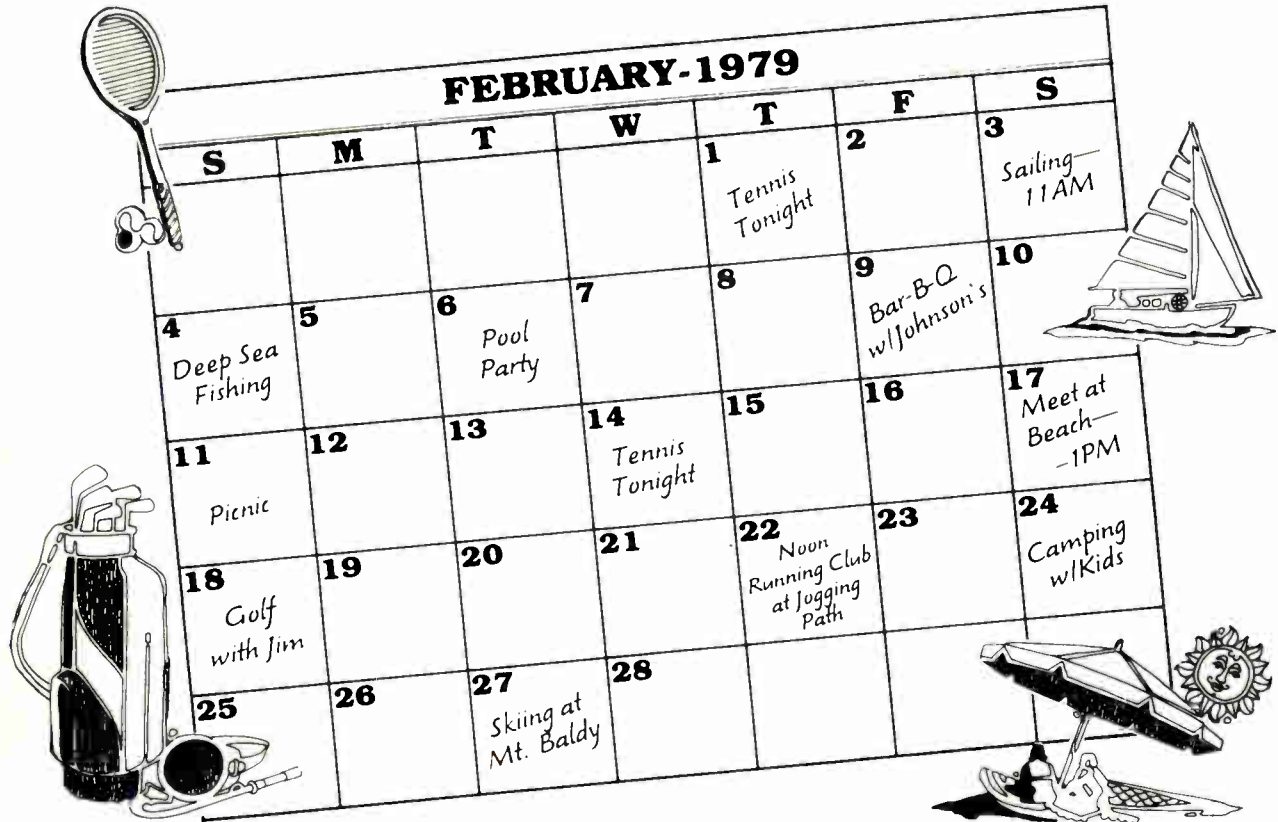

Today, General Dynamics at Pomona has more programs, more new ideas, and new fresh things going on than ever before...ten years ago all we had was the standard missile. Now, the standard missile-1, standard missile-2, Phalanx, DIVAD, Sparrow, Viper, Stinger and other numerous programs are under way. Our 1979 looks bright—1980 and beyond are even brighter. That's where you come in.

We need the engineering staff to build on this success pattern. *Our Opportunity Spectrum* is broad and includes all levels of experience and career responsibilities. We need engineering professionals in the following disciplines.

- Digital & Analog
- Circuit Design
- Guidance & Control
- Systems
- Avionics
- Test Equipment Design
- Electro-Optical
- Telemetry Systems
- Microwave/Antenna
- Microelectronics
- Reliability
- Power Supply
- Military Operations Research
- Electronic Packaging
- Test Systems
- Radar Systems
- Signal Processing
- Components
- Dynamics

Tell me where your interests are. Your resume will enable me to match you up within my organization. You'll hear from me soon—perhaps we can talk further about our enjoyable Southern California lifestyle. Send your resume to:

R.M. Kemp, V.P. Research & Engineering

GENERAL DYNAMICS *Pomona Division*

P.O. Box 2507/Pomona, California 91766

An Equal Opportunity Employer M/F, U.S. Citizenship Required

Telecommunications Engineers

Reaching Out To Face The Challenge Of Our Environment...

on the San Francisco Peninsula

The need to communicate is universal. In Palo Alto, California we are pioneering the development of computer controlled business and residential voice and data communications systems, utilizing real-time stored program control and minicomputer/microprocessor implementation. The challenge we face is to give human dimensions to state-of-the-art technology. Join us. At BNR, one of the leading R&D laboratories in North America, you can experience the innovative freedom, technical challenge and rapid professional growth inherent in contributing to the concept and design of the most advanced telecommunications systems. Our continuing growth has created a variety of openings for engineers and managers who enjoy working in an environment of exploration, and individual recognition:

Technical Management

We require a MS/PhD in EE or CS and up to 8 years of related telecommunications experience to manage teams of hardware, and systems engineers in the design, documentation, specification of future telecommunications systems.

Hardware Engineering

Designs include data networks, digital and analog microprocessor-based peripheral equipment for PABX switching systems. We require a BS/MSEE and experience in the areas of digital and analog design, microprocessors, transmission, codecs, phase-locked loops and TTL.

Power Engineering

Design, test and evaluate small solid state switching power supplies. Requires a BSEE and 3+ years of experience, including design of analog and magnetic circuits and magnetic components.

Systems Engineering

Define new EPABX features, software, specification requirements and evaluate transmission performance for digital telecommunications systems. Analyze complex data communications networks. We require a BS/MSEE or CS and 3+ years of telecommunications experience.

We offer excellent compensation, one of the best benefits programs on the San Francisco Peninsula, generous relocation assistance, a progressive and stimulating environment, and outstanding opportunities for personal recognition and professional growth.

For prompt consideration and reply, please send your resume to Ellen Ohmer, Employment Manager, BNR INC., Mail Stop 454, 3174 Porter Drive, Palo Alto, CA 94304. An equal opportunity employer.



BNR

Subsidiary of
Bell-Northern Research
The R & D Laboratory for
Northern Telecom and Bell Canada

POSITIONS VACANT

Electronics Engineer (Sr. Level)—Background in signal processing, instrumentation, ultrasonics/acoustics. Should have good theoretical background but must be practically oriented. Research & Development laboratory. Send resume Energy & Minerals Research, P.O. Box 409, Kennett Square, Pa. 19348, Attn: Mr. Don Culp.

EMPLOYMENT SERVICES

Electronic engineering growth positions with clients located nationally. Our service is enhanced by the fact that I am an EE with 20 years in industry and over 10 years in placing professionals on an employer fee paid basis. Send your resume to Joe Torassi, Director, J. Anthony & Associates, PO Drawer AD, Lynchburg, OH 45142. 513 364-2305

BUSINESS OPPORTUNITY

How To Earn Money As A Consultant (including specimen contracts) \$25. Business Psychology Int'l 890/44 National Press Bldg., Washington, D.C. 20045.

Minority Interest For Sale—Marketing oriented entrepreneur wanted for key position in Medical electronics company located in Denver area. Stock available. Contact Vern D. Kornelsen, 1018 First National Bank Bldg., Denver CO 80293 Tele: (303) 893-0011.

SELLING OPPORTUNITY AVAILABLE

West German Distributor wanted manufactures of electronic products to represent in europ. Contact: Mr. Helmut Holzer, Holzer Corporation D8031 Eichenau.

FREE

Your dream job.

We hope you're happy in your current position, but there's always that ideal job you'd prefer if you knew about it.

That's why it makes sense to have your resume on file in the Electronics Manpower Register, a computerized data bank containing the qualifications of career-conscious ELECTRONICS readers just like yourself.

You'll benefit from nation-wide exposure to industry firms privileged to search the system, and since the computer never forgets, if you match up with their job requirements you'll be brought together in confidence.

To take advantage of this free service, mail your resume to the address below.

ELECTRONICS MANPOWER REGISTER
Post Office Box 900/New York, N.Y. 10020

■ Abbott Transistor Labs	149	Data Translation Inc.	37	■ Kethley Instruments	34
■ AEG Telefunken	49	Dialight	174	■ Krohn-Hite Corporation	5
■ Alltech	120	Digital Equipment Corporation OEM 11 Group	144, 145	■ Lambda Electronics Corporation	163 to 166
■ Alco Electronic Products (Sub. of Augat)	161	‡ Dow Corning Resins & Chemicals	151	Lexidata Corporation	6
American Oil and Supply Co	148	Duncan Electronics (Syston-Donner)	40	Lumonics Research	120
American Microsystems Inc.	156, 157	‡ Dynabyte	68	* Marconi Instruments Inc.	68
■ Amp Inc.	75-82	EH International	184, 185	* Micro Devices Div. of Emerson Electric Co.	158
Amptek Incorporated	8	■ Electronic Navigation Industries	3rd Cover	* Micro Networks Corporation	47
Amphenol North America Division	140, 141	Elevam Electronic Tube Co Ltd	170	Microtechnical Industries	194
Amplifier Research	167	Fairchild (Semiconductor Operations Division)	38, 39, 51	■ Miller-Stephenson Chemical Co. Inc.	130, 131
‡ Aromat	171	* Feme S.P.A.	6E	Mostek Corporation	29 to 33
■ Augat Inc.	136	■ John Fluke Mfg Co.	15, 98	* Murata Mfg. Ltd	12E
■ B & K Precision Dynascan Corporation	175	Frequency Devices Inc	162	Mitel Semiconductor Inc.	52
Bausch & Lomb Scientific Optical Products	161	■ GenRad	45	‡ NEC Microcomputers	62, 63
Belden Corporation	169	■ Gould, Inc./Instrument Systems Div./T & M	146	■ Newport Labs	64
The Bendix Corporation Electrical Comp. Div.	155	■ Grayhill Inc.	154	■ Non-Linear Systems, Inc.	8, 162, 170
Berg Electronics	27	‡ Guildline Instruments, Inc.	158	Noritake Electronics, Inc.	125
■ Bourns Inc.	4th cover	Harris Semiconductor	54, 55	■ O.K. Machine & Tool Co.	134
■ The Buckeye Stamping Co.	148	‡ Heath Co Schlumberger	47	Ohio Scientific	13
‡ Bud Industries	175	■ Hewlett-Packard	17-26	Optron, Inc.	14
* Burr Brown Research Corporation	7E	■ Hipotronics Inc.	160	■ Permag Corporation	182
‡ Centralab Electronics Division	152, 153	‡ Honeywell Florida	176	* Philips Elcoma	2E, 3E
‡ Centronics	71	■ Honeywell TID	53	* Philips TMI	4E
Cherry Electrical Products	1	Intel-Microcomputer Components	90, 91	‡ Philips TMI	67
* Chicago Miniature	12E	Intel Special Products Div.	92-93	Plessey Peripheral Systems	118, 119
Citizen America Corporation	177	Intel Telecommunications	10-11	■ Power One Inc.	28
Control Electronics	8	Intel Microcomputer Systems	94, 95, 96, 97	Projects Unlimited	161
Cromenco	2	Intelligent Systems Corporation	182	Racal-Dana Instruments Inc.	182
■ Custom Electronics	179	International Crystal Mfg. Co.	180	RCA Solid State	60, 61
Data Instruments	120	* Jepico Co Ltd.	8	Robinson Nugent Inc.	9

Check

- Transistors
- Capacitors
- Diodes
- IC's

CONTROLLED HEATING ... where it counts THERMO-PROBE

Heat any integrated circuit or electronic component to its rated temperature with a heat probe. Accuracy $\pm 3^\circ\text{C}$ or better. Or check the component's temperature with a thermo-couple probe. Model 810 Thermo-Probe does both. Reads out directly in $^\circ\text{C}$ and $^\circ\text{F}$ on a large $4\frac{1}{2}$ -inch meter.

MTI MICRO-TECHNICAL INDUSTRIES

P.O. Box 287 South Laguna, CA 92677

TELEPHONE (714) 545-3734

TWX 910 596-1325 MICROTECH LBEH

Circle 194 on reader service card

From Electronics Magazine Book Series. Zero-risk trial offer.



Memory Design: Microcomputers to Mainframes

The technology, devices, and applications that link memory components and system design. As published in *Electronics*. \$12.95

Electronics Book Series

P.O. Box 669, Hightstown, N.J. 08520

Send me _____ copies of "Memory Design: Microcomputers to Mainframes" at \$12.95 per copy

Discounts of 40% on orders of 10 or more copies. I must be fully satisfied or you will refund full payment if the book is returned after ten-day trial examination.

Payment enclosed Bill firm Bill me

Charge to my credit card:

American Express Diners Club

Visa Master Charge

Acc't No. _____ Date exp. _____

On Master Charge only, first numbers above name _____

Name _____ Title _____

Company _____

Street _____

City _____ State _____ Zip _____

Signature _____

• Rohde & Schwarz	67, 1E
• SDSA	9E
• Siemens AG Munich	62, 71
Siliconix	142, 143
Sprague Electric	59
TEAC Corporation	56
■ Tektronix	8, 139
■ Tektronix	7
• Tektronix Datatek NV	8E
Teletype	173
Telpar Inc.	177
Texas Instruments Components	2nd cover
■ Vactec Inc.	178
• Varadyne Industries Inc.	152, 153
Viking Industries	73
Voltek Corporation	181
■ Wavetek Indiana	116
• Wavetek San Diego Inc.	171
Xciton	170
• Zeltron	151
Zero Corporation	16

Classified and employment advertising

F. J. Eberle, Manager 212-997-2557

BNR, Inc.	192
Bonneville Products	188
Burroughs	190
Continental Personnel, Inc.	187
Corey Associates	186
Douglas, McDonald	192
Engineers Index	186
General Dynamics	191
General Electric Co.	190
Grumman Aerospace Corp.	188, 189
Harris Corp.	188
Litton Systems, Amecom Div.	187
National Personnel Consultants	186
North American Biologicals	186
Stephen, E.J.	186
Taft personnel	187

■ For more information of complete product line see advertisement in the latest Electronics Buyers Guide
• Advertisers in Electronics International
‡ Advertisers in Electronics domestic edition

Advertising Sales Staff

Advertising sales manager: Paul W. Reiss

1221 Avenue of the Americas, New York, N.Y. 10020

[212] 997-4371

Atlanta, Ga. 30309: Michael Charlton

100 Colony Square, 1175 Peachtree St., N.E.

[404] 892-2868

Boston, Mass. 02116: Frank Mitchell

607 Boylston St.

[617] 262-1160

Chicago, Ill. 60611

645 North Michigan Avenue

Jack Anderson [312] 751-3739

Robert M. Denmead [312] 751-3738

Cleveland, Ohio 44113: William J. Boyle

[716] 586-5040

Dallas, Texas 75201: John J. Uphues

2001 Bryant Tower, Suite 1070

[214] 742-1747

Denver, Colo. 80203: Harry B. Doyle, Jr.

123 Speer Blvd. #400

[303] 837-1010

Detroit, Michigan 48202: Jack Anderson

1400 Fisher Bldg.

[313] 873-7410

Fort Lauderdale, Fla. 33308: Michael Charlton

3000 N.E. 30th Place

[305] 563-9111

Houston, Texas 77002: John J. Uphues

601 Jefferson Street, Dresser Tower

[713] 659-8381

Los Angeles, Calif. 90010: Robert J. Rielly

Robert E. Boedicker, 3200 Wilshire Blvd., South Tower

[213] 487-1160

Minneapolis, Minn. 55435: Robert M. Denmead

4015 W. 65th St.

[312] 751-3738

New York, N.Y. 10020

1221 Avenue of the Americas

John Gallie [212] 997-3616

Matthew T. Reseska [212] 997-3617

Philadelphia, Pa. 19102: Matthew T. Reseska

Three Parkway

[212] 997-3617

Pittsburgh, Pa. 15222: Matthew T. Reseska

4 Gateway Center

[212] 997-3617

Rochester, N.Y. 14534: William J. Boyle

1175 Pittsford-Victor Rd., Pittsford, N.Y.

[716] 248-5620

San Francisco, Calif. 94111: Don Farris

Dean Genge, 425 Battery Street,

[415] 362-4600

Paris: Patrick Mouillard

17 Rue-Georges Bizet, 75116 Paris, France

Tel: 720-73-01

United Kingdom & Scandinavia: Robert Ghey

34 Dover Street, London W1

Tel: 01-493-1451

Scandinavia: Andrew Karnig and Assoc.

Kungsholmsgatan 10

112 27 Stockholm, Sweden

Tel: 08 51 68 70 Telex: 179 51

Milan: Luigi Rancati

1 via Baracchini, Italy

Phone 86-90-656

Brussels:

23 Chaussee de Wavre

Brussels 1040, Belgium

Tel: 13-73-95

Frankfurt/Main: Fritz Krusebecker

Liebigstrasse 27c, Germany

Phone 72 01 81

Tokyo: Tatsumi Katagiri, McGraw-Hill

Publications Overseas Corporation,

Kasumigaseki Building 2-5, 3-chome,

Kasumigaseki, Chiyoda-Ku, Tokyo, Japan

[581] 9811

Business Department

Thomas M. Egan

Production Manager [212] 997-3140

Carol Gallagher

Production Manager International

[212] 997-2045

Betty Preis

Production Manager Domestic

[212] 997-2908

Roberta Cummings

Production Manager Related Products [212] 997-

2044

Thomas Kazich, Production Assistant

[212] 997-2843

Frances Vallone

Reader Service Manager

[212] 997-6057

Electronics Buyers' Guide

H.T. Howland, General Manager

[212] 997-6642

Regina Hera, Directory Manager

[212] 997-2544

Roberta Cummings, Production Manager

[212] 997-2044

Thomas Kazich, Production Assistant

[212] 997-2843

Frances Vallone, Reader Service Manager

[212] 997-6057

Classified and Employment Advertising

Frank Eberle, Manager

[212] 997-2557

The Power Elite



ENI truly is the Power Elite. In fact, when you want the ultimate in power flexibility, there's simply nothing finer in all the world. And our instrumentation can meet all your application needs, for RF signal generator amplification, RFI/EMI testing, signal distribution, RF or data transmission, NMR/ENDOR, ultrasonics and more.

ENI's selection of Class A power amplifiers is unsurpassed, combining a frequency spectrum

of 10 kHz to 1 GHz with power outputs that range from 300 milliwatts to over 4,000 watts. Rugged, compact and versatile, these power amplifiers can be driven by virtually any signal source. They're completely broadband and untuned, amplifying inputs of AM, FM, TV, SSB and pulse modulations with minimum distortion. The unconditional stability and failsafe design make them impervious to severe load conditions (open or

short circuit), delivering their rated power to any load, regardless of match.

Clearly, when it comes to meeting your power amplification needs, ENI is in a class by itself.











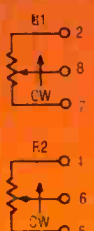



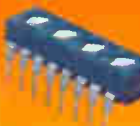

For detailed technical specifications, a demonstration or our latest full-line catalog, write: ENI, 3000 Winton Road South, Rochester, New York 14623. Call (716) 473-6900, or Telex 97-8283 ENI ROC.

ENI

The World's Leader in Power Amplifiers

Circle 901 on reader service card

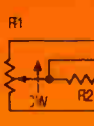
Find Your Trimmer Application Here...

  <p>Model 7102B</p>	  <p>Model 7103C</p>	  <p>Model 7104D</p>	  <p>Model 7105A</p>	  <p>Model 7125B</p>	  <p>Model 7106B</p>	  <p>Model 7126C</p>	  <p>Model 7107C</p>	  <p>Model 7108A</p>
--	--	--	--	--	--	--	--	--

And incorporate trimmers and resistors in a single MFT™ package!

All trimmer applications require a fixed resistor or resistors to either divide a voltage or limit a current. The revolutionary MFT trimmer/resistor package, pioneered by Bourns, combines cermet trimmers and fixed resistors into a single JEDEC DIP package. More than just a DIP trimmer, the MFT trimmer/resistor contains the total trimmer circuit in one DIP package.

Nine different MFT trimmer/resistor models, available in a broad range of resistance values, provide both multi-trimmer versions and various combinations of fixed resistors and trimmers that will satisfy almost any trimmer application.

Increased Reliability — Fewer PC board connections and pre-tested circuitry provide increased reliability. MFT trimmers/resistors are manufactured simultaneously on a common substrate, resulting in better temperature tracking than discrete components. Standard tempco tracking is 50ppm/°C at -55°C to +125°C.

Saves Time, Space and Money — Auto- or hand-insertion of one component instead of many; less components to purchase, stock and handle; simplified circuit design; and less PC board space required. A multitude of advantages means increased productivity and lower on-board cost.

Worldwide Availability — MFT trimmers/resistors are now available throughout the world from Bourns authorized representatives, distributors and international marketing affiliates.

For new applications, or your next generation of design, join the growing number of engineers who are specifying MFT trimmers/resistors. Call or write today for your MFT catalog. Or, see the EEM directory (Volume 2, pages 3791-3801).

TRIMPOT PRODUCTS DIVISION, BOURNS, INC.,
1200 Columbia Avenue, Riverside, CA 92507.
Phone: 714 781-5204, TWX: 910 332-1252.

European Headquarters: Bourns AG, Zugerstrasse 74 6340 Baar, Switzerland. Phone: 042 33 33 33. Telex: 78722.

SALES OFFICES: Ariz. 602 257-9015 • Calif. 213 582-6391, 408 377-5740 • Colo. 303 751-2600 • Fla. 395 771-6501 • Ga. 404 393-9H80 • Ill. 312 255-1903 • Ind. 317 844-8462 • Md. 301 247-0400 • Mass. 617 237-4730 • Mich. 313 882-1717 • Minn. 612 835-2252 • Mo. 816 358-8100 • N.J. 609 933-2600 • N.M. 505 296-0749 • N.Y. 516 271-3500, 607 722-2187 • Oh. 216 659-3131 • Tex. 214 233-5591 • Wash. 206 285-1300 • Canada 514 487-3434, 416 636-5511.

BOURNS®

For Immediate Application—Circle 120 For Future Application—Circle 220