

SEPTEMBER 14, 1978

MEMORY MAKERS SLOW TO EMBRACE STANDARD PINOUTS/85

Driver/receiver chips meet new data-transmission standards/ 125
Coherence boosts confidence in frequency-domain measurements/ 132

1470 SW1105 CASASO DEC80
SE SAWICKI
DATA ACQUISITION SYSTEMS
105 N CHAPEL ST
TORRINGTON CT

FOUR DOLLARS A MCGRAW-HILL PUBLICATION

Electronics®

FIRST OF A SERIES
**CODECS
ANSWER
THE CALL**



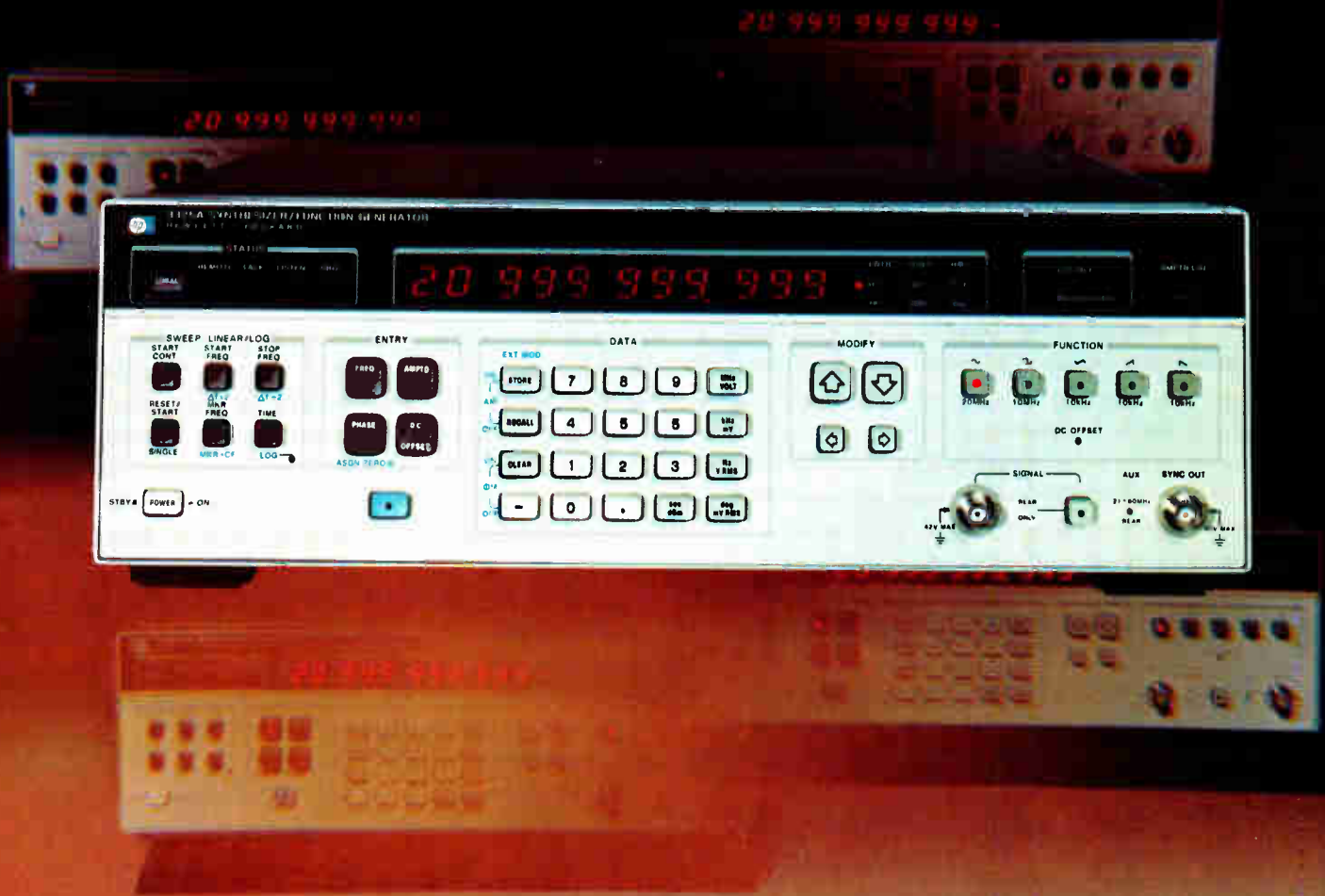

Introducing a programmable 1 μ Hz to 21 MHz* synthesizer, function generator and sweep oscillator in one \$3000** instrument.

For unprecedented performance per dollar, use HP's 3325A Synthesizer/Function Generator in applications such as testing communication and servo systems or simulating geophysical and biomedical transducers.

Frequency synthesizer. The easy-to-use front panel lets you select sinewave, frequency (11-digit resolution) and up to 10V peak-to-peak amplitude into 50 Ω . Direct readout of units on the 3325A is given in peak-to-peak, rms or dBm. And for low-distortion audio and VLF/ULF testing, the 3325A can be used as a low-cost frequency standard as well.

Function generator. Squarewaves to 11 MHz with 20 nsec rise time let you evaluate timing and gating circuits with precision. Or, use the triangle and ramp waveforms to 11 kHz with 0.05% linearity for accurate VCO testing and amplifier performance analysis.

Sweep oscillator. Sweep linearly over 13 decades or logarithmically over 7 decades without phase discontinuity and simplify swept frequency measurements on networks. Sweep-time selection ranges from 0.01 to 99.9 seconds.

Automatic testing. Combine the 3325A with a computing controller via the HP-IB*** for easy programming and versatility in production testing. Isolated interface and floating input/output simplifies system design.

And there's more. Ten storage registers for quick recall, external amplitude and phase modulation, $\pm 719.9^\circ$ phase offset, auxiliary 21 to 61 MHz output, self test, and synchronization capability with other instruments. Plus two field installable options: An oven-controlled 10 MHz oscillator for stability of 0.05ppm/week (\$550**) and a 40V peak-to-peak output to 1 MHz (\$200**).

Get all the details on this new wideband frequency synthesizer, programmable function generator or phase-continuous frequency sweeper from your local HP field engineer.

* Sinewave specification only.

** Domestic U.S.A. price only.

*** HP's Implementation of IEEE Standard 488.1975.

HEWLETT  PACKARD

1507 Page Mill Road, Palo Alto, California 94304

For assistance call: Washington (301) 948-6370, Chicago (312) 255-9800, Atlanta (404) 955-1500, Los Angeles (213) 877-1282

098144

SURPRISE!

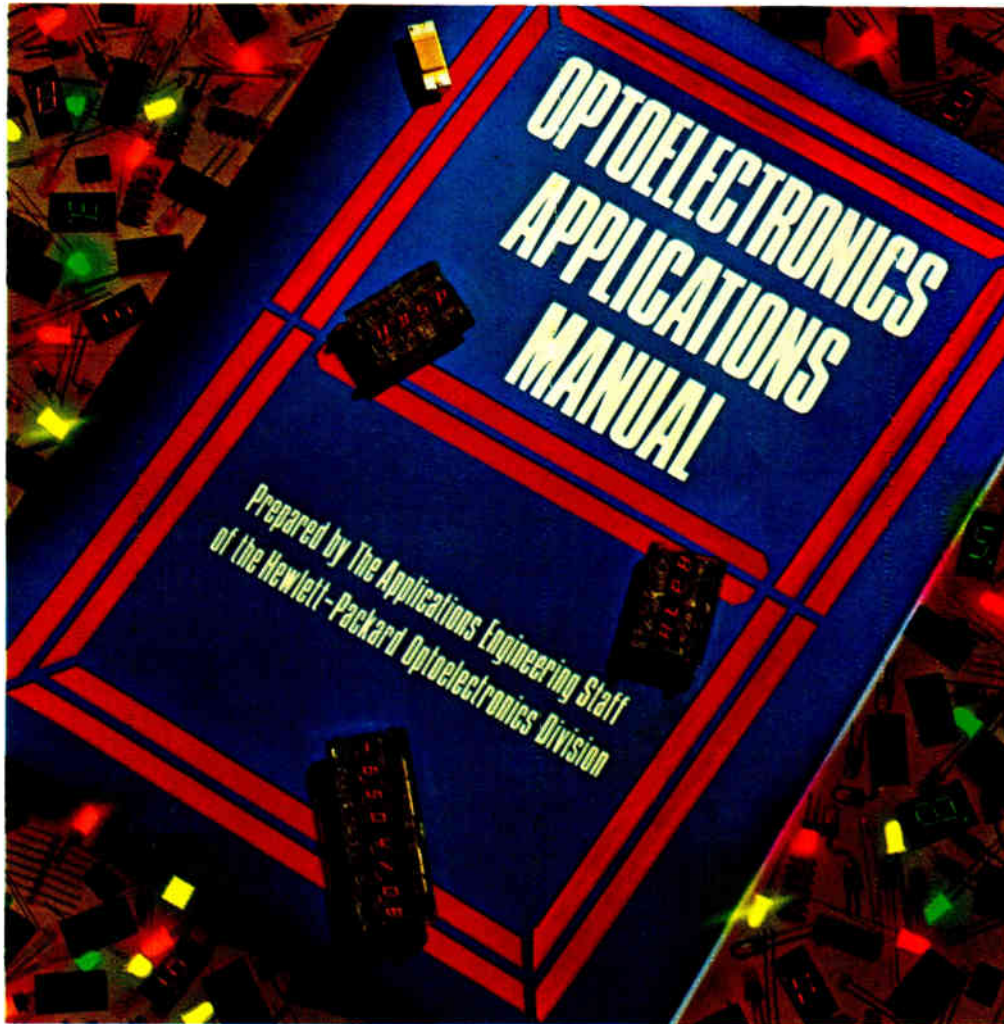

A Treasury of Opto Applications from HP.

Just published by McGraw-Hill and authored by the Applications Engineering Staff of Hewlett-Packard, this 279 page hardcover book is a practical guide to the use of optoelectronic devices and a foundation for the development of new design ideas. This volume demonstrates the broad potential for optoelectronic components and how to take full advantage of optoelectronics in your design.

In nine chapters you'll explore everything from theory of LED operation, design, packaging, contrast enhancement — even practical insights into photometry and radiometry.

You'll find this book not only invaluable, but will find it can save you time, effort and costs. Contact any HP franchised distributor for your copy — only \$19.25* ask for HPBK-1000, Optoelectronics Application

Manual. They're in stock right now. In the U.S., contact Hall-Mark, Hamilton/Avnet, Pioneer Standard, Schweber, Wilshire or the Wyle Distribution Group (Liberty-Elmar) for immediate delivery. In Canada, just call Hamilton/Avnet or Zentronics, Ltd. *U.S. Domestic price only

HEWLETT  PACKARD

1507 Page Mill Road, Palo Alto, California 94304

Make light of your toughest problems.

Those aggravating stuck node digital troubleshooting problems won't leave you in the dark anymore. Light has arrived in the form of Hewlett-Packard's 547A Current Tracer.

The vast majority of digital troubleshooting faults can be tracked right down to the component level by HP's 5004A Signature Analyzer or an HP Logic Probe. However, zero voltage situations like the microcomputer example below in which line D2 is stuck low always present special difficulties.

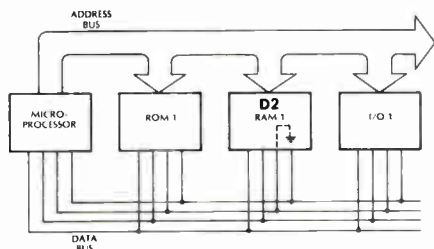

02824

Circle 2 on reader service card

No voltage based tool will take you further unless you're prepared to start cutting board traces and unsoldering components in an attempt to isolate the faulty circuit element.

Enter the HP 547A Current Tracer.

It responds inductively to current pulses in the circuit from 1mA to 1A by lighting up. Just follow the light down the circuit path and it will lead to the exact component or wiring fault that is sinking the current (in this case, RAM 1).

The 547A does it without risky circuit trace cutting or hit or miss component replacement. It's just a very straightforward and simple procedure.

No usable test current on the circuit trace you're working with? That's no problem either. Use the 547A in conjunction with the HP 546A Logic Pulser to inject current pulses into your circuit for equally simple, equally fast results.

Compact, simple and affordable enough to use when you need them: \$350 for 547A Current Tracer, \$175 for 546A Logic Pulser, \$125 for 545A Logic Probe, \$990 for the powerful 5004A Signature Analyzer.

Call your nearest Hewlett-Packard Field Office today, or write. We'll send full details on all these illuminating tools. All prices are domestic USA only.

**HP MAKES
DIGITAL TROUBLESHOOTING
EASIER THAN EVER**

HEWLETT  PACKARD

1507 Page Mill Road, Palo Alto, California 94304

For assistance call: Washington (301) 948-6370, Chicago (312) 255-9800, Atlanta (404) 955-1500, Los Angeles (213) 877-1282

39 Electronics Review

MEMORY: TI takes wraps off its 64-K random-access memory, 39
FIBER OPTICS: Studio-quality TV looks OK in Bell tests, 40
COMPUTERS: Air Force's fault-tolerant computer has budget ills, 41
COMPANIES: General Instrument to broaden its chip business, 42
MILITARY: Air Force wants more data on wind, 44
COMMUNICATIONS: SBS pushes on despite legal snag . . . , 46
. . . as Sperry Univac sets up 5-meter earth stations, 46
CODECS: Interface circuit relies on bipolar technology, 48
NEWS BRIEFS: 50
PACKAGING & PRODUCTION: Varian unit makes 975-wafer slice, 50
MICROPROCESSORS: AMD snubs Intel, chooses Zilog's Z8000, 52

67 Electronics International

GREAT BRITAIN: Dual-crystal setup gives stable frequencies, 67
FRANCE: Optical fiber transmits current-measurement data, 68
JAPAN: Directional couplers aid optical-fiber TV transmission, 70
WEST GERMANY: Double-laser system yields tiny scalpel, 70

81 Probing the News

GOVERNMENT: Pentagon to fund major IC program, 81
MEMORIES: The standards puzzle, 85
COMPUTERS: A look at the IBM-plug-compatible picture, 88
ABROAD: British work toward multimicroprocessor systems, 92
COMPANIES: Intel thrives by taking on IBM, 96

105 Technical Articles

COMMUNICATIONS: Competition stiff for huge codec market, 105
Multichannel shared codecs cost less and save on power, 108
N-MOS codec packs in analog and digital circuitry, 111
DESIGNER'S CASEBOOK: Negative-output regulator tracks input, 116
Controller selects mode for multiphase stepping motor, 117
Op amps and counter form low-cost transistor curve tracer, 118
COMMUNICATIONS: Data improves with chips for drivers, receivers, 125
INSTRUMENTS: Coherence, averaging functions boost confidence, 132
POWER SUPPLIES: Why switching types are rivaling linears, 141
ENGINEER'S NOTEBOOK: Digital differentiator finds acceleration, 147
CALCULATOR NOTES: HP-25 finds thyristor's conduction angle, 148

161 New Products

IN THE SPOTLIGHT: Big bubble memory bows, 161
Chip pair eases dynamic-RAM refresh, 169
32-segment LCD driver saves space and money, 176
COMPONENTS: Floodgates open for large liquid-crystal displays, 180
INSTRUMENTS: 1.3-GHz analyzer has -80-dBm sensitivity, 190
SEMICONDUCTORS: MOS chip controls floppy disks, 202
PACKAGING & PRODUCTION: Unit programs n-MOS EPROMS, 210
MICROCOMPUTERS & SYSTEMS: Tape unit offers random access, 222
DATA ACQUISITION: 16-channel system handles low voltages, 234
MATERIALS: 242

Departments

Publisher's letter, 4
Readers' comments, 6
News update, 8
People, 14
Editorial, 24
Meetings, 26
Electronics newsletter, 33
Washington newsletter, 57
Washington commentary, 58
International newsletter, 63
Engineer's newsletter, 150
Products newsletter, 241
New literature, 246
New books, 250

Services

Reprints available, 226
Employment opportunities, 254
Reader service card, 273

Highlights

The cover: Codec race heats up, 105

With telephone networks going digital, there is great competition among semiconductor makers over integrated coder-decoders, and this series zeroes in on the various technologies and architectures. A searching overview precedes articles on a discrete shared-channel codec (p. 108) and an n-MOS single-chip codec for installation in each telephone (p. 111). Future articles will cover other approaches.

Cover is by John Alun Rennie.

Reveille sounds again for ICs, 81

The U. S. Department of Defense plans to spend \$200 million over the next six years on research into large-scale integrated-circuit production, with the aim of increasing throughput 100 times. The Government's reawakened interest in IC research stems from a conviction that the U. S. is beginning to lose its semiconductor leadership.

Chips meet new transmission standards, 125

The new EIA electrical standards, RS-422 and -423, mean faster, farther data transmission. A low-power family of driver and receiver chips offers an integrated solution to configuring these system parts to the new specifications.

Coherence comes to spectrum analysis, 132

Thanks to digital technology and the fast Fourier transform, the coherence function can be added to the capabilities of the low-frequency spectrum analyzer. It measures the extent to which different system inputs contribute to the output. Averaging also is possible.

And in the next issue . . .

New techniques surface in high-density chip packaging: a special report . . . an integrated driver for bar-graph displays . . . another codec.

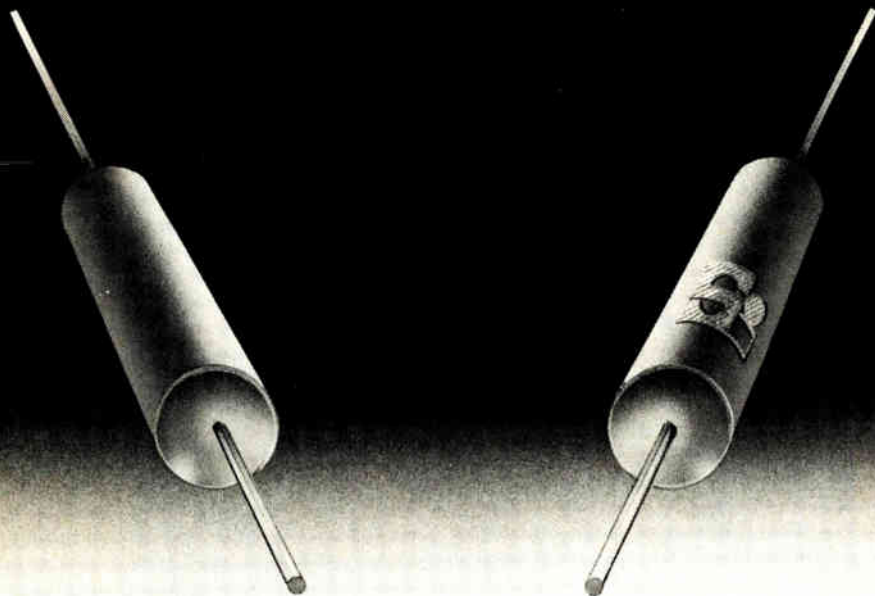

Theirs. Ours.

Can't see the difference? Small wonder. Film capacitors are film capacitors, are film capacitors. Ours do what theirs do, theirs do what ours do. Why, then, should you buy ours? Well, they're priced right. And we do the very best job we can in every way: best materials, careful manufacture, complete QC. We try for 100% reliability in product and delivery and we come at least as close as anyone else and closer than many.

We make film capacitors: metallized polyester, polycarbonate, polypropylene, polyester, polystyrene film and foil capacitors. Very good ones.

We're not a giant and capacitors are *all* we make. No widgets, swidgets or other components. Just capacitors. So we can't afford anything but top quality and reliability. But, since everyone claims these things, we have to be very price competitive as well. We are.

And, we care. About quality. And price. And delivery. We have to care. So that you will think Seacor and buy our capacitors. We have a catalog describing the capacitors we make in some detail. It's free of course. Please write or phone for it. We can arrange samples, too. Of ours, not theirs.

SEACOR INC., 598 Broadway, Norwood, N.J. 07648 ■
Tel. (201) 768-6070 ■ Telex 135354
West Coast: 5460 White Oak Avenue, Encino, CA 91316 ■
Tel. (213) 981-1827

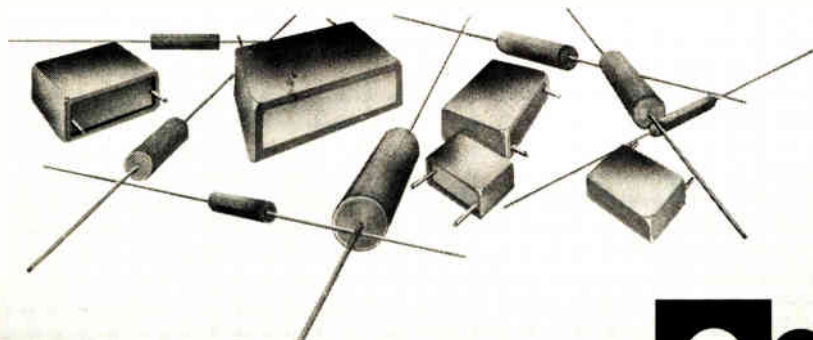

Everything in Film Capacitors

Circle 6 on reader service card



Readers' comments

Switched information

To the Editor: The Probing the News on digital communications technology ["Digital signals grow stronger," July 20, p. 88] includes an ambiguous statement that warrants clarification.

In the fourth paragraph, the article mentions that Northern Telecom's DMS-300 digital switching will go into full operation in 1979, linking Canada with the worldwide network. The next sentence says that AT&T "has not yet tried to implement a system like Northern's."

If the Northern system referred to is the DMS-300, this statement is wrong. The Bell System's No. 4 Electronic Switching System is fully digital and comparable to any of Northern Telecom's digital toll switchers. The first No. 4 ESS went into service in January 1976, handling domestic long-distance calls.

Since 1976, Bell Labs has developed a version of this system with standard international signaling capabilities. This version began service in New York on April 15, 1978, linking the U. S. to other parts of the world. The Bell System plans to have two more No. 4 ESSs with international signaling capabilities in service by 1979, when Northern Telecom's comparable DMS-300 is scheduled for introduction.

Amos E. Joel Jr.
Bell Laboratories
Holmdel, N. J.

Zero confusion

To the Editor: In view of a minor difficulty experienced by several readers who tried my circuit ["Adapting the M6800 processor for automatic number dialing," July 6, p. 128], perhaps I should have clearly specified in the article how to dial zeros. The rotary dial telephone generates a sequence of 10 pulses for the dialed digit 0; therefore, any zeros in the phone number should be programmed into memory with the hexadecimal equivalent of 10, which is A. [Also, note that the logic element used in the circuit was the SN75491.—ED.]

Moshe Bram
Mount Clemens, Mich.

39 Electronics Review

MEMORY: TI takes wraps off its 64-K random-access memory, 39
FIBER OPTICS: Studio-quality TV looks OK in Bell tests, 40
COMPUTERS: Air Force's fault-tolerant computer has budget ills, 41
COMPANIES: General Instrument to broaden its chip business, 42
MILITARY: Air Force wants more data on wind, 44
COMMUNICATIONS: SBS pushes on despite legal snag . . . , 46
. . . as Sperry Univac sets up 5-meter earth stations, 46
CODECS: Interface circuit relies on bipolar technology, 48
NEWS BRIEFS: 50
PACKAGING & PRODUCTION: Varian unit makes 975-wafer slice, 50
MICROPROCESSORS: AMD snubs Intel, chooses Zilog's Z8000, 52

67 Electronics International

GREAT BRITAIN: Dual-crystal setup gives stable frequencies, 67
FRANCE: Optical fiber transmits current-measurement data, 68
JAPAN: Directional couplers aid optical-fiber TV transmission, 70
WEST GERMANY: Double-laser system yields tiny scalpel, 70

81 Probing the News

GOVERNMENT: Pentagon to fund major IC program, 81
MEMORIES: The standards puzzle, 85
COMPUTERS: A look at the IBM-plug-compatible picture, 88
ABROAD: British work toward multimicroprocessor systems, 92
COMPANIES: Intel thrives by taking on IBM, 96

105 Technical Articles

COMMUNICATIONS: Competition stiff for huge codec market, 105
Multichannel shared codecs cost less and save on power, 108
N-MOS codec packs in analog and digital circuitry, 111
DESIGNER'S CASEBOOK: Negative-output regulator tracks input, 116
Controller selects mode for multiphase stepping motor, 117
Op amps and counter form low-cost transistor curve tracer, 118
COMMUNICATIONS: Data improves with chips for drivers, receivers, 125
INSTRUMENTS: Coherence, averaging functions boost confidence, 132
POWER SUPPLIES: Why switching types are rivaling linears, 141
ENGINEER'S NOTEBOOK: Digital differentiator finds acceleration, 147
CALCULATOR NOTES: HP-25 finds thyristor's conduction angle, 148

161 New Products

IN THE SPOTLIGHT: Big bubble memory bows, 161
Chip pair eases dynamic-RAM refresh, 169
32-segment LCD driver saves space and money, 176
COMPONENTS: Floodgates open for large liquid-crystal displays, 180
INSTRUMENTS: 1.3-GHz analyzer has -80-dBm sensitivity, 190
SEMICONDUCTORS: MOS chip controls floppy disks, 202
PACKAGING & PRODUCTION: Unit programs n-MOS EPROMS, 210
MICROCOMPUTERS & SYSTEMS: Tape unit offers random access, 222
DATA ACQUISITION: 16-channel system handles low voltages, 234
MATERIALS: 242

Departments

Publisher's letter, 4
Readers' comments, 6
News update, 8
People, 14
Editorial, 24
Meetings, 26
Electronics newsletter, 33
Washington newsletter, 57
Washington commentary, 58
International newsletter, 63
Engineer's newsletter, 150
Products newsletter, 241
New literature, 246
New books, 250

Services

Reprints available, 226
Employment opportunities, 254
Reader service card, 273

Highlights

The cover: Codec race heats up, 105

With telephone networks going digital, there is great competition among semiconductor makers over integrated coder-decoders, and this series zeroes in on the various technologies and architectures. A searching overview precedes articles on a discrete shared-channel codec (p. 108) and an n-MOS single-chip codec for installation in each telephone (p. 111). Future articles will cover other approaches.

Cover is by John Alun Rennie.

Reveille sounds again for ICs, 81

The U. S. Department of Defense plans to spend \$200 million over the next six years on research into large-scale integrated-circuit production, with the aim of increasing throughput 100 times. The Government's reawakened interest in IC research stems from a conviction that the U. S. is beginning to lose its semiconductor leadership.

Chips meet new transmission standards, 125

The new EIA electrical standards, RS-422 and -423, mean faster, farther data transmission. A low-power family of driver and receiver chips offers an integrated solution to configuring these system parts to the new specifications.

Coherence comes to spectrum analysis, 132

Thanks to digital technology and the fast Fourier transform, the coherence function can be added to the capabilities of the low-frequency spectrum analyzer. It measures the extent to which different system inputs contribute to the output. Averaging also is possible.

And in the next issue . . .

New techniques surface in high-density chip packaging: a special report . . . an integrated driver for bar-graph displays . . . another codec.

EDITOR-IN-CHIEF: Kemp Anderson

EXECUTIVE EDITOR: Samuel Weber

MANAGING EDITORS: Arthur Erikson,
Gerald M. Walker

SENIOR EDITORS: William F. Arnold,
Ray Connolly, Lawrence Curran

ART DIRECTOR: Fred Sklenar

ASSOCIATE EDITORS: Howard Wolff,
Alfred Rosenblatt

DEPARTMENT EDITORS
Aerospace/Military: Ray Connolly
Circuit Design: Vincent Biancomano
Communications & Microwave:
Harvey J. Hindin

Components: Nicolas Mokhoff
Computers: Anthony Durniak
Industrial: John G. Posa
Instrumentation: Albert F. Shackil
New Products: Michael J. Riezenman,
Richard W. Comerford
Packaging & Production: Jerry Lyman
Solid State: Raymond P. Capece

CHIEF COPY EDITOR: Margaret Eastman

COPY EDITORS: Ben Mason, Mike Robinson,
Steven Weitzner

ART: Charles D. Ciatto, *Associate Director*
Paula Piazza, *Assistant Director*

EDITORIAL SECRETARIES: Janet Noto,
Penny Kaplan, Maryann Tusa

EDITORIAL ASSISTANT: Marilyn B. Rosoff

REGIONAL EDITORS
Boston: Lawrence Curran
Pamela Hamilton (617) 262-1160
Dallas: Wesley R. Iversen (214) 742-1747
Los Angeles: Larry Waller (213) 487-1160
New York: Bruce LeBoss (212) 997-3444
San Francisco: William F. Arnold
Robert Brownstein (415) 968-2712
Washington: Ray Connolly (202) 624-7592
Frankfurt: John Gosch
London: Kevin Smith
Paris: Arthur Erikson
Tokyo: Charles Cohen

McGRAW-HILL WORLD NEWS

Editor: Michael Johnson
Brussels: James Smith
Milan: Andrew Heath
Moscow: Peter Hann
Paris: Andrew Lloyd
Stockholm: Robert Skole
Tokyo: Robert E. Lee

PUBLISHER: Dan McMillan

ADVERTISING SALES MANAGER:
Paul W. Reiss

MARKETING ADMINISTRATION MANAGER:
Wallis Clarke

CIRCULATION MANAGER: Karl Peterson

MARKETING SERVICES MANAGER:
Tomlinson Howland

RESEARCH MANAGER: Margery D. Sholes

The state of flux in the codec industry really became clear to Communications Editor Harvey Hindin when he was gathering the information for the summary chart of specifications shown on page 107. "The parameters quoted sometimes changed several times during the six-week period I was getting them together," Hindin notes. "Many codecs are still developmental in nature and new versions and modifications are still being made.

"There's also the competitive pressure. As news breaks and people leak rumors and issue preliminary data sheets, others decide that they have to do as well or even better. It's like a market survey. Since some data, like power dissipation, is critical as far as telephone applications are concerned, no one wants to have the worst spec." But, Hindin asks, "How do you quote—conservatively? on the basis of how many samples and tests? And what supply voltage do you use and what temperature and what kind of operating conditions? Even though test procedures are usually well established, there's still room for variability in results."

To complicate matters, some reluctant companies submitted data after the deadline, and some were even too late to be included in the chart. And in other cases the manufacturers wouldn't release information at all. A few even went so far as to say they had never heard of codecs, and others wouldn't talk until they learned that the competition already had disclosed information. "It was a real chicken-and-egg situation. Rather than having a specific policy regarding release of

data, it seemed that all too often the policy was to act on the basis of what others were doing," says Hindin.

Hindin, who joined the staff of *Electronics* back in April, is not unacquainted with the vagaries of high-technology companies. The 40-year-old editor, who holds BSEE and MSEE degrees from the Polytechnic Institute of Brooklyn (now New York), has worked at such companies as Sperry Gyroscope and Airborne Instrument Labs. He has also taught engineering science at the State University of New York at Stony Brook and is the author of 55 articles in refereed IEEE publications.

To paraphrase the TV commercial about the brokerage house, when Hewlett-Packard talks, everyone listens. So when the giant instrument-maker turns out what Nick Pendergrass of its Loveland division calls "one of the most complex instruments ever built at the division," the rest of the world had better take notice. The product in question is the 3582 spectrum analyzer and, despite its complexity, development work was "surprisingly smooth," says Pendergrass, now a project manager. But it did take some time: the project was already under way when Pendergrass brought his expertise in digital signal processing (he has a doctorate from Cal-Berkeley) to HP in January 1976. For the results of the project, see the article on the 3582 on page 132.



September 14, 1978 Volume 51, Number 19 98,794 copies of this issue printed

Published every other Thursday by McGraw-Hill, Inc. Founder: James H. McGraw 1860-1948. Publication office 1221 Avenue of the Americas, N.Y., N.Y. 10020; second class postage paid at New York, N.Y. and additional mailing offices. ID# 972400.

Executive, editorial, circulation and advertising addresses: Electronics, McGraw-Hill Building, 1221 Avenue of the Americas, New York, N.Y. 10020. Telephone (212) 997-1221. Teletype 12-7960. TWX 710-581-4879. Cable address: MCGRAWHILLNEWYORK.

Subscriptions limited to professional persons with active responsibility in electronics technology. No subscriptions accepted without complete identification of subscriber name, title or job function, company or organization, and product manufactured or services performed. Based on information supplied, the publisher reserves the right to reject non-qualified requests. Subscription rates: in the United States and possessions \$15 one year, \$26 two years, \$38 three years; company addressed and company libraries \$20 one year, \$36 two years, \$50 three years; APO/FPO addressed \$35 one year only, Canada and Mexico \$17 one year, \$29 two years, \$43 three years; Europe \$42 one year, \$71 two years, \$100 three years; Japan, Israel and Brazil \$70 one year, \$115 two years, \$165 three years; Australia and New Zealand \$35 one year, \$170 two years, \$240 three years, including air freight; all other countries \$45 one year, \$80 two years, \$112 three years. Limited quota of subscriptions available at higher-than-basic rate for persons allied to held served. Check with publisher for these rates. Single copies: \$4.00. Please allow four to eight weeks for shipment.

Officers of McGraw-Hill Publications Company: Gordon L. Jones, President; Paul F. McPherson, Executive Vice-President; Group Vice-President: Gene W. Simpson; Senior Vice-Presidents: Russell F. Anderson; James E. Boddorf, Planning & Development; Ralph R. Schultz.

Editorial; Vice-Presidents: Denis C. Beran, European Operations; David P. Forsyth, Research; James E. Hackett, Controller; Eric B. Herr, Economics; Thomas H. King, Manufacturing; Robert L. Leyburn, Circulation; John W. Patten, Sales; Edward E. Schirmer, International. Officers of the Corporation: Harold W. McGraw, Jr., President, Chief Executive Officer, and Chairman of the Board; Robert N. Landes, Senior Vice President and Secretary; Ralph J. Webb, Treasurer.

Title registered in U.S. Patent Office. Copyright © 1978 by McGraw-Hill, Inc. All rights reserved. The contents of this publication may not be reproduced in whole or in part without the consent of copyright owner.

Where necessary, permission is granted by the copyright owner for libraries and others registered with the Copyright Clearance Center (CCC) to photocopy any article herein for the base fee of \$0.50 per copy of the article plus \$0.25 per page. Payment should be sent directly to the CCC. Copying done for other than personal or internal reference use without the express permission of McGraw-Hill is prohibited. Requests for special permission or bulk orders should be addressed to the publisher. ISSN 0013-5070/78\$0.50 + 25.

Subscribers: The publisher, upon written request to our New York office from any subscriber, agrees to refund that part of the subscription price applying to copies not yet mailed. Please send change-of-address notices or complaints to Fulfillment Manager; subscription orders to Circulation Manager, *Electronics*, at address below. Change-of-address notices should provide old as well as new address, including postal zip code number. If possible, attach address label from recent issue. Allow one month for change to become effective.

Postmaster: Please send form 3579 to Fulfillment Manager, *Electronics*, P.O. Box 430, Hightstown, N.J. 08520.

**Searching
for signals
buried
in noise?**

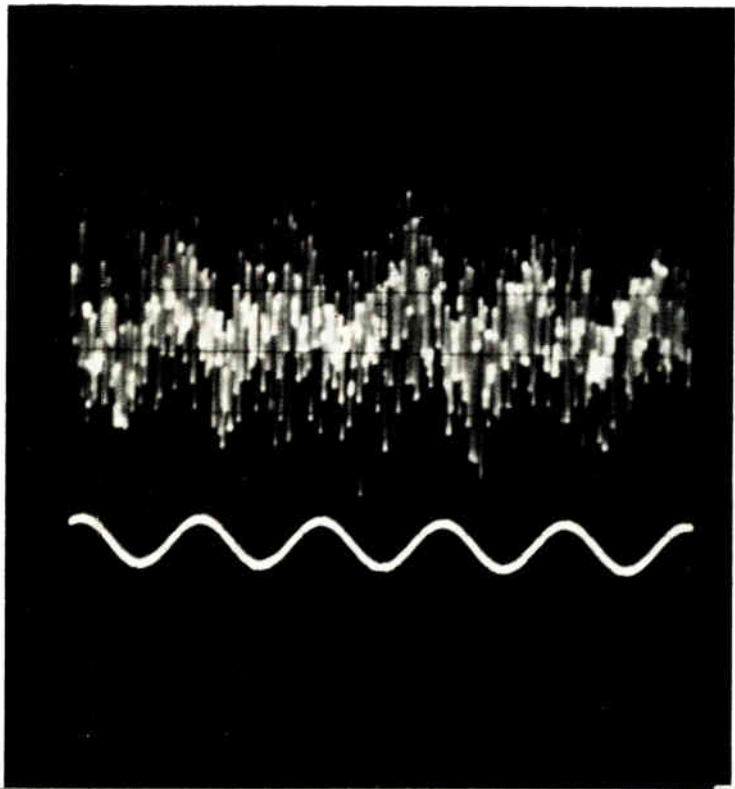

**New
narrow band
filter
finds and
tracks them
automatically**

Krohn-Hite's New Model 3800 Narrow Band Tracking Filter can find and lock on a signal below 100 kHz and track it automatically. With or without an external frequency reference. Even if it's buried 10 dB below the background noise level. And the Model 3800 costs only \$1,995.

Other features include:

- Bandwidth variable from 1 kHz down to 0.001 Hz
- Filter Q to 100,000,000
- Automatic gain control with 70 dB dynamic range

For immediate information call us at (617) 580-1660.

**KH KROHN-HITE
CORPORATION**

Avon Industrial Park, Avon, MA 02322 • (617) 580-1660 TWX 710 345 0831

SALES OFFICES ALA., Huntsville (205) 534-9771; ARIZ., Scottsdale (602) 994-5461; CAL., San Jose (408) 292-3220, Inglewood (213) 674-6850, COL., Denver (303) 773-1218, CONN., Canton Center (203) 525-7647; FLA., Orlando (305) 894-4401; GA., Atlanta (404) 455-1206, HAWAII, Honolulu (808) 941-1574; ILL., Arlington Hts. (312) 394-3380, IN., Fort Wayne (219) 485-0845, KS., Lenexa (913) 888-0215, LA., Lafayette (318) 984-3516, MD., Towson (301) 321-1411, MASS., Waketield (617) 245-5940, MICH., Southfield (313) 569-4497, MINN., St. Paul (612) 645-5816, MO., St. Louis (314) 731-5400, N.M., Albuquerque (505) 255-2330, N.J., Cherry Hill (609) 482-0059; N.Y., Elmont (516) 488-2100, Rochester (716) 473-5720, Syracuse (315) 437-6666, Vestal (607) 785-9947, N.C., Burlington (919) 227-3639; OHIO, Chesterland (216) 729-2222, Dayton (513) 434-8993, OKLA., Tulsa (918) 299-2636, ORE., Portland (503) 297-2248; TEX., Dallas (214) 661-0400, Houston (713) 688-1431, UTAH, Sandy (801) 942-2081, VA., Falls Church (703) 573-8787, WA., Bellevue (206) 454-3400, CANADA, Montreal, Quebec (514) 341-7630, Ottawa, Ontario (613) 235-5121, Toronto, Ontario (416) 445-9900, Vancouver, British Columbia (604) 253-5555, Halifax, Nova Scotia (902) 454-8321, St. John's, Newfoundland (709) 726-2422

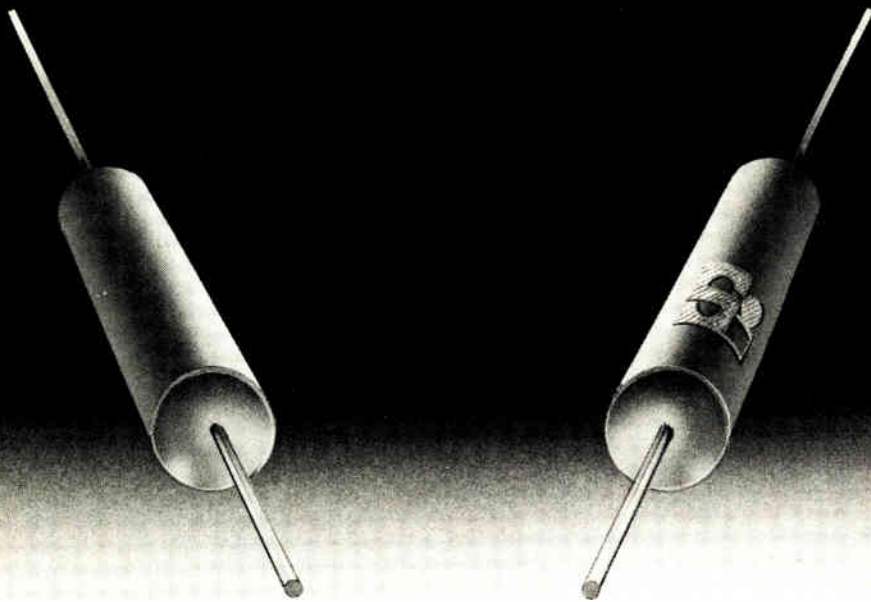

Theirs. Ours.

Can't see the difference? Small wonder. Film capacitors are film capacitors, are film capacitors. Ours do what theirs do, theirs do what ours do. Why, then, should you buy ours? Well, they're priced right. And we do the very best job we can in every way: best materials, careful manufacture, complete QC. We try for 100% reliability in product and delivery and we come at least as close as anyone else and closer than many.

We make film capacitors: metallized polyester, polycarbonate, polypropylene, polyester, polystyrene film and foil capacitors. Very good ones.

We're not a giant and capacitors are *all* we make. No widgets, swidgets or other components. Just capacitors. So we can't afford anything but top quality and reliability. But, since everyone claims these things, we have to be very price competitive as well. We are.

And, we care. About quality. And price. And delivery. We have to care. So that you will think Seacor and buy our capacitors. We have a catalog describing the capacitors we make in some detail. It's free of course. Please write or phone for it. We can arrange samples, too. Of ours, not theirs.

SEACOR INC., 598 Broadway, Norwood, N.J. 07648 ■
 Tel. (201) 768-6070 ■ Telex 135354
West Coast: 5460 White Oak Avenue, Encino, CA 91316 ■
 Tel. (213) 981-1827

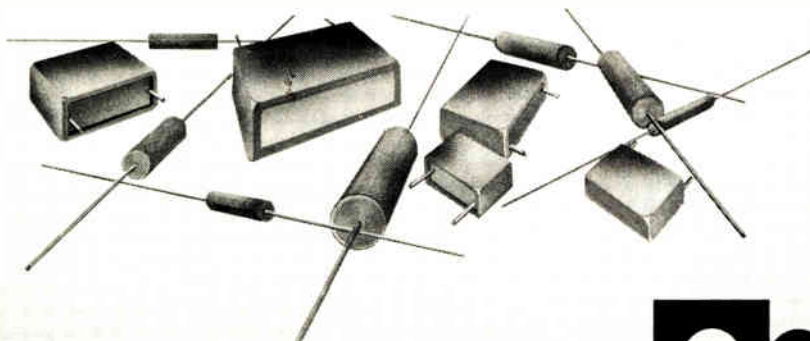

Everything in Film Capacitors

Circle 6 on reader service card



Readers' comments

Switched information

To the Editor: The Probing the News on digital communications technology ["Digital signals grow stronger," July 20, p. 88] includes an ambiguous statement that warrants clarification.

In the fourth paragraph, the article mentions that Northern Telecom's DMS-300 digital switching will go into full operation in 1979, linking Canada with the worldwide network. The next sentence says that AT&T "has not yet tried to implement a system like Northern's."

If the Northern system referred to is the DMS-300, this statement is wrong. The Bell System's No. 4 Electronic Switching System is fully digital and comparable to any of Northern Telecom's digital toll switchers. The first No. 4 ESS went into service in January 1976, handling domestic long-distance calls.

Since 1976, Bell Labs has developed a version of this system with standard international signaling capabilities. This version began service in New York on April 15, 1978, linking the U. S. to other parts of the world. The Bell System plans to have two more No. 4 ESSs with international signaling capabilities in service by 1979, when Northern Telecom's comparable DMS-300 is scheduled for introduction.

Amos E. Joel Jr.
 Bell Laboratories
 Holmdel, N. J.

Zero confusion

To the Editor: In view of a minor difficulty experienced by several readers who tried my circuit ["Adapting the M6800 processor for automatic number dialing," July 6, p. 128], perhaps I should have clearly specified in the article how to dial zeros. The rotary dial telephone generates a sequence of 10 pulses for the dialed digit 0; therefore, any zeros in the phone number should be programmed into memory with the hexadecimal equivalent of 10, which is A. [Also, note that the logic element used in the circuit was the SN75491.—ED.]

Moshe Bram
 Mount Clemens, Mich.

HP 5328A Universal Counter. The Right Performance At The Right Price.

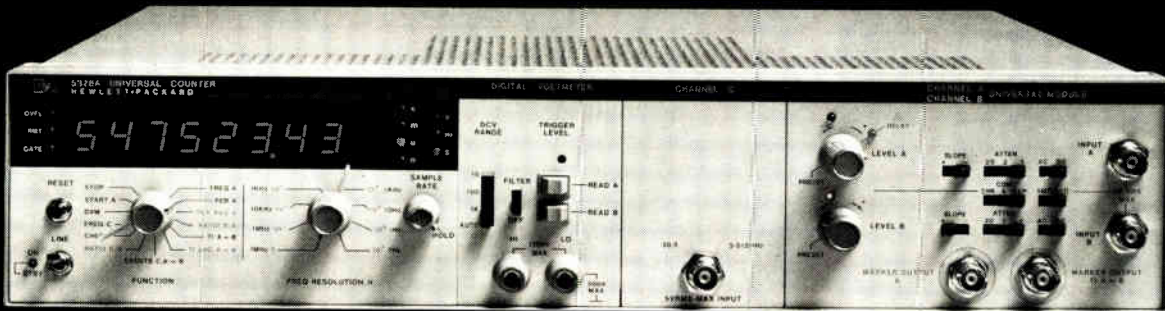

If you're looking for a medium priced universal counter with the capability to do just about any counting job and the versatility demanded by tough systems applications, look no further.

For only \$1300* the HP 5328A Universal Counter is a basic 100 MHz/100ns instrument that expands to meet your needs. Optional modules let you expand its capabilities to 512 or 1300 MHz and 10 ns time interval.

You can select an optional built-in DVM (single-ended or full floating, 10 μ v to 1000v) for accurate determination of trigger levels and for external digital voltage measurements. Only HP offers it.

*U.S. Domestic price only.

Other options let you make use of an ultra-stable time base and HP Interface Bus Operation including full remote control of the counter and the DVM.

Sound good?

There's more information available for you on the HP 5328A Universal Counter and the full line of sophisticated HP electronic counters.

Just call your nearby HP field office or write for our new electronic counter brochure.

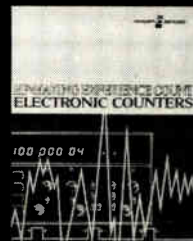

HEWLETT  PACKARD

1507 Page Mill Road, Palo Alto, California 94304

For assistance call: Washington (301) 948-6370, Chicago (312) 255-9800, Atlanta (404) 955-1500, Los Angeles (213) 877-1282

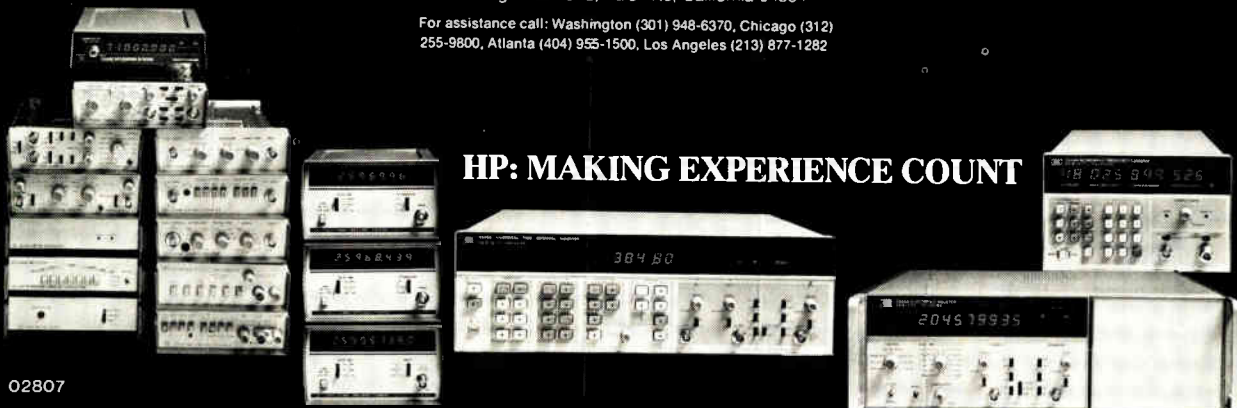

02807

HP: MAKING EXPERIENCE COUNT

Circle 7 on reader service card

Price makes the difference in



Actual size

North Atlantic Synchro Panel Meters for angle readout

Salient Features Include:

- Angle or engineering units
- Pin programmable
- No separate power needed (operates off the stator and rotor signals)
- 0.1° Resolution
- $\pm 2^\circ$ offset adjust for final systems zeroing
- 50 – 1200 Hz
- Tracking Converter

A true price performance breakthrough in Synchro Angle Position Indicators — the North Atlantic Model 800; a small size panel meter with an equally small price. It uses discrete components complimented by an LSI chip. It's pin programmable and universal for all synchros and resolvers.



NORTH ATLANTIC
industries, inc.

60 Plant Avenue, Hauppauge, New York 11787
(516) 582-6500/TWX: 510-227-9660/Cable: NO ATLANTIC

News update

■ RCA Corp. is getting bullish on home computers, despite the prophecies of doom from several quarters. It plans to have two boards for its Video Interface Processor by mid-October—one that generates music and another that creates color video displays. The VIP computer, an outgrowth of the CDP1802 evaluation kit [*Electronics*, March 31, 1977, p. 94], was designed for hobbyists to create and play video games, generate graphics, and develop microprocessor control functions.

The VP-550 Super Sound Board will come with a computer program called PIN (for Play It Now) that permits users to easily transcribe sheet music or to compose their own music for playing on the VIP. The \$49 board generates a variety of sounds over a four-octave range, some of which resemble those of conventional musical instruments. Priced at \$69, the VP-590 Colorboard will allow the VIP to provide video displays in eight colors. A user can select one of three background colors for the display and then specify one of eight foreground colors for each of 64 areas on the screen.

■ The race to supply the U.S. Army's General Support Rocket System is heating up. Norden Systems of Norwalk, Conn., a division of United Technologies Corp., plans to deliver the first fire control system for Vought Corp.'s version of the rapid-fire artillery rocket system in late fall. Vought, which selected Norden to supply the system [*Electronics*, March 2, p. 84], heads a team that is pitted against a Boeing-Teledyne tandem.

Thus far, Norden has completed design of the fire control system and demonstrated a working brassboard. Norden also plans to deliver three additional GRS systems in early 1979. The equipment will be tested in a series of competitive missile firings, operational tests, and environmental tests to determine who will win the prime contract to produce the rocket system, which is scheduled to enter service in the early 1980s. **Bruce LeBoss**

Presenting The New **11V03**

Featuring

RX02® New Double Density Dual Floppy Disk Drive

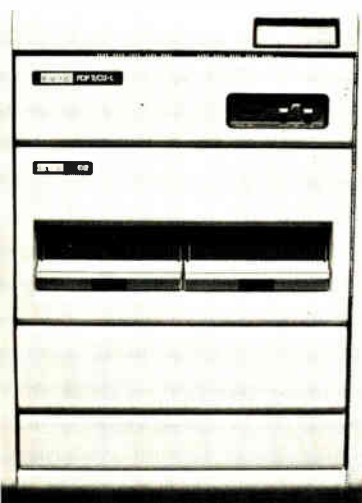

- Latest 11/03-LC® 9 slot backplane.
- 1M BYTE Dual Density RX02®
- Provides more open slots.
- Choice of LA36®, VT52®, VT100®
- DEC RT-11® (version 3B) software included.
- Standard DEC® installation and on-site warranty.

First computer is all the
•computer company you'll ever
need to know. . . .

- . . . Attractive OEM and Educational discounts for systems and components.
- . . . Stocking a complete line of LSI-11®, LSI-11/2® and 11/03® products for IMMEDIATE DELIVERY.
- . . . Custom configurations available.
- . . . Personalized service.
- . . . To order call 312/920-1050

Call **First** first for all your
DEC® computer needs—
312/920-1050

Standard 11V03 configuration 4 slot backplane			New 11V03 configuration 9 slot backplane																											
<table border="1"> <tr><td colspan="2">CPU</td></tr> <tr><td colspan="2">16K memory</td></tr> <tr><td>serial interface</td><td>floppy interface</td></tr> <tr><td>bootstrap</td><td>open</td></tr> </table>		CPU		16K memory		serial interface	floppy interface	bootstrap	open		<table border="1"> <tr><td colspan="2">CPU</td></tr> <tr><td colspan="2">16K memory</td></tr> <tr><td>Floppy</td><td>/ /</td></tr> <tr><td>Serial</td><td>/ /</td></tr> <tr><td colspan="2">Bootstrap</td></tr> <tr><td colspan="2">open</td></tr> <tr><td colspan="2">open</td></tr> <tr><td colspan="2">open</td></tr> <tr><td colspan="2">open</td></tr> </table>		CPU		16K memory		Floppy	/ /	Serial	/ /	Bootstrap		open		open		open		open	
CPU																														
16K memory																														
serial interface	floppy interface																													
bootstrap	open																													
CPU																														
16K memory																														
Floppy	/ /																													
Serial	/ /																													
Bootstrap																														
open																														
open																														
open																														
open																														
\$9,050	Price	FCC LIST	\$9,475																											
30 Days	Delivery	60 Days																												
Included	DEC® Installation	Included																												
On-Site parts & labor	DEC® 90 Day Warranty	On-Site parts & labor																												
RT-11® plus enhancements	Operating System	RT-11® plus enhancements																												
32K bytes	Memory*	32K bytes																												
1 Dual	Number of open slots available	4 Dual or 4 Quad																												

* Other memory modules available 16K, 32K, and 64K bytes.



computer corporation

corporate square/825 north cass avenue/westmont, illinois 60559/(312) 920-1050

®Registered trademark of Digital Equipment Corp., Maynard, Mass.

™Registered trademark of First Computer Corporation

Am 25LS2516

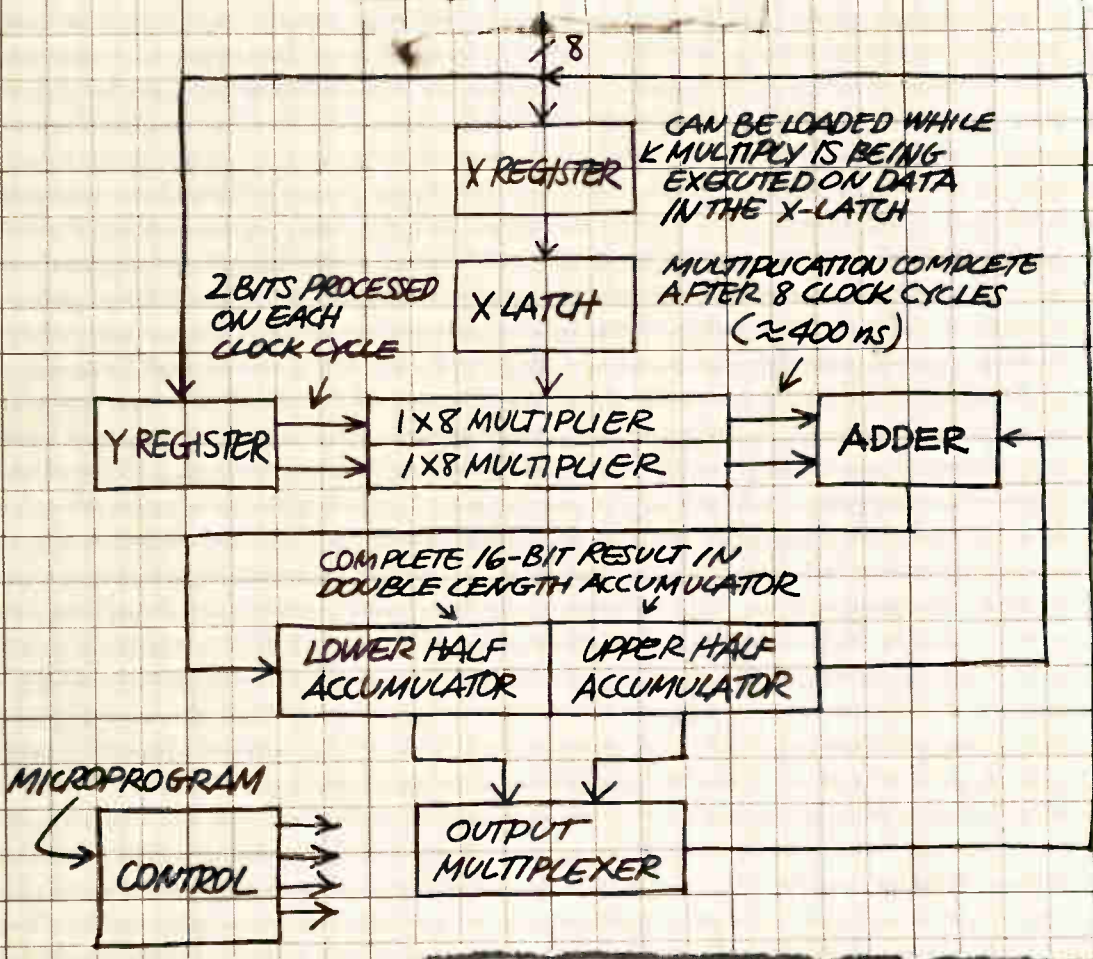

AMAZING NEW MULTIPLIER DIET.

Lose pound after pound of board fat from the very first day. Feel better. Look better. Get Advanced Micro Devices' new Am25LS2516. Forty pins of muscle. Not an ounce of fat.

Say hello to another space saver from The Space Savers: the Am25LS2516. It's a new 8 x 8-bit LSI serial/parallel multiplier and accumulator. With the equivalent of 625 gates, it replaces two of our older Am25LS14's, but it doesn't stop there. It also replaces an adder/subtractor, a register and five other packages in the process.

It's a low-power Schottky, 40-pin, dual-in-line part. It's twice as fast as the Am25LS14. It's cascadable to a 16 x 16 array by using just two Am25LS2516's and no additional support packages. It's programmable by microinstructions and works cheerfully with the whole Am2900 family.

If you're doing medium-to-high-performance, real-time signal processing — if you'd like to get the job done with one package — the Am25LS2516 app note and data sheet are must reading.

Start taking the Am25LS2516 today. And lose pounds of ugly board fat.



Multiple technologies. One product: excellence.
901 Thompson Place, Sunnyvale, California 94086
Telephone (408) 732-2400

Who do you think of
for high-performance 16K RAMs?

Next time,

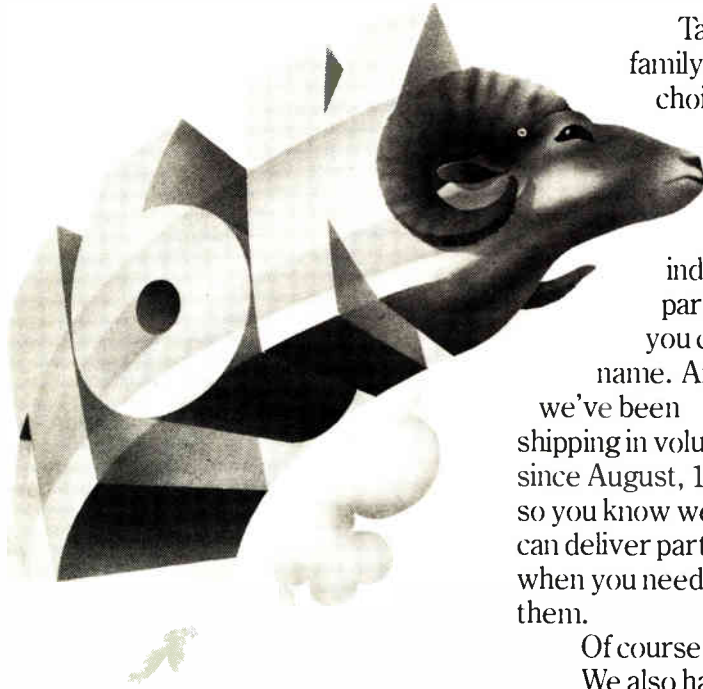

Take your pick: our μ PD416 standard family offers a whole range of performance choices—extending to 120 ns access time and 320 ns cycle time. In either plastic or ceramic packages.

Every characteristic of our μ PD416 family meets or exceeds industry standards, which means our parts are suitable for any application

you can

name. And we've been shipping in volume since August, 1977, so you know we can deliver parts when you need them.

P/N	t_{RAC}	t_{RC}	I_{DD1}	I_{DD2}
μ PD416-5	120 ns	320 ns	35 mA	1.5 mA
μ PD416-3	150 ns	375 ns	35 mA	1.5 mA
μ PD416-2	200 ns	375 ns	35 mA	1.5 mA
μ PD416-1	250 ns	430 ns	35 mA	1.5 mA
μ PD416	300 ns	510 ns	35 mA	1.5 mA
$t_a = 0^\circ\text{C to } +70^\circ\text{C}$				

Of course, 16K RAMs are just part of our story. We also have a broad selection of other memory components, led by our industry standard

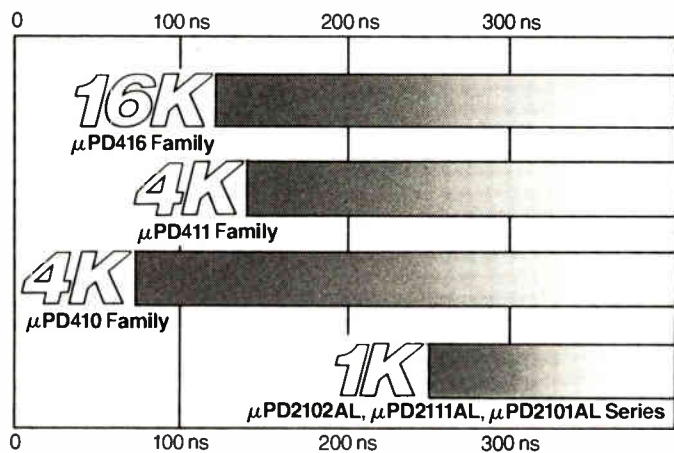

REPS: Action Unlimited, Arlington, TX; Spring, TX. Burton-Medley Associates, Grandview, MO. Cerco, San Diego, CA. Contact Sales, Inc. Burlington, MA. D/Z Associates, Inc., Denver, CO. Electronic Innovators, Inc., Minneapolis, MN. Eltron, Phoenix, AZ. HLM Assoc., Northport, NY. Parsippany, NJ. Imtech, Inc., Cleveland, OH. Dayton, OH. Kaytronics Limited, Ville St. Pierre, Quebec; Downsview, Ontario; Surrey, British Columbia. L & M Associates, Pikesville, MD; Montpelier, VA. Harry Nash Associates, Willow Grove, PA. R.C. Nordstrom & Company, Lathrup Village, MI. Perrott Associates, Inc., Fort Lauderdale, FL; Clearwater, FL; Orlando, FL. Santana Sales, Costa Mesa, CA. Stone Component Sales, Waltham, MA. Technology Sales, Inc., Palatine, IL. Trident Associates, Inc., Sunnyvale, CA. Tri-Tronix, Albuquerque, NM. Tri-Tronix, NW., Mercer Island, WA. 20th Century Marketing, Inc., Huntsville, AL; Greenville, TN. Wolff's Sales Service Company, Raleigh, NC.

DISTRIBUTORS: Almo Electronics Corp., Philadelphia, PA. Baltimore, MD. Bell Industries, Bellevue, WA. Century Electronics, Albuquerque, NM; Wheatridge, CO; Salt Lake City, UT. Norman Davis Electronics, South Euclid, OH. Diplomat/Westland, Inc., Sunnyvale, CA. Diplomat/Southland, Inc., Clearwater, FL. Diplomat/Lakeland, Inc., Elk Grove Village, IL. Diplomat/IPC of Mass., Chicopee Falls, MA. Diplomat, Holliston, MA. Diplomat/Northland, Inc., Farmington, MI. Diplomat/Electro-Com

think NEC.



4K Dynamic RAM (μ PD411), with access time down to 135 ns, and our highly successful high-speed 4K Static RAM (μ PD410), with access times down to 70 ns. Plus CMOS RAMs, Bipolar PROMs, 1K and 4K Static RAMs, and mask programmable ROMs up to 64K bits.

At NEC, we've built a reputation for advanced technology and volume delivery. We're also known for remarkable product reliability — thanks to experienced designers and meticulous manufacturing techniques, backed by 100% burn-in and testing with MIL-STD-883 methods. The result is an overall rejection rate of under 0.5%.

What's more, we offer thorough customer support, including documentation, testing, and special selection. And our engineers are always available to help with specific applications problems.

Our new product catalog will give you a better idea of just how much we can do for you, not only in memories but also in 8-bit and 4-bit processors and peripherals.

To get your free copy, clip your business card or letterhead stationery to this page and send to: NEC Microcomputers, Inc., 173 Worcester Street, Wellesley, MA 02181.

If you haven't thought of NEC before, you will.
Next time.

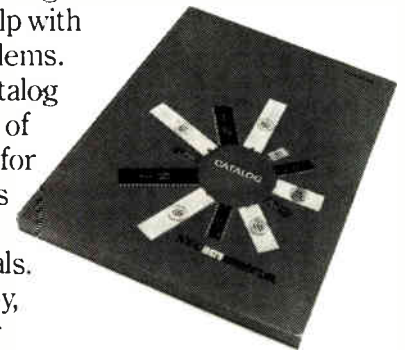

NEC
NEC Microcomputers, Inc.

Corp., Minneapolis, MN. Diplomat/St. Louis, Inc., St. Louis, MO. Diplomat/IPC Corp., Totowa, NJ; Mt. Laurel, NJ. Diplomat Electronics Corp., Woodbury, NY. Diplomat/Alta-Land, Inc., Salt Lake City, UT. Future Electronics Corp., Montreal, Quebec; Rexdale, Ontario; Ottawa, Ontario. Hughes-Peters, Inc., Cincinnati, OH; Columbus, OH. Intermark Electronics, Sunnyvale, CA; Santa Ana, CA; San Diego, CA. Kent Electronics, Houston, TX. G.S. Marshall, Sunnyvale, CA; Irvine, CA; El Monte, CA; San Diego, CA; Phoenix, AZ. Milgray Electronics, Inc., Freeport, NY; Orange, CT. Repron Electronics, Inc., Livonia, MI. Resco/Raleigh, Raleigh, NC. Semiconductor Specialists, Inc., Chicago, IL; Burlington, MA; Farmington, MI; Minneapolis, MN; Hazelwood, MO; Pittsburgh, PA; Dallas, TX; Milwaukee, WI. Sterling Electronics, Phoenix, AZ; Sun Valley, CA; San Diego, CA; Baton Rouge, LA; Waltham, MA; Albuquerque, NM; Dallas, TX; Houston, TX; Seattle, WA. Summit Distributors, Inc., Buffalo, NY. Summit Elec. of Roch., Inc., Rochester, NY. Technico, Inc., Columbia, MD; Roanoke, VA. Western Microtechnology Sales, Sunnyvale, CA.

REGIONAL SALES OFFICES: Western Region, NEC Microcomputers, Orange, CA (714) 633-2980. Eastern Region, NEC Microcomputers, Melville, NY (516) 293-5660.



OPTRON REFLECTIVE OBJECT SENSORS

NEW, LOW COST DEVICES
OFFER HIGH RELIABILITY
FOR NON-CONTACT SENSING

OPTRON's new OPB 706 and OPB 707 reflective object sensors provide solid state reliability at a low cost for non-contact sensing applications.

Ideal applications for the OPB 706 and OPB 707 include detection of edge of paper or cards, EOT/BOT sensing, tachometers, motor speed controls, and proximity detection.

The devices combine a high efficiency solution grown gallium arsenide infrared LED with a silicon N-P-N phototransistor (OPB 706) or maximum sensitivity photodarlington (OPB 707) in a plastic package. The photosensor senses radiation from the LED only when a reflective object is within its field of view.

With LED current of 20 mA, the output of the OPB 706 is typically 750 μ A when the device is positioned 0.050 inch from a 90% reflective surface. Under similar operating conditions, the output of the OPB 707 is typically 35 mA.

A built-in light barrier in both devices prevents response to radiation from the LED when there is not a reflective surface within the field of view of the sensor. With no reflective surface, the maximum sensor output due to crosstalk between the sensor and LED is 0.200 μ A and 10 μ A for the OPB 706 and OPB 707.

The OPB 706 and OPB 707 and other low cost, high reliability OPTRON reflective transducers are immediately available. Custom designed versions are available on request.

Detailed information on the OPB 706 and OPB 707 reflective object sensors and other OPTRON optoelectronic products ... chips, discrete components, optically coupled isolators, and interrupter assemblies ... is available from your nearest OPTRON sales representative or the factory direct.



OPTRON, INC.

1201 Tappan Circle
Carrollton, Texas 75006, USA
TWX-910-860-5958
214/242-6571

People

Cochran seeks standard digital recorder approach

Trade secrets are usually exchanged under the table. So why is Leroy C. Cochran broadcasting the fact that he is giving them away?

Because he is not talking just for his own benefit. The new general manager for audio products at Ampex Corp. in Redwood City, Calif., is willing to disclose proprietary techniques in the hope of spurring interest in a set of standards for digital audio-recording equipment. This new equipment area promises extreme noise immunity for broadcasters and recording houses.

"It's crucial that a sensible standard be adopted before we all go off and do things our own way," says the 39-year-old Cochran, who holds degrees in both electrical engineering and accounting and has spent the last 10 years specializing in accounting. "Unlike the mainframe computer industry, there is no single manufacturer who dominates the recording and broadcasting industry and whose recording scheme could become the tacit standard."

Revealing. What Cochran is doing is to reveal what would usually be considered sensitive and secret information at, for example, technical conferences, in the hope that others will see enough merit in the Ampex approach to copy it. "I've gone out on a limb already by detailing Ampex's method for editing digital recordings," Cochran says. "That scheme represents a lot of money's worth of research and analysis. But I would really hate to see a situation where a recording made on one manufacturer's machine could not be played on another's because of a lack of a standard."

The fight may be hard for Ampex. Another industry heavyweight, 3M Co., has already introduced a commercial digital recording system with its own recording format. At the same time, a second front is shaping up in the Far East, where Sony Corp. may be moving ahead with plans to market a commercial recorder that uses the same format



No secret. Ampex's Leroy Cochran hopes others will like his design enough to use it.

as its consumer digital recorder.

Cochran proposes a pair of standards: one for broadcasting and one for recording. "There are differences that need to be addressed," he explains, "the bit-rate and sampling frequencies for broadcasting must be consistent with efficient communications, whereas the standard for the recording industry must lend itself to maximum manipulation and creativity." Therefore, he thinks that the broadcast standard should have a faster bit rate than the recording industry standard.

Cochran, who joined Ampex in 1973 and now moves up from being controller of his division, sees second-generation prices dropping an order of magnitude from the present \$250,000 within three to five years. As would be expected, the first-generation gear is likely to be grabbed by the major broadcasting networks and recording houses. However, Cochran says some of the smaller independents may buy some just for the "notoriety."

Swystun likes what he sees in I²L and n-channel codecs

Moving from one design career with semiconductor suppliers to another with a semiconductor user, Eugene

TEKTRONIX
thinks your logic analyzer
should be as versatile
as you are

So ours let you connect probes *fast*.



The Harmonica Connector:
fast, convenient probe
connection

Logic analyzer versatility can often mean the difference between spending time on a problem...or on its solution. With some logic analyzers, for example, probe connections can take up to 70% of your time.

A variety of Tektronix probes give you that time back. The patented *Harmonica Connector* eliminates attaching individual connectors to each test point. Our *Quick Connect Probe* allows you to measure

any number of test points, without constantly attaching and re-attaching connectors. Use the *Low Profile Dip Clip* for easy access to integrated circuit pins. There's even a *special probe for the GPIB*. The result is convenience and efficiency that can encourage you to use your logic analyzer more frequently—and make you more productive.

Fast probe connections: they help make our Logic Analyzers versatile. So you

can do today's job and tomorrow's. So you can change applications without changing your logic analyzer.

Contact Tektronix Inc., P.O. Box 500, Beaverton, OR 97077. In Europe, Tektronix Ltd., P.O. Box 36, St. Peter Port, Guernsey, Channel Islands.

Tektronix
COMMITTED TO EXCELLENCE

TEKTRONIX LOGIC ANALYZERS THE VERSATILE ONES

For information, call (503) 251-7222

For demonstration, circle 14

People

Swystun, 36, the new vice president of development for BNR Inc., has some very strong ideas about coder-decoders. He believes that integrated injection logic and n-channel metal-oxide-semiconductor technologies look best right now for codecs.

"I²L should be able to give the chip size you need as well as the speed,"

he says. "But n-channel is *the* technology. It's good for dynamic and static parts." Furthermore, "the VLSI thrust will produce the needed cost reduction. That will happen. There's no doubt about that at all." (Others disagree. (See story on p. 105).

Swystun and his new employer, which is a wholly owned subsidiary

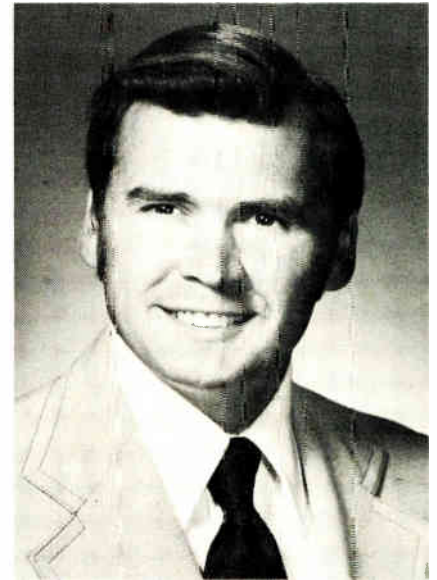

View. Low power really means little in present codecs, says Gene Swystun.

Fill 'er up.



Once you've got your equipment designed, there's always the problem of what to do for an enclosure. You want to be sure that it gets just the right degree of protection and just the right degree of impressiveness at just the right price.

There are two options. You can shop around at a lot of different enclosure companies and try to find a lot of different alternatives. Or you can come to Zero.

At Zero, you'll find the world's most comprehensive source of enclosure capability. You'll find the Centurion Elite™ case, the premium case that gives you the most impressive look you can get in a case that's practically a portable vault.

You'll find the Centurion Logolite™, an economical, lightweight case that you can personalize with your logo.

And you'll find the Centurion Valuline™, the widest selection of economical top-opening instrumentation cases in the world.

Just about any case you can possibly need is already here, in stock, waiting for you to fill 'er up.

ZERO
We make you look good.

Zero Corporation • Burbank, CA 213/846-4191 • Monson, MA 413/267-5561

Circle 16 for "Call Me, I'm Interested."
Circle 169 for "Mail Catalog."

of Bell-Northern Research Ltd., the jointly owned research arm of Northern Telecom Ltd. and Bell Canada, the Canadian phone company, are evaluating codecs from four chipmakers, he says. With a Ph.D. in electrical engineering, he formerly was director of advanced developments at Signetics Corp., which is developing an I²L codec. Before that he was director of memory engineering at American Microsystems Inc. Altogether, he spent about seven years designing and developing semiconductors.

From where he sits, he sees a "critical mass of effort" being put into I²L and n-channel technologies. He does not see nearly the same amount of effort going into another codec contender—complementary MOS—and so tends to discount it.

"C-MOS is a candidate, but the penalty you pay is extra size," he declares. "There's no advantage to the low power consumption that C-MOS offers you in a codec. The edge is with n-channel because it's smaller and cheaper." The low power advantage of C-MOS is useless because telecommunications systems still have a lot of transformers and transistor-transistor-logic parts. "Why reduce power when you have all that junk still hanging around there?" he asks.

See us at WESCON booth #319 and #321

16 Circle 169 on reader service card

Electronics/September 14, 1978

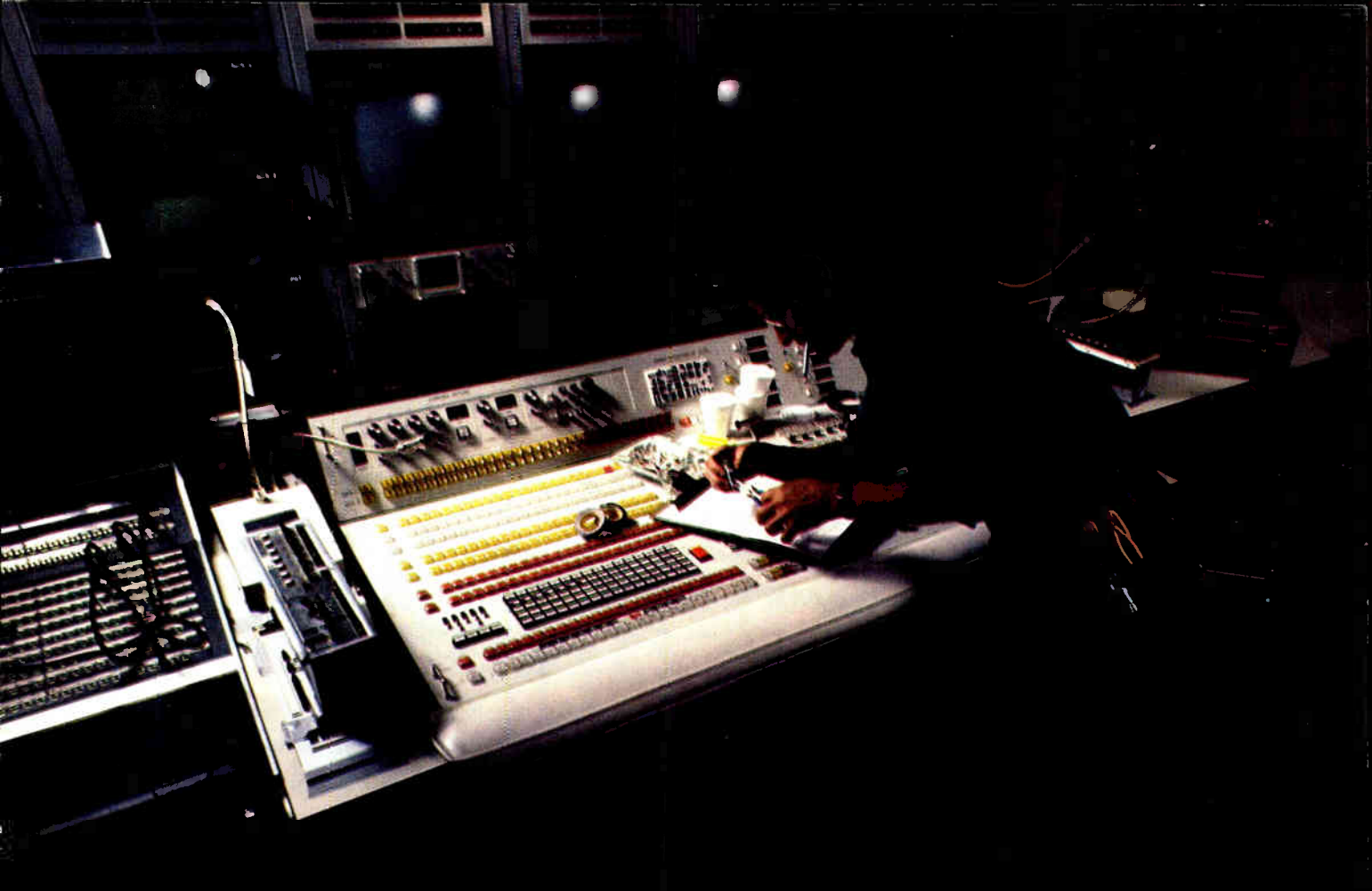

You may not know how expensive a pushbutton really is until months after it's paid for.

The true measure of a pushbutton's cost isn't so much what you pay. It's how many times you pay it.

If you spend less in the first place, you could end up with a higher price tag from what you spend over and over in repair costs and downtime.

That's why it's worth it to specify the

MICRO SWITCH Advanced Manual Line (AML) of pushbuttons, rockers, paddles and indicators. It's the most complete line of manual controls ever offered, designed to save you money from start to finish.

AML is easy to wire, thanks to single-level termination, simple snap-in PC board mounting and sub-panel mounting that uses individual strip or matrix hardware (see inset). The result is low installed cost.

And of course, you get traditional MICRO SWITCH reliability and long life. Which means money savings over the long haul.

No matter how many words you use to describe the broad AML lineup, it all comes

down to just two: cost effectiveness. For a panel that's pleasing to the eye as well as the budget.

If you'd like a personal demonstration just call 815/235-6600.

MICRO SWITCH is also ready to provide you with field engineers for application assistance and a network of authorized distributors for local availability.

AML. It's the closest a line of pushbuttons can come to paying for itself.

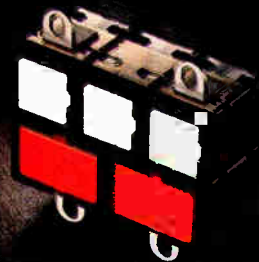

New full-guarded pushbuttons



MICRO SWITCH

FREEPORT, ILLINOIS 61032
A DIVISION OF HONEYWELL

Circle 17 for Data

hp TIME INTERVAL MULTIMETER

LINE OFF ON

2.83



1742A OSCILLOSCOPE (100MHz)
HEWLETT • PACKARD



1743A OSCILLOSCOPE (100MHz)
HEWLETT • PACKARD



1715A OSCILLOSCOPE (200MHz)
HEWLETT • PACKARD



1722B OSCILLOSCOPE
HEWLETT • PACKARD



1725A OSCILLOSCOPE (275MHz)
HEWLETT • PACKARD

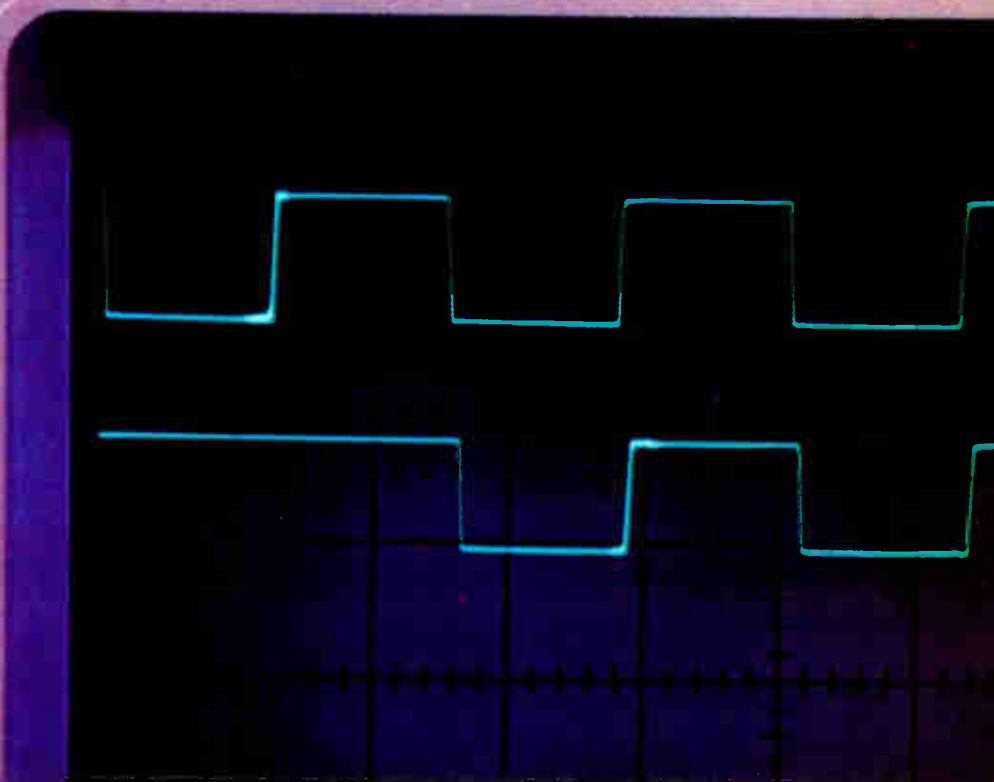

MICROPROCESSOR
CONTROL

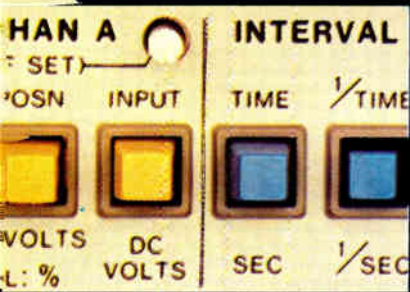

DELTA-TIME
MEASUREMENT

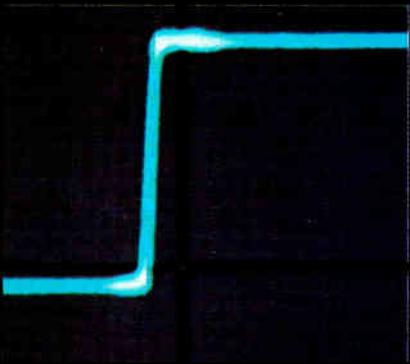

DIGITAL READOUT



OPTIONAL STATE
DISPLAY

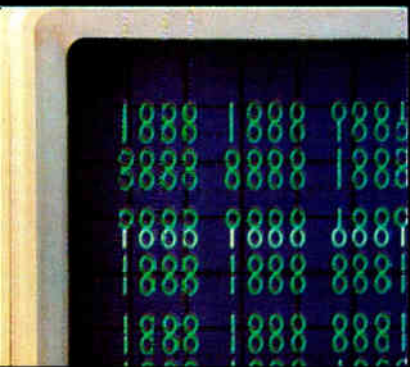

THIRD CHANNEL
TRIGGER VIEW

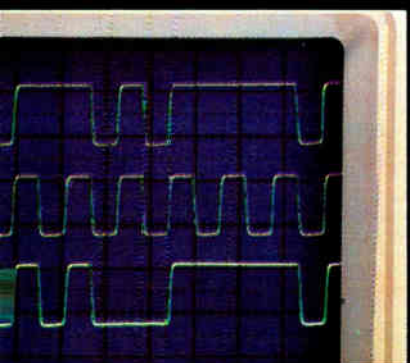

When you want top scope performance plus speed and accuracy in time-interval measurements...

HP's Δ -time family is the Answer.

And a solution to your unique set of measurement problems. With bandwidths up to 275 MHz, crisp dual-trace displays and large screen viewing. Plus advanced Δ -time capability for unparalleled speed and accuracy in time-interval measurements. You'll be able to evaluate transition times, propagation delays, clock phasing and more with greater ease than was previously possible.

Simplified, more accurate measurements. Pulse-period, pulse-width jitter and all digital timing measurements are simplified with the Analog Ramp Δ -time group. By setting the two marker display of start and stop points, signal drift errors are virtually eliminated. And for convenient trace expansion, you can still easily switch to conventional delayed sweep. Choose from the new 100 MHz 1742A with third-channel trigger view (\$2650*); the general purpose 200 MHz 1715A (\$3100*) and 275 MHz 1725A (\$3450*); or the microprocessor-controlled 275 MHz 1722B (\$4900*) which electronically calculates Δ -time, frequency, dc voltage, instantaneous voltage and percent amplitude measurements.

Crystal-controlled accuracy. For precision measurements (to 0.002% ± 1 count at 15° to 35°C) in lab and field applications, consider the crystal-referenced 100 MHz 1743A (\$3300*). It simplifies your tasks by making time measurements automatically, even dynamic timing measurements. Our exclusive triggered Δ -time mode eliminates the need for scope control adjustments.

Just select your start and stop points, then read the time interval directly from the five digit LED display. You'll find it a real plus in

set-up and production service. And for that augmented insight into digital systems, the third-channel trigger view shows clock/data line activity in relation to the trigger signal.

Pushbutton troubleshooting. You can enhance the operation of any family member with HP's Logic State Switch option. This gives you pushbutton selection of either a time domain or data domain display when used with HP's 1607A Logic State Analyzer. It's a sanity saver when designing or trouble-shooting logic circuitry.

Rounding out HP's Δ -time family are the features you expect from a high-performance oscilloscope. Like a human engineered front panel and switch selectable 50 ohm/1 megohm input impedance.

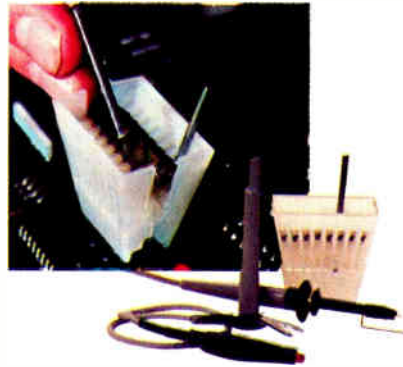

Plus HP's **Easy IC Probes** which help you avoid shorting hazards and improve closely spaced probe connections.

User benefits and convenience are what the Δ -time scope family is all about. Call your local HP field engineer today for more details.

* Domestic U.S.A. price only.



HEWLETT  PACKARD

1507 Page Mill Road, Palo Alto, California 94304

For assistance call: Washington (301) 948-6370, Chicago (312) 255-9800, Atlanta (404) 955-1500, Los Angeles (213) 877-1282

Circle 19 on reader service card

088-9

Intel's 2147 is with volume availability



Intel's 4K static RAM, the 2147, is the industry standard for high speed, low power memory design, delivering access times to 55ns with traditional MOS economy. Now there are new military and even lower power versions, too. And all 2147 components are available now to support volume production.

From the start, designers have been attracted to the 2147's low active power dissipation and automatic power down on deselection. In stand-by mode, the 2147 can dramatically reduce overall power consumption compared to systems where all components dissipate constant power. It allows you to substantially simplify design of cache, fast buffer, control store and even large main memories. And since we've widened supply tolerance from $\pm 5\%$ to $\pm 10\%$, design is easier and even more economical.

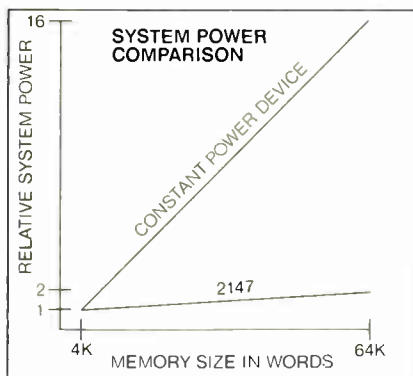

Now our new 2147L low power version takes you a step further, with maximum standby current of just 10 mA—about 1/10th that of bipolar 4K static RAMs.

There is a new military version, too, manufactured in

total compliance with MIL-STD-883B, Level 5004 and 5005 specifications. It gives you 2147 performance over the full mil temp range and is offered in three levels of product assurance: Level B, Level C and Extended Temperature Range.



here in force, and two new versions.



HMOS is the key to the 2147's high producibility, high speed, high reliability and low power. It's the high performance technology we pioneered with our 2115A/2125A 1K static RAMs. And it has led to such dramatic advances as our 8086 16-bit micro-computer. We've delivered millions of HMOS devices, a proven track record of volume availability.

	2147	2147L	2147-3	M2147
Max. Access Time (ns)	70	70	55	85
Max. Active Current (mA)	160	140	180	180
Max. Standby Current (mA)	20	10	30	30
Operating Temperature Range (°C)	0-70	0-70	0-70	-55 to +125

HMOS means reliability, too. We've already matched the dependability of our long-time standard 1K static RAM, the 2102A. Get the details in our comprehensive Reliability Report #18.

The 2147 uses the widely accepted 18-pin, 4K x 1 standard pinout. It's fully static and can be used in both clocked and unclocked systems. All versions are directly TTL compatible in all respects: inputs, outputs and operation from a single +5V supply.

Order 2147's directly from your Intel distributor. Or, for more information, contact your local Intel sales office or write: Intel Corporation, 3065 Bowers Avenue, Santa Clara, CA 95051.

intel® delivers.

Europe: Intel International, Brussels, Belgium, Telex 24814.

Japan: Intel Japan K.K., Tokyo, Telex 781-28426.

U.S. and Canadian Distributors: Alliance, Almac/Stroum, Component Specialties, Cramer, Hamilton/Avnet, Harvey, Industrial Components, Pioneer, Sheridan, Wyle/Elmar, Wyle/Liberty, L.A. Varah or Zentronics.

Circle 21 on reader service card

Allen-Bradley Electronic Components: We have what you need.

**Our distributors have
them when your
need is now.**

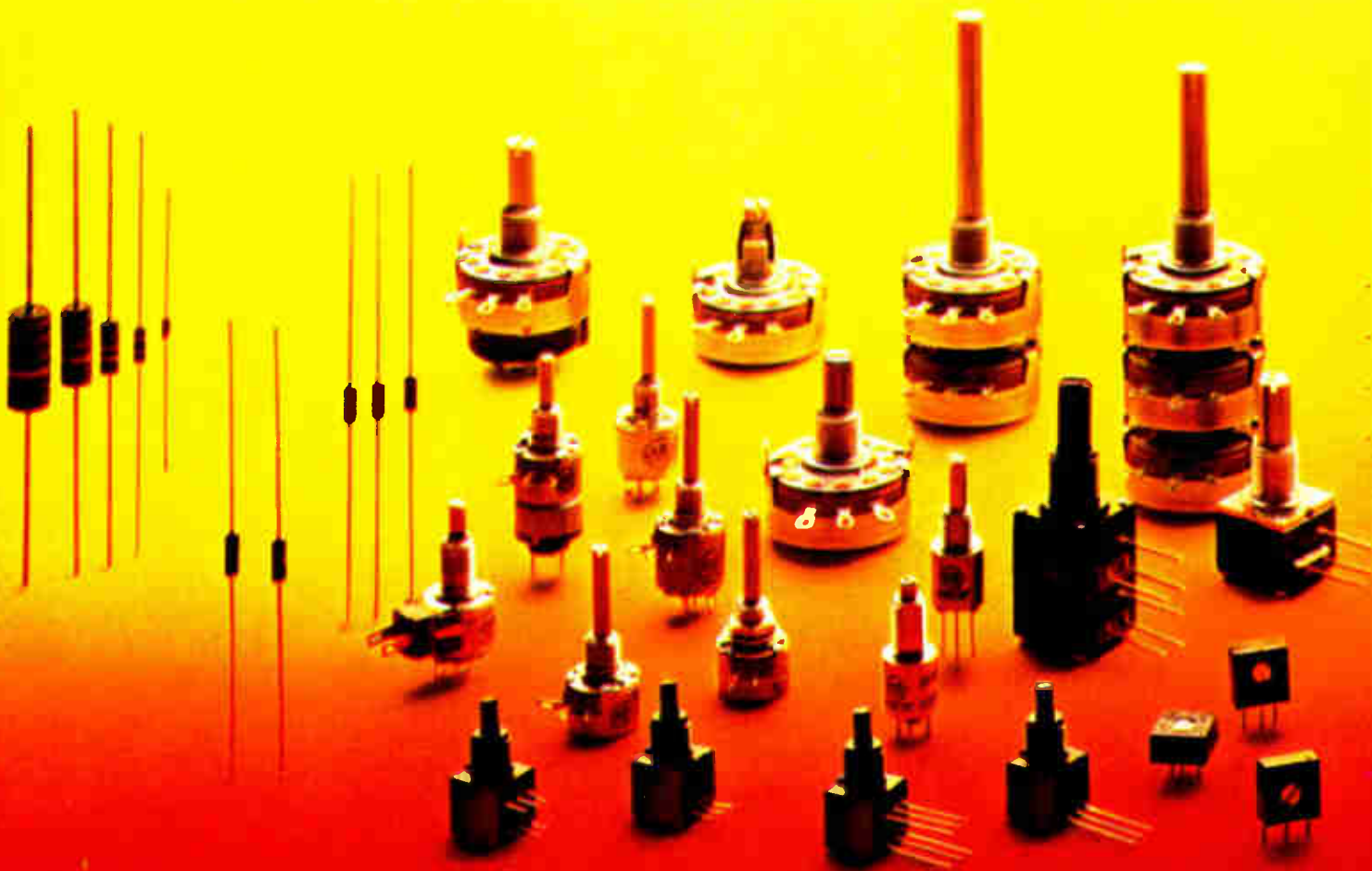

FIXED RESISTORS



Type BB, CB, EB, GB, HB: Hot molded. 1.0 ohm to 100 megs. Tolerance $\pm 5\%$, 10% , 20% . $\frac{1}{8}W$, $\frac{1}{4}W$, $\frac{1}{2}W$, $1W$, $2W$ at $70^\circ C$. Pub. EC21.



Type CC: Cermet film. 10 ohms to 22.1 megs. Tolerance ± 0.5 and 1% . TCR ± 50 and ± 100 PPM/ $^\circ C$. $\frac{1}{8}W$ at $125^\circ C$. $\frac{1}{4}W$ at $70^\circ C$. $\frac{1}{2}W$ at $70^\circ C$. Pub. EC33.



Type FM: Metal film. 20 ohms to 357K ohms. Tolerances from $\pm 1\%$ to $\pm 0.05\%$. TCR ± 25 , ± 15 and ± 10 PPM/ $^\circ C$. $\frac{1}{4}W$ at $70^\circ C$. $1/10W$ at $125^\circ C$. Pub. EC54.

RESISTOR NETWORKS



I-DIP: Thick film (Cermet). 10 ohms to 1 meg. Tolerance to $\pm 1\%$. TCR to ± 100 PPM/ $^\circ C$. 542 standards, 14 and 16 pins. Pull-ups, ladders, terminators, O-pads. 18 pin and user trimmable options. Pub. 5840.



Thin Film: Custom packages and chips. Chrome/cobalt film. Tolerance to $\pm 0.015\%$. TCR ± 25 PPM/ $^\circ C$. Tracking to ± 5 PPM/ $^\circ C$. Ladders, dividers, customs.

POTENTIOMETERS



Type J: $1\frac{1}{2}$ " diameter. Hot-molded. 50 ohms to 5.0 megs. 2.25W at $70^\circ C$. 100,000 cycle rotational life. Single, dual, triple sections. SPST switch optional. Pub. 5200.



Series 70: $\frac{3}{8}$ " square MOD POT.* Hot-molded, cermet, conductive plastic. 50 ohms to 10 megohms. 100,000 cycle rotational life. Single, dual, triple, quad sections. Options include switches, vernier drives, concentric shafts. Pub. 5217.



Type G: $\frac{1}{2}$ " diameter. Hot-molded composition. 100 ohms to 5.0 megs. 0.5W at $70^\circ C$. 50,000 cycle rotational life. SPST switch optional. Many other options. Pub. 5201.



Type M: 10.0 MM (.394") cube. Conductive plastic element. 100 ohms to 1.0 meg. 25,000 cycle rotational life. Single, dual sections. Switches optional. Case, bushing, shaft are non-metallic. Pub. 5239.

TRIMMERS



Type A: $\frac{1}{4}$ " diameter, single turn. 10 ohms to 2.5 megs $\pm 10\%$. 0.5W at $85^\circ C$. Immersion sealed, 6 terminal options. TCR ± 35 PPM/ $^\circ C$ typical. Pub. 5238.



Type E: $\frac{3}{8}$ " square, single turn. 10 ohms to 2.5 megs $\pm 10\%$. 0.5W at $70^\circ C$. Immersion sealed, 14 terminal options. TCR ± 35 PPM/ $^\circ C$ typical. Pub. 5219A.



Type D: $\frac{3}{8}$ " dia., single turn. 10 ohms to 2.5 megs $\pm 20\%$. 0.5W at $70^\circ C$. Dust cover, 8 terminal options. TCR ± 35 PPM/ $^\circ C$ typical. Pub. 5240.



Type RT: $\frac{3}{4}$ " long, 20 turn. 10 ohms to 2.5 megs $\pm 10\%$. 1.0W at $40^\circ C$. Immersion sealed, 4 terminal options. TCR ± 35 PPM/ $^\circ C$ typical. Pub. 5237.

These products are typical of a complete line of Allen-Bradley quality electronic components. You get fast off-the-shelf delivery on standard and many special items from your Allen-Bradley distributor. For complete facts, write for Pub. 6024.

Quality in the best tradition.



ALLEN-BRADLEY

Milwaukee, Wisconsin 53204

EC168

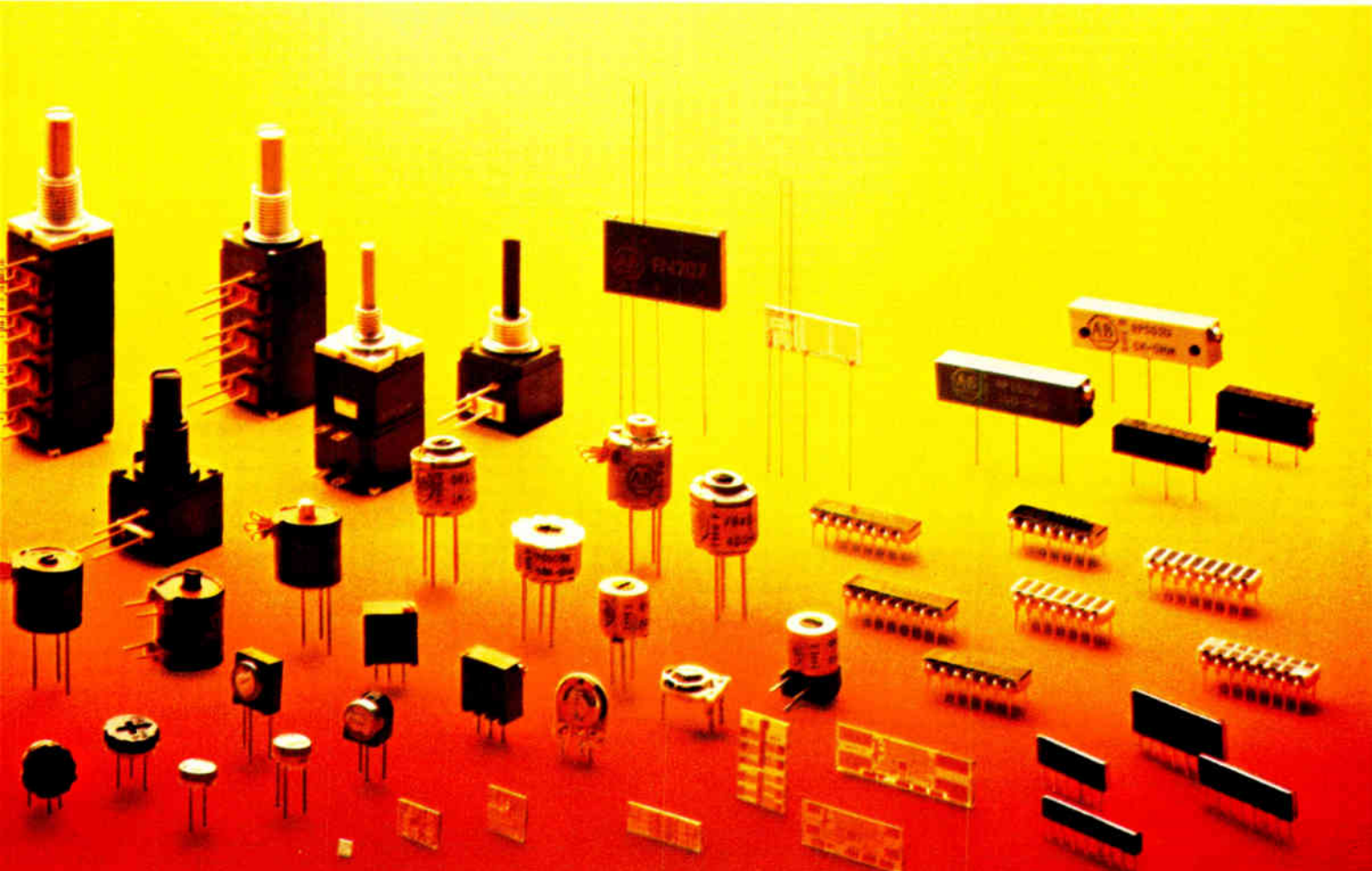

Will video-text systems travel well?

There is a sleeping giant lurking out there, and it would be well for Americans to start getting used to the idea that one day they may be asked to have it in their homes and offices. It goes by different names in different countries—the British call it Viewdata, the French have dubbed it Antiope, and, on this side of the Atlantic, the Canadians have yet to christen their upcoming system.

What all of them are is video-text information services, and the British and French, at least, are busily getting a jump on the rest of the world by industriously selling their approaches to other nations. The British Post Office to date has invested close to \$20 million in Viewdata and has sold the software—the guts of all the systems—to the West German and Dutch post offices. The French, who started later than the British and say that they therefore have benefited from their rivals' experience to produce a more flexible arrangement, are pushing to have Antiope adopted as the European standard teletext system.

All this is very well, but where does the U. S.—and, by the way, Japan—come into it? Right now, virtually nowhere. While it is possible to obtain some cable-television information about the stock market, weather, time, fruit and vegetable prices, and the like, such data presentation is archaic compared to video-text systems because the viewer cannot dial up for it.

Some watchers of the telecommunications industry are beginning to wonder nervously about the absence of technology giants like America and Japan, particularly now that

Canada, too, has announced that it will dip its toe into the water next year with a pilot link using telephone lines. AT&T says it has no present plans to test such a system; it may be presumed that the Japanese, a people whose keen interest in mass circulation of facts has made facsimile a commonplace, are watching developments and seriously considering the options available to domestic telecommunications companies.

But does Ma Bell know something about the American market that the others don't? It is within the realm of possibility that Americans are getting just a bit oversold on and underinterested in magical technological systems for the home. Take, for example, video cassette recorders: sales this year will reach about two thirds of what was predicted—500,000 units versus 750,000—though the industry is hopeful that things will improve. Even video games seem to have settled quietly into a post-shakeout mode. And all the *Brave New World*-ish talk about home computers is little more than just that—talk.

The big question, then, revolves around the mood of the American consumer, the condition of the dollar, and inflation. Just how anxious is the average person to dial up for news, advertisements, and the like, most of which are found on commercial TV? Will Bell take the plunge, or will it be left for some hardy telecommunications pioneers to hitch their wagons to the concept of video-text information services and ride off in search of fame and fortune? Or is it back to newspapers?

NEW . . . Simple, economical picoampere measurement!



Model 480

DON'T GUESS . . . MEASURE leakage currents and semiconductor parameters with dmm ease.

SENSITIVITY DMM'S CAN'T MATCH!

Stable resolution of 1 picoampere provides 4 decades greater sensitivity than most dmm's. Seven ranges cover the full span of low-current measurements.

ACCURACY DMM'S CAN'T MATCH!

Less than 0.2mV input voltage drop

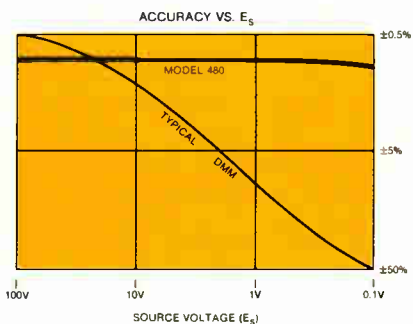

(burden) keeps Model 480 from disturbing the circuit under test. This significant improvement over dmm's maintains accuracy throughout semiconductor voltage levels.

EASY TO USE!

The well-protected input is readily connected into any low-current loop. High normal-mode rejection keeps line frequency interference (often found in low-current circuits) from affecting the measurement. High common-mode rejection and an isolated input permit in-circuit measurements.

LOW COST - \$329!

Priced to be cost-justifiable for each location where low-current measurements are made. Saves time, saves money.

NECESSARY FOR BIFETS.

Taking advantage of BIMOS/BIFET technology requires leakages be reduced to picoampere levels.

CALL NOW.

Find out how Keithley's 480 can aid your design. Also ask about our extensive dmm line — from \$199 for 4½ digits!

TOLL FREE: 800-321-0560

In Ohio call (216) 248-0400

Keithley Instruments, Inc., 28775 Aurora Road, Cleveland, Ohio 44139, U.S.A. (216) 248-0400. In Europe: Heiglhofstrasse 5, D-8000 München 70, West Germany. (089) 7144065.

Keithley...
The best value in DMMs.

KEITHLEY

Circle 25 on reader service card

depend- ability

Our customers just plug in our power supplies and forget about them. Fortunately, these same customers don't forget about us. Which helps to explain why we are now the world's largest manufacturer of SCR supplies.

In a word: dependability. In another word: reliability.



One- and three-phase rack-mounted power supplies from 500 to 10,000 watts. Call TOLL FREE 800-631-4298 for complete information and prices, or write for our catalog.



ELECTRONIC MEASUREMENTS INC.

405 Essex Road, Neptune, N.J. 07753
Phone: (NJ, HI, AK) 201-922-9300. TOLL FREE 800-631-4298
Specialists in Power Conversion Equipment

Meetings

Eascon—Electronic and Aerospace Systems Convention, IEEE, Sheraton International Hotel, Arlington, Va., Sept. 24-27.

Distributed Data Processing, AIAA, Ramada Inn-Rosslyn, Washington, D. C., Sept. 25-26.

Convergence 78—International Conference on Automotive Electronics, Society of Automotive Engineers (Warrendale, Pa.), Hyatt Regency Hotel, Dearborn, Mich., Sept. 25-27.

ISHM 78, International Society for Hybrid Microelectronics (Montgomery, Ala.), Radisson Hotel, Minneapolis, Sept. 25-27.

International Electrical Electronics Conference and Exposition, IEEE, Automotive Building, Toronto, Sept. 26-28.

MEDE 78—Military Electronics Defense Exposition, Kiver Communications SA (Millbank House, Surbiton, Surrey, England), Rhein-Main Halle, Wiesbaden, West Germany, Oct. 4-6.

Land-Mobile Telecommunications Symposium, National Research Council (2100 C St. N.W.), Washington, D. C., Oct. 5.

ISA/78 International Conference and Exhibit, Instrument Society of America, Philadelphia Civic Center, Philadelphia, Oct. 15-19; with the Joint Automatic Control Conference, Oct. 18-20.

NCF-NEC/78—National Communications Forum and National Electronics Conference, National Engineering Consortium, Inc. (Oak Brook, Ill.), Hyatt Regency O'Hare Hotel, Chicago, Oct. 16-18.

1978 Design Automation Workshop, IEEE, Michigan State University, East Lansing, Mich., Oct. 18-21.

Engineering in Medicine and Biology, IEEE, Marriott Hotel, Atlanta, Oct. 21-25.

What the learning curve has done for Mostek's 16K RAM.

Learning curve experience has made Mostek the leader in dynamic RAM production, reliability and performance. Now, Mostek introduces the MK4116-2, industry's fastest 16K RAM, at just 150ns access time and 320ns cycle time.

The new 4116-2 offers all the features found in Mostek's industry standard 16K RAM family. In addition, for flexibility in system design, VBB power supply now operates over the range of -4.5 volts to -5.7 volts allowing -5 volt operation with TTL, or -5.2 volt operation with ECC systems.

Mostek's MK4116-2 is available now. With over two year's production experience,

Fast access				
	Access Time	Cycle Time	Active Power (MAX)	Standby Power (MAX)
MK4116-2	150ns	320ns	482mW	30mW
MK4116-3	200ns	375ns	462mW	20mW
MK4116-4	250ns	410ns	462mW	20mW

Mostek has built more 16K RAMs than any other supplier. And this production momentum is now solving the industry shortage of 16K RAMs.

Comprehensive performance and environmental testing ensure reliability in your system. Every 16K RAM we ship is thoroughly tested to rigorous screens and stresses.

Take advantage of Mostek's industry standard performance and reliability now. Call or write: Mostek, 1215 West Crosby Road, Carrollton, Texas 75006; Telephone 214/242-0444. In Europe, contact Mostek GmbH, West Germany; Telephone (49) (0711) 701045.

MOSTEK.

Mostek's one-chip Codec. The low power answer to digital-voice-switching.



An. Only

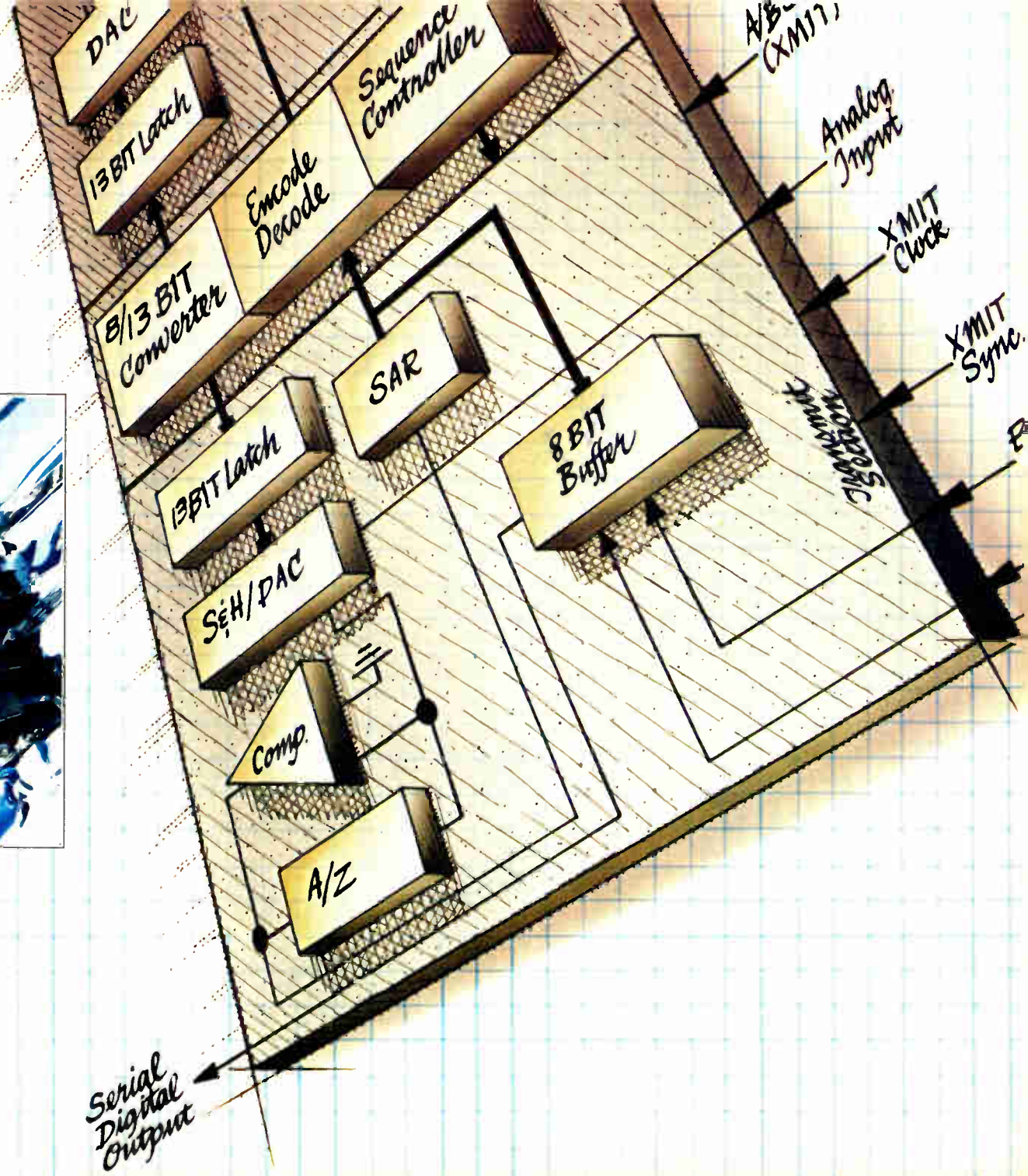

Designed to offer industry's lowest operating power, Mostek's new family of Codec integrated circuits is available now. This new CMOS family also features single-chip operation, a choice of 16 or 24-pin packages and a variety of on-chip functions.

30mW power dissipation

Operating power for Mostek's Codec family is a low 30mW (typ). Power supply operation of $\pm 5V$ and the elimination of pull-up resistors through TTL-compatibility further enhance

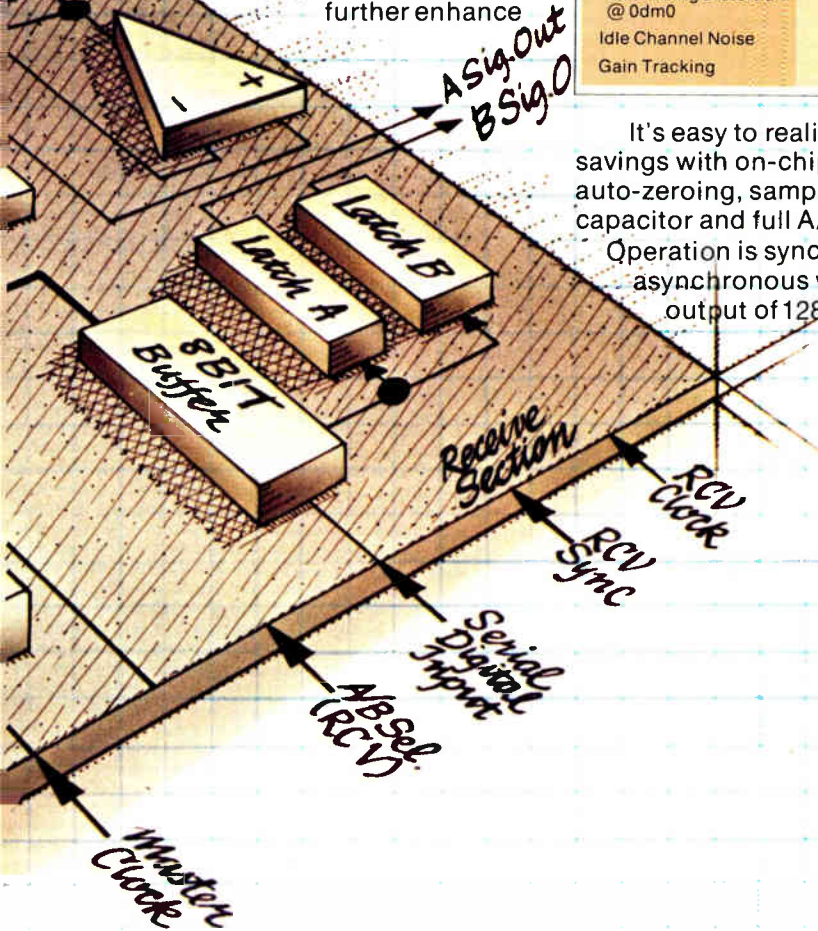

low power considerations. With the thousands of codecs required in applications like PCM Channel Banks and PBX Systems, the low power advantages of economy and reliability are essential.

Mostek's Codec family

	MK5150	MK5155	MK5116
Power (Active)	30mW typ	30mW typ	30mW typ
Pins	24	16	16
Type	μ -Law	A-Law	μ -Law
Full A/B Signalling	Yes	No	No
Asynchronous Operation	Yes	Yes	Yes
Supply Voltage	$\pm 5v$	$\pm 5v$	$\pm 5v$
Reference Voltage	$\pm 2.5v$	$\pm 2.5v$	$\pm 2.5v$
Signal to Quantizing Distortion @ 0dB0	40 dB typ	40 dB typ	40 dB typ
Idle Channel Noise	12 dBm cO	-85 dBm Op	5 dBm cO
Gain Tracking	± 0.1 dB	± 0.1 dB	± 0.1 dB

It's easy to realize system savings with on-chip features like auto-zeroing, sample-and-hold capacitor and full A/B signalling. Operation is synchronous or asynchronous with serial data output of 128KHz-2.04MHz.

Industry's smallest package

Mostek's two newest codecs are available in space saving 16-pin packages. The MK5116 (μ -Law) and the MK5155 (A-Law) meet domestic and international needs in applications like D3, T1 carrier, pair gain, PBX, C.O. and more. The 16-pin codecs are especially suited for PBX applications that do not require signalling. To further reduce system complexity, compatible filters are coming soon

from Mostek—the leader in telecommunication technology.

For more information on Mostek's low power codecs and the full communication family—tone/pulse dialers, tone receivers, and repertory dialers—contact Mostek, 1215 West Crosby Road, Carrollton, Texas 75006; Telephone 214/242-0444. In Europe, contact Mostek Brussels; Telephone (49) (0711) 701045.

MOSTEK®

“AMP has a better angle for board-to-display connections. The Laminar System”

It's the reliable way to connect glass and ceramic substrate displays. By utilizing insulating film instead of molded housings, Laminar connectors eliminate mechanical stresses caused by display or housing warp. Each contact can track the display surface without applying any bending force, thereby reducing the likelihood of damage.

Laminar connectors match applications. There are clip-solder types for mounting angles of 0 to 90 degrees and clip-to-clip types for popular contact centerlines and board thicknesses. With many hundreds of configurations available, you won't have to compromise your design to fit the connector.

Wherever you use them, Laminar connectors mean extra economy. Since conventional molded housings are not necessary, costs are substantially reduced. In addition, they are available with economical tin-plated, as well as gold-plated contacts.

Laminar connectors also mean superior reliability. Because their contact design provides proper normal force to assure good electrical connection, even with the deposited circuitry on glass displays.

There are more good reasons why you should try the AMP Laminar System, not the least of which is AMP engineering service and support. It means over 2,000 scientists, engineers and aides around the world are available to help you. In production. In quality control. In prototype sampling. And wherever you need higher performance products and lower installed costs.

AMP Laminar connectors are already available in a broad variety of pre-formed shapes, and custom designs can be made to your special order. For complete information on the entire line, just call Customer Service at (717) 564-0100. Or write AMP Incorporated, Harrisburg, PA 17105.

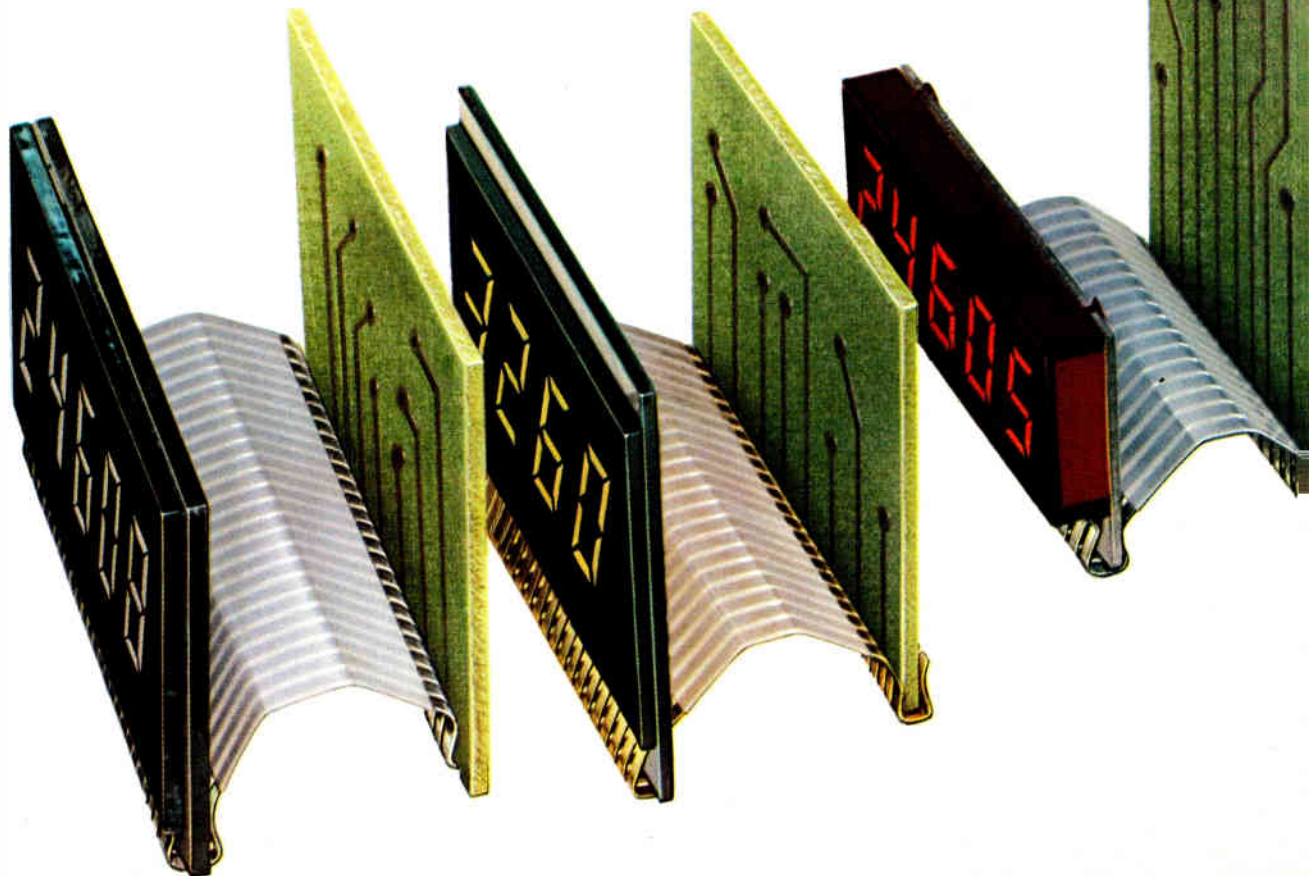



AMP has a better way... The Laminar System.

The clip-solder type of Laminar connector has a lot of packaging flexibility. It not only provides board-to-display connection in a full variety of angles from 0 to 90 degrees, but also, with its solder tyne construction, allows mounting virtually anywhere on a pc board without sacrificing valuable board real estate.

AMP is a trademark of AMP Incorporated.

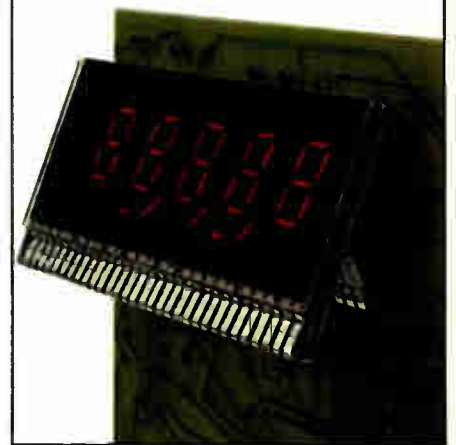

SEE US AT
ELECTRONICS SHOW, LJUBLJANA

AMP

INCORPORATED

Circle 31 on reader service card

PLUG-INS

HIGH PERFORMANCE IN SCOPES

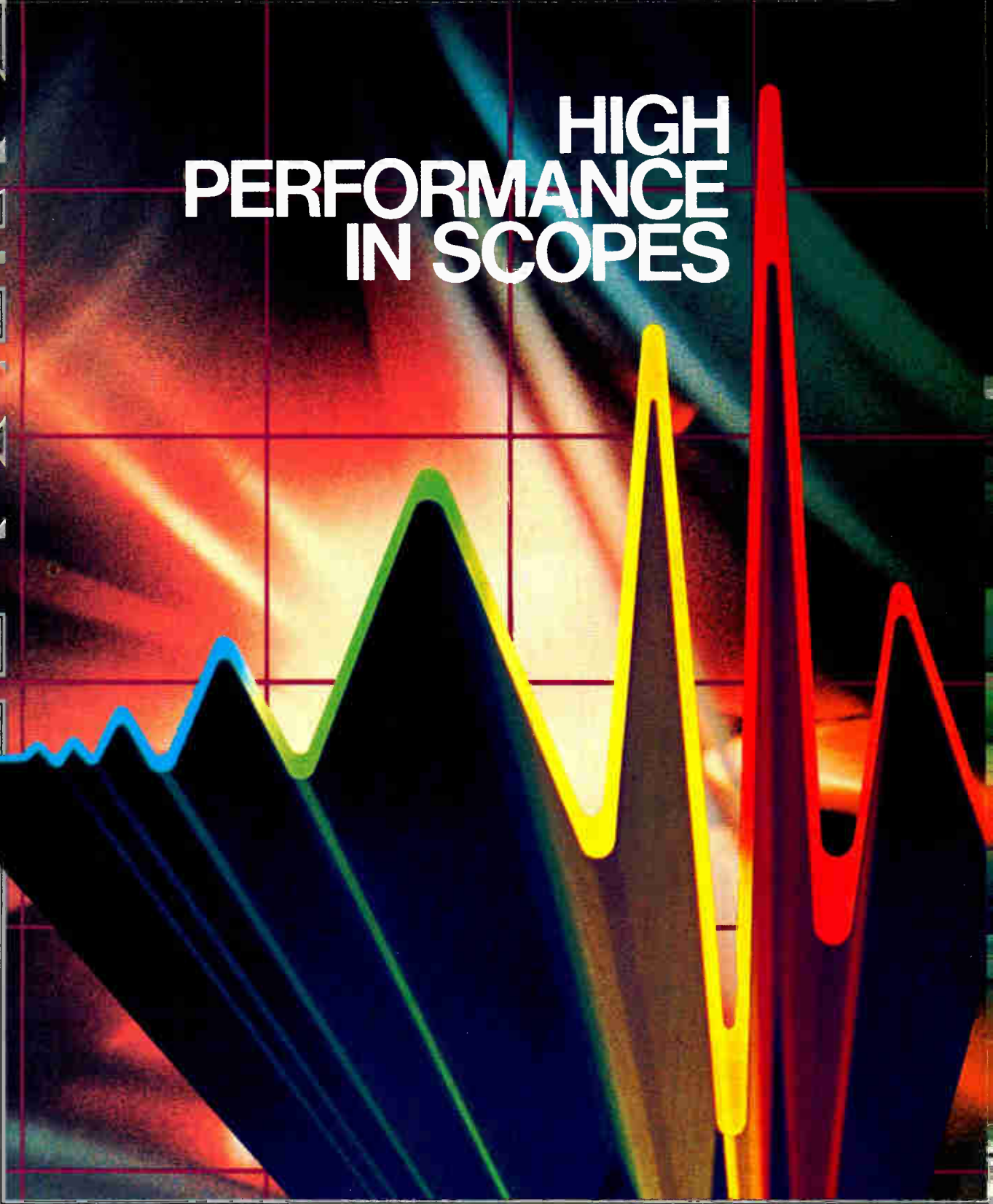

Measure with confidence. Every time.

Tektronix plug-in oscilloscopes stand at the forefront of modern measurement capabilities. And with good reason. Our tradition of innovative excellence has always been aimed at the best performance possible.

Each measurement situation creates its own unique demands. With this thought in mind, we've pushed toward new limits in all aspects of scope technology. The widest real-time bandwidth. The fastest usable writing speeds. Multiple storage modes. Interactive analog-digital capabilities. Dual beams in a single crt. High sensitivity differential amplifiers. And much more.

No matter what your measurement situation, we offer a 5000 or 7000 plug-in oscilloscope that fits. From circuit design to plasma physics research. From balancing rotating machinery to measuring the accuracy of D to A converters. With every scope representing the same superior research and engineering.

Where is your own measurement situation headed? We'd like to help with your future. Contact us. Write:

Laboratory Oscilloscopes
Marketing Dept. 39/327
Tektronix, Inc.
P.O. Box 500
Beaverton, Oregon 97077

Tektronix[®]
COMMITTED TO EXCELLENCE

For Technical Data circle #32

For Demonstration circle #255

Hitachi working on plug-compatible EE-PROMs

American chip makers may have promised them, but it looks as if Hitachi Ltd. will be first to deliver EE-PROMS compatible with microprocessor systems. Already demonstrated in the lab is a 2,048-bit EE-PROM—electrically erasable programmable read-only memory—**that has the attributes U. S. chip makers are looking for:** single +5-v operation with E-PROM-compatible 25-v write and erase, blinding 100-ns access time, and a tiny cell size: 17.5 by 17 μm . Next year, Hitachi plans to bring out a 16-K EE-PROM that, like its 16-K static random-access memory, is interchangeable with the industry-standard 2716 E-PROM.

Intel produces one-chip filter for codec

Already supplying customers with one-chip coder-decoders for the growing digital telecommunications market [*Electronics*, April 13, p. 77], Intel Corp. is now shipping monolithic filters made with n-channel MOS technology to customers (see p. 48). The 2912 pulse-code-modulation line device sits between the codec and the two-wire-four-wire hybrid, or subscriber-loop interface circuit (SLIC), which links the four-wire transmission circuitry to the two-wire connection to the telephone. The 16-pin 2912 has a transmitting filter with 50-HZ and 60-HZ rejection and a receiving filter, gain adjustment in both directions, and **compatibility with U. S. and European standards.** The Santa Clara, Calif., company claims low power consumption for the device: maximum ratings are 290 mw with an electronic SLIC, 440 mw with a hybrid, and 74 mw in power-down.

Codec from AMD to make debut

Look for Advanced Micro Devices Inc. of Sunnyvale, Calif., to join the codec parade when it starts shipping samples of a two-chip codec within a month or two (see p. 105). **“Our pin-programmable μ - or A-law codec is designed to handle two channels at a time,”** says Russ Apfel, linear systems and applications engineering manager. Both n-MOS and bipolar technologies are used. The n-MOS chip is 15,000 square mils and is made with five masks; the bipolar one measures 10,000 square mils and is made with seven masks. Both are in 24-pin packages.

Top IBM scientist asks for unregulated ACS service

In what is being viewed as a major policy statement, Lewis Branscomb, vice president and chief scientist at IBM Corp., has called for the deregulation of so-called value-added carriers. Specifically citing AT&T's recently proposed Advanced Communications Service [*Electronics*, Aug. 3, p. 79], Branscomb says the fact that Bell proposes to offer ACS over the existing regulated Data Phone Digital Service “indicates there is a line between regulated pure transmission services and value-added services. **AT&T should be allowed to offer the value-added features of ACS on a competitive and unregulated basis.**” Branscomb was keynote speaker at the IEEE Comcon '78 fall meeting in Washington, D. C.

256-K bubble memory due from National

Not wanting to be left in the dust following announcements by Rockwell International Corp. (see p. 161) and Texas Instruments Inc. of 256-kilobit magnetic-bubble memories [*Electronics*, Aug. 17, p. 39], National Semiconductor Corp. is releasing details of its 256-kilobit part, due in sample quantities at the end of 1979. Called the NBM 2256, the 16-pin design follows current thinking in having a block-replicate approach with chevron patterns. **But the part will have extra redundancy and an on-chip error**

map to ensure **256 good loops of 1,024 bits each**. Target specifications include 3- μ m bubbles, access time of less than 7 ms, a shift rate of 100 kHz, and power dissipation of less than 1 w.

At the same time, Sperry Rand Corp.'s Sperry Univac division reports it has fabricated a 256-k bubble-memory chip, housing a 2.7- μ m bubble. The chevron-shaped device will operate at 200 kHz and uses the block-replicate architecture that greatly reduces memory cycle time over the major-minor-loop approach. The Blue Bell, Pa., computer maker is fabricating bubble devices to determine the architecture best suited for its purposes and to compare its costs and margins with what vendors offer. Sperry Univac is interested in bubbles for terminals, minicomputers, and communications processors.

HP pushes GaAs FET into 18-to-26-GHz area

Hewlett-Packard Co. has raised the frequency ceiling on gallium-arsenide field-effect transistors to the K-band region of 18 to 26 GHz. Moreover, HP designers reported at this month's eighth European Microwave Conference in Paris that **they believe that the 26-to-48-GHz band may be obtainable**. The GaAs FET has a gain of 9.8 dB at 18 GHz and an extrapolated maximum frequency of 80 GHz in a broadband oscillator circuit. The 200-mw device is in pilot production in Santa Rosa, Calif., and is expected to offer a neat transistor solution to conventional circuitry built around Impatt or Gunn diodes for such applications as microwave sweep oscillators and signal generators. The device is made with silicon ion-implanted into a GaAs substrate to form both the channel and n⁺ contact layer.

New top capacity coming from CDC in large disks

Using an enhanced version of what is frequently called IBM 3350-type technology, Control Data Corp.'s peripherals operation in Minneapolis is readying for introduction this week **a fixed-media hard-disk drive with a capacity of 635 megabytes per spindle**. When marketed as an IBM-compatible drive, the unit will be configured to appear to the system as two logical volumes of 317.5 megabytes each—the largest capacity currently offered by IBM on its 3350s.

Work under way at GI on 1980 microcomputer

Intent on having a second-generation family of 16-bit microcomputer devices available by mid-1980, General Instrument Corp.'s Microelectronics group is **now defining the advanced central processing unit and associated chips**. The Hicksville, N. Y., group expects a decision before year's end on one of several choices: strike out on its own development program for a multichip set, second-source another firm's multichip microcomputer but add a little extra, or either develop or second-source a single-chip microcomputer. The first is the least likely option, notes Frank Jelenko, marketing manager.

Computer scientists to view technology of the Chinese

A group of 15 computer scientists will leave at the end of September on the first formal group visit to the People's Republic of China to view Chinese computer technology. **At the invitation of China's engineering society**, the Institute of Electronic and Electrical Engineers is coordinating the tour. Its leader is Merlin Smith of IBM Corp.'s Thomas J. Watson Research Center in Yorktown Heights, N. Y., and president of the IEEE Computer Society.

MACRO PERFORMANCE FROM UNITRONIX



ON MICROCOMPUTERS LSI-11's, TERMINALS & WORD PROCESSORS FROM **digital**

When you need microcomputers, you need them now — whether it's one module or an entire system. Our inventory of DEC systems and components can help you meet the tightest production schedule. We handle the complete line of DEC LSI-11/2 and 11/03 products for immediate delivery.

- Call UNITRONIX for
- discounts, delivery and individual service — regardless of quantity
 - Software support
 - Systems for business, industry and laboratories
 - Custom configurations



PDP11/03 Systems with RXV11 floppy disc drive or the new DEC RL01 5 MB hard disc drive



Terminals — VT-52, VT-55, New VT-100, LA-35, LA-36, LA-120, LA-180, LAV-11, PDT-11

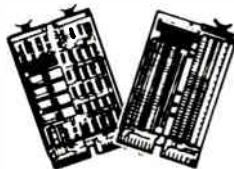

LSI-11 Modules



Word Processors — WT-78 Systems with business applications

Call UNITRONIX for fast, dependable service and a complete selection of the latest microcomputer products from DEC. Send for FREE INFO KIT.



UNITRONIX

CORPORATION

198 Route 206, Somerville, N.J. 08876 ■ (201) 874-8500

digital and DEC are registered trademarks of Digital Equipment Corporation

What's the difference precision V-F converter About \$77.

between our and everybody else's?

We'll tell you about our LM 331 converter family. Then you decide how much you ought to pay.

First, the LM 331 guarantees worst case 0.01% non-linearity.

Next, the LM 331 operates from 4 to 40 volts with no loss in performance. So it'll run in any system.

What's more, our LM 331 has a temperature drift of 50ppm/°C max. And there are even more parameters that will amaze you.

Now. How much should you pay for a precision V-F converter that does all this? \$80? No. National's volume production expertise and linear leadership gets you \$80 performance for just \$3.

With all the flexibility we've built in at a price like this, you can use our converters as A/D converters, to solve system isolation problems, in sweep generators, phase locked loops, as F-V converters, in precision tachometers; in just a whole bunch of applications you may not have considered before.

When you send in the coupon below, we'll fill you in further on the details.

National Semiconductor Corporation	E9/14
2900 Semiconductor Drive	
Santa Clara, CA 95051	
Gentlemen: If what you've told me about your high-accuracy V-F converters is accurate, I'd like to know more.	
Name _____	
Title _____	
Company Name _____	
Address _____	
City _____ State _____ Zip _____	

 **National Semiconductor**

POWER DIVIDERS

Broadband, 0.5 — 4.2 GHz • Only 0.2 dB insertion loss
Isolation over 30 dB midband, 25 dB at bandedges • Octave bandwidths
Two way • up to 10 W (matched output)

- High performance microstrip construction
- Housed in rugged RFI-shielded aluminum case
- Available with BNC, TNC, SMA and Type N connectors
- Meets MIL-202E standards
- Also useful as power combiners at signal levels up to +10 dBm

Now you can specify and purchase state-of-the-art power dividers at 1/3 to 1/2 the price of competitive units, with immediate off-the-shelf delivery, from Mini-Circuits, of course.

This breakthrough in price/performance is a natural extension of our extensive experience in high-volume manufacturing, exacting quality control and thorough testing. This expertise assures you highly reliable power dividers with guaranteed repeatability of performance at lowest cost.

So, if you are among the thousands of companies now using Mini-Circuits' signal-processing units in your systems designs, add power dividers to the list of price/performance industry standards available from Mini-Circuits.

\$39.⁹⁵



Model	Frequency Range, GHz	Insertion Loss, dB Typ. Max.	Isolation, dB Typ. Min.	Amplitude Unbalance, dB	VSWR (All Ports) Typ.	Power Rating-W Divider Combiner	Price	Qty.
ZAPD-1	0.5-1.0	0.2 0.4	25 19	±0.1	1.20	10 W 10 mW	\$39.95	1-9
ZAPD-2	1.0-2.0	0.2 0.4	25 19	±0.1	1.20	10 W 10 mW	\$39.95	1-9
ZAPD-4	2.0-4.2	0.2 0.5	25 19	±0.2	1.20	10 W 10 mW	\$39.95	1-9

Dimensions 2" x 2" x 0.75" Connectors Available: BNC, TNC, available at no additional charge \$5.00 additional for SMA and Type N

2625 East 14th Street Brooklyn, New York 11235 (212) 769-0200
 Domestic and International Telex 125460 International Telex 620156

International Representatives: □ AFRICA: Alitra (PTY) Ltd. P.O. Box 9813 Johannesburg 2000, S Africa □ AUSTRALIA: General Electronic Services 99 Alexander Street, New South Wales, Australia 2065 □ ENGLAND: Dale Electronics, Dale House, Wharf Road, Frimley Green, Camberley Surrey □ EASTERN CANADA: B D Hummel, 2224 Maynard Avenue, Utica NY 13502 (315) 736-7821 □ FRANCE: S C I E - D I M E S 31 Rue George - Sand 91120 Palaiseau, France □ GERMANY, AUSTRIA, SWITZERLAND, DENMARK: Industrial Electronics GMBH 6000 Frankfurt/Main Klüberstrasse 14 West Germany □ INDIA: Gaekwar Enterprise, Karna Mahal, M L Dananukar Marg, Bombay 400 026, India □ ISRAEL: Vectronics, Ltd. 69 Gordon Street Tel-Aviv Israel □ NETHERLANDS, BELGIUM, LUXEMBOURG: Coimex Veldweij II Hatterem Holland

□ NORWAY: Datamatik AS, Østensjøveien 62 Oslo 6 Norway □ SINGAPORE & MALAYSIA: Electronics Trading Co (PTE) Ltd. 87 Bukit Timah Road Singapore 9 Malay Peninsula □ SWEDEN: Intergrad Elektronik AB Box 43 S-18251 Djursholm Sweden

U.S. Distributors: □ NORTHERN CALIFORNIA: PENN-STOCK Co. Foothill Office Center 105 Fremont Avenue Los Altos CA 94022 (415) 948-6533 □ SOUTHERN CALIFORNIA, ARIZONA: Crown Electronics 11440 Collins Street No. Hollywood CA 91601 (213) 877-3550
 NEW YORK: MICROWAVE DISTRIBUTORS COMPANY
 61 Mall Drive Commack NY 11725 516 543-4771

R 34/Rev A

64-K RAM unveiled by U. S. chip maker outperforms 16-K units

Texas Instruments to offer samples in October for \$125; RAM operates from single 5-V supply, dissipates 3 $\mu\text{W}/\text{bit}$

With other memory manufacturers expected soon to follow suit, Texas Instruments Inc. last week became the first U.S. chip maker to unveil a 64-k dynamic random-access memory. To be available in sample quantities at \$125 each in October, the new TMS 4164 is quite a performer, according to TI's specifications. It not only quadruples the density of the current generation of 16-k dynamic RAMs but it outperforms them in many important respects as well.

Perhaps most dramatic is the improvement in power dissipation. Operating from a single +5-volt supply, the new part dissipates only 200 milliwatts maximum, or 3 microwatts per bit. In contrast, TI's older 16-k device, the TMS 4116, uses three supplies (+5, -5, and +12 v) and dissipates more than twice as much power—462 mW, or 28 μW per bit. Also improved are the access times, which range from 100 to 150 nanoseconds, and the minimum cycle times, which range from 250 down to 200 ns.

These parameters, coupled with a 64-k-by-1-bit organization and a standard 16-pin package, make the part particularly well suited for use in minicomputers and mainframes. The potential for the part and others like it is enormous. Indeed, some industry analysts expect 64-k dynamic RAM sales to reach 25% of the

predicted \$1 billion worldwide metal-oxide-semiconductor memory business by the early 1980s. As for TI, it "hopes to reach initial volume production levels of several thousand chips per month by the end of the first quarter of next year," says John Hewkin, strategic marketing manager for MOS memory in Houston.

Likely to follow soon with 64-k RAM announcements of their own are Motorola, Mostek, Intel, National Semiconductor, and Nippon Electric, Japan. The only semiconductor maker with a jump on TI is Fujitsu Ltd. of Japan, which announced its 64-k earlier this year and is now supplying samples. That memory, however, requires two power supplies +7 and -2 v. In achieving its

single-supply operation, TI has made a significant development in MOS design. All 5-v MOS devices now on the market require a negative supply for reverse-biasing the substrate to make inputs and outputs compatible with transistor-transistor logic—on-chip circuits called charge pumps generate the negative voltage. The new RAM, however, contains no on-chip substrate-biasing circuit—TI designers have altogether eliminated the need for negative voltages.

"Although it is TTL-compatible on the outside, the inside is geared more toward achieving an optimal speed-power product," says G. R. Mohan Rao, who headed the design team at TI.

He refuses to get more specific,

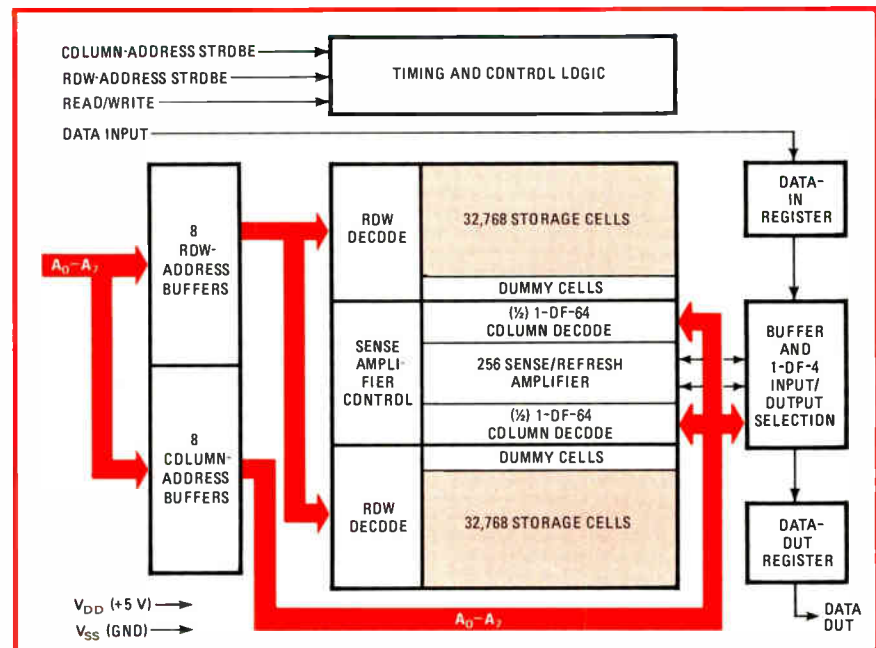

Twin arrays. Block diagram of TI's dynamic 64-K RAM shows it divided into two 32,768-bit storage areas. Cells are refreshed by 256 sense amplifiers every 4 milliseconds. The chip has no need for negative voltages, unlike current 4- and 16-K memories.

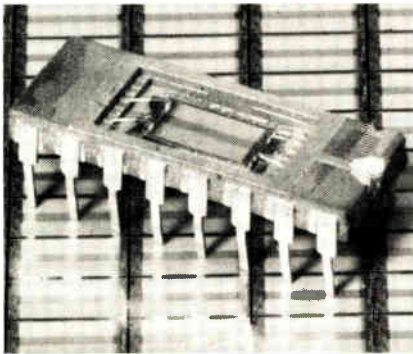

65,536 bits. Division of new RAM into two sections shows clearly in photo of 132-by-252-mil chip and its 16-pin package.

saying only, "People will be surprised when they see how we did it."

Long refresh period. In contrast to the 128-cycle/2-millisecond refresh used in current 4-K and 16-K dynamic RAM designs, the 4164 incorporates a 256-cycle/4-ms refresh period. This means that systems designed for the TI part can easily be modified to use 128-cycle 64-K parts, should the upcoming parts be designed this way. But the reverse shift will not be possible.

"We saw no good reason to use a 128-cycle refresh," says John Hewkin. "The 256-cycle refresh period allows the same 64-kilohertz oscillator to be used when upgrading from the 16-K." Adds Rao, "The only savings [from using 128-cycle refresh] might be 1 bit in the row counter and multiplexer, but since these parts come in 4- and 8-bit multiples, no full packages can be dropped." And he asks, "When you sit down to design the 256-K RAM, how can you do it with 128-cycle refresh? It would take 1,024 more sense amplifiers."

Using only 256 sense amplifiers and scaled-down MOS n-channel double-level polysilicon-gate technology, TI has kept the bar size for the TMS 4164 down to 33,000 mil² (132 by 252 mils). "With 60% of the area taken up by the array, it's the first dynamic RAM not dominated by the peripheral circuitry," Rao says.

TI used test chips in parallel with computer-aided design to develop its design ideas. "The tricky part was to get 40 internal clocks on the chip to be timed together," Rao continues.

"Using our approach, the major internal clocks are guaranteed not to have a timing skew—even if the row and column strobes from the user are nonperiodic." □

Fiber optics

Studio-quality TV looks OK in tests

Tests of fiber-optic equipment carrying voice conversations are being carried out all over the country, mostly by telephone companies. But just how good is the gear for carrying television signals?

At Bell Laboratories in Holmdel, N. J., researchers Andres Albanese and Harry Lenzing are looking into this question, particularly whether fiber optics can carry studio-quality TV signals from a satellite earth station antenna to the video operating center that distributes the signals to individual receivers. With first test results starting to come in, the answer seems to be yes.

"We want to directly compare the capabilities of fiber optics and coaxial cable under the same set of conditions," says Albanese. "And we want

information on transmission methods and picture-quality factors like signal-to-noise ratio, insertion loss, linearity requirements, and practical transmission distances."

Two systems. The fiber-coax comparison system links a 10-meter earth station antenna over a 1-kilometer run in Holmdel; it can handle both analog and digital signals. The coaxial cable and 12-fiber ribbon cable are laid side by side in a duct and have been functioning since last February. The fiber cable, made by Bell, is identical with the cable laid in a Chicago installation that has been successfully conveying telephone conversations for one year. A typical fiber has a core diameter of 55 micrometers, an outer diameter of 110 μm , and a 0.23 numerical aperture and transmits light at 830 nanometers.

For most of the tests, the optical transmitter, shown in the figure, is modulated with a 70-megahertz intermediate-frequency signal that is frequency-modulated by the video signal. Results indicate that a color video channel can be transmitted with a 68-decibel signal-to-noise ratio, 0.1-dB differential gain, and 0.5° differential phase over a link 4.1 kilometers long. This well exceeds

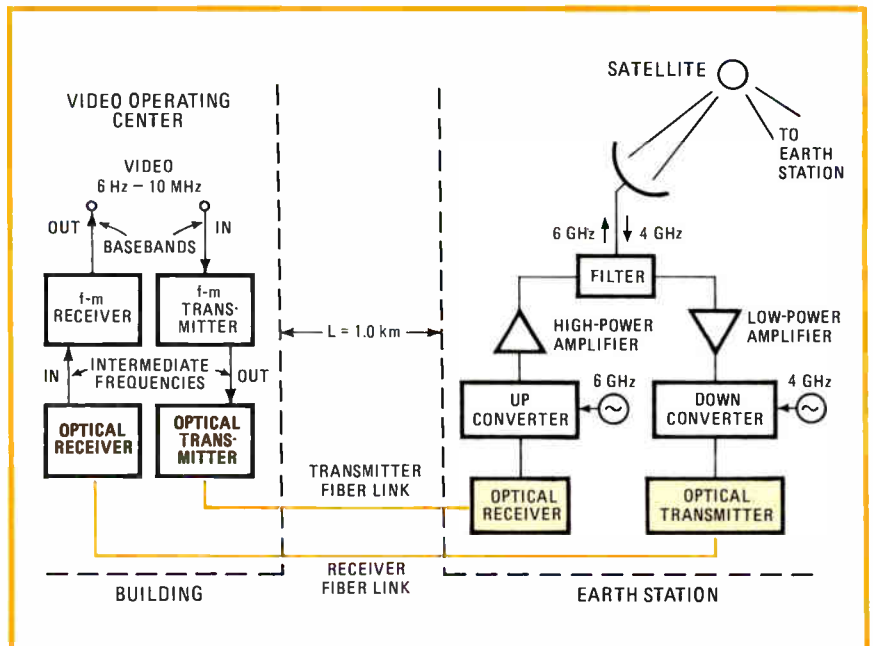

Entrance link. Transmitter/receiver system in Bell's test can interchange the fiber-optics links (shown) with coaxial cable for comparing transmission and reception characteristics.

the noise figure for studio-quality requirements.

Frequency modulation at 70 MHz was chosen instead of other modulation techniques because it uses existing fm terminals and is compatible with existing radio equipment. Moreover, this fm technique relaxes the linearity requirement on the transmitter and receiver.

At the same time, the fiber-optic transmission line has been shown in the Bell tests to be superior to the coaxial cable in that no equalization circuits are needed and it is immune to electromagnetic interference. As an added and important bonus, the fiber cable is smaller than the coaxial cable and was easily run into an almost filled cable duct, into which more coax would not fit.

Supplemental tests. The 1-km link at Holmdel has been supplemented since July with a 0.5-km link at Bell's nearby Indian Hill site. The Indian Hill tests use only a fiber-optic link with a light-emitting-diode source whereas the Holmdel facility has both a diode and a laser, as well as the coax system. However, the new site will test more equipment combinations.

So far, results at Holmdel show a 25-dB link loss for the laser transmitter and 12 dB for the LED. For a signal-to-noise ratio of 68 dB and the fiber attenuation of 6 dB/km, the maximum link length is 4.1 km for the laser source and 2 km for the LED. But if the s/n ratio is lowered to 53, still a usable figure, the lengths are 6.3 km and 4.2 km, respectively. The s/n figure needed varies according to the system application and noise budget.

More work is planned in the coming months with different transmitters and receivers as well as modulation schemes at both sites. But for now, the Bell researchers are happy. Notes Albanese: "We have met the system objectives and feel optimistic. It's a matter of getting used to fibers—we had no unexpected problems." For example, the fiber-optic connectors developed in house by Bell proved as practical as commercial electrical connectors, he reports. □

Air Force's SOS-based fault-tolerant unit going great, but budget bodes ill

There's both good news and bad news about the Air Force's fault-tolerant spaceborne computer. On the plus side, researchers say they have whipped significant large-scale-integration process problems, clearing the way to building the first working hardware.

No funds. However, "it looks like there's no money for prototypes until 1981," reports Capt. Roy L. Schmeising, who heads development for the service's Space and Missile Systems Organization in Los Angeles. Overall Samsco budget pressures are the cause of the program stretch-out, he says.

The first LSI parts, logic circuits built of complementary metal oxide semiconductors on sapphire substrates are now being delivered by RCA Corp.'s Solid State Technology Center, Somerville, N. J. Others are expected from Hughes Aircraft Co.'s Microelectronic Products division, Newport Beach, Calif. The silicon-on-sapphire structure was chosen because it is more resistant to radiation than circuitry on bulk silicon.

Started more than three years ago, the spaceborne computer is intended to be "self-healing" through an innovative architecture and system design, giving it up to five years of operating life. A self-healing computer is one that can correct for failure of its components without outside help. Through a combination of architecture and software, the computer can switch automatically from a failed part to one that works, choosing from an array of standbys.

Customized. Rather than construct the central processing unit from a collection of standard logic chips, the Air Force partitioned its computer architecture to meet its self-healing requirement and then had each piece implemented in custom LSI chips. The result is some 22 types of chips, including a regis-

ter arithmetic/logic unit, a 1-k-by-1-bit static random-access memory, a 2-k-by-4-bit read-only memory, and a ROM sequencer, to name the few standard kinds of chips. The other chips cannot be described so succinctly; because of the partitioning, they perform combinations of functions that are not standard.

The silicon-on-sapphire technology is deemed to be the only way to get radiation-resistant devices to survive space missions and to run at the needed rate of 200,000 operations per second. While the concept of the computer was proved in late 1977 by a brassboard model built with discrete parts by prime contractor Raytheon Co.'s Equipment division, Sudbury, Mass., none of the LSI chips have been built until now. Raytheon is proposing design simplification to reduce the 20 or so logic types to about 10.

The LSI devices have an average line width of 0.22 mil and between 2,500 and 3,000 devices per chip, with each chip measuring an average of 220 mils on a side, according to Arnold Van Doren, Raytheon's project manager. The chips have a speed of 7 nanoseconds per gate, he adds.

Survival. Completed, the computer is expected to occupy 1.3 cubic feet, weigh 50 pounds, and dissipate 35 watts. It will have a cycle time of 1 microsecond. Air Force studies estimate that continual reconfiguration to correct component failures will give a 95% chance of surviving a five-year mission. This compares with a 35% chance for three redundant computers and 44% for four machines.

Making the fabrication job rough is the number of pins required on some chip packages—up to 84—because of the complexity of providing interconnections between the working and backup modules. This number of leads is 20 more than the 64-pin packages now considered the

practical limit for production devices. "We tried configuring the computer with 64-pin packages, but ended up with more than 30 different logic types," Schmeising says.

With the first prototype chips in hand, "we have proved that C-MOS/SOS, which does not have a good reputation for driving a computer bus, can do the job." To reach its operating speed and throughput, the computer's logic circuits must drive a 700-to-1,000-picofarad bus capacitance, with a 100-ns rise time. "We got 60 ns at capacitance in the tests," he says.

Schmeising estimates that \$15 million to \$20 million is required to build prototypes for flight testing in the early 1980s. Even without full funding, a lower-level program is planned to push critical LSI work. By going ahead with device testing for radiation, reliability, and extended life, "we can refine out risks considerably in the meantime," he says. □

Companies

GI to broaden its chip business

Having reached some significant milestones in the microcomputer and memory fields, General Instrument Corp.'s Microelectronics group in Hicksville, N. Y., is setting out on a new tack. Principally a supplier to

producers of television and nonvideo games, as well as toys, the group is shifting its engineering resources toward nonconsumer markets that seem to offer even more lucrative business opportunities and greater stability.

"We are viewed as a manufacturer of large-scale integrated circuits for the consumer market, but we are beginning to see our niche defined

more accurately by the words 'communication' and 'control,'" explains Edgar A. Sack, the senior vice president who runs the group.

Steady. "We are now beginning to deal with a different set of customers whose volume requirements are of higher orders of magnitude," says marketing manager Frank Jelenko. "Also," he continues, "they don't readily change designs from year to year, as do those in the games market." This means that engineering resources need not be expended annually to develop new software, he says.

Some of the non-game and non-toy applications for microcomputers and memories Jelenko identifies are in automobiles ("a few in the dashboard and a couple in the engine and elsewhere"), in digital tuning of radio and TV receivers, in ballast-type controls for lighting, and in

Widening. Though doing well selling their chips to toy and TV games makers, GI's Bob McDonald (seated) and Frank Jelenko are looking for other users—manufacturers of industrial controls and telecommunications.



GI adds silicon-gate process for 64-K ROM

General Instrument Microelectronics not only is trying to shift its emphasis from consumer to nonconsumer markets but also is making a major change in process technology. In effect conceding that its traditional n-channel metal-gate process is not suited for building very dense read-only memories, the Hicksville, N. Y.-based group is going to a new silicon-gate process to fabricate its first 65,536-bit n-channel ROMs, due in sample quantities by January 1979.

Called the RO-3-9364, the edge-activated 64-K ROM will be pin-for-pin-compatible with Mostek Corp.'s 24-pin MK36000 "in virtually every way," says Robert A. McDonald, general manager of GI's Industrial Business unit. A and B versions, having maximum access times of 850 and 450 nanoseconds, respectively, will list for \$10 to \$12 in lots of 1,000 and \$8 to \$10 at the 10,000-piece level. Meanwhile, a 9364C with a 350-ns access time will be priced at \$13 to \$14 and \$9.50 to \$11 in like quantities.

Having a chip area of about 38,000 square mils, the 9364 "is our initial push into high-density, silicon-gate n-channel ROMs," says McDonald. Right behind it will be a 28-pin edge-activated 64-K ROM, followed by 24- and 28-pin fully static 64-K ROMs, "all of which will hit the market by the first quarter of 1979," he adds.

There will be other new n-channel silicon-gate products, too, including an 8-bit microcomputer in late 1979. "These will basically be the same 8-bit parts we have now, but will take advantage of silicon-gate technology to offer bigger ROMs on board, faster speeds, and lower cost," McDonald says. Why go to silicon-gate processing now? McDonald answers, "We eventually would have had to do it for performance. We decided to bite the bullet now and use the 64-K ROM as the springboard for getting us into it."

To all buyers of our tough little connectors:

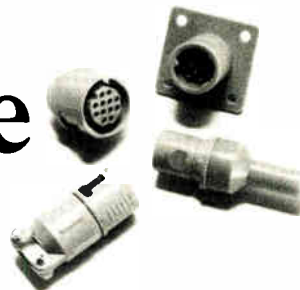

we can save you money on the cable assembly, too.



We have the facts and figures needed to get you out of the cable assembly business.

We can supply any of our miniature Thorkom connectors complete with cable—fully assembled, with a top-quality molded strain relief.

It's our Vikord custom cable assembly service.

The cable can be any length you need, pre-tested for IR and continuity.

Plugs and receptacles can be on one or both ends.

And the molded strain relief can be straight or right angle. Either way, it's flexible and sealed for protection from the environment.

Good delivery. With most standard 22 gauge cables, we can give you delivery on the complete Vikord assemblies in two-to-four weeks. Other sizes may take longer.

Savings. You get all kinds. First, your cost of the assembly should be less. Second, you get a higher quality, longer lasting, professional looking product. Third, you have the assemblies you need when you need them.

The details. They're in our latest Thorkom/Vikord catalog. Send the coupon to get your free copy.

Or, if you'd like specific facts, figures and a sample quicker than that, call us: (213) 341-4330.

O.K. Send me

- details on your Vikord cable assemblies.
- details on your Thorkom connectors.
- the name of your nearest rep./distributor.

My potential application is: _____

NAME: _____ TITLE: _____

COMPANY: _____ PHONE: _____ EXT.: _____

ADDRESS: _____

CITY: _____ STATE: _____ ZIP: _____

 **Viking**
CONNECTORS

Viking Industries, Inc.

21001 Nordhoff Street, Chatsworth, CA 91311, U.S.A./ (213) 341-4330/TWX 910-494-2094

motor controls for air conditioners, refrigerators, and power tools. "These areas alone offer a potential market of 215 million microcomputers annually," he states.

However, GI is not about to abandon a good thing. It wants to expand it. GI shipped 1.1 million 16,384-bit read-only memories and more than 800,000 electrically alterable ROMs in its recent fiscal quarter ended Aug. 25. What's more, it shipped in excess of 100,000 8-bit microcomputers in August alone. In fact, "we will have shipped over 1 million single-chip 8-bit microcomputers in 1978," claims Robert A. McDonald, general manager for GI's Industrial Business unit, which encompasses microcomputers and memory.

Seasonal. McDonald notes that though the games market has served as "a good theater" for GI to introduce its microcomputers and provided the impetus behind getting the necessary design and production machinery in place, "it's not the kind of market we want to be dedicated to." A reason for this decision is that the games market is seasonal and "all visibility to the market is lost after Christmas," says Jelenko. Furthermore, "the games market has to be supported each year. . . . We will just spend a much smaller percentage of our engineering resources next year toward developing game software."

An indication of GI's continuing commitment to the games market, Jelenko notes, is the planned introduction of the PIC 1655A, a single-chip 8-bit microcomputer with higher drive currents and lower cost than the existing 1655. It is designed to compete with 4-bit microcomputers, such as Texas Instruments Inc.'s TMS 1000, in toys and games using light-emitting-diode displays.

Samples of the 1655A will be available in the fourth quarter of 1978, as will be samples of an 18-pin version of the 28-pin 1655. Called the PIC 1645, the latter will have less ROM (256 by 12 bits) than the 1655 and will be tailored for low-end motor-control applications. These will be followed in the first quarter of 1979 by the PIC 1670, which will

have 1,024 lines of 12-bit ROM and 48 by 8 bits of random-access memory. The 1670 will be for high-end nonconsumer products and, Jelenko says, "allows us to do complex applications that we can't do with less ROM or RAM." □

Military

Air Force wants more data on wind

The Air Force is going shopping for a system that will tell it more about the wind, especially in areas where it is difficult or impossible to place ground weather stations. This month the Electronic Systems division at Hanscom Air Force Base, Bedford, Mass., will ask for industry proposals to develop a wind-sounding system that will eventually go aboard both weather reconnaissance aircraft and cargo planes carrying troops and equipment to be dropped by parachute.

The system will use pressure, temperature, and humidity sensors in the parachute-borne radiosonde that will also carry an Omega navigation receiver to develop wind profiles between the plane that drops the sondes and the ground. Similar sensors have been used before by the National Oceanic and Atmospheric Administration to map winds. But they were sent aloft in balloons from ground weather stations.

Data produced by the NOAA radiosonde are usually telemetered to a large computer on the ground for data reduction. The Air Force, on the other hand, will put a minicomputer in the sonde-dropping aircraft to plot the wind profiles in real time. The plan is to put the system in 10 Military Airlift Command C-141 cargo ships and 20 Air Weather Service WC-130 weather reconnaissance planes.

MAC will use the system to calculate an optimum release point that considers wind direction and velocity changes for the aircraft that may follow. The Air Weather Service wants the wind-sounding system to

better track hurricanes and typhoons, and to develop a better data base on wind speed and direction in areas such as the Western Pacific Ocean, where few ground weather stations exist.

Capt. William Bennett, manager for the wind-sounding program at the Electronic Systems division, says, "In combat drops, the C-141 equipped with the wind-sounding system goes in ahead of the strike force to show planes following where to drop." That is where the real-time requirement comes into play.

The wind-sounding program is in ESD's Global Atmospheric and Environmental Systems office. A typical combat airdrop mission would have an instrumented C-141 in the lead drop sondes at intervals as it approaches the target. The sensors, plus a small Omega receiver in each sonde, will get three signals every 10 seconds from the navigation-aid transmitters. The pressure, temperature, and humidity data will be telemetered with the Omega information over a band between 400 and 406 megahertz to a receiver aboard the mother ship.

There the data will be digitized and fed to the minicomputer that separates and processes the signals to provide the wind velocity, pressure, temperature, and humidity for display to an operator. The data is also printed out for later analysis on the ground, as well as used immediately to calculate the best release point for the mission.

Continuous position. The computer will use the phase data in the Omega signals to calculate the sonde's position continuously as it descends. That position is a function of the wind velocity and direction. Temperature, pressure, and humidity data assist here by reducing errors in determining the sonde's altitude. Bennett says the computer will probably be a 16-bit minicomputer with a memory of 32 kilobytes or less.

The development phase of the contract will call for two preproduction systems—one each for the C-141 and WC-130 aircraft. They will be very similar, Bennett says, except that the C-141 hardware will be

NOW-Airpax offers its snap-action magnetic circuit breaker in a choice of handle styles.

Baton Handle

Paddle Handle



Think of the design possibilities attainable with this versatile line of magnetic circuit breakers. Baton or paddle handles in a choice of red, yellow, green, blue, black, or white. You're sure to find the combination that perfectly suits any panel design and color scheme.

But aesthetics is not the only reason for selecting these breakers. Consider the many other outstanding features:

Longer Life. Patented Airpax snap-action mechanism results in up to 5 times greater operational life.

Lower Cost. Sells for under \$5 each in small quantities, even less in larger quantities.

Smaller size. Power switching and circuit protection are combined in a package smaller than any other magnetic circuit breaker.

Operates at DC or 50/60Hz. Eliminates the need to specify, order, and stock separate units. 400Hz also available.

Current Ratings: 0.10 to 20 amperes at 32V dc; 0.10 to 15 amperes at 120V ac; 0.10 to 7.5 amperes at 50V dc, 250V ac, 50/60 and 400Hz.

U.L. and C.S.A. Recognized.

Five Year Warranty.

AIRPAX
A North American Philips Company

Airpax Electronics, Cambridge Division, Cambridge, Maryland 21613. Phone: (301) 228-4600.

Telex: 8-7715, TWX: 710 865-9655.

Other factories in Europe and Japan.

The Pro In Protection

Other Airpax Circuit Breakers

Circle 45 on reader service card



TYPE AP
20 amp max Sealed
For military applications



TYPE 203
20 amp max
Illuminated handle
Snap-in mounting



TYPE APG
50 amp max
Choice of handle styles
and colors



TYPE APL
100 amp max
The Original Standard



TYPE 205
100 amp max
Dustproof enclosure



TYPE 209
100 amp max
Molded case
U.L. and C.S.A. listed

removable and the WC-130s will be permanent installations. In all, 32 C-141s will be fitted out to accept the system. Flight tests of both aircraft are to begin at Eglin Air Force Base, Fla., two years after the development contract is awarded. □

Communications

SBS, facing legal snag, pushes on . . .

The future of Satellite Business Systems Corp. is up in the air because of a court battle regarding legality of its joint ownership by International Business Machines Corp., Communications Satellite Corp., and Aetna Life and Casualty Co.

Hearings. Ruling on a Justice Department challenge of the Federal Communications Commission decision that authorized the McLean, Va., firm to provide domestic satellite communications service, a U.S. appeals court late last month overturned the FCC authorization. The court said the FCC should have given more consideration to the antitrust questions and should have held hearings on those issues before granting a license to the company. The court's decision sends the case back to the FCC for such hearings.

The legal stumbling block comes a month after SBS reported the success of Project Prelude, a test of the technical feasibility and market potential of its planned service for integrated digital, voice, and television communications via satellite [*Electronics*, July 20, p. 48].

Despite the dispute over its ownership, SBS intends to continue installing equipment for a planned January 1981 opening. Although the company is disappointed, a spokesman says it does not expect the decision "to impede the establishment of our system."

Reconsideration. The question the FCC must reconsider is whether IBM and Comsat's partnership in SBS violates Section 7 of the Clayton Antitrust Act by lessening competi-

tion or creating a monopoly. Key is whether IBM and Comsat were likely to have entered the market separately. When it approved SBS in January 1977, the FCC said that the venture was not anticompetitive and that, even if it were, approval would be in the public interest because SBS would provide a service that could compete with AT&T.

Earlier this month, a spokesman for the commission's litigation division said it has not decided yet whether to appeal the decision or to accept it and hold the hearings.

If the FCC holds the hearings and finds SBS to be in violation of Section 7, it could cancel its license. But Calvert Cray, a litigation analyst at Bache Halsey Stuart Shields, New York, says, "A more likely outcome would be for the commission to decide after a hearing that SBS doesn't violate the statute. After all, the recent history of Section 7 in the courts indicates that it is violated only by the most blatant combinations, and I think a pretty radical change in the standard would be required before SBS could be considered in violation." □

. . . as Sperry uses 5-m earth stations

While officials in Washington, D. C., play ping-pong with the fate of the planned Satellite Business System, one independent manufacturer has gone ahead and developed its own satellite communications network for the computer-to-computer transfer of data. Established by Sperry Rand Corp.'s Sperry Univac division in Blue Bell, Pa., the network is the first commercially licensed system for all-digital two-way transmission in the C band (6 gigahertz up, 4 GHz down) to use 5-meter-diameter antennas.

Provided by American Satellite Corp. of Germantown, Md., and linked to the Westar I synchronous satellite, the network's hardware currently consists of two earth stations—one each at development centers in Blue Bell and Roseville,

Minn. Other earth stations are projected for installation at Univac centers in Salt Lake City and in Irvine and Cupertino, Calif.

Applications. Large Univac Series 1100 computers at Roseville and smaller Series 90 computers at Blue Bell supply processing power for developmental groups using the network. Principal applications will be the transfer of data related to hardware design, software development and applications programs, and the exchange of manufacturing and financial information. The system will also be used for technical conferences via freeze-frame television and for high-speed facsimile, says Nate Pearlman, a Univac systems engineer.

"The key objective in establishing this new network is to optimize data-communications control procedures and formats for use over dedicated satellite links," says R. C. Phillips, vice president of Univac's Major Systems division. Most computer communications protocols designed for use over old analog telephone links "can't be applied intact over satellite links," adds Pearlman. This is because the long propagation delay of satellite communications would make the system inefficient with respect to speed and error rates, among other factors, he explains.

Compensating. The effect of propagation delay, Pearlman says, can be offset by developing digitally controlled techniques that make more efficient use of the link's wide bandwidth, excellent reliability, and high signal-to-noise ratios. The Univac network has a present capacity of 112 kilobits/second and a bit-error rate of 2×10^{-8} , and this rate is "at least two orders of magnitude better than what we've experienced with the [Bell System's] Digital Data Service," he claims.

Using Univac's Universal Data Link Control, a bit-oriented, full-duplex protocol, Pearlman says, "we are provided with peak performance for a mixed satellite-terrestrial communications network." Further, because the system has but one voice channel for supervisory functions, extensive voice circuitry is elimi-

The first choice in MOSFETS

for Hi-Rel and RF applications.



First choice for good reasons! As a pioneer in MOS technology, GI produces one of the broadest lines of MOSFETs available anywhere. In fact, you can choose from over 160 different off-the-shelf MOSFETs including switching and RF MOSFETs, and analog switches shown here...

plus a wide choice of JEDEC 2N and 3N types. But there's a lot more to GI than a broad line of MOSFETs. GI's high volume production capacity and quality processing standards meet all your Hi-Rel needs, large or small.

Try General Instrument's MOSFETs for your next project and see for yourself why GI is the First Choice. For direct technical assistance just call (516) 733-3204.

We help you compete.

MOSFET TRANSISTORS

TYPE	PART NUMBER	V _{DS} /I _{DM} VOLTS-MH	I _{DM} mA-TYP.	V _{GS} mA V-MIN/MAX.	r _{DS(on)} OHMS-TYP.	PART NUMBER	V _{DS} /I _{DM} VOLTS-MH	I _{DM} mA-TYP.	V _{GS} mA V-MIN/MAX.	r _{DS(on)} OHMS-TYP.	
P-CHANNEL ENHANCEMENT MODE	MEM511	30/30	0.05	3/6	150	MEM560C	30/30	0.2	1/3.5	175	
	MEM511A	30/30	0.5	3/6	300	MEM560	30/30	0.05pA	1.5/3	150	
	MEM511C	25/25	0.05	3/6	150	MEM561C	25/40	0.5pA	2/5.5	150	
	MEM517	30/25	0.15	2.5/5	35	MEM566	40/40	0.05pA	2/5.5	150	
	MEM517A	30/25	0.15	2.5/5	35	MEM566A	40/40	0.1	2/5.5	80	
	MEM517C	30/40	0.03pA	3/6	150	MEM567	40/40	0.2	1.5/3	150	
	MEM520	25/25	0.1pA	3/6	700	MEM567A	35/35	0.1	2/5	150	
	MEM520C	50/50	0.1	3/6	700	MEM567A	30/30	0.05pA	2.5/5.5	150	
	MEM556	45/40	0.3	3/6	100	MEM567B	45/1200	0.05pA	2.5/5.5	100	
	MEM556C	35/35	0.1	1.5/3	100	MEM567C	35/1200	0.05pA	2.5/5.5	100	
DUAL P-CHANNEL ENHANCEMENT MODE	MEM550	30	0.1	3/6	250	MEM554A	30	0.03	2/5	100	
	MEM550C	25	0.2	3/6	250	MEM554B	35	0.02pA	2/5	100	
	MEM551	30	0.03pA	3/6	250	MEM554C	35	0.02pA	2/5	100	
	MEM551C	25	0.03	3/6	250	MEM554D	35	0.02pA	2/5	100	
	MEM554	30	0.03	2/5	100	MEM554E	35	0.02pA	2/5	100	
N-CHANNEL ENHANCEMENT MODE	MEM562	20/130	10pA	0.5/4	150	MEM711	25/130	0.1	0.5/1.5	50	
	MEM567C	20/130	10pA	0.5/4	150	MEM712	25/130	0.1	0.5/2	30	
	MEM563	20/130	10pA	0.5/4	40	MEM712A	30/130	0.1	0.5/2	30	
	MEM563C	20/130	10pA	0.5/4	50	MEM713	20/130	10pA	0.5/2	30	
P-CHANNEL DEPLETION MODE	MEM554	20/15	10	5	0.01	1.5	MEM632	25/16	6	20	4/2
	MEM554C	20/15	10	5	0.05	1.5	MEM636	20/16	15	50	4
	MEM557	20/110	10	5	0.01	4	MEM637	20/16	15	20	4
	MEM557C	20/110	10	5	0.05	4	MEM638	20/16	10	4	4
	MEM564C	20/16	10	5	1.0	1.5	MEM639	20/16	4	1.10	4
	MEM564C	20/16	10	5	1.0	1.5	MEM655	20/16	3	0.05pA	4
	MEM571C	20/16	10	5	1.0	1.5	MEM660	20/130	3	0.05pA	4
	MEM610	20/16	10	5	1.0	1.5	MEM667	20/100	3	0.05pA	4
	MEM614	20/16	10	5	1.0	1.5	MEM670	20/100	4/30	50	4
	MEM618	20/16	10	5	1.0	1.5	MEM680	25/16	2/20	50	4
	MEM618	20/16	10	5	1.0	1.5	MEM681	25/16	3/20	50	4
	MEM618	20/16	10	5	1.0	1.5	MEM682	20/16	15	20	4
	MEM619	25/16	6	20	4/2	20	MEM683	20/16	15	20	4
	MEM630	25/16	6	20	4/2	20					
	MEM631	25/16	10	20	4/3	20					

MOSFET ANALOG SWITCHES

FUNCTION	DESCRIPTION	PART NUMBER	P-P INPUT RANGE	ON RESISTANCE	TEMPERATURE RANGE	BUFF/PACKAGE
ANALOG SWITCHES	4 Channel Switch	MEM780	20V	300Ω	65 to +85 (Plastic DIP) 65 to +125 (Ceramic DIP, Flat Pack)	P-14 Plastic DIP
		MEM781	30V	1000Ω		D-14 Ceramic DIP
		MEM851	25V	350Ω		F-14 Flat Pack
		MEM855	40V	1000Ω		
DRIVER	4 Channel Driver	MEM856	25V	150Ω		P-24 Plas. DIP, D-24 Cer. DIP, F-24 Flat Pack
		MEM857	25V	150Ω		P-14 Plas. DIP, D-14 Cer. DIP, F-14 Flat Pack
		MEM853	25V	150Ω		

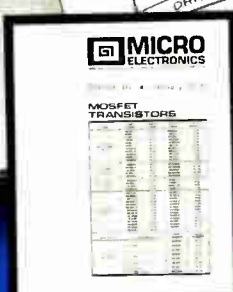

For a free copy of our 112-page MOSFET Catalog, call (516) 733-3107, or write General Instrument Microelectronics, 600 West John Street, Hicksville, New York 11802.

nated and, Pearlman says, "the cost of a communications facility such as this is comparable to that of high-quality, terrestrial lines of equivalent bandwidth." □

Codecs

Interface relies on bipolar technology

Although only the coder-decoder chip has been fabricated in silicon so far, Motorola Inc. has released details of a three-chip subscriber-channel unit aimed at the market for central-office and PABX digital switching.

But surprisingly, the Communications group in Phoenix, Ariz., which designed the unit, is prouder of its interface circuit, called the subscriber-loop interface circuit, or SLIC, than of the codec and filter chips. It believes the SLIC (or hybrid, in Bell System vernacular), which takes decoded analog signals from the filter chip and conditions them for

driving the noisy telephone lines, will withstand extremely tough environmental conditions.

For example, the SLIC is specified to survive extreme voltages—like on-line transients as high as 1,500 volts caused by lightning—points out Steve Kelley, principal staff engineer for strategic marketing and product development at Motorola. Moreover, the chip must be powered by the 48-volt dc telephone line drive and be so well protected against 60-hertz signals that it can survive when it is inadvertently connected to the 120-v ac household line voltage. Technically, the SLIC, dubbed the XC3419 by Motorola, converts two-line differential talk-and-listen signals to four single-ended lines, generates the off-hook signal, and provides line current to the telephone.

Tough technology. The SLIC is built with bipolar technology because MOS devices cannot withstand such extreme voltages, Kelley explains. As extra protection, Motorola adds transient-suppressing diodes to the chip, which must take a momentary surge of 50 amperes. A pair of

power transistors is also added to supply the short-circuit current drive, which is 120 milliamperes in the worst case—too much power for an integrated circuit to dissipate.

Although Motorola uses bipolar technology for the SLIC, it builds its codec and filter chips with complementary-metal-oxide-semiconductor technology. Many manufacturers lean toward a similar three-chip approach, though the choices encompass n-channel and complementary MOS and bipolar.

C-MOS decisions. Motorola says it took a good long look at the various technologies it could have used for the codec and filter—and saw bipolar technology as a close contender before settling on C-MOS. "We never considered n-channel MOS, because C-MOS alone best serves all the various circuit functions needed in a codec and filter. C-MOS builds a better op amp; n-MOS, without active loads, can't give you as much gain, so you need more stages, and the resulting three-pole roll-offs are difficult to compensate," Kelley says.

The main reason for choosing

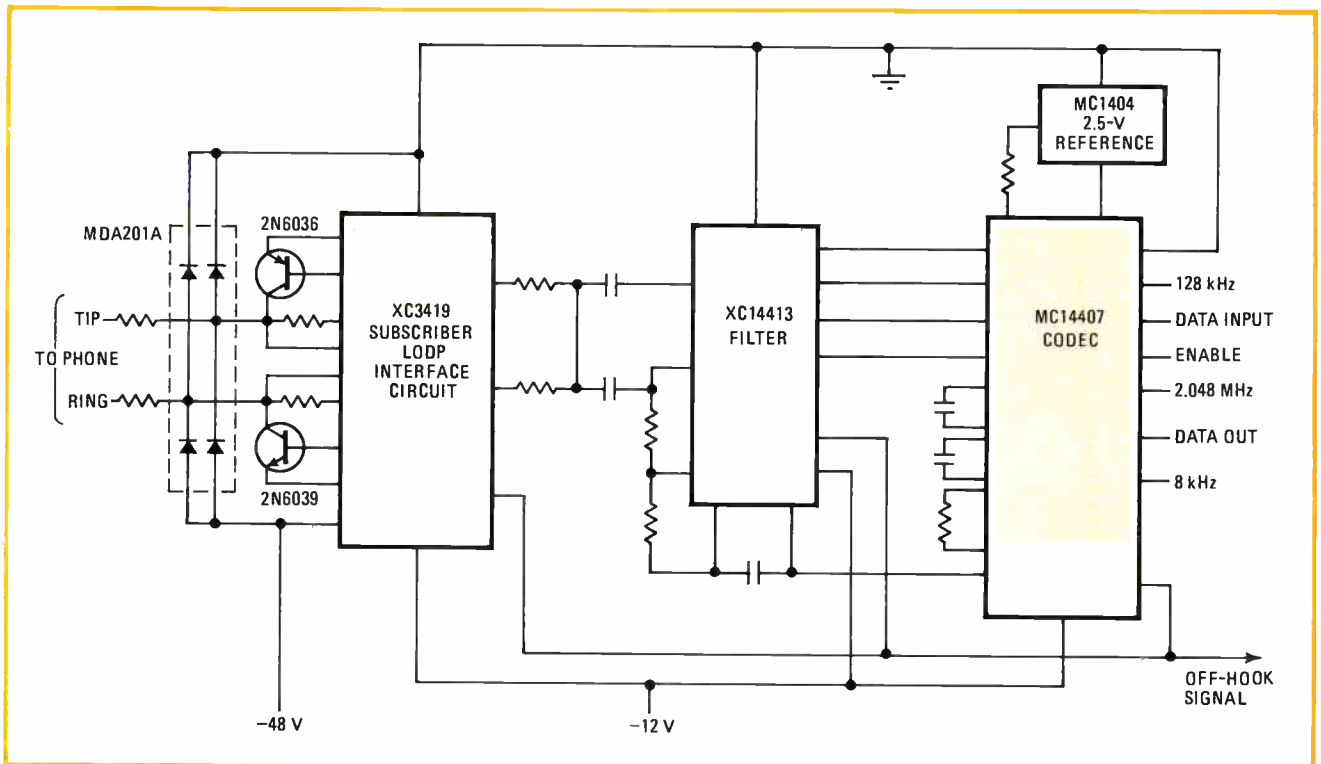

Trio. Motorola's three-chip subscriber channel unit uses C-MOS for its filter and codec and has a bipolar subscriber-loop interface circuit (SLIC). The SLIC's outboard components provide current drive for the telephone line and protect against transients.

Rx for painful "make or buy" decisions



EMM multi-configuration memory

No longer need you agonize over whether to invest engineering and production time to build your own memories or settle for an available system that doesn't quite meet your requirements. The EMM MICRORAM 3500 multi-configuration memory makes all that pain unnecessary.

The 3500 offers 128K x 22 on a single card. But it can be depopulated down to 32K if that is more in line with your immediate needs, yet remain field-expandable up to maximum capacity.

The outstanding characteristic of the 3500,

however, is the number and variety of available options. On-card options include ECC (single bit error correction and multiple bit error detection), and word or byte parity generation and checking. Other optional features include page mode, byte mode, error stop, a fault location LED display, and battery back-up.

No other comparable memory on the market today offers such an extensive "shopping list" of features and options. Call or write us today, and let us prescribe a configuration to solve your memory system problems.



EMM CSD The OEM Systems Division of Electronic Memories and Magnetism Corp.
12621 Chadron Ave., Hawthorne, Calif. 90250 • (213) 644-9881



HYBRID MICROPOWER TONE RECEIVER MH88200

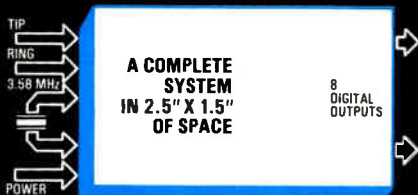

A Natural For:

- Central Office Usage • PABX'S
- Modems • Tone-to Pulse Converters
- Mobile Radio • Remote Controllers

Featuring:

- Micropower CMOS/LSI Circuit
- Only one external 3.579545MHz Crystal Required
- Direct Connection to telephone lines
- AGC Ckt. for accurate twist detection
- 5th Order Elliptic Filters
- Three Output code formats available
- Digit "Acquisition" and "Release" times adjustable using external RC network

Contact the leader in tone receivers and CMOS technology for more information:



1745 JEFFERSON DAVIS HWY
SUITE 611
ARLINGTON, VA. 22202
TEL 703-243-1600

MITEL
Semiconductor

Electronics review

News briefs

Fairchild comes on FAST.

Fairchild Camera & Instrument Corp. will begin providing samples Oct. 1 of the first nine devices in a new digital logic family that combines the best of both Schottky worlds, high speed and low power. Called FAST (for Fairchild Advanced Schottky TTL), the family has typical gate delays of 3 nanoseconds and typical power consumption of 4 milliwatts per gate, about 25% that of conventional Schottky devices. Fairchild, in Mountain View, Calif., will announce later this year the introduction schedule for 57 members of the family, which is made with the company's established Isoplanar and Schottky technologies.

Hitachi to assemble RAMs in Texas

Hitachi Ltd. of Tokyo, is establishing a semiconductor manufacturing operation in Irving, Texas. To be called Hitachi Semiconductor America, the new company is expected to begin assembling metal-oxide-semiconductor memories next spring in an 11,000-square-foot plant now under construction.

LCDs predicted to take over as major display

Liquid-crystal displays will show a dramatic 25% compound annual growth through 1982, putting them in top position in the display industry by the mid-1980s, according to Creative Strategies International, a San Jose, Calif.-based research firm. Until that time, light-emitting diodes will remain as the display industry leader, primarily because of low prices and extensive use in consumer goods. Gas-discharge displays are expected to lose ground and end up third by 1982 in what will be a \$455 million worldwide optical-display market, but they will stay competitive in single-digit applications, with plasma panel displays a key growth area.

C-MOS, however, is low power consumption—the MC14407 codec and the XC14413 five-pole elliptic filter each draw less than 100 milliwatts and power down to less than 1 mw. Motorola has used that inherent quality of C-MOS to give its three-chip system a telecommunications selling point—minimal power consumption when the phone is on the hook. Motorola's entire system, as it is now designed, will power down to less than 10 milliwatts—a tenth that of most other manufacturers' codecs alone. □

Packaging & production

Varian machine slices 975 wafers at one go

There's more than one way to slice wafers from a silicon ingot. In the semiconductor industry, the wafers are usually cut with a diamond-tipped blade that produces wafers up to 20 mils thick. However, the process wastes silicon because the

kerf—the place where the cut is made—is wide. This wastage is one of the problems that researchers have begun to tackle at the Lexington (Mass.) Vacuum division of Varian Associates.

But Varian is not producing wafers for ordinary semiconductors. The division is funded by the Department of Energy to come up with cheaper methods of slicing wafers from silicon ingots for photovoltaic solar cells. The work is part of the low-cost solar array project administered for the DOE by the Jet Propulsion Laboratory, Pasadena, Calif.

Varian has developed a prototype machine that is expected to slice 975 wafers at a time. This is accomplished by widening the cutting head to handle ingots more than 19 inches wide, about a threefold increase. Moreover, the cutting head that holds each of the 1/4-in.-high blades weighs about a ton—mostly because the blades must be held under a tension of about 200,000 pounds per square inch.

So far, the Varian machine's

A few cents a day



...brings a year's subscription to the industry's most complete technical library—Motorola's.

Save \$9.75 on data books alone plus postage!

We want to keep you completely up-to-date on one of the largest and most complete lines of semiconductors in the industry—Motorola's.

So we're making this offer: just \$15 (approximately the cost of the postage alone) brings you six, timely, special mailings of all technical publications on Motorola semiconductor products introduced over a period of an entire year!

Not only data sheets but data books (of which six are already identified), application notes, brochures, selection guides and many other publications that will keep your semi library current and usable.

Here's what your literature update subscription will bring you in the next 12 months:

1. Six issues (bimonthly) of Semiconductor Update—a periodical briefly describing all new products introduced by Motorola Semiconductor Group within the previous two-month period.
2. An accompanying six-times-a-year package of data sheets and other literature covering all new products described in each Update issue.
3. The following scheduled data books—
Microcomputer Products
MPUs, MCUs, Memories, and Support Products
Interface Products
Power Products
Power transistors and thyristors
CMOS Products
 —and other data books not yet on our schedule.

Plus new application notes covering all product lines from MPUs to discrete RF and power devices.

Plus reliability data, descriptive product and applications brochures.

And, of course, our Master Selection Guide and Catalog, which will be updated and reprinted early next year. (If you don't have our existing MSG&C, we'll send you one when we receive your subscription, just to keep you fully acquainted with Motorola products.)

And if you order now, we'll also send you copies of the Motorola MECL and LSTTL data books which have recently been published and would not normally be part of any new-subscriber package.*

For the biggest technical literature bargain in the industry, plus special periodic mailings, enter your subscription now.

It's only pennies a day!

Mail to Motorola Semiconductor Products Inc.,
 P.O. Box 20912, Phoenix, AZ 85036.

*Offer expires September 30, 1978.

Include me in!

Here's my \$15 check or money order for one year's subscription to the Motorola literature update program. Motorola Semiconductor Products Inc., P.O. Box 20912, Phoenix, AZ 85036.

Name _____

Title _____

Company _____

Address _____

City/State/ZIP _____

Please include Master Selection Guide in first mailing.



MOTOROLA
 Semiconductor Group

Low cost* Data General Mini- computer compatible analog I/O systems.

The ADAC 535 Series of analog I/O systems are field proven, high performance systems that plug directly into the bus of any Data General Mini-computer.

The systems are hardware and software compatible with Data General Mini's and feature 12 bit A/D resolution, 35 or 100 KHz throughput, 16 to 64 analog inputs, 1 to 4 12 bit D/A converters, program control/program interrupt/DMA interface, programmable gain amplifier with auto zeroing and DC/DC converter.

Send for full technical data on the 535 Series and other mini/microcomputer data acquisition and control systems:

ADAC Corporation,
15 Cummings Park, Woburn,
MA 01801. (617) 935-6668.

* Basic System Price in single quantities..... \$1,295

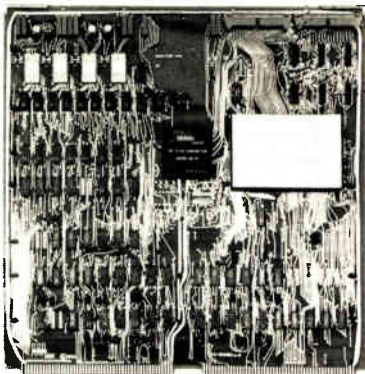

GSA Contract
Group 66

adac

corporation

Electronics review

developers have sliced just two ingots, and these without too much success. But they are not at all fazed.

"We're as confident as we can be several years from the goal that we can meet the numbers DOE has set for us," says Robert G. Wolfson, manager for advanced materials at the division, which manufactures Czochralski crystal-pulling furnaces as well as wafering machines now used mainly to slice sapphire and quartz. From each cutting cycle, Varian must deliver 1,000 wafers that are 12 mils thick—with a kerf loss of just 6 mils—from a 4-in.-diameter ingot at cutting rates of up to 9 millimeters per hour. By 1986, the cutting process should add no more than \$5.78 per square meter of silicon produced to the cost of the purchased ingot, taking into account material, labor, and equipment costs.

In contrast, a commercially available Varian wafering machine has cut 300 wafers per cycle. The kerf width was 10 mils for a 16-mil-thick wafer, and the cutting rate was 3.5 mm/hr. Wolfson says that works out to a cost for the cutting process of \$81.80 per square millimeter of silicon produced.

(Also funded by the DOE, Crystal Systems Inc., Salem, Mass., has cut silicon wafers 4 mils thick, with a 6-mil kerf, using a modified commercial machine from Varian and wires impregnated with diamonds on their cutting surfaces [*Electronics*, July 20, p. 44]. It is now working with a new slicing machine with 500 wires in a blade head that moves over the silicon.)

In the prototype machine, the secured ingot reciprocates back and forth over the 8-mil-thick carbon-steel blades. A silicon-carbide abrasive suspended in oil bathes the ingot and does the cutting.

Jonathan R. Fleming, project engineer for slicing equipment, says the first cut with the huge prototype produced no unbroken wafers because of problems, since solved, in evenly distributing the slurry and in applying the tension to the blades. The second cut resulted in a wafer yield between 40% and 50%, with 12-mil-thick wafers and 8-mil kerfs.

Fleming says the yield would have been as high as 98%, except that many wafers broke after the cut because cement holding the ingot to the reciprocating head loosened. □

Microprocessors

AMD snubs Intel, chooses Zilog part

The race for dominance in the emerging 16-bit microprocessor market has hardly begun, but already things are heating up. Fueling the fire is an agreement signed last month between Advanced Micro Devices Inc. and Zilog Inc. The terms are for AMD to second-source Zilog's forthcoming Z8000 microprocessor and for the two to jointly develop a suite of peripheral devices under an exclusive five-year pact covering the U. S. market.

Industry marketers, who mostly refuse to go on the record, generally agree that the signing adds credibility to the Z8000 design. At the same time, one industry figure notes, the deal "takes luster away from the [Intel] 8086." After all, why should AMD, already a second source for Intel's 8048, 8080, and 8085 microprocessors, not line up behind the 8086, which is essentially compatible with the 8-bit products?

New line. "We can sell the Z8000 as a better part," answers Sven E. Simonsen, vice president and technical director for AMD in Sunnyvale, Calif. "It has up to 30% higher throughput at a lower clock rate, a more regular architecture, and a more powerful instruction set." Because the 8086 was made compatible with the 8080 family, it has limitations, he continues. "The 8086 is the end of a line—the Z8000 is the start of a new one. With the 8086, we could only compete on pricing and delivery."

The deal may also trigger some intense jockeying for second sourcing as other chip makers take turns lining up behind either of the two 16-bit machines. For example, Mos-tek Corp., which is a second source

Before you buy another instrument, analyze all your costs.

USIR's Instrument Acquisition Analyzer makes it easy. And free.

In five minutes you'll be able to compare the commitment of ownership with rates for rental using this handy slide chart. USIR's Instrument Acquisition Analyzer automatically compares inputs such as true annual ownership costs, monthly rental rates, and lifetime equipment utilization. You may avoid decisions you'll regret for the next five years.

Buy, rent or lease, USIR is the right choice.

USIR has more new test equipment than anyone else, all with a variety of acquisition options. And we can provide you with fast information about equipment availability and delivery with our nationwide computer system, IDIOM (Inventory and Delivery Information in One Minute).

But service doesn't stop there. We provide extras like return reminders when your requested rental period is up, a 25% discount if we fail to repair or ship you a replacement for faulty equipment within 48 hours, and a Product Evaluation Program for substantially reduced rates on selected new products.

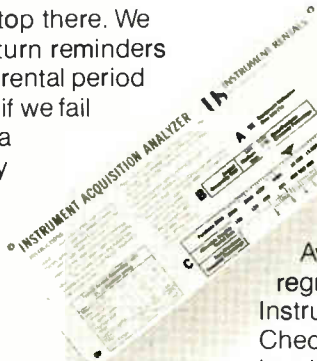
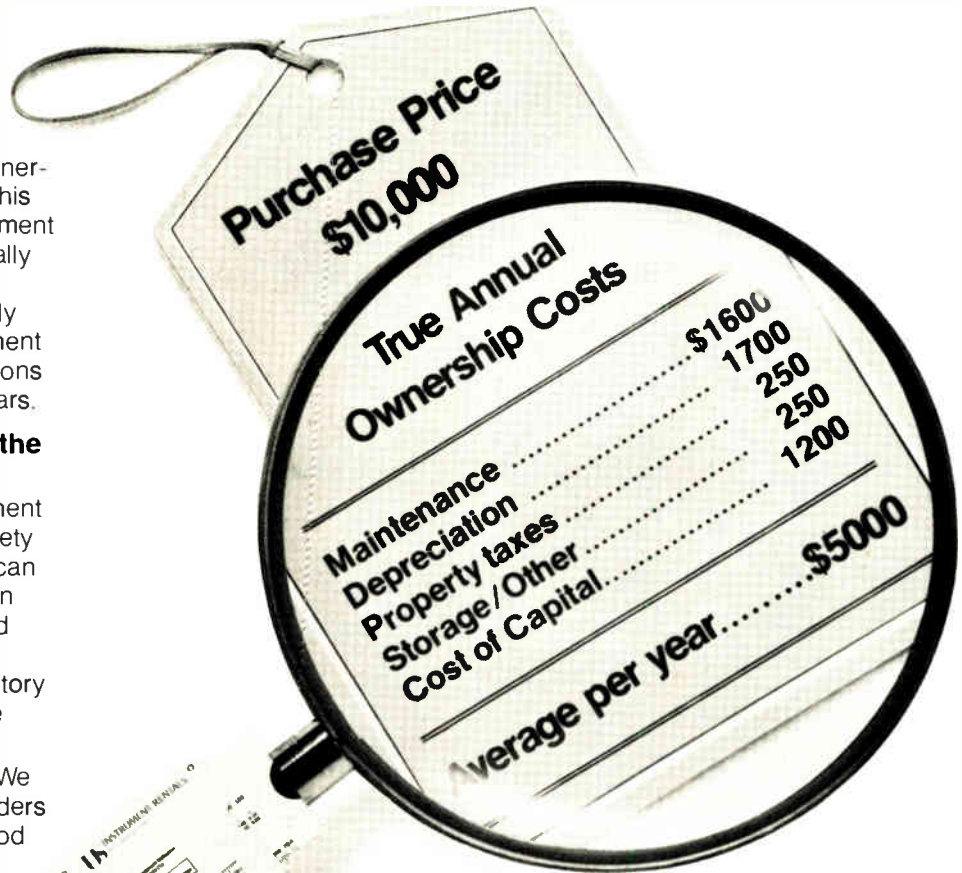

Analyze before you buy.

Avoid buying something you'll regret later. Send for USIR's free Instrument Acquisition Analyzer. Check the bingo card, or if you're in a hurry, call our corporate headquarters. United States Instrument

Rentals, Inc., 951 Industrial Road, San Carlos, CA 94070, phone (415) 592-9225. For a quote on a specific piece of equipment, please contact the USIR office closest to you. We have offices in most major cities—just check the Yellow Pages.



US
INSTRUMENT
RENTALS, INC.

HP's Small Wonders

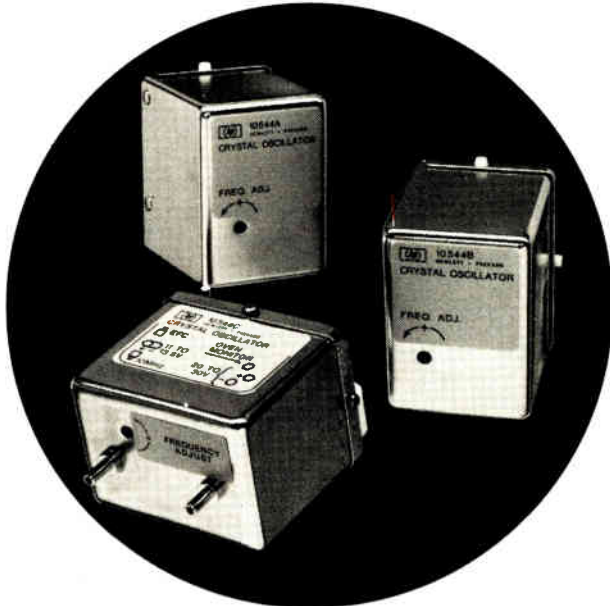

High performance oscillators at budget prices

- Aging rate: $<5 \times 10^{-10}$ /day
- Phase noise: <150 dB (1 KHz offset)
- Time domain stab.: $<1 \times 10^{-11}$ (1 s.)
- Operation: 55°C to 71°C
- Prices start at \$625* discounts for quantity

Build HP's 10544 Series Oscillators into microwave systems that need high spectral purity after multiplication—or into instrumentation,

communication and navigation systems. Use them wherever you need a stable, spectrally pure, rugged, compact, reliable 10 MHz source.

*prices domestic U.S.A. only.

HEWLETT  PACKARD

1507 Page Mill Road, Palo Alto, California 94304

For assistance call: Washington (301) 948-6370, Chicago (312) 255-9800, Atlanta (404) 955-1500, Los Angeles (213) 877-1282

02821

Circle 54 on reader service card

Just published: 1978 EBG!

Completely new listings of catalogs, new phone numbers, new addresses, new manufacturers, sales reps, and distributors! The total market in a book—four directories in one!

**To insure prompt delivery
enclose your check with the
coupon now.**



Electronics Buyers' Guide
1221 Ave. of the Americas
New York, N.Y. 10020

Yes, please send me _____ copy(ies) of 1978 EBG.
 I've enclosed \$25 per copy delivered in the USA or Canada.
 I've enclosed \$35 per copy for delivery elsewhere (\$47 if shipped by Air). Full money-back guarantee if returned in 10 days.

Name _____
 Company _____
 Street _____
 City _____ State _____ Zip _____

Electronics review

of Zilog's 8-bit Z80, is expected to cast its vote for a 16-bit microprocessor within the next 90 days. But with AMD's exclusive rights in the U. S., Mostek or anyone else would essentially have to pirate the part—by designing a functionally compatible Z8000—a difficult task in view of the Z8000's complexity.

For Zilog, the deal allies it with an aggressive marketing organization of second-source products and furthers its intention of making the Z-bus, Zilog's bus protocol, the standard for 16-bit microprocessors, says Robert B. Field, vice president, marketing. Moreover, the Cupertino, Calif., company will continue the pressure by announcing "in the near future" second sources for the Z8000 in Europe and Japan as well as similar pacts for the Z8, a lower-end 8-bit microprocessor due out with the Z8000 [*Electronics*, Jan. 19, p. 42]. Field also hints that other deals may be coming for other Z8000-compatible devices.

Terms. Under the AMD-Zilog pact, AMD agrees to pay Zilog a \$200,000 "creativity fee" and develop an unspecified range of parts. In return, Zilog gives AMD the Z8000, a serial input/output device, a memory-management buffer, a parallel I/O chip, and a first-in-first-out memory buffer. AMD hopes to be providing samples of its Z8000 a few months after Zilog.

Because the next two years is a crucial design-in time for 16-bit devices, the joint effort will allow the two companies "to help each other to take as big a share of the market as we can," Simonsen says.

Although the 8086 is being shipped in small quantities, the Z8000 is not yet available. In fact, it has slipped its due date, and no samples are expected before December, according to Zilog. Simonsen acknowledges it is risky to second-source an unavailable part, but "it would be more risky and take more time if we were to develop our own versions of the 8086, for example."

Intel declines comment on the pact, but the industry expects a second source for the 8086 to materialize as early as next year.

The new era in wafer cleaning.

Introducing Uniplane System 4000 Scrubber.

Never before has a scrubber been able to clean wafers like this one.

Brush scrubbing is better for cleaning gross particulate matter. High pressure scrubbing is better for getting down into the fine geometry of wafers. Sometimes what's really needed is a combination of the two.

Only the new Uniplane System 4000 Scrubber gives you all these capabilities—in one

microprocessor-controlled unit. Including keyboard, display, program editing, program manipulation, and error function display.

You can program it to brush scrub, high-pressure scrub, or both. In any sequence.

Which means you can tune the scrubber to your process. Not force your process into the limitations of a scrubber.

You end up with cleaner wafers. And greater yields.

System 4000 Scrubber is part of Kasper's Uniplane System 4000—the new era in wafer processing. Whether used in-line with other System 4000 processing stations, or as a stand-alone station, it ushers in its own new era in wafer cleaning.

Get in touch with your local Kasper office right away for details. Or write Kasper Instruments, 749 North Mary, Sunnyvale, CA 94086, (408) 733-9800.



Circle 55 on reader service card

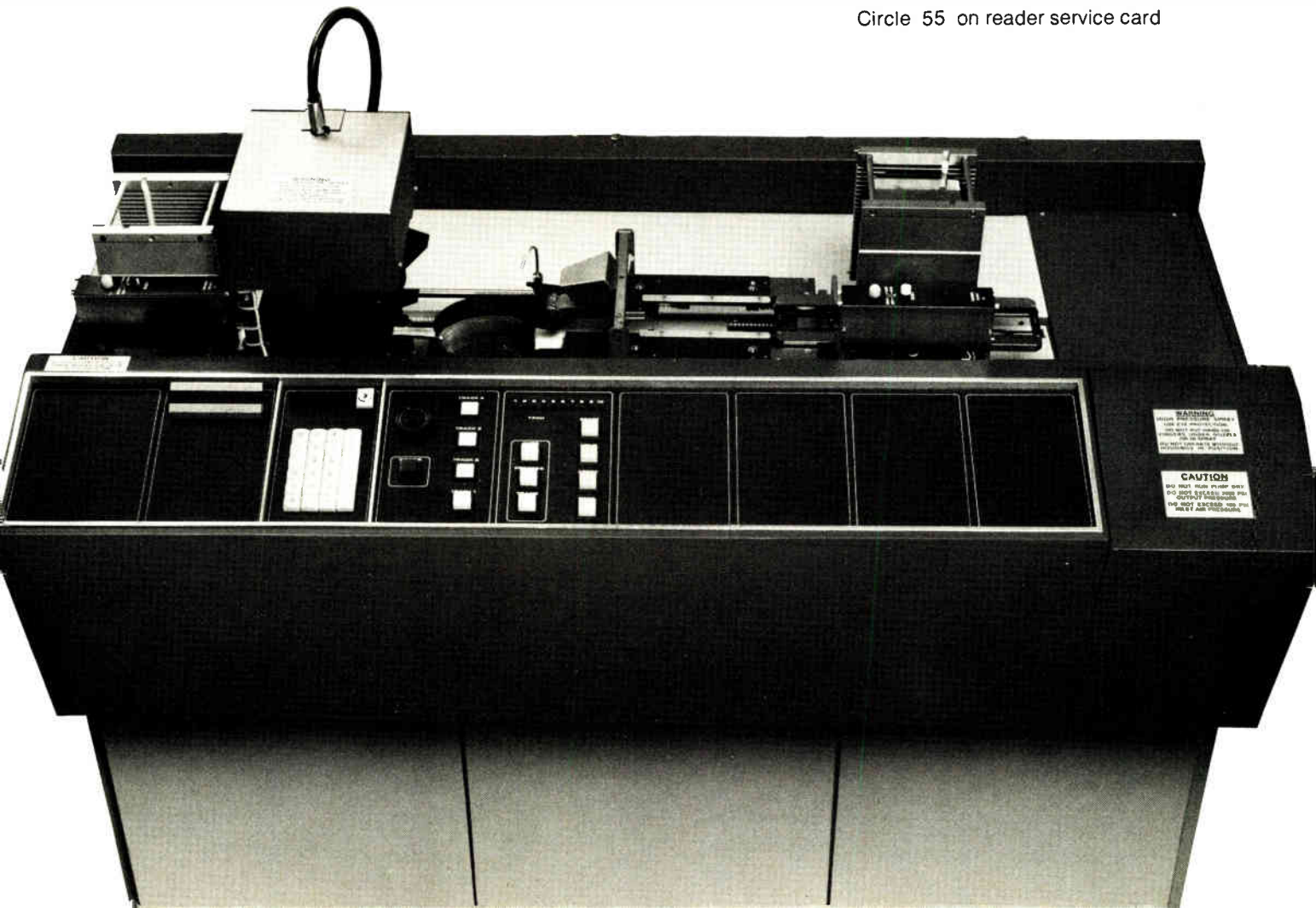

From the Leader in High-Voltage Interface IC Technology

HERE'S COMPREHENSIVE DATA ON HIGH-PERFORMANCE INTEGRATED CIRCUITS

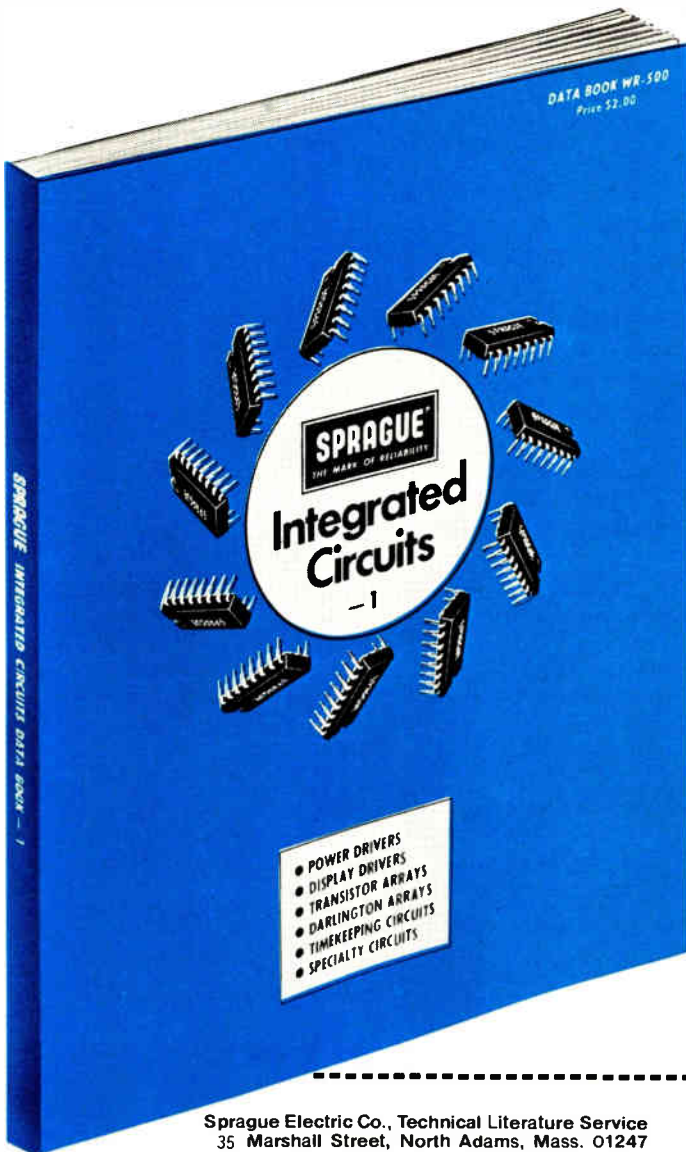

Just off the press is a *new* 240-page 7" x 9" data book which provides a comprehensive guide to high-performance ICs, with special emphasis on interface circuits.

This *new* Sprague Integrated Circuit Data Book features essential technical data on power-peripheral drivers; high-voltage display drivers; high-current transistor and Darlington arrays; MOS, CMOS, and BiMOS circuits; and specialty devices such as op amps, quad current switches, and amplifier-detector/SCR firing circuits.

To secure this valuable book, call your nearest Sprague district office, sales representative, or franchised semiconductor distributor. Or, if you prefer, mail the handy order form today.

DISTRICT OFFICES AND SALES REPRESENTATIVES:

ALABAMA, Sprague Electric Co., 205/883-0520 • ARIZONA, Sprague Electric Co., 602/279-5435
 • CALIFORNIA, Sprague Electric Co., 213/649-2600; Wm. J. Purdy Co., 415/347-7701; KCE Corp., 714/278/7640 • COLORADO, Wm. J. Purdy Co., 303/777-1411 • CONNECTICUT, Sprague Electric Co., 203/261-2551 • DIST. OF COLUMBIA, Sprague Electric Co. (Govt. sales only), 202/337-7820 • FLORIDA, Sprague Electric Co., 305/831-3636 • ILLINOIS, Sprague Electric Co., 312/296-6620; D. Dolan Sales, 312/286-6200 • INDIANA, Sprague Electric Co., 317/253-4247
 • MASSACHUSETTS, Sprague Electric Co., 617/899-9100; Sprague Electric Co., 413/664-4411
 • MICHIGAN, Sprague Electric Co., 517/787-3934 • MINNESOTA, HMR, Inc., 612/920-8200
 • MISSOURI, Sprague Electric Co., 314/781-2420 • NEW JERSEY, Sprague Electric Co., 201/696-8200; Sprague Electric Co., 609/795-2299; Trinkie Sales Inc., 609/795-4200 • NEW MEXICO, Wm. J. Purdy Co., 505/266-7959 • NEW YORK, Sprague Electric Co., 516/549-4141; Wm. Rutt, Inc., 914/698-8600; Sprague Electric Co., 315/437-7311; Mar-Com Associates, 315/437-2843 • NORTH CAROLINA, Electronic Marketing Associates, 919/722-5151 • OHIO, Sprague Electric Co., 513/866-2170; Electronic Salesmasters Inc., 800/362-2616 • PENNSYLVANIA, Sprague Electric Co., 215/467-5252; Trinkie Sales Inc., 215/922-2080 • TEXAS, Sprague Electric Co., 214/235-1256
 • VERMONT, Ray Perron & Co., Inc., 617/762-8114 • VIRGINIA, Sprague Electric Co., 703/463-9161 • WASHINGTON, Sprague Electric Co., 206/632-7761 • WISCONSIN, D. Dolan Sales, 414/482-1111 • CANADA, Sprague Electric of Canada, Ltd., 416/766-6123 or 613/238-2542.

Sprague Electric Co., Technical Literature Service
 35 Marshall Street, North Adams, Mass. 01247

Enclosed is check (or money order) for \$2.00;
 please send *new* IC Data Book to:

(name) _____ (title) _____
 (company) _____ (mail section or dept.) _____
 (street) _____
 (city) _____ (state) _____ (zip) _____

Mass. residents add 5% sales tax. No stamps or cash, please.



... and you thought we only make great capacitors.

Air Force awards Boeing \$129 million for B-52 digital avionics

By giving a \$129 million contract to Boeing Wichita Co., the Air Force has committed itself to full-scale development of a new digital Offensive Avionics System for its B-52G and H heavy bomber series. The OAS will control the Short-Range Attack Missile, the B-52's main armament, and the air-launched cruise missile now in development. Under the 36-month contract, Boeing will spend **two years equipping a B-52G test aircraft with the new avionics and the third year on flight tests.** The firm will use equipment provided by the Government, like the USAF strategic common doppler radar and Honeywell's Geans inertial navigation package, and has also picked the following subsystem contractors: IBM Federal Systems of Owego, N. Y., for avionics processors; Lear Siegler Instruments of Grand Rapids, Mich., for the attitude-heading reference system; Honeywell Avionics of Minneapolis for the radar altimeter; Sperry Flight Systems of Phoenix for controls and displays; and Norden Systems of Norwalk, Conn., for radar modifications.

Bendix gets \$2 million for microwave landing prototype from FAA

The Federal Aviation Administration is giving Bendix Corp. just under \$2 million for prototype development of the so-called "Basic Wide" microwave landing system to be used for precision all-weather approach and landing at large airports. Under the award, which runs about two years, the company's Baltimore-based Communications division will begin **delivering hardware in 10 months for installation and tests by the FAA next summer** at the National Aeronautics and Space Administration's test center in Wallops Island, Va. Texas Instruments, the other FAA-qualified competitor, initially entered the competition but did not remain in the bidding, an FAA official said. The MLS time-reference scanning-beam system developed by the U. S. and Australia was qualified as the next world standard this year by the International Civil Aviation Organization.

Japan still supplies 65% of U. S. color TV imports

Imports accounted for nearly a quarter of the domestic supply of nearly 10.1 million color TV receivers in the U. S. market **for the 12 months ended June, the first year in which Japanese exports were restrained by the Orderly Marketing Agreement.** New Commerce Department data shows that nevertheless, out of nearly 2.5 million color TV imports, Japan shipped 1.63 million color receivers, or 65%. Taiwan was second with 458,000, followed by Korea with 182,000, Canada with 172,000, and Mexico with 22,600.

NBS seen biased in touting emi as 'pollution' problem

The electronics industries are unhappy about the National Bureau of Standards' publicity for its Nov. 2-3 Government, industry, and consumer conclave on electromagnetic interference—billed as "a major workshop on the growing problem of 'electromagnetic pollution.'" To be held at NBS's headquarters in Gaithersburg, Md., the meeting will deal with emi radiated by transportation, communications, medical, industrial and consumer products. Commerce Department sources say that a number of companies, which they decline to identify, have written Secretary Juanita Kreps and her staff **challenging the validity and fairness of an NBS statement that reported "some observers believe emi may become one of the top environmental problems in the 1980s because of the proliferation of electronic products and components in American life."**

The Pentagon's VHSI: will it fly in Monterey?

The newest piece of Pentagon jargon is VHSI, an abbreviation for the program in very-high-speed integration it will unveil Nov. 14 at Monterey, Calif. VHSI is likely to reverberate quickly up the peninsula into Silicon Valley when the microcircuit industry learns it is the name of the Defense Department's ambitious new six-year plan to spend an estimated \$200 million on advancing the state of the integrated-circuit art (see p. 81). It will differ from industrial VLSI efforts in emphasizing much higher speeds and uneconomically large die sizes.

Site of the unveiling will be Monterey's Del Monte Hyatt House, headquarters for the three-day Government Microcircuit Applications Conference sponsored by DOD, its military services, and the other Federal agencies that consider themselves heavily involved in high technology. Most semiconductor industry specialists have rated past Gomac gatherings as certainly informative, sometimes useful, but rarely profitable in terms of developing new business leads. This year, however, the VHSI premiere seems to guarantee that the conference will shed that not-for-profit, tutorial image.

Breakthroughs and breakdowns

In addition to DOD's detailed proposal on how to sponsor new breakthroughs in microcircuits, Gomac's audience will also get to hear a blistering critique of "the biggest single deficiency" in modernizing America's armed forces—the incredibly long and costly lead times between development of a technology and the delivery of production hardware to users. Leading his audience down that barrier-strewn pathway will be Rep. Richard Ichord, the plain-spoken Missouri Democrat who chairs the House Armed Services Committee's research and development subcommittee. Ichord's presentation will draw on the findings and present preliminary conclusions of an extensive investigation by his subcommittee that could prove newsworthy.

While Congressman Ichord's keynoter should appeal to the national interests of Gomac's audience, DOD's announcement of its major shift in policy on funding microcircuit technology is certain to generate major questions. Why is DOD reversing its *laissez-faire* approach to microcircuit development?

What each of the several different but equally

valid answers to the question have in common is economics. Or, more crudely, money. DOD has carefully monitored the hectic and expensive competition within the U.S. semiconductor industry during the past decade and a half. It has carefully plotted the advances in technology and noted that the rising U.S. curve is beginning to flatten out while other nations, capitalizing on prior American achievements, move to catch up.

Lack of capital

The pace of American technology has not slowed because it is running out of ideas but because it is short on investment capital in a high-risk market. The Pentagon has watched with quiet anxiety as America's most innovative microcircuit producers generally have remained unresponsive to the military's peculiar, low-volume requirement, while cultivating larger, more responsive civilian markets. Military leaders believe they saw U.S. technological dominance eroding as manufacturers necessarily paused to profit from long production runs and recoup some of their heavy investments in capital equipment, rather than make existing hardware obsolete with more expensive innovation.

What appears to have broken the back of Government resistance to intervening in America's most successful example of a competitive free market at work, however, was the increasing number of capital-starved semiconductor manufacturers who turned to foreign sources.

Changes yet to come

Technological leadership is the keystone in the arch of U.S. defense policy. The eager response by foreign manufacturers to every opportunity to acquire American technology and access to its markets was more than policy makers could take. Thus the Government has responded through the Defense Department with its \$200 million program for developing the technology it calls VHSI.

There is no doubt that VHSI will influence the course of the American microcircuit industry. One clear consequence is that the Gomac-80 scheduled for Houston 26 months hence is sure to draw a record crowd. Beyond that, however, even Gomac's sophisticated audience can only guess at what other changes DOD's new market entry will bring.

Ray Connolly

Winning the Space Race



If space is your problem, TEAC cassette data recorders are the solution. They give you big-recorder performance and features without using up a huge amount of area or budget. Used individually or in combination, the time-tested R-81 or the brand new R-61 will make your data acquisition tasks quick and convenient—in the field, laboratory or office.

With the R-81 you get seven data channels and four switchable speeds for a wide range of time base conversion options. The R-80 has the same four-speed versatility as the R-81, with four data channels. And the single-speed R-61 is the lightest, most portable data recording package available. Naturally, they all feature famous TEAC durability and dependability.

TEAC R-81, R-80 and R-61: for space-saving, high-quality data recording.

TEAC

TEAC CORPORATION, 3-7-3, Naka-cho, Musashino, Tokyo, Japan, Phone: (0422) 53-1111

U.S.A.: B.J. Wolfe Enterprises Inc., 10760 Burbank Blvd., North Hollywood, Calif. 91610 England: International Instruments Ltd., Cross Lances Rd., Hounslow, Middx W. Germany: nbn Elektronik Starnberg, 813 Starnberg, Max-Emanuel-Str. 8 France: Tekelec Airtronic S.A., Cite des Bruyeres, Rue Carle-Vernet 92 Sevres Holland: SIMAC Electronics, Veenstraat 20, Veldhoven Italy: A.E.S.S.E. S.R.L., Corso Lodi, 47 20139 Milano Norway: Rodland & Reitsmo A.S., Gladengveien 3A, Oslo 6 Sweden: Teleinstrument ab, Maltesholmssvagen 138, Vallingby Denmark: Danbit, Plantagevej 23, 2680 Scolrod Strand Switzerland: Wenger Datentechnik, Bruderholzstrasse 45, 4053 Basel Australia: Jacoby, Mitchell Ltd., P.O. Box 70, Kingsgrove, N.S.W. 2208

Circle 59 on reader service card

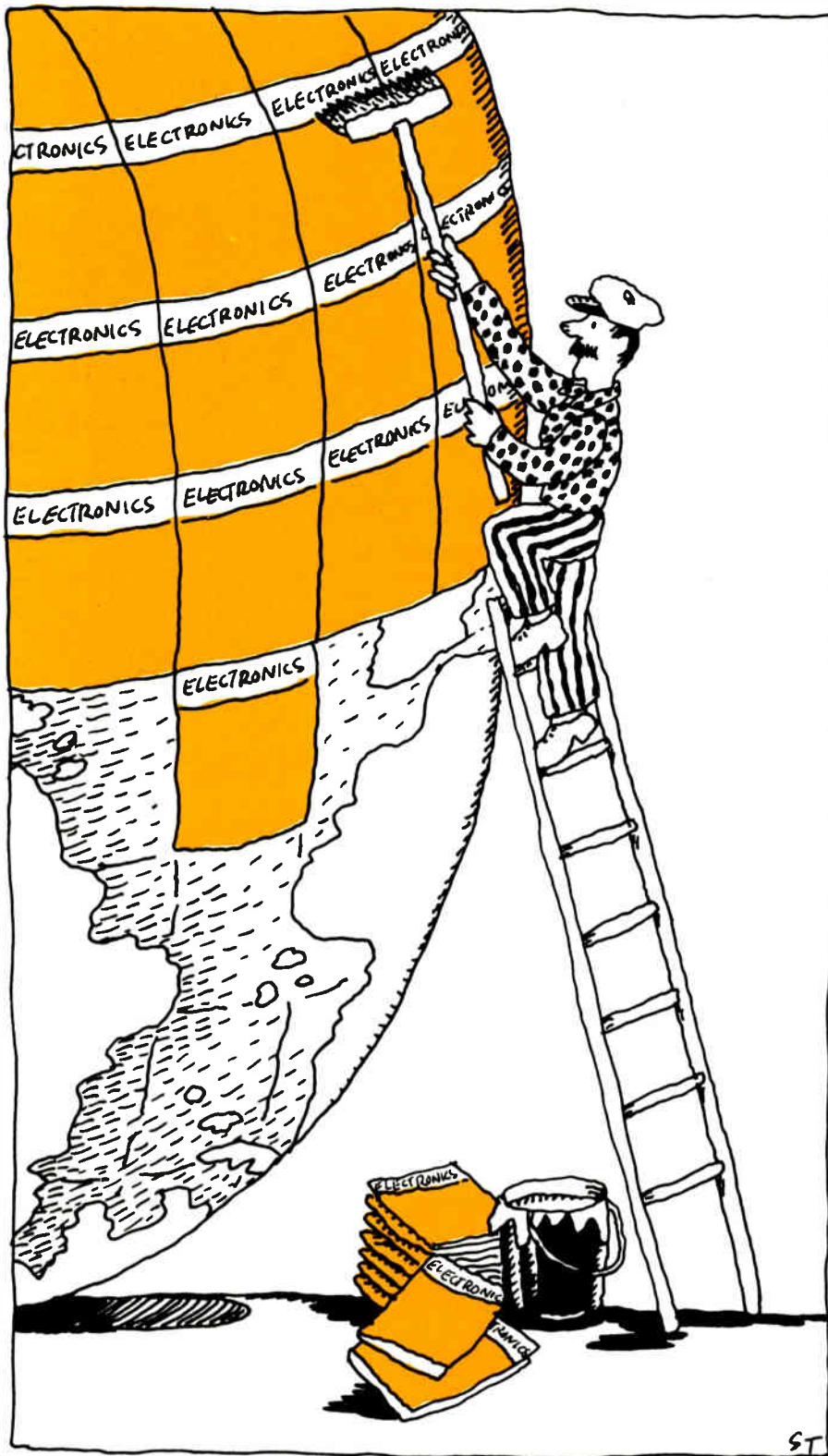

**From San Frantokyo
to Copenhagen—around the
world in 26 issues.**

Electronics magazine's exclusive worldwide coverage applies both to the technology and to the market.

The technology: Electronics is the only international observer of the rapidly changing technology. Our overseas editors don't just travel overseas. They live and work in the electronics capitals of the world. They report on the technology in San Francisco, Tokyo, Moscow, Tel Aviv — wherever that technology is happening.

The market: Another exclusive — the only international coverage of the market. Advertisers can augment the North American edition of Electronics with the International Edition. The full run reaches 91,200 subscribers in 127 countries. Two other options are available to international advertisers — the Russian language edition of Electronics and the Japanese language magazine, Nikkei Electronics.

The bottom line: Write down the percentage of your sales you'd like to come from overseas. Then put at least that percentage of your advertising budget into Electronics magazine. The companies which follow this simple rule will one day own this market.

Electronics Magazine
1221 Avenue of the Americas
New York, N. Y. 10020



ST

**Worldwide coverage.
Another reason your ad sells best in Electronics.**

Guaranteed overnight package service.

It doesn't just mean you can get your money back. It means you won't have to.

Next Day Express Mail guarantees* overnight service by 10 a.m. Or your money back. All of it.

But we know you really want to get your package there on time. Not to get your money back.

This guarantee is our straightforward demonstration of confidence. After all, we handle millions of packages that have this guarantee. So you better believe we're going to be on time.

All you have to do is to get your package to an Express Mail Post Office before 5 p.m. Anything mailable, up to 70 pounds.

We'll get it to the destination Express Mail Post Office ready to be picked up as early as 10 a.m. the next business day.

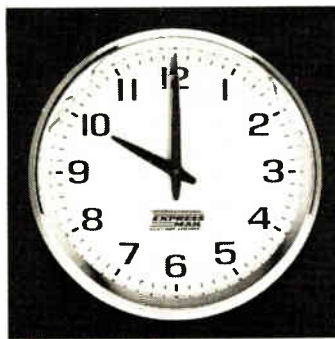

**City to city,
Post Office to Post Office,
by 10 a.m. Guaranteed.**

What does it cost? A lot less than you'd think. For example, it's only \$8.50 to get a 5-lb. package from N.Y. to L.A.

For about two dollars more, we'll deliver it right to their door by 3 p.m. If not earlier. Weekends and holidays, too.

We've got over 1,000 Express Mail Post Offices in over 400 cities. So you'll probably find one that's located right near you.

Got something to ship in a hurry? Ship it Express Mail.

With our guarantee, we have to be tough on ourselves. And that makes it easier on you.

**EXPRESS
MAIL®**
NEXT DAY SERVICE

*Our guarantee: 100% refund of Express Mail postage upon application at origin if mailed by 5 p.m. at an Express Mail Post Office and not available for claim at a destination Express Mail Post Office by 10 a.m. next business day or delivery not attempted to addressee by 3 p.m. of the next day (unless delayed by strike or work stoppage). ©1978

U.S. Postal Service



RCA first in CMOS.

Now you can get a faster 5101 from RCA. Fast.

It's the fastest 5101 you can get. 250 ns access at 10 μ A leakage, plus a range of other speed/leakage values. And they're available fast, from stock. At any participating RCA Solid State Distributor.

Unique 10 V, 256 \times 4 RAM.

The CDP1822 is a 10 V, 250 ns version of the 5101 with 256 \times 4 organization. Which makes the 1822, like the 5101, ideal for use with the RCA 1800 microprocessor.

In-use simplicity.

Both RAMs have separate data inputs and outputs—the outputs are TTL compatible.

And there are two Chip-Select inputs for easy system expansion.

For immediate delivery contact your RCA distributor. For more information contact RCA Solid State headquarters in Somerville, NJ; 1130 Brussels, Belgium; Sunbury-on-Thames, Middlesex, England; Quickborn 2085, W. Germany; Ste.-Anne-de-Bellevue, Quebec, Canada; Sao Paulo, Brazil; Tokyo, Japan.



Type	Leakage μ A	Access Time, ns	Voltage V	Temperature Range, $^{\circ}$ C
MWS5101DL-1	10	250	5	0 to +70
MWS5101DL-2	50	250	5	0 to +70
MWS5101DL-3	200	350	5	0 to +70
MWS5101DL-8	500	450	5	0 to +70
CDP1822D	1000	250	10	-40 to +85
CDP1822CD	500	450	5	-40 to +85

RCA COS/MOS experience is working for you.

Japan's largest computer due at end of 1979

Deliveries of Japan's largest computer, the M-300H from Hitachi Ltd., will start in the fourth quarter of 1979 or first quarter of 1980. The new machine will be the largest so far of a line of software-compatible computers using completely different hardware and built by Hitachi and Fujitsu Ltd. with government financial aid. Hitachi claims that the average instruction execution time of its system will be **10% faster than that of the next largest machine in the line**, Fujitsu's M-200—78 ns compared with 85 ns. It also claims that the M-200H is 1.7 times faster than IBM's top-of-the-line 3033.

The new computer will have bipolar emitter-coupled-logic circuits with 550 gates in its central processing unit and 16-K n-MOS dynamic random-access memories in its main memory. Main-memory size options range from 4 megabytes to 16 megabytes. Up to four CPUs may be used in multiprocessor arrangement, and Hitachi engineers say that the addition of an integrated-array processor to the CPU about quadruples its speed for complex scientific and technical computations. The company expects demand for 100 systems over five years, with rental starting at about \$190,000 a month.

Siemens spends \$250 million on two EDP plants

The drive of Siemens AG to become a bigger force in electronic data processing is shifting into high gear. The West German firm is spending \$250 million on a just-completed 115,000-square-meter facility and another of about 80,000 m² under construction. The outlay for the two Munich facilities amounts to **the biggest single investment the company has ever made**. As for its business, the Siemens Data Processing and Information Systems division did about \$600 million last year, and a 16% increase is expected in 1980. Even so the division will still be in the red, although it is West Germany's second biggest EDP supplier, commanding 20% of the computer market. IBM is first with 58% of the market.

Flat-screen display for Viewdata shows 960 characters

With an eye on the potential market for low-cost, portable business Viewdata terminals, General Electric Co. Ltd.'s Hirst Research Laboratory has developed a 960-character flat-screen display that accommodates a complete Viewdata/Teletext page. Based on dc electroluminescent technology, the display produces 24 lines of 40 bright yellow characters. **Still needed for the system and being developed by the GEC lab is an integrated-circuit display driver.**

Also under development is a 480-character display, and an 80-character module is now being evaluated by the British Post Office as a possible second source to the display made by Phosphor Products Ltd. for its automatic call-recording system. Meanwhile, Phosphor Products has received a contract from the Ministry of Defence to develop red, green, and blue dc electroluminescent displays in addition to the conventional yellow digits available.

Peripheral chips for microprocessors coming from NEC

Three LSI peripheral chips sought by users of microprocessors are about to become available simultaneously in Japan and the U. S. Nippon Electric Co. says it will ship samples of its μ PD765C programmable floppy-disk controller (see p. 202) and μ PD769C high-speed serial interface in October, and its μ PD3301C/D programmable cathode-ray-tube controller in November. **All three parts will be available in production quantities in**

April. They are compatible with 8080 systems and also with NEC's μ COM1600 16-bit microprocessor. Using fine-pattern H-MOS technology, they will operate from a single +5-v supply and use a high-frequency crystal for their clocks.

Thomson aims electronic PABX at low end

Determined to become a factor in world PABX markets, the Société des Téléphones STE (Thomson Ericsson) has added two new and smaller electronic private automatic branch exchanges to the P line it launched last year. Thomson figures that the smaller of the two, the P10, could become a strong seller in the fast-growing low end of the market. Built around a Zilog Z80 microprocessor, the unit combines a switching circuit and an operator's console in a single cabinet about the same size as an oversized office typewriter. Capacity is up to six outside lines and up to 24 extensions. **The unit, which offers most features of other electronic PABX systems, is highly modular.**

French working on 90-Mb/s coax phone link

At the behest of the government-run French telecommunications agency, Thomson-CSF has begun to develop what the two believe will be **the fastest digital coaxial-cable telephone transmission system so far**, one that operates at 900 Mb/s. Feasibility trials for the link are some 18 months off, but Thomson-CSF has already fabricated experimental versions of two crucial components for the system's repeaters. They are the comparator and signal regenerator circuits, both built around field-effect transistors integrated on gallium-arsenide chips to get switching speeds fast enough for 900-Mb/s transmission.

Sensor to enable Spacelab to study earth's surface

Under contract to Bonn's ministry for research and technology, the West German aerospace firm Dornier System GmbH is working on a multimillion-dollar microwave measuring and remote sensing system that is to be tested during the first Spacelab mission. The system will be able to investigate the earth's surface in fine detail, whatever the weather and terrain, by using a side-looking radar. Sending out microwave pulses and measuring the radiation returned from the surface, the system will generate **microwave pictures that give information on soil conditions, vegetation, harvest yields, and the like.**

Addenda

Now that they have designed a 1,024-bit static random-access memory that boasts 10-ns speed, engineers at Nippon Electric Co. are pushing into faster zones. Employing 3- μ m design rules and positive photoresist with the company's diffusion self-aligned n-MOS technique, **the designers are planning to use even finer lines to get faster devices.** . . . An experimental 13-bit monolithic analog-to-digital converter **accurate to 1/2 the least significant bit** has been built by Matsushita Electric Industrial Co. It uses p-MOS analog switches in its sample-and-hold circuits, integrated injection logic, and two types of npn transistors; conversion time is 16 μ s. The devices are due at the end of next year. . . . General Electric Co. Ltd. has followed its announcement of a silicon-on-sapphire capability with word that **it is well advanced on a V-groove MOS process**, selected for its high-voltage, high-current capability.

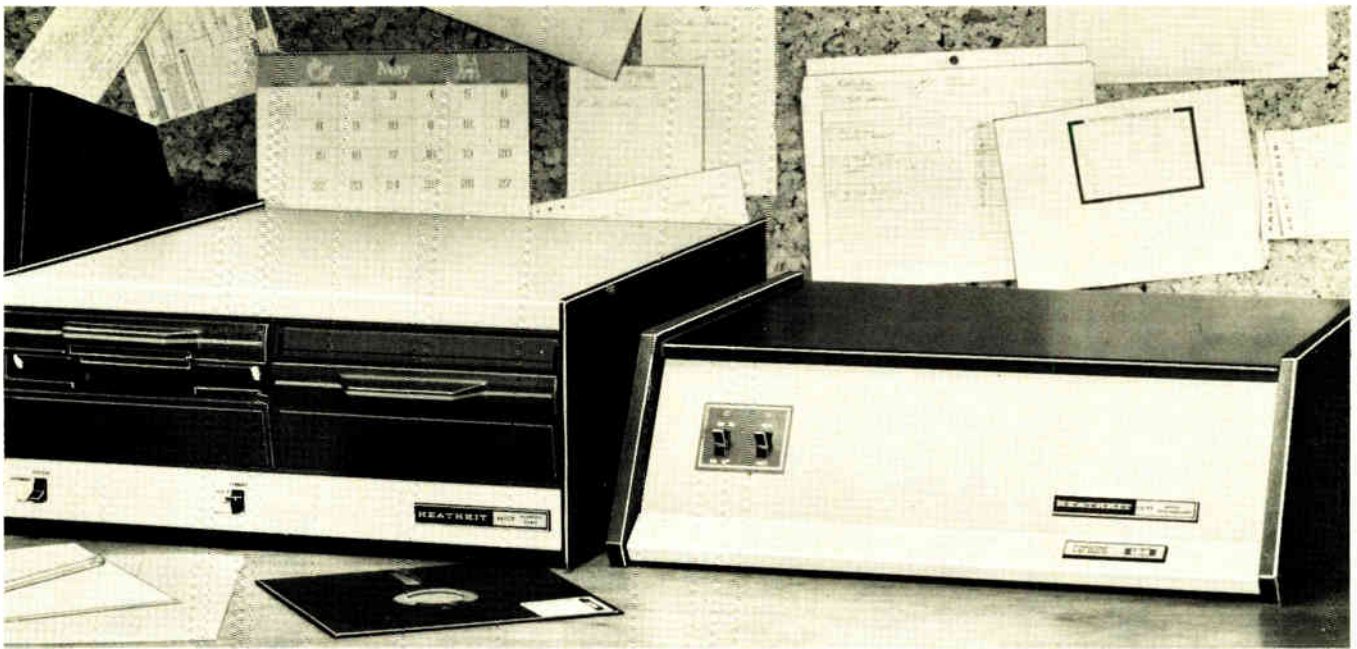

You can risk a lot of money for a personal or business computer...OR you can talk to Heath!

If you work with computers, you know how much of an asset they are to your business. Fast, accurate data handling, instant retrieval of important information and storage of vital records and statistics are all part of the computer revolution. Computers mean better business, but there's another side to them as well.

Computers can work for, educate and entertain you right in your own home. Because they are true "open-end" machines, the number of ways you can use a computer at home is limited only by your imagination and programming prowess. Computers can also be an important adjunct to your children's education and an introduction to the modern technological world.

Best of all, computers happen to be FUN! There are hundreds of fascinating and challenging games that can stimulate your brain and provide hours of relaxation and recreation. And because the computer can make its own decisions, you can "compete" at any level you program into it.

No matter what your computer application, Heath Company has the unit for you. Our H8 is an 8080A-based machine with an "intelligent" front panel that is ideal as a programming trainer and instruction tool.

The powerful H11 is based on the most successful commercial computer in the world, the Digital Equipment Corporation PDP-11. These two computers, along with a complete line of peripherals and I/O devices, make Heath your home computing system headquarters.

Heathkit computer systems provide the documentation you need to get up and running right - complete step-by-step assembly manuals, comprehensive operating procedures and complete and thorough rundowns of software programs. What's more, Heathkit computer systems include the systems software you need to start programming right away. The H8 includes a front panel monitor program, Benton Harbor BASIC, assembly language, text editor and console debugger. The H11 includes editor, relocatable assembler, link editor, absolute loader, debug, executive and dump programs plus BASIC and FOCAL.

Heathkit computer systems are designed to give you personal home computing at its very best. And since they're backed by Heath's 54-year reputation for honesty, reliability and quality, you know that a Heathkit computer system is one of the best personal investments you can make!



HEATHKIT COMPUTERS

Electronics / September 14, 1978

FREE!

Read about nearly 400 top-value electronic kits you can BUILD yourself - for fun, for satisfaction, and for SAVINGS!

Heath Company, Dept. 510-450
Benton Harbor, Michigan 49022



Send for your HEATHKIT Catalog!

Heath Company, Dept. 510-450
Benton Harbor, Michigan 49022

HEATH
Schlumberger

Please send me my FREE Heathkit Catalog.
I am not on your mailing list.

Name _____

Address _____

City _____ State _____

CP-154 _____ Zip _____

E-H announces a brilliant new concept in switch matrix design

The μ Matrix™

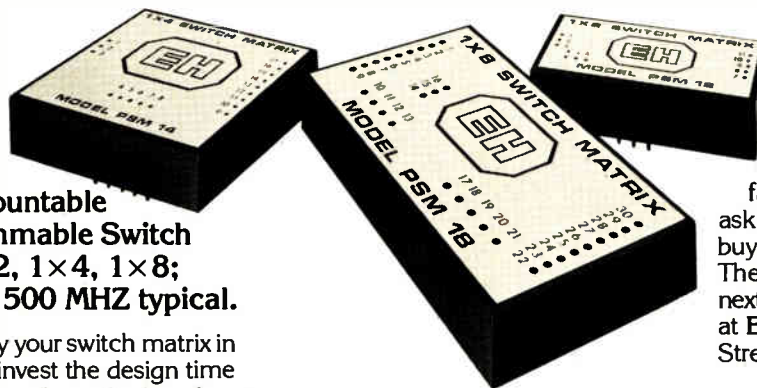
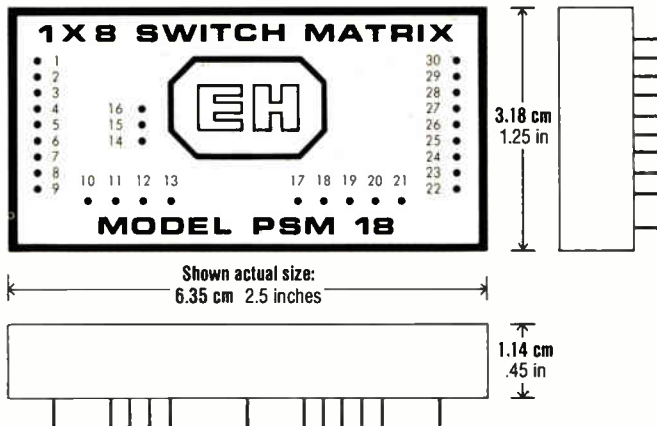

**PC board mountable
TTL Programmable Switch
Matrices 1×2, 1×4, 1×8;
Bandwidth > 500 MHz typical.**

Now you can buy your switch matrix in a package and invest the design time you'll save in more important work.

- Get a quick and inexpensive (\$50 to \$180)* answer to switching problems in networks, computer interfaces, and test systems. (Put the Matrix right next to the device under test!)
- Simplify backplane and bus design

*U.S. Domestic Price Only

and eliminate rat's nest wiring problems.

- Save system space, cut your component count and reduce manufacturing assembly time. One of our 1×8's will replace 8 relays and all associated circuits.
- Simplify design and documentation by a factor of eight.
- You can even eliminate one layer on a pc board.

Those are the highlights of our new and growing μ Matrix family. For the whole story, ask for a demonstration. Better yet, buy one. Do your own evaluation. Then tell us how many you'll need next year. (415) 834-3030. Write us at E-H International, Inc. 515 11th Street, Oakland, CA 94607.



See us at Wescon Booth Nos. 714-716

Digital compensation technique in crystals yields ultrastability

Racal to develop IC version based on method developed at University of Bath that promises low production cost

By adopting a novel digital method of compensating for temperature-induced frequency drifts in quartz-crystal frequency references, researchers at the University of Bath in England have achieved frequency stabilities of 5 parts in 10^8 over a 40°C operating range. Only the best analog-compensated frequency references are as stable.

Moreover, the new technique has a tighter performance spread and promises lower production costs. It also rivals the stability of bottom-range oven-controlled crystals without high current drain or long warmup times.

According to Prof. William Gosling of the School of Electrical Engineering at Bath, the new crystal reference could be a key element in the development of future single-sideband mobile-radio receivers, where instant startup, low power consumption, controllable performance, and low production costs are all necessities. But the crystal reference could also find its way into instrumentation and distributed synchronous data nets.

IC coming. Now that the technique has proved feasible, Racal Dana Instruments Ltd. in Bracknell, Berks., is to develop an integrated-circuit version [*Electronics*, Aug. 31, p. 68]. If this succeeds, a cost-reduction program will aim at producing a frequency reference to be marketed

alongside the company's range of oven-controlled crystals, says Keith P. Thrower, director of the Advanced Developments division.

Racal and the Science Research Council funded the work at Bath, and Racal holds patents on the technique. The decision to go ahead will depend on costs, says Thrower, who will be content to achieve initial accuracies of one part in 10^7 .

The technique rests on the use of two co-mounted crystals, one a conventional high-stability AT-cut and the second Y-cut to give it a large temperature coefficient of frequency. The two are in good thermal contact so that changes in the frequency of the Y-cut crystal can be used to represent the temperature of the crystal pair.

The high-stability crystal serves as a frequency reference in a phase-locked-loop frequency synthesizer capable of frequency increments of

about 0.3 hertz over a range of about 75 Hz, sufficient to compensate for any likely frequency drifts over a 50°C range.

The frequency synthesizer output is adjusted by the second temperature-sensitive Y-cut crystal, whose output is counted against that of the high-stability AT crystal. The output word of the counter, held in a latch, represents the temperature of the crystal pair and is used to address a programmable read-only memory.

PROM data. The data stored in this 256-by-8-bit PROM corresponds to the temperature characteristics of the crystal pair employed. The output of the PROM is an 8-bit word, sufficient to define 256 frequency synthesizer increments. Thus, for each increment in the temperature register of the Y-cut crystal, the appropriate correction is made by an 8-bit-output word from this ROM.

Data stored in the PROM corre-

Cooperation. In a Bath University technique, two co-mounted quartz crystals, one with a high-stability cut and the other with a temperature-sensitive cut, work together to compensate for temperature-induced frequency drifts in a digital frequency synthesizer.

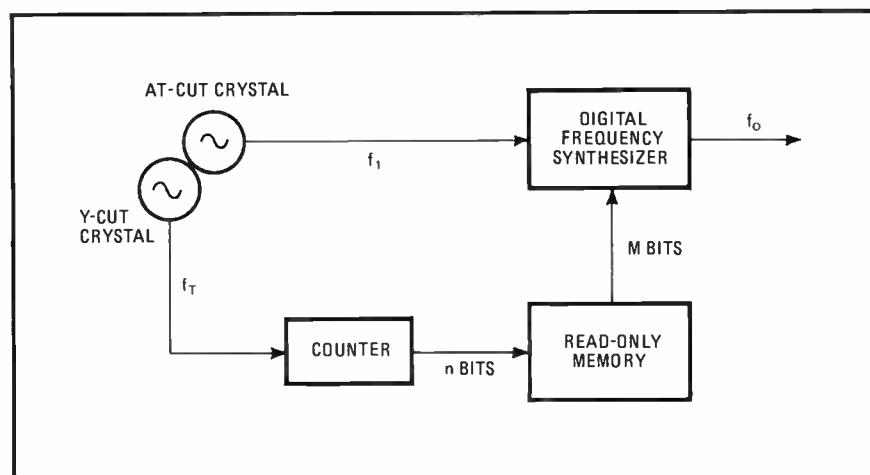

sponds only to that particular pair of crystals for which it was programmed. That, says researcher G. A. Warwick, is why an automatic programming system is a basic element in the concept. The circuit can then be calibrated rapidly on the production line, ensuring very high accuracies in the field. Warwick claims that individual testing and matching techniques are impossible with the rival analog temperature-compensating techniques. Instead, he says, the manufacturer approximates a temperature-frequency curve for each crystal batch, so that there is a wide spread of the temperature coefficients resulting.

One big advantage of the automatic programming system for the Bath scheme is that no absolute measurement of temperature is required during cycling. All that is needed is in the dual-crystal setup to temperature-cycle the systems and

load each read-only-memory address with the value that brings the actual frequency in line with the specified frequency.

The technique developed at Bath University parallels work at the U.S. firm, Hewlett-Packard Co., which is using a single crystal made to vibrate in two modes simultaneously to produce temperature-stable and temperature-sensitive frequency pickups. But, says Gosling, this technique requires a complex crystal technology whereas the Bath approach uses well-proven crystal-cutting techniques.

He says his technique could be reduced to two chips: one a custom-built chip, the other a PROM, with a typical power consumption of around 30 milliwatts. It could provide an accurate frequency reference within 1 second of being switched on, as well as an excellent signal-to-noise ratio. □

France

Optical-fiber transmission featured in airborne current-measurement device

Flying over the wheat fields of France is a Falcon 10 business jet fitted out with a current-measuring

device that transmits its digitized data over an optical fiber. The instrument easily outperforms air-

borne devices employing the conventional measuring technique, says its developer, the government aerospace research outfit Onera.

Its function in the jet is to measure the current emitted by the discharge of electric potential. Such corona discharges can interfere with communications and navigation systems. Highly effective dischargers are needed, and accurate, rapid measurements of the currents they emit are necessary.

Parts. The experimental device from the Office National d'Etudes et de Recherches Aérospatiales is built around a neon tube intermittently illuminated as current is emitted, a Quartz et Silice QSF 600A monofiber, a photodiode, and a measuring system. There are no manufacturing plans afoot, but Onera does expect there will be commercial devices eventually.

The standard method of measuring the discharge is to isolate the discharger from the aircraft mass but connect it by an insulated wire to the measurement system and thus indirectly to the plane. Unfortunately, the wire can act as an antenna, picking up lots of interference. Moreover, if the data-collection system malfunctions, it may disconnect the discharger from the plane.

As the figure shows, the approach taken at the Onera laboratory in Chatillon is to make the discharger out of a ceramic capacitor in parallel with a miniature neon tube. This circuit converts the charge into optical digitized energy.

Discharge current passing through the capacitor increases the potential across its ends, causing the neon tube to light. As the tube lights, it discharges the current, and recharging begins. The process continues at a rate proportional to the current.

The neon tube acts as a light source for the 10-meter-long optical fiber, and its flashes are picked up by a photodiode at the end of the fiber. The diode is the front end of a preamplifier converting the light pulses representing the current into a digital format for transmission to the data-collection system.

The optical fiber is a good dielec-

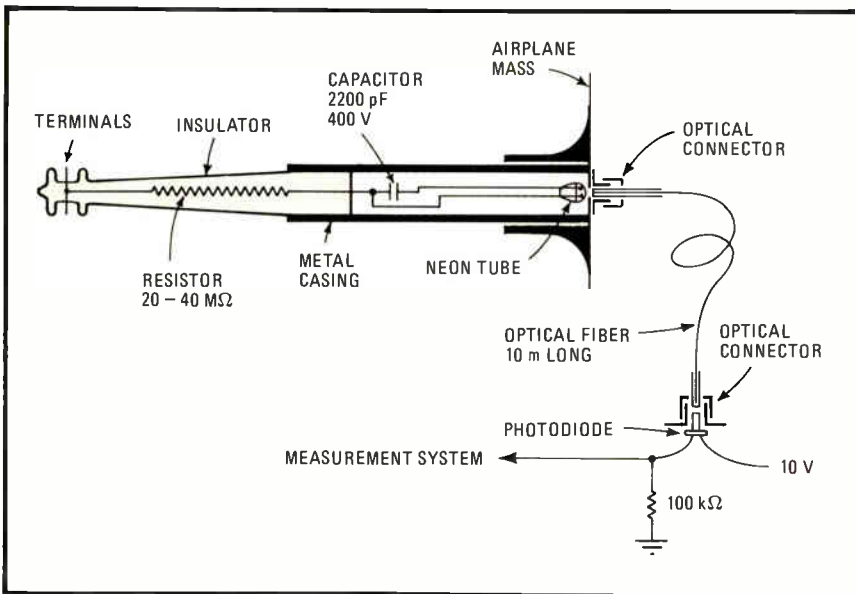

Light work. A potential discharger uses a circuit of a capacitor and a neon tube. The circuit discharges the potential and serves as an optoelectronic source at the same time.

No Other Compact Timer/Counter Packs This Much Performance For Under \$1,000*.

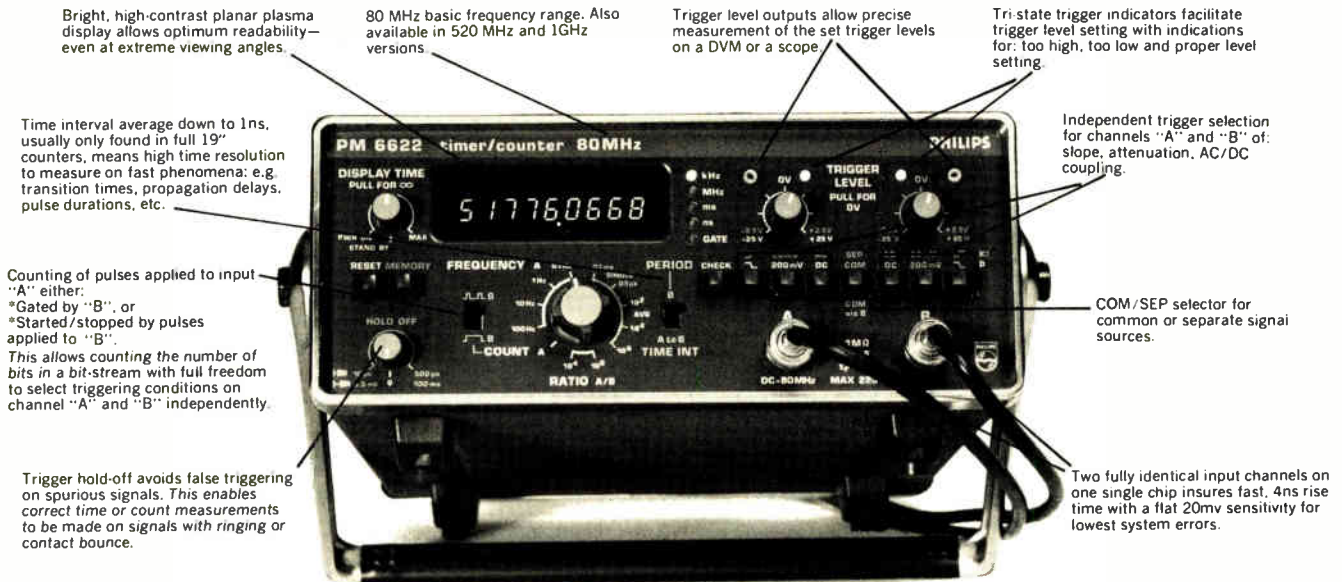

Ask Us To Prove It Right In Your Office.

Contact us today for a demonstration of Philips top of the line universal timer/counter—80, 520 and 1000MHz models. We'll show you that when both price and performance count, you should buy Philips.

We'll show you how the PM 6620 series makes demanding measurements easier and more accurate. You'll see how easy it is to customize the right model for your specific purpose, using our three different models, five time bases and seven options.

A wide range of options adapt this compact counter including: Xtal oscillators up to $5 \times 10^{-10}/24h$; BCD output; analog output, IEEE-488 bus interface; battery supply; carrying case and 19" rackmount.

If your application calls for less measuring power ask about our 6612 80MHz counter/timer for \$740.00*.

For immediate information, or to schedule a demonstration, use our toll-free hot line number,

*U.S. Domestic Price only.

(800) 631-7172, except Hawaii, Alaska and New Jersey. Calls placed in New Jersey, please call collect (201) 529-3800, or contact

Philips Test & Measuring Instruments, Inc.

In the U.S.:

85 McKee Drive
Mahwah, New Jersey 07430
Tel. (201) 529-3800

In Canada:

6 Leswyn Road
Toronto, Canada M6A 1K2
Tel. (416) 789-7188

Mail To: Philips Test & Measuring Instruments, Inc.

Robert J. Grassi
Product Manager
Philips Test & Measuring Instruments
85 McKee Drive
Mahwah, New Jersey 07430

E 9/78

- Please send me literature on the PM 6620 series of timer/counters.
 Please send me literature on the PM 6612 80MHz counter/timer.
 Please contact me so you can demonstrate one of the compact Philips counters.

Name _____
Title _____
Company Name _____
Street _____
City _____ State _____ Zip _____
Phone (Area Code) _____



Test & Measuring
Instruments

PHILIPS

tric, guarding against the dangers of extremely high potentials. For example, it will protect the data-collection system against the high charges that may result from lightning strikes, says Pierre Durrenberger, an engineer on the project.

Less noise. Onera developed its transmission method as part of its program to reduce aircraft electrical noise. "We are aiming for an electrically clean aircraft," says Jean-Louis Boulay, an engineer at the Chatillon lab. The defense ministry backs its work, and Avions Marcel Dassault/Bréguet Aviation, the important military and civil aircraft maker that manufactures the Falcon 10, supplied the test plane and set up

the discharger that it is carrying.

The Onera engineers envision an increasing role for optical fibers in all aspects of airborne data-transmission systems. "We will be using optical fibers, not only for protection systems, but also for functional devices such as control circuits," says Boulay. Work on such devices is also under way in the U. S.

One other application of the current-measuring device is under development. It will be used to detect dangerous levels of electrical charges in storage tanks containing explosive fuel or other chemicals. But this is only the beginning, say Onera engineers: many more applications are likely. □

Japan

Directional couplers send TV signals down a single optical-fiber cable

If optical fibers are to make it in show biz, then some way must be found to cut the costs of television transmission systems. Matsushita Electric Industrial Co. thinks it can do just this, with its experimental couplers for bidirectional TV transmission on a single optical fiber.

Engineers at Matsushita's Central Research Laboratories in Osaka have developed directional couplers that pass the output of a light-emitting-diode transmitter to the input of a p-i-n photodiode receiver over a single optical fiber. The directional couplers separate the transmit and receive channels by more than 44 decibels. Their loss is only 3.7 dB,

including the 3 dB inherent in splitting the power equally among transmit and receive.

Operation. The directional coupler at the transmitter sends slightly less than half the power it receives down the line. The directional coupler at the receiver sends slightly less than half the incoming power to the photodiode, where it is detected.

The resulting system is flat within ± 0.5 dB over a frequency range extending from 20 hertz to 11 megahertz. Differential gain is less than 1%, differential phase is less than 1°, and sag is less than 2%.

For both transmit and receive, the largest source of interference is

reflection at the couplers from the opposite transmission direction. To reduce it as much as possible, Matsushita cuts the fiber ends at the directional couplers at an angle that causes most of the reflection to leak into the cladding. The company says that reflections are at most 0.05% of the transmitted signal, or 33 dB below the forward signal, and typically 0.03%, or more than 35 dB below. Reflections at splices measure less than 0.02%.

The components have not yet been translated into commercial products. Masakazu Fukai of the central labs says that such products are awaiting standardization among the fiber manufacturers because best results are obtained when the fibers in the components match those in the transmission lines.

Fibers. Typically, the experimental systems have used Nippon Sheet Glass Co. SI-100 optical fibers, which are of the type that has a step change in the index of refraction. Numerical aperture of these fibers is 0.27, core diameter is 100 micrometers, and cladding diameter is 150 μ m.

This optical cable is suitable for bidirectional circuits with 11-megahertz bandwidths and distances between repeaters of about 1 kilometer when used with an LED transmitter. Greater distances between repeaters are possible with higher-output LEDs or laser diodes.

In the experimental system, the light-emitting diode and p-i-n diode used in the transmitter and the receiver, respectively, have short lengths of optical fiber attached for best coupling to a transmission line. The actual output at the LED is 0.630 milliwatt; received power at the p-i-n diode is -24 dBm. □

West Germany

Double-laser setup yields tiny scalpel

Neurobiologists have a new tool to work with: a laser beam used under a microscope as a scalpel. Research-

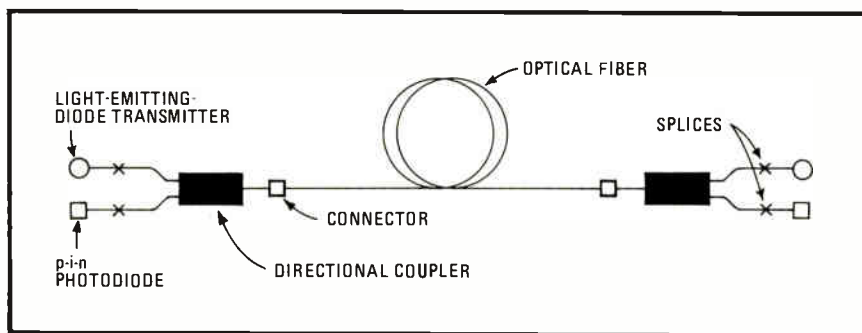

One cable. Directional couplers for TV transmission permit coupling of the output of an LED light source and the input of a p-i-n photodiode detector with only a single optical fiber.

electronica78

International Trade Fair
for Components and Assemblies
in Electronics
Munich, 9 - 15 November 1978
Fair Grounds



electronica — Technical Sessions Programme
8 - 10 November 1978
8th International Congress on Microelectronics
13 - 15 November 1978

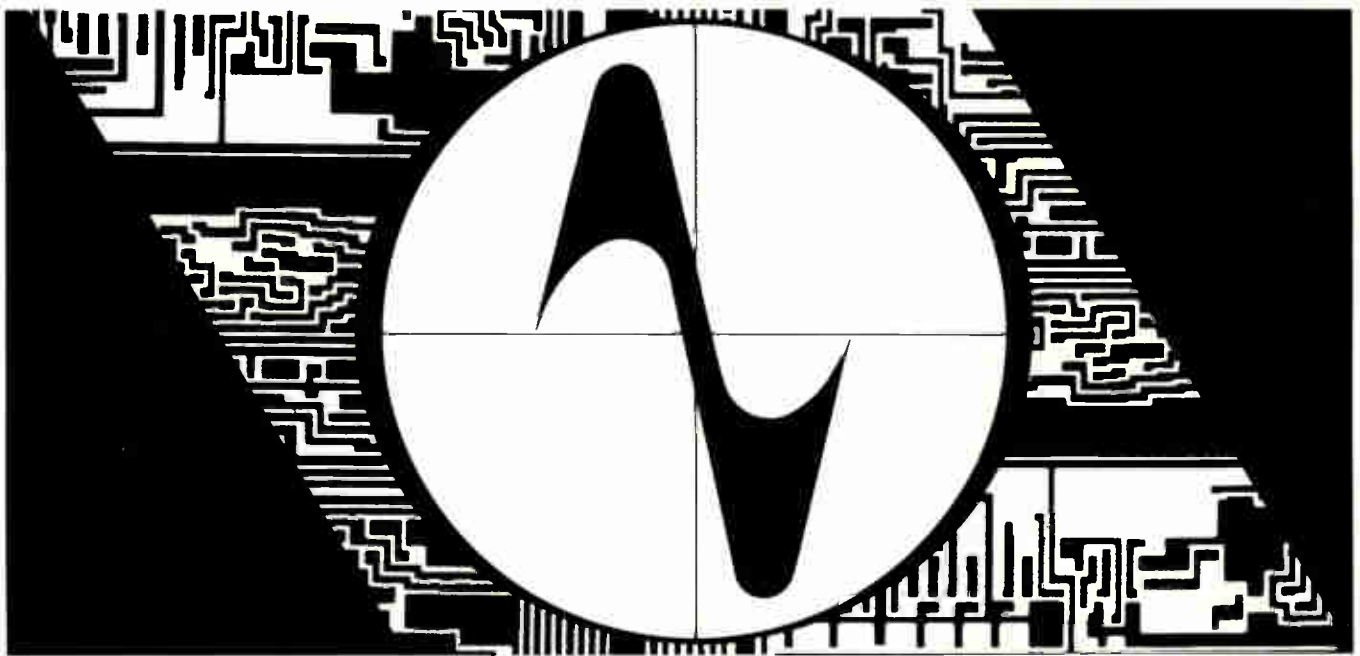

Please forward to us detailed information

electronica 78-Coupon

Name

Address

Münchener Messe- und Ausstellungsgesellschaft mbH, Messengelände, Postfach 12 10 09,
D-8000 München 12, Federal Republic of Germany, Tel. (089) 51 07 - 1

ers at the Max Planck Institute for Psychiatry in Munich have already begun to apply this subminiature "cutting torch" to cell cultures of the nervous system grown outside the living organism. They have succeeded in severing minute extensions of living nerve cells without damaging the cells themselves.

In the nervous system, axons, as these extensions are called, link one cell to another and transfer both electrical impulses and molecules between them. Finding out more about the transport of information over these intercellular communications networks is the ultimate aim of a group of institute researchers.

The precise microsurgery possible with the new laser microscope is already giving important clues to the regenerative ability of the intercellular networks. "We were able to cut the axons of individual cells by laser shots with high accuracy," says Ellen Rieske, a member of Georg

Kreutzberg's group. "With mechanical means, such fine micromanipulations are impossible to perform without damaging or completely destroying the cell."

Two lasers. The new tool, developed at Munich-based Biotechnik GmbH, has two lasers whose light is colinearly fed into the microscope's lens system. One laser produces the cutting beam, and as many as 100 of its 8-nanosecond pulses of light may be fired in a second. This laser uses nitrogen as its active medium and generates light at a wavelength of 337.1 nanometers, in the invisible ultraviolet range. Its pulse output power may be set between 4 and 40 kilowatts.

The other laser, a helium-neon version, emits light in the red range. Its visible beam is used to steer the invisible cutting beam to its target. The light of the latter beam is deflected onto the object plane, where it is focused to a point less

than 1 micrometer in diameter. The red laser has a 632.8-nm wavelength and a 500-microwatt continuous output power.

Burn away. This focal point constitutes the "blade" of the laser scalpel, Rieske says. "Its power density gets up to 50 billion watts per square centimeter, high enough for biological material to evaporate instantly." By moving the microscope's stage relative to the laser focal point, minute operations on the cells can be performed. Ordinarily it takes but one laser shot to sever a cell's axon, she explains.

The microscope with its two lasers is contained in a box (see photograph) that can be sterilized to prevent contamination of the cell cultures. The temperature inside the box is a constant 36°C, which insures that heat will not expand the microscope's optical components and throw them out of alignment, impairing the laser's cutting accuracy. The cutting operations can be observed on a monitor by the researcher.

The institute's work thus far has shown that cells vary in their regenerative ability. Axons grow back to almost their original length within 3 to 12 hours, even after repeated severings. Cells with only two or three axons, called bi- or tripolar cells, regain almost their original shape. The group eventually hopes to find methods and substances that enhance and speed up the regenerative process.

More work. The Planck Institute specialists are also applying the laser microscope in another set of neurobiological experiments that they are carrying out with an American guest researcher, Guenter Gross. Usually, cells grow and interconnect in completely unpredictable fashion into highly complex networks, Rieske explains.

Such disorderly networks make investigating intercellular communications very difficult. "We are currently working on a technique to control the formation of cells and their axons by laser operations and thus to cultivate a two-dimensional model nervous system," she says. □

Laser surgery. Neurobiologists Ellen Rieske and Georg Kreutzberg are looking at a monitor screen showing the target area of a laser microscope (in the sterilizable box).

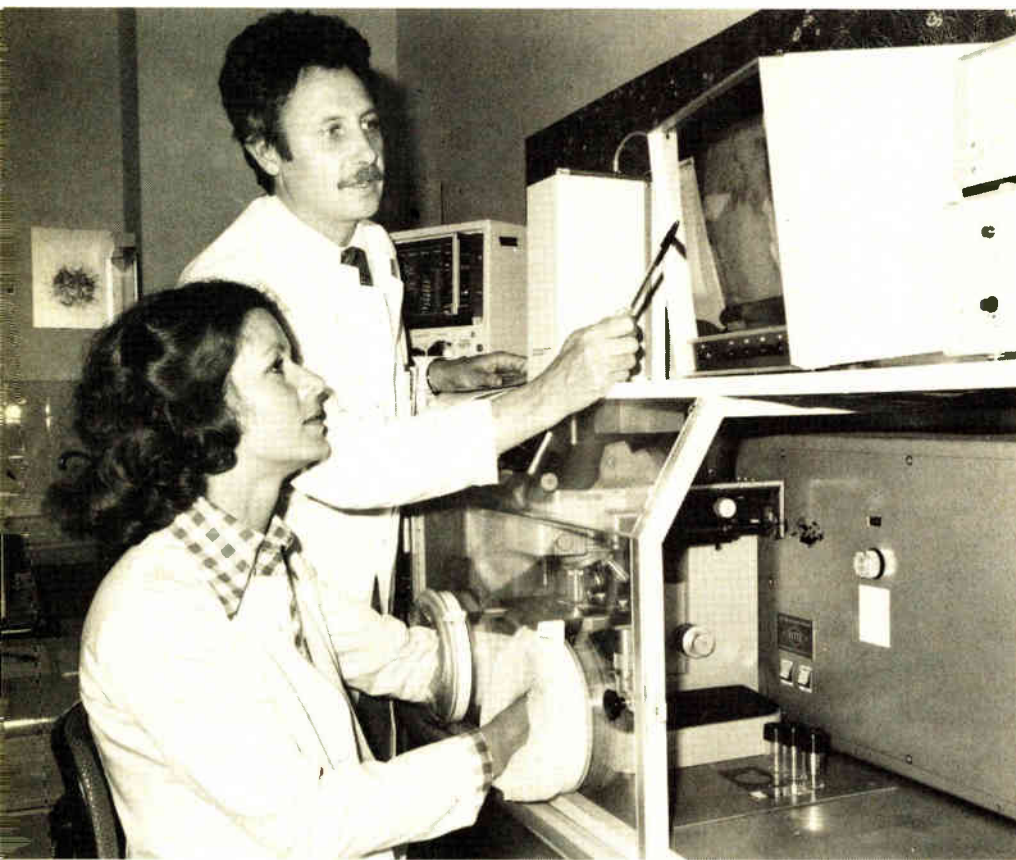

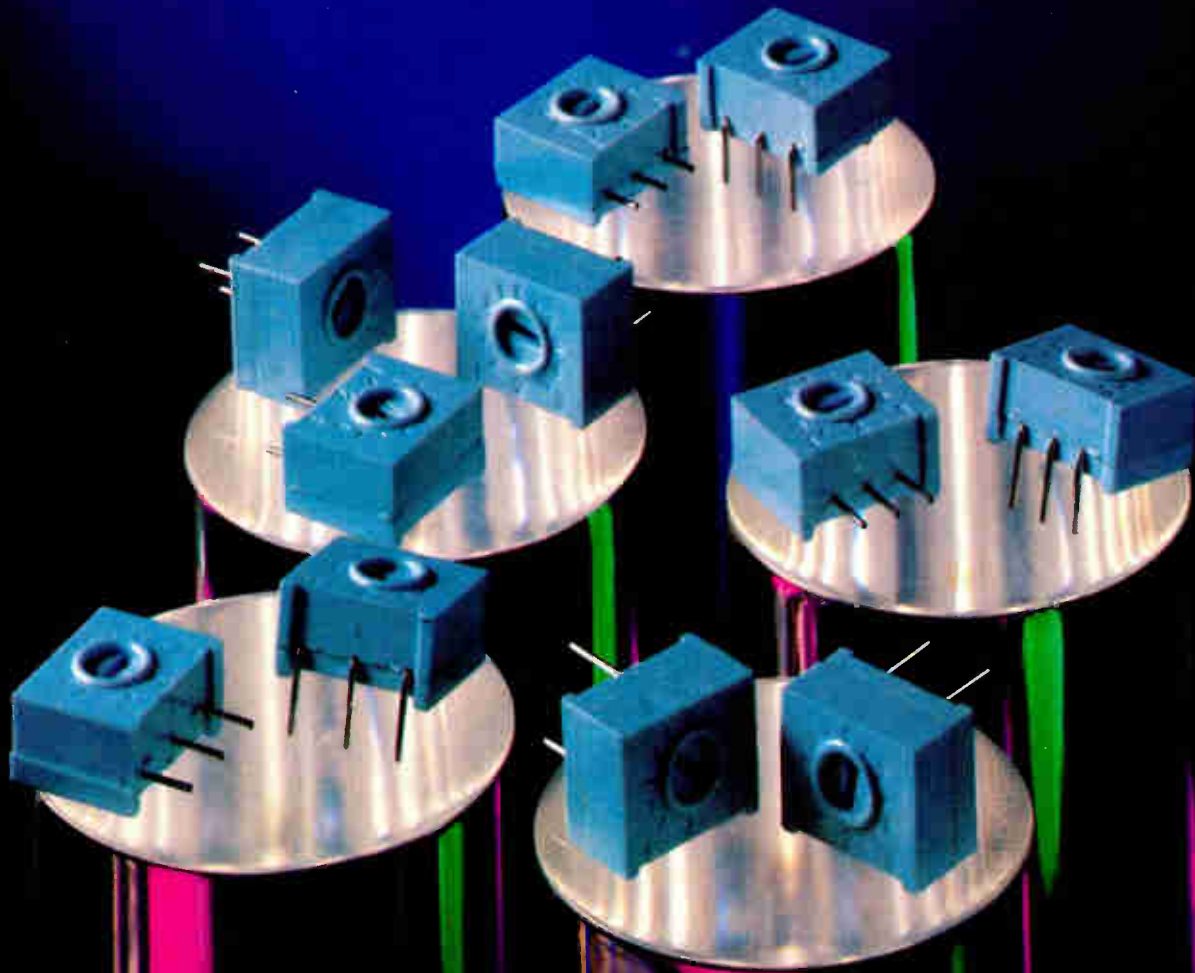

Go the full 360 with CTS...

Series 360 single turn cermet trimmers. You couldn't travel in better trimmer circles than CTS. With the CTS Series 360 family, 1 of the 11 pin styles is sure to satisfy your trimmer needs. And that's especially true if you're designing for digital voltmeter-ammeter-ohmmeter applications, TWX equipment, sweep generators, oscilloscopes, aircraft radio and navigation equipment, computer peripheral equipment, automotive braking equipment, calculators, engine and emission control analyzers or fire detection equipment. Plus our latest application, the speaker phone.

How's that for a full circle of satisfied needs!

You get all-around performance from the CTS 360 cermet trimmers. Eleven popular grid spacings in-

cluding top and side adjust on .100", .125", .150" and T0-5 centers. Power rating 1 watt @ 25°C, ½ watt @ 85°C. Standard TC ± 150 ppm/°C throughout the resistance range. Settability .03%. New gold plated multicontact wiper for lowest possible noise level. Mini dimensions: .360" x .434" x .298".

The price of each 360 style is low; your CTS distributor's inventory is high—call him today; get it promptly.

For nonstandards—and for complete information—write directly to the company that has put millions into electronics for industry. CTS of West Liberty, Inc., 6800 County Road 189, P.O. Box 266, West Liberty, Ohio 43357. Phone (513) 465-3030.

CTS CORPORATION

ELYHART, INDIANA



A world leader in cermet and variable resistor technology

FOR RENT

Intel's amazing new generation
Intellec® Series II
Microcomputer Development Systems
... everything you'll ever need to
develop a microcomputer-based product.

The Intellec Models 210, 220 and 230 are the first fully integrated, packaged tools for developing and testing your microcomputer-based products. They'll each fit easily on your lab bench to help cut months from your design cycle.

You can rent the newest generation microcomputer development systems today from REI and start taking advantage immediately of the fast, flexible and cost-efficient Intellec systems. Each can help you build a more reliable product. And because these new Intellec systems are so compact, they use less of your valuable laboratory bench space than any other microcomputer development aid on the market.

Model 230 is the most powerful member of the Intellec Series II family, providing you two double-density floppy diskettes with over 1-million bytes of on-line data storage, 64K bytes of RAM and an integral CRT.

The compact Model 230 also gives you a detachable, type-writer-style keyboard with upper and lower case characters and cursor controls. Its powerful ISIS-II Diskette Operating System has relocatable and linkable software and allows the use of two high-level programming languages, PL/M-80 and FORTRAN 80, plus the microcomputer industry's most comprehensive line of macro assemblers. The system has over 1-million bytes of on-line diskette storage and will support up to 25-million total bytes. The System Monitor (in ROM memory) provides a Self-Test system diagnostic, and interfaces for a printer, paper tape reader/punch and universal PROM programmer are also provided. Model 230 gives you access to all the tools needed for your development work, including software editors, assemblers, compilers and debuggers, plus Intel's famous In-Circuit Emulators - ICE-80, ICE-85, and ICE-48.

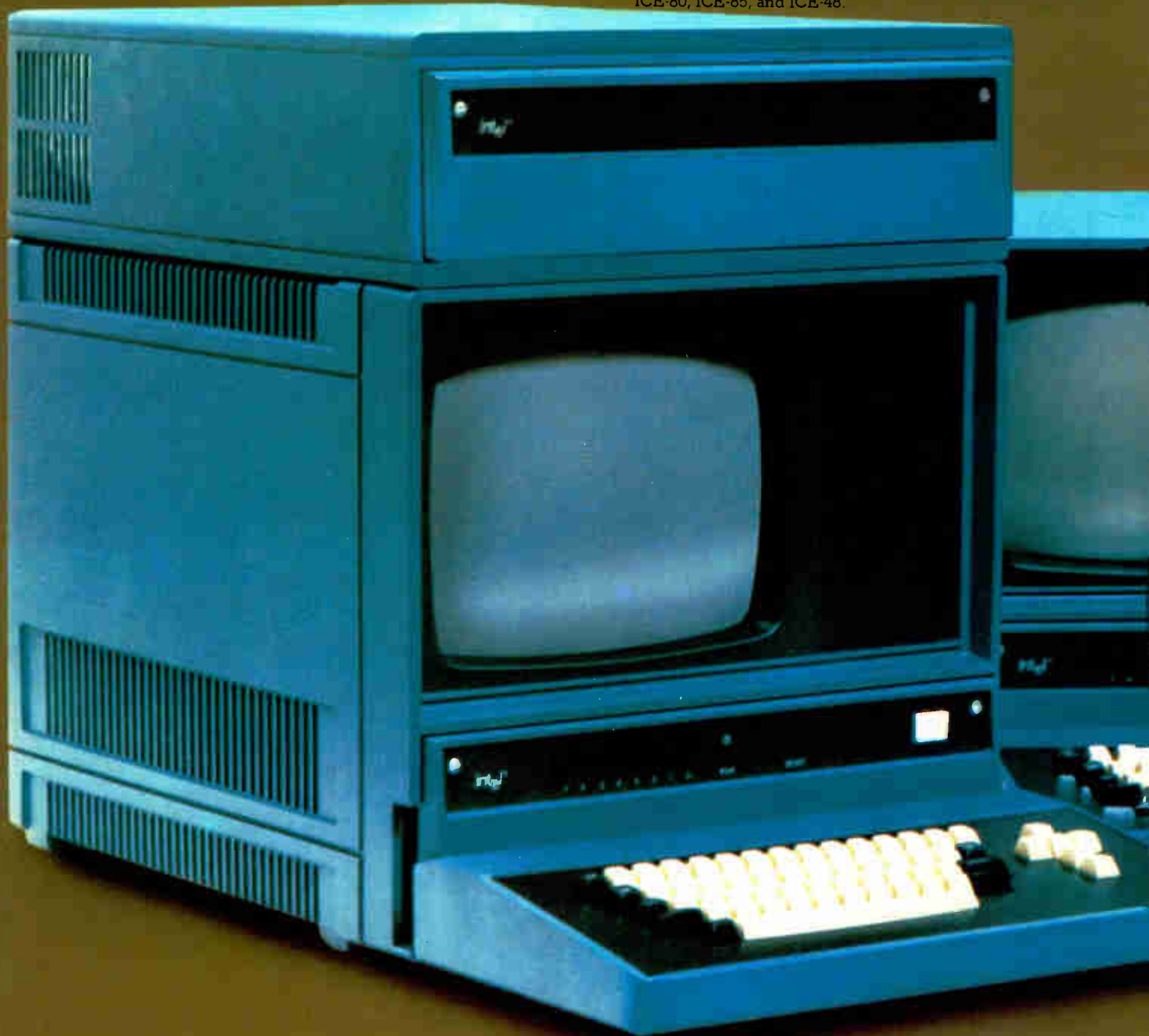

...NOW...

For medium-scale system development, you can rent the Model 220. Now.

The Intellec Model 220 is also a complete packaged development system. It has an interactive, 2500 character CRT with typewriter-style keyboard and a full-sized 2MK byte floppy diskette drive and 6-slot MULTIBUS card cage in one compact unit. Model 220 gives you 32K bytes of RAM program memory and 4K bytes of ROM. The IHS-II Diskette Operating System has a relocating 8080/8085 assembler, and the new system interfaces directly to the ICE In-Circuit Emulators.

The Intellec Model 210 rents for the lowest price of any packaged, full support development system available—anywhere.

Model 210 gives you the minimum system required for the rapid, efficient development of microcomputer software. It has a ROM based editor/assembler combination which allows the development of small 8080 or 8085 programs completely in RAM memory, which minimizes your use of paper tape. Plus you can also rent a ROM assembler/editor for Intel's family of MCR-48 single-chip microcomputers. The compact Model 210 has 32K bytes of RAM, 24K bytes of ROM and its own microprocessor. Self test diagnostics capability is built-in. And it's easy to get started, too. All you have to do is interface the Intellec 210 to your terminal!

You can extend the powerful resources of an Intellec Series II system into your own prototype for fast and efficient software debug in your product's final hardware environment. Just put your product on ICE... ICE-80, ICE-85, or ICE-48, all off-the-shelf at REI.

To emulate your own CPU or your entire prototype system in real time or single-step mode, simply rent the appropriate In-Circuit Emulator module to match your system's micro-processor. And you can begin software debugging as soon as your prototype has a processor socket and true structure.

Capability-enhancing peripherals are available for short-term rental, too.

You can add to the already extensive capabilities of the Intellec Series II system with a variety of immediately available peripherals. These include two Intellec Printers, two diskette based peripherals (one single-density with 9 million bytes of storage, the other double density with 1 million bytes of storage). You can also choose a high-speed paper tape reader and a universal PROM programmer... all of which are for rent today from REI.

Rental Electronics, Inc.
Another of the AMERICAN companies

More than 12,871 state-of-the-art instruments...
off-the-shelf, throughout North America.

I want to know more about the Intellec Series II now!

Tell me more about: Model 230 Model 220 Model 210

Call me at _____

- Send me a copy of your free illustrated Rental Catalog.
- I might be interested in buying—on a money-back guarantee—some of your late-model, well-maintained "previously owned" equipment. Send me your just-published Equipment Sales Catalog.
- Also, I have a pressing need right now for the following: _____

Please phone me immediately at _____

NAME _____ TITLE _____
COMPANY _____
ADDRESS _____
CITY _____ STATE _____ ZIP _____
PHONE NUMBER _____ EXTENSION _____

Complete this coupon and return it today to
REI, 19347 Londerius St., Northridge, CA 91324. GSA #GS-04S-21963 Neg

Northridge, CA (818) 952-7200
Anaheim, CA (714) 829-0563
Mesa, AZ (602) 942-8545
Dallas, TX (214) 881-2062
Houston, TX (713) 780-7218
Burlington, MA (617) 675-2771
Oakland, NJ (609) 332-2257; Gaythersburg, MD (301) 945-0800
Des Plaines, IL (312) 527-0829; Ft. Lauderdale, FL (305) 771-3100
Cleveland, OH (216) 442-8261; Seattle, WA (206) 641-6444

© 1978 Rental Electronics, Inc.

Beaverton, Oregon (416) 835-2813
Manassas, VA (703) 884-8623
Montreal, Quebec (514) 881-8388

Circle 75 on reader service card

System 45:

**Our friendly computer
could speed through your tough
technical problems...**

**if the boss would just get
finished with his.**

He has problems, too. The versatile System 45, along with HP-created management programs, can help him with forecasting, project management, basic statistics —even payroll and inventory control. He can also create and access departmental data bases for administrative chores. But you won't wait but a couple of minutes because the System 45 is a speedy workhorse. When

it's your turn, you, too, can take advantage of HP programs for applications as diverse and as valuable as differential equations, waveform analysis, eigenvalues and eigenvectors, regression analysis, linear equations and numerical integration to name a few.

You'll get answers fast. System 45 will display a 20 variable, 20 constraint linear programming solution in under five minutes. And tackle a Fast Fourier Transform of a set of a 1,024 full precision data points in less than a minute.

Anyone in your department can easily create and run their own special programs using System 45's enhanced BASIC language.

You can generate charts and graphs, interface with your instruments, add peripherals for extra storage, input and output. You can solve problems needing up to 62K bytes of

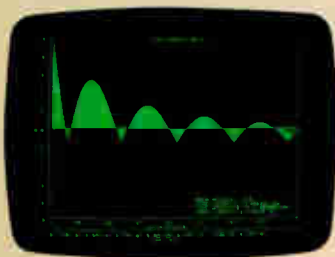

Waveform Analysis



Regression Analysis



Bar Chart

memory. Stated simply, System 45 is powerful, versatile and friendly: a productive, cost-effective tool for practically everyone in your department, even the boss. For brochures describing System 45 and the HP programs of interest to you, call the HP Literature Center toll-free day or night. The number is 1-800-821-7700, extension 302. (In Missouri, call 1-800-892-7655, extension 302.)

HEWLETT *hp* PACKARD

3400 E. Harmony Road, Fort Collins, Colorado 80521

For assistance call: Washington (301) 948-6370, Chicago (312) 255-9800, Atlanta (404) 955-1500, Los Angeles (213) 877-1282
Ask for Desktop Computer Sales Department.

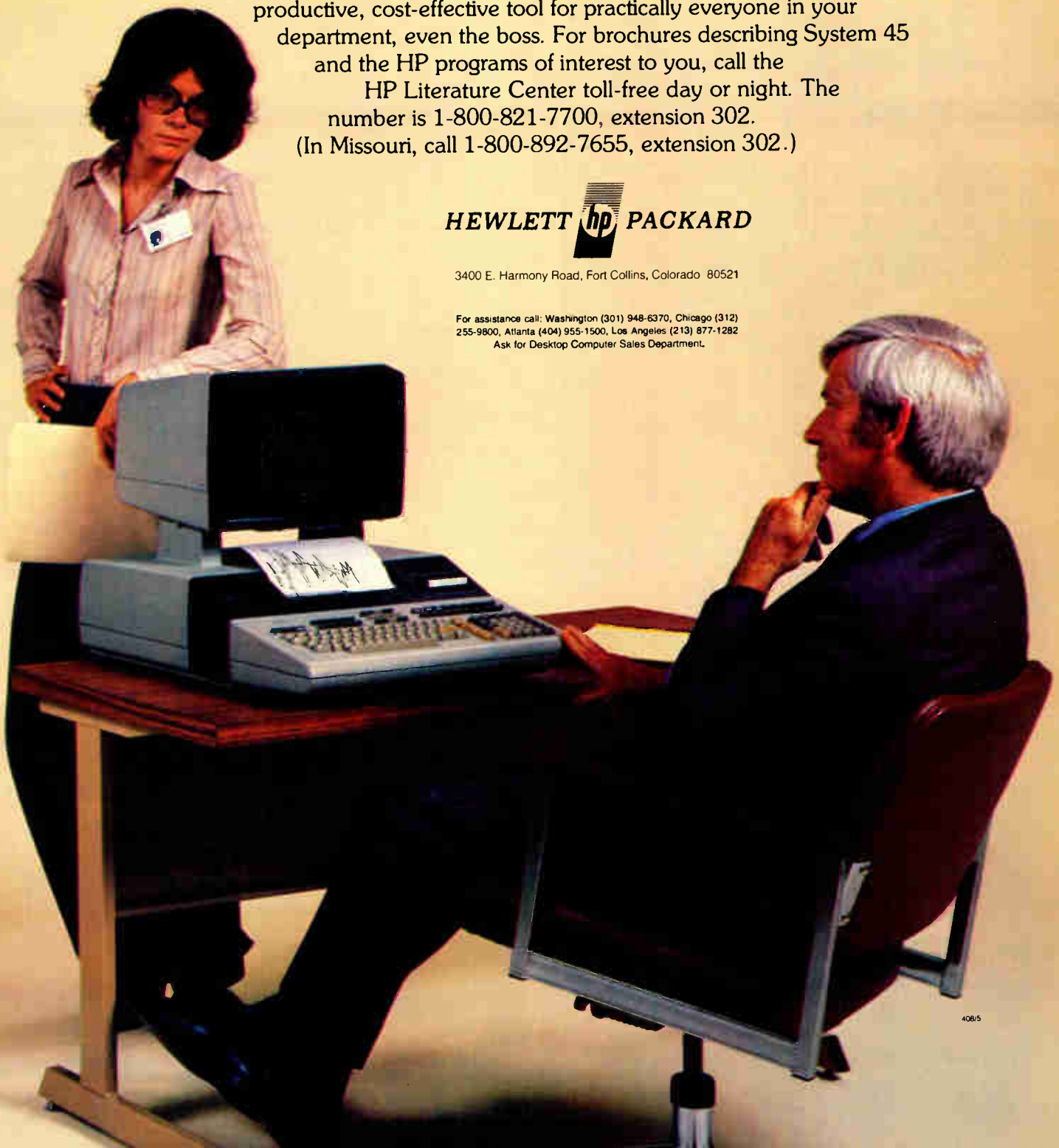

408/5

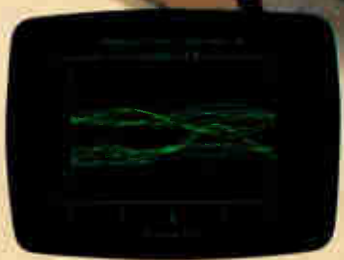

Andrews Plot



Active Filter Design



RIA QC Plot

Circle 77 on reader service card

LINEAR GOES LSI IN A

I²L AND LINEAR GET IT ALL TOGETHER ON A SINGLE CHIP

DON'T MAKE WHAT YOU CAN BUY. ESPECIALLY A 10-BIT ANALOG TO DIGITAL CONVERTER.

Now you don't have to build it from scratch. The AD571 gives you high accuracy and high speed and offers true 10-bit accuracy to within $\pm 0.05\%$ and guarantees no missing codes over its entire operating temperature range. A con-

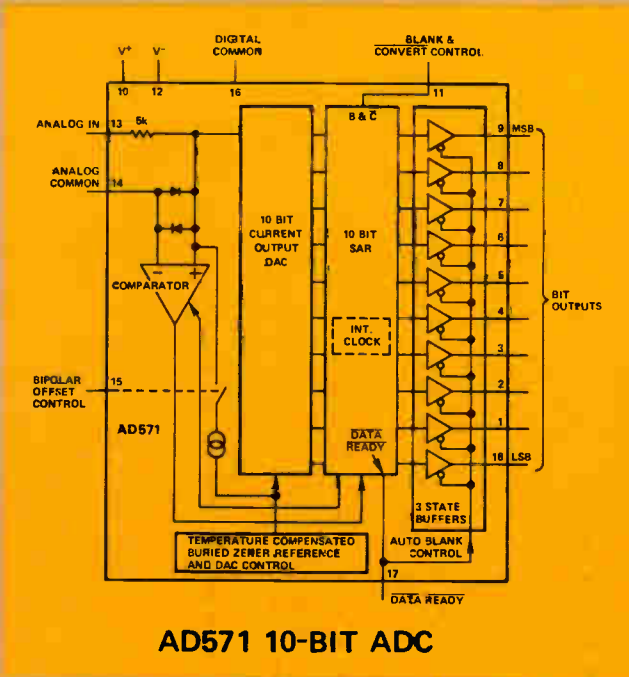

- 10-bit Laser Trimmed DAC.
- 10-bit SAR.
- Clock.
- Synchronized interface logic.
- 3-state buffer.
- Latching comparator.
- Precision buried zener reference.

Our new AD571 analog-to-digital converter is the very first and only chip to combine I²L digital circuitry, precision bipolar linear circuitry and laser wafer trimming on a single, high density 120 x 150 mil chip.

It is also the very first to be so complete. The AD571 is a 10-bit monolithic successive approximation ADC that includes a clock, reference, comparator, SAR, and internal DAC. All the components required to perform a complete A/D conversion cycle are on the chip.

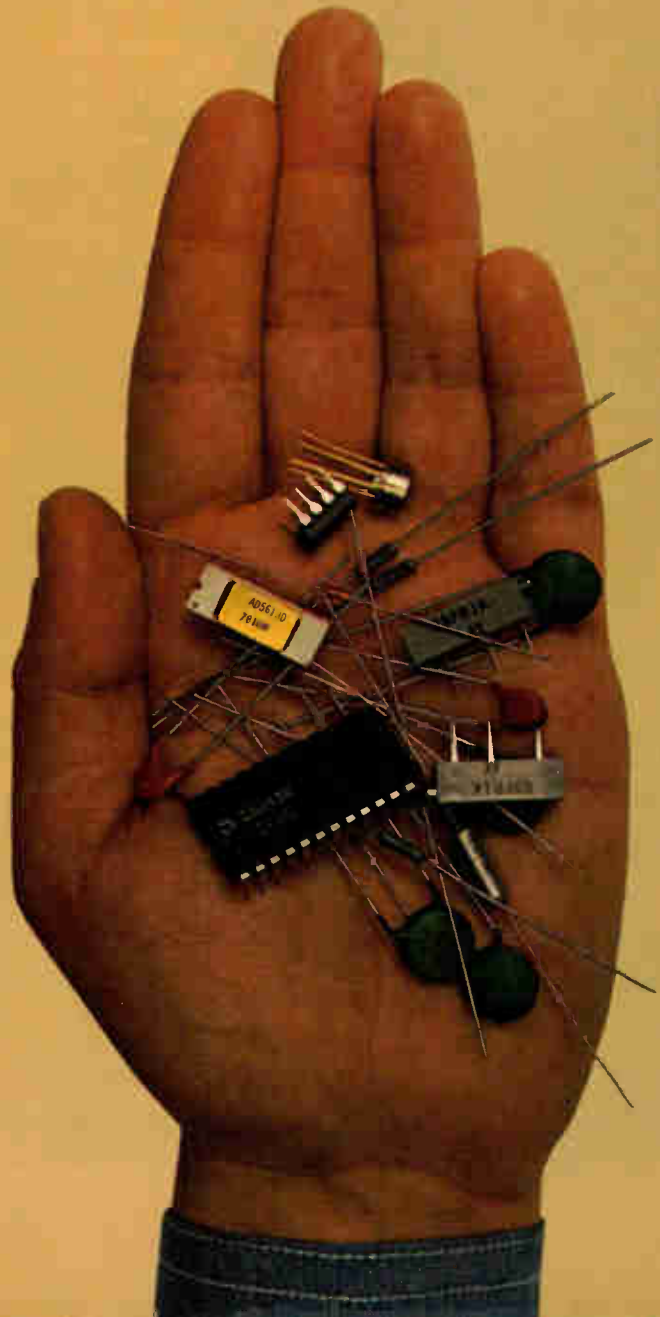

COMPLETE 10-BIT ADC.

version time of 25 microseconds means the AD571 will serve well as the core converter for high speed data acquisition systems.

Its three-state output buffers allow easy digital multiplexing of multiple AD571s, and a minimum of external interface components will provide quick connection to a microprocessor bus.

So don't just take our word for it, if you still want to build your own add up the parts. (Hint: we did and it takes 19, and the parts alone cost approximately \$23.) And don't forget to add board space, assembly, trimming, and testing.

**YOU GET MORE FOR LESS.
ONLY \$21⁵⁰ IN 1000s.**



The AD571, the world's first complete 10-bit ADC is so inexpensive it's hard to ignore. It gives you everything you ever dreamed of in a 10-bit successive approximation ADC and then some. Even the die-hard "build-it-yourself" bunch can't come up with a cheaper, or more complete fast precision ADC. For specs and information, call Doug Grant at (617)935-5565. Analog Devices, Inc. P.O. 280, Norwood, MA 02062.



 **ANALOG
DEVICES**

WAY OUT IN FRONT.

Analog Devices, Inc., Box 280, Norwood, MA 02062; East Coast: (617) 329-4700; Midwest: (312) 894-3300; West Coast: (213) 595-1783; Texas: (214) 231-5094; Belgium: 031 37 48 03; Denmark: (02) 845800; England: 01/94 10 46 6; France: 686-7760; Germany: 089/53 03 19; Japan: 03/26 36 82 6; Netherlands: 076 879 251; Switzerland: 022/319704; and representatives around the world.

Circle 78 on reader service card



Test track for fast LSI

The race is to the swift in LSI testing. And on this test track, you can really perform—at speeds of up to 20 MHz. Tektronix announces the high performance test tracks on the new S-3270 and S-3250 Automated Test Systems.

This team of test systems doesn't have a speed limit that keeps you in obsolescence. As microprocessors move faster—and we've already tested several that operate at 12 MHz and more—you'll be able to test them. That's a proven claim that not everyone in this business can make.

While the S-3270 handles device characterization, the S-3250 takes care of production testing or incoming inspection. Both give you uninterrupted error logging at 20 MHz. Both feature dual memory architecture, 8K of memory behind each pin, and high-performance drivers for set-up and hold measurements in one pass, and fast I/O bus testing.

The systems work together to solve the test problems of the faster, more complex devices. The S-3270 starts the race in characterization, delivering data in concise, readable form. Both systems use TEKTEST III, a device-oriented, English-like language. The S-3250 interfaces with popular handlers and probers, for optimum throughput. Together, the S-3270 and S-3250 take you from the start of the race through the checkered flag.

Don't get stuck on a track that will soon be obsolete. Call us at Tektronix to find out more about winning the LSI testing race with the S-3270 and S-3250.

For Technical Data circle #80
For Demonstration circle #81

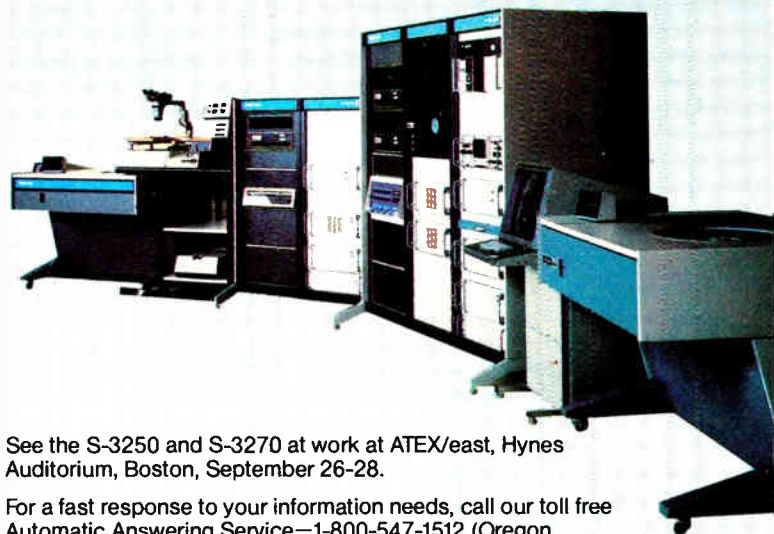

See the S-3250 and S-3270 at work at ATEX/east, Hynes Auditorium, Boston, September 26-28.

For a fast response to your information needs, call our toll free Automatic Answering Service—1-800-547-1512 (Oregon residents, call collect, 644-9051)—or call your nearest Tektronix field office.

Tektronix, Inc., P.O. Box 500, Beaverton, OR 97005.

Tektronix[®]
COMMITTED TO EXCELLENCE

Pentagon to fund major IC program

Six-year development of very-high-speed circuits with goal of increasing chip throughput 100 times could cost \$200 million

by Ray Connolly, Washington bureau manager

Troubled by intelligence estimates that other nations are rapidly eroding America's leadership in integrated circuits, the Department of Defense is moving to counter the challenge. After years of leaving IC development to the competitive marketplace, the Pentagon is executing an about-face with a six-year development program that industry leaders estimate will cost \$200 million. To be called VHSI—for very-high-speed integration—when it is launched in the fiscal 1979 year that begins Oct. 1, the program will involve all three military services, half a dozen of their newest weapons platforms, and all of the semiconductor companies that believe they can respond to the Defense Department's competitive goals.

For its investment the military expects to advance the technology of integrated circuits so that manufacturers can deliver circuits in production quantities—not just laboratory prototypes—that would measure 400 mils on a side and “provide 100 times the processing throughput of present ICs,” says Larry W. Sumney, VHSI project leader. Sumney is a specialist for electronic devices and IC technology on the staff of the under secretary of defense for research and engineering.

Sumney and his boss, Leonard Weisberg, will unveil the VHSI program and goals on Nov. 14 at the Government Microcircuit Applications Conference near the heartland of America's semiconductor industry in Monterey, Calif. Weisberg is director of electronics and physical sciences in the office of Ruth M. Davis, deputy under secretary for research and advanced technology,

APPLICATIONS FOR VERY-HIGH-SPEED ICs		
Application	Typical processing requirements (millions of instructions)	
	Current	Future
Weapons targeting control	0.1 – 1.0	10 – 100
Radar systems	1 – 10	100 – 500
Video / Imaging	10 – 20	200 – 1,000
Wideband data communications	10 – 30	500 – 2,000
Electronic warfare	25 – 100	1,000 – 10,000

where the VHSI effort will be managed. Weisberg believes VHSI “can affect not only the future military capability of the United States but also the electronics industry.”

Goals. While the Pentagon and the military services are still refining VHSI's technical goals and exact dollar requirements, its outlines are emerging. The program got its name, for example, because Defense officials want to stress speed over industry-oriented efforts to achieve density processing under very large-scale-integration programs.

As for the competitive threat, classified intelligence data shows the U.S. technology lead has slipped from an estimated 5 to 10 years to 3 to 5 years and is continuing to diminish. However, the Defense Department declines to identify the direction of the threat on security grounds, even though industry sources are convinced that the VHSI effort is more a response to Japan's government-sponsored VLSI program [*Electronics*, June 9, 1977, p.99] than to any Soviet Bloc challenge.

But the Pentagon does admit it

can no longer remain aloof from the U. S. IC industry, using no more than 7% of its output, and waiting for reluctant manufacturers to qualify ICs to rigid military specifications and then produce a customized product in small quantities.

The VHSI program will move to focus industry interest on future military needs—and advance the state of the art—by establishing three committees reporting to a fourth overview committee headed by Sumney. The most important of the three will deal with VHSI delivery and have approximately half the program's budget to develop an industrial production capability for the circuits.

Feeding into this group will be a lithography committee, with an estimated 20% to 25% of the budget, to advance IC lithography beyond optical limits to submicrometer dimensions. Its emphasis will be on electron-beam or X-ray lithography “or some combination of the two,” Sumney says, and perhaps deep ultraviolet technology.

The final feeder unit, with 25% to

Probing the news

30% of the program's fund, will be called DAST—for its mission of chip design, architecture, software, and testing. Each of the three committees reporting to Sumney will be headed by a representative of one of the three military services, he says, with the possibility of periodically rotating the chairmanships of the committees among the Air Force, Army, and Navy.

Systems. In addition, each of the services will select at least two military systems areas at the start of the project for brassboard demonstrations of VHSI potential (see "Applications for very-high-speed ICs," p. 81). Ideally, Sumney says, a project's potential use of VHSI must be "essentially open-ended;" that is, capable of almost unlimited performance gains.

Of the two selected projects, he says, one will be used for "a shrink system demonstration" to show the advantages VHSI circuits can achieve through reduced size, weight, and power consumption. The second will be used to demonstrate a high-priority, highly advanced capability possible with one or more VHSI chips. Both approaches, to be funded separately as advanced technology demonstrations, will guide the eventual design of VHSI circuits.

The Pentagon's technical goals for deliverable circuits, while measured somewhat differently from industry's existing standards, are staggering. The product of the clock rate times the number of gates will be the overall figure of merit for VHSI devices, rather than the speed-power product, Sumney explains, since "in practice the power dissipation is roughly constant—realistically, less than 4 watts per square centimeter."

While specific numbers are still being massaged, the VHSI delivery committee and its subcontractors are expected to be charged with setting up in-plant pilot production lines capable of:

- Delivery of 1,000 2-megabit militarized random-access memories, with additional requirements for read-only memories, programmable logic arrays, and perhaps an analog-to-digital converter.



Speedier electronics. The Pentagon's VHSI program would mean faster processing for radar, weapons control systems, and imaging systems aboard such craft as the F-16.

- Delivery of 1,000 specified militarized logic ICs with a clock period of at least 3×10^{12} times the number of gates. In bipolar technology, for example, this translates into 30,000 gates and a 200-megahertz clock, while the n-channel metal-oxide-semiconductor goal would be 150,000 gates and a 30-MHz clock. Assuming appropriate memory, these figures "equate roughly to a processing throughput of 1 million instructions per second on a single chip," says the VHSI project office.

- Establishing a minimum-feature size of 0.5 micrometer, while escalating silicon chip sizes to 400 mils on a side. However, this goal will be approached cautiously with an interim milestone of 1.2 μm compared to today's 2 to 5 μm . All VHSI work will be done with silicon, Sumney says, although the Defense Advanced Research Projects Agency will continue to pursue its separate efforts with gallium arsenide, which could be ready for VHSI development in about three years.

- Delivering devices capable of mil spec performance, especially in the -55°C to $+125^{\circ}\text{C}$ range, with a failure rate equal to or less than 0.1% per thousand hours at 125°C . Offsetting these tough specs will be a softening of packaging requirements and elimination of a radiation-hardening standard against nuclear blasts. The Defense Department will be satisfied if packaging comes up to "high-reliability commercial practice," while radiation-hard digital devices will not be required—although technologies amenable to

hardening will win a plus in proposal evaluations.

Backup. Critical to the VHSI delivery committee's achievement of these goals will be the feeder efforts of the support groups in advanced lithography and DAST, Sumney says. The lithographic unit will push for development of commercially available equipment with an alignment capability of 0.1 μm in addition to a resolution of 0.5 μm —both breakthroughs—plus a 15-minute exposure per 3-inch wafer or mask. However, it will support development of resists with at least three times present sensitivity levels that are capable of maintaining resolution under subsequent processing, and urge development of dry processing equipment for ICs to achieve high-yield precise resist removal.

Technical goals for the DAST committee will be equally challenging. It will be responsible for promoting commercial availability of hardware for automated chip testing; sponsoring new or improved chip architectures to minimize costly customization; developing on-chip test circuits and fault-tolerant designs, including redundancy; and pursuing parallel processing/multi-channel architectures that would reduce random interconnects.

Orientation of the VHSI effort will be toward the single large chip, Sumney points out, since circuits on the same piece of silicon have obvious performance and life-cycle advantages over multiple chips that must be interconnected, making them vulnerable to malfunctions. □

Finally! A unique low-cost multi-turn cermet that speaks for itself!

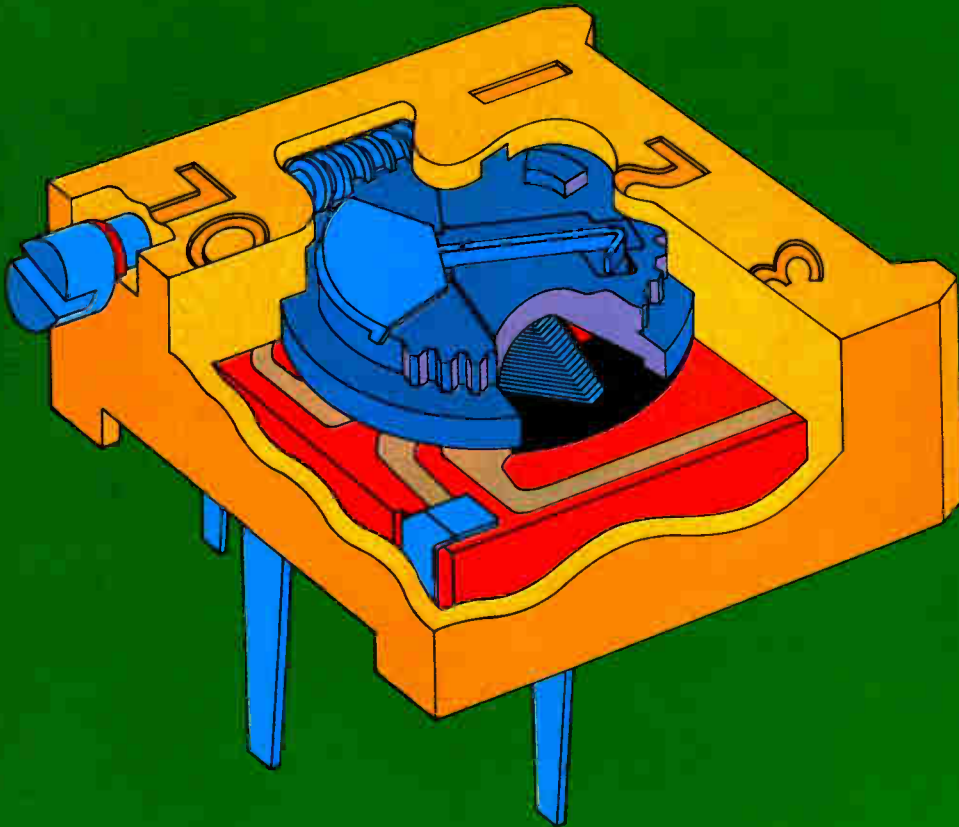

The New Spectrol 3/8-inch Model 64

Unique mechanical design of rotor, clutching assembly, and housing provides superior setability and stability with virtually no backlash . . . 28-fingered brush contact for low CRV . . . compact 3/8-inch square sealed unit . . . top-adjust or side adjust with 6 configurations . . . directly replaces the models 3299 and 66. Available new from the factory and 75 distributor outlets.



Spectrol

SPECTROL ELECTRONICS GROUP

UNITED STATES Spectrol Electronics Corporation 17070 E. Gale Avenue, City of Industry, Calif. 91745, U.S.A. • (213) 994-6983 • TWX (213) 584-1314
UNITED KINGDOM Spectrol Reliance Ltd. Draxton Way, Swindon, Wiltshire, England • Swindon Z1101 • TELEK 44200
ITALY SP Electronics spa Via Carlo Pisacane 7, 20018 Pieve (Milan) Italy • 02 30 241 • TELEK 50011

Memories

Pinout standards causing grief

While rule for 32-K EPROMs appears settled with provisions for both one and two supplies, 64-K dynamic RAM knot is still tied

by Raymond P. Capece, Solid State Editor

That elusive ideal—standard pin designations in memory chips—is as slippery as ever, even though manufacturers and designers dread a repetition of the chaos that existed a few years ago in 4,096-bit dynamic random-access memories. While the dynamic RAM picture has settled down considerably, another new device—the 32,768-bit erasable programmable read-only memory—is causing paroxysms among would-be standards writers.

If so many people strive for standards, and so many others at least passively support them, why then are they so difficult to settle? A review of the progress, or lack of it, in big dynamic RAMs and erasable PROMs provides some answers—in parallel with a refresher course in the feisty

manufacturers' marketing rivalries.

For dynamic RAMs, only two related questions have to be settled in the coming 65,536-bit devices: what to do with pin 1 and whether the standard should specify one power supply or two supplies.

Regarding the pin, the simplest approach is to do nothing, as Texas Instruments Inc. does in its TMS 4164 (see p. 39). Making the pin a no-connect, reasons TI, automatically makes the device plug-compatible with the 64-K RAMs of other manufacturers, several of which may use the pin for a negative supply voltage or a special function. Also, TI's part requires only a single +5-volt supply.

Yet the 64-K pinout closest to standardization by the Joint Elec-

tron Device Engineering Council, the group that makes such decisions, is the two-supply 16-pin package. It has survived the first two steps in the Jedec procedure: the decision to conduct a letter ballot, and approval by 90% of the dues-paying committee members who receive the ballot. To become official, it now need only be approved by the council, says Jeff Schlageter. He is manager of the MOS RAM design department at Advanced Micro Devices Inc. in Sunnyvale, Calif., and chairman of Jedec's JC-42 subcommittee on semiconductor memories.

As for the single-supply standard

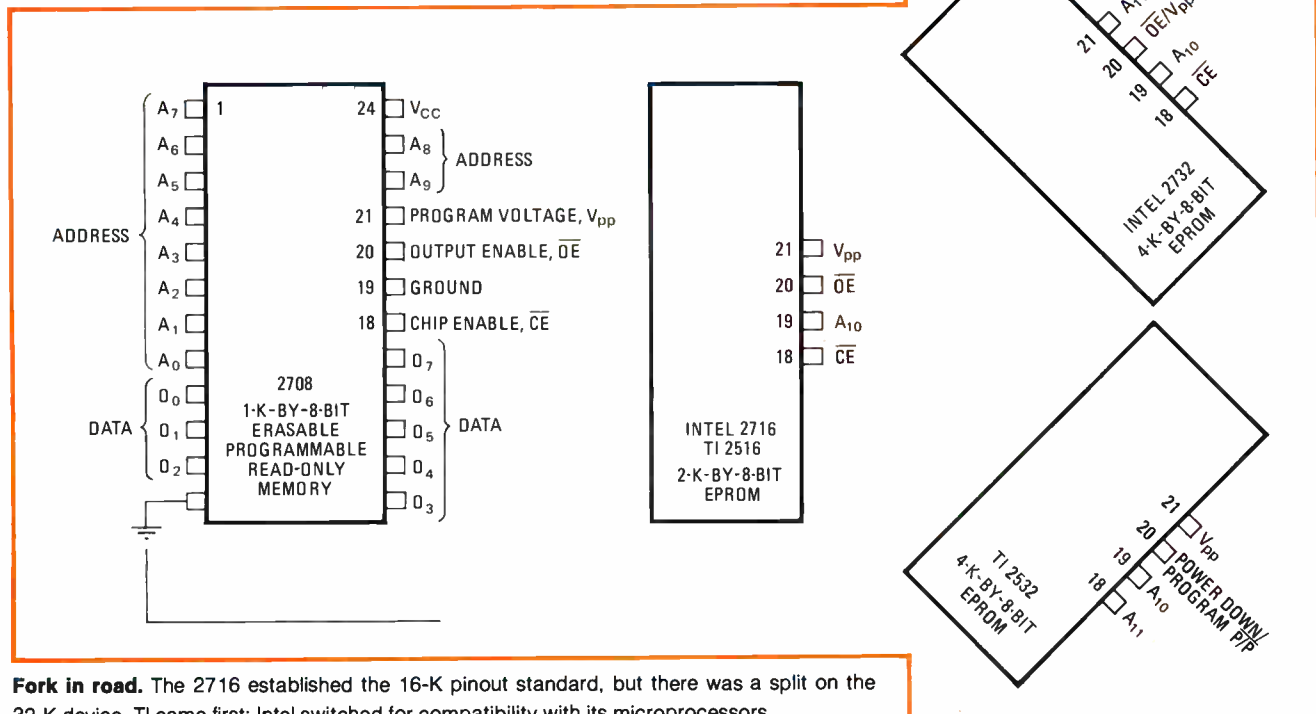

Fork in road. The 2716 established the 16-K pinout standard, but there was a split on the 32-K device. TI came first; Intel switched for compatibility with its microprocessors.

F.W. Bell's Model 1776 Current Meter...

...the better way
to measure ac, dc,
ac-on-dc current



Clamp-on probes mean you measure current without breaking the circuit. As a result, there is no insertion loss in dc and only a negligible one in ac. Three probes, which are automatically self-calibrating, provide ranges from 10 A FS to 1000 A FS. Accuracy is $\pm 1.0\%$ dc and $\pm 2.5\%$ ac. Measurements are fast, accurate and safe.

- 3½ digit readout
- 3 current ranges
1000 A, 100 A, 10 A
- Peak—Read—Hold
- Fully portable
115/230 Vac, 50/60 Hz
or rechargeable integral
batteries for
TROUBLESHOOTING
R & D
MAINTENANCE

Fw **BELL INC.**[®]
A Subsidiary of
The Arnold Engineering Company
4949 Freeway Drive East
Columbus, Ohio 43229
Phone: (614) 888-7501
TWX: 810-337-2851

Probing the news

(TI's), it is one step behind the two-supply measure on the Jedec ladder. Apparently, it will be approved, too. Explains Schlageter: "Some companies simply won't be able to make a single-supply part; Jedec can't shut them out of the market." As a result, both versions probably will be official, with the one-supply part probably becoming the industry's *de facto* standard. While the differences between the two 64-K RAMs will not be great, a look at the situation among the makers and standards-bearers of the 32-K EPROM reveals how complicated such things can become.

Intel ahead. At the 16-K level, Intel Corp. led the way; its single 5-v supply 2716 soon became the generally accepted industry standard erasable PROM. TI had made a go of it with a three-supply version; although it still ships many of them, it has become an Intel second source with its 2516.

In the next generation of parts, the 32-K level was reached first with a simple ROM because it is easier to build than an erasable PROM. Coming out with 32-K ROMs almost simultaneously just over a year ago were TI and Mostek Corp., the former with its TMS 4732, the latter with the now-discontinued MK 32000. The parts are identical in their single 5-v operation and 24-pin packages. Both also use pin 18 for A_{11} , the address line needed for the doubling of storage capacity.

The trouble started when Intel announced its 32-K ROM, the 2332, with the additional address line not on pin 18 but on pin 21. Larry Jordan, Intel's strategic marketing manager for MOS memories, reasoned: pin 18 had to be used for the chip-enable so that the ROM would operate properly with Intel's own microprocessors. What is done with the ROM is a commitment on the erasable PROM, so sure enough, when Intel announced its 32-K part, there was the A_{11} address line on pin 21.

Meanwhile, back at JC-42, voting was already progressing on the TI-Mostek pinout, and a favorable decision appeared certain. On first ballot, 90% requirement was missed by a scant half percent; ultimately,

though, a revote established the pinout as standard. Now Intel appealed, arguing that by this time it was committed to its own pinout. The committee, acknowledging Intel's importance, sent out another letter ballot—and Intel's layout was approved. Thus, 32-K erasable PROMs were blessed with two standards, a consummation greeted coolly by some members who wondered why the group had not been informed earlier of Intel's plans.

But Dave Ford, Motorola Semiconductor's strategic marketing manager and a member of the JC-42 committee, does not regard the dual standard as a serious problem, saying that two is better than four or five. "We meet only four times a year, and our function is not to plan products," Ford says.

Derrell Coker, Mostek's strategic marketing manager and voice on JC-42, says that while Jedec tries to be on top of the market, it can never solve the problem of getting competing technology leaders to talk about what they are planning.

Systems. In the case of the 32-K erasable PROM, Intel was designing a part to work with its microprocessors, explains Jim E. Coe, memory marketing manager at American Microsystems Inc., who was presenting Intel's case when working there before joining AMI. "The second standard is great for them—they need it for their microprocessors. With the 8048, 8085, and 8086 microprocessors, Intel went to a multiplexed-bus approach, so that the data and address are on the same pin. A systems-oriented house, Intel put the address latches on board the memory chips, which get the address-latch-enable signal from Intel microprocessors." Coe also thinks the output-enable pin, unique to Intel erasable PROMs, "is handy for problems of bus contingency."

In any event, the split is interesting. Mostek's Coker expects Signetics Corp. and Motorola to line up behind the TI pinout, as will Mostek. "These three are big price cutters, whereas Intel has traditionally been a high-price outfit, using the leverage of its microprocessors to keep memory prices up," and that could be a dangerous game in the case of the 32-K erasable PROM. □

The
performance
you
need.

The
convenience
you
want.

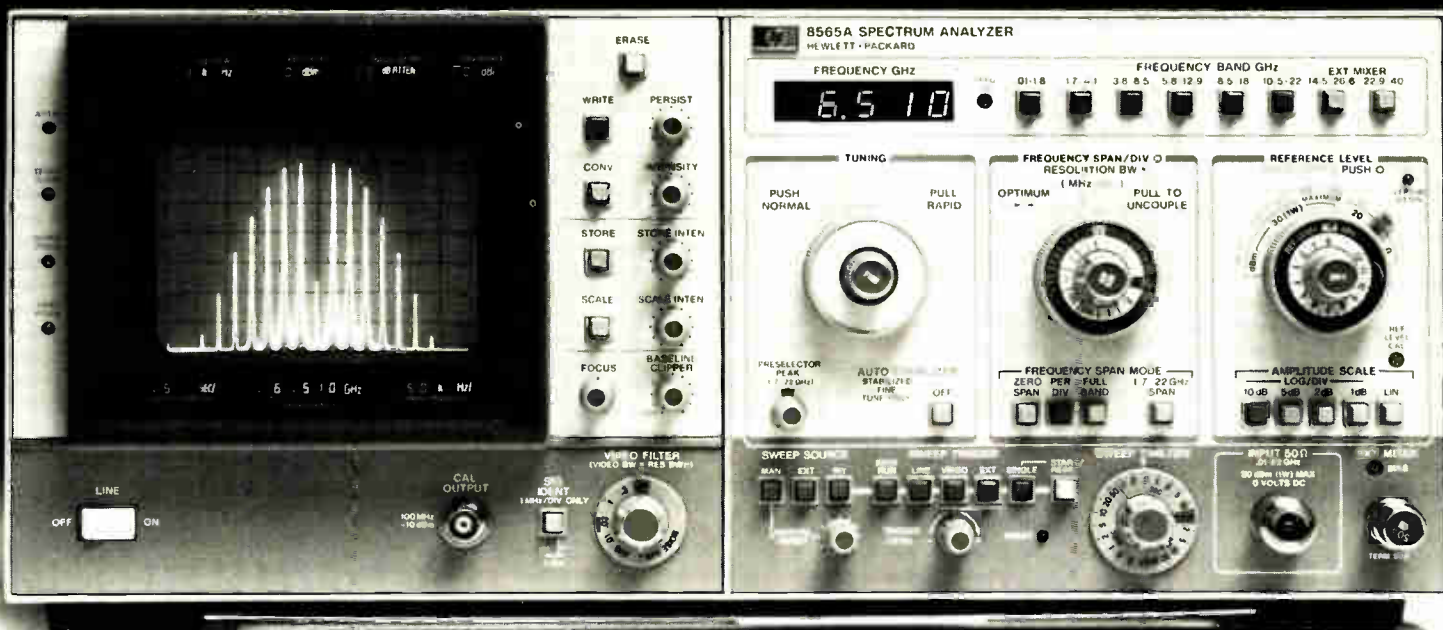

HP's 8565A Microwave Spectrum Analyzer gives you both.

Here's a combination of fully-calibrated performance, with wide dynamic range from 10 MHz to 22GHz (extendable to 40 GHz), plus operating features that make it extremely easy to use.

Frequency response is within ± 1.2 dB to 1.8 GHz, and from ± 1.7 dB at 4 GHz to ± 4.5 dB at 22 GHz. These figures include all input circuitry effects as well as frequency band gain variations. Internal distortion products are 70 dB down from 10 MHz to 18 GHz; 60 dB, 18 to 22 GHz.

Resolution bandwidths from 1 kHz to 3 MHz are provided, with 100Hz optionally available. The resolution filters are all synchronously tuned to prevent ringing. For frequencies from 1.7 to 22 GHz, an internal preselector provides more than 60 dB rejection; permitting measurements of distortion products as small as 100 dB down.

As for convenience, the 8565A makes most measurements using just three controls: tuning frequency, frequency span and amplitude reference level.

Resolution, video filtering and sweep time are automatically set to the proper values. Bright LED's in the CRT bezel give you all pertinent operating conditions right there with the trace being viewed. And a scope camera records these data along with the CRT trace.

The 8565A Spectrum Analyzer gives you the capability you need and the convenience you'll fast appreciate. Domestic U.S. price is \$18,900 (add \$800 for 100 Hz resolution). Find out more by calling your nearby HP field office, or write.

HEWLETT  PACKARD

1507 Page Mill Road, Palo Alto, California 94304

Computers

Are plug-compatibles vulnerable?

Makers of mainframes that use IBM 370 software see good days, but some observers say leader will make moves to end the game

by Anthony Durniak, Computers Editor

Will the gold-paved ways of the IBM 370 plug-compatible market crumble with the introduction of IBM's E and H series in 1979-80? To gauge by the ever-thickening ranks of vendors of IBM-compatible mainframe computers, it would appear not. Some industry observers, though, question the market's long-term potential.

The most recent entry is add-on memory maker Cambridge Memories Inc. of Waltham, Mass., which late last month announced three

processors compatible with the low-end IBM 370/115, 125, and 135 computers (see "Cambridge joins the marketing ranks"). Cambridge is joining other recent entrants, including Two-Pi Co. [*Electronics*, May 11, p. 228], Magnuson Systems Inc. [*Electronics*, May 25, p. 93], National Semiconductor Corp. [*Electronics*, May 11, p. 81], and Mitsubishi Electric Corp. [*Electronics*, Aug. 31, p. 48], in a market pioneered by Amdahl Corp., with early competition coming from plug-compatible

manufacturers Intel Corp. and Control Data Corp.

Like most of his competitors, Cambridge executive vice president Richard Eagan says the large installed base of IBM mainframes and the tremendous amount of software written for them makes the market attractive. The impetus for many of the newer competitors, he says, is that "user acceptance has been indicated by Amdahl's success."

But Robert Fertig, director of the technology analysis group of Advanced Computer Techniques Corp. of New York, marketing consultants, says that "for all its competitiveness, the 370 plug-compatible business will likely be short-lived because of the anticipated introduction in early 1979-80 of new IBM hardware, particularly the E and H series [*Electronics*, Aug. 17, p. 44].

Complex. The debate over the future of the IBM-compatible concept revolves around a series of intertwined technical and business questions. The major attraction of the IBM-compatible units is their improvement on IBM's price/performance ratio, achieved by using state-of-the-art large-scale integration for logic and memory chips that use less power and run cooler. In addition, internal architectural changes provide higher rates of data input/output, improved diagnostics, and other features unavailable from the computer industry giant. Although the guts of their hardware are not identical with the internal hardware of the 370, most of the manufacturers have put machine-level software, called microcode or firmware, into their machines to interpret and emulate

Cambridge joins the marketing ranks

The IBM-compatible computers from Cambridge Memories will offer 10% to 15% higher performance than their IBM counterparts yet will sell at approximately 80% of the IBM price, says product manager Kent E. Crombie. Although this is Cambridge's initial entry into the market as a direct marketer, the company has been involved for some time as the initial backer of and now 40% partner in IPL Systems Inc., Bedford, Mass. IPL is the firm that developed and manufactures the Omega 480-1 IBM 370/138- and 148-compatible mainframe marketed since 1977 by Control Data Corp., Minneapolis, Minn.

Built with a combination of emitter-coupled logic and transistor-transistor logic, Cambridge's Model 1 has a processor cycle time of 480 to 1,130 nanoseconds, equal to or slower than IBM's 115 cycle time of 480 ns. The Model 2 also comes in with speed equal to that of the IBM Model 125, but Cambridge's Model 3, with a cycle time between 180 and 850 ns, beats the speed of the IBM's 135, which has a cycle time that ranges from 275 to 1,485 ns.

In the matter of memory capacity, Cambridge offers up to 2 megabytes—some four times the 524-kilobyte limit on the IBM 135. The MOS static random-access memory chips are now 4-K; Cambridge plans to move to 16-K chips as they become available. More input/output than IBM's is also offered by Cambridge. Cambridge has a standard byte-multiplexer channel and two block-multiplexer channels with two additional block channels optionally available on the Model 3. IBM supports one byte-multiplexer channel on the 115 and 125, and it, too, can have up to two block channels on the 135.

IBM's maximum I/O data rate on the 155 and 125 is 900,000 bytes per second, where Cambridge's is 2,600,000 bytes/s. On the IBM 135 the I/O rate is 2,400,000 bytes/s while Cambridge's Model 3 operates at up to 3,700,000 bytes/s.

Recalibrate.

(Your thinking and your budget)

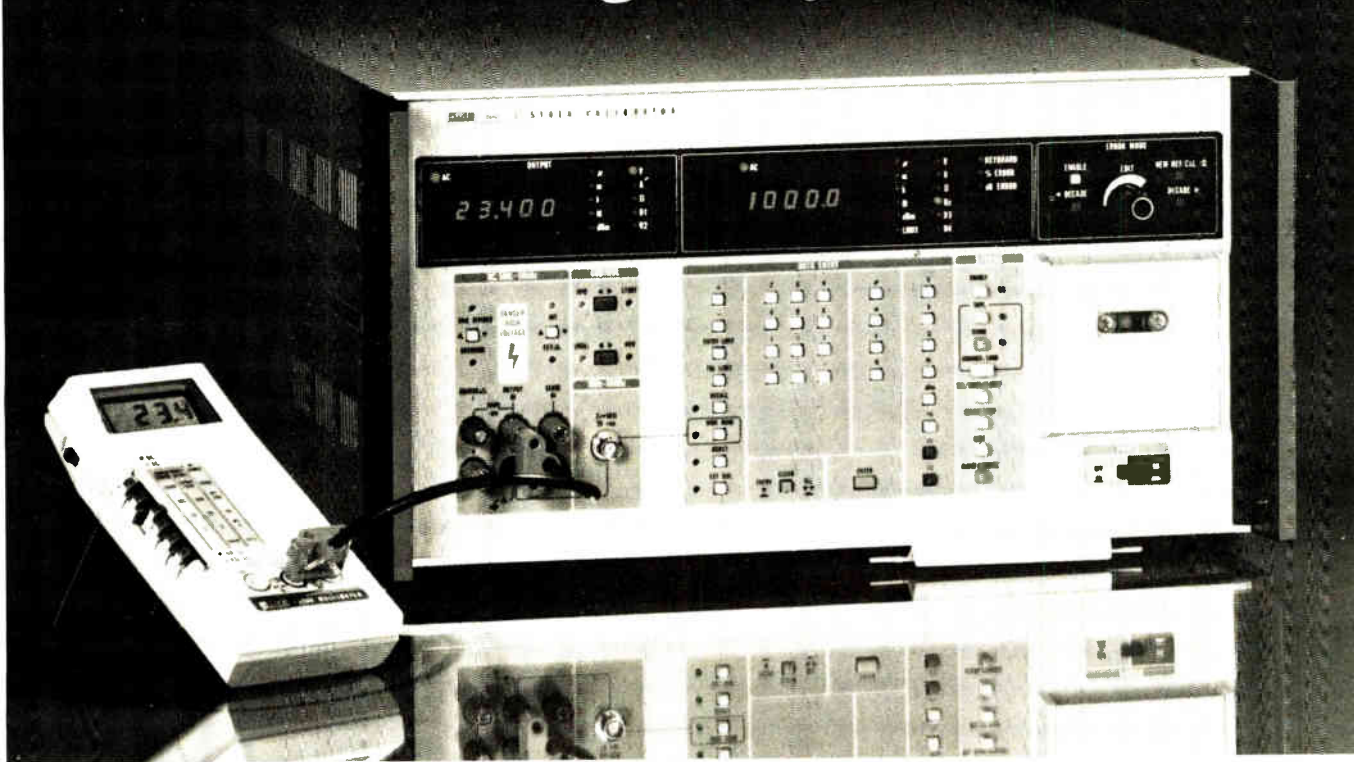

Our new 5100/5101A calibrators can calibrate VTVMs, VOMs, 3½-, 4½- and most 5½-digit DMMs around, in a fraction of the time it takes you now! (It's a cal lab in a box! All at an average price under \$9,000.)

For \$10,000 to \$15,000, you could invest in an intricate maze of instruments that takes a wizard to operate. Or, you could fill a room with computer-based hardware and expensive talent. About \$100,000 worth.

The Fluke μ P-controlled alternative.

We've designed the new 5100A and 5101A for production test, QA and cal lab applications that need large system flexibility at a fraction of large system cost.

The heart of our new meter calibrators is a microprocessor that eliminates mechanical switches—the largest contributor to failure in conventional calibrators.

And, you can enter your tolerances

in dB, volts or percent. The μ P converts for you! For safety, store current or voltage limits and protect both your operator and the meter being calibrated.

Microprocessor control also facilitates scaling (for linearity checking), and makes your calibrator a *rangeless* instrument, always selecting the proper range for maximum resolution, *automatically!*

Automation or economy? Fluke has both.

The 5100A is perfect for manual bench operation or integration into your existing cal system to upgrade it to Fluke standards of calibration

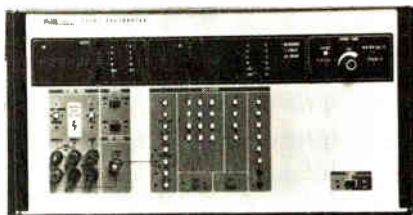

excellence. Priced at \$6,995, you save dollars but don't sacrifice accuracy or overall performance.

For perfection in automated calibration, you'll want the 5101A with its *mini-tape cassette reader*, a unique new feature that allows you to store up to 58 calibration settings, including limits and tolerances. Only \$9,495.

Both models have a friendly calculator-type keyboard. And, both have the RS232 or IEEE 488 system options you want for remote operation or hard-copy printouts of results.

Call (800) 426-0361*, toll free. Ask for complete technical specs or the location of your local Fluke office or representative. Or, write: John Fluke Mfg. Co., Inc., P.O. Box 43210, Mountlake Terrace, WA 98043. In Europe: Fluke (Nederland) B.V., P.O. Box 5053, Tilburg, The Netherlands. (013) 673973. Telex: 52237.

Prices U.S. only.

*Alaska, Hawaii, Washington residents please call (206) 774-2481.

Command Performance: Demand Fluke Calibrators.



COSMAC VIP

\$249* gets the entire family into creating video games, graphics and control functions. For starters.



COSMAC VIP, the completely assembled, ready-to-operate RCA Video Interface Processor, opens up a whole new world of computer excitement. New challenges in graphics, games and control functions. Yet it's just \$249.00.

Easy to buy. And easy to program, thanks to its unique, easy-to-use interpretive language. You get a complete how-to book including programs for 20 games: fun, challenging, and ready to load and record on your cassette.

Simple but powerful.

Built around an RCA COSMAC microprocessor, the VIP is a complete computer system that can grow with you. It has 2K of RAM, expandable on-board to 4K. Plus a ROM monitor, audio tone output to a

built-in speaker, power supply, and 8-bit input and output ports for control of relays, sensors, or other peripherals.

Soon RCA will offer options for color graphics and 256 tone sound generation. An optional auxiliary keyboard will open up an exciting world of two-player games.

Take the first step now.

Check your local computer store or electronics distributor for the VIP. Or contact RCA VIP Marketing, New Holland Avenue, Lancaster, PA 17604. Phone (717) 291-5848.

*Suggested retail price. Does not include video monitor or cassette recorder.

The fun way into computers.



Circle 273 on reader service card

Probing the news

the IBM instruction set—and thereby run all software written for the IBM computers.

“The makers exist in the mainframe business because the 370 exists with its largely technological weaknesses,” Fertig agrees. “But the E and H series products will presumably incorporate technologies at state-of-the-art levels equal to, or ahead of, those currently used by 370-compatible machines,” he warns. In addition, Fertig says that any changes made by IBM in the instruction set or microcode will not be announced until the new machines are delivered—often 12 to 18 months after they are announced—giving IBM a head start in the market.

Paul Magnuson, president of Magnuson Systems, echoes the confidence of his competitors. “We have things in development to stay ahead of IBM with price/performance so I don’t see a problem.” As for the time lag between IBM’s announcement of new products and the delivery of their details, Magnuson feels his company “can catch up quickly. We’re a smaller company and we have a good feeling for what things make sense to build in with microcode changes.”

Changeable. Eagan notes that because Cambridge’s machine is microcoded and stores that microcode in electrically alterable read-only memories, any changes IBM makes can be copied and easily added to his machine to keep it compatible. And Jared Anderson, Two-Pi’s president, says IBM will have to inform its rivals about changes—whether it wants to or not. “Changes in the operating system software or microcode appear to the programmer as a new instruction. And IBM will have to explain to him what that instruction does. That’s all we need to know.”

Despite the debate, increased activity is expected in the market for the near future. “There are a tremendous number of people with IBM plug-compatible peripherals and I wouldn’t be surprised if those peripheral companies also entered the mainframe business,” Anderson says.

Just published: 1978 EBG!

Completely new listings of catalogs, new phone numbers, new addresses, new manufacturers, sales reps, and distributors! The total market in a book—four directories in one!

To insure prompt delivery enclose your check with the coupon now.



Electronics Buyers' Guide
1221 Ave. of the Americas
New York, N.Y. 10020

Yes, please send me _____ copy(ies) of 1978 EBG.
 I've enclosed \$25 per copy delivered in the USA or Canada.

I've enclosed \$35 per copy for delivery elsewhere (\$47 if shipped by Air). Full money-back guarantee if returned in 10 days.

Name _____
Company _____
Street _____
City _____ State _____ Zip _____

Specify the panel meter you'd be proud to have designed yourself

Panel meters from General Electric can add a lot to the overall quality of your product. Accuracy. Reliability. Attractiveness.

How do you design this kind of quality?

Start with the *suspension system*. The moving parts. You'll want one of two kinds (depending on what kinds of physical abuse your panel meter may be exposed to). In a *taut band suspen-*

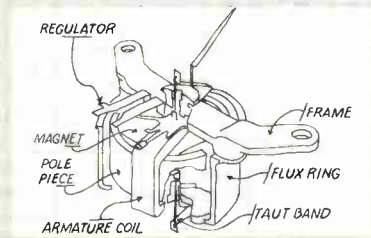

sion system, the moving mechanism is suspended between two ribbons of platinum-nickel alloy welded securely to a resilient, shock-resistant anchor. This suspension system design keeps friction to an absolute minimum.

The aluminum pointer is attached to an oversized, high-torque armature coil of fine copper wire, for fast response and accuracy you can count on.

Pivot-&jewel suspension maintains high performance and reliability in high vibration environments. The armature assembly is supported by highly polished, hardened-steel pivots selected

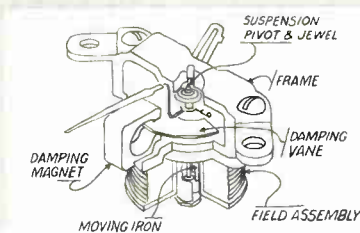

for wearability. The pivots are designed with a radius that will minimize friction level to give maximum performance. The 1/10-carat jewel bearings are of ceramic material that is stronger than glass jewels and has greater scratch and impact abrasion resistance.

Pointers are tapered to a radius point as small as .38 mm, combining high readability with superior reading accuracy. Scales on the meter face are available with mirror backing that will align the reader's eye perpendicular to the face, eliminating parallax error.

Self-protecting features are important, too. All GE panel meters are housed in a tough, *molded case* of high-impact styrene. Special gaskets are available for assembly in *BIG LOOK*® type panel meters between the window and case to keep out contaminants. Ultrasonically placed mounting studs assure that the meter will fit your panel exactly. Choice of meter styling (*BIG LOOK*® or *HORIZON LINE*®) lets you

pick the shape and appearance that will best enhance your product. (Color masks are also available for *HORIZON LINE*® in red, blue, green, black, yellow and white.)

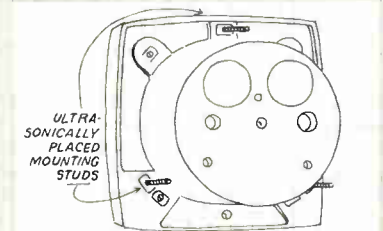

Hundreds of GE panel meters are available for almost any conceivable monitoring or measurement task.

And when you buy a GE panel meter, you also get more than 80 years of meter manufacturing experience and a sales network that is literally worldwide. For a free guide entitled, "Pick the Right Panel Meter," write to General Electric Co., Section 592-82, Schenectady, N.Y. 12345.

Specify General Electric... just for good measure.

GENERAL  ELECTRIC

Circle 91 on reader service card

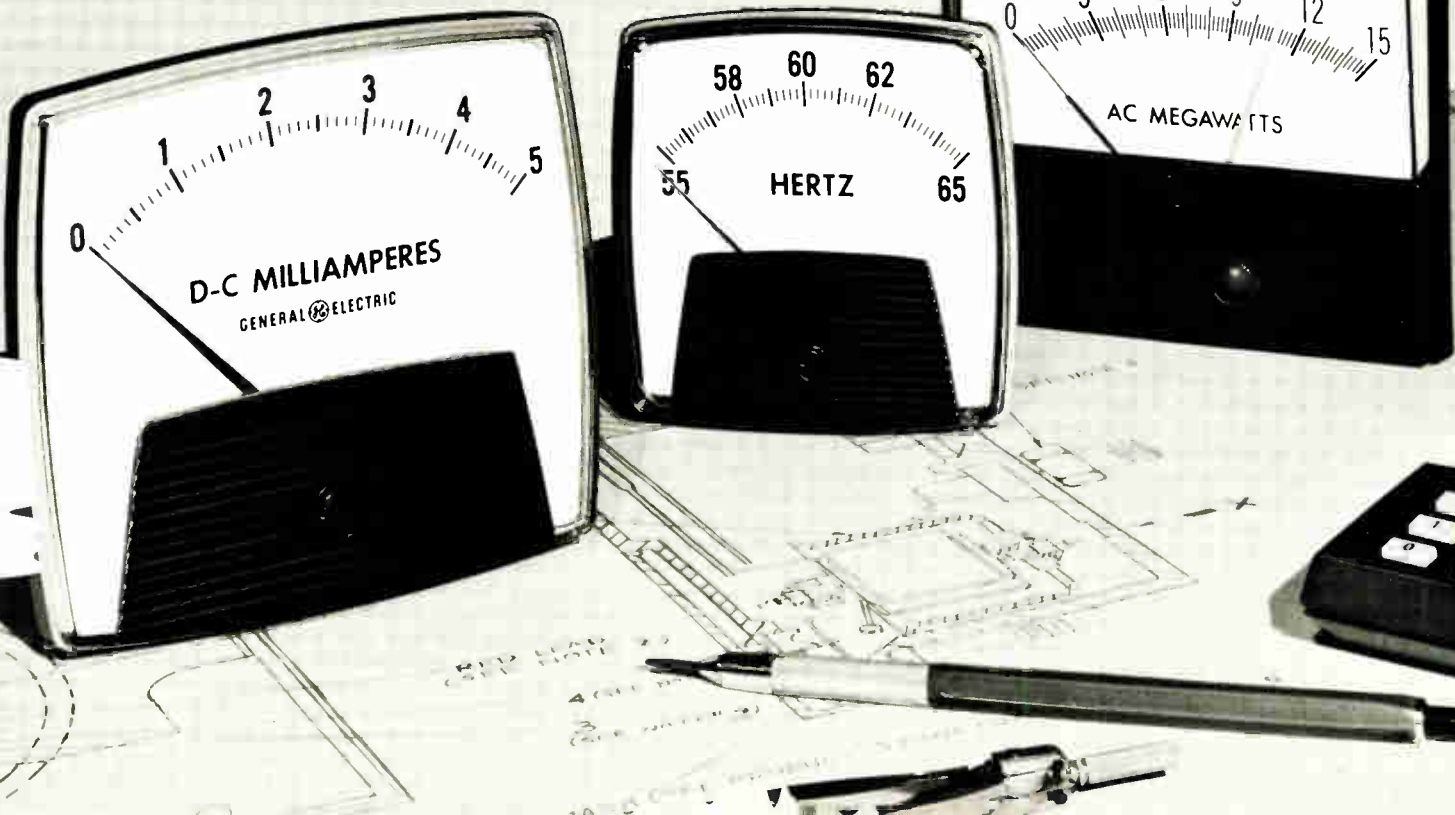

Electronics abroad

British work on multimicro systems

Major research effort is aimed at real-time use
by such companies as airlines and brokerage houses

by Kevin Smith, London bureau manager

The growth in real-time computer systems like those used by airlines and banks or for process control is spurring a major research effort in British universities and research laboratories to tap the growing power of the microprocessor in the first generation of multi-microprocessor systems.

Most recently, Britain's National Physical Laboratory announced that it was teaming with Scicon Microsystems Ltd., a commercial software consultant, to develop a multi-mini/microcomputer system called Demos that could link up to 100 computers via an 8-million-word-

per-second parallel ring. This ambitious project is paralleled by several others.

These systems, say proponents, promise modularity that allows expansion, flexibility in matching microcomputers to a required response speed, and low cost when compared with the present generation of time-shared mainframe computers and minicomputers.

Significant. The concept could have a major impact on computing technology over the next decade. "Multiprocessor technology is one of the most important and difficult areas today," says Prof. J. E. Brignell of London's City University, a leading researcher in the field. "Computer programmers have been trained to analyze problems sequentially because that's the way computers have worked till now."

E. L. Dagless, who is establishing at University College, Swansea, Wales, an academic program for the subject with a general-purpose multi-microprocessor system based on six Intel 8080s, cites two reasons for the growing interest. First, the microprocessor allows the user to build his computing power in modular steps, and this can be important in specific industrial and commercial applications, since it allows a system to grow. Next, it lets an engineer tailor his system to a specific task so that it can be split into identifiable modules, each assigned to a processor. The partitioning can be accomplished by pipelining or paralleling processors.

Wired. At University College in Wales, researchers are working with a multimicro-computer system of six Intel 8080s.

Still a third reason for going to a multiple-microprocessor system could be to increase the microcomputer's brute computing power. It is by far the most difficult problem and one that raises the most skepticism among the industry's mainframe traditionalists.

However, few present-generation microprocessors are suitable for such close coupling. "We chose the F100-L because it was designed by computer systems engineers," says Brignell, "and has features like indivisible bit testing and setting, which you need for semaphore protection. However, newer-generation microprocessors could incorporate these features." In fact, one British company has a processor specifically for multiprocessor operation on the drawing board and is currently canvassing interested semiconductor manufacturers.

The power of multiprocessor technology has also been demonstrated in specialized sectors of the mainframe market. ICL's distributed-array processor, with its 100 million instructions per second, uses an array of simple processing elements distributed through the memory of a conventional mainframe computer. Also, Plessey Telecommunications Ltd. has gone to multiprocessor architecture to achieve a high-integrity exchange secure against the failure of any one element.

Finding places. Where will the systems make their first market impact? Demos, says Wilkinson, is especially suited to applications where large numbers of activities take place in parallel: interactive and financial-transaction processing, for one, where large data bases can be

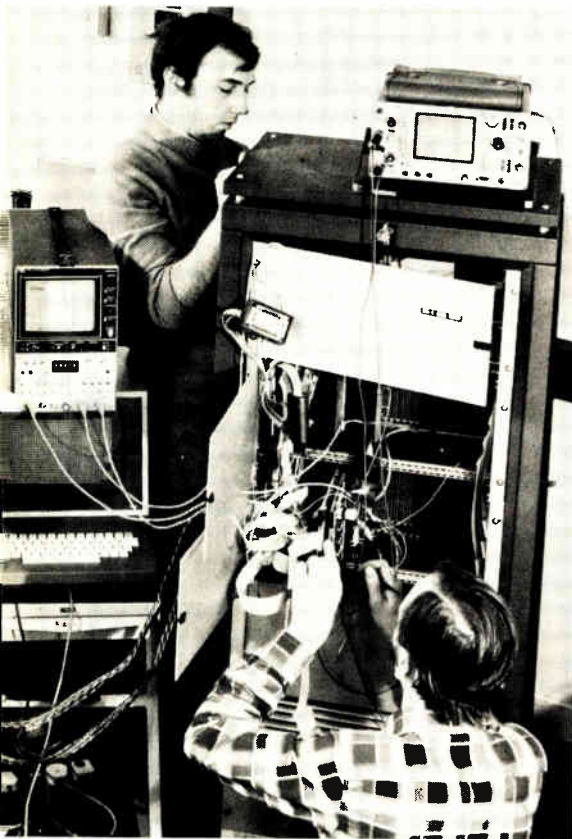

divided on a disk-per-computer basis to allow fast and efficient file access.

Interface control. Telecommunications is another major application area. In collaboration with Warwick University, Systems Reliability Ltd. in Luton is developing a closely-coupled multi-microprocessor system as a universal interface processor in data-communication systems. Its job is to switch together data terminals and data links having widely different data rates and lengths. The system, which should be ready for the end of this year, uses Texas Instruments Inc.'s 9900 16-bit microprocessor.

But problems crop up with increasing processor integration. As each calls on the other's resources, where memory and data channels are shared, contention between processors and administrative overhead can clog the system.

Loosely coupled systems present fewer problems than closely coupled ones. At the Royal Signals Research Establishment in Malvern, for example, researchers have gone for an asynchronous bus linking Intel 8080 microprocessors, each performing a specific function that is frozen into read-only memory. The team is using its Discus system to test Ptar-migan, a digital switch, for the British Army.

At the University of Kent in Canterbury a packet-switching protocol is being used by a team under F. K. Hanna to link a five-node network of Digital Equipment Corp. LSI-11s. The system, which could be employed in such applications as implementing a hospital data-collection system, uses no particular inter-connection structure, because one processor broadcasts to all others simultaneously over all links. The system offers high integrity, modularity, and plasticity of programming since programs can readily be changed on line.

Difference. One big distinction between dedicated systems of multiple-microprocessor and general-purpose multi-microprocessor architectures comes at the software level. A dedicated multiple-processor system has little need of general-purpose software because it is directed to one application. However, multi-micro-computer systems require a high-

level operating system if they are to be sufficiently general.

The Royal Signals Research Establishment is using Coral high-level real-time language, and University College at Swansea is using a high-level language developed at the University of Strathclyde in Glasgow by a group that pioneered the virtual-machine concept. At the National Physical Laboratory, to cut software costs, workers are using Concurrent Pascal, a recently developed high-level language. All of

these high-level operating systems have the kind of generality that allows them to be run on yet-to-be-invented multi-microprocessor systems.

Not everyone, though, is convinced that the first generation of multi-microprocessor systems coming out of the universities and research labs is architecturally sound. Brignell takes a jaundiced view and argues that some systems have been thrown together with far too little thought. □

BEGONE CURSED ALIAS

The new Precision 616 cuts clean with programmable ease. 80 dB/octave attenuation slopes and time domain filters superior to Bessel. Up to 16 filter channels, programmable for gain and cutoff frequency. Interfaces with mini, micro or GPIB. Typical



phase match is $\frac{1}{2}^\circ$, with worst case of 2° . You get performance that used to require a custom instrument, without paying a custom price. Call Don Chandler, 607-277-3550, or write for complete specs and a demonstration.



PRECISION FILTERS, INC.

303 W. Lincoln, Ithaca, N.Y. 14850



A Mux in Linear Wonderland

PMI Takes the Nonsense Out of Analog Multiplexers

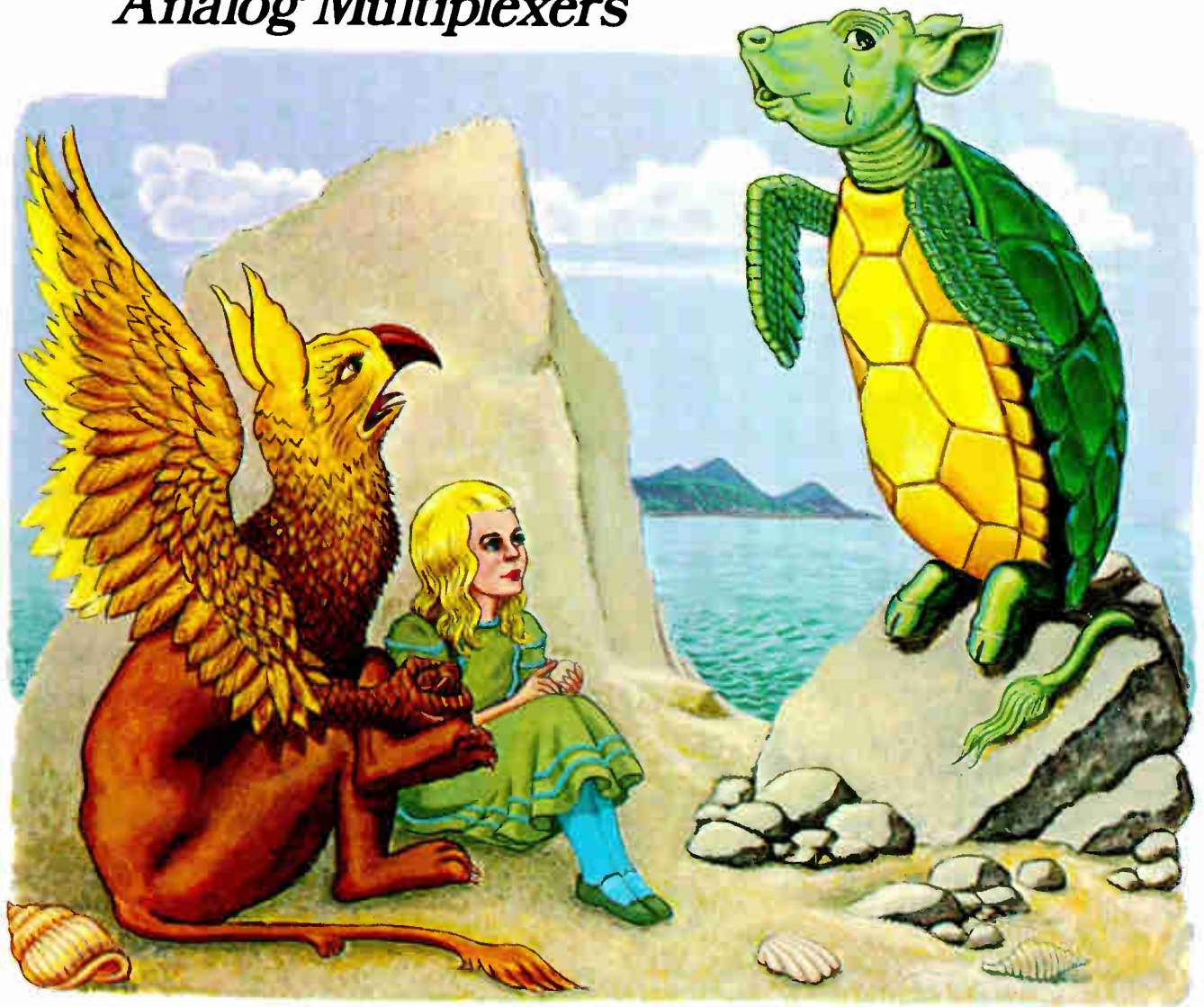

Alice's nonsensical Wonderland was full of things with strange sounding names no one would ever explain to her. Like the Gryphon, the half-bird/half-beast that sat around saying things like, "Hjckrrh!" And the famous Jabberwock; Alice learned to beware of it, even though she never found out what it was, except that it had eyes of flame and burbled as it came whiffing through the tulgey woods.

In Linear Wonderland, engineers have a similar problem in trying to understand what a MUX means. They know that a lot of people make analog multi-

plexers. But they must get as confused as Alice when they try to compare PMI's Improved BIFET MUXes with other people's Standard BIFET or CMOS versions. It's like comparing slithy toves with borogoves.

Consider the things most important to designers of multiplexed systems, such as "OFF" isolation, and crosstalk; protection from overvoltage and low cost. They can get all that *only* from PMI's new protected monolithic MUXes, but they have to compare *ours* to *theirs* to understand why.

CMOS is well known for static blowout and latch

up, but PMI's proven BIFET technology allows us to build the protection right into the chip, without expensive dielectric isolation, external or internal series resistors, or special handling requirements. No other manufacturer of either CMOS or BIFET MUXes does that.

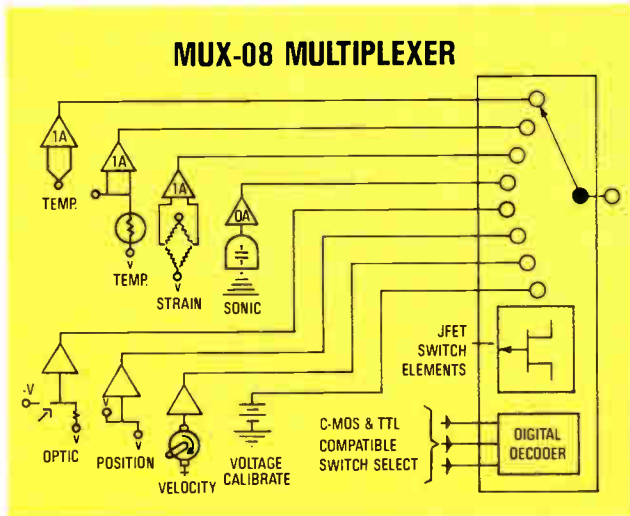

PMI MUX	DESCRIPTION	PIN COMPATIBLE WITH
MUX 08	8 Channel Single Ended	DG 508A, HI 508A, LF 11508
MUX 24	4 Channel Differential	DG 509A, HI 509A, LF 11509
MUX 16	16 Channel Single Ended	DG 506A, HI 506A, AD 7506
MUX 28	8 Channel Differential	AD 7507, HI 507A

If you're tired of nonsense, challenge us. Find out if we really have made comparisons with other monolithic multiplexers meaningless. See if a PMI MUX really gives you BIFET reliability and low cost, while also giving you guaranteed break-before-make action and full protection from overvoltage or power supply interruption. Just send in the coupon for your free "NO NONSENSE" sample. And just turn the page to see where our sales offices and distributors are.

Lewis Carroll could get away with nonsense with his readers, but ours won't put up with it. They *know* the difference between slithy toves and borogoves. Here's the speed-power tradeoff table and prices.

Part No.	Switching Time (μ SEC. MAX.)	Supply Current (mA Typ. at $\pm 15V$)	100-UP (U.S. OEM)
MUX-08/24/E	1.3	10.5	\$ 7.50
MUX-08/24/F	2.1	6.8	\$ 6.40
MUX-16/28/E	1.5	16.0	\$13.50
MUX-16/28/F	2.1	11.0	\$11.00

"Crosstalk?", said the PMI MUX; "just study my specs. As for crosstalk and 'OFF' isolation, I'm almost 10 times better than my closest CMOS competitor. Compare me to the best Standard or Improved BIFET switches. My crosstalk is still 6 dB *lower*."

At the same time, every PMI MUX is protected against failure in the event of power loss, just like the best (and most expensive) CMOS versions.

And speaking of prices, once again there is no logical comparison between them and us. The fact is, we sell them for 30 to 50% less, so we pay for the better performance, not the customer. And price comparisons don't mean much against Standard BIFET versions, either, since our improved BIFET technology allows us to offer precision performance they don't offer at any price.

Just keep in mind the Mad Hatter's advice, "You can't take *less* than nothing, but it's very easy to take *more* than nothing." He knew a lot about buying components.

How much is "more" in Linear Wonderland language? With PMI's MUX Series, it means 1.0 μ sec switching that settles fast with *no* ringing. It means "ON" resistance of 300 Ω , far lower than any monolithic MUX on the market. And it means that our MUXes give you protected analog and digital inputs and full compatibility with CMOS or TTL, without using external pullup resistors (theirs do).

Since you already have enough nonsense to cope with in Linear Wonderland, we made upgrading easier by putting our analog MUX in dual-line packages like theirs. To upgrade any system, just drop in ours in place of theirs:



Precision Monolithics, Incorporated

1500 Space Park Drive
Santa Clara, California 95050

(408) 246-9222 TWX: 901-338-0528 Cable: MONO

Send me a no nonsense MUX

check which type

MUX08 MUX16 MUX24 MUX28

Mail to:

Precision Monolithics Inc., 1500 Space Park Drive
Santa Clara, CA 95050

My name _____

Title _____

Company _____

Dept. _____

Address _____

City _____ State _____ Zip _____

Phone (_____) _____

9E5008

Companies

Intel thrives by taking on IBM

Leasing, service bureau, and mainframe business adds up to \$285 million of company's \$401 million in 1977 sales

by William F. Arnold, San Francisco regional bureau manager

Competing against IBM Corp. may not be the surest way to success, but for Intel Corp. it looks like the best of several worlds. The San Francisco-based company enjoys a thriving three-part business: leasing systems based on IBM computers, running a service bureau, and selling mainframes under its own name into the growing IBM-compatible marketplace. These activities yielded \$285.7 million of the corporation's \$401.8 million in 1977 revenues.

Although the company started 11 years ago by leasing IBM-based systems through its Financial Services group, its Data Products group attracts most attention because it serves the bustling IBM-compatible market. For this market, competitors build IBM-*software-compatible* machines but use more up-to-date architecture and technology, such as emitter-coupled logic and air cooling, to offer price or performance advantages over IBM System 370 and initial 303X series mainframes.

"Business couldn't be better," declares John H. Clark, president of the Data Products group. His staff sold 52 machines last year, expects to sell about 200 this year, and looks forward to a 300-machine business next year—not bad for a group that brought out its first machine only last year. That was the AS/6, which is equivalent to the 370/158, to which has been added the AS/4, which is 40% more powerful than IBM's 370/148, and the AS/6, which is equivalent to the 370/168 and newer 3032 machines. This month it extended the range downward by introducing the AS/3 in two models: the \$570,000 model 4, equivalent to the 370/148 and the \$490,000 model

3, which Clark says has 1.5 to 1.8 times the power of an IBM 370/138.

Of course, there is competition. On the high end Intel's AS/6 encounters streaking Amdahl Corp.'s 470 V/5 machine. At the low end its machines face such newcomers as Magnuson Systems Inc.'s M80 [*Electronics*, May 25, p. 93], National Semiconductor Corp.'s System 400 [*Electronics*, May 11, p. 81], and Two Pi Co.'s V/32 [*Electronics*, May 11, p. 228]. But Clark says that it meets only IBM in the middle ranges.

Unique spot. "Intel is positioned uniquely in the market," observes Jean Michael Gabet, director of research in the computer division of Gnostic Concepts Inc., a Menlo Park, Calif., market-research firm. "For years as a computer-leasing company it was a go-between for IBM and the end user. This gave it a thorough understanding of the customer's needs for software, hardware, and maintenance, something

Happy days. John Clark, president of Intel's Data Products group, sees blue skies ahead.

special that the others don't have. I tend to look at Intel as somewhere between a commodity trader, where the commodity is CPU and hardware, and a service company."

Buyer. Also unique to Intel is the fact that it makes nothing it sells under its own name. Under exclusive licenses, the AS/6 comes from Japan's Hitachi Corp.; the other mainframes come from National. When the bids call for more extensive systems, Intel uses nonimpact printers from Siemens AG of West Germany, disk drives from Sperry Inc.'s ISS group, and main memories from Intersil Co. and National. Clark likes this arrangement because "there are so many people in the terminal and front-end business."

Clark also says that Intel is not interested in the stand-alone hardware or minicomputer business. Its market is hardware with special-applications software, such as a general accounting package for businesses, because "the real add-on value is in applications packages," he says. Nevertheless, Intel also markets Data General's CS lines of business minicomputers [*Electronics*, May 25, p. 40] and is negotiating with National to offer its 400 series and Magnuson for its M80 line.

Still, sharing a market with IBM is like being a fly in a bear's cave. "Where will Intel's market be when IBM's E and H series computers appear?" asks Steven Cottrell, senior analyst with Creative Strategies International, a San Jose, Calif., market-research group. He expects the E series computers to have dramatically improved price/performance ratios, that could shrink the cost advantage of the plug-



compatible market. "IBM won't let the [mainframe] market get away from it," says Gnostic's Gabet, who pegs it at "certainly less than 15,000 units over the next five or so years." He thinks that the new IBM machines will have 370 emulators so that IBM will be able to upgrade its customers' present machines.

Conceding that IBM is "damn tough competition," Clark says Itel plans "to penetrate their installed base by 5% a year over five years" and will announce competitive machines shortly after IBM introduces the E and H series. "We expect a 2-to-1 price/performance improvement from IBM," Clark says. "We're prepared to react to that."

Hard threat. Some believe another threat is IBM's attempt to protect its software through microcoding, or putting software into hardware, often called firmware. But, according to Clark, "firmware is no big deal if you understand software and hardware and have firmware machines," which Itel does. Its machines have twice as much reloadable control store as do IBM's, and it is developing enhancements to its rival's operating system in firmware, he says. Concurring, James Siehl, director of end-user products marketing for National's Computer Products group, says all his group's machines are in microcode, which is "easier to change than a hardwired architecture like Amdahl's."

Some problems may be more immediate, however. One example: the joint venture with Hitachi could be setting up a potentially powerful competitor. They are developing a computer that is 50% more powerful than IBM's 3033 for introduction in 1980, Clark says. "They have the technology, we have the understanding of IBM architecture, software, and diagnostics," he explains.

And what about the relationship with National, which is making more and more noise about becoming an independent computer company? "The relationship is a good one," according to Clark, who says the exclusive agreement on the AS/4 and 5 runs through 1980. "That gives us four years in the marketplace with one product," which he thinks is good.

As for National's potential threat,

Clark's answer is: "You have to have an established sales and service organization to be credible in the marketplace." He notes that, although Itel had been offering peripherals under its own name since 1971 when it brought out its mainframes, "we had to convince customers that we were in the central-processing-unit business and were a long-term player." Clark says that his 550 market representatives and 330 systems-support engineers are split into three groups on a worldwide basis: micro- and minicomputer for special-applications software, general systems in the 138 and 148 class, and large systems in the IBM 3031 and 3032 equivalent machines.

National's basic assumption, according to Siehl, is that "we will continue to have an agreement with Itel." He says his company will actively market the System 400 as a mainframe processor for original-equipment manufacturers and intends to expand its products to OEMs "and to end users, if appropriate." But for any end-user business, Siehl says, National will select fairly narrow markets "where we feel comfortable—we'll stay in areas where our semiconductor technology affords us an advantage." However, Creative Strategies' Cottrell looks for the Itel-National relationship to be "at arm's length after 1980" and for National to go after the end-user market directly.

There is probably enough business for everyone. "The market is so vast that one would have a hard time even approximating how many people use IBM computers," observes Jared Anderson, president of Two Pi. "Itel should do really well so long as IBM doesn't change the rules," meaning changing the microcode extensively. Observing that "no company can service the entire market," Siehl says that IBM actually created two markets, the plug-compatible and the independent-service companies. "You look at the raw numbers and the market is huge," he says, but "you don't have to be a \$20 billion corporation to have a successful product. People overlook the fact that with 3% to 4% you can have a successful market share." But Clark says, "I'd love to see us get 10% of the monthly shipments." □

PMI SALES OFFICES

CALIFORNIA

1500 Space Park Drive
Santa Clara, CA 95050 (408) 985-6616
9800 S. Sepulveda Blvd., Suite 818
Los Angeles, CA 90045 (213) 670-3791

FLORIDA

115 Palm Bay Rd., N.W., Bldg. 200, Suite 10 C
Palm Bay, FL 32905 (305) 725-2900

ILLINOIS

605 East Algonquin Road, Suite 470
Arlington Heights, IL 60005 (312) 437-6697

MASSACHUSETTS

200 W. Cummings Park, Suite M-32
Woburn, MA 01801 (617) 933-1517

PENNSYLVANIA

P.O. Box 346
Ridley Park, PA 19078 (215) 521-1441

PMI DISTRIBUTORS

BELL INDUSTRIES

Gardena - (213) 515-1800
(714) 521-4914
Sunnyvale - (408) 738-1111

CENTURY ELECTRONICS

Albuquerque - (505) 292-2700
Salt Lake City - (801) 972-6969
Wheatridge - (303) 424-1985

CESCO ELECTRONICS

Montreal, Quebec - (514) 735-5511

FUTURE ELECTRONICS

Montreal, Quebec - (514) 735-5575
Ottawa, Ontario - (613) 232-7757
Rexdale, Ontario - (416) 675-7820

GERBER ELECTRONICS

Dedham - (617) 329-2400

HALL-MARK ELECTRONICS

Austin - (512) 837-2814
Baltimore - (301) 796-9300
Bloomington - (612) 884-9056
Dallas - (214) 234-7300
Earth City - (314) 291-5350
Elk Grove - (312) 437-8800
Ft. Lauderdale - (305) 855-4020
Huntington Valley - (215) 355-7300
Huntsville - (205) 837-8700
Houston - (713) 781-6100
Orlando - (305) 971-9280
Raleigh - (919) 832-4465
Shawnee Mission - (913) 888-4747
Tulsa - (918) 835-8458
West Allis - (414) 476-1270
Worthington - (614) 846-1882

HARVEY ELECTRONICS

Binghamton - (607) 748-8211
Fairfield - (201) 227-1262
Lexington - (617) 861-9200
Norwalk - (203) 853-1515
W. Henrietta - (716) 334-5920
Woodbury - (516) 921-8700

INTEK ELECTRONICS

Vancouver - (604) 324-6831

INTERMARK ELECTRONICS

San Diego - (714) 279-5200
(714) 453-9005
Santa Ana - (714) 540-1322
Sunnyvale - (408) 738-1111

LIBERTY/ELMAR

Bellevue - (206) 453-8300
Commerce - (303) 287-9611
El Segundo - (213) 322-8100
Mt. View - (415) 961-3611
Phoenix - (602) 249-2232
San Diego - (714) 565-9171

PIONEER ELECTRONICS

Cleveland - (216) 587-3600
Dayton - (513) 236-9900
Elk Grove - (312) 437-9680
Indianapolis - (317) 849-7300
Livonia - (313) 525-1800
Pittsburgh - (412) 782-2300

SEMI-DICE

Long Beach - (213) 597-0358

WESTATES ELECTRONICS

Chatsworth - (213) 341-4411
Costa Mesa - (714) 549-8401

**For some
microprocessor labs, support
means an operating manual
and a long distance number.**



For Tektronix labs it means installation. Training. And on-site service. All from local specialists.

Our lab opens the door to many of the best chips on the market: like the 8080 and 8085, The Z-80, The 6800, The TMS 9900. Specifying a new microprocessor won't mean learning or purchasing major new equipment.

WE'LL GET YOU GOING RIGHT.

Any new tool deserves a proper introduction. With Tektronix, that means installation and simplified training direct from the manufacturer.

We have what it takes: local field offices from coast to coast, staffed by experts who get your microprocessor development lab up and running—and your design team thoroughly at ease with the system—in short order. Tektronix quick service, exceptional documentation and quality assurance are all part of the package.

MORE OF THE BEST

Total Tektronix support is just one of many features—including the following—that make our design aid the most comprehensive you can find.

PROGRESSIVE EMULATION

Software can be tested, traced and debugged on a microprocessor identical to the one in your product design. Then software and hardware can be integrated and debugged stepwise, from partial to full in-prototype emulation.

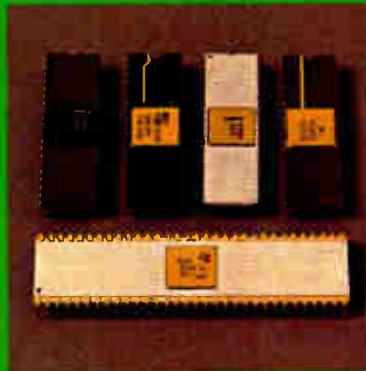

INCREMENTAL MAPPING

Application programs may be mapped over to the prototype in 128-byte address blocks, so you can localize problems quickly.

REAL TIME ANALYSIS OPTION

You can easily trace and debug hard-to-find timing or sequence problems by dynamic, full-speed monitoring; dual 48-bit breakpoint registers; and an extensive set of triggering conditions.

Tektronix has been building great instrumentation with full service back-up for 30 years. That's why 95% of all Tektronix customers come back for more. Ask your local Tektronix Sales Engineer for the full story, or write Tektronix, Inc., P.O. Box 500, Beaverton, Oregon 97077. (503) 644-0161. In Europe, Tektronix, Ltd., P.O. Box 36, St. Peter Port, Guernsey, Channel Islands.

Tektronix
COMMITTING TO EXCELLENCE

**Tektronix
microprocessor
development labs.**

**Designed by
people on your side
of the bench.**

Circle 99 on reader service card

What is a Stackpole?

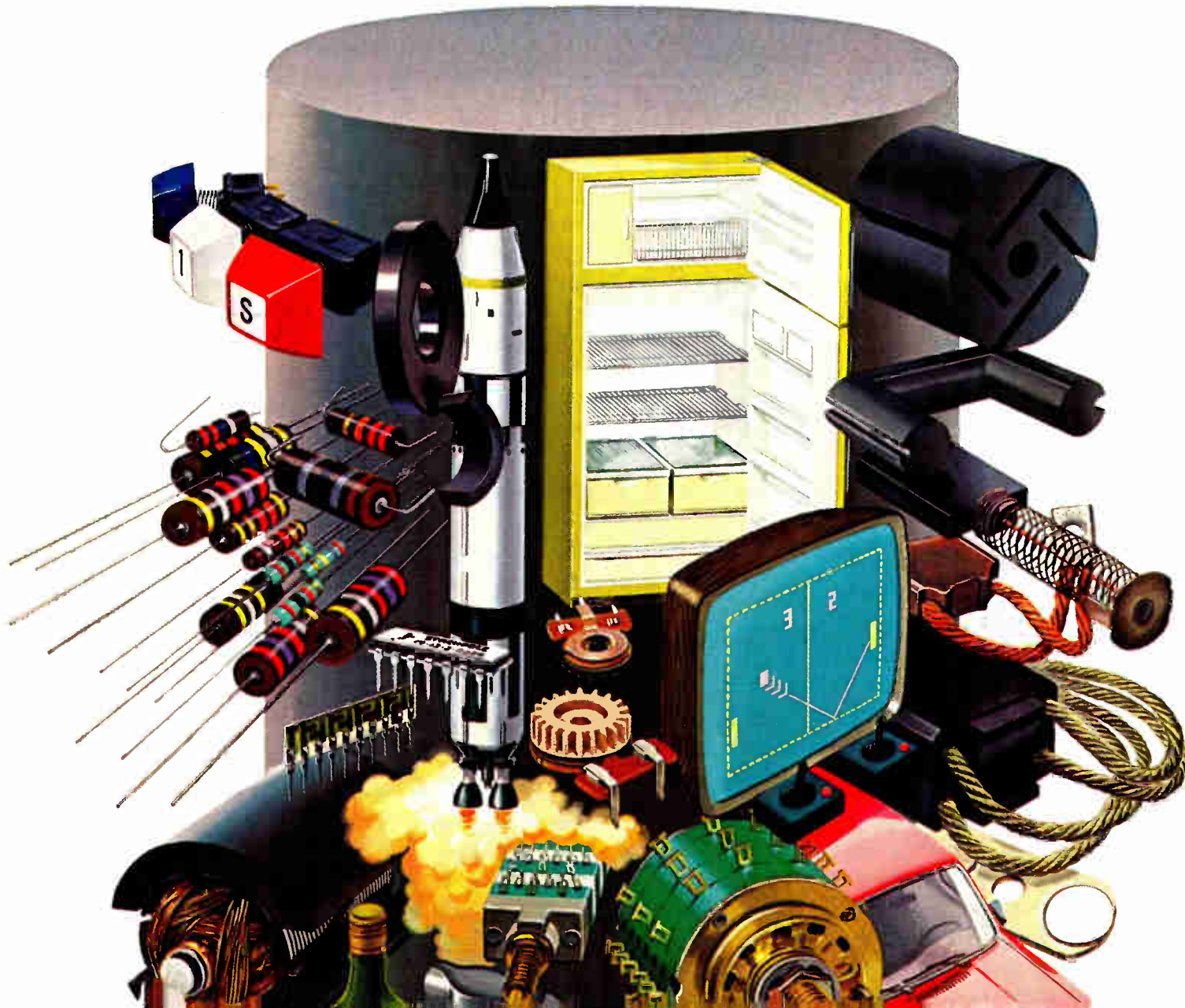

A Stackpole is a very large corporation, one of the largest privately held manufacturing companies in the United States. Stackpole is also the name for hundreds of products, made in two million square feet in eighteen plants and sold all over the world.

A Stackpole is an organization of dedicated people with manufacturing, engineering, marketing and management know-how. And a special willingness to help solve your material and component problems.

A Stackpole is a switch.

We're a giant switch-maker. We produce more slide switches than anyone else in the world. All shapes. All sizes. And all kinds of other switches—rotary, rocker and keyswitches. We're a big part of the giant consumer electronics industry.

A Stackpole is a resistor.

We're one of the largest resistor companies, with capacity in the billions. We provide the world with carbon-comp, carbon-film, variable, industrial and special-purpose resistors, as well as resistor networks.

A Stackpole is a ferrite.

Hard and soft. Stackpole is one of the world's largest producers of ceramic magnetizable powders. Our permanent magnet materials are used in a variety of applications. From refrigerator door gaskets to motor segments.

Stackpole is also a major supplier of soft ferrite cores used in the electronics industry. From TV sets to power supplies.

A Stackpole is an automotive brush.

We're the leading supplier of automotive brushes in the U.S. Other brushes, too. And our Carbon Division makes a lot more than brushes. Carbon and graphite anodes. Plates. Rods. Billets. They're all Stackpole.

Graphics. Without

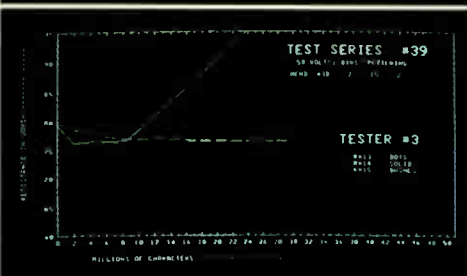
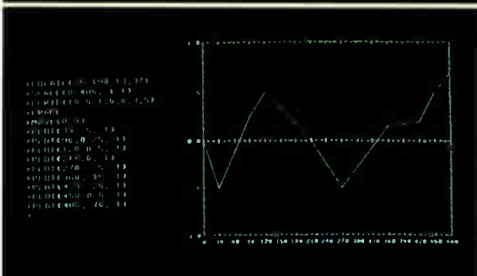
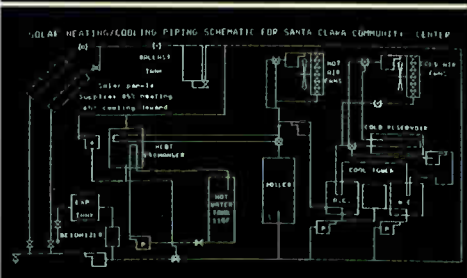
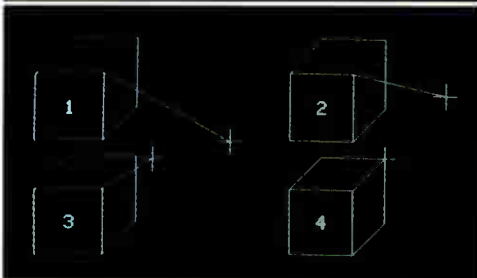
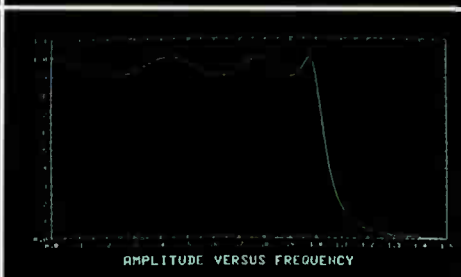
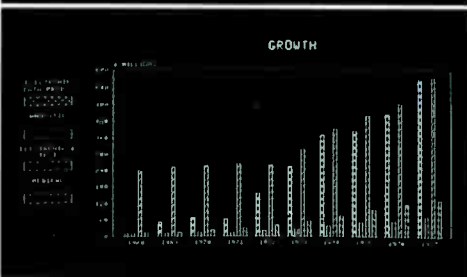
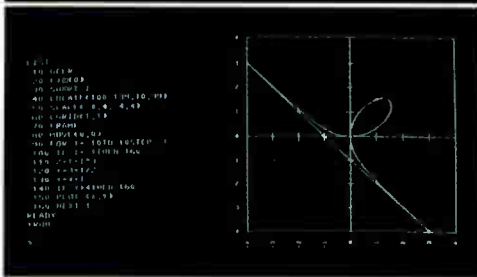
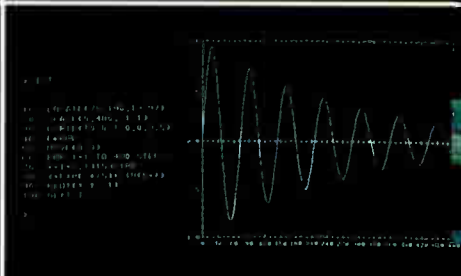
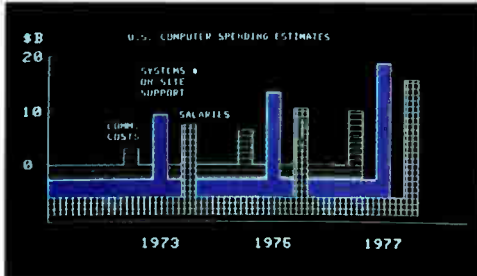
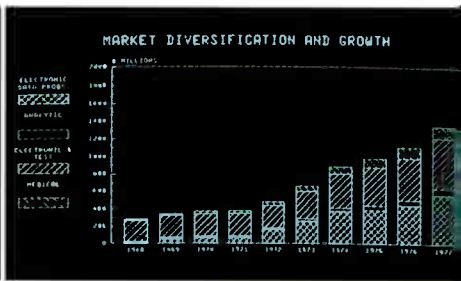
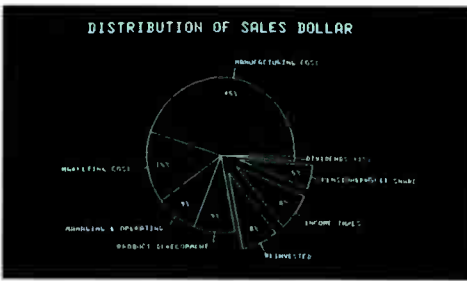
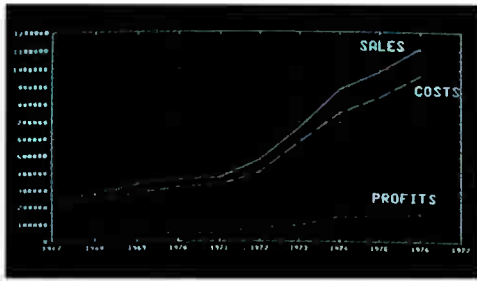

graphics software.

You just lost your last excuse for sticking with alphanumerics. Because with HP's new 2647A Intelligent Graphics Terminal, you get graphics without digging into your CPU's software.

A picture's worth a thousand numbers.

On an alphanumeric terminal, your data's just a screen full of numbers. But with the 2647A you can plot tabular data as a bar graph, or a pie chart, or a linear or logarithmic line graph. Quickly, with just a few keystrokes.

Now you can really see your data, not just look at it.

What's more, with the 2647A you can zoom in and out. Pan right, left, up, down. Selectively erase. Shade important areas to make them stand out. Use a rubber-band line to make a quick sketch.

Without any help from your programming department.

It's more than smart.

The 2647A's the smart way to get graphics from tabular data without software.

But what if your CPU's output isn't tabular? Or if you'd like to plot derived data, say a three-month moving average from monthly sales figures? Or if you need more than a bar graph, pie chart or line graph?

The 2647A's not just smart, it's intelligent.

You can program it to reformat data from your CPU, or to compute more data, in easy-to-write BASIC. And you can program it in AGL, our high-level graphics language extension of BASIC. Its powerful commands, such as FRAME, AXES, LABEL, LOCATE and PLOT, put sophisticated graphics at your fingertips.

Either way, your program runs on the 2647A without

any help from your CPU.

Hard copy's easy.

How do you get graphics into your briefcase?

The 2647A makes graphics as portable as alphanumerics. It interfaces easily with our 9872A Four-Color Plotter (which can even make overhead transparencies), and with our 7245A Thermal Plotter-Printer. All you need is an interface card, a cable and the peripheral itself.

And to keep costs down, more than one 2647A can share the same hard copy peripheral.

You still get alphanumerics.

You don't have to give up alphanumerics to get graphics. Because the 2647A's also a programmable alphanumeric terminal for interactive use on-line or by itself.

With independent alphanumeric and graphics memories. Eight soft keys you can define to do several steps with a single keystroke. A bright, easy-to-use, high resolution display. And built-in dual cartridge tape drives for 220K bytes of mass storage.

Best of all, the 2647A with full memory and data communications interface costs only \$8300*.

Which makes it easy to get the picture.

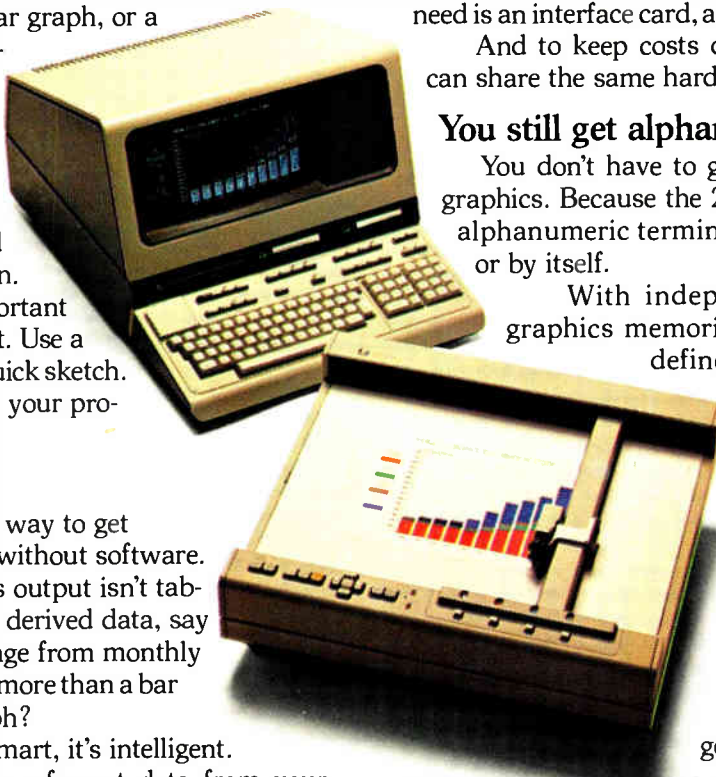

HEWLETT  **PACKARD**

42805HPT9

*U.S. domestic list price

- Send me more information about graphics without graphics software.
- Show me graphics without graphics software.

Name _____ Title _____

Company _____

Address _____

City/State/Zip _____

Phone _____

Mail to Hewlett-Packard, Attn: Ed Hayes,
Marketing Manager, Data Terminals Division, Dept. 627,
19400 Homestead Road, Cupertino CA 95014.

Say you've been doing some IF testing in the kHz range, and now you need to switch to the RF MHz range. With the high performance Model 3002, you just change the lever/indicator switches on the front panel. With anyone else's signal generator you reach for a different model—and drop a few thousand more dollars.

So if your testing needs go from as low as 1 kHz to as high as 520 MHz, you should go with Wavetek's Model 3002. It's also programmable and GPIB compatible, so it knows its way



around any automatic test system.

Of course your primary concerns may be accuracy and stability. In that case, Model 3002's 0.001% accuracy and 0.2 ppm/hr stability will be two primary reasons to buy it. The unit also has internal and external AM and FM modulation capability

and +13 dBm (1 Volt) of leveled output power.

You can get into Model 3002 for as little as \$3,400. The GPIB compatible version with an optional programmable attenuator and reverse power protection will set you back about \$4,700. But think how far it'll take you. Wavetek Indiana, Inc., 66 N. First Ave., P.O. Box 190, Beech Grove, Indiana 46107. Telephone (317) 783-3221, TWX 810-341-3226.

WAVETEK[®]

Circle 104 on reader service card

**Now you can go from 1 kHz to
520 MHz by changing settings...
instead of signal generators.**

FREQUENCY
1KHz-520 MHz





Technologies, architectures compete for huge codec market

by Harvey J. Hindin, *Communications and Microwave Editor*

□ There's a new integrated circuit in town, and it's making quite a stir in both the semiconductor and communications industry. Dubbed the codec, it is already widely available from many manufacturers, and it promises to sell in million-unit quantities as a result of the telephone industry's worldwide turn to digital technology [*Electronics*, July 20, p. 88].

Codec is short for encoder-decoder. An encoder contains all the elements needed to convert analog voice into digital data for transmission over a telephone line. Conversely, a decoder contains the elements that perform the digital-to-analog conversion needed to restore the sound of the voice after transmission.

Previously, these conversions were achieved by high-speed a-d and d-a converters multiplexed over many analog channels. But now the advances in large-scale integration have made it economically feasible to encode each channel separately and multiplex the resulting digital signals (see "What the codec does").

Short-term applications of codecs are likely to be concentrated in central stations and in larger private exchanges. This market still represents millions of parts, according to forecasts from semiconductor manufacturers [*Electronics*, April 13, p. 77]. There is also that eventual possibility of one in each phone—and there are 398 million telephones in the world. But for the longer term, because codecs will take time to impact the fiscally and technologically conservative telephone industry, applications are expected in transmission systems, local and tandem (interoffice trunk switching) offices, private automatic branch exchanges, and ultimately, local subscriber loops and telephones. And, since codecs will sell for a few dollars each in large quantities, it is easy to see what is exciting the semiconductor industry.

The major telephone companies represent the largest portion of the potential market. It hardly comes as a surprise, then, that they are doing development work in this field themselves. The biggest of all, American Telephone & Telegraph Co., is thought by industry observers to be working on its own codec through Bell Laboratories. A spokesman notes a "vigorous codec program is going on, but no information is available yet." In

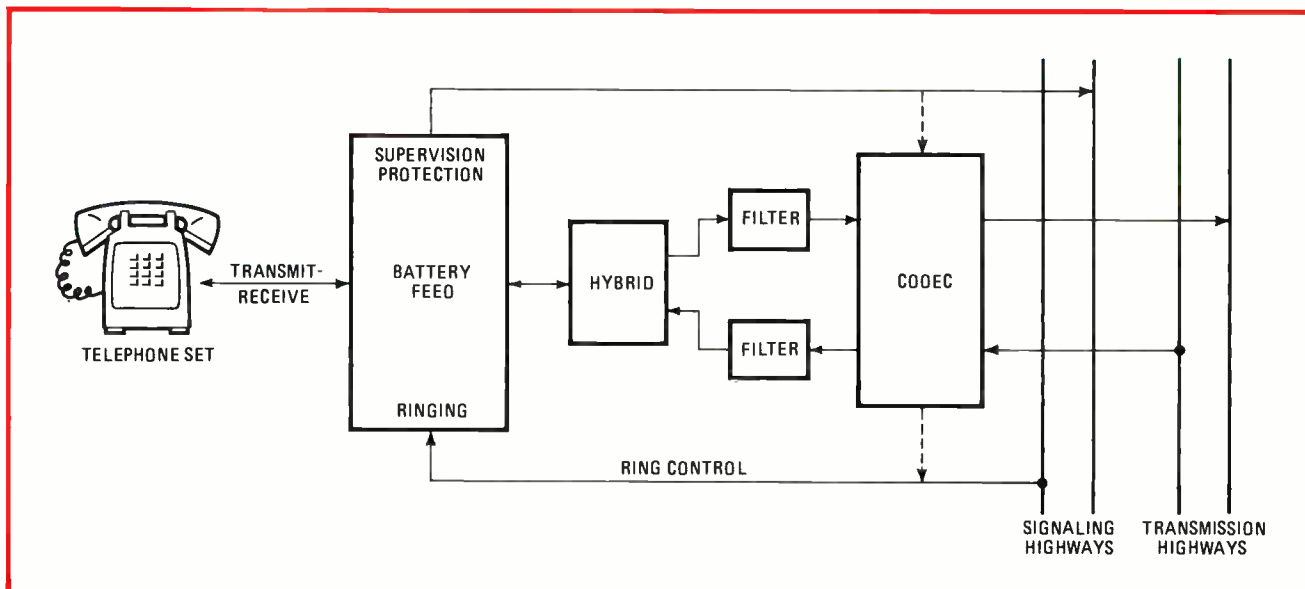

Placement. A one-chip codec without on-board filters would fit in a private branch exchange or central office switching system just before the so-called transmission highways. Ultimately it might interact with signal-line highways for ringing and other functions.

contrast, aggressive Northern Telecom of Canada has already released some information on a codec it has been working on. One feature is an on-chip filter, which alone is enough to set Northern's codec apart from most of the others that have been announced. Moreover, according to John Mahoney, division general manager of the company's Digital Switching division, the codec "will be used in the DMS-100 large digital local switch, which has a capacity of up to 100,000 conversations and will be shipped by the end of the year for service in 1979."

Among semiconductor manufacturers, only American Microsystems Inc. also claims an on-board filter. So it is interesting and perhaps strange, as one industry observer chose to put it, that Northern Telecom and AMI recently entered into a "custom fabrication" agreement for production of Northern Telecom-developed codecs over the next two years.

Doing it

The manufacturers now producing codecs use a diversity of approaches in building them. Still, the specifications the codecs must satisfy are well-defined by the telephone industry. Consequently, although the chip counts, processes, and architectures may vary widely, the results must satisfy certain performance requirements.

At present, one-chip and two-chip devices and totally discrete components are all available. Proponents of the one-chip approach claim that this is the way the codec will finally go, so "why not do it now?" They assert that the use of a single-process technology has not required compromise on any specifications.

Two-chip advocates disagree, saying that different functions are better served by different processes. They claim that the use of two separate processes has not only allowed them to far exceed telephone industry requirements but also lets them build smaller and therefore more reliable devices. The small die size also boosts the production yield and thus lowers final cost.

A third viewpoint is advocated by Precision Monolith-

ics, which is making parts available for so-called shared codecs. In this approach, discrete codec parts are simultaneously used by 8, 12, or more channels. The company believes this is the most efficient in cost and power when these factors are measured on a per-channel basis.

To further complicate matters, some manufacturers keep encoder and decoder separate. Among other advantages, they claim that they can meet requirements this way in a smaller package with fewer pins.

Actually, there is not even agreement as to how many functions a codec should perform in a complex telephone network. According to Ron Hlavinka, General Instrument Corp.'s telecommunications marketing manager, a "true codec performing all the required telephony functions has yet to be developed" on one or even two chips. GI, along with Motorola Inc., has chosen to produce one chip for both the μ and A laws (see "What the codec does"), leaving the user to pick the one he wants by pin selection.

As for process technologies, there is a variety being utilized in codecs. These include both n-channel and complementary metal oxide semiconductor, integrated injection logic, and charge-coupled devices. As industry observer Benjamin Rosen of Morgan Stanley & Co., a New York investment firm, points out, "The codec affords us a good example of how there can be reasoned difference as to what constitutes the right technological direction—in this case the optimal process and design."

Table 1 summarizes the approaches being followed by representative codec manufacturers. Key specifications are given where they are available for one- and two-chip approaches. Precision Monolithics' shared codec has too many components to be included here, but they are discussed in detail in the technical article on page 108.

Intersil Inc., Fairchild Camera & Instrument Corp., and Advanced Micro Devices Inc. are also working on codecs, but it is too early for any information to be available about them. In addition, industry giant Texas Instruments Inc. is playing it close to the chest and will

REPRESENTATIVE SINGLE AND TWO-CHIP CODECS AND KEY DEVICE SPECIFICATIONS

Manufacturer	Intel	Mostek	Signetics	Motorola	American Microsystems	General Instruments	National Semiconductor	Siliconix
μ -law part (s)	2910	MK5150 MK5116 ¹	ST100	MC14407 ⁴ MC14406 ¹	S2900 coder S2901 decoder	AY3-9900 ⁴	MM58100 LF3700	DF331 coder DF332 decoder DF334 decoder ²
A-law part (s)	2911	MK5155	not available	MC14407 ⁴	S2902 coder S2903 decoder	AY3-9900 ⁴	MM58150 LF3700	DF341 DF342
Process technology	n-MOS	C-MOS	I ² L	C-MOS	C-MOS	n-MOS	C-MOS bipolar	C-MOS
Die size (mil ²)	22,000	31,280	36,000	34,125	info not available	19,500	25,600 11,550	19,162 16,386
Mask count (with final coat)	9	10	10	7	8	6	info not available	info not available
Number of chips	1	1	1	1	1 ³	1	2	1 ³
Filter on chip?	no	no	no	no	yes	no	no	no
Number of power supplies (not including reference)	3	2	3	1	2	2	2	2
Voltage supply values	+12, \pm 5	\pm 5	\pm 12, + 5	10 - 16	\pm 5	+ 9, + 5	\pm 12	\pm 7.5
Mode of operation	asyn/syn	asyn/syn	asyn/syn	asyn/syn	asyn/syn	asyn/syn	asyn/syn	syn
Number of pins	24 22	24/16 16	24	28/24 28	18 coder 16 decoder	24	28/20 22/20	14
Voltage reference on chip?	yes	no	no	no	no	reference not needed	yes	no
Power dissipation (typ): active (mW) standby (mW)	220 110	30 not available as option	375 50 (max)	80 0.5	(includes filter) 200 25	300 not available as option	250 < 10	45 not available as option

¹ no signaling version ² TTL compatible signal output ³ separate coder and decoder ⁴ pin selectable conversion law

not even say if work is in progress.

European companies, while not included on the chart, have not been napping. Siemens AG of Germany has taken a two-chip n-MOS and bipolar approach in its A-law codec but does not yet have a μ -law device. Sweden's Ellement is said to be cooperating with National Semiconductor's C-MOS and bipolar effort.

In England, General Instrument Microelectronics Ltd. is one of the first companies on the market with a pin-selectable μ - or A-law device with full CCITT compliance. It uses an off-chip delta-sigma modulator to convert data to pulse-code-modulated form. Pye Ltd., Ferranti Ltd., Plessey Co., and General Electric Co. Ltd. are also hard at work in this area. As in the U. S., there are probably too many potential suppliers, and a shakeout appears just as inevitable.

Strangely enough, no Japanese codec activity has been visible—a state of affairs that no one in the American semiconductor industry expects to last much longer.

What are the tradeoffs?

Obviously, manufacturers want a small chip, the fewest possible number of masks, and simple processing to maximize their yield. Users want a minimum number of standard power supplies with wide tolerances. Low active power dissipation and a possible standby mode are also desirable as may be a voltage reference on the chip, depending on the conversion method used. Microprocessor selection of time slots may be useful in certain cases, as may be various interfaces for phone ringing, dial pulse echoing, and other special codec functions. Also, where

timing cannot be derived from local clocks, asynchronous operation may be required.

None of the codecs available has all of these features or options simultaneously. Clearly, compromises have had to be made. Unfortunately, the various manufacturers disagree as to which of the codec requirements are more important.

However, power dissipation is accepted as one of the more critical characteristics, especially when codecs are installed in individual telephones. It is dogma that no external power can be connected to the telephone, so that all power must come from the relatively low-level line. In this regard, C-MOS parts are inherently superior to n-MOS and bipolar devices. For instance, Motorola's C-MOS part dissipates 80 milliwatts in its active mode and just 0.5 mw typical in standby. In contrast, the n-MOS parts dissipate 220 to 300 mw active and 110 mw standby. Moreover, three of the codecs, General Instrument's n-MOS, Mostek's C-MOS, and Siliconix' C-MOS do not have standby modes.

Codecs from Signetics Corp. are being tested by International Telephone and Telegraph Corp., and General Instrument's device was developed in conjunction with the British Post Office. In addition, National Semiconductor Corp. says it has shipped thousands to two telephone companies. But actually most manufacturers have made samples available to all comers, and it appears that "everyone is buying from everyone." Small-quantity prices seem to be rather arbitrary, and no one knows what a really large quantity would go for dollar-wise.

Industry observers and the semiconductor manufac-

turers themselves believe that there has to be a significant shakeout. Right now there are a dozen or so possible manufacturers, both domestic and foreign. Once the customers start making volume buys and the trends become clear, it is probable that the losers will abandon their own idiosyncratic designs and become second sources for the preferred approach, whatever that may

be. Marketing clout, reproducibility, low cost, high performance, and early delivery as usual will determine who's who in codecs.

The two articles that follow offer a detailed account of the shared-codec approach and an n-MOS one-chip design. Articles on codecs implemented with C-MOS and 1^2L processes will appear in subsequent issues. □

What the codec does

In any telephone network, the input voice information is an analog time-varying signal. In a digital net of the time-division-multiplexed kind, this voice-data input is digitally sampled by the codec at discrete, uniform intervals. These intervals are determined by the Nyquist sampling theorem, which states that any signal can be ultimately reconstructed if it is sampled at a rate equal to twice its highest frequency of interest. The universally accepted rate for a telephone conversation is 8,000 samples per second because voice data transmission up to 4,000 hertz has been found to have enough fidelity for practical purposes.

The voice signal must be band-limited at 4 kilohertz by a low-pass filter to prevent it from being distorted by the codec's analog-to-digital and digital-to-analog conversions. Ultimately semiconductor manufacturers will incorporate the filter in the codec itself, and there is some feeling that even the full-duplex hybrid, which allows two-way conversions, will end up in the codec.

The digitally encoded information is transmitted in bit-serial form. This technique allows data transmission from 24 voice channels into 24 time slots on a single, serial-transmission highway or bus. One 8-bit code word from each voice channel is transmitted in its associated time slot, and the bus format groups the 24 8-bit time slots into a 192-bit block.

Overall synchronization is provided by adding 1 bit and the resulting 193 bits are designated a frame. This last frame synchronization bit defines the boundary between time slots 1 and 24 and serves to keep the time-slot counter of the far-end receiver synchronized with that of the near-end transmitter. The 8-kHz frame repetition rate then produces the characteristic 1.544-megabit-per-second data used in all AT&T T1 systems. The 8-bit data block corresponding to one sample of a given voice channel is demultiplexed by time-slot identification at the receiver.

The critical step in the process of forming the digital pulse-code-modulation signal is the assignment of a binary code to each analog sample as it is presented to the codec. This is usually done by a system of nonlinear quantization referred to as companding and performed by a compander (compressor-expander).

In a typical companded transmission system, the analog signal is passed through the compressor part of the transmitting compander before being transmitted. At the receiver the analog signal is passed through the expander part of the receiver compander. The process boosts low-level signals, making them better able to compete with the system noise, and attenuates high-level signals, preventing them from saturating the system.

A digital realization of the desired companding law is obtained by segment or chord approximation to the curve shape. North American PCM systems use digitally realizable approximations to the so-called μ -255 law. For this encoding law, there is a total of 8 chords for each input polarity, with each chord having 16 equal steps. The step size within each chord is constant, but doubles in size from one chord to the next, starting with the chord nearest the origin.

European telephone systems also use a chord or segment approximation but in accordance with the so-called A law. A total of eight segments is again used for each polarity. For the four chords nearest the origin, however, the step size remains the same and the four chords about the origin are merged into a single chord. After the first two chords, the steps double in size from one chord to the next.

In practice, there is not much difference between the two laws. Controversy over which is "better" exists but involves various nontechnical arguments concerning the place of origin. In any case, most codec manufacturers are making both laws available for the two markets.

Multichannel shared codecs cost less and save on power

by Guido Pastorino,
Precision Monolithics Inc., Santa Clara, Calif.

□ One option for the designer of pulse-code modulation systems is to assemble a coder-decoder from separate large-scale integrated circuits and share it among eight or more channels. Such a codec uses less power and costs less per line than the single-chip-per-channel approach

advocated by most integrated-circuit manufacturers.

The idea has a long pedigree. The earliest codecs, which were built out of discrete transistors and passive components, were shared devices, and LSI shared codecs have been going strong for as much as two years. Such devices can be found, for instance, in carrier systems, digital private-branch exchanges, and remote terminals, including a number of systems that meet or exceed telephone system specifications. In a typical digital exchange, this kind of codec may be shared among 8, 12, or 24 lines. Such a design is at present being considered by AT&T for the D4 channel-bank codec.

A shared codec digitizes the signals from each channel in turn. It takes a sample from the first channel, assigns

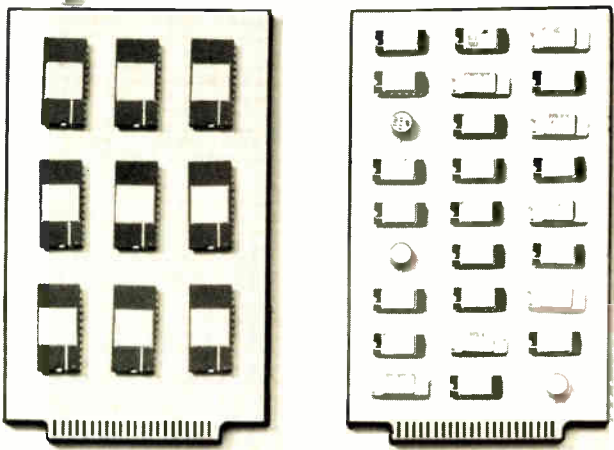

1. Packaging density. Only 9 of the necessary 24 ICs for a per-line codec fit on the board at left, whereas all the ICs needed for a 24-line shared codec fit on a board on the same size at right. Packaging density is a prime factor favoring the shared-line codec approach.

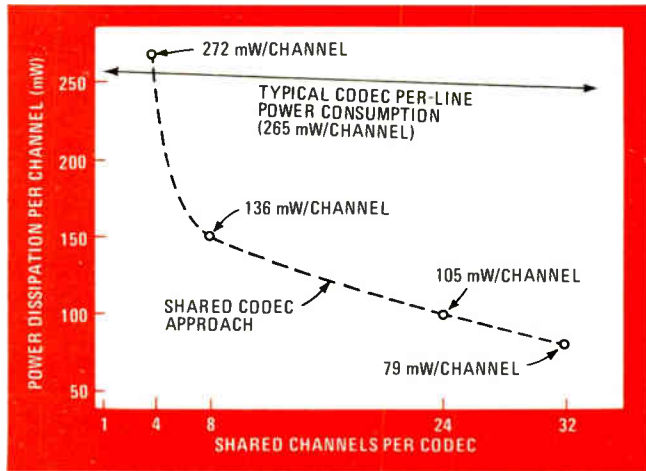

2. Less power. As the number of codecs shared per channel increases, the power dissipation per channel decreases rapidly. With the per-line codec approach, dissipation is constant, regardless of the number of channels. A curve comparing prices would be similar.

it a digital value, puts it out on the PCM line, and starts over again with the second channel. This contrasts with the per-line approach in which each line requires its own codec and the time-slot interfacing is done digitally, usually by busing the codec outputs.

To share or not to share?

In a shared-codec system, the multiplexers, references, sample-and-hold circuits, digital-to-analog converters, and other devices are all implemented as separate LSI circuits. The multiplexers and sample-and-hold circuits, in particular, are manufactured to exhibit much lower crosstalk than their discrete counterparts, seriously weakening the argument that per-line codecs are necessary to eliminate interchannel crosstalk.

Moreover, the use of shared codecs allows the appropriate process technology to be used for the different codec functions. In the per-channel approach, it is not always practical to optimize all functions at the same time on the same chip, since different functions are sometimes best performed by different technologies.

The budget's the thing

As far as the engineer is concerned, however, the key reasons for going to shared codecs are the power and cost budgets and the package count (Fig. 1).

Figure 2 and the table show how low the power consumption can become with two distinct shared-codec configurations. The per-line 24-channel codec, which encodes with two d-a converters and decodes with one, has a total codec power consumption of 2,541 mw, which divided by 24 yields a per-channel power consumption of only 106 mw. The 32-channel codec has exactly the same component count as the 24-channel system and also exactly the same total power dissipation, but the per-channel power dissipation drops to 79 mw.

Then there is the cost factor. Estimates indicate that the per-channel cost of the Precision Monolithics devices used for an 8-channel system with one digital-to-analog converter each for the receiving and transmitting functions are \$3.92 per channel, in 100,000-piece quantities,

and the per-channel cost for the devices in the 24-channel system is \$2.36 per channel for the same quantity. For the 32-channel system, cost shrinks to about \$2.00 per channel.

In terms of package count (a major size and reliability consideration), shared codecs are competitive with per-line codecs if shared over eight or more channels. When the per-line device is contained on one chip, the package count for both systems is about the same. When the per-line system is a two-chip set, the package count favors the shared-codec system. For the 24-channel codec system in the table, the total package count would be 24 even with a generous 10-package allowance for the successive-approximation register and miscellaneous digital components. With a per-channel system, allowing two extra packages for reference supplies, the package count would be 26 for a one-chip system and 50 for a two-chip system.

Building a shared codec

A typical shared-codec system, such as a 24-channel D3/T1-type bank, may be built with a set of three 8-channel shared codecs (Fig. 3). This design is easy to construct and requires only noncritical layout techniques. It uses six d-a converters to encode and decode 24 channels. More advanced systems use two converters to encode two groups of 12 channels and one converter to decode 24. The theory of operation of those more advanced systems is the same as the one for the 8-channel systems.

Each input to the transmitting multiplexer is preceded by a transmitting filter, and each output of the receiving multiplexer is followed by a receiving filter. The receiving and transmitting filters are identical, except that the receiving filters have a frequency response peak between 3 and 4 kilohertz to correct for frequency rolloff caused by the zero-order-hold capacitors at the output of the receiving multiplexer.

In the next step, the transmitting filter outputs are applied to the transmitting multiplexer, which is the first of the two stages of the analog sampling system. The

COST/POWER BUDGETS FOR TWO SHARED CODEC SYSTEMS

System configuration	24-channel			32-channel		
	with one d-a converter for receiver, two for transmitter					
	Number required	Power dissipation (mW)	Unit cost in quantities of 100 (\$)	Number required	Power dissipation (mW)	Unit cost in quantities of 100 (\$)
Digital-to-analog converter	3	423	27.00	3	423	27.00
Sample-and-hold amplifier	2	320	19.00	2	320	19.00
Reference	1	15	1.95	1	15	1.95
Comparator	2	206	6.00	2	206	6.00
High-speed operational amplifier	1	110	2.50	1	110	2.50
Multiplexer	7	1,092	52.50	7	1,092	52.50
Successive-approximation register and miscellaneous digital components	10	375	20.00	10	375	20.00
TOTALS	26	2,541	128.95	26	2,541	128.95
Per-channel	1.08	106	5.37	0.8	79	4.02
Large-quantity per-channel cost			2.36			2.05

multiplexer connects each of the channels, in sequence, to the sample-and-hold circuit, functioning as a single-pole, eight-throw switch that cycles through all eight channels at an 8-kHz rate.

After all the switching transients have died down, the output of the multiplexer is sampled by the sample-and-hold circuit, which becomes the second stage of the analog sampling system. The output of this circuit remains constant throughout the entire analog-to-digital conversion period. It is fed through a resistor into the comparator, which together with the a-d conversion logic and the digital-to-analog converter make up the codec's a-d converter.

The comparator has one resistor in series with its positive input terminal (through which the sample-and-hold output enters) and another resistor in series with its negative input terminal. The resistors' job is to convert the d-a converter output, currents $I_{oc}(-)$ and $I_{oc}(+)$, into voltages that can be compared with the one from the sample-and-hold output. Current $I_{oc}(+)$ flows only for negative signals (indicated to the d-a converter by a binary 1), while $I_{oc}(-)$ flows only for positive signals (indicated by a binary 0).

To satisfy the successive-approximation criterion used in this system, the input to the a-d conversion logic must be binary 1 whenever the magnitude of the analog voltage exceeds the product of R and either $I_{oc}(-)$ or $I_{oc}(+)$. For a positive analog signal, the output of the comparator is a binary 1 whenever the analog voltage exceeds $I_{oc}(+)R$. For a negative voltage, however, the output of the comparator is a binary 0 whenever the analog voltage magnitude exceeds $I_{oc}(+)R$. The exclusive-OR gate inverts the output of the comparator for a negative analog signal.

The a-d conversion logic, which consists of a successive-approximation register with supporting logic, operates in a standard manner. After the encode command is generated by the system timing and switching logic, the encode-decode pin of the converter is placed in the

decode or binary 0 state forcing both $I_{oc}(+)$ and $I_{oc}(-)$ to zero. The comparator is then disconnected from the d-a converter and acts as a polarity detector. The sign-bit pin is forced to 0 during the first clock cycle to allow the result of the polarity detection to be clocked into the a-d conversion logic as the sign bit.

This sign-bit generation ends with the arrival of the next clock pulse. Following this, the input on the d-a converter's encode-decode pin is returned to binary 1 to reconnect the comparator. The bit adjacent to the sign bit, the most significant bit, is forced to 0 and all succeeding bits are forced to 1. The second input to the exclusive-OR gate resumes the inverse value of the sign bit, and the input analog voltage is again compared with the $I_{oc}(+)R$ or $I_{oc}(-)R$ product.

If the magnitude of the analog voltage exceeds $I_{oc}(+)$ or $I_{oc}(-)R$, the output of the exclusive-OR gate becomes a binary 1, indicating that the trial bit (the 0 on the MSB) should be a 1. The next clock pulse will then clock in the 1 for the MSB. Had the analog voltage magnitude been less than $I_{oc}(+)R$ or $I_{oc}(-)R$, then the output of the exclusive-OR gate would be 0 and a 0 would have been clocked into MSB on this clock pulse.

This successive-approximation procedure continues until all the binary bits have been determined, and the resulting binary number represents the best approximation to the analog input. Since two converters are used per codec, the system is completely asynchronous and decoding and encoding functions can be performed simultaneously.

Putting it together

In order to multiplex a large number of channels through the same codec with the least amount of distortion for low-level signals, both short acquisition time and superior accuracy (low zero-scale error) are required of the sample-and-hold circuit. The accuracy itself is severely affected by a secondary term that is designated the droop rate.

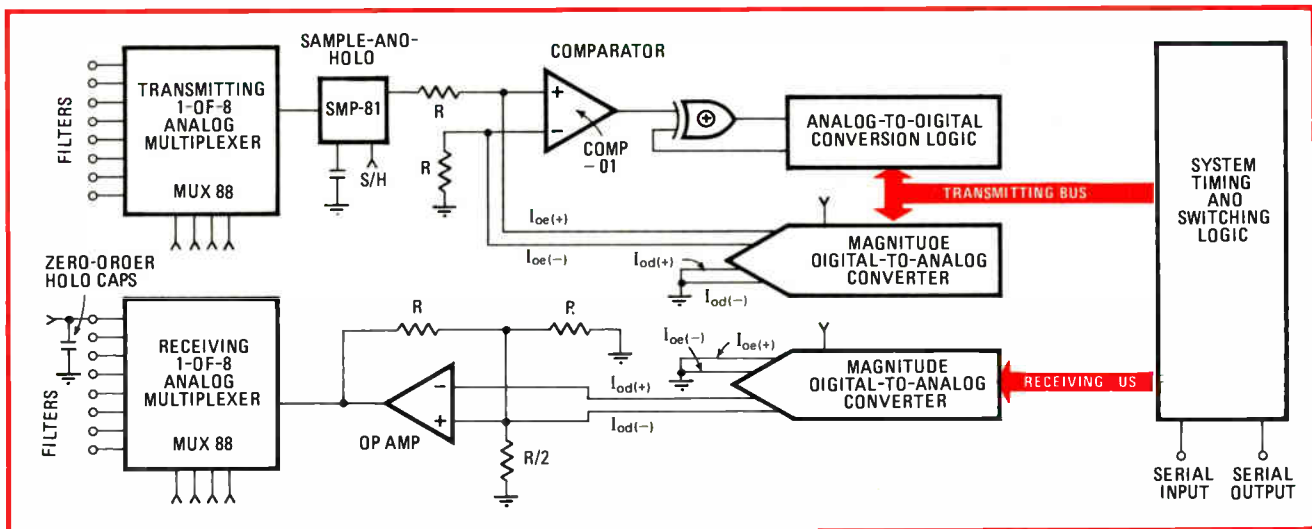

3. Typical system. A 24-channel D3/T1-type bank may be built with a set of three 8-channel shared codecs. Only a portion of the repetitive system is shown for simplicity. In this particular configuration, six d-a converters encode and decode all 24 channels of the system.

A suitably designed sample-and-hold amplifier, such as the SMP81, takes the codec's needs into account when addressing the acquisition and accuracy problems. Acquisition time is reduced by force-feeding current into the hold capacitor whenever there is a large difference between the input and the output voltages. Proper input characteristics are provided by zener-zap circuitry. This is trimmed at the wafer stage, so as to introduce input offset voltage of the proper polarity to null out any zero-scale error due to charge transfer.

Drop rate is minimized by the use of ion implantation. As a result, the sample-and-hold amplifier has rates comparable to those obtainable with field-effect-transistor versions, but without their severe temperature degradation. Where the droop rate of FET sample-and-hold circuits deteriorates with increasing temperature in the 0°C-to-70°C temperature range, the SMP-81 droop rate actually becomes better. Because of bias-current-canceling techniques, it actually goes through zero at approximately 70°C.

The multiplexers require very low crosstalk between channels and minimum susceptibility to damage from the inadvertent application of signal and power in the wrong sequence. This implies devices designed around a bipolar-FET approach. The MUX88 eight-channel multiplexer is a good example. It operates over a wide range of supply voltages, including single supply, and is pin-compatible with most of the popular complementary-metal-oxide-semiconductor and FET multiplexers. Be-

cause operation is break-before-make, two channels can never be simultaneously applied to the output.

The companded 8-bit μ -law system, which has the equivalent resolution of a 12-bit system, makes heavy demands upon the comparator. For example, the input offset voltage should be small compared to 1.0 millivolt and the input offset current should be small compared to 200 nanoamperes. This requirement is satisfied by the CMP-01 precision comparator, which typically has 0.3-mV offset voltage and 25-nA offset current.

All codecs require precise references for the converters. The PMI REF-01 and REF-02 were designed for use with multiplying converters. A band-gap approach is used because the energy bandgap of silicon is a fundamental physical property and not a process variable. Compatible thin-film resistors and zener-zap trimming of the bandgap slope itself provide a stable, precise reference with a low temperature coefficient.

The companding converters required for d-a conversion have internal ladder networks that make them applicable in almost any codec configuration. They are capable of decoding up to 32 channels at the CCITT 2.048-megabit rate.

In conjunction with the sample-and hold amplifier, comparator, and successive-approximation register, the companders can easily encode 8 to 12 channels. In transceiver applications, the encode/decode pin may be sequenced so that the same device may be used for both encode and decode. □

□ A single-chip coder-decoder can be an elegant, economical, and highly reliable integrated circuit, but it can be even more than that. The use of n-channel silicon-gate metal-oxide-semiconductor technology permits a versatile large-scale integrated codec that packs in many extra analog and digital functions. As well as enhanced capability, the n-MOS process allows a voltage reference on chip, and one that needs no precision components or external adjustments at that. The result is

N-MOS codec packs in analog and digital circuitry

by Ben Warren, John Huggins, and Marcian Hoff,
Intel Corp., Santa Clara, Calif.

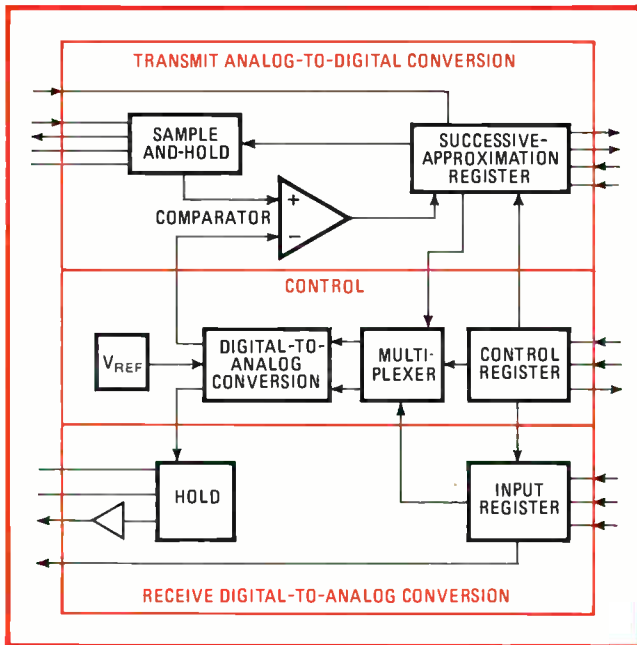

Small and capable. The single-chip-per-channel 2910/11 meets the specifications of North American and European standards for PCM codecs. It performs all conversion functions and, when interfaced with a microcomputer, performs time-slot computations.

the 2910/11 pulse-code-modulation codec. The 2910 conforms to the North American PCM protocol, and the 2911 is designed for the European protocol. Each is a metal-mask option of a basic chip.

Use in the telephone system puts stringent requirements on this IC. It must perform analog-to-digital and d-a conversion of voice data while meeting strict gain-tracking, stability, and noise standards. The telephone industry specifies PCM encoding for compatibility with existing transmission facilities, and it also specifies framing, signaling, and companding laws.

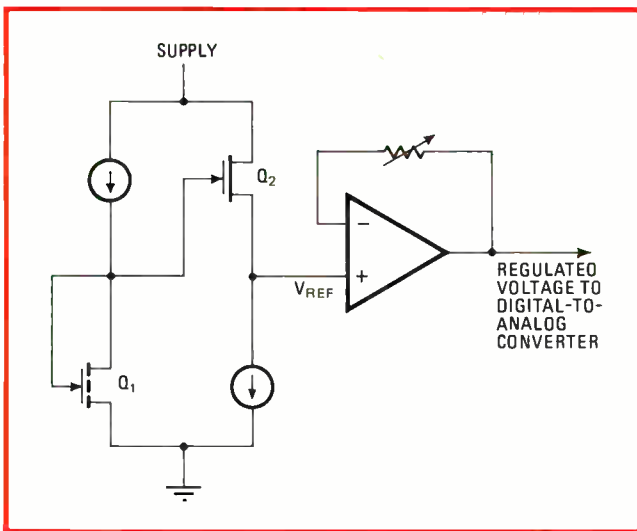

1. Stable reference. To meet the stringent requirements for loop gain in a codec design, the d-a converter must have a precision reference. By using the difference in threshold voltage between enhancement-mode and depletion-mode devices for this purpose, temperature and supply effects are greatly reduced.

However, in approaching the design of a telephone codec, there are many options to be considered, in functions as well as in process technology. For example, codecs have been used primarily for transmission between switching centers, but a properly configured device could be useful in the switching systems themselves. Once digitized, voice signals could be routed by logic gates, rather than by analog switches.

All PCM codecs are intended for use in time-multiplexed systems, and the 2910 is designed to digitize the voice signal before it is assigned its time slot in the data stream. Thus each incoming analog line or trunk must have access to a codec. In such a setup, significant power and hardware savings can be realized with this chip. Because the input lines typically operate with relatively low duty cycles, it is designed to be quiescent when its input is inactive, and thus it will not occupy a time slot in the voice data stream or draw power from the supply. More hardware is saved because any 2910 can be assigned to any open time slot. This capability permits switching in small systems without needing additional logic in the data stream.

Reducing the burden on the system controller is another asset made possible by the 2910 codec. The part incorporates circuitry that permits it to perform the PCM multiplexing and demultiplexing operations at the right instant with no more input than a time-slot assignment and two bits to select the desired operational mode. Since microprocessors are rapidly coming into use as controllers for telephone switching systems, the 2910 is designed to operate much as an intelligent peripheral chip does.

Why n-channel?

Although some analog functions are included in modern n-MOS microcomputer and memory devices, the codec analog circuitry has not been implemented in an n-channel process previously. However, meeting the rigorous codec requirements means that, by extension, any low- or medium-speed analog LSI problem can be solved with the process. Also, the superior n-channel density in logic applications allows numerous analog and digital functions on the same substrate.

For example, with n-channel technology, charge-transfer devices and switched capacitors can be used to form economical filters. Furthermore, a random-access memory, a read-only memory, a programmable ROM, a-d and d-a circuitry, precision references, and additional codec logic are combined on the same substrate.

Buried-ion reference

All telephone networks need consistent gain in the transmission loop; therefore each codec-equipped line must perform its a-d or d-a conversion with a known stable insertion loss or gain. This requirement may be met by supplying the d-a converter with a stable reference voltage.

Such a reference may be added through the use of external precision components, but in this single-chip codec, the reference is built in. In any event, there are three key requirements that must be met.

The first is initial accuracy at the device level. If each

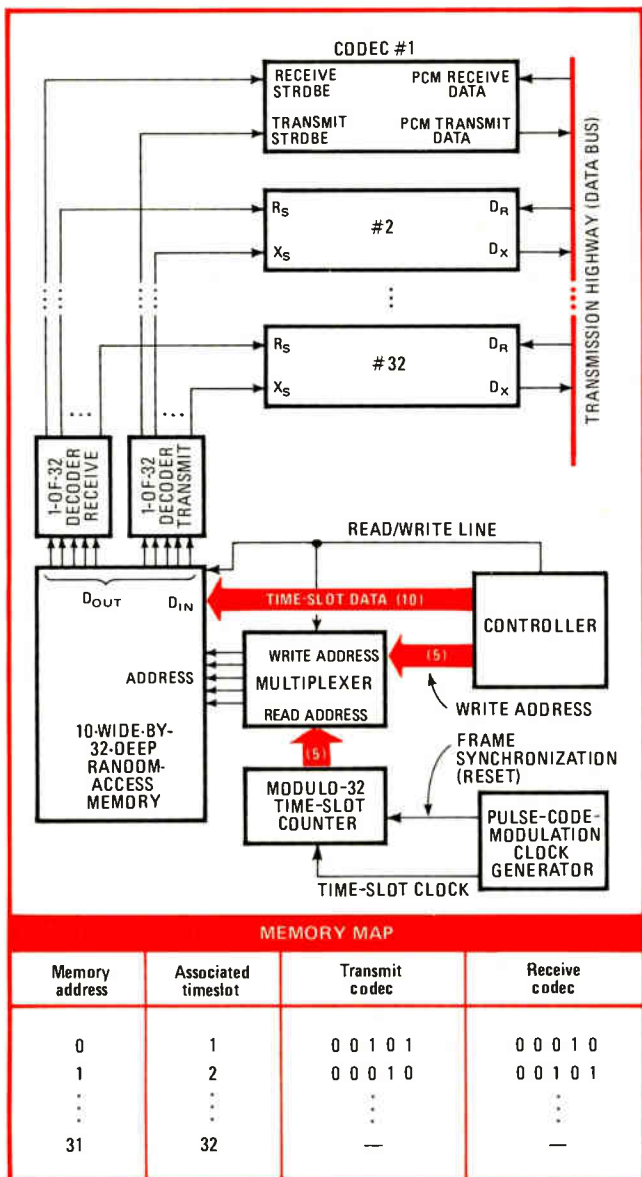

2. External time slots. A common controller requires one RAM location for each time slot. Output and receive data are strobed concurrently. Two external memory words and time slots are required to establish a two-way conversation. The first two locations in the map indicate a call between codecs 5 and 2 in time slots 1 and 2.

block in the system is sufficiently accurate, no gain adjustment is necessary. Furthermore, the reference must not drift appreciably with age, for a change in gain over the 40-year normal life of a telephone system can cause its instability and failure. Reliable operation also requires low temperature and voltage coefficients. Finally, local generation of the reference is necessary. Very-low-level voice signals preclude designs that share the reference for many codecs (because system noise will interfere), as well as designs that distribute the reference signal any distance (because voltage drops accumulate).

To obtain the 2910's on-chip voltage reference, Intel uses its customary approach for standard two-layer polysilicon n-channel devices and two separate threshold-adjusting implants. These implants permanently lodge ions in the crystal-structure channel regions, which are

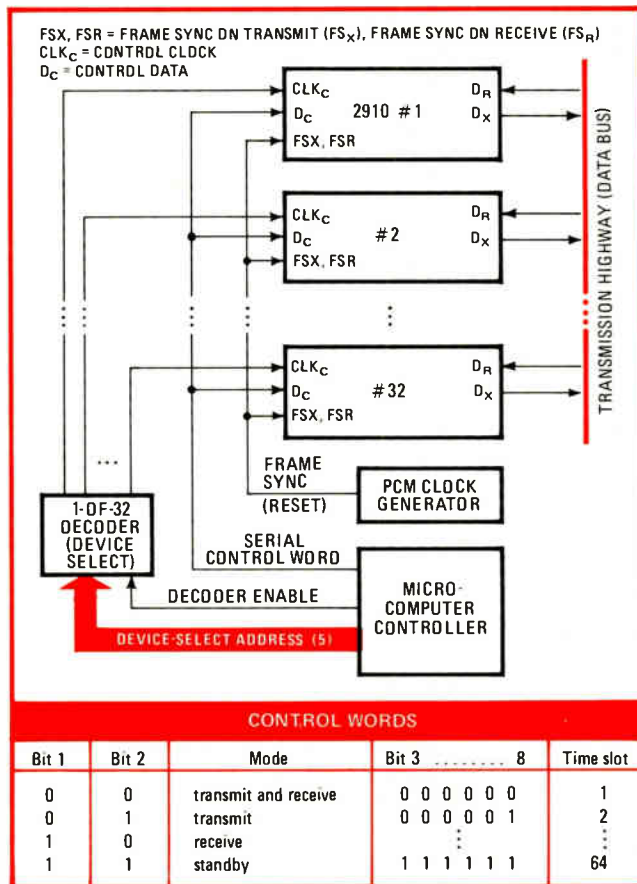

CONTROL WORDS				
Bit 1	Bit 2	Mode	Bit 3 8	Time slot
0	0	transmit and receive	0 0 0 0 0 0	1
0	1	transmit	0 0 0 0 0 1	2
1	0	receive
1	1	standby	1 1 1 1 1 1	64

3. Local switching. A significant hardware reduction is achieved using the 2910 as a programmable switching element. Time slots for each direction are made independently over a single bit-serial input by shifting in an 8-bit control word specifying transmit, receive, neither, or both. The control words contain two fields: 2 bits to show the direction and 6 to define the time slot.

then sealed with a high-integrity thermal gate oxide. Diffusion of the ions is not measurable below 900°C, resulting in a very stable threshold. It is this stability that is the basis for the codec's reference.

The reference circuit (Fig. 1) generates a voltage equivalent to the difference in thresholds of devices Q_1 and Q_2 . Q_1 is an enhancement device, while Q_2 is a depletion device, and in such a configuration the temperature effects cancel and supply-voltage coefficients are greatly reduced. Thus V_{ref} variations over time, temperature, and supply can be held to less than 0.07 decibel.

Since the difference in the devices' thresholds, and hence V_{ref} , is a function of two separate implants, there is a chance for a mismatch that will lead to a stable but nonstandard voltage. Thus a trim circuit is included, which works by setting polysilicon fuses in an operational-amplifier feedback circuit. Manufacturing tolerance on this operation is ± 20 millivolts around a nominal 3.15 volts.

Time-slot assignment

A crucial function in any PCM system is assignment of the encoded voice to a time slot in the data stream. A codec that can take much of this responsibility can go a long way towards reducing system complexity and cost,

The quest for standardization

The vastness, complexity, and interdependence of telephone systems makes standardization an all-embracing rule, for economy as well as for successful operation. There are three basic aspects to this standardization, each of which bears upon the design of a successful coder-decoder chip.

First of all, there is component standardization, which benefits the device manufacturer, the system manufacturer, and the telephone company alike. There are two aspects: designing the codec as both a switching and a transmission device, and, as Intel has done, extending the versatility of software control to the codec.

The result is a part that can be used in all basic classes of telephone systems—not only transmission channel banks and central-office switching systems, but also remote line modules and concentrators, private automatic branch exchanges, key telephones, telemetry, secure communications, and other digital applications.

Secondly, there is system standardization. The manufacturer of telephone equipment generally seeks a production life cycle of 20 to 30 years in order to amortize the hefty costs of planning and developing systems that fit

into their proper niches in the telephone network. Generally, his prices are based on such a life cycle, but he can be hurt badly if a basic system cannot be modified easily to follow the phone companies' changes in system architecture and service capabilities. Hence there is increasing emphasis on software control and microcomputers in new switching systems—and in the design of codecs.

Above all, there is network standardization. Here standards and practices exist so that wholesale modifications to the telephone network need not be made to accommodate new equipment. Since pulse-code modulation and time-division multiplexing are used for transmission between switching centers in most digital applications, network standardization benefits by the use of the PCM codec on the subscriber side of the switching system. Special interfaces and hybrids are therefore not necessary at the interfaces between systems.

In the long run, PCM and TDM standardization will extend to the other side of the switching system. Then interfaces will disappear as PCM switching-system highways are integrated with PCM span lines to satellite systems and with PCM trunk lines to other offices.

improving reliability, and eliminating components in the circuitry common to all phones in the network. A comparison of systems will bring this out.

Figure 2 represents a small system with 32 codecs and a single transmission highway with 32 time slots (a system where the number of slots equals the number of phones is called nonblocking). For the sake of simplicity, only the select and data interfaces of the codecs are shown in the figure.

Local conversations in this system can be set up if the PCM transmit-data output of the caller's codec is strobed onto the bus at the same time that the PCM receive-data input of the listener's codec is strobed on. A common controller performs dynamic time-slot assignments with the help of a RAM that has an individual location associated with each time slot. Thus the memory must have enough locations to address or select all codecs in the system.

As the memory map in Fig. 2 indicates, there are two fields in each 10-bit word addressing the receiving codec. Of course, two memory words—and two time slots—are required to establish a two-way conversation.

The amount of hardware used is impressive. A pair of 1-of-32 decoders is required to select simultaneously one transmitting and one receiving codec in each time slot. The address multiplexer permits the controller to write new time-slot assignments into the RAM via the R/W line, and the 5-bit counter continuously sequences the memory through all 32 locations, once per time frame of the data stream. Moreover, the controller must maintain a record of all calls in progress, which generally requires a separate, more accessible memory (not shown).

In contrast, the same system built with 2910 codecs and a low-cost microprocessor or single-chip microcomputer (Fig. 3) can handle the time-slot assignment with a single 1-of-32 decoder for device selection. The controller can assign time slots for each direction of transmis-

sion directly to each codec by shifting in an 8-bit control word over a single bit-serial input.

As the memory map in Fig. 3 shows, the control word contains two fields, the first specifying the mode of operation and the second specifying the time slot. If the mode field specifies neither transmit, nor receive, nor both, the codec enters a reduced-power standby state, and remains in it until another time-slot assignment forces it into activity. The only restriction in the clocking rate is that the 8-bit control word must shift in less than one frame, typically 125 microseconds. However, this shifting can be asynchronous with respect to all other 2910 clocks because the codec addressed will take care of any necessary synchronization.

These two system approaches demonstrate how on-chip time-slot computation can reduce hardware and interface complexity. Similarly, reliability doubles with the on-chip interface. Since the time-slot logic is contained in each codec, the amount of critical common circuitry is reduced, thereby cutting the chances of a multiple-line failure.

The 2910 can be used as well in systems with 24 and 48 lines and also within the modules of larger systems. Nor is it restricted to nonblocking systems. In a blocking system, the number of codecs that can be handled is determined by the size of the requirement for simultaneous call handling. For example, blocking systems of 100 subscribers (and 100 codecs) may be served by a 24-channel network with dynamic time-slot assignment.

In addition to the savings in systems hardware, large savings in cabling can be realized. For example, a simple T1 line (a twisted pair in each direction) can link a central office with a remote line module, which may be blocking or nonblocking. A blocking module will act as a concentrator and may also have the capability to complete local calls, thus enhancing cabling and central-office equipment savings. □

Meet the *real* OEM display

It's easy to design in... it gives you a good system image.

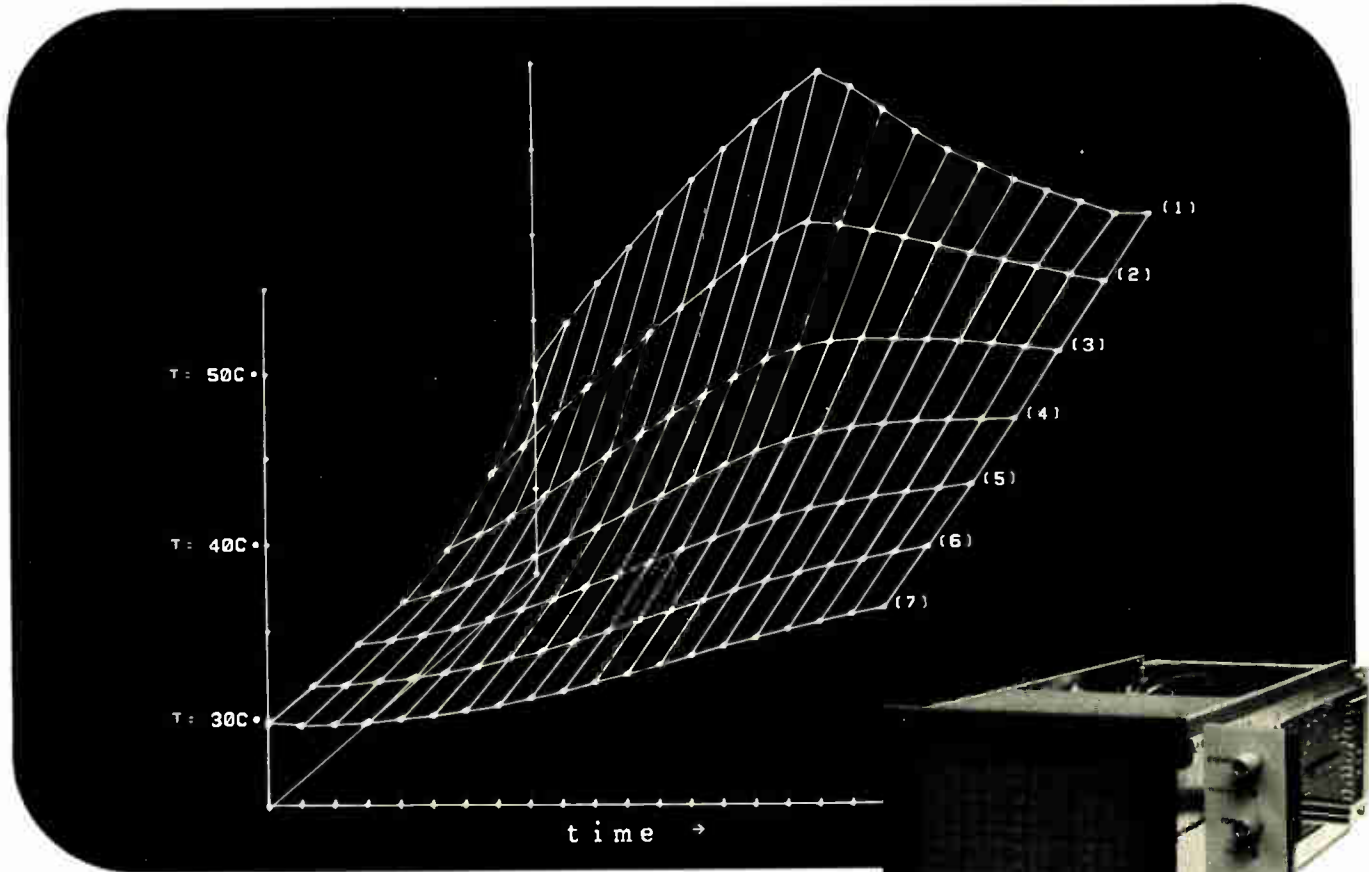

Easy viewing, even in high-ambient light, is provided by HP's new 1340A with post-accelerator CRT. You get a bright image on the 114 cm² (17.7 in²) screen for easy evaluation of intricate presentations.

Versatile interface is the result of a set of internal switches that let you select input impedance, input sensitivity, polarity and bandwidth. One display model can be used with a variety of different instruments and systems.

Crisp displays of complex graphics and alphanumeric data is assured by a 0.46mm (0.018 in.) spot that focuses uniformly over the entire viewing area, regardless of intensity level.

Flexible location of controls is possible with the 1340A's separate control panel. You can locate intensity, focus, gain and trace-alignment controls to suit your particular system. Or, with Option 001 you can use your own controls.

Easy system integration is the result of the 1340A's packaging flexibility. Open frame, desk top, vertical stack and rack mount versions easily adapt to nearly any system configuration.

HP's new 1340A is a true OEM display component. And to accommodate most OEM requirements, options such as different phosphors and TTL blanking as well as a choice of packaging schemes are available. For only \$1,000*, you get a cost-effective display that easily adapts to almost any instrumentation system.

So for a better image of your system's performance, look into HP's new OEM display. For further details, ask your local HP field engineer.

* Domestic U.S.A. price only.

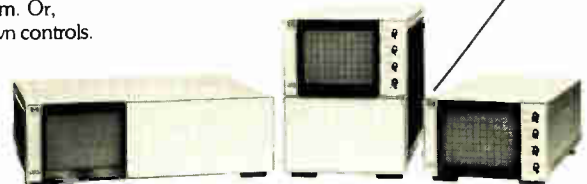

HEWLETT  **PACKARD**

1507 Page Mill Road, Palo Alto, California 94304

For assistance call: Washington (301) 948-6370, Chicago (312) 255-9800, Atlanta (404) 955-1500, Los Angeles (213) 877-1282

Negative-output regulator tracks input voltage

by Gil Marosi
Intech Function Modules Inc., Santa Clara, Calif.

By using an astable multivibrator in a flyback arrangement to develop negative voltages from positive ones, this regulator ensures that its output tracks the input, such that $V_o = -V_{in}$. The voltage-controlled circuit requires only three active devices, all of them transistors.

Q_1 and Q_2 form the free-running oscillator, as shown in the figure. With Q_2 on, the V_{in} voltage is impressed across resistor L , causing the current through L to increase linearly. The peak value of current reached before Q_2 turns off will be directly proportional to the magnitude of the output voltage developed across capacitor C_4 .

During the time the current through the inductor increases, no voltage can be developed across C_4 because diode D is back-biased. When Q_2 switches off, however, the collector voltage drops from V_{in} , and the capacitor charges to a negative voltage. This occurs because the charging current through the coil makes D turn on,

thereby causing a negative voltage at the output.

The field across L then begins to collapse and D is biased on, placing the output voltage ($V_o + V_d$) across L , where V_d is the diode drop. The current through L must then fall linearly to zero. This completes one cycle of the flyback operation.

The input voltage is next compared with the output voltage at the summing node, at the base of Q_3 . This transistor amplifies the voltage difference and transforms it into a current that is used to control Q_2 's turn-on time. Thus if V_{out} should fall, the control current will act to increase the on time of Q_2 , thereby increasing the peak current through L and so raising the output voltage. This analysis assumes that V_{in} emanates from a stiff source—that is, an increased current demand will not cause a drop in V_{in} because of an increased voltage drop across the source's internal impedance.

Without Q_3 , the load regulation would be directly proportional to a change in load current (I_L) and so a 10% change in I_L would cause a 10% change in load voltage V_L . Q_3 ensures that such a change in I_L causes only a 0.2% change.

Component values are given for a circuit that operates with an $I_L = 20$ milliamperes, a $V_o = -5$ volts, and an astable multivibrator operating at 50 kilohertz ($\tau = 20$ microseconds). Equations are given in order to facilitate the design of regulators for specific parameters. □

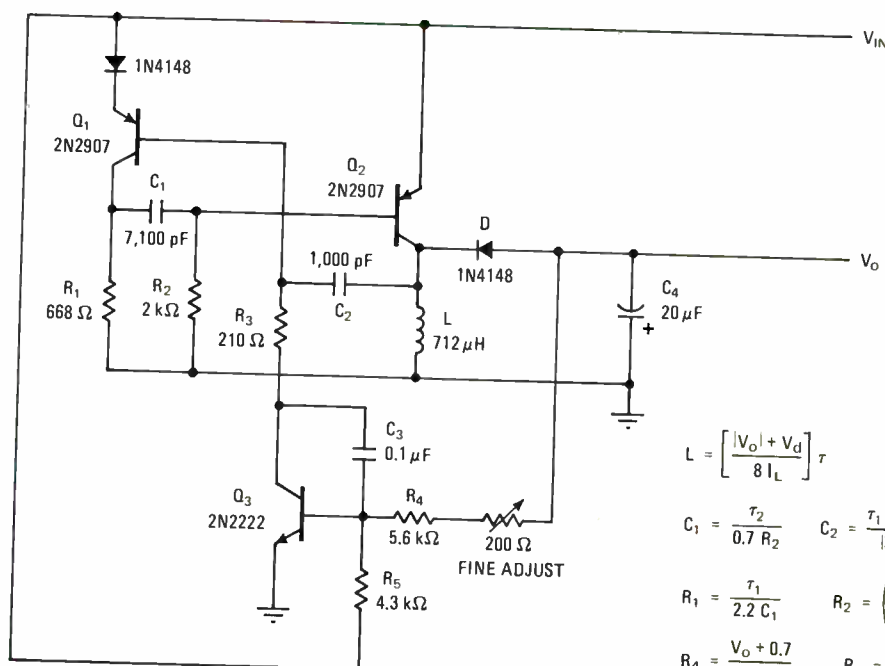

$$L = \left[\frac{|V_o| + V_d}{8 I_L} \right] \tau \quad \frac{\tau}{2} = \tau_1 = \tau_2 \quad I_p = 4 I_L$$

$$C_1 = \frac{\tau_2}{0.7 R_2} \quad C_2 = \frac{\tau_1 (1 \text{ mA})}{|2 V_o|} \quad C_3 = \frac{5 \sqrt{L C_4}}{R_4} \quad C_4 = \frac{\tau_2 I_L}{|\Delta V_o|}$$

$$R_1 = \frac{\tau_1}{2.2 C_1} \quad R_2 = \left(\frac{|V_{in}| - 0.7}{I_p} \right) \beta_{O2} \quad R_3 = \frac{|V_{in}| - 0.8}{I_L}$$

$$R_4 = \frac{V_o + 0.7}{1 \text{ mA}} \quad R_5 = \frac{V_{in} - 0.7}{1 \text{ mA}}$$

Flyback follower. Regulator uses astable multivibrator Q_1 - Q_2 and inductor to generate negative output voltages from positive inputs while also ensuring that $V_{out} = -V_{in}$. Differential amplifier Q_3 serves to develop feedback control voltage to readjust on time of Q_2 and thus voltage developed across L and C_4 when $V_{out} \neq -V_{in}$. Component values are given for $I_L = 20$ mA, $V_o = -5$ V, and $f = 50$ kHz.

Controller selects mode for multiphase stepping motor

by Oldrich Podzimek
Electrical Engineering Research Institute, Prague, Czechoslovakia

Offering a selection of the most common stepping modes, these circuits are an inexpensive solution to the problem of torque control in four- and five-phase motors. The mode can be changed simply by the flip of a switch.

The basic circuit is the same for either stepping motor. It consists of a 4-bit binary-coded-decimal counter, a BCD-to-decimal converter, and several gates that serve as phase detectors.

The four-phase controller is shown below. The 74193 counter advances with each input-clock pulse at a frequency determined by individual requirements. Note

that the 74193 can count up or down and so may be used to step the motor in the opposite direction if desired.

As the counter increments or decrements, the output of the 7442 4-to-10-line decoder switches in a manner dependent on switch S. If S connects port A' of the 7442 to the A port of the 74193, the decoder's output will move from 0 to 7 in sequence. Otherwise, the output will switch to even values every other count (S connected to logic 0) or switch to odd values (S connected to logic 1).

A combinational logic circuit using gates G₁-G₄ converts the 7442's output to phase information in order to drive the motor. As can be seen in the truth table, either one or two windings of the motor will be active at any given time.

The motor will step most smoothly when S is connected to A. When S is connected to L, the step angle will be doubled, and only one of four motor windings will be excited at any given instant, thereby improving the efficiency of the step operation for a given torque. Note that when S is in the H position, the step angle will be the

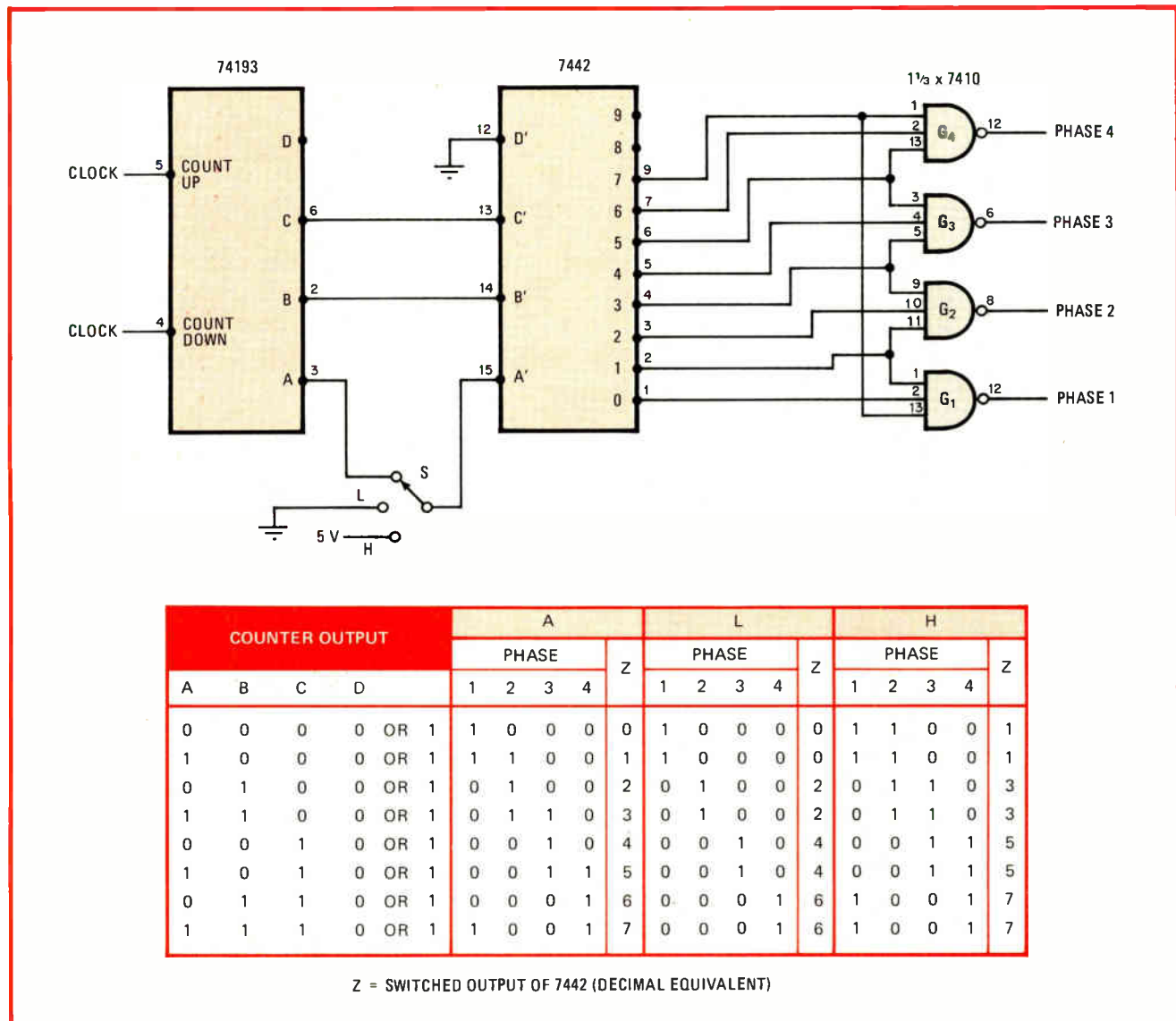

1. **Multimode.** Step controller uses up-down counter, decoder, and logic to control excitation of four-phase motor windings. Switch S selects one of three possible operating modes, ranging from smooth-stepping to high-torque.

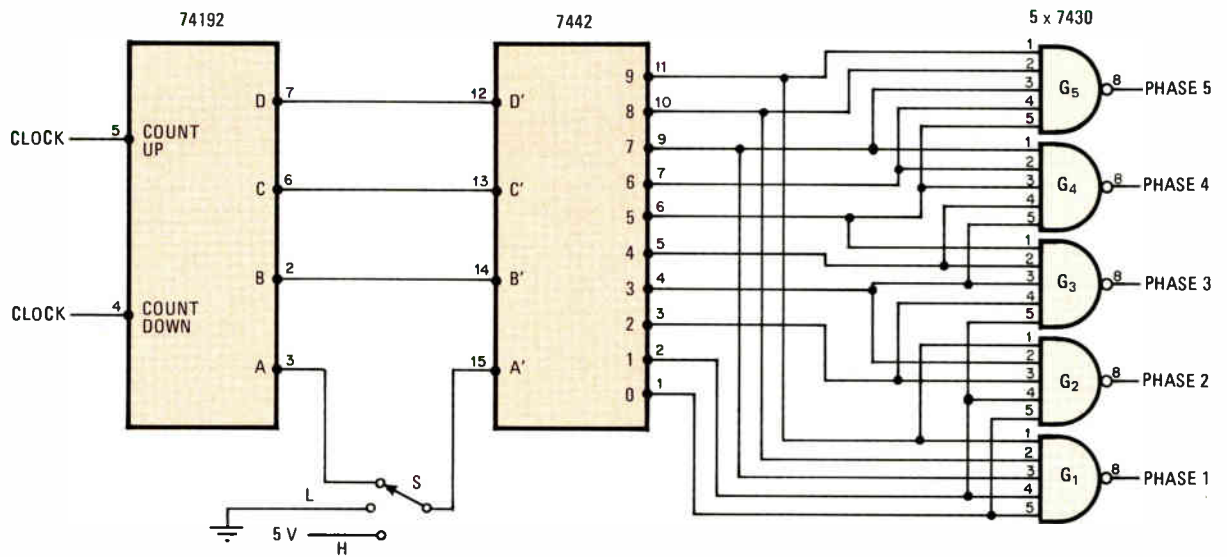

COUNTER OUTPUT				A					L					H							
				PHASE					Z	PHASE					Z	PHASE					Z
A	B	C	D	1	2	3	4	5	Z	1	2	3	4	5	Z	1	2	3	4	5	Z
0	0	0	0	1	1	0	0	0	0	1	1	0	0	0	0	1	1	1	0	0	1
1	0	0	0	1	1	1	0	0	1	1	1	0	0	0	0	1	1	1	0	0	1
0	1	0	0	0	1	1	0	0	2	0	1	1	0	0	2	0	1	1	1	0	3
1	1	0	0	0	1	1	1	0	3	0	1	1	0	0	2	0	1	1	1	0	3
0	0	1	0	0	0	1	1	0	4	0	0	1	1	0	4	0	0	1	1	1	5
1	0	1	0	0	0	1	1	1	5	0	0	1	1	0	4	0	0	1	1	1	5
0	1	1	0	0	0	0	1	1	6	0	0	0	1	1	6	1	0	0	1	1	7
1	1	1	0	1	0	0	1	1	7	0	0	0	1	1	6	1	0	0	1	1	7
0	0	0	1	1	0	0	0	1	8	1	0	0	0	1	8	1	1	0	0	1	9
1	0	0	1	1	1	0	0	1	9	1	0	0	0	1	8	1	1	0	0	1	9

Z = SWITCHED OUTPUT OF 7442 (DECIMAL EQUIVALENT)

2. Multiphase. Controller for stepping five-phase motors is similar to that for four-phase case. Five 5-input NAND gates and some additional wiring are the only new changes required for enabling up to three phases of a motor to be excited simultaneously.

same as in the preceding case, but two motor windings will be active at any time, power input will be doubled, and 41% greater torque will be obtained.

A similar circuit suitable for stepping five-phase

motors is shown above. In this case, either two or three phases of the motor are excited simultaneously. This circuit can be extended to solve a general m-phase motor problem. □

Op amps and counter form low-cost transistor curve tracer

by Forrest P. Clay Jr., Clarence E. Rash, and James M. Walden
Old Dominion University, Department of Physics, Norfolk, Va.

For a curve tracer, this relatively simple circuit is unusually inexpensive. Used to test small-signal bipolar transistors as well as junction diodes, it generates the

waveforms needed to display or plot their characteristic curves on an oscilloscope or X-Y plotter, interfacing directly with either. Operational amplifiers, one transistor, and a single binary counter are the only active devices needed.

Central to the circuit is a current generator made up of an op amp driven by the counter. It supplies eight levels of base current in sequence to the transistor under test. Op amps A₁ and A₂, with the aid of the R₁-R₂-C₁ timing network, initially produce both square and triangular waves at test points A and C (TPA and TPC), respectively. S₁ selects the waveform frequency—either

Control production line costs

with 100% automated inspection by an OPTOMATION™ Instrument System from General Electric

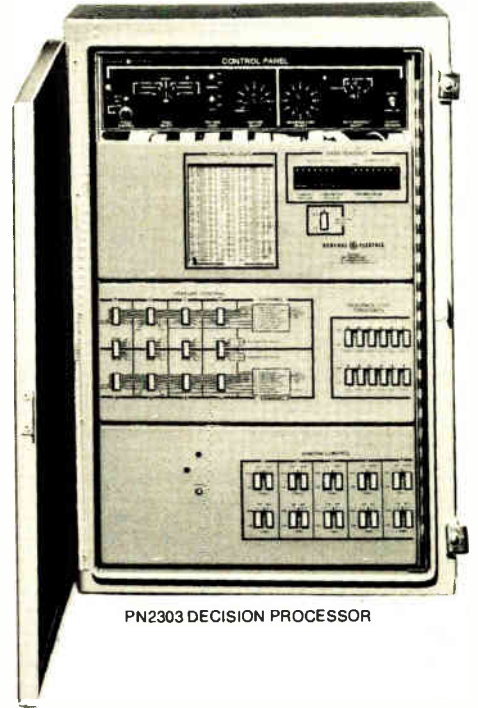

PN2303 DECISION PROCESSOR

An OPTOMATION Instrument System adds electronic vision and decision-making to your automated manufacturing processes. It consists of a solid-state CID Camera and a switch-programmable Decision Processor.

It helps prevent large quantities of defective products, or self-damage on expensive machines—with its fast, accurate, automatic, solid-state electronics.

An OPTOMATION Instrument System is the logical adjunct to a production line, to monitor the line and catch minor errors early, before they can develop into costly big ones.

The OPTOMATION Instrument System has applications throughout the manufacturing process, from initial piece-part inspection, through production, to the final product.



TN2000 END LENS VIDEO CAMERA



TN2500 REMOTE HEAD CAMERA

For more information:

Optoelectronic Systems Operation
General Electric Company
Room 201, Building 3, Electronics Park
Syracuse, New York 13221
315-456-2832 or 2808

"OPTOMATION" is a trademark of the General Electric Company

100 Years of Progress for People

GENERAL  ELECTRIC

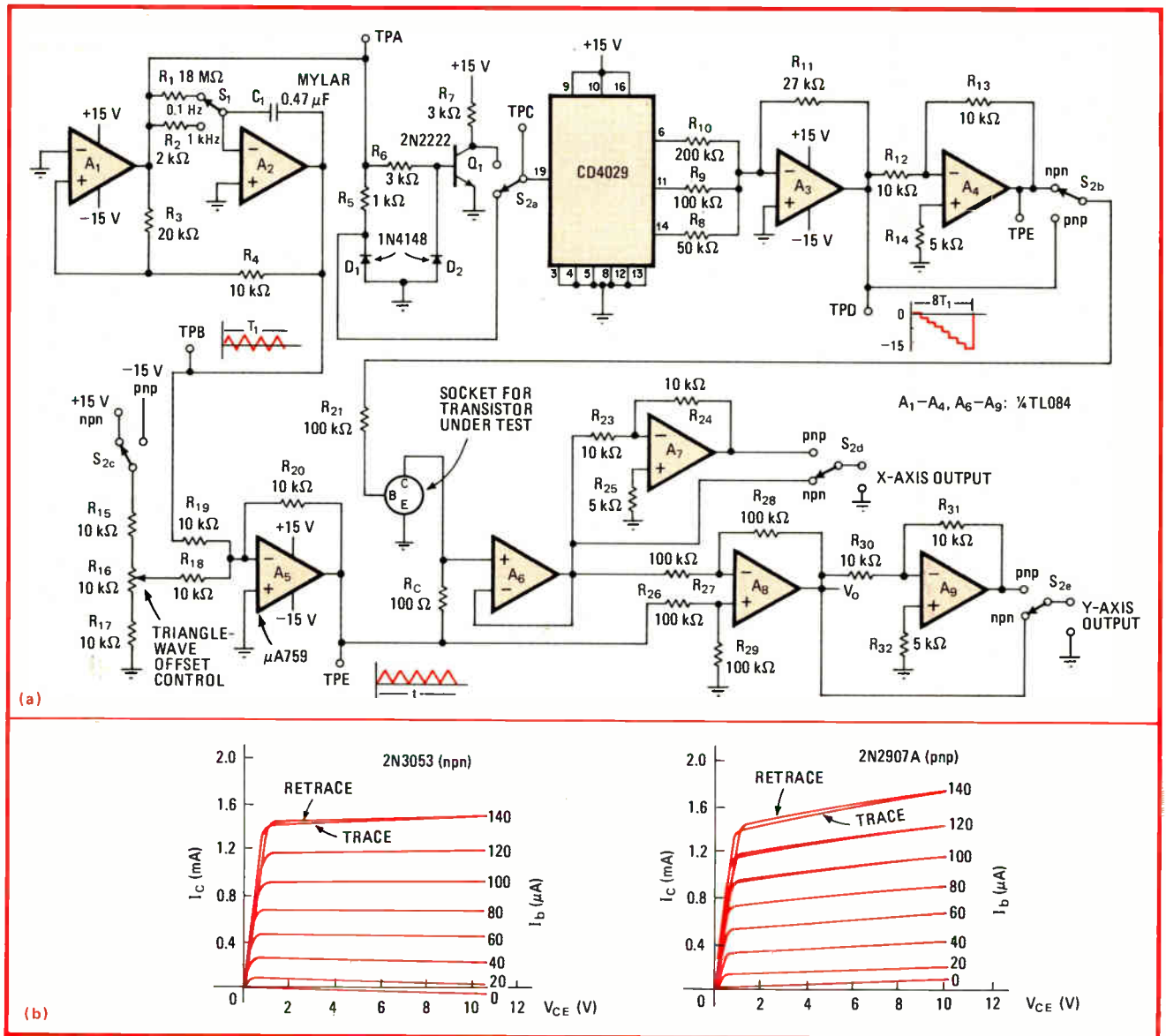

Current family. Tracer produces set of eight curves of collector current vs collector voltage from npn or pnp transistor under test. Diodes may also be checked in circuit's pnp-transistor mode (a). Representative curves are plotted using X-Y recorder (b). Note temperature effects seen on the retrace portion of curves for higher values of I_b and I_c .

1 kilohertz for output onto an oscilloscope or 0.1 hertz for plotting with an X-Y recorder.

The waveform at TPA is then shaped by D_1 - R_5 or D_2 - R_6 into a clock pulse suitable for the 4029 binary counter. The signals emanating from the Q_a , Q_b , and Q_c ports of the counter, when fed into a binary-weighted summation network (R_7 - R_{11}), produce an eight-step staircase waveform at the output of A_3 or A_4 , depending upon whether a pnp or npn transistor is under test. The actual base current value is determined by appropriate selection of R_{21} . The collector current can be calculated from $I_c = V_o/R_c$.

Both the collector-biasing voltage for the transistor under test and the linear-deflecting voltage for the X-axis output to the scope are derived from the triangle wave. The first voltage is obtained by using S_{2c} and R_{16} , which permit the proper dc component to be added to the triangle signal.

Note that the Y axis is stepped at one eighth of the rate at which the X axis is scanned. Thus, if the sampling rate is 1 kHz, each of the eight current levels is swept at a rate 125 Hz, well above the rate at which flicker is detectable on a scope.

The circuit is easy to use. Simply place ganged switch S_2 into whichever position is correct for the type of transistor being measured (nnp or pnp); place the transistor into the test socket; and apply circuit power. To test a diode, insert its anode and cathode leads into the emitter and collector sockets, respectively, and put S_2 in the pnp mode.

Figure 1b shows two representative families of curves the circuit produced on an X-Y recorder for the two types of bipolar transistor. □

Designer's casebook is a regular feature in *Electronics*. We invite readers to submit original and unpublished circuit ideas and solutions to design problems. Explain briefly but thoroughly the circuit's operating principle and purpose. We'll pay \$50 for each item published.

**BEFORE YOU LOSE YOURSELF IN
16-BIT MICROCOMPUTER HARDWARE,
TAKE A COLD, HARD LOOK
AT THE SOFTWARE BEHIND IT.**

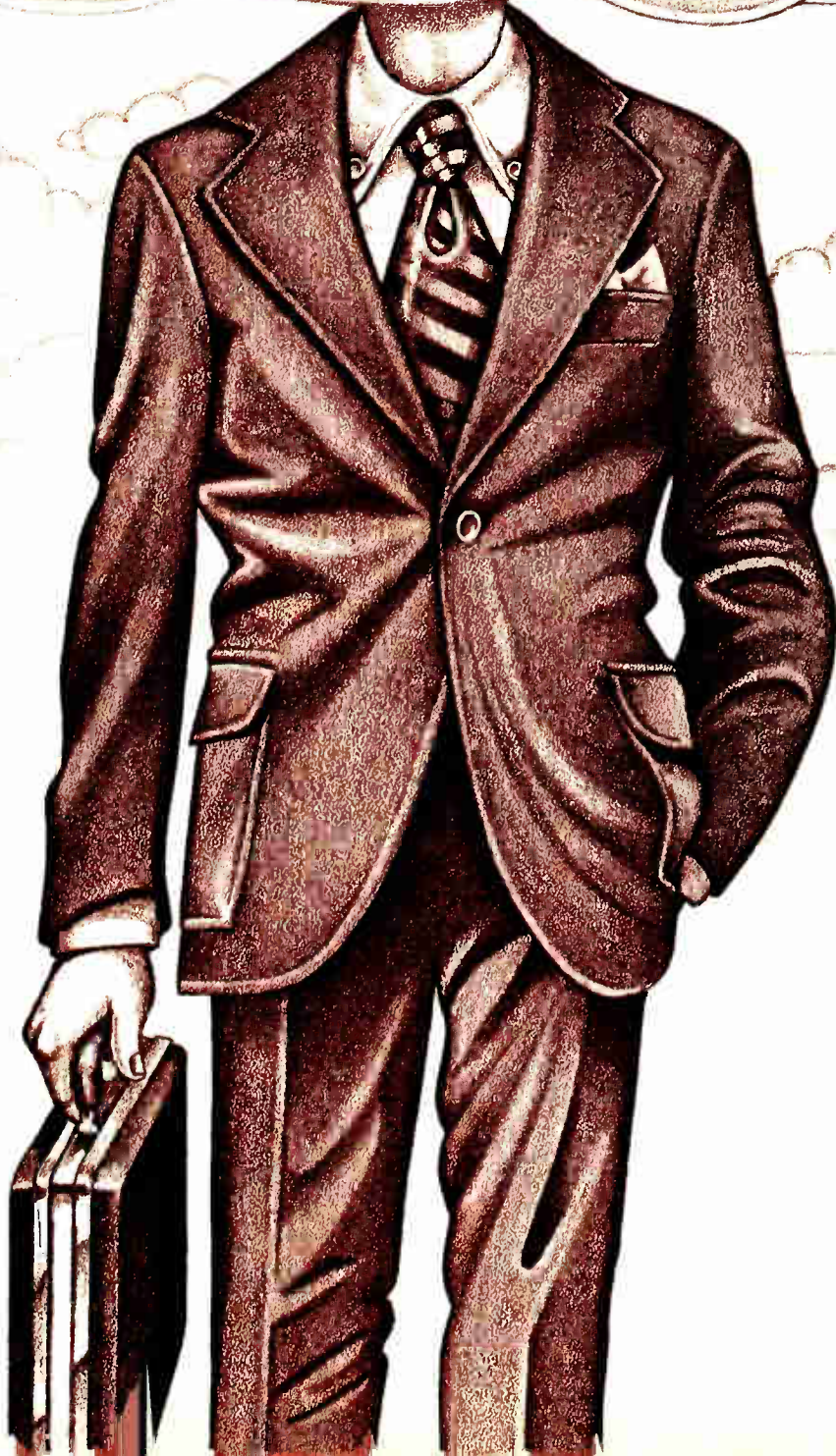

DIGITAL'S 16-BIT MICROCOMPUTERS. SOFTWARE SO RELIABLE WE'LL EVEN WARRANTY IT.

Moving up to 16-bits is a whole new world of power and capability.

But if you don't pick the right software, it can also mean a whole new world of problems.

At Digital, we've been perfecting the technology of 16-bit micros for over five years. And the development of the 16-bit PDP-11 software that runs them for over eight years. So it stands to reason that we'd know more about your needs — in both development and run-time environments — than anybody else in the market.

With the LSI-11/2 board microcomputer and PDP-11/03 box microcomputer, we've built a line of processors, memories, and interface modules that's the standard of the industry. And we've put them together for you in a variety of convenient packages.

What's more, the software that runs them all has proven so reliable, we even offer a 90-day Software Warranty. No other micro manufacturer makes this kind of offer. Because nobody else has the support to back it up.

Introducing our 900-person worldwide support team.

At Digital, customer back-up doesn't just mean a service desk back at headquarters. We've got a worldwide network of dedicated software specialists — people who know our microcomputer software inside-out. And who can answer any problem you've got. Whether it takes a phone call or an on-site visit.

Our software people are trained to be more than just service experts. You can count on them for training, advice, even design assistance.

They'll do whatever they can to help you develop your flexibility — and expand your market.

You've got a great future in our past.

Because all of our 16-bit software is based on the PDP-11 — the most widely programmed family of minicomputers in the world — you can be sure that we'll never lead you to a dead end.

Even if you don't know what your market will require next year — or six months from now — you'll know that with Digital's microcomputer software, you'll have the flexibility to move up in capability, or down in price. Whatever your customers want. Whatever your competition demands.

Choosing Digital software means you never lose your software investment. You can build on it in any direction the market or your own innovations take you.

Proven development tools. To speed your time to market.

We know that you're selling in one of the fastest-moving fields in industry. We know that quick response to market opportunity can mean the difference between being a huge success and being an also-ran.

That's why we've concentrated on making our software development equipment and procedures as efficient and simple as possible.

Our microcomputer development system is simply the world's lowest-cost dual-floppy based full-function software development system — bar none.

And our innovations in interactive technology have made our RT-11 the easiest-to-learn, easiest-to-use development software around — even though it has the most complete set of mature 16-bit development tools in the industry.

We offer two powerful editors, three sophisticated debuggers, and a wide choice of languages.

You'll also find that choosing Digital software automatically opens the door to one of the world's largest collections of ready-made programs. Chances are, a lot of your development work has already been done. DECUS (Digital Equipment Computer Users Society) maintains a complete program library and offers a wide range of resources for Digital customers.

How to become a software expert.

We figure one of the best ways to build our business is to help you build yours. So we're committed to helping you become a software specialist in your own right. We'll provide anything from tutorial documents to complete field orientation seminars. There's a network of Digital Training Centers designed as a resource for you. And there's more.

Learn more about PDP-11 software at home.

We've got a unique software manual, "Introduction to RT-11," which tells how to use Digital software tools to write, debug, and execute your own programs.

For a limited time only, this award-winning manual is yours for the asking. Just write on your letterhead, specifying your interest in LSI-11/2 boards or PDP-11/03 boxes, to: Digital Equipment Corporation, One Iron Way, Marlborough, MA 01752.

If you'd like to receive our new booklet, "The Systems Approach to Microcomputer Systems," contact your local Digital sales office or Hamilton Avnet distributor, or call toll-free 800-225-9220 (in Mass. and Canada 617-481-7400, Ext. 5144).

And take a cold, hard look at the 16-bit microcomputer software reliable enough to be warranted.

digital

The PDP-11/03 box microcomputer.



The LSI-11/2 component board microcomputer.

EVERYTHING YOU NEED TO PUT 16-BIT POWER INTO YOUR MICRO PRODUCT IS RIGHT ON THIS PAGE.

Operating System Software

- Floppy and hard disk based single-user real-time systems (RT-11).
- Minimal-cost disk based software for high-volume users (RT²).
- Multi-tasking/multi-programming system for complex real-time applications (RSX-11s).
- Minimal size ROM-based executive for FORTRAN/MACRO language applications (SIMRT).

Languages

- Full PDP-11 series MACRO assembler with conditional assembly, cross referencing and program segmentation capabilities (MACRO-11).
- Full ANSI Standard FORTRAN with real-time extensions, automatic RAM/ROM program segmentation and specially optimized code optimization to take advantage of the LSI-11's optional floating-point instruction set. (FORTRAN/FT-11).
- Interactive extended BASIC with assemble-language interfacing capability, PRINT . . . USING formatting for business applications, and multi-user (timesharing) capability (BASIC/RT-11, Multi-User BASIC/RT-11).
- Other interactive languages, such as APL and FOCAL.

Editors, Debuggers & Utilities

- A choice of two interactive editors — one designed to be easy-to-learn for the novice user (EDIT) and another "programmable" editor, with scope support, for more complex text manipulation (TECO).
- A choice of program debugging aids — octal (ODT) and symbolic (DDT) for assembly language applications, and a specially designed tool for FORTRAN application debugging (FDT).
- Linkage editing facilities to combine relocatable modules into final applications. Included are capabilities for separating ROM and RAM application segments, linking to previously-defined ROM modules, automatically generating overlay programs for disk-based applications, and automatic retrieval of needed application modules from system or user-defined libraries (LINK). Also, utilities to build, list, and maintain MACRO and object-program libraries (LIBR).
- Complete set of file maintenance, backup, directory and utility programs to simplify development and data storage tasks. (PIP, DUP, DIR).
- Other programming utilities to detect changes in program files which have introduced errors (SRCCOM), to inspect data files in readable formats (DUMP), and more.

Software Development Operating System (RT-11)

- Fully interrupt-driven overlapped input/output for fast program execution.
- Device-independent access to any of a wide range of peripheral devices (floppy disk, cartridge disk, terminals, line printers, magnetic tape, etc.) without program modifications.
- Simultaneous execution of foreground and background tasks, such as printing of listings on line printers or terminals while concurrently doing program editing, compilation, or debugging.
- English-like high level command language — easy-to-use and recall because it speaks your language, not computer jargon.
- Full English-text error messages immediately identify problems in the development process, without wasting precious time searching through manuals.
- Nested "command file" execution allows frequently used groups of system commands (to produce a new copy of a system for sources, or other functions) to be stored away and recalled for execution with one simple command.
- Background batch processing support, allowing long-running jobs to be completed without user intervention (perhaps rebuilding an application overnight, using the otherwise idle system time).

Training

- (1) Self-paced RT-11 home study — explains how to use the software tools to write, debug and execute programs.
- (2) Courses — offered at seven regional training centers or on site:
 - Introduction to Minicomputers covers computer concepts & the fundamentals of assembly language programming.
 - LSI-11 Hardware & Interfacing provides LSI-11 system operation and detailed interfacing information.
 - PDP-11 Fundamentals and Instructions covers instructions and programming techniques common to all PDP-11's.
 - MACRO-11 is an in-depth assembly language course.
 - Real Time Operating System (RT-11) teaches students to use RT-11 for program development.
- (3) On-site specialized training — reduces expenses and allows emphasis on points of particular value to your software needs.

digital

Data goes faster, farther with chips for drivers, receivers

Family of Schottky devices meets new EIA electrical standards

by David A. Laws and Roy J. Levy,
Advanced Micro Devices Inc., Sunnyvale, Calif.

□ Hundreds of kilobauds, a mile of cable: today's high-performance data-processing systems can meet these demands with ease if their line drivers and receivers meet the Electronic Industries Association's new standards RS-422, -423, and -449. A designer turning to these in preference to RS-232-C will welcome a family of low-power Schottky-technology quad receivers and drivers.

The new standards go far beyond the 20-kilobaud, 50-foot maximum requirements of the 10-year-old RS-232-C and move beyond its single-ended operation to include differential operation (see "What's the standard story?"). While they can be implemented with discrete circuitry and operational amplifiers, they are a natural for straightforward integration. However, the standards are sufficiently unfamiliar to warrant the discussion that follows of the new devices in terms of the requirements that spawned them.

These chips provide for unbalanced-transmission-line communications up to a 300-kilobaud rate or up to a distance of 4,000 ft with a 3-kilobaud rate, and balanced-line communication at a 10-megabaud rate up to 4,000 ft. Development of the dice was a joint effort between AMD and National Semiconductor Corp. Moreover, other manufacturers, including Texas Instruments Inc., are making members of the family.

Although these drivers and receivers were conceived for data communications applications, their performance makes them useful also for transmission among the various parts of a computer or central processing unit. So the EIA is considering the development of specifications covering their use in the party-line mode most favored in such applications.

The devices, labeled Am26LS29, -30, -31, and -32, are a family of quad drivers and receivers using Schottky transistor-transistor logic. Each chip incorporates four drivers or four receivers, together with control logic, in a standard 16-pin package.

RS-422 is implemented with a -31 driver and a -32 receiver. The single-ended RS-423 configuration is achieved with a -29 or -30 driver and the -32, which can be used as a single-ended or differential receiver.

Driving the lines

The -29 and -30 (Figs. 1a and 1b, respectively) consist of four single-ended line drivers designed to meet or exceed the requirements of RS-423. Buffered driver outputs are provided with sufficient source and sink current capability to drive 50-ohm transmission lines and large capacitive loads.

Each of the four driver inputs, as well as the enable-mode control input, is a pnp Schottky input. Since there are two inverters between each input and output, the driver is noninverting. When operating in the RS-423 mode, the -29 and -30 require ± 5 -volt supplies. This setup allows the outputs to swing symmetrically about ground, producing a true bipolar output.

The -29 has a three-state output enable, while the -30 provides mode control, which permits operation as a dual differential driver. Each output of the -30 is designed to drive the RS-423 50- Ω load with an output voltage equal to or greater than +3.6 v in the low state. Each output is also current-limited to 150 milliamperes in either state.

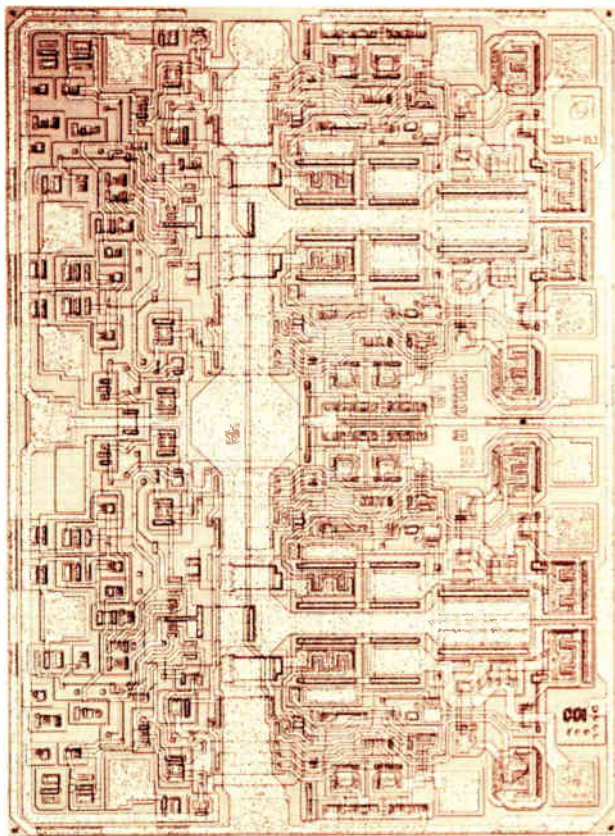

Typical die. The driver/receiver circuits in low-power Schottky technology are a cooperative effort of Advanced Micro Devices and National Semiconductor. This Am26LS29 die is 70 by 94 mils.

What's the standard story?

The most widely used standard for interfacing between data terminals and data communications equipment is the Electronics Industries Association's RS-232-C, which defines a single-ended, bipolar, unterminated circuit. It is intended for serial data interchange over less than 50 feet at rates under 20 kilobauds. A protocol as well as an electrical standard, it specifies handshaking signals between terminals and communications equipment.

The single-ended circuit uses a single conductor to carry the signal with the voltage referenced to a single return conductor (part a of the figure). This conductor may also be the common return for other signal conductors. It is the simplest way to send data, as it requires only one signal line per circuit.

However, this simplicity is often offset by an inability to discriminate between a valid signal produced by the driver and the sum of the driver signal and externally induced noise signals, commonly called crosstalk. Also, operation in multiwire systems tends to produce radiated emission on neighboring circuits. These problems may be solved, but at the expense of circuit performance.

Since noise and crosstalk are both directly proportional to transmission-line length and bandwidth, RS-232-C restricts both. To control radiated emission, it limits the slew rate of drivers to 30 volts per microsecond, which works with the length limitation to limit reflections on unterminated lines.

To allow the newer data communications systems to utilize their full performance capabilities, the EIA issued RS-422 and -423, two new electrical standards, in 1976. They define interface standards for higher data rates and longer distances than possible with RS-232-C.

RS-423 defines a single-ended, bipolar-voltage, unterminated circuit. It extends the distance and data-rate capabilities to 4,000 ft and 3 kilobauds. Higher rates of 300 kilobauds are permitted over a maximum of 40 ft.

RS-422 gives a balanced-voltage differential operation capable of significantly higher performance than are single-ended configurations. It can accommodate rates of 100 kilobauds over 4,000 ft or up to 10 megabauds over shorter distances. These improvements stem from the advantages of a balanced configuration, which is isolated

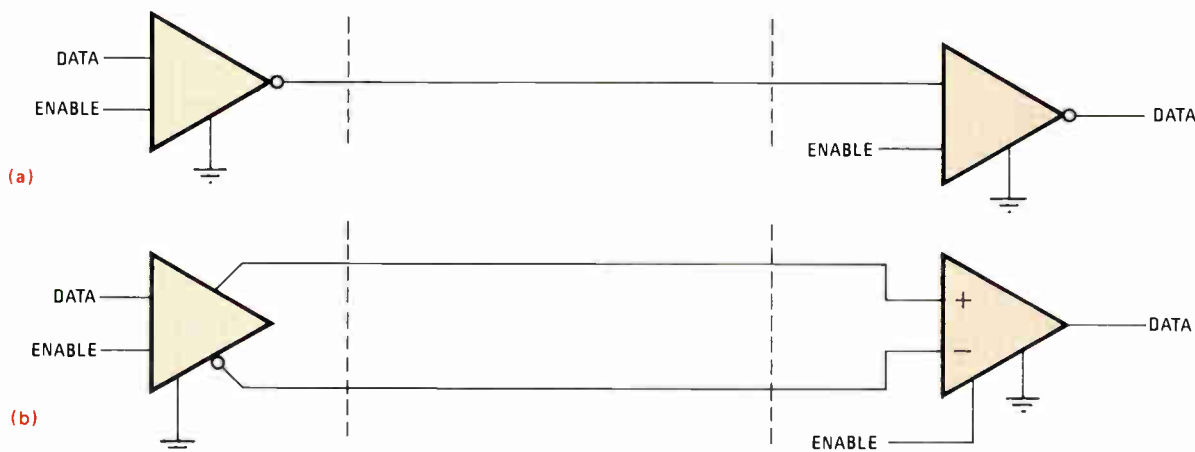

KEY PARAMETERS OF EIA SPECIFICATIONS

Characteristics	EIA RS-232-C	EIA RS-423	EIA RS-422
Form of operation	single-ended	single-ended	differential
Maximum cable length	50 ft	2,000 ft	4,000 ft
Maximum data rate	20 kilobauds	300 kilobauds	10 megabauds
Driver maximum output voltage, open circuit	± 25 V	± 6 V	6 V between outputs
Driver minimum output voltage, loaded output	± 5 to ± 15 V	± 3.6 V	2 V between outputs
Driver minimum output resistance, power off	$R_0 = 300 \Omega$	$100 \mu\text{A}$ between -6 to $+6$ V	$100 \mu\text{A}$ between $+6$ and -0.25 V
Driver maximum output, short-circuit current I_{SC}	± 500 mA	± 150 mA	± 150 mA
Driver output slew rate	30 V/ μsec max	slew rate must be controlled based upon cable length and modulation rate	no control necessary
Receiver input resistance R_{IN}	3 to 7 k Ω	≥ 4 k Ω	≥ 4 k Ω
Receiver maximum input thresholds	-3 to $+3$ V	-0.2 to $+0.2$ V	-0.2 to $+0.2$ V
Receiver maximum input voltage	-25 to $+25$ V	-12 to $+12$ V	-12 to $+12$ V

from common-mode currents among other pluses.

Differential operation (part b of the figure) is implemented by a differential driver (essentially two single-ended drivers with one always producing the complementary output-signal level to the other), a terminated twisted-pair transmission line, and a differential line receiver. The driver signal appears as a differential voltage to the line receiver, while the noise signals appear as a common-mode signal. A receiver with a sufficient common-mode voltage operating range can discriminate between them.

The adoption of these two standards made it necessary to fully specify the remaining functional and mechanical characteristics of the interface. Consequently, the EIA issued standard RS-449 in 1977. It describes a total of 30 interface circuits and defines 37-pin and 9-pin interface connectors and their pin assignments. The key features of the three new standards are shown in the accompanying table.

While these EIA standards define interfaces compatible with current integrated-circuit technology and provide significant performance advantages over the older standard, equipment designed to use these specifications can be made to operate with unmodified RS-232-C equipment.

A similar group of specifications has been defined by the international-standards groups of the CCITT (the International Telegraph and Telephone Consultative Committee). Recommendations V.10 and V.11 are essentially European equivalents of RS-422 and RS-423 respectively, and recommendations V.24 and V.54 are compatible with RS-449. In addition, the International Organization for Standardization's draft proposal DP-4902 describes the 37-pin and 9-pin interface connectors.

For both devices, a slew-rate control pin is brought out separately for each output to allow control of the output ramp rate (rise and fall time). This provides suppression of near-end crosstalk to other receivers in the cable.

Differential drivers

The -31 (Fig. 1c) is a quad differential line driver designed to meet RS-422 while operating with a +5-v supply. It has high-speed, skew-matched, differential outputs with typical propagation delays of 12 nanoseconds and residual skew of 2 ns. Both differential line outputs are designed for three-state operation to allow two-way half-duplex or multiplex party-line operation.

The -31's outputs are designed to source or sink 20 mA each, so that they can generate at least 2 v across a 100- Ω load, as required by the standard. It also meets the RS-422 requirement that the driver not load the line should its power supply fail.

Receivers

The -32 (Fig. 1d) is a quad line receiver operating from a +5-v supply, which can be used in differential or single-ended modes to satisfy RS-422 or -423 applications. The three-state outputs, which can sink 8 mA, incorporate a fail-safe input/output relationship that keeps the outputs high when the inputs are open.

The chip meets the required receiver input specification of a ± 200 -millivolt threshold sensitivity over a ± 7 v

common-mode range. The same circuitry assures excellent rejection of the power-supply ripples that can be troublesome when switching the high currents involved in a system's interfaces.

A typical hysteresis of 30 mv provides the -32 with differential noise immunity. This feature is important since signals received on long lines can have slow transition times; without hysteresis, a small amount of noise around the switching threshold can cause erroneous sensing in the receiver output.

A mask option—the Am26LS33—on the -32's input resistors modifies the receiver to improve operation in environments with high common-mode noise. An input-differential, or common-mode, voltage range of ± 15 v is achieved at the expense of a minor decrease in input threshold sensitivity (to ± 500 mv from ± 200 mv) over the common-mode range.

Implementing the circuits

Integrating these drivers and receivers did pose some special design challenges. A particular requirement of the -29 shown in the opening figure and the -30 was to provide a high output impedance in the power-off and disable mode over a wide common-mode range.

Output circuitry similar to a TTL totem pole meets these challenges. The chief modification is an added controlled current source to supply the high-current symmetrical drive required by the output transistors in both source and sink modes. The current source is designed around a pnp current mirror.

With the -31 balanced differential line driver, the challenge is the RS-422 requirement for very low residual skew between true and complementary outputs (typically 2 ns). An emitter-coupled differential amplifier and a symmetrical balanced drive are the answer.

The -32 receiver must detect differential input signals of less than 200 mv over a 7-v common-mode range, difficult to achieve with a single 5-v supply. Providing the necessary hysteresis also is a consideration. A balanced pair of differential amplifiers with Darlington inputs and a very tightly matched resistor attenuation network meet these requirements. It is balanced so that the common-mode range is achieved outside of the operating V_{∞} range.

System applications

The Am26LS29-33 series can be combined in several configurations for data communications networks. A unidirectional RS-423 communication link can be constructed using the -29, -30, and -32 (Fig. 2a). Either the -29 or -30 will meet bipolar signaling requirements.

If a single-ended line is needed without a bipolar requirement (Fig. 2b), the -31 can be used by biasing the reference terminal of the receiver to about 1.5 v. A balanced-line, single-direction RS-422 application uses the -31 and -32 (Fig. 3a). If bidirectionality is required, an extra termination should be added (Fig. 3b).

In the party-line mode found in intercomputer communications, the most common usage is that of a four-wire, full-duplex exchange system (Fig. 4). This mode involves two pairs of wires each handling a single direction of traffic. While this design is simple to imple-

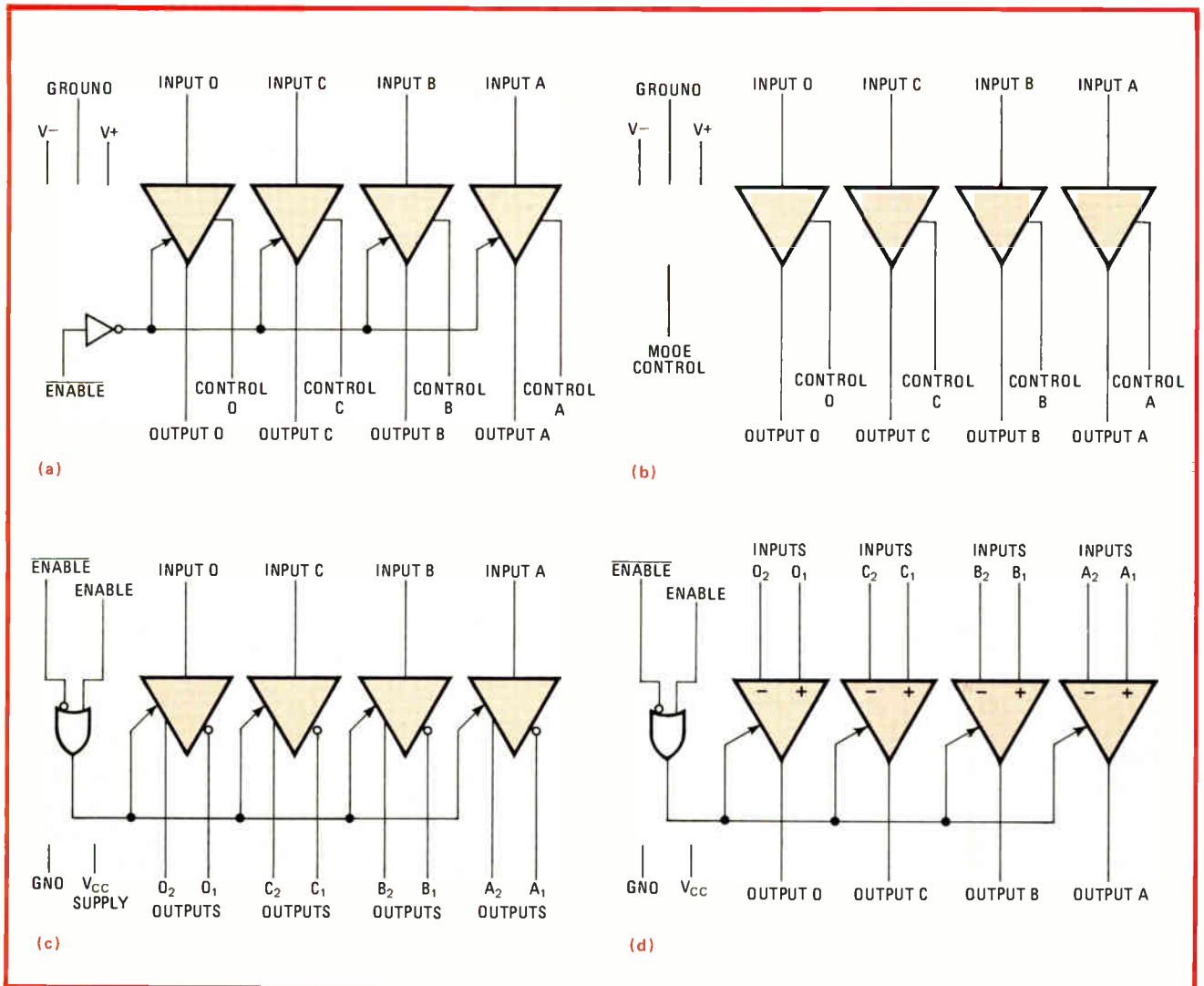

1. What's inside. The Am26LS29 driver (a) has a three-state output control, while the Am26LS30 driver (b) has a mode-control input that allows it to operate as a dual RS-422 driver or as a quad single-ended device. The Am26LS31 receiver (c) has common enable and disable functions while the Am26LS32 receiver (d) has complementary enable and disable functions.

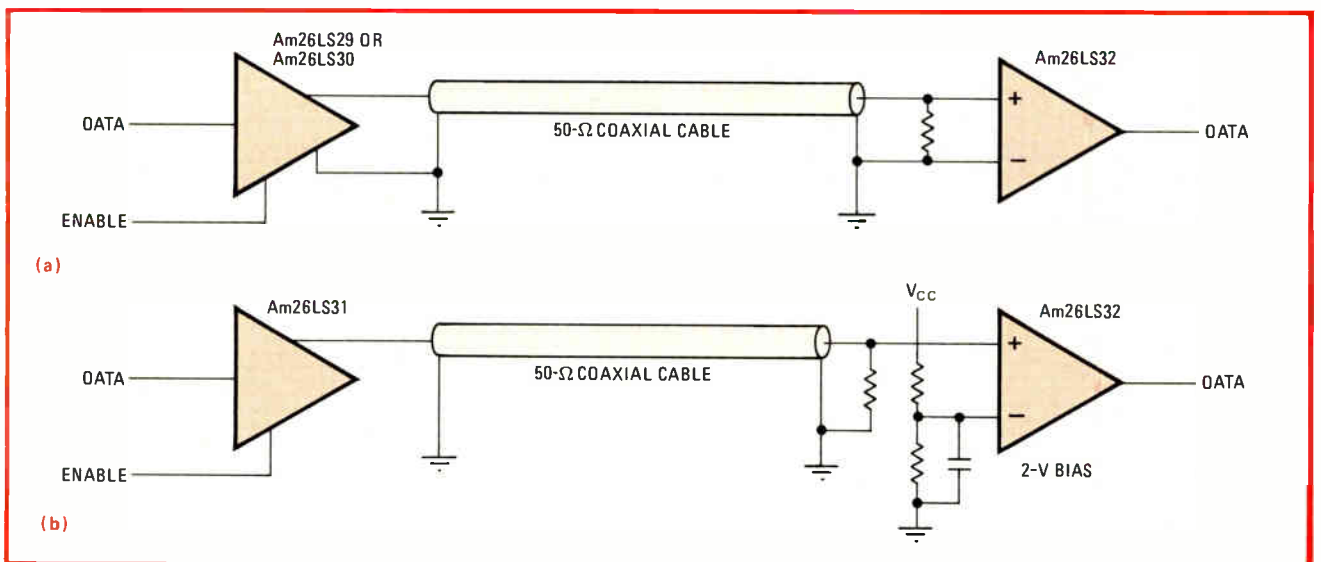

2. Single-ended line. Unidirectional lines can be either bipolar (a) or nonbipolar (b): the configuration chosen depends on external circuit and system requirements. In either case, the line-driving and -receiving requirements of RS-423 can be satisfied.

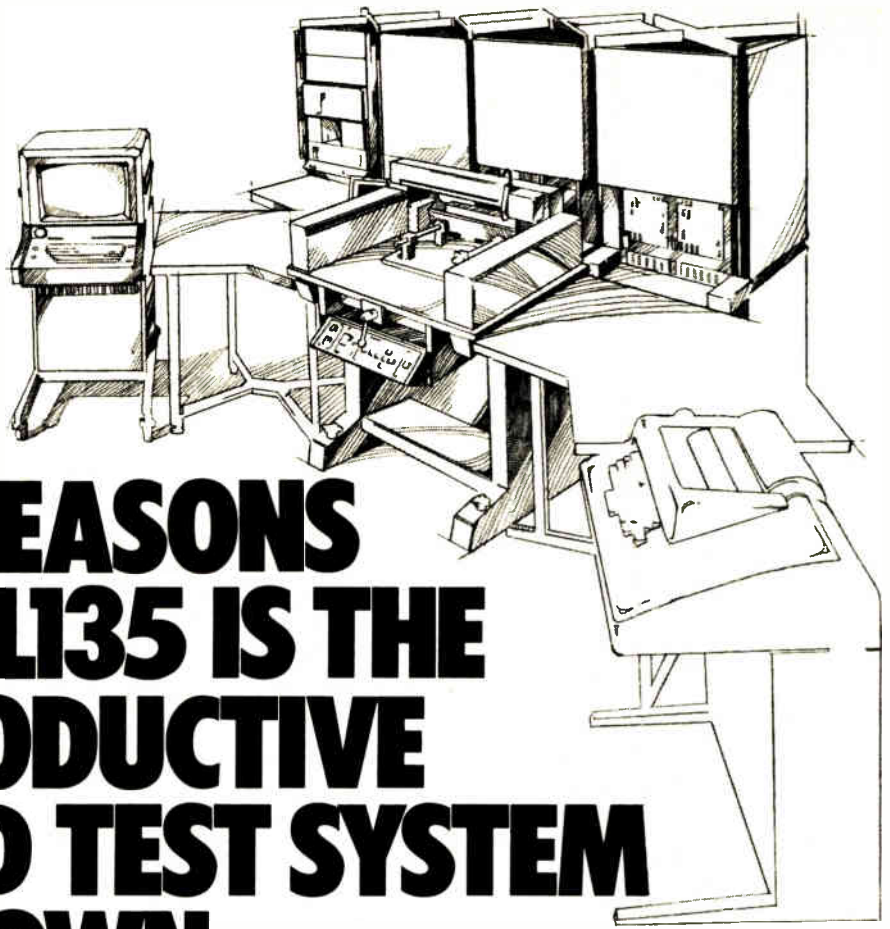

TWELVE REASONS WHY THE L135 IS THE MOST PRODUCTIVE LSI BOARD TEST SYSTEM YOU CAN OWN.

To compare productivity in LSI board testers, take their three common operations: diagnosing, testing, and programming. Now, to each operation apply the basic measures of productivity: cost, throughput, and quality of testing.

The L135 has the highest diagnostic throughput, the lowest operating cost. No other test system comes even close.

1. The L135 finds bad LSI devices on long buses.

The Electronic Knife does it. It takes just a few more probes after regular guided probing finds the failing bus. Without the Electronic Knife, you're faced with trial and error replacement of LSI chips. Or skilled technicians tying up the system for an hour or more per bad IC.

2. The L135 makes fewer diagnostic probes – by an order of magnitude.

State-sensitive trace does it. Most LSI boards are loaded with multi-input LSI chips linked through “wired-and” bidirectional buses. These often require hundreds of diagnostic probes per fault. State-sensitive trace cuts the number dramatically.

3. The L135 produces immediate probe commands.

The on-line circuit model with a large random-access memory does it. With circuit structure immediately accessible, the operator does not wait for commands between probes. Other test systems that use fault dictionaries often delay each command several seconds, adding minutes to each diagnosis.

4. The L135 mechanizes probing.

The M150 Automatic Prober does it. Seven to ten times faster than a human operator, the M150 speeds up board diagnosis even more because its operation is both error-free and fatigue-free.

The L135 delivers the highest quality of testing, thereby slashing costs for diagnosis later at systems test and service out in the field.

5. The L135 emulates LSI-board operating environments.

5-MHz clock-rate testing does it. To ensure adequate board quality, you usually have to run LSI boards at clock rates as the last step in testing. Only the L135 provides test rates of up to 5-MHz, the speed of many microprocessors seen in today's products.

6. The L135 emulates and tests CPU sets.

Multiple drive/compare phase control does it. During clock-rate testing, the test system must first replace the CPU set and then test it at speed. The associated microprocessors usually receive multi-phase inputs and generate multi-phase outputs. The L135 provides the necessary, easy-to-program, precise phase controls over driver inputs and comparator strobing.

7. The L135 tests and diagnoses analog circuits.

Integrated ac-dc-parametric capability does it. The L135 offers many analog force-and-measure functions through matrix connections, all completely integrated into system hardware and software. If these capabilities aren't integrated into the test system, they must often be added to accommodate the increasing analog content of LSI boards. That prolongs test time and slows diagnosis considerably.

8. The L135 tests at dc and clock-rate on the same channel.

All-speed pin compatibility does it. In clock-rate testing, high-speed tests are usually applied on the same pins tested earlier with dc. The L135 allows you to apply both types of tests at the same system channel, eliminating the need for awkward switching or extra channel capacity.

9. The L135 has enough clock-rate channel capacity for the big jobs.

444 I/O pins does it. Big LSI boards have upwards of 250 edge-connector pins, all active. In addition, you need simultaneous access to dozens of internal test points and devices invisible to the edge connector. The L135 offers the highest clock-rate channel capacity, enough for all foreseeable LSI boards.

10. The L135 cuts total programming time.

The P400 Automatic Test Generation System does it.

The P400 automatically generates all the dc patterns and diagnostic data for the toughest part of most LSI boards: the jungle of random digital logic, as well as those portions containing modeled LSI devices. Total programming time is shorter. The best of the so-called "automated test generation" techniques offered by other systems still require manual pattern-writing. That takes longer and costs much more.

The L135 cuts the time needed to get products into the production line and out to the market place.

11. The L135 cuts system time for debugging.

Immediate-response debug software does it. During test-plan debugging, the L135 responds to the test engineer's commands and displays results immediately. Total debugging time is cut to a fraction because the test engineer is not distracted by system delays; he can concentrate on his circuit and his test plan.

12. The L135 readily assembles the many parts of LSI test plans.

Structure-merge programming does it. Test plans originate in many places: manual patterns and circuit models, learned data from known good boards, circuit and device simulators, automatic pattern generators, etc. The L135's structure-merge software and its straightforward protocol assembles them all into a coherent package, saving your engineers hours of tedious and costly work. For more information on these and other L135 features, write Teradyne, Inc., 183 Essex Street, Boston, Massachusetts 02111.



Coherence function and averaging boost confidence in spectrum measurements

by N. A. Pendergrass,
Hewlett-Packard Co., Loveland Instrument Division, Colo.

□ Digital technology and the fast Fourier transform can do more for the low-frequency spectrum analyzer than just increase its speed. They can add an altogether new and extremely useful capability to the instrument—the ability to measure coherence—and they can also significantly enhance the accuracy of existing measurement techniques by the use of averaging.

Coherence, time averaging, and rms averaging are all complicated statistical functions that are difficult to perform with analog methods. Seeing how they are implemented on the HP-3582 dual-channel spectrum analyzer [*Electronics*, April 27, p. 170] will demonstrate the power of these new types of measurement.

The need for averaging

In the real world, processes are often random or involve large random components. The evaluation of a signal spectrum containing random components requires averaging if the estimate is to be accurate. Indeed, to obtain a perfect model of the spectrum would require sampling the waveform for an infinite time, and the calculation from a single segment of a random process could never more than approximate the true spectrum.

The voltage waveform displayed in Fig. 1a is white Gaussian noise sampled for 10 milliseconds by the HP-3582 spectrum analyzer. Figure 1b shows a single record of the spectrum of the same sample over a 25-kilohertz range. The true spectrum would be flat, but the single-record spectrum has rather large deviations about its mean magnitude, and such a degree of uncertainty allows little information to be derived from it.

Root-mean-square averaging of many more samples reduces this uncertainty. For instance, if the source of the white Gaussian noise shown in Fig. 1 is sampled 256 times and rms-averaged, the result is a nearly flat spectrum that resembles the true, or expected, spectrum (Fig. 2).

Since averaging many spectra can take a long time, especially at very small bandwidths, it is desirable to average only the number of values required to obtain the necessary level of confidence and smoothing in the estimate. Table 1 relates the 90% confidence interval to the number of averages required for Gaussian random input signals. In other words, 90% of the measurements on

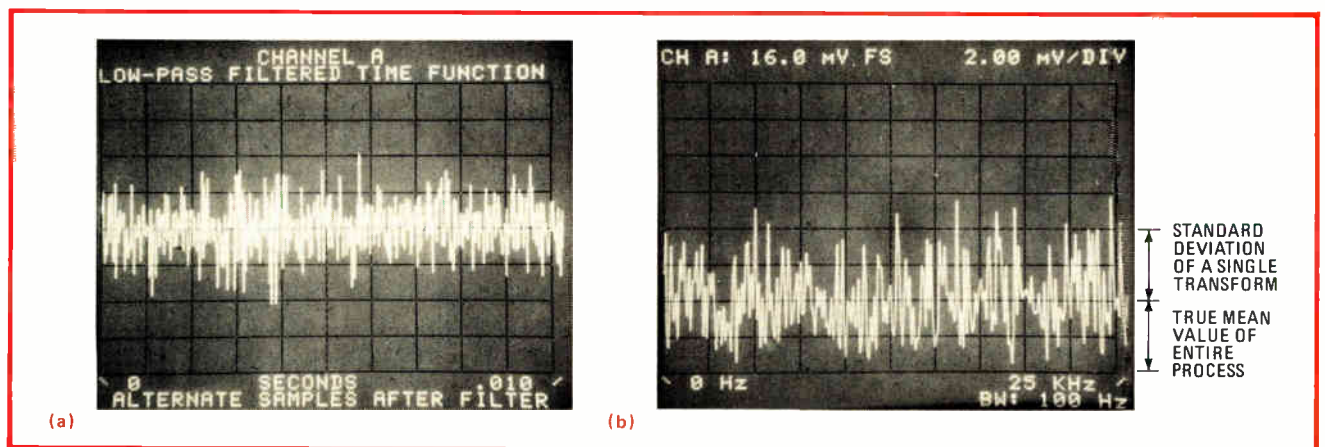

1. Gaussian sample. The waveform displayed (a) is a single 10-millisecond sample from a Gaussian white-noise source. The single-record spectrum of the same noise source (b) illustrates the magnitude of the deviation from the flat spectrum ideally expected.

Gaussian noise will be within the interval indicated. Since noise is generally Gaussian or nearly so, the table should have wide application.

To use the table, first decide on the allowable statistical tolerance in decibels. Then find the number of averages having 90% limits that are within the tolerance bounds. For instance, if a ± 2 -dB accuracy band can be tolerated, then the 16-average routine is what is needed. Remember that the limits given are statistical, not absolute; they state that, on the average, the true value of amplitude will lie within the stated bounds in 9 out of 10 measurements.

For example, suppose that a random-noise source has been measured, 32 spectra have been rms-averaged, and a marker at 1,000 hertz shows a signal level of -55 dBV.

In this case the table can be interpreted to indicate that the true signal amplitude has a 90% probability of being in the range of -53.6 dBV to -56.2 dBV.

Time averaging

Another technique for enhancing an estimate is time averaging. Unlike rms averaging, it does not smooth the spectra but reduces the noise relative to a desired signal. It would be very difficult to do without a digital approach and the FFT.

With this technique, input waveforms are first averaged as time records one after another. However, averaging several time records is exactly equivalent to vector-averaging the corresponding spectra one after another. This is done by taking the real and imaginary parts of the complex spectrum and averaging them over time (as opposed to rms averaging, in which the squared values of their magnitudes are averaged).

The noise-reducing action of time averaging is most easily understood in the frequency domain. Figure 3 illustrates how the resultant obtained by vector averaging at a given frequency causes the interfering signals' average to approach zero.

Time averaging is done with the aid of a synchronizing

TABLE 1: 90% CONFIDENCE LIMITS FOR RMS AVERAGING

	Number of averages						
	4	8	16	32	64	128	256
Upper limit(dB)	+ 4.7	+ 3.0	+ 2.0	+ 1.4	+ 1.0	+ 0.7	+ 0.5
Lower limit(dB)	- 2.9	- 2.2	- 1.6	- 1.2	- 0.8	- 0.6	- 0.4

TABLE 2: 90% CONFIDENCE LIMITS ON THE MEASUREMENT OF THE AMPLITUDE $|H|$ AND PHASE ϕ OF TRANSFER FUNCTIONS

Measured value of coherence function		Number of averages				
		16	32	64	128	256
0.2	$ H $ (dB) ϕ ($^\circ$)	+ 5.2, -14.6 ± 54	+ 3.8, -7.1 ± 34	+ 2.8, -4.2 ± 23	+ 2.1, -2.7 ± 16	+ 1.5, -1.8 ± 11
0.3	$ H $ (dB) ϕ ($^\circ$)	+ 4.2, -8.4 ± 38	+ 3.1, -4.8 ± 25	+ 2.2, -3.0 ± 17	+ 1.6, -2.0 ± 12	+ 1.2, -1.4 ± 8
0.4	$ H $ (dB) ϕ ($^\circ$)	+ 3.5, -6.0 ± 30	+ 2.6, -3.6 ± 20	+ 1.8, -2.3 ± 14	+ 1.3, -1.6 ± 10	+ 1.0, -1.1 ± 7
0.5	$ H $ (dB) ϕ ($^\circ$)	+ 3.0, -4.5 ± 24	+ 2.1, -2.8 ± 16	+ 1.5, -1.9 ± 11	+ 1.1, -1.3 ± 8	+ 0.8, -0.9 ± 5
0.6	$ H $ (dB) ϕ ($^\circ$)	+ 2.5, -3.5 ± 19	+ 1.8, -2.2 ± 13	+ 1.3, -1.5 ± 9	+ 0.9, -1.0 ± 6	+ 0.7, -0.7 ± 4
0.7	$ H $ (dB) ϕ ($^\circ$)	+ 2.1, -2.7 ± 15	+ 1.5, -1.7 ± 10	+ 1.0, -1.2 ± 7	+ 0.7, -0.8 ± 5	+ 0.5, -0.6 ± 4
0.8	$ H $ (dB) ϕ ($^\circ$)	+ 1.6, -2.0 ± 12	+ 1.1, -1.3 ± 8	+ 0.8, -0.9 ± 6	+ 0.6, -0.6 ± 4	+ 0.4, -0.4 ± 3
0.9	$ H $ (dB) ϕ ($^\circ$)	+ 1.1, -1.3 ± 8	+ 0.8, -0.8 ± 5	+ 0.5, -0.6 ± 4	+ 0.4, -0.4 ± 3	+ 0.3, -0.3 ± 2

TABLE 3: 90% CONFIDENCE LIMITS ON COHERENCE FUNCTION MEASUREMENTS (MIN, MAX LIMITS)

Measured value of coherence function	Number of averages				
	16	32	64	128	256
0.4	0.15, 0.59	0.23, 0.54	0.28, 0.50	0.32, 0.47	0.34, 0.45
0.5	0.25, 0.67	0.33, 0.63	0.39, 0.59	0.42, 0.57	0.45, 0.55
0.6	0.36, 0.74	0.45, 0.71	0.50, 0.68	0.53, 0.66	0.55, 0.64
0.7	0.50, 0.81	0.57, 0.78	0.61, 0.76	0.64, 0.75	0.66, 0.73
0.8	0.65, 0.88	0.70, 0.86	0.74, 0.84	0.76, 0.83	0.77, 0.82
0.9	0.81, 0.94	0.85, 0.93	0.87, 0.92	0.88, 0.92	0.88, 0.91

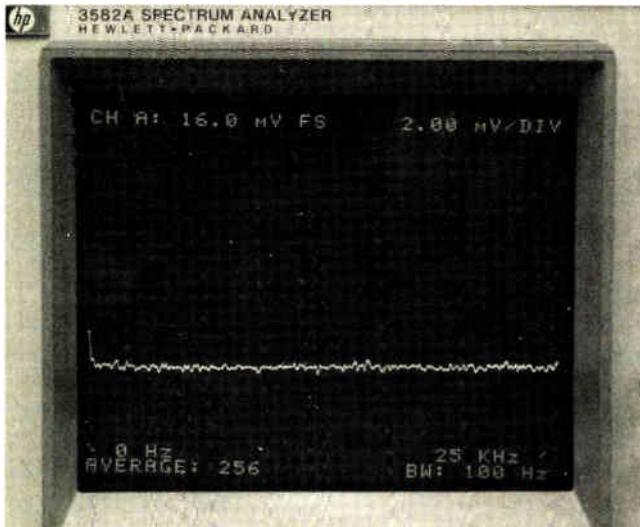

2. Smoothed spectrum. This spectrum of a Gaussian noise source is the result when 256 samples of the input are recorded and then rms-averaged. The spectrum resembles the ideal white-noise spectrum because of the smoothing action of rms averaging.

trigger signal. Assume that several time records of the same length, each starting at the trigger instant, have been taken and converted into the frequency domain by the FFT. The magnitude and phase of each time record then corresponds to a frequency component of the input spectrum.

At each frequency component, the signal can be separated into two parts: one that is at some fixed phase ϕ , relative to the trigger, and one that is not (Fig. 3a). The latter might be noise or an interfering signal, but its phase angle θ on successive samples is random relative to the trigger (Fig. 3b). Since the interfering signal is not fixed in phase from record to record, its vector average will approach zero (Fig. 3c). On the other hand, the signal component, being phase-synchronous vis-à-vis the trigger, is unaffected because it has the same phase at each sample.

An interfering signal or noise, therefore, can be reduced by time averaging if a suitable trigger is available. The magnitude in decibels of the improvement in the signal-to-noise ratio is approximately $10 \log_{10}(K)$, where K is the number of averages. For example, if 256

time records are averaged, the s/n ratio is improved by about 24 db.

Notice that time averaging does not smooth the spectrum estimate—it only reduces the magnitude of an interfering waveform. The spectrum of any interfering noise that remains will be much smaller but decidedly ragged (Fig. 4).

The coherence function

The coherence function when used on a transfer function measurement is the fraction of output power attributable to an input signal. It is unique to digital implementations of network and spectrum analyzers and yields a lot of information about several hard-to-measure factors. It gives insight into the accuracy with which the transfer function of a noisy system is being measured at each frequency point. It can be used to compute s/n ratio at an output or to draw attention to nonlinearities in the system under test. It can also be used to study cause-and-effect relationships between possible noise sources and the waveforms at other points in a system.

Perhaps the best way to see how the coherence function can do all of these things is first to examine how it is computed along with a transfer function in the HP-3582. Then the situations that do not involve the transfer function become more comprehensible.

Consider the transfer function measurement shown in Fig. 5. Notice that there is added noise that could interfere with the measurement accuracy. This is not unusual—the extra noise could be room sounds in loud-speaker testing, noise in measurement transducers such as accelerometers, or simply the noise that is produced by an amplifier.

The usual approach for measuring the transfer function is to estimate the input $S_A(f)$ and the output $S_B(f)$ and then find the transfer function $H(f)$ by dividing output by input spectra and subtracting their phase angles:

$$|H(f)| = \frac{|\hat{S}_B(f)|}{|\hat{S}_A(f)|}$$

at angle $\phi_B - \phi_A$ where the symbol $\hat{}$ is used to indicate an estimate. But if the noise spectrum $S_N(f)$ is significant in any portion of the spectrum of the output $S_B(f)$, this traditional approach will give rise to errors because $S_B(f)$

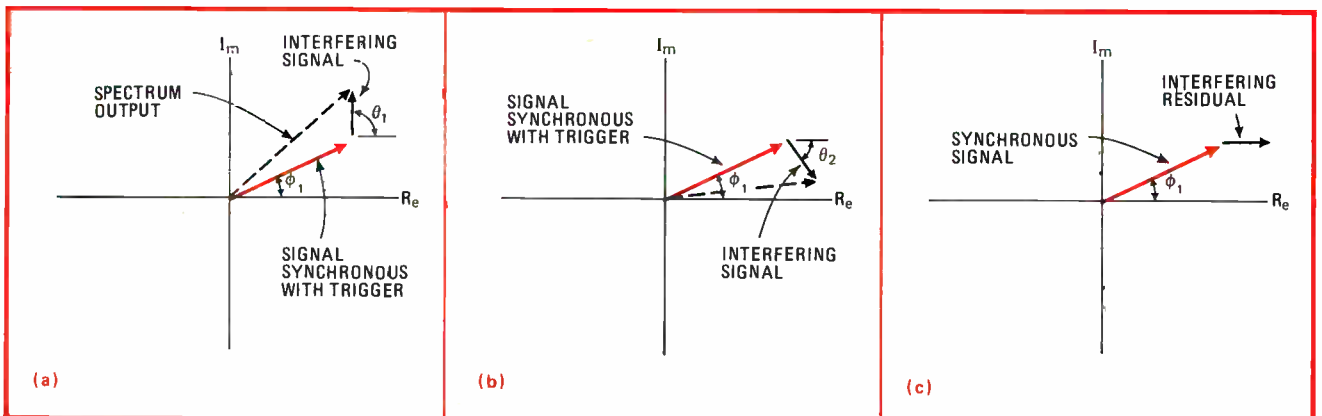

3. Time-averaging action. The vector diagram above represents two (trigger-synchronized) FFT output samples and their vector-averaged resultant. Each signal contains random-noise components that approach zero when vector-averaged together.

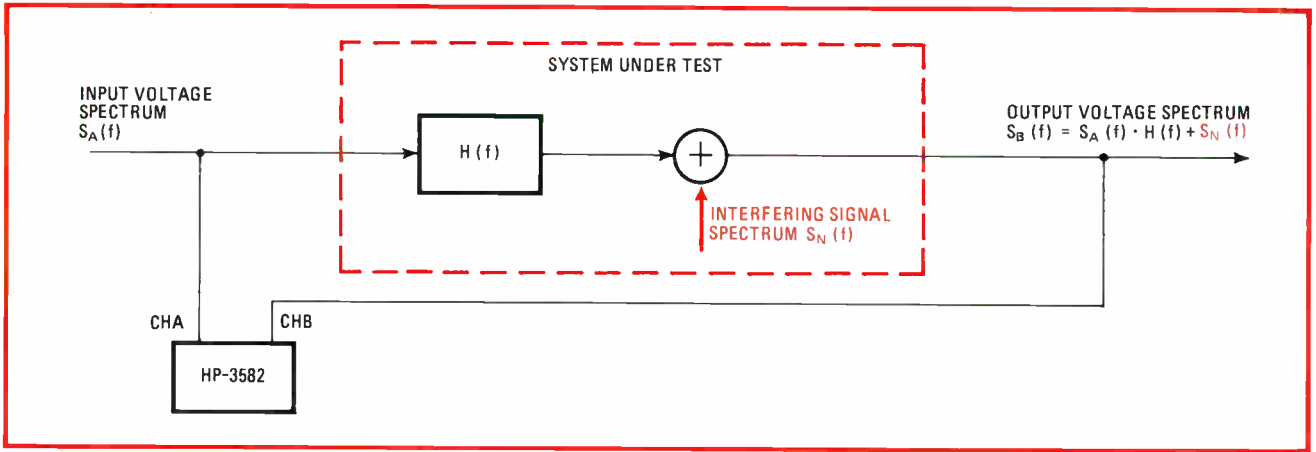

5. System measurements. Block diagram shows a typical transfer-function measurement setup using the HP-3582 dual-input spectrum analyzer. The output containing additional noise has been injected by a source somewhere in the system.

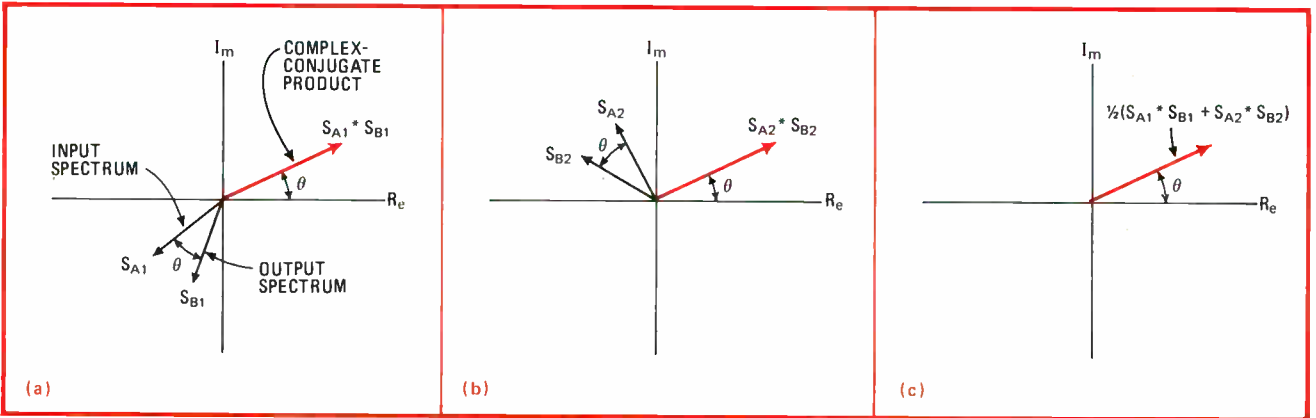

6. Noise-free. The complex-conjugate products of two records (a, b) are vector-averaged to yield the cross-power spectrum (c). Since no noise is present, they are all related by the transfer function's phase angle (θ), and no cancellation in magnitude takes place.

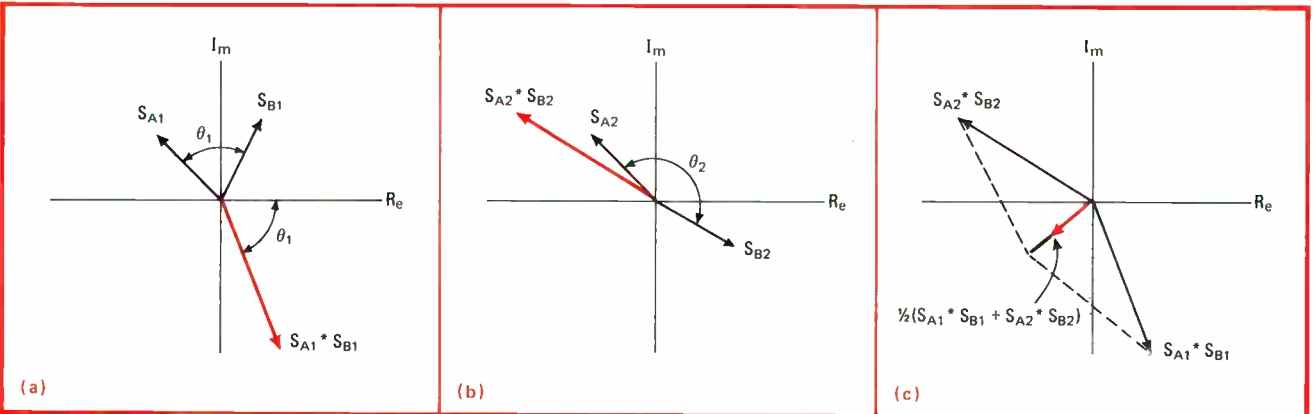

7. Input lost. With only noise generating the output, the magnitude of the cross-power spectrum resultant that will be formed (c) will approach zero because of the random phase relationship of each vector-averaged complex-conjugate product (a, b).

$$\lim_{ave \rightarrow \infty} S_{AB}(f) = S_A^*(f)[S_A(f) \cdot H(f)] = |S_A(f)|^2 \cdot H(f)$$

The cross-power spectrum gives the handle needed to reduce the effect of noise in the measurement, since the transfer function estimate is easily obtained by dividing the cross-power spectrum estimate by the square of the magnitude of the input spectrum estimate. This is a much better estimate of the transfer function than the one described earlier and is used in the HP-3582.

The coherence function also depends on the cross-power spectrum to remove the part of the output (noise) that is not consistently phase-related (or coherent) with the input. The coherence function γ^2 is defined as the squared magnitude of the cross-power spectrum divided by the magnitude squared of both the input and output spectrums, or:

$$\gamma^2 = \frac{|S_{AB}(f)|^2}{|S_A(f)|^2 |S_B(f)|^2}$$

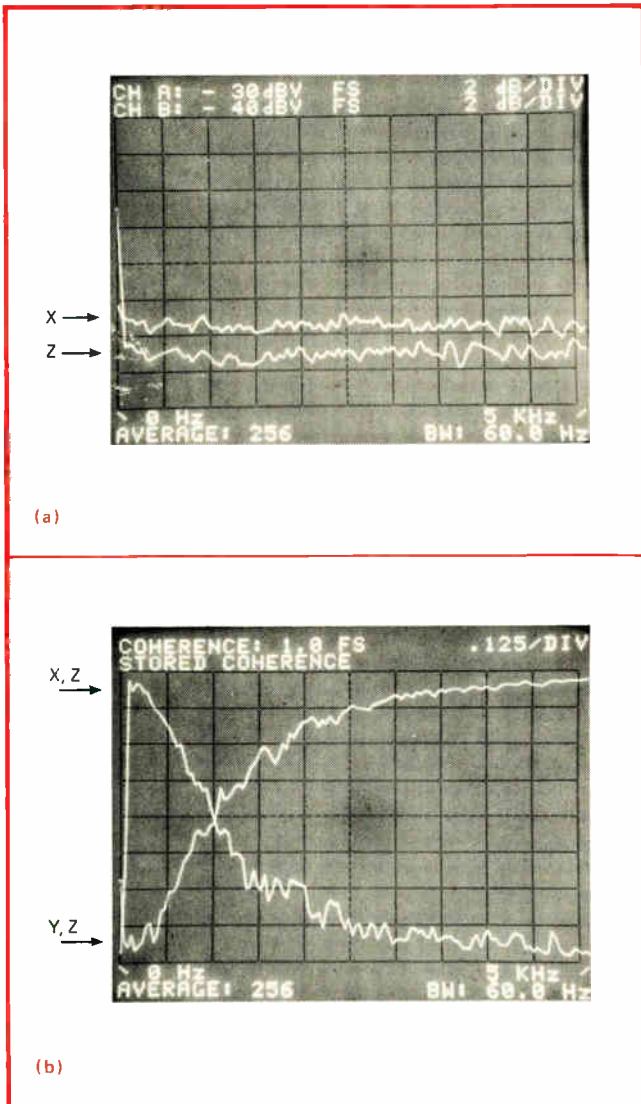

8. Dual input. The spectrums of input X (identical to input Y) and output Z are shown in (a) but reveal little about X's and Y's contributions to output. The coherence functions between each input and output (b), however, show what each input contributes to the output.

The discussion of the cross-power spectrum should make one important property of the coherence function obvious. The function gives that fraction of the power at the output of a transfer function that came from the input. The cross-spectrum estimate converges to the product of the input and the output due to the input. Therefore, the numerator of the coherence does not have the noise in it, but the denominator does. Mathematically, then, this yields the ratio of power out due to input exclusive of noise to the total power out including noise:

$$\begin{aligned} \lim_{ave \rightarrow \infty} \gamma^2 &= \frac{|S_A(f)^2 \cdot H(f)|^2}{|S_A(f)|^2 \cdot |S_B(f)|^2} = \frac{|S_A(f)|^2 \cdot |H(f)|^2}{|S_A(f)|^2 \cdot |S_B(f)|^2} \\ &= \frac{|S_A(f)|^2 \cdot |H(f)|^2}{|S_B(f)|^2} \end{aligned}$$

This is an important interpretation of the coherence function. That is, over frequency it gives a measure of that fraction of output that came from the input only.

The s/n ratio is then given by $\gamma^2/(1-\gamma^2)$ where $(1-\gamma^2)$ is the fraction of the output that is noise. Note that γ^2 always has a value between 0.0 and 1.0. A value of 1.0 indicates perfect coherence.

System nonlinearities

Nonlinearities in a transfer function measurement generate distortion products and cause portions of the input signal at one frequency to appear at others. If the input signal is not periodic, as is the case with noise, the phases of the distortion-produced signals will be random relative to the actual input at the distortion product frequencies. The distortion products are eliminated by the converging action of the cross-power spectrum computation in just the same way as the interfering noise is. The transfer function measurement when made with the cross-power computation and averaging reduces the nonlinear effects, whereas if done by the simple division method, it could again result in a significant error. The coherence function indicates the presence of nonlinearities by yielding values less than 1.0 at those frequencies where distortion products are present, assuming no interfering noise is present.

All along in this discussion, the term "estimate" has been used. In the face of significant noise or nonlinearity, averaging must be used to smooth the transfer function and coherence computations and reduce the errors.

If averaging is not used, the transfer function obtained by using the cross-power method may be inaccurate. The coherence will compute to 1.0 in this case even if interference is present. Of course, if nonlinearities or interference are not present, then the computations are accurate without averaging unless a random input is used (see Tables 2 and 3).

Multiple inputs

The coherence function is particularly useful when investigating cause-and-effect relationships in multiple-input systems. It gives a measure of how much output power (either desirable or undesirable) at a frequency can be attributed to each input source without modifying the operation of the system under test. (Mechanical vibration occurring at full throttle in a twin-engine plane is one example.)

Consider the system shown in Fig. 8, which has two possible sources of noise at the output. Usually some unknown transfer mechanism is involved and often the offending sources cannot be selectively turned off.

In this example, it is determined that source X is a white noise and so is source Y. The output spectrum at Z is also found to be nearly white, as shown in Fig. 8a. But which source is the offender?

Both the transfer and coherence functions can help answer the question. The coherence functions measured between X and Z and then Y and Z are shown in Fig. 8b, indicating that not one but both sources contribute to the output noise. The only difference between sources is in how much noise they contribute versus frequency. Note that each source accounts for a coherence of 0.5 or 50% of the output noise at the 1,000-Hz intersection. Thus the coherence function shows the transfer functions are balanced, giving the output a nearly flat spectrum. □

THE FAST

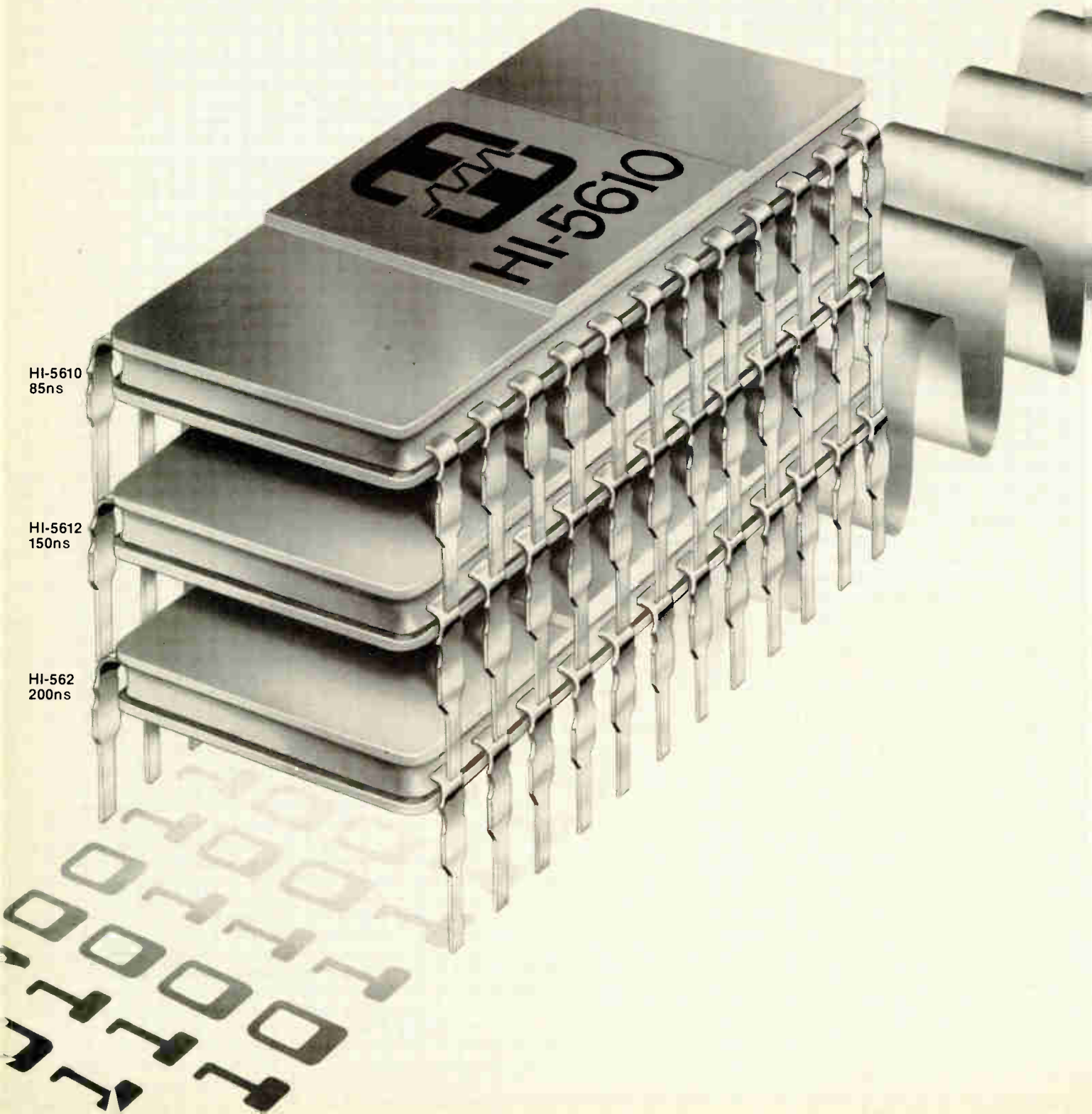

HI-5610
85ns

HI-5612
150ns

HI-562
200ns

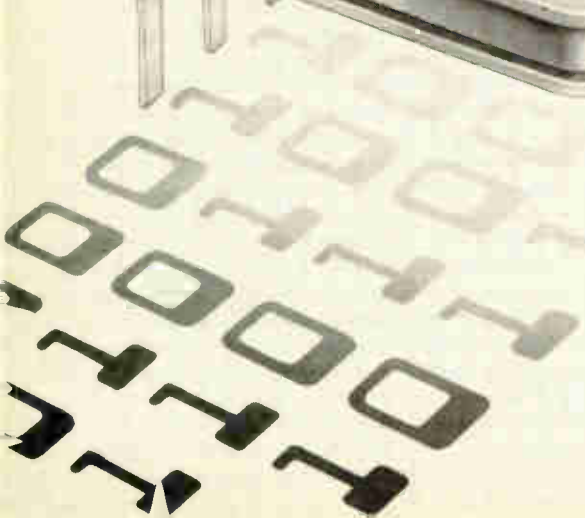

STACK.

Now.. Harris offers the most advanced family of high-speed D/A Converters in the industry.

Recently Harris introduced the HI-562. The first D/A Converter to combine high-speed performance with true 12-bit accuracy.

Now we've outdone ourselves. With two new high-speed models. The HI-5610, 10-bit. And the HI-5612, 12-bit. The most advanced line of high-speed, high-performance D/A Converters in the industry today.

- Faster, more accurate than any existing monolithic circuit.
- Less expensive, smaller than competing hybrids and modules.
- With laser-trimmed nichrome resistors for added accuracy and stability.

Now Harris provides you with a prime source to meet your most demanding data conversion design needs: A/D converters, CRT graphic displays, process control systems, precision instruments, data acquisition systems or communication terminals.

Need speed? The new HI-5612 is the fastest 12-bit D/A Converter on the market today.

Want superior performance? These devices are the only fast D/A converters to have feedback and gain setting resistors included internally.

And now, we give you economy, too! The HI-562 is available at a new low price, making it price competitive with run-of-the-mill devices that can't touch it performance-wise. Whichever you choose, you get fast settling time, excellent linearity, low gain drift, and each device is fully monotonic over temperature.

Available in 24-pin DIP, all three models operate on +5V and -15V supply voltages and +10V reference.

Check out our new fast stack...then call the Harris Hot Line today. Or write: **Harris Semiconductor Products Division, P. O. Box 883, Melbourne, Florida 32901.**

	HI-562	HI-5612	HI-5610
Bits	12	12	10
Settling Time to $\pm 1/2$ LSB	200 ns typ	150 ns typ	85 ns typ
Differential Linearity (0-75°C)	$\pm 1/2$ LSB max	$\pm 1/2$ LSB max	$\pm 1/2$ LSB max
Low Gain Drift (0-75°C)	± 5 ppm/°C	± 5 ppm/°C	± 5 ppm/°C
Output Current	5 mA	5 mA	5 mA

HARRIS HOT LINE!
1-800-528-6050, Ext. 455

Call toll-free (except Hawaii & Alaska) for phone number of your nearby Harris sales office or expedited literature service.

Harris Technology
...Your Competitive Edge



HARRIS
SEMICONDUCTOR
PRODUCTS DIVISION
A DIVISION OF HARRIS CORPORATION

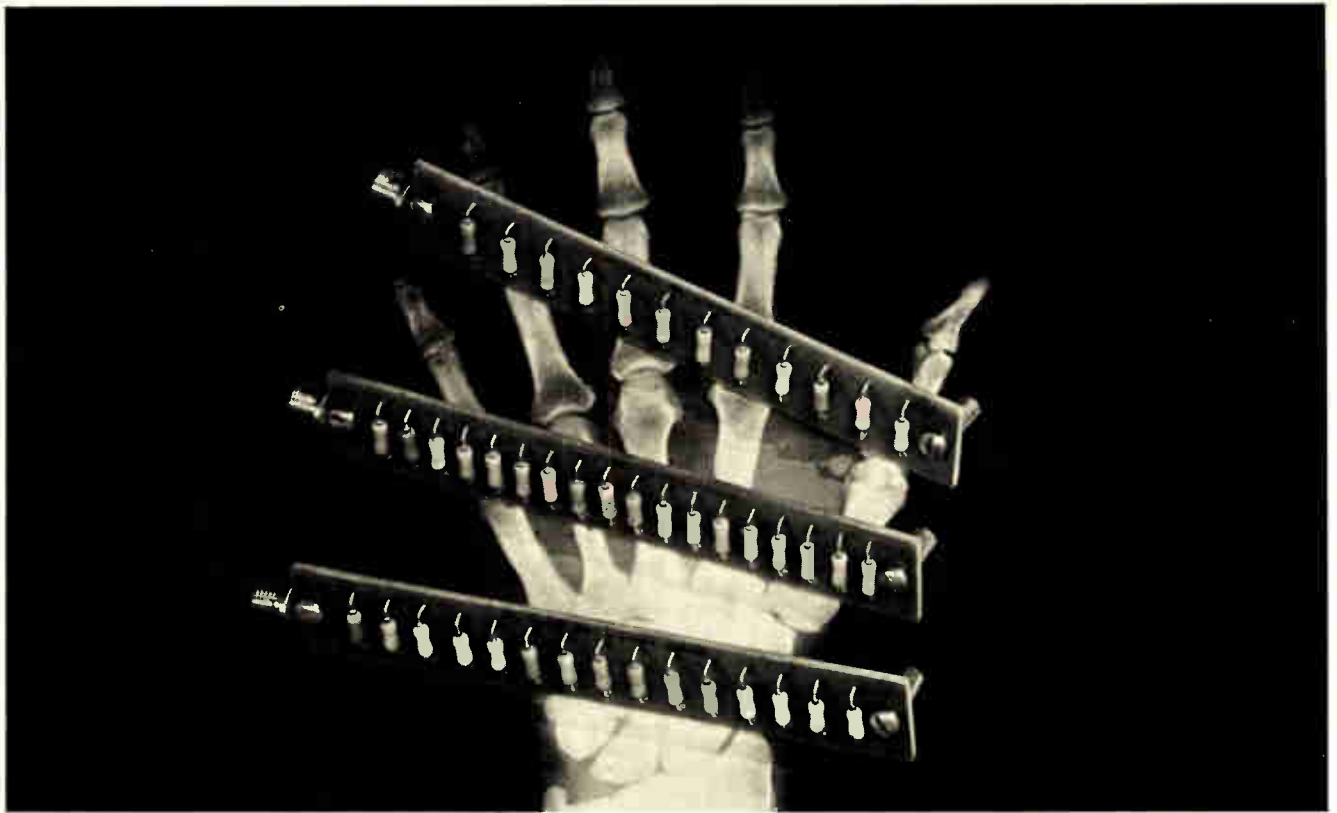

"X-WAY STIC"

High Quality - Low Cost Rectifiers for X-ray Power Supplies.

Semtech Corporation introduces "X-WAY STIC" a new series of open rectifier sticks specifically designed for X-ray power supplies.

Each X-WAY STIC utilizes hermetically sealed Metoxilite multi-chip "avalanche" rectifiers mounted on a PCB. These Metoxilite multi-chip rectifiers (technology initially developed for high reliability aerospace programs), are now available at reduced prices.

In addition to X-ray power supplies, these rectifiers can be effectively used in most standard, single and polyphase circuits. Designed for use in oil environment.

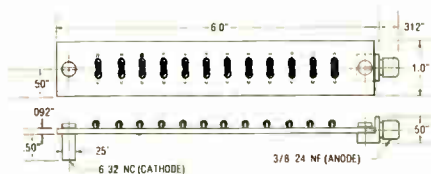

Types: X100KS, X125KS & X150KS
 PIV (operating): 100, 125 & 150kV
 PRV (test): 125, 150 & 175kV
 Average Rectified Current @ 55°C Oil: 150mA
 Reverse Current @ PRV: 1.0 μA
 Recurrent Surge (10 cycles @ 60 Hz rate): 7.5A
 Single Cycle Surge @ 8.3ms: 25A
 Forward Voltage @ 50mA: 160, 190 & 220V

RELIABILITY COSTS LESS!

OTHER X-WAY STIC TYPES AVAILABLE:



1975 NATIONAL SBA SUBCONTRACTOR OF THE YEAR

SEMTECH
CORPORATION

652 Mitchell Road, Newbury Park, California 91320
 (805) 498-2111 • (213) 628-5392 • TWX: 910-336-1264
 CHICAGO: (312) 352-3227 • DALLAS: (214) 234-6523
 FLORIDA: (305) 644-5404 • MARYLAND: (301) 937-0070
 NEW YORK / NEW JERSEY: (201) 964-9305
 SAN FRANCISCO: (415) 494-0113 • SEATTLE: (206) 455-4807
 CANADIAN SALES: Avotronics, Ltd. (416) 493-9711
 EUROPEAN SALES: Bourns AG Zug, Switzerland (042) 232-242

Why switching power supplies are rivaling linears

Use of power transistors instead of a bulky transformer keeps efficiency high, size small, and power consumption low

by Malcolm Burchall, *Gould Inc., Electronic Components Division, El Monte, Calif.*

□ Today's switching regulated power supplies are beginning to compete with linear types for the system designer's vote. They certainly deserve it if efficiency, small size, and low power consumption are what he wants most. And sometimes, in the context of a particular system's overall requirements, they may still be the better choice despite their greater noise, slower transient response, higher ripple, and generally higher price.

The virtues of the switching power supply stem from its smaller size. Its vices, on the other hand, stem from what makes that smaller size possible: the substitution of a high-frequency switching system based on power transistors for the bulky 50-to-60-hertz input transformer of the linear supply.

Approximately 80% of the linear supply's bulk is accounted for by three components: the input transformer, the reservoir electrolytic capacitors, and the heat sinks (Fig. 1). The transformer provides input/output isolation and reduces the relatively high input voltage to a level more nearly matching the required dc output level. The reservoir electrolytic capacitors perform two functions: they store enough energy to keep the output in line with the specifications in the event of short interruptions in the input, and they filter the raw, rectified dc from the rectifiers to an acceptable level. The heat sinks are needed to cool the power-dissipating components (rectifiers and series-pass transistors).

In the switching regulated power supply, most of the bulky components are replaced by solid-state circuits (Fig. 2). The switching system uses power transistors that turn on and off at rates of 20 kilohertz or more, the ratio of their on to off time being determined by a detector-amplifier configuration. This high-frequency operation allows smaller components to be used for the energy-storage capacitor, rectifiers, and filtering network. Being small, all these elements dissipate less heat and therefore need less—sometimes nothing—in the way of heat sinking than their larger linear counterparts.

Efficiency, size and weight

All other things being equal, then, linear power supplies have lower efficiencies. The usual efficiency for a good linear under nominal operating conditions is about 50%, and even the best of the new high-efficiency linears achieve only 53% to 56%.

Switchers, on the other hand, typically have 75%

efficiencies, with some claims as high as 85%. To provide an output of 100 watts, a 133-w input is required of a switcher, while 200 w, at least, would be needed for a linear. The linear supply's efficiency is also highly dependent on the input line voltage, unlike the efficiency of the switcher, which is considered a theoretically lossless pulse-width-modulated device. As such, it acts as a dc-to-dc transformer that keeps output power constant by compensating for an increase in input voltage by a decrease in input current.

Another consideration is power loss density, or the power dissipation of a given group of components expressed in terms of their volume. For similar types of equipment, the maximum power loss density is determined by the temperature rating of the components used, the ambient temperature, and the method of heat extraction used (convection or forced cooling). Theoretically, this means that a switcher producing 100 w of output power with an internal loss of 33 w can be one third the size of a linear power supply that has an

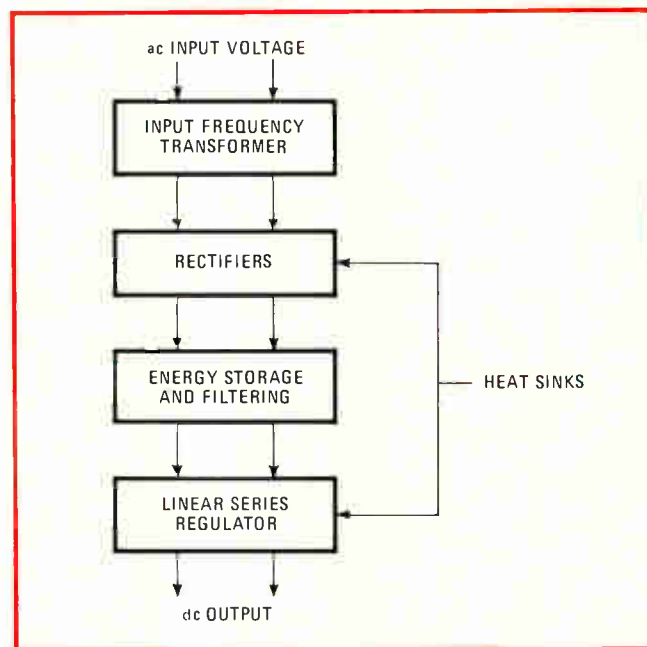

1. **Conventional.** Sizeable linear power supply consists for the most part of large input transformer, bulky electrolytic capacitors, and large heat sinks for the rectifiers and regulator.

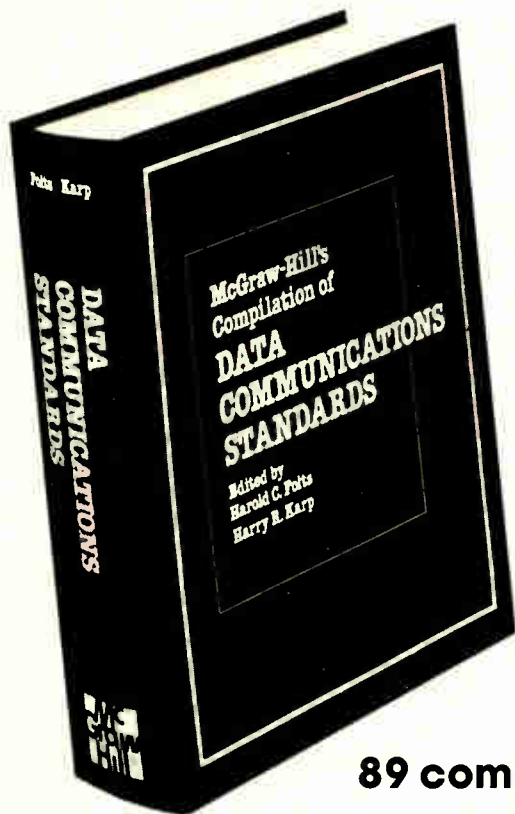

Instant American Data Comm

Edited by HAROLD C. FOLTS, data communications standards consultant; and HARRY R. KARP, Editor-in-Chief, *Data Communications*, McGraw-Hill Publications Company. 1133 pages.

89 complete and unabridged standards

Consultative Committee for International Telephone and Telegraph 43 standards, including ...

- V.2 Power levels for data transmission over telephone lines
- V.15 Use of acoustic coupling for data transmission
- V.54 Loop test devices for modems (and provisional amendments, May 1977)
- X.25 Interface for terminals operating in the packet mode on public data networks
- X.28 Interface for a start/stop mode on a public data network situated in the same country
- X.29 Procedures for exchange of control information and user data between a packet mode DTE and a packet assembly/disassembly facility (PAD)
- X.95 Network parameters in public data networks

Electronic Industries Association 13 standards, including ...

- RS-232C Interface between data terminal equipment and data communication equipment employing serial binary data interchange
- RS-269B Synchronous signaling rates for data transmission
- RS-363 Standards for specifying signal quality for transmitting and receiving data processing terminal equipments using serial data transmission at the interface with non-synchronous data communication equipment
- RS-449 General purpose 37-position and 9-position interface for data terminal equipment and data circuit-terminating equipment employing serial-binary data interchange

International Organization for Standardization 11 standards, including ...

- ISO 646-1973 7-bit coded character set for information processing interchange
- ISO 1745-1975 Information processing—basic mode control procedures for data communications systems
- ISO 3309-1976 Data communication—high-level data link control procedures—frame structure

American National Standards Institute 11 standards, including ...

- X3.4 Code of information interchange
- X3.24 Signal quality at interface between data processing technical equipment for synchronous data transmission
- X3.36 Synchronous high-speed data signaling rates between data terminal equipment and data communications equipment
- X3.44 Determination of performance of data communication systems

Federal Standards 11 standards, including ...

- FED-STD-1003 Bit oriented data link control procedures
- FED-STD-1010 ASCII bit sequencing for serial-by-bit transmission
- FED-STD-1011 Character structure for serial-by-bit ASCII transmission
- FED-STD-1012 Character structure for parallel-by-bit ASCII transmission

access to all and International unications Standards

Data communications standards are undeniably necessary and helpful. But ... the proliferation of standards by the many committees and groups has left the data communications equipment user and designer searching through numerous publications to find the applicable standards for each job.

Now: that time- and effort-wasting trial is over.

With the publication of this landmark resource, you can quickly and accurately determine exactly which standards apply to the project at hand, and speedily integrate those standards into your own network requirements.

Presents all relevant data communications standards promulgated by:

- Consultative Committee for International Telephone and Telegraph (CCITT)
- International Organization for Standardization (ISO)
- American National Standards Institute (ANSI)
- Electronic Industries Association (EIA)
- Federal Telecommunications Standards Committee (FTSC)

Need to know the latest standards for...

- data transmission over public data networks?
- computers and information processing systems?
- peripheral equipment?
- signal quality and analog and digital interfaces?

It's all here, and more, complete with introductory descriptions of the groups that promulgate the standards ... and relational charts of similar interfacing standards produced by different groups.

Design Engineers Find the technical specs you need instantly.

Planning Engineers Determine which standards apply to a vast range of networks and components.

Operations Managers Learn whether the equipment you're buying will operate at all applicable standards.

Return coupon to:
Data Communications Standards
P.O. Box 669
Hightstown, New Jersey 08520

Send me _____ copy (copies) of **DATA COMMUNICATIONS STANDARDS** (099782-9) on a 10-day money-back guarantee. I understand that if I am not absolutely satisfied, I may return the book(s) within ten days at no further obligation. Otherwise, McGraw-Hill will bill me \$165. for each copy, plus applicable sales tax, shipping and handling charges.

SAVE MONEY! Enclose payment in full, plus local sales tax, and McGraw-Hill pays all regular shipping and handling charges. Ten-day money-back guarantee still applies.

_____ Check enclosed _____ Bill me _____ Bill my company _____ Company purchase order #

This offer subject to acceptance by McGraw-Hill

Order today using this coupon!



Name _____
Title _____
Company _____
Address _____
City _____ State _____ Zip _____

Introducing aCT 1

(avionic computer terminal)



Now for the first time you can quickly test computers "on-line" with Conic's portable Avionics Computer Terminal. (We call it act 1).

It can inspect, modify and correlate computer and computer controlled systems operation *in real time* by combining the capabilities of hardware and software development systems, a production tester, and system support equipment in one single instrument. Use it for unattended automatic testing.

Conic puts a dramatic advance in avionic computer testing on the line with you.

act 1 gives you:

- Three hardware breakpoints which may be logically linked or used independently
 - Up to 65K of external memory which can substitute for and/or extend the Target Computer (TC) memory
 - Independent mapping of four TC memory zones
 - Two 1K, 16 bit stacks for the memory address bus and the memory data bus. A 1K, 8 bit stack is available to monitor external signals
 - The ability to disassemble any section of the TC memory. Program execution may be monitored and displayed on the CRT or the optional line printer
- Simplified commands which may be entered via the internal keyboard, keypad or cassette tape recorder or the external paper tape punch

To get the whole story of act 1, call or write Bill Strauser at Conic Data Systems, 9020 Balboa Avenue, San Diego, CA 92123. Phone (714) 279-0411.

CONIC DATA SYSTEMS

↓ A subsidiary of Loral Corporation

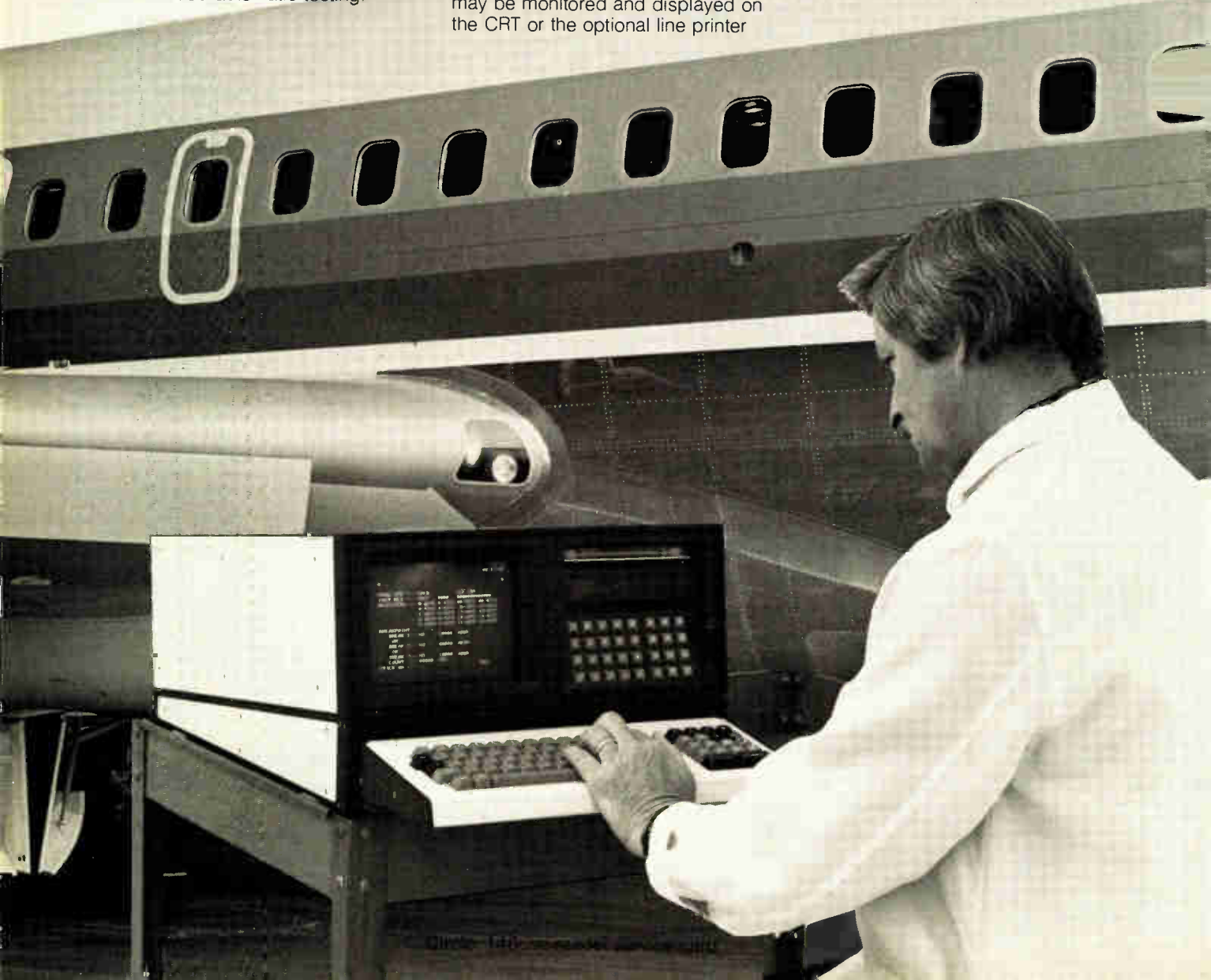

the count-up interval must be greater than that encountered during the count-down time.

If the period between A_1 's toggling times, and thus the measuring cycle $t = (T_1 + T_2)$, are small, then the derivative of the input wave, $f'(t)$, may be assumed to be constant over the measuring cycle, and $f'(t) = K$. Therefore the change in the average frequency with respect to time t is:

$$\frac{f_u - f_d}{t} \rightarrow f'(t) = K \quad (2)$$

Substituting for $f_u - f_d$ in Eq. 1 yields:

$$R = K T_1 t \quad (3)$$

where R now represents acceleration and T_1 and t are known constants.

If the change in $f(t)$ is negative (deceleration), the

number of pulses received during the first (down) counting interval will be greater than that received during the next (up) counting time. Hence, neither a carry nor a borrow pulse will appear at A_2 , and A_5 is not triggered. Therefore G_4 is disabled, G_5 is enabled, and A_3 is triggered at the end of every other T_1 period.

The end result of this operation is that A_2 first counts up during the initial T_1 period and down for the second T_1 period, at the end of which time the Q output of A_1 moves low and the next measuring cycle starts. Thus the latched output of A_2 is still given by Eq. 3, where K now represents the rate of decrease of $f(t)$. The state of the retriggered A_5 indicates whether $f(t)$ is accelerating or decelerating ($Q = 1$ or $Q = 0$, respectively). \square

Engineer's notebook is a regular feature in *Electronics*. We invite readers to submit original design shortcuts, calculation aids, measurement and test techniques, and other ideas for saving engineering time or cost. We'll pay \$50 for each item published.

Calculator notes

HP-25 finds thyristor's conduction angle, output power

by William D. Kraengel Jr.
Valley Stream, N. Y.

Thyristors have enjoyed increased popularity ever since optocoupler and microprocessor drivers have made them convenient to use in such applications as traffic-light controllers and microwave ovens. A thyristor's most important parameter is generally considered to be its conduction angle for a specified power output, and these HP-25 programs aid in the design of power systems using thyristor controllers by finding the set angle required for proper circuit operation, or alternatively, the output power for a specified conduction angle. Either the average or root-mean-square values of current or voltage may be determined directly for thyristors operated in either the half-wave or full-wave modes.

Unfortunately, the conduction angle cannot be uniquely determined, but rather must be found using an iterative approach. The first program can solve two iterative equations that hold true for all thyristors operating in the half-wave case:

$$\Theta_c = 360^\circ \left[\frac{\sin 2\Theta_c}{4\pi} + \left(\frac{X_{rms}}{X_L} \right)^2 \right]$$

or:

$$\Theta_c = 360^\circ \left(\frac{\sin 2\Theta_c}{4\pi} + \frac{P}{P_L} \right)$$

where:

Θ = the half-cycle conduction angle (that is, the number of electrical degrees during which the thyristor is in conduction for each half cycle of the applied ac input voltage)

X_{rms} = load voltage or thyristor current

X_L = rms line voltage or current (full conduction)

P = power dissipated by the load

P_L = power dissipated by the load at full conduction. The 360° in both equations becomes 180° for the full-wave case, and 4π becomes 2π .

The second program solves the inverse equations for voltage, current, and power when Θ_c is known:

$$X_{av} = \frac{(1 - \cos \Theta_c) X_L}{\pi 2^{1/2}}$$

$$X_{rms} = \left(\frac{\Theta_c}{180} - \frac{\sin 2\Theta_c}{2\pi} \right)^{1/2} \frac{X_L}{2^{1/2}}$$

where X_{rms} and X_L are as defined previously and X_{av} is the average voltage across a load or the average current through the thyristor when operating in the half-wave mode. These equations are also useful under full-wave conditions, where X_{av} is twice that of the half-wave case, and X_{rms} is $2^{1/2}$ times its former value. For the case where both E_{rms} and I_{rms} are known, the program also solves $P = E_{rms} I_{rms}$, which holds true for both the half- and full-wave conditions.

Because the first program solves for Θ_c using the iterative approach, an initial guess for Θ_c must be stored in one of the available registers. Unless the value can be predicted approximately, 90° is a reasonable choice. A step size for the program iteration must also be specified. Its value should be kept small—say about 10^{-5} —so that the program can converge toward a solution. The final value of Θ_c will be displayed in the same register in which the initial value was stored.

For initial guesses far from the actual value of Θ_c , convergence is slow and the program may take several minutes to run. A good guess will enable the program to converge on Θ_c in 20 to 25 seconds, or less if the initial guess is very good.

The second program displays 1.41 after performing the calculation for the various parameters. This number has no significance, but is rather a byproduct of the program's calculations. Additional register arithmetic is performed in accordance with the program instructions to unite the appropriate factors in order to display the desired parameter. Θ_c , E_L , and I_L are overwritten while the program is run and consequently must be stored

again before each new run.

A numerical example illustrates the programming procedure. Two systems, one using a triac controller, the other a silicon controlled rectifier, require 450 watts of energy from a heater circuit that normally draws 10 amperes from a 120-volt line. What must the conduction angles be for the triac operating in a full-wave mode, and for the SCR operating in a half-wave mode? What are E_{rms} across the heater and I_{rms} through the heater for both? What is the average current (needed to determine the power the heat sink for the thyristors must be capable of dissipating)?

Using the first program and placing power function 450, 120, 10 in R_0 , 90 in R_1 , and 10^{-5} in R_2 as instructed yields a θ_c of 113.83° for the SCR and 78.60° for the triac. Note the total conduction angle for the triac is $2(78.60^\circ) = 157.20^\circ$. Placing the value of 113.83 into the second program with the line voltage and current previously specified yields $V_{rms} = 73.49$ across the heater, $I_{rms} = 6.12$ and $I_{av} = 3.16$. Recalling the contents of R_4 yields $P = 450.02$ w. Repeating the process using $\theta_c = 78.60^\circ$ and the instructions peculiar to the triac operating in the full-wave mode yields $V_{rms} = 73.48$, $I_{rms} = 6.12$, and $P = 449.49$ when the contents of R_5 are recalled. □

HP-25 THYRISTOR PROGRAMS

Program 1: θ_c for specified output			Program 2: E, I, P, for specified θ_c	
Line	Code	Key	Code	Key
01	00	0	01	1
02	23 07	STO 7	24 05	RCL 5
03	24 01	RCL 1	14 05	f cos
04	13 15	GTO 15	41	-
05	21	$x \leftrightarrow y$	15 73	$g \pi$
06	23 06	STO 6	02	2
07	01	1	61	X
08	23 07	STO 7	71	\div
09	24 01	RCL 1	23 00	STO 0
10	24 01	RCL 1	02	2
11	24 02	RCL 2	61	X
12	61	X	23 01	STO 1
13	23 05	STO 5	24 05	RCL 5
14	51	+	01	1
15	31	\uparrow	08	8
16	31	\uparrow	00	0
17	02	2	71	\div
18	61	X	24 05	RCL 5
19	14 04	f sin	02	2
20	15 73	$g \pi$	61	X
21	04	4	14 04	f sin
22	61	X	15 73	$g \pi$
23	71	\div	02	2
24	24 00	RCL 0	61	X
25	51	+	71	\div
26	03	3	41	-
27	06	6	14 02	$f \sqrt{\quad}$
28	00	0	02	2
29	61	X	71	\div
30	41	-	23 02	STO 2
31	15 71	$g x=0$	02	2
32	13 49	GTO 49	14 02	$f \sqrt{\quad}$
33	24 07	RCL 7	61	X
34	15 71	$g x=0$	23 03	STO 3
35	13 05	GTO 05	15 02	$g x^2$
36	21	$x \leftrightarrow y$	24 06	RCL 6
37	24 06	RCL 6	61	X
38	71	\div	24 07	RCL 7
39	01	1	61	X
40	41	-	23 04	STO 4
41	15 22	$g 1/x$	02	2
42	24 05	RCL 5	61	X
43	61	X	23 05	STO 5
44	23 41 01	STO-1	02	2
45	15 03	$g ABS$	14 02	$f \sqrt{\quad}$
46	24 02	RCL 2	23 61 06	STO x 6
47	14 41	$f x < y$	23 61 07	STO x 7
48	13 01	GTO 01	13 00	GTO 00
49	24 01	RCL 1		

Instructions for program 1
<ul style="list-style-type: none"> Key in program and enter RUN mode Specify equation's step size (tolerance) (δ), STO 2 For half-wave case, store power function or voltage/current function (P), \uparrow, (E_L), \div, (I_L), \div, STO 0 OR (X_{rms}), \uparrow, (X_L), \div $2 f \sqrt{\quad} \div g x^2$ STO 0 For full-wave case, store power function or voltage/current function (P), \uparrow, $2 \div (E_L)$, \div (I_L), \div STO 0 OR (X_{rms}), \uparrow, (X_L), \div $2 f \sqrt{\quad} \div g x^2$ STO 0 Estimate conduction angle (θ_{ci}), STO 1 Calculate half-cycle conduction angle f PRGM R/S

Instructions for program 2
<ul style="list-style-type: none"> Key in program and enter RUN mode Specify half-cycle conduction angle (θ_c), STO 5 Store line voltage and current (E_L), STO 6, (I_L), STO 7 Initiate calculation f PRGM R/S 1.41 is displayed after calculation is completed Press RCL 4 or RCL 5 to find power dissipated by load under half-wave or full-wave conditions, respectively To display half-wave or full-wave value of E_{av} or E_{rms}, call out register containing that function, multiply by R_6 To display half-wave or full-wave value of I_{av} or I_{rms}, call out register containing that function, multiply by R_7 Peak value of voltage or current (E_{peak}, I_{peak}) for the given conduction angle may be found by multiplying register 6 or 7, respectively, by $\sin \theta_c$

Registers for program 1	
R_0	f (P), f (E), and f (I)
R_1	θ_c (init) \rightarrow θ_c (final)
R_2	δ
$R_6 - R_7$	in use

Registers for program 2	
R_0	f (E_{av}), f (I_{av}) : half-wave
R_1	f (E_{av}), f (I_{av}) : full-wave
R_2	f (E_{rms}), f (I_{rms}) : half-wave
R_3	f (E_{rms}), f (I_{rms}) : full-wave
R_4	P : half-wave
R_5	$\theta_c \rightarrow P$: full-wave
R_6	E_L
R_7	I_L

Electron-beam welding cuts connector production costs

Precious metals and base metals with widely different melting points have been hard to weld together in strips long enough for the economical production of connector contacts. But electron-beam welding can join metals that till now could never be welded together except under tightly controlled laboratory conditions.

Technical Materials Inc. of Lincoln, R. I., has developed such a welding process and refers to the product as Dual Metal Strip. Production of connector contacts is already benefiting at such places as Honeywell Inc.'s Micro Switch division in Freeport, Ill., where **a change from hand-welded contacts to the electron-beam-welded type has so far saved \$164,000 in production time and material costs.** The possible metal combinations are many—copper, nickel alloys, steels, and all precious metals all can be paired. Moreover, the process can join metals of different tempers.

Improving phototransistor pulse response

Murdock Taylor of Exide Power Systems division, ESB Inc., Raleigh, N. C., points out that the pulse response of a phototransistor can be greatly improved with much less circuitry than in Peter Kindlmann's combined transistor array and capacitor arranged in a bootstrap feedback configuration [*Electronics*, Aug. 17, p. 105]. Taylor says that a standard cascode configuration, in which a Litronix IL-CT6 optoisolator is coupled to the emitter of a 2N2222A transistor having a 1-k Ω load resistor, **should result in rise and fall times of less than 0.5 μ s.** (By itself with a 100- Ω load, the phototransistor of the IL-CT6 has typical rise and fall times of 5.0 and 25 μ s, respectively.) Naturally, rise and fall times of the circuit could be improved beyond 0.5 μ s by decreasing the 1-k Ω load resistor.

Why test at the bare-board level?

Is the yield from your functional pc-board tester too low? Then a new Teradyne booklet called some "Hows and Whys of Testing Bare Boards" could cut your functional test time. The publication relates testing to the rest of the manufacturing process, emphasizing **the reduced start-up times and rapid rise to high yield possible with automatic bare-board test equipment.** Free copies of the booklet are available from the Publications Department, Teradyne Inc., 183 Essex St., Boston, Mass. 02111.

Battery storage continued

Al Schamel, a design engineer at Tektronix, wants to amplify Kenneth Kerwin's item on this page on July 20, "Simple switch saves battery during storage." He notes that although it is true that the battery-level meter in the Tektronix 1107 nickel-cadmium battery supply is connected across the battery output, it is not the only cause of battery discharge. The level of current drawn by the meter circuit from the battery is very low in relation to the ampere-hour rating of the battery, and in fact, even if the meter circuit is disconnected, the self-discharge characteristics of the nickel-cadmium cell will discharge the battery.

Schamel points out that the 1106 operator's manual contains information on the battery's maintenance and extended storage, including a method of removing the load from the meter circuit without modifying the instrument.

Jerry Lyman

The Birth of a Notion.

Robert H. F. Lloyd
President
CONVER Corporation
RCA Solid State Division,
'57-60, R&D and
Mfg.-Mgmt.
IBM, '60-68,
Product Development
Mgmt.
ADVANCED MEMORY
SYSTEMS (now
INTERSIL) '68-71,
Founder and President
NATIONAL SEMI-
CONDUCTOR, '75-77
Group Director,
MOS/LSI

Unlike the rest of the electronics industry, the power supply business hasn't changed much in the past decade.

There have been few significant advances in technology, scant improvement in reliability, and little, if any, real reduction in costs.

It's time someone applied high technology to power supplies.

It's time someone applied the quality standards of the data processing industry to make power supplies more reliable.

That's why we've started CONVER. Because it's time someone started meeting your needs. We're going to. Starting with this, our first product:

The industry's first 27-watt power switcher-competitively priced with linear supplies.

The CONVER 2000 Series "Silent Switcher" 27 watts, 4 outputs. 5V-4A, $\pm 12V-0.3A$, $-X-0.2A$ with other voltages and single 5V output versions available. Negligible conducted and radiated noise. A lower component count, for higher reliability, UL-recognized. Changeable from 115 to 230V. Interchangeable with higher-wattage switcher Type OL50. Guaranteed longer than any other switcher available. Price 1-9 pcs. \$80.00. 1000 pcs. \$50.00 ea. And available right now.

Just contact us at 10631 Bandle Drive, Cupertino, CA 95014.
Phone (408) 255-0151.

We're going to change the way you think about power supply suppliers.

CONVER



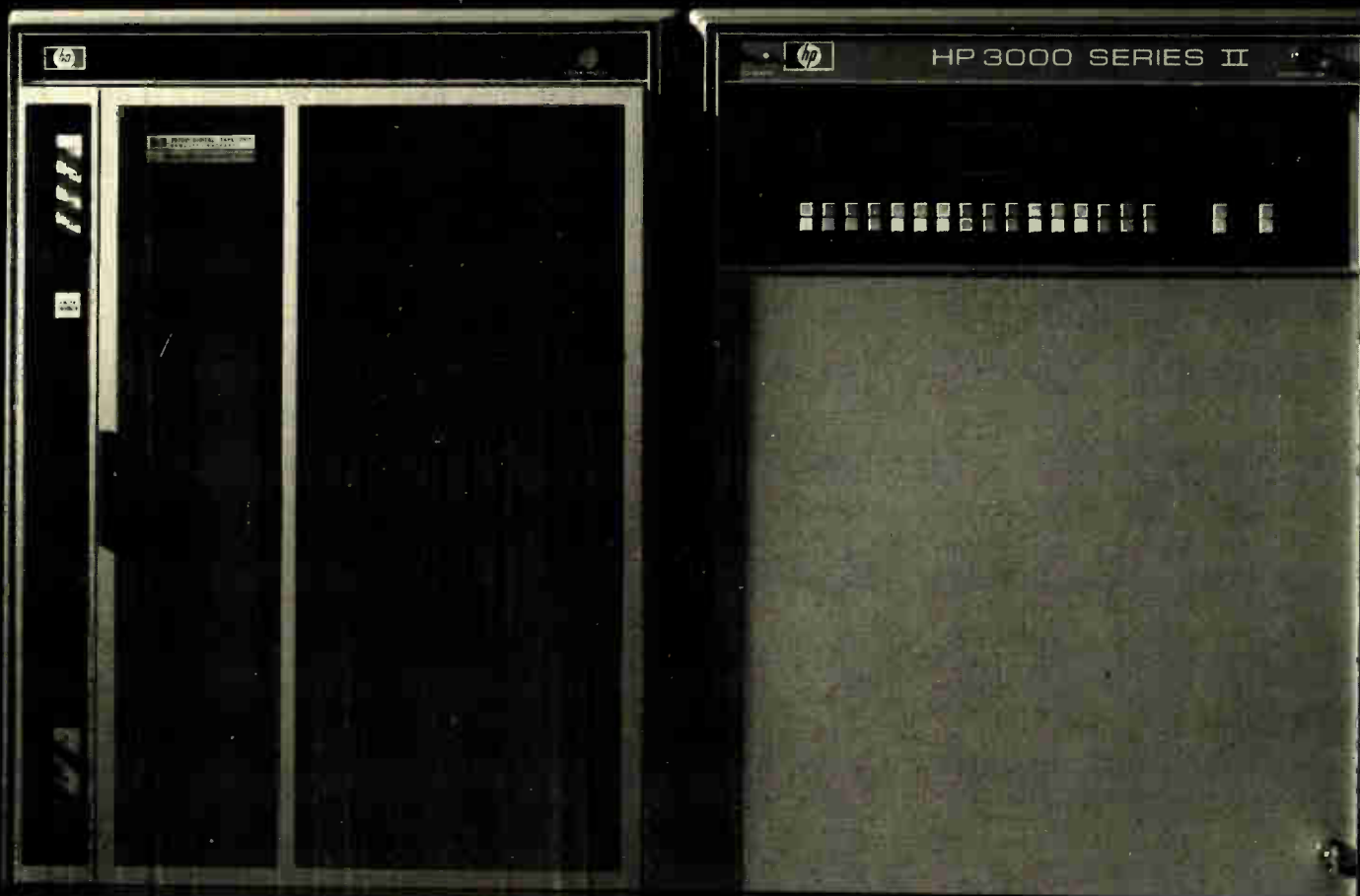

WHEN HEWLETT-PACKARD WANTED TO PROTECT THEIR MEMORIES, THEY REMEMBERED US.

When a computer loses power, its volatile memory goes blank. Plain, simple, and costly.

It doesn't have to happen.

Because Gates Energy cells and batteries provide dependable standby power. They furnish the energy when the local power company can't.

That's why more and more major computer manufacturers are making Gates an integral part of their products.

Our energy cells have outstanding capability for float



charging. So, they're always at peak power for emergency situations.

And, for portable instrumentation, Gates Energy cells offer safe, reliable sealed lead-acid construction and extended discharge service.

Learn more about Gates Energy. Send for our comprehensive information packet full of design data, spec sheets and application notes. Circle our Reader Service Number, or write us directly.

Gates Energy Products, Inc., 1050 South Broadway, Denver, CO 80217. Phone (303) 744-4806.

GATES ENERGY

High flexibility

Pragmatic. Asthetic.



From hard use lab assignments to easy going office jobs — the flexibility of Cramer Hi-Model is unlimited.

Cramer offers the options on a complete line of Hi-Models. Choose footings, posture backs, casters. All Hi-Models are available in a vast selection of decorative fabrics. Frames and legs in mirror, or brushed chrome. We offer Auto-Lift for immediate height changes — Posi-Lok for less frequent height adjustments.

Whatever the job type or individual need — Cramer is high in design and practicality.

CRAMER

C CRAMER INDUSTRIES INC.

625 Adams Street, Kansas City, KS 66105
Phone: 913/621-6700
Toll Free: 800/255-4096

Showrooms in spaces 982 to 985 Chicago Merchandise Mart
Kansas City, Los Angeles

Circle 153 on reader service card

MOTOROLA KEEPS THE BAD GUYS

A police officer, crouching in the darkness outside a tenement, speaks into his portable radio...

"This is 2L7. I'm covering the front door..."

"Right, 2L7," comes the answer.

"This is 2L14.

I've got the rear

covered and

sent a man up onto the roof..."

The police are converging on a sniper, and thanks to two-way radio, every officer knows where every man is located.

Unfortunately, so does the sniper. He found out simply by tuning in police radio channels.

In the same way, a fugitive might learn where all the police roadblocks are located, and escape. Or a narcotics smuggler might learn that federal agents are waiting for him, and simply take his lethal cargo by an alternate route.

ELECTRONIC PRIVACY AT WILL.

It became apparent that a private medium of communication would help the police do their job better, and Motorola applied its talents to solving this problem of electronic eavesdroppers.

We came up with a Digital

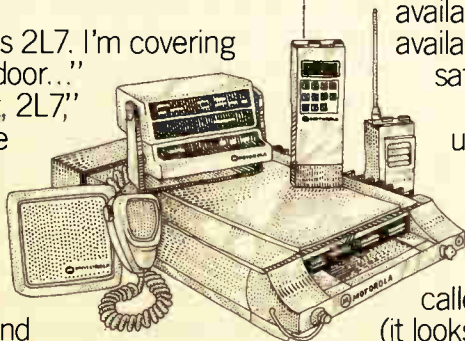

Voice Protection (DVP) system that gives the highest level of voice security commercially available, a system that's available only to public safety agencies.

A police officer uses Motorola DVP by touching the buttons on a microprocessor-controlled device called a Code Inserter (it looks like a hefty pocket calculator) and plugging the Code Inserter into his field radio. This transfers the code to Motorola radios equipped for DVP reception.

Each radio contains two integrated circuits. One of them converts regular speech

into digital speech. The other scrambles that signal through what engineers call a multi-register non-linear combiner algorithm.

MICROPROCESSOR HANDLES TWO SEXTILLION CODES.

Any voice message passing through this formidable process sounds to an eavesdropper like impenetrable static—but, of course, the police, with compatible DVP equipment, can hear each other clearly.

Motorola's DVP system has an astonishing capacity for keeping a secret. It can scramble voice communication



FROM TUNING IN THE GOOD GUYS.

through more than two sextillion (that's a two with 21 zeroes) different codes.

If the DVP function isn't being used, voice messages come through loud and clear on standard two-way radios.

Esoteric as it sounds, this system is being used right now by the police in one of our major cities. Its performance there suggests that it may soon be working for public safety agencies all over the country.

IMAGINATIVE ELECTRONICS.

The microprocessor technology that makes Motorola's DVP system work is at the heart of

many of the things Motorola makes today. For we're not only one of the world's largest manufacturers dedicated exclusively to electronics, but also one of its foremost designers of custom and standard semiconductors.

We've come a long way from the time when we put radios into cars fifty years ago, and put TV sets into America's living rooms. Now we make hundreds of models of two-way radios, and although we no longer make home TV sets



A microcomputer, drawn larger than life.

here at all, we do make some of the most advanced and durable TV cameras and monitors for industrial security systems.

We make microelectronics technology do a lot of other things, too. Like carrying telephone service to places where there are no phone lines. Transmitting electrocardiograms and voice messages simultaneously from the scene of an accident to a nearby hospital. Helping busy people stay in touch while they're on the go with pocket-sized pagers.

And, of course, keeping the bad guys from tuning in the good guys.



MOTOROLA

Making electronics history since 1928.

Circle 155 on reader service card

For further information, write Public Affairs Office, Corporate Offices, Motorola, Inc., 1303 E. Algonquin Road, Schaumburg, Illinois 60196.

Motorola and  are registered trademarks of Motorola, Inc.



Get to your
state flow and

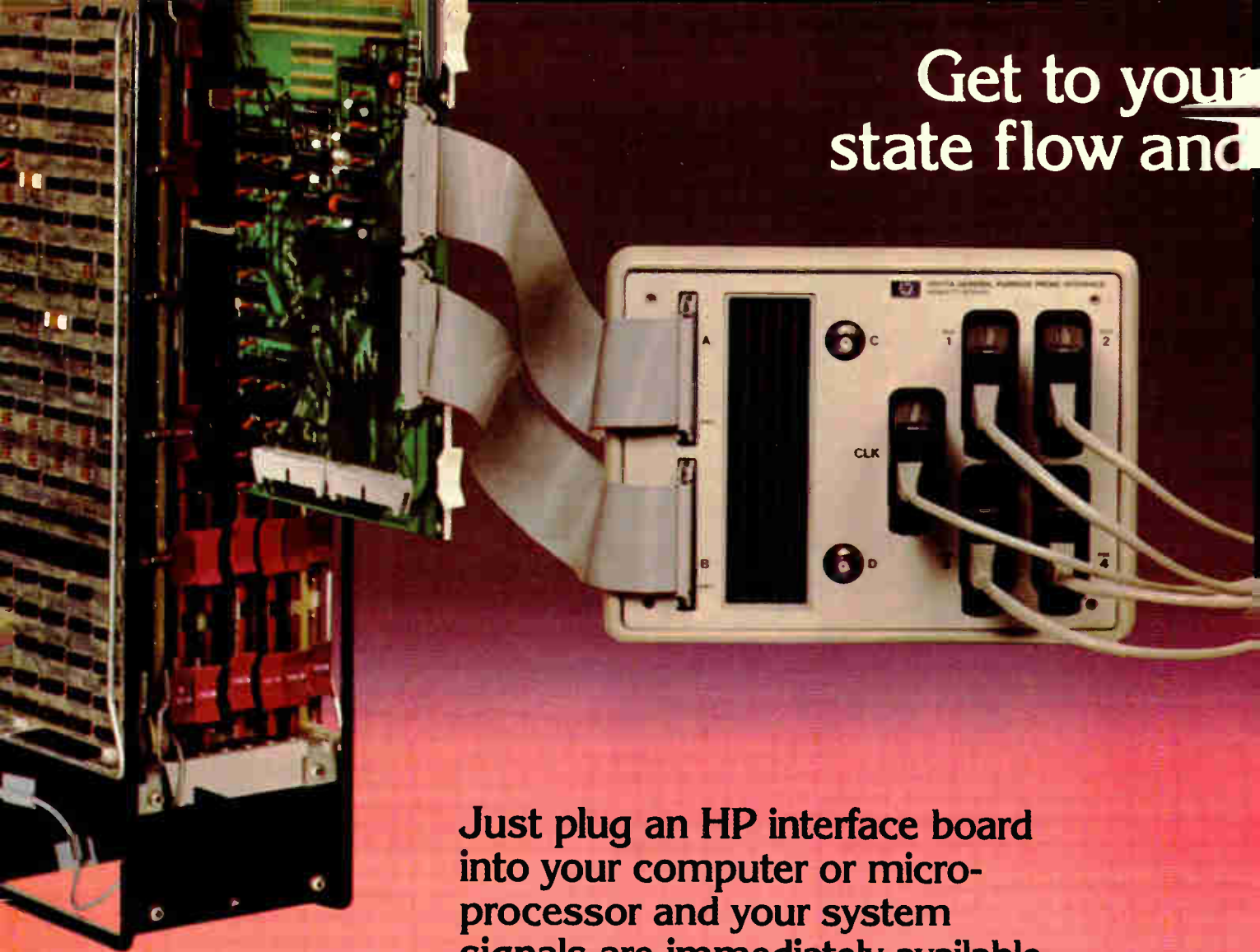

Just plug an HP interface board into your computer or microprocessor and your system signals are immediately available for detailed analysis.

Now, it's easy to get a clear picture of system activity in your minicomputer or microprocessor with HP's 1610A Logic State Analyzer and one of HP's interface boards. Just plug into the system . . . use a simplified menu concept for quick set-ups . . . and with a few simple keyboard entries, you'll have an easy-to-interpret display of your state flow including address, data and control line activity, or the time interval between specific bus-arbitration steps.

Whether you're designing or maintaining a minicomputer or microprocessor-based system, here's a powerful combination that lets you quickly solve state flow problems and analyze handshake operations. Now, you can easily evaluate and optimize your programming, lowering testing and troubleshooting costs.

Find out how this versatile combination of HP's 1610A (priced at \$9500*), minicomputer interface boards (\$300*) and the 10277A general purpose interface board (\$400*) can help you get at your system problems quickly. See the listing for available boards dedicated to various minicomputers. For complete details, contact your local HP field engineer today.

* Domestic U.S.A. price only.

minicomputer/microprocessor bus problems quickly.



Easy set-up.

Simple keystrokes let you define sequence requirements for a specific bus-arbitration process. And by selecting the count time, you can measure the elapsed time intervals between all of the specified sequences. Now you can accurately troubleshoot timeout problems or optimize time-dependent code.

Quick analysis of state flow or bus arbitration.

Trace-list menu lets you observe the results of the specified handshake. The time interval adjacent to each event can be either relative (between each event) or absolute (referenced to the trace start). And by defining another trace specification, you can easily monitor program flow in the numerical bases of your choice.

TRACE LIST		TRACE-COMPLETE					
LABEL BASE	A OCT	B BIN	C BIN	D BIN	E BIN	TIME DEC	
SEQUENCE	173862	0	1	0	0	6.8	US
SEQUENCE	173870	0	0	0	1	6.0	US
SEQUENCE	173874	0	0	0	0	1.6	US
SEQUENCE	173876	0	0	0	1	7	US
SEQUENCE	173876	0	0	0	0	17.29	MS
START	173832	1	1	1	1	1	US
+01	173532	0	0	0	0	1	US
+02	173532	0	0	0	0	1	US
+03	000000	0	0	0	0	1	US
+04	000000	0	0	0	0	1	US
+05	000000	0	0	0	0	1	US
+06	000000	0	0	0	0	1	US
+07	000000	0	0	0	0	1	US
+08	177544	0	0	0	0	1	US
+09	177564	0	0	0	0	1	US
+10	177564	0	0	0	0	1	US
+11	177564	0	0	0	0	1	US
+12	177564	0	0	0	0	1	US
+13	177564	0	0	0	0	1	US
+14	17754	0	0	0	0	1	US

- Boards now available include:
- | | |
|---------------------|---------------------------------|
| Model Number | Minicomputer |
| 10275A | DEC PDP/11 (UNIBUS) |
| 10276A | DEC LSI/11 (Q-BUS) |
| 10277A | General purpose probe interface |



1507 Page Mill Road, Palo Alto, California 94304

For assistance call: Washington (301) 948-6370, Chicago (312) 255-9800, Atlanta (404) 955-1500, Los Angeles (213) 877-1282

08815

Circle 157 on reader service card

FORGET HYBRIDS. 12 BIT

12 BITS, 12 BUCKS. OUR NEW AD7541 CMOS M-DAC GIVES YOU EVERYTHING A HYBRID CAN'T.

Our new AD7541 is the world's only true 12-bit-accurate monolithic multiplying DAC. Its low, low price, only \$12 in 1000s, is big news. But more important is the performance of the AD7541. It offers full 4-quadrant multiplication and guaranteed 12-bit linearity (0.012% over temperature).

The AD7541's inputs are TTL and CMOS logic compatible. For the AD7541's current output, settling time is 500 nanoseconds, typically, 1 microsecond maximum. High density CMOS and laser wafer trimming of its onchip thin film resistors are the keys to the AD7541's high performance, low power, low price and small size. In addition, single-chip construction inherently offers vastly improved reliability over multi-chip hybrid designs.

Below: unretouched photo of AD7541 and typical DAC80 with lids removed.

AD7541



THIS.

DAC80

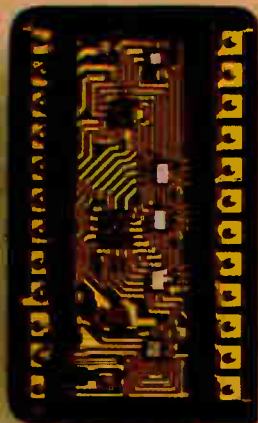

NOT THIS.

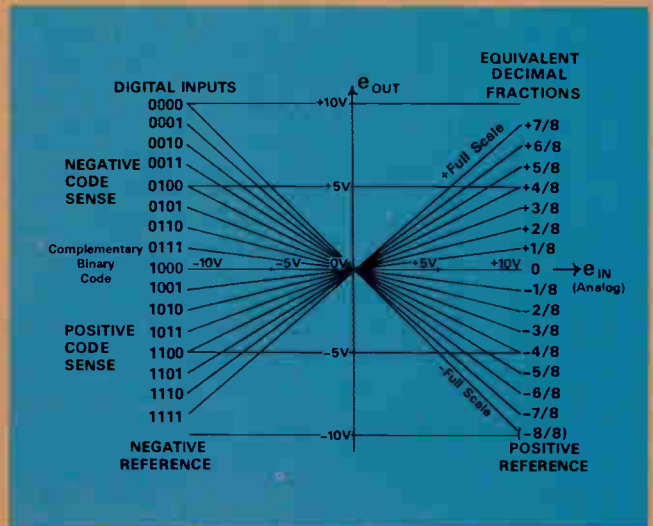

TRUE 4-QUADRANT MULTIPLICATION. UNLIMITED APPLICATIONS.

The 4-quadrant multiplication feature of the AD7541 M-DAC permits it to function with both positive and negative variable references, either AC or DC, without any circuit changes. This opens up a wide range of applications for the AD7541 in digitally controlled gain or attenuator circuits, synchro-to-digital converters and ratio-metric low-power converters, as well as digitally controlled power supplies.

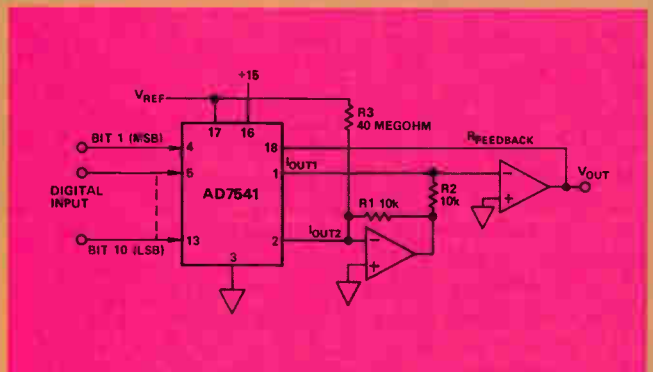

DACS GO MONOLITHIC.

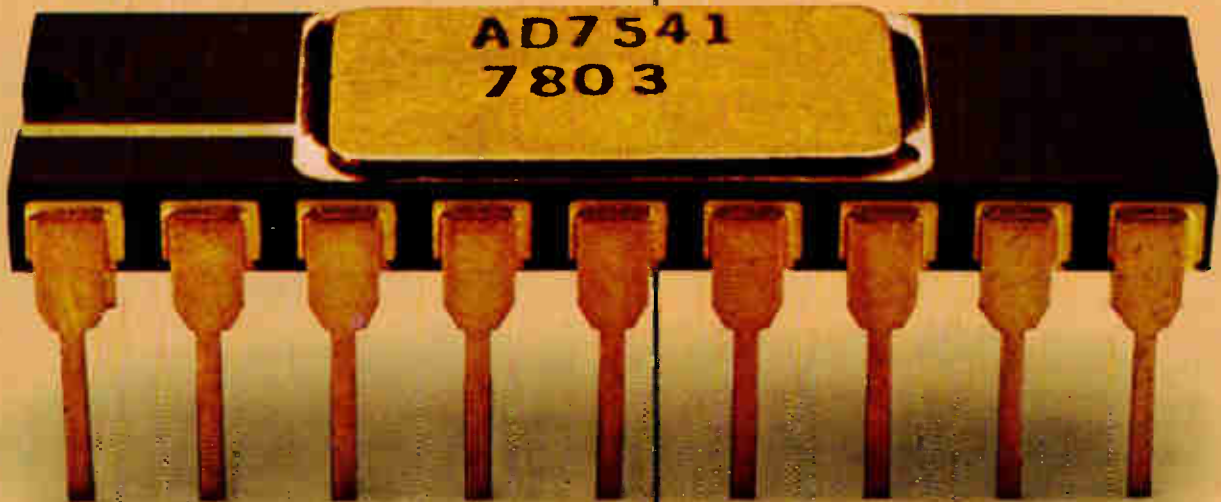

SPEED, ACCURACY AND LOW PRICE.

The new AD7541 CMOS M-DAC is the world's first 12-bit monolithic M-DAC. It's the smallest and least expensive available and provides 12-bit resolution with true 12-bit linearity. And even if you don't take advantage of the multiplying capability, at \$12/1000s it still makes a dandy d/a converter. And it's completely monolithic. For hi-rel applications, the AD7541 is available from stock fully screened to MIL-STD-883A, Class B. For complete specs and information, call Doug Grant at (617) 935-5565. Analog Devices, Inc., P.O. Box 280, Norwood, MA 02062.

\$12



WAY OUT IN FRONT.

You Get Much More When You Rent Test Instruments From GE:

Tremendous Inventory



**Quick·rental[®]
instruments**

Over 15,000 instruments available for rental by the week or month! . . . And more are being added every day. You get the test instruments you need for short-term projects or rush situations from General Electric because we stock in depth. Immediate shipment of the newest and most up-to-date equipment from all of the top manufacturers like HP, Tektronix, Honeywell, Gould Brush, Fluke, and hundreds of others, all calibrated to manufacturers' specs and thoroughly checked out.

General Electric has six stocking inventory centers and over 40 rental sales offices; you

are never more than a phone call away from the instruments you need.

For your FREE RENTAL CATALOG Call Collect (518) 372-9900 or your nearest sales office listed below or write General Electric Company, Apparatus Service Division, Building 4, Room 210, Schenectady, N.Y. 12345.

ALA. BIRMINGHAM (205) 925-9449 • ARIZ. PHOENIX (602) 278-8515 or 8516. TUCSON (602) 294-3139 • CAL. LOS ANGELES (213) 642-5350, SACRAMENTO (916) 383-4986, SAN FRANCISCO (415) 436-9260 • COL. DENVER (303) 320-3255 • CONN. SOUTHWINGTON (203) 621-4059 • FLA. JACKSONVILLE (904) 751-0615, MIAMI (305) 696-0811 • GA. ATLANTA (404) 457-5563 • ILL. CHICAGO (219) 933-4500 or (312) 854-2994 • IND. INDIANAPOLIS (317) 639-1565 • KY. LOUISVILLE (502) 452-3311 • LA. NEW ORLEANS (504) 367-6528 • MO. BALTIMORE (301) 332-4713 • MASS. BOSTON (617) 396-9600 • MICH. DETROIT (313) 285-6700 • MINN. MINNEAPOLIS (612) 522-4396 • MO. KANSAS CITY (816) 231-4377 or (816) 231-4620, ST. LOUIS (314) 965-7115 • NEW JERSEY CLIFTON (201) 471-6556 • N.Y. BUFFALO (716) 876-1200, SCHENECTADY (518) 385-2195 • N.Y.C. CLIFTON, N.J. (201) 471-6556 • N.C. CHARLOTTE (704) 525-0311 • OH. CINCINNATI (513) 874-8512, CLEVELAND (216) 441-6111, TOLEDO (419) 691-3501 • ORE. PORTLAND (503) 221-5101 • PA. PHILADELPHIA (609) 424-4450, PITTSBURGH (412) 462-7400 • S.C. GREENVILLE (803) 277-4093 • TENN. MEMPHIS (901) 527-3709 • TEX. BEAUMONT (713) 842-4514, DALLAS (214) 357-7341, HOUSTON (713) 672-3570 • VA. RICHMOND (804) 232-4576 • WASH. SEATTLE (206) 854-0211 • W.V. CHARLESTON (304) 345-0920 • WISC. MILWAUKEE (414) 744-0110 • PUERTO RICO PONCE (809) 843-4225 or 4625.

GENERAL  ELECTRIC

Big bubble bows

Quarter-million-bit memory is supported by multichip module, controller board, and development system

by Raymond P. Capece, Solid State Editor

Rockwell International Corp.'s quarter-million-bit bubble memory, its first such commercial device, is making a grand entrance amid a crowd of supporting products, including a multichip module, a controller board, and even a bubble-memory development system. And to follow through on its opening act, the company plans a big production number: delivery of small quantities on all items in 90 days.

Clearly, the race is on between Rockwell and Texas Instruments Inc., which announced its upcoming quarter-million-bit bubble memory last month [*Electronics*, Aug. 17, p. 39]. The bubble chips themselves are comparable in performance, similar in structure and appearance, and matched in price—\$500 each in unit quantities.

What, then, is Rockwell's strategy for one-upping the Texans? In the long term, Rockwell is selling reliability—a product that has been proven good enough for data recorders in space. In the short term, the selling point is a systems approach with various support products available now, so that designers can get acquainted with the idiosyncrasies of the device.

"We're giving the designer something he can use right now," explains John Archer, director of bubble memory products in Rockwell's Electronic Devices division in Anaheim, Calif. "The multichip module takes him right to TTL, and the controller board is bus-compatible with our 6500 microprocessors and Motorola's 6800."

The module is a printed-circuit board containing four bubble chips and the necessary linear circuits to

reach the voltage swings of transistor-transistor logic. The 9 $\frac{3}{4}$ -by-6-inch board, called the RLM658, thus has a million-bit capacity and is designed for 8-bit-wide operation with a data rate of 100 kilobytes per second. It is priced singly at \$2,500.

Built on a similar pc board, the RCM650 bubble-memory controller contains all the random logic and discrete components needed to interface the serial bubble operation to a parallel, byte-oriented bus structure. It can handle as many as 64 bubble chips—up to 16 megabits—and has a unit-quantity price of \$1,000.

Probably the most significant sup-

port product is Rockwell's development system. The \$11,400 system has essentially the same hardware as the System/65 that Rockwell offers for its 6500 microprocessor family, with the addition of a pair of million-bit bubble boards and a controller board. In fact, \$6,000 for the three boards is all those who already possess a System/65 need to get into bubbles.

"We've designed our bubble and control modules to plug right into the System/65," explains Archer. "They can even plug into Motorola's Exorciser development system."

The RBM256 bubble-memory

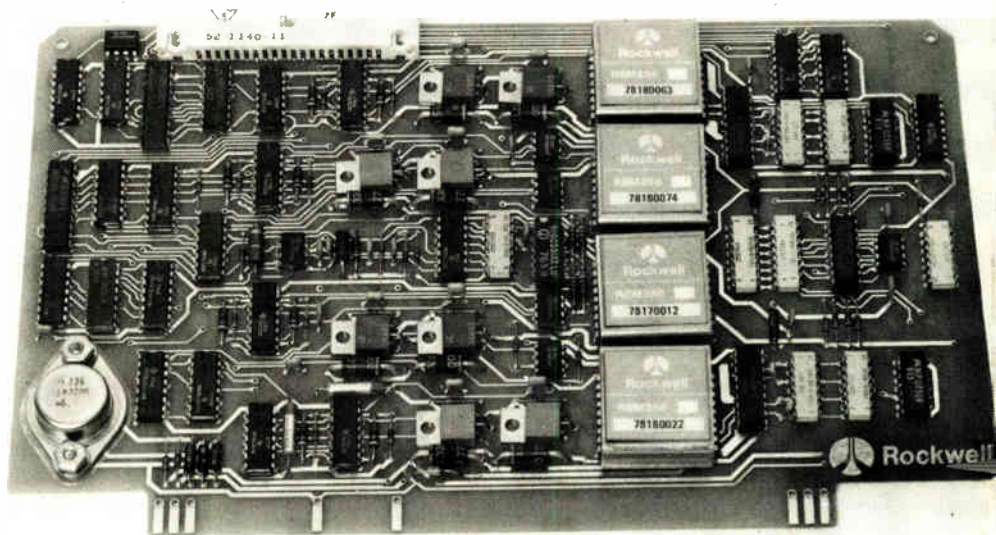

New products

chip itself has few distinct differences from TI's part. The architecture of the two is the same—both use a dual-port block-replicate structure, and both divide the loops into even- and odd-bit halves. Whereas the 18-pin Rockwell device is organized into 1,025-bit loops, TI's loops contain 1,137 bits, or bubble positions. "We wanted to keep it as close as possible to a binary part, which TI's is not," says Archer. The data access in the Rockwell part, he explains, is by 1,024 blocks of 256 bits per block. "We felt that was

extremely important in applications such as fixed-head-disk replacement," he maintains. TI says, however, that new markets, rather than replacement sales, are its chief targets.

Rockwell's chip has 282 loops in all, 260 of which are guaranteed fully functional. Redundancy has been the trend in bubble-memories, and some failed loops are permitted; they are simply masked out and not used, somewhat as bad tracks on a disk memory are avoided.

One striking difference between



Your broadest choice is now even broader.



New value and capability in microwave measurement

HP: MAKING EXPERIENCE COUNT.



02807A



the two bubble chips, however, is that TI has chosen to provide a special loop that is dedicated to the masking out of bad loops, while Rockwell provides no such on-chip masking. It decided instead that mask data should not reside within the device. "For one, because of the circuits required, it's more cost-effective to put the masking data in programmable read-only memory — and since we will supply the PROM, the redundancy is transparent to the user," explains Archer. "More important, we expect that many users

will be pushing the bubble devices to the operating limits, and masking data shouldn't be subject to the same error possibilities as the rest of the chip."

Rockwell is certain that reliability will become a major issue in bubble-memory devices, especially as temperature-range limits are pressed. It is specifying an operating-temperature range of -10° to 70°C for the RBM256 package and guaranteeing full data retention over a range of -50°C to 100°C . According to Archer, Rockwell is working

on extending the operating specification to cover the temperature range from -25°C to 100°C .

The actual die size of the bubble chip is one square centimeter, and the structure is based on a 14-micrometer period with 3- μm bubbles. Archer says that in 1979, Rockwell will introduce a million-bit chip that can be used in parallel with and will be packaged identically to the quarter-million-bit device.

Rockwell International Corp., Electronic Devices Division, P. O. Box 3669, Anaheim, Calif. 92803. Phone (714) 632-3729 [338]

of counters



New unmatched resolution and versatility in time interval measurement.

Two new instruments from Hewlett-Packard give you capabilities you've never had before.

5342A Microwave Counter

Now, a more useful high-performance microwave counter — and for 20% less than you might expect to pay. Microprocessor-controlled. 18 GHz range. Superior FM tolerance. Amplitude discrimination. For the first time, measure input signal level simultaneously with frequency using just one instrument. And via the keyboard, define your frequency or your amplitude offsets to be added to or subtracted from the measurement. \$4500*; add \$1000* for amplitude option.

5370A Universal Time Interval Counter

Now, a new standard of time interval measurement with the highest single

shot resolution of any counter, ± 20 ps. Plus, a keyboard with statistics computation for more complete time interval characterization. And the highest resolution period and frequency measurements of any counter — eleven digits in 1 second all the way up to 100 MHz. All this for \$6500*.

HP—Your Real Choice In Counting.

Fifteen HP counters span a capability range no other manufacturer even approaches. From the usual, simple, low cost "frequency-only" units to the most sophisticated high speed universal counters with performance that is simply unmatched anywhere.

*U.S. Domestic price only.



Call or write today for our new Electronic Counter Brochure, or call your nearest HP office for applications information.

HEWLETT *hp* PACKARD

1507 Page Mill Road, Palo Alto, California 94304

For assistance call: Washington (301) 948-6370, Chicago (312) 255-9800, Atlanta (404) 955-1506, Los Angeles (213) 877-1282.

Circle 160 on reader service card

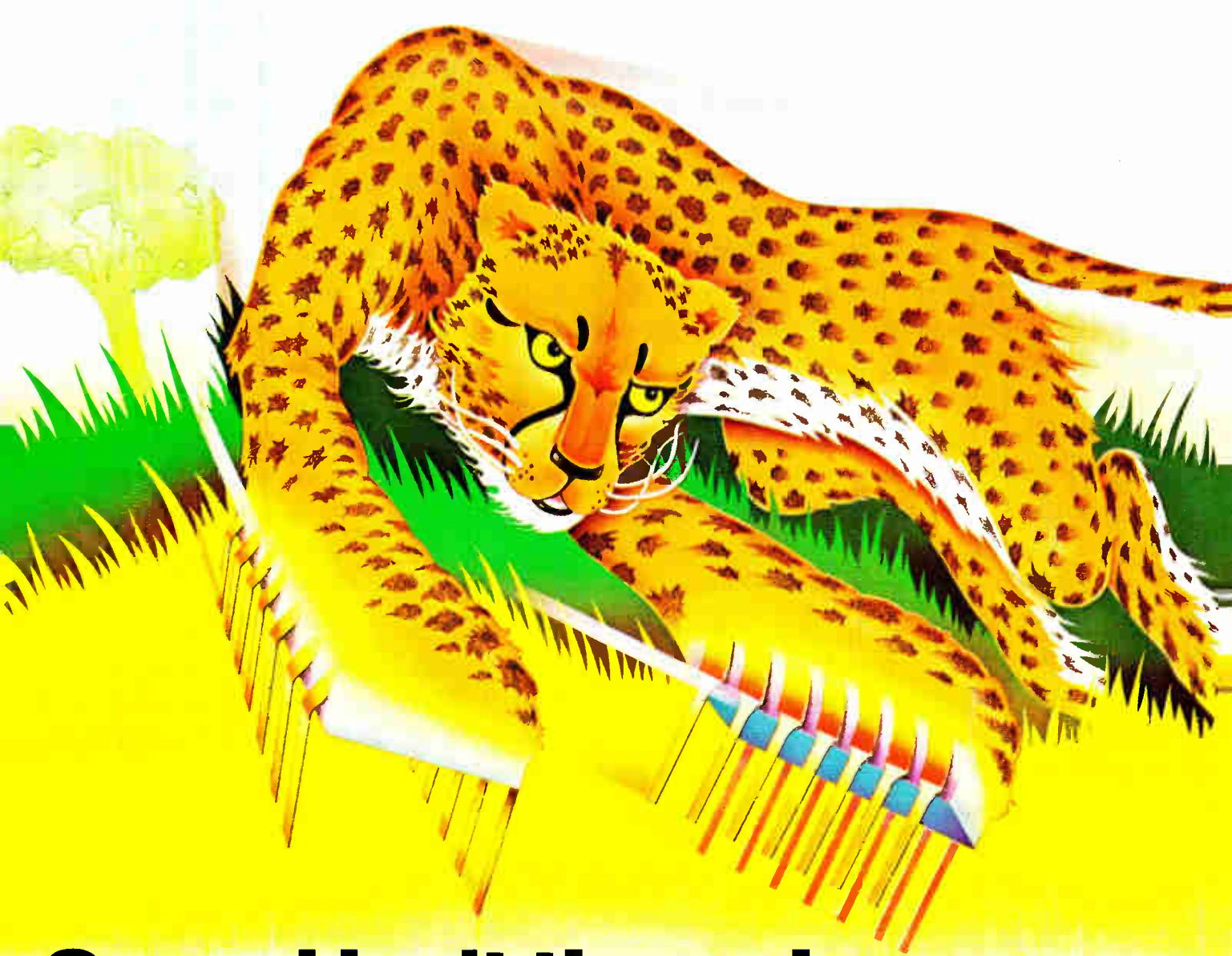

Speed isn't the only reason our LSI testers are moving so fast.

Sure, speed is important when you're testing complex LSI and VLSI devices, but there are a lot of other factors to consider before you spend a hundred, two hundred or three hundred thousand dollars for a semiconductor test system. Things such as: How soon do I recoup my investment? Is the system powerful enough to meet my testing needs as they become more complex? What and how much software support can I expect? How about training, application support, installation and service?

These are all valid questions that you should ask of any test system manufacturer before you

make a decision to buy. We'd like to give you some of Fairchild's answers.

Is the system powerful enough to meet my testing needs as they become more complex?

With the fast moving pace of semiconductor technology, you have to be careful that today's effective tester doesn't become tomorrow's white elephant.[®] This won't happen with Sentry.

Today, Sentry systems will routinely handle microprocessors, peripheral chips, bit slices, phase lock loops, RAMs, ROMs, shift registers, universal asynchronous receiver/transmitters (UARTS) and digital hybrids in technologies

such as NMOS, PMOS, CMOS, SOS, ECL, DTL, TTL and I²L.

And your Sentry system will keep pace with the technical requirements of tomorrow's most complex devices as well. Devices such as high performance, extended function microprocessors, large memory circuits and the most versatile special purpose devices are well within the testing capability of the Sentry.

How soon do I recoup my investment? Testing costs are rising fast. But today, thanks to Sentry's throughput, 196K computer memory and real-time multiprocessing capability, this cost can be reduced, despite the increased complexity of your devices.

Determining the effectiveness of your investment, however, is difficult. It depends upon the device or devices to be tested, the extent of testing (functional, parametric, dynamic, etc.), number of multiplexed stations, system architecture and a host of other factors. With over

2000 test systems installed throughout the world, Fairchild is in a unique position to evaluate your needs. Our application and systems engineers will help you determine the most effective and economical solution to your present and future requirements. Just give us a call.

What and how much software support can I expect? As the undisputed leader in semiconductor testing, Fairchild offers the broadest range of software. It includes problem solving software such as general-purpose utility programs, debugging aids, analysis/characterization programs, FACTOR enhancements and peripheral control routines for delivering management information; Device test programs for virtually every type, class and family of semiconductor; and Systems operating software to control all the internal system functions, housekeeping, test data exchange between peripherals, processors and memory and the self diagnosis routines to verify its own operating integrity. And all Sentry systems feature a high level of source program compatibility to minimize programming costs as you increase or expand your Sentry test facility.

How about training, application support, installation and service? Our products made us number one in the semiconductor test industry. Our service keeps us there. Training centers in the U.S., Europe and Asia have taught over 5000 engineers and technicians the latest in LSI and VLSI testing techniques. Our worldwide application staff will help you develop test programs to suit your requirements so your Fairchild system is productive from the moment it's installed. And our field service group will be close by to keep your system running.

What if I have a dedicated memory testing application? Fairchild's Xincom III can handle your most exacting memory testing requirements: static and dynamic MOS, bipolar and CCD devices. It can be used in production and incoming inspection for qualification testing or in the QA department and engineering labs for complete circuit characterization.

The Xincom III features Fairchild's unique distributed architecture that controls up to eight test satellites, each with two heads. This means that you can do real time foreground testing of up to 16 different devices simultaneously; a capability unmatched by any other memory tester.

And, while this testing is going on in the foreground, you can utilize Xincom III's background capability for program development, data analysis and logging and for printer/CRT interaction.

Here's where speed is really important. The unprecedented demand for Sentry and Xincom systems has us working three shifts already. To assure the 1978 delivery of your system, you'd better hurry. Just mail the coupon today or better still, give us a call. **Fairchild Test Systems Group**, Fairchild Camera and Instrument Corp., 1725 Technology Drive, San Jose, California 95110 (408) 998-0123

Fairchild: First in LSI testing

Please send data on the following: Sentry V VII VIII

Xincom III I'd like to talk with a Fairchild engineer.

My testing needs include: _____

Name _____

Title _____

Company _____

Address _____

City _____ State _____ Zip _____

Area Code _____ Phone _____



FAIRCHILD

Circle 165 on reader service card

Today's demand- product excellence



Whether for the products of the past, the present or the future today's demand is for product excellence.

That is where Piher components score. They are the end result of years of in-house product research and

development, high quality engineering and final manufacture. No licence agreements, no sub-contract work. Piher is in control of every component that bears its name – from start to finish.

Piher has seven manufacturing centres throughout Spain employing over 3,300 people, each one with its own research and development laboratories. As an indication of scale – and customer demand – the company produces over 10 million carbon film resistors every day, making it the third largest in its field.

Whether your need is for active or passive components, contact





your nearest sales office for information on Piher components. The name is today's guarantee of product excellence.

Piher Servicios Centrales S.A.
Riera Cañadó, 1.
Badalona, Barcelona Spain
Telephone (93) 389 03 00 Telex 59521

Piher International Limited
Horton Road, West Drayton
Middlesex, England
Telephone West Drayton 40513
Telex 934167

Piher International Corporation
505 West Golf Road
Arlington Heights, Chicago
Illinois 60005, USA
Telephone (312) 640 8300
Telex 254190

Piher International GmbH
Tuchergartenstr. 4
D - 8500 Nurnberg
West Germany
Telephone (0911) 533051 Telex 623354

Piher International S.A.
21 Rue Paul Fort
F - 75014 Paris
France
Telephone 541 00 08
Telex 270107F

Piher International SpA.
Via Cenisio 34
I - 20154 Milan
Italy
Telephone 314 532 & 316 213
Telex 37488

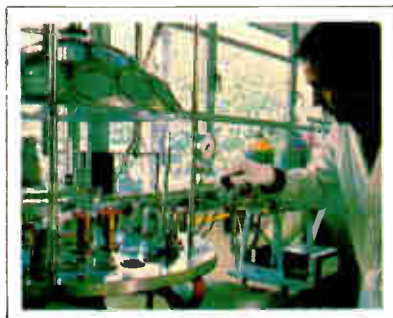

HP's new concept in DMM's gives you more time to be creative.

Free yourself from time-consuming lab-bench measurements with HP's new 3467A Logging Multimeter.

It is a total measurement station, doing jobs that used to require several instruments. The 3467A combines a 4½-digit DMM, four-channel scanner, digital thermometer, math functions, and printer with timer in a single instrument. It simplifies setups and measurements and gives you a record of data in the units you need (°C, dB, etc.) . . . unattended or manually.

Identify "hot spots." The multi-channel 3467A lets you measure temperature changes directly in °C or °F at more than one location. And, with its built-in math functions, printer and timer, you can get a permanent record of temperature changes with respect to time.

Characterize amplifiers and filters directly in dB. The 3467A does the work for you. It combines true RMS measurements to 100 kHz, four inputs, and math functions. The 3467A will give you dB response directly; and print auto-

matically at preset time intervals, or manually when you press the "Print" button.

Analyze temperature dependent parameters. Use the 3467A's mixed function capability to measure temperature on channels 1 and 2 plus voltage or resistance on the remaining two channels. Then, using the math functions, you can get direct printout of such parameters as amplifier gain vs. temperature.

Component selection. Sort resistors to desired tolerance without a precise reference resistor. Simply select the ohms function, enter the reference value as a stored constant and measure your resistors. The 3467A calculates and prints out tolerance values in $\Delta\%$ directly.

Find out how the new HP 3467A Logging Multimeter, priced at \$2200*, can make your R&D measurements easier. Your local HP field engineer has all the details. Call today.

* Domestic U.S.A. price only.

Circle 168 on reader service card

HEWLETT  PACKARD

1507 Page Mill Road, Palo Alto, California 94304

For assistance call: Washington (301) 948-6370, Chicago (312) 255-9800, Atlanta (404) 955-1500, Los Angeles (213) 877-1282

098/45



Chip pair eases dynamic RAM refresh

Memory controller and memory-address multiplexer can be used with present 4-K and 16-K dynamic RAMs as well as future 64-K devices

by Nicolas Mokhoff, Components Editor

System engineers eager to design with dynamic random-access memories soon find their eagerness dulled by the dozen or so medium-scale integrated circuits needed for all the RAMs' complex timing requirements. With Motorola's MC 3480 dynamic-memory controller chip, all the row- and column-address timing signals, as well as refresh controls, are generated on command from a compatible microprocessor, such as the company's own M6800.

"By combining the memory controller with our memory-address multiplexer and refresh address counter, the MC 3242A, we are able to save the design engineer 60% in printed-circuit board area," says Bill Carns, linear interface planner. "The

two-chip set can be used with presently available 4-K and 16-K dynamic RAMs that are housed in a standard 16-pin package. Consequently, future expansion into a 64-K 16-pin configuration will be a simple matter, since the timing characteristics are identical."

Instead of an on-board master clock, the controller operates off five general timing inputs that, upon command from the microprocessor, help generate all the required row and column address signals, as well as the read and write commands. The five timing inputs use external timing delays to sequentially select the proper output signals to be enabled. They generate up to four row-address control strobe signals

for addressing a memory bank of up to 4-K- or 8-K-by-8 data blocks.

The RAS commands are encoded from two address lines (A_{12} and A_{13}) from the microprocessor. A column-address strobe signal is also generated for all the data blocks, as is the read/write signal to the RAMs specifying whether data is being read out or written into the memories.

The timing signals may be generated from a number of sources: one-shots, high-frequency counters or shift registers, delay lines, or the basic microprocessor clock through the MC (memory clock) pin on the controller chip.

The controller, in conjunction with a separate oscillator, also generates all the refresh timing, needed to

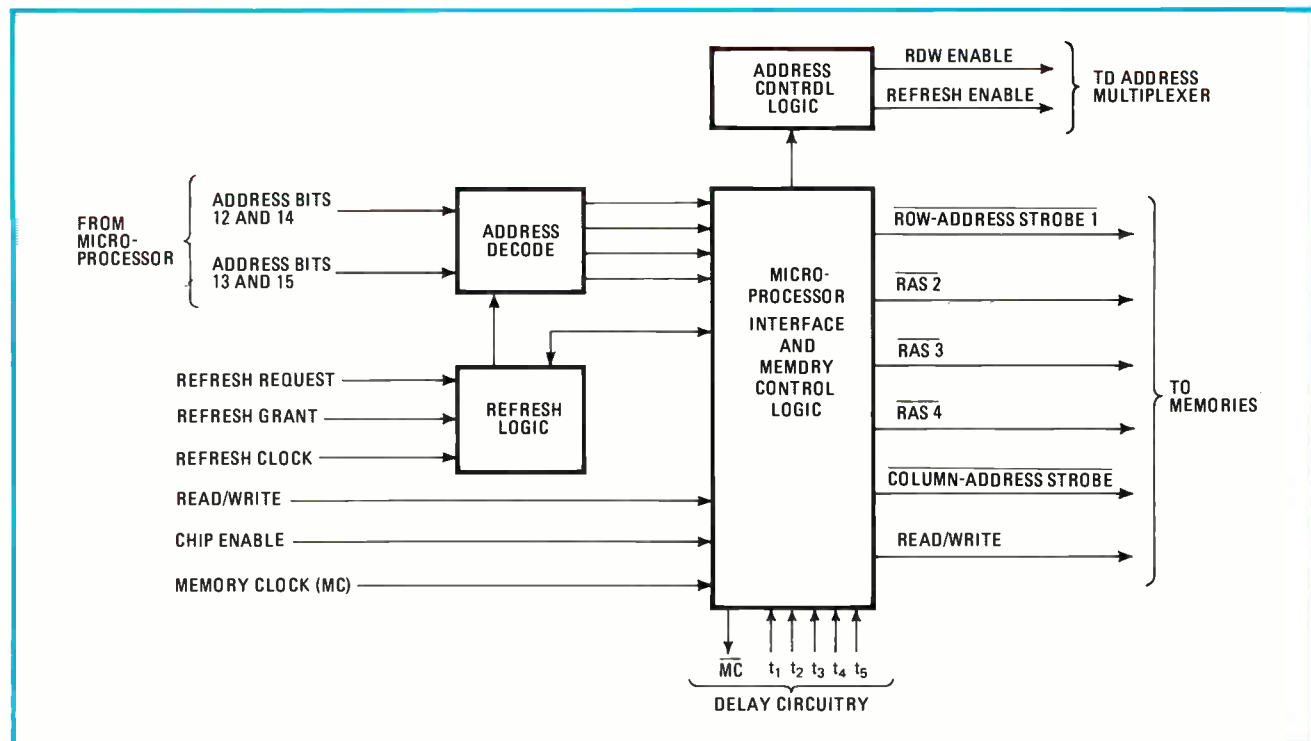



FOR TRULY STATE-OF-ART INDICATOR AND DISPLAY (FULL COLOR) SCREENS —

ELMITRONS

- as bright as 2000 cd/m²
- line width to 0.15 mm
- recording/reproduction rate to 2 mm/μsec
- clearly and distinctly broken-down spectrum from red through intermediate colors to green — for dependable performance even in bright sunlight
- a choice of screens: spherical and flat, round and square, 6 to 20 inches, deflection angles 50° to 100°, afterglow from 0.001 s to 10 s

Available in a comprehensive range :

single- or double-ray (i. e. with one or two beam systems), with rear screens, with screen grids.

Also available in a **special vibration — impact — explosion proof make** for the most trying conditions and high altitudes.

Exporter:



32/34 Smolenskaya-Sennaya
121200 Moscow
USSR
Tel. 251-39-46, Telex 7586

New products

insure the retention of data in dynamic RAMs. The refresh cycle is initiated through the refresh grant line from the microprocessor system clock at the rate of the refresh clock from the outside oscillator. It is triggered by a refresh request from the controller to the processor. This, in turn, produces the enable signals for the address multiplex and refresh counter, signaling to this circuit that a refresh cycle is about to start and specifying which half of the multiplexed address is to be written into the memories.

Also, the refresh-grant input signal from the system clock can be used to distinguish between a refresh command and a direct-memory-access command. This prevents a DMA from occurring during a refresh cycle thus ensuring that data is not lost.

The other half of this chip pair multiplexes 14 address bits from the microprocessor into the seven address inputs to the memory device. In addition, the MC 3242A has a 7-bit counter that generates the 128 sequential addresses required for the refresh cycle. "A unique feature of our memory-address multiplexer is the chip-enable control pin," says Carns. "If left disconnected, the chip can be used as a functional replacement for the Intel 3242, only without its detect-zero function. When the pin is grounded, the chip's outputs end up in a three-state condition. This feature adds flexibility for such conditions as the removal of power. The outputs at that time go to a three-state condition and subsequently, when power is returned, return to a known address." The address is all 1s; the outputs go there when the CE pin goes high.

Both the 24-pin controller and 28-pin address multiplexer are Schottky-transistor-transistor-logic parts and operate from a 5-v supply. Motorola is supplying samples of the 3480 this month and has parts available off the shelf at prices ranging from \$4.70 to \$6.85 in quantities of 100 for both chips, depending on the package desired by the user.

Motorola Semiconductor Products Inc., Box 20912, Phoenix, Ariz. 85036 [339]

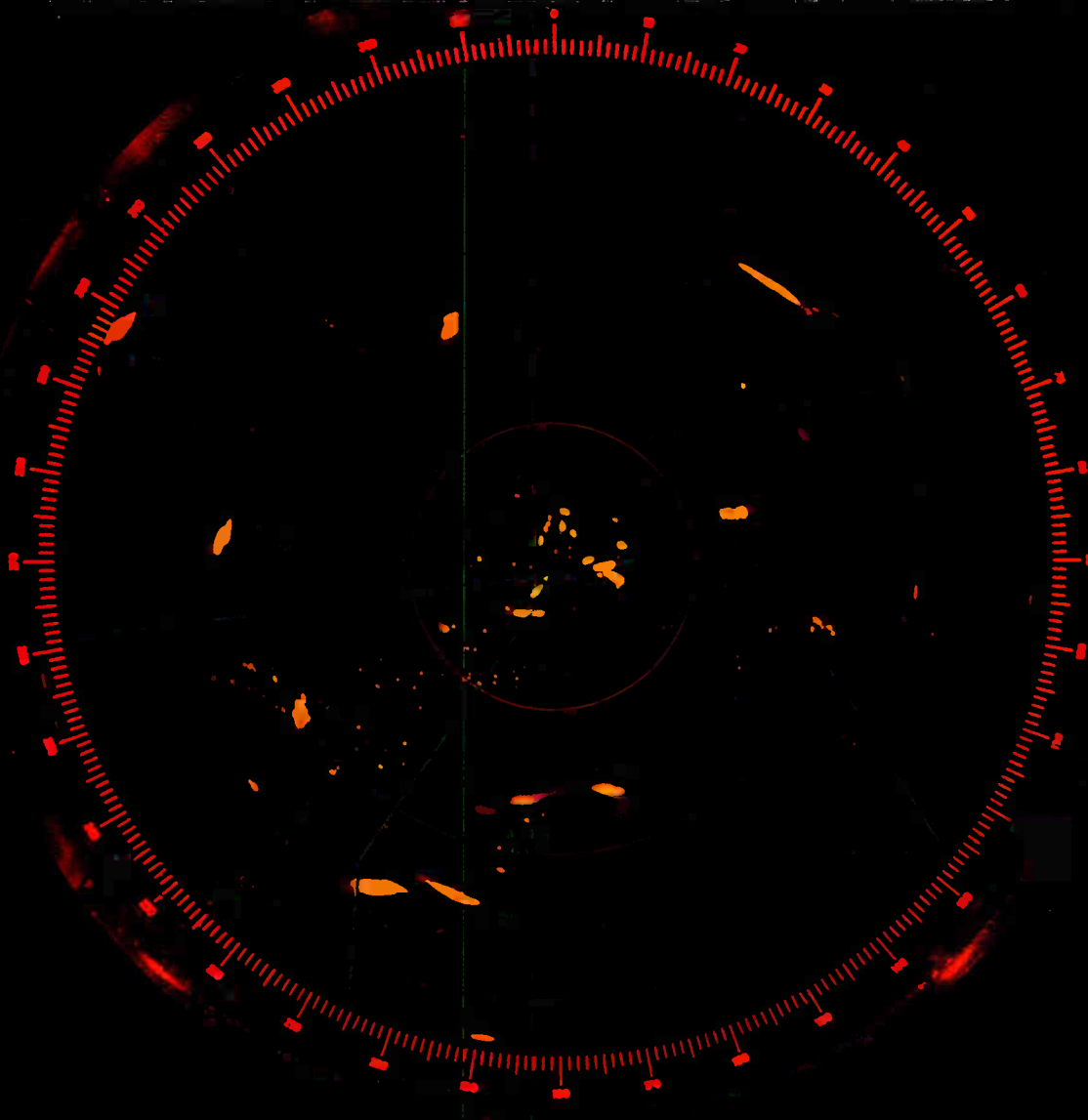

PPI radar + crystal-clear synthetics with THOMSON-CSF's penetration phosphors

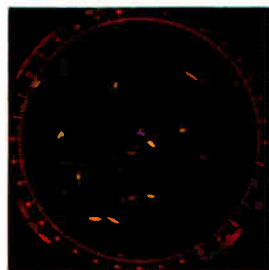

Standard PPI radar display, using long, orange mode of operation (18 kV operating voltage).

+

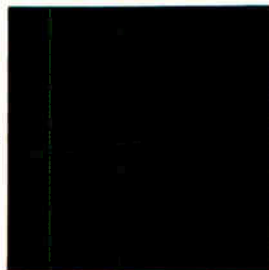

Synthetic radar data display, using short-persistence, green mode, refreshed at 50 or 60 Hz (9 kV operating voltage).

=

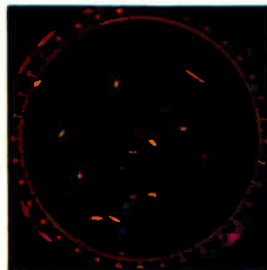

A combined display in which crystal-clear, rapidly changing synthetic data are superimposed on a standard PPI-type display.

come see us at stand No. 321
Boston - September 19-21



THOMSON-CSF

DUMONT ELECTRON TUBES / 750 BLOOMFIELD AVENUE / CLIFTON NJ 07015 / TEL. : (201) 773.00.00

France - THOMSON-CSF Division Tubes Electroniques / 38, rue Vauthier / 92100 BOULOGNE-BILLANCOURT / Tél. : (1) 604.81.75

Germany - THOMSON-CSF Elektronenröhren GmbH / Leerbachstr. 58 / 6000 FRANKFURT am MAIN.1 / Tel. : (0611) 71.72.81

Italy - THOMSON-CSF Tubi Elettronici SRL / Viale degli Ammiragli 71 / I - 00136 ROMA / Tel. : (6) 638.14.58

Japan - THOMSON-CSF Japan K.K. / TBR Building / Kojimachi 5-7 / Chiyoda-Ku / TOKYO / T 102 / Tel. : (03) 264.63.41

Spain - THOMSON-CSF Tubos Electronicos S.A. / Alcalá 87 / 7ª Dcha / MADRID 9 / Tel. : (1) 226.76.09

Sweden - THOMSON-CSF Elektronrör AB / Box 27080 / S 10251 STOCKHOLM 27 / Tel. : (08) 225.815

United Kingdom - THOMSON-CSF Components and Materials Ltd. / Ringway House / Bell Road / BASINGSTOKE RG24 0QG / Tel. : (0256) 29155 / Telex : 858865

Circle 171 on reader service card

Why take a chance?

If you're not up to date on new electronics products, you might make a costly mistake. Don't risk it.

New Product Trends In Electronics

Number One
by the editors of Electronics Magazine
333 pages, \$14.95

Every year thousands of new electronics products enter the market and compete for your attention. With all the demands on your time, it's hard to select out the few that are really significant. And it's very easy to miss those that can make a difference in the success of your projects. Until now.

Only the most important...

new equipment and materials are chosen to appear in the "New Products" section of *Electronics*. Now these stories—from December 1976 through November 1977—are brought together in this instant-access information resource. No more going back through past issues. No more wondering if you've overlooked something you really needed to know about.

Technology plus marketing...

Product descriptions, applications, and operation are meticulously researched by our team of specialists in direct contact with the people responsible for each product's development. An insider's view of market and technology trends is presented to keep you up-to-date on where product development is... and where it's going.

Emphasizing function, more than 800 products are divided into 60 categories. You can pick up this catalog of important new products and instantly find the one that solves a specific problem you're having right now. Cross-references make it easy to match products to needs across a wide range of technology.

Or just browse through it when you have a few minutes to explore all the exciting developments throughout the industry.

Either way, it's a great way to stay in touch—professionally and enjoyably.

Order today, using the coupon below, and don't forget the other valuable books in the Electronics Books Series.

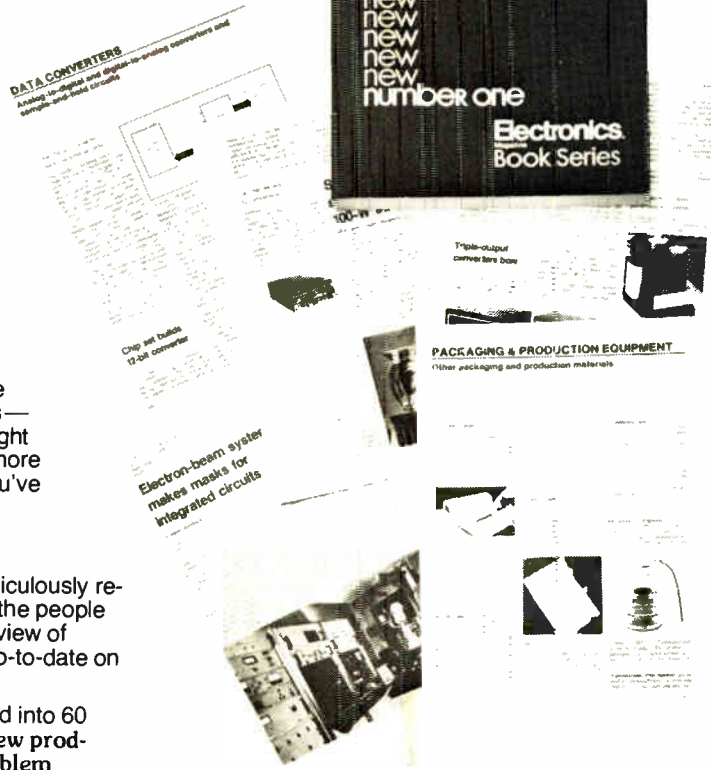

- amplifiers
- industrial equipment
- semiconductors
- power supplies
- displays
- memory products
- communications equipment
- computers
- components
- instruments
- packaging and production equipment
- data converters

Electronics Book Series
P.O. Box 669, Hightstown, NJ 08520

- 1. Microprocessors**
Send me _____ copies at \$8.95 per copy.
- 2. Applying Microprocessors**
Send me _____ copies at \$9.95 per copy.
- 3. Large Scale Integration**
Send me _____ copies at \$9.95 per copy.
- 4. Basics of Data Communications**
Send me _____ copies at \$12.95 per copy.
- 5. Circuits for Electronics Engineers**
Send me _____ copies at \$15.95 per copy.
- 6. Design Techniques for Electronics Engineers**
Send me _____ copies at \$15.95 per copy.
- 7. Memory Design: Microcomputers to Mainframes**
Send me _____ copies at \$12.95 per copy.
- 8. New Product Trends in Electronics**
Send me _____ copies at \$14.95 per copy.

Discounts of 40% on orders of 10 or more copies of each book.



If after my 10-day free-trial examination I am not fully satisfied I understand that my payment will be refunded.

- Payment enclosed Bill firm Bill me
Charge to my credit card:
 American Express Diners Club
 BankAmericard/Visa Master Charge*

Acct No. _____ Date Exp. _____

*On Master Charge only, first numbers above name _____

Name _____ Title _____

Company _____

Street _____

City _____ State _____ Zip _____

Signature _____

FOTOCERAM®. What the Swiss are seeing red about.

FOTOCERAM materials are replacing ruby wire-guides in high-speed, computer-controlled impact matrix printers. The printers operate by moving a single, vertical column of print wires across a horizontal line. Individual wires are activated in sequence to impact an inked ribbon against the paper, forming characters from patterns of dots. Those characters are generated at speeds up to 300 per second.

Precise vertical alignment of the print wires is extremely important. Up to now, many print-head manufacturers have used synthetic ruby wire guides because of their durability. Holes in the guide must be laboriously machined to less than 0.015 inch diameters, with a total tolerance within 0.001 inch. And the finished ruby guide must go through a polishing and assembly operation. It's an expensive proposition!

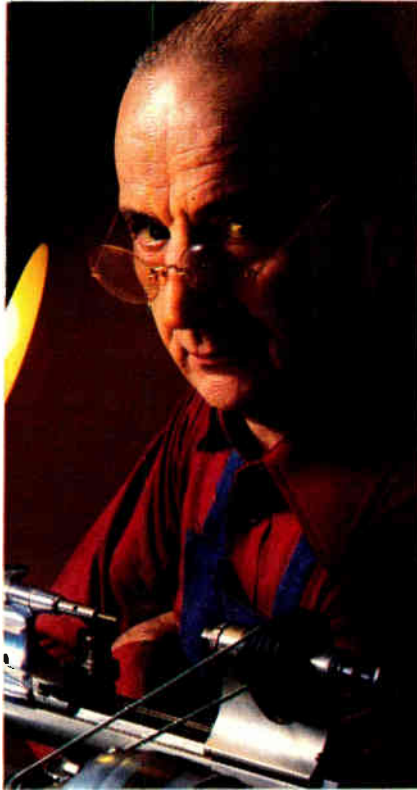

FOTOCERAM materials by Corning compete on price and durability. Using a FOTOCERAM brand glass-ceramic, derived from Corning's unique photosensitive glass, extremely small

holes can be chemically machined with precision. Manufacturers' tests show that FOTOCERAM wire guides exhibit excellent

wear characteristics equal to ruby. They can withstand the constant motion of the wires through the guide holes. And they can be mass produced at significantly lower cost than ruby.

The FOTOCERAM material is only one of a family of unique FOTOFORM materials that can be precision etched with holes of almost any shape and size. In excess of 50,000 holes per square inch, in pieces as thin as 0.010 inch. Holes, slots and channels, as small as 0.002 inch. And with tolerances within 0.001 inch. These photosensitive materials can be precision-etched, machined, cut, milled, chamfered, ground, lapped, polished, sealed to glasses or ferrites, and even metalized.

FOTOFORM materials offer you engineering flexibility—the flexibility to do it your way.

We've given the Swiss something to think about. Maybe we've given you an idea. FOTOFORM and FOTOCERAM materials are being used to solve design problems for a wide variety of applications. Chances are they can solve a problem for you.

FOTOFORM and FOTOCERAM materials by Fotoform Products Group, Corning Glass Works, Corning, New York 14830, (607) 974-4304.

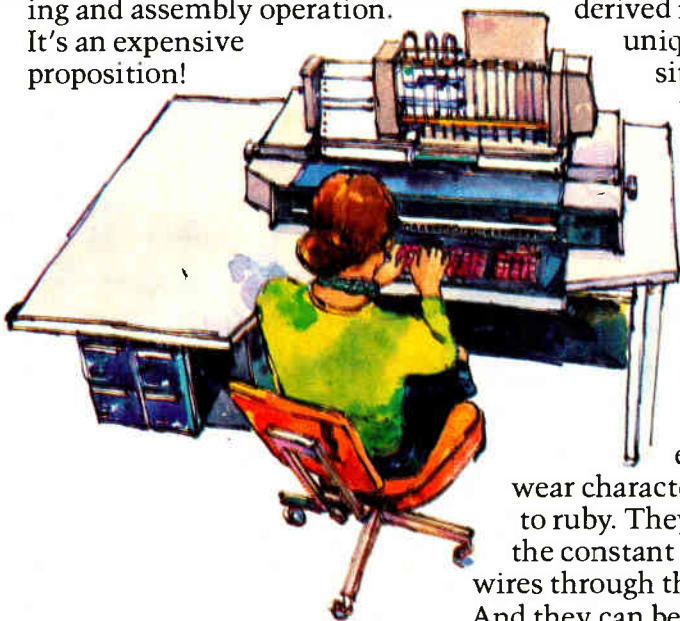
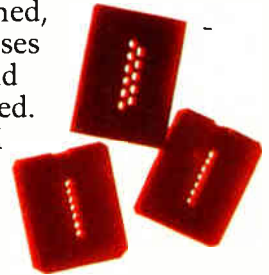

CORNING

Suddenly your last year's Electronics Buyers' Guide is as outdated as last year's phone book

Just published; 1978 Electronics Buyers' Guide. Completely new listings of catalogs, new phone numbers, new addresses, new manufacturers, sales reps, and distributors! The total market in a book—four directories in one!

1.

Directory of products. Over 4,000 products, over 5,000 manufacturers.

2.

Directory of catalogs. Includes six post-paid catalog inquiry cards for 10-second ordering.



3.

Directory of manufacturers. Local sales offices, reps, and distributors, with phone numbers. Number of employees and engineers, dollar volume, name of company contact.

4.

Directory of trade names of products and their manufacturers. You can trace a product by its trade name only.

The only book of its kind in the field.

If you haven't got it, you're not in the market.

To insure prompt delivery enclose your check with the coupon now.

Electronics Buyers' Guide
1221 Ave. of the Americas
New York, N.Y. 10020

Yes, please send me _____ copy(ies) of 1978 EBG.

- I've enclosed \$25 per copy delivered in the USA or Canada.
 I've enclosed \$35 per copy for delivery elsewhere (\$47 if shipped by Air). Full money-back guarantee if returned in 10 days.

Name _____

Company _____

Street _____

City _____

State _____

Zip _____

ASTRO-MED



UNDER \$2500

UNDER \$1400



UNDER \$4500

Battery Powered Recorders

... with the super accuracy of the Pathfinder™ position feedback galvanometer ... clean, skip-free tracings on low cost thermal paper ... portability ... rechargeable battery in Dash I and Dash II. The Super 8 is optionally available for 12VDC operation (battery not included) or for 110/220 line power.

For complete details ask for catalog.

Visit us at WESCON Booth Number 1025



ASTRO-MED DIVISION

ATLAN-TOL INDUSTRIES, INC.

Atlan-tol Industrial Park, West Warwick, R.I. 02893/(401-828-4000)

Circle 175 on reader service card

LCD driver saves space and money

C-MOS chip includes 32 latches to relieve microprocessors of display refresh chore, has on-board oscillator

by Larry Waller, Los Angeles bureau manager

Large liquid-crystal displays, teamed with microprocessor control, are getting ready to move into such new areas as point-of-sale signs for retailing. They have been delayed until now by the cost of their drive circuits, mostly of the standard 4000 series, which are typically put together in expensive multichip configurations to accommodate the special symbols and nomenclature needed by different users.

To provide a single drive chip that can serve all LCDs, Hughes Aircraft Co.'s Microelectric Products Division has developed a complementary-metal-oxide-semiconductor circuit that handles any standard or custom display with up to 32 segments. Called the HLCD 0438, the part even works as a smart peripheral, relieving the microprocessor of the task of refreshing the display, according to Norman Moyer, manager of MOS design at

the Newport, Calif., division.

"Our objective was a standard part for custom displays as simply the best way to interface with LCDs," he explains. The Hughes division has built up extensive capabilities in both LCD and C-MOS technologies from its participation in the digital watch business, and its experience is reflected in the new driver.

The HLCD 0438 handles both field-effect and dynamic-scattering displays. Because of its serial-input configuration, the driver needs only three input lines: one for the clock, one for the data, and one for the load command. Besides C-MOS, the inputs are compatible with n-MOS and transistor-transistor logic.

As a smart peripheral, the driver relieves the microprocessor of the task of generating the waveforms required to drive the display by latching the data to be displayed, Moyer says. The frequency of the ac

drive for the display can be set by a user-provided clock, or it may be generated internally by the driver. In the latter case, a frequency-determining capacitor must be connected to the frequency-control input of the circuit.

Another important feature of the 0438 is that several of the drivers may be cascaded by connecting the backplane output of one chip to the frequency-control input of the next, thus allowing one capacitor to provide frequency control for all. Alternatively, the frequency-control inputs may all be connected to a common driving signal. As far as load capacity is concerned, Moyer says that up to 100 displays can be driven at 10 kHz. "You will run out of money for displays before you run out of load capacity," he says.

The chip will run off supply voltages from 3 to 15 v dc. If the on-chip oscillator is used at a frequency of 15 kHz, the current requirement is 20 μ A. If the oscillator is not used, this drops to 5 μ A. Data setup time is 200 ns, data hold time is 100 ns, the load pulse width is 200 ns, and the data-output propagation delay is 300 ns. The operating temperature range is -40° to $+70^{\circ}$ C.

The unit, which sells for \$4.45 each in lots of 1,000 or more pieces, has a delivery time of 30 days. Since it replaces a number of 4000 series discrete devices (shift registers, gates, data latches, and oscillators), it will offer both lower cost and higher reliability, in addition to smaller size.

Microelectronic Products Division, Hughes Aircraft Co., 500 Superior Ave., Newport Beach, Calif. 92663. Phone (714) 759-2411 [340]

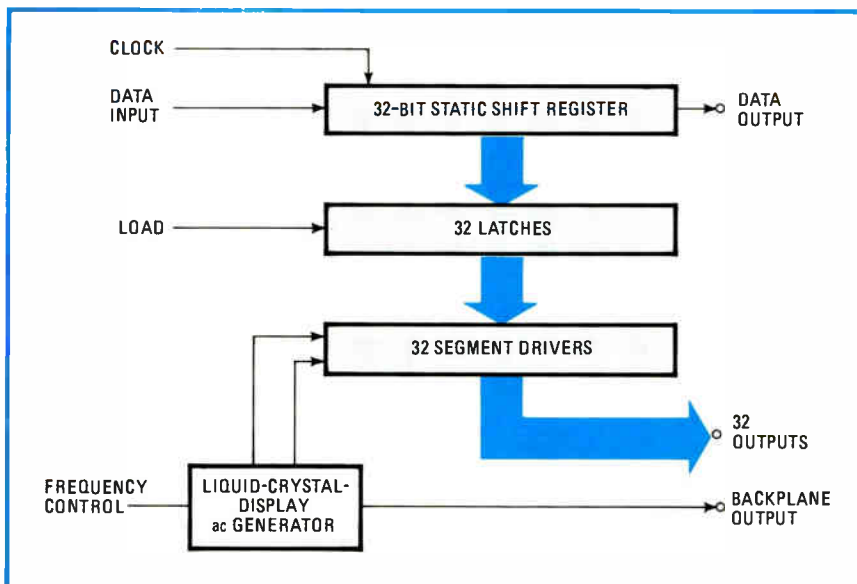



Our family gives you a flat answer.

Our new flat cable connector family has both standard and stackable sockets, PCB connectors and headers, all designed for lowest total applied cost.

In socket connectors our BA Series gives you a low profile package with the option of either open or closed cover design for both end-cable and through-cable applications.

Our BD Series stackable socket line concept permits stacking two connectors on a wire-wrappable post.

For direct solder applications our BC Series handles PCB connector needs.

Featured with the product family is a simple universal termination system designed for minimum tooling cost.

For your header applications our low profile BB Series line is available for both vertical and right-angle mounting in solder or wire-wrappable designs.

Contact GTE Sylvania, Connector Products Operation, Box 29, Titusville, PA 16354. Phone: 814-589-7071.

Remember, good connections run in our family.

DEC[®] never had it so good

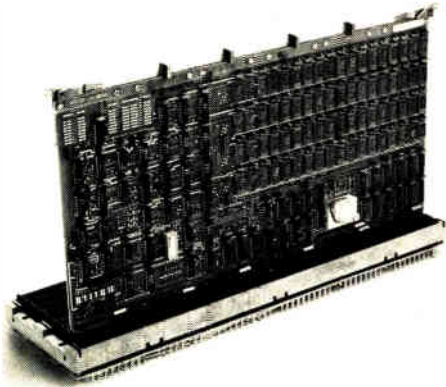

DEC's semiconductor memories:

If you want to, you can always buy semiconductor memories for your DEC mini's from DEC.

But they tend to be bulky (16K bytes to a board for some mini's and *five* boards for their ECC unit).

And you probably already know about DEC's pricing structure on additional memory.

®Registered trademark of Digital Equipment Corporation

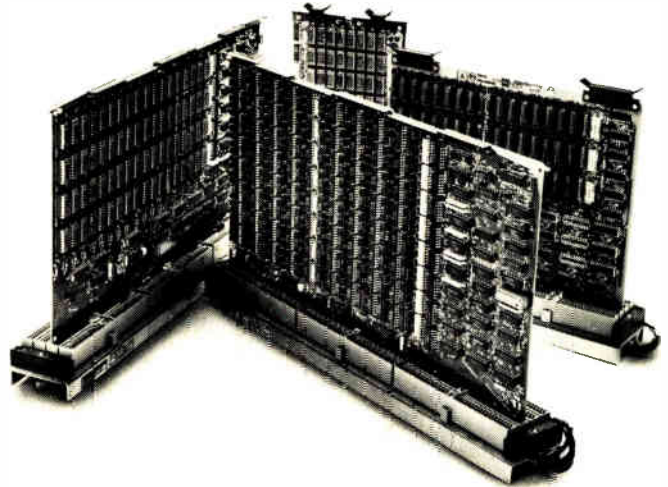

Plessey's:

We offer a complete family of DEC-compatible semiconductor memories.

64K, 128K and 256K bytes (with ECC) for the DEC PDP-11[®] series. 128K words for the PDP-8A[®]. And 64K bytes for the LSI-11[®], PDP-11/03[®] and our own Micro-1.

Our plug-compatible memories cost less and run faster than DEC's. Reliability is ensured through 100% component burn-in and 100% board testing. Each and every memory is then run in the minicomputer it was designed for before we ship it out the door.

This kind of care has made us the largest independent supplier of DEC-compatible peripherals. Our product line presently includes add-in/add-on core and semiconductor memories, cartridge disc systems, floppy disc systems, mag tape systems, complete computer-based systems, and a wide variety of backplanes, expansion chassis, and other accessories.

We're the only real alternative to DEC for all your miniperipherals, a complete single source. For all the details, please contact the nearest Plessey sales office today.



Plessey Peripheral Systems

17466 Daimler, Irvine, California 92714, (714) 540-9945

WE HAVE MET MIL-STD 1553 AND IT IS OURS!

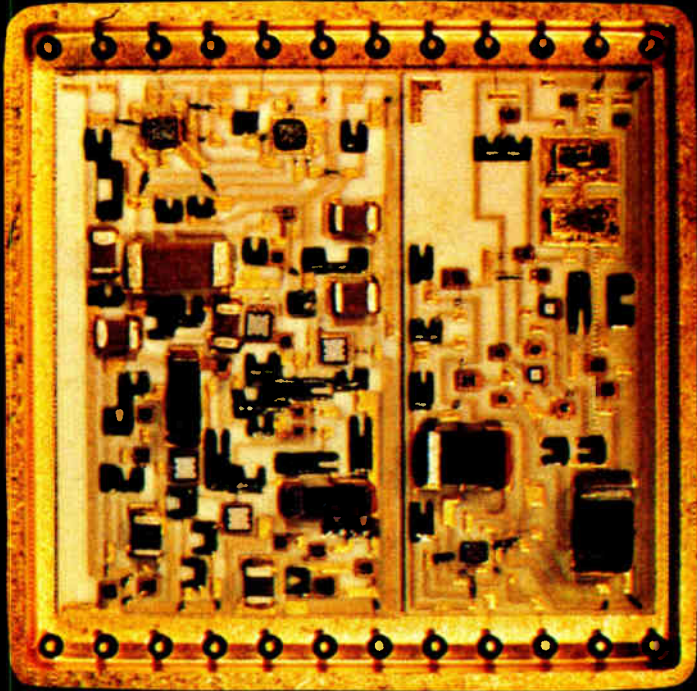

**New! CT-1231 Hybrid
Microcircuit Driver-Receiver
Module:**

**Ready now for avionics
systems interfacing with the
1553 data buss.**

**For aircraft, missile,
shipborne and ground
applications.**

**From CTI, naturally.
Look no further!**

This 1.25-inch square plug-in package performs the front end analog function of inputting and outputting data through the transformer to the data buss.

The Receiver accepts Manchester II bi-phase encoded data from a transformer coupled to the data buss, at up to 40V p-p differential, and provides TTL-compatible outputs. The Receiver includes an effective filter to help meet the 1553 error rate requirements.

The Driver accepts Manchester II encoded complementary TTL data, and produces a 40V nominal p-p bi-phase output across a 140-ohm load.

Screened to Class B requirements of MIL-STD-883, the CT-1231 is available now to end your 1553 RTU front end worries.

Also Available: Driver-Receivers to meet McDonnell-Douglas SPEC A-3818 for Sinusoidal Output Drive Requirements.

CIRCUIT TECHNOLOGY INCORPORATED

160 Smith St., Farmingdale, N.Y. 11735 Phone (516) 293-8686 (213) 374-7446
ENGLAND: Phone (09327) 87418 • Telex 881-4536

Circle 179 on reader service card

Components**Floodgates open
for large LCDs**

0.5-in., 4-digit displays for
clocks, instruments, available
in big production quantities

For liquid-crystal displays to move as definitively into larger consumer products and instruments as they did into digital watches, what is needed is a marketing, rather than a technological, advance. The required next step, according to industry sources, is for a big, independent LCD producer to come out with a standard large-digit line, assuring customers of a stable supply. Accordingly, Beckman Instruments Inc., acknowledged kingpin of the noncaptive LCD makers, is introducing 0.5-inch, four-digit, seven-segment displays, initially for use in portable clocks and instruments.

Beckman's strategy strongly confirms the market view just described, according to Rey Harju, marketing manager for LCDs at the company's Advanced Electro-Products division. "Major manufacturers need major suppliers," he states, adding that the Fullerton, Calif., division already has good-sized production orders in the bag. Earlier this year [*Electronics*, Feb. 3, p. 33], it discussed LCD plans, but awaited building up production capability sufficient to allow off-the-shelf delivery before announcing details at Wescon on Sept. 13.

Beckman is offering three types of displays in two packages, explains Harju. All of them have similar electrical specifications. The model 737-01 is intended for clocks; the 739-03, a 3½-digit unit with special symbols, is aimed at instruments; and the 739-04 is suitable for both applications. The 737-01 connects only on one side, while the others have connections on both sides for more flexibility.

The new displays typically draw

4.4 μ A from a supply voltage of 4.5 v rms. However, they may be operated at any voltage from 3 to 20 v and will draw less than 8 μ A. Both packages are offered in versions that allow operation in transmissive, reflective, and transreflective modes, and have a polymer seal for humidity resistance.

The model 739-04 has three decimal points between digits and a colon in the center of the display. For clocks, the 737-01 adds a bell symbol, to show when the alarm is set, and a flag to indicate the passing seconds. All of the displays operate from -10° to $+55^{\circ}\text{C}$ ($+14^{\circ}$ to $+131^{\circ}\text{F}$). At 25°C (77°F), segments typically turn on and off within 100 μ s. At 0°C , the turn-on time is typically 120 μ s and the turn-off time 180 μ s. The displays may be stored from -30° to $+70^{\circ}\text{C}$.

In setting up a dedicated production line for the 0.5-in. displays, Beckman is making what it terms a significant investment in an important extended area of the LCD market. Building the new displays uses "the same expertise, but slightly different technology, as our watch LCD line," says Harju. The major difference is going to polymer sealing from the glass-frit sealing used in the watch units. This not only does away with the high temperatures needed to seal glass, but is easier to work with in the most critical process—alignment of segments.

Prices of the three displays are similar. In quantities of 500 pieces or more, polarized units are \$7 each and nonpolarized displays go for \$5.45. When the quantities rise to 10,000, the prices drop to \$4.45 and \$3.50, respectively. All are available from stock.

Advanced Electro-Products Division, Beckman Instruments Inc., 2500 Harbor Blvd., Fullerton, Calif. 92634 [341]

**Four-pole relays handle
ac and dc, isolate to 2,500 V**

Composed of four individual input/output modules, Opto 22's four-pole solid-state relay can handle ac

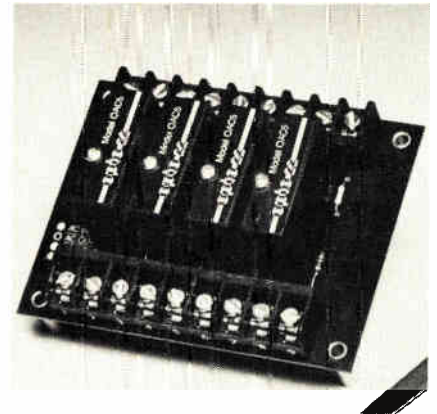

loads of 120 or 240 v, dc loads of 60 or 200 v, or user-specified combinations of these voltages. The relays provide 2,500-v peak optical isolation, and each module is protected by its own plug-in fuse.

Control voltage for the relays can be 5, 15, or 24 v, and power terminations are made on a barrier strip at such distances as not to affect logic-level terminals. Units are available from stock.

Opto 22, 5842 Research Dr., Huntington Beach, Calif. 92649. Phone (714) 892-3313 [344]

**Instrumentation amplifier
has low voltage drift**

Because of the sizable temperature variations commonly found in industrial environments, instrumentation amplifiers designed to work with such process-measuring devices as strain gauges, thermocouples, resistance-temperature detectors, and other remote sensors and transducers have to be insensitive to tempera-

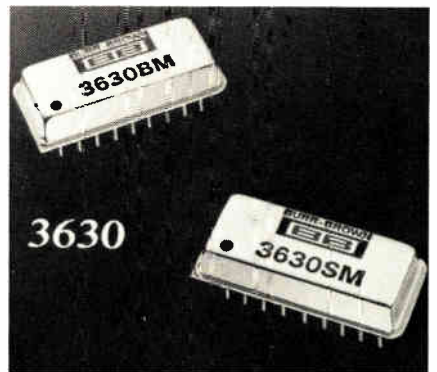

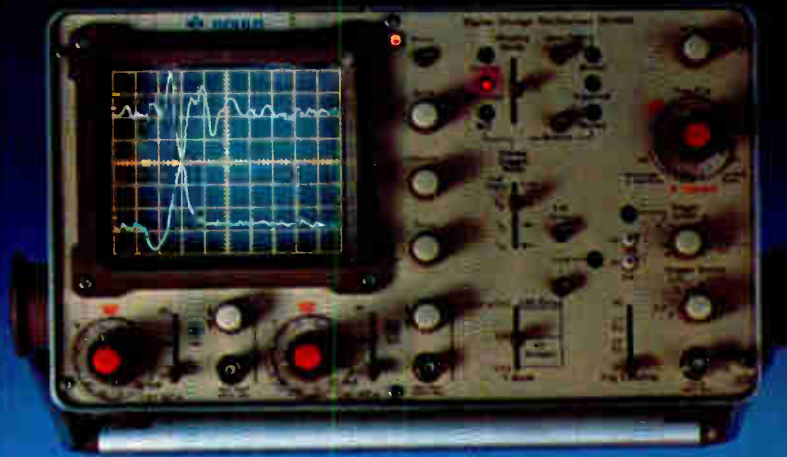

Now Gould offers a range of digital storage oscilloscopes that offer a world of advantages over conventional tube storage technology, beginning with being able to capture transient or "one-time" events and store them indefinitely for display or hardcopy printout. This makes them ideal for electronic, electromechanical, educational, and biophysical applications.

Both the OS4000 and the new OS4100 combine the capabilities of semi-conductor memory with a bright, stable, flicker-free display. This technique allows analysis of signal build-up and decay characteristics through pre- and post-trigger viewing. Expansion of the display after storage permits detailed study of specific areas of the trace.

The new model—OS4100—also offers you stored X-Y displays, channel sum or

difference and a maximum of $100\mu\text{V}$ per cm sensitivity with noise suppression. A unique trigger window circuit assures capture of transients of unknown polarity.

Other outstanding features include automatic operation, display of stored and real time traces simultaneously and hard copy memory output in digital or analog form. And IEEE488 is available for compatible interfacing.

If features like these aren't enough to lure you away from less sophisticated instruments, remember that Gould scopes are backed by a two-year warranty of parts and labor, exclusive of fuses, minor maintenance and calibration. And application assistance, customer training and worldwide service centers are part of Gould's customer support program.

Extend your storage capabilities beyond the conventional.

 **GOULD**

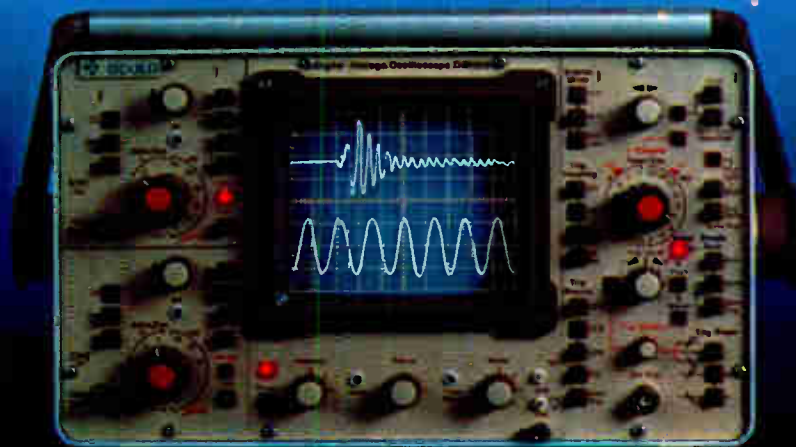

We torture our coils today...

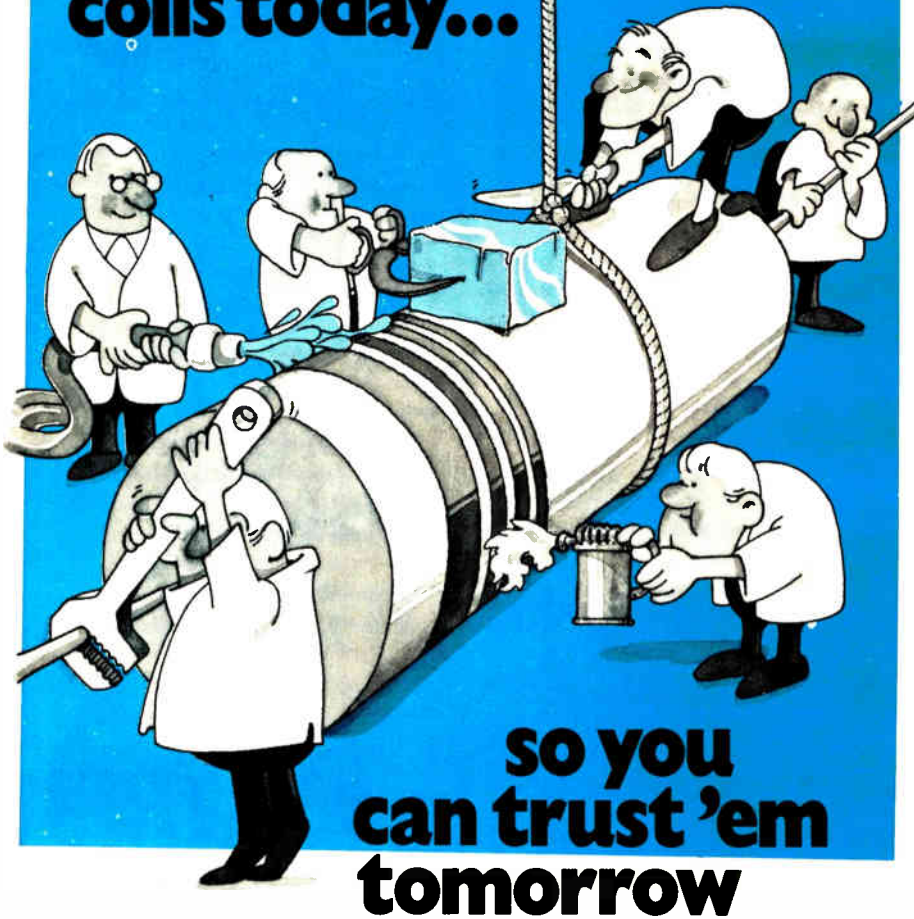

so you can trust 'em tomorrow

Rugged environment? Routine trips through torture test prove out the reliability of typical inductive components selected at random from production runs. This sample is subjected to a series of high and low temperature extremes with performance characteristics verified for conformance to Military Specification MIL-C-15305. In addition, periodic samples are subjected to other torture tests: Mechanical Shock — 18 shocks at 100g force Vibration — 12 hours to 20g force Humidity — 10 days to 98% R.H. Terminal Strength — Pull and Twist Immersion — Cyclic Load Life — 2000 hours at elevated temperature. Performance characteristics hold the line.

We are proud that we can't make 'em fail. Our failure is your assurance of reliability. Any better reason for specifying Delevan inductors?

Our Environmental Test Laboratory is sanctioned by DESC with electro/mechanical equipment calibrated and certified under MIL-C-45662. This service is available to you.

Ask us about our repair and calibration service of Boonton Q Meters, Model 260.

INDUCTIVE COMPONENTS — CLUTCH AND BRAKES FOR ELECTRONIC AND AEROSPACE INDUSTRIES

Delevan
Division



**AMERICAN
PRECISION
INDUSTRIES INC.**

270 QUAKER RD. / EAST AURORA, N. Y. 14052
TELEPHONE 716/652-3800 TELEEX 081-293

Other Divisions
Basco • Dustex • A.P.I. of Tennessee • A.P.I. (U.K.) Ltd.



New products

ture. That is why designers at Burr-Brown Research have developed a hybrid instrumentation amplifier, the model 3630, that has voltage drift of only $\pm 0.25 \mu\text{V}/^\circ\text{C}$ at a gain of 1,000.

The unit also features a nonlinearity within 0.01% maximum at that gain. At a lower gain of 100, voltage drift increases only slightly, while nonlinearity decreases to within a maximum of 0.003%. Initial offset voltage is a very low 25 μV , which can be zeroed as required.

The 3630's $10^{10}\text{-}\Omega$ input impedance preserves the unit's accuracy when amplifying low-level signals by minimizing the effects of source loading. Even in the presence of a source impedance imbalance of 1 k Ω , the common-mode rejection is a minimum of 106 dB with a gain of 100. The unit's noise level is 1.2 v, peak to peak, and bias current is a maximum of 20 nA.

To provide high initial accuracy, low temperature coefficient of resistance, and TCR matching, the resistor network is fabricated of Nichrome deposited on silicon. By laser-trimming the network, offset voltage is reduced, and the common-mode rejection and offset-voltage drift are optimized.

Packaged in an hermetically sealed 18-pin dual in-line package, the unit will operate from -25° to 85°C . In quantities of 100 and up, the 3630 is priced at \$25 each. Delivery is from stock to four weeks.

Burr-Brown Research Corp., P. O. Box 11400, International Airport Industrial Park, Tucson, Ariz. 85734. Phone Dennis Haynes at (602) 746-1111 [343]

Power resistors slash inductance with new twist

The models MS 260N, 310N, and 313N axial-lead power resistors are film resistors that have better performance characteristics than most wound-wire types. They employ patented resistance films fired onto a solid ceramic core in special serpentine patterns that reduce inductance, so that their inductance is about



More cost efficiency...

Introducing Series III SOLID STATE KEYBOARDS

Now: Ferrite Core Reliability At Lower Prices



More cost efficiency you can put your finger on...

Just imagine, a solid state keyboard at a price you can afford that delivers MTBF's in excess of 40,000 hours, is unaffected by contaminants, has excellent resistance to static discharge and EMI, plus high speed operation without "misses." Well the keyboard professionals have done it again—the Series III keyboard.

That's right, the SERIES III will provide cost efficiencies you can put your finger on. It's designed to increase operator productivity and performance under demanding

operational and environmental conditions. This means cost efficiency for you—reduced downtime, lower repair cost, fewer service calls, satisfied customers, and lower prices. That's total value!

It's in the unique SS3 ferrite core keyswitch

We've built our reputation on ferrite core switching technology. And once again, we've advanced our technology through the unique SS3 keyswitch.

Like its proven and successful predecessor, the SS3 keyswitch is mechanically simple and contact-

less. The SS3 is designed with fewer parts, lower profile and exceptional feel while maintaining excellent resistance to environmental factors. This combined with a 100 million cycle life test rating offers unsurpassed cost efficiency.

You have our word on quality—Cortron

All Cortron® Series III Solid State Keyboards are 100% inspected and tested to insure your specifications are met. We're so sure of our reliability that we have extended our warranty to 2 full years. Let us convince you.

We've touched on a few of the many cost efficiency benefits that Cortron Series III Solid State Keyboards offer you and your customers. There's much more we can talk about. For full cost efficiency details and our Cortron Series III Solid State Keyboard brochure, write or call Cortron, A Division of Illinois Tool Works Inc., 6601 West Irving Park Road, Chicago, Illinois 60634. Phone (312) 282-4040. TWX: 910-221-0275. Toll free line: 800-621-2605.



CORTRON

A DIVISION OF ILLINOIS TOOL WORKS INC

THE KEYBOARD PROFESSIONALS

Copyright: © Illinois Tool Works Inc. 1978

Circle 183 on reader service card

New products

equal to that of a straight piece of wire as long as the actual resistor.

Resistors with power ratings to 12.5 w, resistance values to 30 M Ω and tolerances to 0.1% are available. They exhibit temperature coefficients of 50 ppm/ $^{\circ}$ C or less in the temperature range from -15° to 105° C and can function at tempera-

tures up to 275° C. Maximum operating voltages as high as 6,000 v are attainable.

For values up to 5M Ω in quantities of 100 and up, unit prices are approximately \$2. Initial quantities of most resistors can be delivered from company stock, while production quantities require a delivery

time of four to six weeks.

Caddock Electronics Inc., 3127 Chicago Ave., Riverside, Calif. 92507. Phone (714) 683-5361 [345]

Small push-button switch responds to delicate touch

The J-B-T switch is a subminiature single-pole, double-throw push-button switch that responds to a touch lighter than that needed by any other push-button switch at present on the market, according to its manufacturer.

Rated for 0.4 vA at 20 v, ac or dc,

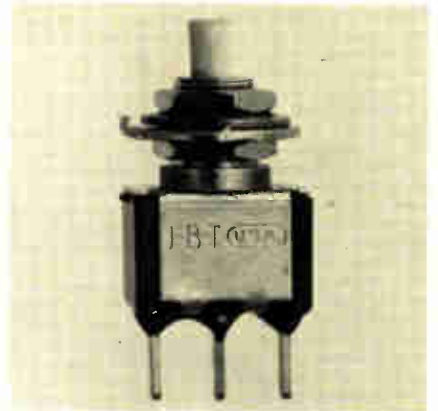

and for 1 A at 125 v ac, the switch has a life-under-load of 60,000 make-or-break cycles.

Cutler-Hammer, 424 Chapel St., New Haven, Conn. 06509. Phone (203) 772-2220 [346]

Some potentiometers adjust to user's preference . . .

Offered in the standard resistance range from 200 Ω to 500 M Ω with a power rating of 0.2w, the RVA-0911-313 line of subminiature trimming potentiometers can be adjusted from the front or through a funnel in the back with a standard screwdriver. Alternatively, they may be manually adjusted with a knurled knob.

The units also feature an opening in the adjustment knob that allows flux detergent flow through them during dip-soldering operations. Both vertical- and horizontal-adjust-

We meet you anywhere in between

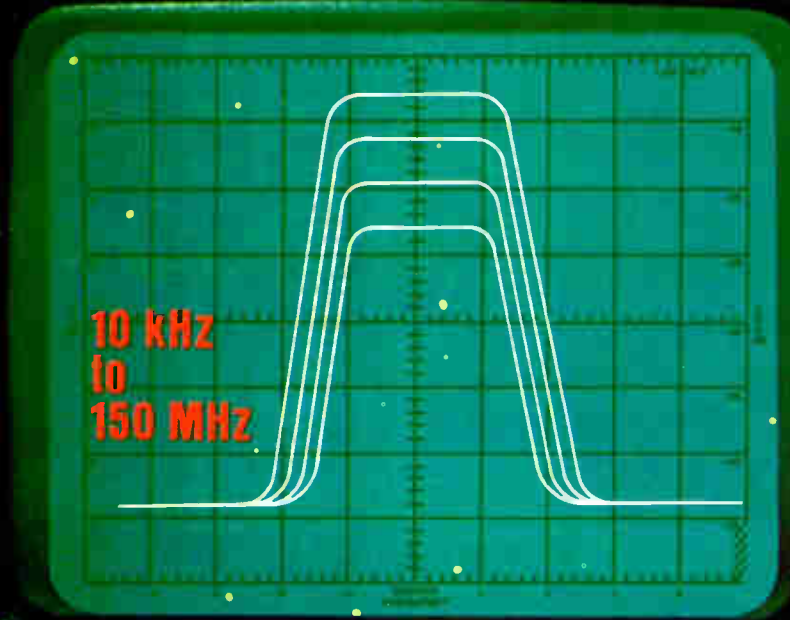

Reeves-Hoffman CRYSTAL FILTERS

We build quality crystal filters from 10 kHz to 150 MHz, compact monolithics from 5 MHz. We design by computer for fast service and assured performance. All work is done in-house, including pre-aging, temperature testing and packaging to your requirements. Cable, call or write for information.



Discrete



Monolithic

Where there's no place for "second best"

Reeves-Hoffman

Division, Dynamics Corporation of America
400 W. North St., Carlisle, PA 17013 U.S.A.
Phone: 717-243-5929 TWX: 510-650-3510

The Place To Be

Oregon is a very special place, with a pace and a flavor that can be found nowhere else.

We are proud of our home state.

It offers a pleasant alternative to the pressures of a crowded megalopolis.

It is also a place to discover new horizons in personal and professional development. At our

R&D and manufacturing complex

in Beaverton, we are continually testing

the limits of technology in

electronic instrumentation, graphic computing systems, and computer peripherals.

We chose to build an electronics community in Oregon for a very special reason.

Our motive is people.

Creative men and women who can help us continue an exceptional growth program, and a commitment to excellence.

Tektronix and Oregon. THE Place.

If you have the technical or marketing skills we need, contact us.

Professional Placement, TEKTRONIX, INC.,

P.O. Box 500, 9E,

Beaverton, Oregon 97077.

A full color print of this scene is available at no obligation. Just drop a note to Bill Eppick at the above address.

An Equal Opportunity Employer

Tektronix[®]
COMMITTED TO EXCELLENCE

SUNSET/SUNRISE



Plenco helps Fisher Pierce control the light...

Fisher Pierce photoelectric outdoor lighting controls provide approximately 13 years of dependable street light control, according to the manufacturer, Fisher Pierce Division, Sigma Instruments Inc., Braintree, Mass., who says—

"Independent of time of day, season or weather, the controls switch on at the same evening daylight value, off when morning daylight returns. They're rated for 5000 on-off operations on loads of 1000 watts or 1800 volt-amperes."

Our Plenco 308 Black phenolic molding compound was specified for molding the base of the 6841/6842 models. The molder, Elm Industries, Inc., West Springfield, Mass., tells why:

"Your 308 compound offered us high temperature capability, low moisture absorption, high rigidity, good dimensional stability, and economy, too—features required by Fisher Pierce."

Let Plenco help you throw a little light on your own particular molding problem. Dial (414) 458-2121 and you've got it—Plenco selections, experience, service.

PLENCO
THERMOSET PLASTICS

PLASTICS ENGINEERING COMPANY
Sheboygan, WI 53081

Through Plenco research... a wide range of ready-made or custom-formulated phenolic, melamine-phenolic and alkyd thermoset molding compounds, and industrial resins.

New products

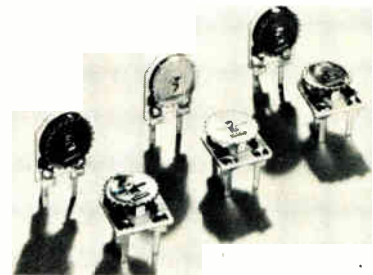

ment units are available with tolerances of either $\pm 30\%$ or $\pm 20\%$, a maximum working voltage of 250 v dc, linear taper, and a typical mechanical rotation of 260° .

Murata Corp. of America, 1148 Franklin Rd., S. E., Marietta, Ga. 30067. Phone (404) 952-9777 [347]

... while others opt for the rigors of military life

The model 714 nonwirewound trimming potentiometer is designed for military-grade applications where minimizing space is a key design criterion. A MIL-R-39035-qualified part, the 714 is housed in a $\frac{1}{4}$ -in.-high, humidity-proof package of heat-resistant plastic. Potentiometers are available in the range from 10Ω to $1 \text{ M}\Omega$, are rated for 0.25 w at operating temperatures of 85°C , and offer a maximum temperature coefficient of $100 \text{ ppm}/^\circ\text{C}$. The units feature extremely high resolution and exhibit excellent characteristics in high-frequency circuits.

In quantities of 100 and up, each model 714 is priced at approximately \$6. They are available from stock.

Techno Components Corp., 7803 Lemona Ave., Van Nuys, Calif. 91405. [348]

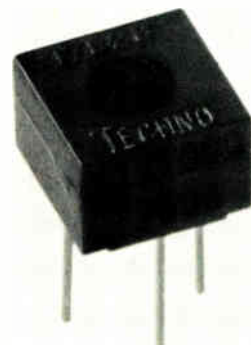

A 32K byte dual floppy microcomputer system for only \$2900* complete.

Standard Features:

- Dual 8" floppys store 500,000 characters on line
 - 32K bytes of static RAM
 - RS-232 C at 75 to 19,200 baud
 - 16 line parallel I/O
 - Rack or tabletop mounting
 - UL-recognized power supplies
 - BUS oriented computer architecture
 - Four slots used — four slots open for expansion
- Comes complete with disk BASIC
 - Includes Interactive Assembler/Editor
 - Main processor is an ultra-fast 6502A
 - Has auxiliary Z-80 and 6800 micros which allow execution of virtually all 6502, 6800, 8080 and Z-80 code!
 - User programmable interrupt vectors on all three micros



The C3-OEM is an ultra-high performance microcomputer system. Its powerful 6502A microprocessor (now triple sourced) out-benchmarks all 6800- and 8080-based computers in BASIC and machine code using the BASIC and assembler provided standard with this system.

In fact, the C3-OEM executes standard BASIC language programs at speed comparable to small 16 bit minicomputers.

Ohio Scientific has a vast library of low cost software for the high performance 6502A including an on-line debugger, a disassembler, several specialized disk operating systems and applications programs such as our word processor package and a data base management system. However, the C3-OEM is not just limited to 6502 based software. This remarkable machine also has a 6800 and a Z-80 microprocessor.

The system includes a software switch so that machine operation can be switched from one processor to another under software control!

So, one can start with existing 6800, 8080 or Z-80 programs while developing new software for the ultra-high performance 6502A.

The C3-OEM isn't cheap. It's a quality product with mechanical features like UL-recognized power supplies, a three-stage baked-on enamel finish and totally modular construction.

It is the product of Ohio Scientific's thousands of micro-computer systems experience. In fact, all the electronics of the C3-OEM have been in production for nearly a year and have field proven reliability. And, best of all, this machine is available now in quantity for immediate delivery!

A full spectrum of add-ons are now available including more memory, up to 16 serial ports, 96 parallel I/O lines, a video display, a parallel line printer interface and a 74 million byte Winchester disk drive.

*25-49 unit price

1-4 \$3590.

5-9 \$3300.

10-24 \$3100.

Phone (216) 562-3101
or write for more information
and the C3-OEM representative
in your area.

OHIO SCIENTIFIC

1333 S. Chillicothe Rd.
Aurora, OH 44202

Circle 187 on reader service card

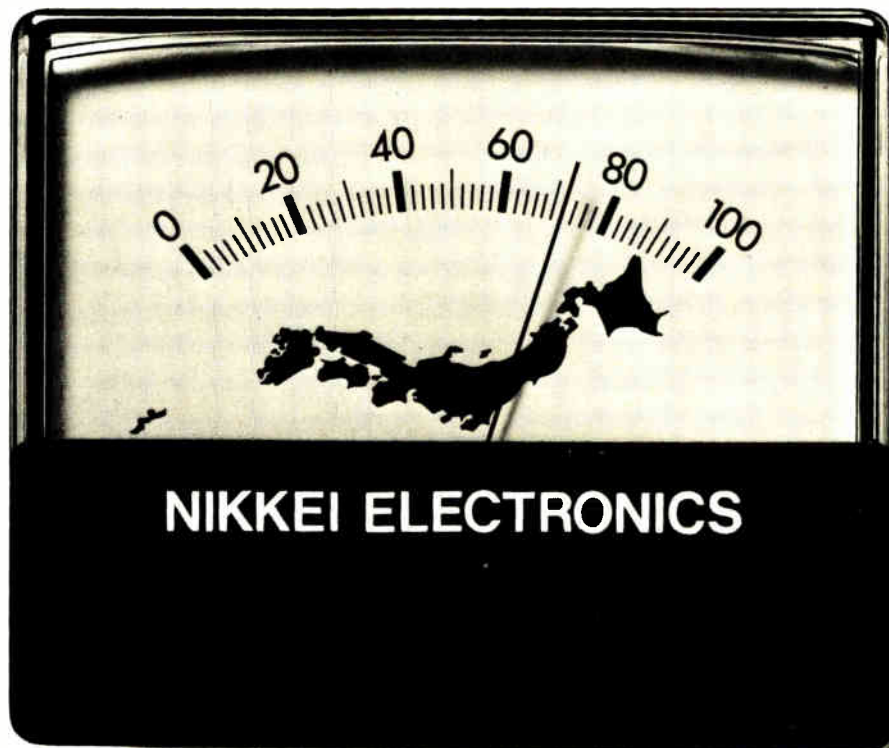

The Japan Output Check.

If the output isn't measuring up to your input in your approach to the Japanese market, it may be that you are switched to the wrong setting.

And since we are talking about a ¥164 trillion market, you can't afford to take chances.

You need to do things the right way in Japan.

And make your name known to the right people.

Which is where we come in.

As Japan's leading electronics magazine, we are in a unique position to help get your message across. A bi-weekly, Nikkei Electronics is delivered

direct to the desks of more than 37,000 key decision makers in the electronics industry.

Nikkei Electronics. For sure feedback from Japan.

Subscriptions: 36,550 (as of Jan. 23rd, 1978)
Regularly audited by the Japan ABC.

For further information, write to:
H.T. Howland, Marketing Services Manager,
Electronics, McGraw-Hill Publications Co.,
1221 Avenue of the Americas, New York,
N.Y. 10020, U.S.A. Tel: (212) 997-6642

Japan's foremost electronics publication

Nikkei Electronics

NIKKEI-McGRAW-HILL, INC.
The publisher of Nikkei Electronics
Wataru Makishima, Manager, Advertising,
Nikkei Annex Bldg. 2-1-2, Uchi-Kanda, Chiyoda-ku,
Tokyo, Japan. Telex: J26296 NKMCGRAW

SE 7000: Multiband performance — Multi-channel check-out

SE 7000 Series Instrumentation Recorders give you 8 speed recording up to 2MHz Direct, 500 kHz FM and up to 30 k bpi HDDR. The SE 7000 has in addition a unique range of features essential to lab quality recording, with a convenience, simplicity and reliability that no other recorder can offer.

Consider, for instance, the versatile built-in calibrator module with DVM for "set and forget" control, and the unique simultaneous all-channel FM electronics to electronics facility, without tape movement — the higher reliability of hard-wired, all speed active filters, equalisers and other tape speed

sensitive components — the proven dependability of co-planer format resulting in more gentle tape handling and lower tape wear.

Don't accept second best. We would like to show you how the SE 7000 can match your requirements in instrumentation recording.



EMI EMI Technology

EMI Technology Inc.,
55 Kenosia Avenue, Danbury CT 06810,
Tel 203-744-3500 T W X 710-456-3068

SE 7000M — the only wideband portable with built-in 14 channel electronics to electronics FM calibration and pre-record checkout.

A member of the EMI group. International leaders in music, electronics and leisure.

Circle 189 on reader service card

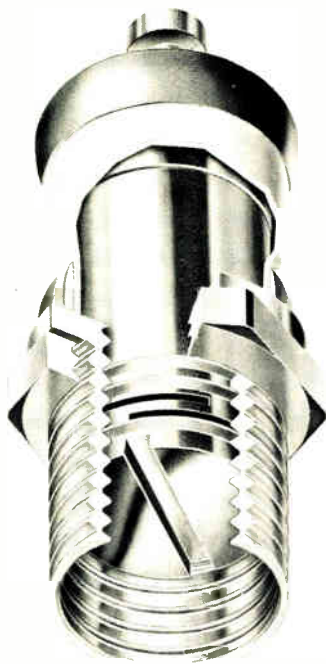

variable capacitors

... made by Johanson. Quality without compromise is our target in the design and manufacture of capacitors in sizes, mounting configurations and capacitance values to meet every application. Perhaps that's why—for more than three decades—superior variable capacitors have been synonymous with the name Johanson, where standards of excellence always come first.

The heart of this trimmer consists of a one piece integral contact drive mechanism press fitted to concentric rotor tubes (U.S. Patent No. 3,469,160).



The standard of excellence!



MANUFACTURING CORPORATION
Rockaway Valley Road
Boonton, N.J. 07005
(201) 334-2676, TWX 710-987-8367

Circle 190 on reader service card

New products

Instruments

Network analyzer is sensitive

Costing only \$11,500, 4-to-1,300-MHz unit picks up -80 -dBm signals

To calculate the impedance and the transmission and reflection coefficients of radio-frequency transistors, filters, and amplifiers, the magnitude and phase of both incident and reflected signals must usually be measured. Until now, engineers had a choice of two approaches to the task: hook up a vector voltmeter and measure amplitude and phase at various frequencies, or use a \$25,000 automatic analyzer system. Low-cost systems built around diode detectors generally bottom out around -50 to -60 dBm and are therefore not of much use in measuring the values of small-signal transistors and amplifiers.

Hewlett-Packard has changed this picture with its model 8754A rf network analyzer, an instrument

whose \$11,500 price is almost 3.4 dB below the \$25,000 level. With its 4-to-1,300-MHz swept-signal source and cathode-ray-tube display, the 8754A measures and displays the magnitude, phase, absolute power, and polar reflection coefficients of incident and reflected signals. Moreover, it is sensitive enough to detect signal levels down to -80 dBm, according to Larry C. Stratford, product manager for network analyzers. And its narrowband intermediate-frequency amplifier (20-kHz bandwidth centered at 1 MHz) is sharp enough to reduce spurious responses significantly. "For example," Stratford explains, "if you used a 100-MHz signal on a filter whose center frequency was 200 MHz, a diode-detector instrument would register a response to the signal generator's second harmonic. But the 8754A's tuned input would reject that harmonic."

Clever design of the signal source and receiver front end is the key to the 8754A's low price/performance ratio. Instead of using precision phase-locked-loop oscillators, as is done in the company's higher-priced 8505A, the designers of the new analyzer employ a pair of open-loop, varactor-tuned oscillators. This de-

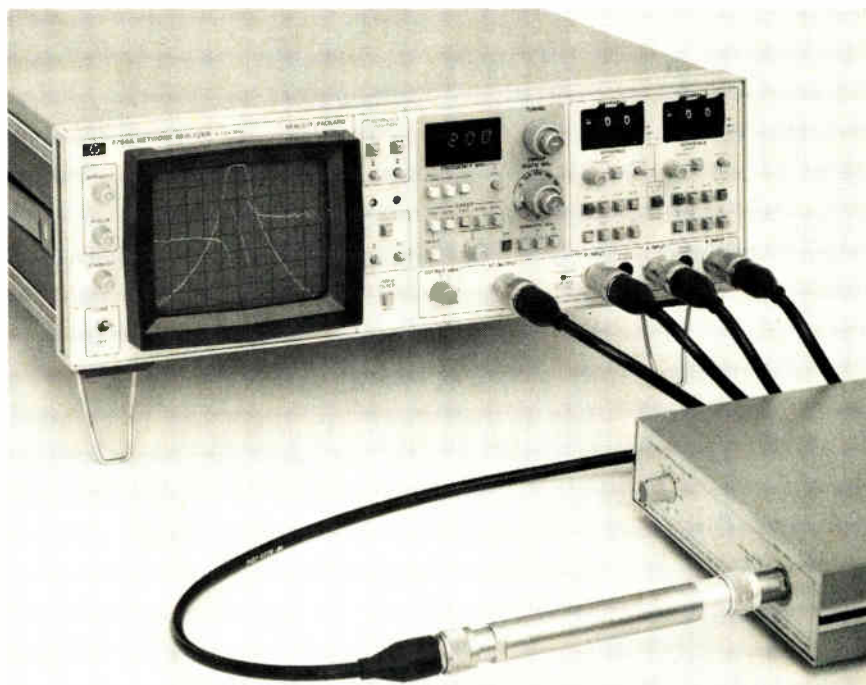

MORE PULL in a smaller package?



Check these curves.

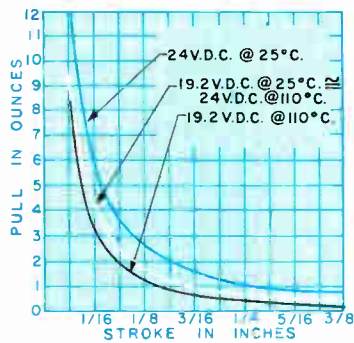

T-4 (3/8" long) Intermittent duty

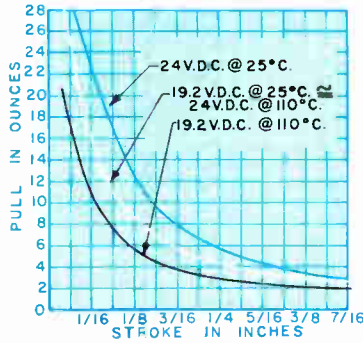

T-8 (1" long) Continuous Duty

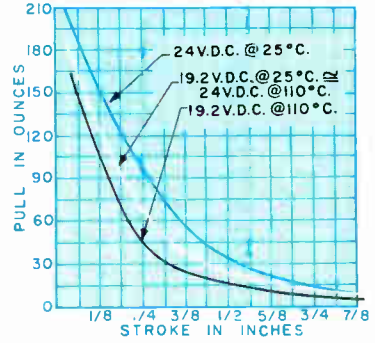

T-12 (1 1/2" long) Intermittent Duty

Ounce-for ounce, inch-for-inch Guardian Tubular Solenoids pack more power... because our tubular designs assure total magnetic field enclosure and result in efficient, powerful operation. More efficient than other DC solenoids. They give you more power in less space, plus UL and CSA recognition.

Easy to design-in. Easy to install. By design.

Guardian Tubulars work in any position. Close tolerance between plunger and bobbin means no possibility of double seating. So they work in your product just the way you want them to work.

Mount them directly into panel by inserting threaded bushing thru installation hole and tightening nut on lock washer. Or, mount with standard bracket.

Either way, Guardian Tubulars install without damage to the solenoid. Look how the

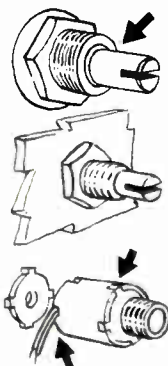

notched tube-steel shell mates with notched end plate. Result? A stronger assembly that takes more torque when installing... with no chance of damage. The leads emerge thru a notch in the steel shell, so they *will* not, *can* not be sheared by rotation during installation.

Once you put a Guardian Tubular in your product... forget it. Typical mechanical life is 20 million. That's probably longer than your product's life expectancy... due primarily to the unique Valox[®] 420 molded bobbin.

Variations and specials? Guardian's got 'em. Any DC voltage from 6 to 240. Push type or pull type operation. Return springs, silencers, termination variations, special mountings... you name it and we'll deliver it with the high quality craftsmanship and low prices that have made Guardian Number 1 in Solenoids—and that keeps us here on top.

Let the Guardian Angel reveal all the pull charts and curves in full size. Send for your free copy of our 72 page catalog.



This mark indicates recognition under the component program of Underwriters Laboratories Inc.



GUARDIAN[®]

GUARDIAN ELECTRIC MANUFACTURING CO. 1550 West Carroll Avenue—Chicago, Illinois 60607 • 312/243-1100

Circle 191 on reader service card

A CRT Yoke for all reasons

Military

Airborne (HUD, HDD, VSD, HSD), shipboard, ground systems, missile systems.

Compact, lightweight, encapsulated to withstand physical stress. Special ferrite core designs.



Commercial

Computer terminals, monitors, medical applications, hard-copy machines, etc.

Engineered and tooled for volume production. Cost-effective and geometry corrected.

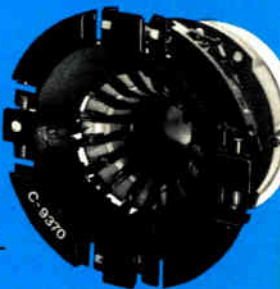

Special Designs

Phototypesetting, random graphics, flying spot scanners, mappers, vidicons.

Designed for low residual and superior resolution using special assembly techniques.



Send us your reasons for needing a better yoke. We'll supply technical data sheets, recommendations, engineering assistance.



syntronic

Syntronic Instruments, Inc.
100 Industrial Road, Addison IL 60101
Phone (312) 543-6444

New products

sign produces its swept output by beating the oscillator frequencies against each other as one oscillator slews from 3.6 to 3.0 GHz and the other goes from 3.6 to 4.3 GHz. The resulting difference frequency is kept at a constant 10-dBm level.

Another way in which HP keeps costs down is to use thin-film components for the receiver's three input mixers. In addition to saving space and money, these sampling mixers provide excellent broadband matching. "The return loss at the inputs is greater than 20 dB," says Doug Rytting, lab section manager for network analyzers. "This shows there is very little reflection due to mismatch."

The inputs to which Rytting refers receive signals from the outputs of the 11850A three-way power splitter, the 8502A transmission and reflection test set, the 8748A S-parameter test set, or a pair of high-impedance probes or other in-circuit measuring accessories. Basically, the test sets inject the 8754A swept source's signal into a two-port device and then detect and deliver a reflected and transmitted version of that stimulus to the analyzer's A and B inputs. The receiver compares these two signals with a reference signal to develop the inputs for a display processor.

The user can switch between polar and rectangular displays at the touch of a button. Resolutions for the two are 2.5° or 0.25 dB per major division. When the polar mode is used, a slide-in Smith chart allows direct reading of impedances.

The 8754A is available eight weeks after receipt of order and can be configured to interface with the IEEE-488 general-purpose bus.

Hewlett-Packard Co., 1507 Page Mill Rd., Palo Alto, Calif. 94304 [351]

Portable thermometer makes in-circuit testing easy

Even though temperature sensitivity is a major factor in the performance of most discrete devices, only on rare

ELEC-TROL BLUE BOY REED RELAYS

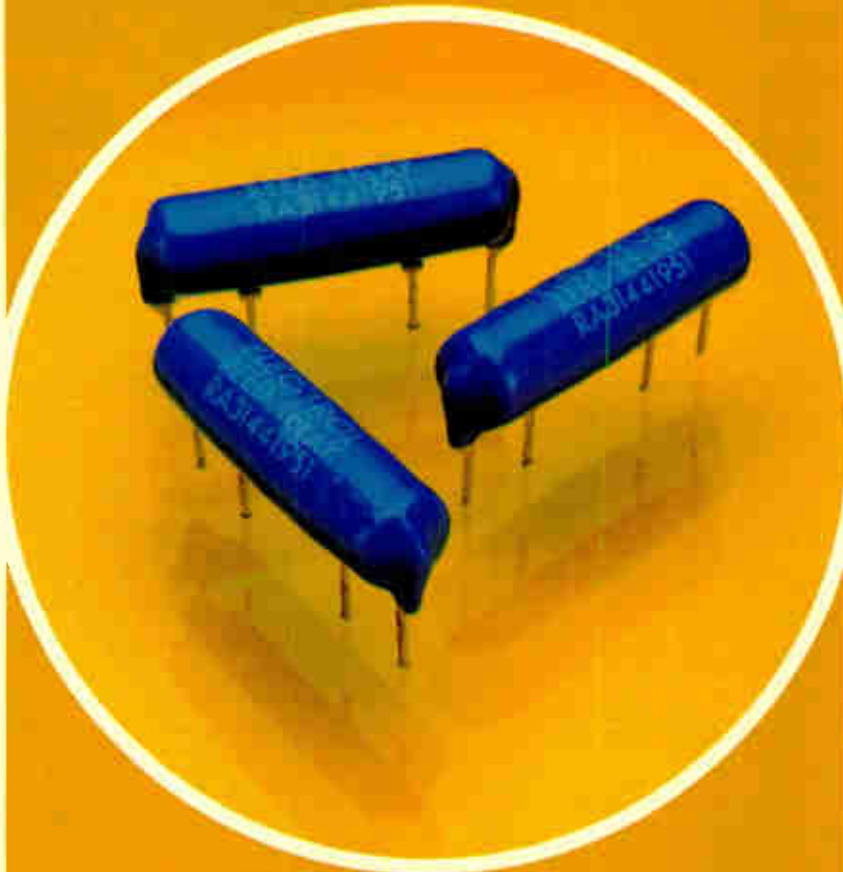

NOW TWO GRADES OF LOW-PRICED SEALED RELAYS

Elec-Trol now offers its Blue Boy Reed Relays in both an instrument and a commercial grade. The instrument grade provides low and stable contact resistance over a large number of operations, for use in such applications as ATE systems, data acquisition and telecommunications.

The new commercial-grade units have a higher contact resistance and a lower life expectancy but are well suited for applications where contact resistance is not critical, such as switching into high impedance loads, for use in such end-products as microwave ovens, water heaters, and TV's.

Both grades are totally encapsulated in rock-hard epoxy, and the reed switch contacts and coil are secured to a rigid internal lead frame which incorporates the PCB terminals. These little inch-long units incorporate a 1 Form A hermetically-sealed reed switch, and can switch low-levels up to 10W with 5-48 VDC coils. For prices or samples, contact your local Elec-Trol distributor.

Elec-Trol, Inc., 26477 N. Golden Valley Road, Saugus, CA 91350, (213) 788-7292 (805) 252-8330. TWX 910-336-1556.

ELEC-TROL

Circle 193 on reader service card

ELEC-TROL RELAYS



FULLY-SEALED

Elec-Trol's new commercial grade Blue Boy Reed Relays are now offered in production quantities for as low as 59¢, and both commercial and instrument-grade units are available from distributor stock. Although completely sealed against hazardous environments, production cleaning solvents, and rough handling, these Blue Boys cost far less than standard sealed units. For pricing and product information, contact your local distributor.

Ask about free samples.

AUTHORIZED DISTRIBUTORS

ALABAMA HUNTSVILLE
Component Distributors, Inc. (205) 883-7501

CALIFORNIA IRVINE
Acacia Sales, Inc. (714) 549 0954,
(213) 971-2428

CALIFORNIA SAN DIEGO
Acacia Sales, Inc. (714) 565 4365

CALIFORNIA SUNNYVALE
Acacia Sales, Inc. (408) 745-7200

CALIFORNIA VAN NUYS
Patane Avionics, Inc. (213) 988-4455

CANADA DOWNSVIEW, ONT.
Semad Electronics Ltd. (416) 635-9880

COLORADO LAKEWOOD
Acacia Sales, Inc. (303) 232-2882

FLORIDA CLEARWATER
Diplomat/Southland, Inc. (813) 443-4514

FLORIDA FORT LAUDERDALE
Component Distributors, Inc. (305) 971-4950

ILLINOIS ELK GROVE VILLAGE
Diplomat/Lakeland, Inc. (312) 595-1000

MASSACHUSETTS HOLLISTON
Diplomat/New England, Inc. (617) 429-4121

MICHIGAN FARMINGTON
Diplomat/Northland, Inc. (313) 477-3200

MINNESOTA MINNEAPOLIS
Diplomat/Electro-Com, Inc. (612) 788-8601

MISSOURI ST. LOUIS
Diplomat St. Louis, Inc. (314) 645-8550

NEW JERSEY EDISON
Brothers Electronics, Inc. (201) 985-3000

NEW YORK MT. VERNON
Sonkin Electronic Distribution, Inc.
(914) 668 9809

OHIO SOLON (CLEVELAND)
Repco (216) 248-8900

OREGON BEAVERTON
Parrott Electronics, Inc. (503) 641-3355

PENNSYLVANIA HUNTINGDON VALLEY
Shap Electronics Co., Inc. (215) 698-9550

TEXAS DALLAS
Solid State Electronics Co. of Texas, Inc.
(214) 352-2601

TEXAS HOUSTON
Harrison Equipment Co. (713) 652-4750
Solid State Electronics Co. of Texas, Inc.
(713) 785-5436

UTAH SALT LAKE CITY
Diplomat/Alta Land, Inc. (801) 486 4134

Circle 258 on reader service card

PDP-11* interface . . . from MDB

Peripheral Device Controllers ■ Systems Modules
General Purpose Interface Modules
Communications/Terminal Modules
I/O Cables ■ Accessory Hardware

When it comes to PDP-11 interface, MDB has it:

- Peripheral Device Controllers for most major manufacturer's
 - Printers
 - Card equipment
 - Paper tape equipment
 - Plotters

- Systems Modules
 - IEEE instrumentation bus
 - DR11B Direct Memory Access single quad module
 - DR11C General Purpose Interface module, a direct DEC equivalent
 - Digital I/O Module
 - Unibus Terminator

- General Purpose Interfaces

11B Direct Memory Access with 12 IC positions for user logic

11C Module with 16 bit input and 16 bit output registers; 20 user wire wrap positions

1710 Bus Foundation Module with pins for 40 user IC positions

Wire Wrappable Module with pins for 70 user IC positions

- Communications/Terminal Modules

MDL-11 Asynchronous

Serial Line Adapter
MDL-11W Asynchronous Serial Line Adapter with line frequency clock

MDU-11 Synchronous Serial Line Adapter

- Cable Subassemblies
 - I/O cable for 20mA current loop

I/O cables for EIA Asynchronous and Synchronous

Double-ended jumper cable

GP I/O 50, 40, 34, 26 and 20 conductor ribbon cables

MDB interface products always equal or exceed the host manufacturer's specifications and performance for a similar interface. MDB interfaces are completely software transparent to the host computer. MDB products are competitively priced, delivery is 14 days ARO or sooner.

MDB places an unconditional one year warranty on its controllers and tested products. Replacement boards are shipped by air within twenty-four hours of notification. Our service policy is exchange and return.

MDB also supplies interface modules for LSI-11*, IBM Series/1, Data General and Interdata computers. Product literature kits are complete with pricing.

MDB 1995 N. Batavia Street
Orange, California 92665
714-998-6900
SYSTEMS INC. TWX: 910-593-1339

*TM Digital Equipment Corp.

Circle 194 for PDP; 259 for LSI; 260 for IBM; 261 for DG; 262 for Interdata.

New products



occasions does an engineer measure the actual operating temperature of individual circuit components. The reason for this is simple—until now, there has not been a quick, easy way to make exact measurements. So designers have had to be content with techniques like measuring the temperature of ambient or exhaust air.

The model 392 Heat-Prober changes that situation. The pocket-sized, 6-by-3-by-1-in. temperature meter weighs a mere 10½ oz and has a 4½-digit light-emitting-diode display that reads from -50° to 140°C with a resolution of 0.1°C. From 140° to 500°C, it has a resolution of 1°C. When used with any one of a number of optional, application-tailored, platinum resistance-temperature-detector probes, the unit takes readings that are accurate to within ±0.5% of full scale, ±1 digit. Measurement repeatability is within ±0.2% of full scale.

Among the optional probes offered is the model 145, shown in the accompanying photograph. The spring-loaded sensing element provides positive-pressure feedback to the operator to ensure that good surface contact is maintained throughout the reading. Readings are updated three times a second, and the unit's response time is about a second or more depending on the temperature being measured. Another of the probes available is the model 123, which is intended for measuring the surface temperatures of dice and molds.

The Heat-Prober is available from stock and is priced at \$395 in single

\$4900*



Unretouched Photograph
of Screen



Since 1973, Intelligent Systems Corporation (ISC) has combined sound research and development with aggressive marketing to give the industry unparalleled performance at phenomenal prices. In color. Now for the newest addition to our product line: the Intecolor 8070 Series I Business System. The complete small system. It features our 19" color display and 8080A micro computer. Also available in a 13" color display version, with an additional built-in mini disk drive (8071). It includes a 110 CPS bi-directional

desk-top printer, a dual 8" floppy disk drive for 512K bytes of storage, Intecolor Business BASIC with print using and double precision. Optionally available: FORTRAN IV with double precision. Software by Microsoft®

The price? \$4,900, 100 piece price. Just \$7,000 on a single lot basis. For the business system even small companies can afford. Contact your local ISC sales representative for a demonstration of how the Intecolor Series I Business System can solve your business problems. A payroll software package

is included free with purchase. Terms—5% prepaid, or net 20 days. **Color Communicates Better**



Intelligent Systems Corp.®

5965 Peachtree Corners East
Norcross, Georgia 30071
Telephone 404-449-5961 TWX: 810-766-1581

ISC SALES REPRESENTATIVES: AL (also MS): Huntsville 205/883-8660, AZ (also NV): Phoenix 602/956-5300, CA: Los Angeles 213/476-1241 or 213/937-5450, Goleta 805/964-8751, Mountain View 415/964-9300, San Diego 714/292-8525, Irvine 714/557-4460, CO (also WY): Denver 303/759-0809, FL: Ft. Lauderdale 305/776-4800, Melbourne 305/723-0766, Orlando 305/425-5505, Valparaiso 904/678-7932, GA: Atlanta 404/459-1035, IL (N.): (also IN, WI): Northbrook 312/564-5440, KS (also W, MO, NB): Shawnee Mission 913/362-2366, LA: Mandeville 504/525-9701, MD (also DC, VA): Bethesda 301/656-3061, MA (also ME, NH, RI, VT): Framingham 617/879-7530, MI: Madison Heights 313/588-2300, MN (also SD, ND): Minneapolis 612/822-2119, MO (E.): (also S, IL, IA): St. Louis 314/821-3742, NM: Albuquerque 505/265-5655, NY (also CT, NJ): Holcomb 716/657-6291, White Plains 914/949-6476, NC: Durham 919/682-2383, OH (also KY): Cleveland 216/267-0445, Dayton 513/434-7500, OK: Oklahoma City 405/528-6071, OR: Portland 503/620-5800, PA (E.): (also DE): Wayne 215/688-7325, PA (W): (also WV): Pittsburgh 412/892-2953, SC: Columbia 803/798-3297, TN: Knoxville 615/588-2417, TX (also AR): Austin 512/451-5174, Dallas 214/661-0300, Houston 713/780-2511, San Antonio 512/828-0937, UT: Salt Lake City 801/973-7969, WA (also ID, MT): Bellevue 206/455-9180, **EUROPEAN EXPORT SALES:** Techexport, Inc., Cambridge, MA 617/661-9424, **ENGLAND:** Techex, Ltd., Bournemouth 0202-293-115, **FRANCE:** Peritec, Rueil 749-40-37, **SWITZERLAND:** Intertest, AG, Bern 031-224481, **AUSTRALIA:** Anderson Digital Equip., Mt. Waverly, Victoria, Melbourne 543-2077, **CANADA:** Cantec Rep., Inc., Ottawa, Ont. 613/255-0363, Pointe Claire, P.Q. 514/694-4049, Toronto, Ont. 416/675-2460, **CANADA:** Datamex, Ltd. (Distributor), Dorval, Que. 514/636-9774, Ottawa, Ont. 613/244-1391, Toronto Ont. 416/787-1208, Vancouver, B.C. 604/684-8625, **CENTRAL & SOUTH AMERICA, MEXICO, CARIBBEAN:** American Business Systems, Atlanta, GA 404/394-9603, **FAR EAST:** Computers International, Los Angeles, CA 213/382-1107

*100 piece U.S. domestic price

Circle 195 on reader service card

Two new coolers for plastic power devices—less than a dime each.

Here are two practical solutions for solving your cooling problems.

The new Series 289 and 290 are Wakefield's lowest cost standard heat sinks for plastic package semiconductors.

These compact units are designed for circuit board applications with either natural or forced air convection. The 289 accommodates one semiconductor while the 290 can handle either one or two devices.

You absolutely cannot find better coolers at this price—anywhere.

Try one free. See for yourself. Just cut out and mail for a free sample.

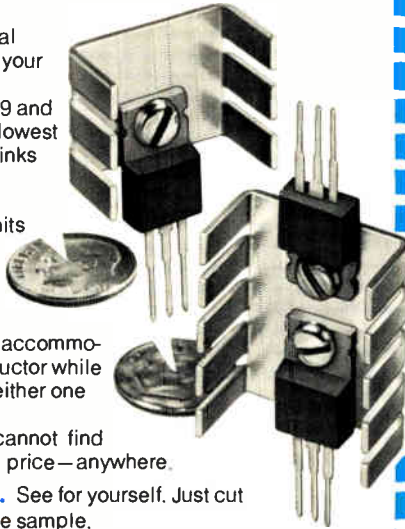

EG&G WAKEFIELD

Components Division
77 AUDUBON ROAD, WAKEFIELD, MA 01880 (617) 245-5900

Circle 263 on reader service card

Buzzzzz.

(Write for new catalog.)

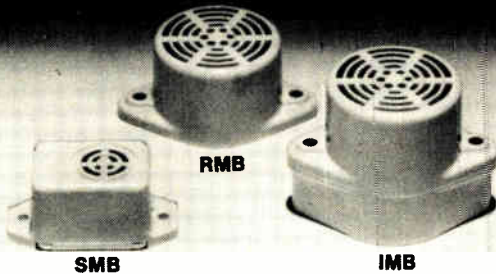

Solid state electronic MICRO-BUZZER from CITIZEN: High reliability, competitively priced with immediate delivery.

A complete range: SMB 1.5, 6, 12, 24, VDC
RMB 3, 6, 12, 24, VDC
IMB (Intermittent) 6, 12, VDC

CITIZEN

CITIZEN AMERICA CORPORATION
1710 - 22nd St.
Santa Monica,
CA 90404

Toll Free (800) 421-6516
In Calif. (213) 829-3541
TWX: (910) 343-6450

Name _____
Company _____
Address _____
City _____ State _____
Zip _____ Phone _____

New products

quantities. Probe prices range from \$70 for a simple stick-on probe to \$225 for the model 145; the model 123 is priced at \$195. Also available is a \$75 calibrator, model 10382, which can check the meter's accuracy to within $\pm 0.1^\circ\text{C}$ at four points: 0° , 100° , 140° , and 400°C .

Heat-Prober Division, William Wahl Corp., 12908 Panama St., Los Angeles, Calif. 90066. Phone (213) 822-6144 [353]

Wideband rf millivoltmeter boasts full-scale true rms

Instead of resorting to other techniques to obtain readings in the ultrahigh-frequency band, the model 9301A holds to the root mean square. The instrument covers the 10-kHz-to-1.5-GHz range with accuracies within $\pm 1\%$ of full scale up to 500 MHz, within $\pm 1\%$ of full scale $\pm 5\%$ of reading to 1 GHz, and within $\pm 15\%$ of reading to 1.5 GHz.

Readings made in any of the eight ranges, whose full-scale values vary from 100 mV to 300 V, are obtained using a dual sampling process that is insensitive to temperature variations, such as those that can be introduced just by picking up a voltage probe. The voltmeter comes with its own probe, which, along with circuitry internal to the meter, compensates for ambient noise in the vicinity of the probe. When the probe is terminated in the $50\text{-}\Omega$ input connector provided, residual noise is less than 20 mV.

The meter's sample-and-hold feature permits operators to make





If logic board testing problems have you feeling like this...

Check HP's strategy.



Testing may be your most frustrating and costly production bottleneck. But now, HP can help you make the right move in logic-board testing. Here's how the DTS-70 can help you increase throughput while cutting production and warranty costs.

HP's simulator-based system, at a cost roughly equivalent to comparison testers, increases testing efficiency. It gives

known fault-detection effectiveness. And it provides design feedback by analyzing circuits for failure modes and testability before they're even built.

Fault-diagnosis, under computer direction, quickly isolates faulty components, part failures with intermittent symptoms, and races.

Compatibility with other HP instruments via the HP-IB* lets you easily adapt the DTS-70 to your specific testing requirements.

Independent test-program generation, using a separate station and the DTS-70's minicomputer, eliminates a big bottleneck by allowing test-program generation while testing is in progress on the same system.

Expansion capability lets you add up to two more test stations and up to ten software generating stations as you expand without investing in additional computing power.

Learn more about HP's strategy for circuit board testing and why a simulator-based system can be a more cost-effective solution. Mail the coupon today or call your local HP field engineer.

* HP's implementation of IEEE Standard 488-1975.

HP Board Testers—the right decision.

HEWLETT  PACKARD

P.O. Box 60001, Loveland, Colorado 80537

For assistance call: Washington (301) 948-6370, Chicago (312) 255-9800, Atlanta (404) 956-1500, Los Angeles (213) 877-1282

298/42

I want to make the right decision now!—Please send me the FREE brochure describing HP's solution to logic-board testing. Hewlett-Packard, P.O. Box 60001, Loveland, CO 80537

Name _____
 Title _____ Phone _____
 Company _____
 Address _____
 City/State _____ Zip _____

Circle 197 on reader service card

The Indicator With a Memory

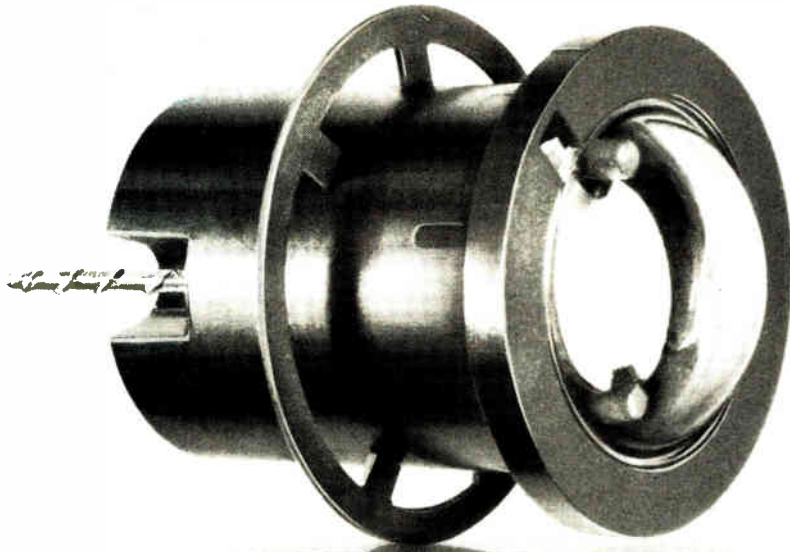

New!

The P35 panel mount memorizing indicator from Ferranti-Packard.

The P35 features:

- Long life (100 million operations minimum)
- Excellent visibility (light reflecting disc)
- Choice of 5 fluorescent disc colors
- Enclosed housing
- Simple mounting

A 1 millisecond, 250 mA current pulse sets or resets the disc, status is retained indefinitely by remanent magnetism.

Uses include:

Transient recorders, Industrial process displays, Contact status indicators, Field equipment.

Discover how you can use the P35 indicator—Fill out the reader service card or write direct today.

When clear displays count, specify:



Ferranti-Packard Limited

Electronics Division
6030 Ambler Drive
Mississauga, Ontario
Canada L4W 2P1
Telephone: (416) 624-3020
Telex: 06-961437



Actual Size

New products

measurements when it is necessary to insure that the probe is carefully placed. A switch on the probe lets the user initiate this mode of operation, make the measurement while watching the probe, and turn to the meter within about 3 minutes to take the reading.

The 9301A can be programmed using a parallel binary-coded-decimal word that is compatible with transistor-transistor-logic. Complete with probe, the millivoltmeter sells for a price of \$1,295 and is available from stock.

Racal-Dana Instruments Inc., 18912 Von Karmen Ave., Irvine, Calif. 92715. Phone (714) 833-1234 [354]

Generator modulates at preset user-defined frequencies

When ordering the model 3003 signal generator, the user can specify any two modulation frequencies between 100 Hz and 10 kHz to which he or she has frequent recourse. The unit is then delivered with these internally generated, switch-selectable frequencies, in addition to the standard modulation frequencies of 400 Hz and 1 kHz.

Operating in the 1-to-520-MHz range, the 3003 also features an external modulation capability that, together with its internal capabilities, allows the operator to create a-m-a-m, fm-fm, and a-m-fm signals. Output levels may be varied continuously between 0.1 v and 1 v. Output level, as well as fm deviation and percent a-m modulation, can be displayed on the instrument's analog meter.

The generator is accurate to within 0.001% of selected frequency and stable to within 2 ppm/hr. Optionally, it can be configured for both frequency and level control via an IEEE-488 bus. Other options include a high-stability reference oscillator. Priced at \$3,230, it is deliverable six to eight weeks after receipt of order.

Wavetek Indiana Inc., 66 N. First Ave., Beech Grove, Ind. 46107. Phone Mario Vian at (317) 783-3221 [355]

The quarter billion keyboard. Our unique "Golden Touch" capacitive keyboard is rated at 250,000,000 MCBF per keyswitch. That's at least double anybody else's rating. New patented features make the "Golden Touch" exceptionally resistant to moisture, dust and electrical noise. We guarantee a 1% AQL and give a two-year warranty. Every "Golden Touch" we produce is designed precisely to your specifications... because we sell only to volume OEM manufacturers. So you name whatever options, circuitry, configuration and legends you want. All this at competition-beating prices.

DIGITRAN

The Digitran Company, a division of Becton, Dickinson and Company
855 South Arroyo Parkway • Pasadena, California 91105
Phone: (213) 449-3110 • TWX 910-588-3794

Circle 199 on reader service card

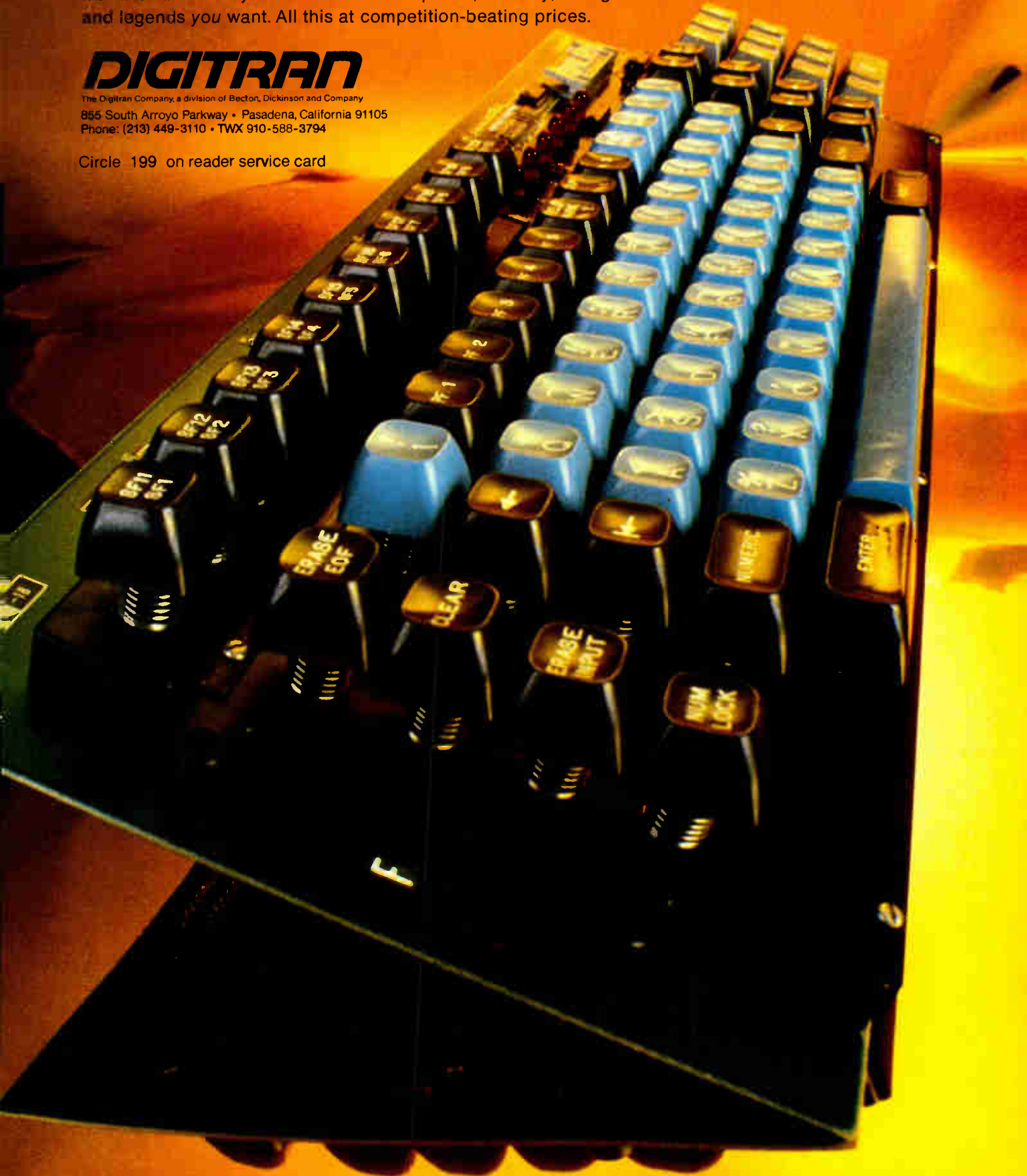

NOW YOU CAN GET BOTH PACKAGE DENSITY AND CIRCUIT DESIGN FLEXIBILITY.

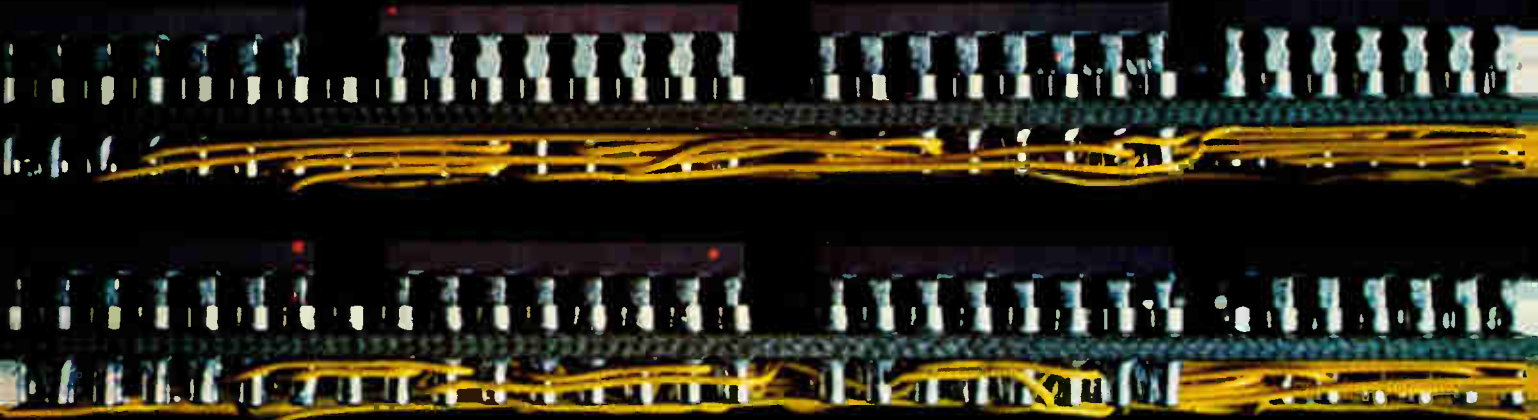

Planar boards on 0.6 inch centers. Photograph shown 2x size.

Introducing Augat's patented Planar stitch-wire. A high speed, low cost system that eliminates the high engineering cost of breadboarding, complete circuit card prototyping and extensive debugging. As a result, turn around time can be cut by one-half to one-third.

Augat's stitch-wire system works like this. After components are mounted on Planar boards, a stitch-wire machine welds insulated wire to stainless steel pads.

Wiring instructions can be furnished using punched tape programs or wire lists. You can also do special wiring configurations including twisted pairs or wiring on the compo-



nent side. Changes can also be made simply, either by stitch-wire machines or by hand soldering.

Adopting stitch-wire is easy, because Augat stocks the wiring machines and a wide range of general purpose Planar boards. Including boards compatible with most mini and micro-computers. These boards feature large etched power and ground planes.

The combination of large planes and low profile wiring makes them ideal for high speed logic. What's more, we can design and produce stitch-wire boards to your specifications. Or we can provide the

boards and equipment you need to do the job.

Augat stitch-wire offers density and flexibility advantages you can't get anywhere else. To find out how you can get started with stitch-wire, write Augat Planar Systems, Inc., 14751 Califa Street, Van Nuys, California 91411. Tel. (213) 786-3974.

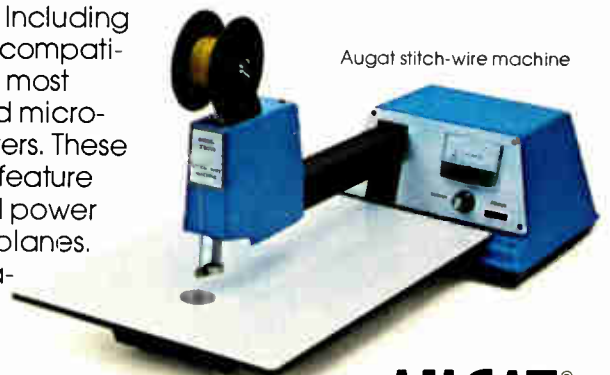

Augat stitch-wire machine

AUGAT®

Augat interconnection products, Isotronics microcircuit packaging, and Alco subminiature switches.

Let a SHARP display out front reflect the quality inside.

Sharp's long experience and pioneering technology provide you with a vast array of reliable, long-life LCD displays for a wide variety of applications.

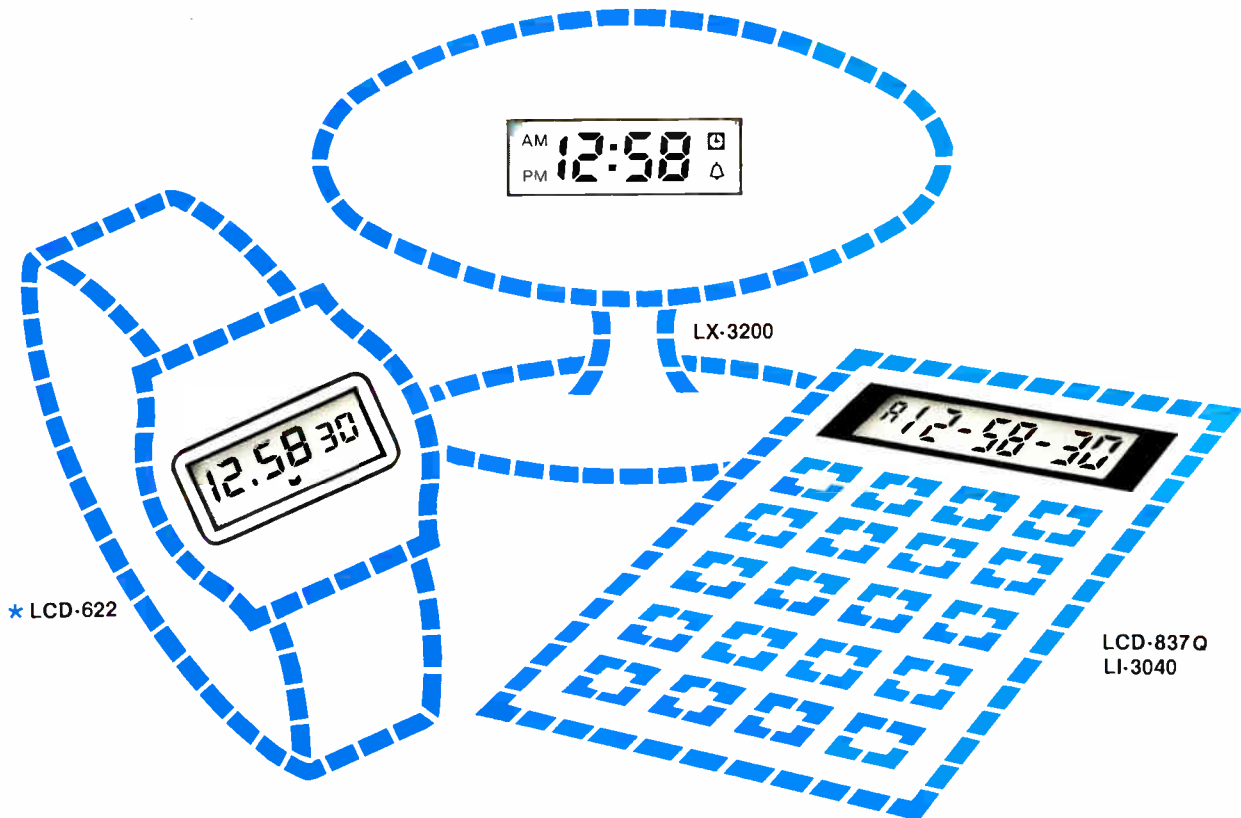

★ LCD-622

LX-3200

LCD-837Q
LI-3040

LCD Watch Displays

LCD-622

5-1/2 digits for numbers, symbols for colon (o) and \heartsuit (day display), and with Kit Supply available (LSI: LR-5105). Also displays with 24-hour mode but without Kit Supply (LCD-609, LCD-611).

LCD Clock Modules

LX-3200/LX-3501G

Various sizes from slim type (0.2" with optional color and back light (LX-3200) to 0.5" number height with 24-hour mode on 3V operation (LX-3501G).

Also models

LX-3403 (time correction, wake, sleep timer, audio timer, snooze), LX-3405G (slim type with 0.4" number height and PCW for both sides), and

LX-3406H:



Clock-Calculator Kit

(Low priced!)

LCD-837Q/LI-3040/Polarizer/
Rubber Connector

For hour, minute, second/month, date, day and 12/24 hour mode and alarm for clock, or 8 digits and percent calculation, etc. for calculator.

SHARP LCD DISPLAYS

See SHARP LCD displays at the:
JAPAN ELECTRONICS SHOW '78 Tokyo Oct. 6-11

SHARP CORPORATION
INTERNATIONAL DIVISION
ELECTRONIC COMPONENTS DEPT.

22-22, Nagaike-cho, Abeno-ku,
Osaka, Japan
Tel: (06)621-1221
Telex: 5267286 (SHAPEX J)



* We regret to report the photo of Sharp's LCD-622 model on page 52 of the July 20th, 1978 issue appeared reversed due to a printing error

High Voltage Products

from **ERIE**

SILICON RECTIFIERS

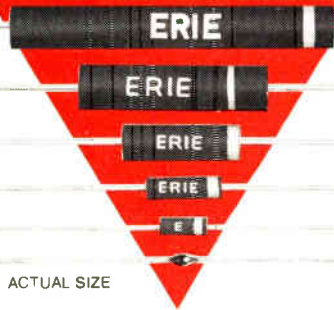

ACTUAL SIZE

VOLTAGE MULTIPLIERS



POWER SUPPLIES



- "MINIATURIZATION" is our specialty
- Custom design
- "In-house" capability
- MIL approved facilities
- Hi reliability

TYPICAL APPLICATIONS

- Military • Industrial
- Commercial
- CRTs • PMTs • SITs
- I-SITs • LLLTV • Lasers
- Image Intensifiers
- Detectors
- Electrostatic Applications



Write for new catalog
or call ...

ERIE

ERIE TECHNOLOGICAL PRODUCTS, INC.
ERIE, PENNSYLVANIA 16501
(613) 392-2581

New products

Semiconductors

Chip controls floppy disks

MOS device can handle double-density, double-sided units, has three scan modes

Most floppy-disk controllers have been designed for single- or double-sided, single-density disks. So, with the introduction of double-sided, double-density floppy disks earlier this year, interfacing the disk drives and the central processor has become a problem for most users. But NEC Microcomputers Inc. is offering a solution: the μ PD765C—a one-chip n-channel metal-oxide-semiconductor device.

The 40-pin plastic-packaged chip is compatible with both single- and double-density disks. It allows four data record lengths—128, 256, 512, and 1,024 bytes per sector—for each of the two densities. Thus, the chip is fully compatible with standard IBM formats and is also capable of handling a variety of other standard

and nonstandard arrangements.

Its multiple device-select lines allow the 765 to control up to four floppy-disk drives. Multiple head-select lines allow for double-sided recording, making possible a multi-track transfer capability in which the chip automatically transfers from a given track on one side of a disk to the corresponding track on the other side. Multisector transfer capability is also provided.

Three scan modes reduce both the time and the amount of main memory required for handling transactions between the floppy disk and its host computer. One of them compares the entire data field on a disk, on a byte-by-byte basis, with data in the processor's memory. This procedure, which is commonly used to verify correct writing onto a disk, needs only half as much main memory as it would if the chip lacked the comparison feature. The other two scan modes identify bytes that are, respectively, greater than or less than a computer-provided comparison word.

The 765 restores the head to track 00 with a seat command. "It's easier to have this command than to have to count steps," says Richard J. Weiner, a member of the micropro-

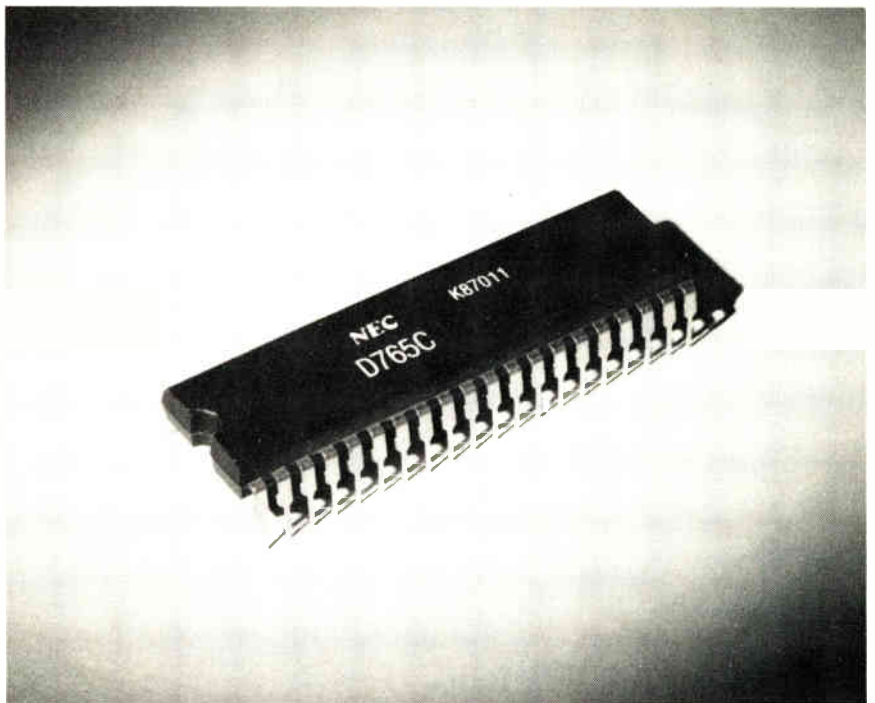

cessor technical staff. Other features include internal address mark detection circuitry, hand-shaking signals to a phase-locked loop, and programmable head-load time—2 to 256 ms in 2-ms increments. Head unload time can be programmed from 0 to 240 ms in 16-ms increments.

The chip is compatible with the IBM 3740 and System 34 and is designed to work with the 8080A, 8085, and Z80 microprocessors. It is also compatible with the industry-standard 8257 direct memory access chip. The 765 requires a single 5-v dc power supply. It will sell for \$38.10 in hundreds and have a delivery time of 60 days after Oct. 1. NEC Microcomputers Inc., 173 Worcester St., Wellesley, Mass. 02181. Phone Richard Weiner at (617) 237-1910 [411]

Monolithic codec available commercially

Because it worked with several major manufacturers of telecommunications equipment, National Semiconductor Corp. is shipping the industry's first commercially available monolithic single-channel coder/decoder to meet both U.S. and CCITT specs. Labeled the TP3000, the part is available in both μ - and A-law companding versions.

The codec is fabricated with National's complementary-metal-oxide-semiconductor/bipolar technology and will be followed by a series of monolithic codec systems. It contains all that is needed for a single-channel pulse-code-modulated codec: input and output sample-and-hold circuits, nonlinear digital-to-analog converter, comparator, on-chip voltage reference, successive-approximation logic, digital input/output buffers, auto-zero circuitry, and control logic.

The TP3000 system samples a bandpass-filtered (300-Hz-to-3.4-kHz) analog signal at an 8 kHz rate. It converts the sampled voltage to an 8-bit companded digital code and loads the code into a high-speed serial output buffer that can operate between 64 and 2,100 kilobits per

second. Either system (TP3001 for μ law; TP3002 for A law) will also accept an incoming 8-bit PCM word and automatically interrupt the encode cycle to decode it and update the codec's output sample-and-hold. National Semiconductor Corp., 2900 Semiconductor Dr., Santa Clara, Calif. 95051. Phone Kurt Siem at (408) 737-5712 [413]

Baud-rate generator uses single 5-V supply

A programmable divider, called the COM8046 baud-rate generator, uses depletion-mode loads to let it operate from a single 5-volt power supply. It produces a full spectrum of 16 asynchronous data-communication frequencies for 1X, 16X, and 32X UART/USRT/ASTRO/USYNRT devices.

Giving the user a choice of 32 output frequencies, the part is fabricated with Standard Microsystems' Coplamos and Clasp technologies. It

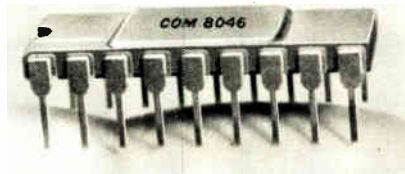

contains an on-chip crystal oscillator to provide the master reference frequency and can also accept an external reference. The COM8046 includes a reprogrammable read-only memory and an output disable. The part also may be used as a frequency shift keyer.

Standard Microsystems Corp., 35 Marcus Blvd., Hauppauge, N. Y. 11787. Phone (516) 273-8898 [414]

Precision 2.5-V reference ICs come in three package types

A trio of precision 2.5-v reference integrated-circuit chips whose output voltages are trimmed internally

TOTAL FREQUENCY CONTROL FROM ERIE

HIGH FREQUENCY AT CRYSTALS



Erie AT Crystals are used over the frequency spectrum from 950 kHz to 200 MHz. Low temperature coefficient, extremely high Q, economical. Used in TCXO and VCXO oscillators, temperature controlled and, non-controlled oscillators, and filter applications. All size cans.

LOW FREQUENCY CRYSTALS



Low frequency crystals are available from 1 kHz to 1MHz in a broad variety of crystal holders and mounting configurations. Erie is a leading source for all types of high quality, Low Frequency Crystals.

CRYSTAL OSCILLATORS



Erie offers a broad range of economical as well as highly sophisticated Crystal Oscillators. These

small size oscillators are available in a wide range of frequencies. Hermetically sealed crystals assure long term stability. Design assistance available.

CRYSTAL FILTERS

Erie quartz crystal filters are specified for use in communications receivers ... as well as for radar, sonar and space applications.



Write for brochure describing Erie Crystals, Filters, Oscillators and Ovens.

ERIE

ERIE FREQUENCY CONTROL DIV. OF ERIE TECHNOLOGICAL PRODUCTS

Carlisle, Pa. 17013
717/249-2232

Only MFE makes this, that, and everything in between.

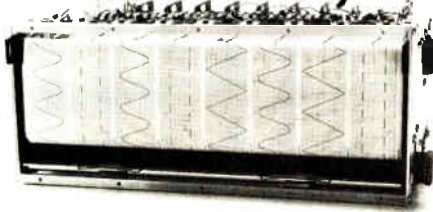

Our eight-channel V-series recorder module.
(Actual size: 6.5" x 16.5" x 10.4")

We make the widest range of inkless, thermal-writing OEM strip chart recorder modules in the industry. Twenty models in all. Everything from our new lightweight, miniature, single-channel, DC model to eight-channel modules that write on plastic or chemically coated paper.

We also offer the industry's widest range of recorder options—including single- or five-line alphanumeric thermal edge printing (on selected models), event markers, paper take-up, and rack-mounted or portable cases. All at very competitive prices.

MFE. We give you just what you want in OEM recorders. Everything.

For a brochure on our complete line of recorders, contact MFE Corporation, Keewaydin Drive, Salem, NH 03079. Tel: 603-893-1921. TWX 710-366-1887/TELEX 94-7477. In Europe: MFE Products Sa, Vevey, Switzerland, Tel. 021 52. 80, 40/TELEX 26238. (MFE has complete worldwide representation. Contact us for the rep nearest you.)

#1 in OEM Recorders.

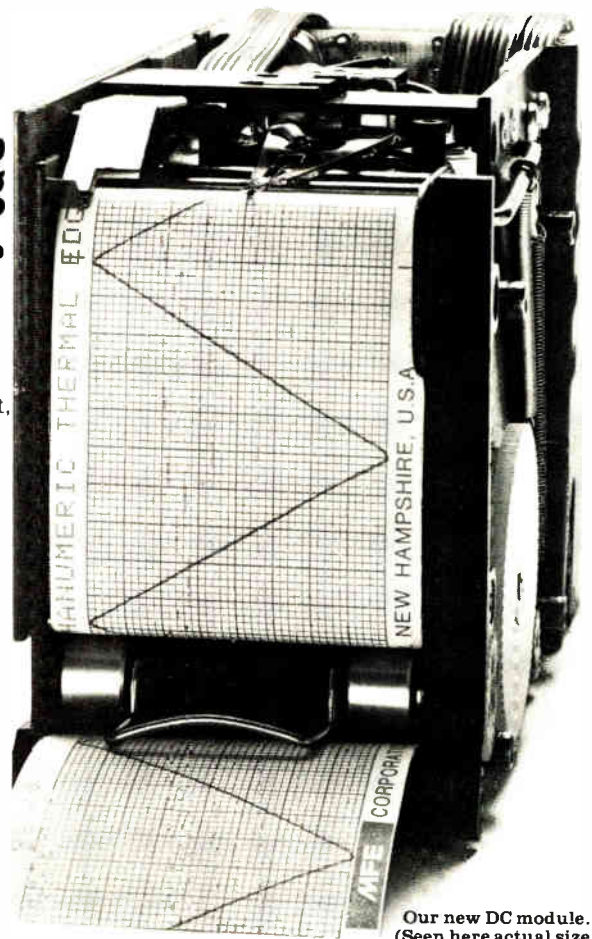

Our new DC module.
(Seen here actual size.)

Circle 204 on reader service card

WHO NEEDS A VIDEO OP AMP

**With 1 GHz Gain Bandwidth Product
and
70 Nanosecond Settling to 0.01%?**

Far more people than you would have imagined! People who require the performance of a true differential input op amp at frequencies from DC to beyond 100 MHz, with the ease of using a 741 at 100 kHz. Those who want a ± 5 volt output to reach an accuracy of 0.01% in 70 nanoseconds. Others who require this state-of-the-art performance from -55°C to $+125^{\circ}\text{C}$, and many more who require the high reliability provided by MIL STD 883 processing.

Your application may not need the full temperature range or the hermetically sealed DIP, but for many industrial applications these and other features of the new Video Op Amp offer you vital reliability.

All of this and more is available to you off-the-shelf with the 1435 – The op amp that solves problems you didn't even try to solve before!

*Picture an unsolvable
problem that you've had...
now imagine what the 1435
would have done!*

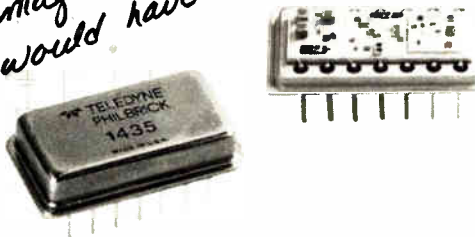

TELEDYNE PHILBRICK

Allied Drive at Route 128
Dedham, Massachusetts 02026
Tel: (617) 329-1600

TWX: (710) 348-5726
Telex: 92-4439
Cable: TELEPHIL

New products

to within $\pm 1\%$ is available from Silicon General Inc. Designated the SG1503, -2503, and -3503, the devices are interchangeable with the MC1503 and AD580 voltage-reference ICs. They each require less than 2 mA of quiescent current and deliver in excess of 10 mA with total load- and line-induced tolerances of less than 0.5%. Input voltage may range from 4.5 to 40 v. The temperature coefficient of output voltage is less than 20 ppm/ $^{\circ}\text{C}$.

The new voltage references come in three types of packages: a hermetically sealed TO-39, three-pin metal can (T-package); eight-pin ceramic (Y-package); and plastic (M-package) miniDIP. The units can be specified over the full military temperature range of -55°C to $+125^{\circ}\text{C}$, or for less stringent applications.

Price of the SG3503M, for example, is \$1.50 in 100-piece lots. All parts are available from distributor and factory stock.

Silicon General Inc., 11651 Monarch St., Garden Grove, Calif. 92641. Phone J. Castellano at (714) 892-5531 [416]

Fast turn-off SCRs use compression assembly

Two lines of inverter silicon controlled rectifiers sport up to 20 times the thermal cycling life of conventional SCRs because of the way they are constructed. FMC Corp. compresses the silicon chip of the SCRs between a pair of molybdenum disks so that soldering, intermetallic bonding, and the high-temperature brazing of silicon to molybdenum are eliminated. The result is a compression assembly for the high-current devices, applicable to uninterruptible power supplies and induction heating equipment, that puts far less stress on the chip.

Both lines are rated at 430 A rms and at 275 A average. The high-voltage 279 series comes in any of six blocking voltages from 700 v to 1,200 v in 100-v increments at turn-off times of 30 or 40 μs maximum. The 309 series also has six blocking voltages but these are from 100 to

SOLID STATE POWER

**Off-The-Shelf Designs...
Standard Models...
We've Got 'Em!**

**Big performance plus
big savings in time,
effort and dollars**

Solid State GaAs FET Power Amplifiers

Series GLWA low cost Class A linear amplifiers with power outputs of 2.0 watts (3.7-4.2 GHz), 1.3 watts (4.4-5.0 GHz), or .8 watts (5.9-6.4 GHz). Other power ratings up to 3.3 watts, and other frequencies up to 7.9-8.4 GHz also available. Features include positive hermeticity of GaAs FET devices, low noise figure, built-in protection, high MTBF.

Solid State High Efficiency Power Supplies

Series HEPS high current switching regulator power supplies feature better than 85% efficiency. Up to 6000 watts DC power (30 VDC @ 200 amps) with built-in voltage/current/thermal fault protection, internal forced air cooling.

Solid State Class A Linear Power Amplifiers

Series LWA, power module packages for systems applications. 26 standard models, frequencies from 5 MHz to 4.2 GHz, power output up to 100 watts. Ideal replacement for TWT amplifiers. Series LAB, instrument version with built-in power supply. Choice of 62 standard models with such features as gain control, leveling, external modulation.

Solid State Class A/B High Power Kilowatt Amplifiers

Series EWAL, PWAL, PAL deliver up to 1000 watts of A/B linear power. Standard models, frequencies from 2 MHz to 500 MHz, plus standard designs for frequencies up to 3 GHz. Bandwidths up to several octaves. Electronic or circulator protection. Ideal for applications such as ECM/EW jammers, and TV transmitters, add-on AM amplifiers, etc.

Solid State AM Modulator/Power Amplifiers

Series PAM, operate in VHF, UHF and VHF/UHF transceivers. Up to 1 KW peak envelope power; low distortion transmission, $\pm 5\%$. Typical standard model covers 225-400 MHz band, for use with up to 7000 channels.

Solid State High Power TV Transmitter Amplifiers

Series TVA, for CCIR and NTSC low and high band television broadcast applications. Visual and aural power output: up to 1000 watts. Broadband operation over 54-88 MHz and 174-230 MHz ranges. Max. MTBF and min. MTTTR.

Solid State Class C Protected Power Amplifiers

Series EWA, PWA are used in applications requiring high power and maximum bandwidth. 60 standard-design EWA models have electronic protection, frequencies from 1 to 1000 MHz, octave/decade bandwidths, power up to 1000 watts. Series PWA is circulator-protected, more than 160 standard models, frequencies from 100 to 4200 MHz, power up to 1000 watts.

Solid State High Level Baseband and Baseband Distribution Amplifiers

Series BBA and BDA, designed for CCIR and Intelsat telecommunication applications. Standard models with single or multiple output, gain up to 30dB.

Solid State Class A Wide Band Linear Multi-Couplers

Series LMC and LLMC, for connection of several receivers to a single antenna. Frequency range from 2 MHz to 2 GHz in decade and octave bandwidths.

Solid State IF Amplifiers

Series IFA, ideal for telecommunication applications. Center frequencies of 70, 700 or 1100 MHz, with low group delay and low input/output return loss.



MICROWAVE POWER DEVICES, INC.

Adams Court, Plainview, N.Y. 11803 • Tel. 515-433-1400 • TWX 510-221-1862

Circle 205 on reader service card

From Electronics Magazine Book Series. Zero-risk trial offer.



New Product Trends in Electronics, Number One

From "New Products," state-of-the-art materials and equipment, arranged according to function. \$14.95

Electronics Book Series

P.O. Box 669, Hightstown, N.J. 08520

Send me _____ copies of "New Product Trends in Electronics, Number One" at \$14.95 per copy

Discounts of 40% on orders of 10 or more copies. I must be fully satisfied or you will refund full payment if the book is returned after ten-day trial examination.

Payment enclosed Bill firm Bill me
Charge to my credit card:
 American Express Diners Club
 Visa Master Charge

Acc't No. _____ Date exp. _____

On Master Charge only, first numbers above name

Name _____ Title _____

Company _____

Street _____

City _____ State _____ Zip _____

Signature _____

A DESIGN TOOL FOR YOUR MOST DEMANDING RELAY APPLICATIONS

Here's a vacuum relay that offers high power switching in a small, light and rugged package for demanding relay applications.

This relay will carry 30 A at 2.5 MHz, and withstand voltages up to 10 KV. It weighs in at just 3 oz., occupies only 2.35 cubic inches, and has a very low contact resistance. It is designed to outlast any conventional relay in a similar application.

The ITT Jennings RJ2B has Mil. Spec. ruggedness and documentation. It has been field proven for years in critical applications such as antenna switching, coupler matching, and pulse forming networks. Our relay will operate at high altitude or vibration levels, under pressure, at high temperatures, or in any extreme environment. The RJ2B relay also has sealed contacts for safe use in volatile atmospheres.

ITT Jennings, the pioneer of high voltage vacuum products, now offers the RJ2B Vacuum Relay for your application. Phone or write, ITT Jennings, 970 McLaughlin Avenue, San Jose, CA 95122, (408) 292-4025.



Circle 206 on reader service card

The magazine you're reading now, could be your own.

Drop off the routing list. Get your own fresh, unclipped copy mailed to your home or office. Turn to the subscription card in the back of the magazine. If somebody has beat you to it, write: Electronics, P.O. Box 430, Hightstown, N.J. 08520.

New products

600 v, with turn-off times of 20 or 10 μ s. Both series, available in 1/2-inch flatpacks, can also be furnished with a dv/dt capability of either 200 v/ μ s or 500 v/ μ s.

An 1,100-v, 279-series inverter SCR with 30- μ s turnoff is priced at \$62.40 in 10-piece quantities. A 309-series SCR, rated at 600 v with 10- μ s times. Delivery time is approximately six to eight weeks.

Semiconductor Products Division, FMC Corp., Broomfield, Colo., 80020. Phone Art Connolly at (303) 469-2161 [418]

16-K RAM uses single 5-V power supply

Beginning in October, Intel Corp. plans to start supplying samples of a 16,384-bit dynamic random-access memory that operates from a single 5-v power supply. The part also features low power drain in both standby and operational modes and access times lower than 100 ns. "The applications we see for it are in the mainframe area as a replacement for cache buffer memories," declares James Oliphant, product manager for the memory components group. He also targets a market in small systems "where 64 kilobytes would be too much memory."

Dubbed the 2118, the device also offers designers an upgrade from Intel's 2117 16-K RAM, which requires three power supplies. On-chip substrate bias in the 2118 eliminates the need for the -5- and -12-v supplies. Noting that the 16-K market is "going up substantially," Oliphant says that the 2118 is targeted at the market segment that needs speeds normally associated with transistor-transistor logic.

Three speeds will be offered: 80-, 100-, and 120-ns access times. The maximum standby power is 22 mw and operating power is 99 mw for the 120-ns device and 190 mw for the 80-ns version. Prices will be competitive with the 150-ns 16-K devices—under \$15 in high volume.

Intel Corp., 3065 Bowers Ave., Santa Clara, Calif. 95051 [419]

The Cardedge Connector

for Microcomputer Modules and Microprocessors

4 thru 200 Contacts
.100 Contact Spacing

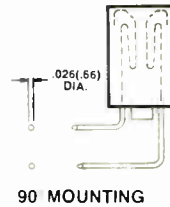
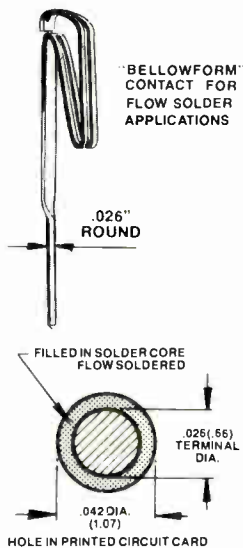
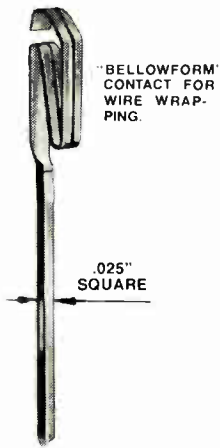
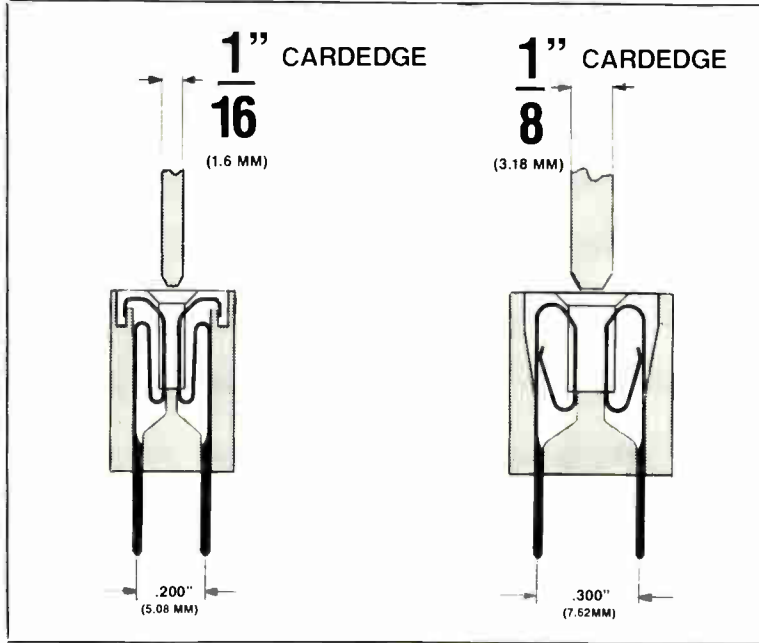
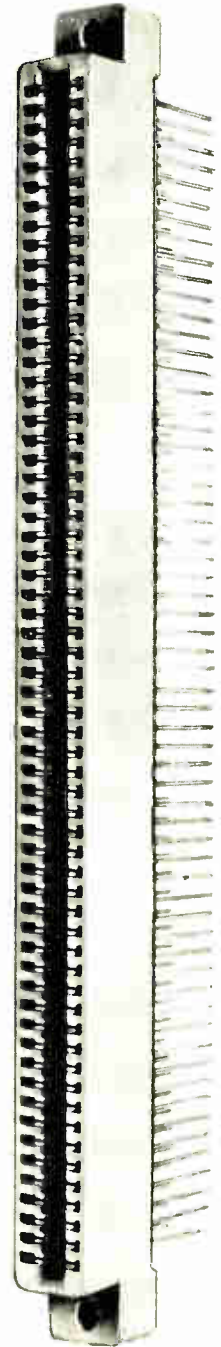

122 CONTACTS
1/16 BOARD THICKNESS
ACTUAL SIZE

122 CONTACTS
1/8 BOARD THICKNESS
ACTUAL SIZE

CONTINENTAL CONNECTORS IN A QUALITY WORLD OF ELECTRONICS

For our nearest direct sales representative or distributor, see your electronics directory.

CONTINENTAL CONNECTORS

CONTINENTAL CONNECTOR CORPORATION • WOODSIDE, NEW YORK 11377

PHONE: (212)899-4422

New from Electronics... when you can't afford to reinvent the wheel.

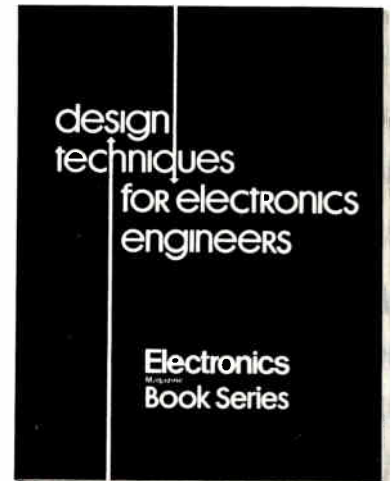

Here's just a sampling of the vast range of useful information you'll have at your fingertips...

- How to use soluble masks to protect pc boards from solder.
- How to evaluate power dissipation in microcircuit design.
- How to hand-solder DIP circuits to save testing dollars.
- How to compare the power of C-MOS with TTL.
- How to really look at low-drift IC op amps.
- How to accurately trim closed resistor loops.
- How to drive LEDs directly from C-MOS logic outputs.
- How to convert coordinates and find SWRs graphically.
- How to compare coaxial-cable shielding effectiveness.
- How to calculate resistance for sum and difference networks.
- How to use a programmable calculator to analyze filter designs.
- How to compute response of RLC networks with a short program.
- How to eliminate stray signals in remotely gain-switched op amps.
- How to chart power losses for hybrid-combined amplifiers.
- How to reduce IC FET op-amp input bias currents.
- How to build timing circuits for noisy environments.
- How to approximate waveforms with exponential functions.
- How to increase an instruction set without increasing word length.
- How to extend the life of digital recording heads.
- How to add numeric readout to logic probe displays.
- How to pick the right film for better oscilloscope pictures.
- How to use a frequency counter to measure capacitance.
- How to evaluate high-energy pulse effects on materials.
- How to operate a logic gate as a flip-flop.
- How to choose the right detector for rf power measurements.
- How to measure the access time of bipolar read-only memories.
- How to test power supplies quickly and cheaply.
- How to get the most out of a digital multimeter.
- *And much, much more.*

Order today, and don't forget the other valuable books in the Electronics Books Series listed on the coupon below.

<p>Electronics Book Series P.O. Box 669, Hightstown, NJ 08520</p> <p>1. Microprocessors Send me _____ copies at \$8.95 per copy.</p> <p>2. Applying Microprocessors Send me _____ copies at \$9.95 per copy.</p> <p>3. Large Scale Integration Send me _____ copies at \$9.95 per copy.</p> <p>4. Basics of Data Communications Send me _____ copies at \$12.95 per copy.</p> <p>5. Circuits for Electronics Engineers Send me _____ copies at \$15.95 per copy.</p> <p>6. Design Techniques for Electronics Engineers Send me _____ copies at \$15.95 per copy.</p> <p>7. Memory Design: Microcomputers to Mainframes Send me _____ copies at \$12.95 per copy.</p> <p>8. New Product Trends in Electronics Send me _____ copies at \$14.95 per copy.</p> <p>Discounts of 40% on orders of 10 or more copies of each book.</p>		<p>If after my 10-day free-trial examination I am not fully satisfied I understand that my payment will be refunded.</p> <p><input type="checkbox"/> Payment enclosed <input type="checkbox"/> Bill firm <input type="checkbox"/> Bill me</p> <p>Charge to my credit card:</p> <p><input type="checkbox"/> American Express <input type="checkbox"/> Diners Club</p> <p><input type="checkbox"/> BankAmericard/Visa <input type="checkbox"/> Master Charge*</p> <p>Acct No. _____ Date Exp. _____</p> <p>*On Master Charge only, first numbers above name. _____</p> <p>Name _____ Title _____</p> <p>Company _____</p> <p>Street _____</p> <p>City _____ State _____ Zip _____</p> <p>Signature _____</p>
--	---	--



Almost perfect.

Our new ADM-42 doesn't have quite everything. But it comes so close, you might never notice.

Because it's a complete, semi-intelligent terminal for just about any application you can name. And it does just what you want it to do, just when you want it done.

The ADM-42 is completely self-contained, and provides you with flexibility of format, security, editing, interface, and transmission. It also features a full two-page display as standard equipment. Not as an option. And it comes with a truly staggering array of options.

THE MORE YOU USE IT, THE SMARTER IT SEEMS.

We gave the ADM-42 a bright, easy-to-read 2000 character display. A full 128 ASCII character set. 16 function keys for 32 separate commands. And five separate cursor control keys.

The 42's behavior modification gives you a factory installed personality for an alternative ESC sequence lead-in—in addition to the standard

ESC. And End Block character. A New Line character sequence. A field separator. And even a function sequence preamble.

Its status displays on the screen give you a conveniently wide range of information at a glance. While its special symbols indicate the entry of control characters in memory. Also, all control characters can be stored using the escape sequence or program mode. And the Field Protect Mode allows rapid data entry into forms or instruction pages.

THE ADM-42 WILL HAND YOU ANOTHER LINE.

The terminal's displayed data is formatted in 24 lines per page, 80 characters per line. And, to top it off, it comes with a 25th line established and reserved exclusively for status indicators and messages of up to 79 characters.

As if all this weren't enough, the ADM-42 has an impressive list of options. Like synchronous transmission with various line protocols. An extended memory capable of adding

data space up to a maximum of 8 pages. And programmable function keys, to name but a few.

THE ADM-42 IS ONE TOUGH ACT TO FOLLOW.

The ADM-42 has just about everything. Including a microprocessor that increases reliability and ease of operation. Any way you look at it, in fact, it's one pretty smart buy.

So if you're thinking of upgrading to a more intelligent terminal, at a more than reasonable price, call us today. Or better yet, contact your local distributor.

We'll show you how easy it is to move up to the ADM-42.

The terminal that's so smart, you'll swear it's got a mind of its own.

ADM 42 Getting smarter all the time.



LEAR SIEGLER, INC.
DATA PRODUCTS DIVISION

matrox

SBC-80 MULTIBUS

displays

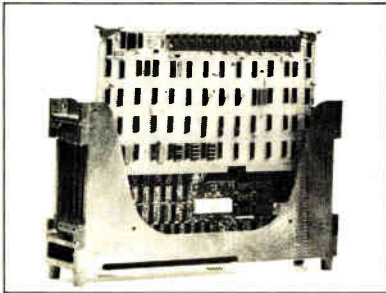

MATROX has the most complete line of CRT display boards for Intel's Multibus in the industry. We have alphanumeric; graphics; color; black and white; variable resolution; external/internal sync; 50/60 Hz; software and much, much more. Just plug the board in the Multibus, connect video to any standard TV monitor, and presto, you have added a complete display to your system at a surprisingly low cost.

MSBC-2480	24 lines x 80 character alphanumerics	\$ 350*
MSBC-256	256 x 256 dot graphics	\$ 650
MSBC-512x256	512 x 256 graphics	\$ 850
MSBC-512	512 x 512 graphics	\$1150
MSBC-1024	1024 x 256 graphics	\$1150
MSBC-24/320	24 x 80 alpha; 320 x 240 graphics combined	\$1150
RGB-256	256 x 256 x 4; 16 color or grey graphics	\$1250

And we have other uP displays and display controllers. These include state of the art OEM alphanumeric LED displays, alphanumeric video RAM's and CRT graphics controllers. They come as complete, ready to use sub-systems (single chips, modules, PCB's). Many of them are plug-in compatible with other buses (PDP-11, LSI-11, S-100, Prolog). If we don't have the display you require, we will design it for you.

IF YOU NEED A DISPLAY FOR YOUR uP, LET US KNOW. WE ARE READY TO HELP YOU.

US. REPS WANTED *100 quant.

matrox electronic systems

2795 BATES RD., MONTREAL, QUE H3S 1B5
TEL. (514) 481-6838 or (514) 735-1182; TLX. 05-625651
U.S. ONLY, TRIMEX BUILDING, MOORE'S, N.Y. 12958

New products

Packaging & production

Unit programs n-MOS EPROMs

Programmer uses software, not hardware, to handle present and future memories

In most systems that can program a variety of programmable read-only memories, a set of personality cards or modules plugs into a master unit. But E-H International's new model 4 substitutes software for these cards, which usually contain the sockets and electronic hardware required by a particular erasable PROM.

Moreover, the model 4's program accommodates the pinouts for all currently available triple- and single-power-supply n-channel metal-oxide-semiconductor erasable PROMs, as well as those of the future, according to Jerry D. Rampelberg, program manager of the PROM programmer section. This is because Texas Instruments and Intel have already announced the pinout schemes for their future n-MOS erasable PROMs. "We've even got TI's 128-K part in there," he says.

The program involves more than just selecting the pins of the model 4's pair of zero-insertion-force sockets; it chooses the proper programming algorithm, as well. Triple-supply erasable PROMs use a looping algorithm, whereas the single-supply types program one address at a time, Rampelberg says. Hooked to a microprocessor development system, the model 4 will directly program any single-supply part. However, to program a triple-supply erasable PROM, it first passes the data through an internal buffer, which comprises 16,384 bits of random-access memory.

"I'm glad they stopped building the triple-supply EPROMs bigger than 16-K," says Rampelberg, "because we could get away with 16-K of RAM buffer. There's no way we could have made so compact a unit if we

had to put 128-K of RAM inside." The unit's designers put the 16-K RAM to other uses, too. For example, a user can store 16-kilobits of data from two 2708s in the RAM and then put it into one 2516 without powering down or changing modules.

Operation of the model 4 is easy. When it is turned on, the unit displays the letter D on its eight-digit readout, to remind the operator to enter the device type. He then presses the D key on the hexadecimal keyboard and follows it with a single hexadecimal number. D₁ through D₃ correspond to the 2704, 2708, and 2716 triple-supply erasable PROMs. D₄ through D_A set up the programmer for the 2508/2758, 2516/2716, 2532, 2732, 2564, 2764, and TI 128-K parts, respectively.

To interface the model 4 with a computer or microprocessor development system, there is an RS-232-C port or a standard 20-mA current-loop port. For in-circuit emulation, a master PROM may be loaded into RAM, removed and replaced with a 24-pin cable and plug, and then the address data stored in the RAM buffer altered to debug both software and hardware in the system being emulated.

The compact \$2,495 programmer is about the size of a desktop adding machine and weighs about 5 lbs. Along with the model 4, E-H is also introducing its model 16B, a gang programming version. In addition to the model 4's programming features, the gang system tests the copy PROMs for proper insertion, opens, shorts, and for adequate grounding and sufficient power-supply current. It also blank-checks them before programming and verifies them afterwards. The 16B's price is \$4,995. E-H International Inc., 650 Almanor Ave., Sunnyvale, Calif. 94086. Phone (408) 245-3900 [391]

Connector-adapters simplify in-circuit flat-cable tests

The most irksome faults are usually those associated with cables—they can come and go with a simple unno-

For OEM: All kinds of memory; one kind of quality.

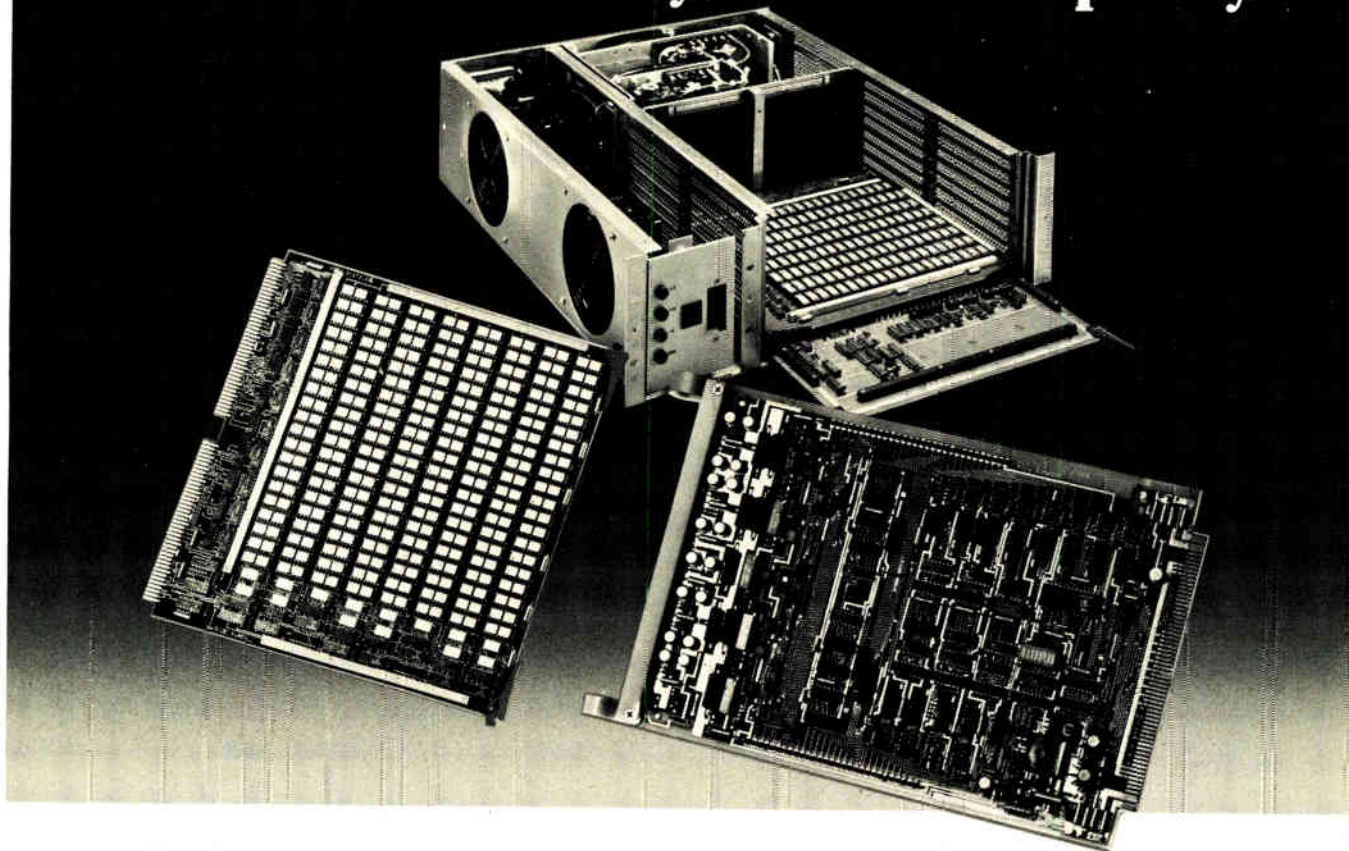

Control Data offers a complete line of semiconductor and core memory. Enclosures, too. And all are precision-engineered and built with the same concern for quality that goes into every product we manufacture.

Now with Error Checking and Correction

Expanding on our popular 94550 line of Semiconductor Memory, the "94552" is available as a single 64K x 22 array card (16 bit word with 6 bits of ECC). A single Timing/Control Card permits you to expand to 512K words by adding more storage module cards. All mount in an EIA 19" rack only 5¼" high.

New Core Compatible Semiconductor Memory

Available as a single board system, the 94553 with timing and control on one board is compatible with our multi-sourced industry standard 94300 core memory. Options are 32K or 128K of storage per board and variable word-lengths of 16 to 20 bits. With expandability and modular field expansion of up to eight boards, system storages of 256K and 1024K are possible.

Ideal for Byte-Wide Minicomputers

Utilizing Unitemp temperature independent core, stable over the entire 0°—90°C MT range, the 94432/94433 core memory is available as a 32K x 8/9 bit word. Offering a respectable 350 nanosecond access and 1 microsecond full

cycle, the memories are compatible with many popular minicomputers on today's market.

Put quality behind your nameplate. Call us at 612/830-6135 or if in Europe, contact one of our European representatives. Or return coupon to:

Len Muehleisen, Product Sales Manager
Computer Memory Manufacturing Division
8001 East Bloomington Freeway
Bloomington, Minnesota 55420

E9-14

Please tell me more about your
 Semiconductor Core Memories

Name _____ Title _____

Company _____ Phone _____

Address _____

City _____ State _____ Zip _____

GD CONTROL DATA
CORPORATION

More than a computer company

Pinlite® displays.

Almost an endless variety.



Every day the variety of high-contrast Pinlite incandescent digital displays gets more endless as we add new, feature-packed models to meet the needs of military, avionics, marine, and business machine applications. And we're adding complementary connectors and connector/diode assemblies to make them easier to package, too.

Even though we've expanded our line, every Pinlite display still incorporates all those outstanding features you need, including 9,000 foot lambert brightness, 120° viewing angle, per-segment life of over 100,000 hours, wide operating temperature range, and direct compatibility with standard TTL driving networks and multiplex circuits. Every one of our 3/16" to 5/8" characters is enhanced by our patented cross-over filament arrangement which eliminates open corners for improved readability.

With Pinlite displays now more available right from stock, it will pay you to check them out. Write or call today for the whole story.



REFAC
electronics corporation.

P.O. Box 809, Winsted, CT 06098 (203) 379-2731

Circle 212 on reader service card

If this magazine is worth your time, it's worth 58¢.

Drop off the routing list. Avoid the Perils of Passalong. Get your own fresh, unclipped copy mailed to your home or office. \$15 (58¢ per issue) for a one-year U.S. subscription. (\$17 in Canada.) Turn to the subscription card in the back of the magazine. If somebody beat you to it, write: Electronics, P.O. Box 430, Hightstown, N.J. 08520.

New products

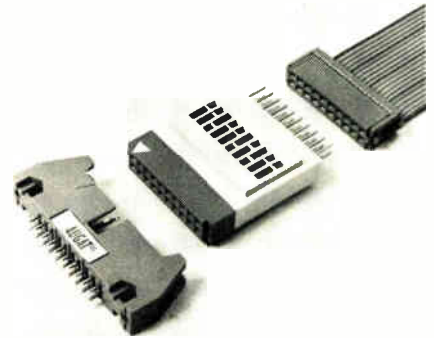

ted flex that results in endless hours of circuit testing. Thus the latest connector-adapters from Augat will be readily welcomed.

Called the Intra-Switch and the Intra-Connector, the two devices provide a means of thoroughly checking flat cables. The Intra-Switch, shown, allows line-by-line testing of flat cables. Positioned between a male and female connector, the device allows each conductor to be taken in and out of service by means of recessed sliding switches. The switches are pushed open or closed with a pointed implement, say a pen or probe.

When mated to a male header, the Intra-Connector forms a T connector to which two female connectors can be mated. Leaving one side of the T bar unmated provides pin-access to each conductor in the flat cable, so that the cable can be tested while in circuit.

Both units are available in 20-, 26-, 34-, 40-, and 50-pin versions that mate with standard, dual-row male and female plugs. In quantities of less than 99, prices for the Intra-Connector begin at \$6.10 for a 20-pin model. For a 20-pin Intra-Switch, the price is \$12.20.

Augat Inc., 33 Perry Ave., Attleboro, Mass. 02703. Phone (617) 222-2202 [392]

Bonding system automates chip-to-substrate mounting

A microcomputer-controlled die-bonding system, the HMC-1985, automates the mounting of chip

Jim Frazier put over 150,000 businesses in touch with government.

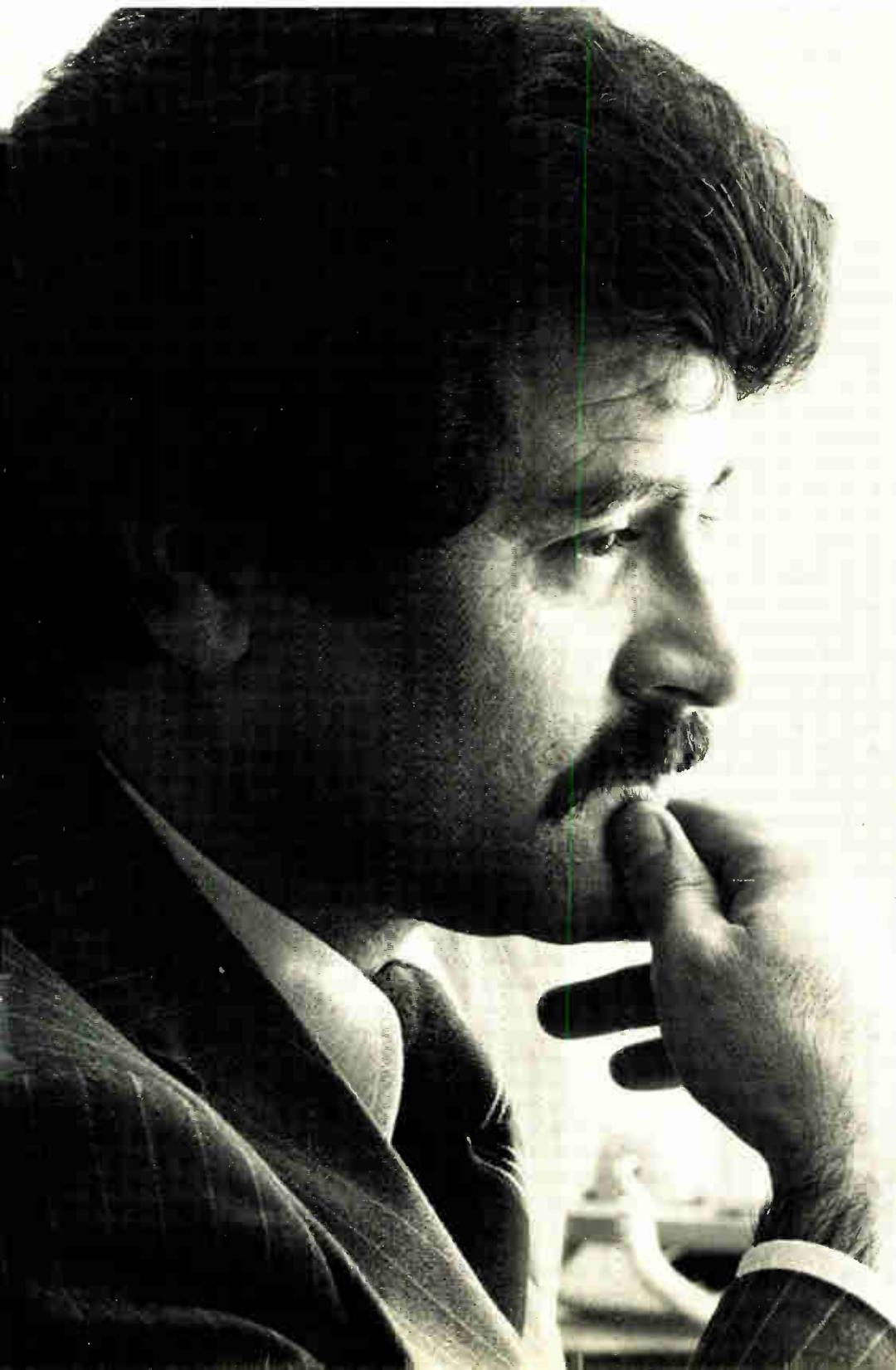

A government agency planned on sending out questionnaires to business.

But the questionnaires were long and involved, and many respondents would obviously need help.

Jim Frazier, a Bell System Sales Supervisor to the Federal Government, recommended setting up an incoming WATS line—an 800 number—that 150,000 businesses could contact.

Then he suggested setting up outgoing WATS lines—so if businessmen couldn't be helped on the spot, they'd be called back.

And, finally, he set up a program to train employees in how to answer business inquiries courteously and effectively.

This is all by way of saying that Jim Frazier is one of a number of dedicated, creative Bell System representatives serving federal departments and agencies.

You'll find that their first step—before making recommendations—is to understand how your department or agency operates.

What they recommend can make things go smoother and easier for you.

No question about it.

The system is the solution.



monolithics mix

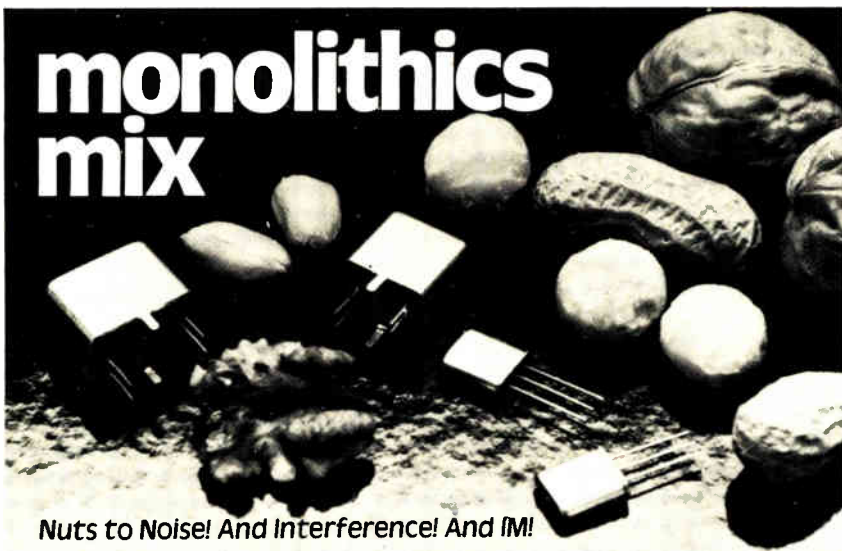

Nuts to Noise! And Interference! And IM!

That's what monolithic filters are all about — selectivity. Our monolithic filters will crack your toughest requirement. And you won't have to shell out your whole parts budget. Over 60 stock models at 10.7 and 21.4 MHz save design time and production cost. Others from 5 to 180 MHz. Send for complete specs now.

The standard in monolithic crystal filters

NUTS TO NOISE!



Piezo Technology Inc.
2525 Shader Road, Orlando, FL 32804
(305) 298-2000

Circle 214 on reader service card

New products

components on hybrid substrates. It uses closed-circuit television to allow the operator to work out a bonding routine by interactively programming the system. Once programmed, the system automatically selects the appropriate die collet and positions the substrate for die mounting. Cycle rate is 3,600 cycles per hour, and the basic 200-position memory is expandable to 1,200 positions. With 200-position memory, the HMC-1985 is priced at \$27,500.

Hughes Aircraft Co., Industrial Products Division, 6155 El Camino Real, Carlsbad, Calif. 92008. Phone (714) 438-9191 [396]

System tests RC networks for real-time process control

Manufacturers of hybrid circuits who want to gather data on individual resistor-capacitor networks at several production stages have been faced with a dilemma. Should they invest heavily in laser-trim systems, which are capable of providing real-time parameter measurements for process control but are most cost-effective only at the trimming stage? Or should they use standard component test systems, which are considerably less expensive but lack the rapid data-reduction capabilities needed for real-time monitoring?

In introducing the model 2230H hybrid-circuit test system, GenRad feels it offers a new choice. The unit adds data-logging and -reduction capabilities, a data-output link, and 4 kilowords of additional random-access memory to the company's basic 2230 system. With these features, the system can test, gather data, and reduce it for 25 resistors per second. Moreover, it costs \$25,000, about one fourth the price of laser-trim systems.

The 2230H's data-reduction capabilities include continuous calculation of minimum, maximum, mean, standard deviation, and slope on each component in circuits containing as many as 35 elements. Each component is checked for shorts or opens, and a record maintained on the number passing or failing. A

DISCOUNT CALCULATORS



\$5.00 Rebate on TI-57
Coupon included with calculator

Hewlett-Packard		Texas Instruments	
HP-19C	219.95	TI-25	24.95
HP-29C	139.95	SR-40	21.95
HP-31E	49.95	TI-55	39.95
HP-32E	65.95	TI-57	49.95
HP-33E	82.95	TI-58	94.95
		TI-59	219.95
		58/59 Mods	29.95
		PC100A	149.95
		PROGMR	47.95
		BUS-ANAL	24.95
		MBA	57.95
		TI-5040	79.95
		DataChron	39.95
		HP-37E	61.95
		HP-38E	98.95
		HP-67	359.95
		HP-91	259.95
		HP-92	399.95
		HP-97	599.95

Accessories available at discount

Sharp PC-1201	73.50	Sharp EI-5808	32.95
Sharp EL-8145	33.50	Canon P10-D	72.50
SCM 2200	259.95	Atari CX2600	149.95

For faster delivery use cashiers check or money order. Add shipping: 1% of your order (\$2.00 min.). East of Miss. Riv. add \$1.00. Calif. Res. add 6% tax. (Visa/MC accepted, 3% surcharge on HP calcs.). Subject to availability.

ORDER TOLL-FREE **800-421-8819** OUTSIDE CA, AK, HI

For technical information call (213)744-1444

tam's
INCORPORATED
SINCE 1947

TAM'S Dept. E8
3303 S. Hoover St.
Los Angeles, CA 90007
(213) 744-1444

Circle 265 on reader service card

Volksmeter + A Little Extra For Less



LM-3.5A \$155
0.5% Accuracy

- Measures VDC, VAC, Ohms, DCmA & ACmA.
- Auto zero & Polarity.
- Battery powered with charger unit included.
- 1.9"H x 2.7"W x 4.0"D.
- Large 0.3" LED display.



Non-Linear Systems, Inc.
Originator of the digital voltmeter.
Box N, Del Mar, California 92014
Telephone (714) 755-1134 TWX 910-322-1132

Circle 266 on reader service card

Electronics/September 14, 1978

AQ Microprocessor Analyzers won't give your chip the bends.



Our clip-on probe connection is fast and safe. Your microprocessor chip remains in its own socket, or can be soldered in. There is no possibility of static damage or bent pins, and no risk of degrading socket reliability by insertion of damaged test plugs.

AQ Microprocessor Analyzers are the cost effective alternative to in-circuit emulators and CRT analyzers. Their powerful features include the ability to examine or modify the contents of all memory, I/O ports, and internal registers, including the program counter and stack register.

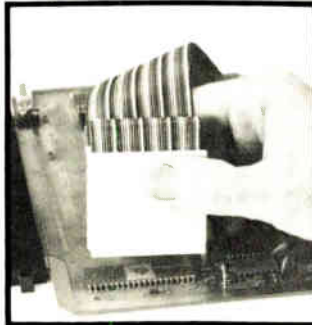

Use its inter-active features to quickly diagnose your 6800 or 8080 family systems from breadboard and software development to production testing, training, and field service.

Write or call today for a free brochure with full engineering details.

AQ SYSTEMS, INC.

1736 FRONT STREET, YORKTOWN HEIGHTS, NY 10598
(914) 962-4264

Circle 215 on reader service card

A stepper drive system for only \$12.60!



A quality stepper motor and IC driver that cuts design costs, simplifies circuitry, minimizes space

We've just put the cost of an incremental drive stepping system within reach! And we've simplified your job in doing so. The \$12.60 includes our K82701-P2 12V dc stepper motor and our SAA1027 IC driver in 100 piece quantities, basically all you need for a complete system, if you supply dc voltage and stepping pulse. The motor has a 7½° step angle, 200 steps/sec pull-in rate and 6.0 oz-in working torque. If these specs don't suit your proposed application, we have 7 other motors to choose from with pull-in rates and working torque values to satisfy most drive applications. 15° step angles are also available, as are 5V dc models. Any one of the 7 can be driven by the IC driver without the need for discrete power stages. Use of the driver, in fact, cuts the cost and complexity of your circuitry to the bone. It's small in size, low in cost and assures maximum stepping accuracy in conjunction with our stepper motors. Find out more about NAPCC stepper systems.

Write for information today!

NORTH AMERICAN PHILIPS CONTROLS CORP.

Cheshire, Conn. 06410 • (203) 272-0301

Circle for information only 267

Circle 268 for immediate need

For maximum warning and minimum size, you can't buy a better audio indicator than our new Series AI-250. Features include Piezo transducer, P.C. PIN or flange mounting, low power consumption, and a 4 KHz, 89 dbA sound pressure rating at one foot. Get full details on the AI-250 and our entire line of Audio Indicators by contacting Projects Unlimited, Inc., 3680 Wyse Road, Dayton, Ohio 45414. Phone (513) 890-1918. TWX 810-450-2523.



OUR NEWEST WARNING



Circle 269 on reader service card

215

MEASURE ANY ELECTRICAL LOAD

simultaneous amps/volts/watts readout
with display hold
fast · easy · precise

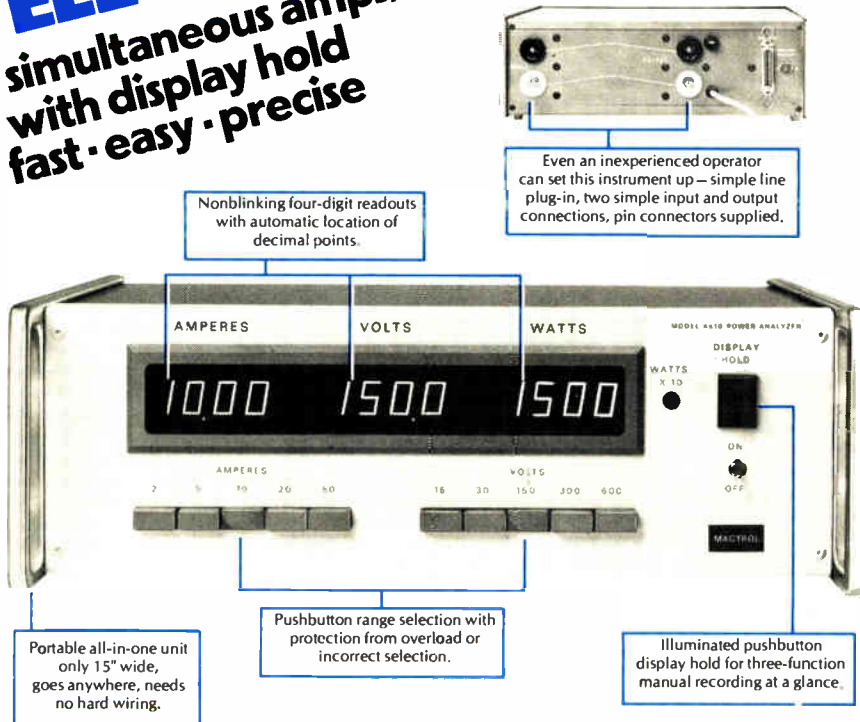

Here is a rugged, versatile instrument that easily and accurately performs countless test and analysis operations on anything that uses electrical power: motors, transformers, appliances, resistance units, even light bulbs.

By simultaneously displaying amps, volts, and watts, it does the work of three conventional power-measuring units; and with its easy-to-read digits and pushbutton display hold it minimizes chances for operator error—almost anyone can handle its simple setup and equally simple operation.

True RMS readouts, high surge capability, no need for burden compensation or other correction, many other advanced features. Ranges 0-50 amps, 0-600 volts, 0-30,000 watts. Typical accuracy better than .5 percent. Analog and digital outputs optionally available. The unit can also be used as a secondary standard for testing other instruments.

Request information today.



MAGTROL, INC.

70 GARDENVILLE PARKWAY WEST BUFFALO, NEW YORK 14224 716-668-5555

see our catalog in
THOMCAT
or call us toll-free at
800-828-7844
(except New York State)

Circle 216 on reader service card

Just published: 1978 EBG!



Completely new listings of catalogs, new phone numbers, new addresses, new manufacturers, sales reps, and distributors! The total market in a book—four directories in one!

To insure prompt delivery enclose your check with the coupon now.

**Electronics Buyers' Guide
1221 Ave. of the Americas
New York, N.Y. 10020**

Yes, please send me _____ copy(ies) of 1978 EBG.
 I've enclosed \$25 per copy delivered in the USA or Canada.
 I've enclosed \$35 per copy for delivery elsewhere (\$47 if shipped by Air). Full money-back guarantee if returned in 10 days.

Name _____
Company _____
Street _____
City _____ State _____ Zip _____

New products

macro-instruction keyboard lets users program specification limits, scanner connections, component types, and the frequency with which data is displayed.

In addition to the basic 16 scanning channels, 20-kiloword operating system software, 8-kiloword user-accessible RAM, and ohmmeter module, options such as channel expandability to 64 in groups of 16 and a capacitance-measuring bridge module are offered. Delivery is eight weeks after receipt of order.

GenRad Inc., 300 Baker Ave., Concord, Mass. 01742. Phone (617) 369-4400 [393]

Plasma etcher has new slant on production processing

The MH-100 is a general-purpose production etcher that may make the whole dry-plasma-etching industry stand up and take note. The system is the first commercially available system to use a planar radial-flow reactor with a vertical, rather than horizontal, chamber [*Electronics*, Aug. 31, p. 117]. This makes loading more convenient and improves cleanliness and process observation.

The microprocessor-controlled unit can accommodate 50 2-in., 33 3-in., or 24 4-in. wafers. It costs about \$85,000.

Materials Research Corp., Orangeburg, N. Y. 10962. Phone (914) 359-4200 [399]

Socket-carrier accepts hard-to-handle packages

The SOT-23 socket-carrier is designed to facilitate testing of SOT-packaged devices, which are growing in popularity, especially among hybrid manufacturers. A three-lead SOT device is loaded into the socket, which snaps easily into the carrier and makes contact with an embedded lead frame. Once loaded, the device is protected and prepared for testing in either a standard flat-pack socket or an automatic handler.

The same socket-carrier can be used repeatedly. Individual socket-

ATTACH GROUND-STRAP**PLACE INSERTER OVER I.C.****LOCK INSERTER**

IC INSERTION TOOL

36-40 PIN CMOS-SAFE

Unique new insertion tool. Also aligns bent-out pins. A twist of the handle compresses the pins to proper .600 inch spacing and locks the IC into the tool. Then simply place the tool on the socket and depress the plunger for instant and accurate insertion. Features heavy chrome plating throughout for reliable static dissipation. Includes terminal lug for attachment of ground strap.

\$795

EACH

MINIMUM BILLING \$25.00 ADD SHIPPING CHARGE \$1.00
NEW YORK STATE RESIDENTS ADD APPLICABLE TAX

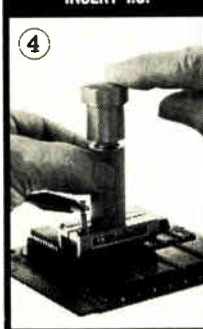

OK MACHINE & TOOL CORPORATION
3455 CONNER ST., BRONX, N.Y. 10475 U.S.A.
TELEX 125091

INSERT I.C.**REMOVE INSERTER****"LOADED" P.C. BOARD**

Circle 217 on reader service card

THE COMMISSION OF THE EUROPEAN COMMUNITIES

SYMPOSIUM ON COMPUTER-AIDED DESIGN OF DIGITAL ELECTRONIC CIRCUITS AND SYSTEMS

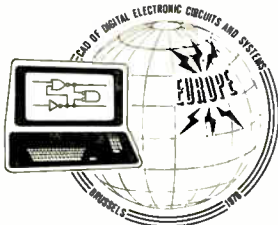

Dates : 27 - 29 November, 1978

Venue: Brussels Hilton Hotel
Brussels, Belgium

Topics: STATE-OF-THE-ART

- Product Specification and Synthesis
- Modelling and Logic Simulation
- Design for Testability
- PCB and Chip Layout

EUROPEAN COMMUNITIES CAD ELECTRONIC STUDY

- Details and Results
- Future Developments

USERS AND SUPPLIERS VIEWS

- Experience with Integrated CAD Systems
- Engineering Component Data-bases
- Component Modelling
- Testing
- L.S.I. Technology Requirements
- Custom L.S.I. Design Economics

For further information

Koness Belgium Congress S.A.
Rue de l'Industrie 17
1040 Brussels, Belgium

Telephone: (02) 230 02 53
Telex: B 62995

Circle 270 on reader service card

PRINTED CIRCUIT SLIDE



We've used the inner mechanism of our best quality toggle switch to create the world's greatest SLIDE SWITCH SERIES. You

have available a high current capability built into a compact, low profile case. Available either for upright or right angle mounting, all on 0.1" centers.

Call our applications people for details, applications, samples and quantity quotations.

See us at WESCON, Booth No. 414-416

RIGHT ANGLE TOGGLE



Just imagine, a TOGGLE SWITCH mounted on its side and designed specifically for PC use! Nothing is makeshift about this switch, it's engineered just for this application with many quality features built in. Available with silver contacts, rated at 5A - 125 VAC, or in gold for dry circuit needs. Make us prove what we say by calling for samples and a cost saving quotation.

Circle 33 on reader service card 217

NEW!

Standard Grigsby "SM" P/Rel Series

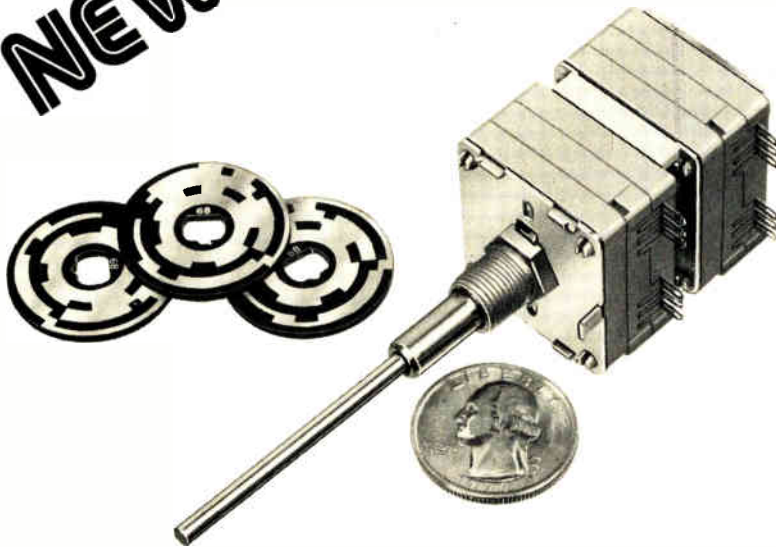

Now Available in a New 1" Package for Digital Switching

An economical alternative to conventional Rotary Switches . . . from 8 to 40 positions, featuring a dual ball and star wheel drive! Available with standard or custom codes to match your exact circuit requirements . . . single or concentric shafts to your specifications . . . fully programable to any "truth table." For more detailed information, send for the "SM" P/Rel brochure.

FROM THE SWITCH EXPERTS . . .



standard grigsby, inc.

Dept. 14, 920 Rathbone Avenue
Aurora, Illinois 60507
Phone: 312/844-4300
TWX: 920-232-3138

Circle 218 on reader service card

The magazine you're reading now, could be your own.

Drop off the routing list. Get your own fresh, unclipped copy mailed to your home or office. Turn to the subscription card in the back of the magazine. If somebody has beat you to it, write: Electronics, P.O. Box 430, Hightstown, N.J. 08520.

New products

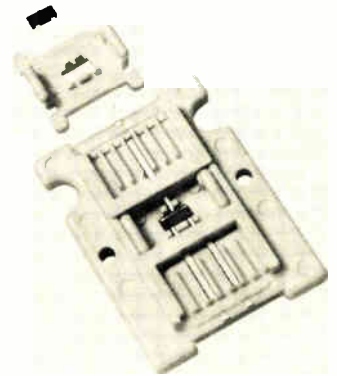

carriers are priced at \$1.43 in quantities of 1,000 and up and are available from stock.

Textool Products Inc., 1410 W. Pioneer Dr., Irving, Texas 75061. Phone (214) 259-2676 [395]

Unit covers pc boards, hybrids with conformal Parylene coat

The model 1010 deposition unit covers printed-circuit boards, hybrid circuits, stators, rotors, and various substrates with a pin-hole-free conformal coating of Parylene. Designed for limited production runs, the unit has automatic liquid-nitrogen control and a chart recorder that monitors temperature and pressure during the coating process. It may also be equipped with a vapor-phase adhesion system.

The coater can accommodate 14 6-by-6-by-1/2-in. pc boards or up to 370 1-by-1 1/2-in. hybrid circuits. Because the coating process is completely contained within the unit, it can be used under clean-room condi-

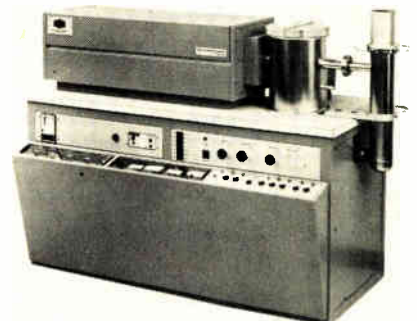

Introducing

SELECTO-SYNC™

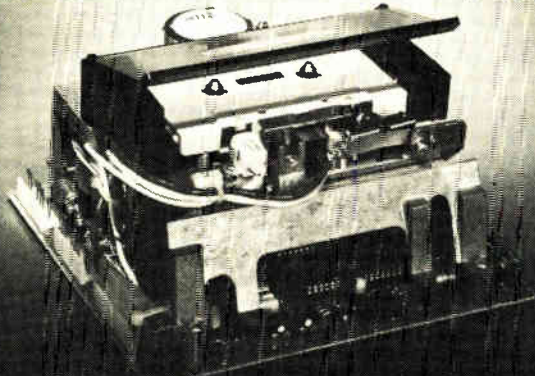

A Unique Cassette Transport with Synchronous Capstan Speed Control from Triple I, manufacturers of PHI-DECK® cassette transports.

- Fully Remote Controllable
- Four Motor Design
- Cast Chassis

Digitally Selectable Speeds over a 15 to 1 range. Excellent speed regulation, low flutter and wow, extremely low jitter. For Analog or Digital use.

- Low Speed Recording, High Speed Playback
- Extreme Low Speed Operation — Data Acquisition
- High Speed Operation — System Loaders
- Critical Timing Operations

Write or call for more information.

(405) 521-9000

4605 N. Stiles P.O. Box 18209 Okla. City, Ok 73154



Circle 34 on reader service card

Electronic Load Cells...

Interface for

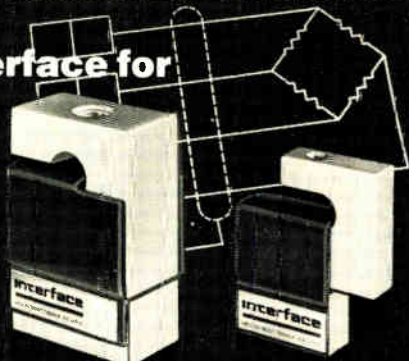

Precision Force Measurement

Want to measure force, weight, thrust—with precision? Start with accurate, dependable instrumentation at the source!

Super-Mini strain gage load cells—with capacities from 10 to 1000 pounds—provide a *guarantee* error band for non-linearity, hysteresis AND repeatability of less than ±0.04%—are thermally compensated to within 8PPM/°F—operate in tension or compression with 3mV/V output, nominal—are priced from \$160 each.

Five pound to 100 ton capacities offered in other models—all with 2 year warranties. Interface, Inc., 7401 E. Butherus Dr. Scottsdale, Arizona 85260 USA. (602) 948-5555 Telex: 668-394.



Low Profile



Sealed Super-Mini



Minibeam

interface

ADVANCED FORCE MEASUREMENT

Circle 36 on reader service card

MAKING MEMORIES

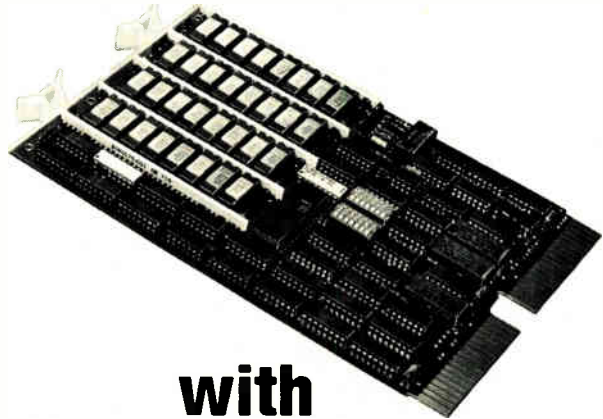

with MINI/BUS® PC BOARD BUS BARS

A high density add-in expansion memory for the DEC LSI-11, MSC 4601, packs up to 32K words of memory in a single option slot. Mini/Bus helps make it all possible, and with a mean time between failures of 100,000 hours.

Monolithic Systems Corporation engineers used Mini/Bus to solve size constraint problems, shorten assembly time, simplify testing, eliminate numerous filter capacitors, and increase reliability.

For more details on how Mini/Bus can handle your design problem, contact the Mini/Bus product specialist at

ROGERS

ROGERS CORPORATION

Chandler, AZ 85224

(602) 963-4584

EUROPE: Mektron NV, Gent, Belgium. JAPAN: Nippon Mektron, Tokyo

DEC and LSI-11 are registered trademarks of Digital Equipment Corp.

For Information Only Circle #37

For Immediate Need Circle #219

Keep it after 2 weeks
only if it solves your
L-R-C
testing
problems.

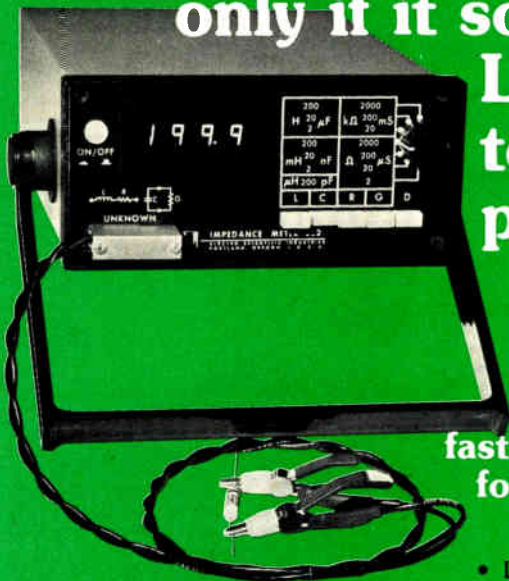

\$695

(U.S.A. only)

fast digital accuracy
for L,R,C,G and D

You can order ESI's Model 252 Digital Impedance Meter on a 2-week Free Trial basis, because we know the first several hundred buyers agree it's the most cost-effective tester on the market for reactance (L,C) and loss (D,R,G). Its performance rivals machines costing three to four times as much and its reliability is second to none.

It's simple, fast and accurate and comes with four-terminal Kelvin Klips®. Options include an autorange version (Model 253), a low frequency Model 254 (120 Hz), special sorting fixture and front panel dust cover. Check these other features:

- Lightweight; tiltstand handle.
- 0.25% basic accuracy.
- Wide ranges (especially on autorange option).
- 1 kHz test frequency (120 Hz optional).
- Four measurements/sec.
- External bias.
- 4-terminal connection.
- Analog outputs.
- Low power design.
- Large 3½ digit display—no manual balance to fuss with.
- Input protection.
- Convenient calibration.

**2-WEEK
FREE TRIAL**

Order Now or Send for
New Full Color 8-page
brochure!



esi.
ELECTRO
SCIENTIFIC

Electro Scientific Industries
13900 N.W. Science Park Dr.
Portland, Oregon 97229
(503) 641-4141

Circle 39 on reader service card

New products

tions. The unit can either be purchased or leased.

Union Carbide Corp., Electronics Division Materials Group, 8888 Balboa Ave., San Diego, Calif. 92123. Phone (714) 279-4500 [394]

Backplane probes spring
to ensure pin contact

The "A" style spring-loaded probe is designed to provide firm contact with the pins on the back panels of wrapped-wire boards and other pin-devices under going test. They are available in seven standard sizes from 0.035 to 0.156, so that they may be configured to accommodate different center-to-center pin spacings. They are priced from \$0.85 to \$1.50 in 100-up quantities and can be obtained from stock.

Everett/Charles Inc., 2867 Metropolitan Pl., Pomona, Calif. 91767. Phone (714) 593-7481 [397]

Tester checks turn-off times
for SCRs and transistors

Capable of measuring silicon controlled rectifier or transistor turn-off times of 10 to 500 μ s, the SCR turn-off-time tester applies forward currents of 10 to 500 A with pulse widths of 20 to 500 μ s and fall rates of 4 to 300 A/ μ s. It also offers reverse voltages of 5 to 50 v, reapplied voltage rise rates of 10 to 500 v/ μ s, and forward blocking voltages of 20 to 2,000 v.

Turn-off times are displayed on a digital readout, turn-off time ranges are continuously adjustable, and a go/no-go failure indicator is provided. An oscilloscope can be used with the unit to monitor all currents and voltages. No special training is required to operate the tester.

The 24-by-29-by-78-in. unit is priced at \$27,000; test fixtures are available at extra cost. Delivery is four to six months.

Semiconductor Division, Westinghouse Electric Corp., Youngwood, Pa. 15697. Phone (412) 925-7272 [401]

From Electronics Magazine Book Series. Zero-risk trial offer.



New Product Trends in Electronics, Number One

From "New Products," state-of-the-art materials and equipment, arranged according to function. \$14.95

Electronics Book Series

P.O. Box 669, Hightstown, N.J. 08520

Send me _____ copies of "New Product Trends in Electronics, Number One" at \$14.95 per copy

Discounts of 40% on orders of 10 or more copies. I must be fully satisfied or you will refund full payment if the book is returned after ten-day trial examination.

Payment enclosed Bill firm Bill me
Charge to my credit card:
 American Express Diners Club
 Visa Master Charge

Acc't No. _____ Date exp. _____

On Master Charge only,
first numbers above name _____

Name _____ Title _____

Company _____

Street _____

City _____ State _____ Zip _____

Signature _____

HOW COULD THE INDUSTRY STANDARD 5½-DIGIT DMM BE IMPROVED?

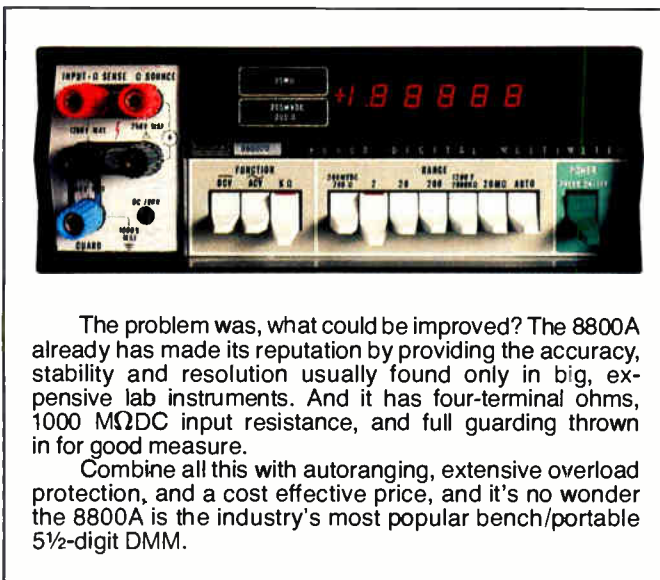

The problem was, what could be improved? The 8800A already has made its reputation by providing the accuracy, stability and resolution usually found only in big, expensive lab instruments. And it has four-terminal ohms, 1000 MΩDC input resistance, and full guarding thrown in for good measure.

Combine all this with autoranging, extensive overload protection, and a cost effective price, and it's no wonder the 8800A is the industry's most popular bench/portable 5½-digit DMM.

Now look at the 8810A.

It's modular! You can buy the lab-performance DC mainframe for only \$695. Add the six-range ohms converter for \$175 any time you wish.

It's got true rms ac! Actually you can choose either the true RMS converter module for accurate measurements of most waveforms at \$275, or the average-responding AC converter module at \$150. Both are spec'd to 100 kHz.

For data recording, there's a data output option.

It's specified for one year! You know how much money you can save by eliminating the time and expense of shorter re-cal cycles. And this kind of long-term stability is just what you'd expect from Fluke.

So now, in addition to the industry standard 8800A, you have your choice of application-oriented and cost-saving configurations of the new 8810A, choices you'd expect only from Fluke.

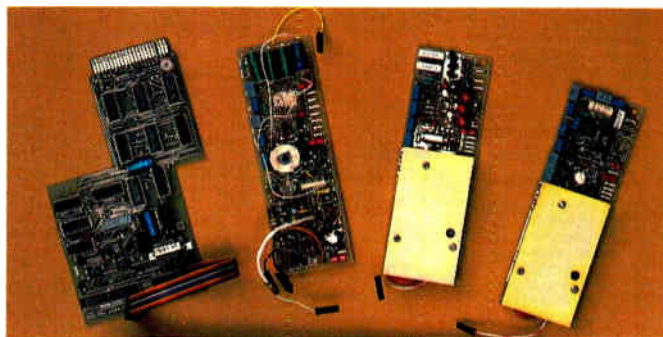

Field-installable options snap-in when you need them.

CALL (800) 426-0361*, TOLL FREE. Or, contact one of the more than 100 Fluke offices or representatives, worldwide. In the U.S. and all countries outside of Europe, contact: John Fluke Mfg. Co., Inc., P.O. Box 43210, Mountlake Terrace, WA 98043, U.S.A. Telex: 32-0013.

In Europe, contact: Fluke (Nederland) B.V., P.O. Box 5053, Tilburg, The Netherlands. Tel.: (013) 673973. Telex: 52237.

Prices U.S. only.

*Alaska, Hawaii, Washington residents please call (206) 774-2481.

COMMAND PERFORMANCE: DEMAND FLUKE DMMs.

Hipotronics inc.

HIGH VOLTAGE DC POWER SUPPLIES AND POWER PACKS

Standard supplies from 1 kW to 50 kW

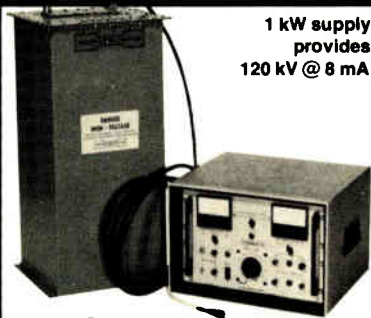

1 kW supply provides 120 kV @ 8 mA

Power Supplies

Complete range of unregulated high voltage dc supplies with voltage outputs from 1 kV to 1000 kV and current outputs from 10 mA to 50 Amps available in standard designs at economical prices. Fully instrumented and protected, these supplies are ideal for:

- Laboratory use
- Capacitor charging
- Laser supplies
- CRT supplies
- Marx generators
- Many more

5, 7.5 & 10 kV @ 5 mA OEM Power Packs



Power Packs

Miniaturized, oil-filled steel cans for OEM use. Voltages from 2.5 kV to 100 kV at 2, 5 & 10 mA. Low cost, high reliability.

Metered Power Packs

Same miniature power packs available with simplified or deluxe controls for rack-mounting. Short circuit current limit option makes these ideal for cap charging applications.

Write or call for complete details.

HIPOTRONICS

HIPOTRONICS, INC.

P O Drawer A, Brewster, NY 10509
(914) 279-8031 Twx 710-574-2420
Amex Symbol HIP

New products

Microcomputers & systems

Tape unit offers random access

Fixed addresses plus microcomputer add up to easy accessing of data

Microcomputer users looking for mass storage in a microperipheral will be interested in the DECTape II, a magnetic-tape transport from Digital Equipment Corp., aimed at its own LSI-11 family and other plug-compatible microcomputers. Officials in DEC's Marlboro, Mass., components group are billing the unit as a random-access intelligent tape subsystem that can read and write 262 kilobytes of data on block-addressable, preformatted magnetic-tape cartridges.

The unit consists of three parts: the DECTape II tape cartridge (which

is based on the 3M Co.'s DC-100 cartridge), the tape drive, and a microprocessor controller card that provides the intelligence. Rolando Esteverena says that data is formatted in the unit "in a file-oriented directory, which allows addressing of 512 blocks each 52 bytes long, and it can go randomly to each of these blocks." Esteverena is LSI-11 market and product planning manager in the components group.

The system stores information at fixed positions like a floppy disk device, rather than at unknown or variable positions as in conventional magnetic-tape systems. Because it is a fixed-address device, the host computer does not need to know where the tape has stopped.

To locate a desired block, the host computer requests to read or write a numbered block. The address of the block currently passing over the head is read by the microprocessor, which then calculates the tape motion required to find the requested location and accomplish the requested task. James King, engi-

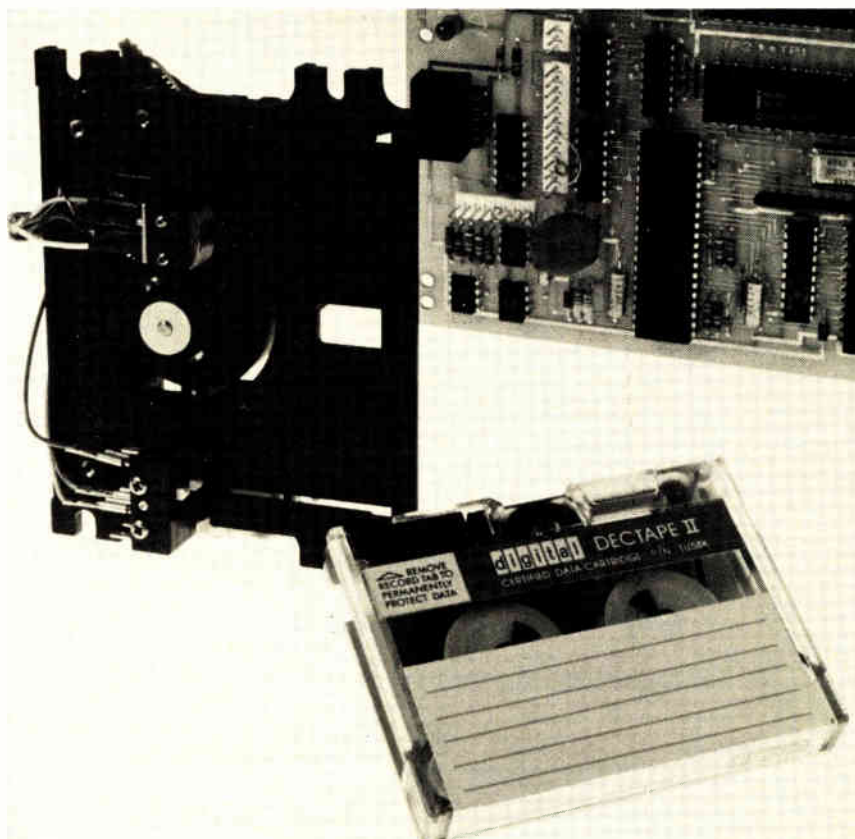

AN HONEST 8-BIT MASTERPIECE.

Our new S68047 Video Display Generator will emancipate you from TTL bondage. It's the easiest, thriftiest way yet to convert your digital data into colorful words and pictures for home computers, games, educational tools, annunciators and remote control indicators. Our single-chip circuit, compatible with the AMI 6800 microprocessor or any other 8-bit computer, saves you at least three times the cost of an equivalent TTL system. It takes real leadership qualities to come up with ideas like this. Perhaps that's why AMI has conceived more MOS masterpieces than any other company in the business.

You can get the picture 14 different ways with the S68047 Video Display Generator. These include six alphanumeric, four full graphics four-color and four full graphics two-color modes.

The 40-pin package, plus a minimal number of support components, connects directly with the TV or color monitor's video circuits, or to the antenna terminals via an external FCC approved RF modulator.

The on-chip ROM provides 64 ASCII 5 x 7 dot matrix characters on a 16 x 32 display matrix. The full graphics density can go up to a maximum of 192 x 256 dots.

We build in all the controls for interfacing with the host 6800 MPU, as well as addresses for the video display RAM and/or ROM.

You get all this for the low price of \$11 (plastic/S68047P) and \$14.50 (ceramic/S68047) in 100-999 quantities. So contact your nearest AMI distributor for all the graphic details. Or write to AMI Marketing, 3800 Homestead Road, Santa Clara, CA 95051. Phone (408) 246-0330. Our VDG could make your product the people's choice.

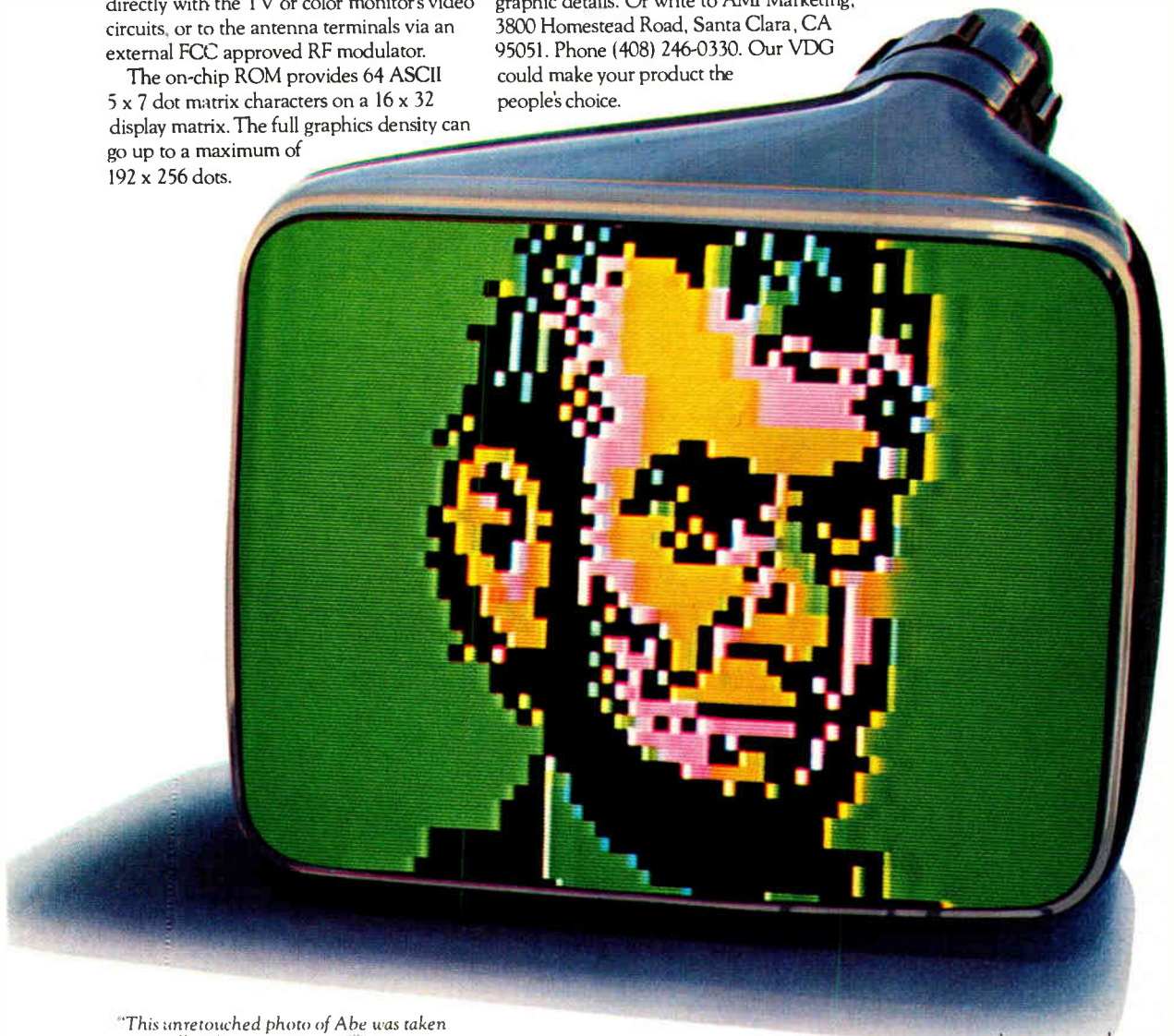

"This unretouched photo of Abe was taken right off a TV screen. Honest!"

See us at WESCON: Booth 578.

AMI
AMERICAN MICROSYSTEMS, INC.

THE GREAT ESCAPE

It's not only the 361 days of sunshine

It's also seagulls and beaches . . . and community leaders who recognize the importance of an industrial base for economic and cultural progress.

Pinellas County on Florida's West Coast offers all of these plus the things you always hope will be at an expansion site, or a relocation for your business — excellent transportation systems, low living costs, a skilled and productive work force, who take pride in a job well done, and the tenth lowest state in local taxes in the U.S.

The Pinellas County Industry Council is ready to assist you with your relocation or new location plans

Make your **Great Escape** to Florida's West Coast!



Pinellas County Industry Council

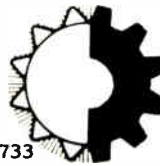

P.O. BOX 13000Q St. Petersburg, Fl. 33733

Name _____
 Company _____
 Street _____
 City _____ State _____ Zip _____
 Telephone _____

In cooperation with the Division of Economic Development, Florida Department of Commerce.

Circle 224 on reader service card

New products

neering manager, points out that this feature "allows you to go to the middle of the tape to block 37, for example, read and massage the data in that block and put it back into block 37 without disturbing any other information."

Cartridge life is specified at 5,000 passes, and tape length is 140 feet. Read-write speed is 30 inches per second, while speed in the search mode is 60 in./s. Each controller board can drive two cartridges, and average access time is 9.3 s. King is aware that the speed is not blazing—minifloppy disks offer access times of 500 milliseconds, he notes, "but our emphasis is on low cost and medium performance."

He adds that DECTape II falls between standard serial cassettes and floppy disks, with faster access and storage—and better data integrity than cassettes—at "about half the cost of comparable products." DECTape II has an asynchronous full-duplex serial output compatible with RS-232-C, -422, and -423 interfaces, with the appropriate interface standard and baud rates selectable by jumpers on the control board. Transmission rates range from 150 to 38,400 bauds.

A single-drive unit has a price of \$620 singly or \$446 in hundreds; prices for the dual-drive model are \$780 and \$562 respectively. Evaluation units will be available in October, with volume production before the end of this year.

Components Group, Digital Equipment Corp., 1 Iron Way, Marlboro, Mass. 01752. Phone Rolando Esteverena at (617) 481-7400, Ext. 6650 [371]

HOPE The project a ship launched.

First there was the hospital ship S.S. HOPE, now retired. Today HOPE is an established project which has carried its goal of improving health through education to 24 developing countries of the world and the United States.

Give to:

PROJECT HOPE

Department A
Washington, D.C. 20007

Basic interpreter simplifies 8080-system coding chores

Now there's a faster, easier way to program Z80-, 8086-, and 8085-based systems for process control and data acquisition—use the XYBasic interpreter. With it, high-level-language programming can be done in as little as one tenth the time of assembly coding. XYBasic has all the features of standard Basic plus

Here's a benefit you can't get with any other counter.

Tektronix.

Made by Tektronix. One benefit that no other manufacturer can offer. And, one benefit that separates TM 500 Counters from the rest of the pack. Quality design, manufacturing expertise and a nation-wide sales and service organization support every piece of instrumentation carrying the TEK name.



TM 500, from Tektronix, is a line of nearly 40 modular plug-in test and measurement instruments. Five versatile TM 500 Counters are joined by DMM's, pulse, function and specialized generators, power supplies, oscilloscopes, calibration instruments and amplifiers.

Each TM 500 Counter is designed with a different combination of specifications. The TM 500 Counter family includes two universal counter/timers, a low-cost instrument, and two communications-oriented, high-frequency counters.

These modular counters can be mixed and matched with any of the other TM 500 Plug-ins to create test sets customized to your application. Choose six different mainframes: three sizes of benchtop mainframes, a suitcase-like Traveler Mainframe or a standard, rackmountable mainframe.

There's only one family of counters that offers you all this performance and the name to prove it. TM 500 from Tektronix.

For additional information about TM 500 Instruments, please call Tektronix' automatic answering service (toll free) at 1-800-547-1512. Oregon residents call collect on 644-9051. For even faster service, call your local Tektronix Field Office.

In Europe write: Tektronix Limited, P.O. Box 36, St. Peters Port, Guernsey, Channel Islands.

TM 500
Designed for
Configurability

Tektronix®
COMMITTED TO EXCELLENCE

For Technical Data circle #41
For Demonstration circle#225

TEKTRONIX® TME

DC 508 1GHz COUNTER

03 3787406

DIGITAL



DELAY



LINES



Data Delay Devices offers the widest variety of Digital Delay Units. 14 pins DIP and 16 pins DIP. 1 to 10 outputs and digitally programmable delay time. These units eliminate the interfacing in T²L circuits and save PC board real estate.

With the following advantages:

- T²L input and outputs
- Fast rise — Time on all taps
- Each tap isolated with 10T²L Fan-out capabilities
- Exact delay at each tap
- 2,000 NS total delay
- Up to 10 taps
- Digitally Programmable

Request complete catalog



**DATA DELAY
DEVICES**



253 CROOKS AVE., CLIFTON, N.J. 07011 Tel. (201) 772 1106

New products

control commands and the versatility to customize input/output features. The latter two give the power of assembly-language programming with the ease of programming in Basic.

The language consists of a 7-kilobyte interpreter with built-in editor. It takes as little as 5 seconds to load XYBasic into a microcomputer or development system. With the read-only-memory version, XYBasic appears instantly when the system is turned on. Powerful debugging commands, TRACE and BREAK, let the user follow the execution of the program. The first shows every line that is executed and prints all modified variables; the second interrupts the program at any variable or line number.

Control features include a unique software-interrupt command (ENABLE) that effectively multiplies the power of the user's computer. It allows external-device monitoring and program execution at the same time, and automatically checks to see if the specified condition is met before executing each program statement. A DELAY command builds real-time delays into the program without the addition of a real-time clock. In addition, XYBasic has a number of bit-manipulation commands, such as ROTATE, SHIFT, and TEST, usually found only in an assembler.

In conjunction with the interpreter, a Run-Time/Compiler package has also been developed. This package produces stand-alone systems that execute without special operator start-up commands. The Run-Time/Compiler compresses the XYBasic code, allows programs to run anywhere in memory, and increases execution speed—all in only 5 kilobytes of memory.

Versions are available for all environments. These include SBC/80, CP/M, and Isis-II, as well as the ROM and a ROM Squared version which allows user-generated code to reside in the same ROM as XYBasic. There is also a patchable I/O version that allows the user to tailor XYBasic to fit his system. An extended package includes transcen-

ELECTRONICS REPRINTS

No. of
copies
wanted

Articles

- ___ R-815 Higher power ratings extend V-MOS FETs' dominion 8 pp \$2.00
- ___ R-813 Data-link control chips: bringing order to data protocols 10 pp \$3.00
- ___ R-811 Multiplexing liquid-crystal displays 10 pp \$3.00
- ___ R-809 New methods and materials stir up printed wiring 10 pp \$3.00
- ___ R-801 World market report 1978 24 pp \$4.00
- ___ R-734 Microcomputer families expand 20 pp \$4.00
- ___ R-730 Special report—Automotive electronics gets the green light 10 pp \$3.00
- ___ R-728 Flexible circuits bend to designers' will 10 pp \$3.00
- ___ R-724 Special report—Technologies squeeze more performance from LSI 22 pp \$3.00
- ___ R-722 Demands of LSI are turning chip makers towards automation 12 pp \$3.00

Books

- ___ R-803 New product trends in electronics—Electronics Book Series 333 pp \$14.95
- ___ R-732 Memory design—Microcomputers to mainframes—Electronics Book Series 180 pp \$12.95
- ___ R-726 Design Techniques for Electronics Engineers: 293 time-saving ideas in 48 chapters—Electronics Book Series 370 pp \$15.95
- ___ R-711 Circuits for electronics engineers: 306 circuits in 51 functional groups—Electronics Book Series 396 pp \$15.95
- ___ R-701 Applying microprocessors—Electronics Book Series 191 pp \$9.95
- ___ R-608 Basics of Data Communications—Electronics Book Series 303 pp \$12.95
- ___ R-602 Large Scale Integration—Electronics Book Series 208 pp \$9.95
- ___ R-520 Microprocessors—Electronics Book Series 154 pp \$8.95

Payment must accompany your order

Make check or money order payable to Electronics Reprints. All orders are shipped prepaid by parcel post. Allow two to three weeks for delivery. For additional information call (609) 448-1700 ext. 5494.

Mail your order to:

Janice Austin
ELECTRONICS REPRINTS
P.O. Box 669
Hightstown, N.J. 08520

Electronics/September 14, 1978

INTRODUCING THE BENDIX PORTABLE MODULE TESTER



Now automatic, on-the-spot module testing is on the way.

Here's a new way to test anything from a printed circuit board to a complex logic system. And you can do it on the job.

Our new portable unit weighs just 30 pounds and has no moving parts. Yet it does everything that stationary digital cabinet-type units can. It eliminates downtime while modules are tested away from the job site. Does away with trial-and-error testing and unwarranted returns, too.

You can take it on board planes or ships, to hospitals, to labs, to computers or communications equipment, and to sophisticated quality-

control operations in mass production plants.

Highly trained operators are not needed. Programming procedures are so easy to pick up. And an interactive display system makes operation easier still. Test systems are stored on solid-state cards, providing reusable data memory.

The Basic Bendix unit is capable of testing cards to 64 pins and has the capacity to expand to 256. Additional options are available including:

- Fault Isolation Testing
- Digital Voltmeter/Frequency Counter
- Teletype Interface and Advanced Software Aids.

For more information, contact: Bendix Corporation, Test Systems Division, Teterboro, N.J. 07608. Or call (201) 288-2000, extension 1789.



Circle 227 on reader service card

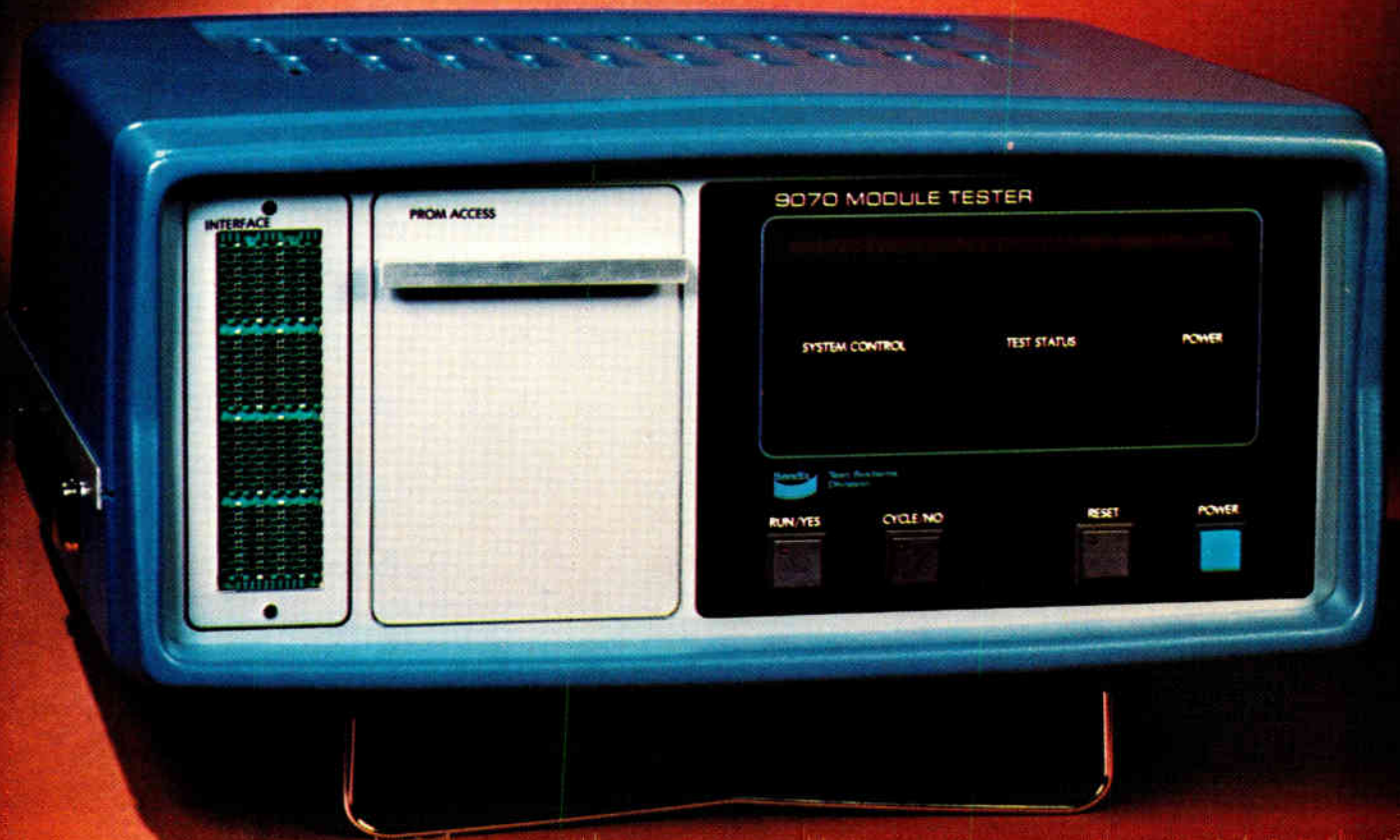

Why our monitors are good for your image.

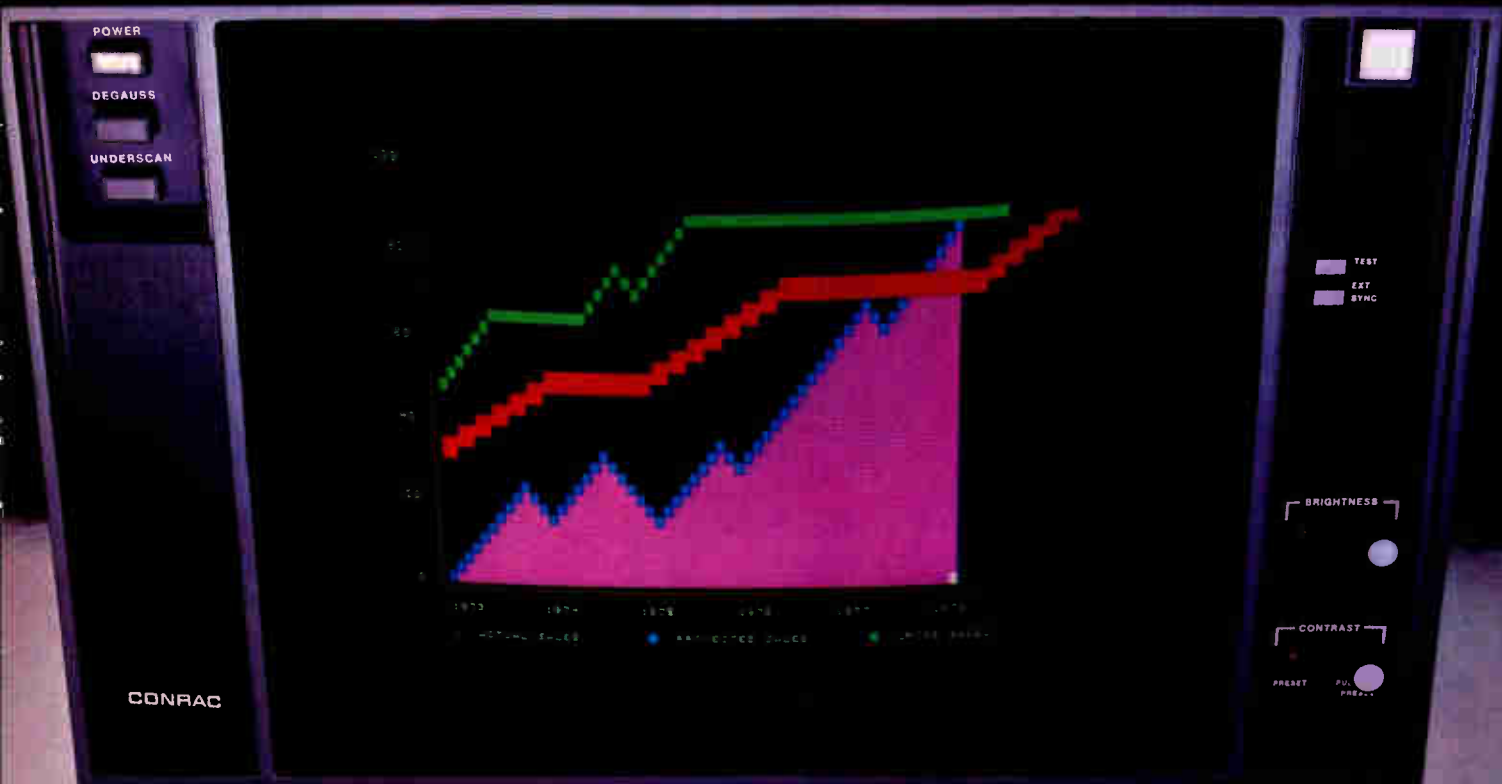

With a Conrac OEM monitor in your system, you can relax. Because image is what we're all about. Just how good is Conrac's visual quality?

Good enough to be preferred by demanding network broadcast professionals six-to-one over all other brands combined.

For your demanding customers, we make a broad line of color and monochrome monitors, including RGB display, computer-generated imagery, graphic display, and alpha-numeric display types.

A wide range of models assures you a monitor that fits your system's needs. Standard or custom, Conrac quality is more than screen deep.

All our monitors feature advanced, modular circuitry design for maximum reliability and serviceability in the field. Color models include convenient pullout drawers for full front-access to critical controls.

And since Conrac monitors are manufactured in the U.S., there's always fast access to parts.

Call or write today for the complete story on Conrac price/performance advantages. Conrac Division, Conrac Corporation, 600 North Rimsdale Avenue, Covina, CA 91722. Phone (213) 966-3511; Telex 67-0437.



CONRAC

We're more than meets the eye.



Waiting for an outbreak of HOPE

Give to:



Department A, Washington, D.C. 20007

New products

dental and string functions.

All versions are available from stock for as little as \$295. The XYBasic programming manual may be purchased separately for \$20.

Mark Williams Co., 1430 West Wrightwood Ave., Chicago, Ill. 60614. Phone (312) 472-6659 [373]

Floppy-disk interface lets OEMs put it all together

The FDI-L11 floppy-disk interface provides all the electronics necessary to interface floppy-disk drives with Digital Equipment Corp.'s LSI-11 family of microcomputers. All that original-equipment manufacturers need add is the floppy disk drive itself and a power supply to assemble a complete high-performance floppy disk system.

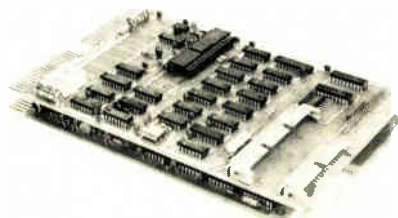

The two-board unit can control up to four full-size and three mini-floppy drives simultaneously. It transfers data by direct-memory access to minimize processor overhead, and has an addressing capability to 128 kilowords with a choice of four interrupt levels.

The FDI-11 is priced at \$945 in single quantities and is available for delivery within 30 days after receipt of order.

Computer Technology, 6043 Lawton Ave., Oakland, Calif. 94618. Phone (415) 451-7145 [376]

Desktop computer comes with 1 megabyte storage and Basic

Based on a 3-MHz 8085 microprocessor, the Impak M-1 desktop comput-

USC UPCC/REPC CONNECTORS

Draw Pull and Screwlocking. Built to MIL-c-55302 and Commercial Specifications Printed Circuit and Related Applications. REPC Connectors are Removable, Re Entrancy, Crimp Contact Types.

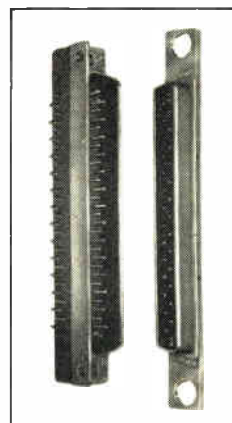

1 of over 20,000 Connector Types Manufactured. Send today for UPCC-REPC-A, Series 32-page Catalog.

U.S. COMPONENTS, INC.

Leader in advanced engineering design

35 Carlough Rd.
Bohemia, N.Y. 11716
(516) 589-8080

Cable. COMPONENTS, NYK

Circle 229 on reader service card

MOVING?

Please give us 4 weeks advance notice. Attach the label for your old address, write in your new address below, and send to Fulfillment Manager, Electronics, P.O. Box 430, Hightstown, N.J. 08520.

OLD
ADDRESS
LABEL

NEW ADDRESS

Name _____

Address _____

City _____

State/Province _____

Zip/Postcode _____

Country _____

GAINESVILLE IS READY FOR ELECTRONICS

Gainesville is quickly becoming the medical research center of the south. Electronics and medicine have joined forces. Today more than ever before these two industries support each other. The University of Florida's Electronic Research Laboratories (directly assisting Florida's industries), the accessibility of Gainesville to the southeastern markets, available sites and existing buildings, low taxes, and adequate area labor population make Gainesville very attractive. Add to these a mean temperature of 69.9, the Atlantic Ocean, the Gulf of Mexico, year round recreation, and major sport attractions and you can come to only one conclusion: Gainesville is READY for Electronics.

Write for Information

GAINESVILLE
AREA CHAMBER OF COMMERCE
GAINESVILLE
FLORIDA 32602
Dept. X / P.O. Box 1187 / (904) 372-4771

The 1000L Series Amplifiers . . .

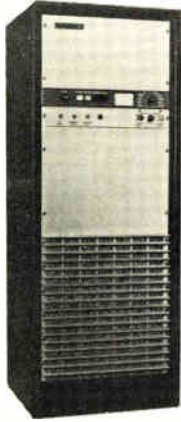

Model 1000L
designed to
your needs
and our
standards

- 1000 watts CW linear
- 4000 watts pulse
- 10 kHz to 220 MHz
- Instantaneous bandwidth
- Low harmonic distortion
- Adjustable gain
- Unconditionally stable
- Remote control operation
- Fully protected
- Human engineered

Powerful and uncompromising in quality and performance. These versatile high-power amplifiers are ideal for general laboratory use, EMI susceptibility testing, equipment calibration, biological research, NMR spectroscopy, ultrasonics, and many other applications. The series also includes Model 1000LM8 (1 to 220 MHz), Model 1000LM9 (1 to 200 MHz), and Model 1500LA (1 to 150 MHz) with a 1500-watt output. For complete information on our high-power amplifiers, call 215-723-8181 or write:

Amplifier Research
160 School House Road
Souderton, PA 18964

AR **AMPLIFIER
RESEARCH**

Circle 230 on reader service card

New products

er includes a built-in cathode-ray tube for 1,920-character displays, two double-density floppy-disk drives for 1 megabyte of storage, and a Basic software package. The cost of the complete system is \$7,300.

Storage capacity is optionally expandable to 4 megabytes with the addition of three double-density dual-disk drives. The Basic support software includes utilities; a disk operating system with text editor and facilities for job, file, and storage management; debugging programs; and diagnostics.

A Fortran IV package is also offered as an option. The Fortran IV Level 2 ANSI compiler includes three-dimensional arrays, up to two levels of nested parentheses in format statements, mixed-mode arithmetic, and an M-80 assembler that generates relocatable code compatible with the Fortran IV object code.

IMEX Computers, 54 Middlesex Turnpike, Bedford, Mass. 01730. Phone (617) 275-

Add-in memory offers 32-K storage for LSI-11

The DS-115S is an add-in 32-K memory that is compatible with the LSI-11, LSI-11/2, and PDP-11/03 and is available in both parity (18-bit) and nonparity (16-bit) versions. Cycle and access times are 500 ns and 325 ns, respectively.

On board the DR-115S is refresh circuitry as well as logic circuitry that allows the board to be equipped with a battery backup. Switches mounted in a dual in-line package provide address strapping. In addition, peripheral lockout can be set for the upper 4 kilobits or 2 kilobits of memory.

The DS-115S is priced at \$1,475 for the parity and \$1,400 for the nonparity version. Models with 16-K and 8-K memory capacity are also available in parity and nonparity versions. Delivery of the 32-K DS-115S is 30 days.

Dataram Corp., Princeton-Hightstown Rd., Cranbury, N. J. 08512. Phone (609) 799-0071 [378]

ITI COMMUNICATION
PRODUCTS



VERSATILE VF AMPLIFIERS For Your System Needs...

- | | |
|-------------|--------------|
| ■ Limiter | ■ Power |
| ■ Repeater | ■ Microphone |
| ■ Equalizer | ■ Bridging |
| ■ Low-Pass | ■ High-Level |
| ■ Wide-Band | ■ Squelch |

Ask ITI for detailed specs. Mounting shelves and equipment boxes, some pre-wired for your convenience, also available.

The TLC Line: • Amplifiers • Attenuators
• Bridges-Coils • Conference Systems •
Signalling and Terminating Equipment
and Hardware.

write or call . . .

ITI Electronics, Inc.
(ESTABLISHED 1947)
369 LEXINGTON AVE. • CLIFTON, NJ 07011
phone: 201-546-3900

Circle 47 on reader service card

LSI-11/2 USERS

AAM-11 • Auto-answer/Auto-dial low speed modem/serial interface. Requires only a 'CBS' DAA unit. Emulates DL-11E and DN-11. Software transparent. \$650

BUS-11 • Direct X-Y graphics display of bus activity on your oscilloscope. Selectable qualifiers and address window. Use stand-alone or connect to logic analyzer. Start/stop address strobes for software loop timing analysis. *Invaluable diagnostic.* \$300

TEXT-11 • Screen editor package for RT-11. Use with any cursor controlled CRT. Context switch between 2 files. *What you see is what you get!* \$500

Coming soon:

ASD-11 • Auto-answer/Auto-dial synchronous/asynchronous interface for your high speed modem.

FEP-11 • Intelligent front-end communications processor for up to 4 synch/asynch lines. Fully buffered. Character/line pre-processing. Multi-protocol support. Reduces CPU terminal support overhead. DMA transfers.

Dealer/OEM inquiries invited

Nortek

The LSI-11 specialists.
2432 NW Johnson • Portland, OR 97210
503-226-3515

Circle 48 on reader service card



BIG INCH[®]

MINIATURE STEPPER MOTORS

Here are stepper motors that will operate from your present circuitry — you don't have to provide extra logic for pulse sequencing if it's not already accessible. HSI's BIG INCH steppers can be pulsed from simple "on-off" switching or from single phase, two phase, or four phase supplies. Torque is up to 2.7 oz-in at a 1.5° step angle; operating range is 0 to 400 PPS.

Motors are available with various step angles from .09° to 36°. Weighing only 2-1/2 oz., and a mere 1-1/16" dia., they can provide an ideal solution to many of your size and weight problems.

Send for information now!



HAYDON SWITCH & INSTRUMENT, INC.
1500 Meriden Road, Waterbury, CT 06705 / (203) 756-7441

Have Representation Call Circle #67

Information only Circle #68



true RMS V-A-W measure-ability plus

- true RMS volts-amps-watts
- usable at all power factor levels
- digital readout to 5999
- wide range 70-250 VAC, 1-10 amps, 70-2500 watts
- 100 mW resolution
- 0.5% accuracy
- small size, lightweight
- low cost—\$1250
- available nationwide from YEW stocking distributors.

YEW's new model 2509 digital V-A-W instrument is an outstanding, low cost solution to accurate RMS measurements. What's more, it's backed by YEW's long experience in true RMS standard measurements and a nationwide service organization. Find out how the new 2509 can be put to work for you. Write Yokogawa Corporation of America, 5 Westchester Plaza, Elmsford, N.Y. 10523. Phone: 914-592-6767.

YEW[®] YOKOGAWA
CORPORATION
OF AMERICA

Circle 70 on reader service card

That's why you need to talk to us when you need SCR's. In the up to 35 amp range, we can offer you more package designs than anybody in the business. And where quality is concerned, we absolutely refuse to take a back seat to anyone.

With our SCR's you not only get all the design flexibility you could want, you get quality and quick delivery at a price that's comparable or possibly even less than what you're paying now.

Get in touch with our local representative or call us at 817-267-2601.

If you want to talk SCR's, we speak your language.

TECCOR

TECCOR ELECTRONICS, INC.
P.O. BOX 669 EULESS, TEXAS 76039

Circle 231 on reader service card

Nobody else can say that about SCR'S.

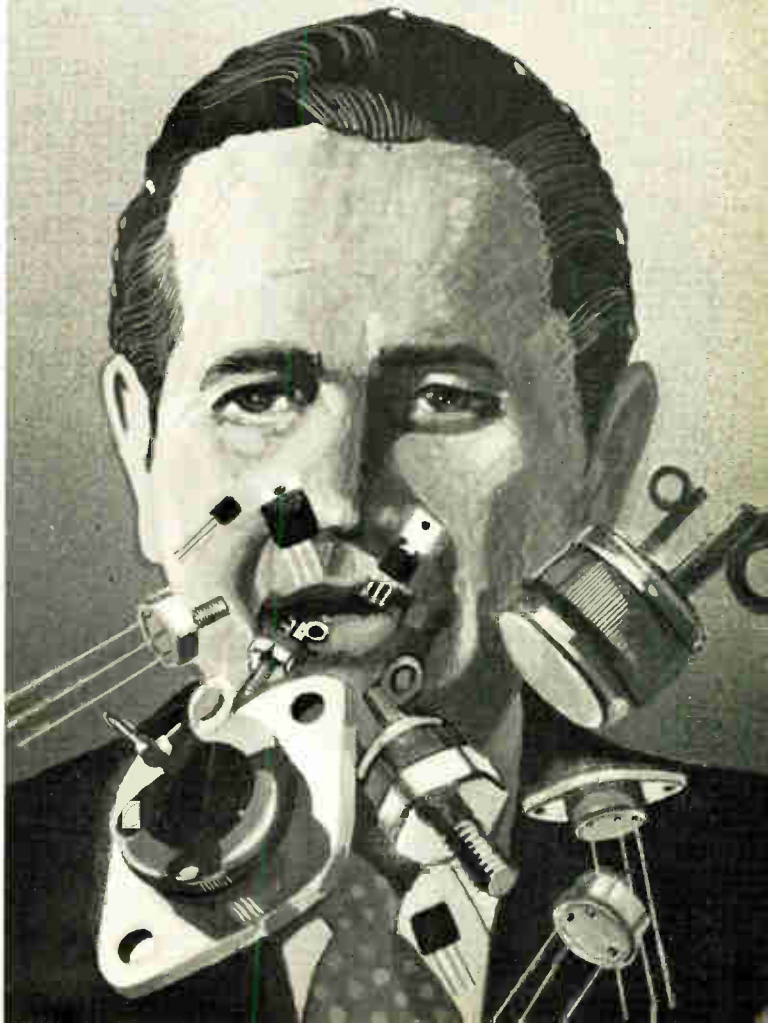

You know Hamlin reed switches. Now get to know Hamlin reed relays.

Hamlin has long been Number One in reed switches. Now make Hamlin your Number One choice for printed circuit board and dual-in-line packaged reed relays.

Hamlin reed relays are hermetically sealed in epoxy with a choice of Form A, B or C contacts. Diode or electrostatic shielding is optional. These are available as dry reed and mercury-wetted, no-bounce operation. One mercury model permits operation in any position — a Hamlin first!

All offer long life at moderately low cost, fast switching and good isolation between input (coil) and output (contacts).

Use Hamlin reed relays with the same confidence you have in Hamlin reed switches for all military, industrial and commercial applications in the world of computers, telecommunications and industrial controls.

For more information on these exciting new products and the complete Hamlin line of relays up to 40 amps, write or call: Hamlin, Inc., Lake & Grove Streets, Lake Mills, WI 53551, 414-648-2361.



HAMLIN
INCORPORATED

Circle 232 on reader service card

1348

REPRINTS AVAILABLE FROM *ELECTRONICS*

No. of
copies
wanted

Articles

- ___ R-815 Higher power ratings extend V-MOS FETs' dominion 8 pp \$2.00
- ___ R-813 Data-link control chips: bringing order to data protocols 10 pp \$3.00
- ___ R-811 Multiplexing liquid-crystal displays 10 pp \$3.00
- ___ R-809 New methods and materials stir up printed wiring 10 pp \$3.00
- ___ R-801 World market report 1978 24 pp \$4.00
- ___ R-734 Microcomputer families expand 20 pp \$4.00
- ___ R-730 Special report—Automotive electronics gets the green light 10 pp \$3.00
- ___ R-728 Flexible circuits bend to designers' will 10 pp \$3.00
- ___ R-724 Special report—Technologies squeeze more performance from LSI 22 pp \$3.00
- ___ R-722 Demands of LSI are turning chip makers towards automation 12 pp \$3.00
- ___ R-720 How EEs feel about engineering—3-part series 26 pp \$5.00
- ___ R-718 Display makers strive to refine their technologies 8 pp \$3.00
- ___ R-716 Special report—Japanese wave

in semiconductor technology 24 pp \$3.00

- ___ R-714 Special report—active filter technology 6 pp \$3.00
- ___ R-710 Personal computers mean business 8 pp \$2.00

Books

- ___ R-803 New product trends in electronics—Electronics Book Series 333 pp \$14.95
- ___ R-732 Memory design—Microcomputers to mainframes—Electronics Book Series 180 pp \$12.95
- ___ R-726 Design Techniques for Electronics Engineers: 293 time-saving ideas in 48 chapters—Electronics Book Series 370 pp \$15.95
- ___ R-711 Circuits for electronics engineers: 306 circuits in 51 functional groups—Electronics Book Series 396 pp \$15.95
- ___ R-704 Thermal design in electronics 52 pp \$5.00
- ___ R-701 Applying microprocessors—Electronics Book Series 191 pp \$9.95
- ___ R-608 Basics of Data Communications—Electronics Book Series 303 pp \$12.95

- ___ R-602 Large Scale Integration—Electronics Book Series 208 pp \$9.95
- ___ R-520 Microprocessors—Electronics Book Series 154 pp \$8.95
- ___ R-011 Computer-aided Design 135 pp \$4.00

Charts

- ___ R-516 Electronic symbols \$2.00
- ___ R-213 Electromagnetic spectrum (updated 1976) \$3.00
- ___ R-326 Optical spectrum (6-page report and chart) \$3.00

Payment must accompany your order

Make check or money order payable to Electronics Reprints. All orders are shipped prepaid by parcel post. Allow two to three weeks for delivery. For additional information call (609) 448-1700 ext. 5494.

Mail your order to:
Janice Austin
ELECTRONICS REPRINTS
P.O. Box 669
Hightstown, N.J. 08520

Introductory offer to new members of the COMPUTER PROFESSIONALS' BOOK CLUB

any two
of these great
professional books
for only
\$2.95
values up
to \$64.90

Two special bonus books come to you
for \$2.95 with your first club selection

Be sure to consider these books as well—



783/578
THE COMPULATOR BOOK
Building Super
Calculators &
Minicomputer
Hardware with
Calculator Chips
by R. P. Haviland
Pub. price, \$10.95
Club price, \$ 9.30



783/845
**THE 8080A
BUGBOOK**
MICROCOM-
PUTER INTER-
FACING AND
PROGRAMMING
by P. R. Rony,
D. G. Larsen &
J. A. Titus
Pub. price, \$9.95
Club price, \$8.45



785/252
**CHESS AND
COMPUTERS**
by D. Levy
Pub. price, \$12.95
Club price, \$10.50



654/158
**PROGRAMMING
LANGUAGES**
by A. B.
Tucker, Jr.
Pub. price, \$17.50
Club price, \$13.50



491/380
**MICRO-
COMPUTER-
BASED DESIGN**
by J. Peatman
Pub. price, \$24.50
Club price, \$17.50



772/223
**COMPUTER
STORAGE
SYSTEMS &
TECHNOLOGY**
by R. E. Matick
Pub. price, \$29.95
Club price, \$23.95



773/009
**MINI-
COMPUTERS:
Structures and
Programming**
by T. G. Lewis
& J. W. Doerr
Pub. price, \$13.95
Club price, \$11.75



768/749
**MICRO-
PROCESSOR/
MICRO-
PROGRAMMING
HANDBOOK**
by B. Ward
Pub. price, \$9.95
Club price, \$8.45



783/934
**FUTURE
DEVELOPMENTS
IN TELECOM-
MUNICATIONS**
by J. Martin
Pub. price, \$34.95
Club price, \$24.50



770/115
**A DISCIPLINE OF
PROGRAMMING**
by E. W.
Dijkstra
Pub. price, \$18.95
Club price, \$15.75



191/603
**APPLYING
MICRO-
PROCESSORS**
New Hardware,
Software and
Applications
Edited by
L. Altman &
S. E. Scrupski
Pub. price, \$16.95
Club price, \$13.25



783/56X
**MICRO-
PROCESSOR
PROGRAMMING
FOR COMPUTER
HOBBYISTS**
by N. Graham
Pub. price, \$12.95
Club price, \$10.95



353/670
**MICRO-
PROCESSORS &
SMALL DIGITAL
COMPUTER
SYSTEMS FOR
ENGINEERS &
SCIENTISTS**
by G. A. Korn
Pub. price, \$27.50
Club price, \$18.95



701/30X
**DATA BASE
DESIGN**
by G. Wiederhold
Pub. price, \$21.50
Club price, \$15.95

save time and money
by joining McGraw-Hill's

COMPUTER PROFESSIONALS' BOOK CLUB



HERE is a professional club designed to meet your day-to-day needs by providing practical books in your field on a regular basis at below publisher prices. If you're missing out on important technical literature—if today's high cost of reading curbs the growth of your library—here's the solution to your problem.

The Computer Professionals' Book Club was organized for you, to provide an economical reading program that cannot fail to be of value. Administered by the McGraw-Hill Book Company, all books are chosen by qualified editors and consultants. Their understanding of the standards and values of the literature in your field guarantees the appropriateness of the selections.

How the Club operates: Every month you receive free of charge *The Computer Professionals' Book Club Bulletin*. This announces and describes the Club's featured book of the month as well as alternate selections available at special members' prices. If you want to examine the Club's feature of the month, you do nothing. If you prefer one of the alternate selections—or if you want no book at all—you notify the Club by returning the card enclosed with each *Bulletin*.

As a Club Member, you agree only to the purchase of four books (including your first selection) over a two-year period. Considering the many books published annually, there will surely be at least four you would want to own anyway. By joining the club, you save both money and the trouble of searching for the best books.

MAIL THIS COUPON TODAY

COMPUTER PROFESSIONALS' Book Club
P.O. Box 582 Princeton Road, Hightstown, New Jersey 08520

Please enroll me as a member and send me the three books indicated. I am to receive the two bonus books at the introductory price of \$2.95 plus my first selection, plus tax, postage, and handling. If not completely satisfied, I may return the books within 10 days and request that my membership be cancelled. If I keep the books, I agree to take a minimum of three additional books during the next two years at special Club prices (guaranteed 15% discount, often more). I will receive the Club Bulletin 13 times a year. If I want to examine the featured selection, I need take no action. It will be shipped automatically. If, however, I want an alternate selection—or no book at all—I simply notify the Club by returning the convenient card always enclosed. I will always have a minimum of 10 days in which to return the card and you will credit my account fully, including postage, if this is not the case. Membership in the club is continuous but cancellable by me at any time after the four-book purchase requirement has been filled. *This order subject to acceptance by McGraw-Hill. Orders from outside the continental U.S. must be prepaid. Company, business, or institutional tax exemption status is not applicable to purchases made through individual Club memberships. All prices subject to change without notice. Offer good for new members only. A shipping and handling charge is added to all shipments. Members are billed when books arrive.*

Write Code # of 1st bonus book selection here	Write Code # of 2nd bonus book selection here	Write Code # of 1st book selection here
<input type="text"/>	<input type="text"/>	<input type="text"/>

Name

Address

City State Zip

EXTRA SAVINGS: Remit in full with your order, plus any local and state tax, and McGraw-Hill will pay all regular postage and handling charges. **P39310**

SOLID STATE Temperature Protection

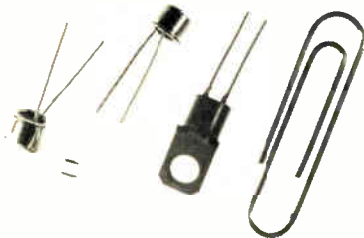

- High Temperature Coefficient
- Low Cost
- High Reliability
- Temperature Range 57-140°C
- Simple to Apply

CANADIAN THERMOSTATS AND CONTROL DEVICES LTD.

2255 Dandurand Street,
Montreal, Quebec H2G 1Z6
(514) 270-7135
TELEX 05-25277

Circle 85 on reader service card

The EMR is dead.



Long live Motorola solid-state relays!

For logic level designs where you need solid-state reliability, convenience, versatility, standard packages, multiple sourcing and low-cost, solid-state relays are the only way to go!

Motorola presents a new broad line of SSRs and I/O modules which is vastly superior to EMRs for power designs, PC boards and I/O systems . . . and with performance/reliability advantages over similar contemporaries.

Contact Motorola Subsystem Products, P.O. Box 20912, Phoenix, AZ 85036, (602) 244-3103 or circle the reader number.



MOTOROLA INC.

236 Circle 236 on reader service card

New products

It is priced at \$170 in 100 quantities. Delivery of the SDM858 is stock to two weeks.

Burr-Brown, P. O. Box 11400, Tucson, Ariz. 85734. Phone (602) 746-1111 [381]

Multiplying 12-bit d-a unit gives high linearity for \$12

Producing a monolithic, four-quadrant multiplying digital-to-analog converter that offers features like 12-bit resolution, nonlinearity guaranteed to be within 0.01%, and current settling time to within 0.01% of full-scale resolution of 1 μ s is a feat in itself. But being able to produce such a high-performance unit, the complementary-metal-oxide-semiconductor ICL7541, so that it sells for \$12 in quantities of 1,000 and up, takes even more of a technological effort.

"The ICL7541 multiplying d-a converter is, we believe, one of the most carefully engineered devices of its type on the market," says Skip Osgood, data acquisition products marketing manager for Intersil. The company claims that the unit is the first integrated circuit to be fabricated with active laser trimming and absolute matrix positioning.

Other laser-trimming systems adjust the resistances in the R-2R ladder network by cutting a metal link to lop off discrete resistor segments. Intersil's technique allows continuous active trimming of on-chip thin-film resistors during wafer sorting. Trimming of the most critical resistors is done on a separate resistor in parallel with a small portion of the main body transistor. "This 'trim tab' technique desensitizes the laser-trimming effect," notes Osgood, "and retains nearly constant density in the main resistor, thus improving aging and reliability characteristics."

The unit's other specifications also reflect the engineering effort that went into the device's development: maximum nonlinearity temperature coefficient is 2 ppm of full-scale resolution per °C, gain error is 0.3% of FSR, maximum gain error temper-

DIGITAL COMMUNICATION AND SIGNAL PROCESSING

(PRINCIPLES, DESIGN,
APPLICATIONS & PLANNING)
University of Ottawa, Canada
December 11-13, 1978

This intensive three-day seminar will be given by a team of Internationally known AUTHORITIES in the field.

Dr. Donald SCHILLING Professor, City College, City Univ. New York
Mr. J. Thomas MARKLEY President, Raytheon Data Systems, U.S.A. Systems, U.S.A.
Dr. Kamilo FEHER Assoc. Prof., University of Ottawa and Consultant SPAR Ltd.
Mr. Charles TERREAU Vice President, Bell Northern Research
Mr. Douglas MORAIS Vice President, Farinon Canada Limited
Mr. Wence ZENKO Engineering Manager, Canadian Marconi Co.

COURSE HIGHLIGHTS

Background and also advanced material covering design, planning, original applications and analysis of digital modulation and digital communications engineering will be presented. The practical approach adopted and the presented digital signal processing, multiplexing baseband cable, LOS microwave and satellite system examples are intended for the training of a large group of communications engineers and managers. The notes and K. Feher's book recently published on Digital Modulation Techniques provide state-of-the-art material.

For additional information, please write or call:

Dr. Kamilo FEHER, P. Eng.
Assoc. Prof. Elect. Eng.
University of Ottawa
Ottawa, Ontario, Canada K1N 6N5
Tel: 613-231-2288
or: Mr. Rene LeHenaff
Tel: 613-231-2355

Circle 92 on reader service card

BY POPULAR DEMAND!

MS-215 Dual Trace Miniscope



With Rechargeable
Batteries & Charger Unit. **\$435**

- 15-megahertz bandwidth.
- External & internal trigger.
- Auto or line sync modes.
- Power usage — < 15 W.
- Battery or line operation.
- 2.9" H x 6 4" W x 8.0" D.



Non-Linear Systems, Inc.

Originator of the digital voltmeter.
Box N, Del Mar, California 92014
Telephone (714) 755-1134 TWX 910-322-1132

WESCON BOOTH #1507

Circle 94 on reader service card

How fast can you measure rise time, fall time and pulse width?

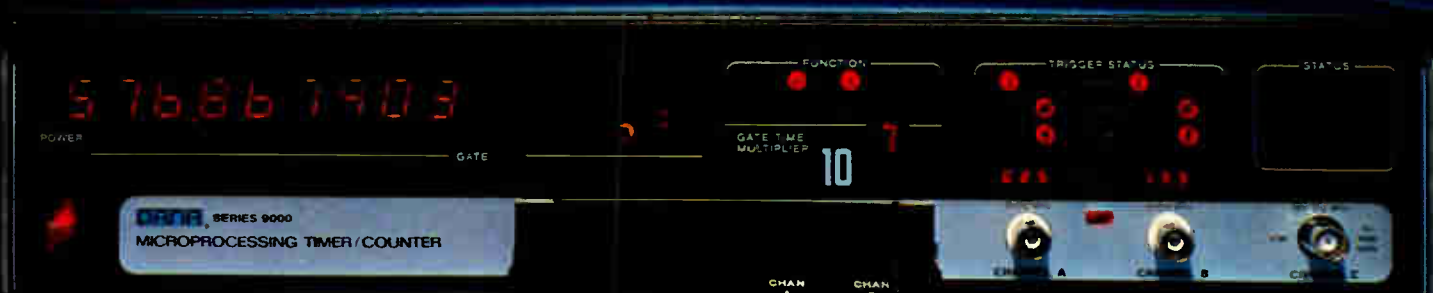
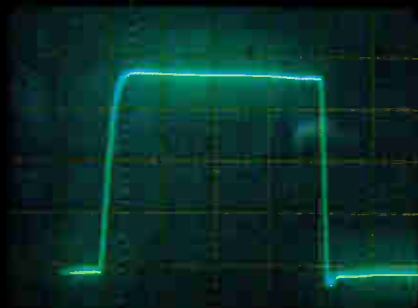

Your way.



(About 5 minutes.)

1. Connect signal to scope.
2. Adjust trace intensity.
3. Adjust focus. 4. Select VOLTS/DIV range.
5. Select TIME/DIV range. 6. Adjust vertical gain to fill screen for location of 10% & 90% points. 7. Locate 10% point. 8. Locate 90% point. 9. Determine horizontal displacement between 10% & 90% points. 10. Multiply displacement by horizontal scale factor.

That's RISE TIME. Only 9 more steps and you've got PULSE WIDTH and FALL TIME.

Our way.

(About 5 seconds.)

1. Connect signal.
2. Push  button for RISE TIME. 3. Push  button for PULSE WIDTH. 4. Push  button for FALL TIME.

The rest is automatic.

Your move.

Give us a call and we'll tell you how the 9000 Microprocessing Timer/Counter can solve your measurement problem the easy way.

RACAL-DANA

RACAL

Racal-Dana Instruments, Inc., 18912 Von Karman Avenue, Irvine, CA 92715,
Phone: 714/833-1234.

Circle #96 for Product Demonstration
Circle #237 for Literature Only

THEY WENT THATAWAY. ...TRANSIENTS, that is!

And you'll know when and how long. In a hard copy printout.

Source or load transients are identified in an instant with Programmed Power's Model 3500 Power Line Disturbance Monitor and its transient direction and polarity detection option. Another option prints out the transient duration in microseconds.

Other options, nine in all, include 50-441Hz line monitoring; DC bus monitoring simultaneously with AC line; undervoltage or overvoltage duration in milliseconds with outputs for remote data logging.

The most versatile line monitor around.

Fast deliveries.

We also make award-winning Frequency Converters and UPS.

For more information, contact:



Power Line Disturbance Monitor



Franklin Electric

Programmed Power Division

995 Benicia Ave., Sunnyvale, CA 94086, (408) 245-8900, Telex: 357-405

Circle 238 on reader service card

Autoranging Lab/Systems 5 1/2 -digit DMM \$995.*

Model 3500 Autoranging Lab/Systems 5 1/2-digit DMM with 1 μ Volt/1 Milliohm Sensitivity DC and AC.

When performance counts, count on Data Precision. Our Model 3500 offers autoranging, remote ranging and trigger, 2 and 4 wire resistance measurement, DC and AC voltages plus DC/DC and AC/DC ratio measurement, BCD output with a basic DC accuracy of $\pm 0.007\%$.

Measures: DCV 1 μ V to 1000V; ACV 1 μ V to 700V RMS, 30Hz to 100KHz; Resistance 1 milliohm to 12 Megohms. 1000 M Ω Input Impedance through 10VDC.

*price U.S.A.

DATA PRECISION
...years ahead



For complete information or a demonstration, contact your local Data Precision representative or Data Precision Corporation, Electronics Avenue, Danvers Industrial Park, Danvers, MA 01923, USA, (617) 246-1600, TELEX (0650) 921819.

New products

ature coefficient is 5 ppm of FSR/ $^{\circ}$ C, maximum power supply rejection is 20 ppm of FSR/%, and power dissipation is 20 mw.

Intersil Inc., 10710 N. Tantau Ave., Cupertino, Calif. 95014 [383]

System inputs analog data to MM1 microcomputer

Designed to interface analog signals with the Control Logic MM1 microcomputer, the MM1-AI/AO 32-channel analog data-acquisition system plugs directly into a slot in that computer's Polybus. The specific number of channels available depends on whether single-ended or differential inputs are required; up to 32 channels are available in the

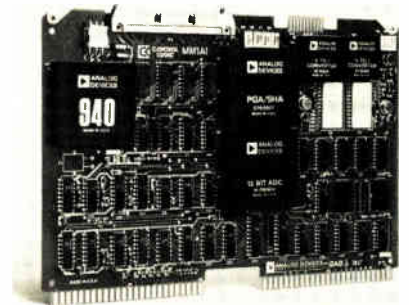

former case and 16 in the latter.

The unit's analog-to-digital converter can be configured by users to accept any of three voltage input ranges: 0 to 10 v, -5 to +5 v, or -10 to +10 v. Adding a signal-conditioning board allows the MM1-AI/AO board to accept 32 4-to-20-mA current-loop signals for industrial and process-control applications. Two 12-bit d-a channels on the board provide output voltages of 0 to 5 v, 0 to 10 v, ± 2.5 v, ± 5 v, or ± 10 v.

The system uses memory-mapped I/O so that the board appears to the microcomputer as a memory block that uses the microcomputer's standard address, data, and control buses. As a result, program storage requirements are reduced and program execution time decreases. The unit is priced at \$1,050 and is deliverable in 30 days.

Control Logic Inc., Nine Tech Circle, Natick, Mass. 01760. Phone (617) 655-1170 [388]



Introducing the OPEN-MINDED datalogger.

The new DigiTec Datalogger 3000 takes an open-minded approach to data acquisition. Open-minded because it is a comprehensive microcomputer system dedicated to data acquisition; not just a microprocessor based, hardware-oriented datalogger.

The Datalogger 3000 provides standard capabilities not even *optionally* available on other dataloggers; for example:

- a built-in CRT display prompts the user in programming and displays more information than possible with conventional dataloggers.
- a mini cassette loads the system program, provides absolute memory back-up, and records data
- unique linearization capability. Six linearization tables; 4 preprogrammed and 2 completely open. You're free to define both open tables with *any* 16 points along *any* curve to linearize your specific inputs. And since the Datalogger 3000 is truly a computer, it actually interpolates measurements that fall between points you've entered. The result: the most accurate measurements possible.
- the 3000 can be programmed from the front-panel, a remote CRT terminal or even a host computer.
- and of course an alphanumeric printer, alarm limits with relay outputs and English messages, scaling & offset factors, engineering units, composite video output and other features also come standard on the Datalogger 3000

“... a new-generation data acquisition system that unites the capabilities of a precision datalogger with the intelligence of a computer.”

DigiTec

**UNITED
SYSTEMS
CORPORATION**

918 Woodley Road, Dayton, Ohio 45403
(513) 254-6251, TWX (810) 459-1728

So, if you're open-minded and interested in a revolutionary approach to data acquisition, contact us. Find out how the Datalogger 3000 can take an open-minded approach to your application.

Call Daryl Barnaby, (513) 254-6251 collect.

Circle #101 for Information Only

DIGITEC: Precision measurements to count on.

Circle #239 for Demonstration Only

HARD WORKING ECONOMY OR HIGH PERFORMANCE VERSATILITY— THE CHOICE IS YOURS.

No matter which Gould strip chart recorder you choose, you get rugged design and outstanding reliability. Both the Model 105 and the Model 110 are at home in your plant or in the lab and both offer 99.9% linearity, 10 chart speeds and sealed follow-up elements.

The Model 105 recorder features a die-cast flat bed design, easy loading z-fold paper, one or two channels, 1 mV full scale to 10 volt measurement range, multicolor felt tip writing and English or metric chart speeds.

The Gould Model 110 offers the additional versatility of plug-in amplifiers covering a wide

range of fixed and multispans voltages and temperatures. The Model 110 features a lifetime guaranteed fine line thermal pen, roll paper and is available for rack mounting or portable operation.

It all depends on what your application calls for, hard-working economy or high performance versatility. Gould has both.

For complete information contact Gould Inc., Instruments Div., 3631 Perkins Ave., Cleveland, Ohio 44114. (216) 361-3315.

For brochure call toll free: (800) 325-6400, ext 77. In Missouri: (800) 324-6600.

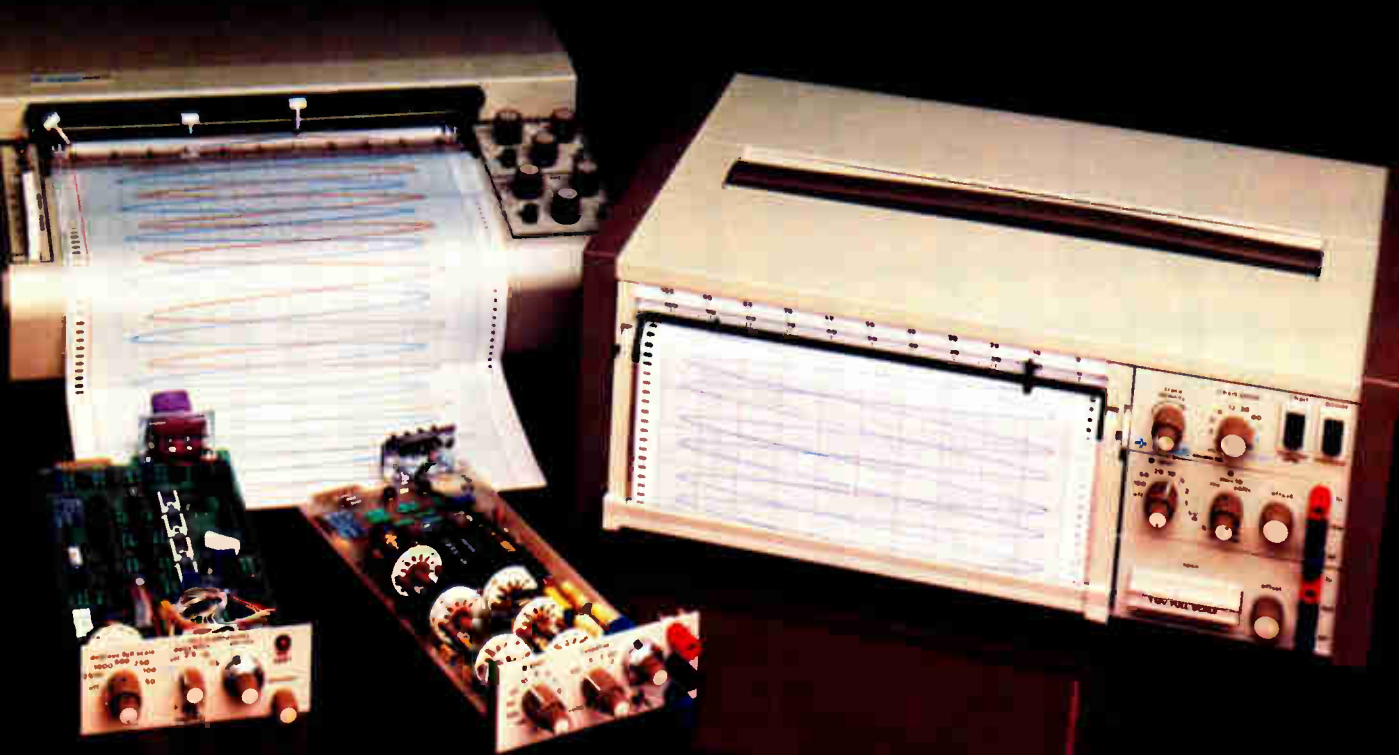

Circle 240 on reader service card



GOULD

HP quadruples memory of desktop computer

A new desktop computer from Hewlett-Packard will support up to 256 kilobytes of random-access memory—four times the memory limit of the top-of-the-line 9845 desktop unit. Dubbed the 9835, **the microprocessor-based machine will reportedly run programs written in assembly language or Basic.** It will be available with either a single-line readout or a full-blown cathode-ray-tube display. The computer will offer direct memory access and 15 levels of interrupt to facilitate data input and output, especially in data-acquisition applications.

Protection, but not cost, added to power supply

ACDC Electronics of Oceanside, Calif., has just redesigned its popular 5-v, 3-A model EC5N3B open-frame power supply **so that the unit now includes over-voltage protection as a standard feature.** Previously, it was available as an option. The supply was granted UL recognition on Aug. 4.

Programmer ready for the big PROMs

When 64- and 128-kilobit programmable read-only memories arrive on the scene, Data I/O's System 19 with its 128-kilobit random-access memory capacity will be ready to program them. The standard version of the Issaquah, Wash., company's programmer **just made it through design in time for introduction at Wescon/78,** according to Wayne M. Paulson, product marketing specialist. "The decision to bring it to the show was made on Aug. 15," he declares. The \$2,225 instrument features 32 kilobits of RAM and a dual serial data port for current-loop and RS-232-C interfaces. It will share booth space with the single-button \$1,495 production programmer, the System 17.

High-voltage capability added to test system

To satisfy the increasing need for full-voltage testing of high-power components, Teradyne Inc. of Boston is offering a **high-voltage power supply that extends the capability of its J273B Linear Test System to 300 v—five times higher than its previous value.** The M230 provides programmable current clamping at 30-mA intervals up to a maximum of 200 mA. The \$2,000 unit has a delivery time of 14 weeks.

Low-cost counter area gets more competitive

A pair of 100-MHZ counters, scheduled for introduction early next month, seem to herald a shift in Hewlett-Packard's competitive emphasis from a strictly performance approach to a more balanced price and performance one. **The counters, an \$800 microprocessor-based unit and a \$375 instrument built with Intersil's 7216 counter chip,** are both two-channel types. The higher-priced HP 5315A uses HP's custom multiple-register counter chip and Mostek's 3870 4-bit microprocessor, whereas the less expensive HP 5314A is built with the 10-MHZ Intersil IC preceded by a prescaler to reach 100 MHz.

Second sources

- Two equivalents to the Motorola MC1496 and MC1596 double-balanced modulator/demodulators have been announced by **Plessey Semiconductors, Irvine, Calif.**
- **National Semiconductor Corp., Santa Clara, Calif.,** has introduced its MM 5257 4-kilobit static RAM—a pin-for-pin replacement for the TMS 4044 made by Texas Instruments.

New products/materials

Quartz materials available for use by original-equipment manufacturers include as-grown cultured quartz bars, lumbered bars, wafers, and dice. The materials are used in the



fabrication of microprocessors, channel elements, saws, and other applications requiring a frequency standard. These products come in a variety of sizes and orientations, and can be made to customer specification.

Motorola Inc., Communications Division, 1301 Algonquin Rd., Schaumburg, Ill. 60196 [479]

Two pelletized foam concentrates can be used with high-temperature thermoplastics to simplify the injection-molding process. Foam Kon 28 is recommended for use with Nylon 6, 6/10, 6/12, polyphenylene sulfide, polysulfone, polycarbonate, and amorphous nylon. Foam Kon 29 should be used with modified polyphenylene oxide and thermoplastic polyester. The foam concentrates can be handled more easily and offer more consistent shot-to-shot part weights than dry powder blending. In quantities of 1,000 pounds or more, Foam Kon 28 and 29 sell for \$2.05 per pound.

LNP Corp., 412 King St., Malvern, Pa. 19355 [480]

A highly conductive coating deposited on a transparent polyester film is designed for electric-field shielding, grounding, and preventing the build-up of static charges. Teckfilm can be used as a transparent panel for shielding visual displays in

instrumentation equipment, control panels, computer-processing printers, peripheral equipment, and large-electrode displays. It is available in continuous lengths, with a standard 34-in. width and 0.005-in. thickness. It has a surface resistivity of 14 to 16

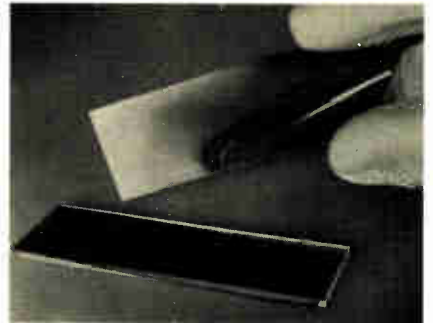

ohms/sq, a 70% to 80% visible light transmission, and an operating temperature of -60° to 150°C . It sells for \$18 per ft. up to 24 ft.

Technical Wire Products Inc., 129 Dermody St., Cranford, N. J. 07016 [475]

See the

Unexpected

When unexpected or out-of-sequence events occur in your system, the Model 532 Intelligent Logic State Analyzer can show you exactly what happened.

But that's not all. As an intelligent analysis tool, the Model 532 contains an unexpected number of powerful features in its compact, 10-pound package:

Broad Monitoring

32 channels with 250 words of storage.

Display Versatility

Hexadecimal or binary; use a scope, video terminal, or LED readout.

Triggering Flexibility

21 different modes.

Signature Analysis

Computes signature of data collected.

Programmability

Stores tests in RAM or UV PROMS for later automatic playback.

Automatic Operation

Offers remote testing via RS-232 or IEEE-488 bidirectional interfaces.

The Model 532 is also unexpectedly cost-effective and easy-to-use. Use our toll-free hotline to arrange a demonstration or for additional information.

 **PARATRONICS INC.**

890 Charcot Avenue • San Jose • CA 95131 • Tel. (408) 283-2251/TW: (415) 358-2204
Outside California — CALL TOLL FREE (800) 538-9713

List Price \$1800.00

For Additional Information Circle #242

For Demonstration Circle #241



The right connection.

CAMBION electronic components are known around the world for superb quality, dependability and durability. There are many reasons. CAMBION precision electronic components and other CAMBION products are much more than the prime metals and materials that go into them. More than excellent design and engineering. More than stringent quality control and the highest standards in the industry. More than on-time delivery. More than the experience of satisfying OEM needs for over 30 years.

More than the positive motivation of a dedicated, responsible on-line team of workers.

CAMBION products are the sum of all these parts. That's why you get so much from CAMBION. So much goes in. That's why every CAMBION product is the right connection for *your* products and *your* customers' satisfaction.

And that's how we can afford to guarantee every CAMBION product.

Write today for free, full-line catalogs of the right CAMBION connections for you.

CAMBION[®]

Cambridge Thermionic Corporation
445 Concord Avenue, Cambridge, MA 02138

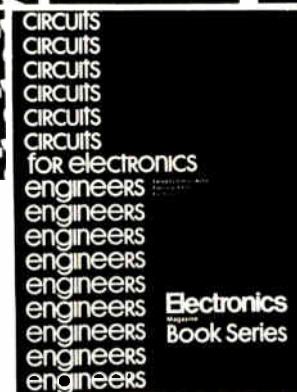
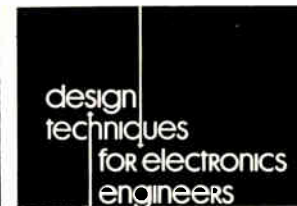
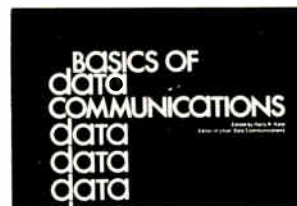
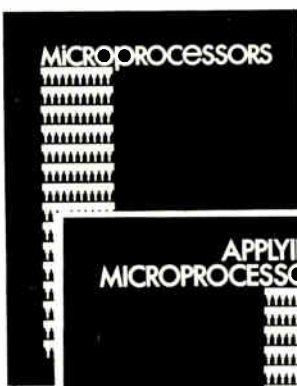

Electronics Magazine Book Series

1. Microprocessors

What you must know about available microprocessor technology, devices, information, 4th printing. \$8.95

2. Applying Microprocessors

2nd and 3rd generation technology. 26 detailed applications from data networks to video games. \$9.95

3. Large Scale Integration

Covers the basic technology, new LSI devices, LSI testing procedures, plus system design and applications. \$9.95

4. Basics of Data Communications

Includes 47 articles from Data Communications magazine covering more than 11 key areas. \$12.95

5. Circuits for Electronics Engineers

Contains 306 circuits arranged by 51 functions from Amplifiers to Voltage Regulating Circuits. Saves design drudgery. \$15.95

6. Design Techniques for Electronics Engineers

Nearly 300 articles drawn from "Engineer's Notebook." A storehouse of design problem solutions. \$15.95

7. Memory Design: Microcomputers to Mainframes

The technology, devices, and applications that link memory components and system design. \$12.95

8. New Product Trends in Electronics, Number One

From "New Products," state-of-the-art materials and equipment, arranged according to function. \$14.95

Electronics Book Series
P.O. Box 669, Hightstown, NJ 08520

1. Microprocessors

Send me _____ copies at \$8.95 per copy.

2. Applying Microprocessors

Send me _____ copies at \$9.95 per copy.

3. Large Scale Integration

Send me _____ copies at \$9.95 per copy.

4. Basics of Data Communications

Send me _____ copies at \$12.95 per copy.

5. Circuits for Electronics Engineers

Send me _____ copies at \$15.95 per copy.

6. Design Techniques for Electronics Engineers

Send me _____ copies at \$15.95 per copy.

7. Memory Design: Microcomputers to Mainframes

Send me _____ copies at \$12.95 per copy.

8. New Product Trends in Electronics

Send me _____ copies at \$14.95 per copy.

Discounts of 40% on orders of 10 or more copies of each book.



If after my 10-day free-trial examination I am not fully satisfied I understand that my payment will be refunded.

Payment enclosed Bill firm Bill me

Charge to my credit card:

American Express Diners Club
 BankAmericard/Visa Master Charge*

Acct No. _____ Date Exp. _____

*On Master Charge only, first numbers above name _____

Name _____ Title _____

Company _____

Street _____

City _____ State _____ Zip _____

Signature _____

Milestones in technology.

1963: the first single capstan computer tape drive.

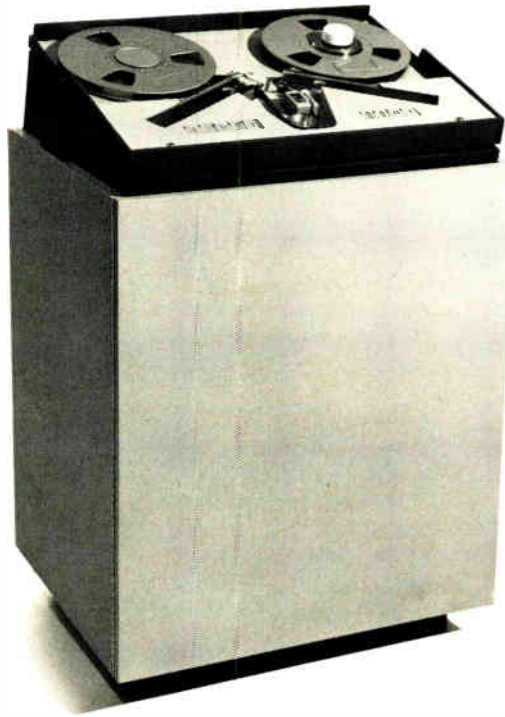

Will you help us with the projects of 1978— and the years to come?

Our TM-7 computer tape drive was the first with a single capstan tape transport. Because it involved 80 percent fewer parts than previous tape transports, and because it greatly improved stop-start times, it revolutionized this aspect of the computer industry.

In the years since we have developed many other milestones in magnetic recording—for science, for industry, and for entertainment.

Now, in 1978, the pace of our developments is faster than ever and we need your help.

If you have experience in analog/digital electronics, servos, microprocessors, precision mechanical design and packaging, you can become a part of one of our elite design teams.

We need system level engineers and technicians as well as design specialists.

Don't miss your chance for a career with Ampex—a career that will let you take part in developing the technological milestones of the years to come.

Call collect (415) 367-2846 or send your resume now to N. Puckett, Ampex Corporation, Building 2, 2655 Bay Road, Redwood City, CA 94063.

We are an affirmative action employer M/F.

AMPEX

New literature

Data-acquisition products. A 24-page handbook gives detailed applications information for an 8-bit, 8-channel data-distribution system; a 12-bit, 16-channel data-acquisition system; a 2-channel analog-output system; and a 2-channel analog-input system. All are tailored for microprocessor-based applications. Specifications are provided for amplifiers, converters, and generators. Micro Networks Corp., 324 Clark St., Worcester, Mass. 01606 [426]

Laminates. Information on preimpregnated materials and multilayer laminates is presented in a six-page brochure. Both single- and double-pressure preregs, plus such physical properties as tolerance, glass construction, copper-cladding thickness, and dimensional stability, are listed. Graphs show thermal curves for both types when used in hot or cold presses. Included is a prepreg lay-up chart. Lamination Technology Inc., 2720 S. Main St., Santa Ana, Calif. 92707 [429]

Subminiature switches. A 16-page catalog of subminiature and micro-miniature toggle, rocker, and push-button switches containing specifications, mounting information, and



prices is being offered by C&K Components Inc., 103 Morse St., Watertown, Mass. 02172 [427]

Producing character graphics. A Fortran IV subroutine that allows the drawing of six styles of alphabetic characters, three styles of numbers, and 48 special mathematical symbols is described in a 57-page publication. Twenty-two symbols for graph plotting are also given. The program requires a computer that can accommodate a 30-bit word length. The booklet sells for \$2.30 each. Ask for Number 003-003-01921-6. Superintendent of Documents, U. S. Government Printing Office, Washington, D. C. 20402

Subassemblies. More than 200 products, including analog-to-digital and digital-to-analog converters, sample-and-hold amplifiers, analog multiplexers, operational amplifiers, voltage-to-frequency and frequency-to-voltage converters, and power supplies, are presented in a 184-page product guide. Specifications for each product are listed. Teledyne Philbrick, Allied Drive at Route 128, Dedham, Mass. 02026 [432]

Hewlett-Packard Low Cost Lab

SINGLE OUTPUT

DUAL

new

Up to 10 watts
Eight models, 10V to 100V
\$130 to \$185*

Up to 30 watts
Eight models, 7.5V to 320V
\$275 to \$350*

10 watts
Dual Output 0-25V isolated,
with two controls
\$175*



For detailed Technical Data Sheets on these low cost Power Supplies, circle the reader service number. Can't wait? Call your local Hewlett-Packard Sales Office ... they'll send you the data sheets, and a complete DC Power Supply Catalog covering all Hewlett-Packard Power Supplies including: low cost lab, general purpose, special purpose, digitally programmable and OEM modular supplies.

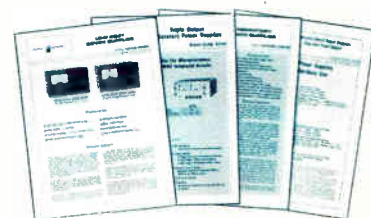

IC sockets. Specifications for the ICN/ICY series of sockets with pins for either soldering or wire wrapping and for the ICL series of low-profile sockets with solderable pins are



Printers and plotters. "Total Output," a 28-page brochure, describes the applications and specifications of 47 printers, plotters, and printer-plotters. It discusses how these units can be used in communications, computer-aided design, general data processing, mapping, scientific research, and word processing. Additionally, diagrams show the range of input sources and outputs available, interfacing schemes, Versaplot software organization, and remote and off-line systems. Listed are specifications for resolution, speed, and width, and the number of columns per line, character-set size, dot-matrix dimensions, and the standard available fonts for each unit. Versatec, A Xerox Company, 2805 Bowers Ave., Santa Clara, Calif. 95051 [434]

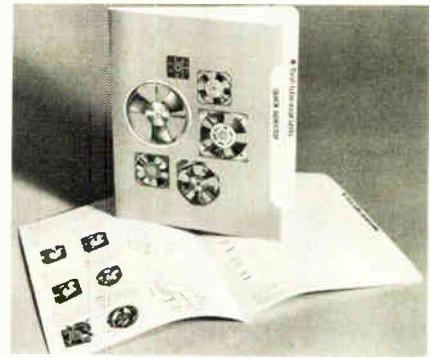

dimensions, sound, power, and construction are provided. The fans range in size from 3.14 inches in diameter and 1.51 in. deep to 10 in. in diameter and 3.50 in. deep. Technology Services Inc., 16 Wilton Rd., Westport, Conn. 06880 [433]

Tube-axial fans. A four-page catalog gives technical information on 11 models of cooling fans for electronic and computer hardware. Performance curves and specifications on

Photocells. Intended for the design engineer, "Photoconductive Cell Application Design Handbook" discusses the photocell design, theory, and application for 89 types of cadmium-sulphide and cadmium-selenide bulk-effect photoconduc-

listed in a four-page pamphlet that is available from Robinson-Nugent Inc., 800 E. Eighth St., New Albany, Ind. 47150 [431]

The Choice In Power Supplies

OUTPUT

Up to 30 watts
Dual Range, 0-20/0-40V
\$350*

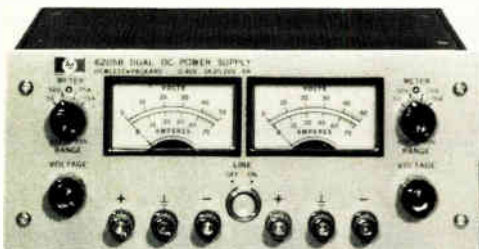

TRIPLE OUTPUT

new
Up to 10 watts
0 to 6V with 0 to +18V
& 0 to -18V (Tracking)
\$195*



Up to 30 watts
Two models: 0-6V OR 0-18V with
0 to +20V & 0 to -20V (Tracking)
\$355*



With HP's broad line of Low-Cost Lab Power Supplies — you select exactly what you need ...

- Output ratings from 6V to 320V, 10W to 30W
- Continuously adjustable output controls
- Overvoltage and overcurrent protection
- Voltage and current metering

HEWLETT  PACKARD

1507 Page Mill Road, Palo Alto, California 94304

For assistance call Washington (301) 948-6370, Chicago (312) 255-9800, Atlanta (404) 955-1500, Los Angeles (213) 877-1282
Circle 247 on reader service card 21803

New literature



tors. An outline of the design considerations in selecting the appropriate cell is also given. The 24-page handbook also provides spectral response curves for the various photoconduc-

tive materials, along with data on temperature-and speed of response. Curves also indicate cell resistance, variation of conductance with hysteresis, color temperature response, and power derating at ambient temperature. A photometry nomograph relates candlepower, distance, and foot candles. Clairex Electronics, a division of Clairex Corp., 560 S. Third Ave., Mount Vernon, N. Y. 10550 [435]

Data communications. Secondhand modems for use with data communications equipment are featured in a 23-page brochure. Specifications and prices are provided for these modulator-demodulators, which operate at speeds from 2,400 to 9,600 bits/second. Also offered are adapters and accessories, and solid-state buffers, for use with the devices. Racal-Milgo Information Systems Inc., 8600 N. W. 41st St., Miami, Fla. 33166 [436]

Radio-interference measurement. The International Special Committee on Radio Interference has released a 213-page document on radio-interference measuring apparatus and methods. This publication includes the texts of all related documents, recommendations, specifications, and reports. Information is provided on measurement apparatus, conduction and radiation measurement of radio interference, audio-frequency interference measurement, disturbance measurement due to switching operations, and the statistical considerations in determining the limits of radio interference. Ask for C.I.S.P.R. 16. International Electrotechnical Commission, 1 rue de Varembe, 1211 Geneva 20, Switzerland [437]

Keyboards. To make it as easy to order a custom keyboard as to buy a standard one, this 32-page catalog supplements information on five

First

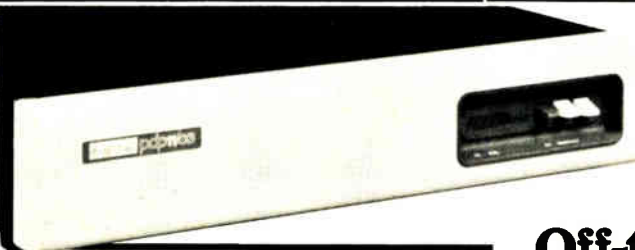

The small box PDP-11/03[®], member of DEC's PDP-11[®] family, is designed to provide extensive system-building capabilities and efficient, realtime handling of communications or process control. Full 30 day warranty is provided.

DEC's PDP-11/03[®] With All New Space Saving LSI-11/2[®] Components. And It's Available NOW

Off-the-shelf From... FIRST COMPUTER CORPORATION At Dramatic Savings, In Three Sizes.....

**To Order Call or Write:
312/920-1050**

Description		Price
11/03-HB [®]	16K Bytes	\$2095.00
11/03-HC [®]	32K Bytes	\$2395.00
11/03-HD [®]	64K Bytes	\$3195.00

Full Line Of Interfaces And Peripherals Available.

First

computer corporation
corporate square/825 north cass avenue/westmont, illinois 60559

[®]Registered trademark of Digital Equipment Corp., Maynard, Ma.



standard keyboards and accessories with a designer's worksheet for those who need specialized boards. Several pages of diagrams point out the differences between these products. Additional aids are a keyboard timing and specifications chart. Ask for KBC-78. Cherry Electrical Prod-

ucts Corp., P. O. Box 718, Waukegan, Ill. 60085 [421]

Specification guide. "The Electro-Mechanical House," a 112-page catalog contains a wide assortment of Hollingsworth solderless terminals and connectors, Molex nylon connectors, Bivar printed-circuit board hardware, and Waldom Speedy-Tys spacers and electronic hardware. Specifications and dimensions are given for the items listed. Waldom



Electronics Inc., 4301 W. 69th St., Chicago, Ill. 60629 [422]

Resistors. Electrical, environmental, and mechanical specifications for Cerbon and cermet trimmer resistors are given in a 16-page brochure. It is available from Centralab Electronics Division, Globe-Union Inc., 5757 N. Green Bay Ave., P. O. Box 591, Milwaukee, Wis. 53201 [423]



First

DEC's Latest LSI-11/2® Saves Space and FIRST COMPUTER CORPORATION Saves You Time and Money!

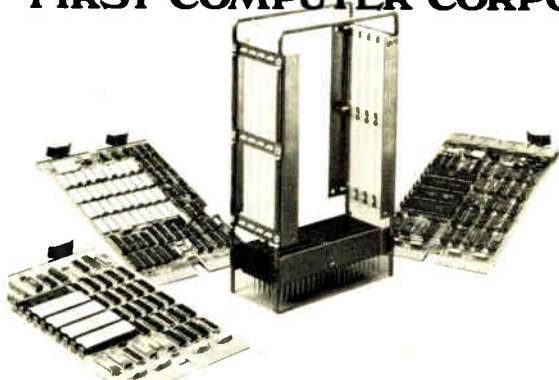

To Order Call or Write:
312/920-1050

Description	Price		
	1	2-9	10-24
KD11-HA® LSI-11/2 microcomputer	\$ 625	\$ 590	\$ 555
MSV11-DB® 8K word RAM (16K Bytes)	\$ 680	\$ 640	\$ 595
MSV11-DC® 16K word RAM (32K Bytes)	\$1170	\$1100	\$1030
MSV11-DD® 32K word RAM (64K Bytes)	\$2160	\$2040	\$1920
KD11-HC® KD11-HA plus MSV11-DC	\$1520	\$1435	\$1295
KD11-HD® KD11-HA plus MSV11-DD	\$2240	\$2115	\$1990
DLY11-J® 4 line serial interface	\$ 420	\$ 395	\$ 370
DLV11-E® serial line modem control	\$ 270	\$ 255	\$ 240

Other Quantity Discounts Available on Request

First

computer corporation

corporate square/825 north cass avenue/westmont, illinois 60559/(312) 920-1050

®Registered trademark of Digital Equipment Corp., Maynard, Ma.



Get a quote on economical precision KL-3 coldweld crystals.

You may be happily surprised. Because today our coldweld crystals cost no more than solder seal crystals for $\pm .001\%$ calibration tolerance, and are only slightly more expensive than solder seal crystals with looser tolerances. The specs are definitely better.

Frequencies in 11 ranges from 8 to 160 MHz. Drift ± 20 ppm/ -30 to $+70^\circ$ C. Maximum aging from 3 ppm/year to 5 ppm/year depending on frequency ordered.

Good specs at unbeatable prices. See the Gold Book, EEM, or write: CTS Knights, Inc., 400 Reimann Ave., Sandwich, IL 60548. Phone (815) 786-8411.

CTS KNIGHTS, INC.



Circle 105 on reader service card

Cambridge, MA—CAMBION now has ready a new revised edition of Catalog 119-A covering IC Accessories, designated 121. The updated catalog contains many new products introduced by CAMBION since the original catalog was published. Some of the important additions to be found in the new catalog include products for packaging digital systems, new panels, sockets, socket cards, IC card files, drawers and trays. Free copies of Catalog 121 are available from CAMBION.

CAMBION is a manufacturer of a broad range of electronic components for industry including, in addition to IC accessories, chokes, coils and micro-programmable Numerical Controls. For further information write: Cambridge Thermionic Corporation, 445 Concord Avenue, Cambridge, MA 02138. Or telephone: (617) 491-5400.

Updated CAMBION[®] IC Accessories Catalog available FREE

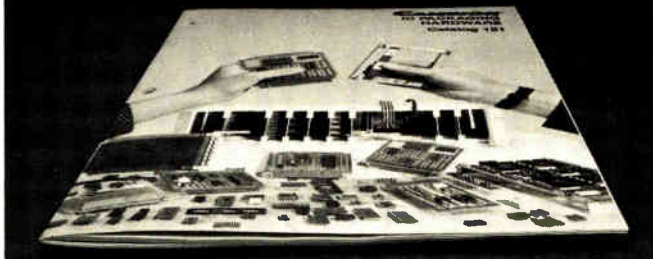

New books

Energy Reference Handbook, 2nd ed., Thomas F. P. Sullivan, Government Institutes Inc. (Washington, D. C.), 344 pp., \$15.95.

Process and Device Modeling for Integrated Circuit Design, Fernand Van De Wiele, Walter L. Engl, and Paul G. Jespers, eds., Noordhoof International Publishing (Reading, Mass.) 867 pp., \$39.50.

Surface Wave Filters: Design, Construction and Use, Herbert Matthews, ed., Wiley, 521 pp., \$29.95.

Topics in Applied Physics, Vol. 19: Optical and Infrared Detectors, R. J. Keyes, ed., Springer-Verlag, 305 pp., \$39.60.

Handbook of Simplified Solid-State Circuit Design, 2nd ed., John D. Lenk, Prentice-Hall, 429 pp., \$16.95.

The Radio Amateur's Handbook: The Standard Manual of Amateur Radio Communication, Tony Dorbuck, ed., American Radio Relay League (Newington, Conn.), 711 pp., \$8.50 (paper).

The Assurance Sciences: An Introduction to Quality Control and Reliability, Siegmund Halpern, 431 pp., Prentice-Hall, \$16.95.

Electronics Dictionary, 4th ed., John Markus, McGraw-Hill, 864 pp., \$24.50.

Integrated Circuits Technology and Applications, F. F. Mazda, Cambridge University Press, 210 pp., \$24.95.

Thin Films: Interdiffusion & Reactions, J. M. Poate, K. N. Tu, and J. W. Mayer, eds., Wiley, 578 pp., \$35.00.

Telephony and Telegraphy, 3rd ed., Sydney F. Smith, Oxford University Press, 278 pp., \$16.50.

Take a Chance with Your Calculator: Probability Problems for Programmable Calculators, Lennart Rade,

Berg Quickie Connectors are the logical cable interface for Digital minicomputers

Berg Quickie™ Connectors rapidly, reliably terminate multi-lead, flat, round conductor cable—without pre-stripping. Quickie designs allow for visual inspection before and after assembly.

Digital Equipment Corporation likes the Quickie connector's ease of termination and how its askewed tines strip away insulation to assure positive electrical contact. They like the way Quickie Headers latch to maintain connection integrity through vibration and impact. Digital has found it can rely on Berg . . . to supply the products and the application

machines that precisely meet its demanding interconnection needs.

Berg is experienced. We read interconnection needs like Digital computers read data. We have the products, the background, and the back-up to do the job. Your job. Let's work on it, together. Berg Electronics, Division E. I. du Pont de Nemours & Co., New Cumberland, Pa. 17070—Phone (717) 938-6711.



BERG ELECTRONICS

Circle 251 on reader service card

We serve special interests—yours!

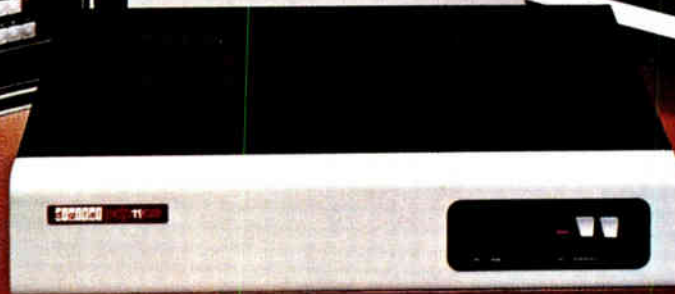
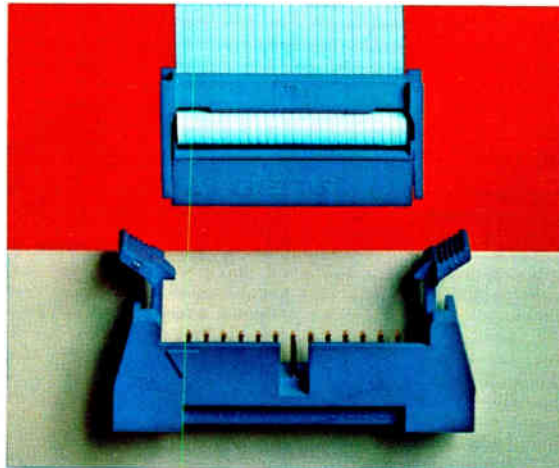

MAGNETIC SHIELDING

Material For Relays,
Transformers, Power Supplies,
CRT's, PMT's & other components:

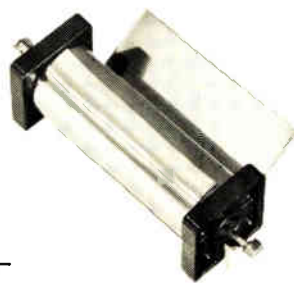

- CO-NETIC AA ALLOY —
High Permeability
.002" to .100" thick

EXCLUSIVE: Perfection Annealed —
No further anneal required if severe
forming is avoided.

- NETIC S3-6 ALLOY — High Saturation Induction.
.004" to .095" thick



MAGNETIC SHIELD DIVISION
PERFECTION MICA CO.
740 North Thomas Drive
Bensenville, Ill. 60106, USA
Phone 312 / 766-7800
TWX 910-256-4815

Send for
Material, Application
and Fabrication
Guide MG-4

Circle 252 on reader service card

State-of-the-art equipment and materials arranged according to function

As published in *Electronics*, more
than 700 products from 500 ven-
dors, all carefully researched by
the editors. Cross-referenced
company index.

Electronics Magazine Book Series.



333 pages
\$14.95

Electronics Book Series

P.O. Box 669, Hightstown, N.J. 08520

Send me _____ copies of "New Product Trends in Electronics,
Number One" at \$14.95 per copy.

Discounts of 40% on orders of 10 or more copies.

I must be fully satisfied or you will refund full payment if the book is
returned after ten-day trial examination.

Payment enclosed Bill firm Bill me

Charge to my credit card:

American Express Visa Diners Club Master Charge

Acc't No. _____ Date exp. _____

On Master Charge only, first numbers above name _____

Name _____ Title _____

Company _____

Street _____

City _____ State _____ Zip _____

Signature _____

New books

Dilithium Press (distributed by
ISBS), 163 pp., \$6.95 (paper).

**Using Digital and Analog Integrated
Circuits**, L. W. Shacklette and H. A.
Ashworth, Prentice-Hall, 303 pp.,
\$10.95 (paper).

Digital Image Processing, Rafael C.
Gonzalez and Paul Wintz, Addison-
Wesley Publishing, 431 pp., \$29.50
(hardcover), \$19.50 (paper).

**The Theory of Information and
Coding: A Mathematical Framework
for Communication, Encyclopedia of
Mathematics and its Applications,
Vol. 3**, Robert J. McEliece, Addison-
Wesley, 302 pp., \$21.50.

**Symmetry and Separation of Vari-
ables, Encyclopedia of Mathematics
and its Applications, Vol. 4**, Willard
Miller, Addison-Wesley, 285 pp.,
\$21.50.

**Analysis of Linear Dynamic Sys-
tems**, John B. Lewis, Matrix Pub-
lishers, 862 pp., \$29.95.

Handbook of Practical CB Service,
John D. Lenk, Prentice-Hall, 323
pp., \$14.95.

Computer Modeling of Gas Lasers,
Kenneth Smith and R.M. Thomson,
Plenum Press, 416 pp., \$42.50.

**Current Interruption in High-Voltage
Networks**, Klaus Ragaller, ed., Ple-
num Press, 360 pp., \$37.50.

**Data Processing Cost Reduction and
Control**, Dick H. Brandon, Van
Nostrand Reinhold, 191 pp., \$17.95.

**Passive and Active Microwave Cir-
cuits**, J. Helszajn, John Wiley &
Sons, 274 pp., \$27.50.

Handbook of Audio Circuit Design,
Derek Cameron, Reston Publishing
(a Prentice-Hall Co.), 255 pp.,
\$17.95.

**Dictionary of Logical Terms and
Symbols**, Carol Horn Greenstein,
Van Nostrand Reinhold, 188 pp.,
\$11.95.

DON'T GET BURNED. GET LEXAN® 940.

RESIN

LEXAN 940 resin is one material that keeps you from getting burned on metal's costs and flame retardant plastics' processing problems.

That's because it has metal-like strength at the price of plastic, meets or exceeds most agency flammability standards and, unlike other flame retardant materials, has excellent process stability, flow, and mold release properties.

LEXAN 940 features all standard LEXAN resin properties: 12 ft-lbs/in notched Izod impact strength, optimum dimensional stability, high dielectric strength, exceptional clarity or molded-in color, high gloss and lower finished part cost than metals.

In addition, LEXAN 940 meets UL 94 Standard for V-O², has an Oxygen Index of 35, is rated at 110°C for continuous use with impact, and

produces significantly less smoke emission and toxic gas evolution upon ignition.

And with LEXAN 940 resin, the proof is in the products. For case histories and complete data, write: LEXAN Products Department 318, General Electric Company, One Plastics Avenue, Pittsfield, MA 01201.

*This rating is not intended to reflect hazards presented by this or any other material under actual fire conditions.

WHAT THE WORLD IS COMING TO: GE PLASTICS Circle 253 on reader service card
LEXAN® NORYL™ VALOX® GENAL®

GENERAL  ELECTRIC



ELECTRICAL ENGINEERS - TEST SYSTEMS

ZENITH's reputation for integrity, quality and reliability earned over the past 60 years is ZENITH's greatest asset. The dedication of the people at ZENITH to quality without compromise has made and continues to make ZENITH the nation's leader in Color Television.

This commitment to manufacture state-of-the-art products and continued quality, demands: the establishment of new functional areas...the expansion of old ones...the dedication of creative Engineers willing to "go the distance," and to push towards excellence in every endeavor. Immediate openings are available for these Engineers in the following areas:

Integrated Circuits — Modules — Chassis/Tuners

If you are degreed with at least 5 years directly related experience and have expertise in electrical testing techniques our Test Systems Group has a lot to offer you:

- On-going projects in such areas as integrated circuits, LSI, tooling systems, digital circuitry and automatic test equipment;
- A unique project management approach enabling you to interface with design engineering, test equipment and manufacturing in the development and evaluation of testing specifications and current procedures;
- An opportunity to utilize the widest range of your skills and abilities in a broadly defined functional area.

The successful candidates can expect an excellent salary and benefit package, along with outstanding concrete opportunities for professional growth.

Our location on the boundary between Chicago and its suburbs offers a variety of lifestyles — urban, suburban and rural — along with all the cultural and educational advantages of a major metropolitan area.

Respond in confidence now! Arrange a telephone interview with our Engineering Management.

Call Collect (312) 745-6066
Michael Maciekowich 8 a.m. to 5 p.m.

Or send a letter with resume to:

Michael Maciekowich
RADIO CORPORATION
1900 North Austin Avenue
Chicago, Illinois 60639

An Equal Opportunity Employer m/f



SECTION MANAGER

In-Process Inspection

Modern, well-equipped 450,000 sq. ft. computer peripheral fabrication and assembly plant needs a seasoned floor manager to direct and coordinate all In-Process Q.C. and inspection efforts.

- Products include line printers, display terminals, magnetic tape units, and disc products;
- Will direct a staff of four supervisors and 70 inspectors;
- A strong background in Q.C. and/or inspection techniques as applied to electro-mechanical assembly and several years management experience required;
- A degree in E.E., M.E. or related engineering discipline preferred.

Attractive living conditions, excellent wages and benefits, and an impressive corporate growth record makes this a very fine opportunity for an individual who wishes to make a long term commitment to southern coastal Maine, and the computer industry.

For further information, please forward your resume to or call Mike Pendergrass, Sr. Personnel Representative, 207-854-9701, Data General, 80 Eisenhower Drive, Westbrook, Me. 04092. An Equal Opportunity Employer M/F



ELECTRICAL ENGINEER

Are you looking 100% involvement, "A to Z" responsibility? We have an opening for an Equipment Designer who will be responsible for developing, designing, fabricating, installing and debugging electrical controls and equipment.

A Degree in Electronic or Electrical Engineering is preferred. One or more years of experience in Microprocessor Controls would be a definite plus.

To investigate this position with our 1,600 employee facility located in Central Pennsylvania, please forward your resume to, reply P-7780, Electronics.

Class. Adv. Dept., P.O. Box 900, N.Y., N.Y. 10020

DON'T GET BURNED. GET LEXAN® 940.

RESIN

LEXAN 940 resin is one material that keeps you from getting burned on metal's costs and flame retardant plastics' processing problems.

That's because it has metal-like strength at the price of plastic, meets or exceeds most agency flammability standards and, unlike other flame retardant materials, has excellent process stability, flow, and mold release properties.

LEXAN 940 features all standard LEXAN resin properties: 12 ft-lbs/in notched Izod impact strength, optimum dimensional stability, high dielectric strength, exceptional clarity or molded-in color, high gloss and lower finished part cost than metals.

In addition, LEXAN 940 meets UL 94 Standard for V-O*, has an Oxygen Index of 35, is rated at 110°C for continuous use with impact, and

produces significantly less smoke emission and toxic gas evolution upon ignition.

And with LEXAN 940 resin, the proof is in the products. For case histories and complete data, write: LEXAN Products Department 318, General Electric Company, One Plastics Avenue, Pittsfield, MA 01201.

*This rating is not intended to reflect hazards presented by this or any other material under actual fire conditions.

WHAT THE WORLD IS COMING TO: GE PLASTICS
LEXAN® NORLY® VALOX® GENAL®

Circle 253 on reader service card

GENERAL  ELECTRIC



Classified section FOR ENGINEERING/TECHNICAL EMPLOYMENT OPPORTUNITIES

CLASSIFIED SALES REPRESENTATIVES

Cleveland Mac Huestis	216/781-7000	Houston Mike Taylor	713/659-8381	Philadelphia Dan Ferro	215/568-6161			
Atlanta 404/892-2868	Dallas Mike Taylor	214/742-1747	Los Angeles Ana Galaz	213/487-1160	Pittsburgh Dan Ferro	412/391-1314	
Boston Jim McClure	617/262-1160	Denver Shirley Klotz	303/837-1010	New York Larry Kelly	212/997-3594	San Francisco M.E. Kenny	415/362-4600
Chicago Bill Higgins	312/751-3733	Detroit Mac Huestis	313/873-7410	New York M. Melton	212/997-2422	Stamford William Eydt	203/359-2860

Computer Design Engineers

San Francisco Peninsula

Expansion of our Systems Development staff has created opportunities for:

Manager Digital Communications Hardware

BSEE/MSEE with 10 years experience and demonstrated management skills required.

Engineers/ Sr. Engineers

- Openings at all levels in the areas of:
- Central Processor Design
 - Peripherals Controllers
 - Memory Systems Design
 - I/O Systems Design

These positions require BSEE/CS or MSEE/CS plus 2-5 years design experience. Familiarity with 1 or more of the following: MOS/LSI, Bit Slice devices; telecommunications, minicomputer I/O systems, and Assembly language.

Four-Phase Systems offers excellent compensation in a stable growth environment where **INDIVIDUAL ACHIEVEMENT IS RECOGNIZED**. Contact C. Horn, 800/538-9660, or 408/255-0900, or send resume to Professional Employment, FOUR-PHASE SYSTEMS, 10700 N. De Anza Blvd., Cupertino, CA 95014. Equal employment opportunity is our pledge & practice. Four-Phase Systems



CURRENT Opportunities

- | | |
|--------------------------------------|----------|
| • Program Mgr. Sig. Processing | \$35,000 |
| • Program Mgr. Millimeter Wave Radar | \$35,000 |
| • Laser Radar Tracking/Pointing | \$35,000 |
| • Test Equipment Design | \$25,000 |
- Call or Write: Barry Gruber

- | | |
|-------------------------------|----------|
| • Compiler Design | \$30,000 |
| • Real Time Operating Systems | \$28,000 |
| • Micro-Processor Programmers | \$23,000 |
- Call or Write: Walt Abrams

MANY MORE CHALLENGING OPPORTUNITIES AT.....

JUDGE
ELECTRONICS SERVICES, INC.

PERSONNEL CONSULTANTS
Suite 100
Two Newton Executive Park
Newton Lower Falls, MA 02162
(617) 965-9700

MOS/LSI Designer

You will work with our instrument designers to design MOS/LSI circuits using CMOS and NMOS processes. Activities extend from initial device conception, prototype evaluation, to technical support for production groups. Responsibilities also include project leadership for IC design and supervision and checking circuit layouts.

Your background should include several years experience in MOS/LSI design using CMOS, NMOS, or PMOS processes and logic/system design. Experience in MPU design is a plus.

We design and manufacture custom, in-house, state-of-the-art MOS, bipolar and hybrid linear and digital IC's for our electronic test and measurement instrumentation and computer peripherals. The Tektronix Microelectronics Components Group offers the challenges and growth potential of the semiconductor industry, stability of an established diversified corporation, and the Pacific Northwest.

Salary is open. Benefits include educational support, insurance and profit sharing programs.

Send detailed resume and salary history to Roy Epperson, TEKTRONIX, INC., P.O. Box 500 I.94, Beaverton, Oregon 97077.

An Equal Opportunity Employer m/f/h

Tektronix
COMMITTED TO EXCELLENCE

Your ideal career and your ideal hometown. You can have both at TI.

Your kind of work. Your kind of town.

You don't have to give up one to get the other at Texas Instruments.

TI has dozens of hometowns.

You like bright lights, blue skies and sports champs? We give you Dallas. Houston. Austin. Or Lubbock, Texas.

You crave New England autumns? We can make you happy in Attleboro, Mass.

You want a dramatic change? How about Singapore. Madrid. Nice. Buenos Aires. Or Tokyo.

You can wind up almost anywhere when you get with TI.

Career-shopping at TI is a trip itself. Through technology.

You have more than 20 major product fields to pick from. And we're leaders in many of them.

For example, TI recently:

- Strengthened its competitive position in the MOS memory market with the 16K-bit dynamic



RAM, 4K-bit static RAM and the 16K-bit EPROM

- Expanded its microprocessor family with new peripherals and minicomputer subsystems
- Accelerated development of high-performance structures and processes required to continue the company's leadership in semiconductor components
- Introduced the first commercial equipment using magnetic bubble technology
- Achieved high-volume production of the most sophisticated handheld calculator on the market
- Continued development of three-

dimensional seismic data gathering and processing, an exclusive approach to petroleum exploration

- Developed a microprocessor-controlled Loran C receiver for navigation and a VHF/FM transceiver for marine communications

Today, you can have the kind of career you want without compromising your lifestyle.

People join TI for love of technology. They stay for a lot of reasons.



Send for the 34-page picture story of TI people, places, and opportunities. And send us your resume in confidence to

George Berryman,
P. O. Box 225474,
Dept. CA1, MS 67,
Dallas, TX 75265.

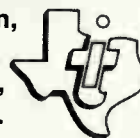

TEXAS INSTRUMENTS

INCORPORATED

An Equal Opportunity Employer M/F



ELECTRICAL ENGINEERS - TEST SYSTEMS

ZENITH's reputation for integrity, quality and reliability earned over the past 60 years is ZENITH's greatest asset. The dedication of the people at ZENITH to quality without compromise has made and continues to make ZENITH the nation's leader in Color Television.

This commitment to manufacture state-of-the-art products and continued quality, demands: the establishment of new functional areas...the expansion of old ones...the dedication of creative Engineers willing to "go the distance," and to push towards excellence in every endeavor. Immediate openings are available for these Engineers in the following areas:

Integrated Circuits - Modules - Chassis/Tuners

If you are degreed with at least 5 years directly related experience and have expertise in electrical testing techniques our Test Systems Group has a lot to offer you:

- On-going projects in such areas as integrated circuits, LSI, tooling systems, digital circuitry and automatic test equipment;
- A unique project management approach enabling you to interface with design engineering, test equipment and manufacturing in the development and evaluation of testing specifications and current procedures;
- An opportunity to utilize the widest range of your skills and abilities in a broadly defined functional area.

The successful candidates can expect an excellent salary and benefit package, along with outstanding concrete opportunities for professional growth.

Our location on the boundary between Chicago and its suburbs offers a variety of lifestyles - urban, suburban and rural - along with all the cultural and educational advantages of a major metropolitan area.

Respond in confidence now! Arrange a telephone interview with our Engineering Management.

Call Collect (312) 745-6066
Michael Maciekowich 8 a.m. to 5 p.m.

Or send a letter with resume to:

Michael Maciekowich
RADIO CORPORATION
1900 North Austin Avenue
Chicago, Illinois 60639

An Equal Opportunity Employer m/f



SECTION MANAGER

In-Process Inspection

Modern, well-equipped 450,000 sq. ft. computer peripheral fabrication and assembly plant needs a seasoned floor manager to direct and coordinate all In-Process Q.C. and inspection efforts.

- ... Products include line printers, display terminals, magnetic tape units, and disc products;
- ... Will direct a staff of four supervisors and 70 inspectors;
- ... A strong background in Q.C. and/or inspection techniques as applied to electro-mechanical assembly and several years management experience required;
- ... A degree in E.E., M.E. or related engineering discipline preferred.

Attractive living conditions, excellent wages and benefits, and an impressive corporate growth record makes this a very fine opportunity for an individual who wishes to make a long term commitment to southern coastal Maine, and the computer industry.

For further information, please forward your resume to or call Mike Pendergrass, Sr. Personnel Representative, 207-854-9701, Data General, 80 Eisenhower Drive, Westbrook, Me. 04092. An Equal Opportunity Employer M/F



ELECTRICAL ENGINEER

Are you looking 100% involvement, "A to Z" responsibility? We have an opening for an Equipment Designer who will be responsible for developing, designing, fabricating, installing and debugging electrical controls and equipment.

A Degree in Electronic or Electrical Engineering is preferred. One or more years of experience in Microprocessor Controls would be a definite plus.

To investigate this position with our 1,600 employee facility located in Central Pennsylvania, please forward your resume to, reply P-7780, Electronics.

Class. Adv. Dept., P.O. Box 900, N.Y., N.Y. 10020



Work in radar at Hughes... where the pulse is quickening.

Help build complex avionics systems for the world's most advanced aircraft. The AWG/9 weapon control system. The Phoenix missile. And radar for the Air Force's F-15 Eagle and the Navy/Marine Corps' P/A-18 Hornet.

The life-blood of Hughes includes electro-optics and data systems, too. We developed the world's first operating laser, and produced laser rangefinder and designator systems for a variety of ground and airborne applications. Our infrared night vision systems permit aircraft to identify surface targets in total darkness.

And how about liquid crystals and holographic optics? Our Display Systems Laboratory is involved in exciting new technology in this area to support our emerging Head-up Display product line.

For stable work in these and other long-range defense projects, consider our current openings:

Display Systems Engineers: Additional capability sought in analog and digital design of video circuits, applications of microprocessors and optical design.

Mechanical Engineers: For mechanical design/packaging of radar transmitters, power supplies and display equipment. Required familiarity with high voltage design techniques, thermal and structural analyses, producibility and maintainability of hardware design.

Experienced in packaging of electronic avionics hardware for conceptual layout of radar receivers, master oscillators and associated electronic components.

Capable of innovative and imaginative physical design. To direct lead designers in layout/design of radar control and display equipment.

Circuit Designers: For design/development of high/low voltage aerospace power supplies and associated equipment for radar transmitter applications.

Experienced in analog/digital circuit design.

To design VHF/UHF low noise medium power amplifiers, IF amplifiers, filters, VHF phase lock loops, VCOs and VCXOs, and frequency synthesizers for radar receivers.

Microwave Circuit Designers: With ability to use microstrip techniques to design low noise and medium GaAs FET amplifiers and components for radar receiver applications.

To design components (couplers, switches, circulators, mixers, integrated subassemblies) for radar receivers, and Gunn diode oscillators and phase lock loops to control them. Use stripline, microstrip and coaxial techniques.

Microwave Engineers & Physicists: Background in electromagnetic theory to design microwave systems and antennas.

All the above positions require an engineering or scientific degree from an accredited university. Please send your resume to: Professional Employment—E, Dept. 27, Aerospace Groups, 11940 West Jefferson Blvd., Culver City, CA 90230

HUGHES

HUGHES AIRCRAFT COMPANY

U.S. citizenship required. Equal opportunity M/F/H/C employer.

engineering

ENGINEERING MANAGERS

For some companies, achieving long-range goals is a challenge. For Northrop Corporation it's a necessity.

Because as a prominent, innovative force... a leader in the Electronic Countermeasures industry... modern technology continually looks to us for answers.

In order to achieve our far-reaching goals and maintain our leadership role in the state-of-the-art, we are currently seeking gifted Engineering Managers to join us:

MANAGER / SUPPLIER QUALITY

Manages Supplier Quality Unit; inspects and tests purchased material; reviews purchase documents and Receiving Acceptance Test procedures.

Minimum 4 years quality related experience, 2 years of which are in a supervisory capacity.

MANAGER / COMPONENTS ENGINEERING

Manages Component Engineering Unit; develops and implements plans and procedures.

BSEE or equivalent exposure; 7 years related experience; 2 years of which in a supervisory capacity; and background with DOD equipment requirements.

MANAGER / LABORATORY SERVICES

Manages Laboratory Services Section; establishes and maintains a Calibration System; coordinates Capital Equipment planning and standardizes acquisition of Measuring and Test Equipment; maintains and supports Environmental Testing.

Engineering degree or technical school equivalent, 8 years related experience, 4 years of which in a supervisory capacity; with broad knowledge of electronics, mechanics and state-of-the-art measurement practices and techniques; and experience with DOD systems requirements.

In addition to an outstanding salary/benefits program, we offer an environment that allows you to establish, direct and surpass a challenging array of goals. Qualified candidates should send resume, in confidence, to:

Manager, Department W79

NORTHROP CORPORATION

Defense Systems Division
600 Hicks Road, Rolling Meadows, Illinois 60008

NORTHROP

an equal opportunity employer

ELECTRONICS ENGINEERS ROBINS AIR FORCE BASE, GEORGIA

Challenging civilian career opportunities in the following areas:

ELECTRONIC WARFARE SYSTEMS
RADAR SYSTEMS
COMPUTER CONTROLLED
WEAPONS SYSTEMS
DIGITAL AVIONICS SYSTEMS
AUTOMATIC TEST EQUIPMENT
OPERATIONAL FLIGHT PROGRAMS
COMMUNICATION-NAVIGATION
SYSTEMS
ELECTRO-OPTICAL
WEAPONS SYSTEMS
AVIONICS SYSTEMS

Robins AFB is Georgia's largest employer and borders Warner Robins, Georgia's largest certified city. Middle Georgia offers high quality living at a moderate cost. It is an ideal location for a variety of outdoor activities with an average temperature of 65 degrees and an average yearly rainfall of 46.3 inches. Nearby facilities provide for fishing, hunting, golf, tennis, boating, and other leisure activities. With Atlanta just 100 miles to the north, professional sports and "big city" civic and cultural events are within easy reach.
Salary range: \$12,947 to \$21,883 DOE. Excellent fringe benefits including relocation assistance. Applicants should have a degree or be a registered PE and be a U.S. citizen. All qualified applicants will receive consideration without regard to race, color, sex, national origin, age, marital status, nondisqualifying physical handicap, or political affiliation. Reply in confidence to: Warner Robins Air Logistics Center/DPCEP, Robins AFB, GA. 31098. Phone (912) 926-5711 or 5821.

"ELECTRONICS ENGINEER"

National Trucking Industry Trade Association in Washington, D.C. seeks Automotive Electronics Engineer. Responsibilities would be with programs relating to the application of electronic technology to trucks. Work would include research; dealing with Federal agencies; and involvement in motor carrier, and automotive industry committees. Some travel required. Applicants should be Engineering graduates. Background in vehicle control, instrument or diagnostic systems highly desirable. Written and oral communication skills essential. Salary commensurate with background and experience.

P-7851 Electronics
Class. Adv. Dept. P.O. Box 900
N.Y. N.Y. 10020

WIRE LINE WANTED

Manufacturers' Agent established in 1946 desires line cords, cord sets and bulk wire line to sell on a straight commission basis. Presently selling component parts to the original equipment manufacturers. There will be no conflict with salesmen selling to other type outlets. One man sales organization selling in mid-south with headquarters in Jackson, MS. Owner is MBA graduate from Harvard. Will consider stock imports.

W. T. McDonnell
P.O. Box 2024
Jackson, MS. 39205

ENGINEERS—MANUFACTURING SUPERVISORS—SCIENTISTS

A Nationwide Placement Service. Our clients pay all fees and interview expenses. All transactions conducted in strict confidence. Send resume to:

E. J. Stephen

EXECUTIVE SEARCH AND PLACEMENT
TRI-STATE MALL • CLAYMONT, DE 19703
(302) 798-6861

Hughes announces a banner year for career opportunity.

Positions are now available in our El Segundo Divisions . . . where Hughes ideas become practical working products.

ENGINEERS

ENGINEERS

Electronic Engineers

These assignments involve design, development, checkout, and support of specialized electronic test equipment from the component through the systems level. A BSEE or BS Physics degree is preferred, with emphasis and interest in electronics and/or optics.

Mechanical Engineers

Responsibilities include design, development and checkout of specialized mechanical, vacuum, liquid, and/or cryogen production test equipment. A BSME degree is desirable.

Mechanical Design Engineers

Positions involve working with fit, form, and function criteria applicable to engineering design and drafting procedures. Preferred is a BSME degree.

Process Engineers

Includes work in (1) process selection, development, checkout, and resolution of manufacturing problems in metallic and/or non-metallic areas; (2) review of manufacturing drawings for technical correctness in materials and process call-outs; (3) material and equipment selection; (4) technical support for training and certification of production personnel; and (5) specifications writing. A BS Chemistry, Material Sciences, Mechanical Engineering, Metallurgical Engineering, or Physics (Applied) is desirable.

Environmental Engineers

These assignments involve conceptual design of environmental chambers and other equipment, procurement and checkout of equipment, fixture design, and engineering support of operational equipment. A BS Environmental Engineering or BSME is preferred.

Quality Assurance Engineers

Should have a comprehensive knowledge of reliability, maintainability, quality, and value engineering principles and techniques, including the application of audio-visual methods, cost controls, data processing techniques, process controls and statistical methods.

Production Engineers

Requires experience in mechanical or electrical design, and knowledge in manufacturing and production engineering. A BSEE, BSIE, BSIT, or BSME degree is preferred.

Test Engineers

These positions involve the production floor support of electronic and/or electro-optical production test equipment. A BSEE degree is desirable.

Industrial Engineer

Applicants should have a thorough knowledge of plant layout techniques, work flow,

standardization, methods analysis, assembly and fabrication techniques, machine capability, tooling, time and motion analysis, and time standards and processes. A BSIE degree is preferred.

Facilities Design Engineers

Candidates will independently propose designs, conceptual arrangement diagrams and calculations requiring ability to originate solutions to unique design problems in architectural, civil, electrical, mechanical or structural engineering fields.

Failure Analysis Engineers

Positions involve responsibility for component reliability and failure analysis. Must have a thorough knowledge of modern techniques for analyzing failures in components, including complex semiconductor devices. Experience should include special analysis techniques such as SEM and optical micrography, microprobe analysis, component curve tracing, functional testing of memories, microprocessors and other complex semiconductor devices. Requires BSEE or Physics degree or equivalent and some lead assignment experience.

Manufacturing Project Engineers

Openings exist for experienced production-oriented personnel to provide technical direction for Production Engineering activities in the manufacture and test of state-of-the-art laser and electro-optic systems. Responsibilities include formulation of production plans and test concepts, direction of test experiment implementation tasks, interface with program and project offices, financial and manpower planning and many other tasks associated with the function of the technical aim of a manufacturing facility in a phenomenal growth environment.

SUPERVISION

Quality Assurance Supervisor

Test experience is required, as is experience in supervising a Quality Assurance Section.

Chemical Engineering Supervisor

Position requires extensive related experience in supervising a process laboratory, plus a BS Chemical degree.

Electronic Engineering Supervisor

Must be experienced in design and/or production engineering. Requires a BSEE degree.

Mechanical Engineering Supervisor

Must be experienced in supervising a highly technical mechanical engineering operation. Requires a BSME degree.

Production Supervisors

Positions require prior experience in supervising electronic, optical, or mechanical assembly areas.

For consideration, call (213) 648-2063 or (213) 648-2067, apply in person, or send resume to: Hughes Professional Employment, 2060 E. Imperial Highway, (2 blocks east of Sepulveda),

Our employment office hours are:
Weekdays 8:00 a.m. to 7:00 p.m.,
Saturday 9:00 a.m. to 12 noon.

HUGHES

HUGHES AIRCRAFT COMPANY

U.S. Citizenship Required.
Equal Opportunity M/F/HC Employer

Engineers

**Stability
+ Growth
Opportunity!**

The SYSTEMS division of Litton has DOUBLED its size in the past four years, and TRIPLED volume in SALES creating one of the more STABLE environments in industry.

Positions of uncommon potential are now available in Defense and non-Defense contracts. Ask us about them!

ANALOG OR DIGITAL PROCESSING

- LSI application
- High speed data conversion
- Power supplies

TELECOMMUNICATIONS SYSTEMS DESIGN

- Advanced digital subsystems including TDM
- RF and analog subsystems including frequency synthesis and FDM techniques
- Microprocessors and related real-time operating systems software
- Voice switching systems

ELECTRONIC WARFARE SYSTEMS

- State-of-the-Art, ESM/ECM
- Signal processing

ELECTRONIC WARFARE PROCESSING — HARDWARE

- Microwave subsystem design
- Circuit design — RF, video, analog, high speed A/D converters
- EW digital subsystem design — signal sorting, microprocessors/microcontroller design, computer interfacing

RF

- Microwave communications and receiving systems
- High Sensitivity DF Receivers
- Solid state microwave component design

We are located in a pleasant college town in Maryland with rolling hills, and the Chesapeake Bay and nation's capital less than an hour away. If this sounds like the opportunity you seek, please send your resume including salary history in confidence to:

W.L. McAmis



**Amecom Division
LITTON
SYSTEMS, INC.**

5115 Calvert Rd., College Park, MD 20740
An equal opportunity employer. M/F/H

Electronics Engineers

San Francisco Peninsula

Hewlett-Packard Corporate Labs, located in Palo Alto, has immediate Research and Development openings for Engineers.

Analog

Opportunity to design and build state-of-the-art analog electronics to extend the bandwidth capabilities of magnetic recording. The electronics will be used to write and read data at above 20 megabits/sec. PhD or equivalent experience with state-of-the-art analog design experience at high data rates.

Digital

Opportunity to design and build ECL Electronics to analyze errors in high speed data streams. The electronics will interface to a minicomputer for which software will be developed. PhD or equivalent experience with state-of-the-art digital design and software experience. Bit slice microprocessor experience is desirable.

Hewlett-Packard provides a stimulating work environment and outstanding compensation and benefits. Please send resumes to Allan J. Richardson, 1501 Page Mill Road, Palo Alto, CA 94304. We are an equal opportunity employer dedicated to affirmative action.

HEWLETT  PACKARD

Job-seekers... be the first to know with McGraw-Hill's Advance Job Listings

By having our weekly ADVANCE JOB LISTINGS sent to your home every Monday you can be the first to know about openings both in and out of your field. AJL will enable you to contact anxious recruitment managers BEFORE their ads appear in upcoming issues of 21 McGraw-Hill publications. To receive a free sample copy, plus information about our low subscription rates, fill out and return the coupon below.

ADVANCE JOB LISTINGS / P.O. BOX 900 / NY 10020

PLEASE SEND A SAMPLE COPY
OF ADVANCE JOB LISTINGS TO

NAME

ADDRESS

CITY

STATE ZIP

If you're not enjoying your career, Hughes Missile Systems Group has a proposition for you.

Join us in the beautiful, suburban community of Canoga Park. Here we can offer you the casual lifestyle many people seek, plus the challenge of exciting research and development projects.

Advancement opportunities are plentiful for ambitious and bright engineers, and our stimulating state-of-the-art programs will keep you interested year after year.

Why not look into our opportunities today?

MISSILE SYSTEMS ANALYSTS

Company-funded programs plus exciting long-range contracts have created several truly fine career opportunities, at both entry and senior levels, in our Advanced Programs Laboratory for systems analysts to engage in the conceptual design and development of advanced Radar and Electro-optical Missile guidance systems. Tasks involve definition of requirements, functional design, analysis and operational software development/integration. Our experience suggests that incumbents most comfortable on the job are those with BS, MS, PhD degrees in EE, ME, Aerospace, Computer Science or Physics, combined with a background in one or more of the following disciplines:

- Detection/estimation theory
- Advanced signal processing techniques
- Classical or modern control theory
- Target signature analysis
- Optical design/analysis
- Pattern recognition
- Real time software design
- Waveform analysis
- Kalman filter and estimation theory

RF ENGINEERS

Experienced in microwave circuit design. Duties will involve Circuit Analysis/Design for automatic test station and writing programs for automatic test units and circuit subassemblies. A background on equipment operating at frequencies up to 16 GHz is desirable.

COMPUTERIZED TEST EQUIPMENT ENGINEERS

- Experience in digital/logic and analog circuit design. To perform digital and analog circuit analysis/design for an automatic test circuit cards. Power supply design/analysis experience desired for some positions.
- To design software/hardware for minicomputer-based automatic test equipment. Requires experience on digital systems. H.F. 21MK/RTE experience highly desirable.

SYSTEMS TEST & EVALUATION ENGINEERS

To perform developmental test of missiles at systems/subsystems level; plan tests and evaluate results. Experience desired in guided missiles, avionics, or airborne radar technology. Digital hardware and software helpful. BSEE desired.

CIRCUITS DESIGN ENGINEERS

With recent relevant experience in the design and development of RF/IF, digital, or analog circuits for missile guidance systems. MSEE, software/hardware integration experience also desirable. Must be familiar with applicable state-of-the-art components—phase and frequency lock loops, wide and narrow receivers, use of microprocessors.

SYSTEMS ENGINEERS

These positions require system engineering for missile systems using radar and electro-optical technologies. This includes defining design characteristics, interfaces, test requirements, and performing trade studies. Weapons experience not required, but previous systems engineering, servo analysis, or circuit or logic design experience in the above technologies is desirable.

SYSTEMS ANALYSTS

To perform design and analysis for state-of-the-art electro-optical missile seekers. Job assignments require ability to develop mathematical models for missile guidance systems performance evaluation. Proficiency in advanced one and two-dimensional signal processing techniques desired.

DIGITAL SYSTEMS DESIGN ENGINEER

To participate in digital systems analysis and designer trade offs on RF components, subsystems and systems. Write design requirements, specifications and test requirements. Do RF modeling, hybrid missile flight simulation. Knowledge of Machine Languages, Basic and Fortran. Familiarity with microprocessor use in analytical and control systems. Interface equipment to systems.

AUTOMATIC TEST EQUIPMENT (ATE) SYSTEMS ENGINEERS

Several openings in our ROLAND Division for system test engineers with a background or interest in computer based automatic test equipment, for testing L band and K_u band radar units. Must be familiar with Basic or Atlas programming. Will be responsible for unit application software development, maintenance, and tasks related to production test stations.

PRODUCT ENGINEERS

Experienced in CAD, including interactive graphics; ability to do product design for high-rated production and knowledge of hybrid microelectronics and circuit partitioning required. Design experience in hybrids and electronic subassemblies desirable.

MICROWAVE ENGINEERS

Growth in microwave product development requirements for radar missiles has created immediate openings in:

- Microwave Antennas
- Solid State Transmitter
- Microwave Sources and Receivers
- Missile Radomes
- RF/Microwave Mechanical Systems Engineering

LSI/DESIGN AUTOMATION FOR THE 80's

- LSI Design Engineers needed for analog and digital circuit design for MOS/CCD and bipolar custom LSI. Positions require complete design responsibility including partitioning, establishing design requirements and directing layout and evaluation testing.
- IC Manufacturing Support Engineers to interface between LSI design group and IC production facilities. Positions require knowledge of IC production and assembly techniques and the ability to schedule and monitor IC prototype and production manufacturing.

Our offers include an excellent salary and benefits package. For immediate and confidential consideration, please send your resume and salary history to: Employment Manager, Hughes Missile Systems Group, Fallbrook at Roscoe, Canoga Park, CA 91304.

U.S. citizenship required • Equal opportunity M/F/HC employer

HUGHES
HUGHES AIRCRAFT COMPANY

AN IDEAL SETTING FOR CREATIVE TECHNOLOGY



From the pleasant rolling lands and lakes of Michigan's vacationland, CPI is quietly developing state-of-the-art peripheral equipment which is competing, and winning, in the world market. We need more good minds who can use our vast resources to contribute.

MANUFACTURING ENGINEERING MANAGER

Responsibilities encompass technical and material support and test equipment maintenance. Tooling strengths and material selection are required. A BSME, or equivalent, and minimum of 5 years electro-mechanical product manufacturing/engineering design experience required.

MANUFACTURING ENGINEERS

Selected candidates will provide in depth assembly operations support in the production of medium and high speed printers. Involvement includes trouble-shooting, initiating and updating new procedures and processes of new product designs. BSME, BSEE, or equivalent, coupled with a minimum of 3 years directly related experience is essential.

MANUFACTURING ENGINEERING TECHNICIAN

Exceptional opportunity for an individual with demonstrated knowledge of tools and equipment used in assembly processes, a strong working knowledge of test equipment, and one to three years directly related experience. Technical school education, or equivalent experience, preferred.

These manufacturing positions offer exceptional career potential, competitive salaries and excellent benefits. For confidential consideration, please forward your resume, including salary history, to: **Bob Brown**

COMPUTER PERIPHERALS INC.

 a subsidiary of
CONTROL DATA CORPORATION

1480 N. Rochester Road - Box E-31
Rochester, Michigan 48063

313-651-8810 Ext. 232

Affirmative Action Employer

ELECTRONICS ENGINEERS

Specializing in the placement of Electrical Engineers Nationally. All fees company paid. This is only a partial listing. Send resume.

Project Mgr.	30K	Power Eng.	23K
Design E.E.	21K	Controls Eng.	23K
Installation	22K	Systems Eng.	22K
Sr. Systems	25K	Facilities	25K
Project Eng.	22K	Mechanical Des.	24K

COREY ASSOCIATES

Suite 230, 105 Wolf Rd., Albany, NY
12205

POSITION VACANT

Department Chairperson: Fenn College of Engineering of Cleveland State University is accepting applications and nominations for the position of chairperson for the department of technology. The department of technology has five full-time faculty, several adjunct faculty, and 215 undergraduate students. The department offers the final two years of a two-plus-two program in cooperation with local community colleges. Baccalaureate programs are offered in civil, electrical, electronic, industrial and mechanical technology. A minimum of masters degree in a related area is required. The qualifications sought in the new chairperson include teaching and administrative experience. Industrial experience is desirable. Salary and academic rank are dependent on qualifications. Starting date: July 15 or September 15, 1979. Inquiries, applications, and nominations should be directed to: Dr. Chester J. Kishel, Chairperson, Search Committee, Fenn College of Engineering, Cleveland State University, Cleveland, Ohio 44115. Or call (216) 687-2045. Equal Opportunity Employer, M/F/Handicap.

Wanted: Electronics Engineers: 140

Fortune 500 companies within 250 miles. Our clients offer growth and advancement. If you are experienced in design, analog and circuitry, familiar with DOD Stds. or UL and NEMA, ME, EE IE, or Non-degreed, send your resume today: Check-Mate Int'l, 5700 Southwyck, Toledo, Oh, 43614

Electrical Engineering Department of

the Naval Postgraduate School seeks faculty member in the radar and electronic warfare systems area. Teaching responsibilities encompass both hardware and signal processing aspects. The position requires doctorate, dedication to high quality teaching and strong interest in research. Candidates with expertise in areas related to radar, such as electromagnetics, applied electronics, signal processing and microwaves will receive consideration if a strong interest in developing capabilities in radar and EW is indicated. Send resumes, publication list and references to Chairman, Electrical Engineering Dept. (Code 62), Naval Postgraduate School, Monterey, CA 93940. An equal opportunity/affirmative action employer.

Some ballplayers can deliver in the clutch.

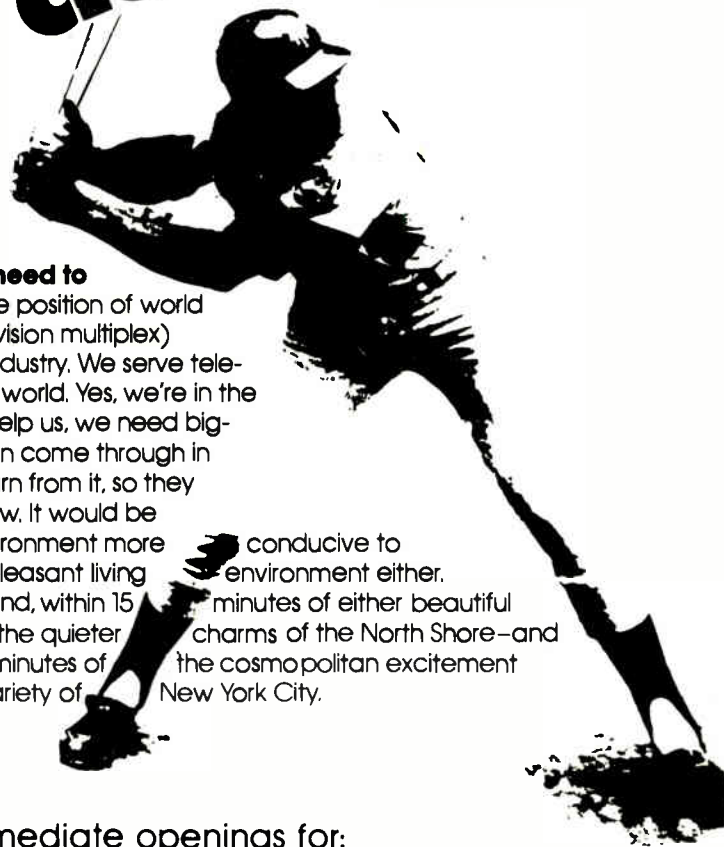

So can some engineers. And they're the kind we need to keep us growing. In just nine years we've come to the position of world leader in the design and manufacture of TDM (time division multiplex) equipment for the fast-growing telecommunications industry. We serve telecommunication carriers in 49 countries throughout the world. Yes, we're in the big leagues now and expect to keep on growing. To help us, we need big-league talent. Engineers who can come through in the clutch for us today. And learn from it, so they can do even better tomorrow. It would be hard to find, anywhere, an environment more professional growth. Or a more pleasant living

We're in central Long Island, within 15 minutes of either beautiful Atlantic beaches or the quieter charms of the North Shore—and within 60 minutes of the cosmopolitan excitement and variety of New York City.

conductive to environment either.



We have immediate openings for:

DESIGN ENGINEERS—(E.E. Degree)

Development—You'll be creatively involved with the use of microprocessors in telecommunications systems. You must have 3-6 years' experience in designing digital and linear I.C.'s and transistors.

Power Supplies—To qualify here, you'll need at least 3 years' relevant experience with an emphasis on DC to DC inverters plus a familiarity with switching techniques.

PRODUCT ENGINEERS— Electronic Packaging (M.E. Degree)

Senior Level—For this challenging assignment, you'll need a Degree or equivalent working experience plus 5-10 years in packaging electronic equipment. You must have knowledge of sheet metal manufacture, and thermal design.

Junior Level—0-1 year's electronics packaging experience is desirable, but we'll consider above average college grads with good verbal communications skills and plenty of drive and ambition. This is an exceptional growth position.

SENIOR TEST ENGINEER—(E.E. Degree)

The ideal experience for this position will include: prior design exposure in a high technology engineering group working in a small team environment plus 5-7 years' related test experience, reviewing and improving basic product circuit and logic design, and a background in the design of test fixtures for digital and analog equipment. You must also have some microprocessor design and automatic test set design experience with emphasis on hardware design.

SYSTEMS ENGINEER—(E.E. Degree)

We'd prefer your experience to have been in the telecommunications industry, performing systems or field engineering along with some background in technical writing. But what counts is the ability to match existing systems to our customers' needs and facilities. You'll be defining systems, and performing system configurations after reviewing sales application for a particular facility. Supporting production test on systems problems and effecting necessary engineering changes will also be an important part of your role.

For all these positions we offer the immediate attraction of a generous salary and benefits package, and—even more important to you, the ambitious professional—strong promise of career growth as our own growth continues.

To arrange for a confidential interview, please send your resume including present salary and requirement with indication of specific position in which you are interested to, or call: Patrick H. Augustine, Director, Personnel at (516) 231-5005 (no agency calls, please). Databit, Incorporated, 50 Davids Drive, Hauppauge, New York 11787. We are an equal opportunity employer m/f.

Databit
INCORPORATED

SOFTWARE SYSTEMS ENGINEERS



A NEW CAREER IS AS CLOSE AS YOUR PHONE

Call us collect
714-632-1001

Rockwell International's Marine System Division has a variety of software career opportunities for you.

Principal systems are real-time command control, radar and automatic test equipment. Applications include scientific analysis, algorithm developments, simulation modeling, data monitoring, and control systems operations. Prefer degree in Engineering/Math with emphasis on computer solutions to complex engineering problems.

If you have been thinking about making a change but have let it drift from one week to the next, why not get things in motion. Just pick up the telephone and tell us about your qualifications. It's as simple as that.

After you have talked with us on the phone, you can expedite matters by immediately mailing your resume to:

**Autonetics Marine Systems Division
Rockwell International
3370 Miraloma Avenue
Anaheim, CA 92803
ATTN: D/EL-W2, BA39**



Rockwell International

Equal Opportunity Employer M/F

ENGINEERING PROFESSIONALS:

Accelerate your career with

Itek Applied Technology

on the beautiful
San Francisco Peninsula

Applied Technology continues to excel as a leader in the development of state-of-the-art advanced radar warning systems. Located on the beautiful San Francisco Peninsula, you can expect pleasant weather all year 'round, great schools, and plenty of outdoor activities to compliment the rich sporting and cultural events of both San Jose and San Francisco. Opportunities currently exist in the following:

Staff Engineer — Advanced Systems

Systems analysis and design of advanced EW warning, direction-finding and reconnaissance systems. Broad systems level background with good knowledge in RF Systems, digital processing and computer control. Requires 10-12 years' experience & BS/MS/SEE.

Engineering Specialists Sr. Engineers

— Electro Magnetic Engineering

Millimeter front end design—wide frequency range ECM related RF receivers. Formulate, describe and specify all aspects of a receiving subsystem, i.e., frequency coverages, sensitivity, signal to noise, dynamic range, effects of compression and input/output interfaces. Knowledgeable in present state-of-the-art components and techniques. Specific design emphasis on broadband RF amplifiers and mixers and associated passive and active circuit components for millimeter front ends.

Engineering Specialists

— Advanced Computer Applications — Computer Systems Architect

Provide technical leadership and key design contribution for architectural design and development of a family of military computer systems and subsystems to include: multi-processor systems, distributed systems, uniprocessor memories, I/O and performance monitoring. Significant applicable experience in the conceptual development, architectural development, design and application of state-of-the-art microprogrammed MSI/LSI digital computer equipment. BS/MS/SEE with 2-3 years' directly applicable experience and a total of 7-10 years experience required.

Sr. Process Engineers— HMS Process Engineers

You will define processes, materials and equipment required to fabricate thick and thin film micro-circuits. Will be assigned responsibility for fabrication of thin-film prototype development substrates and for providing support to manufacturing. Plan, coordinate and implement research and developmental activities to resolve problems related to materials and processes.

The benefits are great, and the opportunities even greater. For immediate consideration, please send your resume to Professional Staffing, Dept. ELEC-831, 645 Almanor Avenue, Sunnyvale, CA 94086. We are an equal opportunity employer. U.S. citizenship is required.

ENGINEERS/SCIENTISTS:

**You'll like working
at Lockheed in
Sunnyvale on the
San Francisco Peninsula**

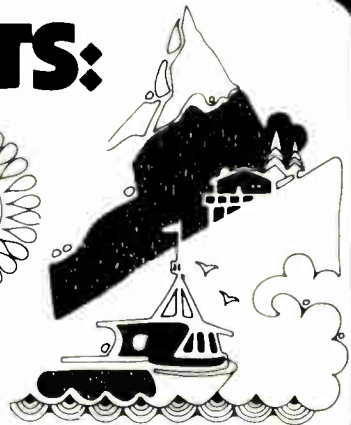
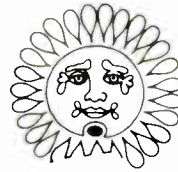

Lockheed Missiles & Space Company is a name worth remembering. Our career opportunities have never been better for professionals eager for a challenging, responsible, meaningful environment. Your talents will expand with the diversification of programs we have to offer, and your lifestyle will be pushed to its limit, with nearby beaches, ocean fishing, boating, wine country, fine schools, theatres, sporting events, and our year 'round sunny, fresh air atmosphere.

Investigate the following opportunities available at Lockheed:

- Guidance System Analysis
- Advanced Communications Systems
- RF Antenna Engineering
- Scientific Programming and Analysis
- Electro-Optical System Design and Analysis
- Test Equipment Design
- Reliability Engineering
- Software Systems Development
- Applications Programming
- Control Systems Engineering
- Signal Processing Systems
- Digital Circuit Design
- Microprocessor Applications and Software
- Mini & Micro Computer Architecture
- Systems Definition & Analysis

Most of these positions require an appropriate degree.
Several positions offer opportunities at all levels. Interested?

For immediate consideration, please forward your resume to
Professional Employment, Dept. Elec-914, P.O. Box 504,
Sunnyvale, California 94086, or call weekdays collect at (408) 743-2200.
We are an equal opportunity affirmative action employer.

LOCKHEED
MISSILES & SPACE COMPANY

MOTOROLA

Your Future Is As Solid As Our Name.

Motorola's dynamic Semiconductor Group in beautiful Phoenix, Arizona holds the promise of real professional challenge for ambitious and aggressive engineers who seek to expand their expertise in a growing industry. You can build a solid career with Motorola, and discover, as well, a unique new lifestyle in the sun-filled, thriving Southwest.

Phoenix offers all of the cultural advantages of a major urban area, but with a healthy outdoor climate and abundant recreational possibilities. Plus, you'll find low taxes, plentiful inexpensive housing, and a relaxed pace that sets us way apart from the hassles of bigger cities.

Consider your future...

PHOENIX AREA OPENINGS

- DESIGN ENGINEERS
- DEVICE ENGINEERS
- TEST ENGINEERS
- PROCESS ENGINEERS
- SYSTEMS ENGINEER
- LAYOUT DRAFTERS

AUSTIN CAREER OPENINGS

- PROCESS ENGINEERS
- DESIGN ENGINEERS

For Phoenix opportunities call **Greg Rendahl** at (602) 962-3573 or send your resume to **Motorola, Semiconductor Group, Employment, P.O. Box 20903, Phoenix, Arizona 85036.**

For Austin opportunities call **Jerry Fulton** at (512) 928-6868 or send your resume to **Motorola, Semiconductor Group, Employment, 3501 Ed Bluestein Blvd., Austin, Texas 78721.**



MOTOROLA INC.
SEMI CONDUCTOR GROUP

An Equal Opportunity Employer M/F

Make The SWITCH To **TRW** VIDAR

Innovators in Digital Telecommunications

At TRW Vidar we've earned our reputation as one of the leaders in digital technology and its applications in the growing field of telecommunications.

We're looking for new people with fresh ideas and top technical ability, already trained and competent in another industry, but interested in blending their expertise into the world of telecommunications.

If your interest and background are in any one of the following broad areas, then you should explore the challenging Engineering activities at our company:

- * ANALOG DESIGN
- * DIGITAL DESIGN
- * SOFTWARE DESIGN
- * SYSTEM DESIGN

TRW Vidar is involved in the widest variety of communications technology available anywhere. This plus outstanding benefits, learning opportunities, promotional opportunities through dynamic growth and our location on the beautiful **SAN FRANCISCO PENINSULA** make our company the first one you should investigate for your professional & technical development.

Make the change to TRW Vidar—take that important career step now! Call Dick Duncan in our Employment Department and discuss your background, or, if you wish, simply send him a resume outlining your experience. TRW Vidar, 77 Ortega Avenue, Mt. View, CA 94040 415/961-1000.

An equal opportunity employer M/F



TRW VIDAR
TRW VIDAR
TRW VIDAR

An equal opportunity employer M/F

PROJECT ENGINEERS \$18-28,000

Blue chip growth client company needs numerous EE's for their Corporate Engineering function:

SR. SYSTEMS ENGINEERS to provide leadership in systems control and instrumentation technology for complex manufacturing processes.

SR. ENGINEER—EQUIPMENT to install, debug and run equipment for the production of thin film SIP and DIP resistor networks.

PROCESS ENGINEER—NETWORKS to develop process and control systems for production of resistor networks, select subordinate engineers.

Clearly demonstrated professional and/or academic achievement required. Location: small Northeast city.

WETERRINGS & AGNEW
PROFESSIONAL PLACEMENT CONSULTANTS

425 MIDTOWN TOWER
ROCHESTER, NEW YORK 14604 • 716 454 3888

TALENT IS OUR PRODUCT

At Raytheon Service Company we are seeking degreed Electrical Engineers who desire to shed the confines of office and desk. You will be working on a recently developed surface to air missile defense system. Your assignment will begin in New England and continue to White Sands, New Mexico.

Ideal candidate will be experience in one of the following area; hands on test and evaluation or troubleshooting of: radars, digital signal processors, transmitters, antennas and related microwave equipment.

Positions offer excellent benefits and salaries commensurate with experience. Phone me for further information and send resume to: Steve Dorrance, 2 Wayside Rd., P.O. Box 503, Burlington, MA 01803, (617) 272-9300, Ext. 495.



An Equal Opportunity Employer M/F

Electronic engineering growth positions with clients located nationally. We would be glad to consider your resume. Joe Torcassi (EE), Director, R.J. Bushee & Associates, 1001 Carew Tower, Cincinnati, OH 45202. 513/621-2015.

M.E.s, I.E.s, E.E.s, Ch.E.s—Let our search firm represent you to our clients nationally and overseas. If you are seeking a more prestigious position with increased responsibilities and a better future, send a resume or request a position profile and at no charge we will provide you with interview opportunities. Register in our exclusive Executive Search Program. All replies strictly confidential. All fees employer paid at Management Recruiters, 1900 Point West Way, Suite 281, Sacramento, CA 95815. (916) 920-0441.

South? technical/professional placement network—fee paid. Murkett Associates, Box 527, Montgomery, AL 36101.



Would you hire an engineer who couldn't understand this magazine?

Of course not. **ELECTRONICS** is the technical publication for technical people. If they can't understand it, they can't receive it. That's why, when you're looking for qualified engineers, you should consider our Classified Section.

For only \$46.00 per inch your recruitment advertising will reach 46,000 pre-screened engineers—that's just \$1 per thousand!—as they're reading to combat job obsolescence, while they're thinking about their future and bettering themselves.

There's no charge for typesetting and free layout service is provided.

For more information call or write:

ELECTRONICS

Post Office Box 900
New York, N.Y. 10020
Phone: 212/997-2556

ENGINEERS

The Boeing Company in Seattle, Washington offers a variety of challenging engineering career opportunities in support of a wide range of programs. You won't find a better opportunity to enjoy the relaxed life-styles and abundant recreational activities of the unspoiled Pacific Northwest in the "Nation's Most Liveable City."

We'd like to hear from you if you have U.S. citizenship, a B.S. degree in engineering or computer science and an interest in the following:

TECHNOLOGY ENGINEERING

- ELECTRICAL/ELECTRONIC PARTS EVALUATION
- WIRING AND CONNECTOR DESIGN
- GUIDANCE AND CONTROL ANALYSIS
- ANTENNAS AND PROPAGATION
- ELECTROMAGNETIC COMPATIBILITY
- ELECTROMAGNETIC PULSE ANALYSIS

TEST ENGINEERING

- AUTOMATED TEST INSTRUMENTATION DEVELOPMENT
- ELECTRICAL/ELECTRONIC TEST
- TEST SYSTEMS SOFTWARE DEVELOPMENT
- TEST PROGRAM PLANNING
- FLIGHT/MISSION/SYSTEMS TEST

E/E DESIGN ENGINEERING

- COMPUTERS AND DISPLAYS DESIGN
- DIGITAL CIRCUIT DESIGN
- ELECTRONIC PACKAGING DESIGN

E/E MANUFACTURING ENGINEERING

- MICROELECTRONICS
- ELECTRONIC EQUIPMENT
- PRINTED WIRING BOARDS

SYSTEMS ENGINEERING

- SYSTEMS DESIGN AND ANALYSIS
- SYSTEMS REQUIREMENTS DEFINITION

SOFTWARE ENGINEERING

- OPERATIONAL SOFTWARE DEVELOPMENT
- SOFTWARE/COMPUTING SYSTEM DESIGN AND ANALYSIS
- SOFTWARE/COMPUTING SYSTEM TEST AND EVALUATION

Send your résumé to The Boeing Company, P.O. Box 3707-LPX, Seattle, WA 98124.

An equal opportunity employer.

BOEING
Getting people together

COMMUNICATIONS ENGINEERS



Rockwell's Electronic Systems Group has advance state-of-the-art opportunities for you in Southern California.

Our positions require a current secret clearance, a BS, MS, or PhD degree in EE or Physics, and in-depth R & D experience in any of the following areas:

- **Signal Intelligence Systems (RF)**
- **Signal Processing Systems**
- **Microwave (Long Line) Systems**
- **Voice & Digital Data Transmission**
- **Spread Spectrum Techniques**
- **RF and Analog Micro Circuitry**
- **Large Scale Communication Systems**
- **Shipboard Multiplexing**
- **Command and Control**

If you have been thinking about making a change but have let it drift from one week to the next, why not get things in motion by just picking up the telephone. It's as simple as that!

After you've talked with us on the phone, you can expedite matters by immediately mailing your resume to:



**Electronic Systems Group
Rockwell International
3370 Miraloma Avenue
Anaheim, CA 92803**

D/EL-W, BA39

We STILL need good people. And especially SEMICONDUCTOR APPLICATIONS ENGINEERS.

Send your resume to the good people company, Signetics, MS 300, 811 East Arques Avenue, Sunnyvale, CA 94086. We are an equal opportunity employer m/f.

The Good People Company.
Signetics
a subsidiary of U.S. Philips Corporation

ELECTRONIC ENGINEERS COMPUTER SCIENTISTS

IF YOU ARE DOING WELL IN YOUR PRESENT POSITION YOU'RE THE TYPE OF PERSON OUR CLIENTS WANT TO TALK TO. You are probably good at what you do.

Predictions indicate 1978 to be the most dynamic year in a decade for engineering employment. NOW IS THE TIME TO LAY THE GROUNDWORK FOR YOUR FUTURE. Don't regard your present position as a temporary holding pattern or a place to wait for a lucky break. Present positions are the action base for future moves.

RCI is a technical search firm with an outstanding reputation representing a broad base of nationwide clients serving the Electronics industry. If you are interested in advancing your career, call us or send your resume or a brief hand written description of your background including present salary and geographic preferences, in confidence, to:

Search Director-Room G
REGIONAL CONSULTANTS INC.

213 West 9th Street
Cincinnati, Ohio 45202
513/579-1513

The "Local National" Technical Search Firm

(representing EEO clients only.)

ADAC	52	Data Delay Devices	226	■ Hewlett-Packard	2nd c., 1, 2, 7, 18-19, 54, 76-77, 87, 102-103, 115, 156-157, 162-163, 168, 197, 246-247
Advanced Micro Devices	10-11	■ Data Precision	238	■ Hipotronics, Inc.	222
■ Airpax Electronics (Division North American Philips)	45	■ Delevan Division, American Precision Industries, Inc.	182	Intel Memory Systems	20-21
■ Alco Electronic Products (Sub. of Augat)	217	Digital Equipment Components	121-124	Intelligent Systems Corporation	195
■ Allen-Bradley	22-23	‡ Digitran Company	199	■ Interleca, Inc.	219
American Microsystems, Inc.	223	Ebauches SA	174	ITI Electronics, Inc.	230
American Telephone & Telegraph Co. Long Lines	213	* E G & G Wakefield	196	ITT Bauelemente Gruppe Europa	7E
■ Amp., Inc.	30-31	EH International	66	ITT Jennings	206
Ampax *	245	Elec-Trol, Inc.	193	■ Johanson Manufacturing Corporation	190
Amplifier Research	230	Elong Electronorgtechica	170	Kasper Instruments	55
Analog Devices	78-79, 158-159	■ Electro Scientific Industries	220	■ Keithley Instruments	25
AQ Systems	215	■ Electronic Measurements	26	■ Keystone Electronics	271
Astro-Med	175	■ Electronic Navigation Industries	3rd c.	■ Krohn-Hite Corporation	5
■ Augat, Inc.	200	Elevam Electronic Tube Co. Ltd.	235	■ Lear Siegler	209
* AVX Ceramics	154-155	* Eltrade/National Semiconductor	12E	■ Magnetic Shield Division Perfection Mica Co.	252
■ F. W. Bell, Inc. Division of Arnold Eng. & Allegheny Ludlum	86	■ EMI Technology	189	* Magneti Marelli (Servizio Immaginee Promozione)	160
CEC Division/Bell & Howell Co.	235	EMM/CMP	49	Magtrol	216
Test System Division, The Bendix Corporation	227	* Enertec Schlumberger	13E	Matrox Electronic Systems	210
Berg Electronics Division of Dupont	251	■ Erie Technological Products	202-203	MDB Systems	194
■ Bourns, Inc.	4th c.	Fairchild Systems Technology	164-165	■ MFE Corporation	204
■* Burr Brown Research Corporation	183	■ Ferranti-Packard, Ltd.	196	* Membrain Limited	53
■ Cambridge Thermionic Corporation	243, 250	‡ First Computer Corporation	9, 248-249	■ Microswitch, Division of Honeywell	17
Canadian Thermostats & Control Devices	236	■ John Fluke Manufacturing Co., Inc.	89, 221	■ Microwave Power Devices	205
* Carlo Erba SA	187	Gainseville Area Chamber of Commerce	229	■ Mini-Circuits Laboratory	38
■ Circuit Technology Inc.	179	* Ganz Measuring Works	6E	Mitel Semiconductor Inc.	50
Citizen America Corporation	196	■ Gates Energy Products, Inc.	152	Mostek Corporation	27-29
* C Itoh & Company, Ltd.	73	* GEC M-O Valve	11E	‡ Motorola Corporate	154-155
Commission of European Countries	217	■ General Electric A & Sp Operation, Semiconductor	119	■ Motorola Semiconductor Products	51, 236
‡ Computer Professional Book Club	232A, 232B, 233	‡ General Electric Instrument Rental Division	160	Munchner Messe	71
Conic Data Systems	146	■ General Electric Panel Meter	91	* Murata Manufacturing Co. Ltd.	16E
Conrec Div/Conrec Corporation	228	■ GE Plastics	253	National Connector Division Fabri-Tek, Inc.	271
■ Continental Connector Corporation	207	■ General Instrument Microelectronics	47	■ National Semiconductor Corporation	36-37
■ Continental Specialties	272	■ Gould, Inc./Instrument Systems Division/T & M	181, 240	‡ NEC Microcomputers	12-13
■ Control Data Corporation	211	■ GTE Sylvania/Conntor Products Operation	177	■ Nicolet Instrument Corporation Oscilloscope Division	234
Conver Corporation	151	Guardian Electric Manufacturing Co.	191	Nikkei-Electronics	188
■ Corning Glass Works, Fotoform Products Group	173	■ Hamlin	232	■ Non-Linear Systems, Inc.	214, 236
‡ Cortron Div of Illinois Tool Works, Inc.	183	Harris Semiconductor	138-139	Nortek, Inc.	230
Cramer	153	Haydon Switch & Instrument, Inc.	231	■ North American Philips Controls	215
‡ Cts Corporation	73, 250	‡ Heath Co. Schlumberger	65	■ North Atlantic Industries	8

‡ Ohio Scientific	187	Sprague Electric	56
■ O.K. Machine & Tool Co.	217	■ Stackpole	100-101
Optron, Inc.	14	■ Standard Grigsby Inc.	218
* Oscilloquartz	69	Statek Corporation	83
Paratronics, Inc.	242	■ Syntronic Instruments, Inc.	192
* Peterborough Development Corporation	9E	Tam's Inc.	214
* Phillips Industries	2E-3E	TEAC Corporation	59
⊕ Phillips TMI	69	■ Teccor Electronics, Inc.	231
■* Phillips TMI	4E	■ Tektronix Datatek NV	90
■ Piezo Technology	214	■ Tektronix - MDA	98-99
Piher	166-167	■ Tektronix	32, 80, 15, 225, 185
Pinellas County	224	* Teledyne Philbrick	204
Plastics Engineering Co.	186	Teradyne, Inc.	130-131
Plessey Peripheral Systems	178	Thomson CSF	171
Precision Monolithics	94-95, 97	* Tokyo Sokuhan Co. Ltd.	271
■ Precision Filters	93	Triple I	219
Programad Power	238	‡ US Instrument Rentals Inc.	53
■ Projects Unlimited	215	■ United Systems Corporation (Sub Monsanto)	239
Recal-Dana Instruments, Inc.	237	U.S. Postal Service	61
* Recal Dana Instruments Ltd.	74-75	Unitronix	35
* RCA	12-13	U.S. Components, Inc.	229
RCA Solid State	62	University of Ottawa	236
RCA CCVE	90	Viking Industries	43
■ Reeve-Hoffman	184	* V/O Techmashexport	10E
Refec Electronics Corporation	212	■ Wavetek Indiana	104
‡ Rental Electronics, Inc.	74-75	Yokogawa Corporation of America	231
* Rhone Poulenc - Chimie Fine	9	Zero Corporation	16
* Riken Denski Co., Ltd.	252		
Rogers Corporation	219		
* Rohde & Schwarz	1E, 65		
S.A.T. Inc.	235		
■ Sascor, Inc.	6		
Semtech Corporation	140		
* SEPA S.P.A.	199		
* Sescosem Thomson CSF	8E		
* Schnaffer, Hans	14E		
* Sternice	8E		
Sharp Corporation	201		
* Siemens A G Karlsruhe	60		
* Sime Brondi SRL	15E		
* Solartron	17E-20E		
■ Spectrol Electronics	84		

Classified and employment advertising

F. J. Eberle, Manager 212-997-2557

Boeing Company	267
Commonwealth Sales Co.	258
Computer Peripherals	262
Corey Assoc.	262
Data General	256
Databit, Inc.	264
Four-Phase Systems	251
Hewlett Packard	260
Hughes Aircraft	257, 259, 261
Itel Applied Technology	264
Judge Electronics	254
Litton Systems, Amecom Div.	260
Lockheed Missiles & Space Co.	265
Motorola, Inc.	266
Northrop Corp.	258
Raytheon Service Co.	266
Regional Consultants, Inc.	268
Rockwell International	264, 268
Robins AFB	258
Signetics	268
Stephen, E.J.	258
TRW Vidar	266
Tektronix	254
Texas Instruments	255
Weterrings & Agnew	266
Zenith Radio	256

■ For more information of complete product line see advertisement in the latest Electronics Buyers Guide
 * Advertisers in Electronics International
 ‡ Advertisers in Electronics domestic edition

Advertising Sales Staff

Advertising sales manager: Paul W. Reiss
 1221 Avenue of the Americas, New York, N.Y. 10020
 [212] 997-4371

Atlanta, Ga. 30309: Michael Charlton
 100 Colony Square, 1175 Peachtree St., N.E.
 [404] 892-2868

Boston, Mass. 02116: Frank Mitchell
 607 Boylston St.
 [617] 262-1160

Chicago, Ill. 60611
 645 North Michigan Avenue
 Jack Anderson [312] 751-3739
 Robert M. Denmead [312] 751-3738

Cleveland, Ohio 44113: William J. Boyle
 [716] 586-5040

Dallas, Texas 75201: John J. Uphues
 2001 Bryant Tower, Suite 1070
 [214] 742-1747

Denver, Colo. 80203: Harry B. Doyle, Jr.
 123 Speer Blvd. #400
 [303] 837-1010

Detroit, Michigan 48202: Jack Anderson
 1400 Fisher Bldg.
 [313] 873-7410

Fort Lauderdale, Fla. 33306: Michael Charlton
 3000 N.E. 30th Place
 [305] 563-9111

Houston, Texas 77002: John J. Uphues
 601 Jefferson Street, Dresser Tower
 [713] 659-8381

Los Angeles, Calif. 90010: Robert J. Rielly
 Robert E. Boedicker, 3200 Wilshire Blvd., South Tower
 [213] 487-1160

Minneapolis, Minn. 55435: Robert M. Denmead
 4015 W. 65th St.
 [312] 751-3738

New York, N.Y. 10020
 1221 Avenue of the Americas
 Michael J. Stoller [212] 997-3616
 Matthew T. Reseska [212] 997-3617

Philadelphia, Pa. 19102: Matthew T. Reseska
 Three Parkway
 [212] 997-3617

Pittsburgh, Pa. 15222: Matthew T. Reseska
 4 Gateway Center
 [212] 997-3617

Rochester, N.Y. 14534: William J. Boyle
 1175 Pittsford-Victor Rd., Pittsford, N.Y.
 [716] 248-5620

San Francisco, Calif. 94111: Don Farris
 Dean Genge, 425 Battery Street,
 [415] 362-4600

Paris: Patrick Mouillard
 17 Rue-Georges Bizet, 75116 Paris, France
 Tel: 720-73-01

United Kingdom & Scandinavia: Robert Ghey
 34 Dover Street, London W1
 Tel: 01-493-1451

Scandinavia: Andrew Karnig and Assoc.
 Kungsholmsgatan 10
 112 27 Stockholm, Sweden
 Tel: 08 51 68 70 Telex: 179 51

Milan: Luigi Rancati
 1 via Baracchini, Italy
 Phone 86-90-656

Brussels:
 23 Chaussee de Wavre
 Brussels 1040, Belgium
 Tel: 13-73-95

Frankfurt/Main: Fritz Krusebecker
 Liebigstrasse 27c, Germany
 Phone 72 01 81

Tokyo: Tatsumi Katagiri, McGraw-Hill
 Publications Overseas Corporation,
 Kasumigaseki Building 2-5, 3-chome,
 Kasumigaseki, Chiyoda-Ku, Tokyo, Japan
 [581] 9811

Business Department

Thomas M. Egan
 Production Manager [212] 997-3140

Carol Gallagher
 Production Manager International
 [212] 997-2045

Betty Preis
 Production Manager Domestic
 [212] 997-2908

Roberta Cummings
 Production Manager Related Products
 [212] 997-2044

Thomas Kazich, Production Assistant
 (212) 997-2843

Frances Vallone
 Reader Service Manager
 [212] 997-6057

Electronics Buyers' Guide
 H.T. Howland, General Manager
 [212] 997-6642

Regina Hera, Directory Manager
 [212] 997-2544

Roberta Cummings, Production Manager
 [212] 997-2044

Thomas Kazich, Production Assistant
 [212] 997-2843

Frances Vallone, Reader Service Manager
 [212] 997-6057

Classified and Employment Advertising

Frank Eberle, Manager
 [212] 997-2557

TERMINAL BOARDS

READI-MADE CUSTOM-MADE

READI-MADE

Keystone standardized Read-Made terminal boards will cut your production cost by eliminating the tooling and setup charges usually applied to nonstandard boards. Our boards will meet all commercial and military specifications. We have a vast selection of materials, sizes and terminals to meet the widest range of circuit building. And they are available from our stock.

CUSTOM-MADE

If our standardized boards do not meet your requirements we can custom fabricate to your specifications. Our complete facilities are available to you - tool and die fabrication, precision machining, punching, stamping, assembling & marking. You can select from our large inventory of materials, terminals and hardware to meet your own special needs.

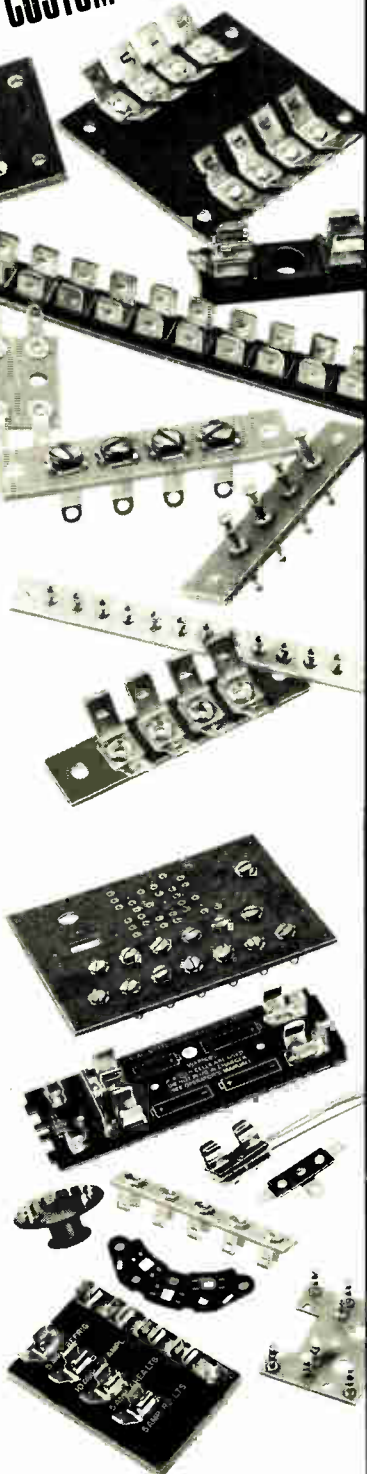

MOLDED CONNECTORS

Our specialty is meeting your special molded connector requirements. We manufacture to your specifications, or assist you in design. Standard or non-standard contact spacings; state-of-the-art thermosetting and thermoplastic materials; innovative terminal options like our rolled/formed contact, box, crimp, blade and tuning fork plus the typical standards. Most options available in full or selective plating. Complete in-house design, engineering, manufacturing, quality control. We've been satisfying the needs of the computer, military hardware, telecommunications, and instrumentation industries for twenty years. Bring us your problem — today.



FABRI-TEK INC. NATIONAL CONNECTOR DIVISION

9210 Science Ctr. Drive / Minneapolis, MN 55428 / (612) 533-3533

- Send molded connector literature
- Call me - immediate requirement

Name _____
Title _____

Company _____

Address _____

City _____ State _____ Zip _____

Telephone _____



NEW FREE CATALOG ON REQUEST

KEYSTONE

ELECTRONICS CORP.

TWX 710-581-2861 CABLE-KEYELCO

49 BLEECKER STREET, NEW YORK, N.Y. 10012 212-475-4600

\$44.95 KNOW-IT-ALL

CSC's multi-family Logic Probe 1 with memory.
Already the industry standard for performance and value.

This compact, enormously versatile test and troubleshooting aid is like a pencil-sized scope at your fingertips. Simply connect its clip leads to the circuit's power supply, set a switch to the proper logic family, and touch the probe tip to the node under test.

LP-1's unique circuitry does the work of a level detector, pulse detector, pulse stretcher and memory. HI LED indicates logic "1," LO LED, logic "0," and all pulse transitions — positive and negative, as narrow as 50 nanoseconds — are stretched to 1/3 second and displayed on the PULSE LED. One-shot, low-rep-rate narrow pulses — nearly impossible to see even with a fast scope, are easily detectable and visible. And you can indefinitely store single-shot as well as low-rep-rate events.

At frequencies above 1 MHz, there is an additional indication with unsymmetrical pulses: duty cycles of less than 30%, light the LO LED; over 70%, the HI LED. In all modes and circuit states, LP-1's high input impedance virtually eliminates loading problems. The unit also features overvoltage and reverse-polarity protection, interchangeable probe tips, cables and other optional accessories.

Order today. Call 203-624-3103 (East Coast) or 415-421-8872 (West Coast): 9 a.m.-5 p.m. local time. Major credit cards accepted. Or see your CSC dealer. Prices slightly higher outside USA.

Logic Family Switch — TTL/DTL or CMOS matches Logic "1" and "0" levels; CMOS position also compatible with HTL, HiNIL and MOS logic.

PULSE/MEMORY Switch & LED — PULSE position detects and stretches pulses as narrow as 50 nanoseconds to 1/3 sec.; MEMORY stores single-shot and low-rep-rate events indefinitely; HI/LO LED's remain active.

HI/LO LED's — Display level (HI-logic "1", LO-logic "0") of signal activity.

Interchangeable probe tips — Straight tip supplied; optional alligator clip and insulated quick-connecting clip available. Optional input ground lead.

Plug-in leads — 36" supplied, with alligator clips. Virtually any length leads may be connected via phono jack.

*Mfr.'s rec. resale. Slightly higher outside U.S.

© 1978 Continental Specialties Corporation

Specifications

Input impedance: 100,000Ω

Thresholds (switch selectable)	DTL/TTL	HTL/CMOS
logic "1" thresholds (HI-LED)	2.25V ± .15V	70% Vcc ± 10%
logic "0" thresholds (LO-LED)	0.80V ± .10V	30% Vcc ± 10%

Min. detectable pulse width 50nsec. guaranteed

Pulse detector (PULSE LED) in PULSE position of PULSE/MEMORY switch, 1/3-sec. pulse stretcher makes high-speed pulse train or single events (+ or - transitions) visible; in MEMORY position, first transition lights and latches LED

Operating temperature 0-50°C

Physical size (l x w x d)

5.8 x 1.0 x 0.7" (147 x 25.4 x 17.8mm)

Weight 3oz. (0.85Kg)

Power leads removable 36" (914mm) with color-coded insulated clips; others available

Input protection overload, ± 500V continuous; 117 VAC for less than 15 sec.; reverse polarity, 50V; power leads reverse-voltage protected.

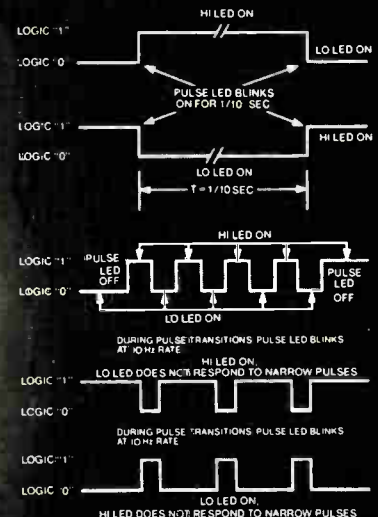
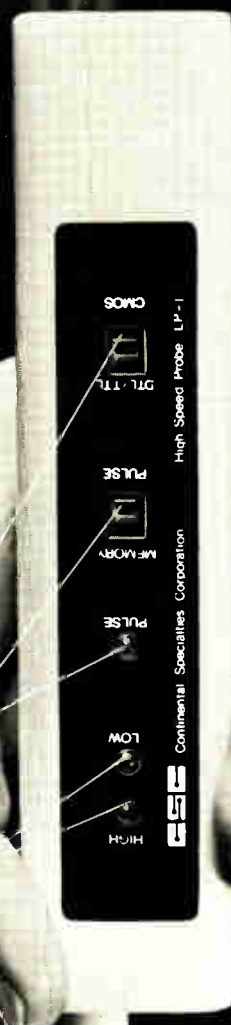

CONTINENTAL SPECIALTIES CORPORATION



70 Fulton Terrace, Box 1492, New Haven, Ct 06509

203-624-3103 TWX 710-465-1227

WEST COAST: 351 California St., San Francisco, CA 94104,

415-421-8872 TWX 910-372-7992

GREAT BRITAIN: CSC UK LTD.

Spur Road, North Feltham Trading Estate,

Feltham, Middlesex, England.

01-890-0782 Int'l Telex: 851-881-3669

See us at WESCON Booth Numbers 504-510 for free samples and live demonstration



Electronics

Reader Service

For additional information on products advertised, new products or new literature, use these business reply cards.

Complete entire card. Please print or type. Circle the number on the Reader Service postcard that corresponds to the number at the bottom of the advertisement, new product item, or new literature in which you are interested. To aid the manufacturer in filling your request, please answer the three questions.

All inquiries from outside the U.S. that cannot reach Electronics before the expiration date noted on the Reader Service postcard must be mailed directly to the manufacturer. The manufacturer assumes all responsibilities for responding to inquiries.

Subscriptions & Renewals
Fill in the subscription card adjoining this card. Electronics will bill you at the address indicated on the card.

Electronics September 14, 1978 This reader service card expires December 14, 1978

NAME _____ TITLE _____

PHONE (_____) _____ COMPANY _____

STREET ADDRESS (Company or home check one) _____

CITY _____ STATE _____ ZIP _____

Was This Magazine Personally Addressed to You? Yes No

Industry classification (check one):

- | | | |
|--|--|--|
| <input type="checkbox"/> a Computer & Related Equipment | <input type="checkbox"/> e Test & Measuring Equipment | <input type="checkbox"/> j Independent R&D Organizations |
| <input type="checkbox"/> b Communications Equipment & Systems | <input type="checkbox"/> f Consumer Products | <input type="checkbox"/> k Government |
| <input type="checkbox"/> c Navigation, Guidance or Control Systems | <input type="checkbox"/> g Industrial Controls & Equipment | |
| <input type="checkbox"/> d Aerospace, Underseas Ground Support | <input type="checkbox"/> h Components & Subassemblies | |

Your design function (check each letter that applies):

- x I do electronic design or development engineering work.
 y I supervise electronic design or development engineering work.
 z I set standards for, or evaluate electronic components, systems and materials.

Your principal job responsibility (check one)

- t Management
 v Engineering

Estimate number of employees (at this location): 1. under 20 2. 20-99 3. 100-999 4. over 1000

1 16 31 46	61 76 91 106	121 136 151 166	181 196 211 226	241 256 271 348	363 378 393 408	423 438 453 468	483 498 703 718
2 17 32 47	62 77 92 107	122 137 152 167	182 197 212 227	242 257 272 349	364 379 394 409	424 439 454 469	484 499 704 719
3 18 33 48	63 78 93 108	123 138 153 168	183 198 213 228	243 258 273 350	365 380 395 410	425 440 455 470	485 500 705 720
4 19 34 49	64 79 94 109	124 139 154 169	184 199 214 229	244 259 274 351	366 381 396 411	426 441 456 471	486 501 706 900
5 20 35 50	65 80 95 110	125 140 155 170	185 200 215 230	245 260 275 352	367 382 397 412	427 442 457 472	487 502 707 901
6 21 36 51	66 81 96 111	126 141 156 171	186 201 216 231	246 261 338 353	368 383 398 413	428 443 458 473	488 503 708 902
7 22 37 52	67 82 97 112	127 142 157 172	187 202 217 232	247 262 339 354	369 384 399 414	429 444 459 474	489 504 709 951
8 23 38 53	68 83 98 113	128 143 158 173	188 203 218 233	248 263 340 355	370 385 400 415	430 445 460 475	490 505 710 952
9 24 39 54	69 84 99 114	129 144 159 174	189 204 219 234	249 264 341 356	371 386 401 416	431 446 461 476	491 506 711 953
10 25 40 55	70 85 100 115	130 145 160 175	190 205 220 235	250 265 342 357	372 387 402 417	432 447 462 477	492 507 712 954
11 26 41 56	71 86 101 116	131 146 161 176	191 206 221 236	251 266 343 358	373 388 403 418	433 448 463 478	493 508 713 956
12 27 42 57	72 87 102 117	132 147 162 177	192 207 222 237	252 267 344 359	374 389 404 419	434 449 464 479	494 509 714 957
13 28 43 58	73 88 103 118	133 148 163 178	193 208 223 238	253 268 345 360	375 390 405 420	435 450 465 480	495 510 715 958
14 29 44 59	74 89 104 119	134 149 164 179	194 209 224 239	254 269 346 361	376 391 406 421	436 451 466 481	496 511 716 959
15 30 45 60	75 90 105 120	135 150 165 180	195 210 225 240	255 270 347 362	377 392 407 422	437 452 467 482	497 702 717 960

Electronics September 14, 1978 This reader service card expires December 14, 1978

NAME _____ TITLE _____

PHONE (_____) _____ COMPANY _____

STREET ADDRESS (Company or home check one) _____

CITY _____ STATE _____ ZIP _____

Was This Magazine Personally Addressed to You? Yes No

Industry classification (check one):

- | | | |
|--|--|--|
| <input type="checkbox"/> a Computer & Related Equipment | <input type="checkbox"/> e Test & Measuring Equipment | <input type="checkbox"/> j Independent R&D Organizations |
| <input type="checkbox"/> b Communications Equipment & Systems | <input type="checkbox"/> f Consumer Products | <input type="checkbox"/> k Government |
| <input type="checkbox"/> c Navigation, Guidance or Control Systems | <input type="checkbox"/> g Industrial Controls & Equipment | |
| <input type="checkbox"/> d Aerospace, Underseas Ground Support | <input type="checkbox"/> h Components & Subassemblies | |

Your design function (check each letter that applies):

- x I do electronic design or development engineering work.
 y I supervise electronic design or development engineering work.
 z I set standards for, or evaluate electronic components, systems and materials.

Your principal job responsibility (check one)

- t Management
 v Engineering

Estimate number of employees (at this location): 1. under 20 2. 20-99 3. 100-999 4. over 1000

1 16 31 46	61 76 91 106	121 136 151 166	181 196 211 226	241 256 271 348	363 378 393 408	423 438 453 468	483 498 703 718
2 17 32 47	62 77 92 107	122 137 152 167	182 197 212 227	242 257 272 349	364 379 394 409	424 439 454 469	484 499 704 719
3 18 33 48	63 78 93 108	123 138 153 168	183 198 213 228	243 258 273 350	365 380 395 410	425 440 455 470	485 500 705 720
4 19 34 49	64 79 94 109	124 139 154 169	184 199 214 229	244 259 274 351	366 381 396 411	426 441 456 471	486 501 706 900
5 20 35 50	65 80 95 110	125 140 155 170	185 200 215 230	245 260 275 352	367 382 397 412	427 442 457 472	487 502 707 901
6 21 36 51	66 81 96 111	126 141 156 171	186 201 216 231	246 261 338 353	368 383 398 413	428 443 458 473	488 503 708 902
7 22 37 52	67 82 97 112	127 142 157 172	187 202 217 232	247 262 339 354	369 384 399 414	429 444 459 474	489 504 709 951
8 23 38 53	68 83 98 113	128 143 158 173	188 203 218 233	248 263 340 355	370 385 400 415	430 445 460 475	490 505 710 952
9 24 39 54	69 84 99 114	129 144 159 174	189 204 219 234	249 264 341 356	371 386 401 416	431 446 461 476	491 506 711 953
10 25 40 55	70 85 100 115	130 145 160 175	190 205 220 235	250 265 342 357	372 387 402 417	432 447 462 477	492 507 712 954
11 26 41 56	71 86 101 116	131 146 161 176	191 206 221 236	251 266 343 358	373 388 403 418	433 448 463 478	493 508 713 956
12 27 42 57	72 87 102 117	132 147 162 177	192 207 222 237	252 267 344 359	374 389 404 419	434 449 464 479	494 509 714 957
13 28 43 58	73 88 103 118	133 148 163 178	193 208 223 238	253 268 345 360	375 390 405 420	435 450 465 480	495 510 715 958
14 29 44 59	74 89 104 119	134 149 164 179	194 209 224 239	254 269 346 361	376 391 406 421	436 451 466 481	496 701 716 959
15 30 45 60	75 90 105 120	135 150 165 180	195 210 225 240	255 270 347 362	377 392 407 422	437 452 467 482	497 702 717 960

Electronics Reader Service

If the cards below have already been used,
you may obtain the needed information
by writing directly to the manufacturer,
or by sending your name and address,
plus the Reader Service number and issue date,
to Electronics Reader Service Department,
P.O. Box No. 2530, Clinton, Iowa 52734.

Affix
Postage
Here

Electronics

P.O. Box No. 2530
Clinton, Iowa 52734

Affix
Postage
Here

Electronics

P.O. Box No. 2530
Clinton, Iowa 52734

Tomorrow ideas today.



Using solid-state technology to replace bulky tube-type equipment, ENI's broadband amplifiers are tomorrow ideas available today. ENI's Class A power amplifiers already cover the frequency spectrum of 10 kHz to 1 GHz, with power outputs ranging from 300 milliwatts to over 4000 watts. And we're still climbing. Driven by any signal generator, frequency synthesizer or sweeper, ENI's compact portable amplifiers are completely broadband and untuned. Amplifying inputs of AM, FM, SSB, TV and pulse modulations with minimum distortion, these rugged units are

versatile power sources for general laboratory work, RFI/EMI testing, signal distribution, RF transmission, laser modulation, data transmission, NMR, ultrasonics and more. Designed to be unconditionally stable and failsafe (impervious to severe load conditions including open or short circuit loads), ENI power amplifiers will deliver their rated power to any load, regardless of match. For information write: ENI, 3000 Winton Rd. So., Rochester, New York 14623. Call 716-473-6900. TELEX 97-8283 ENI ROC.

ENI

World's Leader in Solid State Power Amplifiers

Circle 901 on reader service card

Inside and Out...



You can't find a better resistor network

KRIMP-JOINT™ reliability inside . . . dimensional perfection outside. Bourns SIP resistor networks deliver superior performance and trouble-free operation.

Inside: The Bourns exclusive KRIMP-JOINT lead frame termination design provides both a mechanical and electrical bond that lap or butt joint construction just can't deliver. The lead is crimped onto the network element and a high-temp, reflow resistant solder is used to prevent failure during wave soldering and in-circuit thermal cycling and vibration.



Outside: Revolutionary transfer molding technique developed by Bourns eliminates the mold gate which results in a perfectly formed molded thermoset plastic package. No rough edges and accurate dimensions make stacking and automatic machine insertion virtually trouble-free. Improves moisture performance, too.

The Result: The best designed, highest quality SIP resistor networks available. Superior load life, better thermal shock performance and lower, more uniform tempco.

Bourns low profile SIPs are compatible with DIP sockets and are only .190 inches high. That's standard for all 6, 8, and 10 pin configurations with:

- 5, 7, or 9 resistors and one common pin
- 3, 4, or 5 isolated resistors
- 12 resistors, dual terminator — now available in all pin configurations

Added features — compatible with auto insertion and auto test equipment, competitive pricing, distributor availability, and the best delivery in the business.

We also have a broad line of DIPs with equally high quality design and performance.

Get in on the inside track with Bourns Resistor Networks . . . Write today for new catalog.

TRIMPOT PRODUCTS DIVISION, BOURNS, INC., 1200 Columbia Avenue, Riverside, CA 92507. Phone: 714 781-5415. TWX: 910 332-1252.



BOURNS®

For Immediate Application — Circle 120 • For Future Application — Circle 220