

JUNE 23, 1977

**ONE-CHIP CPU MAKES QUICK WORK OF MINICOMPUTER DESIGN/113**

16-bit microcomputer bites off big chunk of controller jobs/118

How you cut software costs with analog I/O chips/130

FOUR DOLLARS A MCGRAW-HILL PUBLICATION

# Electronics®

**DESIGNED FOR  
WEAR AND TEAR**

1420 WELLS CAMB NOV77  
MATT NEILL  
2516 NE CLACKAMAS  
PORTLAND OR

97232

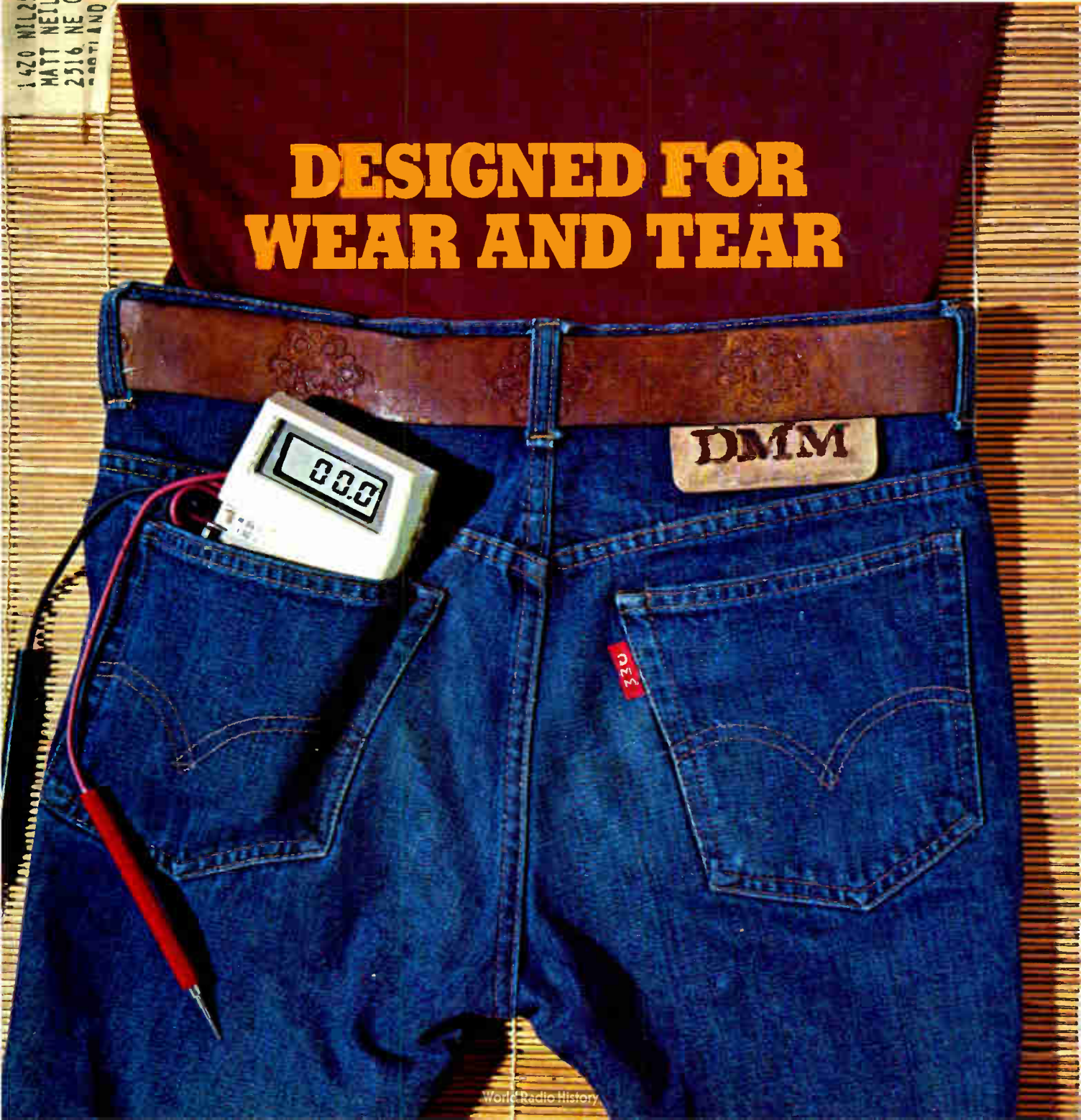

# HP quality, convenience and low prices mean big value in DMM's.

**\$225\*—The HP 3476A—3½ Digits—**Autoranging, automatic polarity and automatic zero make the 3476 a big value. It's a convenient size to hold in your hand or carry in your briefcase. Just \$225\* for the "A" version for AC line operation in your lab or \$275\* for the portable "B" version (with built in batteries and recharging circuit).

**\$375\*—The HP 970A—3½ Digits—**Handheld, autoranging, automatic polarity and zero, the 970 is totally self-contained and totally convenient. And the readout can be inverted with a flick of your thumb for easy reading. On the job measurement has never been easier.

**\$400\*—The HP 3435A—3½ Digits—**Autoranging or manual operation and wide-range operation, plus built-in batteries and recharging circuits bring you laboratory

accuracies and portability in the same unit. If you don't need battery operation, option 001 gives you line operation only for just \$335\*.

**\$500\*—The HP 3465B—4½ Digits—**1  $\mu$ V sensitivity gives you performance you'd normally expect from a 5½-digit multimeter. Fully portable too, with its own nickel-cadmium batteries and recharging circuit. Dry-cell operation and a rack-mount version are available in the 3465A for as low as \$425\*.

**Confidence** in low-cost DMM's comes from knowing you've made the right decision. HP's quality and service give you assurance. Contact your local HP field sales engineer or write today for more information.

\*Domestic U.S.A. price only.

**HP DMM's...  
the right decision.**

097142



Circle Number 900 on Reader Service Card

HEWLETT **hp** PACKARD

1507 Page Mill Road, Palo Alto, California 94304

For assistance call Washington (301) 948-6370, Chicago (312) 255-9800, Atlanta (404) 955-1500, Los Angeles (213) 877-1282

world radio history

# SURPRISE!

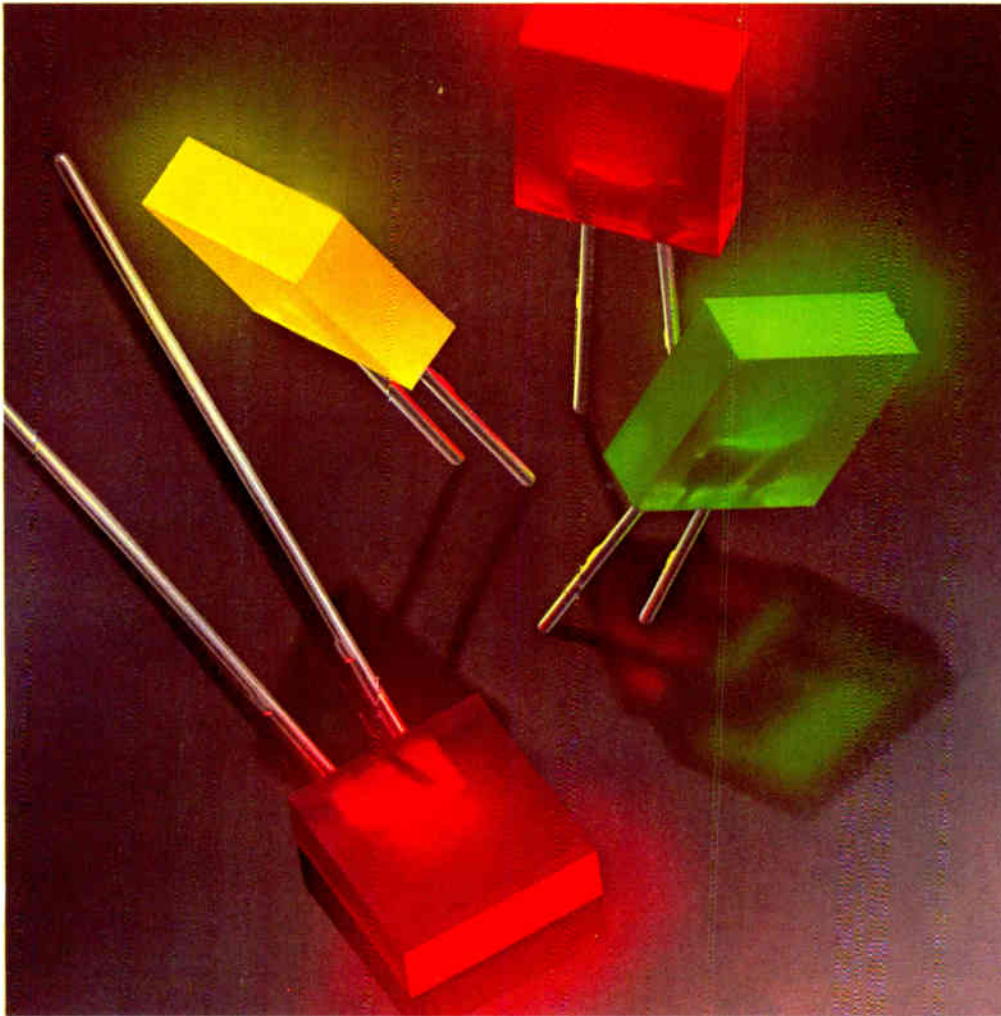

## The World's First Rectangular LED Lamps

For the first time LEDs are offered in a rectangular epoxy package. Available in high-efficiency red, yellow and green, they feature a flat, high intensity, light emitting surface.

And, since they're end or side stackable, they're ideal for flush mounted panel indicators, backlighting legends, and linear arrays. Plus you get long life and solid state reliability. And they're in stock right now. Choose our 5082-4570 for yellow, the 5082-4670 for high efficiency red, or the 5082-4970 for green. Priced at \$1.00\* in quantities of 1000. \*U.S. Domestic prices only

In the U.S., contact Hall-Mark, Schweber, Wilshire or the Wyle Distribution Group (Liberty-Elmar) for immediate delivery.

In Canada, contact Schweber Electronics or Zentronics, Ltd.

**HEWLETT  PACKARD**

Sales and service from 172 offices in 65 countries.  
1407 Page Mill Road, Palo Alto, California 94304

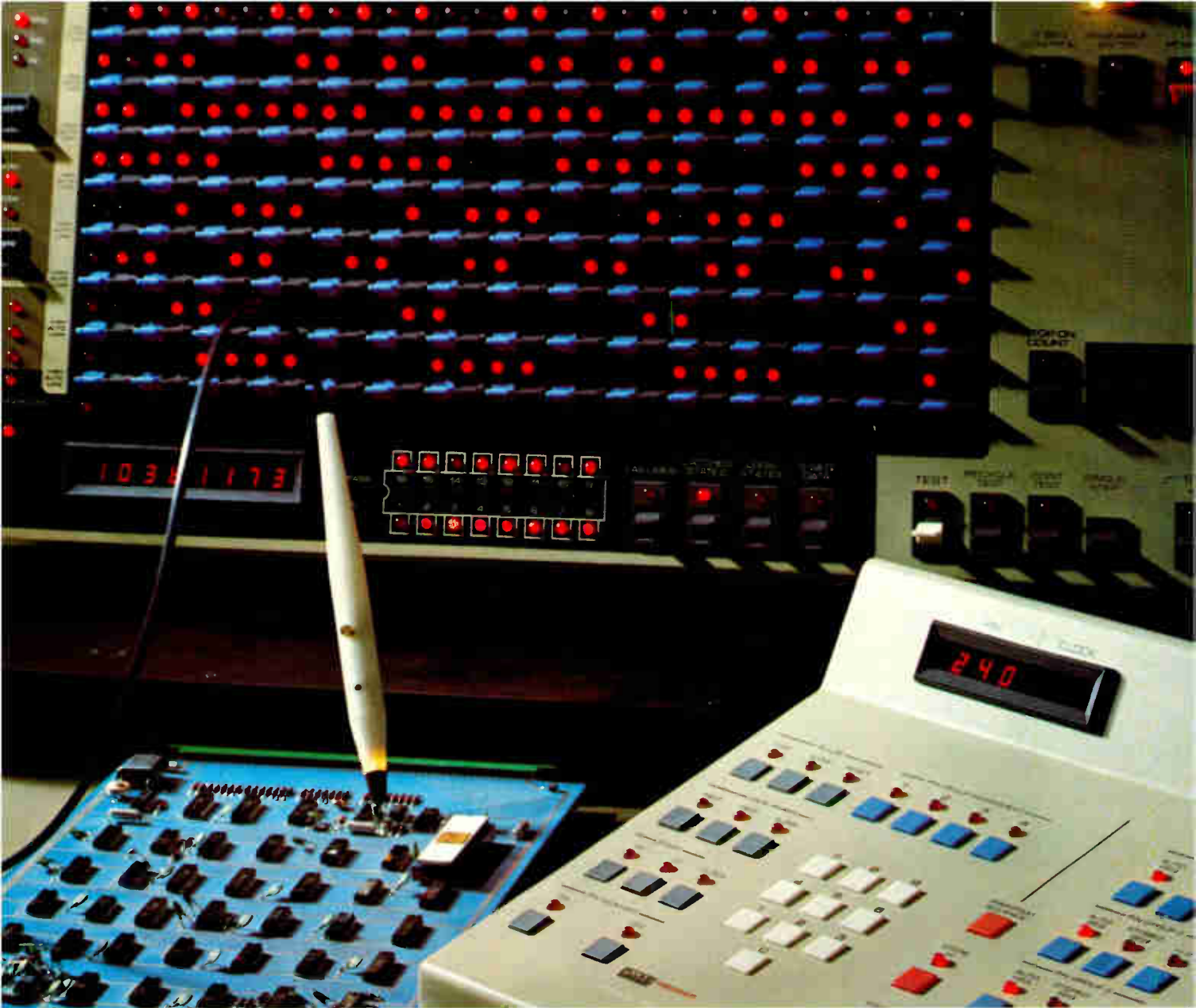

# THE ONLY LOGIC TESTER DESIGNED FOR MICROPROCESSOR BOARDS.

A fresh start for logic board testing.

Microprocessors are here.

If you are like most electronic manufacturers, you're either using  $\mu$ P's or you plan on using them soon. But how do you test your boards so you can ship a dependable microprocessor-based product?

With the new Fluke Trendar 3040A.

For a fraction of the cost, it does what other systems can't do. It fully tests microprocessor boards with either user-defined bit-by-bit test patterns or automatically-generated patterns, interchangeably, via simple push-button commands. A unique

new interface allows the necessary handshaking between  $\mu$ P board and tester. Any type of advanced digital logic board can be tested at system operating speeds. Diagnosis can be made by an operator using the guided clip/probe option.

And it not only performs higher confidence tests, it cuts your costs. It eliminates the programming delays and complexities of mini-computers and their peripherals. Editing is on-line. The effect of a program change on circuit behavior is instantly displayed. Programs

are done in a fraction of the time.

All this at a price you can afford.

For data out today, dial (415) 965-0350. Fluke Trendar, a subsidiary of John Fluke Mfg. Co., Inc., 630 Clyde Avenue, Mountain View, CA 94043.

Fluke (Nederland) B.V., P.O. Box 5053, Tilburg, The Netherlands. Phone: (013) 673-973. Telex: 52237.

**FLUKE**<sup>®</sup>

## 29 Electronics Review

SOLID STATE: V-MOS process gets first test in new memories, 29  
MICROWAVES: GaAs FETs reach new highs in power, frequency, 30  
CONSUMER: TI makes noise in toys and games, 31  
Home video-tape recorder offense kicks off in fall, 32  
NAVIGATION: LSI-11 to help steer America's Cup yachts, 34  
MILITARY: Belgians ordering operational RPVs, 36  
NEWS BRIEFS: 38  
COMPUTERS: Single-board units hit price low, 38  
COMMUNICATIONS: AT&T subsidiary wins \$100 million Iran award, 40

## 77 Electronics International

WEST GERMANY: Video-disk recorder aims at broadcasting, 78  
JAPAN: Battery-operated liquid-crystal panel readied, 78  
WEST GERMANY: Selenium plate records X rays, 79

## 91 Probing the News

COMMUNICATIONS: Smaller earth stations widen market, 91  
Digital TV: when, not if, 94  
MILITARY: Lasers help GIs shoot straighter, 96  
COMPANIES: Burr-Brown soars toward \$25 million mark, 98  
CONSUMER: Timex goes on the offensive, 102

## 106 Technical Articles

INSTRUMENTS: Rough life of DMM puts tough demands on design, 106  
MICROPROCESSORS: One-chip CPU packs minicomputer power, 113  
Microcomputer seeks a big bite of low-cost controller tasks, 118  
DESIGNER'S CASEBOOK: Single IC forms pulse-width modulator, 126  
Comparators replace mechanical set-point meter, 127  
High-impedance op amp extends 555 timer's range, 129  
COMPONENTS: Analog output chips shrink a-d software, 130  
ENGINEER'S NOTEBOOK: Transistors provide temperature control, 134  
Pulsed-voltage measurements check LED quality, 136

## 143 New Products

IN THE SPOTLIGHT: Low-cost ICs convert light to current, 143  
SEMICONDUCTORS: Inexpensive v-f converter is highly linear, 149  
INSTRUMENTS: Compact 600-megahertz counter sells for \$595, 155  
SUBASSEMBLIES: Family of 36 dc-to-dc converters bows, 160  
INDUSTRIAL: Infrared detector cools itself, 164  
COMPONENTS: New process hikes capacity of Ni-Cad cells, 171  
MATERIALS: 178

## Departments

Publisher's letter, 4  
Readers' comments, 6  
News update, 8  
Editorial, 12  
People, 14  
Meetings, 20  
Electronics newsletter, 25  
Washington newsletter, 69  
Washington commentary, 70  
International newsletter, 77  
Engineer's newsletter, 138  
New literature, 182

## Services

Employment opportunities, 188  
Reprints available, 196  
Reader service card, 197

## Highlights

### Cover: A tough DMM for tough demands, 107

A liquid-crystal display driven by a custom analog-to-digital converter chip keeps power demand low in a new portable digital multimeter. The complementary-metal-oxide-semiconductor chip simplifies external circuitry and incorporates additional features that make the meter more useful. This article is the latest in the continuing series of product development profiles.

Cover photographed by John Ashworth.

### Digital television is on its way, 94

By the mid-1980s, digital video processing will be found in many broadcast studios, although the switchover to analog home receivers will certainly take decades. The technology is already here, and various companies are producing different pieces of the necessary equipment.

### Two chips extend range of 16-bit design, 113 & 118

A high-performance minicomputer central processing unit on a chip and an n-channel metal-oxide-semiconductor single-chip minicomputer break new ground in 16-bit technology. The CPU (p. 113) will complement general-purpose single-board minicomputers. The microcomputer (p. 118) will serve low-cost control applications.

### And in the next issue . . .

A special report on displays . . . the first of a three-part examination of electronics engineers, their careers, and their future.

EDITOR-IN-CHIEF: Kemp Anderson

EXECUTIVE EDITOR: Samuel Weber

MANAGING EDITOR: Arthur Erikson,  
*International*

SENIOR EDITORS: Laurence Altman,  
Ray Connolly, Lawrence Curran,  
John Johnsrud, H. Thomas Maguire,  
Stephen E. Scrupski, Gerald M. Walker

ART DIRECTOR: Fred Sklenar

ASSOCIATE EDITORS: Howard Wolff,  
Alfred Rosenblatt

DEPARTMENT EDITORS

*Aerospace/Military:* Ray Connolly  
*Circuit Design:* Vincent Biancomano  
*Communications & Microwave:*  
Richard Gundlach  
*Components:* Lucinda Mattera  
*Computers:* Raymond P. Capece  
*Consumer:* Gerald M. Walker  
*Instrumentation:* Stephen E. Scrupski  
*New Products:* H. Thomas Maguire,  
Michael J. Riezenman  
*Packaging & Production:* Jerry Lyman  
*Solid State:* Laurence Altman

CHIEF COPY EDITOR: Margaret Eastman

COPY EDITORS: Ben Mason, Mike Robinson

ART: Charles D. Ciatto, *Associate Director*  
Paula Piazza, *Assistant Director*

EDITORIAL SECRETARIES: Janet Noto,  
Penny Rothman

EDITORIAL ASSISTANT: Marilyn B. Rosoff

FIELD EDITORS

*Boston:* Lawrence Curran (Mgr.), Pamela Leven  
*Los Angeles:* Larry Waller (Mgr.)  
*Midwest:* Larry Armstrong (Mgr.)  
*New York:* Bruce LeBoss (Mgr.)  
*San Francisco:* Bernard Cole (Mgr.)  
Judith Curtis  
*Washington:* Ray Connolly (Mgr.)  
*Frankfurt:* John Gosch  
*London:* William F. Arnold  
*Paris:* Arthur Erikson  
*Tokyo:* Charles Cohen

McGRAW-HILL WORLD NEWS

*Editor:* Michael Johnson  
*Brussels:* James Smith  
*Milan:* Andrew Heath  
*Moscow:* Peter Hann  
*Paris:* Andrew Lloyd  
*Stockholm:* Robert Skole  
*Tokyo:* Robert E. Lee

PUBLISHER: Dan McMillan

ADVERTISING SALES MANAGER:  
Paul W. Reiss

MARKETING ADMINISTRATION MANAGER:  
Wallis Clarke

CIRCULATION MANAGER: Karl Peterson

MARKETING SERVICES MANAGER:  
Tomlinson Howland

RESEARCH MANAGER: Margery D. Sholes

Reflecting the international nature of electronics, the careers of two of our authors started on separate continents and finally crossed to a third. Until they joined Fairchild Semiconductor, about all Dan Wilnai and Peter W. J. Verhofstadt, who coauthored the article about Fairchild's 9440 microprocessor that starts on page 113, had in common was the fact that they both earned their engineering degrees in 1963.

Wilnai was born in Tel Aviv, Israel, and received his degree from the Technion-Israel Institute of Technology, while Verhofstadt, who hails from Heyen, the Netherlands, gained his degree from the Technische Hogeschool, Eindhoven. Wilnai served as a technical officer in the Israeli Air Force and then joined Elta Electronics in Ashdod, Israel, as a project leader. In September 1974, he moved to Fairchild Semiconductor, where he is now manager of the processor development group.

Verhofstadt was associated with Siemens AG in Munich, Eurocontrol in Brussels, and Transitron Corp. in Wakefield, Mass., working on the design and development of digital computer systems and digital integrated circuits. He joined Fairchild in 1970 and has been responsible for the development of most of the company's new digital product lines. He is now manager of Advanced Products Operations.

To achieve the rather ambitious goals of the 9440 project, a multidisciplinary task force was created, headed by Verhofstadt. The company's I<sup>3</sup>L technology development was handled by the R&D organization under Thomas Longo, James Early, and Madhu Vora. System architecture and logic design were provided

by Chuck Erickson and Bob Moeckel under Wilnai. The circuit was designed by Hemraj Hingarh of the I<sup>3</sup>L circuit design group headed by Dick Crippen. Support was provided by the software engineering group directed by Ashok Suri.

As it happened, the first assignment in microprocessors for John Bryant, the principal designer of Texas Instruments' 9940 one-chip microcomputer and co-author of the article about it on page 118, was designing TI's version of Intel's 8080 microprocessor. But once TI planners decided that their 9900 16-bit microcomputer family was the way to go, Bryant became a systems engineer responsible for defining peripherals in support of the big 9900 CPU. That role served him well as program manager of one-chip, low-cost 9940 member of the family.

"It wasn't easy to define a one-chip architecture to handle the complex instruction repertory of a powerful general-purpose CPU like the 9900 and still make the chip cost-competitive with lower-performance competition," says Bryant. "It required several logic innovations to do the job," he recalls.

Like most TI-ers, he has been at the company all his professional life. He started at the Houston IC facility in 1972, after getting his EE degree from the University of Arkansas. He also has an MSEE from Texas A&M and is close to an MBA from the University of Houston.



June 23, 1977 Volume 50, Number 13 96,968 copies of this issue printed

Published every other Thursday by McGraw-Hill, Inc. Founder: James H. McGraw 1860-1948. Publication office 1221 Avenue of the Americas, N.Y., N.Y. 10020; second class postage paid at New York, N.Y. and additional mailing offices.

Executive, editorial, circulation and advertising addresses: Electronics, McGraw-Hill Building, 1221 Avenue of the Americas, New York, N.Y. 10020. Telephone (212) 997-1221. Teletype 12-7960 TWX 710-581-4878. Cable address: MCGRAW HILL NEW YORK.

Subscriptions limited to professional persons with active responsibility in electronics technology. No subscriptions accepted without complete identification of subscriber name, title or job function, company or organization, and product manufactured or services performed. Based on information supplied, the publisher reserves the right to reject non-qualified requests. Subscription rates: in the United States and possessions \$14.00 one year, \$35.00 three years; company addressed and company libraries \$20.00 one year, \$50.00 three years; APO/FPO addressed \$35.00 one year only; Canada and Mexico \$16.00 one year, \$40.00 three years; Europe \$40.00 one year, \$100.00 three years; Japan, Israel and Brazil \$85.00 one year, \$165 three years; Australia and New Zealand \$90.00 one year, \$240 three years, including air freight; all other countries \$45.00 one year, \$112.00 three years. Limited quota of subscriptions available at higher-than-basic rate for persons allied to field served. Check with publisher for these rates. Single copies: \$4.00. Please allow four to eight weeks for shipment.

Officers of McGraw-Hill Publications Company: Gordon L. Jones, President; Paul F. McPherson, Executive Vice-President; Group Vice-President, Gene W. Simpson; Senior Vice-Presidents: David G. Jensen, Manufacturing; Ralph R. Schutz, Editorial; Vice-Presidents: James E. Boddorf, Planning & Development; James E. Hackett, Controller; Robert L. Leyburn, Circulation; Edward E. Scherrer, Sales.

Officers of the Corporation: Harold W. McGraw, Jr., President, Chief Executive Officer, and Chairman of the Board; Robert N. Landes, Senior Vice President and Secretary; Ralph J. Webb, Treasurer.

Title registered in U.S. Patent Office; Copyright © 1977 by McGraw-Hill, Inc. All rights reserved. The contents of this publication may not be reproduced in whole or in part without the consent of copyright owner.

Subscribers: The publisher, upon written request to our New York office from any subscriber, agrees to refund that part of the subscription price applying to copies not yet mailed. Please send change-of-address notices or complaints to Fulfillment Manager, subscription orders to Circulation Manager, Electronics, at address below. Change-of-address notices should provide old as well as new address, including postal zip code number. If possible, attach address label from recent issue. Allow one month for change to become effective.

Postmaster: Please send form 3579 to Fulfillment Manager, Electronics, P.O. Box 430, Hightstown, N.J. 08520.



# AT \$795.00 EVERYONE CAN HAVE HIS OWN NEW PHASEMETER

Krohn-Hite's new Model 6200 has the specs to meet many of your phase measuring applications at about 1/2 the cost of any other digital phasemeter (specs like 0.5° accuracy, ±180.0° continuous display, sine or square waveforms from 10 Hz to 1 MHz and input voltages from 0.1V to 120V rms.)

Think of all the circuit design, equipment calibration and component inspection areas where a low cost, easy-to-use digital phasemeter would pay for itself practically overnight!

Call or write today, at this price you can afford to put a 6200 to work for you.

**KH KROHN-HITE CORPORATION**

Avon Industrial Park, Avon, Mass 02322 • (617) 580-1660

SALES OFFICES: ALA., Huntsville (205) 534-9771. ARIZ., Scottsdale (602) 994-5461. CAL., San Jose (408) 292-3220, Inglewood (213) 674-6850, COL., Denver (303) 773-1212. CONN., W. Hartford (203) 525-7647. FLA., Orlando (305) 894-4401. GA., Atlanta (404) 237-7272. HAWAII, Honolulu (808) 941-1574. ILL., Arlington Hts. (312) 394-3380. KS., Overland Park (913) 384-2710. LA., Lafayette (318) 984-3516. MD., Baltimore (301) 321-1414. MASS., Wakefield (617) 245-5940. MINN., St. Paul (612) 645-5816. MD., Hazelwood (314) 731-5400. N.M., Albuquerque (505) 255-2330. N.J., Cherry Hill (609) 482-0059. N.Y., Elmont (516) 488-2100, Rochester (716) 328-2230, Syracuse (315) 437-6666, Vestal (607) 785-9947. N.C., Burlington (919) 227-3639. OHIO, Chesterland (216) 729-2222. Clayton (513) 434-8993. OKLA., Tulsa (918) 299-2636. ORE., Portland (503) 297-2248. TEX., Dallas (214) 661-0400, Houston (713) 688-1431, VA., Falls Church (703) 573-8787. WA., Bellevue (206) 454-3400. CANADA, Montreal, Quebec (514) 341-7630, Ottawa, Ontario (613) 235-5121, Toronto, Ontario (416) 445-9900, Vancouver, British Columbia (604) 253-5555, Halifax, Nova Scotia (902) 454-8321, St. John's, Newfoundland (709) 726-2422.

## Why did it fail?

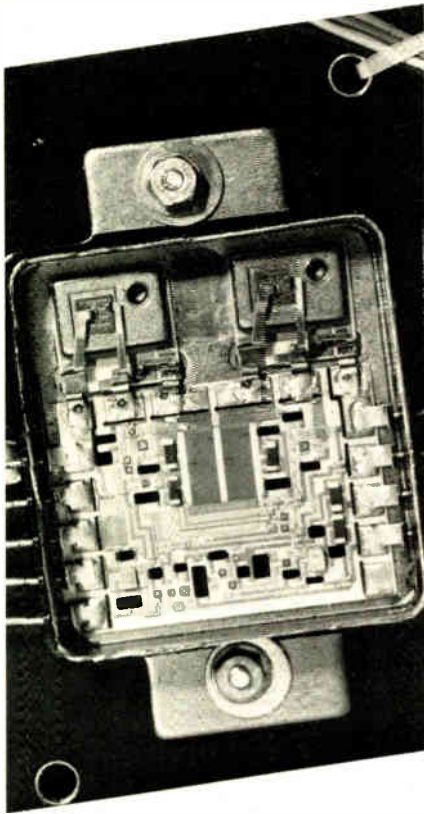

Locating circuit failures has always been a slow, tedious process. If only there were some way to **see** and **measure** the heat patterns created by failed components and connections, you could save much time and effort.

**Now you can.** UTI will show you.

## Readers' comments

### Recalculate those figures

**To the Editor:** In your story about the blockbuster calculators Texas Instruments Inc. just announced [May 26, p. 42], in the text and again over the picture you refer to 240 steps of program memory in Texas Instruments' SR 52. In fact, it has only 224 steps.

In the fourth line from the end, you refer to two levels of subprograms available in Hewlett-Packard Co.'s HP 67 and 97. They both have three levels, not counting the stack. And five lines above there, there is a typographical error: the \$750 unit is the HP 97.

John R. McGinley Jr.  
Van Cleef, Jordan, and Wood Inc.  
New York, N. Y.

### Revise that report

**To the Editor:** Your report [June 9, pp. 36-8] on the recent microelectronics workshop held at John Hopkins University's Applied Physics Laboratory contains two errors. First, I chair the research and development technology committee of the Computer Science Research and Development Council, not the council itself, which is chaired by a senior individual from the Naval Material Command. Second, it was not the council but members of the V/Stol advanced development team that indicated a technical preference for the SPL-1 language.

B.A. Zempolich  
Assistant Technology  
Administrator, Air 360B  
Naval Air Systems Command

### Correction

Those readers who have been experiencing difficulty in getting their trapezoidal-waveform generators for an electronic music synthesizer to work [March 17, p. 97]: take heart. A 10-microfarad input capacitor was inadvertently omitted from the input lead to Q<sub>1</sub>. This device is part of the RC network that differentiates the input signal.

Also, transistors Q<sub>1</sub>, Q<sub>2</sub>, and Q<sub>3</sub> may be general-purpose devices. A few readers in Europe have experienced difficulty in acquiring the devices originally specified.

## Thermography tells you instantly!

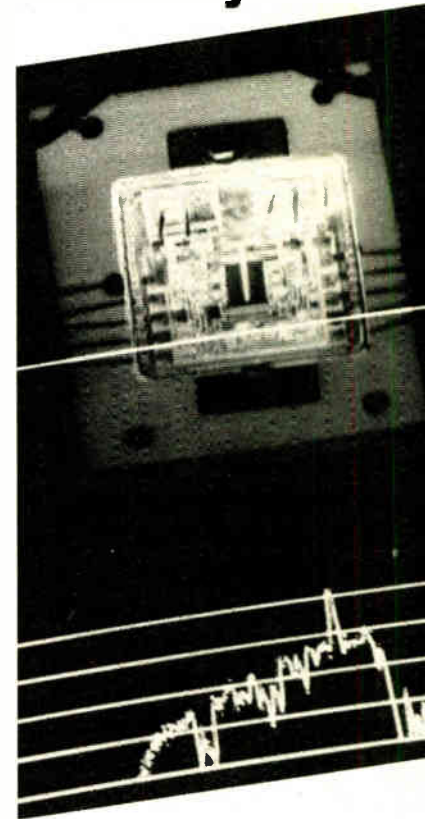

The new UTI-Spectrotherm Thermal Imaging System makes heat patterns visible for quick identification of faults. High-resolution images like this may be viewed on the CRT and recorded on film or tape.

Along with the picture, you get rapid quantitative measurements of temperatures from -27°C to +990°C. You may position the index line anywhere on the image

to produce a graphic profile and readout of temperatures.



New Model 900  
Thermal Imaging  
System

Get the facts from UTI. Call 408/738-3301, use inquiry card, or write to 325 N. Mathilda, Sunnyvale, California 94086.

# UTI

Circle 197 on reader service card





# Individually Excellent.



# Together...Superb!

## like instrumentation with the interface

Individual HP measuring instruments and computers are excellent soloists. You'll get a much more powerful performance, however, when you combine their capabilities interactively via the Hewlett-Packard Interface Bus (HP-IB).\*

Thanks to HP-IB, you can orchestrate a system for making faster and more accurate measurements. A system that can process data and provide

answers, on your terms, in printed or plotted form. A very flexible system, so you can easily change the composition and size of your measurement ensemble. All at a cost-effective price.

Why not assemble an HP-IB solution tuned to your measurement problem, small or large? HP has more than 60 instruments and computing controllers available with HP-IB—right now—and the list is growing rapidly.

To learn more, send for our new HP-IB brochure. It covers interface standards applications, and available HP-IB products.

\*The widely-accepted HP-IB is our implementation of the IEEE-488 Interface Standard. Internationally, HP-IB is in concert with the IEC main interface document.

HEWLETT-PACKARD  
1507E Page Mill Road  
Palo Alto, CA 94304



- Send free HP-IB brochure.
- Contact me to discuss HP-IB.

Name \_\_\_\_\_

Position \_\_\_\_\_

Company \_\_\_\_\_

Address \_\_\_\_\_

City \_\_\_\_\_ State \_\_\_\_\_ Zip \_\_\_\_\_

Phone \_\_\_\_\_ IPG 702



For assistance call Washington (301) 948-6370, Chicago (312) 255-9800, Atlanta (404) 434-4000, Los Angeles (213) 877-1282

Circle 7 on reader service card

world radio history

**"How do I pick the right test instrument?"**

**ASK US!**

**... or look in our book**

Our 1977 rental catalog has detailed specs. on more than 800 instruments, grouped by product type for fast price/performance evaluation.

So, look in our book or ask over the phone.

# Call Continental Rentals

Div. Continental Leasing Co., Inc.  
175 Middlesex Turnpike, Bedford, MA 01730  
(617) 275-0850

FOR IMMEDIATE RESPONSE CALL:  
N.E. (617) 275-0850; L.I. (516) 752-1622;  
NY, NJ (201) 654-6900; Gtr. Phila. (609) 234-5100;  
Wash., D.C. area (301) 948-4310;  
Mid West (312) 439-4700;  
So. Central (214) 690-1706;  
Costa Mesa, CA (714) 540-6566;  
L.A., CA (213) 477-7521;  
Santa Clara, CA (408) 735-8300.  
Circle 8 on reader service card

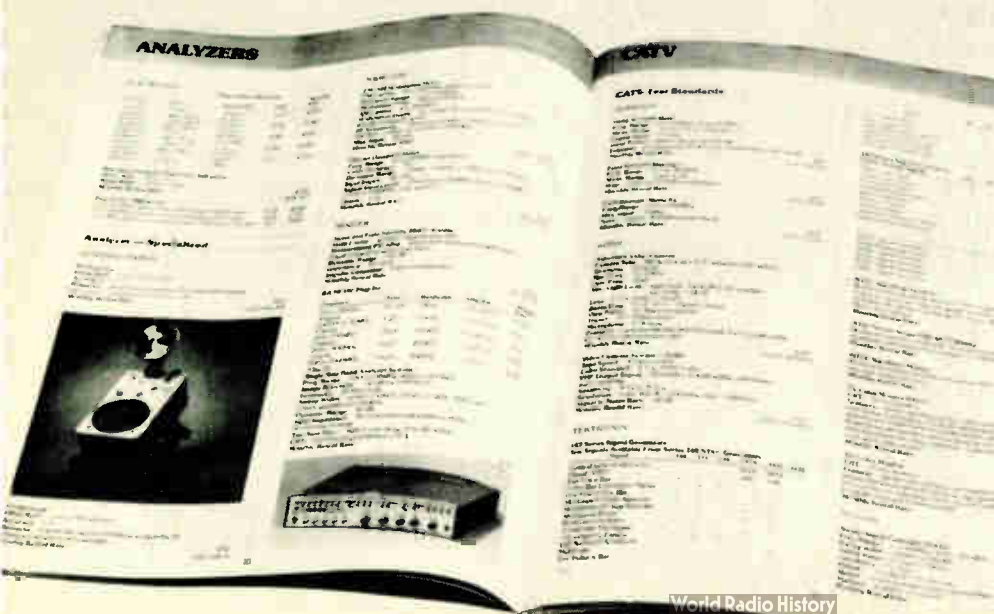

## News update

■ Owning a household pet often winds up costing more than one might first expect. So it is with the personal electronic transactor, or PET, a cassette-programmable personal computer from Commodore Business Machines Inc. of San Francisco.

Really an intelligent, interactive visual-display unit, PET contains an 8-bit microprocessor, 9-inch black-and-white cathode-ray-tube terminal, 73-key keyboard, and 4,096 bits of random-access memory and was to be distributed through retail stores for \$495 [*Electronics*, March 31, p. 89, and May 12, p. 36]. However, when Commodore took the wraps off its PET model 2001 at the Consumer Electronics Show in Chicago earlier this month, the personal computer was sporting a \$595 price tag, and reports were circulating around McCormick Place, the site of the big show, that it may soon go to \$700 or higher.

"The firm price is \$595, instead of \$495, because we finally have a product," explains Arnold Karush, Commodore's assistant sales manager. The \$495 figure, he continues, "was never a price we were selling at but was an estimated price. It wasn't until the CES that the unit was for sale. And," he adds, "we never took an order at \$495."

Karush says Commodore officials, after examining the cost of producing PET, decided the firm could not sell the personal computer at \$495 and make a decent profit. This may be especially so, since distributors generally receive a heavy discount. But will PET soon be selling for \$700 or higher, as reported? "At \$595, we're comfortable, at least for the foreseeable future," states Karush.

Although Karush declines to explain why the targeted price of \$495 could not be reached, reports are that some of the firms supplying component parts of the system could not meet early cost projections. PET is based on the 8-bit 6502 metal-oxide-semiconductor microprocessor made by MOS Technology of Norristown, Pa., which Commodore acquired last year.

**Bruce LeBoss**

# Introducing the intelligent LED display.



DL-1416  
4-character  
module

I I N T E R F A C E J U S T L I K E A R A M

Photograph of display actual size

## Alphanumerics at the lowest cost ever.

This newest Litronix Alphanumeric display has built-in ASCII decoder, multiplexer, memory and LED drivers. That means it needs only the inputs you'd feed a RAM. Operates directly off a microprocessor bus. Creates all 64 ASCII characters 0.16" high — shown in actual size above.

No alphanumeric display has ever been so simple to use. Actuated entirely by TTL logic levels. Needs only a +5v supply.

And it's by far the most economical way to create alphanumeric displays as long as 80 characters. Because you don't need to supply all that built-in circuitry externally.

The DL-1416 4-character modules can be butted end-to-end to make displays of any length with equal spacing between all characters.

Now available at stocking distributors.

**I'm in favor of intelligence.  
Tell me more.**

For DL-1416 data phone (408) 257-7910 or send coupon.

NAME

TITLE

ORGANIZATION

ADDRESS

ZIP

PHONE

Mail to Litronix, Dept. E, 19000 Homestead Road,  
Cupertino, CA 95014. Phone (408) 257-7910.

# litronix

**Op  
amps  
our  
way.**

Advanced Micro Devices offers the industry-standard operational amplifiers: LF155, 156 and 157. Our way. Which is to say:

- MIL-STD-883 for free. • Each part checked, tested, checked and tested again.
- Each part tested at three temperatures. (The competition tests at one. Maybe two. Rarely three.)
- Our op amps last longer.
- When we test, we leave no ion unturned. (And that goes for everything we make. All AMD linear parts are created equal.)

So next time you're in the market for fully-tested op amps, get them our way: AMD's LF155, 156 and 157. (If you need a couple samples to qualify, just grab a phone. They're on the way.)

## Advanced Micro Devices

Bipolar LSI. N-channel, silicon gate MOS. Low-power Schottky.  
Multiple technologies. One product: excellence.



Advanced Micro Devices, Inc. • 901 Thompson Place, Sunnyvale, California 94086 • Telephone (408) 732-2400 •  
Distributed nationally by Hamilton/Avnet, Cramer and Schweber Electronics and regionally by Arrow, Bell,  
Century Electronics, Future Electronics and RAE Electronics.

Circle 254 on reader service card

## Engineering jobs and the tax laws

At a time when the U. S. is moving into new world telecommunications markets, particularly in the Middle East, there has been an outflow of American engineers and administrators from the area as a result of new tax rulings. The long-term consequences for American engineering employment—already at a disadvantage compared with other countries—could be extremely serious.

That there is far more to the Middle East market for electronics than military systems is good news. But the fact that much of the new growth is in national telecommunications systems—to be followed later by television and other consumer products that rely on telecommunications—will make it tougher for American companies to compete with their European and Japanese counterparts.

Unlike American leadership in military systems, national telecommunications technology around the world is not far behind that of the U. S. Moreover, foreign exporters have the added advantage of being able to work hand in glove with their own governments to gain entry into new markets—sometimes the aid extends to low-cost government loans to buying nations for the purchase of engineering services and hardware.

It is heartening that the Western Electric Co.—whose parent American Telephone & Telegraph Co. seems to conduct most of its business with the Government these days in court—is undertaking a major move back into the international marketplace. Yet some people, such as Continental Telephone Companies' chairman Charles Wohlstetter, see a distinct handicap to U. S. telecommunications manufacturers who must send engineers abroad if they are to succeed in overseas markets. That handicap is the Tax Reform Act of 1976, which cut the earned-income exclusion for U. S. engineers and

other citizens working abroad to \$15,000 from the former level of \$20,000 or \$25,000.

Under the new rules, the cost of moving an engineer and his family abroad, educating his children in private schools, paid vacation time, and other cost-of-living benefits are now all taxable. The result, Wohlstetter charges, is that “an American employee in the Middle East occupying a \$25,000 job can actually cost his company up to three times that amount; and because of all this, an American firm can hire approximately two and a half British engineers for the price of one American.” Compounding this are the tax law changes that recapture the previously deductible U. S. tax credit for foreign losses and eliminate benefits to U. S. companies operating in developing nations.

Wohlstetter may be right when he calls the “crazy quilt” of complex and conflicting laws and regulations a dangerous threat to promising new employment opportunities. Engineers and other technology-oriented workers tend to give less thought to the peculiarities of tax and trade laws than they do their own developed specialties unless they move into a management role where they are obliged to consider the impact of such peripheral issues on their jobs. Yet these are precisely the issues that determine whether or not they will have a job in the years to come.

While it is true that not all the side effects of new Government regulations can be foreseen, there is no reason to ignore them once they are spotted. The Congress still has tax reform very much on the agenda. During its work on a new tax law, it should take a hard look at whether what seemed to be revenue-draining loop hole may not have been a relatively low-cost incentive to increased international trade and higher technological employment.

# What gives GE power modules the big edge in reliable control?

## A \$1 million circuit.

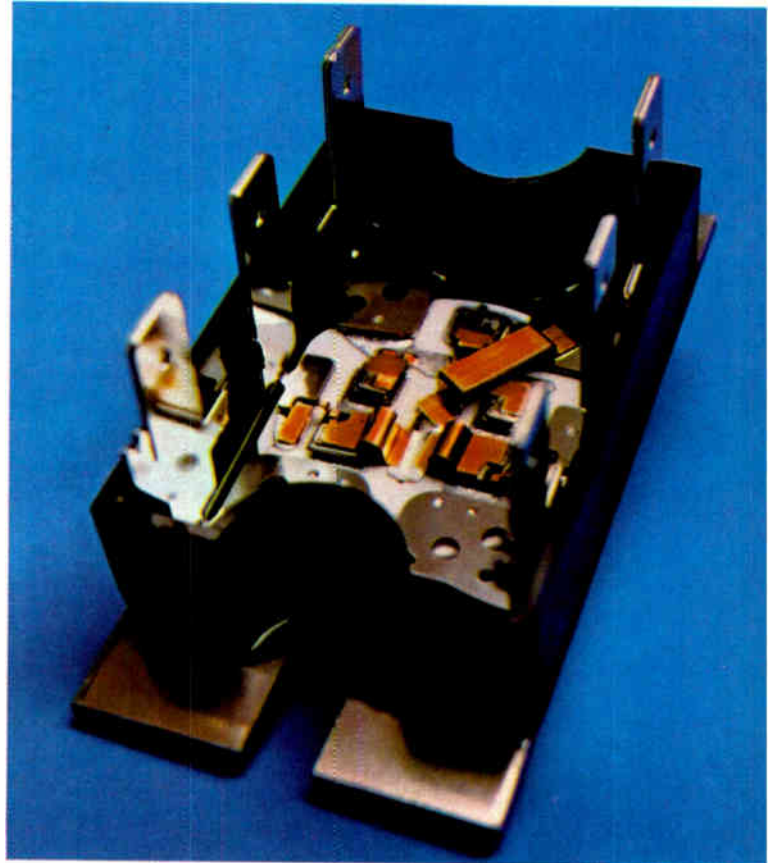
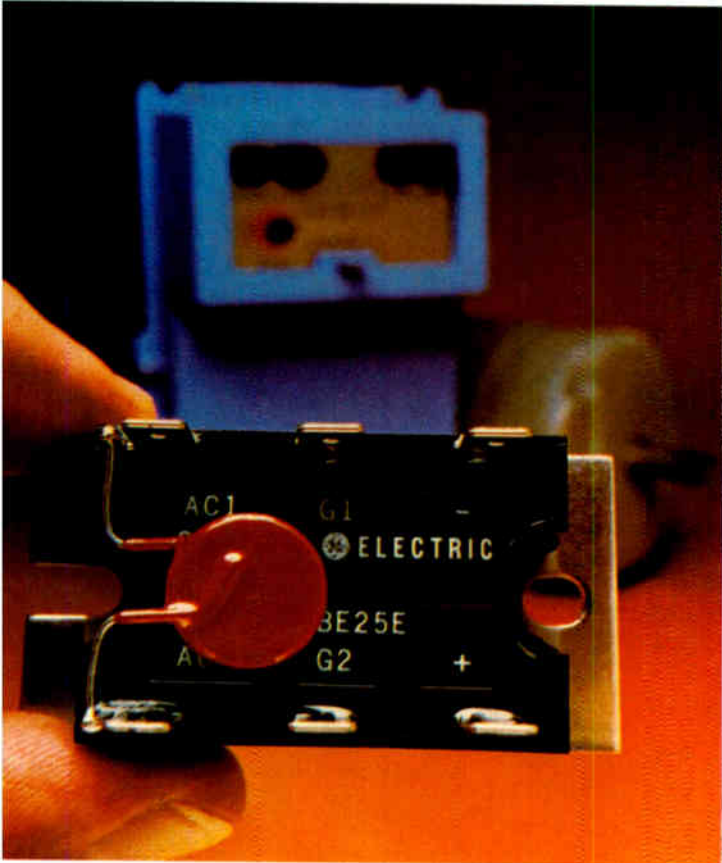

GE's \$1 million R&D investment to find better power modules brings you a whole new concept in power semiconductor packaging. GE's new WV Series of power modules offer designers a quantum leap forward in reliable control for DC motors, programmable/numerical controls, motor starters, magnetic clutches and brakes, heat controls, and battery chargers.

Four unique and patented internal construction features combine to achieve this reliability. 1. All semiconductor pellets are Power Glas passivated to give stable blocking life. 2. Thermally matched "strap" contacts reduce thermal fatigue and eliminate the use of flying internal leads that can be damaged during assembly. 3. Solid copper conductor runs replace less dependable thick film conductor runs. 4. Semiconductor pellets are copper bonded directly to BeO ceramic (an industry first) to lower the junction temperature by improving both thermal conduction and electrical isolation.

Besides internal construction features, each WV power module is equipped with a GE-MOV<sup>®</sup> varistor for transient protection. Each is equipped with extra wide spaced, easy-to-connect terminals that meet both UL and NEMA specifications. Each unit arrives factory-tested and ready-to-use.

It's the kind of reliability that you expect from General Electric, the world's leading manufacturer of power semiconductors. For more information, call your nearby GE electronic components sales engineer or write General Electric, Co., Electronics Park 7-49, Syracuse, NY 13201. 222-01

**There's more  
to GE semiconductors  
than meets the eye**

**GENERAL  ELECTRIC**



**OPTRON**  
full line

**DIP ISOLATORS**  
**DIP ISOLATORS**  
**DIP ISOLATORS**

*OPTRON's complete line of optically coupled plastic DIP isolators offers immediate availability of standard devices for almost every application ... plus competitive pricing, high reliability and excellent customer service.*

**Check these features and choose the device best suited for your application.**



**GENERAL PURPOSE**

A full selection of DIP isolators with transistor and darlington outputs to match all popular industry standards. Current transfer ratios range from 2.0% to 500%.



**HIGH VOLTAGE**

For applications requiring an interface with high voltage circuits, select the OPI 6000 DIP isolator with a 300 volt output transistor.



**AC OPERATION**

The OPI 2500 DIP isolator features two input LED's operating in inverse parallel and is ideal for applications where the LED is driven from an AC line.



**CUSTOM SELECTION**

If your application demands "something a little different," OPTRON specializes in DIP isolators to meet special customer requirements.

For reliability data and technical specifications on OPTRON's complete line of plastic DIP isolators, contact your nearest OPTRON sales representative or the factory direct.



**OPTRON, INC.**

1201 Tappan Circle  
Carrollton, Texas 75006, U.S.A.  
TWX-910-860-5958  
214/242-6571

## People

DEC's Brick helps  
the LSI-11 sail away

Robert Brick is delighted about his part in this year's America's Cup race as the new account manager for the LSI-11 microcomputer at Digital Equipment Corp.'s Components group, Marlboro, Mass. He is acting as project manager for the LSI-11, which is being used by the Independence syndicate in its two sailing vessels competing for the U. S. spot in the prestigious race off Newport, R. I. (see related story, p. 34). Both the *Independence* and the *Courageous* are using the DEC microcomputer to compute such critical racing factors as the boat's position, true wind speed, and wind direction.

"I think I'll be able to look back at this assignment with a lot of satisfaction," observes the 35-year-old Brick, himself an avid sailor and eight-year DEC veteran. "It's something like the guy who builds a color TV set from a kit and then never stops talking about it."

But the modly dressed Brick is quick to point out that he is one member of a DEC team that also includes David Schanin, LSI-11 applications engineer, and programmer Scott Gerren. All three have spent recent weekends—mostly at Marblehead, Mass., where the two boats are in preliminary trials—working with the boats' navigators, Peter Lawson of *Independence* and William Gorch of *Courageous*.

The navigators and the DEC team first met March 5, when Lawson and Gorch spelled out what they wanted from a microcomputer—the first to be used in such a race. It boiled down to faster throughput, greater accuracy, and more memory than was possible with the desk-top scientific calculator the navigators had previously used to derive critical data during a race.

"In just about two months, we had the system up and running," Brick says. Lawson wrote the programs for the calculator, and Gerren worked with him to translate them into the Focal language. Brick, who worked his way up from sales engineer in

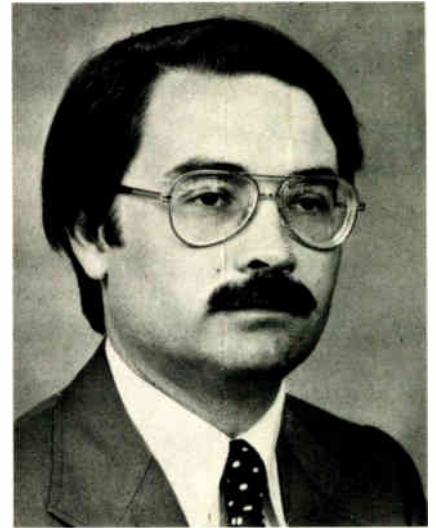

**Sailor's aide.** Robert Brick supplies America's Cup yachtsmen with faster answers.

branch offices to the LSI-11 marketing spot, helped with the cabling layout and also designed the aluminum box that protects the system from saltwater. Schanin has been overall systems integrator.

By early June, the program was debugged. DEC is helping fine-tune the system during the trials. Brick hopes the *Independence* or the *Courageous* will be the U. S. cup defender, but no matter how things turn out, he says, "we've all thoroughly enjoyed the whole experience."

TI's Shelly looks to widen  
digital-watch market

Lubbock, Texas, may not be the time capital of the world yet, but Ronald W. Shelly is doing his best to make it that. The 33-year-old Shelly moved there from Dallas early this month to head up Texas Instruments Inc.'s Time Products division. He was named to the post two months ago, just days after the division slashed its plastic-cased digital watch prices to a minimum of \$9.95.

Shelly says his firm will be the first watch company ever to sell through supermarkets. The under-\$10 watch family—now limited to models with light-emitting-diode displays—is key to TI's attempts to open the digital-watch market to



# PMI's CMP-01/02 precision comparators:

Need a 100 nsec., low-cost precision comparator with instant DELIVERY? Our CMP-01 is it, in stock at all our distributors. Need even BETTER input performance than the CMP-01? Choose the CMP-02! That includes MIL-STD-883A CLASS B parts, too. On the shelf.

If you use LM111 or LM311-type comparators, you can usually use one of our CMP-01's as a pin-for-pin replacement. Of course, you will have to settle for improved performance, such as higher slew rate, faster settling time, higher open loop gain, higher

CMMR, and lower offset voltage, offset current, bias current, and tempco's . . . AND A LOWER PRICE!

To get these high performance precision comparators all you have to do now is call in your order to your local PMI distributor. If you want a data sheet, circle the bingo number or give us a call.

# in stock.

Circle 15 on reader service card



Precision Monolithics, Inc.  
1500 Space Park Drive  
Santa Clara, CA 95050  
©(408) 246-9222. TWX: 910-338-0528

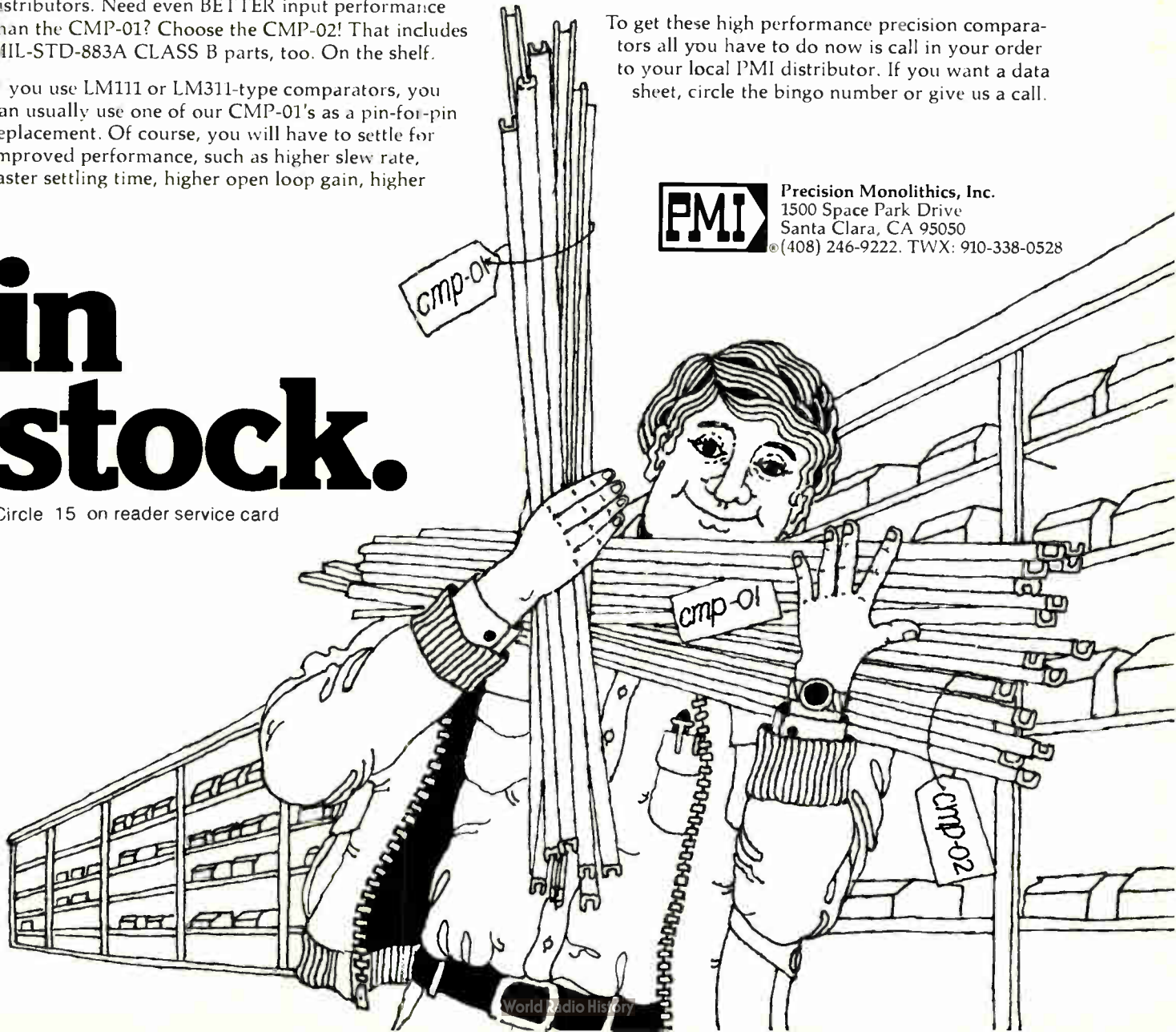

# The new chip inductor. A miniature specifically designed for reflow soldering and hybrid circuits.

Delevan proudly announces another first in hybrid circuit component design. Only .1" square by .075" high, the newest member of the Delevan Micro-i, inductor series was engineered to withstand the hi-temperature exposure of reflow soldering used for thick film processing.

High temperature insulated magnet wire is thermal compression bonded to gold plated metallic solder rails. The solder rails wrap around the sides of an alumina substrate to provide a visual indication of the solder bond.

Thermal exposure during assembly or rework is a severe test of component capability . . . and can be a controlling factor in reliability and performance.

When dependability is first priority, check out the new series 103 miniature leadless chip inductor . . . built to stand the heat. Ask for bulletin 103.

**Delevan**  
Division



AMERICAN  
PRECISION  
INDUSTRIES INC.

270 QUAKER RD./EAST AURORA, N. Y. 14052  
TELEPHONE 716/852-3800 TELEEX 091-293

OTHER DIVISIONS OF AMERICAN PRECISION INDUSTRIES INC.  
BASCO • DUSTEX

## People



**First.** Robert Shelly expects watches in supermarkets will spur impulse buys.

ever-increasing volumes, particularly through nontraditional distribution channels. "We've test-marketed watches in supermarkets in the Northeast, and now we're setting up an extensive food broker network," he says. The watch will be sold in the common blister pack, but the customer will be able to open it in order to try on the watch and see whether it works.

**Market increasing.** Shelly, a seven-year TI veteran, expects the watch to sell: "We figure that the \$9.95 watch will increase the size of the market by maybe 10% or 15%. At that price, a watch can be considered an impulse buy, and so it can't help but increase the total market."

The firm estimates that 15 million digital watches were sold in the U. S. last year and 18 million worldwide. This year's worldwide total could climb to 25 or 30 million if manufacturers keep up with demand.

Besides shaving prices, watchmakers can help expand the market by adding options and putting "a lot of different functions on a customer's wrist," Shelly says. "Liquid-crystal watches bring us the opportunity to keep coming up with innovations." Unlike LED models, the LCD watches open up multifunction markets with such features as elapsed-time, time-zone, and alarm functions. While Shelly refuses to discuss future watch products, he hints that the firm's LCD line—introduced last month and now limited to classical timekeeping—is the one to watch.



**FREON\*** **(BLACO-TRON\*\*)**  
**A rose by any other name  
 will clean as well.**



Why shouldn't BLACO-TRON precision cleaning solvents clean the same as FREON? They are completely interchangeable. DuPont calls their line of fluorinated solvents "FREON". We call ours "BLACO-TRON". So now you have a choice.

If they are equivalent, why should you try BLACO-TRON? Service. The service you get only from Baron-Blakeslee—for 45 years the accepted leader in advanced design precision

cleaning equipment and solvents

Chances are good that the machine you are now using to clean with FREON was developed by Baron-Blakeslee!

WRITE TODAY for complete "Precision Cleaning Solvents Guide". Contains full tech data on all BLACO-TRON fluorinated solvents.

**BLACO-TRON®**  
 FLUORINATED SOLVENTS—NOW THERE IS A CHOICE

**...and now there's a FULL BOUQUET of BLACO-TRON 'roses'**

Whatever type BLACO-TRON fluorinated solvent you need, you'll find it equivalent to the FREON solvent you may have been using:

FREON TF	BLACO-TRON TF
FREON TMC	BLACO-TRON TCM
FREON TE	BLACO-TRON TE
FREON TES	BLACO-TRON TES
FREON TMS	BLACO-TRON TMS Plus
FREON TA	BLACO-TRON TA
FREON T-E 35	BLACO-TRON T-E 35
FREON T-P 35	BLACO-TRON T-P 35
FREON T-WD 602	BLACO-TRON TWD



**Baron-Blakeslee** 1620 South Laramie Ave., Chicago, Ill. 60650—Offices in All Principal Cities. — (312) 656-7300

\*FREON is DuPont's registered trademark for its fluorocarbon cleaning agents.

\*\*BLACO-TRON is Baron-Blakeslee's registered trademark for its fluorocarbon cleaning agents.

Circle 17 on reader service card

# Pinpoint The Problem

## HP's Current Tracer locates low impedance logic faults.

By tracing current to sources or sinks, it can find the one bad component on a bus, pinpoint hairline solder bridges or backplane shorts. It quickly troubleshoots wired AND/OR and 3-state busses in all logic families. No cutting circuit traces or removing good circuit elements. Sensitive only to AC currents with fast transitions; adjustable sensitivity of 1 mA to 1 A; single lamp readout displays relative current levels. Model 547A, \$350\*. Also available are HP's 546A Programmable Logic Pulser for single pulse or streams (\$150\*) and HP's Logic Probes and Clip for voltage based problems. \*Domestic U.S. prices only.

Northeast, contact Schweber: Westbury, NY; Somerset, NJ; Danbury, CT.  
West, contact Wyle-Elmar: Denver, CO; Mt. View, CA.  
Wyle-Liberty: Seattle, WA; Phoenix, AZ; San Diego, CA; El Segundo, CA.  
Elsewhere, contact your nearby HP sales office, or write.

HEWLETT  PACKARD

1507 Page Mill Road, Palo Alto, California 94304

Circle 20 on reader service card

## 1977 Answer Book. It makes your job easier. \$25.

Who makes what? Over 4000 products, more than 5000 manufacturers with their local contracts and distributors, directory of trade names and catalogs, post-paid inquiry cards for 5-second ordering of current catalogs.

**Electronics Buyers' Guide**  
1221 Ave. of the Americas  
New York, N.Y. 10020

Yes, send me a copy of The Answer Book. I've enclosed \$25 (USA and Canada only, elsewhere send \$35).  
Full money back guarantee if returned within 10 days.

Name \_\_\_\_\_

Company \_\_\_\_\_

Street \_\_\_\_\_

City \_\_\_\_\_

State \_\_\_\_\_

Zip \_\_\_\_\_



World Radio History

## Meetings

**International Conference on Nuclear and Space Radiation Effects**, IEEE, College of William and Mary, Williamsburg, Va., July 12 - 15.

**IEEE Power Engineering Society Summer Meeting**, IEEE, Maria Isabel Sheraton and Camino Real Hotels, Mexico City, Mexico, July 17 - 22.

**Summer Computer Simulation Conference**, ISA, IEEE, et al., Hyatt Regency O'Hare Hotel, Chicago, July 18 - 20.

**1977 International Conference on Crime Countermeasure Science and Engineering**, IEEE et al., Oxford University, Oxford, England, July 26 - 29.

**ACM-Pacific 77 - Exploring the Small Computer**, ACM, LeBaron Hotel, San Jose, Calif., July 28 - 29.

**Electromagnetic Compatibility Symposium**, IEEE, Olympic Hotel, Seattle, Wash., Aug. 2 - 4.

**IFIP Congress 77**, International Federation for Information Processing (Toronto, Ont., Canada), Royal York Hotel, Toronto, Aug. 8 - 12.

**Medinfo 77 - World Conference on Medical Informatics**, International Federation for Information Processing, Harbour Castle Hotel, Toronto, Ont., Aug. 8 - 12.

**Conference on Active Microwave Semiconductor Devices and Circuits**, Cornell University, Ithaca, N.Y., Aug. 16 - 18.

**NBS Seminar on Time and Frequency: Standards, Measurements, and Usage**, National Bureau of Standards, Boulder, Colo., Aug. 22 - 26.

**Product Liability Prevention Conference**, IEEE, New Jersey Institute of Technology, Newark, N.J., Aug. 24 - 26.

**Intrasociety Energy Conversion Engineering Conference**, IEEE, Sheraton Park Hotel, Washington, D.C., Aug. 28 - Sept. 3.

# What we put in makes ours better

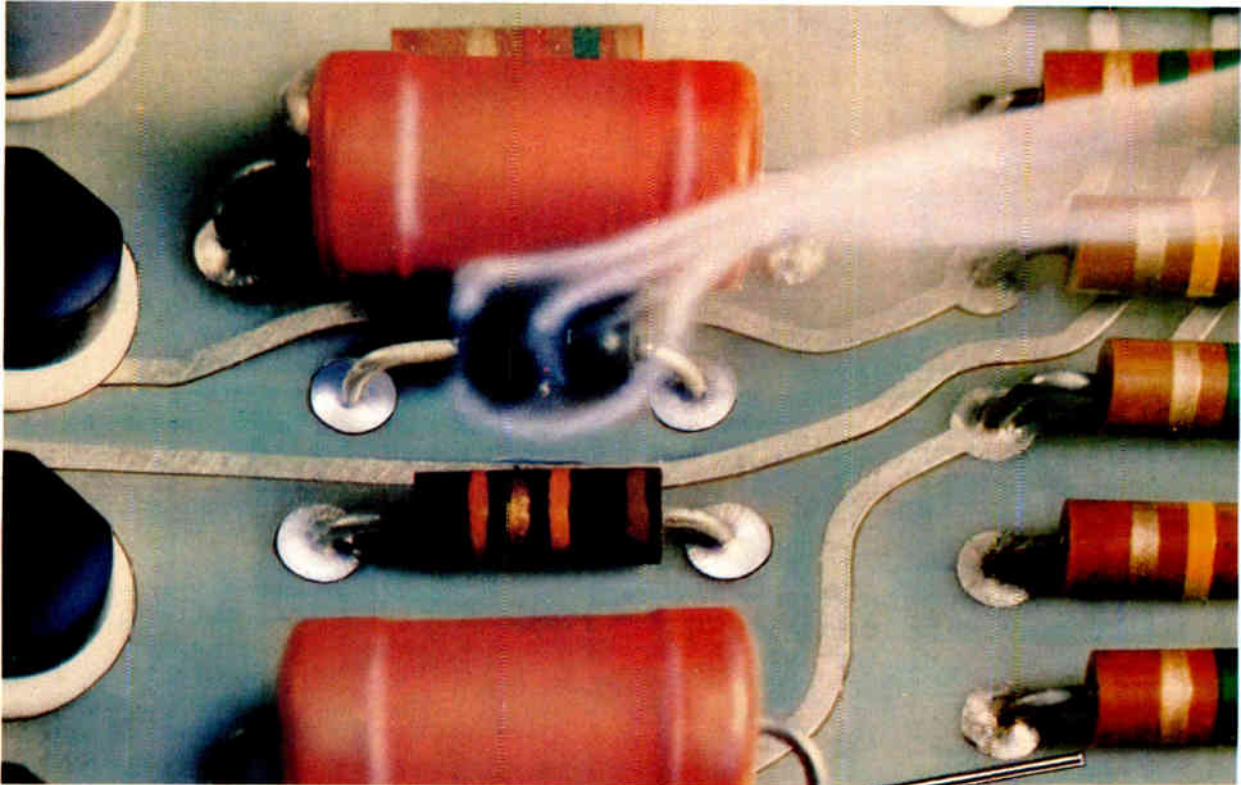

 **That's why this  
can't happen with **SUPERECTIFIER****

The one thing worse than component failure is a component failure that destroys the equipment. That's why GI makes SUPERECTIFIER. Our epoxy encapsulation is flame retardant and UL Listed, so your equipment will never go up in smoke. But we didn't stop there.

First we eliminate component failures caused by the stresses of automatic insertion and wave soldering by metallurgically bonding—brazing both the junction and leads at greater than 600°C. No soft solders. No pressure contacts. And no environmentally created intermittents.

Then we build in extra quality—exceeding military reliability and environmental requirements by glass passivating the junction with our patented glass compound. Then and only then do we encapsulate to give you uniform size, clear marking and easy handling. And finally we put in our low, low price. So why pay more when you get it all in SUPERECTIFIER.

Call or write for our complete catalog today.

**SUPERECTIFIER—**  
as good as if you designed it yourself.

**GENERAL INSTRUMENT CORPORATION**  
**DISCRETE SEMICONDUCTOR DIVISION**  
600 West John Street, Hicksville, New York 11802 (516) 733-3333

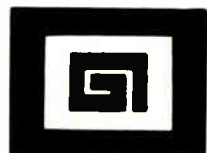

# More weapons for The Battle of the 80's

**Now a multiple attack against outmoded,  
large and bulky microcomputers.**

This multiple attack features a stand alone Microcomputer Board, Zilog's mighty MCB, that has the capability to communicate with both serial and parallel I/O devices, has its own RAM and ROM capability and is backed up by a second board containing a disk controller and additional memory allowing the use of Zilog's complete disk operating system and applications' software.

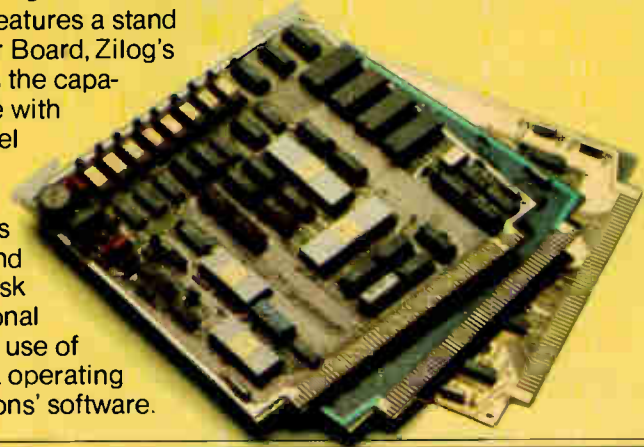

## Announcing the Z80-MCB. An assault against big board computers.

A single 5-volt power supply does it. And it's small—only 7.7 x 7.5 inches with a standard 122 pin edge connector with 100 mil spacing that is designed for ease of use.

## A squad of fighters against obsolete hardware.

Here's what Zilog's new weapon gives you:

- Z80-CPU single-chip n-channel processor with 158 instructions.
- 19.6608MHz crystal oscillator divided to 2.457MHz for Z80-CPU operation and dividable by Z80-CTC to provide any other desired system frequencies.
- 4K bytes dynamic RAM.
- Capacity for 4K bytes on non-volatile memory.
- Programmable serial I/O port with RS-232 or current loop interface.
- Universal parallel I/O with two independent 8 bit ports.
- Z80-CTC for programmable baud rate generation or other user functions such as real time clock.
- Bus drivers are provided for memory and I/O expansion to other boards.
- One-half K-byte monitor software has terminal handler, load and punch routines as well as set and display memory commands. A GoTo command begins execution of user programs. The 1K-byte version adds more debug aids such as set and display registers and breakpoints. The 2K and 4K-byte versions include a floppy disk controller and even more debug capability.

## A second board gives you the advantage.

A second board gives you a 8-drive floppy disk controller and additional RAM backed up by a full disk operating system. Plus, you get the applications software you need: file, edit, assemble, debug, and high level languages such as BASIC, and more will be announced soon. This second board contains 12K of dynamic memory and additional 8 bit programmable parallel I/O ports.

## Additional boards give you expansion capability.

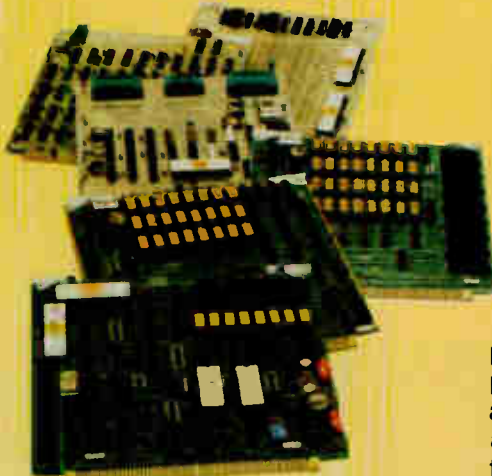

- Z80-RMB Memory Board: Contains 16K bytes of dynamic random access memory along with sockets for up to 8K bytes of ROM.
- Z80-IOB Input/Output Board: Allows the MCB to be expanded via the backplane bus to allow additional I/O interface channels. 64 programmable I/O lines per board.
- Z80-PMB PROM Memory Board: Contains sockets for up to 32K bytes of EPROM or PROM and additional programmable I/O channels.

Circle 23 on reader service card

- Z80-PPB PROM Programmer Board: Allows the user to program PROM's or EPROM's electrically.
- Z80-SIB Serial I/O Board: Provides additional four (4) serial duplex channels.
- Z80-VDB Video Display Board: Interfaces the MCB to a standard video monitor. This board contains 256 bytes of memory and also interfaces to a ASCII standard keyboard.

## A versatility of attack: you can buy only as much as you need.

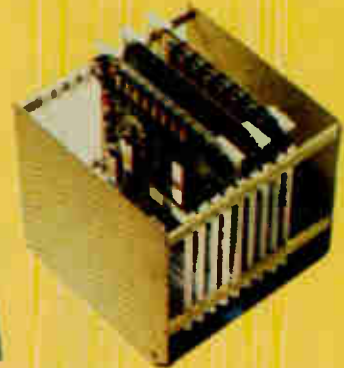

We provide a modular approach to complete computing and processing systems. Zilog products are available as a basic CPU card, a card set or a complete self-contained computer with floppy disks.

Behind all this is Zilog's pledge to stay a generation ahead. We're the specialists who are responsible for the development of the most successful first and second generation microprocessors.



# Zilog

10460 Bubb Road, Cupertino, California 95014  
(408) 446-4666/TWX 910-338-7621

EASTERN REGION: (617) 890-0640

MIDWESTERN REGION: (312) 885-8080

WESTERN REGION: (213) 540-7749

EUROPE (ENGLAND): (0628) 36131/2/3

AN AFFILIATE OF EXON ENTERPRISES, INC.



# Who helps TV get its act together?



Scenes from TV programs do not imply  
an endorsement of EECO products.

Blame it on us. We helped to make today's pre-recorded TV programming possible. We developed a video time code and sophisticated magnetic video tape editing equipment which changed the entire art of editing. And which won a special Citation during the EMMY awards in 1972.

So, almost every time you turn on your TV set, EECO enters your home. We're telling you now because we thought it's time you knew we do more than make thumbwheel switches, tape readers, and packaging hardware.

EECO is part of your life.

## EECO

1441 East Chestnut Avenue, Santa Ana, California 92701 Phone 714/835-6000

Circle 24 on reader service card



## **AMD to make Intel's 8085 micro family**

Intel Corp.'s three-chip 8085 microcomputer family—a minimum-parts enhanced-version of the 8080 system—will get a big boost in the general-purpose 8-bit marketplace. The big Santa Clara, Calif., microcomputer manufacturer has lined up its neighbor, Advanced Micro Devices Inc., as a second source for the new MCS-85. AMD, now a principal alternate source for the 8080, will begin offering the 8085 central processing unit this fall and the other parts of the basic set by year's end.

To overcome AMD's initial resistance to spending the funds required to copy the 5-volt MCS-85 family, **Intel agreed to a product-and-technology package:** AMD gets the 85 family mask sets and test tapes in exchange for a commitment to supply Intel with unspecified 8-bit-compatible peripheral-chip designs. (Intel is already well along in designing a wide range of 8-bit peripherals.) Meanwhile, a second-source agreement, including some technology exchanges, has been arranged with Siemens AG for marketing the MCS-85 family. Japan's Nippon Electric Corp. will also be an MCS-85 supplier, but without a technology exchange agreement. First shipments of the CPU are due in 1978.

## **Circuit from TI could drop price of games to \$10**

Look for video games to go the route of digital watches and calculators, with low-end retail prices dipping under \$10 by Christmas, thanks to a new ball-and-paddle circuit that Texas Instruments Inc. will put into production next month. **At least six games makers plan to use the TI chip in high volume**, including Venture Electronics, Micro Electronic Systems Inc., and Interstate Industries Inc., which showed their versions on the floor of this month's Consumer Electronics Show in Chicago.

Called "Super-Spin" for the wicked arc the ball cuts as its horizontal speed decays, the TI circuit is the first of a family of single-chip parts that next year will include strategy and action games, possibly with on-chip color and digital scoring. The firm is trying to get the total system cost down to \$5 by next year.

## **National chip supplants horizontal, vertical TV controls**

National Semiconductor Corp. has come up with a technique that should make both horizontal- and vertical-hold controls, as well as factory presets, obsolete. It is a simple linear integrated-injection-logic countdown chip that for less than \$1 delivers a phase-locked horizontal scanning frequency and counts down from it to get an injection-locked vertical output pulse.

The key to the synchronization system is a **new 503-kilohertz ceramic resonator**, made by MuRata Corp. of America, Rockmart, Ga., that gives a more accurate initial frequency reference than the LC and RC voltage-controlled oscillators now used. Also, it does not require shielding from the set's yoke, as LC circuits do, and it exhibits more stability over temperature changes, including warmup, than RC oscillators.

## **HP prepares to issue products using SOS circuits**

Hewlett-Packard Co. will introduce "a series of major products" over the next nine months that will use complementary-MOS circuits built with the silicon-on-sapphire process, says executive vice president John A. Young. HP is already producing SOS read-only memories and substituting them for other ROMs in its 2640, 2644, and 2645 general-purpose display terminals to gain firm field-reliability data on the SOS parts. Thus far, says Young, the devices "are meeting our yield estimates and **exceeding the performance results we anticipated.**"

Meanwhile, HP Laboratories in Palo Alto is pursuing bubble memory technology. "The bubble memory will first show up in a terminal product, where small, high-speed memories are required," possibly within the next 12 months, says Young.

**TI, National rush  
to market  
National's op amp**

National Semiconductor's half-dollar LM351 bi-FET op amp [*Electronics*, March 3, p. 26] will have company in the market: Texas Instruments also will have parts next month. The TI version, called the TL076, will be screened from a new TL070 low-noise op amp family. But besides second-sourcing the National device, TI will have a proprietary dual version and two quads, one of which will be pin-for-pin compatible with Raytheon's RC4136, popular in audio systems. Coming in August for its original TL080 series: a low-power unit that pushes power dissipation down to 280 microamperes, a tenth of the figure for earlier parts.

**Intech converter  
balances accuracy,  
speed, and price**

Intech/Function Modules Inc. of Santa Clara, Calif., will soon be offering a 16-bit analog-to-digital converter module with what **promises to be the best compromise among accuracy, speed, and low price** in the business. Designated the A-858-16, the unit typically yields  $\pm 1/2$  least significant bit at 16 bits with  $\pm 3/4$  LSB linearity guaranteed and conversion time of 40 microseconds maximum. Priced at \$425 per single unit, it will offer a range of sample and hold amplifiers.

**National to offer  
easy-to-use, \$1  
transducer chips**

Continuing to pioneer in monolithic transducers, National Semiconductor Corp. of Santa Clara, Calif., will shortly go into production with a pair of low-cost bipolar chips that maintain a tight linearity over a broad range of temperatures. **They are easier to use and cost less than rival devices.** Programmed by an external resistor, one device, the LM134, develops a current that is directly proportional to temperature. The other device, the LM135, behaves like a zener diode, producing a voltage that varies linearly with temperature. Once calibrated at one temperature, military versions of the sensors hold linearity error to within  $1^{\circ}\text{C}$  over the range of  $-55^{\circ}\text{C}$  to  $+125^{\circ}\text{C}$ , whereas commercial versions maintain linearity to within  $2^{\circ}\text{C}$  from  $-25^{\circ}\text{C}$  to  $+100^{\circ}\text{C}$ . The price of the commercial versions will be under \$1 apiece for 100 or more.

**Addenda**

Scientists at Sandia Laboratories report that they have used **electron beams to induce the experimental production of fusion neutrons**. The feat, accomplished for the first time in the U. S., is considered an important preliminary step toward the long-range goal of generating energy by controlled thermonuclear fusion. . . . Ultratech of Santa Clara, Calif., has become **the first mask maker to purchase an electron-beam lithographic system** to make low-defect semiconductor master masks. Previous purchasers have all been semiconductor manufacturers. . . . TRW Inc.'s large-scale-integrated products operation has reduced the power consumption of its 130-nanosecond 8-by-8-bit multiplier to 1.2 watts from 1.8 w.



# Introducing the hungry ECLIPSE.

Data General's new ECLIPSE S/130 computer has a bigger appetite for work than any other mid-range mini. And enough speed and versatility to wolf down any kind of data you have to dish out.

The hungry ECLIPSE computer is built around the same powerful architecture as our super high-speed ECLIPSE S/230. Added to that is a host of special features that make the hungry ECLIPSE unique. Like our fast micro-coded floating point and efficient character string instruction sets. And our second-generation WCS general-purpose user microprogramming ability that results in unmatched throughput in demanding applications. To top it off it also includes AOS, our amazing new heuristic multi-programming advanced operating system, and of course the full range of Data General's economi-

cal big-computer peripherals, software and worldwide support.

Now, you don't have to skimp along with an undernourished mini that's too limited for your work. Or splurge on one that's too fat just to get the performance you need. Just order an ECLIPSE S/130 computer. It will make your work load a lot leaner. Want more food for thought? Send for our brochure.

- Send your S/130 brochure.  
 Send your S/130 brochure and have your sales representative call.

Mail to: Data General, Westboro, MA 01581

Name \_\_\_\_\_

Title \_\_\_\_\_

Company \_\_\_\_\_

Address \_\_\_\_\_ Tel. \_\_\_\_\_

City \_\_\_\_\_ State \_\_\_\_\_ Zip \_\_\_\_\_

ECLIPSE is a registered trademark of Data General Corporation.  
 © Data General Corporation, 1977

**Data General**  
 It's smart business.

Circle 27 on reader service card

Data General, Westboro, MA 01581, (617) 366-8911. Data General (Canada) Ltd., Ontario.  
 Data General Europe, 15 Rue Le Sueur, Paris 75116, France. Data General Australia, Melbourne (03) 82-1361.

# The only Double-Balanced Mixers with a 2-YEAR GUARANTEE

featuring Hi-Rel tested diodes-

still only

# \$7.95

(500 pieces)

\$9.95 (1-49)

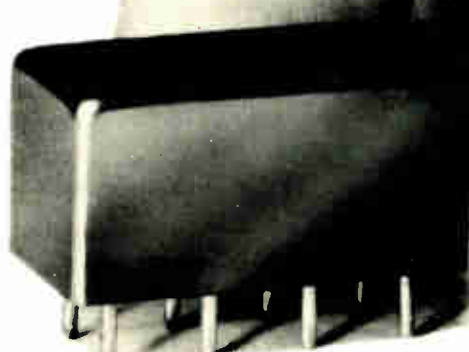

\*including diodes!

Yes, a two-year guarantee for DBM's is now a reality . . . made possible by an accelerated-life diode screening program adopted at Mini-Circuits.

Each Schottky diode used in Mini-Circuits' SRA-1 mixers is now preconditioned by the HTRB (High Temperature Reverse Bias) technique, previously reserved almost exclusively for semiconductors assigned to space applications. With HTRB testing, each diode is operated for 168 hours at 150°C with one volt reverse bias applied.

To screen out "infant mortality", the diodes are deliberately stressed to accelerate aging and to force time-related failure modes to take their toll. In conventional testing or "baking", the diode does not experience anywhere near the stress encountered with the HTRB program. Hence, the ability at Mini-Circuits' to locate the potentially-unreliable diodes before they are assembled into SRA-1 units. And, with double-balanced mixers, the overall reliability hinges almost entirely on the diodes used.

Yes, the HTRB procedure costs us more and screens out more devices. But our goal is to improve reliability to a level unmatched for off-the-shelf DBM's at no increase in cost to our customers. You — our customers by your overwhelming confidence in our product line have made us the number one supplier of DBM's in the world.

To earn your continuing support, we are now employing HTRB Hi-Rel testing for every diode used in the SRA-1, at no increase in cost to you. So, for the same low price of \$7.95, you can purchase our SRA-1, with a two-year guarantee, including diodes.

To ensure highest system reliability demand highest quality diodes on your source-control drawings and purchase orders. Specify SRA-1 mixers, with HTRB tested diodes from Mini-Circuits' . . . where low price now goes hand-in-hand with unmatched quality.

#### MODEL SRA-1

Freq. range (MHz) LO: 0.5-500. RF: 0.5-500. IF: dc-500

Conversion loss (dB)	Typ.	Max.
One octave from band edge	5.5	7.0
Total range	6.5	8.5
Isolation (dB)	Typ.	Min.
Lower band edge to:		
LO-RF	50	45
one decade higher	LO-IF	45
Mid range	LO-RF	45
	LO-IF	40
	LO-RF	35
	LO-IF	30

Upper band edge to:

one octave lower LO-IF 30 20

Min. Electronic attenuation (20 mA) 3 dB

Signal, 1 dB compression level + 1 dBm

Impedance all port: 50 ohms



World's largest manufacturer of Double-Balanced Mixers

## Mini-Circuits

MINI-CIRCUITS LABORATORY

837-843 Utica Avenue, Brooklyn, NY 11203 (212) 342-2500 Int'l Telex 620156 Domestic Telex 125460

99 Alexander Street, New South Wales, Australia 2265 □ ENGLAND: Dale Electronics, Dale House, Wharf Road, Kluwerstrasse 14 □ EASTERN CANADA: B.D. Hummel, 2224 Maynard Avenue, Utica, NY 13502 (315) 736-7821 □ NETHERLANDS, BELGIUM, LUXEMBOURG: Comex, Veldweg 11, Hatterem, Holland □ NORWAY: Datamatik AS, Ostensjoveien 62, Oslo 6, Norway □ SWEDEN: Integerad Elektronik AB, Box 41, S-182 51 Djursholm, Sweden □ AFRICA: Alitra (PTY) Ltd, P.O. Box 9813, Johannesburg 2000, S. Africa □ SINGAPORE & MALAYSIA: Electronics Trading Co. (PTE) Ltd, 87 Bukit Timah Road, Singapore 9, Malay Peninsula □ INDIA: Gaekwar Enterprise, Kama Mahal, M.L. Dananukar Marg, Bombay 400 026, India □ ISRAEL: Vectronics Ltd, 69 Gordon Street, Tel Aviv, Israel

U.S. Distributors: □ NORTHERN CALIFORNIA: Cain-White & Co., Foothill Office Center, 105 Fremont Avenue, Los Altos, CA 94022 (415) 948-6533 □ SOUTHERN CALIFORNIA, ARIZONA: Crown Electronics, 11440 Collins Street, No. Hollywood, CA 91601 (213) 877-3550

For other Mini Circuit Lab Products See ADS on pgs. 1, 45, 50, 51.

MICROWAVES is published monthly except two issues in June, by Hayden Publishing Co., Inc., 50 Essex Street, Rochelle Park, NJ 07662. Controlled circulation postage paid at Waseca, MN, New York, N.Y. and Hammond, IN, postage pending at Easton, PA.

World Radio History

Circle 28 on reader service card

## V-MOS process gets first test in new memories

Coming in July is 45-ns 1-k static RAM, to be followed soon by 4-k part with access time of under 100 ns

American Microsystems Inc.'s \$10 million investment in v-MOS is about to be tested with a wide range of memory products. With its V-groove metal-oxide-semiconductor process, AMI hopes to be at the cutting edge of semiconductor product design and alter its somewhat disappointing performance in standard digital products over the last two years.

The timetable for the new devices has them coming hot and heavy. Next month, the Santa Clara, Calif., manufacturer will sample a \$6.20 (in quantities of 100 and up) 45-nano-second, 1,024-bit static random-access memory. This will soon be followed by an under-100-ns, 4,096-bit static RAM. Application for these high-speed statics will be in the big mainframe buffer and cache memory designs now served by bipolars.

In read-only memories, a 16,384-bit ROM is now being sampled, with higher-density 32,768- and 65,536-bit versions in development. Coming also is an 8,192-bit static RAM; a 16-k electronically programmable ROM using a proprietary v-MOS-related, floating-gate design; and a series of very-high-speed, high-density, and low-power dynamic RAMs.

**Impressive.** What is particularly impressive about the v-MOS parts is that even AMI's first-generation devices, built with relaxed 5- and 10-micrometer photolithographic techniques, offer significantly higher

performance than production second- and third-generation designs done in more conventional n-channel MOS. For example, the fastest 1-k and 4-k n-MOS statics typically operate with an access time of about 150 ns.

But perhaps even more important, AMI's v-MOS process will quickly undergo next-generation iterations using 4- $\mu$ m fabrication rules that will increase the performance by 50% while reducing chip sizes and therefore costs by the same amount [*Electronics*, March 3, p. 32].

Key to the high performance of the new family of devices, says Robert Yu, memory engineering design manager, is the vertical n-channel MOS transistors with gates formed on the face of V-shaped grooves etched in the silicon. The advantage, says Yu, comes from the fact that the v-MOS transistor has a short (about 1- $\mu$ m) channel length

that is achieved by diffusion and not by stretching lithography. Moreover, the structure lays out efficiently; a typical transistor has a 25- $\mu$ m channel width, though the surface V-groove gate area is only 10 by 10  $\mu$ m.

Very little scaling is being used in the first generation of devices. For example, the 4-k static RAMs now being sampled measure about 89 by 155 mils. In the improved versions, chip size will be reduced to about 89 by 117 mils. "And this is with very little tweaking and scaling," says Yu. "Where present n-MOS techniques are starting to run out of gas, v-MOS is just gathering steam."

**Comparison.** Terry Holt, department manager for memory engineering at AMI, says, "With v-MOS we expect this year and next to be where our competition will be, in terms of performance, two and four

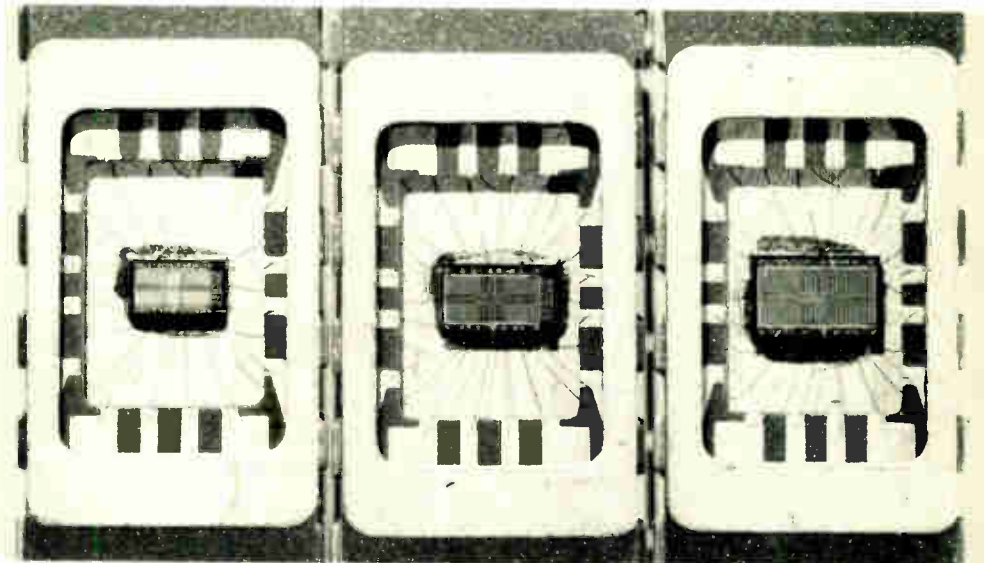

**V-MOS.** AMI will supply samples of its 1-k S4015-3 static RAM with 45-ns access time, shown unpackaged at right. RAMs to come have access times of 35 ns, middle, 28 ns, left.

### How AMI does it

Although at first glance V-metal-oxide-semiconductor circuit devices may appear more complex than ordinary silicon-gate devices, the critical processing steps in V-MOS, after the initial wafer processing, are really no harder than the critical steps in high-performance n-channel processing.

Easiest to build are V-MOS read-only memories, where the cell is basically an array of V grooves at the intersection of narrow interconnection lines. One set of interconnections are the diffused bit lines, which are also the drains for the V-MOS transistors, and the other set are the polysilicon gates. A seven-mask grounded-source V-MOS process features selective oxidation; it needs one more mask than ROMs made with depletion-load MOS processing.

For dynamic random-access memory, cells are built with a six-mask metal-gate process that relies on floating-gate structures to get around the grounded-source limitation of V-MOS ROMs. It is done by adding diffused buried layers, which then double as dynamic RAM storage capacitors. For static RAMs, American Microsystems Inc. uses a conventional six-transistor cell in which ion-implanted n-MOS devices serve as pass gates for unselected cells, two V-MOS transistors are cross-coupled with polysilicon-to-diffusion contacts for storage control, and n-MOS loads and resistor-aligned n-MOS devices are used as pass gates for transferring data to the bit lines.

To fabricate V-MOS erasable programmable ROMs, an extra layer of polysilicon is added to the grounded-source process. Like conventional double-polysilicon erasable PROMs, the chip is programmed by injecting hot electrons from the channel of the selection device, through a gate oxide, into a floating gate. But whereas the standard process requires a 27-volt programming voltage, V-MOS erasable PROMs require only a 15-V pulse.

years from now. Nevertheless, AMI can expect intense competition in these new high-performance markets. For example, Intel Corp., with an extension of silicon-gate n-channel processing, which the company calls H-MOS for high-performance MOS, is already sampling a 4-k static RAM that operates at 45 ns typically and at 70 ns maximum. It has also introduced a 16-k erasable, programmable ROM that requires

only a single 5-volt supply.

Meanwhile, Fairchild Camera and Instrument Corp., Mountain View, Calif., booster buffer memory performance with new 93470 and 93471 4-k static transistor-transistor-logic parts that have typical access times of 30 to 35 ns. And for fast main-frame designs, Fairchild has its 4-k and 16-k dynamic RAMs sporting access times well below 100 ns built with its Isoplanar process. □

---

### Microwaves

---

## Gallium-arsenide field-effect transistors are reaching new highs in power, frequency

Compact and versatile solid-state phased-array radar systems are exactly what the U. S. Air Force and Navy want for frequencies up through X band (8 to 12 gigahertz). But the missing link for such systems has been a source that meets power and bandwidth requirements with reasonable efficiency. Enter the gallium-arsenide field-effect transistor, which, military spokesmen say,

“looks like it will be that source.”

The services' optimism is based largely on work at Texas Instruments Inc.'s Central Research Laboratories in Dallas. William Wisseman, manager of the labs' advanced microwave components branch, claims: “GaAs power FETS make active element phased-array radars feasible at X band.” What's more, he says, the devices “will be a

primary source of microwave power at frequencies from 4 to 30 GHz.”

Wisseman's conviction that the gallium-arsenide devices will replace Gunn and Impatt diodes in many systems operating at X band is based on the performance they recently achieved under a pair of Air Force and Navy contracts. As part of a \$650,000 Air Force-funded effort, TI's GaAs power FETS delivered 3.2 watts at 10 GHz with 6-decibel gain and 22% efficiency. “We're getting 5.1 w out of a single device at 8 GHz with 5-dB gain and 35% efficiency,” Wisseman says.

Under a \$158,000 Navy contract, TI has obtained 1.3 w with 20% efficiency and 19.2-dB gain over a 9-to-10-GHz range from a breadboarded three-stage driver portion of a four-stage amplifier. The goal is 5 w at X band with 25-dB gain and 20% efficiency. The five-year program, begun last October, ultimately calls for “building a 100-element-or-so phased-array radar,” states Eliot Cohen, the project manager of the first phase of the program at Naval Research Laboratories in Washington, D. C. RCA Laboratories, Princeton, N.J., is working in parallel with a similar award.

Until the GaAs FETS came along, “the only way to get a phased-array radar at X band was with vacuum tubes—but these are much narrower-band systems,” continues Cohen. Earlier solid-state attempts included the use of lower-frequency S-band transistor amplifiers with frequency multipliers to reach X band. But these “didn't give us the efficiencies or bandwidth we wanted. GaAs FETS are particularly attractive because they combine the power, efficiency, and bandwidth we want in one device.”

According to Cohen, TI is presently achieving higher device power levels than RCA at 8 GHz and above, but things could change. “We're concentrating our efforts now on designs that are reproducible, reliable and, eventually, low in cost,” says Fred Sterzer, director of RCA Laboratories' microwave technology center. Thus far, RCA has achieved over 1 w at 10 GHz with a 16-gate

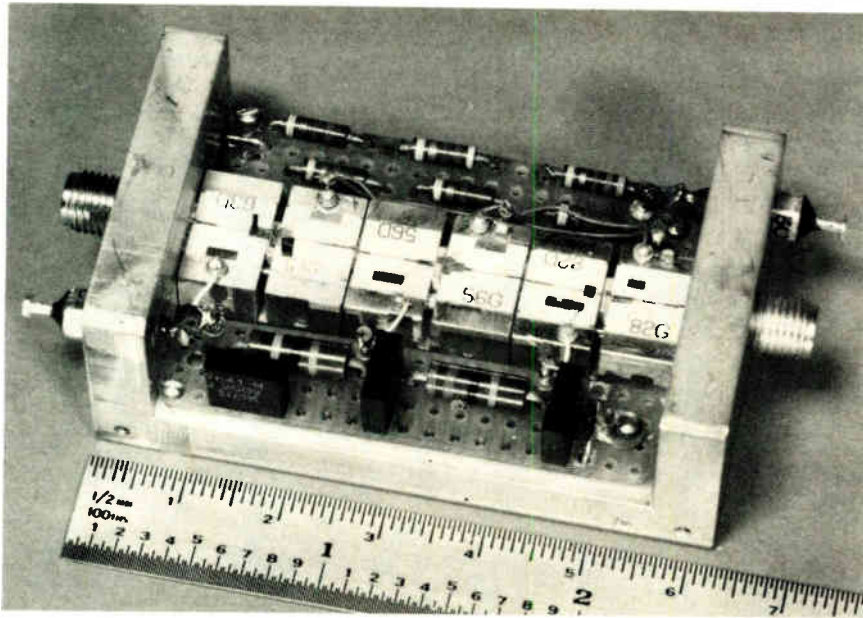

**Breadboard.** TI's three-stage GaAs FET driver amplifier yields 1.3 W cw, 19.2-dB gain at 9 to 10 GHz. White areas are alumina microstrip impedance-matching networks.

device and 4 w at 4 GHz with a 48-gate device. The more gates, the greater the power-handling capability of the device.

TI still has 10 months to go on its two-year Air Force program. According to Chern Huang, project engineer at the Air Force Avionics Laboratory at Wright-Patterson Air Force Base, Ohio, TI will demonstrate the power capability of GaAs FETs by producing lab devices that deliver 4 w continuously and 6 w pulsed at X band with 25% efficiency. It will also try to establish the ability to build some numbers of GaAs FETs that deliver 1 w cw and 2 w pulsed at 10 GHz with 20% efficiency and 6-dB gain. Also, Huang points out, TI will apply the GaAs FETs in subsystems, including in addition to amplifiers for phased-array radar, broad-band amplifiers for driving higher-power traveling-wave tubes for electronic countermeasures, and a voltage-controlled oscillator for detector systems now using Gunn oscillators.

**Price cut.** Perhaps indicating what can happen to the cost of the GaAs FETs, TI plans to reduce prices this summer by more than 75% on its optically defined line of commercial devices. (The new, higher-power devices are made with 0.5-to-1.0-

micrometer-wide gates defined with electron-beam techniques; self-aligning optical techniques could also meet the dimensions but are more complex, according to Wisseman.)

The price of TI's MSX803, which delivers 1 w at 8 GHz, will be slashed from \$1,000 to \$250 in lots of 1 to 9, with similar reductions for lower-power GaAs FETs. "I would anticipate that TI will offer a 2-w-at-8-GHz electron-beam-defined GaAs power FET before the year is out," Wisseman says. "While the price is not set, it likely will be between two and three times that of the 1-w devices," or about \$500 to \$750. □

## Consumer

### TI makes noise in games, toys

Texas Instruments Inc. has come up with a cheap way to add bells and whistles to consumer products. It is a complex-sound generator, and the firm is using a combination of bipolar linear and integrated-injection-logic techniques to yield a single chip that the user can program—with external resistors and capacitors—to deliver almost any sound.

The circuit, which will be available later this month, was designed for the video-game market, but it is tagged at \$1 in production volumes—inexpensive enough, TI hopes, for the price-conscious toy market as well. "It will be affordable not only for games, but for toy cars, helicopters, organs, dolls, horses, or anything, in fact, that makes a noise," says Ron Johns, manager of the company's consumer circuits department in Lubbock, Texas. It can be used in any application that requires audio feedback to the operator, he stresses, adding that he has already pocketed an order from an appliance manufacturer. Uses in consumer and industrial equipment could include alarms on timers and controls, he says.

**Tailoring.** By varying the values of adjustable external components, toy and equipment makers can get the custom sounds that distinguish their products from others on the market. Adding logic to switch in different sets of components produces different sounds for the same product. For example, a video-game manufacturer can generate the pulsating sound of an airplane engine, followed by the shrill wail of a bomb dropping, followed by an explosion. This switching logic must now be implemented by the manufacturer, although TI is designing a programming chip that, when mated with the sound generator, will give a series of about eight standard sounds.

TI provides three different on-chip sound-generation circuits—a super-low-frequency oscillator, a voltage-controlled oscillator, and a noise-generation system that consists of a noise oscillator to supply random frequencies to a noise generator and a noise filter to round off the square-wave output of the noise generator. These are shown in the block diagram on page 32. All three are fed to the chip's 1<sup>1</sup>L mixer, which selects either one or any combination of the three inputs and feeds it to the circuit's envelope generator and modulator.

The voltage-controlled oscillator circuitry, for example, produces a tone that is dependent on the voltage

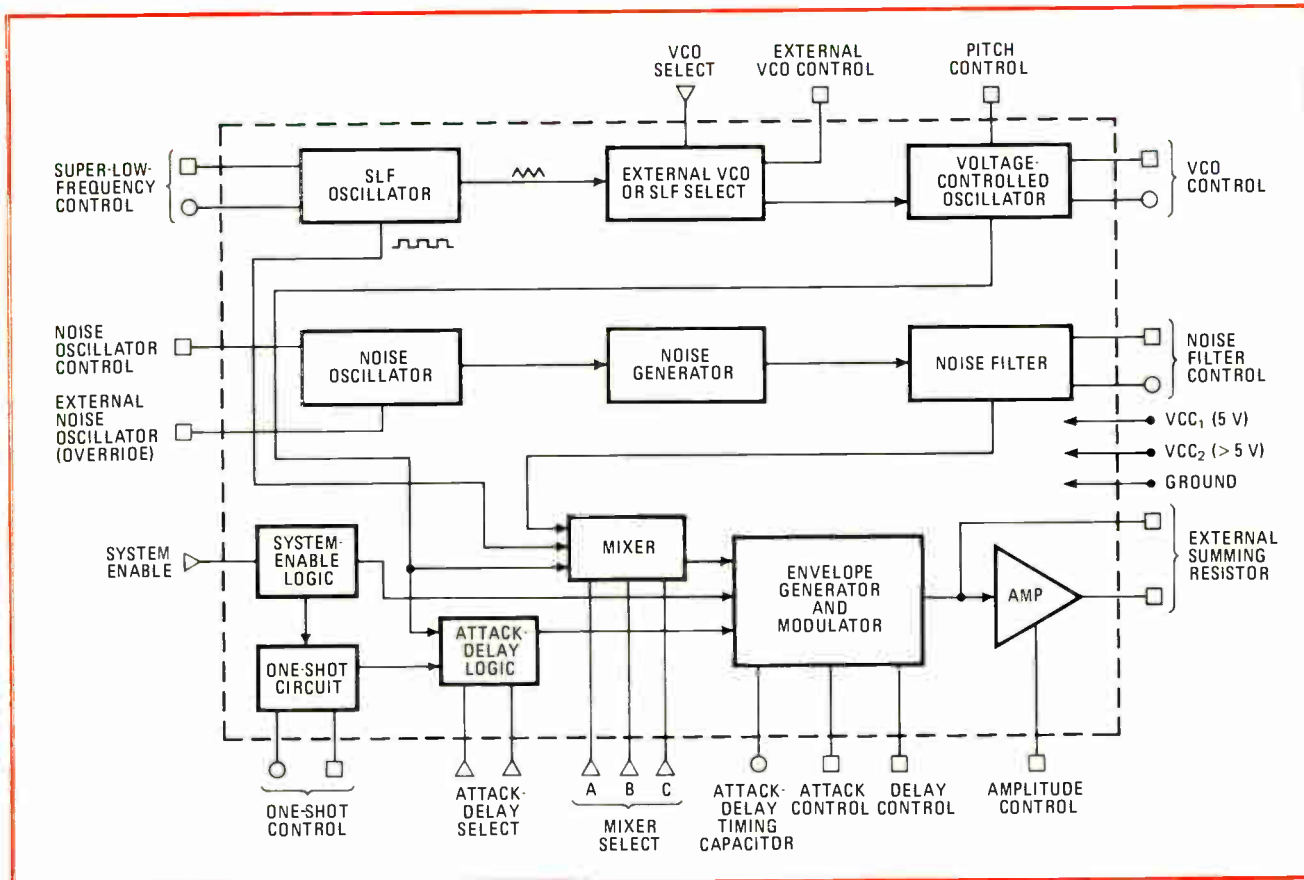

**Noisemaker.** Sounds produced by Texas Instruments' one-chip sound generator depend on input voltages set on resistors (squares), capacitors (circles), and logic levels (triangles). The hope is that the chip's \$1 tag will make it attractive for both toy and game markets.

fed to its input: the higher the voltage, the lower the frequency. By using the triangular-wave output of the super-low-frequency oscillator at the vco input, the circuit will produce an oscillating frequency for, say, a siren. The 28-pin device also has an external vco control pin to which a dc voltage can be applied to give a single tone, or any type of waveform can be used to get a frequency-modulated output.

The chip also contains one-shot logic for producing sounds that last less than two seconds, such as bells, gunshots, or explosions, rather than the continuous sound of, for example, a train or car engine or a siren. Logic on the chip determines the envelope, or amplitude-time relationship, of the mixer's output, and circuitry within the chip's envelope generator section tailors the rise and fall time of the envelope to produce the desired sound.

The resulting sound is fed to the

chip's output amplifier, which is designed to interface with sound modulators, or additional amplifier stages. Though the chip has input pins for control resistors and capacitors, the user would only rarely use all of them to generate his sounds, Johns points out. And where the user needs the chip for a single, dedicated sound, the seven logic input pins can be hardwired for either high or low logic levels. □

## Home VTR offense kicks off in fall

This fall when the new television programming season gets under way, a growing number of home videotape record and play units will be on the receiving end. Almost all of the TV set makers, U. S. and Japanese, have now made commitments to market one of the Japanese-devel-

oped, 1/2-inch VTR formats, and at the recent Consumer Electronics Show in Chicago, home VTR makers agreed that demand will outstrip supply.

This year, probably about 225,000 units will be sold, but the figure should jump to 750,000 or more units by 1978 and climb into the million-plus neighborhood by 1979 as prices drop. So far, only Sony Corp., with its \$1,300 Betamax, and Quasar Electronics, with its \$995 VX-2000, have had any experience selling systems in the home VTR market.

**Others plunging.** That is going to change rapidly as the others plunge in between now and Christmas. Prices for VTRs will probably stay around \$1,000 while the VTR firms get a foothold. "The magic number—the price at which these products will really begin to take off—is around \$700," points out Richard F. O'Brien, vice president



# On the balance a T900-Series Oscilloscope gives you the most performance for your dollar

Low-cost oscilloscopes traditionally offer a compromise in performance in return for low price. Over-simplified circuits reduce accuracy and require frequent calibration. Cost cutting in the selection of components limits reliability. With many low-cost scopes, the specs are there, but the performance isn't.

There are no compromises with TEKTRONIX T900-Series Oscilloscopes. No corners have been cut where accuracy and reliability are concerned. And with six models to choose from, you can match the performance you require with your budget. Bandwidths range from 10 to 35 MHz. Four T900 Scopes feature dual trace and one has single shot storage. A rackmount model is also available.

The 35 MHz T935 with dual input channels and delayed sweep is well suited for the design, production and service of computer peripherals, point-of-sale terminals, machine controls and communications equipment.

The dual channel, 15 MHz T922 is an excellent choice for classes in basic electricity and electronics. The large, bright 8 x 10 cm display makes classroom demonstrations more visible. The easy-to-use control layout makes learning signal measurement techniques simple and straightforward.

When you buy a T900-Series Oscilloscope, you also receive the full support of the Tektronix worldwide sales and service organization. T900 Accessories include a wide selection of probes, a low-cost camera, a versatile stand for convenient scope positioning and a viewing hood.

Performance, reliability and service. That's why Tektronix is setting new standards for low-cost oscilloscopes.

- T921—DC to 15MHz; single trace, mono time base . . . . . \$ 695\*
  - T922—DC to 15 MHz; dual trace, mono time base . . . . . \$ 850\*
  - T932—DC to 35 MHz; dual trace, mono time base . . . . . \$1195\*
  - T935—DC to 35 MHz; dual trace, with delayed sweep. . . . . \$1395\*
  - T912—Storage Model, DC to 10 MHz; dual trace, mono time base . . . . \$1300\*
  - T922R Rackmount—DC to 15 MHz; dual trace. . . . . \$1175\*
- Voltage probes are included on all T900 Oscilloscopes except the T922R.

For complete specifications on the T900 Oscilloscope Family, contact your Tektronix Field Engineer. Or write Tektronix, Inc. P.O. Box 500, Beaverton, OR 97077. (503) 644-0161, Ext. T900. In Europe, write Tektronix Limited, P.O. Box 36, St. Peter Port, Guernsey, Channel Islands.

\*U.S. sales prices are F.O.B. Beaverton, OR. For price and availability outside the U.S., please contact the nearest Tektronix Field Office, Distributor, or Representative.



**Tektronix®**  
COMMITTED TO EXCELLENCE

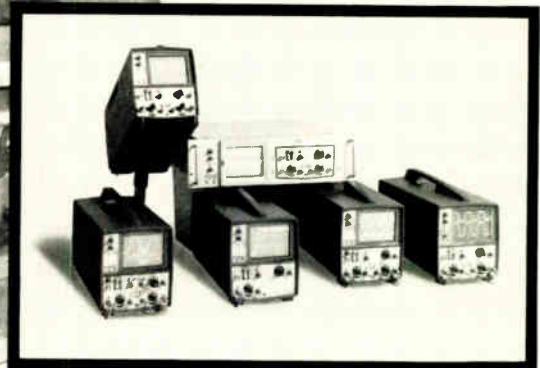

For Technical Data circle 33 on reader service card  
World Radio Review Demonstration circle 32 on reader service card

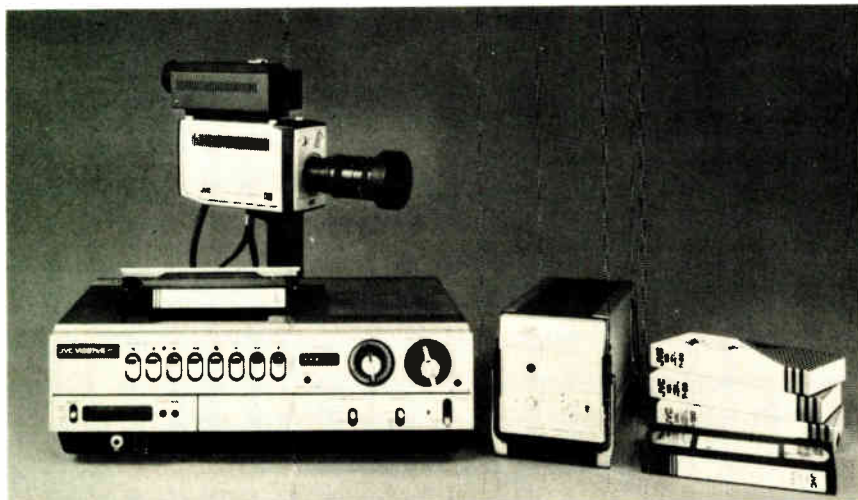

**Home VTR.** JVC Industries will market two-hour Vidstar VHS video-tape recorder for \$1,280, as well as a single-tube color television camera and blank tape cassettes.

for marketing of JVC Industries Co., Maspeth, N. Y., a subsidiary of Victor Company of Japan Ltd. "But I don't think it's going to be easy to get that price down very quickly unless some maker decides to start selling at a loss."

**Incompatible designs.** In the meantime, the competitors will be jockeying to establish favorable market positions, hoping that the lack of a standard design does not confuse consumers. The differences are largely on the mechanical side, with the systems each feeding the tape in and out of the cassette differently. There are also variations in tape speed. The one-hour JVC tape runs, for example, at 33.35 millimeters per second, Sony's Betamax at 40 mm/s, and Matsushita Electric Industrial Co.'s VX-2000 at 52.1 mm/s. Moreover, the Sony format has a more complicated read-head mechanism than Matsushita's.

**Opposite sides.** The two biggies in color TV, RCA Corp. and Zenith Radio Corp., are on opposite sides. Starting in August, RCA will market the video home system in a two- and four-hour format made for it by Matsushita. The unit has a slowed-down tape speed to accomplish the four-hour play. Zenith is committed to market one- and two-hour Beta-format units made to its specifications by Sony. Zenith's VCR system will also have a black-and-white camera and sound attachment. Nei-

ther Zenith nor RCA has announced prices yet.

Both GTE-Sylvania and Magnavox have opted for Matsushita's four-hour VHS equipment to be marketed late this fall. Admiral and General Electric have made no announcements yet.

Of course, the Japanese producers will also be selling VTRs with their own brand names in the U. S. Besides Sony, Sanyo, Toshiba, and Pioneer will be using the two-hour Beta format. JVC plans to have 4,500 to 5,000 units available in this country by October. Price for the two-hour Vidstar VHS deck is \$1,280. Cassettes will be \$19.95 for two hours, \$15.95 for one hour, and \$11.95 for a half hour.

Panasonic, Hitachi, Sharp, and Mitsubishi will sell four-hour units made by Matsushita. Meanwhile, Quasar, which is part of Matsushita, will continue to market the single-videohead VX 2000 originally developed in Japan by Matsushita as an under-\$1,000 alternative.

What about video disks? Says Jack Sauter, marketing manager for RCA's Consumer Electronics division, "There's no reason why the VTR and the disk cannot stand together in the market. The disk will be a low-cost means of playback, and the tape will offer record and play." RCA, he states, will continue to develop its capacitive video disk, to be introduced sometime next year. □

## Navigation

### LSI-11 to help steer America's Cup boats

Microcomputers will probably be plotting courses in this year's America's Cup yacht race, scheduled for September off Newport, R. I. Out of the six sailing vessels already competing in trials to determine the two finalists, three are using Digital Equipment Corp.'s LSI-11 to help the navigator determine such things as the boat's position and the true wind speed and direction.

Usually, the navigator is too busy figuring these critical race factors on a scientific calculator to offer much of his sweat and muscle in actually helping sail the 12-meter-class sloop. Peter Lawson, however, is looking forward to being a more useful crew member. Lawson is navigator of *Independence*, one of three U. S. sloops competing for the honor of defending the America's Cup.

**Automatic.** "I like to sail, and the computer will allow me to do more of that," Lawson says. Data from the boat's sensors are digitized and fed into the 16-bit LSI-11 automatically. Previously, Lawson had to feed data to his desk-top calculator by hand. The computer gives him information faster, providing solutions to problems that will influence his skipper's tactics. Such problems might include how to turn, or "tack," and in which direction, and what sail combination might be best.

Lawson's *Independence* has been dueling with *Courageous*, 1974's successful U. S. defender, in match races off Marblehead, Mass. *Courageous* carried a Data General Nova minicomputer in 1974. This time out, *Courageous* is using the LSI-11. So is *Sverige*, the Swedish entry.

The microcomputers are protected against salt water by specially designed aluminum boxes, points out Robert Brick, new account manager for the LSI-11 at DEC in Marlboro, Mass. Military-type connectors funnel cable in and out of the under-15-pound boxes. Sensors and instru-

# Put the world's largest CMOS capacity to work on your LSI needs.

What do you look for when choosing a CMOS LSI supplier? Probably a supplier with proven capability in CMOS and the resources to handle high-volume projects without jeopardizing deliveries. **That's Motorola.**

Motorola delivered more CMOS in '76 than anyone else, from an unmatched line of standard logic and special equipment-oriented functions. **That's proven capability.**

New capacity at our facility in Austin, Texas, gives Motorola the world's largest CMOS capacity. It's on board and ready to meet your needs for custom or standard LSI. **That's resources.**

Motorola was a pioneer in CMOS circuits for digital watches, and we're still state-of-the-art with our latest: MC14470, MC14480, 81, and 82. Our MC14433 single-chip 3½ digit A/D converter brought a new dimension to digital meters, and a new dimension to putting linear and digital CMOS together on one chip, with op amps alongside gates. We've continued this linear/digital combination, at even lower power, with the MC14461 CMOS smoke detector IC. Since these wafers roll off the same lines as our high volume digital CMOS, it's a high-confidence, high-reliability process.

When it comes to telephones, we've had the right numbers all along with our standard MC14408, 409, 410 and 419. Why not list yours with us, too. In support of the meteoric CB industry, we've supplied customs as well as the standard MC145104, 5106, 5107, 5109 and 5112 phase-locked loop frequency synthesizers.

**It's already supporting these.**

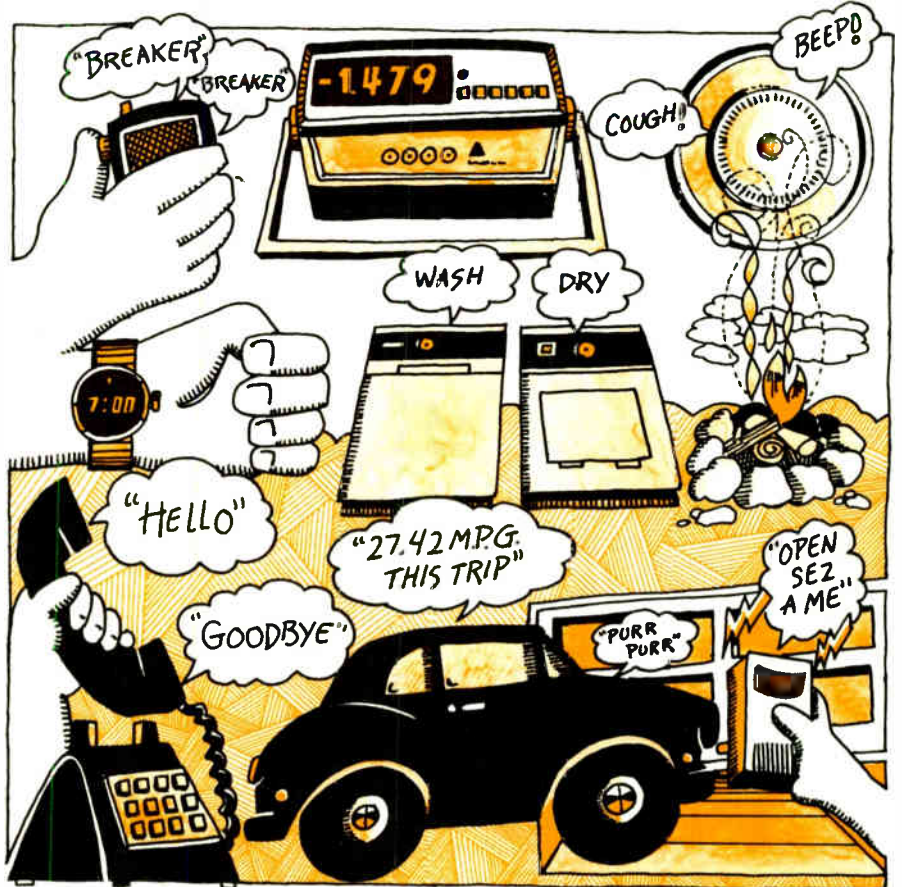

So it goes for things like garage door openers, in-dash and underhood automotive systems, and appliance controls. And, there's more just around the corner: internally programmed watch chips to keep your product current, an internally pro-

grammable processor, or one-chip microcomputer, to shorten design cycle times in many applications, and one kilobit RAMs for battery backup systems. You name it.

You name it. We'll build it. In CMOS, in volume.

**Call This Toll-Free Number Today  
For Applications Assistance Tomorrow:  
1-800-453-2400 (In Utah, 1-800-662-250C)**



**MOTOROLA Semiconductors**  
*The mind to imagine... the skill to do.*

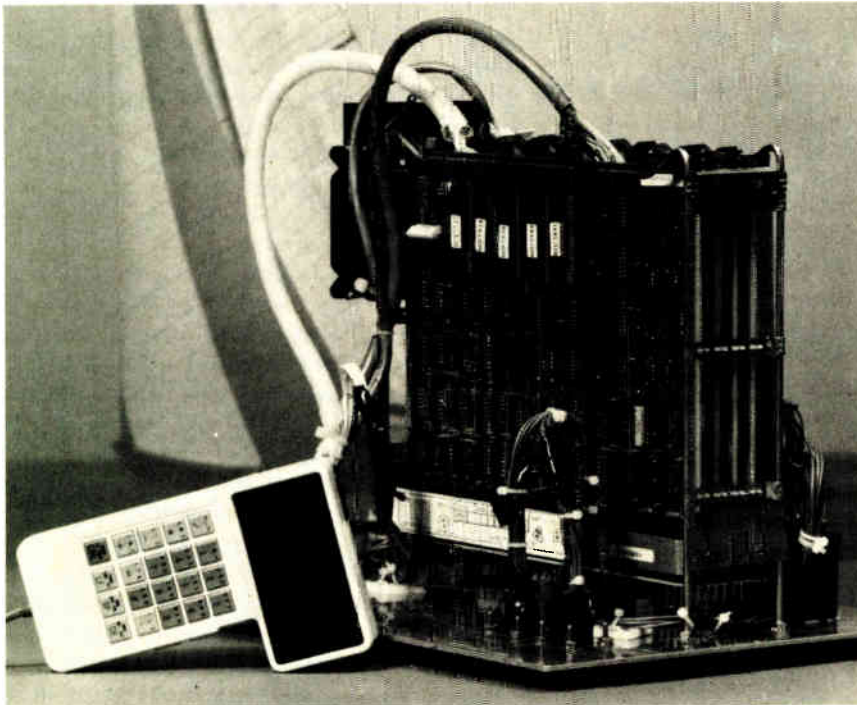

**Aide.** Hand-held terminal from Termiflex is used to call up programs and display on light-emitting diodes sailing data stored and processed in Digital Equipment's LSI-11.

ments for the system, including the analog-to-digital conversion, are provided by Signet Scientific Co., Burbank, Calif. Data is read out on the light-emitting-diode display of a hand-held terminal from Termiflex Corp., Nashua, N.H.

**Input.** The sensors consist of a cup anemometer and wind vane on the sloop's mast that derive analog signals representing apparent wind speed and direction, a knotmeter that indicates speed through the water, and an electronic compass that gives digital indication of the boat's heading. The LSI-11 samples the digital signals several times a second and converts apparent wind speed and direction to the true wind speed and direction. It also precisely computes the boat's relative position—in both time and distance—to marks along the race course.

Another important LSI-11 function, Brick points out, is computing "velocity made good" to a mark. This is the rate at which the boat is closing on a mark, even though it may not be sailing directly toward it. It is important to know this, Brick says, because the skipper may, for example, want to alter tack to obtain

the optimum direction and speed for that part of the race.

In all, a navigator can call up 24 different programs, loaded into 16,384 words of metal-oxide-semiconductor random-access memory before the race begins. Programs include ones for calculating velocity made good and true wind speed and direction for competing boats. Two 12-volt batteries power the system. □

---

### Military

---

## Belgians ordering operational RPVs

This year, while the United States military is still debating the need for remotely piloted vehicles, Belgium will field the first of two squadrons of 20 jet-powered RPVs for battlefield surveillance.

At the Washington meeting of the National Association of RPVs earlier this month, Belgium's contractor, Manufacture Belge de Lampes et de Material Electroniques of Brussels, described its latest step. With the aid of Teledyne Brown Engineering Co.,

Huntsville, Ala., it is adding low-light-level television reconnaissance as an option to its Epervier system, which now operates with either still cameras or an infrared line scanner. The goal: an upgraded system—called Asmodée—that can be sold to other countries in Europe and the Middle East.

**Limbo.** American programs are moving slowly, on the other hand, with current interest centered on developing recoverable mini-RPVs for reconnaissance. Still in limbo are larger vehicles like Boeing's Compass Cope for high-flying reconnaissance and the competitive Northrop Corp. and Beech Aircraft efforts to develop TEDS (for tactical expendable drone system) mounted with a warhead for defense suppression. Production prospects are dim by industry estimates.

The Army, now the lead RPV developer, is concentrating its efforts on the mini XMQM-105 known as Aquila, but it is not scheduled for engineering development before October 1978. The Naval Air Systems Command will have no more than \$8 million next fiscal year to begin conceptual development of an over-the-horizon reconnaissance RPV for shipboard launch. The Air Force is off to an even later start on small RPVs. Its expendable Harassment vehicle program has uncertain internal support and is in funding difficulty with a Congress that argues the military RPV case has not been proved. All three services contend that lack of strong interest from field commands has slowed progress.

The Army's Aviation Systems Command, St. Louis, is developing the Aquila, which is a 146-pound radio-controlled, recoverable drone with a 22-lb payload. Lockheed Missiles & Space Co. has received close to \$16 million over two and a half years for building 23 Aquilas. They have been used for testing battlefield reconnaissance 20 to 30 kilometers behind enemy lines by television and still cameras, as well as for testing laser range-finding and target designation.

Shaped like a "flying wing," Aquila is 6 feet long with a 12-foot

# The most uncompromising electrolytic capacitors are available on 24-hour delivery.

Why wait? Our "L" Series of miniature aluminum electrolytic capacitors is yours without long lead time. After all, your time is too valuable to you, and you're too valuable to us to drag our feet on delivery.

That's why we maintain such a large inventory of standard miniature electrolytics at our Secaucus, N.J. warehouse as well as at our distributors—to make sure your orders are filled fast!

**No compromise on lead types, either.** We offer our "L" Series electrolytics with both axial and radial leads so you never need settle for second best. It's the same reason we offer so

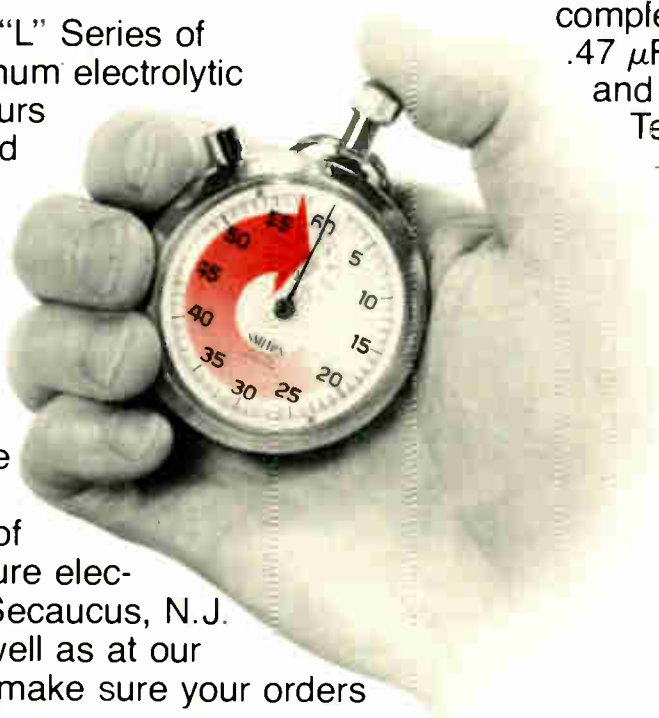

complete a range from .47  $\mu\text{F}$  to 10,000  $\mu\text{F}$ , and from 6.3 to 100 volts.

Temperature range is from  $-40^{\circ}\text{C}$  to  $+85^{\circ}\text{C}$ . Standard capacitor tolerances: +50%, -10%.

**And no compromise on price.**

In fact, "L" Series prices are extremely competitive. For samples, prices and literature, call or write: Panasonic, One Panasonic Way, Secaucus, N.J. 07094; (201) 348-7268

**Panasonic**  
just slightly ahead of our time

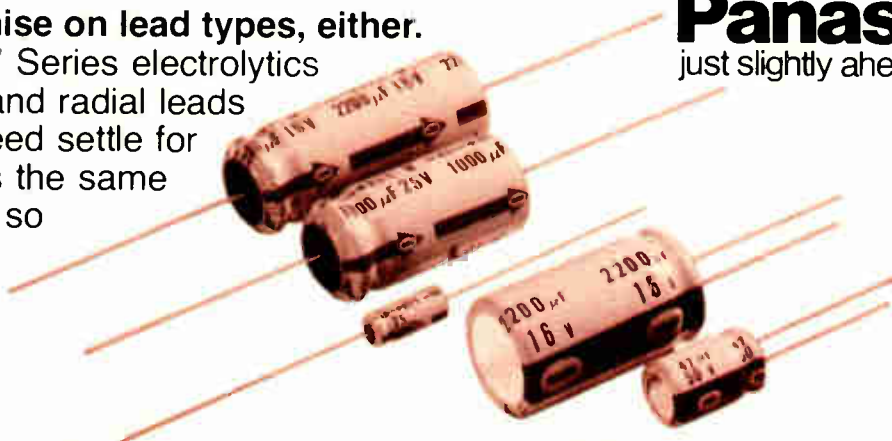

wingspan and is powered by a 112-horsepower engine that drives a propeller at the rear. Maximum flight time is 3 hours, top speed is 120 miles per hour. Tests with a classified Honeywell laser range-finder on board should be completed this year. The Army expects to request engineering development proposals by next spring.

Navy ship commanders remain to be convinced of the ability to recover RPVs safely and make their components safe for shipboard handling, says Rear Adm. Carl J. Seiberlich, assistant deputy chief of naval operations for air warfare. He explains that the Navy had a disastrous experience with multiple crashes of the Drone Antisubmarine Helicopter, 60 of which are in storage "presumably awaiting the Resurrection." Apparently the helicopters themselves were reliable—the problems were chiefly in the electronic controls, which were subject to interference from shipboard electronic systems. Sieberlich suggests the Navy might be more inclined toward expendable, single-shot systems if proved cost-effective. This would eliminate problems of recovery, maintenance, and storage at sea, he says.

Epervier, Belgium's 342-lb Epervier, developed for \$15 million, is not pushing the state of the electronics art, but is built from solid-state equipment "that works," points out MBLE's Albert Dellicour, RPV program manager. While the drone is larger, heavier, and costlier than Aquila—\$150,000 each vs an Army goal of \$10,000 to \$15,000—its 44-lb payload is double Aquila's. So is its maximum turbojet speed of 310 mph. While Epervier missions average only 20 minutes, its 40-to-50-mile range matches Aquila's, Dellicour points out. Moreover, it can fly automatically, controlled by a memory pre-programmed before flight, or it can accept program changes in flight by pulse-coded radio signals. Most of the on-board electronics, including the planned low-light-level TV adapted from a Hughes Aircraft military satellite, and its S- and L-band transmitters, is considered classified by the Belgians. □

## News briefs

### RCA improves bipotential picture-tube gun

RCA Corp.'s Picture Tube division claims "very substantial progress" in obtaining improved focus performance in both high-focus-voltage bipotential, in-line gun and tripotential in-line gun color picture tube designs. The significant advantage of the high-focus bipotential gun, says Joseph Colgrove, division vice president and general manager, is that it uses only one focus voltage (9 kilovolts) as compared with two focus voltages (7 and 13 kV) in the tripotential gun, which should reduce receiver and tube manufacturing costs and increase reliability. In addition, RCA claims that the high focus bipotential gun has better edge and corner sharpness than the tripotential types. The new tube will be available next year in 25-inch, 100° deflection and 19-in., 90° deflection tubes. The company will also market a 25-in., 100° tube with a tripotential gun. Both Zenith and GTE-Sylvania are now marketing tripotential gun tubes.

### Sprague and GE put a-m/fm radio on single chip

A single bipolar integrated circuit from Sprague Electric Co., Worcester, Mass., performs all the functions of a low-cost a-m/fm radio except for vhf tuning. Housed in a 16-pin dual in-line package, the ULN-2204A was developed for General Electric Co., which has begun radio production using it. The device is now available commercially to other radio makers. In the a-m mode, it is a complete superheterodyne broadcast or shortwave receiver, including automatic gain control. In fm operation, it acts as a high-gain intermediate-frequency amplifier/limiter and phase-shift detector.

### EIA names counsel Ray Johnson acting general manager

The Electronic Industries Association's Raymond E. Johnson, general counsel, will become EIA acting general manager on June 15 pending the selection of a new president to succeed V. J. Adduci, who has resigned [*Electronics*, May 26, p. 75]. Johnson will have all the authority of the executive office until the appointment of a new president, by Sept. 1.

### GenRad unveils fast board tester

GenRad Inc., Concord, Mass., has taken the wraps off the successor to its model 1792D printed-circuit board tester. It is called the 1796 and can mix analog and digital statements so that both kinds of pins can be tested under software control. The price, comparable with that of the 1792, will range from \$125,000 to \$300,000, with \$200,000 for a typical system.

## Computers

### Single-board units hit price low

Two single-board microcomputers quietly introduced by Intel Corp. at the National Computer Conference last week could become one of the industry's hottest OEM items, especially among manufacturers of high-volume microcomputer-controlled equipment.

One board costs less than \$100, the other less than \$200, making them the lowest-priced computer boards in their performance bracket.

Yet both are full computers, completely assembled and tested and ready for software development.

The under-\$100 board, designated the SBC 80/04, is designed specifically for stand-alone use in dedicated applications. The other, the SBC 80/05, features the bus structure made popular by its more powerful predecessor, the SBC 80/20 [*Electronics*, March 17, p. 121]. This structure allows it to act not only as a stand-alone computer but as part of a low-cost distributed processing system or in a multiprocessor system as a remote slave to one or several 80/20 master boards.

Key to the substantially lower cost of the 80/04 and the 80/05 is the

# The chip with the sensitive nose.

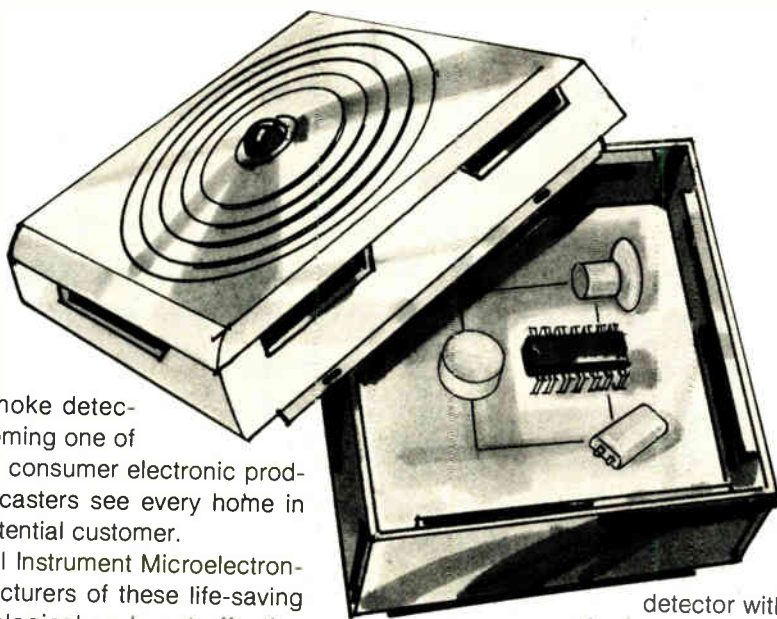

Early warning smoke detectors are fast becoming one of the hottest selling consumer electronic products. Market forecasters see every home in the world as a potential customer.

Now, General Instrument Microelectronics offers manufacturers of these life-saving devices a technological and cost-effective breakthrough that can help to develop the full market potential of the smoke alarm market. It's the new MEM 4962.

A single-chip LSI package, the MEM 4962 includes a FET input, detector, voltage comparator, oscillator, trigger, horn driver and C/MOS output. That's all the circuitry you need for a "sensitive nose" to detect combustion.

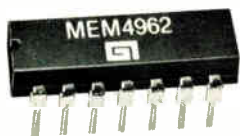

GI's new MEM 4962 replaces more than 30 discrete components now being used in conventional ionization smoke alarms. You know

what that can do for your inventory costs and assembly time.

Switch your product to GI microcircuit technology and you can offer your customers a competitive priced smoke

detector with super-sensitive reliability, long battery life, and audible reminder when battery power is too low for safety. All this from a single-chip package.

Whatever you manufacture — smoke detectors, microwave ovens, TV or stereo sets, TV games, calculators, organs, pianos, data and telecommunications equipment — chances are GI has the circuitry to help you be more competitive. Write today or call the leader in microcircuit technology — General Instrument Microelectronics, 600 West John Street, Hicksville, New York 11802, Telephone: (516) 733-3107.

**We help you compete.**

**GENERAL INSTRUMENT CORPORATION  
MICROELECTRONICS**



## Electronics review

higher level of integration made possible through the use of the new MCS-85 family of microcomputer components, in which a three-chip system replaces up to 10 or more 8080 system components. In addition, the three power supplies formerly required for 8080 systems are replaced by a 5-volt supply.

The SBC 80/04 board contains 256 bytes of random-access memory, and the SBC 80/05 512 bytes of RAM. Moreover, each of the 6.75-by-12-inch boards contains sockets for up to 4 kilobytes of reprogrammable or masked read-only memory. But because it is designed for distributed and multiprocessing applications, the SBC 80/05 also contains the same bus-control logic for determining input priorities used in the SBC 80/20. This control logic allows up to four SBC 80/05 boards or any high-speed controller to share the system bus in serial or daisy-chain priority fashion. Once bus control is achieved, a bus bandwidth of up to 5 megabytes per second is possible. □

## Communications

### AT&T to build network for Iran

American Telephone & Telegraph Co.'s Iranian subsidiary will begin work July 1 under a contract worth about \$100 million for the first year of a 10-year program to engineer a \$10 billion public and military communications system for Iran. And Western Electric Co., AT&T's manufacturing arm, is expected to be a major competitor for the remaining \$900 million of Iran's \$1 billion annual outlay for installing telecommunications hardware.

This was revealed by American Bell International Inc.'s John A. McCarthy, engineering plans vice president, in an interview in Washington during a two-day mid-June seminar on "Future Directions in International Telecommunications" sponsored by Arthur D. Little Inc., Cambridge, Mass. His disclosure came on the heels of another by

Western Electric's James S. Herbert, executive vice president, that his company plans to move vigorously into supplying telecommunications systems "to meet the needs of developing nations." Herbert told the ADL forum that Western Electric "is just getting organized" to move back into the international market, one it pulled out of in the 1920s.

As for Iran, the Shah has approved the communications program, McCarthy said, and funding of the new ABII contract will begin July 1. AT&T established the subsidiary in August 1975 when it received its first contract to study Iran's telecommunications system and its needs [*Electronics*, Aug. 21, 1975, p. 49]. ABII will now provide Iran with systems engineering, maintenance, personnel training, and billing systems. That Iran expects hardware vendors to establish production facilities in the country was made clear at the time of the original 1975 agreement, when the Shah indicated Iran's policy was to develop a "modern technological capability and increased manufacture of communications equipment."

**Western Electric.** In its international role, Western Electric will offer its products and engineer, furnish, install, and maintain large networks, Herbert says. To do this it will "obtain resources from the Bell System and/or other companies.

Herbert cites WE's first major international marketing success—a \$408 million contract he negotiated with Saudi Arabia in early June to supply and install a new microwave communications network with the support of subcontractor Collins Systems International Inc. Collins will provide the bulk of the Intra-Kingdom Microwave Project's radios, and Western Electric will provide the transmission microwave carrier and multiplexing equipment.

While Western Electric "has not decided yet" whether it will enter into joint ventures overseas with other companies, Herbert added that his company will consider licensing overseas companies in contracting countries to manufacture hardware "on a case-by-case basis." □



# You've just been ripped off!

If E&L Instruments' 24-page "Complete Bugworks" isn't over there on the facing page, then somebody got to it before you did. You're missing out on the most comprehensive "do-it-yourself" product line in the electronics industry. But don't complain because he got there first. Get your own "Bugworks" straight from the "Bugs" themselves. Fill out the coupon below and send it off today.

**E&L<sup>®</sup>****E&L INSTRUMENTS, INC.**61 First Street, Derby, Conn. 06418  
(203) 735-8774 Telex No. 96 3536

Name \_\_\_\_\_

Address \_\_\_\_\_

City \_\_\_\_\_

State \_\_\_\_\_ Zip \_\_\_\_\_



# THE COMPLETE BUGWORKS



## SK-50

Here's the one-half size version of the SK-10. It has all the features of the SK-10 except for size, and carries a modest price tag, making it especially attractive for class-room use. Its compact size allows it to be used in many locations while the SK-10 proves to be particularly handy on rack-mount PC cards.

**E & L INSTRUMENTS, INC.**  
61 First Street, Derby, Conn. 06418

# Solderless

If you are involved in any aspect of circuit design, experimental construction of electronics or are merely interested in learning about analog or digital techniques, then you should take a good look at the full line of E&L products that are featured in this brochure. They represent the least expensive, quickest and most direct route to mastering the world of electronics.



From simple solderless breadboards to complete design stations, E&L has the products, the instruments and the educational material that will enable you to design and build your own system.

After browsing through the next 22 pages of products, check the back cover for all ordering information including OEM, Educational and Industrial discounts.

## SK SERIES.

### SOCKETS FOR CIRCUIT DESIGN ... SIMPLE BUT VERSATILE.

Start your circuit designing with E&L's SK series. These solderless breadboards enable you to insert all your electronic components directly into a spring matrix, without adapters, for instant circuit construction. All components of 20 to 26 gage insert directly. From 1/2 watt resistors and the smallest diodes to plug-in DIP

packages from 8 to 40 pins. Spread the leads when TO-5 package is desired. All interconnects are made with solid 22 gage wire, stripped 1/4" (6.35 mm) on each end, eliminating the need for special jumper sets. Combine the solderless sockets with E&L's sophisticated instruments and you have great design systems.

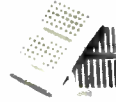

SUGGESTED RESALE PRICE \$2.25

### SK-20

The SK-20 is a miniature breadboarding socket that is an excellent replacement for standard DIP sockets in custom breadboarding, particularly in the interfacing

version. The SK-20 is perfect for permanent installation where the 5 common contact points are of prime importance for fan-in/fan-out.

## SK SERIES SPECIFICATIONS

**Contacts:** Nickel Silver  
**Typical Insertion Life:**

Based on 22 gage components, a minimum of 10,000 insertions.

**Average Contact Resistance:**

5 milliohms

**Lead Size Accommodations:**

20 to 26 gage (1/2 watt resistor to small diodes)

**Housing:** Acetal Co-polymer

**Useable Temperature Limit:**

105°C

### "The Lifetime Guarantee"

All of E&L's SK sockets now carry a lifetime guarantee. If a unit ever fails to meet your requirements, return it to E&L, postpaid, for a free replacement. No questions asked.

### SK-10

**Physical:** .33" H (8,4 mm) x 2.2" W (5,6 cm) x 6.5" L (16,5 cm)

**Mounting Holes:** (Designed for # 4 flat head screws) 1.46" (3,71 cm) across width x 3.08" (7,82 cm) across center line to each end.

### SK-50

**Physical:** .33" H (8,4 mm) x 2.2" W (5,6 cm) x 3.4" L (8,6 cm)

**Mounting Holes:** (Designed for # 4 flat head screws) 1.46" (3,71 cm) across width x 3.08" (7,82 cm) across center line to each end.

### SK-20

**Physical:** .33" H (8,4 mm) x 1" W (2,54 cm) x 1.75" L (4,45 cm)

**Mounting Holes:** 1.56" (3,96 cm) center to center

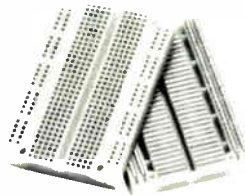

SUGGESTED RESALE PRICE \$8.50

### SK-50

Here's the one-half size version of the SK-10. It has all the features of the SK-10, except for size, and carries a modest price tag, making it especially attractive for classroom use. Its compact size allows it to be used in many locations where the SK-10 proves to be too large, particularly on rack mounted PC cards.

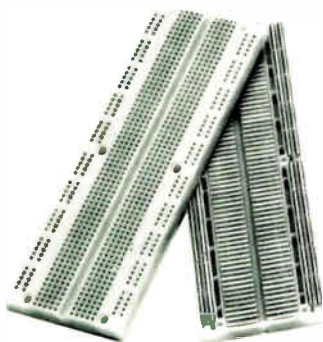

SUGGESTED RESALE PRICE \$16.50

### SK-10

The SK-10's unique matrix configuration is embedded in a high temperature plastic molding. It gives you 64 pairs of 5 common spring contacts for principle circuit construction and a series of common buss strips (8) of 25 connections each.

# Breadboarding



## BP SERIES

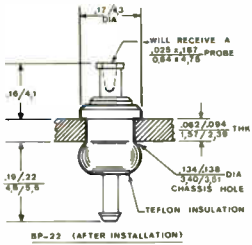

## QUALITY BREADBOARDING JACKS AND PINS BP-22

The BP-22's are Teflon<sup>®</sup> insulated breadboarding jacks for use in metal panels of  $\frac{1}{16}$ " (1,57 mm) to  $\frac{3}{32}$ " (2,36 mm) thickness. Solderless interconnections are made with 22 gage solid wire. The BP-22 mounts in a .136" (3,45 mm) hole without soldering.

SUGGESTED RESALE PRICE \$9.30 (pkg. of 25)

## BP-24

A reusable adapter pin that allows up to 16 gage wires to be inserted in the BP-22, 25 or any of the SK-10/SK-20 Sockets. Large electrolytics can thus be breadboarded as simply as a DIP IC.

SUGGESTED RESALE PRICE \$11.50 (pkg. of 100), \$3.25 (pkg. of 25)

## BP-25

A breadboarding pin where spacing on .100" (2,54 mm) centers is desired. .0595" (1,50 mm) hole size. A protruding metal tip that will engage the opening in the top of another pin allows "stacking."

SUGGESTED RESALE PRICE \$8.50 (pkg. of 25)

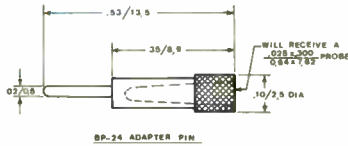

BP-24 ADAPTER PIN

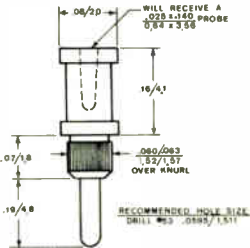

BP-25 BREADBOARDING PIN

## UPC-101, UPC-102

### SPECIAL PURPOSE PRINTED CIRCUIT BOARDS



## UPC-102

The 102 circuit board features dual SK-10 circuit patterns and adds a card edge connector for plug-in use. .156" (3,96 mm) centers; 22 connections.

SUGGESTED RESALE PRICE \$15.00

## UPC-101

The 101 is an exact duplication of the SK-10 circuit pattern. A drilled hole pattern and circuit pattern identical to the SK-10 allows the designer to go directly from his breadboard to final soldered unit without laying out the circuit again.

SUGGESTED RESALE PRICE \$6.50

## THE INTERFACE SOCKET



## FOR PERMANENT CONNECTION TO PRINTED CIRCUIT BOARDS

A variation on the original solderless breadboarding socket gives you another inexpensive way to construct instrument/computer interfaces. In addition to the normal 5 parallel contacts on top, a tab is punched out at the bottom of the contact pin. Interfacing is made simple by quick and permanent connection of the contact pin to the printed circuit board.

## SPECIFICATIONS

**SK-10-1F18** — 18 pairs of rear solder tabbed connectors/46 pairs of standard connectors.  
SUGGESTED RESALE PRICE \$18.75

**SK-10-1F36** — 36 pairs of rear solder tabbed connectors/28 pairs of standard connectors.  
SUGGESTED RESALE PRICE \$19.75

**SK-20-1F8** — 8 pairs of rear solder tabbed connectors.  
SUGGESTED RESALE PRICE \$3.25

**SK-50-1F18** — 18 pairs of rear solder tabbed connectors/15 pairs of standard connectors.  
SUGGESTED RESALE PRICE \$10.50

## MOUNTING DETAILS

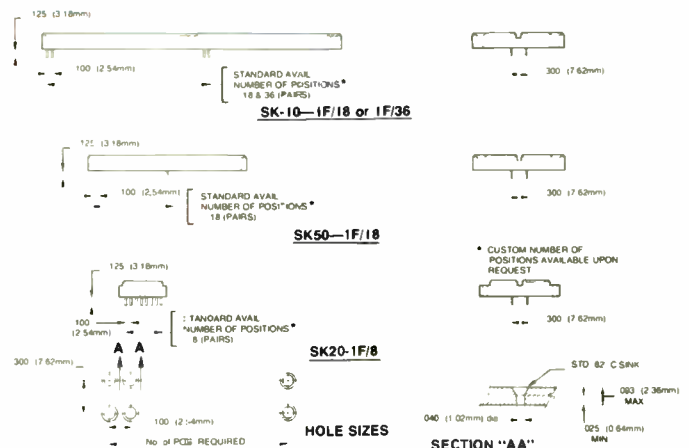

# Universal

E&L has designed a series of compact, inexpensive, reliable and rugged units to meet the needs of small labs, educational institutions and hobbyists. These units are available either in kit or assembled form.

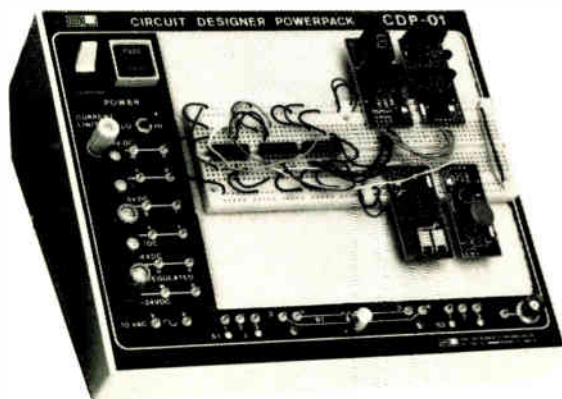

## CDP-01

### THE ALL-PURPOSE GENERAL DESIGNER

Here is all you need for a wide variety of circuit work. From CMOS Logic, TTL, Linear IC's to simple R/C design. A central work area covered by Velcro® Loop Material gives you complete freedom in attaching different units to the instrument. Terminals are labeled for easy identifica-

tion and the unique dual current limiting concept saves precious IC's from burn-out. The power supplies have the capacity (.75A and .25A) to do any reasonably sized job that fits on the working surface. Each CDP-01 comes with a hard backed SK-10 Socket. Available in kit (CDP-01K) or assembled (CDP-01A) form at either 115V or 230V.

## SPECIFICATIONS

### POWER SUPPLIES SUPPLY A

Voltage (DC) 5V  
Type Trimmer adjustable  
Tolerance (volts) N/A  
Output Current  
Low Setting 100 ma  
High Setting 750 ma  
Current Limiting Yes  
Noise and Ripple Less than 10MV  
Overload Indicator LED Indicator

### SUPPLY B

+15/-15V fixed, tracking  
14.15/15.75  
50 ma  
250 ma  
Yes  
Less than 20MV  
LED Indicator

In addition to the above supplies, the CDP-01 provides +24/-24V dc (unregulated) fused internally at 1/4 amp. Also available on the front panel are two connections to one of the low voltage secondary windings — nominally 10V ac. The primary fuse will blow in the event of a short.

### CONTROLS:

- (1)—Off/On Switch (with integral light)
- (1)—Low/High current limiting switch.
- (1)—Uncommitted linear 10K slide pot with center tap (detent)
- (2)—Uncommitted slide switches — SPDT (1/2 amp @ 125 V dc)

### Connectors:

- (25) BP-22 — Insulated solderless breadboarding pins.
- (1) SK-10 with permanent backing.
- (1)—BNC Connector
- (6)—5 Way Binding Posts

### Miscellaneous:

- Center portions of panel covered with Velcro® Loop Material for attachment of external components.
- (3) Fuses — (2) 1/4A and (1) 3/4A Slo-Blo. (For additional Velcro to attach custom components, use V-04.)

### Physical:

- 3.5" H (8,9 cm) x 7.6" W (19,3 cm) x 9" L (22,9 cm)
- Sloped Approx. — 17°
- Weight — 5 lbs. (2,27 Kg)

SUGGESTED RESALE PRICE ASSEMBLED — \$150.00, KIT — \$110.00

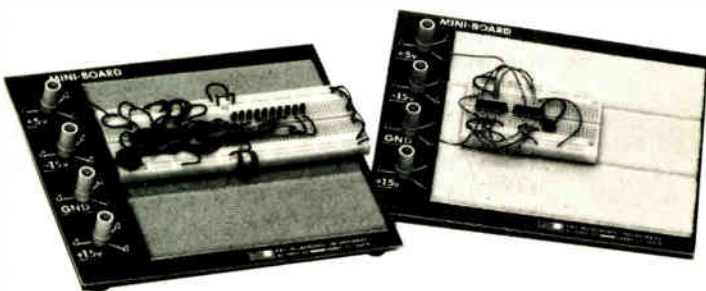

## SPECIFICATIONS

- Base:** 1/16" (1,57 mm) G-10—Approx. 7" (17,8 cm) x 8" (20,3 cm)
- Connectors:** (4) Binding Posts, (12) Breadboarding Pins
- Sockets:** (1) SK-10 with Velcro® Hook Material Backing (SK-50 with the MB-101)
- Mounting Area:** 6" (15,2 cm) sq. Velcro Loop Material

## MB-100

### MINIMUM COST BREADBOARDING PACKAGES

MB-100 is an exceptionally flexible circuit design aid. A simple mounting board with binding posts and solderless breadboarding pins and a detachable SK-10 socket. In addition to the socket, you can mount any kind of electronic components, relays, meters, transformers, etc., with Velcro®. E&L supplies a hard backing for the rear of the socket.

SUGGESTED RESALE PRICE \$29.10

## MB-101

The same base and capabilities as the 100 with an SK-50 replacing the SK-10.

SUGGESTED RESALE PRICE \$21.10

# Designers



## BREADBOX III

## BREADBOX IV UNIVERSAL POWERED BREADBOX

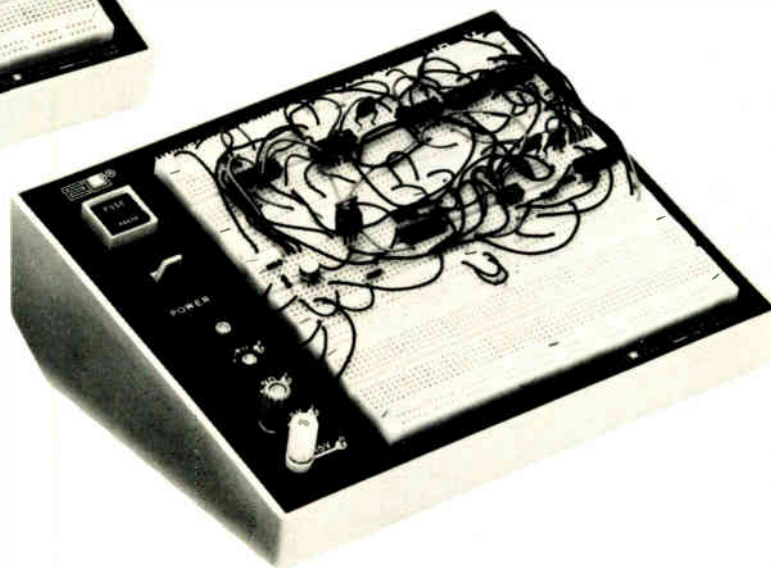

### FOR ANALOG OR DIGITAL WORK, THE MOST BREADBOARDING CAPABILITY FOR THE LEAST MONEY.

The Breadbox III is the most economical approach to either digital or analog work. Simply plug in your own components on 3 SK-10

sockets and you're ready to build your own circuits. With 4 binding posts for external power and BNC's for scope probe connections and other instrumentation as well. The Breadbox III may be ordered as Option 1 with the sockets detachable and held by Velcro®.

### SPECIFICATIONS

- Connectors:** (4) 5 Way Binding Posts  
(2) BNC Connectors  
(6) BP-22 Solderless Breadboarding Pins
- Sockets:** (3) SK-10 Sockets
- Miscellaneous:** Molded Plastic Box  
Painted and Screened Metal Panel
- Physical:** 3.5" H (8,9 cm) x 7.6" W.  
(19,3 cm) x 9" L (22,9 cm)  
Sloped Approx. 17°  
Weight — 3 lbs. (1.12 kg.)

SUGGESTED RESALE PRICE  
STANDARD — \$72.25, OPTION 1 — \$77.75

### A LOW PRICED, COMPLETELY SELF POWERED DESIGNER.

Two husky power supplies, +5V and +/-15V, plus a breadboarding area of 3 SK-10 sockets large enough to handle almost any design. That's the Breadbox IV. For both digital

and analog designs, the Breadbox IV is the most reasonably priced instrument in the field. Available in kit (BB-IVK) or assembled (BB-IVA) form at either 115V or 230V.

### SPECIFICATIONS

- Power Supplies:** +5V @ 3/4 AMP  
±15V @ 1/4 AMP
- Line & Load Regulation:** Less than 5%
- Noise & Ripple:** Less than 5 mv on +5V  
Less than 10 mv on ±15V
- Connectors:** 4-five way binding posts  
4-BP-22 Solderless Breadboarding Pins  
3-SK-10 Sockets
- Miscellaneous:** Molded, high-impact, plastic case.  
Painted and screened metal panel.  
Internally lighted, on-off switch.  
Fused @ 3/4 AMP
- Physical:** 3.5" H (9 cm) x 7.6" W (19,3 cm) x 9" L  
(22,9 cm)  
Sloped Approx. — 17°  
Weight — 7 lbs. (3,18 kg.)

SUGGESTED RESALE PRICE  
ASSEMBLED — \$135.00, KIT — \$94.50

# Linear/Analog

**OAB-1**  
**THE COMPLETE, PORTABLE AND**  
**INEXPENSIVE, OP-AMP BREADBOX**

**STS-01**  
**A STARTER KIT FOR**  
**A MODEST BUDGET**

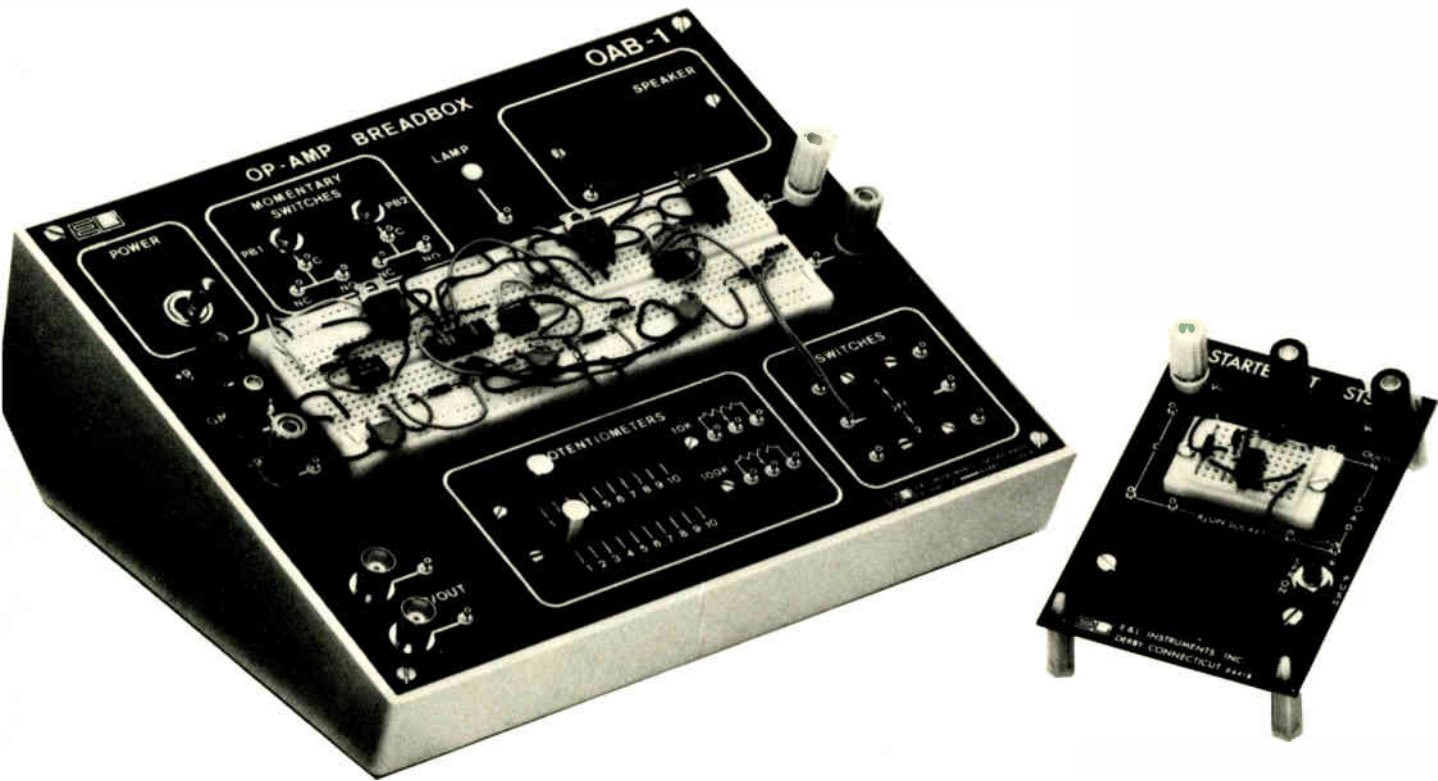

An instrument package for linear design work. For testing op-amps or actual circuit design, the battery powered OAB-1 gives you the SK-10 breadboard and BP-22 jacks

for complete solderless design. Available either in kit (OAB-1K) or assembled (OAB-1A) form. The OM-1 manual works well with the OAB-1.

Here's a kit fit for even the most modest budgets. An SK-20 Socket combined with speaker, breadboarding pins, battery clips, mounting spacers and a test switch. The result is a simple but flexible means of building and testing op-amp circuits. Use the learning manual OM-1 for a comprehensive introduction to op-amp work.

SUGGESTED RESALE PRICE \$14.00

## SPECIFICATIONS

- Power Supply:** (2) 9 volt cells (not supplied)  
**Controls:** (2) SPST Pushbuttons  
(2) 3-position slide switches  
(2) Slide Pots — 10K and 100K  
**Connectors:** (1) SK-10 Breadboarding Socket  
(5) 5-way binding posts  
(30) BP-22 Solderless Breadboarding Pins  
(2) BNC Connectors  
**Miscellaneous:** LED indicator light  
Incandescent Lamp (load)  
Miniature speaker  
**Physical:** 3.5" H. (8,9 cm) x 7.6" W. (19,3 cm) x 9" L.  
(22,9 cm)  
Sloped Approx. 17°  
Weight — 5 lbs. (2,27 kg.)

SUGGESTED RESALE PRICE  
ASSEMBLED — \$90.00, KIT — \$60.00

# Designers



## OA-2 THE COMPREHENSIVE APPROACH TO DESIGNING OP-AMP CIRCUITRY

## OA-3 TWO FLOATING POWER SUPPLIES FOR OPEN-ENDED DESIGNING

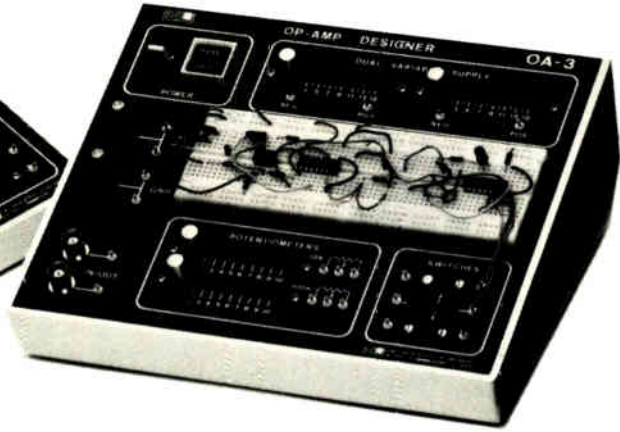

Fixed +5V and +/-15V power supplies with large current capacity, a sensitive null detector and a full function generator with external frequency adjustment are all the tools you need for linear work and interfacing to TTL

Logic. The circuit is assembled on the SK-10 and externally connected by BP-22 breadboarding pins. Available in kit (OA-2K) or assembled (OA-2A) form at either 115V or 230V.

The OA-3 features fully floating variable power supplies that form an exceptionally flexible unit. The highly regulated power supplies make the OA-3 most practical for unusual voltage requirements. The variable power and the fixed 5V supply open up the full range of

linear circuit work. The OM-1, OA-2M and the BRS-1, 2 educational materials are perfect for class or home study of linear circuits. Available in kit (OA-3K) or assembled (OA-3A) form at either 115V or 230V.

### SPECIFICATIONS

<b>Power Supplies:</b>	<b>Supply A</b>	<b>Supply B</b>
Type	± 15V	+ 5V
Volt. tol.	Fixed, tracking	Fixed, regulator
	14.25/15.75	4.7/5.3
Output current	200 ma. each supply	500 ma.
Current limiting	Yes	Yes
Noise/Ripple	Less than 20 mv	Less than 10 mv

### Function Generator:

Waveforms — Sine, square and triangle.  
 Frequency — Internal 500Hz or externally adjustable from 1Hz to 100KHz  
 Distortion — < 3% all waveforms  
 Amplitude — Better than 5V peak to peak — all waveforms

### Null Indicator: 2 LED's

Input amplitude w/o overload — 15V maximum  
 Sensitivity — detects less than 10/100 mv difference (switchable)  
 Indicator — low, null, high (both off at null)

### Controls:

Off/On switch (Integral Light)  
 Null sensitivity switch  
 Internal/External frequency selector on function generator  
 (2) uncommitted SPDT slide switches  
 (2) Slide Pots — 10K and 100K

### Connectors:

(1) SK-10 Solderless breadboarding socket  
 (4) 5-way binding posts  
 (29) BP-22 Solderless Breadboarding Pins

### Physical:

3.5" H (8.9 cm) x 7.6" W (19.3 cm) x 9" L (22.9 cm)  
 Sloped approx. — 17°  
 Weight — 7 lbs. (3.18 kg)

SUGGESTED RESALE PRICE  
 ASSEMBLED — \$175.00, KIT — \$120.00

### SPECIFICATIONS

<b>Power Supplies:</b>	<b>Supplies A&amp;B</b>	<b>Supply-C</b>
Type:	0 to plus 15 VDC 0 to minus 15 VDC	5 VDC
	Front Panel Adjustable	Trimmer Adjustable
Volt. Tol:	± 10% of Scale (or 1 volt)	—
Output Current:	50 ma	100 ma
(Max)		
Noise/Ripple:	Less than 20 mv	Less than 10 mv

### Controls —

Off/On switch (Integral light)  
 (2) Uncommitted SPDT Slide Switches  
 (2) Slide Pots — 10K and 100K  
 (2) Slide Pots For Variable Supplies

### Connectors —

(1) SK-10 Solderless Breadboarding Socket  
 (2) 5 Way Binding Posts  
 (22) BP-22 Solderless Breadboarding Pins  
 (2) BNC Connectors

### Physical —

3.5" H (8.9 cm) x 7.6" W (19.3 cm) x 9" L (22.9 cm)  
 Sloped Approx — 17°  
 Weight — 7 lbs. (3.18 kg)

SUGGESTED RESALE PRICE  
 ASSEMBLED — \$155.00, KIT — \$102.50

# Analog / Digital

## DD-1 THE ORIGINAL DIGI-DESIGNER

The least expensive entry into digital circuits, the most dynamic area of circuit design. The DD-1 comes complete with a stable internal power supply, pulsers, status switches, I/O connectors, a 6 frequency clock, 4 LED indicators and the SK-10. This complete package

meets all of your requirements. At this price the DD-1 is a must for every student, technician or engineer doing digital circuit design. Available in kit (DD-1K) or assembled (DD-1A) form; at either 115V or 230V.

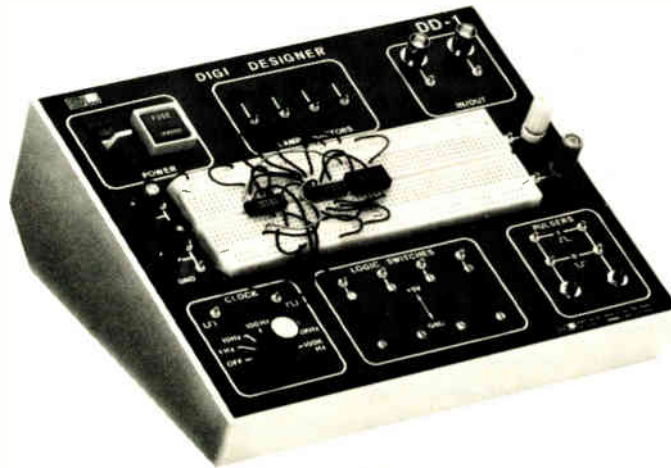

DC-2, an IC package with the appropriate integrated circuits (IC-1) and DD-1 form the DC-3 package. (\$126.75)  
"Digital Electronics and

Laboratory Computer Experiments," published by Plenum Press is an excellent reference tool for DD-1 self-instruction.

### SPECIFICATIONS

#### Power Supply:

##### Output:

5 volt DC (user adjustable from 4.0 to 7.0V)  
400 ma (5% regulation)

##### Clock:

Six Frequencies: nominal outputs, 1, 10, 100, 1K, 10K and 100KHz.

Outputs: normal and inverted

Amplitude: nominally 5v peak to peak

##### Switches:

(2) debounced pushbuttons (logic 0/logic 1)

(4) SPDT Slide Switches to apply ground or 5 volts to circuit

##### Logic Lamps: (4 LED type)

ON—greater than 2.5V

OFF—less than .5V

Input Impedance—22K  $\Omega$

##### Connectors:

(1) SK-10 Socket

(4) 5-way binding posts

(22) BP-22 Solderless Breadboarding Pins

(2) BNC Conductors

##### Physical:

3.5" H (8,9cm)  $\times$  7.6" W (19,3cm)  $\times$  9" L (22,9 cm)

Sloped Approx.—17°

Weight—5 lbs. (2,27 Kg)

SUGGESTED RESALE PRICE

ASSEMBLED — \$127.75, KIT — \$77.75

## CD-1 CMOS/TTL DESIGNER A NEW GENERATION OF DIGITAL DESIGNING

The new CMOS designer, CD-1, is the most advanced trainer available. It has a fully variable output voltage that allows the user to work with CMOS logic directly as if it were normal TTL circuitry. TTL circuit work is possible by setting the mode selector to TTL position. In

fact, with the CD-1 there are virtually no restrictions on designs. Associated educational materials are available for use in formal teaching situations.

Available in kit (CD-1K) or assembled (CD-1A) form at either 115V or 230V.

The CMOS-M and the associated IC's (CMK-1) plus the CD-1K form the CMC-3 package. (\$123.50)

### SPECIFICATIONS

#### D.C. Power Supplies:

**Fixed:** +5 Volt  $\pm$  5%

2% load regulation

1 Amp, short circuit protected

**Variable:** +3 to +15 Volt

Adjustable from front panel slide switch 100 ma for external use

**Clock:** 6 frequencies — nominal outputs 1, 10, 100, 1K, 10K, 100KHz  
Complementary Outputs: TTL/CMOS Compatible

#### Switches:

1 — TTL/CMOS Selector switch: places entire unit in either mode

2 — debounced pushbuttons with complementary outputs

4 — logic level slide switches

#### 4 Logic Lamps:

TTL/CMOS compatible logic indicators (L.E.D. type)

#### Connectors:

(1) SK-10 breadboarding socket (will accept up to 8-14 pin DIP IC's)

(2) uncommitted BNC connectors, case grounded to panel

(2) five-way binding posts

(22) BP-22 Solderless Breadboarding Pins

#### Physical:

3.5" H (8,9cm)  $\times$  7.6" W (19,3cm)  $\times$  9" L (22,9cm)

5 pounds (2,27 Kg)

Sloped Approx. — 17°

SUGGESTED RESALE PRICE

ASSEMBLED — \$145.00, KIT — \$97.50



# Designers



ADD-8000



## MALMSTADT AND ENKE'S DESIGN FOR THE CLASSROOM

The Premiere Breadboarding System. The ADD-8000 is designed with unparalleled flexibility to form a unique aggregation capable of use as a digital voltmeter, a frequency counter and an analytical instrument.

Dr. Howard Malmstadt and Dr. Chris Enke have designed a mainframe complete with every basic function capable of sophisticated unitized circuitry: voltages, waveform generator, 7 segment displays and LED indicators, BCD source and all the necessary switches. V/F, A/D conversions, counter/timer and analog

switches are only the beginning.

The ADD-8000 is totally flexible and expandable. It is supported by an experimental workbook, the ADDbook One, and can be used in conjunction with Electronic Measurements for Scientists. Published by W. A. Benjamin, Co., available at your local bookstores.

In addition, Drs. Malmstadt and Enke have designed a complete set of adapter boards and plug-ins, that can easily be installed in older models, such as the EU801A or EU801C, updating them to today's technology.

See separate brochure No. 803-0148.

SUGGESTED RESALE PRICE \$995.00  
(Complete System)

## ADD-8000 SPECIFICATIONS

Entire System includes:

- 1 - ADD-8000 Mainframe
- 1 - ME-T/ADD - Terminal Block (2 BNC's and 4 five-way binding posts)
- 1 - ME-C/QOA - Quad Op-Amp Card
- 1 - ME-C/BBD - Breadboarding Card
- 1 - ME-C/PAS - Programmable Analog Switch Card
- 1 - ME-C/DVM - Voltage-to-Frequency Card
- 1 - ME-C/CTF - Counter-Timer-Frequency Meter Card
- 1 - Resistor Array - allows the PAS card to become a D/A Converter
- 1 - ME-M/1 - ADDbook One
- 1 - ME-J/RO - Readout Jumper Set
- 1 - ME-J/CW - Pre-cut wire package

## MAINFRAME DESCRIPTION

- Function Generator - sine, square and triangle
- Precise adjustable voltage reference source
- BCD encoded source
- Two 4-digit decimal readouts
- LED Status Indicators
- Binary Switch Register
- LED Binary Readout
- Regulated Current-Limiting Power Supply - 5V @ 3A and  $\pm 15V$  @ 250 ma
- 21 Slot Card Bin
- Velcro<sup>®</sup> surfaces to attach 2 uncommitted SK-10's
- SK-50 interface socket - to patch front panel functions

# Analog / Digital

ADAM

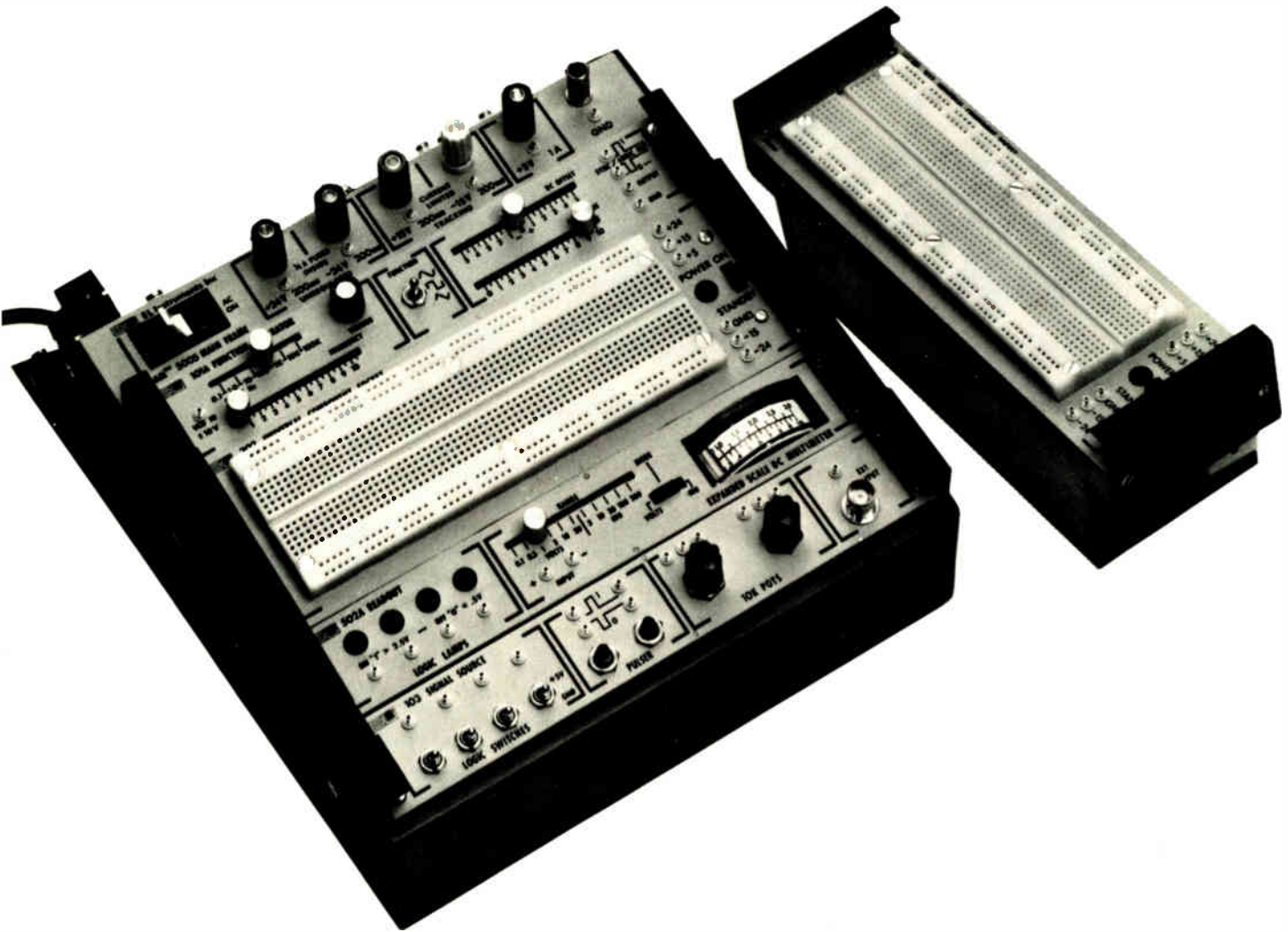

## THE MODULAR BREADBOARDING SYSTEM

Custom design your own instrumentation/breadboard package. Take your basic ADAM, use the 5005 powered mainframe and a wide range of individual plug-in modules to meet your own requirement for a specific job or

custom circuitry.

The basic 5005 Mainframe contains all power supplies necessary to operate the separate modules plus power for the circuit being designed on the panel-mounted SK-10 universal component socket.

The basic ADAM System includes:

- 5005 Mainframe and power supplies
- 103 Signal Source Module
- 101 Function/Pulse Generator
- 302 Universal Component Socket Module (2)
- 502 Readout and DC Multimeter Module

Individual circuits may be saved and you can continue using the balance of the instrument. Plus, you can expand the entire system simply by adding a blank mainframe (5000) and drawing power from the main unit. See separate brochure 803-0122.

SUGGESTED RESALE PRICE \$510  
(Complete System)

# Design Systems



## ELITE SERIES

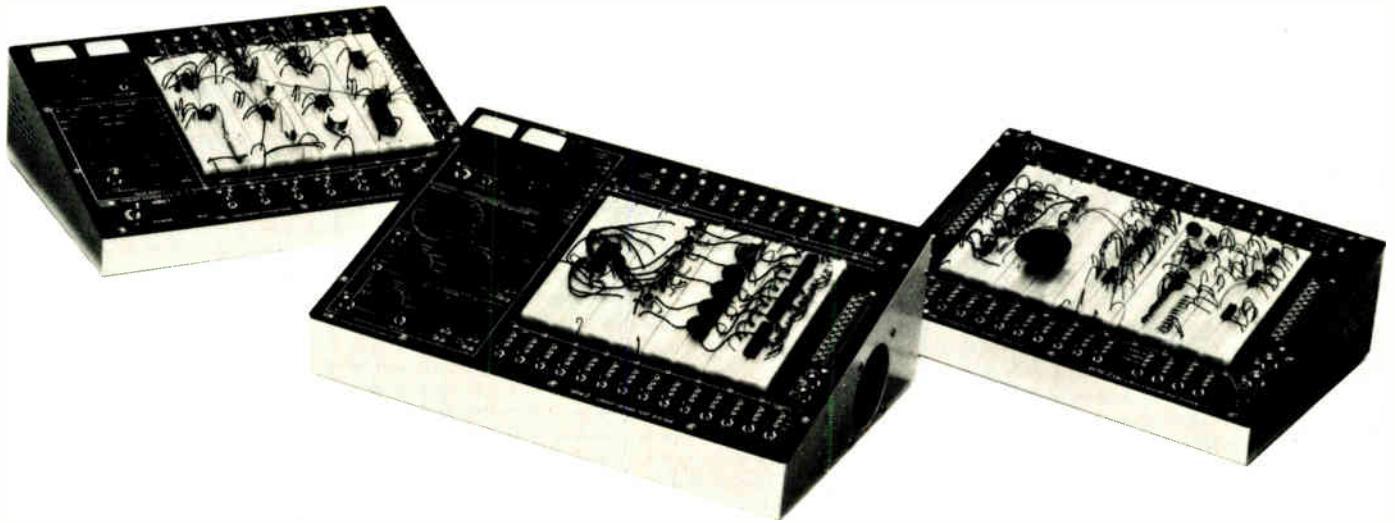

### ELITE 1 A COST EFFECTIVE, FLEXIBLE, LARGE SCALE DESIGNER

ELITE 1 is a fully operational breadboarding system, compatible with CMOS logic work. A fully metered (current/voltage) variable stable supply (from 2-10V @ 2 amps), ideal for CMOS or TTL, is complemented by a wide range pulse generator (1Hz to 1MHz) with variable pulse width and amplitude. ELITE 1 also has 4 SK-10's and status monitors, switches and I/O connections.

SUGGESTED RESALE PRICE  
STANDARD — \$725.00  
OPTION 1 — \$750.00  
OPTION 2 — \$790.00

### ELITE 2 THE TOP OF THE LINE

All the ELITE 2 needs is an oscilloscope and you have a complete development system. Intermix analog and digital, discrete and integrated logic and work with all of the logic families. ELITE 2 has the capabilities to accomplish almost anything in electronics. Three floating, regulated meter supplies, a full function/pulse generator (1Hz-1MHz), buffered logic lamps (+/- input), a complete array of switches, and I/O connectors and 4 SK-10 sockets. ELITE 2 is the top of the line in circuit design.

SUGGESTED RESALE PRICE  
STANDARD — \$1435.00  
OPTION 1 — \$1460.00  
OPTION 2 — \$1500.00

### ELITE 3 THE PACKAGED DESIGNER FOR TTL WORK

Save time, save money. ELITE 3 is all you need for your TTL applications. It carries a large power supply (2.5 amps @ 5V), ample switches (that can be ordered as pulsers or bounce free), and I/O connectors that make it a natural for designing a custom interface on a cost-effective basis.

A new option allows the 5 SK-10 sockets to be mounted on a 1/8" (3,18mm) thick piece of plexiglass, permitting removal of the whole socket area. Please indicate your preference.

See separate brochure No. 803-0103.

SUGGESTED RESALE PRICE  
STANDARD — \$410.00  
OPTION 1 — \$435.00  
OPTION 2 — \$475.00

# Educational

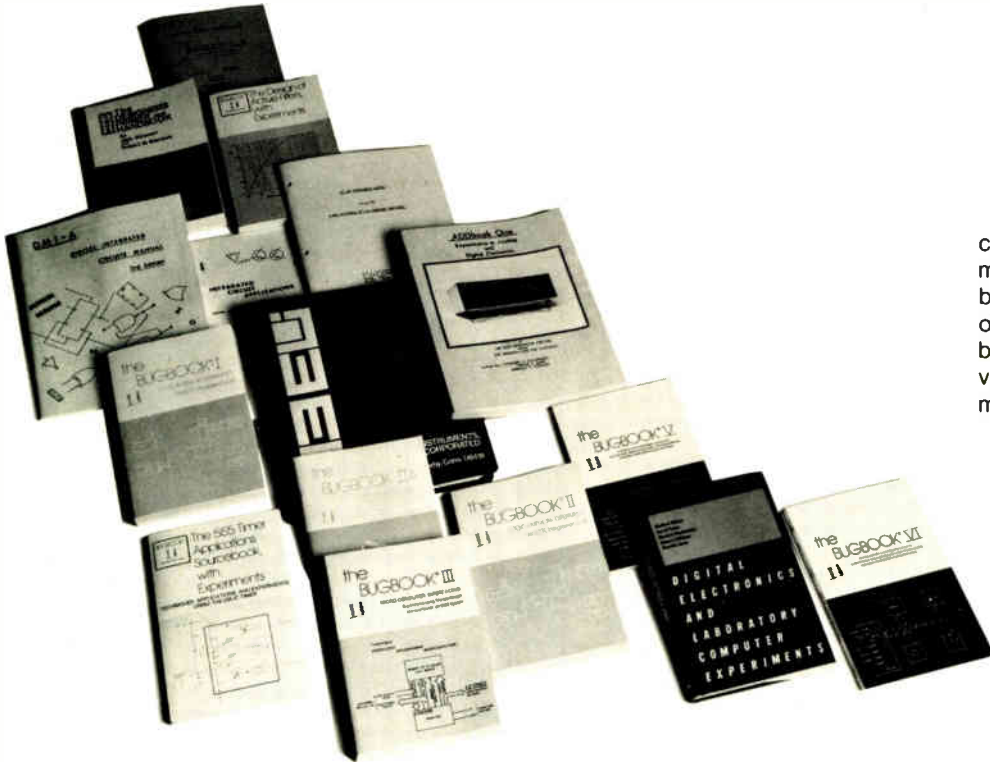

E&L offers a group of carefully selected texts, manuals, and reference books that relate to the area of circuit design concepts, basic digital electronics, advanced techniques and microcomputers.

**Bugbooks I and II** — 750 pages of a well-illustrated and comprehensive text with integral experiments to carry the user from basic digital electronics, such as gates and codes (digital), to sophisticated circuits employing random access memories, sequencers, 4 decade counters and dot matrix displays. Thanks to the unique structure of each Bugbook, users can pick and choose appropriate experiments and questions and proceed at their own pace and depth of interest. Each book is soft bound.

SUGGESTED RESALE PRICE \$17.00

**Bugbook IIA** — Interfacing and Scientific Data Communications. A supplement to Bugbooks I & II covering more advance topics in Digital Electronics; in particular, transmission of data with asynchronous techniques using the ASC II code; how to use RS 232/20ma current loops in combinations with the universal asynchronous receiver/transmitter. Soft bound.

SUGGESTED RESALE PRICE \$5.00

**IS — Instructor's Manual**  
This supplementary manual to the Bugbooks I & II is necessary for instructor use in the classroom and laboratory or for individual use in home-study situations. The Manual provides supplemental information including answers to the questions at the end of each experiment, suggestions for further reading, a discussion of the philosophy of the authors in their approach to digital electronics, and organizational suggestions for a lecture/laboratory course. This material is a must for individuals who are taking the course on a self-teaching basis; the answers to the experimental questions provide important feedback concerning the extent to which the material has been learned.

SUGGESTED RESALE PRICE \$3.00

**Bugbook III — Micro Computer Interfacing.** Experiments using 8080 Microprocessor system. Soft bound, 597 pages. This is unique text written in a self teaching style with experiments that thoroughly explain how to use, interface and program microcomputers. It focuses on a microprocessor system that uses the 8080 microprocessor and describes both in a general and specific manner. How to interface, how to program, how to work with the I/O busses, working with timing loops and more. The Bugbook III has been used successfully by individuals who are just experimenters or all the way through direct integration into formal classroom studies in universities. The book contains over 60 experiments, over 200 definitions.

SUGGESTED RESALE PRICE \$15.00

**Bugbook V.** Introductory Experiments in Digital Electronics, 8080A Microcomputer Programming, and 8080A Microcomputer Interfacing. 493 pages.

The Bugbook V is the first book in an integrated approach to self-instructed basic digital electronics, breadboarding, and 8080A microcomputer interfacing/programming. Detailed laboratory experiments cover the 7440-series of TTL integrated-circuit chips, including the concepts of signal gating; AND, OR, NAND, and NOR gates, truth tables, decoders, demultiplexers, counters, flip-flops, latches, monostable multivibrators, and the 555 timer. The accompanying text provides background information on these subjects. Answers to all tests and laboratory experiment questions are provided in the text.

SUGGESTED RESALE PRICE \$9.50

# Materials



**Bugbook VI.** Introductory Experiments in Digital Electronics, 8080A Microcomputer Programming, and 8080A Microcomputer Interfacing. 490 pages, May, 1977.

The second book in an integrated approach to basic digital electronics, breadboarding, and 8080A microcomputer interfacing/programming. Also written for self-instruction, Bugbook VI integrates the digital concepts discussed in Bugbook V into a treatment of 8080A microcomputer interfacing and programming. Detailed laboratory experiments in Bugbook VI cover device select pulse and memory address pulse generation; accumulator input/output; memory mapped input/output; three-state bussing; the 8080A instruction set; advanced input/output concepts and experiments; interrupt servicing; and the design of a modest 8080A-based microcomputer. Answers to all tests and laboratory experiment questions are provided in the text.

SUGGESTED RESALE PRICE \$9.50

**BRS-1** — The first of the Bugbook Applications Lines is the 555 Timer Applications Sourcebook. E&L proudly introduces this new addition to the Bugbook Series, the Bugbook Reference Series. The BRS-1 is a laboratory workbook and reference textbook that provides theory and applications of the versatile 555 timer chip. The organization and electrical characteristics of the 555 are discussed and then followed by applications, including monostable multivibrators, astable square wave generators, regulated power supplies, measurement circuits, switching regulators, games, telephone, music and automotive circuits, circuits for the ham, photographer and CB buff. Like the original Bugbooks, the BRS-

1 is self-instructional and has sixteen experiments included. The parts to do *all* the experiments come as a separate package, known as the BK-1.

SUGGESTED RESALE PRICE \$6.95

**BRS-2** — The second of the Bugbook Reference Series is a user-oriented text/workbook covering the best design of the various types of low-pass, high-pass, bandpass and notch filters built around operational amplifiers. 26 experiments, design graphs, tables and numerous illustrations make BRS-2 an excellent guide for the experimenter and hobbyist. An inexpensive 4-function calculator can be used to solve all equations and calculations. The parts to do *all* of the experiments come as a separate package, known as the BK-2.

SUGGESTED RESALE PRICE \$8.50

**BRS-3** — The third addition to the Bugbook Reference Series describes D-Bug. Use the BRS-3 to debug assembly language programs for any 8080 microcomputer system. D-BUG may reside in either 1,024 words of EPROM or R/W memory and can be used to examine and modify the contents of memory, punch and read paper tapes (audio cassettes) and single step through an assembly language program using the breakpoint feature. Two complete source listings are included, and examples are used throughout the book to demonstrate valid D-BUG commands and operations.

SUGGESTED RESALE PRICE \$5.00

**ADDbook One** — The ADDbook directly integrates the ADD-8000 and the Electronic Measurements for Scientists to form a truly comprehensive teaching system for Analog and Digital techniques. A large format (8½" x 11") book of 400 pages. It gives experimental implementation of the ideas brought out in the Electronic Measurements for Scientists, in up to the minute hardware designs.

SUGGESTED RESALE PRICE \$7.00

**Designers Primer and Handbook CMOS-M** — Our recent publication in the CMOS circuitry area has been updated. New IC's have been covered, additional reference material added and redesigned. We also are offering CMK-1, a kit containing the necessary components to do all of the experiments.

SUGGESTED RESALE PRICE \$6.00

**Digital Electronics and Laboratory Computer Experiments** by Plenum Press, New York and London. This new guidebook is designed to teach the basic principles of digital electronics and microcomputer applications in the laboratory.

By the proven use of graded experiments, the student is instructed in the application of computer technology to scientific data collection and analysis problems in the laboratory. All seventeen experiments have been thoroughly tested and found to be error free, making this book a reliable manual for both laboratory courses and self-instruction.

The DD-1 Digi-Designer has been used to work one-to-one with each of the experiments.

SUGGESTED RESALE PRICE \$15.00

**Digital Fundamental DC-2** — An experimental approach to understanding digital electronics. The DC-2 is supplied in a lab binder format, with ample area for diagramming and circuit design. This volume covers items from simple switching devices to the complex 74181 Arithmetic-Logic Chip. The text ties directly into the DD-1 Designer and can be easily integrated into formal courses as a lab book. All the IC's necessary to do all of the experiments in the DC-2 are available in the kit IC-1.

SUGGESTED RESALE PRICE \$9.00

**DM-1A — Digital Configuration Manual**

This soft cover text lists almost 6000 IC's with their general type called out and referenced to one of 700 different pin outs. All types, including TTL, ECL, DTL, CMOS, MECL, MOS and LSI, are included.

SUGGESTED RESALE PRICE \$7.00

**OP-AMP Experiment Manual OM-1** — The OP-AMP Experimenter's Manual. This book is a useful tool for understanding how Op-Amps work. The softbound volume contains 12 chapters on various experiments for learning linear integrated circuits. It is designed to work with the Op-Amp designers, the Op-Amp Breadbox, or Starter Kit.

SUGGESTED RESALE PRICE \$4.00

**Integrated Circuit Applications and Experiments OA-2M** — A compilation of almost 200 experiments mainly covering linear circuitry with added information on complementary digital circuitry. The OA-2M covers an up-to-date spectrum of applications of IC's that range from simple circuits through complex waveform generators. Designed to be used with the OA-2 or the OA-3.

SUGGESTED RESALE PRICE \$4.00

# Innovator

## Innovator Series

With this inexpensive, easy to use teaching system, students are involved on their very first day with the exciting world of digital electronics. Text/workbooks are integrated with the hardware. A separate teacher's manual gives the instructor valuable lesson information,

insight into the problems a student will encounter, supplemental course work and answers to the text questions. Each idea presented by the authors, Rony and Larsen, is immediately reinforced with an experiment. The low cost of the materials makes it possible for each student to have his own

work station and to learn by doing. The experimental unit is small and portable, allowing the possibility for lab homework and extra experimentation by the ambitious student. The component parts used to demonstrate various aspects of digital circuitry are plug-in outboards. These outboards plug into

one of the SK series on the outer edge leaving the center portion open to build the particular circuit under study. The student actually uses IC's, resistors, transistors, LED's, etc. The system approaches the student first with the individual outboards as tools leaving later lessons open to theory.

## BASIC OUTBOARDS

The "Basic Outboards" make up the initial system. They contain the fundamental modules needed to carry out the associated experiments in Bugbooks I & II. They are used to control and monitor what's going on in the breadboarded digital circuit under design/study.



### LR-1 POWER OUTBOARD

Used when operating the SK-10/Outboard System from a 6 volt battery. It guarantees that power cannot be applied backwards; it also gives the user a positive indication of power on. It comes complete with 2 insulated Alligator clips for attaching to a battery.

#### Specifications

Polarity reversal protected Indicator Light — LED  
Lead lengths — 18" (45, 7cm) terminated in Alligator clips.

SUGGESTED RESALE PRICE  
ASSEMBLED — \$11.50, KIT — \$6.76

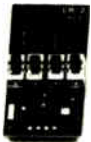

### LR-2 LOGIC SWITCH OUTBOARD

Allows user to set either logic state 1 or 0 at output terminals.

#### Specifications

4 logic switches — spdt — rated 1/2 Amp @ 125V  
4 "pull up" resistors connected to Vcc

SUGGESTED RESALE PRICE  
ASSEMBLED — \$16.40, KIT — \$8.50

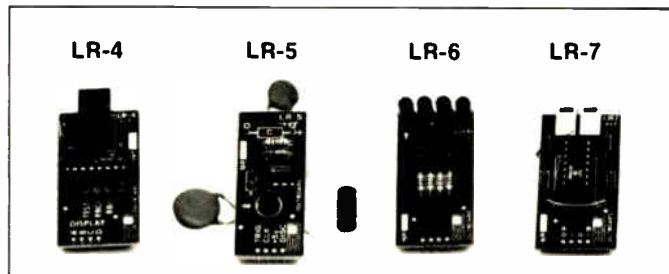

### LR-4 SEVEN SEGMENT DISPLAY WITH DECODER/DRIVER

Gives a numeric readout (0 to 9) based on Binary Code Decimal (BCD) Input. Used in counting circuits, 0/1 indication, etc.

#### SPECIFICATIONS

**Input:** BCD, TTL input (5 volts nominal)  
**Indicator:** LED, 7 segment display  
**Current (max.):** 140 ma.  
**Miscellaneous:** (4) BP25's — solderless interconnecting jacks for independent connections to Lamp Test, Blanking Output, Blanking Input and Decimal Point. Display and Associated IC are mounted in IC sockets allowing replacement without soldering.

SUGGESTED RESALE PRICE  
ASSEMBLED — \$26.65, KIT — \$19.00

### LR-5 CLOCK OUTBOARD

An outboard that can be used as a standard TTL "clock" that is adjustable via external capacitors inserted across the "C" terminals or as a timer through external components that can be constructed on the SK-10

#### Specifications

**Clock:** Frequency adjustable from .1 to 20K Hz. for a capacitance range of 5pf to 100  $\mu$ f.  
**Capacitors supplied:** .03, .33 and 1.0  $\mu$ f.  
**Miscellaneous:** Indicator Light — LED: 20 ma. (max.)

SUGGESTED RESALE PRICE  
ASSEMBLED — \$14.80, KIT — \$10.50

when the Outboard is installed. The Outboard contains its own indicator for showing the output condition (e.g. — when clocked at a specific frequency, the light blinks on/off at that frequency).

### LR-6 LED LAMP MONITOR OUTBOARD

This outboard gives the user an indication of the logic levels at various points in the circuit under observation. Because the input is used to drive a transistor, a high input resistance results so the circuit is not "loaded" down by the indicator.

#### Specifications

4 Logic Lights — LED Indicators  
**On:** logic state 1 (greater than 2.5 volts)  
**Off:** logic state 0 (less than .5 volts)  
**Input Impedance:** 4,700 ohms  
**Current:** 80 ma. (max.)

SUGGESTED RESALE PRICE  
ASSEMBLED — \$15.00, KIT — \$10.00

### LR-7 DUAL PULSER OUTBOARD

Two miniature spring loaded switches are electronically "debounced" — that is, change state from 0 to 1 or 1 to 0, without any spurious signals when actuated.

#### Specifications

2 miniature spring-loaded momentary contact switches. Outputs: 2 each switch: one normally "zero," one normally "one." Outputs reverse on switching.  
**Current:** 20 ma. (max.)

SUGGESTED RESALE PRICE  
ASSEMBLED — \$15.55, KIT — \$11.50

# Series

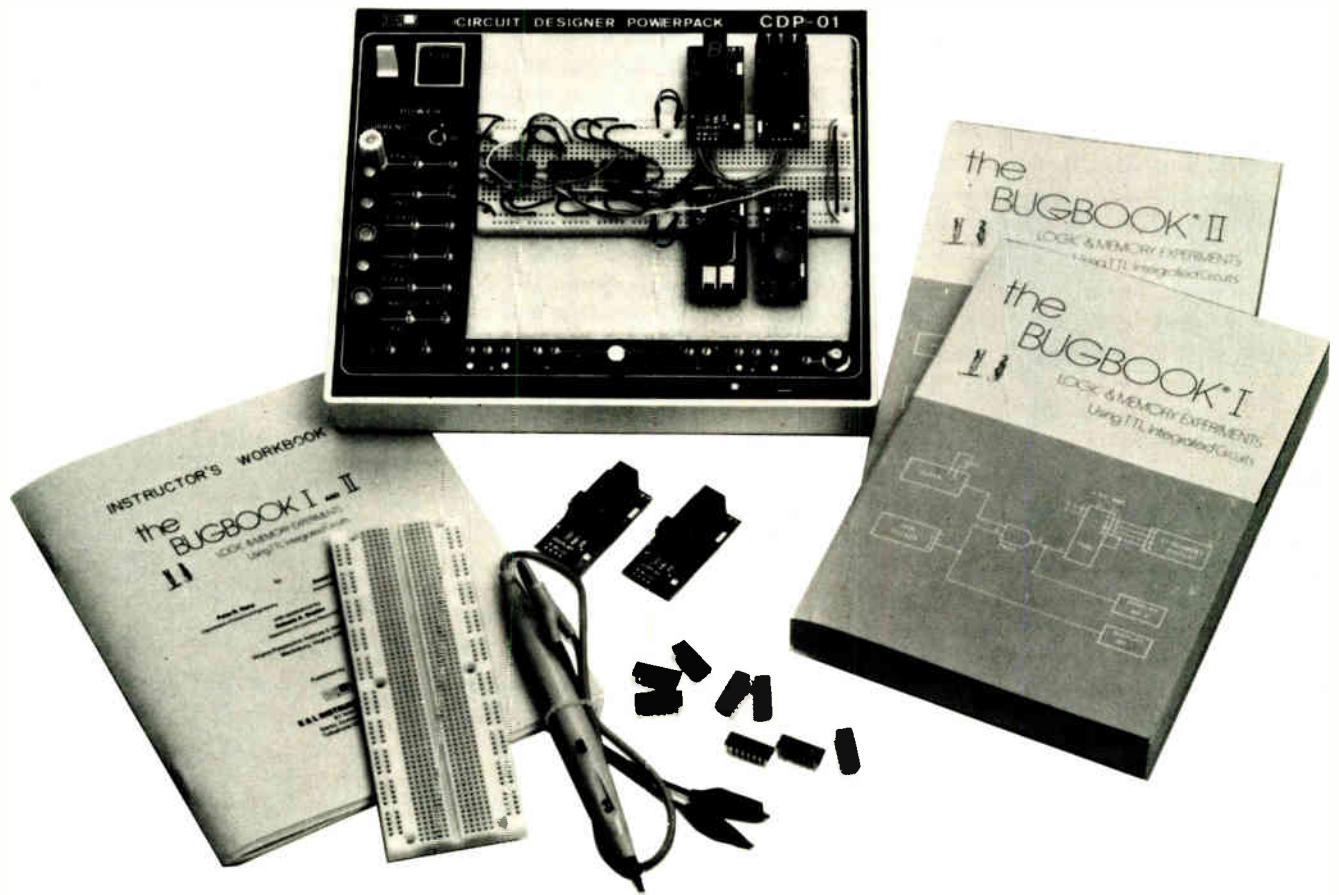

## Innovator Systems

E&L has put together a number of specific combinations of the outboards and associated items for ease of specification and use by teachers and individual users.

**IS-2** — Basic outboards, IC's, wire, SK-10, Bugbooks I & II, a comprehensive assemblage for the beginner. As the student progresses, additional IC's and a power supply may be added to cover all topics and in-depth analysis of particular phases of interest. Available in Kit (IS-2K) or Assembled (IS-2A).

SUGGESTED RESALE PRICE  
ASSEMBLED — \$138.65, KIT — \$105.00

**IS-5** — All of the above (IS-2) plus an additional LR-4, IS-EC1 electronics component package. CDP-01 power supply, LT-2 (Logic Probe) instructor's manual and label set BGB-1. Available in Kit (IS-5K) or Assembled (IS-5A)

SUGGESTED RESALE PRICE  
ASSEMBLED — \$377.05 KIT — \$295.76

## INSTRUCTOR'S PACK IS-IP-1

To adequately handle most contingencies in a classroom situation, including the need for demonstration experiments, extra work assignments, special projects, and replacement Outboards and wire, E&L recommends that each instructor equip himself with the following items:

**Contains Accessory Packages 1, 2 and 3 (see separate listing) Plus All of the Following:**

1. Four extra SK-10 sockets
2. One CDP-01, assembled
3. Two "Bugbook I and Bugbook II."
4. Two Instructor's Manuals
5. Two BGB-1 Bugback packages.
6. Additional Outboards. Two each of the following:
  - a. LR-1A Power Outboard
  - b. LR-2A Logic Switch Outboard
  - c. LR-4A Seven-segment LED Display Outboard
  - d. LR-5A Clock Outboard
  - e. LR-6A LED Lamp Monitor Outboard
  - f. LR-7A Dual Pulser OutboardOne each of the following:
  - g. LR-10A Programmable Counter/Timer Outboard
  - h. LR-11A Universal Outboard
7. Zero-insertion-force sockets
  - a. Two 24-pin IC sockets
  - b. Two 40-pin IC sockets
8. No. 22 gage solid wire cut to length with  $\frac{1}{4}$ " (6,4mm) stripped ends.  
Six (6) colors of each of the following lengths:
  - a. Ten (10) lengths of  $1\frac{3}{4}$ " (4,5cm)
  - b. Ten (10) lengths of 3" (7,6cm)
  - c. Four (4) lengths of 6" (15,2cm)

Additional Software

- a. TTL Databook by Texas Instruments
- b. TTL Cookbook (Lancaster) by H. Sams

SUGGESTED RESALE PRICE \$890.00

# Innovator

## THE DATA TRANSMISSION OUTBOARDS

One area of great concern to individuals in digital electronics today is interfacing and Scientific Data transmission. To meet this need E&L offers three unique outboards that directly use Bugbook IIA for their experiments.



### LR-13 LINE DRIVER/RECEIVER — RS232 INTERFACE OUTBOARD.

A dual line driver/receiver specifically intended for a UART to Modern Interface

- Can interface any TTL to Modern/MODEM to TTL
- Acts as a schmitt trigger, sine to square wave converter
- Exhibits either a high differential or high common mode noise immunity
- Use with the LR-21 to interface to MODEM

SUGGESTED RESALE PRICE  
ASSEMBLED — \$39.80, KIT — \$28.00

### LR-14 TTL/20 MA CURRENT LOOP INTERFACE OUTBOARD.

Interface TTL (+5V) to teletypes and CRT's.

- +5V TTL I/O; fan in of 1; fan out of 10
- logic 1 with 3 ma; logic 0 with 15ma.
- optically isolated for ground loop elimination
- on board regulation (regulator not isolated from ground)
- data speed — DC to 30 K bit/sec. (typ)

SUGGESTED RESALE PRICE  
ASSEMBLED — \$40.00, KIT — \$28.80

### LR-21 UNIVERSAL ASYNCHRONOUS RECEIVER/TRANSMITTER (UART)

LR-21 covers 8 bit parallel binary input asynchronous serial output and visa-versa.

- It operates at speeds to 30 kilobaud.
- Double buffered allowing storage while another word is being sent or received.
- Has 3 state outputs permitting positive buss operation.

### SPECIFICATIONS

Two supply voltages are required, +5 volts and -12 volts. It is possible to replace the latter by a -15 volt supply. Fanout at each output: one TTL load.

Will accept clock frequencies to 480 KHz, and transmits data at rates of up to 30K baud.

Requires the following minimum pulse widths for the indicated inputs:

Input	Minimum pulse width, nsec.
Clock Pulse	1000
Control Strobe	300
Data Strobe	190
External Reset	500
Status word enable	500
Reset data available	250
Received data enable	500

Permits the following options for the asynchronous serial data work:

Start bit	1	Parity bits	0 or 1
Data bits	5, 6, 7 or 8	Stop bits	1 or 2

Provides the following flag signals:

Transmitter buffer empty	Parity error	Overrun
End of character	Transmitter buffer empty	Framing error
Data available		

Contains an independent buffered receiver and an independent buffered transmitter that can be clocked independently. However, the control bits apply to both receiver and transmitter simultaneously, so both the transmitted and received words must have the same number of data bits, parity bits, and stop bits.

SUGGESTED RESALE PRICE  
ASSEMBLED — \$60.00, KIT — \$40.00

## THE "STACKABLE" OUTBOARDS™

E&L's Stackable Outboards include a number of circuits that are configured in such a manner that they may be inserted directly into the SK-10, or they may be vertically assembled onto each other to perform a complete function in a number of ways. There are a

number of these combinations that have been evolved, for example: *To obtain a complete counting circuit, assemble on the LR-17 (BCD Decode Counter) the LR-19 (LATCH) and finally, the LR-4 (7 segment Readout/Decoder Outboard).*



### LR-19 LATCH OUTBOARD

The LR-19 incorporates a positive edge triggered latch which can be used as a 4-bit memory with complementary outputs, Q and Q-bar. STROBE and CLEAR inputs are provided.

SUGGESTED RESALE PRICE  
ASSEMBLED — \$29.00, KIT — \$25.00

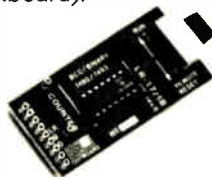

### LR-17/18 BCD DECODE COUNTER/4 BIT BINARY COUNTER

These Outboards differ only in the substitution of a 4-bit binary counter IC chip (LR-18) for a BCD decode counter IC chip, (LR-17). A DPDT switch permits either a free running counter or a counter that can be reset to 0 from a remote input. The decade counter can also be remotely reset to 9.

SUGGESTED RESALE PRICE  
LR-17 ASSEMBLED — \$18.25, KIT — \$15.25  
LR-18 ASSEMBLED — \$18.50, KIT — \$15.25



### LR-22 DECODER OUTBOARD

This 4-line to 16-line decoder Outboard can be stacked into the LR-18 binary counter to produce a 16-state sequencer. Its main use is as a microprocessor output decoder.

SUGGESTED RESALE PRICE  
ASSEMBLED — \$24.00, KIT — \$16.50



### LR-23 MULTIPLEXER OUTBOARD

The LR-23 is a 16-line to 1-line multiplexer that can select information appearing at any one of sixteen different input channels and provide it in inverted form at a single output. It is very useful for multiplexing data into a microprocessor input port.

SUGGESTED RESALE PRICE  
ASSEMBLED — \$23.50, KIT — \$15.50



# Series



## SUPPLEMENTAL OUTBOARDS

In keeping with the concept of flexibility and expansion of the basic Innovator Series, the following items are now available to complement the original Outboards®, Bugbooks®, and CDP-01.

### LR-16 VARIABLE POWER SUPPLY

With 15 VDC input, this small variable supply adjusts the output voltage continuously from approximately 3 to 14 volts DC.

### SPECIFICATIONS

(With 15 volts in)  
Output voltage: 3 to 14 volts  
Regulation: -1%  
Output current: 100 ma. (max.)

SUGGESTED RESALE PRICE  
ASSEMBLED — \$18.50, KIT — \$16.00

### LR-25 TTL BREADBOARDING OUTBOARD

The LR-25 combines the functions of the basic outboards on a single DC board. All the basic controls and monitor elements needed for digital work are contained in a very hard supplement suitable for even advanced design work. The HEX decimal display is not supplied with the base unit but is available as an option.

### SPECIFICATIONS

(8) LED type indicators  
(4) Logic Switches  
(2) Bounce-Free Pulsers  
(1) Variable Clock (frequency selected by external capacitor)

SUGGESTED RESALE PRICE  
LR-25 ASSEMBLED — \$61.10  
LR-25 KIT — \$36.50  
HEX OPTION — \$22.50

### LR-110 KLUGE CARD OUTBOARD

This board complements the LR-11. It represents a simple way of building permanent circuits that are routinely used as part of a design.

SUGGESTED RESALE PRICE \$6.65

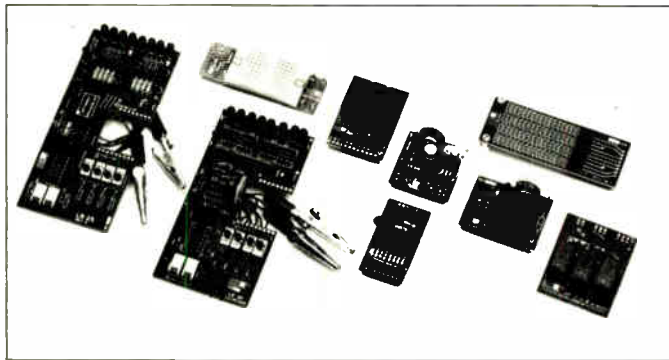

### LR-30 CMOS BREADBOARDING STATION

Identical in function to the LR-25 but modified to operate over a range from 3 to 15 volts. This unit is not available with the HEX decimal optional display.

### SPECIFICATIONS

Input voltage 3-15 volts  
(8) LED indicators  
(4) Logic Switches  
(2) Bounce-Free Pulsers  
(1) Variable frequency clock selected by external capacitor; adjustable through outboard potentiometer.

SUGGESTED RESALE PRICE  
ASSEMBLED — \$43.00, KIT — \$33.00

### LR-27/28 THREE DIGIT LATCHES

Three character HEX-decimal displays. The 27 and 28 are identical except for independent displays with common strobe on the 28.

SUGGESTED RESALE PRICE  
LR27 & 28 ASSEMBLED — \$87.50  
LR 27 & 28 KIT — \$75.00

### LR-10 PROGRAMMABLE TIME/COUNTER

A counter/timer that allows the user to program various combinations of time delays and frequency generation.

### SPECIFICATIONS

#### Programmable Timer/Counter

**Timer Length** XR2240/2340  
microseconds to days; accurate to .5%  
TTL Outputs

**Maximum "toggle" rate**  
1.5 meg. hz.

**Current:** 8-BP25's — solderless interconnecting pins for connections in parallel to 16 pin IC socket and header for programming.

NOTE: One unused 16 pin header is supplied for user's designed projects; one 16 pin header is supplied with components for experimental use.

SUGGESTED RESALE PRICE  
ASSEMBLED — \$48.50, KIT — \$29.00

### LR-11 UNIVERSAL OUTBOARD

The SK-20 Universal component socket is combined with BP-25 solderless breadboarding pins. All connections are made without soldering — only 22 gage solid wire is needed for interconnections.

SUGGESTED RESALE PRICE—\$11.00

### LR-15 PULSE GENERATOR

A variable pulse generator that covers a broad spectrum of frequencies: the pulse width is adjustable by the built-in potentiometer.

The base frequency is selected by external capacitors that simply plug into the two BP-25's at the rear of the generator.

SUGGESTED RESALE PRICE  
ASSEMBLED — \$16.00, KIT — \$11.25

### LR-31 FUNCTION GENERATOR OUTBOARD

The LR-31 Function Generator Outboard can generate a square wave and either a sine wave or a triangle wave. Frequencies of 0.01 Hz to 1 MHz are possible, depending on the value of the user selected capacitor. With a single capacitor the dynamic frequency range is greater than 1000:1.

SUGGESTED RESALE PRICE  
ASSEMBLED — \$46.40, KIT — \$36.00

### LR-32 4 DECADE COUNTER OUTBOARD

The LR-32 Decade Counter Outboard is a complete 4 decade counter including 4 decade counters, latches, display drivers, display multiplexing circuitry and 4, 7-segment LED displays. The carry output of the LR-32 4 Decade Counter Outboard is available so that LR-32's can be easily cascaded. When used in conjunction with the LR-33 Quartz Crystal Outboard, frequency counters, period meters and event counters can be easily constructed.

SUGGESTED RESALE PRICE  
ASSEMBLED — \$99.00, KIT — \$77.00

### LR-33 QUARTZ CRYSTAL OUTBOARD

The LR-33 Quartz Crystal Outboard uses a state-of-the-art MOS-LSI technology to provide stable, programmable frequency source. With the on-board thumb-wheel switch or jumpers on the bread-boarding socket, you can select an output frequency of from 1 MHz to 0.01 Hz, by factors of ten.

SUGGESTED RESALE PRICE  
ASSEMBLED — \$75.00, KIT — \$50.33

### LR-34 UNIVERSAL TRANSISTOR OUTBOARD

The LR-34 Universal Transistor Outboard enables you to easily breadboard TO-3 and TO-220 power transistors, SCR's, triacs and solid state voltage regulators. With transistor sockets provided on the outboard, it is very easy to switch between either a TO-3 or TO-220 device.

SUGGESTED RESALE PRICE  
ASSEMBLED — \$15.00, KIT — \$10.80

# Microprocessor

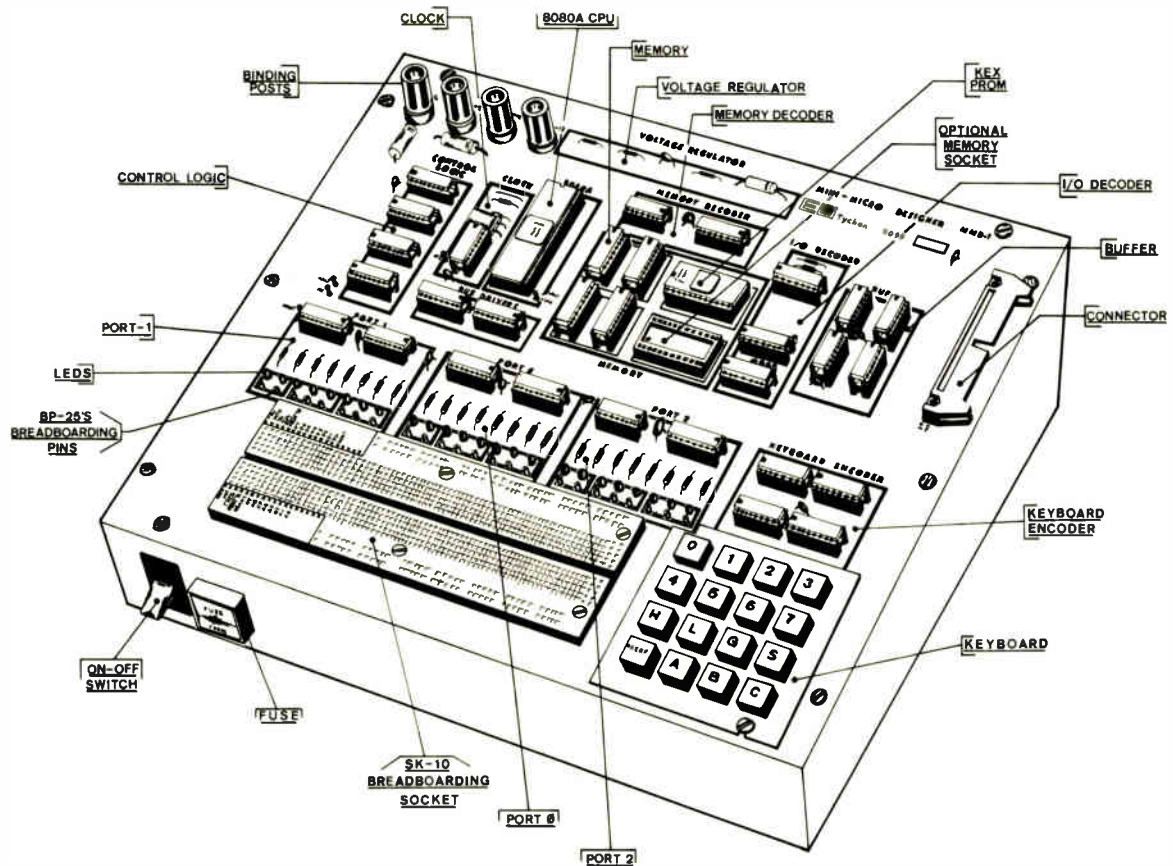

CONTROLS, SOCKETS, CONNECTORS, AND CIRCUIT FUNCTIONS

FIGURE - 1

## MMD-1

**MMD-1 8080A Based Computer** for training and hardware development. The Mini-Micro Designer is a low cost, expandable system totally supported by The Bugbook educational materials. The Bugbooks are the ideal introduction to computers for the beginner as well as those with considerable technical background and experience. The texts, which double as laboratory manuals, start with digital coding and microcomputer programming and advance the student to the practical aspects of programming and interfacing. The MMD-1 features direct keyboard entry of data and instructions in easily understood octal code.

The MMD-1 is the only microcomputer system now

on the market that permits the user to design his own interface in 10 to 20 minutes and implement the design with ordinary hook up wire and standard readily available 7400 series IC's. No special assembly tools are needed.

All in all, the student can carry out over 60 experiments in the Bugbook texts as well as many other circuit designs without the need for soldering or the construction of simple circuit functions. Available either in kit (MMD-1k) or assembled (MMD-1A) form at either 115V or 230V operation.

See separate brochure # 803-0144.

SUGGESTED RESALE PRICE  
ASSEMBLED - \$600.00, KIT FORM -  
422.80

## SPECIFICATIONS

**Central Processor**  
8080A or equivalent

### Memory

Read / Write, Random Access (RAM); 512 words by 8 bits furnished on main MMD-1 circuit board.  
Expandable up to a total of 65,536 words. (Additional power required over 2500 words.)  
Programmable Read Only (PROM) programmed to permit keyboard entry of data in octal code; keyboard executive program (KEX) 256 words by 8 bits.  
(Open socket on board permits an additional 256 words.)

### Display

Light-emitting diode lamps (LEDs); three groups of eight individually latched and addressable under software control.  
LEDs display low address, high address and memory contents.

### Data Entry

Keyboard; 16-switch with keys organized in octal code 0 to 7, Hi address (H), Lo address (L), go (G), reset (RESET), examine / deposit (S) and three optional keys (A, B, and C).

### Interface Socket

E & L SK-10/IF 18. Direct interface connection includes  $\bar{D}_0 - \bar{D}_7$ ;  $\bar{A}_0 - \bar{A}_7$ ;  $\bar{I}_n$ ,  $\bar{O}_u$ t,  $\bar{M}E\bar{M}\bar{W}$ ,  $\bar{+}5$ ,  $\bar{G}ND$ ,  $\bar{M}E\bar{M}R$ ,  $\bar{I}N$ T,  $\bar{I}N$ T,  $\bar{W}A$ I,  $\bar{R}E\bar{A}D$ Y,  $\bar{T}A\bar{C}K$ .  
Open area on socket will take up to five 16-pin ICs and discrete components with 20 to 26 AWG wire leads.

### Ribbon Cable Connector

Dual, 20-pin wired the same as the SK-10 interface socket with A8 thru A15 added.

### Internal Power Supply

Line Voltage - 115V or 230V ac, fused

### Outputs

+ 5V dc @ 1.5A  
+ 12V dc @ 150mA  
- 12V dc @ 150mA

### Microprocessor Chip Set

1	8224	Clock Generator and Driver
4	8111-2	1024-bit (256 by 4) static MOS RAM
2	8216	4-bit parallel bidirectional bus drivers.
1	1702	2048-bit (256 by 8) programmable read only memory (PROM) (Factory programmed as KEX PROM)

### Dimensions

12" (30.5cm) by 10" (25.4cm) by 3 1/2" (8.9cm)

### Weight

6.3 pounds (2.86kg.)

# Systems

## AND ACCESSORIES

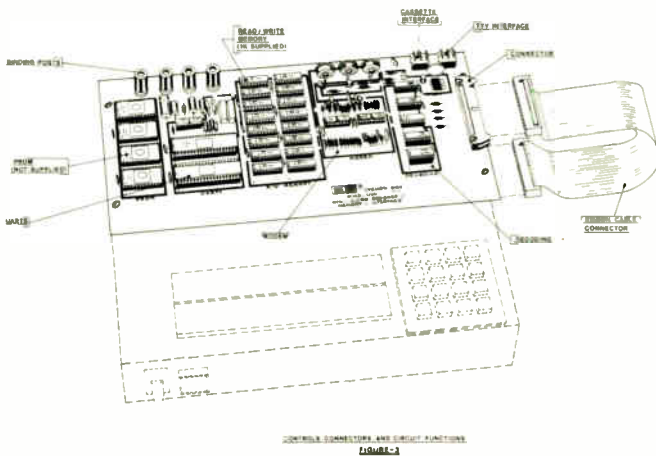

### MMD-1/MI MEMORY-INTERFACE BOARD

The Memory and Interface Board (M/I) is an accessory designed to permit hardware and software development to be performed on the MMD-1 microcomputer system.

The M/I board provides additional memory and teleprinter and audio cassette recorder interface. The use of an Audio Cassette Recorder allows for low cost storage of data in the course of software development.

The M/I board uses two universal asynchronous receiver transmitters (UART) for synchronization, formatting and parallel series conversions necessary for communications with teleprinters. The UARTS handle

data in blocks of 8-bits. The American National Standard Code for Information Interchange (ASCII) is employed in the 8-bit data block.

The M/I board contains a relay driver circuit for use with a teleprinter paper tape reader relay. This option permits software control of all reader start/stop operations.

No restrictions are placed on the format for communications with the audio recorder as the recorder need not be directly interfaced with any other terminal for printing or display of readout.

Available in kit (MMD-1/MIK) or assembled (MMD-1/MIA) form.

SUGGESTED RESALE PRICE  
ASSEMBLED — \$250.00, KIT — \$194.50

### SPECIFICATIONS

#### Power Consumption

(with maximum memory installed):  
+5V dc @ 1A  
+12V dc @ 0.1A  
-12V dc @ 0.25A

#### Memory:

Read/Write (RAM) 2048 words capacity. (1024 words supplied.)  
Programmable ROM (PROM) 1048 word capacity (non supplied).

#### Teleprinter Interface:

Full Duplex, 20mA current loop  
110 Baud  
Reader Relay Control

#### Audio Recorder Interface:

Software controlled.  
Two-tone audio 2125 Hz/2975 Hz (FSK)  
UART formatted  
300 Baud Data Rate  
Output Impedance: 47K ohms  
Output Signal: 1volt ac (2V P-to-P)  
Input Impedance: 10K ohms  
Input Signal: 1 volt ac (2V P-to-P)

#### Ribbon Cable Connector:

Dual, 20-pin wired to full computer buss. (Interconnecting cable supplied — 6" long.)

### MMD-PP PROM PROGRAMMER

In those applications where the user of the MMD-1 needs to permanently hold his programs, he will find the MMD-PP a valuable tool. It is specifically designed to pop the 1702A PROMS used in the MMD-1 and is remarkably easy to use thanks to the control PROM that accompanies the MMD-PP . . . only a few strokes on the keyboard and the transfer of data can take place. The Programmer allows the 1702 to accept data from the memory on board the MMD-1 or from another PROM

when inserted in the "master" socket on the Programmer itself.

The Programmer allows the user to verify the popped PROM versus the master or versus the program in MMD-1 memory. Zero insertion force sockets are used to minimize the danger of damaging the PROM's leads. The unit comes complete with interconnecting cable to attach it to the MMD-1 and is available in kit (MMD-PP/K) or assembled (MMD-PP/A) form.

SUGGESTED RESALE PRICE  
ASSEMBLED — \$216.50, KIT FORM — \$161.00

### SPECIFICATIONS

Capable of Programming: 1702 (A) Only  
Typical Time to Program: Four (4) Minutes

#### Programming Mode:

- A.) Copy a Master PROM.
- B.) Copy any 256 word block of MMD-1 Memory, i.e. RAM or PROM.

#### Verify Mode:

- A.) Compare contents of the programmed PROM with contents of a Master PROM.
- B.) Compare contents of the programmed PROM with any 256 word block of MMD-1 Memory, i.e. RAM or PROM.

#### Transfer Mode:

Transfers (copies) data from a Master PROM to a fixed buffer zone in MMD-1 RAM. The data can then be modified (edited) and a new PROM programmed directly from the buffer zone.

#### Power Supply:

Self contained (not available for external use), no external supplies required.  
115/230 volt operation.

#### MMD-1 Clock Speed:

The standard 6.750 MHz crystal *must* be used when using the PROM programmer.

#### Control Prom:

The PROM Programmer makes use of the MMD-1 computer to perform its function via a Control PROM located on the popper. This PROM resides at address 377 000 through 377 377 in the MMD-1 memory array.

Zero insertion force sockets are used for MASTER, VERIFY and PROGRAM positions.

Size: 3.5" H (8,9cm) x 7.6" W (19,3cm) x 9" L (22,9cm)  
Weight: 7 lb x (3,18Kg)

Accessories — Accessory # 1 — Additional 40 pin connector and Interconnect Cable \$15.00

# Microprocessor

## HEX KEYPAD

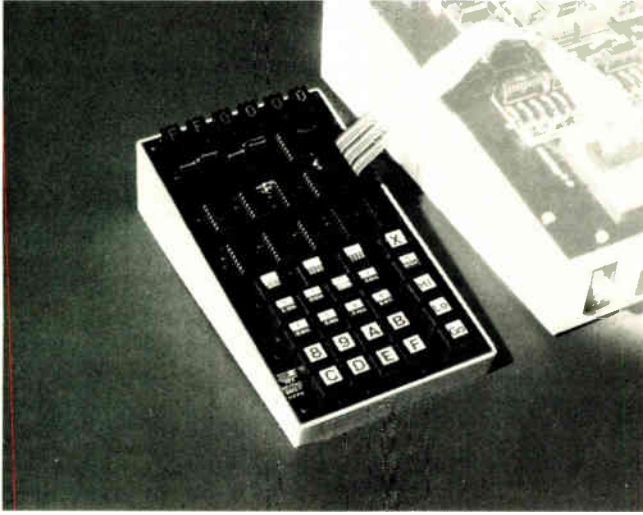

The Hex Keypad has been developed as a general purpose, microcomputer, data entry/display device for persons who find it convenient to work with Hex-decimal Coding. The keyboard section generates four bit Hex code corresponding to the legends on the keys. The keys are priority encoded such that if two or more keys are struck simultaneously the value of the highest order will be output. This feature prevents the generation of false codes and simplifies the processing of data from the Keypad. The Keypad can also be jumper

selected for device codes 0 thru 7.

The Keypad is used in conjunction with E&L's Mini-Micro Designer (MMD-1) to permit direct Hex programming of the computer or as a separate I/O device. To convert the MMD-1 for direct hexadecimal programming simply replace the existing KEX prom, in position "O" with the Hex L/D prom provided and interconnect the two units with the cable provided.

## MMD-HEX-1 (without displays)

### SPECIFICATIONS

**Data Entry:** The keyboard section has a 16 key Hex Encoded keypad plus 8 encoded function keys, priority encoded.

**Interfacing:** Interconnect capable via a 28 pin DIP double ended ribbon cable. One end goes to the committed portion of the SK-10 on the MMD-1 and the other end goes to the 28 pin DIP socket on the keypad. The following signals are utilized:

GND	Breadboarding pins
- 5V	provided for
	external use

IN  
OUT  
AO thru A7  
DO thru D7

**Power Requirements:**  
Approx. 1/4 AMP

**Device Selection:** The keypad is jumper selectable for device codes 0 thru 7. Factory wiring is for use with the HEX L/D PROM.  
Keyboard — Device Code 001

**Physical:** Dimensions — 7 3/4" (19.7cm) L x 4 1/8" (11.4cm) W x 3" (7.6cm) D  
Weight — Approx. 1 lb

SUGGESTED RESALE PRICE  
ASSEMBLED — \$125.00, KIT — \$105.00

## MMD-HEX-2 (with Displays)

### SPECIFICATIONS

**Displays:** Three pairs of Hexadecimal Latched Displays, provided for. One pair is supplied standard while the additional two pairs are optional

**Data Entry:** The keyboard section has a 16 key Hex Encoded Keypad plus 8 encoded function keys, priority encoded

**Interfacing:** Interconnect capable via a 28 pin DIP double ended ribbon cable. One end goes to the committed portion of the SK-10 on the MMD-1 and the other end goes to the 28 pin DIP socket on the Keypad. The following signals are utilized:

GND	Breadboarding pins
- 5V	provided for
	external use

IN  
OUT  
AO thru A7  
DO thru D7

**Power Requirements:**  
Approx. 1 AMP (fully loaded with all displays)

**Device Selection:** The keypad and each pair of Hex Displays is jumper selectable, for device codes 0 thru 7, via headers. Factory wiring is for use with the Hex L/D Prom

Keyboard — Device Code 001  
Data — Device Code 002  
Lo Address — Device Code 000  
Hi Address — Device Code 001

**Physical:** Dimensions — 7 3/4" (19.7cm) L x 4 3/8" (11.4cm) W x 3" (7.6cm) D  
Weight — Approx. 1 lb.

**Accessories —** Accessory #1 — Two (2) Hexadecimal displays (T.I. # 311) \$33.00

SUGGESTED RESALE PRICE  
ASSEMBLED — \$185.00, KIT — \$155.00

## MMD-1/SS

The Student Station is a package built around the LR-25. This package will give the user the material to do most of the experiments in Bugbooks V and VI. It includes an extra SK-10 socket, IC's, 28 pin dual interconnecting Cable, wire and miscellaneous components.

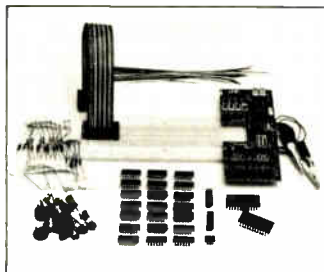

SUGGESTED RESALE PRICE  
ASSEMBLED ONLY — \$150.00

# Accessories

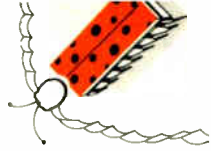

## COMPATIBLE ACCESSORIES

## PL1, PL2

## DEC 2

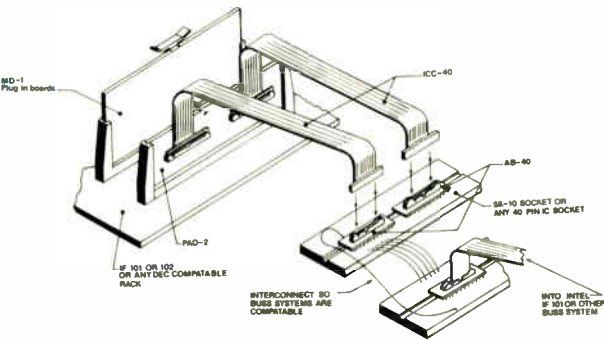
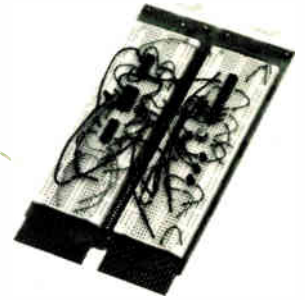
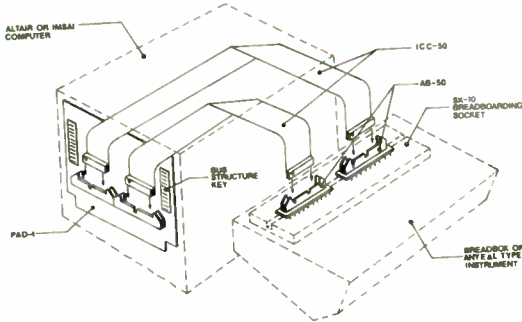

The Plug In Socket Boards are used to construct semi-permanent wired circuits in a totally solderless manner. They can be plugged into card edge connectors (such as those on the Adam or Elite) that are part of larger breadboarding systems, or can be used in card racks as part of "finished" systems.

The DEC 2 uses the interfacing version of the SK-10, which hard wire a portion of the socket directly to edge connectors eliminating the need for jumpers. The DEC 2 uses standard DEC spacing on the edge connector and is particularly useful as a supplemental card in the MD-1 Microprocessor.

The PL 1 and PL 2 offer standard SK-10 sockets all of which are available for construction of circuitry; external connections to the edge connector are made by "jumping" to the appropriate interconnecting jack with 22 gage wire.

### SPECIFICATIONS

Printed Circuit Boards: 1/16" (1,57mm) G10  
 Size: 4.5" (114,33mm)w x 9.5" (25,44cm)L.  
 Edge Connectors: Gold Plated  
 Card Pullers: Molded Plastic

SUGGESTED RESALE PRICE  
 PL-1 - \$52.50, PL-2 - \$38.50

(2) SK-10-1F 18 Sockets  
 (72) Contact Card Edge Connector: 125" (3,18mm) spacing

SUGGESTED RESALE PRICE \$76.50

## S-100 BREADBOARDING CARD

The S-100 will buss and fit into Altair or Imsai units to build semi-permanent interfaces and circuits.

Hardwired interface sockets contact the edge connector of the plug-in card giving the user access to every signal generated by the microcomputer, including those presently unassigned. The Data and Address buss structures are segregated for easy identification and external connection can be made through the AB40 or AB50.

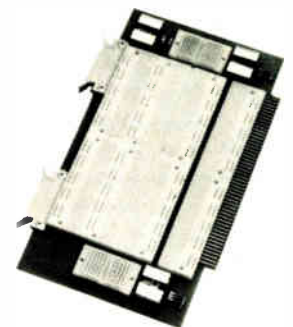

Standard 10" x 5" card size, with 100 gold plated fingers. Breadboarding area committed to S-100 buss.

SUGGESTED RESALE PRICE \$69.00

### ALTAIR<sup>®</sup> / IMSAI<sup>®</sup> COMPATIBLE

**PAD-1** - New breadboarding aid for the Altair<sup>®</sup> / Imsai<sup>®</sup> owner; plugs directly in the Altair<sup>®</sup> / Imsai<sup>®</sup> buss. Use with optional cable and dual-in-line adapter, listed below, with your PAD-1 to plug your Altair<sup>™</sup> / Imsai<sup>®</sup> unit into an SK-10 Breadboarding Socket, Breadbox, or other E&L Breadboarding instruments.  
 SUGGESTED RESALE PRICE \$35.00

**AB-50** - A plug/socket combination to adapt 50 wire strip cable to 50 pin dual-in-line plug. Use with PAD-1 to plug into the SK-10 Socket.  
 SUGGESTED RESALE PRICE \$22.50

**ICC-50** - 50 wire strip cable with female, strain-relieved connector on each end. Comes standard at 18" (45,7cm) long. Plugs directly into the AB-50.  
 SUGGESTED RESALE PRICE \$32.50

### MD-1/DEC<sup>®</sup> COMPATIBLE

**PAD-2** - For MD-1 and DEC<sup>®</sup> buss system owners. This board is similar to the PAD-1 but configured to plug into the MD-1 Interface Board or any other system using a dual DEC connector.  
 SUGGESTED RESALE PRICE \$27.50

**AB-40** - A plug/socket combination to adapt 40 wire strip cable to 40 pin dual-in-line plug. Use with PAD-2 to plug into the SK-10 Socket.  
 SUGGESTED RESALE PRICE \$20.00

**ICC-40** - 40 wire strip cable with female, strain-relieved connector on each end. Comes standard at 18" (45,7cm) long. Plugs directly into the AB-40.  
 SUGGESTED RESALE PRICE \$31.50

# Universal

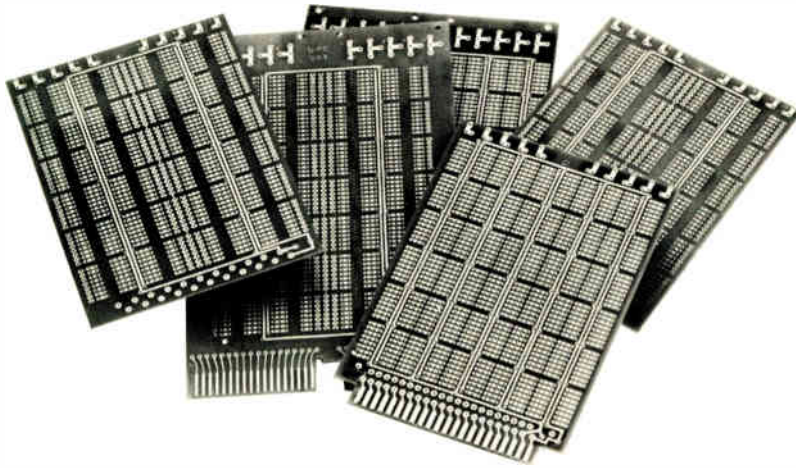

**AB-8 & AB-10** — Two reusable adapter boards that allow the instant use of 8 or 10 pin To-5 devices in any DIP socket or SK breadboarding socket.

SUGGESTED RESALE PRICE  
AB-8 — \$3.05, AB-10 — \$3.35



You will find E&L an excellent source for standard printed circuit boards for those instances where permanently soldered circuits are required. All items are made from  $\frac{1}{16}$ " (1.57mm) G10 with 2 ounces of copper. All edge connectors have a heavy-wear gold plate. Hole size is .040" (1.01mm) (drilled, *not* punched).

**UPC-201** — An intermix board for high density packaging of IC's and discrete components; a single sided board. .156" card edge spacing -22 contacts.

SUGGESTED RESALE PRICE \$16.00

**UPC-202** — Identical to the 201 except no card edge connection.

SUGGESTED RESALE PRICE \$13.50

**UPC-203** — A dual sided board meant for high density packing of 14/16 pin DIP

IC's. Has cut-away back plane. Double 22 card edge connector on .156" (3,9mm) centers. Takes 24 IC's.

SUGGESTED RESALE PRICE \$17.00

**UPC-301** — Same as 201 but has dual DEC termination (.125" (3,2mm) centers).

SUGGESTED RESALE PRICE \$17.50

**UPC-303** — Same as 203 but has dual DEC termination (.125" (3,2mm) centers).

SUGGESTED RESALE PRICE \$20.00

## LOGIC PROBES

We offer two inexpensive probes for TTL logic work. Both feature LED readouts.



### LT-2

A dual state logic probe with great features at a great price! Two LED's indicate logic states. A switchable "pulse stretch mode" lets you see pulses as narrow as 50  $\mu$  secs. With a cost this low you cannot afford not to have one handy.

SUGGESTED RESALE PRICE \$27.50

### LT-3

A truly incredible combination "pulser/probe" in one compact package at a price that makes it available to anyone doing digital design, trouble-shooting or circuit analysis. The unit injects a pulse when switched to "pulse" mode. When in the "detect" position, it will detect short pulses and normal "high" states using the two LED's as readouts — thus, the user can both inject pulses to change logic states and measure the states with the same instrument.

SUGGESTED RESALE PRICE \$38.90

### SPECIFICATIONS

#### LT-2

Operating Voltage	5V $\pm$ 10%
Full "on" Current	80 ma
Frequency Response	DC-12MHz
Input Impedance at DC	600K ohm
Min Pulse Width Detection	50 nsecs
Storage Feature	Yes

#### Indicating Levels

(Switchable)  
Red LED "on" at greater than 2.4V  
Green "on" at less than 7V  
Both off on open circuit  
 $\frac{1}{2}$  lb  
(supplied with 2 probe tips)

Weight (Shipping)  
Size

6 65" (16.9cm)  $\cdot$  6" (15.2mm)

#### LT-3

Operating voltage	5V $\pm$ 10%
Full "on" Current:	100ma
Input Impedance:	30K ohm min
Pulse Duration:	in parallel with 50 pf
Min Det Width	200

Storage Feature:  
Indicating Levels:

No  
Red LED on at greater than 1.5V  
Green lights with pulse of 200 ns. or more  
100 ohms max

Output Impedance:  
Output Pulse Width  
Output Pulse Amplitude:  
Weight (Shipping)  
Size

4 0V min (P-P open circuit)  
approximately 1 millisecond  
 $\frac{1}{2}$  lb.  
6 65" (16.9cm)  $\cdot$  .6" (15.2mm)

# Design Aids

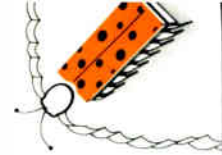

In the various books E&L publishes, components are required to do the referenced experiments. These have been gathered together in packages for your convenience. They are:

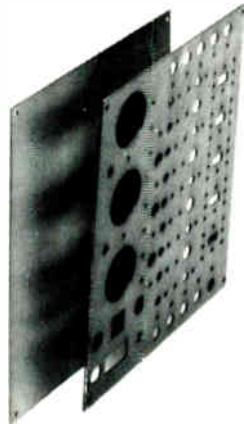
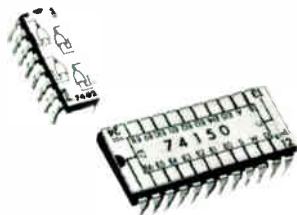

**BGB-1** — This concept for the identification of DIP integrated circuit chips consists of approximately 500 individual self-adhesive labels with printed "pin-outs" that show the logic function and pin numbers for the commonly used 7400-series TTL integrated circuit chips. These labels stick to the backs of the ICs. They eliminate the need to constantly refer to manufacturer's specifications for individual pin functions.

SUGGESTED RESALE PRICE \$6.50

**BK-1** — Components necessary to do *all* the experiments in the BRS-1 Workbook

SUGGESTED RESALE PRICE \$25.00

**BK-2** — Components necessary to do *all* the experiments in the BRS-2 Workbook.

SUGGESTED RESALE PRICE \$20.00

**CMK-1** — Components necessary to do *all* the experiments in the CMOS-M Workbook.

SUGGESTED RESALE PRICE \$25.00

**SJ-160** — E&L has prepackaged 160 different lengths of pre-stripped 22 gage wire to make your circuit work that much easier.

SUGGESTED RESALE PRICE \$5.50

**UMP-01** — Inevitably when you need to design a custom instrument, you have to make a special panel. E&L has come up with a prepunched panel to alleviate this problem. It has a wide variety of holes in popular sizes, arranged for convenient mounting of the components. (Approximately 7 $\frac{3}{4}$ " x 9 $\frac{1}{4}$ " (19,7cm x 23,5cm).)

SUGGESTED RESALE PRICE \$8.50

**UMP-02** — An unpunched panel (7 $\frac{3}{4}$ " x 9 $\frac{1}{4}$ " (19,7cm x 23,5cm))

SUGGESTED RESALE PRICE \$4.00

**H-06** — The high impact molded case used to mount the UMP-01.

Same case as used on the DD-1.

SUGGESTED RESALE PRICE \$5.50

For those instruments that require additional Velcro<sup>®</sup>, E&L offers the following packages:

**V-01** — 1 pc. SK-10 permanent backing with 6 mounting screws.

1 pc. 2" (5cm) x 6" (15cm) of self-adhesive Loop material.

2 pcs.  $\frac{1}{2}$ " (1,3cm) x 2" (5cm) of self-adhesive Hook material.

SUGGESTED RESALE PRICE \$3.00

**V-02** — 1 pc. 2" (5cm) x 6" (15cm) of self-adhesive Loop material.

SUGGESTED RESALE PRICE \$1.50

**VO-3** — 2 pcs.  $\frac{1}{2}$ " (1,3cm) x 2" (5cm) of self-adhesive Hook material.

1 pc. SK-10 permanent backing with 6 mounting screws.

SUGGESTED RESALE PRICE \$1.25

**VO-4** — 6 pcs.  $\frac{1}{2}$ " (1,3cm) x 2" (5cm) of self-adhesive Hook material.

SUGGESTED RESALE PRICE \$1.25



## AP-1, AP-2 and AP-3

E&L packages a number of special items together for those who wish the convenience of satisfying all their needs at one time since they may be difficult to obtain locally.

**IS-AP-2 Components — Electrical** — IS-AP-2 is an electrical component package containing 93 resistors, 32 capacitors and 8 LED's.

SUGGESTED RESALE PRICE \$30.00

## IS-AP-1 TCOLS AND SOCKETS

1. 5" chain nose pliers.
2. Screwdriver (4" blade  $\frac{1}{8}$ " lip width), or equivalent.
3. Wire stripper/cutter.
4. Two, different color, 100 ft. rolls of No. 22 gauge, insulated wire
5. Two 14-pin IC sockets
6. Two 16-pin IC sockets
7. Two 24-pin IC sockets

SUGGESTED RESALE PRICE \$30.00

**IS-AP-3** — A package containing 104 IC's in the 74 series.

SUGGESTED RESALE PRICE \$210.00

**EC-1** is a package containing 26 IC's, 16 resistors and 64 pieces of pre-cut wire, the components necessary to do most of the experiments in the Bugbooks I and II. (Note: IC's to do all the experiments, see AP-3.)

SUGGESTED RESALE PRICE \$46.50

**IC-1** — IC's necessary to do the experiments in the DC-2 manual.

SUGGESTED RESALE PRICE \$40.00

# ORDERING INFORMATION, TERMS AND CONDITIONS

- All prices shown are for individual purchases. OEM, Educational and Industrial users should consult their local master distributor for applicable discounts.
- All prices and specifications are subject to change without notice.
- All material is priced F.O.B., Derby.
- All items may be ordered either 115V or 230V; 50/60 Hz at the same price. If you require 90V or 240V operation, it has to be done on a special order and requires special time and subject to a surcharge. (Check with the factory.)
- E&L guarantees its kits for 90 days after purchase for parts only; the guarantee is one year for parts and labor on assembled units. See the SK breadboarding page of this brochure for our unique "lifetime" guarantee on all sockets.
- All items featured in this brochure are carried by your area master distributor. In addition, you will find many local computer stores, electronics distributors and university book stores carry a major cross-section of the popular units. If you cannot find a local store carrying E&L products, contact your area master distributor who will direct you to a nearby one or who will process your order directly in the case of OEM, Education or Industrial clients. Please direct your purchase orders to the master distributors of local stores, NOT the factory.
- There are several items and terms used in this brochure that are subject to trademark acknowledgement. They are: Teflon<sup>®</sup> by The Dupont Co., Velcro<sup>®</sup> by the American Velcro Corporation, Altair<sup>®</sup> by MITS, Imsai<sup>®</sup> by IMS Associates, Inc., and DEC<sup>®</sup> by the Digital Equipment Corporation.

## DOMESTIC REPRESENTATIVES

### 01001-06907

ELECTRONIC MARKETING CO.  
1092 Johnson Road  
Woodbridge, CT 06525  
(203) 397-1461

### 07001-07999/08800-11999

SHORTESS-RAWSON & ASSOC.  
155 U.S. Route 22  
Springfield, NJ 07081  
(201) 467-8585

### 12000-14905

NACO ELECTRONICS CORP.  
P.O. Box 276  
N. Syracuse, NY 13212  
(315) 699-2651

### 08000-08799/16800-19980

SHORTESS-RAWSON & ASSOC.  
P.O. Box 193  
Sauderton, PA 18964  
(215) 723-8733

### 20001-29945

NINE ASSOCIATES, INC.  
Dandridge House  
10680 Main Street  
Fairfax, VA 22030  
(703) 273-1803

### 30001-39776

NINE ASSOCIATES, INC.  
The 5750 Building  
Suite 219  
5750 Major Blvd.  
Orlando, FL 32805  
(305) 351-1841

### 40003-47997/15001-16799

RIXAN ASSOCIATES  
5062 Wadsworth Road  
Dayton, OH 45414  
(513) 222-0011  
(513) 278-4216

### 48001-49972/53001-54999

60001-61999/62300-62399  
62500-62999  
MARTEC ASSOCIATES  
2351 E. Oakton Street  
Arlington Heights, IL 60005  
(312) 956-8090

### 55001-58856

COMPUTER DEPOT, INC.  
1716 Midwest Plaza Bldg.  
Minneapolis, MN 55402  
(612) 338-6714

### 59400-59937/83500-83876

97001-99950  
JON JOLLY, Inc.  
5416 California Ave. S.W.  
Seattle, WA 98136  
(206) 938-4166

### 50001-52808/62001-62299

62400-62499/63001-69299  
SIR JOHN, Co.  
P.O. Box 7143  
Overland Parks, KS 66207  
(913) 649-8952

### 70001-79999

TESCO, INC.  
12115 Self Plaza Suite 203  
Dallas, TX 75218  
(214) 328-5484

### 59001-59399/69300-69367

80002-83499/84001-84780  
BILL NEWMAN & COMPANY  
711 Vallejo, Suite 207  
Denver, CO 80204  
(303) 534-1356

### 85001-86515/89001-89114

90001-93555  
EDWARDS ASSOCIATES  
608 Silver Spur Road  
California Federal Bldg. Suite 320  
Palos Verdes Penn., CA 90274  
(213) 377-0975

### 89301-89835/93556-96970

Inform Distributors, Inc.  
80 W. El Camino Real Suite C  
Mountain View, CA 94040  
(415) 961-2828

## CANADA

### F103

Cardinal Industrial  
Electronics Limited  
11619-145 Street  
Edmonton, Alberta  
T5M 1V9  
telephone: 403-455-4122  
telex: 037-2372

### F110

John Fortin  
Company Limited  
\*main office\*  
660 King Edward Street  
Winnipeg, Manitoba  
telephone: 204-774-6286  
telex: 07-587500

### F121

R-A-E Industrial  
Electronics Limited  
1629 Main Street  
Vancouver, British Columbia  
telephone: 604-687-2621  
telex: 045-4550



**E&L INSTRUMENTS, INC.**

61 First Street, Derby, Conn. 06418  
(203) 735-8774 Telex No. 96 3536



# The Electronics Book Series offers you:

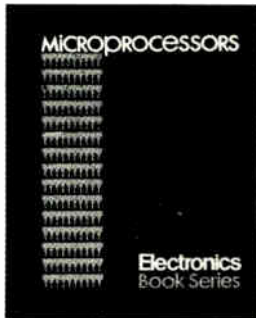

**1**

## MICROPROCESSORS

This book cuts through the confusion, presenting the design and application potential of this exciting technology in a manner that will appeal to the design engineer who needs to know how to use microprocessors as well as the system analyst who must assess the tradeoffs between microprocessors and other techniques to accomplish his system goals.

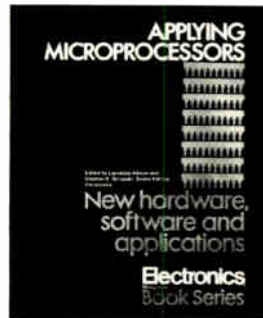

**2**

## APPLYING MICROPROCESSORS

This new book completes the engineer's transition from the old methods of electronic design to the new world of microprocessor engineering. The book contains the up-to-date and ready-to-use information that every designer needs to know about the new technology.

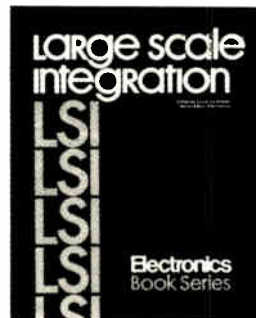

**3**

## LARGE SCALE INTEGRATION

"Large Scale Integration" deals with the entire range of design applications main memory systems, peripheral memories, memory controllers, on-line industrial controllers, data acquisition boards, communication systems, calculators, watches, etc.

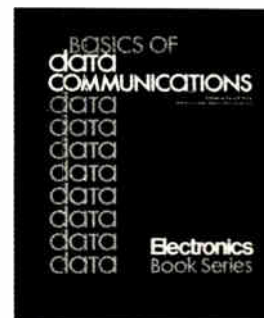

**4**

## BASICS OF DATA COMMUNICATIONS

Chances are you are going to be a part of the data communications market. There's no better place to start than getting a copy of "Basics of Data Communications"—a 316-page compilation of essential articles which have appeared in Data Communications magazine.

Use form below to order your copy. Prices on 10 copies or more, available upon request.

### Electronics Book Series

P.O. Box 669, Hightstown, N.J. 08520



- 1**  Send me \_\_\_\_\_ copies of "Microprocessors" at \$8.95 per copy.
- 2**  Send me \_\_\_\_\_ copies of "Applying Microprocessors" at \$9.95 per copy.
- 3**  Send me \_\_\_\_\_ copies of "LSI" at \$9.95 per copy.
- 4**  Send me \_\_\_\_\_ copies of "Basics of Data Communications" at \$12.50 per copy.

Full payment must accompany my order.

I must be fully satisfied or you will refund full payment if the books are returned after ten-day trial examination.

Name \_\_\_\_\_ Title \_\_\_\_\_

Company \_\_\_\_\_

Address \_\_\_\_\_

City \_\_\_\_\_ Country \_\_\_\_\_

Signature \_\_\_\_\_

**Just off the press:**

# Newest in Electronics Magazine Book Series

New 408-page collection of electronic circuits edited for ease and practicality of use by Samuel Weber

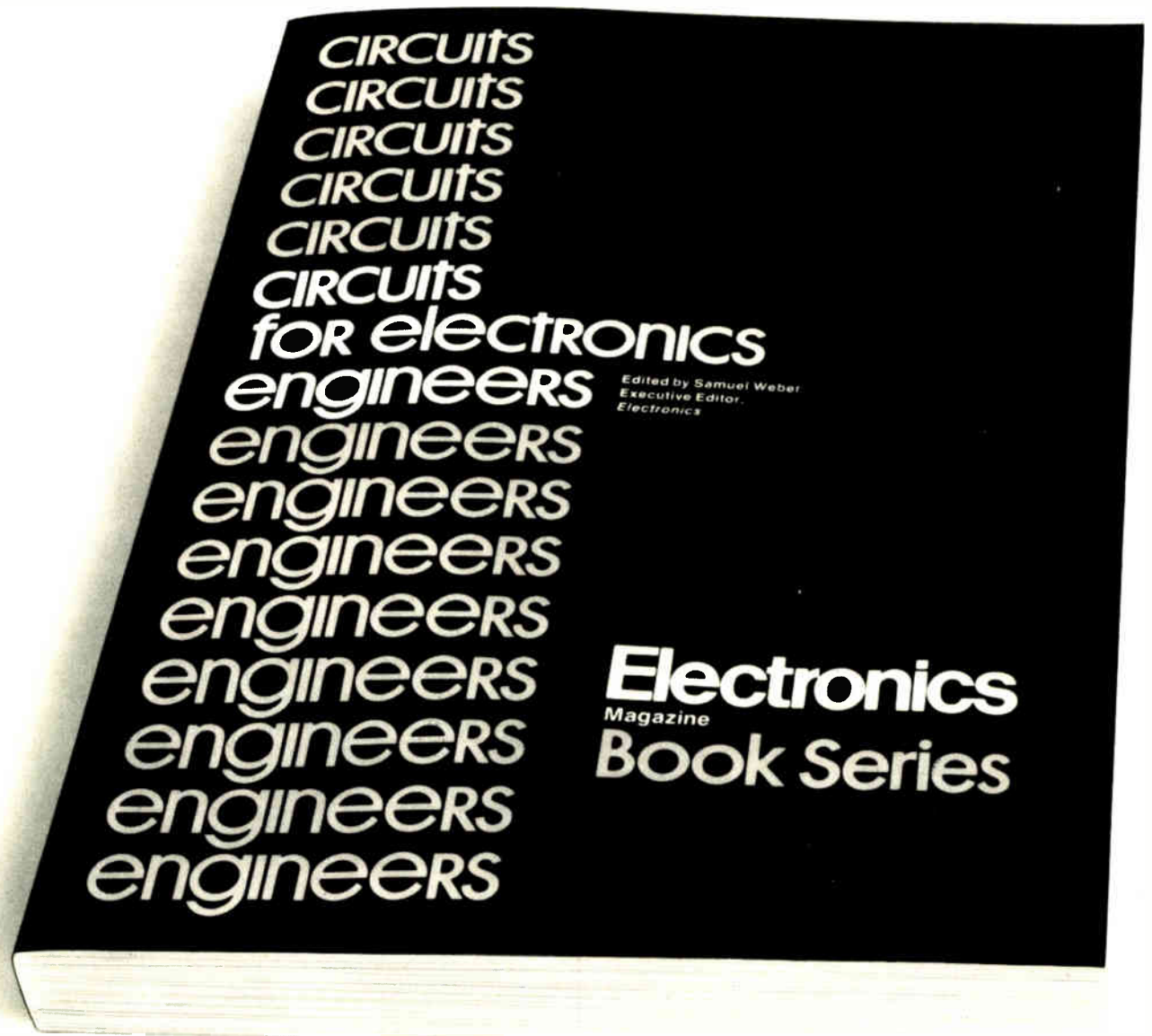

# 41. Protection circuits

## Phase-sequence detector trips circuit breaker

By Terry Maloney  
National Semiconductor Products Inc. Phoenix, AZ

Some three-phase line-powered equipment is sensitive to the direction of rotation of the three phases. For example, if two of the connections to a three-phase motor are inadvertently reversed, the motor will reverse direction—a disaster if the motor is used to drive a pump or the compressor of an air conditioner. To guard against this failure, a low-power circuit can be built from standard complementary-MOS components that will detect the phase inversion and trigger a circuit breaker. Moreover, the circuit, which interfaces directly with CMOS logic, can be appended easily to a line-undervoltage or line-unbalanced detector.

In the circuit (Fig. 1), the line voltages are stepped down and isolated by control transformers. The sine waves for phases A, B, and C are half-wave-rectified and shaped by the MR4001 diode and MP53172 transistor, and shaped again by a CMOS inverter. The resulting rectangular waveforms are shown as A', B', and C' in Fig. 2.

The shaped outputs A', B', and C' are now combined with one another in the AND gates Q<sub>1</sub>, Q<sub>2</sub>, and Q<sub>3</sub> to produce the waveforms A''C', A''B', and B''C' for comparison. These outputs are referred to as X, Y, and Z in Fig. 2). The pulses X, Y, Z appear sequentially; this sequence will change to XYZ if, for instance,

the B and C phases are interchanged.

The X, Y, and Z pulse trains are applied to D-type flip-flops FF<sub>1</sub> and FF<sub>2</sub> in such a way that the Q<sub>2</sub> output of FF<sub>1</sub> is high if the sequence is XYZ (i.e., if the line phase sequence is ABC), and Q<sub>2</sub> is low if the sequence is YXZ. For the XYZ sequence, an X pulse sets Q<sub>1</sub> and D<sub>1</sub> high; then the Y pulse resets Q<sub>1</sub> and D<sub>1</sub> low. The Z pulse then clocks the low from D<sub>1</sub> to Q<sub>1</sub>, making Q<sub>1</sub> high.

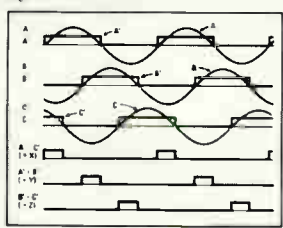

2. Operation. Line phases A, B, and C are rectified and shaped to produce waveforms A', B', and C'. Overlaps of these rectangular waves produce AND-gate outputs A''C', A''B', and B''C' for comparison. These outputs are referred to as X, Y, and Z. Line phase sequence ABC generates XYZ. Sequence ACB generates YXZ. These pulse trains cause flip-flop outputs to signal any phasing error.

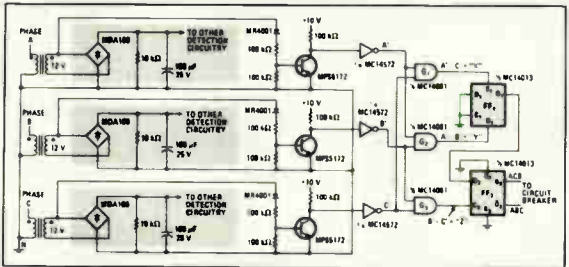

1. Phase insurance. Incorrect sequence of line phases is detected by flip-flops which trigger circuit breaker to prevent three-phase motor from running in reverse. Phase sequence ABC makes Q<sub>1</sub> high, but sequence ACB makes Q<sub>1</sub> high; either output can be used to control protection devices. This phase-reversal detector can be a simple addition to other control circuitry, as shown here.

310

Either Q<sub>1</sub> or Q<sub>2</sub> can be used to trip a circuit breaker via a solid-state or electromechanical relay, and thus pull a valuable piece of equipment off the line before it is damaged.

The MDA100 bridge rectifier, 10-k $\Omega$ ohm resistor, and 100-microfarad capacitor, shown in the gray area of

Fig. 1, are representative of typical applications requiring line-voltage detection. They are included in Fig. 1 to demonstrate how easily the phase-sequence detector can be added to other detection circuitry. They can, of course, be omitted, and the "bottom" of the transformer can be connected directly to circuit ground.

## Current and power limiter protects switching transistor

By R. M. Smit  
Bur-Brow Research Corp. Tucson, AZ

Although a switching transistor dissipates little power in normal operation, it must be protected from destructive current and power overloads. Current-limiting alone is not sufficient protection; power-limiting is also necessary. But fortunately, a few components can be added to conventional current-limiting circuitry to provide power-limiting. A voltage rise across a transistor is sensed and used to cut down the drive current.

To understand why current-limiting alone fails to provide adequate protection, consider a switching transistor controlling a 100-ohm load connected to a 100-volt supply. The power dissipated in the load might be about 100 watts, but the maximum power dissipated in the transistor is merely the load current times the transistor's saturation voltage (if switching losses are neglected). The load current is about 1 ampere, so the transistor dissipates less than 1 w. A designer might use a 3-v device and provide a current-limiting level of 15 amperes.

Suppose, however, that the load is short-circuited so that the collector of the switching transistor is connected directly to the 100-v supply. Then the transistor dissipates 150 w, which destroys it.

To prevent this destruction, a power-limiter is required. Power-limiting can be added to a standard current-limiter by use of only four simple components. In Fig. 1, Q<sub>1</sub> is the switching transistor, and the conventional current-limiter is formed by Q<sub>2</sub>, R<sub>2</sub>, and R<sub>1</sub>. The power-limiter consists of capacitor C, diodes D<sub>1</sub> and D<sub>2</sub>, and resistor R<sub>3</sub>. To illustrate the operation of the circuit, assume that Q<sub>1</sub> is saturated and in normal operation. As the load current increases, the voltage drop across R<sub>1</sub> increases, turning on transistor Q<sub>2</sub> and thus shunting drive current away from the base of Q<sub>1</sub>. Therefore, Q<sub>1</sub> begins to come out of saturation, so its collector voltage rises. This voltage across Q<sub>1</sub> further turns on Q<sub>2</sub> through R<sub>3</sub> and regeneratively turns off Q<sub>1</sub>.

Diodes D<sub>1</sub> and D<sub>2</sub> form a switch so that the collector

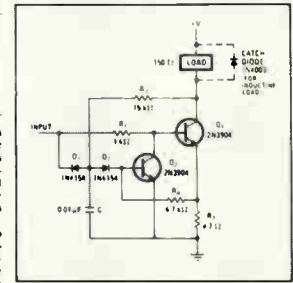

Two-way protection. Switching transistor Q<sub>1</sub> is protected against excess current and/or excess power dissipation if load current approaches limit. R<sub>1</sub> drop turns on transistor Q<sub>2</sub> to shunt base drive from Q<sub>1</sub>. A voltage rise across Q<sub>1</sub> acts through R<sub>3</sub> to turn on Q<sub>2</sub>, and turn on Q<sub>2</sub>. Capacitor C provides delay that allows Q<sub>2</sub> to saturate with each new cycle, and turn power-line-erase ignore transient high currents. Diodes D<sub>1</sub> and D<sub>2</sub> level power-line-erase individual is low voltage of Q<sub>1</sub> is sampled only when its input is high. This switch also resets the power-limiting circuitry with each cycle of the input. The value of capacitor C is chosen to give the power-limiting portion of the circuit a turn-on delay, allowing time for Q<sub>2</sub> to become saturated. This delay also permits higher current transients to flow during switching, such as those that might occur in a switching regulator in which the catch diode must be discharged during each cycle.

The current-limiting portion of the circuitry is active at all times, protecting the switching transistor from current overloads. The circuit was set up to be driven by a TTL-level signal and to switch a 100-ma load at 400 Hz to +5 V. The protection circuit can easily be modified for nearly any input and output configuration. If a PNP transistor switch is to be protected, transistor Q<sub>2</sub> should also be a pnp, and the polarities of D<sub>1</sub> and D<sub>2</sub> should be reversed.

311

### Two typical pages. Note valuable explanatory text.

Here is a book compiled and organized to save electronics engineers many hours of drudgery designing what's already been designed or "re-inventing the wheel". This is the fifth in the Electronics Magazine Book Series, following *Microprocessors*, *Large Scale Integration*, *Basics of Data Communications*, and *Applying Microprocessors*.

*Circuits For Electronics Engineers* is a compilation of most useful circuits from the pages of Electronics magazine, most from the well-known Designer's Casebook series. More than a collection of circuit diagrams, the designer will find step-by-step rules, performance data, component values, manufacturers' type references, follow-up references, and other material for effective guidance.

The end result is a complete, practical easy-to-use manual for engineers and advanced technicians involved in research, development, design, tests, or production of any kind of electronics hardware.

**Mail coupon now. Will pay for itself first time you use it.**

After ten years of experience as an electronics engineer himself, Samuel Weber joined the staff of Electronics and has been Executive Editor of the magazine since 1970. In addition to his editorial responsibilities he has authored many articles on electronics and edited three books on electronics circuitry.



346 circuits from all over the world—arranged by 51 of the most useful functions designers use to implement their systems, including—Amplifiers • Analog to digital & digital to analog converters • Counters • Detectors • Discriminators • Display circuits • Function generators • Integrators • Logic circuits • Memory circuits • Operational amplifier circuits • Power supplies • Protection circuits • Switching circuits • Temperature control • Timing circuits • Voltage regulating circuits • ... and many more.

### Electronics Book Series

P.O. Box 669, Hightstown, NJ 08520

Send me \_\_\_\_\_ copies of "Circuits for Electronics Engineers" at \$15.95 per copy. Full payment must accompany order.

I must be fully satisfied or you will refund payment if the book is returned after ten-day free trial examination.

Name \_\_\_\_\_ Title \_\_\_\_\_

Company \_\_\_\_\_

Address \_\_\_\_\_

City \_\_\_\_\_ State \_\_\_\_\_ Zip \_\_\_\_\_ Country \_\_\_\_\_

Signature \_\_\_\_\_

Discounts of 40% on orders of ten or more copies.

Payment enclosed  Bill firm  Bill me

Credit Cards Charge My Book To:

American Express  Diners Club  
 Master Charge  BankAmericard

Acct. No. \_\_\_\_\_

Date Card Expires \_\_\_\_\_

Interbank No. \_\_\_\_\_  
1st No's above name of Master Charge only R-71A



# This plant specializes in advanced IC technology.

It takes a lot of research, development, design, and production know-how to turn out a good line of semiconductor devices . . . it also takes a lot of sophisticated equipment . . . plus a lot of specially-educated and skillfully-trained people mutually striving for product excellence.

At Sprague Electric's Semiconductor Division, we have accumulated over fifteen years of intensive experience in the manufacture of *innovative* semiconductor devices . . . devices making special contributions to technology . . . devices manufactured under the most exacting QAR program . . . devices that assure total customer satisfaction.

We have built the kind of operation it takes to produce semiconductors compatible with today's as well as tomorrow's requirements.

We proudly invite customers and prospects to tour our plant, the nation's finest semiconductor facility of its type. Here you will see the magnitude of effort that goes into properly designed and manufactured devices. You'll be pleasantly surprised!

Write or call George Tully or Bob Milewski to arrange a visit. You can reach them at the Semiconductor Division, Sprague Electric Co., 115 Northeast Cutoff, Worcester, Mass. 01606. Tel. 617/853-5000.



#### FOR FAST INFORMATION, CALL YOUR NEAREST SPRAGUE SALES OFFICE:

ALABAMA, Sprague Electric Co. 205/883-0520 • ARIZONA, Sprague Electric Co. 602/279-5435 • CALIFORNIA, Sprague Electric Co. 213/649-2600 Wm J. Purdy Co. 415/347-7701 KCE Corp. 714/278-7640 • COLORADO, Wm J. Purdy Co. 303/777-1411 • CONNECTICUT, Sprague Electric Co. 203/261-2551 • DIST. OF COLUMBIA, Sprague Electric Co. (Govt. sales only) 202/244-6006 • FLORIDA, Sprague Electric Co. 305/831-3636 • ILLINOIS, Sprague Electric Co. 312/678-2262 • INDIANA, Sprague Electric Co. 317/253-4247 • MASSACHUSETTS, Sprague Electric Co. 617/899-9100, Sprague Electric Co. 413/864-4411 • MICHIGAN, Sprague Electric Co. 517/787-3934 • MINNESOTA, HMR Inc. 612/920-8200 • MISSOURI, Sprague Electric Co. 314/781-2420 • NEW JERSEY, Sprague Electric Co. 201/696-8200, Sprague Electric Co. 609/795-2299, Trinkle Sales Inc. 609/795-4200 • NEW MEXICO, Wm J. Purdy Co. 505/266-7959 • NEW YORK, Sprague Electric Co. 516/549-4141, Wm. Rutt Inc. 914/698-8600, Sprague Electric Co. 315/437-7311, Mar-Corn Associates. 315/437-2843 • NORTH CAROLINA, Electronic Marketing Associates 919/722-5151 • OHIO, ElectronicSalesmasters Inc. 800/362-2616, Sprague Electric Co. 513/278-0781 • PENNSYLVANIA, Sprague Electric Co. 215/467-5252 Trinkle Sales Inc. 215/922-2080 • TEXAS, Sprague Electric Co. 214/235-1256 • VERMONT, Ray Perron & Co. Inc. 617/762-8114 • VIRGINIA, Sprague Electric Co. 703/463-9161 • WASHINGTON, Sprague Electric Co. 206/632-7761 • CANADA (Ontario), Sprague Electric of Canada Ltd. 416/766-6123 • CANADA (Quebec), Sprague Electric of Canada Ltd. 514/683-9220



... and you thought we only make great capacitors.

## **White House cancels CDC Sovlet sale; Peking unit shipped**

Control Data Corp. has won one and lost one in its two-year struggle to get U. S. approval of the sale of two of its Cyber series computers to the Soviet Union and the Peoples Republic of China. The proposed sale to Russia of a large Cyber 76, worth \$13 million, **was in effect canceled this month** when President Carter's adviser for national security affairs, Zbigniew Brzezinski, wrote Commerce Secretary Juanita Kreps that the President opposes the sale. The Commerce Department grants export licenses subject to presidential approval.

The Cyber 76, proposed for world weather watch studies as part of Soviet membership in the World Meteorological Organization, has a large 60-bit-word core memory of 30.72 megabits, a smaller semiconductor memory of 1.98 megabits, seven input/output channels, and six peripheral processors plus another for maintenance control. The Department of Defense vigorously opposed the sale. But CDC says it gained approval and shipped early this spring a smaller \$3 million Cyber 172 to Peking to analyze seismic data in that nation's drive to locate new oil reserves. The Cyber 172 and its 10 peripheral processors, 12 I/O channels, and 1,000-nanosecond cycle time are within U. S. export guidelines [*Electronics*, Nov. 27, 1975, p. 59].

## **Satellite solar-power systems a distant possibility, Frosch says**

A satellite solar-power system "appears to be technologically feasible," but its development and use are "between 25 and 100 years" away, Robert A. Frosch told a Senate committee in June hearings to confirm his nomination as head of the National Aeronautics and Space Administration. Supposing thermal energy were collected by large space-based solar-cell arrays, **"we have only the sketchiest ideas of the costs"** of converting that energy into electricity and transmitting it to earth for distribution by microwaves or other means, Frosch said.

But NASA will get a better handle on satellite solar-power economics—including the cost of erecting large space structures—when it begins using the Space Shuttle, Frosch believes. The transmission problem "will have to be attacked on its own merits," but only after "we have a better capability for the appropriate structures and experiments in space."

## **Military export barriers seen raising U. S. costs**

Military electronics and weapons exporters are braced for a declining market and higher U. S. unit costs following President Carter's policy statement that "the dollar volume [in constant fiscal 1976 dollars] of new commitments in fiscal 1978 **will be reduced from the fiscal 1977 total**" of more than \$20 billion. America "will not be the first supplier to introduce into a region newly developed, advanced weapons systems which would create a new or significantly higher combat capability," Carter ruled. "Also, any commitment for sale or coproduction of such weapons is prohibited until they are operationally deployed with U. S. forces, thus removing the incentive to promote foreign sale in an effort to lower unit costs for Defense Department procurement." Development or significant modification of advanced systems for export is also barred, the President added.

Industry sources declined to be quoted for attribution on the new policy—"we don't want that 'merchants of death' tag," one explained—but most agreed that the policy would further escalate unit costs of U. S. systems, particularly of tactical aircraft and missiles.

## Expendable RPVs stumble on avionics costs

With the Carter Administration stressing short-term improvements in existing defense systems plus a number of major programs described by one general as “the big eaters”—the B-1 bomber and missile-firing submarines are two examples—money for the engineering of new systems is tight. Remotely piloted vehicles are one casualty of that trend, and the frustration of money-hungry RPV contractors was much in evidence at the recent Washington meeting of the National Association of RPVs.

“This place sounds like the terminal ward in a hospital,” complained one registrant after listening for two days to industry and military leaders who regularly exchanged criticism of each other. They could agree only that the need for RPVs lacks significant support from military users and has not been sold to Congress.

The meeting had more whimper than bang right from the start when the Directorate of Defense Research and Engineering’s William E. Stoney, tactical programs chief, labeled the \$30 million forecast for fiscal 1978 RPV programs as a “zero growth” budget. Nor is the outlook likely to change next year, he said later. While contractors like Boeing Co. and Northrop Corp. argued that RPV “technology is here” and has been proved cost-effective, Air Force Lt. Gen. Robert Marsh, commander of the Electronic Systems division, said industry proposals have done no more than “tickle my fancy” but have not yet convinced him he would be doing the country a disservice if he failed to recommend them. This, Marsh said, is what still needs to be done.

### Vietnam’s plateau

RPV development reached a plateau following a high level of success by Israel in the Middle East and by the U.S. Air Force in Vietnam. Israelis employed them for anti-tank missions and electronic jamming and as decoys to draw surface-to-air missile fire away from following fighter-bombers over the Golan Heights. Marsh cites the 25 million frames of high-resolution reconnaissance photographs taken during 25,000 sorties by modified, recoverable Firebee drones over Vietnam. The Firebees represented “quick and dirty” modifications but were expensive, Marsh said. They contained an estimated \$2 million reconnaissance package, industry officials say, including a special \$500,000 electronically controlled camera developed by Itek Corp.

But that is history. Significant military support for RPVs is unlikely to come until

industry can make them small, cheap and expendable, for use on a one-shot basis for tactical reconnaissance and, more importantly, for such defense suppression missions as taking out enemy radars in advance of an air strike.

That is now the electronics industry’s biggest challenge, since there is good reason to believe that recoverable RPVs may never be successful. As one advocate of the technology at the Air Force Systems Command puts it: “In a combat situation, you don’t want to have to determine whether an incoming vehicle is theirs or ours. It takes too much time, manpower, and money. If all ours are expendable, then you know you can shoot down anything coming over your lines because it must belong to the enemy.” Expendables would also eliminate another problem with RPVs—shipboard recovery at night and in bad weather on a rolling sea.

### The avionics costs barrier

But if single-shot RPVs are to be cheap, their avionics costs must come down substantially. Rear Adm. Carl J. Seiberlich, deputy naval operations chief for air warfare, figures the \$20,000 to \$25,000 cost of an RPV airframe and engine can be halved for expendables, but not the \$100,000 required for avionics in an over-the-horizon reconnaissance and targeting system. “That leaves a high unit cost for a nondestructive vehicle,” he points out.

Gen. Marsh’s lighthearted observation that “maybe a toy manufacturer should produce RPVs, since he’s unfamiliar with the aviation [industry’s] push to get performance” and to meet tough military specifications first (before considering costs) did not sit well with his audience. The suggestion is not as ludicrous as it sounds. The costs of large-scale-integrated semiconductor chips are still coming down, and the technology is still moving fast, while fiber-optics technology for jam-resistant interconnections is not far behind. Marsh’s other recommendation—that lower avionics costs may be obtainable by “putting more of the ‘smarts’ on the ground” and using either a data link or preprogrammed RPVs for missions—holds greater promise.

Whichever way RPV advocates choose to go with their technology, the military message at their association meetings was clear: if remotely piloted vehicles are to have a future in the defense marketplace, they must be both cheap and expendable—goals that can be achieved only by electronics engineering of the most innovative kind.

**Ray Connolly**



# Here Comes the Biggest Discrete News Since Plastic Power!

# Here Comes Motorola TO-220 Silicon Power!

TO-220 PART NO.	RATING	APPLICATION	TECHNOLOGY	PRICE (100+up)
2N6107	70V, 7A, 65W, PNP	General Purpose	Epibase*	.58
2N6109	50V, 7A, 65W, PNP	General Purpose	Epibase*	.58
2N6111	30V, 7A, 65W, PNP	General Purpose	Epibase*	.54
2N6121	45V, 4A, 40W, NPN	General Purpose	Epibase*	.50
2N6122	60V, 4A, 40W, NPN	General Purpose	Epibase*	.55
2N6123	80V, 4A, 40W, NPN	General Purpose	Epibase*	.59
2N6124	45V, 4A, 40W, PNP	General Purpose	Epibase*	.55
2N6125	45V, 4A, 40W, PNP	General Purpose	Epibase*	.59
2N6126	45V, 4A, 40W, PNP	General Purpose	Epibase*	.63
2N6288	30V, 7A, 65W, NPN	General Purpose	Epibase*	.51
2N6290	50V, 7A, 65W, NPN	General Purpose	Epibase*	.54
2N6292	70V, 7A, 65W, NPN	General Purpose	Epibase*	.54
MJE13004	350V, 4A, 75W	General Purpose	Double-diffused Mesa	1.35
MJE13005	400V, 4A, 75W	General Purpose	Double-diffused Mesa	1.70
MJE13006	350V, 8A, 80W	General Purpose	Double-diffused Mesa	1.95
MJE13007	400V, 8A, 80W	General Purpose	Double-diffused Mesa	2.60
MJE13008	350V, 12A, 100W	General Purpose	Double-diffused Mesa	3.30
MJE13009	400V, 12A, 100W	General Purpose	Double-diffused Mesa	3.95
TIP31	40V, 3A, 40W, NPN	General Purpose	Epibase*	.47
TIP31A	60V, 3A, 40W, NPN	General Purpose	Epibase*	.50
TIP31B	80V, 3A, 40W, NPN	General Purpose	Epibase*	.54
TIP31C	100V, 3A, 40W, NPN	General Purpose	Epibase*	.58
TIP32	40V, 3A, 40W, PNP	General Purpose	Epibase*	.50
TIP32A	60V, 3A, 40W, PNP	General Purpose	Epibase*	.53
TIP32B	80V, 3A, 40W, PNP	General Purpose	Epibase*	.58
TIP32C	100V, 3A, 40W, PNP	General Purpose	Epibase*	.61
TIP41	40V, 6A, 65W, NPN	General Purpose	Epibase*	.60
TIP41A	60V, 6A, 65W, NPN	General Purpose	Epibase*	.65
TIP41B	80V, 6A, 65W, NPN	General Purpose	Epibase*	.68
TIP41C	100V, 6A, 65W, NPN	General Purpose	Epibase*	.79
TIP42	40V, 6A, 65W, PNP	General Purpose	Epibase*	.66
TIP42A	60V, 6A, 65W, PNP	General Purpose	Epibase*	.73
TIP42B	80V, 6A, 65W, PNP	General Purpose	Epibase*	.79
TIP42C	100V, 6A, 65W, PNP	General Purpose	Epibase*	.89
TIP47	250V, 1A, 40W, NPN	General Purpose	Epibase*	.62
TIP48	300V, 1A, 40W, NPN	General Purpose	Epibase*	.66
TIP49	350V, 1A, 40W, NPN	General Purpose	Epibase*	.70
TIP50	400V, 1A, 40W, NPN	General Purpose	Epibase*	.82
TIP110	60V, 2A, 50W, NPN Darlington	General Purpose	Epibase*	.70
TIP111	80V, 2A, 50W, NPN Darlington	General Purpose	Epibase*	.75
TIP112	100V, 2A, 50W, NPN Darlington	General Purpose	Epibase*	.84
TIP115	60V, 2A, 50W, PNP Darlington	General Purpose	Epibase*	.79
TIP116	80V, 2A, 50W, PNP Darlington	General Purpose	Epibase*	.84
TIP117	100V, 2A, 50W, PNP Darlington	General Purpose	Epibase*	.94
TIP120	60V, 8A, 65W, NPN Darlington	General Purpose	Epibase*	.86
TIP121	80V, 8A, 65W, NPN Darlington	General Purpose	Epibase*	.96
TIP122	100V, 8A, 65W, NPN Darlington	General Purpose	Epibase*	1.10
TIP125	60V, 8A, 65W, PNP Darlington	General Purpose	Epibase*	.92
TIP126	80V, 8A, 65W, PNP Darlington	General Purpose	Epibase*	1.03
TIP127	100V, 8A, 65W, PNP Darlington	General Purpose	Epibase*	1.18

...and additional types to come!

\*Trademark Motorola Inc.  
All Prices latest available.



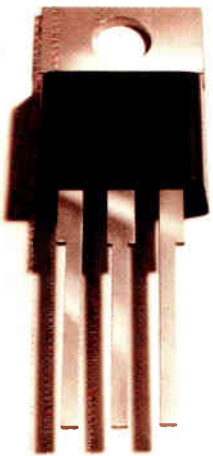

- Lower Prices
- New, Stronger Die Bonds
- Switchmode Planar or EpiBase
- Glass Passivation
- Heavier Leads
- Automated, 2-Piece Assembly
- QC'd, Tested, Audited
- Matched Coefficient of Thermal Expansion Molding Compound

# The Top TO-220 of Them All!

## Motorola TO-220 Silicon Power Tops In Economy!

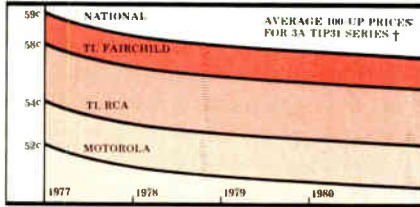

Motorola TO-220 prices are lower. Device by device. Series by series. Quantity by quantity.

And you can get up to 4,999 of any 2N-or TIP- series from your authorized distributor, on the phone, off-the-shelf.

Prices are low because costs are low. Motorola TO-220's utilize cost-effective 2-piece assembly and molded construction on automated assembly lines.

And even though we 100% test all spec'd electrical parameters including SOA, our prices are still as low or lower than the nearest competitor.

The new price leader is ready to save you money.

## Motorola TO-220 Technology Tops In Switchmode!

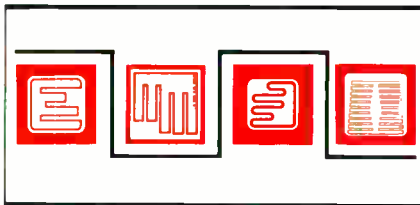

We invented state-of-the-art Switchmode\* and continue to offer the broadest range of chip sizes and specs for your applications... continuous current ratings from 4 to 12 A in 350 and 400 V sustaining voltage versions... crossover speeds less than 0.7µs... and more data sheet specs than you've seen before.

That's what Switchmode is — specs. All essentials you need to design and characterize high-frequency, 100°C inductive applications from our own Designers\* data sheets.

Reverse bias SOA volt-amp capability... high-temperature, clamped inductive load switching specs... switching times

as functions of collector current and temperature... spec'd limits for active region SOA. Limit specs on all critical characteristics.

Switchmode brings you into the design cycle instead of keeping you out!

## Motorola TO-220 Silicon Power Tops In Solid State Support!

Motorola is the only source able to supply all the semiconductors you want to put your designs to work.

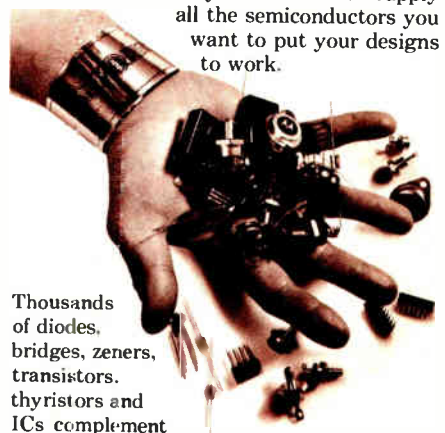

Thousands of diodes, bridges, zeners, transistors, thyristors and ICs complement practically any power design requirement. One stop. Off-the-shelf.

If you can't find it here, you probably won't find it at all.

Truly, we're the production house of the industry.

## Here comes a top TO-220 Offer!



It's all here. TO-220. TO-202. TO-126. TO-127. Four different plastic power capabilities for virtually any application.

We introduced plastic power to the industry 10 years ago and now we offer the most complete lineup of packaging, current, voltage and process technology you can find.

Write Motorola Semiconductors, P.O. Box 20912, Phoenix, AZ 85036. Contact your authorized distributor for additional needs.

†Projected Prices based on experience curve price decay.

## Motorola TO-220 Silicon Power Tops In Reliability!

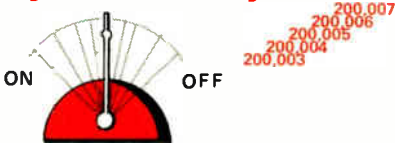

Orders of magnitude more reliability!

We designed it that way. And combined it with our most popular glass-passivated chips. Complete results of the most severe punishment imaginable are summarized here and available in a brochure. Send for it:

Test	Conditions	Total Devices Tested	Total Device Cycles or (Hours)	Percent Failures
Power Cycling	T <sub>J</sub> = 75°C t <sub>on</sub> = 1 min t <sub>off</sub> = 1 min	100	750,000	0.0%
Power Cycling	T <sub>J</sub> = 100°C t <sub>on</sub> = 1 min t <sub>off</sub> = 1 min	1693	8.5 Million	1%
High Temp Reverse Bias	V <sub>CE</sub> = 48V T <sub>A</sub> = 150°C	770	(170K)	0.4%
Temp Cycle	-55°C to +150°C MIL-STD-202 METHOD 107D	600	12.7K	0.3%
Pressure Cooker	15 psig, T <sub>A</sub> = 225°F Devices Suspended over D.I. water	935	(15.8K)	0.1%
Thermal Shock	MIL-STD-750 METHOD 1056.1	150	1500	0.0%

## We Challenge Your Present TO-220 Supplier To Match Motorola's Results!

Motorola TO-220 Power is designed better.

- 2½ times stronger, lead-free die-attach solder.
- cross-hatched die bond areas that control solder thickness and minimize bond degradation.
- moisture barrier moats around bond area.
- ultrasonic wire bonding.
- glass passivation.
- heavier, rugged, flat copper leads.
- industry-proven mold compound used in over 400 million TO-126 and TO-127 units.
- in-process QA controls at all critical points including daily/weekly audits.

Motorola TO-220 silicon power.

Made better to last longer.



# MOTOROLA Semiconductors

The mind to imagine... the skill to do.

# Here Comes A Top TO-220 Offer!



## Hand it to me, Motorola

Send me the best plastic power design package to come along since sliced bread...

- TIP-, 2N- and Switchmode series data sheets
- Complete TO-220 list prices
- Motorola Power Transistor Selector Guide
- Reliability report

Just fill this in and send to:

Motorola Semiconductor Products Inc.,  
P. O. Box 20912, Phoenix, AZ 85036

Name \_\_\_\_\_ Title \_\_\_\_\_  
Company \_\_\_\_\_  
Address \_\_\_\_\_  
City \_\_\_\_\_ State \_\_\_\_\_ Zip \_\_\_\_\_

Please print carefully—this is a mailing label!

## Contact your authorized Motorola distributor for additional TO-220 needs:

ALABAMA, Huntsville	Hamilton Electronics	(205) 837-8700	MARYLAND, Rockville	Schwaber Electronics	(301) 851-3300	OHIO, Cleveland	Pioneer-Standard Electronics, Inc.	(216) 587-9600
ALABAMA, Huntsville	Hamilton/Avnet Electronics	(205) 533-1170	MARYLAND, Savage	Pytronic Industries, Inc.	(301) 792-7000	OHIO, Dayton	Hamilton/Avnet Electronics	(513) 433-0810
ARIZONA, Phoenix	Hamilton/Avnet Electronics	(602) 275-7851	MASSACHUSETTS, Lexington	Harvey Electronics	(617) 881-9200	OHIO, Dayton	Pioneer/Dayton	(513) 236-8900
ARIZONA, Phoenix	Liberty Electronics	(602) 257-1272	MASSACHUSETTS, Newton	Cramer Electronics, Inc.	(617) 969-7700	OHIO, Solon	Cramer/Cleveland	(216) 248-8400
CALIFORNIA, Culver City	Hamilton Electro Sales/L.A.	(213) 558-2000	MASSACHUSETTS, Waltham	Schwaber Electronics	(617) 890-8484	OKLAHOMA, Tulsa	Hall-Mark Electronics	(918) 835-8458
CALIFORNIA, El Segundo	Liberty Electronics Corp.	(213) 322-9100	MASSACHUSETTS, Woburn	Hamilton/Avnet Electronics	(617) 933-8000	PENNSYLVANIA, Horsham	Pioneer/Pittsburgh	(215) 874-5710
CALIFORNIA, Irvine	Cramer/Los Angeles	(213) 771-8300	MICHIGAN, Livonia	Hamilton/Avnet Electronics	(313) 522-4700	PENNSYLVANIA, Pittsburgh	Pioneer/Pittsburgh	(412) 782-2300
CALIFORNIA, Mountain View	Elmar Electronics, Inc.	(415) 961-9811	MICHIGAN, Livonia	Pioneer/Detroit	(313) 525-1800	SOUTH CAROLINA, Columbia	Orise Radio Supply Company, Inc.	(803) 778-5333
CALIFORNIA, Mountain View	Hamilton/Avnet Electronics	(415) 961-7000	MINNESOTA, Eden Prairie	R. S. Electronics	(313) 525-1155	TEXAS, Austin	Sterling Electronics	(512) 838-1341
CALIFORNIA, San Diego	Liberty Electronics	(714) 565-9171	MINNESOTA, Edina	Schwaber Electronics	(612) 941-5280	TEXAS, Dallas	Hall-Mark Electronics	(214) 231-5101
CALIFORNIA, Sunnyvale	Cramer/San Francisco	(408) 739-3011	MISSOURI, St. Louis	Cramer/Minneapolis	(612) 335-7811	TEXAS, Dallas	Hamilton/Avnet Electronics	(214) 681-8661
COLORADO, Commerce City	Elmar Electronics, Inc.	(303) 287-9611	MISSOURI, Earth City	Hamilton/Avnet Electronics	(314) 341-3901	TEXAS, Dallas	Schwaber Electronics	(214) 681-5010
COLORADO, Denver	Hamilton/Avnet Electronics	(303) 534-1212	MISSOURI, Hazelwood	Hall-Mark Electronics/St. Louis	(314) 291-5350	TEXAS, Dallas	Hall-Mark Electronics	(214) 681-5010
CONNECTICUT, Danbury	Schwaber Electronics	(203) 392-3500	NEW JERSEY, Cedar Grove	Hamilton/Avnet Electronics	(201) 239-0800	TEXAS, El Paso	Sterling Electronics	(214) 357-9131
CONNECTICUT, Georgetown	Hamilton/Avnet Electronics	(203) 762-0361	NEW JERSEY, Cherry Hill	Cramer/Pennsylvania	(609) 424-5993	TEXAS, Houston	Midland Specialty Co.	(915) 533-9555
CONNECTICUT, North Haven	Cramer/Connecticut	(203) 236-5641	NEW JERSEY, Moorestown	Arrow Electronics	(609) 235-1900	TEXAS, Houston	Hamilton/Avnet Electronics	(713) 526-4661
FLORIDA, Ft. Lauderdale	Hamilton/Avnet Electronics	(305) 825-5401	NEW JERSEY, NJ Laurel	Arrow Electronics	(609) 234-2133	TEXAS, Houston	Sterling Electronics, Inc.	(713) 827-8800
FLORIDA, Hollywood	Schwaber Electronics	(305) 827-0511	NEW JERSEY, Pennsauken	Hamilton/Avnet Electronics	(609) 892-4000	UTAH, Salt Lake City	Hamilton/Avnet Electronics	(801) 262-8451
FLORIDA, Orlando	Hamilton/Avnet Electronics	(305) 894-1511	NEW JERSEY, Saddle Brook	RESCO Electronics, Div of ASTREX	(215) 925-8900	WASHINGTON, Bellevue	Hamilton/Avnet Electronics	(206) 746-8750
FLORIDA, Orlando	Hall-Mark Electronics	(305) 855-4020	NEW JERSEY, Somerset	Arrow Electronics	(201) 787-5800	WASHINGTON, Seattle	Almair/Strom Electronics	(206) 763-2300
FLORIDA, Orlando	Cramer/Atlanta	(404) 448-9050	NEW JERSEY, Springfield	Schwaber Electronics	(201) 469-8008	WASHINGTON, Seattle	Liberty Electronics Corp.	(206) 763-8200
FLORIDA, Orlando	Hamilton/Avnet Electronics	(404) 448-9050	NEW MEXICO, Albuquerque	Hamilton/Avnet Electronics	(505) 755-1500	CANADA		
FLORIDA, Orlando	Hall-Mark Electronics	(305) 855-4020	NEW YORK, Hauppauge, L.I.	Arrow Electronics	(516) 894-8800	CALGARY, T2E 6L7, Alta.	Vareh's	(403) 276-8818
FLORIDA, Orlando	Cramer/Atlanta	(404) 448-9050	NEW YORK, Rochester	Hamilton/Avnet Electronics	(716) 442-7820	MISSISSAUGA, Ont.	CW Paterson Co., Ltd.	(518) 434-3264
FLORIDA, Orlando	Hamilton/Avnet Electronics	(404) 448-9050	NEW YORK, Rochester	Cramer/Long Island	(716) 481-4000	MONTREAL, Quebec	Casco Electronics Ltd.	(514) 735-5511
FLORIDA, Orlando	Hall-Mark Electronics	(305) 855-4020	NEW YORK, Rochester	Cramer/Rochester	(716) 275-0300	OTTAWA, Ont.	Zentronics, Ltd.	(613) 238-6411
FLORIDA, Orlando	Cramer/Atlanta	(404) 448-9050	NEW YORK, Syracuse	Hamilton/Avnet Electronics	(716) 442-7820	OTTAWA, K2C 2B6, Ont.	Hamilton/Avnet	(613) 226-1700
FLORIDA, Orlando	Hamilton/Avnet Electronics	(404) 448-9050	NEW YORK, East Syracuse	Schwaber Electronics	(315) 437-8671	QUEBEC CITY, Quebec	Casco Electronics Ltd.	(514) 524-4641
FLORIDA, Orlando	Hall-Mark Electronics	(305) 855-4020	NEW YORK, Westbury, L.I.	Hamilton/Avnet Electronics	(516) 333-5900	ST. LAURENT, P.O. HAS 1G2	Hamilton/Avnet	(514) 331-6443
FLORIDA, Orlando	Cramer/Atlanta	(404) 448-9050	NEW YORK, Westbury, L.I.	Harvey Electronics	(516) 333-7474	TORONTO, Ont.	Zentronics, Ltd.	(416) 789-5111
FLORIDA, Orlando	Hamilton/Avnet Electronics	(404) 448-9050	NORTH CAROLINA, Greensboro	Pioneer Electronics	(919) 273-4441	TORONTO, Ont.	Zentronics, Ltd.	(416) 735-5381
FLORIDA, Orlando	Hall-Mark Electronics	(305) 855-4020	NORTH CAROLINA, Winston-Salem	Cramer/Winston-Salem	(919) 725-8711	TOWN OF MOUNT ROYAL, P.Q.	Int'l. Electronics Ltd.	(514) 324-9231
FLORIDA, Orlando	Hamilton/Avnet Electronics	(404) 448-9050	OHIO, Cleveland	Schwaber Electronics	(216) 484-2970	VANCOUVER, B.C. V5X 3J4	Vareh's	(604) 873-3211
FLORIDA, Orlando	Hall-Mark Electronics	(305) 855-4020	OHIO, Cleveland	Hamilton/Avnet Electronics	(216) 481-1410	VANCOUVER, B.C.	Electro-Sonic, Inc.	(604) 274-1555
FLORIDA, Orlando	Cramer/Atlanta	(404) 448-9050	OHIO, Cleveland	Hamilton/Avnet Electronics	(216) 481-1410	WINNIPEG, Man.	Vareh's	(204) 633-6100



# MOTOROLA Semiconductors

# Versatility is written all over its face.



First thing you probably notice—it's a dual filter. Each of the 24db/octave filters can be used as high pass, or low pass, with selectable gain of 1 or 10.

### Consider the possibilities.

Connect the dual channels in series for bandpass, 48db/octave high pass, and 48db/octave low pass, with selective gain of 1, 10, or 100. Butterworth and Bessel modes are available at

the push of a button. And you can select AC or DC coupling.

### Versatility is not just skin deep.

Switch selectable frequency settings ensure repeatability of settings from 10Hz to 1MHz. And repeatability of settings, combined with only .005% distortion at 20 volts output, means you can predict results—without having to calibrate your tail off.

Look a little deeper and

you'll find 100db outband noise rejection, and a remarkably low 25  $\mu$ volts noise.

### Ask for a demonstration.

Versatility like this should be seen to be believed. And wait till you see the price. \$655. Not bad for all that versatility.

Call or write John Hanson at Ithaco, Box 818, Ithaca, N.Y. 14850. Phone. (607) 272-7640.

**ITHACO**

# 7 trimmers handle 95% of your applications.

## Single-turn

With these industry standard cermet trimmers, you're assured design versatility, high quality, and fast delivery.

Just decide what you need regarding: (1) single- or multiturn; (2) sealed or not; (3) size; (4) resistance; (5) pin spacing; and (6) price.

Then call your local Beckman Helipot distributor for *free* evaluation samples. To get his number, or immediate technical literature, call (714) 871-4848, ext. 1776. See how fast and easily you can solve trimmer problems.



### Model 91

- High quality—low price
- Unique brush contact
- Excellent setability
- Protective dust cover
- Top or side adjust
- Standoffs prevent rotor binding, permits board washing
- Small 3/8" dia. size



### Model 72

- 3/8" square
- Sealed for board washing
- Available in flame-retardant SEO housing
- Top or side adjust
- Brush contact
- Excellent setability
- 2 ohms of end resistance



### Model 82

- 1/4" dia. by 0.150" max. height
- Sealed for board washing
- Flame-retardant SEO materials
- 82P—top adjust; 82PA—side adjust
- Brush contact for excellent setability
- Resistance range: 10  $\Omega$  to 1 meg  $\Omega$

## Multiturn

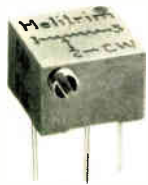

### Model 64

- Miniature, sealed
- 22 turns of adjustment
- 0.25 watt at 85°C
- Resistance range: 10  $\Omega$  to 1 meg  $\Omega$
- 1/4" square for tight P.C. board packaging
- Unique brush contact
- Adjustability—voltage ratio within 0.01%

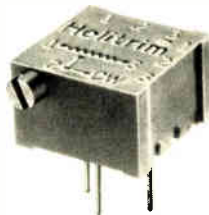

### Model 68

- Low-cost
- Sealed for board washing
- 18 turns for adjustment accuracy
- 3/8" square housing
- Brush contact
- 3 pin styles for efficient packaging
- Broad resistance range: 10  $\Omega$  to 2 meg  $\Omega$
- Operates with 1/2 watt at 25°C

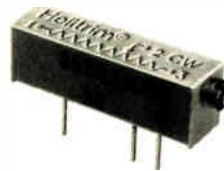

### Model 89

- Our lowest cost multiturn
- Sealed for board washing
- 3/4" rectangular, 0.250" high
- 15 turns for accurate adjustment
- 7 pin styles for mounting versatility
- Panel mount available
- Resistance range: 10  $\Omega$  to 2 meg  $\Omega$

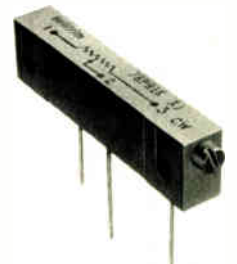

### Model 78

- Military performance, industrial price
- 1 1/4" rectangular, 0.195" wide
- Sealed
- 3 terminal styles: flex leads, P.C. pins, solder lugs
- Power rating: 0.75 watt at 70°C
- 22 turns of adjustment
- Resistance range: 10  $\Omega$  to 2 meg  $\Omega$

# BECKMAN®

HELIPOT DIVISION

## **German laser glass boasts Index of 0.63**

West German glass producer Glaswerk Schott has unveiled a laser glass exhibiting a relative nonlinear refractive index of only 0.63, an unprecedentedly low value, according to the company. **The small index, which is said to compare with 0.9 to 0.95 for the best laser glasses produced by other firms thus far, makes the Schott material well suited for high-energy laser applications.**

Being shown at the current Laser 77 optoelectronic exhibition in Munich, **Schott's LG802 glass is made from fluorophosphate that is enriched with 2% of neodymium.** Because of its small relative nonlinear refractive index, the glass can withstand many more laser shots than conventional phosphate glass, Schott points out. This is a big advantage in high-energy lasers, such as are needed to produce the plasma used in nuclear fusion experiments.

## **Bubble memory from Fujitsu comes In a cassette**

Fujitsu Ltd. has developed a **bubble-memory cassette that contains four 73-kilobit chips and is compatible with equipment of other manufacturers.** With a maximum capacity of 294,912 bits and average access time of 290 milliseconds for a single-loop bubble chip or 3.6 millisecond, for a major-minor-loop chip, the cassette has a power drain of 8.5 watts in operation. It measures 5.2 centimeters long, 5.9 cm wide, and 1.7 cm high and weighs 210 grams. It can be removed more than 20,000 times and is interchangeable with floppy disk, paper tapes, and cassettes for intelligent-terminal, computer, and educational systems.

## **Amdahl tilts at IBM in Europe**

Not content with chipping away at IBM in the U. S. market for large mainframe computers, Amdahl Corp. is going to take on the computer giant in Europe, too. To penetrate the European market, the company is **opening a software and service support center in Great Britain and a manufacturing plant in Dublin, Ireland,** to make and maintain its new 470/V 5, 6 and 7 series of computers. When fully operational in 1978, the new manufacturing base will supply all countries outside the U. S. The company expects to make announcements soon about negotiations with 20 prospective European customers, having already sold two computer systems in West Germany and one in Norway.

## **Personal computers move to Europe**

To better penetrate the growing European personal-computer market, Southwest Technical Products in the U. S. plans to become the first kitmaker to set up an assembly plant in Great Britain. Though final papers have not been signed, **London's pioneering dealer, Computer Workshop, says it has agreed in principle to make the Southwest kits in its new factory in Ware, Herts., for distribution as a joint venture between the two companies.** Computer Workshop now sells the Southwest kits—built around a Motorola 6800 microprocessor, 12 kilobits of random-access memory, a cassette interface, and terminal keyboard—for about \$1,700, but the company says that the price should drop once the factory cranks up in September.

# The Cube widens the gap...

## In Power-Ferrite EC cores for switching power supply chokes

Now available from Ferroxcube are standardized gapped EC cores in four sizes: 35, 41, 52 and 70 mm. The gap lengths have been optimized to prevent saturation of the core due to a high DC field while simultaneously providing maximum impedance to the AC ripple current.

For extreme cases of DC bias, two gapped cores should be used. Under less stringent conditions one gapped and one ungapped core can be used. The chart below shows the DC ampere-turns for both 2-gapped and gapped/ungapped core combinations that will provide a 10% decrease in permeability.

EC Core	2 Gapped Cores	1 Gapped + 1 Ungapped Core
25 mm	325 AT	200 AT
41 mm	370 AT	220 AT
52 mm	540 AT	330 AT
70 mm	860 AT	570 AT

For complete specifications on gapped EC cores, bobbins and hardware, call on The Cube.

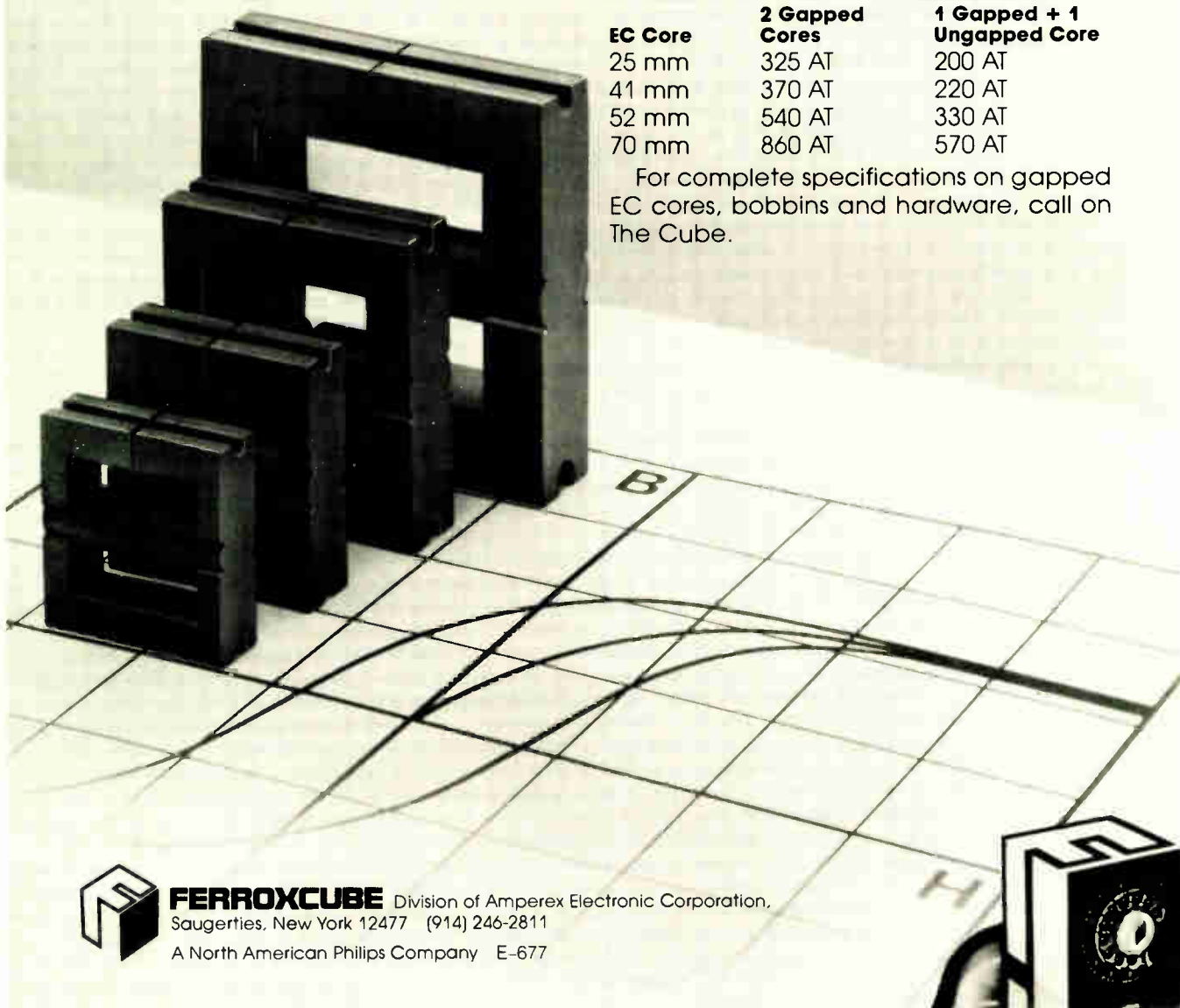

**FERROXCUBE** Division of Amperex Electronic Corporation,  
Saugerties, New York 12477 (914) 246-2811  
A North American Philips Company E-677

## Video-disk recorder aims at jobs in broadcasting

So far, developers of video disks have mainly had mass consumer markets in mind when they conceived their hardware. Not so the people at Bosch-Fernseh, a big West German producer of broadcast equipment. They turned up at this year's Montreux international TV symposium with a working model of a laser picture-storage system that records in real time with "studio" standards.

Fernseh brought its new hardware to the biennial Swiss video show more to sound out the potential market than to try to actually write orders. "We wanted to get broadcasters' reactions," says Hermann Zickbauer, the company's product manager for TV studio equipment. Zickbauer also figures that police departments, libraries, and similar organizations that need to store pictures and look them up fast could be buyers. "We think it will turn out cheaper than microfiche or computer disk storage," he maintains.

**Storage.** The system, which was developed at the research labs of Robert Bosch GmbH in West Berlin and in Lonay, Switzerland, fits about 12 minutes of video signals on a 32-centimeter disk. The frames are stored with a full broadcast bandwidth of 5 megahertz and a signal-to-noise ratio higher than 45 decibels. Audio can be coded in, too, by a sound-in-synch technique.

For stills, the 12-minute playing time works out to 18,000 pictures. Each can be coded with an address and called up within a second.

The recording medium is transparent plastic with a metal film deposited onto one side. Signal tracks are laid down by burning tiny holes in the surface with a frequency-modulated laser beam. The light power involved is between 60 and 100 milliwatts, and the holes are about 1 micrometer wide. For motion pictures, the tracks are laid down in a spiral; for stills, the tracks

are circular. Either way, the disk spins at 25 revolutions per second and one full revolution gives a full frame or picture.

For playback, an unmodulated laser beam is focused onto the signal

track. The light shining through the holes is picked up by a photodiode and amplified. The resulting high-frequency voltage is demodulated to regain the video signal.

Actually, to accomplish all that

## Japanese ready battery-operated liquid-crystal display panel

Battery-operated terminals with large-screen character displays are among the possibilities opened up by a new liquid-crystal display soon to go into production at Hitachi Ltd. Prototype displays shown recently have four rows of 32 alphanumeric characters on a panel measuring 38 millimeters high by 175 mm wide. Each character is a 5-by-7-dot matrix, although each character position is actually a 5-by-8-dot matrix if the cursor dots are included. Production displays will include panels with eight rows, for a total of

256 characters, as well as panels with 7-by-9-dot matrixes for display of the Japanese Katakana syllabary.

The units operate at a maximum unipolar voltage of 15 volts and use complementary-metal-oxide-semiconductor integrated circuits in all drive circuits. Power consumption runs about 100 milliwatts, but most is used in power-supply circuits that set various needed levels and not in actual drive circuits or the panel itself. Thus larger panels and those with more dots per matrix operate at the same power level.



requires some sophisticated techniques. For one thing, the laser light modulator is based on an acoustic crystal with a basic 250-MHz supersonic wave that is amplitude-modulated to diffract the light onto the disk in step with the fm video signal. Then, too, a precision servo system is needed to keep the modulated recording spot focused on the surface of the disk, which is never absolutely flat.

Still another problem is keeping the scanning spot on the right track during playback. This is done by a mirror tilted by a piezoelectric effect. The control signal is derived by shifting the spot at right angles to the track at 25 kilohertz. The track control also makes it possible to freeze frames or to have slow motion or fast motion by making the scanning spot jump tracks as needed during blanking. □

on the well-known effects exploited in photocopying techniques. When exposed to light or other electromagnetic radiation, amorphous selenium exhibits a conductivity that is several orders of magnitude better than under dark conditions.

Depending on the intensity of radiation, the surface charge in a layer of selenium drifts towards its substrate. So, on a charged selenium plate, the radiation impinging on it can be recorded as a charged image. Ink-powder development techniques make the image visible.

Simple as the basic principles are, implementing them for SEL's application is a bit tricky. At this stage of development, the Nuremberg firm does not want to reveal all that goes into the making of the plate.

The fundamentals of the technology involved, however, are straightforward. In an evaporation process carried out in a vacuum, an aluminum plate with a well-defined surface roughness is covered with a layer of selenium. Crucial parameters in this process, the firm says, are the rate of evaporation, the doping level for the selenium, the degree of purity for certain intermediate layers, and the substrate temperature during evaporation. Depending on the application, the selenium layer is from 100 to 500 micrometers thick. Since it can easily be damaged, the layer is covered after evaporation with a thin coating of an organic material.

Besides reusability and the low radiation dose required for producing a record, the selenium plate has a number of other advantages over silver films normally used in diagnostic X-ray equipment. For one thing, its high resolution—0.1 millimeter—allows spotting even tiny tumors, which would be unrecognizable on silver film.

For another, because of the plate's ability to produce high-contrast contours, a clear distinction can be made between fibrous tissue, skin, fatty tissue, and glands. Still another advantage is that the information-storage medium can be simple typewriter paper. And the plates help conserve expensive silver. □

## West Germany

### Selenium plate records X rays as charged images, makes paper copies

Chalk up another use for that versatile material, selenium: as an X-ray recording medium. First introduced industrially for rectifiers in 1928, selenium is used in such devices as photosensing elements, infrared detectors, photocopying machines, and lithographic equipment.

Now, at ITT's subsidiary Standard Elektrik Lorenz AG in Nuremberg, West Germany, engineers of the components division are working on various types of selenium charge carriers. One of them comes in the form of a plate and is aimed at replacing film in X-ray diagnostic equipment. A specific application is in mammography, the technique for

examining a women's breast for cancer by X rays. Concerned over the rising number of women suffering from breast cancer, the German government is funding the SEL work.

Both the selenium plate and its development apparatus have been put through their paces at a West Berlin hospital. But there is still much work to be done before the equipment is ready for the market, the firm cautions. It figures the first perfected and fully automatic units for routine use in hospitals will not be available for two to three years.

**Charged.** The principles underlying the plate's recording capability are fairly simple and are based

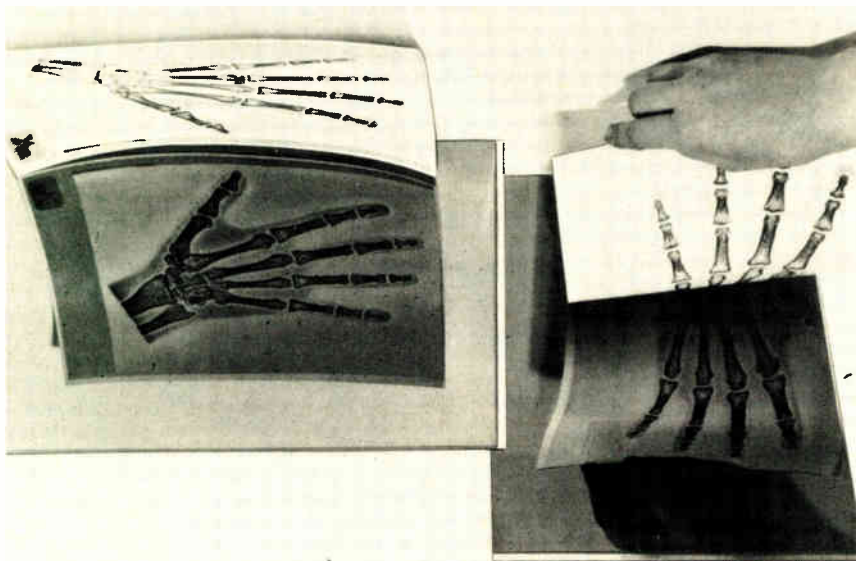





## The General Purpose **EXPLORER II**

**New digital  
oscilloscope for  
low-frequency,  
high precision  
signal measurement.**

**EXPLORER II** is an oscilloscope in every sense of the word— for use in the same way as other oscilloscopes. It has the same sweep controls, trigger controls and amplifier controls.

What makes it different is its precision and enormously improved waveform storage capability. **EXPLORER II** is a digital oscilloscope. Because of this and careful human engineering, a dozen old operating problems have just disappeared.

**Great Storage:** Storage occurs at the touch of a button. The captured waveform has the same quality as live waveforms — amazing quality. There is no trace fading or blooming. If you wish, you can tuck the waveform away, out of sight, for later recall and continue to use the oscilloscope for other things in the meantime. Storage at the touch of a button means more than saving operating steps. It means no blank screen before storage.

**Automatic Persistence:** The **EXPLORER** always displays the last signal waveform until the next signal occurs, even when signals occur only rarely. There are no adjustments or mode switching.

**CRT Independence:** No longer is accuracy dependent on the cathode-ray tube. True voltage and time numerics for any selected point end that problem. The numbers can show differences in both times and voltages, for two selected waveform points. Accuracies and resolution are an order of magnitude greater.

**Write-through Storage:** At the touch of a switch, both live and stored waveforms are shown superimposed. This is far better than split-screen storage, which shows a stored waveform in one area of the screen and live waveforms in another. Write-through storage allows you to see changes as small as 0.025% while they are happening!

**Dual Beam:** **EXPLORERS** with two-channel plug-ins are "dual beam". Both signals are accepted together. There is no need for alternate sweeps or chopped sweeps.

**Cursor Triggering:** It used to be that all you could see on a 'scope was the result of an event. With **EXPLORER** you can see what caused an event to happen. Move the vertical marker line to any desired position. In the cursor trigger mode, this will be time zero, the time the sweep trigger occurs. The trace shows you what happened before and after the trigger.

**Easy Operation:** It's as difficult to describe the "feel" of **EXPLORER II** as it is to describe the feel of a great sports car to someone who has only driven "soft" passenger cars. But once you've had an hour or two of familiarization and used this new digital 'scope you'll know. You'll never want to go back to anything else.

### **EXPLORER III**

Identical to **EXPLORER II**, this unit incorporates an added module that contains a magnetic disk memory and a digital input/output port. To document waveforms for future reference, the diskette preserves the accuracy and resolution of the original. There is no compromise as with a photo document. For computation, the digital I/O allows interface to computers and calculators, also IEEE 488 interface.



**See It Demonstrated.** To really appreciate either of these new 'scopes you have to see them in action. For complete details, including descriptive brochures, send the reader service card or call Bruce Hervey at 608/271-3333.

**NI** COLE  
INSTRUMENT  
CORPORATION

5225 Verona Road  
Madison Wisconsin 53711  
Telephone: 608.271-3333

For Demonstration circle 80

For Information circle 81

Designing

# microprocessor

Get a system overview with this memory map. The 16005 shows how your memory is being utilized in an operating program. Knowing how your memory is organized, you can see at a glance what your program is doing and the relative time being spent in any one memory location. This helps you spot unwanted program sequences or parts of your program that aren't being implemented.

Base page slots storage

I/O ports

Stack storage

Executive, interrupt and subroutine program

Interrupt vector address

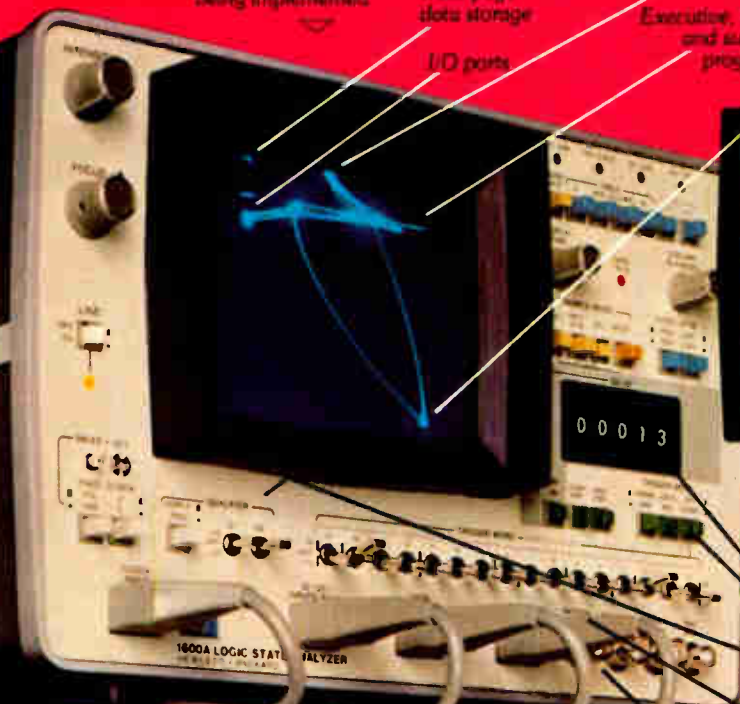

Monitor a serial data stream and compare new data with that previously stored. This display shows software conversion of BCD data to an ASCII format. Column blanking simplifies display by showing only 8 of 16 bits available.

Preamble

Preamble

ASCII of displayed data

Interrupted bits are those that have changed since start-up

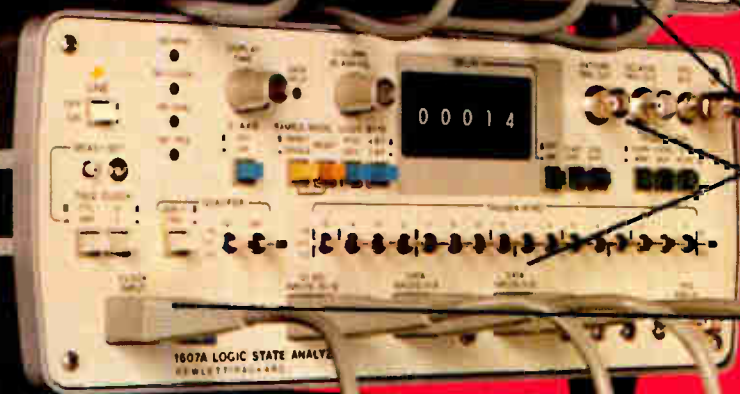

Qualifiers, digital delay and various local or bus-triggering modes give you pinpoint selection of data flow for effective program tracing.

Up to 32 channels let you see all the action on the microprocessor address and data buses plus the I/O, peripherals or any other logic section of your microprocessor system.

Output triggers drive your scope—at the right instant—for making electrical measurements in the time domain.

Dual clock means you can easily relate bus activity to events occurring elsewhere at a different clock rate.

Serial-to-Parallel Converter (HP's 10254A) lets you directly view serial data in relation to parallel data on the system bus.



## FREE DATA DOMAIN SEMINAR

Find out for yourself how HP Logic State Analyzers can broaden your view of the data domain and speed digital design and debugging of your microprocessor-based system. Seminars are scheduled in a number of cities throughout the country. Ask your HP field engineer about specific details on seminars in your area.

# based systems? You've discovered

## a new set of problems. Now discover HP's solutions.

HP's Logic State Analyzers give you a real-time view to help you spot and diagnose intermittent system operation. That can mean faster microprocessor system design and debugging.

The 1611A, priced at \$5000\*, can be tailored to either 6800 or 8080 microprocessors now. And more "Personality Modules" will be available soon. The 1611A lets you view bus activity and external events from the microprocessor's viewpoint. And, mnemonic decoding greatly simplifies interpretation.

The 1600S, with up to 32 input channels, dual clock capability and priced at \$7100\*, gives you a detailed real-time view of system activity from any

vantage point, regardless of differences in clock rate. Add the 10254A Serial-to-Parallel Converter for \$975\* and you can simultaneously view serial data at peripherals.

One or more HP Logic State Analyzers give you greater insight for better understanding of your system's capabilities. That can mean earlier product introduction, lower development costs, a faster return on the development investment.

Your local HP field engineer has all the technical details. Give him a call today. And also ask him about HP's FREE seminars—An Introduction to the Data Domain.

\*Domestic U.S.A. price only

**Fourth occurrence of interrupt**

**Trigger word (vector store location for interrupt sequence)**

**I/O port memory address**

**Observe a selective state. For example, now you can observe all data transfer across an I/O port and exclude all other activity.**

**Read and write data at I/O port**

**Personality modules let you tailor the 1611A for either 6800 or 8080 microprocessors now, with others following soon.**

**Direct display of elapsed time**

**Disable when interrupt line goes high**

**Enable when interrupt line goes low**

**Mnemonic display of instructions**

**Read time intervals directly on the 1611A CRT to quickly determine elapsed time between any two program events. For example, this display shows the length of time it took to clear an interrupt so another interrupt could occur.**

**Output triggers drive your scope—at the right instant—for making electrical measurements in the time domain.**

**Keyboard mode selection and data entry speeds and simplifies setups and analyzer operation.**

**Self test and error messages give quick verification of correct instrument performance and signal when incorrect operation occurs.**

**Debug your programs on operating hardware. Since the 1611A displays program flow in a real-time inverse assembly, you can compare directly with your assembler listing. Trigger on an address, data, external lines or on any combination of the three to pinpoint a specific program location.**

ADDRESS	OPCODE	DATA	EXTERNAL
4004	18	WRITE	00000001
4004	18	WRITE	00010001
4004	18	WRITE	00020001
4004	18	WRITE	00030001
4004	18	WRITE	00040001
4004	18	WRITE	00050001
4004	18	WRITE	00060001
4004	18	WRITE	00070001
4004	18	WRITE	00080001
4004	18	WRITE	00090001
4004	18	WRITE	000A0001
4004	18	WRITE	000B0001
4004	18	WRITE	000C0001
4004	18	WRITE	000D0001
4004	18	WRITE	000E0001
4004	18	WRITE	000F0001

ENABLE TRIGGER	ADDRESS	DATA	EXTERNAL
BT	0147	00	00000011
TRIG	0000-4	FFFB	0000000X
BT	0147	00	00000011
TRIG	0000-4	FFFB	0000000X

ADDRESS	OPCODE	DATA	EXTERNAL
4004	18	WRITE	00000010
4004	18	WRITE	00010010
4004	18	WRITE	00020010
4004	18	WRITE	00030010
4004	18	WRITE	00040010
4004	18	WRITE	00050010
4004	18	WRITE	00060010
4004	18	WRITE	00070010
4004	18	WRITE	00080010
4004	18	WRITE	00090010
4004	18	WRITE	000A0010
4004	18	WRITE	000B0010
4004	18	WRITE	000C0010
4004	18	WRITE	000D0010
4004	18	WRITE	000E0010
4004	18	WRITE	000F0010

**HEWLETT hp PACKARD**

1507 Page Mill Road, Palo Alto, California 94304

For assistance call: Washington (202) 944-8576, Chicago (312) 235-0800, Atlanta (404) 950-1328, Los Angeles (213) 977-1322

# ANNOUNCING THE WORLD'S BROADEST LINE OF FIBER OPTIC CABLE.

## THE FUTURE IS NOW.

If you're working in a field that uses connectors like the ones shown here, you now can be working with fiber optics.

Because now there's Galite.<sup>®</sup>

The world's first line of optical communication cable that's broad enough to let you select exactly the right cable for your application. (Of course, your replacement optical connectors may look quite different from these old standards.)

So now you can bring the major advantages of optical communications to your product before it starts to look — and act — obsolete.

The world's broadest line of fiber optic cable begins with Galite 3000, which covers the biggest range of applications, and can be used up to 1100 feet. With its wide acceptance angle of light, it's the most efficient cable to couple, splice, and connect. And in most applications, it allows you to use proven, efficient, and durable LEDs, rather than the more fragile and temperature sensitive semiconductor lasers. But that's just the beginning.

We also offer, with varying light acceptance angles, Galite 1000, for use up to 150 feet. Galite 2000, for up to 250 feet. Galite 4000, for up to 3300 feet. Galite 5000, for beyond 3300 feet. And soon we'll be producing Galite 6000 and 7000 for even greater distances and wider bandwidths.

With this kind of choice, you can specify the exact characteristics for optimum performance in your application — strength, propagation efficiency, thermal compatibility, chemical resistance, weight — and cost.

What's behind this line of fiber optic cable nobody else can offer is a company with experience nobody else can match. We've pioneered in glass fiber optic products since 1959 and are now the world's largest manufacturer, with over 2 trillion feet shipped.

We also have the country's most integrated production facility where we do everything from formulating the glass to making complete systems including light sources, detectors, and connectors. So we can keep reliability up. And costs down.

Why not call, write, or circle the reader service number for our new information package, "Fiber Optics Now."

But don't put it off until tomorrow. Because tomorrow is already here.

Galileo Electro-Optics Corporation, Galileo Park, Sturbridge, Massachusetts 01518, 617-347-9191.

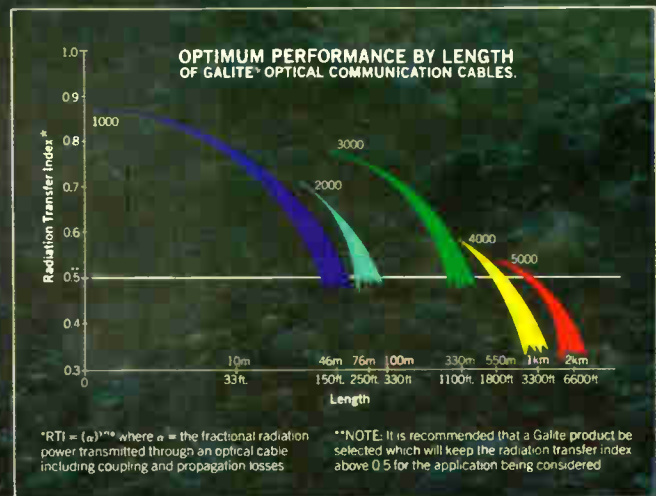

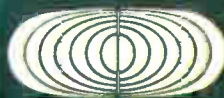
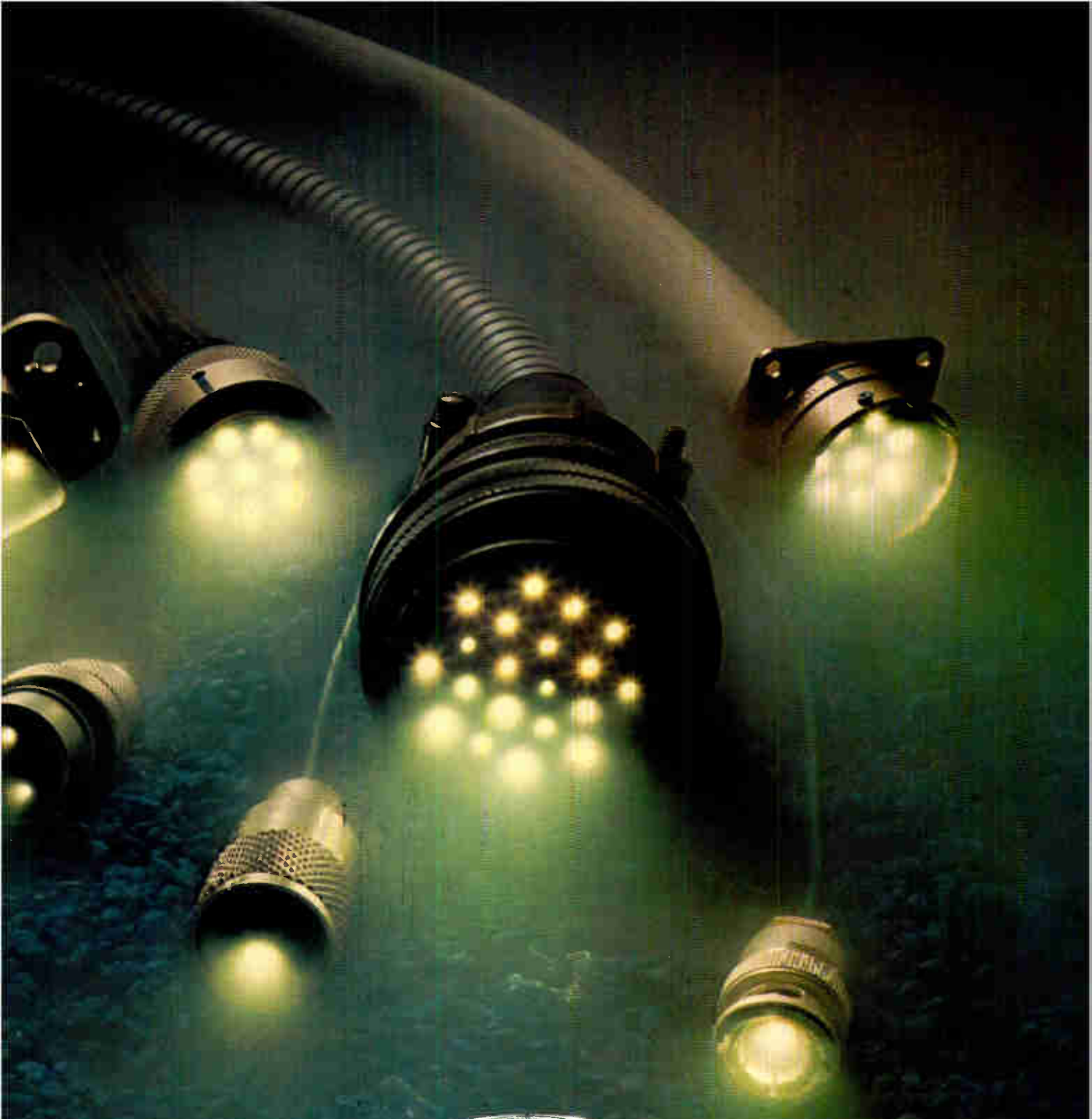

**Galileo Electro-Optics Corp.**

**THE FIRST COMPANY TO BRING FIBER OPTICS  
OUT OF THE LAB AND INTO PRODUCTION.**

# AMP research discovered Bonded Lubrication 5 years ago.

## It's now today's better way to extend contact life without compromising performance.

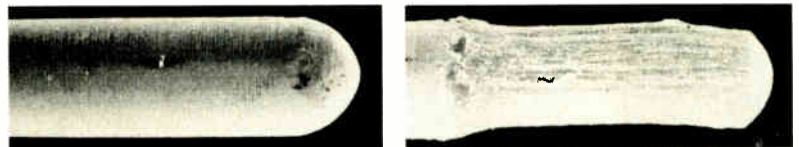

Through the electron microscope, the dramatic improvement AMP Bonded Lubrication makes in contact life and performance is clearly evident.

Dramatic difference in wear between contacts utilizing the unique AMP Bonded Lubrication Process and ordinary contacts is shown by these electron images.

With the popular DUALATCH connectors, Bonded Lubrication has reduced plating thickness requirements and more than doubled the previously accepted cycle life of 10,000 insertions and withdrawals.

For example, look at the effect on the connector contact shown. Not only is wear to the plated surface greatly reduced by the permanent lubrication but it

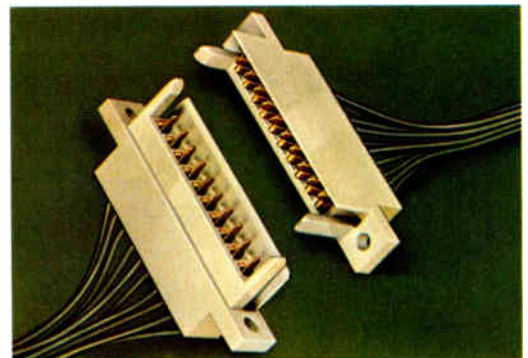

significantly lowers the insertion forces when mating high-pin count connectors. Now Bonded Lubrication can be applied to a variety of contact geometries without compromising electrical performance.

Or consider what AMP lubrication leadership has done for contacts used in our tin-plated products like surface mount ZIF connector and Bifurcated Leaf types. Their lubricated contact surfaces are protected from the detrimental effects of oxidation and fretting corrosion. Indeed, there are now applications where high performance tin-plating, with the correct contact design and Bonded Lubrication, can be used in place of noble metals.

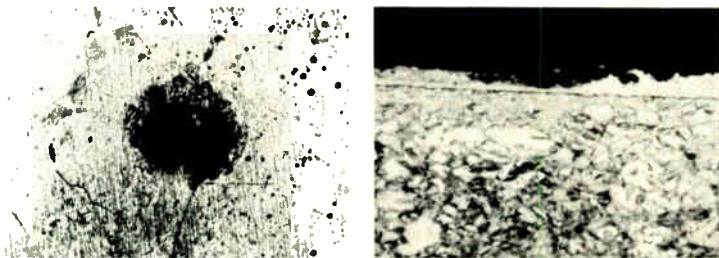
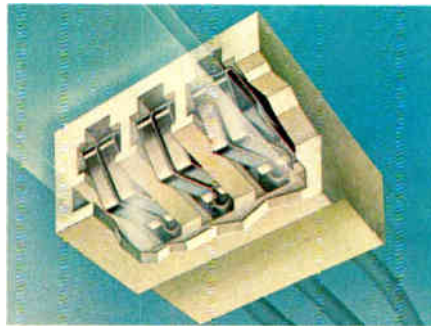

High Resolution scanning electron microscope at AMP's Materials Research Laboratories displays 3-dimensional pictures of surface oxidation and fretting corrosion on non-lubricated contacts.

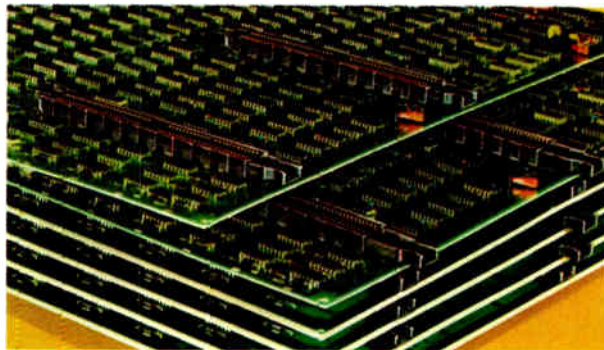

AMP lubricated contacts are today's answer to extended contact life and performance, and together we can search out better ways to assist your designs.

For more information on the products mentioned, circle the reader service number. For more technical information on lubrication just call Customer Service at (717) 564-0100, extension 8400. Or write on your Company letterhead to AMP Incorporated, Harrisburg, PA 17105.

**AMP has a better way.**

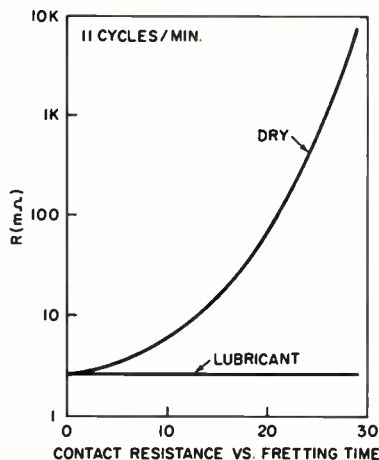

Flat, stable resistance of contacts with AMP lubrication compared to dry contacts.

**AMP**  
INCORPORATED

# Superior performance here...

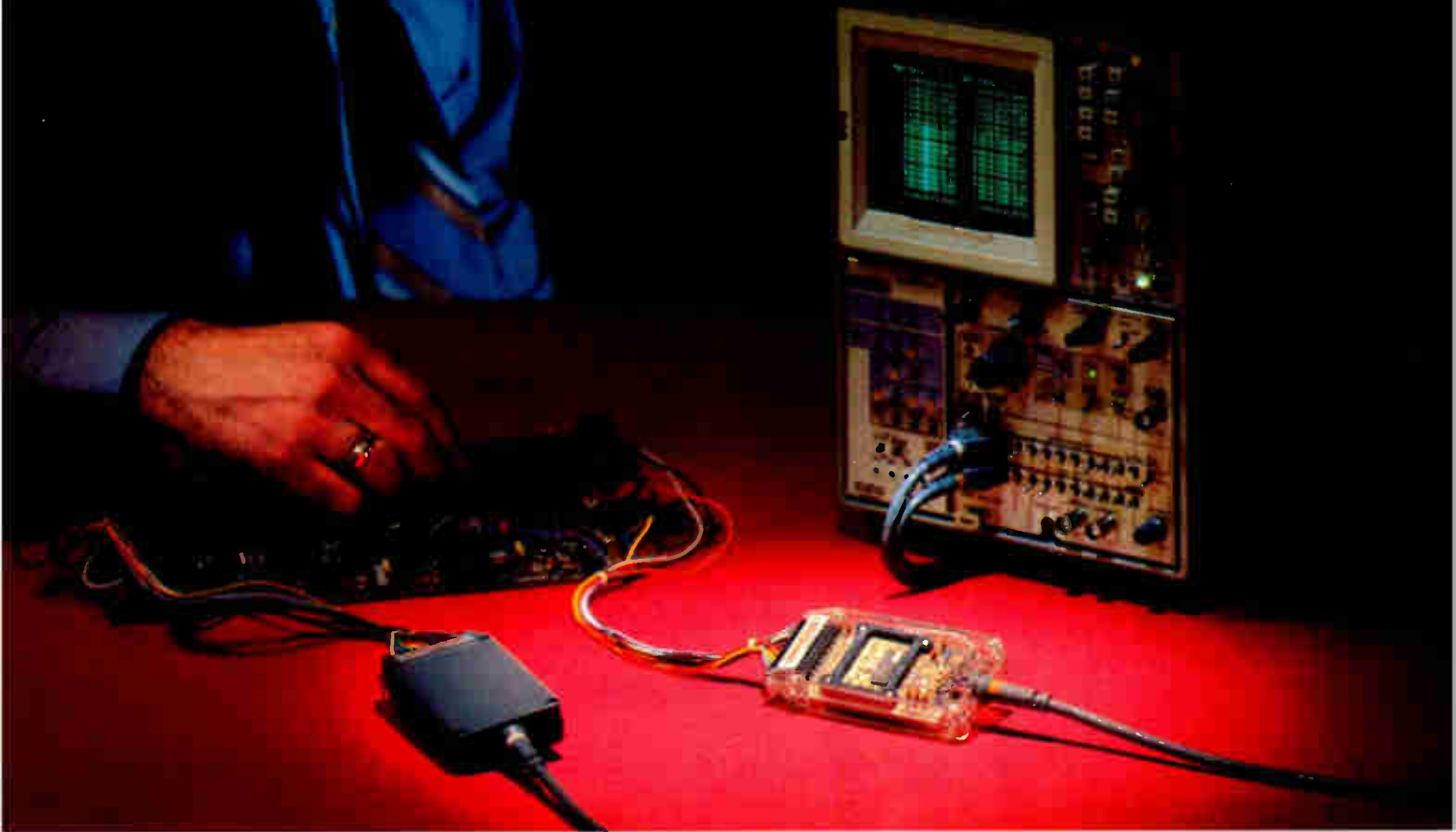

## ...starts here.

Look inside today's innovative electronic products. You'll find more and more circuitry on hybrids. Take, for example, the TEKTRONIX P6451 Data Acquisition Probe shown above. Thanks to hybrid circuitry, the P6451 is the most versatile data acquisition probe on the market. (In fact, almost all its circuitry resides on two thick-film hybrids.) That's why more resources are being dedicated to hybrid design, fabrication, and testing than ever before.

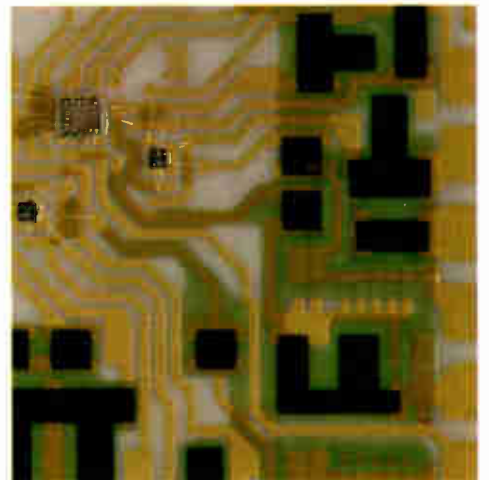



However, it takes more than innovative hybrid design to be successful in the fast-paced electronics marketplace. Successful designs must be repeatable and manufacturable. How does a circuit designer know when the design is repeatable and manufacturable? By testing.

At Tektronix, hybrid prototypes are evaluated using a TEKTRONIX S-3260 Automated IC Test System. The evaluation team—the hybrid designer and test engineer—begins by investigating whether or not the prototype functions as designed. This sometimes leads to a complete device characterization, a process that requires exhaustive testing.

When a hybrid is characterized, every measurable parameter and function is tested, actual limits of performance are determined, and then its behavior is documented for all the various sets of input conditions in all their combinations and permutations. That's a lot of testing and it can quickly build mountains of test data. A system that merely performs accurate and repeatable tests is not enough. The evaluation team must also have the tools to reduce the data mass into a useable form. The S-3260 is a combination general-purpose IC test system and a data processing system—a totally integrated package that both acquires and processes test and measurement data.

You'll find TEKTRONIX S-3260's used for device characterization, process evaluation, production testing, and field failure analysis. Tektronix IC test systems are used by the world's leading communications companies, aerospace contractors, computer manufacturers, semiconductor manufacturers, and by the military.

Serious about performance? Then you should know about Tektronix IC test systems. Write Tektronix, Inc., P.O. Box 500, Beaverton, OR 97077. In Europe write Tektronix Limited, P.O. Box 36, St. Peter Port, Guernsey, Channel Islands.



"It works, but . . ." Test engineer and device designer evaluating the prototype. Information gathered here guides the circuit designer as he adjusts his design for volume production.

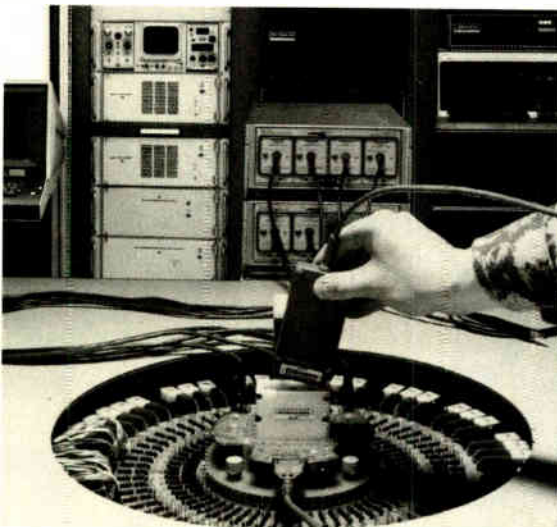
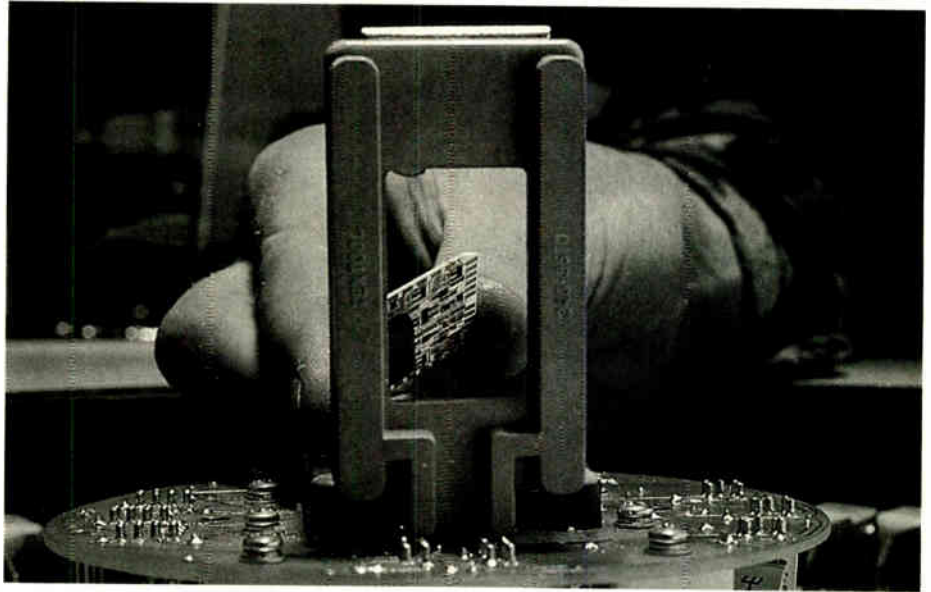

Hybrid circuits are tested throughout the manufacturing process. Information gathered here alerts production engineers to manufacturing and process problems.

Final test of the completed data acquisition probe. Information gathered here dramatically reduces the labor involved in calibration and troubleshooting.

**Serious about performance?  
Then you need to know about  
Tektronix IC Test Systems.**

**Tektronix®**  
COMMITTED TO EXCELLENCE

For Technical Data circle 88 on Reader Service Card

For Demonstration circle 89 on Reader Service Card

World Radio History

# The P400 makes excuses obsolete.

A new product comes on line and the circuit boards start piling up. This is when the excuses begin:

"I can't get near the computer."

"I need more programmers."

"I just got schematics last week."



It's a difficult time for a test engineer because the success of an important product can hang in the balance.

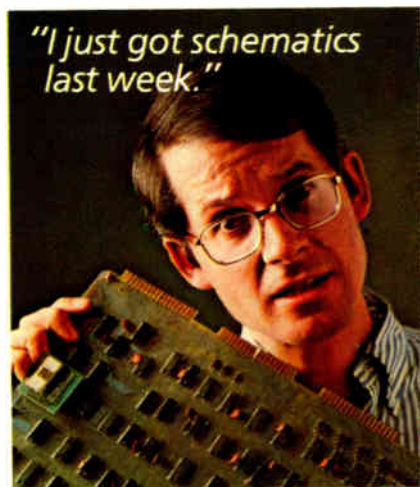

But Teradyne's P400 Automatic Programming System has changed all that. Used with L100 series test systems, the P400 creates the entire test program

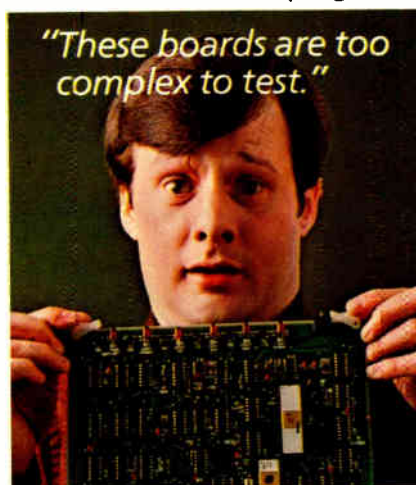

automatically. It gives you all input patterns, provides all diagnostic data, and resolves all races. It cuts programming time from weeks to days. And it does it all without tying up the computer on your production tester or increasing your programming staff.

Suddenly, new programs can be ready on time, even in the face of the tightest schedules. And even for the most complex boards.

Just as important, the P400 spares you all the boring work it usually takes to deliver new programs. You get typically better than 95% fault coverage simply by using the telephone to access a large computer containing the P400 software.



The P400 Automatic Programming System.

Now there's no reason for being late.

And we think that's the way you want it.

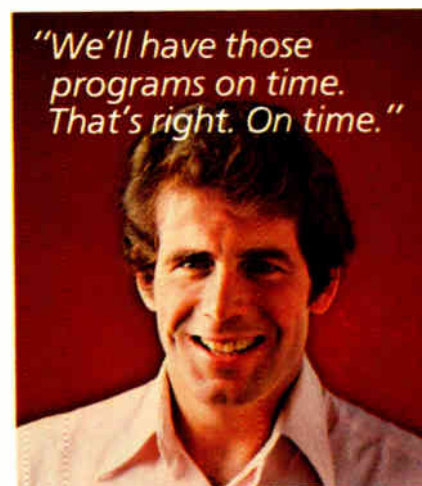

## TERADYNE

183 Essex Street, Boston, Mass. 02111

## Earth station market widens

Standard B terminal, with its smaller antenna and price tag, permits poorer nations to join satellite communications club

Next month, international telecommunications service using a new class of satellite earth station will begin in the West African nation of Mali. The country's Standard B earth station, the first of its kind to become operational anywhere, will begin providing two-way telephone and Telex service, plus television reception.

Supplied by GTE International Systems Co. in Waltham, Mass., the station represents a substantial reduction in the entry fee a country must pay to use international satellite communications. Until recently, the outlay had been between \$5 million and \$6 million for the much larger Standard A stations with 30-to-32-meter-diameter antennas. The B stations have an antenna 11 m in diameter and usually cost from \$1 million to \$2 million for a turnkey system—antenna, ground structures, and the electronics equipment.

The price tag of the Standard A stations, plus the charge of \$7,380 a year to lease a channel on one of the Intelsat IV or IVA geostationary orbiting satellites, was never an obstacle to the large industrial countries. But the smaller emerging nations simply could not afford it. Now, the Standard B's lower price has opened a market that could reach \$80 million in the next five years, says Glenn T. Sacra, president of the GTE company. Most of his competitors agree on the market size.

But GTE is by no means alone in winning or bidding for new Standard B business. Nippon Electric Co. is generally conceded to be the company to beat in the race for the 30 to 50 stations most competitors think will

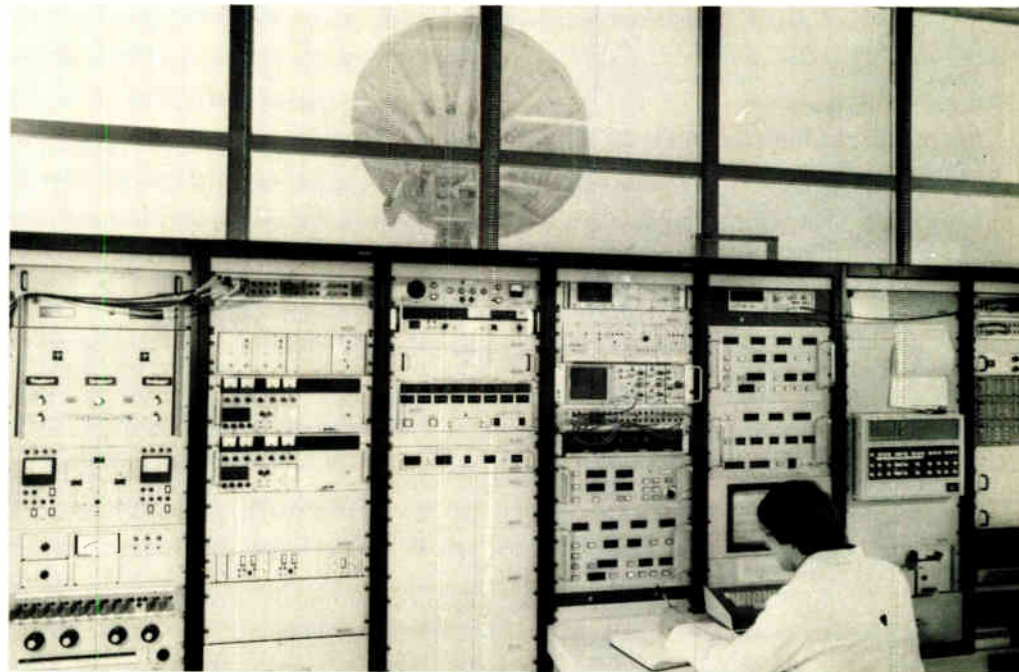

**Big ear.** Earth station installed by GTE International Systems in Fucino, Italy, is similar in size and complexity to Standard B stations. It is used for Marisat communications.

be built in the next five years. The company has technical ability, a good product, and a financing arrangement for needy countries that nettles competitors (see "Competing with Japan," p. 92).

Other companies in the Standard B race include California Microwave Inc. of Sunnyvale, Calif.; Collins Radio group of Rockwell International Corp., Dallas; Com/Tech Laboratories Inc. of Smithtown, N. Y.; Marconi Communications Systems Ltd., Chelmsford, Essex, England; Sistemi di Telecomunicazioni via Satelliti, an Italian consortium; and Telespace, a French joint venture.

STS is made up of Italy's three major telecommunications compa-

nies—GTE Italia, SIT-Siemens and Sitri, which, together, have a turnkey system. Telespace unites France's two largest electronics companies—Thomson CSF and Compagnie Générale d'Electricité.

Nippon Electric Co. figures to be a big winner for still another major reason. Not only does it supply turnkey systems, but the company is also one of the few that make the modulation equipment. The others are Digital Communications Corp., Gaithersburg, Md., and ITT Space Communications Inc., Ramsey, N. J.

The Japanese firm has installed or is building 25 earth stations similar to Standard B but using the earlier frequency-modulation/frequency-division multiplexing. GTE is building

## Probing the news

15 such installations. "I expect there will be another 30 to 50 Standard B stations sold worldwide in the next two or three years," says Ronald Lutz, head of Technology Resources, a suburban Paris consultant firm that NEC uses for its earth station business.

Telespace's business in the 11-meter fm/FDM stations has been mainly with French-speaking African nations—one each to Chad and Mali—and there are 12 on order from Tahiti. Bernard Cheney, commercial director for Telespace, adds that the French post office has also ordered several.

**Colonies.** England's Marconi Communications Systems Ltd., Chelmsford, Essex, has sold a station similar to a Standard B for the Apollo spacecraft network in the Atlantic. Philip R. Clowsen, space sales and systems manager, will not specify which countries Marconi is eyeing, but he hints that former British colonies are the likely markets. Com/Tech Labs' group manager for international marketing, John Smith, says, "We have proposals outstanding with NATO people in Europe and with just about everybody in the Middle East."

California Microwave is dealing with Oman and Thailand and has made proposals to about 10 other emerging nations, according to Robert Friedman, vice president for

satellite communications. At ITT Spacecom, general manager John Lamoreaux says the company has supplied 15 domestic earth stations to Indonesia. These are usually smaller than Standard B facilities. Lamoreaux pegs the Standard B market at \$25 million over the next 14 months, "but the potential market is many times larger if you can count those [countries] who say they're thinking about putting a system in but don't have firm plans and need financing."

In the Italian joint venture, STS general manager Marcello Pahor notes that GTE Italia provides the receiving-chain hardware for the turnkey system the company offers, with SIT-Siemens being responsible for the transmitting chain and Sitri handling integration, installation, and testing. Pahor probably best sums up the competitive situation in the Standard B business: "In this field, you have to be everywhere or not at all. A lost bid gives you a lot of experience."

Similar stations smaller than Standard A units have been in use, but the \$1.5 million Mali station will be the first to use equipment featuring single-channel-per-carrier, pulse-code-modulated/phase-shift-keying modulation techniques instead of the earlier fm/FDM. All Standard B stations must use single-channel-per-carrier modulation beginning next year.

The newer African nations are prime sites for Standard B stations

because of their relatively crude voice communications systems—usually entailing high-frequency radios or days of waiting to place international phone calls. Some of the countries identified by manufacturers as candidates include Sierra Leone, Botswana, Swaziland, Chad, Uganda, Tanzania, San Salvador, and Costa Rica. Island sites also targeted by station suppliers include Malta, Cyprus, and Cuba.

The companies going after the business usually act as system integrators: they purchase or manufacture some of the major subsystems and assemble and test the stations before delivery. Antennas are supplied principally by Com/Tech Laboratories; E-Systems Inc. of Dallas; and R F Systems Inc., Cohasset, Mass.

**Meets standards.** Carl Faflick, vice president for engineering at GTE International Systems, says the single-channel-per-carrier PCM/PSK modulation technique was selected last year by the Intelsat consortium for Standard B because it meets international standards for such characteristics as noise distortion and bandwidth established by the CCITT. The single-channel-per-carrier feature, while not new, requires less radiated power from the earth station because the channel is cut off when no transmission is taking place. (Usually 60% of a telephone conversation involves no transmission.) But the technique requires more satellite power than earlier modulation schemes. That is reflected in Intelsat's charge per channel, which is 1.5 times that for leasing a Standard A channel, or a little more than \$11,000 a year since the Standard A charge has been reduced to \$7,380 from \$8,600 a year.

The Standard B stations will typically have 12 to 24 channels each, supporting that many two-way phone conversations. But as many as 24 Telex circuits can be put on one voice channel, so Telex traffic will undoubtedly be heavier than voice communications as the emerging nations link with overseas sites. □

This article was written in Boston by Senior Editor Lawrence Curran. Reporting was contributed by Arthur Erikson in Paris, William Arnold in London, Lois Bolton in Milan, Charles L. Cohen in Tokyo, Bruce LeBoss in New York, Lawrence Waller in Los Angeles, and Bernard Cole in San Francisco.

## Competing with Japan

It is a familiar theme. The non-Japanese competitors for Standard B earth station business have a lot of respect for Nippon Electric Co. But there is some irritation, too, with the financing advantage the Japanese firm has through government-backed loans. Typical comments include these:

- Glenn Sacra, president of GTE International Systems Co.: "Standard A stations in Egypt and Paraguay were financed on a concessionary basis by the Japanese, and NEC got both of those. It was the equivalent of a soft loan that might be offered by the U. S. Agency for International Development for, say, 15 to 30 years at 2% to 4%." In contrast, U. S. competitors must work with the Export-Import Bank and can do no better than six to eight years at 8% or 9%.
- Robert Friedman, vice president, California Microwave: "The government-sponsored financing policies Nippon is able to offer many of these emerging countries are important. They're pretty hard to beat."
- John Lamoreaux, general manager of ITT Spacecom: "The Japanese are extremely tough. They've got the technical know-how and good product and good financing to make it tough for all of us in this business."

If you're designing equipment that requires a numeric or alphanumeric printer here's an opportunity to upgrade capabilities, increase reliability, and maybe even cut costs, too.

**"Spanning Hammers" Reduce Parts, Raise Reliability**  
Our innovative microprinters have only about one third the number of parts you'll find in conventional single hammer per column printers. Ours are simpler, so they're more reliable. Each spanning hammer forms the characters for three columns, therefore, only five hammers are required to print all fifteen columns.



**Full 54 Character Printing In All Columns** Our special bar matrix character formation permits printing of A-Z, 0-9, and eighteen symbols in all columns at speeds at up to 90 lines/minute.

**More Good News** Users of your equipment will like our easy-handling snap-in ribbon cartridges, the economy of printing on inexpensive plain paper, and the flexibility of being able to make multiple impressions when the need arises. In addition, there are also optional ticket and ticket/tape mechanisms available.

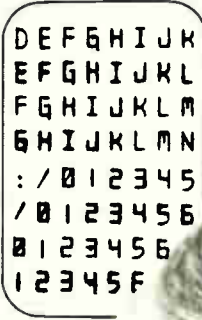

And you'll like the fact that our printers are made right here in the U.S.A. So your design and engineering people can have easy access to our design and engineering people.

**Let's Exchange Print-Outs**  
Send us a sample of your present printout and we'll send you a copy of ours. Plus, we'll send you full details on our series PR 1500 printer. Sheldon-Sodeco, 4 Westchester Plaza, Elmsford, N.Y. 10523; Phone (914) 592-4400. \*in 100's  
**SHELDON-SODECO**  
A COMPANY OF



**NOW... A FULL  
ALPHANUMERIC,  
15-COLUMN  
IMPACT PRINTER...  
FOR LESS  
THAN  
\$110.00\***



**SPECIAL OFFER**  
Thru Sept. 1, 1977  
15-column alphanumeric printer  
with control electronics for  
ASCII/BCD input.  
Only \$295.  
You save \$106.

0111 00100110 11100100 11011100 10011011 10010011 01110010 011

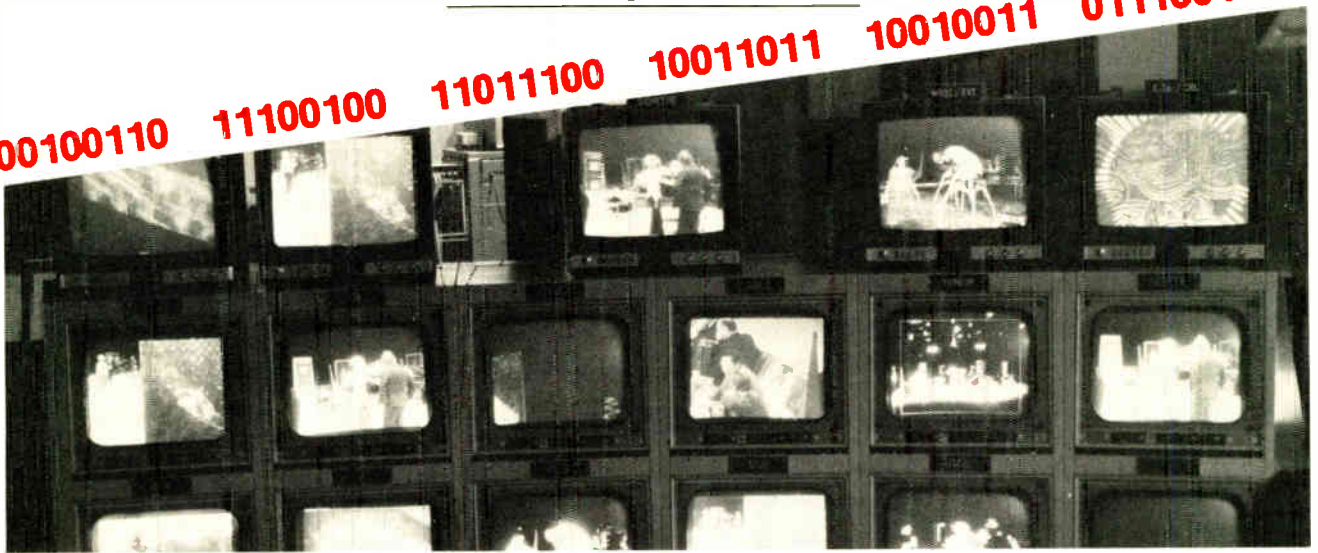

Communications

## Digital TV: when, not if

Technology and first generation of hardware are available  
amid predictions of takeover starting in mid-1980s

by Arthur Erikson, Managing Editor, *International*

A switch to digital television would obsolete millions of conventional TV sets around the world. But the time is fast approaching when broadcasters will be working not with analog waveforms but with bit streams from their cameras up to the transmitters. By the mid-1980s, certainly, digital video processing will dominate in many studios in many countries. By that time, too, receivers with frame stores could well be on the market.

"The technology is already here," maintains Charles Rhodes, chief engineer for television products at Tektronix Inc. of Beaverton, Ore. Already here, too, is a first generation of hardware. For example, at Montreux' international TV symposium in early June, held biennially at the Swiss lakeside resort, just about every video-tape recorder company had a digital time-base corrector to talk about. Digital frame stores turned up in the offerings of a half-dozen manufacturers, some of them paired with special-effects systems. Thomson-CSF Laboratories, in fact,

had a digital noise reducer based on a frame store. All the new character generators for superimposing titles and headlines on TV screens were digital. Also, of course, where the video is still handled in analog form, the controls are usually digital if the system is at all elaborate.

**Revolution.** "We're in the midst of a technological revolution," says Joseph Flaherty, vice president for technology at Columbia Broadcasting System. Indeed, semiconductor technology is moving so fast that video-equipment designers face a special kind of future shock, pointed out a panelist at a Montreux round table on equipment trends. Step advances in very large-scale-integrated circuits (VLSI) will come along at much shorter intervals than generations of TV equipment.

Even if they cannot come up with a transmission standard, broadcasters and equipment makers figure to keep on moving toward fully digital processing. Just before Montreux, Britain's Independent Broadcasting Authority demonstrated the

major elements for a digital studio video-processing chain including mixer, switcher, tape recorder, and color-bar generator. The experimental equipment, IBA reports, produces excellent half-width color images. The coding is at eight levels with a sampling frequency of four times the PAL color subcarrier of 4.3 megahertz.

No equipment maker as yet has a complete digital video-processing chain to offer, but many of the necessary links have already been forged. They are impressive, particularly those that convert analog video waveforms into digital words and then read a whole TV frame of 525 or 625 words into a semiconductor memory. Once in the memory the digital "picture" can be manipulated numerically to achieve all sorts of wondrous results.

**Potential.** One possibility with frame stores is reconstructing a 625-line PAL or Secam picture from a 525-line NTSC picture. Standard converters that do this have been on the market for some five years. Marconi

101 11001001 10111001 00110111 00110111

Communications Systems was first, with a \$500,000 design based on hardware developed at IBA. Since then, converters have been decked out with all sorts of additional features even though their prices have been slashed as memory-package costs have slid down the learning curve. Quantel Ltd., a small British firm, lauds its new \$150,000 DSC converter, which is as much a frame synchronizer as a converter. Working in a PAL/PAL mode, for example, the equipment can correct timing errors on poor tapes.

**Art form.** The frame stores also help produce video effects—fades, dissolves, wipes, zooms, split screens, and the like—that can startle the most jaded televiewer. “Because of technology, TV is becoming an art form,” enthuses Robert Cobler, who heads the international operations for the Grass Valley Group Inc., a California subsidiary of Tektronix. Grass Valley’s new production mixer, first shown at the late-March meeting of the National Association of Broadcasters and also very much on view at Montreux, derives its panoply of video effects from hardware developed by the Nippon Electric Co. The frame synchronizer is NEC’s 16,384-bit-memory packages and its Z-80 microprocessor, and the video processor NEC’s DVP-15. The interface is courtesy of Grass Valley, of course.

Grass Valley, obviously, is not the only company around that can arrange a neat frame-up. Britain’s Quantel had a brand new frame processor to show at Montreux, its DFP 5000, which carries price tags starting at \$65,000 and running on up to \$120,000. The equipment is based on a 4-megabit memory built up from 16,384-bit packages, with one Motorola 6800 microcomputer to exercise the memory and a second for the video effect controls.

Then there is the “squeezzoom” frame store synchronizer, which can manipulate four video inputs at a time. It comes from a small Gainesville, Fla., company called Vital Industries. Company president Nubar Donoyan says the secret is the way the memory, built around 4,096-bit packages, is managed by a 6800 processor. He quotes a price of \$85,000 for the first channel, plus

\$18,000 for each of the other three. “We will have a simple frame store built around 64-k packages and priced around \$39,000 by next year,” proclaims Donoyan, who may find himself waiting for the semiconductor houses to deliver.

Not all the frame store makers have video effects in mind. “We’re not thinking of going into digital effects,” reports Renville McMann, president of Thomson-CSF Laboratories, the Stamford, Conn., arm of the big French company. “We’re thinking more of digital color correction and digital amplifiers.”

McMann’s lab already has a strong foothold in digital TV with a \$20,600 digital noise reducer introduced at NAB in March and seemingly destined to sell well—already 50 have been ordered. The instrument cuts overall noise in color TV signals by anywhere from 8 to 12 decibels. For chroma noise, the figures are even more impressive—20–24 db. The coding rate is at three times the subcarrier frequency, using an 8-bit analog-to-digital converter. Fast emitter-coupled logic is used, and the memory is built around 192 16-k packages.

McMann expects to see all-digital production plants within 10 years. He also expects that frame stores will spill over from studio equipment into home receivers one day. Although he thinks they may actually be charge-coupled devices rather than purely digital, frame stores that will add somewhere between \$50 and \$70 to the cost of the set sound feasible to McMann. “People will pay the extra money,” he figures, “because you can demonstrate the results in a showroom.”

**Soon here.** Before then, drastic price drops in sight for frame stores figure to push them into studio equipment. Bosch-Fernseh, the big West German producer of studio equipment, unveiled at Montreux a \$10,000 multipurpose frame store that can be paired with Bosch’s BCN tape recorders to facilitate editing, get fast or slow motion, or turn tapes into archive storage. Hermann Zickbauer, Bosch’s product manager for TV broadcast equipment, is convinced the cost of a full field store will get down to several hundred dollars one day. □

# RF power

We’ve made the most of it... You can, too!!

All wrapped up in a neat little package, our Model 510L is an ultra-wideband RF power amplifier whose wide range of frequency coverage and power output provide the user with the ultimate in flexibility and versatility in a laboratory instrument. Easily mated with any signal generator, this completely solid state unit amplifies AM, FM, SSB, TV, pulse and other complex modulations with a minimum of distortion.

Constant forward power is continuously available regardless of the output load impedance match making the 510L ideal for driving highly reactive loads.

Unconditional stability and instantaneous fail-safe provisions in the unit provide absolute protection from damage due to transients and overloads.

This outstanding unit covers the frequency range of 1.7 to 500 MHz with a linear power output of more than 9.5 watts and there is no tuning.

For further information or a demonstration, contact ENI, 3000 Winton Road South, Rochester, New York 14623. Call 716-473-6900 or TELEX 97-8283 E N I ROC



## ENI

The world's leader in solid state power amplifiers

Military electronics

# Lasers to keep GIs on target

Systems help train troops by keeping track of hits at war games, teaching recruits to handle rifle, and improving marksmanship

by Lawrence Curran, Boston bureau manager, and Stephen E. Scrupski, Instrumentation Editor

Surging military interest in the laser as training tool has spurred development of at least four systems designed to sharpen combat tactics or improve marksmanship. One is already in use, while the others are well on their way along the development route. The four are:

- Miles (for Multiple Integrated Laser Engagement System), for use as a scoring system in war games.

- IDFSS (for Infantry Direct Fire Simulator System), somewhat similar to Miles.

- Capon, intended to help familiarize the recruit with proper firing procedure.

- Lasertrain, a marksmanship training system.

Miles is now in the engineering development phase for the Ground System division in Orlando, Fla.,

which is part of the Army's Materiel, Development and Readiness Command. Xerox Corp.'s Electro-Optical Systems operation in Pasadena, Calif., has the \$7.5 million prime contract for the system. Lt. Col. David Cours, project director in Orlando, says full-scale production is planned for early 1979.

**Realer games.** It combines gallium-arsenide lasers and complementary-metal-oxide-semiconductor microprocessors to add realism to war games. Using a laser attached to a weapon and silicon photodetectors on men and vehicles, Miles is more objective than the present method of using an umpire to judge if an infantryman is "killed" by the "enemy." In its simplest form, a 1-pound transmitter incorporating a GaAs-diode laser is mounted on an infantryman's M-16 rifle; detectors are on his helmet and a body harness. The transmitter's wavelength is 9,040 angstroms, in the near infrared.

In use, the sound of a blank round being fired triggers the transmission of a pulse-code-modulated laser beam from the transmitter, which is battery-operated. When the beam is detected by the target's photodetectors, the logic in the receiver electronics decodes it to sound an alarm. A rifleman "killed" by a well-aimed shot hears a continuous buzzing, which he can stop only by removing a key from the laser transmitter on his own rifle. His transmitter can then be made to work again only when one of the war-game controllers inserts a special key. For a

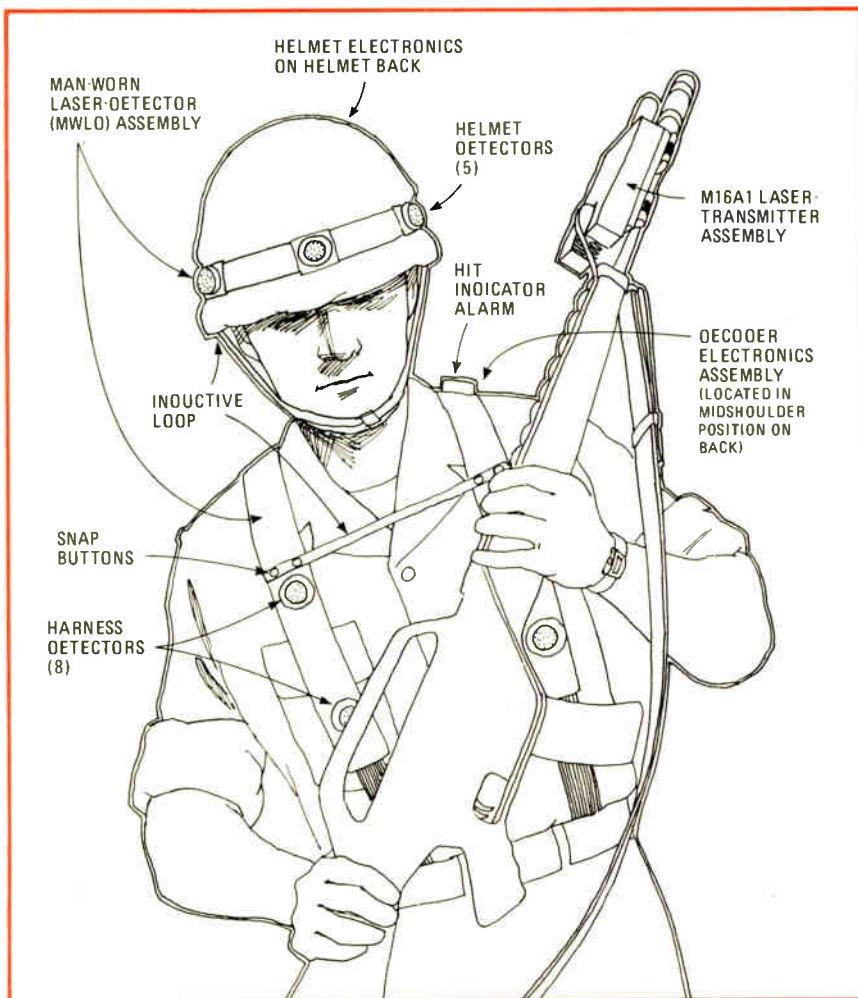

**Miles gear.** Equipment detects hits from others with similar laser guns.



near miss, an intermittent buzzing warns the infantryman.

The major difference between Miles and IDFSS, says Warren Birge, director of the special programs division at International Laser Systems Inc. in Orlando, which makes IDFSS as well as Lasertrain, is that Miles is intended to train troops in combat tactics while IDFSS evaluates the combat tactics of trained units.

IDFSS also uses laser-equipped rifles and a set of p-i-n photodiode detectors. But it has a radio telemetry unit and antenna in the helmet to transmit hit information back to a central computer. When a man is "hit," his rifle is disabled, and the computer is notified. The computer enables a commander to run several tactical variations of an attack, then compare kill statistics. Birge says there are now 66 IDFSS setups in use by the Army at various installations.

**Zeroing in.** On the target-firing level, a pair of systems is being evaluated. The newer one is called Capon and was developed at the Naval Training Equipment Center in Orlando. For use before the recruit goes out to the range, it teaches proper aiming, breathing, and trigger-squeezing procedures. Capon uses a GaAs laser and battery pack mounted on the rifle; the target comprises four photodetectors—one at each corner of a diamond shape—and lights to show the direction of offset from the bull's-eye. When the laser illuminates all four photodetectors simultaneously, the bull's-eye lights up. When the shot is off, only the detectors in the direction of the miss will be illuminated by the laser, and a corresponding light will flash. The system recently went through tests by the Marine Corp at Parris Island, S. C., and Quantico, Va. The next stage would be engineering, followed by production.

While Capon does not help the inferior marksman, the Army is now evaluating a system that is aimed at doing that: International Laser System's Lasertrain. It uses a replica of the M-16 rifle with a laser on the barrel and batteries in the stock. A detector assembly on the target senses the hit, and a television screen on the scoring console displays the location for the coach. □

# Pinlite® displays.

## Almost an endless variety.

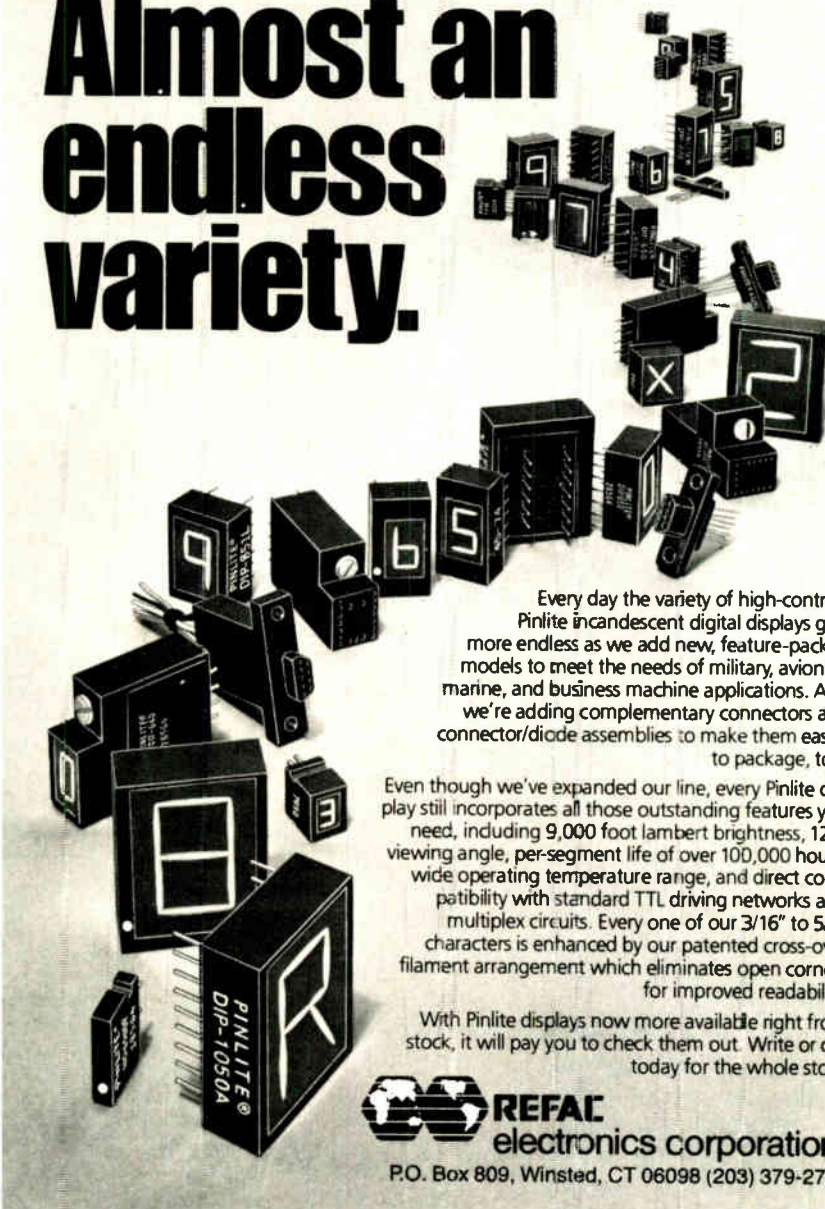

Every day the variety of high-contrast Pinlite incandescent digital displays gets more endless as we add new, feature-packed models to meet the needs of military, avionics, marine, and business machine applications. And we're adding complementary connectors and connector/diode assemblies to make them easier to package, too.

Even though we've expanded our line, every Pinlite display still incorporates all those outstanding features you need, including 9,000 foot lambert brightness, 120° viewing angle, per-segment life of over 100,000 hours, wide operating temperature range, and direct compatibility with standard TTL driving networks and multiplex circuits. Every one of our 3/16" to 5/8" characters is enhanced by our patented cross-over filament arrangement which eliminates open corners for improved readability.

With Pinlite displays now more available right from stock, it will pay you to check them out. Write or call today for the whole story.

 **REFAC**  
electronics corporation.  
P.O. Box 809, Winsted, CT 06098 (203) 379-2731

Circle 97 on reader service card

Companies

## Burr-Brown nears \$25 million mark

Credit for the move into new data conversion and acquisition markets goes mainly to president Burns and his low-key management style

by Larry Waller, Los Angeles bureau manager

Tucked away out of the industry mainstream in sun-washed Tucson, Ariz., Burr-Brown Research Corp. is carefully picking new niches to win a widening part of its market: data conversion and acquisition devices and control components and subsystems. One result is that the privately owned firm sailed profitably through the recession, with sales jumping from \$12 million in 1975 to \$16 million last year. Now, they are soaring through projections, officials say, approaching \$25 million.

What is Burr-Brown doing right in a field marked by fierce competition with much larger firms?

Generally, credit is given by associates to president James J. Burns, an informal, low-pressure ex-Motorola engineer who not only reoriented Burr-Brown's product line, but whose management style is decidedly different from his predecessor's. It started in 1971, "when I came here and took an undefined job, with no title and no one working for me," he recalls. At that time, from all reports, Burr-Brown was stuck at the \$7 million level and seeking a fresh viewpoint to jolt it forward.

What Burns found, after choosing his own title of "director of new business development" (which made him "kind of an internal consultant"), was "technology approaching the obsolete." But Burr-Brown did have strong points in existing analog circuit and interfacing capabilities, which he quickly augmented by acquiring a company with experi-

ence in thin-film hybrid and monolithic integrated circuits. After a close look at more than 100 potential market segments, Burns says that he concluded in 1973 that "data conversion was the place we had to be." Programs to implement this decision proved the takeoff point, he says.

By late 1974, the company had its first such product, called Micromux, a two-wire system for remote acquisition of data used in severe-environment process control. Shortly after, Burr-Brown began turning out analog-to-digital and digital-to-analog converters, both sold separately and incorporated into subsystems. It also jumped into the microcomputer peripheral field with an interface board for Intel processors, the first of what is now its fastest-growing product line. The company, in sum, has been turning out two new products a month since 1975.

That pace has gained the respect of Burr-Brown's competitors. Robert Boole, corporate marketing director at Analog Devices Inc. in Norwood, Mass., sees Burr-Brown "as a strong competitor. They seem to be looking for the same kind of growth we've had in recent years." From \$30 million in 1975, sales at Analog are expected to be near \$50 million this year.

Boole adds that he looks for Burr-Brown to put more effort into monolithic devices at the same time that Analog is getting its hybrid circuit operation up to speed. "There's room for both of us to grow in the way each wants," he says, "especially with the boom in interface circuits for microprocessors."

Basic to what Burns describes as a marketing-oriented strategy is "searching out those product niches where Burr-Brown can offer a



**At ease.** The style of James Burns at Burr-Brown is informal, with ties "sort of trowed on." Meetings are open-door affairs.

# First...



## Grayhill brought you the different DIP Switch.

# Now...



## Grayhill brings you all the different DIP Switches you need!

### Different actuations

Raised and recessed rockers for back panels  
Toggles for front panel usage  
Side actuated "Piano-DIP™" for access from racked boards

### Different circuitries

SPST in 9 sizes, from 2 to 10 rockers; the DIP-C®, SPDT switching and the Double-DIP™, DPDT circuitry in 1, 2, 3 and 4 rocker versions.  
Toggle DIP™ available with SPDT circuitry, 2, 3 or 4 stations; DPDT with 1 or 2 stations.  
Piano DIP™ (side actuated) from 4 to 10 stations, SPST circuitry under each rocker.

### Different performance standards

Two exclusive features improve Grayhill DIP Switch reliability. Molded-in terminals protect against contact contamination. Reliable spring loaded sliding ball contact system provides DIP Switches life-rated at 50,000 operations, with positive wiping action and immunity to normal shock and vibration.

### Different delivery standards, too

Most Grayhill DIP Switches are available off the shelf in production quantities from Grayhill or its nationwide distributor network.

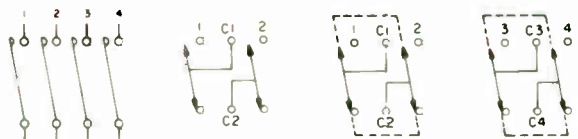
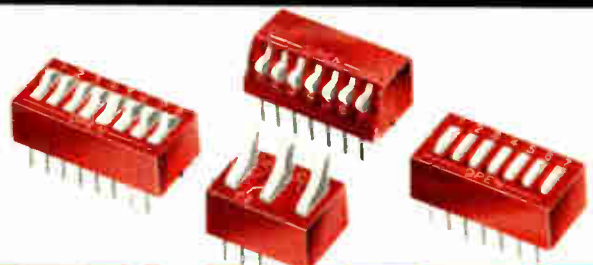

CLOSED



OPEN

For detailed information on Grayhill DIP Switches, consult *EEM* or write for Bulletin #276 to Grayhill, Inc., 561 Hillgrove Ave., La Grange, Illinois 60525, phone: (312) 354-1040.



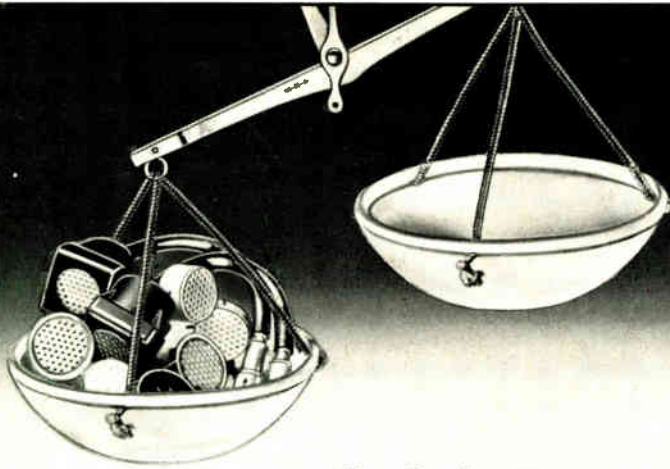

## Remote Control Lifts Your Product into a new Dimension.

How can you differentiate your product from the competition? Why not add remote control as a new and almost mysterious feature? Remote control will lift your product into a new dimension.

We produce supersonic transducers for most of the leading European radio and TV manufacturers. But remote control is not limited to this industry only.

Name us your product and make use of our offer: Free proposals for remote control by supersonic transducers... You'll see, it works. And the price might be lower than you expect.

**SALOTA**

Phone West Germany: 0911-32177

Telex 622 466 hoco d

Raabstr 24 · D 8500 Nürnberg/West Germany

Circle 100 on reader service card

# DELTA IS READY WHEN YOU ARE.®

**WITH DELTA AIR FREIGHT THAT OFFERS YOU MORE PRIME TIME FLIGHTS TO MORE PRIME MARKETS.** Delta covers 90 prime markets throughout the Western Hemisphere. Few shipments are too large, none are too small. Pickup, delivery available.

**WITH DELTA AIR EXPRESS THAT GUARANTEES SHIPMENT ON THE FLIGHT YOU CHOOSE.**

Airport-to-airport or door-to-door. Local pickup, delivery available. Shipments accepted up to 90 minutes before flight departure time.

**WITH 3D AIR FREIGHT (DELTA DENSITY DISCOUNT)™ THAT GIVES YOU 40% OFF REGULAR FREIGHT RATES.**

Shipments with a density of 25 lbs. or more per cubic foot get 40% discount. Applies to non-containerized shipments of 250 lbs. or more.

**WITH DASH (DELTA AIRLINES SPECIAL HANDLING) THAT GETS YOUR SMALL PACKAGE THERE IN A BIG HURRY.** Up to 90

inches, width + length + height is acceptable, at airport ticket counters up to 30 minutes before flight time. 60 minutes freight terminals.

Ship prepaid or collect, cash or approved credit. COD, RFC, Signature Service, advanced charges and excess valuation on request. DASH shipments prepaid.

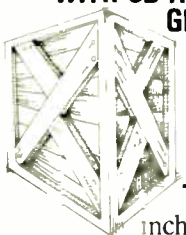

100 Circle 201 on reader service card

unique advantage." The one-board processor interfaces are an example, he says, containing complex hybrid circuits and proprietary monolithic chips available nowhere else. Burr-Brown has attempted to position itself in this way throughout its data-conversion lines.

**Philosophy.** Another part of the Tucson firm's philosophy is that, because it is relatively small, "we can't afford to make big mistakes." Putting it another way, marketing manager and 11-year veteran Gene E. Tobey says, "We don't expect to be a developer of new technology, but to be among the first to use it." Several years ago, for instance, Burr-Brown got in the forefront with active laser trimming of networks. "This permits trimming out offsets and nonlinearities that couldn't be done with passive trimming," Tobey explains. "The result is a premium product that commands top prices."

In the development cycle, Tobey says, lead time varies from six months to several years. "Hybrids and discrete assemblies go pretty fast; monolithic chips are the riskiest in terms of time." For a small firm, Burr-Brown plows a hefty percentage of sales into research and development: about 7% to 8% now, with hopes of pushing it perhaps to 10%.

Tobey notes a "considerable shift in the character of the company over the past three years" and attributes it to Burns. Besides the product changes, he points to "tighter operations, a commitment to growth, and insistence on long-range planning." Another indication is the changing sales mix, which in 1974 saw 25% of revenues from microcircuits and 75% from modular devices. Now, more than 60% of sales comes from microcircuits incorporated into signal conditioning—data conversion components and assemblies.

Possible clouds on the horizon, on which Burns keeps a wary eye, are semiconductor giants pushing their high-volume converter chips into the subsystem level. But "it's nothing new that the semi houses are moving toward us," Burns observes. "We'll have to keep moving away from them and search out those niches." □

Electronics/June 23, 1977



## Data General. A la carte.

Now, you can buy our DASHER™ terminals, even if you don't own a Data General computer system. Select our fast impact printer and our user-oriented video display. Both are interface-compatible with any standard computer system.

Choose either 60 or 30 cps versions of the DASHER printer, which has a standard typewriter keyboard, u/l case, 132 columns.

DASHER display features a 1920 character screen, u/l case, convenient detached keyboard, programmable function keys, and a monitor that tilts and swivels.

Just as DASHERS' features make them easy to use, their attractive appearance makes them

easy to fit into any environment.

And of course they are solidly reliable and easy to maintain, a Data General trademark. For more details call your Data General sales office or nearest independent supplier of Data General terminals. Or send the coupon. Even a bit of Data General in your computer system is better than none.

---

Send details on  DASHER printers     DASHER displays  
 Have salesman call.

I'm interested in \_\_\_\_\_ no. / \_\_\_\_\_ type terminals.

Name \_\_\_\_\_

Title \_\_\_\_\_

Company \_\_\_\_\_

Address \_\_\_\_\_ Tel. \_\_\_\_\_

City \_\_\_\_\_ State \_\_\_\_\_ Zip \_\_\_\_\_

Mail to: Data General, Westboro, MA 01581  
 DASHER is a registered trademark of Data General Corporation  
 © Data General Corporation, 1977

---

EM

**Data General**  
 It's smart business.

Data General, Westboro, MA 01581, (617) 366-8911. Data General (Canada) Ltd.,  
 Ontario. Data General Europe, 15 Rue Le Sueur, Paris 75116, France. Data General Australia, Melbourne (03) 82-1361.

Consumer electronics

## Timex goes on the offensive

As LCD watch competition expands, Timex turns to marketing and distribution strengths to counter heavy impact of watch-making semiconductor firms

by Gerald M. Walker, Consumer Electronics Editor

"Timex is in to stay—we are a leader and still will lead," declares Carl Igelbrink, corporate manager of marketing electronics for Timex Corp. "There's more to the watch market, even the digital-watch market, than price."

With that challenge, Timex underscores its determination to do battle with the semiconductor manufacturers whose digital-watch lines have pounded deep wedges into its traditional lower-cost domination. This year the battle ground is clearly the new liquid-crystal-display lines that arrived in force at this month's Consumer Electronics Show.

Making its first appearance at this big, multi-product Chicago show, Timex introduced 10 LCD watches in its Marathon line, some with six digits and stopwatch, priced from \$46.95 to \$65. The firm now has 41 LCD models, the lowest being pegged at \$27.95.

As in the past, however, Texas Instruments startled the field, this time by unveiling 15 LCD watches at \$27.95 to \$48.95—all backlighted by phosphor-lined tubes filled with radioactive tritium. (The tritium excites the phosphor coating of the tubes.) The new line gives TI altogether 60 light-emitting-diode and LCD watch models.

National Semiconductor Corp.'s Consumer Product division, which also has LCD watches at the \$27.95 price point, got into the tritium backlight competition with a range starting with standard four-digit models and going upward through lithium-battery models and six-digit models to the top of its line: six-digit tritium-lit chronographs.

As though anticipating the next

move in the market, Fairchild Camera and Instrument Corp.'s Consumer Products group has come out with a metal-case LCD watch at \$19.95 and another with a metal strap at \$24.95. Fairchild will probably have a tritium model as well.

**Advantages.** Thus, facing formidable competition, how will Timex manage? After-sales service, advertising, point-of-sale displays, and one of the world's largest distribution systems will make the difference, says Igelbrink. As for the technology, Timex has had good results from its acquisition of RCA's former liquid-crystal manufacturing operation but is also buying modules.

"The semiconductor firms have a technology reservoir, but that reservoir is big enough to be available to everyone," the former General Foods marketer comments. Nor is Timex overly concerned about a price war. "It is a misconception that Timex makes the lowest-priced watches in the U.S. We have survived against competitors having lower prices in the past."

Perhaps its major head-on competitor, Texas Instruments, is also convinced that Timex is not about to quit the growing sector of the market represented by digital watches. Thus, after establishing price leadership in LED watches where Timex was not heavily committed, TI now is driving on the LCD field where Timex is heavily committed. The new line uses complementary-MOS chips rather than the integrated-injection-logic circuits put into the LED watches.

Although TI made its impact in LED timepieces through an intensive automation program, the LCD line is

at present only about 50% along toward total automation, says Ronald W. Shelly, manager of the time products division. Part of the reason for going across the board with the tritium backlights was to simplify the automation program; the main reason was to insure high-volume use to bring cost down rapidly.

Neither Timex nor TI is anxious to add extra features. Shelly comments that as market segments for calculator watches, chronographs, and the like grow, TI "will look into these opportunities." Timex's Igelbrink is more emphatic. "You won't see a Timex watch that gives you high tides in Hawaii—not even in Hawaii." However, he adds that Timex will have a tritium-lighted watch if this feature proves to be a seller. □

**Bright time.** One of 10 models in Timex' Marathon line. Firm made its first appearance at Consumer Electronics Show.

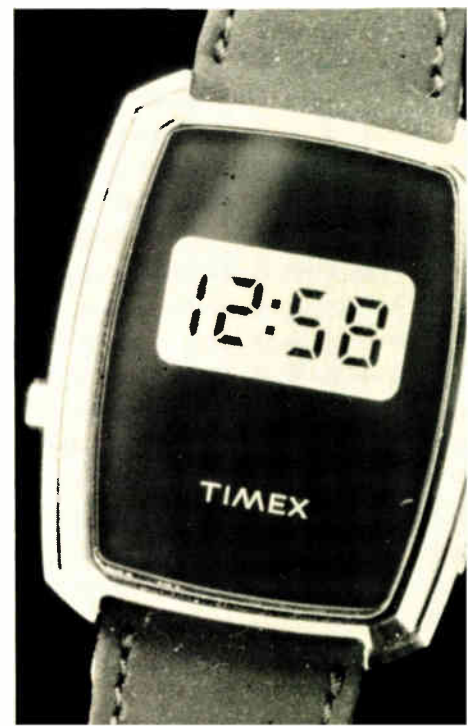

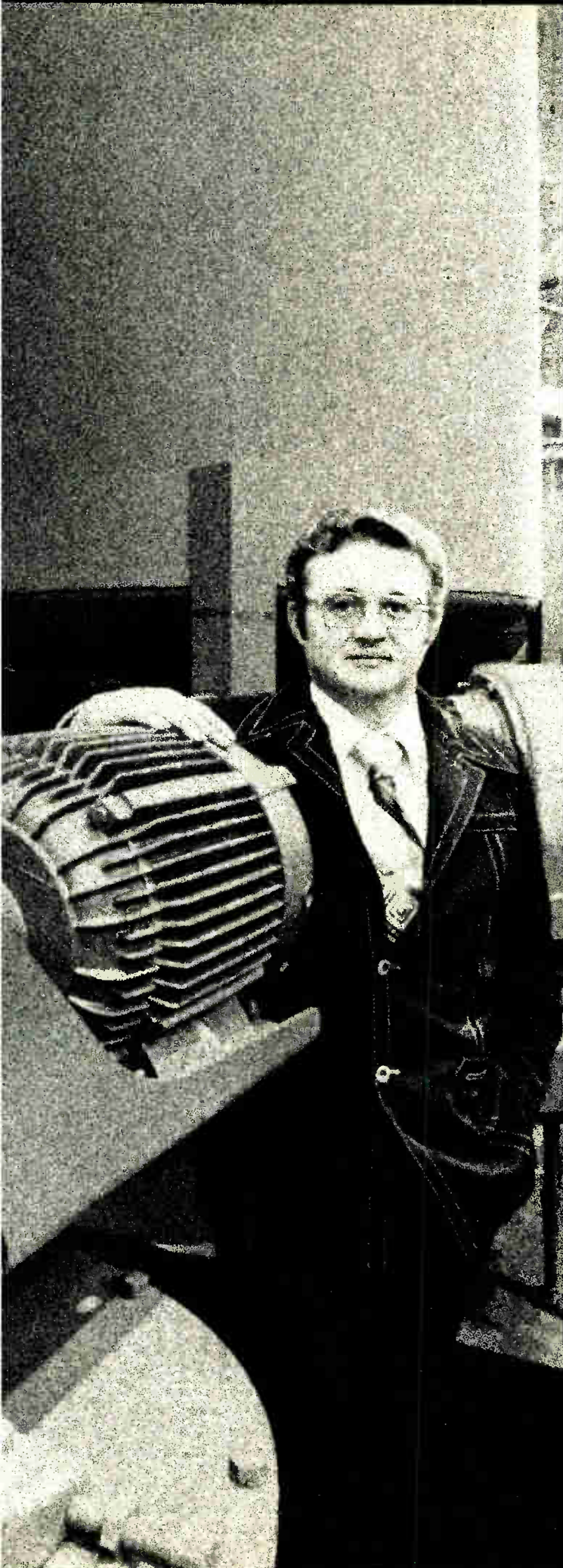

**"Kodak helped us set up a reprographics program that could save us more than \$100,000 a year."**

**Dennis Thurgood,  
Document Control Manager,  
EIMCO PMD Division,  
Envirotech Corporation,  
Salt Lake City.**

"EIMCO PMD is a leading manufacturer of pollution control equipment. Since much of this equipment has custom engineered features, we generate more than 2,000 drawings a month.

"We started working with Kodak back in 1973, expanding our microfilm capabilities. Most recently, we set up a reprographics center with a Kodak Startech processor. Doing the photoreproduction work internally has resulted in substantial dollar savings.

"Also, we have increased the individual drafter's capacity. Before, he was doing a basic pencil-to-paper operation. Now he comes to us and says, 'I need to get from here to here, can you help me?' And we can. Scissors drafting, opaquing, second originals via blowbacks from microfilm are all part of our capabilities. Making the drafter more efficient is probably the major justification for the installation.

"And it's certainly paying its way. We figure we'll save more than \$100,000 a year for the next five years. We've reduced cost by doing photoreproduction work internally; saved drafting time through reprographic techniques; and we've gotten our files under control with microfilm."

**Reprographics can help you, too.**

Send for more details about EIMCO'S use of reprographic techniques, plus a complete listing of Kodak products and other applications. Write: Eastman Kodak Company, Graphics Markets Division, Dept. \_\_\_\_\_, Rochester, N.Y. 14650.

**VERSATILITY IN  
REPROGRAPHICS**



Circle 103 on reader service card

# Interested in network variety? Select from a spectrum of 540 standards.

Allen-Bradley has the popular configurations you need. Pull-ups, Pull-downs. Line Terminators. Networks to complement Core Memory Sense Amplifiers. TTL to ECL Translators. O-Pad Attenuators. All styles available from your Allen-Bradley *Electronic Distributor*. Call for specs or check your EEM Catalog. If you need specials, contact your local Allen-Bradley district office for fast turn-around. Ask for Publication 5840. A-B is an experienced twin-film manufacturer, i.e. precision thin film and thick film.

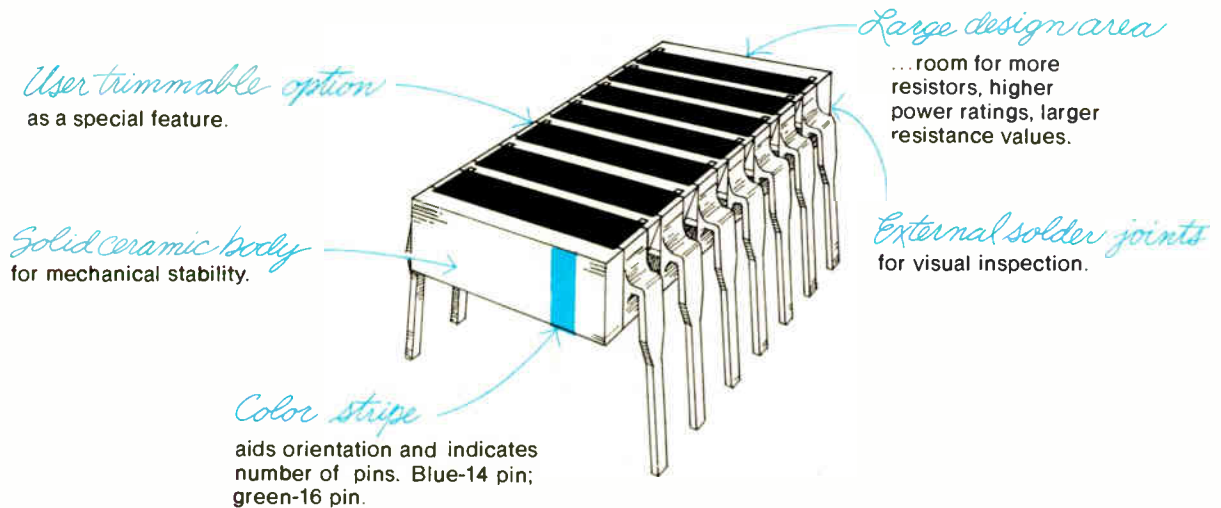

## Quality in the best tradition.



**ALLEN-BRADLEY**  
Electronics Division  
Milwaukee, Wisconsin 53204



# Broad range of I-DIP standards

## PULL-UP/PULL-DOWN

Two basic configurations (314A-14 pin; 316A-16 pin). Each available in 81 resistance values for unused TTL gates, parallel high speed circuitry, wired OR circuits, TTL-MOS interfacing and pulse squaring.

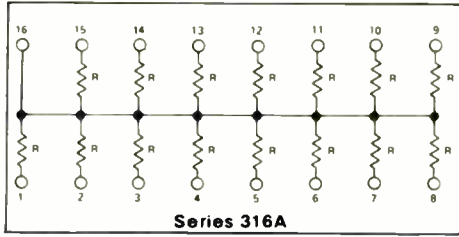

## LINE TERMINATION

Two basic configurations (314B-14 pin; 316B-16 pin). Each available in 81 resistance values for transmission line termination, power gate pull-up, current limiting and logic level translation.

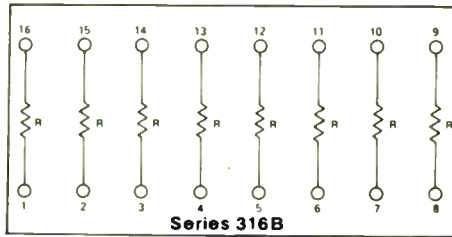

## PARALLEL TERMINATION

Two basic configurations (314E-14 pin; 316E-16 pin). Each available in eight R1/R2 combinations for a wide range of impedance values.

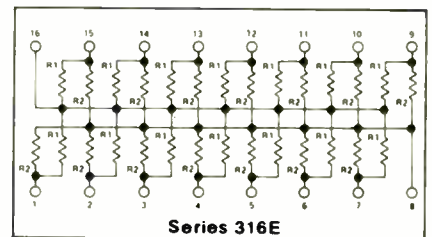

Standard Resistance Values R (Ohms),  $\pm 2\%$  Tolerance

22	51	120	300	680*	1600	3900	8200	20K	47K*	120K	680K*
24	56	130	330*	750	1800	4300	9100	22K*	51K	150K*	1M*
27	62	150*	360	820	2000	4700*	10K*	24K	56K	180K	
30	68	160	390	910	2200*	5100	11K	27K	62K	220K*	
33	75	180	430	1000*	2400	5600	12K	30K	68K*	270K	
36	82	200	470*	1100	2700	6000	13K	33K*	75K	330K*	
39	91	220*	510	1200	3000	6200	15K*	36K	82K	390K	
43	100*	240	560	1300	3300*	6800*	16K	39K	91K	470K*	
47	110	270	620	1500*	3600	7500	18K	43K	100K*	560K	

Characteristic Impedance  $Z_0$

R1/R2	$Z_0$	R1/R2	$Z_0$
81/130	50	220/330	132
120/200	75	330/390	179
90/660	80	330/470	194
130/210	80	330/680	222
160/260	100	1.5K/3.3K	1.03K
220/270	121	3K/6.2K	2.02K
180/390	123		

## $\pm 1\%$ TOLERANCE

The values marked with an asterisk of Series 314A, 314B, 316A and 316B in the table above are available with  $\pm 1\%$  tolerance. Add the letter "F" on the end of the part number to indicate the optional  $\pm 1\%$  tolerance.

## SENSE AMP TERMINATOR

Three basic configurations complement the 7520 series of core memory sense amps.

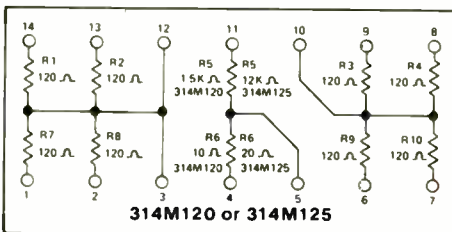
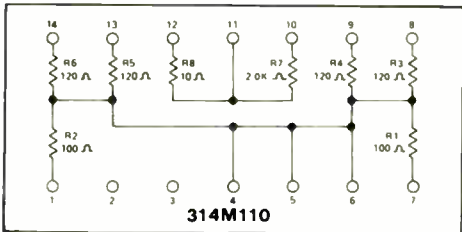

For sense line applications with two 711 dual voltage comparators.

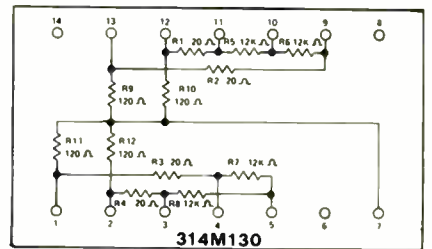

## 8 BIT R/2R LADDER NETWORKS

Designed for use with D/A and A/D converters with bipolar or CMOS switches.

Part No. R Value  
 316L08253 25K  
 316L08503 50K  
 316L08104 100K



## TTL to ECL TRANSLATOR

Contains six TTL to ECL translators.

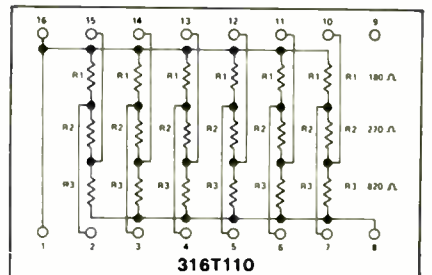

## O-PAD ATTENUATOR

Two basic circuits for fixed voltage attenuation with impedance matching.

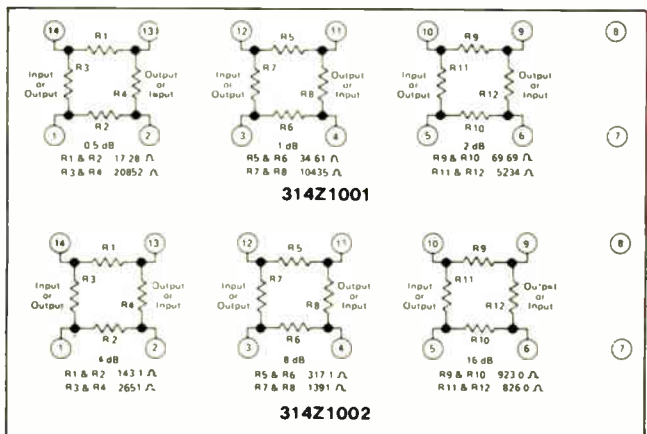

## INTERCONNECT NETWORKS

For shorting and matrix interconnections, 14 pin, 314X101; 16 pin, 316X101. Other configurations available.

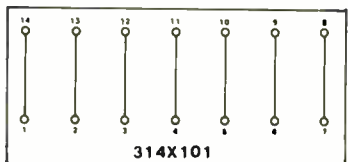

**ALLEN-BRADLEY**

Electronics Division  
 Milwaukee, Wisconsin 53204

# Product development profile

## Rough life of digital multimeter puts tough demands on design

by Norman Strong, *John Fluke Manufacturing Co., Mountlake Terrace, Wash.*

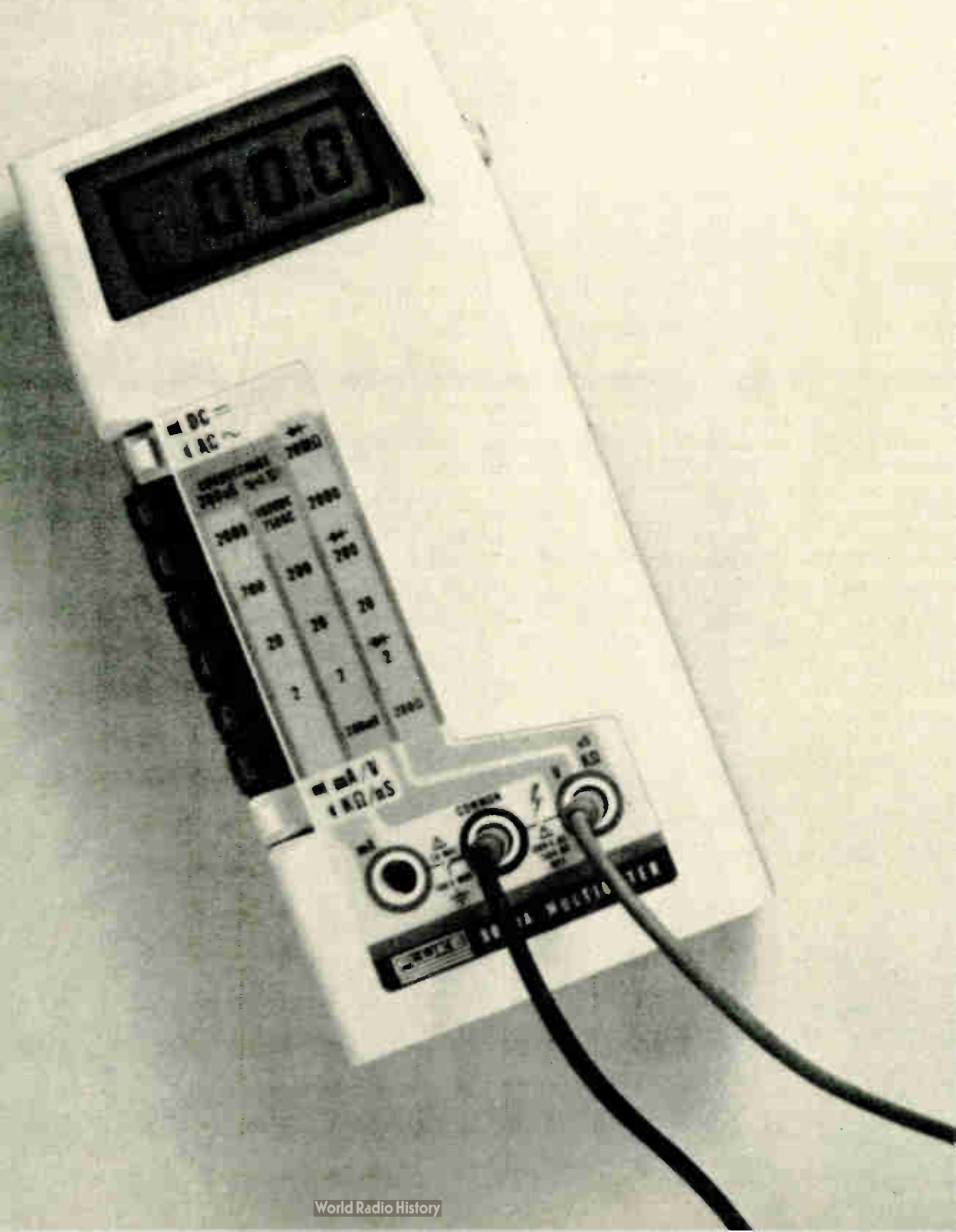

---

Hand-held instrument has custom analog-to-digital converter chip, as well as a liquid-crystal display that is directly driven; combination reduces parts count and keeps power demand low

---

□ The hip-pocket life of a portable digital multimeter calls for a tough instrument. The portable DMM must put up with rough handling, electrical abuse, adverse environments, and long periods without calibration. The instrument also must be small, light, operate from batteries, and sell for less and work more easily than does its bench counterpart.

To meet these stringent demands was the goal of the designers of the 8020A. Long battery life immediately suggested a liquid-crystal display coupled to complementary-metal-oxide-semiconductor logic. Small size and low cost dictated a low parts count. And a tolerance for electrical and mechanical abuse required a sturdy plastic case and good input-protection circuitry.

#### A-d converter chip

Although there were several good one- and two-chip analog-to-digital converters on the market, with more to come, each one had drawbacks that made it unsuitable for multimeter applications—especially when used with an LCD display. Every general-purpose a-d converter required the addition of external display drivers, as well as dual power supplies and the usual passive components. These requirements largely vitiate the advantages of large-scale integration.

Fluke chose to simplify external circuitry by designing a custom C-MOS a-d converter chip capable of directly driving an LCD display and incorporating additional features useful in a multimeter application. The conversion technique chosen was a version of the familiar dual-slope converter; it has high accuracy, adequate speed, and enjoys general acceptance throughout the electronics industries. The design goals for the chip, built by Intersil Inc., Santa Clara, Calif., are:

- 2,000 count ( $\pm 1,999$ ) for higher precision than with 1,000-count instruments.
- Single 9-volt battery operation to keep size small and operating costs low.
- Direct LCD drive to simplify circuitry.
- Crystal-controlled clock oscillator for near-perfect rejection of line interference.
- Digitally selected 2-v and 200-millivolt ranges requiring no external components changes.
- True differential input for a simpler ac-to-dc converter.
- A single, floating, external reference voltage to simplify the ohmmeter protection circuits.
- Ratio accuracy to within one count when

making measurements of high resistance.

- Near-zero bias current at all input terminals.

The inputs to the chip (Fig. 1) are routed through a series of switches (actually MOS transistors), which set up operations during different portions of the measurement cycle. Each measurement cycle is divided into automatic-zero, integrate, and deintegrate periods (Fig. 2).

During auto-zero, switches connect the buffer and integrator inputs to the internal common-voltage line. This closes a loop around the integrator and comparator to the auto-zero capacitor,  $C_2$ , removing the system offset voltage. The switches also connect capacitor  $C_1$  to the 1-v reference, charging  $C_1$  in preparation for the deintegrate period.

Because the 8020A is designed to operate from a supply as low as 6 v, the usual 6.4-v reference zener had to be replaced with bandgap type of reference, which operates at the bandgap voltage of silicon, (about 1.2 v) and has exceptional stability. A voltage close to the desired 1-v reference also makes for a much less critical voltage divider.

During integration, the unknown input voltage is connected to the noninverting inputs of the buffer and the integrator. These are both high-impedance inputs and allow a true differential measurement.

#### Two integration periods

There are two available integration periods. For the 2-v range (used for three resistance-range inputs), there is the 1,000-count period corresponding to one cycle of the ac 60-hertz line (which helps the meter to reject external 60-Hz signals). For the 200-mv range (used for all other inputs), there is the 10,000-count (10 60-Hz cycles), which increases the sensitivity by a factor of 10. A logic signal applied to the three-state range pin on the chip selects either integration period or a third choice in which the reference input is swapped with the unknown to allow inverse resistance measurements.

After integration,  $C_1$  is connected to the buffer through the deintegrate switches in the opposite polarity from the unknown (which is determined by the output state of the comparator). When the integrator returns to the threshold, the comparator changes state and the count is transferred to the decoder and LCD driver for display. A new auto-zero period begins.

The reading rate is three per second, ideal for liquid-crystal readout, where faster rates might

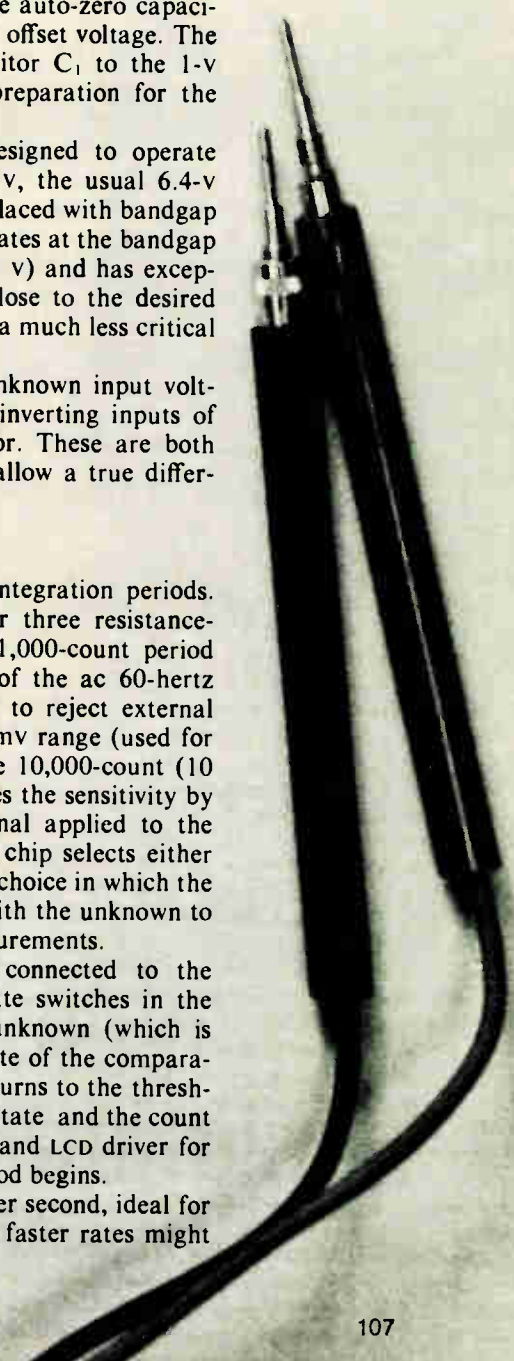

## Strong competition

The Fluke 8020A enters one of today's most competitive arenas in electronic instruments—3<sup>1</sup>/<sub>2</sub>-digit portable digital multimeters. There are at least nine other such DMMs on the market with prices ranging from approximately \$100 to about \$250. As with any instrument, potential buyers will have to size up the total specification package, along with convenience features.

One of the basic requirements is accuracy. For dc voltages, the \$169 8020A has an accuracy to within 0.25% of reading  $\pm 1$  digit. This beats all lower-cost instruments and even some higher-priced ones, such as the \$195 Weston 6000, which has 0.35%  $\pm 2$  digit accuracy. (But Weston's unit also has automatic ranging, which the Fluke unit and others do not). There are at least five higher-priced units that come in with 0.1%  $\pm 1$  digit accuracies on dc volts—the \$279 Ballantine 3028A, the \$249.50 Danameter II 2100A, the \$234 Data Tech model 22, the \$189 Data Precision model 175, and the \$235 Simpson model 464D. (Prices differ because different features are offered.) Their manufacturers say the accuracy specs will hold for a time span of one year.

Accuracy on ac voltage ranges gets a little more complicated, since it can vary with frequency. Most meters are

specified with at least three different ac voltage accuracies, each over a certain frequency range. Here, the 8020A's basic ac voltage accuracy of 0.75%  $\pm 2$  digits from 45 hertz to 1 kilohertz appears to be about right for its price. Again, it is possible to do better with higher-priced instruments, as is true with accuracies for ac and dc currents and for resistance readings.

One basic choice facing buyers will be between those instruments that use light-emitting-diode readouts and thus require rechargeable batteries (such as the Simpson and Data Precision meters) and those that use the lower-power liquid-crystal displays and thus can use disposable batteries (such as the Fluke, Data Tech, and Dana meters). The rechargeable units give about six to eight hours of operation and then require overnight recharging. Alkaline batteries, however, generally can give more than 200 hours of operation before they must be replaced.

The Fluke unit has an exclusive feature—it can read conductance, thereby allowing resistance measurements up to 10,000 megohms, which would be useful in measuring leakage in capacitors, diodes, cables, and printed-circuit boards.

**Stephen E. Scrupski**

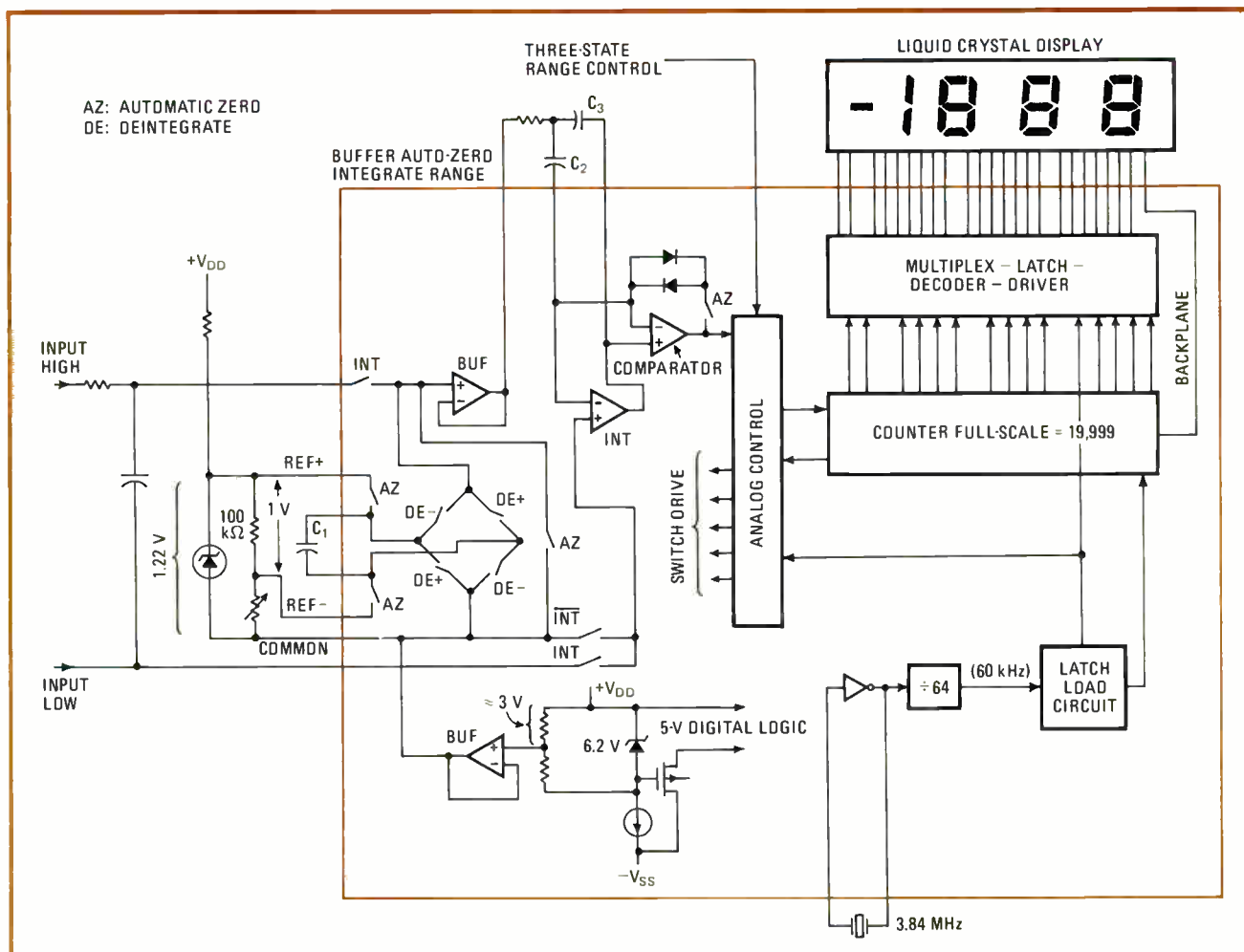

**1. Converter chip.** The C-MOS analog-to-digital converter chips, within the inner box, basically comprises the counter, display drivers, integrator, buffer amplifiers, and FET switches set by the analog control block during the automatic-zero, integrate, and deintegrate periods.

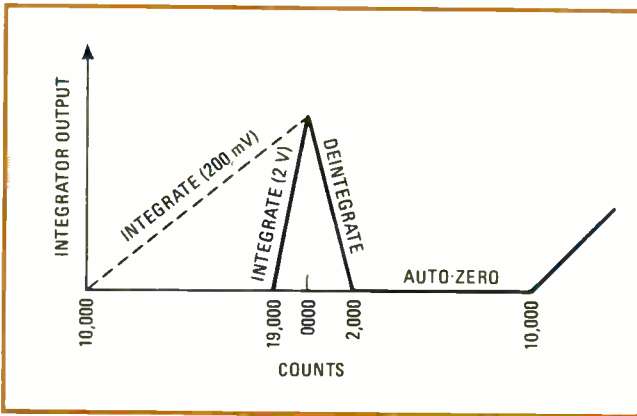

**2. Measurement cycle.** The basic measurement cycle has three periods. During auto-zero, offset is removed and the reference capacitor is charged. During integration, the unknown input is integrated for either 1,000 counts or 10,000 counts. During deintegration, the reference capacitor voltage is integrated until it causes the integrator to return to its threshold, and the count is displayed.

cause false readings because of the generally slow response time of the LCD. Rapid alternation between 6 and 7 might appear as an 8, for example.

Although clock frequency for the counter circuitry is 60 kilohertz, it is obtained from a 3.84-megahertz oscillator divided by 64 in an on-chip six-state counter. This high oscillator frequency allows use of the highly stable, low-cost AT-cut crystal, which is not available below 2 MHz. Also, crystals close to the television color-burst frequency (3.58 MHz) benefit from the very low production costs of this high-volume equipment.

### C-MOS benefits

When Intersil was first asked to design the a-d chip, there was some question about the practicality of meeting some of the very stringent performance requirements. Three, in particular, stood out:

- Low power dissipation (less than 20 milliwatts).
- Input currents in the low-picoampere region.
- Very low noise (less than 30 microvolts peak-to-peak).

Intersil slightly modified its low-voltage C-MOS process to meet these requirements in a chip measuring 124 by 149 mils. The device is packaged in a 40-pin dual in-line package and operates at voltages down to 6 v from the single 9-v alkaline battery. Current drain is less than 1.5 milliamperes.

Low power dissipation is an inherent characteristic of C-MOS devices—unless the frequency of digital switching rises into the megahertz region. However, lowering the supply voltage will reduce the current. Since Fluke wanted to operate from a battery whose voltage might be anywhere from 6 to 10 v, the digital logic section was internally regulated to 5 v, while the analog circuits continue to operate at the full battery voltage. This low voltage for the digital section limited the current drain to 300 microamperes.

A zener diode buffered by a large p-channel MOS source follower supplies the digital logic with the 5 v. It also supplies the internal common voltage, which is divided down to 3 v from the positive supply. A buffer amplifier presents a low impedance at the common

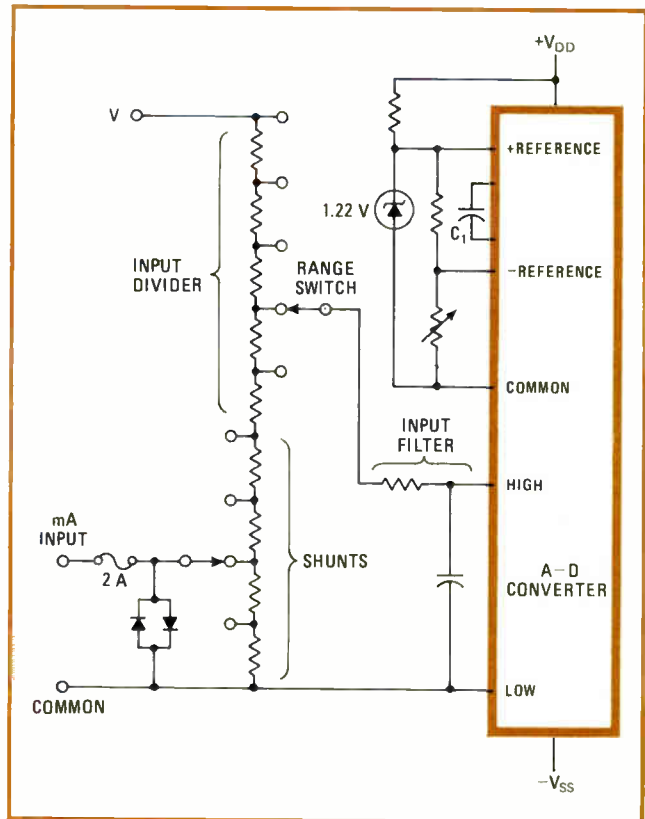

**3. Voltage and current inputs.** Unknown input voltages are applied across the divider string of resistors, while unknown currents are applied through a separate input jack, preventing damage to the shunts. For current measurements, the meter input may be connected to any switch position to pick up the voltage across the shunt, since unknown input currents do not flow through the divider.

terminal so that current may be drawn from the supply by circuits external to the chip.

The ohmmeter ranges of the 8020A require exceptionally low leakage currents at the input and reference terminals. The availability of field-effect transistors with negligible gate currents is another inherent advantage of C-MOS processing, but such circuits are susceptible to damage from static charges. Therefore, when the gate of a FET is brought out to an input pin, a small diode is added for static-charge protection—an important consideration in an instrument for field environments. Even with the diode, the leakage is typically less than 1 pA at operating voltage and room temperature. Low leakage is especially important in this system because any charge that the external capacitors lose through leakage will show up as an error in the instrument reading.

### Reducing charge injection

Another way the capacitors can lose (or gain) charge is by charge injection from the switches. As the gate of a FET switch is driven off, its gate-to-drain capacitance injects a charge on any capacitor tied to it. This changes the voltage across the capacitor. However, in the C-MOS chip, each switch comprises an n-channel FET and a p-channel FET in parallel. If the gate-to-drain capacitances of the transistors are equal, the net charge injection will be zero, since the positive-going signal turning off the p-

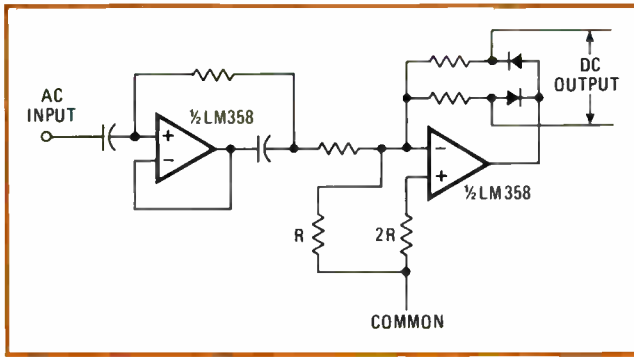

**4. Ac/dc converter.** To measure ac input signals, the meter converts them to dc with a full-wave rectifier. Since both sides of the output are connected to one side of the amplifier, offset voltage is canceled, and, with the choice of resistors R and 2R to supply bias current, offset current is traded for offset voltage.

channel FET will exactly cancel the negative-going signal turning off the n-channel FET. Cancellation is not perfect, but capacitor voltage changes less than  $2 \mu\text{V}$ .

If regular low-threshold (0.6-v) n- and p-channel transistors were used, the ones in the analog switches would have turned out to have too much leakage. This comes about because MOS transistors have exponential characteristics at low currents such that:

$$\text{Drain current} = a (e^{qV_{GS}/kTn} - 1)$$

where  $a =$  a constant,  $V_{GS} =$  the gate-to-source voltage (threshold—a negative quantity),  $q =$  the charge on an electron,  $k =$  Boltzmann's constant,  $T =$  device temperature on the absolute scale,  $n = 2$  (a constant for Intersil's low-voltage process).

This equation shows that to reduce the drain current by a factor of 10 requires a 0.12-v change in threshold voltage. Thus raising the threshold voltage of the tran-

sistors in the analog switches to greater than 1 v means that under no signal conditions will leakage currents be significant. (The increase in threshold from the 0.6 v of the low-threshold transistors to 1 v reduces drain current about 1,000 times.) To achieve this drastically reduced threshold, an extra step of ion implantation is needed during fabrication of the transistors.

### Cutting noise

The remaining problem was noise. Fluke wanted very low noise to avoid the problem of digit rattle so common on low-priced multimeters. Historically, C-MOS circuits have not been noted for low noise, and anxiety was amplified when preliminary samples of a competitor's C-MOS a-d converter showed  $300 \mu\text{V}$  of noise referred to the input. This was 15 times greater than the 8020A requirement of  $20 \mu\text{V}$  peak-to-peak.

Noise in C-MOS is caused by trapping sites that are filled and emptied at audio and subaudio frequencies. The chip's design attacked noise in two ways. First, a super-clean, gettered, and annealed process minimizes the number of trapping sites per unit area. Second, all FETs that serve noise-sensitive functions were made with very large gate areas. Because their instantaneous drain-to-source noise current is dependent on the percentage of trapping sites under the gate region that are filled at any one time, a large area gives more trapping sites over which to average and thus a smaller drain-to-source current variance (noise). Since the states of the trapping sites are independent of each other, the noise voltage is inversely proportional to the square root of the gate area.

With a big FET area, two other desirable features come free. The source-to-drain dimension (channel length) can be made greater than 2 mils, so that the output impedance is very high. This gives excellent common-mode rejection. Also, the device can be fabricated with a low

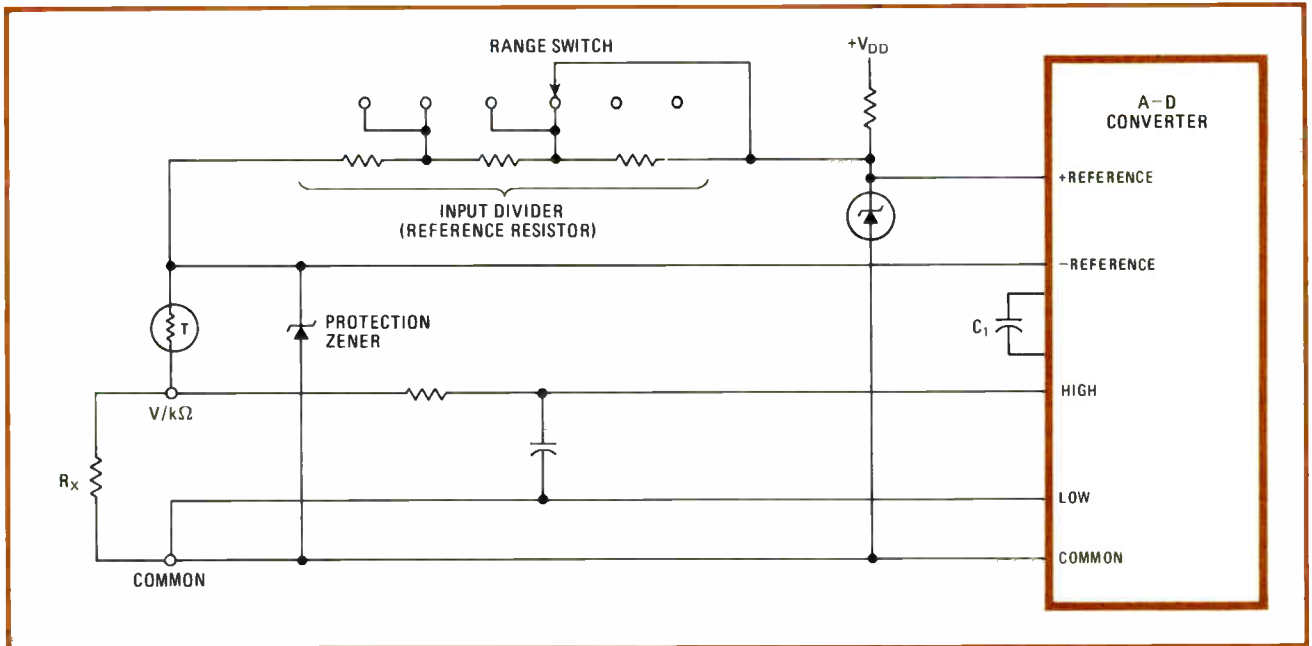

**5. Ohmmeter circuit.** For resistance measurements, the voltage input divider is used as a reference resistor. Its voltage is measured to determine the voltage across, and thus the value of, the unknown resistor. If the roles of the two resistors are reversed, the meter can measure conductance. The thermistor protects the reference resistor by increasing its resistance if the input signal level is too high.

## In-step development

The development program for the 8020A portable digital multimeter was closely tied to the development schedule of the custom C-MOS analog-to-digital converter chip. While the chip was being designed, there was a lot of other work for the three-man design team to do: evaluate liquid-crystal displays from several vendors, figure out how to pack all the components into the hand-held enclosure, and design the circuitry that would protect the meter from all the mishandling and misapplications to which a portable DMM is subjected. However, it was not until the first chips from Intersil proved to work that the designers could be assured that they would complete their job on the schedule established about a year before.

The DMM team formed in October 1975 was headed by Stanley W. Jones (left in photo), who had been manager of test and manufacturing engineering. He broke down the design responsibilities in just about the most logical manner possible: analog and digital. Norman Strong (middle), a 13-year veteran with Fluke, handled the design of the analog portions of the meter, while Peter S. Duryee (right), nine years with Fluke, handled the digital design and the selection of the liquid-crystal display.

"We started out defining the performance requirements for the particular spot in the marketplace we wanted to hit with the 8020A," says Jones, "and then we started looking at Intersil and other semiconductor companies to determine the best LSI approach. We knew right from the beginning that we would have to develop our own chip, since there was nothing available at that time (nor is there now) that would meet all our requirements."

The early part of the project thus was dominated by the selection of the semiconductor process and the manufacturer. "Once that was tied down and we had a quote from Intersil as to how much it would cost and how long it would take, the rest of the project sort of revolved around that schedule," Jones says.

While the chip was in development, Duryee worked with Intersil's David Bingham while also checking on the LCD makers, and Strong worked with Intersil's Lee L. Evans. "We built quite a few breadboards using C-MOS op amps and even built some op amps out of discrete C-MOS transistors in an effort to determine the safest approach from a standpoint of noise and accuracy," Jones says.



"This was by far the smoothest chip development project that Fluke has ever been involved with," he says. That set the tone for the whole project. One of the high points, according to Jones, was when the first run of chips at Intersil actually worked. "The first die they put the probes on worked," he says. "We had some people in Europe at a sales meeting and we sent them a telegram—all we said was: 'The chip works.' That was all they needed to know, because it meant the schedule was realistic."

One of the major problems was maintaining adequate frequency response without many compensation adjustments. The small size and a requirement for no hand-soldered parts eliminated many alternatives. After many iterations of printed-circuit-board layout, a design was created with a compensation adjustment on only the 2-volt range. The solution was to move the first pole of the divider network beyond 35 kilohertz, which required less than 0.5 picofarad of capacitance across the input divider.

**SES**

bias current, and thus only a 0.3-v turn-on voltage is required. This increases the common-mode voltage range of the amplifiers, which also makes operation from a single 6-v supply possible.

### LCD readout

The LCD also is essential to the meter's design, since it is the only type of display that would satisfy the power-drain requirements. However, examples from several vendors did have several problems for DMM applications:

- Poor viewing angle.
- Slow operation at low temperatures.
- Serious degradation with humidity.
- Fragility of the thin glass plates.

The cooperation of engineers from Fluke and from several LCD vendors produced a display satisfying all the requirements originally set for the new multimeter.

By reducing the liquid-crystal thickness, both the speed at low temperatures and the viewing angle improved dramatically. An extra, protective laminate atop the polarizer material helped the display resist degradation for thousands of hours at high humidity.

The final problem was to protect the LCD from rough handling. Since the front is covered by a polarizing film, it seemed logical to protect it with a plastic lens with a mar-resistant surface. Unfortunately, the most mar-resistant plastic tends to shift the polarization of light, once again reducing the viewing angle (and making the display unreadable through Polaroid sunglasses). The solution to this was a special thermosetting plastic-rigid allyl diglycol carbonite inherently hard enough to provide mar resistance without special processing.

The signal conditioners, switches, and the all-important input-protection components extend the basic

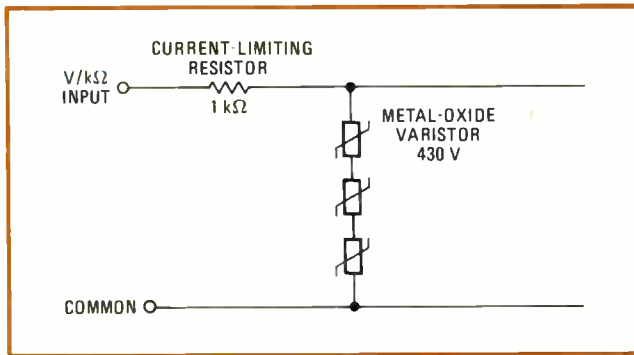

**6. Input protection.** Three metal-oxide varistors are connected in series across the input. If the voltage applied is too high, the varistors will short-circuit to protect the internal circuitry of the meter.

circuitry to the outside world and make the device a multimeter. Figure 3 is a simplified representation of the input circuits, showing how the shunts and input divider are connected to the a-d chip to measure voltage and current. No switching is necessary to get from voltage to current; the user transfers a probe to the appropriate input jack. This helps protect the meter's shunts.

The input divider and the two shunts with the largest resistance are thick-film networks. Thick film was chosen over thin film because it is capable of withstanding severe transient overloads without damage. Even low-energy transients can cause sharp shifts in the value of a thin-film resistor. The low-value shunts are wirewound.

#### Ac/dc converter

Figure 4 is a simplified representation of the ac/dc converter used for ac measurements. The differential output to the a-d converter makes possible both full-wave output and direct coupling. Full-wave output doubles the ripple frequency, allowing much less filtering and resulting in a faster settling time. It also cancels the offset voltage of the amplifiers, since both sides of the output are connected to the same amplifier input.

Without proper corrective design, amplifier bias currents would flow through one of the diodes to only one side of the output, causing a voltage drop in that half of the circuit and an apparent offset. Placing a large resistor ( $2R$ ) in series with one amplifier input and one half that value ( $R$ ) in series with the other, means that the required two units of bias current are supplied through  $R$ . Therefore, offset current can be traded for offset voltage, to which the circuit is insensitive, and the error is cancelled. All resistors in the circuit are contained in a single low-cost network.

#### The ohmmeter

Figure 5 shows the 8020A connected to measure ohms. The input divider used for volts is also used as a reference resistor. Since the same current flows through it and the unknown resistor, the two voltage drops, which are the basis for the dual-integration measurement, are proportional to the respective resistances.

The voltage across the unknown resistance is integrated first, for 1,000 counts, and then the unknown voltage across the reference resistor is integrated down-

ward until the zero crossing. The resulting accumulated count during the deintegrate period is proportional to the unknown voltage and thus to the unknown resistance. By changing reference resistors and a-d ranges, resistances from 0.1 ohms to 20 megohms can be measured by the new multimeter.

For higher resistances, the inverted range, referred to above, comes in. By integrating the voltage across the reference resistor first and using the unknown voltage as the reference during the deintegrate period, the 8020A will read the reciprocal of an unknown resistance—its conductance. This is the only practical means of measuring hundreds or thousands of megohms on a digital multimeter.

In this way, the 8020A can be used to read up to 10,000 M $\Omega$ . The scale is called 200 nanoSiemens (formerly known as the mho, the Siemens is the international unit of conductance). The conductance range extends the usefulness of the multimeter by three orders of magnitude without requiring the addition of a single component.

#### Electrical protection

A positive-temperature-coefficient thermistor protects the reference resistor, the most delicate component, against inadvertent high voltages across the input. This device maintains a low resistance of about 1 kilohm up to a critical temperature, at which point the resistance rises rapidly to thousands of times its original value. If an external overvoltage is applied to the input terminal, a high current flows through the zener clamp and the thermistor. The current heats the thermistor to its switching point, whereupon its resistance increases to protect the internal component. Although the thermistor is in series with the unknown and reference resistors, its voltage drop is not part of either of the independently measured input or reference voltages.

To protect against high-voltage transients, the 8020A has a string of metal-oxide varistors connected across the input in series with a current-limiting resistor (Fig. 6). The varistors look like an open circuit up to their rated voltage. At that point, their conductance increases exponentially, effectively short-circuiting the input pulses. The action is instantaneous and provides positive input protection.

Long-sustained overvoltages will, of course, destroy the varistors. They are designed to fail as short circuits, however, and the current-limiting resistor is designed to fail as an open circuit, so that protection remains positive. The milliampere input terminal is protected by a 2-ampere fuse and a pair of clamping diodes in the standard fashion.

The complete 8020A is built on a single printed-circuit board with fewer than 50 components, all wave-soldered at one time. The LCD display is mounted above the a-d converter chip, and the single 9-v transistor battery is connected to the pc-board by a flexible connector with snap-on terminals (the fuse holder is mounted on the battery connector). Battery life, using an alkaline battery, is over 200 hours. Calibration is an annual affair involving three adjustments; one for dc, one for ac, and one for ac frequency response. □



# One-chip CPU packs power of general-purpose minicomputers

by Dan Wilnai and Peter W. J. Verhofstabt,  
*Fairchild Camera and Instrument Corp., Palo Alto, Calif.*

**E**vidence of the quickening pace in 16-bit microprocessors are two new devices that extend the range of these systems—one into the heart of minicomputer design and the other into low-cost controller designs. While both break new ground in 16-bit technology, the chips are as different as they possibly could be.

One of them is a high-performance minicomputer central processing unit built with integrated injection logic. Designed by Fairchild Camera and Instrument Corp., it is intended to implement general-purpose single-board minicomputers. The chip, part of Fairchild's 9400 microcomputer series, can execute the instructions of a well-established minicomputer family.

The other is an n-channel metal-oxide-semiconductor single-chip microcomputer that fits into the low end of Texas Instruments Inc.'s line of 9900 microcomputers. Containing all the processing, program memory, data storage, and input/output capability needed for control applications, the 9940 will serve as a dedicated stand-alone controller in high-volume equipment designs where a minimum of computation is required.

The two articles that follow, written by the designers of these devices, describe the technical details of the chips and how they can be used in data processing (Fairchild's and control applications (Texas Instruments'). The Fairchild article starts in the next column and the Texas Instruments story begins on p. 118.

□ One of the new breed of 16-bit microprocessors, the Fairchild 9440 puts an entire minicomputer central processing unit on just one bipolar chip. Since all this power is packed in a single 40-pin package, a designer can now for the first time build a full-blown minicomputer on a board. Side by side with the 9440 go large-scale-integrated interface circuits and plenty of directly addressable memory—as much as 32,768 16-bit words that can be any combination of instructions and data.

Rather than adding yet another instruction set to the already crowded repertoire, the new chip executes the same instruction set as the Nova series of general-purpose minicomputers built by Data General Corp. To fully utilize this instruction set, Fairchild provides its own complete software package that includes all the needed program development aids, as well as a full set of diagnostic programs and high-level languages.

Basic to all this capability is the Isoplanar integrated-injection-logic process, which Fairchild calls  $I^3L$ . The use of  $I^3L$  means that high density combines with high performance—160-microwatt consumption and 4-nanosecond propagation per gate—to yield a 16-bit microprocessor about the size of most 8-bit metal-oxide-semiconductor designs, but of course much more powerful. It also means that all the 9440's control lines, as well as its information bus, have low-power Schottky transistor-transistor logic. Power supply requirements for the chip are +5 volts and a 180-milliampere injection current.

The chip itself is modestly housed in the 40-pin package diagrammed in Fig. 1. Instructions as well as data are stored in homogeneous external memory, and a 16-bit-wide, three-state information bus carries both data and address between the microprocessor and the other computer elements.

The 9440 can directly service up to 63 peripheral input/output devices through programmed I/O as well as interrupt-driven I/O, and it also permits direct memory access. A single I/O instruction can at once control operation of the peripheral device and transfer a word between it and the 9440.

The interrupt system allows any peripheral device to interrupt the normal program flow on a priority basis. Device priority can be established off chip by daisy-chain connection of a serially propagated interrupt-priority signal. However, the processor can foil the inter-

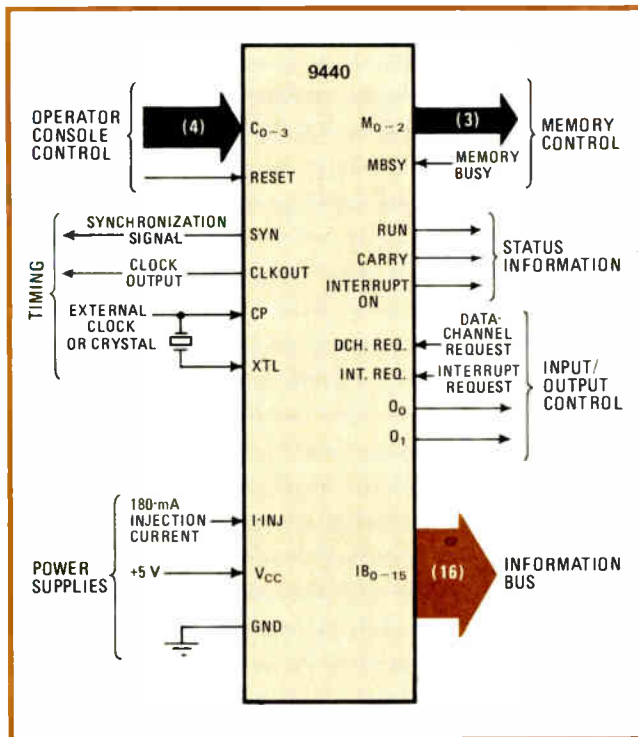

**1. One-chip minicomputer.** The Fairchild 9440 is a high-performance 16-bit bipolar microprocessor built with Isoplanar integrated-injection-logic technology. It executes the same instruction set as Data General Corp.'s Nova series of general-purpose minicomputers.

rupt capability of any given I/O device by putting a mask bit on the information bus.

It is worth noting that the DMA arrangement is a true one in the sense that the I/O device is not under the control of the central processing unit but rather is communicating directly with memory over the information bus after the 9440 puts the latter into its floating or high-impedance state. This allows external circuitry to provide fast DMA at a rate limited only by memory or device speeds.

Internally, the processor is organized around four general-purpose accumulators and an arithmetic/logic unit. The ALU has two 4-bit-wide input ports and operates on two 16-bit words in four consecutive steps, taking one 4-bit "nibble" per step. Data can be moved in either direction between memory and any accumulator, and all I/O data transfers (except in the DMA mode) take place through the accumulators as well.

### Architecture

The 9440 can be thought of as a collection of data paths and the controllers of these paths. The signal trafficking is shown in Fig. 2, where the upper portion depicts the data flow and the lower portion shows controller functions.

The data path portion of the processor includes an ALU, a bank of eight 16-bit registers, and two multiplexers, all linked by 4-bit-wide data paths.

Four of the registers serve as the general-purpose accumulators. Of these, accumulators AC<sub>2</sub> and AC<sub>3</sub> are also used as index registers, and AC<sub>3</sub> can also serve as a subroutine-linkage register during a jump instruction.

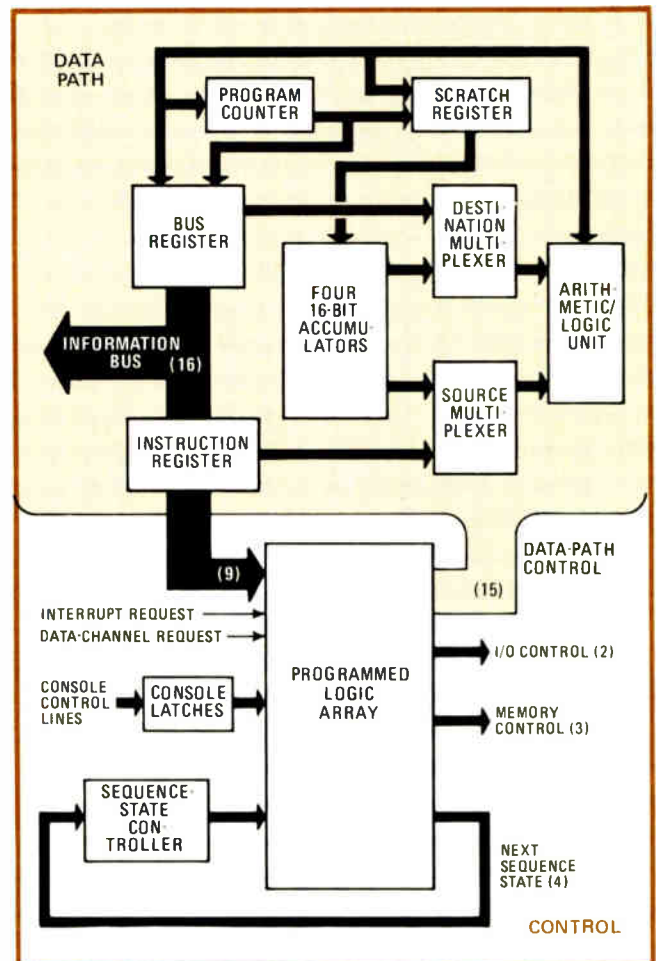

**2. Architecture.** Comprising a collection of data paths and the circuitry necessary to control those paths, the 9440 governs main memory and all peripheral I/O equipment, performs all arithmetic, logic, and data-handling operations, and sequences the program.

Specific data is delegated to the other four registers — the bus register, the instruction register, the program counter, and a scratch-pad register. The bus register, connected to the bidirectional information bus, can either supply or receive 16 bits of parallel data. The instruction register is loaded also with 16 bits in parallel, directly from the information bus during an instruction-fetch operation. The program counter is normally incremented to take instructions from consecutive memory locations. However, its contents can be incremented twice by the skip class of instructions or be changed entirely by the jump class of instructions. The scratch pad holds the data from the ALU for one cycle before putting it into the destination accumulator.

The destination and source multiplexers, handling the 16-bit words in groups of four nibbles each, are tied into all four accumulators and select source and destination registers for each operation. The multiplexers receive other inputs as well, from the bus and instruction registers, which permit the ALU to be used for effective-address calculations and other purposes.

The controller portion of the 9440 is structured around a 16-state microcode implemented with an internal mask-programmed logic array. For each of 72

possible data path operations, there is a corresponding 24-bit word in the logic array. Each word comprises the following signals:

- Data-path control signals—15 bits.
- Memory control lines  $M_{0-2}$ —3 bits.
- Input/output control lines  $O_{0-1}$ —2 bits.
- Pointer for next sequence state—4 bits.

The data-path control signals, which are internal to the 9440, handle the program counter and the bus and instruction registers, as well as the ALU, the four accumulators, and all multiplexing. The memory-control lines handle reading and writing, as well as loading of the memory-address register. The bits of I/O control tell the I/O devices what to do. The state pointer indicates the next one of the 16 states in the operating sequence of the logic array.

The particular 24-bit control word leaving the logic array is determined by an input word, 19 bits wide and carried on five signals, that address the logic array. The input signals are:

- Instruction register—9 bits.
- Operator console control lines  $C_{0-3}$ —4 bits.
- Sequence-state pointer—4 bits.
- Interrupt-request line—1 bit.
- Data-channel-request line—1 bit.

The instruction register is loaded directly from the instruction codes that are stored in the homogeneous external memory and conveyed to the register by the information bus. The console control lines  $C_{0-3}$  are encoded with information for the manual control, including functions such as run, step, halt, reset, and so on.

The sequence-state pointer keeps track of the current operating state of the PLA. The interrupt-request line is an input pin on the 9440 that is shared by all I/O devices. The data-channel-request line is also shared by all I/O devices and is used for requesting direct access to the 9440 memory.

The instruction set of the 9440 processor divides up into four classes: two types of memory-reference instructions, arithmetic/logic instructions, and I/O instructions.

The first class of memory instructions consists of referencing without register (that is, not requiring use of the accumulators). They are used for modifying memory (such as increment- or decrement-and-skip-on-zero) and for branching (as in jump instructions).

The second class of memory instructions, referencing with register, moves 16-bit words between memory and the accumulators. This class comprises loading of the accumulators from memory and storing into memory from the accumulators.

The arithmetic/logic instructions, as the name implies, perform arithmetic (add, add complement, subtract, increment, and negate) or Boolean (AND, complement, and move) operations on the contents of two registers. The result of each operation, together with the carry bit, can be rotated right or left and tested for skip conditions as a part of the same instruction. After the shift, the result may also be loaded in the destination register if desired.

The final class of instructions is the I/O instructions, which move data between the 9440 accumulators and

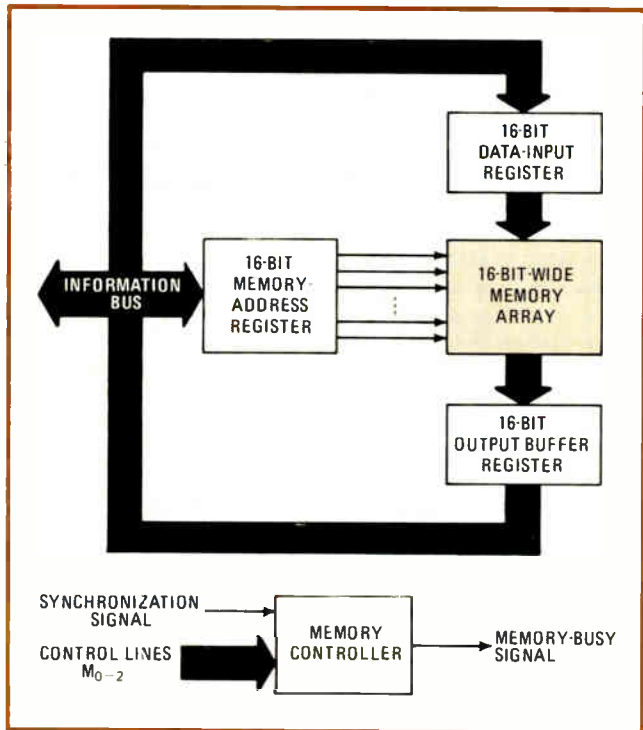

**3. Memory organization.** The external memory system of the 9440 requires a 16-bit-wide memory array. The memory-address register defines an address in the array, the data-in register holds the data to be written, and the output buffer register holds the data read.

buffers (up to three) in the peripheral-device interface. The control functions, already mentioned as included in these instructions, comprise four commands: start, stop, clear, no operation. The instructions may also test the status flags in the I/O device and the central processor.

The 9440 has flexible memory-addressing structure that spans eight different modes. There are four different types of addressing—absolute addressing of page zero (the first 256 locations in memory), and relative addressing involving either of two accumulators or the program counter—and each type may either be direct or indirect, for a total of eight modes.

### Relative addressing

Relative addressing permits a variation of +127 or -128 locations about an index, which can be a location in accumulators  $AC_2$  or  $AC_3$  or the program counter. Relative addressing with an accumulator is useful for gathering consecutive entries from a table in memory, for example, where a displacement is added to an incremental index in the accumulator. Relative addressing with the program counter is useful for jumping to nearby locations when it is desirable to have a relocatable program.

In the case of direct addressing, the 15-bit computed value is the actual address used to read or store the operand. In the case of indirect addressing, the computed value is the address of an address; moreover, indirect addresses may be nested such that the data read from an indirectly addressed location may be another indirect address.

An auto-increment feature of the 9440 comes into

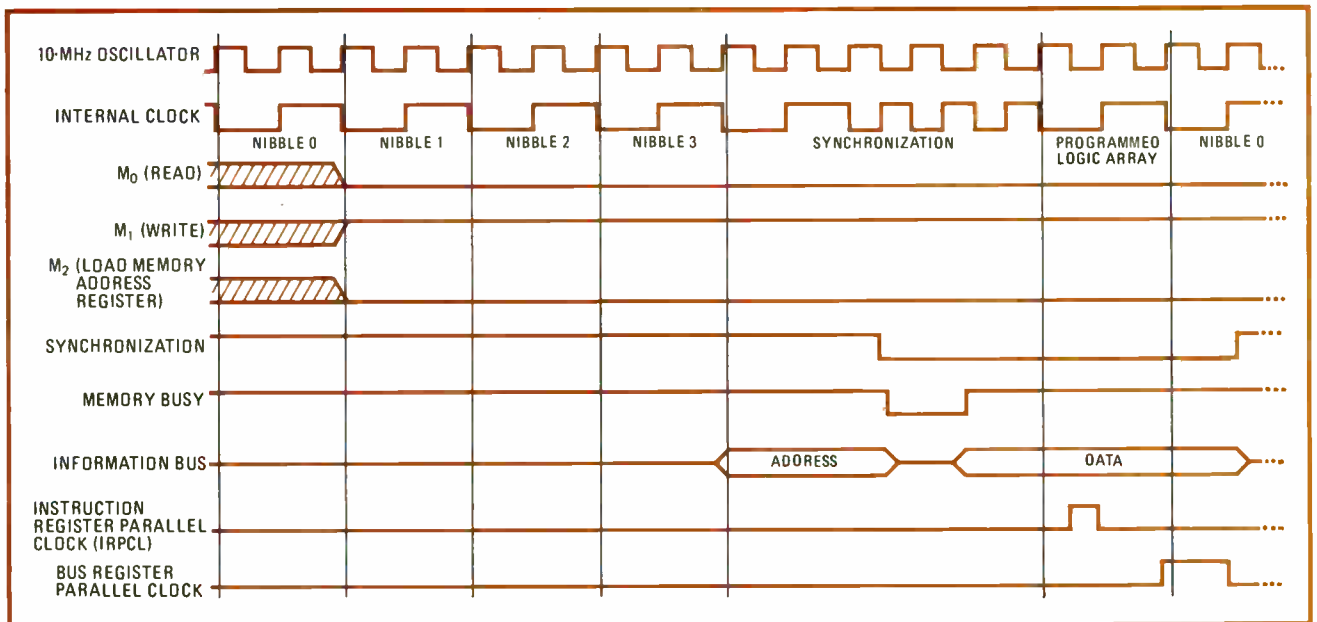

**4. Read operation.** In a memory-read operation, the address appears on the information bus at the end of the fourth 4-bit nibble. Once address information is latched into memory, reading begins and the 9440 receives a memory-busy signal that instructs it to remove the address from the information bus. After reading is completed, the memory applies its output buffer to the bus and stops the busy signal.

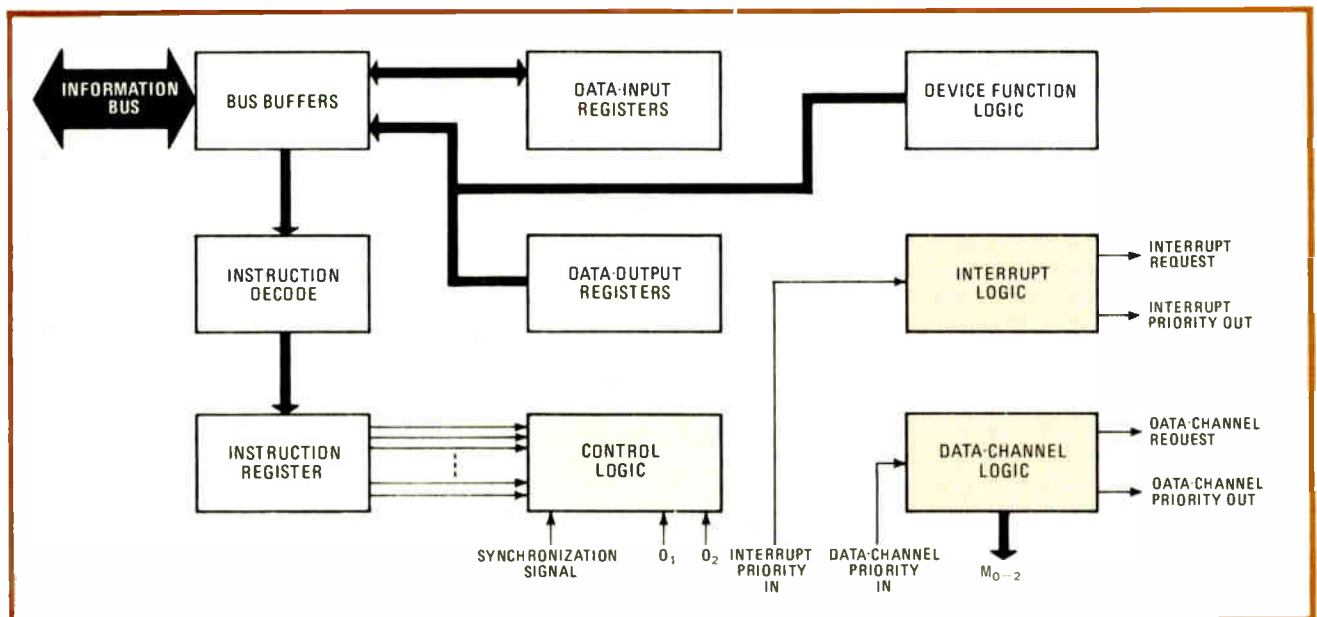

**5. Interfacing I/O.** The 9440 can directly address as many as 63 I/O devices. Peripheral devices interface under either program or interrupt control or by direct access to the main memory using the data-channel-request line. Lines  $M_{0-2}$  control the main memory, and lines  $O_{0-1}$  define the I/O function. Devices requesting interrupt (or data channel) at the same time are serviced by priority.

play when octal locations 20–27 are indirectly addressed—that is, whenever one of these locations is specified by a memory reference instruction in an indirect-address mode, the contents of the selected location are first incremented and then the new value is treated as the new address. The new address can again either be direct or indirect. In a similar fashion, a built-in auto-decrement feature can be used by indirect addressing of octal locations 30–37.

A typical external main-memory system, shown in Fig. 3, is organized around a 16-bit-wide memory array. A memory-address register defines an address in the

array. Two other registers, the data-in register and the output buffer register, hold the data to be written into and the data to be read from main memory, respectively, and also interface with the information bus.

Memory operations are controlled by the  $M_{0-2}$  lines, which are common to the 9440 and to all I/O devices capable of direct memory access. Any device wanting to use the memory has to activate the appropriate control lines:  $M_0$  is memory read,  $M_1$  is memory write, and  $M_2$  is load memory-address register.

Any operation on the memory must be specified for either read or write, and the location in the memory

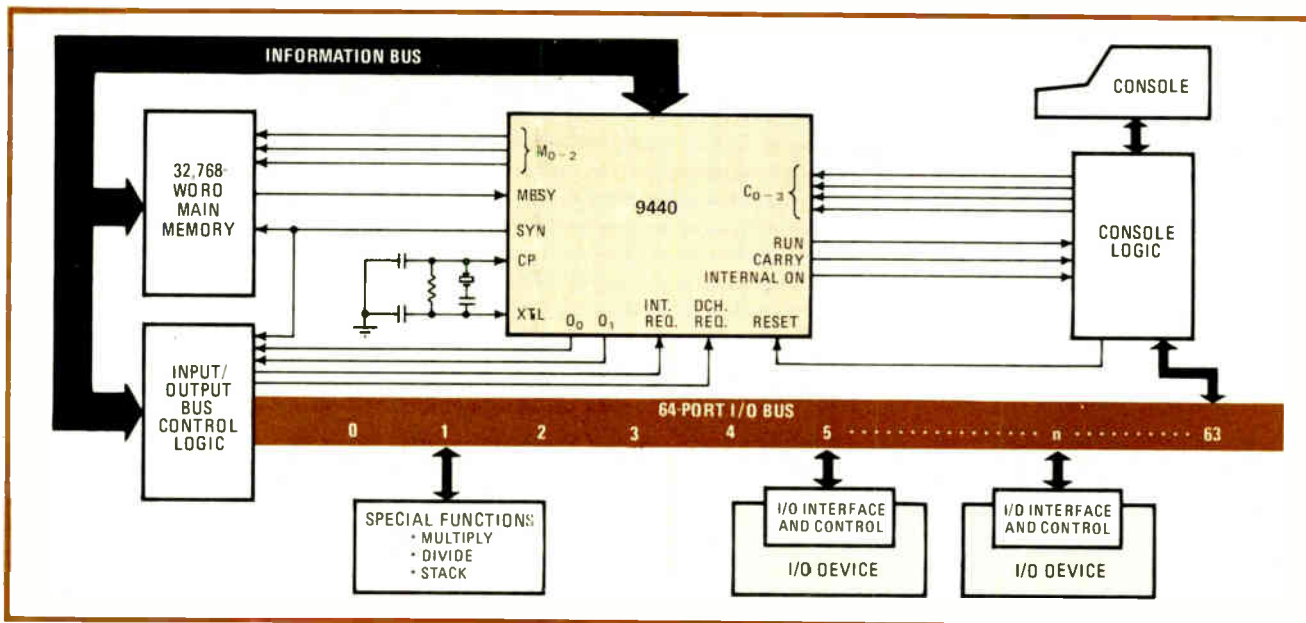

**6. System configuration.** A typical computer system connects the 9440 as a central processing unit to main memory, peripheral devices, and an operator's console. Since it participates in the data transactions on the information bus, the console is treated as an I/O device and is connected to I/O port 63. Port 1 is reserved for special functions, such as hardware math and stack instructions.

array must be specified as well. Since the information bus in the 9440 is shared by both addresses and data, the information on the bus during each cycle must be clearly defined.

A memory-read cycle is shown in Fig. 4. At the beginning of the cycle, the 9440 asserts both  $M_0$  (read) and  $M_2$  (load memory-address register). The address is then put on the information bus at the end of the fourth nibble, and after a deskewing delay period, a synchronization signal is asserted.

Next, the memory latches the address into the memory-address register and sends the 9440 a memory-busy signal. The data stored in the accessed location is then read. When the 9440 receives the busy signal, it takes the address off the information bus. After the read operation is completed, the memory connects its output buffer to the information bus and terminates the busy signal. Finally, the 9440 loads the data read from the memory into the bus register or the instruction register and terminates the synchronization signal. Then the memory disables the output buffers.

A write operation is initiated in much the same way, except that a second cycle is required, at which time the 9440 asserts  $M_1$  (write), and the data to be written into memory is then put on the information bus.

### Interfacing with the outside

The structure of the I/O interface within the 9440 system is shown in Fig. 5. Peripheral devices communicate with the processor through the common information bus. To avoid conflicts on the bus, the devices are sent a synchronization signal. The function that the I/O device is to perform is conveyed over the information bus and on the  $O_0$  and  $O_1$  lines.

To allow the I/O devices to interface under program control, each should provide two signals as status indicators—one to indicate that the device is busy and another

to signal that it is available. The 9440 can therefore probe the status of a given device by asking it to place its status signals on two lines ( $IB_0$  and  $IB_1$ ) of the information bus.

Since there may be several devices requesting interrupt simultaneously, device priority is established by a daisy-chained connection of an interrupt-priority signal. Each device has an interrupt-priority input line and an interrupt-priority output line. When there are no interrupt requests, the priority signal propagates serially throughout the chain. The first device requesting an interrupt breaks the chain by blocking the priority signal and receives first recognition by the 9440. It then answers the interrupt-acknowledge instruction received from the processor by placing its device code on the information bus. The 9440 can, however, disable the interrupt system in any I/O device by "masking" the particular device with an I/O instruction sent over the information bus.

For operation under direct memory access, three control lines similar to the interrupt control lines are available. The data-channel-request line, like the interrupt-request line, is common to all I/O devices. Priority under DMA can be established just as under interrupt control by data-channel-priority input and output lines, with a serially propagated priority signal daisy-chained between I/O devices.

A typical system configuration is shown in Fig. 6. The 9440 is connected to 32,768 bytes of main memory and to I/O bus control logic, as well as to operating console logic. All but two of the 64 ports on the I/O bus can be used for peripheral devices and can operate under program, interrupt, or DMA control. Port 1 is reserved for special functions such as hardware multiply/divide instructions and memory stack instructions. Port 63 is saved for special central-processing-unit instructions such as mask out or read switches from the console. □

# 16-bit microcomputer is seeking a big bite of low-cost controller tasks

by John D. Bryant and Rick Longley,  
Texas Instruments Inc., Houston, Texas

□ One-chip microcomputers have staked out a claim to low-cost controller applications, and the device that is likely to grab a good share of the gold is the first 16-bit one-chip unit. The TMS 9940, the latest addition to the 9900 16-bit family, is a 5-volt stand-alone microcomputer containing all the necessary central processing and control logic, memory, and input/output capability needed for many low-cost controller applications.

The on-chip memory consists of 128 bytes of read/write random-access memory and 2,048 bytes of either mask-programmable read-only memory or (as an option) reprogrammable ROM. The total capacity exceeds most 8-bit one-chip devices.

The 9940 can address 32 bits of general-purpose I/O devices and can be expanded to 256 additional bits of

I/O, or three to five times more than the smaller one-chip microcomputers. Equally important, processing 16-bit words makes it inherently faster than 4-bit and 8-bit microcomputer chips. The longer words also make it better at controlling equipment requiring higher precision—12 bits and up, for example, in an analog-to-digital conversion.

What's more, the 9940 is the only one-chip unit with an architecture and instruction repertory identical to a well-established microcomputer family. A user can move directly from it into the higher-performing multichip 8- and 16-bit members of the 9900 family with no additional expense in basic software development.

Like all members of its family, the new chip (Fig. 1) processes data over two independent, parallel data and

**1. The big one-chipper.** This 16-bit one-chip microcomputer has all the processing blocks for handling a wide range of control applications. On-chip memory consists of 128 bytes of RAM and 2,048 bytes of ROM. The 9940 can address 32 bits of I/O, expandable by another 256 bits.

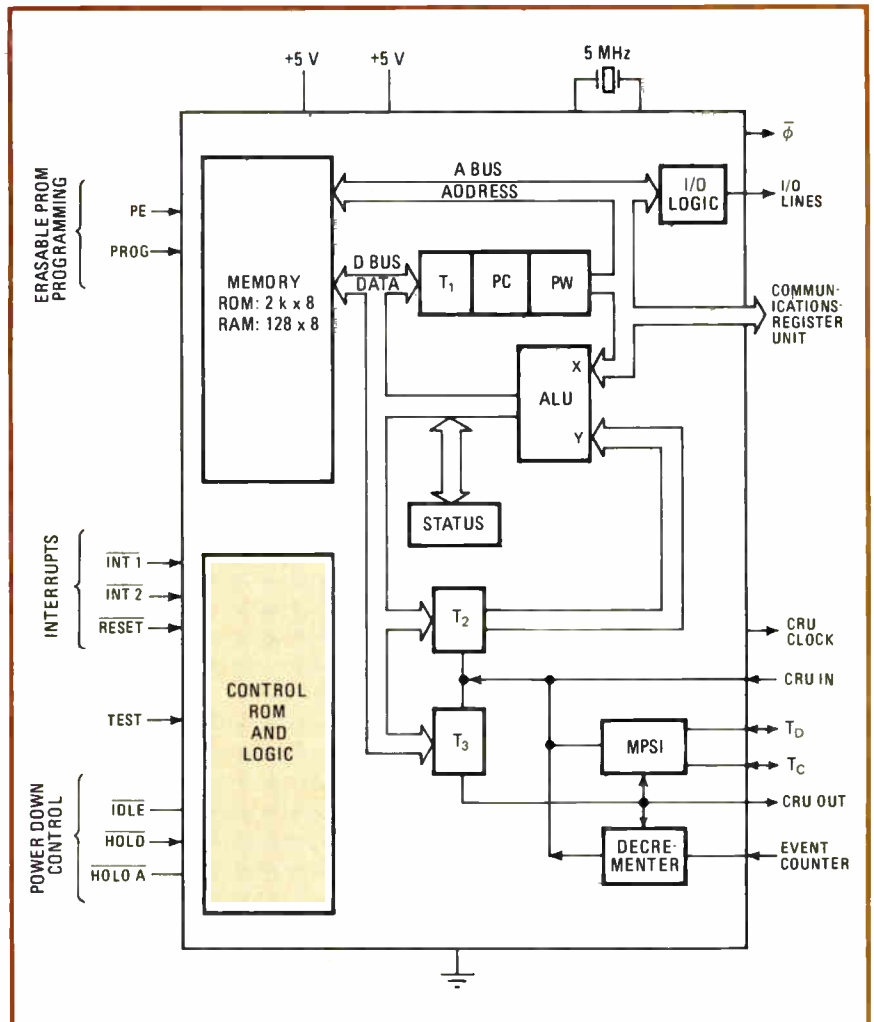

instruction bus lines under the direction of a 4,000-bit microprogrammable control ROM (tinted in the figure). [For details of this organization, which follows popular minicomputer architecture, see *Electronics*, May 27, 1976, p. 99.]

### How it's organized

The 9940's central processing unit sends a memory address to the on-chip memory over the bus labeled A and sends or receives data over the bus labeled D. Temporary 16-bit registers, T<sub>1</sub>, T<sub>2</sub>, and T<sub>3</sub>, store intermediate addresses and operands, while another 16-bit hardware register called the program counter (PC) stores the value of the address of the next instruction to be executed. An 11-bit hardware register, called the workspace pointer (WP), stores the value of the memory address of the beginning of the register file.

For handling program instructions, the arithmetic/logic unit accepts two independent 8-bit inputs and puts out the 8-bit result on the D bus. It uses high-level techniques called pipelining (starting one operation before completing the previous one) to allow the ALU to rapidly process two bytes of data automatically. The pipelining feature boosts the 9940's throughput two to three times higher than other commercially available one-chip microcomputers.

The program memory is addressable in 8-bit bytes, with a word being defined as two consecutive bytes. The chip employs an advanced memory-to-memory architecture (just as in the TMS 9900 CPU). Blocks of memory, designated workspace register files, replace dedicated hardware registers like the ones used in microprocessor designs such as the 8080 or 6800. This setup makes the chip extremely flexible, since the workspace register files contain 16 contiguous memory words that can function as operand registers, accumulators, address registers, or index registers.

The workspace arrangement is particularly valuable during operations that require a context switch, such as an interrupt or subroutine call. Such an operation in a microprocessor with a conventional multiregister arrangement requires that at least part of the contents of the register file be stored and reloaded. The 9940, on the other hand, can accomplish a context switch with a simple exchange of values in the status register, the PC register, and the WP register.

### Easy to interrupt

Another big advantage of the 9940 over the 4- and 8-bit one-chip devices is its ability to handle many varied interrupts. The chip can implement four hardware interrupt levels, with the highest priority being reserved for the reset function, followed by the decremter and the two user-defined external interrupts.

In interrupt routines, the value of the highest active interrupt level is continuously compared with the interrupt mask in the status register. When the level of a pending interrupt is of higher priority than the mask value, the CPU recognizes the interrupt and performs a context switch.

The context switch is done by fetching the next PC and WP context values from the interrupt vector location,

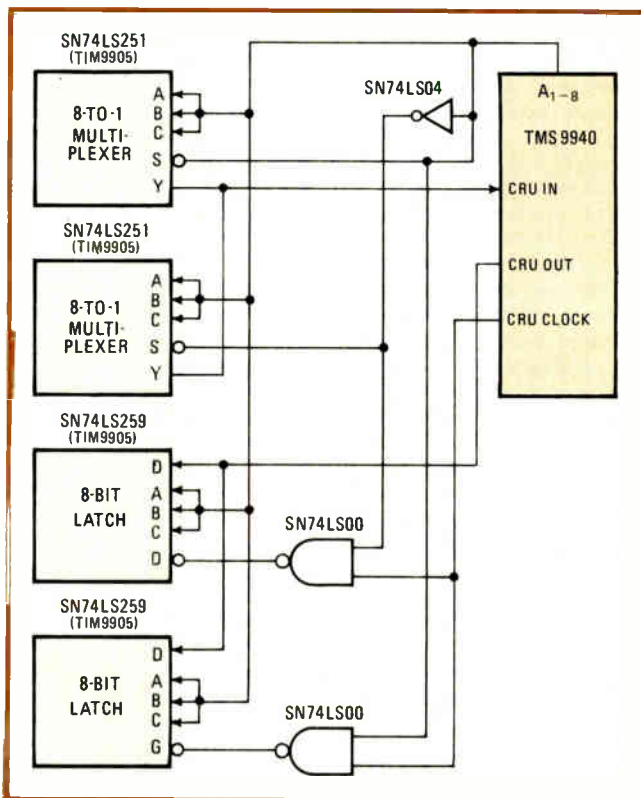

**2. Expanding.** This I/O configuration, which is a 16-bit input and 16-bit output register, requires only a few easily available parts: two 8-to-1 multiplexers, two 8-bit latches, and some gates. The 9940's I/O capability can be expanded to handle 16 of these registers.

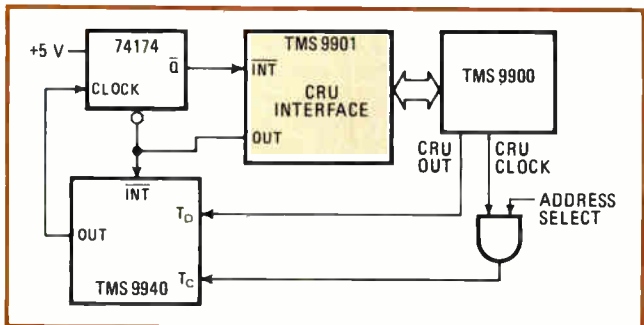

**3. Peripheral processing.** The 9940 makes a good peripheral processor in large multiprocessor systems. In this setup, the 9940 can execute peripheral instructions from a 9900-based system simply by executing the off-loaded instructions sent to its RAM.

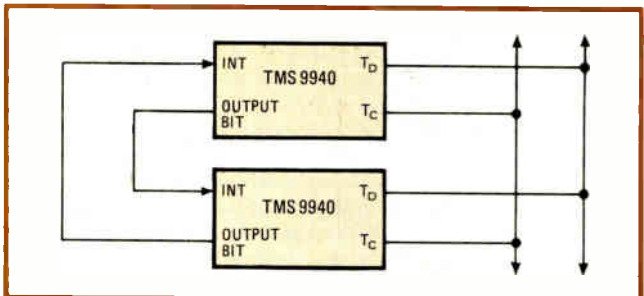

**4. Communicating.** Two 9940s in a multiple processor system communicate through ports T<sub>C</sub> and T<sub>D</sub>. The protocol for multiple systems—additional chips can be included by wire-ORing MPSI signals—treats all devices as receivers except when transmitting.

## How the 9940 measures up

There are two principal competitors to the 9940 available: the 8048 and 3870 8-bit one-chip microcomputers. While benchmark results often depend on the routine performed and therefore could be misleading, the standard method of evaluating such devices is to exercise them through several unrelated routines and compare the results.

The comparison shown in the table is for six routines, each carried out by the 9940, the 8048, and the 3870. The results are formulated using three measures: program steps—reflecting the power of the instruction set and the nonrecurring software development costs—memory bytes—the smaller needed to do the job, the better, especially in restricted memory systems such as single-chip microcomputers—and execution speed. In each category the 9940 won. It required fewer program steps, less memory, and did the jobs quicker.

The routines are defined as follows:

1. Increment a four-digit binary-coded-decimal counter and compare to a limit. Four BCD digits are stored in random-access memory as a software counter. The

counter is incremented and the result is compared with a RAM-resident limit.

2. Process I/O data. The manipulations required of this routine are: (a) input byte A from port 1. (b) input byte B from port 2. (c) compare A to B and then act as follows: (1)  $A = B$ ; set flag and exit. (2)  $A > B$ ; output A, reset flag, and exit. (3)  $A < B$ ; output B, reset flag, and exit.

3. 16-digit BCD add. Sixteen decimal digits are in RAM for each of two numbers, A and B. The sum  $A + B$  is computed in BCD and placed in 16-digit location C.

4. 8-bit binary multiply. The 16-bit product of two 8-bit binary quantities defined in RAM is computed and stored.

5. Interrupt context switch. This routine reflects the overhead involved in saving a set of working registers before processing an interrupt and restoring them afterward.

6. String search. A block of 15 bytes is defined in RAM and is searched for a string of three contiguous bytes. Two partial finds occur before a match is found. When the match is found, a flag is set and the string's starting address is returned.

Routine	Program steps			Memory bytes (8-bit)			Execution time ( $\mu$ s)		
	9940	8048	3870	9940	8048	3870	9940	8048	3870
1) Increment/compare 4-digit BCD counter	10	20	17	20	26	25	30.4	60	62
2) Process I/O data	13	18	19	26	23	28	44.2	47.5	61
3) 16-digit BCD add	8	11	24	18	15	27	163.2	177.5	478
4) 8-bit binary multiply	1	14	25	2	17	28	32.4	185	373
5) Interrupt context switch	1	5	17	2	5	17	11.6	20	68
6) String search	20	39	48	40	46	58	380.8	815	969
Total	53	107	150	108	132	183	662.6	1,305	2,011

while storing the previous PC, WP, and status-register context values in the reserved registers (13, 14, and 15) of the new workspace file.

Meanwhile, the routine loads the interrupt mask with a value that is one less than the interrupt level being serviced—a step that automatically masks out all lower-priority interrupts. Of course, if a higher-priority interrupt becomes active during a service routine, a second context switch occurs to service it. When the higher-priority routine is complete, a return instruction (RTWP) restores the previous service-routine parameters to the processor, completing processing of the lower-priority interrupt.

### Plenty of I/O too

The 9940 I/O configuration consists of three separate interfaces: the general-purpose on-chip I/O, the I/O expansion, and the multiprocessor system interface. As in the 9900 parent chip, I/O data communication with the outside world is through the communications register unit, a versatile bit-oriented interface. The CRU makes I/O bits accessible in fields of 1 to 16 (specified via CRU instructions), with each bit specified by an address present on the A bus. The processor instructions that

drive the CRU interface can set, reset, or test any bit in the array, or move data between memory and I/O.

The general-purpose on-chip I/O consists of 32 lines that can be independently programmed to be input or output ports, with each port consisting of 1 to 16 lines. The lines can be set, reset, tested, read, or written through the CRU interface. Simple software instructions accomplish direction programming, which can be changed in real time.

A nice feature of the 9940 is its direct expandability to as many as 256 bits of additional I/O lines simply by using standard transistor-transistor-logic components. Figure 2 illustrates the configuration for implementing a 16-bit input and 16-bit output register expansion: two 8-to-1 multiplexers, two 8-bit latches, and a few gates. The CRU addresses can be decoded as needed to implement as many as 16 such interface registers. But in any given system application, only the exact number of interface bits needed to interface the specific peripheral devices must be provided. In other words, it is not necessary to have a 16-bit interface register to interface an 8-bit device.

The 9940 instruction set, a subset of the 9900-family instruction repertory, contains 58 instructions. The use





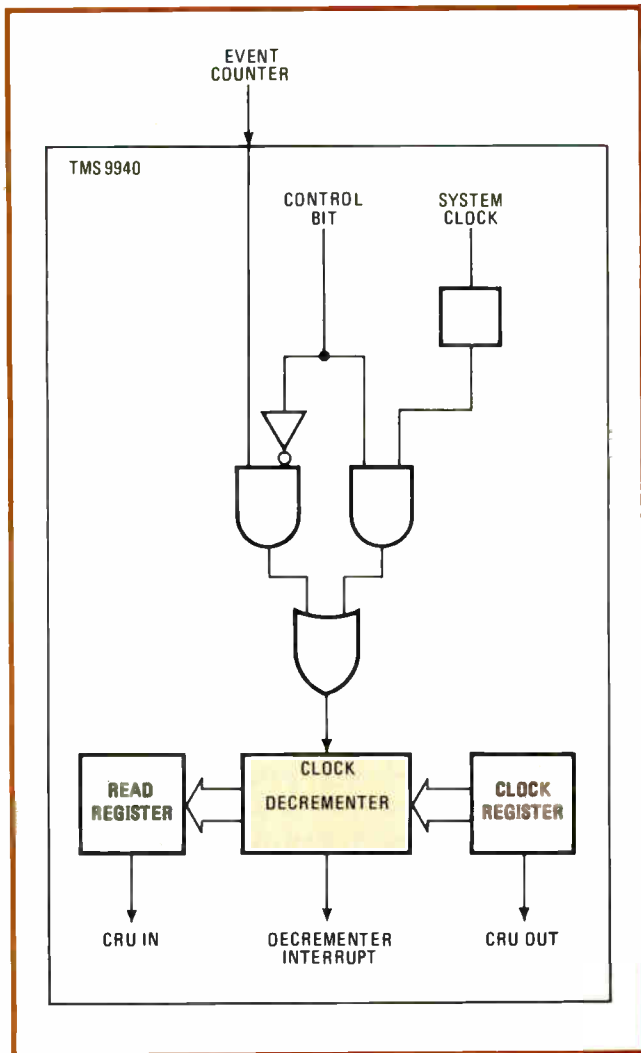

**6. Multipurpose.** The 9940's decrementer register can also be used as a programmable interval timer, programmable event timer, or programmable event counter. As an event counter, the positive edge transition of the EC signal initiates the count.

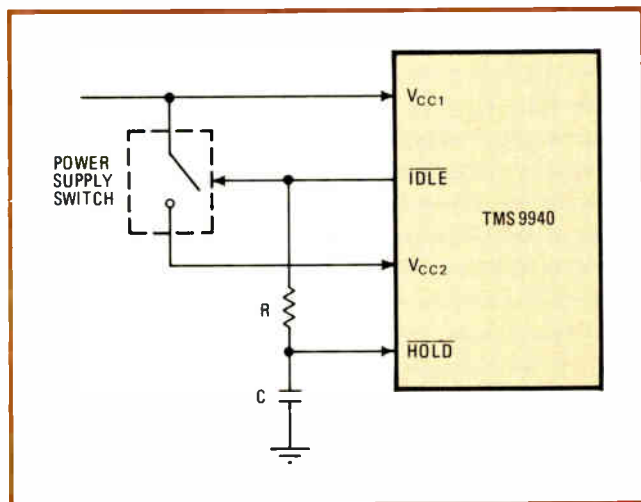

**7. Powering down.** The 9940 has a convenient power-down mode, accomplished when the IDLE instruction is executed and a low value is output on IDLE. That opens the power supply switch. The switch is closed with an interrupt forcing the chip into IDLE high.

To become a sender, the 9940 executes an LDCR instruction (load memory bits on CRU) to the dedicated MPSI addresses. The  $T_D$  signal then automatically switches to the output mode to send data, and the  $T_C$  signal sends out the CRU clock strobe. After completion of the instruction,  $T_D$  and  $T_C$  revert to the input mode to switch the device back to receiver status.

The software required for each communication between two 9940s is shown in Fig. 5a, and the software sequence during a transfer is shown in Fig. 5b. The sender starts the transfer by loading the first word to the MPSI and issuing an output command to interrupt the receiver. The receiver takes in the MPSI data, acknowledges receipt to the sender, and checks to see if the transfer is complete. If incomplete, the receiver enters a wait loop to wait for the next word to be sent.

Once receipt has been acknowledged, the sender sends the next word, checks for completion of transfer, and enters a wait loop to wait for the next acknowledgment. When the transfer is finally complete, the receiver executes a return instruction to return it to its original program. The transfer rate consists of the sum of the sender and receiver sequences and is 31.2 microseconds per byte, as shown in Fig. 5b.

A useful feature of the 9940 is the 14-bit decrementing register (Fig. 6), which can also be programmed as a programmable interval timer, an external-event timer, or an external-event counter. The decrementer functions as an interval timer simply by using the proper start value. It will then issue interrupts at the chosen interval.

It functions as an event timer by reading the timer values at the start and stop points of the event of interest and comparing the two values. The difference will be a direct measurement of the elapsed time.

When programmed as an event counter, the decrementer functions as it does for event timing, except that the event-counter pin (EC) replaces the system clock as the clock input. A positive edge transition on EC will decrement the count. When the count reaches zero, the decrementer is reloaded with the programmed start value and an interrupt is issued. The EC pin can also function as a positive-edge-triggered interrupt by loading a start value of one.

### Power down

Applications that have low duty cycles (like those that interact with human beings) or require low power dissipation can make use of the 9940's convenient power-down capability. The chip is powered by two separate power supplies:  $V_{CC1}$ , which powers the RAM, decrementer, and interrupt logic; and  $V_{CC2}$ , which powers the rest of the circuitry (Fig. 7).

Power down is accomplished when the IDLE instruction is executed and a low value goes out on IDLE to open the power-supply switch. Sending an interrupt into the CPU forces the processor out of its IDLE mode and puts out a high value on IDLE that closes the switch and powers up the rest of the circuitry. The HOLD input is a Schmitt-trigger input that will keep the CPU stopped until  $V_{CC2}$  has settled.

A system designer can build prototypes using the 9940

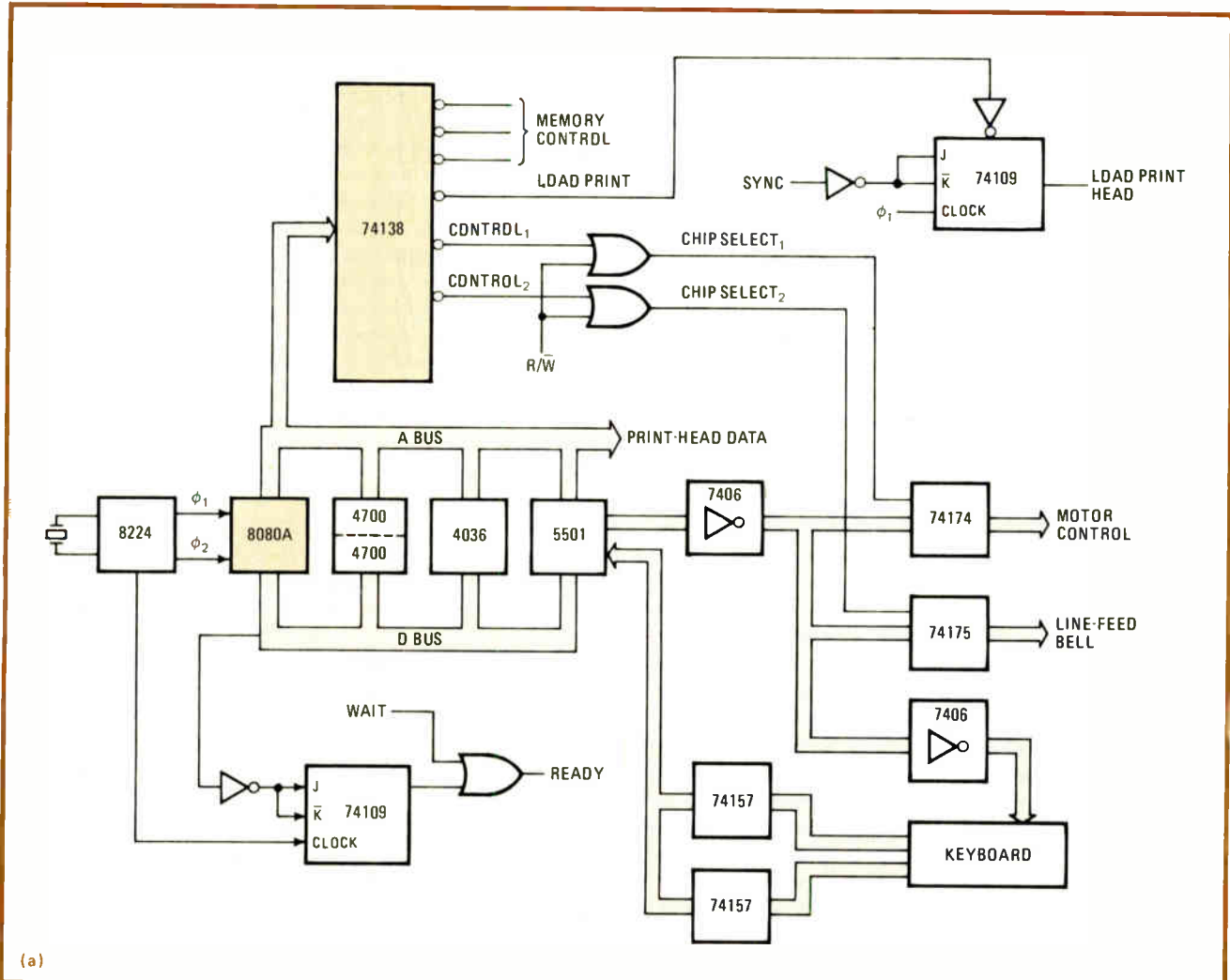

by several methods. Other family members (such as the TMS 9900 and TMS 9980 CPUs) can be used for software development. The 9900 microcomputer board also makes a good starting point for this development.

The 9940 implements three additional instructions (decimal add, decimal subtract, and load immediate data to interrupt mask), which are not in the basic 9900 instruction set. These instructions are defined by operational codes corresponding to those for XOP 10 to XOP 12 (internal software interrupts) of the 9900 (only XOP 0 to XOP 7 are implemented as general XOPs on the 9940). Executing one of these operational codes in a 9900 system will force a context switch to allow software emulation of the operation directly performed in the 9940. In this way, the two machines will maintain in-line machine-code compatibility.

Another alternative uses a microprocessor prototyping laboratory that is available to support all members of the 9900 family. The MPL provides real-time emulators that minimize hardware development. In addition, it has trace/analyzer functions to give to the system developer the capability of real-time monitoring and debugging. Pertinent data and control signals may be sampled and saved in a host RAM until occurrence of a user-specified event. The target microprocessor may be single-stepped

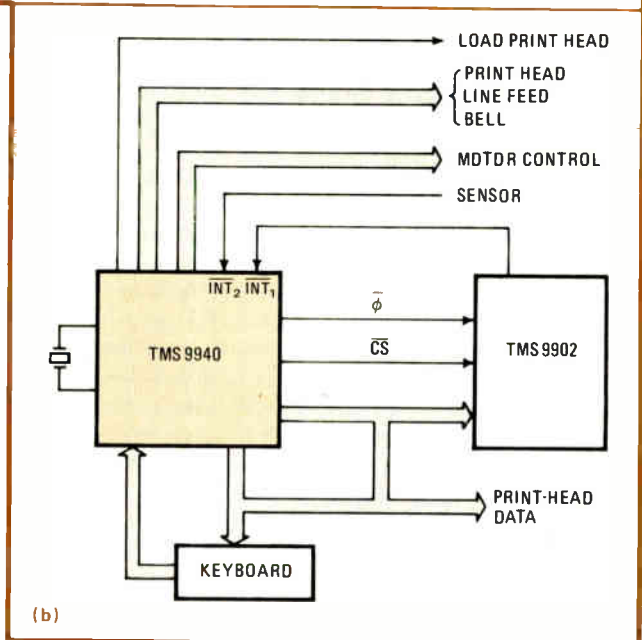

**8. Terminal design.** Using a 9940 instead of an 8080 to build terminals saves money. This TI 745 terminal requires 17 ICs (a) when an 8080 does the job and only two (b) with the 9940. Besides the processor, all that is needed is a 9902 communication controller.

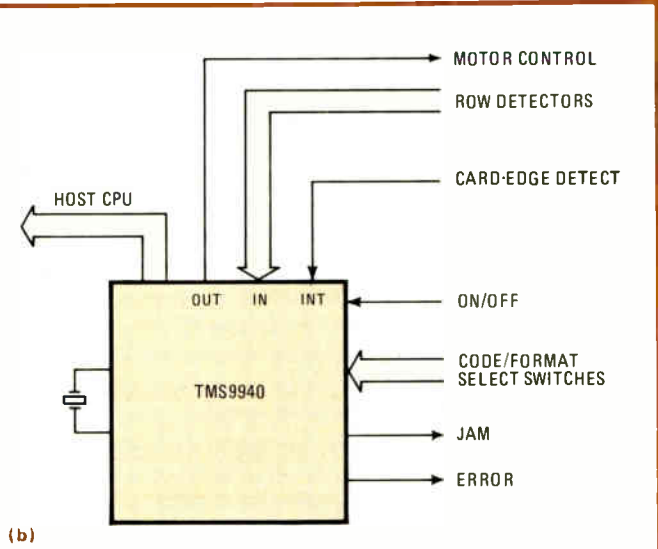
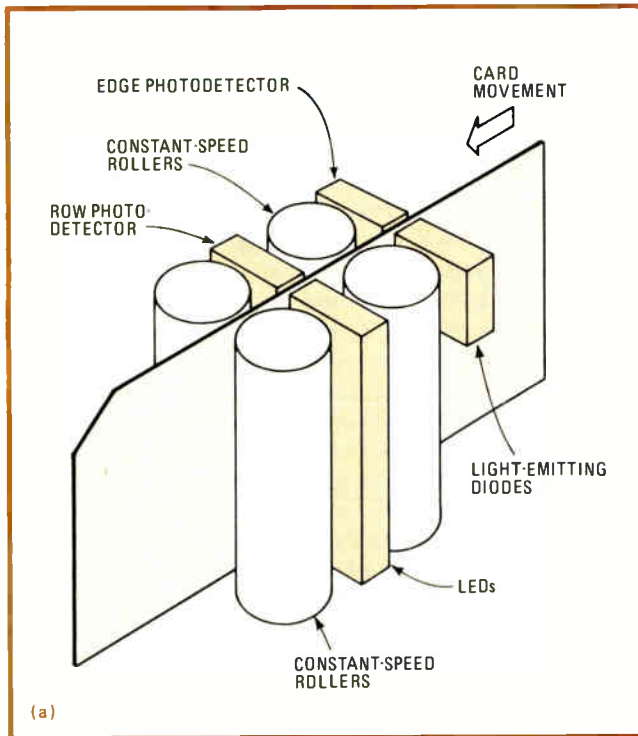

**9. Very smart.** By itself, the 9940 can implement an intelligent card reader for the IBM standard 12-row, 80-column card. The chip goes into action when the front edge of the card passes the edge detector, generating an interrupt that allows it to synchronize itself to the card.

through its program so that internal registers and target memory can be examined and altered.

As the prototype progresses into hardware, the micro-computer board or the MPL CPU can be replaced by the reprogrammable-ROM version of the chip (9940E). For volume production, the mask-ROM version (9940N) would be the most cost-effective solution.

**Applications abound**

Microprocessors have proven valuable in data terminals, such as the Texas Instruments 745 portable terminal. This unit is a low-cost, light-weight terminal offering such features as selectable print speeds (10 and 30 characters per second) on a thermal print head with a 5-by-7-dot matrix. It has a built-in acoustic coupler and can provide switch-selectable half- or full-duplex operation from an ASCII standard keyboard. The hardware required to implement this terminal with an 8080A microprocessor is shown in Fig. 8a, and the hardware when built with a 9940 is shown in Fig. 8b.

With the 8080A, the microcomputer portion of the 745 design requires 17 integrated circuits. The memory consists of 2 kilobytes of ROM program memory (two 4700s) and 64 bytes of RAM (one 4036). Moreover, the peripheral interface chip, the 5501, contains a universal asynchronous receiver/transmitter, programmable interval timers, interrupt control, an 8-bit input port, and an 8-bit output port. The remaining circuitry is used for I/O buffering and expansion where needed and for general system overhead duties.

The 8080A controls all operations of the terminal, including scanning, debouncing, and encoding the

keyboard, encoding the print data into the 5-by-7-dot format, timing the thermal reaction of the print head, controlling the stepper motor, which positions the print head, and even ringing the bell at the end of the line. Data is sent to the print head over the address bus (using dummy MOV M instructions) and strobed into the print latch by the LD PRINT HD signal.

The design is much simpler with a 9940 microcomputer. In fact, it takes only that chip and a 9902 asynchronous communications controller. Software multiplexes 12 of the 32 I/O lines on the microcomputer among the 9902 interface, the keyboard scan, and print-head data output. The remaining 20 I/O lines are used to interface to the rest of the system requirements.

The 9940 also makes handy work of intelligent peripherals designs, such as the card reader for the standard 12-row, 80-column card. A card-reading mechanism (Fig. 9a) is equipped with rollers that move the card at a constant rate. The front edge of the card is detected by the edge detector to synchronize the reader to the card. Photodetectors are then sampled at appropriate intervals to determine the column code punched on the card.

The 9940 is a one-chip solution to this application (Fig. 9b). The on/off control is an input bit, which is sampled to determine if the card reader is being used. When an on condition is detected, the chip sends a signal that turns on the roller motors and activates the light-emitting diodes. When the front edge of the card passes the edge detector, an interrupt is generated to allow the 9940 to synchronize itself to the card. The chip's interval timer measures the appropriate time intervals for the data as each column passes through the photodetector.

As each column is read, the chip can make the appropriate conversion from the switch-specified card code to the specified format (e.g., Hollerith to ASCII). Before transferring the data, the chip can process it to perform such functions as deleting extraneous characters, prescaling or normalizing numerical data, checking for special characters and issuing appropriate commands, and verifying data via use of check summations. The data then goes to the host processor through the MPSI or through an external asynchronous interface chip. □

When we surveyed the pulse generator market, we discovered that what many of you wanted was unavailable: a Wavetek pulse generator.

Model 801 takes care of that.

It's a 50 MHz pulse generator with independent width, rate, and delay controls. It's a versatile instrument, with double pulse

capability, a pulse burst mode, and a pulse reconstruction feature. But above all, it's a Wavetek, as you can see, and as you can tell by the low price (just \$995).

We could go on about the fixed ECL, TTL, and  $\overline{\text{ECL}}$  outputs, and the variable outputs up to plus and minus 20 volts. Or the adjustable rise/fall from less

than 5 nanoseconds. But this is an ad, not a data sheet. So why not circle our reader service number and get all the specs on Wavetek's first pulse generator: WAVETEK, 9045 Balboa Avenue, P.O. Box 651, San Diego, CA 92112. Telephone: (714) 279-2200, TWX 910-335-2007.

**WAVETEK®**

# Nobody ever put one of these on a pulse generator before.



Circle 125 on reader service card

## Single C-MOS IC forms pulse-width modulator

by Mark E. Anglin  
Novar Electronics, Barberton, Calif.

A pulse-width modulator can be constructed with a single complementary-metal-oxide-semiconductor integrated circuit if the IC's field-effect transistors control the duty cycle of a free-running oscillator. The output resistance of the FET varies almost linearly with input voltage over portions of its characteristic curve, permitting the circuit to be used for applications in switching power supplies and analog conversion in data-communications systems.

This circuit uses a CD4007 dual complementary pair plus an inverter device, which comprises three n-channel and three p-channel enhancement-type MOS transistors. As shown in the figure, inverters  $I_1$  and  $I_2$ , each formed by two gates in the 4007, themselves form an astable multivibrator in conjunction with resistor  $R$  and capacitor  $C$ . The frequency of oscillation of the multivibrator is given by:

$$f = 1/1.4 RC$$

The 1-megohm resistor, left in the figure, limits the feedback current into  $I_1$ . This prevents the input circuit from burnout and the inverter from switching prematurely and affecting the desired frequency of operation.

The two remaining gates in the 4007, one n-channel and one p-channel gate, are connected across the output of  $I_1$  and  $R$ . This network is designed to modify  $R$  and

**Single IC modulator.** Pulse-width modulation is achieved by varying duty cycle of free-running oscillator in accordance with input voltage  $V_c$ . Output impedance of FETs shunts switching-time element  $R$ , permitting adjustable duty cycle.

thus control switching times  $t_1$  and  $t_2$ .

The oscillation (switching) times for this device may be expressed by two equations:

$$t_1 = RC \ln [(V_{dd} - V_{tr})/V_{dd}]$$

and

$$t_2 = RC \ln (V_{tr}/V_{dd})$$

where  $t_1$  is the on time and  $t_2$  is the off time of the oscillator,  $V_{tr}$  is the threshold voltage at the gate's input, and  $V_{dd}$  is the supply voltage.

When the oscillator's output is high, diode  $D_1$  may conduct. The p-channel output resistance will be in parallel with  $R$ , neglecting the diode's forward resistance. The p-channel gate's output resistance will decrease as  $V_c$  decreases.

Similarly, when the oscillator's output is low,  $D_2$  may conduct, and the n-channel output is placed in parallel with  $R$ . The n-channel's resistance will decrease as  $V_c$  increases. The duty cycle of the oscillations (in other words, control of the on and off times) is variable from 1% to 99% of the operating frequency. The duty cycle is directly proportional to the amplitude of the control voltage  $V_c$ .

The component values in the figure yield an oscillation frequency of 1 kilohertz. The change in oscillation frequency as a function of duty cycle is minimal; although the basic frequency of oscillation is modified by the FETs across  $I_1$ , the output impedance of one always increases, and the other's decreases proportionately, for any value of control voltage  $V_c$ . Thus, the average resistance shunted across  $R$  during a cycle is constant. □

Designer's casebook is a regular feature in *Electronics*. We invite readers to submit original and unpublished circuit ideas and solutions to design problems. Explain briefly but thoroughly the circuit's operating principle and purpose. We'll pay \$50 for each item published.

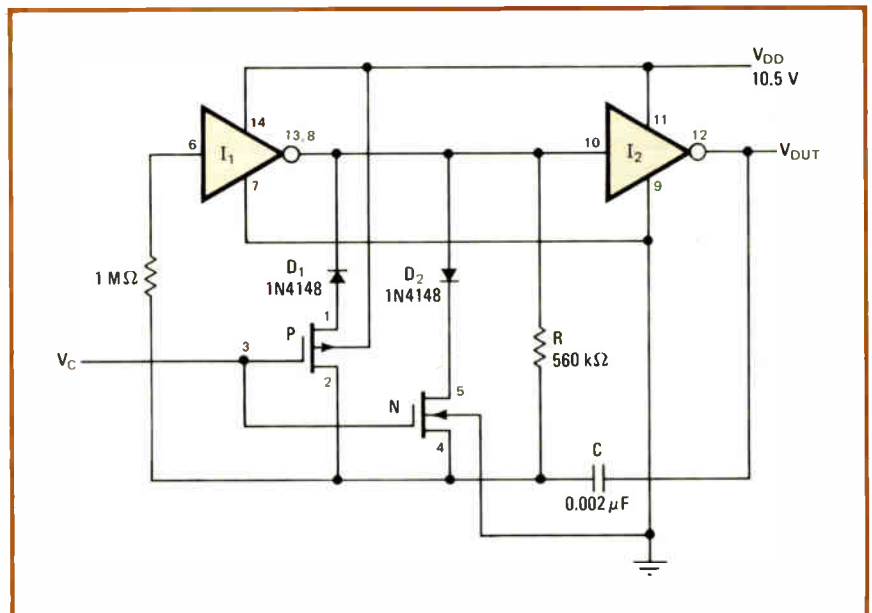

# Comparators replace mechanical set-point meter

by Louis A. Perretta  
HNU Systems Inc., Newton, Mass.

A standard ammeter and a simple comparator circuit can replace the expensive and bulky mechanical dual-set-point meters used for most process control applications. This electronic circuit provides higher efficiency at low cost and can be built on a printed-circuit card. With a slight modification to the basic circuit, a double high set point and a double low set point may be established—a feature that is not available from the mechanical meter.

The mechanical meter used for industrial purposes contains internal relays and a 115-volt power supply to drive them, as well as a meter that triggers when its pointer or indicating device comes into contact with the high or low set points on the meter dial.

In the electronic circuit shown in the figure, the mechanical set control is replaced by two potentiometers, transistors Q<sub>1</sub> through Q<sub>5</sub>, and the LM319 operational amplifier. A 1-milliampere meter indicates conditions at the output of the monitored circuit. The meter is

no longer part of the relay triggering circuit, and the relays no longer need a power supply. If the circuit is to control heavy loads, relays must be employed, but they draw only little power from output transistors Q<sub>4</sub> and Q<sub>5</sub> and can be placed far from the metering circuit.

In normal operation, an input signal is applied to each of the two op amps in the LM319, which compares it to a previously set (high- and low-point) reference. In the circuit, the reference voltages are adjustable from 0 to -5.6 v. This is made possible by the biasing arrangement at Q<sub>1</sub>, in which diodes Z<sub>1</sub> and D<sub>1</sub> are configured to supply a constant -5.6 v at its emitter. The voltage across potentiometers R<sub>3</sub> and R<sub>6</sub> thus may vary between two references, one at -5.6 v and the other at -0.6 v, so that the input to the comparator can vary between -5 v and ground.

When the input voltage, as set by the meter, exceeds the high or low reference, the appropriate output of the LM319 fires and switches either transistor Q<sub>4</sub> or Q<sub>5</sub>, which closes the proper relay.

The high and low reference points may be set by using the meter. Switching switch S<sub>1</sub> to P<sub>1</sub> removes the metering circuit from the input signal, and the meter then displays the high-point reference voltage, which can be adjusted by R<sub>3</sub>. With S<sub>1</sub> moved to position P<sub>2</sub>, the desired low-level voltage may be adjusted with potentiometer R<sub>6</sub>.

The voltage drop across zener diode Z<sub>1</sub> and the

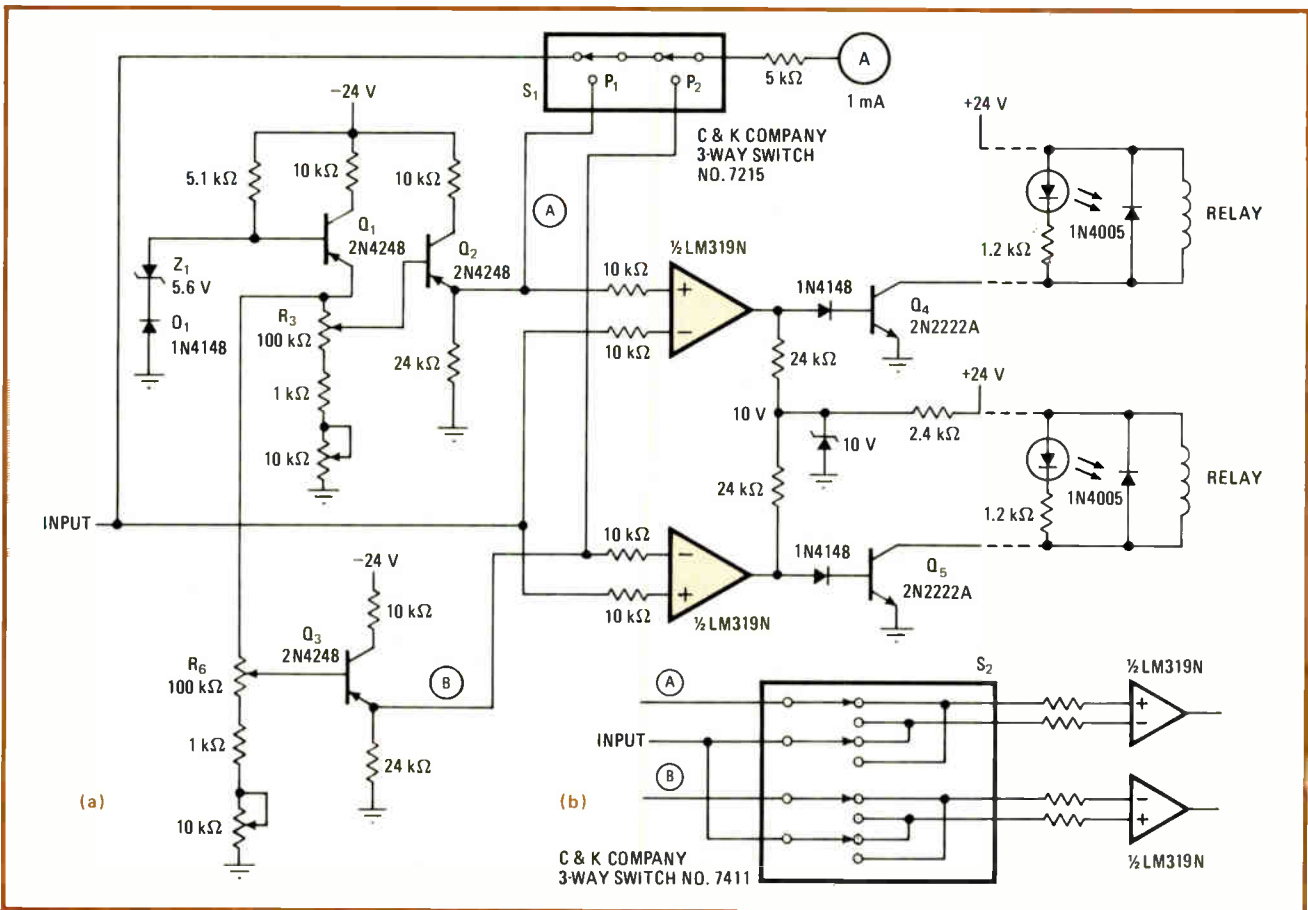

**Mechanical to electrical conversion.** Implementation of dual-set-point meter using standard meter and comparator circuits (a) is low-cost and reliable. When a three-way switch is added to circuit (b), double high and low set points can be set.

# TI's new 16K EPROM programmed here.

Texas Instruments has a new EPROM, the 16k TMS-2716.

And Pro-Log has a Personality Module to program it.

The TMS-2716 is an enlarged version of the popular 2708, and programs exactly the same. Because of its pin compatibility with the 2708, the new TMS-2716 allows users to double memory size without extensive circuit revisions and thus add creative innovations to their products. Its erasability means quicker turnaround on design and program corrections.

The TMS-2716 EPROM is priced at \$54.75 in 100-unit quantities.

Pro-Log's TMS-2716/2708 Personality Module, when used with Pro-Log's stand-alone Series 90 PROM Programmer master control unit, will program, list, duplicate and verify not only the TMS-2716 but the 2708/L08 as well. The dual TMS-2716/2708 Personality Module can also be used with Pro-Log's single button Series 92 Peripheral PROM Programmer/Duplicator master control unit.

The TMS-2716/2708 Personality Module utilizes Pro-Log's innovative programming technique whereby blocks of from one to sixteen words can be programmed in as little as 2.5 seconds after keying is complete.

The master control units are microprocessor-based and lead users step-by-step through each programming operation to make successful programming easy.

A TMS-2716/2708 Personality Module (PM9053) costs \$450. Courtesy of TI, Pro-Log will supply a free TMS-2716 EPROM with each of the first 100 modules purchased.

A Series 90 master control unit costs \$1,800.

A Series 92 master control unit, including a TTY interface, is \$995.

PROM Programmer options include TTY, paper tape reader, parallel I/O, RS232 and CMOS RAM buffer.

Pro-Log also has PROM Personality Modules for virtually all popular MOS and bipolar PROMs.

For more information contact Pro-Log Corporation, 2411 Garden Road, Monterey, CA 93940, phone (408) 372-4593.



**PRO-LOG**  
CORPORATION

**Microprocessors at your fingertips.**

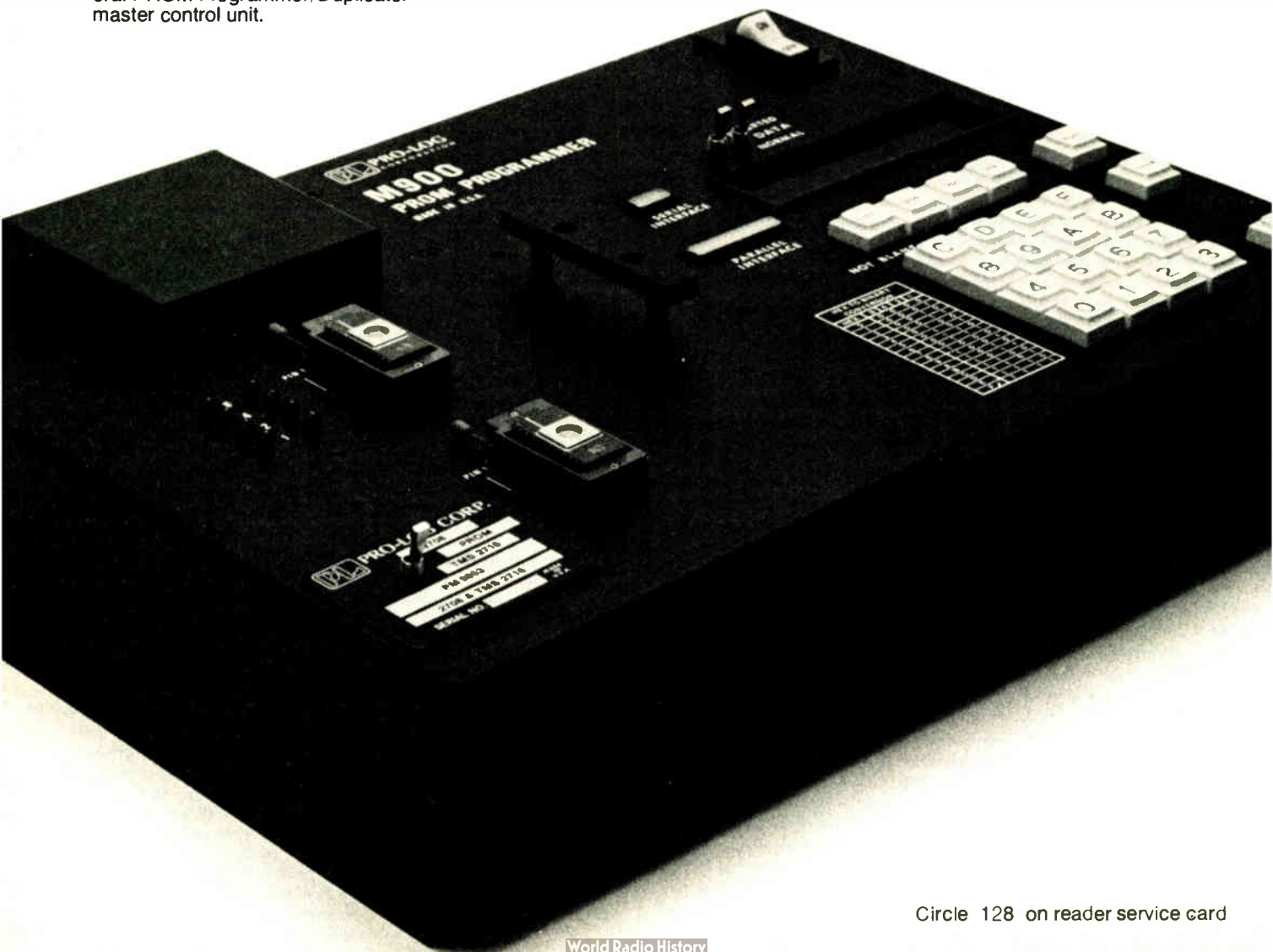

Circle 128 on reader service card



number of standard diodes ( $D_1$ ) determines the range of reference voltages possible. Reversing diode polarities and changing  $Q_1$ ,  $Q_2$ , and  $Q_3$  to npn devices produces positive reference voltages.

To establish double high set and low set points, a four-pole, three-way toggle switch is placed in the path of transistors  $Q_2$  and  $Q_3$  and the input of the op amp, as the lower part of the figure shows. □

## High-impedance op amp extends 555 timer's range

by Ronald Zane  
University of California, Los Angeles, Calif.

The period of oscillation of the 555 timer can be increased 20 times or more if the timing components are replaced by a feedback loop containing a transistor and a very-high-impedance input operational amplifier configured as an integrator. The circuit is an inexpensive way of generating timing periods of hours or days to control industrial processes, to turn on lights in the home for burglar protection, and for like applications.

As shown in the figure, resistor  $R_5$  and capacitor  $C$  combine with the CA3140T op amp to make the integrator that controls the period of oscillation in the 555. The very low offset current of this op amp (typically 3 picoamperes but no greater than 30 pA) permits accurate integration of very low input currents (100 pA). Thus it ensures excellent control over the actual oscillation times.

The timer, operating in its astable-multivibrator mode, produces a change of state at pins 3 and 7 each time the input signal requirements are met at the threshold and trigger ports of the device. The output moves low when the input at the threshold terminal is greater than two thirds the supply voltage  $V_s$ . It stays low until the trigger input detects decay of the input signal's voltage to less than one third of  $V_s$ . Then the output assumes a high state.

Transistor  $Q_1$  switches in accordance with pin 7 of the

555; point  $E_1$  will be at ground when  $Q_1$  is on, and at  $V_s/2$  when  $Q_1$  is off, because of the voltage divider made up of  $R_1$  and  $R_2$ . The voltage at  $E_2$ ,  $V_s/4$ , is determined by the divider made up of  $R_6$  and  $R_7$  ( $R_1$ ,  $R_3$ , and  $R_4$  in series hardly affect the calculation).

When  $Q_1$  is on, the current through  $R_5$  at the inverting input of the op amp is thus:

$$I = \frac{(V_s/2 - V_s/4) R_4}{R_5(R_3 + R_4)} = \frac{V_s R_4}{4R_5(R_3 + R_4)}$$

and when it is off, the current is:

$$I = \frac{(0 - V_s/4) R_4}{R_5(R_3 + R_4)} = \frac{-V_s R_4}{4R_5(R_3 + R_4)}$$

The magnitudes of these currents are the same. The integrator then operates on this input current. Because its output is  $E_3 = dV_s/dt = I/C$  by definition, and because  $E_3$  switches between one third and two thirds of the supply voltage each cycle, the oscillator's period is:

$$t = \int_{1/3}^{2/3} \frac{C}{I} dV_s = \frac{8(R_3 + R_4) R_5 C}{3R_4} = 50 R_5 C$$

The low offset current of the op amp allows  $R_5$  to assume values in the hundreds of megohms. Even when  $R_5$  equals 110 M $\Omega$ , the current through it is 1.8 nanoamperes, far exceeding the op amp's offset current.

If  $R_5$  is 110 M $\Omega$  and  $C$  is 1 microfarad, the 555's period is 5,500 seconds. Since  $R_5$  and  $C$  can be increased, periods of 10 hours or more may be realized with inexpensive components. If a 510-M $\Omega$  resistor and a 10- $\mu$ F capacitor is used in the integrator, the oscillation period will be 70 hours. The bare 555, which may use a maximum timing resistance of 20 M $\Omega$ , coupled with a 10- $\mu$ F capacitor for its timing capacitance, would have an oscillation time of only 280 seconds. □

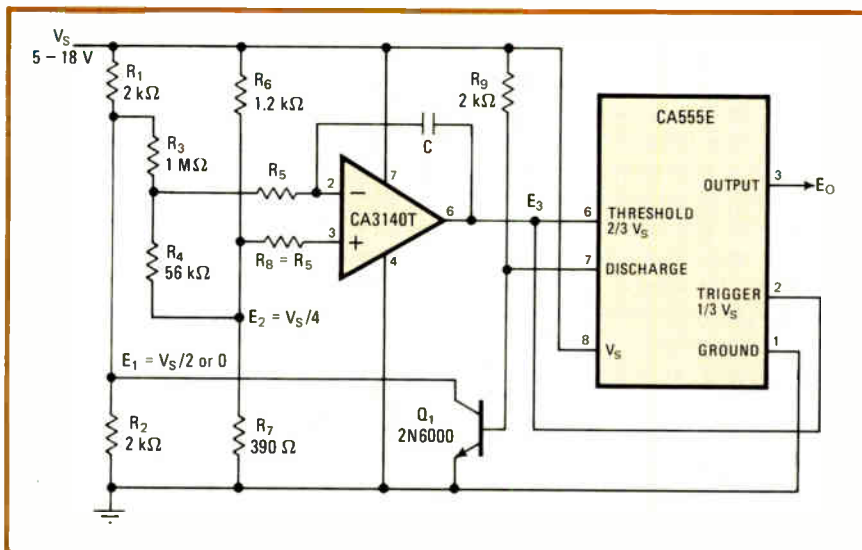

**Time-magnification.** Oscillation frequency of a 555 may be lowered 20 times or more if a low-input-current, integrating op amp is used to replace timing components. One oscillation every few days is possible if a high-value capacitor,  $C$ , is used in integrator.

# Analog output chips shrink a-d conversion software

When microprocessor systems use the new devices, it becomes easier to create a low-cost program for analog-to-digital conversion

by Andrij MROZOWSKI, *Burr-Brown Research Corp., Tucson, Ariz.*

□ The most economical way of digitizing analog inputs to a microprocessor-based data system is not always the easiest. For example, when software can be used for the conversion logic, it keeps hardware costs attractively low but is often discouragingly extensive. Still, even designers with little programming know-how can adopt the approach if they use either of two new microprocessor output units that shrink the software to manageable proportions.

Of course, putting the conversion logic into software is practical only under two conditions. The analog inputs to the data system must be few, and its conversion speed must be relatively slow.

The MP10/11 analog output units work with most of

the popular microprocessor chips [*Electronics*, May 26, p. 106]. Completely self-contained, they incorporate a pair of 8-bit digital-to-analog converters, address decoding, and control logic.

## Simple hookups for the 8080 and 6800

Under microprocessor control, either unit may be made to perform simultaneously as both a d-a converter and a successive-approximation a-d converter. For this kind of operation, one of the device's two channels provides its normal analog output, while the other channel, in conjunction with a comparator, handles the analog input data.

Figure 1 shows the hardware implementation for the

**1. Trimming hardware costs.** Implementing a successive-approximation routine in software saves the expense of an analog-to-digital converter in microcomputer data systems. With minimal software, a single two-channel analog output unit (the MP10 or MP11) simultaneously delivers analog output data and converts analog input data for Intel's 8080 (a) or Motorola's 6800 (b) microprocessor family of chips.

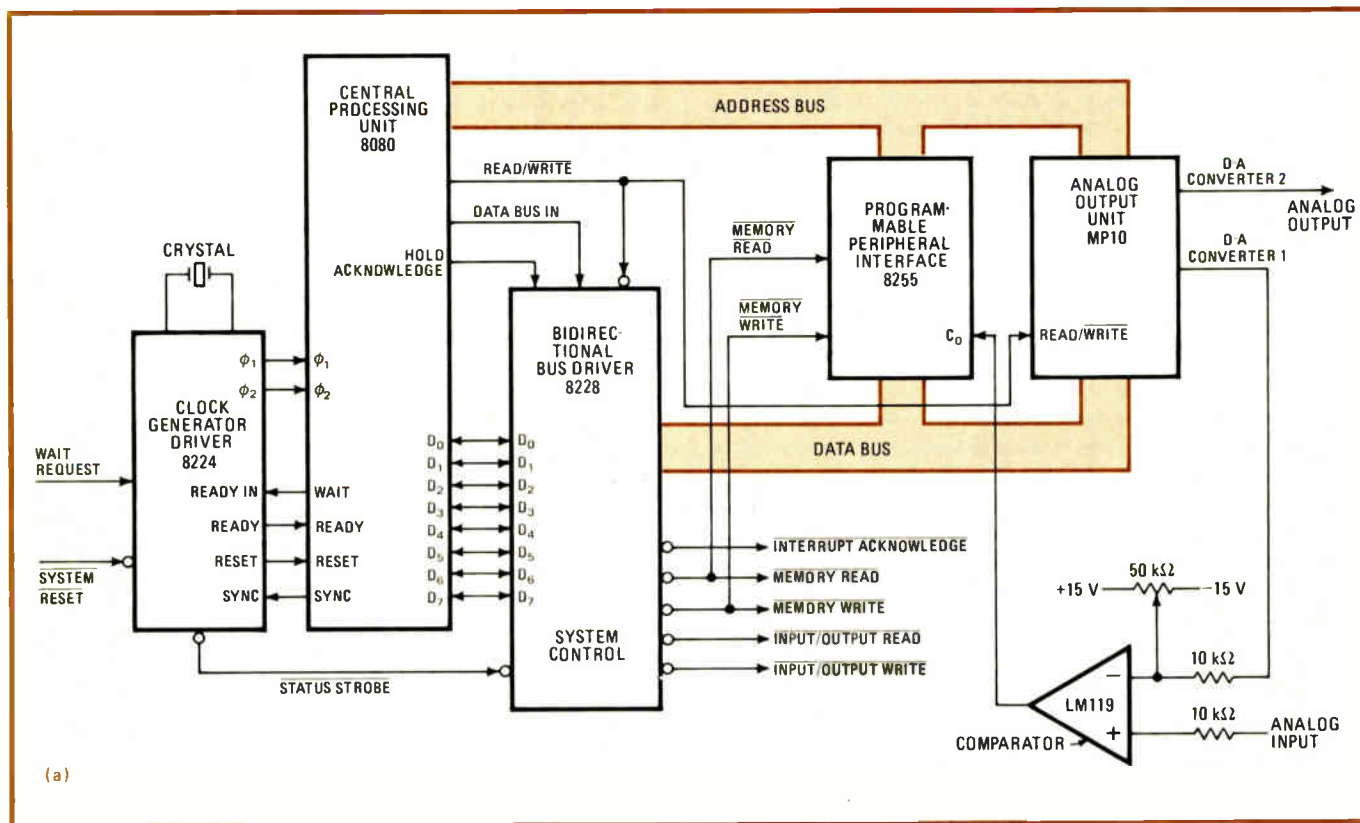

MP10 with the 8080 (a) and the MP11 with the 6800 (b). In each case, the successive-approximation logic for the a-d conversion is done in the software.

Essentially, this is how it works. In a successive-approximation a-d conversion, the analog input is compared to known outputs of a d-a converter. To do this, the microcomputer first turns on the most significant bit of the digital data, then waits for the outputs of the d-a converter and comparator to settle, and lastly reads the status of the comparator output.

If the comparator indicates that the MSB voltage is smaller than the analog input, the MSB input to the d-a converter stays on, and the microcomputer turns on the next MSB. If the comparator indicates that the MSB value

is larger than the analog input, the microcomputer turns this MSB off and the next MSB on. The cycle repeats until all 8 bits of the d-a converter have been tested.

When the conversion is complete, the input to the d-a converter will be a digital representation of the analog input signal. Also, the microprocessor stores this digital value in its accumulator register.

### Minimal software necessary

The program (Fig. 2) for the MP10 working with the 8080 is intended to be used as a subroutine. It is 51 bytes long and executes in under 90 microseconds if the microprocessor cycle time is 500 nanoseconds. Before employing this subroutine program, the user must

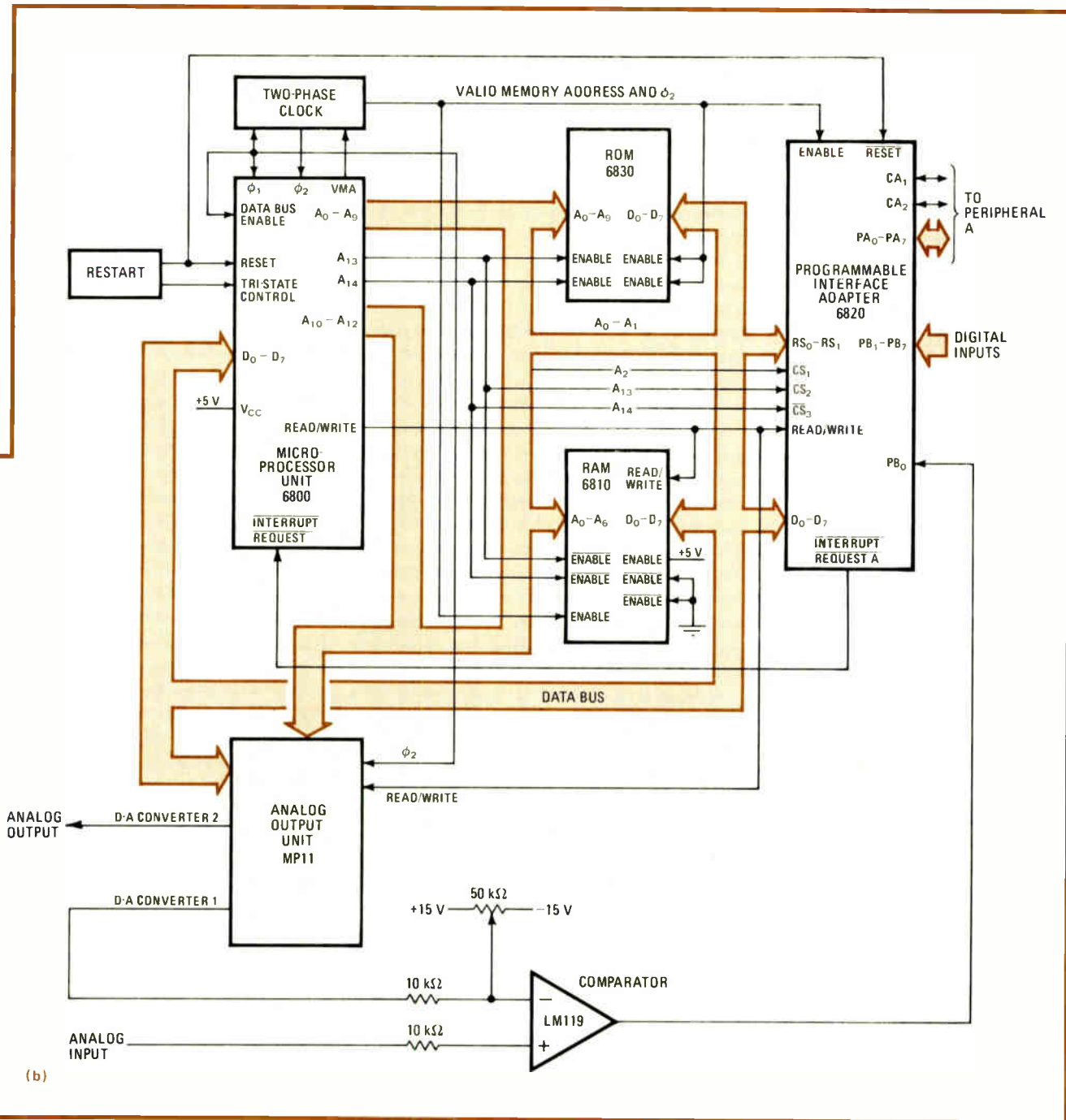

FLOW CHART

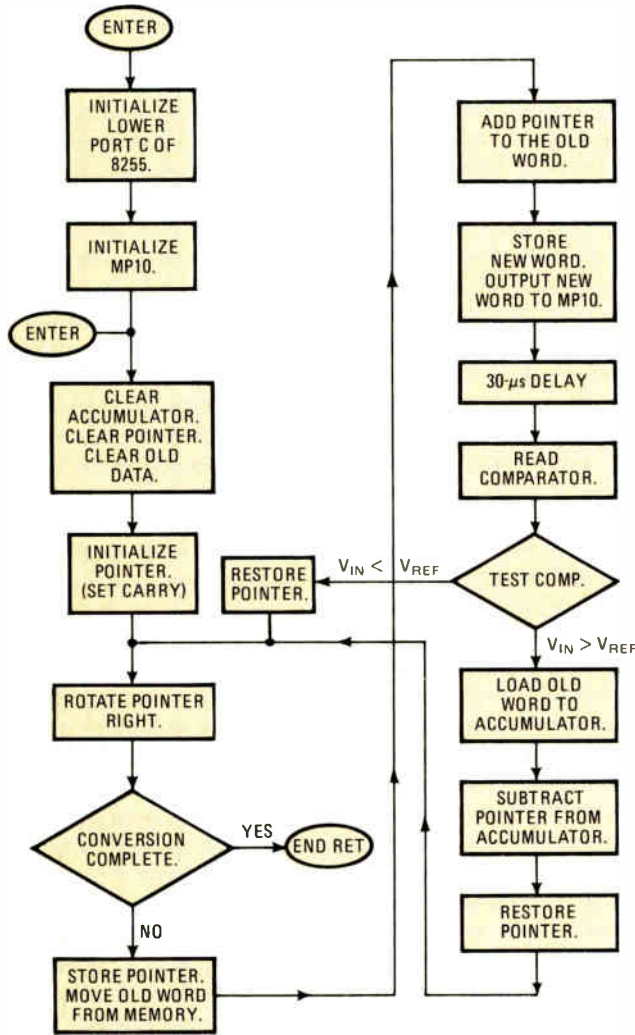

PROGRAM

```

8080 MACRO ASSEMBLER VER 3.0
MVI A,81H
STA ADDR1,SET PORT C LOWER AS INPUT
MVI A,80H
STA ADDR2,INITIALIZE MP10
XRA A ,CLEAR ACC
MOV E,A ,POINTER
MOV M,A ,OLD RESULT
STC ,INITIALIZE POINTER
LOOP1:RAR ,ROTATE POINTER
MOV E,A ,STORE POINTER
JC END ,CHECK IF LAST BIT COMPARED
MOV A,M ,MOVE OLD WORD FROM MEMORY
ADD E ,ADD POINTER TO THE OLD WORD
STA ADDR3,STORE NEW WORD
STA ADDR4,OUTPUT DATA TO MP10
MVI E,04H,INITIALIZE DELAY LOOP
LOOP2:DCR B
JNZ LOOP2
LDA ADDR5 ,READ OUTPUT OF THE COMPARATOR
ANI 01H ,CHECK OUTPUT OF THE COMPARATOR
,COMPARATOR OUTPUT=0 WHEN VIN<VREF
,COMPARATOR OUTPUT=1 WHEN VIN>VREF
JNZ LOOP3 ,Z=0 INC SAR
,Z=1 DCR SAR
MOV A,E ,RESTORE POINTER
JMP LOOP1
LOOP3: LDA ADDR3
SUB E ,NEW WORD-POINTER
STA ADDR3 ,STORE NEW WORD
MOV A,E ,MOVE POINTER TO ACC.
JMP LOOP1
END: RET ,RETURN TO CALLING ROUTINE
END
    
```

2. For the 8080. Successive-approximation subroutine for the 8080 microprocessor and the MP10 analog output unit executes in 833 microseconds. The user may reduce this by about 20 μs by moving the initialization to the microprocessor's monitor program.

specify the following mine program instructions:

- ADDR1, the initialization address of the programmable peripheral interface—one bit of this device's lower port C may be dedicated as an input to read the output from the comparator.
- ADDR2, the initialization address of the MP10.
- ADDR3, the memory location where the final result is stored.
- ADDR4, the address of the MP10's d-a converter to be used in the successive-approximation routine.
- ADDR5, the address of the lower port C of the programmable peripheral interface.
- Loop 1, a JUMP address.
- Loop 2, a JUMP address.
- Loop 3, a JUMP address.
- END, the address of the return (RET) instruction.

Of course, the positions of the JUMP addresses depend on where the program is stored. The user may remove the initialization portion of the subroutine and store it in

the microprocessor's monitor program, so that the programmable peripheral interface and the MP10 need not be initialized every time the subroutine is executed. This will save about 20 μs of execution time.

**Delay time depends on comparator speed**

The comparator should have a slew rate of at least 6 volts/μs in order to work with the 30-μs delay called for in the program. If the comparator is slower, the user may easily modify the delay routine by changing the value of N in the MVI B instruction. N, which is set equal to 4 in this example and stored in the 8080's register B, indicates how many times the delay loop must be iterated for all signals to settle properly. For the MP10 program:

$$N = \frac{(25 \mu s) + (\text{comparator slew rate})}{7.5 \mu s}$$

The delay time, then, is simply:

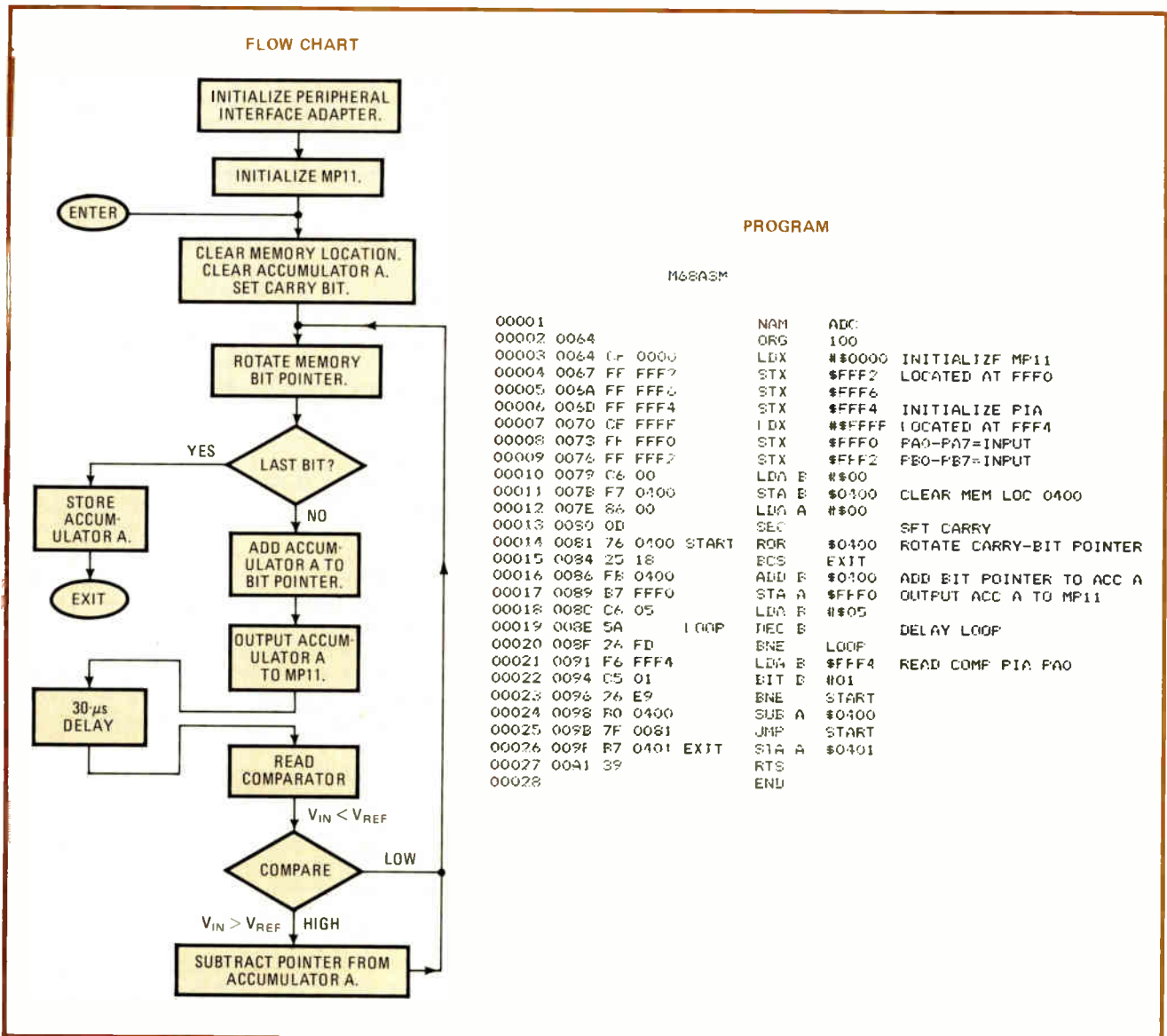

**3. For the 6800.** Subroutine dubbed ADC acts as successive-approximation register for the 6800 microprocessor and the MP11 analog output unit. Execution time, which is about 630 microseconds for this program, may be decreased by 36  $\mu$ s if the MP11 is initialized on power-up.

$$T_{\text{delay}} = (7.5 \mu\text{s}) \times N$$

Then the total conversion time becomes:

$$\text{total conversion time} = (593 \mu\text{s}) + (8 \times T_{\text{delay}})$$

Therefore, extending the delay from 30 to 50  $\mu$ s will increase the execution time from 833 to 993  $\mu$ s, permitting a comparator with a slew rate of 1 V/ $\mu$ s to be used.

### Working with the 6800

Similarly, the program for the MP11 and the 6800 (Fig. 3) is also intended to be used as a subroutine—one named ADC and stored at memory location 0100. Here, the microcomputer's programmable interface adapter is located at address FFF4, while the MP11 is at FFF0. Memory location 0400 stores a bit pointer, and memory location 0401 will contain the final result.

If the MP11 does not have to be initialized every time subroutine ADC is called, execution time may be reduced

by 36  $\mu$ s. Otherwise, execution time may be calculated from:

$$\text{total conversion time} = (390 \mu\text{s}) + (8 \times T_{\text{delay}})$$

where:

$$T_{\text{delay}} = (6 \mu\text{s}) \times N$$

As in the MP10 program, the value of N depends on the speed of the comparator and is stored in register B of the microprocessor. However, for the MP11 program, N may be computed from:

$$N = \frac{(25 \mu\text{s}) + (\text{comparator slew rate})}{6 \mu\text{s}}$$

To sum up, then, in a small system where only one analog input is needed and where conversion time is not critical, the MP10/11 analog output units can make it much simpler to realize a software successive-approximation register.  $\square$

## Transistor sensors provide reliable temperature control

by M. W. S. Thomas  
Hydraulics Research Station, Wallingford, Oxon., England

The known voltage-to-temperature relationship at a transistor pn junction allows it to be used as a low-cost sensing element for temperature-control circuits. With constant current through the transistor, the base-to-emitter voltage,  $V_{be}$ , varies linearly with temperature. Because the thermodynamic relation for energy transfer between two or more bodies also is linear in this case, an easy design procedure using these simple equations can be developed for heat-transfer applications.

The method is best explained by an example that shows how a circuit may be designed for temperature monitoring and control in a central heating system. A boiler initially operating at  $82^\circ\text{C}$  ( $T_b$ ) is to maintain a room temperature ( $T_r$ ) of  $21^\circ\text{C}$  when the outside temperature ( $T_a$ ) is  $0^\circ\text{C}$ . Thus the heat lost by the room to the outside must be transferred to the room by the boiler. This leads to the heat equation:

$$T_b - T_r = K(T_r - T_a) \quad (1)$$

where  $K$  is defined as the system constant. Substituting the initial temperature values, the value of  $K$  is determined to be approximately 3, and the equation becomes:

$$T_b - 4T_r + 3T_a = 0 \quad (2)$$

Although the constant was determined by the initial temperatures, this equation is valid for an infinite number of temperature combinations of  $T_a$ ,  $T_b$ , and  $T_r$ .

It is necessary to transform the heat equation to an electrical equation. This can be accomplished if equal and opposite terms are added to (2),  $T_b$ ,  $T_a$ , and  $T_r$  are set equal to each other—permissible from (2)—and  $T_c$  is defined as the desired room temperature. This yields the equation:

$$8T_c - T_b - 4T_r - 3T_a = 0 \quad (3)$$

This equation can be solved electronically by an inverting summing amplifier, as shown in the figure, if all temperatures at the transistor pn junctions can eventually be expressed by their corresponding voltages. Since this relationship is known, the equation to be solved is of the form:

$$V_o = K_1(8T_c - T_b - 4T_r - 3T_a) \quad (4)$$

where  $V_o$  is zero volts at thermal equilibrium and  $K_1$  is a constant. The summing amplifier's output voltage is:

$$V_o = -R_{fb} \left[ \frac{V_{cc}}{R_c} - \frac{V_{ob} + V_b}{R_b} - \frac{V_{or} + V_r}{R_r} - \frac{V_{oa} + V_a}{R_a} \right] \quad (5)$$

Neglecting the amplification factor, it is necessary to match the coefficients of all terms in (4) and (5), as both are equal to  $V_o$ , to find the value of the gain-controlling resistance elements  $R_{fb}$ ,  $R_a$ ,  $R_b$ , and  $R_r$ . This may be done by grouping the constant and the temperature-dependent terms of (5) together. This yields:

$$V_o = -R_{fb} \left[ \left( \frac{V_{cc}}{R_c} - \frac{V_{ob}}{R_b} - \frac{V_{or}}{R_r} - \frac{V_{oa}}{R_a} \right) - \left( \frac{V_b}{R_b} + \frac{V_r}{R_r} + \frac{V_a}{R_a} \right) \right] \quad (6)$$

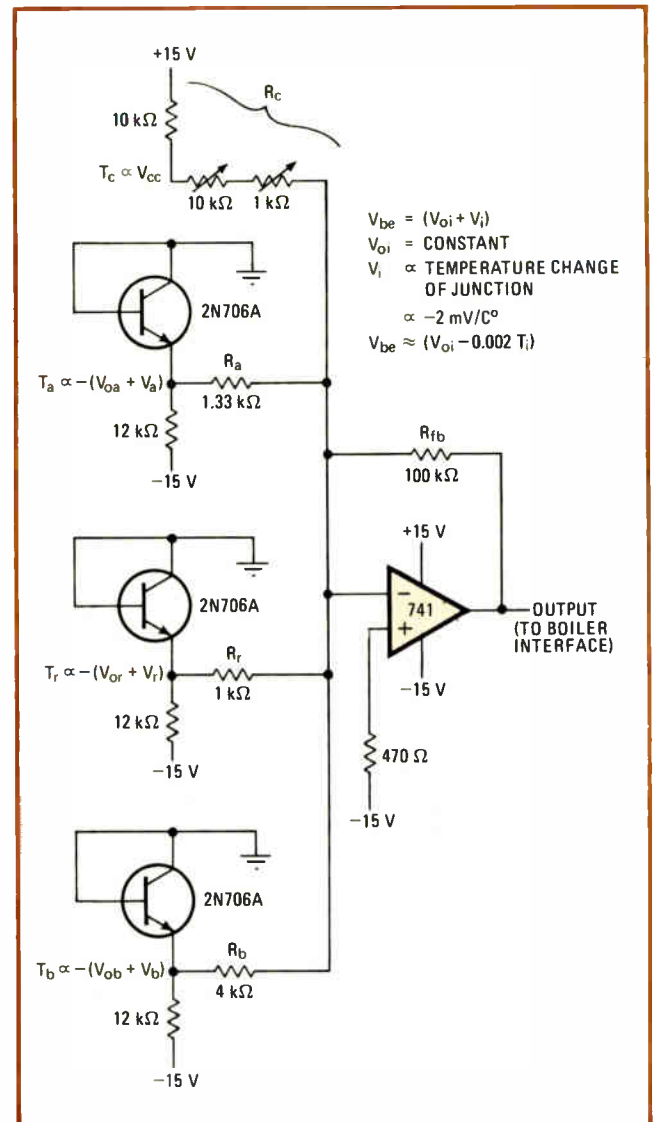

**Summing thermostat.** Operational amplifier output reflects sum total of changes in  $T_a$ ,  $T_b$ ,  $T_c$ , and  $T_r$ , informs boiler to increase temperature of room when necessary. System is linear over  $T_c$  range of  $4^\circ\text{C}$  to  $27^\circ\text{C}$ . Accuracy of system is not appreciably affected by op amp temperature or distances separating sensors.

If  $R_b = 100$  kilohms,  $R_a = 1.33$  k $\Omega$ ,  $R_b = 4$  k $\Omega$ , and  $R_r = 1$  k $\Omega$  for a  $V_{cc}$  of 15 v, the final equation is:

$$V_o = -25 \left( \frac{4C}{R_c} - V_b - 4V_r - 3V_a \right) \quad (7)$$

where  $C$  is a constant. The coefficients of (7) and (4) match and the heat equation is now equivalent to the electrical equation.

The circuit must now be calibrated to ignore the constant term. This is done by placing the three monitoring transistors in a container of pure water at the desired temperature (for example, 21°C), placing the 1-k $\Omega$  room-control potentiometer in  $R_c$  at the center of its range, and adjusting the 10-k $\Omega$  trimmer (also part of  $R_c$ ) for zero output voltage. The temperature of the bath may be changed to another temperature, say 15°C, and the 1-k $\Omega$  control adjusted for zero output again.

In both cases, the position of the pot is noted so that a

dial may be calibrated for it. Each transistor is then placed in contact with the boiler, the room temperature, or the outside, depending on its monitoring function. The op amp should be placed in an area that will not undergo major short-term variations in temperature. The temperatures  $T_a$ ,  $T_b$ ,  $T_c$ , and  $T_r$ , once determined, are constant for a relatively short time because of environmental changes that may affect personal preferences. Once calibrated, the circuit will maintain  $T_c$  for any variance in any variable including the only truly independent variable in the system,  $T_a$ .

The output of the op amp will be zero when  $T_c = T_r$  for any boiler or outside temperature. When  $T_c$  is greater than  $T_r$ , the output of the op amp should be positive, and the boiler should turn on, raising its temperature. A suitable interface will be needed to drive the boiler solenoid, which should not respond when the output voltage is negative. □

## Pulsed low-power source energizes solenoids and relays

by Tom Rogers

United Telecommunications Inc., Shawnee Mission, Kan.

Simultaneously activating the track switches of a model railroad from just its standard low-voltage power supply is a neat hobbyist's trick. But the circuit that makes it possible also can serve in any application where low-power sources must supply tremendous currents for activating mechanical-latch solenoids and relay coils. The circuit stores the source's energy and releases it in a burst through those devices.

The source—in this case a 20-volt supply—is stored on a capacitor and then discharged instantaneously through a low-resistance inductor. The unit's operation is analogous to that of a strobe circuit, where a blinding light is produced by storing a small voltage on a capacitor and quickly discharging it to form a pulse of energy.

The supply typically provides only 6 volt-amperes—barely enough to supply the required current to one switch, and certainly not enough to operate larger switches. But, with capacitor  $C_1$  included as shown in the figure, large currents may be produced. The 20-v ac or dc input from the accessory terminals of the power

supply charges  $C_1$  through lamp  $L_1$  and diode  $D_1$  in the half-wave rectifier circuit.

The lamp resistance limits the charging current to approximately 120 milliamperes and is also used as a charging indicator. When the capacitor voltage is approximately equal to the peak value of the input voltage, the lamp is extinguished. The energy stored in the capacitor at this time is about 3.5 joules.

One of the external momentary-contact push buttons may now be depressed. The capacitor will discharge through the appropriate low-resistance relay coil. The instantaneous current through the coil will be very great for a few microseconds, enough to switch the relay but not long enough to damage its coil. Diode  $D_2$  provides protection for the capacitor by preventing the coil's counter-electromotive force from appearing across it.

The energy stored by the capacitor may, of course, be increased by raising the value of capacitance or input voltage ( $E = CV^2$ ). The current produced as the capacitor discharges will be directly proportional to the energy stored.

Recharging the capacitor is accomplished in three seconds or so. Charging currents, and thus charging times, are easily changed by substitution of appropriately rated lamps for the one used in this circuit. If the charging current is kept low enough, other devices connected to the power supply will not be affected by this circuit's operation.

The circuit also suits applications where it is necessary

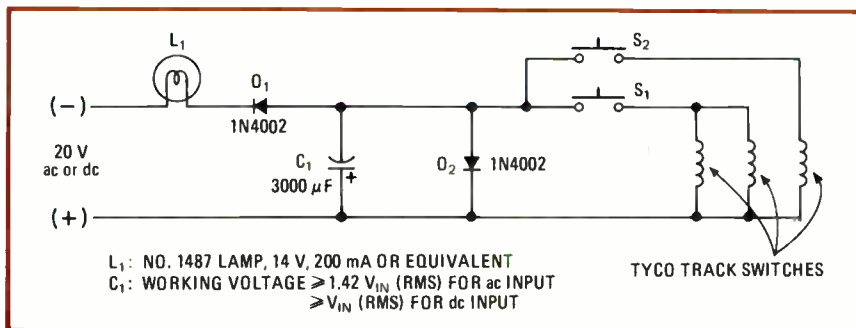

**High-current pulser.** Energy in low-power source is stored on capacitor, then released to provide latch-type relays with high-current pulse. Lamp is charging indicator and limits current to relays in applications where small continuous current is necessary.

to keep the external switches closed after the initial switching pulse has been applied. The holding current will be much less than the initial current, and the current supplied continuously will be a function of the lamp, coil,

and diode (forward) resistances. The limited current should not overheat the transformer or the coil might be damaged. Holding currents for the particular solenoid can be supplied by the manufacturer. □

## Pulsed-voltage measurements check LED quality

by Terence Klein  
Xcitor, Latham, N.Y.

The suitability of a light-emitting diode for high-pulse-current applications can be easily determined by a test that measures the voltage drop across the LED at high currents. The use of a pulsed constant-current source to drive the diode and determine its high-current capacity subjects neither it nor the user to the "smoke test," yet the resulting voltage drop across the LED may point up the existence of an internal fault, such as a high-resistance pn junction, a substrate fracture, or a shunt path around the junction. The results of the measurement are independent of LED optical properties.

As shown in the figure, a Darlington amplifier using a MPSU95 device provides a current to a test LED through the AD7510DIKN quad analog switch. The current source is adjustable from 0 to 100 milliamperes. A 555 timer configured as an astable multivibrator drives a second timer, and the combination provides adjustable duration time and repetition rates for switching all analog gates simultaneously.

The outputs of three of the analog gates, each having an on resistance of 75 ohms, are tied together to reduce the equivalent impedance to 25 Ω, to minimize the

voltage drop across the gates during conduction. Capacitor C<sub>1</sub> is connected across the LED when the gates are on; thus the voltage across the capacitor is the peak voltage of the diode under test.

This voltage is applied to the noninverting input of the 741 operational amplifier. The op amp is a unity-gain buffer, so that even low-impedance voltmeters may be placed across its output for measuring the LED's voltage (a digital voltmeter is preferable, however).

Once the user knows the test specifications of the diode, he makes a one-time adjustment of the duration time and repetition rate with an oscilloscope (for many tests, this could be 30 microseconds at 1 kilohertz). The next step is to calibrate the current source by placing an ammeter in series with the calibrating terminals. The resultant voltage across the LED can be measured with a DVM set at its fastest sampling mode.

Diodes likely to fail in an actual circuit from high resistance, substrate fracture, or die-casting faults might produce much higher voltages than expected. Low voltage drops across the LED for a specified current could be the result of shunt paths surrounding the pn junction.

If care is taken in minimizing circuit ground-point differences, and if the 741's output voltage is trimmed to zero after shorting the op amp's socket terminals during pulsed measurements (to zero out the effects of lead drop), this method of measuring the voltage across an LED easily yields an accuracy greater than 1%. □

Engineer's notebook is a regular feature in *Electronics*. We invite readers to submit original design shortcuts, calculation aids, measurement and test techniques, and other ideas for saving engineering time or cost. We'll pay \$50 for each item published.

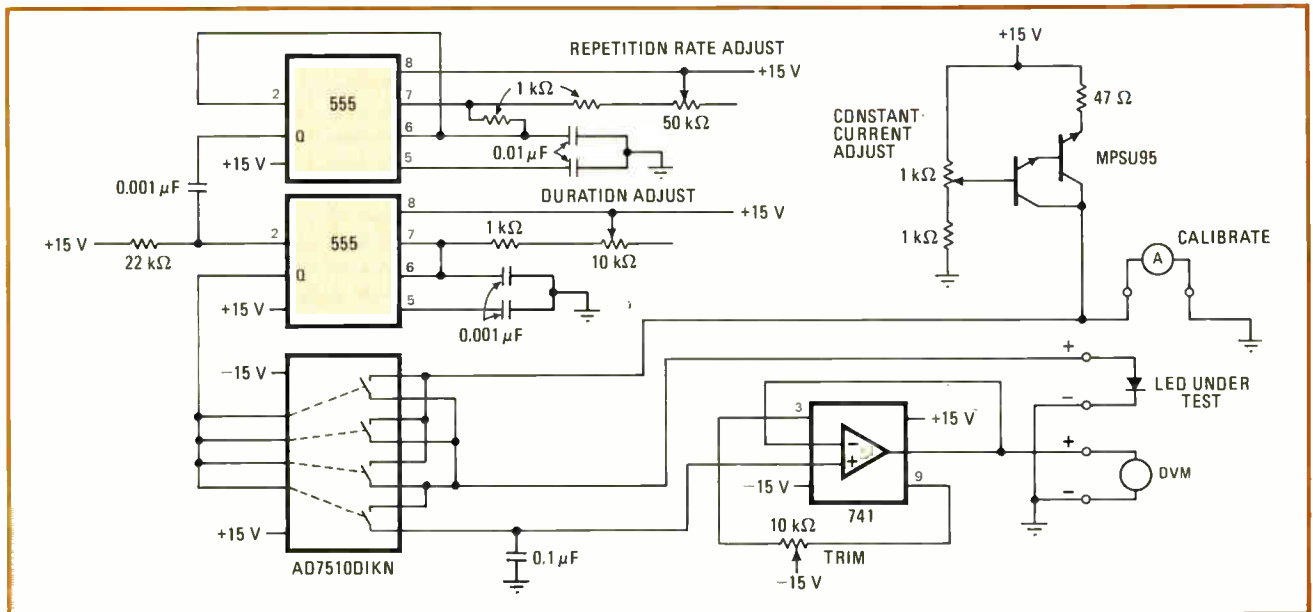

**Fast and accurate.** Quality-control determination is obtained at low cost by observing DVM directly in lieu of time-wasting oscilloscope measurements, which are subject to errors of judgment by the observer. DVM reading may indicate faults in diode's pn junction.



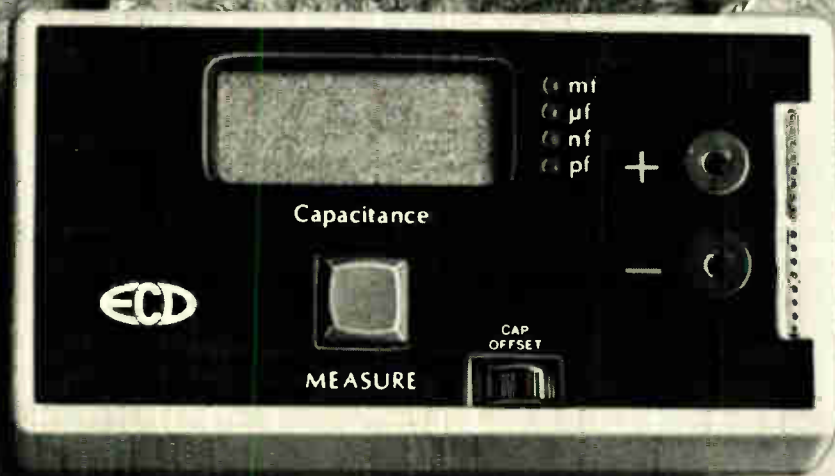

## My shirt, yes...my C-Meter, no.

Test the kind of guy who'll give you the shirt off his back: ask him for his C-Meter.<sup>®</sup>

He knows that his C-Meter gives him a definite edge. It exposes an obvious efficiency: capacitors are easier to measure than resistors.

No more twiddling and nulling. No need for expensive, tight-tolerance capacitors or tweak pots. With its pushbutton speed, high accuracy (0.1%), small size

and versatility (0.1 pf to 0.2 farads), the C-Meter makes you a more productive engineer.

You owe it to yourself to try one on. It'll cost no more than a fine suit: stocked locally at only \$289.00.

ECD CORP.  
196 Broadway, Cambridge  
Mass. 02139 (617) 661-4400



Visit us at Electro '77, Booth #1311

SALES OFFICES: AL, Huntsville (205) 534-5896; AZ, Scottsdale (602) 947-7841; CA, Costa Mesa (714) 540-7160; CA, Sunnyvale (408) 733-8690; CO, Denver (303) 750-1222; FL, Winter Haven (813) 294-5815; GA, Chamblee (404) 457-7117; IL, Elk Grove Vill (312) 593-0282; IN, Indianapolis (317) 293-9827; MD, Silver Spring (301) 622-4200; MA, Burlington (617) 273-0198; MN, Minneapolis (612) 781-1611; MO, Kansas City (816) 358-7272; NJ, Camden (215) 925-8711; NM, Albuquerque (505) 299-7658; NY, Great Neck (516) 482-3500; (212) 845-7177; Syracuse (315) 446-0224; NC, Raleigh (919) 787-5818; OH, Centerville (513) 433-8171; TX, Houston (713) 688-9971; TX, Richardson (214) 231-2573.

## **A couple of meters can find shorts in pc gate inputs**

Why remove integrated circuits or, worse, cut etched connections from a printed-circuit card when trying to determine which of a number of paralleled gate inputs has a short to ground? **It's faster and nondestructive if you use a volt-ohmmeter and digital voltmeter to measure the small voltage drop associated with the short**, says Martin Ewing of the California Institute of Technology in Pasadena, Calif. (An ohmmeter alone won't do, of course, because of the low impedances involved.)

Set a volt-ohmmeter, such as the Simpson 260, to its  $R \times 1$  scale, and connect it between the node in question and ground, providing a constant current of about 100 milliamperes. Then use the DVM (say, an HP3476) in its millivolt range to probe the etched wiring and pinpoint the defective gate input. **You simply note the location of increased voltage drop brought about by high current through the portion of the etched wiring adjacent to the shorted gate.** Typical etched connections produce a voltage drop of about 1 mv per inch with these currents, so useful results can also be obtained with partial shorts up to nearly 100 ohms.

## **Bargain basement for GaAs FETs— well, almost**

Now that gallium-arsenide X-band power field-effect transistors at 1 watt and above are available from multiple sources, **prices of these costly devices are starting to come down.** One supplier, Texas Instruments Inc., plans to cut prices by 75% on its 1-w 8-gigahertz GaAs FETs. For example, the TI MSX 803, a device selling for \$1,000 in small quantities, will be slashed to \$250. Other manufacturers of 1-w and above devices—RCA Corp., Microwave Semiconductor Corp., and Japan's Nippon Electric Corp. and Fujitsu Ltd.—all plan to follow suit.

## **Signal-driven exclusive-OR gate detects state changes**

An exclusive-OR gate can detect a change in state of a logic signal more conveniently than can a one-shot, says N. Ghani of the Computer Laboratory at Newcastle University, Newcastle-upon-Tyne, England. A one-shot can directly sense state changes in only one direction, so additional circuitry is needed to handle both positive and negative changes. **But a quad 7486 exclusive-OR gate, driven by the signal and its delayed version, can sense both types of changes,** Ghani says.

Three of the gates can be used as inverters producing a delay. The fourth is in the exclusive-OR mode, taking in the signal and its delayed counterpart. Whenever the input changes state—whether it is positive- or negative-going—the 7486 will produce a narrow negative pulse with a width equal to the delay. If no inverters are used in producing the delay, then a positive pulse will be generated.

## **Don't raise the bridge; lower the river**

A roadblock to wider usage of film-carrier packaging of integrated circuits is that IC houses have not produced chips with the input/output pads required for bonding to the tape's copper interconnects. One solution is to **put the metallic bumps on the tape**, along the lines of a Pactel Corp. process. But the Westlake Village, Calif., firm could only supply the tape in strips, not in the large reels needed for IC assembly.

However, the Dyna Tape division of National Semiconductor's subsidiary Dyna-Craft Inc. will be able to deliver reels of a bumped film carrier by the year's end. There's no isolation between lead frames, so on-tape Testing is impossible. But in 1978, the Santa Clara, Calif., company will supply isolated lead-frame tapes on reels.

**Stephen E. Scrupski**

# NATIONAL ANTHEM



A Review of New Products and Literature from

National Semiconductor

## LM140/340: Better Specs At The Same Price

Our LM140 series of three-terminal voltage regulators now offers a combination of features that gives you a higher-performance part, but with no increase in its price.

For example, our LM140 boasts superb low-frequency ripple rejection under load—to 80 dB, typ., depending on the output voltage level; excellent high-current load regulation at high input voltages—0.60%/A; line regulation, 0.06%/V; output current capability in excess of 1 A (with an adequate heat sink for the TO-3 package); and very low thermal feedback effects. Of course, internal thermal overload protection, internal short-circuit current limiting, and output transistor safe area protection are also included.

Now look at our brand new LM340. We're the first manufacturer to offer this commercial part with line and load regulations identical to the MIL version, yet priced the same as competing, less-tightly-spec'd devices.

And we've made both the LM140 and the LM340 very easy to use—they need very few external components, and are available in a wide range of fixed outputs between 5 V and 24 V. Ask too, about our LM140A and LM340A; these feature tighter output voltage tolerances and even better line/load regulation than the LM140/340. 

## Protected CD4000's

Not all CD4020/40/60 CMOS counters have Schmitt triggers on the clock inputs. Ours do. And these Schmitts eliminate the problems commonly encountered on clock inputs in the competition's devices.

The CD4020B and CD4060B are 14-stage ripple-carry binary counters; the CD4040B is a 12-stage version. All advance one count on the negative transition of each clock pulse, reset to the zero state with a logical '1' at the Reset input (independent of the clock), operate between 3 V and 15 V, run at 8 MHz (at  $V_{DD} = 10$  V), and are low-power-TTL compatible (fan-out of 2 driving 74L, of 1 driving 74LS). 

## Support Circuits, Faster 8080A's Added

Less than one year ago we entered the 8080A marketplace with our INS8080A—a pin-for-pin, function-for-function replacement for you-know-who's MPU. But that was only the start. Since then we've added two more versions of that microprocessor, as well as a complete family of support circuits.

The new versions of our original 2- $\mu$ s cycle time INS8080A are the INS8080A-1, which has a 1.3- $\mu$ s cycle time, and the INS8080A-2, with a 1.5- $\mu$ s cycle time.

In addition to the faster 8080A's, we now offer ten types of interface circuits to support 8080A system design.

- DP8212 is an 8-bit  $\mu$ o port that you can use to implement all major peripheral and MPU  $\mu$ o system functions.
- INS8255 is a programmable peripheral  $\mu$ o interface that features direct bit set/reset capability.
- DP8301 is a microprocessor interface latch element (MILE) with on-chip status flags for 'handshake' control and interrupt generation. It drives TTL, NMOS, PMOS, and CMOS circuitry.
- DP8224 is a crystal-controlled clock generator and driver, which also provides a status strobe and oscillator outputs for external circuits.
- DP8228/8238 are system controller and bus driver circuits that generate all needed read/write control signals, provide drive and isolation for the 8080A's bidirectional data bus, and a user-selected single-level interrupt vector.
- DP8304 is an 8-bit bidirectional bus transceiver with high active outputs to both ports, a Tri-State<sup>®</sup> chip enable control, and transmit/receive control.
- INS8251 is a universal communications interface (USART) for data com-

munication in 8080A and other bus-structured systems. (Available in April.)

- DP8216/8226 are  $\mu$ o buffer drivers (4-bit parallel transceivers) suited to both 8080A and general MPU applications. (Available in April.) 



## Video Modulator for Display, Game Systems

Our LM1889 lets you display video information—from VTR's, games, test equipment, etc.—on any standard black-and-white or color television receiver, and also lets you encode composite video. In addition, the LM1889 together with our MM57100 and MM53104 form a complete video game system.

Consisting of sound and chroma sub-carrier oscillators, quadrature chroma

modulators, rf oscillators and modulators for any two low-band vhf tv channels, the LM1889 interfaces audio, color difference, and luminance signals to a tv receiver's antenna terminals.

The LM1889 features dc channel switching, a wide range of operating voltages, excellent oscillator stabilities, low intermodulation, and a 5- $V_{pk-pk}$  chroma reference signal. 

A Review of New Products and Literature from National Semiconductor

A

# Not Just Another Pretty Shift Register



We've added two National-proprietary circuits to our line of digital products—the DM86LS52 and DM86LS62 shift registers. But if you're thinking, "Ho hum, just another shift register," you're wrong. For in each 18-pin package there are two registers—an 8-bit serial type in parallel with an 8-bit I/O type.

Such a device is called an 8-bit dual-rank shift register. And what that means is that each package gives you a bidirectional circuit designed to interface parallel and serial bus lines. Thus, you can transfer 8-bits-wide parallel data to a serial line, and vice versa.

The DM86LS52 lets you synchronously clear the registers, while the DM86LS62 lets you simultaneously transfer data between the serial and parallel registers.

To duplicate such functions with standard components would require about 13 packages; a single DM86LS52 or 62 does it all, and at about half the cost.

Specifics of these new bus-oriented registers include edge triggering on the positive transitions of the clock; pnp transistor inputs; input disable dominant over output disable; Tri-State® buffered, 8-bit common I/O pins; n-bit cascadability; 36-MHz (typ.) shift frequency; and 305 mW (typ.) power dissipation. 

## Second-Source 8-Bit D/A Converters

Our LMDAC08 and LM1508/LM1408 monolithic D/A converters are direct replacements for the DAC-08 and MC1508/MC1408, respectively, and carry very low prices in 100-up quantities.

These current-output D/A's feature high-speed operation (typical settling times to within  $\pm 1/2$  LSB are 100 ns for the LMDAC08 and 150 ns for the LM1508/LM1408); full-scale current matching to  $\pm 1$  LSB; and typical full-scale drifts of  $\pm 10$  ppm/°C (LMDAC08) and  $\pm 20$  ppm/°C (LM1508/LM1408). Excellent reference-to-full-scale current matching eliminates current trims.

Both the LMDAC08 and LM1508/LM1408 interface directly with DTL, TTL, CMOS, etc., logic levels. They operate between  $\pm 4.5$  V and  $\pm 18$  V, and dissipate only 33 mW, typical, at  $\pm 5$  V. 

## 8-Bit-Wide Tri-Safe™ PROMs Increase Memory Density



The DM74S470 (open collector) and DM74S471 (Tri-State®) PROMs are Schottky-clamped, 2048-bit memories organized 256 x 8. The DM74S472 (Tri-State) and DM74S473 (open collector) PROMs are also Schottky clamped, but are 4096-bit parts organized 512 x 8.

Although the word width is 8 bits—which, by the way, is ideal for MPU applications—these memories are housed in 20-pin DIPs only 0.3-inch wide. And this means that you get the increased memory density of 0.6-inch-wide designs, but at the better packing density of older, 4-bit-word designs in 0.3-inch-wide packages.

The combination of National's Tri-Safe™ programming and advanced, low-voltage titanium-tungsten fusing assures you of extremely high programming yields and the most reliable long-term stability you can buy.

The DM74S470/471 feature address access times of 60 ns (max.), while the DM74S472/473 have address access times of 65 ns (max.). The enable access time for all these parts is 30 ns, maximum. 

# BI-FET™, Integrating A/D Analog Building Block

BI-FET technology — an IC process pioneered and introduced by National Semiconductor more than a year ago (see *National Anthem*, January 1976)—combines JFET and bipolar transistors on the same chip. For our LF13300, BI-FET technology provides a unity-gain, high-input-impedance (>1000 MΩ) buffer, a comparator and integrator, and nine rugged JFET analog switches.

As a result, the LF13300's accuracy is sufficient for use in DPMs of up to 4½ digits, or in data acquisition systems of up to 14 bits plus sign. The LF13300 is in fact ideal for use with our ADB4500P BCD digital and ADB1200P 12-bit binary building blocks. (You're more familiar with these ADB parts per their older numbers—MM5330 and MM5863, respectively.)

In general, the LF13300 eliminates many discrete components and reduces system complexity. In particular, the LF13300 features automatic offset correction, an analog input range of ±11 V with ±15-V supplies, a supply range of ±5 V to ±18 V, and TTL- and CMOS-compatible logic.



# APPLICATIONS CORNER

## How to Build a Digital Thermometer

Analog electronic thermometers have been available for some time, but they are generally difficult to read and, besides, are relatively fragile. Digital thermometers, on the other hand, are both easy to read and rugged.

The digital thermometer described here uses a ADD2500 2½-digit DPM chip for A/D conversion and display decoding. The LM134 programmable current source operates here as the temperature sensor, and the LM555 timer as a dc/dc converter. The DS8866 and the pnp transistors drive the NSB3882 display.

The LM134 makes an excellent temperature sensor: it has a constant temperature coefficient of +0.30%/°C (0.167%/°F); and its noise immunity and current programmability make it

ideal for remote sensing use. Output-current flow through a sense resistor scales the LM134's output voltage—in this case, to 10 mV/°F, which is one count of the DPM or 1°F displayed.

Besides a +5 V input, the ADD2500 draws 18 mA from a negative supply. This comes from the dc/dc converter (at -15 V) as a regulated current via the 2N5457 FET, the LED, and the 2N3904. The negative supply of the ADD2500 is internally Zener regulated; it, together with the two diodes and the resistor string between ground and I<sub>EE</sub>, establish a low-drift offset voltage for the LM134's sense resistor.

The finished thermometer requires only a single, unregulated +12 V supply, and operates from -29°C to +60°C (-20°F to +140°F).

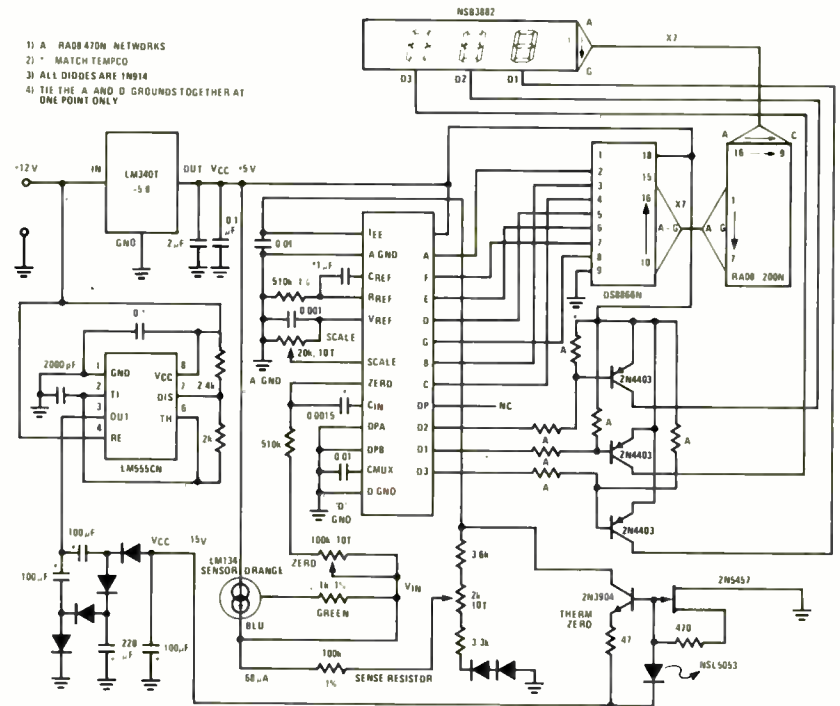

## What You See Is What You Get: Chart Describes Pressure Transducers

Our new *Transducer Features Chart* shows you, at a glance, what's available in our line of IC pressure transducers.

The chart lists basic product type numbers on a vertical axis, and package options, etc., on a horizontal axis. At the projected intersection of the basic part number and the number of the option, the chart shows you the complete model number of the combina-

tion you've selected. Conversely, the absence of a number indicates that the combination you've selected is not a standard part.

So if you're working with pressure transducers, the *Transducer Features Chart* is a handy short-form guide to National's pressure transducer products. Just ask for a copy, and it's yours.

## SC/MP Applications Handbook

Simple to use . . . cost effective . . . applications oriented. These terms are all descriptive of SC/MP—National's very popular single-chip 8-bit microprocessor. In support of such descriptors, National now offers the *SC/MP Microprocessor Applications Handbook*, which, in its 145 pages with 68 illustrations, defines SC/MP's internal architecture, pin-outs, and interfacing techniques—from an applications point of view.

The text also addresses the concepts, principles, hook-up details, and general implementation procedures that relate to the many applications for which SC/MP is so well suited.

The information is organized in capsule form so that the reader can use it to expand, modify, or customize a

given application. Those applications within the text are organized by class—A/D and D/A systems, keyboard/display systems, multiprocessor systems, and so on.

A great amount of general design data are also included, and the material covers the instruction set, addressing modes, I/O capabilities, interrupt structures, and other applications-related features.

The *SC/MP Microprocessor Applications Handbook* costs \$5.00 per copy. Send your check or money order—no cash, please—to Marketing Services M/S 520, National Semiconductor Corp., 2900 Semiconductor Drive, Santa Clara, CA 95051. (California residents add 6% sales tax, please; San Francisco Bay Area residents, 6.5%)

## MOS/LSI Databook

Our newest catalog is also a first edition. We've finally put together a definitive compendium of information describing our extensive line of MOS/LSI products.

This 1977 *MOS/LSI Databook*, describes our circuits for clocks, counters/timers, electronic organs, TV, A/D converters, CB radios, watches, calculators, control-oriented processors, keyboard encoders, and interface drivers, and also gives complete information about our LED displays, clock modules, and custom MOS/LSI capabilities.

It's all here—720 pages of data sheets, application notes, package drawings, definitions—and it's worth its price.

The *MOS/LSI Databook* costs \$4.00 per copy. Send your check or money order—no cash, please—to Marketing Services M/S 520, National Semiconductor Corp., 2900 Semiconductor Drive, Santa Clara, CA 95051. (California residents add 6% sales tax, please; San Francisco Bay Area residents add 6.5%)

## LED Catalog

Our new *LED Short Form Catalog* details our line of LED lamps and numeric displays.

The page headings of the ten-page catalog describe its content: Special Feature Lamps (constant current, side view, and high-lens types); Panel Indicators (red, green, and yellow); General Purpose Lamps; Numeric Displays; and Watch Display Die. For each lamp grouping the catalog shows appropriate application areas, lamp features, and the technical specifications for each lamp.

There's also a LED lamp locator that charts lens type versus lamp size, which lets you quickly locate the part number of the lamp suited to your specific needs; mounting clip information for panels and PC boards; and two pages of drawings of various mounting techniques, which name the sources of connectors and other mounting hardware. The catalog closes with a listing of National's LED segment and digit drivers, which shows, for each driver, its input compatibility,  $V_{out}$ ,  $I_{out}$ , input code, and so on.

Our *LED Short Form Catalog* is free for the asking. Simply check the box on this issue's VIP card.



## VIP CARD

Complete card and mail to  
NATIONAL SEMICONDUCTOR  
Attn: Marketing Services  
2900 Semiconductor Drive  
Santa Clara, CA 95051

## INDEX

Please send me the information that I have checked:

- |  |  |
|--|--|
| <input type="checkbox"/> LM140/140A/340/340A Regs., Pg. A, Col. 1  | <input type="checkbox"/> LMDAC08, Pg. B, Col. 2              |
| <input type="checkbox"/> CD4020B/40B/60B Counters, Pg. A, Col. 1   | <input type="checkbox"/> LF13300 A/D Block, Pg. C, Col. 1    |
| <input type="checkbox"/> INS8080A-1-2 MPU's/Support, Pg. A, Col. 2 | <input type="checkbox"/> ADD2500 DPM, Pg. C, Col. 2          |
| <input type="checkbox"/> LM1889 Video Mod., Pg. A, Col. 2          | <input type="checkbox"/> LM134 Current Source, Pg. C, Col. 2 |
| <input type="checkbox"/> DM86LS52/62 Registers, Pg. B, Col. 1      | <input type="checkbox"/> Press. Transd. Chart, Pg. C, Col. 2 |
| <input type="checkbox"/> DM74S470/471/472/473 PROMs, Pg. B, Col. 3 | <input type="checkbox"/> LED Catalog, Pg. D, Col. 3          |

Please send me the literature that I have checked:

- |   |   |
|---|---|
| <input type="checkbox"/> AN-168 MM5856 Universal Timer Applications | <input type="checkbox"/> AN-172 Pulsed Power Supply Operation of Selected MM2102 Static RAM |
| <input type="checkbox"/> AN-171 PROM Power-Down Circuits            | <input type="checkbox"/> AN-178 Applications for an Adjustable IC Power Regulator           |

Your End Product or Application: \_\_\_\_\_

Have Salesman Call  YES  NO

Please print clearly; this information will be used for our mailing list.

NAME \_\_\_\_\_ TITLE \_\_\_\_\_

COMPANY \_\_\_\_\_

ADDRESS \_\_\_\_\_

CITY \_\_\_\_\_ STATE \_\_\_\_\_ ZIP \_\_\_\_\_

# Low-cost ICs convert light to current

Monolithic optoelectronic circuits combine low-temperature diffusion and ion implantation to boost gain and blue sensitivity

by Bernard Cole, San Francisco bureau manager

Combining an advanced low-temperature diffusion process with a new ion-implanted photodiode fabrication technique, National Semiconductor Corp. has developed a new family of linearized-output bipolar optoelectronic integrated circuits aimed at replacing discrete phototransistors and hybrid arrays in numerous applications.

The first three parts in the new family, available in sample quantities next month, include the LM1890, a light-to-current converter with an on-chip voltage reference and light-biased comparator; the LM1891, a gain-programmable light-to-current converter, and the LM1892, a two-terminal light-to-current converter with a claimed leakage current of zero in darkness.

Designed as single-chip solutions for problems that up to now have required several discrete phototransistors and peripheral circuits or hybrid combinations costing as much as \$50, the new linear opto ICs will cost only 50 cents to \$1 in volume—scarcely more than does a single phototransistor.

Typical applications will include light meters, camera controls, electronic flash controls, smoke detectors, modulator/demodulators in infrared links or in audio systems for home movie projectors, linear optoisolators, optical servo loops, wheel position sensing, headlight dimmers, light threshold detectors, color sorting, and fluid density measurements.

Features of the new all-monolithic family, says design engineer Dennis Monticelli, include convenient low-cost eight-pin dual in-line clear plastic packages, blue-enhanced photodiode spectral response, and nomi-

nal conversion gain of about 8 microamperes per foot-candle at 2,865 K. What's more, the line boasts accurate absolute conversion gain from on-chip trimming, linear conversion gain over several decades of light intensity, high-impedance cascoded current-source outputs with wide compliance down to 1 volt, a dark current of less than 1 nanoampere, and high supply rejection. The design has been optimized for battery operation—at +2.5 v for the LM1890-91 and +1 v for the LM1892.

In addition, the use of an on-chip comparator on the LM1890 with adaptive biasing insures the bias

current is only 1% of the output, independent of light level. Dynamic range of the gain-programmable LM1891 is 40 decibels. Operating as a light-controlled oscillator, the LM1892 has a dynamic range of over 5 decades, from 1 hertz to 100 kilohertz.

Each die is calibrated during wafer sorting using a reference light source and a computer-controlled metal-link blowing technique, Monticello says. The chips are mounted in DIPs molded using a proprietary clear compound, rather than inserted in TO-5, TO-18 or TO-92 metal packages with glass windows as is the common practice. A small recess

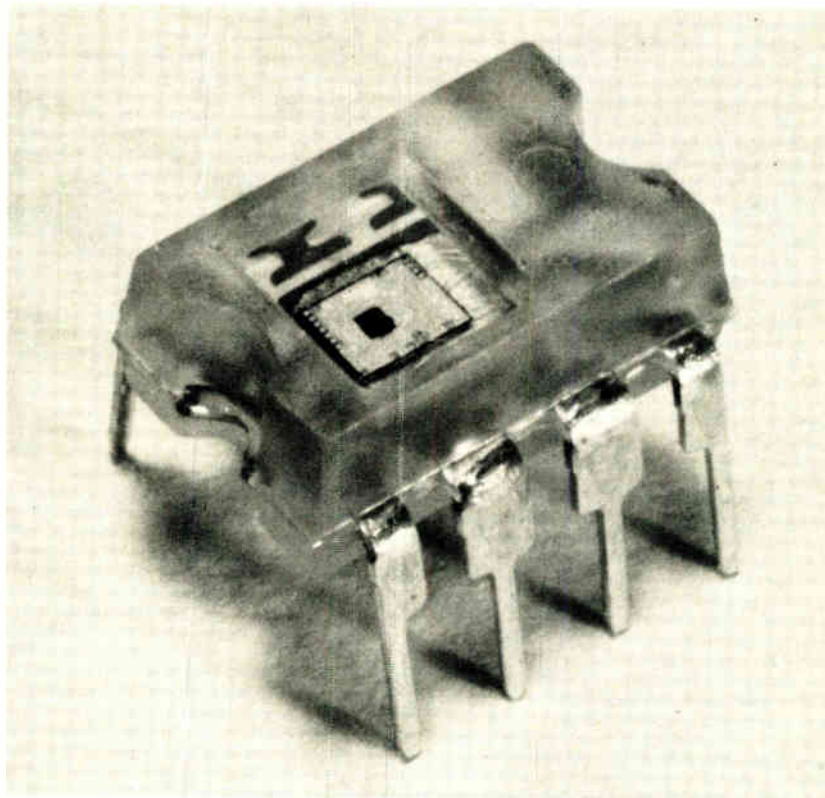

# GREAT NEW COMBINATION

Ultra High Speed A/D Converter  
(100 MHz per second)

Buffer Memory for High Speed data buffering  
(up to 100 MHz per second)

ADC1106-100  
A/D converter



MEM  
1108-100/2560  
buffer memory



Operating in conjunction with Phoenix Data's new ADC1106-100 A/D converter that combines ultra-high-speed (100 MHz per sec.) with very high resolution (6-bit binary or 2's complement output) and exceptional accuracy ( $\pm 0.75\% \pm \frac{1}{2}\text{LSB}$ ), the new MEM1108-100/2560 High Speed Buffer Memory allows the user to buffer (signals of 100 MHz) ultra-high-speed analog data conversions for greater efficiency and more effective use of computer interfacing. Data blocks of 2560 A/D converted data words can be accumulated and stored in memory at rates of up to 100 megawords per second while memory readout is accomplished at up to a 4 megaword rate when using the internal buffer clock or at any other selected rate up to 4 MHz when using an externally supplied clock.

If it's stability, accuracy, speed or all-around quality you need in Data Conversion, contact Ron Brunner, director of marketing, or your area representative.



## PHOENIX DATA, INC.

3384 W. OSBORN RD. PHOENIX, AZ. 85017  
PHONE (602) 278-8528, TWX 910 - 951 - 1364

### New products

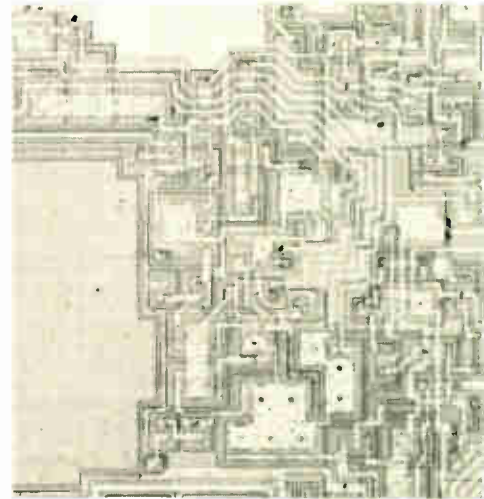

is formed in the package to allow a light filter to be conveniently inserted if needed, thereby reducing the infrared response. A second layer of aluminum is used on the die to shield the low-level control circuitry from incident light.

Special processing was developed to provide the blue-enhanced photodiodes (left portion of chip, above) and pnp and npn transistors with common-emitter forward-current gain ratios substantial enough to handle the low-level currents, Monticelli says. The use of ion implantation allows the fabrication of a shallow photodiode junction close enough to the surface to boost the normalized conversion efficiency to 60% in the visible light range and to increase the sensitivity in the blue portion of the spectrum.

Low-temperature diffusion processing and the use of a graded 1- to 5-micrometer epitaxial layer provide good forward-current gain ratios, while holding junction leakages to less than 1 picoampere at room temperature. Comparisons between photocurrent and various reference currents take place at levels as low as 2 nA, using a reference-current generator that is free from the problem of compounding leakage and current gain errors. Using a reinjector current-division chain to provide a ratio of 5,000:1 avoids this problem, Monticelli says.

National Semiconductor Corp., 2900 Semiconductor Drive, Santa Clara, Calif. 95051 [338]



**Dialight  
meets your needs  
with something  
new...**

# Dialight is now your for rockers and toggles



We've already made quite a name for ourselves in indicator lights, LED readout displays, LED indicators and illuminated switches.

Dialight's success in these areas is built on our ability to see your most important needs . . . and meet them consistently.

# second source to C&K



We see a need for a dependable second source of miniature rockers and toggles, a need we can now meet with these advantages:

Dialight quality. Direct replacement to C&K. Competitive prices. American-made. World-wide distribution.

Now with Dialight you have a choice: of local or national distributors offering off-the-shelf delivery.

Your Dialight distributor is ready right now, with thousands of rockers and toggles for whatever needs you have.

We can prove it right now: just call your local Dialight representative as listed below for immediate

cross reference to C&K products. We'd like to send you a copy of Dialight's new "Meet Your Need" Miniature Rocker and Toggle Switch catalog. Circle the reader card number at the bottom of the page, or contact us directly:

Dialight, a North American Philips Company, 203 Harrison Place, Brooklyn, N. Y. 11237.



**FOR IMMEDIATE CROSS-REFERENCE TO C&K PRODUCTS,  
OR ENGINEERING ASSISTANCE  
CONTACT YOUR LOCAL DIALIGHT REPRESENTATIVE.**

**EASTERN**

**Cartwright & Bean Inc.**  
Memphis, Tenn.  
phone: (901) 276-4442

**Cartwright & Bean Inc.**  
Atlanta, Ga.  
phone: (404) 255-5262

**Cartwright & Bean Inc.**  
Ft. Lauderdale, Florida  
phone: (305) 791-3989

**Cartwright & Bean Inc.**  
Orlando, Florida  
phone: (305) 422-4531

**Cartwright & Bean Inc.**  
Gretna, La.  
phone: (504) 362-4649

**Cartwright & Bean Inc.**  
Raleigh, N.C.  
phone: (919) 781-6560

**Cartwright & Bean Inc.**  
Charlotte, N.C.  
phone: (704) 337-5673

**Cartwright & Bean Inc.**  
Huntsville, Ala.  
phone: (205) 533-3509

**L. D. Lowery, Inc.**  
Broomall, Pa.  
phone: (215) 528-5170

**L. D. Lowery, Inc.**  
Lanham, Md.  
phone: (301) 459-1556

**Precision Sales, Inc.**  
No. Syracuse, N.Y.  
phone: (315) 458-2223

**Mullin Technical Sales Co., Inc.**  
Needham, Mass.  
phone: (617) 444-4780

**Metropolitan NYC**  
Contact Factory

**MID-AMERICA**

**D. Dolin Sales Co.**  
Chicago, Ill.  
phone: (312) 286-6200

**Hilltronics**  
Ferndale, Michigan  
phone: (313) 398-5556

**K W Electronic Sales Inc.**  
Dayton, Ohio  
phone: (513) 890-2150

**K W Electronic Sales Inc.**  
Cleveland, Ohio  
phone: (216) 831-8292

**K W Electronic Sales Inc.**  
Worthington, Ohio  
phone: (614) 888-0483

**K W Electronic Sales Inc.**  
Allison Park, Pa.  
phone: (412) 487-4300

**R. G. Ragon, Inc.**  
St. Paul, Minn.  
phone: (612) 488-0201

**K & M Sales Company**  
Shawnee Mission, Kansas  
phone: (913) 262-1444

**K & M Sales Company**  
St. Louis, Missouri  
phone: (314) 423-2420

**Southern Sales Corp.**  
Indianapolis, Indiana  
phone: (317) 299-2992

**WESTERN**

**Westrep**  
Pico Rivera, Calif.  
phone: (213) 949-2551

**Tesco**  
Dallas, Texas  
phone: (214) 328-5484

**R. G. Bowen Co., Inc.**  
Englewood, Colo.  
phone: (303) 789-1884

**R. G. Bowen Co., Inc.**  
Salt Lake City, Utah  
phone: (801) 363-8801

**Moulthrop Sales Inc.**  
Pleasanton, Calif.  
phone: (415) 846-0550

**Electronic Sources, Inc.**  
Bellevue, Washington  
phone: (206) 453-0800

**Electronic Sources, Inc.**  
Portland, Oregon  
phone: (503) 292-0701

**Stitzer - Dodd Inc.**  
Phoenix, Ariz.  
phone: (602) 944-2237

**EASTERN CANADA**  
**Munro Electronics Comp. Ltd.**  
Mississauga, Ont.  
phone: (416) 676-1042

**WESTERN CANADA**  
**Arwin Technical Sales**  
N. Vancouver, B.C.  
phone: (604) 980-4346

# Dialight meets your needs.

## *DIALIGHT*

203 Harrison Place, Brooklyn, N. Y. 11237

(212) 497-7600 TWX #710-584-5487

## New products

Semiconductors

### V-f converter is highly linear

Low-cost monolithic unit has maximum nonlinearity of 0.01% at 10 kilohertz

In the last few months, the performance of monolithic voltage-to-frequency converters has improved appreciably, yet prices have remained attractively low. Now, from Burr-Brown, an established leader in hybrid technology, comes an impressive v-f chip with a maximum guaranteed nonlinearity of 0.01% at 10 kilohertz and with the capability to operate at frequencies of up to 0.5 megahertz. Pricing starts at a low \$6.10 each for 100-unit lots.

Designated the VFC32, the device may be used as either a v-f converter or an f-v converter. It has a six-decade dynamic range, spanning 0.5 hertz to 0.5 MHz. At the top frequency, maximum nonlinearity is 0.2%, tightening to 0.05% at 100 kilohertz.

The unit accepts voltage inputs of 0 to +10 volts or 0 to -10 v, and

positive current inputs of up to 0.25 milliamperes. Its output is an open collector, so the VFC32 is compatible with a number of logic families, including diode-transistor logic, transistor-transistor logic, and complementary metal-oxide-semiconductor logic.

The number of external components required is minimal—just an RC network for setting up the full-scale frequency, a pull-up resistor, and a one-shot capacitor. Stability is adequate for most applications—maximum drift of the full-scale frequency is 100 ppm/°C and the input offset voltage drift is less than 2 ppm/°C.

In all, three models and two package configurations are available. The lowest-cost version, the VFC32KP, is in a 14-pin epoxy dual in-line package; it operates from 0°C to 70°C. The BM and SM versions are packaged in hermetically sealed TO-100 metal cans, with the VFC32BM operating over the temperature range of -25°C to +85°C and the VFC32SM operating from -55°C to +125°C.

Price for the VFC32KP is \$10.20 each for less than 10, dropping to \$6.10 for quantities of 100 to 249. Similarly, the BM model sells for \$13.90 singly or \$8 for 100 to 249. The full military-range device, the

VFC32SM, is \$19 each for less than 10 or \$11.70 for 100 to 249.

Burr-Brown Research Corp., International Airport Industrial Park, Tucson, Ariz. 85734  
Phone (602) 294-1431 [411]

Hex digit driver interfaces

MOS circuits with LED loads

Designed to interface low-voltage metal-oxide-semiconductor integrated circuits with high-current loads, such as light-emitting-diode displays, the D140 hex digit driver is able to work from a supply voltage as low as 3 volts. The monolithic bipolar circuit contains six indepen-

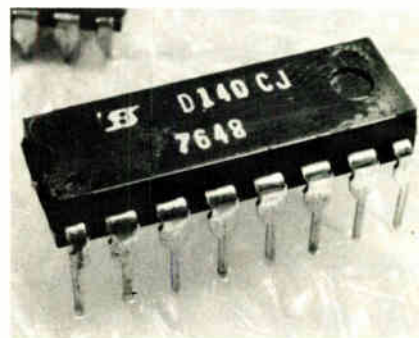

dent drivers, each of which includes a high-gain Darlington stage and a current-limiting resistor network. Each of the device's six drivers can sink up to 90 milliamperes at a 3-v supply voltage. In small quantities the D140 sells for \$2.24; in hundreds, the price drops to \$1.56. Delivery is from stock.

Siliconix Inc., 2201 Laurelwood Road, Santa Clara, Calif. 95054. Phone Jim Graham at (408) 246-8000 [414]

Transistor has cut-off frequency of 300 MHz

When biased at a collector current of 500 milliamperes and a collector voltage of 5 volts dc, the KS6038 has a cut-off frequency of 300 megahertz. A companion unit, the KS6039, has an  $F_T$  of 200 MHz under the same bias conditions. In addition to serving as class A amplifiers, both units can be used as fast switches. In

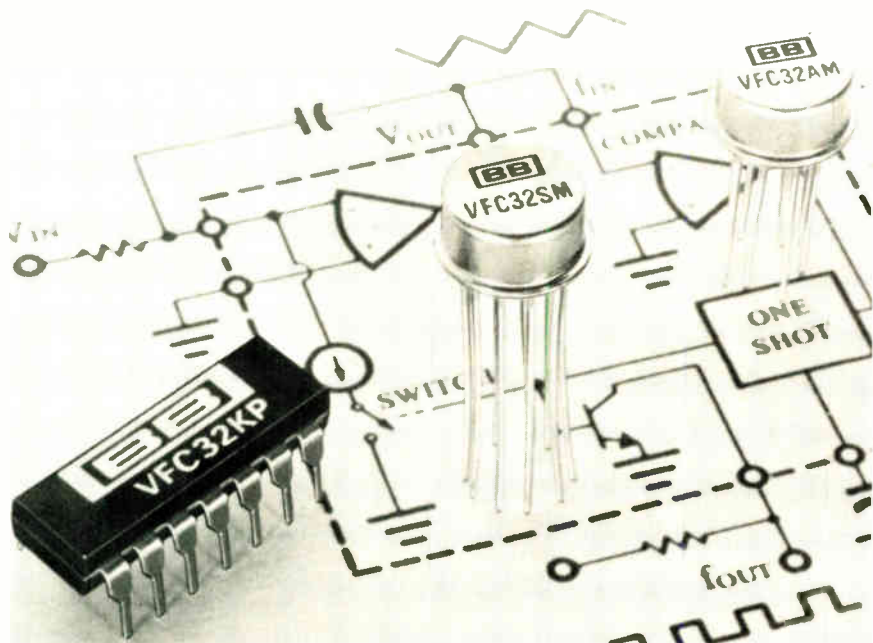

# Thin-Trim<sup>®</sup> capacitors

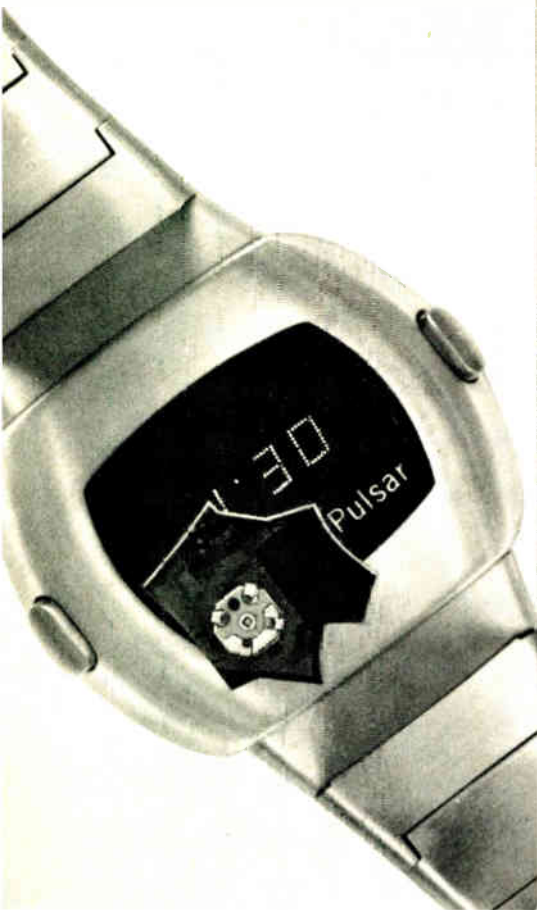

Tucked in the corner of this Pulsar Watch is a miniature capacitor which is used to trim the crystal. This Thin-Trim capacitor is one of our 9410 series, has an adjustment range of 7 to 45 pf., and is .200" x .200" x .050" thick. The Thin-Trim concept provides a variable device to replace fixed tuning techniques and cut-and-try methods of adjustment. Thin-Trim capacitors are available in a variety of lead configurations making them very easy to mount.

A smaller version of the 9410 is the 9402 series with a maximum capacitance value of 25 pf. These are perfect for applications in sub-miniature circuits such as ladies electronic wrist watches and phased array MIC's.

Johanson Manufacturing Corporation, Rockaway Valley Road., Boonton, N.J. 07005. Phone (201) 334-2676, TWX 710-987-8367.

*Johanson*

MANUFACTURING CORPORATION  
Circle 150 on reader service card

## New products

this latter mode, they are both capable of turning a collector current of 1 ampere on and off in a total switching time of 200 nanoseconds—a turn-on time (delay time plus rise time) of 50 ns, a storage time of 125

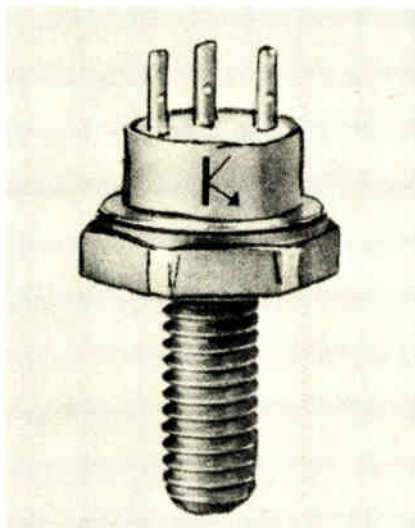

ns, and a fall time of less than 25 ns.

Both transistors are bonded with gold eutectic solder in a TO-60 isolated package. All internal leads are aluminum and are ultrasonically bonded. For quantities of 100 to 999 pieces, the KS6038 sells for \$3.50 each, while the KS6039 is priced at \$3.10 each for the same quantities. Production quantities are available from stock.

Kerton Inc., 7516 Central Industrial Drive, Riviera Beach, Fla. 33404. Phone George Reiland at (305) 848-9606 [413]

### Four-quadrant multiplier is accurate to within 0.25%

The AD534L is a laser-trimmed monolithic four-quadrant multiplier with a maximum multiplication error of 0.25% at 25°C. Other versions are the AD534K and AD534J with maximum errors of 0.5% and 1%, respectively. For operation over the military temperature range from -55°C to 125°C there are the S and T versions with maximum errors of 2% and 1%, respectively. The units are all offered in an hermetic TO-100 can and are available from

stock. Prices, in hundreds, are \$16, \$24, \$36, \$45, and \$60 for the J, K, L, S, and T versions, respectively.

Analog Devices Inc., P.O. Box 280, Norwood, Mass. 02062. Phone (617) 329-4700 [415]

### Circuit controls automobile ignition

A monolithic circuit, the MC3333, forms the basis of an advanced automotive ignition system that utilizes a flux-averaging sensor instead of the conventional points and condenser. Flexible enough to be used in a variety of configurations, the circuit needs only one external active component—a Darlington driver transistor (MJ10012) to supply the current to the primary winding of a high-energy spark coil.

The MC3333 can operate with battery voltages from 4 to 24 v dc. Called a Vari-Dwell ignition circuit, it is supplied in a 14-pin plastic dual in-line package at a price of \$2.25 each in hundreds. The device is also available in standard chip and flip-chip forms.

Motorola Semiconductor Products Inc., P. O. Box 20912, Phoenix, Ariz. 85036. Phone (602) 244-6900 [417]

## TOPICS

### Semiconductors

**Motorola Semiconductor Products Inc., Phoenix, Ariz.,** has developed a series of uhf power transistors for use in the 100-to-500-megahertz range. The five units in the series range from the MRF321, which puts out 10 watts at a gain of 12 decibels, to the MRF327, which puts out 80 W at a gain of 7.3 dB. . . . **Texas Instruments Inc., Dallas, Texas,** is second-sourcing several products originated by National Semiconductor Corp. Among them are the LM193, LM293, LM393, and LM2903 dual differential comparators. TI is also second-sourcing National's LM117, LM217, and LM317 three-terminal regulators.

# SORENSEN IS THE SOURCE. FOR MODULAR SWITCHING POWER SUPPLIES.

## Check our standard features:

- 10 models, 1.8V to 56V with power levels ranging up to 225 watts.
- 115/220 Vac input by external barrier strip change.
- 50/60-Hz operation with no derating.
- Logic shutdown for system applications.
- Extra long hold-up time.
- Low ripple & noise through use of double-stage filtering.
- Wide-range output voltage adjustment.
- Built-in adjustable overvoltage protection.
- Superior line and load regulation.
- Internal adjustable current limiting.
- UL component recognition.
- High power-to-weight ratio.
- 20-kHz switching.
- Size (in.): 3.313. 5.125. 9.500.
- Immediate delivery.
- Made in U.S.A. of quality components.
- Five-year warranty, backed by worldwide service organization.



**\$295.**  
**5V 30 Amps.**

## Check our specifications:

**AC Input Power:** 98 Vac-132 Vac, 187 Vac-250 Vac.

Frequency: 47-63 Hz single phase. 360-440 Hz (double rms Ripple spec.) *No derating.* Voltage selectable by a single link on the front panel.

**Voltage Regulation:** Line: 0.03% over full AC input range.

Load: 0.03% for zero to full load.

**Voltage Ripple:** Typical 2m V rms, 20mV pk-pk (20Hz to 20 MHz).

Max. 5mV rms, 50mV pk-pk (20Hz to 20MHz).

**Temperature Coefficient:** 0.01% max. per °C.

**Stability:** 0.05% max. for 24 hours after warm-up.

**Transient Response Time:** Output voltage returns to within 1% in less than 1.2 ms following a step-load change from either 50% to 100% or 100% to 50% of full load.

**Overshoot:** No overshoot at turn-on, turn-off or power failure.

**Hold-Up Time:** Full regulated voltage holds up for 40ms after removal of power at full load, and nominal input and output voltages (80ms for half load).

**Overvoltage Protection:** Built-in adjustable overvoltage protection standard on all models.

**Efficiency:** Up to 78%.

**Remote Sensing:** Voltage drops can be compensated for up to the max. specified terminal voltage.

**Paralleling:** May be directly paralleled without derating.

**Soft-Start:** In-rush current is limited by soft start circuit.

Model No.	Nominal Voltage	Output Voltage Range (Vdc)		Output Current				Price
		min.	max.	@40°C	@50°C	@60°C	@71°C	
SSD2-30	2	1.8	3.0	30.0	27.0	22.5	15.0	\$295
SSD5-30	5	4.7	6.5	30.0	27.0	22.5	15.0	295
SSD9-20	9	6.5	9.5	20.0	18.0	15.0	10.0	295
SSD12-15	12	9.5	13.0	15.0	13.5	11.2	7.5	295
SSD15-12	15	13.0	17.0	12.0	10.8	9.0	6.0	295
SSD18-10.5	18	16.0	21.0	10.5	9.4	7.8	5.2	295
SSD24-8.5	24	20.0	26.0	8.5	7.6	6.3	4.2	295
SSD28-7	28	25.0	33.0	7.0	6.3	5.2	3.5	295
SSD36-5	36	32.0	43.0	5.0	4.5	3.7	2.5	295
SSD48-4	48	42.0	56.0	4.0	3.6	3.0	2.0	295

**For OEM discounts call:  
Sorensen, (603) 668-4500.  
676 Island Pond Road,  
Manchester, NH 03103.**

Circle 151 on reader service card

**SORENSEN**  
POWER SUPPLIES

A Raytheon Company

**You're staking your reputation  
on your first major design  
change since 1884.**

**You'd better take a  
good look around before  
you pick a MOS company  
to make your microcircuits.**



# Singer did.

We looked pretty good to them.

With the success of their Athena 2000 home sewing machine, today we may look even better.

This revolutionary new machine by Singer can sew 25 different stitch patterns at the touch of a button. And it's entirely controlled by a single MOS circuit made by AMI.

Singer eliminated 350 mechanical parts by redesigning around this dense little chip. At the same time, they added immensely

to the performance and safety features of the machine.

We did such a good job on the Athena machine that Singer gave us the contract for their next two models of electronic sewing machines.

Singer chose AMI because of our reputation for solving MOS problems quickly, confidentially and economically. In the past eleven years, some of the world's biggest companies have come to us for the same reasons.

We're designing custom chips for many Fortune 500 companies like Singer. With your reputation riding on every product that you make, maybe you'd better take a good look at us, too. Write to Custom Product Marketing, AMI, 3800 Homestead Road, Santa Clara, California 95051. Or contact your local AMI sales office. It could be the beginning of another success story.

**AMI**  
AMERICAN MICROSYSTEMS, INC.



## One company can cut keyboard costs. Even when their keyboards cost more.

The most expensive mistake you'll ever make selecting a keyboard could be spending too little. In the long run, that adds up to cutting corners, not costs.

So to make sure you get the keyboard that really meets your needs, MICRO SWITCH uses Value Engineering.

Through Value Engineering, we look at your particular product needs to design a cost-effective solution to your problems. That means designing a keyboard that interfaces with your total system and meets your needs. Precisely.

It also means we can often lower your total system cost. For example, we might be able to incorporate into a keyboard several levels of codes that you had been paying for separately. And at a much higher cost.

Or maybe customize

integrated circuits to provide you more logic for less money.

Besides giving you cost-efficiency, MICRO SWITCH keyboards out-feature practically every other in the industry.

You can choose LED or incandescent lighting. Tactile or linear feel. Sealed versions for military and industrial uses. Alternate or momentary action. Encoding techniques that'll meet any code requirement.

There are also wired-only assemblies or separate modules available. And you can pick from the industry's largest legend library.

Standard, solid state Hall-effect technology throughout the line delivers reliability no mechanical keyboard can offer. Plus, we back up every keyboard we make with a 1% Acceptable Quality Level and a two-year

warranty.

It all adds up to quality you can put your fingers on every time.

For more information, call 815/235-6600.

With MICRO SWITCH, you'll be paying for keyboards instead of mistakes.



### MICRO SWITCH

FREEPORT, ILLINOIS 61032

A DIVISION OF HONEYWELL

MICRO SWITCH products are available worldwide through Honeywell International.

Circle 154 on reader service card

World Radio History

**Instruments**

---

**600-MHz counter  
sells for \$595**

---

Portable unit uses  
building-block approach for  
low cost, high flexibility

---

Small companies looking to carve a niche out of a market dominated by the industry's giants often turn to custom circuitry to provide some price or performance edge. But when engineers at Aero Marine Electronics Inc. of Delran, N. J., focused their sights on the high-frequency counter field, they also saw that custom chips can be very expensive for a small company and could cause the firm to lose flexibility in designing other counters.

Therefore the three-year-old firm's engineers did some comparison shopping of standard devices. After finding what they felt were "the best available off-the-shelf parts for the job," says executive

vice president Neal Mumbert, "we applied them to achieve performance value, portability, small size and weight, and low price." The result is an 8-digit 600-megahertz frequency counter, the FC600A, that Aero Marine is about to begin selling for \$595, including a telescoping antenna, regulated ac power converter, and attaché carrying case. Initial deliveries are set for September.

The unit's sensitivity is 10 millivolts root mean square from 6 to 100 hertz, 25 mv rms to 500 MHz, and 50 mv rms to 600 MHz. Weighing only 1.5 pounds, the portable counter is intended for service, maintenance, and calibration applications in aircraft, marine, two-way radio and television broadcast markets, as well as on production lines and in laboratories, says marketing director Jack Taylor.

The FC600A consists of three building blocks—counter, oscillator, and front-end—and a 0.4-inch light-emitting-diode display. The heart of the counter building block is the LS 7031, an off-the-shelf six-decade up counter with an eight-decade latch and multiplexer in a 40-pin dual in-line package from LSI Computer

Systems Inc. of Melville, N. Y.

The counter's oscillator has an aging rate of 3 parts per million per year and is accurate to within 5 ppm over the full operating range of 0°C to 55°C after a 15-minute warm-up. An optional temperature-compensated crystal oscillator (\$150) has an aging rate of 1 ppm/year and is accurate to within less than 0.1 ppm over specific ranges but 1 ppm over the full temperature range.

The counter consumes less than 4 watts, drawing 300 milliamperes from a 12-volt dc source. It also can be powered from line voltage with the ac converter and, for true portable operation for up to four hours continuous, from three 9-v transistor-radio-type alkaline batteries.

Some unique front-panel features of the FC600A are an analog field-strength meter for use in peaking and nulling transmitters, a "super-bright" button that gives a 100% increase in LED display intensity for use under high ambient light conditions, and a test button to check the counter's calibration.

In keeping with its approach of using "the best available off-the-shelf parts for the job," Aero Marine is packaging the FC600A in the 5.5-by-3.75-by-1.75-inch case that has been popularized in the digital multimeter line offered by Data Precision Corp. of Wakefield, Mass. But Mumbert hopes the similarities won't stop there. "What Data Precision did in the digital multimeter field," he says, "we intend to do in the counter market."

Aero Marine Electronics Inc., 1819 Underwood Blvd., Delran, N. J. 08075 [351]

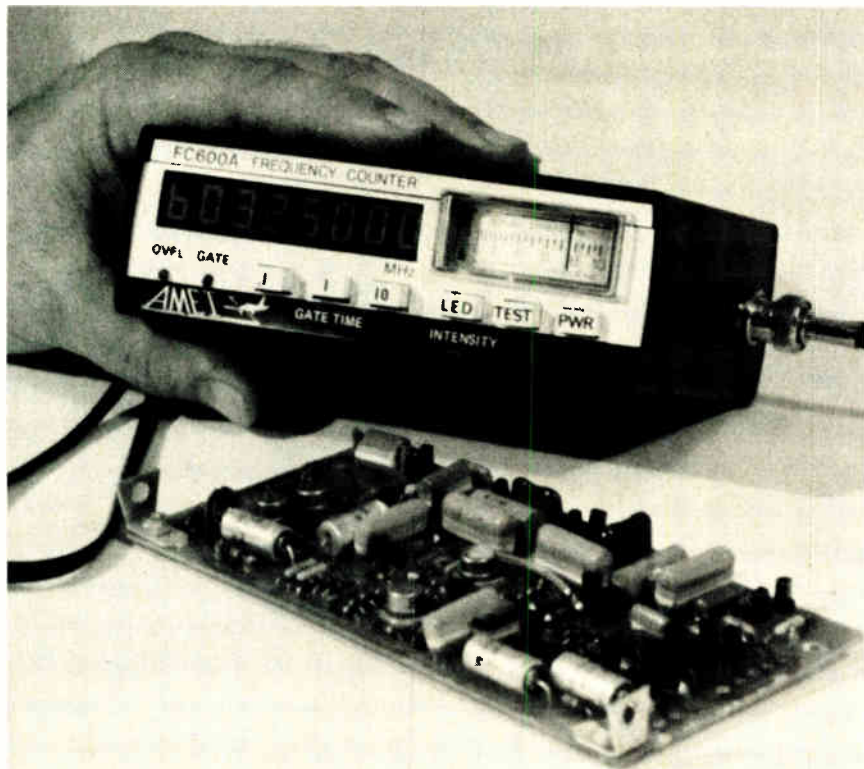

---

**100-MHz scope resolves  
time intervals to 0.002%**

Capable of making time-interval measurements quickly and easily with a resolution of 0.002%, a 100-megahertz dual-channel oscilloscope also provides third-channel trigger viewing and automatic trace overlapping. The model 1743A uses an averaging technique to improve its

## New products

accuracy and resolution over previous delta-time scopes. It also allows measurement of events close to the trigger by permitting the measured interval to begin simultaneously with the trigger.

The scope contains a five-digit light-emitting-diode display with 300% overrange. For time intervals of 5 microseconds or longer, measurement resolution is 0.002%; shorter intervals are measured to 100 picoseconds. The new scope sells for \$3,300.

Inquiries Manager, Hewlett-Packard Co., 1501 Page Mill Road, Palo Alto, California 94304 [353]

### DPM is small in size, power consumption, and price

The model AN2575 panel meter is a 3½-digit instrument that combines small size and low power consumption with high accuracy and a one-piece price of only \$69 (\$49 each in hundreds). The meter takes up only 7.2 cubic inches of space behind the panel and weighs less than 5 ounces. Power consumption is a low 800 milliwatts from a single 5-volt supply, while an extra-cost option is available to reduce power consumption to 350 mw.

The meter has a maximum absolute error of 0.05% of reading plus 1 count, with a temperature coefficient of 50 ppm of reading/°C. To make



the most of its accuracy, the AN2575 has a bipolar differential input with a maximum bias current of 100 picoamperes and an input resistance in excess of 1,000 megohms. The meter is offered with full-scale ranges of 199.9 millivolts and 1.999 volts. Latched and buffered

parallel binary-coded-decimal outputs and provision for three-wire ratiometric operation are offered as options. The meter is available from stock.

Analogic Corp., Audubon Road, Wakefield, Mass. 01880. Phone (617) 246-0300 [356]

### Scope calibrator provides digital display of error

A three-in-one instrument for calibrating oscilloscopes, the model 6125B time and amplitude calibrator includes a 3½-digit readout for displaying deviations up to ±10%. The unit's three main functions are calibrating amplitude, sweep and delay time, and rise time.

The amplitude and sweep-and-delay time functions can be used in two modes: as a source of accurate



signals for the calibration of oscilloscopes (and other instruments) and as a source of variable signals of which the deviation is accurately known—for checking to see if the instrument under test meets its specifications. In the second mode, a vernier control on the 6125B is adjusted until the signal on the oscilloscope screen covers the proper number of divisions. The percentage deviation, if any, is then displayed on the meter.

As a rise-time calibrator, the instrument simply puts out a clean signal with a rise time of 1 nanosecond. It also puts out 200-megahertz and 500-MHz sine waves. It sells for \$1,875 and has a delivery time of 60 days.

Ballantine Laboratories Inc., P. O. Box 97, Boonton, N. J. 07005. [354]

### Unit displays four logic signals on one-channel scope

A portable hand-held instrument, the 45-B logic analyzer gives the user the ability to display four channels of digital logic waveforms simultaneously on a single-trace oscilloscope. The unit is intended to help both designers and field-service personnel observe the complex timing relationships that exist among digital signals. Capable of operating from the ac line or with a 9-volt battery, the 45-B sells for \$149.95 including a battery and an ac adapter. It handles a wide range of logic families without adjustment.

Digital Broadcast Systems Inc., 4306 Governors Drive, Huntsville, Ala. 35805. Phone (205) 837-2183 [358]

### Compact 15-MHz scope sells for \$289

Priced at only \$289, a 15-megahertz oscilloscope weighs 3 pounds and measures 2.7 inches high by 6.4 in. wide by 7.5 in. deep. Called the model MS-15 Miniscope, the instrument includes such features as internal and external triggering, automatic and line synchronization, and a horizontal input. It has 12 vertical gain settings, from 10 millivolts per division to 50 volts per division. The



horizontal time-base settings range from 100 nanoseconds per division to 500 milliseconds per division. The unit can be powered by batteries or the ac line.

Non-Linear Systems Inc., P. O. Box N, Del Mar, Calif. 92014. Phone (714) 755-1134 [355]

# A digital F.R.A. with an exciting new feature.

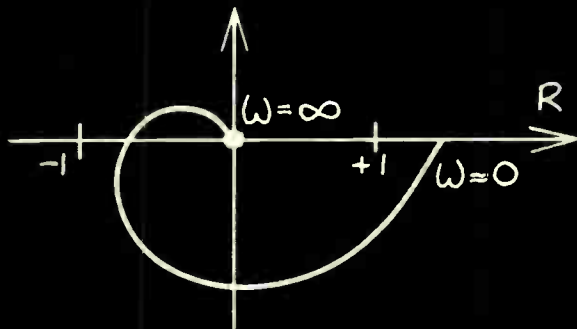

## Simplicity.

EMI has taken the complexity out of digital F.R.A. operation. In fact, our SM2001A is so simple that, in effect, all the operating instructions are on the front panel, reducing test time from minutes to seconds.

But don't think that simplicity means a sacrifice in performance. The SM2001A has complete harmonic analysis capability, so it's a frequency response analyzer in the fullest sense. Innovative digital techniques ensure high stability, resolution and accuracy. And a range of custom-built accessories provides unique flexibility.

Accessories include facilities for frequency

extension, two-channel operation, plotter and computer interfaces. There are also modulator/demodulator and reference synchronizer units.

Frequency range is 0.00001 Hz to 999 Hz (up to 999 kHz with frequency extension).

The price is easy, too. The SM2001A costs far less than competitive equipment.

Contact EMI for complete information.

EMI Technology Inc., Instrumentation Division,  
55 Kenosia Avenue, Danbury, CT 06810 (203) 744-3500,  
TWX: 710-455-3068



EMI Technology Inc., Instrumentation Division.  
A member of the EMI Group. International leaders in music, electronics and leisure



# Digital introduces DECstation. A big computer system that's small enough for anyone.

Digital put an amazing LSI version of the PDP-8 inside a DECscope, added some ingenious interconnecting devices and created something new. The DECstation. A complete computer system big enough to do all kinds of work and small, simple and inexpensive enough to do it for almost anyone.

**DECstation. A complete computer system in disguise.** It looks like a terminal, but look again. The DECstation has a powerful general purpose computer, a video terminal, a dual diskette drive, and its own special operating system. What's more, you can hook up two different printers and a second dual diskette drive. Then put the whole thing in a mini-desk, and when you're done you'll have the smallest big computer you've ever seen.

**The Video Data Processor. It's the big reason the DECstation's so small.** The VT78 Video Data Processor is a computer wrapped in a terminal. Inside the familiar DECscope you'll find an LSI version of the PDP-8 with 16K words (32K characters) of MOS memory and built-in interfaces. Two serial asynchronous ports feature speeds from 50 baud to 19.2 kilo-

baud. A disk port interfaces with up to 4 diskette drives. A parallel I/O port for printers and custom interfacing provides data transfer rates up to 180 kilobits/sec. All standard.

**You can go from carton to computer in less than an hour.** If you can push a button, you can run a DECstation. Because one button is all it takes to start things up. The bootstrap and self-test routines are built in.

Put it together, plug it in, and immediately you can begin to run anything from the PDP-8 software library. Which means you start with one of the most comprehensive sets of software tools available in a small system. Including two proven operating systems: OS/78 for stand alone applications and RTS/8 for real-time. OS/78, an extension of

OS/8, supports a number of languages, including FORTRAN IV and BASIC. So all you have to do is load the operating system and start programming your application.

Whatever that application, if you're looking for a sophisticated little system, at the right price, and a remarkable OEM tool, consider DECstation. \$7995 each. \$5436 OEM quantity 50.

For our free brochure, write Digital Equipment Corporation, Parker Street, Maynard, MA 01754. European headquarters: 81 route de l'Aire, 1211 Geneva 26. Tel: 42 79 50. In Canada: Digital Equipment of Canada, Ltd.

**digital**

PDP-8 Marketing Communications

Digital Equipment Corporation, Parker Street, PK3-1, M34  
Maynard, MA 01754.

E6237

Send me the free DECstation brochure. (please print)

Name \_\_\_\_\_

Company \_\_\_\_\_

Address \_\_\_\_\_

City \_\_\_\_\_ State \_\_\_\_\_ Zip \_\_\_\_\_

Phone \_\_\_\_\_ OEM \_\_\_\_\_ End-user \_\_\_\_\_

Application \_\_\_\_\_

\_\_\_\_\_ Please send additional information about the PDP-8 family.

## New products

Subassemblies

### 36 dc-to-dc converters bow

Single- and dual-output units keep high efficiency even when lightly loaded

A 36-model line of high-efficiency dc-to-dc converters is the first foray into the converter field for Computer Products Inc., a leading supplier of encapsulated switching power supplies. It sells the supplies under its own name and to 17 other companies for resale.

The new converters offer 65% efficiency at full rated load. But more importantly, the efficiency drops only slightly under light loading. The single-output models, for example, retain an efficiency of 60% when the loading drops to 20%, an important point, "because most dc-to-dc converters don't usually run at full rated load," points out project engineer Thomas Pantelakis. He says that "we go so far as to tell users in our data sheet what the efficiency compared to full load will be."

The PM900 series includes 5-watt and 6-w models, single- and dual-outputs, and dc input voltages of 5

volts and 12 v. The single-output models are offered with outputs of 5, 9, 12, and 15 v at currents from 400 milliamperes to 1 ampere. The dual-output versions put out either  $\pm 12$  v or  $\pm 15$  v at currents from  $\pm 190$  mA to  $\pm 230$  mA. Altogether, there are eight single-output converters in the line and four with dual outputs. But there are 36 distinct model numbers because each converter is offered in three popular pin configurations. The single-output models are priced at \$67 in small quantities; the dual-output units sell for \$79.

All models in the family have line regulation to within 0.02%. No-load to full-load regulation ranges from 0.02% to 0.04%, depending on the model. Other strong features of the PM900 series are low ripple and noise, radiation shielding on all six sides, and an absence of mechanical squeal. The latter is a problem in some converters when wires and cores begin to vibrate in the audio range during switching; the inverters in the PM900 series oscillate at ultrasonic frequencies, thus avoiding the problem.

Maximum peak-to-peak ripple is either 35 or 50 millivolts over a 20-megahertz bandwidth, depending upon model. Maximum noise, over the same bandwidth, is 1 mv for all models. The units offer output-current limiting and short-circuit protection for up to eight hours and

are all housed in cases measuring 2 by 2 by 0.380 inches. Delivery is from stock, or consult the factory for large orders.

Computer Products Inc., 1400 N.W. 70th St., P. O. Box 23849, Fort Lauderdale, Fla. 33307. Phone (315) 974-5500 [381]

### Analog-to-digital unit converts 14 bits in 12 $\mu$ s

A modular analog-to-digital converter, the ADC1131, uses the successive-approximation technique to combine a resolution of 14 bits with a maximum conversion time of 12 microseconds. Four analog input ranges can be programmed by the user: 0 to 20 volts, 0 to 10 v,  $\pm 10$  v, and  $\pm 5$  v. Two versions of the converter are offered: the 1131J has a maximum differential linearity error of 1 least significant bit and a small-quantity price of \$279; the 1131K reduces that error to  $\frac{1}{2}$  LSB, while raising the corresponding price to \$369. Both units are guaranteed not to miss any codes over the temperature range from 0°C to 70°C, and both have a gain temperature coefficient of no more than 10 ppm/°C.

A companion converter, the ADC1130, is similar to the preceding units except that its maximum conversion time is 25  $\mu$ s instead of 12  $\mu$ s. Maximum differential linearity error for this unit is 1 LSB, and its small-quantity price is \$239. The converters are all available from stock.

Analog Devices Inc., P. O. Box 280, Route 1 Industrial Park, Norwood, Mass. 02062. Phone (617) 329-4700 [385]

### 16-channel data-acquisition system resolves 12 bits

The ZMP 1000 is a self-contained 16-channel data-acquisition system with a resolution of 12 bits. The unit, which is furnished in an insulated steel case measuring 3.0 by 4.6 by 0.375 inches, is capable of multiplexing 16 channels of real-time





**Need an industrial version  
of our famous DOT and DIT  
military transformer?  
TRW/UTC has a stock answer.**

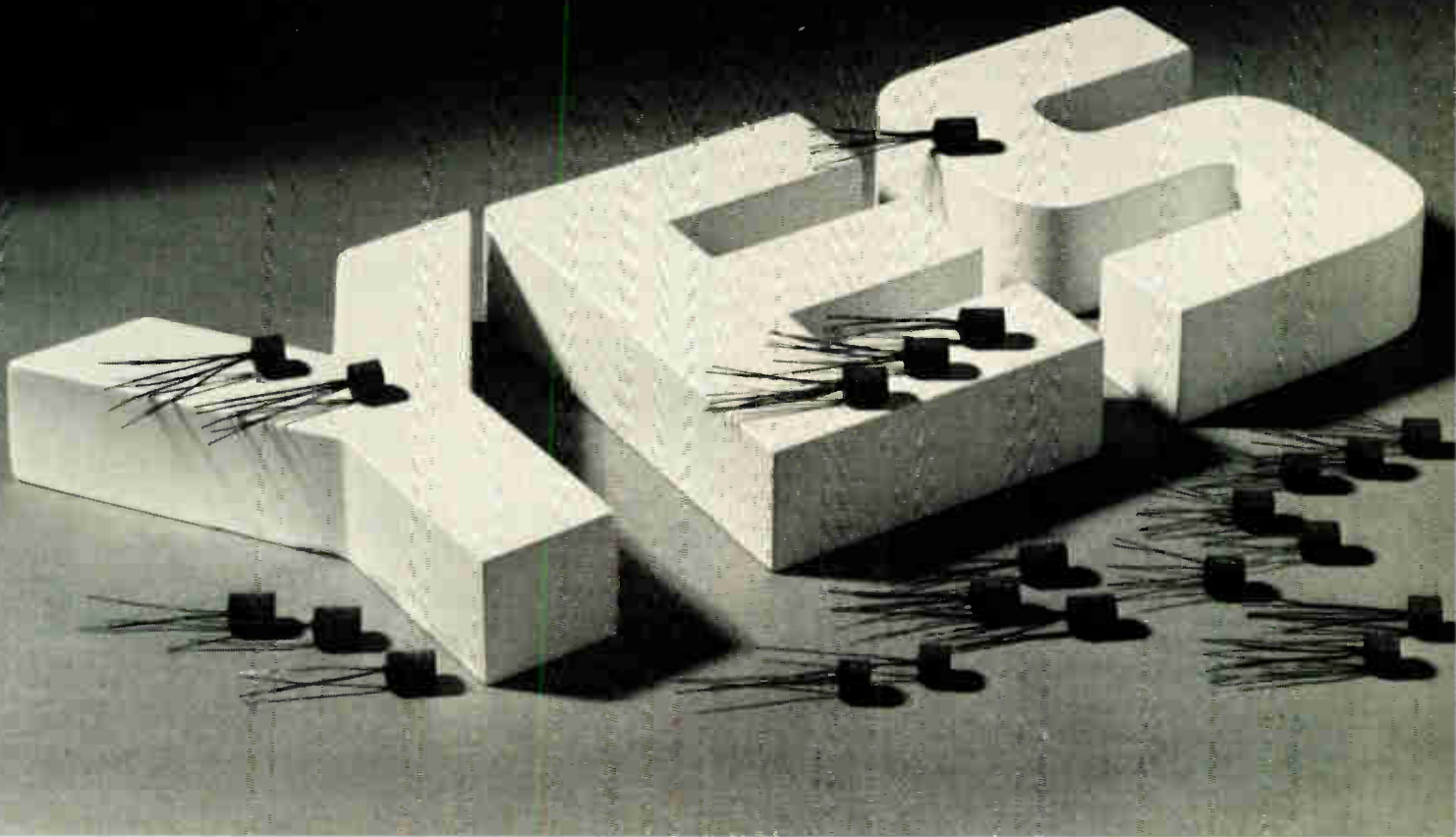

Now industrial users of transformers who need the space/performance of a high grade well tested product can choose from the I-DOT and I-DIT line of audio, signal, pulse or power transformers and inductors.

You see, we relaxed some of the environmental specifications of our prominent line of Mil spec DOT and DIT transformers, but kept the identical excellent electrical performance. Only the cost was reduced.

And the nice part, this industrial counterpart to the world renowned military line is a stock product available now at your authorized TRW/UTC distributor.

The I-DOT family has a frequency response of  $\pm 3$  db, 300 hertz to 20K hertz. The I-DIT has a  $\pm 3$  db, 400 hertz to 100K hertz, and is available both with flexible leads and with uninsulated dumet wire leads for printed circuit board mounting.

Check your authorized TRW/UTC local distributor for immediate off-the-shelf delivery or contact TRW/UTC Transformers, an Operation of TRW Electronic Components, 150 Varick Street, New York, N.Y. 10013. Area code: 212-255-3500.

**TRW UTC TRANSFORMERS**

ANOTHER PRODUCT OF A COMPANY CALLED TRW

# Divide and conquer

Pick a Plessey prescaler and you've conquered the major problems in your high-speed counters, timers and frequency synthesizers.

Because we can give you everything from ultra-fast dividers that tame the terrors of TACAN to inexpensive IC's that cut the costs of your CB's.

They're all guaranteed to operate from dc to at least the frequencies shown. They all provide low power consumption, low propagation delays and easy system interfaces, with most of them available in commercial and MIL-temp versions.

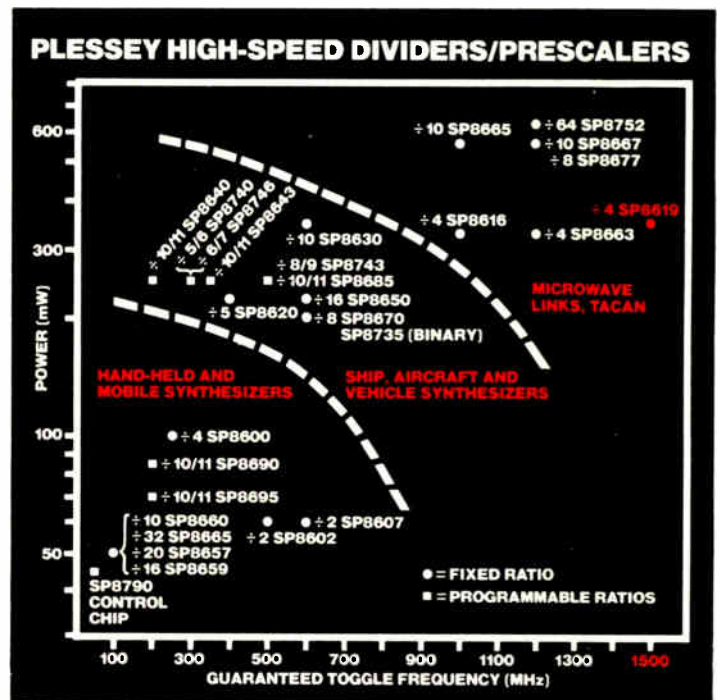

And they're all available now, so contact us for details or a demonstration. We'll show you a winner.

## Show me, Plessey:

Your dividers and prescalers sound like they can save me some money and a lot of grief.

Have a salesman call  Send more details

Name \_\_\_\_\_

Telephone \_\_\_\_\_

Company \_\_\_\_\_

Address \_\_\_\_\_

City/State/Zip \_\_\_\_\_



**PLESSEY SEMICONDUCTORS**

1641 Kaiser Avenue, Irvine, CA 92714  
Tel: (714) 540-9979. TWX: 910-595-1930

Represented world-wide



## New products



physical data from prime sensors. Monotonicity is guaranteed over the system's full operating temperature range of 0°C to 70°C.

With a maximum analog-to-digital conversion time of 12 microseconds, the ZMP 1000 is capable of throughput rates as high as 50,000 channels per second. Maximum differential linearity error is 1 least significant bit, and there are no missing codes. The unit's 16 channels are either single-ended or pseudo-differential; for true-differential operation, it provides only eight channels. Its price, in hundreds, is \$300 each. Delivery is from stock to 30 days.

Zeltex Inc., 940 Detroit Ave., Concord, Calif. 94518. Phone (415) 686-6660 [384]

### 8-bit hybrid a-d converters have 2.5- $\mu$ s conversion time

MN5140 series hybrid analog-to-digital converters are high-speed 8-bit units with a maximum conversion time of 2.5 microseconds. The devices operate from supplies of  $\pm 12$  volts and +5 v. An otherwise-similar series, the MN5130, is for operation from  $\pm 15$  v and +5 v. Both series have models for operation from 0°C to 70°C, from -55°C to 125°C, and over the latter range with processing to the military stan-



dard MIL-STD-883, Class B.

Both series are guaranteed to be linear within half a least significant bit over the full temperature range. And both are accurate to within 1 LSB at 25°C, with a maximum temperature-induced error of 2 LSB.

Housed in 18-pin hermetic dual in-line packages, the converters are laser-trimmed for adjustment-free operation. They typically dissipate 680 milliwatts. In small quantities, the commercial units sell for \$59 each, and the military versions are priced at \$118. Contact the company for pricing on the high-reliability devices.

Micro Networks Corp., 324 Clark St., Worcester, Mass. 01606. Phone (617) 852-5400 [386]

### Programmable regulator is accurate to within 0.1%

Two precision programmable voltage regulators offer control of output voltages to within 0.1% without the use of any external components. Designated the model LH0075 positive regulator and the LH0076 negative regulator, the circuits use a constant-current source in combination with a string of laser-trimmed thin-film resistors to provide eight standard voltages: 3, 5, 6, 8, 9, 12, 15, and 18 volts dc. Other voltages up to 27 v can be obtained by adding one external programming resistor. Similarly, current limiting, between 0 and 200 milliamperes, can be achieved by adding two more external resistors. Both units are designed for easy current boosting.

The devices provide line regulation to within 0.008% per volt and load regulation to within 0.075%. Devices rated for operation over the commercial temperature range from -25°C to 85°C sell for \$12.95 each in hundreds, while military-grade units (-55°C to 125°C) go for \$18.75 each in the same quantity. Product availability is from stock to four weeks.

National Semiconductor Corp., 2900 Semiconductor Dr., Santa Clara, Calif. 95051. Phone (408) 737-5000 [389]

### Line of uninterruptible power supplies is expanded

Semiconductor Circuits Inc. has expanded its line of uninterruptible power supplies from 9 to 36 models. The expanded family now offers a choice of 12- or 24-volt back-up battery and two types of triple output: +5 v dc with either  $\pm 12$  v or  $\pm 15$  v. Various models offer bipolar outputs rated at  $\pm 100$ ,  $\pm 200$ , or  $\pm 300$  milliamperes and 5-v outputs capable of delivering 1, 2, or 3 amperes. A key feature of the designs is their reliability: mean times between failures are in excess of 50,000 hours at 25°C. Prices range from \$155 to \$225 for single units down to \$148 to \$205 each in quantities of 10 or more. Production quantities yield even larger savings. Deliveries are from stock to two weeks.

Semiconductor Circuits Inc., 306 River St., Haverhill, Mass. 01830. Phone (617) 373-9104 [387]

### Modules reduce distortion errors in CRT displays

C104/C104B correction modules are solid-state function blocks designed to minimize geometric (pin-cushion) and focus distortion in flat-face cathode-ray tubes that use magnetic deflection. These units produce wideband corrected output functions for horizontal and vertical deflections plus dynamic focus.

Both modules feature a bandwidth of 10 megahertz, a slew rate of 400 volts per microsecond, a settling time (to within 0.1%) of 400 nanoseconds, and a typical uncertainty of 0.2% of full scale. The C104 is a voltage-output device, while the C104B has a current output. The output impedance of the C104 is 50 ohms. Pricing on the C104 is \$395 each in quantities of one to nine pieces. For the C104B, the corresponding price is \$275. Delivery time is four weeks. Intronic Inc., 57 Chapel St., Newton, Mass. 02158. Phone (617) 332-7350 [388]

## Industrial Infrared detector cools itself

---

Thermoelectric cooling gives  
specific detectivity of  
 $2.5 \times 10^{11}$  cm-Hz<sup>1/2</sup>/watt

---

Manufacturers of industrial smoke-detection, intrusion-alarm and optical gauging systems may want to take a good look at the new model TO-5-TE lead-sulfide infrared detectors being offered by Sanders Associates Inc., Nashua, N. H. The thermoelectrically cooled detectors, housed in hermetically sealed TO-5 cans, provide the high degree of sensitivity and long-term stability required for these and other applications, including moisture detectors and gas analyzers.

That is the opinion of Paul Murphy, manager of the detector group in Sanders' Defensive Systems division. He says that lead sulfide operates in the near infrared, with a

spectral response from the visible out to about 3.5 micrometers. With their built-in thermoelectric cooling, these detectors operate at 2.3 micrometers—near the peak of the band where a variety of illuminators, including tungsten lamps, are readily available.

The two principal specifications for the detectors are responsivity and specific detectivity. The responsivity of the TO-5-TE is  $10^6$  volts per watt. The specific detectivity,  $D^*$ , which is a figure of merit related to the device's signal-to-noise ratio, ranges from  $2.5$  to  $5.0 \times 10^{11}$  cm-Hz<sup>1/2</sup>/watt at a chopping frequency of 400 Hz and at the detector's peak wavelength. That figure for  $D^*$ , Murphy says, is better than those of the few other detector materials, such as indium arsenide, that operate in the 2- to 3-micrometer region.

It is the thermoelectric cooling to approximately  $-20^\circ\text{C}$  that provides the good detectivity. Murphy says it is done by using a heat-transfer bismuth-telluride material below the detector to draw heat down through the pedestal to the flange of the TO-5 package for dissipation. The cool-

ing function requires from 1 to 2 watts of power.

The detector elements, in a lens-capped package, are available in three standard sizes: 1-by-1, 2-by-2 and 3-by-3 millimeters. The single quantity price of the largest unit is \$200, or \$100 in quantities of 250. Delivery time is two to three weeks.

Sanders Associates Inc., 95 Canal St., Nashua, N. H. 03060. Phone the marketing manager for detector products at (603) 885-3010 [371]

---

## Linear-motion pots have 60- and 100-mm strokes

A series of industrial linear-motion slide potentiometers with long-life conductive-plastic elements is offered with 60-millimeter and 100-mm stroke lengths and resistances of 1,000, 5,000, and 10,000 ohms  $\pm 20\%$ . The MM-4 and MM-6 series devices are linear to within 1%. With their minimum life of 250,000 cycles, they are expected to be used in lighting controls, analog set-point controllers, speed controls, and so on. The shorter units sell for \$10 each in hundreds, and the longer ones go for \$12 apiece in the same quantity.

Waters Manufacturing Inc., Longfellow Center, Wayland, Mass. 01778. Phone (617) 358-2777 [374]

---

## Microprocessor-based system provides tight positioning

A microprocessor-based digital servo-control system is available for use in applications requiring a faster and more accurate response than stepper motors provide. The model DS 2200 is programmable for position, velocity, and acceleration. In addition to running a complete program, the system can perform critical in-progress functions without reprogramming. Easily reprogrammed, it has applications wherever acceleration and velocity must be controlled so as not to excite the mechanical

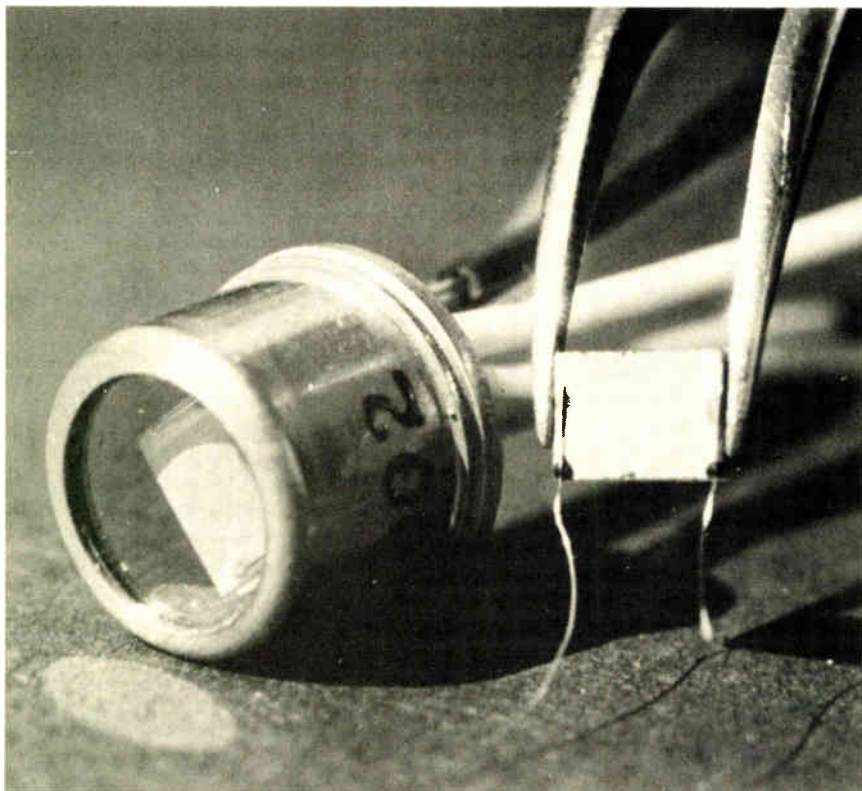

# Adaptable.

Kodak precision line film LP4 and LP7—line projection film on either a 4- or 7-mil base. It is designed for producing high-quality negatives of line originals. This tough Estar base film provides . . .

- high contrast
- wide latitude in exposure and development
- orthochromatic sensitivity
- matte level sufficient for quick and easy drawdown
- machine processing
- minimum pinhole tendency

It adapts to your needs and conditions. Can help cut waste and save money.



Our "Take a New Look" packet outlines all product details and performance charts for the Precision Line products. For your free copy, write Eastman Kodak Company, Dept. P04805, Rochester, N.Y. 14650!



## Kodak PRECISION LINE film LP4 and LP7

RESULTS COUNT



INTRODUCING **A NEW  
REVOLUTIONARY**

MULTI-DIGIT  
SOLID STATE READOUT

**BELOW \$1.**

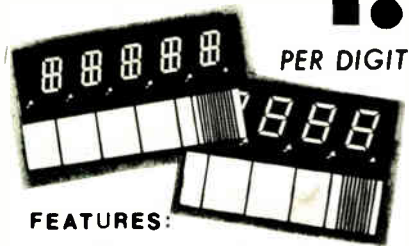

**FEATURES:**

- Non-fatiguing ELECTROLUMINESCENT light
- Space saving thin profile
- Wired for multiplexing
- Low a.c. power consumption
- Compatible with IC logic decoders and segment drivers
- Rugged, pluggable laminated plastic construction

**SPECIAL TRIAL OFFER**

ORDER FROM STOCK at **97¢** per digit, any of the following multi-digit readouts having 2 to 5 digits:  
 1/2" high with 9-segments  
 0.6" high with 7-segments  
 (minimum order--\$10.)



**T.L. ROBINSON CO., INC.**  
 P.O. BOX D, EAST AURORA, N.Y. 14052  
 TEL. (716) 652-2111 TELEX: 91566

Circle 202 on reader service card

**Gas Sensing Semiconductor**

**FIGARO  
TGS  
GAS  
SENSOR**

quickly senses even small amount of gas.

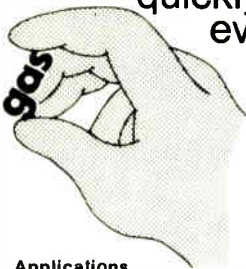

**Applications**

1. Natural Gas-Leak Alarm
2. Propane Gas-Leak Alarm
3. Carbon Monoxide Detector
4. Automatic Fan Control
5. Fire Alarm (Detecting combustible gases contained in smoke)
6. Alcohol Detector (Detector for drunken driver)
7. Air Pollution Monitor

Please contact any of the addresses below directly for catalogs and price/delivery information

**FIGARO ENGINEERING INC.**

●Head Office: 3-7-3 Higashitoyonaka, Toyonaka City, Osaka, 560, JAPAN TELEX 05286155  
 FIGARO J CABLE FIGARO TOYONAKA  
 TEL (06) 849-2156

●North America: 3303 Harbor Boulevard, Suite D-8, Costa Mesa, California 92626, U.S.A.  
 TELEX 678396 CABLE FIGARENGIN  
 COSTAMESA TEL (714) 751-4103

166 Circle 166 on reader service card

**New products**

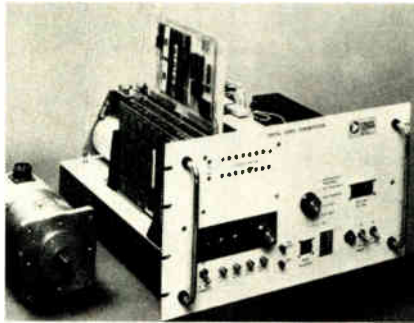

resonances of the system that is being regulated.

The unit takes in data as parallel 8-bit bytes. Position data is given as three bytes, while velocity and acceleration each require one byte. Data output is a serial pulse train with a maximum frequency of 10 kilohertz. Positioning accuracy is to within 1 bit.

Torque Systems Inc., P. O. Box 588, Waltham, Mass. 02154. Phone (617) 891-0230 [373]

**Shaft encoder withstands heavy mechanical loading**

Designed for physically demanding applications, the model 70B shaft-encoder employs an internal flexible shaft coupling to protect its delicate encoder elements from heavy axial and radial shaft loading. The unit, which provides a fixed number of pulses for every shaft rotation, is available with a variety of options: bidirectional output, ref-



erence pulse, dual-channel output, and others. Output voltage is either 5 or 12 volts at a current rating of 20 milliamperes.

Measuring 3 by 3 by 6 inches, the 70B meets NEMA 12 (dust-tight), NEMA 4 (water-tight), and NEMA 3 (weatherproof) requirements. It sells for \$180 and has a delivery time of two weeks.

Kessler-Ellis Products Co., Atlantic Highlands, N. J. 07716. Phone (201) 291-0500 [375]

**Timer board provides high accuracy for long periods**

A repeat cycle timer for applications requiring the accurate, continuous repeating of long cycle times is avail-

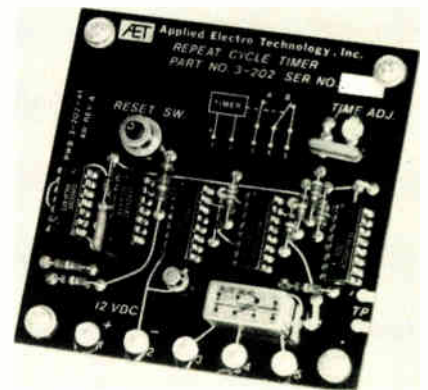

able as a conformal-coated circuit board. The model 3-202 uses a crystal-controlled oscillator to provide cycle times that are accurate to within 0.005% for periods from a few hours to several months. Its output is a form C (single-pole double-throw) relay that can handle 2 amperes at 28 volts dc. The relay switches periodically at a factory-set rate specified by the customer. A reset button is provided to ensure that the first cycle is as accurate as all that follow it.

Operating-temperature range for the 3-202 is -30°C to 65°C. The maximum temperature-induced error is 0.025%. In its standard configuration, the circuit requires an input supply voltage of 12 v dc ±15%. Priced at \$82.97 for one to nine pieces, the timer has a delivery time

# If you have one of these...



## ...you can start automatic testing with one of these.

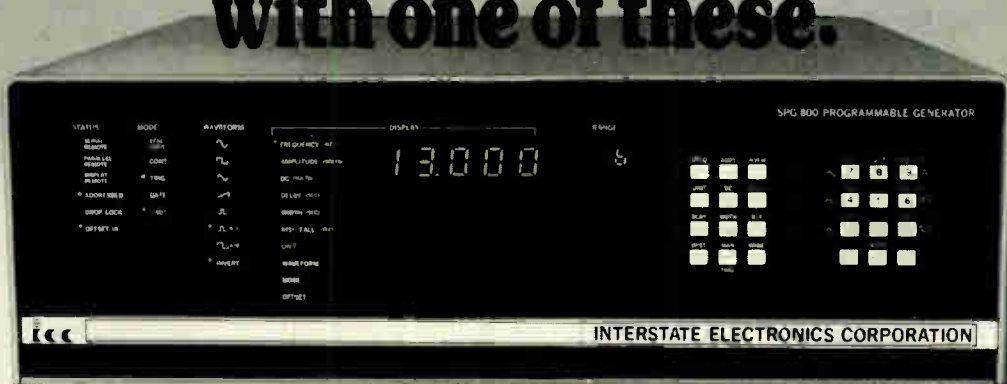

Now you can get into automatic testing equipment (ATE) for well under \$10,000, total cost.

All you need is one of the units pictured, the new SPG-800 Synthesized Programmable Generator, and a little do-it-yourself effort. Just use one of the units pictured to store your test procedure program with simple instructions to command the SPG-800 (and any other programmable instruments you use) and you're off and running.

No more knob spinning. No more hooking up counters and scopes and voltmeters to your signal source. Now automatic testing is within reach of every manufacturer—along with the savings in time and labor it means.

And the Model SPG-800 is a modular instrument. So you can get started with just the basic unit for only \$3195. It is a combination programmable function generator operating in the 0.1Hz to 13MHz range and a programmable DC voltage source.

Now or later, add Interstate's low cost field-installable plug-in cards and you'll have a programmable synthesizer and pulse generator too—four programmable test instruments in one.

Interfacing the SPG-800 is easy, too. Use its basic ASCII interface or one of its (optional) plug-in cards for the IEEE bus, the RS-232C or 20 mil loop or parallel interface.

No matter what configuration you order, you'll find the SPG-800 easy to program and reliable in use. And the optional operator control panel—in English—is easily learned by non-technical personnel, so you can program it directly, the day you get it.

If you didn't think your company could afford ATE, it's time to re-think... write today for more information Or call us at (714) 772-2811 or (800) 854-3825 toll free.

### The new SPG-800.

Please send me full information

Name  Title

Company

Address

City  State  Zip

Telephone Number

Interstate Electronics Corp.  
Department 7000  
P.O. Box 3117, Anaheim, CA 92803

## INTERSTATE ELECTRONICS CORPORATION

SUBSIDIARY OF **ATO**

Circle 167 on reader service card

# LOW NOISE MODULAR DESIGN

## Switching Power Supplies!



A new line of compact, modular-design switchers that simplify design for 300-600 watt applications and sell for less than 90¢ per watt! End users benefit from low EMI noise levels and highly reliable operation plus easy add-on and maintenance features. Get everything you need to know to evaluate this high quality, money-saving line from:

**Jim Daly**  
phone (612) 830-5800  
TWX 910 576 2978  
or write: 7801  
Computer Ave. So.  
Minneapolis, MN 55435.



## CONTROL DATA CORPORATION

Circle 203 on reader service card

# This Publication is Available in MICROFORM

from...

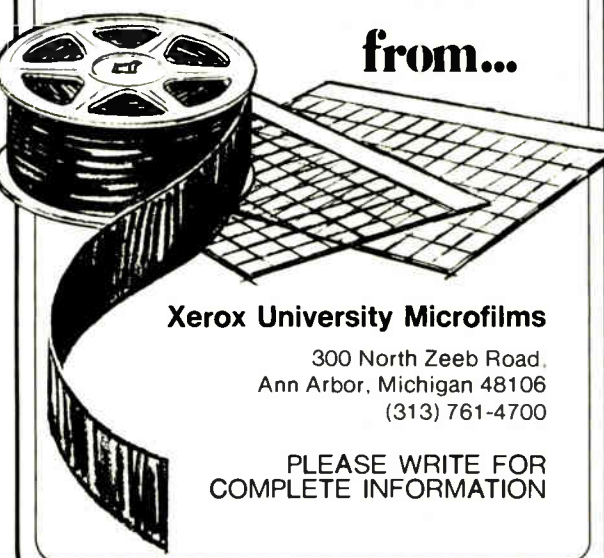

**Xerox University Microfilms**  
300 North Zeeb Road,  
Ann Arbor, Michigan 48106  
(313) 761-4700

PLEASE WRITE FOR  
COMPLETE INFORMATION

### New products

of five weeks from receipt of order.  
Applied Electro Technology Inc., 2220 S. Anne St., Santa Ana, Calif. 92704. Phone (714) 556-6570 [376]

#### Unit converts and displays synchro and resolver data

The SR300 shaft-angle encoder-indicator is a panel-mounting instrument that converts analog synchro or resolver data into a four-digit display and an equivalent binary-coded-decimal output. The unit may be specified to read directly in degrees of shaft rotation ( $0^\circ$  to  $359.90^\circ$  or  $\pm 179.90^\circ$ ), or it can be scaled to read in any units that can be linearly related to a shaft angle. Configured like a digital panel meter, the SR300 measures 2.156 inches high by 4.5 in. wide by 7.5 in. deep. It is powered by the ac line and may be specified to accept 11.8-, 26-, or 90-volt synchro or resolver data at either 60 hertz or 400 Hz. In small quantities, the encoder-indicator sells for \$585; a three-digit version is priced at \$480. Delivery time is six weeks.

ILC Data Device Corp., Airport International Plaza, Bohemia, N. Y. 11716. Phone Don Lavaglio at (516) 567-5600 [377]

#### Line-voltage analyzer stores worst-case readings

A new type of integrating ac voltage-to-frequency converter, for which a patent is pending, permits high-speed ac measurements so that a compact instrument can monitor the line voltage as often as twice each cycle. Each measurement is compared with values stored in two memories—the highest and lowest readings obtained so far. A switch allows the user to read the present line voltage or to look at the two stored values. A second switch offers a choice of three time bases: one-half, one, or two cycles. The LVA-110 sells for \$545.

Power-Science Inc., 8076 Engineer Road, San Diego, Calif. 92111. Phone (714) 292-4422 [378]



# *ii*incredibly versati*ii*le

You know about the cost/quality bind. So do a lot of other people.

That's why *iii* recommends and sells Rubycon capacitors. They're hard to beat for dependability and long-life in a competitively-priced capacitor.

And they're ideally suited for a wide variety of products. So you're probably using our Rubycon capacitors already . . . in that calculator on your desk, the CB in your car, the video game you gave the kids . . . and dozens of other places.

Write or call Jim Ambrose for samples and literature. And let's talk about using Rubycon capacitors in your own products.

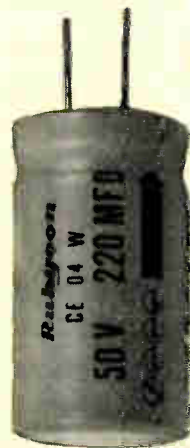
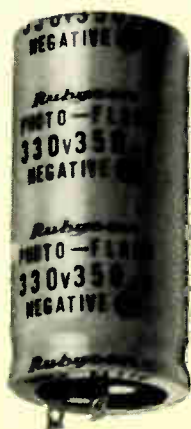

Rubycon Capacitors. An *iii* exclusive.

*ii*inquiries *ii*invited



2244 South Western, Chicago, IL 60608, (312) 847-6363

# EMI/RFI shielding materials...components... sub-systems

The beginning of any answer to your EMI/RFI problems is right here.

## GASKETS AND GASKET MATERIALS

- Strip Gasketing...with and without environmental seal
- Sheet Gasketing...with pressure seal
- Standard Gaskets...including connector and waveguide gaskets...environmental or pressure seal optional
- Custom Gaskets...designed and factory-fabricated to customer specifications

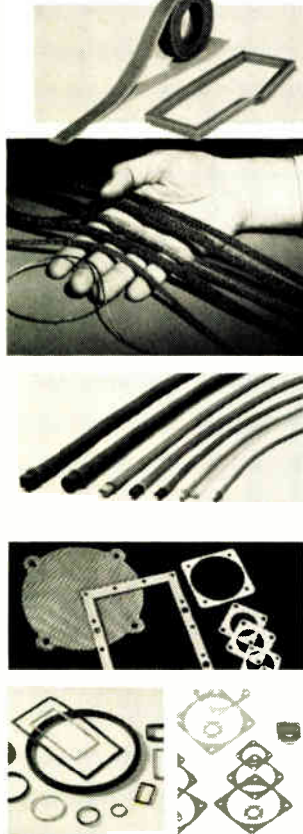

## SHIELDING AND CONDUCTIVE COMPONENTS

- Static Discharge Buttons
- Grounding Components
- Cable Shielding Tapes
- Flexible Cable-Shielding Covers
- Shielded Raceways
- Shielded Conduit Fittings

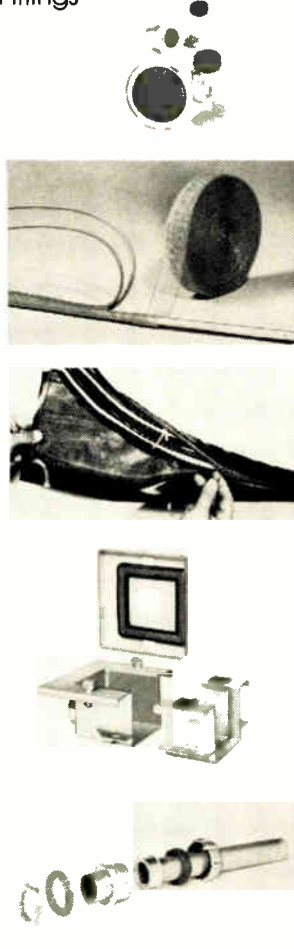

## SHIELDING FRAMES AND ASSEMBLIES

- Shielded Frames...ready-to-mount...pressure or weather seal optional
- Custom-Fabricated Frame Lengths...ready for customer assembly
- Bulk Frame-Strip Gasketing
- Shielded Windows...ready to install...custom-fabricated
- Shielded Ventilating Panels
- Shielded Air Filters

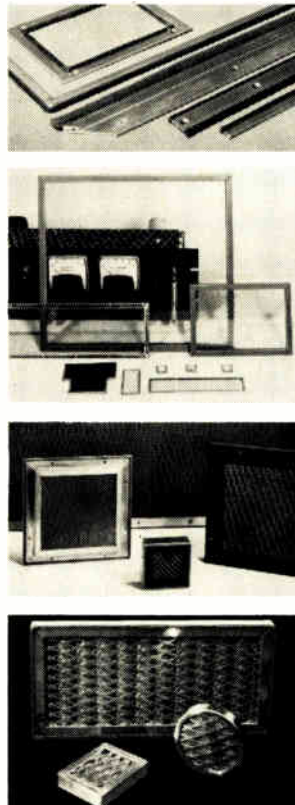

## CONDUCTIVE-ELASTOMER EMI/RFI XECON® GASKETS AND COMPOUNDS\*

- Composite EMI/Pressure-Seal Gasketing...7 durometer ratings...sheets, strips, custom die-cut gaskets, molded gaskets
- Armored Xecon™ High-Tensile-Strength Gasketing
- Vulcanized Xecon™ Pressure-Seal Gaskets
- O-Ring Gaskets for Waveguides
- Standard Connector Gaskets
- Conductive Adhesive
- Conductive Compounds...for EMI/RFI shield coating, caulking, cementing

\*Xecon gasketing compounds are homogenous conductive elastomers consisting of high-grade silicone in which are suspended microscopic silver-coated glass particles that provide the conductive path through the gasket.

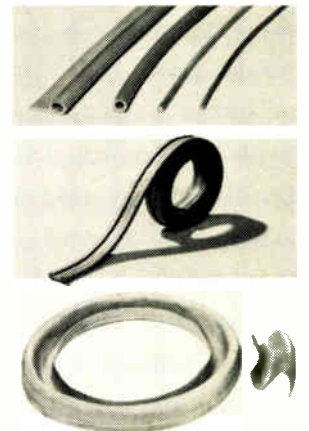

## New products

### Components

## New process hikes cell capacity

Plate improvements allow 5% to 35% capacity increase in rechargeable batteries

In the battery business, the name of the game is increase energy capacity without increasing size. General Electric Co. has done just that with a line of high-capacity, rechargeable nickel-cadmium cells in the following standard ANSI sizes: 1/2AA, AA, 1/2subC, A<sub>F</sub>, subC, 1/2D, and D. Typical of the performance of the new line is that of the D cell: at a C rate of discharge it has an energy capacity of 4 ampere-hours, compared with 3.5 A-h for a standard nickel-cadmium D cell.

A major innovation in plate technology, allowing better use of the active material, gives the cells their high capacity, according to GE engineers. The process combines a non-screen stipple substrate with a

patented plaque material that has a high energy density. In addition, an advanced winding technique allows more plate to be wound.

Aside from capacity, the new batteries are essentially identical to standard units, except for a slightly higher internal impedance. They are equipped with four-piece resealable safety vents, can be operated in any position, and can be stored for extended periods. Cells can be charged up to 1,000 times and can sustain continuous overcharging for long periods with no damage.

The high-capacity batteries are expected to find application in such diverse areas as radio transceivers, portable instruments, power tools, and calculators.

General Electric Co., Battery Department, P. O. Box 992, Gainesville, Fla. 32602. Phone (904) 462-4742 [341]

### Self-regulating transformers are stable to within 1%

At least 50% smaller than equivalently rated ferroresonant regulators, a line of miniature regulating transformers provides output regulation

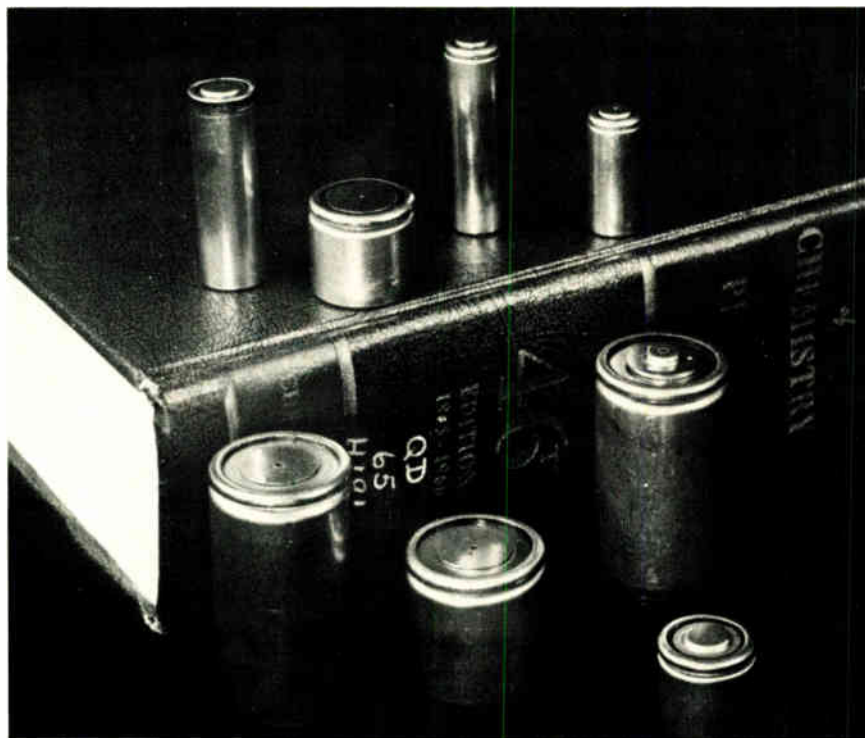

# Build better resolution, accuracy and stability for a lot less money!

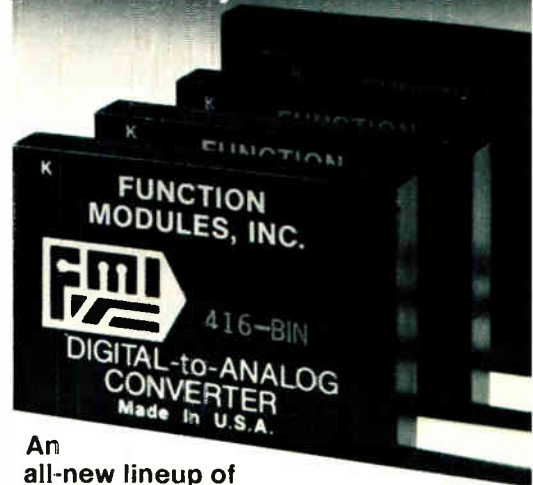

### An all-new lineup of high-resolution D/A Converters

#### Compare these features!

- Selectable current or voltage output
- 14 and 16-bits binary available
- 4 and  $\pm 4\frac{1}{2}$  digits BCD
- Low non-linearity and non-linearity drift
- 168 hours burn-in at 85°C
- Delivery off-the-shelf

You'll enjoy more resolution, accuracy and temperature stability for the price with the complete team of Intech/Function Modules high-resolution Digital-to-Analog Converters than from any others available . . . anywhere. Each DAC—packaged in a 2" x 3" x .4" case—has a built-in temperature-compensated reference network,  $\pm 2$  ppm/°C binary or BCD weighted wire-wound resistor network, fast current switches and op-amp. Plus, every model provides optional external offset and gain adjustments, too!

MODEL	RESOLUTION	ACCURACY	STABILITY	PRICE (1-24)
414-BIN	14-Bit Binary	$\pm 0.003\%$	$\pm 3$ ppm/°C	\$156.00
416-BIN	16-Bit Binary	$\pm 0.002\%$	$\pm 2$ ppm/°C	\$184.00
416-BCD	4-Digit BCD	$\pm 0.005\%$	$\pm 3$ ppm/°C	\$167.00
418-BCD	$\pm 4\frac{1}{2}$ -Digit BCD	$\pm 0.005\%$	$\pm 3$ ppm/°C	\$205.00

DAC's . . . off-the-shelf . . . today!  
Details . . . for the asking . . . today!

### intech/function modules

282 Brokaw Road  
Santa Clara, Calif. 95050  
Phone (408) 244-0500  
TWX: 910-338-0254

# POLYIMIDE VS. EPOXY

**Kerimid®601**

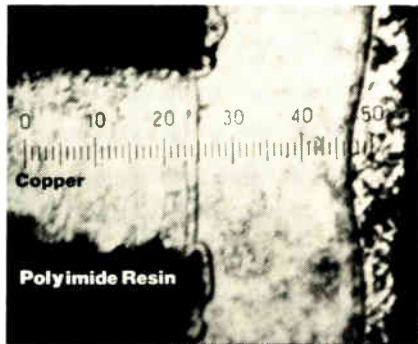

**Epoxy**

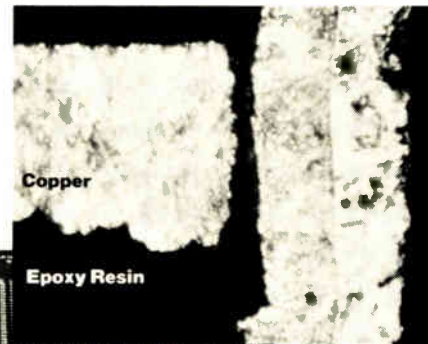

After drilling and soldering extreme magnification shows no resin smear or delamination interrupting circuitry.

After drilling and soldering extreme magnification shows smear and delamination causing circuit malfunction.

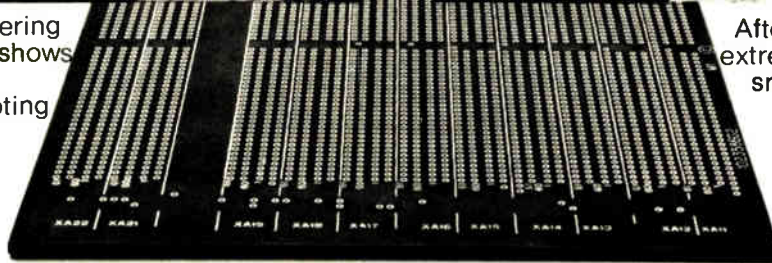

## Now approved for military use.\*

Kerimid 601 can significantly improve production yields by dramatically reducing smear and delamination. Which, when you consider the defective rate of epoxy boards, more than pays for the higher cost of Kerimid 601. Not to mention the gain it offers to your reputation for reliability in meeting promised delivery dates and in ultimate in-use functioning. In fact, one customer of ours hasn't rejected one circuit board due to smear or delamination in three years.

Kerimid 601 makes all this possible because it brings to circuit packaging the twin advantages of high heat resistance (4-500°F) and epoxy processability (355°F/200Psi). Additionally, void-free laminates offer improved characteristics over epoxies in z-dimensional stability and moisture resistance.

We think the combination of production and performance advantages offered by Kerimid 601 makes it well worth your investigation.

For more information, direct inquiries to: Rhodia Inc. Specialty Plastics Department, P.O. Box 125, Monmouth Junction, New Jersey 08852 (201) 846-7700.

Rhone-Poulenc, 22 Av. Montaigne, Paris-8e, France 256-4000.

**KERIMID® 601**   
A SUBSIDIARY OF RHÔNE-POULENC

\* MIL P-13949/10 Amendment 2; MIL P-55617 revision B; MIL G-55636 revision B.

## New products

to within 1%. The Mini-Reg devices are offered for use at 60 hertz and 400 Hz, for 115- and 230-volt ac lines. The regulators are relatively insensitive to frequency shifts and are unaffected by rectified loads. A MIL-T-27 version in a hermetic can measuring 2.375 by 2.75 by 3.875 inches weighs less than 2 pounds and is operable from  $-55^{\circ}\text{C}$  to  $125^{\circ}\text{C}$ . It provides a regulated output of 115 v ac at 60 Hz from a line varying between 105 and 125 v ac. Power rating is 250 watts. This unit sells for \$39 in lots of 500 pieces.

Power-Controls Division, KEM Co., 142 Peconic Ave., Medford, N. Y. 11763. Phone Howard Kanner at (516) 654-2084 [343]

10-position code switch needs only  
0.18 square inch of front-panel area

Pico series 10-position subminiature code switches occupy less than 0.018 square inch of panel space per decade and incorporate a bidirectional push-button mechanism to provide ascending and descending numerical functions. The switches are available with four-line binary-coded decimal or complementary-BCD output codes. The Pico-131-AK, a typical BCD unit, sells for \$4.25 each in hundreds.

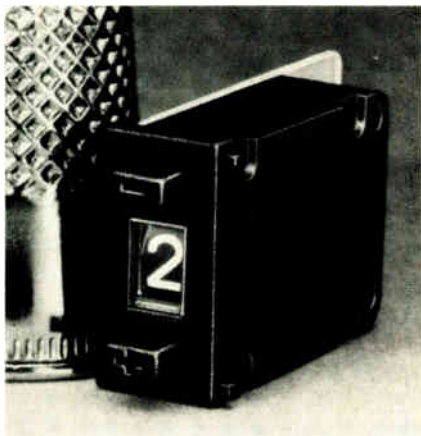

Alco Electronic Products Inc., 1551 Osgood St., North Andover, Mass. 01845. Phone Tom Clark at (617) 685-4371 [344]

Light-emitting-diode lamp replaces  
incandescent bulbs in push-button telephones

Designed to replace the miniature incandescent bulbs used in illuminated telephone push-buttons, the 5SBS lamp is a light-emitting diode mounted in a short #5 base. The lamp is available in three colors—red, amber, and green. At a forward current of 20 milliamperes, the LEDs have typical outputs of 50 millicande-

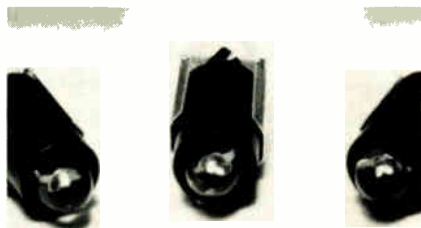

Circle 173 on reader service card →

This coupon will bring you  
instant data on Intech's  
Modular and Monolithic  
V/F and F/V Converters...  
which give you accuracy from  
.005% to .4% max.,  
operational to 1Mhz,  
at prices from  
\$8.95 to \$179.00.  
They're  
available.  
Now!

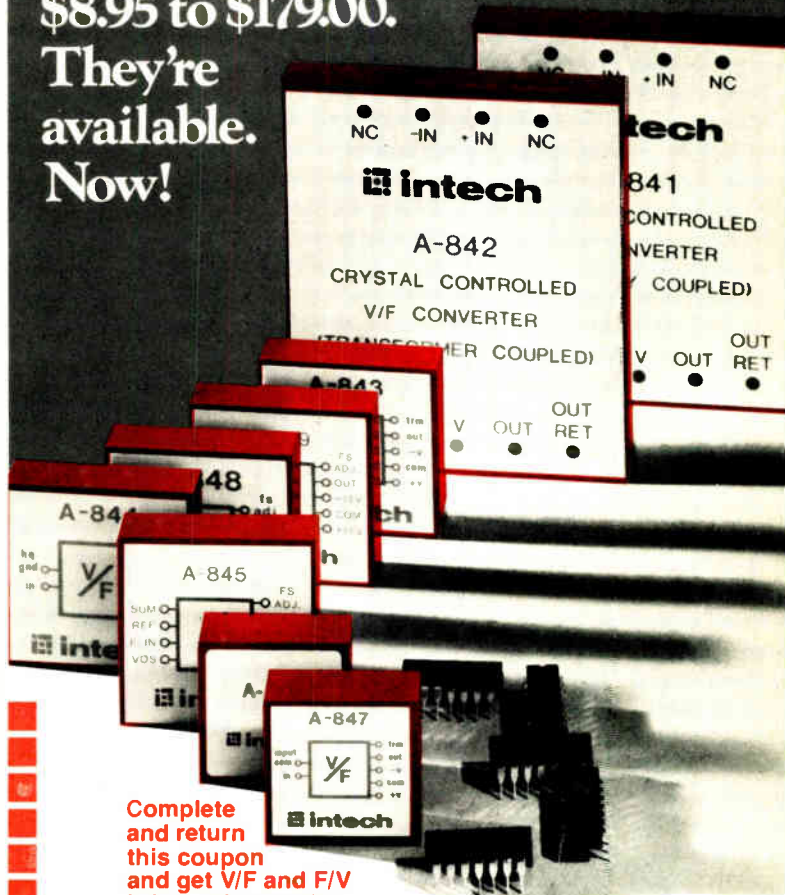

Complete  
and return  
this coupon  
and get V/F and F/V  
information on the  
broadest line of converters  
on the market today!

### intech/function modules

282 Brokaw Road, Santa Clara, California 95050  
Phone (408) 244-0500 TWX: 910-338-0254

- I need Modular performance. Tell me more.
- I'm a Monolithic type. What have you?
- I don't know you, Intech. Convert me.
- Phone me, IMMEDIATELY, at \_\_\_\_\_ (A.C.) \_\_\_\_\_ (Number)

Name \_\_\_\_\_ Title \_\_\_\_\_

Organization \_\_\_\_\_

Address \_\_\_\_\_ Mail Stop \_\_\_\_\_

City/State/Zip \_\_\_\_\_

Phone \_\_\_\_\_

# ULTRA FINE LINE PRINTING

50—70"  
Lines & Spaces  
by screen printing technique

*custom production*

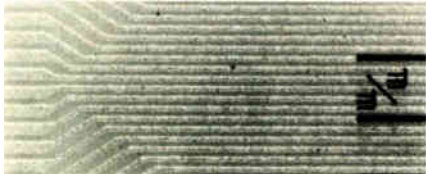

Low cost    Mass production

### Applications

1. Plasma display panel
2. Thermal printer head
3. Multi layer HIC etc.



**MFP corp.**

25-1, Minami-cho 6-chome, Fuchu,  
Tokyo, 183 Japan Tel. 0423-68-3341

Circle 174 on reader service card

## This Publication is Available in MICROFORM

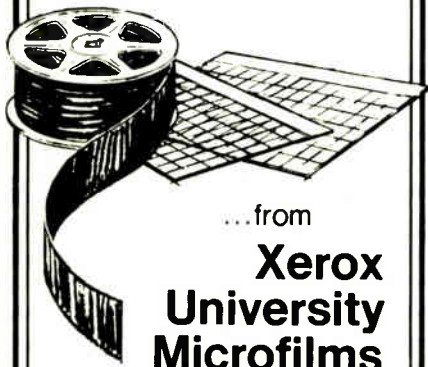

...from

**Xerox  
University  
Microfilms**

300 North Zeeb Rd.,  
Ann Arbor, Mich. 48106  
(313) 761-4700

PLEASE WRITE  
FOR COMPLETE  
INFORMATION

## New products

las (red), 35 mcd (amber), and 24 mcd (green). The lamps are available with built-in resistors for operation with voltages ranging from 5 to 48 v dc. For ac operation, rectifiers can also be built in. In large quantities, the 5SBS sells for as little as 80 cents each.

Data Display Products, 303 N. Oak St., Inglewood, Calif. 90301. Phone (213) 677-6166 [345]

### Quartz crystal occupies only 0.0077 cubic inch

Claimed to be the world's smallest quartz crystal, the S-45 measures a mere 0.078 by 0.275 by 0.285 inch. Gold-plated and mounted in a hermetic metal holder, it meets the requirements of MIL-C-3098. Intended for use in hand-held pagers,

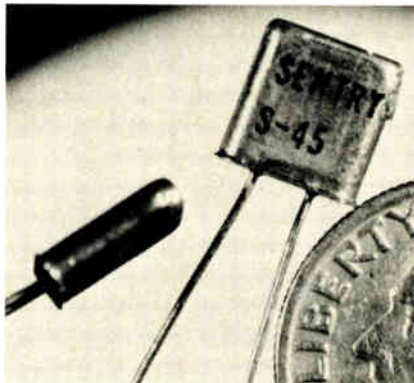

miniature citizens' band transceivers, and similar compact communications gear, the crystal is available in fundamental frequencies from 6 to 25 megahertz and in overtone frequencies from 18 to 125 MHz.

Sentry Manufacturing Co., Crystal Park, Chickasha, Okla. 73018. Phone (405) 224-6780 [346]

### Carbon-composition trimmer saves both space and money

Series 278 carbon-composition trimming potentiometers are intended for commercial applications requiring a small, inexpensive device. The

miniature 17/32-inch-diameter adjustment knob takes up little space and allows vertical and horizontal-mounting configurations. Resistances from 100 ohms to 5 megohms

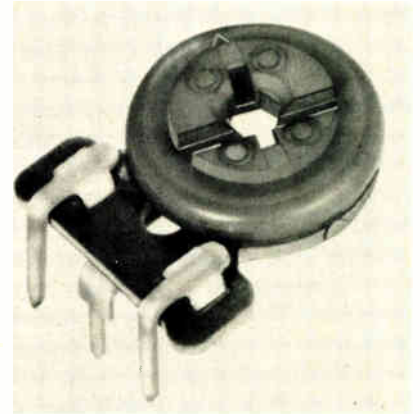

are offered with a standard tolerance of  $\pm 30\%$ . Power rating is 0.25 watt at 55°C derated to no load at 100°C. In production quantities, the pot sells for less than 12 cents apiece.

CTS of Elkhart Division, 1142 W. Beardsley Ave., Elkhart, Ind. 46514. Phone Ray McCuddy at (219) 295-3575 [347]

### Low-profile relay stands 0.415 inch above pc board

Designed for applications in which height is a problem, the model 240 miniature low-profile relay is a dc device with an installed height of only 0.415 inch. Available in both single-pole double-throw and double-pole double-throw versions, the unit can be driven from transistor-transistor-logic circuits with a driver buffer. Sensitive and standard coils are available, as are coil voltages from 5 to 24 v dc. Typical operate

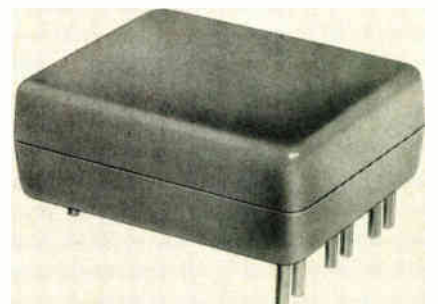

# VACTEC Photodetectors

The Industry's Broadest Line Provides More Semiconductor Detectors for More Design Applications

Vactec serves manufacturers of a wide range of modern electronic products. Pictured are a few examples. All these devices are both made and sold by Vactec, including complete lines of LDR's (photoconductive cells, CdS and CdSe); silicon solar cells, as well as silicon high speed and blue enhanced cells; NPN phototransistors and darlington's; opto-couplers (LED/LDR, lamp/LDR and neon/LDR); selenium photovoltaic cells; silicon photodiodes, blue enhanced and PIN; and custom C-MOS and bi-polar IC's. Write for technical bulletins on the types that suit your requirements. Or send your application, and Vactec will recommend the right cell for the job.



## Vactec, Inc.

2423 Northline Industrial Blvd.  
Maryland Heights, Mo. 63043  
(314) 872-8300



**Electronic Organs**

LED or lamp/LDR Vactrols for audio, and CdS cells for swell pedal controls.

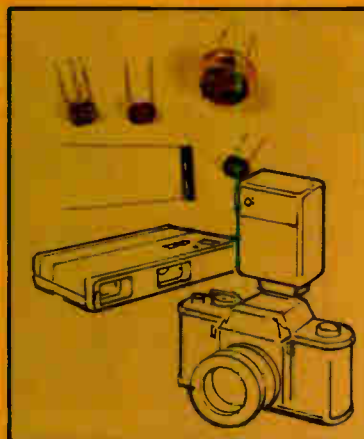

**Cameras and Projectors**

CdS or blue enhanced silicon photo-diodes for automatic shutter timing, aperture servo systems for automatic projector focus, and slave flash controls.



**Triac Motor Controls**

A special Vactrol gates a triac for forward and reverse motor operation as in hospital beds.



**LED Watches**

Photoconductive or phototransistor chip controls LED brightness.

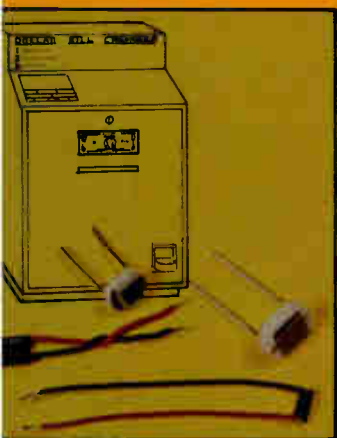

**Dollar Bill Changers**

Silicon photovoltaic cells analyze optical characteristics.



**Machine Tool Controls**

High-speed photovoltaic cells or transistor arrays help computer control repetitive operations, non-contact sensing, and counting and weighing.



**Telephone Equipment**

Neon/LDR Vactrols sense ringing. Direct a-c coupling, slow LDR response isolates electronics from noise.



**Scientific Instruments**

Blue enhanced silicon or selenium photovoltaic cells detect solutions densitometrically for precise blood chemistry and other analyses.

**Sexy Skanners  
to detect  
small stuff.**

.001 inch and smaller.  
Coaxial fiber optic design puts  
the phototransistor  
in the tip away  
from lamp or LED heat  
for negligible drift.  
Response time from skanner to  
amplifier output in  
5 microseconds.

And there's more.  
Widest selection of subminiature  
photoelectric sensors ever offered.  
Controls and automation systems  
to match. 3 day shipments.

SEND FOR COMPLETE CATALOG.

**SKAN-A-MATIC**<sup>®</sup>  
CORP.  
P.O. BOX 5, ELBRIDGE, N.Y. 13060  
PHONE (315) 689-3961

Circle 176 on reader service card

**This  
Publication  
is Available in  
MICROFORM**

from...

**Xerox University Microfilms**  
300 North Zeeb Road,  
Ann Arbor, Michigan 48106  
(313) 761-4700

PLEASE WRITE FOR  
COMPLETE INFORMATION

time of the 240 is 3 milliseconds.

Deltrol Controls/Division of Deltrol Corp.,  
2745 S. 19th St., Milwaukee, Wis. 53215.  
Phone (414) 671-6800 [348]

### Compact solid-state relays are rated up to 40 amperes

Although they occupy less than a third of a cubic inch, solid-state relays in the J-TAB series have current ratings from 5 to 40 amperes and voltage ratings up to 280 volts ac. More importantly, they have 1-millisecond peak-surge ratings that are 25 times the steady-state-current limit. This allows them to handle applications with high turn-on current transients. Electro-mechanical relays in similar applications would need very high current ratings to avoid contact welding.

The optically coupled J-TAB devices require a control current of approximately 15 milliamperes at 5, 12, or 120 volts. They have an isolation-voltage rating of 2,500 v ac and a maximum leakage rating of 1 mA. Pricing for 120-v models, in thousand-piece lots, ranges from \$3.75 each for the 5-A JTA-1205 to \$12 each for the 40-A JTA-1240. Delivery time is from six to eight weeks. Theta-J Relays Inc., 1 DeAngelo Drive, Bedford, Mass. 01730 [349]

### Thick-film resistor networks have protective molded coat

A line of thick-film resistor networks intended mainly for use in pull-up and pull-down applications is protected by a tough, uniform molded coating. Available in 6-, 8-, and 10-pin single in-line packages, the networks are available for immediate shipment in 49 standard values from 33 ohms to 1 megohm. The standard circuit consists of five, seven, or nine resistors with one common pin and no isolation. A typical price is 29¢ each for the six-pin, 100-ohm circuit in thousands. Dale Electronics Inc., Box 74, Norfolk, Neb. 68701 [350]





## “Get yer connectors here!”

When it comes to connectors, there are vendors — and there are interconnection specialists. There's quite a difference. When your interconnection problem can't be solved by off-the-shelf (or off-the-cart) equipment, that's when you need us. Our speciality is solving interconnection problems. That means, for starters, designing a system to fit your unique requirements. Then tooling up, manufacturing, and assembling the system at our completely-equipped plant. And finishing up with on-time delivery, installation, and service.

We've been solving interconnection problems for many “blue chip” companies for 20 years. So your problem won't throw us. And with our high standards of quality, we won't throw you for a loop, either. Don't settle for just any off-the-street solution. See the interconnection specialists.

**FABRI-TEK INC.**  
**NATIONAL CONNECTOR DIVISION**  
 9210 Science Ctr. Drive • Minneapolis, MN 55428  
 (612) 533-3533

**TELL ME MORE!**

- Fabri-Pak™ backpanel systems
  - Flat cable connector systems
  - Military
  - Send literature
  - Molded connectors
  - Commercial
  - Have salesman call
  - Plate connectors
  - Telephone connectors
- Name and Title \_\_\_\_\_  
 Company \_\_\_\_\_  
 Address \_\_\_\_\_  
 City, State, Zip \_\_\_\_\_  
 Telephone \_\_\_\_\_

Circle 204 Fabri Pak TM backpanel systems  
 Circle 205 Flat cable connector systems  
 Circle 206 Molded connectors

Circle 207 Plate connectors  
 Circle 208 Telephone connectors  
 World Radio History

# Why should you join the Payroll Savings Plan now? Maybe you'll find out later.

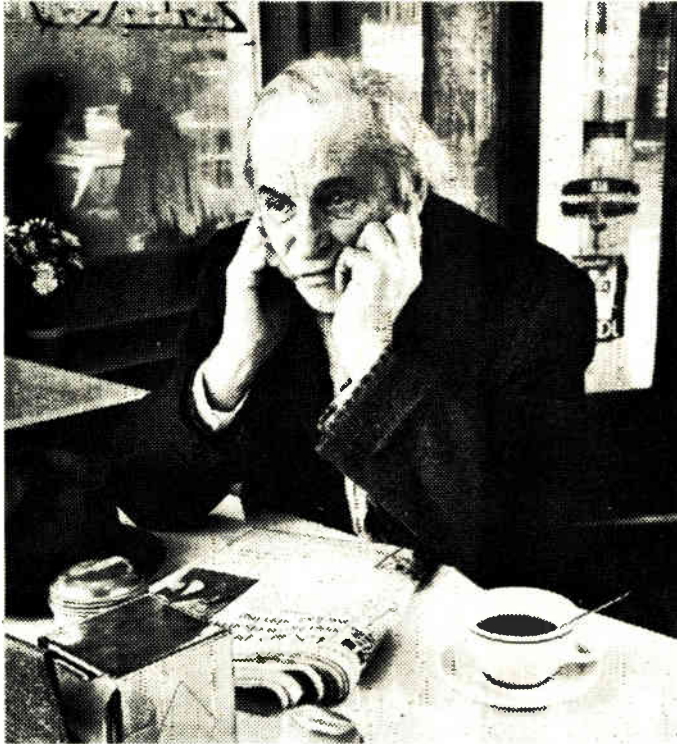

The future can be too late for saving. So if you want security, you'd better start today.

The Payroll Savings Plan makes it easy. Because an amount you choose is automatically set aside from each paycheck to buy U.S. Savings Bonds. That way, your savings build, year after year.

So start today. Because tomorrow, today will be yesterday.

Now, E Bonds pay 6% interest when held to maturity of 5 years, 4% the first year. Bonds are insured if lost, stolen or destroyed. When matured, the cash can be cashed at your bank. Interest is not subject to state or local income taxes, and federal tax may be deferred until redemption.



## Take stock in America.

Join the Payroll Savings Plan.

**Ad Council** A PUBLIC SERVICE OF THIS PUBLICATION AND THE ADVERTISING COUNCIL

## New products/materials

An opaque epoxy especially developed for coating light-sensitive components can be applied directly to integrated-circuit chips. Called Epo-Tek H62, the material is a thermally conductive, electrically insulating formulation. It adheres well to metallic, glass, ceramic, and semiconductor surfaces. The one-component thixotropic paste requires no refrigeration in shipping or storage and has a room-temperature shelf life of up to six months. Curing requires 30 minutes at 150°C or 60 minutes at 120°C, resulting in a volume resistivity of 10<sup>14</sup> ohm-centimeters and a lap shear strength of 1,000 pounds per square inch. The operating-temperature range extends from -67°C to 330°C. Trial evaluation kits are available at a price of \$15 for 3 ounces. Deliveries are from stock.

Marketing Department, Epoxy Technology Inc., 65 Grove St., Watertown, Mass. 02172 [476]

**Rf-gasketing material** Alu-Flex is a rubber-impregnated aluminum-wire cloth that can be used for pressure-sealing gases and liquids and for providing low-resistance connections between metal surfaces, as well as for shielding against radio-frequency interference. The material is available in two formulations: Alu-Flex HT, for high-temperature use, and

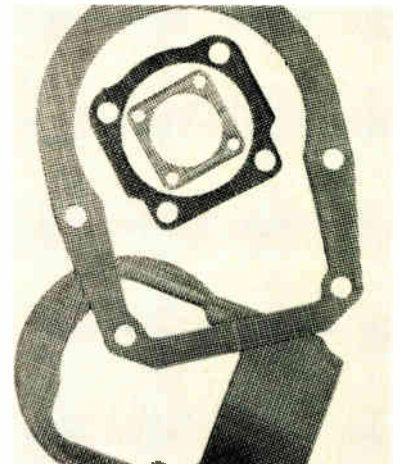

Alu-Flex Standard. The HT formulation is impregnated with silicone rubber for operation from -65°F to 500°F. The standard material, which

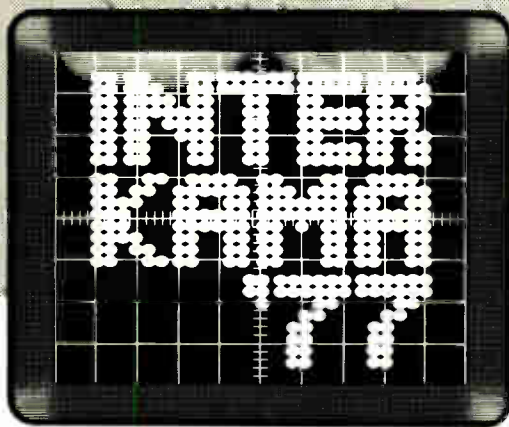

# THE CONGRESS THAT IS TODAY'S POINTER TO TOMORROW'S DEVELOPMENTS

For years the INTERKAMA CONGRESS has enjoyed world-wide significance. Specialists of international standing present papers on pace-making progress in fields of current interest. A 'must' for forward-looking automation and instrumentation men. Fill in and return the coupon for full particulars and application card.

**Note the date:** October 5 and 6, 1977, with repeat discourses on October 10 and 11, 1977.

## LECTURE SERIES

### 1) Measuring technique and pattern recognition in production engineering

Measuring and testing in production engineering, non-destructive test methods, image evaluation, pattern recognition of situation and state, recognition of conspicuity, plausibility checks "intelligent" television sensors.

### 2) Automation of measuring and checking systems

Microprocessors as component parts of measuring systems, spatially distributed measuring networks, automatic signal analysis for the determination and prediction of magnitudes which cannot be measured directly and for early warning to faults or hazardous system states.

### 3) The use of progressive control procedures

Experience gained with model making, estimation of parameters and states and the use optimum adaptive multi-control systems in complex processes.

### 4) Control rooms and control desks

The place of the human being in automated systems, integration of various tasks in a control desk (e.g. process control and arrangement of process supervision), rationalization and planning the manufacture of control rooms, Input/Output screen terminals. Actual examples.

### 5) Spatially distributed process computer systems

Microprocessors as integrated components of control and regulating systems, their effect on the construction of process computer systems and their programming procedures, new possibilities and limits, data transfer via busbar systems including optic conductors.

### 6) Reliability and safety (appliances)

Methods for the improvement of reliability, definition and assessment of safety, proper functioning of appliances and programs for safety devices, fault recognition facility, self-monitoring, cost of reliability.

### 7) Reliability and safety (systems)

Methods for the improvement of reliability, definition and assessment of safety, proper functioning of appliances and programs for safety devices, fault recognition facility, self-monitoring, cost of reliability.

### 8) Computer-aided design and application programming of regulating, controlling and monitoring systems

Automation concepts, design of processes and equipment suitable for automation, new programming procedures (software production) in as much as they have a substantial effect on application programming.



## INTERKAMA CONGRESS: OCTOBER 5 AND 6, 1977, REPEAT DISCOURSES ON OCTOBER 10 AND 11, 1977

An international event within the world's largest instrumentation and automation fair -- INTERKAMA '77, in Düsseldorf, October 6 to 12, 1977

### GET MORE INFORMATION

Complete and mail to: Düsseldorf Messe-gesellschaft mbH - NOWEA - Z 2, Congress Dept. P.O. Box 32 02 03, D-4000 Düsseldorf 30, West Germany. Please send me a copy of the full Congress Programme and an application card.

Name and initials \_\_\_\_\_

Address \_\_\_\_\_

Postal code \_\_\_\_\_ Phone \_\_\_\_\_

# Industry's First 14-Bit A/D In a DIP

- Highest resolution A/D available in a DIP
- Fully specified from 0° to 70°C
- +1/2 LSB linearity error
- 0.04% accuracy
- Conversion time: 250  $\mu$ sec max
- Power consumption: 230 mW typical
- Adjustment free
- 24-pin hermetic DIP

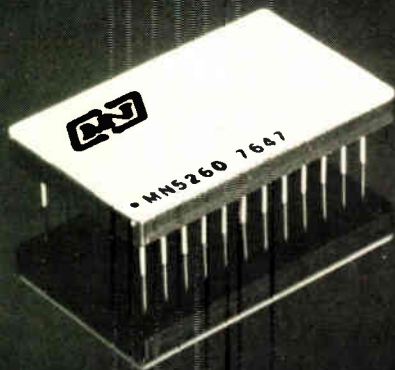

**MN 5260**  
**\$219.00\***

\* in 100 quantity



Micro Networks Corporation  
324 Clark Street, Worcester, MA 01606  
(617) 852-5400 TWX 710-340-0067

## New products/materials

is impregnated with neoprene, has a range of  $-20^{\circ}\text{F}$  to  $220^{\circ}\text{F}$ . Both types are available in two thicknesses—16 mils and 20 mils—as custom-cut parts or as sheets up to 8 inches wide.

The Auburn Manufacturing Co., 306 Stack St., Middletown, Conn. 06457 [477]

**An air-firable thick-film system of materials** is intended for the fabrication of planar dc gas-discharge displays. The system includes Nicyl 9530 nickel-electrode composition, silver conductor 7713 for glass-seal feedthroughs, crossover dielectric 9740, and contrasting dielectric 9741. All compositions are designed for compatibility with soda-lime glass substrates. The materials can all be fired in air, in conventional belt furnaces, at  $570^{\circ}\text{C}$  to  $600^{\circ}\text{C}$ .

E. I. du Pont de Nemours & Co., Wilmington, Del. 19898. Phone (800) 441-9475, Ext. 7665 [478]

**Low-K dielectric pastes** for screen-printing thick-film crossovers or multilayer circuits can be refired many times without softening. In fired films 1.4 to 1.7 mils thick, the materials have a dielectric constant of less than 10, a breakdown voltage in excess of 550 volts, and an insulation resistance of more than  $10^{10}$  ohms. To accommodate processing other materials on the substrate, the pastes are offered with three firing-temperature ranges:  $750$  to  $810^{\circ}\text{C}$  (Iso-Ohm 1003),  $800^{\circ}$  to  $890^{\circ}\text{C}$  (1005), and  $880^{\circ}$  to  $1,000^{\circ}\text{C}$  (1007).

Thick Film Systems Inc., 324 Palm Ave., Santa Barbara, Calif. 93101 [479]

**A punchable epoxy-glass laminate** for making two-sided printed-circuit boards with plated-through holes is intended to replace the more expensive composite laminates commonly used for such applications. Called GEM, the material is now in pilot production. When it goes into full production later this year, the company estimates that it will sell for \$1.60 per square foot in the 59-mil gage with 1-ounce copper foil bonded to both sides.

New England Laminates Co., Elm Street, Walden, N. Y. 12586. [480]

# ELECTRONICS REPRINTS

No. of  
copies  
wanted

## New reprints

- \_\_\_ R-716 Special report—Japanese wave in semiconductor technology 24 pp \$3.00
- \_\_\_ R-714 Special report—active filter technology 6 pp \$3.00
- \_\_\_ R-713 Electron-beam lithography draws fine line 10 pp \$3.00
- \_\_\_ R-712 Special report—large-scale integration 16 pp \$3.00
- \_\_\_ R-710 Personal computers mean business 8 pp \$2.00
- \_\_\_ R-708 So you want to be a consultant 6 pp \$2.00
- \_\_\_ R-706 Low-cost dual delayed sweep method 6 pp \$2.00
- \_\_\_ R-705 Powering up with linear ICs 12 pp \$3.00

## Charts

- \_\_\_ R-516 Electronic symbols \$2.00
- \_\_\_ R-213 Electromagnetic spectrum (updated 1976) \$3.00
- \_\_\_ R-326 Optical spectrum (6-page report and chart) \$3.00

## Books

- \_\_\_ R-704 Thermal design in electronics \$5.00
- \_\_\_ R-701 Applying microprocessors—Electronics Book Series \$9.95
- \_\_\_ R-608 Basics of Data Communications—Electronics Book Series \$12.50
- \_\_\_ R-602 Large Scale Integration—Electronics Book Series \$9.95
- \_\_\_ R-520 Microprocessors—Electronics Book Series \$8.95
- \_\_\_ R-011 Computer-aided Design 135 pp \$4.00
- \_\_\_ R-032 Active Filters 88 pp \$4.00
- \_\_\_ R-031 Circuit Designer's Casebook 182 pp \$5.50 (outside U.S. \$12.00)

## Payment must accompany your order

Make check or money order payable to Electronics Reprints. All orders are shipped prepaid by parcel post. Allow two to three weeks for delivery.

Mail your order to:

Janice Austin  
ELECTRONICS REPRINTS  
P.O. Box 669  
Hightstown, N.J. 08520

Back issues now available:

1960 to 1969, \$5.00 each  
1970 to 1973, \$3.00 each  
1974 to 1976, \$4.00 each

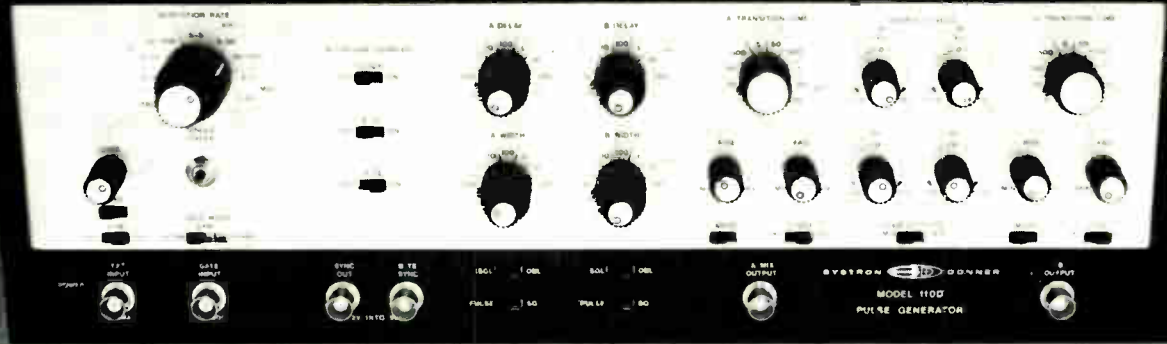

S-D's new dual channel  $\pm 18\text{v}$  pulse generator

# THE LOGICAL CHOICE

Attention all of you working with 2 and 4-phase logic systems, bipolar logic, radar testing and simulation, and with complex waveforms of all types: the new S-D 110D dual-channel pulse generator is for you.

In one compact instrument, Model 110D contains two complete pulse generators with all pulse parameters separately controllable for each channel. You can also *mix* the channels to produce complex waveforms and *delay* one channel from another.

That's why you can produce a true 2-phase system (4-phase with two slaved 110D's) as well as double and triple pulse pairs and controllable pulse trains for data simulation. For

sheer variety of pulses, nothing today touches Model 110D.

Model 110D is the latest member of a growing family of S-D pulse generators whose distinguished ancestors — Data-pulse Models 110B, 110A, and 110 — set the industry standards in their time.

**Key 110D data:**  
Amplitude,  $\pm 18\text{v}$  into 50 ohms • DC offset to  $\pm 18\text{v}$  • rise/fall time variable from 5 ns to 500 millisecc • repetition rate 50 MHz • Price \$2,250 (U.S. only). Get the facts on the first modern-day

2-channel pulser.

Contact Scientific Devices or Systron-Donner at 10 Systron Drive, Concord, California 94518, Phone (415) 676-5000.

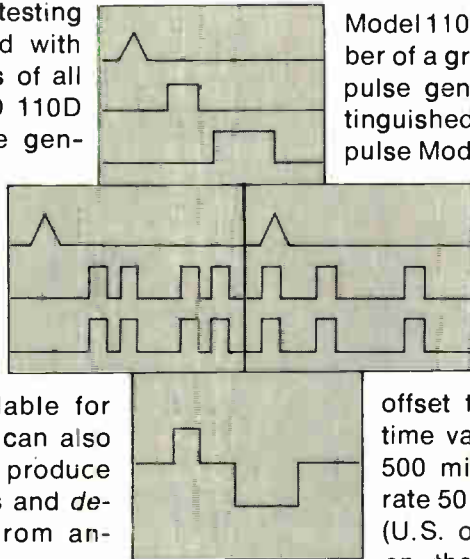

SYSTRON  DONNER

Now!

# 25/35 Amp PRESSFIT SCRs...



with any  
gate sensitivity  
you want...

voltages  
to 800V.



unsurpassed  
surge current  
capability...

and glass  
passivation...

priced as low  
as \$1.15!

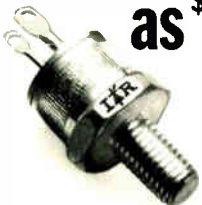

Type IR30, IR32, 20RA, 21RA, 22RA and 23RA with voltages to 800V and minimum  $I_{GT}$  from 1 to 100 mA. Unsurpassed surge capability and high temperature stability from hard glass passivation to help make them the most reliable pressfits around. Delivery from stock! Call your IR Distributor or Sales Office today. International Rectifier, 233 Kansas, El Segundo, CA 90245. Phone (213) 322-3331, Telex: 66-4464.

# International Rectifier



... the innovative semiconductor people

182 Circle 182 on reader service card

## New literature

**Semiconductor measurement technology.** A technique for using a commercial C-meter with a bias-isolation unit (BIU) for capacitance measurements at bias-voltage magnitudes up to 10 kilovolts without damage to the measuring equipment is described in a newly released report. Basic principles of operation and details of the electrical design of a BIU are also discussed. Copies can be obtained at \$1.45 each using order number C13.10:400-34. Superintendent of Documents, U.S. Government Printing Office, Washington, D.C. 20402.

**Pressure regulator purging.** A question often asked by semiconductor manufacturers is, "How can I be sure my regulator is adequately purged?" A 4-page brochure answers this and related questions by outlining in simplified step-by-step form the procedures required for adequate purging with either a cross-purge or tee-purge assembly. With a cross-purge assembly, one can save time and expense while minimizing the hazards involved in purging a highly toxic or flammable gas. Matheson, 1275 Valley Brook Ave., P.O. Box E, Lyndhurst, N.J. 07071. For a copy of the brochure, circle reader service number 422.

**Instrument/computer interfacing.** A new 12-page brochure is available that offers an easy-to-read explanation of instrument/computer interfacing and the development and use of the Hewlett-Packard interface bus (IEEE Standard 488). Up to 15 different devices can be quickly linked on each bus, providing the user with a previously unavailable system versatility. A bibliography of pertinent literature is included. Inquiries Manager, Hewlett-Packard Co., 1501 Page Mill Rd., Palo Alto, Calif. 94304. [423]

**Wires.** A comprehensive technical booklet is now available containing information on magnet wire, resistance wire, and other major alloys. It covers a wide range of magnet wire film insulations, bare and insulated dimensional data, and the physical

# Large scale integration

# LSI LSI LSI LSI LSI

Electronics  
Book Series

The Electronics Book Series offers you a handbook on the current and revolutionary impact of LSI on digital design. This 220-page book presents a unique opportunity for circuit designers, systems designers, and engineering managers and supervisors to bring their expertise into line with today's LSI design requirements.

### Electronics Book Series

PO Box 669, Hightstown, N.J. 08520

Send me \_\_\_\_\_ copies of "Large Scale Integration" at \$9.95 per copy.

I must be fully satisfied or you will refund full payment if the books are returned after ten day trial examination.

Payment enclosed  Bill firm  Bill me

**Credit Cards Charge My Book To**

American Express  Master Charge  
 Diners Club  BankAmericard

Acct. No. \_\_\_\_\_

Date Card Expires \_\_\_\_\_

Interbank No. \_\_\_\_\_

1st No.'s. above name on Mastercharge only.

Name \_\_\_\_\_

Title \_\_\_\_\_

Company \_\_\_\_\_

Street \_\_\_\_\_

City \_\_\_\_\_

State \_\_\_\_\_

Zip \_\_\_\_\_

Signature \_\_\_\_\_

Electronics  
IS THE SOURCE  
FOR BOOKS, TOO



# 8-Bit high-speed monolithic A/D

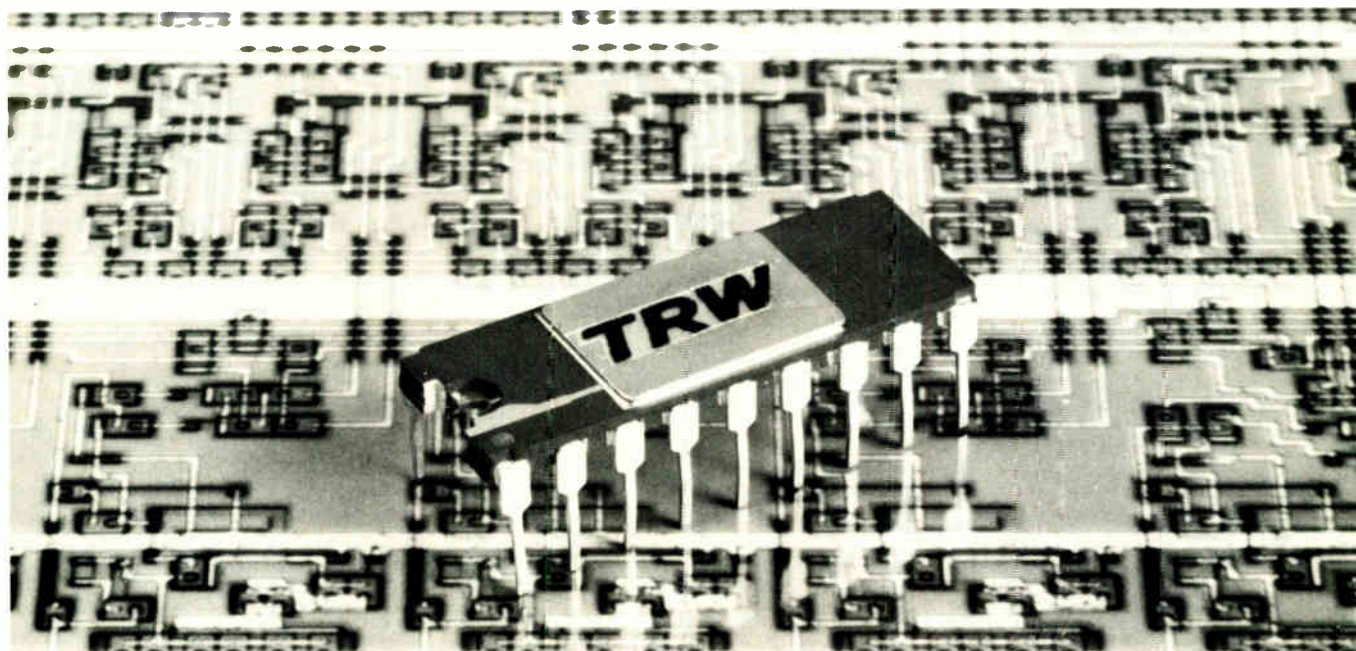

## Priced under \$100

<b>TDC-1002J</b>	<b>1000 ns</b>	<b>\$75 in 100's</b>
<b>TDC-1001J</b>	<b>400 ns</b>	<b>\$175 in 100's</b>

Two performance ranges—400 and 1000 ns conversion times: two price ranges for a wide variety of high-speed A/D applications.

Linearity is  $\pm 1/2$  of LSB. Nine clock periods per conversion. All output bits are ready one clock period after the status signal indicates "ready to convert." There are no missing codes — ever!

TDC-1001J and TDC-1002J are supplied in an 18-pin ceramic DIP package designed to operate at a commercial temperature range of 0° to 70° C.

For more information and complete specifications, call (213) 535-1831, or use this coupon.

TRW LSI Products  
E2/9085 • One Space Park  
Redondo Beach, CA 90278

**Please send data sheets on your 8-Bit A/D Converters.**

NAME \_\_\_\_\_

COMPANY \_\_\_\_\_

DIV/DEPT \_\_\_\_\_

MAIL CODE \_\_\_\_\_

ADDRESS \_\_\_\_\_

CITY \_\_\_\_\_

STATE \_\_\_\_\_

ZIP \_\_\_\_\_

E-6

## **TRW** LSI PRODUCTS

*...from a company called TRW*

## ALCOSWITCH

### WORLD'S SMALLEST BI-DIRECTIONAL SWITCHES

The most wanted features in small code switches. We've been able to reduce size and still retain exceptionally large digits for ease of reading.

An enormous improvement over the traditional thumbwheel types. Simply push the button for dependable action in either direction. Easily snaps together or into a panel opening.

Heavy gold plating on wiping contacts provides low contact resistance over its extremely long life. Available in a variety of codes and some options, too!

Why not call our Customer Service at (617) 685-4371. Our sales people will be glad to answer questions on how this may fit into your next design.

We call these our SMC (small) and PICO (smallest) Series.



**ALCO** ELECTRONIC PRODUCTS, INC.  
1551 OSGOOD STREET, NORTH ANDOVER, MA 01845 U.S.A.

Tel: (617) 685-4371 TWX: 710 342-0552 A SUBSIDIARY OF

AUGAT<sup>®</sup> INC

Circle 184 on reader service card

# 1977 Answer Book. It makes your job easier. \$25.

"What companies make the products I need? How do I contact them locally? How do I get their current catalogs fast?"

Ask The Answer Book. Over 4000 products, more than 5000 manufacturers with their local contacts and distributors, directory of trade names and catalogs, post-paid inquiry "bingo" cards for 5-second ordering of current catalogs.

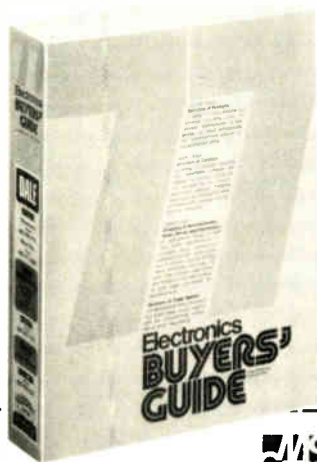

#### Electronics Buyers' Guide

1221 Avenue of the Americas, N.Y., N.Y. 10020

Yes, send me a copy of The Answer Book.

I've enclosed \$25 (USA and Canada only, elsewhere send \$35). Full money back guarantee if returned within 10 days.

Name \_\_\_\_\_

Company \_\_\_\_\_

Street \_\_\_\_\_

City \_\_\_\_\_

State \_\_\_\_\_

Zip \_\_\_\_\_



## New literature



and electrical properties of most of the major resistance and heating-element alloys. Magnet Wire Supply Co., 20731 Marilla St., Chatsworth, Calif. 91311. [424]

**Fiberglass laminates.** A variety of ready-to-use shapes of glass-epoxy insulation components available from open-stock tooling including bobbins, coil-form tubing, header plates and potting forms and structurals is described and pictured in a catalog. Insulators can be individually tooled and quoted to customers' drawings. Stevens Tubing Corp., 128 North Park St., East Orange, N.J. 07019. [425]

**Solid-state relays.** Information to aid prospective users in selecting the proper solid-state relay for their individual needs is available in a 20-page catalog. Charts and graphs



provide complete specifications and design data of ac- and dc-controlled, triac and SCR solid-state relays.



CSC's done it again.

Broken the price and performance barriers with new MAX-100. The multimode, professional portable frequency counter that gives you more range, visibility, accuracy and versatility than any comparable unit at anywhere near its low, low price.

#### **MAXimum performance.**

MAX-100 gives you *continuous readings* from 20Hz to a *guaranteed 100MHz*, with 8-digit accuracy. Fast readings with 1/6-sec. update and 1-sec. sampling rate. Precise readings, derived from a crystal-controlled time base with 3ppm accuracy. High-sensitivity readings from signals as low as 30mV, with diode overload protection up to 200V peaks.

Input signals over 100MHz automatically flash the most significant digit. And to indicate low-battery condition and extend remaining battery

life, the *entire* display flashes at a 1Hz rate.

**MAXimum versatility.** MAX can be used with clip-lead cable supplied. Mini-whip antenna. Or low-loss in-line tap with UHF connectors. For AM or FM; CB, ham, business radio and R/C transmitter or receiver alignment. Monitoring audio and RF generators. Checking computer clocks and other digital circuits. Repair of depth sounders and fish spotters. Troubleshooting ultrasonic remote controls. And hundreds of other applications.

**MAXimum visibility.** MAX-100 features a big, bright 0.6" multiplexed 8-digit LED display, with leading-zero blanking. So you don't have to squint, or work up close. And, MAX's flip-up stand is *built-in*.

**MAXimum flexibility.** MAX-100 operates from *four* power sources,

for use in lab or field. Internal alkaline or NiCad batteries. 110 or 220V with charger/eliminator. 12V with automobile cigarette-lighter adapter/charger. And external 7.2-10V power supply.

**MAXimum value.** Accurate enough for laboratory or field-service applications, MAX is surprisingly economical. At \$134.95\*, complete with clip-lead cable, it's priced low enough for educational or hobbyist use.

For more information, see your CSC dealer or contact us directly.

CONTINENTAL SPECIALTIES CORPORATION



44 Kendall Street, Box 1942, New Haven, CT 06509  
203-624-3103 TWX 710-465-1227  
West Coast: 351 California St., San Francisco, CA 94104  
415-421-8872 TWX 910-372-7992

#### SPECIFICATIONS FOR MAX-100

**Frequency Characteristics** Range: 20 Hz to 100 MHz (guaranteed); 110 MHz typical. Gate time: 1 sec. providing 1 Hz resolution throughout freq. range. Accuracy:  $\pm 1$  count + Time Base error.

**Input Characteristics** Impedance: 1 M $\Omega$  shunted by 56 pf. Connector: phone jack. Coupling: AC Sine Wave Sensitivity: 30 mVRMS; 10 Hz-50 MHz; 100 mVRMS, 50 MHz to 80 MHz; 300 mVRMS, 80 MHz and above. Maximum Input: 200 V Peak, 20 MHz-500Hz; 100 V Peak, 500 Hz-1 KHz, 75 V Peak, 1 KHz-10 MHz; 50 V Peak, 10 MHz and above.

**Internal Time Base Characteristics** Frequency: 3.579545 MHz crystal oscillator. Stability:  $\pm 3$  ppm @ 25°C. Trimmer Adjustment:  $\pm 4$  ppm. Temperature Stability: Better than 0.2 ppm/°C, 0 to 50° C. Maximum Aging Rate: 10 ppm/year.

**Display Characteristics** Display: Eight .6" high LED digits, with anti-glare window. Lead-zero blanking: decimal point automatically appears between

sixth and seventh digit when input frequency exceeds 1 MHz. Overflow: When input signal exceeds 99,999,999 Hz, the most significant (left hand) digit flashes, allowing user to read in excess of 100 MHz. Display update: Fixed 1/6-second plus 1 second gate time. Low Battery Indicator: When batteries or power supply falls below 6.6 VDC, all eight display digits flash at a one-Hz/second rate. During battery operation, flashing display extends operating time of unit.

**GENERAL Power Requirements:** 6 AA Alkaline or NiCad batteries (internal battery compartment); External: 110-220/AC Battery Eliminator charger; Automobile cigarette lighter adapter for both charging and operating; 7.2 to 10 VDC external power supply; Battery Life: Alkaline, 3 hrs., cont. use; 8 hrs. intermittent use. NiCad, 3 hrs., cont. use, 6 hrs. intermittent use. Battery Charging: 12-14 hours required for full charge. Size (HWD): 1.75"  $\times$  5.63"  $\times$  7.75" (4.45  $\times$  14.30  $\times$  19.69 cm). Weight: Less than 1.5 lb. (0.68 kg) with batteries. Accessories Included: 100-IPC clip-lead input cable; detailed applications/instruction manual.

# FREQ. OUT.



\*Manufacturer's suggested retail

# ELECTRONICS ARTICLES AVAILABLE IN REPRINT FORM

No. of  
copies  
wanted

## New reprints

- \_\_\_ R-716 Special report—Japanese wave in semiconductor technology 24 pp \$3.00
- \_\_\_ R-714 Special report—active filter technology 6 pp \$3.00
- \_\_\_ R-713 Electron-beam lithography draws fine line 10 pp \$3.00
- \_\_\_ R-712 Special report—large-scale integration 16 pp \$3.00
- \_\_\_ R-710 Personal computers mean business 8 pp \$2.00
- \_\_\_ R-708 So you want to be a consultant 6 pp \$2.00
- \_\_\_ R-706 Low-cost dual delayed sweep method 6 pp \$2.00
- \_\_\_ R-705 Powering up with linear ICs 12 pp \$3.00

## Charts

- \_\_\_ R-516 Electronic symbols \$2.00
- \_\_\_ R-213 Electromagnetic spectrum (updated 1976) \$3.00
- \_\_\_ R-326 Optical spectrum (6-page report and chart) \$3.00

## Books

- \_\_\_ R-704 Thermal design in electronics \$5.00
- \_\_\_ R-701 Applying microprocessors—Electronics Book Series \$9.95
- \_\_\_ R-608 Basics of Data Communications—Electronics Book Series \$12.50
- \_\_\_ R-602 Large Scale Integration—Electronics Book Series \$9.95
- \_\_\_ R-520 Microprocessors—Electronics Book Series \$8.95
- \_\_\_ R-011 Computer-aided Design 135 pp \$4.00
- \_\_\_ R-032 Active Filters 88 pp \$4.00
- \_\_\_ R-031 Circuit Designer's Casebook 182 pp \$5.50 (outside U.S. \$12.00)

## Other reprints

- \_\_\_ R-703 Special report—memories 16 pp \$3.00
- \_\_\_ R-702 World market report 1977 24 pp \$4.00
- \_\_\_ R-616 Special issue—technology update \$4.00
- \_\_\_ R-614 Power supply choices for sophisticated designs 8 pp \$3.00
- \_\_\_ R-612 Fiber-optic communications special report 24 pp \$3.00
- \_\_\_ R-610 Special report on hybrid-circuit technology 19 pp \$3.00
- \_\_\_ R-606 Special issue—microprocessors \$4.00
- \_\_\_ R-526 How reliable are today's components 16 pp \$3.00
- \_\_\_ R-600 World market report 1976 24 pp \$4.00
- \_\_\_ R-524 Special report on bipolar large-scale integration 12 pp \$3.00
- \_\_\_ R-522 Special report on power semiconductors 12 pp \$3.00
- \_\_\_ R-518 Special issue—productivity \$4.00
- \_\_\_ R-514 Eight ways to better radio receiver design 6 pp \$3.00
- \_\_\_ R-512 Design of circuits for dangerous environments 4 pp \$2.00
- \_\_\_ R-510 Bipolar advances with I<sup>2</sup>L microprocessor 8 pp \$2.00
- \_\_\_ R-508 Designing microprocessors with standard logic 12 pp \$3.00
- \_\_\_ R-506 The case for component burn-in 7 pp \$2.00
- \_\_\_ R-434 Designing automated systems with the new standard interface 12 pp \$3.00
- \_\_\_ R-432 An update on communications satellites 8 pp \$2.00
- \_\_\_ R-430 Choosing the right bipolar transistor model for computer-aided design 20 pp \$3.00

## Payment must accompany your order

Make check or money order payable to Electronics Reprints. All orders are shipped prepaid by parcel post. Allow two to three weeks for delivery.

Cost of orders \$ \_\_\_\_\_  
 Plus 10% handling charge \$ \_\_\_\_\_  
 TOTAL AMOUNT ENCLOSED \$ \_\_\_\_\_

Mail your order to:  
 Janice Austin  
 ELECTRONICS REPRINTS  
 P.O. Box 669  
 Hightstown, N.J. 08520

## SEND REPRINTS TO

Name \_\_\_\_\_  
 Company \_\_\_\_\_ Dept. \_\_\_\_\_  
 Street \_\_\_\_\_  
 City \_\_\_\_\_ State \_\_\_\_\_ Zip \_\_\_\_\_

## New literature

Magnecraft Electric Co., 5575 North Lynch Ave., Chicago, Ill. 60630. [426]

**Microprocessors.** ICs, support systems, and accessories that make up the CDP-1800 COSMAC microprocessor family are described in the MPG-180 40-page product guide. The operation and performance of the CDP1802 microprocessor is described in detail, along with its features, architecture, ratings, characteristics, timing diagram, and in-



struction summary. RCA Solid State Division, Box 3200, Somerville, N.J. 08876. [427]

**Load cells.** Catalog 351 provides formulas and coefficients that will allow the user to determine the maximum allowable load limits for installation, information that is vital for the proper selection of a load cell. A selector chart is also included. Lebow Associates, 1728 Maplelawn Rd., Troy, Mich. 48084. [429]

**Cermet trimming potentiometers.** A 56-page booklet is a compendium of information on cermet trimming potentiometers. Nine key advantages of using cermet trimmer technology are discussed and compared with those of metal-film, carbon, and wirewound technologies. Beckman Instruments Inc., Technical Information Section, Helipot Division, 2500 Harbor Blvd., P.O. Box 3100, Fullerton, Calif. 92634. [430]

**NEW RECORDER**

# Writes on Computer Cards

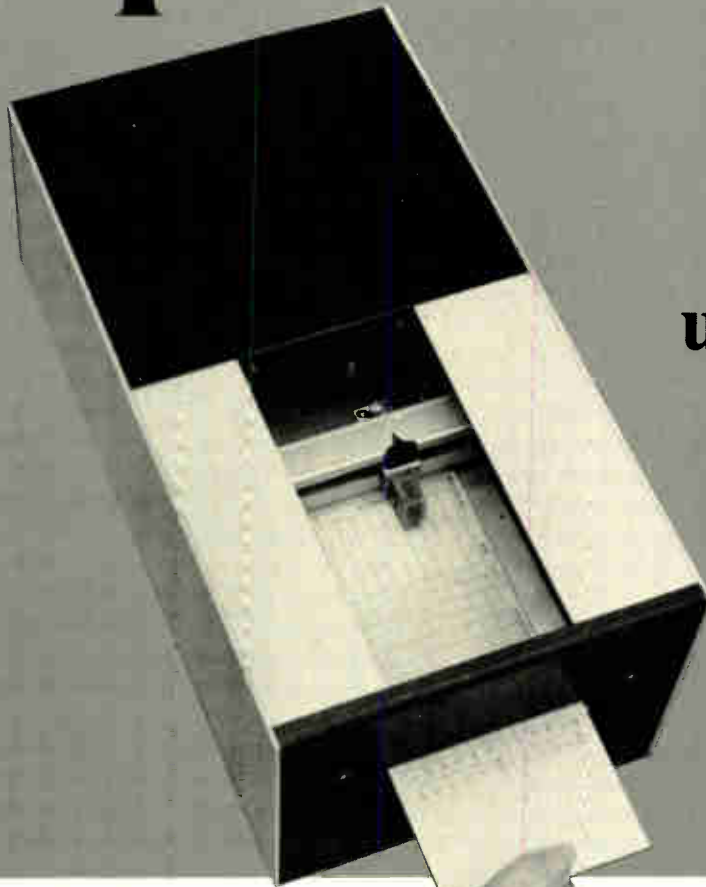

**unique X-Y  
design**

- ✓ Creates space-saving records on 80 column Hollorith cards
- ✓ Versatile — optional dc analog or incremental input



- ✓ Minimum OEM cost
- ✓ New federal process record requirements make this unique recorder a must in food, chemical and drug process plants. Circle no. 187 for brochure

**houston  
instrument**

**THE  
RECORDER  
COMPANY**

DIVISION OF BAUSCH & LOMB

ONE HOUSTON SQUARE (at 8500 Cameron Road) AUSTIN, TEXAS 78753  
(512) 837-2820 TWX 910-874-2022 cable HOINCO  
TELECOPIER  
EUROPEAN OFFICE Rochesterlaan 6 8240 Gistel Belgium  
Phone 059/277445 Telex Bausch 19399

# Classified section FOR ENGINEERING/TECHNICAL EMPLOYMENT OPPORTUNITIES

## CLASSIFIED SALES REPRESENTATIVES

Atlanta . . . Joe Lane . . . 404/892-2868  
 Boston . . . Holt Buchanan . . . 617/262-1160  
 Chicago . . . Bill Higgins . . . 312/751-3733

Cleveland . . . Mac Huestis . . . 216/781-7000  
 Dallas . . . Mike Taylor . . . 214/742-1747  
 Denver . . . Shirley Klotz . . . 303/837-1010  
 Detroit . . . Mac Huestis . . . 313/873-7410

Houston . . . Mike Taylor . . . 713/659-8381  
 Los Angeles . . . Stan Kassir . . . 213/487-1160  
 New York . . . Dave Hawksby . . . 212/997-3594  
 Philadelphia . . . Dan Ferro . . . 215/568-6161

Pittsburgh . . . Dan Ferro . . . 412/391-1314  
 San Francisco . . . M.E. Kenny . . . 415/362-4600  
 Stamford . . . Holt Buchanan . . . 203/359-2860  
 XEROX 400 TELECOPIER . . . 212/997-6800

## BSEE/MSEE FOR MOS/LSI DESIGN NEW VACANCIES

An expansion in our design effort has created opportunities for professionals with two or more years of recent experience in logic and circuit design and a BSEE or MSEE degree. Device Application included in the experience is preferred.

Also, we have need for a design engineer specifically experienced in MOS/LSI circuit development. This individual must have a good familiarity with memory devices. Apart from the above, we will consider applications for an entry design engineer position. This requires a BSEE or MSEE and an interest in logic and circuit design.

*Reply in confidence to:*



**Mr. T. F. Wade, Manager  
 Personnel Resources  
 Microelectronics Division  
 NCR Corporation  
 8181 Byers Road  
 Miamisburg, Ohio 45342**

*An Equal Opportunity Employer*

## 90,000 engineers and managers for \$46.00

For only \$46.00 per inch your recruitment advertising in ELECTRONICS' Classified Section will reach 90,000 career-conscious engineers and managers as they're reading to combat job obsolescence, while they're thinking about their future and bettering themselves.

There's no charge for typesetting and free layout service is provided. For more information call or write:

**ELECTRONICS**

Post Office Box 900  
 New York, N.Y. 10020 • Phone: 212/997-2556

## Applications Engineer

Working directly with Tektronix' customers and sales engineers by telephone and travel, you will provide technical applications and product support, training, new product planning, development and introduction, and market research for assigned products.

Presently we have openings for the following products:

**Microprocessor Design Aids  
 Logic Analyzers  
 Intelligent Graphic Systems  
 Test Instrumentation**

Your background in design or applications of these products, good communications skills and desire to work in marketing is necessary. Experience with microprocessors and ASSEMBLY or high level programming is desirable. Formal education might include a BSEE/CS and marketing courses.

Salary is open. Benefits include educational support, insurance and profit sharing programs. Located near Portland, Oregon we are within a two hour drive from the Cascade Mountains or Ocean Beaches. The close-by nature playgrounds and the City of Portland provide for a variety of recreational and cultural interests.

Send resume to Roy Epperson,  
 TEKTRONIX, INC., P.O. Box 500, E94,  
 Beaverton, OR 97077.

An Equal Opportunity  
 Employer M/F.

**Tektronix**  
COMMITTED TO EXCELLENCE

We have been placing graduate  
**ENGINEERS**  
 in **FEE-PAID** positions  
 THROUGHOUT THE U.S. since  
 '59. Over 1,000 client companies.  
 We are graduate engineers work-  
 ing full-time for you. Send resume  
 & salary history today or request  
 confidential application.  
**ATOMIC PERSONNEL, INC.**  
 Suite L, 1518 Walnut St., Phila., Pa. 19102  
 An Employment Agency  
 For All Technical Fields

\* RF-MICROWAVE  
 SEMICONDUCTORS \*  
 Design & Project Eng'rs.  
 • BS, MS, PhD. •  
 Nat'l Unadvertised Positions  
 • \$16-30K •  
 P'nB Consultants, Box 261 (M)  
 Wayne, PA 19087  
 The Engineers Who  
 Talk Your Language



## Exciting, New Electro-Optical Technologies Open New Windows in Space

Can you contribute to the development of an integrated, infrared focal plane containing millions of detectors, with charge-coupled devices for detector readout?

Can you advance micro-electronics and signal-processing technology to include space-borne, programmable, signal processors and electro-optical, tunable spectral filters?

Are you familiar with high-energy-laser beam control, adaptive optics, holographic-display lens design, thermal

imaging, or erectable optics structures?

Do you have the imagination and analytical skills to assemble these new technologies into revolutionary new system concepts?

If so, our steadily expanding Aerospace Groups would appreciate hearing from you.

We are involved with a wide variety of state-of-the-art programs.

It's exciting!  
It's important!  
It's fun!

Please send your resume to Engineering Employment, Hughes Aerospace Groups, 11940 West Jefferson Blvd., Culver City, CA 90230.

A degree from an accredited institution, varying levels of experience, and US citizenship are all required. We're an equal opportunity, M/F/HC employer.



## Help Create Tomorrow's Products at WANG!

### Field Engineers

Job No. E 3116

Must be knowledgeable on 2314 type and/or storage module disk drives. Experience with vacuum column type (16 BPS) tape drives is a plus. BSEE preferred.

### Computer Systems Engineer

Job No. E 3115

3 years experience in all areas of logic computer systems. Responsibilities include training of service personnel, documenting diagnostics and systems procedures. BSEE required.

### Technical Writers - Hardware

Job No. E 3113

These positions require individuals with extensive writing experience in digital hardware and some exposure to software along with publications knowhow.

### Component Reliability Engineers

Job No. E 3117

Put your true potential to the test! WANG is offering a unique opportunity for take-charge individuals. Candidates must be thoroughly familiar with semiconductors with a strong background in ROM, RAM, microprocessors, etc. Position requires BS or MSEE degree and relevant experience. These are key positions with excellent salaries and earning potential.

### Quality Control Engineer

Job No. E 3118

Self-motivated individual needed to assist and support our Quality Control and Manufacturing Departments in spotting problem areas and determining best solutions. Will also perform light tests and set up test parameters on computer products. You must have an engineering or equivalent degree and have relevant experience. Ability to communicate effectively, both in writing and orally, required.

Excellent salaries and earning potential plus superior company benefits. We are an affirmative action/equal opportunity employer. Please send resume including academic background and salary history and requirements, indicating Job Number to:

Manager, Professional Recruiting  
(617) 851-4111

**WANG** LABORATORIES, INC.

One Industrial Avenue, Lowell, Massachusetts 01851

## GTE LENKURT ... on the SAN FRANCISCO PENINSULA ...

is a leading supplier of  
microwave, multiplex, carrier  
and data transmission systems  
to the U.S. common carrier  
communications industry.

## PCM & Data Product Development Engineer

Immediate opportunity exists for an Engineer with 3-5 years experience in analog and digital circuit design for product development of high speed digital transmission systems. BSEE required.

We offer extremely attractive benefits and salary structure! Send detailed resume to Dean E. Hammer, Professional Employment, GTE Lenkurt, 1105 County Road, San Carlos, CA 94070. An equal opportunity employer.

**GTE LENKURT**

# FREE

## Your dream job.

We hope you're happy in your current position, but there's always that ideal job you'd prefer if you knew about it.

That's why it makes sense to have your resume on file in the Electronics Manpower Register, a computerized data bank containing the qualifications of career-conscious ELECTRONICS readers just like yourself.

You'll benefit from nation-wide exposure to industry firms privileged to search the system, and since the computer never forgets, if you match up with their job requirements you'll be brought together in confidence.

To take advantage of this free service, mail your resume to the address below.

**ELECTRONICS MANPOWER REGISTER**  
Post Office Box 900/New York, N.Y. 10020

## POSITIONS VACANT

**Electrical Engineering Technology**—Upper division E.C.P.D. accredited Bachelor of Technology Program seeks visiting professor to replace faculty member on a two year leave of absence. M.S. Degree in Electrical Engineering required with teaching and industrial experience desirable. Position available Fall 1977, 10 month contract. Send resume and references to Prof. J. Adams, Department of Electrical Engineering Technology, Rochester Institute of Technology, One Lomb Memorial Drive, Rochester, New York 14623. RIT is an Affirmative Action/Equal Opportunity Employer.

**Electrical Engineering Technology** faculty position—Assistant/Associate professor, depending upon qualifications, beginning in September 1977, hopefully to be filled by August 1. Applicants must have a Master's degree, preferably in the area of electrical/electronic engineering. P.E. or E.I.T. qualifications are highly desired. Three to five years of relevant work experience is necessary. Teaching experience is desired. Applicants should have competencies in electrical systems, digital logic, rotating machines, circuit design, energy converters and electrical distribution. Send resume and references to Dr. D. F. Hackett, Chairman, Technology Division, Georgia Southern College, Box 8044, Statesboro, GA 30458. Affirmative action/equal opportunity employer.

**Electronics Design Engineer** Sacramento Peak Observatory is seeking a highly qualified Engineer with a broad range of experience in analog, signal processing, video, computer, digital and interfacing. Work will consist of the development of circuitry related to scientific instrumentation as well as supervising the maintenance of existing equipment. This hands-on position requires hardware familiarity with a wide range of electronic devices and equipment. Salary \$19,000 and above. Send resume and salary history to: Frank A. Hegwer, Sacramento Peak Observatory, Sunspot, New Mexico 88349. AN EQUAL OPPORTUNITY EMPLOYER.

**Position available immediately** for electronics engineer to work with a group of neurophysiological laboratories. Applicant should have experience in design, repair and maintenance of electronics equipment; experience with neurophysiological equipment and minicomputers would be useful. Salary negotiable. Send resume and references to: Frank P. Hunter, Research Director, University of Virginia, Division of Biomedical Engineering, Medical Center Box 377, Charlottesville, VA 22901 (804) 924-2391.

**RATES** \$46 per advertising inch ( $\frac{1}{8}$ " ). Commissionable.  
**SIZES**  $\frac{3}{8}$ " to 10" deep in widths of one column ( $1\frac{3}{8}$ " ), two ( $3\frac{3}{8}$ " ), three ( $5\frac{3}{8}$ " ), and four ( $7$ " ).  
**CLOSING** Two weeks prior to mailing.  
**MAILING** One week prior to issue date.  
**ISSUE DATE** Every other Thursday.  
**AD ORDERS/BOX NUMBER ANSWERS** Send to Electronics, Post Office Box 900, New York, N.Y. 10020.

## UNIVERSITY OF SOUTHERN COLORADO

Assistant Professor of Electronic Engineering Technology to teach electronics manufacturing and circuits in ECPD Accredited Program. Ms in EET or EE and minimum of 3 yrs. work experience in electronics desirable. Start August 22, 1977.  
**Contact Dr. Ray Sisson, Dean of the School of Applied Science & Engineering Technology, USC, 2200 Bonforte Blvd., Pueblo, Colo. 81001, Phone (303) 549-3260 by July 5, 1977.**

*USC is an Equal Opportunity/Affirmative Action Employer*

## POSITION VACANT

**Senior Product Engineer—Electronic**—The Door Operating Equipment Division of The Stanley Works, headquartered in Farmington, Conn., is seeking an Electronics Engineer. The successful applicant must have proven abilities as project manager on product development programs, and will be responsible for evaluation of field requirements and problems, for product design and development, and for coordination with factory on new design. Must be degreed, with a minimum of five years experience in electronics; solid state devices, logic circuits, and power control of fractional H. P. motors. Knowledge of microwave technology and infrared devices helpful. Submit your resume, including salary history to: The Stanley Works, Corporate Employment, Dept. 609E, P.O. Box 1800, New Britain, Conn. 06050, Stanley Tools, Stanley Hardware, Stanley Steel. An Equal Opportunity Affirmative Action Employer.

## POSITION WANTED

**Project & Technical Director/Research & System Engr. Manager** — Over 15 years industrial and academic experience in electronic/electrical systems, controls, and instruments. Seek a challenging opportunity to apply my proven management and technical capabilities. Willing to discuss how I can make a major contribution to a growing organization. Reply to PW-5020, Electronics. (609) 799-1385.

**Are you looking for a man in Europe?** American Engineer BSEE with 7 yrs. experience in the European electronic components and equipment market seeks position of responsibility with a dynamic firm. Fluent French & German. Located in Switzerland. PW-5123, Electronics.

## SELLING OPPORTUNITY WANTED

**Manufacturers Rep metro. NY area** wants additional lines to electronics industry. RA-5021, Electronics.

# PRINTER ENGINEERS

Computer Peripherals, Incorporated, the joint venture company of Control Data Corporation, NCR Corporation and ICL Limited is involved in a major expansion program. We have immediate openings in the following areas:

## MICROPROCESS ENGINEER

Candidate will have responsibility for hardware/software design and implementation of Microprocessor techniques to peripheral computer controller devices. Applicants for this position must demonstrate experience in:

- Design and implementation of microprocessor controllers
- TTL Logic Designs on peripheral equipment
- Intel 8080 Microprocessor family or equivalent

## MECHANICAL PROJECT ENGINEER

Outstanding growth opportunities exist in creative line printer development group for imaginative and creative project leader. Experience should include vibration, stress, structural, dynamic and thermal analysis of electro-mechanical equipment. Responsibilities will also include product definition and generation of product specification. Supervisory experience with engineers and technicians essential.

## NON-IMPACT PRINTER SPECIALISTS

Our vigorous growth has created immediate opportunities in our Ink Jet and Electrophotographic programs for Program Managers, Project Engineers, and design and development specialists in a variety of disciplines. An advanced degree in engineering or physics or a Bachelor's degree with equivalent advanced experience is required, plus the creative ability to develop new directions in non-impact printer technology.

## ELECTRICAL TECHNICAL SPECIALIST

We have an immediate opening for an individual with 5-7 years experience at the senior technical level with 1-2 years experience with technical leadership of subordinate lab personnel. Digital logic circuit design experience required. Associate Engineering Degree in Electronics and background in electrical photography or lasers highly desirable.

For all engineering positions above, BS required, MS preferred, plus 2-5 years relevant experience.

We offer competitive salaries and benefits and outstanding growth potential. Please send resume to:

**Mr. Bob Brown**



**COMPUTER PERIPHERALS, INC.**  
1480 N. Rochester Road Box  
Rochester, Michigan 48063  
1-313-651-8810

*An Affirmative Action Employer*

Advanced Micro Devices	10-11	■ General Instrument Corporation	21	Refac Electronics Corp.	97
■ Aico Electronic Products (Sub. of Augat)	184	■ Grayhill, Inc.	99	Reliability, Inc.	193
■ Allen-Bradley	104-105	■ Hewlett-Packard, Corporation	1,2nd C, 7,20,82-83,195	■ T. L. Robinson Company, Inc.	166
American Microsystems, Inc.	152-153	Houston Instrument	187	Rhone Poulenc—Chimie Fine	172
■ Amp, Inc.	86-87	Inteltec 77, Basel	196	• Rohde & Schwarz	1E-5E
‡ Baron Blakeslee	17	Intech/Function Modules	171,173	Salota GmbH & Co. KG	100
• Bayer AG	13E	Intel—Microcomputer Components	18-19	• SEPA S.P.A.	103
‡ Beckman Instruments, Hellpott	76	‡ International Importers, Inc.	169	• SGS ATEs	25E-36E
■ Bourns, Inc.	4th C.	International Rectifier Corp., Semi. Div.	182	Sheldon-Sodeco Div. Landis & Gyr, Inc.	93
• Burr Brown	17	Interstate Electronics	167	• Siemens AG Munich	76
• Carlo Erba S.P.A.	81	■ Ithaco, Inc.	75	■ Skan-A-Matic Corp.	176
Continental Rentals	8	■ Johanson Manufacturing Corp.	150	Sodeco	81
■ Continental Specialties	185	■ Krohn-Hite Corp.	5	Sorensen, Div. of Raytheon	151
■ Magnetic Components Group, Control Data Corp.	168	Litronix	9	Sprague Electric	68
Coors Porcelain	3rd C.	• Matsuo Electric Co., Ltd.	21E	Systron-Donner, Concord	181
• C.P. Clare International	15E	■ Metex Corp.	170	■ Tektronix	33,88-89
Data General Corp.	27,101	MFP Corp.	174	Teradyne, Inc.	90
■ Delevan Div., American Precision Ind.	16	Micro Networks	180	• Thomson CSF Division D.T.E.	39
Delta Air Lines	100	■ Microswitch, Div. of Honeywell	154	Toko, Inc.	195
■ Dialight Corp.	145-148	■ Mini-Circuits Laboratory	28	• Trio Kenwood Corporation	165
Digital PPG	158-159	■ Motorola Semiconductor Products	35,71-74	■ TRW LSI Products	183
Dusseldorfer Messgesellschaft mbH—NOWEA	179	‡ National Connector	177	■ TRW/UTC Transformers	161
‡ Eastman Kodak Co., Graphic Markets Division	165,103	National Semiconductor Corp.	139-142	United Systems Corp., Sub. Monsanto	193
■ ECD Corporation	137	‡ Nicolet Instrument Corp., Oscilloscope Div.	81	UTI	6
EECO—Electronic Engineer Co. of Calif.	24	Optron, Inc.	14	■ Vactec, Inc.	175
Electronic Navigation Industries	95	‡ Panasonic, Industrial Div.	39	• V/O Techmasheport	22E
■ E & L Instruments	40-64	• Philippe Elcoma	78,8E,11E	Wavetek San Diego	125
■ EMI Technology	157	• Philippe Industries	6E-7E	Zilog	22-23
• Exel Electronics	14E	• Philippe TMI	16E-17E		
‡ Ferroxcube Corp., A Div. of North Amer. Philips	78	Phoenix Data	144		
Figaro Engineering, Inc.	166	Plessey Semiconductors	162		
■ John Fluke Mfg. Co., Inc.	2	■ Precision Monolithics	15		
‡ Galileo Electro-Optics Corporation	84-85	• Procond S.P.A.	23E		
■ General Electric, A & Sp Operation, Semiconductor Products	13	Pro-Log	128		
■ General Instrument, Microelectronics	37	• Racal Instruments Ltd.	18E, 19E		
		• Racal Thermionic Ltd.	84-85		

### Classified and employment advertising

F.J. Eberle, Manager 212-997-2557

Atomic Personnel, Inc.	188
Computer Peripherals, Inc.	191
GTE Lenkurt	190
Hughes Aircraft	189
NCR Corporation	188
P'NB Consultants	188
Tektronix	188
Univ. Of Southern Colorado	191
Wang Laboratories, Inc.	190

■ For more information of complete product line see advertisement in the latest Electronics Buyers Guide  
 • Advertisers in Electronics International  
 ‡ Advertisers in Electronics domestic edition



# Price & Performance that can't be matched!

DigiTec's full-function Universal Counter/Timers and Frequency Counters supply extended frequency ranges at a ratio of price to performance that can't be matched.

Outstanding features include dual input channels with independent controls, high input sensitivity, oven controlled crystal, and full 9 digit LED display with autoranging.



50 MHz . . . . .	Universal Counter . . . . .	8510A . . . . .	\$725
150 MHz . . . . .	Frequency Counter . . . . .	8720A . . . . .	625
150 MHz . . . . .	Universal Counter . . . . .	8520A . . . . .	850
500 MHz . . . . .	Universal Counter . . . . .	8530A . . . . .	995
600 MHz . . . . .	Frequency Counter . . . . .	8730A . . . . .	795
1 GHz . . . . .	Frequency Counter . . . . .	8740A . . . . .	995
1 GHz . . . . .	Universal Counter . . . . .	8540A . . . . .	1295



918 Woodley Road, Dayton, Ohio 45403  
(513) 254-6251, TWX (810) 459-1728

*DigiTec: precision measurements to count on.*

*These instruments available under  
GSA contract GS-00S-27741.*

"Information only" Circle 109 on Reader Service Card.

"Demonstration only" Circle 209 on Reader Service Card.



## Your most difficult burn-in problems are my bread and butter

I'll design you the optimum facility for dynamic burn-in up to 200°C for your production quantities of IC's, RAMs, ROMs, Microprocessors or other components. How? With the new CRITERIA IV system plus the experience my company has in logging 10 billion device-hours in our Houston burn-in service. Interested? Want a full presentation with costs? Call me right now or mail the card today.



**Reliability, Inc.**

P. O. Box 37409/Houston, Texas 77036  
713/666-3261/TWX: 910-881-1739

# Large scale integration

LSI  
LSI  
LSI  
LSI  
LSI

Electronics  
Book Series

The Electronics Book Series offers you a handbook on the current and revolutionary impact of LSI on digital design. This 220-page book presents a unique opportunity for circuit designers, systems designers, and engineering managers and supervisors to bring their expertise into line with today's LSI design requirements.

#### Electronics Book Series

PO Box 669, Hightstown, N.J. 08520

Send me \_\_\_\_\_ copies of "Large Scale Integration" at \$9.95 per copy.

I must be fully satisfied or you will refund full payment if the books are returned after ten day trial examination.

Payment enclosed     Bill firm     Bill me

**Credit Cards Charge My Book To**

American Express     Master Charge  
 Diners Club     BankAmericard

Acct. No. \_\_\_\_\_

Date Card Expires \_\_\_\_\_

Interbank No. \_\_\_\_\_

1st No's. above name on Mastercharge only.

Name \_\_\_\_\_

Title \_\_\_\_\_

Company \_\_\_\_\_

Street \_\_\_\_\_

City \_\_\_\_\_

State \_\_\_\_\_

Zip \_\_\_\_\_

Signature \_\_\_\_\_

**Electronics**  
IS THE SOURCE  
FOR BOOKS.TOO



#### Advertising Sales Staff

**Advertising sales manager:** Paul W. Reiss

1221 Avenue of the Americas, New York, N.Y. 10020  
[212] 997-4371

**Atlanta, Ga. 30306:** Glen N. Dougherty  
100 Colony Square, 1175 Peachtree St., N.E.  
[404] 892-2868

**Boston, Mass. 02116:** Frank Mitchell  
607 Boylston St.  
[617] 262-1160

**Chicago, Ill. 60611**  
645 North Michigan Avenue  
Robert W. Bartlett [312] 751-3739  
Robert M. Denmead [312] 751-3738

**Cleveland, Ohio 44113:** William J. Boyle  
[716] 586-5040

**Dallas, Texas 75201:** John J. Uphues  
2001 Bryant Tower, Suite 1070  
[214] 742-1747

**Denver, Colo. 80203:** Harry B. Doyle, Jr.  
123 Speer Blvd. #400  
[303] 837-1010

**Detroit, Michigan 48202:** Robert W. Bartlett  
1400 Fisher Bldg.  
[313] 873-7410

**Houston, Texas 77002:** John J. Uphues  
601 Jefferson Street, Dresser Tower  
[713] 659-8381

**Los Angeles, Calif. 90010:** Robert J. Rielly  
Bradley K. Jones, 3200 Wilshire Blvd., South Tower  
[213] 487-1160

**Minneapolis, Minn. 55435:** Robert M. Denmead  
4015 W. 65th St.  
[312] 751-3738

**New York, N.Y. 10020**  
1221 Avenue of the Americas  
Michael J. Stoller [212] 997-3616  
Matthew T. Reseska [212] 997-3617

**Philadelphia, Pa. 19102:** Matthew T. Reseska  
Three Parkway  
[212] 997-3617

**Pittsburgh, Pa. 15222:** Matthew T. Reseska  
4 Gateway Center  
[212] 997-3617

**Rochester, N.Y. 14634:** William J. Boyle  
1175 Pittsford-Victor Rd., Pittsford, N.Y.  
[716] 586-5040

**San Francisco, Calif. 94111:** Don Farris  
Robert J. Rielly, 425 Battery Street,  
[415] 362-4600

**Paris:** Alain Offergeld  
17 Rue-Georges Bizet, 75116 Paris, France  
Tel: 720-73-01

**Geneva:** Alain Offergeld  
1 rue du Temple, Geneva, Switzerland  
Tel: 32-35-63

**United Kingdom & Scandinavia:** Robert Ghey  
34 Dover Street, London W1  
Tel: 01-493-1451

**Scandinavia:** Andrew Karnig and Assoc.  
Kungsholmsgatan 10  
112 27 Stockholm, Sweden  
Tel: 08 51 68 70 Telex: 179 51

**Milan:** Luigi Rancati  
1 via Baracchini, Italy  
Phone 86-90-656

**Brussels:** Alain Offergeld  
23 Chaussee de Wavre  
Brussels 1040, Belgium  
Tel: 13-73-95

**Frankfurt/Main:** Fritz Krusebecker  
Liebigstrasse 27c, Germany  
Phone 72 01 81

**Tokyo:** Tatsumi Katagiri, McGraw-Hill  
Publications Overseas Corporation,  
Kasumigaseki Building 2-5, 3-chome,  
Kasumigaseki, Chiyoda-Ku, Tokyo, Japan  
[581] 9811

#### Business Department

**Thomas M. Egan**

Production Manager [212] 997-3140

**Gayla Black**

Production Manager [212] 997-2044

**Carol Gallagher**

Production Manager International  
[212] 997-2045

**Dorothy Carter**

Production Manager Domestic  
[212] 997-2908

**Frances Vallone**

Reader Service Manager  
[212] 997-6057

#### Electronics Buyers' Guide

**H.T. Howland,** General Manager  
[212] 997-6642

**Regina Hera,** Directory Manager  
[212] 997-2544

**Gayla Black,** Production Manager  
[212] 997-2044

**Frances Vallone,** Reader Service Manager  
[212] 997-6057

#### Classified and Employment Advertising

**Frank Eberle,** Manager  
[212] 997-2557

# Maybe TOKO Converters will convert you!?

We think so. Otherwise we would not have bought space in this publication. Below are some of the specifications of the new TOKO DC-DC converter Modules, F • M • K Series and E (floating type) Series. For complete details, please circle on the reader service card.

## FMK-Series

● **1-Channel PLUS Output** Input, Vin:  $+5V \pm 10\%$   
Output, Vout:  $+6V \pm 4\%$  to  $+24V \pm 4\%$  for different types  
Current, Io: 7-13mA to 100-167mA, depending on type  
Conversion Efficiency: 65-75%

● **1-Channel MINUS Output** Input:  $+5V \pm 10\%$   
Output, Vout:  $-5V \pm 4\%$  to  $-20V \pm 4\%$  for different types  
Current, Io: 7-13mA to 100-200mA depending on type  
Conversion Efficiency: 55-75%

● **2-Channel PLUS MINUS Output** Input, Vin:  $+5V \pm 10\%$   
Output, Vout:  $\pm 6V \pm 5\%$  to  $\pm 20V \pm 5\%$  for different types  
Current, Io:  $\pm 3-25mA$  to  $\pm 12-84mA$  depending on type  
Conversion Efficiency: 55-70%

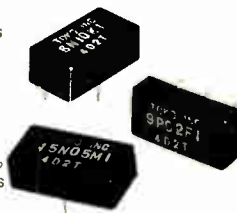

## E-Series (Floating Output)

Input, Vin:  $5V \pm 10\%$ ;  $12V \pm 20\%$ ;  $24V \pm 20\%$   
Output, Vout:  $5V \pm 6\%$ ,  $12V \pm 5\%$ ,  $24V \pm 5\%$ ,  
 $\pm 12V \pm 6\%$  and  $15V \pm 6\%$

Current, Io: 150-300mA, 25-125mA,  
15-60mA,  $\pm 12 \pm 63mA$  and  
 $\pm 10$  to  $\pm 50mA$

Rated Output, Po: 1.5W  
Conversion Efficiency: 60-65%

Regulation:  
VS Input Current,  $\pm 1.0$  to  $\pm 1.5\%$   
VS Output Current,  $\pm 4.0$  to  $\pm 8.0\%$



TOKO is known worldwide for precision electronic parts, highest quality and dependable performance. TOKO sales offices in the U.S.A., West Germany, United Kingdom, and Hong Kong. Eleven other offices and ten factories in Brazil, Kcrea, Taiwan, Hong Kong, Singapore, Malaysia and Malta.



### Toko, Inc. Head Office

1-17, Higashiyukigaya, 2-chome, Ohta-ku, Tokyo 145 Japan Tel: Tokyo 727-1161

### Toko America Inc.

350 Fifth Avenue, New York, N.Y. 10001 U.S.A. Tel: 212-736-0245~8

### Toko America Inc. Chicago Branch

5520 West Touhy Avenue, Skokie Illinois 60076, U.S.A. Tel: 312-677-3640~43

- COILS FOR RADIO, TV & STEREO MPX
- COIL BLOCKS
- CERAMIC FILTERS
- MECHANICAL FILTERS
- TUNERS
- POLYVARICONS
- TOKO-SCHADOW MINATURE PUSHBUTTON SWITCHES
- KEYBOARD SWITCHES
- WIRE MEMORY SYSTEM
- MICRO COMPUTERS
- TOKOM-80
- IC MEMORY
- SEMICONDUCTORS
- PULSE TRANSFORMERS
- DELAY LINES
- DC-DC AC-DC CONVERTER MODULES

Circle 195 on reader service card

Record with Hewlett-Packard

## An easy-to-use high sensitivity XY.

## Just connect and record.

A 5 microvolt change pops out of a smooth, quiet trace when recorded by Hewlett-Packard's Model 7047A XY Recorder. It's the most sensitive, most easily used XY we've ever built. There are virtually no restrictions on input lead connections at any sensitivity—even 20  $\mu V/cm$ ! A unique input circuit responds to signals as small as  $1/2 \mu V$  and maintains 130 dB CMR—even without a guard connection. Just connect and record. Other outstanding features include acceleration of almost 10G, calibrated zero offset, time base for either axis, TTL remote control and much more. Send for product data

and the two technical notes we've just published on the subject of high sensitivity recording and HP's amazing Model 7047A. The XY that makes high sensitivity recording a simple matter of connection. Price \$3,130. Other HP XY's priced from under \$1,000 (domestic U.S.A. prices only).

11705

HEWLETT  PACKARD

1507 Page Mill Road, Palo Alto, California 94304

For assistance call Washington (301) 948-6370, Chicago (312) 255-9800, Atlanta (404) 955-1500, Los Angeles (213) 877-1282

Circle 210 on reader service card

World Radio History

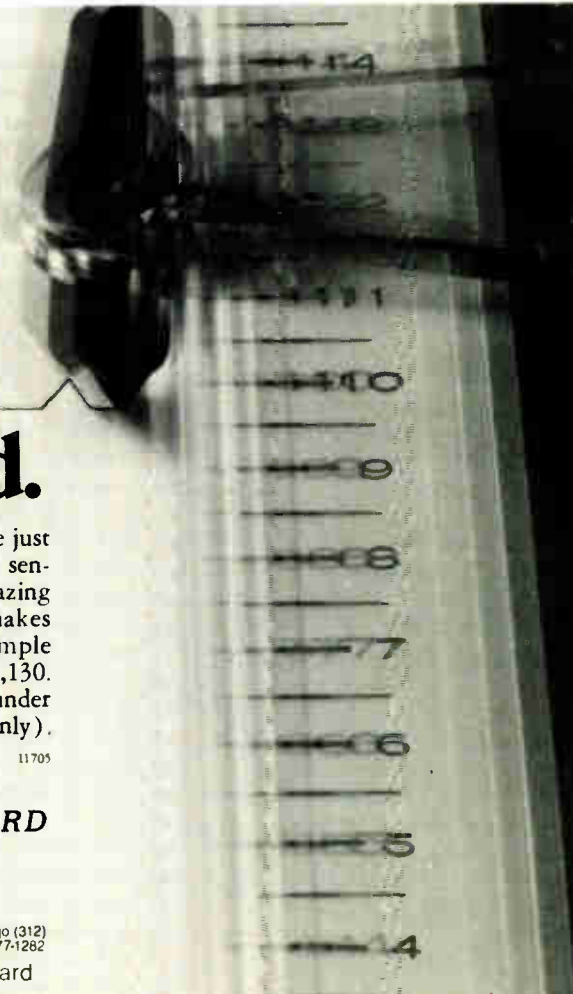

## Exhibition of Industrial Electronics and Electrical Engineering in the Halls of the Swiss Industries Fair

As the most significant event of its kind in this field, the Ineltec exhibition for 1977 will give a comprehensive survey of the market for industrial electronics and electrical engineering. More than 700 exhibitors from 14 countries will display reliable products

and innovations, processes and services offered by more than 1600 suppliers from 24 countries.

September 6 and 7, 1977: Conferences on "Modular Systems and Applications in Control and Automation Technology".

September 8, 1977: Symposium on international marketing and current marketing problems of the fields of industrial electronics and electrical engineering.

Youth visitors day for students and apprentices on Saturday, September 10, 1977.

Literature, conference programs and catalogues:  
Secretariate Ineltec 77  
Postfach  
CH-4021 Basle/Switzerland  
Phone 061 26 20 20  
Telex 62685 fairs ch

**Basle/  
Switzerland  
Sept. 6  
to Sept. 10,  
1977**

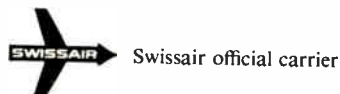

# ineltec

Circle 196 on reader service card

## FEATURE ARTICLES FROM *ELECTRONICS* AVAILABLE IN REPRINT FORM

No. of copies wanted

### New reprints

- R-716 Special report—Japanese wave in semiconductor technology 24 pp \$3.00
- R-714 Special report—active filter technology 6 pp \$3.00
- R-713 Electron-beam lithography draws fine line 10 pp \$3.00
- R-712 Special report—large-scale integration 16 pp \$3.00
- R-710 Personal computers mean business 8 pp \$2.00
- R-708 So you want to be a consultant 6 pp \$2.00
- R-706 Low-cost dual delayed sweep method 6 pp \$2.00
- R-705 Powering up with linear ICs 12 pp \$3.00
- R-703 Special report—memories 16 pp \$3.00
- R-702 World market report 1977 24 pp \$4.00
- R-616 Special issue—technology update \$4.00
- R-614 Power supply choices for sophisticated designs 8 pp \$3.00
- R-612 Fiber-optic communications special report 24 pp \$3.00

- R-610 Special report on hybrid-circuit technology 19 pp \$3.00
- R-606 Special issue—microprocessors \$4.00
- R-526 How reliable are today's components 16 pp \$3.00
- R-600 World market report 1976 24 pp \$4.00
- R-524 Special report on bipolar large-scale integration 12 pp \$3.00

### Books

- R-704 Thermal design in electronics \$5.00
- R-701 Applying microprocessors—Electronics Book Series \$9.95
- R-608 Basics of Data Communications—Electronics Book Series \$12.50
- R-602 Large Scale Integration—Electronics Book Series \$9.95
- R-520 Microprocessors—Electronics Book Series \$8.95
- R-011 Computer-aided Design 135 pp \$4.00
- R-032 Active Filters 88 pp \$4.00
- R-031 Circuit Designer's Casebook 182 pp \$5.50 (outside U.S. \$12.00)

### Charts

- R-516 Electronic symbols \$2.00
- R-213 Electromagnetic spectrum (updated 1976) \$3.00
- R-326 Optical spectrum (6-page report and chart) \$3.00

### Payment must accompany your order

Make check or money order payable to Electronics Reprints. All orders are shipped prepaid by parcel post. Allow two to three weeks for delivery. For additional information call (609) 448-1700 ext. 5494

Back issues now available:  
1960 to 1969, \$5.00 each  
1970 to 1973, \$3.00 each  
1974 to 1976, \$4.00 each

Mail your order to:  
Janice Austin  
ELECTRONICS REPRINTS  
P.O. Box 669  
Hightstown, N.J. 08520

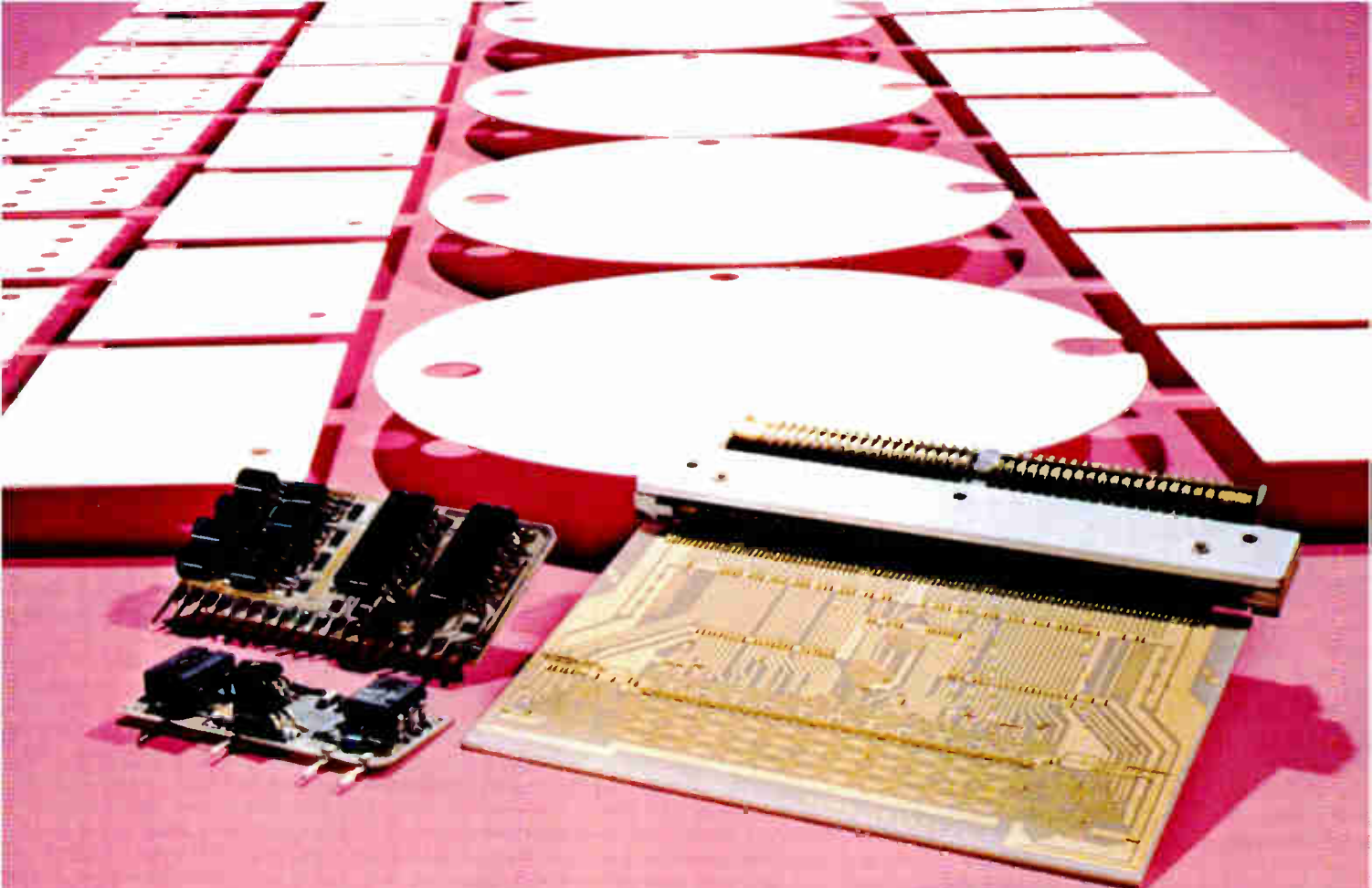

## For Greater Production Efficiency And Higher Yield, Start With a Dependable Base.

To maintain your yields and product quality, you need a dependable foundation for your thick- or thin-film circuits. On your production line and in service, Coors alumina ceramic substrates provide that measure of dependability.

Remarkable mechanical strength enables them to survive the rigors of high-speed, automated processing. Coors quality assurance program constantly monitors composition, dimension, and surface of substrates for greater yield. Our substrates' superior electrical, mechanical and chemical properties provide reliable operation in the field.

A choice of materials, backed with facil-

ities for laser scoring, green scoring and metallizing, means Coors can match a substrate to your circuit specifications and finishing requirements. With tooling on hand for more than 1000 shapes, we can speed your designs and save you tooling charges.

The final elements of Coors dependability are a special substrate service group to give you personal follow-through on your substrate orders, and an additional plant that will provide faster delivery in late summer, 1977.

For complete details on Coors substrates, write for our Electronic Ceramic Handbook, or call your local Coors representative.

**For fast service, call Coors Substrate Hotline: (303) 279-8320.**

**Coors** CERAMICS

**Coors Porcelain Company**

600 Ninth Street/Golden, Colorado 80401  
(303) 279-6565/Telex 45-593

Circle Number 901 on Reader Service Card

# Highest Honors for Mil-Spec Trimmers



Only Bourns is qualified to all 18...

A medal to Bourns from Bourns — slightly arrogant, but well deserved. We examined all competitive Mil-Spec Trimmer capabilities and found that no one even came close to the sheer number of approvals we've achieved... eighteen in all! And they're manufactured with the same dedication to quality, service and value that has made Bourns Number One in trimmers for twenty-five years!

... and at a new level of reliability

Not only did we invent the trimming potentiometer in 1952, but we're reinventing it all the time. Patented design innovations incorporated into our Mil-Spec line have brought a new level of reliability unequalled in the industry:

**NEW DRIVE SYSTEM** — Substantial reductions in material wear and increased rotational life are derived from this "pin-free, lock-free" construction.

**SWAGE BOND** — High energy "sonic swaging" transforms the cermet element and the termination into an integral one piece unit, providing a connection that is electrically and mechanically more reliable.

**CHEVRON SEAL** — This unique shaft-to-housing environmental seal is "O-ringless," resulting in uniform torque without any springback.

**WRAP-AROUND WIPER** — With this feature, wiper pressure is consistent, allowing for better "setability" and lower CRV.

Find out for yourself why we're number one, send for complete technical information from the award winner — Bourns, direct or through your local distributor.

**TRIMPOT PRODUCTS DIVISION, BOURNS, INC.** • 1200 Columbia Ave. Riverside, CA 92507 • Phone: (714) 781-5050. TWX 910 332-1252.

## WIREWOUND

Style	Characteristics	Qualified Terminals	Description
<b>MIL-R-27208</b>			
RT10	C2	L, P	1" long
RT12	C2	L, P, Y	1 1/4" long
RT22	C2	L, P, W, X	1/2" square
RT24	C2	L, P, W, X	3/8" square
RT26	C2	W, X	1/4" square

## MIL-R-39015

RTR12	D	L, P, Y	1 1/4" long
RTR22	D	L, P, W, X	1/2" square
RTR24	D	P, W, X	3/8" square

## CERMET

Style	Characteristics	Qualified Terminals	Description
<b>MIL-R-22097</b>			
RJ12	C, F	L, P, Y	1 1/4" long
RJ22	C, F	L, P, W, X	1/2" square
RJ24	C, F	L, P, W, X	3/8" square
RJ26	C, F	P, W, X	1/4" square
RJ50	C, F	P	1/4" round

## MIL-R-39035

RJR12	C, F	L, Y	1 1/4" long
RJR24	C, F	P, W, X	3/8" square
RJR26	F	P, W, X	1/4" square
RJR28	C, F	P	1/2" long
RJR32	C, F	D	3/8" long DIP



International Marketing Offices: European Headquarters — Switzerland 042/23 22 42 • Belgium 02/218 2005 • France 01/2039633 • Germany 0711/24 29 36 • Italy 02/32 56 88 • Netherlands 70/87 44 00 • United Kingdom 01/572 6531 • Norway 2/71 18 72 • Sweden 764/20 110 • Japan 075/921 9111 • Australia 02/55 00 00 • Israel 03/9566 51 • Israel 77 71 15/6/7

For Immediate Application — Circle 120  
or For Future Application — Circle 220