

MAY 12, 1977

SPECIAL: WHERE ELECTRON-BEAM LITHOGRAPHY STANDS/89
FILM TECHNOLOGY DOMINATES COMPONENTS CONFERENCE/114

97232

FOUR DOLLARS A MCGRAW-HILL PUBLICATION

Electronics®

STACY HILLMAN
MATTY HESSELL
2316 NE CLACKAMAS
PORTLAND OR



**A new
memory
milestone**

The \$2 Pot with the \$5 Linearity...

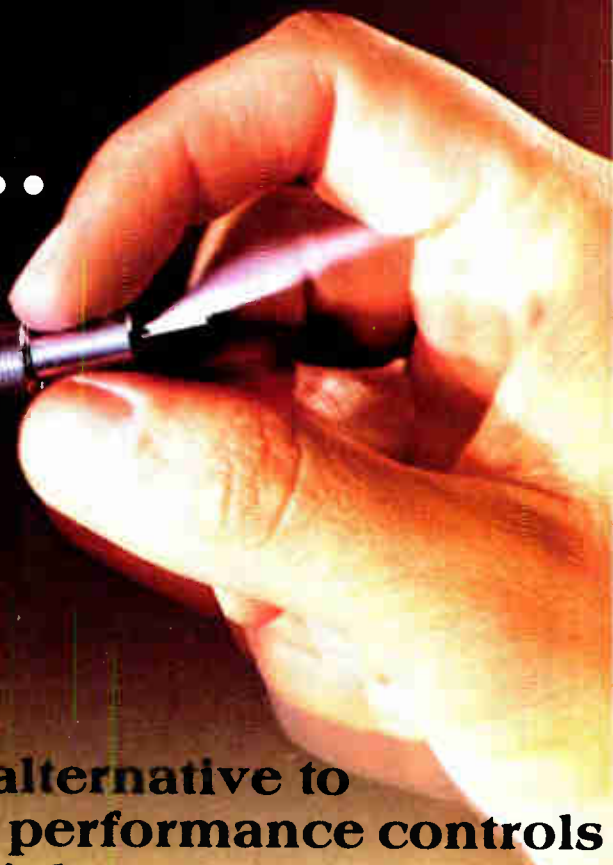

COMPARISON OF DIAL SETTING ACCURACY
(Possible production variation — unit to unit)

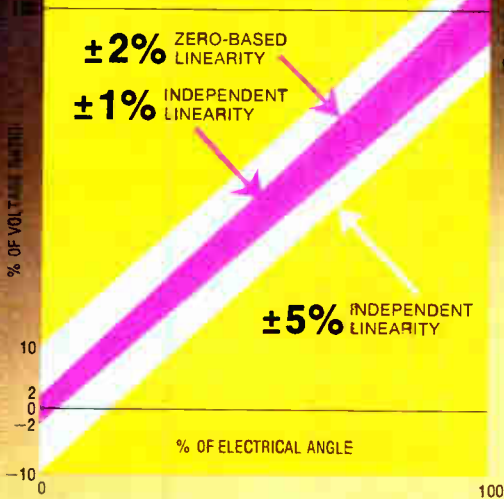

Your alternative to lower performance controls and higher cost precisions.

LASER-TRIMMED SAVINGS

Now, for about \$2*, the Bourns® Model 87/88 semi-precision, single-turn potentiometer delivers $\pm 2\%$ zero-based linearity. Compare the accuracy to the \$5 precision pot with $\pm 1\%$ independent linearity that you're buying now . . . especially the performance at the low end setting, where dial setting accuracy is most critical. Laser trimming and advanced element design† deliver performance and savings in a $\frac{5}{8}$ " square modular package.

MOVE UP FROM INDUSTRIAL GRADE CONTROLS

Again, for about \$2, the Model 87/88 offers 200-300% greater panel setting accuracy over industrial grade controls. They're perfect for applications requiring close, consistent calibration of output-to-panel setting and versatility of design.

MODEL 87/88 — THE ALTERNATIVE

Don't compromise your application with lower performance controls or pay a premium for precision pots. Specify the alternative — Bourns Model 87/88. Write or call today for complete technical information.

\$2 SEMI-PRECISION MODULAR POTS . . . BEAUTIFUL!

TRIMPOT PRODUCTS DIVISION, BOURNS, INC., 1200 Columbia Avenue, Riverside, California 92507, Telephone (714) 781-5122 — TWX 910 332-1252.

PERFORMANCE/COST COMPARISON			
Type	Element	Linearity	Approx. Cost
HIGHER COST PRECISION POTS	Conductive Plastic	$\pm 1\%$ Independent	\$5.00
BOURNS 87/88 SEMI-PRECISION POTENTIOMETERS	Conductive Plastic	$\pm 2\%$ Zero-Based	\$2.00
	Cermet	$\pm 2.5\%$ Zero-Based	
LOWER COST CONTROLS	Conductive Plastic/Cermet	$\pm 5 - 10\%$ Independent	\$1.00

* Production quantities, Domestic U.S.A. price, Single cup unit only.
† Patent Pending



International Marketing Offices: European Headquarters — Switzerland 042/23 22 42 • Belgium 02/218 2005 • France 01/2039633 • Germany 0711/24 29 36 • Italy 02/32 56 68 • Netherlands 70/87 44 00 • United Kingdom 01/572 6531 • Norway 2/71 18 72 • Sweden 764/20 110 • Japan 075/92* 9111 • Australia 02/55-0411 03/95-9566 • Israel 77 71 15/6/7

World Radio History

Circle 900 on reader service card

Introducing push-button microprocessor system debugging.

HP's 1611A Logic State Analyzer ... Dedicated to all 8080 or 6800 based systems.*

View program flow in mnemonics. With CRT data and address selectable in either hexadecimal or octal formats and external lines in 1's and 0's.

Maintain testing control. LED indicators show status at all times. You can monitor system operation at normal speed or step the microprocessor and give control to the 1611A for single or multiple keyed steps.

Enter data quickly and easily. The hexadecimal keyboard makes trigger and qualifier data entry as easy as operating a calculator. And the CRT display gives you a quick visual check on your entries.

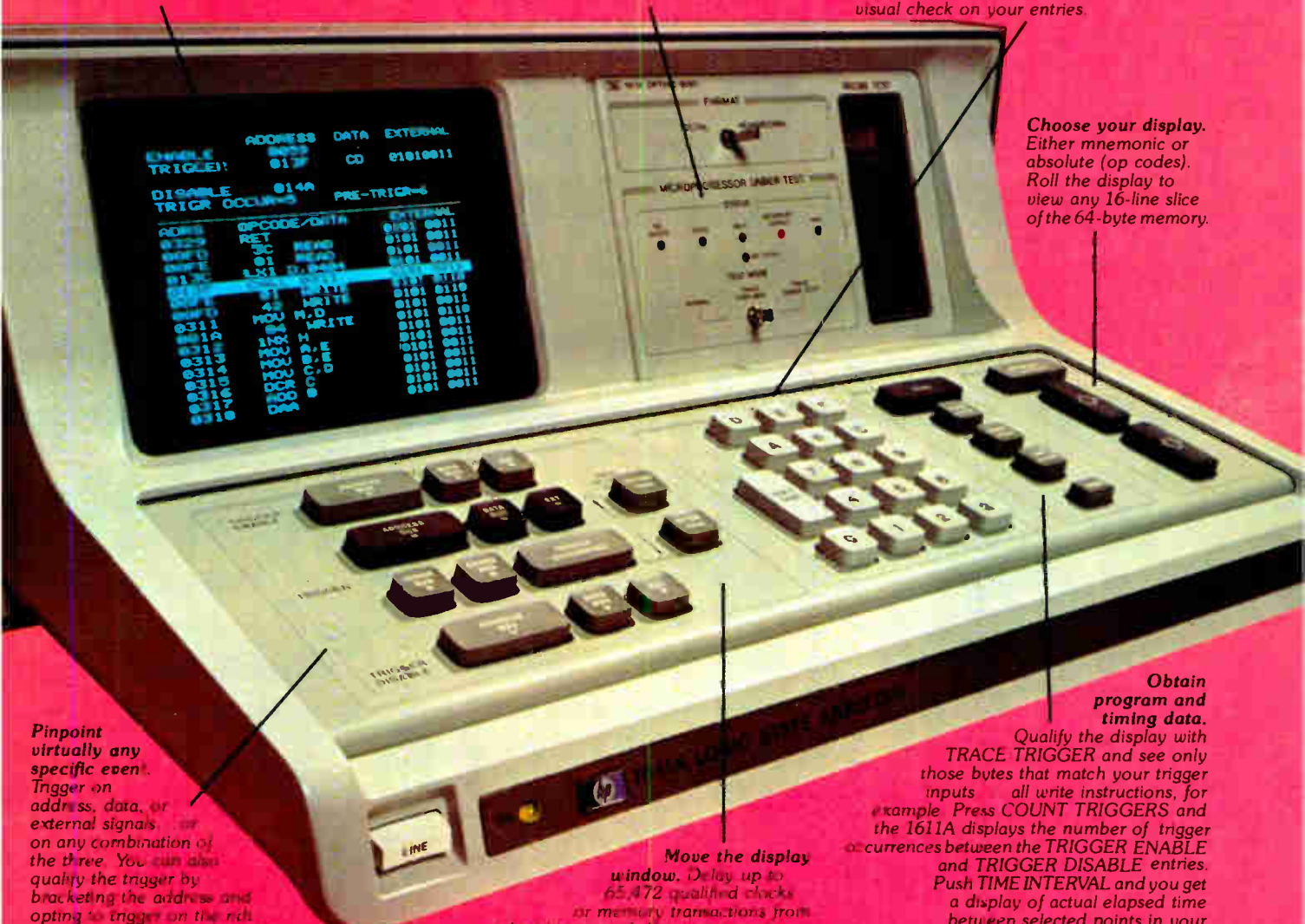

Choose your display. Either mnemonic or absolute (op codes). Roll the display to view any 16-line slice of the 64-byte memory.

Pinpoint virtually any specific event. Trigger on address, data, or external signals, or on any combination of the three. You can also qualify the trigger by bracketing the address and opting to trigger on the nth occurrence of the trigger word. TRIGGER ENABLE and DISABLE keys act as arm and disarm circuits providing unparalleled pinpointing flexibility.

Move the display window. Delay up to 65,472 qualified clocks or memory transactions from the trigger word. Or, pre-trigger to see up to 63 bytes leading up to the trigger word (injection time).

Obtain program and timing data. Qualify the display with TRACE TRIGGER and see only those bytes that match your trigger inputs—all write instructions, for example. Press COUNT TRIGGERS and the 1611A displays the number of trigger occurrences between the TRIGGER ENABLE and TRIGGER DISABLE entries. Push TIME INTERVAL and you get a display of actual elapsed time between selected points in your program on your hardware.

The 1611A should be on hand when you start up your microprocessor-based system. Imagine the time you'll save with push-button operation and an unparalleled view of your system's operation; viewing things dynamically that you never could see before. And there's more: self test; trigger outputs to drive external equipment; error messages to warn of improper operation or setup; and the choice of two initial "μP personality modules" that let you tailor the 1611A to either 8080 or 6800 based systems.



Let HP's 1611A, priced at \$5,000**, help you speed development, production-line testing or service. Ask your local HP field engineer for all the details. Ask him about HP's digital seminars too. He can tell you when one will be held in your area and how you can attend.

*and more modules for other microprocessors to come
**Domestic U.S.A. price only.

HEWLETT hp PACKARD

Sales and service from 172 offices in 33 countries.

1700 Page Road, Palo Alto, California 94304
Telephone (415) 951-3441, Telex 535 107 500
©1980 Hewlett-Packard Company, P.O. Box 1700

World Radio History

Managing the data domain.

Circle 1 on reader service card

1950
1960
1977

's—Low-cost Digital Voltmeters Sell For \$1500

's—Digital Voltmeters Add Multiple Functions

—Low-cost Digital Multimeters Sell For \$225 From HP

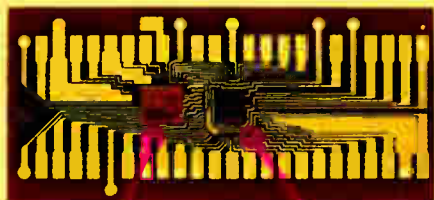

New component technologies greatly reduce production costs and at the same time improve performance—bulky wire-wound resistors used as a precision attenuator are replaced by tantalum nitride deposited on a sapphire chip. 5 micron line widths and laser trimming yield resistance values to 10 megohms with 50 ppm ratio accuracy.

Reducing the large number of interconnections and parts needed for HP multimeters is this CMOS Control chip. It includes counters, buffer storage, code conversion for display, display scanner, autorange circuits, several ROM's, most of the analog switches and a range-hold function.

History tells the story.

Today, digital multimeters from Hewlett-Packard offer five functions for 15% of the price of 1950 single function DVM's. And remember how much noise they made? Not a bad track record when you consider that the 1950 dollar is worth two of today's inflated version.

What's behind this remarkable story? It's no secret—it's technology. The same technology that gave us the digital watch, pocket calculator, home TV games, and for many of us our own personal computer. At Hewlett-Packard, we've always developed the very latest in voltmeter technology allowing us to offer this top quality at prices so low. Look at just a few of the advances responsible for today's exciting low prices.

If you'd like to know more about the new DVM's from HP—especially our prices, contact your local HP field office for more information. Or, use the Reader Service Card to get complete literature on HP's new generation of low-cost DVM's.

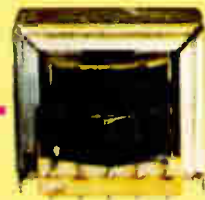

Great time saving results from automatic insertion of components into printed-circuit board along with completely auto-

ated testing of final unit. Even the power transformer is wave soldered along with other components.

To assure you a reliable product, each multimeter developed by HP is designed to survive abuses such as: 230VAC into every terminal pair on every

function and range setting, current overloads into current measuring terminals, 1000V dc into any terminal pair, and 15KV static discharge.



High-impact polycarbonate case withstands 100 G's shock. Cost savings is about two-to-one over metal units. Input terminals and cover simply drop into place further reducing assembly time and cost.



L.E.D., solid-state readout consists of monolithic chips that are magnified through use of two lenses. The final display is 30% larger giving you a more readable display.

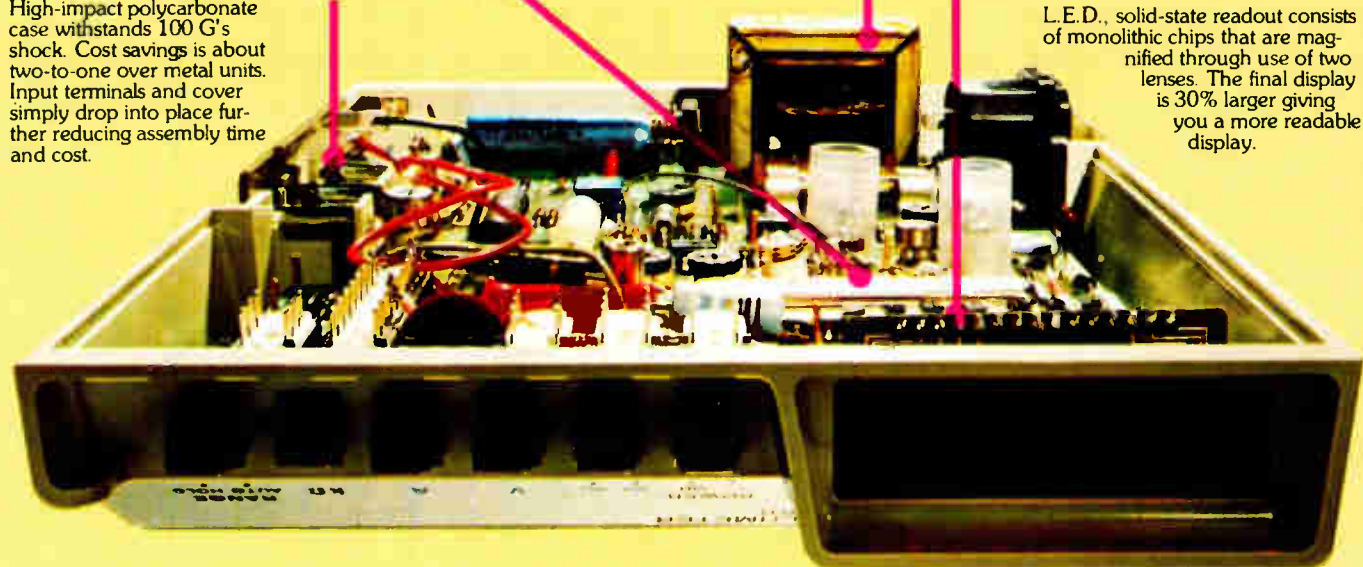

HEWLETT **hp** PACKARD

US 746A

1507 Page Mill Road, Palo Alto, California 94304

For assistance call: Washington (301) 948-6370, Chicago (312) 255-9800, Atlanta (404) 955-1500, Los Angeles (213) 877-1282

Circle 2 on reader service card

World Radio History

31 Electronics Review

CITIZENS' BAND: TI to market single-sideband set, 31
PACKAGING & PRODUCTION: Philips projects masks to 0.1 μm , 32
COMMUNICATIONS: Israeli teleprinter writes two alphabets, 33
FIBER OPTICS: GTE is first to carry public's calls, 34
EMPLOYMENT: Demand for executives up at top levels, 36
COMPUTERS: Commodore offers new household PET, 36
NEWS BRIEFS: 38
MICROWAVES: TRW builds 5-GHz GaAs modem chips, 40
CONSUMER: IEEE revamps its spring conference in Chicago, 43
PERIPHERALS: Maker hammers at printer cost, 43

53 Electronics International

INTERNATIONAL: Europeans ready 2-hour video recorders, 55
JAPAN: Quartz watch uses solar cells, 55
GREAT BRITAIN: 8-bit a-d converter is Europe's fastest, 55
JAPAN: Power transistors aimed at hi-fi, 56

67 Probing the News

SEMICONDUCTORS: From TI's perch, things look good, 67
CONSUMER: CB picture muddy as 23-channel sets sell, 70
ENERGY: Carter plan faces long struggle, 74
CONSUMER: Where there's smoke, there will be ICs, 78

89 Technical Articles

PACKAGING & PRODUCTION: Electron-beam lithography is here, 89
SOLID-STATE: 4-k static RAM runs fast on little power, 99
DESIGNER'S CASEBOOK: Clamp controls wave-form offset, 104
BI-FET devices improve absolute-value amplifier, 105
555 timer IC freezes digital panel meter display, 105
COMPUTERS: Microcomputer set packs it all into three chips, 109
COMPONENTS: Advances in film extend component capabilities, 114
ENGINEER'S NOTEBOOK: Sweep source reduces incidental fm, 120
CALCULATOR NOTES: SR-52 solves network equations, 121

131 New Products

IN THE SPOTLIGHT: Time-delay relays get cheaper, 131
Monolithic IC converts rms values to dc, 133
INSTRUMENTS: Serial data generator runs at 50 megahertz, 137
MICROPROCESSORS: Intel introduces four I/O boards, 147
COMPONENTS: Miniature trimmers have 0.2% stability, 156
MICROWAVES: YIG-tuned front ends cover 8 to 40 GHz, 169
PACKAGING & PRODUCTION: Unit bonds tape-mounted ICs, 182
MATERIALS: 196

Departments

Publisher's letter, 4
Readers' comments, 6
News update, 8
Editorial, 12
People, 14
Meetings, 20
Electronics newsletter, 25
Washington newsletter, 49
Washington commentary, 50
International newsletter, 53
Engineer's newsletter, 124
New literature, 204

Services

Employment opportunities, 214
Reprints available, 226
Reader service card, 227

Highlights

Cover: 4-k static RAM is fast and power-thrifty, 99

A typical access time of 150 nanoseconds and a typical power dissipation of 80 milliwatts at 4 megahertz are the achievements of a new static 4,096-bit static random-access memory, the latest landmark memory development. A clocked sense amplifier and polysilicon load resistors help skirt the usual power-speed compromises.

Cover illustration is by Art Director Fred Sklenar.

The view from Dallas is optimistic, 67

This year's semiconductor sales, for all firms worldwide, will rise to \$6.625 billion, 18% over those of 1976, predicts Texas Instruments. The prognosis from the Dallas firm, known for its conservative estimates, is slightly under the industry consensus in *Electronics'* year-opening survey.

Electron beams trace finer lines, 89

For large-scale-integrated circuits to advance in density and complexity, pattern lines narrower than 1 micrometer are necessary. Electron-beam lithography looks like it will be the answer.

Conference to mull film technology, 114

Film technology and the often related subject of production techniques will dominate the discussions at this year's Electronic Components Conference. There will be 16 sessions at the affair, which opens May 16 in Arlington, Va.

And in the next issue . . .

What you should know about active filters . . . packaged analog input/output systems for microprocessors shrink to near chip size.

EDITOR-IN-CHIEF: Kemp Anderson

EXECUTIVE EDITOR: Samuel Weber

MANAGING EDITOR: Arthur Erikson,
International

SENIOR EDITORS: Laurence Altman,
Ray Connolly, Lawrence Curran,
John Johnsrud, H. Thomas Maguire,
Stephen E. Scrupski, Gerald M. Walker

ART DIRECTOR: Fred Sklenar

ASSOCIATE EDITORS: Howard Wolff,
Alfred Rosenblatt

DEPARTMENT EDITORS
Aerospace/Military: Ray Connolly
Circuit Design: Vincent Biancomano
Communications & Microwave:
Richard Gundlach
Components: Lucinda Mattera
Consumer: Gerald M. Walker
Industrial: Raymond P. Capece
Instrumentation: Stephen E. Scrupski
New Products: H. Thomas Maguire,
Michael J. Riezenman
Packaging & Production: Jerry Lyman
Solid State: Laurence Altman

CHIEF COPY EDITOR: Margaret Eastman

COPY EDITORS: Everett C. Terry, Ben Mason

ART: Charles D. Ciatto, *Associate Director*
Paula Piazza, *Assistant Director*

EDITORIAL SECRETARIES: Janet Noto,
Penny Rothman

EDITORIAL ASSISTANT: Marilyn B. Rosoff

FIELD EDITORS

Boston: Lawrence Curran (Mgr.), Pamela Leven

Los Angeles: Larry Waller (Mgr.)

Midwest: Larry Armstrong (Mgr.)

New York: Bruce LeBoss (Mgr.)

San Francisco: Bernard Cole (Mgr.)

Judith Curtis

Washington: Ray Connolly (Mgr.)

Frankfurt: John Gosch

London: William F. Arnold

Paris: Arthur Erikson

Tokyo: Charles Cohen

McGRAW-HILL WORLD NEWS

Editor: Michael Johnson

Brussels: James Smith

Milan: Andrew Heath

Moscow: Peter Hann

Paris: Andrew Lloyd

Stockholm: Robert Skole

Tokyo: Robert E. Lee

PUBLISHER: Dan McMillan

ADVERTISING SALES MANAGER:

Paul W. Reiss

MARKETING ADMINISTRATION MANAGER:

Wallis Clarke

CIRCULATION MANAGER: Karl Peterson

MARKETING SERVICES MANAGER:

Tomlinson Howland

RESEARCH MANAGER: Margery D. Sholes

Semiconductor technology, particularly in the integrated-circuit area, is beginning a big move into an entirely new phase. The next generation of highly complex electronic functions will be accomplished more by innovations and refinements in production techniques than in novel circuit approaches. In other words, the new crop of exceedingly dense chips—packing in far more circuit elements than can large-scale integration—is on the horizon.

What has been slowing the trend toward ultra-dense circuits is that current technology is pushing up against the limits of dimensions that can be achieved by optical lithography. While there are still some ways left to squeeze finer lines out of optical approaches, a number of researchers have been looking ahead to more exotic techniques, and one of the most promising of those is electron-beam lithography.

On page 89, you'll find a detailed article on electron-beam technology and where it stands. Authored by a team from IBM, this extremely significant article describes the widespread efforts now going on in numerous companies and research organizations. As might be expected, electron-beam lithography is not simply a substitution of a beam of electrons for a beam of light. Resists are different, etching methods must be modified, and, the greatest change of all, computer technology must be harnessed if the benefits of the high resolution and high speeds inherent in the electron-beam approach are to be fully realized.

The keystone of tomorrow's electronics circuits is the high density that approaches like electron-beam lithography make possible. For a

preview of what that world with its circuit line widths of 0.1 micrometer and less—lines only 0.008 micrometer wide have already been made in the laboratory—turn to our 10-page report.

What happened to the great citizens' band boom? After the break-neck sales pace of last year, when makers and merchants alike were pushing 23-channel sets off the shelf to make way for the just-approved 40-channel sets, 1977 has been a bit of a bust.

To be sure, a lot of 40-channel sets are being snapped up by consumers. But the inventory overhang in 23-channel sets is not the roughly 2 million that had been expected. Instead, observers now feel that some 3 million to 5 million 23-channel sets will be sold this year, mostly at or below cost. The reason for the surprise: no one figured in the parts that were waiting to be built into sets. Thus, 40-channel prices have sagged in response to the 23-channel glut.

All in all, the CB market has cooled off. Last year's estimated sales of 10 million sets just about doubled the number of sets in use—22 million. The outlook now for this year is not the 12 million more sets that some forecast, but more like 8 million. For the complete story on the somewhat tarnished glitter of 40-channel CB, turn to page 70.



May 12, 1977 Volume 50, Number 10 95,557 copies of this issue printed

Published every other Thursday by McGraw-Hill, Inc. Founder: James H. McGraw 1860-1948. Publication office 1221 Avenue of the Americas, N.Y., N.Y. 10020; second class postage paid at New York, N.Y. and additional mailing offices.
Executive, editorial, circulation and advertising addresses: Electronics, McGraw-Hill Building, 1221 Avenue of the Americas, New York, N.Y. 10020. Telephone (212) 997-1221. Teletype 12-7960 TWX 710-581-4879. Cable address: MCGRAW HILL NEW YORK.

Subscriptions limited to professional persons with active responsibility in electronics technology. No subscriptions accepted without complete identification of subscriber name, title or job function, company or organization, and product manufactured or services performed. Based on information supplied, the publisher reserves the right to reject non-qualified requests. Subscription rates: In the United States and possessions \$14.00 one year, \$35.00 three years; company addressed and company libraries \$20.00 one year, \$50.00 three years; APO/FPO addressed \$35.00 one year only; Canada and Mexico \$16.00 one year, \$40.00 three years; Europe \$40.00 one year, \$100.00 three years; Japan, Israel and Brazil \$65.00 one year, \$165 three years; Australia and New Zealand \$90.00 one year, \$240 three years, including air freight; all other countries \$45.00 one year, \$112.00 three years. Limited quota of subscriptions available at higher-than-basic rate for persons allied to held served. Check with publisher for these rates. Single copies: \$4.00. Please allow four to eight weeks for shipment.

Officers of McGraw-Hill Publications Company: Gordon L. Jones, President; Paul F. McPherson, Executive Vice-President; Group Vice-President, Gene W. Simpson; Senior Vice-Presidents: David G. Jensen, Manufacturing; Ralph R. Schultz, Editorial; Vice-Presidents: James E. Boddorf, Planning & Development; Robert L. Leyburn, Circulation; Edward E. Schirmer, Sales.

Officers of the Corporation: Harold W. McGraw, Jr., President, Chief Executive Officer, and Chairman of the Board; Robert N. Landes, Senior Vice President and Secretary; Ralph J. Webb, Treasurer.

Title registered in U.S. Patent Office; Copyright © 1977 by McGraw-Hill, Inc. All rights reserved. The contents of this publication may not be reproduced in whole or in part without the consent of copyright owner.

Subscribers: The publisher, upon written request to our New York office from any subscriber, agrees to refund that part of the subscription price applying to copies not yet mailed. Please send change-of-address notices or complaints to Fulfillment Manager; subscription orders to Circulation Manager, Electronics, at address below. Change-of-address notices should provide old as well as new address, including postal zip code number. If possible, attach address label from recent issue. Allow one month for change to become effective.

Postmaster: Please send form 3579 to Fulfillment Manager, Electronics, P.O. Box 430, Hightstown, N.J. 08520.

from **KEPCO** by **TDK**

the series

RMK

25 KHz SWITCH-MODE POWER SUPPLIES

- 75% efficiency
- 90-130V a-c input (brownout protection)
- d-c input
- $\pm 10\%$ output adjustment
- adjustable current limit
- adjustable overvoltage
- logic level on-off
- 1 millisecond recovery

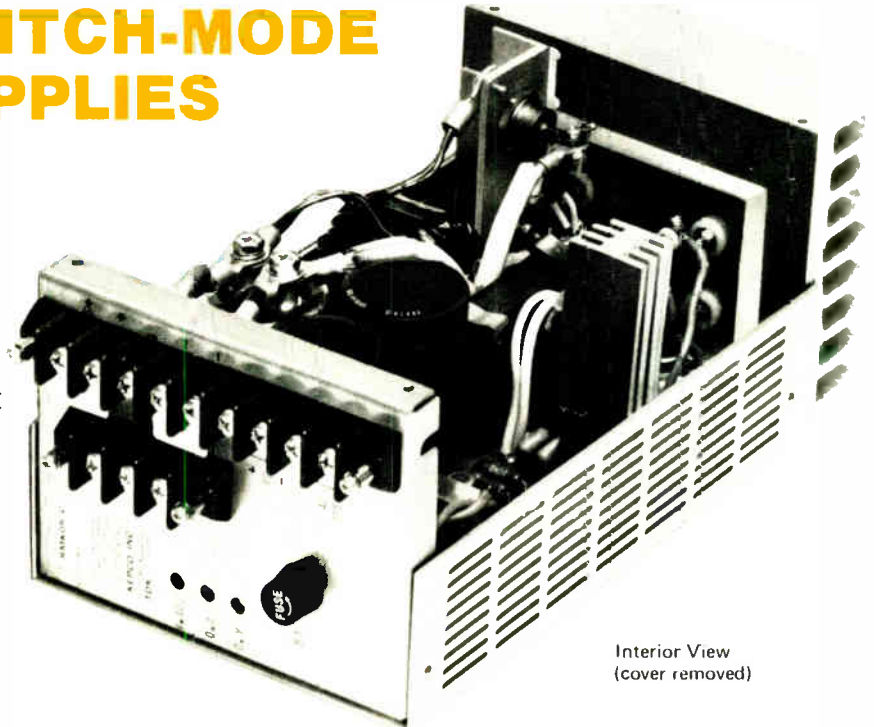

Interior View
(cover removed)

BLOCK DIAGRAM OF
THE RMK SWITCH-MODE
POWER SUPPLY

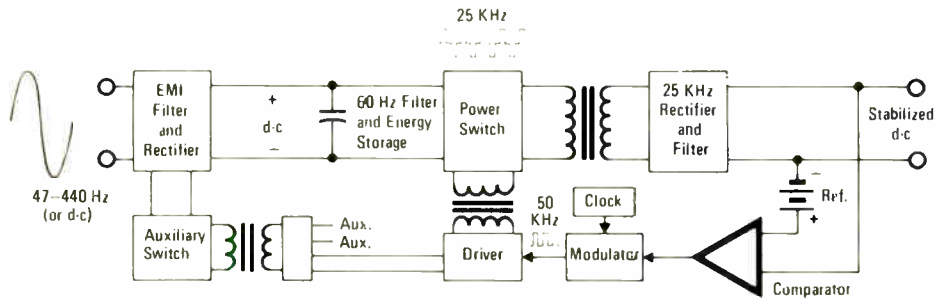

50°C OUTPUT
RATINGS FOR
THE KEPCO RMK
POWER SUPPLIES

PKG.	5V	9V	12V	15V	24V	SIZE	WGT.	PRICE
"A"	10.0 A	6.0 A	5.0 A	4.0 A	2.5 A	2 3/16" x 5 1/8" x 7 1/2"	3.0 lbs.	\$179.00
"B"	26.0 A	15.0 A	12.0 A	10.2 A	7.5 A	3 3/32" x 5 1/8" x 8 3/4"	4.75 lbs.	259.00
"C"	30.0 A	17.2 A	14.5 A	12.3 A	8.0 A	4 1/16" x 5 1/8" x 8 3/4"	5.25 lbs.	299.00

other switching power supplies from **KEPCO/TDK**

- **115/230V a-c input switching power supplies, Series RMX** offers the same outputs in the same package sizes as RMK.
- **Triple output switchers, Series RMT** combines a 5V, 10A output with your choice of: $\pm 12V @ \pm 1A$ or $\pm 15V @ \pm 1A$ or $+12V @ 1A$, $-5V @ 1A$ or $+15V @ 1A$, $-5V @ 1A$ or $+12V @ 1A$, $-9V @ 1A$.

Ask your Kepco Rep to show you the clean layout, and cool operation of the KEPCO/TDK switching power supplies. Compare performance, stability, noise, temperature rise. . . compare the Kepco 5-Year Warranty!

For complete specs,
write Dept. BTF-14

KEPCO

© 131-38 SANFORD AVENUE • FLUSHING, N.Y. 11352 U.S.A. • (212) 461-7000

New
Lower
Prices



Start Getting Your Money\$worth Out of Power Modules

Now, you can really start getting your moneysworth out of power modules with Abbott's new LOW COST series. Designed to give you 100,000 hours of trouble-free operation (that's 11½ years), these reliable units meet the needs of OEM engineers. Their purchase price is about \$7 per year of service. The model LC series feature:

- 47-420 Hz Input Frequency
- 0.1% Regulation
- +60°C. Ambient Operation
- Single and Dual Outputs
- 1 Day Stock Delivery

These units provide more quality per dollar compared to similar items on the market. See table below for prices on some of our LC models. Many other LC models are listed in our catalog.

If analyzing the many similar power supplies on the market is confusing; if you are concerned about the long-term reliability of those units, then decide on an Abbott power supply for your system. Your best buy in OEM power modules is ABBOTT.

Abbott also manufactures 3,000 other models of power supplies with output voltages from 5 to 740 VDC and with output currents from 2 milliamps to 20 amps. They are all listed with prices in the new Abbott Catalog with various inputs:

60 \overline{A} to DC
 400 \overline{A} to DC
 28 VDC to DC
 28 VDC to 400 \overline{A}
 12-38 VDC to 60 \overline{A}

5V @ 6 Amps	5V @ 10 Amps	12V @ 10 Amps	15V @ 4 Amps	28V @ 1 Amp	±12V @ 1.2 Amps	±15V @ 4 Amps
LC5T6	LC5T10	LC12T10	LC15T4	LC28T1	LLC12T1.2	LLC15T4
\$62	\$73	\$99	\$73	\$62	\$87	\$119.00

Please see pages 1054-1056 Volume 1 of your 1975-76 EEM (ELECTRONIC ENGINEERS MASTER Catalog) or pages 612-613 and 620 Volume 2 of your 1975-76 GOLD BOOK for complete information on Abbott Modules.

Send for our new 60 page FREE catalog.

abbott transistor

INDUSTRIAL PRODUCTS DIVISION
 general offices eastern office

5176 W. Jefferson Blvd./Los Angeles 90016
 (213) 930-1040 Telex: 69-1398

1224 Anderson Ave./Fort Lee, N.J. 07024
 (201) 224-6900 Telex: 13-5332

Readers' comments

The chairman dissents

To the Editor: The March 17 Washington commentary [p. 50] refers to "the misguided concept of one-carrier-per-region fostered by FCC Chairman Richard Wiley." Quite frankly, there is no factual basis for this characterization of my position.

Indeed, in Docket 18262 I was a strong and vocal advocate for rejecting the staff recommendation to limit cellular system applications to wireline carriers. For your information, I have consistently supported agency actions that would maximize full and fair competition in the mobile radio market.

I hope that this brief letter will clarify my position concerning competition in the mobile radio field.

Richard E. Wiley
 Federal Communications
 Commission
 Washington, D. C.

Watch those thetas

To the Editor: There is a rather minor error in the Calculator note "Program analyzes spectrum of oscilloscope wave forms" [Feb. 3, p. 119], which I think the readers of your magazine will want to know about.

The author gives the phase angle Θ_n by $\Theta_n = \tan^{-1}(-b_n/a_n)$, which is correct when the corresponding term of the Fourier series is, as he specifies, $C_n \cos([2 \pi nt/T] + \Theta_n)$. However, the program actually calculates $\Theta_n = \tan^{-1}(a_n/b_n)$, which is the correct result if one takes the corresponding term in the Fourier series to be $C_n \sin([2 \pi nt/T] + \Theta_n)$.

Indeed, if we work the author's example, we get a phase angle of about 30°. This checks with his example because the corresponding term in it is $\sin(3t + 30^\circ)$, which equals $\cos(3t - 60^\circ)$.

One thus has either to redefine Θ_n as above or change the program to compute Θ_n as it was defined. This can be done by transposing his instructions 38 and 39 and then inserting the instruction CHS between 38 and 39.

LeBaron O. Ferguson
 University of California
 Riverside, Calif.

With higher speeds and density ...

Here are three new COS/MOS ideas, good buddy.

A new 40-channel CB synthesizer and two other circuits prove: RCA COS/MOS has really got the hammer down on the rip strip of hot new applications. In these circuits and more to come, you have improved speeds and density to work with. Plus the other COS/MOS advantages. All adding up to better performance and significant cost and space savings.

1 40-Channel CB: cut costs of ownership.

Our new synthesizer IC combines receiving and transmitting oscillator functions on a single chip. Result: lower CB manufacturing cost—and more. The low power requirements and environmental ruggedness of COS/MOS help reduce power-supply and operating costs, and make it a natural for use in vehicles. Operating between 15-20 MHz with no pre-scaler, TA10336 has a transmit-receive shift, 6-bit channel code, and a 10.24 MHz reference.

Circle 210

2 FIFO Register: simplify microprocessor interfacing.

On a single chip you get 4 independent FIFO registers that can be used in parallel. CD40105B is 4 bits by 16 bits long, is expand-

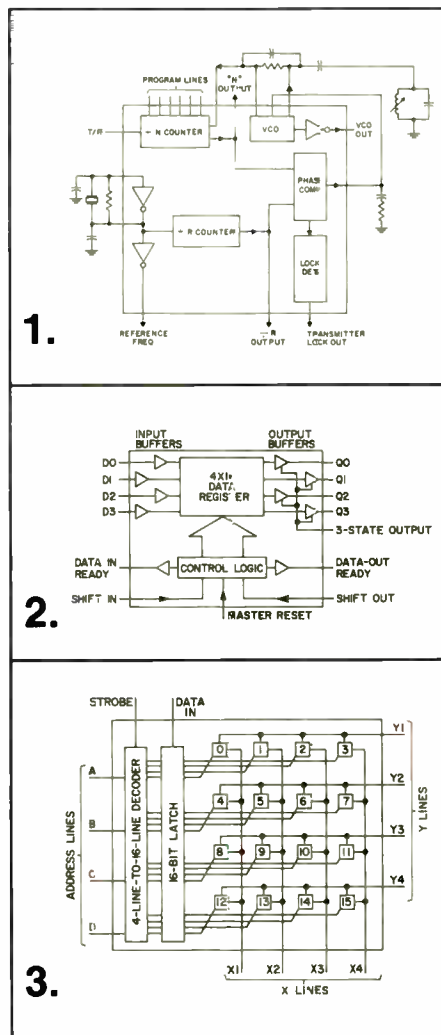

able, and features independent asynchronous inputs/outputs (outputs are 3-state). It really shines in microprocessor applications requiring input/output peripheral buffering.

Circle 211

3 4 x 4 Crosspoint Switch: lower the cost per crosspoint.

The CD22100 is 16 switches on a single chip, replacing 16 relays (at about 1/3 the cost) or 3 standard ICs. This can mean major space savings in in-house telephone and data communications systems, for example. And of course fewer connections means higher reliability. Coming soon: a 4x4x2 crosspoint switch.

Circle 212

For more information on these COS/MOS integrated circuits, contact your local RCA Solid State distributor.

Or write: RCA Solid State, Box 3200, Somerville, NJ 08876; Sunbury-on-Thames, Middlesex TW16 7HW, England; Ste.-Anne-de-Bellevue, Quebec, Canada; Fuji Bldg., Tokyo, Japan.

RCA COS/MOS experience is working for you.



Got a crash project?

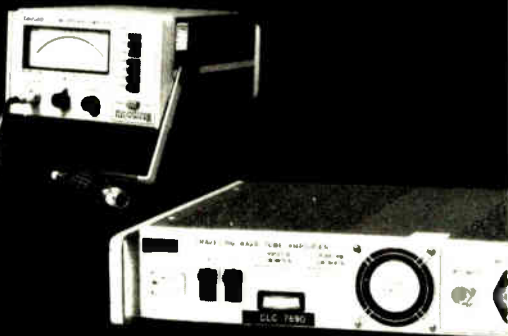

If it calls for power supplies, amplifiers or bridges — call the "Instrument Professionals" whatever the task, they can help you match your equipment needs to your budget, insuring on-time delivery to keep your project on schedule!

Write or call for data on our other specialties: Instrument Leasing • Computer Peripherals • Equipment Sales • Instrument Service.

Get our FREE Catalog 

Call Continental Rentals

Div. Continental Leasing Co., Inc.
175 Middlesex Turnpike, Bedford,
MA 01730 (617) 275-0850

FOR IMMEDIATE RESPONSE CALL:
N.E. (617) 275-0850; L.I. (516) 752-1622;
NY, NJ (201) 654-6900;
Gtr. Phila. (609) 243-5100;
Wash., D.C. area (301) 948-4310;
Mid West (312) 439-4700;
So. Central (214) 690-1706;
Costa Mesa, CA (714) 540-6566;
L.A., CA (213) 477-7521;
Santa Clara, CA (408) 735-8300.

Circle 8 on reader service card

News update

■ Its first militarized minicomputer has been successfully demonstrated "ahead of schedule," says United Technologies Corp.'s Norden division in Norwalk, Conn. Designated the PDP-11/34, it is now ready for the military market, with production units slated for delivery in July.

The Norden computer is a version of the medium-performance PDP-11/34 designed by Digital Equipment Corp. [*Electronics*, Nov. 11, 1976, p. 14], which licensed Norden to militarize, manufacture, and market its small but highly successful commercial PDP-11 family. Built from the ground up to meet severe environmental requirements of airborne (MIL-E-5400), shipborne (MIL-E-16400) and land-based (MIL-E-4158) specifications, the PDP-11/34M is identical to its commercial counterpart both functionally and bit for bit and therefore meets the main goal of the enterprise—it can use DEC's extensive PDP-11 software library.

The PDP-11/34M is available in a chassis using either a half air-transport rack with a 16,384- or 32,768-word core-memory module or the optimal full-rack chassis with up to 131,072 words. Typically, the militarized computers are twice the price of the commercial versions.

"The development of both digital units took less than six months from turn-on to completion," says Harold L. Ergott, Norden vice president for computer products. Before their recent demonstration, the PDP-11/34M central processing units passed all qualification tests.

Norden's Computer Products Center marketing group has received over 1,800 inquiries about the computers. In fact, a division spokesman says it has made its first PDP-11/34M sale but declined to give details. Norden will announce its second computer in the militarized PDP-11 family about midyear as well as "a product enhancement that will increase the 34M's throughput," the spokesman notes. That is believed to be a cache memory, while the new computer is probably a militarized version of DEC's LSI-11 single-board microcomputer.

INTRODUCING A NEW
REVOLUTIONARY
MULTI-DIGIT
SOLID STATE READOUT

BELOW \$1.

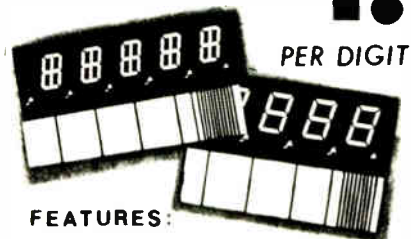

FEATURES:

Non-fatiguing ELECTROLUMINESCENT Light
Space saving thin profile
Wired for multiplexing
Low a.c. power consumption
Compatible with IC logic decoders and segment drivers
Rugged, pluggable laminated plastic construction

SPECIAL TRIAL OFFER

ORDER FROM STOCK at 97¢ per digit, any of the following multi-digit readouts having 2 to 5 digits:
1/2" high with 9-segments
0.6" high with 7-segments
(minimum order--\$10.)

T.L. ROBINSON CO., INC.
P.O. BOX D, EAST AURORA, N.Y. 14052
TEL. (716) 652-2111 TELEX: 91566

Circle 229 on reader service card

Gas Sensing Semiconductor

FIGARO TGS GAS SENSOR

quickly senses
even small
amount
of gas.



Applications

1. Natural Gas-Leak Alarm
2. Propane Gas-Leak Alarm
3. Carbon Monoxide Detector
4. Automatic Fan Control
5. Fire Alarm (Detecting)
6. Combustible gases contained in smoke
7. Alcohol Detector (Detector for drunken driver)
7. Air Pollution Monitor

Please contact any of the addresses below direct, for catalogs and price/delivery information

FIGARO ENGINEERING INC.

- Head Office: 3-7-3 Higashitoyonaka, Toyonaka City, Osaka, 560, JAPAN TELEX 05286155 FIGARO J. CABLE FIGARO TOYONAKA TEL (06) 849-2156
- North America: 3303 Harbor Boulevard Suite D B, Costa Mesa, California 92626, U.S.A. TELEX 678396 CABLE FIGARENGIN COSTAMESA TEL (714) 751-4103

Circle 230 on reader service card

Designer's guide to the hot numbers in LICs.

BiMOS Op Amps: they mix technologies to match circuit needs.



CA3140

Most useful op amp since the 741. MOS/FET input plus bipolar speed and 4-44 V supply voltage. Does most jobs better than 741 or many premium op amps — at far less cost.

CA3160 CA3130

Universal op amp, available with compensation (3160) or without (3130). Very low priced, yet with features for general purpose, FET input (1,500,000 M Ω), wideband (15 MHz), micropower and high current uses.

CA3100

Wideband op amp (40 MHz) for both large and small signals. High open-loop gain, slew rate (25 V/ μ sec) and output current, plus fast settling time.

BiMOS combines the best of Bipolar and MOS in versatile, easy-to-use, low-cost op amps that are simple to manufacture in high volume. It's the op amp technology of today — and tomorrow. Millions of BiMOS devices have been produced and sold. Most are available off the shelf.

Circle 271

Variable Op Amps: as easy to use as a transistor.

CA3080

Programmable op amp: differential voltage input, current output. Variable voltage-power, bandwidth, slew rate, input and output current. \$0.59 @ 1K.

CA3094

Programmable power switch/amplifier. Adds integral Darlington output to CA3080 circuit to provide 300 mA peak current.

CA3060

Variable op amp array: 3 variable op amps plus zener bias regulator to use as current control or voltage reference source. All on one chip.

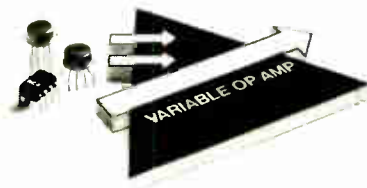

Circle 272

Micro Power Op Amp.

CA3078

Delivers up to 6.5 milliamps with standby power as low as 0.7 microwatt. Programmable input terminal for tailoring response and slew rate without sacrificing power.

Circle 273

Gold CHIP

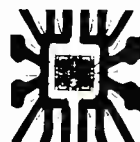

The metalization is gold, and the chip is hermetically sealed with a layer of silicon nitride. The result is corrosion-free, extended life added to the economy of an advanced, rugged plastic package. In short, Gold CHIP (Chip Hermeticity In Plastic) gives you better than standard plastic reliability at the same price as plastic.

There are over 25 Gold CHIP types including these popular numbers: CA301A, CA307, CA311, CA324, CA339, CA555, CA741, CA747, CA748, CA1458, CA3401, CA3724, CA3725.

Circle 274

ARRAYS

RCA amplifier, diode and transistor arrays help you reduce parts cost, save space, cut insertion costs and increase reliability. Choose from 24 different arrays that allow you to create new circuit designs and do the jobs you want done.



RCA Array circuit diagrams and free sample offer

Circle 275

For more information, contact your local RCA Solid State distributor.

Or write: RCA Solid State, Box 3200, Somerville, NJ 08876; Sunbury-on-Thames, Middlesex TW16 7HW, England; Ste.-Anne-de-Bellevue, Quebec, Canada; Fuji Bldg., Tokyo, Japan.

RCA Linear experience is working for you.

RCA

The 2900 Family: Two years later.

1975. Advanced Micro Devices introduces the world's best 4-bit microprocessor slice, the Am2901, along with a few support circuits.

1977. It's a whole new family. Now there's an Am2901A just like the Am2901, only better. Now there are 18 support circuits, two or three second sources and all the software you'd ever want. The 2900 family has become the family of the future. Here's why:

The first family.

The Am2900 family is the first group of products designed specifically for microprogrammed machines. Microprogramming is rapidly becoming the most popular way to design medium- and high-performance systems, to reduce development time, make changes easily, and conveniently add new features.

Less weight, less size.

With the Am2900 family, it's not uncommon for entire boards to be eliminated. You'll shrink system size and weight, increase

overall reliability and reduce manufacturing costs.

Time goes by, price goes down.

In July 1975, we told you we'd reduce the cost of the Am2901 by 30% per year. We've done it twice. Once in April 1976 and once in March 1977. The Am2900 family gets less and less expensive all the time.

We're so popular, we're the industry standard.

The Am2900 family is the most widely used Bipolar LSI family in:

- Minicomputers: For emulators, high-performance CPU's and add-ons by eight out of the top ten U.S. manufacturers.
- High-performance controllers: For discs, tapes, floppy discs and universal controllers.
- Communications: For PBX systems, central exchanges, multiplexers and modems.
- Military: For radar processors, display systems and the Navy's new standard avionic computer, the AN/AYK-14.

The Family:

CPU Slice (ALU and general registers)	Am2901A, 2902, 2903*, 2904*
Microprogram Control Units	Am2909, 2910*, 2911
Branch and Instruction Control for Microprogram Sequencers	Am29803, 29811
LSI Bus Interface Devices	Am2905, 2906, 2907, 2915A, 2916A, 2917A
Priority Interrupt Control	Am2913, 2914
Main Program Control	Am2930* 2931* 2932*
New More Powerful MSI functions	Am2918, 2919, 2920, 2921, 2922

*In Development

Plus:

Schottky and low-power Schottky MSI, MOS static and dynamic RAM's and all the devices you need to build your high-performance microcomputer.

We don't sell and run.

Advanced Micro Devices offers learning aids to help speed up designs and keep your engineers up-to-date on the very latest microprogramming techniques. Learning aids and application materials like these perennial favorites:

- A 16-Bit Microprogrammed Computer
- The Am2900K1 Learning and Evaluation Kit
- The Microprogramming Handbook

- A High Performance Microprogrammed Disc Controller
- In development:
- Vertically Microprogrammed State Machines
 - An emulation of the Am9080A/8224/8228 using the Am2900 family

And two terrific design aids:

AMDASM

Our powerful, easy-to-use microprogram assembler offering software support through the worldwide INFONET time-sharing division of Computer Science Corporation. (It supports user-defined mnemonics for producing microinstructions up to 128 bits wide, and includes formatting and default features as well as tape generation for PROM programmers. If you've got the other guy's MDS system, ask for AMDASM/80. It comes on a floppy disk and runs under their operating system.)

AMDS

Beginning this fall, we'll be offering hardware support with the Advanced Microprogram Development System. (It's the first prototyping system especially designed for microprogramming systems.) It'll help speed up construction of prototype systems and generation and de-bug of microcode. Resident AMDASM, of course!

The Am2900 family.

It's today's product family for tomorrow's high-performance machines. Am2900. Remember that number. You're going to be hearing it a lot.

Advanced Micro Devices

Bipolar LSI. N-channel, silicon gate MOS. Low-power Schottky.
Multiple technologies. One product: excellence.



Circle 251 on reader service card

First steps on ending unfair trade practices

The United States electronics industry has won a couple of important decisions recently in its fight against unfair import practices by foreign makers, but the war is far from over. First, the International Trade Commission, an arm of the U.S. Government established by Congress a few years ago, ruled that imports of television sets, mainly from Japan, have hurt U.S. manufacturers. That decision had been sought by four manufacturing companies and 11 labor unions, which had joined together into a group called Compact. The ITC remedy would be to slap hefty import duties on both black-and-white and color sets.

Then, late last month, the U.S. Customs Court, in an entirely separate action, upheld the accusation brought by the Zenith Radio Corp. that a special Japanese government tax situation benefiting Japan's consumer electronics exports was, in fact, a bounty or a grant. Thus, by United States law, such imports would be subject to a countervailing duty equal to the unpaid taxes. That duty would amount to from 13% to 20% of the products' value.

Finally, in an internal action that is not subject to judicial review, the Treasury Department has ordered that the entry bonds posted by importers of television sets be more than doubled, up from 9% to 20%. The bonds were first ordered posted to meet possible penalties following a Treasury Department finding, in March 1971, that most Japanese set makers were guilty of dumping their wares in the U.S. market by selling them for less than they were asking in their domestic market. The increase in the bonds was imposed

after examination of the department's records through 1974 showed that dumping, far from going away, actually worsened.

These actions give long-awaited support to wide-ranging complaints that the Japanese consumer electronics companies have been competing unfairly in the American market for years. Now the ball has been thrown to President Carter, who must decide what proposals to veto, which to approve, and how to balance domestic job needs with international political realities.

Some of the remedies proposed — especially some suggested by the International Trade Commission — have drawbacks. At the very least, critics say, the American consumer will have to pay a significantly higher price if the duties and bond levies are passed along. On the other hand, some observers say that the television set inventory is now so huge that prices will not rise for quite a time.

Later this month, the leading industrial nations will gather in London for an economic summit meeting. Should the U.S. decide to raise an import-duty barrier against low-priced imports, it risks antagonizing a number of nations, and the meeting could be a scorcher.

Yet, in all fairness to the domestic manufacturers and their thousands of workers, the goal of the U.S. Government now should be to take whatever limited steps are needed to restore fairness to the markets that have been shown to be hurt by imports. The balance between unrestricted trade and protectionism has swung too far and has stayed there too long. It's time that it was started back toward equilibrium — toward a fair and orderly market.

Our REF-02's a TWOFER.



Free!

**TEMP
TRANSDUCER**

with the purchase
of each
PMI REF-02
5V reference.



FREE

5 VOLT REFERENCE
with purchase of
each PMI REF-02
temperature transducer.

At \$1.95 (100's), our new 5 Volt reference circuit, REF-02, is a good buy. But when you consider that we've wired up an unused pin to give you—at no additional cost—a temperature transducer, it's a **steal**. And it is very accurate, from super low (-150°C) to super high ($+170^{\circ}\text{C}$)!

Let your imagination explore the idea for a minute. Let's say your system design requires a **voltage reference**. What could you do with a free temperature sensor? monitor cabinet temperature thermal drift correction prevent thermal runaway.

The feedback signal for a temperature control loop is right here, at the REF-02.

And if you've designed in a **temperature sensor** and could use a good voltage reference (ours is very reliable—referenced to the bandgap energy of silicon) the REF-02 offers a way to simplify your design. One part doing the work of several invariably translates into savings. **Two-fer-the-price-of-one.**

WANT CHIPS?

Send a P.O. We're glad to sell REF-02 Chips. And you'll find them easy to calibrate in your hybrid. How about knowing the ambient temperature **inside** your package!

For data sheet, App. Note, or name of your nearest PMI distributor, write, phone or TWX us. Ask about the Twof'er.



Precision Monolithics, Incorporated
1500 Space Park Drive, Santa Clara, CA 95050
(408) 246-9222. TWX: 910-338-0528
Cable MONO.

Circle 12 on reader service card

MILITARY
APPLICATIONS

A/D CONVERTERS

by

MSK

Accuracy

Speed

Size

Repairability

Military

Temp. Range

-55° C to +125° C

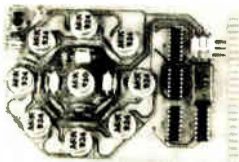

- 4 Bit/50 nSec; Low Cost
- Ideal for Radar Scan Converters
- Holds Absolute Accuracy Over Temperatures
- Tracks a 10 MHz Analog Input



- 9 Bit/ 200 nSec.
- < 2 Bit Drift Over Temperature
- Insensitive to Clock Frequency

For Further Information Call or Write
M.S. Kennedy Corp.

Pickard Drive, Syracuse, New York 13211
Tel. 315-455-7077

People

National's Raphael intends to fight Intel head on

Howard A. Raphael, the new director of product marketing for microprocessors at National Semiconductor Corp., intends to compete head on with the microprocessor leader, Intel Corp.—and he says he has *carte blanche* to do it.

“National is going to be a broad-based microprocessor supplier with a more extensive line of peripheral circuits than Intel,” declares the 30-year-old Raphael, whose last post was manager of low-end microcomputers at Intel. By 1980, he sees his Santa Clara, Calif., firm with a 30% to 35% share of what he predicts will then be a \$1 billion microprocessor market. “The microprocessor is the darling of the semiconductor industry,” he says, “and from what I see it’s also the darling of National.” Total sales at National should top last year’s \$325 million, and the firm is already second in microprocessors with 15% to 20% of industry sales.

N-channel expansion. Raphael will concentrate on expanding National’s n-channel metal-oxide-semiconductor effort, using as a base its successful second sourcing of microprocessors like Intel’s 4004 and its best-selling 8080. In addition, National produces important peripheral circuits like Western Digital’s synchronous-data-link controller and a universal synchronous receiver/transmitter from Signetics.

But Raphael is out to go way beyond these circuits. “We want to establish industry precedents,” says the man who was responsible for defining and marketing Intel’s MCS-4, -40 and -48 microcomputer families. He looks forward to introducing 10 new products over the next six months, all aimed squarely at Intel’s share of the market. He will expand the 8080 series, although he will not second-source the higher-performance 8085, which he regards as “not ambitious enough for a second-generation product.” Instead, National will develop its own new microprocessors, he says, and he will expand National’s peripherals. He

also plans to update the 16-bit Pace microprocessor, which indicates conversion to an n-channel design. Farther along, he is looking at specific market areas, including applications in instruments, process control, and minicomputers.

Raphael, holder of a bachelor’s degree in electrical engineering from Rochester Institute of Technology, believes he has the resources to pull National into a leadership position. He plans to double his own marketing staff to 40 people by the end of the year. He also is planning a few marketing surprises affecting the way “we interface with the sales force.”

As for Intel, “we’re gaining on them,” he says. Eventually, “Intel will be relegated to being just one member of a large group of innovative microprocessor manufacturers.”

Friedman of Analogic takes on new markets for growth

Analogic Corp., insists its recently elected president, Bernard Friedman, sells more digital panel instruments than anyone else in the world, and he has no intention of changing that. But Analogic is changing; for some 30% of its backlog of well over \$10 million is in areas the firm was not in two years ago, according to the burly and voluble Friedman.

Panel instruments and data-conversion and -acquisition modules, after all, are an original-equipment manufacturer’s business, “and we’ll never get away from the OEM business,” he observes, “but we’d like to get away from the kind of OEM business typical in the electronics industries, where everyone wants to get a bigger market share by cutting price.” That aim has led Analogic into a good bit of custom work that could be richly rewarding.

Medical tomography. Some of the custom effort has led to its being selected by 8 of the 10 leading manufacturers of medical tomography systems to supply the image-processing electronics, Friedman points out. Those systems sell for \$250,000 or more, and the image-

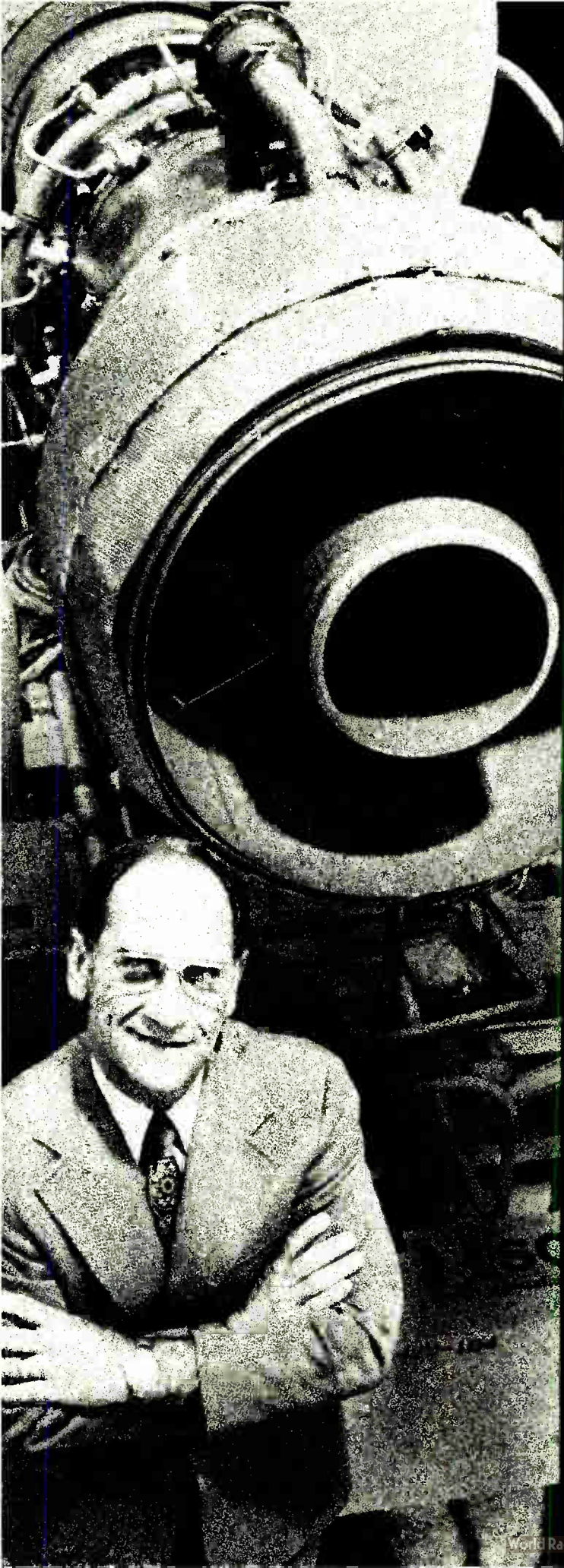

"We saved \$42,000 by cutting down redrawing time the first year we switched to reprographic techniques."

**Earl Lind, Graphics Supervisor
Solar, an International
Harvester Group, San Diego.**

"Solar makes gas turbines. Big ones. And they are shipped all over the world. Generally, each customer orders a slightly different version of the basic engine.

"Before we switched to reprographic techniques, we would redraft the entire drawing, even if the change was no more than 10%. Now we make a blowback from microfilm or create a same-size photo copy, opaque unwanted detail, then redraft as required. Or—if the changes are going to be minor—we reproduce it on wash-off film and let the drafter wet-erase what is not wanted and then draw in the new details.

"We figure—even with the limited mechanized processor we had when we first went to reprographics—that we saved \$42,000 in engineering drafting time the first year. And that saving was in spite of the fact that we had to start up a new facility and hire two technicians to run it.

"Later we installed a Kodak Supermatic processor and relocated our drafting reproduction area next to our photo lab and copy camera area. As a result, we've found that we're saving about 50% of the processing time for the photo lab and the copy camera facility. Everything we turn out—from publicity photos to engineering drawings—is going through the Supermatic processor."

Reprographics can help you, too.

Send for more details about Solar's use of reprographic techniques, plus, a complete listing of Kodak products and other applications. Write: Eastman Kodak Company, Graphics Markets Division, Dept. R04804 Rochester, N.Y. 14650.

**VERSATILITY IN
REPROGRAPHICS**



New miniature metallized capacitors for professional and consumer electronics

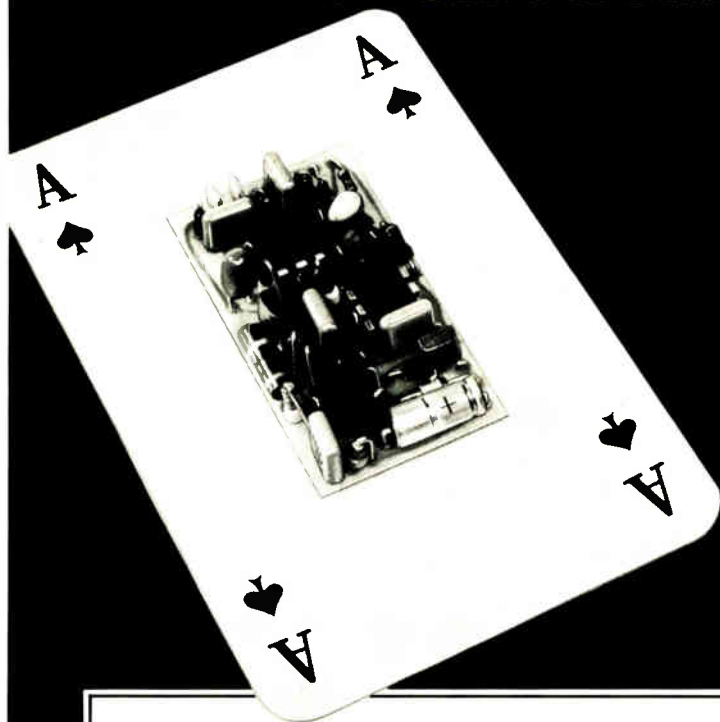

WIMA MKS 2 min

5 and 7.5 mm lead spacing. Up to 1.0 μF
Ultra miniature size, previously unattainable.

WIMA MKS 3

7.5 and 10 mm lead spacing. Up to 1.0 μF
Subminiature size and suitable for most applications.

Long term reliability with high dielectric and case insulation. Designed for easy mounting and for double-sided printed circuit boards.

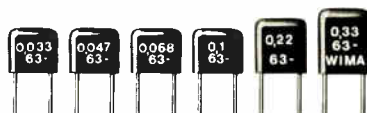

WILHELM WESTERMANN

Spezialvertrieb elektronischer Bauelemente
P.O.-Box 2345 · Augusta-Anlage 56
D-6800 Mannheim 1 · Fed. Rep. of Germany
Tel.: (6 21) 40 80 12

People



Changing. Data acquisition for tomographic scanners helps Friedman branch out.

processing portions represent a healthy fraction of that total amount.

But Friedman, who helped get Analogic started in 1969, maintains that the company is not turning its back on its traditional business—those data modules, and especially the digital panel instruments. Of the latter, Friedman argues that “you don’t walk away from a business in which you’re the biggest, but the electronics for the tomography systems is a logical extension of what we do. What we provide is really a precision data-acquisition system.”

Other products. Analogic also has designed and is building the electronics portion of consumer scales, an electronic pH meter for a major U.S. supplier, and the electronics for a European atomic-particle accelerator. Recently the company won a substantial contract from Intel Corp. to supply analog-to-digital interface boards for single-board computers and introduced a \$39 digital panel instrument [*Electronics*, March 17, p. 40] that is expected to set a brisk sales pace.

It would disappoint Friedman if Analogic failed to top \$15 million in fiscal 1977 sales, and it would not surprise him if the company were able to hit as high as \$20 million in gross sales next year. A good bit of the backlog is already in hand to assure that kind of performance. In contrast, it took three years for the company to grow from \$5.3 million to \$10.3 million in sales in 1976.

MIL-SSR UPDATE

Ready for military service: Our new AC power SSR.

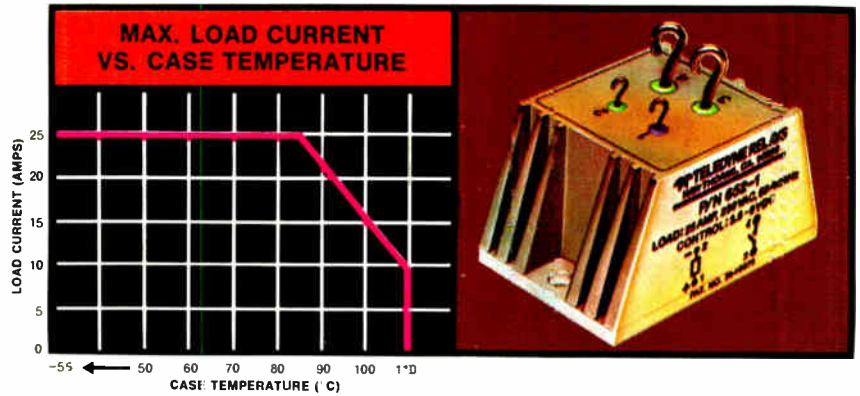

Commercial relays are no match for severe military or aerospace environments. But there's no doubt about our new 652 Series. Designed expressly for military and aerospace applications, this new AC SSR is packaged in a rugged, hermetically sealed aluminum case with the internal circuit assembly encapsulated to resist shock and vibration. What's more, all circuit components are military grade including the inverse parallel SCRs that provide reliable output switching — up to 25 Amps — over the frequency range of 45-440Hz.

Other features include logic compatible input drive

circuitry, optical isolation, and zero voltage turn-on to reduce EMI.

To top it all off, our 652 Series is designed to meet MIL-R-28750 and all categories of MIL-STD-704A, with an operating ambient temperature range of -55°C to +110°C.

For complete specification data, contact your nearest Teledyne Relays sales office listed in EEM, Gold Book and Electronics Buyers' Guide. You'll find we have the experience, products, and technical support to meet all your SSR needs — including a quick reaction capability to design SSRs specifically for your application.

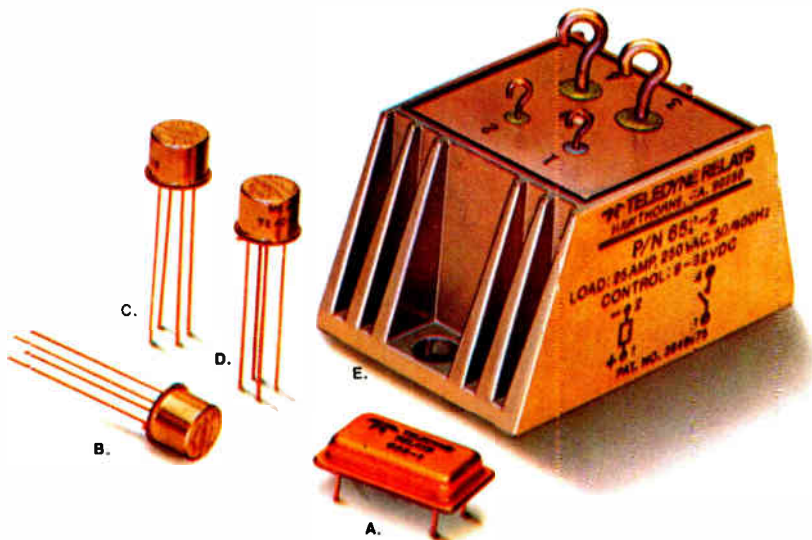

TELEDYNE'S MILITARY SSRs

- A. P/N 683-1 DC SSR
DIP package, with output rated at 600mA/50VDC
- B. P/N JM640-1 Bi-polar SSR
Mil P/N M28750/5, TO-5 package, with bi-polar (AC/DC) output rated at 60mA/40V
- C. P/N JM643-1 DC SSR
Mil P/N M28750/6, TO-5 package, with output rated at 300mA/40VDC
- D. P/N JM643-2 DC SSR
Mil P/N M28750/7, TO-5 package, with output rated at 100mA/250VDC
- E. 652 Series AC Power SSR
Output rated at 25A/250VRMS

TELEDYNE RELAYS

3155 West El Segundo Boulevard, Hawthorne, California 90250
Telephone (213) 973-4545

**CHAMP mass-termination connectors
you can use anywhere with low power.
Affordable technology
from AMP.**

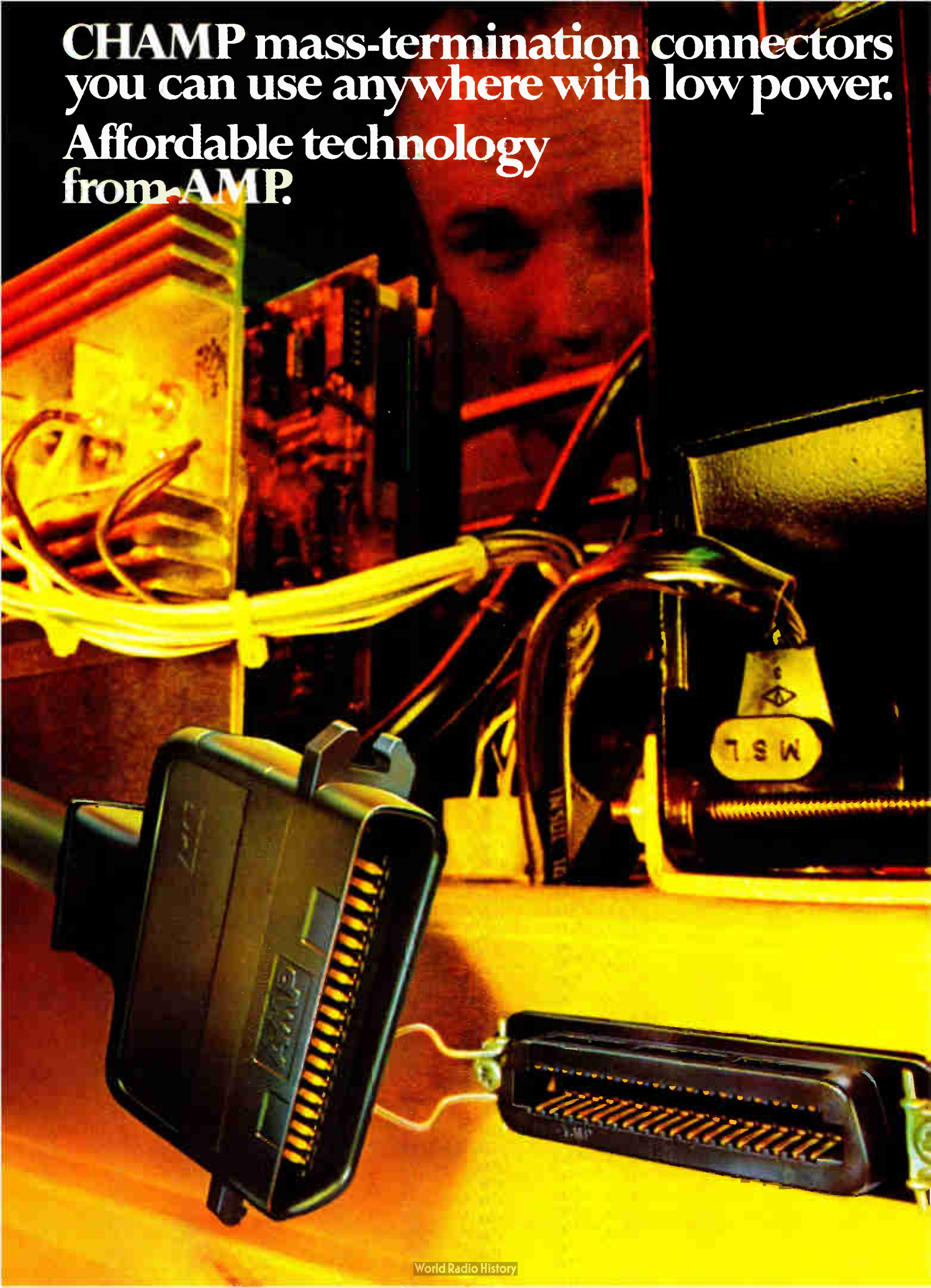

A complete connector terminated at one stroke—
that's mass-termination. Fast. Reliable. Low cost.
That's AMP.

CHAMP connectors handle unstripped solid and stranded
wire, multi-conductor cable, even woven and laminated
cable without costly wire preparation. They're especially
useful for cable-to-cable, cable-to-panel and cable-to-
printed circuit board connector applications. And are
available in 14, 24, 36, 50 and 64 positions, with a
broad variety of mounting accessories.

With all this versatility, you'll find CHAMP connectors
at work in a wide range of equipment such as
instrumentation, test equipment and business machines.

So come to AMP, the Company which believes
professional engineers deserve support. We will work
with you from the laboratory to your production line.
At AMP, our goal is to make sure you get the most
from our products—and from yours.

For more information on CHAMP mass-termination
connectors, just call Customer Service at (717) 564-0100.
Or write AMP Incorporated, Harrisburg, PA 17105.

AMP has a better way.

AMP
INCORPORATED

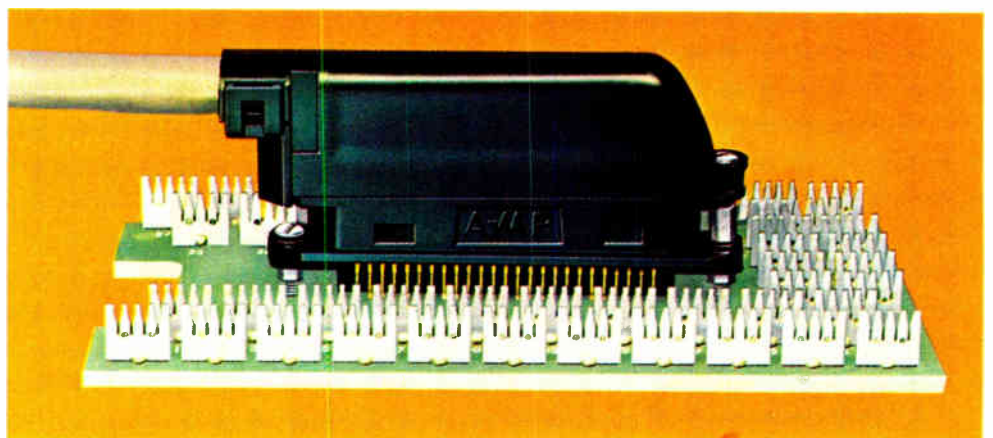
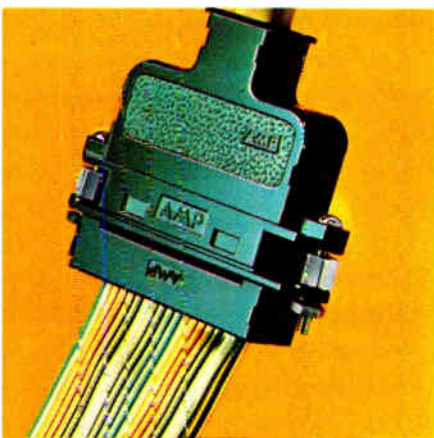
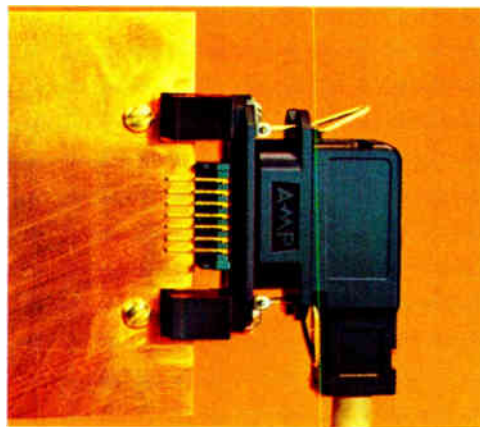
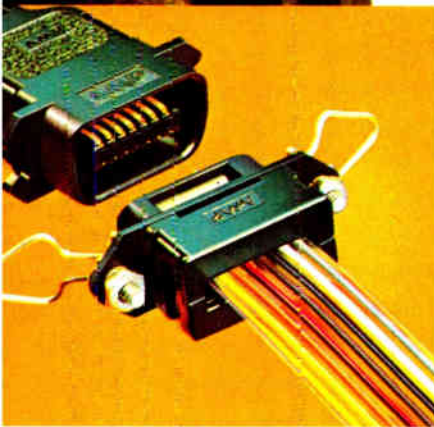



**We make
hardware
needs easy.**



Battery holders? Handles with spring-loaded detents? Metric spacers? Stand-offs? Mounting clips? Knobs with collet locks? You'll find them all and a lot more besides in the Cambion collection. Whatever you pick it will say quality on your equipment. Want our catalog, or samples or a sales engineer? Write: Cambridge Thermionic Corporation, 445 Concord Avenue, Cambridge, MA 02138. Phone: 617-491-5400. In California: 2733 Pacific Coast Hgwy., Torrance, CA 90505. Phone: 213-326-7822.

Standardize on

CAMBION
The Guaranteed Electronic Components

Meetings

Seventh International Symposium on Multiple-Valued Logic, IEEE, University of North Carolina at Charlotte, May 24-27.

Semicon/West 77, Semiconductor Equipment and Materials Institute (Mountain View, Calif.), San Mateo Fairgrounds, San Mateo, Calif., May 24-26.

1977 Incremental Motion Control Systems and Devices Symposium, University of Illinois, Ramada Inn, Champaign, Ill., May 24-27.

Microwave Power Symposium, International Microwave Power Institute (Edmonton, Alta., Canada), Radisson Hotel, Minneapolis, May 24-27.

Power Industry Computer Applications Conference, IEEE, Royal York Hotel, Toronto, Ont., Canada, May 24-27.

Electron, Ion, and Photo Beam Technology Conference, IEEE, Rickey's Hyatt House Hotel, Palo Alto, Calif., May 25-27.

Conference on Laser Engineering and Applications, IEEE, Washington Hilton, Washington, D. C., June 1-3.

31st Annual Frequency Control Symposium, U.S. Army Electronics Command (Fort Monmouth, N. J.), Howard Johnson's Regency Hotel, Atlantic City, N. J., June 1-3.

10th International Television Symposium and Technical Exhibition, Swiss PTT, Montreux Casino, Montreux, Switzerland, June 3-10.

32nd International Aeronautics and Space Show, Groupement des Industries Francaises Aeronautiques et Spatiales (Paris, France), Le Bourget, France, June 3-12.

11th Annual Consumer Electronics Show, Electronic Industries Association, McCormick Place, Chicago, June 5-8.

Chicago Spring Conference on Con-

sumer Electronics, IEEE, Marriott Hotel, Chicago, June 6-7.

Conference on Pattern Recognition and Image Processing, IEEE, Rensselaer Polytechnic Institute, Troy, N. Y., June 6-8.

National Association for Remotely Piloted Vehicles Symposium, NARPV (Dayton, Ohio), Hyatt Regency Hotel, Washington, D. C., June 6-8.

1977 Intermag—International Magnetism Conference, IEEE, Los Angeles Hilton, Los Angeles, June 6-9.

MIMI '77—International Symposium and Exhibition on Mini and Microcomputers (P. O. Box 354, 8053 Zurich, Switzerland), Kongresshaus, Zurich, June 7-9.

Conference on Technology of Printed-Circuit Boards, Technology Conferences Associates (El Segundo, Calif.), Hacienda Hotel, El Segundo, Calif., June 8-9.

International Conference on Communications, IEEE, O'Hare Inn, Chicago, June 12-15.

National Computer Conference, IEEE *et al.*, Dallas Convention Center, Dallas, June 13-16.

1977 Power Electronics Specialists Conference, IEEE, Rickey's Hyatt House, Palo Alto, Calif., June 14-16.

Electric Measuring Instrument and Automation Exhibition, Japan Electric Measuring Instruments Manufacturers' Association (Tokyo), Osaka Merchandise Mart, Osaka, Japan, June 15-17.

1977 International IEEE/AP-S Symposium, USNC/URSI Meeting and URSI International Electromagnetic Symposium, IEEE and URSI, Stanford University, Palo Alto, Calif., June 20-24.

14th Design Automation Conference, IEEE and ACM, International Hotel, New Orleans, June 20-22.

Mostek is giving six month's notice.

Mostek is giving notice and the industry is taking it. Because what was just recently a 4K RAM company is now a broad line MOS company.

We've taken the experience gained through our 4K RAM technology and developed an exciting array of memories and microprocessors. Each with the same dependable performance.

You're looking at six years worth of new industry standards. But Mostek did it in just six months.

▶ The 16K RAM—the smallest, fastest, most reliable 16K in the industry.

▶ The Z80 family of microprocessors—the third-generation microprocessor with increased performance and reduced memory cost.

▶ The 3870 microcomputer—with full capability on a single chip.

▶ The 34000 16K ROM—with the fastest access time in the industry—350 ns.

▶ The 4104 4K static RAM—the best speed/power product in the industry.

▶ SDB 80—Z80 power with 16K bytes of RAM. Available as OEM or development board.

Not bad for six month's work. And the next six will be just as impressive. Because if Mostek is to be remembered for one thing, it won't be a RAM, ROM, or PROM. It will be for a commitment to the industry—to provide innovations, advance technology, and set the highest reliability standards.

So, if you still think Mostek's only industry standard is the 4K RAM, forget it. That was only the beginning. Or haven't you noticed?

MOSTEK

1215 West Crosby Road,
Carrollton, Texas 75006 (214) 242-0444.

In Europe, contact:

MOSTEK GmbH West Germany,
Telephone: (0711) 701096;

MOSTEK ASIA HongKong, Telex:
85148MKA H X

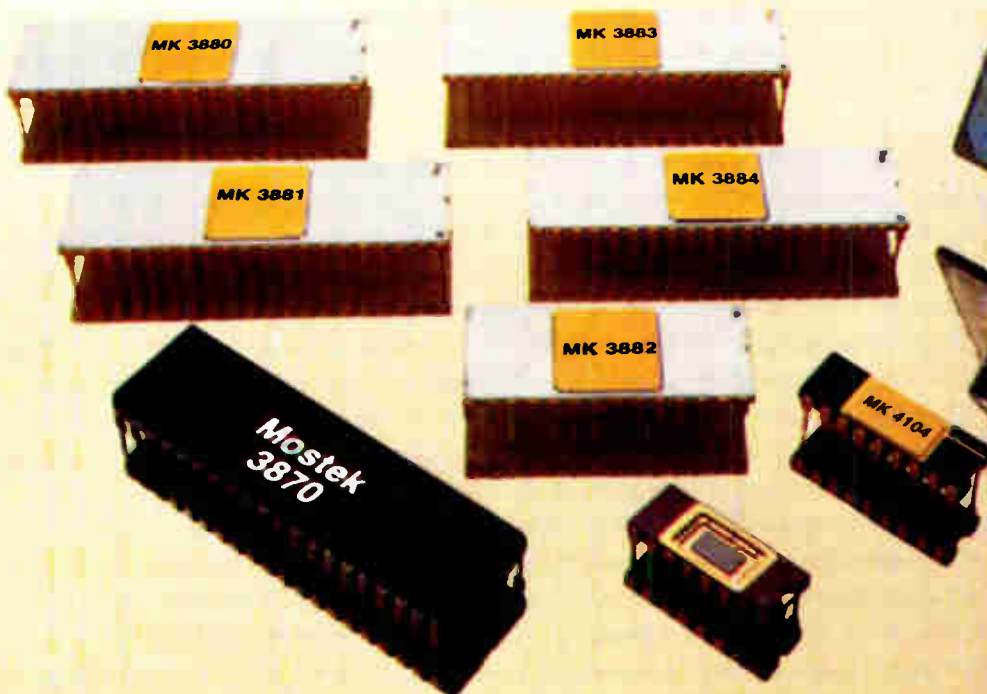

MK 4116

Circle 21 on reader service card

A new direction in microprocessor design aids.

Introducing a software development system that supports a variety of microprocessors: first the 8080 and 6800, then the Z-80*, with a wide selection to follow. Assembler software for two microprocessors is provided from those available at the time of purchase, and software for each additional microprocessor may be purchased as an option with a minimum of added expense.

This feature alone means that you can *change* direction without having to make a major investment in a new design aid. Choose a component on the basis of its suitability for a particular project, then, if it seems desirable, switch to another for the next project.

*Available late summer 1977.

It also means that you don't have to relearn your software development system each time you use a different microprocessor chip. And that can save valuable time.

The 8002 offers several other time-saving features to ease the task of program creation: a text editor that simplifies software entry and revisions, an assembler with macro capability, and dynamic trace for software debugging.

Since microprocessor-based program creation and prototype design typically go hand in hand, the 8002 also offers three progressive option levels for program emulation and debugging, prototype emulation and debugging, and real-time prototype analysis.

The 8002 Program Emulation and Debugging System, which adds an emulator processor and software for a selected microprocessor, enables the developmental software to be run, tested, changed, traced, and debugged on the desired microprocessor. The

THE TEKTRONIX 8002 MICROPROCESSOR LAB



emulator microprocessor is identical to the microprocessor in the designer's prototype. If the software is to be executed on an 8080 in the prototype, for example, an 8080 microprocessor chip is used in the emulator processor.

The 8002 Interactive Prototype Emulation and Debugging System adds a Prototype Control Probe for a selected microprocessor. With the probe inserted into the prototype, developmental software and hardware may be tested, traced, and debugged together.

The 8002 Real-Time Prototype Analyzer System adds real-time trace and an 8-channel Analyzer Probe. At this level bus transactions and events external to the microprocessor may both be monitored.

One final advantage: the Tektronix name. Tektronix has always been responsive to the instrumentation needs of the design engineer . . . and the 8002 Microprocessor Lab is no exception. Its ability to deal with a

number of different microprocessors, its many convenience features for software development, and its capabilities for software/hardware debugging, make it a unique design tool.

As a leading electronics instrument company, Tektronix offers you a full line of options and peripherals, from the three 8002 option levels . . . to PROM programming facilities for the 1702 or the 2704/2708 MOS PROMs . . . to a line printer and choice of system terminals.

Backed by years of experience, Tektronix also offers you a rare commodity in the field of microprocessor development tools: local Field Engineers and local service. A nation-wide network of Field Offices and Service Centers is ready to help you realize the full benefits of the 8002.

For more information or a demonstration of this new software development tool, write Tektronix, Inc., P.O. Box 500, Beaverton, Oregon 97077.

For availability outside the U.S., please contact the nearest Tektronix Field Office, Distributor, or Representative.

The 8002... with multiple microprocessor support.



Tektronix[®]
COMMITTED TO EXCELLENCE

For Technical Data circle 22 on reader service card
World Radio History For Demonstration circle 23 on reader service card

Interested in network variety? Select from a spectrum of 540 standards.

Allen-Bradley has the popular configurations you need. Pull-ups, Pull-downs. Line Terminators. Networks to complement Core Memory Sense Amplifiers. TTL to ECL Translators. O-Pad Attenuators. All styles available from your Allen-Bradley *Electronic Distributor*. Call for specs or check your EEM Catalog. If you need specials, contact your local Allen-Bradley district office for fast turn-around. Ask for Publication 5840. A-B is an experienced twin-film manufacturer, i.e. precision thin film and thick film.

User trimmable option
as a special feature.

Solid ceramic body
for mechanical stability.

Color stripe
aids orientation and indicates
number of pins. Blue-14 pin;
green-16 pin.

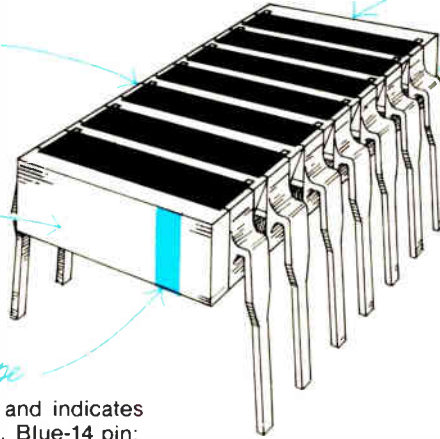

Large design area
... room for more
resistors, higher
power ratings, larger
resistance values.

External solder joints
for visual inspection.

0540

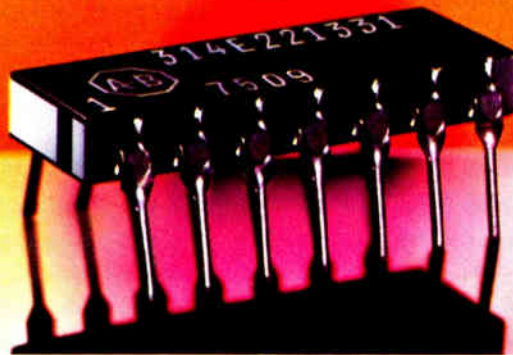

Quality in the best tradition.



ALLEN-BRADLEY
Electronics Division
Milwaukee, Wisconsin 53204

EC149

TI unveils 16-bit microcomputer on a board . . .

The first 16-bit microcomputer on a board to be offered by a semiconductor manufacturer is being introduced by Texas Instruments Inc. Called the TM990/100M, **it is aimed at manufacturers of industrial equipment.** The 7½-by-11-inch board contains TI's TMS9900 16-bit processor and 1,024 16-bit words of programmable read-only memory expandable to 64-k, 4-k of static random-access memory expandable to 8-k, as well as MOS peripherals for programmable input/output. The capabilities of the board place it between the SBC 80/10 and the 80/20 in Intel's 8080-based line of one-board computers, but its 16-bit architecture and advanced interrupt capabilities make it more suitable for real-time industrial jobs than the others, according to Al Lofthus, TI's program marketing manager for the 9900 line.

Priced at \$450 in single quantities, the TI board is competitive with most of the 8-bit boards on the market. Accessories to the TM990 will include a calculator-like microterminal for entering hexadecimal code, a four-slot chassis, and interfacing cables.

. . . plus a powerful development system

At the same time, TI is making a major entry into another business with its FS990 microcomputer development system. The floppy-disk-based system is capable of emulation, logic analysis, and program implementation. Designed for in-circuit emulation in 990-based systems, the FS990 is one of the **most powerful microcomputer development tools yet introduced by a semiconductor manufacturer.** It uses Fortran and interactive control language (called AMPL) for software development and has a basic price of only \$13,600. Options include a PROM programmer, trace data module kit, and 810 printer.

RCA leaves SelectaVision on back burner

RCA Corp., which will market a version of Hitachi's video tape recorder in the U.S., has left its own SelectaVision VideoDisc program in limbo. While RCA president Edgar H. Griffiths says the firm is **continuing its development work on the program**, he states, "We have not made a decision to go forward. On the other hand, we have not made a decision that we will not go forward."

Griffiths lists several key requirements that have to be satisfied before RCA can make a judgment. First is the need to have a disk that can play 1 hour per side. "Today, we have such a disk in two different forms in our labs." Second, RCA wants to be certain that after introduction of the system it can "reduce the price rather drastically, down into the area of \$400 or less." The third and perhaps most important aspect, he notes, is that "we must have a ready access to software . . . the movies and the programming which people would like to watch on a disk."

HP spreads use of C-MOS on sapphire

Hewlett-Packard is applying its complementary-MOS-on-sapphire technology, not only to the microprocessor discussed at the International Solid State Circuits Conference [*Electronics*, Feb. 17, p. 82], **but to a complete microcomputer chip set**, including read-only and random-access memories. The process also will be used to make the first single-chip interface to the IEEE-488 standard interface bus. The 8,000-transistor interface chip replaces about 200 standard TTL chips that would be needed if all features of IEEE-488 were used. The chip holds about 8,000 transistors.

Amendments readied for IEEE ballot . . .

A sure sign of members' continuing uneasiness about IEEE affairs, two more new propositions to amend its constitution are in the works. The first is intended to **put teeth into the IEEE engineering employment guidelines** finally issued several years ago but never really driven home to company management. This amendment would require hearings of complaints from members regarding unfair employment practices and publication of the hearing proceedings in the IEEE periodical, Spectrum.

The other amendment is aimed at election practices and would **guarantee competition for the office of president**. At each general election voting members would have an opportunity to nominate a candidate for president for the next election to run against whomever the board of directors nominated. If no nominated candidate gathered a third of 1% of the total eligible to vote, the present petition system would be used.

. . . as presidential election heats up

The IEEE leadership is also nervous. Now that the board of directors has nominated Ivan A. Getting, president of Aerospace Corp., El Segundo, Calif., to run for president in 1977, the action, putting forward an unknown with **no experience in institute matters, could backfire**. The reason: Irwin Feerst, a well-known candidate from two previous elections, is off and running again and has a good shot at winning this year. The result: look for a promotional blitz to put Getting into the limelight.

Higher-precision resistors due from Allen-Bradley

Allen-Bradley Co. is broadening its resistor business into higher-precision applications. It plans to introduce **its first metal-film resistors within the next few months**. The line, rated at 0.25 watt at 70°C and 0.1 w at 125°C, will be available with tolerances as low as 0.05% and temperature coefficients down to 10 ppm/°C. The Milwaukee firm will stock only 25-ppm parts in the more popular resistor values.

GI to unveil new LSI chips for consumer items

General Instrument Corp.'s Microelectronics group is set to preview several new large-scale-integrated circuits for entertainment systems, television games, and other consumer equipment. Among them: **a new two-chip digital tuning system for stereos** consisting of an n-channel MOS tuner/control chip and an electrically alterable read-only memory with 100 14-bit words for maintaining station information when the set is off. The preview will come around the time of the Consumer Electronics Show in Chicago, although the firm does not exhibit there.

The Hicksville, N. Y., firm also will unveil a top-of-the-set converter through which all the different channels can be pretuned into the TV, a new Gemini programmable game set, a remote-control version of its tank battle game, and two circuits that convert the black-and-white video outputs of its ball and paddle games to a single-color composite video signal.

NCR eyes bubbles for peripherals, CCD for processors

NCR Corp. is looking at bubble memories for computer systems. Says William Buster, vice president for manufacturing in the Major Systems division, "They're slow, but there's a place for them in slow-speed terminals and cache memories, for example." While **NCR plans to use bubble devices in peripherals**, says Buster, it sees charge-coupled devices as more suited for processor products.



PUSH

to initiate automatic in-circuit testing of all of your analog, hybrid and digital boards.

Test *all* of your printed circuit boards and, in many cases, completely eliminate costly functional testing. Faultfinders FF101C and FF303 in-circuit test systems give you the flexibility you need with a broad range of CPU/peripheral compatibility. And you can get full time utilization of the system computer with foreground/background programming to execute automatic program generation, text editing, data analysis or file maintenance *even while you're testing boards.*

You'll be testing more boards, bigger boards and more complex boards, so now is a good time to start checking on what Faultfinder in-circuit test systems can do to make the job more cost-efficient. Call your Faultfinder

representative:

Latham, Tom Coleman, (518) 783-7786;

Irvine, Chuck Hulst, (714) 549-4901;

Chicago, Al Roraus, (312) 696-0335;

San Francisco, Bruce Douglas, (408) 432-9020;

Waltham, Thomas McLaughlin, (617) 890-4717

Europe, Marty Liebman, (49) 6196-44008;

England, Mike Cook, (44) 4204-3443.

Or start with the coupon.

FFI **FAULTFINDERS Inc.**
15 AVIS DRIVE, LATHAM, NY 12110

O.K., Start.

Show me how Faultfinder in-circuit test systems can improve our production testing of printed circuit boards.

NAME _____ TITLE _____
COMPANY _____
ADDRESS _____ ZIP _____
PHONE _____

Common RF Transistor Failures—that shouldn't happen

Most RF circuits are plagued with semiconductor failures that are costly to you as an Original Equipment Manufacturer in terms of reworks, lost customers and lost profits. These are failures that just shouldn't happen. With TRW RF Semiconductors' technological advances, there's no reason for you—or your circuits—to suffer from these annoying failures any longer.

Eliminate Costly Mismatch Failures

TRW's RF Transistors are guaranteed to withstand all mismatch conditions (any magnitude, any phase angle). This guarantee eliminates costly failures due to inadvertent mismatches in your laboratory, on your production line or in the field. TRW's RF devices are 100% on-line tested for VSWR to assure you die-mount integrity and overall ruggedness.

Eliminate Ballast Resistor Failures

TRW's unique diffused ballast resistors eliminate peeling and micro-cracking—two of the primary causes

of failures associated with thin-film, metal ballast resistors (see Point 1 in illustration below). Since TRW's ballast resistors are diffused directly into the silicon die (see Point 1a), resistance values from 25Ω to 100Ω are achieved. The practical limit with thin-film ballasting is only 8Ω to 10Ω . These higher ballast levels provide near-perfect finger-to-finger and cell-to-cell current sharing thereby eliminating deadly "hot-spotting" by equalizing temperature distribution.

Eliminate Secondary Breakdown Failures

TRW's exclusive avalanche protection mechanism eliminates the problem of secondary breakdown, a failure mode not handled by ballasting alone. The voltage across the transistor junction is never allowed to reach breakdown. The P-N diode of the ballast resistor is diffused to avalanche several volts less than the transistor junction. Under severe mismatch conditions when voltages in excess of breakdown occur, the diode conducts the full avalanche cur-

rent, thus protecting the transistor junction. True "full circle" VSWR protection of your RF devices is achieved.

Eliminate Metal Migration And Crowding Failures

Another primary wear-out mechanism in RF transistors—metal migration—is prevented because of TRW's exclusive etchless gold die metallization process. The etchless process (see Point 2) prevents finger scalloping, characteristic of all etching processes and eliminates resultant current crowding where metal fingers are necked down (see Point 2A). The gold metallization system not only capitalizes on the vast improvement in electromigration properties of gold over aluminum, but also assures you that the metal lifetime design criteria are retained in the manufacturing process.

Eliminate Failures From Intermetallic Formations

Intermetallic formations and resultant failures you find with other

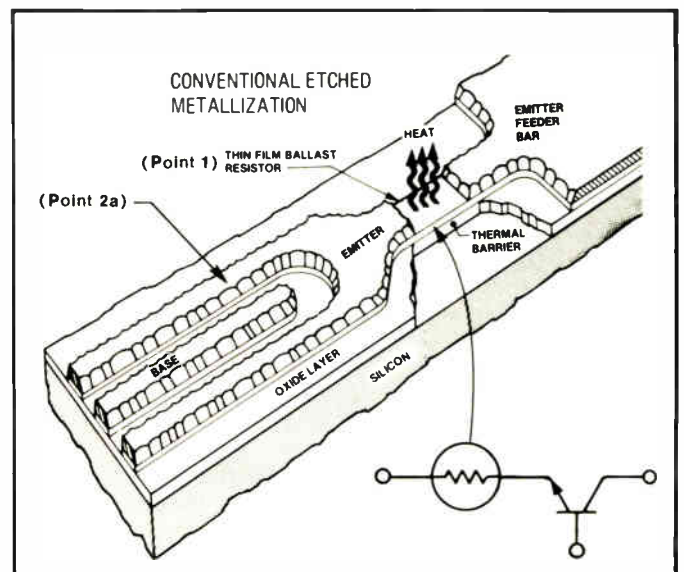
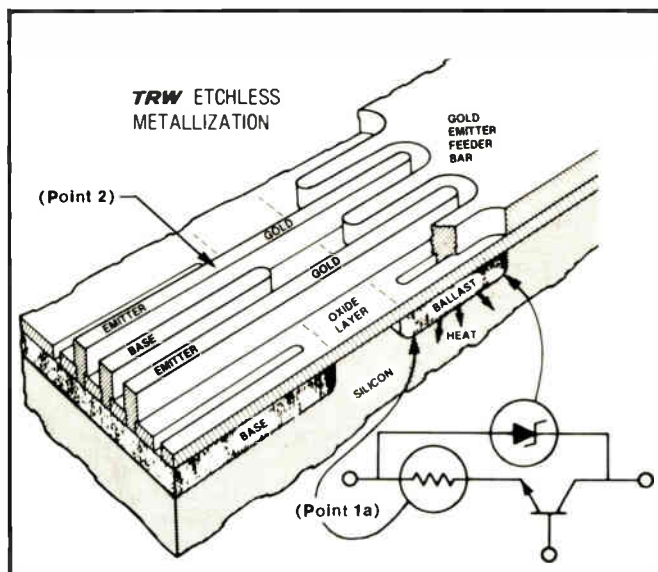

RF devices are prevented by TRW's use of gold metallized die, gold wire bonds and gold package metal. Gold wire bonding does not work-harden and is thousands of times more resistant to fatigue than is the more

brittle aluminum wire alternative. TRW's gold thermal-compression bonding technique provides you with bond-to-pad mechanical integrity, not possible with aluminum or ultrasonic bonding systems.

Performance And Reliability

Take advantage of TRW Semiconductors' performance and reliability in your next circuit design. Check our chart. We have RF devices for every circuit requirement. More details are available in our Product Selection Guide.

RF POWER TRANSISTORS & HYBRIDS—BUILT-IN RELIABILITY

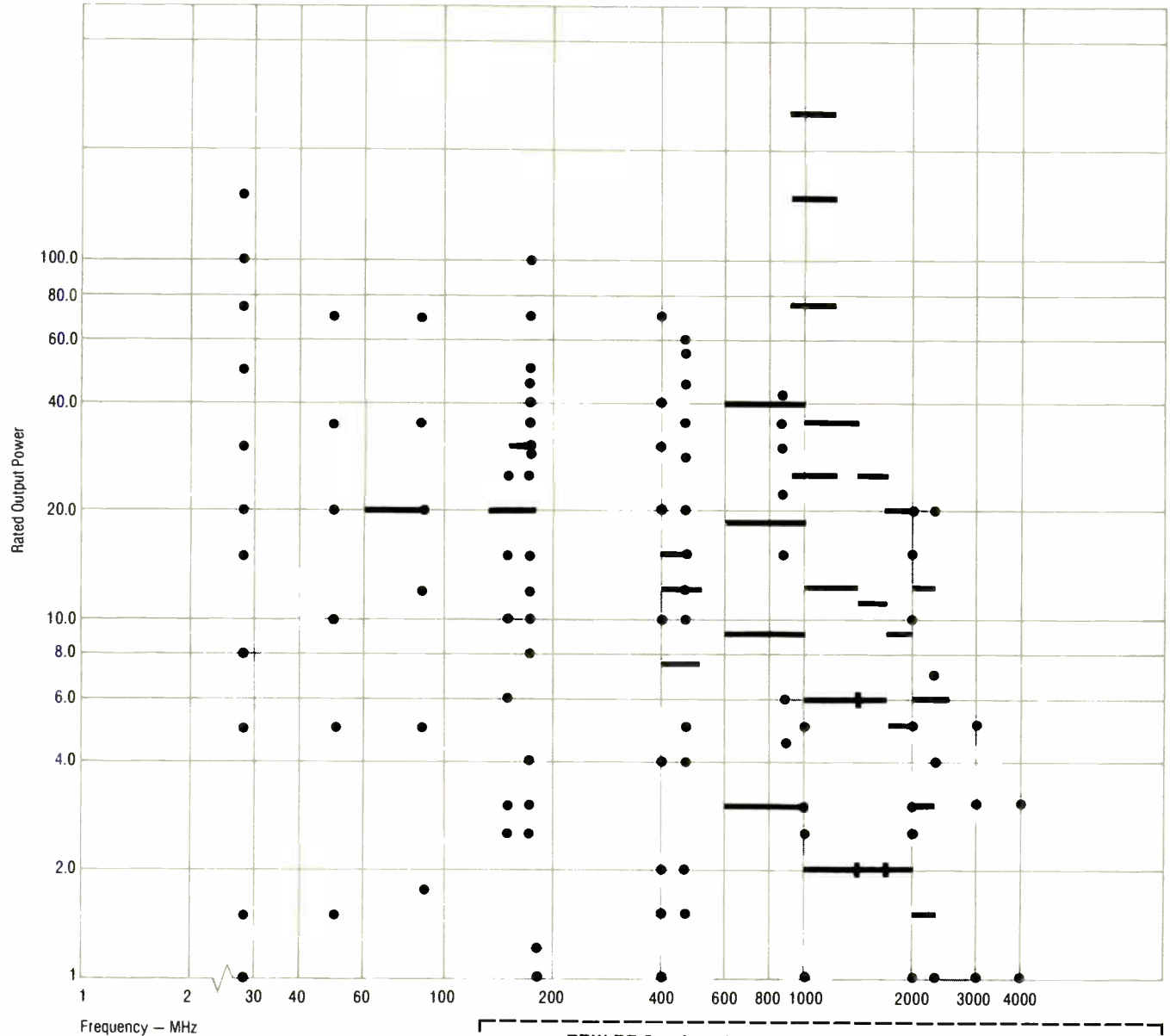

Aren't they worth checking out?

Use this coupon, or call Warren Gould at (213) 679-4561 for complete specs and samples of TRW RF discretely and hybrids—milliwatts to kilowatts, 1MHz to 4GHz. When it comes to RF semiconductors, we're ready to help.

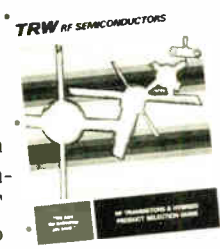

TRW RF Semiconductors
 An Electronic Components Division of TRW Inc.
 14520 Aviation Blvd., Lawndale, California 90260

Please send me your new RF Product Selection Guide.
 Please have an applications engineer contact me: _____ (PHONE)

NAME _____
 POSITION _____
 COMPANY NAME _____
 ADDRESS _____
 CITY _____ STATE _____ ZIP _____ E

TRW RF SEMICONDUCTORS
 ANOTHER PRODUCT OF A COMPANY CALLED TRW

Our PROM Programmer travels light.



Retire your wheelbarrow.

Our microprocessor-based PROM Programmer is fully portable. It weighs less than 15 pounds and comes in an attache case making it as easy to use in field service as it is on the production line or on an engineer's bench.

Using our field proven plug-in PROM Personality Modules, the stand-alone Series 90 PROM Programmer programs, lists, duplicates and verifies every major MOS and bipolar PROM. Its master control unit costs only \$1,800.

The single-button Series 92 Peripheral PROM Programmer/Duplicator control unit, including a TTY interface, is \$995.

PROM Personality Modules cost from \$360 to \$450 and plug into either control unit.

Pro-Log routinely submits PROM Programmers and PROM Personality Modules to PROM manufacturers for evaluation and approval. Contact us for approval status on the PROM Personality Module you want.

PROM Programmer options include TTY, paper tape reader, parallel I/O, RS232 and CMOS RAM buffer.

For a demonstration of PROM Programmers "to go," or for the latest version of our 48-page PROM User's Guide, contact Pro-Log Corporation, 2411 Garden Road, Monterey, CA 93940. Phone (408) 372-4593.

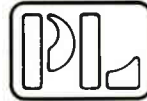
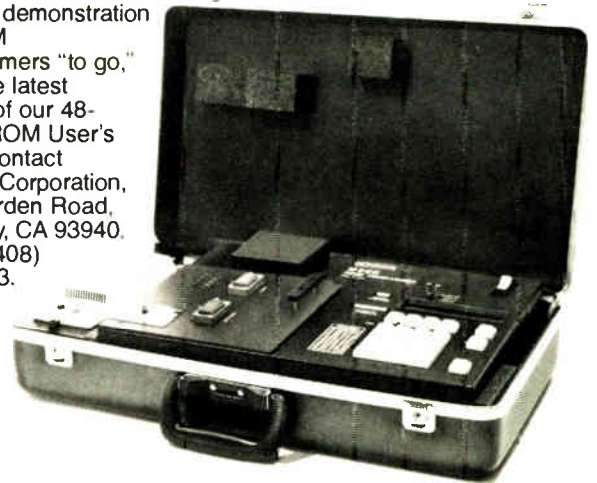

PRO-LOG
CORPORATION

Microprocessors at your fingertips.

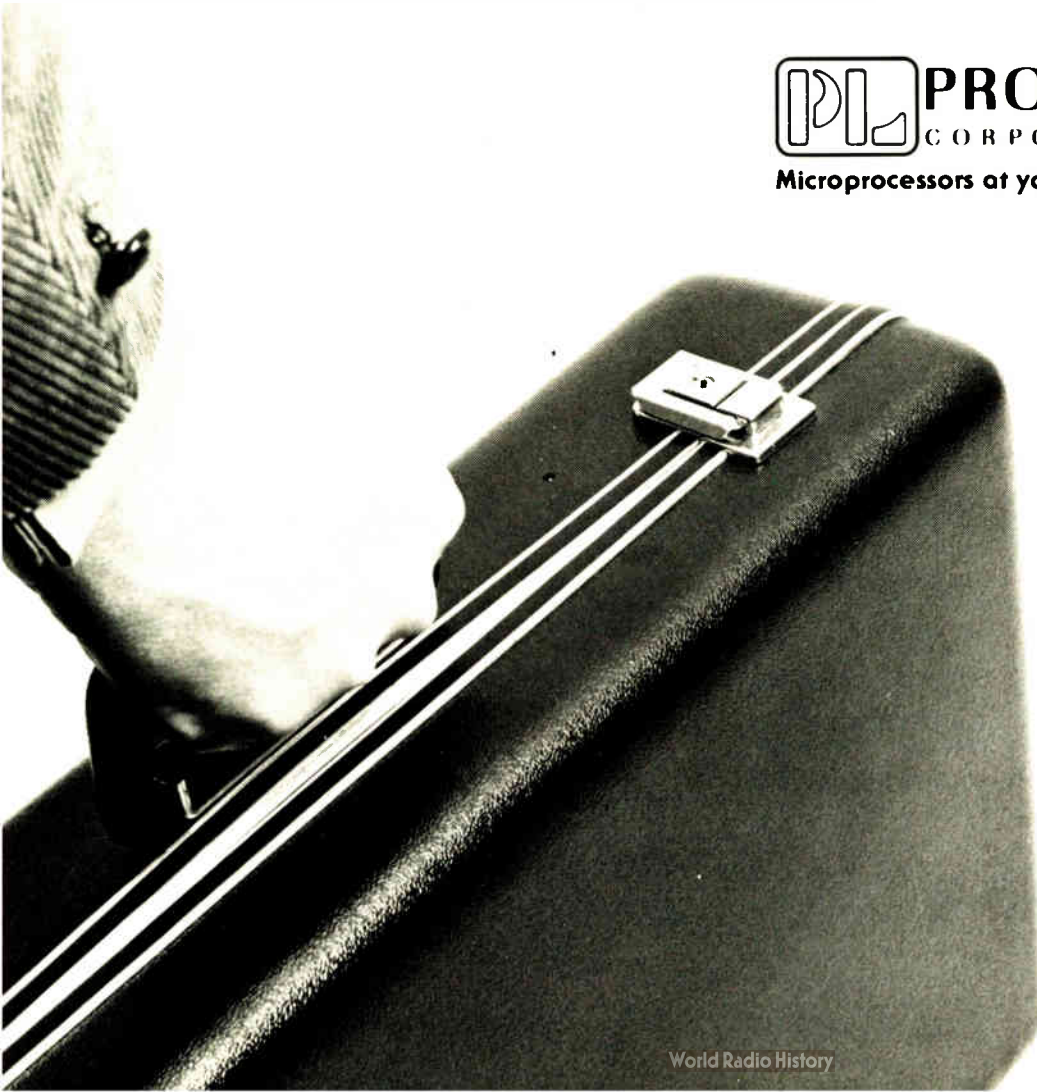

Circle 30 on reader service card

TI introduces microprocessor-based citizens' band radios

Units at high end of product spectrum are initial entry into wide-ranging market in "personal communications"

Texas Instruments announced it was entering the citizens' band radio market last week, and it did so in typical Texas fashion with all guns blazing. The Dallas firm introduced a pair of new 40-channel combination a-m and single-sideband radios that are the first to be built around microcomputers and a charge-coupled-device filter. One mobile and the other a base station, the radios operate with little manual adjustment and perform tasks, such as "dialing" at the push of a button numbers of other units stored in memory, well outside the scope of conventional CB radios.

But the entry into CB is apparently just the beginning for TI, which has become a formidable competitor in the consumer areas of low-end calculators and digital watches. Stewart Carrell, group vice president for consumer products in Dallas, is not just after CB radio, being well aware of the present price-cutting situation and seeming market plateau (see p. 70).

"We see a rapidly growing personal-communications market which is much more than CBs," says Carrell. "It may be difficult to define this market exactly, but it's easy to visualize mobile and land communications and control systems that are truly personal in the sense of portability and person-to-person cordless communications."

To get the word out, the company showed its CB systems at Newcom 77, a conference held in Las Vegas last week for distributors of industrial and consumer electronics. But volume production is not expected until later this year.

The new radios are the SM-172 mobile rig and the SM-173 base station. Says Michael Cochran, who managed their development and is now manager of the new personal communications department in Dallas, "We approached the problem with a fresh viewpoint since it was a new field for us."

The radios are highly digital, having one 4-bit, p-channel TMS1100 microcomputer in the transceiver and another in the handset. The handset and built-in microphone look like nothing so much as a calculator, what with five light-emitting-diode readouts and push buttons scanned by microprocessor.

Computerized ssb. Besides serving to automate functions, the microcomputers helped Cochran make single sideband as simple to generate and receive as a-m. They aid in "throwing away the clarifier" of ssb, the time-consuming process for hand-tuning the voice signal. The key here is the several-hundred-stage CCD filter: the microcomputer electronically controls the filter's bandpass and bandwidth to maintain an automatic lock on frequency.

The radios, with triple-conversion receivers, also: automatically scan channels, automatically measure standing wave ratio and shut down the set if it is too high, and provide automatic level and gain control.

Also new is a noise blanker, which eliminates noise pulses by tempo-

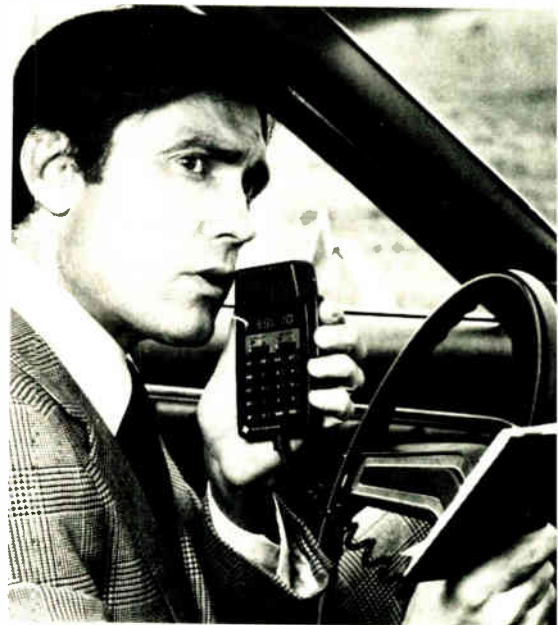

Control unit. New 40-channel SSB/a-m CB radio is first to allow selective calling of other parties. Mobile rig's transceiver and 4-inch speaker mount out of sight.

rarily shutting down the signal path through the receiver, leaving the signal itself relatively unaffected.

The radios have 12 watts of peak envelope power of selectable upper and lower sideband with variable frequency offset, plus 4 w of a-m output. The mobile unit will sell for \$325, the base unit for \$375.

Distributors at the Newcom show came away impressed. "The newest thing I've seen and in a class by itself," said Mel Munsell of Interstate Electric Co. of San Antonio.

Though Hy-Gain Electronics, Motorola, and others are said to be working on microprocessor-based designs, TI's were the only units at the Newcom show actually to use microcomputers. TI's prices are

Electronics review

relatively high, however, even for SSB radios. Says Carrell: "We've not tried to catch anybody's eye on price alone. Nobody can match our per-

formance now, but we don't kid ourselves on how fast the competition can move—we're steeled for the Japanese thrust." □

Packaging & production

Philips develops mask projection system with alignment accuracy to 0.1 micrometer

The Dutch have developed a contactless mask-to-wafer projection system that aligns successive mask images to a previously unattainable 0.1 micrometer. This positioning accuracy is an order of magnitude better than that attainable with previous projection systems, says Steve Wittekoek, manager of the Silicon Repeater (SIRE) project at N. V. Philips Gloeilampenfabrieken.

Step and repeat. The computer-controlled system projects integrated-circuit patterns onto a silicon wafer in step-and-repeat fashion. This contactless method offers twice the yield, Wittekoek points out, because it gets around the effects of mask damage and the transfer of mask defects to the wafer—problems encountered with the conventional contact printing that is the basis for today's semiconductor wafer processing. The masks also last much longer. They are simple to make and inspect, because each is magnified five times unlike the same-size conventional masks.

For many of these reasons, semiconductor companies are either switching to projection lithography or are experimenting with it. It costs more than contact printing initially but the savings in mask costs and increased yields make up the difference with no fuss.

(Perkin-Elmer Corp.'s Electro-Optical division in Norwalk, Conn., is the only supplier of projection lithography equipment in the U.S. It says it has delivered its \$120,000-plus Micalign system to 25 IC manufacturers.)

So far, Philips has built two prototype SIRE systems. One is being used experimentally at its Eindhoven laboratories, where the four-year devel-

opment effort took place. The other is producing trial memory circuits at a Philips semiconductor facility. Other systems will be installed at subsidiaries abroad.

Basic to the system are a pair of helium-neon lasers—one for projection, the other for position-sensing—and hydraulic slides on granite bases that move perpendicularly to each

other. The X-axis slide holds the silicon wafer on a vacuum chuck while the Y-axis slide supports the image-projection column and its lenses and illumination equipment. The slide movement deviates from a straight line by no more than 0.03 micrometer.

Interferometer. A laser interferometer measures the relative positions of the two slides to within 0.03 μm and, together with a servo system, automatically keeps them aligned with $\pm 0.1\text{-}\mu\text{m}$ accuracy. The Y slide also carries a turntable with as many as four masks in a vacuum clamp and moves them to be projected onto the wafer.

As Wittekoek explains it, a coarse alignment is first done manually. Illuminated by light from the projection laser, markers on mask and

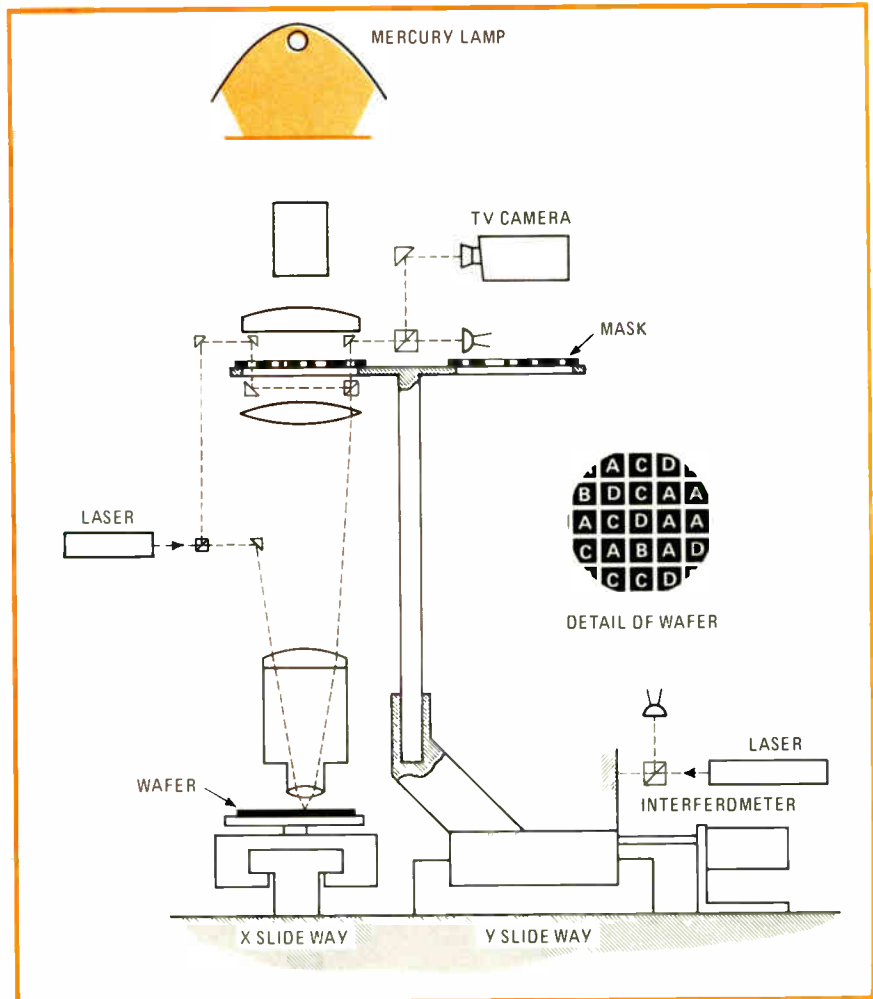

Projector. Computer-controlled Silicon Repeater projects five-times-magnified IC masks onto silicon wafer. Laser interferometer helps position slides for accurate alignment.

wafer are projected on a television screen and lined up for X, Y, and rotational displacement using joy sticks. Then, an automatic, computer-controlled mode rotates the mask until it aligns parallel to the X axis to within 0.1 μm over 1 centimeter. Next, the wafer is positioned in the Y direction and rotated until it aligns with the mask that is then projected onto the wafer.

Laser techniques. Responsible for the SIRE system's high positioning accuracy are the laser-based, automatic alignment techniques, Wittekoek says. Two markers on the mask and two on the wafer serve as aligning criteria. The light from the wafer marker is modulated electro-optically so that the image of the marker oscillates at the modulation frequency of 10 kilohertz.

The common image of the wafer

marker and the marker on the mask is detected by a photodetector. Phase-sensitive detection at 10 kHz pinpoints a deviation of the wafer marker of $\pm 0.1 \mu\text{m}$ from the aligned position. This deviation is then corrected by the hydraulic slides.

The computer, a Philips process-control machine, controls the steps in the alignment and exposure programs. A 1,000-watt mercury lamp projects the image of the mask. The projection lenses can image 2- μm details over a field 10 millimeters in diameter.

A chip is projected in about 1 s. This includes exposure time—about a half second for a 1 μm -thick resist layer—and a half second for positioning the slides. The system is being used with silicon wafers 2 and 3 inches in diameter, but it could accommodate 4-in. wafers as well. □

fixed character width. Letters are tied together, often three or four at a time. Older mechanical teletypewriters, printing Arabic as English would be printed, unavoidably produced incorrectly spaced and hence, poorly legible messages.

Variable line width. Koor Systems' machine, which uses digital logic contained on as many as 16 circuit boards in its model BT-3502, overcomes the spacing problem by using a variable-width line format and character sets stored in programmable read-only memory. Although English letters can be written with a 5-by-7-dot matrix, the characters on the BT-3502 are generated by matrixes 7 dots high and 20 dots wide, with no space between matrixes. Horizontal lines are printed with a dot at every third location. Since dot locations are only 0.005 inch apart, these dots appear to touch. The high resolution is to facilitate the intricate curves of alphabets such as Hebrew, Arabic, and the Arabic-like Farsi spoken in Iran.

For English, characters are 5 dots wide (spanning 13 locations) with a 7-location space between each character. The resolution possible with the 13-location width can be seen in the accurate generation of diagonals: not just the 45° diagonal as in the letters Y and X, but the off-diagonals of the letter V.

Because the matrixes are adjacent, the bilingual teleprinter prints continuous letters; the link-up of characters presents no problem. The only hitch is that the lines on the standard 69-character-wide format may no longer be of equal width.

Another feature is the bidirec-

Communications

Israeli teleprinter switches easily between two different alphabets

People adept at languages move easily from one to another, regardless of the alphabet in which they are written. Now there is a teletypewriter that can do the same thing, just being introduced into the U. S. by an Israeli manufacturer, Koor Systems Ltd. of Petach Tichva.

The company's electronic teleprinter can send and receive messages in almost any combination of two alphabets because it uses a dot-matrix printer with a programmable character set. The machine is not a translator; it will only send or receive in whichever of its two languages the original text is written.

Local post office. Koor Systems, the data communications equipment subsidiary of Israel's \$300-million-plus conglomerate, Koor Industries Ltd., began developing its unit in 1972. "The local post office had

been using two different teleprinters, one in Hebrew and another in English," says Noah Horowitz, general manager of Koor Systems, speaking at his distributor in New York, Solcoor Inc. "They thought it would be good to combine them into one unit. Then we decided to look at other alphabets as well."

The idea was good, but the design was far from simple, for other alphabets present problems that English, and even Hebrew, do not. The Arabic alphabet, for example, has no

Two tongues. Koor Systems' teleprinter switches between almost any two alphabets. Shown here are English and Farsi, the language of Iran similar to Arabic.

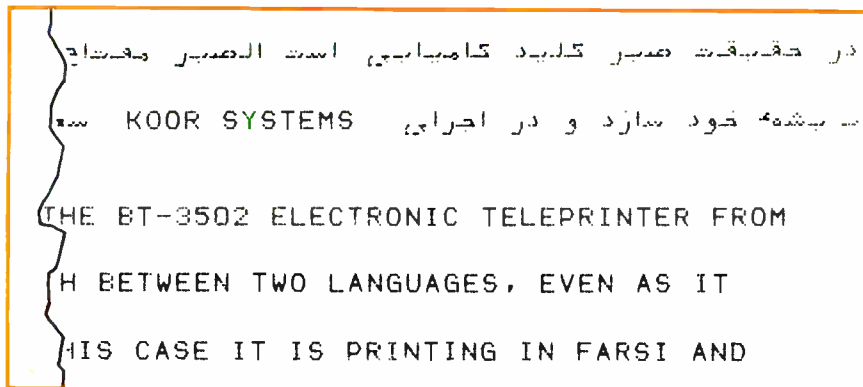



Linguist. Desk-top teleprinter, the model BT-3502, costs around \$4,000, relies on PROMs to switch between alphabets.

tional printing to accommodate both English (left to right) and Hebrew or Arabic (right to left) text. Rather than storing the message in memory and printing in only one direction, the logic is designed to print all messages as they are sent over the relatively slow Telex (5-bit Baudot code) and TWX (8-bit ASCII code) lines. Extra commands are encoded to instruct left-to-right or right-to-left printing and to identify the language being transmitted. The hard-wired logic of the BT-3502 can instantaneously switch between the alphabets.

A pair of alphabets with fixed-width characters fits in a 16,384-bit PROM. But languages having the variable letter link-up require up to 32,768 bits. More than two alphabets could be handled by the teleprinter by simply adding more PROMs, Horowitz points out. The limit of two is set by the number of letters that fit legibly on a printer key. Also, most potential users seem to need only two, he says.

Evaluation. According to Horowitz, the Koor teleprinter is being evaluated by major telecommunications common carriers, including RCA Global Communications Inc. and ITT World Communications Inc. The price of about \$4,000 to the end user is comparable to that of the heavy-duty unit with paper-tape reader and punch made by Teletype Inc., the industry leader in the U. S. But Horowitz points out his bilingual machine—alphabets also include Russian and Greek—replaces two single-alphabet units. □

Fiber optics

GTE first to carry public's calls

That final length of cable installed by the phone company in Long Beach, Calif. last month may look like ordinary cable on the outside, but it certainly looks different on the inside. It is a fiber-optic cable, and it means the race to provide the first telephone service to the public over light waves has been won by General Telephone and Electronics Co.

With the installation of that cable, GTE's General Telephone Co. of California began a year-long field trial of optical equipment carrying actual phone calls over a 5.6-mile stretch between a long-distance switching center in Long Beach, Calif., and a local exchange in Artesia.

Other fiber-optic systems announced by common carriers are one in Chicago to be turned on this summer by American Telephone & Telegraph [*Electronics*, Feb. 3, p. 48] and another north of London being installed by Standard Telephone and Cables for the British phone system [*Electronics*, April 28, p. 67].

The system in the California trial was designed and developed by GTE

Laboratories Inc., Waltham, Mass. Standard pulse-code-modulated systems produced by GTE Lenkurt Inc. of San Carlos, Calif., provide the digital signals to the optical communications link, which operates at the 1.544-megabits-per-second T-1 rate used by all telephone companies. The optical-fiber cable was developed by General Cable Corp., Greenwich, Conn., using Corning Glass Works fibers.

Although the 1-inch-diameter cable currently carries only 24 simultaneous telephone conversations on two of its six fibers, the cable's capacity is far greater. The company is using so few voice channels because it conveniently replaced a 24-channel copper-wire link. Two optical fibers are held as spares, and two others are used for tests.

Conventional pulling. GTE's prototype cable, which it pulled with conventional cable-laying methods through 58 manholes, contains an extruded plastic core with a helical groove cut out of each side and a copper wire in the center to add strength. Six graded-index optical fibers are encapsulated in a flat assembly placed in one of the grooves. The other groove houses three pairs of 22-gauge insulated copper wire. The entire assembly is as shown in detail in the drawing below.

In the transmitter section, gal-

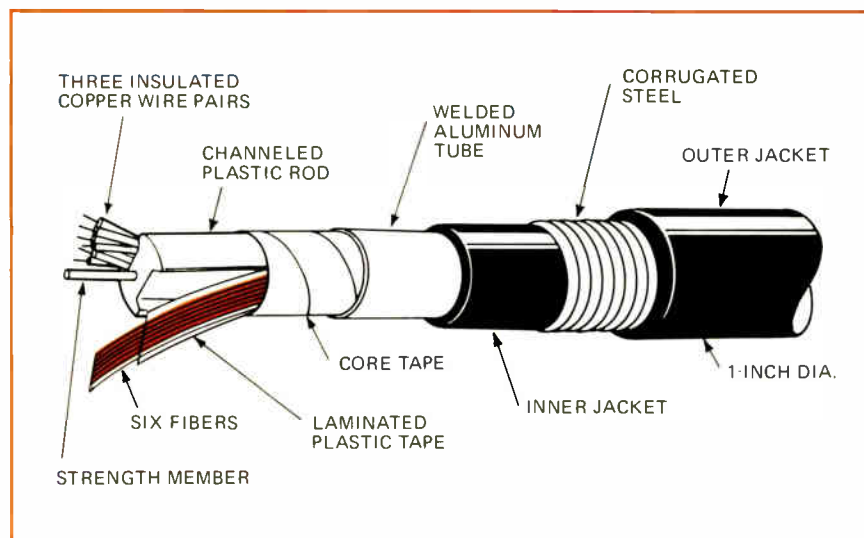

Cable view. Polyethylene-jacketed cable contains six graded-index optical fibers in flat plastic tape. Attenuation of each fiber averages around 9 decibels per kilometer.

On the balance a T900-Series Oscilloscope gives you the most performance for your dollar

Low-cost oscilloscopes traditionally offer a compromise in performance in return for low price. Over-simplified circuits reduce accuracy and require frequent calibration. Cost cutting in the selection of components limits reliability. With many low-cost scopes, the specs are there, but the performance isn't.

There are no compromises with TEKTRONIX T900-Series Oscilloscopes. No corners have been cut where accuracy and reliability are concerned. And with six models to choose from, you can match the performance you require with your budget. Bandwidths range from 10 to 35 MHz. Four T900 Scopes feature dual trace and one has single shot storage. A rackmount model is also available.

The 35 MHz T935 with dual input channels and delayed sweep is well suited for the design, production and service of computer peripherals, point-of-sale terminals, machine controls and communications equipment.

The dual channel, 15 MHz T922 is an excellent choice for classes in basic electricity and electronics. The large, bright 8 x 10 cm display makes classroom demonstrations more visible. The easy-to-use control layout makes learning signal measurement techniques simple and straightforward.

When you buy a T900-Series Oscilloscope, you also receive the full support of the Tektronix worldwide sales and service organization. T900 Accessories include a wide selection of probes, a low-cost camera, a versatile stand for convenient scope positioning and a viewing hood.

Performance, reliability and service. That's why Tektronix is setting new standards for low-cost oscilloscopes.

T921—DC to 15MHz; single trace, mono time base \$ 695*
 T922—DC to 15 MHz; dual trace, mono time base \$ 850*
 T932—DC to 35 MHz; dual trace, mono time base \$1195*
 T935—DC to 35 MHz; dual trace, with delayed sweep. \$1395*
 T912—Storage Model, DC to 10 MHz; dual trace, mono time base \$1300*
 T922R Rackmount—DC to 15 MHz; dual trace \$1175*

Voltage probes are included on all T900 Oscilloscopes except the T922R.

For complete specifications on the T900 Oscilloscope Family, contact your Tektronix Field Engineer. Or write Tektronix, Inc. P.O. Box 500, Beaverton, OR 97077. (503) 644-0161, Ext. T900. In Europe, write Tektronix Limited, P.O. Box 36, St. Peter Port, Guernsey, Channel Islands.

*U.S. sales prices are F.O.B. Beaverton, OR. For price and availability outside the U.S., please contact the nearest Tektronix Field Office, Distributor, or Representative.



Tektronix
COMMITTED TO EXCELLENCE

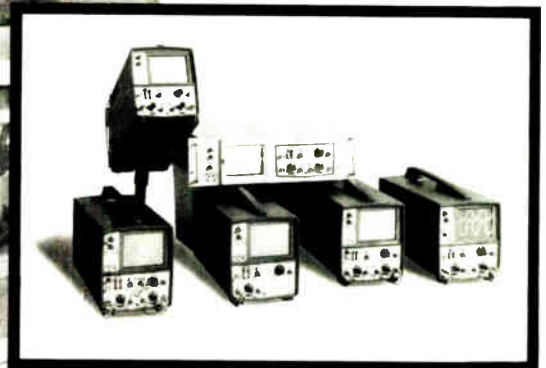

For Technical Data circle 34 on reader service card
 For Demorstration circle 35 on reader service card

lithium-aluminum-arsenide heterostructure light-emitting diodes launch an average of 60 microwatts into the fibers at a wavelength of 815 nanometers; the receiver sensitivity is 0.5 nanowatts of average optical power for a 10^{-8} bit error rate. Optical repeaters in the system use high-radiance LEDs and avalanche photodiodes. The repeaters are powered from a central-office 180-volt dc source and fed at a constant 140 milliamperes over one of the copper-wire pairs in the cable. At the repeater, a dc-to-dc converter provides a range of voltages.

Laying the cable, workmen looped the six fibers back on themselves to form a total distance of 21.6 miles connected through eight repeaters. "Measurements at this length proved that the fiber-optic circuits are significantly quieter than the copper-wire circuits, spanning 5.6 miles and using only five repeaters, that they replaced," says Leo L. Davenport, president of GTE Labs. He expects GTE to use optical transmission systems on a permanent basis in the early 1980s on the busy trunk routes linking switching centers in metropolitan areas. □

Employment

Exec demand up at top levels

Judging by their heavy demand for top managers, the electronics industries are the healthiest they have been for at least seven years, says one of the largest executive recruiting firms in the country, Korn/Ferry International Inc. of Los Angeles. "We believe the situation reflects the creation of new positions to cover new technologies and new markets," adds John E. Lohnes, managing director of the firm's eastern region.

In the first three months of 1977, electronics companies had the second largest numbers of vacancies to fill among the 10 industries into which the recruiter divides its clients. Moreover, they represented 15% of Korn/Ferry's vacancy list,

compared to 9% for the same period in 1976, and the total number of vacancies increased by almost 20%. In first place were vacancies at consumer products firms—at 19% for both quarters—while financial services (banks and insurance firms) dropped from first place at 22% last year to third place at 13%.

Never higher. "Demand for top managers in electronics has never been higher in the seven and a half years since we started making quarterly analyses by industry," declares Lohnes. By top managers he means the likes of general managers and vice presidents of engineering, marketing, and sales.

Backing up his belief that new technologies and markets are responsible, he points to semiconductor companies setting up consumer electronics organizations and to nonelectronics companies moving into new operations that require managers with electronics know-how. Among the latter, he singles out automotive companies setting up or strengthening electronics divisions, as well as petrochemical and controls firms.

A hot commodity is expertise in distributed processing, adds Mark L. Tomchin, a Korn/Ferry vice president. This goes for minicomputer companies wanting to expand into intelligent terminals and communications links, and others applying the technology to their operations.

Barometer. From its years of analyzing vacancy lists, Korn/Ferry has also pieced together an economic barometer of sorts for the electronics industries, Tomchin says. "At the top of a business cycle, demand is for production managers to turn out products. As a downturn occurs, the need grows for financial people to help minimize losses, maximize profits. At the bottom of the slope, there's an increase in general-manager activity as companies fire the people held responsible for profit and loss difficulties. At the upturn, demand increases for marketing managers." Right now, then, electronics seems to be bottoming out in some areas but upturns seem to be more prevalent.

What effect will these trends have

on jobs for engineers? Lohnes points out that a gain in demand for top managers for high-technology companies usually precedes an increase in jobs to fill engineering departments. This fanout of demand is already being felt and should continue to increase. □

Computers

Commodore offers household PET

Heavy price competition in the personal-computer market may start sooner than many expected, if Commodore Business Machines Inc. has its way. In June, the calculator and digital-watch maker plans to begin producing a \$495 cassette-programmable model called the Personal Electronic Transactor (PET), model 2001, that contains an 8-bit microprocessor, 9-inch black-and-white cathode-ray tube, 73-key keyboard, and 4,096-bits of random-access memory operating with a Basic program language.

Not surprisingly, Christopher Spencer, European marketing director, likens the firm's entry now to the situation in 1970 when the company marketed the first single-chip pocket calculator to sell for less than \$200. "That changed the pocket calculator from being an office machine for specialists to one for general use," he says. Likewise, PET moves personal



2001. \$495 computer enters programs supplied by Commodore or user into cassette player built in at left of keyboard.

Siemens 203 isn't the world's most beautiful semiconductor memory tester...until you use it.

Siemens 203 Semiconductor Memory Device Test System doesn't need smoked plexiglass and brushed aluminum to give some pretty spectacular results in production testing, device characterization, and incoming inspection. It is the fastest, most efficient test system available. And there's nothing more beautiful than testing RAM's, ROM's, and shift registers at a lower cost/device without sacrificing test quality for speed. And, with less downtime and easy service and maintenance, the 203 looks prettier all the time.

Beneath the skin, the 203 is the most attractive memory device tester you can buy. It offers total test flexibility in all aspects of high-speed functional and DC parametric testing. Its microprogrammable processor generates address sequences and data patterns at *true* 20 MHz test rates, enhancing its beauty for use with future high-speed devices. Multicycle timing is provided by 16 independently programmable channels. And, the high-resolution 1 NS clock permits meaningful time-related device tests, ensuring accurate, repeatable test results.

Unlike some beauties that age quickly, the 203 easily tests 16, 32, or 65K RAM's.

The 203 Test System is unique in the semiconductor memory test field. It offers unmatched test capability at the lowest overall cost...and that's simply beautiful.

May we send you our brochure? Please write or call: Siemens Corporation, Measurement Systems Division, 3 Computer Drive, Cherry Hill, N.J. 08034 (609) 424-2400

SIEMENS

The more you use it,
the prettier it gets.

computers out "from being a prerogative of the specialist world of the computer people."

Besides foreseeing a ready market in schools, Spencer forecasts business applications, such as inventory keeping and accounting, and home uses for recipe libraries, dictionaries, diaries, self-improvement exercises, and games like bridge. Though not an industry giant, the company appears to be the first large consumer electronics company to take a bead on the burgeoning market. By combining features everyone wants into one lower-price package, it beats the small specialist companies now dominating the market, the established chipmakers who are supplying microprocessor evaluation kits [*Electronics*, March 31, p. 89], and the traditional minicomputer manufacturers whose products cost many times more—with the same performance, Commodore claims.

MOS chip. Really an intelligent, interactive visual-display unit, PET is based on the 8-bit 6502 metal-oxide-semiconductor microprocessor made by MOS Technology Inc., which Commodore acquired last year.

The n-channel silicon-gate device operates at 1 megahertz with a typical instruction time of 4 microseconds, according to PET designer Leonard Tramiel, son of the firm's president. It needs 12 kilobits of operating read-only memory, and its 4,096-bits of RAM can be expanded up to 32 kilobits, Tramiel says. Commodore ties the 44-pound unit together with a Hewlett-Packard interface bus so that plotters, recorders, and floppy-disk memories can be hung on the unit, he says.

The video-display unit can show 40 columns by 25 lines from among 64 standard ASCII characters or 64 graphics-related characters. The display also features a winking cursor with full motion control. The keyboard allows editing and screen-control functions.

Though games can be programmed into PET, the unit can only play games such as blackjack because it cannot write fast enough, Tramiel says. Early next year, he plans a bigger version with a larger

News briefs

Foundation to honor TV researchers

An annual award of 100,000 Deutschmarks (about \$42,500) for contributions to television research has been established by the Edward Rhein Foundation of Hamburg, West Germany. The prize will be given to individuals, not companies, and be based on a technical paper written in German or English. Papers will be judged by an advisory council headed by Walter Bruch, inventor of the PAL color TV system. Another member is James Hillier, executive vice president of RCA/David Sarnoff Research Center, Princeton, N. J. Details on nominations for the award are available from Rhein Foundation, 2000 Hamburg 67, Kloeppersteig 3, West Germany.

IEEE names Emberson acting general manager

The Institute of Electrical and Electronics Engineers has appointed one of its staff members, Richard M. Emberson, 63, to be acting general manager. Emberson moves into the job on June 1, replacing Herbert J. Schulke, who resigned earlier this year, effective July 22 [*Electronics*, Feb. 3, p. 45]. Meanwhile, a special committee will continue to search for a permanent replacement. Late in April, it reported that it would need another three to six months to recruit a new general manager from outside the organization. Emberson is scheduled to retire in two years.

NCR adds 5 general-purpose computers to line

NCR Corp. of Dayton, Ohio, expanded its 8000 series of general-purpose computers with the recent addition of five new systems. All are designed to operate within a complete communications architecture that the firm will announce this summer. Included is the N-8450 with a multiple-mode processor derived from the company's Criterion architecture. It has a processor cycle time of 112 nanoseconds with a main memory expandable from 128 kilobytes to 1 megabyte. Purchase price starts at \$90,900.

Honeywell reduces memory prices

Honeywell Information Systems is lowering prices on memory modules for its large-scale Series 60 Level 66 and 68 and Series 6000 computer systems. The changes include decreases of 14% on rental and 35% on purchases of all memory modules above 512 kilowords for the Level 66 and 68. Purchase prices on Series 6000 memory also are reduced 35%. Stephen G. Jerritts, vice president and general manager of the Waltham, Mass.-based group of Honeywell Inc., says the changes—in the wake of memory system price reductions by IBM Corp. [*Electronics*, April 14, p. 80]—"were in accord with industry trends and recent competitive actions in the marketplace."

IEEE's Electro77 does well in New York

"One damn good show after two or three bad ones in New York," is how Ted Shields of the Electro77 operating staff sums up last month's show and convention. Attendance figures should hit 26,500 after the final audit, the highest attendance in five years. Last year's Electro76, in Boston, attracted 22,900. Numbers of exhibit booths were up as well, with 565 booths this year, compared to 517 in Boston and 365 when the show was last in New York in 1975.

Data General sues Fairchild

Data General Corp., the Southboro, Mass. minicomputer manufacturer, has asked a Wilmington, Del., court to intervene in what the company believes is a misappropriation of trade secrets by Fairchild Camera and Instrument Corp. in developing the Fairchild 9440 microprocessor. The Data General suit charges in part that Fairchild violated software licensing agreements and unlawfully used Data General plans and schematics to develop the 9440, a 16-bit unit, similar to its own microNova, that uses Data General's Nova software programs.

LSI-11 & SBC-80 USERS.

Single Board Real Time Analog I/O Systems

...Widest Selection, Fast Turnaround, Lowest PRICES

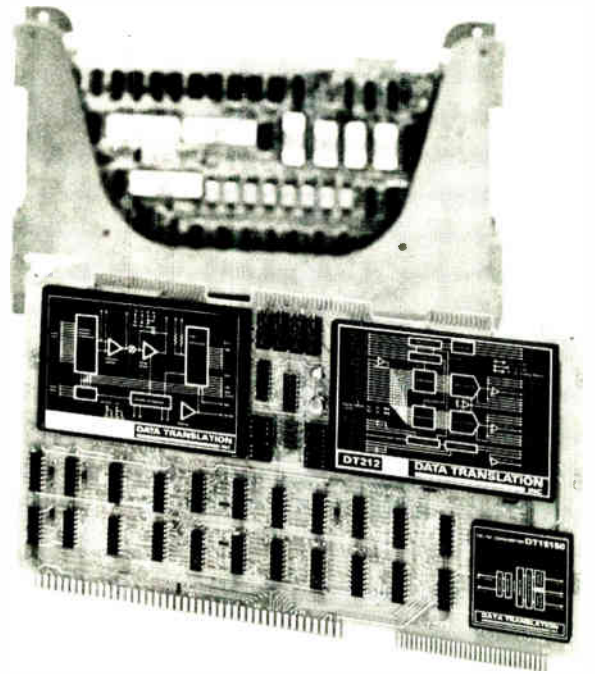
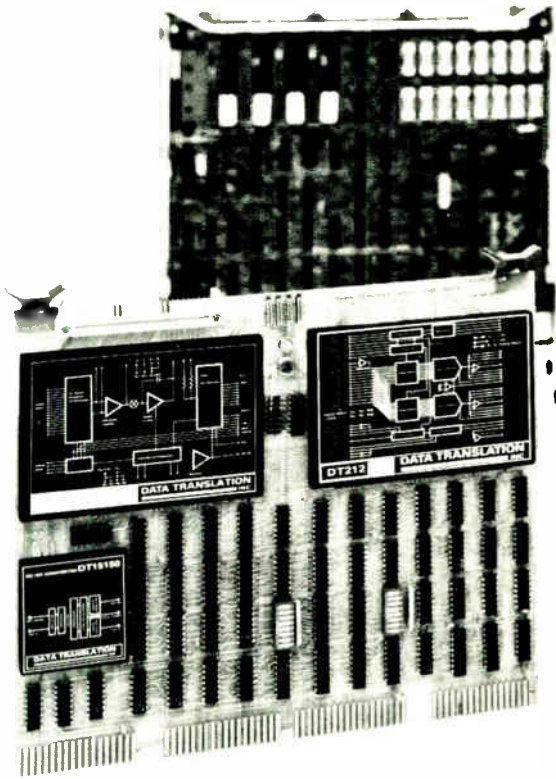

These single board systems provide the most cost effective and fastest way to get analog signals into and out of your LSI-11 and SBC-80. Just plug in the board and hook-up your analog signals. Get a headstart on solving your system's problems without the headaches of designing an analog front end.

We've got the broadest selection of input and output capability—10mV to 10V or 4-20mA inputs, up to 64 channels on a single board, line amplified buffered D/A outputs, point plotting, or 4-20mA outputs—all at a cost that says you can't afford to do it yourself.

Concentrate on the software and other key system requirements... and let us take care of your analog problems. We've seen them all and solved them in these systems... no mysteries, no tweaking.

Prices are surprisingly low, with 8-bit models starting at \$295 and 12-bit models at \$395 both in OEM quantity.

Send for full technical data or call us.

DATA TRANSLATION
INC

23 Strathmore Rd., Natick MA 01760
(617) 655-5300 Telex 94-8474

SALES OFFICES: AZ, Scottsdale 602-994-5400; CA, Cupertino 408-257-5131; CA, Santa Ana 714-540-3245; CO, Denver 303-837-1247; IA, Cedar Rapids 319-362-0503; KS, Prairie Village 913-649-4000; MD, Fulton 301-953-3724; MA, Waltham 617-890-1776; MO, St. Louis 314-997-1515; NJ, Parlin 201-727-6454; NM, Albuquerque 505-292-1212; NM, Las Cruces 505-523-0601; NY, Rochester 716-334-2445; UT, Salt Lake City 801-466-6522; VA, Arlington 703-527-3262; WA, Bellevue 206-455-1246.

A New Standard of Keyboard Quality

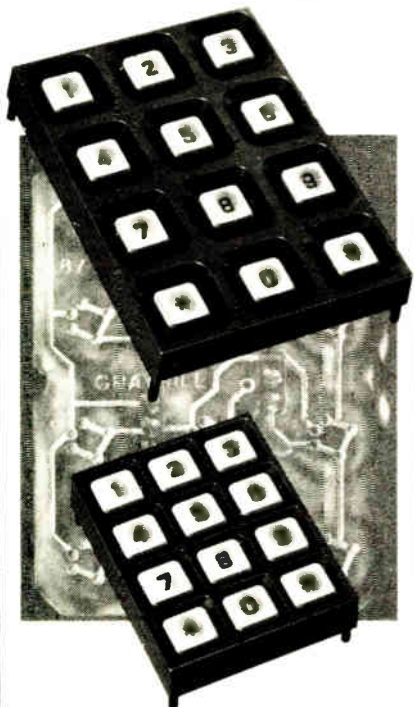

Grayhill 3x4 Keyboard Pads for data input and telecommunications

2 out of 7 coded output—tested for millions of operations!

- ½" or ¾" button centers
- Excellent tactile and audio feedback
- Patented snap-action dome contact provides rugged, durable performance

These new Grayhill low-profile, 12-button keyboard pads feature a 2 out of 7 coded output, standard mounting dimensions, and are ready for top-side or sub-panel mounting. The contact system is life-rated for 3,000,000 operations per button, and is readily interfaced with logic circuitry. The new Grayhill Series 87 modules offer excellent audio and tactile feedback characteristics with total button travel of only .015". These durable keyboards are molded of tough ABS plastic; feature buttons with black on white molded-in legends as standard, and a variety of other legend options including clear snap-on caps for user legending. Complete specifications and truth table are provided in Bulletin #262, available free on request from Grayhill, Inc. 561 Hillgrove, La Grange, Illinois 60525 (312) 354-1040.

Grayhill
INC.

Electronics review

keyboard, two cassettes for program load, and an upper- and lower-case graphic set. □

Microwaves

TRW builds 5-GHz GaAs modem chips

After being snubbed for years as an integrated-circuit material because of processing troubles, gallium arsenide is again sparking interest. This time it is being considered for high-speed modulators/demodulators in military communications equipment operating in the microwave region of 1 gigahertz and up.

"Frequency is the name of the game, because it [GaAs] has a factor-of-five advantage over silicon," says Barry Dunbridge, who heads the program under a technology development contact with the Navy. He manages the Microelectronic Center for TRW's Defense and Space Systems group in Redondo Beach, Calif. The firm will unveil the two chips (modulator and demodulator) at the National Aerospace and Electronics Conference, May 17-19 in Dayton, Ohio.

Actually, these first chips are intended to replace discrete 5-GHz modulator/demodulators of silicon used in a microwave communications system. Dunbridge points out that silicon integrated circuits could not even be considered for this replacement since they would reach only to around 500 megahertz.

Improvements. Compared to the discrete-component demodulator, the TRW device has improved characteristics at the 5-GHz carrier frequency, Dunbridge says. Its data rate goes to 1 gigabit per second, against 0.8 Gb/s. And it occupies only 0.75 cubic inch and weighs 0.04 pound, compared to 20 in.³ and 2 lb for the discrete version.

Epitaxially deposited on the bi-phase-shift-keyed demodulator chip, measuring 56 by 68 mils, are a trio of transferred-electron devices and capacitors and resistors. There are also two metal levels for greater

density and coplanar transmission lines for controlling power transfer. Two of the transferred-electron devices function as logic and gates and the third as an injection-locked oscillator. The 75-by-80-mil modulator adds monolithic field-effect transistors as differential amplifiers, implemented in the gallium arsenide, but omits transmission lines.

Dunbridge thinks the current TRW gallium arsenide IC program is noteworthy in light of the problems researchers have had with the material. "Nobody really understood it in the '60s and early '70s," he recalls. Not only were circuits usually off the mark in reaching performance goals, but surfaces "tended to disassociate" during processing at around 600°C. According to Dunbridge, improvements in silicon processing technology make the present GaAs work possible.

"We've gotten mastery over the last few years of uniformity and reproducibility," he says. In laying down epitaxial layers in GaAs, the company employs the same kind of masks and additives used with silicon. Oxides and nitrides, for example, are deposited in a surface "capping technique." Adds Dunbridge, "The only thing we can't do is solid-state diffusion. It doesn't work." The firm fabricated its two chips at the small-scale-integration (fewer than 100-device) level, with a mesa technique in n-channel technology.

Ion implant. TRW will be working on ion implantation, which Dunbridge calls "the key to gallium arsenide's future," later this year. It would "allow building planar devices and do away with epitaxy completely," he predicts. Yields can be improved and densities achieved in the large-scale-integration range of 1,000 or more logic gates per chip. The still experimental epitaxial chips are about 18 months away from being introduced into equipment.

The TRW Microelectronics Center has had a GaAs IC program for about three years, with contracts from the Department of Defense and the Air Force, in addition to the Navy. The firm has no present plans for nonmilitary GaAs work, Dun-

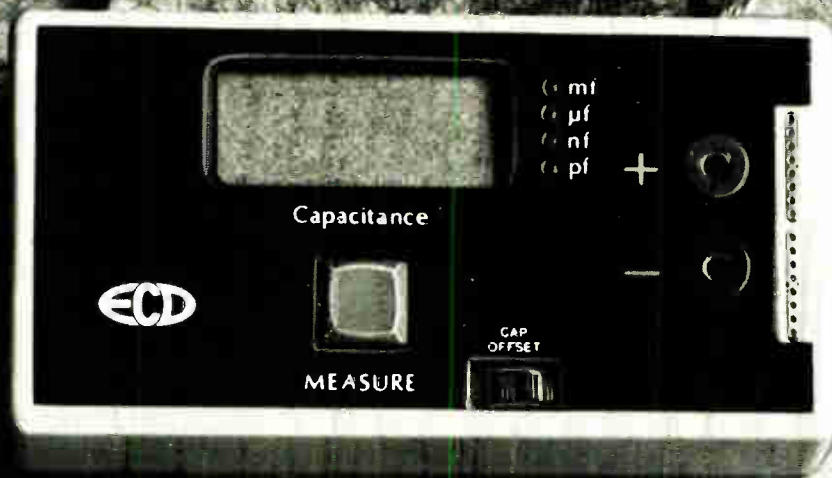

My shirt, yes...my C-Meter, no.

Test the kind of guy who'll give you the shirt off his back: ask him for his C-Meter.[®]

He knows that his C-Meter gives him a definite edge. It exposes an obvious efficiency: capacitors are easier to measure than resistors.

No more twiddling and nulling. No need for expensive, tight-tolerance capacitors or tweak pots. With its pushbutton speed, high accuracy (0.1%), small size

and versatility (0.1 pf to 0.2 farads), the C-Meter makes you a more productive engineer.

You owe it to yourself to try one on. It'll cost no more than a fine suit: stocked locally at only **\$289.00**.

ECD CORP.
196 Broadway, Cambridge
Mass. 02139 (617) 661-4400



SALES OFFICES: AL, Huntsville (205) 533-5836; AZ, Scottsdale (602) 947-7841; CA, Costa Mesa (714) 540-7160; CA, Sunnyvale (408) 733-8690; CO, Denver (303) 750-1222; FL, Winter Haven (813) 294-5815; GA, Chamblee (404) 457-7117; IL, Elk Grove Vill (312) 593-0282; IN, Indianapolis (317) 293-9827; MD, Silver Spring (301) 622-4200; MA, Burlington (617) 273-0198; MN, Minneapolis (612) 781-1611; MO, Kansas City (816) 358-7772; NJ, Camden (215) 925-8711; NM, Albuquerque (505) 299-7658; NY, Great Neck (516) 482-3500; (212) 895-7177; Syracuse (315) 446-0220; NC, Raleigh (919) 787-5818; OH, Centerville (513) 433-8171; TX, Houston (713) 688-9971; TX, Richardson (214) 231-2573.

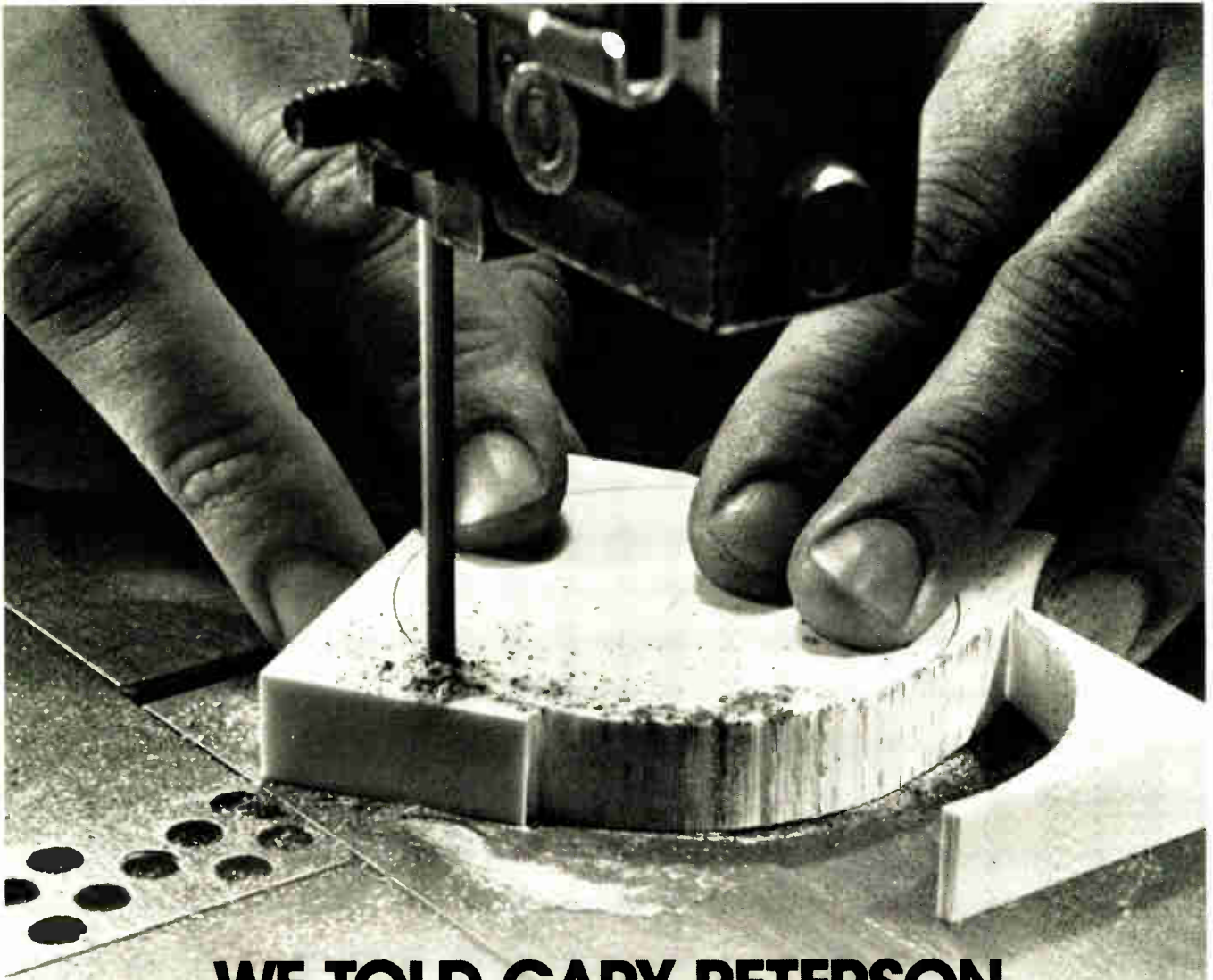

WE TOLD GARY PETERSON TO CUT IT OUT.

Design engineer Gary Peterson chose MACOR machinable glass-ceramic instead of alumina or beryllia for the 2½ inch diameter circuit base that is the heart of a new angle transducer manufactured by Hewlett-Packard.

In the past, such parts might have been made from alumina or beryllia in a time-consuming, costly process that involves casting or pressing in a mold, then grinding and polishing to desired flatness.

Parts made from MACOR machinable glass-ceramic can be cut from bar stock with ordinary metal-working tools in one-tenth the time. Says Peterson: "MACOR enabled us to develop a product

With MACOR™
machinable glass-ceramic
from Corning, it's easy



New HP 3810A Total Station electronic distance and angle measuring device.

with minimum tooling."

With MACOR machinable glass-ceramic, milling, threading, and boring can be per-

formed to precision tolerances of ± 0.0005 inch, using standard metalworking tools and equipment. No firing is required after machining. Available in sheet, rod and bar stock in standard sizes.

For more information and complete specifications, phone or write: Machinable Glass-Ceramic Department, Corning Glass Works, Corning, New York 14830/(607) 974-8626

MACOR machinable glass-ceramic. A better way of doing things . . . from Corning.

CORNING

Electronics review

bridge says, although markets might open up in instruments and telephone communications. GaAs integrated circuits known to be in commercial use are from Hewlett-Packard Co., which several years ago incorporated 2-GHz chips into high-speed counters. □

Consumer

IEEE revamps spring conference

This year, an expanded IEEE Chicago Spring Conference will take in more of consumer electronics than just TV sets. Forty-one wide-ranging papers plus a couple of special events should lure many newcomers to the June 6-7 meeting.

At least 2,000 engineers are expected to attend, says conference chairman Walter Ciciora of Zenith Radio Corp. Exhibitors, too, will have their pick of a full floor of booths, 10 hospitality suites, and up to 30 demonstration parlors, which the Institute of Electrical and Electronics Engineers has arranged to be available at the Marriott Hotel near O'Hare Airport.

Acknowledging that the spring

conference had in the past neglected audio technology, Ciciora points out that this year's audio session will be the biggest of the conference. It will include papers on loudspeakers, phonograph cartridges, a-m stereo, and a single-chip a-m/fm IC radio.

Papers array. Other technical sessions will cover digital techniques for citizens' band radio, as well as video games, display systems, video tape recorders, and projection TV. One afternoon will be devoted to semiconductor tutorial papers highlighted by a discussion of charge-coupled devices. Worth noting, too, are a paper from RCA Solid State division on a bulk-MOS 40-channel CB frequency synthesizer, another from Arthur D. Little Inc. on transmitter identifier systems for CB radio, and the first public discussion of efforts to develop a standard TV demodulator for TV broadcasting.

Also new this year are two short courses to be offered before and after the formal conference. On June 5, the Sunday before the meeting, Illinois Institute of Technology will sponsor a conference for consumer electronics engineers on microprocessors. June 8 to 10, there will be a short course on television systems jointly sponsored by IIT and the spring conference. □

Maker hammers at printer cost

Would you believe that a small manufacturer can put together a high-speed impact line printer for hundreds of dollars instead of the typical price in the thousands? What makes this possible is that Dataproducts Corp., a major manufacturer of line printers, will sell to the little guy the key element that makes its printers successful—the hammer that strikes the type bar to create the printed image.

The company's cheapest line printer sells for \$4,000. Like other printer firms, the company already sells its hammers to large-volume original-equipment manufacturers in the computer industry. Under its new program, the Woodland Hills, Calif., firm sells its Mark IV hammer, the most proprietary part of its printer, for \$14.95 each in quantities of 1,000. It will supply the hammers either individually or in standard or custom hammer banks.

One satisfied customer is Decision Data Inc., a small manufacturer of printing keypunch equipment in Horsham, Pa. Its keypunch equipment, selling for \$6,000 to \$8,000, prints on cards, rather than continuous rolls of paper and requires a printer with a speed of 1,500 lines per minute. The equipment uses either three or four hammers to cover 80 or 96 columns respectively. The same information may be repeated on many lines, allowing considerably fewer hammers to be used than the customary one hammer per column. Decision Data declines to reveal the exact cost of the printer assembly, conceding only that it is in the low hundreds of dollars.

MACOR™

Machinable Glass-Ceramic

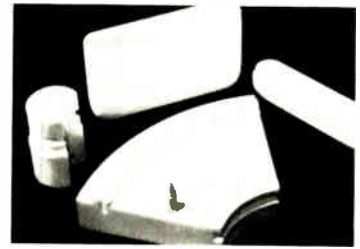

General

MACOR parts do not sacrifice strength, hardness, or porosity to achieve this machinability.



Machining

Only standard tools and equipment are required. Tolerances of $\pm .0005''$ routinely achieved. Wafers cut as thin as $.005''$.



Metallization

Thick film metallization by using metal inks (silver, gold and silver/platinum). Thin film metallization by sputtering.

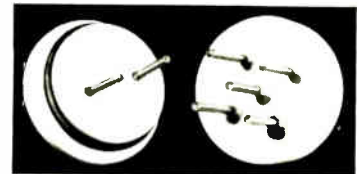

Sealing & Joining

Hermetic seals using glass frits good to 800°F. Strong joints using epoxy. Soldered joints on metallized parts.

Features at a Glance

Machinable with ordinary metalworking tools. No firing needed after machining. Excellent dimensional stability. Good thermal shock resistance. Ultra high dielectric strength. Compatible thermal expansion coefficient. Low thermal conductivity. Low loss tangent. Zero porosity and zero water absorption. Non-magnetic.

Machinable Glass-Ceramic Part E577
Corning Glass Works, Corning, NY 14831

CORNING

Circle 43 on reader service card

43

“RF design without here today with our new

“Our rugged new VMP 4 power transistor will change the way you design RF power stages, front ends and switching amplifiers. It’s immune to load mismatch burnout and secondary breakdown, provides high gain over a broad band, has wide dynamic range and very low noise characteristics. It’s a first in VHF MOSFETs. And Siliconix VMOS technology made it possible.”

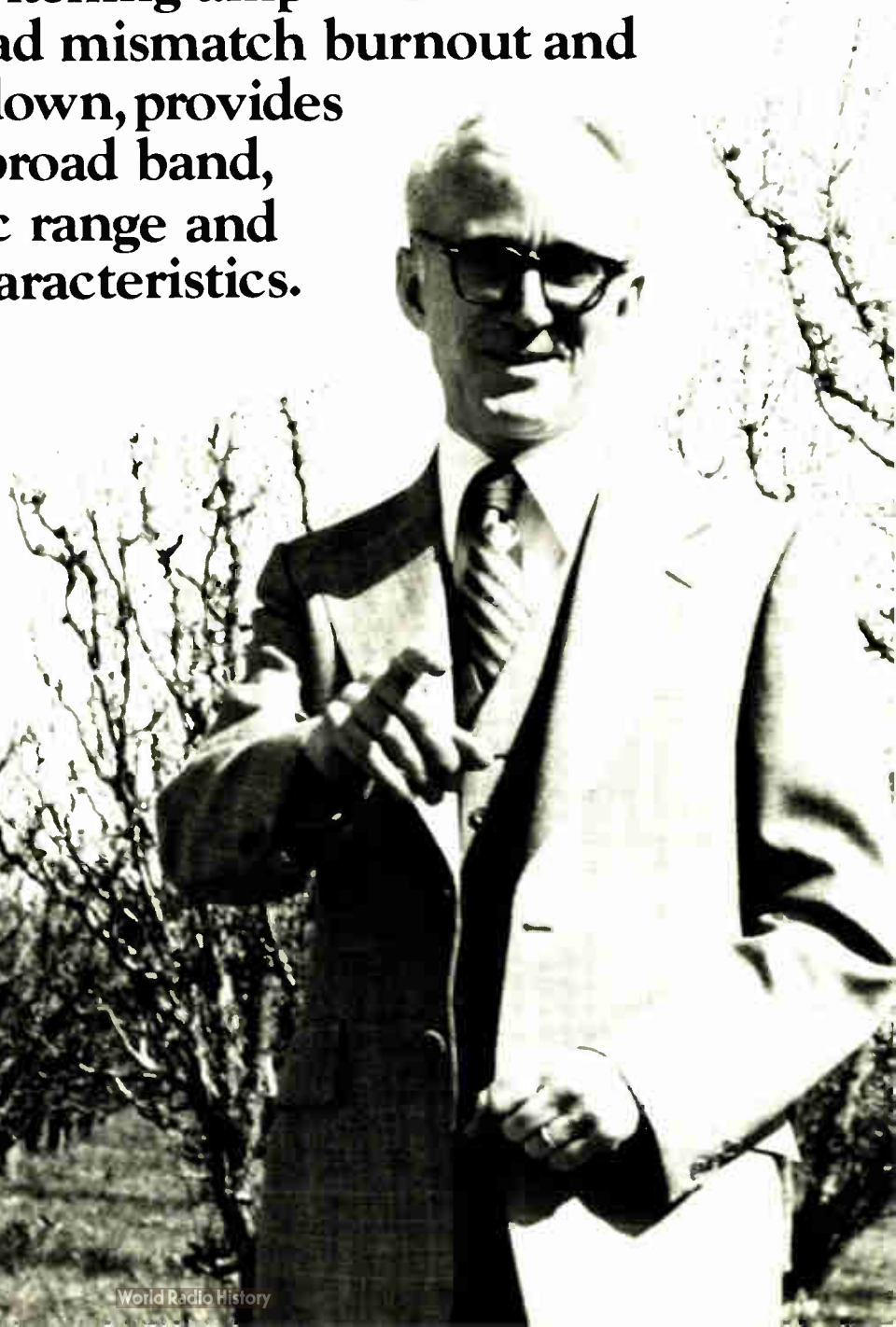

bipolar problems - it's MOSPOWER[®] FET."

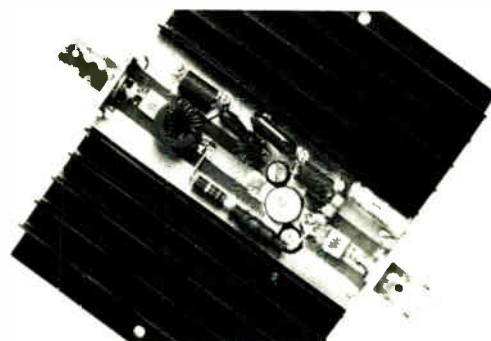
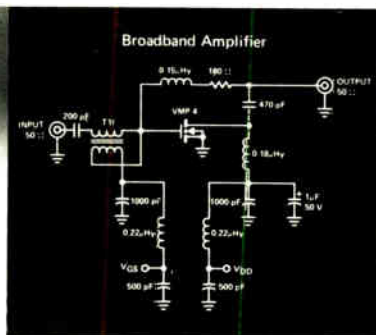

Until now, RF designers have had to live with the basic limitations of bipolar transistors that complicated VHF/UHF transmitter and transceiver design. You had to build costly stages, with careful load matching and extra components to prevent thermal runaway and load mismatch failures.

Our new VMP 4 MOSPOWER FET changes all that. It's the first commercially available FET to operate at high power at radio frequencies offering better than 10W class C at 150 MHz. It's also the first with ideal characteristics for small-signal applications as well as linear power and switching amplifiers. So you can use it at any VHF transceiver stage, achieving new economies in design, production and maintenance.

The VMP 4 is, first of all, a high reliability, high performance power transistor offering input impedances that are easier to match over broad bands and capable of unsaturated gain of as much as 18 dB at 200 MHz. It can operate under the most adverse RF loads—short circuit to open circuit. So it eliminates mismatch burnout and loss of available output power.

Now efficient class D, E and F switch mode designs are practical with the VMP 4. Since the VMP 4 is MOSFET, it's a majority carrier device, with no minority carrier storage time. So it can, for example, switch 2A in less than four nanoseconds, or 10A in less than six. That's 10 to 200 times faster than bipolars.

As a front end in VHF transceivers, the VMP 4 offers low noise figure as well as high dynamic range due to its small-signal linearity. It's minimum gain is 15 dB at 150 MHz, with a typical small-signal noise figure of 2.5 dB at 150 MHz. Two tone intermodulation intercept point is a high +46 dBm.

Siliconix has the VMP 4 in stock now, for as low as \$13.97 in 100-up quantities. To encourage you to see how the VMP 4 can improve your RF design, we're offering a single VMP 4 plus applications notes and data sheet at the 100-up price.

To place an order, or for more information, contact our franchised distributors: Components Plus, Elmar, Future, Hamilton/Avnet, Pioneer, Quality Components, Semiconductor Specialists, Wilshire or RAE. Siliconix Incorporated, 2201 Laurelwood Road, Santa Clara, CA 95054 (408) 246-8000.

 Siliconix incorporated

BUY OUR NEW LOW AND KEEP YOUR



Call the ITT Semiconductors Representative nearest you • Engine: California: (213) 995-1571 • Palmdale: California: (415) 961-5265 • Canada: (416) 625-9022 • Illinois: (312) 884-0990 •

POWER SCHOTTKY 2¢ TO YOURSELF.

Our new LS/74 gives you an AQL of 0.15%. Free.

That's a big extra that could cost you as much as 2¢ per device from most other manufacturers. With us it's standard. It means that you don't have to specify "per spec" or "manufacturer's pre-conditioning program". It also means that you don't have to waste a lot of time and money on incoming inspection.

But that's not the only way our LS/74 line saves you money. You get improved performance and better speed/power than standard TTL. You can use less costly power supplies than with standard TTL and CMOS or pack more computing capability with the same power consumption. You can expect longer, more reliable life with this lower power consumption per function.

Right now we've got 34 LS functions in a reliable Low Power Schottky TTL ready for immediate delivery. In the next few months, we'll introduce 65 more complete with the latest complex functions. And by the end of the 3rd quarter this year, we'll be able to offer you a very complete and up-to-date line of Low Power Schottky microprocessor support functions.

That's our 2¢ worth. Now get detailed technical information on our new LS/74 series Low Power Schottky. Write ITT Semiconductors, 74 Commerce Way, Woburn, MA 01801. Telephone (617) 935-7910.

74LS TYPE	FUNCTION	74LS TYPE	FUNCTION
74LS00	Quad 2-Input Nand Gate	74LS109A	Dual JK Flip Flop W/Pre-set and Clear
74LS02	Quad 2-Input Nor Gate	74LS132	Quad 2-Input Nand Schmitt Trigger
74LS04	Hex Inverter	74LS138	3 to 8 Line Decoder/Demultiplexer
74LS08	Quad 2-Input And Gate	74LS139	2 to 4 Line Decoder/Demultiplexer
74LS09	Quad 2-Input And Gate (C.C.)	74LS157	Quad 2-Input Mux, Non Inverting
74LS10	Triple 3-Input Nand Gate	74LS158	Quad 2-Input Mux, Inverting
74LS11	Triple 3-Input And Gate	74LS174	Hex D Type Flip Flop W/Clear
74LS13	Dual 4-Input Nand Schmitt Trigger	74LS175	Quad D Flip Flop W/Clear
74LS14	Hex Schmitt Trigger	74LS194A	4-Bit Universal L/R Shift Register
74LS15	Triple 3-Input And Gate	74LS195A	4-Bit Parallel In Parallel Out Shift Register
74LS20	Dual 4-Input Nand Gate	74LS257	Quad 2-Input Mux, Non Inverting Tri State
74LS22	Dual 4-Input Nand Gate (C.C.)	74LS258	Quad 2-Input Mux, Inverting Tri State
74LS27	Triple 3-Input Nor Gate	74LS279	Quad S-R Latch
74LS30	8 Input Nand Gate		
74LS32	Quad 2-Input Or Gate		
74LS51	Dual 2-Wide 2/3-Input And/Or Invert Gate		
74LS54	4-Wide, 2-Input And/Or Invert Gate		
74LS74	Dual D Flip Flop		
74LS90	Decade Counter		
74LS93	4-Bit Binary Counter		
74LS95B	4-Bit Parallel-Access Shift Register		

ITT
SEMICONDUCTORS

Second To None

Ohio: (513) 435-3750 • Texas: (214) 243-7851 • New York: (315) 451-5980 • Pennsylvania: (215) 688-6990/1/2/3 • Georgia: (404) 339-6715 • Lexington, Massachusetts: (617) 861-0880

Electronics/May 12, 1977

Circle 46 on reader service card 47

micrometers through a calcium-fluoride lens 5 centimeters long.

Electronics/May 12, 1977

49

Mini-microcomputer users.

Here are analog and digital

Washington commentary

Donald Baker's last look at antitrust

Federal antitrust history of the last quarter-century has convinced many that Republican administrations tend generally to be more vigorous in the field than their Democratic counterparts. The performance of Donald I. Baker, now leaving the Justice Department as assistant attorney general for antitrust, supports that view. In the electronics community he will be remembered best for the initiation of the case against American Telephone & Telegraph Co., as well as the ongoing prosecution of the International Business Machines case. Baker's ability to cogently summarize the pros and cons of such complex issues as telecommunications competition and its impact is widely respected within the legal community. Thus it seems his departing estimate before the American Bar Association's Washington spring meeting of U.S. antitrust activity and its future course, summarized below, is worth the attention of Electronics' readers.

Ray Connolly

Some American institutions are better understood than others. Take baseball, for example, [as compared to] antitrust enforcement. Swope to Morrison to Baker simply does not have the same ring as "Tinker to Evers to Chance." And so I shall attempt to explain some of the whys and wherefores of the workings of the Antitrust division as I have known it. I want both to look back at where we have been during the past year and look ahead to where I think we are going in the next years.

Stiffening jail terms

We have dramatized the criminal aspects of price fixing. Our sentencing guidelines, which were issued to all division attorneys and economists earlier this year, put the Antitrust division on record as recommending substantial prison terms for defendants convicted of price fixing. This seems to be the only way to get home to persons who may be tempted to fix prices that the personal price to them may be high. Individual fines do not seem to do it.

We have gone beyond the Sherman Act to bring home the criminality of price fixing. As attorneys for the Department of Justice, we are authorized to enforce a wide range of criminal statutes, some of which include very strong remedies. Being an antitrust lawyer today also means being a criminal lawyer, because we in the Antitrust division are going to be criminal prosecutors.

We have tried to provide forthright guidance to business in one of the most complex areas of antitrust enforcement: antitrust and interna-

tional commerce. The Antitrust Guide to International Operations, issued in January, takes on many of the hard questions faced by American firms when they enter into business arrangements overseas, and by foreign firms seeking to do business in the United States. This international antitrust guide is designed to eliminate some of the uncertainty which has prevailed in this area. While it is important to discourage illegal transactions, it is equally important not to discourage innocent business transactions which facilitate our national interests as a great trading nation.

Through imaginative lawyering we managed to come up with novel relief of far-reaching implications in the GE-Westinghouse turbine generators case. We were able to do so without the necessity of a large lawsuit by modifying existing consent decrees against the potential defendants.

The injunctive relief drafted there will, we hope, effectively increase the amount of competition in the turbine generator market. The decree modifications, and the theory behind them, are an important step in dealing with structural problems—the problems of shared monopolies and concentrated markets.

We have continued the division's role as a forthright advocate for competition policy and for cutting back on anticompetitive Government regulation of business. In the last three months alone, we have filed more than 20 memoranda and briefs before regulatory agencies. We assess before regulatory agencies the competitive implications and problems behind such diverse subjects as electronic banking, air pollution, deep-water ports, and media cross-ownership.

Stimulating competition

Increasing efficiency and the role of competition in regulated industries is an area of antitrust law to which I have long been committed and which still has the potential for substantial returns. Our regulated-industries program is well in place now, and we are beginning to see those returns with increasing frequency. Fortunately, our effort seems to be receiving support from President Carter, as it did from President Ford before him.

Well I remember five years ago, and (more starkly) nine years ago, when the Antitrust division felt that it was fighting a lonely battle in its efforts to bring competition to the securities, banking, transportation, and communications industries. At long last we may see deregulation become "acceptable politics."

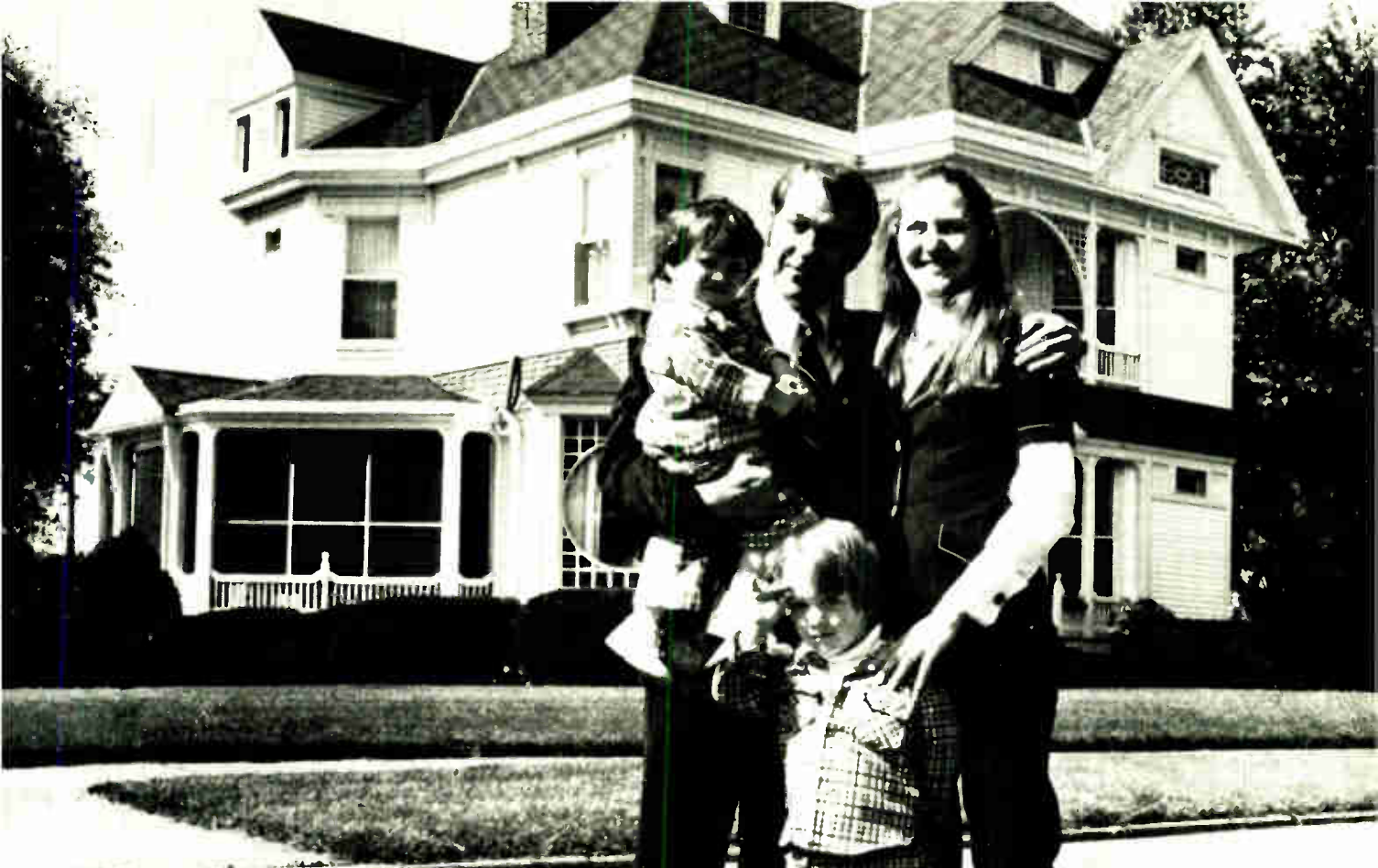

Tom and Barbara Herrold just bought their spacious Wabash, Indiana home for \$31,500.

What do you think relays are going for around here?

10 rooms, 8 fireplaces, 6 porches, 11 foot ceilings, oak paneling, choice neighborhood, mint condition—all for \$31,500. That's Wabash value. And that's why our relays are in such demand. They are made right here—switches and all—to rigid specifications in a hospital-clean environment where heat, humidity and dust are controlled so quality can be assured. Just to be certain, 3 billion test cycles are run every day.

When you purchase Wabash relays you get the kind of quality the Herrold's got in their home. And at a price that gets you the kind of value the Herrold's got. We've got over 6,000 variations of dry reed relays for sale. Contact us. When you see the asking price, you will know you found a new home for your relay requirements.



The Econo-Miser. The most automatically manufactured dry reed relay available. 1 and 2 pole standard types. Less than one dollar in quantity.

Coils, Relays & Transformers

wabash

of
Wabash, Indiana

and Huntington, Indiana; Farmington, Missouri; Tipton, Iowa and South Boston, Virginia

For information and quotes write or call:

Wabash, Inc., Dept. RA-7, 810 N. Cass St., Wabash, Ind. 46992 Tel: 219/563-2191 TWX 810-290-2722

When you want modern, cost-efficient high vacuum pumping, you want Cryo-Torr[®] High Vacuum Pumps. No liquid nitrogen. No liquid nitrogen traps. And no process chamber contamination problems. Instead you get fast, clean, trouble-free, oil-free pumping of all gases in high vacuum systems — all the time.

Take our Cryo-Torr 7 High Vacuum Pump. It's the perfect replacement for conventional 6" oil diffusion or turbomolecular pumps. Not only does it eliminate liquid nitrogen consumption, but it saves on electrical power requirements — and, at the same time, delivers all

the performance dependability and fast pumping speeds you need.

Ideal for use in vacuum deposition equipment, sputtering systems, and ion implanters, Cryo-Torr High Vacuum Pumps get you out of the liquid nitrogen trap for good. Think of the money you'll save. For more information write or call CTI-Cryogenics, Kelvin Park, Waltham, Massachusetts 02154. Telephone: (617) 890-9400.

CTI-CRYOGENICS

DON'T FALL INTO THE LIQUID NITROGEN TRAP.



HELIX
A Helix Company

Circle 52 on reader service card

World Radio History

Non-ionizing radiation to be studied by International group

The International Radiation Protection Association plans to set up a new international committee for protection against non-ionizing radiation, particularly at microwave frequencies. The decision, taken at IRPA's fourth international congress in Paris in late April, follows recommendations of a five-man working group that pointed out the lack of international agreement on the effects and control of such radiation. The aim of the group, which will be a yet-to-be-named 12-person specialist committee, will be to help find solutions to potential health problems in commercial areas. The working group was made up of Danish, Polish, French, and American members, including a representative of the National Bureau of Radiological Health, an arm of the Food and Drug Administration.

Nixdorf to expand in U.S. via Entrex acquisition

Unperturbed by all the talk about what has been called the impenetrability of the tough American market for data-processing equipment, West Germany's Nixdorf Computer AG is raising its sales targets on just that market. By the end of this decade, the Westphalia-based small-computer and terminal-equipment producer plans to do around \$100 million worth of business per year in the U.S. Helping the German company to achieve that goal will be Entrex Inc., the Burlington, Mass., peripherals maker that Nixdorf will take over this month. The Entrex acquisition will push the number of people the Nixdorf group employs in the U.S. to about 1,100. Thus far, the German company has installed roughly 3,500 EDP systems in the U.S.

Satellite misses stationary orbit, but functions well

Despite the launch mishap that put its GEOS satellite into a non-geostationary orbit, the European Space Agency figures that it can get a reasonable scientific return from the satellite. Even in its elliptical orbit, GEOS can be seen at least seven hours a day by the European scientists who plan to run experiments using it, and the initial in-orbit tests went well.

The poor performance of the Delta 2914 launcher came at a bad time for ESA because its financial circumstances are already tight. The agency has been watching the McDonnell Douglas investigation into the launch failure very closely before giving the go-ahead for its orbital test-satellite launch in mid-June. This is scheduled to use the Thor-Delta 3914, which is functionally similar to the 2914.

Plessey plans subnanosecond ECL attack

Already producing devices based on emitter-coupled-logic technology, Plessey Semiconductors plans to strengthen its market position by introducing even speedier ECL products with nanosecond and subnanosecond specifications. The British company starts with an SP10200 series of 24 pieces that is typically 40% faster—or down to 1-nanosecond gate delays—than competitors' products. Following that are two subnanosecond devices. The SP16F60, with 0.5-nanosecond gate delay function, is three times faster than its ECL-3 counterpart, and the SP10F131 dual D flip-flop, with a 650-megahertz clockrate, is four times faster than its ECL-10k counterpart. Plessey, which says the new devices come from a high-speed variant of its Process-3 bipolar production line, aims the two products toward interfaces between computer LSI chips and peripherals, and in telecommunications, respectively.

Here's why REI can rent you what you want when you want it.



Our inventory. It's the biggest in the industry, with over 8,000 items of electronic test equipment in stock and ready to go. And it's getting better all the time, because we add more state-of-the-art equipment every month. This means we can deliver one special instrument... or a dozen... within hours of the time you place your order.

Now, more than ever, renting makes sense... to stretch your equipment budget, to fill temporary needs, and to avoid the long delivery lead times associated with purchasing. And renting from REI makes even more sense... because we're better equipped to fill your needs than any other rental company.

Send for our catalog today for a description of our rental, rental/purchase and leasing plans, and for our low rental prices. Or call the instant inventory center nearest you for immediate assistance.

Rental Electronics, Inc.,
99 Hartwell Avenue, Lexington, Mass. 02173.
Please send me your free instrument rental catalog:

Name _____ Title _____

Company _____

Address _____

City _____ State _____ Zip _____

Tel. Number _____

Rental Electronics, Inc.

Burlington, MA (617) 273-2770 • Gaithersburg, MD (301) 948-0620 • Oakland, NJ (201) 337-3757 • Ft. Lauderdale, FL (305) 771-3500
Des Plaines, IL (312) 827-6670 • Dallas, TX (214) 661-8082 • Mountain View, CA (415) 968-8845 • Anaheim, CA (714) 879-0561
Rexdale, Ontario (416) 677-7513

Circle 54 on reader service card

European companies ready 130-minute video recorders

Hard behind their Japanese counterparts, European consumer electronics producers are introducing video cassette recorders that can capture more than two hours of color programs without cassette change. First on the scene is Grundig AG, West Germany's largest entertainment electronics producer, which unveiled its VCR 4000 long-play system at the Hanover Fair last month and is now delivering it to retailers. Next is Philips Gloeilampenfabrieken, Europe's biggest electronics firm, which plans to introduce its system, the N1700, at the radio and television show in West Berlin late in August.

The two companies developed their respective systems on their own but consulted closely with each other to ensure compatibility. Both use the PAL color-TV standard that most European countries have adopted.

The long-play video recording equipment overcomes a big market-penetration obstacle that Grundig calls the "60-minute hurdle." Now, on one 130-minute cassette, users can record, say, an entire soccer match or a feature-length movie.

The longer playing time of video recording systems developed in Europe, Japan, and elsewhere is expected to have a big impact on equipment sales. In a market study, Grundig concludes that "at least in the so-called pacesetter countries, the breakthrough for the new medium has finally been achieved."

Compatible. Both the Grundig and the Philips equipment achieve their 130-minute breakthrough as the result of three design steps: lowering the tape speed to 6.56 centimeters per second, narrowing the video track to 85 micrometers, and doing away with the spacing between the individual tracks. Crosstalk or other interference between the directly adjacent tracks is prevented by having the two magnetic heads offset

by 15° with respect to each other. The control track, at the upper edge of the tape and thus well outside the recording area, has been widened to 0.7 millimeter. The greater width makes for steady pictures.

As the Grundig units at Hanover showed, the recorders have excellent picture reproduction and sharpness. The visible resolution is 3 megahertz, and the signal-to-noise ratio is 48 decibels.

One special feature on the Grundig versions are quartz-controlled servos for the magnetic head and tape-drive systems. Further, the capstan and the head disk have a beltless direct drive with optoelectronic control. Of note on the Philips recorders is an electronic digital clock that can be programmed for equipment turn-on and turn-off as long ahead as four days before a selected program is due to be broadcast. The recorder's built-in TV-receiving portion features automatic fine tuning. □

Great Britain

8-bit a-d converter is Europe's fastest

A very fast 8-bit analog-to-digital converter, easily the speediest 8-bit commercial unit in Europe and possibly anywhere, is being introduced by Cambridge Consultants Ltd. Designed primarily for applications in radar signal processing and transient recorders, the ADC 30.8 performs full 8-bit conversion every 33 nanoseconds with a 0.8% maximum nonlinearity rating, the firm says.

Buttressing the performance of the \$6,000 unit is a 10-picosecond rms figure for the aperture time uncertainty, or amount of timing error, says codesigner Julian Coles. That figure is low compared with the minimum 40-picosecond figure

Quartz watch uses solar cells

To cut down on the exasperating trips to the jewelers to get electronic-watch batteries replaced, Citizen Watch Co. of Tokyo turned to a

space-age solution—silicon solar cells. The result, Citizen's quartz solar-cell watch, is selling well in most major cities of the world.

At \$150 in Japan, it costs about \$35 more than a regular battery-operated analog stainless watch with quartz oscillator. But consumers seem to think the extra cost is worth it: more than 50,000 have been sold in eight months.

Weighing about 75 grams, sleek and thin with a stainless-steel flexible band and snap-shut case, the watch includes a second-hand stopper, time set, and power-saving switch. It comes in white face and black face, with the eight solar cells on the face resembling shuttered windows. It has a guaranteed accuracy of ± 15 seconds per month and requires only 10 minutes of light every day.



needed for an 8-bit, 30-megahertz a-d converter, and the firm achieves it by "paying particular attention to it," observes project director Robin Smith-Saville. Though much is shrouded in commercial secrecy, Smith-Saville says that the design uses optimized circuits throughout, such as "an optimized diode sampling gate" in the sample-and-hold circuitry in the front ends, stemming from extensive computer analysis.

Helping, too, is a new high-speed comparator from Plessey Semiconductors. Called the SP750B, the integrated circuit, which features simplified decoding, is two to three times faster than any competing device with an input-to-output time of 3.5 ns, according to codesigner Chris Davies. The device was designed by Plessey from specifications from Cambridge Consultants and was funded by the Ministry of Defence.

The basic layout, on one printed-circuit board, is not too unusual. An input amplifier receives the analog signals "to prevent spikes being thrown into the signal source," Davies says. It feeds the matched, ultrahigh-speed, low-jitter sample-and-hold circuitry, the output of which is split two ways: one going to the most-significant-bit parallel converter composed of 15 SP875Bs and the other buffered output joining the MSBs output to the least-significant-bit parallel converter composed of 21 SP750Bs. That decoded output, joined by interconnected inputs from the MSB data store and the redundancy arithmetic, feeds the converter's output latches.

In all, each sampled signal has 256 values assigned to it for accurate processing, Davies says. Apparently one trick is to use redundancy in the system to speed it up. The circuitry, for example, infers a mistake by the MSB and puts out a correct LSB code and instructions to correct the MSB code.

Emitter-coupled-logic is used because "it's quiet," Davies says. "We could have gotten away with transistor-transistor-logic with a lot of

it, but it could have lessened throughput."

The sample command input and the offset binary-coded-decimal digital output, overrange, and internal 30-MHz clock signals are all compatible with a 50-ohm impedance and ECL. The unit, made at the company's plant in Bar Hill, Cambridge, England, comes complete with power supplies in a low-profile 19-inch case. Cambridge Consultants, which is owned by Arthur D. Little Inc. of the U.S., has produced a commercial 4-bit 20-MHz converter, a 6-bit 30-MHz unit for the military, and a 20-bit 400-kilohertz unit for an unnamed client. □

Japan

Power transistors aimed at hi-fi

The superior characteristics needed for high-fidelity amplifiers coupled with ease of application and fabrication are major advantages claimed for new MOS FET audio-output transistors developed by Hitachi Ltd. Better frequency response, lower harmonic distortion, lower noise, and lack of annoying transients when driven to clipping levels—compared to present bipolar transistors—are improvements that listeners will notice when the company starts selling amplifiers with these devices in June.

What's more, with improved performance comes improved reliability. Absence of secondary breakdown and thermal runaway in this type of transistor means that amplifiers are less likely to require repairs.

The transistors are available in matched p-channel and n-channel sets for true complementary-symmetry operation. Nominal output power of a pair operated in class-B push-pull is 50 watts. With the proper heat sink attached to the TO-3 case, each transistor has a power dissipation rating of 100 w. Maximum current is 7 amperes and maximum voltage 120 volts, although a premium version rated at 140 v will be available and should give about 80 w

of output power. The n-channel HS 8401 and p-channel HS 8402 will be available on the open market after the end of the year.

Amplifier designers should be happy to find that these devices operate in the enhancement mode, which eliminates a bias power supply to set operating current. High input impedance and high gain also make the devices easy to drive. Input capacitance is also relatively low, about 400 to 500 picofarads for the n-channel device. The p-channel unit runs higher, 600 to 800 pF, due partly to its greater gate width.

The high current rating is achieved, simply stated, by making the channel wide enough to carry the current: 40 centimeters in n-channel devices and about 50 cm in p-channel devices, some 500 to 1,000 times the width of channels in small-signal devices. Transconductance is proportionally large, typically 1 mho, making for high gain, which reduces drive requirements compared with other devices.

Increasing the voltage rating is more difficult. An offset drain is used—actually a lateral gap between the edge of the gate and the edge of the drain. By itself, though, the offset drain could lead to trouble because an inversion layer may form in the portion of the channel without an overlying gate and increase the saturation voltage. Formation of an inversion layer is prevented by implanting ions in this region to a depth of less than 1 micrometer. Typically, saturation voltage for current of 7 A is only 7 v, at most 15 v.

Processing conditions for drain and source diffusion are identical with those used for signal transistors. In fact, fabrication is carried out on same line. What's more, implantation conditions are similar to those used for processing other devices.

Unfortunately, the high-voltage rating that makes these devices ideal for audio-power amplifiers makes them less than ideal for other applications. Still, the performance so far shown by these devices would be adequate in many applications and gives some indication of what could be expected from optimized devices. □

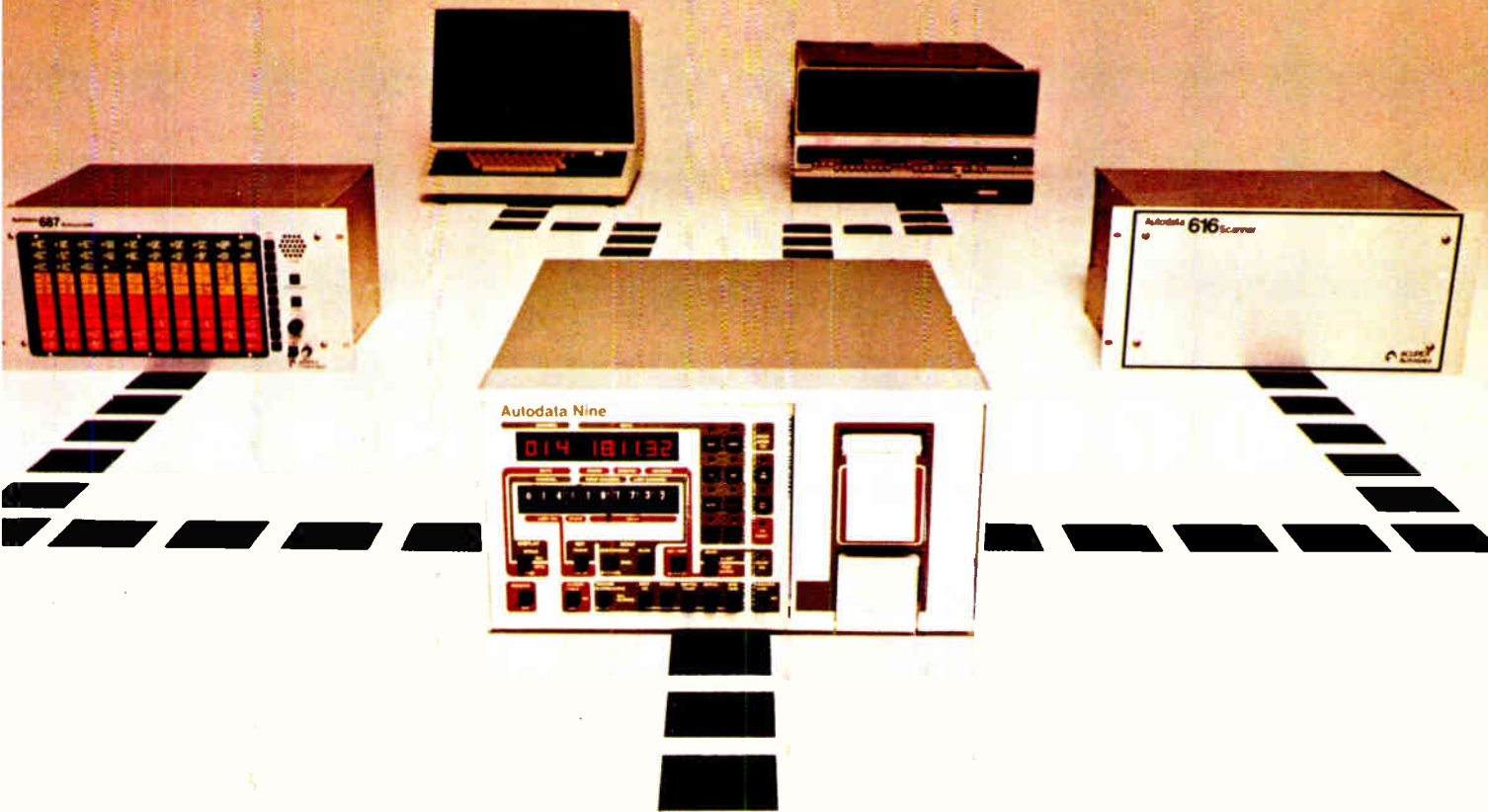

YOU DRAW THE LINE.

Monitor/alarm/control applications simplified: The Autodata Nine flexibility allows you to tailor a system to your needs by selecting the right options - just draw a line. Almost any line — from the Autodata Nine to computers, to CRTs, to Annunciator Panels, to Remote Scanners and to what you require. Here's how some of our customers draw their lines:

A major government agency needed a line on agricultural **data acquisition**. By plugging in an Autodata Nine they now measure (and record on paper tape) such diverse input as solar activity, soil moisture levels and weather data — over *several* hundred channels.

The engineers at a West Coast power plant are concerned about preventing excessive motor bearing, winding and boiler tube temperatures. **Process monitoring** is a natural for the Nine. And at this installation, it performs two-out-of-three logic for alarming and automatic shutdown, and informs the operator of problems through annunciator panels, and data printout.

We lined up another Nine for a marine biology study. The intent was to determine the effects of heat on marine life by varying water temperature in 30 tanks using cost effective **supervisory control**. Again, through a single Autodata Nine, temperatures were sampled, read and — when required — corrected by the incremental control of valve positioning.

We placed Autodata Nines at each of several engine test stands for one customer. He then drew a line from each to his central computer. Now they serve as **smart front ends** acquiring and manipulating data on temperature, pressure and flow under computer control (or manually if the computer is down). And since less software was required in the computer, the system was on line fast at the lowest cost.

These examples only begin to indicate the Nine's versatility. Get the Autodata Nine into your diagram — just draw a line around our number on the bingo card.

 **ACUREX**
Autodata Formerly Vidar Autodata

485 CLYDE AVE., MOUNTAIN VIEW, CA 94042 (415) 964-3200 (TWX) 910-379-6593

World Radio History

Circle 57 on reader service card

LEDs, make

For most displays, they're up to 8 ways better.



You've seen their bright, large, eye-pleasing characters in inexpensive calculators. They're called, technically, "Vacuum Fluorescent Indicator Panels" or, for short, **FIPs**. Actually, **FIPs** are modern developments of very old technology, that of the vacuum tube. In fact, they're triodes, complete with plate (anode), cathode, and grid, but with the addition of a phosphor on the segmented plate so the characters will glow. Brightly.



THE CHART TELLS THE STORY
Even though NEC is among the world's largest producers of both LEDs and gas discharge (plasma) displays, we see **FIPs** rapidly taking over for most applications—such as calculators, data & POS terminals, clocks, radios, car dashboards, microwave oven controls, instruments, CB, TV, etc. For obvious reasons, that are summarized in the chart at far right.

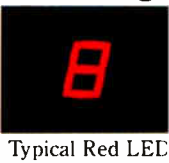

AND THERE ARE OTHER GOOD REASONS, SUCH AS RELIABILITY & LONG LIFE. The tremendous variety of uses that **FIPs** can be put to calls for very high acceptance standards. NEC has developed what may be the most rigorous QA and QC in the world. In a recent, routine test cycle, a total of 1085 **FIPs** of various models were put through a total of 15 grueling tests...with a single failure. The tests, and their standards, are described in the new **FIP Selector Guide**, available by mailing the coupon in this ad.

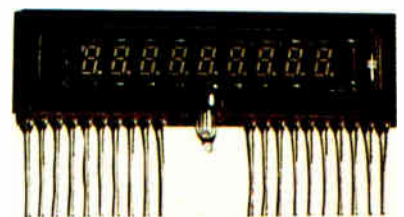

way for FIPs.*

ONE GLANCE TELLS THE COST/PERFORMANCE STORY. The larger the character size, the better the direct savings. That doesn't take into account the additional indirect savings from such things as simpler circuitry, fewer failures, and easier assembly. Check this graph, to get the idea.

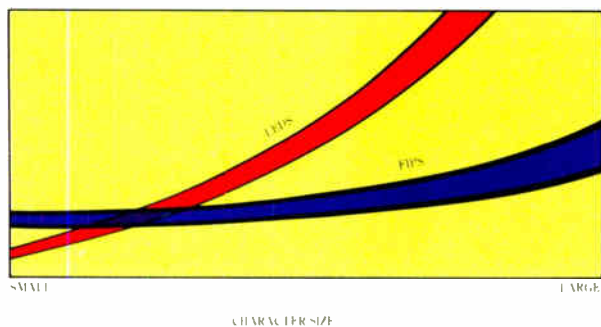

THE STORY ON BRIGHTNESS AND LIGHT BANDWIDTH. FIPs' phosphors are selected to be extremely efficient converters of electrical energy to light energy, minimizing power input. In addition, the light is spectrum-wide, from red to violet, and can thus be filtered to provide any single hue desired. The light predominates in the blue-green area, which overlaps the standard curve of human eye response (see graph), so the viewer perceives the maximum of brightness for the minimum of power input. And—the gentle, soothing blue-green glow is considered to be much less fatiguing to the eye than red and orange colors.

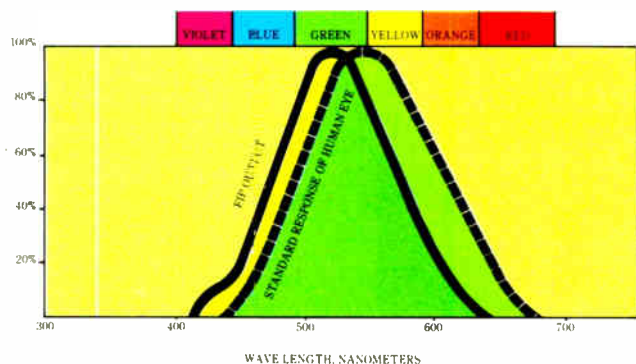

LED/GAS DISCHARGE/FIP COMPARISON CHART

	LED	GAS DISCHARGE	FIP
VOLTAGE	-1.7-5V	-150-200V	-10-40V
POWER/CHARACTER	high	low	low
CURRENT	high	low	low
MOS IC DIRECT DRIVE	no	no	yes
THIN & FLAT	yes	yes	yes
VIEWING ANGLE	wide	wide	wide
BRIGHTNESS	moderate	moderate	high
MOUNTING EASE	good	good	good
COST/PERFORMANCE	fair	good	excellent
READABILITY	fair	fair	outstanding
COLOR CHOICE	limited, fixed	red, limited	many - filterable

33 TYPES AVAILABLE IN HIGH VOLUME — **HOW TO SELECT YOURS?** Easy. Send for our just-off-the-press FIP SELECTOR GUIDE. It tells everything you need to know to select exactly the FIP for your application. Then, mail the postpaid return card bound into the guide, and we'll send you the data sheets you require, with the comprehensive specifications. Make sense? Then we hope to hear from you soon. Mail coupon, or telephone us at (408) 738-2180, Telex 34-7475.

NEC

NEC America, Inc.

CLIP THIS TO LET US HEAR YOUR RESPONSE

NEC America, Inc., Electron Devices Div.
3070 Lawrence Expressway
Santa Clara, CA 95051

Send me that 8-page FIP Selector guide.
My application is (or will be) _____.

Call me for immediate requirement at
(____) _____, extension _____.

NAME _____

TITLE _____ MAIL STOP _____

COMPANY _____

STREET _____

CITY _____ STATE _____ ZIP _____

*Registration Pending

Stretch your mind. Think Amphenol® connector systems.

Don't back off from your big idea. We can help you make it work. And work right.

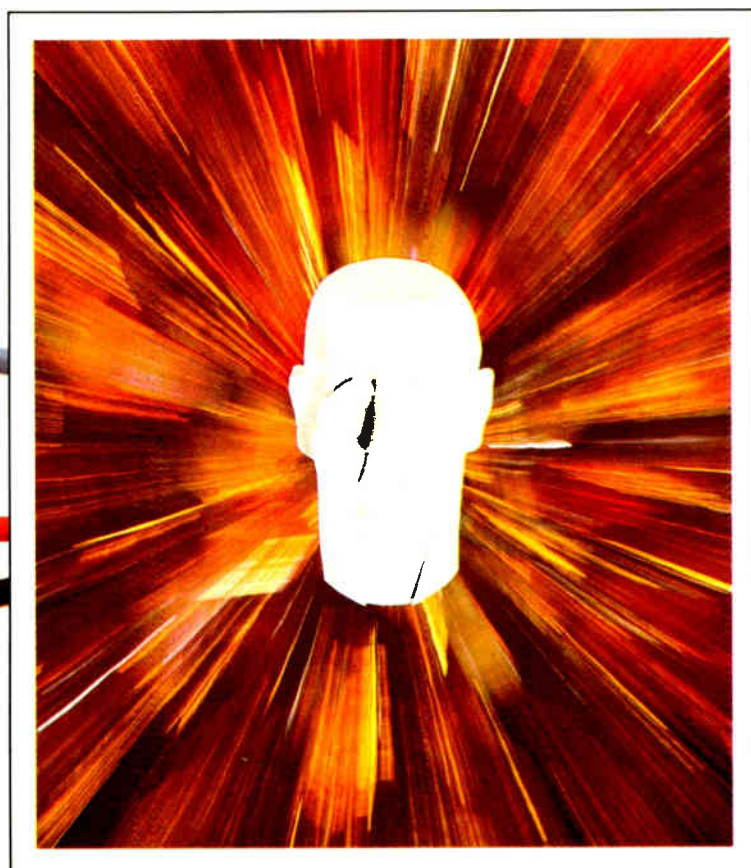

Dare to be different. We'll back you up with Amphenol connectors. We may already have the kind that'll make your big idea work.

But if we have to create something totally new to match your idea, we'll go all out—even to designing the required termination tooling. Our connector design specialists are known for the way they tackle the unknown. With a spirit that yields the answers.

Think of it this way: we can help you avoid a lot of false starts. And give you measurable quality and economy. The people who use the Amphenol con-

nectors shown here know that's true. They think of us first when they need connectors for consumer and business products, data and word processing equipment, aerospace and military applications, telephony, and more.

Got a mind-stretching idea? Then include Amphenol connectors in your thinking. To get started on the right track, just call us at (312) 986-2320 or write to: Amphenol North America Division, Bunker Ramo Corporation, Dept. A57A, 900 Commerce Drive, Oak Brook, Illinois 60521.

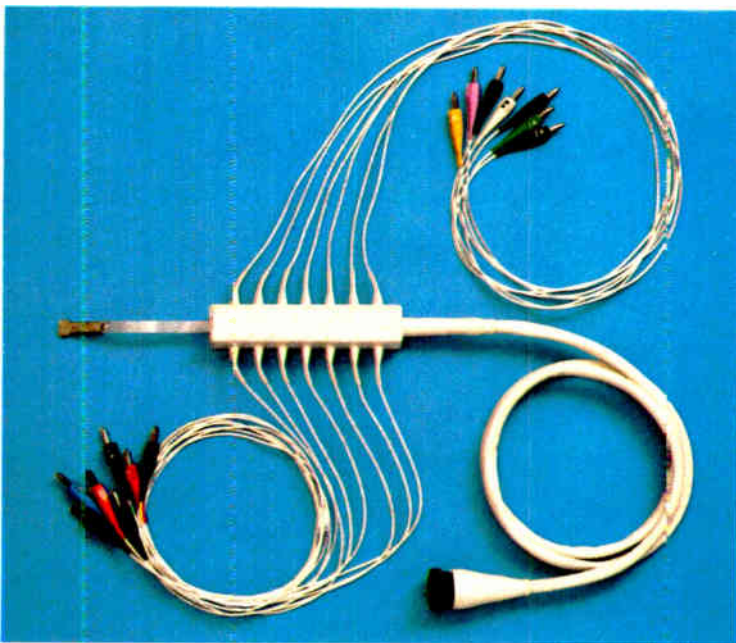

Medical interface cables for critical applications. Provide reliable patient monitoring and medical electronics interface. Custom-made for reliability, good looks.

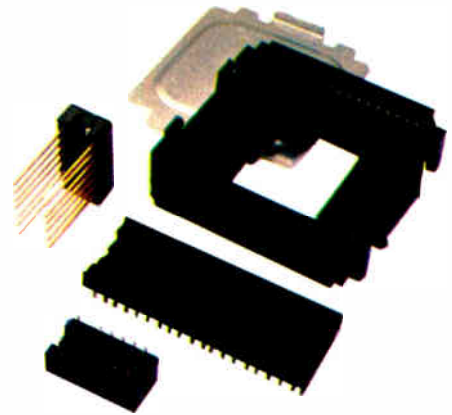

No more unsoldering for IC replacement. Dual-inline IC's or planar leadless MOS/LSI's plug right into 800 Series devices.

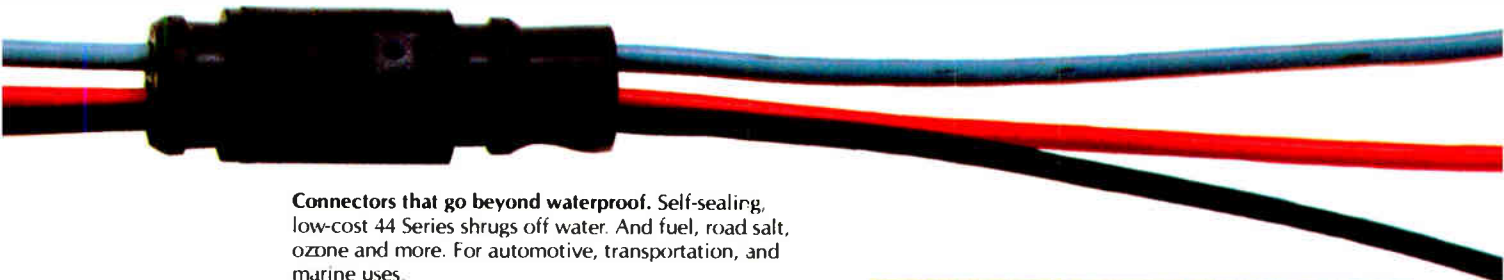

Connectors that go beyond waterproof. Self-sealing, low-cost 44 Series shrugs off water, And fuel, road salt, ozone and more. For automotive, transportation, and marine uses.

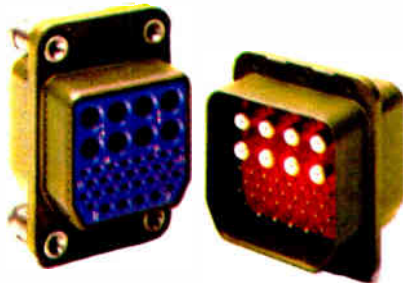

Rack-and-panel connectors that advance the state of the art. 94 Series environmental connectors utilize polymer-retention discs to retain the 20, 16 and shielded size contacts.

A way to slash telephone key-set installation costs. System 66 connectorized blue-field panels are pre-wired. No cables to punch-down.



Precision optical connectors from stock. Optimum components for emitter-to-cable, cable-to-detector, and cable-to-cable junctions. All with standard SMA size mating.

The right idea
at the
right time.

AMPHENOL **BUNKER RAMO**®

Circle 61 on reader service card 61

Intel delivers the first

The Intel® 2716 is the first 16K UV-erasable and electrically programmable read only memory (EPROM). The 2716 operates from a single 5 volt power supply, has a static power down mode and features fast, single address location programming. It makes designing with EPROMs faster, easier and more economical than ever before. Then, when you're ready for production quantities, move rapidly to Intel's new pin-for-pin compatible 16K ROM, the 2316E.

Since the 450 nsec 2716 operates from a single 5 volt supply it is ideal for use with the newer higher performance +5V microprocessors such as Intel's 8085 and 8048. The 2716 is also the first EPROM with a static power down mode which reduces the power dissipation

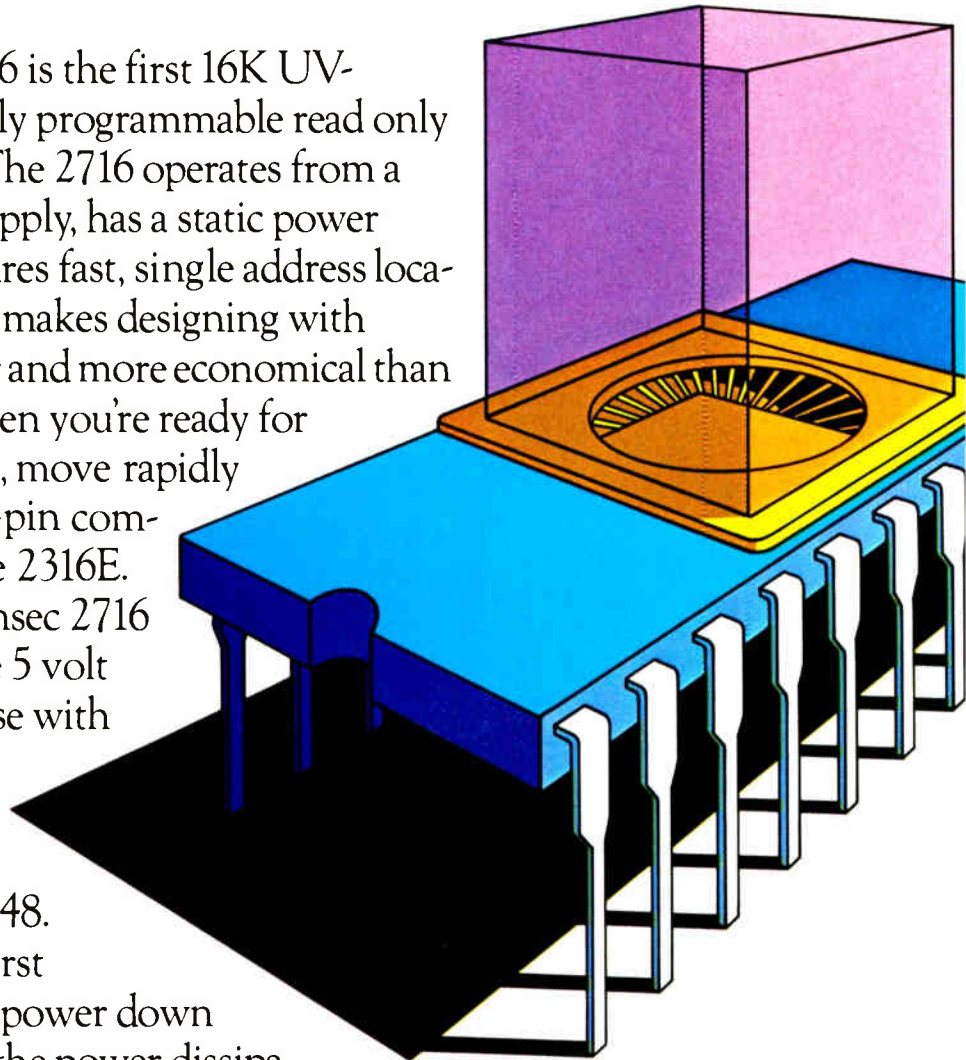

without increasing access time. Active power dissipation is 525 mW while standby power is only 132 mW—a 75% savings.

The 2716 has the simplest and fastest method yet devised for programming EPROMs—single pulse TTL level programming. No need for high voltage pulsing because all programming controls are handled by TTL signals. Now you can program on-board, in the system, in the field. You can program any location at any time—either individually, sequentially or at random, with the 2716's single

5 volt 16K EPROM.

address location programming. Total programming time for all 16,384 bits is only 100 seconds.

The 2716 EPROM is pin compatible and directly interchangeable with Intel's new 450 nsec 2316E mask programmed ROM. Debug your systems using

EPROM and when the pattern is firm, order the 2316E ROMs and plug them directly into the 2716 sockets. Turn around time on ROMs

INTEL EPROM & INTERCHANGEABLE ROM FAMILY					
EPROM	Interchangeable ROM	Size	Organization	Power Supply	Max. Access Time
2716	2316E	16K	2K x 8	+5, only	450 nsec
2708	2308	8K	1K x 8	+12, ±5	450 nsec
1702A	1302	2K	256 x 8	+5, -9	1 μsec

has been reduced to 6 weeks ARO. If you prefer, ship the first few products with 16K EPROM and switch to 16K ROM in the field. Either way you get the flexibility of EPROM and the economies of ROM. Both from Intel.

Double the size of your program memory, improve performance, and get your product to market faster with Intel's reprogrammable 2716. And save money in production with the compatible high speed mask programmable 2316E ROM. The fastest way to get started is to order the new 2716 16K EPROM from your local Intel distributor. Contact: Almac/Stroum, Components Specialties, Cramer, Elmar, Hamilton/Avnet, Industrial Components, Liberty, Pioneer, Sheridan or L.A. Varah. And for quick turn around on the 16K mask programmable 2316E contact your local Intel sales office.

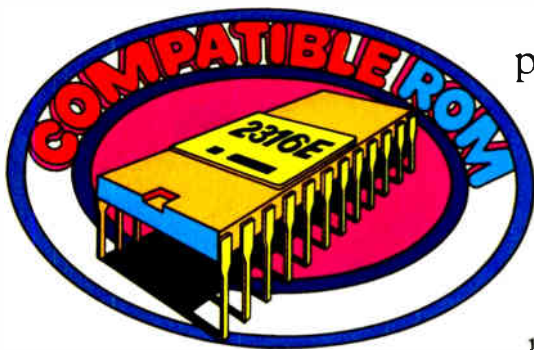

For technical information and a copy of "The New 16K EPROM" article reprint (AR-42) use the reader service card or write: Intel Corporation, 3065 Bowers Avenue, Santa Clara, California 95051.

For technical information and a copy of "The New 16K EPROM" article reprint (AR-42) use the reader service card or write: Intel Corporation, 3065 Bowers Avenue, Santa Clara, California 95051.

intel[®] delivers.

YOUR
PRODUCT



If your products produce raw data but your customers want results, here's a ready-made answer:

HP computing controllers.

HP computing controllers can make your instruments "smart," fast. Economically. And without hassle.

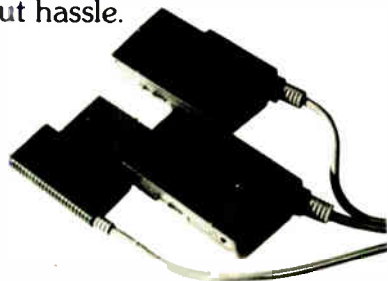

First, they're easy to interface. You simply connect your product to the appropriate HP interface card and plug into the computing controller. We know of users who have been up and running in less than a week. And you can choose from four commonly used interfaces—BCD, bit-parallel, RS-232C or HP-IB (HP's implementation of IEEE Standard 488-1975).

You can reduce development costs. Easy programming and easy interfacing save many costly hours in developing a ready-to-market product. And the costs are all up-front with HP computing controllers—visible before you make a commitment.



You can extend product life cycles. A mature product can receive a shot-in-the-arm when enhanced with automatic data acquisition and analysis capability. The cost could well be less than \$4000, depending on the specific computing and control requirement.

Ease of interfacing lets you consider retrofitting at custom-

er locations, if you desire. And worldwide HP service stands ready to back you up if needed.



You can increase customer satisfaction. The addition of data acquisition and analysis, inexpensively through HP computing controllers, adds visible value to your product—at a competitive price. Value, plus your customers' demonstrated respect for HP products, adds up to customer satisfaction.

We think these are powerful reasons why you should write for our brochure without delay.

From computers-on-a-board to general-purpose systems, HP can meet your interfacing needs.

HEWLETT  PACKARD

P O Box 301, Loveland, Colorado 80537

For assistance call Washington (301) 948-6370, Chicago (312) 255-9800, Atlanta (404) 955-1500, Los Angeles (213) 877-1282

1967
J259



1970
J283



1972
J273



1975
J387



Is this the end of the line?

Wherever semiconductors are tested in high volume, one name says it all—Teradyne. Some of our systems have made history in their own right: the J259, which was industry's first computer-operated IC test system, the J283, the J273, the J325, the T317, the J387, to name a few. It all adds up to an installed base of almost a quarter of a billion dollars and a record of on-line experience no one else even approaches.

Today's Teradyne systems are capable of testing over 80% of all semiconductors being produced, including RAMs and ROMs to 65k, op amps, voltage regulators, chroma and stereo demodulators, TTL, CMOS, ECL, transistors, diodes, and just about every other semiconductor device produced in high volume.

We've won our dominant position at the end of the semiconductor production line and at the beginning of the electronics assembly line through hard work and understanding. What we start, we stay with, but you can see that every time you walk through your production-test or incoming-inspection area.

We've come to think of those places as our turf, and we intend to keep it that way.

TERADYNE

Semiconductor Test Division
Boston, Mass. — Chatsworth, Calif.

From TI's perch, things look good

Firm predicts 18% increase in worldwide sales over 1976's strong \$5.606 billion, with IC market showing a 24% increase

by Bruce LeBoss, New York bureau manager

Texas Instruments' crystal ball is radiating optimism. The reason, to quote Charles M. Clough, semiconductor marketing manager for the giant Dallas firm, is that this year's worldwide semiconductor market "will be up strongly over 1976" followed in 1978 by what is "likely to be a good year." Clough predicts a new peak in 1977 of \$6.625 billion in sales.

Although some consider TI conservative, Clough forecasts an 18% hike over last year, when worldwide sales soared approximately 32% to a record \$5.606 billion. That 18% prediction is not far below the industry consensus as reported at the beginning of the year [*Electronics*, Jan. 6, p. 88]. In 1976, for the first time, sales of integrated circuits topped those of discrete components (\$2.880 billion vs \$2.726 billion). This year, they will lead growth with a 24% rise to \$3.580 billion, while sales of discretives, estimates Clough, will grow 12% to \$3.045 billion.

The U. S. semiconductor market, which jumped 33% from \$1.8 billion in 1975 to \$2.39 billion last year, will continue to track with the world market and tack on another 18% this year to reach \$2.83 billion. Leading that growth, says the TI marketer, will be the computer and industrial market segments with gains of 26% and 24%, respectively, while the consumer, Government, and distribution segments each post a 14%-to-15% increase in semiconductor revenues. The growth in computer end-equipment sales will be paced by minicomputers and peripherals, Clough figures, while the industrial segment will be led by the telecommunications industry.

SEMICONDUCTOR MARKET (IN MILLIONS OF DOLLARS)					
	1975	Change (%)	1976	Change (%)	1977
WORLDWIDE					
Total	4,235	+32	5,606	+18	6,625
IC	2,028	+42	2,880	+24	3,580
Discretives	2,207	+23	2,726	+12	3,045
DOMESTIC					
Total	1,800	+33	2,390	+18	2,830
Computer	340	+26	430	+26	540
Distribution	310	+55	480	+15	550
Consumer	380	+42	540	+15	620
Industrial	380	+32	500	+24	620
Government	390	+13	440	+14	500

SOURCE: TEXAS INSTRUMENTS INC.

On the basis of trends in new orders, Clough sees the domestic computer market for semiconductors growing to \$540 million this year, up from \$430 million last year and \$340 million in 1975. During the first half of 1976, TI's major computer customers "returned strongly to the logic market" thanks to their 25% to 45% planned equipment growth and refurbishment of low year-end 1975 inventory levels. As a result, Clough explains, his semiconductor competitors' "lead times lengthened suddenly . . . and they predicted further lead time deterioration throughout the year." As this was happening, small- and medium-sized computer customers turned to distributor stocks for immediate needs and placed orders with 16 to 20 weeks' lead time with semiconductor manufacturers.

During the second half of 1976, procurement by the major computer customers held at high levels, and by year-end their inventories were in line. Meanwhile, Clough notes, procurement at the second-tier comput-

er customers dropped in the fourth quarter as they balanced backlog to be in line with short lead times. "Ordering through distribution also dropped as products ordered direct from semiconductor manufacturers in the second and third quarters were shipped."

Decrease. This year has seen a drop in procurement by major computer customers in January and February as they all negotiated new contracts, followed by a recovery to "very high" levels as all users refurbished inventories and began ordering for a "strong upside year." At the same time, Clough continues, second-tier computer customers, whose backlogs and inventories were in line at year-end, began procuring semiconductors 2½ times faster than the rate of the previous quarter.

Forcing additional demand upon these second-tier computer manufacturers, adds Clough, is the fact that Digital Equipment Corp.'s minicomputer lead times are "now out to 12 to 18 months for small units."

Striding along with the computer

Probing the news

sector, the U.S. industrial market for semiconductors will continue its strong growth rate and reach \$620 million in 1977, up from \$500 million last year and \$380 million in 1975, predicts Clough. During 1976, that segment's growth was spurred largely by the change from electrical to electronic telecommunication switching systems, "creating a strong and continually increasing demand for semiconductors." Also, he adds, "Western Electric's move to outside procurement for memory, particularly 4-k RAMs" was a strong factor. Meanwhile, the machine tool industry "turned up in mid-1976 . . . driven by strong car sales," and the instrumentation market was up steadily throughout 1976.

In full swing. The industrial market shows that production of switching systems is in full swing. Additionally, says Clough, 4-k RAM usage will dominate 1977, with 16-k RAM designs starting in the fourth quarter of 1977. But while Western Electric went to outside suppliers to fill its 4-k RAM needs, Clough believes it will try to build 16,384-bit RAMs in house—something that "would impact on us." Additionally, he notes, the machine tool and instrumentation markets, again aided by strong car sales, will continue their steady growth.

Car production, which was up by 28% to 8.5 million units in 1976, also was a major reason the domestic consumer market for semiconductors grew to \$540 million last year from \$380 million in 1975, and will again lead that market to \$620 million in 1977, according to Clough. Semiconductor content per car went from \$12 in 1975 to \$14.76 last year when electronic ignition systems were standard equipment. Additionally, microprocessor engine control development programs for the 1979 model year were begun by the Big Three auto makers in 1976. In other consumer areas, semiconductor content per color television set went from \$14 in 1975 to \$15 last year, while TV set sales to dealers jumped from 6.5 million to 7.7 million units. Also, semiconductor demand was strong from watch, video-game, and

calculator manufacturers, with "microprocessor applications up sharply in games, microwave ovens, and other appliance controls."

The outlook for the consumer market in 1977, says Clough, is that demand will be strong, with TV accessories, automotive, and new applications the main growth segments. Auto makers are quite bullish: they are forecasting about 11 million units, and their projections for the second quarter of 1977 are the highest since 1973. "Semiconductor demand is up sharply, despite the slowdown caused by the severe winter, for current standard production programs (for example, Chrysler's lean burn spark advance) and specialty accessories (like Ford's lighted door lock)." Additionally, he continues, "microprocessor engine-control development programs are in full swing and will [bring to] \$27.50 [the] semiconductor content per car" in 1979 and "other microprocessor development programs coming fast (such as cruise controls and feedback carburetor) will add \$10 to \$14 in semiconductor content per car."

For color TV, demand was down in January and February of this year, but was "up sharply in March and April," notes Clough. However, "TV accessories—game controllers, terminals, telephones, and video players—are the fastest growth por-

Likes what he sees. Charles M. Clough, TI's semiconductor marketing manager, predicts strong 1977 followed by a good 1978.



World Radio History

tion" of that market, "driving semiconductor content to \$25 in 1977." Among the services that these accessory equipments will provide through the TV, which is fast becoming a "home communications center," says Clough, are games, data retrieval, a message center, and even the home newspaper.

Distributors up. Distributors' sales, which last year tacked on a whopping 55% increase to reach \$480 million, will be up sharply in the first and second quarters and grow moderately in the second half of 1977, totaling \$550 million by year's end, predicts Clough.

The result of last year's rush to distributors by smaller computer companies was a strong upsurge in first quarter 1976 distributor sales. "Erroneously predicted lengthening lead times encouraged some distributors to over-order in anticipation of a product shortage which didn't happen," he says. Nonetheless, sales were up again in the second and third quarters and dropped slightly in the fourth quarter.

During the first quarter of this year, distributor sales were up in both January and February and "hit record levels in March," Clough says. Unlike a year ago, distributor inventories are in line with sales, and bookings from the distributor to the semiconductor manufacturer have swung up sharply. "Second quarter resales will be up by 12% to 15% over the first quarter," he continues, "and increase moderately in the third and fourth quarters."

As for the Government market for semiconductors, which last year jumped 13% to \$440 million, it "will continue its present growth rate as electronic content increases in new strategic and tactical military systems," says Clough. The U.S. Government market will hit \$500 million in 1977, he estimates.

Last, but by no means least important, Clough notes that while "billings are going up nicely" the industry is healthier in that there's a "stronger degree of normalcy" with respect to customer demand and usage. "Total unit demand is rising," he says, and the percent of new unit entries that are for near-term (current month to three months out) "is up sharply." □

Introducing Robert Bosch Mini-Giants

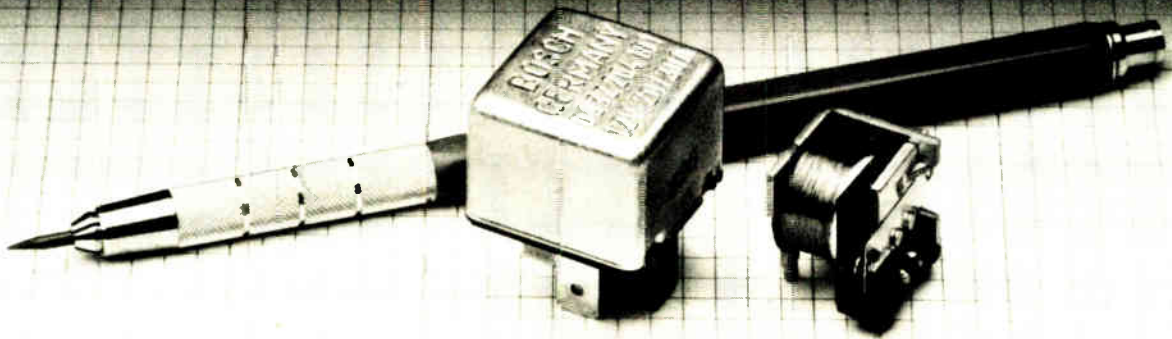

30-amp relays with a quarter-million cycles: smallest for the price

We invite you to compare the high technology advantages of Bosch Mini-Giants to the relays you're now using. We're confident you'll find Mini-Giants hard to beat on all the important criteria.

Versatility. Bosch has engineered the Mini-Giants to be at home in any 12- or 24-volt application—remote controls, generators, automotive systems, construction machinery, marine applications, agricultural equipment, hospitals, storage systems and more.

The same Mini-Giant that can switch the low current of an alarm can also control the high 30-amp load of a heating system.

Size. Bosch technologists have designed a PC board type relay that is 1" x .8" x .7" or just over half (.56) a cubic inch. The plug-in type (not including the plug prongs) is 1" x 1" x .8," still less than a cubic inch.

Capacity. Bosch plug-in Mini-Giants cover the entire power range up to 30 amps, with a peak current capacity of 60 amps. Even the standard 15-amp PC type is available in a 30-amp version on special order.

With one group of relays covering such a range of applications, you can cut down substantially on part numbers and simplify your stocking operations.

Reliability. All Mini-Giants are good for a minimum of 250,000 cycles at the rated current. This compares with 100,000 cycles in many comparable relays from other manufacturers.

And Bosch uses the finest materials for long life (at least 10 million cycles at no load). For example, we build the leaf springs of our plug-in relays from high-grade silver and bronze.

Cost. Bosch Mini-Giants give you all these benefits combined at

a surprisingly low price. You really should compare.

For more information. Fill out the coupon below and we will contact you to discuss your specific needs and answer your questions. Or call (312) 865-5200 and ask about relays. Either way, do it now.

Robert Bosch Corporation,
Department O/ESL
2800 South 25th Avenue,
Broadview, Illinois 60153

Name _____

Address _____

City, State, ZIP _____

Telephone _____

E/5/77

MINI-GIANTS
ROBERT BOSCH

Circle 69 on reader service card

Consumer electronics

When will 23-channel faucet run dry?

Most U.S. CB firms believe leftover sets are almost gone as they stick with 1977 sales estimates of 8 million to 10 million units.

by Larry Armstrong, Midwest bureau manager

The once-ebullient citizens' band radio market has settled down to wait out the end of the supply of 23-channel sets, which are still being sold—at absurdly low prices. Nevertheless, most CB manufacturers and importers remain confident that their January estimates that 8 million to 10 million units would be sold in 1977 will prove to be accurate. The Electronic Industries Association estimates 1976 sales at over 10 million.

They have, however, revised their forecasts of the sales split between the surplus 23-channel radios and the newer 40-channel version. "There have been a heckuva lot more 23-channel units than anyone appreciated," says Gus Wirth, president of Kris Inc., Cedarburg, Wis. "Everyone added up the units, but no one added up the parts waiting to be built into sets." Earlier, most manufacturers felt that only 2 million 23-channel sets remained in the inventory after last year's Christmas flurry of hearty price cutting; now, most concede that 3 million to 5 million 23-channel sets will be sold this year, mostly at or below cost.

The impact, of course, is being felt at the bottom line, as earnings sag while unit sales remain level or slightly up. Much of the industry swallowed its red ink late last year, when losses could be made up in annual reports by abnormally high first-half profits. The rest are taking inventory write-downs now.

Because manufacturers are anxious to get on with the business of selling CB at a profit, 40-channel pricing has started to soften to meet the low-priced "holdover" 23-channel units. With very rare exceptions,

though, the price moves have been labeled "promotional" as manufacturers seek to match the seasonal promotions of the rest of the consumer electronics industry, or they have come as incentives offered to distributors and dealers.

Blow in Japan. Most surprised and hurt by the attack the U.S. CB market has taken are the Japanese firms that supply the lion's share of the market. Haruki Tomono, president of Cybernet Electronics Corp., Japan's leading CB manufacturer, now expects U.S. demand for 40-channel sets to top out at about 6 million or 7 million units this year. Behind his forecast are unusually strong first quarter shipments, which total over 2 million units, according to the Japanese Ministry of Finance (see table). May shipments, however, will dip below 500,000, and will stay at that low level through July or August, Tomono says.

While substantially below his original estimate of 10 million 40-

channel sets in the U.S. in 1977, Tomono's new forecast is well above that of even the most optimistic domestic manufacturers and importers, who put 40-channel sales at between 5 million and 6 million units. "There is no question that we were bullish, and our predictions aren't coming to pass," says Paul E. Davis, vice president of Chicago's Dynascan Corp. and general manager of its Cobra Communications division.

Davis originally guessed that 9 million 40-channel CBS would be sold during 1977, along with 2 million 23-channel sets. He has revised his forecast into the 8-million-to-10-million range on which the industry seems to have settled. He breaks down that figure into 5 million or 6 million 40-channel units and 3 million or 4 million 23-channel leftovers.

But Davis is not worried about the dollar value of the market: "There will be fewer units sold this year, but

JAPANESE CB EXPORTS TO U.S. (SETS WITH FINAL INPUT OVER 100 mW)			
	1976	1977	CHANGE
JAN.	641,505	583,535	-57,970
FEB.	696,140	726,734	+30,594
MARCH	1,060,312	746,659	-313,653
APRIL	1,168,894		
MAY	1,273,295		
JUNE	1,472,918		
JULY	1,664,029		
AUG.	1,289,728		
SEPT.	1,349,596		
OCT.	877,297		
NOV.	761,746		
DEC.	861,930		
TOTAL	13,117,390	2,056,928	

SOURCE: JAPANESE MINISTRY OF FINANCE



Series X-20
Actual Size

WE'RE WARNING YOU...™

... panel mounting is made very easy with these new piezo crystal audio indicators. They fit a 1.125" (28.6mm) diameter opening in panels as much as 0.125" (3.2mm) thick. Behind panel depth only .500" (12.7mm)! Can be used for computer terminals ... or remote control warning, fault detection and alarm devices ... or to replace other, larger alarms. Continuous tone 35mm diameter sounding element really gets attention. Rated to 85 dbA at 3.3 kHz; 6 to 16 vdc; current drain just 10 mA. Terminals accept 0.187" (4.76mm) disconnects, screws or solder. Ask for free catalog and a demonstration.

Where to buy an audio indicator for every need:



3680 Wyse Road, Dayton, Ohio 45414
Tel. (513) 890-1918, TWX 810-450-2523

Distributors throughout the world.

CALIFORNIA, COSTA MESA
Mar Vac Electronics

CALIFORNIA, SUNNYVALE
Pyramid Electronics

COLORADO, DENVER
Waco Electronics Inc.

MASSACHUSETTS, SHARON
Adcour

MICHIGAN, FARMINGTON
CMP Distributor Co.

MISSOURI, ST. LOU'S
Olive Industrial Elec.

NEW JERSEY, WAYNE
Gordon/Horne, Inc.

NEW YORK, ROCHESTER
Ossmann Component Sales

OHIO, CINCINNATI
Hughes Peters Inc.

OHIO, CLEVELAND
CMP Distributor Co.

OHIO, COLUMBUS
Hughes Peters Inc.

OHIO, DAYTON
NASCO

TEXAS, DALLAS
GARLAND

K. A. Electronics

WASHINGTON, SEATTLE
Frank Jackson & Associates

WISCONSIN, MILWAUKEE
Taylor Electric Co.

B. C. VANCOUVER
Deskin Sales Corp.

ONTARIO, TORONTO
Deskin Sales Corp.

ONTARIO, WILLOWDALE
Electro Sonic, Inc.

QUEBEC, MONTREAL
Deskin Sales Corp.

Circle 117 on reader service card

Beyond the ordinary!

DigiTec printers are precision crafted instruments, offering reliability, workmanship and features that distinguish them from the ordinary. Ideal for laboratory, systems or OEM applications. Their sought-after features include: floating decimal, selective data blanking, systems interface, red and black print, data grouping and front panel paper loading and ribbon changing without exposure of electronic components.

Selected models include a crystal clock, an events counter, and 10 to 21 column recording capability.



DigiTec.

**UNITED
SYSTEMS
CORPORATION**

918 Woodley Road, Dayton, Ohio 45403
(513) 254-6251, TWX (810) 459-1728

DigiTec: precision measurements to count on.

*These instruments available under
GSA contract GS-00S-27741.*

When reliability counts

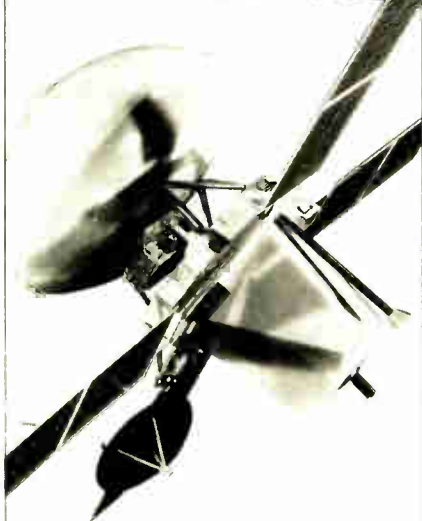

Count on Custom mica paper capacitors

Custom mica paper capacitors are used in a wide variety of applications from spacecraft to medical electronics — areas where component failure can be fatal.

For this reason, every capacitor we produce is subjected to stringent quality control testing. After all, our customers have to count on reliability!



CMR — wrap and fill

CEM — epoxy molded

CER — epoxy housed

Write for FREE Techni Tips:



CUSTOM ELECTRONICS, INC.
12 Browne Street, Oneonta, NY 13820
PH: 607-432-3880 TWX: 510-241-8292

Probing the news

the average prices are higher. We'll come out about the same as 1976, about \$900 million to \$1 billion at retail," he says. He contends that while there will be 23-channel CBS around through August, they will be the harder-to-sell midline merchandise; "The really low-priced stuff had washed through by the end of last year."

His estimates are borne out by his firm's first-quarter results. Dynascan took its 23-channel inventory write-downs last year, and, while first-quarter profits were down 38% to about \$1.7 million, sales were up 69% to \$37.4 million.

Year's wait. "It's certainly going to take the better part of this year to get the 40 going and the 23 gone," echoes David C. Thompson, president of SBE Inc., Watsonville, Calif. But Thompson still figures that 5.5 million 40-channel sets will sell in 1977, along with an equal number of 23-channel CBS.

Adds Lawrence M. Kraines, president of Krako Enterprises Inc. in Compton, Calif.: "While the market has not stabilized as we thought earlier, I'm sticking with my 10-million-unit projection. What happened was the guess of 2 or 3 million 23-channel CBS in the pipeline turned out to be more like 5 million." By June, these will be sold, and 40s will be back strong in the second half, he contends, to split the year 50-50 with the 23s.

Price cutting on 23-channel sets started last August when the Federal Communications Commission approved the Jan. 1 expansion to 40 channels; it quickened as 40-channel introductions approached. E. F. Johnson Co. waited until it had 40-channel sets on the market before it cut its prices on 23-channel units, and is now one of the few manufacturers still shipping 23-channel sets. "But we're down to our last 23-channel inventories, and 23-channel prices are starting to edge back up," says Craig Reitan, marketing vice-president for the firm's newly formed Johnson American Inc. subsidiary in Clear Lake, Iowa.

Johnson's late move onto the 23-channel battlefield left it with only

marginal first-quarter profits of \$282,000—a 91% drop—on sales of \$19.3 million, down 35% from last year's first quarter. Its poor showing prompted Johnson, one of the last firms to cut 23-channel prices, to become one of the first firms to cut 40-channel prices. And last month Johnson cut list prices from 17% to 23% across its line.

Not universal. Price cutting on 40-channel sets has not yet afflicted all of the industry, and most of those that have rolled prices back have left themselves the option of reinstating their earlier, higher 40-channel prices. "We have a promotion running, and it expires the end of this month," states John D. Mueller, marketing vice president at Motorola Inc.'s Automotive Products division in Schaumburg, Ill. "We do not consider it a rollback. We believe a price-value relationship will be re-established in this industry, or a whole slew of people will go out of business." Motorola is one of the few firms that opted not to cut prices on 23-channel sets at all.

Regency Electronics Inc. also has run promotions with dealers and distributors, such as selling them a dozen 40-channel sets for the price of 10. But it has left pricing up to the dealer, and has not changed its suggested list prices. "If demand remains constant and 23-channel supplies dry up, 40-channel prices will move back up," says Steve Crum, marketing services manager for the Indianapolis firm. "We also feel that the model mix will shift upwards toward more fully featured sets, and from mobiles to base stations." That shift may already have started with the introduction by Texas Instruments Inc. of its 40-channel, microprocessor-based unit (see p. 31). Hy-Gain Inc. of Lincoln, Neb., also has introduced a microprocessor-based 40-channel model.

Upward pressure on the yen will keep prices firm, say several importers, including William Thomas of Pathcom Corp.'s Pace Communications division, Harbor City, Calif. Adds Kris Inc.'s Wirth: "We importers are between a rock and a hard place, and where the 40-channel prices are now will be quite firm. The yen revaluation is beginning to hurt us." □

There's a Simpson DPM that's right for your application

All Simpson DPM's feature:

- 0.1% accuracy
- 3-1/2 digit readout
- Automatic zero and polarity
- Dependable LSI circuitry
- Choice of 120/240 V AC or 5 V DC operation
- Panel cutout 1.682" x 3.622". Adaptors available for IEC/DIN and other domestic cutouts
- Input/output edge connector included
- Full 200 hour burn-in
- Backed by the Simpson one-year warranty

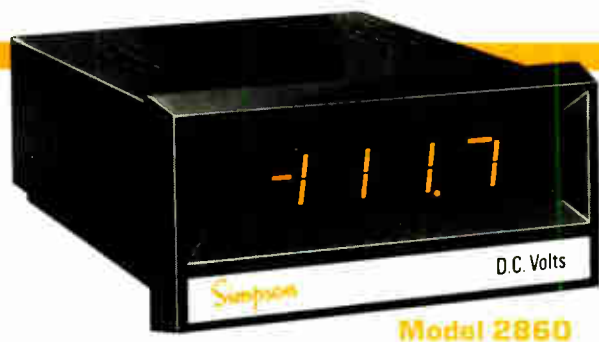

Model 2860

The Dedicated DPM

New Series 2860—high performance at a low price

from **\$46***

- 9 stock ranges available
- Bright 0.43" LED readout

The Systems DPM

Deluxe Series 2850—printer/computer interfacing capability and options for custom applications

\$92*

- 9 stock ranges
- Specials available including AC ranges
- Choice of 0.43" LED or 0.55" planar gas discharge display
- BCD output standard

* 100-lot OEM prices

Available From
Electronic Distributors
Everywhere

Write for Bulletin PB12
containing complete
technical specifications.



Model 2850



Model 2852

SIMPSON ELECTRIC COMPANY

853 Dundee Avenue, Elgin, Illinois 60120

(312) 697-2260 • Cable SIMELCO • Telex 72-2416

IN CANADA: Bach-Simpson, Ltd., London, Ontario

IN ENGLAND: Bach-Simpson (U.K.) Ltd., Wadebridge, Cornwall

IN INDIA: Ruttonsha-Simpson Private, Ltd., Vikhroli, Bombay



KATY INDUSTRIES



INDUSTRIAL
EQUIPMENT
GROUP

Circle 73 on reader service card

Energy

Carter plan faces long struggle

With near-term emphasis on electric cars, photovoltaic R&D would chalk up limited gains; appliance power cuts are an issue

by Ray Connolly, Senior Editor

On April 29, just 10 days after he had broadcast his energy plan to the nation, President Jimmy Carter completed its final version with the evaluation that "the plan is complicated," but he took pains to note also that "above all it is fair." Initial congressional reaction was widespread agreement with Carter's first point but disagreement with the second.

Besides focusing on the complicatedness, much of the congressional criticism arises from the proposed organization of a new Department of Energy that would grant its would-be head, James Schlesinger, unprecedented authority to control fuel prices. These jabs appear to guarantee that Congress will "rewrite, amend, and then write again" the legislative package. This view from one senior staff member at the Energy Research and Development Administration is widely held by other energy bureaucrats and their lobbyist counterparts in industry.

"Carter's relations with Congress in general are off to a bad start," the ERDA staff member points out. "The issues here are policy and organization, not technology. But don't expect much by way of new technology initiatives until the policy and power things are resolved."

There are three specific areas of interest to electronics technologists in the Carter plan—electric vehicles, solar electric energy, and a switch in home appliances from voluntary to mandatory standards of lower power consumption. But most industry officials in Washington are still silently watching the political action, while intensively boning up on issues in order to advise their home offices.

The Electronic Industries Association's president, V. J. Adduci, says, for example, that EIA has no comment on the Carter program and does not expect to have any. Nevertheless, EIA member companies are gathering data on the Carter program for evaluation. According to the Washington representative for one of them: "Just like other manufacturers, we're more concerned for the moment with the plan's heavy emphasis on things like credits for converting plant operations to coal in order to cut imported petroleum consumption." That will not necessarily affect how a company's products are built, but it could raise their costs in the short run.

ERDA's cars. The greatest push electronics technology gets from the plan is ERDA's electric-vehicle program, already being redirected to a near-term payoff in keeping with

Carter priorities. The year after the 1973 oil embargo, electric vehicles for urban use began getting serious U. S. consideration [*Electronics*, Mar. 7, 1974, p. 70].

Two years later, funding was increased with the passage of the Electric and Hybrid Vehicle Research, Development and Demonstration Act of 1976. Now the Carter administration is supplementing this with the award of two contracts for four commuter car models using lead-acid batteries [*Electronics*, April 28, p. 57].

General Electric Co., Schenectady, N. Y., will build two of the vehicles, incorporating such electronic controls as a microcomputer to prevent jack-rabbit starts and other driver abuses that could waste energy or damage the batteries, says ERDA's Gene G. Mannella, acting assistant administrator for conserva-

Electric car. Designed for stop-and-go urban driving, auto shown in sketch is to be built by AiResearch for ERDA. Four-passenger vehicle features flywheel for better acceleration.

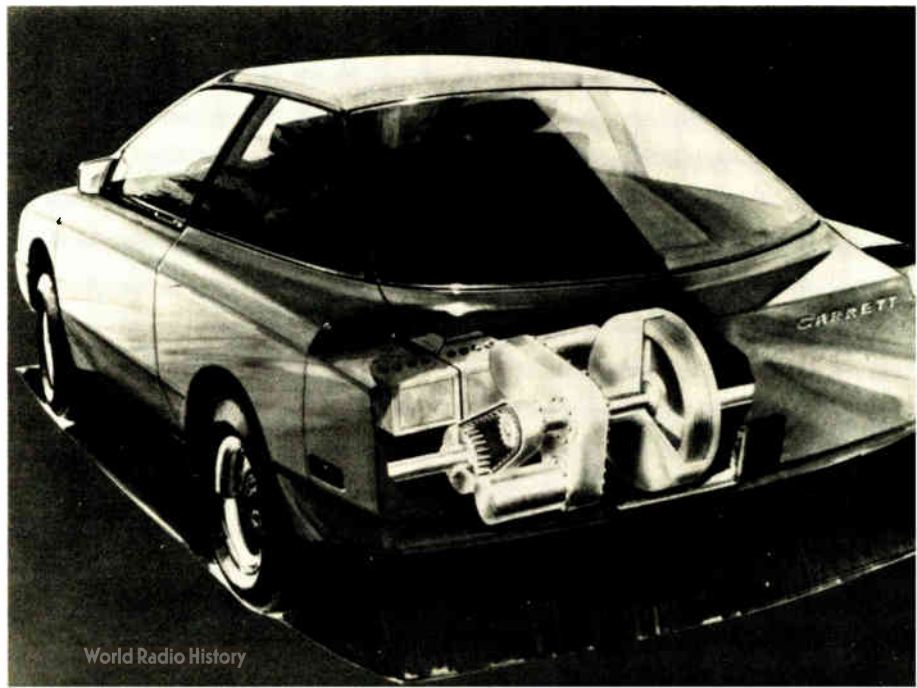

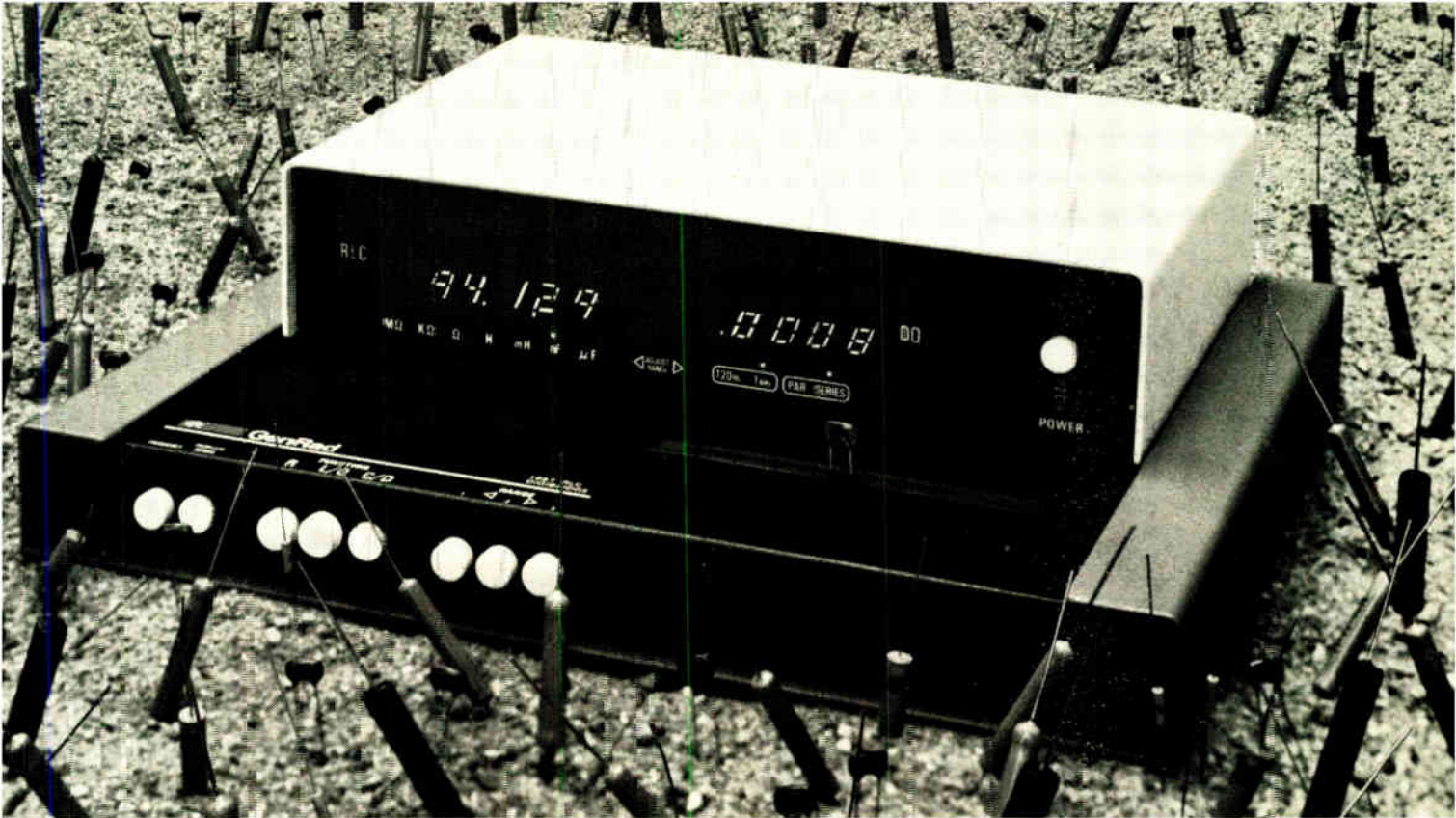

An automatic RLC tester for \$ 995? you've got to be kidding!

There's more to the new GR 1657 RLC DigiBridge™ than its low \$995* price. It's designed with features to lower your R, L, and C component testing cost. That's what it's all about — isn't it?

Measures R, L, C, D and Q.

A microprocessor performs a combination of measurement and control functions in addition to lowering the GR 1657 unit cost.

Fast testing time of three measurements per second, unqualified.

0.2% Accuracy for R, L, and C.

Five full-digit LED display for R, L and C and four full digits are displayed for D and Q. All numbers go to 9.

Wide measurement ranges allow you to test a greater number of component values. Test R from 00.001 Ω to 99.999 M Ω , L from 0.0001 mH to 9999.9 H, C from 0.0001 nF to 99999. μ F, D from .0001 to 9.999, and Q from 00.01 to 999.9.

Microprocessor-directed ranging takes the guesswork out of setting the correct range. Lighted arrows on the front panel indicate which range

button is to be depressed and the correct range is identified automatically.

Three range positions provide measurements in multiples of 100, since each range has two full decades of measurement capability, a feature made possible by automatic decimal point positioning.

Automatic decimal point positioning causes the measurement to be made on the lowest possible range, so maximum resolution is always achieved.

Selectable test frequencies of 1 kHz or 120 Hz (100 Hz) are switched by the operator.

Selectable series or parallel measurement modes are operator specified across the full measurement range of every test parameter.

Hi-Rel Kelvin test fixture accommodates axial and radial lead components.

Now you know there's more to the GR 1657 RLC DigiBridge than its low price. We're not kidding!

**U.S.A. domestic price only.*



GenRad

Circle 75 on reader service card

MONOLITHIC CRYSTAL FILTERS



Heard the one about the 8 poles?

One of our regular customers called us recently with a tough problem. "To sell my radio in the European market I need an eight-pole filter instead of the existing six-pole," (which consisted of three two-pole monolithics mounted on his P.C. board). "And oh, yes! We don't want to make any changes to our board."

Further requirements included a change in bandwidth and a low cost objective. What to do? Fortunately we were able to help (or we wouldn't be writing this). By switching from board-mounted filter components to a P.C. filter assembly which plugs into the same space we came up with an economical eight-pole answer — and in jig time. Result: An improved product and a satisfied customer. We're happy too, with a substantial production order.

This is just one of many cases where by working closely with a customer we apply our knowledge of monolithic filters to the improvement of his products. May we help you? Drop us a line and we promise no more pole-ish jokes.

Pi

Piezo Technology Inc.

2525 Shader Road, Orlando, FL 32804
(305) 298-2000

The standard in
monolithic crystal filters.

Probing the news

tion. Garrett Corp.'s AiResearch Manufacturing Co., Torrance, Calif., will build two others employing a flywheel.

With a forecast range of 75 miles between charges and a 55-mph cruising speed, the cars and their improved batteries could bring consumer acceptance "in a few years rather than waiting a decade or more," Mannella says. This represents a Carter change in ERDA's electric-vehicle program, which has been stressing development of more advanced batteries like lithium-sulfur and sodium-sulfur.

But whether electric cars ultimately make it in a big way with consumers may depend on how entrenched interests in automaking, the petroleum industry, and electric utilities respond. "The politics of this is that power companies love them," explains another ERDA source privately. "EVs recharging all night long all over the big metropolitan areas could really help resolve power plant inefficiencies caused by heavy daytime demand that falls off sharply at night.

"Detroit, on the other hand, can't do much more than publicly praise the idea, but that's pretty faint. This could mean big new capital requirements and training programs for a new business when they're not unhappy with the status quo. Oil companies are keeping quiet about EVs, but not many people believe they're going to sit back and silently watch those gasoline revenues disappear. Their positive option, of course, is to get into the business of renting or selling interchangeable battery packs."

Photovoltaics. Another example that political considerations play a role at least equal to that of budget considerations is seen in the latest Carter energy budget revision dealing with "solar electric and other" power sources. (The "other" category for ERDA now contains outlays for small windmills and other wind machines for rural, residential, and farm use.)

Acting ERDA administrator Robert Fri cites the proposed \$9 million increase to \$224 million for fiscal

1978 as an example of the new energy program's interest in the technology. Though the figure is up 4% from Carter's February revisions to Gerald Ford's January budget, it is still 14% less than the \$260 million the outgoing President sought for the program. Moreover, the April revision would add only \$6 million to ERDA's solar electric program.

The near-term emphasis of the new Carter energy program is reflected best by the overall spending plan. The April revisions drop the total energy budget authority to just under \$3.07 billion. That is down from the \$3.2 billion total of February, which was down from the \$3.3 billion in the Ford budget. Nevertheless, sharp increases within the budget occur in such categories as conservation at \$325 million, nearly double the Ford plan. Much of the conservation emphasis comes in areas such as building insulation, heat pumps, and fuel cells—again, available technologies with the greatest short-term potential.

Appliances. Another conservation target for the national energy plan—after Detroit's "gas guzzlers"—are home appliances, which account for an estimated 20% of energy consumption. Consumer electronics manufacturers are expressing minimal concern so far with the Carter proposal since it addresses only appliances such as furnaces, air conditioners, water heaters, and refrigerators. Yet the plan concerns them to the extent that new legislation is being sought to streamline the appliance regulatory process by replacing present voluntary power-consumption standards based on industry-wide averages with mandatory minimum standards as soon as possible.

The stated goal of the bill is to cut consumption and "achieve significant reductions in energy use with relatively small increases in cost," the plan reads. "If it passes, this is going to have to be mandatory," says one appliance maker's Washington counsel. "If our costs have to go up, so will everyone else's." The unanswered question is: Will consumers balk at the higher prices? "It seems to me there is more inflation in these proposals than meets the eye," he responds. □

This is what counters are supposed to be all about.

Model 5740, 7-digit, 100 MHz Multifunction Counter/Timer. \$295*

Quality you can count on. Data Precision's Model 5740 is a 7-digit, 100 MHz Timer/Counter; a superb laboratory quality instrument.

Data Precision built the 5740 to be exceptionally versatile. It measures frequency, period, period average, elapsed time and total events with the kind of accuracy, sensitivity, and upper frequency capability generally found only in higher priced units.

Consider: 10 mV RMS sine-wave to 20 MHz. 50 mV RMS at 100 MHz. That's excellent sensitivity in anyone's book. And this

sensitivity is a minimum specification (not a typical) allowing lock-in measurements from even extremely weak signals. The 100 MHz bandwidth means the 5740 handles everything from sub-audio to VHF. Seven, not six digit resolution, means 0.1 Hertz resolution at 1 MHz, 1 part in 10 million in period measurements, with the decimal point always automatically correct.

Want even more? A low-cost optional BCD output provides printer and/or computer/system compatibility while providing counter status timing and control/signals as well as reading and decimal-point data.

New Portable, 250 MHz Frequency Counter \$345.00*



We have just introduced a miniature portable frequency counter to give you measurement capability anywhere you need it. Our Model 585 is a full 8 digit, rechargeable battery and line operated precision instrument.

Data Precision Corporation, Audubon Road, Wakefield, MA 01880, USA, (617) 246-1600. TELEX (0650) 949341.

DATA PRECISION
...years ahead

*Price U.S.A.

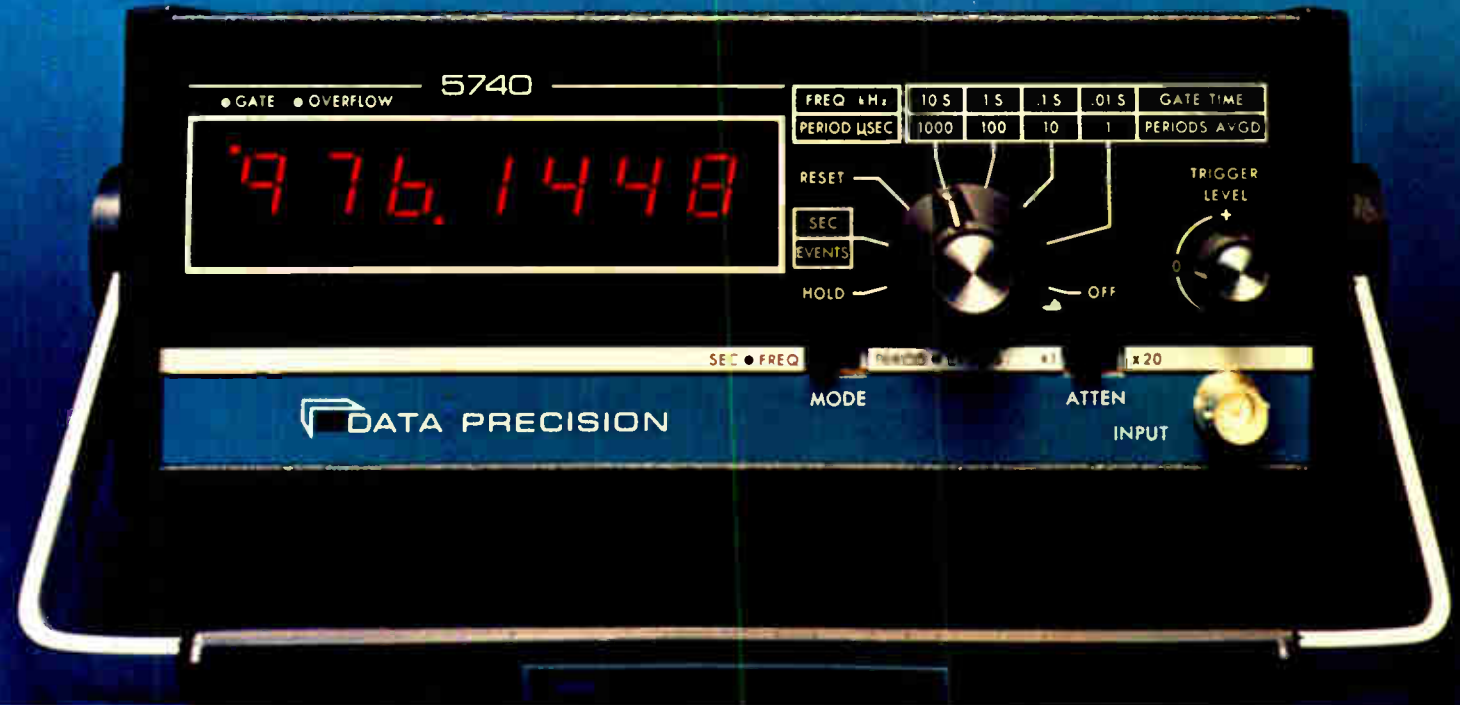

International Representatives

Australia AFBQ/Wah	Broward Labo Elettronica	Kennedy Electronics Elektronisch Labor GFSM B.H.	031-288-710E 226-024	Great Britain West Germans Hong Kong	Wetherby Manchester Winnich	Jarnell Sciencelab GmbH Data Systems	0937-7341 0800-59411 9-243121	New Zealand Norway	Auckland Oslo	David J. Reid Ltd Scaupeter AS	492 189 022 69 44 90 022 60 62 34 022 69 45 56
Brazil BIB20 Bravelles	Labo Elettronica	Fabrikasemits De Groot S.P.R.L.	022 345 91 18	India Iran	Hyderabad Iphatou	International Trade Agencies Diplomat Company Ltd	31543 78701	Pakistan Paraguay Puerto Rico	Karachi Fribourg Miami, FL	International Industries Ltd Sociedad Comercial Rualdo	20111-4 376 363725
Belgium Canada	Webster Instruments Webster Instruments	Webster Instruments Webster Instruments	0119 205 2577 01149 05 908	Israel Italy	Jerusalem Rome/Milan	MRBDY Ltd Amper S.A.S.	609 063 44551 228653	Spain Sweden Switzerland	Madrid Zurich	West Indies Sales Co Hispano Electronica S.A	0176 861 20 01 82 61 42
Chile Colombia Columbian Countries	Antioquia Cali	Naciona Intermodal Ltd Mia Internacional	0640 963 031 22 48 7972	Japan Kenya Korea	Tokyo Nairobi Seoul	Chusho Corporation Engineering & Sales Co. Ltd Asia Trading Co.	031 272 3321 26815 217026	Taiwan Turkey Uruguay	Taipei Ankara Montevideo	Espresso Electronics Ltd Lohan Agencies KB Danus	619 41 08 0760 861 20 01 82 61 42
Costa Rica Denmark Finland France	Montes de Oro DK 8700 Horsens	Electroventas A Instruk	01 264 980 21 32 42 05101 1109	Malaysia Netherlands	Kuala Lumpur The Hague	Phonik & Cine-Equipment Co. Ltd J.M.I. Maldives (P)N. BH13 Koning en Hartman	423801 23251 076082830	Venezuela	Maracaibo	U.T.E. Muhendishive Titaret Ltd Barrod Representaciones	267182 88012 982026 72074

For Demonstration Circle 77 on Reader Service Card

World Radio Review

For Additional Information Circle 238 on Reader Service Card

Consumer electronics

Where there's smoke, there will be an IC

With smoke detector sales expected to reach 10 million this year, semiconductor makers head for market

by Bernard Cole, San Francisco bureau manager

A hot new consumer market for integrated circuits is shaping up in smoke detectors. From sales mainly in industrial applications of a few tens of thousands a year as recently as 1974, smoke detectors have attracted the attention of the home-building industry and home-owning consumers themselves so that U. S. volume exceeded 6 million units last year. Volume this year should range from 10 million to 12 million units, says Richard Ahrons, integrated-circuit applications manager at Motorola Semiconductor, Phoenix. Worldwide, he says, the figure is more like 20 million to 30 million.

"Whatever the figure," says Marvin Vander Kooi, manager of IC product marketing at Siliconix Inc., Santa Clara, Calif., "the bottom line is an estimated 70 to 75 million existing dwelling units in the U. S. alone that could use early-warning

smoke- and fire-detection systems." This does not take into account homes under construction or to be built. The market-research firm Frost and Sullivan says that by 1985 new homes are expected to constitute 65% of the market, existing homes 29%, and other applications 6%.

With that, says another research firm, Venture Development Corp. of Wellesley, Mass., sales of battery-powered units will decline as detectors are built into new homes. And the firm also predicts that ionization types will lose market share dramatically from 85% to 57% by 1981 due to shaken consumer confidence and controversy over possible radiation dangers.

Competition high. With those kinds of numbers being bandied about, it's no wonder that competition among the leading manufacturers of smoke detectors—General Electric Co., Honeywell Inc., Norelco, Gillette, Emhart Corp., Pitway Corp., and Electro-Signal Laboratories, to name a few—is increasing. Prices are dropping, and the manufacturers are looking to reduce their costs by switching from discrete components to integrated circuits—both custom and standard. The semiconductor companies, which once viewed this market as a convenient, relatively high-volume dumping ground for field-effect transistors, bipolar discretes, and silicon controlled rectifiers, are now switching their efforts to the development of single-chip smoke-detector ICs.

Leading the pack is Siliconix with the SM110, an ion-implanted mixed-process monolithic device containing p-channel metal-oxide-semiconductor FETS, junction FETS, and bipolar devices on the same chip. This 50-by-58-square-mil chip replaces 30 to 70 discrete components, says Vander Kooi. It is designed to work in either of the two major detection types—ionization chamber or photoelectric cell—or even in a system that combines both.

The photoelectric type depends for its basic operation on the scattering of light by smoke particles entering a light chamber. In an ionization type, smoke particles cause a decrease in the current resulting from a flow of ionized air inside a sensing chamber. Each requires different circuitry.

In production at Supertex Inc., Sunnyvale, Calif., is a low-power complementary-MOS IC, the SD1A. David Heck, vice president of marketing, says it, too, is designed for

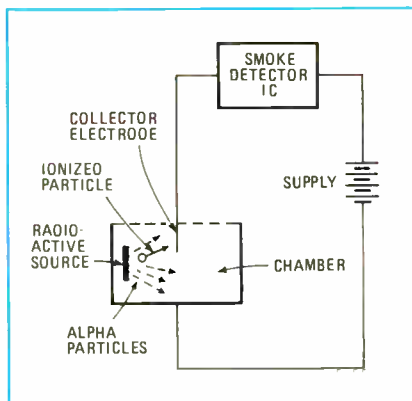

Ionization type. Such a detector operates on the principle of ionization of small air particles from a small radioactive source.

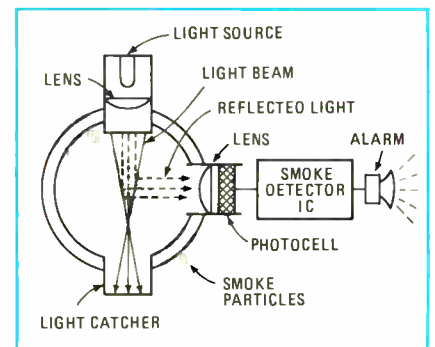

Photoelectric type. Here, smoke crosses the light beam's path, reflecting part of the light. Photocell detects change.

either photoelectric or ionization smoke detectors.

National Semiconductor Corp. is reported to be investigating the possibility of second-sourcing the Supertex part. In addition, says Tim Isbell, director of design for consumer ICs, the Santa Clara, Calif., firm will be offering samples of the LM1801, a bipolar smoke-detector IC, by the end of the second quarter. Motorola, doing a brisk business in custom ICs for smoke detectors for a year or so, will be introducing a standard C-MOS part, the MC14461P, in late May.

Bucking the trend is Micro Components Corp. of Cranston, R.I., a major supplier of custom smoke-detector ICs using integrated-injection and other bipolar technologies. "Although it's possible technically" to build a standard IC, says Charles Grandmaison, vice president of marketing for the firm, "it's unrealistic from a marketing point of view." The difficulty, he says, is that each equipment maker wants its own IC.

He estimates that of the many as 200 or so companies around the world making, or planning to make, smoke detector units, only five or six will be around as major factors two years from now. "It's going to be the watch and calculator market fiasco all over again," he says. □

All for one

The discrete circuitry in the typical home smoke detector usually consists of high-impedance field-effect transistors capable of sensing the low picoampere currents from the detector chambers, numerous resistors and capacitors to bias the circuit properly, additional components to protect the FETs from large static loads from the sensor and to provide low-battery indications, as well as driver transistors to run a blinking light-emitting diode and/or an alarm or buzzer. A single IC can replace most of this. Supertex and Motorola put everything on a single chip. In the Siliconix scheme, the driver transistors are left off the chip. In the National approach the input FET is left off the chip and the driver circuitry included on it.

Digital filtering is old hat



You can now replace ten-bit A/D and D/A converters plus a digital filter module with a single integrated circuit.

Our standard product line already includes devices for audio and video delays, time-base correctors, transversal and real time adaptive filters, convolvers and correlators, and could well be the answer to many of your analog signal processing needs.

Our SAD-1024 is the industry standard in audio and musical effects; our TAD-32, tapped analog delay, is one of the hottest tools in sophisticated circuit design. We have built mask programmed chirp, linear phase, low pass and band pass filters which are the equivalent of a 14 pole filter in a single DIP.

If this doesn't do it, we can put your 19-inch rack into a DIP or two. Just remember, it is cheaper to quantize only in time than in time and amplitude . . . and we know how to do it. We have the tools from "old fashioned" silicon gate MOS to the latest n-channel BBD and CCD technologies.

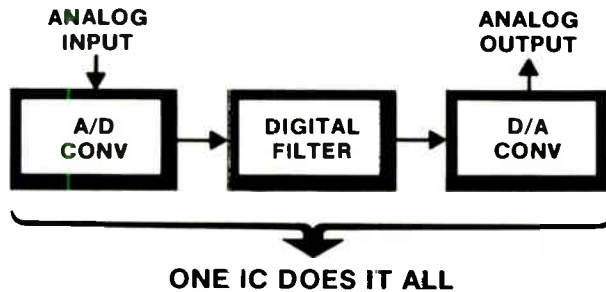

For further information, write or call:

RETICON®

AN EG&G COMPANY

910 Benicia Ave. • Sunnyvale, Ca.94086 • (408) 738-4266

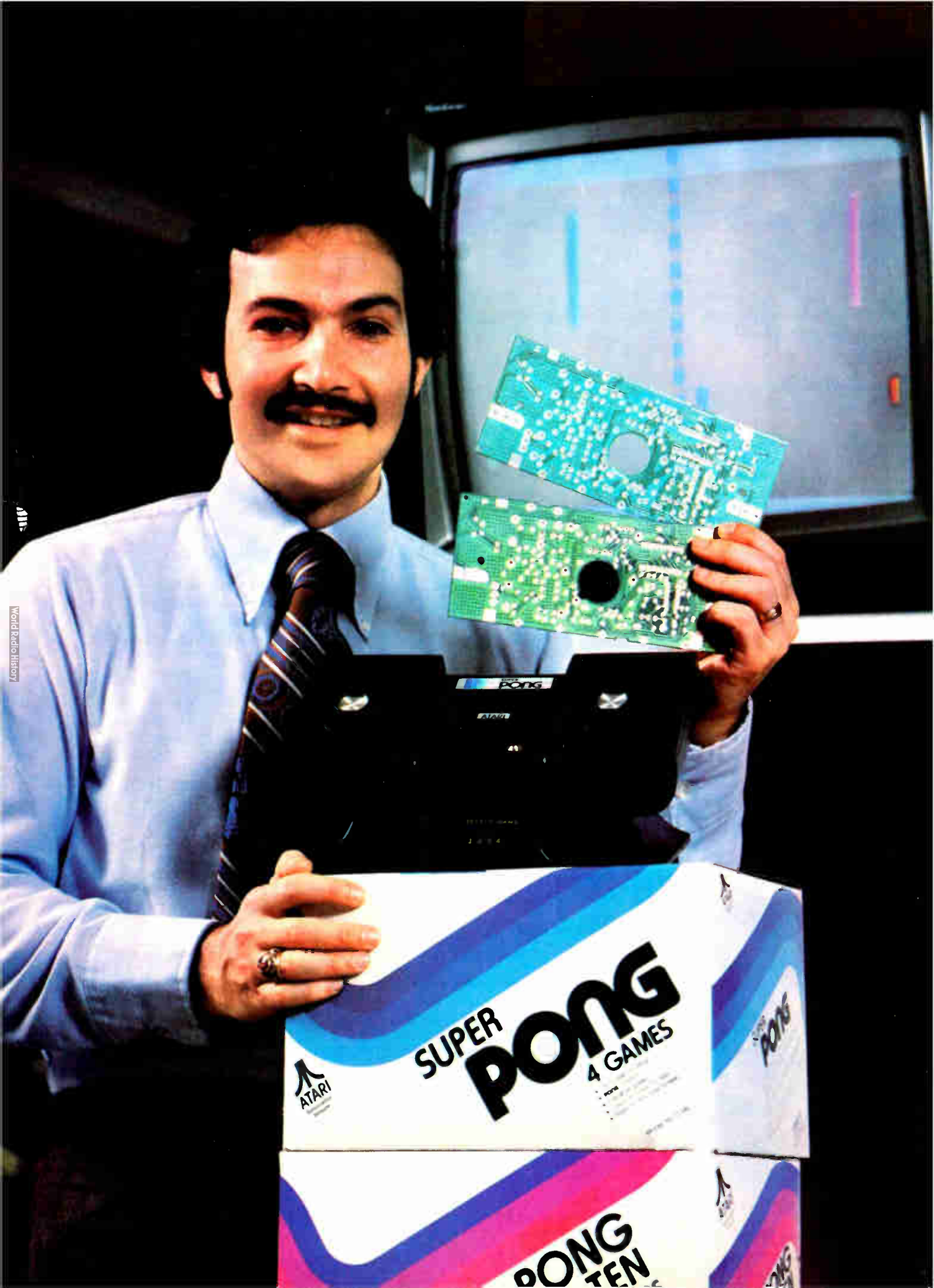

World Radio History

ATARI

SUPER PONG
4 GAMES

PONG TEN

“Photocircuits has two ways to keep us ahead of the game.”

Rick Krieger, Materials Manager, Atari Corporation.

“The game market, like other electronic markets, is not for the faint-hearted. As many have found out, a miscalculation in vendors can cost millions in sales. Photocircuits is one of the very few vendors Atari can trust to handle two-sided plated-through-hole boards in tremendous volume for our short manufacturing season.

“Making the identical board by two separate processes (conventional and additive) Photocircuits not only can deliver higher volume, it is uniquely set up to be a second source to itself. But, as we’ve found out, their additive boards are more than just volume and insurance.

“Our manufacturing manager, Dave Elson, noticed a significant advantage for Photocircuits CC-4 additive boards over conventional boards. He’s saving money in soldering additive. No bridging or soldering problems. But most important, he’s getting 100% yield on additive with 90% at best on conventional. In short, we’re finding additive boards to be much more reliable.”

Are you playing for big stakes, like Rick Krieger and Atari? Remember this: Few suppliers can provide conventional boards in volume like Photocircuits. And no other can help you so quickly to the benefits of CC-4 additive process. In fact, we’re more than delighted to provide you with high quality subtractive boards in large volume while you explore the advantages of our CC-4 additive. Then take your pick for the long run. Just contact your Photocircuits PCB representative about conventional, additive or both. Or call or write Photocircuits, PCK Sales, 31 Sea Cliff Ave., Glen Cove, New York 11542. 516-448-1301. Division of Kollmorgen Corporation.

Photocircuits

Printed circuitry for mass-produced electronics.

BENDIX BRISTLE BRUSH BUNCH.

Opens new horizons for PCB design.

Free and easy are now the bywords for board and board support design with the 70% to 90% reduction in mating and unmating forces offered by the new Bristle Brush Bunch connector series from Bendix.

The need for costly board support systems is minimized.

You get extended interconnection contact counts and versatility—up to 400 contacts per connector.

You can choose from a broad product line:

- 2-, 3- and 4-row Mother Board, Daughter Board, PC receptacle and Input/Output body styles.
- Removable crimp, solderless wrap, straight or 90-degree PC stud and willowy tail termination.

For complete information, contact The Bendix Corporation, Electrical Components Division, Sidney, New York 13838.



CONTACT INNOVATION

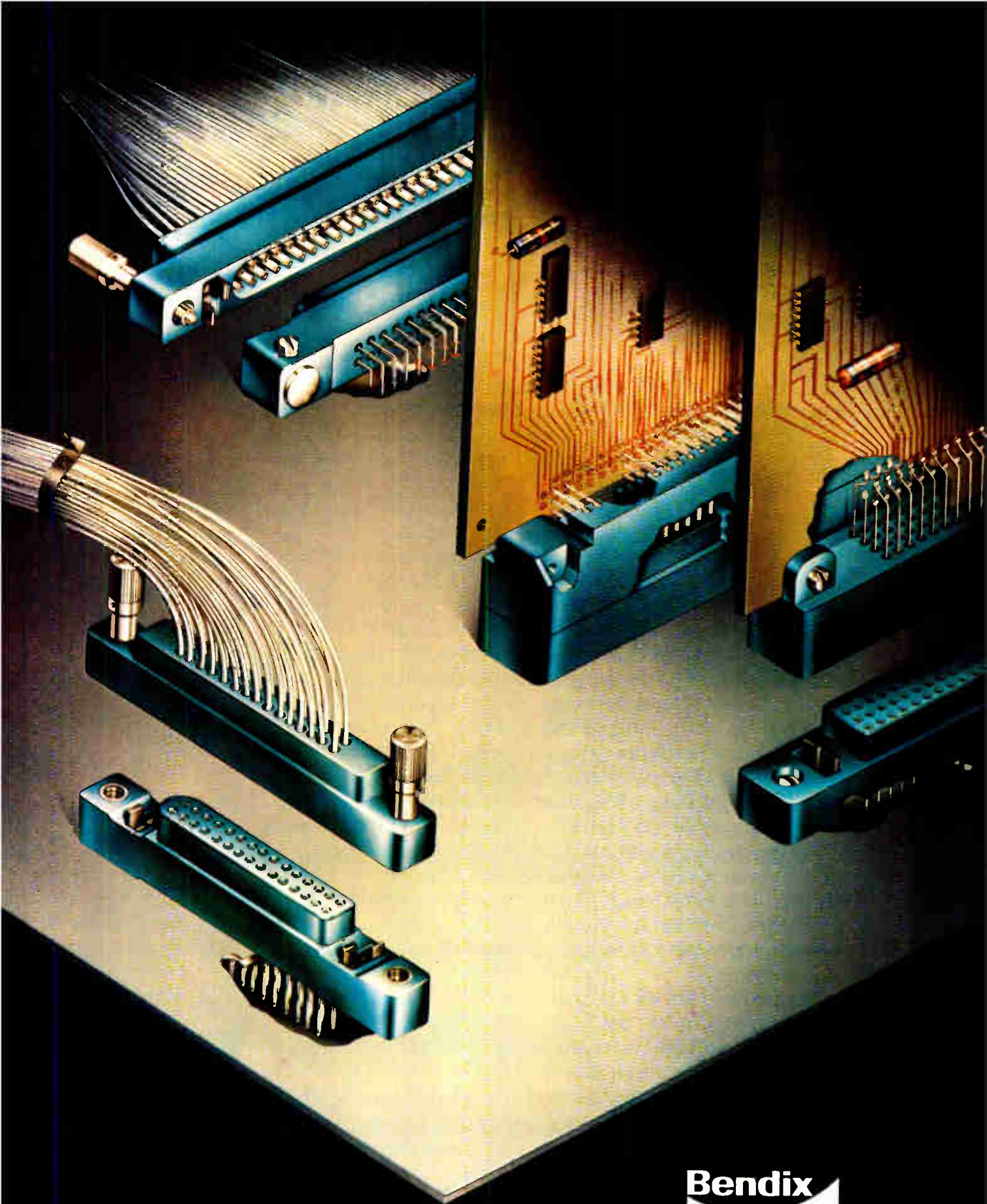

Bendix

Circle 83 on reader service card

STORE

ERASE

RS

OR

VIEW

TIME

ERASE

(PUSH)

MAX

BRIGHTNESS

MAX

WRITE

STORE

DISPLAY

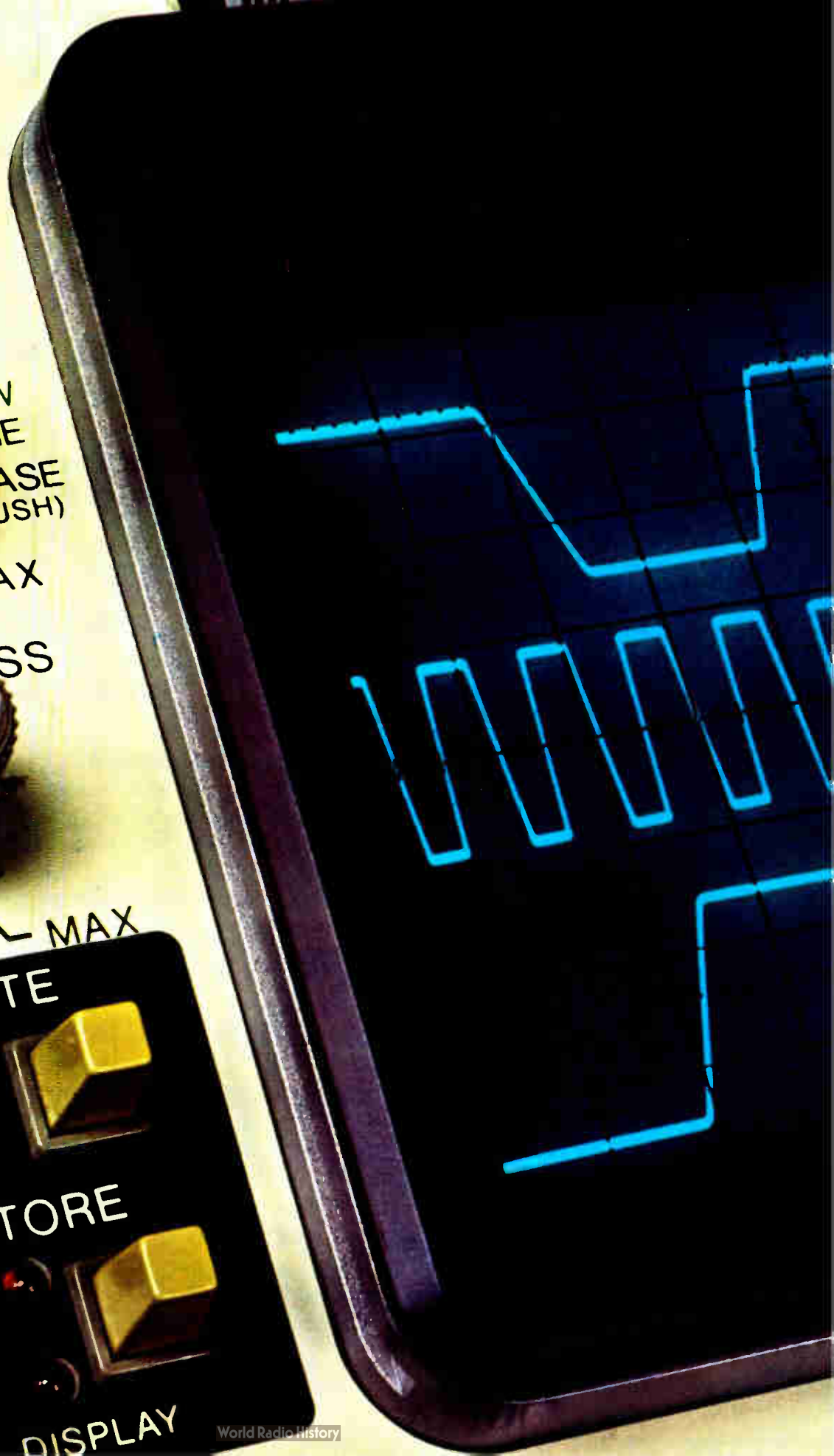

For one easy-to-use scope that: Captures single-shot events... Displays low-duty-cycle signals clearly... Provides three channels for the price of two...

HP's the Answer.

And the new 1741A is your scope. It gives you a unique combination of features for a moderately priced 100 MHz storage scope: Variable persistence for clear viewing of glitches and low-duty-cycle traces; storage for studying single-shot events; and third-channel trigger view for convenience in making simultaneous three-channel timing measurements.

Excellent variable persistence means a bright, sharp trace you'd expect only on a nonstorage scope. The result is an easy-to-read display of fast, low-duty-cycle repetitive signals. And the ability to see leading edges and glitches you'd otherwise miss.

Auto erase/Auto store. In Auto erase you adjust the display rate up to 2.5 per second. After that, it's all automatic, which means you simplify set-ups and eliminate smeared displays of digital data. It's a powerful tool for capturing those elusive glitches in data streams. In Auto store, your 1741A is armed, and as long as the instrument is fully operational and powered, will wait indefinitely, ready to store a random, single-shot event when it occurs.

Third-channel trigger view, selected at the push-of-a-button, lets you observe an external trigger signal along with channel A and B—three traces in all—so you can easily make timing measurements between all three channels. In most applications, that means three-channel capability for the cost of a two-channel variable persistence/storage scope.

For measurement convenience, the

1741A has a selectable 50 ohm input in addition to the standard 1 megohm input. A 5X magnifier permits two-channel measurements as low as 1 mV/div to 30 MHz, without cascading. You can even select a special modification (TV Sync) to tailor this scope for TV broadcast and R&D applications. Priced at \$3950*, the 1741A is an exceptional storage scope value.

Call your local HP field engineer today for all details. And for low-cost variable persistence/storage in a 15 MHz scope, ask him about HP's new 1223A.

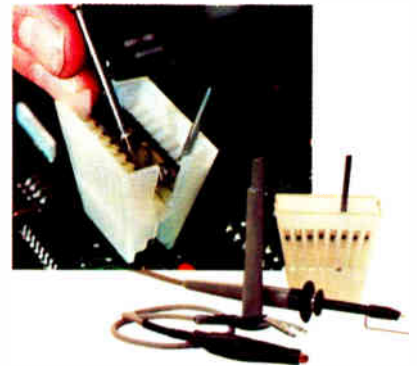

And here's something NEW for scopes. HP's EASY-IC PROBES. A new idea for probing high-density IC circuits that eliminates shorting hazards, simplifies probe connection to DIP's and generally speeds IC troubleshooting. Ask your HP field engineer about them.

*Domestic U.S.A. price only



085-11A

HEWLETT  PACKARD

1507 Page Mill Road, Palo Alto, California 94304

For assistance call: Washington (301) 948-6370, Chicago (312) 255-9800, Atlanta (404) 955-1500, Los Angeles (213) 877-1282

Circle 87 on reader service card

After you look at the specs, look how long they're guaranteed.

The accuracy specs for the Dana 5100 5½ digit multimeter are guaranteed for a full year. Not 90 days. Not 6 months. That means you only have to calibrate it once a year.

All other multimeters have to be calibrated an average of three times a year. At about \$75 a pop. Which makes their \$995 units a lot more expensive to own than the Dana 5100 at \$1145*.

Instead of sitting in the shop for six weeks over the course of the year, the Dana 5100 will stay right where you are. Measuring AC, DC, Ohms and frequency

(yes, frequency too) with very high accuracy. Just like the specs say. For a year at a time.

When you look at it that way, one thing becomes obvious. The cost of owning a multimeter is a lot more important than the price.

Write Dana Laboratories, Inc., 2401 Campus Dr., Irvine, CA 92715 for all the specs. And take a good look. With specs that good, you'll be glad you only have to give it up once a year.

DANA®

Others measure by us.



Dana 5100.
**Ask for a free demonstration
before you consider anything less.**

For Product Demonstration circle 88 For Literature Only circle 89

Electron-beam lithography draws a finer line

Before LSI circuits can become any more complex, line widths must drop below $1\ \mu\text{m}$ —which means switching from optical to electron-beam fabrication

by T.H.P. Chang, M. Hatzakis, A.D. Wilson, and A.N. Broers, *IBM Corp., Thomas J. Watson Research Center, Yorktown Heights, N.Y.*

□ The width of the narrowest line in a large-scale-integrated circuit sets one very obvious limit to the circuit's density and complexity, and this limit is now under pressure from advances in the rest of LSI technology. Conventional optical lithographic techniques for producing circuit patterns on chips can manage about 2-micrometer-wide lines at best, however, and any success in the submicrometer region will require another form of pattern making, such as electron-beam lithography.

To bring electron-beam lithography to the point where it is useable for volume production of extremely dense LSI circuits, progress had to be made in several different areas. High-resolution electron resists needed developing, and improvements needed to be made in the performance of the systems used for forming and controlling the beam, for moving the workstage carrying the wafer, for generating circuit patterns by computer, and for registering the layers of device and metalization

circuit patterns precisely

The result is the kind of system shown in Fig. 1—one that either makes masks or exposes a circuit pattern directly on a wafer with a higher degree of accuracy and resolution than optical systems. The technology also lends itself to automation, which for direct wafer exposure could mean very rapid turnaround times. Figure 2 shows a surface-acoustic-wave transducer with a line width of $0.1\ \mu\text{m}$ that has been made by direct exposure to an electron beam.

Optical printing

What makes it difficult to refine optical lithography further? Lithography of any kind in semiconductor manufacture is the art of defining on a semiconductor wafer the intricate patterns needed for the fabrication of microcircuits. These patterns are formed by first coating the wafer with a resist—a thin film of light-sensitive

1. An electron-beam system. Developed at IBM Research, the Vector Scan One system (VS1) uses electron-beam lithography for fabricating high-resolution experimental devices. The electron-beam column is shown at the right, the control panel and electronics at the left.

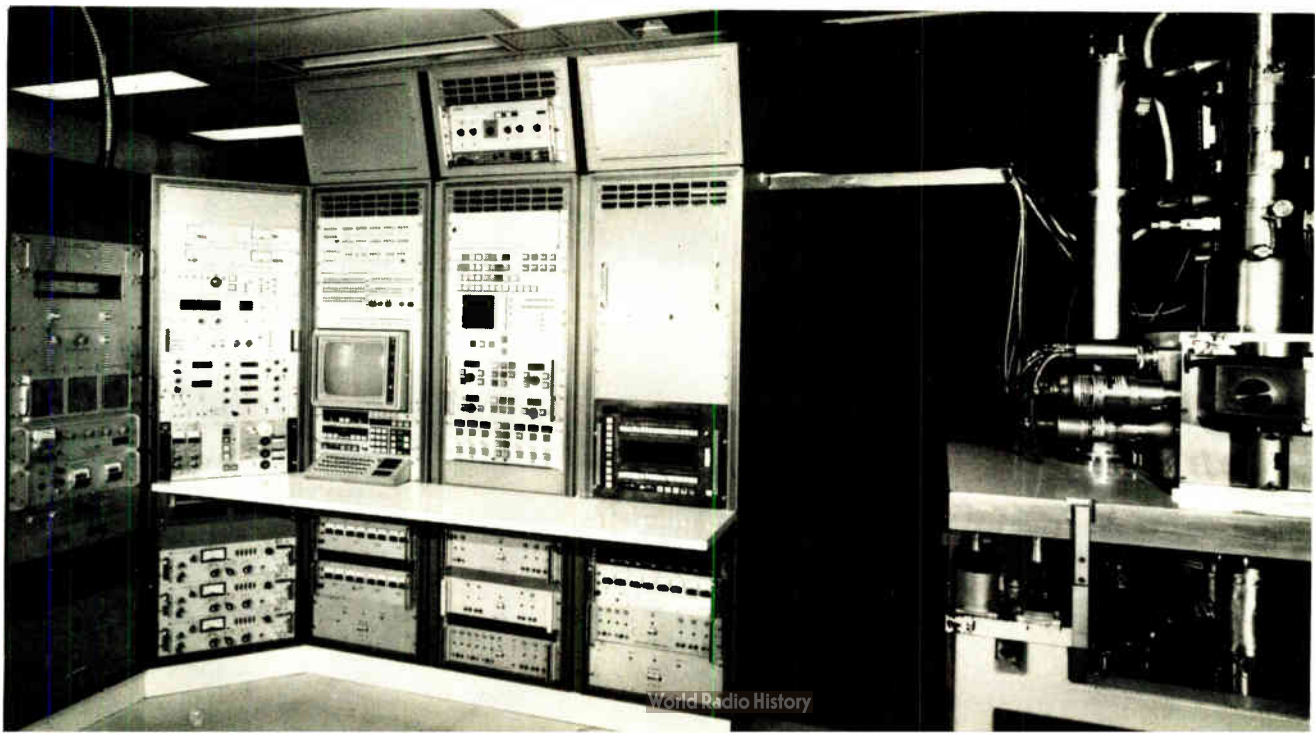

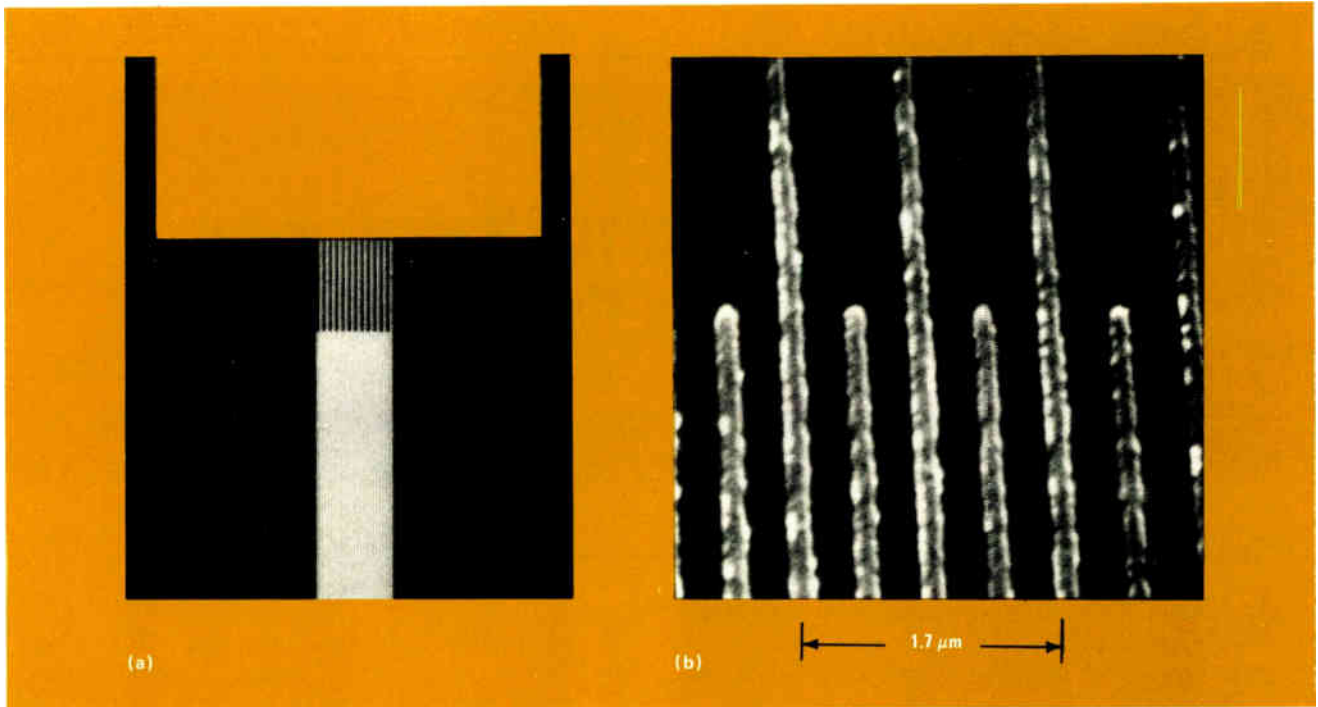

2. Fine lines. This 4.1-GHz acoustic surface-wave transducer (a) gets its submicrometer line widths from electron-beam lithography. Scanning electron micrograph (b) displays details of 0.1- μm metal lines made by this technique. (Source: Hughes Research Labs.)

organic material—and then by shining ultraviolet light onto the coated wafer through a patterned mask. Registration marks on the wafer align with special windows in the mask. Several patterning steps are needed for even the simplest device.

This straightforward and economical contact printing technique is well established. However, the damage that results from bringing the mask into close proximity with the wafer limits device yields, and the diffraction effects that occur between mask and wafer limit line widths to about 2 μm and also limit the accuracy of pattern-to-pattern alignment.

UV projection lithographic systems, in which the wafer is isolated from the mask, alleviate these drawbacks to some extent, only to introduce a new one of their own—for resolutions much below 2 μm , the limited depth of focus of their special optics requires extraordinarily flat wafers.

What electron beams can do

The electron-beam methods overcome these problems and have distinct advantages of their own, chief among which is their high resolution. Lines up to 20 times narrower than the optical limit can be readily generated. Diffraction effects are negligible, because the equivalent wavelength of electrons in the 10-to-25-kilovolt energy range is less than 1 angstrom (10^{-4} μm).

Ultimately, resolution of an electron optical system is limited by aberrations of the electron lenses and the deflection systems and, where a high beam current of more than 1 microampere has to be used, by electron-electron interactions. Resolution of the exposed image, on the other hand, is limited by scattering of electrons in the resist coating and the substrate. In general, line widths below 0.1 μm will require special wafer prepara-

tion. To date lines as narrow as 0.008 μm have been made at International Business Machines Corp.'s Research Center, Yorktown Heights, N.Y.

Equally important is the use of a computer to control the beam of electrons directly. This feature has important implications for both mask making and direct wafer exposure.

In addition, an electron beam has much larger depth of focus than optical systems, and it can readily be used to detect structures on the surface of a sample in the same manner as in the scanning electron microscope. The capability can also be exploited to control the accurate overlay of one pattern on another.

Three resist requirements

To realize the full potential of electron-beam lithography, it has been necessary to develop resists specifically suited to electron exposure. These "electron" resists, like the photo resists used in UV printing, are polymeric solutions that can be spin-coated on to the sample prior to pattern writing. After pattern exposure, the resist is developed in a solution that dissolves away either the unexposed portion (negative resist) or the exposed portion (positive resist).

A material's suitability for use as an electron resist, whether positive or negative, depends on its:

- Sensitivity—defined as the minimum electrical charge required for its complete development and customarily measured in electron charge deposited per unit area (coulombs per square centimeter). It must be achieved without significant thinning of the exposed area for negative resists or the unexposed area for positive resists.
- Resolution—indicated by the minimum line width that can be developed in a resist layer of a given thickness.

TABLE 1: CHARACTERISTICS OF ELECTRON RESISTS MATERIALS

Material	Type	Typical sensitivity (C/cm ²)	Resolution (minimum line width reported) (μm)	Compatibility with semiconductor fabrication processes
KTRF-KMER-KPR (Kodak)	negative	5 × 10 ⁻⁶ **	1	good
Silicones	negative	10 ⁻⁵	0.5	fair
Epoxidized polybutadiene	negative	5 × 10 ⁻⁸ **	?	fair
Shipley AZ-1350	positive	5 × 10 ⁻⁵ *	1	good
Poly (α-methyl-styrene)	positive	10 ⁻⁴ *	?	poor
Poly (methyl methacrylate)	positive	5 × 10 ⁻⁵ * 5 × 10 ⁻⁶ **	<1,000 Å	good
Poly (butene-1 sulfone)	positive	10 ⁻⁶	0.5	good
Polydiallylorthophthalate	negative	10 ⁻⁶ **	2	good
Poly glycidylmethacrylate ethyl acrylate	negative	5 × 10 ⁻⁷ **	0.5	good

*No thickness loss after development **Significant thickness loss

Compatibility with fabrication processes—including resistance to chemical etching, adhesion to the substrate, temperature stability of the resist image, resistance to ion-etching methods, and so on.

Many materials have been tried as electron resists, and some are listed in Table 1. In general, negative resists have the highest sensitivity (although at considerable thickness loss). Also, the developed negative-resist pattern has sloping walls that preclude its use with processes requiring steep or undercut walls.

With both resist types, ultimate resolution is determined by electron scattering both within the resist layer and back from the silicon substrate rather than by the resist material itself. In general, when high aspect ratios (height/width) are required, a positive resist in combination with lift-off or electroplating processes results in better resolution than a negative resist in conjunction with a subtractive etching process.

In the lift-off process, a vapor of the desired material to be put down on the silicon wafer is evaporated in vacuum on to the wafer through the openings in the resist film. Some is also deposited on top of the resist and is subsequently removed by soaking the workpiece in a solvent—a process that works satisfactorily only if the resist has an undercut profile.

With electroplating, a thin conductive layer is applied to the workpiece prior to the application of the resist. After resist exposure and development, the workpiece is inserted in a plating bath, and metal is plated onto the resist-free regions. Since in this case the metal line profiles will conform to the resist profile, the resist profiles should be as close to vertical as possible in order to obtain uniform plating.

For subtractive processes (e.g. the chemical etching used in producing photomasks) or dry etching methods

(e.g. ion milling, reactive ion etching, and sputter etching), negative-resist profiles are often acceptable, and their higher sensitivity can be used to advantage. In these processes the developed resist pattern protects an underlying film of the desired material, but good edge definition is generally harder to obtain.

The resist field remains very active. Many laboratories are making concentrated efforts to improve the sensitivity of positive resists and the contrast and edge sharpness of negative resists.

Projection systems

Broadly speaking, electron-beam lithographic systems can be grouped into projection systems and scanning systems. The projection systems have potentially a lower cost and higher throughput than the scanning-electron-beam systems.

Two types of beam projection systems have been developed specifically for semiconductor device fabrication: the 1:1 and reduction projection systems.

Work on one-to-one projection systems has been under way for many years. It began at Westinghouse and has been more recently pursued by Mullard in England and Thompson CSF in France.

A schematic of Mullard's system is shown in Fig. 3a. This projection system employs a photocathode masked with a thin metal pattern. Photoelectrons from the cathode are accelerated onto the sample by a potential of about 20 kilovolts applied between cathode and sample. A uniform magnetic field focuses these photoelectrons onto the sample (anode) with unity magnification. Sample and wafer can, in principle, be as large as desired, and samples 5 centimeters in diameter have been successfully exposed.

In the system, image position is detected by collecting

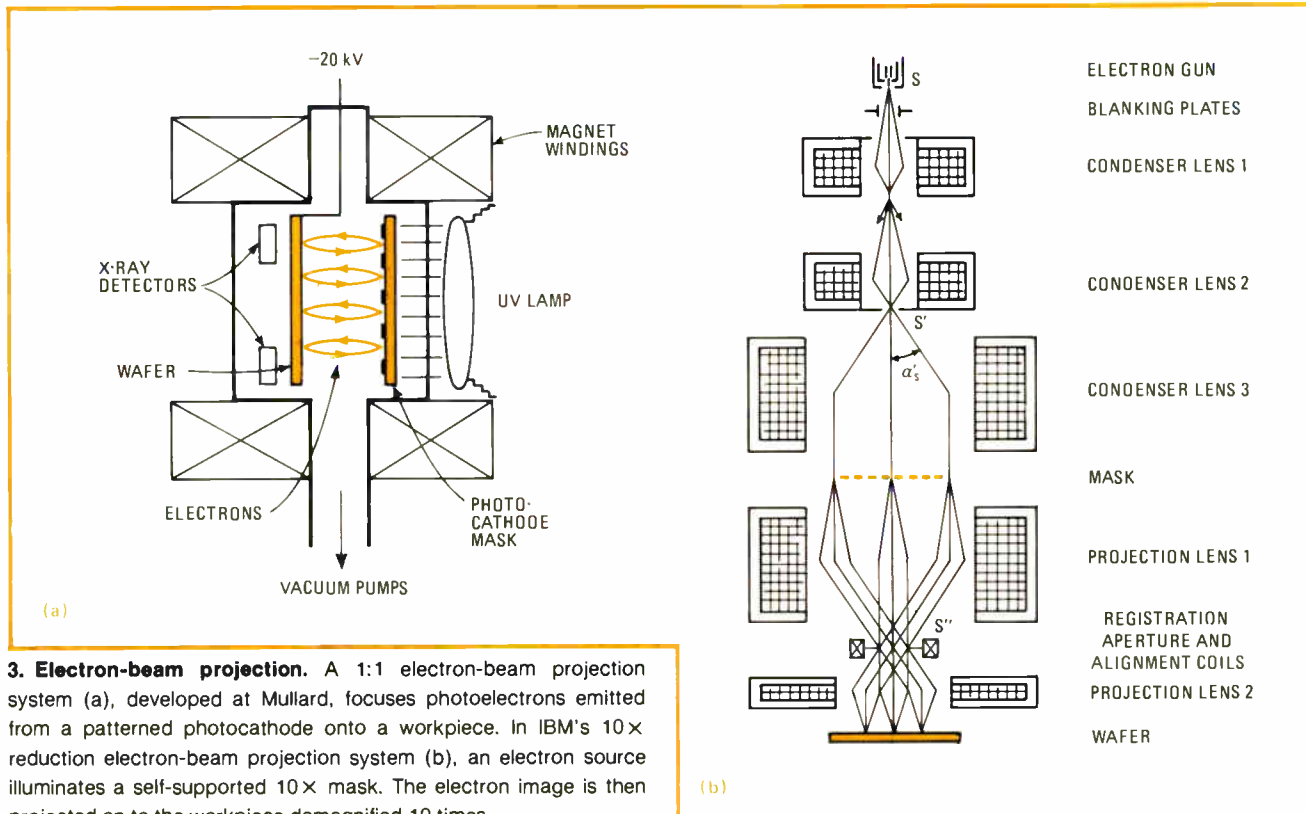

3. Electron-beam projection. A 1:1 electron-beam projection system (a), developed at Mullard, focuses photoelectrons emitted from a patterned photocathode onto a workpiece. In IBM's 10x reduction electron-beam projection system (b), an electron source illuminates a self-supported 10x mask. The electron image is then projected on to the workpiece demagnified 10 times.

characteristic X rays from marks on the wafer with the X-ray detectors shown. (During this process the photocathode is masked so that only the alignment marks are illuminated.) Magnetic deflection is then used to position the pattern with an accuracy of $0.1 \mu\text{m}$. Image current density is about $10^{-5}\text{A}/\text{cm}^2$ (1-second exposure for $10^{-5}\text{coulombs}/\text{cm}^2$ resist sensitivity) for cesium iodide photocathodes, which have the best lifetime and resistance to poisoning. The dominant aberration limiting resolution is chromatic aberration, and theoretical estimates of minimum line width vary from $0.5 \mu\text{m}$ to $1 \mu\text{m}$. So far, the technique has been used to make operating semiconductor devices with lines $2 \mu\text{m}$ wide.

Because the wafer forms part of the imaging system, its flatness is critical if pattern distortion is to be avoided. An electrostatic chuck may be essential to hold the wafer for satisfactory performance. Another difficulty arises because scattered electrons from the sample are accelerated back onto the wafer into unwanted locations, giving rise to a background exposure that reduces the effective contrast in the image.

Figure 3b shows the reduction type of projection system developed at IBM Research. The basic concept for this system, which is the electron-optical analogy of reduction optical projection cameras, was first described by researchers at Tübingen University in Germany. The mask is a freely suspended metal foil. A special electron-optical system illuminates the mask and forms a sharp demagnified image of it on the wafer. The demagnification factor is 10x, and a field 3 millimeters in diameter and line widths of down to $0.25 \mu\text{m}$ can be produced.

For alignment, the system uses its scanning mode of operation. In this mode the illuminating beam is focused

onto the mask rather than flooding it as in the case of image projection. The focused beam scans across the mask, and an image of this focused beam scans across the sample. Scattered electrons are collected from the sample to detect sample position, and correction is made by shifting the projected image with deflection coils placed between the two projection lenses.

Fabrication of the mask is the major obstacle to the successful application of reduction projection systems to device production. The possibility of replacing the foil mask altogether, by a photocathode/accelerating-structure combination, has been reported recently. If realized, it could open up some interesting new possibilities.

Scanning electron-beam systems

The most direct method for high-resolution pattern generation is scanning-electron-beam lithography. In this approach, the pattern is written with a small electron beam, which is generally controlled (deflected and turned on and off) by a computer.

Application of scanning electron-beam techniques to semiconductor processes emerged in the mid-1960s following the development of the scanning electron microscope at Cambridge University. By 1966 the high-resolution potential of electron-beam fabrication had been demonstrated both at universities like Tübingen, Cambridge, and Berlin and at companies like Westinghouse, IBM, Karl Zeiss, SRI, GE, AEI, and Mullard. Close behind them, electron-beam efforts were started at Texas Instruments, Hughes Research, Thomson CSF, Hitachi, Western Electric, and the University of California, Berkeley. In the late 1960s JEOL and the Cambridge Instrument Co. produced electron-beam equipment

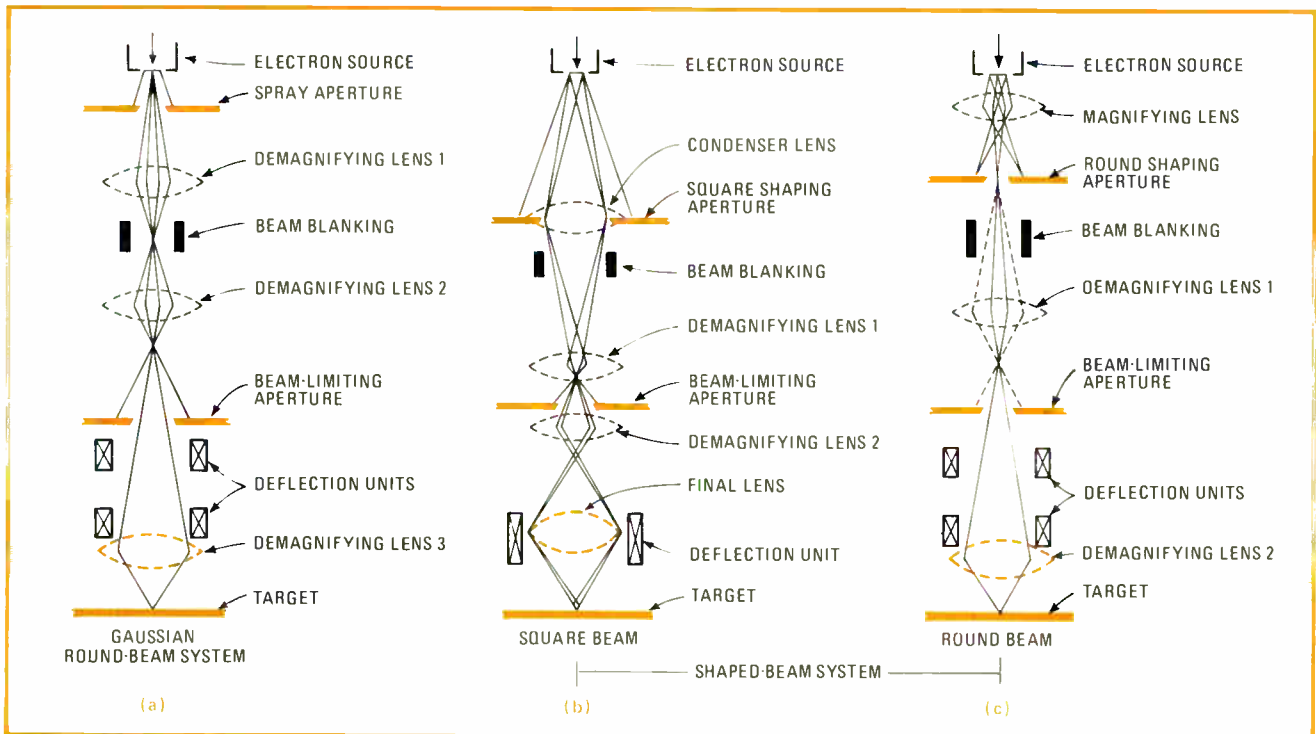

4. Beam forming. Electron beams for lithographic work on details of a mask or wafer can be Gaussian or formed into square or round shapes. In the Gaussian round-beam system (a), the probe-forming concept of the scanning electron microscope is used. The square (b) and round (c) beams instead use square or round apertures to modify the beam, which is then demagnified on to the workpiece.

capable of basic-process and experimental-device studies. By 1970 a good many other industrial companies had become involved in the technology. For example, in 1974 Bell Labs announced its scanning electron-beam mask maker. One of the latest developments is a system capable of direct device fabrication in an actual manufacturing environment—the ELI from IBM’s East Fishkill Laboratory.

The lithographic approach to be selected for a given operation will ultimately depend on the device requirements and cost considerations. There are still, however, several major unknowns that could significantly influence this selection. One is the in-plane wafer distortion associated with thermal processes. Should this distortion be excessive, it will not be possible to obtain adequate pattern overlay for high-resolution full-wafer printing systems.

Broadly speaking, electron-beam systems have two major components: the beam-forming and -deflection system, and the pattern-generation and -control systems.

Beam forming and deflection

Beam-forming systems use either the Gaussian round-beam approach or the shaped-beam (square or round) approaches of Fig. 4.

Gaussian systems use the conventional probe-forming concept of the scanning electron microscope (Fig. 4a). In general, two or more lenses focus the electron beam onto the surface of the workpiece by demagnifying the electron-gun source. High flexibility can be achieved since the size of the final beam can be readily varied by changing the focal length of the electron lenses. To

ensure good line definition, the beam size is generally adjusted to about a quarter of the minimum pattern line width.

In the square-beam approach (Fig. 4b), an electron source illuminates a square aperture at the center of a condenser lens placed immediately after the gun. The condenser lens images the gun crossover (1:1) into the entrance pupil of a second condenser lens. This lens together with a third condenser lens demagnifies the square aperture to form the square beam. A fourth lens images the square beam (1:1) onto the target plane. The size of the square beam is generally equal to the minimum pattern line width. To achieve equivalent resolution, the edge slope of the intensity distribution of the square beam (defined as 10% to 90% points) is made equivalent to the beam size (50% intensity) of a Gaussian round beam.

In the case of the round shaped beam, a lens focuses a magnified image of the gun crossover onto a round aperture, and two condenser lenses demagnify the round aperture onto the plane of the target (Fig. 4c).

Round-beam systems (Gaussian or shaped) are generally simpler than square shaped-beam systems and have more flexibility. However, the square beam has more current in the spot (current is proportional to spot area for the same gun brightness) and therefore offers higher exposure speed in cases where speed is limited by beam current and/or beam stepping rate. Difficulties with the square-beam systems may arise when angle lines are required or when some lines have dimensions that are not integral multiples of the beam size. In the latter case, overexposure in the overlapping regions will occur.

Deflection systems for electron beams are generally

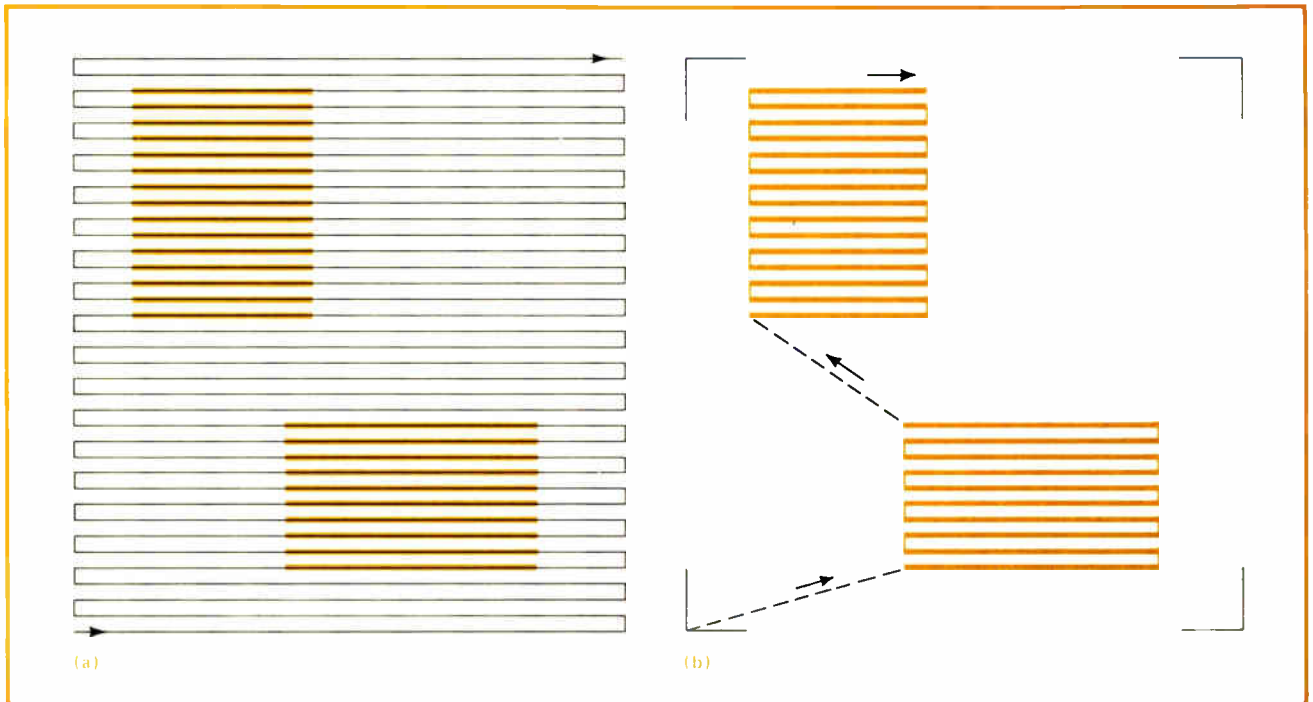

5. Chip scan. In the raster-scan system of electron-beam lithography (a), the beam scans the entire area of the chip while switching on and off according to the pattern data. In the vector scan system (b), the beam is scanned only over the parts where writing is required.

electromagnetic, though electrostatic systems and even a partly electromagnetic, partly electrostatic system exist.

Three electromagnetic approaches have been employed: a double-deflection pre-lens, single-deflection in-lens, and single-deflection post-lens. As the deflection field is inevitably coupled with the focusing field of the magnetic lens, the design of the deflection system must also take into consideration the effect of the lens field. Computer-aided-design programs have been developed to analyze this complex problem and to arrive at an optimization procedure. Distortion terms caused by field curvature and the isotropic astigmatism of the electron-lens system can be corrected dynamically, whereas other aberrations cannot.

Analysis of the three systems shows that without dynamic corrections an optimized pre-lens double-deflection system offers the best performance. With dynamic corrections, the performance of the pre-lens double-deflection and in-lens single-deflection systems rated nearly equal, and the post-lens single-deflection gave poorer results. For high beam currents of more than 1 microampere, when electron-electron interactions must also be considered, deflection *in* the lens is favored.

IBM's Vector Scan One (VSI) is a Gaussian round-beam system that uses a lanthanum hexaboride gun, three magnetic lenses, and a pre-lens double-deflection unit. It achieves exposures of 1- μm lines over a 4-by-4-mm field and 0.5- μm lines over a 3-by-3-mm field at a beam semiconvergent angle (α) of 1×10^{-2} radian without any dynamic corrections. The α value, together with the brightness of the LaB₆ gun of 1×10^6 A/cm² steradian, gives a current density of 300 A/cm². The measured distortion for a 2-by-2-mm field is 0.1 μm and the calculated distortion for a 4-by-4-mm field is 0.85 mm. Typical working distance of the lens is 5 cm.

A shaped-square-beam lithography system (ELI) designed by IBM's East Fishkill Laboratory employs a tungsten filament gun and a large-gap final lens with a single-deflection unit inside the lens. This unit, with dynamic focus corrections, can achieve a 5-by-5-mm field with a 2.5- μm square spot having an edge resolution of approximately 0.4- μm at a beam semiconvergent angle of 7×10^{-3} radians. Typical beam current is 3×10^{-6} A at a current density of 50A/cm².

A shaped-round-beam system designed by Texas Instruments (EBMII) features a lanthanum hexaboride gun, a pre-lens double-deflection unit, and a final lens with a focal length of 7.5 cm. With dynamic corrections, a field size of 6.35 by 6.35 mm has been achieved for 1 μm lines with a 3×10^{-3} radian beam semiconvergent angle.

Pattern generation and control

After the beam has been focused and shaped, it must be moved (scanned) over a wafer by a beam-writing technique.

The two basic beam-writing techniques are raster and vector (Fig. 5). In the raster technique (Fig. 5a), the beam is scanned over the entire chip area and is turned on and off according to the desired pattern. In the vector technique (Fig. 5b), the beam addresses only the pattern areas requiring exposure, and the usual approach is to decompose the pattern into a series of simple shapes such as rectangles and parallelograms.

Raster scan places less stringent requirements on the deflection system because the scanning is repetitious and distortions due to eddy currents and hysteresis can be readily compensated for. It can also handle both positive and negative images. Vector scan is more efficient but requires a higher-performance deflection system. In

addition, it has several other advantages not readily available to the raster-scan technique—for instance, ease of correction for the proximity effects of electron scattering, and a significant compaction of data that can lead to a much simpler control system.

Proximity effects are created by scattered electrons in the resist and backscattered electrons from the substrate, which partially expose the resist up to several micrometers from the point of impact. As a result, serious variations of exposure over the pattern area occur when pattern geometries fall in the micrometer and submicrometer ranges. A vector-scan correction technique consists of adjusting the beam stepping rate and hence the exposure intensity for each pattern element. These adjustments can be readily integrated into the data that describes the pattern. A corresponding raster-scan correction method has yet to be developed.

Two main approaches have been used to expose and register patterns over the surface of the mask or wafer—the step-and-repeat and the continuously-moving-table approach.

In a step-and-repeat system, the pattern is exposed by deflecting the electron beam over a square field, typically a few millimeters on a side, with the workpiece stationary. After the exposure, the workpiece is moved to a new location, the beam is registered to the sample, and the pattern exposure repeats. This process continues until the whole wafer is covered. In each field location, the pattern can be generated using either the vector-scan or raster-scan technique.

The most widely used step-and-repeat systems employ vector scanning. The vs₁ system is one example (Fig. 6a), and similar systems have been developed by Texas Instruments, Hughes Research, Mullard, Hitachi, Bell Northern, and several other establishments for their own research and development work. Several electron-microscope companies (Thomson CSF, Cambridge Scientific Instrument, Cambridge, Maryland, ETEC, Hayward, California, and others) have also produced commercial systems of this type

In vs₁, the chip pattern is analysed in terms of rectangles, parallelograms, triangles, and others taken from a random-shape store of curved shapes or repetitive groups of shapes. Data is transferred from the computer to a high-speed pattern generator that drives dual-channel digital-to-analog converter units. These units consist of low-speed high-precision d-a converters, which address the beam to each pattern element, and high-speed low-accuracy d-a converters, which perform the fill-in of each element. In experimental tests, the d-a units together with a large-bandwidth deflection amplifier have been able to deflect the electron beam at a stepping rate of 10 megahertz (i.e. 100 nanoseconds for each beam location) and still give good exposures. An automatic registration system digitally enhances the signal-to-noise ratio of the registration signal.

The vs₁ typically handles chip sizes 2,000 times the minimum pattern lines width, but it can also generate larger sizes by joining adjacent patterns. It has fabricated high-resolution devices with registration accuracy in the order of 0.1 μm for 1-μm line patterns.

One such device is the 8,192-bit FET RAM shown in

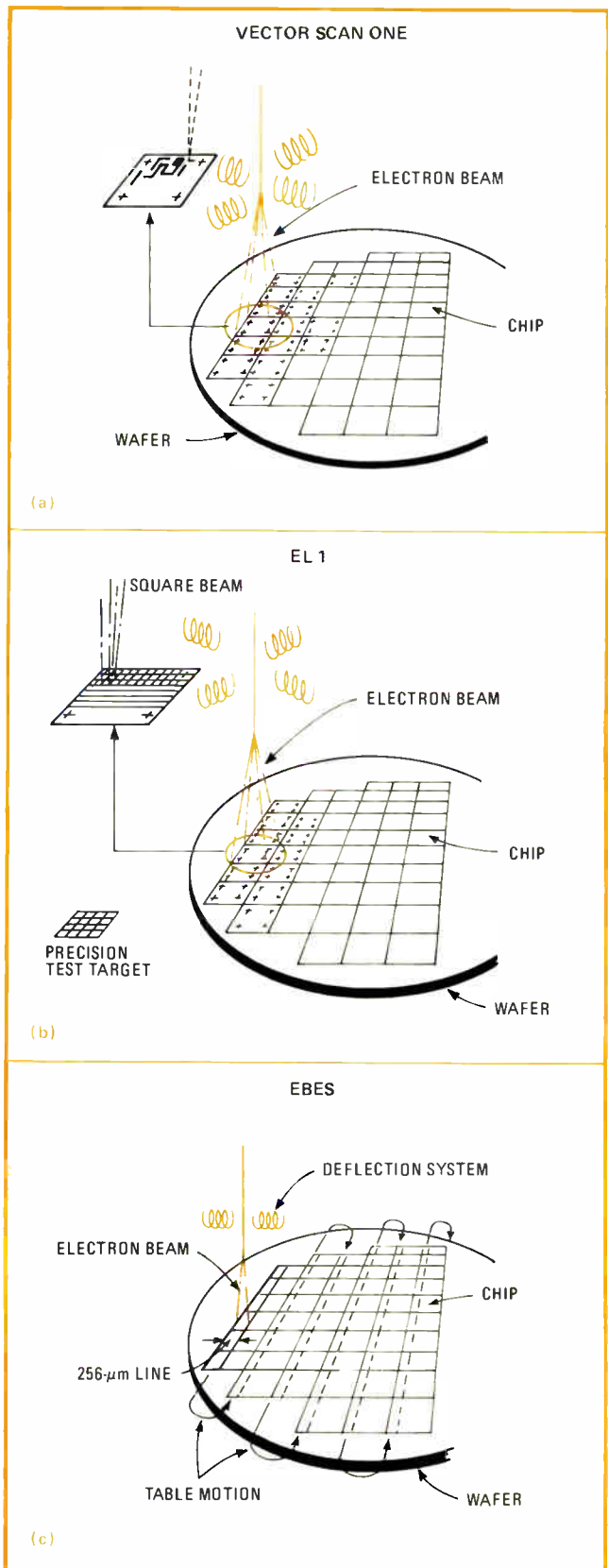

6. Pattern distribution. Two approaches are being applied to distribute patterns over wide surfaces. The step-and-repeat method of IBM's vs₁ (a) and EL 1 (b) exposes patterns over a square field. Then the workpiece is stepped to a new location. In Bell Telephone Labs' EBES (c), the table moves continuously while the beam scans a strip.

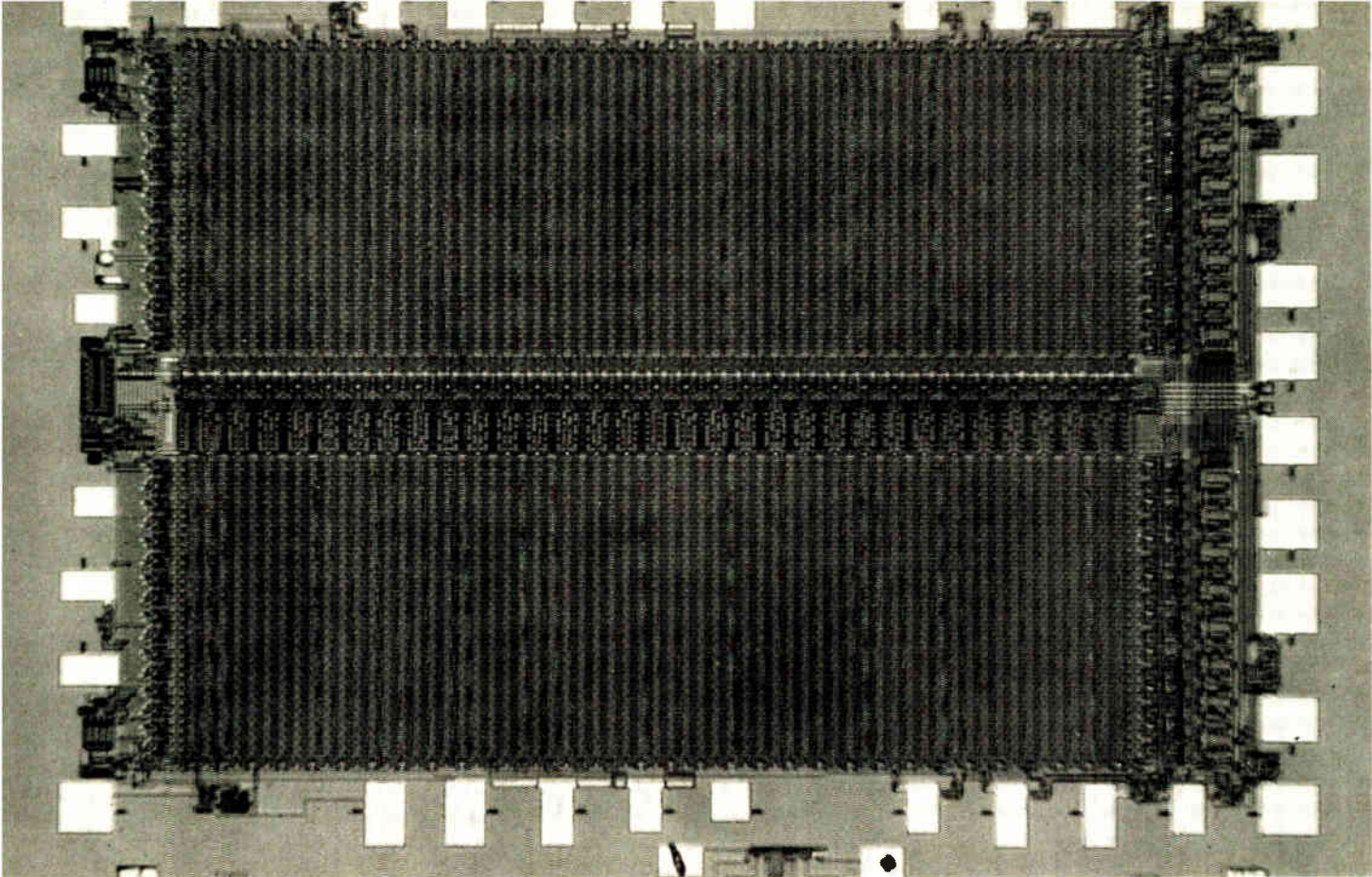

Fig. 7. The device has a channel length of approximately $1.25\ \mu\text{m}$ and an access time of 90 ns. As a lithography exercise, the same 8-k chip has also been made with a line width of $0.6\ \mu\text{m}$, with all four pattern levels properly aligned and processed.

Pattern writing time of the VS1 system depends on pattern density. At a 10-MHz beam-stepping rate it takes 1 to 2 seconds to expose a typical LSI chip to a pattern occupying about 25% of its surface area.

An important extension of the step-and-repeat system is the incorporation of a precision table controlled by laser interferometry. Originally proposed by Thompson CSF, the idea is to detect errors in table position by laser interferometry and correct for them by deflecting the electron beam. A 1-megabit magnetic-bubble test chip, consisting of $2\text{-}\mu\text{m}$ bubbles contained within a 1-square-centimeter field, has been fabricated by the electron-beam system of Texas Instruments (EBMII), which uses this technique. The refinement allows fewer registration marks to be used per wafer and enables a composite pattern to be stitched together using the laser interferometer as the reference.

The square-beam EL1 system is also a step-and-repeat system. The high-throughput system is the first electron-beam system devoted to direct semiconductor device manufacturing—it has been operating for two years in a production environment.

In this system, shown in Fig. 6b, the pattern is exposed by the $2.5\text{-by-}2.5\text{-}\mu\text{m}$ shaped beam, the size of which equals the smallest dimension of the pattern. A stepped raster-scan technique is used so that distortions caused by eddy currents, thermal characteristics, etc., are repeated and can be readily corrected. Deflection distor-

7. Random-access-memory chip. IBM's VS1 system produced this experimental 8,192-bit metal-oxide-semiconductor RAM. Metalization lines are $2\ \mu\text{m}$ wide, and gate length is $1.25\ \mu\text{m}$. For a demonstration, the VS1 made the same unit with $0.6\text{-}\mu\text{m}$ line widths.

tion errors over a 5-mm field are measured by scanning the beam over a gold calibration grid and corrected by an automatic correction system to a less than 30-part-per-million deviation. An overlay accuracy better than $0.5\ \mu\text{m}$ over a 5-mm field is achieved by the automatic registration system.

The EL1 system has achieved high-speed production of up to 22 $2\frac{1}{4}$ -inch wafers per hour of LSI circuits. Typical performance for producing each 5-mm chip is: registration time of 200 milliseconds, pattern write time of 0.96 s, and table move time of 250 ms.

In a continuously-moving-table system, the electron beam is raster-scanned in one direction, and the table moves continuously in the other direction, while a laser interferometer measures the table position and feeds information back to the control system of the electron beam.

This scheme is the basic principle of the electron-beam exposure system (EBES) developed at Bell Telephone Laboratories (Fig 6c). In EBES, the beam scanning width is fixed at $256\ \mu\text{m}$, and the pattern is formed by joining a number of these strips, which are typically 4 mm long. Pattern registration is performed once for the whole workpiece, but checks are made from time to time to correct for beam drift.

The system uses a $0.5\text{-}\mu\text{m}$ spot with a current density of $10\ \text{A}/\text{cm}^2$ based on reported gun brightness of $10^4\ \text{A}/\text{cm}^2$ steradian and beam semiconvergent angle of 1.3×10^{-2} radian. It has demonstrated a writing speed of

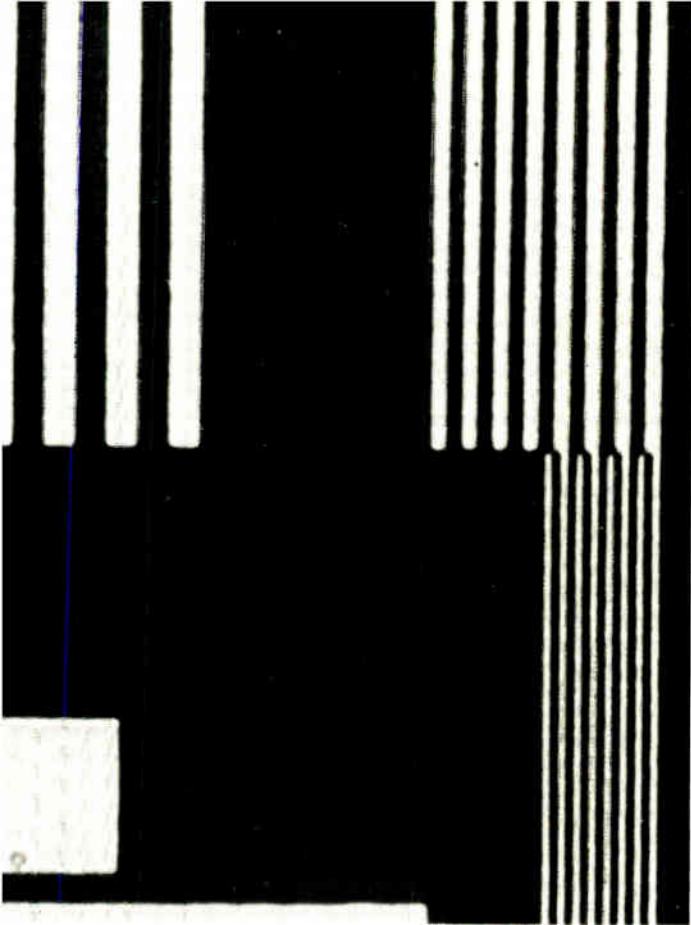

8. Electron-beam mask. High-resolution masks can be made by electron beam systems as in this enlarged portion of a mask generated by Bell Telephone Laboratories' EBES on a chromium surface. Minimum line width on the chromium mask is $0.5\ \mu\text{m}$.

$2\ \text{cm}^2/\text{min}$ based on $0.5\text{-}\mu\text{m}$ addresses (digital X, Y coordinates or increments) and a 20-MHz stepping rate. A $0.25\text{-}\mu\text{m}$ address is also available at a quarter the writing speed. The table moves continuously at a speed of $2\ \text{cm/s}$ with a laser interferometer that can measure increments of $\lambda/24$, where λ is the laser radiation wavelength. Normal time to complete a mask, for a 3-in. wafer is given as 40 minutes ($0.5\text{-}\mu\text{m}$ addresses). A section of a typical electron-beam-generated mask is shown in Fig. 8. Commercial versions of this system are currently being offered by ETEC and Extrion, Gloucester, Mass.

In principle, the step-and-repeat and continuously-moving-table approaches can be applied equally well to both mask making and direct wafer exposure. At present, however, most device fabrication by electron-beam exposure has been with step-and-repeat systems—though this may be simply because there are more systems of this type available. In general, step-and-repeat systems, which do one complete chip at a time, are more suitable for high-resolution work since no pattern-joining error from table inaccuracy need be considered. Also, better registration accuracy has been achieved with this approach to date, because it is less sensitive to problems such as beam drift and wafer distortion.

The continuously-moving-table approach places less stringent requirements on the performance of the electron optics and deflection system and can operate with a

small deflection angle and at a relatively short working distance. In principle, this should allow higher beam-current densities. In addition, as the table is moving during the pattern-writing process, part of the table-movement time need not be considered an overhead as in the step-and-repeat system.

Factors affecting throughput

Throughput for scanning-electron-beam systems is determined by the speed of registration, table motion, and especially pattern writing speed. The same basic factors affect the pattern writing speed for the VSI, ELI and EBES scanning systems.

Consider a typical 2,000-line chip, i.e. with side dimensions equal to 2,000 times the minimum pattern geometry, so that $2.5\text{-}\mu\text{m}$ lines create a 5-by-5-mm chip. The pattern writing time (T) for such a chip is given approximately by $T = N/f$, where N is the number of beam addresses in the chip and f is the beam stepping rate. The top graph of Fig. 9 shows writing time versus beam stepping rate for N values of 16×10^6 , 4×10^6 , and 64×10^6 representing the mode of operation for VSI (25% coverage), ELI, and EBES respectively. (Beam address is taken as a quarter of the minimum pattern line width for VSI and EBES and equal to it for ELI). Not unexpectedly, writing time shortens as the beam stepping rate increases.

In general, beam-stepping rate is limited both by the speed of the deflection system and by the combined effect of beam-current density and resist sensitivity.

Deflection speed is governed by the noise-bandwidth characteristics of the deflection system, digital-to-analog conversion rates, deflection unit impedance, etc. Typical working values reported to date for VSI, ELI, and EBES are 10 MHz, 5 MHz, and 20 MHz respectively.

The beam stepping rate is related to the beam-current density (j) and resist sensitivity (q) by this expression: $f = j/q$. Beam current density is a function of electron optical parameters such as gun brightness, lens and deflection-system aberrations, and electron-electron interaction effects. Published current densities for VSI, LS1 and EBES are $300\ \text{A}/\text{cm}^2$, $50\ \text{A}/\text{cm}^2$ and $10\ \text{A}/\text{cm}^2$ respectively.

Figure 9's two sets of curves show the effect on pattern writing time of deflection speed, beam-current density, and resist sensitivity. Writing time per chip for the three systems is listed in Table 2 (but note that these values in the table are based on simplified data without writing time overheads and do not represent the inherent limit of the three systems).

The writing speeds for the three systems could all be improved. For VSI, the main limitation at present is deflection speed, and improvement in the deflection drivers and d-a converters would be of direct benefit. In addition, the use of more than one beam size (small beam for outline and large beam for fill-in) would also improve speed. At the extreme, deflection system settling time and logic switching time in the pattern generator may present a limit.

For ELI, high speed can be achieved by improving resist sensitivity and deflection speed as neither is at its limit. However, a data-rate limitation may be encoun-

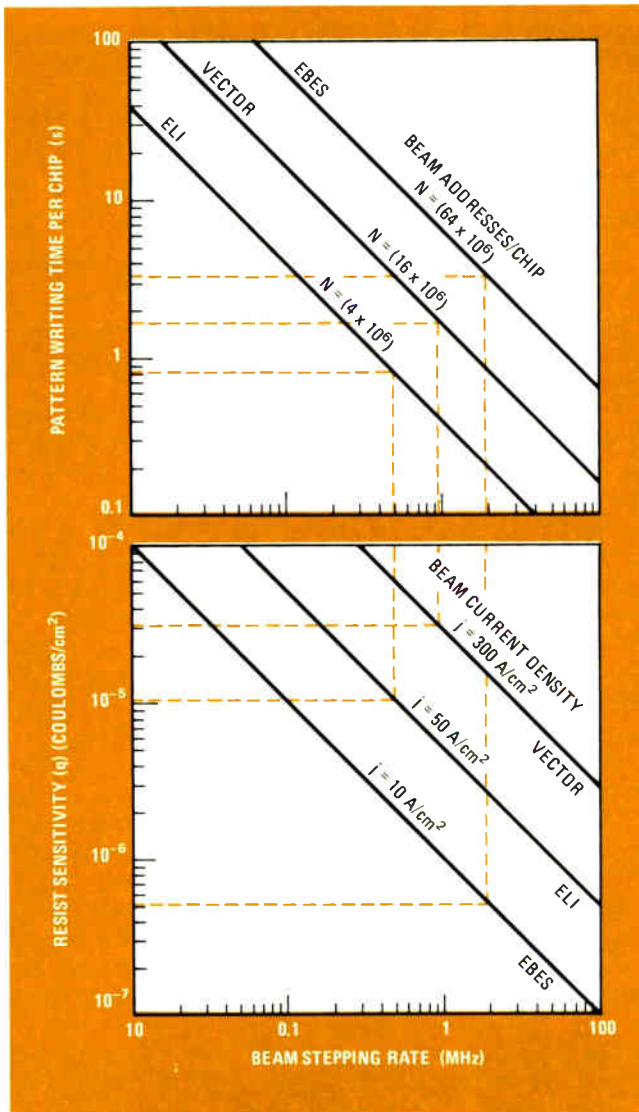

9. Beam stepping rate. The top graph indicates the effect of beam stepping rate on pattern writing time per chip for the VSI, EL1, and EBES. Effects of beam-current density and resist sensitivity on beam stepping rate are shown in the bottom graph, in which three vertical dotted lines indicate the operating stepping rates. Note that systems with low beam-current density require high resist sensitivity.

tered because in this instance each beam position must be individually specified in the data stream.

In EBES, resist sensitivity is already very high, and further speed increase would require some improvement in beam-current density. In principle, such improvement should be possible as discussed earlier. In addition, the number of beam addresses could be reduced by skipping scan lines where no pattern exists. However, table speed and data rate may pose limits.

Three areas of application

A scanning electron-beam system can be used for mask making for conventional optical printing systems, as well as for direct wafer exposure and mask making for advanced high-resolution replication systems.

The electron-beam approach to mask making requires no major changes in an existing optical lithographic

TABLE 2: WRITING TIME FOR TYPICAL ELECTRON-BEAM SYSTEMS

System	Writing time (seconds/chip)	Resist sensitivity needed (coulombs/cm ²)
VSI	1.6	3 × 10 ⁻⁵
EL1	0.8	1 × 10 ⁻⁵
EBES	3.2	5 × 10 ⁻⁷

operation, though the optical printing system restricts resolution. Technical details for the mask-making operation have been resolved, and several systems have been developed for routine use. The main advantages of this approach are improved mask quality and faster turn-around time. Cost has been found to be competitive even when high-cost prototype electron-beam systems are used. Commercial systems for this application should be available in the near future and should widen its usage in the industry.

Direct wafer exposure can be divided into two categories: pattern line width in the optical range (down to 1 to 2 μm) and suboptical line width (1 μm and below).

In the optical range, electron-beam lithography has been used in a manufacturing environment, but it competes directly with present-day UV printing. Its main advantages are sharper pattern definition and greater overlay accuracy. In addition, it should improve yield by eliminating some of the defects caused by the use of masks and greatly reduce turnaround time when circuit customization is required.

For suboptical pattern line widths, the scanning electron-beam approach is at present the only proven fabricating technique. (The only other technologies that could compete in the future are electron-beam projection, X ray, and extensions of contact printing that use shorter-wavelength UV in combination with thin masks that can be conformed to the sample.) But although electron-beam lithography is ready for suboptical geometries, some of the associated processing technologies still require considerable development. Working circuits fabricated to date are chiefly special-purpose high-frequency devices, like microwave transistors, surface acoustic transducers, and high-density magnetic-bubble circuits. Only a few LSI components have been made, primarily for research and feasibility studies to verify the economics and technological benefits of small devices.

In general, the use of scanning-electron-beam lithography for direct wafer exposure still costs more than optical techniques. But the gap is narrowing rapidly, and with improvement in throughput and equipment cost, it should be possible to achieve cost-competitiveness in the future, including suboptical applications.

Lastly, electron-beam techniques can be used to produce masks for other high-resolution replication systems such as X ray, deep UV printing, and 1:1 photoelectron projection printing, which are still in the developmental stages. All these systems promise high-speed printing from a high-resolution mask produced by a scanning electron beam, along with the potential of low production cost. □

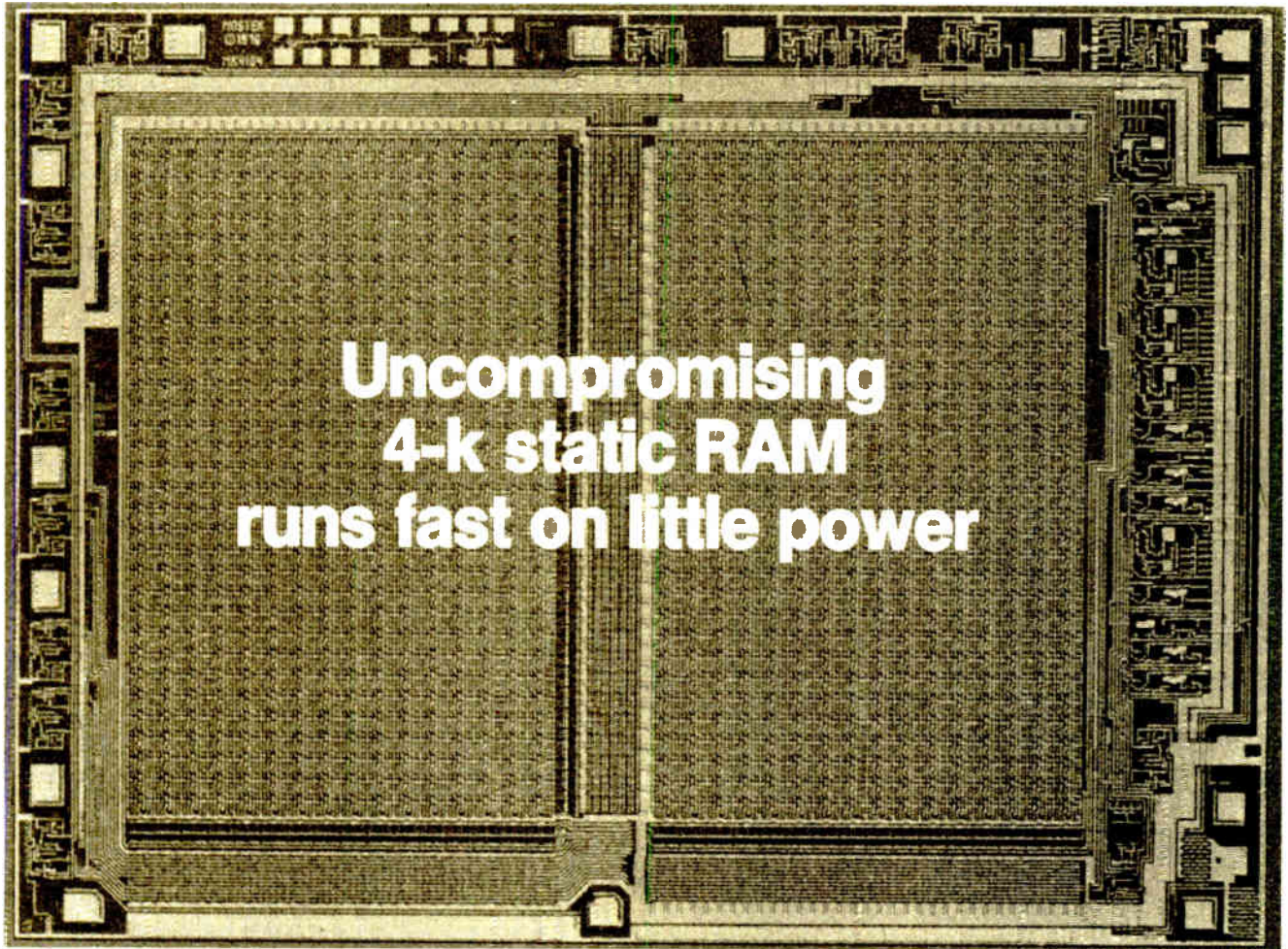

Uncompromising 4-k static RAM runs fast on little power

Clocked sense amplifier and polysilicon load resistors
reduce cell size, as well as cutting power dissipation

by Sam Young, *Mostek Corp., Carrollton, Texas*

□ Easy to use the new crop of n-channel MOS 4,096 static random-access memories may be, but the tug of war between speed and power still looms. However, one RAM stands out because it avoids a compromise between these vital parameters.

Some of its competitors offer fast access times of less than 100 nanoseconds, but require multiple power supplies or dissipate high power. Others, such as complementary-metal-oxide-semiconductor RAMs, use little power, say less than 200 milliwatts, but have access times well above 500 ns. The MK 4104 is special in being both fast and power-thrifty.

Combining static- and dynamic-memory techniques, the chip achieves a maximum access time of 200 ns (150 ns typical) and maximum cycle time of 260 ns. Yet it dissipates typically only 80 milliwatts of active power at

4 megahertz and a very low 8 mw in standby. An additional low-power mode of 1.0 mw is available for battery backup operation, achieved simply by lowering the power supply voltage from 5 volts to 2 or 3 v.

Moreover, the 4104 is extremely easy to use. It needs only a single power supply, which is in the conventional transistor-transistor-logic position. The device is supplied in the 18-pin package now standard for static memories. It is designed to operate at ordinary transistor-transistor-logic levels with loose power-supply tolerances of $\pm 10\%$, greatly reducing the cost of close regulation common with $\pm 5\%$ parts.

In addition, the 4104 can accept any TTL input signal meeting worst-case specifications, thus eliminating all level-converting interface circuits that may be needed with other 4-k static designs. Moreover, since the 4104

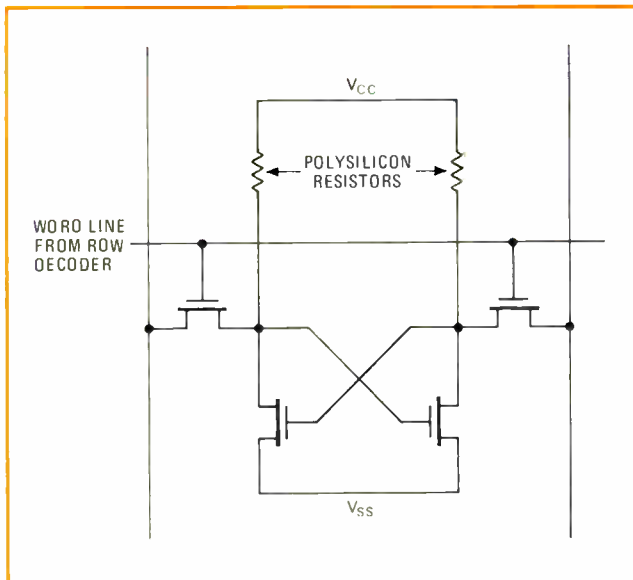

1. New static cell. A new static RAM cell design that uses resistors as loads saves space and reduces power consumption. Each 5000 megohm resistor is an ion-implanted polysilicon device that draws less than 1 nanoampere of current.

was designed to be tolerant of inputs with very slow rise times, it can directly accept signals from low-power Schottky TTL for low-power applications. Finally, the 4104 will sink 4 milliamperes at 0.4 v and source 500 microamperes at 2.2 v, making it agreeable with all types of TTL-compatible data-bus interface circuits commonly used in memory system design.

A new cell design

Unlike typical static memories with their six-transistor cells, the 4104 has cells of only four transistors and two ion-implanted polysilicon resistors that act as loads (Fig. 1). This cell design saves space, as well as reducing power dissipation.

Space is saved because polysilicon load resistors can be fabricated practically in the same region as the transistors themselves (Fig. 2). The cell area is only 2.75 square mils—less than half the size of standard six-transistor cells.

Power is reduced because the high-impedance (5,000-megohm) resistors conduct less than 1 nanoampere of current. Also, using ion-implantation to fabricate these loads allows the load-current levels to be adjusted. The resulting power dissipation is only 20 microwatts per memory cell.

The resistors display a negative temperature coefficient and therefore are self-compensating for the increased current leakages that traditionally occur at elevated temperatures. The low currents in the resistors also allow the cell to retain data even when the power supply voltage is as low as a few hundred millivolts above the transistor threshold voltage (typically 1 v). It is this feature that permits the RAM to retain data reliably at very low levels of supply voltage.

Besides polysilicon resistive loads, the MK 4104 is one of the few 4-k static RAMs to use dynamic (clocked) interface circuits to control the memory array. This

Testing and reliability

The MK 4104 presents no significant testing problems beyond those intrinsic to static RAMs generally. Since the device uses an internal timing generator to strobe the data-out circuitry, the access time is insensitive to address and data patterns, which simplifies worst-case testing for the user.

In order to reduce the time for testing, a user can combine a static cell test with a low V_{cc} mode (2-V) test. Writing and reading data at normal voltage is combined with a wait period at $V_{cc} = 2$ V to verify that all cells are static and that the part can retain data at reduced power-supply voltage.

A principal factor affecting reliability is junction temperature, which is related to power dissipation and ambient temperature. At 80-mW dissipation, the MK 4104 operates at a junction temperature of about 75°C (70°C ambient). Typical nonclocked parts under similar operating conditions have junction temperatures approximately 30°C higher because of their higher power dissipation. The lower junction temperature of the MK 4104 should result in significantly better reliability.

The single 5-V supply reduces stress on oxides and other key areas within the die. Many failure modes requiring high voltage as a catalyst cannot occur within this RAM.

"Soft" errors, another problem plaguing static RAMs, are generally thought to be caused by poor margin-to-input signal levels, poor tolerances to supply noise, or both. Those error signal occurrences are minimized in the MK 4104. The chip is designed for a loose $\pm 10\%$ power supply to increase its tolerance to system noise. Its peripheral circuitry is truly compatible with TTL input levels: a 2.0-V input-high voltage level compared to a 2.4-V level for most other static random-access memories, and an 0.8-V input-low voltage that yields an easy-to-live-with 400-mW worst-case noise immunity.

dynamic interface makes it possible to use performance-boosting circuit techniques similar to those employed in high-performance dynamic RAMs, such as the MK 4027.

Dynamic interfaces and sense amp

As in the 4027, signals generated internally from the chip-enable clock cause the internal circuits to power down once their functions have been accomplished. This results in significantly lower power dissipation. Moreover, dynamic circuits are faster since low-capacitance precharge nodes can be employed to shorten the memory cell's RC discharge-time constant.

Once clocks are provided to power the interface, they may also be used to service dynamic sense amplifiers, further improving speed. The 4104 has a differential sense amp conceptually similar to those of the 4027. It can detect differential signals as low as 100 mv, as compared to other static RAM devices, which can require several volts for reliable operation.

As in the 4027, the dynamic balanced sense amplifier uses several clock phases to achieve low-power, high-performance sensing. High speed is achieved by sensing

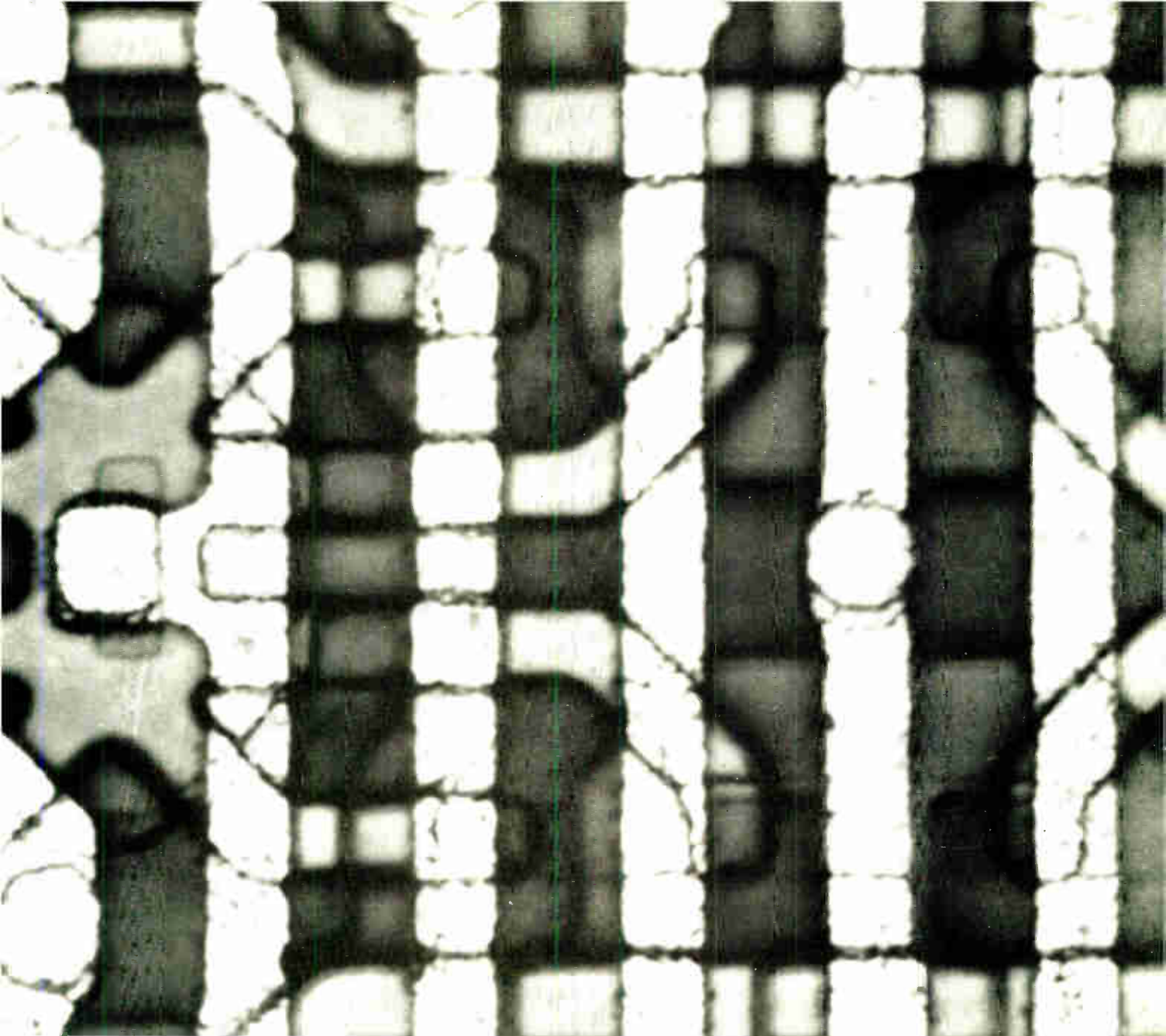

2. Compact. The 4104's cell, which contains four transistors and two ion-implanted resistors, is considerably smaller than conventional six-transistor static cells. Cell area is only 2.75 mil^2 or less than half the size of standard static designs. Power is reduced in half.

a small differential voltage, thereby minimizing the time required to charge the data bus. The sense amplifier is clocked on after enough time has been allowed for a 100-mv differential to appear on the data bus. Since the sense circuit has a 1-mv sensitivity, a 100-mv sense level allows enough margin for circuit and process variations.

Because the interfaces and sense amp utilize clocked operation and dissipate power only for short intervals when activated, the power dissipation is dependent on the clock frequency and therefore is subject to reduction at lower frequencies. For example, the typical power dissipation at 1 MHz is 23 mw, compared to 70 mw at 4 MHz (Fig. 3). By contrast, the power dissipation for a fully static RAM would remain constant at its high (active) level. Because there is no significant dc path during clock-on periods, damage from high currents cannot occur to the memory should the clock input

become shorted to ground when system malfunctioning may occur.

The MK 4104 is organized internally as two 32-by-64-bit memory subarrays, with the row decoders in the middle (Fig. 4), although to the user it is simply a 4-k-by-1-bit RAM. The device contains all buffers, decoders, and internal clock generators needed for complete static operation. The decoders are conventional dynamic NOR-gate circuits. The address buffers are a combination of static and dynamic circuits, permitting a very fast sample-and-hold technique for address capture.

Using the 4104

With a sense amp and interfaces of the dynamic type, this RAM operates differently from its static competitors. The negative-going edge of the chip-enable pulse triggers a sequence of internal clock edges. They activate the

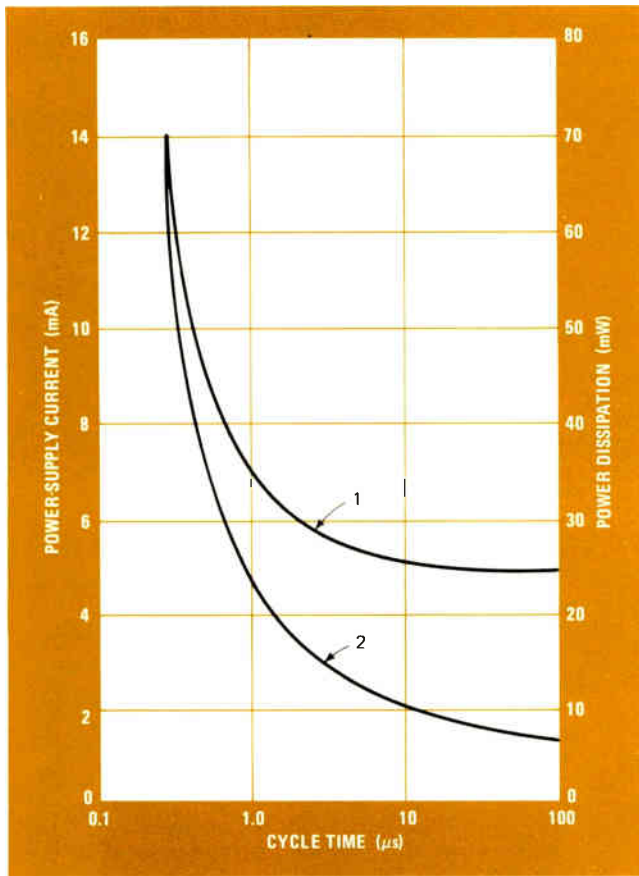

3. Power down. The 4104 is the only static RAM with frequency-dependent power dissipation, resulting from the use of dynamic interface circuits. Clock-on time (low-level) for curve 1 is 100 ns; clock-off time (high-level) for curve 2 is 200 ns. For both curves, ambient temperature is 25°C and power-supply voltage is 5 V.

address buffers, discharge the precharge clock, transfer true and complement address data to the inputs of the row and column decoders, and finally transfer the decoded row and column addresses to the proper word line and column-select line.

Then the static input-address buffers are turned off so that they no longer consume power. After a delay to allow time for the cell to transfer data to the differential output sense circuitry, additional clocks activate the output sense circuitry and finally the output buffer. The data is now available at the output terminals of the device.

Once the data is present, the positive-going edge of the chip-enable pulse causes the precharge clock to go high, discharging all other clocks and opening the output circuit. As long as the chip-enable clock is high, the chip remains in the precharge mode, which is also the low-power standby mode. Data will be maintained indefinitely in this mode. It is now ready for the next cycle: read, write, read/write, or read/modify/write. Each of these operating cycles is initiated by activation of the chip-enable clock.

Address inputs must be stable before this activation. Since these inputs are sampled and latched internally early in the cycle, only a short address-hold time (typically 75 ns) is required. This feature eliminates the need

for system address latches to support the memory. Enhanced performance may be obtained by generating the new address in the previous cycle, thus circumventing the slow-address propagation path.

Data outputs become valid after activation of the chip-enable clock. The data-out pin will be in an open-circuit mode before appearance of valid data for a simple read. By loading the output with a resistor to either the V_{cc} power supply or ground, the user may choose the data-valid direction on the output bus to which the RAM is connected. Now, during a write cycle, the data-out pin will remain an open circuit if the write-enable pin is activated (typically no later than 80 ns after chip-enable). This property permits the designer to employ common-I/O operation, which is useful for most micro-computer systems.

The data-out pin will then contain valid data during the write portion of the read/write or read/modify/write cycle, assuming the write-enable pulse's negative-going edge occurs after the specified access-time interval. Data will remain valid for all cycle types until the chip-enable pin is deactivated.

To write into the MK 4104, data inputs must be valid when the write-enable signal goes negative. Data inputs are sampled internally and must remain valid until all internal nodes are charged. This occurs before the write-enable trailing edge. The write cycle is then completed by either the write-enable signal or the return of the chip-enable signal to the inactive state.

Building a system

The MK 4104 may be easily integrated into large memory configurations in highly compact board layouts. The single-supply device in an 18-pin dual in-line package yields a higher packing density than can be achieved with any dynamic or 22-pin static RAMs.

The pinout was chosen to eliminate crosstalk on critical signals within the array on the storage board. The power pins were positioned to allow maximum connection area between the chip and the power-ground bus of the printed-circuit card. Data-out and data-in pins were positioned to allow optimum placement of decoupling capacitors within the memory array, as well as to separate the clock signals from address signals.

Since refresh is not required, designers can eliminate components that cause time delays, as well as undesirable power-supply transients. And the 5-v $\pm 10\%$ supply, combined with the elimination of refresh transients, greatly eases memory decoupling requirements. In fact, memory system of MK 4104s will require less than a third of the decoupling capacitors recommended for dynamic-RAM systems.

In building memory sizes greater than 4,096 bits, the typical power dissipation of 8 mW results in major power savings to the user. For example, a 16-k-by-9-bit storage board designed with clocked-interface MK 4104s would require 940 mW for the memory array, while the same configuration designed with static-interface RAMs would require approximately 18,000 mW. The larger the memory size or the lower the operating frequency, the greater this differential becomes. The power saving reduces cooling and power costs to the user, as well as

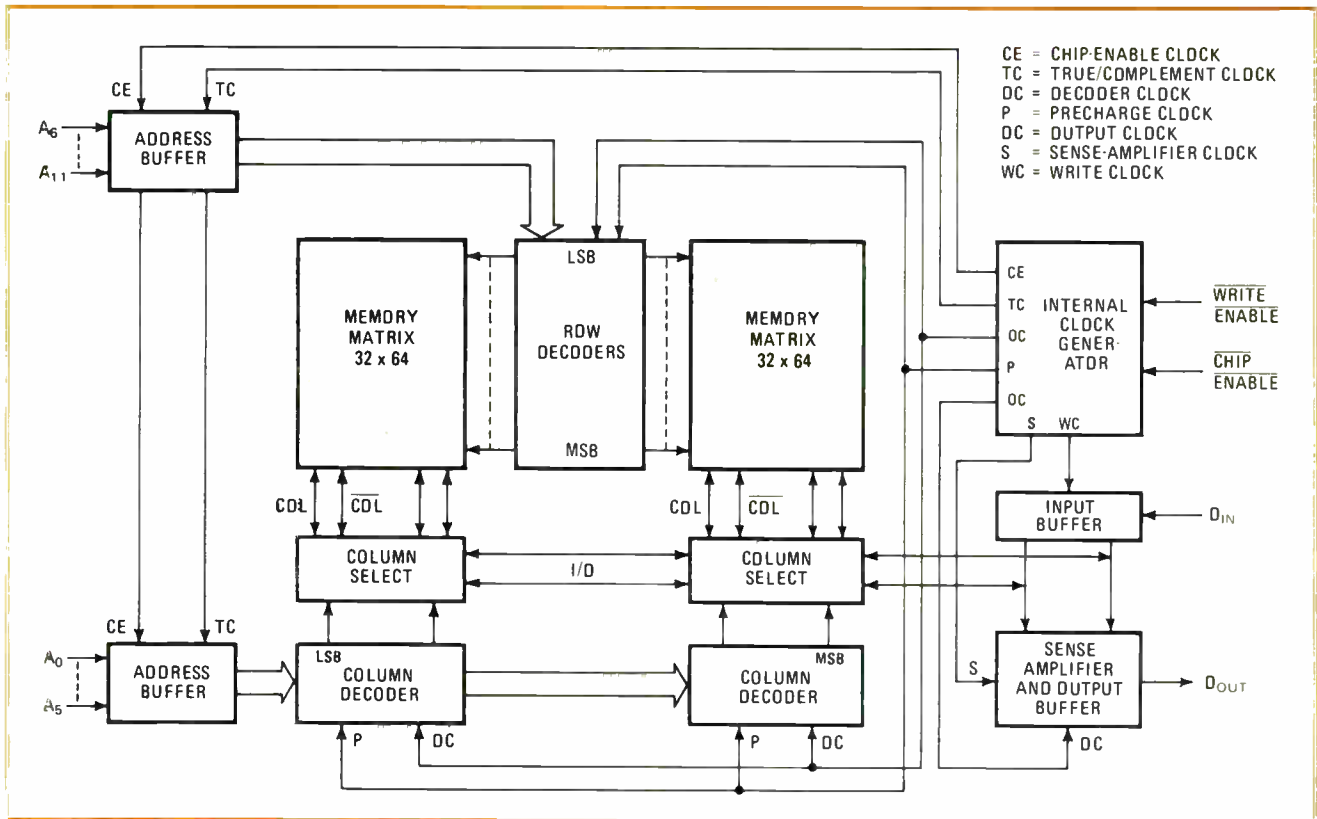

4. Organization. The chip is organized as two 32-by-64-bit arrays, resulting in a 4-k-by-1-bit static device containing all buffers, clock generators, decoders and sense amplifiers. To minimize power consumption, the interface circuits are dynamic.

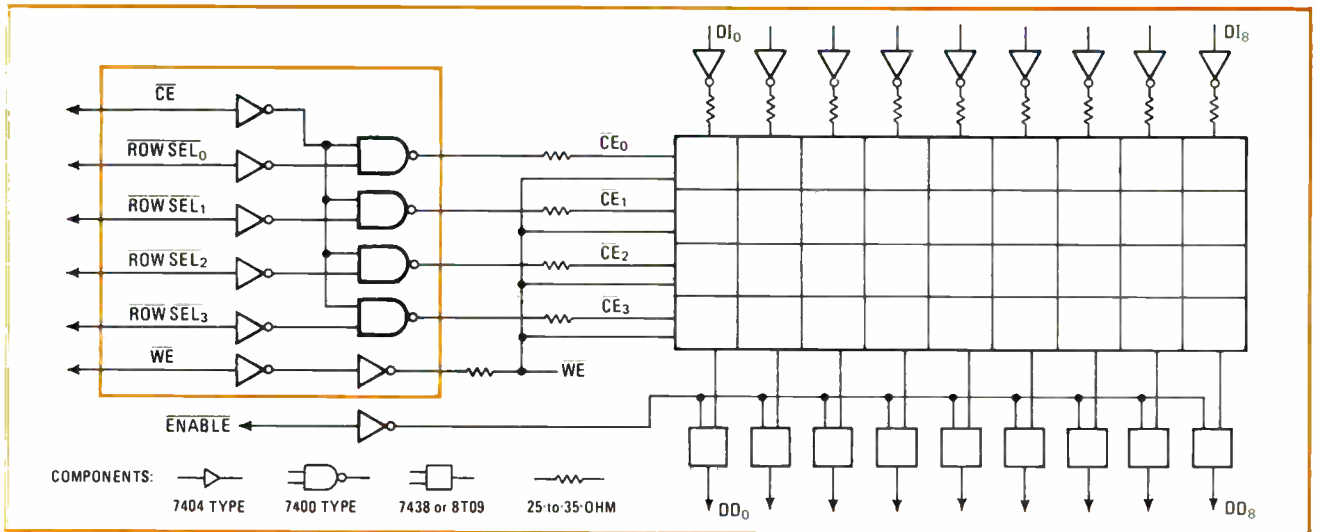

5. Easy driving. The support circuitry required with the 4104 can be designed with standard TTL or Schottky TTL parts. Low capacitance inputs permit high fan-out capability, which is useful in large control systems.

improving overall reliability. At typical system design costs of \$1.00 to \$1.50 per watt, this savings can be significant.

The 16-k-by-9-bit system's basic circuitry (Fig. 5) consists of readily available NAND gates and inverters. These support chips can be standard-TTL, high-speed-TTL, Schottky-TTL, or low-power-Schottky-TTL parts. Since the total signal capacitance is directly related to the number of RAMs connected to each signal, the performance of the overall system may be improved by

dividing the capacitance load among several drivers when large numbers of memory chips must be driven.

For systems using microprocessors with common input/output data buses, the MK 4104's data-in pin may be connected to the data-out pin. To avoid conflict on the data bus, the write operation must be implemented in the early write mode. This merely requires that the write-enable signal be activated prior to the chip-enable pulse, thereby guaranteeing the data-out pin will be open during write operations. □

Automatic clamp controls symmetrical wave-form offset

by George O. Wright
Washington, D.C.

It is often necessary to shift the dc level or offset of a signal. Driving transistor-transistor-logic circuits, for example, requires positive-only signals, but sometimes circuits may need negative-only signals, or symmetry of a wave form about a given dc level may be required. An inverting operational amplifier, an integrator, and a half-wave rectifier can be used to form such an offset control simply and inexpensively.

At the flick of a switch, this circuit clamps the input level at almost any desired value (Fig. 1). Operation of the circuit is based on the principle that the dc value of any periodic wave form can be found by integration. Since the input is dc-coupled, the integrator output V_{dc} will be equal to the dc component of the signal plus any initial dc offset. As a consequence of its integrating operation, the circuit can generate an output symmetrical about the zero axis.

As shown in Fig. 2, the input signal, which may be a sine, triangle, square or ramp wave form, is summed with the inverted output of the integrator A_1 at the inverting input of op amp A_2 . The input wave form at

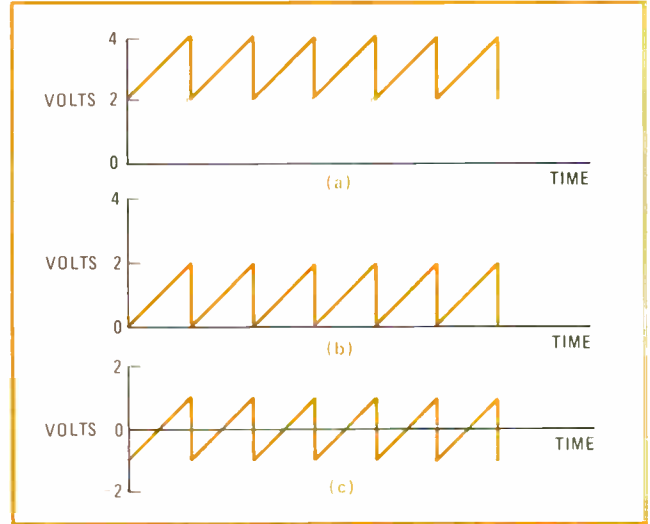

1. Symmetry or clamping desired? Input ramp at: (a) is clamped to zero (b) or is symmetrical about zero (c). Circuit may be modified so that clamping to nearly any voltage level is possible.

this point is displaced downward by an amount equal to its integrated voltage value V_{dc} .

To clamp the output at 0 v, the mode switch is placed in position A. The reference level at the noninverting input of the differential amplifier A_2 becomes minus half its initial peak output swing because of the signal's subsequent peak detection at the output of A_3 . Operation of amplifiers A_1 and A_2 assure that the initial signal to

2. Level adjuster. Components are chosen for a minimum frequency of 1 kilohertz. Resistor R_1 may be a potentiometer to vary position in horizontal axis of symmetry. A variable-gain dc amplifier in series with mode switch permits adjustment of clamping voltage.

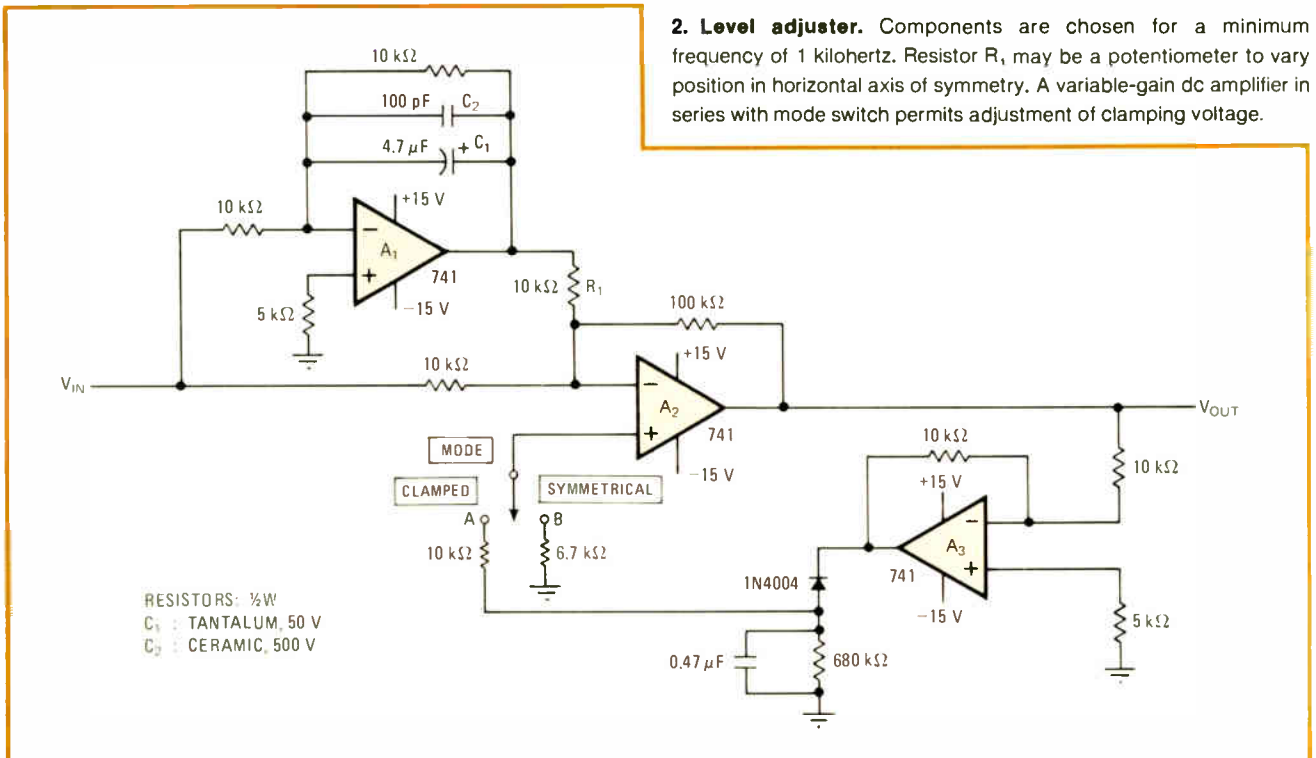

A_3 is symmetrical about 0. The polarity of the output voltage depends on the orientation of the diode—for the direction shown, it is positive-going.

To clamp the output at some other value than 0 v, the mode switch must again be placed in position A, and a dc amplifier must also be inserted in the loop between the rectifier output and the noninverting input of op amp A_2 to control the value of the reference signal.

If the mode switch is placed in position B, the output will always be symmetrical about the zero axis, no matter what the original input level is. This operation is roughly equivalent to removing the integrator from the

circuit and placing a capacitor in series with the input lead to block the dc component of the signal.

Component values in the integrator circuit shown will effectively process signals of 1 kilohertz and higher, up to the frequency limit of the op amp. In general, the circuit will process almost any signal that is symmetrical about a horizontal axis. The exception is pulse trains of single polarity: their short duty cycle makes a symmetrical output impossible because the dc component is less than half the peak value. In this case, R_1 may be adjusted to provide the desired output level, which can be varied over a small range. □

Bi-FET devices improve absolute-value amplifier

by Dan L. Vogler

Lintech Electronics, Albuquerque, N.M.

An absolute-value amplifier, also known as a precision full-wave rectifier, which features wide bandwidth and dynamic range, can be built with high-impedance operational amplifiers to produce a circuit that is more reliable than those implementing the usual phase-cancellation technique. The low input current and wide frequency range of the CA3140 bipolar/field-effect-transistor op amps eliminate the gain and phase-shift errors encountered in other designs.

As shown in the figure, op amp A_1 serves as a unity-gain buffer, op amp A_2 has a gain of +1 during the positive half-cycle of the input wave and a gain of -1 during the negative portions, and A_3 in association with the diode forms a precision clamp.

During the positive portion of the input signal equal voltage is present at both inputs of A_2 . The op amp behaves as a unity-gain follower, as determined by the feedback elements.

During the negative portions, however, the clamping action of A_3 with the diode prevents the voltage at the noninverting input of A_2 from going negative, effectively tying the pin to ground. Op amp A_2 therefore either operates in the inverting mode or else multiplies the signal by a factor of -1.

Precision resistors for the gain-controlling elements of op amp A_2 assure no greater than 2% deviation from the desired gain. The clamping circuit of A_3 can accurately

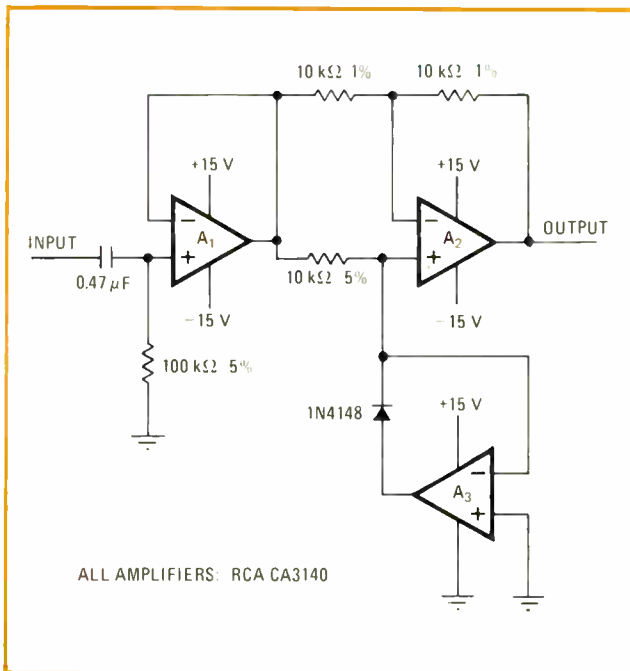

Precision full-wave rectifier. Op amp A_3 , which ensures A_2 follows positive voltages and inverts negative ones, has single-ended power supply to minimize slew time and maximize stability. Power-supply pins are decoupled with 0.47- μ F capacitors.

process signals down to -0.3 volt below the negative supply rail of the amplifier, which in this case is ground.

The result is an absolute-value amplifier which has a dynamic range exceeding 90 decibels and a bandwidth exceeding 1 megahertz. When this circuit is used in conjunction with a peak detector or integrator network, it becomes an invaluable building block in ac-to-dc conversion applications. □

555 timer IC freezes digital panel meter display

by Howard M. Berlin

Wilmington, Delaware

Connecting a 555 timer as an astable multivibrator produces a sample-and-hold circuit that will increase the display time of many digital panel meters. This increase is an advantage in situations where the displayed value changes rapidly, making it difficult to determine an average reading. For example, a sensor monitoring pressure changes near a source of mechanical vibration can produce readings on a 4½-digit DPM that vary as much



HOW DOES DATA I/O KEEP YOU ON TOP OF PROM PROGRAMMING TECHNOLOGY?

We allow you complete design flexibility.

Data I/O programmers are capable of programming all of the more than 200 PROMs currently available.

You'll always be programming to PROM manufacturers' approved specifications.

Data I/O Program Card Sets are tested and certified by the PROM manufacturers themselves before we approve them for manufacturing and distribution to our customers.

If manufacturers change specifications, we

keep our customers updated on how to make proper adjustments to the card sets.

To help you reduce programming costs and reach maximum yields and reliability, we also offer a universal calibrator so that you can conduct your own periodic calibration tests.

We're there when you need us. Data I/O is a worldwide organization. Our field sales and service offices are staffed by Data I/O personnel. Our customers have direct access to us through people who understand the products.

We'd like to tell you more.

This fact filled tabloid gives you valuable information about PROM programming technology. To get your copy, circle reader service number or contact Data I/O Corporation, P.O. Box 308, Issaquah, WA 98027. Phone 206/455-3990.

HOW TO SELECT THE RIGHT PROM PROGRAMMER FOR YOUR NEEDS.



DATA I/O

THE PROM PROGRAMMER PEOPLE.

Programmers from \$1095.00.

as ± 10 digits in a quarter second, making a visual approximation virtually impossible.

When used with a DPM with an external-hold input such as the 4½-digit Fairchild 540921, the 555's signal overrides the internally controlled sampling period at pin N of the meter (see figure). The external-hold port is level-sensitive, so it is desirable to sample the test signal for short times. The output of the timer is a pulse train with a duty cycle of $d = (R_1 + R_2)/(R_1 + 2R_2)$, which can approach 100%, and a frequency of $f = 1.443/C(R_1 + 2R_2)$ hertz.

The 555 output is inverted by transistor Q_1 so that a logic 1 is periodically presented to the external-hold input to sample the input analog voltage at pin S for a

time that is small compared to the total sampling time. When the collector of the transistor is at logic 0, the sample is held and displayed for the number of seconds determined by the ratio d/f . With the values shown, the signal can be displayed for times ranging from 0.7 to 4.2 seconds. Updating is possible every 1 to 4.5 s.

Power for the timer is obtained from the meter, and the current drain is only 4 milliamperes. The circuit has been used for controlling several DPMs simultaneously, with additional transistor circuits connected to pin 3 of the timer. □

Designer's casebook is a regular feature in *Electronics*. We invite readers to submit original and unpublished circuit ideas and solutions to design problems. Explain briefly but thoroughly the circuit's operating principle and purpose. We'll pay \$50 for each item published.

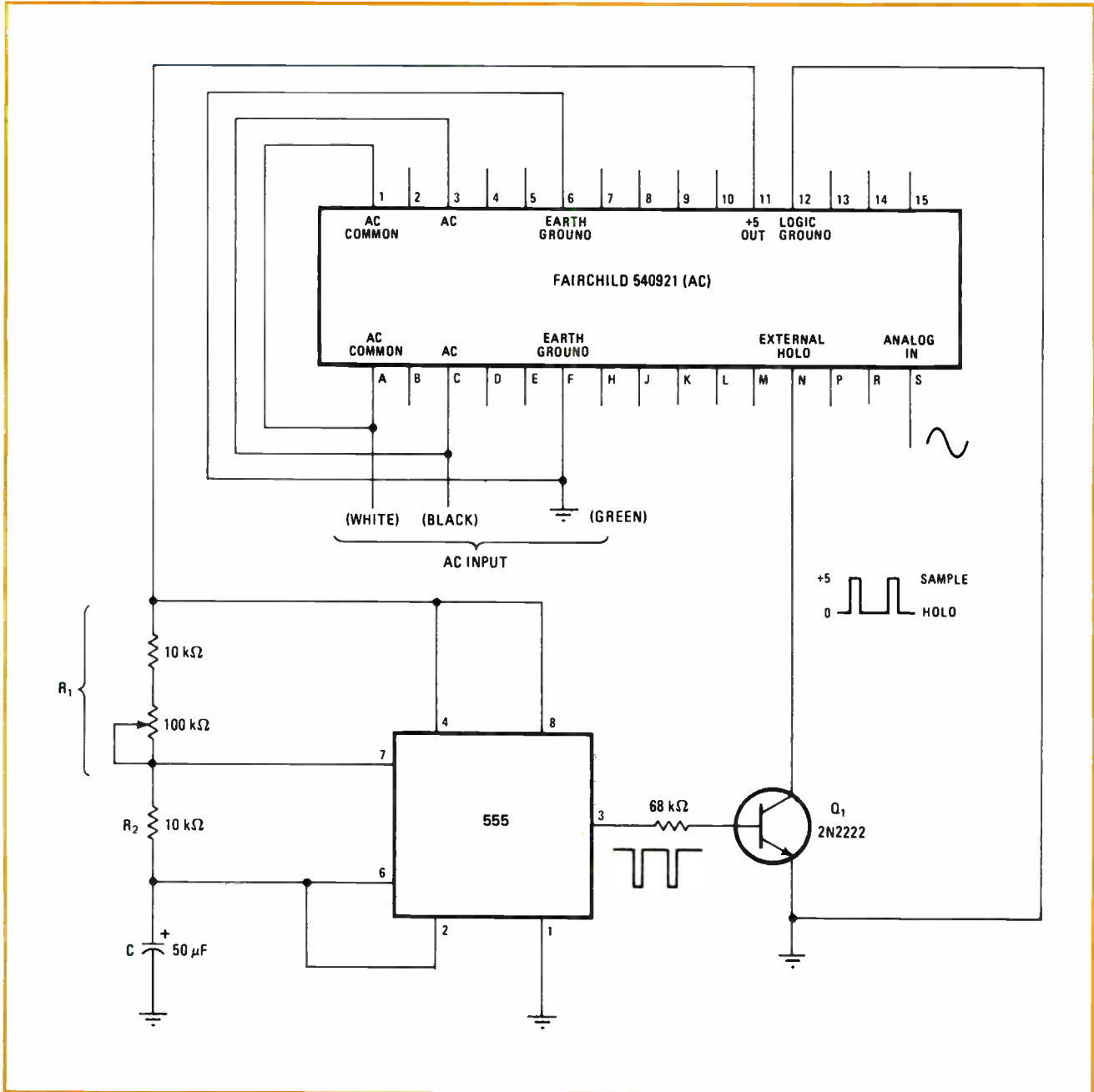

Sample-and-hold timer. A 555 extends the display period to relax hyperactive digital panel meters. The display can be frozen for 0.7 to 4.2 seconds, and updated every 1 to 4.5 seconds. Power for the circuit can be obtained from the DPM's 5-volt supply or a battery source.

For high performance receiver testing, you need high performance signals.

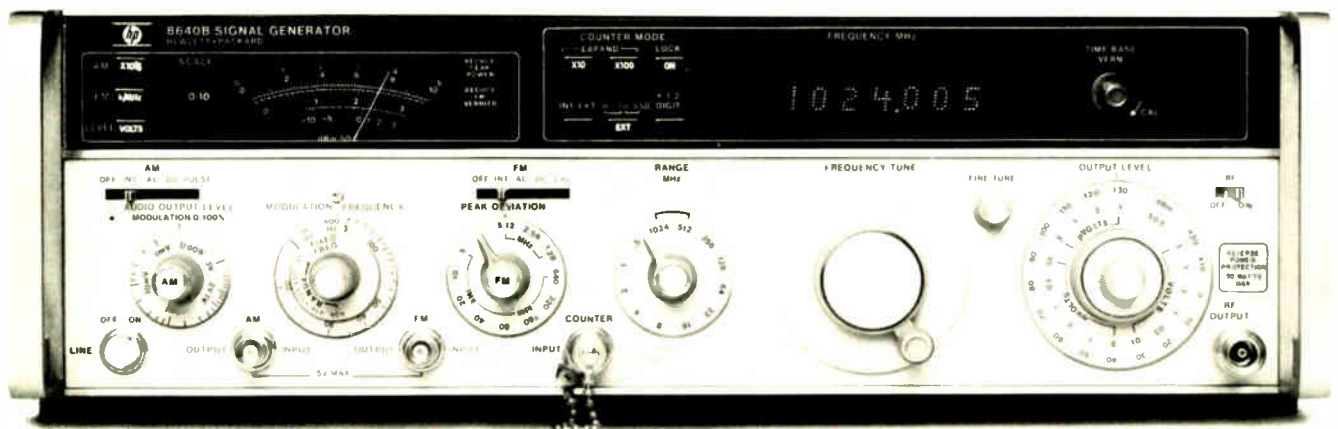

HP 8640B w/Opt. 001, 002, 003 – 0.5 to 1024 MHz.

When HP introduced the 8640B, its product concept brought together the superior characteristics needed for high performance receiver testing:

- Spectral purity <130 dB/Hz, 20 kHz offset
- Wide dynamic range; +19 to -145 dBm
- Phase lock stability/external count capability

Since then we've continued to add to the original capabilities:

- Opt. 001 – Variable modulation
- Opt. 002 – Extended frequency, 0.5 to 1024 MHz
- Opt. 003 – Reverse power protection to 50 watts
- Opt. 004 – Avionics version for NAV/COM tests
- 8640M – Ruggedized/military version

Now with the 8640B you get ½ digit phase-lock resolution (500 Hz, 100 to 1000 MHz), improved modulation and power settability. You can also use the new Model 11710A Down Converter to extend output frequency down to 5 kHz and test standard IF amplifiers at 262 kHz and 455 kHz. 8640B Signal Generator \$6,600* 11710A Down Converter \$930* *Domestic U.S. prices only.

So for your high performance receiver testing, you'll still choose the performance leader in RF signal generators. For more information, call your nearby HP field sales office, or write.

04608B

HEWLETT  PACKARD

Sales and service from 172 offices in 65 countries.
1507 Page M Road Palo Alto Ca 94304

For assistance call: Washington (301) 948-6370. Chicago (312) 677-0400 Atlanta (404) 434-4000. Los Angeles (213) 877-1282

Third-generation microcomputer set packs it all into 3 chips

by D. W. Sohn and Andrew Volk, Intel Corp., Santa Clara, Calif.

□ To take full advantage of the microprocessor's talents, designers usually need a long shopping list of additional chips: series and parallel input/output devices, an interrupt controller, a timer, and read-only and random-access memories. One way to pare that shopping list is the MCS-85, the third-generation three-chip microcomputer system based on the 8085 microprocessor.

Incorporating all these functions into a three-chip set that requires only a single 5-volt supply represents a substantial reduction in package count—plus an improvement in system design throughput of as much as 50% over 8080-based systems. The addition of features

such as higher speed, a more sophisticated interrupt arrangement, simple serial I/O lines, and a multiplexed address/data bus significantly improves system performance. Yet, despite all these refinements, the MCS-85 group retains 100% software compatibility with 8080-based systems.

Because all the chips in the group are multiple-function devices, the component count in any system design is reduced. The group comprises the 8085 central processing unit, the 8155 RAM, I/O, and timer, the 8355 mask-programmable ROM, and the 8755 electrically programmable ROM. Both of the 16,384-bit ROMs feature

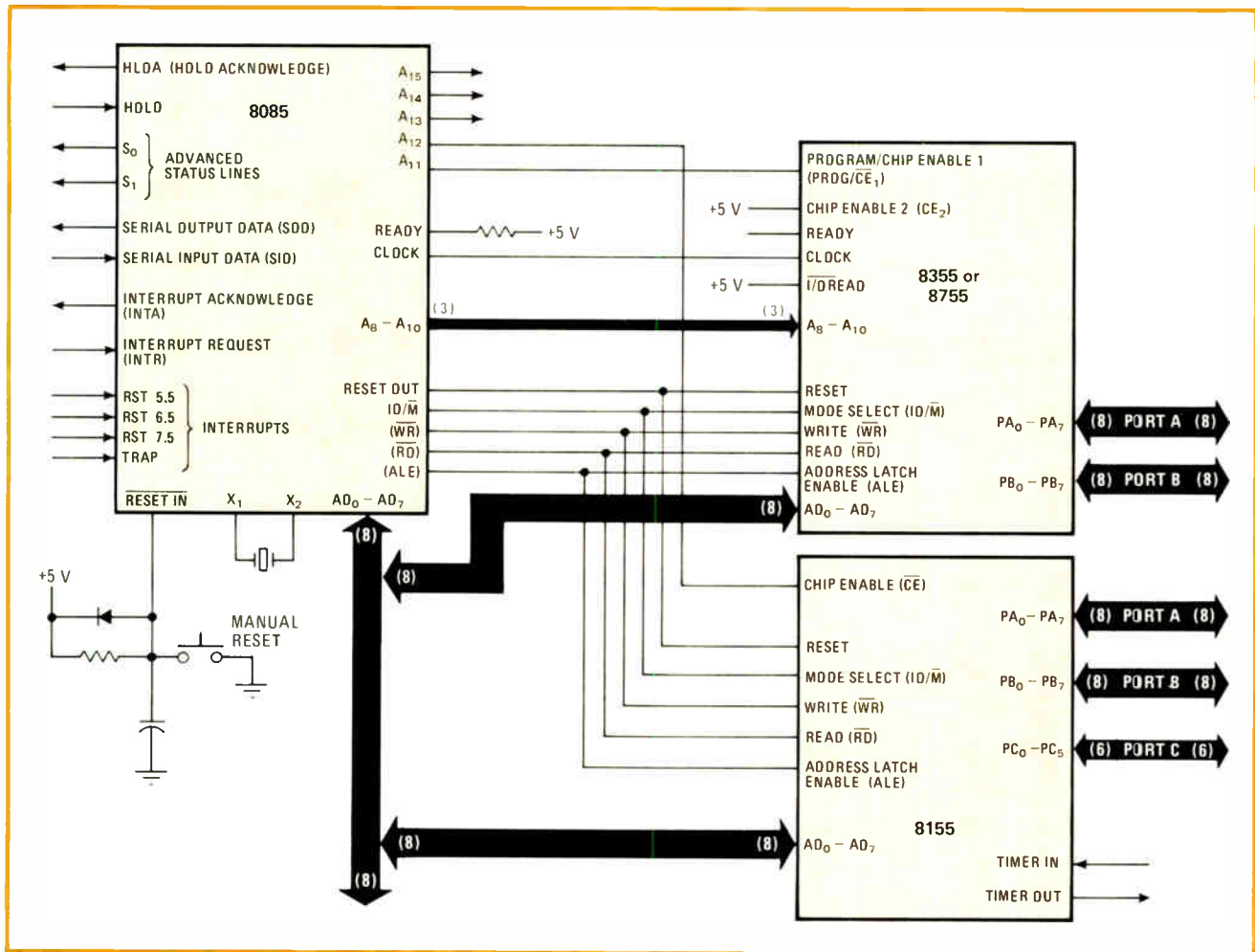

1. Minimum 8085 system. This configuration of the MCS-85 system, which uses three multifunction chips, offers four hardware interrupts, 38 I/O lines, a serial I/O port, and a 14-bit timer. Power requirement is a single +5-volt source, and overall system speed is 3 megahertz.

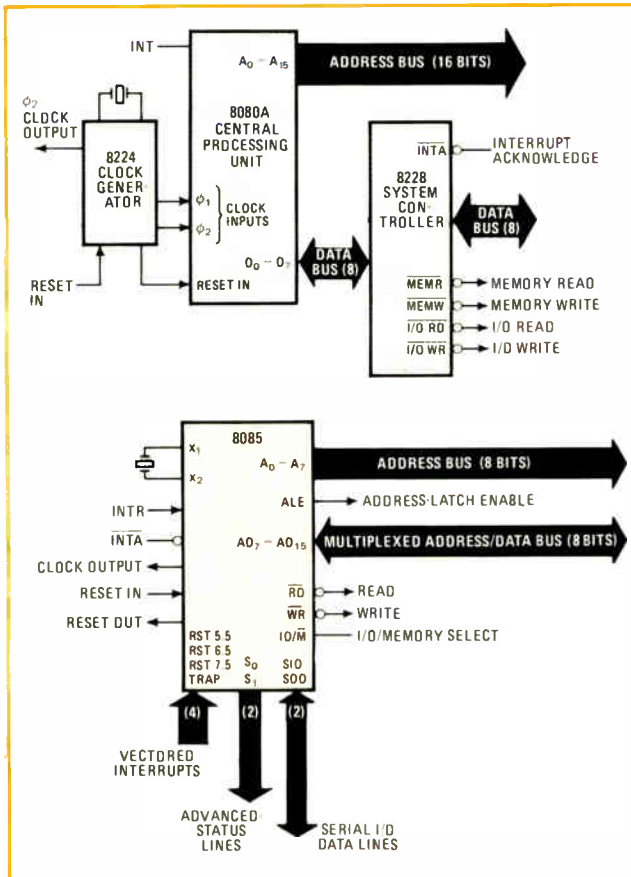

2. CPU groups. The third-generation 8085 chip comprises all functions of the three-chip 8080 group: clock generator, system controller, and CPU. The power of the system is increased by the addition of advanced status lines, hierarchical interrupts, and a serial I/O port.

Interrupt	Restart address (hexadecimal)
RST 0	00 ₁₆
RST 1	08 ₁₆
RST 2	10 ₁₆
RST 3	18 ₁₆
RST 4	20 ₁₆
* TRAP	24 ₁₆
RST 5	28 ₁₆
* RST 5.5	2C ₁₆
RST 6	30 ₁₆
* RST 6.5	34 ₁₆
RST 7	38 ₁₆
* RST 7.5	3C ₁₆

* New hardware interrupts

I/O capability, and either may be teamed with the 8085 and 8155 to build the minimum system of Fig. 1.

As well as fulfilling all the functions of the 8080, the 8085 assumes the roles of clock generator, system controller, interrupt controller, and serial I/O port. It is specified for operation at 3 megahertz, a speed previously attained only by the 8080-1 (selected devices

proven to operate reliably at 3 MHz). More importantly, improvements in CPU-to-memory synchronization permit a much faster overall system speed.

Combining data and address buses

The 8085's multiplexed address/data bus combines all the address and data bits onto 16 lines. This scheme, which frees seven pins, helps make possible the inclusion of the chip's additional features.

In the multiplexing scheme, the lower 8 bits of the 16-bit address are timeshared with the 8 data bits on lines AD₀₋₇. The address latch enable (ALE), a control line unique to the 8085, latches the lower eight address lines into peripheral devices. At the beginning of each machine cycle, the CPU sends out all 16 bits of address along with the ALE output. Upon command from the ALE, the lower 8 address bits are latched into any of the memory components or into an external latch for interfacing with standard memories.

During a write cycle, data appears on lines AD₀₋₇ in the next clock cycle after latching of the 16 address bits. During a read cycle, which has identical timing characteristics, the data appears on the AD₀₋₇ bus from a peripheral unit. The symmetry of the read and write control lines, as well as the elimination of eight lines on the bus, substantially eases system bus design.

No waiting for this bus

Speed limitation is a serious problem in designing an optimal system bus. In most cases, the CPU can handle data faster than the memory can deliver it. Such a disparity necessitates the insertion of a wait state in each memory-access cycle. For example, the 8080-1 operating at 3 MHz requires only a 310-nanosecond access time with no buffer between CPU and memory. With two levels of buffering, each specified at 30 ns, the system bus requires an access time of $310 - (2 \times 30) \text{ ns} = 250 \text{ ns}$. Since standard ROMs have an access time of 450 ns at best, a 200-ns wait period must of necessity accompany each memory access.

The 8085 eases the synchronization problem between CPU and memory by relaxing its access time requirement by almost 50% while preserving the throughput. At a clock speed of 2.0 megahertz, the 8080-1 has an access time requirement of 570 nanoseconds, while the 8080 has a time of 1,025 ns. At 2.5 MHz, the times are 425 and 775 ns, and at 3.0 MHz, they are 310 ns and 575 ns. The net result is an overall increase in system speed without a wait state for memory access; in fact, the 8085 has no wait output pin, unlike the 8080.

8085 vs 8080

The basic internal architecture of the 8085 is similar to that of the 8080. The register file and arithmetic/logic unit in each are almost identical. The major differences are in the timing, control, and address/data bus circuits.

Figure 2 compares the basic functions of the three chips that make up the MCS-80's CPU group and the multifunction 8085. Besides requiring only a single +5-v supply (versus the +5-v, -5-v, and +12-v requirements of the 8080), the 8085 has integrated all the functions of the 8080 CPU, the 8224 clock generator, and

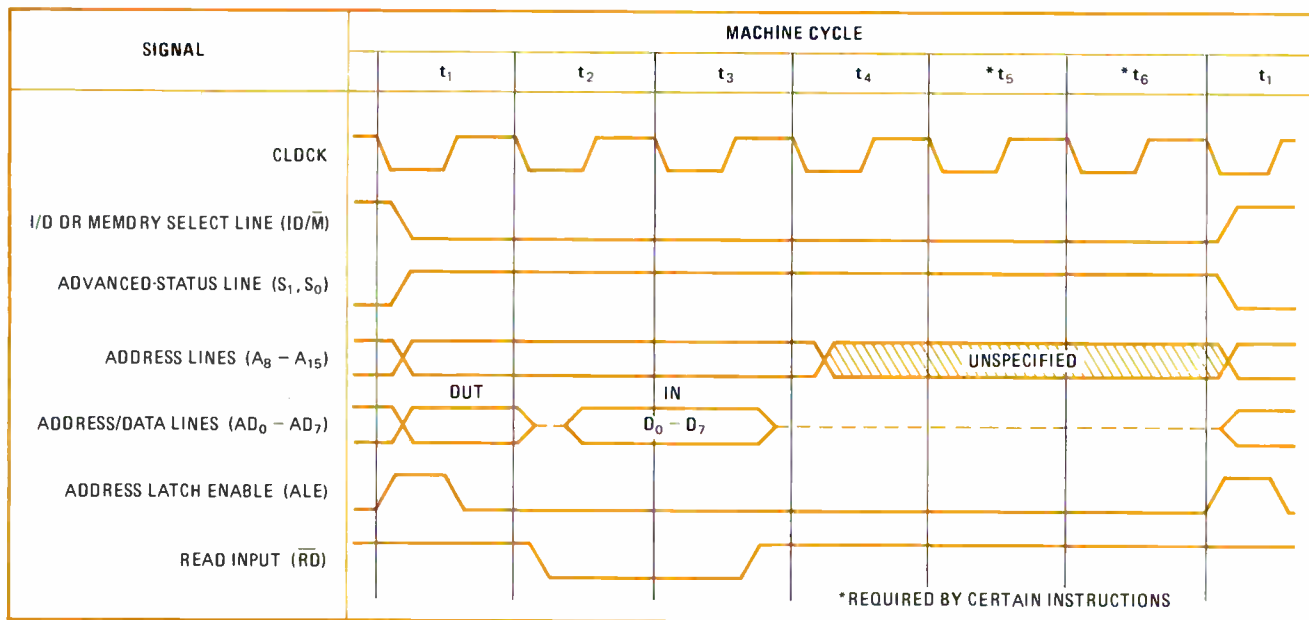

3. Basic bus timing. At the onset of the bus transfer cycle, the 8085 first sends out address over AD_{0-7} and A_{8-15} , and status over the S_0, S_1 , and IO/\overline{M} lines. The lower 8 bits of address, AD_0-AD_7 , are static only for the first clock cycle t_1 ; after t_1 , they transfer data to or from the CPU.

the 8228 system controller—plus a simple serial I/O port and new hardware interrupts that are integrated into a hierarchy with the restart instructions (software interrupts) carried over from the 8080.

The 8085's built-in clock generator can be used with a crystal or an RC or LC network, or it can be driven directly from an external source. The clock generator, running at twice the basic CPU frequency, provides a two-phase, nonoverlapping internal clock signal. One of the phases is buffered and is available as an external clock output equivalent to the phase-two transistor-transistor-logic output of the 8224 clock generator in the MCS-80 family.

The 8085 also provides a Schmitt-action reset input, which effects power-on reset with the addition of only one resistor and one capacitor. And it provides lines for advanced status information describing the bus transfer that will be executed within the forthcoming cycle—as well as including the bus controller functions delegated to the 8228 in the MCS-80 system.

Bus timing

Compatibility with the MCS-80 system dictates that the 8085 must have the same basic bus timing structure. The timing of one machine cycle for a fetch instruction is shown in Fig. 3. At the onset of the bus transfer cycle, the 8085 sends out the address and status information. The status is indicated by the advanced-status lines S_0 and S_1 , and by the mode-select line IO/\overline{M} , which determines whether the cycle is for I/O access or memory access. These three lines give complete information on the type of transfer. The upper 8 bits of address go out on lines A_{8-15} and remain static throughout the transfer. The lower 8 address bits, which go out on the address/data bus, remain stable only for the first clock cycle, t_1 . Afterwards, the bus is used for data transfer to or from the CPU. Because the signals on lines AD_{0-7} are transitory, the ALE line must strobe the address into the

internal address latch of the 8155 or into an external latch such as an 8212.

Following transmission of the address on lines AD_{0-7} , the data bus is ready for data transfer. In a read cycle (such as instruction fetch, memory read, or I/O read), the data bus goes into its high-impedance state at the start of the second clock cycle, t_2 , just like the 8080 bus. At the same time, the read line goes low to indicate that the bus is available and that data is expected from the peripheral device. The 8085 reads the data on the bus during the third clock cycle, t_3 , and the read line then goes high to indicate the end of the transfer cycle.

In a write cycle, the 8085 sends out the data to be written at the start of t_2 , and the write line goes low at the same time. The write line returns high $1\frac{1}{2}$ clock cycles later. The data is then held for another half cycle until the next transfer cycle provides the new address.

Unlike the 8080, the 8085 provides no data-setup time to the leading edge of the write signal. Although setup time is needed for dynamic memory components, it is not required for the Intel static memory family.

The power of the 8085 is further enhanced with hardware interrupts and simple serial-I/O capabilities. Four restart-interrupt input pins—RST 5.5, RST 6.5, RST 7.5, and TRAP—have been added to the eight software interrupts of the 8080. None of the new interrupts requires external logic to insert an instruction during interrupt. A mask register permits any or all of restarts 5.5, 6.5, and 7.5 to be blocked out with software and thus go unrecognized. To interrupt the processor, these interrupts must be both enabled (interrupt-enable flag = 1) and unmasked (mask bit = 0). The TRAP interrupt, however, is unmaskable and can interrupt independently of any enable or mask bit.

All four new interrupts execute an internally fetched restart instruction when recognized. The internal restart causes the program counter to remain in place on the stack and also causes branching to one of four fixed

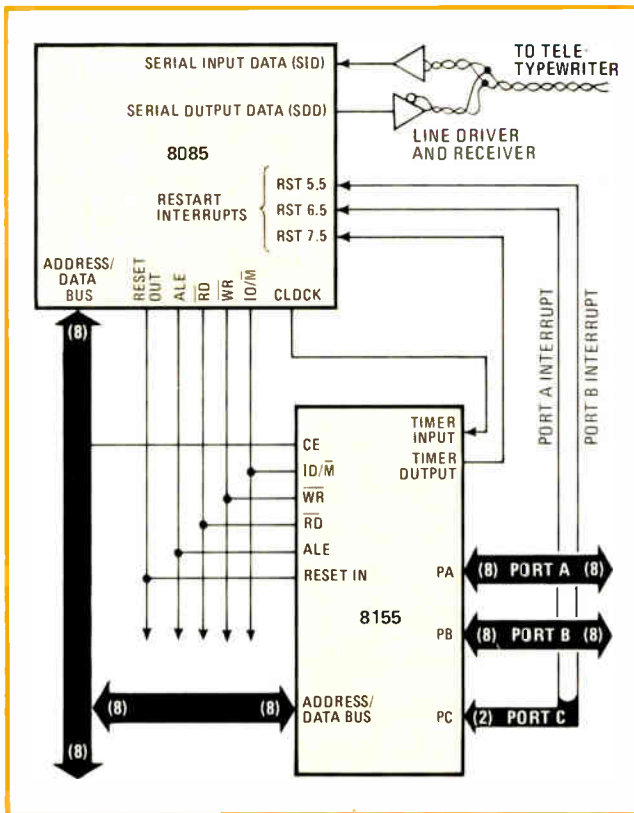

4. Serial interfacing. A teletypewriter interface demonstrates the utility of serial input and output data lines (SID and SOD). Hardware interrupts (RST 5.5, RST 6.5, and RST 7.5) on the 8085 are used by port C to facilitate handshaking of ports A and B.

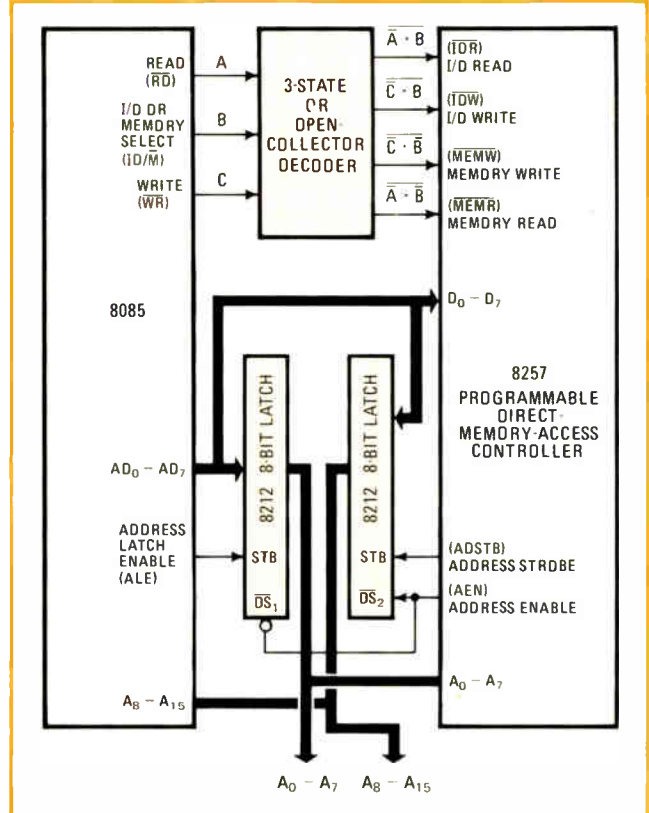

5. Interfacing DMA. Most peripherals in the 8080 family connect to the 8085 without the need for interface buffers. The 8257 direct-memory-access controller requires two 8212 8-bit latches for demultiplexing and a control-line decoding scheme.

locations. The table shows these locations and their relationship to the software restart instruction locations.

Two of the interrupt pins—RST 5.5 and 6.5—are high-level-sensitive like the interrupt-request line (INTR), also found on the 8080. The RST 7.5 input, however, is rising-edge-sensitive, and therefore only a pulse is required to set it. The TRAP input is both edge- and level-sensitive—it must go high and then stay high to be recognized. This ensures that another request can only be generated if the TRAP input returns low and then again goes high and remains high, thereby avoiding any false triggering caused by noise or logic glitches.

Interrupt hierarchy

An especially useful feature of the five interrupt inputs is that they are arranged in a fixed priority that determines the order of recognition when more than one is pending. The hierarchy, from lowest to highest priority, is INTR, RST 5.5, RST 6.5, RST 7.5, and TRAP.

The setting and reading of the masks for the restart interrupts are executed by two instructions: read interrupt masks (RIM) and set interrupt masks (SIM). The masks are initially set to a high level by the reset-in pin. The SIM instruction uses the contents of the 8085 accumulator to program the mask of a specified interrupt. It can also be used to reset the edge-triggered input flip-flop of RST 7.5. The RIM instruction reads the contents of the mask register back to the accumulator. It also reads the status of the interrupt-enable flag and any

pending interrupt requests.

The 8085's serial lines permit simple I/O manipulation. The RIM instruction reads the serial-input-data line, and a SIM instruction writes on the serial-output-data line. Figure 4 shows how the interrupts and serial lines of the 8085 can be configured in a minimum system for communication with a teletypewriter.

8155 RAM plus ultra

The 40-pin 8155 has a 2,048-bit static RAM, 22 I/O pins (organized in three ports), and a binary countdown timer programmed by a 14-bit word. The bus of the 8155 allows it to interface directly with the 8085.

The RAM section is organized as 256 8-bit bytes. The 400-ns access time of the memory allows full-speed operation with no need for wait states, given the relaxed access-time requirements of the 8085.

The I/O section of the 8155 comprises the timer and three ports. The timer does one-shot or continuous counting and produces a pulse or square-wave output, as dictated by programming. It will also start and stop on command, and once stopped, its contents can be read through a count register.

Each of the 22 pins of the three I/O ports can be programmed for input or output. In addition, the 6-bit port C can assume the role of control port, thereby allowing the 8-bit ports A and B to operate in a handshaking mode—that is, PC controlling PA and PB.

The chip-enable, read, write, and mode-select pins

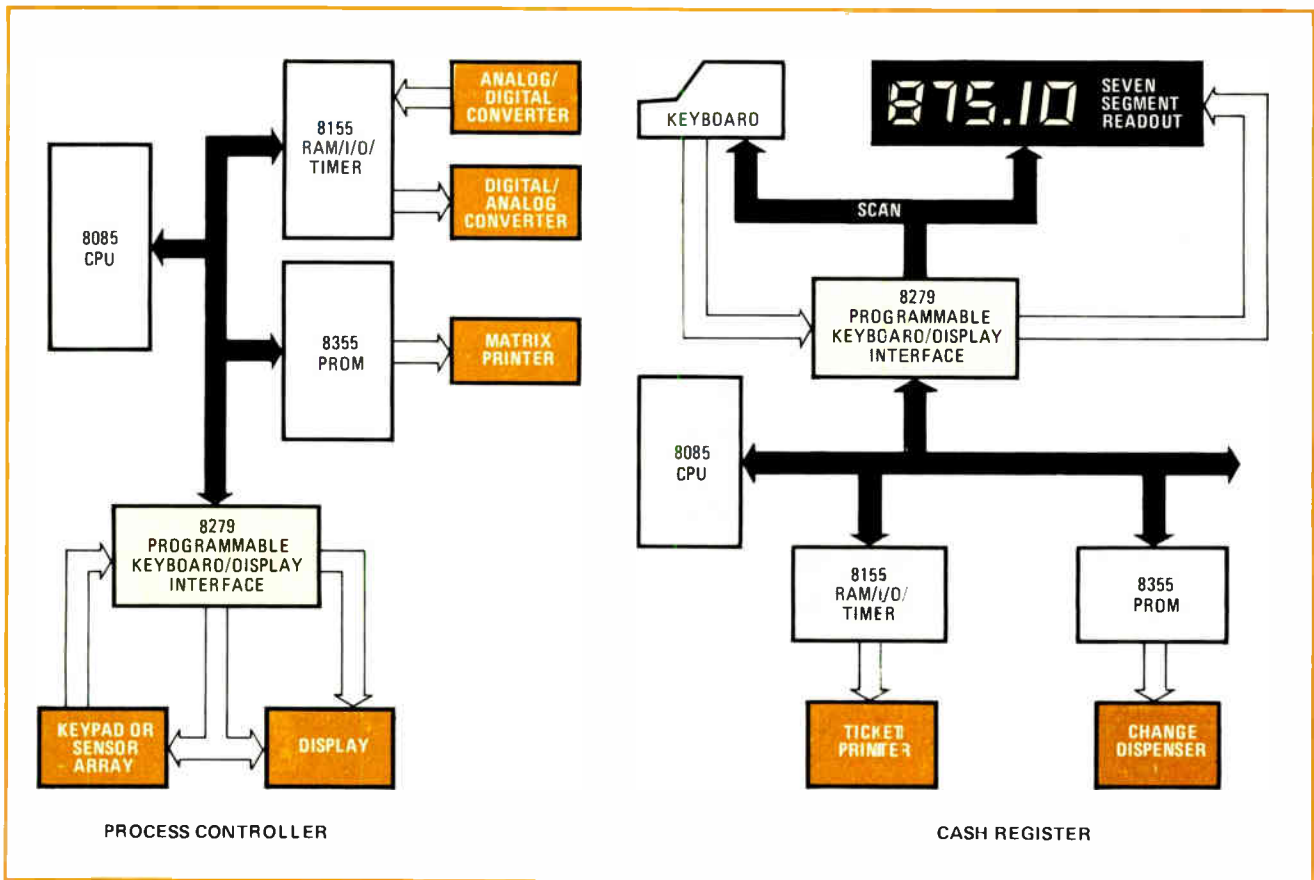

6. Typical applications. The high level of integration in the MCS-85 group makes possible low-chip-count arrangements of complex functions, such as a process controller and a cash register. Both applications use the 8279 programmable keyboard/display interface.

direct the reading and writing of RAM and I/O. There is no access to the 8155 unless the chip enable is active ($CE = 1$). The mode-select line (IO/\overline{M}) determines whether the access is to the RAM ($IO/\overline{M} = 0$), or to the I/O section ($IO/\overline{M} = 1$). Once the mode of the chip is selected, the read and write commands determine the direction of data flow.

The mode-select pin of the 8155 need not be connected to the mode-select pin on the 8085, as is depicted in the system configuration of Fig. 1. Connecting it to the 8085's address line A_{15} , for example, permits memory mapping of the I/O section.

The 8355 mask-programmable ROM, and the 8755 erasable PROM are organized as 2,048 8-bit bytes. Both ROMs have programmable I/O sections, organized as a pair of general-purpose, 8-bit ports. Each pin is individually programmable as input or output. Like the 8155, the ROMs have a maximum access time of 400 ns, so they also interface directly with the 8085 without wait states.

To allow the use of the ROMs with higher processor speeds or on a heavily buffered bus, an automatic wait-state generator is included on each chip. With \overline{CE}_1 low and CE_2 and the address-latch enable high, a ready output pin goes low. If the ready pin on the 8355/8755 is connected to the ready pin on the 8085, the clock input prevents the ready from going high until the rising edge one clock cycle after ALE . This guarantees one wait state from the 8085.

Two chip-enable inputs, the mode-select line, and the

write are in charge of direct access to the 8355 or the 8755. To select the chip, \overline{CE}_1 must be low and CE_2 high. The ROMs can be read with read low and mode-select high. Writing is only possible on the I/O ports, using write control. Memory-mapped I/O may be implemented in the same manner as with the 8155 by tying the ROM's mode-select pin to one of the 8085's memory-selected lines (such as A_{15}) instead of its mode-select pin.

Programming the 8755 is similar to that of the 2708 erasable PROM, but is now much more efficient. Whereas the 2708 required as many as 100 pulses per cell to deposit the information, the 8755 can be programmed bit by bit with only a single 50-millisecond pulse required for each cell.

Compatibility with the 8080 family

The peripherals of the MCS-80 family will also work with the 8085, and most of these circuits require no interface buffers. The 8257 direct-memory-access controller is an exception, requiring a pair of 8212 8-bit latches and a control-line decoding scheme (Fig. 5).

Expansion of the MCS-85 system is easily accomplished with the MCS-80 peripherals and MCS-85 memory components (or a combination of standard memories if 8212 latches are added). The MCS-85 family, with its high level of system integration, lends itself well to the design of complex arrangements, such as the process controller and the cash register in Fig. 6. Both have a lower component count than ever before. □

Advances in film extend component capabilities

Improved manufacturing methods also come in for attention at this month's Electronic Components Conference

by Lucinda Mattera, *Components Editor*

□ The rise of thick and thin films has changed the components landscape irrevocably. Like semiconductors, passive components are no longer single devices but often complex networks of both elements and interconnects. Moreover, most of the new developments in components are tied to improvements in films and production techniques—so closely tied that it is becoming increasingly difficult to separate the two.

Evidence of these changes pervades the program of the 27th Electronic Components Conference, due to open on May 16 in Arlington, Va. Practically every session will at least touch upon film technology, and all but a few sessions will include one or more papers about manufacturing technology. The program will be the largest in years, expanding to 16 sessions from the dozen or so of the recent past.

Some of the more notable highlights will concern:

- Components, such as: multilayer ceramic chip capacitors with a new tab-lead construction that minimizes fracture stresses; thin-film capacitors capable of handling temperatures as high as 300°C; a rotational coupler for a fiber-optic data link across a rotating interface, and an optical-coupler circuit that may dispose of three-winding hybrid transformers in telecommunications applications.
- Films, such as: a new complete base-metal thick-film system of conductors, dielectrics, and resistors; a new high-stability thick-film resistor system for demanding applications, and a thin-film metalization system based on copper.
- Manufacturing and packaging technology, including: a way to test bare semiconductor chips at ultra-high speeds; a comparative analysis of chip-component carriers and packages, and a technique for making intercard connections without backplanes.

To sum it up in the words of program chairman, Charles Tapp, Sandia Laboratories, Albuquerque, N.M.: "This year's conference continues the tradition of providing engineers concerned with electronic parts and packaging with a wide spectrum of papers—ranging from applied research giving insight into critical materials and processes to practical how-to guidance on manufacturing techniques."

For the first time, the Manufacturing Technology

Group of the Institute of Electrical and Electronics Engineers will be taking part in the program, joining the Parts, Hybrids, and Packaging Group of IEEE, old ECC hands. Also, at this year's Design Engineers' Electronic Components show, to be held concurrently with ECC, there will be over 40 major components manufacturers exhibiting. (The conference is sponsored by both IEEE and the Electronic Industries Association.)

Four sessions on components

Traditional components, as the mainstay of ECC, are given ample program time, a quarter of the sessions being devoted to them. There will be two on capacitors, one on discrete components, and one on users' perspectives—the only panel discussion of the conference.

Capacitors get their double-barreled coverage on the same day, in a pair of back-to-back sessions that will reveal several new solutions to old problems.

For example, Sprague Electric Co., North Adams, Mass., has managed to provide wet-slug tantalum electrolytic capacitors with a reverse-bias capability by giving them solid tantalum cases. Previously, wet-slug electrolytics had silver cases and under reverse bias suffered from silver migration that eventually shorted them out. But in tantalum cases, the new electrolytic capacitors can withstand reverse voltages of up to 3 volts. Working voltage ratings for these hermetically sealed units range from 6 to 125 v dc, with a capacitance of 1.7 to 1,200 microfarads.

In a second paper, Sprague will describe a new ceramic dielectric for monolithic capacitors. Designated MFT for middle firing temperature, this dielectric costs less, has better electrical properties, and uses less energy than high-temperature-fired ceramics. It comes in three popular ceramic characteristics: COG, X7R, and Z5U.

Another development in monolithic ceramic capacitors—the fastest-growing segment of the capacitor market—is the new tab-lead construction (Fig. 1) developed at Union Carbide Corp., Greenville, S.C. Tab-lead devices run less risk of fracture stresses caused by the different temperature coefficients of their materials.

As a rule, thin-film capacitors cannot stand too much heat. But Japan's Nippon Electric Co. has discovered how to make thin-film capacitors that will survive 300°C.

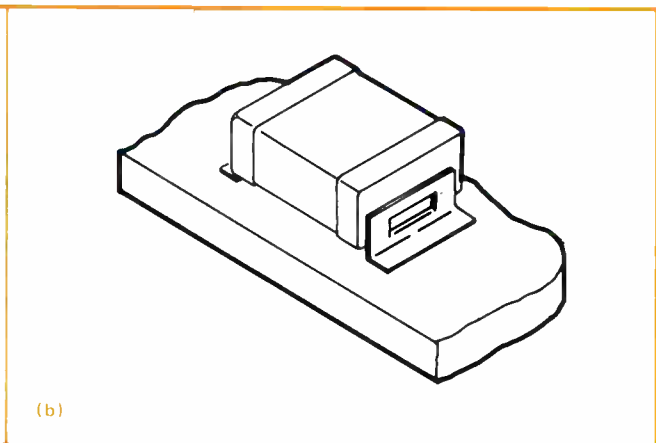
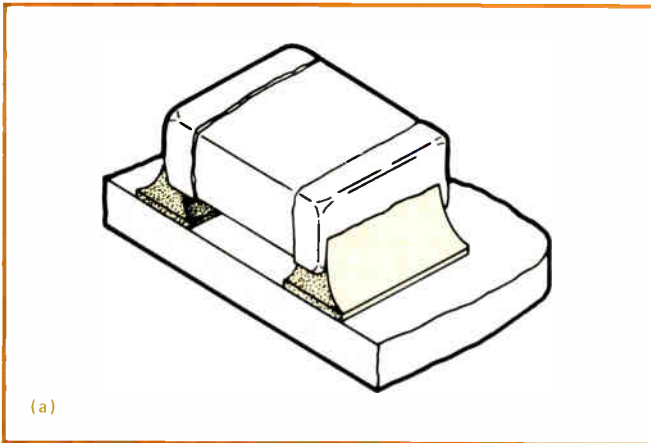

1. Fracture-resistant. Because of the different temperature coefficients of their materials, conventional ceramic chip capacitors (a) may fracture after being reflow-soldered in place. But a new tab-lead configuration (b) designed by Union Carbide reduces this risk.

Besides being useful for high-temperature applications, these devices can also be assembled by thermal-compression bonding at high substrate temperatures or by reflow-solder techniques. Nippon makes the dielectric from tantalum oxide, instead of the more common anodic oxide made from tantalum-nitride films.

Discrete components will have their own session, an unusual mixture of papers. Two of them will be from the Components department of Hughes Aircraft Co. in Culver City, Calif.—one comparing ambient- and case-temperature-controlled burn-in for power transistors, and another examining the performance of thick-film chip resistors mounted on printed-circuit boards. Pressure transducers will be the subject of two other papers—one from Case Western Reserve University of Cleveland, Ohio, about an implantable pressure transducer for biomedical applications, and another from the University of Nebraska in Omaha describing the electrical response of dielectric transducer materials to variations in mechanical pressure.

Possibly the most exciting and informative discussions will stem from the only panel session at the conference, "Component Needs and Trends—A User Perspective," being chaired by John Powers, a technical consultant for the corporate manufacturing staff at IBM Corp., Armonk, N.Y. Powers has lined up a formidable array of speakers from various industry segments.

Speaking for the automotive manufacturing sector will be John Webster, chief engineer of Advanced Product Development at Chrysler Electronics division in Huntsville, Ala.; for telecommunications equipment, John Degan, department head of Components Technology at the Transmission division of Bell Laboratories, North Andover, Mass.; for military equipment, Michael Keller, staff assistant for Combat Support, Department of Defense, Research and Engineering, the Pentagon, Washington, D.C.; and for home entertainment equipment, Wayne Luplow, director of quality, reliability, and safety engineering at Zenith Radio Corp., Chicago. Powers himself will be the spokesman for data-processing equipment.

The session will be thrown open to the audience after each panelist has surveyed the application of components in his special area, not only those devices he uses now but

also those he will be using in the future. The talks will cover components technologies, applications, performance, and trends.

Acknowledging the importance of thick and thin films, the conference devotes one whole session to each of these technologies, as well as including papers directly or indirectly related to thick or thin films in most of the other sessions.

Film stars

In the session on thick-film materials, four of the five papers will emphasize either getting costs down or pushing production throughput up, notes chairman Louis Razzetti, who is with the Aerospace and Electronic Systems division, Defense & Electronic Systems Center, Westinghouse Electric Corp., Baltimore, Md. In line with this theme, Electro Materials Corp. of America, Mamaroneck, N.Y., will argue for porcelain-coated steel as an inexpensive substrate to which existing thick-film technology may be adapted. The company concludes that it is both an economical alternative to ceramic

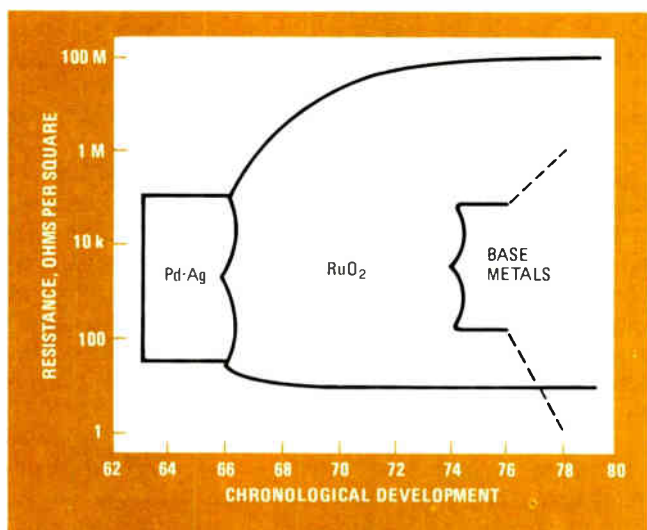

2. Coming on strong. Promising to cut materials costs in half, base-metal thick-film systems are already available in popular intermediate resistance values. From Cermalloy comes a new base-metal system, complete with conductors, dielectrics, and resistors.

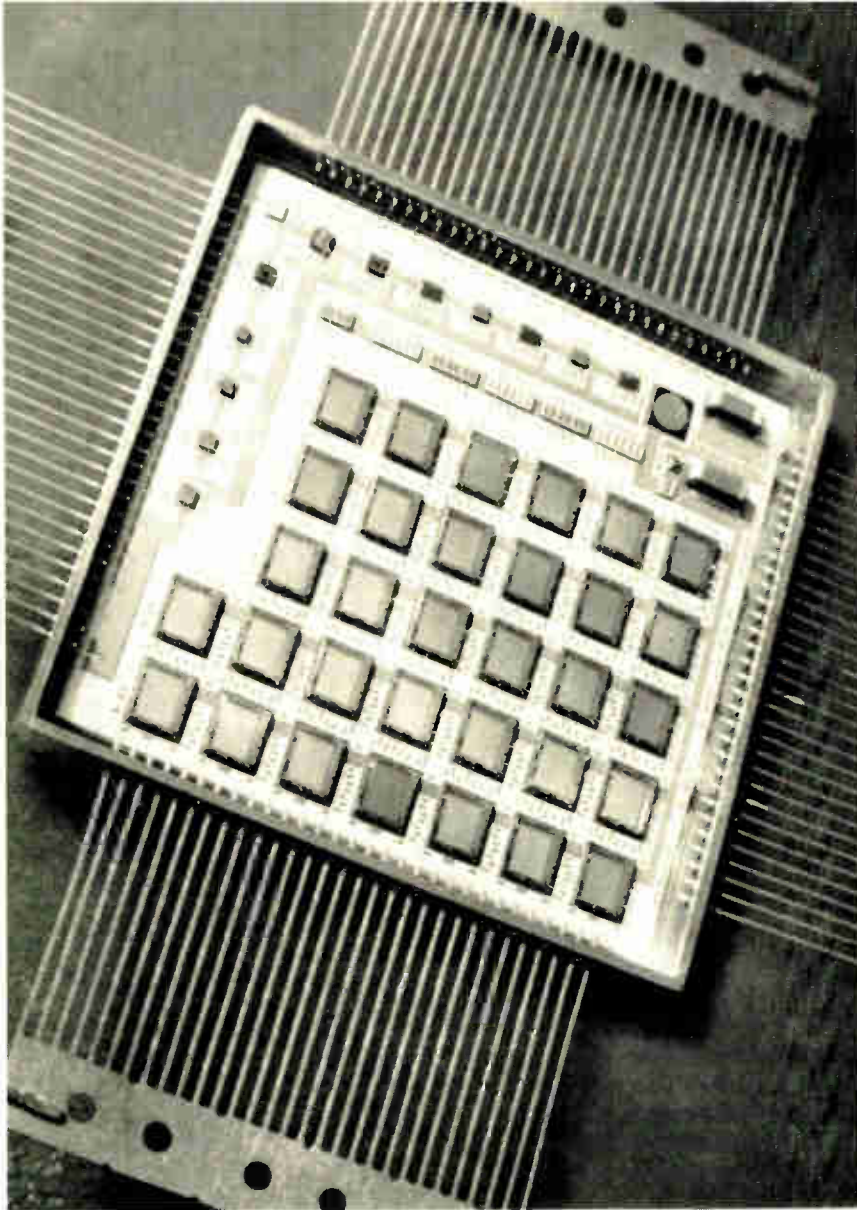

3. Packed to the hilt. Utilizing high-density hybrid technology, Tele-dyne Microelectronics is squeezing entire semiconductor memory systems into single IC-compatible packages. This device is a 2,096-bit C-MOS RAM in a 2-by-2-by-0.18-inch hybrid package.



substrates and a high-reliability alternative to printed-circuit boards.

To dodge the high cost of using noble metals, base-metal thick-film systems are emerging (Fig. 2), among them one from the Cermalloy division of Bala Electronics Corp., West Conshohocken, Pa. Including conductors, dielectrics, and resistors made from alloys of nickel and copper, it is a complete system, says Cermalloy, and it permits routine printing of 4-mil conductor lines with 4-mil spacings—about as good as the resolution obtainable with noble-metal conductors.

A remedy for purple plague, the unwanted gold-aluminum intermetallics that can affect metal-oxide-semiconductor devices, has been invented by the Materials division of AVX Corp., San Diego, Calif. Generally, semiconductor manufacturers employ a costly gold preform at the die-attach operation to obtain a eutectic bond. But the new gold alloy from AVX Corp. can be attached to the die directly, with no preform, without

producing too much in the way of gold-aluminum intermetallics and without making die or wire any the less easy to attach or bond.

Finally, the Photo Products department of E.I. duPont de Nemours and Co.'s Electronic Materials division, Niagara Falls, N.Y., will unveil a high-stability thick-film resistor system aimed at demanding applications, like active filters and precision attenuators. It achieves a temperature coefficient of less than 50 ppm/°C for sheet resistivities ranging from 100 to 100,000 ohms per square. What's more, resistors that start out as small as 1 square millimeter and then are laser-trimmed to twice their initial value change less than 0.15% in resistance in 1,000 hours.

As with thick films, much of the emphasis of the speakers at the session on thin-film technology is on limiting the amount of precious metals used or improving production methods.

A new copper-based thin-film metalization system that interleaves thin copper and nickel films with gold and palladium films comes from Bell Telephone Laboratories in Allentown, Pa. Sheet resistivity of the system is about as good as that of the usual but more expensive

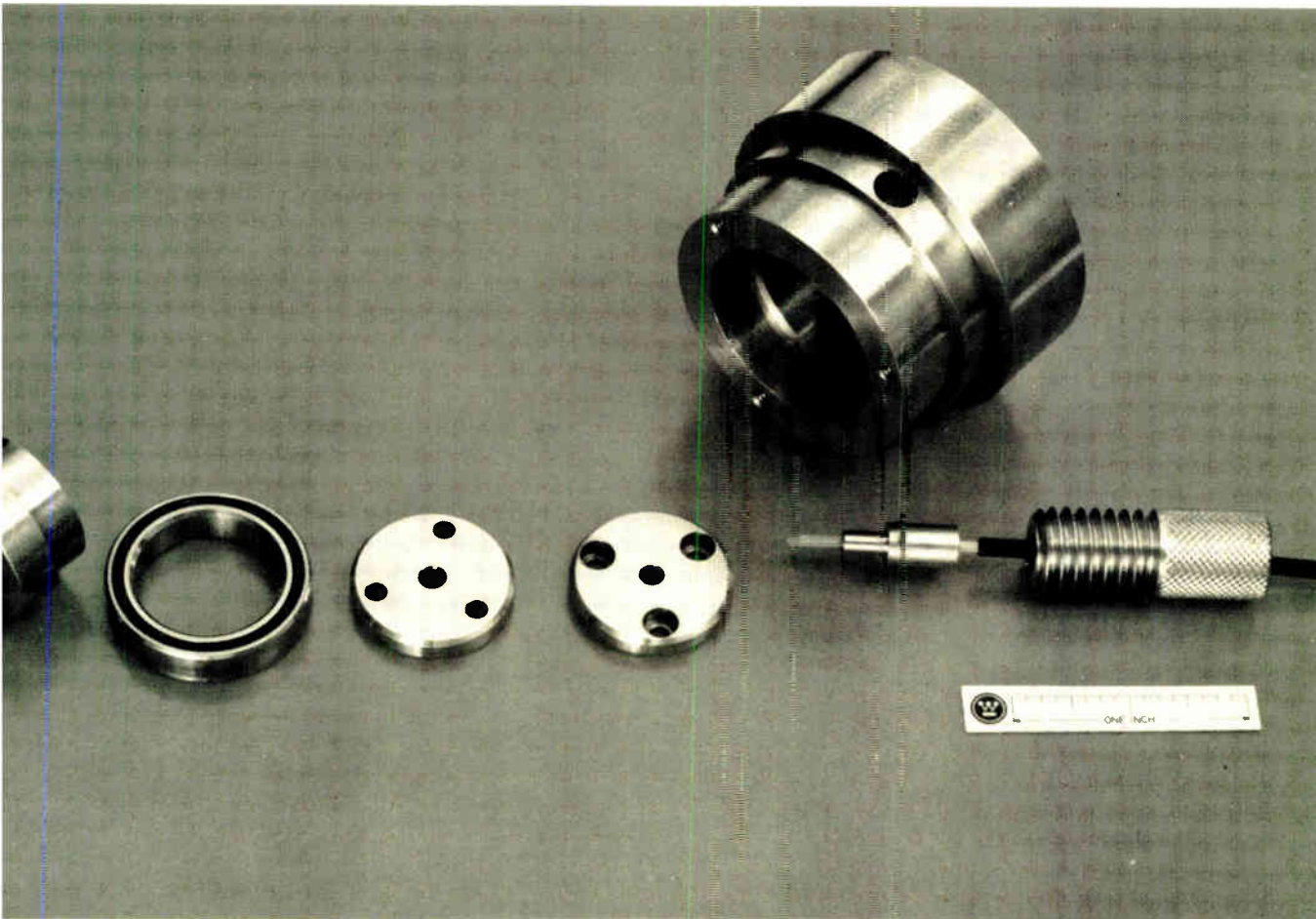

4. Fiber-optic data link. Rotational coupler developed by Westinghouse carries data across rotating fiber-optic interface. Besides being much smaller than its electrical counterparts, the device offers longer life and immunity to electromagnetic interference.

gold-over-palladium system. A second paper from the same Bell facility will examine a gold-over-palladium metalization system coated with reflowed solder. Though their developers say both new metal systems are more prone to attack than conventional gold over palladium, apparently a conformal coating of RTV silicone rubber protects them effectively.

A better sputtering technique

Improving production methods is the goal of researchers at Japan's Fujitsu Ltd. They have discovered a way to upgrade the sheet-resistance uniformity of sputtered tantalum-nitride thin films, as well as increase the deposition rate. Their method yields such uniform resistors that no laser trimming is necessary.

In another paper, passivation coatings for nichrome thin-film resistors will get a stiff examination from National Semiconductor Corp., Santa Clara, Calif.

The use of thick and thin films in practical circuit implementations will dominate the session on hybrid applications. According to chairman David Somerville of Rockwell International in Dallas, Texas, the scope of the session is broad, covering "circuit area optimization,

manufacturability, size and weight reduction, active resistor trimming, high-temperature operation, and thermal considerations."

The papers bear him out. They include: a review of thick-film hybrids for telecommunications equipment; how to optimize element values in hybrid RC active filters; an evaluation of thick-film chip components at 300°C operation; a computerized thermal analysis for predicting the temperatures of the power-dissipating elements in a hybrid, and a thermal characterization of epoxy and alloy component attachment.

Heavy emphasis on production techniques

Manufacturing technology will play a major role at this year's conference, with two sessions of its own, in addition to about a half-dozen related sessions. Both of the principal sessions will concentrate on high-volume low-cost processes for producing reliable products. One centers about automated bonding and handling of hybrid

components, while the other covers deposition and coatings for hybrids.

In the bonding and handling session, RCA Corp., Solid State division, Somerville, N.J., will report on the metallurgical properties needed in a tape-bonding system to assure bond reliability, and Bell Laboratories, North Andover, Mass., will speak about a high-capacity process for attaching external leads to thin-film hybrid circuits by means of solder-vapor-condensation reflow techniques. In its paper, Teledyne Microelectronics of Los Angeles will tell how to test bare semiconductor chips at ultra-high speeds of around 60,000 dice per week. Also, Japan's Hitachi Co. will describe a fully automated assembly system for small-signal transistors, in which wafer probing, die attach, wire bonding, and package molding are all performed completely under computer control.

In the deposition and coatings session, sputtering, a widely used production technique for deposition, will be the subject of a paper from Western Electric Co., North Andover, Mass. Workers at WE have developed an improved system that provides faster throughput and more efficient material utilization than earlier approaches. To be discussed by workers from Teledyne Microelectronics and NASA Lewis Research Center, Cleveland, Ohio, is a production process for protecting hybrids from loose particles and harsh environments by means of a coating of parylene (parylene belongs to a family of linear plastic polymers).

Laser trimming, of course, is an established and widely used production technique. However, after storage at room temperature, trimmed thick-film resistors exhibit positive changes in their values. This post-trim drift can be large and unpredictable, wreaking havoc when the resistors must go into a production cycle. Bell Telephone Laboratories in Allentown, Pa., has studied this problem and will reveal its findings at the deposition and coatings session. Apparently, resistor size does not significantly influence drift, but fired thickness does, and very low, as well as very high, sheet resistivities seem to drift more than the intermediate values.

An unusual session titled "Practical Manufacturing Technology Update" will actually comprise a series of timely reviews of several important component areas. RCA's Solid State division will discuss the reliability and handling problems of complementary-MOS devices, and Teledyne Relays, Hawthorne, Calif., will speak about the selection and limitations of solid-state relays. Fiber optics will be covered by Galileo Electro-Optics Corp., Sturbridge, Mass., and practical component failure rates will be examined by Xerox Corp., Rochester, N.Y. Finally, GTE-Lenkurt, San Carlos, Calif., will show how to build a low-cost waste-treatment facility for an electronics manufacturing plant.

Previewing manufacturing-related sessions

Another aspect of manufacturing technology—materials for bonding—will have its own session, on how to understand and control some of the many problems associated with bonding, says chairman Isaac Pratt, U.S. Army Electronics Command, Integrated Electronics division, Fort Monmouth, N.J. Among the highlights of

the session will be: a paper from Motorola Semiconductor Products Group, Phoenix, Ariz., examining the thermal fatigue properties of die-bond alloys; one from Hughes Aircraft's Technology Support division, Culver City, Calif., reviewing the reliability problems of chip components reflow-soldered with silver or silver-palladium terminations, and another from Bell Laboratories, Allentown, Pa., evaluating the thermal-compression bonding of copper leads plated with thin gold.

From packaging to interconnections

At least two of the papers in the session on packaging technology deserve special mention. Offering yet another detailed and timely study will be Bell Telephone Laboratories—this time the facility in Columbus, Ohio. Researchers there will compare the thermal performance of dual in-line packages on epoxy-metal and epoxy-glass printed-circuit boards.

In the same session, Materials Research Corp., Orangeburg, N.Y., will describe an improved version of the popular 96% alumina substrate. While providing greater mechanical strength, better thermal conductivity, a higher dielectric constant, and less variation in resistivity, the new substrate remains compatible with today's thick-film inks, pastes, and components. Moreover, it permits ink definitions to be finer, claim its developers.

Semiconductor interconnects and carriers will also be getting attention this year in a session that will address "the difficult and increasingly complex problem of handling semiconductor devices, both discretely and ICs," says chairman Robert Waer of GTE Lenkurt Inc. "As overseas labor costs increase, semiconductor producers are finding it necessary to automate and bring packaging operations back home." There are now many ways of handling dice other than the traditional chip-and-wire method, he adds.

For instance, Intel Corp., Santa Clara, Calif., and Hughes Aircraft Co., Newport Beach, Calif., will jointly evaluate the parameters of chip tape carriers, while Motorola Inc., Fort Lauderdale, Fla., will give an analysis of the cost and performance tradeoffs of chip carriers, leadless inverted devices, and SOTs, which are subminiature chip packages (Fig. 3) for hybrid applications. Drexel University, Philadelphia, Pa., will turn its attention to examining the systems flexibility permitted by new chip-carrier packages, such as General Instrument's Minipak.

Additionally, in what promises to be an exciting talk, Teledyne Microelectronics, Los Angeles, will unveil a high-density hybrid packaging technique (Fig. 4) for semiconductor memory devices. By utilizing large-area hybrids and multilevel thick-film metalization, the company has successfully built a random-access-memory system, with 24-k-by-16-bit organization, in approximately one fifth the space needed when conventional individual Cerdip packages are used. The entire system fits on a pc board measuring 6.25 by 10.75 inches.

A trio of papers will highlight the session on interconnections. Bell Telephone Laboratories, Holmdel, N.J., will check out several flat-cable designs for suitability in high-speed digital applications. Sandia Laboratories, Albuquerque, N.M., has found a way to make micro-size

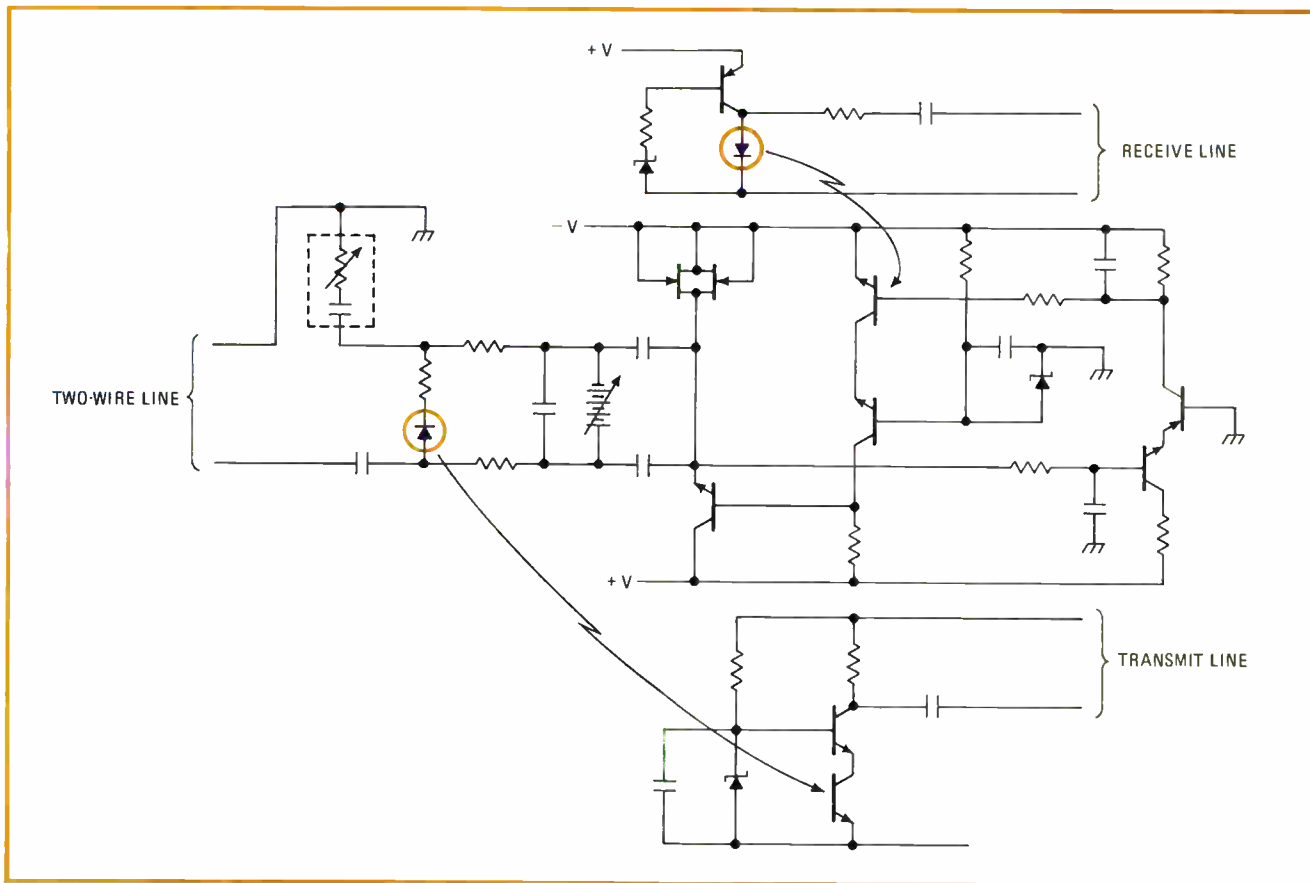

5. Solid-state transformer. Built with optical couplers by Japan's University of Osaka, Tottori University, and the Sendai College of Radio Technology, this solid-state circuit may displace conventional three-winding hybrid transformers in telecommunications applications.

plated-through connections in flexible cables. AMP Inc., Harrisburg, Pa., has discovered how to make intercard connections without backplanes.

Reliability, always one of the foremost considerations in components, again has its share of the limelight this year. As might be expected, the papers will explore some of the many aspects of component reliability, including: a report on the reliability of thick-film capacitors and crossovers by Zenith Radio Corp., Elk Grove Village, Ill., and a routine process control from Rome Air Development Center, Griffiss Air Force Base, N.Y., that yields a dry, clean microcircuit package for the long-term reliability often promised but never delivered by a contaminated package.

The Process Technology Laboratory of Motorola, Phoenix, Ariz., will investigate the influence of temperature and environment on the bond integrity of aluminum ultrasonic and gold thermocompression wire bonds made to silver plate. Another paper from Motorola, this one from the Semiconductor Research and Development Laboratories in Phoenix, Ariz., describes a new test method for separating plastic-outgassing-related bond degradation from other molding-compound variables, such as mechanical stress.

Radiation and fiber optics

Last on the program, but not last in importance, is the split session on radiation effects and optical components. In the radiation half of the session, probably the most

far-reaching paper will be the one from Fairchild Camera and Instrument Corp., Mountain View, Calif. The company finds n-MOS microprocessors, as well as all other n-MOS products, extremely sensitive to ionizing radiation.

The optical-components portion of the session will have three fine strong papers. TRW Inc., Redondo Beach, Calif., has obtained highly reliable performance from commercial-grade optical isolators by screening them first for latent dark-current leakage and premature current-transfer end of life.

Westinghouse Defense and Electronic Systems Center, Systems Development division, Baltimore, Md., has developed a rotational coupler for creating a fiber-optic data link across a rotating interface. The new device is a replacement for electrical units, which are prone to friction, wear, and electromagnetic interference. Applications, projects the firm, include tethered data links, rotating antenna systems, and other equipment that requires the freedom of a freely rotating interface in a hostile emi environment.

From Japan's University of Osaka, Tottori University, and the Sendai College of Radio Technology comes a solid-state circuit (Fig. 5), built with optical couplers, that replaces conventional hybrid coils or three-winding transformers in telecommunications applications. The new device provides a cutoff frequency of about 100 kilohertz, and unlike traditional transformers, which exhibit a power loss, it offers a power gain. □

Narrow-band sweep source reduces incidental fm

by James Isbell Jr.
Radio Astronomy Department, University of Texas, Austin, Texas

A low-frequency oscillator and balanced modulator can generate a 40-kilohertz sweep range centered at 10.7 megahertz, which is suitable for aligning the intermediate-frequency amplifiers in a standard frequency-modulation receiver. The narrow sweep-source is advantageous when observing the test-circuit response on an oscilloscope because the scope pattern is stable, a condition not possible when a wide-band sweep generator is used. The sweep width of the circuit is 2½ times less than that of a commercial sweep source, thus reducing the incidental fm generation to a point where it is not troublesome.

As shown in Fig. 1, a 10.05-MHz crystal-controlled oscillator is mixed with a low-frequency sweep oscillator

centered at 650 kHz. The setup produces an output frequency at 10.7 MHz, which is varied 20 kHz to either side of the center by tuning the 650-kHz oscillator. This method is preferable to controlling the high-frequency oscillator because of stability considerations.

The tuned-input sweep oscillator uses a varactor diode

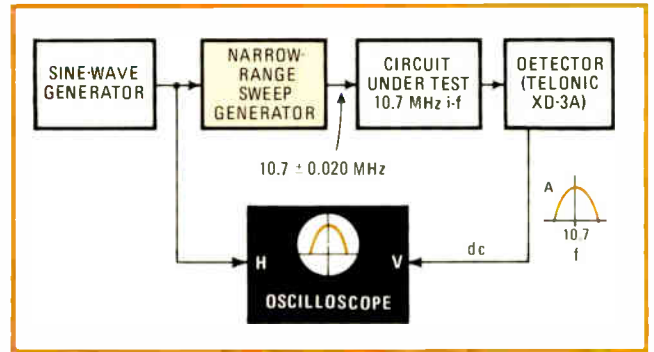

2. Performance second to none. Sine-wave generator output is approximately 0–2 V at frequencies below 100 Hz. Lower sweep rates produce a more stable scope pattern, because circuit response rings less. The detector may be any general peak-detecting type.

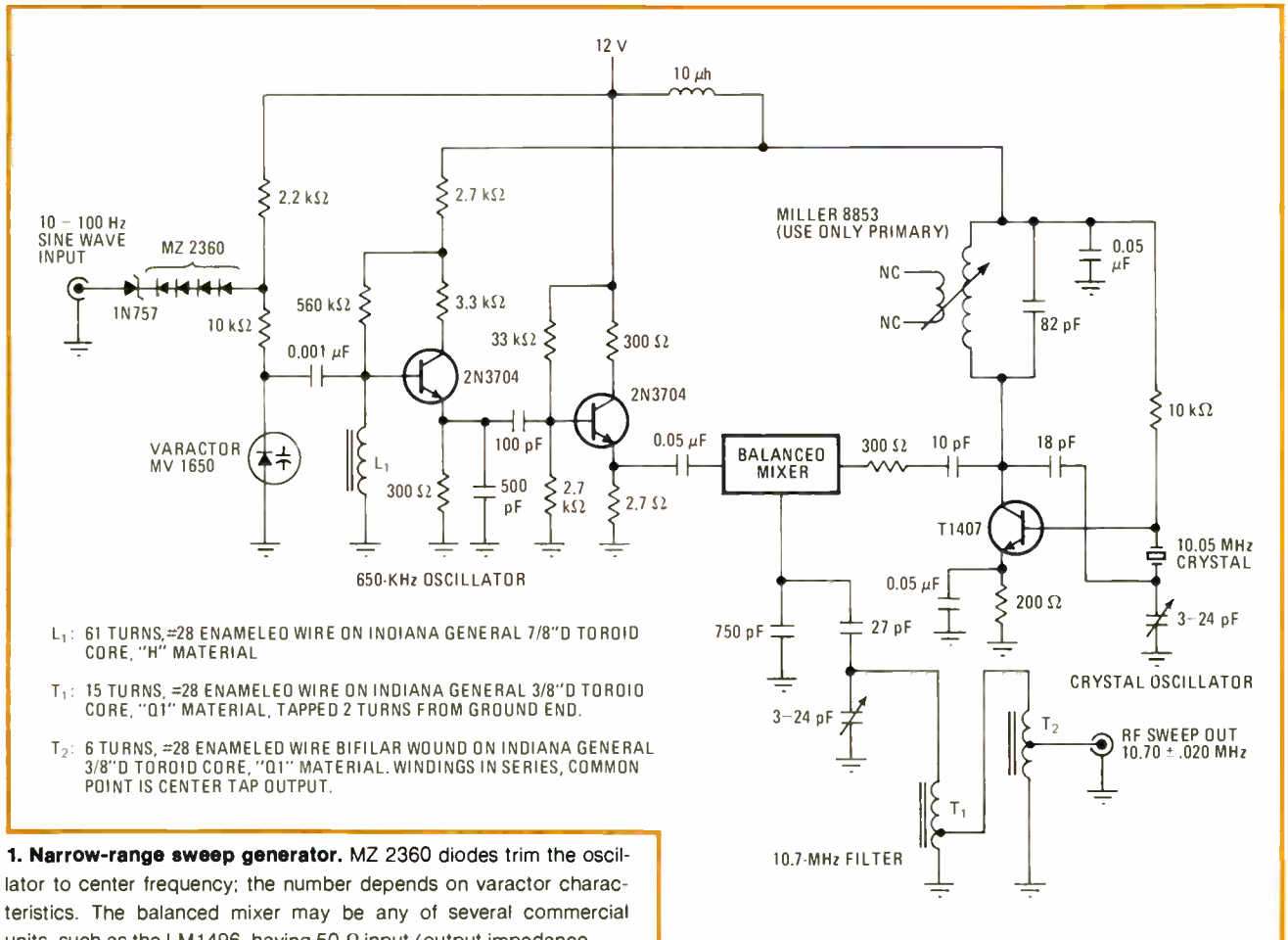

1. Narrow-range sweep generator. MZ 2360 diodes trim the oscillator to center frequency; the number depends on varactor characteristics. The balanced mixer may be any of several commercial units, such as the LM1496, having 50-Ω input/output impedance.

controlled by the amplitude of a sine-wave generator to vary its frequency. The sinusoidal control signal is approximately 2 volts rms at a frequency of 10 hertz. This frequency may be increased, but if it is higher than 100 Hz, the settling-time of the circuit under test can create difficulty in observing its response. While reducing the sine-wave amplitude will reduce the 40-KHz sweep width, it will produce only an infinitesimal reduction because the normal sine-wave amplitude is enough to swamp the varactor.

The output of the balanced mixer is 10.7 ± 0.020 MHz. Other components produced by the modulation process (mostly harmonics) may cause difficulty in obtaining a stable scope pattern. A 10.7-MHz bandpass filter removes these components, and then the signal is presented to the circuit under test (Fig. 2).

The peak output voltage of the i-f amplifiers (which

make up the test circuit) is a function of the input frequency. It must be converted to dc if the circuit's bandpass response is to be observed accurately. A peak-detecting circuit, essentially a rectifier and integrating network, is used for the conversion; in this case, it is a commercial unit, the Telonic XD-3A. The dc signal produced is then applied to the vertical input of the oscilloscope, while the horizontal input is driven by the sine-wave oscillator.

The frequency-response curve is thereby traced out. The pattern remains stable and accurate, because the frequency modulation produced by the narrow-range generator is minimal, and consequently the detector response is not changing with each sweep cycle. □

Engineer's notebook is a regular feature in *Electronics*. We invite readers to submit original design shortcuts, calculation aids, measurement and test techniques, and other ideas for saving engineering time or cost. We'll pay \$50 for each item published.

Calculator notes

SR-52 solves network equations by finding complex determinant

by Chris McIntyre

University of New Brunswick, Saint John, N. B., Canada

Network-analysis methods using the mesh-current, nodal or Thévenin-Norton approach require the use of complex matrixes, and solving them by hand is both a frustrating and error-prone experience. However, this SR-52 program removes the drudgery in solving for the determinant of a 3-by-3 complex matrix, the most common type encountered in engineering problems. The real and imaginary components can be displayed separately, or the answer can be obtained in polar form, with the angle displayed and the magnitude of the vector in memory location zero-zero.

The matrix is set up as shown in the illustration. Once the program is stored in the calculator, the elements are fed into the calculator from left to right, top to bottom, as indicated by the subscripts of the variables. Key Λ is

pressed after each variable has been punched on the keyboard. The subscript of the next variable to be stored will appear on the display. When all variables have been stored, the number 18, which is the total count of the real and imaginary coefficients in the matrix, appears in the display. Unless the 18 is displayed, erroneous answers will result.

Following data entry, pressing **B** yields the real part of the matrix determinant, while pressing **C** produces the imaginary part. The complex determinant is converted to polar form by keying **INV**, **2ND**, **P/R**.

The program can be applied to a nodal analysis of the circuit shown in the figure. The loop equations determined by Kirchhoff's law are:

$$\begin{aligned} V_1 - 2V_2 - jV_3 &= 0 \\ V_1 - V_3 &= -120 + j90 \\ -jV_1 - 2V_2 - V_3 &= 0 \end{aligned}$$

which may be expressed as a 3-by-3 matrix equal to a column of three drive sources. To find voltage V_1 , for example, the equations are solved by the determinant method (see illustration).

The matrix in the denominator has elements corresponding to the coefficients in the loop equations, and

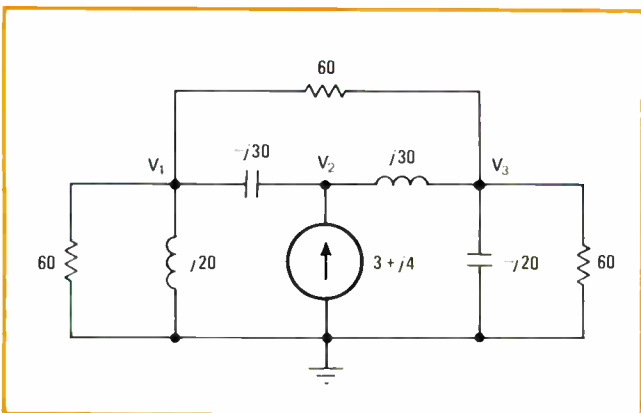

Determining the determinant. Three equations in V_1 , V_2 , and V_3 are written using Kirchhoff current law. Equations yield coefficients of matrixes; determinant method helps solve for each voltage.

$$\begin{vmatrix} {}^1R_0 \cdot X_1 & {}^1R_2 \cdot X_3 & {}^1R_4 \cdot X_5 \\ {}^1R_6 \cdot X_7 & {}^1R_8 \cdot X_9 & {}^1R_{10} \cdot X_{11} \\ {}^1R_{12} \cdot X_{13} & {}^1R_{14} \cdot X_{15} & {}^1R_{16} \cdot X_{17} \end{vmatrix}$$

$$V_1 = \frac{\begin{vmatrix} 0 & -2 & -j \\ -120 + j90 & 0 & -1 \\ 0 & 2 & -1 \end{vmatrix}}{\begin{vmatrix} 1 & -2 & -j \\ 1 & 0 & -1 \\ -j & -2 & -1 \end{vmatrix}} = 106 \angle +98^\circ - 15 \angle j105$$

the matrix in the numerator is the same except that its first column (corresponding to the V_1 's) is replaced by the column of current-drive sources to the right of the

equals signs in the equations. Similarly, to solve for V_2 , the source column replaces column two in the numerator matrix; the denominator does not change. □

SR-52 COMPLEX MATRIX PROGRAM

LOCATIONS	CODES	KEYS	COMMENTS	LOCATIONS	CODES	KEYS	COMMENTS
000-001	46 11	*LBL A	Input and input counter	137-141	60 02 01 09 07	*if flg 2 197	Exchange matrix row 1 with matrix row 2
002-005	36 42 09 08	*IND STO 98		142-143	50 02	*set flg 2	
006-009	01 44 09 08	1 SUM 98		144-147	02 42 06 09	0 STO 69	
010-013	43 09 08 81	RCL 98 HLT	148-151	06 42 06 08	6 STO 68		
014-015	46 15	*LBL E	152-153	46 19	*LBL'D'		
016-019	00 42 09 08	0 STO 98	154-157	36 43 06 09	*IND RCL 69		
020-021	47 81	*CMs HLT	158-161	36 48 06 08	*IND EXC 68		
022-023	46 12	*LBL B	162-165	36 42 06 09	*IND STO 69		
024-027	43 00 08 65	RCL 08 X	166-169	01 44 06 09	1 SUM 69		
028-031	43 01 06 75	RCL 16	170-172	44 06 08	SUM 68		
032-035	43 00 09 65	RCL 09 X	173-177	05 75 43 06 09	5 - RCL 69		
036-039	43 01 07 75	RCL 17	178-182	95 80 01 05 04	= if pos 154		
040-043	43 01 04 65	RCL 14 X	183-187	60 01 00 02 04	*if flg 1 024		
044-047	43 01 00 85	RCL 10 +	188-192	01 94 49 00 00	1 +/- *PROD 00		
048-051	43 01 05 65	RCL 15 X	193-195	49 00 01	*PROD 01		
052-055	43 01 01 95	RCL 11 =	196	12	B		
056-058	42 09 08	STO 98	197-200	00 42 06 09	0 STO 69		
059-062	43 00 08 65	RCL 08 X	201-203	50 01 19	*set flg 1 *D'		
063-066	43 01 07 85	RCL 17 +	204-207	22 50 01	INV *set flg 1		
067-070	43 00 09 65	RCL 09 X	207-209	22 50 02	INV *set flg 2		
071-074	43 01 06 75	RCL 16 -	210-212	43 01 08	RCL 18		
075-078	43 01 04 65	RCL 14 X	213-215	42 00 00	STO 00		
079-082	43 01 01 75	RCL 11 -	216	81	HLT		
083-086	43 01 05 65	RCL 15 X	217-218	46 13	*LBL C		
087-090	43 01 00 95	RCL 10 =	219-222	43 01 09 81	RCL 19 HLT		
091-093	42 09 09	STO 99					
094-097	43 00 00 65	RCL 00 X					
098-101	43 09 08 75	RCL 98 -					
102-105	43 00 01 65	RCL 01 X					
106-109	43 09 09 95	RCL 99 =					
110-112	44 01 08	SUM 18					
113-116	43 00 00 65	RCL 00 X					
117-120	43 09 09 85	RCL 99 +					
121-124	43 00 01 65	RCL 01 X					
125-128	43 09 08 95	RCL 98 =					
129-131	44 01 09	SUM 19					
132-136	60 01 02 00 04	*if flg 1 204					

INSTRUCTIONS

1. Key in program.
2. Initialize:
Press E
3. Enter all matrix coefficients:
[R₀], press A, [X₁], press A, [R₂], A, [X₃], A, etc.
4. Find real component of matrix determinant:
Press B
5. Find imaginary component of matrix determinant:
Press C
6. Convert complex determinant to polar form:
Press INV 2nd P R for angle in degrees;
RCL 00 retrieves magnitude

How to get a lot more into a lot less.

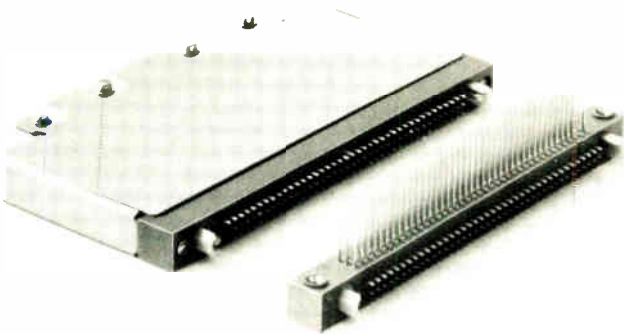
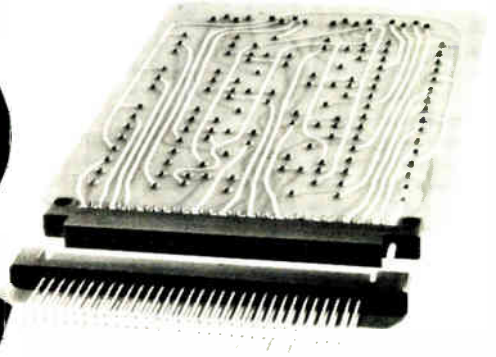

First, with 3 rows of contacts on .100 centers, Viking's unique Nordic 2-piece P/C board connectors and I/O I.C. panel plugs get a lot more contacts into a lot less space.

Second, our unusual polarizing system lets you key each mating pair to prevent cross mating with adjacent connectors of the same type. You can stack a series of Nordic connectors next to one another in cramped space and not worry that they might be cross mated.

Our full line includes 64 and 82 contact models as well as the 120. Contacts on I/O connectors are crimp, snap-on, removable, gold plated and use MIL-T- 22520 tools.

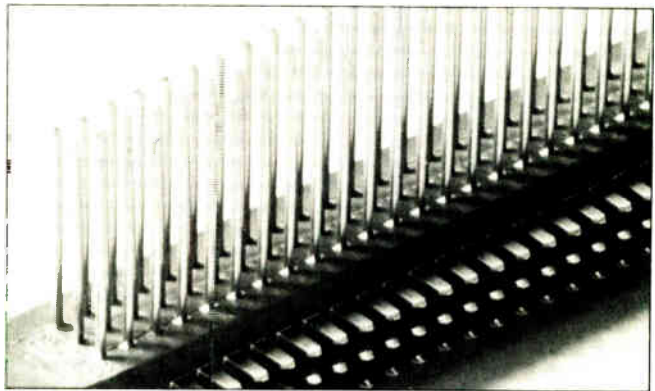

Diallyl Phthalate is the insulator in most models. And all connectors are designed to meet conditions of MIL-C-55302.

If you need them right now, our distributors have most models in stock. For details, use the coupon and get our latest catalog.

O.K. Send me: Your latest catalog with details on the two-piece PC connectors ...and your nearest rep. I have some questions for him.

Name: _____

Position: _____

Company: _____

Address: _____

City: _____ State: _____ Zip: _____



Viking Industries, Inc., 21001 Nordhoff Street, Chatsworth, CA 91311

Interrupts can make a microprocessor program seem faulty

Users of microprocessors should beware of gremlins in the interrupt instructions that can cause correct programs to appear faulty. Take the 6800 system, for example—some of its interrupt-mask instructions are ambiguous, cautions Thomas Adams of the University of Texas Applied Research Laboratories. The problem is that with the set interrupt mask (SEI) and clear interrupt mask (CLI), **the parity of the byte preceding their operation codes must be odd, or the instructions may not work.** But it's easily fixable, adds Adams. Just insert a no-operation instruction (NOP) prior to the SEI or CLI instructions. The NOP instruction has op code 01 and therefore ensures proper functioning of the interrupt masks.

Automatic gear inserts 40-lead DIPs at high speed

As microprocessor activity continues to expand, electronics equipment manufacturers must look ahead to mass production of microcomputer boards. This means automatic insertion of dual in-line packages with up to 40 leads, but present-day automatic inserters stop at 24 pins. A new \$88,600 machine from Northeastern Tool Co., Haverhill, Mass., does the big-package job. The System 640, the first of a new group of machines designed for inserting large LSI packages, can insert 6-lead to 40-lead devices **at rates of up to 2,000 units per hour.**

Learn to program microcomputers at home

In an effort to educate the many engineers and technicians who are still unfamiliar with hardware/software techniques, two California companies—Integrated Computer Systems Inc. of Culver City and Iasis Inc. of Sunnyvale—now offer **home-study courses in microcomputer programming that are quite extensive.**

The Integrated Computer Systems course, called "Self Study Microcomputer Software/Hardware Training Course," includes the popular 8080A microprocessor, 1,024 bits of erasable programmable read-only memory, and 512 bytes of random-access memory (expandable to 1,024), as well as an 8-digit display, keyboard, programmable interface and detailed instruction manual. The cost: \$495, plus a \$75 power source.

The Iasis course, which includes a 250-page instruction book called "Computer in a Book," contains the 8080, 1,024 bits each of PROM and RAM, a keyboard, an 8-digit display, and room for plugging standard interfaces into the system. The cost is \$450 (without power supply).

For more information, call Eric Garen at Integrated Computer Systems, (213) 559-9265, Charles Hornisher at Iasis, (408) 732-5700.

Pick a better color for your display

Getting tired of the same old display colors? Then check out a growing assortment of new colors now becoming available in many different display formats. The harsh red glare of a light-emitting diode, for example, can be replaced with the newer yellow LEDs coming from Monsanto and Hewlett-Packard. (Dana Laboratories of Irvine, Calif., is one firm that swears it's going to switch its instrument lines completely to yellow LEDs.) Then there's the orange color and almost invisible intersegment gaps of Beckman's gas discharge displays. **As for those dull gray liquid crystals, characters on purple, blue, or black backgrounds can now be had** from Integrated Display Systems Inc., Montgomeryville, Pa. Finally, in vacuum fluorescent displays, bluish-green units are available from NEC America Inc., Santa Clara, Calif., and Futaba Industries U.S.A., Compton, Calif.

Laurence Altman

Group portrait: The Class of '77

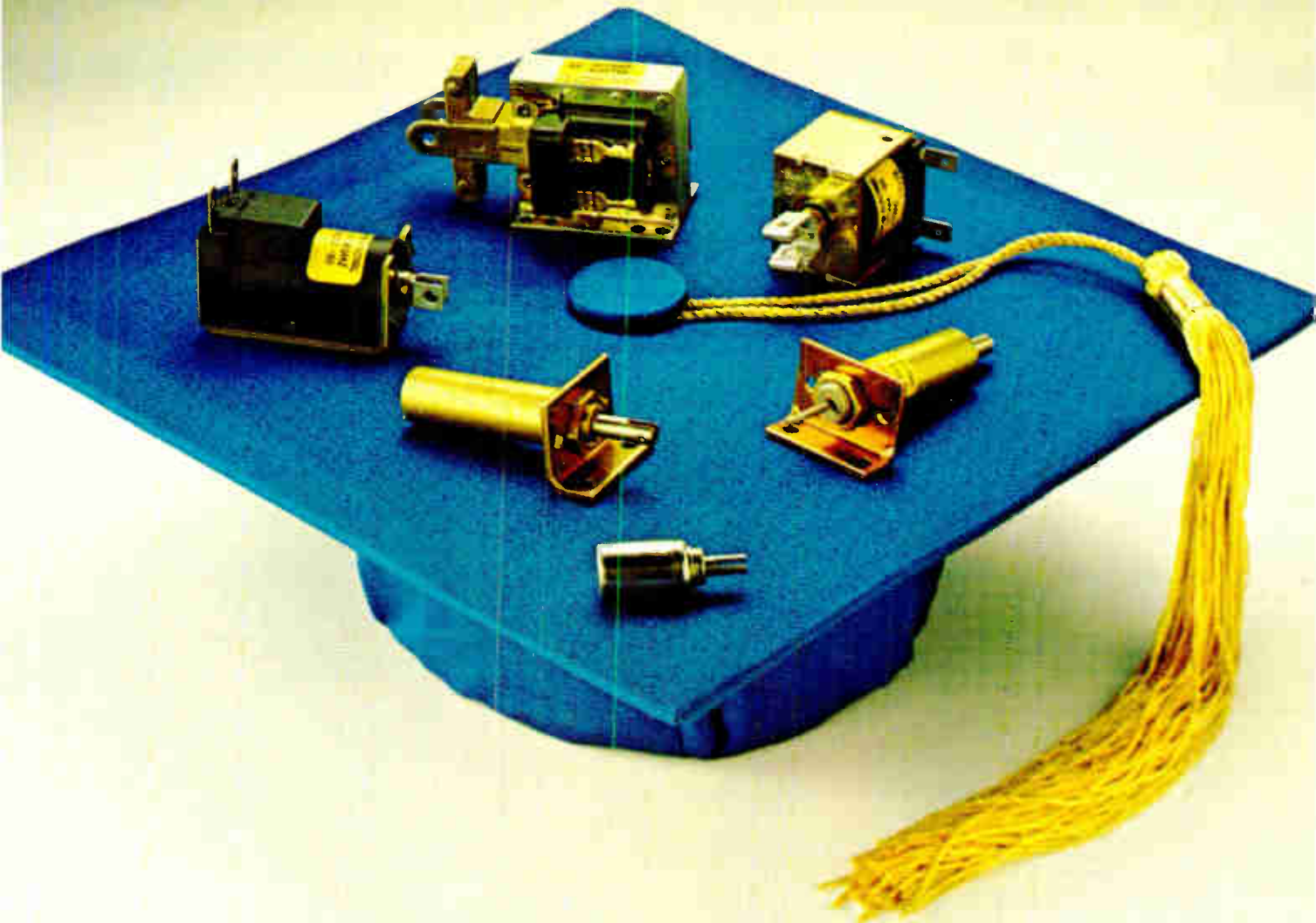

Guardian solenoids are made in all sizes and shapes: Box frame, U-frame, laminated and tubular . . . push 'n pull . . . AC 'n DC. But, it's the WAY they're made that puts them in a class by themselves.

Example: Uni-Guard® II molded bobbin and coil covers are now standard on our box frame and U-frame solenoids. This one design feature alone gives you cost savings of up to 25% . . . with at least 25% longer life.

Example: Our tubular solenoids are made in two basic versions . . . and hundreds of variations. There are the built-to-take it traditional tubulars. Plus, long-life tubulars that survive 100 million operations.

Example: We have more types available from stock than anyone else: A special? You spec it and Guardian's ready to produce it. Return springs, special plunger configurations, terminations, mountings, coil finishes, thermal cutouts, dual windings, external switches . . .

Let your Guardian Angel show you why Guardian is No. 1 In its solenoid class.



Recognized under the component program of Underwriters Laboratories, Inc.

GUARDIAN®

GUARDIAN ELECTRIC MANUFACTURING CO. • 1566 West Carroll Ave. • Chicago, Illinois 60607 • 312/243-1100

Circle 124 on reader service card

Now you can mass terminate with ribbon connectors.

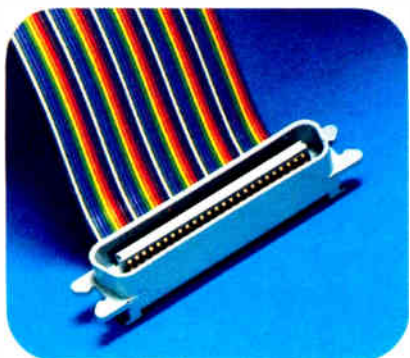

Here's another industry first from 3M that's good news for you: the Scotchflex brand Delta Ribbon Connector System for intra-system or I/O interconnections. In computer applications, in telecommunications, in any place or any way you want to use flat cable and ribbon connectors, this versatile system can do the job at sharply reduced assembly time and labor costs.

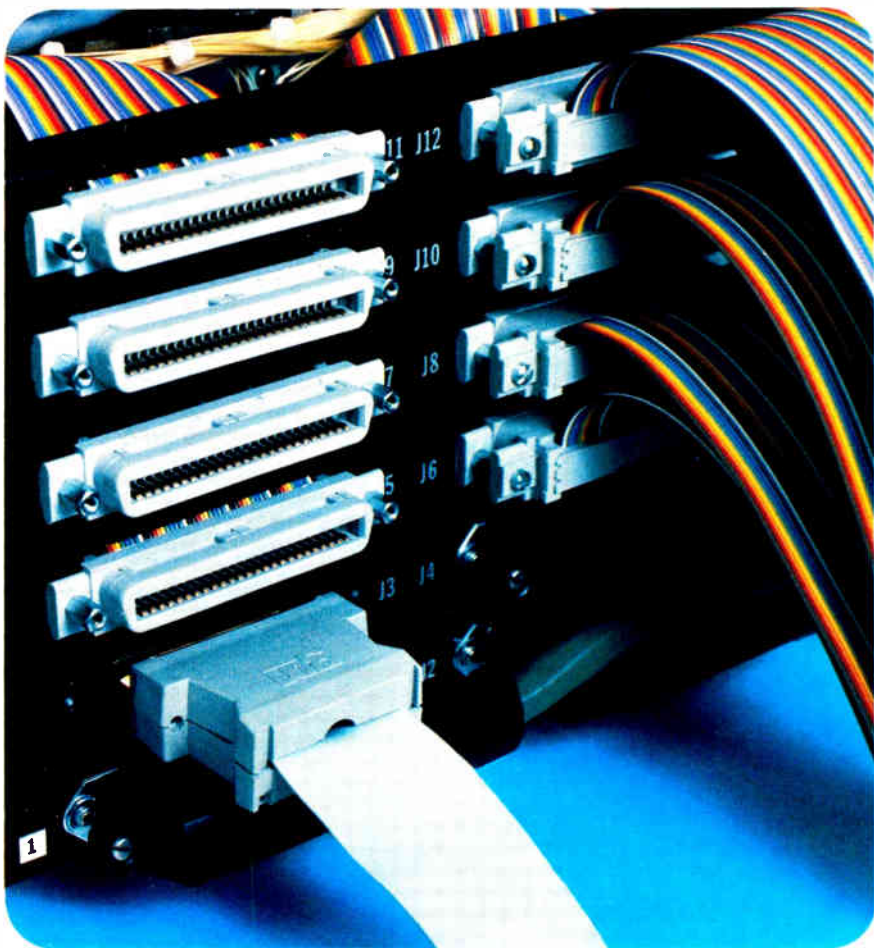

With Scotchflex Delta Ribbon Connectors, no stripping, soldering or other wire preparation is necessary. You can mass terminate a parallel-lay 50-conductor (25-pair) .0425" center-spaced flat cable in less than 30 seconds with one step. That's about ten times faster than other available methods. And thanks to 3M's field-proven, gold-plated beryllium copper U-contacts,

all connections are reliably corrosion-resistant and gas-tight.

After termination, there are more savings. You can buss from point to point without disassembling or breaking existing cables. And there's no need to redesign or rework first generation components. This Scotchflex system mates perfectly with all standard miniature ribbon connectors.

in 30 seconds or less!



There's no costly investment to make in equipment or training. All you need are two locator plates and the Scotchflex manual or pneumatic assembly press. You can start mass terminating assemblies quickly and economically. No special operator skills are required. Rejects and reworking are greatly minimized.

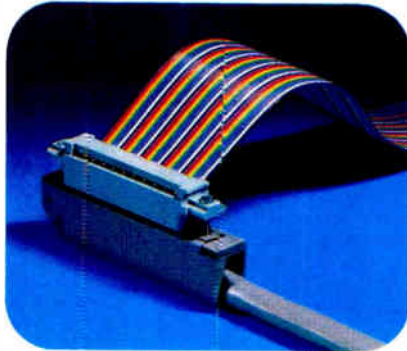

The Scotchflex Delta Ribbon system includes 50-position male and female connectors, plus appropriate bail mount, screw mount and jack screw kits, strain relief clips and dust covers. Color-coded flat cable is available in parallel-lay conductors #28 AWG stranded or #26 AWG solid.

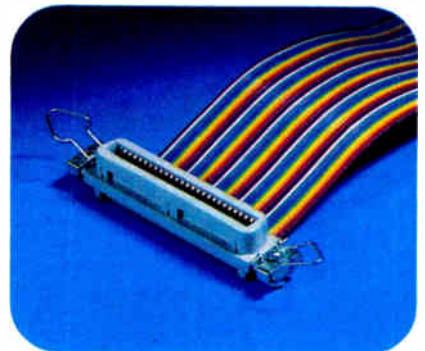

Only 3M offers you so broad a range of flat cable and system components. A nationwide network of stocking distributors. Best off-the-shelf availability. Proven performance. And the unmatched experience of the people who pioneered mass terminations.

"Scotchflex" is a registered trademark of 3M Co.

Scotchflex[®]
systems
from 3M.
The source.



Put your name on
the quality line
of **oem**
miniperipherals
and services.

Ask Control Data.

Test. Evaluate. Compare Control Data Miniperipherals with competition. See for yourself the definite CDC price/performance advantages that give your product a real competitive edge. Most important, check our new OEM Maintenance Program and Financing Plans — two services that make it easier than ever to put your logo on our product and establish a stronger marketing position for your entire line.

Price. Performance. Reliability. Service. **Quality** throughout. Whether you're a large OEM or small, you get all these benefits from Control Data OEM Peripherals — both mini and maxi. For detailed information . . . for evaluation units . . . call our OEM Hot Line: (612) 853-7600.



PRINTERS

300-600-900 lpm HORIZONTAL FONT BAND PRINTERS

Offer your customer reduced paper and total life cycle costs through exclusive choice of 10 and 15 cpi bands. Unique removable 15 cpi band prints 132-character line on 11" paper . . . can be operator-exchanged with 10 cpi band in 30 seconds. Multiple options practically permit you to custom-tailor the printer for your customer's needs. Eleven interchangeable bands, identical spare parts kits. Full, solid stroke characters. top to bottom; print quality never before available in a medium-to-high-speed line printer at its price! Print speeds with 48 character set: 360, 720 and 1130 lpm.

MATRIX PRINTER

For 70 to 200 lpm print requirements, the multi-optioned companion to the Band Printer features bi-directional printing under microprocessor control. Models 9317, 9318

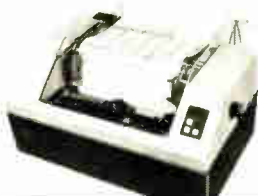

ROTATING MEMORY

Get built-in reliability from Control Data's advanced total technology that produces all three parts — heads, disks, drives — and makes them work as a winning team.

INTERCHANGEABLE WITHOUT CHANGING YOUR DESIGN:

Storage Module Drives. The industry standard. Offers easy system integration through common interface software and firmware. So you can select the best drive for any purpose without costly design modification.

High Technology Mini Module Drives. High-reliability, sealed-media companion to CDC's Storage Module Drive family — SMD interface and format compatible. Fixed, sealed module includes rotary actuator and head-per-track option.



TYPE	CAPACITY	MODEL	MEDIA	INTERFACE
MMD	12 MB	9730-12	Fixed, Sealed	Industry std. SMD I/O format and interface common to all models.
	24 MB	9730-24		
	48 MB	9730-48		
SMD	40 MB	9760	Removable	
	80 MB	9762		
	150 MB	9764		
	300 MB	9766		

DISK PACKS & CARTRIDGES

Get rotating media from the same production line as the end user packs we label with our name and guarantee for the life of the pack. The differences: your specifications and packaging; your private label and color; your shipping container. Packs are offered for all of our OEM drives.

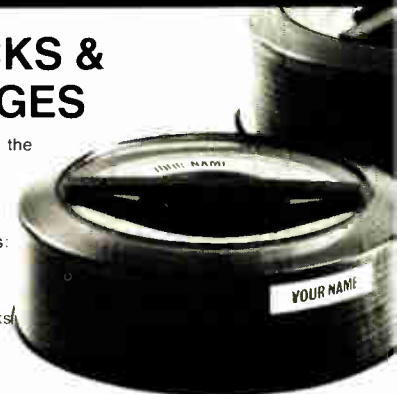

PRODUCT	DATA PACK		DRIVE TYPE		ALIGNMENT PACK	
	CDC Model No.	IBM Model No.	IBM Drive No.	CDC Pack Model No.	IBM Model No.	
Diskettes	9821-60W	3740	3740			
Disk Cartridge	9846	2315	2310	9846-51	2315CE	
	9847	5440	5444	9847-51	5440CE	
Disk Packs	9849	1316	1311/2311	9850-52	1316CE	
	9876			9876-51		
	9877			9877-51		
Data Modules	9778-70	3348-70	3340-70			
	9778-70F		3340-70F			

CARTRIDGE DISK DRIVE

Updated, simplified, field-tested and proven for twice-the-reliability of previous models. Versatile, modular, easy to maintain. 12 MByte standard; 6 and 3 MByte optional. Average access 35 ms. Model 9427H



NON-REMOVABLE "CARTRIDGE MEDIA" DISK DRIVE

The new low-cost, problem-free fixed media companion to Cartridge Disk Drives. Offers the best MTBF rating in the industry. No operator intervention or electrical adjustments needed. Model 9414; 12 or 6 MByte capacity. Cartridge Disk Drive interface.



FLEXIBLE DISK DRIVE

Updated version of the drive specified by more major OEM's than any other. Single or double density capability, ceramic head, daisy chain interface. Current switching, ready interrupt, power reduction and a wide range of options allow tailoring to unique applications. Model 9404

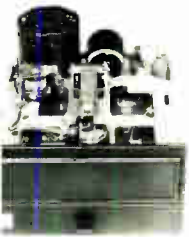

FLEXIBLE DISK DRIVE SUBSYSTEM

Ready made package contains formatter, microprocessor based controller, power supply and drives in a finished table-top or rack-mount package. Model 9472



COMPUTER MEMORY PRODUCTS

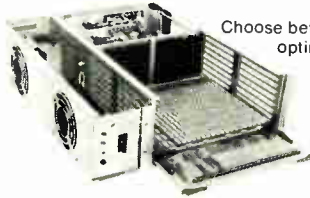

Choose between reliable core memory modules optimized for cost, speed, size. Or select from advanced semi-conductor memory systems. Custom or off-the-shelf standard configurations.

Model No.	Feature	Density	Enclosure 5 1/4" High	Capacity 10 1/2" High	Performance
94200	Cost-optimized	16K x 36 32K x 18	256 KB	512 KB	350 ns. Access 850 ns. Cycle
94300	Speed-optimized	16K x 16 16K x 18 16K x 20	128 KB	256 KB	250 ns. Access 650 ns. Cycle
94320	Ampex 1620 compatible	16K x 16 16K x 18 16K x 20	128 KB	256 KB	275 ns. Access 750 ns. Cycle
94322	Double density	32K x 16 32K x 18 32K x 20	256 KB	512 KB	350 ns. Access 830 ns. Cycle
94400	Size-optimized	4K x 8/9 8K x 8/9 16K x 8/9			300 ns. Access 1000 ns. Cycle
94405	Single (+5) voltage	4K x 9 8K x 9			350 ns. Access 1250 ns. Cycle
94500	4K MOS RAM	32K x 18 32K x 20	512 KB		325 ns. Access 450 ns. Cycle
94501	Low-cost version	32K x 18 32K x 20	512 KB		450 ns. Access 600 ns. Cycle
94550	Double density	64K x 20	1024 KB		325 ns. Access 450 ns. Cycle

Also available:

Loose UNITEMP core. In 18-mil and new 13-mil sizes. UNITEMP is the temperature-independent magnetic ferrite core stable over the entire MT temperature range (0°-90° C).

Enclosures. Two enclosures are available for mounting core or semiconductor modules in a standard EIA 19" rack. Cabinet measures 5 1/4" or 10 1/2" high, 20" deep; cards mount horizontally. Self-contained cooling fans direct air horizontally across the modules. Both core and semiconductor modules can be incorporated to a maximum of 1 megabyte.

oem SERVICES

NEW! OEM Maintenance Services. Now, Control Data can offer you and your customers maintenance on certain specified Control Data peripherals. This service can be provided both scheduled and on-call, in a dozen major U.S. metropolitan areas. You reduce your need to familiarize your maintenance staff with Control Data equipment; to document reliability and maintenance; to capitalize test equipment; to carry spares. Most important, it can free your people and dollar resources for other needs.

OEM Financial Services. Through its Commercial Credit subsidiary, Control Data can now assist with the financial planning of your OEM peripherals purchases, or even provide lease programs for your customers. Your Control Data OEM Representative has complete details.

TERMINALS

DISPLAY TERMINALS

A family of Conversational, Edit and High Performance Intelligent Displays, offering a wide range of features for data entry, console, other display applications. High quality construction backed by a full one year warranty. Trouble-free convection cooling replaces noisy, worrisome fans and filters. Communications to 9600 baud. Detachable keyboards.

INTELLIGENT DISPLAY

Powerful microprocessor can be programmed to control operations between operator, peripherals and communication lines. Built-in self-test diagnostic feature. Capacity: 1920 characters. Edit feature. Optional Bulk Storage, Paging, Hardcopy and polling. Cursor Position and Read. Model 92451

CONVERSATIONAL DISPLAY

Keyboard/display terminal with 1920-character display of 96 or 64 characters. Features built-in printer interface and X-Y cursor addressing. For high-speed data entry, a keyboard with optional numeric cluster is available. Model 92452

EDIT DISPLAY

Edit Display Terminal with 1920 characters. Features microprocessor control, built-in printer interface, function keys, and editing. Unique diagnostic checks readiness of terminal. Model 92456



Ask our oem people

CD CONTROL DATA CORPORATION

You Don't Have To Beg, Borrow Or Buy...



Rent'em From GE

Short or long-term instrument rentals give you flexibility and economy.

GE has over 9,000 instruments available for immediate shipment: □ Tek Scopes □ Biddle Megger Insulation Testers □ H-P Signal Generators □ Honeywell Oscillographs □ Complete Data Systems □ Esterline Angus Recorders □ GE Chart Recorders □ Modems □ Communication Terminals ... all calibrated to the manufacturer's specs.

We have over 100 Sales/Service Centers,

and one of them is near you. In addition to maintaining our Rental Inventory, they can also repair and calibrate your own equipment.

Don't borrow someone else's GE Rental Catalog. **Call collect (518) 372-9900** or your nearest Sales/Service Center.

**Quick-rental[®]
instruments**

GENERAL  **ELECTRIC**

ALA. BIRMINGHAM (215) 925-3104 • **ARIZ.** PHOENIX (602) 278-8515 or 8516, TUCSON (602) 294-3139 • **CAL.** LOS ANGELES (213) 642-5350, SAN FRANCISCO (415) 436-9260 • **COL.** DENVER (303) 371-1260 • **CONN.** SOUTHINGTON (203) 621-4059 • **FLA.** JACKSONVILLE (904) 751-0610 • **GA.** ATLANTA (404) 457-5563 • **ILL.** CHICAGO (219) 933-4500 • **IND.** INDIANAPOLIS (317) 639-1565 • **KY.** LOUISVILLE (502) 452-3311 • **LA.** NEW ORLEANS (504) 367-6528 • **MD.** BALTIMORE (301) 332-4700 • **MASS.** BOSTON (617) 396-9600 Ext. 160, SPRINGFIELD (413) 781-1111 • **MICH.** DETROIT (313) 285-6700 Ext. 208 • **MINN.** MINNEAPOLIS (612) 522-4396 • **MO.** KANSAS CITY (816) 231-4377, ST. LOUIS (314) 965-7115 • **N.J.** CLIFTON (201) 471-6556 • **N.Y.** BUFFALO (716) 876-1200, SCHENECTADY (518) 385-2195 • **N.Y.C.** CLIFTON, N.J. (201) 471-6556 • **N.C.** CHARLOTTE (704) 525-0311 • **OH.** CINCINNATI (513) 874-8512, CLEVELAND (216) 523-6382, TOLEDO (419) 691-3501 • **OR.** PORTLAND (503) 221-5101 • **PA.** PHILADELPHIA (609) 424-4450, PITTSBURGH (412) 462-7400 • **TEX.** DALLAS (214) 357-7341, HOUSTON (713) 672-3570 • **VA.** RICHMOND (804) 232-6733 • **WASH.** SEATTLE (206) 854-0211 • **W.V.** CHARLESTON (304) 345-0920 • **WISC.** MILWAUKEE (414) 744-0110 • **PUERTO RICO** PONCE (809) 843-4225

Time-delay relays get cheaper

Thick-film timing module converts ordinary electromechanical relays into time-delay devices

by Lucinda Mattera, Components Editor

Time-delay relays tend to be large and expensive—but not the new line from Struthers-Dunn. Though no bigger than conventional general-purpose electromechanical units, the relays can sell for as little as half the price of existing devices.

The key to the size and price advantages of the new units is a thick-film timing module that the firm simply wires in place inside an ordinary electromechanical relay. Among the benefits to the user of this approach are low installation costs, design freedom, and high component density, notes Bill Capewell, vice president. The relays, moreover, have Underwriters Laboratories recognition.

“Designers no longer need to worry about the effects of adding a time-delay function to a circuit,” Capewell says. “They can incorporate it as an integral part of any relay in the circuit without any change in wiring or space requirements. What was once a special product is now a standard product.”

Conventional time-delay units sell for as much as \$40, but the new devices typically are priced at under \$20. For example, says Capewell, a regular electromechanical relay going for \$3.50 will now be available with time-delay capability for about \$15.50.

Because of their low price and small size, the new devices are suitable for many applications, including: control of production machinery, such as presses or packaging systems; delay circuits in home-security systems to give owners a few seconds to turn off alarms with a hidden switch before a signal sounds; sequencing air conditioners in a

multi-family building to keep quarters comfortable while reducing peak demand; delaying startup of selected electric motors to protect power systems from overload caused by simultaneous startup, and sequencing of business machines like copiers.

Struthers-Dunn will be offering its time-delay capability in some 6,000 relay configurations. They are available in either preset or adjustable models and in a variety of contact arrangements, including four-pole double-throw. Additionally, the tim-

ing may be for either an off delay or an on delay.

Current-handling capability ranges from low-level units capable of accepting signals as weak as a few milliamperes to power units able to switch currents up to 30 amperes or more. Available voltage ratings range from 12 to 240 volts ac and from 12 to 120 v dc.

The new relays are available from stock.

Struthers-Dunn Inc., Pitman, N.J. 08071.
Phone (609) 589-7500 [339]



What this country needs is a good \$39 DPM.

And we've got it. The AD2026 from Analog Devices. Priced at \$39 in hundreds*, it's the first real alternative to the measurement grade analog panel meter. And the first to give you all the advantages of a DPM at a practical price. Advantages like visual appeal, accuracy, resolution, small size and reliability.



The AD2026 is a three digit, logic powered DPM that measures and displays voltages from -99mV to $+999\text{mV}$ on 0.5" LEDs. It consumes only $\frac{3}{4}$ Watts of 5V power. And because the AD2026 can be scaled with a simple resistive divider on its input pins, you can get direct readout in any engineering unit with equal or better resolution than APMs.

With an accuracy of 0.1% of reading ± 1 digit, the AD2026 is again far superior to conventional APMs, where their inherent inaccuracy usually limits the total performance of the instrument.

The AD2026 conserves on space, too. Its small front panel size of 3.4" x 2.0" and only 0.64" needed behind the panel makes it smaller than $3\frac{1}{2}$ " scale APMs. But its performance outclasses $4\frac{1}{2}$ " APMs.

When it comes to reliability, the AD2026 is unsurpassed. Its I²L technology combines most of the active analog and digital circuitry on *one* chip. The AD2026 has only 14 components and a MTBF of 250,000 hours at 25°C. In a 24-hour-a-day application, you shouldn't expect a failure for 28 years.

A new commercial tester automatically tests all AD2026's for defects such as bad components and solder shorts. It also fully tests both the LSI chip and the complete DPM. Following 168 hours of failure free burn-in, the units are again 100% tested.

The AD2026. Its low price (\$39/100s), small size, superior performance, and remarkable reliability make it the only sensible alternative to APMs. Which is just what this country needed.

Check it out. Return the coupon with your check or money order today to order an evaluation sample at the low 1-9 quantity price of \$62. And when you receive your evaluation samples you will also receive a Credit Certificate for \$23 redeemable when you place your order for the first hundred or more AD2026's.

ANALOG DEVICES
The real DPM company.

Box 280, Norwood, MA 02062
Telephone: East Coast: (617) 329-4700,
Midwest: (312) 894-3300,
West Coast: (213) 595-1783,
Texas: (214) 231-5094.



Please send me _____ AD2026 for testing and evaluation at the low (1-9) price of \$62. (Enclose check or money order.)

Enclosed is my purchase order for 100 AD2026 DPMs at the unbelievably low price of \$39 in 100s.

I'm not ready to order my AD2026 DPM for testing and evaluation, but I would like to receive all available technical information.

E 5/12

P.O. # _____

Name _____

Company _____ Telephone _____

Address _____

City _____ State _____ Zip _____

*Substantial quantity discounts available.

IC converts rms to dc

Monolithic unit, in 14-pin DIP, has 100-kHz bandwidth, comes in two accuracy versions

by Lawrence Curran, Boston bureau manager

An integrated circuit rms-to-dc converter from Analog Devices Inc. has won widespread acceptance from instrument manufacturers without ever having been formally introduced. Jerry G. Fishman, director of marketing for the company's semiconductor division in Wilmington, Mass., says the AD536 [*Electronics*, Sept. 16, 1976, p. 35] has been designed into digital multimeters being produced or developed by all but one of the major suppliers.

The circuit, housed in a 14-pin ceramic DIP, is believed to be the first monolithic IC that directly computes the true-rms value of any complex input waveform containing ac and dc components. Previous units performing the same function have been hybrids or modules, with the hybrids requiring at least two external trimming potentiometers to achieve their rated performance, says David Kress, product marketing specialist. The device offers a bandwidth of 100 kilohertz with an error of $\pm 1\%$ of reading.

The AD536 is laser-trimmed at the wafer stage for input and output offset, positive and negative waveform symmetry, and full-scale accuracy. The device is available from stock in two accuracy grades: the AD536K, with a maximum total conversion error of ± 2 millivolts $\pm 0.2\%$ of reading; and the AD536J, whose maximum error is ± 5 mv $\pm 0.5\%$ of reading. Those specifications are for operation between 0 and 70° C. The K version is priced at \$18.50 each in quantities of 100, with the J unit selling for \$9.95.

Kress says the only external component required is a capacitor to set the low-frequency cutoff. A 68-

microfarad capacitor permits 1% peak-to-peak ripple at 10 hertz. Settling time using a capacitor with that rating is 7 seconds to 1% of final value. Adding an optional second capacitor cuts that settling time to less than a second, Kress adds.

"Many manufacturers who have offered a dc option in a multimeter have done it with an averaging circuit," Kress says, "which isn't as accurate as a true-rms measurement." The frequency response of the 536 with a sine-wave input from 0.1 to 7 v rms is 20 kilohertz to an accuracy of 0.2%. "An averaging technique can deliver the same accuracy up to a point," Kress observes, "but it loses out at crest factors above 3 or 4." Crest factor is a measure of the shape of a waveform and equals the peak value divided by the true rms value of the waveform.

The 536 has a reading error of $\pm 1\%$ at crest factors up to 7, "but it still does well at crest factors up to 25," Kress notes, if peak signals are

limited to the power-supply range. That range is 5 v to 36 v for a single supply, or ± 2.5 v to ± 18 v for a dual supply. The quiescent supply current is a low 1 milliampere at any supply voltage, which is an important factor for battery-powered instruments, Kress notes.

An additional feature of the converter is an auxiliary decibel output not available before with rms converters. The logarithm of the rms output is brought out separately to allow the dB conversion. With an external reference current, the user can set the dB level to any input from 0.1 to 2 v rms and achieve a useful dynamic range of 60 dB. The output scale factor is -3 millivolts per dB, and has a temperature coefficient of -0.33% per °C. The temperature coefficient can be compensated for by adding a resistor and an operational amplifier to deliver a more convenient positive output.

Analog Devices Inc., Route 1 Industrial Park, P. O. Box 280, Norwood, Mass. 02062. phone (617) 329-4700. [340]

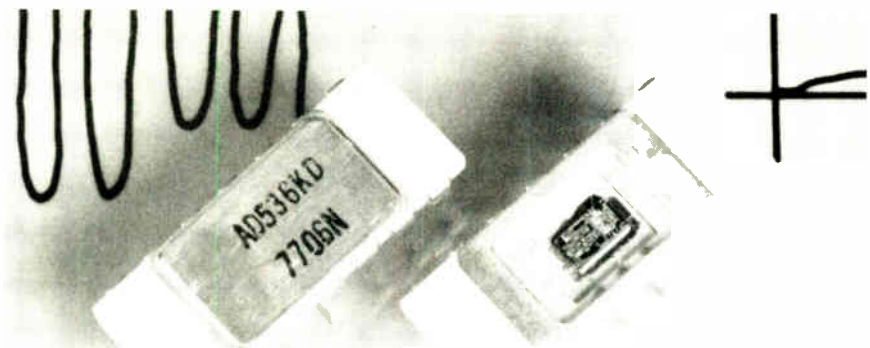

Stretch your test instrument budget

Does a scope always have to be expensive to meet your needs? At B&K-PRECISION we don't think so. B&K-PRECISION offers a full line of scopes that give you the performance and features you need, at substantial cost savings...plus the advantage of immediate delivery and 10-day free trial through local distributors.

B&K-PRECISION to high-priced

B&K-PRECISION has taken a no nonsense, cost-effective, approach to oscilloscope design. All our scopes will trigger at frequencies typically 50 to 100% beyond their rated band-width. They are rugged, dependable instruments, designed to match the features and performance of far more expensive scopes, without matching their high price. An important part of our approach is that you shouldn't have to buy more scope than you need to get the features you want. Before making your next purchase, compare the features and performance you require with what we have to offer. You'll discover that your budget is a lot bigger than you first thought!

30MHz Dual-Trace 5" Triggered Scope with Signal Delay

For the engineer who requires a full-feature 30MHz scope

- Built-in signal delay line permits viewing of high-frequency pulse risetimes
- Triggers on signals up to 50MHz
- Rise time 11.7nS
- 20 calibrated sweeps—0.2 μ S/cm-0.5S/cm
- Built-in high and low-pass filters
- 5mV/cm vertical sensitivity
- Illuminated graticule
- TTL compatible intensity modulation
- X-Y capability using matched DC amplifiers
- P31 blue phosphor
- Internal .5Vp-p \pm 1% calibration source
- 5mV/cm horizontal sensitivity.

Model 1474 \$930 (including two 10:1/direct probes)

15MHz Dual-Trace 5" Triggered Scope

Premium features and performance in a 15MHz dual-trace scope

- Ultra—flat in-band response with smooth rolloff past 15MHz
- Triggers beyond 27MHz
- 24nS risetime
- 19 calibrated sweeps—0.5 μ S/cm-0.5S/cm
- 10mV/cm vertical sensitivity
- Algebraic addition and subtraction
- Illuminated graticule
- X-Y capability using matched DC amplifiers
- P31 blue phosphor
- Internal calibration source
- Built-in TV sync separator
- For fast setup, mode automatically shifts between CHOP and ALTERNATE as you change sweep times.

Model 1472C \$720 (including two 10:1/direct probes)

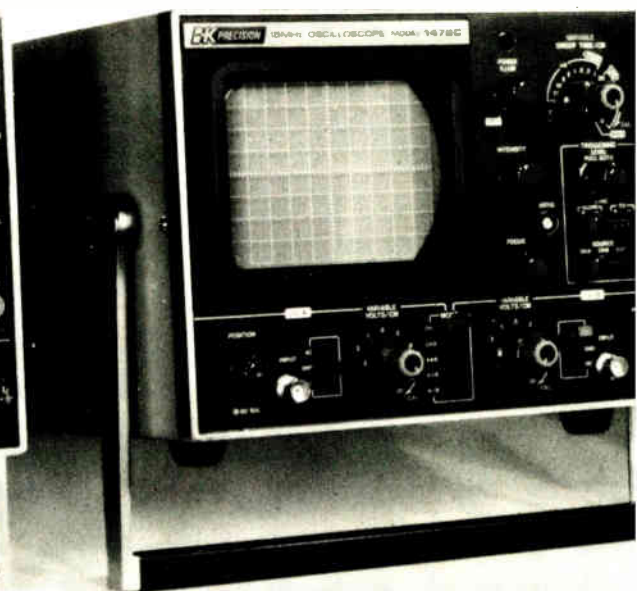
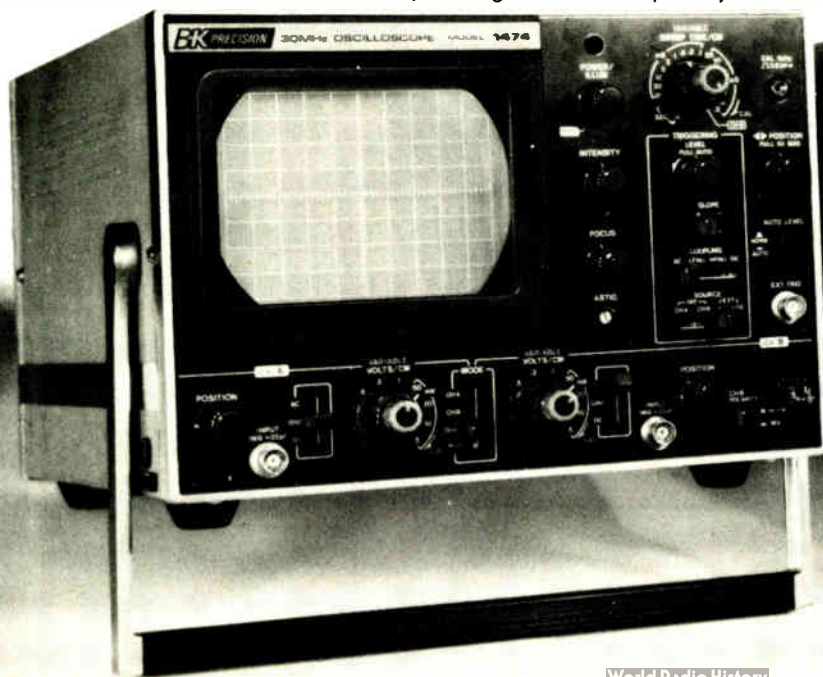

Without stretching your standards... has an alternative oscilloscopes

10MHz Dual-Trace 5" Triggered Scope

Our lowest-cost dual-trace scope more than fills the need in applications where extended bandwidth isn't required

- Triggers beyond 15MHz
- Mode automatically shifts between CHOP and ALTERNATE as sweep time is changed
- 18 calibrated sweeps— $1 \mu\text{S}/\text{cm}$ - $0.5\text{S}/\text{cm}$
- 35nS risetime
- P31 phosphor
- X-Y capability using matched DC amplifiers
- Internal calibration source
- TTL compatible intensity modulation
- 10mV/cm vertical sensitivity

Model 1471B \$570

(Including two 10:1/direct probes)

10MHz 5" Triggered-Sweep Scope

A 5" triggered scope with TTL compatible Z-axis

- 10mV/cm vertical sensitivity
- 35nS risetime
- 18 calibrated sweep ranges— $1 \mu\text{S}/\text{cm}$ - $0.5\text{S}/\text{cm}$
- 5x magnification sweeps to $.2 \mu\text{S}/\text{cm}$
- Vectorscope capability
- Internal calibration source
- Internal TV sync separator
- P31 phosphor
- 11-position vertical attenuator, calibrated in convenient 1/2/5 step sequence
- Built-in calibration source.

Model 1461 \$470

(including 10:1/direct probe)

5MHz 3" Compact Scope

Ideal for many dedicated applications, freeing more expensive scopes from monitoring tasks

- 10mV/div vertical sensitivity
- Direct deflection terminals for waveform display to 450MHz
- Only 6 x 7.5 x 12" • Weighs just 8.5 lbs
- 600 Vp-p maximum input voltage
- Can be externally synced.

Model 1403A \$219

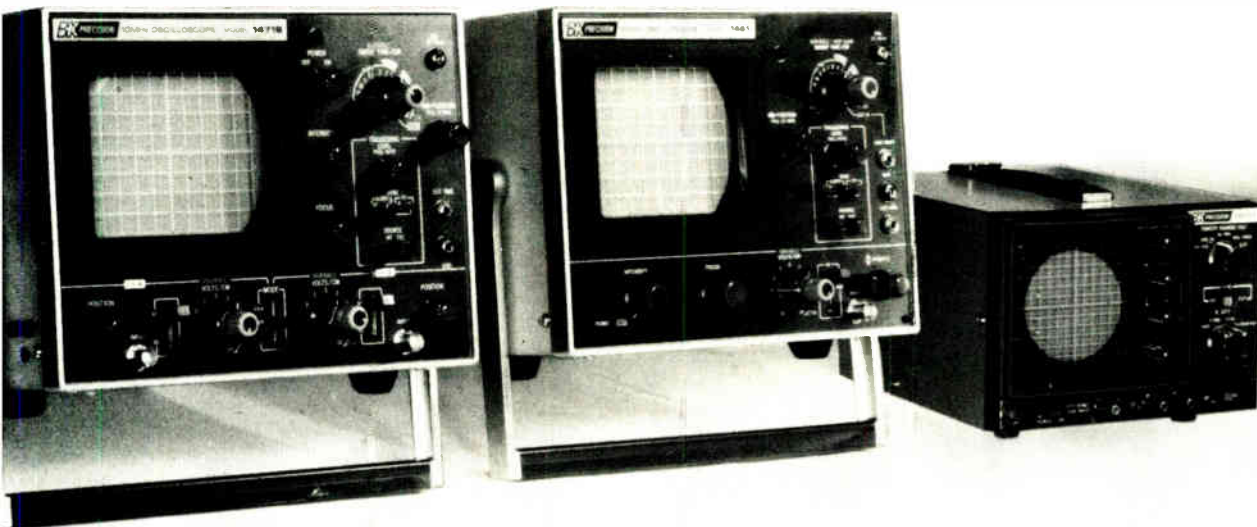

FOR IMMEDIATE DELIVERY,

or 10-day free trial, contact your local B&K-PRECISION distributor. Ask him for Catalog BK-77 with complete information on B&K-PRECISION oscilloscopes, probes and more than thirty other fine instruments, or contact us directly.

For Additional information Circle 134 on Reader Service Card
For Product demonstration Circle 135 on Reader Service Card

B&K PRECISION **DYNASCAN CORPORATION**

6460 W. Cortland Avenue, Chicago, IL 60635 312/889-9087

In Canada: Atlas Electronics, Ontario

International Sales: Empire Exporters, Inc., 270 Newtown Road, Plainview, LI, NY 11803

**"BET YOU CAN'T
BEAT THE
SYSTEM!"**

AND HERE ARE FOUR REASONS WHY:

Bud's Modular Electronic Packaging System gives you options. Option to use circuit boards; to use full-enclosed modules, to use all of one, or a combination of both to develop an electronic package for a variety of applications. Equally important, the Bud System gives you the flexibility to alter your original circuit board/module arrangement for subsequent applications. The options are yours!



1 Movable Snap-in Guides. One reason for the System's flexibility are full-length, impact-resistant guides. You can move them, snap them in and out -- adjust them to a basic pitch of 0.2" to accommodate circuit boards and modules -- without dismantling the System's outer frame. The System will house up to 42 circuit boards; however, even when densely packed, maximum ventilation is assured.

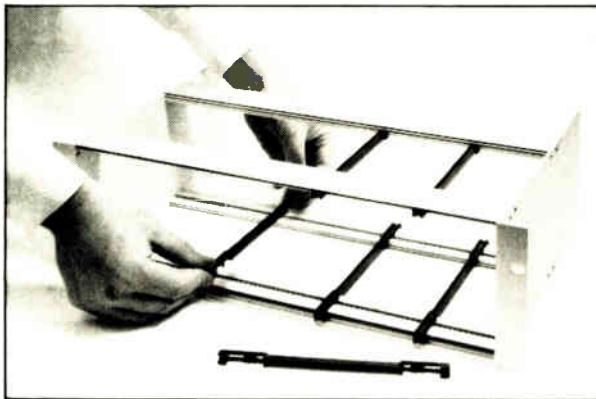

2 Perfect Alignment Between Connector and Circuit Board. The System's distortion-free guides offer packaging flexibility, and also provide the means for positive alignment. All edge connectors, plus panel-type connectors mounted to socket-mounting panels are securely attached at the rear of the guides. Insert circuit boards into the System and they slip directly into the edge connectors. Slide in larger modules and they make perfect contact with the panel-type connectors.

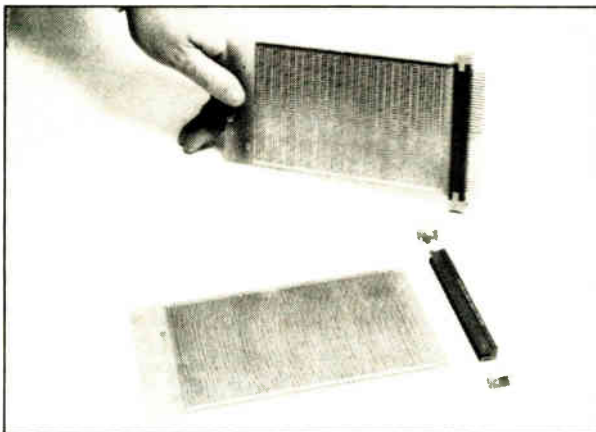
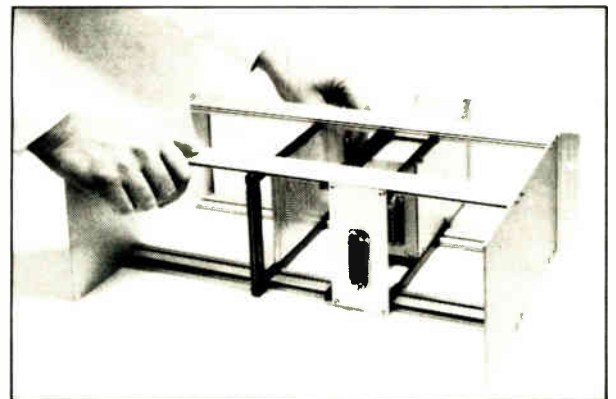

3 Board Profiling is Eliminated. A uniquely designed end foot, easily attached at the end of each guide, not only "leads" circuit boards into edge connectors, but also positions edge connectors so they will accept the full height of the boards. This eliminates board profiling and, in turn, results in maximum contact. Keep in mind the Bud System is designed to utilize a wide universe of circuit boards and edge connectors to give you maximum flexibility.

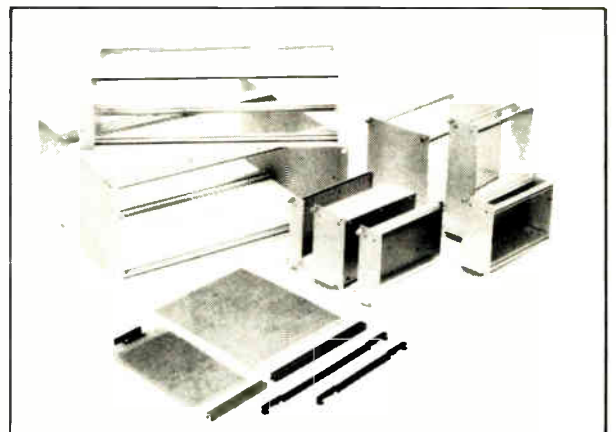

4 A Choice of Components. Regardless of what type electronic package is required for your present or future applications, Bud has the components to develop that package: eight sub-racks (outer frames), 20 sub-units (enclosed modules), six printed board units, eight circuit boards, plus single and double row edge connectors. All are fabricated to exacting tolerances. All are easily assembled. All are in stock -- immediately available.

Your Bud distributor will give you complete data on the Modular Electronic Packaging System. Better yet, he has a demonstration unit. See it. Work with it -- the packaging system that gives you options.

BUD

BUD INDUSTRIES, INC.
4605 East 355th Street
Willoughby, Ohio 44094

"WE'VE GOT THE SYSTEM!"

IT'S IN STOCK AT YOUR LOCAL BUD DISTRIBUTOR.

ALABAMA
Birmingham
James W. Clary Co.
205-322-2486

ARIZONA
Phoenix
Dalis Electronic Supply
602-254-8471

ARKANSAS
Little Rock
Carlton Bates Co.
501-562-9100

CALIFORNIA
Chatsworth
Westates Electronics Corp.
213-341-4411

Los Angeles
RPS Electronics, Inc.
213-748-1271
Mountainview
Elmar Electronics, Inc.
415-961-3611
Riverside
Electronic Supply
714-683-7300

COLORADO
Denver
Electronic Parts Co.
303-744-1992
Newark Electronics
303-757-3351

FLORIDA
Orlando
Hammond Electronics, Inc.
305-849-6060

GEORGIA
Atlanta
Lykes Electronics
404-449-9400

ILLINOIS
Chicago
Newark Electronics
312-638-4411

Palatine
Ohm Electronics
312-359-5500
Peoria
Klaus Radio, Inc.
309-691-4840

INDIANA
Indianapolis
Graham Electronics Supply, Inc.
317-634-8202
Re-Dis-Co., Inc.
317-637-5571

KANSAS
Wichita
Radio Supply Co., Inc.
316-267-5213

LOUISIANA
Lafayette
Ralphs of Lafayette, Inc.
318-234-4507

MARYLAND
Gaithersburg
Pioneer/Washington Electronics, Inc.
301-948-0710
Rockville
Capitol Radio Wholesalers, Inc.
301-881-2270

MASSACHUSETTS
Oedham
Gerber Electronics, Inc.
617-329-2400
West Newton
A. W. Mayer Co.
617-965-1111

MICHIGAN
Ann Arbor
Wedemeyer Electronic Supply
313-665-8611

Livonia
Pioneer/Michigan
313-525-1800
RS Electronics
313-525-1155

MINNESOTA
St. Paul
Gopher Electronics Co.
612-645-0241

MISSOURI
Kansas City
Walters Radio Supply, Inc.
816-531-7015

NEW MEXICO
Albuquerque
Walker Radio Co.
505-247-2288

NEW YORK
Binghamton
Harvey Electronics of Binghamton
607-748-8211
E. Farmingdale
Harrison Electronics
516-283-7990
Lynbrook, L.I.
Peerless Radio Corp.
516-593-2121

NORTH CAROLINA
Winston-Salem
Kirkman Electronics, Inc.
919-722-9131

OHIO
Cleveland
Pioneer/Cleveland
216-587-3600
Radio & Electronic Parts Corp.
216-248-8900

Cincinnati
Hughes-Peters, Inc.
513-242-2000
Columbus
Hughes-Peters, Inc.
614-294-5351
Oayton
Pioneer/Davton
513-236-9900

OKLAHOMA
Tulsa
Oil Capitol Electronics Corp.
918-622-8520

PENNSYLVANIA
Allentown
A. A. Peters, Inc.
215-434-5237
Montgomeryville
Pytticon Industries, Inc.
215-242-6700
Philadelphia
Almo Electronics Corp.
215-698-4000
Pittsburgh
CAM/RPC Electronics
412-782-3770
Pioneer/Pittsburgh
412-782-2300

SOUTH CAROLINA
Columbia
Dixie Radio Supply Co., Inc.
803-779-5332

TENNESSEE
Memphis
Bluff City Electronics
901-523-9500
Nashville
Electra Distributing Co.
615-329-3971

TEXAS
Dallas
Wholesale Electronic Supply
214-824-3001
Ft. Worth
Swieco, Inc.
817-335-6521

Garland
Newark Electronics
214-271-2511
Houston
Harrison Equipment Co.
713-652-4700
San Antonio
Sherman Electronics Supply, Inc.
512-224-1001

UTAH
Salt Lake City
Standard Supply Co., Inc.
801-486-3371

VIRGINIA
Charlottesville
Virginia Radio Supply Co., Inc.
804-296-4184

WASHINGTON
Seattle
Almac/Stroum Electronics, Inc.
206-763-2300

New products

Instruments

Data generator runs at 50 MHz

Versatile unit provides both bit-programmed and pseudorandom sequences

With a 2,048-bit internal memory, Hewlett-Packard's model 8018A 50-megahertz serial data generator can be programmed to perform many functions that were previously difficult, if not impossible. The generator issues programmed bit streams up to 2,048 bits long and pseudorandom binary sequences more than a million bits long. In addition, the unit's memory allows various pre- and post-ambls and other data words or addresses to be inserted between bursts to work with the system under test in such areas as avionics, telecommunications, digital memories, and microprocessor interfaces.

The unit delivers 1,024 bits of stored data on each of two independent output channels, with each bit individually programmable. The channels may also be cascaded to provide a single stream of 2,048 programmable bits. Return-to-zero and nonreturn-to-zero modes are independently selectable on the two channels. Many special coding formats can thus be simulated, such as biphasic or mixed RZ and NRZ data. Single bits in the message stream

can also be synthesized from the memory to provide variable pulse widths.

The data output amplitude can be adjusted for compatibility with several logic families. Two output impedances are provided: 50 ohms and 1 kilohm. Maximum output voltage is 15 volts from the high-impedance source or 7.5 v from 50 ohms. Emitter-coupled-logic output levels, with internally presettable amplitude and offset, may also be selected with a push button.

The 8018A generates pseudorandom binary sequences of $2^n - 1$ bits in length, where n can be 9, 10, 15, or 20. The $2^{20} - 1$ sequence, more than a million bits long, delivers every possible serial combination of 20 bits, except the degenerate case of 20 successive zeros.

The unit can be programmed via the IEEE-488 interface bus, and patterns can be loaded with a card reader. Price of the unit is \$3,475. The bus interface is \$425, and the card reader sells for \$600.

Hewlett-Packard Co., 1501 Page Mill Rd., Palo Alto, Calif. 94304 [351]

DMM with big LED display runs for 7 hours on one charge

A new portable 3½-digit multimeter features automatic polarity and zeroing, true-rms ac readings, a low-excitation ohmmeter circuit, and a 0.5-inch light-emitting-diode display. The meter, model MM300, uses a sealed rechargeable lead-acid

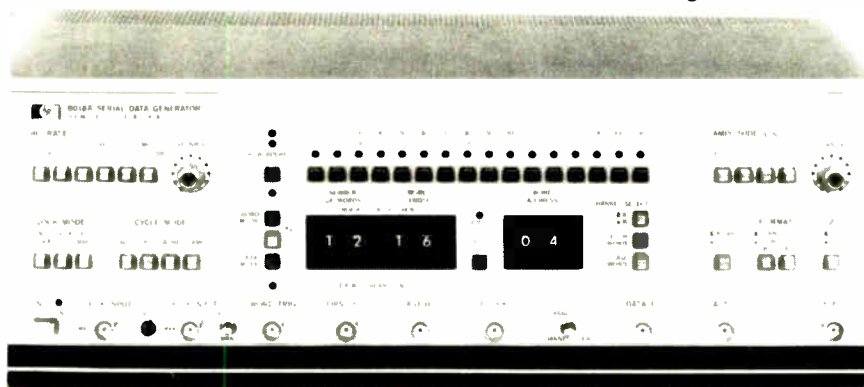

the Chip
makes
the difference
in...

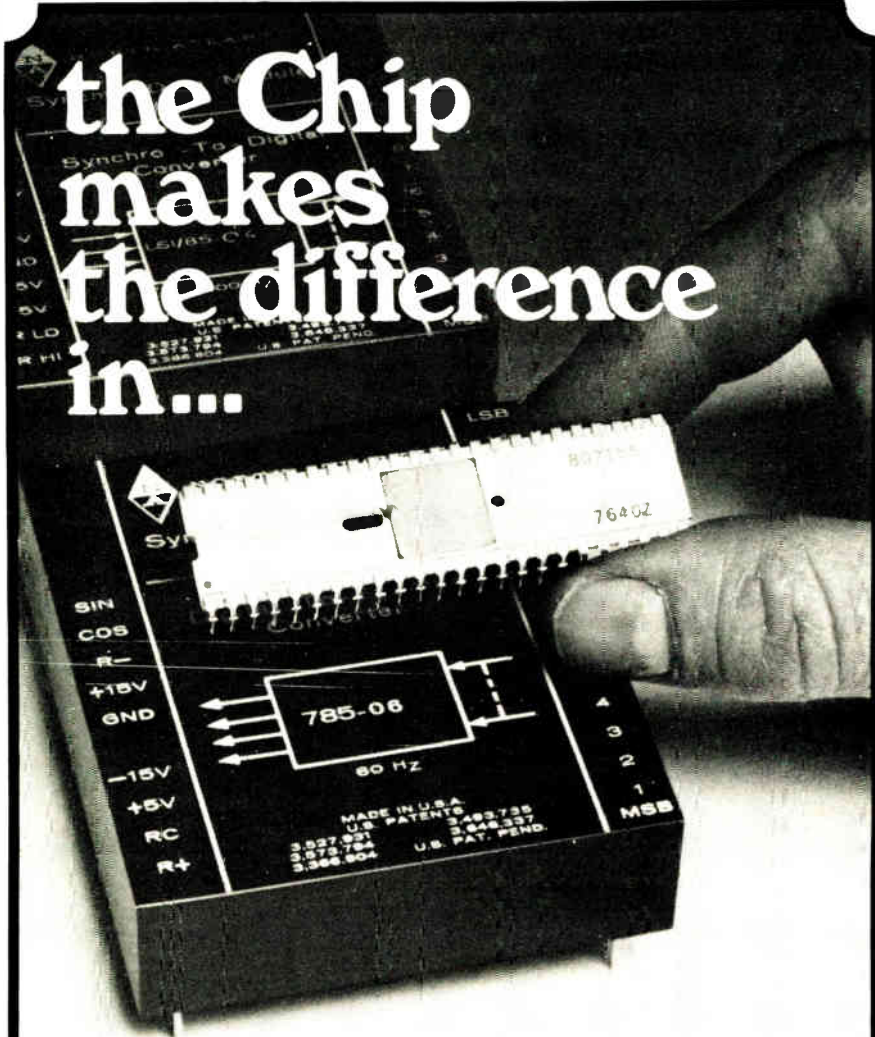

NORTH ATLANTIC SYNCHRO CONVERTERS with LSI's and 100 hour burn-in

- high reliability • best dependability
- low rate of return.

LSI/85 SYNCHRO TO DIGITAL

10, 12 or 14 bits
4-minute accuracy at
3600°/second
All standard Synchros and
Resolvers
Type II Tracking —
no velocity lag

785 DIGITAL TO SYNCHRO

Full 1.25 VA output at 60
and 400Hz
10, 12 or 14 bits
Slew speed 4000°/second
4-minute accuracy under
full load
All standard Synchros and
Resolvers

CALL OR WRITE FOR
COMPLETE SPECIFICATIONS.



NORTH ATLANTIC
industries, inc.

200 TERMINAL DRIVE, PLAINVIEW, NEW YORK 11803
cable: noatlantic / twx: 510-221-1879 / phone: (516) 681-8600

New products

battery, which allows up to seven hours of operation. True rms-readings are obtained by logarithmic conversions carried out by four operational-amplifier circuits.

The meter can be operated from ac or its battery, which is automatically recharged whenever the meter is plugged into the ac line. If the external power drops off, the meter automatically changes over to the battery.

The MM300 has five ac/dc voltage ranges from 200 millivolts to 1,000 volts full scale, six resistance ranges covering 200 ohms to 20 megohms, and five ac/dc current ranges from 200 microamperes to 1.5 amperes. Accuracy of the meter for dc voltage and current is 0.2% of reading ± 1 digit; for ac voltage and current it is 1% ± 5 digits, and for ohms, it is 0.5% ± 1 digit.

Price of the basic meter is \$199.95, while the rechargeable battery is priced at \$18.

De Forest Electronics, 40 Fairfield Place, West Caldwell, N.J. 07006. Phone (201) 575-8670 [352]

Digital filter improves spectrum-analyzer resolution

The model 175 NDF-T is a real-time multichannel instrument intended primarily to improve the resolution of fast-Fourier-transform analyzers. The all-digital unit is typically placed between the output of an analog-to-digital converter and the input to an FFT processor. It accepts digitized signals, translates them down to dc, and then low-pass filters them. The effect of this processing is to allow the FFT analyzer to apply its full resolution to a narrow sample of the input spectrum: in effect, to examine the spectrum through a

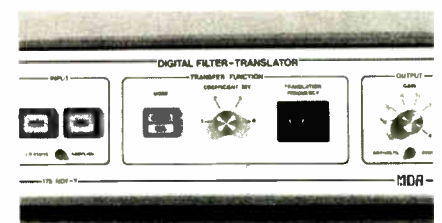



Intel:
\$11.15

AMI:
\$9.35

Our CMOS RAM has a lot less going for it.

You can see that our 1K RAM costs less. What you can't see is that it uses less power, too.

Our S5101 takes only 10 milliamps of operating current to give you 650 nanosecond access time. The competition uses almost three times as much. Our standby power is just 10 microamps. And our L version retains data down to 2.0 volts.

With our part, you also have

far less waiting around. Call up an AMI distributor right now, and he'll supply you right off the shelf.

But we can't promise you less of everything. For instance, we have more packages to choose from—plastic, ceramic and cerdip. We have more RAMs, too, with speeds ranging from 450 ns to 800 ns. They all have the L option in case power retention is critical to your

product, and all of them operate over the full military temperature range.

Want to know more? Check with your nearest AMI distributor or sales office. Or contact us at AMI, 3800 Homestead Road, Santa Clara, California 95051. Phone (408) 246-0330. We'll prove that

less is really more.

AMI
AMERICAN MICROSYSTEMS, INC.

Prices effective 4/1/77

Circle 139 on reader service card

Before you buy another filter, consider our moveable passband.

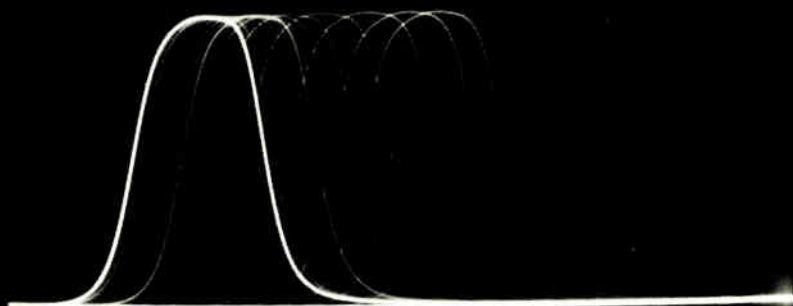

Our tunable bandpass filters provide two big benefits for anyone working in RF and microwave up to 4 GHz.

First, just one of our tunables replaces a whole drawer full of fixed bandpass filters. Less costly, more convenient, faster test set-ups.

Secondly, our tunables are calibrated directly—you get the center frequency you see on the dial—no interpolation or charts needed.

With over 50 standard versions in stock, we can supply a unit for frequencies as low as 48 MHz all the way up to 4 GHz. Each one covers a full octave, and comes with 3% or 5% 3 dB bandwidths. We even stock special purpose units for the

military band (210-420 MHz) and many telemetry bands (210-2310 MHz). And if one of those standards doesn't meet your needs, we'll be glad to quote on special designs for any lab or OEM situation.

Our new Filter Catalog gives complete data on all Telonic Tunable Filters as well as other

types we produce—tubulars, cavity, interdigital, comb-line—all the way to 12 GHz. If you wish a copy, write on your letterhead. If you need immediate information, call us

TOLL FREE (except CA) at 800-854-2436.

Telonic Altair, 2825 Laguna Canyon Road, Box 277, Laguna Beach, CA 92652, 714/494-9401 TWX 910-596-1320 Cable: TELENG Toll Free: (800) 854-2436



Telonic Altair 

New products

narrow window in the frequency domain. Since the translation frequency is set by an array of front-panel switches, the window can be moved as the operator desires.

Unlike the translation frequency, the filter-transfer characteristics of the model 175 are determined by four sets of switch-selectable coefficients contained in plug-in programmable read-only memories. If more than four characteristics are needed, these PROMs can be easily changed. A wide range of standard functions is available, and custom requirements can be accommodated as well.

Data to and from the 175 consists of digital words accompanied by channel synchronizing pulses. Each data word is 12 bits long, providing better than 60 decibels of stop-band rejection. Passband-to-stop band slopes are greater than 150 dB per octave. The number of time-division-multiplexed channels that can be accommodated is limited only by the instrument's overall throughput capacity of approximately 400 kilohertz. The 175 NDF-T sells for \$9,650 in singles. Delivery time is 120 days.

MDA, Nootka Bldg., 10280 Shellbridge Way, Richmond, B.C. V6X 2Z9 Canada. Phone Noulan Bowker at (604) 278-3411 [353]

DPM measures dc volts, rms ac + dc volts, and decibels

A multifunction 3½-digit panel meter, which sells for \$225 in hundreds, can measure bipolar dc voltages and both the true-rms and the decibel values of complex ac and ac + dc waveforms. Designated the model AD2033, the meter has five input ranges each for its voltage and db readouts. For voltage, the full-scale ranges are 199.9 millivolts, 1.999 v, 19.99 v, and 600 v rms. For db, the ranges are 500 mv, 5 v, 50 v.; 500 v, and 625 v rms.

The line-powered meter features full floating input isolation and parallel BCD data outputs. Its readings are accurate to within 0.1% of reading $\pm 0.5\%$ of full scale ± 1



Is production testing **Memory PC Boards** a problem?

Macrodata's MD-107 could be your answer.

Not much larger than your desk, it fits in neatly to a production test environment. And you'll like the cost. Compared to other computer-controlled board testers (or in-house systems) it is inexpensive.

Best of all, it comes with specific software already designed for your diagnostic needs. Yet, the low-cost MD-107 is a sophisticated PC memory board test system that can provide you with many benefits that no other test system can provide.

For instance, the MD-107 can automatically test your memory boards, pinpoint the bad circuits, give you hard-copy rework instructions, guarantee your good boards—and do it all right on your pro-

duction line with your present personnel. In addition to board diagnostics, the MD-107 was designed to do system level testing as well as device characterization of ROM's and RAM's.

Since Macrodata introduced its MD-107 every significant computer mainframe manufacturer has been using this remarkable test system on such devices as the MK4096, the 2107 Series, the MC6605, the 4030, the 4050's, and the 4060.

So if you still think production testing semiconductor memory PC boards has to be a problem, you should find out more about the MD-107.



MACRODATA

Macrodata Corporation, 6203 Variel Avenue, Woodland Hills, California 91354, Phone: (213) 887-5550, Telex: 69-8489

Circle 141 on reader service card

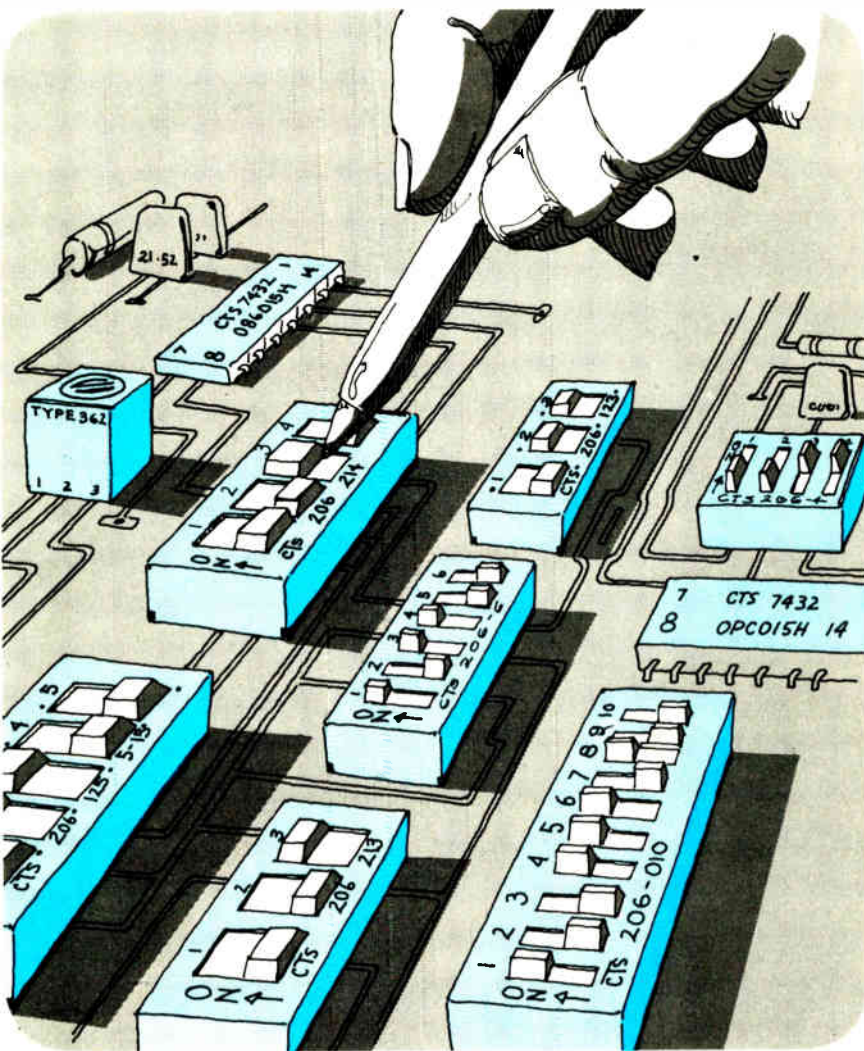

Take your pick... DPST, SPDT or SPST programmable DIP switches

CTS offers them all... with the addition of NEW 2, 3, 4 and 5 section SPDT and DPST switch styles.

A total of 15 Series 206 DIP switch packages are now available from CTS... 7 with SPST actuation, 4 with SPDT actuation and 4 with DPST actuation. All have .100" by .300" centers for PCB or standard DIP socket insertion. Gold plated contacts with nickel barrier assure lowest contact resistance throughout life.

All provide crisp slide actuation and reliable, positive contact wiping

action. Program up to 10 different logic functions with one compact SPST package or up to 5 SPDT or DPST functions with the identical size package.

Use the quality, reliable CTS Series 206 for your next computer, computer peripheral, communication or test equipment switch application. Available from the factory or off the shelf from CTS Distributors. For complete information, write CTS KEENE, INC., 3230 Riverside Avenue, Paso Robles, CA 93446. Phone: (805) 238-0350.

CTS CORPORATION
ELKHART INDIANA
A world leader in cermet technology



New products

count. Gain temperature coefficient is ± 75 ppm/ $^{\circ}\text{C}$, and frequency response with a sinusoidal input is ± 1 digit or 3 db maximum error over the frequency range from 30 hertz to 100 kilohertz. The instrument is available from stock.

Analog Devices Inc., P.O. Box 280, Norwood, Mass. 02062. Phone William Donlan at (617) 329-4700 [354]

4½-digit capacitance meter has dual displays

The model 475 digital capacitance meter is a 4½-digit instrument that simultaneously displays capacitance and dissipation. It has seven capacitance ranges from 200 picofarads full-scale to 200 microfarads. Resolution on the lowest scale is 0.01 pf. Dissipation ranges from 0.0001 to 1.9999. The unit's standard test frequency is 1 kilohertz, but 50-, 60-, and 100-hertz frequencies are also available as options. Accurate to within 0.1%, the meter makes four-terminal measurements and includes such features as charged-capacitor protection and bias capability. Priced at \$2,300, it has a delivery time of 60 days.

Electro Scientific Industries Inc., 13900 N.W. Science Park Drive, Portland, Ore. 97229. Phone (503) 641-4141 [356]

Synthesized signal generator takes aim at mobile radios

Easy to use because of its spin-wheel tuning, the Racal 9081 synthesized signal generator has been optimized for use in the testing and alignment of land-mobile radio equipment. In addition to its normal mode of oper-

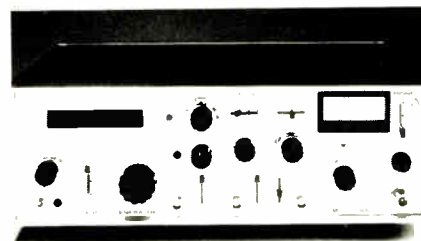

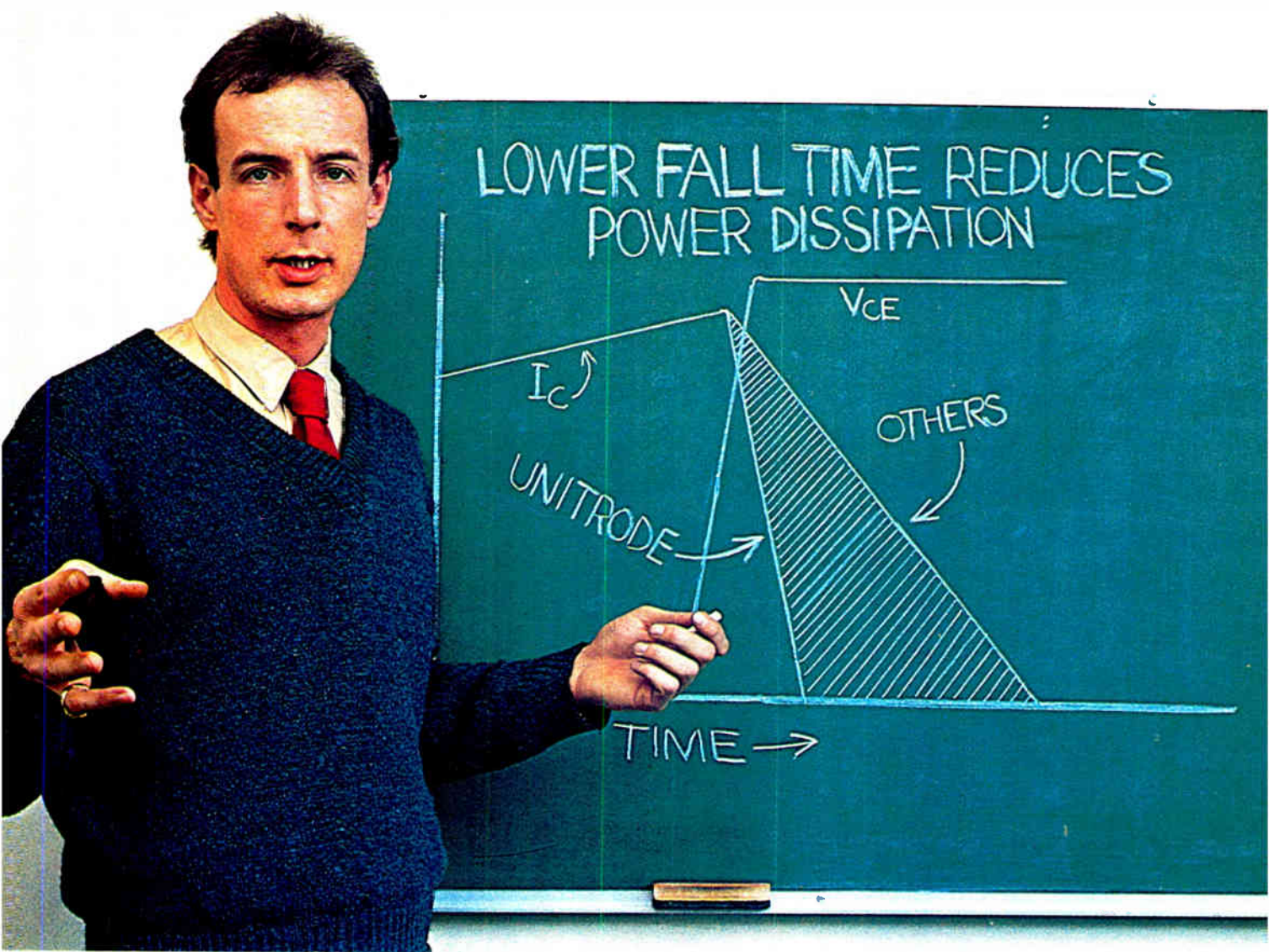

The power switching transistors that don't eat a lot of power.

Power switching transistors can eat up quite a bit of power, causing significant losses, especially during switching.

But now there's the new Unitrode UMT1008/9 and 1003/4 Series of NPN silicon power switching transistors.

And one of their big features is half the fall time of competitive devices. To reduce your switching power losses and simplify your circuitry.

But that's not all. The Unitrode UMT1008/9 and 1003/4 Series also give you three times better $E_{S/b}$ — a reverse bias second breakdown so good it virtually eliminates the possibility of catastrophic circuit failure.

Plus hard glass passivation and rugged clip lead connections to insure the utmost in reliability.

All this with dependable off-the-shelf delivery, the most in-depth applications assistance in the industry, and, of course, competitive pricing.

All of which makes them perfect for all your switching applications, including switching regulators, inverters, converters, horizontal deflection circuits, solid state ballasts, and motor controls.

The new industrial power switching transistors from Unitrode.

Your best source. And only source.

For data sheets, circle the reader service number, or contact Harv Hodsdon, Unitrode Corporation, 580 Pleasant St., Watertown, MA 02172. 617-926-0404.

Types	$V_{CE(sat)}/I_C$	Pkge Style	Fall Time Max.	Pricing 1000 Lot
UMT1008	300V/8A	TO-3	0.4 μ s ⁽¹⁾	\$3.95
UMT1009	400V/8A	TO-3	0.4 μ s ⁽¹⁾	\$4.95
UMT1003	300V/3A	TO-66	0.4 μ s ⁽²⁾	\$1.60
UMT1004	400V/3A	TO-66	0.4 μ s ⁽²⁾	\$1.76

(1) $I_C = 5A, I_{CS} = I_{CS} = 1A$
 (2) $I_C = 2A, I_{CS} = I_{CS} = 0.4A$

Three times better $E_{S/b}$



UNITRODE

World Radio History

Circle 143 on reader service card

Our beauty is skin deep. And then some.

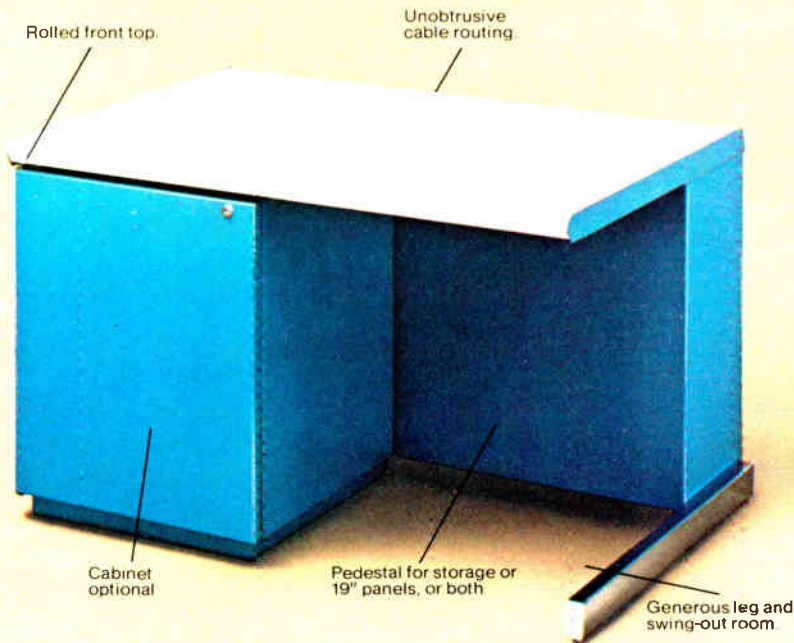

For beautifully efficient use of office space, you can get this Optima desk with bays for instruments, general storage or a combination of both. Cabling from instruments on top are unobtrusively routed into the pedestal. With cantilever construction, chrome legs and rounded top edge, it's the most beautiful desk yet designed for your equipment.

Send for our catalog.

We make you look better

OPTIMA[®]
Scientific-Atlanta

2166 Mountain Industrial Blvd., Tucker, Ga. 30084 • Tel: (404) 939-6340
Europe: Macmerry, East Lothian, Scotland EH33 1EX

Circle 144 on reader service card

1977 Answer Book. It makes your job easier. \$25.

Who makes what? Over 4000 products, more than 5000 manufacturers with their local contracts and distributors, directory of trade names and catalogs, post-paid inquiry cards for 5-second ordering of current catalogs.

Electronics Buyers' Guide
1221 Ave. of the Americas
New York, N.Y. 10020

Yes, send me a copy of The Answer Book. I've enclosed \$25 (USA and Canada only, elsewhere send \$35). Full money back guarantee if returned within 10 days.

Name _____
Company _____
Street _____
City _____ State _____ Zip _____



**Electronics
BUYERS'
GUIDE**

New products

ation, the British-made instrument has a "channelized" mode in which it can be switched very easily between standard communications-channel frequencies. It operates over the frequency range from 5 to 520 megahertz and thus can be used on citizens band, vhf, and uhf radios.

The Racal 9081 can be both internally and externally modulated. Its internal modulation frequencies are 400 hertz, 1 kilohertz, and 5 kHz. Amplitude, frequency, and phase modulation modes are provided. Pricing varies from \$4,000 to \$4,500 depending upon options.

Data Tech, 2700 South Fairview St., Santa Ana, Calif. 92704. Phone W. J. Miller, Director of ICF Products, at (714) 546-7160. In Europe, write to Racal Instruments Ltd., Duke Street, Windsor, Berkshire, SL4 1SB, England [355]

50-MHz pulser provides full trigger and shape control

The model 801 pulse generator provides continuous, triggered, gated, or burst pulse outputs with normal, delayed, or double pulses. Period, delay, and width are independently adjustable. In addition, the primary pulse is shaped by independent rise and fall controls with a 50:1 range.

Outputs include TTL, ECL, comple-

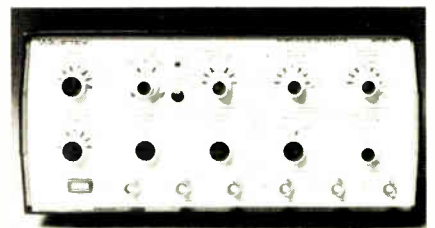

mented ECL, and sync pulses in addition to the main 50-ohm output. Maximum amplitude from the main output is 20 volts peak to peak into an open circuit or 10 v peak to peak into 50 ohms. The model 801 sells for \$995 and has a delivery time of 30 days.

Wavetek, P.O. Box 651, San Diego, Calif. 92112. Phone John Roth at (714) 279-2200 [357]

**IF YOU WANT TO KNOW WHY
GE ENGINEERING STRUCTURAL FOAM GOT INTO
SO MANY BIG THINGS SO SOON, ASK
SPERRY UNIVAC**



BUNKER RAMO



NCR



CONTROL DATA



**SPERRY
REMINGTON**



IBM



**HEWLETT-
PACKARD**



CENTRONICS

SANDERS



OR US.

GENERAL  ELECTRIC

Write Section 237R,
Structural Foam Resins,
Plastics Division,
General Electric Company,
One Plastics Ave.,
Pittsfield, MA 01201.

WHAT THE WORLD IS COMING TO
GE ENGINEERING STRUCTURAL FOAM
LEXAN® NORYL® VALOX®

Circle 145 on reader service card

high voltage ceramic capacitors... Georgia style.

Our "Georgia style" high voltage ceramic caps provide value and performance that are hard to beat . . . by anyone's standards. Ratings to 60 KVDC. Capacities to 9,300 pF. Epoxy resin encapsulation. Minimum size-capacity-voltage ratios. What's more, every capacitor is backed by Murata's 30 years of experience in the field and our "Georgia style" pride in a job well done.

If you need high voltage capacitors for HV power supplies or distribution systems, TV doubler and tripler supplies or virtually any other application, call Murata. Chances are we have just the "Georgia style" HV ceramic capacitor you need.



First in ceramics

1148 Franklin Road, S.E.
Marietta, Georgia 30067
Tel: 404-422-9777
Telex: 54-2329
TWX: 810-763-4723

Circle 146 on reader service card

Microprocessors**Intel gets
into I/O act**

**Microcomputer firm
introduces four interface
boards for its SBC 80s**

In an attempt to grab a share of a market it has created, Intel Corp. has introduced four input/output interface boards as accessories to its SBC 80 single-board microcomputers. Three of the boards are interfaces for analog signals, while the fourth is an optically isolated, digital I/O interface unit.

The move represents an altered marketing strategy for the Santa Clara manufacturer. Although the SBC 80 microcomputers have proven hot items since their introduction over a year ago, Intel has done little to fan the flames outside of supplying memory- and I/O-expanding components. Yet over a dozen companies, in anticipation of a growing market, have seized the opportunity to produce accessory boards compatible with the SBC 80 bus.

"The board manufacturers may know their a-d's, but they're just not intimate with the microprocessor and its bus," explains John Drakeford, product manager of Intel. "Users of the SBC 80 have asked that we provide the capability."

The first of the three boards, the SBC 711, is an analog-input interface with 16 single-ended inputs that may be converted by jumpers to eight differential inputs. On board is a 16-channel, 12-bit data-acquisition module manufactured by Analogic Corp. of Wakefield, Mass. The interface board is fully programmable under control of the central processing unit, though it has no processing power of its own. Inputs can be individually gain-programmed to accept signals from 1 to 10 volts, and space is provided on the board for shunt-resistor conversion

to current-loop inputs, like the 4-to-20-milliamperes control standard.

The inputs are classified as high-level—generally, sensor and transducer signals will require preamplification and conditioning prior to entering the interface. "We've elected to interface only high-level signals, since most control systems have local back up and manual controls, and they get the signals up to high level," says Drakeford. The 711 sells for \$875 in singles.

The SBC 724, counterpart to the 711, is a four-channel analog output board with four 12-bit d-a converters. Both voltage and current-loop outputs are generated under program control. The output board sells for \$750 in quantities of one.

The functions of the 711 and 724 boards are combined in the SBC 732 analog I/O board. The 732 has two 12-bit d-a converters paired with an input configuration identical to the 711. Like the others, the 732 is programmable under CPU control. Its unit-quantity price is \$1,125.

Intel is stressing compatibility among the three boards and with the SBC bus. Says Drakeford, "The input pins are the same for the 711 and the 732, as are the output pins on the 724 and 732, and all the boards, designed for the SBC backplane/cardcage, are interface- and program-compatible."

Intel has learned from the work of other analog-I/O manufacturers, selecting the best features of other interfaces, and adding a few unique features of their own. One feature

that appears on few of the competitive boards is a memory-mapping technique for referencing the 16-bit instructions required to handle the 12 bits of interconversion. By using the technique, Intel can save time with single instructions of the 8-bit 8080.

One feature not found on other interface boards, according to Drakeford, is called auto-addressing, in which the user assigns an address to a certain channel to be set up in a control mode for sequencing the other channels. In so doing, no additional addresses need be assigned to the other channels.

Another feature peculiar to the three boards is the interrupt arrangement. An interrupt signal is provided at the completion of conversion, as well as one at the end of channel scan. This, says Drakeford, frees the CPU to attend to other tasks until flagged by either interrupt or after any number of channels have been scanned.

The third and possibly the most significant function special to the SBC input boards is what Intel calls "pacing"—not a real-time clock, but a timing scheme built around a crystal-controlled time base on both the 711 and 732. Pacing allows, under program control of the analog inputs, external triggering of the a-d conversion through a separate input by some external event. Thus, an on-board capability is provided for conversion at any rate, from once every 900 microseconds to up to 1 second. Explains Drakeford: "Pacing

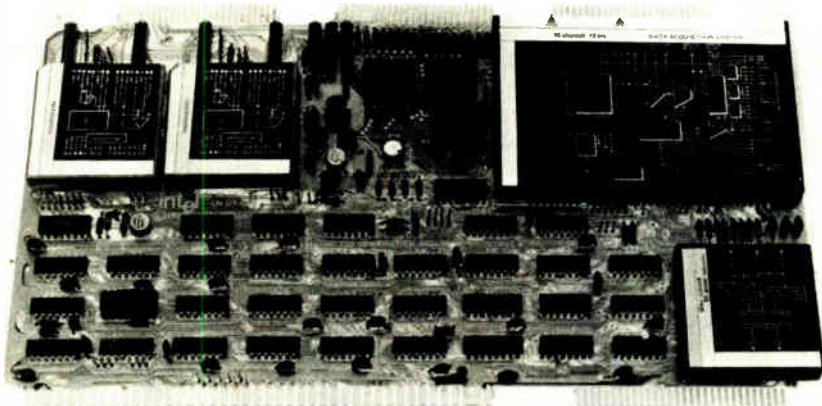

THE FIRST \$5.00* MICROPROCESSOR INTERFACE

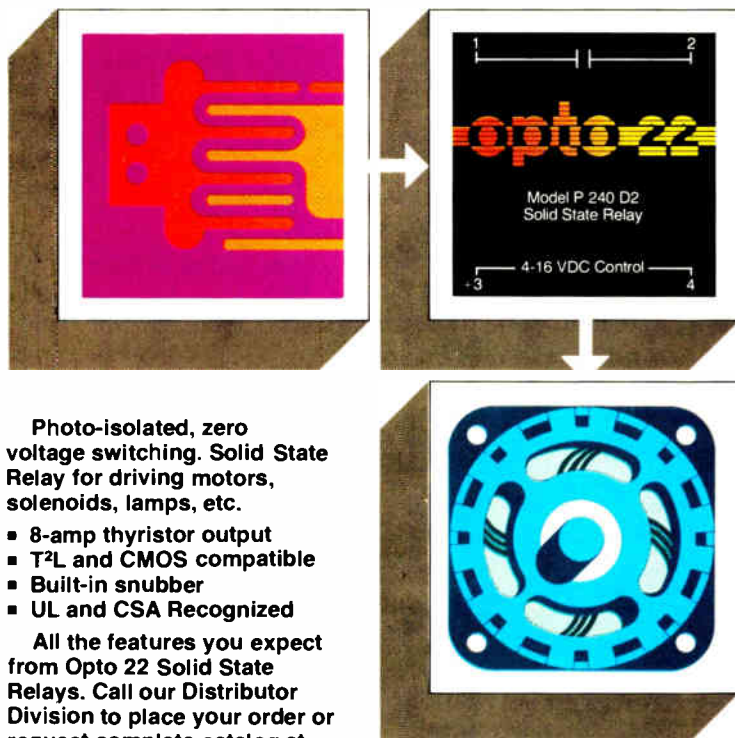

Photo-isolated, zero voltage switching. Solid State Relay for driving motors, solenoids, lamps, etc.

- 8-amp thyristor output
- T²L and CMOS compatible
- Built-in snubber
- UL and CSA Recognized

All the features you expect from Opto 22 Solid State Relays. Call our Distributor Division to place your order or request complete catalog at (714) 892-7676 or (714) 892-3313.

O.E.M. Production Quantities

OPTO 22

5842 Research Drive
Huntington Beach, California 92649

Circle 148 on reader service card

New products

is especially useful for looking at transients and rapidly changing events by signal reconstruction—an accurate timing of the a-d conversion lets you reconstruct and examine the event.”

None of the analog boards provides signal conditioning. They are input-protected by diode clamps and fusible resistors, however, and the outputs are short-circuit-protected.

A fourth interface is the SBC 556, an optical isolated digital I/O interface. With two 8255 programmable peripheral interface chips, the 556 handles 48 I/O lines, organized as 24 dedicated input lines, 16 dedicated output lines, and 16 programmable lines.

Both input and output logic thresholds are user-selectable. Intel provides sockets for plug-in of input and output optical isolators. By choosing a particular Fairchild or Monsanto isolator, the user can have isolated 12-volt levels, transistor-transistor-logic levels, complementary-metal-oxide-semiconductor, or other levels, on any input or output.

Intel is not yet in the business of turnkey systems. Drakeford calls the expansion from chips to microcomputer boards to system accessory boards a “natural progression to open up more areas.”

Intel Corp., 3065 Bowers Avenue, Santa Clara, Calif. 95051 [361]

12-bit microcomputer is compatible with PDP-8E

The Data 12 microcomputer is a 12-bit hardware/software system that, among other things, can execute the instruction set of the PDP-8E mini-computer. “Other things” includes



Electronics / May 12, 1977

1977 Answer Book. It makes your job easier. \$25.

Who makes what? Over 4000 products, more than 5000 manufacturers with their local contracts and distributors, directory of trade names and catalogs, post-paid inquiry cards for 5-second ordering of current catalogs.

Electronics Buyers' Guide
1221 Ave. of the Americas
New York, N.Y. 10020

Yes, send me a copy of The Answer Book. I've enclosed \$25 (USA and Canada only, elsewhere send \$35). Full money back guarantee if returned within 10 days.

Name _____

Company _____

Street _____

City _____

State _____

Zip _____

The Power E...

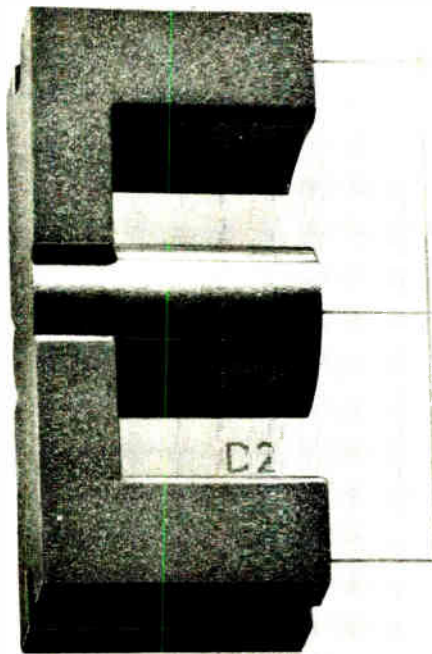

Another small accomplishment from Ferroxcubewith Guaranteed performance!

Manufacturing switch-mode power supplies? Inverters? Converters? Want to simplify transformer and filter design and fabrication? Then take a closer look at one of our latest accomplishments.

Series EC—

Power E Cores in 3C8 material

A transformer operating at high flux densities and high frequencies should be screened to minimize external fields and radiation. The usual method is to use a pot core design or an I and U core combination. But the Power E Core design offers you the advantages of both the pot core and I and U combination.

First, the round center leg makes strip winding easy and insures a high copper or space factor, and the lowest DC resistance. Second, the winding geometry is configured for low-leakage inductance. And . . .

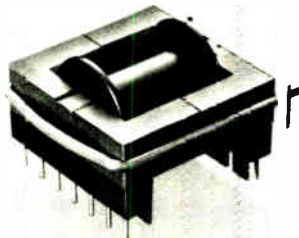
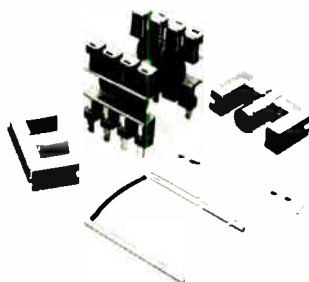

We guarantee the minimum flux density, at 100°C. will be 3300 Gauss. And a maximum loss of 100 milliwatts/cm³ at 16 kHz, at 100°C. and 2000 Gauss.

The new core line has been IEC standardized in four sizes: Types EC-35, EC-41, EC-52 and EC-70, covering transformer throughput power to 1 Kw. We have slotted the cores to accept a mounting bracket that eliminates the assembly problems of the square-legged lamination cores. You also can choose a standard bobbin or PC bobbin for printed circuit board mounting.

Series EC—Power E Cores are fully described in the new Ferroxcube Linear Ferrite Catalog. For your free copy write or call:

Ferroxcube
Division of Ampere Electronics Corp.
5083 Kings Highway
Saugerties, N.Y. 12477
(914) 246-2811

FERROXCUBE

A North American Philips Company



E577

The AC variety pack.

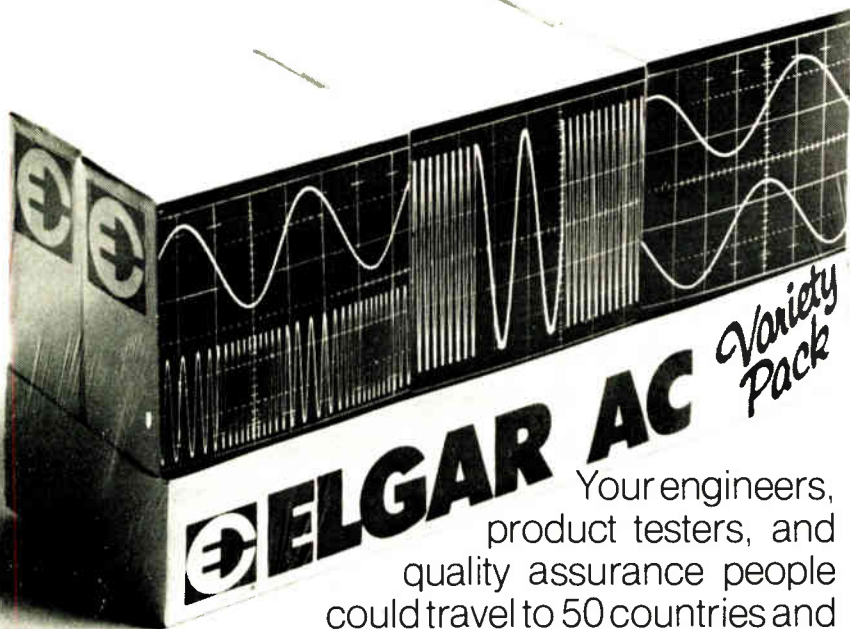

Your engineers, product testers, and quality assurance people could travel to 50 countries and still never see all the kinds of power an Elgar AC Power Source puts out. Its 50 available plug-in oscillator modules let you choose variable or fixed frequencies from 45Hz to 10 KHz. Or you can put in a programmable oscillator and use your imagination. All this in ratings up to 16 KVA. Write us today, and we'll reveal our Sources.

ELGAR

See us at NCC,
Booth #1010/1008

Elgar also is a leading producer of AC Line
Conditioners and Uninterruptible Power Systems.

8225 Mercury Ct., San Diego, California 92111, Phone (714) 565-1155

Circle 150 on reader service card

World Radio History

New products

instructions for floating-point decimal arithmetic, numeric and character string input and output, block memory move and search, and push-pop instructions for recursive subroutine handling. The computer's basic hardware includes an integral tape cassette drive, which provides 262,000 words of mass memory and 4,096 words of high-speed random-access memory. There are an additional 4,096 words of RAM, invisible to the user, in which the system executive is stored.

The executive automatically takes care of all input/output buffering and scheduling, handles logical-physical unit assignment and real-time task scheduling, maintains the date and time through its own real-time clock, and implements the machine's instruction set.

The machine's operating system, which is one step down in the software hierarchy from the executive, allows complete keyboard control of the Data 12. It provides facilities for program preparation, assembly, debugging, and execution. It also has an integral batch processor, thus permitting unattended operation of the system. Standard software also includes the Basic-MS compiler, a smaller Basic interpreter, the Phocal interpreter, and an Algol compiler. All of this software operates within the basic 4,096 words of user memory. If user-written programs require more memory, expansion up to 32,768 words is possible.

The basic computer includes a 20-milliampere current-loop interface, an RS-232 interface, a tape controller, and the hardware and software described above. It sells for only \$1,695 and has a delivery time of 30 to 45 days.

TLF, P.O. Box 2298, Littleton, Colo. 80161.
Phone Frank L. Laczko at (303) 794-1634 [363]

Microcomputer includes
minifloppy disk drive

The System 8 microcomputer is an 8080A-based system with a single minifloppy disk drive. The disk has a

If the print band doesn't get you, the price will. It's that simple.

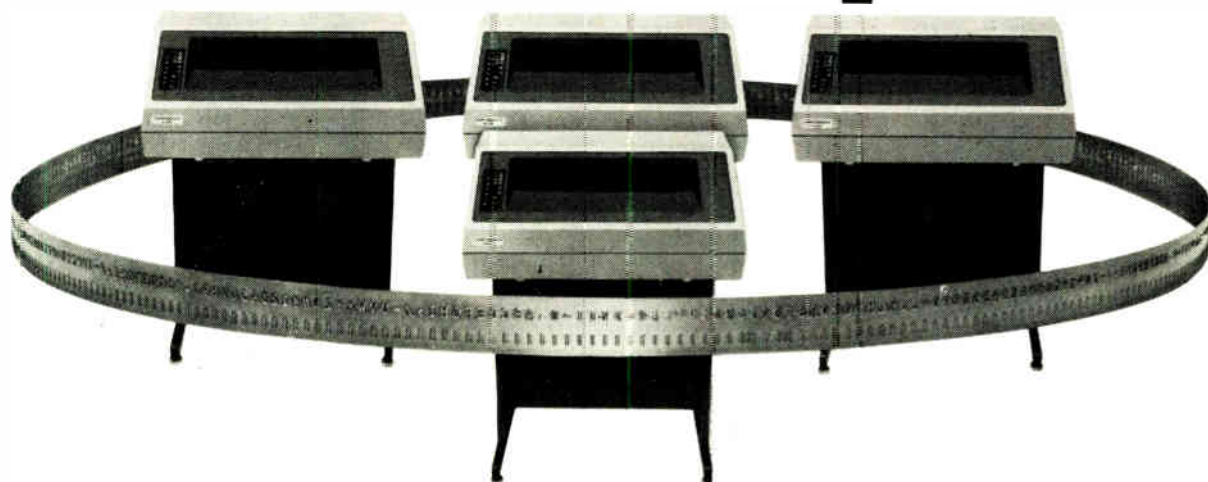

The New Centronics 6000 Series Line Printers.

Centronics now offers you a family of line printers so new in design simplicity, reliability and value that nothing else in the industry today can compare. The outstanding features of the 6000 series only begin with the operator-changeable print band. They also include: the widest choice of speeds — 75, 150, 300, and 600 lpm models . . . with 85% parts commonality. And more — like fully-formed characters and superior print quality . . . microprocessor electronics for increased reliability, and full customizing capability . . . all at a price that's up to 40% lower than what you're paying now for line printers.

Like all Centronics printers, the 6000 series printers are even better because they're backed by more than 100 sales and service offices worldwide. And by the Centronics reputation for stability — and for dependability proven by more than 80,000 printers installed.

The new Centronics 6000 series line printers. Simply better. Write or call today for the new 6000 series brochure. Centronics Data Computer Corp., Hudson, N.H. 03051. Tel. (603) 883-0111. Or Centronics Offices in Canada and throughout the world.

CENTRONICS[®] PRINTERS
Simply Better

CHECK DIGITAL IC'S FASTER THAN A SCOPE, SAFER THAN A VOLTMETER

You're looking at the most convenient and efficient way developed to check digital IC's: CSC's Logic Monitor. It speeds digital design and testing by accurately and automatically displaying static and dynamic logic states of DTL, TTL, HTL and CMOS DIP IC's. All in a compact, self-contained 16-pin circuit-powered unit.

Use it to effortlessly trace signals through counters, shift registers, gating networks, flip-flops, decoders... even entire systems made up of mixed logic families. It's a great way to cut minutes, even hours all along the line from design through debugging.

Nothing could be simpler: just clip it over any DIP IC up to 16 pins, and the Logic Monitor does the rest. Precision plastic guides and unique flexible web insure positive connections between non-corrosive nickel-silver contacts and IC leads. Each contact connects to a single "bit" detector with high-intensity LED readout, activated when the applied voltage exceeds a fixed 2V threshold. Logic "1" (high voltage) turns LED on. Logic "0" (low voltage or open circuit) keeps LED off. A power-seeking gate network automatically locates supply leads and feeds them

to the Logic Monitor's internal circuitry.

Very clever. Very portable. Very effective. And very reasonable, at \$74.95*. See the Logic Monitor at your CSC dealer, or write for our catalog and distributor list.

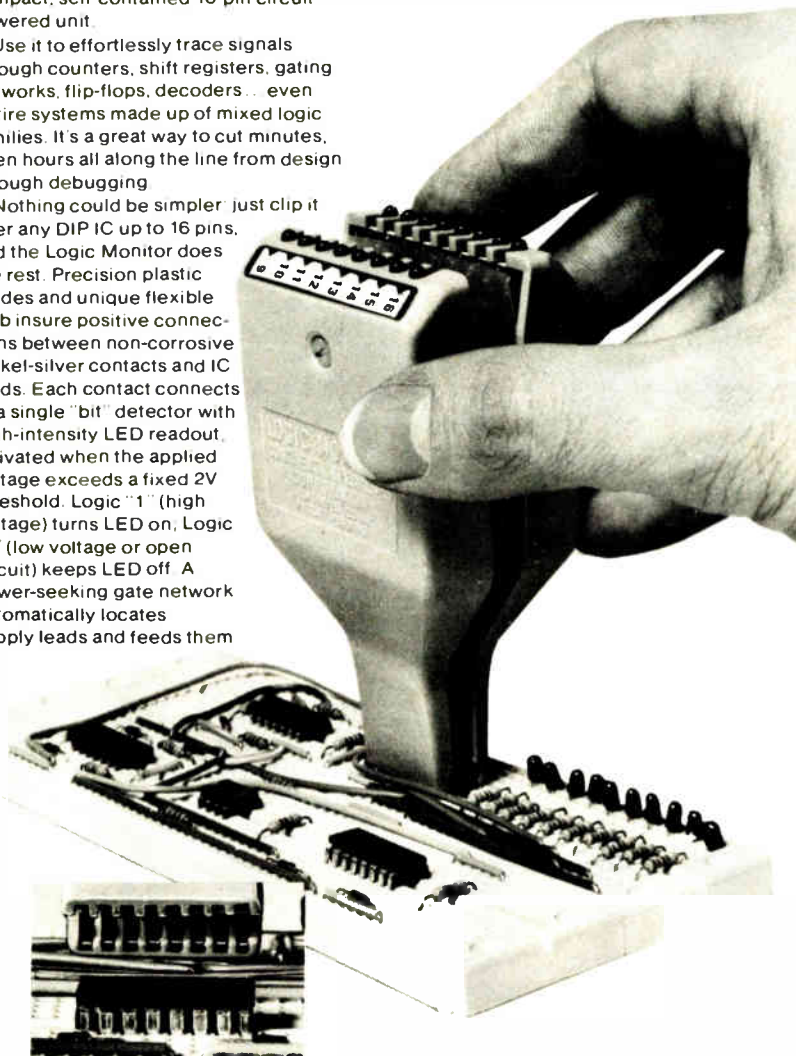

CONTINENTAL SPECIALTIES CORPORATION



EASY DOES IT

44 Kendall Street, Box 1942
New Haven, CT 06509 • 203-624-3103 TWX 710-465-1227
West Coast office: Box 7809, San Francisco, CA
94119 • 415-421-8872 TWX 910-372-7992

© 1976, Continental Specialties Corp.

*Manufacturer's suggested price. Prices and specifications subject to change without notice.

152 Circle 152 on reader service card

New products



capacity of 80 kilobytes of formatted data. Built around the 1.3-microsecond version of the 8080A, the System 8 is supplied with 16 kilobytes of random-access memory, serial/parallel I/O, and a front panel for control and display. Software includes a disk operating system with file management, an editor, an assembler, and a dynamic debugger. The computer sells for \$2,895 and has a delivery time of 30 days.

Gnat Computers Inc., 7895 Convoy Court, Unit 6, San Diego, Calif. 92111. Phone (714) 560-0433 [364]

Turn-key computer offers power-on start

The Altair 8800b Turnkey computer is software-compatible with the standard 8800b, but is better suited for dedicated applications. It has a power-on-start feature, which allows automatic program execution as soon as the computer is energized. It also contains a serial input/output channel that can operate with a variety of peripherals, 1 kilobyte of random-access memory, provision for 1 kilobyte of programmable read-only memory, and a front-panel key switch. The front panel has indicators for HALT, I/O transfer, and interrupt request and enable.

Mits, 2450 Alamo S.E., Albuquerque, N.M. 87106 [367]



Electronics/May 12, 1977

Here are two ways to measure ceramic capacitor reliability

40 15

Major Hi-Rel Programs

You'll find our ceramic capacitors functioning in some of the toughest environments known to man. Here are just a few of the programs. Space: Surveyor, Mercury, Gemini, Apollo (Command Module, LEM, PLSS). Defense: Minuteman II and III, F-14, F-15 and F-16, Polaris and Poseidon, Sparrow, Hawk and Maverick, F-111 and the B-1 bomber.



Years of Hi-Rel Experience

Founded in 1960 to supply ceramic capacitors for Hi-Rel programs, we were a technology leader almost from the start. We were the first to develop precious metal alloy electrode systems; the first to automate chip production to meet a proven failure rate level of .001% per 1000 hours; the first to perfect the use of base metals in electrodes. Latest — the totally redundant fail-safe feed-thru capacitor.

Unlike many companies, we do not have separate chip lines for Hi-Rel military and commercial MonoKap products. You get the same high quality in both. And, you can buy MonoKaps right off our distributor's shelves.



CENTRALAB/USCC

Electronics • GLOBE-UNION INC.

4561 Colorado Blvd., Los Angeles, CA 90039 (213) 240-4880
CERAMIC CAPACITORS • FILTERS • THICK FILM CIRCUITS • SWITCHES
TOUCH SWITCHES • POTENTIOMETERS • TRIMMER RESISTORS

See our complete catalogue in EEM Pages 317-335; and Gold Book Pages 103 to 121 or contact us directly

World Radio History

MICROPROCESSOR

BOOKS



TRAINING

From *Osborne & Associates, Inc.*

FOR THE MICROCOMPUTER USER
HERE ARE THE BOOKS THAT HAVE EDUCATED AN ENTIRE INDUSTRY:

**AN INTRODUCTION TO MICROCOMPUTERS:
VOLUME I — BASIC CONCEPTS**

A highly acclaimed text discussing the fundamentals of microprocessors. This volume has been adopted by more than 300 colleges and universities as a basic text. Topics discussed include: fundamental concepts of computers, organization of the microcomputer, structure of a CPU Serial and Parallel I/O, DMA Interrupts, and address modes. Approximately 300 pages. Order publication #2001. Price \$7.50.

**8080 PROGRAMMING FOR LOGIC DESIGN or
6800 PROGRAMMING FOR LOGIC DESIGN**

Written for the logic designer, these "how to" books discuss the detailed implementation of digital logic with the 8080 microprocessor and 6800 microprocessor, respectively. The design of a portion of a printer controller is used as an example in these texts. Approximately 300 pages each. Order publication #4001 (8080) and #5001 (6800). Price is \$7.50 each.

**THE NEW EDITION OF VOLUME II
— SOME REAL PRODUCTS — IS READY**

**AN INTRODUCTION TO MICROCOMPUTERS:
VOLUME II — SOME REAL PRODUCTS**

This is a revision, introduced in May, 1977. It provides a comprehensive discussion of the function and specifications of more than 20 microprocessors, plus their supporting circuits. Logic for the 9440 to Nova standard buses is given. The Intel 8085 and 8048, have been added. The chapter on PACE has been considerably expanded. Many new support devices are covered. Our new edition also covers use of one microprocessor's support devices with another microprocessor - in particular, use of 8080 support devices with the 6800. Manufacturers' specifications are included for every part described. Approximately 1200 pages, up from 900 pages for the previous edition. Order publication #3001. Price \$15.00.

FOR THE PROGRAMMER WRITING PROGRAMS IN BASIC
HERE IS A NEW SERIES OF BOOKS:

SOME COMMON BASIC PROGRAMS

A compendium of 76 useful programs written in BASIC. Programs for statistical, financial, and arithmetic analysis as well as other programs are included. Approximately 200 pages. Order publication #21002. Price \$7.50.

PAYROLL WITH COST ACCOUNTING — IN BASIC

A comprehensive payroll program with cost accounting. Source listings, operator instructions, file layouts and flow charts. It will run, as is, on a Wang 2200, WCS20 or WCS30. Other BASICs will require some file access statement changes only. Approximately 600 pages. Order publication #22002. Price \$12.50.

AND STILL TO COME IN 1977:

Accounts Payable

Accounts Receivable

General Ledger

Our business application programs are fifth and sixth rewrites of packages that used to sell commercially for \$3,000.00 per package, or more. These programs give you user-tested operator interaction during data entry and error recovery. These are programs written for the real world of operators who make mistakes — for users who find that nothing works correctly the first time. Our programs are tolerant of human error.

A COURSE ON DIGITAL LOGIC DESIGN USING MICROPROCESSORS

In order to be a successful microprocessor user you must be both a programmer and a logic designer. Skills in one area without the other will prevent you from making effective use of microprocessors in a digital logic environment.

This course is intended for engineers and programmers with either logic design or assembly language programming experience. Laboratory exercises conducted during the course require the student to construct interface circuits on our breadboard system, write application programs to drive the interface circuit, then edit, assemble and debug the program using our microcomputer development system.

Topics covered during the course include: How to design microcomputer systems; how to design memory systems; subroutines and interrupts — how and when to use them, DMA; Serial I/O; Parallel I/O; and assembly language programming. The functions of 8080 support circuits are discussed. The course is taught by design engineers who have experience designing systems incorporating microcomputers.

This is a 10-day course; the fee is \$600.00 for students attending at our facilities. Private courses are offered to companies wishing to train 20 or more people in their facilities.

Please include the Book Publication number when ordering books.

Write or call for a free brochure describing our lectures and books.



OSBORNE & ASSOCIATES, INC.
P.O. Box 2036, Department E
Berkeley, California 94702
(415) 548-2805

We'll flip you
over your ceramic capacitor specs...

heads you win tails you win

Heads are our standard line of MCNO-KAPS™. Radial-leaded, epoxy-coated monolithic ceramic capacitors with noble-metal electrodes whose proven formulation has not been modified or compromised. They meet MIL requirements, and are available off-the-shelf in a broad range of capacitances and voltage ratings to meet your specific needs.



Tails are our BME-Radials™. They protect you from the noble metal cost spiral, and save you money right up front. They are the product of our unique BME capacitor technology which eliminates noble metal entirely from electrodes and terminations. But they'll meet most of the same circuit requirements with no sacrifice.

So you see, it's up to you — MONO-KAPS or BME-Radials. Both are immediately available in quantity from the only people who give you the choice. Either will do the job without compromise. Call or write for all the details today.



CENTRALAB/USCC 4561 Colorado Blvd. • Los Angeles, CA 90039 • (213) 240-4880
Electronics • GLOBE-UNION INC.

"See our complete catalog in EEM pages 317 to 335, and gold book pages 103 to 121, or contact us directly."

MONITOR LINE VOLTAGE

Plug-in our \$320.00, M12DLVM and get an unattended record of line voltage variations from 95 to 135V for up to 2 months without reloading. Circle Bingo 156

OR ANY TREND

With this compact, rugged, single channel thermal recorder offering DC to 5 Hz frequency response, plus 2% FS accuracy at any one of 18 fixed speeds from 1/2"/hr to 12"/min. M12D prices start at \$275. Circle Bingo 250

Call or write Ken Grabeau (603) 893-1921 for specs, prices and delivery.



Keewaydin Drive, Salem, N H 03079

New products

Components

Trimmers have 0.2% stability

Miniature series features
1-ohm end resistance for
full-range adjustability

To be introduced this week at the Design Engineers' Electronic Components show in Arlington, Va., is a new miniature trimmer resistor from the Centralab Electronics division of Globe-Union. Designated as series R, the device, which measures only 0.475 by 0.640 inches, has a set stability of 0.2% of the total applied voltage and an adjustability within 0.05% of the total voltage.

Moreover, says D. A. MacDonald, marketing manager, the unit's end resistance is less than 1 ohm, permitting adjustability through its full range of rotation. The resistor element, which is made of either cermet or Centralab's proprietary Cerbon, is extra long, he notes, giving 300° of mechanical rotation and 260° of electrical rotation.

Mounting is horizontal, with lock-in or straight terminals spaced 0.1 in. apart. This tight terminal spacing and the unit's small size permit cluster mounting on center-to-center

spacings of only 0.400 in., points out MacDonald. There is even a choice of adjustment styles, he adds, either a hex-hole/screwdriver style or a screwdriver/finger adjustment knob.

For Cerbon units, available resistances range from 100 ohms to 5 megohms; while for cermet units, they go from 100 ohms to 1 megohm. Tolerances are within $\pm 20\%$ or $\pm 30\%$.

Operating temperature ranges from -55°C to $+105^{\circ}\text{C}$ for Cerbon models, and from -55°C to $+125^{\circ}\text{C}$ for cermet. With constant humidity, the temperature coefficient of resistance is -470 ± 150 ppm/ $^{\circ}\text{C}$ for Cerbon trimmers. Cermet elements exhibit a temperature coefficient of ± 250 ppm/ $^{\circ}\text{C}$ for resistance values from 100 to 999 ohms and from 101 kilohms to 1 megohm, decreasing to ± 150 ppm/ $^{\circ}\text{C}$ for resistance values from 1 to 100 kilohm. In 1,000-piece quantities, these series R trimmers are priced as low as \$0.185 each.

Centralab Electronics Division, Electronic Controls Group, Globe-Union Inc., 5757 North Green Bay Ave., Milwaukee, Wis. 53201. Phone (414) 228-2751 [341]

Thick-film resistor networks save space

With substrate space at a premium, a new series of miniature thick-film resistor networks is just the thing for

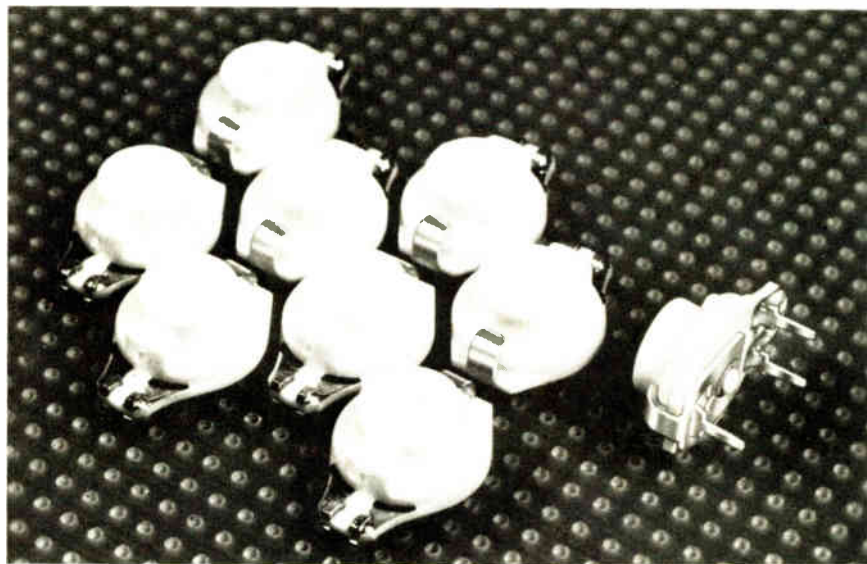

ELEC-TROL SOLID STATE RELAYS



WE'RE COMING ON STRONG!

If you've been reading our ads, you probably know that Elec-Trol sells more dry reed relays than any other independent manufacturer in the U.S.A. But did you know that more and more people are specifying Elec-Trol for high-quality solid state relays? In fact, according to a recent survey, engineers that have used our products ranked us among the leaders in solid state relays.

We are coming on strong with a growing line of solid state relays that are competitively priced. We offer both printed circuit board and standard high power switching models that feature: zero-crossover switching, photo isolation between input and output, positive on/off control, TTL compatibility, long life, and immunity to shock and vibration. We also offer high-quality mercury-wetted relays and dry reed relays—DIP, Open-Line, Encased-Line, Molded-Line, and Blue Boy.

Send for our Solid State Relay Catalog, and ask about our UL recognition.

Elec-Trol, Inc., 26477 N. Golden Valley Road, Saugus, CA 91350. (213) 788-7292. (805) 252-8330. TWX 910-336-1556.

ELEC-TROL

ELEC-TROL MOLDED- LINE REED RELAYS



TOUGH CUSTOMERS!

Now for about one third less than the price of most standard sealed reed relays, Elec-Trol offers its new Molded-Line Reed Relay. Not only do these new units meet the highest performance standards but they are also totally molded in epoxy to stand up against the kind of extreme moisture conditions and mishandling that would side-line ordinary relays. These new "tough customers" provide complete protection even when totally immersed in cleaning solvents.

With every relay you get these features—highest quality, thoroughly tested, dry reed switches • dry circuit to 10 watt load switching capability • terminal spacing based on the 0.1" X 1.0" standard configuration • compact units in sizes from .310" to .630" W X .335" H X .950" L. And you may select from the following options—magnetic shielding • electrostatic shielding • contact run in for one million operations.

These tough new units are available with their hermetically sealed reed switch contacts in Forms 1A through 4A. For more information, use the reader service card. For immediate action, contact your local distributor, representative, or the factory direct.

Elec-Trol, Inc., 26477 N. Golden Valley Road, Saugus, CA 91350. (213) 788-7292. (805) 252-8330. TWX 910-336-1556.

ELEC-TROL



**Three ways
to get a
good CRT yoke**



**Call
Syntronic
(312) 543-6444**



**Write
Syntronic**

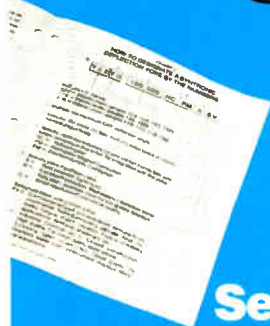

**Use
our Yoke
Selection Guide**

It shows a simplified way to specify the best yoke for your CRT display. Our engineers have developed a unique concept—the yoke energy constant—as a way to estimate yoke inductance and current. From there, it's an easy step to specify a yoke "by the numbers". Try it. Call or write for your copy.* See for yourself how Syntronic's years of experience can add up to getting a better yoke for your display.



syntronic

**Syntronic Instruments, Inc.
100 Industrial Road, Addison, IL 60101
(312) 543-6444**

***Or see Pages 405 to 408 in EEM**

New products

use in hybrid circuits. Made by International Manufacturing Services, the devices come as unpackaged space-saving resistor strips that are passivation-coated for environmental protection. Dubbed I-M-Strips, they are being shown for the first time at this week's DEEC show in Arlington, Va.

The resistor elements are cermet, available in a wide range of resistance values, tolerances, and power ratings. Values range from 10 ohms to 100 megohms, tolerances from 1% to 25%, and power ratings from 75 to 500 milliwatts.

The strips, which contain from two to eight resistors, come in five standard widths—40, 50, 75, 100, and 150 mils. They are attached to a circuit by means of wire bonding, conductive epoxy, or reflow soldering. The substrates are made of 96% alumina.

A typical three-resistor strip, measuring 40-mils wide by 120-mils long by 16-mils thick, is priced at 45¢ each in 500-piece lots. Delivery is within four weeks for initial orders and two weeks for follow-on orders. International Manufacturing Services, 288 East Main Rd., Middletown, R.I. 02840 Phone (401) 849-5242 [342]

**Long-lived one-turn pots
are linear to within 1%**

Able to operate over the temperature range from -65°C to 125°C , two single-turn potentiometers have rotational lives of 10 million turns and linearities of 1%. The servo-mount model 6537 and the bushing-mount



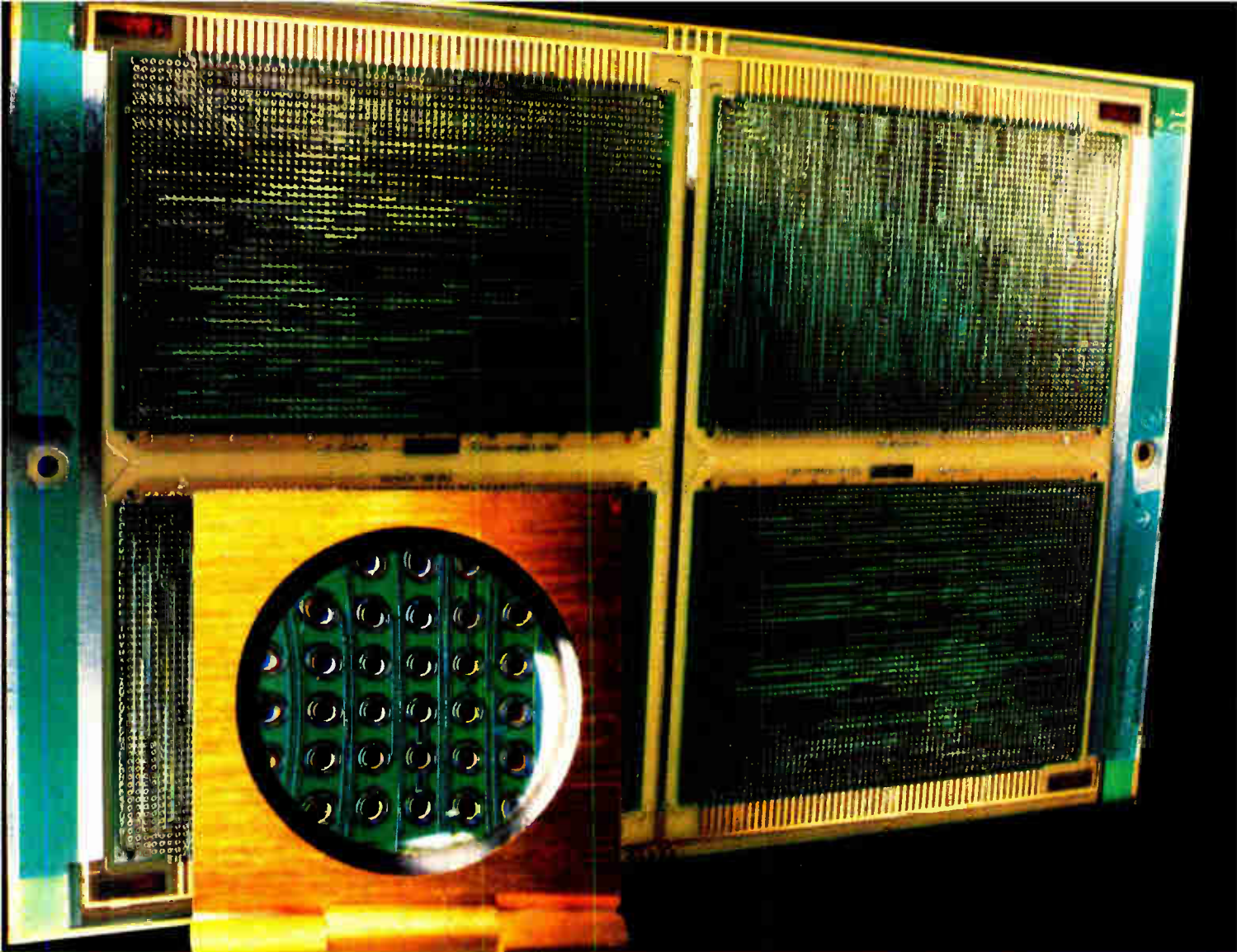

Printed circuit board courtesy of Memorex Corporation

More than a fine line separates RISTON* Dry Film Solder Mask from other masks.

We know fine lines are important to you. That's just one of the reasons why we developed RISTON* Dry Film Solder Mask. Photo-imaging gives precise resolution, even on dense circuitry boards and around critical pad areas. Because there is no bleed-out or solder bridging, inspection is fast, with minimum rework and few rejects. With RISTON Dry Film Solder Mask, application and processing are easy, without specially skilled operators or screen setups and attendant delays.

Reliability? You can count on it!

The uniform thickness of RISTON Dry Film Solder Mask permits handling of the highest density circuitry and offers high impedance integrity with outstanding electrical insulation. Long or short runs are a natural, and boards can be produced up to 21" x 24", one after the other, without multiple recoats or skips.

All of these features of the dry film process with RISTON Solder Mask add up to wide flexibility for the designer. What's more, it comes in a variety of film types which enable masked boards to pass UL flame-

retardant standards. RISTON Dry Film Solder Mask adheres to all common metals and performs consistently under a variety of soldering conditions as well as solder flux cleaning. The result for you is a tough, permanent, well-designed board.

Find out how the benefits of RISTON Dry Film Solder Mask fit your needs. Call your Du Pont RISTON Technical Representative, or write Du Pont Company, Room 35619, Wilmington, DE 19898.

*Registered U.S. Pat. & T.M. Off. for Du Pont's processable dry film photoresist system

RISTON Division



Electronics

World Radio History

Circle 159 on reader service card

HOW DO YOU GET ANALOG SIGNALS INTO YOUR COMPUTER?

Using the new RAMP/Scanner, you can connect any combination of thermocouples, voltage signals or current transmitter signals directly to the input panel. Use two sets of twisted pair wires to tie the RAMP/Scanner into your computer's standard 20 ma current-loop or RS232 port. You'll now have two-way communication between the RAMP/Scanner and your computer in ASCII code. What could be simpler?



The new RAMP/Scanner features a solid-state scanning breakthrough, providing common mode voltage capability in excess of 250Vrms continuous or 600V peak • an auto-ranging dual-slope integrating DVM for high noise rejection • selectable serial transmission rates from 150 to 19,200 baud — and more!
Write or call Newell Tillman at (617) 275-0300.



15 DeAngelo Drive, Bedford, Massachusetts 01730

Circle 160 on reader service card

New products

6637 sell for about \$6 each in production quantities.

The units feature a one-piece precious-metal contact, a silver deposition between the molded-in terminals and the conductive-plastic element, and thermal swaging. All three features are intended to maximize reliability at a reasonable price. The 7/8-inch diameter pots are available with resistances from 1 to 100 kΩ. Deliveries are from stock.

Bourns Trimpot Products Division, 1200 Columbia Ave., Riverside, Calif. 92507. Phone (714) 781-5122 [343]

Solid-state relay handles 40 amperes at 600 V peak

The GB15000 series of solid-state relays now includes a model with a continuous-current rating of 40 amperes and a peak-voltage rating of 600 volts. Features of the new device include an optically coupled input, zero-voltage switching, and a built-in snubber to provide reliable operation in the presence of line transients.

Like other models in the series, the new relay is UL-recognized and CSA-certified. It sells for \$19.50 in lots of 1,000 pieces. Delivery time is four to five weeks.

Gordos/Grigsby-Barton Inc., 100 North Second St., Rogers, Ark. 72756. Phone (501) 636-5000 [345]

Resistors drift only 5 ppm/°C from -55°C to 125°C

Type TK Temp-Stable precision film resistors are offered with temperature coefficients of 5 and 10 ppm/°C. The units, which operate over the range from -55°C to 175°C, maintain their low temperature coefficients up to 125°C. They are offered with resistance values up to 10 megohms and tolerances from 1% (standard) to 0.01%. Shelf stability is typically better than 25 ppm per year, and long-term absolute stability is better than 0.05% for each 2,000 hours of opera-

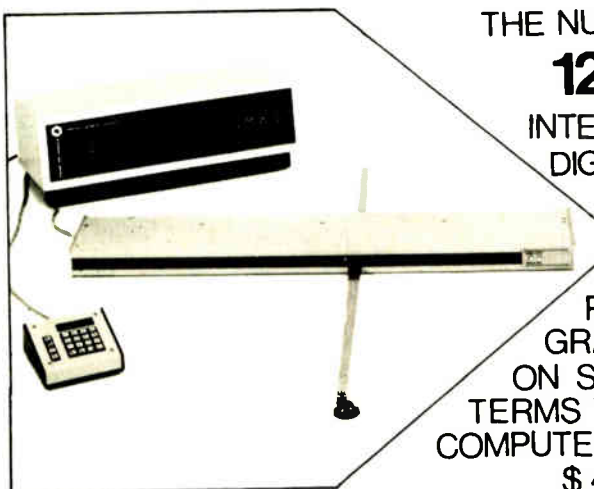

THE NUMONICS
1224
INTELLIGENT
DIGITIZER

PUTS
GRAPHICS
ON SPEAKING
TERMS WITH YOUR
COMPUTER FOR UNDER
\$ 4000.

At last. An electronic graphics calculator that adds the program and memory power of a micro-computer and front-end digitizer. One easy-to-operate unit that's both portable and programmable for custom application and on-site use. Input data via the alpha numeric keyboard or the Electronic Digitizer itself. Data goes directly to the micro-processor for calculations, output to a 16-digit display and/or computer interface. And you've a choice of either character serial or EIA-RS232C output formats standard. Data batching, axis rotation, scaling, point-to-point area and length measurements. . .with the Numonics 1224's library of field changeable programs, we can put your computer on speaking terms with graphics. At less than \$4000. May we tailor one for you?

NUMONICS 418 Pierce St., Lansdale, Pa. 19446 (215) 362-2766

160 Circle 253 on reader service card

Pure logic and hard facts

1. In high-frequency power switching, heat is a prime factor in Darlington failure.
2. Turn-off time is the dominant cause of destructive temperature rise.
3. The faster the turn-off, the cooler the Darlington, the greater the reliability.

Take a look at competitive Darlings in an actual 20 KHz bridge converter circuit:

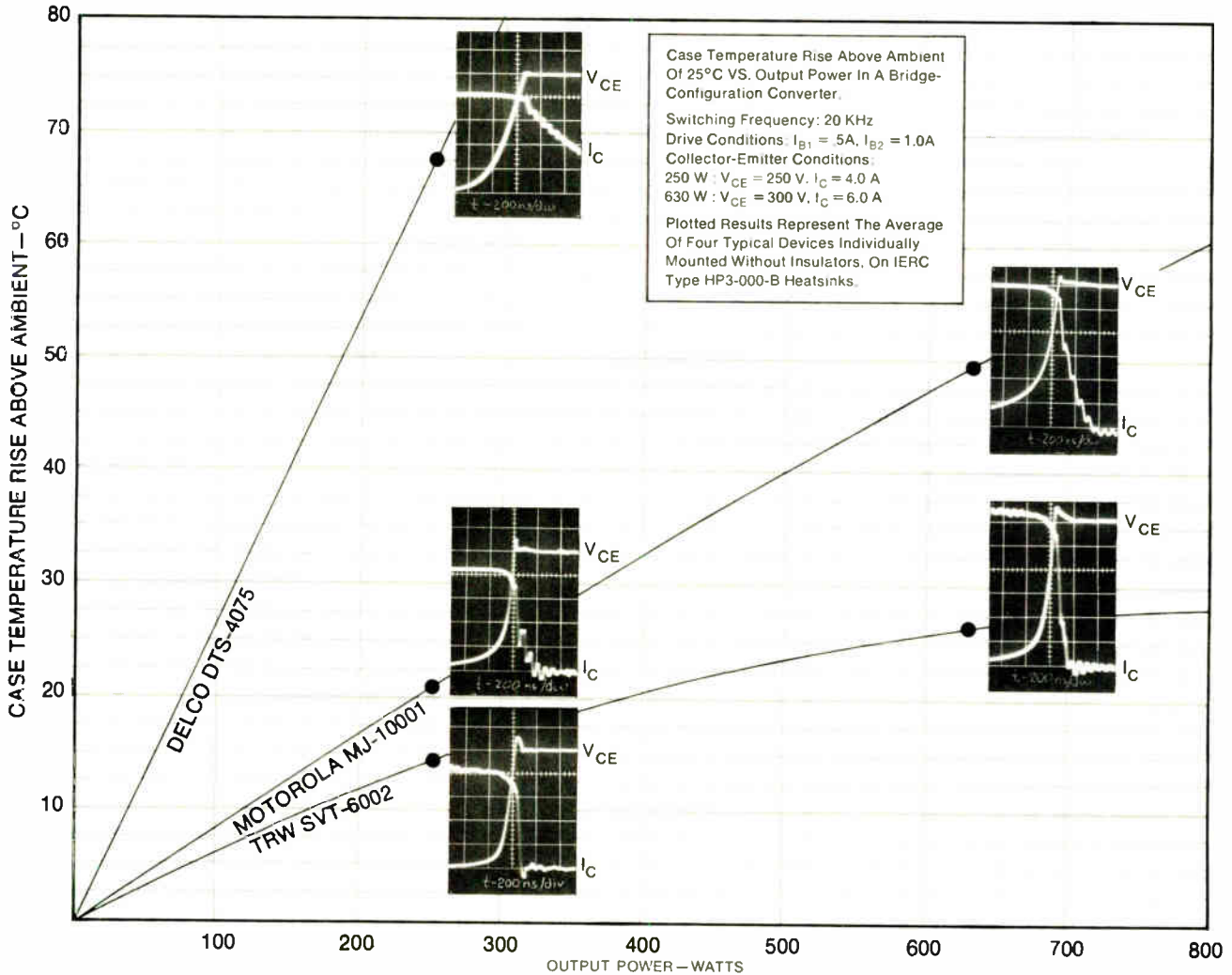

TRW operates at the lowest temperatures for the greatest reliability in high-frequency Darlington off-line switching regulators

And when you're working with high-power, fast-switching Darlings that's no small thing. When you need reliability at high frequencies, the best combination of switchoff time and energy capability add up to greater efficiency and longer life. And what circuit are you about to design that doesn't deserve the best? Particularly when TRW Darlings are not only competitively priced, but are also immediately available in any quantity.

To get all the facts on TRW's high-frequency Darlington, use coupon or phone John Power at (213)679-4561.

TRW Power Semiconductors
 An Electronic Components Division of TRW, Inc.
 14520 Aviation Boulevard, Lawndale, California 90260

Please send me data sheets on TRW's Darlington transistors.

Please send me samples for _____ voltage and _____ current.

Name _____

Company Name _____

Position _____

Address _____

City _____ State _____ Zip _____

TRW POWER SEMICONDUCTORS

ANOTHER PRODUCT OF A COMPANY CALLED TRW

The Refreshing Alternative



MEGATEK Graphic Systems

Local Intelligence · Full Refresh · Zoom, Rotate, Translate · Sharp, Bright Vectors · Powerful Minicomputer · FORTRAN Software · Data Tablet or Joystick · Low Cost

Our Systems are Powerful, Intelligent, and Good Looking... the features YOU look for in a graphics terminal, system or interface. Coupled with MEGATEK Quality and Value, the picture is perfectly clear—MEGATEK is The Refreshing Alternative.

Circle 162 on reader service card
See Our Display At Booth 1216 At NCC

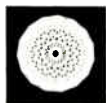

MEGATEK CORPORATION
The Refreshing Alternative

* TEKTRONIX is a registered trademark of Tektronix Inc. use of which in no way constitutes endorsement

HOPE

in a word is what we are.

Project HOPE exists because there are people with hope—people who have given 35 million men, women, and children on four continents the chance for happier, more productive lives through improved health care.

Give to
PROJECT HOPE

Department A
Washington D C 20007

New products



ation. Typical price of a low-value resistor is about \$1.50 each in lots of 100. Small quantities are available from stock; production quantities require four to six weeks.

Caddock Electronics Inc., 3127 Chicago Ave., Riverside, Calif. 92507. Phone Richard Caddock at (714) 683-5361 [344]

GaP LEDs put out up to 25 microcandelas at 50 mA

A series of high-intensity gallium-phosphide light-emitting diodes is available in two sizes and three colors. The smaller T-1 lamps are designated TIL212 (amber), TIL216 (red), and TIL232 (green). The larger T-1/4 devices are designated TIL224 (amber), TIL228 (red), and TIL234 (green). Housed in molded epoxy packages, the LEDs put out up to 25 microcandelas at a current of 50 milliamperes.

The smaller lamps sell for 58 cents each in small quantities and 46 cents in hundreds. The corresponding prices for the larger lamps are 62 cents and 49 cents.

Texas Instruments Inc., Inquiry Answering Service, P.O. Box 5012, M/S 308 (Attn: TIL212-234), Dallas, Texas 75222. Phone Bill Alexander at (214) 238-3940 [347]

Miniature dry-reed relays can switch 100 watts

Although they are compact units that sell for as little as \$1.24 each in production quantities, Powermite dry-reed relays are capable of switching up to 100 watts, 1 ampere.

Records in record time.

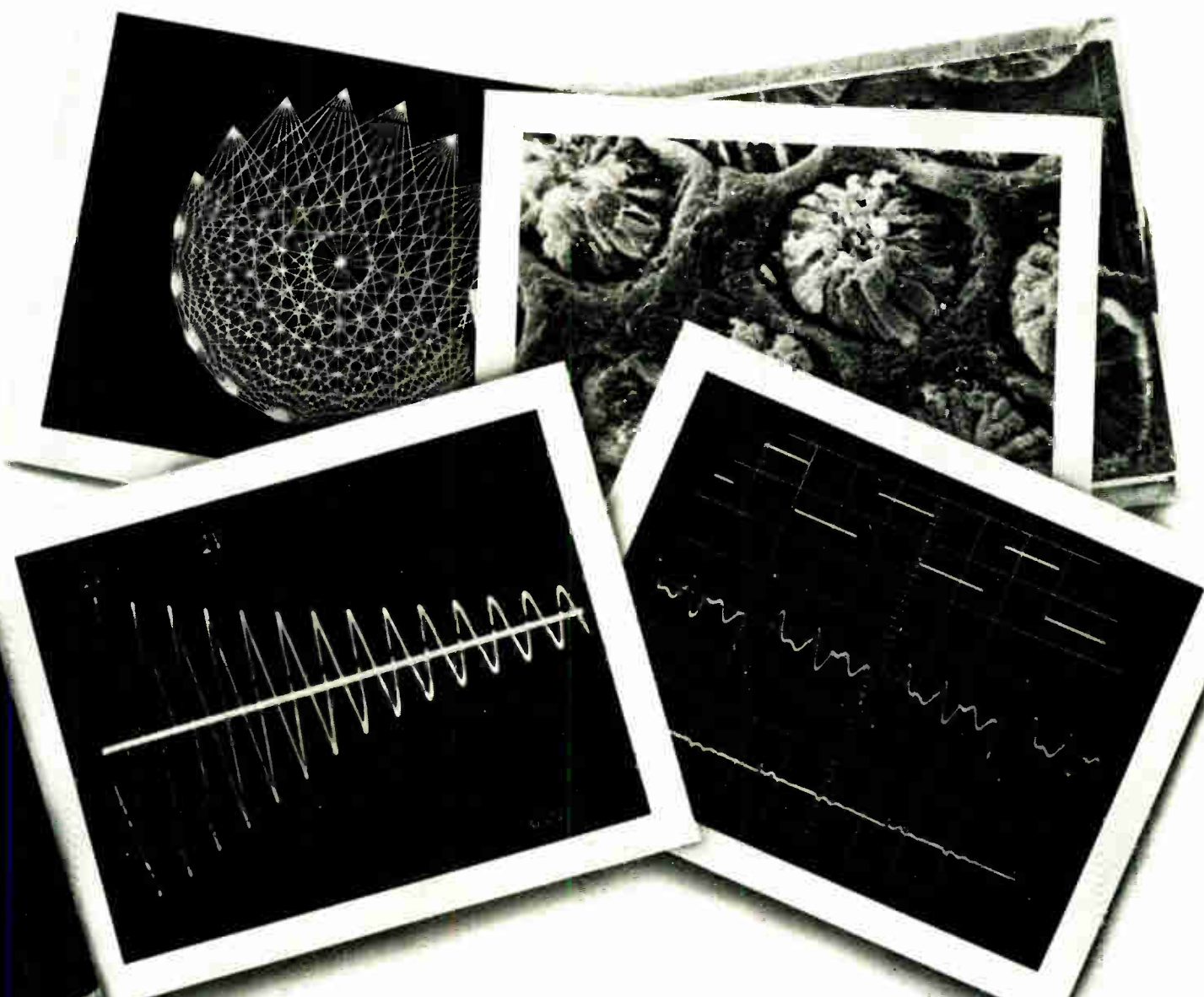

In seconds you can have a permanent copy of your cathode ray tube display with Polaroid's CU-5 Hard Copy Land Camera. Whether you have a computer terminal, an oscilloscope, a closed circuit TV or scanning electron microscope, you'll get economical 3 1/4 x 4 1/4 inch (8.3 x 10.8 cm) photos for study, comparison, pass-along information, reproduction or filing.

Whatever size screen you have, we can probably fit it with the proper hood. Whatever your film needs (black and white, positive/negative, color), Polaroid makes a professional pack film to fill your needs.

You don't have to know a thing about photography to use the CU-5. The exposure setting always remains the

same once it's been set for your particular screen or scope. There's no focusing. All you do is hold the CU-5 with a CRT hood against the display you want copied, squeeze the trigger-like shutter release and you've recorded instantly the data without tying up your terminal.

If you're interested we'll direct you to your nearest Polaroid Professional Products Dealer. Return the coupon or call Polaroid toll free: 800-225-1618 (in Massachusetts, call collect: 617-547-5177).

Polaroid Corporation, Dept. A360,
575 Technology Square, Cambridge, Mass. 02139
I'm interested in Polaroid's CU-5 for CRT recording.

Name _____
Company _____
Address _____
City _____
State _____ Zip _____
Telephone _____

Polaroid

*The CU-5 Camera for CRT
image recording in seconds.*



New Mod Look from Adam.

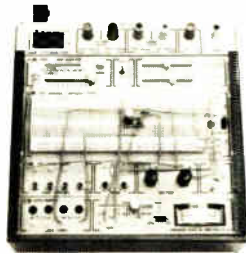

Modular breadboarding system. \$510.00*

It's Adam. E&L Instruments' new modular breadboarding system. To provide you with added flexibility for expansion and development, Adam gives you the 5005 Mainframe that contains all the power supplies necessary to operate each of the separate modules. And here's what else you get:

- 103 Signal Source Module
- 101 Function/Pulse Generator Module
- Two 302 Universal Component Socket Modules
- 502 Readout and DC Multimeter Module

And you make all connections on the panel mounted SK-10 socket with common 22 gauge solid conductor wire. No special patch cords and no soldering needed.

Put this valuable design tool to work in your lab today. Write E&L, or contact your local representative listed below.

*Quantity discounts available.



E&L INSTRUMENTS, INC.
61 First Street, Orby, Conn. 06418
(203) 735-8774 Telex No. 96 3536

Authorized Stocking Representatives

Los Angeles, Calif.
(213) 377-0975
San Francisco, Calif.
(415) 961-2828
Woodbridge, Conn.
(203) 397-1461
Denver, Colorado
(303) 534-1356
Orlando, Florida
(305) 351-1841
Chicago, Illinois
(312) 956-8090
Kansas City, Kansas
(913) 649-8952
New York, N.Y.
(201) 467-8585
Syracuse, N.Y.
(315) 699-2651

Dayton, Ohio
(513) 222-0011
Philadelphia, Pa.
(215) 723-8733
Dallas, Texas
(214) 328-5484
Fairfax, Virginia
(703) 273-1803
Seattle, Washington
(206) 938-4166

Canada
Edmonton, Alberta
(403) 455-4122
Winnipeg, Manitoba
(204) 774-6286
or 772-9295
Vancouver, British Columbia
(604) 687-2621



Circle 164 on reader service card

1977 Answer Book. It makes your job easier. \$25.

Who makes what? Over 4000 products, more than 5000 manufacturers with their local contracts and distributors, directory of trade names and catalogs, post-paid inquiry cards for 5-second ordering of current catalogs.

Electronics Buyers' Guide
1221 Ave. of the Americas
New York, N.Y. 10020

Yes, send me a copy of The Answer Book. I've enclosed \$25 (USA and Canada only, elsewhere send \$35). Full money back guarantee if returned within 10 days.

Name _____
Company _____
Street _____
City _____ State _____ Zip _____



**Electronics
BUYERS'
GUIDE**

New products

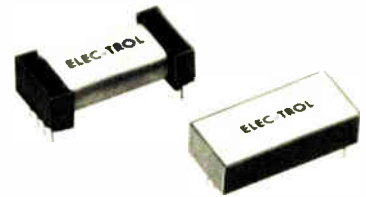

and 200 volts dc. They are especially well suited for applications such as switching the gates of power thyristors or controlling lamps and some reactive loads.

The relays are available with from one to four form A contacts in either an open-line (\$1.24) or epoxy-encapsulated (\$1.76) package. The prices are for production quantities of the one-pole devices. Optional features include magnetic shielding and electrostatic shielding.

Elec-Trol Inc., 26477 N. Golden Valley Road, Saugus, Calif. 91350. Phone (805) 252-8330 [346]

TOPICS

Components

New England Instrument Co., Natick, Mass., manufacturers of the Econopot, has introduced Econopot MKIII—a conductive-plastic semi-precision device intended for industrial applications. Key features include 1% linearity, 5-million-cycle rotational life, and 0.25% output smoothness...

Dialight, Brooklyn, N.Y., has reduced the prices of certain of its LED displays. The price of the 745-0005 5-by-7 dot-matrix display has been cut from \$5.95 to \$2.25 each in thousands, while the 745-0014, -0015, and -0016 have been reduced from \$2.10 to \$1.10...

Elec-Trol Inc., Saugus, Calif., has announced that its printed-circuit-board solid-state relays have received UL yellow card recognition in accordance with UL Bulletin 508, and are listed under file E-58275.

International Components Corp., Chicago, Ill., has announced the introduction of a series of compact dc gearmotors that can handle loads up to 80 ounce-inches.

Tally's low cost of ownership package . . . One printer family . . . Three speed ranges.



40 to 100
lines per minute



55 to 150
lines per minute



70 to 200
lines per minute

The Tally serial printer family. Three speed ranges. And very little price difference from model to model. An ideal OEM package. High parts commonality. Low integration costs. No scheduled maintenance. Design simplicity for inherent reliability. A variety of interfaces. Low prices.

From 40 lines per minute through 200 lines per minute. The Tally T-1200 at 120 characters per second. The Tally T-1202 — with

optimized bi-directional printing that includes skipping over blank spaces at three times the print rate — delivers twice its rated speed by cutting throughput time two to three fold. And the new Tally T-1602 at 160 cps with optimized bi-directional printing keeps pace with line printer speeds.

There's so much more to tell so call your nearest Tally sales office for all the facts.

Tally Corporation, 8301 S. 180th St.,
Kent, Washington 98031.
Telephone (206) 251-5524.

OEM Sales Offices: Boston (617) 272-8070, Chicago (312) 956-0690,
Los Angeles (213) 378-0805, Melbourne Beach (305) 724-0480,
New York (516) 694-8444, San Antonio (512) 733-8153,
San Jose (408) 247-0897, Seattle (206) 251-6730, Business Systems (415) 254-8350.

TALLY

Circle 155 on reader service card

Quietly pays for itself.

Your mini/micro computer system is compact, clean, easy to use and maintain.

Now you don't have to tie your beautiful little system to a thumping, noisy, cantankerous electromechanical printer. Rather, you can use CDI's quiet thermal printers, available in 30-character-per-second versions for OEM applications.

CDI's OEM thermal printers are lightweight (Q3 weighs only 4 pounds), and are stepper-motor driven. There are no solenoids, ratchets, or linkages to burn out or break. All solid state circuitry insures maximum performances and can eliminate costly maintenance headaches. . . . it virtually can pay for itself!

The **Q3 Thermal Printer** features unique dual font capability providing *both* upper and lower case printing.

Two complete character sets are easily interchangeable and user selectable. Wide range of fonts includes ASCII, APL, or custom.

The new **CDI Miniterm 1201 Receive Only** terminal is designed to complement any system. It's small, compact, and so quiet it's even used in hospitals. Ideal for any desk-top application, the Miniterm 1201 R/O is compatible with all major brands of CRT's for hard-copy output.

Find out more about the quiet thermal printers especially for the OEM. The kind of engineering excellence you expect from CDI, a leader in portable terminal manufacturing.

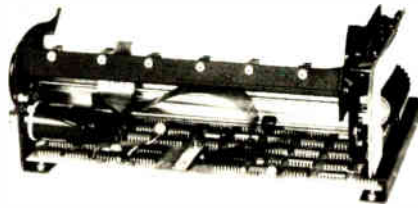

The **Miniterm 1201 RECEIVE/ONLY TERMINAL** . . . Ideal for CRT hard-copy output.

- Compact, super quiet for desk-top use
- 30 characters per second
- Sleek, modern styling complements any system and decor
- 96 character upper/lower case; fonts are interchangeable and user selectable

The **Q3 Thermal Printer** . . . for the OEM building it into his system.

- Compact, only 4 pounds
- Dual fonts
- 80 column thermal printing
- Complete chassis includes print mechanism, paper handling, drive and control electronics, copy lamp assembly and paper



COMPUTER DEVICES INC.

25 North Ave.
Burlington, Mass. 01803
(617) 273-1550

See us at NCC 77 Booth #1513-1517

Circle 166 on reader service card

MDB SYSTEMS presents...The DEC PDP-11* Connection

GP Logic Modules · Peripheral Controllers · Communications Interfaces · Special Purpose Modules

New: MDB DR11C General Purpose Interface and MDL-11 Asynchronous Serial Line Adapter

MDB Systems products always equal and usually exceed the host manufacturer's specifications and performance for a similar interface. MDB interfaces are software and diagnostic transparent to the host computer. MDB products are competitively priced; delivery is usually within 14 days ARO or sooner.

Here are some MDB Systems connections to DEC PDP-11 computers:

- General Purpose Interfaces
 - 11C Module with 16 bit input and 16 bit output registers;
 - 20 user wire wrap positions.

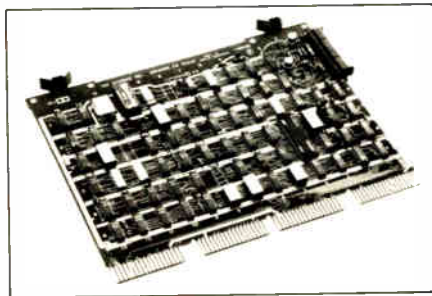

- Pins and sockets optional.
- 1710 Module with 40 IC positions for user logic; sockets optional.
- 11B Direct Memory Access Module with 12 IC positions for user logic.
- DR11C, a direct DEC equivalent.
- Digital I/O Module.
- Wire Wrappable Module with 70 IC positions, sockets optional.
- Unibus Terminator.
- Communications Modules
 - MDL-11 Asynchronous Line Adapter.
 - MDL-11W Asynchronous Line

Adapter with line frequency clock.

MDU-11 Synchronous Serial Line Adapter.

- Device controllers for most major manufacturer's Printers
- Card equipment
- Paper tape equipment

All controllers are software transparent and use PDP-11 diagnostics.

Check first with MDB Systems for your PDP-11 computer interface requirements.

MDB also supplies interface modules for Data General NOVA* and Interdata computers and for DEC's LSI-11 microprocessor.

MDB
MDB SYSTEMS, INC.

1995 N. Batavia St., Orange, California 92665
714/998-6900 TWX: 910-593-1339

*TMS Digital Equipment Corp. & Data General Corp.

"See us at the National Computer Conference".

World Radio History

CIRCLE 111 FOR PDP-11; 112 FOR NOVA; 113 FOR INTERDATA; 254 FOR LSI-11.

CAN THE LEADER IN DIGITAL VOLTMETERS TAKE OVER IN COUNTERS?

Well...

We've seen some surprising changes.

Last time we checked, for instance, we were sitting in the number two spot.* Not too bad for a company that didn't begin building counters until 1973.

But, then again, we had an advantage. We knew what to do. We knew what it would take to be a leader in counters.

Give the guy on the bench, or building a system, a top-performing, Fluke-quality counter at a price a few hundred bucks less than he expected to pay. An honest bargain is always a big seller.



Counters!

But you can see. Take a look at the unit pictured in this ad—you're going to see a lot more on the front panel.

And there are options. Time base options. Frequency extension options. System interface options. We're going to have to send you information for you to get a complete idea of what this counter can do.

But it all starts with the \$995 unit.

An honest bargain from Fluke.

And, meanwhile, when someone asks

if we're going to take over in counters, we just smile, shrug and keep on building those great Fluke counters.

After all, we've only been at it 3 years.

	Time Base Options	
	TCXO	Oven-Stabilized
Frequency:	10.00 MHz	10.00 MHz
Aging Rate: (constant temperature)	$<\pm 3 \times 10^{-7}/\text{mo.}$	$<\pm 1 \times 10^{-7}/\text{mo.}$
Temperature Stability:		
20°C-30°C	$\pm 2 \times 10^{-7}$ typ.	$\pm 3 \times 10^{-9}$ typ.
0°C-50°C	$<\pm 5 \times 10^{-7}$	$<\pm 1 \times 10^{-8}$
Line Voltage: ($\pm 10\%$ change)	$<\pm 5 \times 10^{-8}$	$<\pm 3 \times 10^{-9}$

We know time.

For data out today, dial our toll-free hotline, 800-426-0361.

John Fluke Mfg. Co., Inc., P.O. Box 43210, Mountlake Terrace, WA 98043

Fluke (Nederland) B.V., P.O. Box 5053, Zevenheuvelenweg 53, Tilburg, Netherlands.

Phone: (013) 673-973 Telex: 52237

*Source available upon request.

**U.S. price only.

Frequency Extension Options
520 MHz Prescaler Covers frequency range of 50 to 520 MHz, using a scaling ratio of 4. Sensitivity is 15 mV rms (AGC). Maximum allowable input is 5 V rms (fuse protected). VSWR less than 2:1 into 50 ohms for levels less than 1 V rms.
1000 MHz Prescaler Covers 50 to 1000 MHz using a scaling ratio of 8. Sensitivity is 15 mV rms, and maximum allowable input is 5 V rms (fuse protected). VSWR less than 2.5:1 50 ohms for levels less than 1 V rms.
1250 MHz Prescaler Covers 50 to 1250 MHz using a scaling ratio of 8. Sensitivity is 20 mV to 1000 MHz, increasing to 40 mV rms at 1250 MHz. Maximum input 5 V rms (fuse protected), and VSWR less than 2.5:1 for levels less than 1 V rms.

We know frequency.

For example, a bench/systems box at \$995** with the same programming potential of counters selling \$130 to \$305 and even \$640 more.

That \$995 bargain is our 1953A Programmable Universal Counter/Timer. What does \$995 buy? Here's a good example of how we're changing the counter market. The 1953A is designed for both bench and systems use in frequency, ratio, period(s), time interval and gateable totals measurement. The basic box has a frequency range from DC to 125 MHz at sensitivities to 30 mV. Nine-digit LED display. Full triggering control.



THE SURPRISING NEWCOMER. 1953A COUNTER. **FLUKE**®

Circle 167 for demonstration, circle 255 for literature

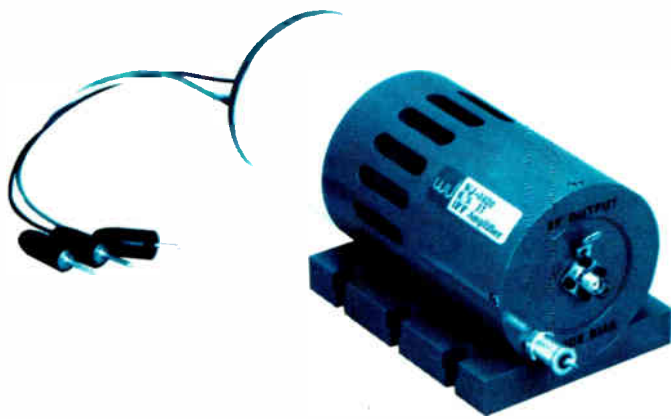

EBS Power Amplifiers Deliver 1 Kilowatt

...and they offer

The EBS (Electron Bombarded Semiconductor) provides high power at frequencies up to 1.2 GHz. The availability of more than 20 dB of gain simplifies the design of Class C power amplifiers by eliminating the need for multiple driver stages. The EBS amplifier offers high efficiency (over 45%), reducing system power requirements.

Designed for use in IFF, radar and communication systems, these rugged, compact amplifiers satisfy a wide range of commercial and military requirements. They can be qualified to meet the environmental specifications of MIL-E-16400 and MIL-E-5400, Class II. And, life tests have demonstrated MTTF's of more than 100,000 hours for CW EBS amplifiers.

For further information on EBS power amplifiers, contact the W-J Field Sales Office in your area or telephone EBS Amplifier Applications Engineering in Palo Alto, California at (415) 493-4141, ext. 2375.

Reliability, Compactness, High Gain and High Efficiency!

Two new additions to Watkins-Johnson's EBS amplifier line are:

WJ-3674		150 W
CW Power	150 W	
Bandwidth	50 MHz	
Center Frequency	10 to 300 MHz	
Gain	23 dB	
Efficiency	45%	
Size	5.5 x 2.0 x 2.0 in. (14 x 5.1 x 5.1 cm)	

WJ-3621		1 kW
Peak Power	1000 W	
Average Power	10 W	
Bandwidth	50 MHz	
Center Frequency	500 to 1200 MHz	
Gain	22 dB	
Size	3.5 in x 1.5 in dia. (8.9 cm x 3.4 cm dia.)	



Watkins-Johnson—U.S.A.: 3333 Hillview Ave., Palo Alto, CA 94304 • (415) 493-4141 • TWX: 910-373-1253 • Telex: 34-8415 • Cable: WJPLA • 700 Quince Orchard Rd., Gaithersburg, MD 20760 • (301) 948-7550 • TWX: 710-828-0546 • Telex: 89-8402 • Cable: WJCEI • United Kingdom: Shirley Ave., Windsor, Berkshire SL4 5JU, England • Tel: Windsor 69241 • Cable: WJUKW-WINDSOR • Telex: 847578 • West Germany: Muenchenerstr. 17, 8033 Planegg • Tel: (089) 859-9441 • Cable: WJDBM-Muenchen • Telex: 529401 • Italy: Piazza G. Marconi, 25 00144 Roma-EUR • Tel: 59 45 54 • Cable: WJROM-ROMA • Telex: 60117

New products

Microwaves

Tuners cover 18 to 40 GHz

YIG-tuned filters and local oscillators track very tightly from -55°C to 85°C

The newest additions to the Varian line of all-solid-state, electronically tuned receiver front-ends extends the range of their VZ-3002 series to 40 gigahertz. These models are specifically designed to reduce the size, weight, and power consumption of the tuner portion of swept-superhetrodyne receivers for military surveillance systems.

Model VZK-3002 spans the frequency range of 18 gigahertz to 26.5 GHz; model VZA-3002 covers from 26.5 to 40 GHz. Both include a 4-stage yttrium-iron-garnet (YIG) filter as the preselector, a YIG-tuned local oscillator that tracks the center frequency of the filter, a balanced

mixer, and a low-noise 160-megahertz intermediate-frequency preamplifier, all in a package that is relatively small and lightweight.

Locating the YIG spheres used for the preselector filter and oscillator resonators in the field of a single magnet not only reduces size, weight and required drive power, but also provides excellent frequency tracking over a temperature range of -55°C to 85°C . Since the YIG spheres share a common magnetic field, only one magnet and a single drive circuit are needed instead of one for each sphere. It is this common magnetic field that makes possible extremely close tracking of the filter and oscillator frequencies.

Model VZK-3002 has a noise figure of 23 decibels and a bandwidth greater than 35 MHz; model VZA-3002 has a noise figure of 28 dB and a bandwidth exceeding 40 MHz. Both measure 4.1 inches by 4.1 in. by 11.6 in., weigh about 15 pounds, and require an input power of 100 watts.

The series also includes six other microwave tuners as well. All use a standard 160-MHz i-f pream-

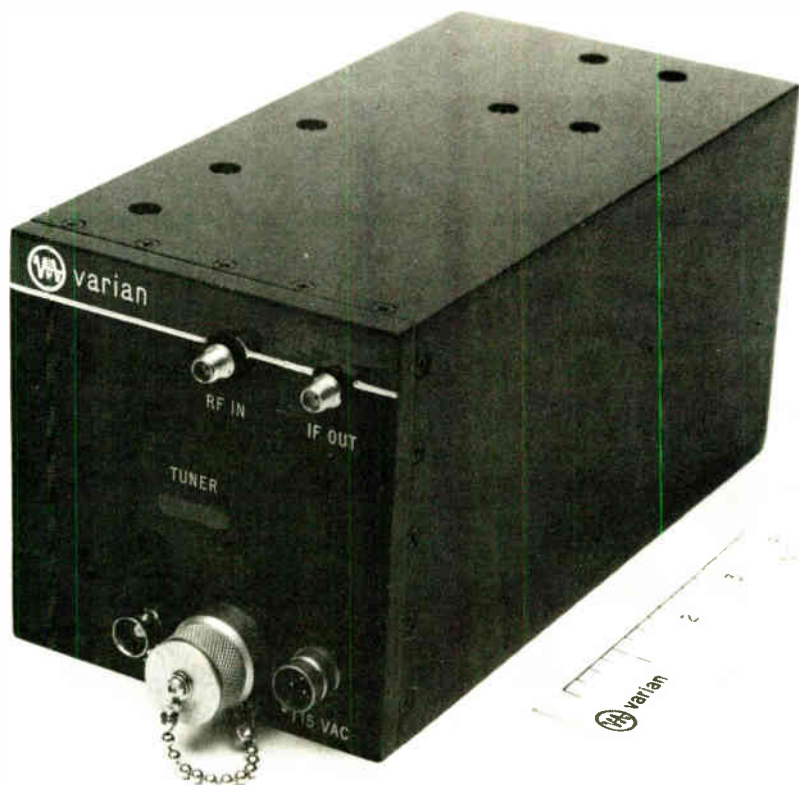

KEEP THE HORSE BEFORE THE CART!

You've probably known design engineers who are half-way through a project before they realize the power supply that could have come from a standard line must all of a sudden be a customized design. And you also know what that means in the way of extra costs. It's the old cart before the horse theory.

Call us when you are in the embryonic stages of your design and we'll work with you in your primary important stages. And not only will you like the fact that our standard lines will both fit your supply and keep you in budget... you'll like the idea of our already field-tested dependability.

Our power supplies are available for OEM computer, point of sale, EDP, bank telling and telecommunications use:

- Switching regulator and linear designs • 11 models — single/multi-output • Voltage ranges, from 2 to 30V • 50 current levels from .01 to 225 amps • Overcurrent/overvoltage protection
- Filtering to meet world-wide EMI requirements • Designed and built to UL, CSA and European safety requirements.

Dependability. That's a word we define as quality and reliability. It's also what design engineers define as our reputation!

NCR

NCR POWER SYSTEMS DIVISION

formerly Scott Electronics
584 S. Lake Emma Road, P.O. Box 898
Lake Mary, Florida 32746
Telephone (305) 323-9250

Series #690

Series #635

Series #680

Series #689

Series #631

Series #672

All TO-3 coolers are not created equal!

These six heat sinks are only a few of the TO-3 coolers available from Wakefield. This broad variety lets you select exactly the cooler you need to meet your particular packaging considerations, cooling requirements and cost limitations.

If you need a TO-3 cooler, there is nobody that can give you a better choice.

Try one free.

See for yourself. Indicate which of these units you want to try and we will be happy to send a free sample.

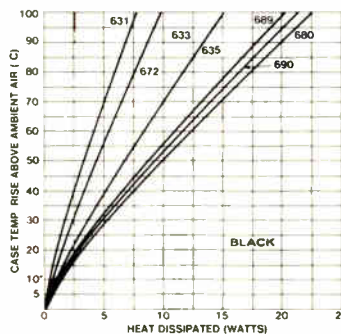

Part No.	Performance (°C/W)		Price (5,000 quantity)	
	Black	Plain	Black	Plain
<input type="checkbox"/> 631	14	17	.132¢	.058¢
<input type="checkbox"/> 672	11	12	.125¢	.062¢
<input type="checkbox"/> 635-1.0	7	8	.216¢	.151¢
<input type="checkbox"/> 689-1.0	5.5	6.6	.299¢	.227¢
<input type="checkbox"/> 690	5	5.5	.300¢	.260¢
<input type="checkbox"/> 680-1.0	4.6	5	.780¢	.650¢



WAKEFIELD ENGINEERING INC.

77 AUDUBON ROAD WAKEFIELD, MA 01880 (617) 245-5900
TWX 710-348-6713

AN EG&G COMPANY

Circle 170 on reader service card

New products

plifier and, among them, provide frequency coverage from 0.5 GHz to 18 GHz.

Varian/Solid State West Division, 611 Hansen Way, Palo Alto, Calif. 94303 [401]

Instrument combines lockbox with microwave counter

The model 371 source-locking microwave counter is actually a combination automatic microwave frequency counter and synchronizer (lockbox). It has the capability to phase-lock virtually any swept signal source in the frequency range from 10 megahertz to 18 gigahertz to its internal time base. The only proviso is that the source have an fm input and that it be manually tunable to within 20 MHz of the desired frequency.

The microprocessor-based instrument is extremely easy to use. In its counter mode, it uses three input ports to cover the frequency range from 20 hertz to 18 GHz with sensitivity to -30 dBm. It can make accurate measurements in the presence of more than 40 MHz of fm, and it is protected against burn-out for inputs up to 2 watts. Priced at \$6,800, the instrument has a delivery time of 90 to 120 days.

EIP Inc., 3230 Scott Blvd., Santa Clara, Calif. 95051. Phone (408) 244-7975 [408]

Coaxial sliding load spans 2.0 to 26.5 GHz

Since the new APC-3.5 connector is now permitting design activity in 3.5-millimeter coaxial lines at frequencies above 18 gigahertz, a need has arisen for instrumentation to make accurate measurements on components built in such lines and operated at such frequencies. Such a piece of instrumentation is the model 911C sliding load, which is designed for use over the frequency range of 2.0 to 26.5 GHz. The unit features interchangeable fittings so that components with either male or female connectors may be checked. Its

HELP WANTED

While it is not our policy to encourage job hopping—quite the opposite, in fact—the headline above must have got your attention for a reason.

Perhaps you should turn to the back of this issue to our Classified Section. One of the job descriptions might fit you.

**If you're
using these,
the best you can expect is
2% linearity and 100,000 cycle life.**



**For about
the same price,
new ECONOPOT
MK III conductive**



**plastic
units provide
1% linearity and
5 million cycle life**

Until now, 2% linearity and 100,000 cycle life was the best you could expect in semi-precision potentiometers selling for about \$2.50 in quantity. Now our new ECONOPOT MK III offers you 1% linearity and 5 million cycle life, plus the infinite resolution and low cost of conductive plastic, and sells for less than

\$3.00 in quantity. Other advantages of ECONOPOT MK III over the best of competition are precious metal contacts, 303 stainless steel shafts, and thermoset plastic terminal supports. All MK III units are single-turn 7/8" diameter bushing mount potentiometers with 1/4" shafts. Send now for details.

new england instrument company

KENDALL LANE NATICK, MASS 01760 • TEL: 617-873-9711 • TWX: 710 346-0398
The leading precision potentiometer manufacturer offering molded conductive plastic, wirewound, conductive film & hybrid technologies.

World Radio History

Circle 171 on reader service card

The cool one from Tecnetics



55% efficiency in a 25 watt DC to DC Converter

Why pay for useless heat when you want power? That's the philosophy behind the new high efficiency 1200 Series 25 volt regulated converter from Tecnetics.

With efficiency as high as 55% at full load under normal conditions, an integral heat sink, improved circuitry and a black anodized aluminum case, this converter operates within a range of -20 C ambient to +100 C case temperature.

Available with a single output, this series features full input-output isolation to 500VDC allowing the user to change polarity and prevent ground loops. Compact size and sturdy barrier strip terminals make this the perfect converter for a wide

variety of military, industrial, aerospace and telecommunication applications.

For more information on the 1200, and hundreds of other power supplies, write for our 26 page catalog.

SPECIFICATIONS: 1200 Series 25 watt DC to DC converter

Inputs: 12 ± 2VDC to 48 + 6VDC

Outputs: 12, 24, 28 and 48VDC

Dimensions: 5" x 4.1" x 1.25" (typ)

Weight: 16 oz.

Price: Single Output — \$198.00

tecnetics® The Power Conversion Specialists P.O. Box 910,
1625 Range Street, Boulder, Colorado 80302 (303) 442-3837 TWX 910-940-3246

Circle 172 on readerservice card

HELP WANTED

While it is not our policy to encourage job hopping—quite the opposite, in fact—the headline above must have got your attention for a reason.

Perhaps you should turn to the back of this issue to our Classified Section. One of the job descriptions might fit you.

New products



center conductor slides and locks for minimum discontinuity. And its movable terminating element has 5.5 centimeters of travel—more than a quarter wavelength at the lowest operating frequency.

The maximum connector and transmission line reflection coefficient for the female configuration varies linearly from 0.022 at 2 GHz to 0.0465 at 26.5 GHz. For the male version, the figure is 0.02 across the full band. And for the load element itself, the maximum reflection coefficient is 0.01 from 2 to 10 GHz and 0.035 from 10 to 26.5 GHz. Furnished in a foam-lined carrying case with two connector-change wrenches and a set of spare center pins, the 911C sells for \$720. Delivery time is four weeks.

Inquiries Manager, Hewlett-Packard Co.,
1501 Page Mill Road, Palo Alto, California
94304 [403]

Subminiature termination operates up to 40 gigahertz

A line of subminiature terminations that mate directly with OSSM and all standard subminiature connectors with a thread size of 10-36 UNS-2A

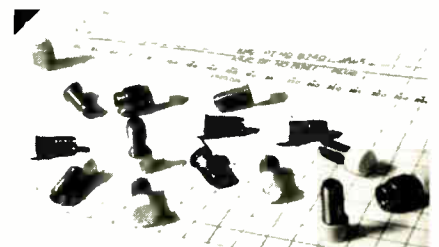

All metallized
polypropylene capacitors
are NOT created equal

**TRW maximizes polypropylene's
stability, insulation resistance, low dissipation factor,
low dielectric absorption, etc., etc.**

Polypropylene dielectrics are great. But they're far from being equal. There are differences in resins, differences in lead attachment, differences in the sophisticated processing it takes to deliver the complete potential of this remarkable dielectric.

As an example, the TRW X363UW polypropylene capacitor utilizes an entirely new termination technique. Result—a low dissipation factor through 10 mfd. Interestingly enough, the TRW X363UW

capacitor, with its film case and epoxy endfill, can pass humidity resistance tests used for hermetically sealed capacitors. That's better than most dielectrics can do.

Reports indicate their low dielectric absorption is meeting a real need in switching regulator power supplies. But we're open to new applications. For complete specifications, use the coupon below.

TRW Capacitors
An Electronic Components
Division of TRW, Inc.
301 West "O" Street
Ogallala, Nebraska 69153

Please send me specifications on your X363UW polypropylene capacitors.
(If you want applications assistance or samples, call our Sales Engineering Department (308) 284-3611 and discuss your requirements.)

Name _____
Firm Name _____
Address _____
City _____ State _____ Zip _____

E

TRW CAPACITORS

ANOTHER PRODUCT OF A COMPANY CALLED TRW

65 watts, 10 MHz-2.5 GHz

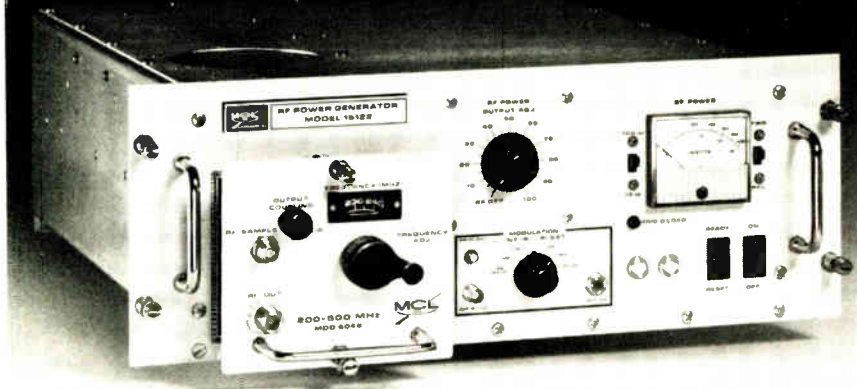

New MCL power generators feature flexibility, high output, minimum distortion.

Main frames for 115 VAC and for 208/220/240 VAC operation. Six standard front panel plug-ins provide frequency range from 10 MHz to 2500 MHz with a minimum output of 65 watts. Two optional plug-in modules are available which produce 100 watts narrow-banded.

Single knob tuning for each plug-in provides exact frequency selection. Front panel, direct frequency readout is accurate to ± 1 percent.

Solid-state mainframe designed for minimum components, optimum reliability. Residual AM held to .1 percent, eliminating nearly all AM distortion in output waveform. Generates continuous or 1 KHz square wave pulsed output. External AM signal generator can be added with single plug-in connection. External pulse circuit is TTL compatible. Automatic VSWR protection.

Write or call for your 4-page power generator brochure: Tom Rys, MCL, Inc., 10 N. Beach, LaGrange, IL 60525. (312) 354-4350.



Circle 174 on reader service card

1977 Answer Book. It makes your job easier. \$25.

Who makes what? Over 4000 products, more than 5000 manufacturers with their local contracts and distributors, directory of trade names and catalogs, post-paid inquiry cards for 5-second ordering of current catalogs.

Electronics Buyers' Guide
1221 Ave. of the Americas
New York, N.Y. 10020

Yes, send me a copy of The Answer Book. I've enclosed \$25 (USA and Canada only, elsewhere send \$35). Full money back guarantee if returned within 10 days.

Name _____
Company _____
Street _____
City _____ State _____ Zip _____

**Electronics
BUYERS'
GUIDE**

New products

offers a typical VSWR of 1.05 at 1 gigahertz. For the model 8740 jack, the VSWR rises to 1.28 at 40 GHz, while for the model 8741 plug, it goes to only 1.25 at 40 GHz. The terminations cover dc to 40 GHz and sell for \$59 each in small quantities.

Kevlin Manufacturing Co., 26 Conn St., Woburn, Mass. 01801. Phone Ernest W. Lattanzi at (617) 935-4800 [404]

Varactor-tuned oscillator puts out 50 mW at 9 GHz

Intended as a replacement for klystron local oscillators, a series of varactor-tuned Gunn-diode oscillators provides more than 50 milliwatts over the frequency band from 8.5 to 9.6 gigahertz. The oscillators,

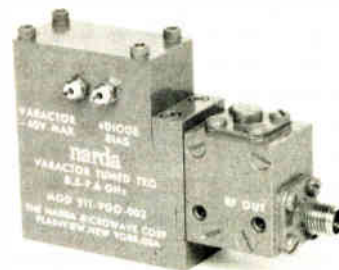

which exceed the requirements of MIL-E-5400, are expected to find applications in electronic warfare systems and fire-control equipment. They can be tuned at a rate of 1 GHz per second when the built-in varactor is driven from a 100-ohm source. Narda Microwave, Plainview, N.Y. 11803. Phone J.P. Schindler at (515) 433-9000 [406]

Four-way uhf power divider withstands opens and shorts

The model FP2066-3 four-way power divider is a medium-power device that safely dissipates any power that may be reflected from its outputs when the average input power level is no more than 91 watts and the peak input power level is a

Weed 'em out before you plant 'em...

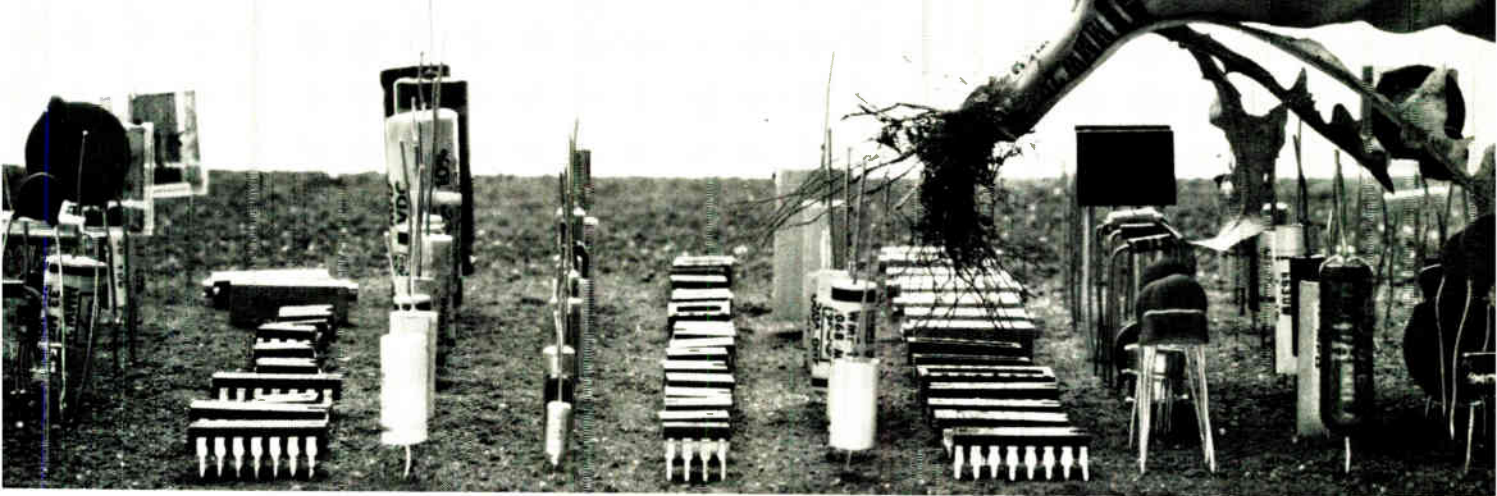

Low volume component testing with the ESI family of "Easy Weeders."

Now Test Resistors, Capacitors and Inductors the Way They Are Specified: + or - % Tolerance.

This high performance Impedance Meter combines with our newest Universal Comparator to create a low cost, fast sorting system and GO-NO GO testing. The Model 251 measures R, L, C and G at 0.25% accuracy. The Model 1412B Comparator offers limits from -100% to +100% or -10.00% to +10.00%. Makes incoming inspection fast, easy, reliable and accurate. Prices: Universal Comparator Model 1412B, \$980; Digital Impedance Meter Model 251, \$1400; Test Fixture Model 1304 (four terminal), \$105.

New Microprocessor R, L, C Meter with D, Q and ESR

Everything you could want in programmable impedance testing—the Model 296 starting at \$4700. Dual 4½-digit displays of C/L and D/Q; dual frequencies of 1 kHz and 120 Hz; wide ranges (C to 200,000 microfarads); 0.1% basic accuracy; autoranging; selectable test voltages; measurement speed as low as 100 milli-seconds; many low cost options such as GPIB interface,



multiple limits and % deviation. Select function, range, voltage, frequency on 24-button panel, or program it remotely.

Linear IC Tester

Model 1234. Devices tested: Monolithic or Hybrid Operational amplifiers. Tests performed: E_{135} , I_{B-} , I_{B+} , DC open loop gain, DC CMRR, oscillation detection. Remarks: 3-digit direct reading digital display which enables GO-NO GO testing. Price: \$1265.

Digital IC Tester

Model 1248. Devices tested: 14 and 16 pins. TTL, DTL and CMOS @ 5V. Tests performed: Fixed pattern, dynamic functional test. Performs 2²⁰ inspections per test in from 1 to 5 seconds. No comparison with a "good" IC is necessary. 4-digit display gives absolute test results. Can also be used to check continuity of resistor network. Price: \$725.

Digital IC Tester

Model 1249. Devices tested: TTL, DTL @ 5V, HTL @ 15V, CMOS @ 5V, 10V, 15V. Tests performed: Same as 1248. Interfaces with manual and automatic handlers. Multiple voltages for CMOS. Price: \$1325.

Prices U.S. only.



Electro Scientific Industries
13900 N.W. Science Park Drive
Portland, Oregon 97229
(503) 641-4141

For Literature requested circle 175
For Demo requested and EEM number circle 110

Closeout Capacitor Sale!

POSITIVELY YOUR LAST CHANCE FOR FABULOUS VALUES
... NAME BRANDS ... NO MORE WHEN THESE ARE GONE
NO BACK ORDERS ... ALL SALES FINAL

PRECISION 10-TURN COUNTING DIAL FOR 1/4-INCH SHAFT

Stock No.	TRW Type	Clardial Type	Description	Qty. Avail.	Was	Sale Price EACH
822-0462	RD-462	462	Clear Finish w/Locking Mechanism	1373	11.36	6.41



TYPE RMC LOW VOLTAGE MAGNACAPS*

Stock No.	Mallory Type No.	Cap. MFD.	WVDC	Qty. Avail.	Was	Sale Price EACH
852-8020	MAG1215	.05	12	2,932	.18	.05
852-8021	MAG1201	1	12	15,094	.18	.05

TYPE MTV MOLDED ELECTROLYTIC CAPACITORS (WITH RADIAL LEADS)

852-3013	20CB50	20	50	864	.49	.09
852-3018	50CB15	50	15	5,603	.49	.09
852-6690	70DJ75	70	75	500	.61	.09
852-6691	1CB100	1	100	475	.47	.09

TYPE CS13 SOLID TANTALUM CAPACITORS

852-0231	BB565K	5.6	6	500	.68	.19
852-0234	BF825K	8.2	35	300	.68	.19
852-0556	BF275KL	2.7	35	344	1.00	.29
852-0717	BB337K	330	6	400	2.88	.49
852-1308	BB157M	150	6	987	1.60	.39

TYPE TAS SOLID TANTALUM CAPACITORS

852-1168	105K035POA	1	35	16,507	1.27	.29
852-5510	106K010POC	10	10	237	1.27	.29

TYPE CL65 LIQUID ELECTROLYTIC TANTALUM CAPACITORS

852-1065	BG181KPE	180	25	549	5.88	1.99
852-1079	BN220KPE	22	100	245	3.75	.99
852-1403	BG101KPE	100	25	80	3.75	.99
852-4105	BG391KPE	390	25	324	5.88	1.99

TYPE TCG TUBULAR COMPUTER GRADE CAPACITORS

852-5137	501U010DIA	500	10	247	2.03	.49
----------	------------	-----	----	-----	------	-----

TYPE FP METAL CAN TRIPLE ELECTROLYTIC CAPACITORS

852-1833	377.1A	40-40-40	450-450-450	350	4.23	.99
----------	--------	----------	-------------	-----	------	-----

TYPE TC TUBULAR ELECTROLYTIC CAPACITORS

854-9110	81A	10	500	200	82	.29
----------	-----	----	-----	-----	----	-----

AIR DIELECTRIC TRIMMERS

Stock No.	All-Star Type No.	Cap. pF	Length Inches	Shaft Dia.	Shaft Extends	Qty. Avail.	Was	Sale Price EACH
695-2100	APC 5814	3.7-35.2	1 3/4	1/4"	3/4"	437	5.65	2.82
695-3500	APL 5820	139.8-145.9	2	1/4"	1/2"	374	7.00	3.50

TYPE 30 PADDERS

Stock No.	Arco Type No.	pF Min-Max	Size, (In.) Dia x L.	WVDC	Qty. Avail.	Was	Sale Price EACH
782-0306	306	170-275	7/8x1 1/16	250	490	2.58	1.29
782-0313	312	880-2330	7/8x1 1/16	250	511	3.63	1.81
782-3712	311	780-2110	7/8x1 1/16	250	1,424	3.35	1.67

SIX STOCKING LOCATIONS FOR TOTAL SERVICE ...

GARDEN GROVE, CA 92641
12311 Industry St.
(714) 894-7581

SANTA CLARA, CA 95050
3160 Alfred St.
(408) 985-2323

FORT WORTH, TX 76102
401 East 8th St.
(817) 336-5401

ELGIN, IL 60120
1355 McLean Boulevard
(312) 697-8200

WILMINGTON, MA 01887
845 Woburn St.
(617) 942-0150

LANDOVER, MD 20785
3705 West St.
(301) 773-6556

Write Fort Worth Location for FREE 1977 Engineering Manual and Purchasing Guide

ALLIED ELECTRONICS

A DIVISION OF TANDY CORPORATION

New products

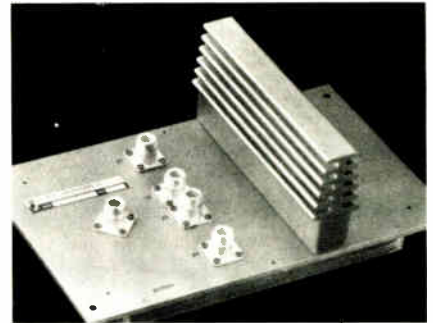

maximum of 365 w. The divider, which operates over the frequency range from 420 to 450 megahertz, provides equal-amplitude in-phase power division among its four outputs. Typical performance features include a maximum insertion loss of 0.2 decibel, a maximum vswr of 1.1, and a minimum isolation between ports of 30 db. In small quantities, the FP2066-3 sells for \$500. Delivery time is about 60 days.

Sage Laboratories Inc., 3 Huron Drive, Natick, Mass. 01760. Phone Tony Cieri at (617) 653-0844 [405]

Tubular band-pass filters cover 2.0 to 12.4 GHz

The HWF series of half-wave tubular band-pass filters are available with center frequencies from 2.0 to 12.4 gigahertz. Intended for use in radar and communications systems, they are fabricated utilizing three to



six sections with 3-db bandwidths from 2% to 15% of the center frequency. Maximum vswr is 1.5, and power rating is 10 watts. The filters are constructed in 0.75-inch tubing and are offered with type N, TNC, or SMA connectors. Prices start at \$150 in unit quantity.

RLC Electronics, Sales Dept., 83 Radio Circle, Mt. Kisco, N.Y. 10549 [407]

Macrodyne fills the megahertz gap.

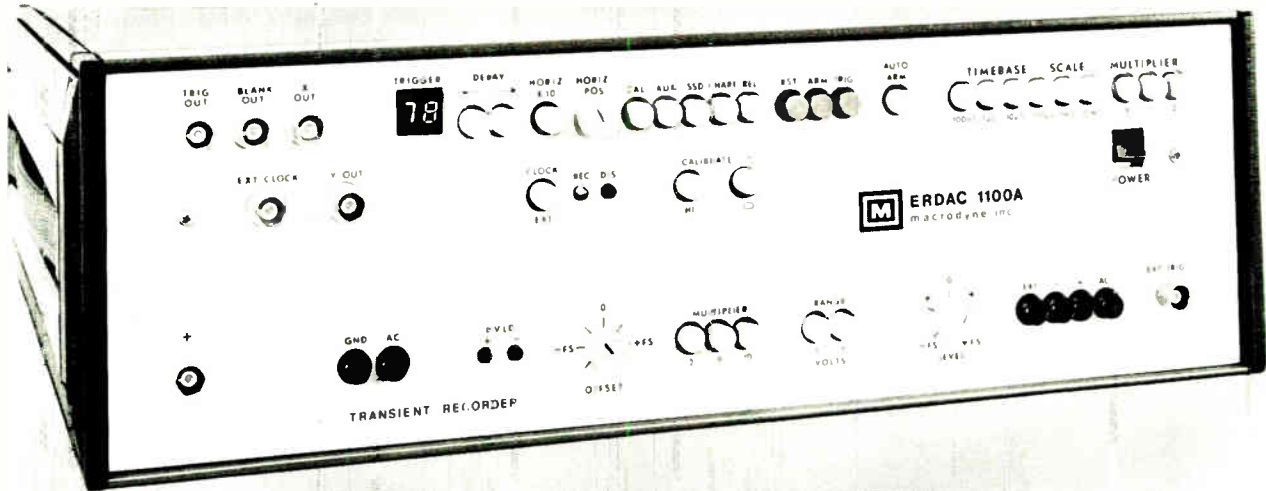

The ERDAC 1100 True 8-bit A/D and storage at 20 MHz. Now at a reasonable price.

Macrodyne's new model 1100 transient recorder now provides the user the capability to monitor transients at a 20 MHz rate for a reasonable price. In fact, the Macrodyne ERDAC 1100's price/performance ratio is twice that of competitive models.

The unique A to D converter is the heart of the ERDAC 1100. Accuracy is unsurpassed and resolution is .4%. That's performance you can count on.

The Macrodyne 1100 provides repetitive outputs in analog form for analysis on display devices. Plus, the 1100 has pre-triggering and post-triggering abilities up to 8900 points. And, a storage capacity of 1024 words, with additional capacity available. The 1100 also provides the optional flexibility for computer control and digital output.

Reliability is assured by Macrodyne's performance in the industry. We back our products with a full one-year guarantee and the excellence of service which has come to be synonymous with

Macrodyne. Drop us a line today or give us a call. We'd like you to discover how the Macrodyne ERDAC 1100 can solve your transient measuring requirements.

Tell me more.

Name _____

Title _____

Company _____

Address _____



macrodyne, inc.

1900 maxon road • p.o. box 1079 •
schenectady, n.y. 12301 • 518/372-5619

SABRE X is Here!

Your ten best reasons for buying it are benefits no other tape recorder/reproducer provides

1. Programmable microprocessor control of tape speeds, operating modes, monitor/alarm and other diagnostic testing functions
2. Tape transport with ten speeds from 240 to 15/32 ips
3. 2⁹ time base expansion and/or contraction ratios
4. 10-speed switchable all-band Direct channel electronics
5. 10-speed switchable all-band FM channel electronics
6. 6 megabit digital data processing per track
7. Usable Direct/FM/Digital channel electronics at 240 ips
8. 88.8 hour record time per tape reel — the industry's longest
9. 4.0 MHz/Track direct Record/Reproduce system
10. The same manufacturing excellence that has made Sangamo a leader in tape recorders for over 16 years

IRIG tape recording/reproduction was never like this. But then, that's the whole point of SABRE X: pushing back the horizons of *our* technology to help you push back yours. We know your needs. So we've given you still more features, including serial

and/or parallel high density electronics, vacuum tape tensioning and modular design. We've made it easy to customize the unit with options ranging from coded computer control, data monitoring and a voice/time code to a tape servo and remote control. We've freed you for virtually unlimited applications, including data reduction, deep space, satellite and space networks, mass data storage and security. We've got your number: SABRE X.

For additional information, call or write:

Sangamo Weston, Inc.
Sangamo Data Recorder Division
P.O. Box 3347
Springfield, Illinois 62714
TEL (217) 544-6411

SANGAMO WESTON

Schlumberger

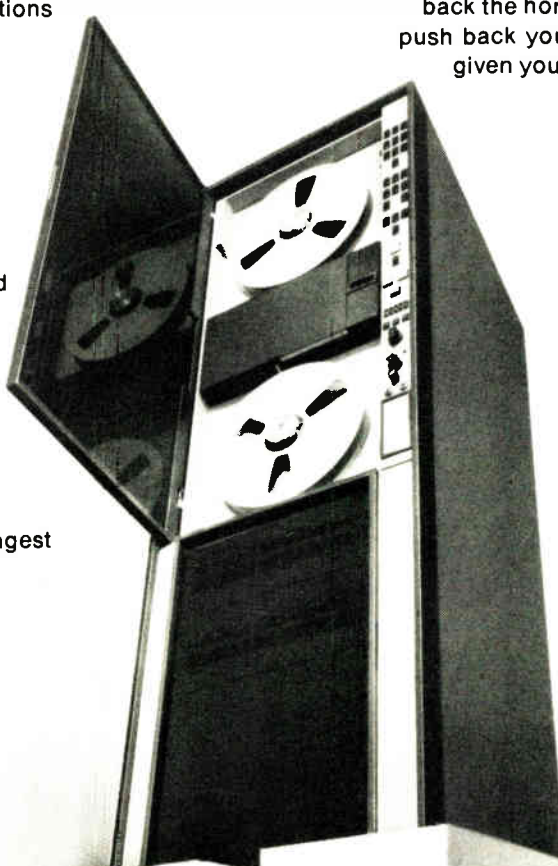

SABRE X

Perkin-Elmer Ultek announces the System 4400, first complete and versatile sputtering system big enough to handle the production throughput needs of semiconductor process people.

Greater throughput of wafers in a uniform and repeatable sputtering process translates instantly into more wafers per dollar. Which is the name of the game.

Our new 4400 Sputtering System, designed for aluminum, AlSi and AlSiCu metallization work, will typically deposit metal on 105 3-inch or 50 4-inch wafers per hour. Step coverage

and uniformity ($\pm 5\%$) are excellent because our annular table rotates the wafers continuously.

The 4400 can perform operations with three different targets in any of its five operating modes—RF deposit, RF bias, RF etch, RF magnetron, DC magnetron—*without ever coming to air.*

Three 8-inch cathode positions are standard. And you can have three-way power splitting for metal alloying.

From atmosphere to 5×10^{-7} Torr takes only 3 minutes. A Meissner trap in the sputtering chamber itself helps; so does a new cryopump that eliminates backstreaming.

Write for complete specs.
Perkin-Elmer Ultek Inc., P.O. Box 10920,
Palo Alto, CA 94303
(415) 967-2100.

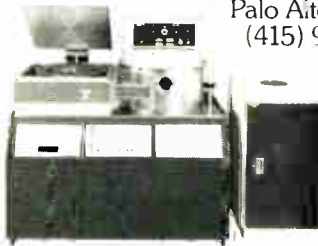

**PERKIN-ELMER
ULTEK INC.**

PRODUCTION SPUTTERING



A single pallet can load 30 3-inch or 14 4-inch wafers into our fast-pumpdown Load Lock.

Circle 179 on reader service card

MS-190 Removes Flux Fast



SAFELY! EFFICIENTLY! ECONOMICALLY! MS-190 and MS-190HD (Heavy Duty) flux removers clean up flux quickly, completely, without harm to components. Used with patented Cobra Solvent Spray Brush (illustrated), the aerosol solvent is converted into an accurately directed, metered spray combined with scrubbing action of the brush for maximum cleaning with minimum waste. Risk of contamination (as in "dip" method) is eliminated. Nonflammable.

Thousands of electronics firms use these highly effective products routinely. You will too, once you've tried them.

SEND \$5 FOR TRIAL PACK

One 16 oz. can MS-190; one Cobra Solvent Spray Brush. Money back if not satisfied.

**ms miller-stephenson
chemical co., inc.**

Danbury, Connecticut 06810 (203) 743-4447

Enclosed is my check for \$5. Please send Trial Pack.

Please send me data and prices on MS-190, MS-190HD and MS-226 (Cobra Solvent Spray Brush).

Intended Use _____

Name _____ Title/Dept. _____

Company _____

Address _____

City _____ State _____ Zip _____

Since our products are For Industrial Use Only, government labeling regulations prevent our sending these trial units to your home address.

LOS ANGELES · CHICAGO · DANBURY, CONN · TORONTO

Circle 180 on reader service card

World Radio History

1702A MANUAL EPROM PROGRAMMER

Features hex keypad, two digit hex address and two digit hex data display. Controls include load, clear, go! (step), key/copy, data in/data out, and counter up/down. Profile card includes high voltage pulse regulator, timing, 8 bit address and 8 bit data drivers/receivers. Two 6½" x 9" stacked cards with spacers. Allows programming in 20 minutes - copying in 5 minutes. Requires +5, -9, and +80 volts.

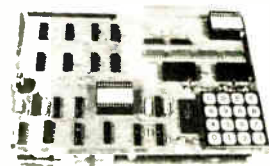

ASSEMBLED \$299.95
KIT \$189.95

NOW

The best of two worlds... use our 1702 EPROM programmer as a manual data/address entry programmer... or connect it to your processor.

IMSAI/ALTAIR computer interface (requires 3 output ports, +1 input port) and software \$49.95

Briefcase unit with power supplies and interface connectors (assembled and tested only) \$599.95

ANNOUNCING

Our NEW 16K Byte Pseudo-Static, IMSAI/ALTAIR compatible RAM. Single card slot. Uses less power than equivalent low power RAM. All memory chips socketed. Uses all prime, factory fresh ICs. High quality, two-sided, through-hole-plated circuit board. Crystal controlled, totally invisible refresh system requires NO software management. Just plug it in and use like STATIC memory.

Complete kit \$349.95

Assembled, tested, and burned in \$549.95

ASSOCIATED ELECTRONICS

12444 Lambert Circle • Garden Grove, CA 92641
(714) 539-0735

Circle 256 on reader service card

Paying More Than \$295 For Waterproof Load Cells?



Why?

Designing electronic weighing, force measuring or test systems for all weather use? You won't find a price this low for any other waterproof and barometrically insensitive strain gage load cell—especially one offering an error band of less than ±0.04%!

Buy a definite competitive edge in price and performance with Sealed Super-Minis that operate in tension or compression—with capacities to 1,000 pounds.

For detailed specifications on 5 pound to 100 ton capacity load cells, call—write Interface, 7401 E. Butherus Dr., Scottsdale, AZ USA 85260. (602) 948-5555, Telex 668-394.



Low Profile



Minibeam



Super-Mini

interface
ADVANCED FORCE MEASUREMENT

Circle 257 on reader service card

"Should you make or buy control assemblies?"

We can simplify the decision.

It all boils down to dollars and cents. And the best way to make a business decision is to compare our quotation for making your next customized control assembly against your true cost of making it in-house.

Keep in mind the sizable capital outlay involved to turn out that first assembly if you do the job internally. Specialized production equipment. Assembly tools. Test equipment. People. Floor space. Additional inventory. You could tie up as much as \$100,000 just to set up.

On the other hand, if we make your control assembly you have none of the initial

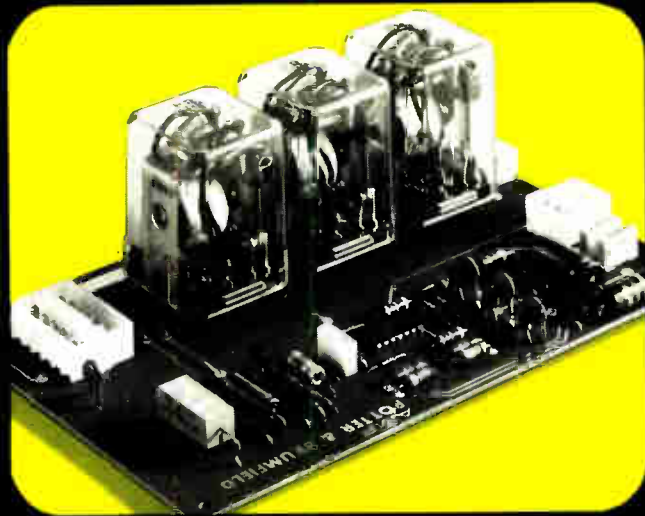

costs. You take advantage of our experience and purchasing discounts. We produce thousands of control assemblies every month. We have the people, the production and testing equipment. We can deliver any number of assemblies to any schedule you require. All 100% functionally tested. Before you decide to do it yourself see your local P&B sales

representative or contact Potter & Brumfield Division of AMF Incorporated, 200 Richland Creek Drive, Princeton, Indiana 47671. 812/386-1000.

AMF
Potter & Brumfield

Potter & Brumfield



Wide Band, Precision **CURRENT MONITOR**

With a Pearson current monitor and an oscilloscope, you can measure pulse or ac currents from milliamperes to kiloamperes, in any conductor or beam of charged particles, at any voltage level up to a million volts, at frequencies up to 35 MHz or down to 1 Hz.

The monitor is physically isolated from the circuit. It is a current transformer capable of highly precise measurement of pulse amplitude and waveshape. The one shown above, for example, offers pulse-amplitude accuracy of +1%, -0% (typical of all Pearson current monitors), 10 nanosecond rise time, and droop of only 0.5% per millisecond. Three db bandwidth is 1 Hz to 35 MHz.

Whether you wish to measure current in a conductor, a klystron, or a particle accelerator, it's likely that one of our off-the-shelf models (ranging from 1/2" to 10 3/4" ID) will do the job. Contact us and we will send you engineering data.

PEARSON ELECTRONICS, INC.

4007 Transport St., Palo Alto, CA 94303, U.S.A.

Telephone (415) 494-6444

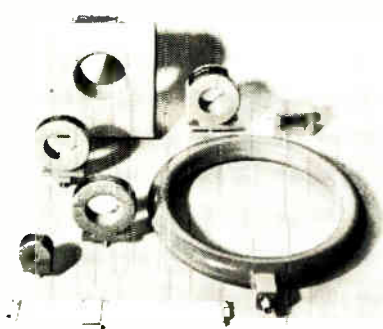

New products

Packaging & production

Unit bonds ICs to substrates

Machine is part of system
for building hybrid circuits
using tape-mounted chips

Bonding tape-mounted integrated circuits to ceramic or other substrates is now an established technique for building multichip assemblies at several large mainframe computer houses [*Electronics*, March 17, p. 90]. However, these large firms have all designed their own equipment for this complex task. The Jade Corp. is now making these techniques available to smaller companies with its low-cost family of machines, which it has designated Massbond Systems.

The series 4800 systems are a family of microassembly machines

that test chips still on the tape carrier, excise the chips from the tape, form the leads, and then bond the chips to a substrate using either reflow soldering or thermocompression bonding.

Currently available is the model 4800 bonder, shown in the photo. This machine takes chips, which have been previously tested, excised, and formed, and bonds them to a substrate. Three earlier machines from Jade test chips on tape (model 5300), excise chips from the tape (model 5100), and from leads (model 4900).

Late this summer, the model 4810 will be introduced. It will combine the functions of the 4800, 4900, and 5100, but not those of the 5300. Production rate of the 4810 will be from 75 to 125 ICs per hour bonded to substrates. A higher-throughput version of the 4810 is already under development.

The model 4800 sells for between \$19,000 and \$20,000 depending upon its exact configuration. The 4810 will be priced between \$25,000

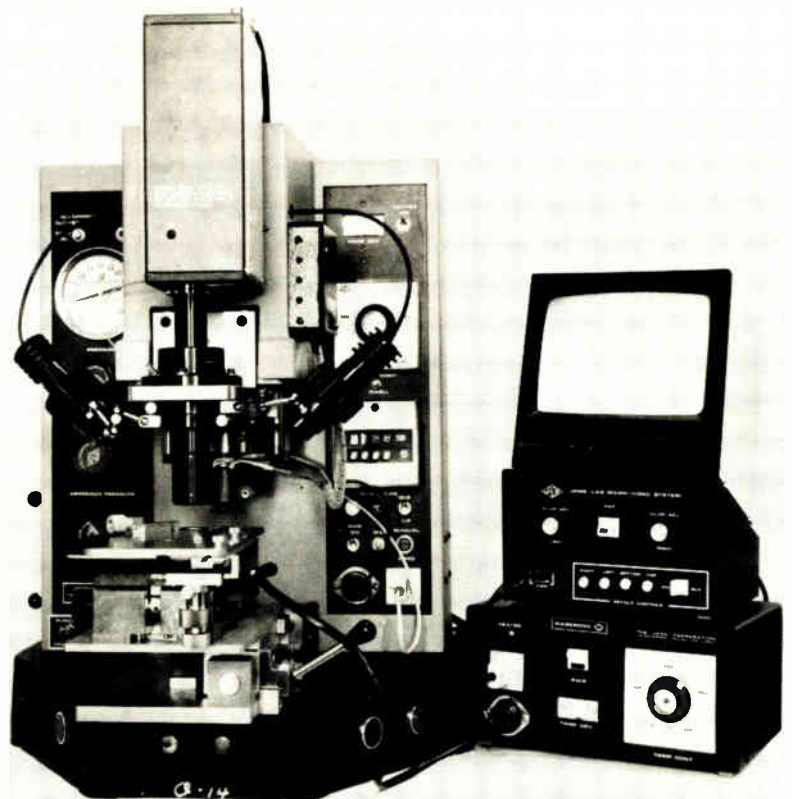

When you need LEDs or more than LEDs...



Dialight is the first place to look. We can help you do more with LEDs... because we've done more with them.

Discrete LEDs come in a variety of sizes, shapes, colors (red, yellow, green in clear or diffused), with or without built-in resistors.

Low cost logic state fault indicators for trouble shooting complex circuits. Designed for close density PC board mounting.

High-brightness bi-color LEDs (red/green) suitable for go/no-go situations. Designed with unique

lenses for the extra visibility you'll want for your most critical applications.

Snap-in mounting LED indicators reduce labor cost. Available in red, yellow or green with or without built-in resistors.

Whatever you need in LEDs, Dialight's probably got it already. For your free 60-page selector guide and listing of our nationwide stocking distributors, contact us today.

DIALIGHT

A North American Philips Company

Dialight meets your needs.

Dialight, 203 Harrison Place, Brooklyn, N.Y. 11237 (212) 497-7600

Circle 183 on reader service card

Unlike beer, tires,
and Italian actresses,
C&K's Flatted Toggle
Switch is appealing
because it's flat.

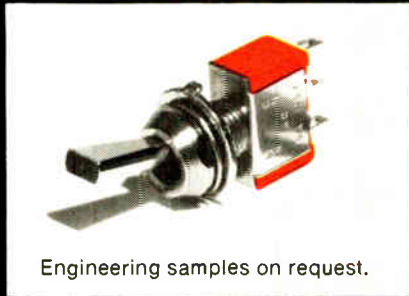

Engineering samples on request.

It's also competitively priced, made in America for rugged high-quality performance, and available in SPDT, DPDT, 3PDT and 4PDT models. A sleek, modern-looking visual design element that's as flat as Twiggy.

For more information, contact:
C&K COMPONENTS, INC.,
103 Morse St., Watertown, MA 02172
Tel: (617) 926-0800. TWX: 710-327-0460
TELEX: 92 2546

"Visit C&K at Nepcon East, Booth 341"

Circle 184 on reader service card

New products

and \$40,000 when delivery begins. The Jade Corp., 3063 Philmont Ave., Huntingdon Valley, Pa. 19006. Phone (215) 947-3333 or twx 510-665-5460 [391]

Board plugs into Intel SBC 80/10 computer system

A microprocessor interface panel compatible with the Intel SBC 80/10 computer system accepts any combination of dual in-line package sizes up to 40 leads. The universal wire-wrap panel has 36 rows of 50 contacts. Power distribution is by

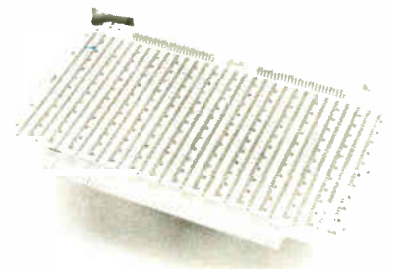

means of large planar areas outside of the main contact area for minimum coupling between power and signal lines.

Augat Inc., 33 Perry Ave., P.O. Box 779, Attleboro, Mass. 02703. Phone (617) 222-2202 [393]

Compact system connects lead frames to hybrid

The Comatel 1500 manually operated production system is a 15-pound portable machine designed to connect lead frames to hybrid circuits. It consists of a cutting tool

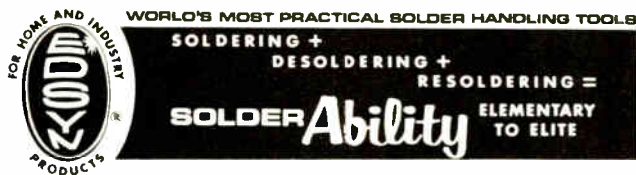
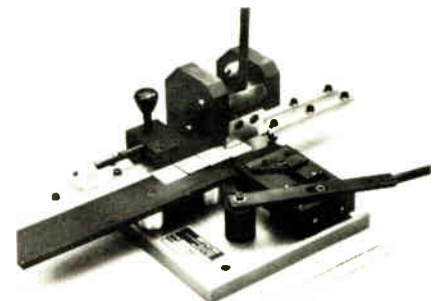

ATMOSCOPETM DIP EXTRACTOR DE180

QUADRAMATIC Action
allows YOU to remove a DIP
from SIDES or ENDS *with the skill of a Surgeon!*



Used with the LONER Soldering Instrument to remove 14-16 point DIP (Dual Inline Pin) components from circuit boards. Several types and shapes can be easily removed in seconds, depending on type of tip being used. The DE 180 DIP Extractor can also be used separately as dual axis hand tongs.

contact your local **DISTRIBUTOR** inquiries invited

Covered by U.S. and Foreign Patents and Pending Applications



**Workers. They've always been with us.
But Magnecraft has a colony of DIPs
that really perform dependably.**

Write for our new DIP Catalog

Magnecraft[®] 5575 North Lynch Avenue, Chicago, IL 60630 312/282-5500
ELECTRIC COMPANY

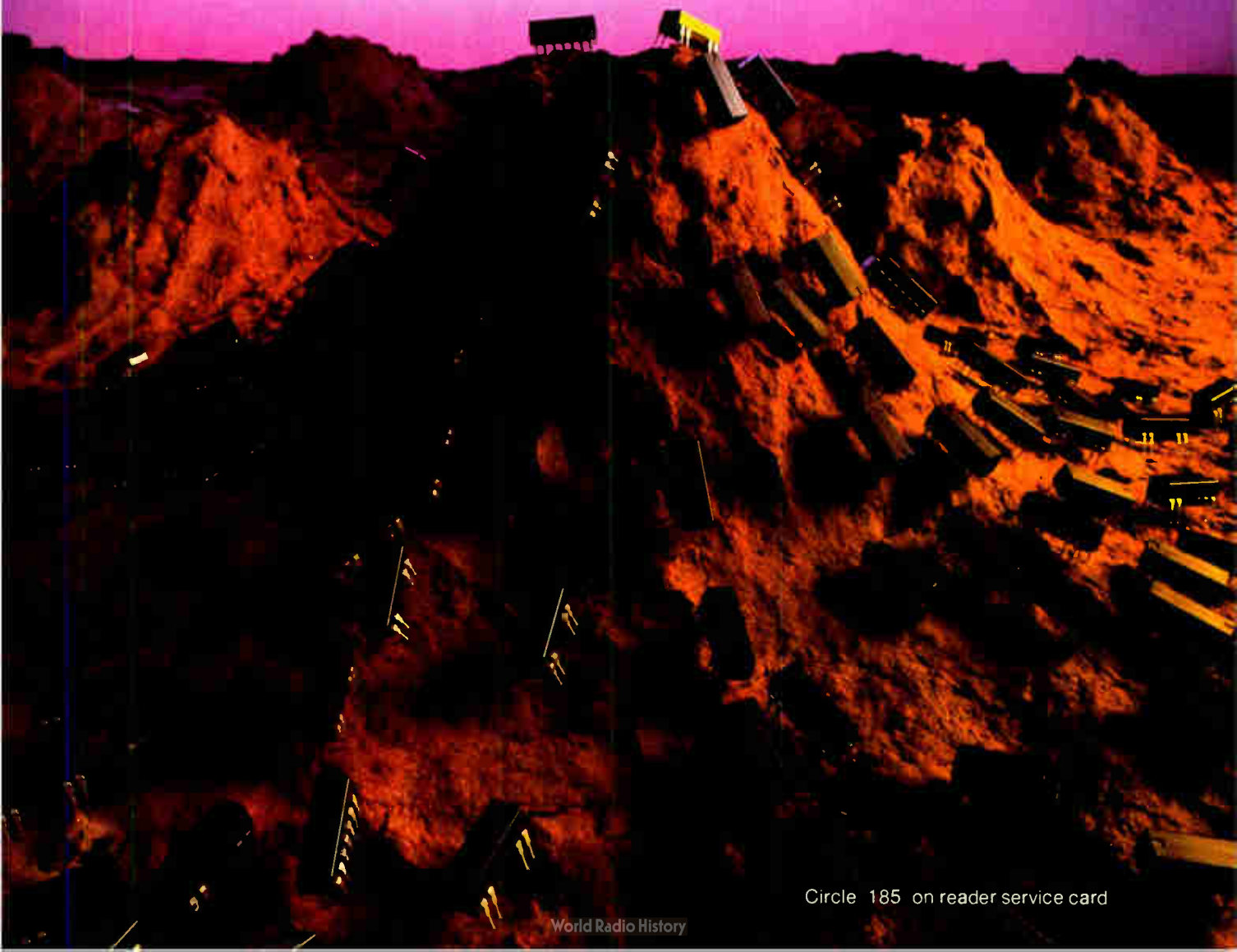

Circle 185 on reader service card

ME434A/B/C

Meets INTELSAT and other international standards

Extensive IF coverage, 35-105MHz

0.1dB/cm sensitivity for amplitude measurements

0.3ns/cm sensitivity for group delay measurements

0.1°/cm sensitivity

for differential phase measurements

Comprehensive BB frequency range,

83.333kHz-12.39MHz

Wideband sweep for simultaneous measurement
of inside and outside bands

Loopback and end-to-end measurements

Wide 20dB dynamic range

Easy readout of comb marker (1,5 and 10MHz)

Simple measurement
of AM-PM conversion coefficient

Lightweight and compact for space-saving installation

Also available:

140MHz-band ME515A/B/C and 70/140MHz dual-band ME525A/B/C

**Everything you expect
from
a microwave system analyzer.**

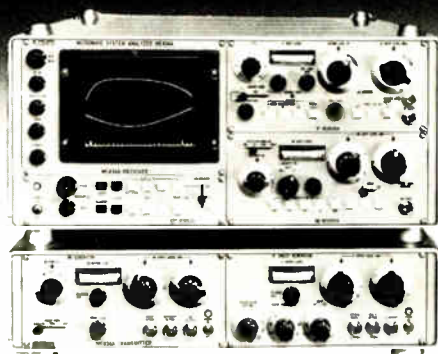

ME434A

Anritsu

ANRITSU ELECTRIC CO., LTD.

MEASURING INSTRUMENTS DIVISION

SALES DEPARTMENT:

12-20, Minamiazabu 4-chome, Minato-ku, Tokyo 106, JAPAN
Phone: (03)446-1111/Telex: 0-242-2353

U.S.A. Tau-Tron Inc. Tel: (617) 667-3874 • West Germany Knott Elektronik GmbH Tel: (08178) 4085 • England Dymar Electronics Limited Tel: Watford 37321 • France Tekelec Airtronic Tel: (1) 946-96-48 • Italy Vianello S.p.A. Tel: 544041 • Sweden Teleinstrument AB Tel: 08-38 03 70 • Singapore O'Connor's (Pte.) Ltd. Tel: 637944 • Malaysia O'Connor's SDN. BHD. Tel: 51563/5 • Australia NEC Australia Pty. Ltd. Tel: Melbourne 560-5233

186 Circle 186 on reader service card

New products

for slicing the side band that holds the contacts, a holding block for securing the ribbon contacts in position during the cutting and inserting sequences, a carriage for advancing the connector strip after substrate insertion, and an exit slide for the finished assembly.

The unit, which will operate only with EMCA Comatel lead frames, can be used to insert leads on one or both edges of the substrate. System throughput, which depends, of course, on the proficiency of the operator, is approximately 360 assemblies an hour. The Comatel 1500 sells for \$950 and has a delivery time of two to four weeks.

Electro Materials Corp. of America, 605 Center Ave., Mamaroneck, N.Y. 10543. Phone George Lane at (914) 698-8434 [394]

Automatic tester

handles 16-pin devices

The LTS/5, which was introduced at Electro77 in New York last month, is an automatic test system specifically aimed at linear (analog) integrated circuits. Although it was originally intended to test such ICs as operational amplifiers, comparators, voltage regulators, and various interface devices, its flexible programming language makes it equally suitable for testing diodes, discrete transistors, analog-to-digital and digital-to-analog converters, and virtually any IC or assembly that has 16 or fewer active pins. Measurement time



Electronics/May 12, 1977

AVX is number 1 in ceramic capacitor efficiency.

AVX offers electronics manufacturers the most capacitor performance at the lowest total cost. That's why we've been building greater reliability into all our multilayer ceramic capacitors. Why we've developed new designs to hold down product cost. And why we package our products for low-cost automatic insertion on our customers' assembly lines.

New product designs include SpinGuard®, a conformally coated axial capacitor that offers multilayer ceramic performance at a lower price. And DIPGuard®,



our new two-pin dual-in-line ceramic multilayer for automatic insertion by the same equipment that inserts IC plastic packages.

Better packaging includes our complete line of taped and reeled capacitors. You can order molded, conformally coated, or glass encased axials, even disc capacitors reeled to your specification, ready to run on your auto-insertion equipment.

AVX quality, plus innovative designs and auto-insertion packaging make AVX products the most efficient capacitors you can put inside your products. Why else would AVX be Number 1 in ceramic capacitor sales.

AVX Ceramics, P.O. Box 867, Myrtle Beach, SC 29577 (803) 448-3191
TWX: 810-661-2252; Olean, NY 14760
(716) 372-6611 TWX: 510-245-2815
AVX Limited, Aldershot, Hampshire, GU12 4RG England, Tel: Aldershot (0252) 312131 Telex: 858473

AVX: The Insiders

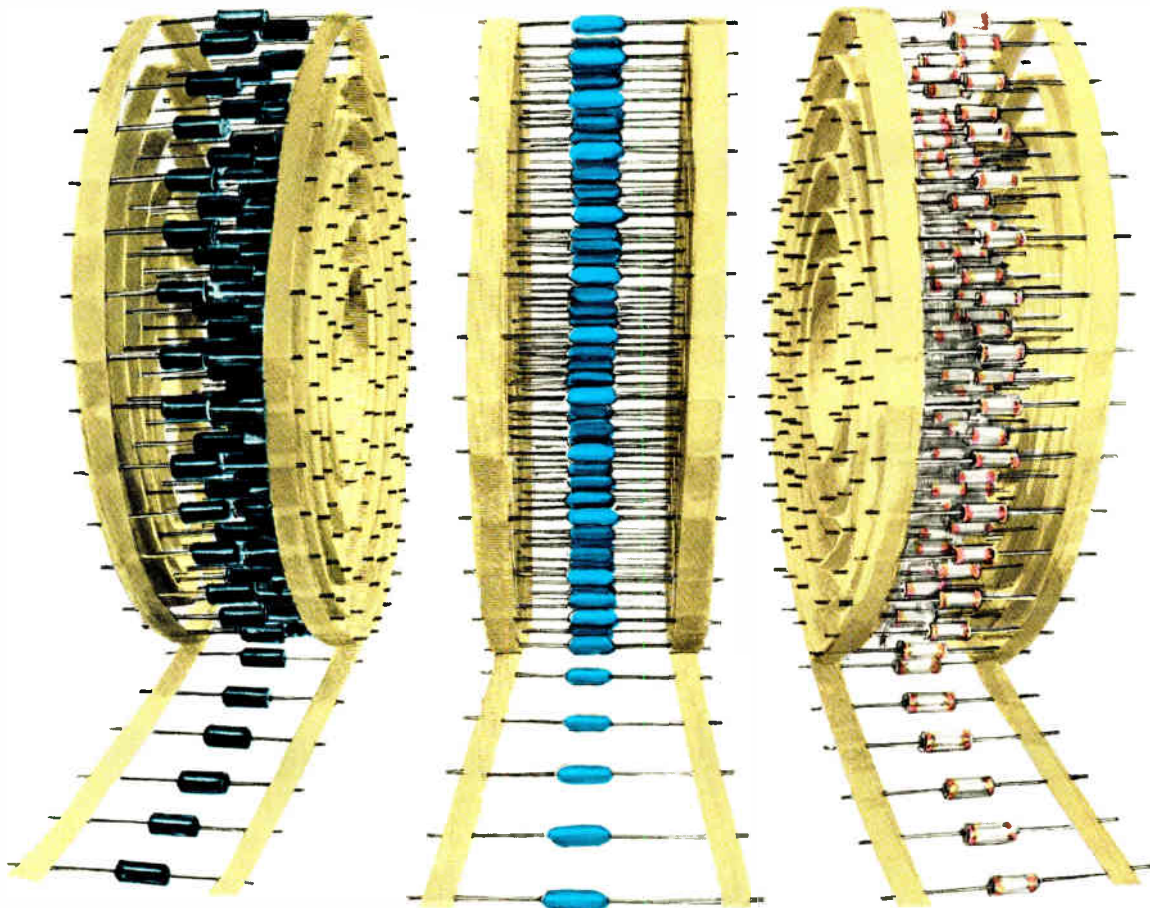

OEM PRICES REDUCED!
 NOW AVAILABLE
 FOR \$99 to \$140 EACH IN
 OEM QUANTITIES. (100-1000)

MODEL DE/200 DISPLAY

EACH CHARACTER POSITION
 DIRECTLY ADDRESSABLE



- Versatile Fluorescent Technology. Complete with interface, drive and refresh electronics.
- Readable up to 20 feet, even under high ambient light conditions.
- 20 alphanumeric character positions.
- Instantaneous display changes. No line shift.
- 14 segment, starburst character design, plus period and comma. All uniformly bright and sharp.

*For Readability, Striking Appearance,
 and Cost-Effective Design*

DE DIGITAL ELECTRONICS CORPORATION
 415 PETERSON STREET, OAKLAND, CALIFORNIA 94601 • (415) 532-2920

Circle 188 on reader service card

New products

is a speedy 40 microseconds.

Controlled by a PDP-11 computer, the test system uses a full Kelvin 8-by-16 switching matrix to connect its stimulus and measuring instrumentation with the appropriate pins of the device under test. Its programmable voltage and current sources are accurate to within 0.1%, while its measurement uncertainty is only 0.05%. A wide variety of hardware and software options, such as wafer probers and a statistical analysis program, are available. Pricing on the LTS/5 ranges from \$75,000 to \$150,000 depending upon options. Lorlin Industries Inc., Precision Road, Danbury, Conn. 06810. Phone (203) 744-0096 [395]

Circuit-board design system runs on a minicomputer

An automatic printed-circuit-board design system is capable of running on any Data General minicomputer that supports RDOS, is outfitted with hardware multiply and divide, and has 32 kilobytes of main memory. It provides fast, fully documented designs for boards holding up to 300 logic devices. Called the Version VIII, the system is offered as either a software package (for users who already own the necessary computer equipment) or as a hardware/software combination. Prices start at \$62,000 for the software only and go up to \$115,000 for a full-blown system.

Among the functions performed



ERASE EPROMS IN MINUTES . . .

Why Wait?

Completely erase your EPROMS fast and efficiently . . . in minutes! Two high intensity systems provide powerful ultraviolet energy. Designed especially for EPROM erasing, they're the UV sources recommended by EPROM manufacturers and users.



The S-52T is the fastest, most powerful UV erasing system. The UVS-54T is a versatile, economical system. Both are equipped with a stand and timer, or can be hand held for on-the-spot erasing.

Call your authorized UVP EPROM lamp dealer today, or write the factory for additional information.

ULTRA-VIOLET PRODUCTS, INC. 
 5100 Walnut Grove Ave. • San Gabriel, CA 91778

Guildline Introduces the only 14 Million Count DVM on the Market Today



Guildline's radical 7-1/2 digit precision digital voltmeter, Model 9577 features standards laboratory accuracy and stability. The 9577 is equally at home on the work bench or in a system application via programmable BCD or IEEE Standard 488.

FEATURES:

- Capability — DC volts, AC (rms) volts, ohms, and ratio
- 0.0004% DC accuracy • Resolution — 1 μ v on 10 volt range
- 20ppm per year stability
- Self-Check via front panel or system mode
- 500 readings per second
- > 1000G Ω input resistance • Digital Filtering



\$3,995.00



Guildline Instruments, Inc.

1997 PALMER AVE., LARCHMONT, NEW YORK 10538 (914) 834-8100

Choose from the great family of HP strip chart recorders.

Hewlett-Packard, the great name in strip chart recorders, lets you choose from a complete family of high quality models. With proven performance in both laboratory and field, the HP recorder family includes general purpose lab recorders, battery operated portables, models with interchangeable plug-in signal conditioners, and recorders specifically designed for OEM users. Select from a wide choice of writing systems; capillary ink, disposable pen, thermal or electric. Operate them anywhere with confidence because HP recorders are backed by a worldwide sales and service organization. Send for complete technical details on the premium quality line from Hewlett-Packard, the great family of strip chart recorders. OEM discounts available.

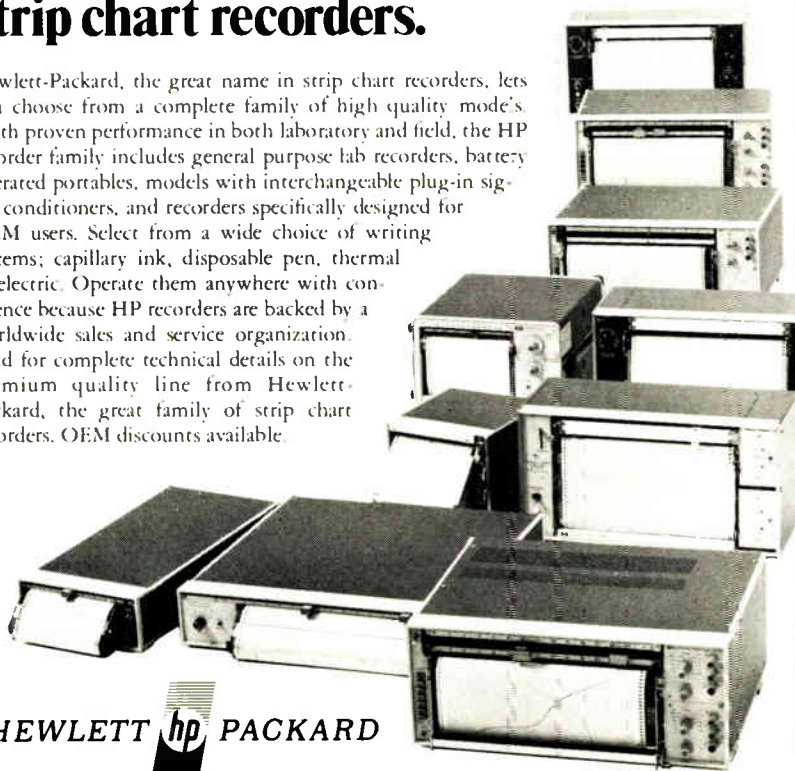

HEWLETT *hp* PACKARD

Sales and service from 172 offices in 65 countries
1101 Page M, Wood Park Rd, California 94093

11702

Circle 190 on reader service card

MICROPROCESSOR POWER SUPPLIES

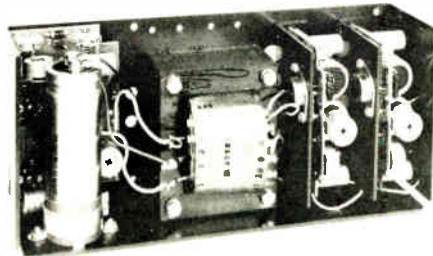

Featuring . . . High Reliability and Low Cost

Now Power/Mate introduces a series of triple output, open frame power supplies designed specifically for microprocessor users.

Based on a rugged, field proven design, the ETR series of microprocessor power supplies features Dual AC Input, remote sensing, adjustable current limiting and plug-in IC regulation throughout the line.

Built to the same rigid quality standards that have made Power/Mate the industry leader, they offer a very impressive 100,000 hour MTBF.

Best of all, the ETR series is economical and in stock. Call or write for our free brochure.



POWER/MATE CORP.

World's largest manufacturer of quality power supplies

514 South River Street/Hackensack, N.J. 07601 /Phone (201) 343-6294 TWX 710-990-5023

190 Circle 259 on reader service card

New products

automatically by Version VIII are design review, component placement and pin assignment, conductor routing, and output for wire-wrap or pc-board implementation. Perhaps equally important is the documentation that the system produces: error reports to the logic designer, component placement data to the thermal analyst, an advanced parts lists to the purchasing department, and connector and backplane information to the people handling systems integration. The main thrust of the system, according to company president Jerry Kreyling, is to identify problems early in the design process when there is still time to do something about them.

Markrevel Inc., 7895 Convoy Ct., Suite 8, San Diego, Calif. 92111. Phone Jerry Harvel at (714) 565-0252 [397]

Enclosure expands from 3 to 24 inches

The Varipak II expandable enclosure is a versatile packaging system that is now available in a 24-inch model. End slots permit adjustment from 3 to 24 inches, making the system adaptable to any packaging technique, be it standard or custom. Like the standard 19-inch Varipak II, the 24-inch unit comes in single- and double-tier versions, but where the smaller unit holds 41 (single) or

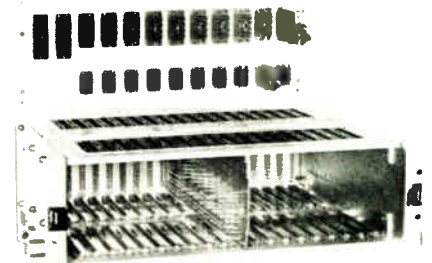

82 (double) cards, the new enclosure can accommodate 54 or 107 boards.

System accessories include marker strips, reinforcement bars, and standard or custom front panels.

Elco Huntingdon, Huntingdon, Pa. Phone Karl Neumuller at (814) 643-0700 [396]

I.F. A-to-D, P.D.Q.

We may have just come up with the triple play of the century, an instant IC IF-to-video-to-digital system.

And we've done it with proven, plug-in Plessey products.

The Plessey SL1550 is a low-noise, high-gain AGC-able front-end amplifier that's not only unique, but superb.

The SL1521 is the simplest, easiest-to-use and least expensive wideband amp you can buy for your log IF strips.

And the SP750 is the world's fastest IC comparator, with a bonus batch of features that reduce your hardware count and increase your reliability.

They all plug together as if they were made for each other and they're available now, so send for all the details.



We'll get back to you, P.D.Q.

PLESSEY SEMICONDUCTORS

1674 McGaw Avenue, Irvine, CA 92714
Tel: (714) 540-9945. TWX: 910-595-1930
Represented world-wide.

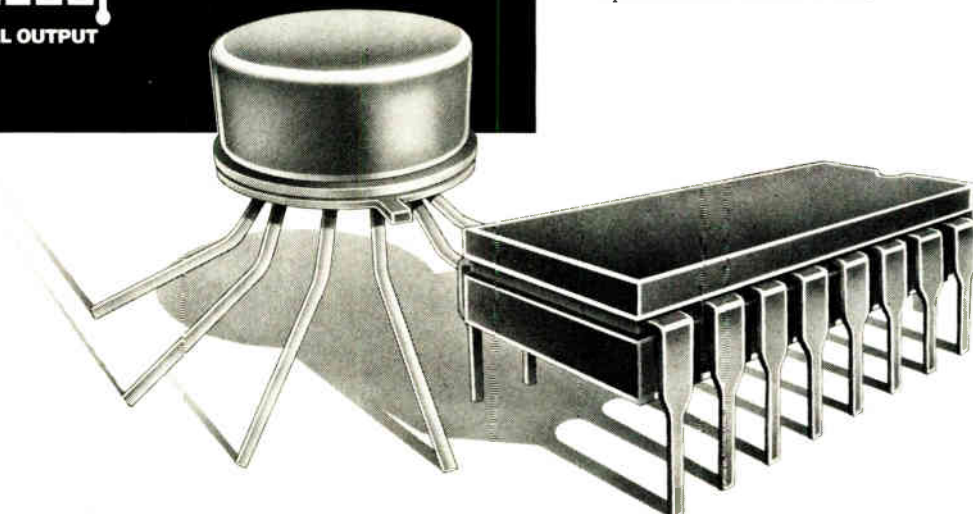
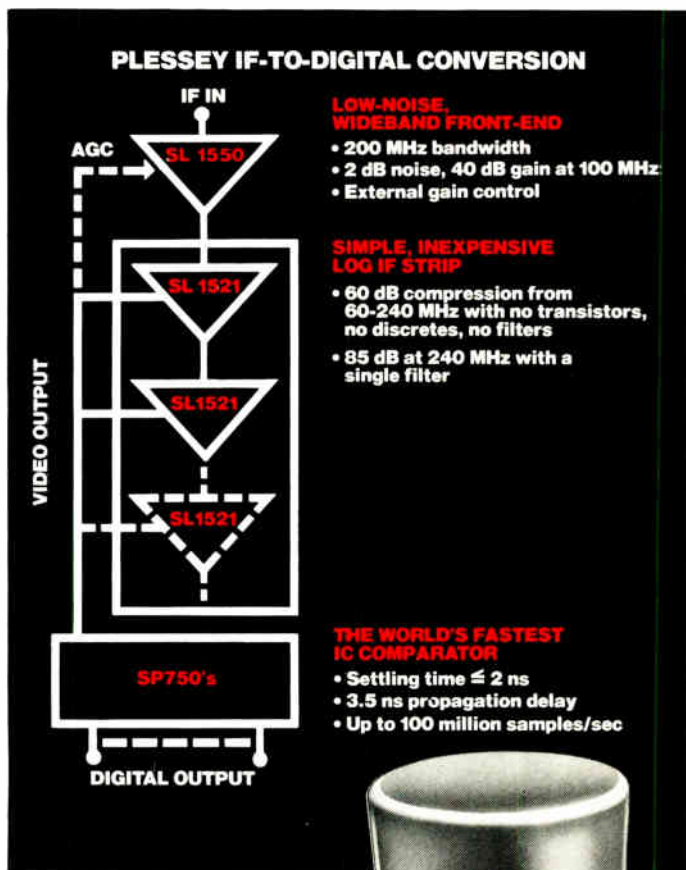

State-of-the-art brought down to earth

Limiting wideband amplifiers TV, radio & telephone communications circuits High-speed dividers

Dynamic Burn-in and Test:

The real cost is not doing it!

What can it cost to dynamically burn-in and test your system's IC's? Almost nothing, when you compare it to the cost of field service calls.

That seems to be your only alternative, by the way. Because Murphy's Law remains in effect. Any part that can fail will fail. Whether you make IC's or buy them, you must throw away the failures before they hurt you. Bring them to Microtest. We find even the most subtle failures economically.

**MURPHY'S
OVENS**

The bad ones are sorted out when it costs you least. We built the famous Murphy's Ovens to serve our own burn-in needs. Additionally, we sell these systems to IC users. For our potential systems customers we perform burn-in and test services, knowing that when they're ready they'll want a system of their own.

To facilitate this service we have the most complete library of burn-in circuits trays and test programs for all industry standard devices and a host of custom circuits. Digital and linear.

We have the best, fastest testers and handlers, and a splendidly efficient information management system.

Most important, we have a staff of failure experts. They know how and where parts fail, even the "good ones." We may even recommend special screening programs designed to match the specific application your circuit must tackle. If you live by Murphy's Law, as we do, you will want a small wall reminder of Murphy's IC Corollary: *If it can fail, it will fail at the worst possible time.* The only way to avoid failure is to let us induce it. For details and Murphy's Corollary, drop us a line or call (408) 739-8001, 743 N. Pastoria Avenue, Sunnyvale, CA 94086. TWX: 910-339-9325.



Microtest

For the most complete test services:
Military and Industrial.

Circle 192 on reader service card

FOR UNDER \$2000, YOU CAN BUY A 300 LPM PRINTER THAT PRINTS FASTER THAN 300 LPM. MAYBE EVEN 50% FASTER.

While the Teletype[®] model 40 132-column printers are rated at 300 lpm (monocase), that figure is somewhat misleading.

Actually, that's quite an understatement since the real printing speed lies somewhere

between 300 and 500 lpm. We wish we could pin our speed down tighter, but throughput takes into consideration a couple of variables. Like different character type belts and an almost infinite number of data patterns.

But speed isn't all we offer for less than \$2000. Because for that money you also get a printer that's completely operational. All you furnish is 115 VAC power and the serial signal source and you're ready to go on-line.

For more information about Teletype model 40 OEM printers, write: Teletype, Dept. 53-P, 5555 Touhy Ave., Skokie, IL 60076. Or call: 312/982-2000.



**THE TELETYPE
MODEL 40 OEM PRINTER.
NOTHING EVEN COMES CLOSE.**

Teletype is a trademark and service mark registered in the United States Patent and Trademark Office.

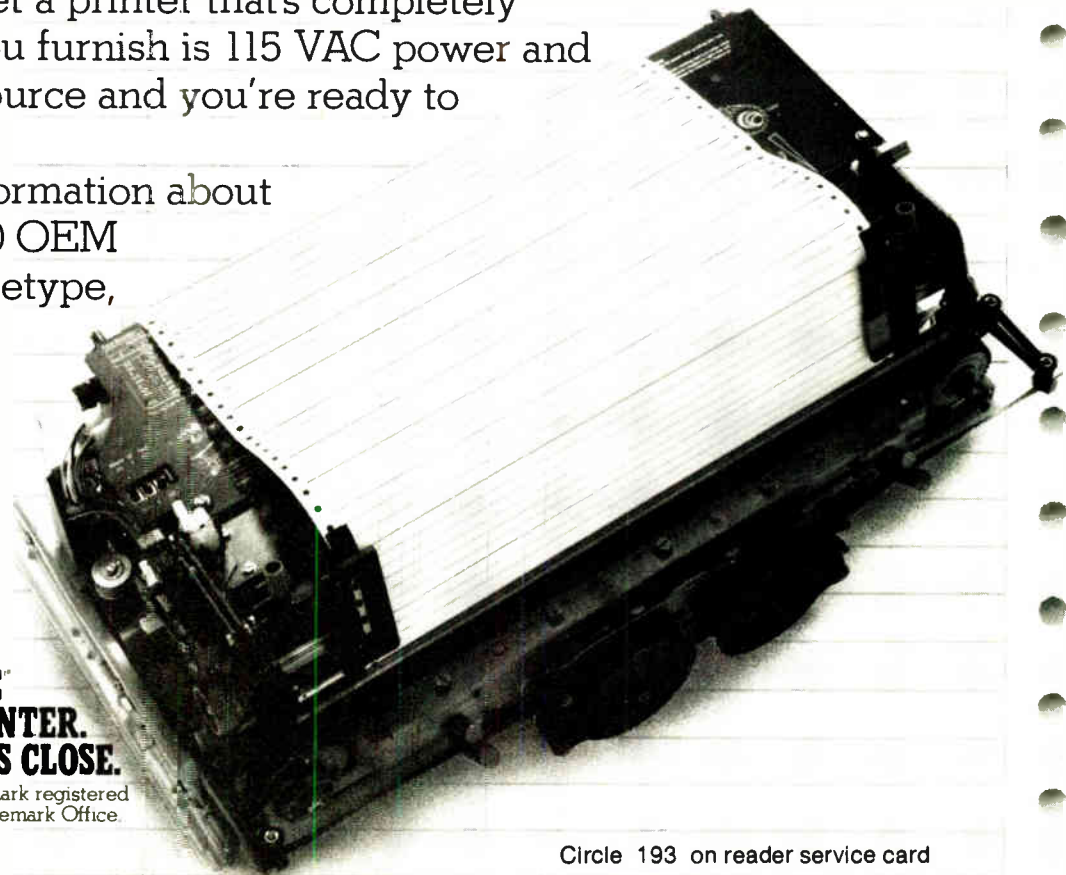

Circle 193 on reader service card

HP 9830A/B* USERS.

You're closer to the world's best desk top computer than you think!

By adding INFOTEK's field proven accessories, your 9830A/B will out-perform any other general purpose desk top system.

Completely compatible with all 9830A/B conventions, our units give your system a combination of speed and versatility superior to any other desk top computer... any make... any model.

The cost is a fraction of what you'd pay for any other approach offering similar capabilities.

32,192-Byte Memory

Where more memory is important, the user area may be increased to 32K bytes with our EM-30... the first and only 16,096-word memory for the 9830A/B! Compared to newly introduced models equipped with commonly used ROM options, the 9830A/B with the EM-30 provides 8,192 bytes more user memory. A truly significant increase in capacity!

With the 9830A/B, the EM-30 provides 2,048 more bytes of memory, is priced right, and is fully warranted for a year.

FAST BASIC ROMS

Infotek's FAST BASIC ROMS add to the machine instruction set where HP left off. These ROMS provide spectacular increases in the work throughput of your 9830A/B. For example, you can process arrays at speeds of 40,000 words per second, attain an I/O capability of 10,000 bytes per second, greatly increase the power of a 9880A/B disk system, and print from a buffer while computing.

By providing 46 additional functions, statements, and commands, the FAST BASIC ROMS give your 9830A/B the most powerful BASIC language repertoire short of \$200,000 systems.

If you need FAST BASIC but don't have enough unused ROM slots, don't give up! You can install our FAST BASIC ROMS without losing any present capability. **Contact us, we'll show you!**

*A Product of Hewlett-Packard Company



HP 9830A/B with the Infotek FD-30 Mass Memory

Floppy Disk Memory System

The FD-30A provides 305K bytes of on-line data that can be searched 50 times faster than your present cassette system. Data throughput is actually four times faster than the 9880A/B Mass Memory. Best of all, no software modifications are required since the FD-30A obeys all cassette syntax.

The FD-30A is the optimum magnetic memory for the 9830A/B. It has the right capacity, speed, and price.

Prices that you'll appreciate

EM-30 Memory, 16K Words	\$4,600	} net \$3,500
Less trade-in of HP 8K Words	1,100	
FAST BASIC I ROM	675	
FAST BASIC II ROM	525	
FAST BASIC I & II as a set	1,050	
FAST BASIC III ROM	525	
FD-30A Mass Memory	3,895	
FD-30S Slave Drive	1,780	
FD-30D Dual Drive System	4,900	
RS-30 High Speed RS 232C Interface	750	
TC-30 Real Time Clock	825	
LP-30 Heavy Duty Line Printer	6,850	
CP-30 Character Printer	3,400	
PS-30 Paper Tape Punch/Reader	3,850	
BP-30 Interrupt Service Printer I/O	525	
FI-30 10K Byte/Sec TTL I/O	395	

All Prices Are U.S. Domestic

NEW! The FD-30S low cost Slave Drive for the FD-30A. Multiple slaves can be used with a single FD-30A so you can increase on-line capacity in blocks of 305K bytes. Also, the FD-30S provides one minute disk duplication under program control or stand-alone.

NEW! BP-30 automatic buffered printing. Your '30 will **continue program execution** while driving a printer as a background task under interrupt control.

Save \$2,100

In our Word Processing Package you get the EM-30, FD-30A, FAST BASIC I and III ROMS, and the CP-30, including software, for a special package price of \$10,850.

Other 9830A/B

Accessory Equipment

RS-30 High Speed RS 232C Interface. Provides seven crystal controlled Baud rates from 150 to 9600/sec.

TC-30 Real Time Clock. Provides time in 10-millisecond increments, is set or read via the OUTPUT and ENTER statements.

LP-30 Heavy Duty Line Printer. A 200 line-per-minute, 132-column printer (128 character set is standard). Comparable in every way to the 9881A, except the LP-30 is lower in price.

CP-30 Correspondence-Quality Character Printer. Provides 14 easily changeable fonts including scientific symbols, UK, German, Scandia, and Cyrillic. Prints and plots at 45 cps.

Contact us direct or through our representatives. Infotek products are sold and serviced through 33 offices in the U.S. and 11 in other countries.

Let us show you how to make your '30 the best desk top computer in the world.



**Infotek
Systems**

1400 N. BAXTER STREET • ANAHEIM, CALIF. 92806
(714) 956-9300 • TWX 910-591-2711

U.S. and Worldwide Distributor Inquiries Are Invited.

Instead of accepting the trade-offs created by undesirable multiple discretes in the form of low current, conventional packages, your special switching circuitry designs can be a reality, with the POWERLITHIC™ transistor module. Available in our standard TO-3, individual glass-passivated chips, or a POWERLITHIC Module like the one shown here, we'll design a custom switch to meet your needs, without long lead time, at a price you can afford.

INDUSTRIAL MOTOR CONTROLS/DRIVES (MC)

With origin of POWERLITHIC™ Darlingtons Power Transistors for use in solid state adjustable frequency and DC motor drives, practical PWM (pulse-width modulation) applications can now be realized, with our standard MC Series, with fast-switching, desirable current capacity and reliability. Standard 150, 400 and 900 volt Transistors and Darlingtons can be configured to your specific packaging requirements.

SWITCHING POWER SUPPLIES (PS)

Characterized by their fast-switching speeds, low power loss and V_{ce} (SAT), standard PS Series POWERLITHIC™ models are the right answer to your very standard or very special needs. Available in JEDEC TO-3 or modified TO-3 styles; 5-40A Darlingtons and 2-15A transistor.

TRANSPORTATION/PORABLE EQUIPMENT (PM)

Circuits may be protected against undesirable junction energy ratings (E_{jth}) and transients of inductive motor energy found in transportation systems and portable, motor driven equipment with the capabilities of PM Series POWERLITHIC™ transistor packaging.

We want to work with you, whether your requirements call for few or quantity. Contact our applications department and request complete information. POWER TRANSISTOR CO., 800 W. Carson St., Torrance, CA 90502. (213) 320-1190

POWERLITHIC™

**TRANSISTOR RELIABILITY
AND PACKAGING VERSATILITY
THAT WILL LET YOU OPTIMIZE
YOUR CIRCUITRY DESIGN TO
KEEP IT YOURS.**



POWER TRANSISTOR COMPANY

Circle 195 on reader service card

EMR

Frequency Response Analyzers For Every Application

From the viscous elastic properties of films and fibers, to the frequency response of hydraulic actuators . . . for the open loop response of a servo system with the loop closed, or the frequency response of the Brooklyn Bridge . . . EMR has a Frequency Response Analyzer that is just right for your application.

Take the low-cost, easy-to-use Model 1312. It's ideal for production testing and basic measurements of phase and amplitude to 20 kHz. Or choose the Model 1410, the full capability, single-channel instrument that has become the industry's standard for most engineering applications. Then there's the Model 1172, the ultimate Frequency Response Analyzer featuring all-digital signal processing, fully-isolated dual measurement channels and a computer-type keyboard entry. With the Model 1180 Plotter Interface, you can plot Bode, Nyquist, or Nichols diagrams with a conventional analog XY recorder.

Let EMR solve your frequency response problems . . . call or write for details or a demonstration.

Sangamo Weston, EMR Telemetry Division
P.O. Box 3041, Sarasota, FL 33578
813-371-0811

SANGAMO WESTON

Schlumberger



Circle 196 on reader service card

New products/materials

Epoxy molding compound E-Form 7-67 is a soft-flow, mineral-filled, short-glass-fiber-reinforced, epoxy transfer-molding compound that retains its insulation characteristics even after prolonged exposure to high temperatures. Designed for the encapsulation of electronic devices, it may be used at temperatures as



high as 570°F. Its room-temperature resistivity is 10^{15} ohm-centimeters, dropping to 10^{14} at 200°F, 10^9 at 500°F and 10^7 at 570°F. The material is easily molded in short cycles and exhibits full hardness on ejection for easy removal from the mold.

Acme Chemicals and Insulation Co., Division of Allied Products Corp., P.O. Box 1404, New Haven, Conn. 06505 [477]

Two liquid-crystal compounds, intended for use in watches, calculators, and similar instruments, extend the active temperature range and reduce costs when mixed with other nematic liquid-crystal systems. Their low negative dielectric anisotropy permits use with most positive systems without materially affecting their positive character. In addition, the two new materials can reduce viscosities, thereby increasing response speeds over the broadened temperature range. Called Vari-Light MBBA and EBBA, the materials are supplied in 20-, 250-, and 1,000-gram borosilicate containers sealed under inert gas. Their shelf life is indefinite at room temperature under these packaging conditions.

3M Co., P.O. Box 33600, St. Paul, Minn. 55133 [478]

A platinum-gold conductor that can be soldered, without burnishing, after repeated firings makes it easy to fabricate multilayer thick-film

Electronics / May 12, 1977

OUR DETECTORS ARE INTO EVERYTHING

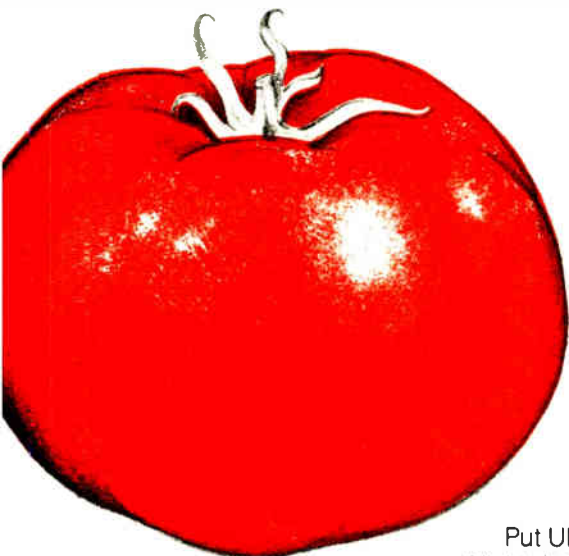

THANKS TO OUR APPLICATIONS ENGINEERS

What does a light detector have to do with a tomato? Plenty, if your job is to determine ripeness by color analysis. That's a big jump from missile guidance systems, but it's the range of applications our detectors work in every day. And, thanks to our engineers, it's the right detector for the job.

Put UDT into your product or process. We make all kinds of light detection devices, instruments and systems — and we can show you how to apply them. It doesn't matter whether you're into:

- Medical Electronics** (such as blood analysis with our UV or blue enhanced photodiodes)
- Consumer Products** (monitoring digital displays with our LED measurement systems)
- Communications** (communication links with our Low Noise series or Detector/Amplifier Combinations)
- Office Machines** (character recognition with the UDT Long Lines)
- Photographic Processes** (measuring thickness of film coating with our General Purpose PIN-10DP)
- Navigation** (star tracking or missile guidance with our Position Sensors)
- Industrial Process Control** (non-contact, optical alignment with the "SC" position sensor or the 131A Linear Displacement Monitor)
- Food Processing** (color analysis with our large area, low cost PIN-220DP or any of our other General Purpose detectors)
- Research & Development** (photometry/radiometry with the UDT 111A, 40X, 80X)

The right light detection and measurement solution can reduce your costs while improving accuracy, efficiency and reliability. Let UDT provide the products, know-how and design assistance you need.

Get us involved today! Call (213) 396-3175.

Years Ahead in the Detection, Measurement and Application of Light.

Circle 197 on reader service card



UNITED DETECTOR TECHNOLOGY, INC.

2644 30TH STREET, SANTA MONICA, CA 90405 • TELEPHONE (213) 396-3175 • TELEX 65-2413

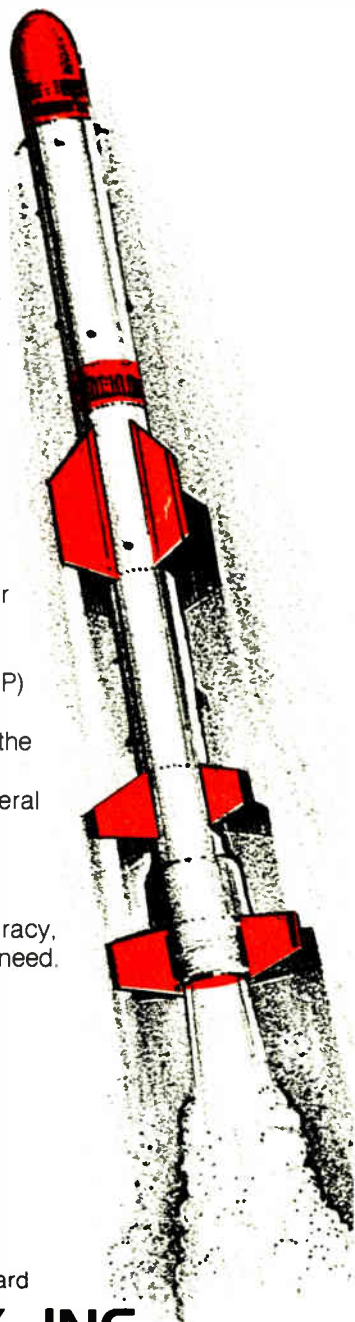

19¢^{*} ea.

An integrated bridge rectifier in a miniature dual in-line package

D I B

DUAL IN-LINE BRIDGE

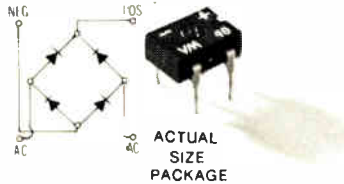

- 4-pin, low-profile DIP
- Leads on standard .10" (2,54 mm) grid
- Compatible with automatic testing, handling and inserting
- 1 Amp at 40°C (I_o)
- 25V to 1000V (V_{RRM})
- 25A Peak One-Half Cycle Surge (I_{FSM})
- Two devices will fit into standard 14-pin DIP socket
- Moisture resistant epoxy package
- Call Lee Miller 214/272-4551, Ext. 206 for more information.

* 100V; 100,000 qty.

Design us in . . . we'll stay there

VARO SEMICONDUCTOR, INC.

P O BOX 676 1000 N SHILOH GARLAND, TX 75040
(214) 272-4551 TWX 910-860-5178

EUROPEAN OFFICE: UK: VARO SEMICONDUCTOR INTERNATIONAL, INC.
Deepdene House, Bellegrave Road, Welling, Kent, England DA163PY, 01-304-6519, 0



New products/materials

circuits. Conductrox 3106 is routinely printable to 5-mil lines and spaces and retains its solderability when it is fired on dielectric as the top layer of a multilayer circuit. Because the paste never needs stirring, it is supplied in plastic syringes as well as in conventional jars. It sells for \$6.72 per gram in evaluation quantities and \$5.85 per gram in production lots. Delivery is within 10 days.

Thick Film Systems Inc., 324 Palm Ave., Santa Barbara, Calif. 93101 [479]

A casting resin with a high dielectric constant can be cast in place in circuit modules, antenna cavities, transmission-line components, and other electronic devices. Called Sty-cast HiK Castable, it is offered with dielectric constants from 6.0 to 19.0. Loss tangents are below 0.002. The two-part materials system consists of

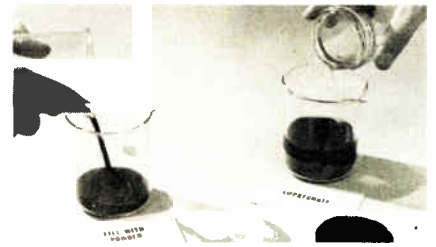

a free-flowing powder, which is first poured into the cavity to be filled, and a clear low-viscosity liquid which is then poured over the powder to infiltrate it. The material must then be oven-cured. It sells for \$20 a pound in 5-lb. quantities.

Emerson and Cuming Inc., Canton, Mass. 02021 [480]

A solderable protective coating for printed-circuit boards, #2621-E Ultra-Seal is applied to boards upon fabrication and serves to protect them from contamination during storage, handling, and component insertion prior to wave soldering. The material is said to improve solderability and to eliminate the need for special handling procedures and for protective packaging in plastic bags. It can be applied by dip, spray, or roller coating.

Kenco Alloy and Chemical Co., Inc., 418 West Belden Ave., Addison, Ill. 60101 [475]

A PROBLEM-SOLVING RECIPE:

1. Start with a packaging or sealing problem.
2. Name the environment and application.
3. Contact Corning.



Together we can cook up a solution!

The ingredients—we've developed hundreds of glass and glass-ceramic materials for specific applications. We wrote the recipes for such things as borosilicate glass used in high-temperature environments, lead-alkali glass for electrical insulation, low-alkali glass for IC applications and the durable PYROCERAM™ Brand cements.

We have the technology to shape your ideas. Chances are we've already developed the material you need for such problems as IC packaging, solid-state displays, special epoxy resins, glass-to-metal seals and disc headers. There's an easy way to find out.

For more information about Corning's glass and glass-ceramic materials and manufacturing capabilities, write or call:



CORNING

ELECTRONIC Materials Dept., Box E-4, Corning Glass Works, Corning, N.Y. 14830 607-974-9000

"DO IT YOURSELF" — no stripping or soldering with the innovative **NEW** Vector Ribbon Cable and Connector System

Tools are FAR LESS costly yet more versatile than others.

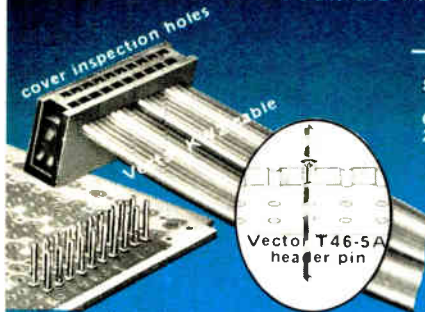

KS-2 Vector plug mates with .025 sq. or rd. pins

Vector P196 Gang Insertion Tool on T46-5A header pins. \$12.50

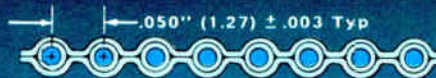
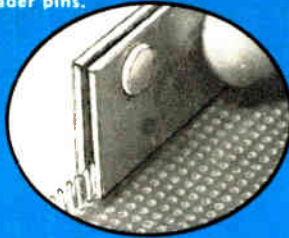

Color coded Vector KW2 cables. 20 to 40 No. 28 tinned copper, PVC insulated. 10' rolls.

SIMPLE ASSEMBLY METHOD

1. Insert cable in plug.
2. Place in P187 fixture.
3. Press halves together with arbor, drill press or vise.

NO OTHER FIXTURE TERMINATES MOST TYPES OF PLUGS

Vector, Alpha, AMP, Ansley, Berg, C.W., 3M & S.A.E. plugs all work by use of unique step design.

MOUNT T46-5A HEADER PINS

1. Drop pin tails in card holes with alignment block under.
2. Slide P196 tool on pins.
3. Push in with 186-1 press. (Can also gang insert other types of pins.)

Vector P187 fixture positions and terminates cable to plug \$29.50



Vector P186-1 Press drives plug into cable. Also gang inserts pins. \$59.50

"Daisy chain" also feasible with plugs mid-span



Vector pre-assembled DIP plug interconnect cables
14-pin \$3.65, 16-pin \$3.79, 24-pin \$7.30
(parts also available to make your own)

VECTOR ELECTRONIC COMPANY, Inc., 12460 Gladstone Avenue, Sylmar, CA 91342 Phone (213) 365-9661 TWX 910-496-1539 501276

Circle 200 on reader service card

HOW TO TRANSFORM ELECTRONIC CONCEPTS INTO PROFITABLE PRODUCTS

An innovative seminar aimed specifically at the electronics industry

This conference will present an integrated comprehensive overview of the entire new product process—including R&D, marketing and market research, financial and planning aspects, and management and performance.

PLACE: New York Hilton, New York City.

DATE: June 13-15, 1977.

PRICE: \$450. (Includes all course materials)

For reservation information, contact:



FROST & SULLIVAN, INC.
106 Fulton Street
New York, N.Y. 10038
(212) 233-1080



PHOTO AND NON-PHOTO CARDS
Mag Stripes, OCR, Bar Code
COMPUTERIZED ID SYSTEMS
DATA CAPTURE TERMINALS
ELECTRONIC EQUIPMENT

BADGE READER MODULE

R.D. Products' Badge Reader Module* is a hand driven dynamic mag stripe card reader. Primary application is as a fixed data entry subsystem in OEM equipment.

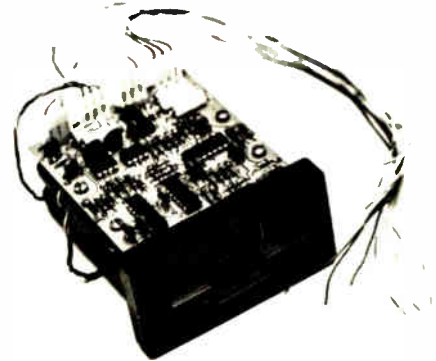

FEATURES

- Hand driven dynamic reader
- Uses photo and non-photo mag stripe cards
- Reads deformed cards
- Wide read speed range
- Complete card reading subsystem
- Buffered TTL level outputs
- One moving part
- Fully enclosed card guide
- Front panel mounting

APPLICATIONS

- Access authorization equipment
- Electronic locks and gates
- Timekeeping systems
- Inventory control systems
- Credit verification equipment
- POS terminals

* U.S. PAT. 3,946,206

R.D. PRODUCTS, INC.

MAIN PLANT • 6132 RT. 96, VICTOR, N.Y. 14564 • TEL (716) 924-7121 • TWX (510) 254-0512
AMSEC ELECTRONICS DIV. • 1675 W 9TH ST., LONG BEACH, CA. 90813 • TEL (213) 432-6544

200 Circle 260 on reader service card

Circle 261 on reader service card

Introductory offer to new members of the ELECTRONICS AND CONTROL ENGINEERS' BOOK CLUB

any one
of these great
professional books
for **\$1.89**
only
values up
to \$42.50

Special \$1.89 bonus book comes to you
with your first club selection



767/556
RAPID PRACTICAL DESIGNS OF ACTIVE FILTERS
by D. E. Johnson & J. L. Hilburn
Pub. price, \$15.00
Club price, \$11.50



771/480
MANUAL FOR MOS USERS
by J. D. Lenk
Pub. price, \$16.95
Club price, \$12.95



637/458
DESIGNING WITH TTL INTEGRATED CIRCUITS
by Texas Instruments, Inc.
Pub. price, \$26.00
Club price, \$17.50



771/456
DIGITAL ENGINEERING, 2/e
by G. K. Kostopoulos
Pub. price, \$24.95
Club price, \$18.95



238/901
APPLICATIONS OF OPERATIONAL AMPLIFIERS: Third-Generation Techniques
by J. G. Graeme
Pub. price, \$18.65
Club price, \$11.95



209/804
ELECTRONICS ENGINEERS' HANDBOOK
by D. G. Fink
Pub. price, \$42.50
Club price, \$32.50



423/156
INTEGRATED ELECTRONICS: Analog Digital Circuits & Systems
by J. Millman & C. Halkias
Pub. price, \$21.00
Club price, \$15.95



209/731
STANDARD HANDBOOK FOR ELECTRICAL ENGINEERS, 10/e
by D. J. Fink & J. M. Carroll
Pub. price, \$41.50
Club price, \$28.50

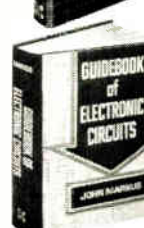

404/453
GUIDEBOOK OF ELECTRONIC CIRCUITS
by J. Markus
Pub. price, \$26.95
Club price, \$21.50



353/387
MINICOMPUTERS FOR ENGINEERS AND SCIENTISTS
by G. A. Korn
Pub. price, \$23.45
Club price, \$15.50



287/341
STANDARD HANDBOOK OF ENGINEERING CALCULATIONS
by T. G. Hicks
Pub. price, \$19.50
Club price, \$15.25



617/97X
HANDBOOK OF OPERATIONAL AMPLIFIER CIRCUIT DESIGN
by D. E. Stout & M. Kaufman
Pub. price, \$24.50
Club price, \$17.50



771/189
ELECTRONIC TROUBLE-SHOOTING
by C. N. Herrick
Pub. price, \$13.95
Club price, \$10.95



124/485
ELECTRICAL ENGINEERING FOR PROFESSIONAL ENGINEERS' EXAMINATIONS, 3/e
by J. D. Constance
Pub. price, \$17.00
Club price, \$12.50

save time and money by joining the ELECTRONICS AND CONTROL ENGINEERS' BOOK CLUB



Here is a professional book club designed to meet your on-the-job engineering needs by providing practical books in your field on a regular basis at below publisher prices. If you're missing out on important technical literature—if today's high cost of reading curbs the growth of your library—here's the solution to your problem.

The *Electronics and Control Engineers' Book Club* was organized for you, to provide an economical reading program that cannot fail to be of value. Administered by the McGraw-Hill Book Company, all books are chosen by qualified editors and consultants. Their understanding of the standards and values of the literature in your field guarantees the appropriateness of the selections.

How the club operates: Every month you receive free of charge *The Electronics and Control Engineers' Book Club Bulletin*. This announces and describes the Club's featured book of the month as well as alternate selections available at special members' prices. If you want to examine the Club's feature of the month, you do nothing. If you prefer one of the alternate selections—or if you want no book at all—you notify the Club by returning the card enclosed with each Bulletin.

As a Club member, you agree only to the purchase of four books (including your first selection) over a two-year period. Considering the many books published annually, there will surely be at least four you would want to own anyway. By joining the Club, you save both money and the trouble of searching for the best books.

MAIL THIS COUPON TODAY

ELECTRONICS AND CONTROL ENGINEERS' BOOK CLUB
P.O. Box 582, Princeton Road, Hightstown, New Jersey 08520

Please enroll me as a member and send me the two books indicated. I am to receive the bonus book at the introductory price of \$1.89 plus my first selection, plus tax, postage and handling. If not completely satisfied, I may return the books within 10 days and request that my membership be cancelled. If I keep the books, I agree to take a minimum of three additional books during the next two years at special Club prices (guaranteed 15% discount, often more). I will receive the Club Bulletin 12 times a year. If I want to examine the featured selection, I need take no action. It will be shipped automatically. If, however, I want an alternate selection—or no book at all—I simply notify the Club by returning the convenient card always enclosed. I will always have a minimum of ten days in which to return the card and you will credit my account fully, including postage. If this is not the case, Membership in the Club is continuous but cancellable by me at any time after the four-book purchase requirement has been filled. This order subject to acceptance by McGraw-Hill. Orders from outside the continental U.S. must be prepaid. All prices subject to change without notice. Offer good for new members only.

Write Code # of \$1.89 bonus book selection here

Write Code # of first selection here

NAME _____

ADDRESS _____

CITY _____

STATE _____ ZIP _____

EXTRA SAVINGS: Remit in full with your order, plus any local and state tax, and McGraw-Hill will pay all postage and handling charges. **E33325**

New literature

UL computer standard. Underwriters Laboratories Inc. has released the third edition of its Safety Standard for Electronic Data-Processing Units and Systems (UL 478). The new document covers electrically operated machine units that, separately or assembled in systems, electronically accumulate, process, and store data.

Copies of UL 478 are available from UL for \$3.50. For \$9 one can

obtain the current edition plus subscription service for any revisions that may be issued. Orders with prepayment should be sent to Underwriters Laboratories Inc., Attn: Publications Stock Dept., 333 Pfingsten Road, Northbrook, Ill. 60062.

Solid-state relays. A 48-page handbook on solid-state relays is made up of 28 pages of tutorial material and 20 pages of catalog data. The tuto-

rial material includes a glossary and typical applications circuits. Gordos/Grigsby-Barton Inc., Rogers, Ark. 72756 [422]

Direct-capacitance measurement. To measure the value of a capacitance that is enmeshed among other circuit elements, it is necessary to make a three-terminal or direct-capacitance measurement. Although the concept of a three-terminal capacitance

One way...



HP's Universal Counters

satisfy the needs for most electronic counter measurements up to 1300 MHz, and do it without breaking your budget. Two distinctly different models are loaded with features, and a wide variety of options are available.

One way is the 5328A for high performance frequency, period and time interval measurements in a modular 8 or 9-digit unit for systems or bench use. Start with the basic 100 MHz/100 ns unit for just \$1300*. Modules expand its capabilities to 512 or 1300 MHz for frequency, 10 ns for time interval and add 10 μ v to 1000v, digital voltage measurements. Other options include ultra-stable time base, and full HP Interface Bus operation. Standard at no extra cost are burst frequency measurement and time interval averaging to

10 ps resolution... matched input amplifiers make this resolution meaningful.

The other way is the 5300B/5308A System for lower cost yet highly versatile 8-digit frequency, period and time interval measurements in a modular portable package that also can be rack mounted. In just 30 seconds, snap on any of 10 other modules including: a full capability DMM, battery pack and 1300 MHz and HP Interface Bus modules. The 5300B/5308A's low \$910* price even includes time interval averaging for resolution to 1 ns!

Use the 10855A Preamplifier for higher sensitivity with any model: 22 dB gain, 2 to 1300 MHz for just \$225*.

To do it your way contact your nearest HP field engineer for full data, or write.

*Domestic U.S. prices only.

along with techniques to measure it have been around for more than 30 years, many engineers are still unfamiliar with its application. Application Note 14 from Boonton Electronics Corp., Rte. 287 at Smith Road, Parsippany, N.J. 07054, provides a tutorial treatment of the subject and includes many practical hints on making measurements—particularly at 1 megahertz. Subjects include three-terminal mea-

surement systems, capacitance bridges and meters, test-terminal loading, remote measurements, the effect of short and long cables, stray capacitance, and measurements on capacitors, semiconductor diodes, and transistors. [423]

Coil-winding equipment. Catalog GS-10 is a comprehensive collection of equipment for winding bobbins, transformers, dual lateral coils,



CATALOG NO. GS-1

COIL WINDING MACHINES



or the other,

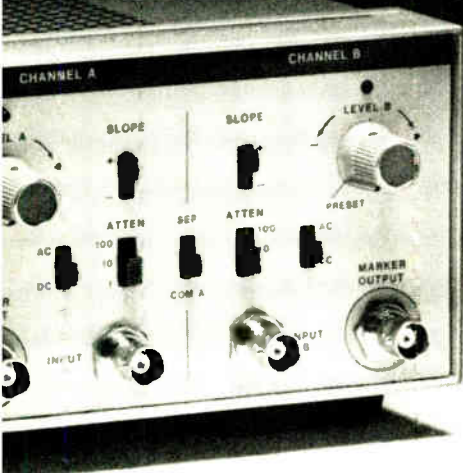

the right performance at the right price.

HEWLETT  PACKARD

1507 Page Mill Road, Palo Alto, California 94304

For assistance call: Washington (301) 948-6370, Chicago (312) 255-9800, Atlanta (404) 955-1500, Los Angeles (213) 877-1282

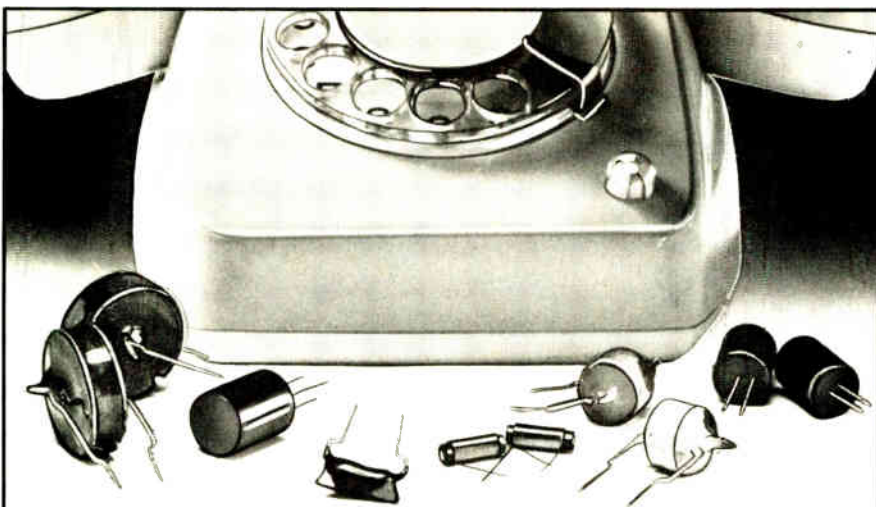

**Our Business is Chokes and Transformers.
For 18 Years. Call SALOTA.**

You'll get a reliable, high quality product. With all the product features you need. And at precisely the right time and in the required quantity.

But you deserve more. SALOTA is world-renowned for its service. Get offers fast. Receive samples within days, even hours. Talk about a custom-tailored product with an experienced partner. And get it for a reasonable price.

Now you know why we say: Call SALOTA.

SALOTA

Phone West Germany: 0911-32177

Telex 622466 hocco d

Raabstr 24 · D 8500 Nürnberg/West Germany

Circle 206 on reader service card

New literature

space-wound resistor coils, armatures, continuous-resistance coils, variable-pitch coils, and coils for laboratory use. The 52-page catalog describes 70 machines, 7 tailstocks, 24 tensions, 14 counters, and a variety of accessories. Copies are available from Geo. Stevens Manufacturing Inc., 6001 North Keystone Ave., Chicago, Ill. 60646 [427]

Nuclear dosimeters. A wide variety of dosimeters for X rays, gamma rays, and other types of nuclear radiation is described in a 16-page catalog put out by Dosimeter Corp. of America, 6106 Interstate Circle, Cincinnati, Ohio 45242. The catalog includes information on a wide variety of other nuclear accessories such as scintillation vials, calibrators, storage cases, and probes. [424]

Dial calculators. A 20-page catalog from Hunter Associates, 792 Partridge Drive, Bridgewater, N.J. 08807, illustrates more than 60 rotary-dial calculators. In addition to conventional circular slide rules, the catalog covers trigonometry calculators, English/metric converters, and special calculators for tensor analysis and probability. [425]

Synchro converters. The line of synchro-to-digital and synchro-to-linear dc converters made by Computer Conversions Corp., 6 Dunton Court, East Northport, N.Y. 11731, is described in the company's new 30-page catalog. Also included are angle encoders and indicators, limit switches, modulators, demodulators, and solid-state control transformers and transmitters. [426]

Using SCRs. Although SCR turn-on should be simple, circuit considerations and device trade-offs add some complexity. Application Data 54-540, "SCR Gate Turn-On Characteristics," provides a thorough explanation of gate terminology, trade-offs, and SCR characteristics so that designers can better specify gate turn-on requirements and assess the merits of a gate trigger circuit. For a copy, write to Semiconductor Division, Westinghouse Electric Corp.,

BI-DIRECTIONAL CODE SWITCH

The industry's smallest BI-DIRECTIONAL CODE switch. Less than 0.6" in height, with large easy to read numerals and mating accessories. Ideal for hand-held instruments subject to field abuse. Heavy gold plating on wiping contacts affords a low contact resistance.

Call (617) 685-4371 today for your "dummy" switch, prices, specifications and catalog.

PICO SERIES

Circle 114 on reader service card

INCANDESCENT PILOT LAMPS

Our sub-miniature LAMP ASSEMBLIES have 5V — 60 ma. rating and 100,000 hour life. Two basic styles available, dome or cylindrical shaped in four colors. The sealed plastic housing contains a T-1 lamp. Choice of 6" insulated leads or pin contacts. Mounting ring is included.

Call today for more information and samples on this and other ALCOLITE products.

MC SERIES ME SERIES

A GOOD FUSE CAN'T HOLD ON WITHOUT A GOOD GRIP.



GET BOTH FROM BUSSMANN.

Don't put a good fuse in the grip of a poor fuse holder. If the holder can't hold on right, the best fuse in the world can't, either.

Some clips just don't have the muscle to hold tight. The fuse gets loose. The heat builds up. You know what happens.

There's an easy way to put a stop to it: Put good Buss fuses in good Buss fuse holders. Our holders are made with the muscle it takes to keep a good tight grip on trouble-free electronics protection.

They'll pay off for you a thousand times over in reliability that's for sure, not for maybe.

Your equipment deserves the best. Bussmann has it for you. A great fuse. And a great grip. Get them together now.

Ask for Buss Bulletin SFB.

SUPPLIED THE ECONOMICAL WAY
THRU DISTRIBUTORS
BUSS FUSES
THE QUALITY LINE



BUSSMANN MANUFACTURING
a McGraw-Edison Company Division
Earth City, Missouri 63045

The Fastest 8-Bit DIP A/D On 24 Pins

- 100 ns/bit
- $\pm 1/2$ LSB linear over temperature
- 9 input ranges
- Adjustment free
- Serial and parallel outputs
- Extended temperature range available (-55° to 85°C)
- Hermetic 24-pin DIP
- Available with Mil-Std-883 Class B processing



MN 5101
\$234.00

(1 to 24 units)



Micro Networks Corporation
324 Clark Street, Worcester, MA 01606
(617) 852-5400 TWX 710-340-0067

New literature

Youngwood, Pa. 15697. In Europe, write to S. Zambelli, CDS Westinghouse, BP107, 72003 LEMANS Cédex, France. [428]

Surge testing. The state of the art in surge testing is presented in an eight-page application note published by KeyTek Instrument Corp., P.O. Box 109, 220 Grove St., Waltham, Mass. 02154. The note covers test wave types and their uses, wave energies, the pulsed-energy handling capabilities of components and protectors, the latest advances in hardware, and a variety of practical considerations. [429]

Multiplying d-a converters. An eight-page application note on differential and multiplying digital-to-analog converters includes a tutorial section and a section that describes some 40 potential applications. All of the applications make use of the DAC-08, an inexpensive 8-bit monolithic converter made by several manufacturers. For a copy of AN-19 call Jean Littrell at (408) 246-9222, or write to Precision Monolithics Inc., 1500 Space Park Drive, Santa Clara, Calif. 95050 [430]

Rental instruments. The 52-page 1977 electronic instrument rental catalog put out by Continental

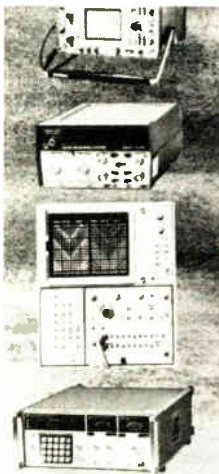

CONTINENTAL
1977
ELECTRONIC
INSTRUMENT
RENTAL
CATALOG

Rentals, Lease, Sales, Service

Rentals presents full specifications and rental rates on more than 800 instruments. Copies can be obtained from Frank Neri, Continental Ren-

PINPOINT HEAT

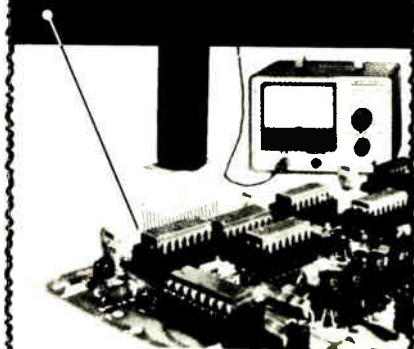

Heat any integrated circuit or electronic component to its rated temperature with a heat probe. Accuracy $\pm 3^\circ\text{C}$ or better. Or check the component's temperature with a thermo-couple probe. Model 810 Thermo-Probe does both. Reads out directly in $^\circ\text{C}$ and $^\circ\text{F}$ on a large $4\frac{1}{2}$ -inch meter.

Models with other temperature ranges available. For details write to:

MTI MICRO-TECHNICAL INDUSTRIES

P.O. Box 287 South Laguna, CA 92677
(714) 545-3734 • TWX910 596-1325 MOCROTEC LBEH

Circle 208 on reader service card

High-Accuracy Phase Meters

0.5 Hz to 2 MHz

Digital or meter
readouts

As low as \$1150



825 E. Middlefield Rd.
Mountain View, CA 94043
(415) 969-6500

Circle 263 on reader service card

7 trimmers handle 95% of your applications.

Single-turn

With these industry standard cermet trimmers, you're assured design versatility, high quality, and fast delivery.

Just decide what you need regarding: (1) single- or multiturn; (2) sealed or not; (3) size; (4) resistance; (5) pin spacing; and (6) price.

Then call your local Beckman Helipot distributor for *free* evaluation samples. To get his number, or immediate technical literature, call (714) 871-4848, ext. 1776. See how fast and easily you can solve trimmer problems.

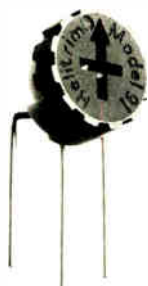

Model 91

- High quality — low price
- Unique brush contact
- Excellent setability
- Protective dust cover
- Top or side adjust
- Standoffs prevent rotor binding, permits board washing
- Small $\frac{3}{8}$ " dia. size



Model 72

- $\frac{3}{8}$ " square
- Sealed for board washing
- Available in flame-retardant SEO housing
- Top or side adjust
- Brush contact
- Excellent setability
- 2 ohms of end resistance



Model 82

- $\frac{1}{4}$ " dia. by 0.150" max. height
- Sealed for board washing
- Flame-retardant SEO materials
- 82P — top adjust; 82PA — side adjust
- Brush contact for excellent setability
- Resistance range: 10 Ω to 1 meg Ω

Multiturn



Model 64

- Miniature, sealed
- 22 turns of adjustment
- 0.25 watt at 85°C
- Resistance range: 10 Ω to 1 meg Ω
- $\frac{1}{4}$ " square for tight P.C. board packaging
- Unique brush contact
- Adjustability — voltage ratio within 0.01%

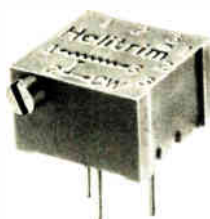

Model 68

- Low-cost
- Sealed for board washing
- 18 turns for adjustment accuracy
- $\frac{3}{8}$ " square housing
- Brush contact
- 3 pin styles for efficient packaging
- Broad resistance range: 10 Ω to 2 meg Ω
- Operates with $\frac{1}{2}$ watt at 25°C

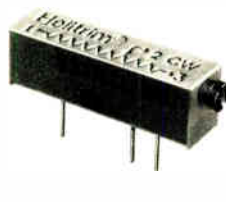

Model 89

- Our lowest cost multiturn
- Sealed for board washing
- $\frac{3}{4}$ " rectangular, 0.250" high
- 15 turns for accurate adjustment
- 7 pin styles for mounting versatility
- Panel mount available
- Resistance range: 10 Ω to 2 meg Ω

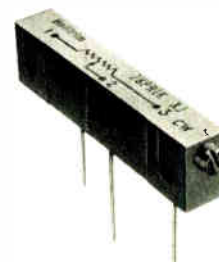

Model 78

- Military performance, industrial price
- $1\frac{1}{4}$ " rectangular, 0.195" wide
- Sealed
- 3 terminal styles: flex leads, P.C. pins, solder lugs
- Power rating: 0.75 watt at 70°C
- 22 turns of adjustment
- Resistance range: 10 Ω to 2 meg Ω

BECKMAN®

HELIPOT DIVISION

When you want a small package delivered fast, it's in the bag.



Delta's DASH guarantees delivery on the flight or routing you specify between all Delta cities. Packages accepted up to 50 lbs. with length plus width plus height not to exceed 90."

And now your DASH shipment can be picked up at your door and delivered to your customer's door. All you have to do is call Delta's toll free number 800-424-1092. (In the Washington, D.C. area, call 466-3131.)

Or bring your package to Delta's passenger counter or air freight terminal at the airport at least 30 minutes before scheduled departure time. Package can be picked up at DASH Claim Area next to airport baggage claim area 30 minutes after flight arrival.

Charges for DASH shipments are nominal. Delta reservations will be pleased to quote actual charges between specific points.



Rate examples (Tax included)

Atlanta-Washington.	\$26.25
Boston-Miami.	\$26.25
Los Angeles-New Orleans.	\$31.50
Dallas/Ft. Worth-Los Angeles.	\$26.25
San Francisco-Atlanta.	\$31.50
Philadelphia-Houston.	\$26.25
New York-Tampa.	\$26.25
Chicago-Orlando.	\$26.25
Detroit-Memphis.	\$26.25

For full details, call Delta reservations. Pick up and delivery at extra charge.

Delta is ready when you are.®

Circle 210 on reader service card

THE SUNSHINE STATE OFFERS HIGHER PROFIT POTENTIALS TO ELECTRONIC PRODUCTS MANUFACTURERS THAN ELSEWHERE IN THE COUNTRY!

Florida's substantial labor and operating cost advantages, plus ready access to the markets of the United States, Latin America and the world, combine to offer a unique profit opportunity for a Florida-based manufacturer.

Before you make any decisions regarding your business, this new industry study documenting Florida's position should be reviewed carefully.

To get your copy of *Florida Profit Potentials in Electronic Products Manufacturing*, write or call:

FLORIDA
WE'RE MORE THAN SUNSHINE

Joe Hennessy, Director
Division of Economic Development
Florida Department of Commerce
107 W. Gaines Street, Room 103E
Tallahassee, Florida 32304
(904) 488-5507

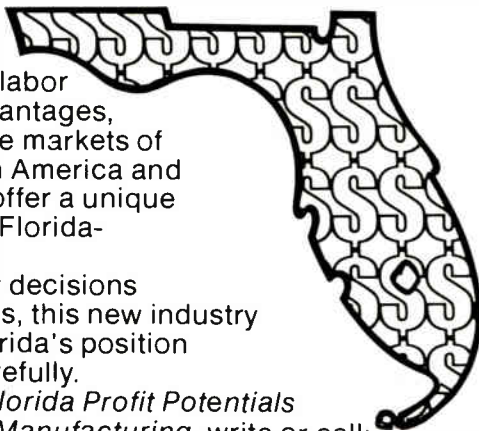

New literature

tals, Div. Continental Leasing Inc., 175 Middlesex Turnpike, Bedford, Mass. 01730 [431]

Microwave semiconductors. The Hewlett-Packard line of rf and microwave semiconductors is covered in a 128-page diode and transistor designer's catalog (Pub. #5952-9825). Among the products described in the catalog are Schottky diodes, signal control diodes, microwave source diodes, devices for hybrid integrated circuits, military approved devices, microwave transistors, and integrated products such as double balanced mixers and comb generators. An index lists each component by number. Copies are offered by the Inquiries Manager, Hewlett-Packard Co., 1501 Page Mill Road, Palo Alto, Calif. [432]

Measurement and control. Analog-to-digital and digital-to-analog converters, voltage-to-frequency converters, sample-hold amplifiers, analog interface subsystems, data-acquisition subsystems, digital panel meters, operation amplifiers and instrumentation amplifiers as well as isolation amplifiers, thin-film networks, and power supplies are among the 300 products for measurement and control described in a 36-page short-form catalog from Analog Devices Inc., P.O. Box 280, Norwood, Mass. 02062 [433]

Centralab products. A 40-page catalog from Centralab covers the company's lines of standard ceramic

CENTRALAB CERAMIC CAPACITORS EMI/RFI FILTERS THICK FILM NETWORKS

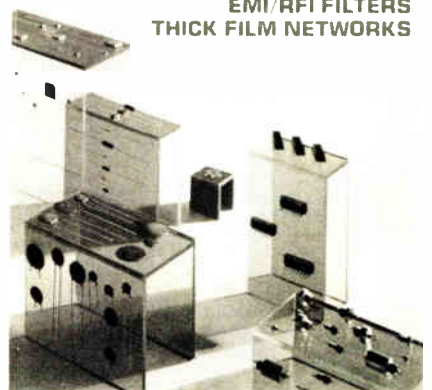

designed for the User, —logically.



Logical Layout

User-oriented controls provide error-free operation because of logical-use grouping, and selective controls, such as completely separate delayed timebase controls.

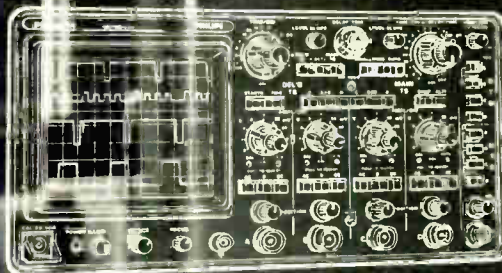

Cold Switching

Permits all the controls necessary for four-trace operation to be positioned in a logical location. Cold switching technology obviates electrical and mechanical problems associated with functional controls.



User-Oriented Features

Solve difficult measuring problems as they arise. Digital Delay enables accurate selection of any particular bit to 99,999 out of the data stream.

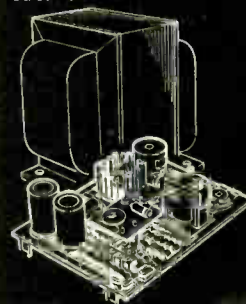

Switching Regulated Power Supply

Gives high efficiency, saves weight (eliminates cooling-fan and filter), and allows instrument use from almost any source without adjustment.

Products that reach ahead because Philips designs ahead. That's why these complex instruments are so easy and efficient to use; they were designed for People . . . who happen to be engineers.

These innovative measurement systems are designed to solve complex measuring problems, dependably, for a long time. They may indeed provide the capability for tomorrow's measuring requirements.



In the United States:
85 McKee Drive
Mahwah, New Jersey 07430

In Canada:
6 Leswyn Road
Toronto, Ontario Canada M6A 1K2

For further information, use our HOT LINE number — 800 631-7172 (New Jersey residents call (201) 529-3800 collect.)

Philips Test & Measuring Instruments, Inc.
A NORTH AMERICAN PHILIPS COMPANY



PHILIPS

Circle 21 or Reader Service Card for Demonstration
World Radio History Circle 265 or Reader Service Card for Information

THE SOURCE FOR POWER SUPPLIES!

New 1977 issue Technipower design/data catalog no. 771

YOURS FREE!

Technipower presents the widest range of mil-qualified, industrial and commercial power supplies ever compiled - all backed by a comprehensive 5-year warranty.

Complete engineering specifications are provided. Special sections are devoted to extensive thermal data tables, a glossary of the NEMA terminology, a metric guide, and other technical information.

Write or call today for your free copy.

TECHNIPOWER, INC. 
A **BENRUS** DIVISION

Benrus Center, Ridgefield, Connecticut 06877
Telephone (203) 431-1300 • TWX 710-467-0666

or
Benrus Technical S.A., #6 Rue de la Corsaz, C.H.-1820, Montreux, Switzerland

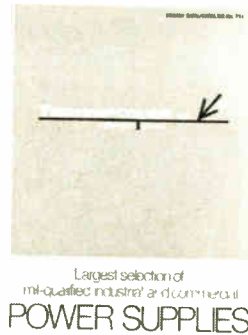

Circle 212 on reader service card

**Now
there's a
Brushless
DC Motor
that makes a
difference!**



A breakthrough in motor design, the AeroFlex Brushless DC Motors feature:

■ A complete package with fully integrated electronics ■ Solid state switching techniques and patented solid state sensing ■ Inverted rotor-to-stator relationship ■ Speed independent non-contacting rotor position sensors.

You no longer have to endure the penalties of brush wear and high power loss. You can have the high starting torque/speed characteristics of conventional, permanent magnet DC motors - plus the brushless advantages of greater reliability, higher efficiency, lower operating temperatures, and a service life limited principally by bearing wear. Also, being brushless, they run without fear of

sparking so they can be used in explosive, corrosive and other hostile environments.

Their application potential is limitless . . . ideal for those areas which require long life reliability, high speed, fluid submersion, low heat generation, etc. They also can be used as AC motor replacements - where high starting torques can eliminate objectionable power drains - and where higher rotational speeds are required than line frequency/speed dependent AC motors can deliver.



**MOTOR PRODUCTS DIVISION
AEROFLEX LABORATORIES INC.**

South Service Road, Plainview, L.I., N.Y. 11803

'Aeroflex is a designer/producer of brushless DC motors and torquers, AC/DC motors, fans and blowers, magnetic sensors, etc.'

212 Circle 266 on reader service card

New literature

capacitors, EMI/RFI filters, and thick-film networks. Specific listings include disk, special-application, and monolithic ceramic capacitors, miniature and subminiature interference filters, and 14- and 16-pin DIPs containing thick-film resistor networks. Copies are available from Centralab Distributor Products, 5757 N. Green Bay Ave., Milwaukee, Wis. 53201 [434]

3-D display modules. An eight-page brochure describes three-dimensional display capabilities and configurations possible with 15 basic

ANALOG GRAPHIC • BUILDING BLOCK MODULES



OEI

Optical Electronics Inc.

analog graphic building blocks designed by Optical Electronics Inc., P. O. Box 11140, Tucson, Ariz. 85734. The brochure includes actual photographs of images generated with the modules. [435]

DTMF signaling. Dual-tone multifrequency (DTMF) signaling, which is familiar to most of us as the basis of the Bell System's Touch Tone dialing system, has many applications in remote supervisory control systems because of its inherent high immunity to noise. A reprinted article that explains DTMF and tells the reader how to build a noise-immune control system is offered by Frequency Devices Inc., 25 Locust St., Haverhill, Mass. 01830. The reprint highlights the five major parameters that endow DTMF with its high noise immunity. [436]

Electronics/May 12, 1977

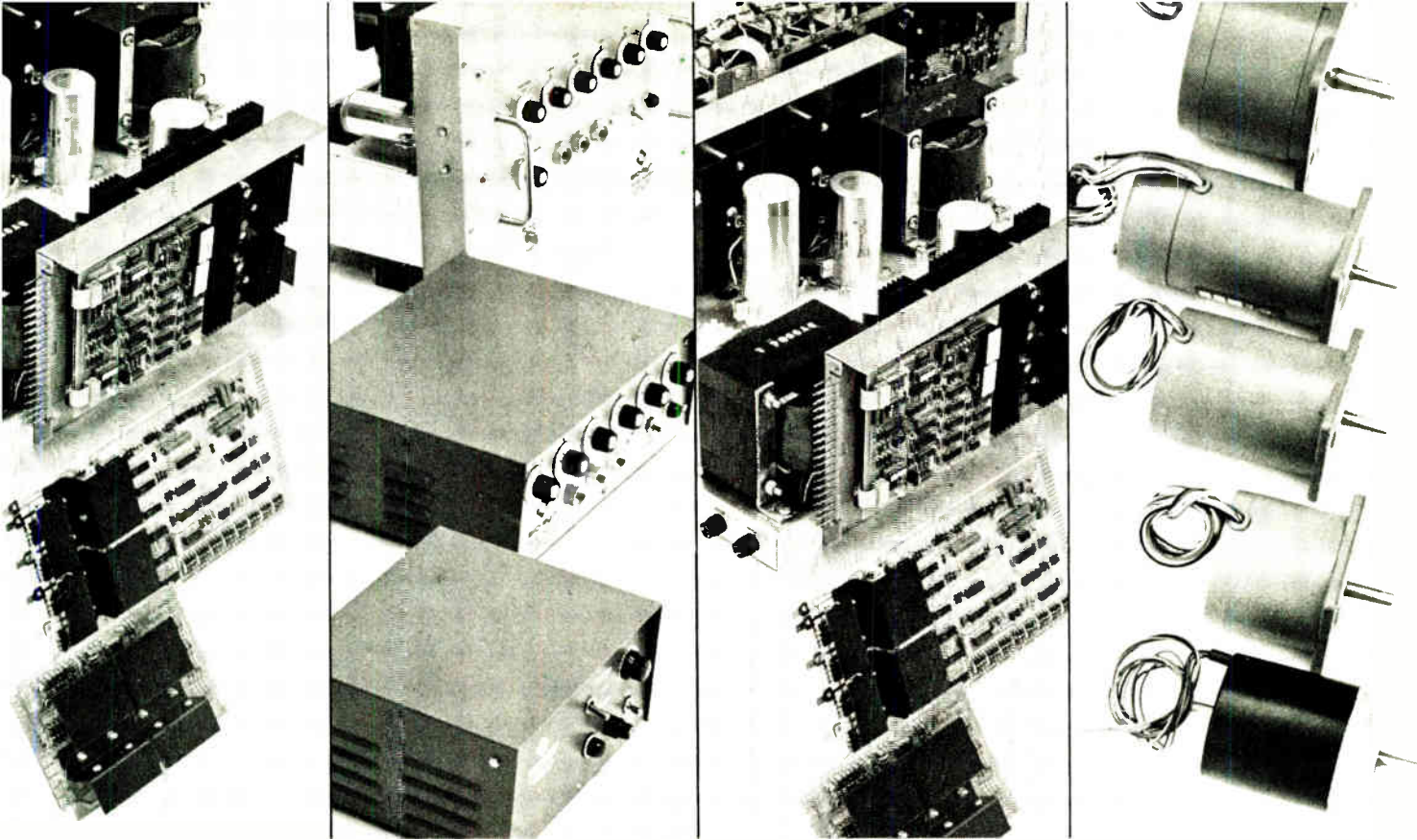

The 10-min. course in stepping motor control.

It's a new concept in step motor controls — and in learning about them. A ten minute, no-nonsense, technical course. Brief — but complete. In one cassette, much about step motors and the capabilities, interfacing, selection of control drives. Engineer-to-engineer.

At \$5.00, you buy expertise in an emerging, vital technology worth many times the modest tuition. Complete with a printed abstract that helps you sum it up.

And Superior has the product that measures up. New Slo-Syn controls that cost less, do more converting digital information to mechanical motion. With modular translator. Preset indexer. For building-block freedom while meeting exact performance criteria.

Now it's no longer cost-effective to do your own circuitry design in

stepper control — not when you can save up to 50% by assembling your tailored system from Slo-Syn modules.

Of course you can buy your drive system fully assembled. Complete with panel-mounted controls. And at a cost/performance ratio that will still surprise you.

Whether you need simple bi-directional positioning or a matrix of task-oriented motions, there is a Superior control drive for you.

A step ahead in positioning.



Superior Electric

Bristol, CT 06010 (203) 582-9561

See new stepping motor controls — DESIGN ENGINEERING SHOW Booth 1100

Send in this coupon today — and get Positioning Tape #1. The first in the series. Keep a step ahead.

Send me your 10-minute cassette course on stepping motor control drives. \$5.00 check or money order enclosed.

Send me new free literature on Slo-Syn control drives.

I'd like a call from my nearest Superior sales engineer.

Name _____ Title _____

Company _____

Street _____

City _____ State _____ Zip _____

Classified section FOR ENGINEERING/TECHNICAL EMPLOYMENT OPPORTUNITIES

CLASSIFIED SALES REPRESENTATIVES

Atlanta . . . Joe Lane . . . 404/892-2868	Cleveland . . . Mac Huestis . . . 216/781-7000	Houston . . . Mike Taylor . . . 713/659-8381	Pittsburgh . . . Dan Ferro . . . 412/391-1314
Boston . . . Holt Buchanan . . . 617/262-1160	Dallas . . . Mike Taylor . . . 214/742-1747	Los Angeles . . . Stan Kassir . . . 213/487-1160	San Francisco . . . M.E. Kenny . . . 415/362-4600
Chicago . . . Bill Higgins . . . 312/751-3733	Denver . . . Shirley Klotz . . . 303/837-1010	New York . . . Dave Hawksby . . . 212/997-3594	Stamford . . . Holt Buchanan . . . 203/359-2860
	Detroit . . . Mac Huestis . . . 313/873-7410	Philadelphia . . . Dan Ferro . . . 215/568-6161	XEROX 400 TELECOPIER . . . 212/997-6800

Engineers

Significant growth coupled with forecasted expansion and a solid commitment to new product development has created exciting professional opportunities for imaginative engineering talent with Gould's fast moving Ocean Systems Division. Immediate openings for:

Sr. Production Engineer (Mechanical)

The selected candidate will have at least a BSME and 10 years working experience. Also necessary is a familiarity with rotary equipment including engines, pumps, motors, and alternators/generators. In addition, exposure to fluid power equipment in the following areas is essential: valves, pumps, and servovalves. A final prerequisite is experience with military documents including weapon specifications as well as familiarity with government drawings in relation to dimensioning, tolerancing, and ANSI Y14.5.

Reliability Engineer

BSME or equivalent and 3 years experience in electro-mechanical component and system analysis plus a familiarity with government contracts are required. Exposure to MIL-Q-9858A and ANSI Y14.5 essential. Involves failure analysis at the component, sub-system and system level. In addition to identifying and writing-up failure analysis reports, candidates must display the ability to recommend corrective action.

If you're up to the large scale challenges and the exhilarating growth pace that have established Gould as an integrated technology company. . . you'll be rewarded with an exceptional salary, a full benefits package and highly-visible advancement opportunities. Submit letter or resume in confidence with earnings history and salary requirements, to:

GOULD OCEAN SYSTEMS DIVISION
18901 Euclid Avenue
Cleveland, Ohio 44117

An Equal Opportunity Employer, M/F/H.



We have been placing graduate **ENGINEERS**

in **FEE-PAID** positions THROUGHOUT THE U.S. since '59. Over 1,000 client companies. We are graduate engineers working full-time for you. Send resume & salary history today or request confidential application.

ATOMIC PERSONNEL, INC.
Suite L, 1518 Walnut St., Phila., Pa. 19102
An Employment Agency
For All Technical Fields

★ **ANALOG/DIGITAL SOFTWARE/FIRMWARE Design & Project Eng'rs**
• BS, MS, Ph.D. •
Nat'l Unadvertised Positions
• \$16-30K •
P'nB Consultants, Box 261 (M)
Wayne, Pa 19087
The Engineers Who
Talk Your Language

Wescom has an extraordinary history of growth in the design, development, and manufacture of electronic telecommunications systems and lists the following career opportunities in their plants in West Suburban Chicago:

SOFTWARE DESIGNERS

We require Design Engineers to assist us in the design and development of software for our telephone switching systems.

You will design and develop the software for a system that is operated by stored program control. This includes the design and implementation of computer programs to operate in a real time environment.

Requirements: B.S. or M.S. in electrical engineering or computer science coupled with a minimum of one (1) year experience with real time systems programming.

HARDWARE DESIGNERS

We are seeking Hardware Designers to join our engineering organization.

To qualify you must be experienced in the design of micro-processor systems, memories and associated interfaces. We require a BS or MS in electrical engineering or computer science and a minimum of 3 years related experience.

Wescom offers a liberal starting salary and full fringe benefit package. If you meet or exceed these requirements, please submit a detailed resume, including salary history in confidence to:

Christine Rosenbach
Employment Manager



8245 S. Lemont Road, Downers Grove, IL 60515

An Equal Opportunity Employer M/F

RATES \$46 per advertising inch (1/8"). Commissionable.
SIZES 1/8" to 10" deep in widths of one column (1 5/8"), two (3 3/8"), three (5 1/8"), and four (7").
CLOSING Two weeks prior to mailing.
MAILING One week prior to issue date.
ISSUE DATE Every other Thursday.
AD ORDERS/BOX NUMBER ANSWERS Send to Electronics, Post Office Box 900, New York, N.Y. 10020.

We have opportunities for Engineers . . .

Instrumentation Engineer

An MS/EE with at least five years experience. Requirements are hardware experience with high voltage, high power circuit design for pulse and dc systems. A knowledge of analog instrumentation problems associated with high power equipment is required.

rf Circuit Design Engineer

A challenging position in rf circuit design and fabrication in a growing R&D electronics laboratory. Knowledge of useful VHF and UHF rf components in discrete and chip form is required. Design and fabrication of hybrid printed circuit board and thick film circuits will be carried out for operation in the 10 to 1000 MHz range. Advanced fabrication and computer aided test equipment will be provided. State-of-the-art hybrid subsystems will be the end product.

These openings provide a chance to join the company ranked seventh in the U.S. in private R&D spending, and live in an attractive New England setting. Please submit your detailed resume with salary history to: E. Marcin, Professional Placement, Silver Lane, East Hartford, Conn. 06108

UNITED TECHNOLOGIES RESEARCH CENTER



An equal opportunity employer

Job-seekers... be the first to know with McGraw-Hill's Advance Job Listings

By having our weekly ADVANCE JOB LISTINGS sent to your home every Monday you can be the first to know about openings both in and out of your field. AJL will enable you to contact anxious recruitment managers BEFORE their ads appear in upcoming issues of 21 McGraw-Hill publications. To receive a free sample copy, plus information about our low subscription rates, fill out and return the coupon below.

ADVANCE JOB LISTINGS / P.O. BOX 900 / NY 10020

PLEASE SEND A SAMPLE COPY
OF ADVANCE JOB LISTINGS TO

NAME _____

ADDRESS _____

CITY _____

STATE/ZIP _____

Engineers and Physicists Application Development Design Evaluation Analysis

Does the opportunity to apply your training and experience to creative engineering, advanced technology and problem solving interest you?

Would you like to work with leaders in your profession—with the support of well-equipped laboratories and prototype fabrication facilities?

If so, we in the Technology Support Division would like to discuss career opportunities with you.

Permanent positions are available in a variety of technical fields in our Components and Processes Laboratory, Developmental Products Laboratory and Advanced Technology Laboratory. Various types of academic backgrounds and levels of experience are needed in the following and in other related activities:

- Complex integrated circuits and microprocessors
- Advanced passive components
- Hybrid microelectronics
- Device physics and failure analysis
- Electronic packaging and interconnections
- High-voltage magnetics and corona
- Semiconductor device characterization
- Component part standards
- Microwave devices and assemblies
- Electronic power supplies
- Electromechanical devices and connectors
- Supplier evaluation and coordination
- Instrumentation and automated testing

Please mail your resume to us today. We promise you a prompt reply. Write Professional Employment, Hughes Aircraft Company, 11940 W. Jefferson Blvd., Culver City, CA 90230

HUGHES

HUGHES AIRCRAFT COMPANY
AEROSPACE GROUP

U.S. Citizenship Required
Equal Opportunity M/F/H/C Employer

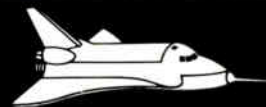

ENGINEERS—JOIN AEL IN SUBURBAN PHILADELPHIA: Now More A Leader Than Ever!

AEL—American Electronic Laboratories, Inc.—is a longtime, well-established leader in electronics design and manufacture. Our continuous R&D and new-product marketing activities have resulted in a current backlog of orders that is very substantial. They've also resulted in the following rewarding career opportunities.

QUALITY CONTROL GROUP LEADER. ASQC quality engineering certification required, along with appropriate technical degree. (E-1)

MICROWAVE COMPONENT DESIGN ENGINEERS. Must be familiar with micro-strip and stripline design techniques. (E-2)

HYBRID PROCESS ENGINEER. Must be familiar with processing techniques used in the manufacture of thick film hybrids. (E-3)

HYBRID DESIGN ENGINEER. Experience in both analog and digital design is required... plus additional experience in thick film and LED display design. (E-4)

DESIGN ENGINEER. Must be familiar with logic design of A/D converters, micro-processors, and digital memories. (E-5)

DESIGN ENGINEER. Must be familiar with the design of image transmission and display equipment, and A/J techniques in TV transmission systems. (E-6)

DIGITAL DESIGN ENGINEER. Digital design experience must include CMOS, TTL, and ECL. (E-7)

SECTION HEAD/RECEIVER GROUP. Must have heavy experience in receiving systems technology, with direct experience in customer interface, proposal writing, and supervision of technical personnel. (E-8)

MICROWAVE/GASFET DESIGN ENGINEER. Must have experience in microwave component development, with two or more years of experience in the design and development of gasset amplifiers. (E-9)

SENIOR ANTENNA STAFF CONSULTANT. Ten or more years of direct design and development experience on military antennas is required. (E-10)

RF ENGINEER. Must have experience in design and development of RF circuits in VHF and UHF spectrums. (E-11)

SOFTWARE ENGINEER. Ten or more years of experience is required in software engineering on large-scale, computer-controlled systems. (E-12)

SYSTEMS ENGINEER. Must have broad sensor and/or communications experience coupled with implementation of real-time computer-controlled systems. (E-13)

SYSTEMS ENGINEER. Systems work background required in the areas of digital hardware and RF/analog hardware. (E-14)

DESIGN ENGINEER-RECEIVERS. Must have experience in RF microwave techniques, with design experience in UHF/VHF and microwave receivers and/or receiver components. (E-15)

BROADCAST TRANSMITTER DESIGN ENGINEER. Required is direct design experience in AM/FM broadcast transmitters and related broadcasting systems equipment. (E-16)

SENIOR ADVANCED CONCEPTS ENGINEER. Your experience must include background in mission and systems threat analysis, with emphasis on new techniques and components in passive surveillance, signal processing, and related EW technology. (E-17)

In these positions you'll enjoy attractive, competitive salaries... many worthwhile benefits (including a dental plan)... totally professional working conditions... and definite career growth potential.

To apply, please send your resume, complete with salary history and the number of the position you're applying for, to: Mr. Peter Hasse, American Electronic Laboratories, Inc., PO Box 552, Lansdale, Pa. 19446. We're an equal opportunity employer.

**AMERICAN ELECTRONIC
LABORATORIES, INC.**

ALL THE ABOVE POSITIONS REQUIRE U.S. CITIZENSHIP

Non-Impact Printer Specialists

Computer Peripherals, Inc., the joint venture company of Control Data Corp., NCR Corp. and ICL Ltd. is involved in a major expansion program.

Computer Peripherals, the nation's leading band-printer manufacturer, is engaged in advanced development programs which are extending the state-of-the-art in non-impact printers. Our vigorous growth has created immediate opportunities in our Ink Jet and Electrophotographic programs for Program Managers, Project Engineers, and design and development specialists in a variety of disciplines. An advanced degree in engineering or physics or a Bachelor's degree with equivalent advanced experience is required, plus the creative ability to develop new directions in non-impact printer technology. Talk with us about growth and un-paralleled creative latitude. Your resume and salary requirement will be reviewed in confidence. Please write Mr. Bob Brown.



COMPUTER PERIPHERALS, INC.

1480 N. Rochester Road Box E-16
Rochester, Michigan 48063
1-313-651-8810

Affirmative Action Employer M/F

FREE Your dream job.

We hope you're happy in your current position, but there's always that ideal job you'd prefer if you knew about it.

That's why it makes sense to have your resume on file in the Electronics Manpower Register, a computerized data bank containing the qualifications of career-conscious ELECTRONICS readers just like yourself.

You'll benefit from nation-wide exposure to industry firms privileged to search the system, and since the computer never forgets, if you match up with their job requirements you'll be brought together in confidence.

To take advantage of this free service, mail your resume to the address below.

ELECTRONICS MANPOWER REGISTER
Post Office Box 900/New York, N.Y. 10020

RF ENGINEERING OPPORTUNITIES

Successful commercial electronics growth Company, located in lovely suburban Maryland, has career opportunities for 2 MANAGERS and several RADIO FREQUENCY ENGINEERING SPECIALISTS.

For the past 2 decades, our organization has promoted several innovative and financially successful product lines—now we are adding new emphasis to our RF organization.

MANAGER, RF DESIGN ENGINEERING

Position calls for strong, creative involvement in the design of marine band synthesized HF exciters, RF receivers, and remote control of exciters—also products utilizing FSK Demodulation techniques.

Successful applicant will have management opportunities to select and direct a team involved in our expanding, currently proven line of communications products.

PRODUCT MANAGER, RF PRODUCTS

Experienced Product Line Manager familiar with RF radio systems, needed to direct product management organization. Responsibilities include development and implementation of business plans, new product proposals, and marketing support.

RF ENGINEERING SPECIALISTS

Excellent opportunities for experienced BS/MSEEs for design of State-of-the-Art Product development. Experience in synthesizers, exciters and receivers desired.

Please submit relevant experience by letter or resume to arrange for personal interview. Our organization is expanding and these openings will be filled shortly! Confidentiality assured. Reply to Personnel Manager, Dept. T, P.O. Box 2351, Sunnyvale, CA 94087.

BOEING Engineers

The Boeing Company in Seattle, Washington has immediate requirements for experienced engineers in a variety of important assignments on a wide range of products as follows:

ELECTRICAL/ELECTRONICS ENGINEERS for:

- Analog and Digital Circuits
- Antennas and Radomes
- Electronic Countermeasures
- Electrical Power Systems Design
- Electronic Packaging
- Electromagnetic Compatibility
- Flight Control Systems
- Guidance and Navigational Systems
- Ground Support Equipment
- Instrumentation Subsystems
- Micro Electronics
- Radar Systems Analysis

LOGISTIC SYSTEMS ENGINEERS for:

- Maintenance/Maintainability
- Spares
- Systems Safety
- Reliability
- Technical Publications

SOFTWARE & COMPUTING SYSTEMS ENGINEERS for:

- Computers and Displays—Design and Development
- Microprocessor Software/Firmware Design and Development
- Real-Time Operational Software Development
- Signal Processing Software Development
- Software/Computing Systems Design Analysis
- Software & Computer Testing and Evaluation
- Support Software Design and Development

SYSTEMS ENGINEERS for:

- Configuration Management
- Product Systems
- Systems Analysis
- System Configuration Development

TEST ENGINEERS for:

- Electrical/Electronic Parts
- Electrical/Electronic Testing
- Flight/Mission/Systems Testing
- Test Program Requirements and Planning
- Wiring and Connector Display

MANUFACTURING TEST ENGINEERS for:

- Analog and Digital Circuit Analysis
- Automatic Test Development
- Custom Hybrid Microcircuit Assembly and Test
- Photo-Voltaic Cell Process and Test Procedure Development
- Test Equipment and Component Design

Candidates must have U.S. citizenship and an appropriate BS degree or higher. Attractive salary, fringe benefits and moving allowances will be offered qualified candidates. And living is a pleasure in the unspoiled Northwest with its many recreational and sports activities and relaxed life-styles.

Look into these outstanding opportunities.

Send your detailed resume now to The Boeing Company, P.O. Box 3707-LDU, Seattle, WA 98124.

An equal opportunity employer.

BOEING

Getting people together

PRINTER ENGINEERS

Computer Peripherals, Inc., the joint venture company of Control Data Corp., NCR Corp. and ICL Ltd. is involved in a major expansion program. We have immediate openings in the following areas:

MICROPROCESS ENGINEER

Candidate will have responsibility for hardware/software design and implementation of Microprocessor techniques to peripheral computer controller devices. Applicants for this position must demonstrate experience in:

- Design and implementation of microprocessor controllers
- TTL Logic Designs on peripheral equipment
- Intel 8080 Microprocessor family or equivalent

ELECTRICAL PROJECT ENGINEER

Experience will include knowledge of microprocessor technology, power supplies, power drive circuitry. Experience directing efforts of other engineers plus technicians is essential. Experience should include budgeting, scheduling of tasks and writing of proposals and specifications.

MECHANICAL PROJECT ENGINEER

Outstanding growth opportunities exist in creative line printer development group for imaginative and creative project leader. Experience should include vibration, stress, structural, dynamic and thermal analysis of electro-mechanical equipment. Responsibilities will also include product definition and generation of product specification. Supervisory experience with engineers and technicians essential.

For all engineering positions above, BS required, MS preferred, plus 2-5 years relevant experience.

We offer competitive salaries and benefits and outstanding growth potential. Please send resume and salary requirements to: Mr. Bob Brown.



COMPUTER PERIPHERALS, INC.

1480 N. Rochester Road, Box E-16
Rochester, Michigan 48063
1-313-651-8810

An Affirmative Action Employer M/F

LOCAL INTERVIEWS IN 1977:

Microprocessor Hardware & Software Engineers
Computer Design Engineers & Programmers
Radar & Communication Engineers
Mechanical Design & Packaging Engineers
Electro-Optics & Laser Systems Engineers
Components & Quality Engineers

Regional Consultants, Inc. is a nationwide technical search firm representing a broad base of clients serving the Electronics field.

We will be conducting interviews in all areas of the country where there are concentrations of technical talent. Our clients are willing to come to you. To meet with them and us, send your resume, including present salary and geographic preferences to:

Search Director

REGIONAL CONSULTANTS, INC.
213 W. 9th Street • Cincinnati, Ohio, 45202
(513) 579-1513

Our Clients are Equal Opportunity Employers

SOUTHEASTERN OPPORTUNITIES

Fox-Morris Associates, a leader in professional engineering placement, presents a partial listing of lucrative career opportunities currently available with our prestige client cos.

Sr. Project Engr—LA	\$25,000
Sr. Inst. Engr—N.C.	\$28,000
Process Control Engr—GA	\$22,000
Product Design Engr—Miss	\$18,000
Project Engr—Tenn	\$20,000
Inst Supv—Houston	\$22,000
Power Dist Engr—S.C.	\$22,000
Mfg Engr—Alabama	\$20,000
Inst Engr—Atlanta Computer	\$18,000
Design Engr—GA	\$16,000
Power Dist Engr—GA	\$17,000
Electronics Engr—Atlanta	\$18,000

All employment costs paid by client cos. No applications or contracts reqd. Reply in conf. to K. Schauer, Mgr, Technical Placement, by resume including present salary.

FOX-MORRIS PERSONNEL CONSULTANTS
2200 CENTURY PARKWAY, N.E.
ATLANTA, GA 30345

POSITIONS VACANT

Electrical Engineering Technology—Upper division E.C.P.D. accredited Bachelor of Technology Program seeks visiting professor to replace faculty member on a two year leave of absence. M.S. Degree in Electrical Engineering required with teaching and industrial experience desirable. Position available Fall 1977. 10 month contract. Send resume and references to Prof. J. Adams, Department of Electrical Engineering Technology, Rochester Institute of Technology, One Lomb Memorial Drive, Rochester, New York 14623. RIT is an Affirmative Action/Equal Opportunity Employer.

Electrical Engineering Technology faculty position—Assistant/Associate professor, depending upon qualifications, beginning in September 1977, hopefully to be filled by August 1. Applicants must have a Master's degree, preferably in the area of electrical/electronic engineering, P.E. or E.I.T. qualifications are highly desired. Three to five years of relevant work experience is necessary. Teaching experience is desired. Applicants should have competencies in electrical systems, digital logic, rotating machines, circuit design, energy converters and electrical distribution. Send resume and references to Dr. D. F. Hackett, Chairman, Technology Division, Georgia Southern College, Box 8044, Statesboro, GA 30458. Affirmative action/equal opportunity employer.

POSITION WANTED

Engineering technician with 10 years hands-on experience in analog, digital, rf, prototype design or assembly and troubleshooting. Mark Worley 1710 Arizona Flint, MI 48506 (313) 785-2602.

OVERSEAS JOBS GUIDE

Job Hunting Guide + Directory of 600 Firms. Details on job sources, resumes, taxes. US\$6.00 + 50¢ P&H (US & Canada). To foreign addresses—add \$1.50 P&H. Friar Books, Dept. EL, 8965 E. Ardenale, San Gabriel, CA 91775.

FREE

Your dream job

We hope you're happy in your current position, but there's always that ideal job you'd prefer if you knew about it.

That's why it makes sense to have your resume on file in the Electronics Manpower Register, a computerized data bank containing the qualifications of career-conscious ELECTRONICS readers just like yourself.

You'll benefit from nation-wide exposure to industry firms privileged to search the system, and since the computer never forgets, if you match up with their job requirements you'll be brought together in confidence.

To take advantage of this free service, mail your resume to the address below. We'll do the rest.

ELECTRONICS MANPOWER REGISTER

Post Office Box 900
New York, N.Y.
10020

Two unique reasons why Hughes can offer you a truly rewarding career in systems analysis

one Continuing responsibility throughout product development. The shaping of basic concepts is only the beginning of your contribution as a Hughes systems analysis engineer. It also includes systems and subsystems optimization, and responsibility for technical integrity of the system



through prototype design and development, production design and testing, and operational phases. You monitor each stage of the program, evaluating all pertinent technical information and suggestions for refinement or possible modification. Your strong involvement from start to finish, and the responsibility you have for a successful outcome, provide the kind of incentives that inspire a man's best efforts.

two "Accent on enlightenment" among technical managers. From immediate supervision to the policy forming level, Hughes managers are aware, vigorous and technically oriented. A high percentage hold advanced degrees in science and engineering—an achievement encouraged and respected at



Hughes. Many present technical managers began their careers just a few years ago as Fellows in the Howard Hughes Masters

and Doctoral Fellowship programs. The resulting climate of rationality assures that your work and professional growth will be recognized and rewarded.



These policies have contributed measurably to the Hughes position of leadership in the aerospace systems industry. The company has grown rapidly from 2,000 employees in 1950 to over 35,000 in 1977. And this growth is continuing.

Hughes systems analysis is not limited to current programs. Much is directed toward the conception and development of advanced systems in electro-optics fire-control radar, lasers,



space sensors, and computer systems.

If you are a graduate of an accredited engineering university, are a U.S. citizen, and have acquired some applicable technical experience, we would like to acquaint you with some of our hundreds of openings.

For immediate consideration, please airmail your resume to:
Professional Employment
Hughes Aerospace Group
11940 W. Jefferson Blvd.
Culver City, California 90230



An equal opportunity M/F/H/C/employer.

WE PROMISE YOU A REPLY WITHIN ONE WEEK

■ Abbott Transistor Labs	6	‡ CTI-Cryogenics	52	• HI-G D'Italia	20E
Acurex/Autodata	57	CTS Corporation	142	Infotek Systems	194
■ ADAC	48	■ Custom Electronics	72	Intel Memory Systems	62,63
Adret Corporation	223	Dana Labs	88	Intel-Microcomputer Components	84,85
Advanced Micro Devices	10-11	Data I/O Corporation	106	■ Interface	180
■* AEG Telefunken	11E	■ Data Precision	77	• Italtel/Siemens	145,149
Aeroflex Laboratories, Inc.	212	Data Translation (Datation)	39	‡ ITT Semiconductor	46,47
■ Alco Electronic Products (Sub. of Augat)	206	Delta Air Lines	210	Kaye Instruments	160
■ Allen-Bradley	24	Dialight Corp.	183	Kedman Company	224
Allied Chemical Co., Metglas Products	221	■ Digital Electronics Corporation	188	■ Kepco, Inc.	5
Allied Electronics	176	• Ducati Elettrotecnica Microfarad	18E	M. S. Kennedy Corp.	14
American Microsystems Inc.	139	E. I. Dupont De Nemours & Co. Inc.	159	‡ Kollmorgen Corp., Photocircuits Division	80,81
AMF Potter & Brumfield	181	‡ Eastman Kodak Co., Graphic Markets Division	15	• L.C.C.	9E
■ Amp, Inc.	18,19	■ EGD Corporation	41	Macrodata Corp.	141
Amphenol North America Div., Bunker Ramo Corporation	60,61	Edsyn, Inc.	184	Macrodyne	177
‡ Analog Devices	132	■ E & L Instruments	164	■ Magnecraft Electric	185
Anriteu Electric Co., Ltd.	186	■ Elec-Trol, Inc.	157	• Magneti Marelli	132
Associated Electronics	180	Electronic Arrays	3rd C	• Matsuo Electric Co. Ltd.	142
AVX Corporation	187	Electronics & Control Engineers Book Club	201,202	• Matsushita Electric Trading Company	125
■ Beckman Instruments	9E,42	■ Electro Scientific Industries	175	M C L, Inc.	174
■‡ Beckman Instruments, Helipot	209	Elgar Corporation	150	‡* MDB Systems	166
The Bendix Corporation, Electrical Comp. Div.	82,83	EMR-Telemetry	196	Megatek Corporation	162
■‡ B & K Precision, Div. Dynascan Corp.	134,135	Faultfinders, Inc.	27	■ MFE Corp.	156
Robert Bosch	69	‡ Ferroxcube Corp., A Div. of North Amer. Phillips	149	MFP Corp.	222
■ Bourns, Inc.	2nd C	Figero Engineering, Inc.	229	Micro Networks	208
■‡ Bud Industries, Inc.	136,137	Florida Department of Commerce	210	MicroTechnical Industries	208
MGR/Bussmann Mfg. Co.	207	■ John Fluke Mfg. Co., Inc.	167	■ Miller-Stephenson Chemical Co., Inc.	180
■ Cambridge Thermionic Corp.	20	■ Frequency Devices, Inc.	244	■ 3M Company (Minnesota Mining & Mfg.)	126,127
• Carlo Erba S.p.A.	81	Frost & Sullivan	200	Microtest Systems, Inc.	192
Centronica	151	■‡ General Electric - Instr. Rental Div.	130	Mostek Corp.	21
C & K Components	184	‡ General Electric, Valox	145	‡ Murata Corporation of America	146
Clairex Electronics	4th C	GenRad	75	NCR Power Systems Division	169
Computer Devices, Inc.	166	• Germanium Power Devices	58	‡ NEC America, Inc., Electron Devices Division	58,59
Continental Rentals	8	Glensyre Electronics, Ltd.	224	New England Instrument Company	171
■ Continental Specialties	152	Grayhill, Inc.	40	Nichicon America Corporation	225
■ Control Data Corporation (peripheral prod.)	128,129	■‡ Guardian Electric Mfg. Co.	125	■ North Atlantic Industries	138
■‡ Corning Glass Works-Electronics Materials Div.	199	Guildline Instruments, Inc.	189	Nurmonics	160
‡ Corning Glass Works, Macor Division	42,43	• Hamlin Inc.	146	■ O.K. Machine & Tool Company	225
		■ Hewlett-Packard Corp.	1,2,64,65,86,87 108,190,204,205	Opto 22	148

Announcing the first major advance in magnetic shielding in 50 years.



METSHIELD™ Fabric

... the first magnetic shielding product made from METGLAS® alloys. METSHIELD fabric can be handled and shaped without performance degradation

Now you have such a shielding. It's METSHIELD™ magnetic shielding fabric — a wholly new flexible product made from Allied Chemical's METGLAS® amorphous metal alloys.

Because of its exceptional strength and flexibility, METSHIELD fabric retains its full shielding effectiveness during fabrication and use.

This reliability of performance — plus the ease with which METSHIELD fabric can be handled and shaped — promises you a significant reduction in the overall cost of shielding.

You can use METSHIELD fabric for a variety of applications, including cathode ray, photomultiplier, vidicon, and image tubes.

To find out how METSHIELD fabric can help solve your shielding problems, phone John Dismukes at 201-455-4031 or Jack Thorp at 201-455-3306. Or send in the coupon.

The time is right for a revolutionary concept in magnetic shielding.

Increased sales of electronic equipment, a trend toward miniaturization, and intensified regulatory considerations have put increased emphasis on electromagnetic compatibility.

Consequently, electronics manufacturers need cost-effective magnetic shielding not plagued by fabrication problems and use limitations associated with conventional nickel alloys.

Send me information on METGLAS® alloys and METSHIELD™ fabric

Name/Title _____

Company _____

City/State/Zip _____

Mail to Metglas Products, Allied Chemical Corporation
7 Vreeland Road, Florham Park, NJ 07932



RF & MICROWAVE SOURCES INFRA-RED, LF, UHF and VHF

RADAR SYSTEMS: 150 MHZ to 35 GHZ

AUTOTRACK ANTENNA MOUNTS: Nike Hercules, Nike Ajax, SCR 584. Capacity 50 lbs. to 10,000 lbs. Light Airborne to Sage Systems

RADAR INDICATORS: PPI-RHI-A/B/C/Scopes

PULSE MODULATORS: 25KW to 10 Megawatts

HIGH VOLTAGE POWER SUPPLIES: Up to 20KV 2A

MICROWAVE TUBES: TWT, Klystron, BWO, Carcinotron, Magnetron Every Frequency

**MICROWAVE COMPONENTS
SONAR SYSTEMS**

SEND FOR FREE 24 PAGE
CATALOG ON YOUR LETTERHEAD



**RADIO RESEARCH
INSTRUMENT CO. INC.**

2 LAKE AVE. EXT., DANBURY, CT. 08610
203-792-6666

Circle 220 on reader service card

ULTRA FINE LINE PRINTING

50—70^μ
Lines & Spaces
by screen printing technique

custom production



Low cost Mass production

Applications

1. Plasma display panel
2. Thermal printer head
3. Multi layer HIC etc.



MFP corp.

25-1, Minami-cho 6-chome, Fuchu,
Tokyo, 183 Japan Tel. 0423-68-3341

Circle 222 on reader service card

Osborne & Associates	154	Syntronic Instruments, Inc.	158
■ Pearson Electronics	182	Tally Corporation	165
Perkin Elmer	179	• Teac Corporation	59
• Philips Elcoma	12E,2E,3E	• V/O Techmashezport	15E
• Philips Industries	46,47	Technipower, Division of Benrus	212
• Philips TMI	19E	Tecnetics	172
‡ Philips TMI	211	■ Tektronix	22,23,35
Piezo Technology	76	■ Teledyne Relays	17
Plessey Semiconductors	191	Teletype	193
Polaroid Corporation	163	■ Telonic Altair	140
■ Powermate	190	Teradyne, Inc.	66
Power Transistor Company	195	T-K Enterprises	224
■ Precision Monolithics Inc.	15	■ TRW/CAPACITORS	173
■ Projects Unlimited	71	■ TRW Power Semiconductors	161
Pro-Log	30	■ TRW RF Semiconductors	28,29
Radio Research Instrument Corporation	222	Ultra-Violet Products, Inc.	188
• RCA Electro Optics & Devices	51	United Detector Technology	197
RCA Solid State	7,9	United Systems Corp., Sub. Monsanto	71
R D Products, Inc.	200	■ Unilrode Corp., Semiconductors	143
‡ Rental Electronics	54	■ Centralab/USCC	153,155
Reticon Corporation	79	Varo Semiconductor	198
■ T. L. Robinson Company, Inc.	230	Vector Electronics	200
• Rohde & Schwarz	1E,21E-24E	Viking Industries	123
• Salots GmbH & Co. KG	206	‡ Wabash Electronics	51
Sangamo Data Recorder Division	178	Wakefield Engrg.	170
• Schlumberger Dept. Instruments	54	Watkins-Johnson Company	168
Scientific Atlanta, Optima Div.	144	• Wavetek San Diego Inc.	15
• S. E. Laboratories Ltd.	4E,37	Wilhelm Westermann	16
• Sternice	43	Wiltron Co.	208
• Shell International Chemical	136,137		
‡ Siemens Compute	37		
• Siemens A G Karlsruhe	7E		
• Siemens AG Munich	52		
Siliconix	44,45		
• Sime Brondi SRL	130		
■ Simpson Electric	73		
• Sonimag	17E		
Statek Corp.	225		
■ Superior Electric	213		

Classified and employment advertising

F. J. Eberle, Manager 212-997-2557

American Electronic Lab. Inc.	216
Atomic Personnel, Inc.	214
Boeing Company	217
Computer Peripherals	216,218
Fox-Morris	218
Gould Oceans	214
Hughes Aircraft	215,219
P/N B Consultants	214
Regional Consultants	218
United Technologies	215
Weecom	214

For more information of complete product line see advertisement in the latest Electronics Buyers Guide

* Advertisers in Electronics International
‡ Advertisers in Electronics domestic edition

FREQUENCY DIFFERENCE MULTIPLIER, FREQUENCY STANDARD

4101/4110

FREQUENCY METROLOGY



FREQUENCY DIFFERENCE MULTIPLIER 4110

This instrument is designed for rapid measurement of the relative frequency difference between two stable sources, one taken as the reference frequency and the other as the frequency to be measured. The technical solution adopted by Adret uses an original process, directly derived from the frequency synthesis technique employed in Frequency Synthesizers. This instrument multiplies a frequency difference by 10,000 in less than 0.2 s and measures a relative difference with 10^{-12} resolution in less than 10 s.

The measurement of the relative difference is provided simultaneously in three forms :

- Digital display with 3 digits and sign
- BCD output
- Analog output

FREQUENCY STANDARD 4101

Many problems associated with frequency metrology call for reference frequencies that atomic standards alone can provide. Some Long Wave transmitters being driven by atomic standards, Adret has developed a synthesized receiver able to pick up any transmitter in the 15-kHz to 200-kHz band. The received frequency is used to phase-lock a crystal oscillator with $5 \cdot 10^{-10}$ stability, which permits to get rid of propagation hazards, broadcasting interruptions and excessive phase variations.

The 1-MHz, 5-MHz and 10-MHz standard frequencies delivered by the instrument are therefore endowed with the long-term stability of the transmitter atomic standard and with the spectral purity of a crystal oscillator.

so let ADRET guide you to the

right instrument :

circle our number on the reader service card, return the coupon or write us on your letterhead. We'll rush you our new 1977 catalog. It gives you a lot of practical tips about frequency measurements as well as the details on our hardware

Circle 223 on reader service card



1630 Manheim Pike,
Lancaster,
Pennsylvania 17601.
Telephone (717) 569-7059.
TWX 510-672-0516

World Radio History

Name _____ Title _____
Firm _____ Phone _____
Address _____
City _____ State _____ Country _____

Use Quick-Wedge to install a bus, connect a motor, mount a p.c. board, cinch up a connector

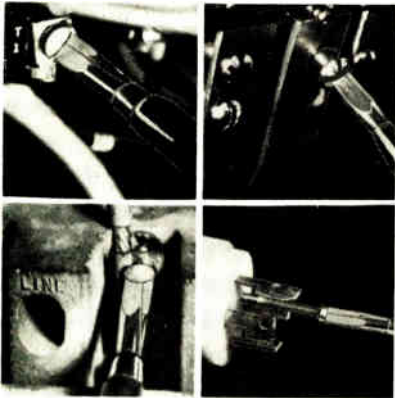

They do all that ordinary screwdrivers do, PLUS they hold and start the screw



QUICK-WEDGE 17 sizes

Screw-holding screwdrivers

Unconditionally guaranteed.

BUY A SET TODAY

See your dealer or write to:

**Kedman Company, P.O. Box 25667,
Salt Lake City, Utah 84125**

© Copyright 1977

Circle 224 on reader service card



LOWPASS FILTERS

**Fast Rolloff
No Insertion Loss
0.001 Hz to 50 KHz
Low Noise**

**FIXED FREQUENCY
RESISTIVE TUNEABLE
PROGRAMMABLE**

FDI manufactures
all types of Filters
Sinewave Oscillators and
Communications Products

**Frequency Devices Inc.
25 Locust Street
Haverhill, Mass. 01830**

(617) 374-0761/TWX 710-347-0314

224 Circle 268 on reader service card

Advertising Sales Staff

Advertising sales manager: Paul W. Reiss

1221 Avenue of the Americas, New York, N.Y. 10020

[212] 997-4371

Atlanta, Ga. 30309: Glen N. Dougherty
100 Colony Square, 1175 Peachtree St., N.E.
[404] 892-2868

Boston, Mass. 02118: Frank Mitchell
607 Boylston St.
[617] 262-1160

Chicago, Ill. 60611
645 North Michigan Avenue
Robert W. Bartlett [312] 751-3739
Robert M. Denmead [312] 751-3738

Cleveland, Ohio 44113: William J. Boyle
[716] 586-5040

Dallas, Texas 75201: John J. Uphues
2001 Bryant Tower, Suite 1070
[214] 742-1747

Denver, Colo. 80203: Harry B. Doyle, Jr.
123 Speer Blvd. #400
[303] 837-1010

Detroit, Michigan 48202: Robert W. Bartlett
1400 Fisher Bldg.
[313] 873-7410

Houston, Texas 77002: John J. Uphues
601 Jefferson Street, Dresser Tower
[713] 659-8381

Los Angeles, Calif. 90010: Robert J. Rielly
Bradley K. Jones, 3200 Wishire Blvd., South Tower
[213] 487-1160

Minneapolis, Minn. 55435: Robert M. Denmead
4015 W. 65th St.
[312] 751-3738

New York, N.Y. 10020
1221 Avenue of the Americas
Michael J. Stoller [212] 997-3616
Matthew T. Reseska [212] 997-3617

Philadelphia, Pa. 19102: Matthew T. Reseska
Three Parkway
[212] 997-3617

Pittsburgh, Pa. 15222: Matthew T. Reseska
4 Gateway Center
[212] 997-3617

Rochester, N.Y. 14534: William J. Boyle
1175 Pittsford-Victor Rd., Pittsford, N.Y.
[716] 586-5040

San Francisco, Calif. 94111: Don Farris
Robert J. Rielly, 425 Battery Street,
[415] 362-4600

Paris: Alain Offergeld
17 Rue-Georges Bizet, 75116 Paris, France
Tel: 720-73-01

Geneva: Alain Offergeld
1 rue du Temple, Geneva, Switzerland
Tel: 32-35-63

United Kingdom & Scandinavia: Robert Ghey
34 Dover Street, London W1
Tel: 01-493-1451

Scandinavia: Andrew Karnig and Assoc.
Kungsholmsgatan 10
112 27 Stockholm, Sweden
Tel: 08 51 68 70 Telex: 179 51

Milan: Luigi Rancati
1 via Baracchini, Italy
Phone 86-90-656

Brussels: Alain Offergeld
23 Chaussee de Wavre
Brussels 1040, Belgium
Tel: 13-73-95

Frankfurt/Main: Fritz Krusebecker
Liebigstrasse 27c, Germany
Phone 72 01 81

Tokyo: Tatsumi Katagiri, McGraw-Hill
Publications Overseas Corporation,
Kasumigaseki Building 2-5, 3-chome,
Kasumigaseki, Chiyoda-Ku, Tokyo, Japan
[581] 9811

Business Department

Thomas M. Egan
Production Manager [212] 997-3140

Gayla Black
Production Manager [212] 997-2044

Carol Gallagher
Production Manager International
[212] 997-2045

Dorothy Carter
Production Manager Domestic
[212] 997-2908

Frances Vallone
Reader Service Manager
[212] 997-6057

Electronics Buyers' Guide

H.T. Howland, General Manager
[212] 997-6642

Regina Hera, Directory Manager
[212] 997-2544

Gayla Black, Production Manager
[212] 997-2044

Frances Vallone, Reader Service Manager
[212] 997-6057

Classified and Employment Advertising

Frank Eberle, Manager
[212] 997-2557

HIGH EFFICIENCY CONVERTERS

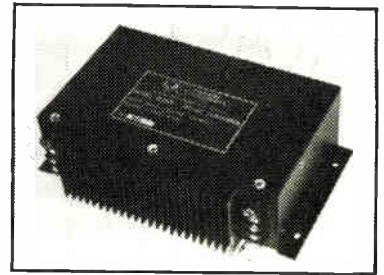

- Input/output voltages: 12, 24, 32, 48, 60, 72 & 120 volts
- Output power ranges: 150-500 watts
- High efficiency — 80% typical
- Fully regulated output voltages
- Output current limiting protection
- DC isolation between input/output/chassis
- Proven performance & reliability
- Custom voltages & current models available

FOR YOUR DC-DC CONVERTER REQUIREMENTS CONTACT:

GLENVRE ELECTRONICS

In Canada:

1551 Columbia Street,
North Vancouver, B.C., Canada V7J 1A3
Phone: (604) 980-6041 • Telex: 04-352520

In the U.S.A.:

Glenayre Electronics Inc.
3631 Interlake Avenue North
Seattle, Washington 98103
Phone: (206) 633-4500

DEALER INQUIRIES INVITED

Circle 269 on reader service card

PROFESSIONAL DISCOUNTS



HEWLETT PACKARD

We are franchised H-P dealer All accessories at discount

HP-21	\$64.00	HP-60	\$140.00
HP-22	100.00	HP-67	236.00
HP-25	116.00	HP-97	395.00
HP-25C	160.00	HP-91	664.95
			295.00

FREE Reserve power pack with purchase of HP-21, 22, 25, 25C, 27 if bought before May 31

Texas Instruments
electronic calculator

TI-30	\$20.00	SR-51-II	\$52.00
1600	21.95	SR-56	79.95
1650	24.95	SR-52	184.95
2550-II	28.50	PC-100	154.95
SR-40	31.00	TI-5050M	88.00
Bus Anst	31.00	5040-PD	108.00
5100	44.95	Money Mgr	20.00

PC-100/SR-52 All Libraries Available
Combo Sales \$322.00 Ask for TI Digital Watches!

Also SCM, Olivetti, National Semiconductor, Casio, Canon, Corvus, APF Sharp, Craig, Sanyo, Record-A-Call, and more. All at great prices!



Programmable Logic Game \$149.95
2000 games possible
Cartridges 17.95
Also Fairchild Watches!

WE WILL BEAT OR MEET ANY COMPETITORS' PRICE IF HE HAS MERCHANDISE ON HAND. 30-day exchange by TK 1 year warranty by manufacturers. All units shipped in original factory cartons with accessories according to manufacturers' specifications. In Calif. call (213) 370-0795 or ORDERS ONLY CALL (800) 421-0367 (other than CA). BankAmericard & Master Charge accepted on most sales. Send money order. Pers ck (2 wks to clear) in CA add 6% sales tax. Add \$3.50 min. shipping charges U-I only \$7.00 for SR-52, PC-100, HP-67, 97. Canada min. shipping charges \$6.50 WE SHIP UPS AIR. Send mail orders to DEPT. EL-E

tkenterprises

1661 Hawthorne Blvd., Lawndale, Ca 90240
(213) 370-5795 **(800) 421-0367**

Circle 270 on reader service card



WIRE WRAPPING TOOL

For AWG 30, .025" (0,63mm) sq. post, "MODIFIED" wrap, positive indexing, anti-overwrapping device

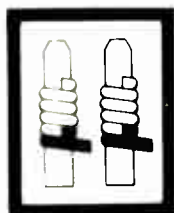

OK MACHINE & TOOL CORPORATION

3455 Conner St., Bronx, N.Y. 10475 / (212) 994-6600 / Telex 125091

Circle 225 on reader service card

NEW

HOBBY-WRAP
Model BW-630



Battery wire wrapping tool

\$34⁹⁵
(batteries
not included)
ONLY
COMPLETE WITH BIT
AND SLEEVE

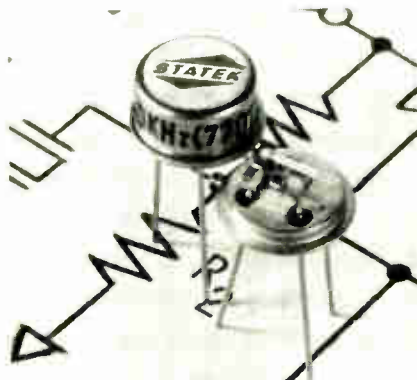

CMOS Crystal Oscillators in low profile TO-5.

Frequency range is 10 kHz to 300 kHz (divided outputs to 1 kHz, low as one cycle per month available). Low milliamp current consumption. Accuracy $\pm 0.01\%$. Shock 1000 g. Hybrid thick and thin film chip and wire design is rugged and ideally suited for portable equipment. Details in Gold Book & EEM.



STATEK CORPORATION
512 N. Main
Orange, California 92658
Telephone: (714) 639-7810
TELEX 67-8394

Circle 91 on reader service card

The low down on low leakage.



Nichicon Aluminum Electrolytic Low-Leakage Capacitors meet the most stringent low-leakage specifications. Yet, they cost up to 50% less than comparable tantalum or film-type capacitors. Why pay more when you can get the same performance characteristics for less?

Free Catalog.

To receive complete catalog information and engineering samples, write to us on your company letterhead.



The pulse of the industry.

nichicon

NICHICON (AMERICA) CORPORATION
6435 N. Proesel Ave. • Chicago, IL 60645 • (312) 679-6530
Division of NICHICON CAPACITOR LTD., Kyoto, Japan

Circle 90 on reader service card 225

The Electronics Book Series offers you:

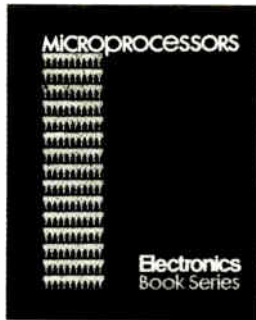

1

MICROPROCESSORS

This book cuts through the confusion, presenting the design and application potential of this exciting technology in a manner that will appeal to the design engineer who needs to know how to use microprocessors as well as the system analyst who must assess the tradeoffs between microprocessors and other techniques to accomplish his system goals.

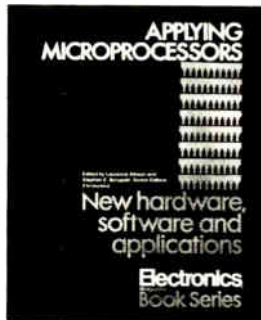

2

APPLYING MICROPROCESSORS

This new book completes the engineer's transition from the old methods of electronic design to the new world of microprocessor engineering. The book contains the up-to-date and ready-to-use information that every designer needs to know about the new technology.

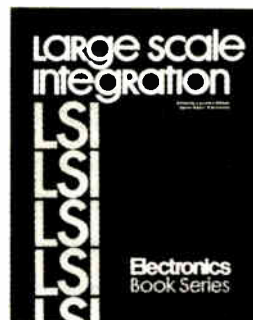

3

LARGE SCALE INTEGRATION

"Large Scale Integration" deals with the entire range of design applications main memory systems, peripheral memories, memory controllers, on-line industrial controllers, data acquisition boards, communication systems, calculators, watches, etc.

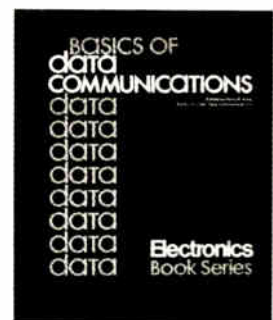

4

BASICS OF DATA COMMUNICATIONS

Chances are you are going to be a part of the data communications market. There's no better place to start than getting a copy of "Basics of Data Communications"—a 316-page compilation of essential articles which have appeared in Data Communications magazine.

Use form below to order your copy. Prices on 10 copies or more, available upon request.

Electronics Book Series

1221 Avenue of the Americas, New York, New York 10020



1 Send me _____ copies of "Microprocessors" at \$8.95 per copy.

2 Send me _____ copies of "Applying Microprocessors" at \$9.95 per copy.

3 Send me _____ copies of "LSI" at \$9.95 per copy.

4 Send me _____ copies of "Basics of Data Communications" at \$12.50 per copy.

Full payment must accompany my order.

I must be fully satisfied or you will refund full payment if the books are returned after ten-day trial examination.

Name _____ Title _____

Company _____

Address _____

City _____ Country _____

Signature _____

The big 32K ROM! Newest discovery in ROM Country

Sure it cuts your parts count and saves money — but that's only the beginning of what the big ROM offers.

Just check these seven other important advantages the EA 3200 brings the system builder:

It keeps pace with the fastest μ Ps on the market. Guaranteed access is a sizzling 350 ns.

It interfaces directly with popular μ Ps like the 8080, 6800, and Z-80.

It cuts power requirements and heat generation. Typical power per bit is 1.6 microwatts on standby and only 15 microwatts operating.

It can upgrade systems started with other popular PROMs and ROMs — because it's pin compatible with parts like the EA 2708 PROM and EA 8308/8316 ROM.

It can be shipped in prototype quantities, loaded with your program, only four weeks after data verification.

It's in stock right now already programmed as an interpreter that converts BASIC language to machine language for the 8080. We can ship you some tomorrow.

And it's made by the specialists in ROMs and PROMs, Electronic Arrays. We deliver over a billion bits every month in 19 different models.

Just contact us in ROM COUNTRY: Electronic Arrays, 550 E. Middlefield Road, Mountain View, California 94043. Phone us on our toll-free WATS line (800) 227-9962 or our regular line (415) 964-4321.

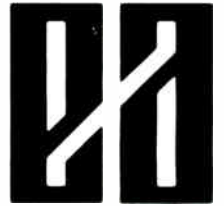

**electronic
arrays, inc.**

**ROM
COUNTRY**

Circle 901 on reader service card



Type 9 CdS photoconductive material offers highest stability!

Stability at high temperatures and less light memory than any other CdS material are the chief characteristics of Clairex's Type 9 CdS. It also offers

improved linearity and broader spectral response.

Clairex photocells with Type 9 material are available in TO-5, TO-8 and TO-18 packages. If you

have photocell stability problems, try Type 9 material.

Clairex® is the industry's specialist in "light" problems. Tell us your

problem; we'll develop the solution. Call (914) 664-6602 or write Clairex, 560 South Third Avenue, Mount Vernon, New York 10550.

TYPE 9 MATERIAL

- LOW TEMPERATURE ERROR
- LOW LIGHT HISTORY EFFECT
- HIGH LINEARITY
- FAST RESPONSE TIME
- RESISTANCE TOLERANCE AT 2 Ft-C: ±33
- TEMPERATURE RANGE: 50 C to +75 C

TYPE	Sensitive Material	Peak Spectral Response (Angstroms)	Resistance at 25°C (Ohms)	Min. Dark Resistance 5 sec. After 2 hrs.	Maximum Voltage Rating (Peak & C.)	Measurement Voltage	Maximum Power 25°C
CL5M9M	1.0μm	7500Å	11K	1.12M	170V	10	0.15 watts
CL700L	9	7500Å	25K	1.67M	100V	10	1.25 watts
CL900L	4.0μm	7500Å	100K	6.7 M	100V	10	0.50 watts

RESPONSE TIME VERSUS LIGHT

Foot Candles	0.1	0.1	1.0	10	100
Rise (Seconds)*	0.5	0.25	0.22	0.05	0.02
Decay (Seconds)**	1.25	0.21	0.09	0.02	0.01

VARIATION OF CONDUCTANCE WITH TEMPERATURE

Foot Candles	0.1	0.1	1.0	10	100
Temperature	% Conductance				
50 C	103	104	104	104	106
25 C	103	104	104	103	106
0 C	98	102	102	103	103
25 C	100	100	100	100	100
50 C	98	102	103	104	99
75 C	96	106	108	109	104

MEASUREMENT DATA • All measurements at 2854 K • Cells light adapted 16 hrs. at 30 ft-c prior to test • Measurement voltage is D.C. applied voltage for measuring resistance • All readings made at 25°C ambient

CLAIRES ELECTRONICS
A DIVISION OF CLAIRES CORPORATION
560 South Third Avenue, Mount Vernon, N.Y. 10550 • (914) 664-6602

CLAIRES ELECTRONICS
A Division of Clairex Corporation