

DECEMBER 23, 1976

TRACKING DOWN BUGS IN MICROPROCESSOR SYSTEMS/57

Navy's computer standardization drive picks up steam/54

How to expand a microcomputer's memory/67

FOUR DOLLARS A MCGRAW-HILL PUBLICATION

Electronics®

1470 N.W. 251 CAMAG NOV77
MATT WELLS
2516 NE CLACKAMAS
PORTLAND OR

FROM COSTS TO CARTER:

**What's on
top executives'
minds**

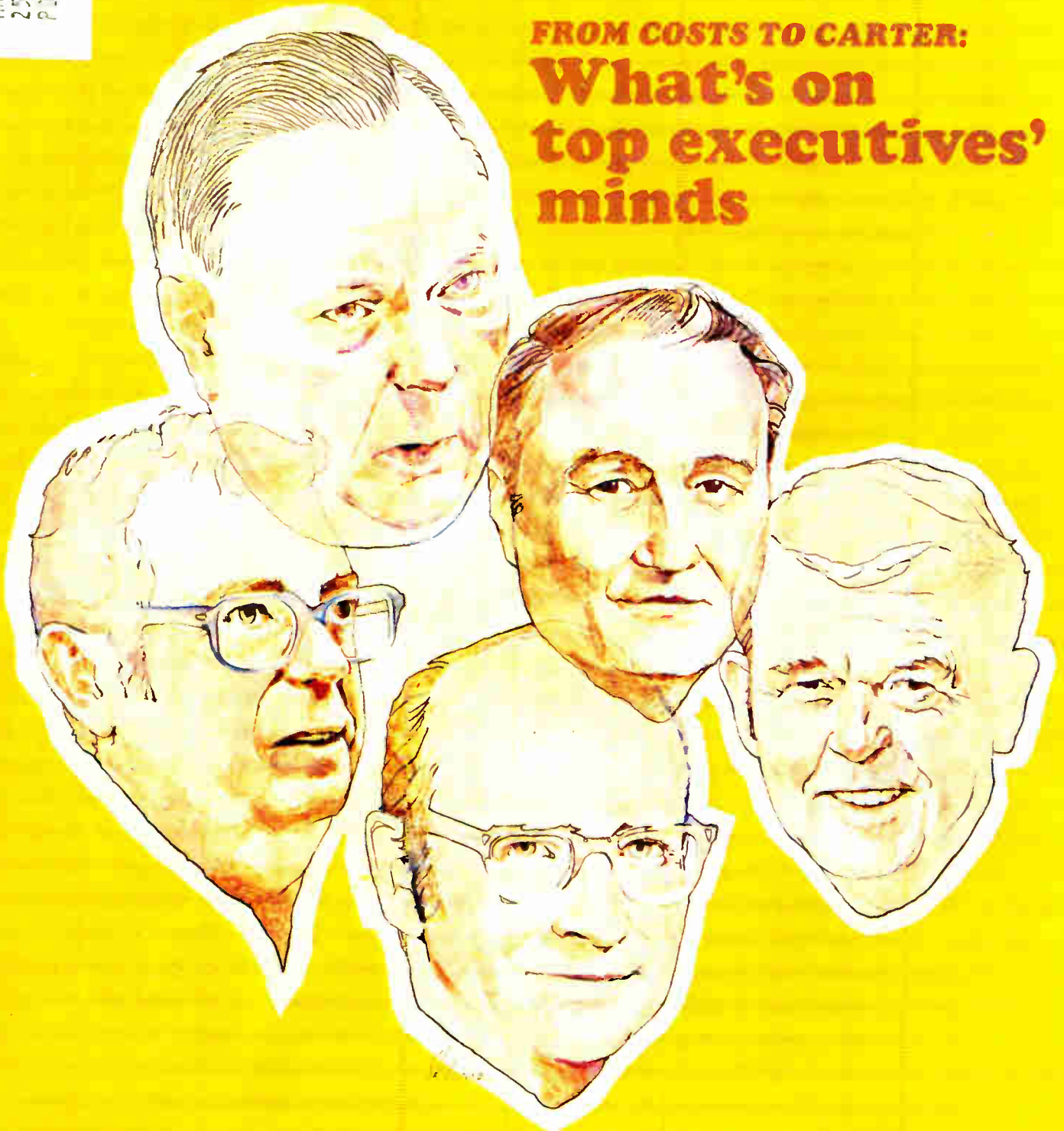

THE SOLUTION TO YOUR NEXT EDP POWER DISTRIBUTION PROBLEM IS RIGHT BEFORE YOUR EYES

You're looking at six products that can solve a lot of problems.

When space is limited, our flat cables are just what you need. Installed in layers, they can follow the contours of almost any enclosure. Break-outs and terminations are easily and quickly made by mechanical means. And they're available in copper or aluminum strip with PVC or Tefzel insulation or as polyester laminated Brand-Rex TAPE CABLE®

A lot of other problems can be solved with our standard round wires and cables — many having dual UL/CSA ratings. They're available with conventional plastics, or irradiated PVC and polyethylene insulations. Brand-Rex has sold millions of feet of these products to leading CPU and peripheral equipment manufacturers around the world. We probably already make an EDP power distribution wire or cable that's just what you need. If we don't, we can design one for you. Just talk to your local Brand-Rex sales-engineer, or write or call Brand-Rex Company, Electronic and Industrial Cable Division, Willimantic, CT 06226. 203/423-7771.

BRAND-REX

ELECTRONIC & INDUSTRIAL CABLE DIVISION

Other Brand-Rex Divisions
Abbot & Co. wiring harnesses
Nonotuck Manufacturing Co. copper wire
Pyle-National Co. electrical connectors
Telecommunications Cable Division
Teltronics, Inc. telephone equipment and components
Brand-Rex Ltd. (Scotland) wire and cable

BRAND-REX CO. A PART OF AVZONA INCORPORATED

**TAPE CABLE® —
FLAT CONDUCTOR
CABLE** — 3 con-
ductors = 12 AWG.
polyester insulation
Available in other
gauge sizes and
number of
conductors

**PVCC® CABLE —
TEFZEL INSULATED
SPLIT COPPER
BUS.** Also available
with one insulated
copper strip

**PVCA® CABLE —
PVC INSULATED
ALUMINUM STRIP.**
Available in = 16 to
2 0 AWG equivalent
sizes

**3 CONDUCTOR
CABLE.** Com-
ponents 12 AWG
stranded PVC
insulated conductors

**IRRADIATED PVC
INSULATED #14
STRAINED
CONDUCTOR**

**PVC INSULATED
#10 AWG
STRAINED
CONDUCTOR**

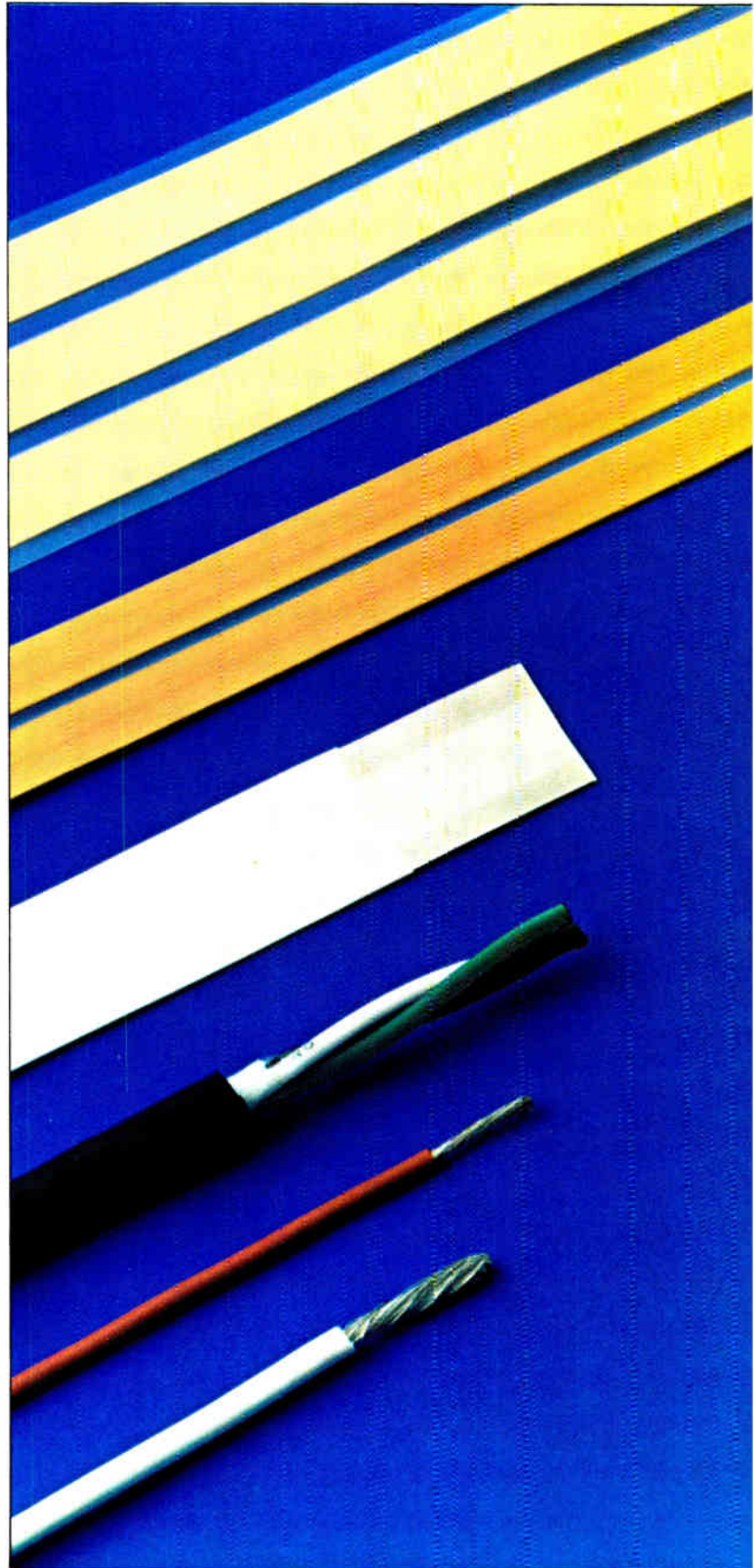

Circle 900 on reader service card

THE SPECTRUM ANALYSIS SPECTRUM

The HP 140 family covers it. Precisely. Conveniently. Completely. From 20 Hz to 40 GHz.

Select normal or variable persistence display or choose economy or high-resolution IF module. Then pick or change your frequency range by simply plugging in the appropriate tuning module.

20 Hz to 300 kHz

The 8556A tuner covers 20 Hz to 300 kHz and comes with a built-in tracking generator. It's calibrated for measurements in both 50 and 600 ohm systems, with accuracies better than ± 1 dB.

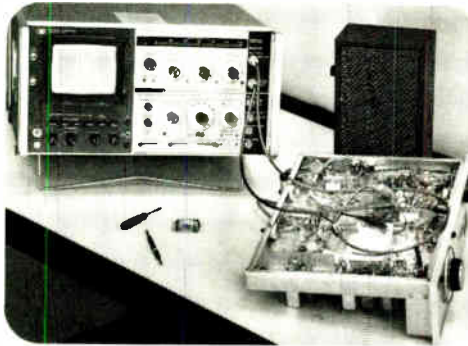

1 kHz to 110 MHz

The 8553B takes you from 1 kHz to 110 MHz with -140 dBm sensitivity. Signals can be measured with $\pm 1\frac{1}{4}$ dB accuracy. Choose the companion tracking generator/counter for wide dynamic range swept frequency measurements and precise frequency counting.

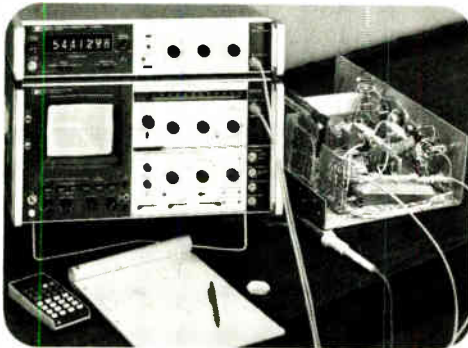

100 kHz to 1250 MHz

Use the 8554B tuning section to cover the 100 kHz to 1250 MHz range. Measure with $\pm 1\frac{3}{4}$ dB accuracy. Its companion tracking generator (500 kHz to 1300 MHz) also works with the 8555A tuning section.



10 MHz to 40 GHz

For 10 MHz to 40 GHz, choose the 8555A. Its internal mixer covers to 18 GHz, accessory mixer for 18-40 GHz. Maximum resolution is 100 Hz. Measure with $\pm 1\frac{3}{4}$ dB accuracy to 6 GHz, $\pm 2\frac{3}{4}$ dB to 18 GHz. For wide scans free from unwanted response between 10 MHz and 18 GHz, add the automatic preselector.

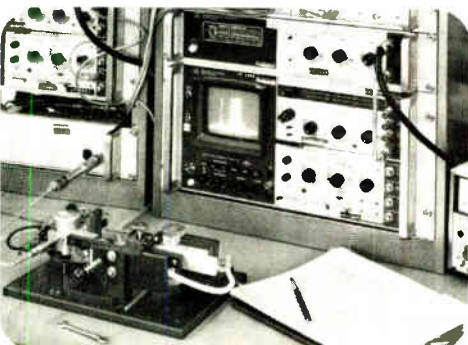

No matter what range you're working in, you need reliable unambiguous answers. HP's spectrum analyzers give you accurate measurements over wide, distortion-free dynamic ranges, time after time. Easy operation too, with front panel markings that really help reduce the possibility of operator error.

But there's much more. Call your nearby HP field engineer or write for the full story on HP's spectrum analyzer spectrum.

HEWLETT  PACKARD

Sales and service from 172 offices in 65 countries.
1501 Page Mill Road, Palo Alto, California 94304

EMI/RFI SHIELDING

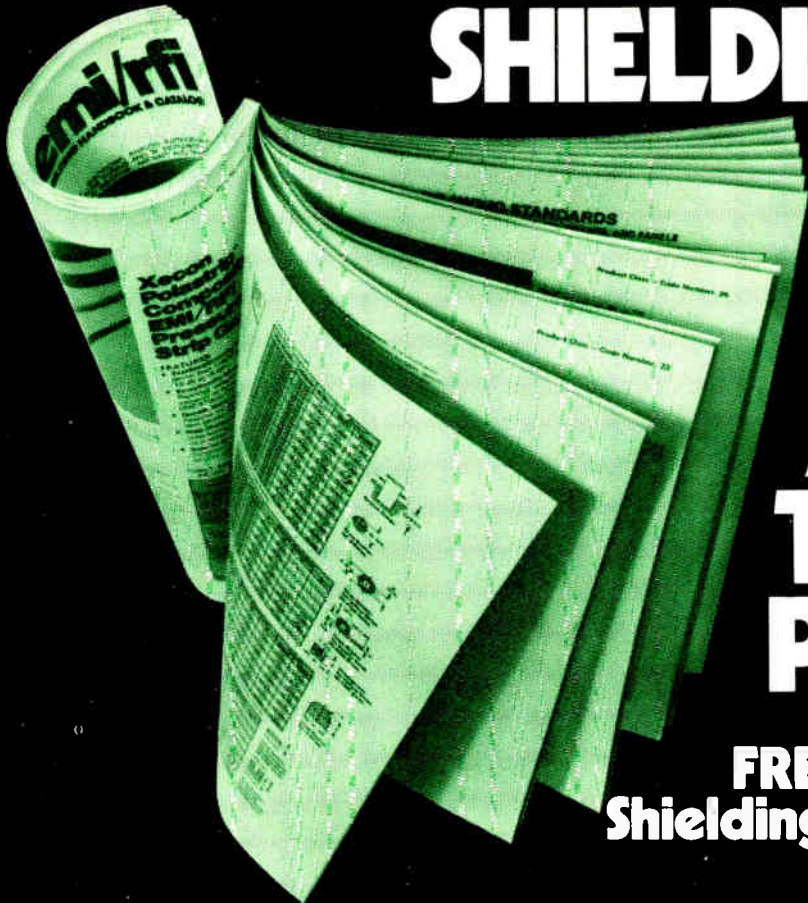

TOUGH ANSWERS TO TOUGH PROBLEMS

FREE...New EMI/RFI Shielding Handbook & Catalog

This abundantly illustrated 124-page handbook presents...a thorough treatment of electromagnetic shielding...practical applications of shielding techniques...a complete guide to EMI/RFI gasket design...a glossary of EMI/RFI terms...and a catalog of products. Edited by the Metex Electronic Shielding Group, leading manufacturer of EMI/RFI shielding materials, components, subsystems.



PLUS
Three more technical services

1 FREE Videotape Presentations

See and hear practical solutions to the problems associated with EMI/RFI shielding.

2 FREE Shielding Seminars

For small groups. Interface with EMI/RFI gasketing experts. Presentations oriented to the group interest. Color slides...videotapes...samples... question-and-answer sessions.

3 FREE Applications Engineering

Get concise, meaningful, technical assistance...technical briefs...personal consultation.

METEX
ELECTRONIC SHIELDING GROUP

Phone...wire...write...send smoke signals...or mail this today.

Metex Electronic Shielding Group:
I accept your offer.

- | | |
|--|--|
| <input type="checkbox"/> Send EMI/RFI Shielding Handbook & Catalog | <input type="checkbox"/> Add my name to your mailing list for applications briefs. |
| <input type="checkbox"/> Have your local field representative phone me. | <input type="checkbox"/> Don't bother me. |
| <input type="checkbox"/> Phone me about applications engineering consultation. | |

NAME _____	TITLE _____ () _____
COMPANY _____	PHONE _____
ADDRESS _____	
CITY _____	STATE _____ ZIP _____

METEX CORPORATION
970 New Durham Rd., Edison, N.J. 08817 • 201-287-0800

CAL-METEX CORPORATION
507 Hindry Ave., Inglewood, CA. 90301 • 213-641-8000

29 Electronics Review

- SPACE: Space Shuttle to process its data on board, 29
- COMPUTERS: IBM research mini trades off hardware, software, 30
- INDUSTRIAL: Microprocessors control plastics-shaping tool, 31
- SOLID STATE: National gambles on 18-, 22-pin 4-k RAMs, 32
- CONSUMER: Video games show winning streak despite shortages, 32
- COMMUNICATIONS: Digital radio uses pulse distortions, 33
- NEWS BRIEFS: 34
- IEEE: Familiar faces fill out IEEE board, 35
- MEDICAL: Iron particles help automate blood tests, 35
- Modules prescribed for implementing different systems, 35
- MILITARY: Microprocessor unit controls F-18 weapons, 36

47 Electronics International

- GREAT BRITAIN: Plessey bets on LED for early fiber-optic links, 47
- AROUND THE WORLD: 47
- JAPAN: High-resolution electron-beam unit exposes ICs fast, 48

51 Probing the news

- ELECTRONICS ABROAD: French electronics look to growth, 51
- MILITARY: Navy rushes to standardize computers, 54
- SEMICONDUCTORS: Plasma etching makes its mark, 56

57 Technical Articles

- INSTRUMENTS: Tester families pinpoint microprocessor flaws, 57
- COMPUTERS: How to expand a microcomputer's memory, 67
- DESIGNER'S CASEBOOK: Encoder aids clock-computer interface, 70
- Engine staller thwarts car thieves, 71
- BUSINESS OUTLOOK: Top executives weigh 1977, 73
- ENGINEER'S NOTEBOOK: Using the 6820 peripheral interface adapter, 85
- Resistance-table program finds nearest standard value, 86

91 New Products

- IN THE SPOTLIGHT: Generator covers 100 hertz to 1 gigahertz, 91
- COMPONENTS: Relays switch 480 volts at 40 amperes, 92
- DATA HANDLING: Data General markets disk drives, 94
- INDUSTRIAL: CRT display for process control is simplified, 96

Departments

- Publisher's letter, 4
- Readers' comments, 6
- News update, 8
- Editorial, 12
- People, 14
- Meetings, 20
- Electronics newsletter, 25
- Washington newsletter, 41
- International newsletter, 45
- Engineer's newsletter, 88

Services

- Reprints available, 44
- Employment opportunities, 98
- Reader service card, 105

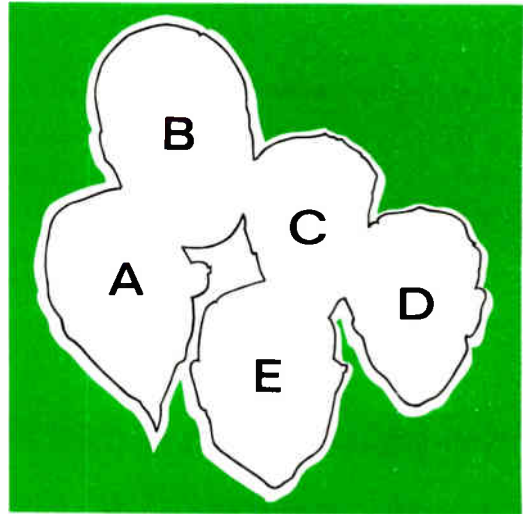

Highlights

Cover: Company leaders preview the new year, 73

Executives at the helm of electronics firms foresee a year of steady growth ahead. Tempering their optimism are such concerns as the strength of the recovery, the direction the Carter Administration will take, and technology inroads by other industrialized nations.

Cover illustration by Art Director Fred Sklenar features J. Fred Bucy of Texas Instruments (A), RCA's Edgar H. Griffiths (B), Gerald G. Probst of Sperry Univac (C), William R. Hewlett of Hewlett-Packard (D), and Motorola's William J. Weisz (E).

Testers face up to microprocessors, 57

Those wonderful little chips that are simplifying system design are complicating prototype troubleshooting. But new families of logic and microprocessor analyzers help designers track down hardware and software faults.

Raising the ante in microcomputer memories, 67

The steady drop in the cost of semiconductor memory has triggered the rush to add more of these chips to microcomputers. And they can handle more memory than they were meant to, if that memory is split into pages, or if extra hardware adds address bits.

And in the next issue . . .

Annual market forecast for the U.S., Europe, and Japan . . . programing the F8 to scan keyboards with no external hardware.



EDITOR-IN-CHIEF: Kemp Anderson

EXECUTIVE EDITOR: Samuel Weber

MANAGING EDITOR: Arthur Erikson,
International

SENIOR EDITORS: Laurence Altman,
Ray Connolly, Lawrence Curran,
John Johnsrud, H. Thomas Maguire,
Stephen E. Scrupski

ART DIRECTOR: Fred Sklenar

ASSOCIATE EDITORS: Howard Wolff,
Gerald M. Walker, Alfred Rosenblatt

DEPARTMENT EDITORS

Aerospace/Military: Ray Connolly
Circuit Design: Raymond P. Capece
Communications & Microwave:
Richard Gundlach
Components: Lucinda Mattera
Computers: Stephen E. Scrupski
Consumer: Gerald M. Walker
Industrial: Raymond P. Capece
Instrumentation: Andy Santoni
New Products: H. Thomas Maguire,
Michael J. Riezenman
Packaging & Production: Jerry Lyman
Solid State: Laurence Altman

CHIEF COPY EDITOR: Margaret Eastman

COPY EDITORS: Everett C. Terry, Ben Mason

ART: Charles D. Ciatto, *Associate Director*
Paula Piazza, *Assistant Director*

EDITORIAL SECRETARIES: Janet Noto,
Penny Rothman, Marilyn B. Rosoff

FIELD EDITORS

Boston: Lawrence Curran (Mgr.), Pamela Leven
Los Angeles: Larry Waller (Mgr.)
Midwest: Larry Armstrong (Mgr.)
New York: Bruce LeBoss (Mgr.)
San Francisco: Bernard Cole (Mgr.)
Judith Curtis
Washington: Ray Connolly (Mgr.)
Frankfurt: John Gosch
London: William F. Arnold
Paris: Arthur Erikson
Tokyo: Charles Cohen

McGRAW-HILL WORLD NEWS

Editor: Michael Johnson
Brussels: James Smith
Milan: Andrew Heath
Moscow: Peter Gall
Paris: Joel Stratte-McClure
Stockholm: Robert Skole
Tokyo: Colin Gibson

PUBLISHER: Dan McMillan

MARKETING ADMINISTRATION MANAGER:
Wallis Clarke

CIRCULATION MANAGER: Karl Peterson

MARKETING SERVICES MANAGER:
Tomlinson Howland

RESEARCH MANAGER: Margery D. Sholes

As 1976 draws to a close and the United States witnesses the start of its third hundred years, it's certainly a time to look ahead a bit at what the future holds for the electronics industries. As we have done for a number of years now, we use our turn-of-the-year issues as vehicles for in-depth reports on the economic and marketing trends for both the year ending and the year ahead.

A quick preview. Next issue will carry the 19th annual *Electronics* market report, a wrap-up of worldwide marketing trends. Based on our extensive market survey—which includes questionnaire, in-person, and telephone data gathering—and on numerous interviews with knowledgeable industry sources, the final report has become an invaluable industry document. Look for it in our Jan. 6 issue.

Now for this issue. On page 57, you'll find one of our more ambitious efforts in bringing the thoughts of

top corporate executives and business leaders to readers. Nearly three dozen executives, analysts and economists share their views on industry trends in the 12-page special report that our editors have put together.

For the report, our domestic and international network of correspondents sought out key executives for interviews. That's our solid state editor, Larry Altman (left, above), for instance, interviewing Mostek's L. J. Sevin. Also reporting for the executives' outlook story were Lawrence Curran in Boston, Larry Armstrong in Chicago, Bernard Cole in San Francisco, Larry Waller in Los Angeles, Bruce LeBoss in New York, Charles L. Cohen in Tokyo, Arthur Erikson in Paris, James Smith in Brussels, and John Gosch in Frankfurt.

December 23, 1976 Volume 49, Number 26
95,062 copies of this issue printed

Published every other Thursday by McGraw-Hill, Inc. Founder James H. McGraw 1860-1948. Publication office 1221 Avenue of the Americas, N.Y., N.Y. 10020, second class postage paid at New York, N.Y. and additional mailing offices.

Executive, editorial, circulation and advertising addresses: Electronics, McGraw-Hill Building, 1221 Avenue of the Americas, New York, N.Y. 10020. Telephone (212) 937-1221. Teletype 12-7960 TWX 710-581-4879. Cable address: MCGRAW HILL NEW YORK.

Subscriptions limited to professional persons with active responsibility in electronics technology. No subscriptions accepted without complete identification of subscriber name, title, or job function, company or organization, and product manufacturer or services performed. Based on information supplied, the publisher reserves the right to reject non-qualified requests. Subscription rates in the United States and possessions \$12.00 one year, \$30.00 three years; company addressed and company libraries \$18.50 one year, \$46.00 three years; APC/JFP addressed \$35.00 one year only; Canada and Mexico \$14.00 one year, \$32.00 three years; Europe \$35.00 one year, \$87.50 three years; Japan, Israel and Brazil \$60.00 per year; Australia and New Zealand \$80.00 per year, including air freight. All other countries \$40.00 per year. Limited quota of subscriptions available at higher-than-basic rate for persons allied to field served. Check with publisher for these rates. Single copies: \$4.00. Please allow four to eight weeks for shipment.

Officers of McGraw-Hill Publications Company: Gordon L. Jones, President; Paul F. McPherson, Executive Vice President; Gene W. Simpson, Group Vice President; Senior Vice Presidents: Ralph Blackburn, Circulation; John B. Hoglund, Controller; Ralph B. Schulz, Editorial; David G. Jensen, Manufacturing; Vice Presidents James E. Boddorf, Planning & Development; Edward E. Scrimmer, Marketing Administration.

Officers of the Corporation: Harold W. McGraw, Jr., President, Chief Executive Officer, and Chairman of the Board; Robert N. Landes, Senior Vice President and Secretary; Ralph J. Webb, Treasurer. Title registered in U.S. Patent Office. Copyright © 1976 by McGraw-Hill, Inc. All rights reserved. The contents of this publication may not be reproduced in whole or in part without the consent of copyright owner.

Subscribers: The publisher, upon written request to our New York office from any subscriber, agrees to refund that part of the subscription price applying to copies not yet mailed. Please send change-of-address notices or complaints to Fulfillment Manager, subscription orders to Circulation Manager, Electronics, at address below. Change-of-address notices should provide old as well as new address, including postal zip code number. If possible, attach address label from recent issue. Allow one month for change to become effective.

Postmaster: Please send form 3579 to Fulfillment Manager, Electronics, P.O. Box 430, Hightstown, N.J. 08520.

five important reasons to specify the **KEPCO JQE** power supply

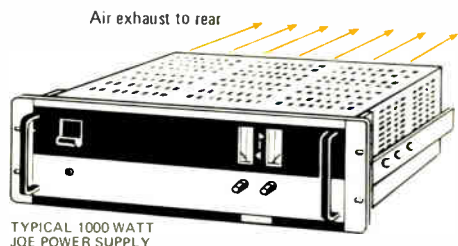

- **JQE deliver their rated output right up to +71°C** without any derating whatever. Moreover, they run cool! Internal blowers actually help circulate the air in your system to keep hot spots from developing.

YOUR MECHANICAL PEOPLE WILL APPRECIATE THIS.

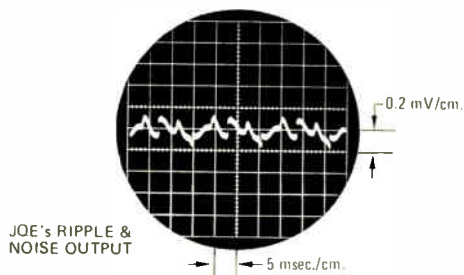

- **JQE produce clean d-c**, less than 0.2 mV rms ripple and noise (1.0 mV p-p including spikes up to 10 mHz). The output varies less than 0.0005% for the worst sort of line variation, and long-term drift is less than 0.01%.

YOUR LOAD WILL APPRECIATE THIS.

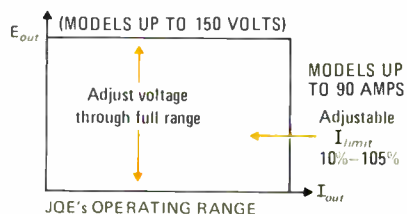

- **JQE are wide-range instruments.** Every JQE can be set from zero to its rated output. What's more, they all have one *additional* volt capacity so that wire drops do not subtract from the voltage available to your load. Buy a 0-15V model to cover the 5V, 6V, 8V, 10V, 12V and 15V loads. A 0-36V model to take care of 18, 24, 28, 32 and 36V jobs.

YOUR BUDGET WILL APPRECIATE THIS.

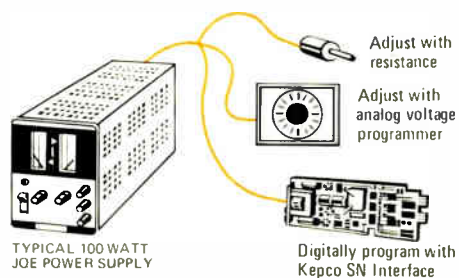

- **JQE are fully programmable**—by resistance (1000Ω/volt) or by voltage (any gain ratio you choose) or by parallel binary or BCD logic. That means you can easily interface your JQE with a computer control bus. (Use the Kepco SN Programmer)

YOUR SYSTEM WILL APPRECIATE THIS.

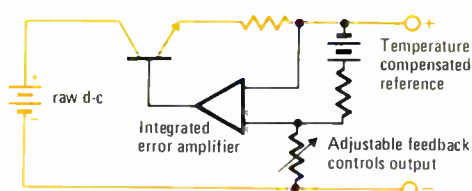

JQE IS AN OPERATIONAL POWER SUPPLY THAT BEHAVES LIKE A LARGE LINEAR AMPLIFIER

- **JQE are linear voltage stabilizers**—which means that JQE are a lot simpler and more reliable than switching machines. (You get a 5-year warranty.) A linear JQE will respond in microseconds to a load shift; will maintain its low output impedance into high frequency pulsed loads; produces no RFI/EMI and doesn't hack up the power line like SCR types.

YOUR NEIGHBORS WILL APPRECIATE THAT.

JQE

is a premium quality voltage stabilizer for the no-compromise job

Write Dept. V-14 for the new Kepco Catalog and Handbook.

KEPCO®

131-38 SANFORD AVENUE • FLUSHING, N.Y. 11352
(212) 461-7000 • TWX #710-582-2631

INTERESTED IN HIGH EFFICIENCY POWER SUPPLIES?

ABBOTT HAS THE ANSWER

Abbott Transistor Laboratories manufactures three complete lines of hermetically sealed, switching regulated power supplies. These rugged and dependable power modules have already found wide use in many military, aerospace and industrial applications. All units are designed to meet the EMI requirements of MIL-STD-461 and the environmental requirements of MIL-STD-810.

Readers' comments

'Copy' isn't the word

To the Editor: In the Nov. 11 *Electronics*, I am correctly quoted as crediting Mostek Corp. with a leadership position in 4,096-bit and 16,384-bit random-access memories [p. 31].

You go on to give Mosaid Inc. the credit for "helping several suppliers copy the part." In fact, this is not how we work, since it is necessary in the contract-design business to be extremely careful in avoiding possible conflict-of-interest situations.

We prepare design analysis reports on other peoples' parts on either a custom or speculative basis. Several houses have bought a basic analysis report from us on the MK4027.

At the level of direct design assistance, however, we would, as a matter of policy, only work with one house at a time or only deal with two companies not in competition with each other—a supplier and a user with an in-house facility, for example. Such an approach is essential to preserving confidential relationships with our clients.

R.C. Foss
Mosaid Inc.
Ottawa, Ont.,
Canada

Series/1 is programmable

To the Editor: In the otherwise accurate account of our recently introduced Series/1 system [Nov. 25, p. 41], there was an apparent misprint. The article states that the Series/1 is "not programable by users," where I believe the author intended to point out that the Series/1 is not *microprogramable* by users.

Since the Series/1 will be marketed primarily to experienced data-processing users, obviously we expect our customers to do a great deal of programing of their own. Although I am sure that many of your readers realized this was an apparent misprint, I did want to bring this slight error to your attention.

George D. Clements
IBM Corp.
Atlanta, Ga.

77% EFFICIENT **70% EFFICIENT** **70% EFFICIENT**

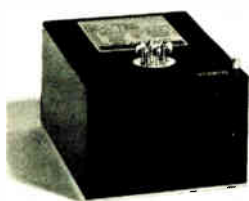

**60 Hz to DC
model VN**

**400 Hz to DC
model UN**

**DC to DC
model BN**

Abbott's Model VN series converts 47 to 440 Hz AC lines to any DC voltage between 4.7 and 50 VDC at output powers of 25, 50 and 100 watts. Line and load regulation are controlled to 0.4% with a peak-to-peak ripple of 100 mV. Efficiencies of 77% are achieved with power densities of greater than 1 watt per cubic inch.

Designed to operate from 380 to 420 Hz AC lines, Abbott's Model UN series offers output powers of 25, 50 and 100 watts at all popular voltages between 5 and 50 VDC, including ± 12 and ± 15 . The full load operating temperature range is -55°C to $+100^{\circ}\text{C}$. Peak-to-peak ripple of 100 mV and load regulation of 0.5% are just a few of the standard features of this line of 70% efficient power modules.

Wide range DC inputs of 20 to 32 VDC can be accommodated by Abbott's BN line of high efficiency DC to DC converters. All popular output voltages between 5 and 50 VDC, including ± 12 and ± 15 , are available at output power levels of 25, 50 and 100 watts. 0.5% line and load regulation, 100 mV peak-to-peak ripple and -55°C to $+100^{\circ}\text{C}$ operating temperature range are a few of the standard features of the BN line.

Complete electrical specifications, size charts and prices for these units are listed in our new 60 page free catalog. Also listed are 12 additional line of power modules, including —

60 A to DC
400 A to DC
DC to DC
DC to 60 A
DC to 400 A

For immediate information on Abbott Modules, see pages 1836-1848 of your 1976-77 EEM Catalog or pages 678-682 Vol. 2 of your 1976-77 GOLD BOOK.

abbott transistor

LABORATORIES, INCORPORATED

Send for our
new 60 page
FREE catalog —

GENERAL OFFICES
5200 W. Jefferson Blvd.
Los Angeles, CA. 90016
(213) 936-8185
Telex 69-1398

EASTERN OFFICE
1224 Anderson Ave.
Fort Lee, N.J. 07024
(201) 224-6900
Telex 13-5332

When your show must go on,

In an industry where aspiring new IC's emerge daily, it helps to know there's an old pro **D/A converter** you can count on to carry the show.

Our DAC-100, introduced in 1970 as the AIM DAC, is an established performer. Proven in a multitude of applications ranging from avionics to commercial monitoring equipment, it's available in over 50 varieties. There are 4 nonlinearity specs, 2 full scale output options, 4 T.C. choices. Temp ranges include $-55^{\circ}\text{C}/+125^{\circ}\text{C}$, $-25^{\circ}\text{C}/+85^{\circ}\text{C}$, and $0^{\circ}\text{C}/+70^{\circ}\text{C}$.

The DAC-100 cuts heat and cost dramatically without sacrificing speed or performance. Its fast settling time will give you more data per second. So our DAC-100 doesn't need to prove itself a star. It has already played the circuit.

Free App. Notes

We have a great bunch of Applications Notes supporting the Old Pro. We'll be glad to send them to you. Just write, phone or TWX us. The numbers are below.

call in our Old Pro.



Precision Monolithics, Incorporated
1500 Space Park Drive, Santa Clara, CA 95050
(408) 246-9222. TWX: 910-338-0528
Cable MONO.

Circle 7 on reader service card

Recording hard data?



Analog or digital?
One or sixteen channels?
Short or long term?
The "Instrument Professionals" can help you make the right choice from the thousands of recorder types and sizes in inventory. Delivery is immediate. Performance guaranteed.

Write or call for data on our other specialties: Instrument Leasing • Computer Peripherals • Equipment Sales • Instrument Service.

Call Continental Rentals

Div. Continental Leasing Co., Inc.
175 Middlesex Turnpike, Bedford, MA, 01730 (617) 275-0850

Metuchen NJ, (201) 549-8500; Galtersburg, MD (301) 948-4310; Dallas, TX (214) 357-1779; Elk Grove, IL (312) 439-4700; Costa Mesa, CA (714) 540-6566; Santa Clara, CA (408) 735-8300; Los Angeles, CA (213) 477-7521

Circle 8 on reader service card

News update

■ In case you were worried whether your newly designed test and measurement instruments meet Underwriters Laboratories safety standards, there's good news and bad news.

First, the good news. The researchers at the lab, who have made at least three attempts to write an acceptable UL 1244 safety standard for instruments, say they will accept instruments for testing. But since no UL standard exists, the instruments will be checked out in one of two ways.

Instrument makers can file for approval under the most recent version of UL 1244. In such cases, the instrument would be submitted for acceptance in UL's Listing and Follow-Up Services Program. The other route is to file under the International Electrotechnical Commission's document IEC 348 for acceptance in UL's Classification Service Program. Meanwhile, UL is devising a design for the UL mark that an accepted instrument may carry.

The bad news is that November has come and gone, and so has UL's prediction that a new draft of its proposed 1244 would be ready by then. The delay in approval of any of the previous three versions was caused by the organization's desire to have its safety standard conform to that of the international body [*Electronics*, Aug. 5, p. 8].

The latest delay came after a coordinating committee decided that extensive revisions are necessary to reach the goal of a truly international document that reflects the view expressed by Don Mader, engineering group leader in UL's Melville, N.Y., office, that "safety should be an international concern, not just a national concern."

As the curtain falls on Act IV of UL's encounter with instrument safety, the coordinating committee has set April 29, 1977 as the date on which a final composite draft is scheduled to be distributed to industry for comment. Earlier, instrument makers had formed an *ad hoc* committee whose job it was to make a unified response to the proposed standard.

Gas Sensing Semiconductor

FIGARO GAS SENSOR

TGS quickly senses even small amount of gas.

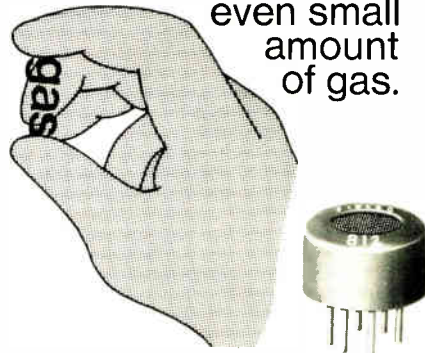

New Models.

some with highly sensitive CO sensor, now on the market.

Please contact the address below directly for catalogs and price/delivery information

FIGARO ENGINEERING INC.

3-7-3 Higashitoyonaka Toyonaka City Osaka 560.
Japan/Tel (06) 849-2156

Cable FIGARO TOYONAKA/Telex 05286155 FIGARO J

Circle 105 on reader service card

Think of what just one company can do to stop pollution. We have.



People start pollution. People can stop it.

Please send me a free copy of your guide.

Name _____

Street _____

City _____

State _____ Zip _____



A Public Service of The Magazine & The Advertising Council

Keep America Beautiful
99 Park Avenue New York 10016

There's a little tiger in every Cherry switch

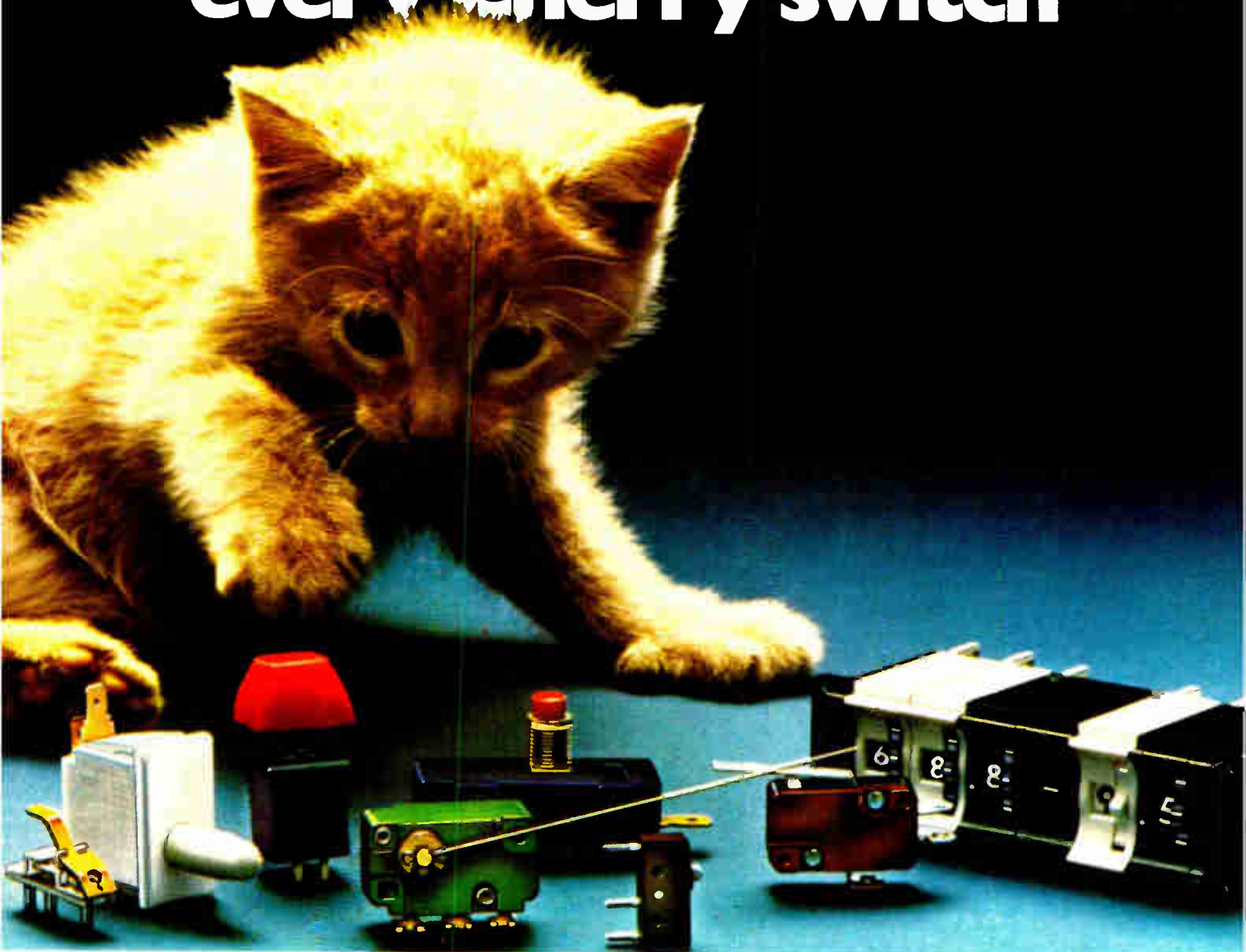

...but we're pussycats to do business with

Our products are tough, but our people aren't... and that's the beauty of dealing with Cherry.

You see, we can control the quality of our switches because we fabricate most of our own parts (moldings, stampings, springs, printed circuits, etc.) And we can keep the price down because we're loaded with automatic equipment to handle high volume.

But the real difference is in the *people* you work with at Cherry... from your first contact with a technically trained sales representative... through careful analysis and recommendations by engineers

who are really concerned about *your* problem... to production scheduling and customer service men who follow-up and expedite to make sure we keep our delivery promise to you.

Of course we're proud of our modern facilities and equipment... but what we're proudest of is our reputation for customer service. Try some.



Test a free sample "tiger" from the pussycats at Cherry. Ask for our latest catalog which contains complete information on all our switches and keyboards, and we'll include a free sample switch. Just TWX 910-235-1572... or PHONE 312-689-7700... or circle the reader service number below.

CHERRY



CHERRY ELECTRICAL PRODUCTS CORP. • 3608 Sunset Avenue, Waukegan, Illinois 60085
SWITCHES and KEYBOARDS — Available locally from authorized distributors.

World Radio History

Circle 9 on reader service card

TRANSISTORS



FAIRCHILD DELIVERS A WEALTH OF WIDGETS.

Transistors.

The last thing on your mind. The first thing you need in a thousand different applications.

So, just for the record, we want you to tuck away this thought:

The next time you need transistors — any transistors in any quantity, in any package — call Fairchild or a Fairchild distributor. Nobody in the world makes more than we do.

Here are some highlights of our line, which we'll be happy to expand upon at your request:

A PLETHORA OF POWER

We are the industry standard when it comes to power TO-5 devices. We have the broadest line on the market. And our failure rate is the lowest in the industry (250K cycles/week of accelerated stress data with a 1.3% failure rate).

A FLOCK OF FACTS

Our Power Data Book can tell you how to get every last ounce of performance out of power devices. It contains device selection guides and cross references, plus information on power technology, safe operating areas, manufacturing, packaging and heat sinking, reliability and product specifications.



A DELUGE OF DARLINGTONS

We also happen to make the world's broadest line of power monolithic Darlington. The most reliable way to get two devices on a single chip. With high current gain. We manufacture every popular industry standard Darlington in both plastic packages and metal cans.

A QUANTUM OF QUADS

Boy, do we have small signal quads. NPN core drivers. PNP core drivers. NPN and PNP general

purpose devices. All excellent for core memory, complementary audio, servos and computer peripherals. Featuring epoxy packaging, high power dissipation, automatic insertability and passivated die.

A JAMBOREE OF JANS

Our QPL list speaks for itself:

Device Type	Qualification			Device Type	Qualification		
	JAN	JTX	TXV		JAN	JTX	TXV
2N706	X			2N2222A	X	X	X
2N708	X	X		2N2369A	X	X	X
2N718A	X	X	X	2N2481	X	X	
2N744	X			2N2484	X	X	X
2N914	X	X		2N2904	X	X	X
2N918	X	X	X	2N2904A	X	X	X
2N930	X	X		2N2905	X	X	X
2N1132	X			2N2905A	X	X	X
2N1613	X	X	X	2N2906	X	X	X
2N2218	X	X	X	2N2906A	X	X	X
2N2218A	X	X	X	2N2907	X	X	X
2N2219	X	X	X	2N2907A	X	X	X
2N2219A	X	X	X	2N2919	X	X	X
2N2221	X	X	X	2N2920	X	X	X
2N2221A	X	X	X	2N3013	X	X	
2N2222	X	X	X				

A NEW WAY TO PACKAGE SMALL SIGNALS

Introducing a second-generation TO-92 package for small signal transistors. A revolutionary TO-92. Offering the very best AQLs in the industry. Specifically, .4% on DC electricals, .65% mechanical and .065% on opens and shorts. Our new package also offers die surface passivation for improved moisture resistance and scratch protection. And epoxy packaging for superb WHTRB and elimination of thermal intermittency.



WHAT MORE CAN WE SAY?

For more information on any of the above, or on any other transistors in our line, write or call for our transistor selection package or contact your Fairchild sales office, distributor or representative today. Or use the direct line to our Transistor Products Group at the bottom of this ad. Fairchild Camera & Instrument Corp., 464 Ellis Street, Mountain View, California 94042. Tel: (415) 962-2094. TWX: 910-379-6435.

FAIRCHILD

CALL US ON IT.
(415) 962-2094

Forward and backward with the IEEE

Anyone who followed the activities of the Institute of Electrical and Electronics Engineers during the past year cannot be blamed if he acts nonplussed. There were a host of conflicting, sometimes perplexing trends in the IEEE's 1976.

For one thing, the main body of members continues to show massive apathy and therefore fails to provide any clear indications of its technical, educational, and professional desires. This apathy provides the leadership with ample opportunity to do just what it wants to do, or put another way, to avoid doing what it does not want to do. Right now there is a bitter internal struggle between those who are determined to develop a meaningful professional-activities program and those who are equally determined to maintain technical activities as the institute's foremost endeavor. The struggle pits career status against technical status.

Unquestionably professional activities have created the power struggles and with them a new sense of vitality not wholly appreciated by the majority of members. The year began with a challenge to the board of directors: petition candidates for president and executive vice president. Both the two petition candidates for president and the petition candidate for vice president were strongly identified with professional activities and based their campaigns on career issues. In addition, members managed to put on the ballot three propositions to amend the IEEE constitution. So far, so good—these were signs of healthy participation in the system.

Another good sign was the apparent opening up of the U.S. Activities Board to inputs from the section-level professional-activities committees around the country. The grass roots finally had an opportunity to participate, somewhat belatedly, in

planning the U.S. activities program. A good move, this initial effort should not be allowed to wither in the coming year.

The election results clearly indicated that the majority of voters wanted changes aimed at professional activities. The combined votes of the petition presidential candidates came to 56% of the total, though neither had the plurality necessary to win. The petition candidate for vice president won. And all three amendments gained more than 50%, but they did not have the two thirds necessary to be adopted. But hold on. The apathetic mass had failed to move, as only 36% of eligible voters returned ballots.

Nevertheless, the percentages strongly suggested that the 1977 board of directors ought to reflect the thinking of those who supported the petition candidates and the amendment propositions. There was an opportunity to do so in selecting the nine non-elected appointees to the board. Instead it was the buddy system, the closed clubhouse of cronies, that prevailed. It is, indeed, curious that an organization so large could not produce more new people with fresh thinking—especially since there are many members clamoring to offer suggestions even when they are not asked.

Clearly, this is not the time to draw up the wagons in circle. The people on the outside are not necessarily the bad guys. But what is to be done now: form a new professional organization, join a union, drop out to pout? We say, none of the above.

The IEEE continues to offer EES the best means of accomplishing their goals. The tide is running in favor of change, to make the institute's dual role in professionalism and technical information not a source of division but a source of strength. But to do so, a New Year's resolution for all IEEE members should be, "I shall participate."

SQUEEZE PLAY.

T10 relays by P&B let you mount your pc boards on 0.5" centers. They work in tight spots like a pro.

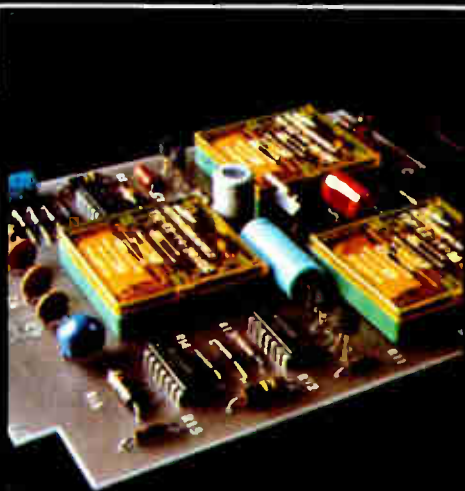

T10s are only 0.375" high. The lowest profile 3 amp relay in the Potter & Brumfield line.

They provide 0.1 to 3 amp switching @ 28V DC in 2, 4, and 6 pole models. Coil ratings are 6, 12, 24, and 48V DC. Permissive make, gold-flashed silver contacts are noted for low contact bounce, long operating life. Bifurcated contacts for low level switching are also available.

These relays are compatible with TTL and CMOS peripheral driver ICs, and TTL and CMOS buffers wired for current sharing. Ideal for telecommunications, copy and reproduction machines as well as computers and peripheral equipment.

Put a squeeze play on costs. Prices are as compact as the relays themselves.

For full information on the T10 series and all P&B relays, see your Potter & Brumfield sales representative or P&B Pro Shop distributor. Or, contact Potter & Brumfield Division AMF Incorporated, Princeton, Indiana 47671. Telephone: 812/385-5251.

European address: Electrical Products Group, AMF International Limited, AMF House, Whitby Road, Bristol B54 4AZ, England. Telephone: (0272) 778383, Telex: 449481, AMMAFOCO, BRSTL.

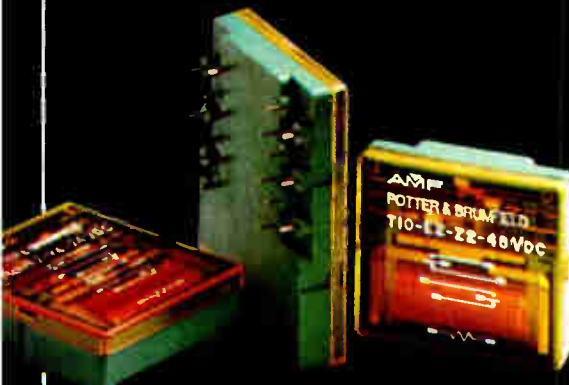

Go with the Pros and you can't go wrong.

AMF
Potter & Brumfield

RCL

OFFERS A
LOW COST
REPLACEMENT
FOR "OBSOLETE"*
OPEN DECK
WAFER SWITCHES

*Not all, but most... ask us!



RCL's

ENCLOSED,
LOW PROFILE
PC SWITCH...
FROM
STOCK!

Send For New '77 Catalog or Call
our Hotline For Name Of Your
Local Representative Or Stocking
Distributor.

(201) 374-3311

AMF

RCL Electronics

General Sales Office:
700 So. 21st Street
Irvington, N. J. 07111

People

Vanderslice cautions on
Federal R&D drop

"As far as GE is concerned, the question 'whither technology?' is almost equivalent to the question 'whither General Electric?'" says Thomas A. Vanderslice, group executive of GE's special systems and products group Fairfield, Conn. "And much of what we expect science and technology to provide in the future will—in the opinion of many in the scientific community—be slower in coming unless present trends are reversed," he warned the Executives' Club of Chicago last month.

Nine year drop. The 44-year-old Vanderslice is most concerned about the decline in Federal funding of R&D: "In the U.S., the percent of GNP devoted to R&D has dropped steadily for more than nine years," he says. While industry R&D expenditures have kept up with inflation, Federal R&D spending has dropped from about 2% of the Gross National Product in 1966 to about 1.2% in 1976—remaining just about constant as total Federal outlays doubled, he points out. "Meanwhile, other countries have registered substantial gains. Underlying the gains of Japan and West Germany were continuing large increases in funding from both industry and government," he says.

"There's nothing wrong with what we're doing in the social programs," concedes the tall, lean GE vice president, "but I would guess that we spill more in Medicare than we'd need to support R&D. With R&D," he concludes, "we're really killing off the 'seed corn.' And we won't see the impact for five or 10 years or more."

He is particularly worried about the universities, which have sustained the most drastic Federal cutbacks. They "provide the trained scientists and engineers we will need in the years ahead," he says. "These are the people who traditionally create not only their own jobs but also employment for hundreds and thousands of others." To attain a 5% unemployment rate by 1985, he



Alarmed. Other countries push R&D, but the U.S. cuts back, Vanderslice points out.

points out, the U.S. will need to create 18 million new jobs.

Vanderslice, a Fulbright scholar, received his Ph.D. in physics and chemistry from Catholic University in Washington, D.C., in 1956, before joining GE, where he was eventually appointed general manager of the firm's Electronic Components Business division, Syracuse, N.Y., in 1970. He was named to his present post in December 1972.

Datatron's Boggs woos
Europe with processor testers

"I expect decisions to buy \$4 million to \$5 million worth of automatic test equipment will be made in Europe in the last month of the year," says William F. Boggs, the new international marketing manager of Datatron Inc.'s Test Systems division. The decisions, delayed for most of the year as business conditions remained stagnant, presage a sharp upturn in the European market for automatic test equipment in 1977, he says. It is his belief that sales during 1977 could exceed \$40 million, partly because the computer industry in France is beginning to do well again and partly because of an upturn in capital-equipment buying.

Boggs, an electrical engineering graduate from the University of

AO

If this is all you're seeing,

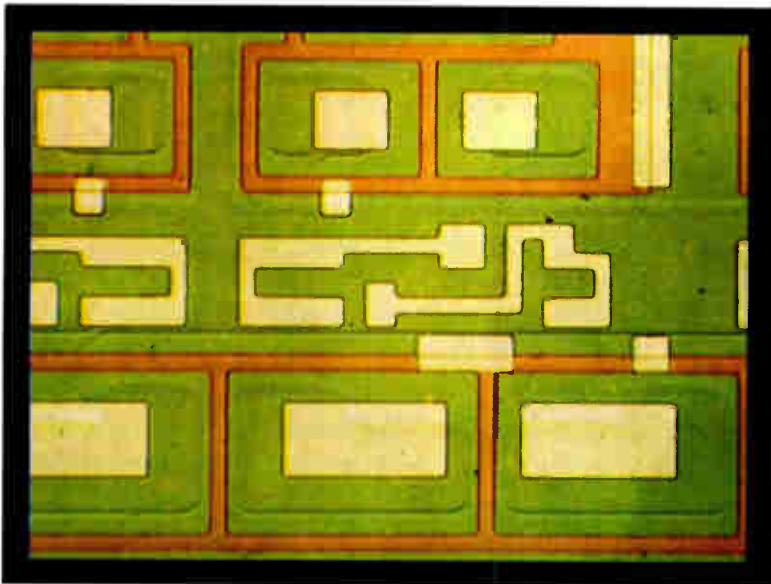

The AO® DICV Differential Interference Contrast Microscope makes the big difference.

With a standard brightfield microscope you see only what is shown in the top sample.

Now look at the bottom sample. The AO DICV Microscope can help you see surface irregularities, inclusions and faults long before final testing. Long before you have invested more production time and money in a circuit or component that is defective.

By using incident light, after Nomarski, the AO DICV Microscope reveals significant detail in outstanding relief through vivid contrast enhancement.

this is what you're missing

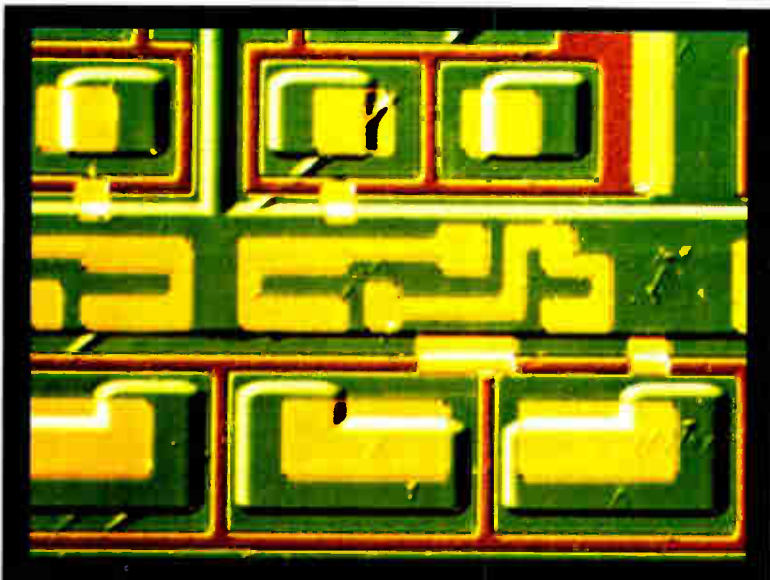

So, if missing detail is costing you money, you can't afford to overlook the AO DICV Microscope. For details or a demonstration see your AO Dealer or write American Optical, Scientific Instrument Division, Buffalo, NY 14215.



AO
American
Optical

Pulse withstand capacitors for colour T.V.

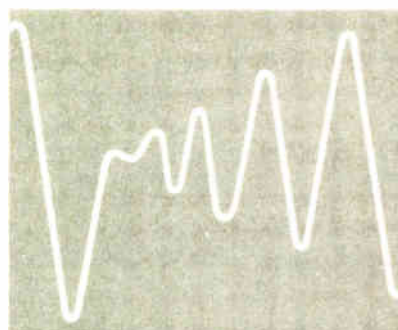
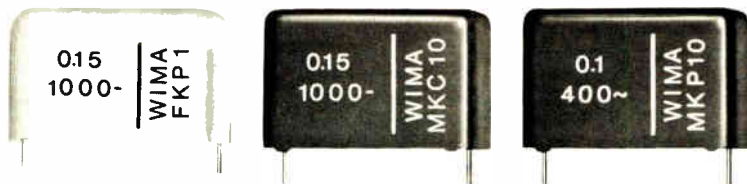

WIMA FKP 1

Polypropylene film and extended foil electrode capacitors encapsulated in cast resin. Self-healing properties. Suitable for sharp-edged or short rise time pulses in thyristor deflection circuits.

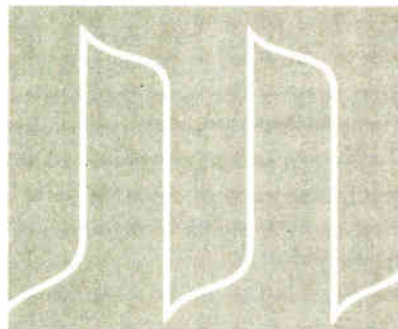

WIMA MKC 10

Metallized polycarbonate capacitors. Particularly suitable for stringent pulse and surge conditions. Low power factor at high frequencies. Self-healing properties. Plastic case design.

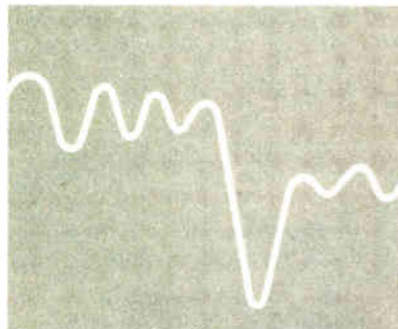

WIMA MKP 10

Metallized polypropylene capacitors in plastic cases. Self-healing properties. Suitable for both high current and pulse circuits owing to low dielectric losses.

- Other special capacitors in metal cases.
- One year successful field experience in equipment by leading manufacturers.
- Suitable for advanced solid-state equipment.
- For professional electronics.



WILHELM WESTERMANN

Spezialvertrieb Elektronischer Bauelemente
D-68 Mannheim 1
Fed. Rep. of Germany
Augusta-Anlage 56
P. O. Box 2345
Tel.: (621) 40 80 12

Write for our new catalogue.

People



Flexibility. The new guys can generally move faster when it comes to making the right tester, says William F. Boggs.

California at Berkeley, comes to Datatron from another test-equipment maker, E-H Research Laboratories, where he was systems marketing manager. He has been spending most of his time lately in Europe, fighting for a share of the market in automatic test equipment.

His weapon? The LSI 800-series of device-test systems, priced in the \$250,000 to \$350,000 range and among the first on the market able to handle microprocessors. How does a small company like the Irvine, Calif., firm—\$2 million in ATE sales in its last fiscal year—expect to compete? "Every time there's a technology change, the old guys don't always meet the customer's changed needs fast enough, and the new guys get their opportunity," Boggs asserts. With microprocessors coming to the fore in Europe, as well as in the United States, "it's time for the new guys."

Sales projection up. Worldwide, eight-year-old Datatron could expect to increase its sales this fiscal year by two and a half to three times, though these are figures Boggs won't confirm, or deny either. As well as selling hard in Europe right now, he is out to establish an organization of engineering representatives there. "My No. 1 goal is to put a strong effort into Europe," he says. Datatron has already had its first success there with its device testers—in November, it shipped an LSI-800 tester system to the British Post Office Research Center in Ipswich.

TO-5 RELAY UPDATE

Maglatch TO-5: the relay with a mind of its own.

Whenever critical switching circuits call for non-destructible memory, choose Teledyne's magnetic latching TO-5 — the relay that remembers. Once set with a short pulse of coil voltage, it will retain its state until reset or reprogrammed — even if system power fails or is shut off. And you get the added advantage of reduced system power demands, since conventional relay holding power is not required.

But memory capability and low power consumption are not the only advantages of our TO-5 maglatch relays. Their subminiature size makes them

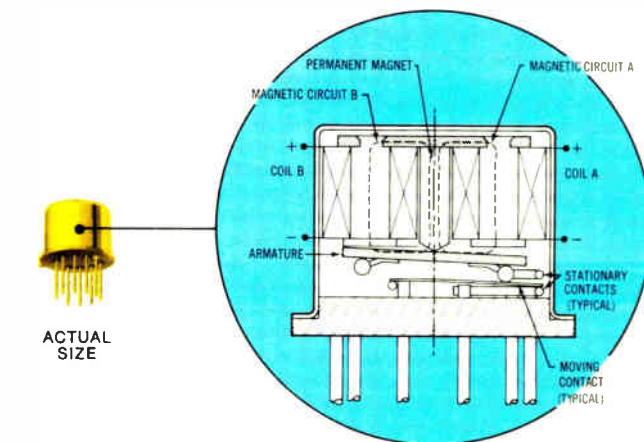

ideal for high density pc board packaging, and they're available in SPDT, DPDT and 4PST contact forms. And for RF switching, their low intercontact capacitance and contact circuit losses provide high isolation and low insertion loss up through UHF.

Our magnetic latching as well as our complete line of TO-5 relays includes military and commercial/industrial types with MIL versions qualified to "L" and "M" levels of established reliability specs. For complete data, contact Teledyne Relays — the people who originated the TO-5 relay.

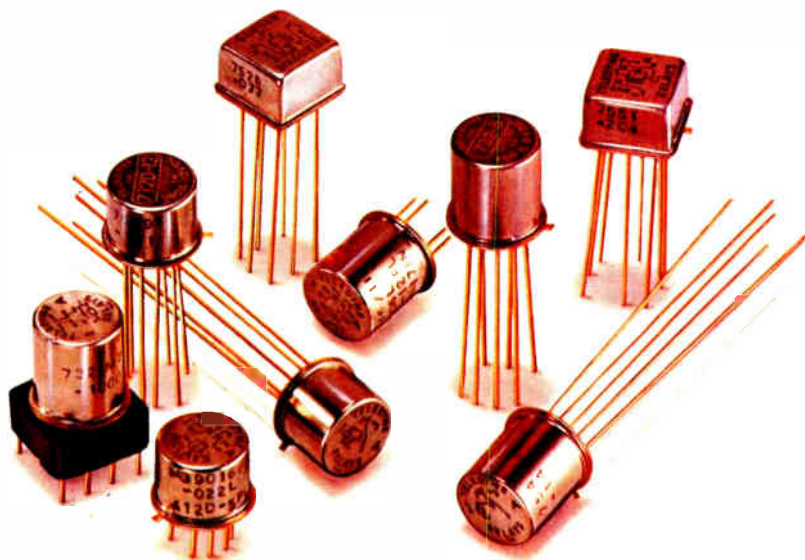

OTHER TELEDYNE TO-5 RELAYS

- **Hybrid "T" Series**
SPDT & DPDT types with internal transistor driver and suppression diode. Military and commercial/industrial versions.
- **"D" and "DD" Series**
With internal suppression and steering diodes. Military and commercial/industrial versions.
- **Centigrad® Series**
World's smallest relay—only .225" (5.72mm) high x .370" (9.40mm) square. DPDT, with optional internal suppression and steering diodes.
- **Hi-Rel Series**
Screened versions for space flight applications (NASA qualified).
- **High Environment Series**
Hi-temperature, Hi-shock, and Hi-vibration types.

 **TELEDYNE RELAYS**

3155 West El Segundo Boulevard, Hawthorne, California 90250
Telephone (213) 973-4545

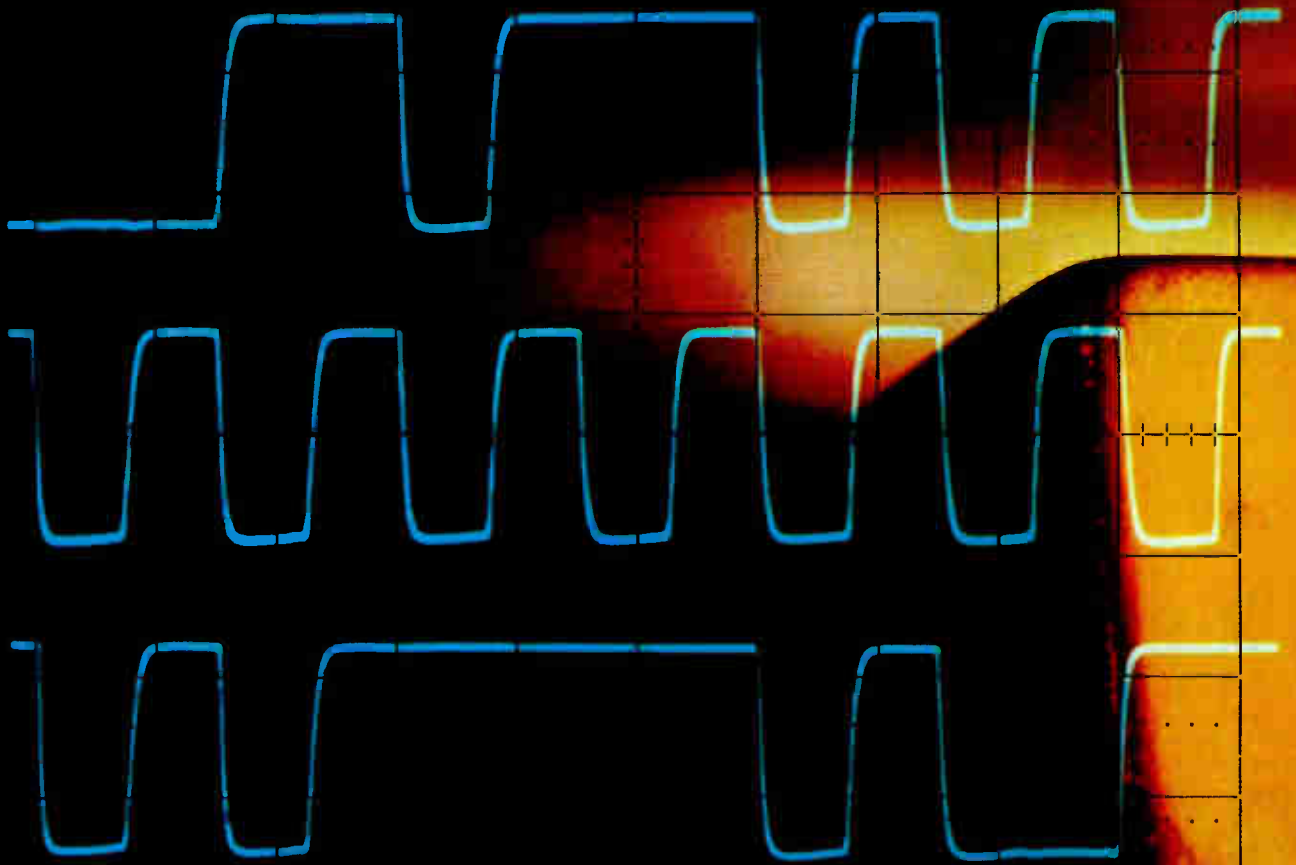

8 3 8	8 8 8	9 8 8 0	8 1 9
8 8 3 8	8 8 8 8	8 8 8	8 9 9
9 8 8 8	9 8 8 8	0 8 8 9	9 0 1
8 3 8	8 8 8	8 8 8	8 9
8 3 8	8 8 8	8 8 8	1 9
8 8 8	8 8 8	8 8 8	8 8 8 9
8 3 8	8 8 8	8 8 8	8 8 9
8 3 8	8 8 8	8 8 8	8 8 9

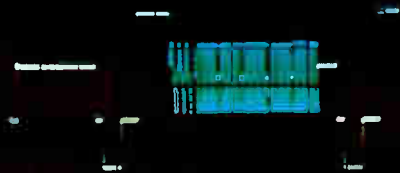

Want a different view with the touch of a button?

HP's the Answer.

And the 100 MHz **1740A** is your scope. With HP's push-button **third-channel trigger view**, you can see your trigger signal along with channel A and B—three traces in all—so you can make timing measurements between all three simultaneously. In most applications, that means three-channel capability for the cost of a two-channel scope.

Here are two more timesaving features you can get at the touch of a button. For data-domain applications, you can combine the 1740A with HP's 1607A Logic State Analyzer and trigger the scope with the analyzer's pattern-trigger or delayed-trigger output. Add the "**Gold Button**" (an optional logic-state push button in lieu of A versus B) for just \$105* and (with the 1607A) you have push-button selection of either logic-flow or real-time display. That means you can view the logic states of operational circuitry for pinpointing a problem. Then push the "Gold Button" and see the waveforms you've selected at that specific point in time. Or, add the **TV sync** (optional for just \$180*) and tailor the 1740A for TV broadcast and TV R&D applications simply by pulling a knob.

The 1740A also has an **X5 vertical magnifier** with the touch of a button for 1 mV/div sensitivity on both channels to 40 MHz without cascading. Again, measurements are simplified because

you can directly monitor low-level signals such as outputs of read/write heads of disc or mag units, power-supply ripple, or medical sensor outputs. You also get selectable input impedance (1 megohm or 50 ohms) plus the time-tested 8 x 10 cm CRT used in the 180 System lab scopes.

At just \$2095*, HP's 1740A, with its three-trace capability, is an exceptional scope value. Call your local HP field engineer today for all the details.

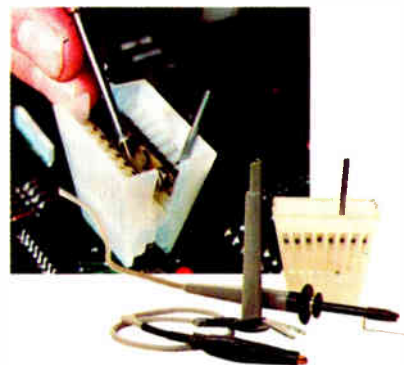

And here's something **NEW** for scopes. HP's **Easy-IC Probes**. A new idea for probing high-density IC circuits that eliminates shorting hazards, simplifies probe connection to DIPs and generally speeds IC troubleshooting. Ask your HP field engineer about them.

*Domestic U.S.A. price only.



HEWLETT  PACKARD

Sales and service from 172 offices in 65 countries.

1507 Page Mill Road, Palo Alto, California 94304
For assistance call Washington (301) 948-6370 Chicago (312) 677-0400
Atlanta (404) 434-4000 Los Angeles (213) 877-1282

(186/11)

Circle 19 on reader service card

Beauty comes in different shapes and sizes.



These smart looking Optima Accent Cases bring you a wide choice of standard sizes, colors and finishes. But in case you want to bring the world something different, you're not boxed in. We'll cut these special beauties to your own specs. With solid walnut or metal sides, sloped or vertical front panels or whatever. We ship knocked-down to save you money.

Send for our catalog. For freedom of design, we give you freedom of choice.

We make you look better

OPTIMA[®]
Scientific-Atlanta

2166 Mountain Industrial Blvd. Tucker, Ga. 30084 • Tel: (404) 939-6340
Europe: Macmerry, East Lothian, Scotland EH33 1EX

Circle 20 on reader service card

CAREER OPPORTUNITIES

Usually the best opportunity to grow in your field lies within your present company. You have made an investment in them. They have an investment in you.

But occasionally the best opportunity lies somewhere else. No one can decide but you.

Companies looking for good people run their recruitment ads in our Classified Section in the back of this magazine. Perhaps you'll find an opportunity there that's worth following up.

Meetings

1977 Reliability and Maintainability Symposium, IEEE, ASME, ASQC, *et al.*, Marriott Hotel, Philadelphia, Jan. 18-20.

Power Engineering Society Winter Meeting, IEEE, Statler Hilton Hotel, New York, Jan. 30-Feb. 4.

Fifth Annual Computer Science Conference, ACM, Marriott Motor Hotel, Atlanta, Jan. 31-Feb. 2.

Distributed Data Processing Conference, American Institute of Industrial Engineers, Americana Hotel, New York, Feb. 1-4.

Electro-Optical Warfare Technical Symposium, Association of Old Crows Cabrillo Coven (San Diego, Calif.), Naval Electronics Laboratory Center, San Diego, Feb. 3-4.

Wincon—Aerospace and Electronic Systems Winter Convention, IEEE, Sheraton-Universal Hotel, N. Hollywood, Calif., Feb. 7-9.

PC-77—Personal Communications Two-Way Radio Show, EIA, Las Vegas Convention Center, Las Vegas, Feb. 15-17.

ISSCC—International Solid State Circuits Conference, IEEE, Sheraton Hotel, Philadelphia, Feb. 16-18.

Optical Fiber Transmission Conference, IEEE, Williamsburg Lodge, Williamsburg, Va., Feb. 22-24.

Comcon Spring, IEEE, Jack Tar Hotel, San Francisco, Feb. 28-March 3.

1977 SAE International Automotive Engineering Congress and Exposition, Society of Automotive Engineers, Cobo Hall, Detroit, Feb. 28-March 4.

Nepcon '77 West—National Electronic Packaging and Production Conference, Industrial and Scientific Conference Management Inc. (Chicago, Ill.), Anaheim Convention Center, Anaheim, Calif., March 1-3.

Dialight Switches

A switch for all reasons.

Reason 1: Dialight offers three switch configurations to meet all your needs—*snap-action switches with silver contacts* for moderate-level applications, *snap-action switches with gold contacts* for intermediate-level applications, and *wiping-action switches with gold contacts* for low-level applications. Each of these ranges is served by two switching actions—momentary (life: 750,000 operations) and alternate (life: 250,000 operations).

Reason 2: Dialight's snap-action and wiping-action switches come in a new modular design concept... a common switch body for either high or low current operation. All 554 series switches and matching indicators have the same rear-panel projection dimensions.

The snap-action switching mechanism guarantees a fast closing and opening rate. This insures that contact force and contact resistance

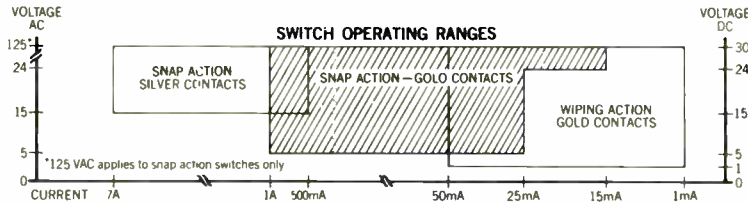

Reason 3: Dialight offers a wide variety of panel and snap-in bezel mounting switches with momentary and alternate action configurations in SPDT and DPDT

types. There are over 240 switch variations to choose from.

The 554 illuminated switch, designed for front of panel lamp replacement, gives you a choice of five different bezel sizes... 3/4" x 1", 5/8" x 3/4", 3/4" square, 5/8" square, and 1/2" square. The first four sizes are also available with barriers. You also get a choice of six cap colors... white, blue, amber, red, green, and light yellow... four different underlying filter colors... red, green, amber, and blue and a variety of engraved or hot-stamped legends... over 300 cap styles... over 100,000 combinations.

There is also a variety of terminal connections... solder blade, quick connect, and for PC board insertions.

Reason 4: Dialight's 554 series is designed as a low cost switch with computer-grade quality.

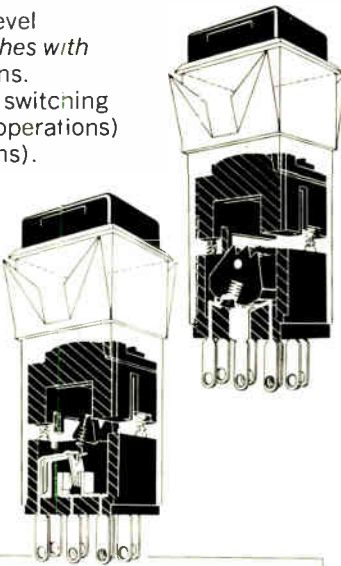

\$1.65 EACH
P/N 554-1121 (1K PRICING)
See Dialight

PRODUCT SELECTOR GUIDE						
SWITCHING ACTIONS	Snap-Silver contacts		Snap Gold contacts		Wiping-Gold contacts	
	SPDT	DPDT	SPDT	DPDT	SPDT	DPDT
MOMENTARY	○	○	○	○	○	○
ALTERNATE	○	○	○	○	○	○
OPTIONS						
	PUSH BUTTON CAP SIZES					
	1/2" Sq.	5/8" Sq.	5/8" x 3/4"	3/4" Sq.	3/4" x 1"	
BEZEL MOUNTING TO ACCOMMODATE	○	○	○	○	○	
BEZEL MOUNTING WITH BARRIERS TO ACCOMMODATE		○	○	○	○	
PANEL MOUNTING TO ACCOMMODATE	○	○	○	○	○	
MATCHING INDICATORS	○	○	○	○	○	

are independent of the switch's actuation speed.

In the wiping-action switch, the contacts are under constant pressure (A unique Dialight design). This insures long life with a minimum build-up of contact resistance.

Both switch types are tease-proof.



DIALIGHT

A North American Philips Company
203 Harrison Place, Brooklyn, N.Y. 11237
(212) 497-7600

The only microcomputer with the power of a PDP-11. The PDP-11/03.

If you've been looking for a microcomputer with minicomputer power at a micro price, join the hundreds of OEMs who've already found it with the DIGITAL microcomputer. The PDP-11/03.

The 11/03 gives you everything you could ask for in a small computer. High performance. High reliability. And a low price — just \$1,357 in quantities of 50. And that micro price buys you mini features that quickly translate into benefits OEMs appreciate. Features like full PDP-11 instructions with eight general purpose

registers for fast program development. RAM (MOS or Core) and PROM memories that let you match the memory with the application. Hardware vectored interrupts with stack processing for real computer power. And multiple-sourced components for sure delivery.

Buying our 11/03 also buys you the chance to start small without staying small. Because you can add up to 32K words of memory, fast floating point instructions, and more. Whenever you and your customers are ready.

Besides growing bigger in size, the 11/03 lets you grow bigger in scope. It's software compatible with every other PDP-11 we offer. From our LSI-11 all the way up to our medium scale PDP-11/70. That means you can take full advantage of Digital PDP-11 software and services.

You can also take advantage of Digital's OEM Referral program — your chance to take on an international marketing and support team without hiring them. The OEM Referral program can help you locate new custom-

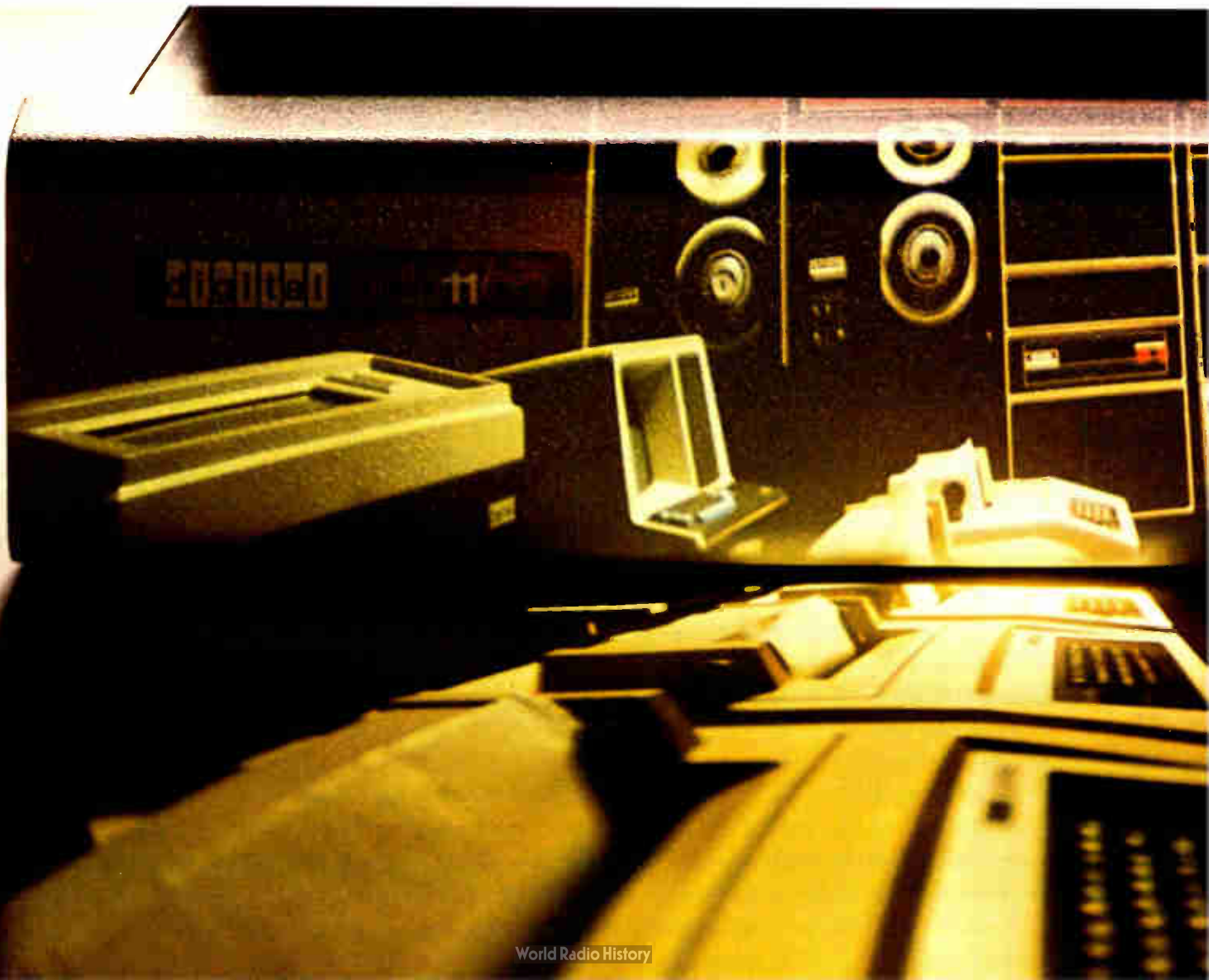

ers and new markets around town and around the world. And it can all start with the PDP-11/03.

So if you're looking for a

proven microcomputer with proven power and performance, get the micro with all the power and performance of a PDP-11.

Digital Equipment Corporation, Maynard, Massachusetts

I'm interested. Please send information.

I'm more than interested. Please have your nearest Digital sales representative contact me.

Name _____ Title _____

Company _____

Address _____ Phone _____

City _____ State _____ Zip _____

E126

Digital's PDP-11/03. Call your nearest Digital sales office. Or send the coupon to Digital Equipment Corporation, Maynard, Massachusetts 01754. (617) 897-5111. European headquarters: 81 Route de l'Aire, 1211 Geneva 26. In Canada: Digital Equipment of Canada, Ltd.

digital

50,000 computers saving managers millions.



WHAT WE DID FOR DIGITAL VOLTMETERS, WE'RE DOING FOR COUNTERS.

O.K. Wake up out there.

Fluke has got a frequency counter design specifically for communications—the 1920A. It sells for \$860.*

We wouldn't bother you if it wasn't worthwhile.

Let's face it. We've had to forge some new ground to get a good footing in the counters marketplace. When you're coming up fast on the leaders, like we are, you can't afford any ho-hum instruments. Each counter gets a little better. And, of course, the guy at the bench benefits.

That's how it is with the 1920A counter.

Some advanced LSI/MOS circuitry gives the unit exceptional specifications. And makes it a little more portable. There's a 9-digit LED display, sensitivity to 15 mV, AGC standard, and a frequency range of 5 Hz to 520 MHz. Optional internal prescalers to 1000 MHz and 1250 MHz cover the UHF television, 900 MHz telecommunications, and beacon bands.

Frequency Extension Options
1000 MHz Prescaler
Covers 50 to 1000 MHz using a scaling ratio of 8. Sensitivity is 15 mV rms, and maximum allowable input is 5 V rms (fuse protected). VSWR less than 2.5:1 at 50 ohms for levels less than 1 V rms.
1250 MHz Prescaler
Covers 50 to 1250 MHz using a scaling ratio of 8. Sensitivity is 20 mV to 1000 MHz, decreasing to 40 mV rms at 1250 MHz. Maximum input 5 V rms (fuse protected), and VSWR less than 2.5:1 at 50 ohms for levels less than 1 V rms.

A few extras take you higher.

Direct and prescaled inputs are color-coded to match their corresponding function switches to facilitate operation. The display incorporates full leading zero suppression, automatic annunciation, overflow, and a self-check mode which lights all digit segments.

Then there are some features we're really proud of—exciting to find in an \$860 unit.



But you knew that, anyway.

Measurement delays have been eliminated. A rapid-access gate free runs in the absence of input signals. It's in position to open the gate for the selected gate time as soon as a signal is sensed. An auto-reset circuit initiates a new measurement every time any front panel switch is activated. The first measurement obtained is always correct.

In addition to normal frequency measurements, there's a burst function.

The unit measures RF bursts of greater duration than the selected gate time. To avoid erroneous reading, the display is automatically reset to zero if the burst width is less than the gate time selected.

An optional resolution multiplier coherently multiplies audio tone signals by 1000, providing a resolution of 0.001 Hz in 1 sec.

But now that we've got your attention, the 1920A really doesn't seem so surprising, does it? Really, it's something you sort of expect, when you come to think about it.

Another great instrument from Fluke.

As far as we can tell, it means two things. A promise to you that Fluke is giving their full attention to counters.

And a lot of worry for our competitors.

For data out today, dial our toll-free hotline, 800-426-0361.

John Fluke Mfg. Co., Inc., P.O. Box 43210, Mountlake Terrace, WA 98043

Fluke (Nederland) B.V., P.O. Box 5053, Zevenheuvelenweg 53, Tilburg, Netherlands.

Phone: (013) 673-973 Telex: 52237

**Domestic price only.*



FOR COMMUNICATIONS. 1920A COUNTER. FLUKE

National moves to bolster its computer operation

Setting the pace for semiconductor houses that are making serious efforts to become major contenders in the computer business, **National Semiconductor Corp. has centralized its diverse computer operations into one computer-product group.** Included are the large systems operations, which will manufacture hardware emulations of the IBM 370/148 and 370/158 central processors; a microcomputer-systems unit, which will build and manufacture 8- and 16-bit microprocessors as both boards and completely boxed subsystems; the general systems operation, which will include the existing IBM add-on and OEM-memory-system group, and a new-business effort—medium to small computers of the IBM system 32 type and down.

Meanwhile, in an effort to regain momentum in the calculator market, National will introduce at the Consumer Electronics Show in January a \$200-to-\$350 watch-calculator combination that will feature sophisticated scientific notation. It will be built with a new two-chip metal-gate complementary MOS chip set that will drive a six-digit display.

NATO defense chiefs agree to buy Awacs

In a deal involving the largest single outlay for electronic equipment in the history of NATO, defense ministers of the alliance have **agreed in principle to go ahead with their purchase of Awacs.** The full cost of the airborne warning and control system would come to nearly \$2.5 billion, with electronics content possibly as much as 50%. The U.S. Air Force also is scheduled to begin receiving deliveries of its version of Awacs next year with the big avionics contracts held by Northrop Corp. and Airborne Instrumentation Laboratory.

Among purchase options being considered by NATO is a total program involving 27 Boeing 707 aircraft with a 360° Westinghouse downward-looking radar atop each fuselage. The system would be capable of picking up low-flying craft that could slip through ground radar. Awacs also would feed data into ground-based warning systems and serve as a weapons-control system to direct defensive planes and missiles in blunting an enemy attack.

Various financial options for purchase of Awacs are to be worked out next month, and NATO defense ministers could approve those in February. Individual member ratification, some to be made by parliaments, would be the final step.

Capacitor DIP permits automatic insertion of devices

Ceramic-capacitor manufacturer AVX Corp. in Great Neck, N.Y., is sampling a molded two-pin capacitor in a dual in-line package designed to lower the consumer's assembly costs. **The packaging permits automatic insertion of a molded capacitor,** heretofore not readily available. The new capacitors will be compatible with the same assembly equipment used for integrated circuit DIPs. They will take up less space on a printed-circuit board, since their lead spacing will be 0.300 inch, compared with 0.350-in. lead spacing for capacitors sealed in glass or plastic packages. Designated DIPGuard, it is aimed at the telecommunications and computer industries and other markets where capacitors are used in high volume.

Fairchild adds maker of gear for data analysis

Fairchild Camera and Instrument Corp.'s instrument division continues to grow beyond production of automatic test systems. It has acquired Data Works Instrumentation of Chatsworth, Calif., **which makes microprocessor-based data-analysis equipment.** The new product line complements Fairchild Instrumentation and Systems group's digital-panel-meter offerings. Gerald Mercola, president of Data Works, will become chief engineer for data system products at Fairchild, based in San Jose, Calif.

TI slashes prices of bi-FET op amps to bipolar levels

Prices of the new low-bias, FET-input operational amplifiers are rapidly dropping to the levels of the monolithic bipolar versions. Texas Instruments has slashed the price of its recently introduced bi-FET quad part [*Electronics*, Sept. 16, p. 146] **to about 33 cents—the TL084 is now \$1.30 per package in lots of 100.**

The Dallas firm will soon be shipping the other members of its op-amp family—two singles and two duals—and it appears that they will be priced as aggressively as the quad. The TL081, for example, will be tagged at 52 cents; the single op amp has the same pinout as the popular 741 and RCA's bi-MOS CA3140. The dual TL082, at 91 cents, boasts a 14:1 improvement in slew rate and 3:1 in unity gain bandwidth over Motorola's MC1458. Also available will be the TL080, an uncompensated single op amp, and the TL083, a dual with input offset voltage null capability.

At the same time, TI will begin screening its output to come up with more expensive "A" versions of each part that will offer the advantages of FET inputs while at least matching the input offset-voltage specification of the appropriate industrial general-purpose standard bipolar device.

Northrop to ship first digital strapped-down system

The heart of the first all-digital strapped-down guidance system to go into production will be delivered after the New Year to McDonnell Douglas Corp. by the Electronics division of Northrop Corp. The division's Precision Products department in Norwood, Mass., will deliver the module, the attitude-reference assembly for the Harpoon missile-guidance system. **The assembly consists of gyroscopes, accelerometer, and associated electronics that digitally create the inertial reference for the weapon,** which is an antiship missile launched from an aircraft or another ship. The assembly is critical to the midcourse guidance of the missile, with terminal guidance being done by an independent K-band radar.

Strapped-down guidance systems are less expensive and more easily mounted than inertial systems that use gimbals, and the Harpoon program is the first to go to production with such a system.

Addenda

It appears that Modicon Corp., the largest manufacturer of programable controllers, **will be merged into Chicago-based Gould Inc.** in February, if Modicon shareholders agree. . . . The Great Time Machine, Quasar's name for parent Matsushita's VX-2000 home video-cassette recorder/player, **will reach U.S. dealers' floors in two weeks.** Optional timer with memory-set feature for the \$995 machine will be available for about \$50 in two months; \$10 remote control "pause" lever for getting rid of commercials is out now. . . . Data General Corp. has delivered the first of its **microNOVA microcomputers on schedule.** The customers are Digital Communications Corp. in Memphis, Tenn., and Southern Railway.

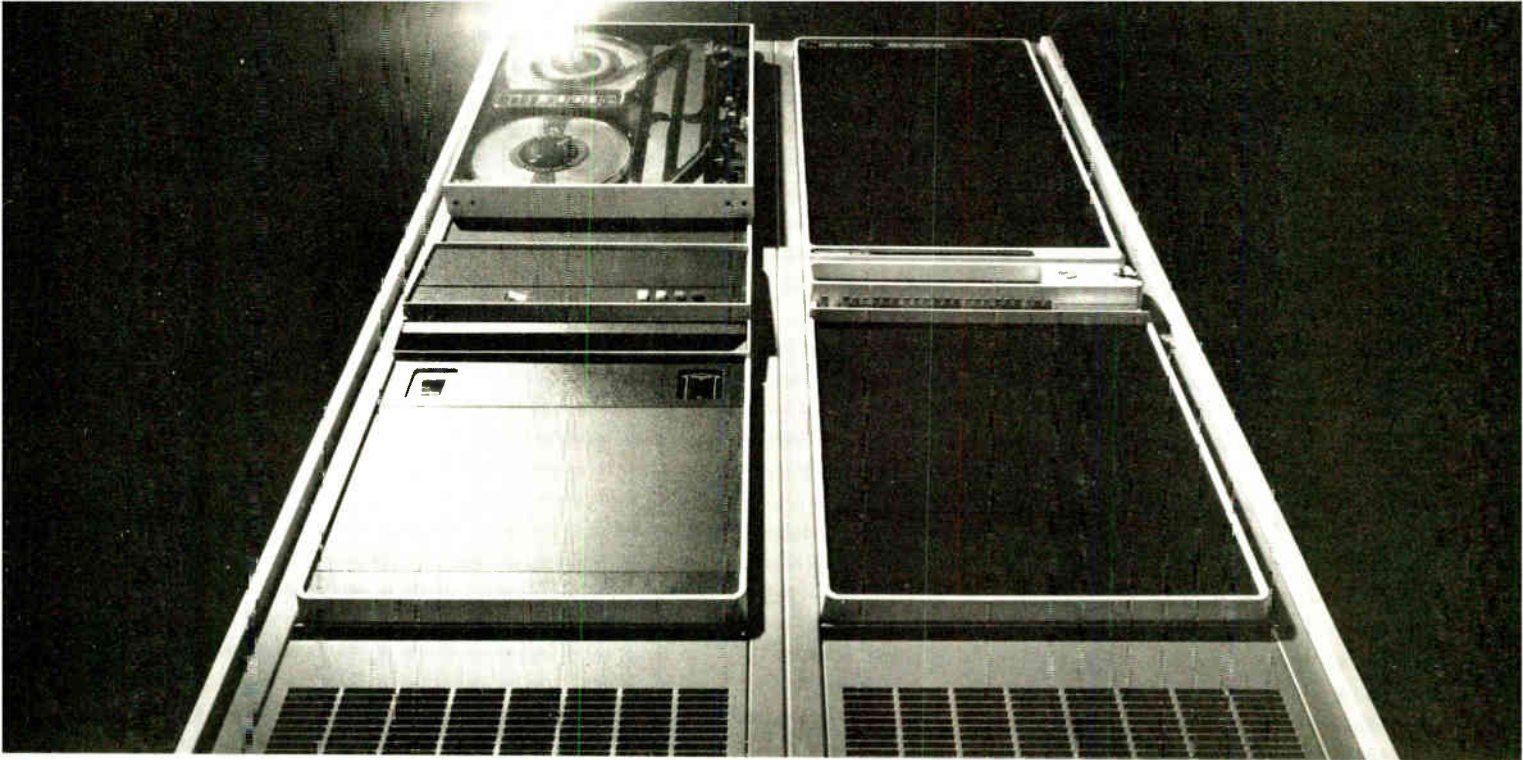

Announcing a giant increase in the NOVA line.

Towering above is the new top of the NOVA[®] line. The NOVA 3/D.

It features a new Memory Management and Protection Unit that lets you do both on-line multitasking and batch operations. Concurrently. For instance, applications that need real-time multi-terminal software and on-going program development.

Plus, the NOVA 3/D features a new, economical, 32K-word MOS memory module. Which is something no other major minicomputer has.

All of which makes the NOVA 3/D more NOVA computer, at a lower price, than you've ever seen before.

What's more, the NOVA 3/D also has all the things that have made NOVA the most popular name in minicomputers.

Things like extended NOVA line instructions. Reliable high-speed MOS and economical 16K-word core memory modules.

The single-board CPU design concept Data General pioneered. The same concept that led to our removeable single-board power supply module.

Plus all the other things you've come to expect from a company like Data General.

Things like field-proven, real-time operating systems: our mapped Real-time Disc Operating System, diskette-based Disc Operating System, and our Real-Time Operating System. They're compatible with the entire NOVA line of computers.

Things like high-level FORTRAN IV and FORTRAN 5, as well as easy-to-work-with extended BASIC. Also fully NOVA-line compatible.

Things like the complete and completely-compatible line of Data General peripherals. All you could ever need to put together any system you could ever need. Including 10 to 90 megabyte discs, diskettes, and our new 30 and 60 cps terminal printers.

And when you do business with Data General, you get the kind of total systems support you can only get from a major computer manufacturer. Everything from sales and systems engineering to field service, training, and special systems design.

Write for information on the new NOVA 3/D. Or call your local sales office.

And see what the NOVA line is up to now.

NOVA 3/D

Data General

☛ Data General, Route 9, Southboro, Mass. 01772, (617) 485-9100. Data General (Canada) Ltd., Ontario. Data General Europe, 15 Rue Le Sueur, Paris 75116, France. Data General Australia, Melbourne (03) 82-1361

NOVA is a registered trademark of Data General Corp.

World Radio History

Circle 27 on reader service card



Plugs into any teletype, terminal, computer or microprocessor development system with a serial 20ma current loop interface. Programs, lists, duplicates and verifies. RS232 and a parallel interface optional.

Program or duplicate your PROMs for under \$1,450.



Duplicates PROMs automatically at the push of a single button. Has quick load, zero insertion force PROM sockets and pass/fail lights.

Use our new Series 92 two ways, as a peripheral PROM programmer, or as a stand-alone PROM duplicator.

It uses the same field-proven personality modules as our popular Series 90 PROM Programmer. We already have modules for more than 100 PROMs with more on the way, so your expansion capability is virtually unlimited.

The price—only \$995 for a master control unit, \$450 or less for a personality module.

And if you need a stand-alone programmer, don't forget our well-established Series 90.

It comes with a hexadecimal display and keyboard. Options include TTY, parallel and RS232 interfaces, and paper tape reader.

Write or call for data sheets, our Prom User's Guide, and our new price list which includes an up-to-date personality module listing.

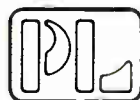

Pro-Log Corporation
2411 Garden Road
Monterey, CA 93940
(408) 372-4593

Space Shuttle to process own data while in flight

Pipeline processor being developed by GE handles instrument data, eases data reduction on ground

When the Space Shuttle zooms to an average of 25 flights a year in the 1980s, its 10,000 cubic feet of experimental instruments could swamp the data-processing capability that the National Aeronautics and Space Administration reserves for such applications. So NASA's Johnson Space Center in Houston is funding development of a new data-handling approach in which a lot of the data is processed in the craft, rather than on the ground.

Now in breadboard at General Electric Co.'s Space division in Valley Forge, Pa., the new on-board experimental data-support facility (OEDSF) is evolving from analyses of the data-processing requirements of more than 70 instruments on the shuttle.

Pipeline. The facility's central processing unit is a pipeline arrangement of logic elements that perform algebraic, trigonometric, and exponential functions. GE did the job with a 5-by-5 array, divided into 20 algebraic, 4 trigonometric, and 1 exponential elements.

"General-purpose computers don't have the speed for real-time processing of sensor data," says Georges Frippel, manager of Advanced NASA programs at the GE division. "We need a pipeline architecture for speed. But typical pipeline processors are nonprogrammable."

Data flows through the GE pipe-

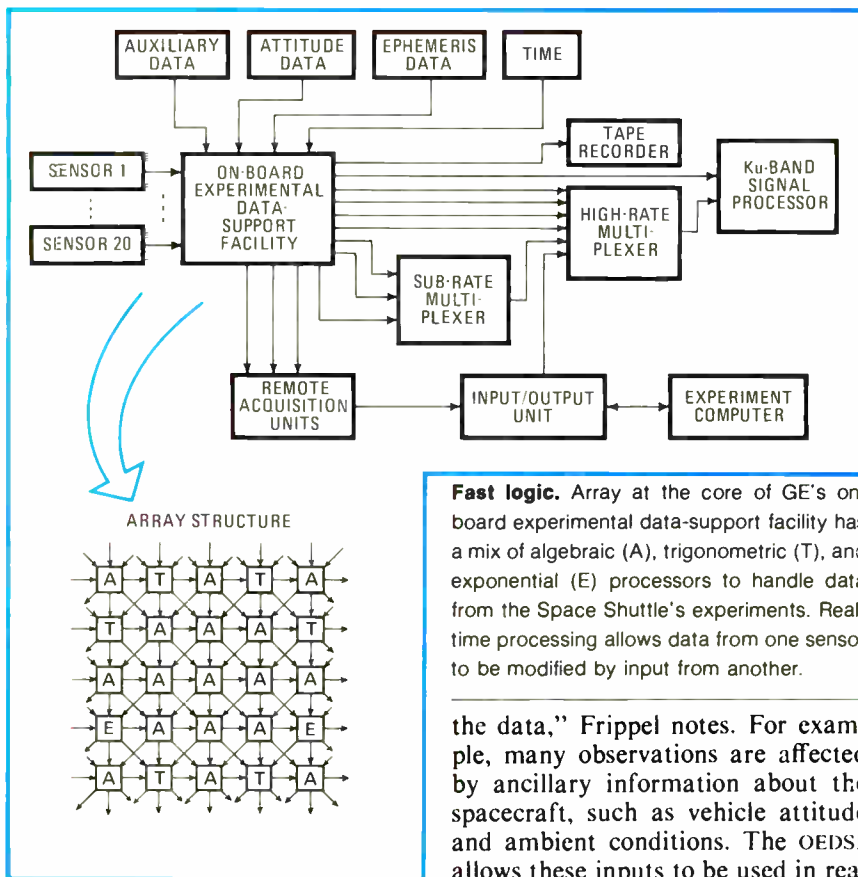

Fast logic. Array at the core of GE's on-board experimental data-support facility has a mix of algebraic (A), trigonometric (T), and exponential (E) processors to handle data from the Space Shuttle's experiments. Real-time processing allows data from one sensor to be modified by input from another.

the data," Frippel notes. For example, many observations are affected by ancillary information about the spacecraft, such as vehicle attitude and ambient conditions. The OEDSF allows these inputs to be used in real time, obviating the need for time-tagging, recording, and correlation with the scientific data.

The instruments also operate synergistically—the data of an infrared spectrometer, for example, corrects that of a scanning radiometer to account for atmospheric effects.

"Compared to equivalent ground-based equipment, we found OEDSF would be considerably cheaper, by a factor of 10:1 to 20:1," Frippel asserts. Robert Giesecke, technical monitor at Johnson Space Center, adds, "We'll save time by having the preprocessing done before the Space

line in a sequential stream, but the path taken is programmable, depending on the data source and, consequently, on what functions must be performed on it. The sequencing program is stored in memory.

Each function takes 250 nanoseconds to perform. At present, the elements are made up of hard-wired discrete components. The array occupies 1 cubic foot, draws 150 watts, and handles data rates to more than 100 megabits per second.

"The OEDSF's greatest benefit resides in its real-time processing of

Shuttle even returns and lands.”

Giesecke explains that, for the earth-resources experiments of the earlier Skylab, “there was a tremendous delay in getting the data out to users. Scientific data was brought back to earth on tape recorders or telemetered to earth and stored on ground-station tapes to be later merged with spacecraft data also on tapes. . . . But this wouldn’t be acceptable for the Space Shuttle, which is expected to make flights every few weeks.”

Brassboard coming. Funds for GE development of a complete brass-board of the on-board data-support facility might come in calendar

1977, Giesecke notes. “At the earliest, we could get an experimental unit onto a mission in calendar 1980,” he says, “and we’re hoping for funds to get production OEDSFs into the early phases of the Space-Shuttle program in the early 1980s.”

Meanwhile, the GE division is looking to LSI to halve the processor’s function time to 125 ns and to permit fabrication of each processing element on a single LSI chip. A complete array would then fit on a single board. “The low production cost of such arrays will justify the dedication of an array to each instrument,” Frappel predicts. □

ly executed instructions in hardwired logic, rather than by working from stored microprograms. In addition, they are developing compiler software that scans source-program instructions and then rearranges them for optimum throughput.

No registers. Since most programs consist of frequent executions of only a small number of “primitive” instructions, such as LOAD, STORE, BRANCH, and ADD, the group has designed a central processing unit that executes such instructions directly with its emitter-coupled-logic hardware. The machine has no general-purpose registers. Instead, circuits are specialized—tailored for each instruction. Complex functions, such as floating-point operations, are performed by the primitive instructions as microinstructions.

Going hand in hand with this approach is a development of a new “intelligent” compiler that adjusts the sequence of operations for the optimum throughput. Project manager George Radin points out that today’s computers simply interpret instructions one at a time and are “surprised” every time they receive a new instruction, since they have no memory of previous instructions they have performed. However, an intelligent compiler can automatically study the program and rearrange it to reduce redundant operations and the time the CPU may be waiting for new data or instructions.

The group also is studying functions that can be better handled in software. An example Radin cites is memory protection. The hardware needed to decode addresses to prevent unauthorized users from gaining access to certain parts of memory is extensive, he says. But such address checking could be easily handled by the intelligent compiler that compares addresses with user codes.

Looking back, Radin points out

Special mini. Experimental IBM minicomputer uses two cache memories—one for instructions and one for data—each accessible by the central processor. The CPU is made of hardwired logic for direct execution of frequently used instructions.

Computers

Altering computer architecture is way to raise throughput, suggest IBM researchers

Despite its decreasing cost, hardware still contributes heavily to a computer system’s costs. This fact, coupled with an increasing insight into computer software, has led researchers at IBM’s Thomas J. Watson Research Center, Yorktown Heights, N.Y., to try to revise computer

architectures by discovering new ways of trading off hardware and software.

In a project called the 801 Mini-computer, based on the ideas of IBM fellow John Cocke, a group of hardware and software specialists has developed ways to perform frequent-

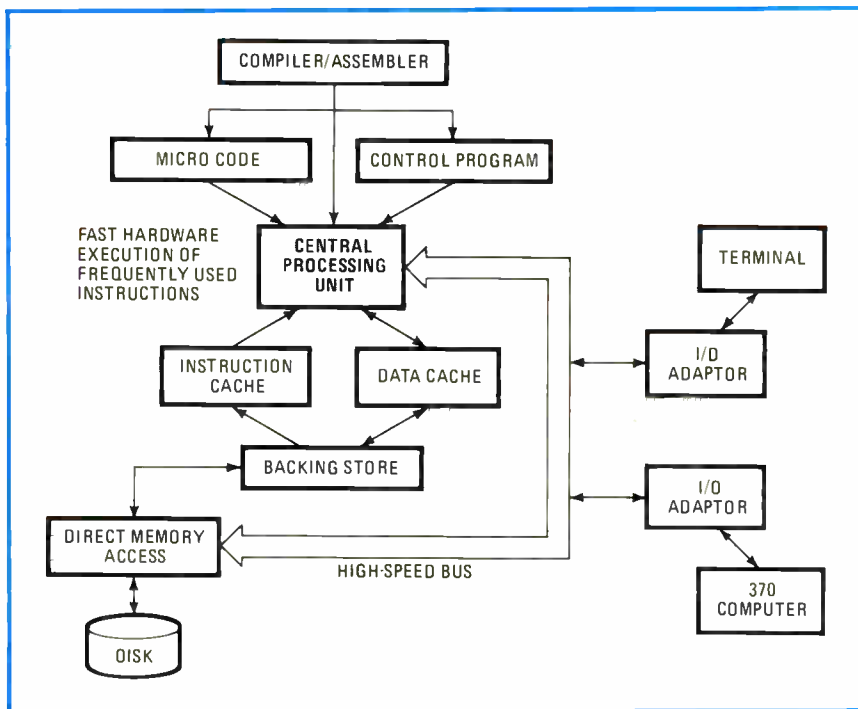

that the industry's very first compiler, the Fortran I, written for the IBM 704, was an intelligent compiler that was designed to reduce machine running time, which then was more costly than programing time. This balance soon shifted, however, as hardware costs dropped and programing costs increased.

Subsequent compilers concentrated on easing programing by offering English-language commands. Thus, Radin notes, the present project harks back to the early days of compilers in its attempt to perform more tasks with software.

Another key feature of the computer is the use of separate cache memories for instructions and data. Other computers may use a single

cache, in which data and instructions are mixed. With separate caches, the central processor can extract information from one cache while the other is busy fetching new information from main memory. However, one question still open, Radin says, is whether the hit ratios—how often the cache already has the requested information, compared to how often it must go out to main memory for it—will be better for the two caches than the hit ratio of a single cache.

Although the group calls the present system a minicomputer, the techniques developed through the study apply to computers of any size, Radin points out. He also points out that the concepts apply to central processors built with any semiconductor technology. □

venture for the \$4 million firm to undertake, Susnjara admits. He adds, "We committed 20% of the corporation's assets to this project." However, he predicts that the market will grow to 200 machines a year.

For help with the unit's electronic control, Susnjara turned to Martin Research, a Northbrook, Ill., microprocessor consultant group. There, president Richard H. Kruse put together three microprocessors that handle all the machine's functions.

Cartesian 5's four tools—typically a saw on a rotary table, two routers, and a drill—are mounted on a commercially available turret; the machine is under the control of Zilog Corp.'s high-performance Z-80 microprocessor. "We originally designed it around an Intel 8080, but moved to the Zilog product because its faster processor speed and better interrupt capability gave us faster tool speeds," Kruse says. Random-access memory is used to store both the machine program and the piece-part program.

Of the machine's 24,576 8-bit words of RAM, 16,384 are used for program storage, Kruse says, "and 8-k words store every piece-part program we've encountered so far, but it can be expanded."

Programing. Cartesian 5 is programed at the machine by a large handheld calculator-type programmer with 25 keys. Its light-emitting-diode display—two rows of five 0.3-inch alphanumeric character matrices—is refreshed by a MOS Technology Inc. 28-pin 6503 microprocessor. "In general, the programmer is used for commanding axis motion and for programing and editing those commands," he says. It also can read out the instructions stored in the RAMS associated with the Z-80.

After the machine is programed, a portable reader/recorder is plugged into the same port, and the piece-part program is dumped out onto a DC 100A industrial data cartridge from Minnesota Mining and Manufacturing Corp. The recorder's tape transport is controlled by an Intel 8080A. "Another Z-80 would have been overkill here," Kruse points

Industrial

Three microprocessors control tool for shaping, cutting plastic parts

Ken Susnjara parlayed an idea he got from his electronic calculator into a new division for his Thermwood Corp. "I'm not an electronics expert, but I figured that if a handheld calculator can store numbers for calculations in progress, why couldn't it store positions and speeds for trimming and machining our plastic parts for the furniture industry?" he asks.

The result is quite a bit more complex than Susnjara's HP-65 calculator. It is the Cartesian 5, a five-axis cutting and sawing tool that Thermwood's new Machinery division will start shipping early next year. The first two units are already trimming thermally molded plastic parts at the firm's Dale, Ind., factory, which supplies decorative plastics to the furniture industry.

The gamble has paid off, Susnjara says. "We've had 13 orders from the woodworking industry, and we expect another 20 or 25 from the plastics industry in the next 60 days." The Cartesian 5 was introduced at the National Plastics Exposition in Chicago earlier this month.

Thermwood is now building a new plant that will build 10 or 12 a month by next summer.

Risk. The machine, which will sell for \$31,500 to \$51,500, depending on table size and options, was a risky



Control. Ken Susnjara holds calculator-like programmer in front of his microprocessor-controlled five-axis machining tool.

out. The transport loads both machine and part programs into the Cartesian 5.

Susnjara was unwilling to use numerical controls adapted from the machine-tool industry. He needed higher speeds, less accuracy, and a system that could handle a variety of cutting and sawing tools. Dual-axis machines adapted for the woodworking and plastics industries typically cost at least \$80,000, "and specialty five-axis machines run a quarter of a million dollars." Susnjara estimates that Cartesian 5 will save as much as 40% in labor costs and about 30% in materials. □

Solid state

National gambles on 4-k RAM pinouts

Just about every semiconductor manufacturer has decided to supply the 150-nanosecond 4027 4,096-bit random-access memory—Mostek's multiplexed 16-pin part that has impressed both suppliers and users with its high speed, low power, and high degree of manufacturability. Every supplier, that is, except National Semiconductor Corp. The firm is gambling on 18- and 22-pin designs it hopes will sway enough users away from the Mostek part to give National a niche in the fast developing sub-200-ns RAM market. The bait it is using is super-high performance—30% to 40% faster than the 4027.

Four kinds. By the end of the first quarter, the Santa Clara, Calif., company will be distributing samples having access times of 100 to 125 ns then and promises 80 ns "within a year or so." There will be four versions: the 18-pin 5270A/71A and the 22-pin 5280A/81A, both with either bi-level or transistor-transistor-logic-level clocking. The bi-level 5270A/80A, says Jeffrey Kalb, director of National's memory-components operations, will come in one of two guaranteed access times, either 100 or 125 ns. "When we complete characterization, though, I

think we can push those numbers down a little more," says Kalb, "possibly to 95 and 115 or 120 ns."

The TTL-level parts, the 5271A/81A combination, will each be specified for 115- and 140-ns access times. Cycle time on all four parts is about 220 ns for a read/modify/write operation, says Kalb. "The write operation alone on these parts is 10 ns," he says, "so you pay almost nothing in reduced system throughput for a write cycle." In large high-performance memory systems, where error-correction techniques are used extensively, this kind of capability, says Kalb, is valuable. "Another important design consideration is that these devices run with power dissipations no higher than those on the present generation of 400-to-500-ns-cycle-time 4-k RAMs," he says.

New design. These new parts, says Kalb, are not produced merely "by tweaking National's present 18- and 22-pin 4-k parts, which have access times ranging from 150 to 200 ns. "This is a totally new design," he says. "In fact, except that the basic cell is not fabricated with double-level polysilicon, many of the new

circuits and cell-design techniques we've developed for these 4-k RAMs will be used in our 16-k RAMs." This new fast family of 4-k RAMs, he says, have a die size of about 18,000 square mils, about 21% smaller than the present generation of devices. Cell size is about 1 mil², only slightly larger than the present 16-k RAMs designed with the double-polysilicon technique.

Like National, other vendors of 18- and 22-pin 4-k RAMs, such as Motorola and Texas Instruments are feeling the heat from Mostek's fast 16-pin device. They are developing versions much faster than their present generation of 150- and 200-ns parts.

"In terms of production parts, 80-ns 4-k dynamic RAMs will be possible within a year or two," explains Kalb, "and by the end of the decade, speeds should be down to 60 ns for 50% to 60% of the production distribution range. In fact, evaluation prototypes of our new series of 4-k RAMs ran about 60 ns. But we decided to put a number of delays in to slow the parts down and make them compatible with present board designs." □

Consumer

Video games show winning streak despite hurdle of chip shortages

Santa may not have as many electronic video games in his sack this Christmas as consumers or manufacturers had hoped, but the order backlog promises everyone a Happy New Year. Among major games makers, the consensus is that something under 3 million units will be sold this year, although they say it could have been 3.5 million if the games had been available. Next year 5 million to 6 million games should be sold.

The big holdup has been the lack of chips. General Instrument Corp.'s Microelectronics division in Hicksville, N.Y., supplies most of the chips but has been unable to meet the demand. Earlier this month, GI

shipped its five millionth chip, a nine-month milestone it expected would take a year.

Easing the future supply situation somewhat are National Semiconductor Corp. and Texas Instruments Inc., which began shipping game chips in the fall.

FCC approval. Another bottleneck for some has been getting type approval from the Federal Communications Commission. Every new game has to be tested and approved for interference shielding before it can be attached to television receivers [*Electronics*, June 24, p. 89]. The line of applicants has been long, and some have failed the tests.

Nevertheless, the signs are favor-



Crowded view. If delays are ironed out, sales next year of video games could reach between 5 million and 6 million units, just about doubling the number sold during 1976.

able for 1977. Two of the games companies' fears have faded. Prices, which range from \$50 to \$150, have stayed quite stable, except for discounting on some low-price modules. Orders have remained quite strong for the post-Christmas period. But there still will be a chip shortage, despite the added capacities of the new suppliers.

Delays in getting to market have been a common harassment. Fairchild Semiconductor's Consumer Products division, Palo Alto, Calif., for example, demonstrated a programmable game at the Consumer Electronics Show in Chicago last June. But it did not get type clearance until October and could not start shipping until November so that only a limited range of products was on department-store shelves by Christmas. Also, according to Fairchild, the delay in getting FCC approval held up development and delivery of the program cartridges that make its product unique. Though 10 cartridges were planned, only three are available, for a total of six games besides the two "resident" in the console.

Even makers using custom chips had problems. Universal Research Laboratories Inc., Chicago, for one, found its supplier had startup problems with the chip for its Indy 500 game.

National Semiconductor Corp.'s Consumer Products division in Santa Clara, Calif., which has a three-game, all-color design, was able to supply itself with enough chips, but had trouble finding other components. National uses an acoustic-wave filter to block interference in the console—a technique that passed the FCC's tests without a hitch, though it does add to the video game's cost.

Significantly, stores that specialize in video games have already begun to open. According to Philip M. Aiken, president of Lectro-Media Ltd., a two-month-old video specialty shop in a high-income section of Philadelphia, people have been turned on by the programmable idea. Fifty orders a day for all games are typical, he says.

New programables. By the middle of next month various companies will demonstrate new microprocessor-based programable models. Besides Fairchild, RCA Corp. recently got approval for its black-and-white programable game, although too late for Christmas sales. National is planning a microprocessor-based game, too. So are Magnavox and Atari Inc., the first firms to introduce games. GI, following up on its successful dedicated, six-game chip, will introduce a programable chip set as well. □

Communications

Digital radio uses pulse distortions

The Air Force's first all-digital radio system, which embodies the application of a novel modulation-demodulation technique, is taking shape at Raytheon Co.'s Equipment division, Sudbury, Mass. The company has a \$16.8 million development contract from the Air Force Electronic Systems division, Hanscom Air Force Base, Bedford, Mass., for three digital troposcatter sets. They will serve as the primary radios for distances greater than line of sight in the Joint Tactical Communications program known as Tri-Tac.

Capt. James Payne, the project manager, says the AN/TRC-170 sets will replace four Air Force 24-channel analog radios: the AN/TRC-66, 97, 113, and 132. The program could be worth up to \$300 million, with eventual production of at least 400 sets, he adds.

Distortions. Multipath distortions in the troposphere, since they cannot be avoided, are used in the TRC-170's design. This is where Manfred Unkauf's modulation-demodulation technique and "distortion-adaptive receiver" come into play. Unkauf is manager of the System Engineering department in Raytheon's Communications Systems laboratory.

Previous digital communications in the troposphere attempted to overcome the multipath distortions by using frequency-shift or phase-shift keying, Unkauf points out. "Prior nonadaptive modulation techniques suffered from an irreducible error-rate phenomenon caused by intersymbol interference created by the distortion," he says.

In contrast, Unkauf uses an adaptive-matched-filter demodulator to optimally combine all distorted multipath signal components. It adds up to performance gains over previous techniques of 10 to 15 decibels or more at bit-error rates of better than 10^{-5} , he says.

The Raytheon approach uses qua-

drature phase-shift-keyed modulation of the carrier, but with a time gate or guard band inserted between pulses. If, after a short interval, a second radio-frequency pulse of the same shape but different phase is transmitted over a channel, the received (and distorted) second pulse will look the same as the first one. However, it will differ from the first pulse by the phase difference set at transmission.

Long dwell. Unkauf says that, if the dwell time between transmitted pulses is long enough, the overlap between the distorted received pulses is minimal and any interference between them can be made negligible. "Under these conditions," he explains, "the matched-filter receiver can make optimum use of all the energy in the received pulses regardless of the distortion. There's no need to convert the signals back to their predistorted form, and this allows more hardware simplicity."

Decision feedback and coherent filtering in the receiver demodulator essentially "inverse-modulates" the received signals in phase. The intermediate frequency input to the distortion-adaptive receiver consists of a train of distorted but nonoverlapping pulses that have pulse-to-pulse relative phase modulation.

But the phases must be made equal, and this is achieved with a reference signal, Unkauf points out. The reference is generated by delaying the input signal, in a surface-acoustic-wave delay line, by exactly 1 baud to align it in time with the digital decision performed on that baud. The decision-feedback process does the inverse modulation, making all phase states equal.

Same phases. This leaves a series of distorted pulses of identical phase state plus thermal noise at the receiver input. So, before passing the reference signal to the classical matched-filter receiver, a recirculating coherent filter reduces the noise in it and stabilizes it against occasional errors in the decision process, Unkauf says. The receiver then multiplies the input and reference signals together to form a video signal.

News briefs

Harris to buy Sanders Data Systems

Cleveland-based Harris Corp. will purchase the Sanders Data Systems division of Sanders Associates, Nashua, N.H., if the \$17 million transaction is approved by both boards of directors. The division accounted for some 14% of Sanders 1976 sales of \$198.3 million, supplying computer-display terminals to commercial customers. But it was not profitable. The sale would result in a pre-tax loss to Sanders of about \$19 million, but will not affect Sanders Military Data Systems division, which markets graphic displays and other specialized terminal systems.

Electronics show to debut next November

The IEEE and the Electronics Representatives Association are sponsoring a new electronics convention and exposition to be held for the first time next Nov. 8-10 in Chicago. Called Midcon, the show and its format, technical program, and special convention events will be modeled after the IEEE's major shows: Electro/77 in New York (April 19-21) and Wescon in San Francisco (Sept. 19-21), says William C. Weber Jr. Weber is general manager of both Midcon and of EEE Inc., El Segundo, Calif., which manages the other shows for the IEEE.

U.S. Supreme Court upholds FCC on interconnection

The U.S. Supreme Court has upheld the Federal Communications Commission's 1974 interconnection ruling that permits use of customer-owned telephone equipment not provided by a telephone company. The Justices rejected an appeal by several state utility commissions and telephone companies that the FCC exceeded its statutory authority when it overturned a North Carolina public utilities commission regulation that all terminal equipment on telephone lines must be supplied by the local telephone company.

Hughes wins Army competition to develop attack helicopter

Summa Corp.'s Hughes Helicopters division, Culver City, Calif., has defeated Textron, Inc.'s Bell Helicopter Co. in the competition to develop the Army's advanced attack helicopter, a program with a \$3.78 billion potential if the Army buys the 536 systems it wants. Under the mid-December award of \$317.7 million to Hughes, the company will proceed with full-scale development of three additional prototypes over a period of 50 months before full-scale production is ordered. The new system is designed to replace the Cobra helicopter produced by Bell.

Telecommunications conference picks up on fiber optics

This month's National Telecommunications Conference in Dallas for the first time devoted technical sessions to fiber-optics technology. The three sessions were among the most heavily attended. Moreover, three companies (Bell-Northern Research, Ottawa, ITT Telecommunications division, Raleigh, N.C., and Spectronics Inc., Richardson, Texas) also devoted booths solely to fiber optics. Bell-Northern, for example, demonstrated an analog and digital communications system in which a duplex optical-fiber cable linked the transmit and receive modules. The cable had an attenuation of 8 decibels/kilometer and a 3-dB bandwidth of 200 megahertz.

Incidentally, the communications market must be in fairly good health. The conference attracted a paid attendance of more than 1,250—a 35% increase over last year.

An integrate-and-dump filter then optimally adds all signal contributions over the baud, is sampled at the right instant by a separate synchronization circuit, and a digital decision

is made to determine the sign or bit state of the filter output. That decision is held for one baud interval and is fed back to close the distortion-adaptive receiver feedback loop. □

Iron particles bound to antibodies help automate radioimmunoassay tests

Tagging complex molecules with radioactivity is part of the well-known radioimmunoassay technique for measuring minute amounts of antigens—hormones, drugs, and other components—in human-blood serum. Now, medical-instrumentation maker Technicon Instruments Corp., Tarrytown, N.Y., has taken this technique one step further. Antibodies, which can “pull” antigens out of blood samples, are bound to microscopic iron particles, which permits automation of the measurement process to an extent never before possible.

“The serum being analyzed passes by a magnet, and the iron particles with antibodies are separated,” explains Edwin C. Whitehead, chairman of Technicon Corp., the parent company. This eliminates the manual-separation step that had been the most time-consuming part of the

radioimmunoassay (RIA) process.

The antibodies attach themselves to radioactively tagged chemical reagents that are similar to the antigens to be measured, as well as to the antigens in the sample. The measurement is made by first separating the antibody/antigen combinations and then measuring the level of radioactivity, which is inversely proportional to the number of antigens in the patient’s blood.

Blood load. Once reagents are prepared, a technician merely loads the analyzer with blood samples, then waits for results to be printed out. Unlike earlier partially automated RIA systems, Technicon’s does not require the operator to move samples from one section to another—from the separator to the nuclear counter, for example.

The operator does not have to be at the machine more than 10% of the

time, says Ed Cohen, director of marketing for immunology at Technicon Instruments. This is about half as much time as with earlier RIA systems.

Technicon’s separator consists of glass tubes surrounded by electromagnets. As blood flows through the tubes, antigens and their antibodies bound to iron particles are drawn toward the tube walls, and the other blood constituents flow on to a waste tank. A valve then shuts off the waste-tank path, the magnets are turned off, and the radioactively tagged material is flushed past a sodium-iodide nuclear detector. The output of the detector is fed to a Hewlett-Packard 9815A calculator that converts the radioactivity count to useful units of measure.

Variation slight. Coefficients of variation in measured quantities are about 3% to 5%, says Cohen. This precision is about twice as good as that of competing systems and much better than the 10% to 20% of manual measurements, he says.

The system could be interfaced to a hospital’s computer to provide more detailed records of tests, as are other RIA systems. But Technicon chose instead to keep the basic cost of the analyzer down to \$35,000, roughly the same as some partially automated analyzers and half the price of others, Cohen points out. □

Familiar faces complete IEEE board

Any thought of bringing representatives of dissident factions into the leadership of the Institute of Electrical and Electronics Engineers flew out the window earlier this month. The remaining 10 positions on the 30-member board of directors for 1977 were all filled by institute regulars.

The nominations committee proposed and the elected members of the board returned Irene Peden and Jerome Suran to the same positions they held on the 1976 board: vice president for educational activities and vice president for publications. Robert Briskman, the unsuccessful board candidate for executive vice president, was kept on the board as secretary-treasurer [*Electronics*, Nov. 25, p. 52]. He was vice president for technical activities on the 1976 board.

Another regular, the 1974 IEEE president, John Guarrera, ends his two-year board term as past president this year and was installed as vice president of the U.S. activities board for next year. That organization has been under fire from members for not getting involved enough on their behalf in professional activities.

Other vice-president-level positions filled: regional activities, Douglas M. Hinton, a region 7 director in 1972–1973; technical activities, Franklin Blecher, a first-time board member; and director region of 10, James Vasseleu, founder of the IEEE section in Australia.

J.E. Barkle, who was division II director for 1975–1976, was named a director-at-large. Also on the board is standards committee director, William R. Kruesi, in a slot created this year. Finally, Herbert Schulke, whose job was considered in jeopardy earlier this year, was retained as general manager which includes a director’s seat. □

Modules prescribed for many systems

Specialized medical instruments, too, can benefit from that popular prescription—a microprocessor-based, bus-oriented, modular approach to design, says the Biomedical Engineering Center for Clinical Instrumentation at the Massachusetts Institute of Technology in Cambridge. It has put together a set of modules that supply 80% to 90% of an instrument’s final structure, at a “savings of weeks” of costly development time.

“The structure is so general that it allows a great number of instru-



COIL-LER

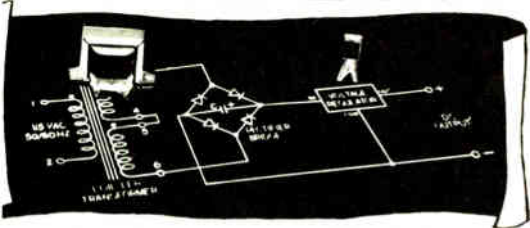

STOCK P.C. POWER TRANSFORMERS

- For use with 3-terminal IC voltage regulators
 - Printed circuit mounting
 - For power supplies for most integrated circuit families
- TTL LOGIC ECL LOGIC
CMOS LINEAR OP AMPS
- 36 models in stock

Write or phone for complete data sheet.

COIL-LER CUSTOM

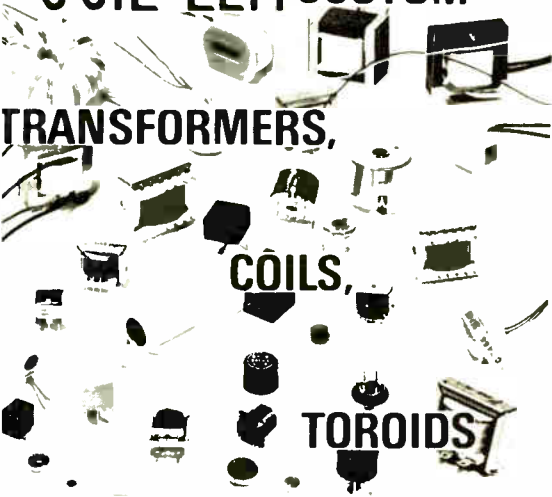

TRANSFORMERS,

COILS,

TOROIDS

Computer aided design of magnetic components and power supply circuits assures exact compliance with specs. Our precision manufacturing facility produces a full range of medium, miniature or ultra-miniature size transformers and coils — bobbin or toroidal wound.

Write or phone for information or quotes.

Electronics review

ments to be developed," says Stephen K. Burns, director of the micro-processing engineering laboratory. Along with the hardware, the center has produced a software system that serves as the base for an applications language.

Inventory. To build an instrument, an engineer looks through an inventory of about 20 6-by-12-inch printed-circuit cards, picks what he needs, and drops them into a 8½-by-7-by-21-inch chassis with 10 slot positions. Built into the chassis are power supplies and a bus structure that resembles Digital Equipment Corp.'s PDP-11 Unibus, with the addition of a 0-10-volt guarded differential analog bus and a hardware priority structure.

The cards are the building blocks. They include: a microprocessor card containing an Intel Corp. 8080 plus two 256-byte read-only memories and a crystal-stabilized clock; a memory card holding 8,192- and also 16,384-byte random-access memories, 16,384-byte ROMs and 2,048-byte static RAMs; analog-to-digital and digital-to-analog converters; a programable and time-of-day clock; a modem; a programable-ROM programmer, and controllers for such peripherals as a cathode-ray-tube display, teletypewriter, typewriter, front-panel keyboard, disk and magnetic-tape units.

A module with its own ROM and RAM is also available for debugging and memory management during system development. A general-purpose interface card provides for the connection of dedicated medical peripherals.

Suppose, says Burns, the need is for a vectorcardiogram, an instrument that measures the magnitude and direction of the heart's electrical activity and charts it as a three-dimensional representation. To record information, store it, refresh an oscilloscope and provide hard copy on a plotter, "we might draw from our inventory a CPU, memory, clock, CRT, keyboard, d-a and a-d modules. We should have to build the vcc preamplifier, multiplexer and isolation circuits. And during the development phase we would probably

add a debugger module."

He notes that as the system became more defined, the general-purpose modules such as the programmable clock, converters, and keyboard interface might be combined on the preamplifier, to boost the 1-millivolt signal by 1,000 for a-d conversion. Signals would be either stored in memory or passed on through the d-a converter to the oscilloscope. The final system would contain five modules drawn from the inventory and one designed specifically for vcc processing.

"Our general-purpose matrix may cost about \$1,500 in a situation where less expensive, more specific hardware might serve," Burns notes, "but it offers savings of weeks of development time, which cost far more than the cost of the matrix."

The Biomedical Engineering Center itself has no interest in making the product commercially, he adds, "but we would like to see it commercially available so we can build other instruments without having to be in small-scale manufacturing." □

Military

Microprocessor to fire F-18 weapons

Because a fighter aircraft has required a hardwired control system to activate and fire each type of missile, bomb or other stores, as they are called, it is hard to change its weapons complement. But the U.S. Navy expects to ease the problem significantly with a new microprocessor-controlled system that accommodates changes primarily through software.

The first Navy aircraft to sport the new stores-management set will be the McDonnell-Douglas Corp. F-18 strike fighter, which will make its maiden flight in mid-1978. Conrac Corp.'s Systems-East division in West Caldwell, N.J., is building the system under a \$3 million-plus contract. But the firm believes it could reap in excess of \$50 million supplying the hardware over the life



COIL-LER MANUFACTURING, INC.

2-E Town Line Circle Rochester, N.Y. 14623
716/442-6630
Representatives in Principal Cities

Your Intellec[®] system shouldn't cost you a nickel... until you use it.

You can rent—right now, today—any configuration of the world-famous Intellec Microcomputer Development System from Electro Rent Corporation. ER was the first significant quantity purchaser of Intel's PL/M-80 high-level programming language resident compiler, and it's available right now for immediate rental and delivery from any of the 11 ER Inventory Service Centers in the U.S. and Canada. You can choose any Intellec system any way that you need it... with an interactive CRT, PROM Programmer, ICE-80 In-Circuit Emulator, dual drive Diskette Operating System with ISIS-II, high-speed printer, or whatever. You can rent it all for as short a time as 30 days. It's fully tested—with ER taking care of the service—delivered when you need it. where you need it.



Neither should your PROMPT 80.

You can conserve your cash and still get the use of the new Intellec PROMPT 80 microcomputer design aid, too. By renting it, now, from ER. This new personal programming aid simplifies the programming of SBC 80 and System 80 microcomputers as well as 8080 microprocessors, 8708, 2708 and 2704 EPROMs, plus the 8255 and 8251 programmable I/O devices from Intel. PROMPT 80 includes an integral keyboard and 16-digit display—which requires neither a TTY nor CRT for display operation—and can also be used as a low-cost 8708 Specialized PROM Programmer peripheral in an Intellec system. It's ready for you to rent today.



Nor your Pro-Log Series 90.

Pro-Log's new Series 90 PROM Programmer is also available for immediate rental and delivery. You can use it to



program—and reprogram—either MOS or bipolar PROM memories of up to 16K 8-bit words with interchangeable "personality card" modules. Personality cards on the shelf now at Electro Rent can be used for the following PROMs: 1702A, 8702A, 5202A, 5204 and 5704 MOS; and the bipolar 82S126, 82S23, 3601, 3604, 3622, 8624 and 5603A PROMs.

Et cetera.

Thousands of products, hundreds of major manufacturers, more than \$15-million worth of equipment on hand from any of the ER Service Centers: Santa Ana, Burbank, Mountain View, CA; Vancouver, BC, Orlando, FL; Elk Grove, IL; Gaithersburg, MD; North Billerica, MA; Southfield, MI; Cedar Grove, NJ; Dallas, TX. For instant service, call call (213) 843-3131. Today.



Complete and mail this coupon, today, to:

4131 Vanowen Place
Burbank, CA 91504

- I like what you say, Electro Rent. Send me your big, free, new catalog
- Specifically, I need a _____ type of equipment, manufacturer and model number immediately. Can you deliver?
- I need HELP! QUICKLY! Phone me NOW at _____ area code _____ phone number

A fast response, please, to:

NAME _____ TITLE _____
 ORGANIZATION _____
 ADDRESS _____ MAIL STOP _____
 CITY STATE ZIP _____

33% more power to the people.

Power/Mate presents Econo/Mate II.

The open frame power supply.

Now Power/Mate brings you 33% more power in the same package size with the second generation of our Econo/Mate series.

The size is the same, the basic components are the same for easy interchangeability. But that's where the similarity ends.

Econo/Mate II adds features like dual AC primary and a plug-in IC regulator for improved regulation.

And Econo/Mate II is tough Computer design, quality control and Power Mate's experience helps insure 100,000 hr. MTBF even at this higher power output.

But for all its features, Econo/Mate II is still, most of all, economical. We wouldn't call it Econo/Mate if it wasn't.

Econo/Mate II is in stock, ready for delivery. Send for our free brochure.

Prices start at \$19.95.

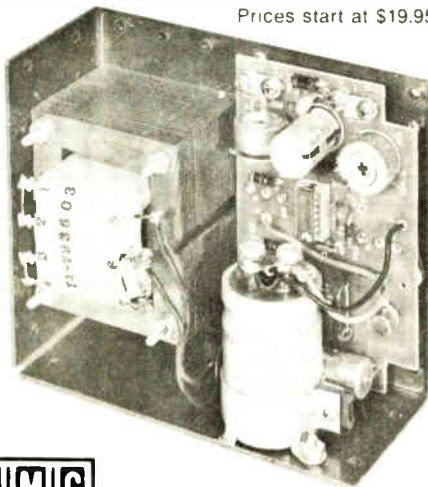

P/M/C
POWER/MATE CORP.

World's largest manufacturer of quality power supplies.

514 South River Street Hackensack, N.J. 07601 / Phone (201) 343-6294 TWX 710-990-5023

Circle 38 on reader service card

DIGITAL MULTIMETERS

NLS proves NLS' DMMs have more capability at lower prices.

NLS' Silver Jubilee Year

THE VOLKSMETER FAMILY

LM SERIES

Features Include:

- Super Rugged - (ideal for field service use).
- Battery powered with batteries and charger unit included.
- Exclusive NLS fuseless protection in kΩ mode - up to 500 vdc or rms ac may be applied without damage.
- Overload indication.
- Automatic zeroing and polarity.
- Operating temperature - 0° to 45°C.
- Large 0.3" LED display.
- Small size: 1.9" H x 2.7" W x 4.0" D.
- Six optional shunts for current measurement - LM-3.5 includes three shunts in values of 10 mA, 100 mA and 1A.



MODEL	RANGES	DC ACCURACY	RESOLUTION	DIGITS	PRICE
LM-3	VDC & VAC	±1% Rdg	1 mV	3	\$125
LM-3.5	1V, 10V, 100V & 1000V	±0.5% Rdg	1 mV	3-1/2	\$147
LM-40	OHMS	±0.1% Rdg	100 μV	4	\$190
LM-4	1 kΩ, 10 kΩ, 100 kΩ, 1 MΩ & 10 MΩ	±0.03% Rdg	100 μV	4	\$227



Non-Linear Systems, Inc.

Originator of the digital voltmeter.

Box N, Del Mar, California 92014 Telephone (714) 755-1134

See your local distributor!

Distributor inquiries invited.

Electronics review

of the current F-18 program.

The management set consists of three basic elements: a central control processor, dubbed the systems management processor, for monitoring and control of the stores; a multiplexed digital bus, also used for other avionics systems aboard the aircraft; and a set of nine station decoders connected to the bus but located out at the firing points.

Full control. All weapons and stores on the F-18 will be controlled by the system except for the forward-looking infrared radar/laser tracker, nuclear arming, and some Harm (anti-radiation) missile functions, points out a spokesman at the Naval Air System Command in Washington, D.C. "Earlier systems used direct-wire analog signals exclusively," he says, with logic handled by switches and relays.

Another difference is that the F-18's system will not use a dedicated control panel, as do other fighters, but will operate with an integrated cockpit control/display. Altogether, the new system "results in a considerable savings in weight from using much less wiring, switches, and relays," says Vern Chute, F-18 avionics group engineer at McDonnell Douglas in St. Louis. Changes in stores, handled through the processor's memory, require little or no extra hardware.

He points out further that "this is the first time the approach is used for such a wide range of air-to-air

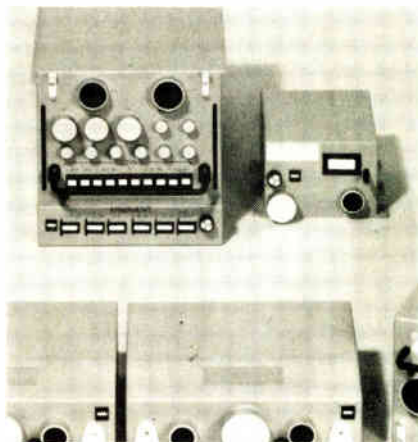

Manager. Central processor, top, controls remote station decoders in fire-control set for F-18, all shown in mockup.

and air-to-ground missiles and bombs." The only other aircraft that handles stores management in similar fashion is the S-3A, the Navy/Lockheed antisubmarine warfare plane. It has a multiplexed bus down to armament decoders, but the decoders have much more limited functions, Chute adds.

Conrac based its design on a militarized 8-bit microprocessor, Intel Corp.'s 8080 "because it has double-precision accuracy and can be programed to operate like a 16-bit machine," says product manager Walter Sherwood. "We're also using current large-scale- and medium-scale-integrated circuitry that offers high reliability."

The 8080, input/output circuitry, and core memory combine to form a microcomputer that takes information from the digital bus "and, depending on the weapon selected, will look at what's available, the station it's on and its status. It then initiates the firing sequence, starting the decoder and turning on things like a missile's radar or the cooling motor in an infrared missile," explains Ray Sears, Conrac's F-18 programs manager. Via the multiplexed bus, the nine station decoders accept instructions from the microcomputer and pass them on to the stores. Each decoder is individually tailored to what it controls. "When the release signal comes, the decoders have the necessary switches to fire the weapon," Sears adds.

Next June, Full-scale development units are scheduled for delivery to McDonnell Douglas starting in June 1978 and will continue for one year. Conrac production units, slated for initial delivery in November 1979, will continue for 10 years.

Current Navy and Marine Corps plans call for the purchase of 800 F-18s. But the Conrac program could pay still bigger dividends. According to a Navy spokesman, the stores-management system could be applicable to future aircraft. For example, it's "open for the F-18L," the land-based fighter to be built and marketed overseas by Northrop Corp. Northrop hopes to sell 2,000 F-18Ls over 15 years. □

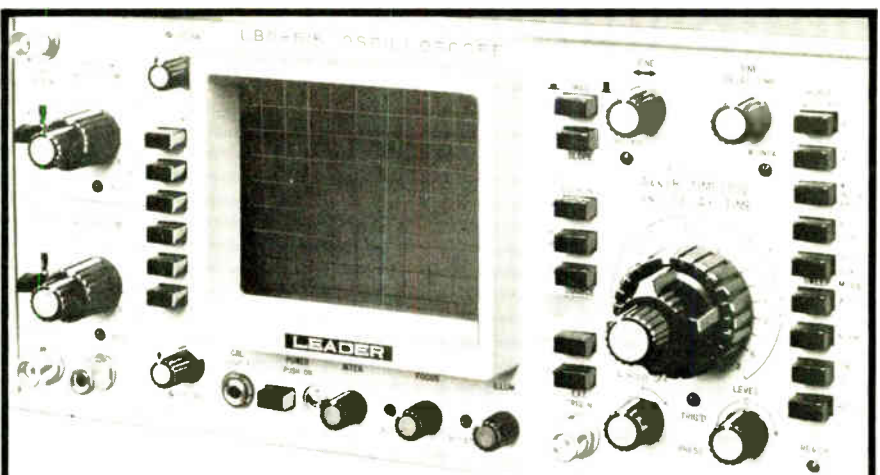

THE 25MHz "NOW" SCOPE with 5sec-1µsec DELAYED SWEEP DUAL TRACE/DUAL CHANNEL

- Built-in delay circuitry, continuously variable, from 1µsec to 5sec ... plus 5mV/Div sensitivity
- Selectable synchronization — automatic, normal, single trace and reset modes with H-F rejection
- X10 magnification; ±3% overall accuracy, both chan's
- Displays leading edge of pulse or pulse train for quick functional determination.
- 20,000:1 delay jitter — X-Y phase difference below 3° @ 100KHz
- External Sweep Sensitivity: (X-Y) 5mV/Div to 2V/Div, 10 steps \$1395. with accessories

LEADER
Instruments Corp.

Tests More ... Tests Better ... for Less!

151 Dupont Street, Plainview, N.Y. 11803 (516) 822-9300
West Coast: 7733 Densmore Ave. Van Nuys, Calif. 91406 (213) 989-2760 In Canada: Omnitron Ltd. Montreal, Quebec

Circle 39 on reader service card

The time you save may be your own.

Used to be you'd get a circuit idea, lay out a pc board, print it, solder everything together, troubleshoot, change your layout, try a new board, and spend absolutely too much time breadboarding. Now A P ACE All Circuit Evaluators let you breadboard in a fraction of the time. Make your changes immediately. Keep full leads on your components. Avoid the heat damage possible with repeated soldering and desoldering. And have a pattern for your board—if you need a board—sitting in front of you. In about as long as it takes to sketch a schematic. Get cooking with ACE. ACE. The All Circuit Evaluator from A P Products.

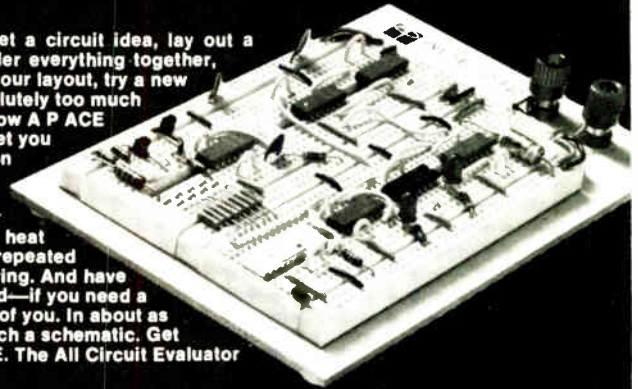

Part No	ACE Model No	Tie Points	DIP Capacity	No. Buses.	No. Posts	Board Size (inches)	Price Each
923333	200-K (kit)	728	8 (16 s)	2	2	4-9/16x5-9/16	\$18.95
923332	208 (assem.)	872	8 (16 s)	8	2	4-9/16x5-9/16	28.95
923334	201-K (kit)	1032	12 (14 s)	2	2	4-9/16x7	24.95
923331	212 (assem.)	1224	12 (14 s)	8	2	4-9/16x7	34.95
923326	218 (assem.)	1760	18 (14 s)	10	2	6-1/2x7-1/8	46.95
923325	227 (assem.)	2712	27 (14 s)	28	4	8x9-1/4	59.95
923324	236 (assem.)	3648	36 (14 s)	36	4	10-1/4x9-1/4	79.95

Order from your A P distributor today. Our distributor list is growing daily. For the name of the distributor nearest you call Toll-Free 800-321-9668.

Send for our complete A P catalog, The Faster and Easier Book.

A P Products manufactures a full line of breadboarding and testing devices as well as a complete line of pre-assembled flat cable/connectors.



**A P PRODUCTS
INCORPORATED**

Box 110-E Painesville, OH 44077
(216) 354-2101 TWX: 810-425-2250

HERMES LOOP ANTENNA

THREE SAMPLE SITES
ON THE NORTH AMERICAN
CONTINENT —

DIFFERENT LATITUDES
DIFFERENT CLIMATE



64°N



42.5°N

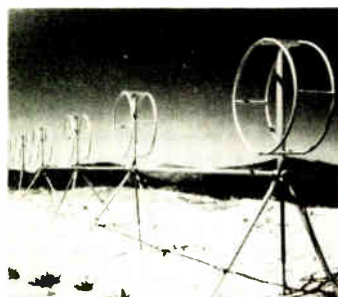

32.5°N



Good Listeners maintain a low profile

Even in the solitude of the forest depths, from rooftops, arctic tundra, swamps to sweltering tropics, 'neath snow, sand or ice,

the Hermes Loop antenna keeps an ear to the sky.

The amazing aperiodic antenna does away with vast log periodic and rhombic arrays - those towering antenna farms.

In rosette configuration, the Hermes loop antenna provides an omnidirectional broadband receiving array in space merely 1/100th that of the traditional antenna farm.

More than 53 government agencies around the world have pressed the loop antenna into service.

A new, even more compact version is available.

Only Hermes Electronics makes it.

2-32MHz
BROADBAND

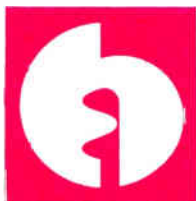

ASK US Send for our Brochure

Hermes Electronics Limited

Suite 315

2020 F Street NW

Washington, DC 20006 USA

202-296 2978

TWX 710 822 1106

EIA sees 12% gain in military outlays in fiscal 1978 . . .

Fiscal 1978 military electronics expenditures will climb to \$14.01 billion, up nearly 12.3% from the \$12.55 billion for fiscal 1977 that began Oct. 1, predicts the Electronics Industries Association in its new "Ten Year Forecast of Government Markets." The 180-page study sees military spending on electronics climbing steadily over the next decade to \$18.91 billion by fiscal 1986.

Procurement in fiscal 1978, EIA says, will rise 15.2% to \$8.48 billion from this year's \$7.36 billion, while RDT&E will grow by 15.5% to \$4.02 billion. Operations and maintenance outlays, however, will slip from \$1.65 billion this fiscal year to \$1.59 billion and remain at that level for two years before beginning a slow upturn.

. . . with aerospace sales flat in 1977 at \$28.9 billion

Although U.S. aerospace companies will begin 1977 with a \$34.6 billion backlog nearly 4% larger than that of a year ago, the Aerospace Industries Association expects next year's industry sales to remain essentially unchanged at \$28.90 billion. That's the forecast of AIA president Karl G. Harr Jr., who says overall 1976 sales of \$28.96 billion will be improved only slightly from the 1975 level of \$28.47 billion.

While major 1976 gains came in military and general-aviation aircraft, Harr attributed the decline for the current year and that anticipated for 1977 to fewer deliveries of commercial transports and civilian helicopters. Military sales, which account for more than half the industry's business, are expected to reach \$15 billion next year, just above the \$14.7 billion spent by the Defense Department on aerospace in 1976. This included procurement outlays of \$7.31 billion for aircraft and \$2.57 billion for missiles. Military RDT&E outlays included \$1.73 billion for aircraft, \$2.46 billion for missiles, and \$640 million for astronautics. NASA's aerospace outlays of \$2.64 billion in 1976 were off from 1975's \$2.73 billion.

ERDA funds Lockheed for lithium cell to power cars

There is renewed Federal interest in alternatives to petroleum to power cars and trucks. The Energy Research and Development Administration has funded Lockheed Missiles and Space Co. to develop a high-energy lithium battery able to power a 1,200-to-1,800-pound automobile up to 200 miles without refueling. In the first year, Lockheed's Palo Alto laboratories will receive \$199,985.

Lockheed proposes a nonpolluting battery fueled with lithium and air, operating in a water-based solution. In 1972 the company disclosed discovery of a high-powered lithium water cell now being developed for possible military use at Minuteman ICBM sites and as a power source for Navy torpedoes. In a collateral ERDA effort, Lawrence Livermore Laboratories in California is studying techniques to produce and recycle the lithium used in the cells.

NASA awarding \$8.3 million to 3 for solar mission

The National Aeronautics and Space Administration is negotiating contracts worth \$8.3 million with three companies to provide three prototype flight subsystems for its Solar Maximum Mission spacecraft. They are scheduled for launch in the third quarter of 1979. The \$69 million SMM program will investigate solar flares.

NASA's Goddard Space Flight Center, Greenbelt, Md., says General

Electric's Space division in Valley Forge, Pa., **will get the largest award, about \$3.5 million**, for the spacecraft's attitude control system. Fairchild Industries of Germantown, Md., will receive about \$2.5 million for the communications and data-handling subsystem for both ground and on-board spacecraft control. McDonnell Douglas Astronautics-East, St. Louis, will get about \$2.3 million for the power module. Each contract will have options for up to six additional subsystems.

The 150-inch-long, cylindrical spacecraft will be powered by solar panels delivering 1,280 watts to the unregulated power module operating between 21 and 35 volts dc negative ground. It is one of the first scheduled for retrieval by the Space Shuttle.

Reactions sought to AAMI standards for medical devices

Medical instrument makers and other organizations affected by 15 proposed medical-device standards to be considered by the Food and Drug Administration are being urged to provide **impact statements and other related data**. The Association for the Advancement of Medical Instrumentation is collecting the material. It has issued the standards in draft form.

Six of the standards apply to implantable and electronic diagnostic or therapeutic devices and safety procedures. Included are proposals for implantable pacemakers, implantable neurostimulators, and safe current limits, plus draft standards covering neurostimulator biocompatibility, electrocardiogram connectors, and implantable pacemakers. Copies are available from AAMI at 1901 Ft. Meyer Dr., Suite 602, Arlington, Va., 22209 at prices ranging from \$2 to \$18 each.

FCC studies 44% cut of uhf TV noise

Television-receiver makers are opposing a petition by the Council for UHF Broadcasting to require a reduction in receiver noise levels on channels 14 through 83. **Makers would have 30 months to drop the level to 10 decibels from the present 18 db**. Despite the opposition from the Electronic Industries Association and EIA-Japan, the FCC has instituted an inquiry under Docket 21010 that calls for comment by Feb. 15 and replies by March 31. The EIA urged the commission to investigate first the cost of cutting the 18-dB noise figure.

U.S. adopts data encryption standard using IBM concept

The first Federal data encryption standard for use by Government and commercial digital computers has been approved by the Department of Commerce following development by the National Bureau of Standards. Details will be disclosed Feb. 15, 1977, when the standard is published to coincide with an NBS computer security conference at Gaithersburg, Md. The new standard, known as FIPS PUB 46, is based on a mathematical algorithm developed by IBM, which has agreed to issue **royalty-free, nonexclusive licenses** for the manufacture, use, and sale of cryptographic electronics associated with the standard. Federal computer users may begin using it six months after its publication. Details are available from Anne Shreve of the NBS Systems and Software division, Washington, D.C. 29234, or by telephoning (301) 921-3861.



**Here in Wabash, Indiana
 Jim Smith gets to meet them all...
 Xerox... 3M... Eastman Kodak... RCA... Zenith...**

They stop at the station for gas and directions when they come to talk to Wabash engineers about transformers and high voltage power supplies.

Wabash, you see is an outstanding source of transformers to a long list of blue chip customers who have come to rely on the custom engineering, sophisticated product, automated winding, high volume production capability and competitive pricing Wabash offers.

Jim doesn't own the Chippewa Service Station—

Circle 43 on reader service card

but the bait house next door. His buddy, Hal Roser, often goes mushroom hunting up in Michigan and that's when Jim gets a chance to meet all these people. And Jim is pretty happy about it—especially since word has gotten back that Xerox, RCA, Eastman Kodak, 3M and Zenith enjoyed meeting Jim.

And, that's just another thing Wabash offers that none of the hundreds of other transformer manufacturers can. A chance to meet Jim Smith.



Wabash custom designed & engineered transformers and high voltage power supplies.

Coils, Relays & Transformers
wabash
 of
Wabash, Indiana
 and Huntington, Indiana; Farmington, Missouri;
 Tipton, Iowa and South Boston, Virginia
 For information and quotes write or call:
 Wabash, Inc., Dept. TA-3, 810 N. Cass St., Wabash, Ind. 46992 Tel: 219 356-8300 TWX 810-333-1533

FEATURE ARTICLES FROM *ELECTRONICS* AVAILABLE IN REPRINT FORM

No. of
copies
wanted

New reprints

- ___ R-612 Fiber-optic communications special report 24 pp \$3.00
- ___ R-610 Special report on hybrid-circuit technology 19 pp \$3.00
- ___ R-606 Special issue—microprocessors \$4.00
- ___ R-600 World market report 1976 24 pp \$5.00
- ___ R-526 How reliable are today's components 16 pp \$3.00
- ___ R-524 Special report on bipolar large-scale integration 12 pp \$3.00
- ___ R-522 Special report on power semiconductors 12 pp \$3.00
- ___ R-512 Design of circuits for dangerous environments 4 pp \$3.00
- ___ R-510 Bipolar integration advances with I²L microprocessor 8 pp \$2.00

Charts

- ___ R-516 Electronic symbols \$2.00
- ___ R-211 Electromagnetic spectrum (16-page report and chart) \$4.00
- ___ R-326 Optical spectrum (6-page report and chart) \$3.00

Books

- ___ R-608 Basics of Data Communications—Electronics Book Series \$12.50
- ___ R-602 Large Scale Integration—Electronics Book Series \$9.95
- ___ R-520 Microprocessors—Electronics Book Series \$8.95
- ___ R-011 Computer-aided Design 135 pp \$4.00
- ___ R-032 Active Filters 88 pp \$4.00
- ___ R-031 Circuit Designer's Casebook 182 pp (U.S. only) \$5.50 (foreign) \$12.00

Other Reprints

- ___ R-518 Special issue—productivity \$4.00
- ___ R-514 Eight ways to better radio receiver design 6pp \$3.00
- ___ R-508 Designing microprocessors with standard logic devices 12pp \$3.00
- ___ R-506 The case for component burn-in 7 pp \$2.00
- ___ R-434 Designing automated systems with the new standard interface 12 pp \$3.00
- ___ R-432 An update on communications satellites 8 pp \$2.00
- ___ R-430 Choosing the right bipolar transistor model for computer-aided design 20 pp \$3.00
- ___ R-428 Designing with low-cost lasers 6 pp \$2.00
- ___ R-504 U.S. forecast 1975 20 pp \$3.00
- ___ R-502 European forecast 1975 20 pp \$3.00
- ___ R-500 Japanese forecast 1975 16 pp \$3.00
- ___ R-426 Special issue—technology update 1974 \$4.00
- ___ R-424 Microprocessor applications 28 pp \$3.00
- ___ R-422 A microprogrammable mini-computer 8 pp \$2.00
- ___ R-420 Computerized text-editing and typesetting 8 pp \$2.00
- ___ R-418 Computer analyses of rf circuits 8 pp \$2.00
- ___ R-416 Optical waveguides look brighter 8 pp \$2.00
- ___ R-414 The ion-implanted n-channel process 6 pp \$2.00
- ___ R-412 Liquid cooling of power semiconductors 6 pp \$2.00
- ___ R-410 Special report on passive components 16 pp \$3.00
- ___ R-408 Bringing sight to the blind 8 pp \$2.00
- ___ R-406 Designing with the new logic, C-MOS and bipolar 16 pp \$3.00
- ___ R-328 Special issue—pervasiveness of electronics \$2.00
- ___ R-324 Semiconductor memories are taking over data-storage applications 16 pp \$3.00
- ___ R-322 Special report: new displays complement old 10 pp \$2.00
- ___ R-320 Special report on designing with flat cable 14 pp \$3.00
- ___ R-318 Special report on auto electronics 16 pp \$3.00
- ___ R-316 Hybrid circuits solve tough design problems 16 pp \$3.00
- ___ R-312 Leadless, pluggable IC packages reduce costs 7 pp \$2.00
- ___ R-310 Penetration color tubes are enhancing information displays 6 pp \$2.00
- ___ R-308 Program for transition from nonlinear to linear transistor model 6 pp \$2.00
- ___ R-306 Charge-coupling improves its image, challenging video camera tubes 8 pp \$2.00
- ___ R-209 Semiconductor RAMs land computer mainframe jobs 15 pp \$2.00
- ___ R-207 Technology gap starts to close for computer peripherals 16 pp \$3.00
- ___ R-205 Bridging the analog and digital worlds with linear ICs 16 pp \$3.00
- ___ R-113 Optoelectronics makes it at last 34 pp \$4.00
- ___ R-104 The new concept for memory and imaging: charge-coupling 12 pp \$2.00
- ___ R-023 Special report on tomorrow's communications 32 pp \$3.50

Payment must accompany your order

Make check or money order payable to Electronics Reprints. All orders are shipped prepaid by parcel post. Allow two to three weeks for delivery.

Back issues now available:
1960 to 1969, \$5.00 each
1970 to 1973, \$3.00 each
1974 to 1975, \$4.00 each

USE THIS PAGE AS YOUR ORDER FORM

Cost of orders \$ _____
Plus 10% handling charge \$ _____
TOTAL AMOUNT ENCLOSED \$ _____

Mail your order to:
Janice Austin
ELECTRONICS REPRINTS
P.O. Box 669
Hightstown, N.J. 08520

SEND REPRINTS TO

Name _____
Company _____ Dept. _____
Street _____
City _____ State _____ Zip _____

UK firm offers novel worldwide instrument warranty

Motivated by a heavy investment in production, testing, and quality-control systems, Gould Advance Ltd. will fuel a New Year marketing drive with what it calls the first worldwide two-year warranty on its instruments. The company, one of Europe's leading oscilloscope producers, **will guarantee labor costs and components found faulty, but not calibration of its line of signal sources, timer-counters, oscilloscopes, and meters.**

Japanese double speed of automated facsimile machines

When Japan's national telephone company begins medium-speed facsimile service next year, four machines that can operate unattended will be ready. Although they are more expensive than previous hardware, advanced technology halves transmission time to 2 and 3 minutes for a letter-size page. **The speed-up, which will significantly reduce transmission costs, especially for long-distance transmission, should perk up domestic fax sales and spark an export push.** Nippon Electric Co. began delivering machines this month, Toshiba and Ricoh are expected to launch their products in February, and Matsushita Graphic Communication Systems Inc. plans an April debut.

The machines, compatible with the 4- and 6-minute equipment operated on the Nippon Telegraph and Telephone Public Corp. network, switch to amplitude and phase modulation of the vestigial sideband to transmit at a printing density of 3.85 lines per millimeter in 3 minutes a page or in 2 minutes a page with 2.57 lines/mm. **For pickup, the Toshiba fax, priced at \$5,045 in Japan, uses a diode array, and the NEC product, at \$4,899, relies on charge-coupled devices.**

Two French firms join to fight competition in semiconductors

Two of France's top semiconductor manufacturers will join forces to improve their competitive clout against companies like Texas Instruments, Motorola, and Philips. Creating the largest industrial complex in France to produce discrete components will be Sescosem, the Thomson-CSF semiconductor division, and Silec Semi-Conductors (SSC), a Silec subsidiary. The two competitors are expected to chalk up sales this year of \$40 million. **The partnership will ultimately join engineering, manufacturing and marketing activities, coupled with streamlining of production and sales facilities.** The organization will be directed by Guy Dumas, previously chairman and managing director of SSC.

Philips squeezes audio-power devices into 9-pin package

Watch for Philips' Elcoma division to announce a range of audio power amplifiers that come in a single in-line (SIL) package with only nine pins. Designed with the single row of pins along one edge and a thermal conduction plate along the other, the SIL chips are easier to connect to heat sinks and provide more flexibility in printed-circuit-board mounting than competitive products, according to the Dutch company. The configuration ensures separation of thermal and electrical conductive paths, and the amplifiers are more highly integrated than other audio-power devices, Elcoma says.

The SIL-9 amplifiers, with outputs up to 9 watts, will go into production next March. Later in the year, other versions will be available at 20 W ratings in a similar package. The SIL package can be made on production lines laid out for conventional dual in-line packages.

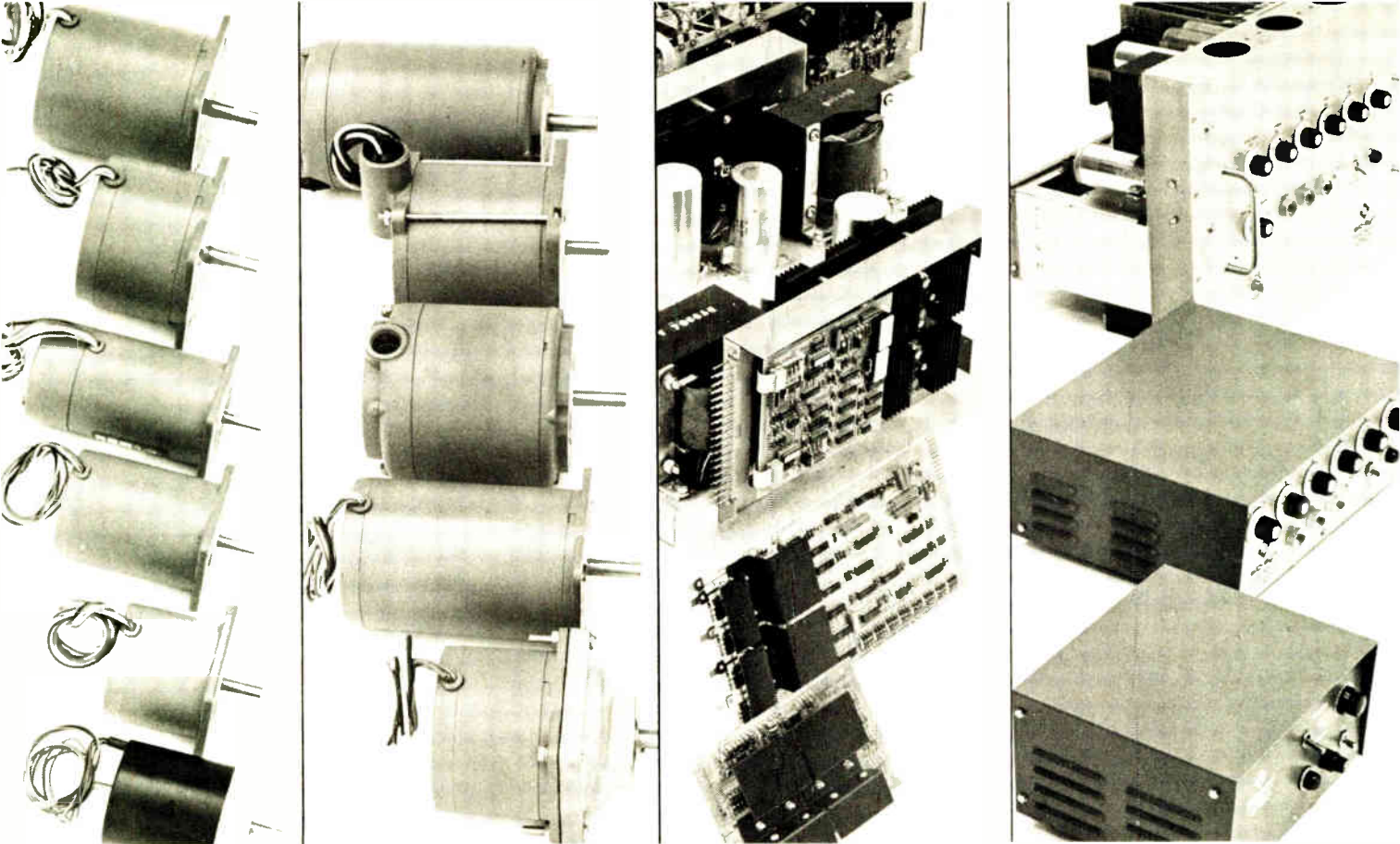

Stepping just came of age.

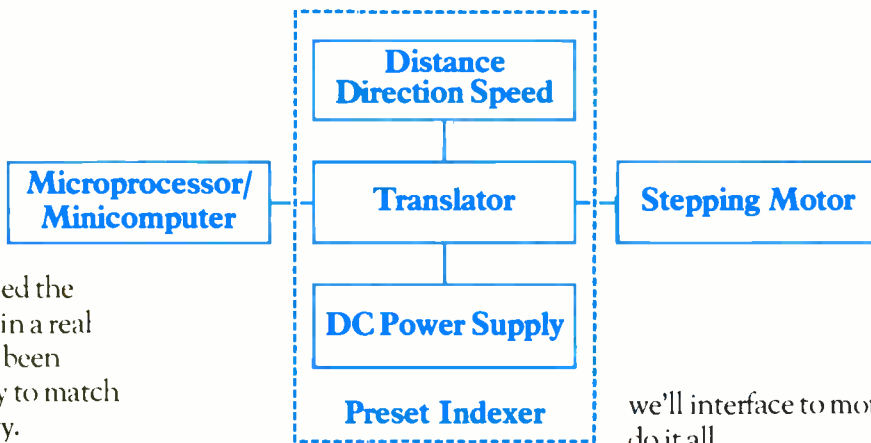

Fifteen years ago, we introduced the first stepper. SLO-SYN.[®] But in a real sense, the stepping motor has been waiting for today's technology to match circuitry with motor capability. Converting electronic input into mechanical output.

For starters. From 0 to 2,000 steps per second in 4 msec with our M060 series (up to 150 oz-in of static torque).

Mid-range. From rest, 12 steps in 12 msec, damped; or 12 steps in 15 msec start – stop – damped, with 100 oz-in of frictional load and 1.2 lb-in² inertia.

High Performance. At 10,000 steps/sec (3,000 rpm), output torque of 525 oz-in, shaft power 1,165 watts (1.65 hp).

The stepper's logical companion is the Slo-Syn translator or preset indexer. The power for moving loads, controlling distance, speed, direction. Velocity control means motion/time efficiency for a wide range of inertial loads.

Drives interface with microprocessors and minicomputers. Design modularity prevents over-design. You control the options: 1) Modular or packaged drives. 2) If you want to provide the logic,

we'll interface to motor. 3) Or we can do it all.

Whatever the manufacturing move, see the company that's in the best position to help. Write The Superior Electric Company, Bristol, CT 06010. Or call us direct (203) 582-9561.

A step ahead in positioning.

 **Superior Electric**

Plessey bets on GaAs LED to win edge in early optical-communications race

Although many companies are working on complex gallium-aluminum-arsenide double-heterojunction lasers to light up future fiber-optic telecommunications systems, Britain's Plessey Co. is relying on simple high-radiance light-emitting diodes to shine more brightly in near-term optical-communications markets.

The company is about to introduce a plug-in transmitter-receiver module. It contains a long-life LED that should fit right into various short-to-medium-haul optical-fiber links. Applications should include military, industrial, avionics, and computer communications with data rates as high as 30 megabits per second.

The high-radiance zinc-diffused GaAs LED in the OML4OD module has been laboratory-tested for more than 20,000 hours with zero degradation, says George Gibbons, manager of microwave and optoelectronic research in Plessey's Allen Clark Research Centre in Caswell, Towcester, Northants. From temperature-accelerated aging tests, he predicts lifetimes of 10^7 hours—until the year 3017.

Market motive. Plessey believes it alone is pursuing simple LED technology for links up to 2 to 3 kilometers, which represent the biggest near-term market. GaAs LEDs win hands down over complex LEDs and lasers in proven reliability, higher temperature stability, ease of modulation, and their potential for low cost, Gibbons declares. However, Plessey plans to have its long-life lasers ready when needed by the high-capacity long-haul telecommunications systems in the 1980s.

Plessey bases its LEDs on the well-known Burrus surface-emitter approach, first developed at Bell Laboratories. In this process, a well is etched through the top of absorbing GaAs near the junction. The resulting small, well-defined area emits

high radiance in the 0.9-micrometer region and couples power efficiently to the single fiber, explains Peter Turton, marketing manager of Plessey's separate Commercial Optoelectronics and Microwave unit. The company's commercial devices range in radiance level from 10 watts per steradian per square centimeter to $35 \text{ w/steradian/cm}^2$. Power launched into the 0.55 numerical-aperture fiber is 100 microwatts and $600 \mu\text{W}$, respectively.

Besides the LED, the module contains the transistor-transistor-

logic-compatible discrete-switching circuitry, a silicon p-i-n diode detector, and "butt-joined" dismountable connectors, Gibbons says. The fiber ends, mounted in tight-tolerance ferrules on both halves of the connection, are held in alignment by either a spring sleeve or a precision cylindrical part, he says.

Links. Since coupling losses are only 1 to 2 decibels, the units can handle links of 1 to 2 kilometers, and these may be joined back to back. The optical cable is made by Britain's BICC of all-silica fiber,

Around the world

Laser range finder measures continuously to 500 m

A laser-based range finder developed in West Germany is the first to move into the price class of good theodolites, claims its developer, Atlas-Elektronik. The price of the Atlas Lara 10, intended for applications in hydrography, hydrology, and off-shore engineering, is \$5,500 in the European market. The instrument, which displays distances in 10-centimeter increments, is also said to be easier to use than such equipment as theodolites and inverted-image range finders.

Even while the target is constantly changing, distances up to 500 meters can be measured with an accuracy within $\pm 10 \text{ cm}$, the company says. Since the equipment needs only a third of a second to figure out distances and display them, measurements can be taken continuously.

Objects as far away as 120 meters need no special reflector because the equipment can evaluate relatively weak return signals. Results can be scanned by data-processing systems, a step toward automation, the company says. The instrument consists of two parts connected by a cable: the 3-kilogram hand-held measuring head and the 4-kg digital indicating unit. It is powered either by a 220-volt ac or a 12-V dc source.

10-cent filter keeps rfi from auto components

The increasing amounts of electronic gear in vehicles—from electronic ignition systems to microcomputers—has designers concerned about electromagnetic incompatibility, including radio-frequency interference. To date, the cost of rfi controls has largely kept them off the road. But, early next year, the Grenoble-based research firm Laboratoire d'Electronique et d'Automatisme Dauphinois will introduce an inexpensive rfi filter for automobiles. By using electrolytic capacitors that solve the basic problem of protecting on-board electronic appliances at a low cost, the four-pole modular filter achieves a price of only about 10 U.S. cents apiece—about one fifth the price of currently available rfi filters. The company predicts volume sales.

Built from capacitance and series-inductance modules that snap together, the filters have cutoff frequencies below 100 hertz. They will be manufactured by the French firms SIC-Safco and Gregoire et Barilleau, which will aim at the radio installer market while negotiating with major automakers.

either step- or graded-index, from Corning Glass Works in the U.S. The module of 102 by 34 by 29 millimeters has an error rate at 25°C of less than 10^{-10} at 30 megabits per second and an operating range of -20°C to +50°C. It works from either a +12-volt or -5-v, 150-ampere power supply.

Earlier versions of the system have been supplied for evaluation to the Central Electricity Generating Board for interference-free power-monitoring and to the British navy for underwater location units. The company also markets an indium GaAs LED that operates in the 1.06- μ m region. □

Japan

Beam set precisely for tiny IC lines

Looking ahead to the coming tremendous increase in density of integrated-circuit chips, Japanese researchers have developed an experimental high-speed, high-resolution

electron-beam system to apply an image with submicrometer lines directly to a wafer. In initial tests on photomasks, a team at Musashino Electrical Communication Laboratory of Nippon Telegraph and Telephone Public Corp. is getting 16-bit positioning resolution in both the X and Y directions over an area 2 millimeters square.

The resulting minimum displacement of the beam between successive exposure points is only 0.03 micrometer. This highly accurate control enables the system to handle submicrometer line widths.

High speed is assured by a maximum clock rate of 5 megahertz, the speed at which the beam is deflected to successive position in 100-hertz increments. Areas larger than 2 by 2 mm are exposed by moving the target stage to expose a pattern in two or more steps.

Engineers began with a JEBX-5A electron-exposure unit from Jeol Ltd., which is controlled by a Texas Instruments 980A computer and has 14-bit resolution. That unit was modified to expose chip patterns on photomasks in about 6 seconds—

about 16 times as fast as the modified unit. However, an additional 7 s is needed to move to succeeding exposures, cutting the increase in speed to a factor of eight.

Modifications. The research team improved the JEBX-5A by developing and incorporating in it a high-speed arithmetic unit, a high-speed 16-bit digital-to-analog converter, and an output amplifier.

The electron-beam column was also somewhat modified, and the beam blaster was speeded up to obtain a 60-nanosecond response time. Better deflection-control amplifiers were built.

The most important task was developing the speedy, high-precision d-a converter. The device achieves 16-bit resolution by digital switching of constant-current generators to yield deflection currents as high as 32 milliamperes in increments of about 0.5 microampere.

The 5 most significant bits control 31 identical JFET switches and 1-milliamper current sources. The 8 mid-range bits generate current through eight junction field-effect transistors that switch eight current generators, which deliver current in binary increments between a maximum of 0.5 milliamper and a minimum of slightly less than 4 μ A.

The 3 least significant bits control three JFET switches and current sources of 1, 0.5, and 0.25 mA. These currents are reduced to proper values by a 1/512 current attenuator and are added in a current bus. The voltage drop across a 50-ohm resistor resulting from this current is the input to the deflection amplifier.

In initial experiments, the equipment has processed masks for optically printing the 1.7-by-1.7-mm wafer of a 1,024-bit dynamic metal-oxide-semiconductor memory with one transistor per bit. A beam current of 1 nanoampere can expose each chip area in only 13 seconds.

Successive beam positions can be controlled in a range of increments from 0.03 μ m to 0.97 μ m. Lines can be drawn at angles of 30°, 45°, and 60°, as well as parallel to the X and Y axes. □

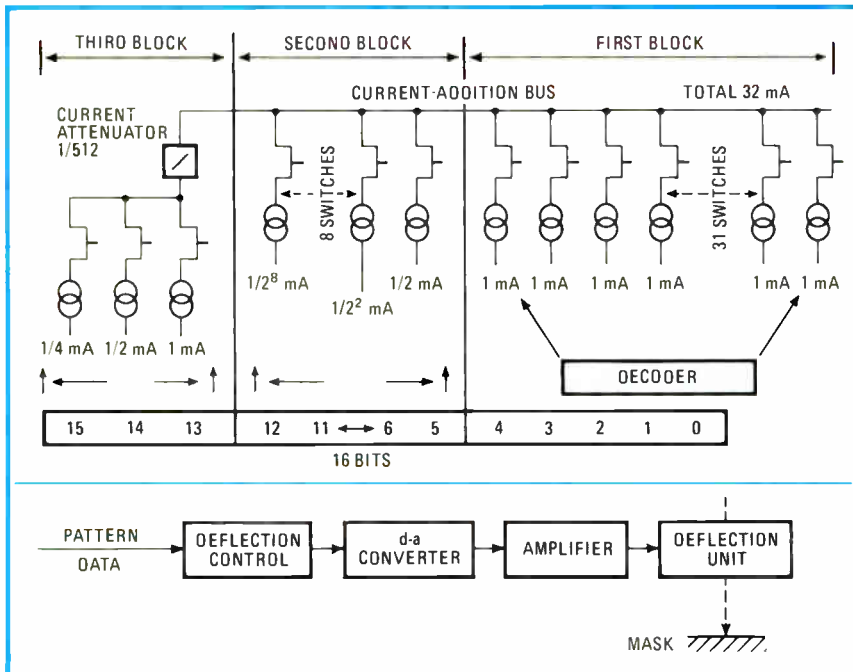

Exposure resolution. Heart of the NTT electron-beam exposure system is high-speed 16-bit digital-to-analog converter (top), which positions exposure points 0.03 micrometer apart. Controlled by patterns stored in computer memory, the system (below) consists of the deflection control, d-a converter, amplifier, and deflection unit.

Introducing push-button microprocessor system debugging.

HP's 1611A Logic State Analyzer ... Dedicated to all 8080 or 6800 based systems.*

View program flow in mnemonics. With CRT data and addresses selectable in either hexadecimal or octal formats and external lines in 1's and 0's.

Maintain testing control. LED indicators show status at all times. You can monitor system operation at normal speed or stop the microprocessor and give control to the 1611A for single or multiple keyed steps.

Enter data quickly and easily. The hexadecimal keyboard makes trigger and qualifier data entry as easy as operating a calculator. And the CRT display gives you a quick visual check on your entries.



Choose your display. Either mnemonic or absolute (op codes). Roll the display to view any 16 line slice of the 64-byte memory.

Pinpoint virtually any specific event. Trigger on address, data, or external signals, or on any combination of the three. You can also qualify the trigger by bracketing the address and opting to trigger on the 16th occurrence of the trigger word. TRIGGER ENABLE and DISABLE keys act as arm and disarm circuits providing unparalleled pinpointing flexibility.

Move the display window. Delay up to 65,472 qualified clocks or memory transactions from the trigger word. Or, pre-trigger to see up to 63 bytes leading up to the trigger word (negative time).

Obtain program and timing data. Qualify the display with TRACE TRIGGER and see only those bytes that match your trigger inputs - all write instructions, for example. Press COUNT TRIGGERS and the 1611A displays the number of trigger occurrences between the TRIGGER ENABLE and TRIGGER DISABLE entries. Push TIME INTERVAL and you get a display of actual elapsed time between selected points in your program on your hardware.

The 1611A should be on hand when you start up your microprocessor-based system. Imagine the time you'll save with push-button operation and an unparalleled view of your system's operation; viewing things dynamically that you never could see before. And there's more: self test; trigger outputs to drive external equipment; error messages to warn of improper operation or setup; and the choice of two initial "μP personality modules" that let you tailor the 1611A to either 8080 or 6800 based systems.



Let HP's 1611A, priced at \$5,000**, help you speed development, production-line testing or service. Ask your local HP field engineer for all the details. Ask him about HP's digital seminars too. He can tell you when one will be held in your area and how you can attend.

*and more modules for other microprocessors to come
**Domestic U.S.A. price only

HEWLETT **hp** PACKARD

Sales and service from 132 offices in 48 countries.

100 Page 44, 2000, 1980, 1981, 1982, 1983, 1984, 1985, 1986, 1987, 1988, 1989, 1990, 1991, 1992, 1993, 1994, 1995, 1996, 1997, 1998, 1999, 2000, 2001, 2002, 2003, 2004, 2005, 2006, 2007, 2008, 2009, 2010, 2011, 2012, 2013, 2014, 2015, 2016, 2017, 2018, 2019, 2020, 2021, 2022, 2023, 2024, 2025

World Radio History

Managing the data domain.

Circle 49 on reader service card

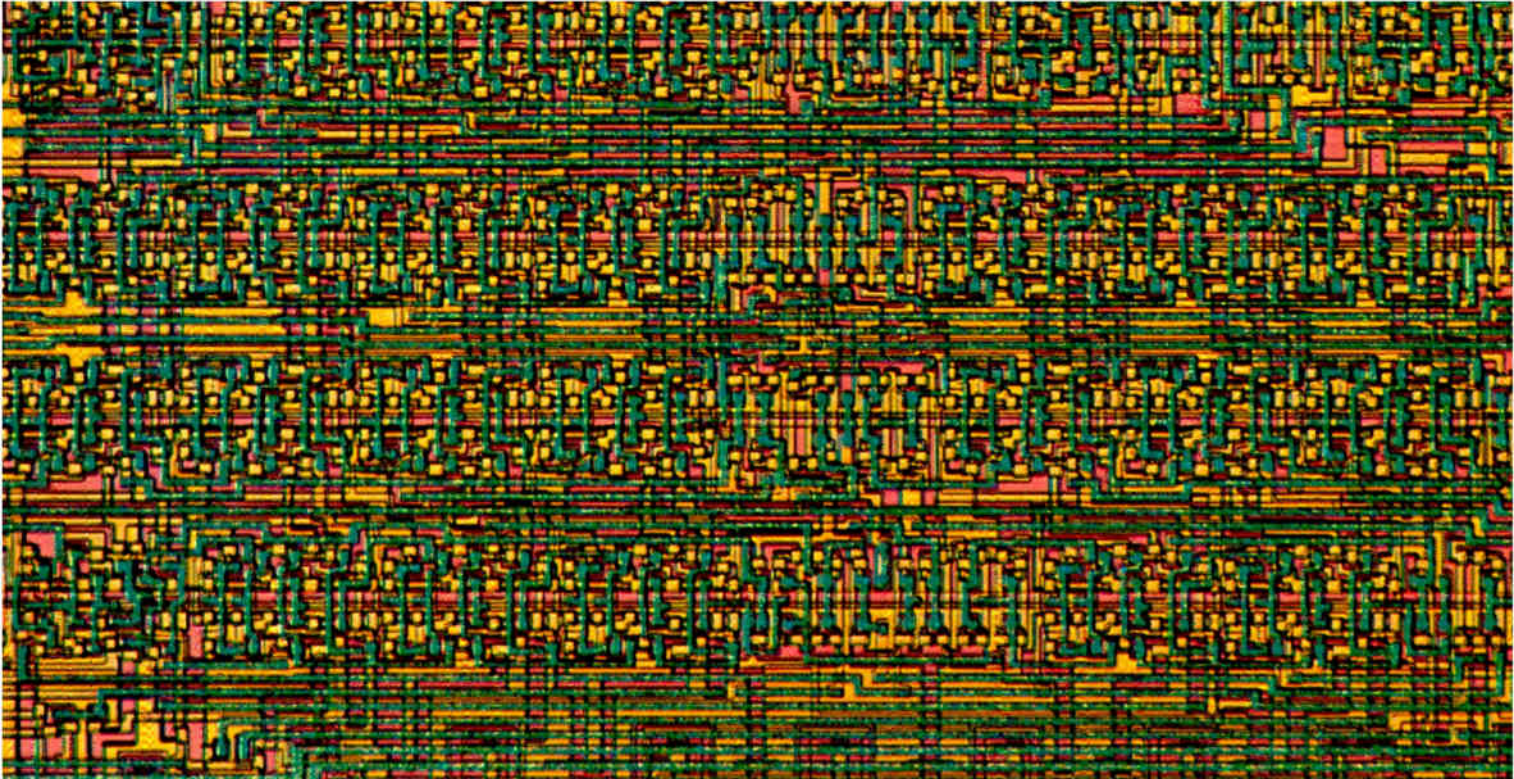

LAST YEAR THIS PROPRIETARY LSI CIRCUIT WAS ONLY AN IDEA. This year it made a good idea into an outstanding product.

Our business is helping original equipment manufacturers exploit the advanced semiconductor technologies to improve performance and reduce costs. We do it by developing proprietary LSI circuits for our customers' exclusive use. Maybe we should be doing it for you.



If you're trying to stay competitive with a new product – or by improving an existing product – now is the time to consider a custom development program. We can help you fully understand the very significant benefits of custom LSI.

Performance Bonuses That Cost You Nothing! The real beauty of LSI is the way it gives you product design options. Once you've made the decision to develop a custom circuit,

there's usually plenty of silicon real estate to use in new and different ways. You can add performance features to the product at virtually no incremental cost. In short, your product can be much better than a competitor's non-LSI equivalent.

High Yields Mean Lower Costs. Our LSI processes are production-proven. We get high yields. Which means you get lower chip costs. Plus, LSI reduces product assembly costs. Your product should have a competitive edge in price.

Low Power Consumption. LSI circuits conserve power. Their low current requirements often permit portability which would otherwise not be possible. Energy conservation in itself is a product advantage these days.

Small Size is Only Part of the Story. Product miniaturization is the most obvious advantage of LSI. Even if small size seems unnecessary for your application, don't overlook the numerous other benefits that we've been talking about.



Our knowledge of the custom LSI approach can help you to evaluate these potential benefits in your own terms. LSI may be exactly what you need. If it isn't, we'll be the first to tell you. Contact us today for some of the answers.



We sell more than circuits.
We sell solutions.

3100 Alfred Street, Santa Clara, CA 95050
Telephone: (408) 247-5350
Cable: Micropower
Telex: 910-338-0154 MICROPWR SNTA

French electronics looks to growth

Telecommunications and color TV to lead predicted rise of 15% from 1976 level of \$4.55 billion despite nation's economic woes.

by Arthur Erikson, Managing Editor, *International*, and Joel Stratte-McClure, *McGraw-Hill World News*

This year started out looking as though it would be mostly wine and roses for the French economy, but it's winding up more like vinegar and thistles. The rise in the cost of living during 1976 was a belt-tightening 12%, the value of the French franc dwindled some 15%, and the unemployment rolls still add up to more than 1 million, a figure that makes the establishment shudder.

Despite its austerity measures, the government is aiming for a growth of about 5% next year for the French economy. With that great an expansion overall, then, and with strong telecommunications and color-television markets almost a certainty, French electronics sales shouldn't do too badly in 1977. *Electronics'* annual survey spots them at \$5.22 billion, up nearly 15% from an estimated \$4.55 billion for 1976. (Dollar amounts are calculated at a rate of 5 francs to \$1.)

Most of the gain will come from telecommunications. The government is gearing up to spend \$21 billion over the next five years to get its long-inadequate telephone system into shape. In late November, the National Assembly approved a \$4.8 billion allocation for phone-system work starting next year. Spending for electronic switching equipment by the government-run phone network will more than double in 1977 to reach \$240 million. With that lift and with a high level of military electronics business, the communications sector will surge some 20% to just under \$1.50 billion next year.

A major beneficiary of this largesse will be Thomson-CSF, the biggest French electronics group. The Compagnie Générale

d'Electricité's CIT-Alcatel also ranks as a major supplier as does ITT's Compagnie Générale de Constructions Téléphoniques.

But some market watchers warn against thinking that the bright star of telecommunications constitutes a galaxy. Louis le Saget, executive vice president of CIT-Alcatel, cautions, "The market for public telecommunications will be respectable because of the high priority given by the government. However, we still are not too optimistic that private consumption and export markets will pick up proportionately."

Glummer still is Jacques Lorre, a forecaster for the semiofficial Bureau d'Information et de Prévisions Economiques. "The austerity program will almost definitely lead to a decrease in consumer spending and industrial investment. It will be a

while before confidence is restored," he maintains.

The downbeat outlook is reflected in *Electronics'* markets charts, particularly in the totals for industrial electronics and test and measuring equipment. For both sectors, next year's rise is pegged at some 6%, which works out to practically flat after inflation is taken into account.

Happy computers. Business for computer makers, however, should not be too bad. The government is spending heavily to get the new national computer company—CII-Honeywell-Bull—solidly into business. It came into being when CGE formally took control of Honeywell-Bull and merged it with the Compagnie Internationale pour l'Informatique, which was set up by the former de Gaulle government to keep France a force in data

FRENCH ELECTRONICS MARKETS FORECAST (IN MILLIONS OF DOLLARS)			
	1975	1976	1977
Total assembled equipment	3,973	4,548	5,223
Consumer electronics	989	1,172	1,300
Communications equipment	1,035	1,197	1,496
Computers and related hardware	1,480	1,668	1,881
Industrial electronics	159	174	183
Medical electronics	132	147	160
Test and measurement equipment	128	135	143
Power supplies	51	55	60
Total components	988	1,128	1,258
Passives	600	676	752
Semiconductors	200	236	270
Tubes	188	217	236

Note: Estimates in this chart are the consensus estimates of consumption of electronic equipment obtained from a survey made by *Electronics* magazine in September and October 1976. Domestic hardware is valued at factory sales prices and imports at landed costs. Exchange rate: \$1 equals 5 French francs.

You get variety, unique design, economy and more when you specify AMP's DIP sockets.

You get more performance.

And that's what all the features of AMP's DIP and microprocessor sockets add up to.

Take variety. You can choose from standard and low profile housings, a wide range of sizes, tin or gold plated contacts, in widths of .300", .400" or .600". And that's only the beginning.

There's design and economy. DIP socket contacts include a unique retention feature. It makes sure that every socket you insert into a pc board will stay there, even during the soldering process.

The design also prevents solder wicking problems. And with AMP automatic insertion equipment,

the sockets can be installed at rates to meet your production needs.

And don't forget AMP's solid backup. You can count on it with the kind of personal attention your product line deserves.

So why not get AMP quality when you need DIP and microprocessor sockets. Just call Customer Service at (717) 564-0100. Or write AMP Incorporated, Harrisburg, PA 17105.

AMP

INCORPORATED

Circle 52 on reader service card

AMP is a trademark of AMP Incorporated.

World Radio History

Probing the news

processing. Chairman Jean-Pierre Brulé has set the merged companies to work on a unified line of hardware. He maintains his company will be a threat to IBM in France before too long. "We expect to outdistance them in computer deliveries within the next five years." Meanwhile, IBM will pick up its usual dominant share of a market forecast at \$1.88 billion for 1977, up from an estimated \$1.67 billion this year.

Highly entertaining. In France, entertainment electronics traditionally has been overshadowed by hardware such as telecommunications gear, military equipment, and computers. But this year consumers found their way back into dealers' showrooms in droves, many of them with color-TV sets on their minds. As a result, color-TV sales shot past the 1-million-set mark for the first time. Along with a strong hi-fi market, that was enough to push set makers' sales up 18.5% to \$1.17 billion, a mere \$20 million below the mark for communications equipment.

Despite the government's austerity measures, color-TV and hi-fi suppliers should score gains again in 1977, but not like this year's. The market forecast is \$1.30 billion for 1977, but that could turn out to be on the high side if the economy fails to shape up.

The outlook is mixed in the components market. "There will not be much private investment, but the activity in telecommunications should keep most [component] producers happy," says Raymond Gênet, an economist at the Philips-group subsidiary RTC-la Radiotechnique Compélec. The components market should move up 11.5% next year to reach \$1.26 billion, the *Electronics* survey forecasts. Like telecommunications equipment makers, color-set producers should raise their parts purchases.

All the same, components makers are not terribly optimistic. "Everybody is expecting telecommunications activity to carry the entire electronics industry," laments Philippe Grouvel, director of marketing studies at ITT's Instruments and Components division in Paris.

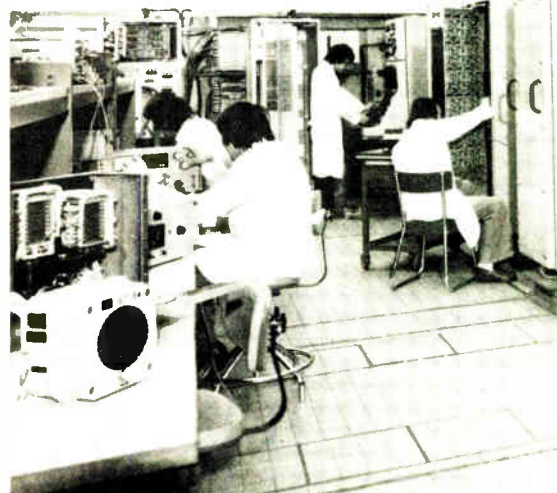

Checkout. Technicians at CIT-Alcatel work on a search and attack sonar. Military electronics hardware is a mainstay of the French electronics markets.

"There will be a slight increase in components used in telecommunications, but people tend to forget that this is only about 35% of the total passive components market. Telecommunications cannot be expected to be that much of a boon."

Slower rise. Much the same feeling prevails at semiconductor houses. Their market snapped back this year from a very poor 1975, bounding up 18% to hit \$236 million. A lesser growth is in sight for 1977, most market watchers agree. *Electronics* forecasts a 14.4% gain to \$270 million.

Explaining the malaise, François Dufaux, European marketing manager for Texas Instruments, says: "The expected recovery in capital expenditure simply did not materialize in 1976. While the brief recovery during the first half of the year eliminated inventories, there was still very little growth. We don't expect the economy to really turn around until mid-1977. We see moderate growth but not the light at the end of the tunnel."

Dufaux' viewpoint is parallel to the opinion of Sescosem, the Thomson-CSF semiconductor division. Assistant marketing manager Yves Thorn says that "while the consumer market picked up in early 1976, the industrial market stayed flat. We foresee an increased use of integrated circuits during the next few years. But sales still haven't returned to 1974 levels in real terms." □

AMP EUROPE

Austria — AMP Austria. Branch of AMP Deutschland GmbH, Markgraf-Ruediger Str. 6-8, 1150 Vienna. Phone: 924191/92

Belgium — AMP Belgium. Branch of AMP-Holland B.V., Rue de Brabant 62-66, Brussels. Phone: 322.17.55.17

France — AMP de France, 29 Chaussée Jules-César. Boite Postale No. 39, 95301 Pantaise France. Phone: 030 82 20, 030 92 30

Germany — AMP Deutschland GmbH, Ampérstrasse 7-11, 607 Langen, B. FFM., West Germany. Phone: (06103) 7091

Great Britain — AMP of Great Britain Limited, Terminal House, Stanmore, Middlesex, England. Phone: 01-954-2356

Holland — AMP Holland B.V., Papierstraat 2-4 's-Hertogenbosch, Holland. Phone: (04100) 25221

Italy — AMP Italia S.p.A., Via Fratelli Cervi 15, 10093 Collegno (Torino), Italy. Phone: 785-656

Spain — AMP Española, S.A., Apartado 5294. Pedro IV, 491, 495, Barcelona 5, Spain. Phone: 307-75-50

Sweden — AMP Scandinavia AB, Datavägen 5, 17500 Jakobsberg, Sweden, Mailing Address: Fack S-175 2J JARFALLA 1, Sweden. Phone: 0758/10400

Switzerland — AMP AG, Haldenstrasse 11, 6006 Luzern, Switzerland. Phone: (414) 235421, 235422, 235423

AMP NORTH AMERICA

Canada — AMP OF CANADA LTD., 20 Esna Park Drive, Markham, Ontario, Ph: 416-493-6222

Mexico — AMP de Mexico, S.A., Apartado Postal 179, Naucalpan de Juarez, Edo, de Mexico, Phone: Mexico City 576-41-55

Puerto Rico — AMP OF CANADA LTD., 677 Calé de Diego, Rio Piedras, Puerto Rico 00924, Phone: (809) 766-2346

United States — AMP Incorporated, Harrisburg, Pa. 17105, Phone: 717-564-0100

AMP SOUTH AMERICA

Argentina — AMP S.A. Argentina 4 de Febrero, 76 Villa Zagla — SAN MARTÍN, Buenos Aires, Argentina, Phone: 752-4612

Brazil — AMP do Brasil Ltda., AV Comendador Martinelli 185, Lapa, Sao Paulo, Phone: 262-4353

AMP PACIFIC

Australia — Australian AMP Pty. Limited, 155 Briens Road, Northmead, N.S.W. 2152 Australia, Mailing Address: P.O. Box 194, Baulkham Hills, N.S.W. 2153 Aus. Ph: 630-7377

Japan — AMP (Japan), Ltd., No. 15-14, 7-Chome, Roppongi Minato-Ku, Tokyo, Japan, Ph: 404-7171

Products and services for many specialized industries are provided by the AMPLIVERSAL Division. In the United States, this division is known as AMP Special Industries.

For AMP products and services in other countries, write: AMP International Division, Harrisburg, PA 17105, USA.

Military

Navy rushes to standardize computers

Program aimed at saving money could prove boon to Univac, Control Data, and little Qantex, maker of magnetic-tape unit

by Bruce LeBoss, New York bureau manager

The U.S. Navy is going all ahead, full, in an attempt to equip its vessels and aircraft with standard militarized computers, peripherals, and software. The program could pay handsome dividends to manufacturers that win full service approval for their equipment, as well as those that win contracts for standard peripherals through bidding expected in the near future.

Through its Tactical Digital Standardization Program, the Naval Electronics Systems Command in Washington, D.C., is looking to save costs in training, documentation, and maintenance and parts inventory, among other things. In the future, for instance, Navy vessels and aircraft will be equipped with standard minicomputers, output printers, CRT-display terminals, disk drives, cartridge storage units, reel-to-reel memory systems, and other peripherals, instead of hosts of different designs.

"Our major thrust is that we want to get commonality in logistics support, training, and software as much as possible," states Capt. Eugene Reiher, director of Navalex' Tactical Digital Systems Office. "We can't afford to support all these different devices. We're running out of the capability and the capacity to do that."

The AN/UYPK-20 minicomputer, built by Sperry Rand Corp.'s Sperry Univac division, has the first—and, thus far, the only—approval. The minicomputer qualified in 1973, two years after the AN/UYPK-7 large shipboard multipurpose/process computer and its associated input/output console, both made by Sperry Univac, became *de facto* stan-

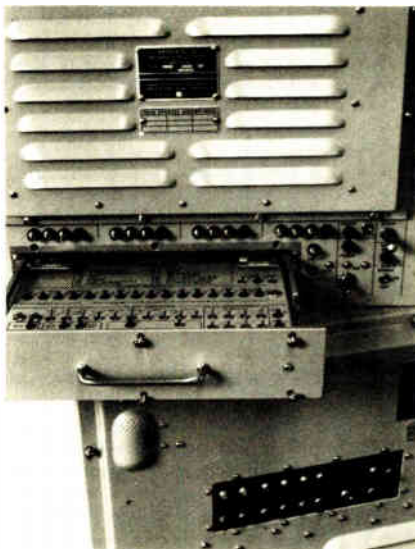

Easy rider. Quantex' data-storage peripheral for Navy standardized-computer program is shown atop Sperry Univac's AN/UYPK-20 militarized minicomputer.

dards, notes Reiher. But three peripherals—a reel-to-reel magnetic-tape disk, an alphanumeric display, and a cartridge magnetic-tape unit—have arrived at the final stages of their qualification procedures. They are to become standards, and the Navy plans to issue competitive specifications soon for additional standard peripherals. Also, Control Data Corp.'s 480 computer, recently designated the central computer for the Navy's new F-18 fighter [*Electronics*, Oct. 14, p. 39], has also been chosen by Navalex as its standard airborne computer—Stacom. Stacom will be known as the AN/AYK-14.

To date, about 800 AN/UYPK-20 minicomputers have been delivered to the Navy under a three-year contract, which recently expired.

Most of these plus a small amount of other hardware have been used in laboratories. Thus the large-quantity orders for equipment to be used on ships and planes are still in the future, and, as one contractor says, "the Navy is expected to soon pull out all stops and start buying in earnest."

In addition to CDC and Sperry Univac, one company that is banking on the Navy's standardization program to provide it with a substantial volume of business is the Qantex division of North Atlantic Industries Inc. in Plainview, N.Y. Under a contract that has already brought more than \$3.5 million in business, Qantex is supplying the \$20,000 cartridge magnetic-tape unit not only for the AN/UYPK-20 minicomputer but for all present and proposed types, says Qantex president Joel A. Kramer. "We conservatively feel the contract is worth about \$50 million in hardware over a five-year delivery period," he asserts. That's a considerable amount of business for the small division.

Swift. Destined to become the AN/USH-26 data-storage peripheral, the Qantex unit is based on the 3M data cartridge and manufactured in modular form for easy matching to widely different purposes and to a number of different computers. With four cartridge transports per unit, it has a capacity of 10 million characters. Access time is faster than that of reel-to-reel tape drives, since it has four tracks on each cartridge, in contrast to serial processing in the reel unit.

Meanwhile, Sperry Univac's Navy Systems division in St. Paul, Minn., has Navy funding for qualification

testing on its RD-358 reel-to-reel magnetic-tape drive, and has already delivered about 100. The division expects to begin qualification testing in February and submit results for service approval about June, says Lee Best, division marketing manager for standard products. "We're guessing that the Navy will want about 25 per year," he says of the RD-358, which costs upwards of \$90,000 per unit. However, "many of the applications we thought would go to the RD-358, have since gone to Qantex' cartridge unit because of its lower cost," adds a division defense marketer in Washington, D.C.

However, there is a cloud on the horizon for Sperry Univac's standardization program with the Navy. The problem centers around the AN/UYK-20 minicomputer, for which a new multiyear contract is being renegotiated. Based on increased testing requirements and expected cost escalation, the division is seeking a price upwards of \$90,000 per unit, more than double the quoted price under the just-expired contract.

Problems. Although Sperry Univac spokesmen would not comment further on the reported price increase or on the reasons for additional testing, it is known that Navalex stopped delivery of the computer in July 1975 because of reliability problems and then again at the beginning of 1976 because of certain deficiencies in logic operations. Both times Sperry Univac worked on solving the problem at its own expense, leading division marketing officials to say the effort would mean little or no profit being made on that three-year contract. Another reason for the unusually high price increase sought by Sperry Univac, it was learned, is that the escalation costs estimated for the prior contract were not in line with what happened in reality but were significantly lower. "We're hoping to have the whole issue resolved and a new contract signed soon after the New Year," says Reiher.

What will the Navy do if the AN/UYK-20 minicomputer contract with Sperry Univac is not renewed? Answers Reiher, "We're looking at several alternatives, but right now, we don't know for certain

what we'll do." There actually are four choices, including going out for a software-compatible 16-bit system, such as the AN/UYK-20. The Navy also is looking at the possibility of adapting changes, for shipboard use, of the new AN/AYK-14 standard airborne computer being developed by Control Data, "but that won't be ready for a couple of years," Reiher notes. "We're also examining the possibility of having 'Chinese copies'

of the AN/UYK-20 made by other manufacturers, and also are thinking about going out and have a manufacturer build a form-fit-and-function replacement that's not a 'Chinese copy.'"

The Navy is talking about purchasing about 175 AN/UYK-20s per year but, adds the Sperry Univac marketer, "it's a requirements contract that could go as high as 1,000 per year." □

DeBug is here.

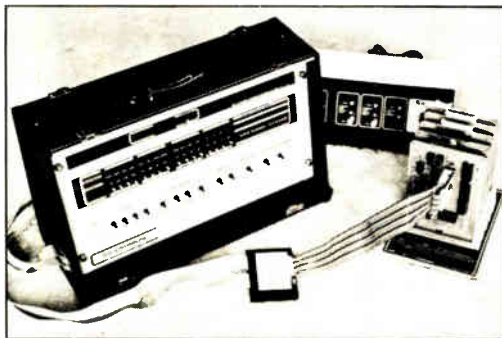

NEW, LOW-COST AQ6800 MICROPROCESSOR SYSTEM ANALYZER. \$875.

Develop and debug micro-computer systems built around the Motorola 6800 microprocessor. And do it economically and efficiently.

Our brand new AQ6800 Analyzer displays all address, data and status information, and permits direct user interaction with memory and all registers including program counter.

It modifies the contents of any random-access memory location . . . examines all

memory . . . sends and receives data from selected I/O ports. As a design aid, our new AQ6800 can help you convert breadboard circuits to prototypes, or you can use it for easy evaluation and fault analysis of micro-processor-based products in production. Add a buffered clip-on probe and use it for field work.

Whatever you do, call one of our stocking representatives and get things moving.



E&L INSTRUMENTS, INC.

61 First Street, Derby, Conn. 06418
(203) 735-8774 Telex No. 96 3536

Authorized Stocking Representatives

Los Angeles, Calif
(213) 377-0975
San Francisco, Calif
(415) 961-2828
Woodbridge, Conn
(203) 397-1461
Denver, Colorado
(303) 744-2501
Orlando, Florida
(305) 351-1841
Chicago, Illinois
(312) 956-8090
Kansas City, Kansas
(913) 649-8952
New York, N. Y.
(201) 467-8585
Syracuse, N. Y.
(315) 699-2651

Dayton, Ohio
(513) 222-0011
Philadelphia, Pa
(215) 723-8733
Dallas, Texas
(214) 690-4004

Vancouver,
British Columbia
(604) 687-2621

Canada
Edmonton, Alberta
(403) 455-4122
Winnipeg, Manitoba
(204) 774-6286
or 772-9295
Fairfax, Virginia
(703) 273-1803
Seattle, Washington
(206) 938-4166

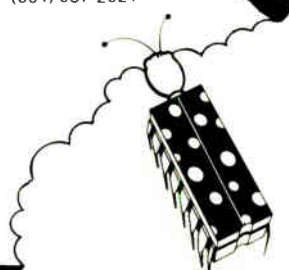

Semiconductors

Plasma etch makes its mark

Bell Northern's system, in VLSI race with electron beam, X ray, and ion implantation, defines aluminum lines down to 2 micrometers

by Laurence Altman, Solid State Editor

Semiconductor manufacturers are scrambling to develop ways to produce very-large-scale integrated circuits—the packing of ultrafine circuit features only 1 to 2 micrometers wide onto a single chip. The first to develop a low-cost 1- μm production system that can implement on a single chip a computer's central processing unit with memory, a 256,000-bit random-access memory, or a similar set of functions will probably own the IC market for a long time to come.

Of all the processes under consideration, fabricating IC geometries directly on a wafer with electron beams certainly has the best potential for VLSI production, because it can easily produce 1- μm lines and spaces, as well as angstrom-deep diffusions. But direct electron-beam wafer fabrication in high-volume production is still many moons away: it is slow and expensive. In the meantime, a more conventional ap-

proach, using a dry plasma etch to build masks or make micrometer-size circuit features directly on silicon, is expected to markedly increase circuit densities.

Plasma etch. One of the leaders in the technology, Bell Northern Research Ltd. in Ottawa, Ont., Canada, has come up with a plasma-etch system that defines aluminum lines to 2- μm , or two and three times finer than today's most advanced photolithography systems. And to prove their point, the Bell researchers have applied their plasma etch to a complementary-MOS process that produces half-size devices that can outperform those built with conventional wet-etch techniques.

What is plasma etching? It's the controlled selective removal of material using chemically reactive radicals in a low-temperature, low-pressure plasma. Because the etching can be highly selective, it is possible to accurately pattern a desired layer

with negligible etching of either a photoresist-etch mask or an underlying layer, as required in IC fabrication. Moreover, the dry-plasma process is no more difficult to use than wet chemical etching—in fact, it's easier. So IC yields should improve, even while resolution is increased.

Processing. In Bell Northern's experimental plasma-etching apparatus diagramed here, the wafers to be etched are positioned on the surface of the lower electrode of a circular parallel-plate capacitor structure that forms part of a quartz vacuum chamber. The etch gas is then bled into the vacuum chamber at a flow rate controlled by the needle valve, and the pressure is set by throttling the mechanical vacuum pump. Pressure is accurately monitored by a capacitance manometer and flow rate by a mass flow meter.

The proof of the process is the performance, and the 21-stage ion-implanted dry-etched ring oscillator that Bell Northern built to test the process performs extremely well. The silicon-on-sapphire 2- μm circuit, operating at 5 volts, exhibits a propagation delay of only 1 nanosecond per stage—five to ten times faster than conventional wet-etched C-MOS structures.

However, most of Bell Northern's competitors are also evaluating dry-etch effectiveness. They are also investigating X-ray and ion-implant mask processes, as well as electron-beam projected and direct-writing techniques. Of all the possibilities, plasma-etch probably ranks at the top of the list of processes that could emerge in production systems within the next 12 months, but most manufacturers won't admit it. □

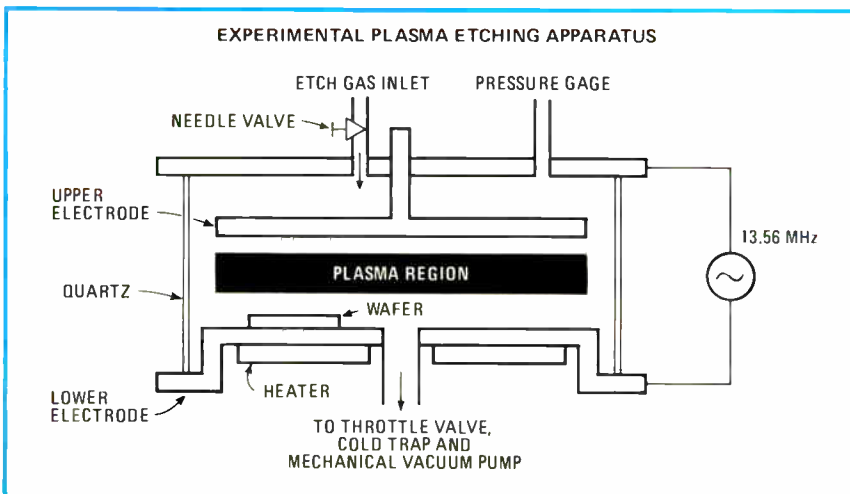

For VLSI. Experimental plasma-etch system from Canada's Bell Northern Research can define aluminum lines to 2 micrometers. That outdoes most advanced photolith systems.

Testers are getting better at finding microprocessor flaws

Hardware and software faults in prototype systems are exposed quickly when designers troubleshoot with logic and microprocessor analyzers, which tenaciously monitor the signal activity on address and data buses

by Andy Santoni, *Instrumentation Editor*

□ Although the microprocessor simplifies system design, it complicates troubleshooting. Especially at the prototype stage, microprocessors bring their own brand of trouble to a project. Malfunctions of hardware and software demand a new kind of thinking and even a new kind of tool to track them down. To fulfill these needs, specialized instrument families are proliferating nearly as fast as microprocessors themselves.

In the prototype-development phase, when the designer checks out the system for the first time, access to the internal workings of the microprocessor is limited—the contents of the registers and latches that store data inside the device cannot be examined directly. However, some indication of how the device and its support circuitry are operating can be obtained by analyzing the signals that pass through the microprocessor's inputs and outputs—especially the address and data buses—at the proper points in the timing cycle.

Two classes of instruments offer the features necessary to examine a microprocessor's buses and other signal lines in detail—logic analyzers and microprocessor analyzers. Logic analyzers—both logic-state and logic-timing monitors—are tailored to the needs of microprocessor-circuit designers by incorporating such features as binary readouts and simplified connections to microprocessor buses.

Adding capabilities

Microprocessor analyzers are similar to logic analyzers but have additional channels and other features such as hexadecimal, octal, or mnemonic displays that further simplify interpretation. They are designed specifically for use with microprocessors, and they are less useful than logic analyzers for general-purpose digital troubleshooting. Some of these analyzers also have interactive circuitry that allows the operator to control some phases of a microprocessor's operation as well as monitor the results.

Analyzers can be employed for hardware and software debugging, regardless of the techniques and equipment used for initial microprocessor hardware and software development. The development methods, including time-shared computer assembly and hand-coding on a single-board or packaged microprocessor-based computer, yield a program that runs without a hitch, but may not perform its intended function when installed in a proto-

type of the final system. Worse yet, the software may perform in an initial prototype but not in a system's final hardware configuration. In addition, the software breakpoints available during development to allow an engineer to home in on a problem are not available after the program is committed to read-only memory.

Complementing waveforms

Many logic-analyzer manufacturers have added features to their products to adapt them for testing microprocessor-based circuits (see Table 1). For example, a capability that helps make a logic analyzer more useful in microprocessor troubleshooting is a readout of logic states in binary notation, with or without an equivalent display in timing-diagram format.

Logic-state analyzers, like the 1600-series instruments from Hewlett-Packard Co.'s Colorado Springs division

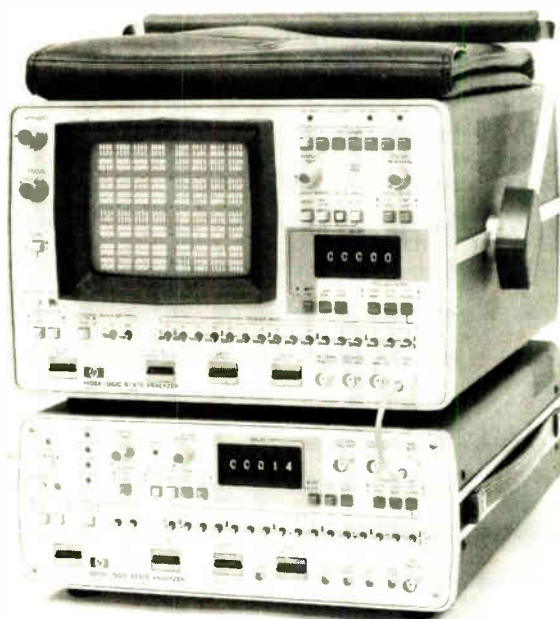

1. Doubling up. When used in tandem, the Hewlett-Packard 1600A and 1607A logic-state analyzers can display up to 32 channels of digital data in binary or map form to facilitate microprocessor-circuit testing. Up to 16 lines at a time appear on screen.

Manufacturer	Model	Display formats	Channels	Memory-bit depth
Biomation	851-D/108	timing, binary, hex, octal, map	8	512
	1650-D/116	timing, binary, hex, octal, map	16	512
E-H Research	1330	timing, binary	8	1,000
Hewlett-Packard	1600A	binary, map	16	16
	1601L	binary	12	16
	1607A	binary	16	16
Tektronix	7D01/DF1	timing, binary, hex, octal, map	16	1,024*
Vector	1625A	timing, binary	16	256

* 1,024 bits by 4 channels, 512 bits by 8 channels, or 256 bits by 16 channels

Source: Electronics

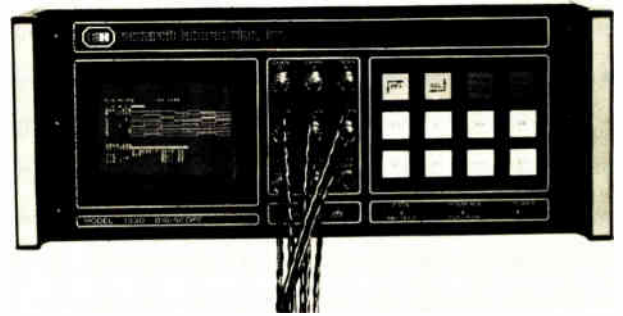

2. Time check. Either a timing diagram or the equivalent binary representation of the activity on eight signal lines may be displayed on E-H Research Laboratories' model 1330 Digiscope. The instrument is controlled by a National SC/MP microprocessor.

(Fig. 1), have always provided binary notation and omitted waveform-like timing-diagram presentations because they were designed to handle synchronous logic, in which changes in logic states always occur on an edge of the system clock.

The system can be used to strobe data into the analyzer, and the logic states between clock transitions can be ignored because they have no effect on the performance of the system. Binary notation was chosen because it is easier to read and to compare with written performance specifications than are timing-diagram waveforms.

Logic-timing analyzers, on the other hand, yield more precise information about the activity on data buses because they strobe data into memory at a rate higher than the clock rate of the system under test. Thus, a logic-timing analyzer is useful in testing asynchronous systems because it can uncover conditions such as a line that changes state before a clock pulse, but not soon enough for the clock to catch the state change.

To make these products simpler to use in checking microprocessor circuits, some logic-timing analyzers have binary readouts in addition to timing waveforms. For example, the model 1625A from Vector Associates Inc. of Bellport, N.Y., displays 16 channels of data in a timing-diagram format.

In addition, the binary states of the 16 lines are read out in a column of 1s and 0s at the right-hand end of the screen. An operation-controlled cursor determines which point in the timing diagram is read out in the binary column.

The model 1330 logic analyzer from E-H Research Laboratories Inc., Oakland, Calif., (Fig. 2) also offers a choice of timing diagram or binary readouts, but in this instrument the binary display replaces instead of complementing the timing diagram. Like HP's state analyzer, the 1330 displays a field of 1s and 0s, rather than a single row.

The user can switch back to the timing diagram for more detailed analysis. But the 1330 has only eight input channels, which limits its usefulness in testing the 16 address lines and eight data lines of common 8-bit microprocessors.

Trying to measure the performance of a microproces-

sor-based circuit without viewing the 16-bit address bus is like trying to measure voltage levels without reference to ground. It can be done—address-bus activity can be inferred from occurrences on peripheral-port lines, just as absolute voltages can be determined from relative measurements. However, if the troubleshooter can view all 16 lines of the address bus simultaneously, he can determine how a program flows and easily ascertain where and how it goes wrong.

Efficient microprocessor troubleshooting, therefore, demands an analyzer that can display at least 16 lines of information. Such a logic analyzer can uncover the precise point in a program where a fault occurs, and by either changing leads on the analyzer or by connecting a separate oscilloscope or other troubleshooting aid, the engineer can search for the cause of the problem.

A number of logic-timing analyzers, like Vector's 1625A, acquire 16 channels of information. The model 1650-D from Biomation Corp. of Cupertino, Calif., has 16 input channels and can store 512 bits of data on each channel with an input sampling rate of 50 megahertz. In its standard configuration, the 1650-D generates a timing-diagram display on the screen of an oscilloscope or a cathode-ray-tube monitor. An optional model 116 display-control accessory converts the display into a truth-table data format in which 16 words of data start at an address in the 1650-D's memory selected by a cursor control. The relative address in the instrument's memory, the 16-bit binary word at that address, and a hexadecimal or octal translation of that word appear at each line of the display.

The Biomation 1650-D and the similar eight-channel model 851-D with its model 108 display-control accessory also have a map mode, which is becoming increasingly popular for quick qualitative analysis of activity on digital lines. First introduced in Hewlett-Packard's 1600A and also provided by Tektronix Inc., Beaverton, Ore., in its model 7D01 logic analyzer and DF1 formatter (Fig. 3), the map mode displays the binary word in each location of the analyzer's memory as a single point on a screen.

A matrix of points on the screen corresponds to binary words, and a point lights up if that word exists in the operation of the circuit under test. Each microprocessor

Troubleshooting with an emulator

The circuit designer who has an in-circuit emulator, an accessory that can be added to most microprocessor-development systems, has a versatile, albeit expensive, alternative to the microprocessor analyzer for troubleshooting. By simply plugging the emulator into the socket that is intended for the microprocessor in the system under test, the circuit designer has access to the internal workings of the central processor. The emulator can display previously executed instructions with corresponding address, data, and status information, as well as examine and alter registers and memory locations.

An in-circuit emulator turns a microprocessor-development system into a much more useful piece of equipment by adding the capability to debug prototype or production hardware and software to the development system's primary role of aiding program generation. An emulator allows the user to assign memory and input/output features of the development system to the circuit under test. The circuit may then operate with the memory and I/O functions provided by the development system, with the memory and I/O functions of its own circuitry, or with a combination of the two.

The major advantages of an in-circuit emulator are provided by a program-tracing memory and breakpoint

registers. These capabilities enable the engineer to examine the steps a microprocessor passed through before it reached a given state, whether desired or not. The emulator can also run the microprocessor program in either a single-step or multiple-step mode.

Most in-circuit emulators and microprocessor-development systems are supplied by semiconductor firms that manufacture microprocessors, although some are made by independents, and most are designed to handle only one manufacturer's microprocessor type. Thus, more than one system may have to be purchased if an engineer wants to use different processors for different projects. More important, an emulator can only be used as part of a microprocessor-development system, and not as a stand-alone instrument, so an engineer who wants to use an emulator for troubleshooting must be committed to the development-system technique for program generation.

If the major application is troubleshooting, a prospective user will find it difficult to justify the development system's cost, which can easily run from \$10,000 to \$20,000. On the other hand, even the most expensive microprocessor analyzers are priced at a comparatively low \$5,000 to \$5,500, and some instruments priced below \$1,500 can perform similar functions.

program yields a map display that can be considered its individual fingerprint. An aberration in proper operation causes a change in the map that is sometimes more dramatic than the change in the same program's binary display. For example, a program that goes off into what should be an unused portion of memory yields a map with bright spots where there should be none. The equivalent binary display might have a change from a 1 to a 0, or vice versa, on one line, which can be a good deal more difficult to spot.

The instrument designed expressly for analyzing microprocessors has more input channels and a more elaborate display than the logic analyzer, and it can convert the data to an alternate format such as hexadecimal, octal, or mnemonic notation. Tektronix' 7D01/DF1, for example, offers a choice of five display modes: timing diagram, binary, hexadecimal, octal, or map. The units plug into a Tektronix 7000-series scope mainframe, and can display two sets of data—one from a known good circuit and one from the circuit under test—for side-by-side comparison. Any data in the test table that differs from the known-good table is intensified to simplify locating faults. The tables contain up to 16 lines of 16-bit words, which can be wired externally to correspond to a 16-bit address bus.

Viewing data

The capability to examine all 16 address lines simultaneously simplifies tracing the flow of a microprocessor program, but still does not give the troubleshooter all the information necessary to determine if the program in the system under test is running precisely as it was written. That requires examining at least one more set of signal lines—the data bus.

To do so, the analyzer must have at least 24 input

3. Multiform. Plugged into a 7000-series oscilloscope mainframe, Tektronix' 7D01 logic analyzer combined with a DF1 digital formatter can handle up to 16 signal lines and display binary, octal, hexadecimal, map, or timing-diagram representations of bus activity.

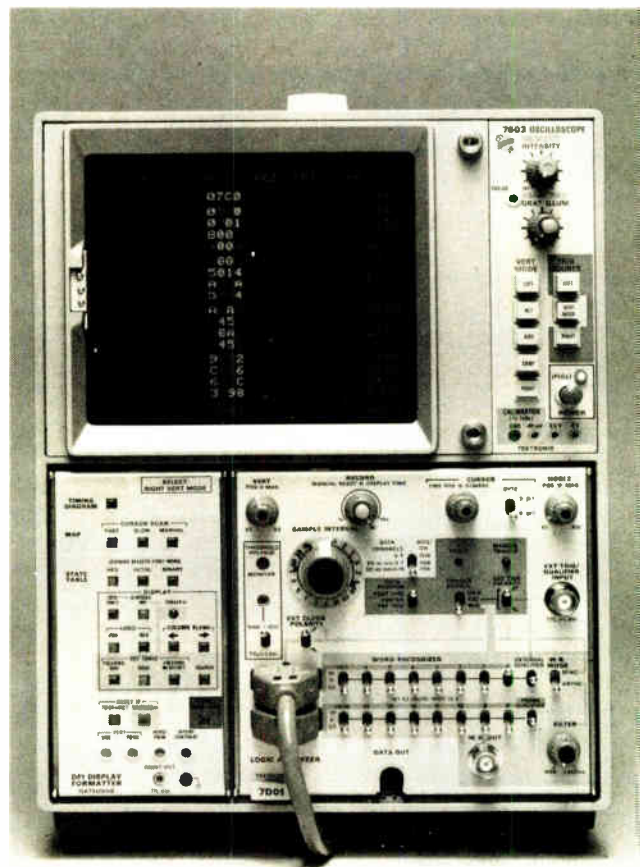

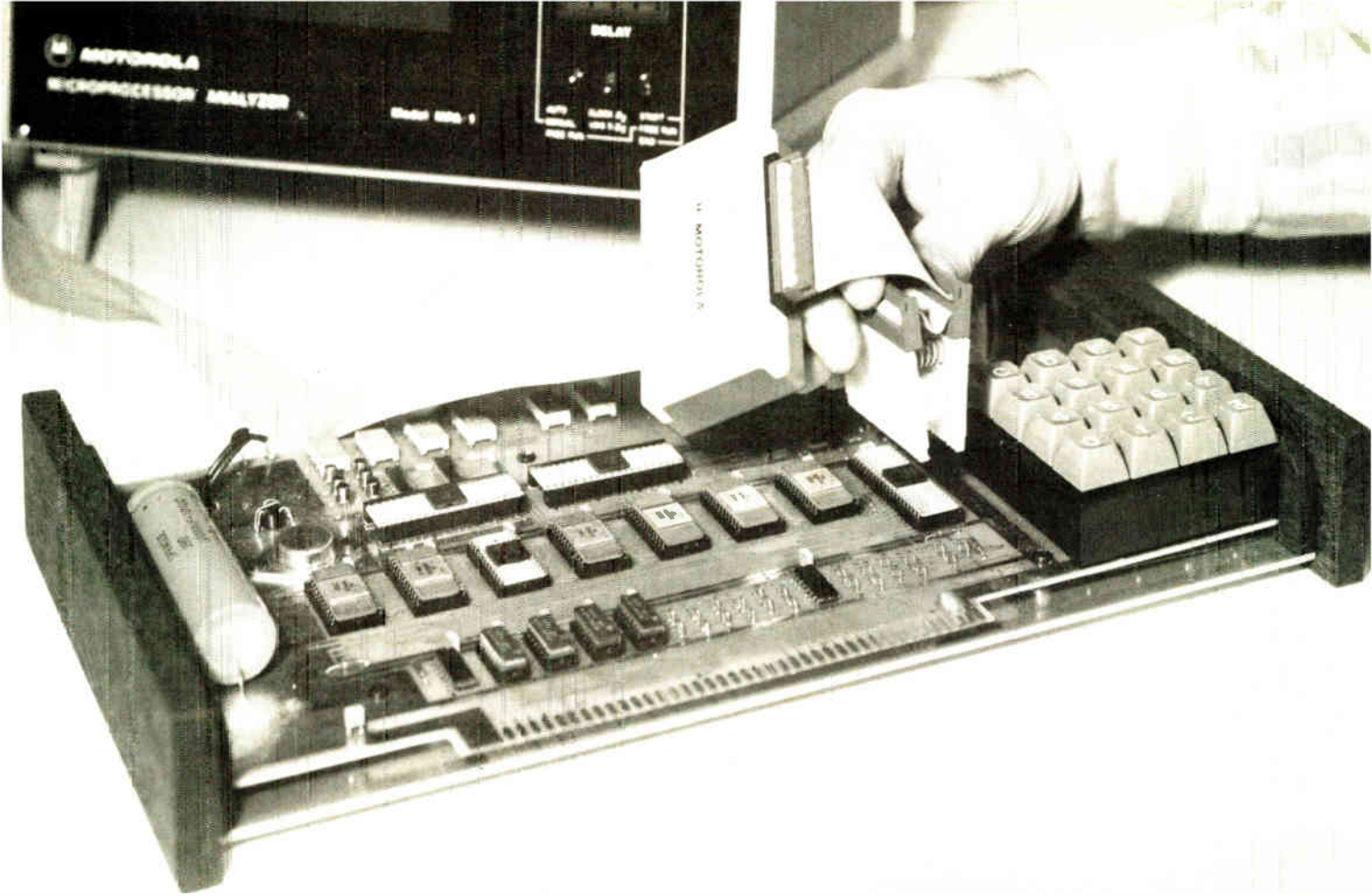

4. Clothespin. Microprocessor analyzers like Motorola's MPA-1 have conveniences like a single clip-on clothespin-like probe, which simplifies connecting the instrument to the circuit under test, and hexadecimal readout, which is easier to interpret than binary rotation.

lines. Sixteen of those lines attach to the address bus, and eight connect to the data bus. Since examining and comparing 24 columns of binary data with another set of 24 columns of 1s and 0s can be tedious and confusing, it is better to convert this data into a more compact form—either hexadecimal or octal notation. Hexadecimal notation is probably the more convenient because most engineers write microprocessor programs in this form and because most microprocessor manufacturers' literature makes use of hexadecimal notation.

A logic analyzer that can acquire 24 or more lines of data and convert that data into hexadecimal notation for display has somewhat limited application in general-purpose troubleshooting of digital circuits, but it is ideal for troubleshooting microprocessor circuits.

One analyzer that has all these capabilities is the MPA-1 from Motorola Data Products, Carol Stream, Ill. (Fig. 4). The MPA-1 evolved from development work at Data Products on microprocessor-based systems. Says Robert Bahnsen, product manager, "We found, as others have, that microprocessor-system development tends to proceed in phases. In the initial checkout phase, the classical sorts of test instruments are still applicable. Voltages must be checked, and waveforms and timing relationships must be verified."

Once the basic hardware has been checked out, says Bahnsen, "individual signals tend to become of secondary importance. The primary concerns tend to have strong software overtones. What are the contents of the

address bus, the data bus, or a given storage location?"

Like the Motorola Exorcisor (see "Troubleshooting with an emulator," p. 59), the MPA-1 microprocessor analyzer is sold through the firm's semiconductor distributors.

Also like the Exorcisor and its system evaluator, the MPA-1 is a program-tracing instrument that monitors the address and data buses of the microprocessor under test. When the program reaches an address set on the analyzer's front panel, that word and the following 31 words are captured in the order of execution and stored in a shift register. This information is then displayed on the instrument's built-in CRT.

An external probe-buffer assembly connects the MPA-1 to the microprocessor system under test. An external probe buffer, which allows a high degree of interfacing flexibility and prevents obsolescence as new generations of processors appear, also simplifies connecting the instrument to the microprocessor, since only a single clip is employed, instead of 24 separate leads. Probe buffers are available for the Exorcisor bus connector and for three families of microprocessors: the 6800, 8080, and PPS-4.

Since much of the activity in microprocessor-based systems is handled outside the address and data buses, looking at more than 24 lines is often convenient. Monitoring the microprocessor's read/write control line is especially useful to make sure that data is moving in the right direction. To monitor such status lines in addition

TABLE 2: MICROPROCESSOR ANALYZERS

Manufacturer	Model	Micro-processor types	Display formats	Readout
Applied Microsystems	Programers' Panel	6800	hex	alphanumeric LEDs
AQ systems	AQ6800	6800	binary	LED lamps
Biomation	168 D	6800, 8080	hex, memory map	CRT
Davco	DM 230	6800, 8080	waveform, hex	LEDs, external scope
Hewlett-Packard	1611A	6800, 8080	mnemonics, hex, octal	CRT
Motorola	MPA-1	Exorcisor, 6800, 8080, PPS 4	hex	CRT
Pro-Log	M422	4004, 4040	binary	LED lamps
	M821	8008	binary	LED lamps
	M822	8080	binary	LED lamps
	M823	6800	binary	LED lamps
Scanoptik	LC 32	adaptable	hex	external CRT
Systron Donner	50	adaptable	binary	LED lamps

Source: Electronics

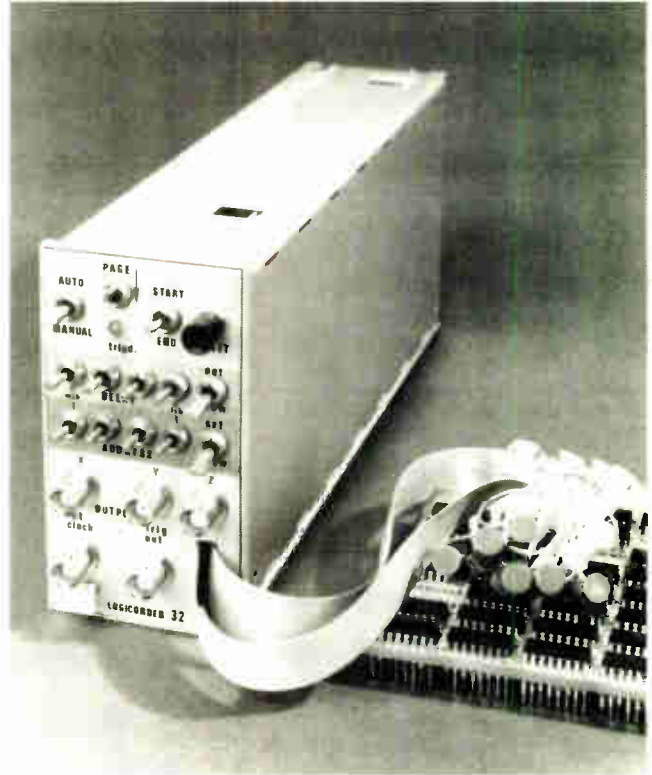

5. Cost-cutting. The Logicorder 32 microprocessor analyzer from Scanoptik is an inexpensive instrument that monitors up to 32 signal lines. It can capture and display data on an external oscilloscope screen in hexadecimal notation.

digits of data, and either two digits of status information or, when used with microprocessors that have 16-bit data buses, two additional digits to display additional bits of data.

The Logicorder 32 can be plugged into a Tektronix TM-500 instrument-system mainframe, or it can be operated from an external 5-volt power supply. The cost of the Logicorder 32 was kept below \$1,000 by not

to the address and data buses, the engineer may either hook up another logic analyzer or oscilloscope or look for a microprocessor analyzer that can handle more than 24 lines.

Checking status

One such instrument is the Logicorder 32 from Scanoptik Inc. of Rockville, Md. (Fig. 5). It can capture 32 channels of address, data, and status information and display it in hexadecimal notation on the screen of an external oscilloscope.

Using front-panel toggle switches, the analyzer triggers at a preset 16-bit address, stores 64 words in memory, and presents the data in two 32-word pages. Each word has four digits of address information, two

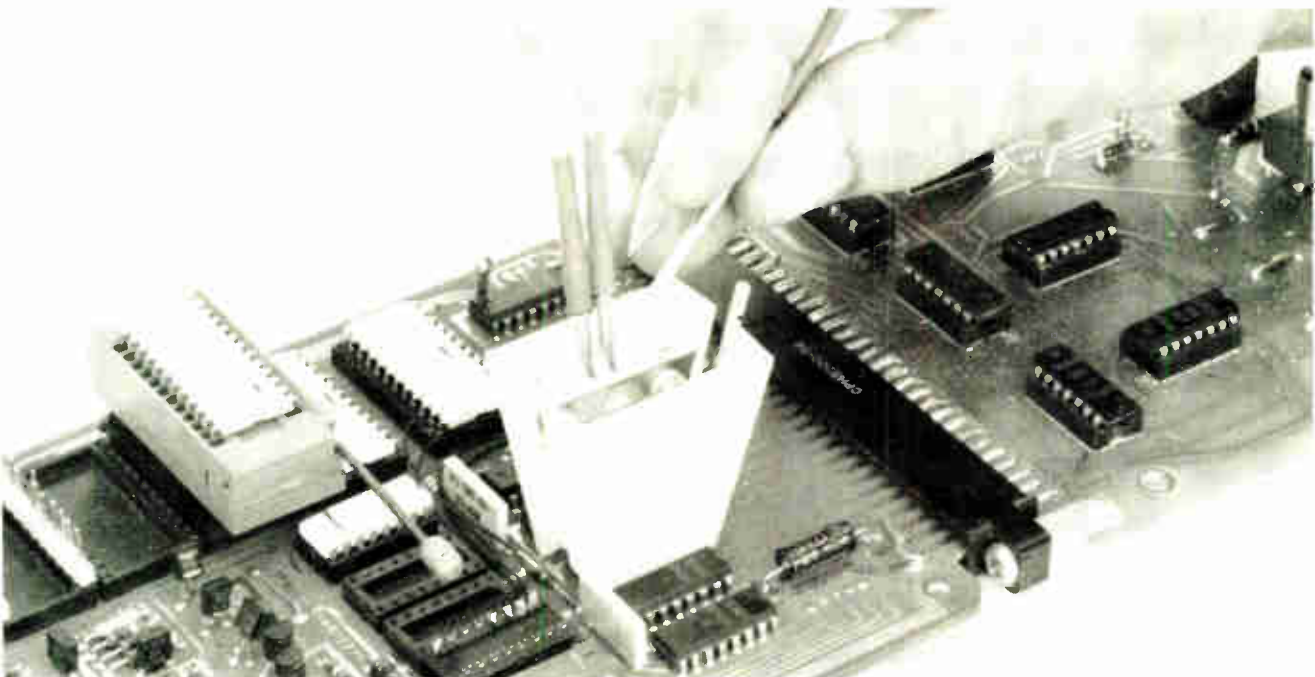

6. Contact housing. A metal pin through this HP test clip contacts an IC's ground pin and the clip's ground plane. With their grabber-hook tips removed, probes can then be inserted into the housing, connecting to both the IC pin and the ground plane.

Quick guide to microprocessor troubleshooting

Bringing up a microprocessor-based circuit does not differ very much from getting any other circuit working, says Walter Jimison, design engineer at Hewlett-Packard Co.'s Stanford Park division in Palo Alto, Calif. Following an orderly and logical plan, he says, is the best way to make sure a circuit performs as expected. Such a routine quickly points the way to solving problems that may have been overlooked. To get a microprocessor-based circuit up and running, Jimison suggests checking out, in order, the power supply, address and data buses, control lines, memory, and software.

Even though a system obviously will not work if power-supply voltages are wrong, many engineers skip checking voltage levels because they have so much—perhaps too much—faith in power sources. But they can avoid a time-wasting search for some other cause of a supply-related problem by making a simple check to ensure that voltages and currents are within specified limits.

Problems with address and data buses, too, can cause a troubleshooter to head off in the wrong direction.

Crossed, open, or shorted bus lines can look like software bugs, and hours can be spent tracing through a program before discovering that software is not at the heart of the problem. One trick for checking the address bus on a Motorola 6800 microprocessor is to use an instruction with a "9D" op code, which causes the program counter to increment repeatedly and, therefore, makes the address bus lines look like a binary counter.

The "9D" instruction is not documented by Motorola, and the firm does not guarantee that it functions properly in all chips; future revisions of the 6800 may not have the instruction at all. But when it works, it is a quick, simple way to ensure that the address bus is physically intact.

As with the address and data buses, control lines should first be examined for wiring errors and then for proper response. Memory should also be checked to make sure that decoders function properly and that the memory yields the expected responses. After the engineer has determined that the memory is functioning properly, he can check program flow and verify system performance.

including a built-in display and by using low-cost modular packaging techniques.

Another 32-channel logic analyzer, the DM 230 from Davco Manufacturing Co. of Morristown, N.J., displays the microprocessor's address, data, and status lines in real time on the screen of an external scope in addition to a hexadecimal readout on light-emitting-diode digits. The DM 230 has an analog channel bandwidth of 50 MHz and rise and fall times of less than 20 nanoseconds, which are sufficient for most microprocessor systems. The scope presentation is divided into eight-line segments of the analyzer's 32 channels.

Connecting conveniently

As important as the convenience of reading data from the microprocessor system under test is the convenience of connecting the test instrument to the system. Standard scope probes can be used with many logic analyzers that have standard oscilloscope-like inputs with BNC connectors and high impedances. Scope probes, readily available in most laboratories, can handle wideband signals with fast rise times and are reasonably easy to use. But they are too large to connect to the closely spaced leads commonly found in microprocessor-based systems, and their heft makes them difficult to keep connected to the points under test, especially when the board is mounted in an awkward position. Worse yet, at least one probe is likely to fall off the test point before all of the 24 or more probes needed in microprocessor testing can be connected.

One step toward solving this problem is Hewlett-Packard's line of miniature scope probes [*Electronics*, September 30, p. 122]. Because these probes are about a third the size of standard scope probes, there is no need for inventive mechanical supports to keep them from falling off test points.

The grabber-hook can be removed from the probe, leaving a long, thin probe with a needle point that can make contact with printed-circuit lands or cut through

insulation. For hands-off testing of 14- or 16-pin ICs, the probes with the grabber hooks removed can be connected through an HP 10024A test-clip housing (Fig. 6). A version of the housing wide enough to fit 40-pin packages could be clipped onto common microprocessors to further simplify troubleshooting; such a housing is being considered by HP.

The alternative employed by many logic-analyzer users is the miniature hook-type probe. This type is especially handy if it is connected to a single cable that plugs into the logic analyzer, as does Tektronix' P6451 high-impedance probe and others. The individual probe wires and the plug-in cable are joined at a pod that contains signal-buffering circuitry to minimize loading of the device under test.

Probing with one clip

Even the smallest test probes do not solve all the problems of interconnecting to microprocessors. They can still become disconnected before all the clips are in place or, worse yet, while the engineer is performing a troubleshooting procedure. The separate leads often end up in a tangle, can be difficult to identify, and are fairly easy to break. Properly connecting 24 or more leads is a tricky and time-consuming process.

In the specialized testing of microprocessor circuits, as opposed to general-purpose digital troubleshooting, it is much simpler to use a single 40-pin test clip than it is to attempt to connect separate test leads. A properly wired clip brings signals into the analyzer on the right channels, eliminating one source of difficulty. This is especially important when the readout is in hexadecimal or octal form, where swapping one pair of leads can make a major difference in the data display. A single clothespin-like probe can also be connected to a microprocessor much more quickly than separate test leads can.

Speed and ease of connection to the microprocessor system under test are especially important in field-service and production-line testing, where the operator is

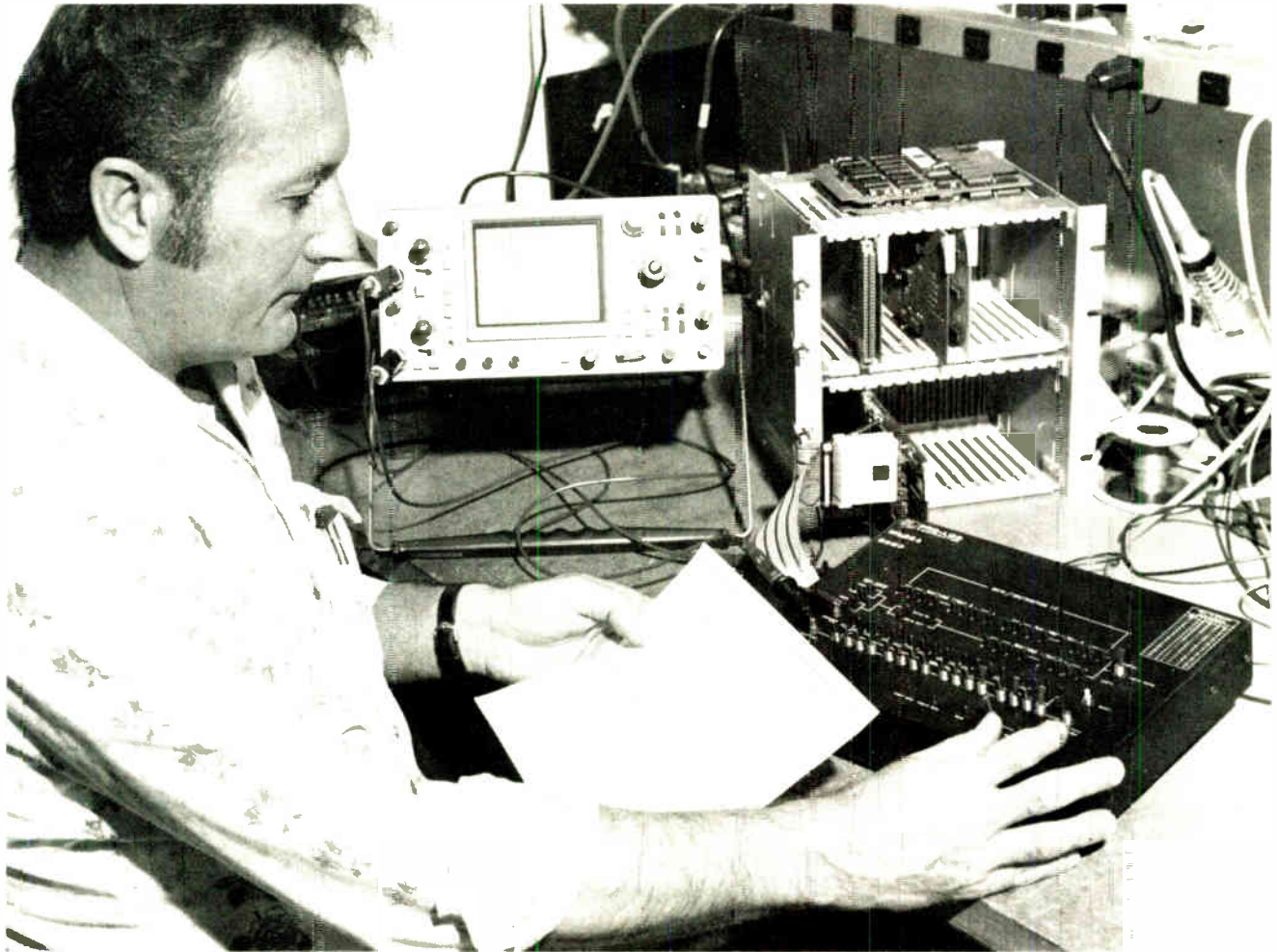

7. Specialized. Microprocessor analyzers are often dedicated to a particular processor type. This Pro-Log unit handles 8080 microprocessors, while other models in Pro-Log's line are capable of testing the 6800, 4004, and 4040 types.

likely not to be an engineer. Such operators are also likely to have less detailed knowledge of the systems under test and therefore be less capable of differentiating between system failures and errors caused by faulty or misapplied test equipment.

For the engineer, simplified connections cut time spent in hooking up the tester, checking the wiring, and correcting errors. That is why most microprocessor analyzers, including the Motorola and Davco units, use single-clip, clothespin-type probes.

Specializing analyzers

In the line of microprocessor analyzers from Pro-Log Corp. of Monterey, Calif., each instrument is designed for a different family of devices and has a test probe to match. For example, the M422, designed for 4040 and 4004 microprocessors, has a 24-pin test clip, while the M822, for 8080 systems (Fig. 7), and the M823, for 6800-type chips, have 40-pin probes. All signals to the analyzers are derived from the microprocessor through the clip-on probes, and the inputs are buffered within the instruments by complementary-metal-oxide-semiconductor circuitry to minimize loading.

The Pro-Log microprocessor analyzers are among the simplest and least expensive. The M823, for example, is

priced at \$650. It captures and displays the microprocessor's address bus, data bus, and control information in either a dynamic (run) or static (step) mode. The analyzer also provides a synchronization signal to trigger external hardware and instruments such as an oscilloscope. A signal from the analyzer can reset the system under test, and other controls allow single-instruction stepping through the microprocessor's program.

Systron Donner Corp.'s model 50 microprocessor analyzer (Fig. 8) performs similar functions. Also low in price (\$865), the model 50 is similar in many respects to a 32-channel logic analyzer, but has many additional features. Its search modes find and identify the first and last instruction in a program loop, and a transfer mode permits stepping forward or backward through programs without setting addresses. The model 50 can be used as a passive real-time monitor or as an interactive breakpoint generator, and a number of units may be interconnected to obtain wider match and display words, more complex trigger conditions, or higher speed.

Along with the passive program-tracing modes, the model 50 can, if the microprocessor permits, halt execution and then step the program and display the result. The step size can be either a single or multiple machine or instruction cycle, or a single or multiple loop. A rear-



8. Generalized. Users can adapt Systron-Donner's model 50 microprocessor analyzer to handle almost any microprocessor type by changing a printed-circuit board and the test cable. A single-clip test probe can be used instead of the grabber-hooks shown.

panel connector accepts either interchangeable custom-wired or universal user-jumperable interface modules that adapt the model 50 pinout to various microprocessor types.

"The only function logic analyzers have over the model 50 is memorizing and displaying past states," says Zoltan Tarczy-Hornoch, director of research at the Concord, Calif., firm. "In many troubleshooting cases, this past memory is of questionable value. Either the problem can be pinpointed, or there is small probability that it will be found within the past 16 or 32 addresses or data." However, the model 50 can strobe and display via an accessory random-access memory, "in case someone needs it," notes Tarczy-Hornoch.

Trace memories find faults

However, other analyzer manufacturers are convinced that trace memories are valuable in tracking down faults in microprocessor programs. In the 6800 Programmers' Panel (Fig. 9), Applied Microsystems of Bothell, Wash., includes a trace memory for reviewing the last 100 program cycles. The instrument, which allows access to program memory, processor registers, and I/O ports, provides for examining and altering data stored in any of these locations. Interface to the system under test is via a ribbon cable and standard 3M-type connector if the system has been designed for use with the panel. Otherwise, the user can build an interface with a microprocessor chip and peripheral circuits, then plug into the

system under test via the microprocessor socket.

In its model AQ6800 microprocessor analyzer (Fig. 10), AQ Systems Inc. has an optional sequence recorder to capture as many as 128 instruction addresses in either of two operational modes. In one mode, the program will run and data will be recorded until the breakpoint is recognized or until the system is manually stopped. In the other mode, the system will run and record a block of 128 instructions before stopping. The latter mode can also be used to step a block of 128 instructions as an alternative to single-step operation.

The AQ6800, which is designed to test 6800-based circuits, allows greater interaction with the microprocessor than do other analyzers. Along with tracing and displaying addresses and data, the AQ6800 can transmit data to and from internal registers, including the program counter, notes Stephen Halpern, manager of engineering at the Yorktown Heights, N.Y., firm. Since the analyzer can modify the program counter, the operator can select a program location and start microprocessor operation from the that point, instead of beginning the program at its normal reset point.

The operator can select a program segment, set initial values into the microprocessor's internal registers and flag bits, then run the program segment. At a hardware breakpoint, internal registers and system RAM can be examined to determine if that section of the program is operating correctly.

The AQ6800, which is marketed through E & I Instru-



9. Interaction. By setting aside a portion of system memory and incorporating the appropriate connector, a designer can configure a microprocessor circuit so that the Applied Microsystems Programmers' Panel can retrieve or change internal registers.

ments of Derby, Conn., can also send data to or receive data from I/O devices and all memory addresses in order to further isolate system malfunctions. These interactive features are provided without imposing design constraints, such as setting aside sections of program memory or including a special connector, on the system under test.

The simplest program-tracing display to interpret is a listing of addresses, data, and commands in the alphanumeric mnemonics employed by the microprocessor supplier. A readout of "CLR B," for example, is certainly more meaningful than, say, "5F," a hexadecimal equivalent. Mnemonics are especially valuable when the microprocessor analyzer is to be used on the production line for final checkout of a board or system. The operator can grasp the flow of the program more quickly if it is presented in mnemonics than if it is presented in binary or even hexadecimal form, and he is less likely to confuse two similar commands.

The HP 1611A microprocessor analyzer converts the digital data entering its memory first into either hexadecimal or octal notation, as selected by the operator, and then into mnemonics, if desired (Fig. 11). The conversion is accomplished via an 8080-based controller that also handles other instrument functions such as keyboard decoding and display-character generation.

A significant feature offered by the 1611A is an extensive triggering capability. The instrument can trigger on an address and data word as long as 24 bits, entered in either hexadecimal or octal form. Another 8 bits of external binary data, accessed via an accessory eight-conductor cable, can be added to the 24-bit trigger word to form a 32-bit trigger word. The trigger word can then be qualified in a number of ways by using additional trigger controls. For example, the trigger word

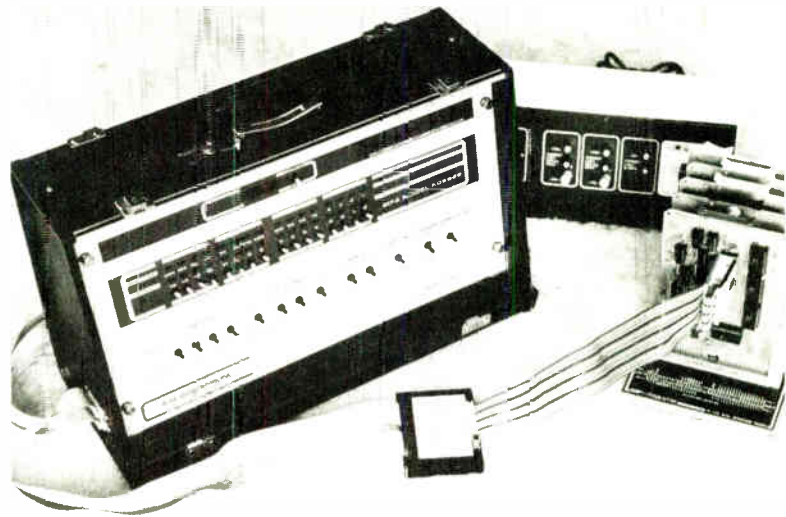

10. Independent. Connected to a microprocessor by a three-state buffered probe, the AQ6800 allows a designer to monitor the system under test and to deposit information into memory and registers without tying up interrupts or memory space.

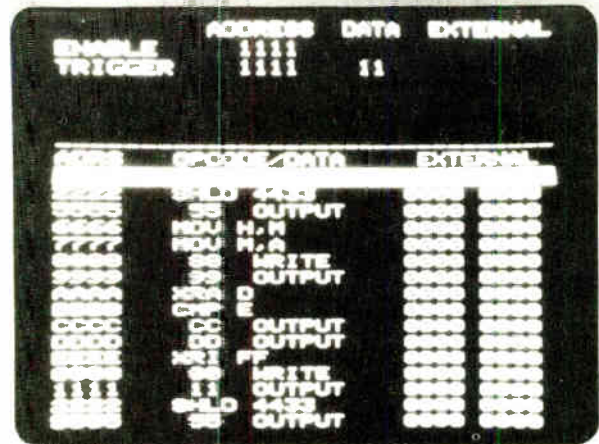

11. Convenience. Along with extensive triggering modes, Hewlett-Packard's 1611A microprocessor analyzer can convert binary information at its inputs into the alphanumeric mnemonics of an 8080- or 6800-type microprocessor's instruction set.

may be enabled or disabled by another word, or it may be recognized only when it occurs a number of times to a maximum of 256.

Another set of trigger controls allows trigger recognition on any occurrence above or below a preselected address. The two triggering modes may be used together to define a band over which any address-bus activity will be recognized.

The instrument can also display the number of trigger matches that occur between two selected points in the

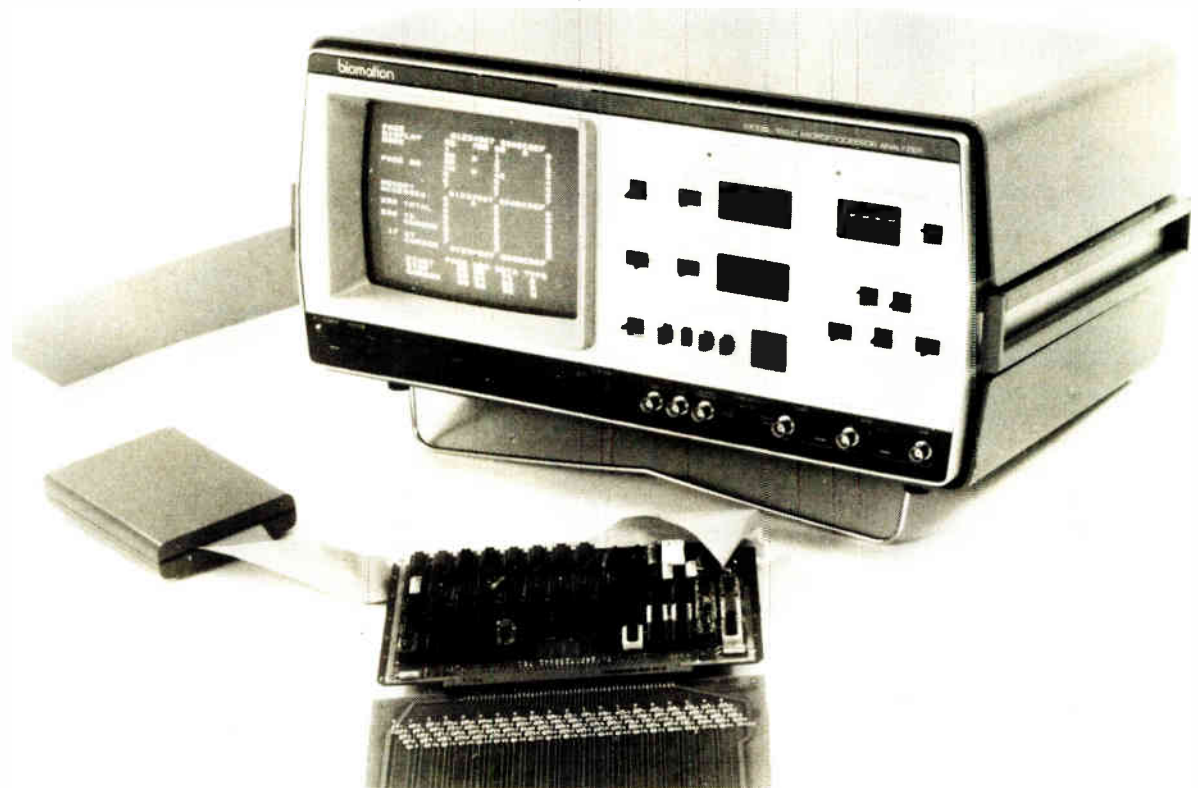

12. Memory map. The map mode in Biomation's 168-D microprocessor analyzer gives the engineer a quick overview of activity in the memory of the system under test and can then home in on specific addresses for a more detailed look.

program, and the time interval between two points. These features can be useful in minimizing the time needed to run an entire program, a segment, or a loop. While such timing information can be calculated from microprocessor data sheets, these calculations are rarely accurate because of variations in operating conditions.

The main probe from the 1611A to the microprocessor under test can be configured in two ways. The cable from the analyzer ends in a pod that contains a 40-pin connector socket in which the microprocessor is placed. The pod is connected to the microprocessor socket in the system under test through a ribbon cable and 40-pin plug. If the microprocessor cannot be removed from the system and it is easily accessible, the connector cable and plug can be replaced by a ribbon cable terminated with a clip-on 40-pin dual-in-line-package connector that provides a direct connection from the pod to the microprocessor.

Displaying accesses

Like the HP analyzer, Biomation's 168-D microprocessor analyzer (Fig. 12) has an array of display modes to allow the user to select the most useful readout. Along with the standard list mode, in which the program is presented as columns of binary or hexadecimal numbers, the 168-D has two memory-mapping modes. The first mode gives an overall picture of the program's operation. The memory is drawn as a graph of the most significant

hexadecimal digit of the address versus the second most significant digit, and a star is displayed for any set of addresses that is used in the program. The second mode shifts to the two least significant digits of addresses so that the operator can take a closer look at address-bus activity.

He can home in on a particular address by first looking at the most-significant-digit map, moving a cursor to a point of interest, then switching to that "page" of the memory. By comparing the "page" numbers displayed in the memory-map mode with a listing of the user program, the operator can determine if the system has occupied or accessed any undefined or disallowed states.

In the page-display mode, the 168-D reads out the activity at each address as an R or W for read or write. An X in the display signifies when both a read and a write occur at an address. When a cursor is positioned at a particular access, the address and data information corresponding to that access are displayed in the lower portion of the display.

The 168-D and the other microprocessor analyzers, logic analyzers, and development systems offer useful tools for the engineer who is working with microprocessor-based systems and with the software that programs and characterizes such systems. Properly used, they can save hours of troubleshooting time and guarantee that the final product will work as designed. □

How to expand a microcomputer's memory

Microcomputers can address more memory than they were meant to if that memory is split into pages or if extra hardware adds address bits

by Howard Raphael, *Intel Corp., Santa Clara, Calif.*

□ Microcomputer designers are rushing to add more memory to their systems, to make room for improved software versions of existing system features or altogether new features in software form. The steady drop in memory-chip cost has triggered the rush, but a bottleneck is created by the fact that most byte-oriented microprocessors have only 16 address lines.

To address more memory than the 65,536 bytes these 16 lines can handle, two techniques are available. They are segmented paging and continuous base addition. Using these techniques, the designer can easily expand read-only memory, to, say, store the multidimensional look-up tables that can replace complex calculations and maybe even speed them up; or he can add extra ROM or random-access memory for, say, the diagnostic programs and facilities that always have user appeal.

Segmented paging, as its name implies, addresses separate segments of memory, and the boundaries

1. Page addressing. The memory is segmented into 32-kilobyte pages. With the delayed-branch accessing method, the local memory can be as large as 65 kilobytes, while with the address select method, 1 address bit is preempted, reducing it to 32 kilobytes.

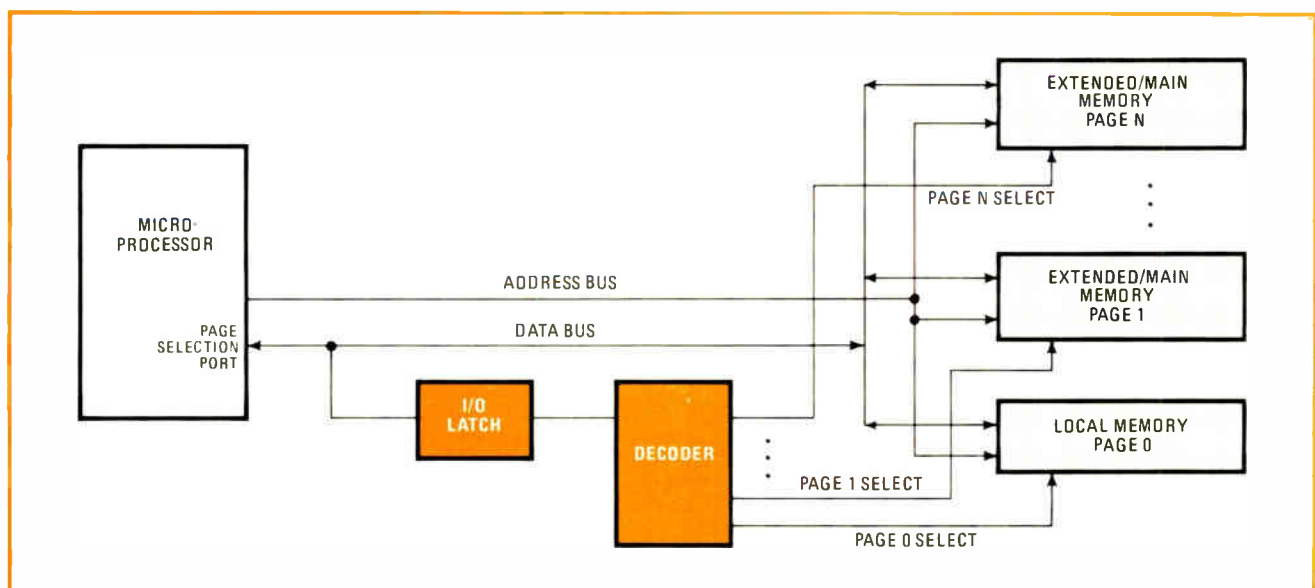
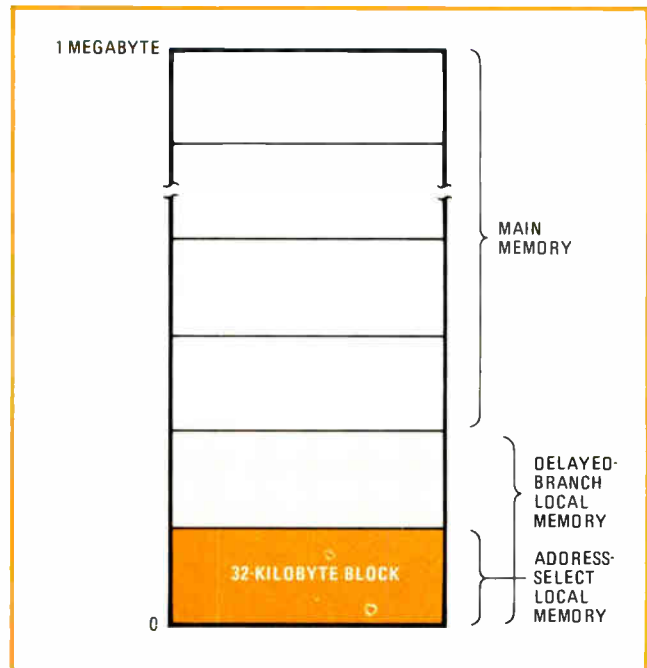

2. Paging memory. In the page-addressing scheme, 5 bits are taken from the microcomputer's output port, or data bus, to designate one of 32 pages in memory. The decoder then selects the appropriate page of the memory to be accessed by the microcomputer's address bus.

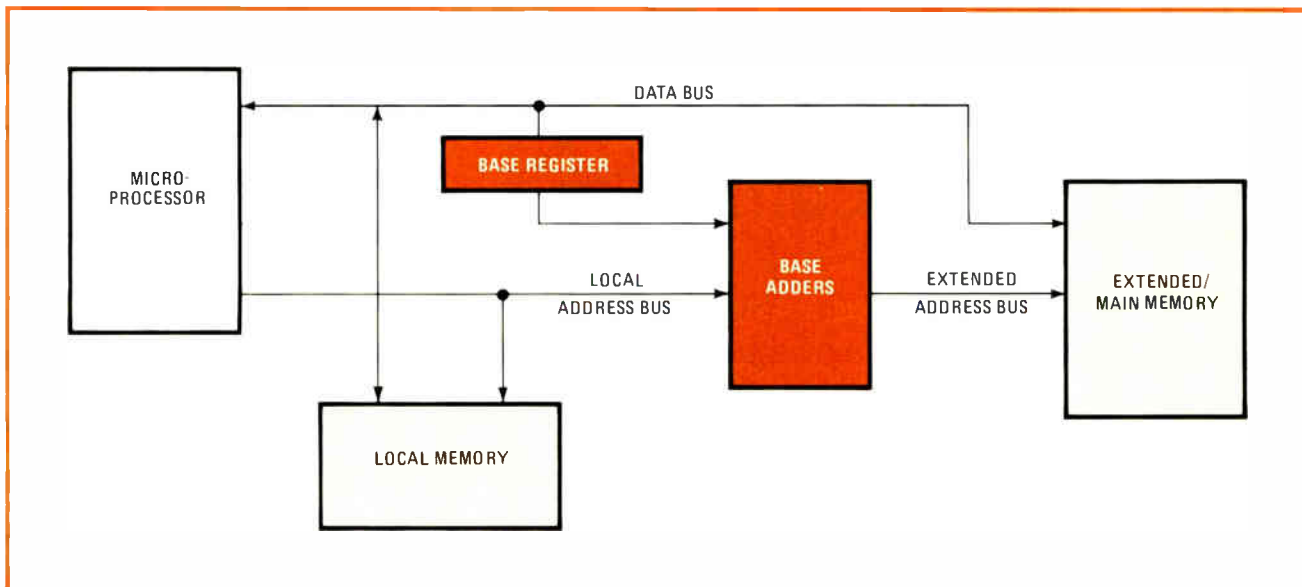

3. Base addition. With a base register and adders, the extended memory can be organized as a continuous 1-megabyte range, or, as shown here, local memory can be set up as 32 kilobytes while the extended main memory overlaps by 28 kilobytes.

between these pages can impose long delays on any data or routines that may need to cross them. However, the technique requires rather less hardware and software than continuous base addition. This other technique, on the other hand, can access a large main memory continuously throughout its range. Obviously the designer will have to compare them carefully in relation to his intended application, weighing their different hardware costs, software overhead, and sensitivity to memory boundaries.

Page addressing

Page addressing treats the microprocessor's normal memory as one page and uses it to refer to the other pages that make up the memory extension. Consider a 1-megabyte memory. Direct addressing of 1 megabyte (2^{20} bytes) would require 20 bits—an impossibility—but page addressing turns this into a two-step process. When the memory is subdivided into 32 32-kilobyte segments, it requires 5 bits to get to a page and 15 bits to find a location within a page. The first 32- or 65-kilobyte segment—the microcomputer's normal memory—is referred to as local memory, and the rest are called main memory (Fig. 1). The local-memory segment, in addition to data and other contents, must contain the program which selects the 30 or 31 other segments in main memory.

The selection process requires that 5 bits from one of the microcomputer's output ports be designated the "page-selection port." These 5 bits, in turn, are decoded with extra hardware to select one of the 31 main-memory pages (Fig. 2). However, to complete the scheme, the location on the selected main-memory page must also be defined.

Suppose we wish to jump from some location in local memory, page 0, to location 512 in page 16. This requires loading the 5-bit page-selection port with a binary 10000 to locate page 16. On completion of that loading instruction, the program execution resumes in

page 16 at the address designated by the contents of the program counter. However, we specifically wanted to be at location 512 in page 16. Thus, we would either have to arrange to be at location 511 in page 0, and insert the page-select I/O instruction there, or we need to make an unconditional jump to location 512 immediately upon entering page 16.

Neither alternative is convenient. Two solutions are possible: the delayed branch or the address-line-select mechanism.

The delayed branch delays the transfer of program execution from page 0 to page 16 by enough time (one or two instruction cycles) to allow the program to execute a branch in page 0 to location 512. The page transfer then is enabled to take effect on the first instruction cycle after the branch. To implement the delayed branch, extra hardware is usually required to count instruction or clock cycles. When this counter reaches the predetermined value, the instruction execution switches pages.

In the second paging approach, the address-line-select mechanism, the most significant bit of the address bus is used to designate either local or main memory. Local memory is enabled when the MSB address line is logical 0, and main memory is enabled when the line is logical 1. If the address bus is 16 bits wide, this allocation of 1 bit requires that local memory be restricted to 15-bit addresses, or 32 kilobytes, a limitation not required by the delayed-branch scheme.

To continue with the example described above, suppose the current program is being executed in local memory (the first 32 kilobytes, or page 0), and then a transfer to page 16 is initiated. The page I/O loads binary 10000 into the page-selection port. Instruction execution, though, cannot begin yet, since the MSB address line is still at logical 0 and must be toggled to enable main memory. To do this, the program, while still operating in page 0, is instructed to perform an unconditional jump to address 32 kilobytes plus 512. Since the program counter now moves beyond the 32-kilobyte limit of page 0, its

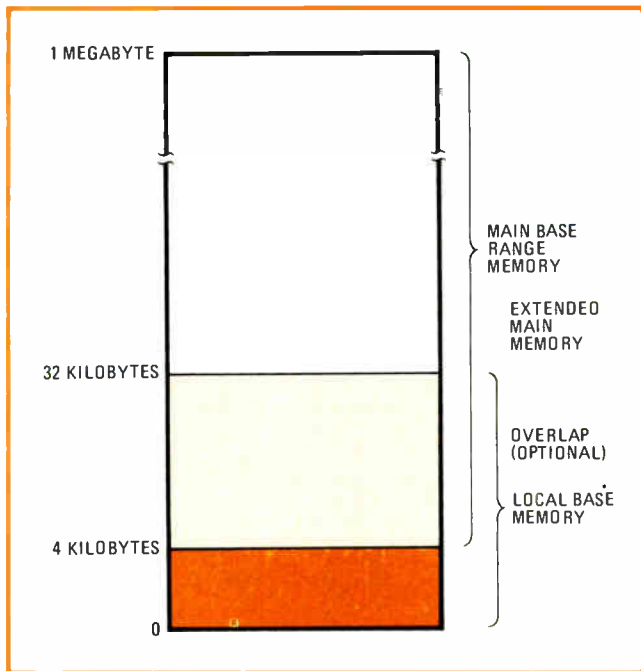

4. Offset. For the base-adder scheme, an offset address is loaded into a base register, the contents of which are then added to the local address bus to generate a 20-bit extended address. Local memory, however, is addressed by the microcomputer's 16-bit bus.

MSB line and hence that of the bus, too, change to logical 1, placing the program counter at location 512. Simultaneously, the I/O port switches the counter to page 16.

The address-line-select scheme thus does not require the additional hardware of the delayed-branch approach, since it uses the MSB address line to enable main memory whenever necessary. However, as noted, use of the memory line does halve the usable local memory.

Both the delayed-branch and address-line-select paging schemes require the extended memory to be segmented into binary-related, unoverlapped memory ranges (pages of 4, 8, 16, 32, or 65 kilobytes). All addressing within these boundaries is relative to a particular page. For some applications, this may be acceptable and even convenient, since unoverlapped boundaries offer some measure of memory protection. But it is time-wasting and therefore unacceptable in other applications, since all excursions to page extensions must originate in local memory and cannot easily occur directly between the page extensions. Instead, switches must be between page 0 and page n and then back to page 0. If overlapping and direct switching are desirable, it is better to use the base-adder technique.

Base addressing

In applying the continuous-base-addressing technique (Fig. 3) to a 1-megabyte memory, the program loads an offset value into a separate 20-bit register through one of the microcomputer's output ports (Fig. 4). It then adds this value to the current value of the 16-bit program counter to develop a new 20-bit address for any location anywhere within the entire memory.

Since the 20-bit extended address bus will cover the full megabyte, local and main memory can be over-

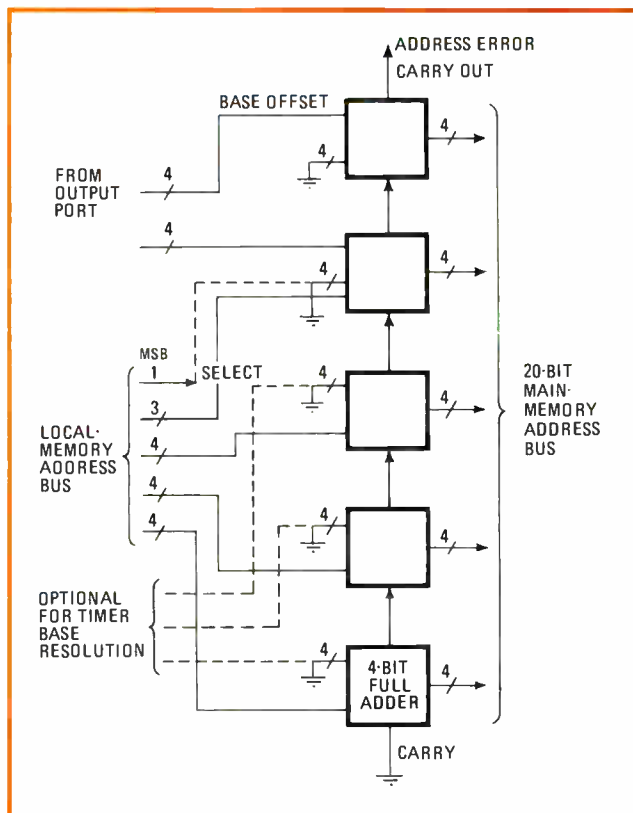

5. Quad adders. In base addition, the base offset value is added to the contents of the address bus by five quad adders. In this example, the most significant bit of the address bus is used to signify that main, not local, memory is to be accessed.

lapped if desired. But usually it is more convenient to divide the memory into two parts: local memory of either 32 or 65 kilobytes, as before, and continuous main memory, comprising the remainder up to 1 megabyte (Fig. 3). Then the system uses local memory for normal operation and calls upon main memory only when it is needed for special data or routines or for distributed-processing communications, the advantage being that only on these occasions is the system slowed down by the extra addition stage.

To call upon main memory, the computer can do one of two things. As in paging, it can use the MSB line of the address bus to cause the switch (Fig. 5), in which case local memory is again restricted to 32 kilobytes. Alternatively, it can designate a separate flag to indicate that the contents of the 20-bit register and the program counter are to be added and used to access main memory.

Although this technique requires extra hardware in the form of the 20-bit offset register and four quad adders, it does offer a way of extending memory that is unaffected by page boundaries.

Interestingly, if only academically so, note that a full 20-bit offset address need not be used if the designer can work with page boundaries. For example, 8 bits could be used to provide the offset in the base register. The total bus width would then be 20 bits, and the base register and the 16-bit local memory bus would overlap to create steps of 4 kilobytes each. □

Priority encoder simplifies clock-to-computer interfaces

by John P. Oliver
Astronomical Time Mechanisms, Gainesville, Fla.

Although a computer can easily be programmed to keep track of time internally, in many cases it is better to allow the processor to read an external clock. This is especially so when the clock must be kept running during downtime and program loading or debugging. Using a 9318 priority-encoding integrated circuit to interface the National MM5314 digital clock chip to a computer permits easy loading of time data into memory under interrupt control, and the entire system requires only a handful of parts.

The complete clock and interface unit is shown in Fig. 1. The MM5314, powered from the ac line, derives

its time base from the 60-hertz line frequency as well. The 100-kilohm resistor is connected to the secondary of the power transformer, to supply the power-line frequency to the 50/60-Hz input of the clock chip. The outputs of the seven-segment digits are multiplexed at a rate of about 1 kilohertz, determined by the RC time constant, and the sequential order is from unit seconds to tens of hours.

The 9318 encodes the address of the highest-priority data line (ordered from D_7 to D_0) having a logical-1 input, into a 3-bit binary code at outputs $\overline{A_0}$ through $\overline{A_2}$. Thus, the encoder is used to indicate which of the seven-segment-output digits is being scanned by the multiplexer, thereby telling the computer the time in a serial format—first in seconds, then tens of seconds, then minutes, and so on. The digits are identified by the address lines, and information for each digit is conveyed by five of the seven segments—a, b, e, f, and g. Segments c and d are not sent to the computer.

Figure 2 details how the omission of the c- and d-segment signals still permits unambiguous identifica-

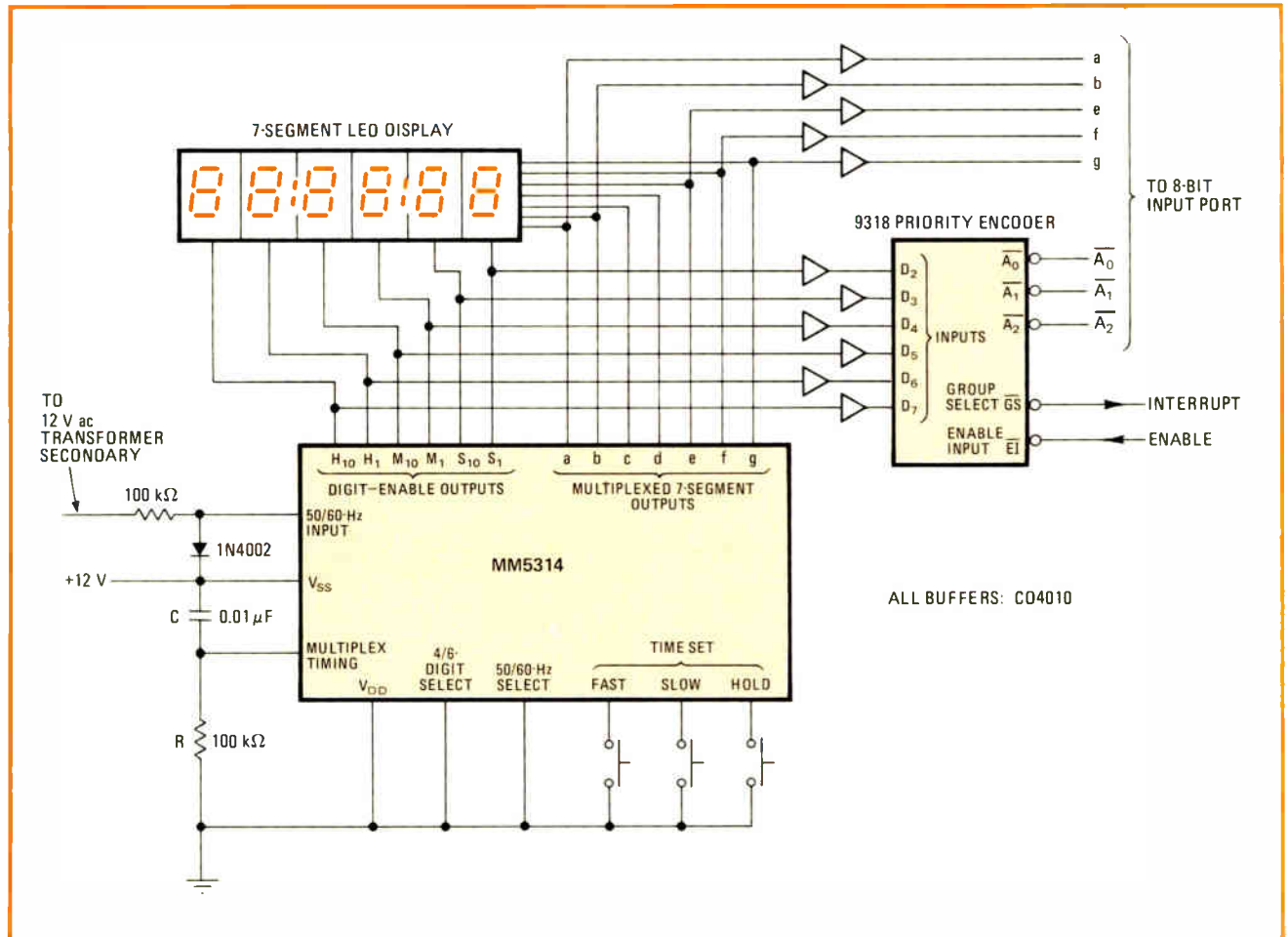

1. Punch in. Complete clock-to-computer interface requires few parts and includes seven-segment LED display. Note that no digit- and segment-drive transistors are required, as the MM5314 chip can power most small displays to reasonable brightness.

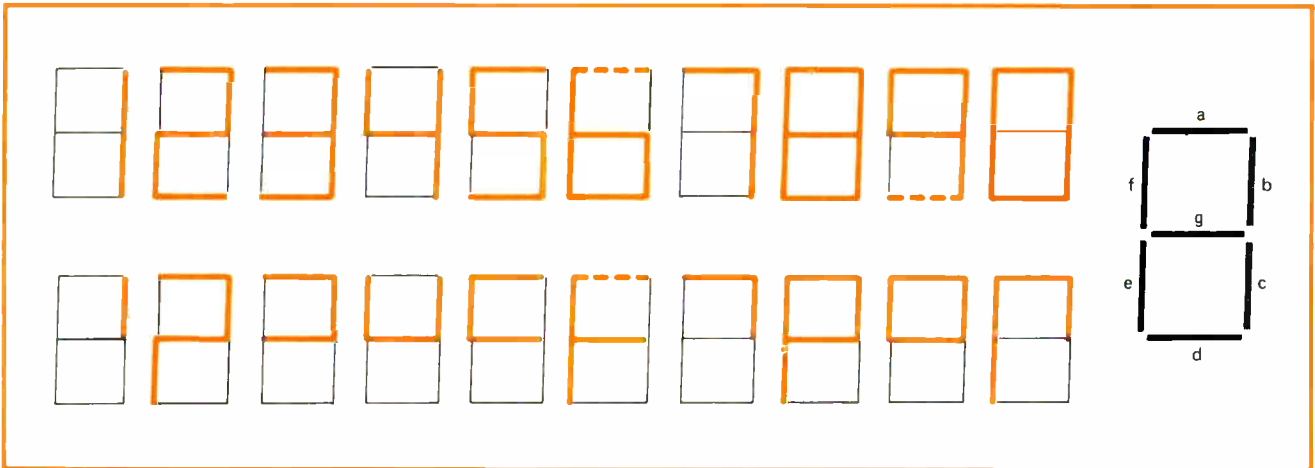

2. Missing segments. Shown above are seven-segment representations of digits 0 through 9. If the c and d segments are omitted, the digits retain their integrity, as seen in the lower figures. Some clock chips will illuminate the "tail" on the digits 6 and 9.

3. Outputs. The upper eight signals go to the input port of the computer, while the remaining two, the group-select (\overline{GS}) and enable-input (\overline{EI}) require an input and output line, respectively.

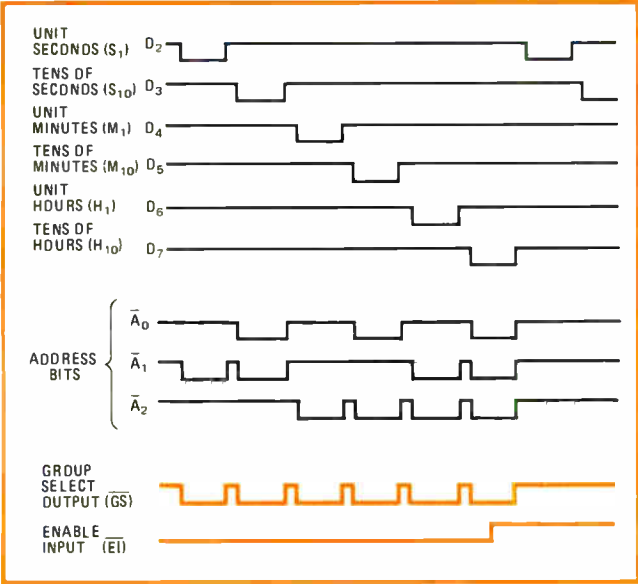

tion of the digits. Actually, the minimum number of lines required for decimal encoding is four—and clock chips having binary-coded-decimal outputs, such as the MM5311, MM5312, and MM5313, will reduce to seven the number of lines to the computer's input port.

The waveforms at the outputs are shown in Fig. 3. Note that all the signals are negative logic. The group-select output (\overline{GS}) of the encoder indicates that priority inputs are present by going low, as it is a negated output. The \overline{GS} output, putting out a pulse as each digit of the display is scanned, can provide an interrupt to the computer. These interrupts can be enabled and disabled within the computer programming or, alternatively, an output line from the computer can be sent to the enable input (\overline{EI}) of the priority encoder. Holding the \overline{EI} high inhibits the \overline{GS} output upon completion of the next digit-segment-output, as implied by the waveforms.

If the latter method of enabling and disabling the interrupts is chosen, the user should beware of possible spurious \overline{GS} output spikes as the \overline{EI} is switched by the computer. □

Designer's casebook is a regular feature in *Electronics*. We invite readers to submit original and unpublished circuit ideas and solutions to design problems. Explain briefly but thoroughly the circuit's operating principle and purpose. We'll pay \$50 for each item published.

Engine staller thwarts car thieves

by Gary L. Grundy
Apple Valley, Minn.

Car thieves are becoming surprisingly astute at finding and disabling theft-prevention devices in automobiles. But what if the vehicle starts and then stalls repeatedly? Chances are the would-be thief won't suspect an anti-theft device but will instead hunt for a new victim, if the car is equipped with a unit that simulates engine malfunction.

When in operation, the device permits the car to start normally and after 12 seconds opens the circuit to the ignition coil, stalling the engine. Four seconds later, the circuit again closes, enabling the thief to restart the engine. The cycle repeats and then after an additional 12 seconds, the engine stalls, and will not start again. By this time, the thief will probably abandon the car a short distance at most from where it was parked.

The circuit of the anti-theft device, shown in Fig. 1, makes use of a 555 timer and complementary-metal-oxide-semiconductor logic for low battery drain. Enable switch, S_1 , which should be concealed, is set by the driver to activate the circuit whenever he leaves his car. A good way for a nonsmoker to conceal S_1 is to use the cigarette lighter—its wire to the battery is simply disconnected and routed to the circuit at point A. A key switch may be

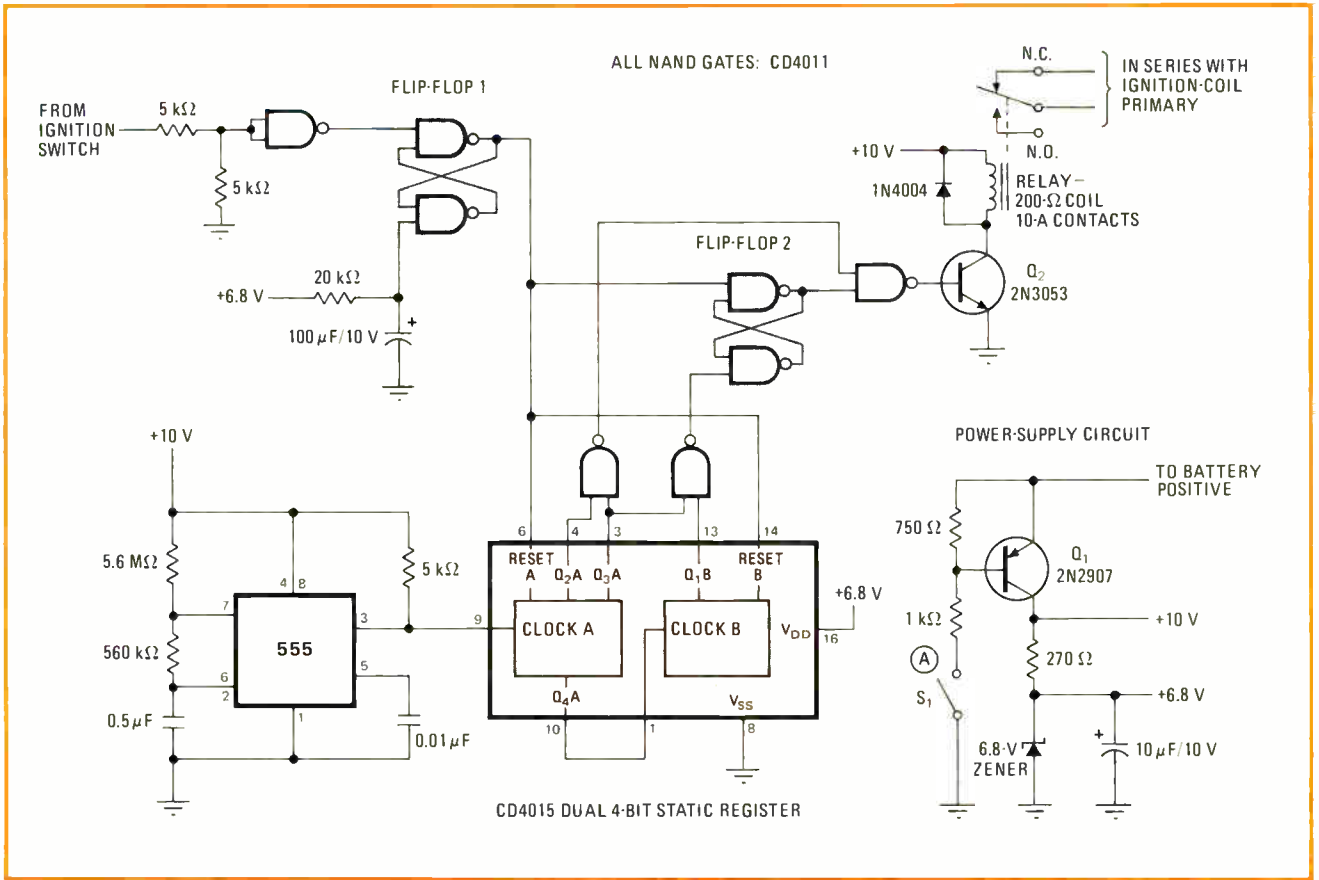

1. No escape. Although a car thief can start a vehicle equipped with this circuit, he soon gets discouraged when the engine stalls repeatedly. Timer circuit periodically removes power from the ignition coil, simulating engine malfunction.

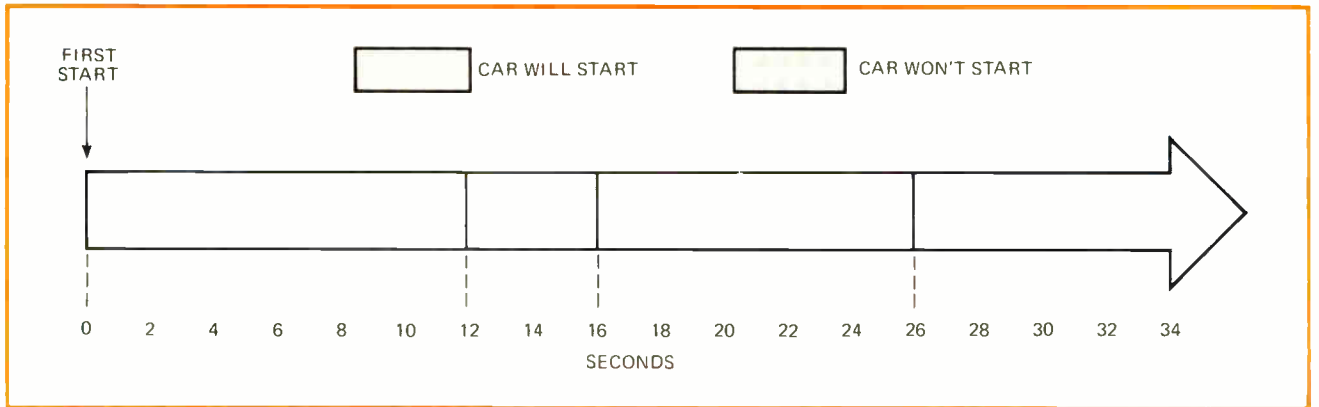

2. Timing. The start-stop cycles for the anti-theft device are 12 seconds and 4 seconds, respectively. After the engine stalls the third time, it can not be restarted until the driver opens the enable switch S_1 , which is concealed within the car's interior.

placed in series with S_1 to safeguard against tampering. Once the circuit is armed by closing S_1 , turning on the car's ignition toggles flip-flop 1, made up of two NAND gates, permitting 0.5-hertz pulses from the 555 timer to enter the CD4015 shift register. The CD4015 contains two 4-bit shift registers, which, in this case, are cascaded. After 12 seconds (six pulses) the NAND gating turns on transistor Q_2 , opening the normally closed contacts of the relay and stalling the engine. After two more timer pulses enter the shift register, the NAND gating turns off Q_2 , enabling engine to be restarted. The cycle is repeated, except that the third application of

ignition voltage toggles flip-flop 2, and the car can not be started again until the driver returns and opens S_1 . The timing sequence is detailed in Fig. 2. To make device unrecognizable as an anti-theft unit, it can be built on a small circuit board and housed in a small box such as those used for pollution controls. An optional alarm that actuates after 60 seconds can be added by connecting pins 5 and 12 of the shift register to an additional two-input NAND gate. The gate output can be made to drive a relay activating the horn, lights, or a siren to draw attention to the abandoned vehicle, if desired. □

THE EXECUTIVES WEIGH 1977

Up. That's the kind of year 1977 will be for the electronics industries, according to most of the top executives participating in *Electronics'* annual survey. But optimism is tempered by a list of concerns ranging from the strength of the economic recovery, to the Carter Administration's ability to cut unemployment and its ability to get along with business, to technology inroads by other industrialized nations. The result is a general feeling that growth will be steady, after a slowdown in the last half of this year. A dominant concern for many company leaders, particularly in the semiconductor and consumer electronics industries, is the need they perceive for the Government to help hold off redoubled Japanese efforts to compete strongly in their markets. Even as they worry about such foreign competition, they express concern about a domestic tax structure with inequalities that serve to effectively choke the supply of capital. All in all, though, the feeling about the year ahead is good.



WILLIAM J. WEISZ
president, Motorola Corp.

"I have no concern about my company or other American companies competing on even terms with our competitors," says Weisz from Motorola's Schaumburg, Ill., corporate headquarters. "And I have no qualms about our technological

competence, but I do about our ability to exercise that competence.

"Once we dedicate ourselves to a problem, we can accomplish almost anything we want. But, with 90% of the problems, we just mouth the words. We don't give it the time and resources, because that takes away from the productive aspects of the job.

"One of the shaping competitive battles is with Japan, and we've got to be damn sure—and I hope the Government realizes this, though I'm not sure it does—that we're competing on even terms," he says. "I suspect, while Motorola isn't a party to the color-TV brouhaha, that there's some lack of *quid pro quo* between the Japanese and us. It runs all the way from revaluation of the yen to issues of dumping, cartelization—the whole pot-pourri of things that are going on," he adds.

Weisz admits that the electronics industries aren't very good at making their views known to Washington. "We talk to people; we legally lobby; we invite them to our trade association meetings; we serve on ad-

visory committees. But at this particular point, we in the electronics business aren't too successful."

He feels that managers must adapt their management styles to fit inflation, especially in multinational companies. "One of the things we must do in the next few years is to make sure that our managers are capable of managing in an inflationary environment. Some international businessmen have adapted to it better than we have. For example, Israel has been suffering 30% inflation rates, and there they've learned how to manage their businesses very successfully."

President-elect Carter, Weisz jokes, "is an engineer; he can't be all bad." Then he adds seriously, "he's a logical thinker, and frankly, if we had a few more engineers in the government, we might be better off. But we Americans seem to have a phobia about putting people with industry experience into Government positions, especially regulatory positions. It's always charged that they will be biased to the industry."

continued



WILLIAM R. HEWLETT
president, Hewlett-Packard Co.

Uncertainty is the cloud in the silver lining for Hewlett. Uncertainties about the new President's policies and some still unresolved international problems will be the chief reasons for a year of unspectacular but steady growth, he says.

"It's always difficult to tell what's going to happen in the marketplace even six months out, much less a year. But 1977 is even more of a question mark," says the HP president.

It is very unclear, he says, exactly what President-elect Carter is going to do about some key economic and international issues facing his administration.

"On the international scene, for example, he's changed his mind about Kissinger. On the domestic scene, he's changed it about the unemployment problem. And there is no guarantee that he won't change his mind again," declares Hewlett.

A critical issue for the Palo Alto, Calif., firm is the stand Carter and the Democratic Congress take on the OPEC oil price increase.

"It's important that we don't see

very sharp increases in the price of oil because of the adverse effect they would have on a number of countries who are our key customers: the nations of Western Europe, Japan, Australia, and South Africa," Hewlett says.

Most countries, he says, are just now recovering from the shock of the first oil price increase and the slightest "economic jostle" could send them all reeling into another inflation/recession cycle.

"On the other hand, it's important that Carter and the new Congress not react too harshly to the oil price increases either," he says. "A hard-nosed attitude on their part by embargoing all goods into Arab and oil producing countries could start an economic war, which would be much more disastrous."

Even with these serious short-term reservations, Hewlett is basically optimistic about maintaining the U.S. technology lead and the ability to compete in the world market. "In electronic and computer technologies, our lead over the rest of the world is so wide that it's inconceivable we could lose it, unless we practically just roll over and die," he says.

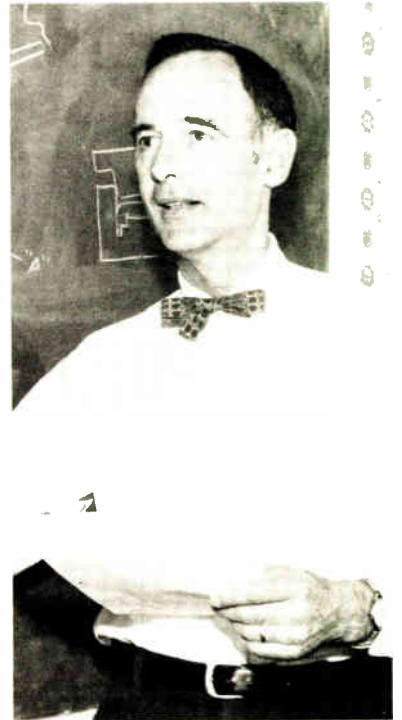

WALTER L. CHERRY
*president,
Cherry Electrical Products Corp.*

Cherry's company should make the biggest switch of its history in 1977. "Six years ago, 85% of our business was in snap-action switches. Now it's more like 50%," he says at his Waukegan, Ill., headquarters. "We see our growth more in electronic devices: keyboards, transducers, and displays."

Sales were up 60% in 1976. "This year has been great, and one reason is because last year was so terrible," he says. "Next year we expect about 20% growth. But we don't really know; we're almost guaranteed a flat start since we're flat now."

Cherry is planning a full year's worth of new switch products. "Since the snap-switch market grows with the GNP—in other words, pretty bad—the only way we can grow is to capture more of the market with new products." The emphasis for the firm will be its entry into several new markets, including solid-state keyboards, Hall-effect transducers, and dot-matrix displays.



WILFRED J. CORRIGAN
*president, Fairchild Camera
and Instrument Corp.*

The recovery of the economy and the semiconductor industry is in the hands of the consumer—or rather, in his pocketbook, maintains Corrigan. "You name the market sector," he says. "If the average consumer isn't ready to buy, no one's ready to buy."

While a slow recovery is in some ways healthy for the semiconductor industry, it is having a short-term negative effect on the employment rate, he says. "Consumers in general are not quite as sure about the recovery, and businessmen reflect that." This cautiousness is reflected in the fact that plant and equipment

spending has been lower during the last few months than it was during the low point of the 1974-75 recession.

With some fluctuations, the semiconductor business is, and will be, relatively immune to this cautiousness, at least through 1977, due mainly to the movement of electronics technology into a number of new high-volume markets, says the head of the Mountain View, Calif. firm.

"The consumer area—especially watches and video games—is strong and will remain so. And capital equipment spending for instruments has resumed its strong upward growth after a slight pause in the spring, especially in new microprocessor- and LSI-based systems."

Microprocessor-based products generally are growing rapidly, Corrigan says. "Most of the sales so far have been for developmental systems. Next year many systems will go into production, and that's when we'll see sales for microcomputers begin to climb dramatically."

Business and retail electronics will see strong growth as large-scale-integrated systems displace the traditional electromechanical devices in office equipment, he says. With the drive by more data-processor users toward the concept of distributed computing, the computer market will continue strong growth, increasingly taking on the characteristics of the capital-equipment industry.

In spite of all these new growth areas, semiconductor shipments have not been quite as high as expected, "which is perhaps just as well," Corrigan holds. If the industry had taken off into a sharp growth curve as it has traditionally done, "we would have been setting ourselves up for another downturn in late 1978."

A gradual but steady growth curve means the amplitude of the industry cycle is less pronounced, but the period between downturns is longer. "In this case, that means a slowdown, and a more moderate one, no sooner than late 1979," he predicts.



L. J. SEVIN
president, Mostek Corp.

No one in the semiconductor industry sounds a louder battle cry than Sevin about unequal tariff barriers in Japanese and American markets. "We're at economic war with Japan, and Washington isn't even fighting on our side," he says.

"Take the GATT negotiations—the primary consideration is to keep those [military] bases in Japan. The Government is using economic concessions—nonreciprocal tariff agreements, 12% for them, 0% for us—to further its political ends. They are negotiating away our birthrights."

The problem is simple, according to Sevin. "The Japanese use their protected markets to build up their production and reduce their costs, and then they come freewheeling over here and kill us."

While the Japanese government is pumping hundreds of millions of dollars into their electronics industry, the subsidies do not bother the president of the Carrollton, Texas, firm. "It's their right."

"But the unequal trade treatment—the tariff differential, and the total willingness of our side to buy outside and the total unwillingness of their side to do business with us—that's what hurts," he says. "Unless, of course, we have something they absolutely need. That they'll buy for a while, until they copy it."

"Let's face it," Sevin says. "We're getting a thorough roughing up from Japan. We hope the Carter administration gets the picture fast. We're not looking for free handouts from Washington—just equal treatment—and that means reciprocal tariffs: they charge us 12%, we charge them 12%."

continued



J. FRED BUCY
chief operating officer,
Texas Instruments Inc.

In concert with the chief executives of many semiconductor companies, Bucy is ready to sound the tocsin over the potential danger of America's losing its technological leadership to other countries, especially Japan.

"The United States Government still does not understand the value of semiconductor technology to our balance of payments," says the Dallas firm's chief operating officer. "Semiconductors are a precious natural resource, and giving the technology away is like committing economic suicide. The companies in Silicon Valley, which in the past have been quick to advocate foreign technology exchanges, are finally beginning to understand this. Perhaps now there will be some solidification on this issue within the industry."

Bucy has long maintained that trading with other countries on an equal footing makes good business sense. But he believes giving them the means of production through technological exchanges or turnkey facilities is counter-productive. In the long run, it comes back to

haunt American manufacturers in their own unprotected domestic markets, he maintains.

This is particularly treacherous, Bucy says, because U.S. firms face high tariffs on electronic exports to foreign markets and little tariff protection in domestic markets. "The U.S. Government lacks a basic understanding of tariff protection and high technology," he says. "It puts protective barriers on low technology and low tariffs on high technology, such as electronics components and equipment. The point is, if the Government doesn't protect our domestic high-technology markets, we won't be able to maintain our leadership and strong export position."

Bucy sees Japan as the biggest potential threat to American semiconductor leadership. "The Japanese government works very closely with Japanese industry. The government there has invested over \$200 million in the electronics industry in five years. Japan is trying to develop a leadership position in very-large-scale integration and, with it, a dominating worldwide position in the computer industry.

"The Japanese want to take over the computer industry. But we can outperform the Japanese and anyone else, if Washington doesn't interfere."

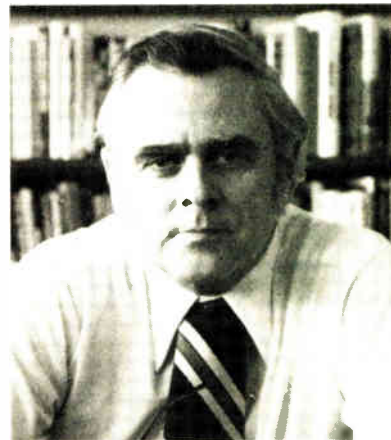

RICHARD LEE
president, Siliconix Inc.

The new year will bring with it a sense of *déjà vu* for Lee, who sees it as a rerun of 1976. And 1976, he says, was "basically a recovery year" for his firm, which supplies bipolar and field-effect transistors and ICs to primarily military and industrial customers.

His two prime indicators are capital spending and the military marketplace. Neither recovered as fast as expected, he says.

Military programs that he expected to be booked and committed by spring were delayed instead. In fact, until the elections were over, the Santa Clara, Calif., firm received essentially no new military business.

"Even though many of these programs are still on hold, we've had assurances that we will receive the business within the next six months, new president notwithstanding," Lee says. Even so, the uncertainty of Carter's views on military spending still means keeping a tight rein on some of the company's more optimistic projections.

"As far as overall military spending, I don't expect Carter to reduce it be very much," he says. "It's more a matter of priorities. For example, I expect that, as an ex-Navy man, he will favor a strong sea force. The change in emphasis in terms of programs may throw some short-term glitches into our planning, but we expect military spending on electronics—and our business—to be up 8% to 10% over this year."

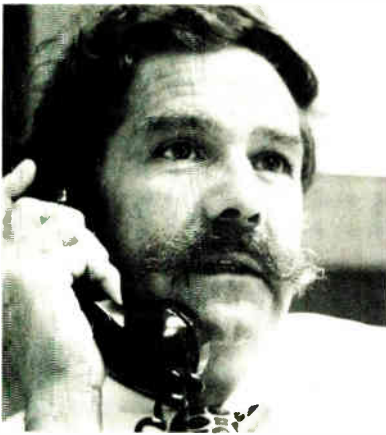

CHARLES SPORCK
president,
National Semiconductor Corp.

Vagueness irritates Sporck. And what is so unsettling to him now is a sense of political and economic vagueness. But he is reasonably confident about the next three years.

So the Santa Clara, Calif., firm is operating on the basis that 1977 will be a period of growth. "We're not 100% confident," he says. "But one thing is certain; we're not all staring into an abyss, as we were in 1975."

He expects the general flattening of the growth curve detected in September to continue through the first quarter of 1977. "Basically, things flattened out because the first half was strong, probably too strong, unrealistically so," says Sporck. "I think everyone was more optimistic than they had a right to be." Most users are backing off a bit, realizing that they over-bought, he says. Now, the order rate is about equal to the usage rate. "No one is increasing inventories until they see how things sort out."

A long-term concern of Sporck's is what he believes is the vanishing U.S. technology lead, resulting from a "pervasive antibusiness, antitechnology attitude." One of the strongest economies outside the United States, he says, is Japan's, where government money is helping private companies develop computer and LSI technologies. "And it's starting to pay," he says. "I have some real concern where that kind of effort will lead."



ROBERT N. NOYCE
chairman, Intel Corp.

The slowness of the nation's economic recovery is a reason for optimism, argues Noyce. "As usual, most businessmen are overreacting to the overaccumulation that occurred at the beginning of the year," he says. "The result is this flatness, a period of readjustment, to be followed by a steady growth rate through next year."

This is a healthy trend for the semiconductor industry as a whole, he holds. "The overall growth curve remains the same—\$5.2 billion total semiconductor shipments in 1976, \$6.2 billion in 1977, and \$6.9 billion in 1978. What's missing, if everyone is cautious and pays more attention to both their markets and their inventories, is the vicious and unpredictable start/stop, up/down spurts in demand and supply."

The Santa Clara, Calif., executive applies what he calls his theory of reverse economics to the possibilities for another downturn. "If we expect a recession in, say, 1978 or 1979, that's precisely when it won't occur, because we all will prepare for it, and, in the process, eliminate the root causes. It's the unexpected that occurs. The best thing that could happen to our industry would be if we expected a recession every year."

He is not too concerned about President-elect Carter reversing any of the inflation-damping policies already in place. "Carter is about the most conservative Democrat—eco-

nomically, at least—that I've seen in 25 or so years," he says. "He's even more conservative than some Republicans."

Noyce also believes there is no cause for concern about Carter's plans for defense spending. "His basic thrust is efficiency of government," he says. "And God knows the Department of Defense could use that." Overall defense spending, he believes, will not be substantially reduced. Rather, it will be a matter of emphasis where the money will be spent.

He, too, is concerned about America's eroding technology lead. "Our two strongest trading partners—Japan and Germany—know a good thing when they see it. And they are beginning to heavily subsidize their electronics industry."

He doesn't advocate similar subsidies in the U.S. as much as a reversal of "economically punitive legislation." The basic research, he says, is not lacking; rather, what's missing is the mechanism for transferring these developments to the market-place: entrepreneurial "seed-technology" companies, such as Intel Corp. in the late 1960s.

"These kinds of companies—a major source of our technological strength now—were possible because of the wide availability of venture capital in the 1960s," Noyce says. "None of the companies in Silicon Valley would exist if it were not for this readily available source of money."

Because of uncalled-for Federal tinkering in the form of pension and tax restrictions, he says, there has been no substantial venture capital available for necessary seed-technology companies since 1970. "So, the source of our technological strength in the 1980s and 1990s, simply does not exist, and that frightens me."

If there is any one thing Noyce believes Carter should change, it's such legislation. "For his purpose it would be ideal," he says. "It would involve no Federal spending, which would help keep inflation down. Because new technologies and industries would be created, it would create more jobs."



HEINZ RÖSSLE

*deputy general manager,
IFT Semiconductor Group*

It's a matter of all hanging together to avoid hanging separately, suggest Rössle. "For the West's industrialized nations, getting inflation and unemployment under control will be the No. 1 priority in 1977."

That view mirrors the sentiments of many top managers in West Germany's electronics industries. A better economic climate in other countries is a major concern since the state of the German economy depends to a large extent on how its trading partners are faring.

Speaking at his group's European headquarters in Freiburg, West Germany, Rössle forecasts: "Next year, strong impulses for the economy can be expected from the automobile and entertainment electronics sectors as a result of higher consumer spending." However, in some other industrial sectors, the critical cost/profit situation must be improved by greater efforts in rationalizing production processes.

As head of ITT's semiconductor operations outside the United States, Rössle sees semiconductors, particularly highly sophisticated types like large-scale-integrated components, gaining wider entry next year into markets such as telecommunications and industrial equipment. He also foresees semiconductors playing increasingly important roles in insuring what he terms a country's electronics future and in strengthening its economic position among the industrialized nations.



EDSON de CASTRO

president, Data General Corp.

A year ago, de Castro was forecasting a 30% growth rate in his company's sales for 1976. He was wrong. The Southboro, Mass., mini-computer maker exceeded that figure to top \$160 million. But this year, de Castro isn't making a public forecast because he's too uncertain about the overall economy.

"Our major concern is the direction of the economy, and the signs are mixed. We don't know if the pause will last for a while or whether there's going to be expansion or contraction. And there's no agreement among the economists so we've got to share some of their indecision," he laments.

But he's pretty sure he knows the impact President-elect Carter will have on the economy. He thinks some of the Carter campaign posture in the North was at variance with his record as governor of Georgia and the attitude toward business reflected by that record.

"We'll have to take a wait-and-see attitude, but there's room for some optimism on the grounds of that fairly conservative record as governor."

De Castro is concerned about the Bay State's business climate and long-term Federal policies that he sees paring the U.S. technological lead over some of the better-developed countries. "I hope I'm wrong, but I think the lead will continue to shrink, because there's been a substantial change in incentives for people to take risks in investments," he says.

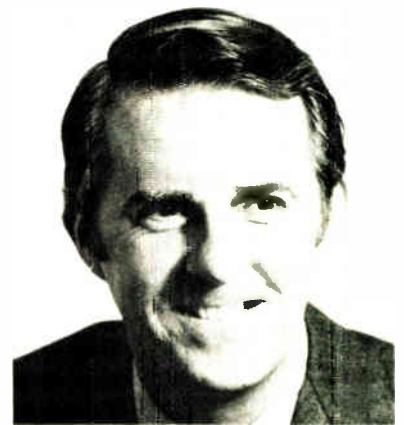

JAMES R. MELLOR

*executive vice president,
Litton Industries*

It won't be a year of drama in the international markets for large aerospace systems, but "it's going to be damn good," in the opinion of Mellor. Despite the campaign rhetoric about limiting export of U.S. weapons systems, he sees the "international arena becoming even more important."

Within several years, he predicts, exporting weapons will account for perhaps 40% of the entire domestic aerospace industry's sales. In addition to the strong Middle Eastern arms buying of recent years, he notes that "NATO Europe is coming back" as a market after relative inactivity over the last ten years.

This preeminence in the international systems marketplace itself means, in Mellor's view, that the U.S. technological lead is being maintained. "No one else has the technology to put together all the parts of large systems that we do, and I don't see them catching up." His company serves as an example of the outflow of technology as it continually exports expertise to production facilities in other countries, particularly West Germany and Canada, he says.

The change in administrations likely will have little impact on U.S. defense spending, he believes, looking at President-elect Carter's statements about the need for a strong defense. "And Congress certainly feels that way, too."



DAVID T. KIMBALL

president, Leeds and Northrup Co.

The technological gap between the U.S. and the rest of the world is still wide, argues Kimball. "It's true there are other nations coming up fast, but the United States is maintaining its lead," he asserts.

But there's still reason for alarm, he says. "We do face a considerable risk in that more and more money [industry and Government] is dedicated to regulatory expenses instead of research and development efforts."

The head of the North Wales, Pa., company sees inflation as the major concern for the coming year. "It all depends on whether labor tries to catch up to their old idea of purchasing power," he says. He envisions 1977 as a strong year and doesn't see a downturn on the horizon through 1977 and into the early part of 1978.

For Leeds and Northrup and the process controls industry overall, he doesn't feel the slowness of the recovery has been particularly harmful. "The recovery is slow, but it's healthy," he asserts. "While the capital spending surge that was anticipated in 1976 never really came, business will begin releasing the brakes in 1977."

The degree to which business will increase next year "depends a lot on what Carter does," says Kimball. He believes the overall effect of the new President's policies will be stimulative, "but we hope not too stimulative."



RAY STATA

chairman and president, Analog Devices Inc.

Sure I trust you, but cut the cards, Stata says, in effect, about relying on firm projections of the economy's course. As are many electronics executives, he is unsure about the Carter Administration's plans. And, although encouraged by some state government initiatives, he is generally unhappy about the business climate in Massachusetts.

He doesn't expect 1977 to be as good as 1976, which saw a big recovery. For 1978, "our posture is that the prospects of a bust are dimming, but the probability is high enough that we have to take it into account," he says.

The Norwood, Mass., company is doing so by slowing its rate of hiring and its inventory building. "But we haven't cut back on investments in new-business activities and new products," Stata asserts. "Our spending couldn't be sustained at its present level if there weren't some optimism about future growth."

Back on the plus side, he is buoyed by his belief that the pervasiveness of electronics promised for so long is, in fact, happening—fueled in large measure by the advent of the microprocessor. "We've seen a lot more smoke than fire surrounding microprocessors," Stata says. "But that's because people are taking time to ingest them."



STANLEY J. KUKAWKA

vice president, Allen-Bradley Co.

The view of 1977 from Milwaukee is heady. Kukawka's Electronics division, which is one of the country's largest resistor manufacturers, is predicting a 25% growth in business for the next year.

"We're following a very good year with what I think is going to be a record year for Allen-Bradley and for the electronics industry," he says. "I feel very strongly about that, and I suspect it will become clear to others as we get into the year."

He concedes the possibility that 1978 might be flat, with a pick-up in 1979, "But a flat year to a record year isn't all that bad."

President-elect Carter and an all-Democratic administration will not affect 1977, Kukawka flatly states. "The momentum is already here. Besides that, Carter is already softening his pre-election rhetoric. For example, he's now saying that it may take two or three years to take care of unemployment. He's going to be a statesman and he will do the things that are right for the country, in spite of what he promised. After all, he's a businessman".

Kukawka's biggest problem—the industry's as well, he says—is going to be keeping a grip on manufacturing costs. "Even though inflation is lower than it has been, we still see material and labor costs marching upward. Our problem will be to try to produce a product at a lower cost in order to offset those increases," he says.

continued



GERALD D. PROBST

*president, Sperry-Univac Division,
Sperry-Rand Corp.*

The signs are "more positive than negative" for the next 12 months, says Probst. Despite his optimism, "we should mention certain problem areas," he says. "These include the continuing currency devaluations in many foreign countries, which have affected our profits. Moreover, the twin evils of inflation and recession continue to affect the rate of Western Europe's economic recovery."

While there has been a pause in the U.S. upturn, Probst says, "we believe that this is only a temporary lull, and the business environment will rebound during 1977."

In spite of these pressures, the Blue Bell, Pa., official expects the division's business to continue to prosper and grow "at a faster rate than the computer industry in general."

Turning to select market areas, he sees his firm expanding its business in such emerging markets as the USSR, Eastern Europe, the Middle East, and South America. He also expects to capture a larger share of the business for supermarket check-out systems and of the manufacturing market.

"The state and local government marketplace continues to be one of our strongest growth areas, as local authorities strive to cope with inflationary increases in budgets for services by automating an increasing number of functions," notes Probst.



RICHARD C. FARLEY

president, Burndy Corp.

Despite scattered clouds in the semiconductor and consumer products areas, the electronics industries can look forward to fair weather, says Farley. "It looks good for 1977 and 1978, primarily because we didn't take off radically in 1976. We had slow steady growth, rather than runaway inflation and a runaway buildup."

Farley expects the Norwalk, Conn., firm's electronics business to do considerably better in 1977 than it did this year. This is due largely to its new gas-tight, high-pressure connectors, which were designed into products as industries began to pick up. Now these projects are going into large-scale production.

The slowdown in new orders during the second half of 1976, "which was a little more than expected," has built a good foundation for 1977 and 1978. And Farley doesn't feel there's anything that President-elect Carter could do to affect the industry in that time. In defense spending, where Carter has threatened budget cuts, "programs are already funded and in production, so there's no way they could be stopped on a short-term basis."

While foreign competitive pressures have materialized in the TV and other finished-product areas, Farley doesn't see America's technology lead eroding in the components business. "I don't see any loss of our lead in components, especially not in the connector business, where all of the American companies dominate the foreign markets."



EDGAR H. GRIFFITHS

president, RCA Corp.

Temperate growth of the economy and the electronics industries will continue, says the newly-named chief executive. "I don't see anything dramatic, no tremendous surge. I think we'll have some modest peaks and valleys, which isn't all bad. It helps us to avoid inflation and makes for more efficient management."

For electronics companies, Griffiths believes the greatest concern next year will be the pressure on margins, "fundamentally a very difficult situation with respect to increasing prices."

"I see 1977 as being a little bit of a start-and-stop kind of year. But, as we go out of 1977 into 1978, we'll go in at a higher pitch than we're going into 1977. Even then, it's going to be a well-modulated growth." He also believes it will take a year, or close to it, before the Carter Administration's economic, social, and defense policies begin to evidence themselves in the marketplace.

The television-receiver industry will sell about 7.5 million sets this year, "an improvement over the previous year but not as good as some people were forecasting," says Griffiths. "The consumer is playing it close to the vest. But there were signs that consumer buying took a dramatic pickup about mid-October." The firm's government business, virtually all electronics, is outstanding, he asserts.

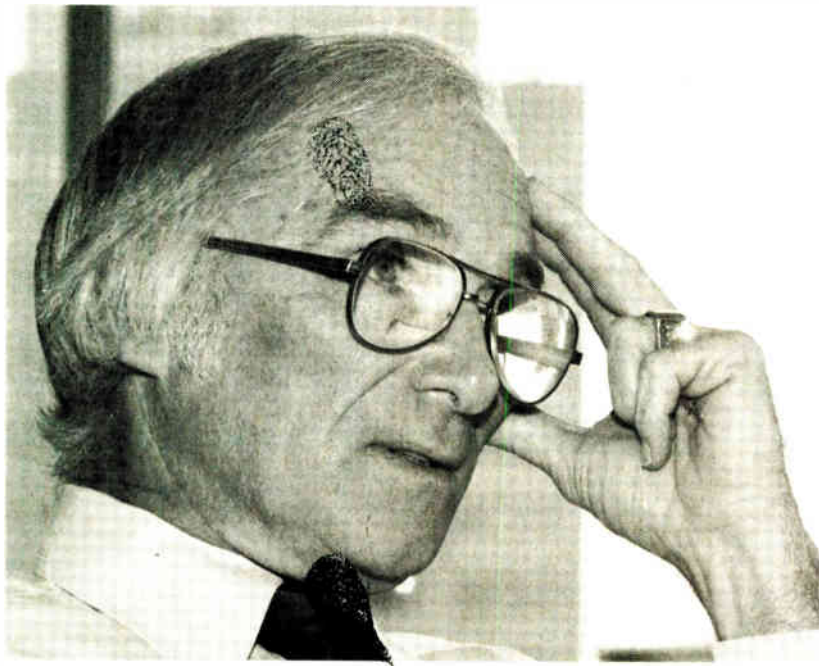

GEORGE J. HART

vice president and general manager, TRW Electronic Components Division

The foreign threat to U.S. technological leadership actually might be a mixed blessing. That's the view of the director of the \$300 million worldwide components operation for TRW's Electronics Group. "The fact that we're talking about it is a good sign," Hart says. The U.S. will continue to need good ideas from others as it always has, and the interchange is healthy, he thinks.

Nor does the domestic economy shape up badly. "We're not forecasting a bad year. If it stays level or only goes up 10%, it's no catastrophe." But, "it is difficult to forecast cyclical business," such as components, he cautions, "because we can't control the end user."

Nobody for the last five years has done a very good job on this type of prediction, he adds, but TRW keeps working at improved techniques of evaluating bookings, industrial averages, and the other standard economic measurements.

Hart, based in Los Angeles, does not see the recent slowdown as entirely negative. By giving companies a chance to digest recent strong orders and to plan without shortages or production pressures, "it's probably a good thing for the country."

In scanning the 1977 horizon, he sees labor demands as the biggest cloud. While workers and unions exert constant pressure to make up for inflation, companies are under heavy price competition, he says. "Printed-circuit prices are still depressed," Hart notes, and component firms selling to the domestic television industry feel the cost effects of its battle with the Japanese.

Indeed, the overall problem of inflation is still very much alive and poses the critical question faced by the new Administration. "I don't know how we can have full employment and low inflation," he says.

As a corporation, TRW has a policy of active discussion with many levels of government and has done so for years. "We spend a considerable amount of time letting them know what we think, and we find they're receptive."

The subjects include foreign and domestic taxes, which are basic to business' ability to provide jobs. As for results of such discussions, "it's hard to tell," Hart says, "but over a period of time it will have an impact."



DONALD R. BEALL

president, Rockwell International Electronics Operations

Specialization will pay off in 1977 for some companies. "Continued growth in our specialized markets" is the prospect, Beall says. Coming off a fiscal year when sales for the first time exceeded \$1 billion, he is confident of further increases.

His organization goes into the new year with a backlog of more than \$300 million in international orders, "which insures continued growth in our worldwide businesses." Beall's operations include Collins Radio, Dallas-based manufacturer of telecommunications and avionics systems, the primarily defense-oriented Autonetics Group, and the Microelectronic Device division, both in Anaheim, Calif. He took over his firm's top electronics post in May of this year, after heading the Collins subsidiary for several years.

The avionics market will be strong for firms with improved products during 1977, he predicts, in both the general aviation and Government segments. Government business, in fact, should show "significant growth."

The Collins telecommunications business, which has been strong, should continue so with new equipment for the microwave and communications switching fields. In the electronic component business, "we have identified new applications that we expect to continue the sharp growth of microprocessors."

"Overall, we are optimistic in our outlook for the coming year," Beall concludes.

continued



SIDNEY L. SPIEGEL

*group vice president,
Wyle Laboratories/Distribution Group*

As the front-line salesmen of electronic components, distribution executives nearly always sport a sunny outlook. It becomes noteworthy, then, when distribution chief Spiegel has to strain to find something good to say about business prospects next year.

"I have to believe sooner or later something will be done to stimulate business, or something will happen to cause an up year. But right now I don't see what evidence anybody has for a strong year in 1977," says Spiegel. As he sees it, other executives in the industry actually agree with his assessment. "But no one wants to say bad things or lower the outlook below 20%."

The problem is, "customers are plain uncertain. No one has a need to place long-term orders," he says. What is even more puzzling about the outlook is what Spiegel terms the peak of uncertainty and how fast it changed. "If you asked me in June, I'd have said 25-30%; in September, 15-20%, and today I don't know," he says. "And I'm not a bear just because we're not getting our share. Our own sales are up 40-45% this year to date."

The basic problem that distribution faces, year in and year out, is its fiercely competitive nature. So, Spiegel says, the new year begins with that worry. "The trouble is that, while 10% growth is good for most industries, for components, it's not good enough." If only a modest upturn occurs, then "it'll be a very competitive year."



ERIC LIDOW

president, International Rectifier Corp.

The November election was good news for the electronics industries, maintains Lidow. "I'm an optimist, not moderate and not cautious," he declares.

His strong views about the bright prospects for the coming year are based on two anticipated developments. The combination of a capital-equipment-based sector that needs to make up for the three-year lack of significant investment and the stimulative economic policies of President-elect Carter should combine to get business back on the track, he believes.

"I feel Carter, who made a commitment to jobs, will have to provide the tools to create them. And that means investment in capital equipment," he says. For such firms as Lidow's Los Angeles-based supplier of high-power switching devices, the scenario he envisions could be a welcome shot in the arm.

While Lidow downplays most problems in the new year, he does say the "tremendous price competition in low-end semiconductors is what bothers me. It's a terribly competitive business." Price cutting could be a troublesome factor, and "anybody can go offshore to cut his costs." Also, "one thing could screw up the recovery—doing away with tax incentives for capital equipment. But I don't believe Carter would do this."



EDOUARD GUIGONIS

senior vice president, Thomson CSF

France's ranking manufacturer of professional electronics equipment expects to log a gain of 17-18% next year, so Guigonis admits he's not spending nights wondering where 1977's business will come from. "What we'll be most concerned with next year is the ratio between order bookings and billings," and the effect of Japanese competitors on that ratio, he says. "As long as it stays above one, we'll know we're not going into a decline."

But keeping the book/bill ratio up won't be as easy as in the past, Guigonis explains. "We used to compete mostly with American and British companies [for export contracts]. Now we're seeing companies from other countries coming in. The Japanese are starting to turn up in bidding for air-traffic control, radar, and that sort of thing."

Already strong in telecommunications exports, the Japanese are a particular worry for Guigonis. "They come in with very low prices in an effort to get 'references' in new sectors of professional electronics," he maintains.

His firm has under its wing a bevy of subsidiaries that produce components and a semiconductor division, Sescosem. Here, the nagging worry is the strong market share of the American giants. "They have a crushing domination in the market and could push us out in six months if they really wanted to," Guigonis argues.



TARO KUNINOBU

president, Matsushita Electronic Components Ltd.

Spring should bring a flowering of the economy in Japan, but Kuninobu sees some potential sources of blight in 1977. If predictions that the inventory glut of citizens' band transceivers in the U.S. will be cleared up by March or April don't pan out, or if the demand is just not as good as expected, the result probably will be oversupply and price competition.

Oil is another concern for Kuninobu and his fellow industry leaders. If the price goes up, it will carry with it the prices of many materials, including steel and nonferrous metals. Increased metal prices will force Japanese firms to strive to reduce materials costs. Added to that should be the perpetually rising wages of labor, he says.

He believes that, in the next five years or so, the Japanese electronics industries will have to find a new path to avoid being crushed between high technology from the U.S. and ordinary products from developing countries. Kuninobu says Japanese firms must plan development and applications for a large share of the market. This may require realignment of the industries and concentration on high-quality and educational products.



LEE L. BOYSSEL

president, Four-Phase Systems Inc.

The curious behavior of the capital spending sector of the economy makes this particular recovery hard to predict, says Boyssel. "Historically, capital spending tends to lag recessionary curves by six to nine months. This time, though, capital spending is lagging more like a year to a year and a half."

With an already sluggish recovery, he sees a slow improvement in spending through June 1977. "Optimistically, we expect it to start turning up toward the end of the first half and end the year on a reasonably strong note. This is pure speculation on our part, because the historical patterns aren't there. And God knows what the economy is going to do. As a result we're being very cautious."

As a maker of intelligent terminals in a rapidly expanding data-processing industry closely tied to capital spending, the Cupertino, Calif., firm should have felt a downturn. But that did not occur, he says.

The reason for the continued strong growth through the recession, he says, "is the sudden realization on the part of major corporations that this thing called distributed processing is a way to save a lot of money." In recessionary times, the company executives become very sensitive about such improvement, he says.



HAROLD H. POPE

chairman, Sanders Associates Inc.

Happy days are here again for defense-oriented electronics companies, say Pope and president Jack L. Bowers. Both are convinced that the new Administration and Congress will, for the first time in years, increase the percentage of the Gross National Product devoted to defense spending. And they are equally bullish about the 20% of New Hampshire firm's \$198 million in commercial revenues.

Pope says that 1977 is difficult to assess, but "I think there's a generally positive sentiment in Congress and the new Administration for maintaining a strong defense posture."

Bowers adds that it's probably not widely recognized that there has been a revamping of funding priorities in Congress over the last several years. "But there are people who are talking as if those priorities hadn't been reordered and saying that there's still a need for large reductions in defense spending. But I feel there's a real belief in Congress that the reordering has gone as far as it can go."

One of Pope's principal concerns is that there isn't adequate recognition by the Government of the pressure on defense-industry profits. Bowers has been heartened recently, though, by action taken by the Cost Accounting Standards Board to make allowance for the cost of money in doing business with the Government.

ANALYSTS EXPECT A HAPPY NEW YEAR

The men on the street—Wall Street—share the consensus of the electronics industries' top executives that 1977 will be an up year. But how high is up? The answer, in the minds of a sampling of analysts who specialize in the electronics industries, depends on confidence in the economy. And that confidence, in turn, depends on a myriad of factors; among them, the gross national product, capital investment, and initiatives in Washington.

"Capital spending looks good and will continue to look good if the overall economy continues to be one of moderate growth. But if it grows too fast, we might be back to the problems of 1974/75," says Hans C. Severiens, vice president and senior technology analyst at Merrill Lynch, Pierce, Fenner, and Smith. But so far, he adds, "the signs we see are encouraging."

"In terms of deflated or real dollars, capital spending in 1976 was down 3–4%, while 1977 will be up 8–9%. Thus, we will see a major shift in physical output," he predicts. "It will be to the benefit of the electronics industries, which did quite well in 1974 and 1975 despite bad economic surroundings and will do fantastically well in 1977 when we have the benefit of a good scenario."

The election of Jimmy Carter, "who seems to be the most conservative of the Democrats and of some liberal Republicans," has set the stage for optimism, he continues. "It adds confidence. If confidence is missing, we won't have a bonanza year in 1977. But if it's there, we will."

Elliot Levine, electronics industry analyst at First Manhattan Co., believes, like Severiens, that the major concern for 1977 is the development of confidence in the economy. Manufacturers aren't building inventory but "they're buying hand-to-mouth," he says. "As a result, there isn't a steady flow of business, but peaks and dips."

Levine also expresses concern over the Japanese and European economies, where he says the outlook for 1977 is more negative than in the U.S. The situation "is very critical," he says, "because a lot of electronics companies in the U.S. are doing 30–40% of their business overseas."

The underpinnings for a pickup in the economy, the

key question for 1977, is a pickup in spending for capital equipment, says Kent A. Logan, vice president for research at Paine, Webber, Jackson, and Curtis.

"We're not going to get a pickup of 4.5–5% in the gross national product unless we have a real pickup of 8–10% in capital spending." An important barometer will be capital appropriations in the fourth quarter of 1976, he says.

Sounding the same theme of cautious optimism is Sal F. Accardo, vice president at Drexel, Burnham, Lambert, who specializes in the semiconductor and instrument industries. His estimate is for a real GNP growth of 4–5%, accompanied by a 7% increase in real capital spending.

Accardo points to the distributors as a key indicator of 1977 semiconductor trends. "At present, these middlemen are seeing strong business trends reflecting an upturn in the broad industrial market, which is composed of small users," he says. "These customers tend to buy long before large users in an upturn."

Economists, too, say that their surveys tend to show that American businessmen are confident that the year will be a good one. For example, a survey of preliminary plans for capital spending done by the McGraw Hill Publications' Economics Department show a 13% increase over the 1976 level for spending on new plants and equipment. The group that includes most electronics industries plans to spend \$3.27 billion, 15% more in 1977 than in 1976. Aerospace companies say they'll put \$1.38 billion into new plants and equipment, 18% more than in 1976.

At the same time, 21% of the respondents in the survey look for rapid growth (5% or more) in the GNP, 61% expect normal growth (3.5–4.9%), and 18% anticipate slow growth (1–3.4%).

And Citibank economists display a measure of optimism by pointing out that there is no need for emergency measures to stimulate the economy. In fact, they say, the third quarter of 1976—the latest surveyed—showed final sales (the measure of the demand for final goods of consumers, business, and governments) up at a 4.4% annual rate, after adjusting for inflation. That is the same rate of increase as in the five previous quarters of the recovery.

Sizing up the curves. Varying degrees of optimism are voiced by First Manhattan's Elliot Levine, left; Drexel, Burnham, Lambert's Sal Accardo, below left; Paine Webber's Kent Logan, below right, and Merrill Lynch's Hans Severiens, right. They see confidence as a key.



Designing with the 6820 peripheral interface adapter

by Jack Gilmore and Ron Huntington
Tektronix Inc., Beaverton, Ore.

A little inside knowledge can save you a lot of design time, even with such a serviceable device as the Motorola 6820 peripheral interface adapter (Fig.1). In working with the PIA, which provides a flexible method of

connecting peripherals to the 6800 microprocessor, be alert for the situations that produce invalid interrupts or cause valid interrupts to be skipped. Also, there is a simple way of making the PIA transfer 16 bits of data very quickly.

Invalid interrupts may occur if the interrupt flag bits in control registers A or B are inadvertently set, for then, a subsequent enable of the interrupt request lines IRQA

1. Peripheral interface adapter. The Motorola 6820 chip, a 40-pin dual in-line package, is a standard adjunct to the 6800 microprocessor and can be used with other processors as well. Those familiar with the device should welcome a few time-saving design tips.

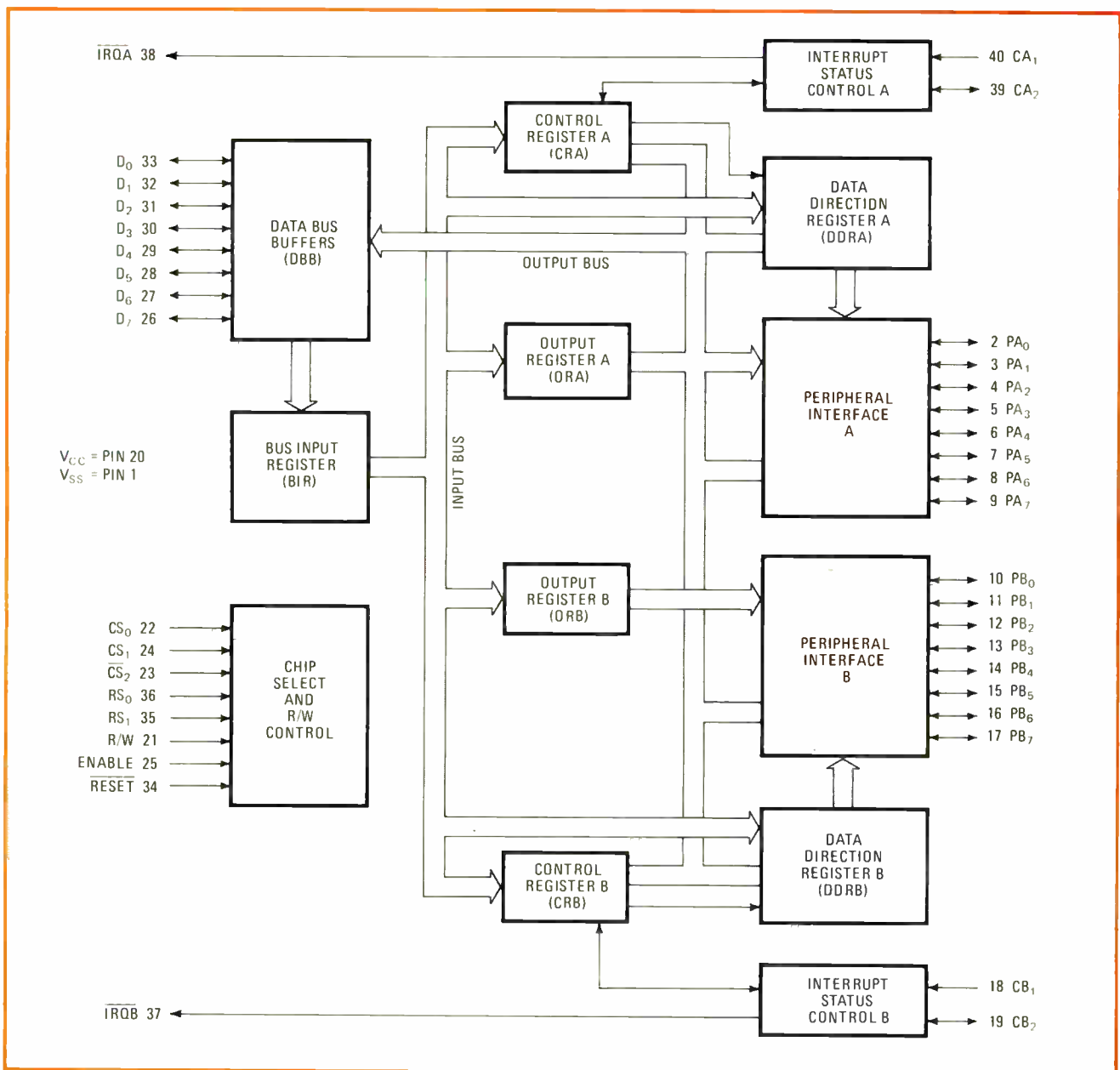

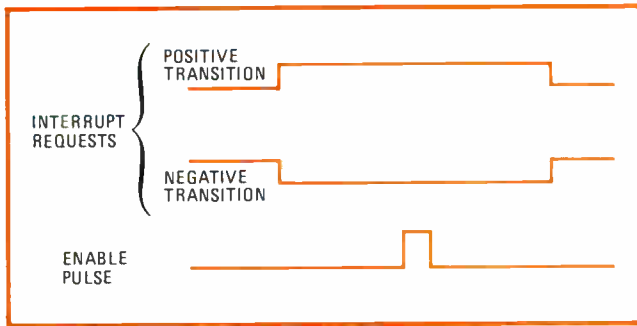

2. Missed interrupts. Neither positive- nor negative-going interrupt request signals on the IRQ lines—the 6820 accepts either—will be recognized unless an enable pulse has occurred since the last transition on the interrupt line. The ϕ_2 clock should be used directly to ensure an enable pulse each cycle.

and IRQB will allow the processor to be interrupted without a valid request. To prevent the flag bits from being set, the interrupt input/output lines CA₁, CB₁, CA₂, and CB₂ should be held high during the reset pulse. To ensure that they are not set improperly, a good idea is to do a “dummy” read of both the A and B data registers prior to the enable sequence.

Valid interrupts may be missed when an interrupt line is enabled during the execution of another interrupt service routine or if the enable signal fails to occur when it should.

Suppose the processor receives a second interrupt request over CA₂ while still servicing an interrupt received earlier over CA₁. Obviously, it has to finish executing the current instruction before processing the second interrupt. But at completion of the current instruction (“read peripheral interface A,” for example), the interrupt flags IRQA₁ and IRQA₂ in the PIA’s control register are reset before the processor can get to the second interrupt. In this way, the second interrupt is missed.

To prevent such a mishap, it is best to restrict the use of interrupt lines CA₂ and CB₂ to peripheral-control outputs and to avoid using them as interrupt inputs.

As for the enable signal, it is as essential to interrupt processing as are the chip-select inputs CS₀, CS₁, and CS₂. Regardless of whether the PIA is programed to accept positive-transition or negative-transition interrupt requests, an enable pulse must have occurred since the last transition (Fig. 2). But if some derivative of the phase-2 clock, instead of the clock itself, serves as the enable input, the enable pulse may not occur every machine cycle. Interrupt requests, which can occur at any time, may therefore be missed.

To prevent this from happening, it is best to use the phase-2 clock directly as the enable signal and in addition to make sure that the time elapsing between inactive and active edges on the interrupt line is greater than the period of the clock.

The handy trick, if you need to dispatch or receive 16 bits of data in a hurry, is to reverse the RS₀ and RS₁ connections to the address bus. Now data to be sent can be loaded into the index register, and, on command, the instruction to store index register will now dispatch the information on consecutive cycles. Conversely, received data can be loaded into the index register for further processing. With this technique, transmission or receipt of data takes only 2 microseconds (two 1- μ s cycles) rather than the 10 μ s required by a normal store-accumulator routine. (This fast transfer is useful for taking advantage of the maximum speed of the 488 bus.)

A final note: to ensure proper operation of the 6820, the reset input should remain low for at least 2 μ s and must be high for at least 1 μ s before the chip is accessed. This information has been detailed in the newer editions of the Motorola 6800 manual. □

Engineer’s notebook is a regular feature in *Electronics*. We invite readers to submit original design shortcuts, calculation aids, measurement and test techniques, and other ideas for saving engineering time or cost. We’ll pay \$50 for each item published.

Calculator notes

Resistance-table program finds nearest standard value

by Charles S. Gaylord
American Telephone and Telegraph Co., Kansas City, Mo.

Designing with precision resistors—those with tolerances of 2% or better—usually forces you into poring over tables and juggling a lot of values. A suitably programed SR-52 calculator can save you all that.

The resistors come in 96 standard ohmic values per decade over a range of 1 ohm to 10 megohms, and each value increments the preceding one by $10^{1/96}$ or 2.42%. The SR-52 program, besides computing which standard value is nearest the one needed, can also step backwards or forwards through the table by either one or four values at a time. The program even makes the display flash if the value found is below 1 Ω or above 10 M Ω .

The table opposite lists the program steps. Specific values within each decade are allotted a grade of 0 to 95; for example, 130 Ω is the 11th grade in the 100-1,000- Ω decade, and 3,090 Ω is the 47th grade in the 1,000-10,000- Ω decade.

The program first analyzes the input value for its grade, finds the nearest standard grade, and translates it into the proper decade. The screen then displays the nearest standard value and flashes if it is not a generally available one. Invalid entries, such as an input of 0 Ω or a negative value, are rejected by the program, which instead flashes a zero in the display. Any flashing output is automatically cleared upon the next entry, or the CLR key can be used.

The first entry is stored in register •R99, the contents of which can only be erased by turning off the calculator. Even if the CLR key is pressed, the program can recall and reenter the contents of •R99. Thus the keyboard and the user registers can be employed for other calculations, such as paralleling ohmic values to obtain a nonstandard resistor or doing delta-wye conversions.

The desired resistance value is entered into C'. The user instructions below also show other operations that may be performed with the A-through-E labels. Note that, in the calculation of the grade, the function

of rounding to the nearest integer is performed by the degrees/decimal conversion key, D.M.S., after fixing the number of decimal places to zero. Rounding with the EE key is another possibility. □

SR-52 PROGRAM FOR FINDING STANDARD RESISTOR VALUES

LOCATIONS	CODES	KEYS
000-001	46 87	LBL 1'
002-003	80 88	if pos 2'
004-005	50 00	st flg 0
006-007	46 88	LBL 2'
008-011	42 00 03 85	STO 0 3 +
012-016	93 05 54 57 00	. 5) fix 0
017-020	37 75 01 54	D.M.S. = 1)
021-024	22 44 00 03	INV SUM 0 3
025-027	42 00 04	STO 0 4
028-030	75 02 54	- 2)
031-035	22 28 42 00 05	INV log STO 0 5
036-039	43 00 02 45	RCL 0 2 y ^x
040-044	53 43 00 03 55	(RCL 0 3 :
045-048	43 00 01 54	RCL 0 1)
049-053	37 42 00 03 54	D.M.S. STO 0 3)
054-058	65 01 00 00 54	\ 1 0 0)
059-062	37 49 00 05	D.M.S. PROD 0 5
063-064	10 94	E' +---
065-067	60 00 89	if flg 0 3'
068-072	85 43 00 00 54	+ RCL 0 0)
073-074	80 77	if pos 4'
075-076	46 89	LBL 3'
077-078	51 69	SBR 9'
079-080	46 77	LBL 4'
081-083	10 22 52	E' INV EE
084-086	60 01 78	if flg 1 5'
087-089	42 09 08	STO 9 8
090-091	46 78	LBL 5'
092-094	22 57 81	INV fix HLT
095-096	46 16	LBL A'
097-100	24 43 09 08	CE RCL 9 8
101-102	90 89	if zro 3'
103	81	HLT
104-105	46 17	LBL B'
106-109	43 09 09 56	RCL 9 9 rtn
110-111	46 19	LBL D'
112-114	22 50 00	INV st flg 0

LOCATIONS	CODES	KEYS
115-116	46 10	LBL E'
117-120	43 00 05 56	RCL 0 5 rtn
121-122	46 11	LBL A
123-124	19 25	D' CLR
125-127	04 41 79	4 GTO 6'
128-130	46 12 25	LBL B CLR
131-132	04 94	4 +---
133-134	46 79	LBL 6'
135-137	60 00 89	if flg 0 3'
138-142	85 43 00 03 54	+ RCL 0 3)
143-146	65 43 00 01	x RCL 0 1
147-149	90 67 54	if zro 7')
150-153	85 43 00 04	* RCL 0 4
154-158	85 93 00 00 01	* . 0 0 1
159-161	95 50 01	= st flg 1
162-163	41 87	GTO 1'
164-165	46 14	LBL D
166-167	19 25	D' CLR
168-170	01 41 79	1 GTO 6'
171-173	46 15 25	LBL E CLR
174-175	01 94	1 +---
176-177	41 79	GTO 6'
178-180	46 13 24	LBL C CE
181-183	75 17 54	- B')
184-185	90 77	if zro 4'
186-188	17 41 78	B' GTO 5'
189-190	46 18	LBL C'
191-193	42 09 09	STO 9 9
194-196	46 67 25	LBL 7' CLR
197-199	09 06 20	9 6 1 x
200-202	42 00 01	STO 0 1
203-207	22 28 42 00 02	INV log STO 0 2
208-210	30 52 07	√x EE 7
211-215	42 00 00 22 52	STO 0 0 INV EE
216-217	17 28	B' log
218-219	70 77	if err 4'
220	86	rset

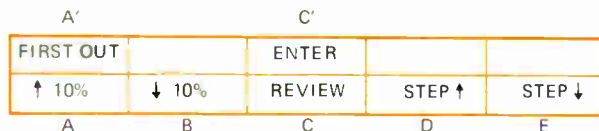

INSTRUCTIONS

- Load both sides of card into calculator.
- Enter any resistance value into C'; nearest standard value will be displayed. If display flashes, resistor is not generally available.

ADDITIONAL FUNCTIONS

- A Increments resistance value displayed by four values in table (↑10%).
- B Decrements resistance value displayed by four values in table (↓10%).
- C Always gives original resistance input; pressing it again returns last displayed value.
- D Increments resistance value displayed to next standard value.
- E Decrements resistance value displayed to next standard value.
- A' Always gives first output value obtained.

Memory produces BCD outputs from 7-segment numerals

Single integrated circuits for converting from binary-coded-decimal to seven-segment coding are readily available, but suppose you want to go in the opposite direction? Then your design can become cumbersome, demanding several logic packages or a large number of discrete gates. But, says Eric Davis, Hudson, Ohio, **a small programable read-only memory makes a simple, inexpensive seven-segment-to-BCD decoder.**

All you need is a 32-by-8-bit PROM, which can cost less than \$1, even in single-unit quantities. To distinguish between the numerals for BCD decoding, only five of the seven segments are needed—a, b, e, f, and g. These are tied to the PROM's address pins A_0 through A_4 . The BCD equivalent of a common-cathode display can then be obtained at the PROM's output pins B_0 through B_3 , or of a common-anode display at output pins B_4 through B_7 .

The truth table for the PROM should be set up so that the output code for a blank is 1111 and the output code for a minus is 1100. Also, the output code for a common-cathode "2", which has an address of 10111, works out as 0010 on pins B_3 through B_0 .

Use rubber breadboards for flexible prototyping

How about a rubber breadboard? As unlikely a material as Dow Corning's Silastic J RTV silicone rubber can offer a fast, easy, and economical way to build prototype circuits, says B. W. Hart, president of Westec Engineering Inc., Colorado Springs, Colo. Westec's engineers found that a circular silicone rubber board, 10 inches in diameter and 1 inch thick, can be made for less than a third the cost of a plastic or metal-clad breadboard. The rubber boards can be drilled or cut to hold components, and **wires and component leads can be stabbed or stapled into the rubber and just as quickly removed.** The rubber easily withstands the heat of soldering. If a new work surface is needed, a thin layer of fresh silicone rubber can be bonded to the existing surface.

How to stay on top of fiber-optic communications . . .

If you're working on communications systems that use optical fiber as the transmission medium, you'll be interested to hear of the newly formed Fiber Optic Communication Information Society (Focis). Its goal is to promote the spread of fiber-optic data communications by increasing the exchange of information between manufacturers and users and by providing **news about the state of the art, commercially available, off-the-shelf products, and system design information.** A year's membership costs \$20 from Focis, P.O. Box 2264, Vernon, Conn. 06066, and brings with it an introductory booklet on the subject, plus a collection of technical data, literature, and industry data sheets.

. . . plus an easy way to access data communications

We've just received a pretty good basic book on data communications networks: "Anatomy of a Computer Communications Network," by Joseph A. Scarpa, national sales manager for computer products for International Communications Corp. It's a 100-page paperback that sells for \$7.50 from the company at 8600 N.W. 41st Street, Miami, Fla. 33166. If you're just entering the field, **the book could go a long way toward steering you through all the new specialized terminology and concepts.**

Stephen E. Scrupski

IN WIRE-WRAPPING HAS THE LINE... HOBBY-WRAP-30 FOR AWG 30 WIRE ON (.025 SQUARE POST)



STRIP

WRAP

UNWRAP

OK MACHINE & TOOL CORPORATION

3455 CONNER STREET, BRONX, NEW YORK, N.Y. 10478 U.S.A. • PHONE (212) 994-6600

TELEX: 125091 TELEX: 232395

Circle 89 on reader service card

TOUCH-TONE*



Telenetics 7603 is a complete Touch-Tone generator and automatic dialer sub-system packaged in a 1/2 cubic inch 32 pin DIP. Telephone standard 2-of-8 tones are transmitted in the conventional manner from manual keyboard entries, or automatically from either internal or external stored program sources. Key entry codes may be 1-of-16, 2-of-8 or binary. Timed output control leads provide line seizing and handset transmitter/receiver muting functions suitable for both telephone and 2-way radio system operation.

Signal purity is assured through a (patent pending) digital synthesis technique that yields less than 1% THD with a worst case (16th order) harmonic product that is 40 dB down from the fundamental. Operating voltage range is 5.5 to 28 volts DC (single supply). Standby current drain 1/2 MA. Typical. Temperature range -30 to 70° C.

- 7507 Analog Switches
- 7508 Multiplexers
- 7509 Solid State Switches
- 7511 Address Selector
- 7516 Touch Tone Decoder
- 7635 Keyswitch Assemblies

Call or write today for catalogs, prices and applications assistance

Telenetics Telenetics, Inc., 4120 Birch Street,
Newport Beach, California 92660
Phone: (714) 752-6363

*R-Registered trademark of AT&T

Circle 109 on reader service card

1702A MANUAL EPROM PROGRAMMER

Features hex keypad, two digit hex address and two digit hex data display. Controls include load, clear, go! (step), key/copy, data in/ data out, and counter up/ down. Profile card includes high voltage pulse regulator, timing, 8 bit address and 8 bit data drivers/receivers. Two 6 1/2" x 9" stacked cards with spacers. Allows programming in 20 minutes - copying in 5 minutes. Requires +5, -9, and +80 volts.

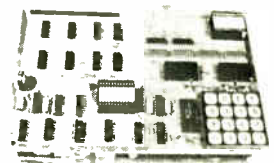

ASSEMBLED \$299.95
KIT \$189.95

NOW

The best of two worlds... use our 1702 EPROM programmer as a manual data/address entry programmer... or connect it to your processor.

IMSAI/ALTAIR computer interface (requires 3 output ports, +1 input port) and software \$49.95

Briefcase unit with power supplies and interface connectors (assembled and tested only) \$599.95

ANNOUNCING

Our NEW 16K Byte Pseudo-Static, IMSAI/ALTAIR compatible RAM. Single card slot. Uses less power than equivalent low power RAM. All memory chips socketed. Uses all prime, factory fresh ICs. High quality, two-sided, through-hole-plated circuit board. Crystal controlled, totally invisible refresh system requires NO software management. Just plug it in and use like STATIC memory.

Complete kit \$349.95
Assembled, tested, and burned in \$549.95

ASSOCIATED ELECTRONICS

12444 Lambert Circle • Garden Grove, CA 92641
(714) 539-0735

Circle 110 on reader service card 89

You Don't Have To Beg, Borrow Or Buy...



Rent'em From GE

Short or long-term instrument rentals give you flexibility and economy.

GE has over 9,000 instruments available for immediate shipment: □ Tek Scopes □ Biddle Megger Insulation Testers □ H-P Signal Generators □ Honeywell Oscillographs □ Complete Data Systems □ Esterline Angus Recorders □ GE Chart Recorders □ Modems □ Communication Terminals ... all calibrated to the manufacturer's specs.

We have over 100 Sales/Service Centers,

and one of them is near you. In addition to maintaining our Rental Inventory, they can also repair and calibrate your own equipment.

Don't borrow someone else's GE Rental Catalog. **Call collect (518) 372-9900** or your nearest Sales/Service Center.

**Quick·rental[®]
instruments**

GENERAL  ELECTRIC

ALA. BIRMINGHAM (205) 925-3101 • **ARIZ.** PHOENIX (602) 278-8515 or 8516 TUSCON (602) 294-3139 • **CAL.** LOS ANGELES (213) 674-7900, SAN FRANCISCO (415) 436-9260 • **COL.** DENVER (303) 371-1260 • **CONN.** SOUTHINGTON (203) 261-4059 • **FLA.** JACKSONVILLE (904) 751-0610 • **GA.** ATLANTA (404) 458-2231 • **ILL.** CHICAGO (219) 933-4500 • **IND.** INDIANAPOLIS (317) 639-1565 • **KY.** LOUISVILLE (502) 452-3311 • **LA.** NEW ORLEANS (504) 367-6528 • **MD.** BALTIMORE (301) 837-4500 • **MASS.** BOSTON (617) 396-9600 Ext. 160, SPRINGFIELD (413) 781-1111 • **MICH.** DETROIT (313) 285-6700 Ext. 212 or 209 • **MINN.** MINNEAPOLIS (612) 522-4396 • **MO.** KANSAS CITY (816) 231-4377, ST. LOUIS (314) 342-7835 • **N.J.** CLIFTON (201) 471-6556 • **N.Y.** BUFFALO (716) 876-1200, SCHENECTADY (518) 385-2195 • **N.Y.C.** CLIFTON, N.J. (201) 471-6556 • **N.C.** CHARLOTTE (704) 525-0311 • **OH.** CINCINNATI (513) 874-8512, CLEVELAND (216) 523-6382, TOLEDO (419) 691-3501 • **OR.** PORTLAND (503) 221-5101 • **PA.** PHILADELPHIA (609) 424-4450, PITTSBURGH (412) 462-7400 • **TEX.** DALLAS (214) 357-7341, HOUSTON (713) 672-3569 • **VA.** RICHMOND (804) 232-6733 • **WASH.** SEATTLE (206) 854-0211 • **W.V.** CHARLESTON (304) 346-9421 • **WISC.** MILWAUKEE (414) 744-0110 • **PUERTO RICO** PONCE (809) 843-4225.

Generator covers 100 Hz to 1 GHz

Synthesized signal source spans broad spectrum in single range; communications test instrument offers resolution of 100 hertz

by Bernard Cole, San Francisco bureau manager

Taking advantage of the experience gained through its 1-to-10-gigahertz microwave-frequency synthesizer, Systron-Donner Corp. has started production of its first signal generator to cover from 100 Hz to 1 GHz in one range. In addition to this wide range, the model 1702 synthesized signal source provides 100-Hz resolution to the user.

In contrast, today's signal generators typically have an upper limit at 512 megahertz and a resolution anywhere from 100 Hz to 10 kilohertz, depending on the range, notes Norm Whitla, communications-test-equipment manager. On the other hand, some systems can cover the spectrum up to 512 MHz in one range, but resolution is anywhere from 1 to 10 kHz.

Higher-resolution systems can achieve the same 100-Hz level, he says, but only by breaking the spectrum down into five or six separate ranges. The model 1702 is accurate over its frequency range to within 0.07 part per million compared with, typically, about 1 to 10 ppm for most systems.

Base prices on most systems range today from about \$2,600 at the low end to about \$6,400 at the high end. The model 1702 costs \$4,150 and has double the frequency range of conventional signal generators. "With the model 1702, not only can a user cover the 512-MHz communications band and go down to about 400 kHz, he can also cover the newer 940-MHz mobile range at the high end and 100 kHz at the low end," Whitla says. "So one instrument covers nearly all applications—two-way fm equipment, i-f range, mobile equipment, communications range,

paggers, and military receivers."

Robert Mayer, project engineer, explains that the model 1702 uses a phase-lock technique in which a discriminator is summed with the modulator input, which in turn controls the frequency of an oscillator. "But whereas others chose to improve accuracy and resolution by concentrating on the oscillator," says Lawrence Kaye, chief engineer for communications equipment, "we chose to improve the discriminator by using a chopper-stabilization technique so that the fm is dc-coupled, and not ac-coupled as it is in other systems."

"Where other instruments require a crystal that must be very stable with temperature, in the model 1702 we don't have to worry about that at all," Mayer says. "And since the modulation is dc-coupled, it's a relatively simple matter to sweep over

very small, as well as very wide, ranges with good resolution."

The model 1702 has a maximum power requirement of 75 watts. Frequency is selected with digital controls, and output levels are shown on a 3-digit LED display.

Modulation modes may be operated internally, externally, or in combination. Output level is variable from 1 volt to 0.1 microvolt, with automatic leveling of about 0.5 decibel typical.

Rf accuracy is within ± 1 to 1.5 dB over the range of 100 kilohertz to 100 megahertz and ± 1.5 to 2 dB up to 1 gigahertz. Residual fm noise is 50 to 100 hertz rms. Residual a-m noise (with bandwidth of 0.1 to 3 kilohertz) is less than 0.1% at +13 dBm.

Systron-Donner Corp., Concord Instrument Division, 10 Systron Dr., Concord, Calif. 94518 [338]



New products

Components

Relays switch 480 V at 40 A

Solid-state ac devices
come with output currents
of 15, 25, or 40 amperes

A series of solid-state ac relays, designed for high line-output voltage applications of up to 480 volts rms, has optical isolation of 3,750 v-rms between control and load circuits. This six-model series 621, with output current ratings of 15, 25 and 40 amperes, is said to be particularly suitable for three-phase switching applications for high line voltages used in Europe. The solid-state relays have a transient peak voltage rating of 800 v.

To attain the higher ratings, Teledyne Relays of Hawthorne, Calif., decided that an entirely new design was necessary, instead of adapting a conventional device by changing

internal circuitry, says Tony Bishop, product manager.

The goal was to produce a unit that could be encapsulated to protect it against arcing at high voltages. The resulting case configuration, with deeply recessed terminals, also accommodates the standard relay-attaching screw.

The six 621 modules have input-control voltage ranges of 3–14 and 12–32 v dc in each of the three lead-current ratings: 15, 25, and 40 A. All have peak surge-current ratings of up to 10 times the maximum steady-state ratings, for 16 milliseconds. A dv/dt specification of 200 volts per microsecond not only represents a very rapid turnoff, but provides added assurance against false triggering from transients with a high rate of rise, Bishop says.

The level of isolation is attained with an optical-coupling device built by an external supplier from Teledyne specifications. The coupler is fabricated of either glass or a hard epoxy, rather than the silicone dielectric materials used in other relays, according to the company.

Silicone does not have the necessary reliability at high isolation voltages, particularly in the 4,000-v range required in applications outside the U.S., he explains.

In testing the relays, Teledyne employs a step-applied ac voltage equal to the rms-breakdown point, rather than the usual ramp-applied dc-voltage technique. This more rigorous approach, for both the optical coupler and completed relay, contributes to meeting high final performance and safety requirements, the spokesman says. The 621 measures a maximum of 1.76 in. wide by 2.81 in. long by 1.22 in. high.

Prices in quantities of one to 24 are \$35.40 for the 15-A unit, \$37.25 for the 25-A, and \$44.85 for the 40-A device. In quantities of 5,000, comparable prices are \$19.95, \$21, and \$25.30.

Teledyne Relays, 3155 W. El Segundo Blvd., Hawthorne, Calif. Phone (213) 973-4545 [341]

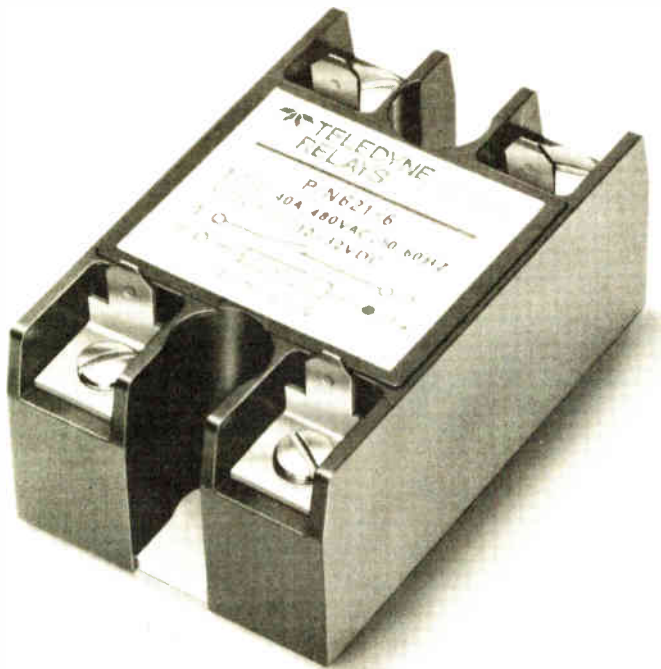

Switch uses formed wires
as springs, contacts, and pins

A push-button switch with only four parts employs two formed wires as contacts, springs, and terminals. Its two other parts are a plastic base and a plastic button plunger. Because of the torsion-bar effect of the wires, contact bounce is typically on the order of microseconds rather than milliseconds, as is typical of snap-action switches. And because the contact surfaces move against each other, they are wiped clean with every actuation. The wire terminals are suitable for both soldering and wire-wrapping, according to the company.

Nominal switch life is greater than 10 million cycles when switching 400 milliamperes at 12 volts. Operating force is approximately 5.8 ounces, with a low-force (3.8-oz) version also available. Designed for direct-strip or matrix mounting on printed-circuit boards, the switch is 0.5-inch square and comes in regular and low-profile versions. A single-pole, single-throw device is standard.

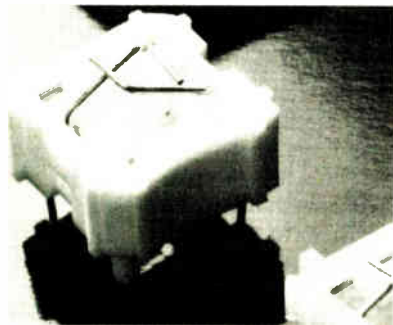

but a double-size dpdt unit is also offered.

For reliable dry-circuit operation, the phosphor-bronze wires are gold-plated over nickel.

RTC Inc., 343 East Fillmore, St. Paul, Minn. 55107. Phone Tom Probst at (612) 222-7488 [343]

Push-button switch
plugs into edge connector

A push-button-switch assembly built directly on a printed-circuit board eliminates soldering problems by plugging into an edge connector. This approach not only eliminates such soldering-related problems as flux contamination of the switch, it also provides a small pc board for complex switch-wiring.

At present, a four-switch assembly and a one-switch assembly are available. Operational modes include momentary-contact, push-push, and interlock. The manufacturer plans to

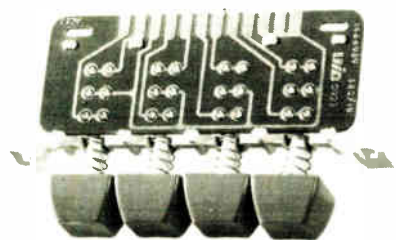

develop a complete line of similar switches. In large quantities, the assemblies sell for approximately 50 cents per switch. Delivery of the devices is from stock.

UID Electronics Division, AMF Inc., 4105 Pembroke Rd., Hollywood, Fla. 33021. Phone (305) 981-1211 [344]

New Space Saver coolers for TO-3 cases meet competition spec for spec — at 1/2 the price.

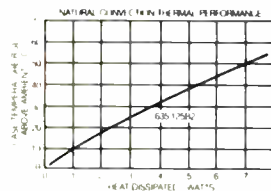

It's true. Wakefield's new Series 635 Space Saver Cooler is directly interchangeable with Thermalloy's 6013 series and replaces other TO-3 heat sinks — yet costs only 11¢ each in 5,000 quantity.

If you're looking for lightweight, one-piece TO-3 heat sinks, you should discover Series 635. We also offer the 635 with hole patterns for TO-66 and TO-220 packages.

Try one free:

See for yourself. Indicate your specs, then cut out and mail for a free sample.

Height: .50" .75" 1.00" 1.25"
Finish: Plain Black Anodize
Configuration: TO-3 Standard TO-3 (8 pin)
 TO-66 TO-220



WAKEFIELD ENGINEERING INC.

77 AUDUBON ROAD WAKEFIELD, MA 01880 (617) 245-5900
TWX 710-348-6713 AN E&G COMPANY

Circle 93 on reader service card

Cut out and mail for a free sample.

The Answer Book. It makes your job easier. \$25.

"What companies make the products I need? How do I contact them locally? How do I get their current catalogs fast?"

Ask The Answer Book. Over 4000 products, 6000 manufacturers with their local contacts, directory of trade names and catalogs, inquiry "bingo" card for 5-second ordering of current catalogs.



Electronics Buyers' Guide

1221 Avenue of the Americas, N.Y., N.Y. 10020

Yes, send me a copy of The Answer Book. I've enclosed \$25 (USA and Canada only, elsewhere send \$35). Full money back guarantee if returned within 10 days.

Name _____

Company _____

Street _____

City _____

State _____

Zip _____



Data handling

Data General offers disk units

Mini maker produces own IBM-3330-type drives, uses only three circuit boards

Teaming small computers with large data bases is a growing trend—and one that Data General Corp. is all set to share in. It is the first mini-computer maker to design and manufacture high-capacity 3330-type disk drives. Introduction of the models 6060 (96-megabyte capacity) and 6061 (192 megabytes) fills out the company's line of memory and storage elements, which now ranges from magnetic cores and semiconductor circuits to magnetic-tape and disk units.

Carl Carman, vice president for

engineering, says that, by tailoring its IBM-3330-type units to the needs of its larger Eclipse and Nova file-based computer systems, the company can cut both its own and its customers' costs.

But performance has not been compromised, he emphasizes. Both units have a data density of 4,040 bits/inch and transfer rates of 806,000 characters/second. Both have dual ports to allow sharing of the data base by multiple processors, and both protect the system from most data-transfer errors by adding an error-correcting code to data in every track sector. Instead of a 51-bit error-correcting code, which is more usual in 3330-type units, Carman says Data General uses a 32-bit code to reduce program overhead and increase disk efficiency.

Other innovations he cites are the use of phase-locked-loop integrated circuits in the interface controller and just three printed-circuit boards. The purchased units that Data General previously offered used 35

boards. But the reduction to three means far fewer connectors and less cabling in the cabinets, which in turn leads to greater reliability and easier servicing.

The phase-locked-loop ICs have been borrowed from communications technology. They slash the parts count in the track-following and data-recovery circuitry in comparison with other 3330-type disks, which Carman says employ mainly discrete components. The phase-locked loops establish a stable reference to recover data coming off the disk at different frequencies as the motor runs at varying speeds.

Robert Kiburz, marketing specialist in magnetic peripherals, adds that the units have been tested for six months at Medical Information Technology Inc., Cambridge, Mass., a supplier of systems and time-sharing services for the health industry. They have been linked to dual Eclipse C/300 processors, serving more than 30 terminals with good error detection and data recovery, adds a Meditech executive.

Price of the model 6060 subsystem is \$24,950, and delivery time is 60-90 days. The 6061 sells for \$29,950, and delivery time is 150 days after receipt of order.

Data General Corp., Route 9, Southboro, Mass. 01803. Phone Robert Kiburz at (617) 485-9100 [361]



Math package increases programing flexibility

Designed as an addition to Computer Automation's basic software and documentation support for the company's LSI-3/05 and LSI-2 series computers, an arithmetic and statistical library package gives the user flexibility in developing his own programs by eliminating the need to write commonly required functions. Arithmetic subroutines available in the math package include floating-point, fixed-point and fractional addition, subtraction, multiplication, division, and compare functions. Single- and double-precision capabilities give the user a choice of the

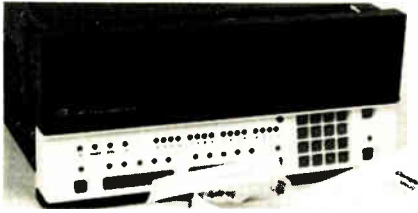

degree of accuracy in performing fixed-point and fractional operations. In addition to the math package, materials supplied include a minicomputer handbook, conversational assembler, utility system, and test routines for the LSI 3/05 and LSI-2. The entire package sells for \$140.

Computer Automation, 18651 Von Karman, Irvine, Calif. 92713. Phone (714) 833-8830 [364]

MOS chip controls flexible printer

Built around a dot-matrix impact-printing mechanism, a stand-alone printer system called the model 140 uses a custom-made metal-oxide-semiconductor chip that gives the user an unusual level of control and flexibility. The chip provides variable-density character generation as well as a 48-character buffer and control logic and timing. Also included in the 140 is a power supply, solenoid drivers, motor control, and all the electronics necessary to operate the printer from external ASCII characters and commands. Character width may be controlled from simple external commands, at the beginning of a line or anywhere within a line, as many times as desired. The user may elect to print characters at a density of 12 charac-

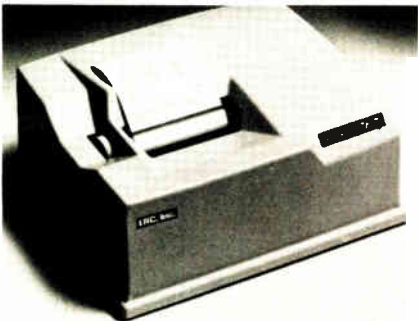

ters to the inch, 10 to the inch, or other density. Characters of double width may be printed at any time by giving the printer a simple command.

Single-unit price is \$495, and OEM discounts are available. Deliveries will begin next month.

LRC Inc., Technical Research Park, Riverton, Wyo. 82501 [365]

Diskettes tailored to minifloppy disk drives

Measuring 5.125 inches in diameter, a recording disk called a Minidiskette is being marketed by Dyan Corporation for use with the minifloppy disk drives developed by Shugart Associates. A standard flex-



ible disk is 7.88 in. in diameter. The Minidiskettes are available in soft-sectored and hard-sectored versions. An alignment diskette is also available. Soft-sectored Minidiskettes have only one index hole. The hard-sectored versions have 10 or 16 sector holes on the inside diameter. The Minidiskette has the same 0.003-inch mylar substrate and oxide coating as standard flexible disks. Life is specified as a minimum of 3 million passes per track. The units are packaged five to a box, and the minimum order is 10 diskettes or two boxes for \$45.

Dyan Corp., 2388 Walsh Ave., Santa Clara, Calif. 95050. Phone William Harry at (408) 247-4109 [366]

Graphic display system uses 2 microprocessors

Because it uses two microprocessors, an interactive graphics display system can be operated as easily as a standard desk-top computer terminal. The display, made by Sanders and called the Graphic 7, is compatible with most computers through an RS-232 interface or a high-speed parallel interface. It is also compatible with the Sanders Graphic 5 product line and is preprogrammed for interactive operations. When used with an optional Fortran graphic subroutine package, it allows the user to begin applications programming immediately.

The heart of the Graphic 7 system is the terminal controller, which includes two microprocessors—a display processor and a graphic controller. The display processor is a general-purpose unit that operates with 16-bit words or 8-bit bytes.

A basic Graphic 7 system is priced at \$32,800.

Graphic Systems, MDS Division, Sanders Associates Inc., Daniel Webster Highway, South, Nashua, N.H. 03060. [363]

Data-acquisition module consumes only 1.5 watts

As microprocessors make it possible to collect and analyze data in the field, a demand is developing for support equipment with sufficiently low power consumption to allow battery operation for a reasonable period of time. Such a piece of equipment is the DT57C01 data-acquisition module. This 16-channel system consumes only 1.5 watts—approximately one third that of standard TTL models. Other than its reduced power consumption, the DT57C01 is similar to its TTL equivalent, the DT5701. Throughput rate is 35 kilohertz, resolution is 12 bits, and small-quantity price is \$295, dropping to \$175 in hundreds.

Data Translation Inc., 23 Strathmore Rd., Natick, Mass. 01760 [367]

Industrial

CRT display simplified

Process-control format and faceplate graphics minimize operator training

By designing the cathode-ray-tube display in process-control systems with the needs and duties of control-room operators in mind, Foxboro claims to have developed a display that is truly easy to understand. Called the Videospec, the system includes a variable-function keyboard in which unmarked keys are assigned functions according to labels on the video screen directly above each key.

The Videospec divides plant infor-

mation into eight categories, which are further subdivided into eight groups of eight loops each. By displaying no more than eight related units of information at a time, Foxboro hopes to markedly decrease the confusion and errors in interpretation. Information is organized in hierarchical fashion, from general to specific levels of operation, so as to lead the operator directly from panel-alarm notification to the specific loop causing the trouble.

A typical display could include overall plant status, the status of a particular process, or the information on as many as eight loops. Individual process loops are displayed in graphics like those on the faceplate of the process controller, providing the operator with familiar values and symbols. The graphics are supplemented with readouts of tags, set points, alarm points, and other information in digital format to save time

in filling out logs and shift reports, the company points out.

Logging is further simplified by a versatile approach to monitoring, trending, and recording. Two types of trending are available—real-time and historical—and either one can be displayed on screen, or drawn by an optional pen recorder. Because the display is updated as frequently as every 5 seconds, an operator who, for example, decides to change the level of liquid in a tank, can watch the change occur in real time on the CRT display.

Also offered is an optional video copier that can immediately duplicate any display on the screen at any time at the push of a button. The Videospec is designed to plug into Foxboro's existing Spec 200 installations.

Prices with the optional process-alarm unit start at about \$28,000, and delivery time is about 22 weeks.

The Foxboro Co., Foxboro, Mass. 02035 [371]

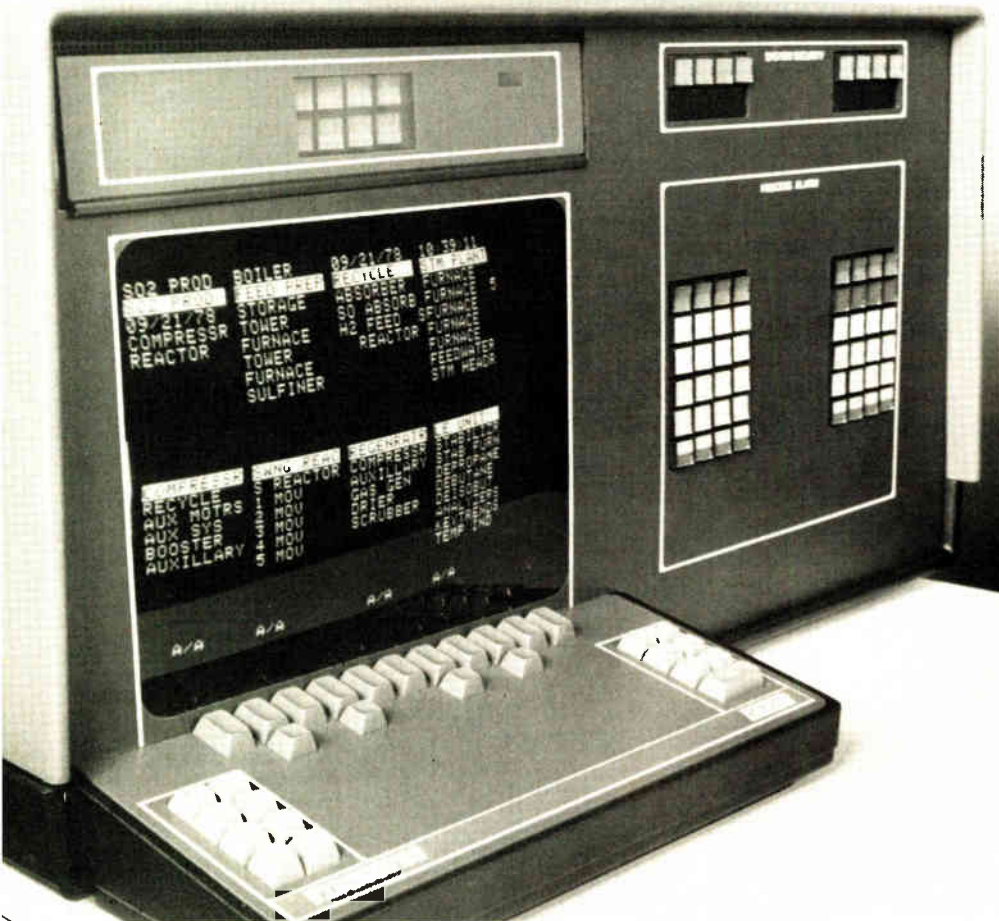

Control multiplexer requires no computer

Automated industrial processes usually send thousands of control signals scurrying throughout a plant, and often multiplexing offers the only alternative to costly wiring installations. Most of these multiplexers require a minicomputer or a microcomputer, but Cutler-Hammer has developed a stand-alone system.

Called Directrol, the self-contained system directs control and monitoring signals between central locations and operating equipment by means of a single shielded pair. A regional group of devices is connected to a local terminal station, and the shielded pair links these stations in daisy-chain fashion, with each acting as a signal repeater. The distance between terminal stations can be as great as a mile. Included in the loop of up to 128 terminals is a single communications station, which monitors the system and keeps the data-carrying signals circulating.

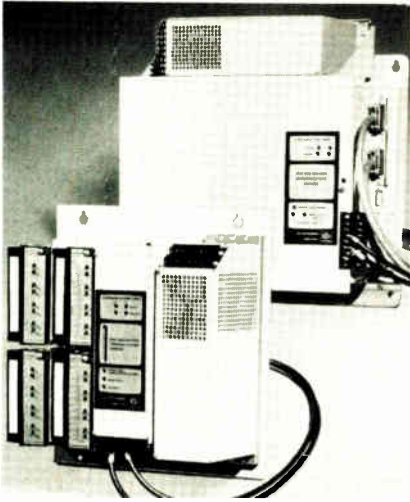

The communications station, which can be located anywhere in the loop, may be connected to a computer for automatic monitoring and control.

A Directrol system can handle up to 4,096 input/output devices. The system is immune to factory electrical noise, the company says, and it provides automatic bypass of a malfunctioning station without disturbing continuous-flow processes.

The smallest basic system is priced at \$6,000, and the installed cost of cable ranges from less than \$1 to \$2 per foot, depending on the installation. Delivery time is about 20 weeks.

Cutler-Hammer Inc., 4201 N. 27th St., Milwaukee, Wis. 53216. Phone (414) 442-7800 [372]

Dc-dc position transducer lasts over 10^8 rotations

A wiperless dc-dc rotary position transducer has a proven rotational life in excess of 100,000,000 rotations. The electromagnetic transducer works with an electronics package consisting of excitation and conditioning circuitry. Together, the two elements produce a smooth, continuous dc voltage proportional to shaft rotation.

Featuring infinite resolution, the transducer has a dead band of less than 0.02° . Starting torque is less than 0.1 ounce-inch, and both accuracy and linearity are within

0.05%. The rotary transducer is approximately 1.5 inch in diameter by 1.3 in. long. Its electronics package measures 2 by 2 by 4. In small quantity, the system sells for \$295. Delivery is from stock to two weeks.

Astrosystems Inc., 6 Nevada Dr., Lake Success, N.Y. 11040. Phone (516) 328-1600 [376]

Tiny pressure transducers provide 300-mV output

Four subminiature pressure transducers that can withstand a 10,000-g shock measure only 0.092 inch in diameter by 0.75 inch long. Capable of a 300-millivolt full-scale output, they are easier to work with than low-output devices.

Key applications of the transducers will be in situations where the disturbance of fluid flow must be minimized: wind tunnels, turbine engines, shock tubes, aircraft intakes, and space vehicles are typical examples.

The four models in the 8507 series have full-scale pressure ranges of 2, 5, 15, and 50 psi. A vent tube at the rear of each model allows it to make differential or absolute measurements. For absolute measurements, the vent must be connected to a vacuum.

Two important features of the new transducers are an integrated temperature-compensation circuit, located next to the pressure sensor, and a maximum overrange nonlinearity of 3% at 3 times full scale. The compensation circuit keeps the

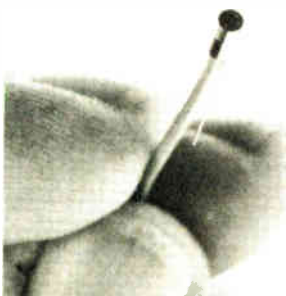

sensitivity shift within 2% of full scale.

Endevco D.I.D., 30700 Rancho Viejo Rd., San Juan Capistrano, Calif. 92675. Phone Jon Wilson at (714) 493-8181 [373]

Noncontacting instruments measure temperature

The Barnes Instatherm is a compact noncontacting thermometer that indicates the temperature of any object or area that can be seen in its viewfinder. The temperature reading is displayed on a built-in meter. A push button on the top of the instrument can be depressed to hold the meter reading.

Instatherm is available in three temperature ranges: -10° to 60°C ,

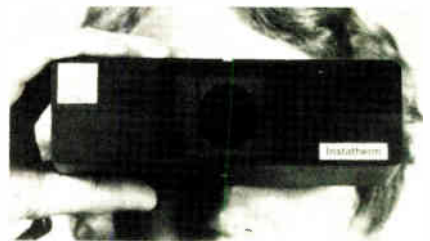

0° to 200°C , and 0 to 600°C . In addition to making absolute temperature measurements, the device can detect small temperature differences by being operated in its differential mode. Instatherm sells for \$700.

Another temperature-measuring instrument from Barnes, called ThermAtrace, shows the temperature distribution across its field of view by superimposing a thermal A-trace on a visual image of the remote object or area.

For hard-copy recording, an optional photographic system using the Polaroid SX-70 is available. The photo will show what the user is looking at, a horizontal line showing the locus of scan points, a trace of the temperature distribution along this line, and a digit identifying the temperature range being used.

ThermAtrace's five ranges are: 10, 30, 100, 300, and $1,000^\circ\text{C}$. It sells for \$6,000.

Barnes Engineering Co., 30 Commerce Rd., Stamford, Conn. 06904 [375]

Classified section FOR ENGINEERING/TECHNICAL EMPLOYMENT OPPORTUNITIES

CLASSIFIED SALES REPRESENTATIVES

Atlanta Joe Lane 404/892-2868
 Boston Holt Buchanan 617/262-1160
 Chicago Bill Higgins 312/751-3733

Cleveland Mac Huestis 216/781-7000
 Dallas Paul Reiss 214/742-1747
 Denver Shirley Klotz 303/837-1010
 Detroit Mac Huestis 313/873-7410

Houston Paul Reiss 713/659-8381
 Los Angeles Stan Kassin 213/487-1160
 New York Dave Hawksby 212/997-3594
 Philadelphia Dan Ferro 215/568-6161

Pittsburgh Dan Ferro 412/391-1314
 San Francisco M.E. Kenny 415/362-4600
 Stamford Holt Buchanan 203/359-2860
 XEROX 100 TELECOPIER 212/997-6800

ENGINEERING CAREER OPPORTUNITIES VALLEY FORGE AREA

Excellent growth positions have developed in our Engineering Department for professionals interested in career development

PRINCIPAL ELECTRICAL ENGINEER

Individual to be responsible for design and development of a capstan servo system for low and medium speed incremental tape drives employing high density recording. 10 years experience with servo mechanisms and feedback control systems from conceptual design through hardware debug and incorporation is essential. Experience in closed loop computer simulation desirable. Individual should have 3-5 years experience in design and development of capstan control systems for standard half inch tape drives of 125 ips and higher. BSEE required. MSEE preferred.

SENIOR MECHANICAL ENGINEER

...to work on high performance tape transport design. Must have experience in analytical and product design of tape path including tape handling, tape dynamics, air bearing and head contour designs. Background in computer simulation techniques is desirable. BSME with 5 to 7 years associated experience is acceptable. MSME preferred.

SENIOR ELECTRICAL ENGINEER

Responsible for design of advanced data recovery circuitry associated with high density magnetic recording. Requires a minimum of 6 years experience on both analog and digital circuitry. BSEE required. MSEE desirable.

MAGNETIC RECORDING HEAD DESIGN ENGINEER

Mechanical/Electrical Engineer experienced in design of high resolution magnetic recording heads for half inch tape. Must be knowledgeable in contour analysis and tape path interfacing. Position requires 6 to 10 years related experience and advanced engineering degree. PhD preferred.

SENIOR ELECTRICAL ENGINEER

Position requires a minimum of 5 years experience in logic design. Experience in magnetic tape drives desirable. Should have some design and/or programming experience with microprocessors. BSEE required. MSEE desirable.

MICROPROGRAMMERS

PRINCIPAL ELECTRICAL ENGINEER

Group supervise design and microprogram controller development. Position requires MSEE and a minimum of 6 years experience in the computer field in similar areas. Background in tape and disc controller experience desirable.

SENIOR ELECTRICAL ENGINEER

Responsible for design and development of a controller for high technology mass storage media. Minimum of 5 years logic design and microprogramming or related experience is required. Position requires BSEE. MSEE preferred. Tape or disc controller experience desirable.

ELECTRICAL ENGINEER

Responsible for design and development of microprogrammed controller. Minimum of 3 years experience in related field required. Logic design in controller field helpful. Tape or disc controller experience desirable.

Computer Peripherals, Inc., the peripherals device arm of CDC/NCR/ICL, offers an attractive starting salary based on qualifications with liberal fringe benefits and a challenging position in our modern facility located in pleasant surroundings near Valley Forge. Please send resume with salary requirements to John E. Shelsy, Manager of Employment, Computer Peripherals, Inc., Valley Forge Corporate Center, 2621 Van Buren Avenue, Norristown, Pa. 19401, An equal opportunity Employer, M/F.



Computer Peripherals, Inc.

RATES \$46 per advertising inch (7/8"). Commissionable.

SIZES 7/8" to 10" deep in widths of one column (1 3/8"), two (3 3/8"), three (5 1/8"), and four (7").

CLOSING Two weeks prior to mailing.

MAILING One week prior to issue date.

ISSUE DATE Every other Thursday.

AD ORDERS/BOX NUMBER ANSWERS Send to Electronics, Post Office Box 900, New York, N.Y. 10020.

ADULT

SENIOR DESIGN ENGINEER

TEST INSTRUMENTS

ADC is an aggressive electronics company involved in the design and manufacture of test equipment for the telephone industry.

We are currently seeking a BSEE with 5 years experience in test instrument design. Background should include analog and audio frequency experience.

Will be involved in development of specifications for state-of-the-art test instruments; perform complete instrument design, including control and display layout, as well as the measuring circuit design; serve as the test instrument consultant to other design engineers and to marketing.

For consideration, please forward resume in confidence to:

MIKE WETHERBEE

ADC PRODUCTS

4900 W. 78th St. Minneapolis, Minn. 55435
An Equal Opportunity Employer

ADULT

POSITION WANTED

Electronic Technical/Engineering Aide—8 years experience radars and CPU's. 4 years weapons system design. 12-15K. Interested in relocation PW-3760, Electronics.

Engineering Position Wanted—Are you designing communications networks, distributed processor systems or microprocessor-based peripheral controllers? If so, you need system throughput analysis. I am expert in simulation modeling for both engineering and process-related problems. PW-3720, Electronics.

OVERSEAS JOBS GUIDE

Job Hunters Guide & Directory of 600 firms. \$6.00 + \$.50 P&H (US \$ check or MO only). foreign—add \$2.00. Friar Books, Dept. EL, 8956 E Ardendale, San Gabriel, CA 91775.

POSITIONS VACANT

Electronics Engineers—All Disciplines, Microwave, Analog, Digital, Circuitry, Instrumentation and Controls, openings nationwide for design, applications and sales. \$14-40K. Fee Paid. Write, in confidence, to Mr. C. Robin, P.E., Dunhill Tech Search, 182 Forbes Road, Braintree, MA 02184, 617-848-6320.

POSITION VACANT

Faculty Position in Experimental Optics—Applications are solicited for a junior faculty position (Assistant Professor) in the Department of Electrical Engineering and Computer Science at M.I.T. Candidates should have an interest in undergraduate and graduate teaching, thesis supervision, and research in the area of quantum electronics or modern optics. The candidate should have had experimental experience, for example, in nonlinear optics, semiconductor lasers, dye lasers, or optical propagation. It is expected that most applicants will have recently received the doctorate, or are currently finishing a doctoral program. Applications from qualified women and minority professionals are encouraged. M.I.T. is an equal opportunity employer. Resumes should be sent to: Professor Paul Penfield, Jr., Associate Department Head, Department of Electrical Engineering and Computer Science, Room 38-401, Massachusetts Institute of Technology, Cambridge, MA 02139. For further information, write Prof. Penfield at the above address.

LOCAL INTERVIEWS IN 1977

MICROPROCESSOR HARDWARE &
SOFTWARE ENGINEERS
COMPUTER DESIGN ENGINEERS & PROGRAMMERS
RADAR & COMMUNICATION ENGINEERS
MECHANICAL DESIGN & PACKAGING ENGINEERS
INSTRUMENT DESIGN ENGINEERS
ANALOG CIRCUIT DESIGN ENGINEERS

We are planning our recruiting trip schedule for 1977 and are scheduled to be in all of the major areas of the country where there is a large concentration of technical talent. Our clients are willing to come to you. To meet with them and us, send your resume, including present salary and geographic preferences—or request a resume form:

Search Director

REGIONAL CONSULTANTS, INC.
213 W. 9th Street
Cincinnati, Ohio 45202
(513) 579-1513

AN EQUAL OPPORTUNITY EMPLOYER M/F

Job-seekers... be the first to know with McGraw-Hill's Advance Job Listings

By having our weekly ADVANCE JOB LISTINGS sent to your home every Monday you can be the first to know about openings both in and out of your field. AJL will enable you to contact anxious recruitment managers BEFORE their ads appear in upcoming issues of 21 McGraw-Hill publications. To receive a free sample copy, plus information about our low subscription rates, fill out and return the coupon below.

ADVANCE JOB LISTINGS / P.O. BOX 900 / NY 10020

PLEASE SEND A SAMPLE COPY
OF ADVANCE JOB LISTINGS TO

NAME _____ ADDRESS _____

CITY _____ STATE/ZIP _____

Electrical Engineers ...work on advanced concepts in COMMUNICATIONS

ITT Aerospace/Optical Division, with an impressive record of achievement underscoring its leadership, continues to expand its techniques in communications—and to extend them to new and widely diverse fields of applications. The following positions will provide a career challenge and due recognition to those who can contribute meaningfully to progress—ours and theirs—at ITT A/OD.

Sr. Digital Communications Systems Design Engineer

Requires BSEE (MS preferred) and 5 plus years experience demonstrating ability to assume technical direction over multiple programs including theoretical and practical aspects of FM, FSK and PSK modulation systems. Activity will include analysis and design of digital and spread spectrum communications systems with emphasis on anti-jamming aspects. Must be able to interface effectively with customers and Company management. . .and contribute significantly to proposal preparation.

Communications Security Design Engineer

Requires BSEE and minimum 3 years experience in design and development of COMSEC circuitry and equipment with emphasis upon its interface with transportable communications equipment. Experience in design of wideband COMSEC systems desirable.

We offer excellent starting salaries, comprehensive benefits with liberal relocation assistance to our outstanding Midwest location which provides ideal living conditions.

Please send resume, including salary history in confidence to: Mr. Larry Haynes, ITT Aerospace/Optical Division, 3700 East Pontiac Street, Fort Wayne, Indiana 46803.

AEROSPACE/OPTICAL

ITT

An Equal Opportunity Employer, M/F

SENIOR ELECTRONICS ENGINEER

Special staff position opening in Electronics and Electro Optics Laboratory of Vought Advanced Technology Center for a research and exploratory development oriented engineer/scientist. Expanding research efforts in area of advanced sensor systems, data and signal processing and display systems affords unique opportunity for professional advancement. Basic requirements are the PhD in Electrical Engineering or Physics, or its equivalent, and five years experience in applied research or development in one or more of the following: Quantum Electronics, IR Sensors, Semi-Conductors, and Related Systems Applications. Project engineering or supervisory experience desirable.

Submit resume including salary history to Dr. John Harkness, Director Technologies.



VOUGHT CORPORATION
Advanced Technology Center, Inc.

Post Office Box 6144 • Dallas, Texas 75222
an LTV Company

An Equal Opportunity Employer

Exhibits Management

The position involves the management, planning, production and execution of exhibits. Extensive interaction with corporate management, marketing management, sales management and advertising management, make this a prime, high exposure position for the right person. All factors of the exhibit function are included: research, creation, estimating, budgeting, logistic supervision and performance evaluation.

The experience necessary for this position includes medium to large exhibitor positions in major trade shows. (Budgeted in the five to six figure area). Experience with electronics or industrial shows is preferred.

Tektronix, Inc., develops, manufactures and markets internationally recognized precision electronic measurement instruments, computer peripherals and related electronic instrumentation. Located near Portland, Oregon we are within a two hour drive of the Cascade Mountains or Ocean Beaches. The close-by nature playgrounds and the city of Portland provide a variety of recreational and cultural interests.

Salary is open. Benefits include liberal educational support, insurance and profit sharing programs.

Please send detailed resume to: Bill Eppick, TEKTRONIX, INC., P.O. Box 500, E14, Beaverton, OR 97077.

An Equal Opportunity Employer M/F.



TEKTRONIX®
committed to
technical excellence

RATES \$46 per advertising inch ($\frac{1}{8}$ ""). Commissionable.
SIZES $\frac{1}{8}$ " to 10" deep in widths of one column ($1\frac{1}{8}$ ""), two ($3\frac{3}{8}$ ""), three ($5\frac{1}{8}$ ""), and four (7 "").
CLOSING Two weeks prior to mailing.
MAILING One week prior to issue date.
ISSUE DATE Every other Thursday.
AD ORDERS/BOX NUMBER ANSWERS Send to Electronics, Post Office Box 900, New York, N.Y. 10020.

PRODUCTION EVALUATION ENGINEER

Pitney Bowes, an international leader in advanced business equipment and systems development and manufacture, is continuing to expand in the most active segments of a large and growing market.

A BSEE is required plus 3 years' experience in the test and evaluation of electromechanical devices. You'll need thorough knowledge of instrumentation and evaluation procedures, and design experience with advanced digital and analog circuitry. Experience with minicomputers and/or microprocessors is highly desirable. You'll also need the oral and written communications skills to clearly and convincingly express your ideas.

You can expect a competitive salary, outstanding benefits, and the opportunity to extend your technical ability over a wide range of projects in a growth environment. Please forward your resume, including salary history, to:

Frank Thompson
Professional Recruitment Representative

 **Pitney Bowes**

Walnut & Pacific Streets
Stamford, Connecticut 06904

An Equal Opportunity Employer M/F

FREE Your dream job.

We hope you're happy in your current position, but there's always that ideal job you'd prefer if you knew about it.

That's why it makes sense to have your resume on file in the Electronics Manpower Register, a computerized data bank containing the qualifications of career-conscious ELECTRONICS readers just like yourself.

You'll benefit from nation-wide exposure to industry firms privileged to search the system, and since the computer never forgets, if you match up with their job requirements you'll be brought together in confidence.

To take advantage of this free service, mail your resume to the address below.

ELECTRONICS MANPOWER REGISTER
Post Office Box 900/New York, N.Y. 10020

CAREER OPPORTUNITIES

TOTAL SYSTEMS ENGINEERING

Think of NCR as over 70,000 people, all involved—one way or another—with the processing of information. We're active. We research, invent, develop, manufacture, market and service many kinds of information products and systems and we do it in all the major cities in the United States plus over 100 foreign countries.

We are seeking career-oriented persons for the positions listed below:

CORPORATE STAFF - R & D

DATA COMMUNICATIONS SYSTEMS

Join the NCR professionals and become a vital part of our growing communication systems planning staff.

We are seeking several highly qualified people to be contributors on our dynamic team that will influence and guide our future in Data Communication Systems. These individuals will be highly qualified in current technologies and also have skills in business planning and program management.

Applicants must have strong systems orientation and substantial experience with communication systems. Creativity with systems concepts and architectures is essential. In addition, several years of pertinent experience and in-depth knowledge in one or more of the following areas are desired.

- Operating system provisions towards communications, including Communication Access Methods.
- Communication Processor Architecture
- Packet Switching Network Architecture
- Communication Link Disciplines, especially SDLC
- Communication Systems Diagnostics
- Interfacing different vendors' terminals and mainframes or minicomputers.

A degree in Engineering, Computer Science or equivalent is required with preference being an advanced degree. An MBA would be a substantial asset. Salary is commensurate with experience.

PRODUCT DEVELOPMENT PROGRAM MANAGEMENT

Growth has created several openings for senior professionals and managers in our Product Development/Program Management areas.

If you have expertise in the above areas dealing with total business systems plus engineering, software and business planning experience, you will want to investigate these outstanding opportunities.

R&D ENGINEERS

Become a part of our Corporate Advanced Development Engineering staff and apply your ideas and skills in the following areas:

- Data Communications, Terminals and Terminal Networks.
- Data Processing, Terminal Systems, Architecture and Software/Hardware interfaces
- Computer Peripherals and Input/Output Subsystems.

If you don't see your career opportunity, write anyhow. We'll evaluate your desires and qualifications. We might have the opportunity you are looking for. Act now! Don't delay!

For a quick response, send your resume to:

Mr. Vernon L. Mirre

Corporate Executive & Professional Recruitment

NCR Corporation

Dayton, Ohio 45479

An Equal Opportunity Employer

TERMINAL SYSTEMS DIVISION-DAYTON DAYTON, OHIO

Our division is actively involved in the design and implementation of financial terminal systems. If you are seeking a "Hands-On Environment" consider the following positions:

SYSTEMS ENGINEERS

Requires the development of concepts and specifications for new systems for financial terminal systems.

Requires the ability to analyze and participate in hardware and software development programs. Basic educational qualifications for these positions are a BS or MS in EE, CS or Math and 2 to 7 years experience.

We offer an excellent fringe benefit package and a salary commensurate with your experience. If you are interested in a challenging opportunity, submit your resume and salary requirements to:

Mr. Robert L. Opalek
Employment Department
Terminal Systems Division-
Dayton
NCR Corporation
Dayton, Ohio 45479



Abbott Transistor Labs Inc.	6	• Neohm Spa	9E
American Optical Scientific Instrument Division	15	■ Non-Linear Systems	38
AMF/Potter & Brumfield	13	OK Machine & Tool Company	89
■ AMP Incorporated	52, 53	• Philips Elcoma	7E, 13E, 43
• Amphenol Tuchel	19E	• Philips Industries	2E, 3E
AP Products Incorporated	39	‡ Philips Test & Measuring Instruments Inc.	4E
Associated Electronics	110	■ Powermate	38
■ Bourns Inc.	3rd Cover	Pro-Log Corporation	28
Brand Rex Corporation	2nd Cover	RCL Electronics Inc.	14
• Carlo Erba	15E	• Rohde & Schwarz	1E
■ Cherry Electrical Products Inc.	9	Scientific Atlanta Optima Division	20
Clairex Corporation	4th Cover	• SDSA	23E
Coil-Ler Mfg Inc.	36	• Seps S.p.A	14E
Continental Rentals	8	• SGS Ates	21E
*■ Dale Electronics Inc. A Subsidiary of Lionel Corporation	10E-11E	• Siemens A.G. Munich	44
Data General Corporation	27	Superior Electric Company	46
■ Dialight Corporation	21	Teledyne Relays	17
Digital Equipment Corporation (OEM)	22, 23	Telenetics, Inc.	89
■ E&L Instruments Inc.	55	• Thomson DTE	16E
Electro Rents	37	‡ Wabash Electronics	43
Fairchild Camera & Instrument Corp.	10, 11	Wakefield Engineering Inc.	93
Figaro Engineering Inc.	8	• Wandel und Goltermann	24E
■ John Fluke Mfg. Co., Ltd.	24	• Wavetek San Diego Inc.	90
‡ General Electric Instrument Rental Division	90	Wima Westermann	16
General Magnetics	104	Classified and employment advertising	
Hermes Electronics, Ltd.	40	F. J. Eberle, Manager 212-997-2557	
■ Hewlett-Packard	1, 18, 19, 49	ADC Products	98
■ Kepco Inc.	5	Anchor Hocking Corp.	103
Leeder Instruments Corp.	39	Atomic Personnel Inc.	103
Metex Corp.	2	Computer Peripherals Inc.	98
Micro Power Systems	50	ITT Aerospace/Optical International Paper Co.	99
Monolithic Memories Inc.	7	NCR Corp., Dayton OH	101
		Pitney Bowes	100
		Regional Consultants Inc.	99
		TRW Globe Motors	103
		Taktronix	100
		Vought Corp.	99
		■ For more information of complete product line see advertisement in the latest Electronics Buyers Guide	
		• Advertisers in Electronics International	
		‡ Advertisers in Electronics domestic edition	

Advertising Sales Staff

Atlanta, Ga. 30309: Glen N. Dougherty
100 Colony Square, 1175 Peachtree St., N.E.
[404] 892-2868

Boston, Mass. 02116: Frank Mitchell
607 Boylston St. [617] 262-1160

Chicago, Ill. 60611
645 North Michigan Avenue
Robert W. Bartlett (312) 751-3739
Robert M. Denmead (312) 751-3738

Cleveland, Ohio 44113: William J. Boyle
[716] 586-5040

Dallas, Texas 75201
2001 Bryant Tower, Suite 1070
[214] 742-1747

Denver, Colo. 80203: Harry B. Doyle, Jr.
123 Speer Blvd. #400
[303] 837-1010

Detroit, Michigan 48202: Robert W. Bartlett
1400 Fisher Bldg.
[313] 873-7410

Houston, Texas 77002: Paul Reiss
601 Jefferson Street, Dresser Tower [713] CA 4-8381

Los Angeles, Calif. 90010: Robert J. Rielly
Bradley K. Jones, 3200 Wilshire Blvd., South Tower
[213] 487-1160

New York, N.Y. 10020
1221 Avenue of the Americas
Warren H. Gardner [212] 997-3617
Michael J. Stoller [212] 997-3616

Philadelphia, Pa. 19102: Warren H. Gardner
Three Parkway,
[212] 997-3617

Pittsburgh, Pa. 15222: Warren H. Gardner
4 Gateway Center, [212] 997-3617

Rochester, N.Y. 14534: William J. Boyle
9 Greylock Ridge, Pittsford, N.Y.
[716] 586-5040

San Francisco, Calif. 94111: Don Farris
Robert J. Rielly, 425 Battery Street,
[415] 362-4600

Paris: Alain Offergeld
17 Rue-Georges Bizet, 75116 Paris, France
Tel: 720-73-01

Geneva: Alain Offergeld
1 rue du Temple, Geneva, Switzerland
Tel: 32-35-63

United Kingdom & Scandinavia: Robert Ghey
Tel: 01-493-1451, 34 Dover Street, London W1

Scandinavia: Andrew Karnig and Assoc.
Kungsholmsgatan 10
112 27 Stockholm, Sweden
Tel: 08 51 68 70 Telex: 179 51

Milan: Luigi Rancati
1 via Baracchini, Italy Phone 86-90-656

Brussels: Alain Offergeld
23 Chaussee de Wavre
Brussels 1040, Belgium
Tel: 13-73-95

Frankfurt/Main: Fritz Krusebecker
Liebigstrasse 27c, Germany
Phone 72 01 81

Tokyo: Tatsumi Katagiri, McGraw-Hill
Publications Overseas Corporation,
Kasumigaseki Building 2-5, 3-chome,
Kasumigaseki, Chiyoda-Ku, Tokyo, Japan
[581] 9811

Australia: Warren E. Ball
IPO Box 5106, Tokyo, Japan

Business Department
Thomas M. Egan,
Production Manager [212] 997-3140
Gayla Black
Production Manager [212] 997-2044
Carol Gallagher
Production Manager International
[212] 997-2045
Dorothy Carter
Production Manager Domestic
[212] 997-2908
Frances Vallone
Reader Service Manager
[212] 997-6057

Electronics Buyers' Guide
H.T. Howland, General Manager
[212] 997-6642
Regina Hers, Directory Manager
[212] 997-2544
Gayla Black, Production Manager
[212] 997-2044

Classified and Employment Advertising
Frank Eberle, Manager
[212] 997-2557

We have been placing graduate **ENGINEERS** in **FEE-PAID** positions THROUGHOUT THE U.S. since '59. Over 1,000 client companies. We are graduate engineers working full-time for you. Send resume & salary history today or request confidential application.

ATOMIC PERSONNEL, INC.
 Suite L. 1518 Walnut St., Phila., Pa. 19102
 An Employment Agency For All Technical Fields



Would you hire an engineer who couldn't understand this magazine?

Of course not. **ELECTRONICS** is the technical publication for technical people. If they can't understand it, they can't receive it. That's why, when you're looking for qualified engineers, you should consider our Classified Section.

For only \$46.00 per inch your recruitment advertising will reach 46,000 pre-screened engineers—that's just \$1 per thousand!—as they're reading to combat job obsolescence, while they're thinking about their future and bettering themselves.

There's no charge for typesetting and free layout service is provided.

For more information call or write:

ELECTRONICS

Post Office Box 900
 New York, N.Y. 10020
 Phone: 212/997-2556

ELECTRONICS ENGINEER

Combine Your Sales Personality And Your Technical Knowledge For An Outstanding Career Opportunity At Anchor Hocking

Position requires Electronic Engineers degree and a minimum of 3 years experience with micro-processors and solid state circuits. Your responsibilities will include developing programs for micro-processors and modifications necessary for customer needs plus interfacing with subcontractors to develop prototype equipment. We offer excellent income, a comprehensive benefit program and excellent opportunities to further your career growth.

For immediate and confidential attention, please send your resume and salary history to:

Corporate Manager of Employment

ANCHOR HOCKING CORPORATION
 109 North Broad St.
 Lancaster, Ohio 43130

An Equal Opportunity Employer M/F

Electrical Engineers

Excellent opportunities with Corporate Research Center of International Paper Company for candidates to design, fabricate and test digital data handling equipment for pilot scale non-impact printing equipment. Requires BSEE (Master's preferred) and 5 plus years experience in high frequency digital communications equipment design.

We are located on a 50 acre site in a scenic wooded park at Sterling Forest in New York State ... 45 miles northwest of New York City.

Please forward resume, including salary history, to Mr. S. L. Boyd, Manager of Scientific & Technological Staffing, R&D Division, International Paper Company, P. O. Box 797, Tuxedo Park, New York 10987.



INTERNATIONAL PAPER COMPANY

An Equal Opportunity Employer, M/F

TRW GLOBE MOTORS

We are a leading manufacturer of precision subfractional horsepower motors and have immediate openings in our Dayton, Ohio plant for a Sales Engineer, Project Engineer and Senior Project Engineer. If you are interested in challenging work, as part of a growing organization with excellent opportunities for personal growth and development, read further.

SALES ENGINEER

Will be responsible for developing new and maintaining existing customers, "price and delivery information," visit customers and assist in developing new applications. College degree in engineering or engineering technology plus several years experience in sales of electronic components or electro-mechanical devices.

PROJECT ENGINEER

Will be responsible for designing miniature (under 1/2 HP) AC and DC motors. BSEE or BSME with 2 to 4 years experience in designing AC or DC motors, steppers, torquers, transformers or solenoids.

SENIOR PROJECT ENGINEER

Will be responsible for designing and developing miniature (under 1/2 HP) AC and DC motors for highly sophisticated industrial application and for handling new design through production start-up. BSEE or BSME with 7 to 10 years experience in design and development of motors or electro-mechanical devices.

We offer excellent salary, advancement opportunity and employee benefits. Send resume, outlining work and salary history, to:

EMPLOYMENT MANAGER

TRW GLOBE MOTORS

2275 Stanley Avenue, Dayton, Ohio 45404

We are an equal opportunity employer and encourage applications from qualified females and minorities

COLOR TV

Chief Reliability Engineer Analyze new design for safety reliability and serviceability. Supervises extensive life testing of TV and Audio products. Analyze field failure data. This is a hands-on supervisory position requiring strong engineering background. If you are interested in growing with a profitable company with excellent fringe benefits, in a small town where winters are mild, send your confidential resume and salary history to:

VP Director of Reliability

Curtis Mathes Manufacturing Co.
 P.O. Box 151, Athens, TX 75751

An Equal Opportunity Employer

Solid State Sine-Cosine Synchro Converter

This new encapsulated circuit converts a 3-wire synchro input to a pair of d-c outputs proportional to the sine and cosine of the synchro angle.

- Complete solid state construction.
- Operates over a wide temperature range.

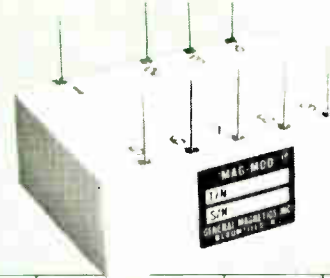

UNIT	DMD 1436-1	DMD 1430-1	DMD 1403-2	DMD 1361-6	DMD 1361-4	DMD 1193-4	DMD 1361-8	DMD 1446-1	DMD 1193-5	DMD 1193-6	DMD 1361-10	DMD 1472-2
L-L SYNCHRO INPUT (VRMS)	11.8	90	95	90	11.8	11.8	11.8	11.8	11.8	11.8	11.8	90
FREQUENCY (Hz)	400	400	60	400	400	400	400	400	400	400	400	60
FULL SCALE OUTPUT (VDC)	±10	±10	±3	±3	±3	±10	±10	±10	±10	±10	±10	±10
OUTPUT IMPEDANCE	<1Ω	<1Ω	<1Ω	<1Ω	<1Ω	<1Ω	<1Ω	<10Ω	<1Ω	<1Ω	<1Ω	<1Ω
L-L INPUT IMPEDANCE	>10K	>30K	>5K	>30K	>5K	>5K	>5K	>5K	>5K	>5K	>5K	>5K
REFERENCE VOLTAGE (VRMS)	26	115	115	115	26	115	26	115	115	115	26	115
ACCURACY SIN/COS (+25°C)	±6MIN	±6MIN	±6MIN	±6MIN	±6MIN	±6MIN	±6MIN	±0.5%	±6MIN	±6MIN	±6MIN	±6MIN
FULL TEMPERATURE SIN RANGE ACCURACY COS	±15MIN	±15MIN	±15MIN	±15MIN	±15MIN	±15MIN	±15MIN	±0.5%	±15MIN	±15MIN	±15MIN	±15MIN
D.C. SUPPLY (VDC)	±15	±15	±15	±15	±15	±15	±15	±15	±15	±15	±15	±15
D.C. SUPPLY CURRENT	<30MA	<30MA	<30MA	<30MA	<30MA	<30MA	<30MA	<30MA	<30MA	<30MA	<30MA	<30MA
BANDWIDTH	>10Hz	>10Hz	external set	>20Hz	>5Hz	>10Hz	>10Hz	>10Hz	>2Hz	>40Hz	>5Hz	external set
SIZE	1.1x3.0 x1.1	2.0x2.25 x1.4	1.1x3.0 x1.1	1.5x1.5 x0.6	1.85x0.85 x0.5	2.01x2.25 x1.4	0.85x1.85 x0.5	2x2.25 x1.4	2x2.25 x1.4	2x2.25 x1.4	2.15x1.25 x0.5	1.1x3.0 x1.1
NOTES	-	dual channel unit	-	-	-	dual channel unit	-	sine output unit	dual channel unit	channel unit	-	-
TEMPERATURE RANGE	-40°C to +100°C	-40°C to +100°C	-40°C to +100°C	-40°C to +100°C	-40°C to +100°C	-40°C to +100°C	-40°C to +100°C	-40°C to +100°C	-40°C to +100°C	-40°C to +100°C	-40°C to +100°C	-40°C to +100°C

High Precision Analog Multipliers

PRODUCT ACCURACY (MCM 1519-1) ± 1% OF ALL THEORETICAL OUTPUT VALUES OVER FULL MILITARY TEMPERATURE RANGE OF -55 C TO +125 C. ZERO POINT ERROR FOR ANY INPUT COMBINATION IS ± 2MVRMS



Features:

- No external trims required
- Distortion free AC output over entire dynamic range
- Linearity, product accuracy and zero point virtually unaffected by temperature

- All units are hermetically sealed and are not affected by external fields
- High analog product accuracy and wave quality allows dual multiplier assemblies to be matched with 1% of point over the specified temperature range
- Full four quadrant operation
- Package size, power supply requirements and other specs. may be altered to your exact requirements at no extra cost.

Specifications:

- Transfer equation: $E_o = XY/10$
- X & Y input signal ranges: 0 to ±10V PK
- Maximum zero point error (X=0; Y=0 or X=±10; Y=0 or X=0; Y=±10): 2MVRMS
- Input impedance: Both inputs 20K min.
- Full scale output: ±10V peak
- Minimum load resistance for full scale output: 2KΩ
- Output impedance: 1Ω
- Short circuit duration: 5 sec.
- Frequency response characteristics (both inputs) 1% amplitude error: DC to 1200 Hz (min.) 0.5 DB Amplitude error: DC to 3500 Hz min. 3 DB point: Approx. 10K hz Roll off rate: 18 DB/octave
- Noise Level: 5MV PK-PK @ 100K Hz approx.
- Operating temp. range: See chart
- Storage temperature range: -55°C to +125°C
- DC Power: ±15V ±1% @ 30MA
- Dimensions: 2" x 1.5" x .6"

Type No.	Product Accuracy	Operating Temperature Range
MCM 1519-1	±0.5%	-55 C - +125 C
MCM 1519-2	±0.5%	-25 C - +85 C
MCM 1519-3	±0.5%	0 C - +70 C
MCM 1520-1	±1.0%	-55 C - +125 C
MCM 1520-2	±1.0%	-25 C - +85 C
MCM 1520-3	±1.0%	0 C - +70 C

Precision AC Line Regulator

Total Regulation 0.15% Max.



Features:

- Low distortion sinusoidal output
- Regulation control better than ten times superior to commercial AC voltage regulators transformer product lines
- No active filters or tuned resonant circuits employed resulting in immunity to line frequency changes
- 6.5 watt output level
- Small size

- Output set to ±1% accuracy - this includes initial set point plus line, load, frequency and temperature changes
 - Foldback short circuit protection provided resulting in protection against overloads and short circuits of any duration
 - Low profile package with straight pins makes the unit suitable for PC board mounting (unit is hermetically sealed)
 - Transformer isolation between all power inputs and the outputs.
- * Other units available at different power levels. Information will be supplied upon request.

Specifications Model MLR 1476-2:

- AC input line voltage: 115V RMS ±20% @ 400 Hz ±20%
- Output: 26V RMS ±1% (for any condition)
- Load: 0 to 250 MA, RMS
- Total regulation: ±0.15% maximum (any combination of line, load or frequency)
- Distortion: 2% maximum
- AC input line current: 100 MA. max. at full load
- DC power: ±15 V DC ±5% @ 15 MA. max.
- Phase angle: 1° max.
- Temp. Range: -40°C to +85°C
- Case Material: High permeability nickel alloy
- Terminals: Glass to metal hermetic seal pins

Circle 104 on reader service card

GENERAL MAGNETICS • INC

135 Bloomfield Ave., Bloomfield, New Jersey 07003 - Tel. (201) 743-2700



FEEL
the pot . . .



CLICK
the switch . . .



GANG
the modules . . .

and add
“feel appeal” to your product.

FEEL THE POT . . . a smooth, quality feel, only from Bourns® 81/82 Model Potentiometers. Rotational torque range, only .3 to 2.0 oz. inch, is consistent for one, two, three or four cup assemblies.

Independent linearity of $\pm 5\%$ and low 1% CRV provide exceptional setability in both cermet and conductive plastic element types.

CLICK THE SWITCH* . . . one that really clicks, with positive action detent at either CW or CCW end. The Bourns Model 85/86 potentiometer/switch combination is rated at 2 amps in DPST style and 1 amp in DPDT. Contacts are constructed of fine silver with gold overlay. This provides exceptionally low contact resistance, for reliable operation at low level analog or logic signal levels — or any application requiring an “on-off” function.

GANG THE MODULES . . . potentiometers and switches. Up to 4 modules can be ganged on the same single or dual concentric shaft, without sacrifice to the satin-smooth feel or the sure-fire click. Other options include a wide choice of bushing and shaft styles, P.C. pins or solder lugs. Think of the possibilities! Now you can specify custom pots and switches assembled from “off-the-shelf” modules — at standard cost and leadtime.

Add “feel appeal” to your equipment with BOURNS Model 80 Family of Modular Potentiometers and Switches. Write or call today for complete technical information, direct or through your Bourns distributor.

FEEL, CLICK, GANG . . . BEAUTIFUL!

TRIMPOT PRODUCTS DIVISION, BOURNS, INC., 1200 Columbia Avenue, Riverside, California 92507, Telephone (714) 781-5122 — TWX 910 332-1252.

*Patent pending



*† Sales Offices: European Hdqtrs. — Switzerland, 042/23 22 42 • Belgium 02/218 2005 • France 01/2039633 • Germany 0711/24 29 36
Italy 02/32 56 88 • Netherlands 070/88 93 18 • United Kingdom 01/572 6531 • Japan 075 92 1121 • Australia 86 9410 • Brazil 257-3535

Circle 901 on reader service card

World Radio History

Clairex optical switches

Order any of our standard designs of optical switches and we'll give you the most reliable units and the best delivery in the industry.

Custom designs take a

little longer. Tell us your needs and we'll design to your specifications. We may even suggest an alternate, more economical solution.

Clairex optical switches

are made with hermetically sealed emitters and detectors for maximum reliability. Glass lenses align the light beam to improve target detection, to minimize false triggering from

stray light, and to reduce dust pickup.

Call (914) 664-6602 or write Clairex®, 560 South Third Avenue, Mount Vernon, New York 10550.

CLI200
CLI200D

Product Data

Optical Switches

GENERAL DESCRIPTION The CLI200 and CLI200D are optical switches consisting of an integrated light emitting diode (LED) and a photodiode detector in a pin-connector output for the CLI200 and a photo-transistor output for the CLI200D. The emitters and detectors are hermetically sealed to provide maximum reliability. They are built on a substrate with glass lenses to align the light beam for accurate target detection and to minimize false triggering from stray light and dust. The package also has a flat window of plastic lenses. The package legs are protected to assure operation.

ABSOLUTE MAXIMUM RATINGS

Maximum Temperature: 50°C to +150°C
Storage Temperature: -55°C to +150°C
Operating Junction Temperature: +100°C

EMITTER (GaAs Diode)

Power Dissipation: 100 mW (derate linearly 1.33 mW/°C at 25°C Ambient P_n)
Maximum Voltage: 3.0 volts
V_r Reverse Voltage: 3.0 volts
Maximum Current: 100 mA (continuous)
I_f DC Forward Current: 100 mA (continuous)

DETECTOR (NPN Silicon)

Maximum Power Dissipation: 50 mW (derate 0.5 mW/°C at 25°C Ambient Temperature P_n)
Total Dissipation: 12.5 mW (at 100°C Ambient Temperature P_n)
Maximum Voltages: V_{ce} Collector to Emitter Voltage: 40 volts
V_{cb} Collector to Base Voltage: 5 volts
V_{eb} Emitter to Base Voltage: 5 volts
Maximum Current I_c: 200 mA (Pulsed)

ELECTRICAL CHARACTERISTICS (V_{ce} = 5V unless otherwise designated)

Symbol	Characteristics	Test Conditions		CLI200		CLI200D		Units
		Min.	Max.	Min.	Max.			
Led V _r V _f	Reverse Voltage		1.5	3	1.5			Volts
	Forward Voltage	I _f = 10 µA I _f = 16 mA		1.5	40	100		Volts
Sensor BV _{ceo}	Collector to Emitter Breakdown Voltage	I _c = 100 µA V _{cb} = 0 V, I _e = 10 µA	50	50	10			Volts
	Dark Current	I _c = 20 µA, V _{ce} = 5V	1	50	1.0		µA	
Coupled I _c V _{CE} (SAT)	Sensor Current	I _e = 20 mA, V _{ce} = 1 mA	5 TYP		150 TYP			µA
	Base or Fall Time	I _c = 2 mA, V _{ce} = 100M I _e = 2 mA, V _{ce} = 5V	11.5 TYP					µsec
tr, tf	Base or Fall Time	I _c = 2 mA, V _{ce} = 100M I _e = 2 mA, V _{ce} = 5V						

All dimensions in 100µm

CLAIREX ELECTRONICS

A DIVISION OF CLAIREX CORPORATION
560 South Third Avenue, Mount Vernon, N. Y. 10550 • (914) 664-6602

A.D. 5/76-10K

CLAIREX ELECTRONICS

A Division of Clairex Corporation

Circle 902 on reader service card

World Radio History