

SEPTEMBER 30, 1976

WANTED BY AIR FORCE: SECURE COMPUTERS/59

Designing modular programs for microprocessors/83

Getting the best performance from bipolar bit slices/91

FOUR DOLLARS A MCGRAW-HILL PUBLICATION

Electronics®

A Flowering of TV Technology

1420 N.11291 CAMAS NOV 71
MATT NEILL
2516 NE CLACKAMAS
PORTLAND OR
97232

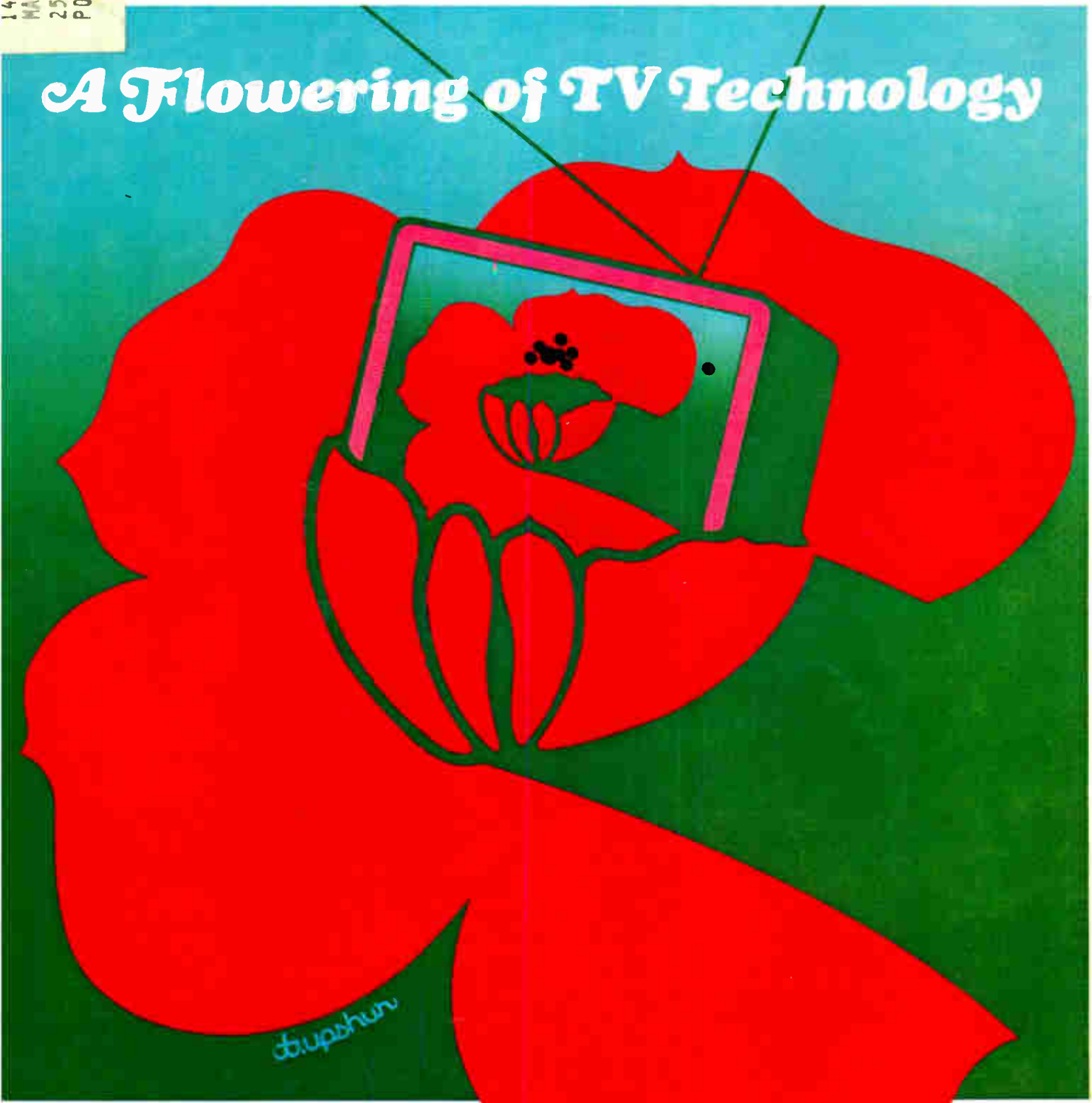

THIRTEEN SOLUTIONS TO YOUR NEXT EDP SIGNAL TRANSMISSION CABLE PROBLEM

WOVEN RIBBON CABLE. Components: PVC insulated twisted pairs

TWISTED PAIR. Components: PVC insulated conductors

JACKETED BONDED RIBBON CABLE. Components: 95Ω air-spaced miniature coaxial cable

DUAL LAYER, JACKETED WOVEN RIBBON CABLE. Components: PVC insulated twisted pairs

BONDED RIBBON CABLE. Components: PVC insulated single conductors

TRI-LEAD. 2 conductors polyimide insulated, center conductor silver coated, Teflon FEP insulation overall

MULTI-CONDUCTOR 95Ω AIR-SPACED COAXIAL CABLE. (White/Green twisted pair for power)

50Ω COAXIAL CABLE — RG-174/U

95Ω MINIATURE AIR-SPACED COAXIAL CABLE — Braided shield

95Ω MINIATURE AIR-SPACED COAXIAL CABLE — Foil shield

100Ω TAPE CABLE — 28 AWG stranded conductors, PVC insulation

80Ω TAPE CABLE — 32 AWG conductors, polyester insulation

85Ω TAPE CABLE — 29 AWG conductors, Teflon FEP insulation

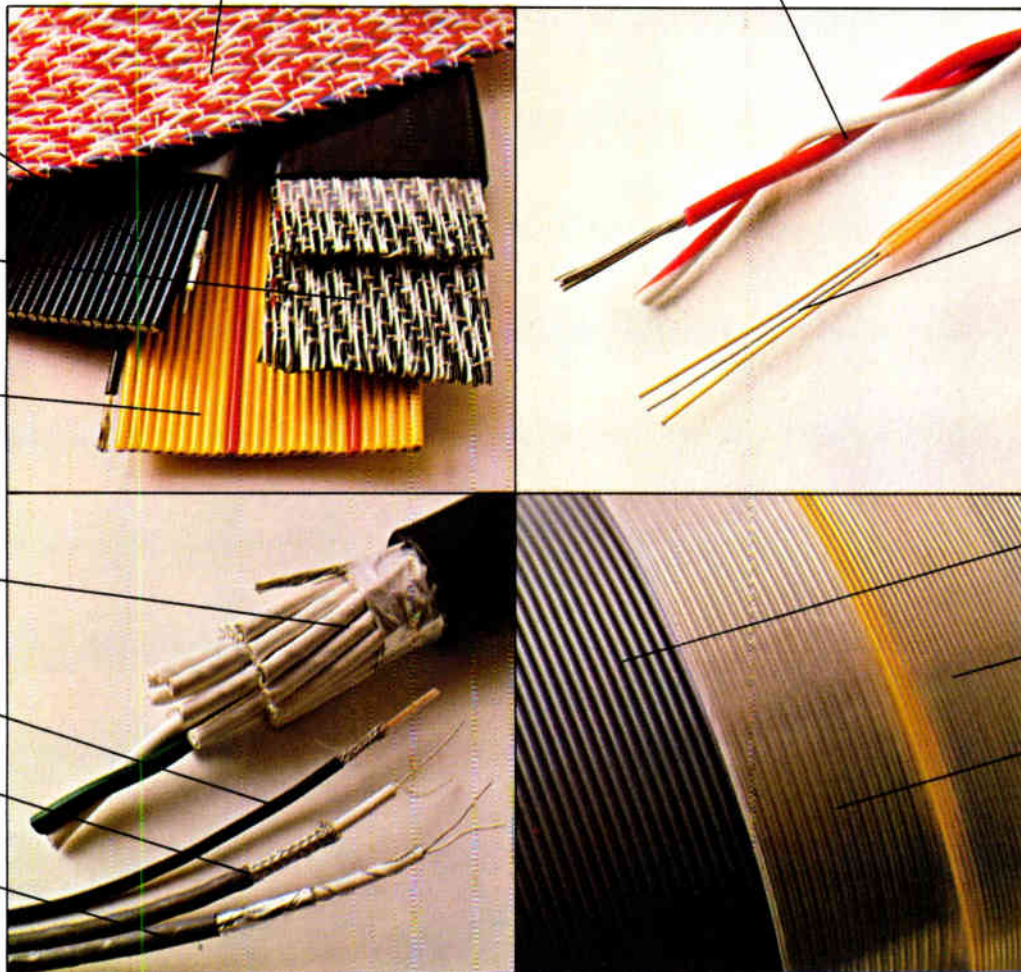

Limited space, cost, mechanical properties and operating environment are just a few of the considerations when specifying signal transmission cable.

Millions of feet sold

That's why Brand-Rex makes over a dozen different kinds of transmission cables . . . for leading CPU and peripheral equipment manufacturers around the world. Options include twisted pairs, standard or miniaturized air-spaced coax in round conventional configurations, or in flat forms such as Brand-Rex TAPE CABLE® or bonded and woven ribbon cable. They're available with a broad range of insulations from PVC, to polyester, to flame-retardant polyethylene, to irradiated types.

Our Engineers can help

Ask Brand-Rex engineers to recommend the best cost/performance cable to meet *your* signal transmission circuit needs. If we don't already make it, we'll design it for you. Call or write your local Brand-Rex sales engineer or Brand-Rex Company, Electronic and Industrial Cable Division, Willimantic, CT 06226, 203/423-7771.

BRAND-REX

ELECTRONIC & INDUSTRIAL CABLE DIVISION

Other Brand-Rex Divisions
 Abbott & Co. wiring harnesses
 Nonotuck Manufacturing Co., copper wire
 Pyle-National Co., electrical connectors
 Telecommunications Cable Division
 Teltronics, Inc. telephone equipment and components
 Brand-Rex Ltd. (Scotland) wire and cable

For high performance receiver testing, you need high performance signals.

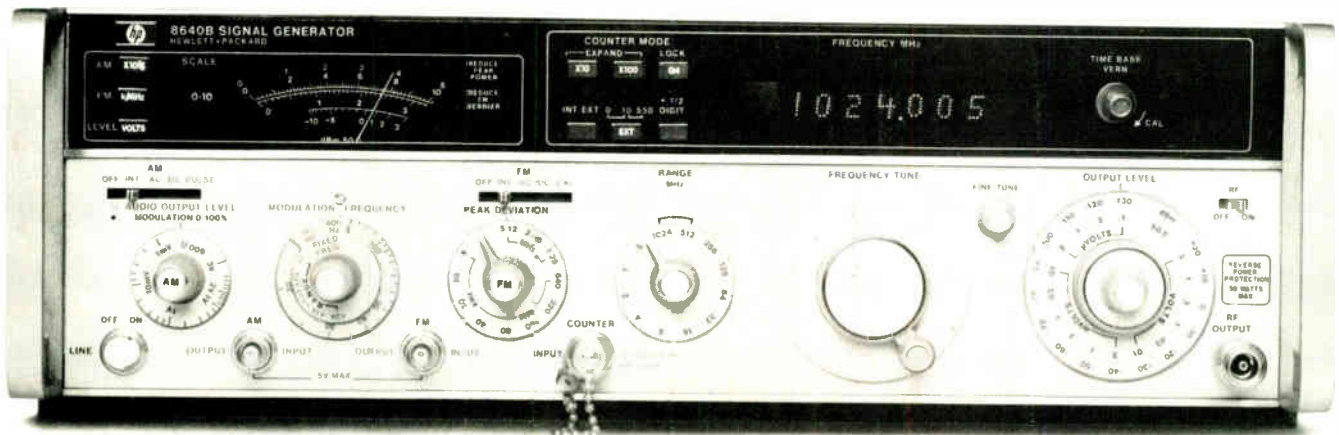

HP 8640B w/Opt. 001, 002, 003 — 0.5 to 1024 MHz.

When HP introduced the 8640B, its product concept brought together the superior characteristics needed for high performance receiver testing:

- Spectral purity <130 dB/Hz, 20 kHz offset
- Wide dynamic range; +19 to -145 dBm
- Phase lock stability/external count capability

Since then we've continued to add to the original capabilities:

- Opt. 001 — Variable modulation
- Opt. 002 — Extended frequency, 0.5 to 1024 MHz
- Opt. 003 — Reverse power protection to 50 watts
- Opt. 004 — Avionics version for NAV/COM tests
- 8640M — Ruggedized/military version

Now with the 8640B you get 1/2 digit phase-lock resolution (500 Hz, 100 to 1000 MHz), improved modulation and power settability. You can also use the new Model 11710A Down Converter to extend output frequency down to 5 kHz and test standard IF amplifiers at 262 kHz and 455 kHz. 8640B Signal Generator \$6,400*, 11710A Down Converter \$930*.

So for your high performance receiver testing, you'll still choose the performance leader in RF signal generators. For more information, call your nearby HP field sales office, or write.

*Domestic U.S. prices only.

HEWLETT  PACKARD

Sales and service from 172 offices in 65 countries.
1507 Page Mill Road, Palo Alto, California 94304

Sharpen your competitive edge.

Use an HP computing calculator for design, analysis, control, and test.

In the highly competitive, high-technology electronics business, everything counts: keeping costs in line, exploring promising design alternatives, shortening lead times, product and prototype testing, increasing productivity. That's where HP computing calculators, software, peripherals, and interfacing capabilities come in. They can help you get and maintain a competitive edge.

Three computing calculators and plenty of peripherals: it's your choice. Three different models—the low-cost HP 9815, the powerful HP 9825 and the all-purpose HP 9830—offer a range of computing power.

HP peripherals include paper tape punch and readers, printers, storage devices, a digitizer, a CRT, and an X-Y plotter. You choose the model and I/O options to configure a system just right for you.

Software, specialized and generalized, helps you look at more alternatives. HP engineers developed software to optimize designs and analyze engineering problems quickly. There's a State Variable package for control system analysis. There's CNAP for circuit design and analysis, BAMP for microwave design and analysis, and Digital Simulation for state and timing analysis.

You can add other programs, too—commonly needed math routines and statistical programs to name but two. Programs are also available for accounting applications, report generation, and financial analysis.

Automate your instruments. We make the connection friendly. From simple data logging to complex integration, our programming commands and interface cards make instrument interfacing easy. Whether your instruments require BCD, bit-parallel, RS-232-C, or HP-IB (HP's implementation of IEEE Standard 488-1975), you plug the correct interface into the calculator and connect the cable to your instrument. It's the friendly connection.

HP computing calculators: from initial design to final test. Whether you're in research, design, production, or test—or all four—we can provide the computing power and programs to help you increase productivity and sharpen your competitive edge. Our new brochure for electronic engineers will show you how. Get a copy from your HP representative, or circle our reader service number in this magazine.

406 15



HP desktop computing systems put the power where the problems are.

HEWLETT  PACKARD

Sales and service from 172 offices in 65 countries.

P.O. Box 301, Loveland, Colorado 80537
 For assistance call: Washington (301) 948-6370, Chicago (312) 677-0400,
 Atlanta (404) 434-4000, Los Angeles (213) 877-1282, Toronto (416) 678-9430

For literature circle 2

For information on OEM applications circle 3

29 Electronics Review

MEMORY: Samples of 92-k bubble memory coming from TI, 29
MILITARY: Millimeter waves look good to Norden, 30
Air Force to issue bids on joint surveillance system, 31
INDUSTRIAL: Computer NC relies on microprocessor trio, 31
MARITIME: Ship automation only just begun, 32
COMPONENTS: New TWT cathodes look promising, 34
TRADE: Curbs sought on TV exports from Japan, 36
IEEE: The ballot letter: fair or foul? 38
NEWS BRIEFS: 38
CAREERS: Employment pacts becoming popular, 40

53 Electronics International

FRANCE: Paris show stars office computers with enhancements, 53
AROUND THE WORLD: 53

59 Probing the News

COMPUTERS: Security worries Air Force, 59
COMMUNICATIONS: CB helps enrich Puerto Rico, 63
ELECTRONICS ABROAD: Military Expo draws army of exhibitors, 67
MINICOMPUTERS: How to sell computers like cars, 71

73 Technical Articles

CONSUMER: New color-TV sets slate major role for LSI, 73
COMPUTERS: Developing modular software for the 8080A, 83
DESIGNER'S CASEBOOK: IC aids car starts by solid-state ignition, 88
Buffer boosts response time of first-in, first-out memory, 89
COMPUTERS: Getting the most out of bit-slice minicomputers, 91
COMPONENTS: Quality assurance: which plan is better?, 97
ENGINEER'S NOTEBOOK: Hints for beginners in microprocessors, 100
Reed-relay switch turns on calculator chip fast, 101
Programming an SR-56 to serve as a stopwatch, 103

106 New Products

IN THE SPOTLIGHT: Pulsed counters climb to GHz range, 106
Multi-family logic probe measures time intervals, 108
MICROPROCESSORS: Computer fits in attaché case, 110
DATA HANDLING: Miniature floppy disk challenges cassettes, 116
PACKAGING & PRODUCTION: System speeds data on yields, 120
INSTRUMENTS: Oscilloscope probes suited for many models, 122
MATERIALS: 124

Departments

Publisher's letter, 4
Readers' comments, 6
News update, 8
Editorial, 10
People, 12
Meetings, 20
Electronics newsletter, 25
Washington newsletter, 49
Washington commentary, 50
International newsletter, 55
Engineer's newsletter, 104

Services

Employment opportunities, 126
Reprints available, 131
Reader service card, 133

Highlights

Cover: Television-set makers go LSI, 73

The metal-oxide-semiconductor and integrated-injection-logic technologies are making their marks in this fall's color-television sets. They have led to innovations in channel tuning and automatic color control. Also on the market is a tripotential tube with 100° deflection.

Cover illustration is by Tom Upshur.

Air Force aims at simple data security, 59

Today's minicomputer technology is the key to an experimental Air Force data base that holds various levels of classified information securely. A combination of hardware and software permits a user access only to information of his security clearance or lower, while permitting him to write data only at his clearance level.

New tools aid linking of software modules, 83

A relocating macroassembler and PL/M compiler, linker and locator programs, and a library manager facilitate the meshing of short, easily debugged software modules into a final 8080A microprocessor program.

Making bit slices do their best, 91

For all-out performance, the best bet for a microprocessor-based minicomputer is the bipolar bit slice. But it takes clever design to ensure the best performance—notably, microprogramed instructions, pipelined architecture, and minimum circuit configuration.

And in the next issue . . .

Peering into computerized axial tomography . . . the make-or-buy decision in power supplies . . . how to optimize component selection for fiber-optic links.

EDITOR-IN-CHIEF: Kemp Anderson

EXECUTIVE EDITOR: Samuel Weber

MANAGING EDITOR: Arthur Erikson,
International

SENIOR EDITORS: Laurence Altman,
Ray Connolly, Lawrence Curran,
John Johnsrud, H. Thomas Maguire,
Stephen E. Scrupski

ART DIRECTOR: Fred Sklenar

ASSOCIATE EDITORS: Howard Wolff,
Gerald M. Walker, Alfred Rosenblatt

DEPARTMENT EDITORS

Aerospace/Military: Ray Connolly
Circuit Design: Don Blattner
Communications & Microwave:
Richard Gundlach

Components: Lucinda Mattera
Computers: Stephen E. Scrupski
Consumer: Gerald M. Walker
Instrumentation: Andy Santoni
New Products: H. Thomas Maguire,
Michael J. Riezenman

Packaging & Production: Jerry Lyman
Solid State: Laurence Altman

CHIEF COPY EDITOR: Margaret Eastman

COPY EDITORS: Everett C. Terry, Ben Mason

ART: Charles D. Ciatto, *Associate Director*
Paula Piazza, *Assistant Director*

EDITORIAL SECRETARIES: Janet Noto,
Penny Roberts, Marilyn B. Rosoff

FIELD EDITORS

Boston: Lawrence Curran (Mgr.), Pamela Leven

Los Angeles: Larry Waller (Mgr.)

Midwest: Larry Armstrong (Mgr.)

New York: Bruce LeBoss (Mgr.)

San Francisco: Bernard Cole (Mgr.)

Judith Curtis

Washington: Ray Connolly (Mgr.)

Frankfurt: John Gosch

London: William F. Arnold

Paris: Arthur Erikson

Tokyo: Charles Cohen

McGraw-Hill WORLD NEWS

Editor: Michael Johnson

Brussels: James Smith

Milan: Andrew Heath

Moscow: Peter Gall

Paris: Joel Stratte-McClure

Stockholm: Robert Skole

Tokyo: Colin Gibson

PUBLISHER: Dan McMillan

DIRECTOR OF MARKETING: Pierre J. Braudé

MARKETING ADMINISTRATION MANAGER:
Wallis Clarke

CIRCULATION MANAGER: Nancy L. Merritt

MARKETING SERVICES MANAGER:
Tomlinson Howland

RESEARCH MANAGER: Margery D. Sholes

We do not find many mathematicians writing articles for *Electronics*. However, if the trend reflected by the microprocessor software article on page 83 continues, we probably will see more as the microprocessor matures.

The reason? Let's hear it from the article's co-author, Paul Rosenfeld. "Intel is producing microcomputer components at very low prices, but unless there is an easy, fast method of developing software, it doesn't matter how cheap the hardware is."

Rosenfeld represents a new breed of key personnel in the electronic components manufacturing business. A graduate in mathematics from the University of California, Berkeley, Rosenfeld is Intel's product manager for microcomputer systems software. He joined Intel about three years ago (and thus counts himself among the company's old-timers) after working on systems software development for about three years at Hewlett-Packard's Data Systems division.

To an increasing extent, much of the burden for assuring the commercial success of a series of microcomputer components is falling upon such software specialists as Rosenfeld and co-author Steve Hanna. Hanna received his math degree from Michigan State University and, after four years of working on database management programs at Burroughs Corp., Detroit, came to Intel two years ago.

"I hadn't even heard of Intel until 1973," he says. "What really impressed me during my first interview was the department manager's seriousness in his commitment to developing high-quality software that satisfied user needs. And he also

convinced me that he had sufficient ability to bring that about." Hanna is now project manager of basic systems software.

What do the authors have in common with engineers? Hanna says "We're all finding that the most important common denominator is engineering discipline—a methodology, a way of looking at problems."

There was a time when television-circuit development in Europe was on one track while TV-circuit designers in the United States and Japan, which have the same color-TV broadcast standards, were on another. But things are changing rapidly, according to our consumer electronics editor, Jerry Walker, who has put together a report on what's happening in color-TV technology. "The key to circuit advances, both in the U.S./Japan and Europe, is large-scale integration. With LSI's capabilities, a lot of the distinctions between the traditionally different approaches are becoming blurred."

This year's crop of TV sets are boasting a level of circuit sophistication that was hard to envision just a few short years ago. Along with advances in such functions as channel addressing, remote controls, and automatic color controls have come in-set memories and other solid-state answers to the challenges facing set designers. Even tubes and the basic chassis are looking a lot different. So, for a round-up on what's in this year's TV sets, turn to page 73.

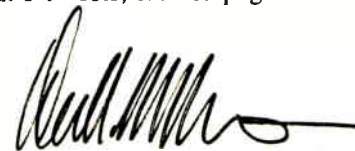

September 30, 1976 Volume 49, Number 20
96,551 copies of this issue printed

Published every other Thursday by McGraw-Hill, Inc. Founder: James H. McGraw 1860-1948. Publication office 1221 Avenue of the Americas, N.Y., N.Y. 10020; second class postage paid at New York, N.Y. and additional mailing offices.

Executive, editorial, circulation and advertising addresses: Electronics, McGraw-Hill Building, 1221 Avenue of the Americas, New York, N.Y. 10020. Telephone (212) 997-1221. Teletype 12-7960 TWX 710-581-4879. Cable address: MCGRAW HILL NEW YORK.

Subscriptions limited to professional persons with active responsibility in electronics technology. Publisher reserves the right to reject non-qualified requests. No subscriptions accepted without complete identification of subscriber name, title, or job function, company or organization, and product manufactured or services performed. Subscription rates: in the United States and possessions \$12.00 one year, \$30.00 three years; Canada and Mexico \$14.00 one year, \$32.00 three years; Europe \$35.00 one year, \$87.50 three years; Japan, Israel and Brazil \$50 per year; Australia and New Zealand \$80.00 per year, including air freight; all other countries \$40.00 per year. Limited quota of subscriptions available at higher-than-basic rate for persons outside of field served, as follows: U.S. and possessions and Canada \$25.00 per year; Europe \$40.00; Japan, Israel and Brazil \$85.00; all other countries \$50.00. Single copies: \$4.00. Please allow four to eight weeks for shipment.

Officers of McGraw-Hill Publications Company: Gordon L. Jones, President; Paul F. McPherson, Executive Vice President; Gene W. Simpson, Group Vice President; Senior Vice Presidents: Ralph Blackburn, Circulation; John B. Hoglund, Controller; Ralph R. Schulz, Editorial; David G. Jensen, Manufacturing; Vice Presidents: James E. Boddorf, Planning & Development; Edward E. Schirmer, Marketing Administration.

Officers of the Corporation: Harold W. McGraw, Jr., President, Chief Executive Officer, and Chairman of the Board; Robert N. Landes, Senior Vice President and Secretary; Ralph J. Webb, Treasurer.
Title registered in U.S. Patent Office; Copyright © 1976 by McGraw-Hill, Inc. All rights reserved. The contents of this publication may not be reproduced in whole or in part without the consent of copyright owner.

Subscribers: The publisher, upon written request to our New York office from any subscriber, agrees to refund that part of the subscription price applying to copies not yet mailed. Please send change-of-address notices or complaints to Fulfillment Manager; subscription orders to Circulation Manager, Electronics, at address below. Change-of-address notices should provide old as well as new address, including postal zip code number. If possible, attach address label from recent issue. Allow one month for change to become effective.

Postmaster: Please send form 3579 to Fulfillment Manager, Electronics, P.O. Box 430, Hightstown, N.J. 08520.

introducing:

A MULTI-OUTPUT POWER SUPPLY

KEPCO MPS 620M



Price:
\$475.00

THREE STABILIZED OUTPUTS

0 to 6V d-c @ 5A	Crowbar Protected
0 to +20V d-c @ 1A 0 to -20V d-c @ 1A	Tracking

a convenient bench top power supply offering the voltage/
current combination required for IC's & microprocessors

- FEATURES:**
- 10-turn controls for high resolution control of the 0—6V output and the tracked 20V outputs.
 - Adjustable crowbar for the 0—6V output ... with indicator.
 - Remote error sensing connections on the panel to accommodate a 1 volt drop in the load wires from the 0—6V output.
 - Full range adjustment of voltages and rectangular current limits (not a "slot" supply, no "foldback" current limiting, and no derating to an ambient of +50°C).
 - All three outputs available simultaneously and at full rating.
 - Convection cooled.
 - Two large recessed meters with switch, to monitor voltage and current.
 - Rack mountable in a 5¼" rack space (¾ width).

KEPCO® For complete specifications, write Dept. FM-14

KEPCO, INC. • 131-38 SANFORD AVENUE • FLUSHING, N.Y. 11352 U.S.A. • (212) 461-7000 • TWX # 710-582-2631 • Cable: KEPCOPOWER NEWYORK

Electronics/September 30, 1976

Circle 5 on reader service card 5

A SMART WAY TO BEAT YOUR POWER SUPPLY SIZE PROBLEM

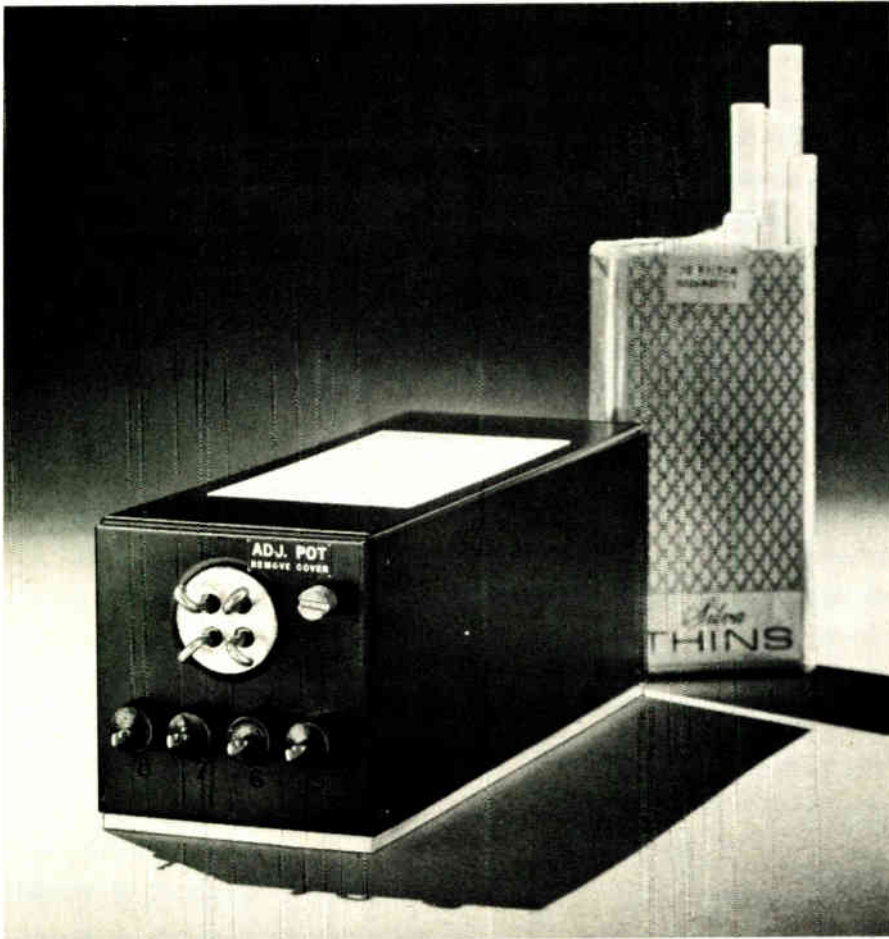

2 1/2" thin, 2 3/8" narrow, 6 1/4" short

yet this converter produces 50 watts of regulated DC power from an input of 20-32 VDC! It weighs less than 2 pounds. This is only one of our wide variety of many small lightweight converters, inverters and power supplies—there are over 3500 models listed in our newest catalog, including size, weight, and prices. If you have a size problem, why not send for an Abbott catalog?

MIL SPEC ENVIRONMENT — All of the hermetically sealed power modules listed in our new catalog have been designed to meet the severe environmental conditions required by modern aerospace and military systems, including MIL-STD-810C. They are hermetically sealed and encapsulated in heavy steel containers. New high performance units meet MIL-

STD-461A for conducted and radiated electromagnetic interference.

RELIABLE — Highest quality components are used in Abbott power modules to yield high MTBF's (mean time between failure) as calculated in MIL-HDBK-217. Typical power modules have over 100,000 hours MTBF — proving that the quality was built in from the beginning.

WIDE RANGE OF OUTPUTS — Any voltage from 5 volts DC to 740 VDC is available by selecting the correct model you need from our catalog with any of a variety of inputs including:

60 A to DC
400 A to DC
DC to DC
DC to 400 A
DC to 60 A

Please see pages 1836-1848 of your 1976-77 EEM (ELECTRONIC ENGINEERS MASTER Catalog) or pages 676-682 Volume 2 of your 1976-77 GOLD BOOK for information on Abbott Modules.

Send for our new 60 page FREE catalog.

abbott transistor
LABORATORIES, INCORPORATED

GENERAL OFFICES
5200 W. Jefferson Blvd.
Los Angeles, CA 90016
(213) 936-8185
Telex 69-1398

EASTERN OFFICES
1224 Anderson Ave.
Fort Lee, NJ 07024
(201) 224-6900
Telex 13-5332

Readers' comments

FCC clarifies TV-game limits

To the Editor: In "The winning ways of video games" [June 24, p. 89], you stated that, by elimination of the radio-frequency modulator in television games, there would be no need for FCC approval. It is unfortunate that most manufacturers and persons in the industry do not grasp the manner in which our equipment-authorization program is organized. Your statement would have been correct if it had said that there would be no need for type approval from the Federal Communications Commission.

Games that couple a video signal to home receivers by an rf signal on an unused channel come under a category of equipment known as Class I TV devices. These require type approval by the FCC; the device to be marketed must be submitted to our laboratory for evaluation before marketing can be initiated.

Elimination of the rf-modulated signal and coupling of the game output directly into the video circuitry of the set will, of course, remove the game from the Class I and obviate the need for type approval.

However, the presence of a 2-megahertz oscillator or the production of signals above 10 kilohertz inside the device will class it as what we call a radio-frequency device. While these presently need no specific authorization from us before marketing, they are nonetheless subject to FCC regulations that limit the radiation of rf signals from the device.

Should such devices be found to radiate signals in excess of our limits or should those signals cause harmful interference to licensed radio services, users and manufacturers alike will discover that FCC approval (not type approval) is indeed required before operation of the device may continue. In many cases, installations employing interfering devices have been shut down by our field engineers.

Michael J. Toia
Laboratory division
Federal Communications
Commission
Laurel, Md.

Creeping up on daylight

We've just brought the integrated dc-to-daylight frequency synthesizer a couple of steps closer to reality.

The new Plessey IC's offer a quick and easy way to lower synthesizer costs while increasing loop response and channel spacing all the way from dc through the HF, VHF, UHF and TACAN bands.

Start with one of our IC prescalers. They feature input ports for VHF and UHF, self-biasing clock inputs, TTL/MOS-compatibility and variable input hysteresis for wideband operation.

Then add one of our two-modulus dividers. All of them provide low power consumption, low propagation delay and ECL-compatibility, and most of them are available in commercial and MIL-temp versions.

Finally, to make things even simpler, add the Plessey SP8760 control chip and phase lock your synthesizer to any crystal up to 10 MHz. All the stability you need with none of the usual headaches and hassle.

If it all sounds too good to be true, contact us today for details and application notes.

Once you've seen the data, you'll see the light.

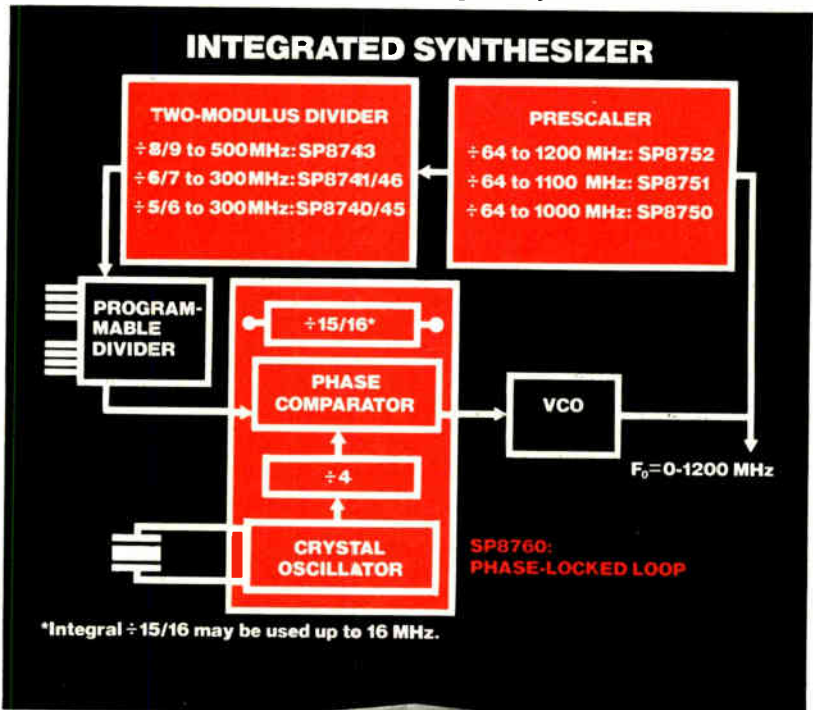

PLESSEY SEMICONDUCTORS

1674 McGaw Avenue, Irvine, CA 92714
Tel: (714) 540-9945. TWX: 910-595-1930
Represented world-wide.

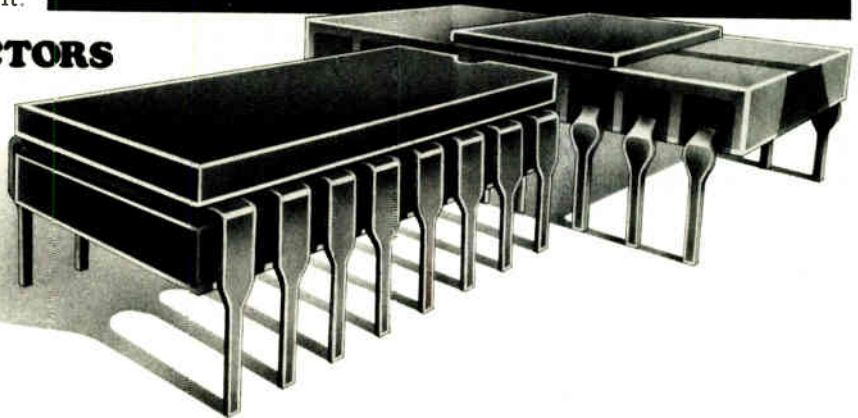

State-of-the-art brought down to earth

Fixed and programmable dividers □ Linear and digital communications circuits

Want to make waves?



Call the "Instrument Professionals". They can tell you which generator, oscillator or synthesizer best fits your needs. They'll have it on your dock tomorrow — guaranteed to make all the waves you need. Renting the right gear will keep your head above water!

Write or call for data on our other specialties: Instrument Leasing • Computer Peripherals • Equipment Sales • Instrument Service.

Circle 8 on reader service card

Call Get our FREE Catalog

Continental Rentals

Div. Continental Leasing Co., Inc.
175 Middlesex Turnpike, Bedford, MA, 01730 (617) 275-0850
Metuchen, NJ (201) 549-8500;
Gaithersburg, MD (301) 948-4310; TX (214) 357-1779; Elk Grove, IL (312) 439-4700; Costa Mesa, CA (714) 540-6566; Santa Clara, CA (408) 735-8300; Los Angeles, CA (213) 477-7521

News update

■ In the year since Aerospace Corp.'s Electronic Research Laboratory at El Segundo, Calif., demonstrated its multiwavelength laser [*Electronics*, Oct. 2, 1975 p. 48], researchers have spent time in more broad research in the field, rather than generating further experimental data on it. Now, they are starting to build the multiplexing modulators necessary for the laser to be used in ultrahigh-speed data communications systems. "We've done the easy part; now we're into the hard part of integrating the optics," notes Harold M. Stoll, a codeveloper. This is an industry-wide effort in lasers, he adds.

At Aerospace, researchers are working toward putting modulators, output couplers, and beam expanders on the same chip. In terms of the multiple-frequency laser itself, potential users have shown "lots of interest, but not too many bucks," he says.

■ Millevision, a computer-controlled system designed to display advertising messages, mostly at shopping centers, has "gone on the back burner," according to Lonnie Berry, manufacturing manager at Millennium Systems Inc. of Santa Clara, Calif., the manufacturer of Millevision. The company is "not actively marketing" the \$75,000 system, he says, because "it didn't generate enough sales."

The system flashes news as well as advertising messages for shoppers [*Electronics*, Sept. 18, 1975, p. 41]. Cartoons were also available for display. But the \$1 million in sales that Millevision generated didn't justify its continued marketing. The company will still deliver on orders (90 days' lead time) but it is now concentrating on other products. Though Berry believes "there is still potential there," he says "other products are more important."

In operation, Millevision's computer edits input data from a keyboard, justifies the text, and stores the information in a floppy-disk system. More than 11,000 characters, plus animated cartoons, can be stored.

Hi-Vacuum Feedthrus with Standard Connectors



COAX
TRIAx
BSHV
MHV
BNC
UHF
MS
N

- Bakeable to 450°C*
- Provide quick disconnect of shielded leads
- Hi-alumina ceramic-metal construction
- Single or multiple units supplied in weldable adapters or standard vacuum flanges

*With lead disconnected



Request Cat. 7110 CC with details, drawings, ordering info.

Ceramaseal, Inc.

A SUBSIDIARY OF INTERPACE

NEW LEBANON CENTER, NEW YORK 12126
518 794-7800-TELEX 145442

Circle 133 on reader service card

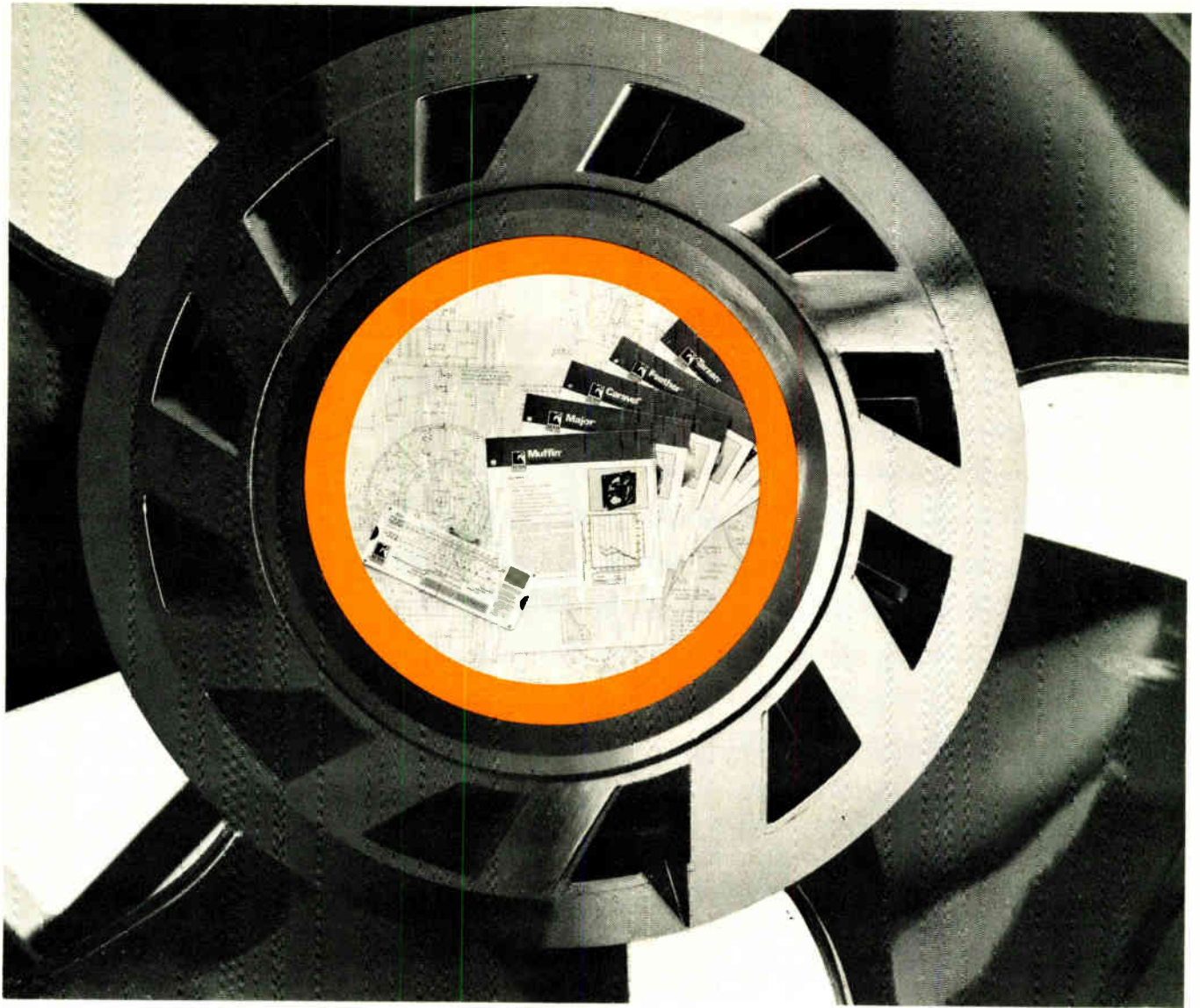

Behind every Rotron fan and blower... Engineering Authority

Rotron's position as the leading authority on the engineering of precision fans and blowers is based on three solid foundations.

□ Rotron really brought the business into being, in the late 1940's, when it began to develop the first compact, high-performance high-reliability air movers for the military, aerospace, and electronics industries.

□ Rotron engineering facilities are unusually extensive, involving 6,000 square feet of aerodynamic laboratories, motor design and electrical test facilities, environmental and life test equipment . . . acoustic chambers and other sophisticated instrumentation.

□ Most telling of all, Rotron product performance through the years—in many thousands of applications, for many hundreds of the most knowledgeable and demanding of users—provides incontrovertible testimony to the company's engineering skills.

For the best engineered fans and blowers you can buy, contact your Rotron representative. For a useful 8-page guide to selecting and specifying fans and blowers (Catalog Sheet ENG 010), write Rotron on your company letterhead.

Why settle for less when the best costs no more?



ROTRON INC.
AN  **EG&G COMPANY**

Woodstock, N. Y. 12498 □ 914 • 679-2401 □ TWX 510-247-9033
Garden Grove, Cal. 92641 • 714-898-5649 • Rotron B.V., Breda, Netherlands, Tel: 79311, Telex: 844-54074

Computer security: a case of priorities

Two seemingly unrelated events of the past few weeks illustrate what appears to be a distorted sense of priorities in military security matters. The Navy moved swiftly to salvage an F-14 fighter that rolled off an aircraft carrier and settled intact into the sea during maneuvers that were shadowed by Soviet ships. The Navy was right in losing no time going after the F-14, which was loaded with highly secret avionics equipment. The Soviets, if they were to recover the fighter, would learn at least as much as their recently defected pilot's MIG-25 plane will reveal to Western officials.

Meanwhile, officials at the computer security branch in the Air Force's Electronic Systems division at Hanscom Air Force Base, learned that their tamper-proofing program, aimed at developing hardware and software that could be built into commercial computers used by the Air Force and other services, will not be funded for the next fiscal year. That puts the program in limbo at a time when it was beginning to bear fruit. A team of computer experts have verified that some five years of effort to build an electronic "gate" within a computer to prevent inadvertent or malicious penetration of its data base truly works.

It was an important first step, had cost only about \$5 million, and promised even more important refinements that would protect computers used by the military against compromising penetrations. Surely the data they hold could be more sensitive and valuable to a potential enemy than the

Navy's F-14 avionics, as secret as they are. Why then, is the Air Force in all likelihood killing a computer security program that might have cost a total of about \$17 million if it were brought to full fruition by 1981, as the timetable now stands?

The money would have been spread over a decade, and the importance of the program extends beyond just military benefits. The development of the security techniques have involved computer companies and academicians as well as the military, and will lead to tamper-proof computers for civilian applications—no small accomplishment at a time when computer penetration has become one of the fastest growing crimes in the U.S.

The money seems a pittance compared to the price of today's weapon systems: an Air Force F-15 fighter, some 240 of which have been requested by the service over the next two fiscal years, carries a unit price tag of about \$15 million. And how effective would those fighters be if plans for their employment were known in advance by an adversary who had penetrated the computer containing those plans?

It's baffling, then, to ponder the squelching of a budding computer security program that would cost about \$12 million more to complete, with all its promise for military and commercial data processing users. It's time for the Air Force's top brass to take another look at its priorities, reinstate the computer security program, and keep its team working on the project, even if it means not buying just one F-15.

Microprocessing becomes a buyer's market.

If you're a MOS microprocessor customer, the last few years haven't been a whole lot of laughs.

One supplier had all the good stuff, made all the rules, told you what you could buy. And when. And for how much.

But something happened to change all that: Advanced Micro Devices.

We make the best microprocessor in the world, the Am9080A, and we make all the support circuits you need. They're yours now, off the shelf, at competitive prices. That's right. Competitive.

But we make more than microprocessor products. We make you a promise:

We'll sell you any part, in any quantity, bundled or unbundled. You're the customer.

So, if you suddenly find yourself having an easier time buying microprocessors, just remember why. And who.

If you're shy, and you're just not sure how to say thank you, an order would be really nice.

Write or phone Advanced Micro Devices, The Buyer's Market.

Ours and Theirs.

(The 9080A & 8080A)

Specification	AMD	Intel
Minimum Instruction Cycle Time	1 microsecond	1.3 microseconds
Maximum Power Dissipation (at 1.3 microsec 0 - 70°)	829 milliwatts	1307 milliwatts
Output Drive	3.2mA @ .4V	1.9mA @ .45V
Minimum Input High Voltage	3.0V	3.3V
MIL-STD-883	Standard	Special

Ours and Ours.

(Am9080A System Circuits)

AMD Part Number	Description	Availability
CPU		
Am9080A/-2/-1/-4	Speeds to 250 nsec. 0 to 70°C	In Dist. Stock
Am9080A/-2	Speeds to 380 nsec. -55 to +125°C	In Dist. Stock
Static Read/Write Random Access Memories		
Am9101A/B/C/D	256 x 4, 22 Pin Speeds to 250 nsec.	In Dist. Stock
Am91L01A/B/C	256 x 4, 22 Pin Speeds to 300 nsec.	In Dist. Stock
Am9102A/B/C/D	1K x 1, 16 Pin Speeds to 250 nsec.	In Dist. Stock
Am91L02A/B/C	1K x 1, 16 Pin Speeds to 300 nsec.	In Dist. Stock
Am9111A/B/C/D	256 x 4, 18 Pin Speeds to 250 nsec.	In Dist. Stock
Am91L11A/B/C	256 x 4, 18 Pin Speeds to 300 nsec.	In Dist. Stock
Am9112A/B/C/D	256 x 4, 16 Pin Speeds to 250 nsec.	In Dist. Stock
Am91L12A/B/C	256 x 4, 16 Pin Speeds to 300 nsec.	In Dist. Stock
Am9130A/B/C/D/E	1024 x 4, 22 Pin Speeds to 200 nsec.	In Dist. Stock
Am9140A/B/C/D/E	4096 x 1, 22 Pin Speeds to 200 nsec.	In Dist. Stock
Dynamic Read/Write Random Access Memories		
Am9050C/D/E	4K x 1, 18 Pin Speeds to 200 nsec.	In Dist. Stock
Am9060C/D/E	4K x 1, 22 Pin Speeds to 200 nsec.	In Dist. Stock

AMD Part Number	Description	Availability
Mask Programmable Read-Only Memories		
Am9208B/C/D	1K x 8 Speeds to 250 nsec.	Factory Stock
Am9216B/C	2K x 8 Speeds to 300 nsec.	Factory Stock
Erasable Read-Only Memories		
Am1702A	256 x 8, 1.0 μsec.	In Dist. Stock
Am2708	1024 x 8, 450 nsec.	4th Q. 1976
Processor System Support Circuits		
Am8212	8-bit I/O Port	In Dist. Stock
Am8216	Non-Inverting Bus Transceiver	In Dist. Stock
Am8224	Clock Generator	In Dist. Stock
Am8226	Inverting Bus Transceiver	In Dist. Stock
Am8228	System Controller	In Dist. Stock
Am8257	Direct Memory Access Controller	2nd Q. 1977
Am8259	Priority Interrupt Controller	2nd Q. 1977
Am9551	Programmable Communications Interface	4th Q. 1976
Am9555	Programmable Peripheral Interface	In Dist. Stock
Am25LS138	1-of-8 Decoder	In Dist. Stock
Am25LS139	Dual 1-of-4 Driver	In Dist. Stock
*Am25LS240	8-bit Inverting Bus Driver	4th Q. 1976
*Am25LS241	8-bit Non-Inverting Bus Driver	4th Q. 1976
*Am25LS273	8-bit Common Clear Register	4th Q. 1976
*Am25LS374	8-bit 3-state Register	4th Q. 1976
*Am25LS377	8-bit Common Enable Register	4th Q. 1976

*All combine high performance and low power in space saving 20-pin package

CPU: 9080A = 480 nsec. - 2 = 380 nsec. - 1 = 320 nsec. - 4 = 250 nsec.
MEM: A = 500 nsec. B = 400 nsec. C = 300 nsec. D = 250 nsec. E = 200 nsec.

Advanced MOS/LSI



Advanced Micro Devices • 901 Thompson Place, Sunnyvale, California 94086 • Telephone (408) 732-2400 •
Distributed nationally by Hamilton/Avnet, Cramer and Schweber Electronics.

Circle 264 on reader service card

1 RCL SWITCH DOES THE JOB OF 12!



- SUBMINIATURE Multi-deck Rotary Switches with ADJUSTABLE STOPS... permitting the user to vary the number of positions instantly.
- Select 2 through 12 positions by moving external plate.
- Up to 4 poles per deck!

Send For New '76 Catalog Or
Call our Hotline For Name
Of Your Local Representative
Or Stocking Distributor.
(201) 374-3311

AMF

RCL Electronics

General Sales Office:
700 So. 21st Street
Irvington, N. J. 07111

People

Awacs manager looks to
two-year break-in period

When the Air Force gets its first production E-3A Airborne Warning and Control System (Awacs) next spring, it will be like Christmas morning for an eager Maj. Gen. Lawrence A. Skantze, the 48-year-old program manager at the Air Force's Electronics Systems division, Hanscom Field, Mass. "It will be very exciting during the first two years, determining how we can most effectively use Awacs as a force multiplier. The scope of what we can do with the system is tremendous," beams Skantze. "It gives battle managers something they've been looking for since the days of Julius Caesar."

With money tight, budgets short, and manpower at its lowest point since just before the Korean war, Skantze asserts that command, control, and communications, or C-cubed, as he calls it, "is just about the most important military business being conducted." While the C-cubed function hasn't changed much over the years, "the means through which we exercise the function is now undergoing startling change," states the New York City native.

Purchases. The Air Force will buy 34 aircraft, including three test planes, through 1980. But Skantze believes there's a 50-50 chance the NATO nations will buy about 25 to 35 E-3As. He notes that the latest Air Force proposal will soon be given to the NATO ministers for consideration at their meeting in December.

But NATO's E-3As will differ from the Air Force planes. NATO wants increased tracking capability, as well as automatic-track initiation and different electronic signal-measuring equipment and radios. The Air Force does plan to double the number of channels that can be tracked simultaneously, but that won't be until the third and last block enters production. It does not believe automatic-track initiation is necessary.

The principal advantage of Awacs, with its sophisticated surveil-



C³ man. The scope of what is done with Awacs will be tremendous, predicts Maj. Gen. Lawrence A. Skantze.

lance, control, and communications systems on a modified Boeing 707 airframe "is that it centralizes the coordination of complex, diverse, and simultaneous air operations," says Skantze of the system's capability to control a total air effort, including interception of enemy aircraft, close air support, airlift, reconnaissance, and ground interdiction.

An engineering graduate from both the U.S. Naval Academy and the Air Force Institute of Technology, Skantze believes the E-3A's flyaway cost of about \$50 million is a bargain. "The system can be our eyes, ears, voice, and brain in national emergencies. What more can we ask?"

GCA's Reagan plans to
fill out the product line

Customers in the semiconductor industry have occasionally pointed out that there are holes in GCA Corp.'s product lines of capital equipment for the semiconductor industry. But if Paul W. Reagan, the new vice president in charge of the IC Systems group has his way, the Burlington, Mass., maker of photo-mask, wafer-processing, and sputtering systems, ion implanters, and

Don't redraw. Restore.

Suddenly you need copies of that old battered drawing — the one with the dirt, creases, and yellowed background. You don't have to redraw to get a like-new second original. One fast, easy way is to have the old drawing reproduced on Kodagraph film or paper.

You'll be amazed at the results...the dense black lines, the clean background, the overall improved legibility — and at the time and money you save. For more information write: Eastman Kodak Company, Graphics Markets Division, Dept. R6857, Rochester, New York 14650.

Kodagraph films and papers Versatility in reprographics



Circle 13 on reader service card

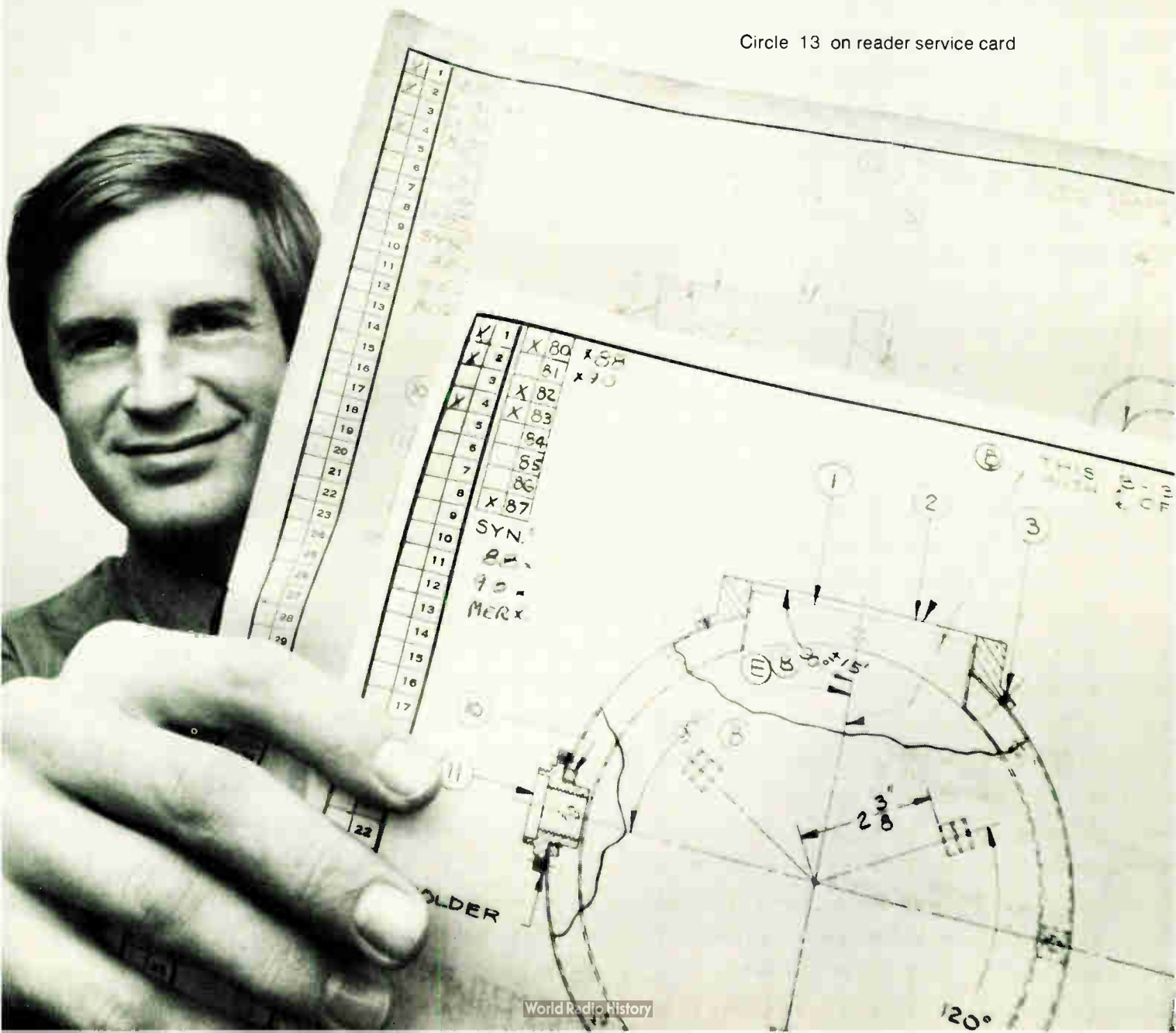

Subminiature capacitors with small mounting areas for printed circuit boards

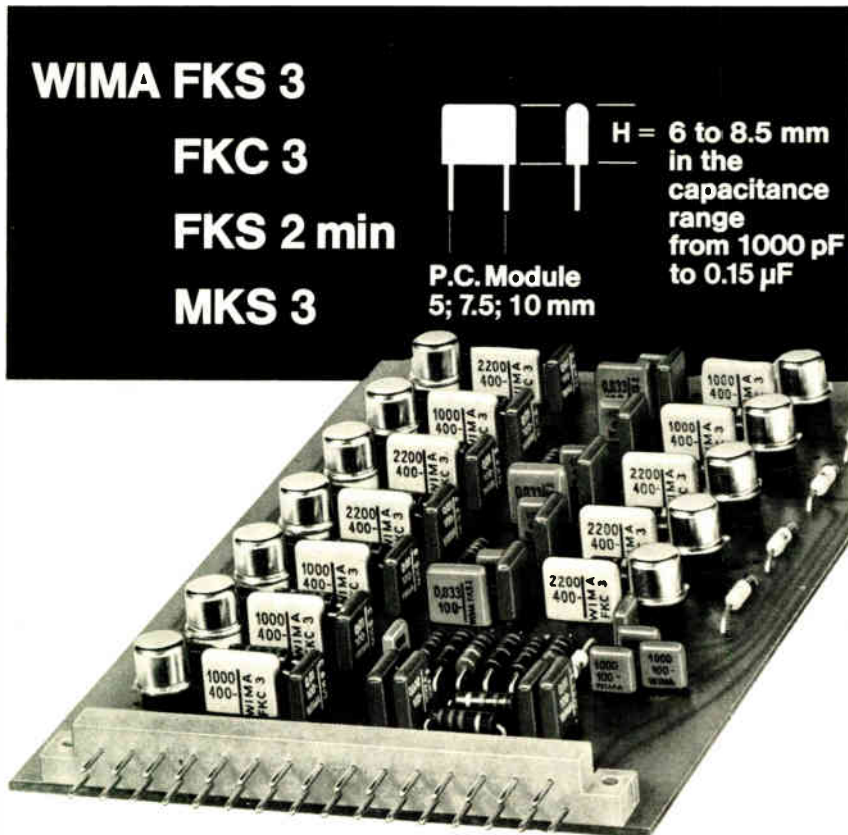

Characteristics:

The design has made better use of the vertical area in order to reduce the mounting area requirement for the capacitor. This facilitates greater packing density and easier mounting on printed boards.

The termination wires are compatible with the standard printed board grid to allow simple insertion. Equally important, the height of the capacitors is compatible with transistors.

These new cast-moulded capacitors are so small that they offer advantages hitherto not obtainable when used on printed circuit boards.



WILHELM WESTERMANN
 Spezialvertrieb elektronischer Bauelemente
 D-68 Mannheim · Fed. Rep. of Germany
 P.O. Box 2345 · Tel.: (0621) 40 80 12

People

bonders will fill out those lines—and then some.

Market oriented. “I want to make this group the most market-oriented equipment manufacturer for the semiconductor industry,” says the 40-year-old Reagan, a business-like veteran of 15 years in the semiconductor industry. This means staying close to the customer’s needs and to technology developments. And he will also establish rigid priorities for allocating development resources within the group, which he says hasn’t been done before.

His IC Systems group “is in the semiconductor imaging and surface treatment business, and we’re going to fill in the holes while continuing to improve our present product lines and evolve new products,” Reagan says. But he won’t say what new products are coming. Right now, he’s making sure the group concentrates on delivering its fiscal 1976 introductions, which include a pattern generator, photorepeater, in-line sputterer, and the Wafertrac wafer-handling system. GCA will finish its fiscal 1976 year with sales well over \$40 million. Sales to the semiconductor industry account for between 40% and 50% of that total.

E beam. In the near future, it wouldn’t be surprising to see Reagan’s group unveil electron-beam mask-making equipment. “There’s pressure from the semiconductor industry for electron-beam mask-making, and GCA will be there with the right timing,” he says. “It’s a question of resolving the technical and business details.” He believes there will be a small number of E-beam mask-making systems in production in a year or two.

Reagan was attracted to GCA, at least in part, because he’s been a customer. (Most recently, he was divisional vice president and general manager of Fairchild Camera and Instrument Corp.’s Digital Products division.) “I always felt GCA was very credible when I was on the other side,” he says. “I saw this move as a tremendous opportunity to do something different yet related to my previous experience, but in a small company.”

What You Need Is What You Get.

Ramtek's new RM9000 modular graphics and imagery system gives you expandability, economy and flexibility.

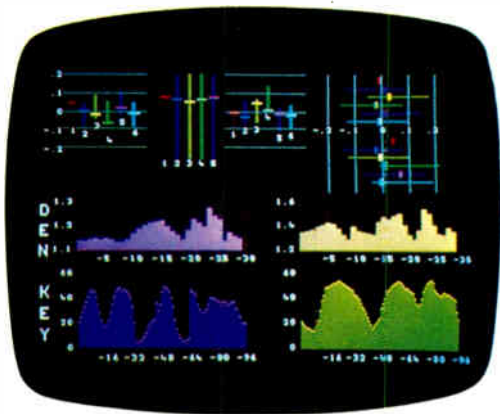

Process Control: Color printing press.



Medical Imaging: Nuclear heart study.

Select The Performance You Need.

The RM9000's total modularity lets you select the exact performance you need to fill your particular application. You pay only for the performance you need. Nothing more. And that's like money in the bank.

Add On As You Have To.

As your needs change and grow, the RM9000's capability will grow right along with them. A comprehensive list of options such as expansion from black and white to grey scale or color—even a complete range of interactive peripherals and additional independent channels.

Microprocessor-Controlled Raster Scan.

The RM9000 is the first raster scan graphics and imagery system to be totally microprocessor

controlled. That means you can implement a higher-order user language to minimize programming costs without a sacrifice in system throughput.

Functional. Reliable. Maintainable.

High reliability is the direct result of intensive testing of components and systems prior to shipment. Solid state components and printed circuit construction are used exclusively. Result? No special preventive maintenance measures are required. In fact, the RM9000 can be pre-programmed with self-diagnostic capability.

You Need To Know More.

To fully appreciate the RM9000's capability, you need more details. Call or write Ramtek Corporation, 585 N. Mary Ave., Sunnyvale, CA 94086. (408) 735-8400.

Our Experience Shows

Compare Multiwire™

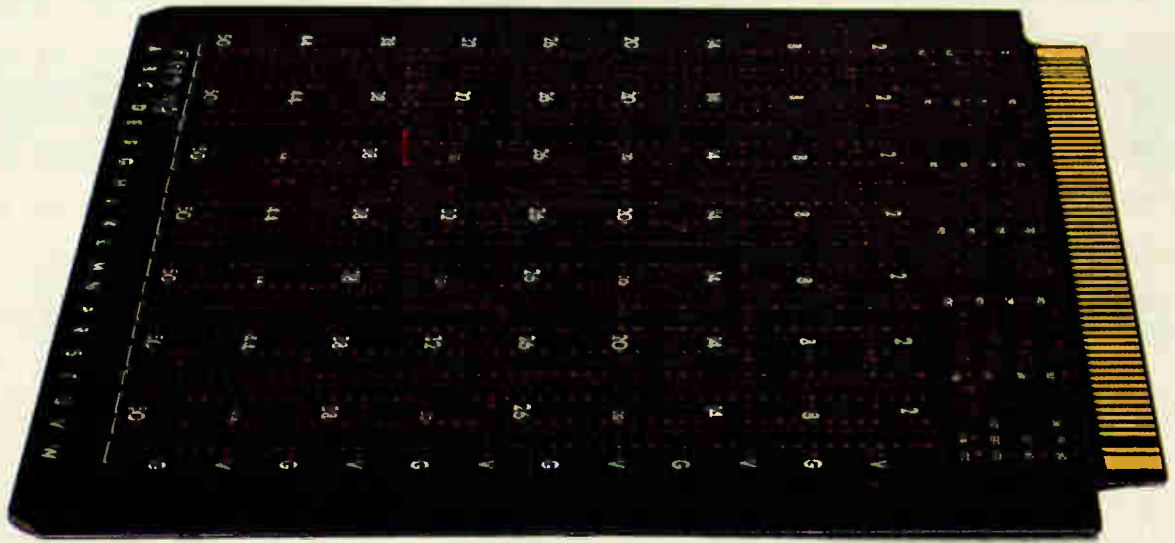

costs less than wirewrapping...



works better than multilayering.

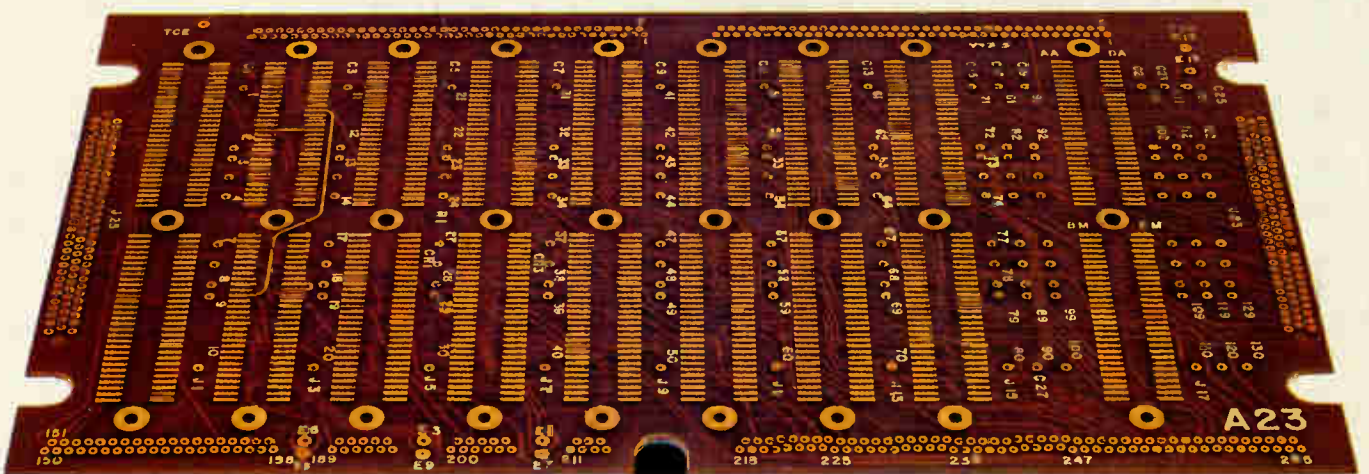

Two major systems — wirewrapping and multilayering — have been used for complex electronic interconnection in the last 15 years. Despite improvements and refinements, each still has inherent disadvantages. That's why Multiwire was created by Photocircuits. It overcomes the disadvantages of wirewrapping and multilayering.

A Multiwire board is basically a customized pattern of insulated wires laid down on an adhesive-coated substrate by a machine operating under numerical control.

Multiwire vs. wirewrapping.

Today, interconnection costs are more important than ever. So take a long, hard look at a key advantage of Multiwire panels. They cost much less than wirewrapping in small or production quantities.

Here's an example of how much less: a Multiwire replacement of a 60 DIP wrapped-wire panel. Total tooling costs were just \$750. In order quantities of 1000 pieces, the Multiwire boards at \$45 each were more than \$30 less than the wrapped-wire panel. (A 40% cost savings.) Multiwire prices also include a 100% continuity check.

But cost is not the only reason for the superiority of Multiwire over wirewrapping. There are also design advantages. For example, Multiwire offers two-dimensional packaging density equal to wirewrapping. But with Multiwire panels, you reduce board-to-board spacing. And Multiwire weighs much less too. So it can contribute substantially toward improving the envelope or three-dimensional package of your product.

Electrically, Multiwire is also superior. The extreme repeatability of the manufacturing process provides much higher electrical reliability as received — this is an important cost-saving factor. In addition, you get the controlled impedance characteristics required without variations.

Multiwire vs. multilayering

With Multiwire, reliability goes up and inspection cost goes down. Multiwire doesn't need extensive inspection — like multilayering does — for nicks, pinholes, hairline cracks, spacing violations and bridging. Yet Multiwire regularly yields better than 99% reliability at incoming inspection.

Compared to multilayering, designing a new Multiwire board is a far simpler operation. Component locations and a wiring list are all we need. Our computer-aided system does the rest.

Since the computer also takes care of deletions and/or additions, engineering changes are simplified. What's more, Multiwire makes it easier to find paths for interconnections, because the insulated wires can cross one another. For these reasons we can deliver finished Multiwire boards to your door in weeks rather than months.

The advantages of Multiwire over wirewrapping and multilayering vary from case to case. We'd like to help you evaluate possible time, cost, design and reliability benefits. For information and price estimates, call the Multiwire Marketing Department at 516-448-1111.

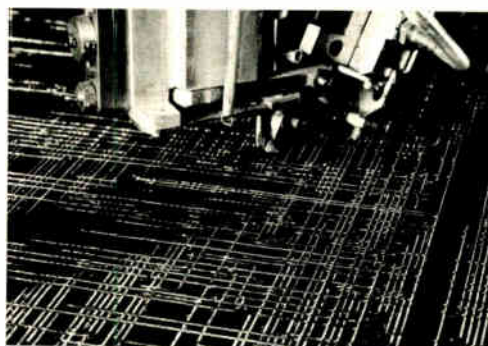
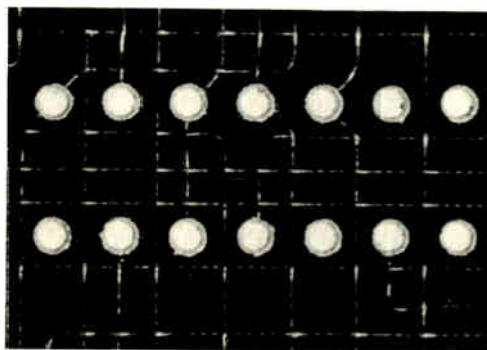

	Wrapped panels	Multi-layers	Multi-wire
Design & tooling cost	Low	Very High	Low
Design & tooling time	Short	Very Long	Short
1st piece delivery	Short to Very Short	Long	Short
Board cost in small quantities	High	High	Medium
Board cost in production quantities	High	Medium	Medium
2 dimensional packaging density	High	High	High
3 dimensional packaging density	Medium	High	High
Weight	High	Low	Low
Ease of changes	Excellent	Poor	Good
High speed electrical characteristics	Fair to Poor	Excellent	Excellent
Interchangeability with other techniques	Fair	Excellent	Excellent
Repairability	Excellent	Poor	Good
Controlled impedance	Poor	Good	Good
Electrical reliability as received	Fair	Good	Excellent

Multiwire from Photocircuits

Division of Kollmorgen Corporation, Glen Cove, New York 11542

Intel 8080 peripherals

Now you can get microcomputer based products out of the lab and into production faster than ever before. Intel® 8080 programmable LSI peripherals give you the competitive advantage by helping you reduce design time, component count and manufacturing and inventory costs. Most of all they'll help you get to market first.

Intel 8080 programmable peripherals are software controlled LSI replacements for hardwired SSI/MSI logic assemblies. You simply attach the appropriate peripherals to the system bus and the +5V supply. Then, with system software, you personalize device operating configurations to suit your applications. Reconfiguration and design changes are made with software. No expensive and time consuming hardware redesigns are necessary.

One peripheral, the 8253 Programmable Interval Timer, is the first LSI solution to system timing problems. It counts out I/O servicing delays, eliminating software timing loops and increasing CPU throughput. It also saves hardware when you need event counters, rate generators or real-time clocks. Each 8253 contains three 16-bit timer/counters.

Our 8257 Programmable DMA Controller is the lowest cost way to handle applications that require high speed data transfer such as disks, magnetic tape, analog interfaces and high speed communication controllers. The four channel 8257 contains all the logic necessary for bus acquisition, cycle counting and priority resolving of the channel requests.

The 8259 Priority Interrupt Controller replaces complex TTL arrays and minimizes component costs. The CPU can change interrupt structure "on the fly" to suit changes in the operating environment, such as time of day or process control parameters. The 8259 handles up to eight vectored priority interrupts. Multiple 8259's can control up to 64 interrupt levels.

Use the 8251 Programmable Communication Controller for "serial I/O." The first true USART in a single chip, the 8251 implements all popular com-

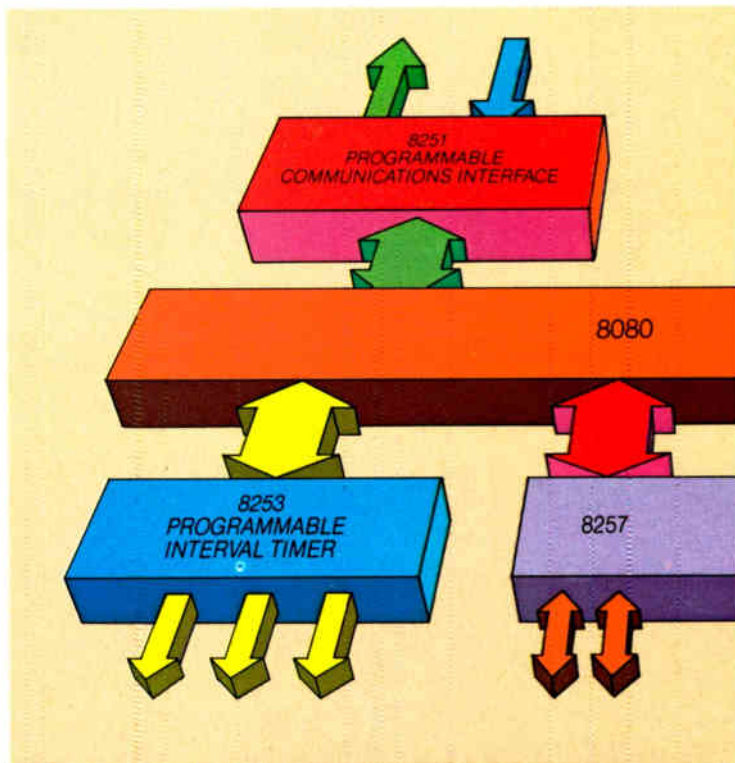

get you to market first.

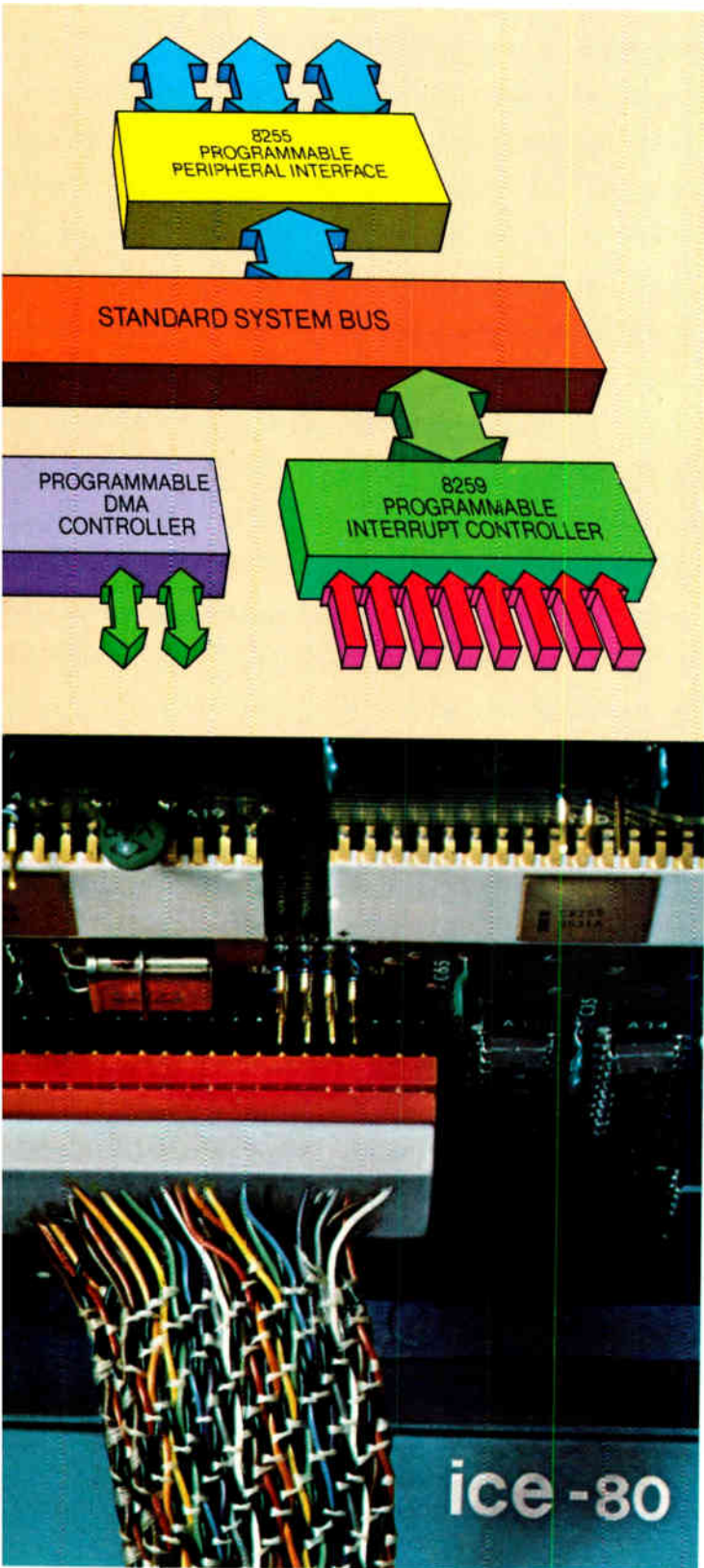

munication protocols, including IBM Bi-Sync. For "parallel I/O," each 8255 Programmable Peripheral Interface gives you 24 versatile I/O lines to interface relays, motor drives, printers, keyboard/display and other parallel equipment.

Once you've selected the peripherals to fit your application, use the Intel[®] Microcomputer Development System for both software and hardware development. Using the Intel[®] CRT terminal, call up the resident text editor. Write the source program to initialize the peripheral and the subroutines for peripheral/system operation. Then you assemble or compile the source programs into an object file using resident macroassembler or resident PL/M compiler—and store the object file on the Intel[®] diskette. With the relocation and linkage capability of the Intel[®] ISIS II diskette operating system, these routines can be added to a system library and called from user programs as needed. Once the main system program is written, the new peripheral device routines are easily linked in. The entire program is now ready to be run on your prototype via the Intel[®] ICE-80™ in-circuit emulation module. ICE-80 lets you debug your software and hardware in your actual prototype environment. Move from system integration and debugging to production in a fraction of the time previously required.

Intel also provides applications assistance, training programs, the largest user's program library, and volume production support. Intel's 8080 programmable peripherals give you the competitive advantage from start to finish. Be first to market.

To order the new peripherals, contact our franchised distributors: Almac/Stroum, Components Specialties, Components Plus, Cramer, Elmar, Hamilton/Avnet, Industrial Components, Liberty, Pioneer, Sheridan or L.A. Varah. For your copy of our 8080 System brochure write: Intel Corporation, 3065 Bowers Avenue, Santa Clara, California 95051.

intel[®]

Microcomputers. First from the beginning.

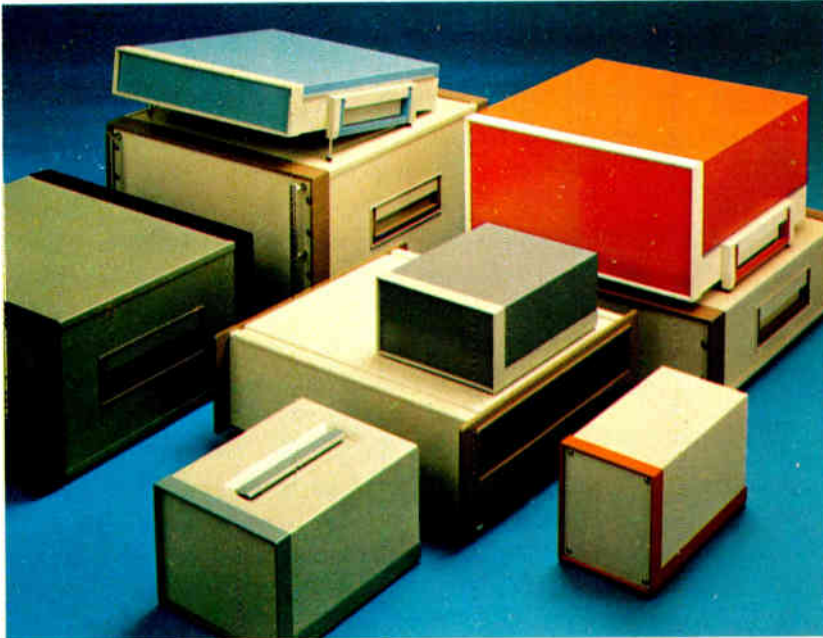

Freedom of choice

That's what's important to us at Optima. And that's why Optima cabinets and cases come in more sizes and colors than any other kind you can buy. With Optima you get 11 different colors to choose from, in fact. And hundreds of different models and sizes. Not to mention a great long list of optional features like rack adapters and perforated panels and tiltstands and spring-loaded handles.

In other words, you can have any enclosure, the way you want it. That's what freedom of choice means. And that's what Optima means, too.

OPTIMA

Optima® Enclosures, a division of Scientific-Atlanta, Inc.
2166 Mountain Industrial Blvd., Tucker, Georgia 30084

SA-87512

Circle 20 on reader service card

Meetings

Computers in Cardiology, IEEE, Chase Park Plaza Hotel, St. Louis, Mo., Oct. 7-9.

ISHM International '76, International Society for Hybrid Microelectronics (Montgomery, Ala.), Hotel Vancouver, Vancouver, B.C., Canada, Oct. 11-13.

Industry Applications Society Annual Meeting, IEEE, Regency Hyatt O'Hare Hotel, Chicago, Ill., Oct. 11-14.

ISA-76—International Instrumentation-Automation Conference and Exhibit, Instrument Society of America (Pittsburgh, Pa.), Astrohall, Houston, Texas, Oct. 11-14.

EUROMICRO—Second Symposium on Micro Architecture, IEEE *et al.*, Venice, Italy, Oct. 12-14.

Second International Conference on Software Engineering, IEEE, ACM, and NBS, Jack Tar Hotel, San Francisco, Oct. 13-15.

1976 Biennial Display Conference, IEEE and Society for Information Display, Statler Hilton Hotel, New York, Oct. 13-15.

1976 Semiconductor Test Symposium, IEEE, Cherry Hill Inn, Cherry Hill, N.J., Oct. 19-21.

Semicon/Europa '76, Semiconductor Equipment and Materials Institute (Golden Gate Enterprises Inc., Santa Clara, Calif.), Zurich, Switzerland, Oct. 19-21.

9th Annual Connector Symposium, Electronic Connector Study Group Inc. (Camden, N.J.), Hyatt House Hotel, Cherry Hill, N.J., Oct. 20-21.

California Circuits Association Fall Symposium, CCA (Palo Alto, Calif.), Marriott Hotel, Santa Clara, Calif., Oct. 20-21.

Annual GIDEP Workshop, Government-Industry Data Exchange Program, Sheraton Hotel, Hartford, Conn. Oct. 20-22.

VALOX



First for electrical construction.

Square-D's new "Qwik-Gard" residential ground fault interrupter demanded high performance. VALOX resin delivered. Unlike most thermoplastics, it combined excellent electricals with a 94 V-O rating per UL Standard 94.* And unlike urea, melamine or phenolic, it provided thin-wall capability for maximum circuitry space; high impact resistance; and lower overall costs.

First for electrical appliances.

Contempra's new crepe maker is another appliance first for VALOX thermoplastic polyester. That's because it delivered a heat-deflection temperature of 420°F and a UL 94 V-O rating. What's more, VALOX resin provided handsome, glossy surfaces with excellent processing economics and molded-in color.

First for automotive electronics.

This rotor is part of Detroit's 35,000-volt high energy ignition system, an application too powerful for phenolic. But VALOX resin's high dielectric strength harnessed this high voltage and delivered superior arc resistance as well. VALOX resin also provided a superior combination of heat, creep, chemical and impact resistance; and processability that allowed the complex mold to be filled easily.

For more data, write VALOX Products Section 285, Plastics Division, General Electric Company, One Plastics Ave., Pittsfield, MA 01201.

*This rating is not intended to reflect hazards presented by this or any other material under actual fire conditions.

THREE MORE FIRSTS FOR VALOX.[®]

RESINS

WHAT THE WORLD IS COMING TO: GE PLASTICS
LEXAN[®] NORLYL[®] VALOX[®] GENAL[®]

GENERAL  ELECTRIC

Circle 21 on reader service card

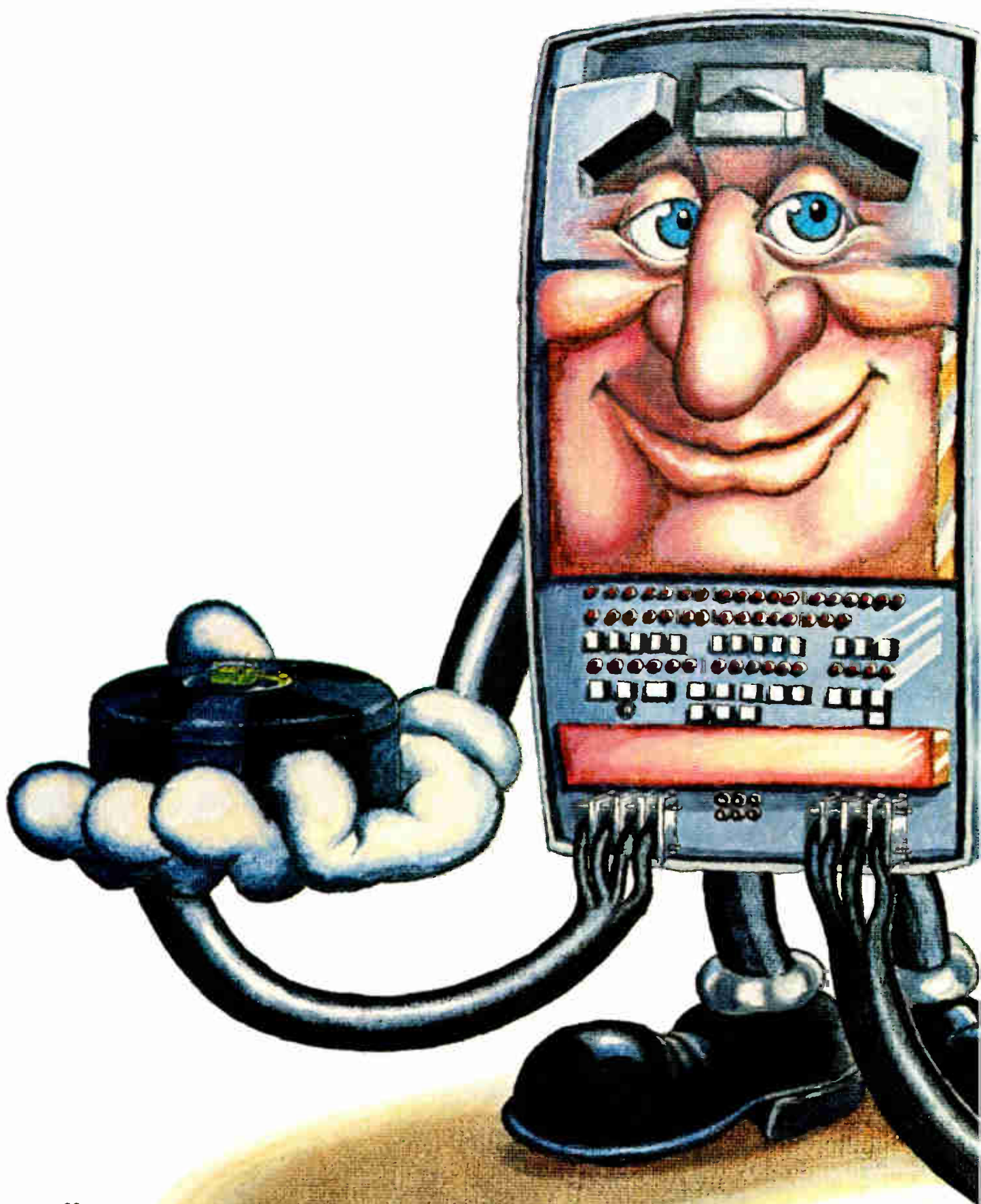

WHEN IT COMES TO 16K RAM TESTING, YOU'VE GOT TO HAND IT TO FAIRCHILD.

Technology marches on. Just as you're beginning to see the light at the end of the 4K RAM testing tunnel, you notice an even bigger problem coming at you from the other direction. The problem is 16K RAM testing; and it promises to be more complex, expensive, and time consuming than 4K RAM testing by several orders of magnitude. But take heart. Before you've even begun to do some serious worrying about 16K RAM testing, Fairchild is here with the solution.

The solution is Xincom III. With Fairchild's Xincom III system, you can test up to 500,000 16K RAM's per month per shift, using as many as 8 dedicated and computer-controlled testers, at a cost of less than \$45,000 per test head.

And while all this rapid, low cost, pass/fail testing is going on in the foreground, the system's host computer can be compiling and storing valuable production, engineering, and business management data in the background.

Things like shmoo plots, histograms, trend graphs, yield analyses, wafer maps and test throughput summaries.



The secret of Xincom III is Fairchild's distributed processing concept. A microcomputer in each tester has sufficient intelligence to allow the tester to stand alone as a pass/fail device; the microcomputer can also perform data manipulation, log test results, and control communications with the host computer. Meanwhile, routine data processing is left to the minicomputer maker's operating system, freeing the bulk of the host computer's intelligence for such important jobs as high level program translation, data reduction to printout, disc storage of results, etc.

Of course, 16K RAM testing is hardly the beginning and end of Xincom III's capabilities. Using the complete set of input software

supplied with the system, it is easily adaptable to anything from TTL/CMOS logic through 64K RAM's and ROM's. And it's no problem at all to test various types of devices, simultaneously, on various test heads within one Xincom III system.

But, for many, 16K RAM testing represents the most pressing memory test problem looming just over the horizon. And we just wanted to assure you that, as always in the field of memory testing, Fairchild has the problem well in hand.

For proof, ask for our free, 22-page, full color brochure containing all the technical data about Xincom III. Better yet, ask for demonstration of the system.

Write or call Fairchild Xincom Systems, a Division of Fairchild Camera and Instrument Corporation, 8944 Mason Avenue, Chatsworth, California 91311. Phone (213) 341-5040. TWX 910-494-2769.



FAIRCHILD

Specifying custom pots for demanding applications was no bed of roses — until Duncan designers grew our New Breed of Hybrids. That's because they came up with a way to make hybrid versions of our entire line of precision pots — at very little extra cost! □ So if you need the precise linearity and low tempco of a wirewound pot and the infinite resolution and long life of conductive plastic, talk to Duncan now. With the industry's broadest line of hybrids, we're sure to have exactly what you're

looking for. □ We've got rotary, straight-line, and multi-turn types (including our famous $\frac{3}{4}$ " 10-turn Pixiepot[®]), with a huge variety of sizes—all available in either linear or non-linear functions. Standard specs like 0.1% output smoothness and ± 70 ppm/°C tempco — even better on special order. All single and multi-turn Mil-R-39023 styles are QPL approved. □ Duncan's New Breed is ready to solve

your toughest application problems now. We'd be happy to send you details.

Duncan's New Breed of Hybrids



*Plant one in your
toughest application.*

DUNCAN ELECTRONICS

SUBSIDIARY

SYSTRON  DONNER

2865 FAIRVIEW ROAD, COSTA MESA, CALIFORNIA 92626
(714) 545-8261 • TWX: 910-595-1128

Actual photo of Hybrid Red Rovers
grown especially for this ad

Four compete to build standard processor for GM . . .

The custom microprocessor being quietly developed by General Motors' Delco Electronics has apparently evolved into a standard GM microprocessor. The prime source is expected to be named within 30 days. Of the 42 firms originally considered a year and a half ago, four are still in the running: Intel Corp., Motorola Inc., National Semiconductor Corp., and Texas Instruments Inc. Delco itself plans to second-source parts of the modular system—a set of four to seven different devices—at a new n-channel MOS factory being built in Kokomo, Ind.

Observers rank Motorola first in the competition; Delco is said to be impressed with the flexibility of the architecture of the M-6800. But vendors concede that none of their current microprocessor products will meet Delco's rigorous specifications, which have been drawn up with inputs from all GM car and components divisions. All the semiconductor manufacturers are proposing 8-bit parallel devices except TI, which is counting on an unannounced member of its 16-bit 9900 family. Intel is offering a custom microprocessor, as well as a high-performance 8085 that it hopes to have available shortly after the first of the year.

. . . as Delco prepares Cadillac information system

The GM custom microprocessor, of course, is still several years from production cars. That is the last of a three-step program at Delco, and, as the first step, Delco is now testing early versions of systems with off-the-shelf Motorola 6800 microprocessor parts that are coupled to custom input/output chips.

That version, or a second-phase version called the Delco hybrid microprocessor (DHM), **may show up as early as next year on some Cadillacs.** The application is reportedly an optional dashboard-mounted information system, called Tripmaster.

Analog Devices DPM to compete with analog units

Analog Devices Inc. in Norwood, Mass., is turning to a proprietary integrated-injection-logic chip and new high-volume production and testing techniques for a digital panel meter that it expects will **compete head-on with instrument-grade analog meters**, both in price and reliability. The 3-digit instrument, priced below \$50, is the first product to be launched by the company's new Instruments and Systems group.

Fluke, British firm push LCD multimeter plans

Preparing for the introduction of its model 8020 digital multimeter in the spring, John Fluke Mfg. Co. of Mountlake Terrace, Wash., **has placed production-volume orders for 3½-digit liquid-crystal readouts** to be delivered the first of next year. Target price is less than \$200.

At the same time, another LCD-readout 3½-digit multimeter, this one from the United Kingdom's Gould Advance Ltd., may soon reach U.S. shores. The firm's Beta model will be sold by Gould's Instrument Systems division in Cleveland.

ADL predicts big year for fiber optics

At least three major fiber-optic systems will be installed during the next year, predicts Arthur D. Little Inc. The Cambridge, Mass., organization, which isn't yet disclosing the locations of those projects, has grown increasingly bullish about the prospects of fiber-optic technology and is **about to assemble operating subsystems and systems** for testing as part of

a study begun in 1973. The study was undertaken for some 80 clients, both in the private and government sectors, on four continents.

Motorola to offer Fortran compiler for Exorciser

To ease the programming burden for users of its 6800 microprocessor, Motorola Semiconductor will soon offer a **resident Fortran compiler for use on the company's Exorciser development system**. The compiler requires only 16 kilobytes of the Exorciser's memory and produces relocatable object code. The Motorola version of Fortran is essentially the same as the ANSI standard, "although it's slightly 'subsetted,'" explains Wesley Patterson, software-product manager.

In comparing Fortran with high-level languages derived from PL/1, such as Motorola's MPL and Intel's PL/M, Patterson says that Fortran, "poor and dumb as it is" because of its lesser data-handling capability and its difficulty in using structured programming techniques, produces more efficient object code and uses less memory.

Ford engine uses only 3 cylinders to save fuel

Ford Motor Co. expects to get fuel savings that average at least 10% with a new 300-cubic-inch six-cylinder engine **that can be electronically switched to three-cylinder operation** when full engine power is unneeded, such as when cruising faster than 45 miles an hour or when decelerating to about 25 mph. The company will introduce the option, called the dual-displacement engine, on some light trucks within the next two years. About 90% of the system, however, is applicable to all the engines Ford makes, opening the door for similar controls in passenger cars. The electronics involves roughly 70 devices, including five standard complementary-MOS circuits, for a total cost of \$10 to \$15.

TRW moves closer to bipolar VLSI

Using an advanced triple-diffused process with an ECL circuit design, TRW Defense and Systems group has broken its own density record set last year with a 16-bit multiplier containing 15,000 gates [*Electronics*, Aug. 7, 1975, p. 101]. TRW's latest effort, a 128-bit shift register, has 260 gates per mil square, a remarkable density because the most dense bipolar-logic technique using I^2L requires 2 mils per gate. Operating at 60 megahertz, it is priced at \$80 in quantities under 100.

With performance data gained from operating the demonstration register, TRW will use its advanced triple-diffusion process to build its first full-size very-large-scale-integrated device by the first quarter of next year. One possibility is a 256-bit serial-parallel correlator, which has already been designed. the correlator has about 40,000 devices on a chip slightly smaller than 1 centimeter square.

Addenda

A military-products group has been formed by Interstate Electronics Corp. of Anaheim, Calif., **to produce computer peripherals**. Along with custom-designed terminals already being shipped, Interstate is planning a line of standard products. All will use a flat-screen plasma display from Owens-Illinois of Toledo, Ohio. . . . Hewlett-Packard has a new family of small computer systems called the HP 1000 **aimed at OEMs and experienced end users** since it doesn't come with much application software. Prices range upward from \$33,500 for a system with 64 kilobytes of semiconductor main memory, a 5-megabyte disk, a 9,600-baud communications-oriented CRT console, and real-time executive operating-system software.

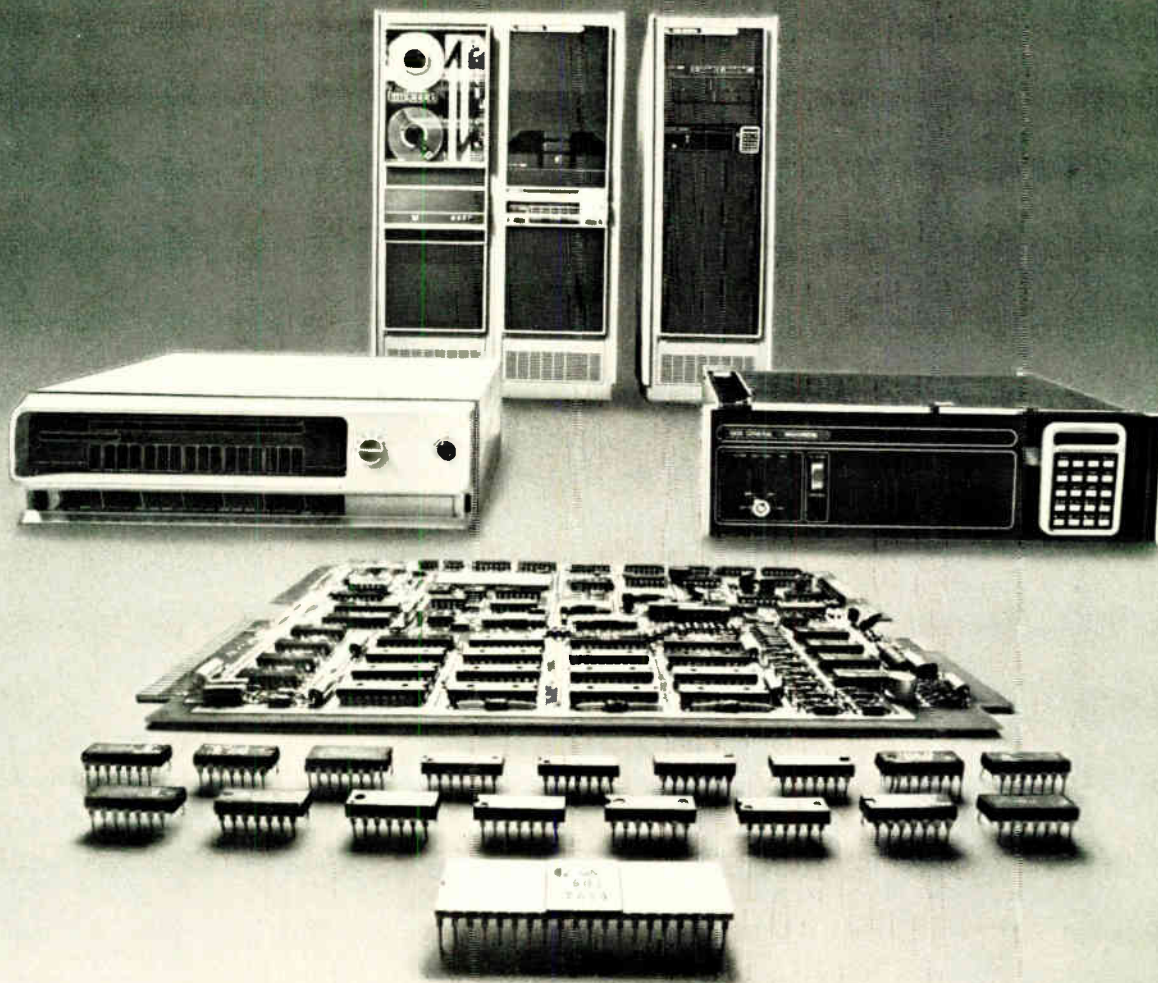

With a line of minis and micros like ours, we don't have to push any one of them.

With other companies, you might set out to buy a microprocessor chip and end up with the whole chassis. Or get a box when all you need is a board.

But Data General doesn't work that way. We don't have to push you into buying something you weren't really looking for. Because we can let you choose from microprocessor chip sets, microcomputer boards, completely packaged MOS minis and full-blown NOVA 3 systems. All four are compatible. And they give you a range of performance with a range of prices.

So, if you're a component user, there are both high-performance microNOVA chip sets and microcomputer boards that feature Data General's mN601 microprocessor. The mN601 is a full 16-bit NOVA-on-a-chip. And the microcomputer is a full 4K-word computer-on-a-board. You package them yourself, for greatest economy. (Speaking of economy, the board costs only \$589 in OEM quantities of 100.)

And if you're not ready for components yet, there's our fully-packaged microNOVA MOS minicomputer. It's available with up to 32K words of MOS memory and peripherals like

our diskette subsystem. And it's supported by our Real-Time Operating System and diskette-based Disc Operating System. You can get our mini with 4K words of MOS memory for only \$1995. Or as a complete development system with the diskette.

If you need bigger systems capabilities, take a look at our NOVA 3 computer. It's compatible with our microNOVA family. And it runs with high-performance peripherals, sophisticated software like Real-Time Disc Operating System, high-level languages like FORTRAN 5 and BASIC, and memory expansion to a full 128K words.

We've got it all. But we won't try to sell it all. Unless it's what you really need. If you don't believe that line, call us. Dial 800-225-9497 (in Massachusetts, 1-617-485-9100, extension 2509) and ask for information on microNOVA and on the free half-day microNOVA seminars that happen this fall all over the country.

Or write for our microNOVA and NOVA 3 brochures. And see for yourself.

DataGeneral

Data General, Route 9, Southboro, Mass. 01772 (617) 485-9100. Data General (Canada) Ltd., Ontario.
Data General Europe, 15 Rue Le Sueur, Paris 75116, France. Data General Australia, Melbourne (03) 82-1361
NOVA is a registered trademark of Data General Corp.

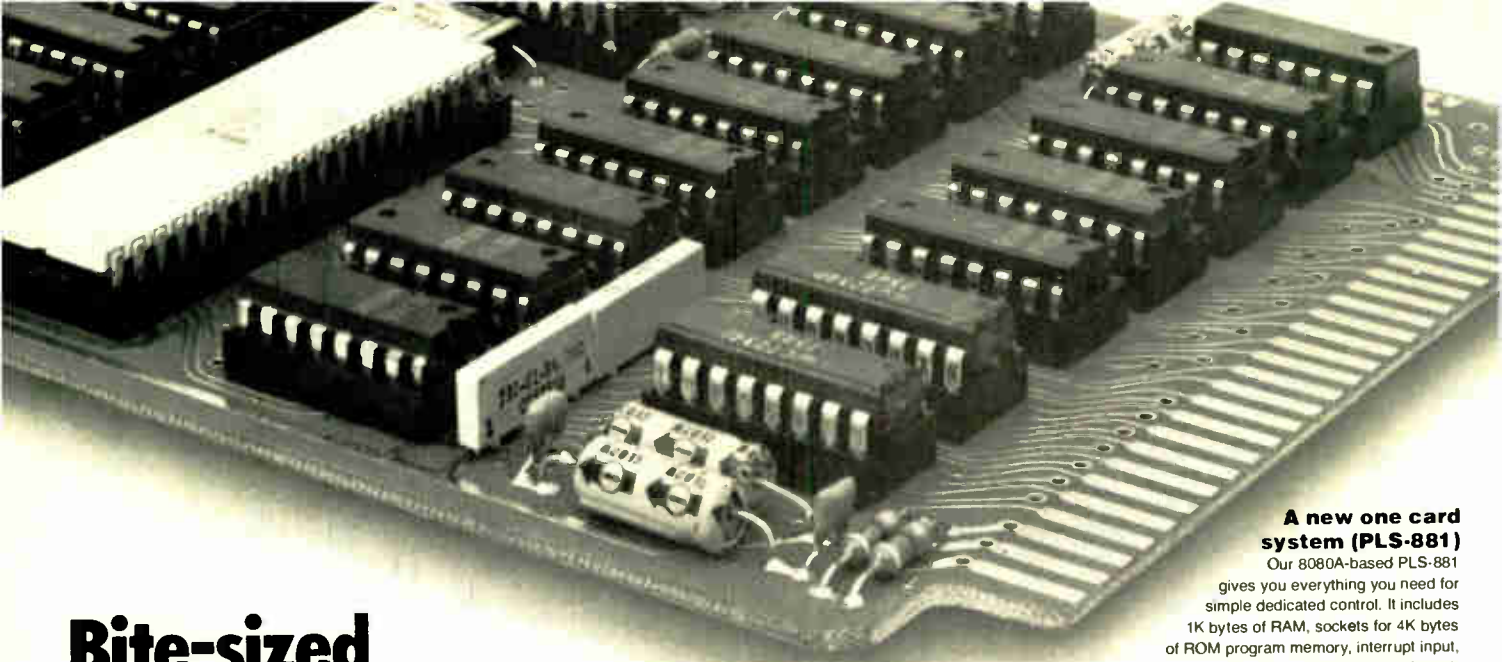

Bite-sized 8080A systems make big boards hard to swallow.

Simple, flexible, standardized Pro-Log 8-bit microprocessor systems a best buy for OEM's.

We sell 8080A, 6800 and 9002 microprocessor cards two ways: as complete single or multicard systems, or as individual CPU and support cards so you can build a system of your own.

Our cards are all standard 4.5" by 6.5" with 56 pin edge connectors. They fit into standard card racks. To keep you from being tied to a specific semiconductor manufacturer for parts, delivery and pricing, our 8080A and 6800-based systems use only second-sourced parts.

Buy 250 of any particular card and we throw in free its manufacturing and assembly plans and non-exclusive rights to manufacture it, allowing you to build your own hardware, relying on us as an established and dependable second source.

We've got 4-bit systems, instruments, education and literature, too.

4-bit 4040 and 4004 systems; 4- and 8-bit microprocessor system analyzers; PROM programmers; a half-day economics seminar for decision makers; a three-day hands on design course for engineers; manuals and support documentation.

Call or write for data sheets or a free copy of The Microprocessor User's Guide.

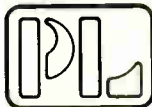

PRO-LOG CORPORATION
2411 Garden Road
Monterey, CA 93940
Telephone (408) 372-4593
TWX 910-360-7082

Belgium: Teteringen

Indelec, B.V. Tel. 01618-19 73

Denmark: Copenhagen

E.V. Johansen Elektronik A-S Tel. 45 183 90 22

Finland: Helsinki

Into Oy Tel. 90-171 123

France: Bagneux

Technitron, Inc.—France Tel. 657-11-47

Germany: Ortlerstrasse

Spezial-Electronic Tel. 089/7600031

Italy: Rome

Technitron, SRL Tel. 805.647 or 872.457

Netherlands: Teteringen

Indelec, B.V. Tel. 01618-19 73

Sweden: Djursholm

Integrerad Elektronik AB Tel. 08/7530330

Switzerland: Zurich

Laser ± Electronic Equipment Tel 01/55.33.30

United Kingdom: Surrey

Technitron, Inc.—U.K. Tel. Camberley 26517

Circle 28 on reader service card

A new one card system (PLS-881)

Our 8080A-based PLS-881

gives you everything you need for simple dedicated control. It includes 1K bytes of RAM, sockets for 4K bytes of ROM program memory, interrupt input, crystal clock, power-on and external reset, three 8-bit output ports, and two 8-bit input ports. It costs only \$195 in 100 piece quantities.

A new, expandable plug-in CPU card (8821)

Our "buffered bus" 8821 processor card implements the 8080A as a fully TTL buffered microprocessor. Add one I/O card and it becomes a complete two-card system. Or expand it to use full 8080A memory and I/O capability—it's compatible with all the Pro-Log ROM, RAM and I/O modules shown here plus many more. The 8821 costs only \$190 in 100-piece quantities. We also have equivalent cards implementing the 6800 and 9002 microprocessors.

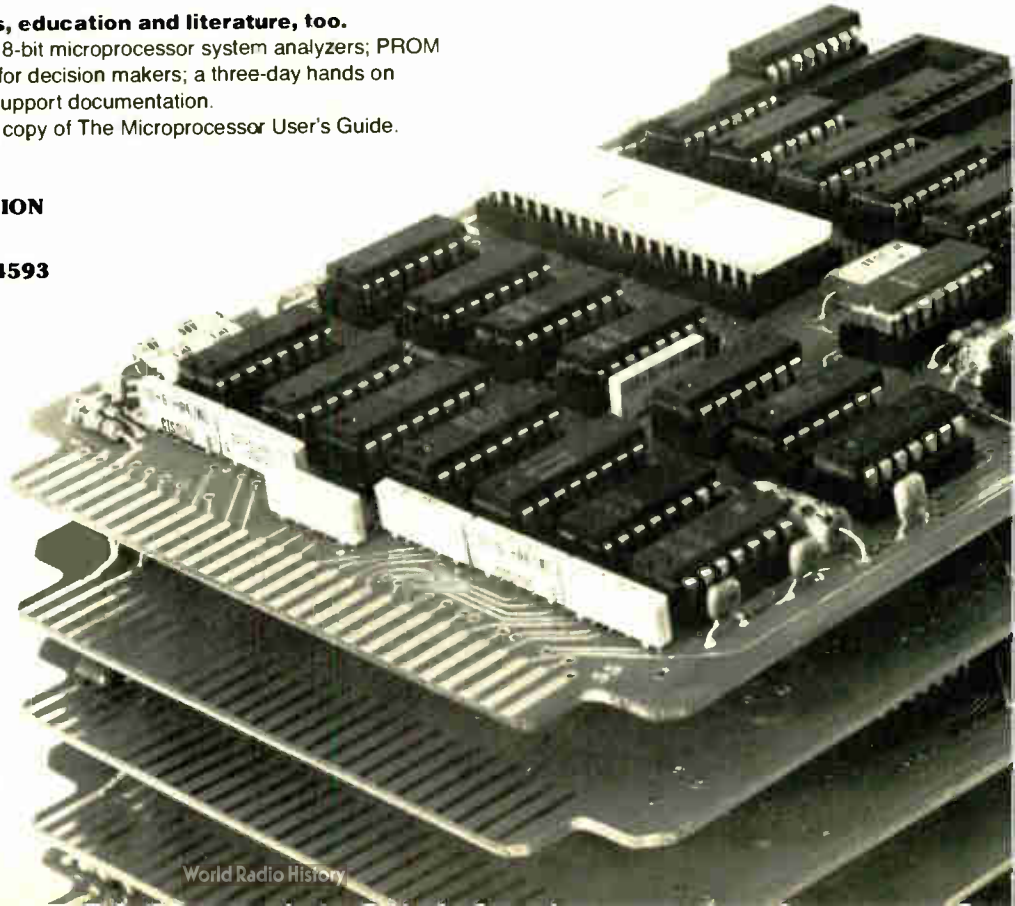

Samples of 92-k bubble memories coming from TI

'Early production units' in 14-pin DIP due by year-end; volume-production goal is less than .0005 cents a bit

Texas Instruments will begin selling samples of a commercial bubble-memory device during the fourth quarter of the year. The memory will be produced on the pilot production line that TI set up in its Dallas semiconductor production facilities earlier this year [*Electronics*, March 4, p. 32]. "These are not laboratory devices; they are early-production units. They are working memories," says H. Dean Toombs, engineering director for TI's Semiconductor group.

Although the firm's Digital Systems division in Houston has built the bubble packages into both computers and terminals for internal customers, the memory, an alternative to electromechanical storage like disks and drums, hasn't been seen outside of TI. "But our target for some small sample quantities is the fourth quarter," Toombs says. "They'll be available to customers who appear to have potential applications that fit the kind of performance and costs we can achieve."

Millicent price. The prices of the 92,304-bit package will range from 40 to 50 millicents per bit when the part, which could be the first commercially available bubble memory, is introduced in production quantities some time next year. This works out to between about \$37 and \$46. "It's possible to see 20 millicents-per-bit prices with this de-

vice," Toombs continues, "but we're not willing to predict when."

The single memory chip is organized in 144 registers of 641 bits each. TI has demonstrated a maximum data rate of 50 kilobits per second for the device, the average time to access the first bit is 4.0 milliseconds, and cycle time for a 144-bit block of data is 12.8 ms. The chip is built with redundant minor loops that the system designer must bypass, "but there are three or four simple ways to get around that problem," Toombs says. Operating temperature range is 0° to 70° C, and nonvolatile storage is effective from -40° to +85° C.

Besides the storage material, the memory package contains two permanent magnets to supply the constant direct-current bias needed to preserve the bubbles—and thus the stored data—when the package is not powered. Wire coils supply a

rotating magnetic-drive field to propagate the bubbles after they've been generated within the epitaxial film.

Everything is packaged in a 14-pin dual in-line package that measures 1 by 1.2 by 0.4 in. high. The chip itself requires no power, but the coils within the package dissipate 0.7 watt, and an external driver, packaged in its own 14-pin plastic DIP, dissipates 0.8 w.

TI is also working on the peripherals needed to interface the new memories to systems. Parts that will be available next year include:

- The TMS 5502, an n-channel metal-oxide-semiconductor controller and interface that interprets commands from the central processor, and formats the data coming from the bubbles. One of the controllers, compatible with Intel Corp. 8080 and TI 9900 microprocessors as well as the TI 990 family

Prototype system available from Rockwell

A division of Rockwell International began delivery this month of a prototype bubble-memory system to a number of customers. Called the POS-8, the system is composed of eight 100,000-bit chips. They are laboratory-evaluation units "to provide potential users an opportunity to obtain hands-on experience with the devices," says E. T. "Jake" Brown, manager of bubble-domain memory products for the Autonetics group's Business Development division in Anaheim, Calif. These units, priced at \$5,000 each to cover the costs of building them in a pilot-production facility, are one-of-a-kind products to enable customers to get a feel for the technology, he says. "We don't believe anyone is going to commit to a bubble design until he's had a chance to play with one."

Brown hopes to sell about 25 of the units by the year-end to "non-classical kinds of customers." Timing of the introduction of a commercial bubble memory system will depend on the feedback. The Autonetics group also has contracts from government agencies to develop bubble memories. One from NASA is for a 100 million-bit satellite recorder. A prototype is to be delivered in early 1977.

of minicomputers, is needed for each system.

- A bipolar clock/timing circuit to supply read, write, and enable signals for up to 64 bubble chips and a total of about 6 million bits.
- A linear current-driver to supply the triangular-wave current drive to the coils packaged with the chips. It

will drive two of the 92-kilobit memories.

- A sense amplifier, similar to that supplied by TI for plated-wire memories, for every two bubble chips. TI is working with an outside vendor to provide a resistor-capacitor network for sense-amplifier loading and termination. □

Military

Efforts in millimeter-wave systems beginning to bear fruit for Norden

The years of spending its own money on developing millimeter-wave technology seem about to pay dividends to United Technologies Corp.'s Norden division in Norwalk, Conn. Both the U.S. Army and Navy are now funding experimental-hardware programs that could, say spokesmen at both services, lead to field equipment by the early 1980s.

Until recently, costs of millimeter-wave hardware, operating in the 30- to 300-gigahertz range with wavelengths of 10 mm to 1 mm have been inordinate. To reduce them, Norden is relying on innovative system

design and microwave-fabrication techniques, as well as applying at these high frequencies relatively new solid-state Gunn and Impatt diodes in place of bulky klystrons.

RPV radar. One of its new systems is a 95-GHz experimental radar that will be flight-tested by the Army next spring. The radar is destined for the Aquila remotely piloted vehicle (RPV), a small unmanned aircraft for battlefield surveillance.

For its initial unit, Norden is using an Impatt diode that operates at about 95 GHz to replace klystrons as the local oscillator in the re-

ceiver/transmitter portion of the radar. Earlier solid-state sources were limited to operation in the 10- and 16-GHz range. For an operational radar, Gunn diodes such as those available in the last few months from Hughes Aircraft Co. and Control Data Corp.'s TRG division, probably will replace the Impatt, says Lester Kosowsky, head of technical systems analysis at Norden. "The Gunn devices have better noise figures at the frequencies we're operating," he says.

Through use of the solid-state source, Norden will also eliminate the high-voltage power supply (typically 2,000 v) required for the klystron. "As a result, the entire transmitter/receiver portion will be packaged to fit on the antenna gimbal," says Kosowsky. "This will eliminate the need for long waveguide runs and rotary joints, both of which introduce power losses on transmission and receiving."

The system has a three-axis gimbal to control a 20-by-17-inch shaped antenna. Peak power output of 6.5 kilowatts is supplied by a magnetron transmitter/modulator. And there are a digital processor and a digital interface unit for transmitting the radar data back to a display unit at a battlefield command post.

Targets. The primary function of the millimeter-wave radar in the RPV would be to detect, locate, and discriminate among stationary targets on the ground, explains James Alimena, Norden's engineering manager for advanced programs. But the radar also is being considered for high-resolution ground mapping and moving-target indication.

While millimeter-wave radars offer much better resolution for a given size of antenna than radars operating at lower frequencies, their range is not as great. "But that's no problem with RPVs, since they have to be close to the target anyway," states Col. Dave Powers, head of the RPV division at the Army Aviation Systems Command in St. Louis. The importance of the millimeter-wave radar, Powers continues, "is that we can look at real-time information, as opposed to a photo that has to be

Military funds millimeter-wave hardware

The millimeter-wave field is spawning a variety of government-funded developments of hardware for tactical warfare applications. Some examples of the programs:

- The U.S. Army Electronics Command in Fort Monmouth, N.J., in addition to evaluating Norden division's 38-gigahertz transceivers, wants hardware for secure communications that operates at 60 GHz. The Aberdeen Proving Grounds also is buying pulsed-power sources operating at 140 GHz and 217 GHz for use in guidance equipment for beam-riding missiles.

- The Naval Ship Systems Command is ship-testing hand-held transceivers from Norden and yoke-mounted radio transceivers from Hughes Aircraft Co.'s Electron Dynamics division in Torrance, Calif. Operating in the 36-38.6 GHz range, the transceivers may be used to replace signal lights for secure communications. The millimeter-wave units would have a narrower beam than signal lights and wouldn't propagate as far as lower-frequency transceivers. The Naval Air Development Center in Johnsville, Pa., also has some millimeter-wave programs underway, as does the Navy's China Lake, Calif. facility.

- The Air Force, at Wright-Patterson Air Force Base in Ohio, is buying continuous-wave sources operating in the 225-GHz range for missile-seeker activity, and Eglin Air Force Base in Florida is active in missile guidance and measurements with the Navy. The Air Force Armaments Laboratory plans flight tests this year of radiometric systems for target designation, ground-mapping, and weapons guidance.

developed, if the RPV returns." The only alternative being evaluated for real-time target acquisition is forward-looking infrared radars. "But FLIRs, while they have better range," notes Powers, "are more susceptible to bad weather."

Tests at sea. For the Navy, Norden has supplied a pair of millimeter-wave transceivers that are now being tested at sea. The 5-pound hand-held units, measuring 5 by 5 by 9 inches, were developed for the Naval Research Laboratory in Washington. They are to provide jam-resistant communications because of the inherently short range

of millimeter waves and the narrow transmission beam widths with which the systems can be designed, points out Sal Amoroso, a senior systems engineer at Norden. Also, they avoid the congestion that exists at the lower frequencies. The full-duplex units, which operate between 36 and 38 GHz, are used line-of-sight with voice, data, and video information transmitted over a 5° beam.

Norden is also building similar units for the U.S. Army's Electronics Command at Fort Monmouth, N.J. Operating at 38 GHz, the units will be on masts for communications between command posts. □

in Alaska. He emphasizes that life cycle costs will be an overriding consideration. "We're encouraging off-the-shelf data-processing equipment wherever possible," the colonel says.

"We'll take basic algorithms and logic from other programs, such as the E-3A, and we are not stipulating the memory size or other parameters. We're spelling out the basic requirements and letting industry come up with solutions," he goes on to explain.

For example, the Air Force envisions about 17 display consoles at each ROCC (10 for the Canadian sites). There's a classified, but very low down-time number, and classified data rate and data-processing speed. Even the option of maintenance at the regional centers by a civilian contractor or the Air Force is still open and will be based on economics.

"With all the savings it will realize we view the JSS as a motherhood program," Vogel notes. "Where most programs are looking for more speed or payload, we want to do as good a job as SAGE does, and do it more economically. We want the guy who can meet the requirement, not necessarily exceed it." He grudgingly accepts the need for carrying two contractors through the 12-18 month design-verification period, justifying it as "almost a software flyoff." □

Industrial

CNC relies on microprocessor trio

Although makers of machine-tool controls have turned to microprocessors to handle some control tasks, most find themselves falling back on racks of hard-wired logic for the functions that demand high computational speeds, such as interpolation of circular cutting paths and controlling multiple servo axes. One new entrant, however, does the job with a trio of powerful microprocessors.

"What our microprocessor tech-

Air Force wants bid for joint system that updates continental surveillance

The Air Force will soon issue requests for proposals for its Joint Surveillance System, a network of radar sensors, data processing, and display equipment intended to keep track of aircraft in U.S. air space. The program is expected to cost some \$250 million over its 20-year life. But it should pay for itself in a quarter of that time by saving more than \$100 million a year, compared to the cost of operating the 1950-vintage semiautomatic ground environment (SAGE) system it will replace.

Latitude. As in other emerging Air Force programs, the two winning contractors for the 12-18 month design-verification period will be given wide latitude in meeting the Air Force's needs. Most recently, the Seek Skyhook balloon-borne surveillance radar, which will be one of the JSS sensors, left a lot of room for ingenuity in the lap of industry [*Electronics*, Aug. 19, p. 33].

The radar sites of the joint system will be manned by Air Force and Federal Aviation Administration personnel. The FAA will own all but five of the 48 continental U.S. radar sites, and about 12 of its new Westinghouse-Electric-built air route surveillance radars, which will be fielded as joint-use sites.

All the radars will provide aircraft tracking data to planned Air Force region-operations-control centers (ROCC) and to the FAA's air-route-traffic-control centers. Most of the radars are older AN/FPS-90 units built for SAGE by General Electric Co. They'll be updated with new magnetrons as part of the JSS program, and some of their other tubes will be replaced with solid-state circuitry.

Col. Stephen J. Vogel, program director of the JSS program office at the Electronic Systems division, Hanscom Air Force Base, Bedford, Mass., reports that locations for the four continental U.S. ROCCs haven't been determined yet. The Air Force has recommended four of its bases—McCord (near Seattle), March (Calif.), Griffiss (N.Y.) and Tyndall (Fla.)—because of the requirement that the control centers be co-located with bases that accommodate E-3A airborne warning and control aircraft. In the event of war, the ROCC mission would be assumed by E-3A aircraft.

ROCC sites. Vogel says the initial request for proposals to equip the ROCCs, is likely to go to industry in early November. Besides the four continental U.S. sites, there will be two sites in Canada and another one



Basics. A small and simple control now does complex jobs for Actron's Stanley Froyd.

nology has done is get us back to a small and simple machine-tool control," comments Stanley G. Froyd, manager of industrial automation for McDonnell Douglas Corp.'s Actron division. The company's Actrion III microcomputer numerical-control, first shown at this month's International Machine Tool Show in Chicago, [*Electronics*, Sept. 16, p. 44] can use the same seven printed-circuit cards to control an inexpensive two-axis lathe or a complex five-axis machining center.

Its basic price is just under \$15,000, "and even under any possible set of options, it can't exceed \$30,000," he says. In contrast, minicomputer-based controls, with special software to interface the control to the machine tool, can easily top \$80,000. By no means a newcomer to machine-tool control, Actron has built some 70 or 80 minicomputer-based systems for metalworking at McDonnell Douglas.

Different tasks. The key to Actrion III's design is a pair of metal-gate, n-channel metal-oxide-semiconductor chips—a 16-bit control unit and an 8-bit arithmetic slice—built by the McDonnell Douglas Nitron division, Cupertino, Calif. These ICs are used for three separate microcomputers, each handling dif-

ferent tasks and storing instructions in up to 8,192 16-bit words of programable read-only memory.

Nitron started shipping the control and arithmetic chip last November. Moreover, the Air Force Aeronautical Systems division at Wright Patterson Air Force Base in Ohio is urging that the military adopt the microprocessor for avionics use [*Electronics*, April 17, 1975, p. 31].

"It takes an enormous amount of computing power to handle machine-tool jobs," Froyd points out. "The three microcomputers in the system's distributed architecture are tied together only in the common data memory." And though the word length of instructions is fixed at 16 bits, data-word length is variable from 8 to 80 bits. Actron uses two of the 8-bit arithmetic chips with a 16-bit control chip in each microcomputer. "The present metal-gate versions each execute 160,000 to 200,000 instructions per second," he says, "but we're about a year away from a pin-for-pin-compatible silicon-gate microprocessor that will be twice as fast."

The three microcomputers have a 250-instruction set. One controls inputs and outputs and another serves as the machine's number cruncher, doing real-time computations. The third computer directs the servos, simultaneously calculating the machine's forward-transfer function for as many as five axes.

Optionally, a fourth microcomputer can be added to drive a cathode-ray-tube display. "It also can tie into a host computer for management information or direct numerical control," says Froyd.

Programable interface. The I/O board also carries a specially designed programable machine interface, a subsystem that's often implemented by machine-tool builders with relays. Actron, however, relies on erasable PROMs that can be programed via the relay-ladder diagrams with which machine-tool users are familiar.

The machine's main memory board stores 1,024 bits of static random-access memory for the interface, as well as 1,024 16-bit words of

RAM "as a mailbox [scratchpad] for the microcomputers to work through," Froyd says. The same board is used to store machine constants: "1,024 by 8-bits of PROM that can be field-programed to customize the control to the machine tool."

Tool offsets, manually entered to compensate for differences in tool length or diameter without reprogramming the punched-paper part-program tape, are stored in electrically alterable nonvolatile memories—metal-nitride-oxide semiconductor units also from Nitron. □

Maritime

Ship automation only just begun

Merchant marines, unlike military fleets, have a long-standing reputation as cheapskates when it comes to electronics. Yet that image is beginning to change now, as shipowners push for streamlined operation that will maximize their return on the millions invested in such large-scale cargo carriers as supertankers.

Behind the push are soaring operating costs—led by sharp increases in fuel prices—that the U.S. Maritime Administration's Harry Feigelson says are "approaching the \$1,000-per-hour range" for many new ships.

Automation of ship operations is the answer for many mariners, according to Marvin Pitkin, Feigelson's associate at Marad, in Washington. Yet the market is just beginning to unfold, Pitkin points out. No more than 2% of the large merchantmen in the world's fleets today have any degree of automation, although he is quick to add that 500 automated ships out of a possible 25,000 to 30,000 represents a major advance over two years ago when the total was nearer 70.

How big is the new market? Pitkin, a co-chairman of the Second International Symposium on Ship Operation Automation in Washington this month, figures it as \$35,000

We blow a fuse for our customers, more than one billion times a month.

**No other company can
make half that statement.**

Which means that more people trust us to supply their PROM requirements than any other company. How did we get to be No. 1? Take a look at our product line and our prices. Consider our reputation for quality parts and on-time delivery. We might be the PROM supplier you are looking for.

For more information call,
TWX or write:

United States
Monolithic Memories, Inc.
1165 East Arques Avenue
Sunnyvale, CA 94086
Tel: (408) 739-3535
TWX: 910-339-9229

Europe
Monolithic Memories, GmbH
8000 Munich 80
Mauerkircherstr. 4
West Germany
Tel: (089) 982601, 02, 03, 04
Telex: (841) 524385

Far East
MMI Japan, K.K.
2-2, Sendagaya 4-chōme,
Shibuya-ku,
Tokyo 151, Japan
Tel: (03) 403-9061
Telex: J26364

MONOLITHIC MEMORIES PROMS

MEMORY SIZE	ORGANIZATION	DEVICE	OUTPUTS	PINS	OPERATING RANGE	MAX* ACCESS TIME (ns)	100-999 PRICE
256	32 x 8	6330/1-1	OC/TS	16	com	50	\$ 2.55
		5330/1-1	OC/TS	16	mil	60	5.00
1024	256 x 4	10149	OE	16	com	30	17.50
1024	256 x 4	6300/1-1	OC/TS	16	com	55	3.25
		5300/1-1	OC/TS	16	mil	75	7.90
2048	256 x 8	**6308/9-1	OC/TS	20	com	65	15.95
		**5308/9-1	OC/TS	20	mil	85	33.50
2048	512 x 4	6305/6-1	OC/TS	16	com	60	7.00
		5305/6-1	OC/TS	16	mil	75	15.95
4096	512 x 8	**6348/9-1	OC/TS	20	com	65	15.95
		**5348/9-1	OC/TS	20	mil	85	33.50
4096	512 x 8	6340/1-1	OC/TS	24	com	90	15.95
		5340/1-1	OC/TS	24	mil	120	33.50
4096	1024 x 4	6350/1-1	OC/TS	18	com	60	15.95
		5350/1-1	OC/TS	18	mil	75	33.50
4096	1024 x 4	6352/3-1	OC/TS	18	com	60	15.95
		5352/3-1	OC/TS	18	mil	75	33.50
8192	1024 x 8	**6386/7-1	OC/TS	22	com	90	Consult Factory
		**5386/7-1	OC/TS	22	mil	125	Consult Factory
8192	1024 x 8	**6380/1-1	OC/TS	24	com	90	Consult Factory
		**5380/1-1	OC/TS	24	mil	125	Consult Factory

*max access time is guaranteed over the complete voltage and temperature variation.
**available October 1976.

Monolithic Memories

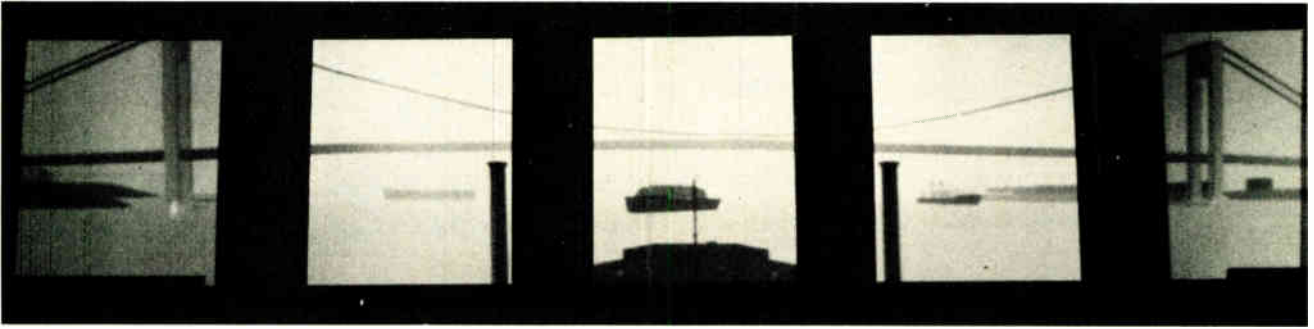

TV view. Bridge-simulation system put together by Sperry Rand Corp. for \$1.5 million is now being operated and monitored by Grumman Data Systems Corp.

to \$150,000 per vessel, depending on its size and the degree of automation [*Electronics*, Sept. 16, p. 60].

Getting there. Automating ship-to-shore communications is a ripe market, Feigelson points out, since 90% of all communications still employs manual Morse-code telegraphy in the 4–28-megahertz range. This could change rapidly with the maritime service just inaugurated over C- and L-band links of the Marisat satellite. But Pitkin believes an even larger potential lies in the automation of such on-board operations as navigation, including anti-collision, weather routing and docking systems, bridge and engine-room functions, and cargo handling.

Automation is accelerating faster in such traders as the Scandinavian countries and Japan than in the U.S., whose fleet is relatively small and antiquated, Pitkin acknowledges. He points out that “aerospace is America’s charmed industry; in those other countries that have no aerospace, it is shipping.”

Nonetheless, he says that the U.S. is a leader in developing on-board automation concepts at Marad’s National Maritime Research Center at Kings Point, N.Y., home of the Merchant Marine Academy. Key to the Kings Point operation is its bridge operations simulator, or Caorf—for computer-aided operations research facility. Unlike most simulators, it is not used for training, but in the development of advanced integrated bridge systems for ships.

Operational since early this year,

Caorf has begun a 5-year research program that will push operational criteria and standards in bridge system design, collision avoidance, ship control and navigation, and analyses of restricted waterways. Instrumentation in the 14-by-20-foot Caorf wheelhouse “is an electronic wonderland,” says one mariner who has seen it. It has radars for relative and true ship motion simulation of up to 40 moving ships and other marine features, as well as a gyro pilot steering control, a propulsion console, controls for bow and stern thrusters, a fathometer collision-avoidance system, and communications.

Later this year, Caorf will add a doppler docking system, radio navigation equipment including Loran, Decca and Omega, plus a wind-direction and -speed indicator. Outside the wheelhouse is a 60-foot-diameter cylindrical projection screen covering a 240° field of view. On it are displayed TV color projections of up to six other moving ships, coastlines, buoys, bridges, piers—anything a watch officer might see—plus a superimposed forebody of the 80,000-ton tanker that the wheelhouse commands. Fog, haze, darkness, and other conditions can be simulated by altering the color intensity of objects on the display. □

Components

New TWT cathodes look promising

For their still-unrivalled high power output, vacuum tubes depend heavily on good cathode design. And par-

ticularly in a traveling-wave tube, a properly curved cathode is essential for good performance in the focused-beam device.

Now, from the Air Force Avionics Laboratory at Wright-Patterson Air Force Base, Ohio, comes what it hails as the most promising new cathode to be developed in 30 years. It’s made from a pliable nickel-based material that is exceptionally easy to form and cut, says Richard Remski, head of the microwave devices group in the Electronic Technology division. In contrast, the usual cathode materials, such as tungsten, are very hard and must be machined to shape. The new plastically deformable material should make the cost of manufacturing cathodes three to five times lower, notes Remski.

Lower temperature. What’s more, operating temperature can be considerably lower, he adds, reducing stress on tube seals and extending tube life. At a pulsed current density of 10 amperes per square centimeter of cathode area, cathodes made with the new material operate at 852°C compared with those made from conventional materials, which operate from 1,000°C to over 1,100°C, Remski reports.

For about a year, the Electronic Tubes operation of Northrop Defense Systems department in Des Plaines, Ill., has been testing and evaluating dish-shaped and flat cathodes made from the new material. And what they’ve found has been so promising that Remski wants more groups to test the new cathodes.

“We will be purchasing cathodes from Northrop [which will be fabricating them for the Air Force] and distributing them to industry people

Super-fast statics

now with 70ns access

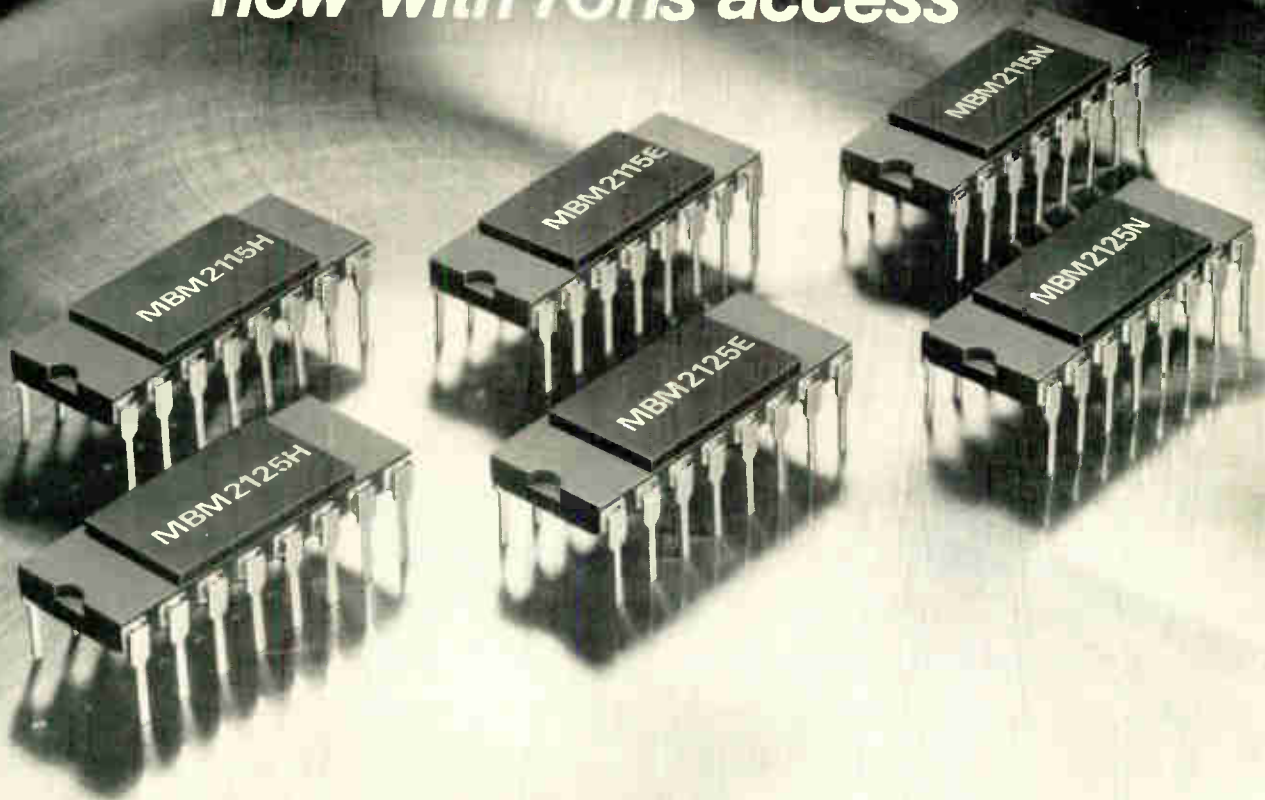

NMOS STATIC RAM MEMORIES MBM 2115/25 Family

FUJITSU
SEMICONDUCTORS

The Fujitsu MBM 2115/25 static NMOS 1K RAM family is the "hands down" choice when it comes to combining the speed advantages of bipolar devices with the low-power/low-cost benefits of MOS technology. With the MBM 2115/25, you get the fastest speed and lowest power dissipation available in the industry-standard pin-outs, and with three speed versions each for either three-state or open-collector configurations. And, of course, you get the added benefit of Fujitsu's unsurpassed reliability.

Super-fast at reduced power

Fujitsu static NMOS 1K RAMs feature super-fast access times via refresh-free operation. And, being MOS, they also provide for reduced power consumption that means extra savings. With the MBM 2115N/25N, maximum access is 120ns, with

a typical of 90ns; the popular MBM 2115E/25E better than substantially, providing a maximum access time of 95ns and a typical of 65ns; and the present speed leaders, the H versions, offer a fantastic 70ns maximum and 55ns typical. Yes, with super-fast access times as low as these, and at a typical power dissipation of only 200mW/chip (N/E versions) or 380mW/chip (H versions), the Fujitsu MBM 2115/25 family is the best choice available today in 1K static RAMs.

Choice of output configuration

The MBM 2115/25 family provides you with a choice of output versions to meet your exact circuit requirements. With the MBM 2115s, you get uncommitted collector outputs, while the MBM 2125s offer three-state outputs. With TTL-compatibility all around and the capacity for driving bus-organized systems, you're sure to find a Fujitsu static 1K RAM

to suit your precise requirements.

Proven reliability and available now

The Fujitsu MBM 2115/25 static 1K RAMs are built by Fujitsu, a maker with proven reliability. Our stringent production and testing standards, and our capability to meet your requirements, all add up to savings and performance that can't be beat. So contact Fujitsu now for the MBM 2115/25 family, or any of your other semiconductor requirements. Availability is NOW!

Write or call for more information to Fujitsu America, Inc., 1280 East Arques Ave., Sunnyvale, California 94086, phone: 408-735-0735 telex: 346393.

FUJITSU LIMITED

Communications and Electronics
Tokyo, Japan

Circle 35 on reader service card

Electronics review

contract imports³ in other consumer product areas like monochrome TV and radios.

The Compact filing caps earlier actions, including this summer's petition to the ITC by GTE-Sylvania Inc. and its Philco subsidiary [Electronics, July 22, p. 42] and the antitrust suit filed nearly two years ago by Zenith Radio Corp. against 31 Japanese TV manufacturers.

Japan's shares. Japanese estimates that 1976 color-TV shipments to the U.S. will peak at a record 2.3–2.4 million units has shaken American market analysts. They visualize the total U.S. color-TV market this year at 8 million units maximum, compared to last year's 6.5 million. "This means Japan will take about 30% of the American market this year, nearly double last year's 16%," one analyst's calculates.

More distressing to some of Compact's members are indications that Japan is aiming at the most popular segment of the U.S. color-TV market—sets with screen sizes of 19 inches and larger. They accounted for 55% of all color-TV imports in the first half, accounting for 558,000 receivers. The number represents an increase of 262.5% from the 1975 January-June imports. □

IEEE

The ballot letter: fair or foul?

Along with the annual election-ballot package received by members of the Institute of Electrical and Electronics Engineers earlier this month came an unexpected insert—a letter from institute president Joseph Dillard. The stated intent was to explain the nominating procedures for president and vice president. However, because this year's election for the two top offices pits candidates nominated by the IEEE's board of directors against two who were placed on the ballot by petition of members, the letter has raised a few eyebrows among members and the hackles of the two peti-

News briefs

NEC demonstrates digital TV system

Borrowing facilities of Comsat Laboratories in Clarksburg, Md., Nippon Electric Co. has demonstrated a new digital television encoding and video-bandwidth-compression terminal that can transmit three color video signals, each with stereo, over the same bandwidth that could previously handle only one analog TV signal. The key to the bandwidth reduction is a composite interframe coding technique in which only the difference in TV elements in successive frames is transmitted. NEC uses its own 4,096-bit n-channel metal-oxide-semiconductor random-access memories to store the picture information, but the company is looking to 16,384-bit RAMs and 65,536-bit charge-coupled devices to decrease the size and cost of the terminal.

GE heads U.S. Aerosat effort

General Electric Co.'s Space division in Valley Forge, Pa., has been selected as prime contractor to build the experimental aeronautical communications satellite, Aerosat. It is to be launched in 1979.

The Aerosat partnership, composed of the Comsat General Corp. of the United States, the European Space Agency, and the Canadian government, chose the GE/Cosmos group to develop a system to transmit two-way voice and data communications and surveillance information via satellites between mainland ground stations and transoceanic aircraft. Two channels of C-band communications will link each of two 43-foot spacecraft with the ground, while five channels of L-band and two channels of VHF communications will be tested between the satellites and aircraft flying over the ocean.

The GE/Cosmos group, which beat out teams led by RCA Corp. and TRW Inc., is composed of the Space division and aerospace companies from six European countries, with support from four additional European nations and Canada. Estimated in excess of \$60 million, the contract specifies a work division of 47% each for the U.S. and Europe, and 6% for Canada.

Wescon attendance climbs

With unaudited attendance totaling slightly more than 38,000, the 25th edition of the Wescon show in Los Angeles earlier this month was the biggest show since the 60's. The completed audit likely will cut this figure to less than 37,000, a spokesman says, but it is still nicely above pre-show projections. Reasons for the jump over last year's 31,000 in San Francisco were said to be a strong business climate, cumulative momentum from Boston's Electro/76 show, and an improved Wescon last year.

Griffiths assumes RCA Corp. helm

Edgar H. Griffiths, president of the Electronics and Diversified Businesses organization of RCA Corp. in New York, has been elected president and chief executive officer of the parent company. He succeeds Anthony L. Conrad, who resigned following disclosure he had failed, until recently, to file personal income tax returns for the years from 1971 through 1975. Griffiths had responsibility for the Consumer Electronics, Solid State, Picture Tube, Distributor and Special Products, and Government and Commercial Systems divisions, as well as RCA Service Co. and the "SelectaVision" project. Sources say his successor will be either Irving Kessler or Julius Koppelman, both group vice presidents under Griffiths.

Aeronutronic Ford bumps Hughes, wins Intelsat V

Aeronutronic Ford Corp. has won a record \$235.5 million contract from the 95-nation International Telecommunications Satellite Organization to build seven Intelsat V large-scale satellites. In winning the job, the company's Western Development Laboratories of Palo Alto, Calif., defeated Intelsat's previous satellite supplier, Hughes Aircraft Co., along with Lockheed Missiles & Space Co., and TRW Inc. [Electronics, Aug. 5, p. 49]. When launched in 1979, Intelsat V's 12,000 voice circuits will double the capability of Intelsat IV-A and be first to use the 14/11-GHz frequencies.

IF YOU DON'T USE OUR 16-PIN 4K RAMS, YOU'VE GOT 18 HOLES IN YOUR HEAD. (OR EVEN 22.)

Compared with 18-pin designs, Fairchild's 16-pin 4K RAMS burn less power. Give you more sources. And conform with the 16-pin package planned for 16K RAMS of the future.

Above all they deliver greater reliability. First, because they employ derated design rules. Second, because they're *100% tested* to the tightest criteria in the industry before we release 'em.

You're ahead with systems design, too.

With Fairchild 16-pin 4K RAMS you have less add-on parts, fewer interconnects, reduced power dissipation, lower voltage clocks and less susceptibility to noise related failure. So you get a better performing system, using less board

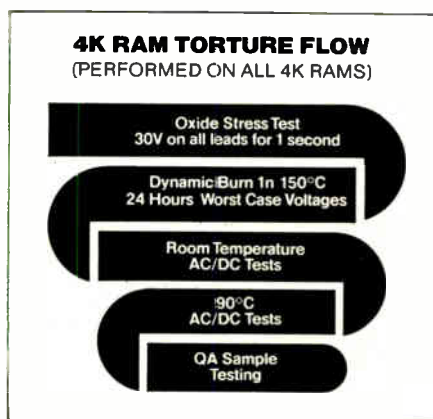

area, for less cost than 18 or 22-pin alternatives.

Our 16-pin format is now the highest volume 4K RAM in production. And from your Fairchild Sales Office, Rep or

Distributor, you get off-the-shelf quantity delivery in plastic or CERDIP — along with complete 4K RAM data pack and app note.

Fairchild Camera & Instrument Corp., MOS Division, 464 Ellis Street, Mountain View, CA 94042. Telephone (415) 962-3941. TWX: 910-379-6435.

Fairchild 16-pin 4K RAMS. They'll help you keep ahead.

FAIRCHILD

WHO ELSE?

What's the right price for this 1 Form A dry reed relay?



If we told you it has a premium quality switch and precision pins (not bent switch leads) would that help? Or that it's magnetically shielded, U/L listed and meets NARM/EIA proposed standards?

Would it help if we told you it's available in both Form 1A and 2A with .1" and .15" pin spacing, is the most automatically manufactured dry reed relay in the whole world and is available from stock...from Wabash? The right price? All the prices are right. They're the under 25, 100 or MORE and 25,000 prices respectively.

Hard to believe, but true. And we have many other types available, handsomely priced, to fit your needs and budget. So if you'd like to know more, write us (on your letterhead) for a free sample, or call us for a high volume price quote and let us show you how, at Wabash, the price is always right.

Relay
wabash

of
Wabash, Indiana

Wabash, Inc., 810 N. Cass St., Wabash, Ind. 46922
TEL (219) 563-2191 TWX: 810-290-2722

40 Circle 40 on reader service card

Electronics review

tion candidates for president.

Essentially, both Irwin Feerst and Robert Rivers, who collected the required 1,448 signatures of members, say Dillard's letter is unfair campaigning on behalf of board nominees Robert M. Saunders and Robert D. Briskman. For one thing, only Saunders and Briskman are mentioned. Dillard insists, however, his only objective was to clear up "confusion" about the mechanics of choosing the candidates.

The IEEE president further states that it did not occur to him that the letter could be interpreted as anything but informative. He insists that merely reprinting specific paragraphs from the IEEE by-laws covering nominations would not have conveyed the care taken by the board in selecting its candidates.

"Some members think that these nominations are done on the crony system, and I tried to have them understand that it's a long and careful screening process," the IEEE president explains.

Interpretation. However, the petition-nominated contenders interpret the situation differently. "It's grossly unfair treatment," Rivers charges. "The whole process is characteristic of the attitude of the present administration towards fairness and towards giving [members] a choice. And the letter violates in spirit Section 12.4 of the Policy and Procedures Manual [which calls for equal exposure to all candidates.]"

Rivers' main complaint is that the letter, in describing how board-selected candidates are nominated, appears to give more weight to the quality of candidates chosen by the directors than to those who seek election by petition. None of the three means of being nominated—board, petition, and write-in—can be classified as abnormal, he adds, but Dillard calls the board's procedure "normal."

"The letter belittles the dedication of members in collecting signatures. I doubt if the present administration is even capable of collecting 1,448 signatures," Rivers says.

Feerst complains, "Electioneering was the intent, but they will lose

more than they gain by these tactics. It's interesting that on this same ballot, there is the 'fair play amendment' requiring that equal publicity be given to propositions to be voted on by members, regardless of source. This letter certainly illustrates the need to ensure by constitutional amendment fair play to all." □

Careers

Employment pacts becoming popular

"Employment contracts for engineering professionals is an idea whose time has come," states a California lawyer who has been advising his employer-clients to negotiate them. Thomas A. Skornia, a partner in Skornia & Rosenblum, which has offices in San Francisco and Palo Alto, says that individually negotiated employment contracts for engineers are becoming increasingly popular, particularly in the semiconductor industry of Silicon Valley.

The wrinkle that's new in the individual contracts, which are routine for top-level executives, is their spread down into middle management. A Skornia client, Advanced Micro Devices Inc., Sunnyvale, Calif., has in the past few years taken the lead in signing engineers and scientists at that level, he says. He estimates that more than 100 of 1,500 total employees are now covered by some kind of individual contract—mostly on a yearly basis—extending down to the salary range of \$20,000 to \$22,000 a year.

Solution. While such agreements increase job security for the engineer and help ensure a stable engineering force for the company, Skornia says its significance reaches further. "It offers an alternative to the interest in professional unions caused by the 1974-75 recession and its resulting job and financial problems."

Skornia presented these views at a panel discussion that was held earlier this month at the Wescon show in Los Angeles. He is counsel for Wema, the trade association, as

The REMEX RFD 1000 — Because It's Versatile. Double or single density with capacity up to 6.4 Mbits... IBM standard or 32 hole hard sectored media without drive modification... IBM compatible or expanded hard and soft sectored formats for application flexibility... Unit select daisy chain capability for maximum controller efficiency... Selectable DC negative voltage for system compatibility... Individual drive housing or two drives horizontally side by side in a 19 inch rack configuration.

The REMEX RFD 1000 — Because It's Reliable. Ceramic head for extended life... Precision machined, die-cast construction... Operator interlock and expandable clutch for media protection... Front panel "head in contact" indicator and optional "head in contact" door lock... Optical write protect to assure data security... Stylus ball lead screw positioning system for long-lived accuracy... Optical track 00 sensing for drive carriage protection.

The Remex RFD 1000 is the RIGHT peripheral from Remex.

This Is The Only Flexible Disk Drive You Will Ever Need

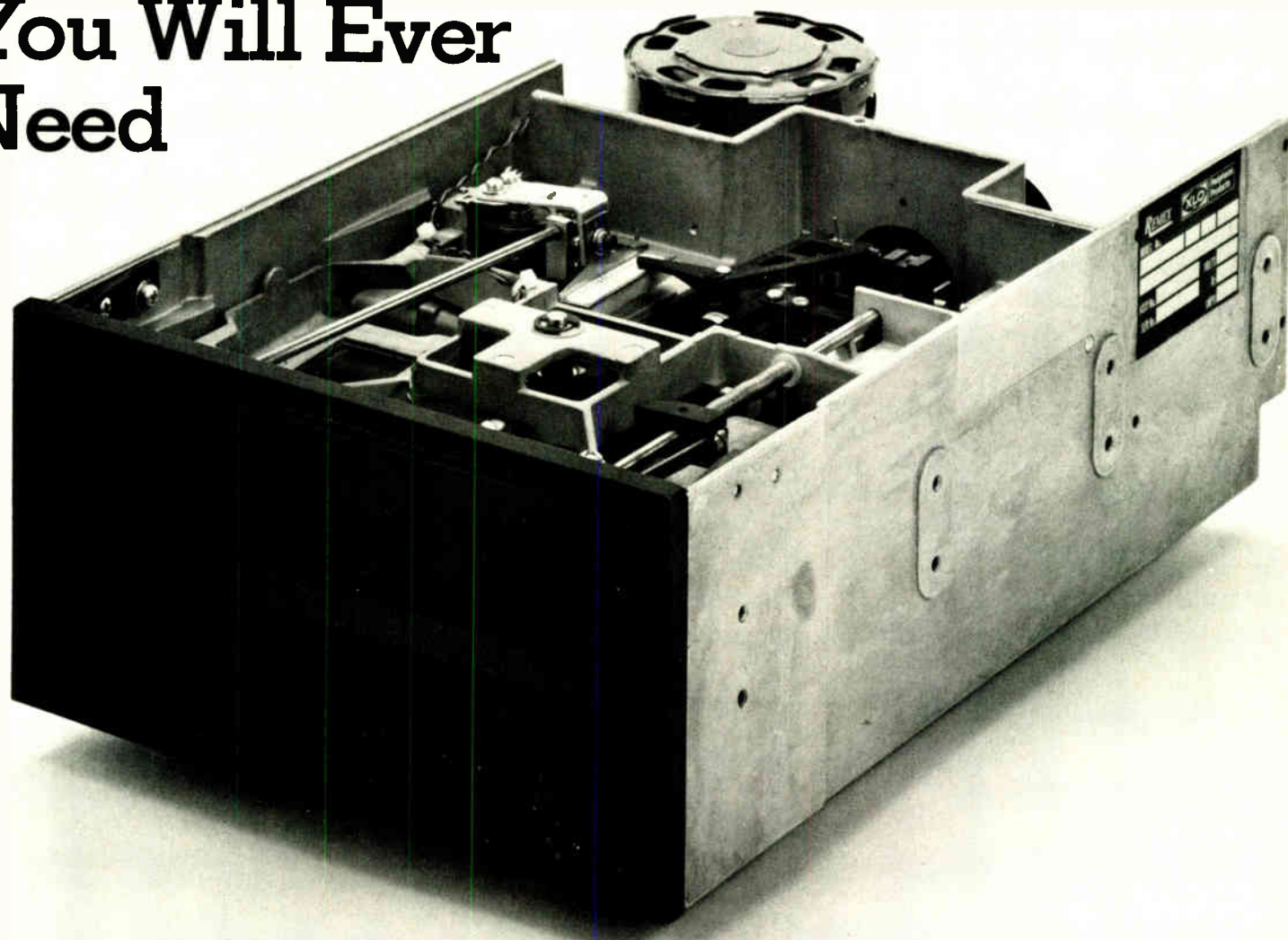

Ex-Cell-O Corporation

REMEX DIVISION

1733 E. Alton Street, P.O. Box C19533, Irvine, California 92713
(714) 557-6860, TWX (910) 595-1715. In Europe and the U.K.: SpA, Microtecnica
Via Madama Christina 147, Torino, Italy 10126.

Circle 41 on reader service card

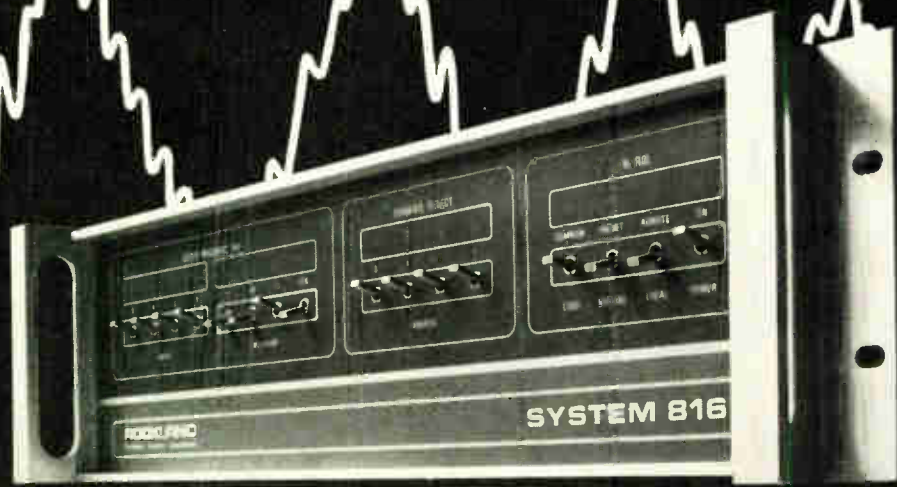

Nail the Noise Axe the Alias Save the Signal

For multichannel data acquisition, or signal processing, our System 816 provides *optimized* filtering in up to 16 channels, under remote digital and/or local on-card or front-panel control. How optimized? *No significant* insertion loss; *flat* passband; *fast* rolloff; *wide* dynamic range; *low* noise; *accurate* cutoff programming.

You can program each channel, individually, for cutoff frequencies you can order between 0.1Hz and 150kHz. Butterworth or Bessel characteristics, you get low-pass, high-pass, band-pass, band-reject functions. If 48dB/octave rolloff still isn't fast enough to prevent aliasing, you can cascade two channels for 96dB/octave.

Everything's modular. Buy only as many channels as you need. Expand later, as required. Program via DTL/TTL, contact closures, or front-panel switches. Read the setting of any channel at any time, via front-panel display.

System 816 is the logical choice when analog signals are to be sampled and digitized . . . to prevent aliasing errors by band limiting before sampling and/or A/D conversion. It is equally useful as a multichannel analog recovery filter, following D/A conversion. In fact, wherever multichannel analog signals are to be band limited, programmably, the 816 is the flexible, economical way to go. (Domestic prices: main frame, \$1600; individual channel plug-ins start at \$750.)

HOW & WHY optimized filters enhance S/N ratios, yet avoid aliasing errors, is explained in great detail in this new 24-page Rockland Handbook. Get it — free, by requesting data on System 816.

Use the inquiry number or write:
Rockland Systems Corporation
230 W. Nyack Road
W. Nyack, N.Y. 10994
TEL: (914) 623-6666
TWX: 710-575-2631

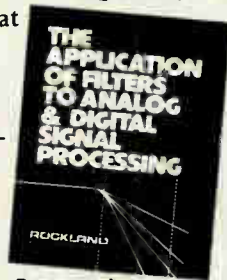

ADVANCED SIGNAL TECHNOLOGY
ROCKLAND
SYNTHESIS • PROCESSING • ANALYSIS

Our Second Decade of Leadership

Circle 42 on reader service card

World Radio History

well as several electronics firms. The agreements began, the lawyer explains, as a "largely defensive" move by the companies to fight "aggressive head-hunting of key personnel by competitors." Additionally, a written definition of employer trade secrets and proprietary data helps defend against misuse of such material by subsequent employers.

Tradeoff. But as a tradeoff for such benefits to the company, the employee gets "tighter definitions of his tenure, compensation, fringe benefits, and equity interests," Skornia points out. "The movement shows signs of coming full circle to the point where employees are now initiating such agreements for their own protection."

Skornia says other semiconductor manufacturers and high-technology firms in the Bay Area are following a similar route, but more slowly than Advanced Micro Devices. "Specific figures are hard to come by, however, since semiconductor firms are especially secretive." He is, however, aware of firms in other parts of the country offering individual contracts far down into the ranks.

A sampling of West Coast semiconductor firms confirms their reluctance to talk about individual contracts, except for Fairchild. An official there flatly says "we don't give contracts, and we don't see any trend." At another company, however, a spokesman explains that if contracts were being offered to selected engineers, he wouldn't admit it because others without them would get upset.

"I would tell companies to have a standard agreement to offer," Skornia says. "Some kind of job security is coming for the engineer, whether it is collective or individual."

Court case. A factor influencing the spread of individual written agreements, according to Skornia, is a February 1976 decision in a California appeals court. It held that a company had violated oral representations made to an employee, who was awarded substantial damages. This case will cause many employers to get in writing the terms and definitions of employment, he says. □

PROVEN PERFORMANCE CRYSTAL CLOCK OSCILLATORS



Motorola's K1100A leads the industry with a crystal clock oscillator that has a proven track record of more than one million units. That's right . . . over one million oscillators are in use by satisfied, repeat customers. That's not all . . . we feature fast deliveries.

How versatile is the K1100A? With over 1200 frequencies already designed, and same day shipment for standard stock frequencies of 4, 4.9152, 5, 10, and 20 MHz . . . you make the decision.

Oscillators are available from 250 kHz to 32 MHz, +0.01% stability from 0°C to 70°C, TTL compatible, and standard +5V dc input.

For full specifications and prices on the oscillator that design engineers trust, write Motorola, Component Products Department, 2553 N. Edgington, Franklin Park, Illinois 60131. Or call (312) 451-1000, ext. 4183.



MOTOROLA
Communications and Electronics Inc.

The CMOS You Want

We're introducing new products. Some are new developments we're proud to take the credit for, and others we're simply alternate sourcing. Some have broad areas of application and some are highly specialized, but they all have one thing in common. Somebody wants them.

That's why our line of standards is so broad. That's why we work so hard to offer you the best in reliability. That's why we led the way with CMOS MSI and LSI. Motorola innovates . . . Motorola produces.

That's the way it's been at Motorola since we put our CMOS technology in gear, that's the way it is now, and that's the way we intend to keep it. By doing what you want, we get what we want.

PRECISION MAKES IT THE SUPER ONE-SHOT



Our new MC14538B is like our industry standard MC14528B Dual Monostable Multivibrator, with one great improvement. We added PRECISION, and made it the Super One-Shot. Pulswidth variation from part-to-part and over the temperature range is a mere $\pm 0.5\%$. Not RCA, nor National, nor anyone else can match it. You'd naturally expect that kind of precision to cost a bundle, so maybe the best part of the Super One-Shot is actually the \$1.76 price. Join the swelling ranks of Super One-Shot users today.

For information circle 200.

ANALOG SWITCHES? PICK THE HOT ONES

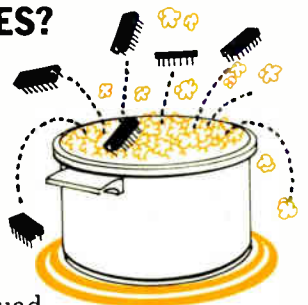

Our Austin, Texas "Silicon Ranch" is popping out great volumes of analog switches, and we've lined up some hot ones. The MC14066B quad analog switch/quad multiplexer is now generally preferred to the older MC14016 because it has significantly lower ON resistance at higher voltages. Try it at \$.70. MC14051B, 14052B, and 14053B are, respectively, 8-channel, dual 4-channel, triple 2-channel analog multiplexer/demultiplexers. All three pin-for-pin replacements for the CD4051B, 4052B, 4053B can control analog signals over the full supply voltage range, and each is priced at \$1.15.

For information circle 201.



MOTOROLA

Is The CMOS You Get

UPGRADE GATE PERFORMANCE WITH CMOS SCHMITT TRIGGERS.

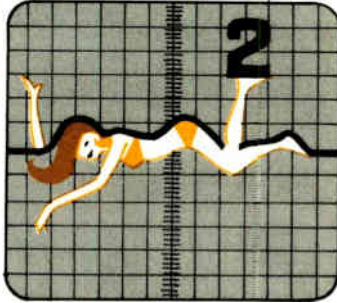

NOW THE PRICE IS RIGHT.

Now it's practical to upgrade gate performance with Schmitt Triggers. The MC14584B Hex Schmitt Trigger and MC14093B Quad 2-Input "NAND" Schmitt Trigger eliminate race problems associated with gate and inverter functions like the MC14011 and MC14069 by squaring up slow changing waveforms. There's no need to change PC boards; they're direct plug-in replacements. Noise immunity also is superior. The kicker is price, and you never saw CMOS Schmitt Trigger prices like these. Each is \$.54.

For information circle 202.

HELLO BUTTONS - GOODBYE DIALS

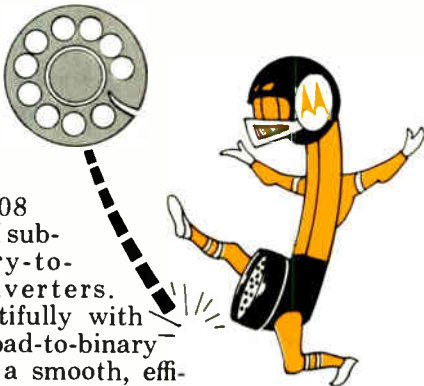

Both the MC14408 and MC14409 MSI subsystems are binary-to-phone pulse converters. Either pairs beautifully with the MC14419 keypad-to-binary code converter in a smooth, efficient, cost effective keypad pulse dialing system with the last number stored for one-push redialing. Add more memory and a little circuitry and it remembers more numbers. No tones required, just push the buttons and get controlled dial pulses. That's Motorola innovation in CMOS LSI. The 408 and 409 are each \$6.98. The keypad encoder is just \$2.25.

For information circle 203.

HAPPINESS IS A PLL APPLICATION FOR THE MC14568B



Can a CMOS MSI Phase Comparator with Programmable Counters find happiness in PLL applications? Judge for yourself. The MC14568B is barely introduced, yet more than a million units are already sold into PLL bliss. Programmable divide-by-N counters like the MC14522B and 14526B extend its counting range and coming soon is a dual BCD/binary counter (MC14569B), specially designed for operation with the 14568B. The plastic MC14568B is an MSI bargain at \$2.61.

For information circle 204.

CMOS TRANSMITTER SENDS... TO REMOTE NMOS RECEIVERS

Start with a 22-channel CMOS LSI remote control transmitter, the MC14422, select the appropriate receiver from either the MC6525 or the MC6526, and you have the essentials of a versatile remote control transmitter-receiver system.

Transmission is by time multiplexing five frequencies over widely spaced transmitter channels, precluding doppler effect interference.

Use it for TV or radio, industrial controls, security systems, electronic games and toys, and anywhere low-power remote control is the object. The MC14422 carries a \$6.10 price tag.



For information circle 205.

¹ CMOS is a trademark of Motorola Inc.

Note: All prices are based on plastic package and 100-999 quantity.

Semiconductors

-CMOS reliability at its best.

We sell solutions.

When the man from Honeywell Test Instruments Division comes calling, you may have more and better reasons to see him than you ever realized.

You see, we sell solutions, not instruments. So if your problem can be solved best by a simple plug-in module, that's what he'll recommend.

But if your needs require sophisticated oscillographs, magnetic

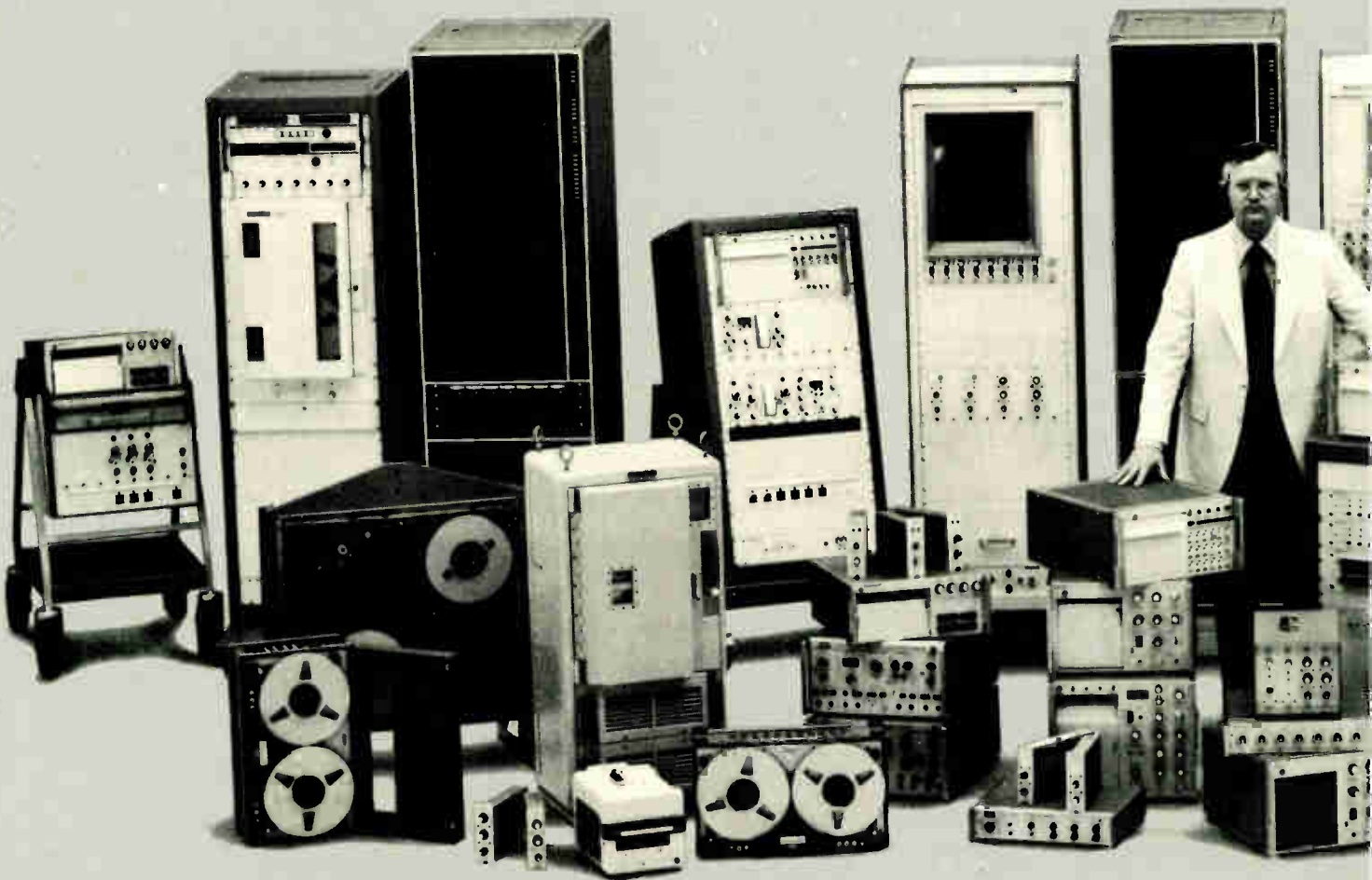

tape recorders/reproducers or custom analog measuring and recording systems, he has the breadth of line and combinations of instrumentation to make exactly the right recommendation. With complete confidence because, in addition to his own expertise, he's backed by the best design, production, application and metrology experts in the instrumentation business.



Honeywell Test Instruments Division — the top trouble-shooters. Call on them when you have any test instrumentation problem. And for a quick look at our complete line of test instruments, be sure to write for our FREE 20-page condensed catalog, Dept. 640, P.O. Box 5227, Denver, Colorado 80217.



Honeywell

For literature Circle 46

Circle 47 on reader service card

TWO FAST MULTIPLIERS For Signal Processing

• SINGLE CHIP

• BIPOLAR

• SINGLE 5V SUPPLY

8-BIT MULTIPLIER 130 Nanoseconds

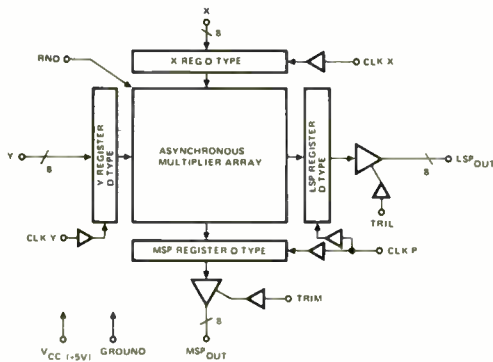

- Parallel 8 x 8 Bit
- Two's Complement
- Internally Latched
- TTL Compatible I/O
- 3-State Outputs
- Rounding Option
- Single Chip Bipolar Technology
- Asynchronous Multiply

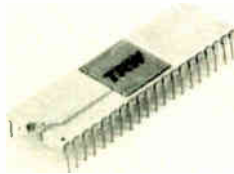

40-Pin DIP

**\$100⁰⁰
Each in
1-24
Quantities**

16-BIT MULTIPLIER 200 Nanoseconds

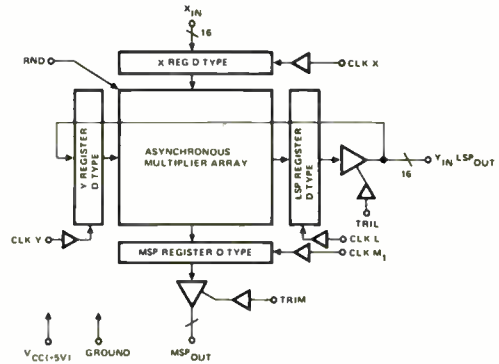

- Parallel 16 x 16 Bit Multiplier
- Two's Complement
- Internally Latched
- TTL Compatible I/O
- 3-State Outputs
- Rounding Option
- Single Chip Bipolar Technology
- Asynchronous Multiply

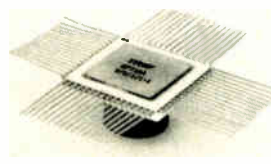

64-Pin Flat Pack
DIP available soon

**\$325⁰⁰
Each in
1-24
Quantities**

Coming next a 128-Bit Shift Register and a 64-Bit Parallel Correlator.

Delivery is 30 days or less. For detailed data, applications information and prices call (213) 536-1977. Or write: TRW Electronic Systems Division, One Space Park, E2/9043, Redondo Beach, California 90278.

LSI products from a company called

TRW

MIG-25 avionics: crude, but probably effective

The Soviet Union “isn’t even close to the United States” in large-scale integrated-circuit technology. However, avionics equipment like radar and countermeasures, which requires high power, “is crude and probably requires much maintenance, but it will probably do the job.” That’s the way one U.S. military official assesses Russian avionics technology after preliminary evaluation of systems on board the MIG-25 Foxbat interceptor now being dismantled by Japanese and American technicians at Hakodate airfield, about 500 miles north of Tokyo.

A first look at the plane’s side-looking radar suggests that “it might be quite effective,” the official says, “but it is too early to say definitely without more tests. It seems to be very high-powered.”

Lithium-sulfur leads electric-car power race

Rechargeable lithium-sulfur batteries hold the lead in the race to develop a new power source for a reliable electric car. Other contenders are nickel-zinc and combinations of lithium with an electrode and an electrolyte. The Federal program cleared a major political hurdle near the end of September when the Congress handily overrode President Ford’s veto of the five-year, \$150 million effort.

The Energy Research and Development Administration’s Argonne National Laboratory in Illinois has begun a market study for its lithium-sulfur brainchild as a prelude to turning it over to industry for further refinement and mass production. Cooperating in the study are battery makers Eagle-Picher Industries, Joplin, Mo.; Globe-Union Inc., Milwaukee; and Gould Inc., Rolling Meadows, Ill. Argonne expects to contract in late 1978 or early 1979 for a 2,500-pound test vehicle, including an 800-pound battery, with a range between charges of about 100 miles in stop-and-go driving and 150 miles in highway driving at 50 to 55 miles an hour.

ERDA’s Lawrence Livermore Laboratory in California is, meanwhile, pursuing an 18-month, \$300,000 study of reactive metals like lithium in combination with an electrolyte and an electrode to produce batteries that can be quickly “recharged” merely by replacing the lithium. Lockheed Missiles & Space Co., which discovered the concept, is participating in the Livermore studies, while NASA’s Lewis Research Center in Cleveland, is testing nickel-zinc batteries in a program to develop a power source with a range of 120 miles.

Expanding competition seen by GSA for Federal phones

Watch for the Federal telephone-equipment market—particularly the procurement of private branch exchanges—to blossom next year, now that the General Services Administration, the Government’s housekeeper, has completed its first competitive procurement. The 10-year \$804,752 award to Master Communications Inc., San Diego, Calif., includes \$496,760 the first year for a 500-line system in the Veterans Administration hospital in Albuquerque, N.M. The PBX will be expandable to 700 lines. The VA has rejected a Mountain States Telephone & Telegraph Co. bid of a Bell 101 ESS system because part of it would have been off the hospital premises.

GSA’s Automated Data & Telecommunications Service says it has identified 26 projects as potential competitive procurements over the next year and expects to “grow increasingly into full competitive procurement of all our PBX requirements where competition is available and feasible.”

Protecting America's color TV industry

By petitioning the U.S. International Trade Commission for relief from the crush of portable color television receivers from Japan, an agglomeration of 11 American trade unions and five corporations has taken the expected and most expeditious course—invoked the escape clause of the Trade Act of 1964 [see p. 36 and *Electronics*, July 22, p. 42]. The quotas on imports sought by the coalition that calls itself Compact—the Committee to Preserve American Color Television—can be invoked by the President if an industry can show it is threatened with serious injury or destruction of its domestic production base.

Compact should have no difficulty making such a showing. But are the petitioners too late? Is Compact merely locking an empty barn? Not quite, even though Japan expects to ship between 2.3 and 2.4 million color sets to the U.S. in 1976. That figure comes close to one third of the total domestic market in a year of improved sales. But Compact is quick to point out that imports are concentrated in the so-called “portable” category—sets with diagonal screen sizes of 19 inches and less—and that imports of portables from Japan in July alone constituted 71.7% of the U.S. portable-color-market production.

The last dozen

Other numbers laid by Compact before the ITC are equally distressing. Compared to 25 companies making TV receivers in 1960, the U.S. now has only 12, three of them foreign-owned: Magnavox, Quasar, and Sony. Three others—Andrea Radio, Curtis Mathes, and Wells Gardner—have less than 0.5 of the market. Among major domestically owned producers—Admiral, General Electric, RCA, Sylvania/Philco, and Zenith—many in the industry expect at least one of them to pass to foreign control before another year has passed.

Why then are none of these majors but Sylvania/Philco members of the Compact petition? While one Compact officer hints strongly that the others will ultimately join, noting that “this is an effort that is just getting off the ground,” there are other reasons, of course. Chief among them is the fact that most of the other manufacturers find themselves in an awkward position regarding Compact membership since they are heavily involved in offshore manufacturing of lines other than color TV. Nevertheless, Compact may achieve its goal of import relief without them. As one official puts

it, “this is an election year and this petition represents directly some 65,000 jobs and many more votes inside and outside of labor.”

For the manufacturing side of Compact, Allen W. Dawson, executive vice president of Corning Glass Works, believes U.S. color TV production “is threatened with extinction.” Its loss, Dawson warns, would mean the loss as well of a “substantial share of the funds for advanced research in electronics that has come from the sales of television receivers and their components.” Color TV production has been for many years, he adds, “a bread-and-butter product of some of the most important companies in the electronics industry.”

Getting Washington's ear

These kinds of cries—particularly those of large blocs of voters—will, it is hoped, attract greater attention in Washington than they have in the past. By passing by the Treasury Department, the Compact petition may eventually get action directly from the White House. Other routes to relief have been unavailing to the television industry thus far. For example, nothing came of the U.S. Tariff Commission finding in November 1971 that monochrome and color-receiver imports posed a threat of serious injury to domestic producers. “By any reasonable standard,” concluded tariff commissioner Moore at that time, “the economic condition of the industry has been deteriorating—production facilities have been closed, output has declined sharply, employment is down substantially, profits have almost disappeared.” The commission found that of the 14 U.S. makers submitting data at that time, three sustained losses in 1966, seven in 1967, nine in 1968, eight in 1969, and 10 in 1970.

There are many who question whether relief from imports now will really matter in the long run for color television. After all, most monochrome-TV production has moved offshore, along with home entertainment radios. Much of the booming citizens' band transceiver market is also being captured by offshore producers, again the Japanese. Is domestic color TV salvageable and worth saving?

Compact says it is, and has assembled a strong case. It deserves no less than a full hearing, and should get it quickly. And if the Compact cause is joined by other major color-TV producers, it will aid the industry in getting the ear of the White House regardless of who may be its occupant next January. **Ray Connolly**

We got the order a few hours ago. The relays will be there a few hours from now.

Our customers think we're 'bout the fastest there is when it comes to shipping relays. This order was extra hot so we got it out in a matter of hours. But we frequently ship orders in 24 hours. And, we can generally promise production and shipment of any order is 360 hours (3 weeks).

We're fast—but we're also something else—good. We make our own switches so we know what our relays will do. But just to make sure,

we run over 3 billion test cycles every day! We make over 6000 variations of dry reed relays so we undoubtedly have what you need. And the cost? Well, you better call and get a quote to believe it! Here in Wabash, money goes a lot further than it does in the big city. We know because we get to the city every so often—though not as frequently or as fast as our relays do.



The Econo-Miser. The most automatically manufactured dry reed relay available. 1 and 2 pole standard types. Less than one dollar in quantity.

Coils, Relays & Transformers
wabash
of
Wabash, Indiana
and Huntington, Indiana; Farmington, Missouri;
Tipton, Iowa and South Boston, Virginia
For information and quotes write or call:
Wabash, Inc., Dept. RB-2, 810 N. Cass St., Wabash, Ind. 46992 Tel: 219/563-2191 TWX 810-290-2722
Circle 51 on reader service card

"I'll tell you why this OEM picked PDP-8. It's good engineering and it's good business."



The man in the picture is Dr. David Kemper, biochemist and product manager in charge of development, production, installation and field support for an amazing analytical device called Rotochem IIa, from American Instrument Co.

The computer inside his product is a PDP-8A from Digital. Dr. Kemper is buying scores of them. Why?

"They're inexpensive in a market that's cost sensitive. They're incredibly reliable in a

market that's reliability oriented. And our customers can get service anywhere in the world. The PDP-8A gives us the performance we need at a price we can't beat. We can offer the capability to run 50 tests on each of 250 patients."

Sensitive but tough. High in performance, low in cost. "Good engineering. Good business." It's the same story you hear from OEMs around the world. And that's why PDP-8's the most

successful minicomputer ever.

Digital Equipment Corporation, Parker Street, Maynard, MA 01754. (617) 897-5111. European headquarters: 81 route de l'Aire, 1211 Geneva 26. Tel: 42 79 50. In Canada: Digital Equipment of Canada, Ltd.

**PDP-8
The Most
Successful
Minicomputer
Ever!**

digital

**50,000 computers saving
managers millions.**

Circle 52 on reader service card

Paris show highlights office systems that have enhanced business functions

The 27th annual Salon Internationale de l'Informatique de la Communication et de l'Organisation du Bureau (Sicob), being held in Paris from Sept. 23 to Oct. 1, is showing consumers little that is revolutionary in office-equipment systems. However, the range of existing products has evolved extensively, and the competition is increasing. Jacques Namur, head of the Computer division of Telex Computers SA, a subsidiary of Telex Corp. of Tulsa, Okla., says, "The trend is to show more integrated office-computer systems, which can serve more purposes at a lower cost, rather than forcing untried products on the market."

Telex Computers SA will display the Lockheed System III office-computer system it has just arranged to distribute in France. Although the Lockheed system is similar to the IBM System/3 and 32 computers, Telex says its after-sales service will enable it to compete with IBM, which traditionally has about 60% of the data-processing market in France.

Introductions. Similarly, Texas Instruments France, although displaying nothing completely new, will use Sicob as a marketing entrée for calculators and processors not yet disclosed in Europe.

France's ITT subsidiary Compagnie Générale de Constructions Téléphoniques, Thomson-CSF's affiliate T-VT, and IBM will likewise display new terminals, printers, and screens. "The companies call them new," says an industry observer, "but most of the items at Sicob are improvements on already existing systems."

An example of how companies are expanding existing systems is Philips' P851M Micromini computer, developed at Philips Laboratories in Rambouillet, France, which completes Philips' P800 office-computer family. "We call it a microminicomputer because it's micro due to size and mini due to software," says Phil-

ips' minicomputer-department head Claude Lacaille.

Philips is also introducing a computer system based on magnetic-tape cassettes for transaction-oriented magnetic ledger-card data processing, peripherals for its entire range of P300 computers, and a new video display unit for its PTS-6000 line.

Microtechnology. The P851M, like most add-ons to existing systems, uses microtechnology, including Philips-developed Locmos large-scale integration, which reduces component count and card size, improves noise immunity, and lowers

power consumption. These benefits make the computer acceptable for industrial applications with the support of proven software, industrial-interface capabilities, and peripherals.

The P851M comes with a 19-inch rack that has space for peripheral controllers, standard input/output, and user-designed boards with the Eurocard format. The general-purpose bus of the Micromini has expansion possibilities for standard I/O controllers and an I/O processor, which ensures rapid data transfer and direct-memory access. □

Around the world

Mitsubishi's 4-k RAM has good power-delay product

A fast 4,096-bit dynamic random-access memory made by diffusion self-aligned (DSA) MOS technology is scheduled for completion by year-end at Mitsubishi Electric Corp. in Japan. First deliveries are slated by mid-1977, upon completion of quality-assurance tests. Access time is 60 nanoseconds.

DSA technology produces the shortest delay of any MOS technology that Mitsubishi can produce economically. It gives a much smaller delay-power product and a smaller chip than bipolar technologies. What's more, the use of ion implantation for deposition of dopants prior to drive-in ensures precise control of the doping concentrations on the chip surface, so that the company is confident it can fabricate the devices commercially.

This is the first known use of ion implantation to control all active-area dopant concentrations. The threshold voltage is sensitive to base-channel-surface doping concentrations, and control of the threshold voltage is necessary to get a low power-delay product and the high yield necessary.

Associative technique yields speed in ICL disk controller

International Computers Ltd. in the UK has built a developmental model of a memory controller that makes a standard disk store act like an associative memory, yet only off-the-shelf transistor-transistor-logic and MOS random-access-memory chips are used. The content-addressable-file store (CAFS) accesses multiple data channels from the disk store and selects for display only the information requested. Like an associative memory, storage locations are identified by the information content. Each word to be stored is simultaneously compared with all previously stored words to determine its correct location by tags such as name and age. Unlike conventional retrieval systems that operate "by remembering where you put it," CAFS accesses information "by what it looks like as well," ICL says.

The CAFS comparator circuit checks the tagged data stream coming off the disk against what the user wants and plucks out only the data with matching tags. The controller, which uses time-division multiplexing, handles data at the rate of 2.5 megabits per second or about 300 kilobytes per second for each channel. With 10 channels, CAFS is estimated to be 10 times faster than conventional disk controllers.

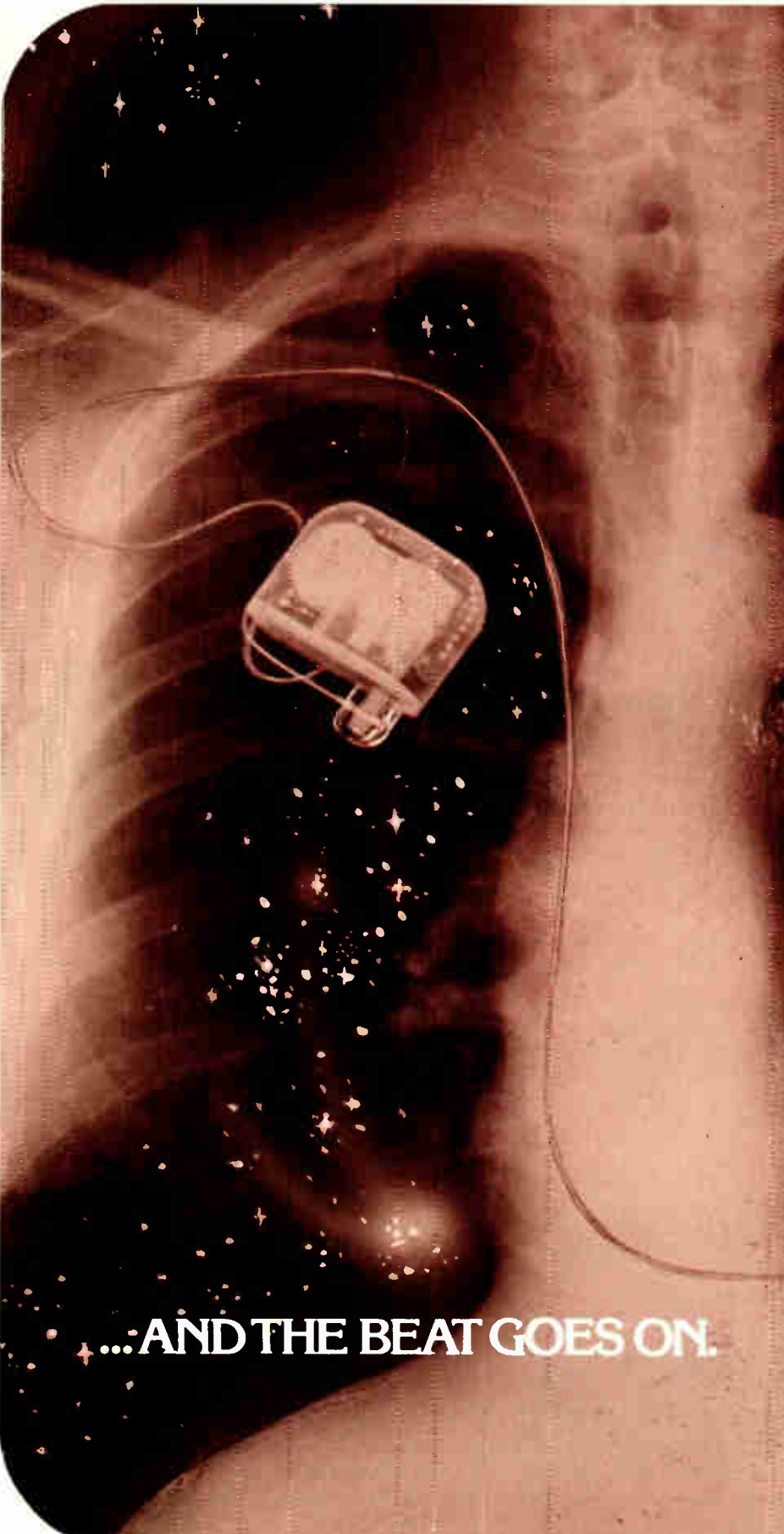

A cardiac pacemaker implanted in a human heart...dependability is often a matter of life or death. The 2N2484 and 2N3799, the transistors used by most pacemaker manufacturers, were designed in the late 1950's. Technology has since passed them by.

Introducing the Hybrid 2N2484 and 2N3799 – the new beat in state-of-the-art hybrid chip design...

These parts have been redesigned by Semicoa for hi-rel applications, including human implantation and space flight applications. By applying up-to-the-minute technology, we have eliminated the problems of the old standbys.

The improvements? Easier handling with larger bonding pads. Flatter beta over greater current swings. No more shorts, metal fatigue and microcracking. Passivated and completely SEM qualified.

For your next critical design, consider the advantages of using a Semicoa chip. Semicoa offers over sixty different NPN and PNP chips, and over 1,000 discrete transistors for your many applications. Each are precisely engineered and manufactured with the personal care and meticulous attention only a specialized company can give. And we're successfully applying the latest technology to custom devices too. Call or write today to find out what Semicoa can do for you.
333 McCormick Avenue, Costa Mesa, California 92626, 714/979-1900

...AND THE BEAT GOES ON.

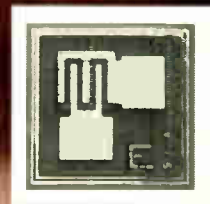

Photo courtesy of
Cardiac Pacemakers, Inc.

SEMICOA

We'll take you places you've never been before

TI pushes sales of digital watch in European market

Texas Instruments is pushing sales of its inexpensive digital watch in Europe. TI's European director of marketing, Michel Motro, claims digital watches will be commanding 9% of the European watch market by the end of 1976. The firm is selling the TI-500 at 40% more than its U.S. price. **Industry observers say the company can command the higher price because of the relatively inexperienced European consumer.**

Japanese deny rumored curbs on color-TV exports

Japan's Ministry of International Trade and Industry denies reports appearing in some English-language papers that MITI intends to impose restrictions on color-television exports next year. Shipments to the U.S. next year will be almost flat, a spokesman says. **This year, he says, Japanese manufacturers were quicker to take advantage of certain opportunities than American manufacturers.** In addition to the rapid improvement in the economy, the events that have increased consumers' desire for television sets included the U.S. Bicentennial, the presidential election, and the Montreal Olympics. [See also "Curbs sought on Japan TV exports," p. 36]

ITT's German firm to manage Greek phone-gear maker

Standard Elektrik Lorenz AG, the West German ITT affiliate, has been given management responsibility over ITT Hellas, Greek producer of telephone-switching gear, telephone sets, and certain television components. The SEL management takeover gives the Greek firm, to be called Standard Elektrik Hellas, direct access to the German company's development capabilities, particularly in the telecommunications field. **The move will help Hellas, which has no R&D facilities, in interesting Greek postal authorities in the electronic switching system, EWS, which SEL helped to develop and is now being installed by the German post office.** Founded in 1968, the Greek firm employs about 500 people.

Piano built around p-channel MOS chips by British firm

Samples of an electronic piano built around custom p-channel MOS large-scale integrated circuits has been developed by General Instrument Microelectronics of Britain. The piano, cheaper than models built with discrete circuits, **is expected to sell for about \$140 in volume—without an amplifier in the expectation that the buyer will plug it into a hi-fi system.** With only one chip, the AY-5-1350, per octave, each key sound is produced by the on-chip elements of an MOS source follower, an MOS series switching circuit, and a tri-state input checker to determine the position of the key. Besides the chip, the musical package includes a master tone generator, frequency dividers, amplifiers, and a main power amplifier. GIM says it has a potential order for 50,000 units from its Glenrothes, Scotland, factory.

China launches its sixth satellite and first TV net

China has recently launched its sixth satellite and inaugurated its first national television network. Although Peking won't disclose the orbit or weight, the satellite is believed to be a low-orbit spy type similar to the three launched last year to watch the sensitive Sino-Soviet border. Photographs and other sensory data are expected to be retrieved upon landing, as with previous spy satellites. Although the Chinese obviously

International newsletter

have a large launch rocket in serial production, speculation last year that Peking may try soon to launch a man into space has yet to be confirmed.

The television network enables Peking to broadcast in color via microwave and coaxial cable to 23 of its provinces and autonomous municipalities. It will be used in "a combat role" in "uniting and educating the people and dealing blows at and liquidating the enemy." To date, the country has depended on an amazing 140 million wired radio outlets. **Now, production of TV sets, a mere 250,000 last year—mostly black-and-white—is expected to soar dramatically.** China has 37 TV stations and 13 relay centers, plus two satellite ground stations.

Fujitsu PROM is second source for Intel 2708

Fujitsu Ltd. has started second-sourcing in sample quantities the popular Intel 2708 Famos programmable read-only memory. Two versions will be available in quantity by year-end. **One, the MB8518H, has an access time of 450 nanoseconds, the same as the Intel part. The slower one, the MB8518E, has an access time of 650 ns.** Both dissipate 850 milliwatts of power and can be programmed in 100 seconds. Like the Intel part, they are erasable with ultraviolet light. The price in Japan for fewer than 100 units is \$34.84 for the E version and \$41.81 for the H version. The company has also begun shipping samples of the MB8308 masked ROM, which is a second source for the Intel 2308.

French group to integrate computer lines

The Franco-American computer group CII-Honeywell-Bull, which officially merged June 30, plans to integrate all product lines in an effort to compete more effectively with IBM Corp. in French computer sales. Chairman Jean-Pierre Brulé says the new program, code-named Unisys, will create a unified range of computers in the mid-1980s that will **combine the Honeywell-Bull series 60, CII's Iris range, and the series 77.** Brulé predicts that CII-Honeywell-Bull, which has annual sales of \$500 million dollars, will be economically viable by the time French government subsidies are terminated in 1980.

Siemens installs computer for press at Dutch newspaper

What Siemens AG says is Europe's first printing press equipped with a process-control computer is now operating at the Dutch newspaper De Telegraaf in Amsterdam. The Siemens model 330 computer is part of the so-called Printamat automation system that the German company has developed for the printing industry. The system includes a page printer, several data-display units, and devices for controlling the presses. **The Printamat handles a number of printing-press jobs including adjusting the compensator rolls, measuring gray shades with a new electron negative-scanning device, storing appropriate data in the computer, and monitoring the production process.**

Nixdorf predicts U.S. sales increase

Nixdorf Computer AG, which already has 3,000 installations in the U.S., predicts that **its U.S. sales will increase by about 20% this year.** What's more, worldwide orders for the first six months of this year are 17.6% higher than in the same period last year. Installations of the company's machines, priced from \$16,000 to \$100,000, now total more than 50,000.

From the leader in power device technology and innovator in plastic packaging . . .

POWER TRANSISTORS

The Designer's Choice from General Electric

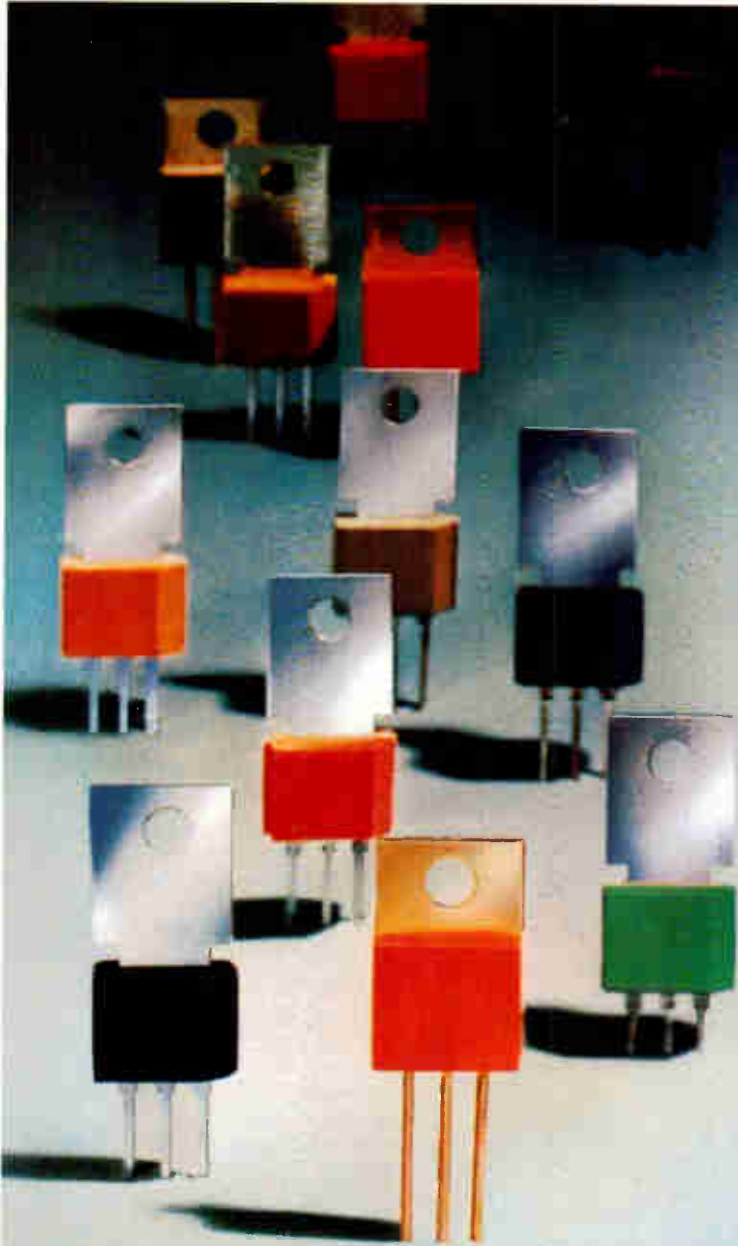

- Excellent free air power dissipation
- Silicone resin plastic encapsulated TO-202 and TO-220AB packages
- Hard solder chip attachment for superior power and temperature cycling capability
- Good current gain
- Fast switching speeds
- Color coded for polarity (NPN or PNP) and lead configuration

General Electric's technology, experience and quality products can serve your industrial application needs. Our Power Transistor Selector Guide and factory personnel are available for your inquiries. Contact your local GE distributor or write to General Electric Co., Electronics Park, Bldg. 7, Box 49, Syracuse, NY 13201.

GENERAL  **ELECTRIC**

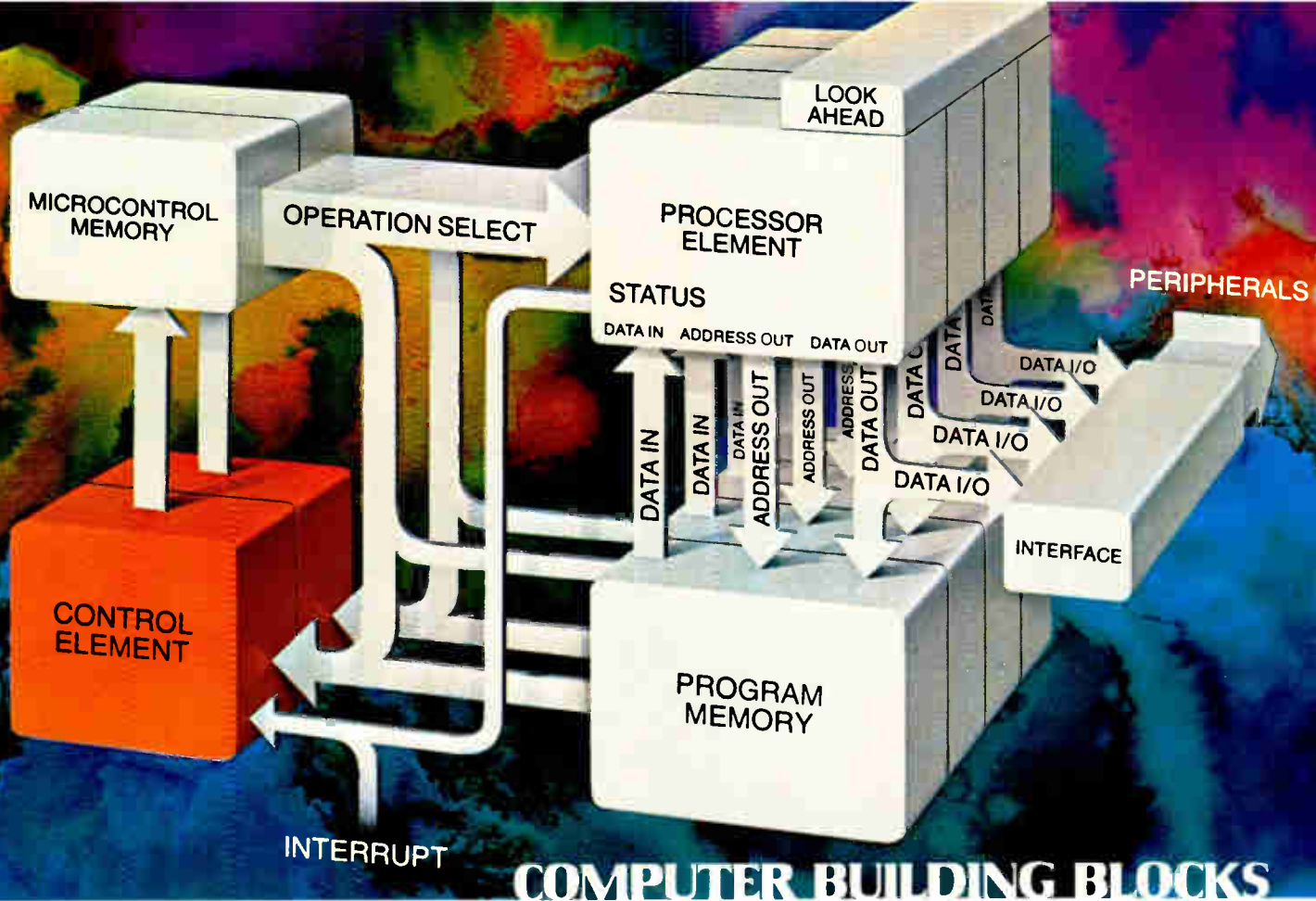

COMPUTER BUILDING BLOCKS

Bipolar building block number one. The control element...SN54S/74S482 Fast. Flexible. Efficient.

TI's new series of bipolar digital building blocks are designed specifically for implementing modularly expandable, high performance computer or controller systems with complete microprogrammability. Build new designs tailored to your applications or emulate existing designs — without loss of software compatibility — and with maximum memory efficiency.

The 'S482 is a key member of this new Series. The highest performance 4-bit-slice Schottky TTL control element available. Use it in any application where bipolar speeds and flexible microprogram control are necessary.

The 'S482 integrates a full adder, four-word push-pop stack, source select multiplexer and address register. All in a space saving 20-pin package. In addition to simple loops and forward sequences, the 'S482 can be used to implement the

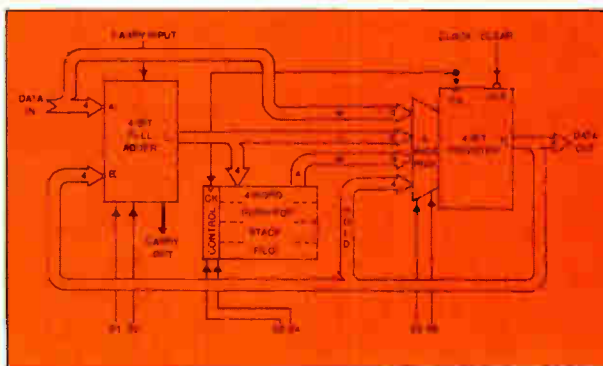

powerful operations needed to decrement, vector, offset or jump (in a single cycle) to any address within the domain of the controller.

Subroutines can be nested up to four levels deep in the 'S482's push-pop stack and be retrieved in the reverse order of occurrence. Moreover, the stack can be updated without changing the output register's contents.

Use the 'S482 as a powerful next-address generator in a microprogrammed CPU. Or, by itself, as a stand-alone simple controller.

The SN74S482N is priced at \$6.30 each in quantities of 100. Available now from your local authorized TI distributor. For a data book describing the 'S482 and TI's full line of bipolar microcomputer components, write to: Texas Instruments Incorporated, P. O. Box 5012, M/S 308, Dallas, Texas 75222.



- | Features |
|---|
| • Expandable to N-bits in 4-bit increments |
| • 25ns maximum address load time |
| • Space saving 20-pin package |
| • SN74S482N for 0 to 70 °C applications |
| • SN54S482J for -55 to 125 °C applications |
| Functions |
| • Generates forward or backward sequences |
| • Implements offset, vector, branch or jump |
| • Stores four return or link addresses |
| • Direct load to output register |
| • Holds or initializes system |

TEXAS INSTRUMENTS
INCORPORATED

World Radio History

Air Force 'kernel' attains computer security using existing technology

by Lawrence Curran, Boston bureau manager



Information please. Lt. Col. Thomas W. Bailey, left, chief of ESD's Computer Security branch, selects information source. Grace Nibaldi, seated, of Mitre Corp. technical staff, assisted by Lt. Paul Karger, center, requests data from the mini after getting clearance.

Unauthorized penetration of computer data bases is one of the fastest growing crimes in the U.S., and legislation to punish offenders is trying to keep pace. But, while in the private sector punishment can be a strong deterrent, the military services have a far more pressing need to prevent the unauthorized penetration in the first place. As one Air Force spokesman puts it, "We can't prosecute the KGB [the Soviet secret police]."

That spokesman is Maj. Roger Schell, program manager for computer security in the Directorate of Computer Systems Engineering at the Electronic Systems division at Hanscom Air Force Base, Bedford, Mass. For the past five years, Schell has lived with the problem of ensuring military computer security. An Air Force-Mitre Corp. team, of which he's a member, has come a long way in demonstrating that security for a data base containing both unclassified and highly classified information is achievable with today's technology, even when some users are not cleared for some of the information.

The team, headed by Lt. Col. Thomas Bailey, chief of the Computer Security branch at ESD, has developed a "security kernel," a combination of hardware and software that runs on a Digital Equipment Corp. PDP-11/45 minicomputer. This kernel ensures that users can get in and out of the multi-security-level data base only the information authorized by their levels of security clearance. It has been operating on the PDP-11/45 for more than a year, but only recently has its detailed design been mathematically verified as being secure.

Development of the security kernel is only one step in a comprehensive Air Force program (see "Where do we go from here?" p. 61) to provide verifiable security in data bases holding information ranging from unclassified to top secret. That data is stored in computers more powerful than the DEC machine, which memory and throughput are limited for the Air Force's operational needs, but adequate to demon-



Sylvania caters to your pressing needs.

Our metal stamping plants are among the most productive in the world. Every day they turn out over 20 million precision parts, all tailored to meet varied customer specifications.

In stamping intricate parts like bifurcated, bellows and cantilever electrical contacts, we can hold tolerances up to .0005" to assure accurate positioning on precious-metal welded dots or inlays and on selective-plated materials.

Electronic monitoring and inspection equipment assure that these tolerances are maintained throughout the full production run.

Hundreds of multislide and light and heavy presses assure that we can handle almost any stamping operation in high volume.

Bring your pressing problems to us and we'll show you the advantage of working with people who know how to stamp out everything.

Contact GTE Sylvania, MFO, 1128 Roosevelt Ave., York, PA. 17405. 717-764-9853.

We're helping you make it.

GTE SYLVANIA

Circle 60 on reader service card

Probing the news

strate the kernel concept. But the program is in danger of being scuttled because it hasn't been funded for fiscal 1977, a fact that ESD officials learned less than two weeks ago.

Costly and slow. Schell says that the military's present approaches to computer security are time-consuming and costly. They include:

- Dedicating a given computer to handling only one class of information, which leads to a costly proliferation of machines.

- "Scrubbing down" the data base, which means time-consuming purging of classified data for use by persons with low levels of security clearance.

- Clearing all users for the highest level of information in the system, which forces a physical review of data output to determine its security level.

These techniques are all used by the Air Force now, and various consultants have estimated that they cost the service between \$20 million and \$100 million a year, while frustrating timely access to stored data. "With the U.S. policy of a flexible and quick response [to military

threats], this is a big problem," Schell maintains. That's why the Air Force and Mitre are working toward specifications for security kernels that can run on a variety of commercial computers that will go into the military inventory.

It was no small task, though, to reach the point where the team could feel comfortable that its prototype security kernel for the PDP-11/45 could be mathematically verified as secure. An algorithmic model defining precisely what it means for a computer to be secure had to be worked out. Then, Mitre programmers reduced the model to subroutines that were the software embodiment of the kernel. In the ESD/Mitre machine, it includes portions of 18 externally callable functions, which, in conjunction with the computer's memory-management unit (MMU), essentially constitute the kernel. The MMU is a standard option offered with the 11/45, and no hardware modification was required to develop the kernel. It is basically a mediation system to determine if the various users are authorized to gain access to the data base they want.

Side effects. It was also important to determine the effects of the kernel on the operating system of the mini-

computer storing data of various security levels. So far, only a laboratory operating system for the security kernel has been developed, "and we found it could be done with no big problem," Schell notes. "Essentially, instead of directly issuing an input/output instruction, the instruction is sent to the kernel to access the disk."

The prototype security kernel's 18 externally callable functions in the 11/45 require less than 1,000 program statements, which means about 17,000 bytes of storage, says Kenneth Biba, a member of the Mitre technical staff. An additional 10,000 bytes identify a user when he enters his identification, determine his level of security clearance, and perform some other housekeeping details, such as determining the addresses of the data to which there has been the most recent access.

The ESD/Mitre team used the three "domains" in the 11/45—user, supervisor, and security kernels—each of which can contain two 64,000-byte sections. Each domain is further subdivided into 16 segments of 8,000 bytes of storage, and each segment is essentially a virtual-memory system, says Biba. The security kernel controls movement of data to and from the 512,000-byte disk and controls what access modes the user may use (read-only, read-and-write, and no access), based on his clearance and the classification of the data.

The kernel permits users to read data that has a lower security classification than that for which they're cleared, but they're not permitted to write data with a lower classification than their own. This provision ensures that a user with a top-secret clearance, for example, cannot inadvertently or deliberately write top-secret data into an unclassified file or segment that could then be read by a user cleared only for unclassified information.

Finally, the terminal through which users gain access to the kernel-based computer must be housed in a controlled area, and the line to the computer must be protected and handle only encrypted information so that only persons authorized to address the data base can do so. □

Where do we go from here?

The DEC PDP-11/45 that houses the Air Force's prototype security kernel for computer security was not designed with military security and the military's need for very large data-base management in mind. Realizing that, the Air Force Electronic Systems division's Computer Security branch has been funding development of larger systems, but how far that development can continue is uncertain in light of withdrawal of fiscal 1977 funds for the security program.

Maj. Roger Schell, program manager for computer-security at ESD, said before learning of the funds cutoff that plans call for designing a security kernel into a Honeywell Information Systems series 68 computer equipped with Honeywell's Multics software—"a fairly secure software system," in Schell's opinion. Such a system, without a security kernel but altered under ESD direction to accommodate the multilevel security problem, is operating at the Air Force Data Services Center in the Pentagon.

After Mitre engineers completed the design of the security kernel for the Multics system, the plan was to give the design to Honeywell to modify and to build three prototype versions. The Air Force would like to have an unverified security kernel running on the Honeywell machine by 1978.

The developers had hoped to integrate a secure front-end processor into a kernel-equipped Multics system by 1980 and to have a prototype of such a system verified as secure by 1981. But that schedule was based on ESD's being able to get funds to continue toward those target dates. To date, Schell says, some \$5 million has been spent on the computer-security program. He estimates another \$12 million will be needed to complete it.



Instrument as shown has pulse-burst option and optional handles.

CMOS parametric testing makes special demands... Meet them with HP's 8015A Pulse Generator.

This pulse generator has standard features and options that make it ideal for MOS and CMOS parametric testing. For example:

You get dual-channel outputs, each variable to 16V. Or, they combine into a single 30V channel adjustable within a $\pm 16V$ window. That versatility makes the 8015A compatible with CMOS, and most MOS devices. You can delay channel B with respect to A for generating 2-phase nonoverlapping clocks. And combine the adjustable B delay with A + B to generate three-level signals.

Selectable source impedance on both channels lets you choose the best output termination configuration for your application. Of course you can vary the width (10ns to 1s), transition time (6ns to 0.5s), and rate (1Hz to 50 MHz). High-speed capability lets you work with advanced TTL and HTL logic as well as MOS. And low rep. rates or manual operation let you slowly step through logic states.

The 8015A options makes CMOS testing even easier. Pulse Burst (option 002) eliminates conventional gating problems. Just set the exact number of pulses you want (from 1 to 9,999) on thumb-wheel switches. That's exactly the number you get... independent of pulse-rate settings.

Upper Output Level Tracking (option 006) automatically keeps clock and data-pulse amplitudes at the proper level relative to the supply voltage. This prevents CMOS circuit damage due to overvoltage on the inputs, even if the power supply is turned off.

Direct Output Amplifier Access (option 004) lets you convert word generator outputs, or TTL signals, to MOS/CMOS levels, or amplify low-level analog control signals to MOS/CMOS levels.

With Remote Control (option 003), you can build the 8015A into a test system and control all pulse parameter ranges with digital signals. Verniers are controlled by

current or voltage inputs.

And TTL Output (option 005) gives you a separate TTL compatible, 50-ohm output that tracks channel A output with fixed TTL levels.

The 8015A, starting at \$2,250*, gives you parametric testing flexibility and saves valuable setup time.

Or, if your need is for functional CMOS testing, consider HP's 8011A. Priced at just \$525*, it gives you high amplitude (to 16V) pulses at rates from 0.1 Hz to 20 MHz, and offers the Pulse-Burst Option.

Contact your local HP field engineer for all the details. Or, write for the 8015A and 8011A data sheets and our Application Note 195 — "Pulse Generator Techniques in CMOS Applications."

* Domestic U.S.A. prices only.

HEWLETT  PACKARD

Sales and service from 172 offices in 65 countries.
1507 Page Mill Road, Palo Alto, California 94304

Circle 62 on reader service card

Communications

CB helps enrich Puerto Rico

Makers of radios and antennas rush to gain advantages of island's available work force and tax-free umbrella

by Bruce LeBoss, New York bureau manager

Trying to satisfy an insatiable U.S. hunger for personal radio equipment, manufacturers of citizens' band radios and related apparatus are turning to the friendly environment of Puerto Rico to establish new production facilities or expand existing ones. They are hoping for higher profits as the market matures.

Other electronics industries have taken advantage of the island's package of incentives and assistance, in addition to its unemployed work force of more than 200,000. But now it's CB that's spearheading the growth of the electronics community. For example, in June, the Commonwealth's Economic Development Administration (Fomento) signed 14 electronics firms to locate factories there, the highest number for a single month in the 26 years of the island's Operation Bootstrap industrialization campaign. Of them, six were targeted for the production of CB radios and related equipment. And two other companies are just now entering CB-antenna production on the island.

Commercial radio sets have been made in Puerto Rico since 1965, when Matsushita Electric Corp. of Japan established its first Panasonic operation in Cagua. Today 22 plants are manufacturing radio and television components or sets, including RCA Corp., Motorola Inc., and Westinghouse Electric Corp. But the current hotbed of activity within Puerto Rico's electronics community revolves around the high-flying CB-radio market, which is expected to reach 10 million units this year, compared with 4.5 million and 2.4 million units sold in 1975 and 1974.

Hy-Gain Electronics Corp. of Lin-

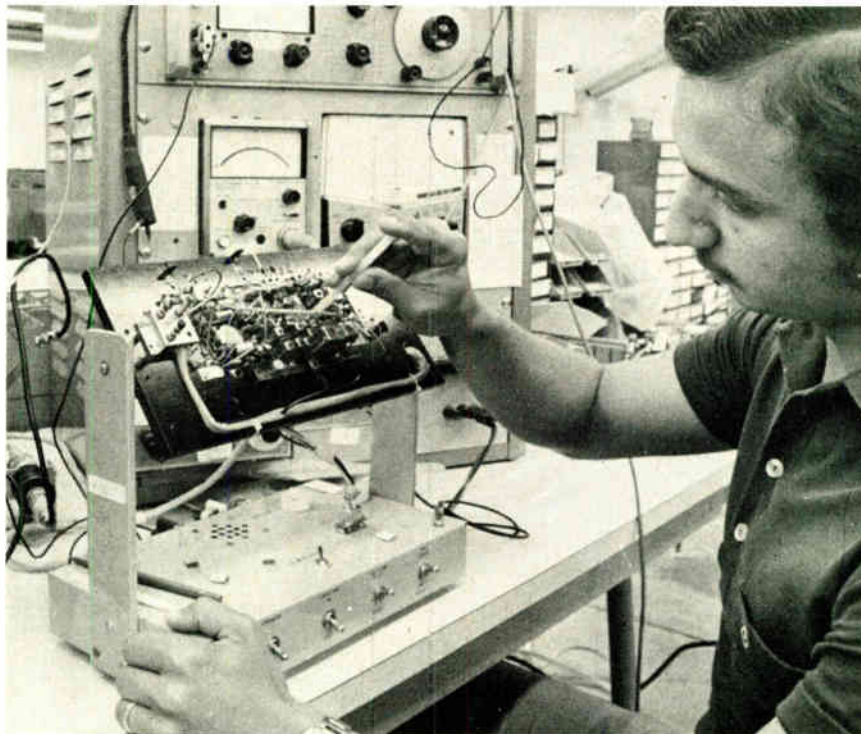

Circuit test. Technician at Motorola's new factory in Vega Baja, Motorola Portavoz Inc., checks a circuit board. Plant will build CB-like two-way fm radio.

coln, Neb., was the first CB-radio manufacturer to come to Puerto Rico when it rented in February 1975 a 35,000-square-foot facility in Naguabo, a small east-coast town where the tax-exemption period is 25 years because of the sparseness of industry. In less than two years, that operation has undergone four expansions, adding an 11,500-square-foot building each time. By next spring, Hy-Gain will have seven plants in Puerto Rico producing an estimated 11,000 CB radios daily. Approximately 1,120 workers in 203,000 square feet of factory space will be earning an annual payroll of \$5.8 million. The firm's capital investment in

Puerto Rico is \$8 million and growing.

Hy-Gain's latest production addition is an 86,000-ft² plant in the coastal city of Humacao, where the firm plans to have 600 workers by next spring. Later this fall, another factory will be opened in San Lorenzo, where 120 employees are scheduled to produce CB-radio antennas in a 36,000-ft² building.

Before coming to Puerto Rico, Hy-Gain manufactured only radio antennas. Today, it's one of the principal producers of CB radios, and all of its units are made on the island. "All but 70 cents worth of CB-radio labor is done in Puerto Rico, the 70

Probing the news

cents representing board-stuffing currently subcontracted out to a Japanese manufacturer," states Andrew A. Andros, Hy-Gain's chairman and president. The little CB-radio production that has not yet been moved to Puerto Rico soon will be. Boards will first be stuffed manually there, "but, by the end of 1977, we plan to install about \$2.5 million worth of automatic-insertion equipment."

Profits. The primary reason for making such capital investments in plant and equipment in Puerto Rico is obvious: the high return on investment. For the fiscal year ended Aug. 31, Hy-Gain will have quadrupled its income posted in the prior year "as a result of operations in Puerto Rico," says Andros. In its financial statement for the first quarter ended Nov. 30, 1975, Hy-Gain said tax-free earnings of its Puerto Rican subsidiary were \$4,473,291. Earnings for the entire corporation during the same period in 1974 totaled a mere \$161,152.

"The move to Puerto Rico, as part of our plan to make Hy-Gain the lowest-cost supplier in the industry, has significant implications for the company," Andros recently told stockholders. "Besides increasing our physical plant capacity, we also benefit from favorable wage rates and the high productivity of the labor force. Importantly," he continues, "no Federal income taxes are payable as long as Hy-Gain de Puerto Rico Inc. qualifies as a Section 931 corporation under the Internal Revenue Code, and no taxes are payable to the Commonwealth of Puerto Rico for 25 years."

The island's unique package of incentives and assistance includes 100% tax exemption for 10 to 25 years, with up to 30 years' exemption on the offshore islands of Vieques and Culebra, as well as discount rents in government-owned factory buildings, worker-training programs, and other forms of financial and technical assistance.

Newcomers. Hy-Gain's highly profitable experience in Puerto Rico is credited with influencing three other CB-radio manufacturers that

recently signed contracts to commence operations on the island. Those three firms, Masco Corp. of Taylor, Mich., Kraco Enterprises Inc. of Compton, Calif., and Breaker Corp. (Hallicrafters) of Arlington, Texas, each will employ 500 workers when they reach full production in 1977. Also, an electronic cousin of the CB radio, a portable two-way fm unit called the Handie-Com, went into production in June at a new Motorola plant, the company's third Puerto Rican factory, which will employ 170 workers. And two CB-radio antenna manufacturers, the Allen Group Inc. of Melville, N.Y., and Tenna Corp. of Cleveland, will employ 250 and 75 workers, respectively.

Masco and Kraco, two of the CB-radio producers that recently found Puerto Rico to be on the right wavelength, will receive a two-year wage subsidy, a measure no longer being offered by the government. Under this special incentive, the commonwealth agrees to reimburse selected companies for up to 25% of their production-line payrolls in connection with the first two years of



Good buddy. Worker checking component assembly at Motorola Portavoz Inc., one of many firms attracted to Puerto Rico by tax abatements and worker supply.

operation. Payments are made after the third and fourth years of successful operation. One way for a U.S. company to qualify was to agree to create a minimum of 500 jobs.

Masco's Puerto Rico subsidiary, R.E.C. Communications Inc., is the fifth and largest factory to locate on the site of the former Ramey Air Force Base, which the commonwealth is redeveloping as an industrial park, industrial research and development center, aviation center, and tourist resort. Masco, which will occupy a 60,000-ft² former military warehouse, will invest \$200,000 in machinery and equipment. Its annual payroll will be \$2.3 million.

Employment. Kraco will occupy 39,000 ft² of space in two rented industrial buildings in the Ponce Harbor district on the south coast. Total investment is \$300,000, and the annual payroll is estimated at \$2.5 million, the same as it is for Breaker/Hallicrafters, which is investing \$300,000 in a 56,300-ft² rented building in Ponce. Meanwhile, the Allen group has begun manufacturing CB-radio antennas in a 40,600-ft² plant in Fajardo on the northeast coast, where the firm has invested \$150,000 and expects its employees to draw an annual payroll of \$1 million.

Allen executive Walter Kissinger, a brother of U.S. Secretary of State Henry Kissinger, indicates that in the future, his company expects to expand into the manufacture of CB radios in Puerto Rico. And Tenna, which was already manufacturing electric motors there, is creating 75 jobs and an annual payroll of \$366,000 as it expands into CB-antenna production in its existing 200,000-ft² plant in Caguas.

Motorola's new Handie-Com plant occupies 28,000 ft² of space in Vega Baja, west of San Juan. Dennis Adams, manager at the new plant, Motorola Portavoz de Puerto Rico Inc., says that within 18 months he will have 170 employees on an annual payroll of \$884,000. So far, he has hired 40 workers, including several graduates of the two-year college-level electronics course at one of the commonwealth's three technical institutes. He says he will easily fill his work force from among 1,300 applicants. □

Name the names that belong to America's famous caps.

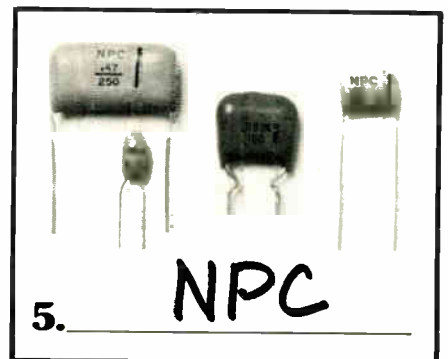
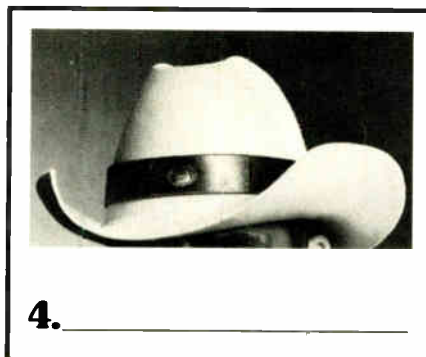

Here's how to get the cap of your choice!

There are many famous names in caps. Now add NPC to your list — with new high-performance Polyester Film and Metallized Polyester Film Capacitors, in addition to Dipped Tantalum. And more types to come! To get one of the caps above for your own, just place an order for ours: Order 5,000 or more pieces of NPC Type ED Polyester Film, Type MR (equal to C280AH/AE/AF) Metalized Polyester Film or Type CT Dipped Tantalum caps. Include your name, home address, hat size and style (number 1, 2, 3 or 4 above). You'll get the best caps money can buy — and the cap of your choice! For our competitive-and-then-some prices and our new Capacitor Catalog, see your NPC distributor or representative. Or write us direct.



*Where Pricing is as
Important as Technology*

NPC[®]
ELECTRONICS

ANSWERS: Think you've named the names?
Drop us a line and we'll tell you if you're right.
But be forewarned, one isn't who you may think it is.

6660 VARIEL AVENUE • CANOGA PARK, CALIFORNIA 91303
(213) 887-1010 • TELEX 69-8481 • TWX 910-494-1954

Talk to the 32,329 decision-makers in Japan's electronics industry.

翻訳

We'll furnish the language.

If you want to reach the most influential group of management and professional electronics engineers in Japan, we're certain you couldn't choose a more important medium than Nikkei Electronics. Or a more helpful one, either.

When you're thinking about selling to our 32,329 decision-makers, we offer you our full communications resources.

For instance, we'll translate your advertising message from English into the kind of Japanese that we know gets results from our readers. Then we'll set type for you. Also lay out the entire ad for you. And, wonder of wonders, there's no extra charge for these services.

Speaking the precise language of our very important readership is just one of the ways Nikkei Electronics gets more value for your yen in Japan.

As the bi-weekly product of Japan's largest business-economic newspaper and McGraw-Hill, Inc., we're by far the most-respected magazine in our field. (About

30% of our material is a translation of specialized contents from U.S. *Electronics*.)

As the only Japanese electronics magazine that's a member of the Japan Audit Bureau of Circulation, we can guarantee exclusivity as well as readability.

Our reader profiles are computer-controlled. The better to provide you with up-to-the-minute information on purchasing patterns. reader

analysis studies and proper market approaches.

And our Reader Information Service is a masterpiece of effectiveness. As many as 3,388 responses per issue, with 57.4% of the respondents acknowledging that they participate in or influence the purchasing decision of their companies.

Talk to the electronics decision-makers of Japan in our pages. We'll even furnish the language. Contact Mr. H.T. Howland (in English), Marketing Services Manager, Electronics, McGraw-Hill Publications Company, 1221 Avenue of the Americas,

New York, N.Y. 10020. Telephone: (212) 997-6642. Or talk to any member of McGraw-Hill's advertising sales staff in the U.S. or Europe, or contact us directly in Japan.



Nikkei Electronics: Ask anybody who can read us.

Electronics abroad

Military Expo draws army of exhibitors

Western Europe's first defense electronics show expects 10,000 visitors to see hardware from 200 manufacturers

by John Gosch, Frankfurt bureau manager

The first exhibition of its kind in Western Europe, the Military Electronics Defence Expo will be held in Wiesbaden, West Germany, from Oct. 6 through 8. And—judging from the number of exhibitors and prospective visitors—it will have an auspicious debut.

The show, which is dedicated to electronic military hardware, is restricted to procurement officials and military-hardware designers. About 136 prime exhibitors will display the wares of about 200 electronics producers from 13 countries. According to London-based Kiver Communications Ltd., which is organizing the event, Expo 76 may attract 10,000 visitors.

Expo 76, Kiver says, caters to a market exceeding \$3 billion a year in Western Europe alone. Also, the oil-rich countries in the Near East are showing enthusiastic interest in military equipment these days. The largest number of companies is coming from the United States—36 in all. Second is West Germany with 35 firms, followed by the United Kingdom (22), Switzerland (12), France (8), and Israel (8).

Visitors to the city's huge Rhein-Main Hall will see electronic hardware ranging from missile-guidance and radar systems to telecommunications equipment, command and control systems, and test equipment. It won't all be complex systems, however. Showgoers will also find a large array of components needed in military-hardware design—micro-wave and solid-state devices, transponders, optoelectronic devices, and all sorts of sensors and detectors.

Concurrent with the three-day exhibition, technical sessions will

heavily emphasize electronic warfare, communications, remotely-piloted vehicles, antisubmarine warfare, and computer technology as applied to weapons systems. A special three-day "case-study" seminar on the application of microprocessors in military equipment will also be staged by Sybex Corp.

Calling. With such a wide range of products on display, it's difficult to single out any. But in the so-called electronic battlefield of the future, tactical communications will be the key. So it's not surprising to find such systems occupying center stage

at the show. Among the hardware being displayed is a computer-controlled telephone-switching system for military/mobile applications. With this system, developed by two German firms, Telefonbau und Normalzeit and Siemens AG, all subscribers can be reached by automatic dialing in their own or in adjoining networks of the same type, even when subscribers frequently change their locations.

The system is divided into two levels—four-wire trunks and two-wire terminals. The former level allows a grid structure to be built,

Call in the field. Computer-controlled phone-switching was developed in West Germany. All subscribers can be reached by automatic dialing.

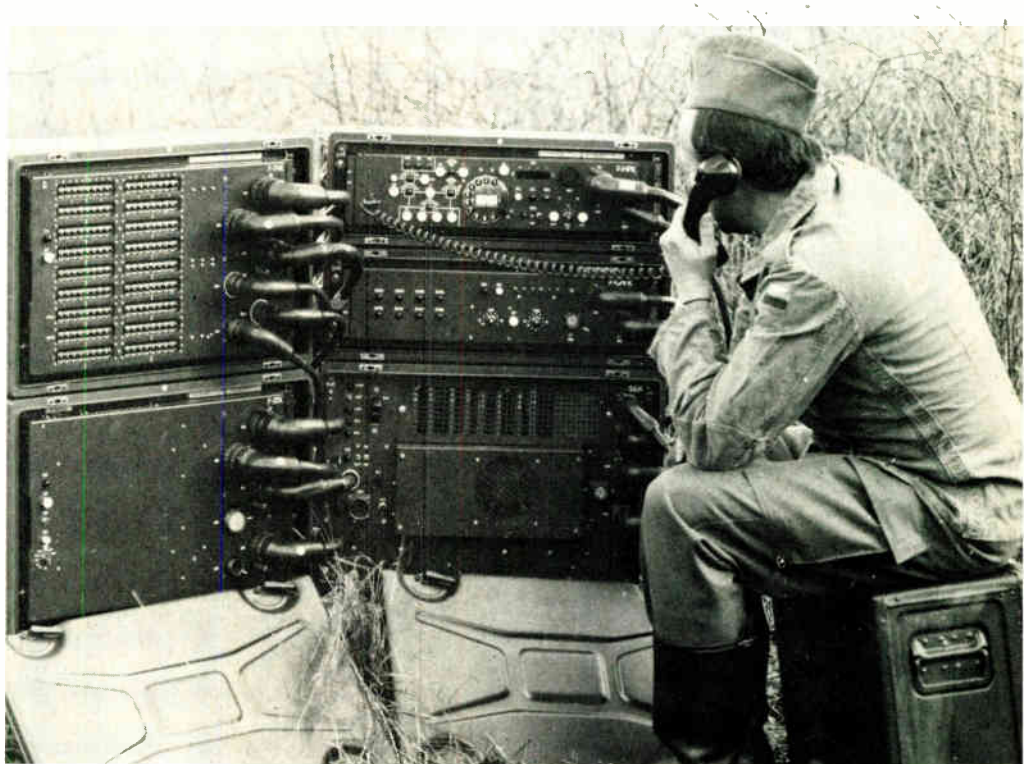

ONE-UP MICROPROCESSORS WITH A SINGLE-CHIP MICRO-SYSTEM

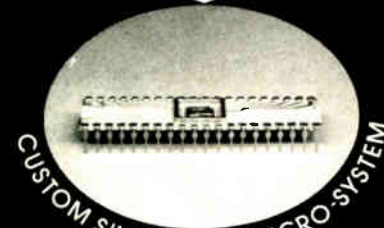
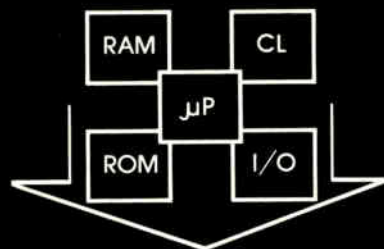

Microprocessor, Memory, I/O and Clock on the same chip optimized to your needs including special instruction set.

Non-Microprocessor functions such as special Counters, Timing, Multiplexers, UARTS, FIFOS, A/D, etc, can be included on same chip.

Performance proven by breadboard simulator.

Proprietary to you - you own the tooling.

PMOS, NMOS, or CMOS.

Guaranteed prototype development - with or without production commitment.

Guaranteed multiple manufacturing sources.

Contact us today for full details.

ALPHATRON, INC.

10340 BUBB ROAD
CUPERTINO, CALIFORNIA 95014
TEL. (408) 446-1494

Probing the news

with the nodal exchanges at the crosspoints. Subscribers are connected through the terminal exchanges to the nodal exchanges. This setup makes it possible to use an automatic search procedure whereby a subscriber can be located anywhere. The search signal travels over all existing paths so that, even when the network is partially destroyed, a connection path is found.

Featured at the stands of Britain's Hawker Siddeley Dynamics Ltd. will be another class of communications link: Linescan equipment and a weather-satellite picture-receiving station. Linescan is an aircraft- or drone-mounted system that scans the terrain overflowed by a sensitive infrared detector. The detector picks up minute variations in IR radiation and records the signals on photographic film.

Starring at the stands of France's Aerospatiale will be the firm's automatic-test-equipment complex for testing avionic devices, ATEC, an autonomous modular system. Its test capability covers analog and digital equipment including radios of the hf, vhf, uhf, VOR/ILS, Tacan, and IFF varieties that operate up to 1,200 megahertz. ATEC has about 600 test programs for equipment used on various types of European and American military and civilian aircraft.

Warnings. Zellweger, a Swiss firm, will show a fully transistorized single-sideband radio system for one-way transmissions from a central point to a number of receivers selectively addressed at the transmitter. The Zellweger system, which operates in the 2-12-megahertz range, has automatic transmitter and antenna tuning. Among possible applications are transmitting early-warning messages to individual military units and sending civil-defense alarm messages.

One small device likely to attract attention is the Avisa infrared warning device from Siemens-Albis AG, a German-Swiss company in Zurich. The hand-held device acoustically signals the presence of an enemy's infrared radiation by a tone that varies in intensity with the received



Warning. Emergency warning system built by Zellweger Uster in Switzerland is a transistorized single-sideband radio that operates in the 2 to 12 megahertz range.

radiation. By turning the 280-gram unit, the direction from which the hostile radiation is coming can be determined within 3° to 5°.

Expo 76 will also cater to shoppers looking for components. One example is a microprocessor from Britain's Plessey Ltd. The company's Miproc-16 is a high-speed bipolar microprocessor already being used in some experimental defense-oriented equipment. The throughput of 2.8 million instructions per second makes the Miproc-16 an attractive device for many signal-processing applications, the company says. The standard versions are designed with dual-sourced Schottky-TTL components, but for some applications, the device is also available as a set of thin-film-hybrid modules. The processor meets many military specifications, including MIL-E-5400.

To be shown by the German firm, Gutekunst KG, will be self-luminous light sources, called Microlights, that are basically sealed glass capsules, internally coated with phosphorus. The phosphorus is excited by tritium gas to luminesce. Since the devices are inherently luminous, they can be used where no electrical supplies are available or to provide additional safety in the event of power failure. Typical applications are in compasses, meters, rifle and telescopic sights, theodolites, and similar instruments.

Microlights are available in a wide range of shapes and sizes and with brightness levels from 20 to 2,000 microlamberts. The standard version comes in a green color, but other models emit blue, yellow, orange, or red light. After six years of operation, the devices still retain up to 50% of their initial brightness, the company says. □

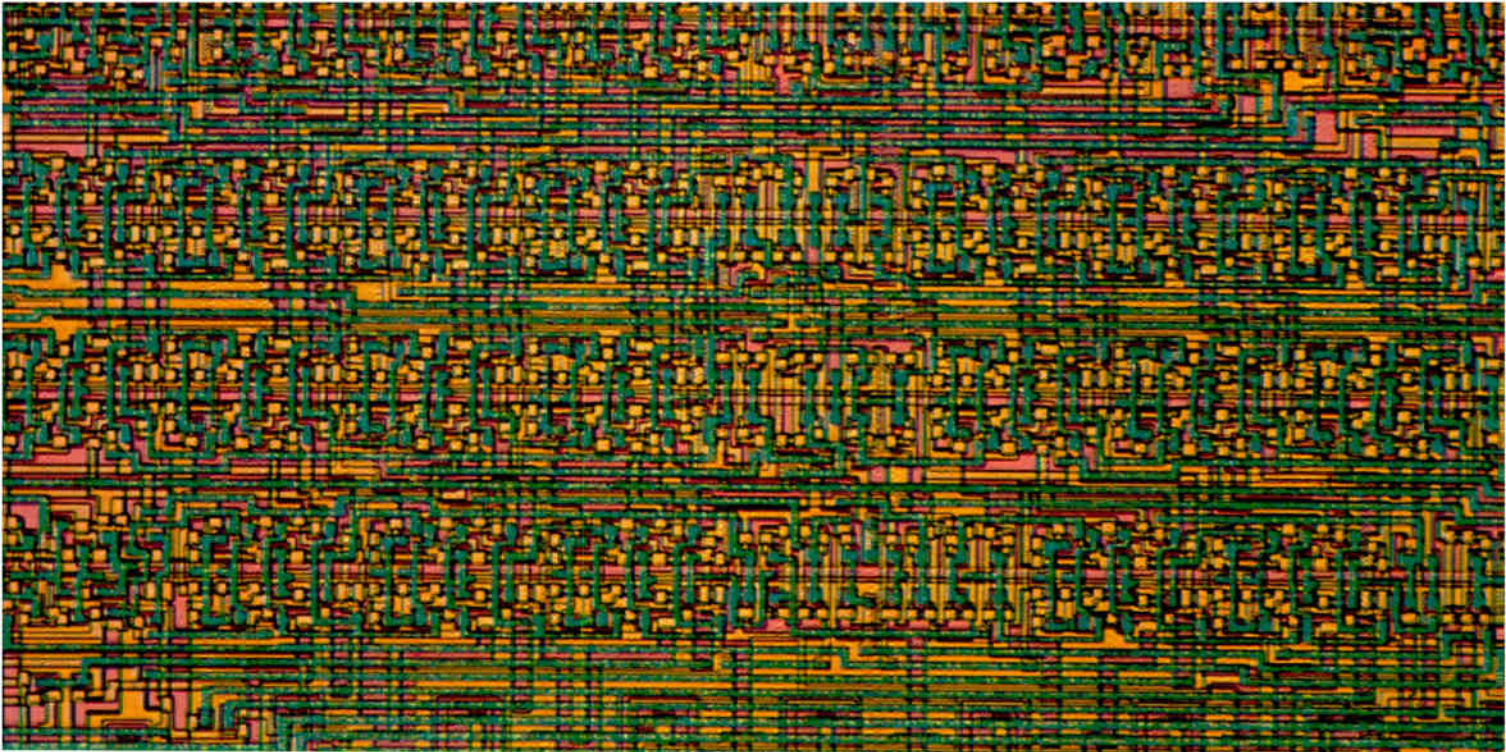

LAST YEAR THIS PROPRIETARY LSI CIRCUIT WAS ONLY AN IDEA.

This year it made a good idea into an outstanding product.

Our business is helping original equipment manufacturers exploit the advanced semiconductor technologies to improve performance and reduce costs. We do it by developing proprietary LSI circuits for our customers' exclusive use. Maybe we should be doing it for you.



If you're trying to stay competitive with a new product—or by improving an existing product—now is the time to consider a custom development program. We can help you fully understand the very significant benefits of custom LSI.

Performance Bonuses That Cost You Nothing! The real beauty of LSI is the way it gives you product design options. Once you've made the decision to develop a custom circuit,

there's usually plenty of silicon real estate to use in new and different ways. You can add performance features to the product at virtually no incremental cost. In short, your product can be much better than a competitor's non-LSI equivalent.

High Yields Mean Lower Costs. Our LSI processes are production-proven. We get high yields. Which means you get lower chip costs. Plus, LSI reduces product assembly costs. Your product should have a competitive edge in price.

Low Power Consumption. LSI circuits conserve power. Their low current requirements often permit portability which would otherwise not be possible. Energy conservation in itself is a product advantage these days.

Small Size is Only Part of the Story. Product miniaturization is the most obvious advantage of LSI. Even if small size seems unnecessary for your application, don't overlook the numerous other benefits that we've been talking about.



Our knowledge of the custom LSI approach can help you to evaluate these potential benefits in your own terms. LSI may be exactly what you need. If it isn't, we'll be the first to tell you.

Contact us today for some of the answers. We'll be happy to send you some fact-filled material that describes actual ways we've helped other companies prosper through the use of custom LSI. If you'd like to talk specifics, call Dan Hauer or Rich Koury at (408) 247-5350.

We sell more than circuits, We sell solutions.



3100 Alfred Street, Santa Clara, CA 95050
Telephone: (408) 247-5350
Cable: Micropower
Telex: 910-338-0154 MICROPWR SNTA

NAME **3** PRODUCERS OF HIGH VOLTAGE CERAMIC CAPACITORS

If you name ERIE first, you're right on target. For we produce a full line of quality High Voltage Ceramic Capacitors . . . 3kV to more than 30kV . . . in the capacitance value and temperature characteristic to suit your circuit needs. We have all sizes and shapes with the terminal arrangement you want. In fact, you name the application . . . chances are ERIE has a standard unit available. If not, let's talk about it.

You'll find ERIE HV Capacitors in electric utility transformers. Miniature power supplies. CRT displays. Lasers. Lightning arrestors. TV power supplies. Image intensifiers for night vision apparatus. Just about any application where high voltage is involved.

So look to ERIE first. When it comes to High Voltage Ceramic Capacitors, ERIE continues to lead the way. Your letterhead request will get you our new catalog HV/SC-200 . . . or call Customer Engineering at our State College, Pa. plant — 814/237-1431.

ERIE TECHNOLOGICAL PRODUCTS, INC.

Erie, Pennsylvania 16512

Circle 70 on reader service card

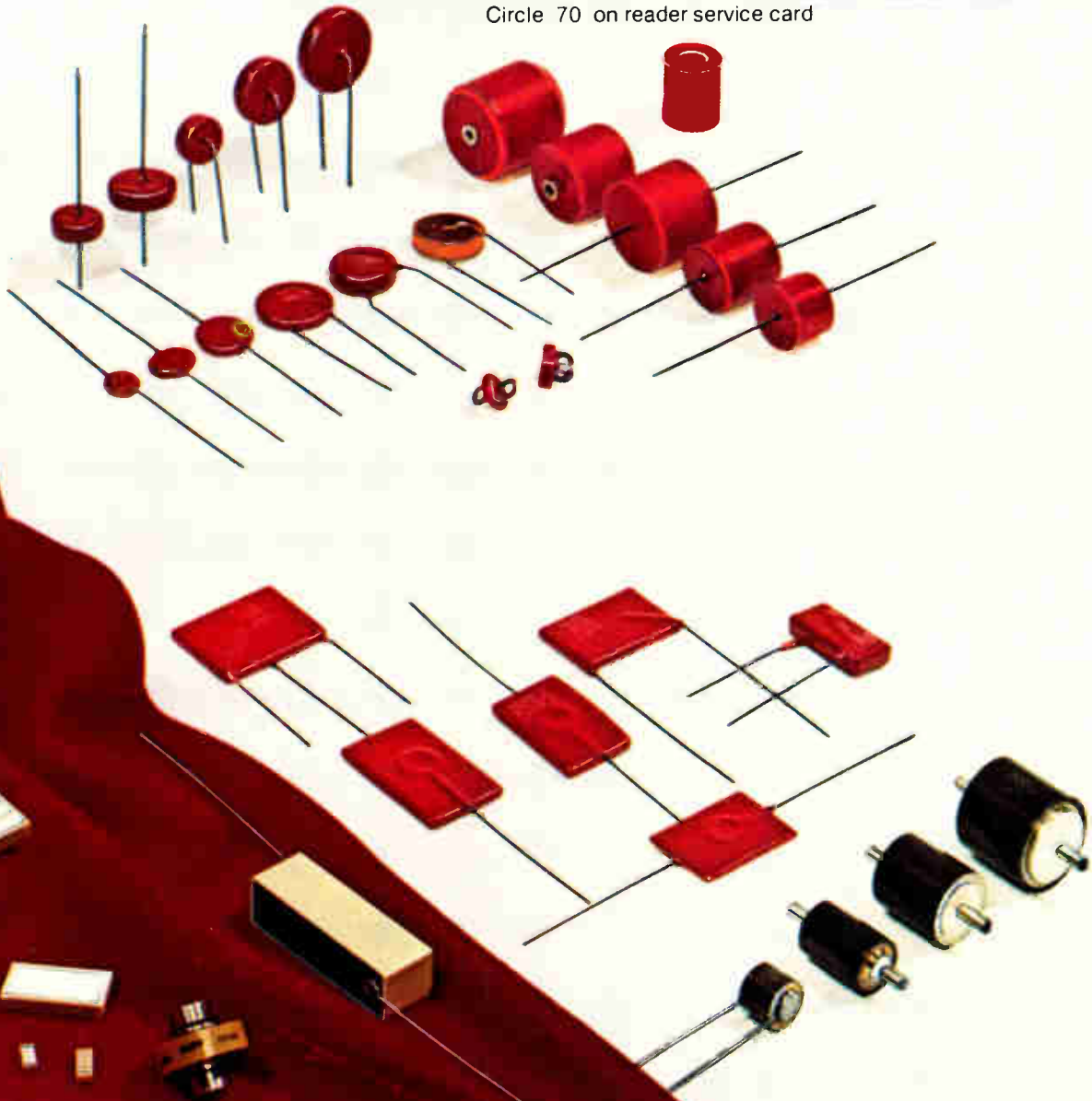

Minicomputers

How to sell computers like cars

Instead of building its own sales force, Microdata sets up exclusive dealerships for its Reality business system

by Larry Waller, Los Angeles bureau manager

In the booming minicomputer business, a common formula for success is to develop a machine that fills a market niche, then put together a crew of aggressive company salesmen to peddle it. But a fast-growing firm based in Irvine, Calif., has found another way to sell business customers on its mini-data-base system, labeled Reality. Instead of a direct sales force, Microdata Corp. for nearly three years has used an expanding network of exclusive dealerships, like the auto industry's.

The results have confounded the skepticism of industry pundits and Wall Street alike. For the fiscal year that ended on Aug. 31, Microdata is expected to have doubled its sales into the \$30 million range and to have boosted its profits from 71 cents a share to about \$1.50. Meanwhile, enthusiastic recommendations from influential financial analysts have lifted Microdata's common share pricings into the mid-20s from a low of 1½ in early 1975.

What the dealers do for Microdata is apparent in the preliminary breakdown for fiscal 1976. Reality accounts for about 60% of total company revenue, 56% of which comes from dealers' sales to end-users and only 44% to company-made sales to original-equipment manufacturers. To date, the company has sold 586 machines, at about \$70,000 apiece.

While the advantage of not having to pour cash into building a direct-sales organization now seems obvious, chairman and president Donald W. Fuller is quick to admit that Microdata did not plan it that way. When he took over the firm in 1970, it was a financially troubled supplier

of central processing units to OEMs. In solving immediate problems, Fuller says he foresaw that the best opportunity for a small firm lay in developing a simple computer system that "would provide timely information for the noncomputer-professional person who actively runs a business." By November 1973, Microdata had Reality, which uses English-language software to enter and retrieve data in real time through remote terminals. It appeals to users who handle lots of data that changes frequently but must always be available for immediate access.

The trouble was, after building Reality, "we couldn't afford to sell it right." At this point, the man with the right idea at the right time appeared: John Keogh, a co-founder of Basic Four Corp., which had been buying small computers from Microdata. Keogh says he chose Microdata because of Reality's potential. His idea was presented to Fuller this way: "I'll set up a dealer organization if I get one of the dealerships."

Growth. Fuller bought the idea, and Keogh spent from July 1973 until January 1975 setting up the network, getting his own dealership in 1974. Microdata now has 26 and ultimately wants to have 40 by the end of 1977. Basically, the dealers buy Reality and peripherals at a 40% discount and negotiate their own software packages with buyers.

Not surprisingly, financial analysts see rosy vistas for Microdata, perhaps \$2.50 a share in fiscal 1977

on zooming growth. But there's still a major area of uncertainty: how long will the dealership system be effective before Microdata has to acquire it to gain more control? And there are questions about Microdata's plans to update Reality.

For his part, Fuller says development is well along on modular improvements for Reality. Capital is adequate, and the company is staffing to handle much larger sales. At present, Microdata is shipping 60 systems a month, generating about \$4.2 million revenue that translates into a \$50 million yearly sales rate. With major competition for Reality a year or two away, Microdata is moving rapidly toward Fuller's stated goal: to become "one of the major minicomputer companies." □



Facing Reality. Microdata's marketing vice president, Phil Cleveland (left), and its president, Donald W. Fuller, are shown with the company's business system, Reality.

New "Cricket" sub-miniatures: Interchangeability plus full 6 amp rating.

Cutler-Hammer introduces a broad new line of quality sub-miniature switches whose specifications meet industry standards for size, terminal spacing and bushing height. They're rated 6 amps. They're fully interchangeable. They feature high torque bushings. They're competitively priced. And they're available right now. For more information on new, interchangeable sub-miniature switches, call your Cutler-Hammer sales office or Stocking Distributor. Just ask for "Cricket."

Flat Lever. Designed for comfortable, finger-tip control. Keyed bushing prevents switch rotation.

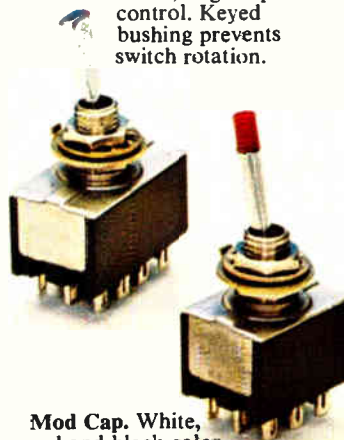

Lever Lock. Locks in position to assure precise control of vital or sensitive functions and equipment. No accidental operation.



Mod Cap. White, red and black color-tipped caps let you choose and vary your operational coding.



Watertight. Toggle or pushbutton. "O" ring seal shuts out dirt and moisture. Keeps switch mechanism dry in adverse environments.

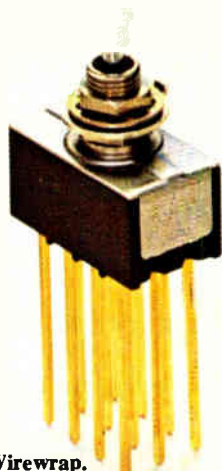

Wirewrap. Gold plated terminals in .750 and .964" lengths to satisfy power or dry circuit requirements.

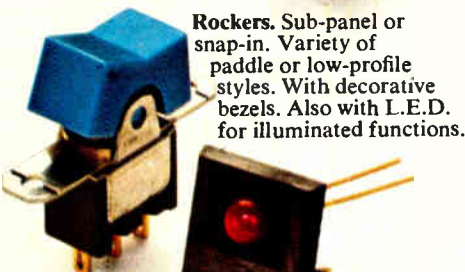

Rockers. Sub-panel or snap-in. Variety of paddle or low-profile styles. With decorative bezels. Also with L.E.D. for illuminated functions.

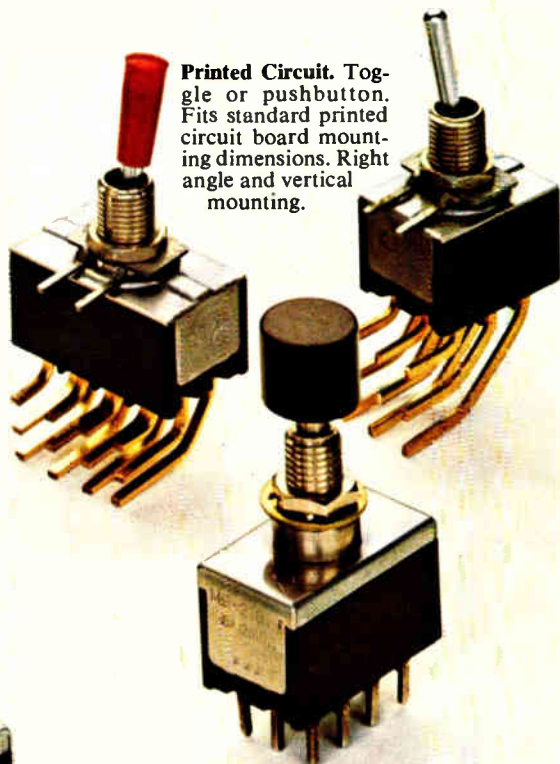

Printed Circuit. Toggle or pushbutton. Fits standard printed circuit board mounting dimensions. Right angle and vertical mounting.

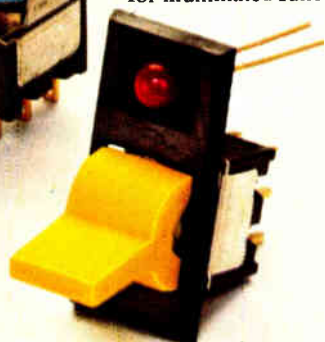

Standard. Toggle or pushbutton. One to four poles. Eight circuits. Two decorator cap styles in a variety of colors. Dry circuit capability, too.



Circle 72 on reader service card

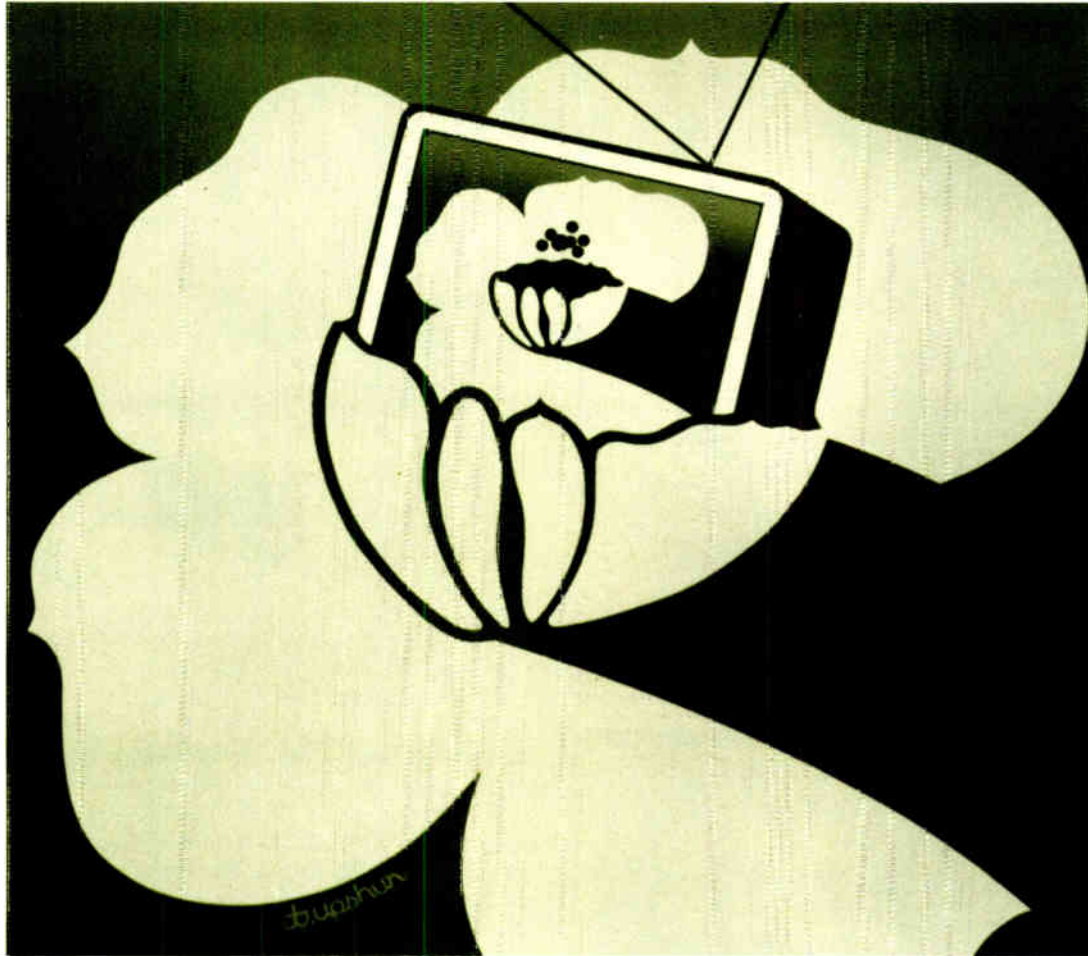

New season's color TV sets slate major role for large-scale integration

MOS devices and PL spearhead the advances
in channel tuning and color control

by Gerald M. Walker, *Consumer Editor*

□ Behind the pretty faces of this fall's new color TV sets are some solid technical advances in station selection, color tuning, and tube design. Many of these innovations are proof that the name of the game among set makers is large-scale integration. In fact, the advances in channel tuning and automatic color control depend largely upon metal-oxide semiconductor devices and integrated injection logic.

Television is an old technology in electronic terms, but it's still lively. "Television is a service whose technology is in continuous transition. It is not a mature technology if it is always changing to balance performance, reliability, and safety," comments Jay J. Brandinger, vice president of engineering for the RCA Consumer Electronics division, Indianapolis, Ind. This year, the innovations here and abroad bear out Brandinger's point. There have been major changes in channel tuners, led by the German

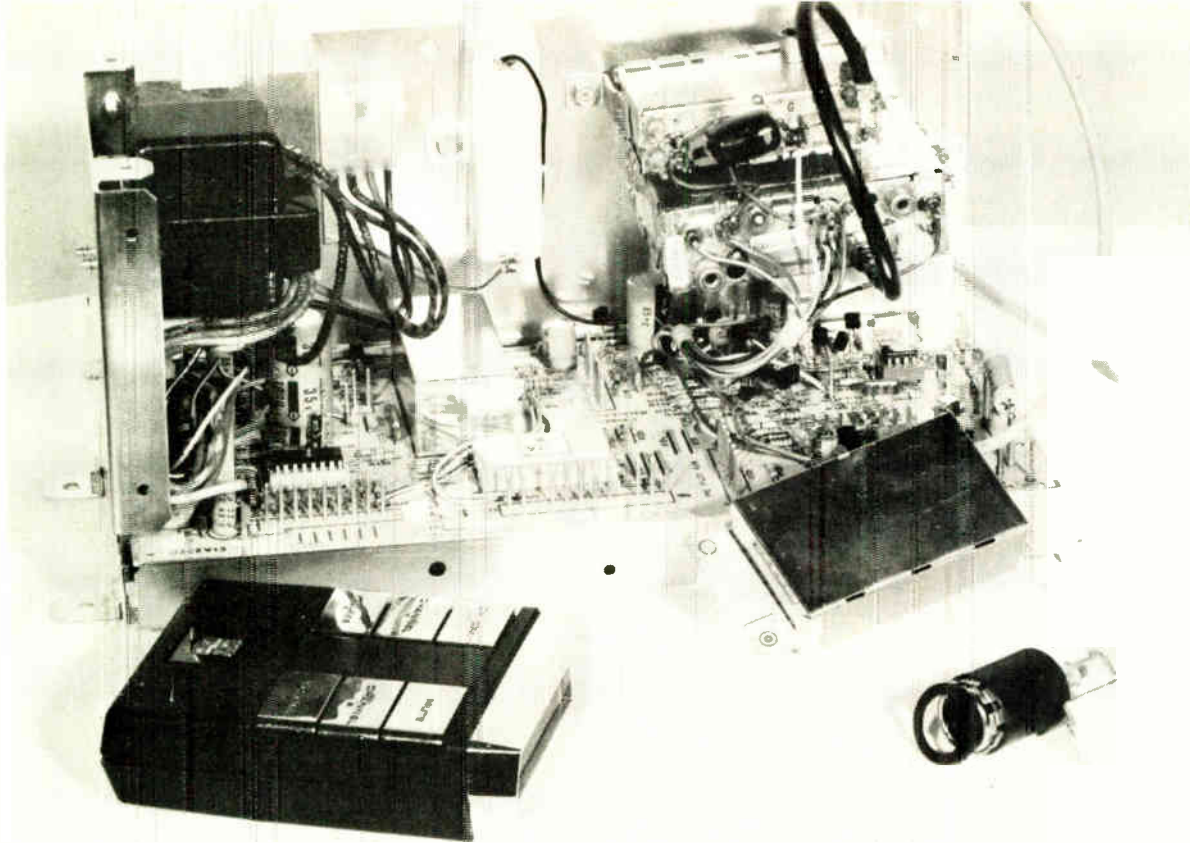

1. Remote afterthought. This new Magnavox tuner features a field-installable remote-control unit. An interface circuit and ultrasound mike (lower right) are put in through the back of the set to handle signals from the hand-held transmitter.

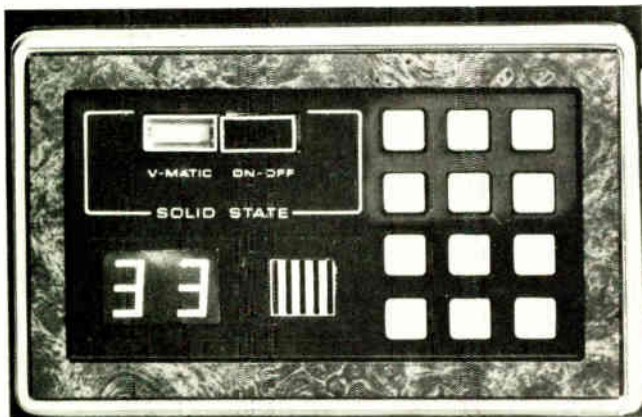

2. Stay tuned. The Magnavox Videomatic Touch-Tune is designed around five ICs supplied by Texas Instruments and has an LED channel-number display. Note the grill between the Touch-Tune buttons and the display behind which the remote mike is housed.

manufacturers. Large-scale-integrated circuits have figured in the impact of digital address systems, often in remote-control units. These have made possible improved performance of varactor tuners. Digital voltage-synthesis and frequency-synthesis techniques have been used, as well as varied digital-memory technologies, including nonvolatile memories. On-screen display of channel number, time, and other information has also been accomplished with minor additions to these digital systems.

Many new sets feature automatic selection of color intensity, brightness, contrast, and hue (primarily flesh tones). Again, set designers have followed different approaches to accomplish this task with internal, factory-set controls or with external signals.

One U.S. manufacturer is introducing a new tube design,

featuring an in-line gun, self-convergence circuits, and a wide deflection angle. Other portions of the chassis have not been neglected either. New integrated circuits have been designed for the audio, intermediate-frequency, and other functions. Also developing is a major thrust to reduce the number of components in sets, to cut the energy consumed in operation, to simplify costly maintenance, and to integrate more functions into more-complex integrated circuits than before.

Electronic tuning picks up.

Perhaps the most significant trend in TV design has been the rapid growth of digital ICs in tuning systems. They also provide the most headaches, as set makers steeped in analog design have had to learn how to apply digital circuits. According to one estimate, the learning process has delayed TV-set makers in this country two model years in applying these MSI devices. They first had to learn how to use digital circuits and then how to protect them from picture-tube arcing and other transients inside the receiver. Now they are learning how to test and handle the digital ICs on the production line.

German companies have been in the vanguard of tuning innovations, particularly in remote tuners with ultrasonic or infrared transmitters. However, American and Japanese companies are rapidly catching up, adding exclusive features as they do so. The advent of digital applications has also opened up new opportunities for semiconductor suppliers such as Sprague Electric, RCA, Texas Instruments, National Semiconductor, Fairchild Semiconductor, General Instrument, Philips, and Intermetall.

While varactor tuners have long been a feature in the upper end of the line from GTE-Sylvania's Entertainment Products group, Batavia, N.Y., it was the Magnavox STAR

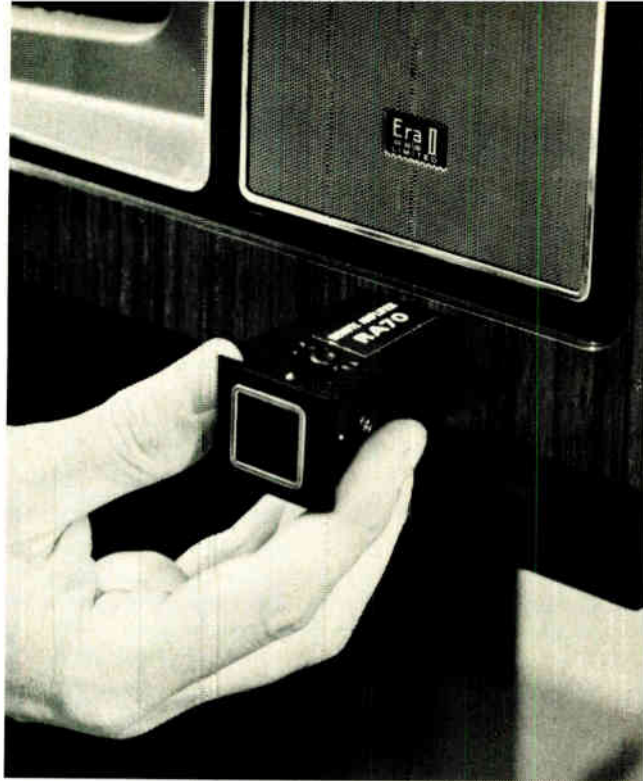

3. Plug-in remote. Admiral's optional remote-control system can be installed by the user on any five new models with the built-in adapter. The set owner removes a cover plate and plugs in the remote-control amplifier. Amplifier and hand-held unit retail for \$99.95.

system that presented the first U.S. digital address system with remote capability designed around an LSI chip. In Japan late last year, Tokyo Shibaura Electric Co. (Toshiba) introduced a multi-chip tuning system capable of being programmed with a day's selection of show times and channel numbers. In Germany, Grundig AG has set the pace among Europeans.

This year, Magnavox, Fort Wayne, Ind., has refined STAR (selective tuning at random), which has random access to as many as 82 channels, by adding on-screen display of time. In adding the clock, the designers made the chip part of the interconnect network on the tuner board so that there was little conversion trouble on the production line.

STAR has a custom-designed single chip provided by Mostek. This p-channel MOS chip incorporates many of the remote linear functions, the station memory for the last-tuned channel, the on-screen channel-display character generator, and all the counting and computing functions necessary to tune the various channels.

Magnavox is also introducing a digital-address tuning system called Videomatic Touch-Tune, which is less complex than STAR and costs half as much. It's a 20-channel voltage-synthesizer tuner built around five ICs. It has made possible the simultaneous introduction of a remote-tuning unit (Fig. 1) that may be installed in the field. The buyer of a Videomatic Touch-Tune receiver may

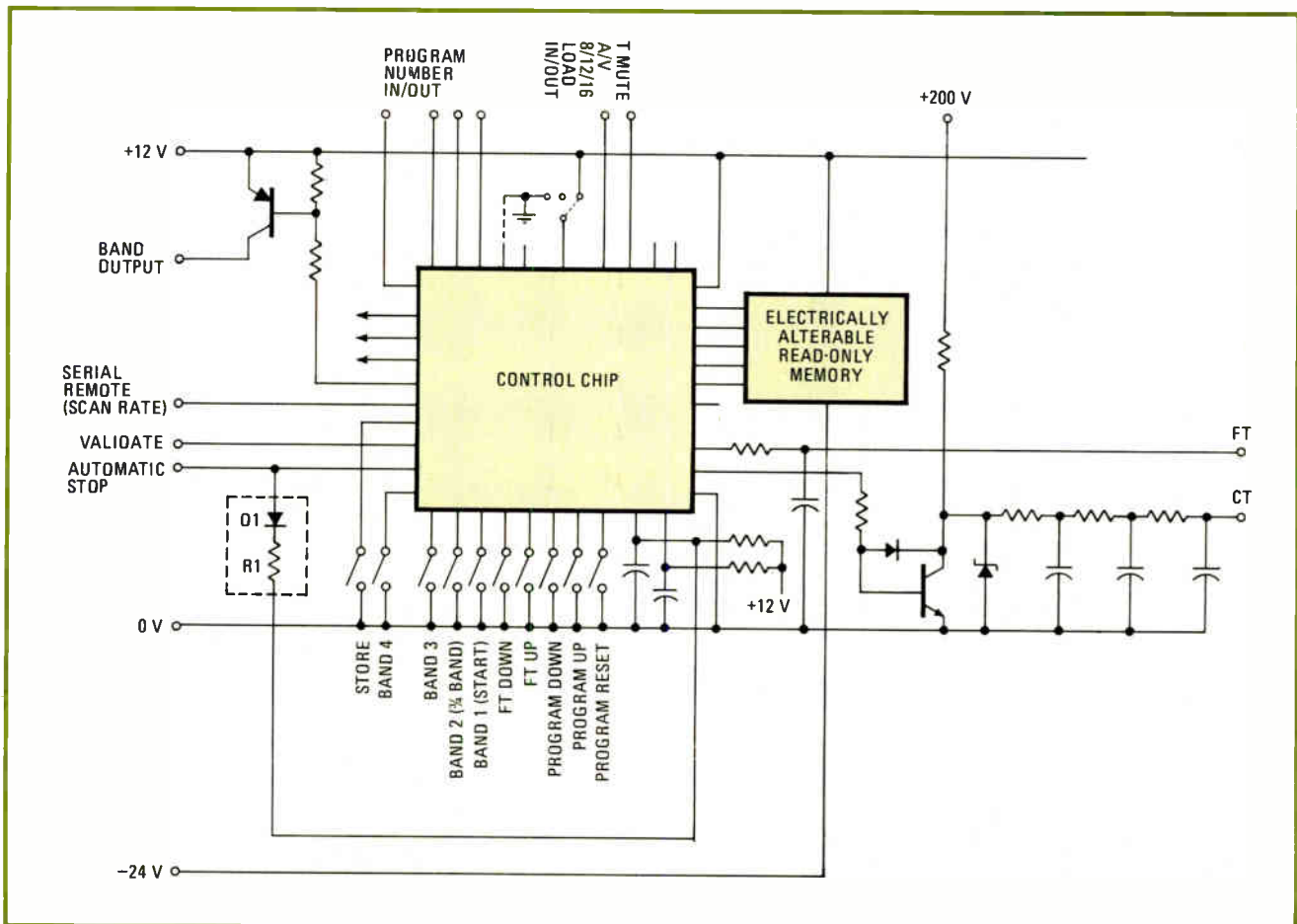

4. Nonvolatile. The General Instrument Economega is a two-chip version of its four-chip Omega digital tuner address system. The control chip now contains the display driver as well. However, the electrically alterable read-only memory is still a separate chip.

Bright projections for projection TV

Suddenly there are more than two dozen companies trying to market projection television sets to home viewers in the United States. Considering the prices—\$800 to \$5,000—and the estimated annual sales—50,000 to 70,000 produced in 1976—that's a lot of competition.

Virtually all of these companies are new to TV-set making; however, they are banking on the hope that projection television will repeat the history of color TV. Fifteen to 20 years ago, color receivers were also very expensive, and pictures were dim and hard to tune. Yet the market eventually boomed, prices came down, and performance has been improved dramatically.

The pioneer in home-projection TV, Henry Kloss of Advent Corp., Cambridge, Mass., anticipates a rerun of this scenario for the big-screen sets. As founder of Advent, Kloss introduced the first practical, three-tube projection TV, VideoBeam 1000, a few years ago, but his company ran into trouble trying to mass-produce it. Earlier this year the company was reorganized and revitalized financially.

The product designed by Advent to open up the home market is the new Videobeam 750, a 6-foot-diagonal, three-tube unit priced at \$2,495. "By 1985, we expect the market will be 800,000 units a year," Kloss predicts, "but projection TV won't really take off until a large company comes in with lower-priced units, in the \$1,350 to \$1,400 range."

There's reason to expect this, since the Admiral group of Rockwell International has confirmed that it plans to develop a projection TV set. Admiral is just coming out of an extensive reorganization of its own and is anxious to establish a new image as a technology leader in consumer products.

"Advent proved that projection TV will sell," says Charles J. Urban, president of Rockwell's consumer operations, "and major companies will follow along. If the consumer wants projection TV, he'll buy it even at a high price."

Thomson-Brandt of France is researching a system it claims is radically different from existing types. Although

details aren't available, Thomson hints it's based on a "projected lantern" technique and may be ready for marketing in three years.

One television heavyweight, Sony Corp., has not been active with its single-tube projection-TV sets. According to the Japanese company, it has sold just 6,000 of its 50-in.- and 40-in.-diagonal models since their introduction a few years ago. As more competition has entered the field, Sony has shown less and less enthusiasm.

Not so the Americans, who are scrambling for a position in the market. Among the problems in turning projection TV into an orderly market is that there are three different ways of making a set, each with its own limitations. Advent's original model 1000 used three cathode-ray tubes for red, blue, and green and Schmidt optics similar to that in high-powered telescopes to project color images on a Kodak Ektalite screen. Brightness was 30 foot-lamberts, compared to almost 100 ft-L for a conventional direct-view receiver.

Advent's new model has three separate tubes with refractive optics, as in less powerful telescopes, in front of the tubes. It has a new plastic screen less susceptible to blemishes than the sensitive Ektalite type. Brightness is around 20 ft-L. Both three-tube models require precisely 8 ft between projector and screen in order for the color images to be in focus.

The most common (and less costly) approach is to use a conventional small-screen TV receiver as a picture source and simply project the image on a large screen at a rather great loss in picture clarity and brightness. Because of the projection optics, some makers install a circuit that inverts the picture raster so that the image hits the screen right side up. Other companies merely install the TV set upside down.

Sony's single-tube model is different in that it uses a souped-up Trinitron tube, increasing picture-tube voltage to increase on-screen brightness. However, the firm has introduced a 120-in.-diagonal video projection system (not for home sales) that has three separate tubes. It's priced at over \$23,000.

purchase the remote tuner afterward, but the dealer need only carry one line of sets to meet customer demands for standard and remote controls (Fig. 2)

Three of the five chips in the Touch-Tune are integrated-injection-logic devices supplied by Texas Instruments Inc. The largest is a 200 mil-by-211-mil, 28-pin, control-processor/read-only memory, which is the equivalent of 1,750 discrete components. Another ROM, the 16-pin station memory and digital-to-analog converter, measures 148 by 160 mils. The third μ L circuit is a 16-pin, 106-by-123-mil, remote decoder. The other two chips are the display decoder, a standard transistor-transistor-logic 7447 16-pin device, and the data conditioner, a TTL-Schottky, 14-pin unit.

The control processor interfaces with a keyboard for channel selection, volume and on/off inputs, and tuning commands. It has a 20-word memory to store band and channel-number information and connects to the station-memory chip. Outputs go to the display and tuner-band switches. In addition, this chip provides latches and debounce for smooth keyboard operation.

As the name implies, the station-memory chip stores 20 station frequencies of 12 bits each that are commanded by the control chip. This ROM is factory-programmed for channels 2 through 13. The dealer can program as many as eight ultra-high-frequency channels. Besides station frequencies, it has automatic-tuning information programmed at the factory.

The data-conditioner IC contains a clock oscillator that may be controlled by a crystal or an LC circuit and a divider to feed an output of 910 or 1,000 megahertz to the station-memory IC and remote-decoder IC. It also contains a gated flip-flop, which is controlled by the output from the d-a converter in the station memory. This input provides a regular, accurate pulse for the integrator filter.

Signals from the optional remote-tuning unit go to the remote decoder, which decodes them and provides volume, mute, and on/off circuitry. Frequencies for the remote functions range from 33.024 to 40.95 kilohertz. The display-decoder chip is a binary-coded decimal, four-line-to-seven-segment decoder that interfaces with the station memory and a light-emitting-diode display of the channel

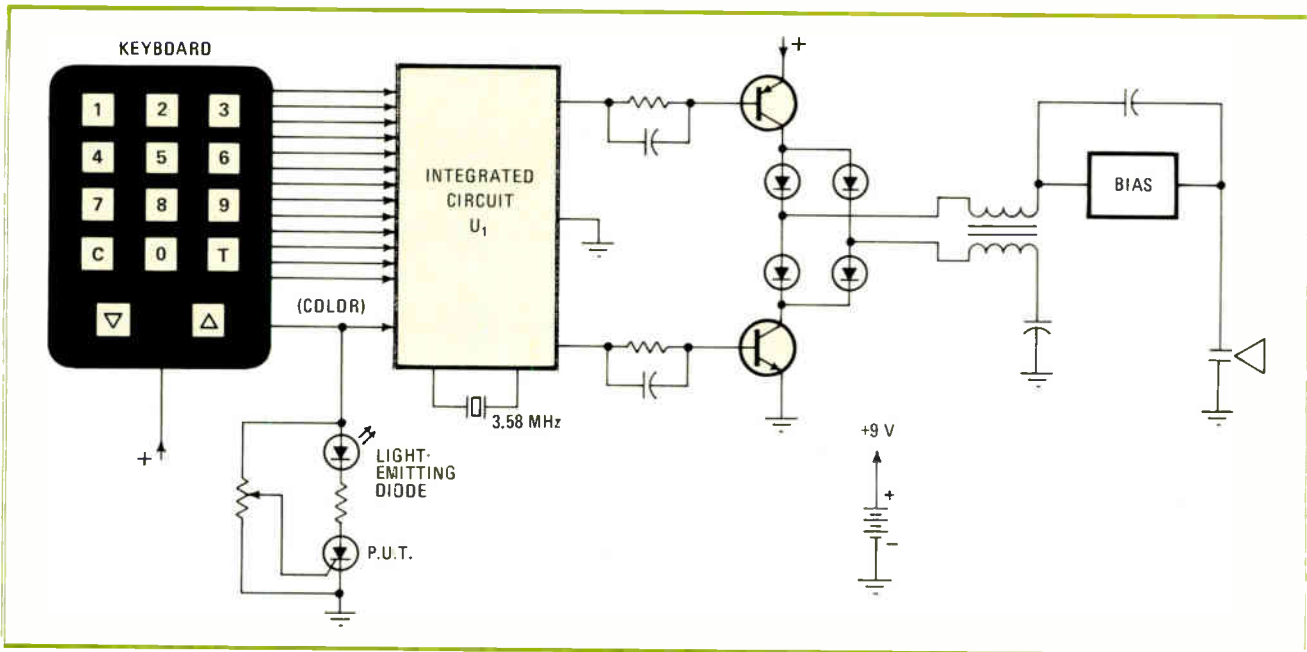

5. Remotest. Simplified schematic of RCA's remote transmitter shows the keyboard arrangement on the hand-held unit. Integrated circuit U₁ consists of a crystal-controlled oscillator and dividers that supply ultrasonic energy to the transducer at one of 14 selected frequencies.

number displayed prominently near the controls.

One of the problems in designing with volatile digital memories, such as the two in this unit, is the need to maintain a constant flow of current to sustain the memory. Magnavox incorporates two batteries: a 1.5-volt alkaline battery to provide current before the set is plugged in at home and a rechargeable nickel-cadmium battery that takes over then.

According to Robert C. Williams, chief engineer for TV tuners at Magnavox, the alkaline battery should last at least a year and the rechargeable battery over 10 years. "This arrangement solves the battery problem, even though we have a volatile memory. There should be no need for the consumer to replace a battery during the life of the set," he says. "One of the advantages of using ²L is that the ROMs require so little current to power up."

Plug in the remote

The first remote-control option that can be installed by set owners has come from the Admiral group of Rockwell International Corp., Schaumburg, Ill. It's a feature of the new Era II Limited sets that have a built-in adapter in 19- and 25-inch models.

The package, priced at \$99.95 retail, consists of a hand-held transmitter that duplicates the tuning panel on the set, a plug-in remote-control amplifier, and a standard 9-v battery. The set owner removes a cover plate over a slot on the front of the TV cabinet and inserts the remote-control amplifier (Fig. 3).

Admiral has chosen a frequency-synthesizer address system with full keyboard address of 82 channels. The first-generation electronic tuner has been designed with discrete components; the only IC is a random-access memory containing the frequency program. However, the next generation will probably be executed on four ICs plus the present RAM, says Wayne L. Bledsoe, vice president of electronics operations for Rockwell's consumer subsidiary.

The firm has also chosen to use a gas-discharge channel display rather than LEDs or on-screen numerals. Bledsoe estimates that, at present, the combined frequency synthesizer and gas-discharge display are more expensive than a combined voltage-synthesizer and LED or on-screen display would be, because of the added cost for change-of-address and display-driver circuits. After integration of the frequency synthesizer, costs of the two probably will be about the same.

Taking the nonvolatile route

To avoid the problem of maintaining volatile memory in digital-tuning address systems, General Instrument Corp. last year devised the Omega tuner designed around four chips, including a metal-nitride-oxide-semiconductor electrically alterable read-only memory licensed from NCR Corp. [*Electronics*, April 1, p. 86]. Now GI's Microelectronics division in Hicksville, L.I., has refined the original design to a two-chip system, called Economega, which will be marketed initially in Europe.

Economega (Fig. 4) has a separate Earom, but has integrated the display and control from the original design on one 40-pin MOS LSI chip. This n-channel device interfaces with the Earom, a remote-control system, and a d-a converter. The Earom stores the tuning and band information for 16 TV programs. Given a limited number of functions to be performed by the address circuits, a single-chip system combining the nonvolatile memory with the control and display circuits is possible.

One of the more elaborate remote-control address systems, with on-screen display of channel number and time, has been developed by RCA as part of its ColorTrak line. Its remote keyboard, in fact, is the only means of instrument control available to the viewer. The complete tuning system uses 10 RCA complementary-MOS chips.

Besides the channel selection and volume up/down control, the hand-held remote unit (Fig. 5) has a button

England delivering video newspaper

More and more Britons will be reading their daily paper via the telly, as the nation's Teletext and Viewdata systems begin to take hold.

Teletext is a system that will let home viewers call up "pages" of alphanumeric information such as news, sports, weather, stock reports, and the like [*Electronics*, Feb. 5, p. 68]. Digital Teletext signals ride piggyback on the analog TV transmission in two lines of each blanking period of the 625-line, 50-field transmission. Each two lines of data pulses, transmitted at 6.937 megabits per second, are enough for one 40-character row of the 24-row page in each 50-microsecond line.

Viewdata links a TV set equipped with a decoder to a telephone, so that the user has access by an alphanumeric keyboard to any of a virtually unlimited number of "pages" of information from remote computer data banks* [*Electronics*, March 4, p. 76]. Trials of Viewdata will begin next year, with full service possible by 1978.

Making the set-top decoders for these two services promises to be a good business for TV manufacturers in England. Already Rank Radio International and Labgear

Ltd. have announced Teletext units.

Rank, claiming the first production sets, will begin cranking them out this month. It will offer 22-inch remote-control color sets that incorporate a Teletext decoder based on about 50 discrete components. Labgear, part of the Pye group owned mostly by Philips, last month began making add-on adaptors, which will convert existing TV sets for Teletext using custom LSI chips from Texas Instruments Ltd. [*Electronics*, June 24, p. 40].

Thorn Electrical Industries Ltd. could be buying Teletext decoders for some of its sets by mid-1977 once there are several chip makers producing decoder circuits. Philips Electrical Ltd. is also getting ready to market them.

Besides TI, Mullard Ltd. and Motorola Semiconductors Ltd. have indicated that they will produce decoder chips. Set makers believe that the decoders will have to be able to handle both Teletext and Viewdata because the latter eventually could be a bigger potential market. On the continent, ITT Oceanic is developing and testing a Teletext system for France, though it probably won't reach the consumer for three years.

for color control and tint control. When the set is put into the color-control mode, the channel display turns red to make the setting easier to identify. The volume-control buttons then are switched to color control. When the set is put into the tint-control mode, the channel display is in green. The volume-up button then changes flesh-tone tint in increments toward magenta, while the volume-down button changes it in increments toward green (Fig. 6).

Grundig AG this year unveiled its new line of automatic-search circuitry, developed jointly with Texas Instruments. Station search is a one-time affair usually performed when the set is first installed. In the search mode, the TV spectrum is scanned at a fast rate. When a strong signal is

encountered, the search goes into slow automatic frequency control, and the search ends at the best tuning point.

When the station is found, its setting is entered into a digital memory by push buttons. The TV channel is then selectable at any time by conventional means or remote control. The afc is always active when selecting a station, which prevents the set from becoming detuned and compensates for temperature effects and component aging.

Infrared remote control, is used on most of Grundig's Super Color 77 models, with a receiver photodiode on the set and an LED hand-held IR transmitter unit. This unit has keys for selecting 12 channels, plus brightness, volume, color saturation, and power-on/-off controls. For each control function, the transmitter produces a specially coded ultra-sound signal, modulates it into the 950-nanometer IR beam and sends it to the receiver diode.

Philips Gloeilampenfabrieken, a producer of components and TV sets, is banking on its frequency-synthesis concept for digital tuning to have a big impact on receiver design. The Dutch firm is gearing up for production of components for its digital channel-selection system [*Electronics*, Aug. 21, 1975 p. 59].

The basic system is four chips, with another five chips providing such functions as automatic-search tuning and direct access to channel numbers. Seven of the chips are MOS, and two are bipolar. One bipolar is a prescaler using subnanosecond emitter-coupled-logic technology.

Competing against the Philips concept is the voltage-synthesis method from Intermetall GmbH, the German member of the ITT Semiconductor group. It has started shipping sample quantities of a pair of MOS ICs that implement the technique [*Electronics*, May 13, p. 87]. They are control and memory chips, which generate digitally all the data required for tuner control—the tuning voltage, the switching voltage for band selection, the afc fine-tuning signal, and so on.

AEG-Telefunken, the German component and receiver firm, supplies a digital programable memory module with

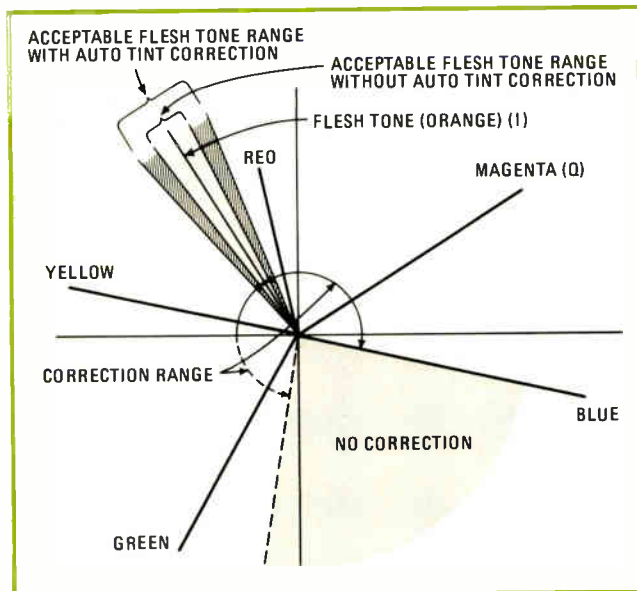

6. Tinting. The RCA automatic phase-correction tint control operates within a wider range of colors than usual flesh-tone correctors. However, the tradeoff in this approach is that the correction circuit alters almost all of the color spectrum except blue.

its phase-locked-loop system. The memory, the DPS 190, stores up to 16 different TV channels. Its PLL system insures high stability of the received frequency by comparing the phase of the tuner oscillator with that of a quartz oscillator.

Color control creates controversy

For the last few years, U.S. set designers have been making color-control adjustment easier. The result is completely automatic, factory-set controls. But, like electronic tuning systems, there is more than one way to achieve automatic color control and little agreement on which is the best way to go. Any approach, however, is a compromise that gains some picture advantages at the expense of others.

GT-Matic II, introduced last year by Sylvania as a second generation of its automatic color control, consists of two ICs;—one for brightness and contrast, the other for color level and tint.

Crucial to all automatic color control is establishing natural flesh tones without too much distortion of other colors, particularly green. In the Sylvania system, a high-speed phase monitor processes each instantaneous bit of color-burst information as it is received. If the bit is within a defined range of colors, the flesh-tone corrector is turned on. If the color bit is outside the range, the corrector is left off or turned off. So flesh tone is corrected only in parts of the picture where it is likely to dominate. The circuit can make on/off decisions at an effective rate of half a million per second.

The other IC uses much the same sample-and-hold techniques as in Sylvania's black-and-white controls. This circuit examines the chrominance portion of the incoming signal to find the highest of the peak chroma (hue and color saturation) levels. It adjusts the peaks to fit an already selected level, thus avoiding viewer adjustments when programs or stations change.

Automatic color control introduced last year in RCA's ColorTrak is user-controlled, like Sylvania's. It is coupled

7. Correct signal. The vertical interval reference (VIR) on nineteenth line of transmitted signal contains a chroma, luminance, and black reference code inserted by broadcaster (right). GE's VIR system identifies line 19, detects presence of a VIR signal, and produces voltage pulses that govern color level and tint control stages on receiver (below). It's possible to set color manually, too.

to the contrast-control circuit, which allows the picture's color content to vary in direct proportion to the contrast-control setting, thus providing a constant ratio of luminance to color gain. The viewer need not adjust the color level when changing the contrast level.

Zenith Radio Corp.'s new Color Sentry system consists of five separate circuits working together. It is much like ColorTrak, except that the user can cut out Color Sentry to use manual controls. The Chicago set maker's system is on 25-in. and some 19-in. receivers. It has a light sensor mounted on the front of the set and an associated control circuit that adjust picture brightness to ambient light, a color-signal monitor that checks the incoming color signal and adjusts for oversaturation from moment to moment, and a tint stabilizer that balances flesh-tone colors. The other two circuits are a color-level lock that locks in programed color levels and maintains color saturation and tint as programing changes and a contrast regulator that maintains a set light-to-dark picture contrast.

Sit back and watch

The tint-correction feature from RCA and Zenith automatically alters the phase of the subcarrier signal in the flesh-tone regions of the screen. This phase-altered signal is applied to the chroma demodulators to minimize flesh-tone errors without distorting colors in other regions. As the

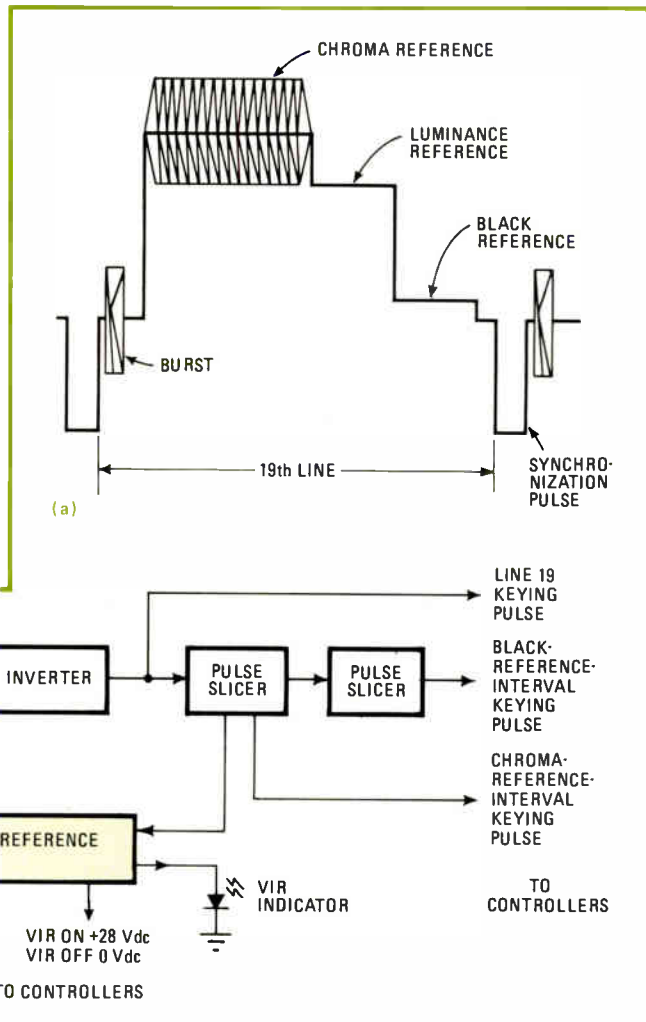

color spectrum in Fig. 6 indicates, all colors except in the blue range are shifted toward flesh tone to some extent, with maximum shift occurring to magenta and yellow-green. However, there is more flesh-tone correction with the automatic tint feature than without it.

GE takes a vertical interval

While the color-control designs used by Sylvania, RCA, and Zenith function within the color-processing section of the receiver, General Electric's Television Business department, Portsmouth, Va., has developed a system that operates with a reference signal broadcast from TV transmitters [*Electronics*, May 27, p. 48]. The vertical-interval reference, or VIR, is a broadcaster's standard suggested by the Federal Communications Commission to code color information on the 19th line of each field of composite video information at the origin (Fig. 7).

The GE VIR system identifies the 19th line and decodes

the information, which automatically adjusts color control. Before the system can perform, a switch on the receiver must be on and the TV station must transmit a VIR signal on line 19. If either of these conditions is not met, the receiver must operate with manual color controls.

Circuitry to detect and process the VIR consists of five off-the-shelf TTL ICs and 30 transistors. The system develops a dc color-controlling voltage by processing the VIR portion of the receiver's simulated blue drive signal. It develops a dc tint-controlling voltage by processing the VIR portion of the receiver's red-chroma signal.

Even with the VIR in operation, a preference-control provides limited viewer control over chroma phase or tint to alter the corrected picture to individual taste. The present VIR module could be integrated into an LSI chip in upcoming model years.

Although GE has taken a unique approach to color control, it's unlikely that other set makers will follow. One problem is that VIR is not transmitted by all TV stations, so that it would be a useless feature in certain parts of the country at certain times. Also, VIR is wiped from video-tape recordings and is not always inserted correctly by the broadcaster prior to retransmission.

A new picture tube

Probably the most talked-about development in television design this year has been Zenith's Able picture tube, initially brought out in a 19-in. screen size (Fig. 8). This in-line, self-convergence, narrow-neck tube is different in three vital areas—a tripotential gun replaces the bipotential type, the deflection angle is 100°, and the glass envelope, made by a new process, has a new shadow mask [*Electronics*, Mar. 18, p. 39].

Zenith has worked for some five years to develop the



8. New tube. Zenith's Ellipse II 19-inch receiver (left) features the new Able picture tube. With its tripotential, extended-field-lens, in-line gun, the 100° deflection tube at the right below is 2½-in. shorter than present delta-gun, 90°-deflection, 19-in. models at the left.

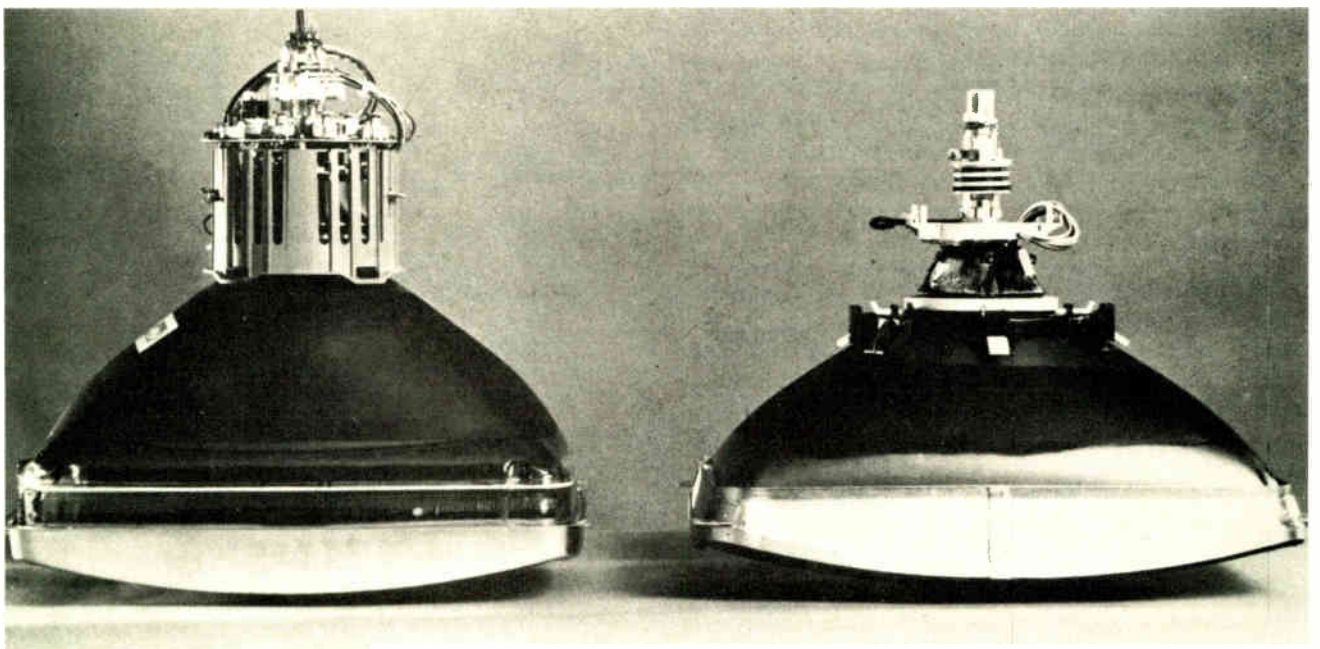

tube. Its aim was to reduce production costs while improving picture clarity over the negative guard-band tube that is used throughout the U.S. and Japan.

Immediately after it was unveiled this spring, other TV manufacturers began evaluating the Able tube. Some find no advantage in the 100° deflection angle over the standard 90° tube, others simply do not want another tube in their product mix, and some will accept the new tube. The new glass has little appeal, for most companies don't foresee the production-cost savings that Zenith claims.

But the tripotential gun has won the industry's praise. The basic objective in developing the tripotential gun was a design whose spot size would be 50% smaller than that of the conventional 90° bipotential tubes.

The reason for reducing the spot size was the decision to design a self-convergence tube with in-line gun for large screens, according to Karl Horn, senior vice president for engineering and research at Zenith. Such tubes for small screens have performed well and cut production costs. But they don't produce sharp enough pictures in large screens.

The solution is the extended-field-lens tripotential gun. "The principal discovery was that the old belief that diameter of the lens determines aberrations, and hence spot size, was incorrect," Horn says. "In electro-optics it's not the diameter, but the length of the field, that affects spot size."

With the tripotential gun, the focus field is three times as long as in an equivalent bipotential gun. Thus there is a longer distance in which to shape the electrons and produce a much smaller spot.

Although it's possible to construct extended-field bipotential lenses by interposing one or more additional electrodes in the lens region, this reduces the lens strength. Increased beam divergence, greater susceptibility to external magnetic influence, and assembly-cost considerations also diminish the appeal of such lenses for the new Zenith self-convergence tube.

The tripotential 4EFL, as Zenith calls the gun, had to undergo compromises to be of practical value. For example, it uses four electrodes, a tradeoff between performance and parts costs. The length of each electrode represents an overall compromise between package size and performance. And lens diameter was restricted by the in-line gun configuration, with a 1 1/8-in.-diameter neck. Nevertheless, the gun has made it possible to increase screen size of in-line tubes without sacrificing picture resolution (Fig. 9).

According to Horn, the company intended to use a 110° deflection tube, but backed off because of the higher power required. However, Zenith engineers found that spot size at the center of the screen was reduced 25% with the wider deflection angle than the standard U.S. 90° tube, but defocusing at the corners and deflection power increased.

Horn concluded that 100° deflection is an optimum tradeoff—there is a 12 1/2% decrease in spot size at the center of the screen; adverse effects at the edges are limited, and power consumption with an in-line, narrow-neck tube was the same as that for a 90°, large-neck, delta tube. He explains, "100° deflection combines the best of 90° and 110° and can compete in price against the old 90°." Zenith is totally committed to 100° deflection, and will use it across its entire TV line eventually, Horn believes, even if some TV makers continue to use 90° tubes.

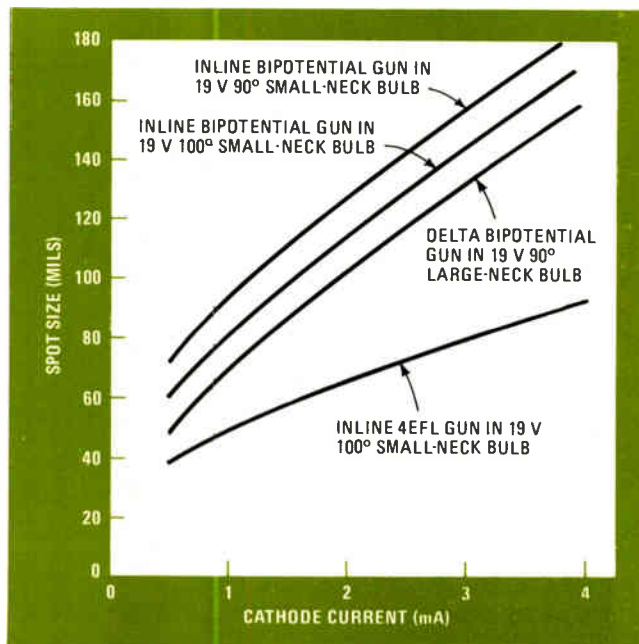

9. On the spot. The goal for the tripotential, extended-field-lens gun designed by Zenith was to reduce spot size by 50% compared to conventional bipotential guns, either delta or in-line, and to extend the economy of in-line self-convergence to large-screen tubes.

The glass is the result of a joint research effort with Corning Glass. An impetus for the development was Zenith's desire to automate tube manufacture, just as it had previously automated assembly of TV-chassis circuit boards. However, the outer dimension of the face plate is almost 2 in. larger than the conventional tubes, even though the tube is 2 1/2 in. shorter. And this extra size has caused other manufacturers to turn thumbs down for now.

Zenith uses a frameless shadow mask and a face panel that does not have the retaining rim usually put on tubes. These two alterations contribute to the automated assembly and the cost savings expected by Zenith.

Japanese approach differs

Japanese TV companies are tending to view the Zenith tube as four separate decisions—gun, deflection angle, shadow mask, and envelope. Just as in the U.S., there will probably be no major move in Japan to adopt the Able tube outright.

Hitachi Ltd., for one, is continuing to develop its own mask-focusing tube with a 22-in. screen. It features a multifocusing gun but with a different voltage distribution from that of the first design announced more than a year ago. Two voltages instead of three are used. The final anode of the gun has the same 25-kilovolt voltage as the aluminumized screen backing, instead of a voltage near 12 kv. The shadow mask potential is about 12 kv.

The higher voltage anode makes for better focus and smaller guns in a 29-millimeter narrow-neck tube. Although electrons have acceleration of 25 kv at the time they are deflected, lower voltage on the shadow mask provides some scan magnification, and sweep power is lower than that required for other 110° tubes, perhaps more like the power for a 100° tube. Though beam current is the same as in other picture tubes, mask focusing just about doubles

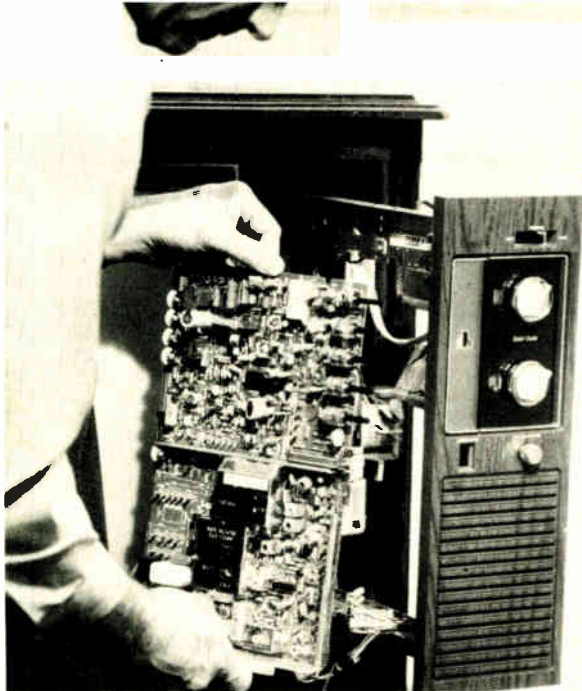

10. The works, the drawer. Quasar's new Super Module contains about 75% of the circuitry for the receiver on one board and can be replaced completely by the serviceman in the field or repaired. The new "works in the drawer" also reduces component count.

the number of electrons reaching the screen compared with other tubes, according to Hitachi.

While fancy LSI digital address systems, automatic color controls, and the new Zenith tube occupy center stage this year, other innovations have reduced costs or improved reliability and picture resolution.

A good example is the Super Module (Fig. 10) from Quasar Electronics Corp., Chicago. On a single universal board, it combines most of the signal-processing and color-control functions. This module, from the company that started the "works in a drawer," reduces component count in 19-in. and 25-in. models from 640 to 554, and cuts hardware and wire requirements. Some 250 feet of connecting wire in previous models have been reduced to 125 ft with the use of inconnect plugs. Total area of printed-circuit boards has dropped from 230 to 170 square inches.

Changes emphasize economy, reliability

Key to the cut in components and interconnects is the use of five ICs to perform most of the receiver's functions. These include a color processor IC, an i-f and automatic-gain-control IC, a video-synchronization IC, an automatic fine-tune IC, and an audio IC. A sixth IC is added in remote-controlled sets.

Admiral also has redesigned its chassis for the 13-in. and the 25-in. sets with an eye toward reducing hand-assembly, as well as components and hardware (Fig. 11). For example, hand-solder operations on the smaller chassis have been cut from 150 to 54 and, for the larger set, from 252 to 112. Factory chassis adjustments for the smaller model are 29 compared to 37 on the previous unit. For the larger model, there are 34 adjustments of coils, controls, and switches, compared to 39 before.

Hitachi has developed an encapsulated flyback power supply that is very small, but comes with primary taps

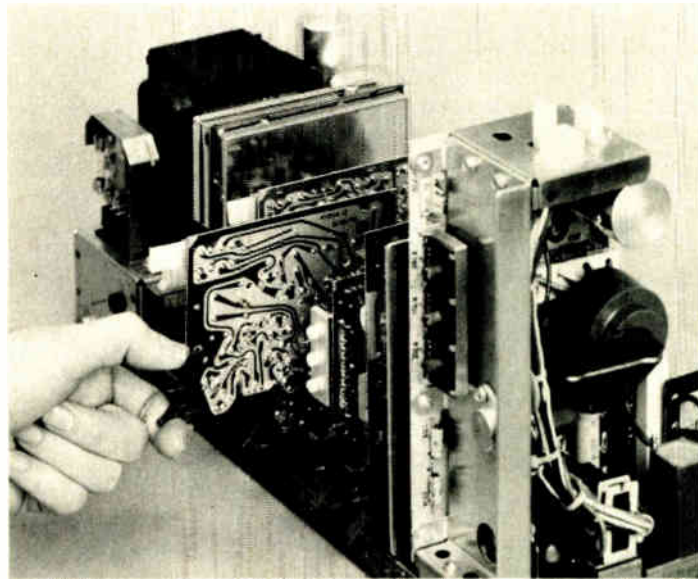

11. Snap action. The seven modules in Admiral's Era II color chassis can be snapped in or out of the interconnect frame that replaces the conventional chassis pan. Each board is assigned a function, and the interconnects are arranged so that servicemen can't mix them up.

permitting use on sets from 10 in. through 26 in., rather than making a different transformer for each screen size. The power supply uses straight rectification rather than a tripler or doubler. Instead of one long stack, several shorter diode stacks are connected between sections of the transformer's secondary winding in a way that distributes the voltage equally among them. The output voltage is controlled by the selection of the primary tap.

Grundig has taken an original approach to better picture resolution. The color-difference output stages generally used are replaced by a red-green-blue drive-circuit module with three complementary push-pull stages. Operated in class-B, these stages consume little quiescent current and hence dissipate only a small amount of power. As a result of the stages' low distortion factor, phase errors are at a minimum. This, in turn, improves picture resolution.

Matsushita Electric Industrial Co. Ltd., has developed a new antenna terminal board that features a feedthrough capacitor and a shielded connector for very-high-frequency signals. The feedthrough capacitor shunts disturbing signals to ground and improves signal-to-noise ratio on VHF by 20 to 30 decibels.

The company has also developed a wideband automatic-frequency-control circuit with a bandwidth of ± 2 megahertz, so that it is possible to pull in channels despite drift of the ultra-high-frequency tuner over a range of ± 2 MHz. The minus side was no problem, requiring only adjustment of the coupling transformer characteristics. However, there is no video signal at frequencies between +1 and +2 MHz for the afc circuit to track.

The circuit was designed so that the sum of outputs from its discriminator and the video synchronization pulses equal an output of 6.5v for zero frequency error. In the region between +1 and +2 MHz, absence of sync pulses (because of absence of video signal) causes the output to drop to 5 v, putting the afc in standby. If there is a deviation higher than +2 MHz, the afc output returns to action. □

Developing modular software for the 8080A

New software tools easily mesh short, debugged software modules into a final applications program for the 8080A microprocessor

by Paul Rosenfeld and Stephen J. Hanna,

Intel Corp., Santa Clara, Calif.

□ The modular approach to software development can save the designer of a microprocessor-based system a great deal of time and expense if he has the proper tools. He can write relatively short and simple program modules, each performing just a part of the over-all task, debug each separately, and finally stitch them all together into the complete program.

The main problem lies in linking the modules together. Without special tools, it is all too easy to lose track of changing memory locations as the different modules are linked. With special tools, the bookkeeping is simplified, and it becomes possible to exploit to the full extent the advantages of writing software module by module, instead of in a single, large, complex, and error-prone program.

These tools are now available to the user of the 8080A microprocessor. A relocating macro assembler and PL/M compiler, plus a linker and a loader program, are now available with the Intel microcomputer development system [*Electronics*, May 29, 1975, p. 95]. A library manager for building software libraries out of frequently used modules is also part of the package.

The designer first writes his program modules and insures that all references from one module to another adhere to a set of specifications. The assembler and PL/M

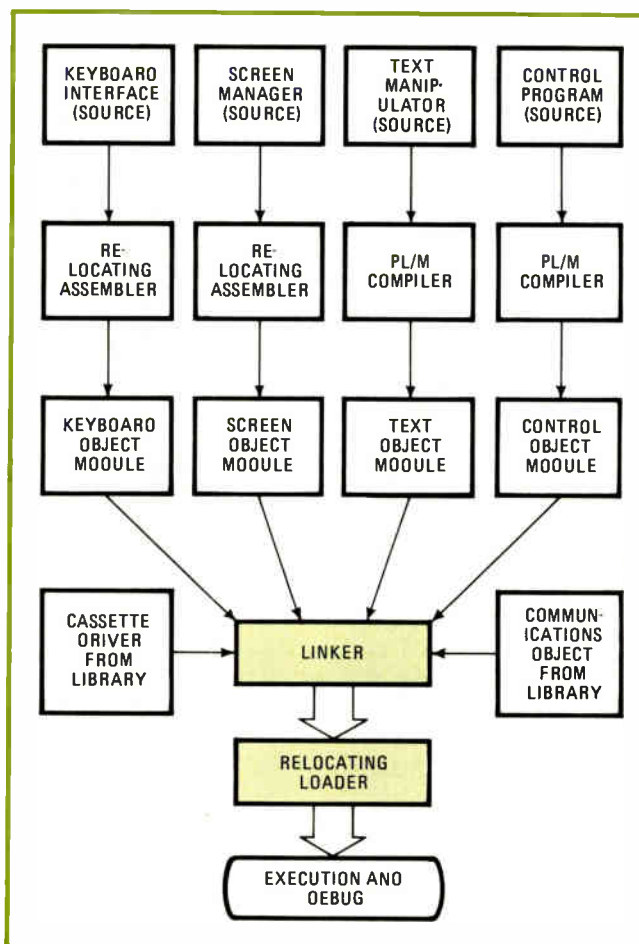

1. The package. New software tools—PL/M compiler, macro assembler, linker, loader, and library manager—allow modular software development. Each module can be designed, using the source language that is most appropriate to it, and then combined.

```

1312-11 8080 MACRO ASSEMBLER
LOC    OBJ          SEQ          SOURCE STATEMENT
                                     NAME    GETLIN
                                     CSEG
                                     PUBLIC KEYIN, BUFFER
0000 210001    C    4    KEYIN:    LXI    H, BUFFER    ; BUFFER ADDRESS
0001 0000    C    5    GND:      MVI    B, 0          ; INITIALIZE COUNT
0002 0000    C    6    IN        IN     0          ; DATA READY?
0003 0000    C    7    ANI     0          ; NO, LOOP UNTIL READY
0004 0000    C    8    JNZ     GND        ; READ DATA
0005 00000    C    9    IN     2          ; STORE IN BUFFER
0006 0000    C   10    MOV    M, A        ; INCREMENT BUFFER ADDRESS
0007 77      C   11    INX   H           ; INCREMENT CHAR COUNT
0008 21      C   12    INR   B           ; CARRIAGE RETURN?
0009 00      C   13    CPI   0DH         ; NO, KEEP READING
0010 00      C   14    JNZ   GND        ; SAVE COUNT IN A
0011 FE00    C   15    MOV   A, B        ; REPLACE CR WITH BLANK
0012 00000    C   16    MVI   M, ' '
0013 7E      C   17    RET
0014 00      C   18    ; DATA SEGMENT DEFINITION
0015 00      C   19    DSEG
0016 00      C   20    ORG   100H
0017 FE00    C   21    BUFFER: DS 128
0018 00      C   22    END
@100

```

2. Keyboard routine. Program, written in 8080A assembly language, takes in a line of text from a CRT terminal keyboard. Note that KEYIN appears as a label for the routine and also as a PUBLIC statement, which means that the routine is to be made available to other modules.

compiler translate these program modules into object code in a special format for use by the linker and locater. The linker next combines the modules into a single sequence, insuring that the references between modules all match. Finally the locater assigns permanent addresses to the various elements. Any module that may be of use in future microprocessor programs can be stored in a library and easily linked in when needed.

All this is easier to visualize in concrete terms—for example, in the context of an intelligent cathode-ray-tube terminal. In developing software modules, its designer is free to use different levels of language for each, whichever he thinks is most appropriate. For example, he might decide to write his keyboard interface and screen display controller as separate modules in assembly language and his basic control program and text manipulator as separate modules in PL/M. He may also be able to pull his communications interface, cassette drivers, or disk drivers from a library of previously written and proven object-code routines (see Fig. 1). Each can be debugged separately and then linked together to form the final product. The whole process resembles the way that hardware modules are developed and debugged separately before finally merging them into a system.

Hardware and software parallels

There are, in fact, surprising similarities in the way hardware and software development techniques have evolved. Hardware design began with discrete-component circuits, in which individual resistors, capacitors, and the like, had to be specified. Then complete integrated-circuit gates were introduced, saving re-creation of each gate whenever it was required. As the level of

```

PL/M-80 COMPILER
TEXT: 00
1 1 DECLARE COUNT BYTE
2 1 DECLARE BUFFER(128) BYTE EXTERNAL
3 1 KEYIN PROCEDURE BYTE EXTERNAL
4 1 END KEYIN
5 1 COUNT = KEYIN ;+READ LINE FROM KEYBOARD
6 1 END TEXT

```

3. Text manipulator. A cathode-ray-tube terminal's text manipulation routine can be written in the high-level language, PL/M. Note that the KEYIN routine is referenced by declaring it to be EXTERNAL, which shows that the linker program can find the routine elsewhere.

integration increased, medium-scale-integrated circuits took on complete functions, and, finally, large-scale-integrated circuits, comprising thousands of gates, allowed the combination of many of these functions onto one chip.

Software design began with binary-level programing, in which every bit had to be specified, much as in the discrete-component approach. Assembly-language programing, equivalent to small-scale integration, relieved the necessity of dealing with individual bits. Use of macroinstructions increased the level of software integration by allowing a group of assembly-language statements to be specified by a single statement, and high-level languages took it one step further by allowing several instructions representing a complete operation to be generated. Finally, the software equivalent of large-scale integration is represented by a group of subrou-

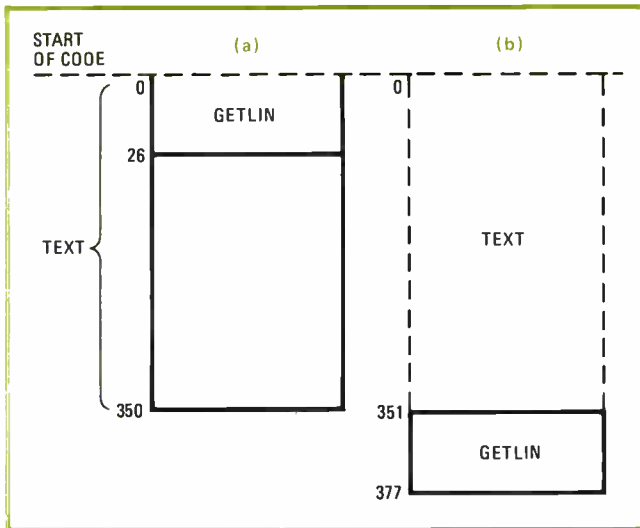

6. Resolving overlaps. The linker combines programs into a single module, noting when code segments overlap in memory, and moves one segment, GETLIN, in this case, up by the required 350 bytes beyond the start of the code.

consecutive locations beginning at 0100. If these locations do not end up assigned to RAM, or if BUFFER should be located elsewhere, the LXI instruction (load register pair immediate) which references BUFFER would still reference locations starting at 0100 (written as 0001).

The first problem—address modification—is solved by having the assembler emit a “relocation record,” which tells the locater which addresses in the code require modification. In this example, the relocation record will contain the two addresses 000A and 0014, the addresses of the second byte in each of the three-byte JNZ instructions. (These locations represent the second and third bytes of the JNZ object code, which contain the locations to which the jump will be made.) Then, when the operator requests the locater to place the GETLIN program in memory starting at a certain address, the locater adds that value to all addresses mentioned in the relocation record. For example, if the code has been relocated to begin at 3120, the result is similar to the listing in Fig. 4. Note that the second and third bytes of the JNZ code become 25 and 31, which, as 3125, corresponds to the new location of GNC.

The second problem—explicit specification of data locations to be in RAM—will occur whenever the designer wants the area storing code to be physically separated from the area storing data, as when ROM is used for code and RAM for data. The relocating macro assembler, linker, and locater on the Intellec system allow the user to specify separate starting addresses for code and data. When the user writes the program, he distinguishes between the code segment and the data segment simply by placing a CSEG pseudo instruction before code sections of the program and a DSEG pseudo instruction just before the data areas. These are evident on lines 2 and 19 in Fig. 2.

These pseudo instructions tell the assembler to generate an intersegment-reference record in its object-code output, indicating which instructions in the code segment refer to addresses in the data segment. In this

example, the intersegment-reference record will call out data-segment information at the address 0100, the location of the BUFFER cited by LXI. The operator can now tell the locater to start the data segment at a separate address, say 6100, and the locater will adjust the LXI object code to reflect this change. The complete program, represented by Fig. 5, has code located at 3120 and data located at 6100. (Note that the manipulation is actually made to the object file. The listing is only shown here for illustration.) The program is now ready to run. This separation of code and data is a complex operation, but with the locater program, the only command required to effect it is:

```
LOCATE KEYBD.OBJ CODE (3120H) DATA (6100H)
where the H designates hexadecimal and the object code
is on the file KEYBD.OBJ.
```

With the PL/M compiler, the same two problems occur, and they are solved in almost the same fashion. The only difference is that the compiler automatically separates code from data, eliminating the need for CSEG and DSEG pseudo instructions.

The linker

The linker, as is now apparent, actually performs two tasks. It combines the “like” segments of several modules (code with code, data with data) into a single module. It also adjusts the references that one module makes to another, permitting two or more modules to function together as one unit.

To see how the linker works, again consider the code segments produced by assembling or compiling the modules GETLIN and TEXT, from Figs. 2 and 3. Imagine that the compiler (or assembler) has always started each code segment at some arbitrary address, called START OF CODE. The code segments from the two modules, as they would exist after compilation or assembly, are shown in Fig. 6. These two segments cannot be combined because the first 26 bytes overlap. But if GETLIN is moved up 350 bytes, as shown in Fig. 6b, the overlap will have been removed.

To do this, the linker must actually relocate the code segment of GETLIN, but instead of moving it to an absolute address, it moves it to an address defined merely as 350 bytes beyond START OF CODE. (The combined segment will, of course, acquire its fixed addresses later from the locater.)

The linker still must match the definition of KEYIN in the GETLIN module with the reference to KEYIN in the TEXT module. The information it needs to do this is provided by the assembler and compiler object modules produced when KEYIN is declared to be PUBLIC in the GETLIN module and EXTERNAL in the other module.

The declaration, PUBLIC KEYIN, caused the assembler to generate a public-symbol definition record, containing the name KEYIN and its address (relative to START OF CODE) in GETLIN. When the program was assembled, this location was 0; now, however, it is 350, because of the modification the linker made when it relocated GETLIN. Similarly, the declaration of KEYIN as EXTERNAL in module TEXT caused the PL/M compiler to generate an external-reference record, containing the name KEYIN and the location of all instructions in TEXT that include a

specific reference to the term KEYIN.

The linker now matches the name KEYIN in the external-reference record with the same name in the public-symbol definition record. It then substitutes the new value of KEYIN (350) into the address portion of the instruction that reference it.

At this point, there is one module instead of two, the external-reference record is no longer needed, and the linker discards it. In its place, the linker generates a relocation record for the locator so that the reference to KEYIN can be adjusted properly when the combined module is located. The public-symbol definition record remains, however, in case another module must be linked to the newly formed combination of GETLIN and TEXT.

Data segments are combined in exactly the same way—by moving one up to make room for the other. Before it is finished, the linker has to return and adjust the intersegment-reference records for the locator, to make sure that all instructions in the code which reference data items can still do so correctly.

“Off-the-shelf” software

One of the most efficient uses of software modules is to put them in a software library. The library-manager program builds a software library from routines provided by the designer and will list its contents for the convenience of the designer.

In the case of the CRT terminal, for example, the routines for the disk drivers already existed, as they had been used for a previous project. Such routines must be accessed from the text manipulator, basic control program, and possibly the communications interface. They can be included simply by using the declarations CALL DREAD and CALL DWRITE shown in Fig. 7.

Recall that when the linker finds a name that has been declared EXTERNAL, it searches all other modules being linked to find a matching PUBLIC declaration. But the designer may also instruct the linker to search through a library looking for any name declared EXTERNAL for which it could not find a PUBLIC declaration for elsewhere. If it finds the name declared PUBLIC in the library, the linker takes the entire routine from the library, includes it in its output, and insures that all references to that name now reference the library routine. (Subsequently, this routine is located to an absolute address by the locator program, and the complete program is then loaded and executed normally.)

The payoff

By adopting this modular technique of software design, which is further enhanced by the use of the high-level language, PL/M, designers of 8080A-based micro-computer systems gain the following benefits:

- Lower development cost—modular techniques and higher levels of software integration can increase a designer's productivity by allowing him to work with larger, self-contained blocks and to fit these blocks together on a macro level. He does not need to concern himself with detailed interfaces between small pieces but only with the overall interface of the larger blocks.
- Higher reliability—the higher levels of hardware integration present in many of today's electronic products

```
PL/M COMPILER
1  COMMINTERFACE. 00
2  1  DECLARE BUFFER(1024) BYTE
3  1  DREAD  PROCEDURE (BUFFER, COUNT) EXTERNAL
4  1  DECLARE BUFFER ADDRESS
5  1  DECLARE COUNT BYTE
6  1  END DREAD
7  1  DWRITE PROCEDURE (BUFFER, COUNT) EXTERNAL
8  1  DECLARE (BUFFER, COUNT) ADDRESS
9  1  END DWRITE
10 1  CALL DREAD( BUFFER, 128)
11 1  CALL DWRITE( BUFFER, 1024)
12 1  END COMMINTERFACE
```

7. Library access. Existing routines can be extracted from a software library by giving the name of the routine. Here a PL/M program for the communications interface portion of the CRT terminal calls up disk drivers simply with the declarations DREAD and DWRITE.

have made them much more reliable than less highly integrated products. The same is true of higher levels of software integration. PL/M usage eliminates the many errors that commonly result from putting small pieces of computer code together.

■ Better documentation and maintenance—the higher level of design integration achieved with these new software products is a great help with documentation. Each subroutine, procedure, or program module can be thought of as a “black box”, and documentation need only specify the function of the “box” and its interface. As a result, the maintenance programmer can easily locate the source of any fault as a particular “box” that is not performing as specified or is interfaced incorrectly.

■ Easier enhancements—very few products ever remain in a constant state very long. The use of modular software makes it simple and straightforward to include additional capability in a software product. New modules may need to be developed to perform the new software functions, but as long as these conform to the specifications of the software bus, they can be easily linked to the original product.

■ Shorter development time—if parts of an earlier project can be used and easily linked with new software, much design time can be saved. If the project can be split among several engineers, each of whom can program and debug his part independently of the others and one of whom then links the parts, project development time can be drastically shortened.

Thus, just as engineers design and use standard hardware modules, modules which can be used over and over again in several products, the same can now be done for software. There is no more reason to discard a software-module design after one use than to discard a hardware design. Through the use of the location and linkage package on the Intellec system, standard software modules for the 8080A can be developed and easily interfaced to software systems with similar software-bus specifications. □

IC boosts starting energy for solid-state ignition

by Charles R. Carter
McMaster University, Hamilton, Ont., Canada

Even in very cold weather, starting need not be a problem in a car with a conventional solid-state ignition system. The addition of a single monolithic integrated circuit and a few discrete devices will keep spark timing accurate and guarantee that six to 10 times more energy than usual reaches the spark plugs.

The circuit is interposed between the ignition points and the solid-state ignition (Fig. 1). Every time the points produce a pulse, the dual monolithic multivibrator IC turns it into a train of pulses by driving a transistor on and off repeatedly. As a result, each spark plug gets many chances to fire with each opening of the points, instead of just one.

A Texas Instruments SN74123 multivibrator is shown in the figure, but for operation at very low temperatures (to -55°C) the SN54123 package can be used in exactly the same way. When the points open, a rising edge at the

B input to mono A occurs, making Q_A go high and \bar{Q}_A go low for 500 microseconds. The falling edge of the Q_A output, applied to the A input of mono B, turns on a Q_B pulse 7 milliseconds long.

The Q_B output from mono B is connected to the A input of mono A. If the B input from the points remains high (in other words, the points remain open), mono A is triggered from Q_B , causing a second pulse of 500 μs to occur 7.5 ms after the first pulse. This second pulse again triggers mono B. This process is repeated over and over, thereby producing a train of pulses. When the points close, mono A is inhibited, and the pulse train is terminated.

The pulse train from the \bar{Q}_A output of mono A is applied to the base of the transistor, which then acts in an identical fashion to the points, insofar as the solid-state ignition is concerned. Thus, when the points open as shown in Fig. 2, a train of pulses is applied to the solid-state ignition, rather than just one pulse as would be the case in normal operation, causing the spark plug to fire many times.

The interpulse spacing provided by mono B is not critical. A lower boundary is determined only by the maximum rate at which the solid-state ignition operates. This is typically 2.5 to 3 ms.

The upper boundary is related to the desired number

1. Extra sparks for better starts. When the toggle switch is set for the multiple-pulse starting mode, the multivibrator IC and transistor send a series of pulses to the ignition every time the points open. After starting, the switch is simply flipped for normal triggering to the solid-state ignition. The zener diode provides 5-V regulation for the IC down to a battery voltage of about 7 V.

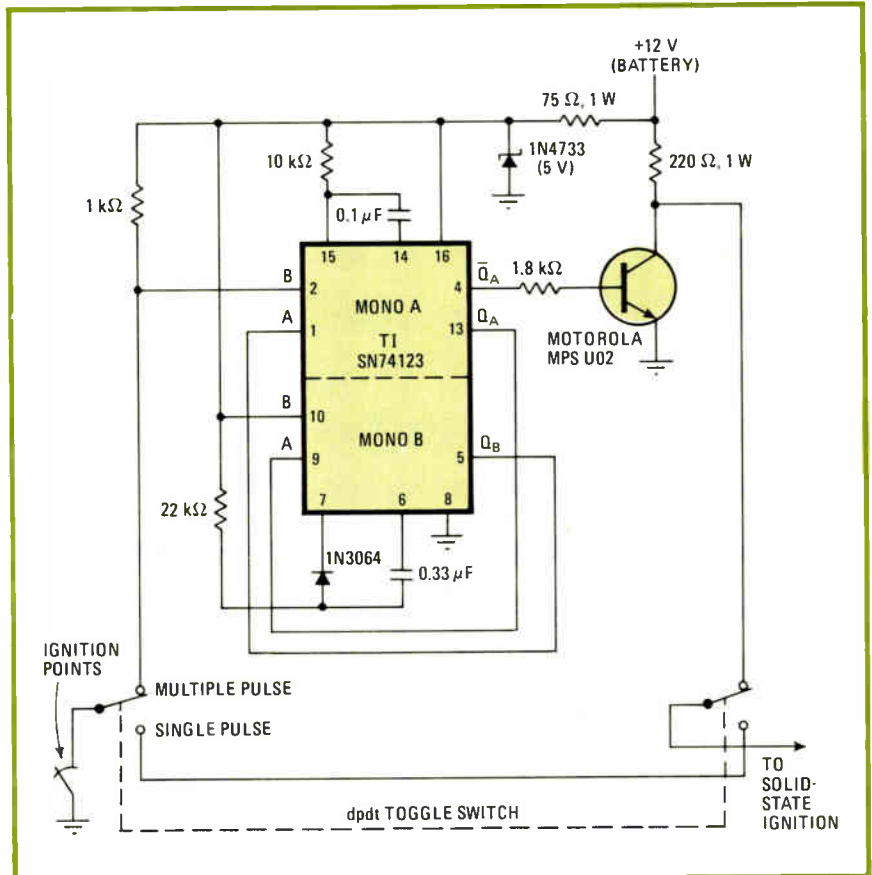

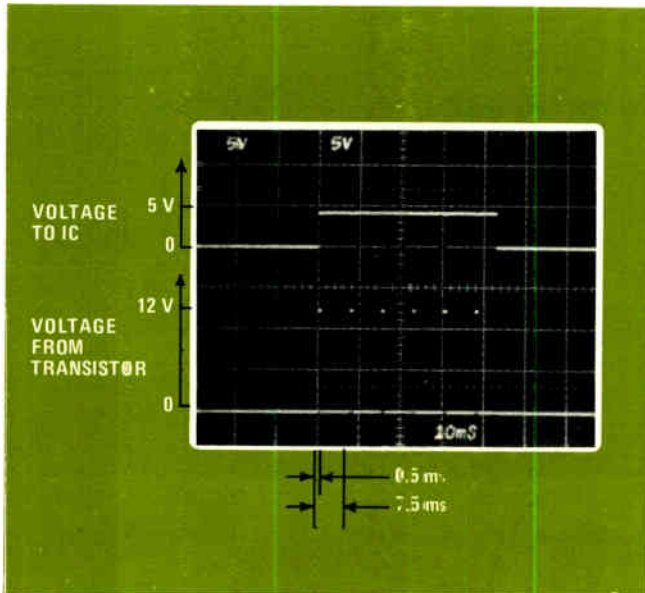

2. Pulses to ignition. Upper trace shows voltage waveform at B input of mono A due to points opening. Lower trace shows the resulting train of pulses, which triggers the solid-state ignition six times. The train of pulses is terminated when the points close.

of pulses that are produced while the points are open. For a V-8 engine with a cranking speed of one revolution per second and a dwell angle of 30° , the 7.5-ms interpulse spacing produces about 10 pulses spaced at 3° intervals while the points are open. Slower cranking speed provides more pulses with a smaller interval in degrees between pulses.

This technique was tested several times in January 1976 on a 1967 Mustang equipped with a solid-state ignition that refused to start in -10°F temperatures and high humidity. After several attempts to start the car had failed, the multiple-pulse circuit was switched in by using the toggle switch. The engine then started almost immediately. For normal driving, the toggle switch is returned to the single-pulse position. □

Buffer speeds response time of first-in, first-out memory

by Jim Edrington
Applied Research Laboratories, University of Texas, Austin, Texas

A pair of integrated circuits can interface a first-in, first-out serial memory to a computer or other digital system with which the FIFO is otherwise incompatible. The interface, consisting of a parallel-access shift-register buffer and a dual flip-flop, is connected exactly like the original FIFO interface but has a response time of less than 50 nanoseconds instead of 850 ns.

One of the most popular FIFOs is the 64-word-by-4-bit type 3341, an MOS device made primarily by Fairchild. Its input or output data rate is 1 megahertz, but it takes

a long time to respond to a request for data transfer.

This delay is illustrated in Fig. 1. After reading the word on the FIFO output, the device using the data sends a shift-out signal to the FIFO, asking for a new word. The output-ready line of the FIFO then goes low for 850 ns, during which no valid output word can become available for transfer. When a new word is ready, the output-ready line goes high again.

Such a long delay between a request and an acknowledgment cannot be tolerated by the many digital systems that include fast transistor-transistor logic. An example is the direct-memory-access port of most computers. The DMA operates with a periodicity of 1,000 ns, which is comfortably longer than 850 ns, but unless it receives a data-ready signal within about 200 ns of the previous transfer, it will skip a cycle. In other words, the FIFO transfers words fast enough to work with the typical DMA, but neglects to alert the DMA till too late.

To provide a faster acknowledgment, a TTL parallel-

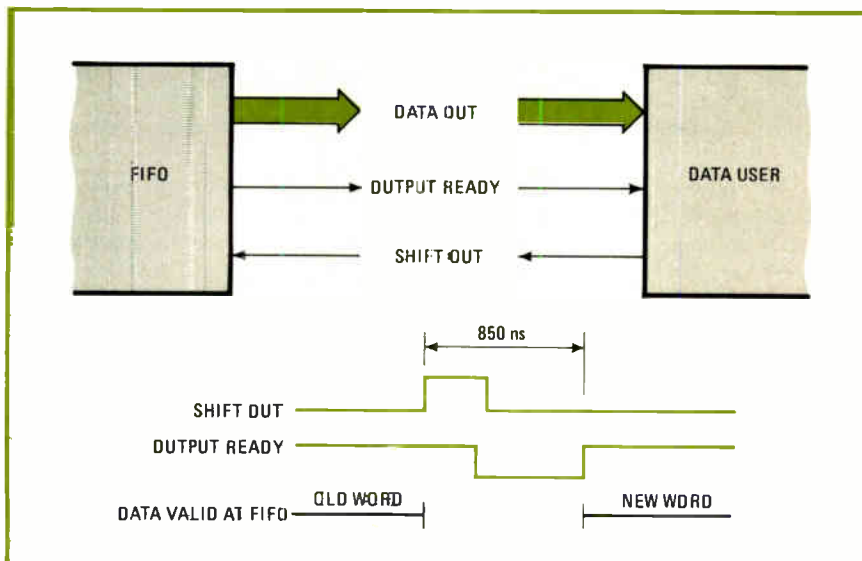

1. Slow acknowledgment. User system reads data word at FIFO output and sends a shift-out signal telling the FIFO to make a new word available. Then 850 nanoseconds elapse before the FIFO acknowledges that the new word is ready. This delay is too long for fast systems, even though their cycle period is 1,000 ns.

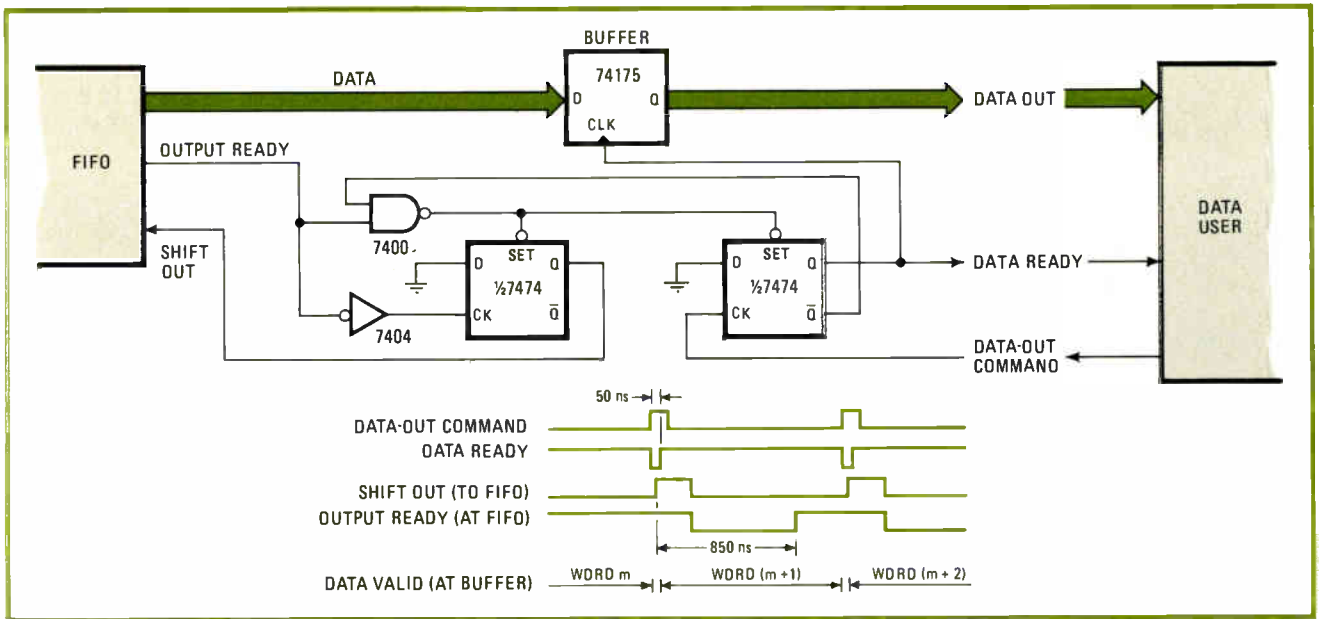

2. Fast acknowledgment. Here, user system reads data word at buffer register, and buffer then takes new word from FIFO and is ready for next data-out command in 50 ns. FIFO has 850 ns to prepare its new output word.

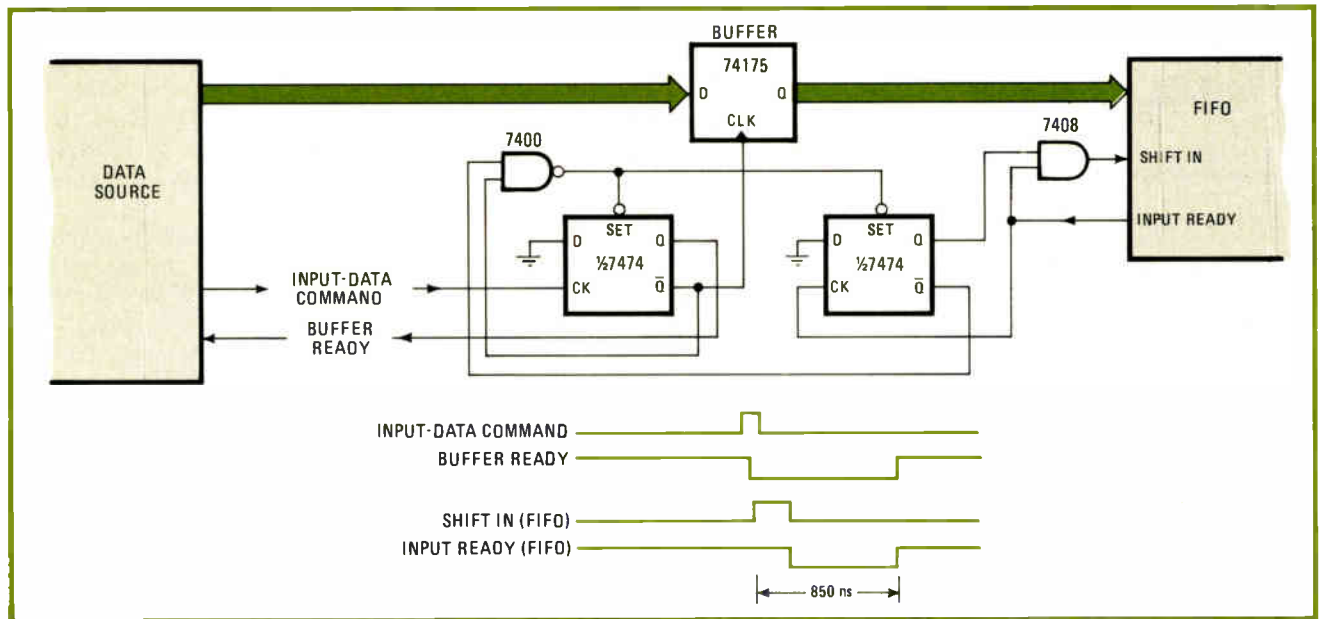

3. Feeding FIFO. Buffer gives prompt acknowledgment to data source that data has been read; when buffer-ready line goes low, source knows that data has been taken. Slow acknowledgment from buffer to FIFO does not hold up a system that requires fast acknowledgment.

access register such as the 74175 is used as a buffer stage between the FIFO and the computer. Two flip-flops provide control for the buffer. The shift-out flip-flop controls the interface between the FIFO and the buffer; it requests a new output word as soon as the buffer register is empty and a new word is available from the FIFO. The data-ready flip-flop takes the place of the FIFO's output-ready signal; it is set true whenever the TTL buffer is loaded with a new word, and it is cleared by a request for data from the DMA. In essence, the TTL buffer is reloaded immediately after each DMA request in time for the following DMA request, as shown in Fig. 2.

A similar circuit may be applied to the input of the FIFO to speed acknowledgment that data has been taken

from the data source. In this case, shown in Fig. 3, the buffer register serves to hold the input word until the FIFO can accept it. When the buffer-ready line goes low, the DMA, I/O port, or other data source knows that the input word has been read into the buffer. The source can then immediately change state to validate a new word.

In neither case is the overall data flow rate increased—the upper limit is still the FIFO's internal rate. However, the buffer permits the FIFO to be used with many devices for which its response would otherwise be too slow. □

Designer's casebook is a regular feature in Electronics. We invite readers to submit original and unpublished circuit ideas and solutions to design problems. Explain briefly but thoroughly the circuit's operating principle and purpose. We'll pay \$50 for each item published.

Designing the maximum performance into bit-slice minicomputers

The three keys: microprogramed instruction, pipelined architecture for a high degree of parallel operations, and minimum circuit configurations

by Gerald F. Muething Jr., *Itek Corp., Applied Technology Division, Sunnyvale, Calif.*

□ Bipolar bit slices are the minicomputer designer's best bet when he must wring all-out performance from a microprocessor-based central processing unit. But it's easy to bungle a bit-slice design and end up with performance not much better than with easier-to-use and cheaper single-chip MOS processors. For the designer to squeeze the most out of the bipolar bit slice, he must construct an architecture that can be microprogramed to achieve a high degree of parallel operations in processing data, which will significantly increase the flexibility and throughput of the computer. Equally important, he must be extremely clever in hooking up the bit-slice chips and other large-scale-integrated circuits to arrive at this efficient architecture with minimum hardware penalty.

The proof is the single board ATAC-16M minicomputer built around the AM2901 4-bit microprocessor slice and the AM2911 program-sequencing chip. It has a 16-bit, general-register, fully pipelined architecture that can execute a unique instruction set or can be readily adapted to a microprogram that's suitable for emulating other computers. It can directly address 65,536 words of memory and has eight levels of priority interrupts and 129 instructions. It can perform an addition in 250 nanoseconds or an instruction as complicated as a 32-bit floating-point multiplication in 16 microseconds over the full military temperature range. That's performance well beyond the range of any minicomputer based on an MOS processor.

Not only are bipolar devices intrinsically faster than metal-oxide-semiconductor devices—3 to 7 megahertz compared to 1 to 3 MHz—but they alone offer the microinstruction capability, instruction-repertoire size, and memory-address capacity needed in systems

that are oriented towards higher performance.

Bit slices are faster because they're built with low-power Schottky transistor-transistor logic with a tenth the gate-propagation delay of equivalent MOS logic. They're more flexible because each bit slice is a vertical segment, or slice, of a processing unit—unlike MOS units, which contain all the arithmetic logic, utility registers, instruction-sequencing logic, program counter, priority interrupt registers, and so on.

Limiting activity

In short, all the computational and control capability of an MOS computer is limited to what's on the microprocessor chip. Also, each MOS chip has its own peculiar architecture and fixed instruction set determined by the manufacturer's design and not easily changed by the computer designer. While these devices are adequate for handling a wide range of control applications and most special-purpose data-processing jobs, they are often inadequate for general-purpose data-processing jobs.

Not so the bipolar bit slice (Table 1). Each slice is a segment of a CPU, so a designer can cascade slices and implement computers of different word lengths. Moreover, the all-important sequencing logic has been removed from the chip and concentrated on a separate sequencer, which is as powerful and complex as are the bit-slice chips themselves. The sequencers permit bit-slice designs to be easily microprogramed—a feature that is next to impossible to achieve with the current crop of single-chip MOS processors with limited sequencing logic.

Indeed, it is this microprogrammable feature of bit-slice designs that makes them so attractive for high-performance minicomputers, since it results in machines with variable instruction sets completely under the control of the user or programmer.

Slicing the chip

The heart of a bipolar minicomputer design using large-scale integration is a bit slice such as the AM2901 (Fig. 1). Each chip contains a full segment of CPU circuitry: a 4-bit arithmetic/logic unit, 16 general-purpose 4-bit registers, a 4-bit Q (extension) register, and 1 bit of left/right shift logic.

The general-register file is designed with a latched, multiport input structure that permits reading from two

TABLE 1: TYPICAL BIPOLAR MICROPROCESSOR LSI SLICES

Manufacturer	Device number	Number of registers	Word width	Micro-instruction width
Intel Corp./Signetics Corp.	3002	11 general	2 bits	7 bits
Advanced Micro Devices	AM2901	16 general + Q (extension)	4 bits	9 bits
Monolithic Memories Inc.	MM6701	16 general + Q	4 bits	8 bits
Texas Instruments Inc.	SBP0400	8 general + two working	4 bits	9 bits

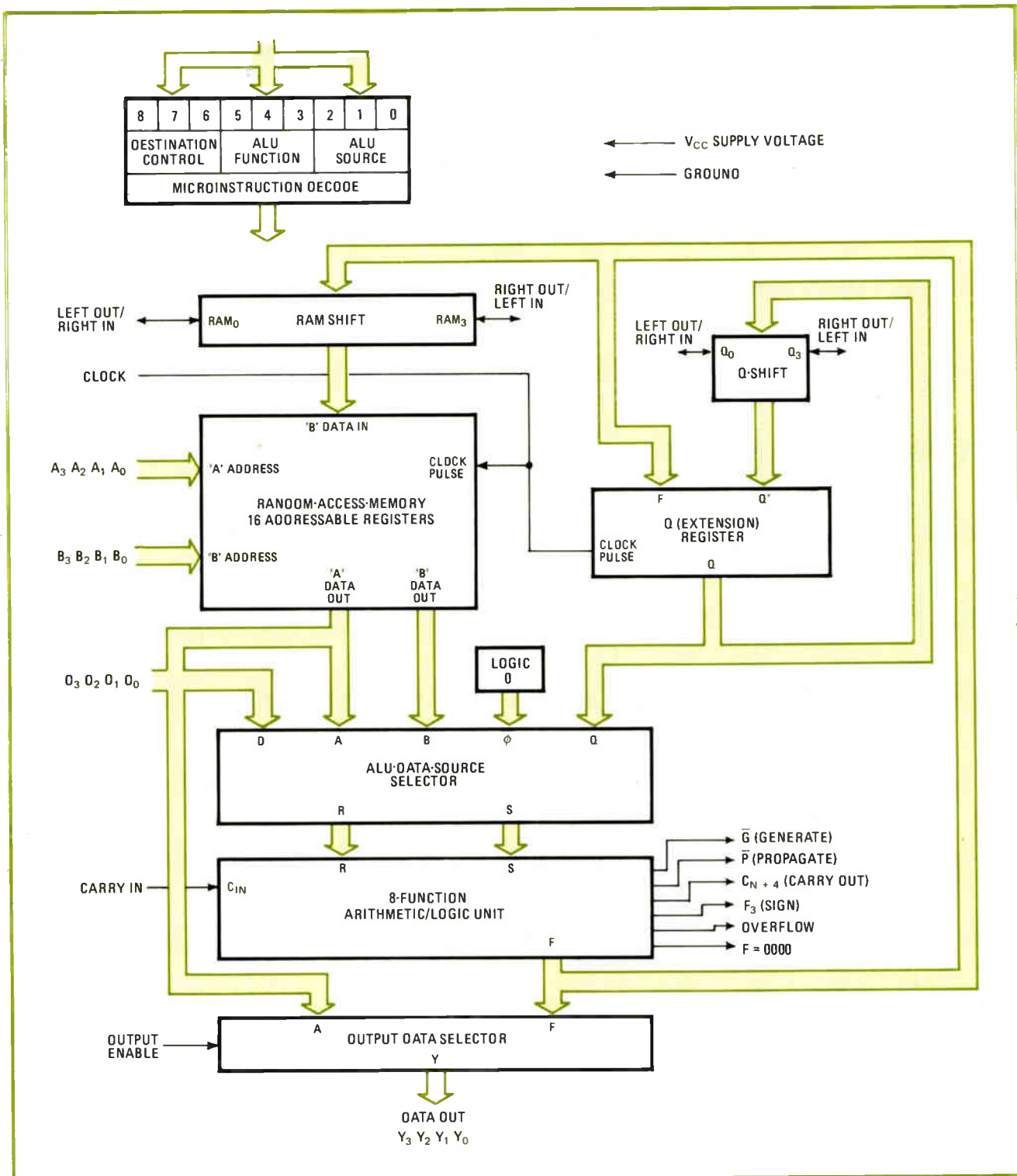

1. The CPU's heart. The AM-2901 4-bit processor slice is a vertical partition of a general-register computer architecture. A 16-bit CPU requires four slices, each containing a 4-bit ALU, 16 general-purpose 4-bit registers, a 4-bit Q register, and 1 bit of left/right shift logic.

input ports simultaneously, operating on them in the ALU, and restoring the result back in the general file—all in a single synchronous clock cycle. While the 2901 can operate at about twice the clock rate of the 9900 MOS processor, the flexible architecture permitted by the bit-slice approach can achieve about a tenfold increase in instruction throughput.

Control commands are entered on the slice through an encoded 9-bit microinstruction, which controls operand and function selection for the ALU and provides destination and shift operations for controlling internal registers. The 4-bit D input port is for data entry, while the three-state Y output port connects the ALU output to an external system bus.

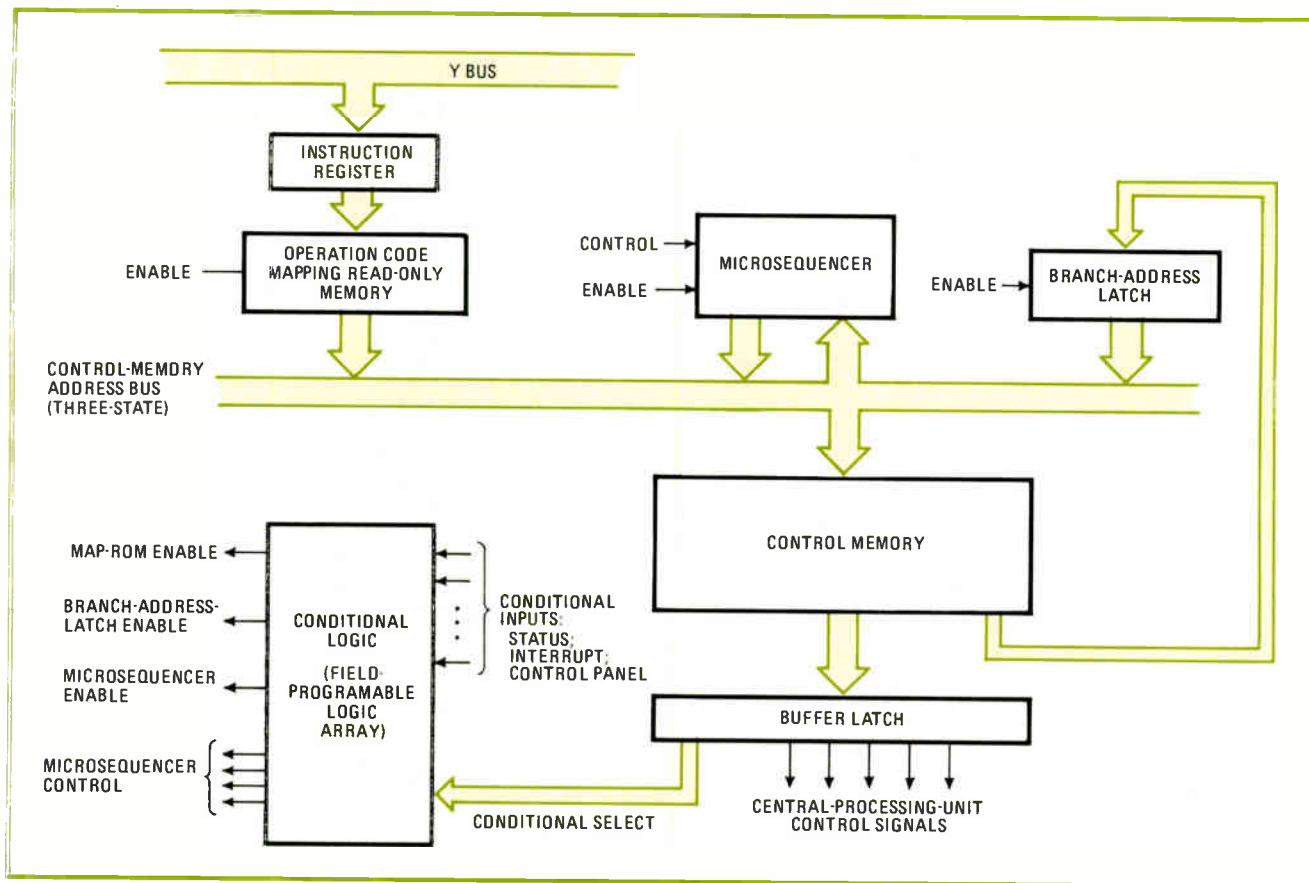

2. Control. Microprogram control was achieved with the AM2911 sequencer, a field-programmable logic array, and nine 4-k bipolar PROMs. During each microcycle, the PLA selects the sources of the next address, based on the condition-select field.

For a 16-bit computer, four slices are linked to form a 16-bit ALU and a file of 16 general registers. These four chips provide the major data-path requirements with minimal external-control components.

Important support

The most important of these support components is the control unit. It determines the power of the processor's instruction set, the flexibility of the CPU, and, generally, the performance of the computer itself. Although a hardwired control unit could be used, rapid change of the computer's instruction set virtually demands full microprogrammed control. This was realized with another member of the bit-slice family, the AM2911 sequencer in conjunction with a field-programmable logic array as a next-address selector and nine 4,096-bit bipolar programmable ROMs (Fig. 2).

Those familiar with microprogramming appreciate the complexity of the random logic often needed to implement microlevel branching and conditional sequencing of complex microprograms. Now this logic is reduced to a single integrated circuit. Meanwhile the nine PROMs perform all conditional testing, as well as controlling the generation of the next microprogram address. Most importantly, these advances in LSI technology make it possible to implement a rather sophisticated microprogram control unit using about the same board area as is taken by the four microprocessor chips.

During microcycle execution, the FPLA selects the

sources of the next control-memory address, based on the condition-select field and conditional inputs. The correct source—map read-only memory, microsequencer, or branch latch—is entered on the three-state control-memory address bus. The FPLA also controls the microsequencer, which permits conditional branching, incrementing, or subroutine entry/exit. The 2911's inputs are tied to the address bus to allow loading of the map ROM or branch addresses into the 2911's internal registers.

Two AM 2911 sequencers and a page bit address a 512-word-by-72-bit control memory store. The result is an efficient single-format control word, which permits a single-phase microinstruction with highly parallel operation that increases speed still more and permits maximum microprogram flexibility and simplicity.

Structuring an efficient architecture

Once the hardware is specified, the next most important task in the development of a high performance CLU is to marry the computer's memory and ALU with the control unit in an efficient structure. This entails setting up data paths and support hardware that will permit a high degree of parallel operations. Several approaches may be used to achieve this goal—instruction-stream pipelining, microinstruction pipelining, auxiliary address-computation logic, or concurrent instruction decode/execution.

In the ATAC-16M computer, all of these techniques

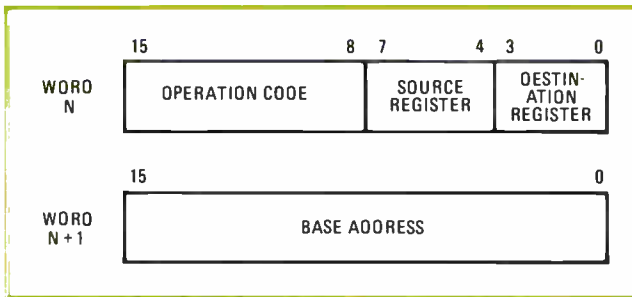

3. Faster. By overlapping or pipelining execution steps, it's possible to achieve higher throughput. Execution of a single instruction may actually require three sequential machine cycles, but, in parallel, the apparent execution time may be cut to one.

were used to achieve the highest performance obtainable with readily available LSI circuits. However, this requires a more complex instruction sequence than computers without paralleling approaches. Consider a typical instruction (machine or assembly-level), such as an indexed 16-bit fixed-point ADD (Fig. 3). Execution involves three 16-bit memory references and the sequential execution of:

- Fetch instruction;
- Decode instruction;
- Fetch trailer (base address);
- Form effective address;
- Fetch memory operand;
- Add memory operand to general register.

The technique of overlapping, or pipelining, these steps in the execution of machine instructions achieves higher throughput by performing parallel time and phase activities on the computer instruction stream. Execution of a single instruction may actually require three sequential machine cycles. But, if three instructions are performed in parallel, the apparent execution time can be reduced to a single cycle.

The time-line graph in Fig. 4 demonstrates how pipelining might be used to improve performance on a string

of sequential, direct-indexed addition (ADD DX) instructions. After initial startup, ADD DX instructions take effectively three microinstruction cycles, although six sequential microinstructions are required to execute each instruction. Since this example requires a total of three memory accesses, Fig. 4 illustrates an overlapped sequence that executes one memory cycle every microinstruction, thereby making maximum use of the memory resource.

Pipeline hardware

While pipeline architecture increases the performance of bit-slice computer designs, its hardware (Fig. 5) is fairly complex. In the simple overlapping instruction in Fig. 4, the instruction being executed must be held so its fields may point to the participating registers of the microprocessor. This implies the need for an instruction register.

After being fetched, the next instruction must be held for decoding. It is stored in the memory-data register for instructions, then transferred to the instruction register on the next microcycle.

Next, the data operand from memory must be held while the microprocessor is performing the ADD. It is sent to the register called the memory-data register for data. Now the base address for the next instruction must be fetched. This requires a register to capture the memory data, which is asynchronous to the current microcycle. This is the memory-data register.

Meanwhile, the present program counter must be incremented to point to the next instruction in the pipeline. Since the microprocessor ALU is busy doing the operand addition, a separate adder or incrementer is required to update the program counter.

If the microprocessor is synchronously clocked, its controlling signal must remain stable until the clock edge ending the microcycle has passed. Unless the decode time and control-store access time are to be added to the microprocessor addition time, some form of

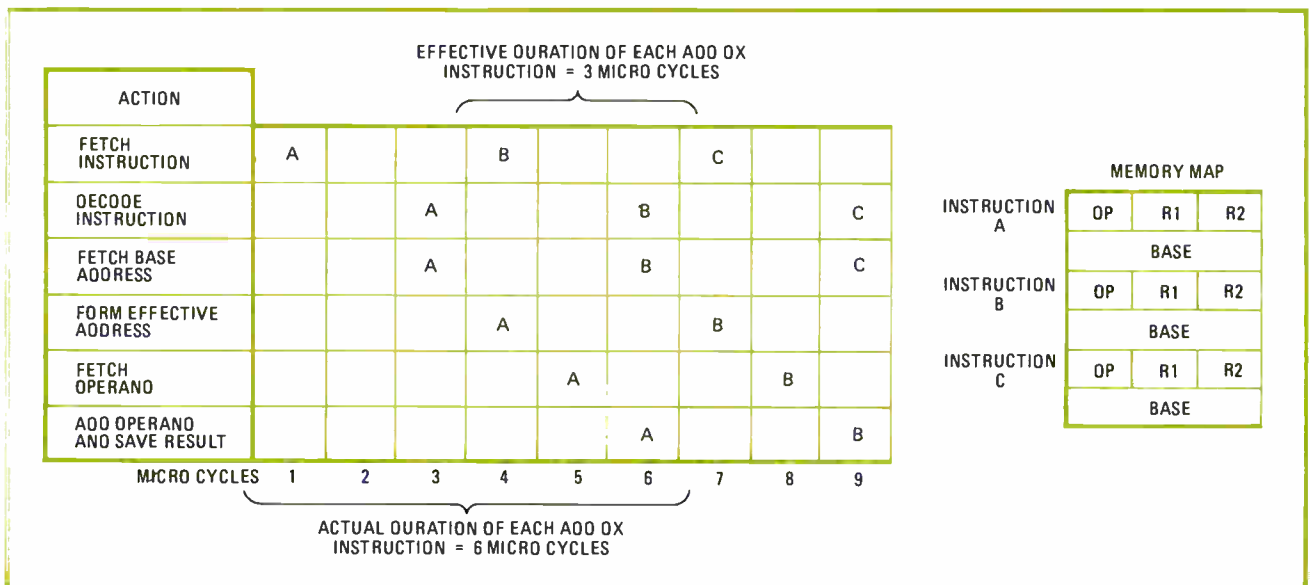

4. Pipelining. Using pipelining for this string of sequential, direct-indexed addition instructions effectively takes three microinstruction cycles, although six sequential microinstructions are required to execute each instruction.

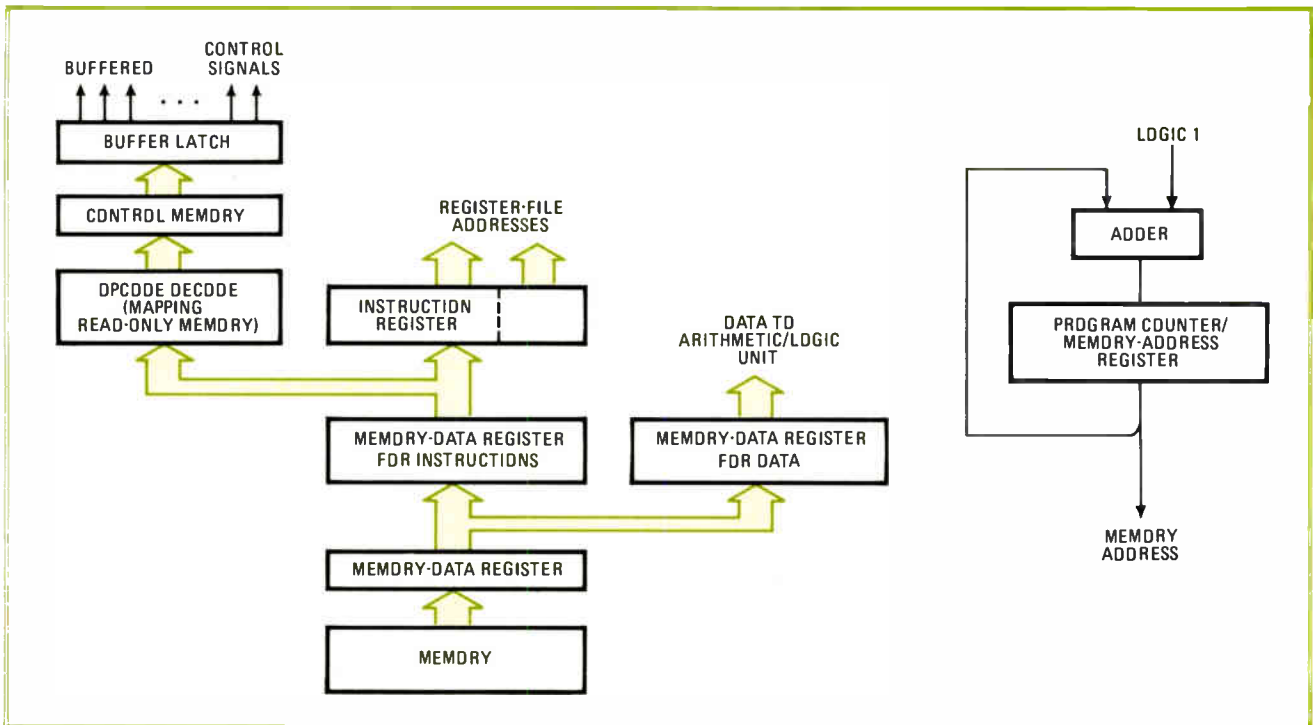

5. Hardware. Although pipelining increases throughput and flexibility, it requires considerably more hardware than nonparallel designs. Implementing the architecture requires many instruction registers, memory-data registers, incrementers, control-memory buffer latches, etc.

control-memory buffer latch must be provided. The next instruction may then be decoded, and the next microinstruction fetched during execution of the current microinstruction.

A block diagram of the entire ATAC-16M minicomputer is shown in Fig. 6. Memory and input/output communicate asynchronously with the CPU through a fully buffered port. The instruction register and memory-data registers discussed above provide all required buffering for maintaining the asynchronous interface and instruction-stream pipeline.

Forming the address

Also shown are four Fairchild Macrologic data-access registers that provide the required address-formation logic, two working registers, and the program counter. The eight automatic vectored priority interrupts are implemented by use of an AM2914 LSI interrupt network.

The instruction set currently microprogramed has 129 machine instructions with eight addressing modes. The repertoire contains single- and double-precision arithmetic, a firmware floating point, and byte-string operators. Other instruction sets tailored to suit specific applications can also be developed.

The single-phase 250-ns microinstruction cycle time was selected to provide adequate timing margins with expected production-component tolerances when operating over the military temperature range of -55°C to 125°C .

Not immediately apparent from the block diagram are several features of the architecture that simplify emulation and provide expansion capability. One example is the ability to break the instruction pipeline between the

memory-data register for instructions and the instruction register. This simple capability, combined with the fully pipelined architecture, permits hardware remapping of instruction fields. Remapping fits new instructions to existing hardware functions, thus providing an emulation capability for other instruction sets. This can be done with no time penalty, providing the remapping logic has a delay less than 250 ns (1 microcycle).

The three-state control-memory address bus and conditional-branch FLPA are other features that allow microprogram sequencing information to be sent to or from the processor. A one-board arithmetic extension processor is available, which uses this capability to provide a 32-bit ALU with substantially improved performance on double-precision fixed point and both normal- and extended-precision floating point.

A logical tradeoff.

On first observation, one may be surprised at the relatively large amount of logic necessary to support the four microprocessor slices. It is possible to fabricate a minimal computer around today's bipolar microprocessors with as few as 35 to 40 supporting ICs. But the tradeoffs indicate that such implementations are inferior on a cost/performance basis.

While many factors influence a CPU's effectiveness in a specific application, some idea of performance comes from reviewing popular parameters, such as the number of instructions, addressing modes, and execution speeds of several LSI bit-slice approaches (Table 2).

The four approaches represent a rather wide range in the performance spectrum. The National Semiconductor Corp.'s PACE is based on the p-channel PACE 16-bit microprocessor. This design addresses the lower end of

TABLE 2: ONE-CARD MICROPROCESSOR BASED 16-BIT CPU's

Characteristic	CPU			
	PACE	MMI 605	ATAC-16M	Miproc
Data length	8/16 bits	16 bits	8/16/32 bits	16 bits
Registers	4 accumulator + stack	4 accumulator	16 general	2 accumulator, index optional
Number of instructions	45	38	129	82
Instruction times:				
16-bit ADD (RR)	8.0 microseconds	0.9 microsecond	0.25 microsecond	0.35 microsecond
16-bit MULTIPLY	None	9.2 microseconds	5.10 microseconds	9.10 microseconds avg
32-bit Floating ADD	None	None	5.75 microseconds	None
32-bit Floating MULT	None	None	16.00 microseconds	None
Addressing modes	4	5	8	3
Direct-addressing	256 word pages	256 word pages	65,536 words	256 word pages
Interrupts	Six priority	One	Eight priority	Optional
Microprocessor element	16-bit PACE	MM6701	AM2901	Plessey LSI chip set
Board area	21 in. ²	63 in. ²	48 in. ²	58 in. ²
Power	+5 V _s -12 V; 16 W	+5 V; 17.5 W	+5 V; 20 W	+5 V; 18 W
Technology	Silicon-gate p-channel MOS LSI	Schottky TTL Standard LSI/MSI	Schottky TTL Standard LSI/MSI	Schottky TTL Standard/custom LSI/MSI

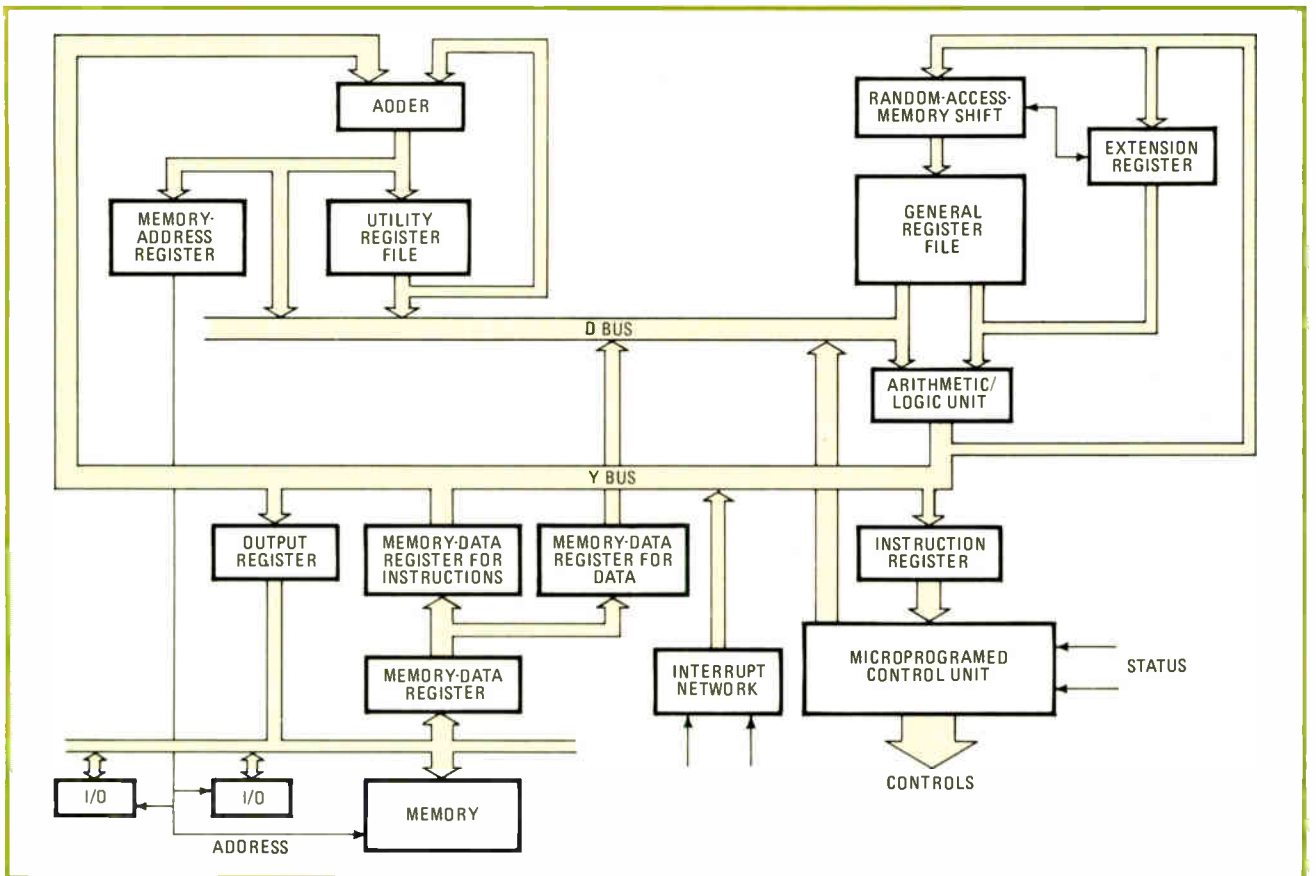

6. The computer. In the single-board ATAC-16M minicomputer, the memory and input/output devices communicate asynchronously with the CPU through a buffered port. Address formation logic, two working registers, and the program counter use Fairchild Macrologic parts.

the computer-performance spectrum and is best used in controller applications not requiring high-performance arithmetic capability. The other CPUs are based on Schottky bipolar technology.

The MMI 605 from Monolithic Memories Inc. and the ATAC-16M are based on similar 4-bit bipolar microprocessor slices. The ATAC-16M is an example of how the addition of modest support logic and a pipeline

architecture greatly extend the performance of the bipolar microprocessor. This approach was also used in the Plessey Co. Miproc, bearing out the premise that the bipolar microprocessor, when combined with a sophisticated pipelined architecture, provides considerable performance improvement over popular MOS units and standard bipolar implementations in arithmetic-oriented applications. □

Component quality assurance: which plan is better?

Key difference between two popular sampling plans is the risk the buyer takes of getting more faulty devices than he expects

by Martin Vyenielo, Lawrence Livermore Laboratory, University of California, Livermore, Calif.

□ Because of today's increasing emphasis on component reliability, many engineers are adopting lot-tolerance-percent-defective (LTPD) sampling as a means of distinguishing between good and bad lots of incoming components. It offers them better protection than the other widely used sampling plan, acceptance-quality-level (AQL) testing.

Essentially, the two plans expose the buyer to differing degrees of risk of accepting lots having faulty components. With AQL sampling, a lot containing the same percentage of defective devices as the specified AQL limit will be accepted 95% of the time, so the producer takes a mere 5% risk of a lot being rejected. In contrast, LTPD sampling reduces to only 10% the probability of accepting a lot having as many faulty parts as the LTPD limit.

With LTPD sampling, then, the consumer runs a much smaller risk of accepting an "unacceptable" lot. In fact, LTPD tables are now part of a number of military specifications, including Mil-M-38510 for microcircuits and Mil-S-19500 for discrete semiconductors.

The reason for the difference between AQL and LTPD sampling plans is fundamental. They are based on prescribed statistical data that establishes the size of the

sample relative to the size of the lot, as well as fixing how many devices in the sample may fail before the entire lot is rejected. So, the protection that each sampling plan offers the buyer is predetermined by the statistics that set it up. These sampling criteria take the form of tables and curves, which are published in a number of military-component specifications, as well as in textbooks about quality control such as those cited in the bibliography at the end of this article.

Sampling is cost-effective

Because components are, for the most part, manufactured by mass-production techniques, a certain percentage of parts will always be defective, making incoming inspection of purchased components essential. The acceptability of each part must be determined according to its conformance to procurement specifications.

If all the devices of a given lot were identical, inspection or testing of any one device would suffice for the entire lot. However, each part is different to some degree from every other, even though all may be manufactured by the same company and by the same process.

To ensure quality, every item in a lot may be inspected, but this approach is expensive and does not

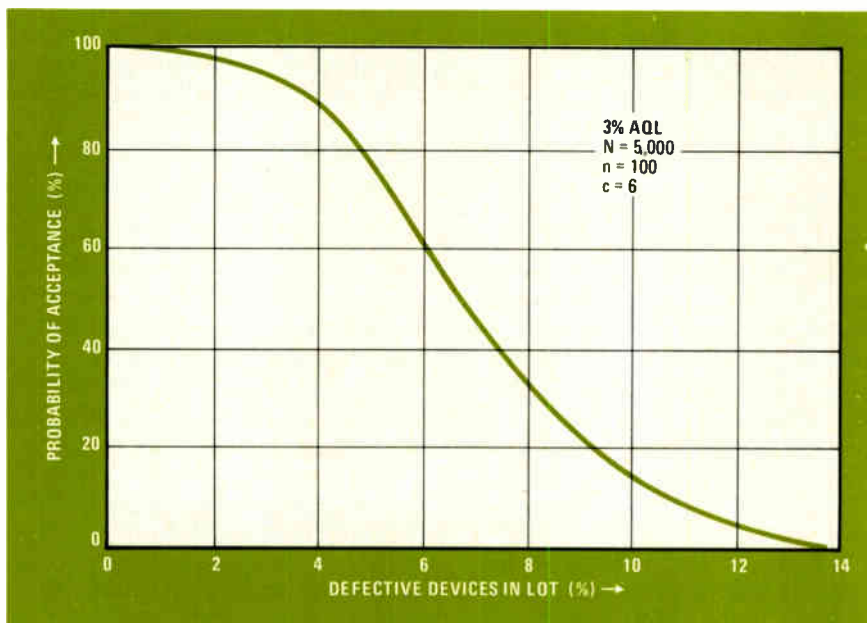

1. A matter of chance. Every sampling plan has its own operating characteristic (OC) curve, which shows the probability of accepting a lot containing a certain percentage of defective components. The OC curve shown here is for sampling a lot (N) of 5,000 devices to a 3% acceptance quality level (AQL), where the sample size (n) is 100 and the acceptance number (c) is 6. If 6 of the 100 parts in the sample are faulty, the lot is rejected. In this example, the probability of acceptance is 75% when even 5% of the components in the lot are defective.

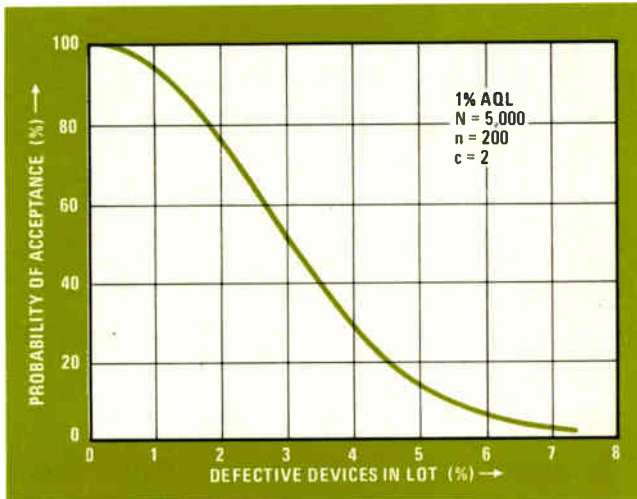

2. AQL—a stacked deck. Published data for setting up AQL sampling plans favors the supplier. With AQL sampling, the probability of acceptance is 95% when the percentage of defective devices in a lot is equal to the AQL limit. For example, with a 1% AQL plan, a lot containing 1% defective devices will be accepted 95% of the time, or 75% of the time, even if 2% of the devices in the lot are faulty.

guarantee that all the defective parts will be discovered. It is far more economical to examine a few items, selected at random from the same lot, and to decide on the acceptability of the entire lot, based on the testing of these few. The price of this economy, however, is the increase in probability that some parts in the accepted lots will be defective.

Statistical methods are well developed for drawing an inference about the quality of a whole lot, based on the testing of just a few randomly selected parts. Every popular sampling plan has its own family of published tables and curves that specify sample size and acceptance number, which is the maximum number of units in the sample that may fail. As a rule, the sample size need not be large—even less than 10% of the lot size. However, the larger the absolute size of the sample, the better the discrimination between good and bad lots.

Needless to say, no sampling plan is perfect—there is always some risk that a good lot will be rejected or that a bad lot will be accepted. The best practical tradeoff is to select a plan that makes the acceptance of good lots more likely than the acceptance of bad lots.

Classifying sampling plans

Sampling plans can be broadly divided into two categories: attribute plans and variables plans. In attribute inspection, a sample is selected at random from a lot, and every unit in the sample is then classified as either good or bad. The number of actual failures is compared with the number of bad units permitted by the plan, and the lot is rejected if the number of faulty components exceeds the level allowed by that plan.

In variables plans, a specific quality characteristic is measured for each unit in the sample. These measurements are then summarized as a simple statistic—for example, a mean value—and this statistic is compared to the value set down by the plan. Although they tend to involve considerably smaller sample sizes, variables

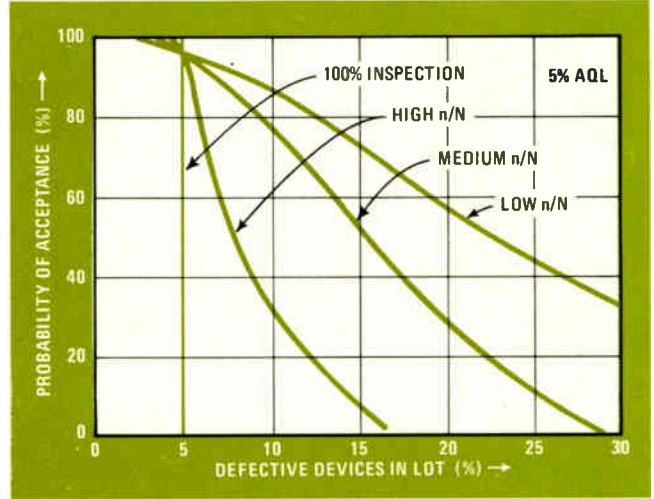

3. Ratio is the thing. The degree of discrimination between good and bad lots depends on the ratio of sample size to lot size. The larger this ratio, the better the discrimination. These OC curves for 5% AQL plans show that lots having 5% faulty devices will be accepted 95% of the time. But to assure that only lots containing no more than 5% defective parts are accepted requires 100% testing.

plans, when they apply, provide the same degree of protection for the buyer as attribute plans.

AQL and LTPD sampling are both attribute plans, each providing buyer protection on a lot-by-lot basis. However, in AQL sampling, a quality level is specified for a lot in such a way that the probability of acceptance is 95% when the lot meets this quality level, which is the AQL percentage. With LTPD sampling, on the other hand, a quality level is specified for the lot so that the likelihood of accepting the lot is only 10% when its quality level is poorer than the selected LTPD value.

Evaluating a sampling plan

Every sampling plan has a corresponding operating-characteristic (OC) curve that is derived from the published data for the particular plan. Such a curve considerably simplifies evaluating the effectiveness of the sampling plan, since it visually depicts the probability of acceptance over a range of lot failure percentages. In other words, an OC curve illustrates the risks inherent in a specific plan.

For example, the OC curve in Fig. 1 is for a 3% AQL plan requiring a random sample (n) of 100 pieces from a lot (N) of 5,000 devices. If the sample selected contains six defective components ($c = 6$) or fewer, the lot is accepted; if the sample contains seven or more failures, the lot is rejected. The probability of acceptance is 95% when 3% (the AQL value) of the lot is faulty, decreasing to 75% if even 5% of the devices are defective.

When an AQL sampling plan is selected, the buyer must decide what the AQL percentage limit should be, but there is no simple rule for determining an appropriate value. One approach, for example, is to review the quality of parts accepted and used in the past, and then analyze this data to set a reasonable AQL limit.

Most published tables and curves for AQL sampling plans are set for a rejection risk of 5%—or a probability of acceptance of 95%—no matter what AQL limit is

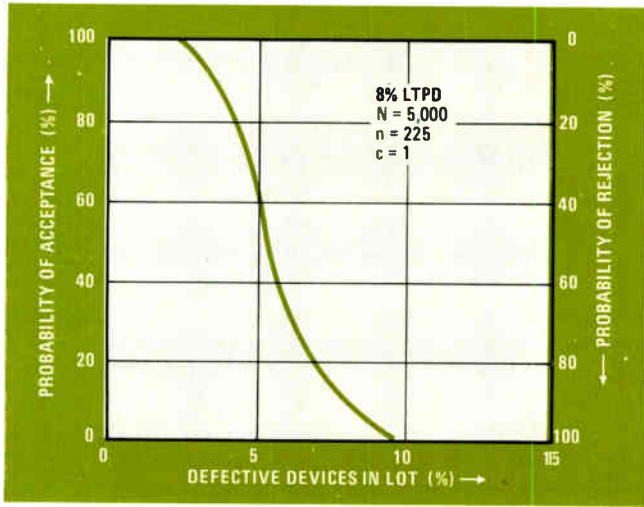

4. LTPD sampling reduces risk. AQL sampling is actually a measure of acceptable quality, whereas lot-tolerance-percent-defective (LTPD) sampling is a measure of unacceptable quality. With the latter, the buyer takes only a 10% risk of accepting lots containing more defective devices than the LTPD limit. For this 8% LTPD plan, the acceptance probability is 10% for 8% defective lots.

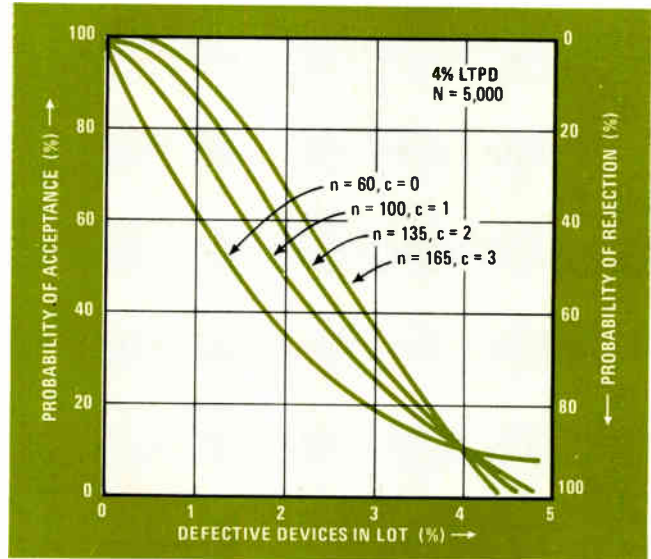

5. Different plans, same result. Regardless of the sample size (n) and associated acceptance number (c), LTPD sampling limits to 10% the risk of accepting lots having more defective parts than the LTPD value. The acceptance probability is 10% at the LTPD limit.

selected. Since this risk represents the probability of rejecting components that would be classified as acceptable if the lot were tested 100%, the rejection risk associated with AQL sampling is generally referred to as a producer's risk.

Even for a producer's risk of 5%, the supplier takes a comparatively small chance of rejection when actual lot quality levels are equal to or smaller than the specified AQL. What's more, because of sampling fluctuations, there is an additional chance of making an erroneous decision at a certain AQL.

Many engineers mistakenly believe that the AQL limit corresponds to the percentage of defective components allowed in a lot—so that an AQL limit of 1% would mean that a lot will not be accepted if it contains more than 1% defective components. This is simply not so.

With a specified AQL of 1%, there is a considerable probability of accepting lots containing more than 1% defective parts, as demonstrated by the OC curve (Fig. 2) for a 200-piece sample and a 1% AQL. A lot containing 2% defective devices will be accepted 75% of the time, while a lot of 4% defective devices will be accepted 25% of the time. There is a 50% chance that a 3% defective lot will be accepted.

As might be expected, OC curves depend on the ratio of sample size to lot size. Figure 3 depicts the OC curves for four different sampling plans, all based on an AQL of 5%. The perfect plan for discriminating between good and bad lots—100% inspection—is, by definition, impossible with sampling. The larger the ratio between sample size and lot size (and the lower the acceptance number), the steeper the OC curve, and the better the discrimination, but the higher the cost of testing.

By specifying an AQL limit, the buyer selects a measure of acceptable product quality, thereby giving the advantage to the supplier. If he were to select a measure of the worst quality instead, by specifying the maximum percentage of faulty parts allowed in the

entire lot, he would be setting a measure of unacceptable quality, which swings the advantage to himself. LTPD screening accomplishes this.

However, like all sampling plans, LTPD screening involves some inherent risk to the buyer because sampling fluctuations can cause defective components to be accepted. But with this type of screening, the risk can be limited to a specified amount.

LTPD sampling increases protection

Because it is based on a different set of published data than AQL plans, LTPD sampling reduces to 10% the buyer's risk of accepting lots having more defective components than the chosen LTPD value. Since this probability concerns the chance of accepting unacceptable material, it is usually called consumer's risk.

Figure 4 shows the OC curve for an 8% LTPD sampling plan. With this plan, lots containing 8% defective devices will be rejected 90% of the time, while lots having 5% defective parts will be rejected, on the average, 40% of the time. There is only a 10% chance that a lot containing more than 8% (the LTPD value) faulty components will be accepted.

The four OC curves plotted in Fig. 5 are similar in only one respect—they all represent a 4% LTPD sampling plan, passing through the point of 10% probability of acceptance when the lot contains 4% defective devices. In each case, although sample size and acceptance number vary, the buyer can be sure that lots having 4% or more defective parts will be rejected 90% of the time. □

BIBLIOGRAPHY

- "Quality Control Handbook," 2nd ed., J.M. Juran, McGraw-Hill, 1962.
- "Quality Control Training Manual," State University of Iowa Section, American Society for Quality Control.
- "Quality Control Theory and Application," Bertrand L. Hansen, Prentice-Hall, Englewood Cliffs, N.J., 1963.
- "AQL or LTPD," Fairchild Progress, Vol. 1, No. 5.
- "Quality Control and Reliability," Norbert Lloyd Enrick, The Industrial Press, New York City, 1966.

Hints for beginners in microprocessors

by Alan Bloch
Chestel Inc., Chester, Conn.

Because microprocessors are usually designed to meet the widest possible market, the one chosen for any specific application probably will not fit the application's requirements exactly. Inevitably, it will be slower than was expected, and its instruction set, however powerful it may be, will have gaps. At some point, the engineer will be tempted to start over again with a minicomputer, but he should hang on and remember that he is working with a processor—not a computer.

Given the right help in the form of programing and peripherals, the processor can do a lot. At Chestel, for example, a private automatic branch exchange (PABX) is controlled by a single Intel 8008. For successful design, it is important to use the processor properly. The following guidelines for proper use may be helpful to those applying a microprocessor for the first time.

■ **Arithmetic.** The typical microprocessor is not a particularly good number-cruncher. If the application

involves extensive arithmetic operations, adding a calculator chip as a peripheral device may be desirable.

■ **Programs.** Programing is simplified by avoiding interruptible subroutines. The program should be arranged so that the microprocessor finishes a task and then looks around to see what needs to be done next. In general, this approach requires first-in/first-out memories at input/output ports that interface with the real world.

It may also be desirable to provide specialized peripheral devices to carry out some tasks in real time. The Chestel PABX, for example, uses tone decoders to put dial-entry data into a processor-acceptable format. The processor could do this job, but it would entail a lot of waiting time (the subscriber's dialing finger can't be scheduled), and during that time the processor wouldn't be available for executing extended subroutines.

■ **Peripherals.** Design of peripheral devices is facilitated if the various information paths that run between the microprocessor and the rest of the system are separated. The Intel 8008, for example, uses a time-shared 8-bit-wide bus to carry 14-bit memory addresses, 5-bit I/O addresses, and 8-bit data bytes in both directions. It is convenient to separate these information streams as early as possible.

The diagram shows how to do this by capturing address bits and storing them in latches, which then control dedicated address buses. The separation process

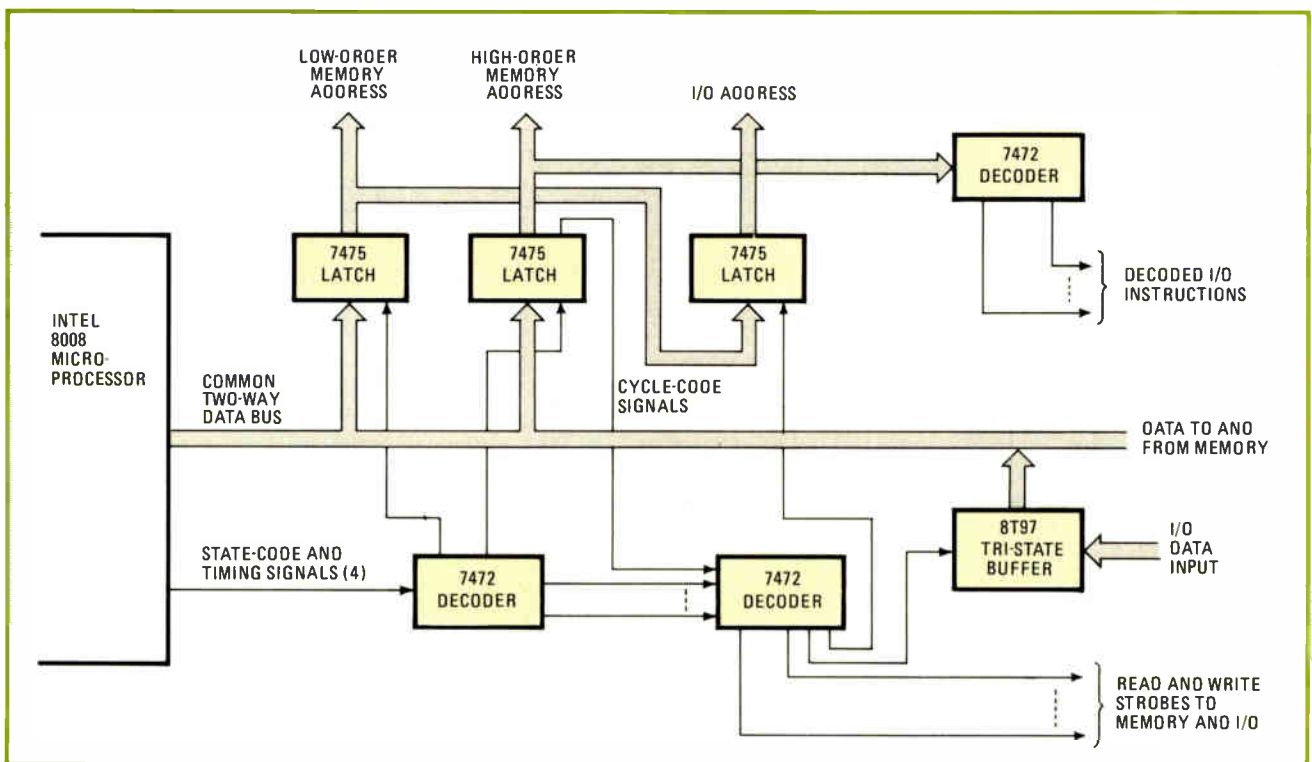

Separate data streams. Peripheral hardware helps a microprocessor do its job. To separate the streams of memory and I/O information, addresses, and data, the information on the common bus of an 8008 microprocessor is demultiplexed, latched, and put on dedicated buses. Timing signals and signals indicating microprocessor states are decoded to control the latches and provide strobes.

is carried even further, using one multiple bus for memory addresses, another for I/O addresses, a third for data transmission to and from the memory, and a fourth for incoming data from I/O ports.

Output instructions to I/O ports are not ordinarily transmitted in an 8-bit format; instead, the instructions are decoded and sent out on dedicated buses, some of which are only 1 or 2 bits wide. The diagramed system also decodes information carried by a number of state buses, which are driven by the microprocessor, and it generates read and write strobes that are sent to the memory and to the I/O ports.

■ **Debugging.** After the program has been written, it is put on magnetic tape or punched-paper tape and loaded into random-access memory. The engineer must, of course, debug it. He should resist the temptation to go home at the end of the day without dumping the updated program. Otherwise, Murphy's Law guarantees a power failure and a day's work lost.

Debugging will be simplified if the operating program is structured as a simple executive routine and a number

of discrete subroutines. The subroutines should be broken down into smaller modules, if possible; an hour spent in modularizing the program structure will save about a day of debugging time.

Above all, software must be documented in detail. Otherwise, development of the next generation of the system will have to start from scratch.

When the program is up and running, the engineer should resist the temptation to order a masked read-only memory. Instead, he should put the program in a programmable ROM and live with it for a while. Someone, somewhere, will find something wrong with it.

■ **Talents.** Designing a system around a microprocessor calls for a mix of hardware and software talent. Programming a microprocessor, though, is different from programming a minicomputer or a full-size computer. The instruction set is limited, and the system usually has only a small memory capacity. Good software people for microprocessors are hard to find, and their expertise usually must be developed in-house. Hiring a consultant would probably turn out to be a wise investment. □

Reed-relay switch turns on calculator chip fast

by Irwin Math
Great Neck, N.Y.

A reed-relay switch, used for fast application of the dc supply voltage, assures proper functioning of calculator chips in systems where supply voltage V_{CC} might otherwise rise slowly. In addition to their use in hand-held calculators, inexpensive calculator chips like the National Semiconductor MM5736 can be designed into logic

systems to serve such functions as control devices, up/down counters, and arithmetic units.

In using these chips, however, it is necessary to apply their dc power quickly. If V_{CC} rises too slowly, the chip simply does not operate properly because the registers on the chip take on random initial values before the multiplexing oscillator gets started.

A battery supply with a single-pole, single-throw switch in the line provides the necessary fast-rise-time characteristic in calculator applications. When the chips are used in logic systems, however, slow-rise-time supplies are often all that are available. Two circuits that can provide fast turn-on of the chips in such systems are shown in the figure.

In a system that includes a dc-voltage source greater

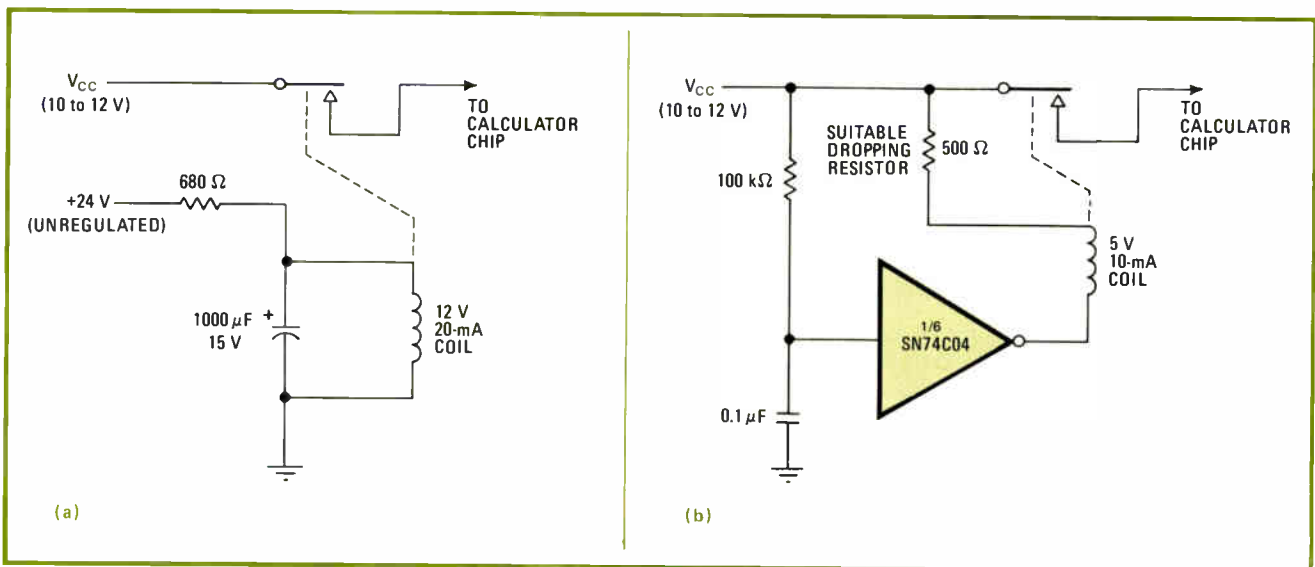

Right turn-on. To allow power supply to reach full voltage before V_{CC} is applied to calculator chip, an RC circuit delays relay closure. Relay in (a) requires a drive voltage greater than the V_{CC} for the chip, and the relay in (b) is driven directly from the V_{CC} line. The values of R and C depend on the V_{CC} level and the relay type. A time delay of 0.1 second is usually adequate for proper operation of the calculator chip.

The Electronics Book Series offers you:

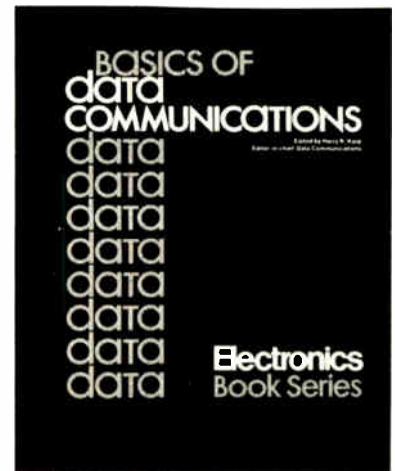
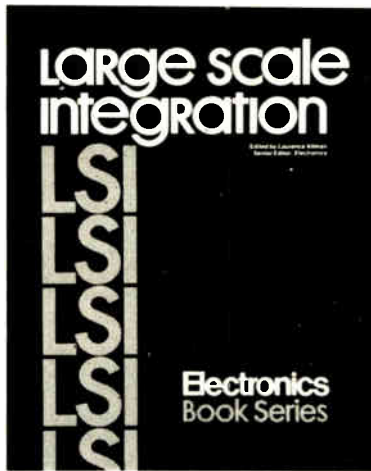
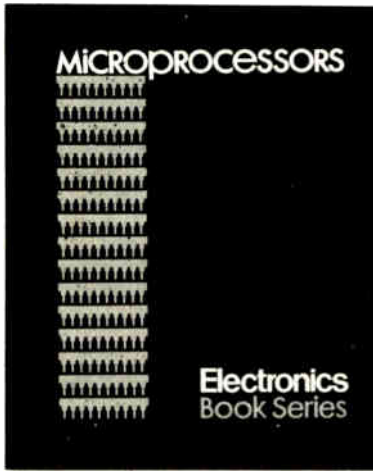

1 MICROPROCESSORS

The microprocessor has permanently changed the methods of designing and building electronic equipment—from process and industrial control to computer-based designs in instruments communication and consumer/commercial equipment.

This book cuts through the confusion, presenting the design and application potential of this exciting technology in a manner that will appeal to the design engineer who needs to know how to use microprocessors as well as the system analyst who must assess the tradeoffs between microprocessors and other techniques to accomplish his system goals.

Using articles from the pages of Electronics, this book contains practical and up-to-date information on available microprocessor devices, technology and applications.

2 LARGE SCALE INTEGRATION

The Electronics Book Series offers you a handbook on the current and revolutionary impact of LSI on digital design. This 220-page book presents a unique opportunity for circuit designers, systems designers, and engineering managers and supervisors to bring their expertise into line with today's LSI design requirements.

"Large Scale Integration" is a compendium of recent articles published in Electronics. Although in some ways it is a companion piece to "Microprocessors" because it explains the new circuits that play in mp systems, it is much more. "Large Scale Integration" deals with the entire range of design applications: main memory systems, peripheral memories, memory controllers, on-line industrial controllers, data acquisition boards, communication systems, calculators, watches, etc.

3 BASICS OF DATA COMMUNICATIONS

Data communications is one of the fastest-growing electronic equipment markets in the U.S.—during the decade of the '70's, better than 15-20% per year, compounded!

Chances are you are going to be a part of the data communications market. There's no better place to start than getting a copy of "Basics of Data Communications"—a 316-page compilation of essential articles which have appeared in Data Communications magazine. From the basic, tutorial, still state-of-the-art information published in the 1972 and 1973 Deskbook issues (now out of print), on through information on the practice of present-day data communications, this book includes forty-seven articles covering more than eleven key areas.

Electronics Book Series • PO Box 669, Hightstown, N.J. 08520



- 1 Send me _____ copies of "Microprocessors" at \$8.95 per copy.
- 2 Send me _____ copies of "LSI" at \$9.95 per copy.
- 3 Send me _____ copies of "Basics of Data Communications" at \$12.50 per copy.

Discounts of 40% on orders of ten or more copies of each book.

I must be fully satisfied or you will refund full payment if the books are returned after ten day trial examination.

Payment enclosed Bill firm Bill me

Credit Cards Charge My Book To

American Express Master Charge
 Diners Club BankAmericard

Name _____
 Title _____
 Company _____
 Street _____
 City _____
 State _____ Zip _____
 Signature _____

Acct. No. _____
 Date Card Expires _____
 Interbank No. _____

(1st No's. above name on Mastercharge only.)

than V_{CC} , such as the unregulated dc from the primary power supply, the arrangement in part (a) of the figure can be used. The higher voltage (24 v from the unregulated dc source) drives an inexpensive spst normally open reed relay in a simple time-delay configuration. The relay closes to apply the V_{CC} voltage to the calculator chip only after full supply voltage has been reached. The relay used in this arrangement can be one of the

Magnecraft W102M series or a low-power equivalent.

When no voltage higher than V_{CC} is available, one section of a complementary-MOS hex inverter such as the SN74C04 can be used, as in (b). Here again, an RC circuit delays application of drive to the relay long enough for V_{CC} to reach full value after turn-on. The inverter easily drives a low-power reed relay such as the Magnecraft W101MX-35. □

Calculator notes

Programing an SR-56 to serve as stopwatch

by Martin Tobias
Boulder, Colo.

A Texas Instruments SR-56 key-programable calculator can be made to count and display minutes and seconds accurately within a few seconds in several hours.

The program is shown in the accompanying table. After loading it, enter: Fix 2 GTO 5 0. The display then reads 0.00. The clock is started and stopped by pressing R/S and is reset by entering GTO 5 0. If the program is stopped while it is changing from one time reading to the next, it is necessary to press RCL 0 after pressing R/S. The time to be displayed is held in register 0 as mm.ss—that is, one or more digits for minutes, a decimal point, and two digits for seconds.

Program steps 00 to 07 and 17 to 25 make the calculator run in a loop, adding 0.01 each time and pausing to display the up-to-the-second count. Steps 08 to 16 are run through when the seconds count has reached 59, and the program then adds 0.41 to clock up one minute and reset the seconds to 00.

Loops 08-16 and 17-25 contain the same number of program steps, making the interval between displayed times visually the same, irrespective of which loop the program goes around.

Steps 21 to 24 are dummy instructions inserted to adjust the cycle time to 1 second. This particular sequence made the author's calculator run slightly fast. It gained 2 seconds in 10 minutes, or 9 s in one hour—about +0.3%. The cycle time can be trimmed by altering the dummy instructions: changing instruction 24 to NOP makes the program run slightly faster, changing instruction 23 to = slows it down. Or, one can delete or add a dummy instruction. The dummy function should not involve rounding-off, however, (e.g. $\frac{1}{4}$ $\frac{1}{4}$), because the round-off error would snarl up instruction 11.

The clock slows slightly as the count increases. Although it may run slightly fast at first, the accuracy will improve as the count proceeds. The attainable accuracy of a few seconds in several hours is adequate for such activities as timing dark-room operations, cuing records into a tape-recorder, or timing a boiled egg. □

Engineer's notebook is a regular feature in Electronics. We invite readers to submit original design shortcuts, calculation aids, measurement and test techniques, and other ideas for saving engineering time or cost. We'll pay \$50 for each item published.

SR 56 PROGRAM			
Title: STOPWATCH			
LOC	CODE	KEY	COMMENTS
00	94	=	
01	59	pause	} displays time
02	33	STO	
03	00	0	
04	12	INV	
05	37	x = t	
06	01	1	
07	07	7	
08	84	+	
09	01	1	
10	94	=	
11	32	x ≥ t	} loop 1
12	84	+	
13	92	.	
14	04	4	
15	01	1	
16	42	RST	
17	84	+	
18	92	.	
19	00	0	
20	01	1	} loop 2
21	46	NOP	
22	46	NOP	
23	46	NOP	
24	94	=	
25	42	RST	
26			
27			
48			
49			
50	92	.	
51	05	5	
52	09	9	} reset
53	32	x ≥ t	
54	15	CLR	
55	42	RST	

REGISTERS	
0	mm . ss

NOTES
Initialize with
fix 2 GTO 50
Start with
R/S
Stop with
R/S RCL 0
if
necessary
Reset with
GTO 50

Scope can double as frequency multiplier

The ramp sweep signal of an oscilloscope can act as a harmonic generator, says Dale Hileman of Sphygmetrics Inc., Woodland Hills, Calif. For example, Hileman says he had to tune a crystal oscillator to exactly 120 kilohertz, so he simply fed the crystal signal into the vertical input of the scope and tuned the sweep to display one cycle. Since the ramp had a frequency equal to the crystal frequency, the harmonic frequencies were the same. However, the harmonics of the ramp are particularly strong—he was able to pick up the 125th harmonic, about 15 megahertz, and beat it against wwv **to tune the crystal exactly to 120 khz, with the scope serving, in effect, as an “indirect” harmonic generator.** Hileman says he can pick up harmonics as high as the 300th, but if the signal gets weak up there, he suggests plugging a lead into the ramp output jack on most scopes and letting it serve as an antenna.

Blow hot to cool

A blast of hot air works better than hot liquid for cooling and leveling the solder that is applied to printed-circuit-board conductors, say T. A. Allen and R.T. Sylvester of Sandia Labs, Albuquerque, N. Mex. The air replaces petroleum-derived polyglycol liquids, thus cutting pollution problems by as much as 90%, according to the two engineers. They have patented such a solder-coating machine and assigned the patent, No. 3,865,298, to the Energy Research and Development Administration so that it's essentially in the public domain. Because of its shorter cycle time, the machine uses only half as much electrical energy as liquid-leveling machines and also cuts the over-all process time by about 70%. The machine also keeps thermal degradation of the board material to a minimum, say the inventors.

Where to go for complex testing of complex devices

Looking for a facility dedicated to the complex testing of today's memories and microprocessors? One of the newest and most complete facilities is Microtest, a Sunnyvale, Calif., supplier of test equipment that claims it can **test all industry-standard microprocessors, including the 8080, 6800, and F8, as well as run the complex text patterns for most types of random-access and read-only memories,** including the 4- and 16-kilobit dynamic RAMS. The company has put much effort into developing a software library of over 1,000 test programs for most memory types in production today. More information can be obtained by calling Gary Voget at (408) 739-8001.

For the record

Although the IEEE Transactions usually tend to be rather theoretical and aimed at the specialist, we can't help but take note of a recent issue that should be of interest to just about everyone in the electronics field. The July 1976 issue of the Transactions on Electron Devices comprises a special bicentennial issue, **“Historical Notes on Important Tubes and Semiconductor Devices.”** Experts write about each type of electronic device, from Nobel laureate William Shockley on the transistor and J. B. Gunn on microwave oscillations in gallium arsenide to A. L. Schawlow on masers and lasers. Copies of the issue are available from IEEE for \$5.00 for members, \$10.00 for nonmembers. . . . And also worth noting from the IEEE is the 1976 standards catalog, which lists over 350 standards publications in 32 pages. Copies are available without charge from the IEEE 345 E. 47th St., New York, N.Y. 10017. —Stephen E. Scrupski

Faster and easier costs less when you build your own ACE.

SPECIAL OFFER!
\$5 OFF ON ACE 201-K!
NOW ONLY \$19⁹⁵



You know the advantages of ACE, the better solderless breadboards from A P Products. You know that there's no faster or easier way of building, testing, fudging and trying circuits and circuit ideas. But maybe you didn't know that two of our ACEs are available as kits. For people who don't mind taking a few minutes to make faster and easier less expensive as well. And when you order from this ad before November 15th, you can save an extra five dollars on our big 201-K.

ACE.
 Solderless plug-in tie points,
 ground plane and binding posts.

Part No.	ACE Model No.	Tie Points	DIP Capacity	No. Buses	No. Posts	Board Size (inches)	Price Each
923333	200-K (kit)	728	8 (16G)	2	2	4-9/16 x 5-9/16	\$18.95
923334	201-K (kit)	1032	12 (14s)	2	2	4-9/16 x 7	\$24.95 Special \$19.95

Ohio and California Residents Add Sales Tax
 All orders subject to acceptance at factory

For quick phone service, call the A P distributor nearest you:

(201) 224-8032	(216) 587-3600	(415) 969-9240	(617) 273-1860
(206) 682-5025	(312) 298-8580	(513) 236-9900	(617) 879-0860
(213) 768-3800	(313) 525-1800	(516) 483-9200	(713) 777-1666
(213) 875-2862	(314) 863-7800	(516) 883-0999	(714) 549-8611
(214) 350-6771	(412) 782-2300	(612) 488-0201	(803) 779-5332
(215) 698-4000	(415) 326-5432	(617) 237-6340	(914) 664-0088

(If no distributors in your area, call factory)



A P PRODUCTS INCORPORATED

Box 110-E Painesville, OH 44077 (216) 354-2101 TWX: 810-425-2250

Circle 105 on reader service card

Gas Sensing Semiconductor

FIGARO GAS SENSOR

TGS quickly senses
 even small
 amount
 of gas.

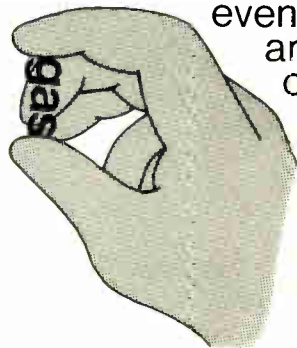

New Models,

some with highly sensitive
 CO sensor, now on the market.

Please contact the address below directly for
 catalogs and price/delivery information

FIGARO ENGINEERING INC.

3-7-3, Higashitoyonaka, Toyonaka City, Osaka 565
 Japan/Tel (06) 849-2156

Cable: FIGARO TOYONAKA/Telex 05286155 FIGARO J

Circle 139 on reader service card

MICROPROCESSOR SERIES NO. 1

**OUR EASIEST-TO-USE
 2650:
 NOW MULTI-SOURCED.**

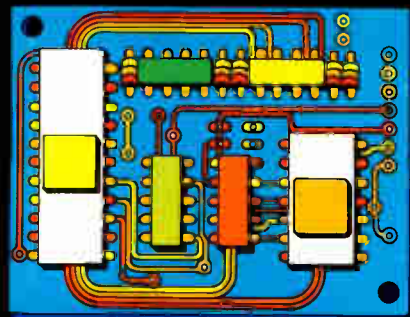

All the 2650's
 you need, in stock at
 Signetics, authorized
 distributors,
 Advanced Memory
 Systems (AMS) and
 Philips, too.

Clip coupon to letterhead.
 Or call (408) 739-7700, Ext. 2982/3
 Please rush me my FREE 2650
 Short Form Catalog.

Name _____ Title _____
 Tel. _____ M.S. _____

811 E. ARQUES, SUNNYVALE, CA. 94086

THINK

Signetics μ P
 a subsidiary of U.S. Philips Corporation

Circle 140 on reader service card 105

Pulsed counters climb to GHz range

In radar applications particularly, system under test does not have to be put in standby mode, but can be kept in normal pulsed mode

by Bernard Cole, San Francisco bureau manager

Reflecting an increase in the Federal budget for communications and radar systems in both the military and civilian sectors, several instrument houses are going into production with new pulsed radio-frequency counters in the gigahertz range.

The advantage of such new counters—available from EIP Inc., Eldorado Instruments Co., and Systron-Donner Corp.—is that in radar applications, particularly, the system under test does not have to be put into a standby continuous-wave mode, but can continue operation in its normal pulsed rf mode. “Until recently, continuous-wave gigahertz counters have been used for this sort of testing,” says Leigh Brite, president of Eldorado, “but the drawback to that approach is that when a system is being tested in the continuous mode, it is down—non-operational. And at an airport, for example, closing down a radar means closing down the runway.”

To attack this market, Eldorado, for one, introduced at Wescon its model 989G (shown above), a heterodyne counter with a range from 925 megahertz to 18 gigahertz that is basically identical to the continuous-mode 989, except that circuits have been added for pulsed-rf measurements.

Sensitivity of the model 989G is -10 dBm (peak) to 10 gigahertz and -5 dBm (peak) to 18 GHz. Minimum rf-pulse width is 100 nanoseconds, and maximum acquisition time is 1 second. Pulse-repetition frequency is 50 to 7,000 picoseconds because it incorporates Eldorado's 100-ps time-interval-meter technology [*Electronics*, Sept. 2, 1976, p. 140], says Brite. The model 989G



pulsed-rf counter has an accuracy that is commensurate with its resolution: 10 kilohertz.

The system, he says, uses the same YIG-tuned-multiplier technique used in cw systems, except for the initial sweep operation. The frequency-measurement method for pulsed rf is similar to the cw technique in that the frequency display (or output) is the composite of the YIG-spectrum line selected and the intermediate frequency counted. However, a cumulative gate count is used for pulsed rf, so that the input cycles are counted only during a selected portion of the rf pulse. Thus, for pulsed rf, a gated cumulative time counter is used, instead of the simple time-base counter used for cw measurements.

For pulsed-rf signal inputs, the YIG sweep cannot be continuous (as for cw), but must be stepped in synchronism with the input rf pulses. To achieve a reasonable acquisition time, a read-only memory is used to set the YIG tuning current for each 200-MHz count line. This ROM is factory-programmed for each YIG. The YIG sweep sequence is initiated by detection of an input signal, as with

cw. The YIG tuning then steps (one step per input rf pulse) until an intermediate-frequency signal is detected.

Already on the market, using the same heterodyne technique, but without the 100-ps technology of the Eldorado system, is EIP Inc.'s model 451, which features fully automatic pulsed-rf counter capability over a range from 300 megahertz to 10 gigahertz and -5 decibels per meter from 10 GHz.

Aiming at the same general market, Systron-Donner Corp. will soon begin production of the first in a family of pulsed-rf counters ranging up to 18 GHz—the model 6063. The product manager, Gail Dishong, says the 6063 will cover the pulsed-rf range from 20 Hz to 6.5 GHz.

Base prices on these counters are \$6,850 for the Eldorado model 989G, \$7,200 for the EIP model 451, and \$3,700 for the Systron-Donner model 6063.

Eldorado Instruments Co., 2495 Estand Way, Pleasant Hill, Calif. 94523 [338]

EIP Inc., 3230 Scott Boulevard, Santa Clara, Calif. 95050 [340]

Systron-Donner Corp., Instrument Division, 10 Systron Dr., Concord, Calif. 94518 [381]



FAST BASIC I begins where Hewlett-Packard left off.

FAST BASIC I is the most powerful general-purpose ROM ever developed for the HP 9830A/B.* With 28 statements, commands and functions, it brings the machine language up to big system level.

Consider this. Array manipulations can now be executed hundreds of times faster than a '30 with a MAT ROM, and thousands of times faster than the basic machine. If your machine has mass memory, FAST BASIC I provides equally important system enhancements.

But don't take our word for it! Try this amazing ROM for yourself completely free of charge. Just mail the coupon and you will promptly receive FAST BASIC I for your own evaluation. After 30 days, if you do not want to purchase it, return it and you have no further obligation whatsoever. Otherwise remit \$675 (the full purchase price) and keep your '30 running FAST BASIC.

*a product of Hewlett-Packard



Infotek Systems

733 EAST EDNA PLACE • COVINA, CALIFORNIA 91723
(213) 966-7431 • TWX 910-584-1812

Infotek Systems
P. O. Box 1436
Covina, CA 91722

Please rush FAST BASIC I to me free of charge. If I do not want to purchase it after using it for 30 days, I will return it to you at your expense.

Name (Please Print) _____

Company _____

Address _____

City/State/Zip _____

Position _____

Serial No.
of my 9830 _____

E

Circle 107 on reader service card

Electronics/September 30, 1976

Guess the number of caps in the jar and win one. Free.

Right—we'd like to give you a free sample.

Just to show you how easy it is to get the right film capacitor for your high energy pulse discharge, communications and instrumentation circuits.

Our line includes metallized film and film-and-foil capacitors with polyester, polycarbonate, polystyrene, polysulfone and polypropylene dielectrics. Values from 0.001-25 μ F, voltages to 900 V and higher, with tolerances as tight as $\pm 0.5\%$. And they're available off-the-shelf from our distributors or in 4 to 5 weeks ARO for production quantities.

Ask for details and your free sample today. You can't lose.



In film caps, it's no contest.

ELPAC COMPONENTS
714/979-4440

Circle 141 on reader service card

MICROPROCESSOR SERIES NO. 2

2650

**DEVELOPMENT HARDWARE
FOR ALL
COST/CAPABILITY LEVELS.**

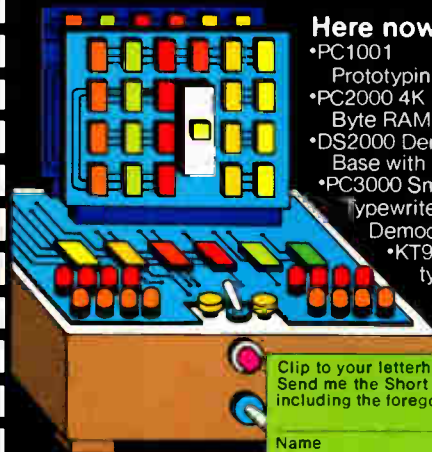

Here now:

- PC1001 Prototyping Card
 - PC2000 4K Byte RAM Card
 - DS2000 Demo Base with P.S.
 - PC3000 Smart typewriter Democard
 - KT9000 Prototyping Kit
- More Soon!

Clip to your letterhead. Send me the Short Form Catalog including the foregoing data sheets.

Name _____ Title _____

Tel. _____ M.S. _____

811 E. ARQUES, SUNNYVALE, CA. 94086

THINK

SINOTICS μ P
a subsidiary of U.S. Philips Corporation

Circle 142 on reader service card

107

Logic probe measures time intervals

Field-service instrument uses plug-in modules to cover a wide variety of logic families

by Michael J. Riezenman, New Products Editor

Unlike other logic probes, which only indicate logic states, the System 7 logic/time probe can also measure pulse widths and other time relationships. The Presta Digital Corp. multi-family instrument system has an optional plug-in timer that allows it to measure time intervals between selected logic-state transitions.

As a standard logic probe, the System 7 can handle any logic family whose high and low levels fall in the range from -15 to $+15$ volts. Plug-in modules are used to set the specific logic thresholds for any given family. Three of these plug-ins can be mounted in the System 7 simultaneously, and a three-position switch is used to choose between them. At present, six plug-ins are offered: TTL/DTL, C-MOS, RTL, ECL, HTL, and HiNHL. The plug-in logic modules sell for \$14.95 each and set their high and low threshold levels to within a tolerance of 2%.

The probe has an input impedance of 1.5 megohms, a maximum input pulse repetition rate of 100 megahertz, and the ability to detect pulses as narrow as 5 nanoseconds. The readout, which is located at the probe tip, uses a single seven-segment display plus a single LED lamp. For a static logic high, the display reads an H. For a static low it reads an L. And for pulses it reads an overlapping H and L while the LED lamp glows to indicate that pulses are present.

Spikes give an indication consisting of the LED lamp plus either the H or the L depending upon the direction of the spike. Open circuits and voltage levels that fall between the high and low thresholds give no indication on either display.

The System 7 mainframe and logic probe, including an ac adapter, sells for \$199.95.

Timing. For making timing measurements, the System 7 adds a plug-in timer to its mainframe. This timer contains a precision ramp generator that allows the user to measure the time between two transitions to within an accuracy of 1% of full scale. The full-scale range is set by a plug-in module. Presently available are plug-ins with the following full-scale ranges: 100 microseconds, 1 millisecond, 10 ms, 100 ms, and 1 second. Each plug-in time module sells for \$14.95, while the plug-in timer is priced at \$124.95.

Timing measurements are made by means of two signal inputs to the System 7. One input is the logic probe, the other is connected directly to the timer. Associated with each input is a two-position switch that determines whether the input will respond to positive-going or negative-going transitions. With these switches set in their proper positions

for a particular measurement and with the inputs connected to the appropriate points in a circuit, a 10-turn potentiometer is adjusted until the LED lamp in the probe turns on. The dial of the pot then gives the desired time interval.

Rounding out the System 7 product line is a standard universal logic pulser. Powered by any ± 5 v to ± 15 v power source, the model 600 delivers pulses of up to 0.5 ampere with a duration of 1 microsecond. It sells for \$79.95.

Because field-service applications often make it necessary to deal with a wide mix of logic types, the System 7 is being aimed particularly at that area. A complete field-service package consisting of the logic probe with all six plug-in modules, the timer with its five plug-in modules, the pulser, a carrying case, and the ac adapter sells for \$499.95. Quantity discounts are available.

Presta Digital Corp., 1331 Newbridge Rd., N. Bellmore, N.Y. 11710. Phone Eugene A. Presta at (516) CA1-4040 [339]

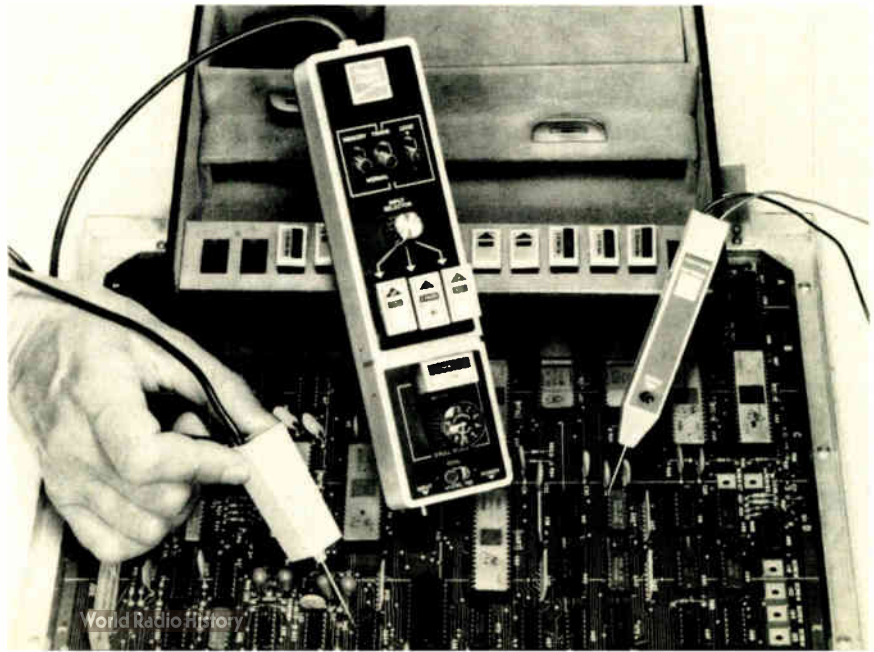

Why should you join the Payroll Savings Plan now? Maybe you'll find out later.



The future can be too late for saving. So if you want security, you'd better start today.

The Payroll Savings Plan makes it easy. Because an amount you choose is automatically set aside from each paycheck to buy U.S. Savings Bonds. That way, your savings build year after year.

So start today. Because tomorrow, today will be yesterday.

Now E Bonds pay 6% interest which is compounded annually at 5 years, 4 1/2% the first year. Bonds are a penalty free stock or dividend. When needed, they can be cashed at your bank. Interest is not subject to state or local income taxes, and federal tax may be deducted at redemption.



Take stock in America.

Join the Payroll Savings Plan.

AQ A public service of this publication and The Advertising Council

A SLIDE WITH PRIDE.

C&K's new Model 1101 subminiature SPDT slide switch has a *proven* internal mechanism be-

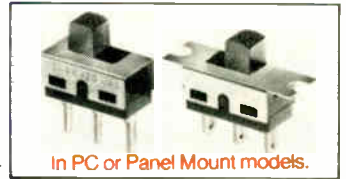

cause it's the same one we've been using for years to build our famous toggle switches. We've retained all the toggle terminal and sealing options and added a spring-loaded teflon actuator. It's a powerful 6 amp (at 120 VAC) slide switch offering 40,000 actuations at full load. Because the actuator is only .200" high, the 1101 slide switch maintains a low profile but deep down it's a proud little son-of-a-toggle.

C&K Components, Inc. 103 Morse St., Watertown, Mass. 02172, U.S.A.
Tel: (617) 926-0800 Telex: 92-2546 TWX: 710-327-0460.

Free Engineering Sample on request

Circle 109 on reader service card

MICROPROCESSOR SERIES NO. 3

2650

HIGHER LEVEL LANGUAGE SPEEDS YOUR DEVELOPMENT.



Available:
(A) PL μ S Compiler for 16- & 32-bit computers and on Time-share, (B) 16- & 32-bit Assemblers and Simulators.

Clip to letterhead. Send me quickly the 2650 Short Form Catalog including data sheets on the foregoing software.

Name _____ Title _____

Tel. _____ M.S. _____

811 E. ARQUES, SUNNYVALE, CA 94086

THINK

SIGNOTICS μ P

a subsidiary of U.S. Philips Corporation

Microprocessors

Computer in a briefcase

Stand-alone system includes keyboard, memory, display and other 'microperipherals'

Even though its components can fit in a space as small as a shoebox, the real promise of the microcomputer—truly portable computing power—has not been achieved until recently. That is because the peripherals needed to communicate with the microcomputer are usually quite bulky, requiring several additional square feet.

Now, however, Digital Electronics Corp. of Oakland, Calif., is introducing the DE68, a fully configured portable microcomputer system structured around the Motorola 6800 and packaged in an attaché-style carrying case. And, unlike most microcomputer systems, which at best offer the user an interface to an external cathode-ray-tube terminal or teletypewriter, the DE68 is a stand-alone system equipped with built-in input/output support peripherals, says Mark Gilford, manager of technical marketing.

These "microperipherals" include a 96-character keyboard, a miniature cassette-tape system for storage of up to 100 kilobytes of program or

data per cassette, and a 20-column alphanumeric display for interactive communications. An optional microprinter is also available to provide hard-copy output.

In addition to the standard 1 kilobyte of random-access memory (expandable to 4, 8 or 32 kilobytes), DE68 has a 5.5-kilobyte programable read-only memory operating system, known as Debug. A novel feature of the Debug firmware is a mnemonic translator, which allows software to be written and debugged entirely in the assembly-language mnemonics of the 6800 microprocessor. Selectable memory entry/display modes allow the user to communicate in assembly mnemonics, hexadecimal notation, or ASCII characters. Debug also has an extensive command set, which can greatly simplify the software-development process. Commands include memory-examine and change, search, and move memory block, as well as tape commands such as load, write to file, and rewind. Other commands allow the user to set multiple breakpoints, software single-step, and to trace 6800 microprocessor-register activity.

All DE68 bus lines are available on a single edge-connector for direct I/O expansion in applications such as diagnostic field-testing, data acquisition, transaction-logging, and process control. A system for microcomputer training, experimental modules, and an educational manual are available. The DE200 random-access alphanumeric display used in the DE68 will also be available as a separate product, specifically designed for microcomputer-system applications.

Since each of the 20 alphanumeric-character positions is directly addressable, says Gilford, "the DE200 can be accurately described as a random-access display." To show a message, a microprocessor simply writes the ASCII character codes into the appropriate display locations. Display changes are instantaneous, with no line-shift effect. The added capability to insert a period or comma after each character suits the DE200 for the display of all arith-

metic and linguistic expressions.

The micro-display tube utilizes fluorescent technology with a starburst character design. Displayed characters are uniformly bright without matching or alignment problems and are readable to 20 feet in high ambient light.

The price of the DE200 display, complete with all interface and refresh electronics, is \$250. Delivery time is 30 days. With the optional microprinter, the DE68 is priced at \$3,500. Delivery time is 60 days.

Digital Electronics Corp., 415 Peterson St., Oakland, Calif. 94601 [371]

General-purpose interface developed for 8080

The UPC 6001 is a general-purpose interface circuit designed to act as a subcontroller between an 8080 or 8080A microprocessor and such peripherals as cassette recorders, floppy disks, punched-card readers, card punches, display terminals, communications channels, and printers. It can also provide full control for direct memory access (DMA) operation. The n-channel silicon-gate MOS device contains control and status registers that are programmed to handle single-character, block (multicharacter), or multiblock transfers on a DMA or interrupt basis. All control logic needed to implement these transfers is contained in the 6001 circuit.

The interface circuit can administer 16 distinct commands that are generated by the microprocessor. The TTL-compatible device is housed in a 40-pin dual in-line package. Delivery is from stock.

SMC Microsystems Corp., 35 Marcus Blvd., Hauppauge, N.Y. 11787. Phone (516) 273-3100 [373]

13-bit a-d converters have three-state outputs

A series of analog-to-digital converters with 13-bit resolutions and accuracies up to 13 bits has three-



1702A MANUAL EPROM PROGRAMMER

Features hex keypad, two digit hex address and two digit hex data display. Controls include load, clear, go! (step), key/copy, data in/data out, and counter up/down. Profile card includes high voltage pulse regulator, timing, 8 bit address and 8 bit data drivers/receivers. Two 6½" x 9" stacked cards with spacers. Allows programming in 20 minutes — copying in 5 minutes. Requires +5, -9, and +80 volts.



ASSEMBLED \$299.95
KIT \$189.95

NOW

The best of two worlds... use our 1702 EPROM programmer as a manual data/address entry programmer... or connect it to your processor.

IMSAI/ALTAIR computer interface (requires 3 output ports, +1 input port) and software \$49.95

Briefcase unit with power supplies and interface connectors (assembled and tested only) \$599.95

ANNOUNCING

Our NEW 16K Byte Pseudo-Static, IMSAI/ALTAIR compatible RAM. Single card slot. Uses less power than equivalent low power RAM. All memory chips socketed. Uses all prime, factory fresh ICs. High quality, two-sided, through-hole-plated circuit board. Crystal controlled, totally invisible refresh system requires NO software management. Just plug it in and use like STATIC memory.

Complete kit \$349.95
Assembled, tested, and burned in \$549.95

ASSOCIATED ELECTRONICS

12444 Lambert Circle • Garden Grove, CA 92641
(714) 539-0735

Circle 230 on reader service card

TEC Has Some Interesting New Products For Your New Ideas



**S-106
SNAP MOUNT**
momentary or alternate action switch/indicator. provides ½" square button with form "A," "B," or "C" contacts, or indicator only. The S-106 is available with a variety of lens colors for 5, 12, or 24 volt operation.



**L-100
PRESS FIT**
indicator eliminates the need for mounting hardware. The L-100 and L-101 provide a low-cost neon or LED panel mount indicator with a fluted lens for excellent side angle viewing. An internal resistor allows a variety of operating voltages.

*If someone beat you to the form, just drop us a note:
TEC, Incorporated, 2727 N. Fairview Ave., Tucson, Ariz. 85705*

Please rush me a sample of the ___ S-106 ___ L-100

My application is _____

___ I would like a copy of your 1976 catalog.

Name _____

Company _____

Address _____

City, State, Zip _____



TEC, Incorporated
2727 N. Fairview Av., Tucson, AZ 85705

Circle 111 on reader service card

This Publication is Available in MICROFORM

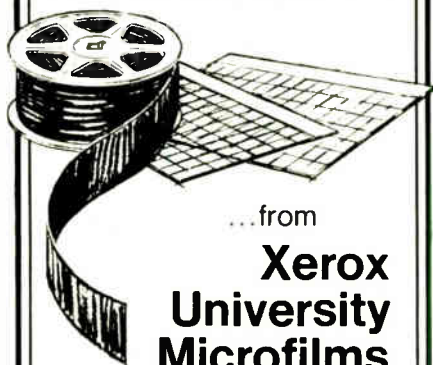

...from

Xerox University Microfilms

300 North Zeeb Rd.,
Ann Arbor, Mich. 48106
(313) 761-4700

PLEASE WRITE FOR COMPLETE INFORMATION

Electronics / September 30, 1976

MICROPROCESSOR SERIES NO. 4

2650 SUPPORT CKTS ARE ALL MULTI-SOURCED.



Available:
interface, ROM,
RAM, PROMs/
EROMs. Coming:
PPI, PCI, A-D
Converters, SDLC.
Specials from
AMS, too.

Attach to your letterhead.
Put me on your reservation list for
the first mailing on upcoming 2650
Interfacing Circuits.

Name _____ Title _____

Tel. _____ M.S. _____

811 E. ARQUES, SUNNYVALE, CA. 94086

THINK

Signetics μ P

a subsidiary of U.S. Philips Corporation

Circle 144 on reader service card

HERMES LOOP ANTENNA

THREE SAMPLE SITES
ON THE NORTH AMERICAN
CONTINENT —

DIFFERENT LATITUDES
DIFFERENT CLIMATE



64°N



42.5°N



32.5°N



Good Listeners maintain a low profile

Even in the solitude of the forest depths, from rooftops, arctic tundra, swamps to sweltering tropics, 'neath snow, sand or ice,

the Hermes Loop antenna keeps an ear to the sky.

The amazing aperiodic antenna does away with vast log periodic and rhombic arrays - those towering antenna farms.

In rosette configuration, the Hermes loop antenna provides an omnidirectional broadband receiving array in space merely 1/100th that of the traditional antenna farm.

More than 53 government agencies around the world have pressed the loop antenna into service.

A new, even more compact version is available.

Only Hermes Electronics makes it.

**2-32MHz
BROADBAND**



ASK US Send for our Brochure

Hermes Electronics Limited

Suite 315

2020 F Street NW

Washington, DC 20006 USA

202-296 2978

TWX 710 822 1106

New products



state TTL-compatible outputs for easy interfacing to microprocessor buses. All units in the series 6100 line include automatic zero correction, an internal reference, and an overrange flag. A multi-slope integration technique allows the converters to combine high accuracy with low price.

Housed in modules that measure 2 by 3 by 0.4 inch, the converters accept bipolar inputs and provide 2's complement binary outputs. Unit prices start at \$69. Delivery is from stock to 30 days.

SGR Corp., Neponset Valley Industrial Park, P. O. Box 391, Canton, Mass. 02021. Phone (617) 828-7773 [374]

Low-cost line printer puts out 2,400 lines/minute

Intended for use with microprocessor-development systems, a standard 80-column line printer will print at speeds up to 2,400 lines per minute. A 132-column version of the unit has a maximum speed of 1,400 lines per minute. Priced at only \$3,000, the printer is said to be able to cut labor costs by reducing three hours of teletypewriter operation to about five minutes, thus practically eliminating the time people waste waiting for output. System interface signals are such as to ease operation of the line printer with most microcomputer

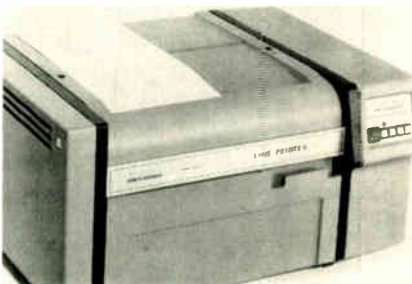

BURN-IN TRAYS

- **HI-DENSITY** trays in programmable and dedicated styles

- **STANDARD** tray sizes fit most ovens

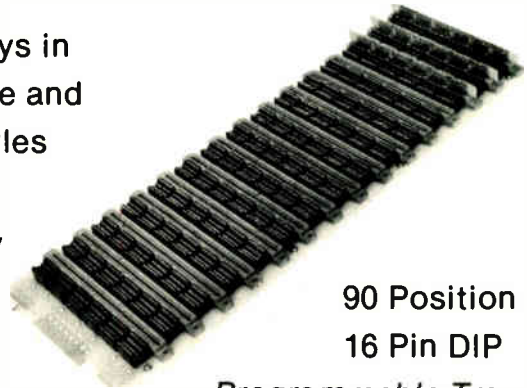

90 Position
16 Pin DIP

Programmable Tray

- **PROGRAMMABLE** trays for popular case styles
- **DEDICATED** trays made to your circuit
- **CUSTOM** trays made to your requirements

WAKEFIELD-SYSTEMS

Engineering, Inc.

Division

Audubon Road Wakefield, Mass. 01880
(617) 245-5900

AN COMPANY

Circle 113 on reader service card

MICROPROCESSOR SERIES NO. 5

**2650 CRASHPROOF
DEVELOPMENT SYSTEM:
TWIN
WITH DUAL FLOPPY DISKS.**



TestWare INstrument (TWIN) lets you develop software and hardware *together* in an actual environment.

Clip to letterhead. Mail now. Please send me 2650 Short Form Catalog full data on TWIN.

Name _____ Title _____

Tel. _____ M.S. _____

811 E. ARQUES, SUNNYVALE, CA. 94086

THINK

Signotics μ P

a subsidiary of U.S. Philips Corporation



COIL-LER



STOCK P.C. POWER TRANSFORMERS

- For use with 3-terminal IC voltage regulators
 - Printed circuit mounting
 - For power supplies for most integrated circuit families
- TTL LOGIC ECL LOGIC
CMOS LINEAR-OP AMPS
- 36 models in stock

Write or phone for complete data sheet.

CUSTOM TRANSFORMERS, COILS, TOROIDS

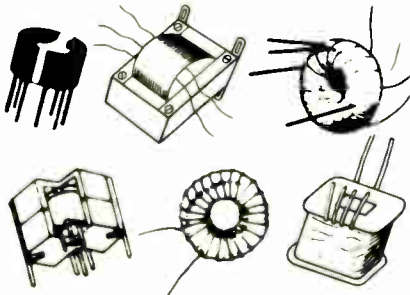

Our precision manufacturing facility produces a full range of medium, miniature or ultra-miniature size transformers and coils — bobbin or toroidal wound. We can meet both your specs and your delivery dates whether for prototype, small or large productions runs. Our experienced engineers are at your service.

Write or phone for information or quotes.



2-E Town Line Circle Rochester, N.Y. 14623
716/442-6630
Representatives in Principal Cities

New products

systems, the company says. Houston Instrument, One Houston Square. Austin, Texas 78753. Phone (512) 837-2820 [375]

Interface devices made for LSI-11 microcomputer

More than two dozen interface and logic-module products for the Digital Equipment Corp. LSI-11 microcomputer are now available from MDB Systems. Among the devices are power supplies; general-purpose logic modules such as the 11B DMA controller; input/output modules for such peripherals as line printers, card readers, and paper-tape

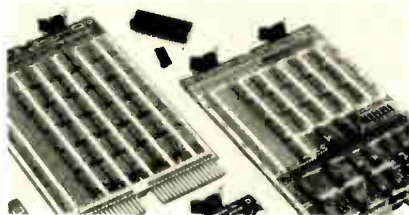

reader/punch controllers, and communications modules for both synchronous and asynchronous serial lines.

Accessory hardware for the LSI-11 includes the DEC-manufactured H9270 backplane/card-guide assembly as well as MDB's BPA84 version, which has double the capacity. The MDB version also mounts in the BA11 standard 19-inch expander chassis complete with cooling and front panel.

MDB Systems Inc., 1995 N. Batavia St., Orange, Calif. 92665. Phone G.M Sylvester at (714) 998-6900 [376]

Modular design enhances microcomputer versatility

A microprocessing system that permits easy adaptability to a wide variety of applications derives its flexibility from its modular construction. The Omnibyte System consists of a family of standard-size cards

Additional copies of 1976 EBG available.

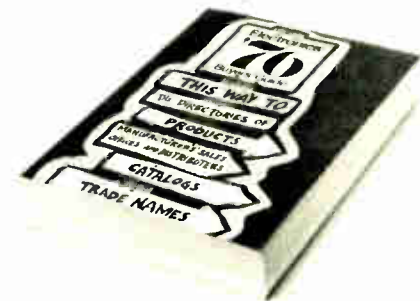

If you purchased a copy of the 1975 EBG, you are probably one of the EBG users responsible for the 91,000 orders of catalogs through our Catalog Service section. You are also probably one of the EBG users who purchased some of the 4,000 products listed in the Products section.

But, most important, you are probably one of the EBG users who has found that from our easy-to-use, single volume, you can get more electronics product and manufacturer directory information, and can obtain more current catalogs, than from anywhere else in the world.

To get a copy of the 1976 EBG, complete the following order form, enclose your payment and place in the mail.

Electronics Buyers' Guide
1221 Avenue of the Americas
New York, N.Y. 10020 USA
Attn: R. Hera-42

- Please send me _____ copies of the 1976 EBG. The cost for copies going to addresses in the U.S. and Canada is \$25. Outside the U.S. and Canada, the cost is \$35. Payment must be enclosed with order.
- If you want overseas copies *air-mailed*, add \$12 per copy.
- My payment is enclosed.

Name _____
Company _____
Street _____
City _____
State _____ Zip _____
Country _____

Electronics/September 30, 1976

New products

that plug into a bus-oriented backplane.

Designed around the Motorola MC6800 microprocessor, the system can be viewed as a microcomputer that contains input/output electronics, or alternatively as an intelligent I/O system that includes a microprocessor and its associated memory. In addition to the CPU board, the system includes various memory cards, communications interface cards, a dual 12-bit digital-to-analog converter card, and a general-purpose card that provides the interface to the backplane and leaves the remainder of the card available for custom circuitry.

A few representative prices are \$295 for the CPU board, \$275 for a card containing 4 kilobytes of read-only memory and 2 kilobytes of read/write memory, and \$80 for the general-purpose card.

Omnibyte Corp., 900 Jorie Blvd., Oak Brook, Ill. 60521 [377]

Open-frame supplies are built to UL standards

The SMP series of open-frame power supplies consists of multiple-output units that offer various combinations of 5, 9, and 12 v dc for direct powering of any popular microprocessor family. All are regulated to within 0.1% for both line and load, and all exhibit a typical ripple of just 0.5 to 2 millivolts rms. The supplies operate from ac lines over the range from 47 to 440 hertz and offer automatic fold-back current-limiting short-circuit protection. Set at the factory to 110% of rated load current, the short-circuit protection is adjustable from 20% to 150%.

Available with power ratings from 40 watts to 160 w, the SMP series units are built to Underwriters' Laboratories recognition standards for electronic data-processing equipment for office use. Single-quantity prices start at \$69.

Standard Power Inc., 1400 South Village Way, Santa Ana, Calif. 92705. Phone (714) 558-8512 [378]

33% more power to the people.

Power/Mate presents Econo/Mate II.

The open frame power supply.

Now Power/Mate brings you 33% more power in the same package size with the second generation of our Econo/Mate series.

The size is the same, the basic components are the same for easy interchangeability. But that's where the similarity ends.

Econo/Mate II adds features like dual AC primary and a plug-in IC regulator for improved regulation.

And Econo/Mate II is tough. Computer design, quality control and Power/Mate's experience helps insure 100,000 hr. MTBF even at this higher power output.

But for all its features, Econo/Mate II is still, most of all, economical.

We wouldn't call it Econo/Mate if it wasn't.

Econo/Mate II is in stock, ready for delivery. Send for our free brochure.

Prices start at \$19.95.

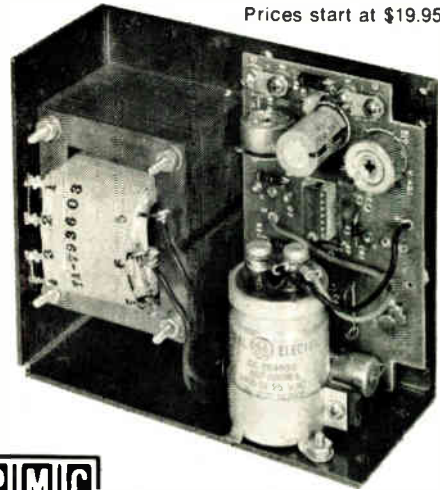

P/M/C

POWER/MATE CORP.

World's largest manufacturer of quality power supplies.

514 South River Street/Hackensack, N.J. 07601 / Phone (201) 343-6294 TWX 710-990-5023

Circle 115 on reader service card

MICROPROCESSOR SERIES NO. 6

2650. APPS ENGINEERS: IN STOCK NOW.

Dozens of people to support systems, hardware, testware, devices in USA and Europe. More coming

Attach to your letterhead. Mail. Send me the list of 2650 Applications Engineers with addresses & phone numbers.

Name _____ Title _____

Tel. _____ M.S. _____

811 E. ARQUES, SUNNYVALE, CA. 94086

THINK

SINOTICS μ P

a subsidiary of U.S. Philips Corporation

Data handling

**Floppy disk
in miniature**

Challenging cassette units,
system is designed for
word-processing, other uses

In servicing the computer industry, floppy-disk systems have grown to produce a comfortable \$36 million a year in sales. However, its lack of portability has until now kept the floppy out of such high-growth markets as word-processing, which have been dominated by the smaller tape-cassette drive.

Aiming to chop away some of the tape-cassette's market share, Shugart Associates has begun production of a miniaturized floppy-disk system that has a third the capacity, is half the size, and costs half as much as the standard floppy. The Minifloppy system (shown in photo with a standard unit) offers designers of minicomputers and microprocessor systems the random-storage capability of the floppy disk in a package the size of most cassette-tape units, says George Sollman, product manager.

Intended applications include word-processing and text-editing systems, minicomputer and microcomputer program storage, power-typing systems, intelligent desktop calculators, and microcomputer stor-

age, a fast-growing market. Also being introduced as part of the system are the SA104 and SA105 minidiskettes and the SA4400 Ministreaker, which can control as many as three Minifloppy drives.

Priced at \$390 in single quantities and about \$250 in volume, the SA400 Minifloppy is based on the proven technology of the Shugart SA800 drive, but it is less than half the price. The data-transfer rate is 125 kilobits per second, the size is only 3.25 by 5.75 by 8 inches, and the weight is three pounds. Sollman says it also has a new direct-drive stepping-motor actuator, which uses a spiral cam. Ac power requirements have been eliminated, he adds, through the use of a dc servo-controller spindle-drive subsystem.

In contrast to the 8-inch diameter of the standard floppy diskette, the minidiskette is only 5.25 in. across and provides 89.6 kilobytes of formatted data, which is about a third as much as the standard configuration. Track density is 48 per inch, maximum recording density is 2,581 b/in., and total unformatted capacity is 109.4 kilobytes. The 35 tracks, which can be formatted for 128 or 256 bytes per sector, will be available in either the soft-sectored SA104 or the hard-sectored SA105. The minidiskettes are priced \$45 each for a box of 10, but the price drops to about \$35 each in large OEM quantities, Sollman says.

The Ministreaker controller, built with large-scale integrated circuits on a 7-by-11-in. printed-circuit board, provides on-line storage ca-

capacity of 241.8 kilobytes. Using the IBM 3740 format with modified gap structures and a 128-byte buffer, the controller operates with a bidirectional input/output. It also provides direct track/sector addressing, asynchronous transistor-transistor-logic host interface, seek overlap, and a simplified command structure. The minicontroller is priced at \$490 each, and this drops to about \$330 each in quantity. Delivery time is about 60 days.

Shugart Associates, 435 Indio Way, Sunnyvale, Calif. 94086 [361]

**Joystick works with
Tektronix graphics system**

Adding to its line of low-cost peripheral devices for the Tektronix 4051 graphics system, Second Source Industries is introducing its model 2005 digitizing joystick. The



model 2005 combines precision potentiometers and variable-resolution electronics to avoid the lag between control-lever position and cursor position imposed by competitive devices that use integrating controls.

A further example of human engineering in the digitizing joystick is its control console, which provides sufficient surface to allow comfortable single-handed operation. While maneuvering the control lever, users have only to extend a finger to activate the cursor-centering switch or the two-position resolution control.

Drawings and schematics may be rapidly digitized by the model 2005 if it is combined with the model 2015 digitizing interface. This feature is configured by mounting the joystick

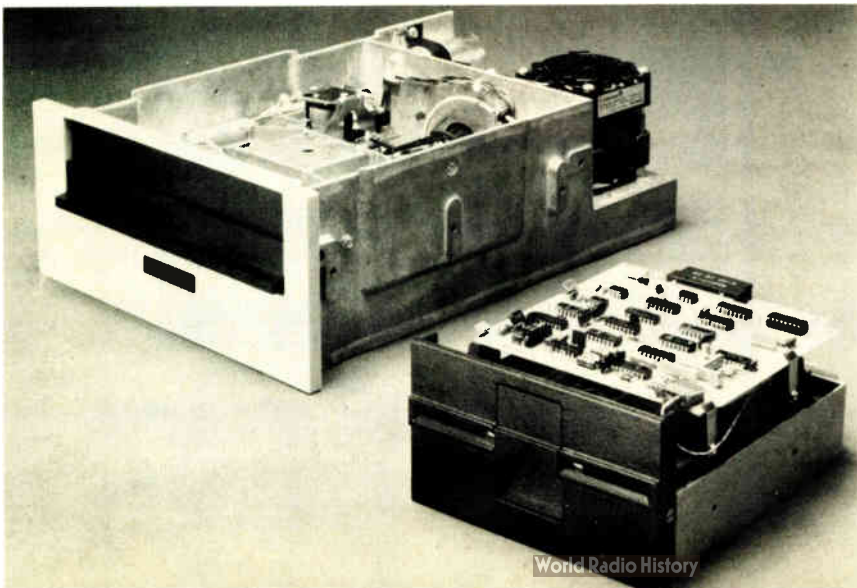

on a copy stand and coupling the control lever to a mechanical telescoping wand.

The digitizing joystick sells for \$380, while digitizer option 2015 is priced at \$135. Both units have a delivery time of 30 days. Large-quantity discounts are available.

Second Source Industries, 906 Treat Ave., San Francisco, Calif. 94110. Phone (415) 282-1171 [363]

D-a board designed for LSI-11 microcomputer

Contained on a single printed-circuit board, the model 600-LSI-11D digital-to-analog system is designed to

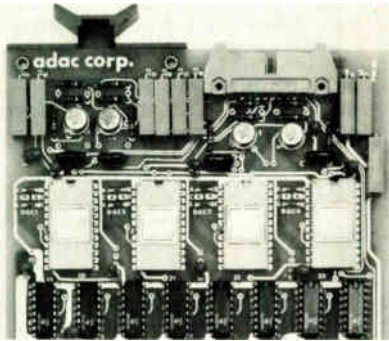

provide LSI-11 microcomputer systems with a visual display of valid data without the extraneous data that usually is generated during updating intervals of a digital-to-analog-converter. Compatible with the LSI-11 and the PDP-11/03, both of which are made by Digital Equipment Corp., Maynard, Mass., the 600-LSI-11D consists of a bus interface, a dc-to-dc power converter, an oscilloscope control, and one, two, three, or four 12-bit d-a converters. The full four-converter system sells for \$850.

If the system's full 12-bit performance must be maintained even when the analog outputs are located far from their intended loads, it may be necessary to add a remote-sensing lead to one or more of the d-a converters. This option adds \$20 per channel.

Adac Corp., 15 Cummings Park, Woburn, Mass. 01801. Phone A.L. Grant at (617) 935-6668 [364]

Solar photovoltaic - greater output now at lower cost!

**Fuel and Maintenance Free
Long Term Reliability for All
mW to KW Applications!**

Unlimited, clean, dependable electric power wherever you need it. Life cycle cost lower than primary batteries and fuel operated generators. Thousands of Solarex panels and systems in use throughout the world.

1335 Piccard Drive/Rockville, Md. 20850
301-948-0202/TWX: 710-828-9709/Cable: SOLAREX



SOLAREX CORPORATION
 CELLS PANELS
 SYSTEMS

All sizes
to 4" diameter
Chevron™
cells (shown)

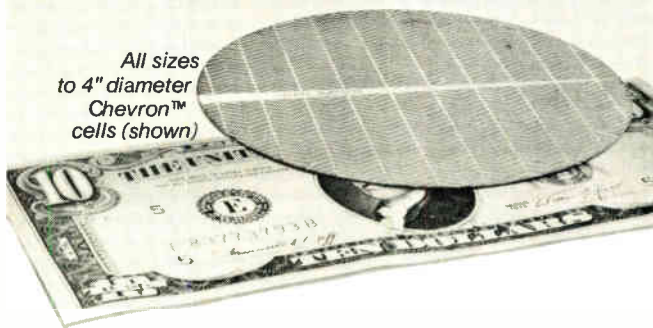

Circle 117 on reader service card

MICROPROCESSOR SERIES NO. 7

**BY SEPTEMBER
THE 2650 IS OVER
30% FASTER.**

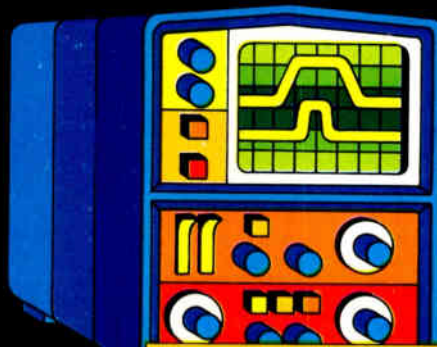

Your system's features can be extended with the speedier 2650. Current 2650 software will apply.

Clip to your letterhead.
Put me on your reservation list for the first mailing of the faster 2650 data sheet.

Name _____ Title _____
Tel. _____ M.S. _____
811 E. ARQUES, SUNNYVALE, CA. 94086

THINK

Signetics μ P
a subsidiary of U.S. Philips Corporation

The easiest-to-use microprocessor

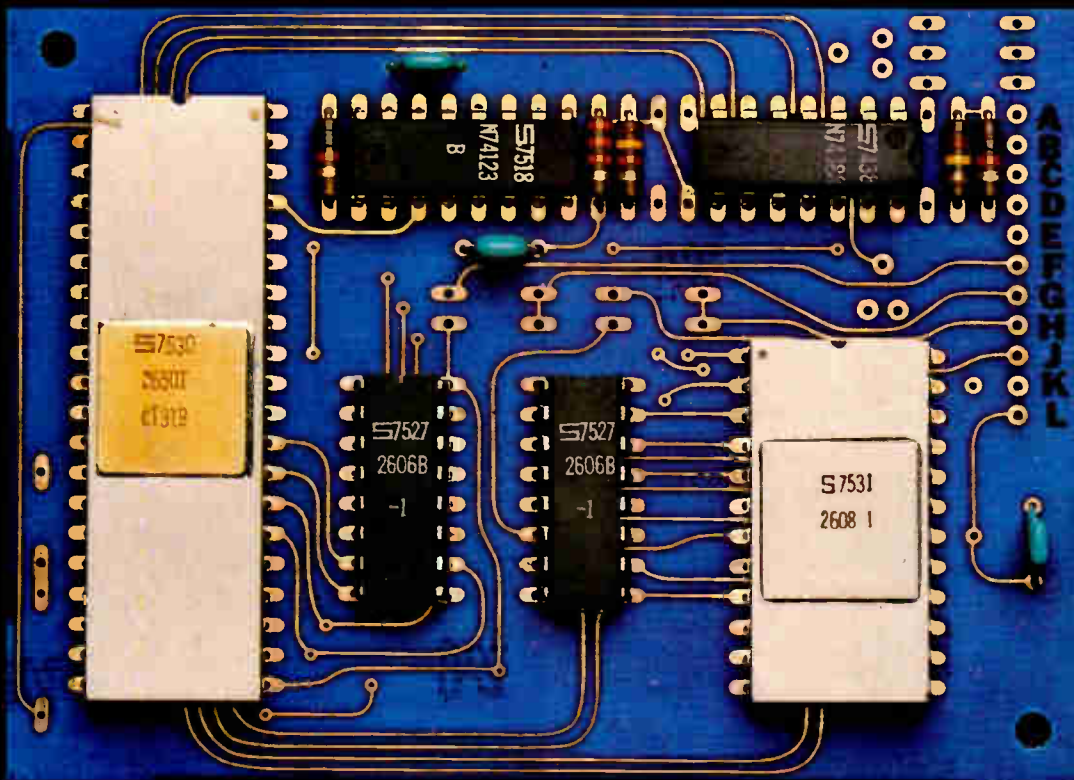

(Photograph approximately 2x actual size.)

The single-chip 2650 is easiest-to-buy, too. Now only \$21.50 (100-up).

Full support of customer and product is the key to ease of development with the 2650. Applications engineers in the U.S. and abroad are at your beck and call at every stage. Software for almost anyone's requirements and machines. Development hardware is versatile and inexpensive. All circuits are multi-sourced.

Flow Chart: How to travel safely and quickly from spec sheet to your μ C.

1 Applications Engineers — in the field now, more coming. Specific assistance to you is available around the USA, and in Belgium, Holland, Germany, France, Sweden, Britain, Italy, etc.

2 Multi-sourced 2650 — available in any quantity from Signetics, at the unprecedented low price of \$21.50. Also available from AMS and Philips, and from Signetics' authorized distributors.

3 Development Software — includes the PL μ S, an extremely efficient High Level Language (compiler) that reduces programming effort and cuts development time. ANSI standard Fortran IV executes on most machines without alteration. 2650AS1000/1100 Assembler and 2650SM1000/1100 Simulator are available in both 32- and 16-bit, on GE and NCSS time-sharing.

4 Multi-sourced Support Circuits — You'll need MOS and/or Bipolar Memories, Interface and Logic. Signetics has *everything* for a complete system. Back up any item from other sources. Coming soon from Signetics are: Programmable Peripheral Interface and Communications Interface, A-D Converters, Synchronous Data Link Controller, 16k NMOS & Bipolar ROMs, 4k & 8k NMOS EROMs, and 8k Bipolar PROMs.

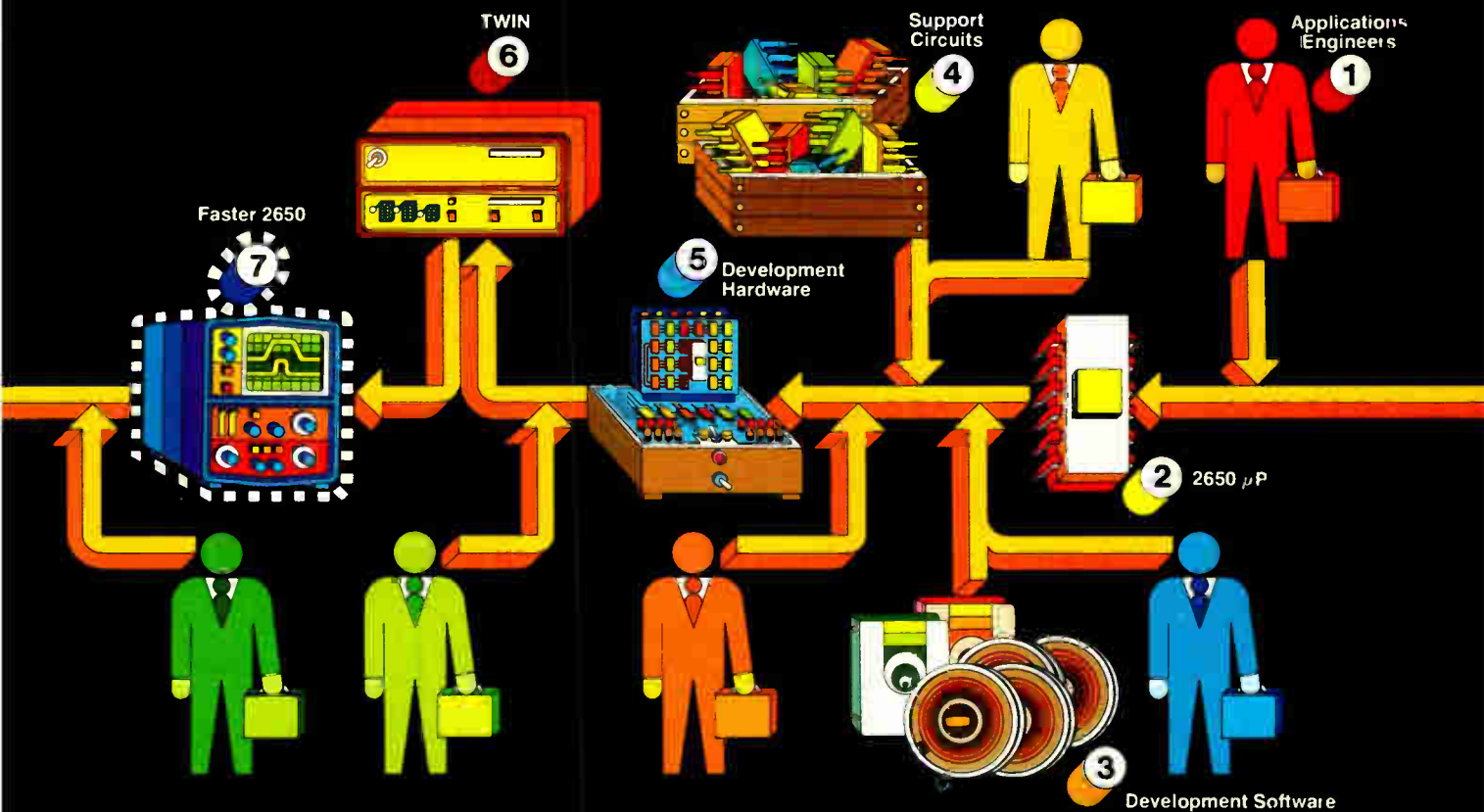

makes the easiest-to-develop microcomputer.

- 5** **Development Hardware** — Design/develop prototype with a variety of cost/capability levels of hardware support. Including prototyping cards and kits, smart typewriter demo card, 4k-byte RAM card, and more. Applications help if you need it.
- 6** **TWIN With Floppy Disks** — “crashproofs” your system checkout. With DOS, Resident Assembler, and Text Editor. You develop programs and circuits together in an actual system environment with TWICE (*TestWare In Circuit Emulator*). PROM programming, too.
- 7** **Over 30% Faster 2650** — By the time you’ve proven out your μC , you’ll have available a faster 2650 if you want it. Uses the same software. For still higher speeds, call Signetics Bipolar Microprocessor Marketing about our 2650 emulator using 3000 series μP .

You go from gleam-in-your-eye to proven prototype in less time for less cost, and the μC you develop is easier and cheaper to produce in quantity, when you start with the 2650. Start now by mailing the coupon.

Attach this to your letterhead for fast response.

Send me complete 2650 short form catalog.

Have a Field Applications Engineer call me for appointment.

My need is: immediate 6 months information only

My application is _____

Name _____ Title _____

Telephone _____ Mail Stop _____

THINK Signetics μP
a subsidiary of U.S. Philips Corporation

811 E. Arques Ave., Sunnyvale, Ca. 94086

New products

Packaging & production

System speeds data on yields

Integrator gives managers real-time information on semiconductor test results

With the increasing use of complex large-scale integration, real-time information about what is happening on the production line is a necessity to managers and executives.

That is why Fairchild Systems Technology division has developed an integrator, a minicomputer-based system for processing and displaying test data. It was introduced at Wescon, along with Sentry VII, the most powerful to date of Fairchild's Sentry series of test systems for logic and memory.

"The integrator is an entirely new concept in semiconductor testing," says Brian Sear, division manager. "Previous approaches gave managers and executives the information, but in basically uncorrelated form. And even though management might get information about yields in minutes or hours, it took days or weeks to understand it and determine where problems were occurring. And by that time, the whole process could be down the tubes."

The new system, Sear says, integrates raw test data from systems on line to tell managers at every level exactly what's going on in the complex process from silicon to board to system. The integrator is a data-processing center with software designed specifically for users and manufacturers of semiconductor devices. Among other things, it provides centralized processing from many test stations and systems. Task-oriented software makes available reports in various forms, including histograms, schmoo plots, wafer maps, and scatter plots.

Both the hardware and the software of the Sentry VII and Fairchild's Xincom III are designed to

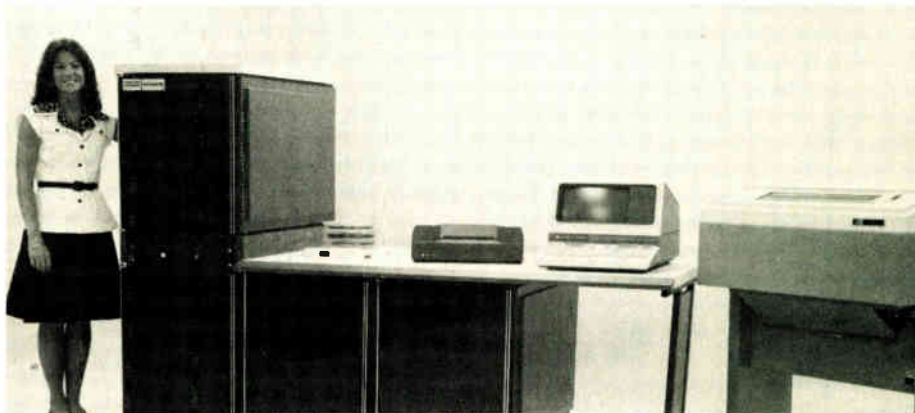

communicate with the integrator's host computer. "This removes the data-management burden from the testers," says Sear, so that they can concentrate on testing. Reports such as yield as a function of process parameters can be generated with ease.

The new Sentry VII tester retains all the advantages of earlier models, such as modular microprocessor architecture that can be configured to solve most testing problems; subroutine nesting to 16 levels, conditional and unconditional branching, and program generation through loop counts. It also provides up to 196 kilobytes of 24-bit-wide core memory and up to 4 kilobytes of local memory. Eight timing generators with 160-picosecond resolution produce highly accurate timing. And for those who may want to add additional programmable instrumentation, the Sentry VII is fully compatible with the IEEE 488 (or HP-HB) interface bus standard.

Base price of the integrator is \$50,000; of the Sentry VII, \$200,000.

Fairchild Camera & Instrumentation Corp., Systems Technology Division, 1725 Technology Dr., San Jose, Calif. 95110 [391]

Chip-carrier memory package offers high density

Designed for use with 4,096-bit RAM devices, a new memory package employs chip carriers to increase circuit density. Memory chips are assembled and tested on the carrier,

which is then reflow-soldered directly to a memory module and handled as a dual in-line package. Interconnections between two or more chips are accomplished through internal circuitry in the carriers' multilayer ceramic substrates. In addition to effectively doubling density, the concept allows selectivity of pretested devices and repairability after they are placed on the mother board. Memory modules are available with row-center spacing of 0.300, 0.400, or 0.600 inch.

3M Co., P. O. Box 33600, St. Paul, Minn. 55133 [393]

Test-socket series accepts most chip carriers

Designed to accommodate all currently-available chip carriers with 14 to 18 leads and body sizes as large as 0.500 in.², Textool's chip-carrier socket series is available in a wide variety of materials suitable for both test and burn-in applications. The sockets incorporate a positive-locking, hinged-lid system that inher-

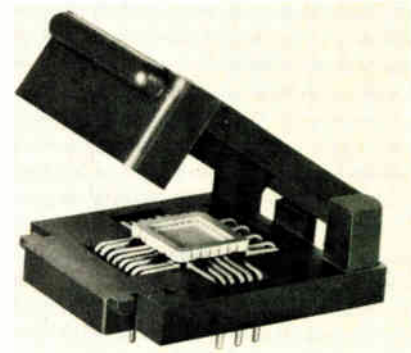

ently eliminates shorting and facilitates fingertip loading and unloading. The lid has an adjustable pressure-pad to secure thin or thick packages, and its minimal overhang at the back of the socket and integral mounting holes permit high circuit-board density. With minor tooling-changes, the sockets will also accept plastic packages less than 0.500 in.² with two- or four-side, straight or formed leads. Pricing in quantities of 100 ranges from \$7.34 for the 14-lead to \$11.51 for the 48-lead model.

Textool Products Inc., 1410 W. Pioneer Dr., Irving, Texas 75061. [394]

PROM programmer has three modes, buffer RAM

The series-1000 microprocessor-controlled programmer for programmable read-only memories offers fully interactive operation by keyboard entry, terminal control, or remote



computer control. An onboard 4,096-by-8-bit RAM permits editing of data, and a 14-digit hexadecimal display gives four digits each of address, copy-PROM data, and master-PROM data, plus a two-digit entry and error code. The keyboard enables the user to list, copy, program, verify, or transfer to remote computer control. An RS-232 and TTY interface is standard and includes a selectable baud rate. PROM personality modules are available for all standard MOS and fusible-link PROMs. Cost of the programmer is \$1,295, and PROM modules are \$250 to \$295; delivery time is three weeks.

Electronics/September 30, 1976

International Microsystems Inc., 122 Hutton St., Gaithersburg, Md. 20760. Phone (301) 840-1078 [395]

Gang terminal-insertion tools speed installation

Fast in-line insertion of multiple terminals with a single press operation is made possible by a series of tools designated models P188 to P198. While insertion rates as high as 1,200 per hour are attainable with the P186-1 arbor press, the terminals may also be hand-inserted for prototype or low-volume production. Using the press in conjunction with an alignment block, up to 43 terminals may be simultaneously inserted. The P196 tool installs T46-5 terminals (0.025-in.² posts) which, when inserted 0.25 inch above and 0.50 inch below the circuit board in two 0.10-inch grid rows become I/O headers and mate with standard female insulation-displacement connectors. The gang terminal-insertion tools are priced as low as \$4.35, and special tool configurations may be designed per customer request.

Vector Electronic Co., 12460 Gladstone Ave., Sylmar, Calif. 91342. Phone Floyd Hill at (213) 365-9661 [396]

Fast laser scriber offers pre-alignment

Using CO₂ lasers ranging from 50 to 300 watts, the KCS series laser-scribing system is designed for high-production scribing of ceramic substrates. Throughput is greatly increased with an optional pre-alignment station which allows the operator to align a wafer while another is being scribed. The scribing table permits 4.75-inch travel in two directions, and the system includes particle collection and closed-circuit television, with an additional option of back-side scribing capability.

Korad, Division of Hadron Inc., 2520 Colorado Ave., Santa Monica, Calif. 90404. Phone Stan Parnas at (213) 829-3377 [397]

V/F-F/V CONVERTERS

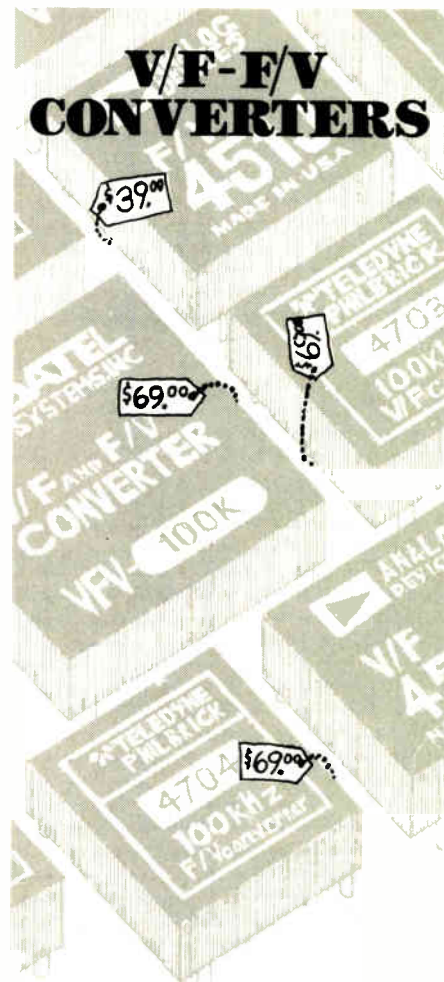

OR



The A-8400 is the world's first monolithic V/F/V with 12 bit accuracy, 100 kHz bandwidth and does both V/F & F/V functions all in a 14-pin DIP which gives you the easiest buying decision in years.

NOW we've made things even easier with the A-8402; a single supply V/F/V with 11 bit accuracy, 100 kHz bandwidth and a supply range from +4V to +18V all in a 14-pin DIP for **\$895**

intech

function modules

282 Brokaw Rd., Santa Clara, CA 95050
Tel. (408) 244-0500, TWX 910 338-0254

Circle 121 on reader service card 121

Instruments

**Scope probes
fit many models**

Units from Hewlett-Packard offer low input capacitances to minimize circuit load

Despite the extensive discussions about digital troubleshooting instrumentation, especially large bandwidth oscilloscopes, logic analyzers, and microprocessor testers, one part of the test system is often overlooked—the probes. What's needed is a probe that is small enough to hook onto closely-packed integrated-circuit pins and printed-wiring patterns while maintaining a low enough capacitance to minimize loading on the circuit that is being placed under test.

A series of scope probes from Hewlett-Packard Co. offers input capacitances as low as 8 picofarads and barrel diameters of 0.13 inch. Along with a new IC test clip, the probes can operate with a variety of oscilloscopes from HP and Tektronix, and their ranges of capacitance adjustment have been chosen to match the needs of different scope models.

Two of the probes are direct, 1:1 units, priced at \$35. The other five models in the series, which are priced at \$90, have 10:1 division ratios. The test clip, model 10024A, is priced at \$15.

The clip includes two ground-plane plates that are connected by springs that hold the clip in place on an IC. The clip's grounding pin can be inserted through the clip to contact any IC pin, which then becomes the ground reference for the clip.

Scope probes can then be inserted into any or all of the 15 other clip positions so that the probe tip is in contact with the IC pin, yet the probe barrel, which is part of the probe's shield, is in contact with the ground plane. The second part of each two-

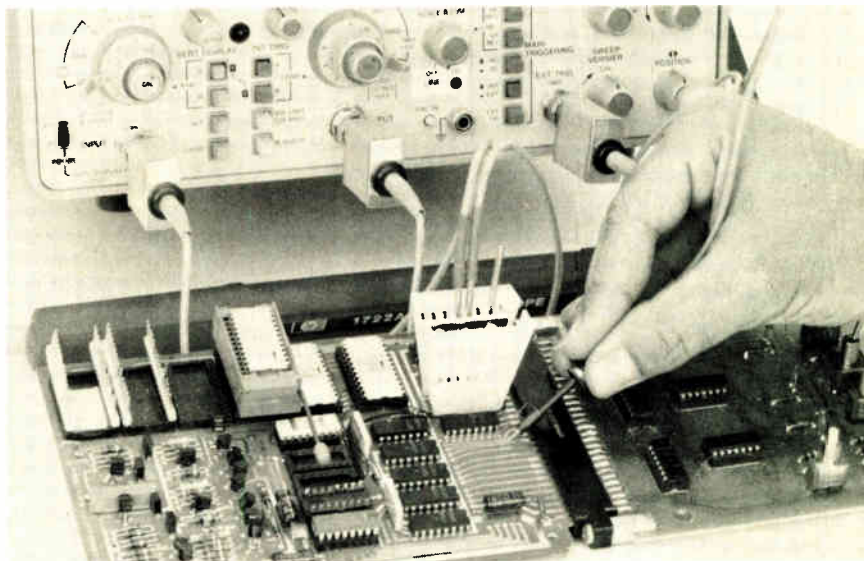

piece probe is a slip-on that converts the contact tip into a standard hooked, spring-loaded grabber, but about one third the size of previous scope probes.

In the 10:1 divider probes, precision film resistors are enclosed within the narrow probe body, and adjustment capacitors are at the scope-connector end.

Inquiries manager, Hewlett-Packard Co., 1501 Page Mill Rd., Palo, Alto, Calif. 94304 [351]

**Modular frequency counters
tailored to specific uses**

Although frequency counters have dropped in price and improved in performance over the past few years, there is still no single unit that can meet all frequency-counting needs in all applications. The variety of uses—from telecommunications and broadcasting to manufacturing and electromechanical measurements—is simply too broad.

The alternate approach, exemplified by Philips' introduction of five instruments at the Wescon show, is to offer several instruments that are built from the same standard modules, yet are differentiated by factory-installed options that tailor the instrument to specific applications. The Philips units fall into two series: the PM6660 series of automatic

frequency counters and the PM6620 series of timer/counters.

The PM6660 series includes two models: the PM6661, an 80-megahertz instrument, priced at \$325, and the PM6664, a 520-MHz unit, priced at \$675. Each has a single front-panel control—an on/off switch—and selection is automatic for trigger level, noise suppression, leading-zero blanking, and, in the case of the PM6664, range selection. The eight-digit, LED-display counters have p-i-n-diode attenuators that are continuously variable over a 50:1 range.

The PM6620 series includes three models: the 80-MHz PM6622, priced at \$965, the 520-MHz PM6624, priced at \$1,365, and the 1-GHz model PM6625, priced at \$1,565. Each has a second 80-MHz channel for measuring frequency, period, period average, multiple ratio, time interval, time-interval average, and totaling of counts.

Each of the PM6620-series counters has a sensitivity of 20 mV on the 80-MHz channels and 10 mV on the higher-frequency channels, a nine-digit gas-discharge display, three-state trigger indicators, and an external start/reset input. In addition, the PM6622 has a trigger hold-off control that can be checked by internal circuitry.

Each timer/counter is available with one of three time-bases: the standard unit, a temperature-con-

trolled crystal oscillator, priced at \$75, and one of two proportionally oven-controlled oscillators, priced at \$170 and \$535, respectively.

At the Wescon show, Philips also introduced two oscilloscopes: the PM 3212, a 25-MHZ dual-trace unit priced at \$1,095, and the PM 3243, priced at \$3,395.

Philips Test & Measuring Instruments Inc., 400 Crossways Park Dr., Woodbury, N.Y. 11797. Phone (516) 921-8880 [352]

Milliwatt standard has overload protection

Thermocouple sensors are capable of great accuracy, but they can easily be damaged by overloads without the user's knowledge. To protect its thermocouple, the model EPM-1 milliwatt test set incorporates an infrared sensor in its circuitry and in this way maintains a maximum uncertainty of 0.015 decibel from 10 hertz to 50 megahertz, 0.025 dB at 100 MHz, 0.04 dB at 200 MHz, and 0.05 dB at 300 MHz. The standard will hold its calibration for at least one year.

Designed primarily to measure power levels of 0 dbm \pm 2 dB with great precision, the EPM-1 can also be used to control the output level of any signal generator with a dc-coupled external amplitude-modulation input. Test heads for operation at impedances of 75, 124, 150 and 600 ohms are available. For telephone-company applications, the EPM-1 sells for \$2,250.

Sales Department, W & G Instruments Inc., 119 Naylor Ave., Livingston, N.J. 07039. Phone Ken Chipman at (201) 994-0854

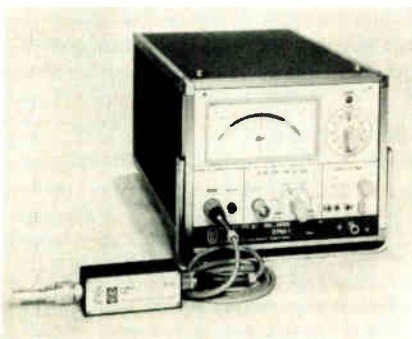

Analog ac meter displays volts and decibels linearly

When making voltage measurements on audio-frequency signals, it is sometimes convenient to measure in terms of decibels and sometimes



more useful to measure in volts. The Heath IM/SM-5238 ac voltmeter has a frequency response of 10 hertz to 1 megahertz \pm 1 dB, and has a pair of push buttons to select either volts or decibels for linear display on a mirrored scale.

The voltmeter is priced at \$89.95 as the model IM-5283 kit and at \$130 as the factory-wired and -calibrated model SM-5283. It has 12 full-scale ranges from 1 millivolt to 300 v or from -70 dB to +40 dB, with variable offset on the decibel scales.

Accuracy is within 4% of full scale on voltage ranges and within 1 dB on decibel ranges at 1 kilohertz. Rear-panel outputs proportional to both voltage and decibels permit the instrument to be used with a sweep generator and an X-Y recorder for automatic frequency-response plots.

Heath Co., Benton Harbor, Mich. 49022 [354]

Dual anti-aliasing filter has programable gain

For its first product, Precision Filters Inc., has come up with a dual anti-aliasing filter that provides at

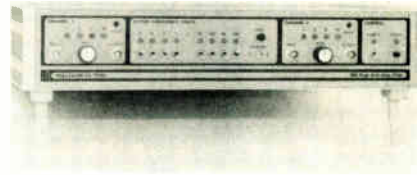

least a 2° phase match between its two channels all the way up to the cut-off frequency. This performance is provided by a pair of six-pole, six-zero, elliptic low-pass filters that cover the frequency range from 10 hertz to 150 kilohertz in unit steps from 1 to 15 in each decade range. By contrast, a pair of eight-pole Butterworth filters specified as having frequency accuracy within 2% may have as much as 20° phase mismatch at cutoff.

Each channel of the model 602 can be independently programed to have a gain of 1, 2, 5, or 10. Passband ripple is 0.1 dB peak to peak, and stop-band attenuation is at least 80 dB. The transition from the pass band to the stop band is extremely sharp—80 dB in one octave.

Price of the model 602 anti-aliasing filter is \$2,850.

Precision Filters Inc., 303 West Lincoln St., Ithaca, N.Y. 14850 [355]

TOPICS

Instruments

Data Laboratories Ltd., Mitcham, Surrey CR4 4HR, England,

is selling in the United States a transient-waveform recorder that can take a measurement every 0.05 microsecond. The single-channel DL920 and dual-channel DL922 made their U.S. debut at Wescon in Los Angeles.

Innovative Electronics Technology Laboratories Inc., Waltham, Mass.,

is marketing a pocket-size digital multimeter that weighs only 10 ounces. The battery-operated 3,000-count instrument measures less than 1.4 by 3.0 by 5.6 inches. . . .

Ithaco Inc., Ithaca, N.Y., has introduced its model 4302 dual filter. Each channel of the two-channel instrument can be set up as a high-pass or a low-pass filter.

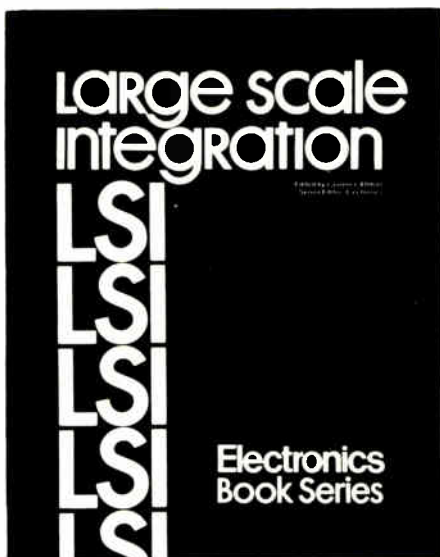

The Electronics Book Series offers you a handbook on the current and revolutionary impact of LSI on digital design. This 220-page book presents a unique opportunity for circuit designers, systems designers, and engineering managers and supervisors to bring their expertise into line with today's LSI design requirements.

Electronics Book Series
 PO Box 669, Hightstown, N.J. 08520

Send me _____ copies of "Large Scale Integration" at \$9.95 per copy.

I must be fully satisfied or you will refund full payment if the books are returned after ten day trial examination.

Payment enclosed Bill firm Bill me

Credit Cards Charge My Book To

American Express Master Charge
 Diners Club BankAmericard

Acct. No. _____

Date Card Expires _____

Interbank No. _____

1st No's. above name on Mastercharge only.

Name _____

Title _____

Company _____

Street _____

City _____

State _____ Zip _____

Signature _____

Electronics IS THE SOURCE FOR BOOKS, TOO



New products/materials

Epoxy surface coat EP3 is a two-part formulation that can be cured either at room temperature or in an oven to form a tough, flexible, protective coating for printed-circuit boards, components, and subassemblies. The clear material has a room-temperature viscosity of about 240 centipoises. Coverage is about 300 square feet per gallon. A 12-pound container of Eccocoat EP3 is priced at \$34.20. Delivery is from stock.

Emerson & Cuming Inc., Canton, Mass. 02021 [476]

A Teflon treating agent for the etching of Teflon and other fluoropolymers to make them more receptive to adhesives is noteworthy for its high viscosity. Chemgrip treating agent is said to be thick enough to be used for spot treatment of small areas in corners and on vertical and sloping surfaces. It contains an activated form of sodium, which, when brought into contact with a fluoropolymer, extracts fluorine atoms from the surface, forming a carbonaceous layer for adhesives.

Chemplast Inc., 150 Dey Rd., Wayne, N.J. 07470 [477]

Needle-fine solder with five-core rosin-flux construction is available in gauges from 22 (0.028 inch) to 34 (0.009 in.). The extremely fine solder is intended for the assembly of miniature electronic modules. It is offered in both 60/40 and 63/37 tin-lead alloys. Standard half-pound reels sell for \$2.50 to \$6.50 each, depending upon the gauge and quantity.

Multicore Solders, Westbury, N.Y. 11590 [478]

A shielding-gasket material called Duosil is made by simultaneously extruding a conductive mesh shielding strip with a controlled amount of shaped silicone rubber. The rubber permeates the mesh to form an integrated structure that combines ruggedness with the capability of forming a good seal, even at low closing forces. Principal use is in cable-television equipment.

Technical Wire Products Inc., 129 Dermody St., Cranford, N.J. 07016 [479]

npe PLASTICS SHOW '76

What's up in electronics?

“Plastics...that's what!”

Plastics' use in electrical/electronic applications could easily quadruple by the end of the century — reaching 6.8 billion lbs. Reason? A rapidly growing technology is leaning away from metal to plastics and plastic-enclosed devices. Stay on top of the dramatically advancing world of plastics at NPE/76, December 6-10, McCormick Place, Chicago.

NPE/76 will be the most comprehensive U.S. plastics exposition in the history of this vital industry. More than 400 participating companies with more of everything... nearly 300,000 square feet of exhibits... new products... and equipment... design consultation services... educational seminars on plastics technology and applications... a cornucopia of new ideas and techniques to spark your company's profits... all available in one place, at one time, under one roof!

New convenience and economy too.

For the first time, a single economical registration fee entitles you to explore your special interests at the exhibits of the National Plastics Exposition as well as attend the eleven seminars of the concurrent National Plastics Conference. The low fee also includes unlimited free bus service between major hotels and McCormick Place.

Advance registration kit available.

Now you can register in advance for even greater economy and convenience. Your advance registration kit includes everything you need to pre-register at a price of \$7.50 (vs. \$10.00 at the door) as well as reserve your hotel room. To obtain your advance registration kit, write, or use the Reader Service Coupon. At NPE/76 you will have five, full, information-packed days. Plan to make the most of every minute.

Your competitive edge!

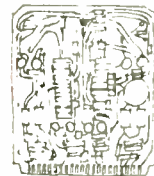

Electronics and plastics are inseparably linked. So there will be a lot of NPE/76 devoted to your specific interests.

- New materials
- New processes
- New applications

...and seminars on management, marketing, processing technology that will enable you to cut costs, increase sales, innovate, and plan for the future.

In the three years since the last Plastics Show, a lot has happened. The plastics industry moves fast. So catch up at NPE/76. Save time and money by registering in advance. Write The Society of the Plastics Industry, Inc., 355 Lexington Avenue, New York, N.Y. 10017, or... CIRCLE READER SERVICE NO. 125...

National Plastics Exposition 

Sponsored by The Society of the Plastics Industry, Inc.

CLASSIFIED SALES REPRESENTATIVES

Atlanta	Joe Lane	404 892 2868	Cleveland	Connie Byers	216 781-7000	Houston	Rick Olstie	713/659-8381	Philadelphia	Dan Ferro	215 568-6161
Boston	Hoti Buchanan	617 262-1160	Dallas	Rick Olstie	214 742-1747	Los Angeles	Stan Kassir	213 487 1160	Pittsburgh	Pam Petka	412 391 1314
Chicago	Bill Higgins	312 751 1733	Denver	Jay Johnson	303 266 3863	New York	Hoti Buchanan	203/359/2860	San Francisco	Mary Kenny	415 362-4600
			Detroit	Mac Huestis	313 873 7410		Dave Hawkstey	212/997/3594	XERO®	100 TELECOPIER	212 997-6800

POSITION VACANT

The Colorado School of Mines is seeking applications to fill a faculty position at the Assistant or Associate Professor level in the area of industrial electronics, control, and instrumentation for the Mineral Industry. Although a Ph.D. degree is desirable, experience in the area is more important. Research in the problems of the Mineral Industry is encouraged. Rank and salary depend upon qualifications. Send a letter of application and resume to Professor Henry A. Babcock, Basic Engineering Department, Colorado School of Mines, Golden, Colorado 80401. An Equal Opportunity Employer.

Product Safety Engineer

Tests and evaluates measurement products to applicable UL and CSA standards. Recommends design changes consistent with intent of circuit to achieve compliance with standards. Writes reports describing construction and tests to testing agencies.

Position requires a BSEE or equivalent; a minimum of 2 years design or test and evaluation experience and a good working knowledge of UL and CSA standards.

Tektronix, Inc. develops, manufactures and markets internationally recognized precision electronic measurement instruments, computer peripherals and related electronic instrumentation. Located near Portland, Oregon, we are within a two hour drive of the Cascade Mountains or Ocean Beaches. The close-by nature playgrounds and the City of Portland provide a variety of recreational and cultural interests.

We offer a competitive salary, profit sharing and an outstanding benefits package.

Please send resumes to: Bob Chambers, TEKTRONIX, INC., P.O. Box 500, E81, Beaverton, OR 97077.

An Equal Opportunity Employer M/F



TEKTRONIX
committed to
technical excellence

THIS SPACE AVAILABLE. ONLY \$322.

Your recruitment advertising in this seven inch space will cost you only \$46 per inch, or \$322.

You'll reach over 68,000 domestic engineers and technical people, as they're reading to combat job obsolescence, while they're thinking about their future and bettering themselves.

There's no charge for typesetting and free layout service is provided. For more information, call or write:

Electronics

Post Office Box 900
New York, N.Y. 10020
Phone: 212/997-2556

EMPLOYMENT SERVICE

Electronics' Industry Newsletter tells you which firms have current employment opportunities, in the field of Electronics, for all types of Engineers, Sales Representatives, Technicians, Executives, Computer Personnel and others. Latest product information is also reported. For information write: Electronics' Industry Newsletter, Dept. 304A, 23573 Prospect Avenue, Farmington, MI 48024.

ELECTRONICS ENGINEERS/MANAGERS

We are recruiting for nationwide openings. Client companies assume all costs & fees—Confidential. Send resume to Career Advisors, 125 Wolf Rd., Albany, N.Y. 12205—Affiliates in Key Cities.

We have been placing graduate **ENGINEERS** in **FEE-PAID** positions THROUGHOUT THE U.S. since '59. Over 1,000 client companies. We are graduate engineers working full-time for you. Send resume & salary history today or request confidential application.

ATOMIC PERSONNEL, INC.
Suite L. 1518 Walnut St., Phila., Pa. 19102
An Employment Agency
For All Technical Fields

Communication Engineers

**Make an impact in the design and development of advanced new products
in Long and Short Range Radio Communications.**

Harris Corporation, RF Communications Division has immediate career opportunities to support a corporate commitment to expand in the domestic and international communication markets. To meet this challenge we are seeking experienced communication engineers who are ready for increased responsibility and the chance to be recognized and rewarded for their professional accomplishments. Our headquarters are located in scenic upstate New York, where we enjoy year round recreational activities, numerous cultural events and one of the nation's best educational systems. Immediate opportunities exist for the following professionals and managers:

- Telephone System Engineers
- Sales Engineers
- International Area Managers
- Digital Engineers
- Mechanical Engineers
- Project Managers

Beyond the challenge and exposure you will receive, we offer an outstanding compensation and benefits program along with liberal relocation assistance.

- Systems Engineers and Managers
- Microprocessor Application Engineers
- RF Circuit Designers

For immediate consideration, please forward resume and salary history to: Personnel Dept. E.



1680 University Avenue
Rochester, New York
14610 U.S.A.

An Equal Opportunity Employer M/F

Job-seekers... be the first to know with McGraw-Hill's **Advance Job Listings**

By having our weekly ADVANCE JOB LISTINGS sent to your home every Monday you can be the first to know about openings both in and out of your field. AJL will enable you to contact anxious recruitment managers BEFORE their ads appear in upcoming issues of 21 McGraw-Hill publications. To receive a free sample copy, plus information about our low subscription rates, fill out and return the coupon below.

ADVANCE JOB LISTINGS / P.O. BOX 900 / NY 10020

PLEASE SEND A SAMPLE COPY
OF ADVANCE JOB LISTINGS TO

NAME _____ ADDRESS _____

CITY _____ STATE/ZIP _____

FREE Your dream job.

We hope you're happy in your current position, but there's always that ideal job you'd prefer if you knew about it.

That's why it makes sense to have your resume on file in the Electronics Manpower Register, a computerized data bank containing the qualifications of career-conscious ELECTRONICS readers just like yourself.

You'll benefit from nation-wide exposure to industry firms privileged to search the system, and since the computer never forgets, if you match up with their job requirements you'll be brought together in confidence.

To take advantage of this free service, mail your resume to the address below.

ELECTRONICS MANPOWER REGISTER
Post Office Box 900/New York, N.Y. 10020

ELECTRONIC ENGINEERS

McDonnell Douglas Corporation, St. Louis, Missouri, has immediate career opportunities to support programs on F-18, F-15, F-4, AV-8B Harrier V/STOL, Future Tactical Strike, Air Combat and Reconnaissance, Harpoon, Tomahawk and Space Shuttle.

AVIONICS

FIRE CONTROL
DIGITAL FLIGHT CONTROL
COCKPIT DISPLAY
COMPUTER SOFTWARE
INERTIAL GUIDANCE
DIGITAL COMPUTERS
ELECTRO MAGNETICS

TECHNOLOGY

GUIDANCE & CONTROL

AGE

FLIGHT SIMULATOR
SOFTWARE
SYSTEMS

FLIGHT SIMULATION

REAL-TIME,
PILOT-IN-THE-LOOP
SOFTWARE
COMPUTER SOFTWARE
DESIGN
VIDEO SYSTEMS

If you meet the above qualifications, please send your resume in confidence to:

J. H. Diller
Section Manager-Professional Employment
Department EL-16
P. O. Box 516
St. Louis, Missouri 63166

MCDONNELL DOUGLAS



An Equal Opportunity Employer m/f

WHAT ARE YOU WORTH?

In today's job market, that is. One way to see if you're in demand is to check the employment opportunities contained in ELECTRONICS' Classified Section.

Another way to get a reading on your value is to place a blind (box number) Position Wanted ad there. The cost is low (only \$1.25 per line) and the results are often rewarding.

For more information call or write:

ELECTRONICS

Post Office Box 900
New York, N.Y. 10020
Phone: 212/997-2556



GOULD

SENIOR ENGINEER Microelectronic Design

This is an outstanding opportunity to make significant contributions in the area of sophisticated hybrid microelectronics. Working in a high technology environment, you will be responsible for development and design, including layout and supervision of support activities through the selection of process and partitioning techniques. A BSEE is required plus a minimum of 3-5 years experience in design and development with a strong digital and analog background.

We offer a very competitive starting salary, excellent benefits, and an exceptional opportunity to grow in a new, and rapidly expanding technology. If you are a U.S. citizen, please send your resume to Dept. ELEC 827.

GOULD OCEAN SYSTEMS DIVISION

18901 Euclid Avenue
Cleveland, Ohio 44117

An Equal Opportunity Employer, M/F/H.



RATES \$46 per advertising inch (1/8"). Commissionable.
SIZES 1/8" to 10" deep in widths of one column (1 3/8"), two (3 3/8"), three (5 3/8"), and four (7").
CLOSING Two weeks prior to mailing.
MAILING One week prior to issue date.
ISSUE DATE Every other Thursday.
AD ORDERS/BOX NUMBER ANSWERS Send to Electronics.
Post Office Box 900, New York, N.Y. 10020.

ELECTRONIC DESIGN ENGINEERS

Challenging work on state-of-the-art television and related equipment, including color, black and white, low light level, and video processing. Strong analog and math required.

Circuit Design—BS/MS - EE/Physics 2-5 years experience.

Senior Design—BS/MS
3-10 years experience.

Send resume to

O. O'Connell, Personnel Manager

Cohu, Inc.

Electronics Division

P.O. Box 623, San Diego, CA 92112

Equal Opportunity Employer (M/F)

METER ENGINEER

We are looking for an experienced electro-mechanical meter design engineer to help us design new meters using D'ARSONVAL movements. Salary for this key position is open. If a good climate and pleasant work conditions with growth opportunity appeals to you, send your resume now.

Steve Mixsell, Division Manager

Airpax Electronics, Inc.

6801 W. Sunrise Blvd.

Fort Lauderdale, Fla. 33313

Equal Opportunity/

Profit Sharing Employer

This Classified Section,

featuring only recruitment and sales opportunities advertising, is designed to provide:

Readers—over 70,000 EE's and technical managers—with a useful and convenient employment market-place to consult whenever they're thinking about their future and bettering themselves. (Like when they're reading ELECTRONICS to combat job obsolescence.)

Advertisers—with low competitive rates (see above), pre-screened qualified circulation, bonus ADVANCE JOB LISTINGS preprint and free ELECTRONICS MANPOWER REGISTER searches and resumes.

We believe we offer both reader and advertiser alike the most complete recruitment program offered by any electronics publication (And, ELECTRONICS is the technical magazine for technical people.)

To find out more about any of the above, contact the Classified sales representative in the McGraw-Hill regional office nearest you.

Not just a recruitment ad.

It's a challenge. And a very unique one at that. As you probably already know, Memorex is back on track... and like never before. We've just completed a succession of record quarters in both sales and earnings. And the demand for Memorex products is at an all-time high. So what's the challenge? Memorex Project '76... an ambitious product development program designed to transform Memorex's turn-around momentum into unquestioned technological and market leadership. The people who will turn this challenge into achievement are not people who answer recruitment ads. They are people who respond to challenge... people who want more out of a job than a paycheck. If you've read this far, that might be you. If you would like more information about joining the Memorex Project '76 Team, there are three things you can do. Send us the coupon, call our information hotline (408) 987-3800, or send us your resume. We are an equal opportunity employer M/F.

MEMOREX TEAM76

Project '76 Team Positions Include:

Senior Logic Design Engineers Mechanical Engineers Microprogrammers Add-on Memory Engineers Datacommunications Engineers Magnetic Head Engineers Systems Programmers Display Terminal Engineers Magnetic Recording Circuit Engineers Ceramic Process Engineers Peripheral Interface Specialists Mechanism Designers

EL

Memorex Project '76 Team
Memorex Corporation
San Tomas at Central Expressway
Santa Clara, CA 95052

Name _____

Address _____

City, State, Zip _____

Phone _____ Occupation _____

Employer _____ Years Experience _____

Electronics advertisers

Abbott Transistor Labs Inc.	6	Motorola Communication & Electronics	43
• Adret Electronique	35	■ Motorola Semiconductor Products Inc.	44-45
Advanced Micro Devices	11	☞ Nikkei Electronics	66
Alphatron	68	Nucleonic Products Co. Inc.	65
AP Products Incorporated	105	• Philips Elcoma	2E-3E, 54
Associated Electronics	111	■ Plessey Semiconductors	7
■ Bourns Inc.	3rd C.	■ Powermate	115
Brand Rex Corporation	2nd C.	■ Pro-Log Corporation	28
• Carlo Erba	72	R2E	51
C&K Components	109	Ramtek	15
Clairex Corporation	4th C.	RCL Electronics Inc.	12
Coil-Ler Mfg Inc.	114	Rockland Systems	42
Continental Rentals	8	• Rohde & Schwarz	1E
‡ Cutler-Hammer Inc.	72	Rotron Incorporated	9
■ Dale Electronics Inc. A Subsidiary of Lionel Corporation	8E-9E	• Schlumberger	4E
Data General Corporation	27	Scientific Atlanta Optima Division	20
Digital Equipment Corporation (DEM)	52	• Seimart	17
Duncan Electronics (Division of Systron Donner)	24	‡ Semicoa	54
‡ Eastman Kodak Company Graphics Division	13	• Sepa S.p.A	16
• Electrol	66	SGS Ates	37
Elpace	107	Signetics Corporation 105, 107, 109, 111, 113, Division of U.S. Philips 115, 117, 118-119	
■ Erie Technological Products Co. Inc.	70	Society of the Plastics Industry, Inc.	125
Fairchild Semiconductor Inc.	39	Solarax Corp	117
Fairchild Systems Technology	22-23	TEC Inc.	111
Figaro Engineering Inc.	105	Texas Instruments Incorporated Components Div.	58
‡ Fujitsu Limited	35	• Thomson DTE	15E
‡ General Electric Valox Division	21	TRW Systems Group	48
General Magnetics	132	Wabash Electronics	40, 51
General Semiconductor Industries, Inc.	57	Wakefield Engineering Inc.	113
• Gould Advance	10E-11E	■ Wavetek Indiana Inc.	13
GTE Sylvania Parts Division	60	Wima Westermann	14
Hermes Electronics, Ltd.	112	XLD-REMEX	41
■ Hewlett-Packard	1, 2, 62		
• Hi G D'Italia	14E		
Honeywell Test Instrument Division	46-47		
Infotek Systems	107		
Intech/Function	121		
Intel Corporation	18-19		
■ Kepco Inc.	5		
‡ Kollmorgen Corp. Photocircuits Div.	16-17		
• Membrain Limited	16E		
Micro Power Systems	69		
Monolithic Memories Inc.	33		

Classified and employment advertising

F. J. Eberle, Manager 212-997-2557	
Airpax Electronics Inc.	128
Atomic Personnel Inc.	126
Career Advisors	126
Gould Ocean Systems	128
Harris Communications	127
McDonnell Douglas Corp.	128
Memorex	129
Tektronix Inc.	126

■ For more information of complete product line see advertisement in the latest Electronics Buyers Guide
 • Advertisers in Electronics International
 ‡ Advertisers in Electronics domestic edition

Advertising Sales Staff

Pierre J. Braudé New York [212] 997-3468
 Paris Tel: 720-73-01
 Director of Marketing

Atlanta, Ga. 30309: Glen N. Dougherty
 100 Colony Square, 1175 Peachtree St., N.E.
 [404] 892-2868

Boston, Mass. 02116: Frank Mitchell
 607 Boylston St. [617] 262-1160

Chicago, Ill. 60611
 645 North Michigan Avenue
 Robert W. Bartlett (312) 751-3739
 Robert M. Denmead (312) 751-3738

Cleveland, Ohio 44113: William J. Boyle
 [716] 586-5040

Dallas, Texas 75201
 2001 Bryant Tower, Suite 1070
 [214] 742-1747

Denver, Colo. 80203: Harry B. Doyle, Jr.
 123 Speer Blvd. #400
 [303] 837-1010

Detroit, Michigan 48202: Robert W. Bartlett
 1400 Fisher Bldg.
 [313] 873-7410

Houston, Texas 77002: Paul Reiss
 601 Jefferson Street, Dresser Tower [713] CA 4-8381

Los Angeles, Calif. 90010: Robert J. Rielly
 Bradley K. Jones, 3200 Wilshire Blvd., South Tower
 [213] 487-1160

New York, N.Y. 10020
 1221 Avenue of the Americas
 Warren H. Gardner [212] 997-3617
 Michael J. Stoller [212] 997-3616

Philadelphia, Pa. 19102: Warren H. Gardner
 Three Parkway,
 [212] 997-3617

Pittsburgh, Pa. 15222: Warren H. Gardner
 4 Gateway Center, [212] 997-3617

Rochester, N.Y. 14534: William J. Boyle
 9 Greylock Ridge, Pittsford, N.Y.
 [716] 586-5040

San Francisco, Calif. 94111: Don Farris
 Robert J. Rielly, 425 Battery Street,
 [415] 362-4600

Paris: Alain Offergeld
 17 Rue-Georges Bizet, 75116 Paris, France
 Tel: 720-73-01

Geneva: Alain Offergeld
 1 rue du Temple, Geneva, Switzerland
 Tel: 32-35-63

United Kingdom & Scandinavia: Robert Ghey
 Tel: 01-493-1451, 34 Dover Street, London W1

Scandinavia: Andrew Karnig and Assoc.
 Kungsholmsgatan 10
 112 27 Stockholm, Sweden
 Tel: 08 51 68 70 Telex: 179 51

Milan: Luigi Rancati
 1 via Baracchini, Italy Phone 86-90-656

Brussels: Alain Offergeld
 23 Chaussee de Wavre
 Brussels 1040, Belgium
 Tel: 13-73-95

Frankfurt/Main: Fritz Krusebecker
 Liebigstrasse 27c, Germany
 Phone 72 01 81

Tokyo: Tatsumi Katagiri, McGraw-Hill
 Publications Overseas Corporation,
 Kasumigaseki Building 2-5, 3-chome,
 Kasumigaseki, Chiyoda-Ku, Tokyo, Japan
 [581] 9811

Australasia: Warren E. Ball
 IPO Box 5106, Tokyo, Japan

Business Department

Thomas M. Egan,
 Production Manager [212] 997-3140

Gayla Black
 Production Manager [212] 997-2044

Carol Gallagher
 Production Manager International
 [212] 997-2045

Dorothy Carter
 Production Manager Domestic
 [212] 997-2908

Frances Vallone
 Reader Service Manager
 [212] 997-6057

Electronics Buyers' Guide

H.T. Howland, General Manager
 [212] 997-6642

Regina Hera, Directory Manager
 [212] 997-2544

Gayla Black, Production Manager
 [212] 997-2044

Classified and Employment Advertising

Frank Eberle, Manager
 [212] 997-2557

FEATURE ARTICLES FROM *ELECTRONICS* AVAILABLE IN REPRINT FORM

No. of
copies
wanted

New reprints

- ___ R-612 Fiber-optic communications special report 24 pp \$3.00
- ___ R-610 Special report on hybrid-circuit technology 19 pp \$3.00
- ___ R-606 Special issue—microprocessors \$4.00
- ___ R-600 World market report 1976 24 pp \$5.00
- ___ R-526 How reliable are today's components 16 pp \$3.00
- ___ R-524 Special report on bipolar large-scale integration 12 pp \$3.00
- ___ R-522 Special report on power semiconductors 12 pp \$3.00
- ___ R-512 Design of circuits for dangerous environments 4 pp \$3.00
- ___ R-510 Bipolar integration advances with PL microprocessor 8 pp \$2.00

Charts

- ___ R-516 Electronic symbols \$2.00
- ___ R-211 Electromagnetic spectrum (16-page report and chart) \$4.00
- ___ R-326 Optical spectrum (6-page report and chart) \$3.00

Books

- ___ R-608 Basics of Data Communications—Electronics Book Series \$12.50
- ___ R-602 Large Scale Integration—Electronics Book Series \$9.95
- ___ R-520 Microprocessors—Electronics Book Series \$8.95
- ___ R-011 Computer-aided Design 135 pp \$4.00
- ___ R-032 Active Filters 88 pp \$4.00
- ___ R-031 Circuit Designer's Casebook 182 pp (U.S. only) \$5.50 (foreign) \$12.00

Other Reprints

- ___ R-518 Special issue—productivity \$4.00
- ___ R-514 Eight ways to better radio receiver design 6pp \$3.00
- ___ R-508 Designing microprocessors with standard logic devices 12pp \$3.00
- ___ R-506 The case for component burn-in 7 pp \$2.00
- ___ R-434 Designing automated systems with the new standard interface 12 pp \$3.00
- ___ R-432 An update on communications satellites 8 pp \$2.00
- ___ R-430 Choosing the right bipolar transistor model for computer-aided design 20 pp \$3.00
- ___ R-428 Designing with low-cost lasers 6 pp \$2.00
- ___ R-504 U.S. forecast 1975 20 pp \$3.00
- ___ R-502 European forecast 1975 20 pp \$3.00
- ___ R-500 Japanese forecast 1975 16 pp \$3.00
- ___ R-426 Special issue—technology update 1974 \$4.00
- ___ R-424 Microprocessor applications 28 pp \$3.00
- ___ R-422 A microprogrammable mini-computer 8 pp \$2.00
- ___ R-420 Computerized text-editing and typesetting 8 pp \$2.00
- ___ R-418 Computer analyses of rf circuits 8 pp \$2.00
- ___ R-416 Optical waveguides look brighter 8 pp \$2.00
- ___ R-414 The ion-implanted n-channel process 6 pp \$2.00
- ___ R-412 Liquid cooling of power semiconductors 6 pp \$2.00
- ___ R-410 Special report on passive components 16 pp \$3.00
- ___ R-408 Bringing sight to the blind 8 pp \$2.00
- ___ R-406 Designing with the new logic, C-MOS and bipolar 16 pp \$3.00
- ___ R-328 Special issue—pervasiveness of electronics \$2.00
- ___ R-324 Semiconductor memories are taking over data-storage applications 16 pp \$3.00
- ___ R-322 Special report: new displays complement old 10 pp \$2.00
- ___ R-320 Special report on designing with flat cable 14 pp \$3.00
- ___ R-318 Special report on auto electronics 16 pp \$3.00
- ___ R-316 Hybrid circuits solve tough design problems 16 pp \$3.00
- ___ R-312 Leadless, pluggable IC packages reduce costs 7 pp \$2.00
- ___ R-310 Penetration color tubes are enhancing information displays 6 pp \$2.00
- ___ R-308 Program for transition from nonlinear to linear transistor model 6 pp \$2.00
- ___ R-306 Charge-coupling improves its image, challenging video camera tubes 8 pp \$2.00
- ___ R-209 Semiconductor RAMs land computer mainframe jobs 15 pp \$2.00
- ___ R-207 Technology gap starts to close for computer peripherals 16 pp \$3.00
- ___ R-205 Bridging the analog and digital worlds with linear ICs 16 pp \$3.00
- ___ R-113 Optoelectronics makes it at last 34 pp \$4.00
- ___ R-104 The new concept for memory and imaging: charge-coupling 12 pp \$2.00
- ___ R-023 Special report on tomorrow's communications 32 pp \$3.50

Payment must accompany your order

Make check or money order payable to Electronics Reprints. All orders are shipped prepaid by parcel post. Allow two to three weeks for delivery.

Back issues now available:
1960 to 1969, \$5.00 each
1970 to 1973, \$3.00 each
1974 to 1975, \$4.00 each

USE THIS PAGE AS YOUR ORDER FORM

Cost of orders \$ _____
Plus 10% handling charge \$ _____
TOTAL AMOUNT ENCLOSED \$ _____

SEND REPRINTS TO

Name _____
Company _____ Dept. _____
Street _____
City _____ State _____ Zip _____

Mail your order to:
Janice Austin
ELECTRONICS REPRINTS
P.O. Box 669
Hightstown, N.J. 08520

SOLID STATE 3 WIRE SYNCHRO TO LINEAR D.C. CONVERTER



RESPONSE CURVE

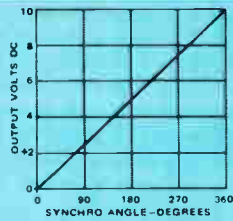
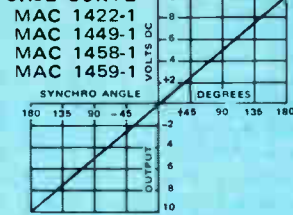

RESPONSE CURVE

MAC 1460-1
MAC 1461-1

FEATURES:

- Develops a DC output voltage linearly proportional to a synchro angle over a $\pm 180^\circ$ range.
- Completely solid state with all of the inherent advantages over a mechanical system such as:
 - High reliability (since there are no moving parts)
 - Light weight—6 ozs.
 - Small size
 - All units hermetically sealed

- Wide temperature range operation
- Output short circuit protected
- Three wire inputs isolated from ground
- Package size may be altered at no extra cost
- Units can be altered to accept different line to line voltages or different operating frequencies at no extra cost
- Not affected by reference voltage or power supply variations.

UNIT	MAC 1422-1	MAC 1449-1	MAC 1458-1	MAC 1459-1	MAC 1460-1	MAC 1461-1
TRANSFER EQUATION	$\pm IV/18^\circ$	$\pm IV/18^\circ$	$\pm IV/18^\circ$	$\pm IV/18^\circ$	$+IV/36^\circ$	$+IV/36^\circ$
ACCURACY (+25°C)	½%	½%	½%	½%	½%	½%
ACCURACY (-25°C+85°C)	1%	1%	1%	1%	1%	1%
L - L SYNCHRO INPUT (VRMS)	11.8	90	11.8	90	11.8	90
FREQUENCY (Hz)	400	400	60	60	400	400
FULL SCALE OUTPUT	$\pm 10V$	$\pm 10V$	$\pm 10V$	$\pm 10V$	+10V	+10V
OUTPUT IMPEDANCE	$<1\Omega$	$<1\Omega$	$<1\Omega$	$<1\Omega$	$<1\Omega$	$<1\Omega$
L - L INPUT IMPEDANCE	$>10K$	$>30K$	$>2K$	$>10K$	$>10K$	$>30K$
REFERENCE VOLTAGE (VRMS)	26	115	26	115	26	115
OPERATING TEMP. °C	-25 - +85	-25 - +85	-25 - +85	-25 - +85	-25 - +85	-25 - +85
D.C. SUPPLY	$\pm 15V$	$\pm 15V$	$\pm 15V$	$\pm 15V$	$\pm 15V$	$\pm 15V$
D.C. SUPPLY CURRENT	$\pm 75MA$	$\pm 75MA$	$\pm 75MA$	$\pm 75MA$	$\pm 75MA$	$\pm 75MA$
BANDWIDTH	10Hz	10Hz	OPT.	OPT.	10Hz	10Hz
WEIGHT	6 oz.	6 oz.	6 oz.	8 oz.	6 oz.	6 oz.
SIZE	3.6x2.5x0.6	3.6x2.5x0.6	3.6x3.0x0.6	3.6x3.0x1.0	3.6x2.5x0.6	3.6x2.5x0.6

A.C. LINE REGULATION

A new method has been developed which allows us to provide a low distortion highly regulated AC waveform without using tuned circuits or solid state active filters of any kind.

The result is a frequency independent AC output regulated to 0.1% for line and load with greater than 20% line variations over a wide temperature range.

FEATURES:

- 0.1% total line and load regulation
- Independent of $\pm 20\%$ frequency fluctuation
- 1 watt output
- Extremely small size
- Isolation between input and output can be provided

Specifications: Model MLR 1476-1

AC Line Voltage: 26V $\pm 20\%$ @
400Hz $\pm 20\%$

Output: 26V $\pm 1\%$ for set point

Load: 0 to 40ma

Total Regulation: +0.1%

Distortion: 0.5% maximum rms

Temperature Range: $-55^\circ C$ to
 $+125^\circ C$

Size: 2.0" x 1.8" x 0.5"

Other units are available at different power and voltage levels as well as wider temperature ranges. Information will be furnished upon request.

SOLID-STATE SINE-COSINE SYNCHRO CONVERTER - NON VARIANT

This new encapsulated circuit converts a 3 wire synchro input to a pair of dc outputs proportional to the sine and cosine of the synchro angle independent of a-c line fluctuations.

- Complete solid state construction
- Operates over a wide temperature range
- Independent of reference line fluctuations
- Conversion accuracy—6 minutes
- Reference and synchro inputs isolated from ground

Specifications Model DMD 1508-2

Accuracy: Overall conversion accuracy 6 minutes. Absolute value of sine and cosine outputs accurate to $\pm 30MV$

Temperature Range: Operating $-40^\circ C$ to $+85^\circ C$, Storage $-55^\circ C$ to $+125^\circ C$

Synchro Input: 90V RMS $\pm 5\%$ LL 400Hz $\pm 5\%$

DC Power: $\pm 15V$ DC $\pm 10\%$ @ 50MA

Reference: 115VRMS $\pm 5\%$ 400Hz $\pm 5\%$

Output: 10V DC full scale output on either channel @ 5ma load

Temperature coefficient of accuracy: ± 15 seconds/ $^\circ C$ avg. on conversion accuracy ± 1 MV/ $^\circ C$ on absolute output voltages

Size: 2.0" x 1.5" x 2.5"

Units are available with wider temperature ranges and 11.8V LL, 26V reference synchro inputs. Information will be supplied upon request.

There is No Substitute for Reliability



GENERAL MAGNETICS • INC

135 Bloomfield Ave., Bloomfield, New Jersey 07003 - Tel. (201) 743-2700

Circle 132 on reader service card



FEEL
the pot . . .



CLICK
the switch . . .



GANG
the modules . . .

and add "quality-touch" appeal
to your product.

FEEL THE POT . . . a smooth, quality feel, only from Bourns® 81/82 Model Potentiometer/switch assemblies. Rotational torque range, only .3 to 2.0 oz. inch, is consistent for one, two, three or four cup assemblies.

Independent linearity of $\pm 5\%$ and low 1% CRV provide exceptional setability in both cermet and conductive plastic element types.

CLICK THE SWITCH* . . . one that really clicks, with positive action detent at either CW or CCW end. The Bourns Model 85/86 potentiometer/switch combination is rated at 2 amps in DPST style and 1 amp in DPDT. Contacts are constructed of fine silver with gold overlay. This provides exceptionally low contact resistance, for reliable operation at low level analog or logic signal levels — or any application requiring an "on-off" function.

GANG THE MODULES . . . potentiometers and switches. Up to 4 modules can be ganged on the same single or dual concentric shaft, without sacrifice to the satin-smooth feel or the sure-fire click. Other options include a wide choice of bushing and shaft styles, P.C. pins or solder lugs. Think of the possibilities! Now you can specify custom pots and switches assembled from "off-the-shelf" modules — at standard cost and leadtime.

Add "quality-touch" appeal to your equipment with BOURNS Model 80 Family of Modular Potentiometer/Switches. Write or call today for complete technical information, direct or through your Bourns distributor.

FEEL, CLICK, GANG . . . BEAUTIFUL!

TRIMPOT PRODUCTS DIVISION, BOURNS, INC., 1200 Columbia Avenue, Riverside, California 92507, Telephone (714) 781-5122 — TWX 910 332-1252.

*Patent pending



Clairex Optical switches

Order any of our standard designs of optical switches and we'll give you the most reliable units and the best delivery in the industry.

Custom designs take a

little longer. Tell us your needs and we'll design to your specifications. We may even suggest an alternate, more economical solution.

Clairex optical switches

are made with hermetically sealed emitters and detectors for maximum reliability. Glass lenses align the light beam to improve target detection, to minimize false triggering from

stray light, and to reduce dust pickup.

Call (914) 664-6602 or write Clairex®, 560 South Third Avenue, Mount Vernon, New York 10550.

June 1976

Product Data

CLI200 CLI200D



Optical Switches

GENERAL DESCRIPTION The CLI200 and CLI200D are optical switches consisting of an infrared light emitting diode as the emitting element and a phototransistor as the detecting element. The emitters and detectors are hermetically sealed to provide maximum reliability. They also have glass lenses to align the light beam for accurate target detection, to minimize false triggering from stray light and reduce dust pickup. The switches have short leads that plug into printed circuit boards for soldering. All units are pretested to insure operation.

ABSOLUTE MAXIMUM RATINGS

Maximum Temperature: 55°C to +150°C
 Storage Temperature: +100°C
 Operating Junction Temperature: +100°C

EMITTER (GaAs Diode)

Power Dissipation: 100 mW derate linearly 1.33 mW/°C
 At 25°C ambient Pt

Maximum Voltage: 3.0 volts
 V_R Reverse Voltage

Maximum Current: 60 ma (continuous)
 I_F DC Forward Current

DETECTOR (NPN Silicon)

Maximum Power Dissipation: 50 mW derate 0.5 mW/°C
 Total Dissipation at 25°C Ambient Temperature P_T
 at 100°C Ambient Temperature P_T 12.5 mW

Maximum Voltages:
 V_{CEO} Collector to Emitter Voltage: 40 volts
 V_{ECO} Emitter to Collector Voltage: 5 volts
 Maximum Current I_C = 200 ma (Pulsed)

ELECTRICAL CHARACTERISTICS (25°C Free Air unless otherwise designated)

Symbol	Characteristics	Test Conditions		CLI200		CLI200D		Units
		Min.	Max.	Min.	Max.			
V _R	Reverse Voltage		1.5	3	1.5		Volts	
V _F	Forward Voltage		40		40		Volts	
BV _{CEO}	Collector to Emitter Breakdown Voltage		50		100		Volts	
I ₀	Dark Current		1		10		ma	
I _C	Sensor Current	I _F = 20 ma, V _{CE} = 5V	1	50	10	150 TYP	ma	
V _{CE(SAT)}	Collector to Emitter Saturation Voltage	I _F = 2 ma, V _{CE} = 5V, R = 100Ω	5.1 TYP		15 TYP		volt's	
t _r , t _f	Rise or Fall Time	I _F = 2 ma, V _{CE} = 5V, R = 100Ω					μSEC	
t _r , t _f	Rise or Fall Time						μSEC	

All dimensions = .005"

CLAIREX ELECTRONICS
 A DIVISION OF CLAIREX CORPORATION
 560 South Third Avenue, Mount Vernon, N. Y. 10550 • (914) 664-6602
 A.O. 5/76-10M

CLAIREX ELECTRONICS
 A Division of Clairex Corporation