

MARCH 4, 1976

SAFETY: A GROWING CONCERN IN INSTRUMENT DESIGN/117

Using optical isolators in linear applications/105

Reliable design with solid-state power devices, part 1/111

FOUR DOLLARS A MCGRAW-HILL PUBLICATION

Electronics®

Special report
**TRAFFIC JAM IN
CITIZENS BAND**



1420 NW 25th CANA6 NOV77
MATT NEILL
2516 NE CLACKAWAS
PORTLAND OR
97232

The Right DMM Decision Means Five-Function Autoranging for only \$225*

Introducing HP's 3476A DMM

The price is a big story in itself. But performance and reliability play a large part too. Take a look at the 3476A:

Autoranging—a big plus in a low cost DMM. It lets you concentrate on the point of measurement... minimizes reading errors... and speeds readings too. All readings are made directly in volts, kilohms, or amps—on an LED display. And there's a rangehold button to speed and simplify repetitive measurements.

Five functions—all the functions you want and need in a low cost DMM. Simply push the appropriate button to read AC volts, DC volts, AC or DC current, and ohms. There's no worry about polarity or zero... they're both automatic.

Advanced design—both circuit and packaging. And both contribute to high reliability. One circuit board contains all the electronics.



Tantalum nitride on sapphire processing allows replacement of all front end precision resistors by a single chip. That means greater reliability and better temperature stability. Of course it's input protected.

Convenient size—just right to hold in your hand... take with you in a brief case... or use on your bench. An optional carrying case and probe kit let you hang the instrument from a strap for "no-hands" operation. The "A" version (\$225*) operates from the AC line for lab use. And for portable applications, the "B" version (\$275*) has built-in batteries and recharging circuitry.

The 3476A is backed by HP's service organization... another big plus for a low-cost DMM. With these prices and features, why not put your hands on the 3476A for your 3-1/2 digit measurements? Your local HP field engineer can tell you how.

*Domestic U.S.A. prices only.

**HP DVM's—
the right decision**

Actual Size

065/52



HEWLETT **hp** PACKARD

Sales and service from 172 offices in 65 countries.

1500 Page Mill Road, Palo Alto, California 94304

World Radio History

The Universal Counter.

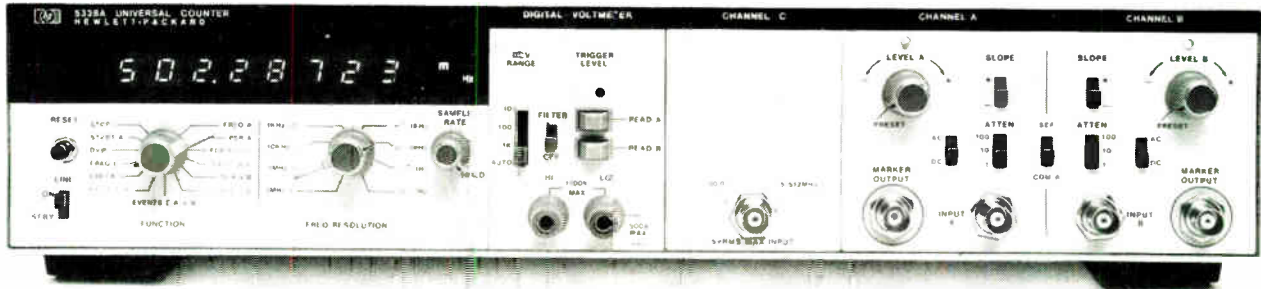

Everything you're likely to need. The HP 5328A.

Here's a counter so versatile, it can really be called universal. You get high accuracy, operating ease and a low price tag of just \$1300*. It's modular so you can buy the capability you need. Not more. Not less. Start with the basic 8-digit instrument with 100 MHz frequency range and 100 ns single shot T.I. resolution. You also get period, 10 ps time interval averaging, ratio, scaling and totalizing. Then you can add more: 512 MHz with 9 digits and 15 mv sensitivity; time base aging $< 5 \times 10^{-10}$ /day; and 10 ns single shot time interval with improved averaging. But look what else you get:

UNIQUE TRIGGER LIGHTS

tell you what's happening. They're on when the input is greater than trigger level and vice versa. And they blink when the input channel is triggering from 0 to 100 MHz. Standard.

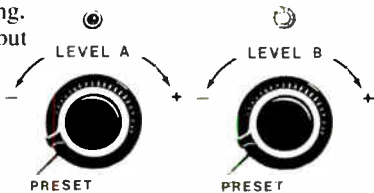

UNIQUE BUILT-IN DVM gives an instant accurate digital display of trigger levels.

Or use this option to measure external voltages 10 μ v to 1100V auto-ranged, integrating, full floating, high common-mode rejection with switchable input filter. Optional.

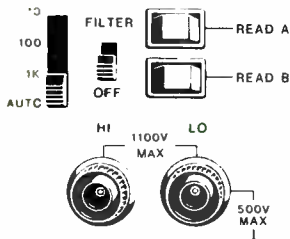

HIGH SPEED MARKERS

show just what your counter is doing with your input waveform. Use the markers on the second channel of your scope to see where the counter is triggering. Really useful thanks to the 5328A's 100 MHz ECL outputs. Standard.

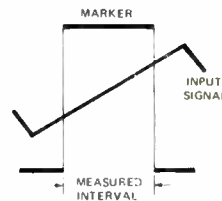

EASY SYSTEMS INTERFACE

with the HP Interface Bus simplifies integration of the counter into a system. You get this programability plus standard format data output with a single connector. Optional.

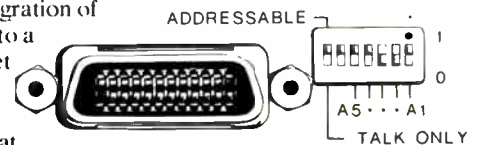

ARMED MEASUREMENTS

solve difficult dynamic measurement problems. The counter goes to work when your command tells it to. Ideal for burst frequency or sweep generator linearity measurements. Standard.



These are just a few things, of course. There are many more thoughtful engineering innovations that combine to give you everything you're likely to need in a general purpose, medium-priced counter for a long time to come. We talk about them in our 12 page booklet. Write for one or ask your nearby HP field engineer for a copy. We want you to find why we call this universal counter universal.



Sales and service from 172 offices in 65 countries.
1501 Page Mill Road, Palo Alto, California 94304

Circle 1 on reader service card

HP displays.

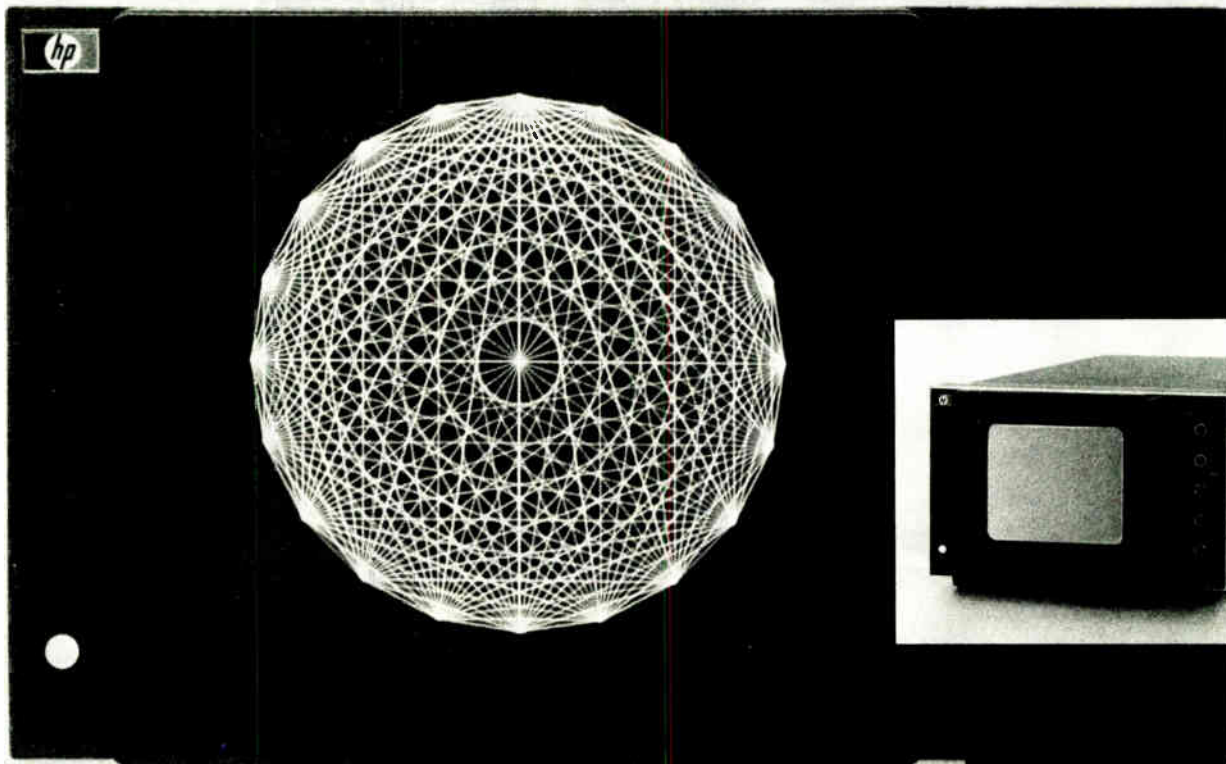

Because your system deserves a bright, sharp image.

You put a lot into each OEM system: good circuit design, quality components, careful testing. But end users will judge it by the information they get from the display. They expect bright, sharp images. That's why HP's 1332A, 1333A, and 1335A CRT displays make excellent choices for all types of systems—from spectrum, network, and chemical analyzers, to automatic test systems.

Each display has a very small spot size that focuses uniformly over the complete viewing area, regardless of writing speeds or intensity level. This eliminates the need to refocus at each intensity setting and assures crisp images, even around the outer edges of the screen. Fine image detail with excellent contrast and uniformity make them particularly well suited for applications involving complex graphics, especially those with alphanumeric data.

The 1335A, a variable-persistence, storage, and non-storage display, introduces a totally new CRT design optimized exclusively for information display. It offers exceptionally good resolution over the entire 8 x 10 cm screen. And the 1335A is versatile too. Any operating mode—erase, store, write, conventional, or variable persistence—can be selected with manual front-panel controls, remote program inputs, or a combination of both. Manual controls can be inhibited entirely during remote operations. The 1335A is a welcome

addition to medical and instrumentation systems.

OEMs who need a larger viewing area and a brighter image at faster scan rates like the 1332A. They appreciate its 9.6 x 11.9 cm viewing area, its superior performance, and the ease with which the 1332A, like the others, integrates into a variety of racks and cabinets.

For photographic recording of displayed data, the new 1333A offers new performance levels. Its extremely small spot size of 0.20 mm (0.008 in.) provides the exceptional quality necessary for easy and accurate photo evaluation. And its 8 x 10 cm screen allows reproduction on Polaroid film with very little optic reduction. For convenience, all frequently used controls on all of these displays have been placed on the front panel for maximum accessibility.

Which display best fits your requirements? Let your local HP field engineer help you decide. Or write for specific details. We'll help you pick a display that makes your system look as good as it actually is.

085 9 A

HEWLETT  PACKARD

Sales and service from 172 offices in 65 countries
1501 Page Mill Road, Palo Alto, California 94304

31 Electronics Review

SOLID STATE: Full one-chip controller sells for under \$10, 31
MEMORY: Texas Instruments moves bubbles into pilot production, 32
CONSUMER: Electric range stores cooking programs, 33
COMMUNICATIONS: AT&T wants laws to bar competition, 33
INDUSTRIAL: Microprocessors smarten controllers, 34
MILITARY: Tactical R&D up in fiscal 1977 budget, 36
RELIABILITY: Military testing too strict on microprocessors, 38
PACKAGING & PRODUCTION: Nitride film seals at low temperature, 40
NEWS BRIEFS: 42
SOLID STATE: Read-only memory reaches 32-k bits, 42
CONSUMER: Calculator plays chess, 44

53 Electronics International

JAPAN: Self-coupled laser may work in memories, 53
AROUND THE WORLD: 53

67 Probing the News

YOU AND YOUR CAREER: Manpower predictions draw fire, 67
COMPONENTS: Thick film rolls on, 70
TESTING: 4-k RAM users check on reliability, 72
COMMUNICATIONS: Britain to get wired city—via phone, 76
MEMORIES: Static RAMs are on the move, 78

91 Technical Articles

COMMUNICATIONS: Citizens' band clamor gives headaches, 91
DESIGNER'S CASEBOOK: Counter measures low frequency, 100
Hexadecimal encoder debounces keyboard, 101
COMPONENTS: Optical isolators improve many linear circuits, 105
INDUSTRIAL: Achieving megawatt reliability, part 1, 111
INSTRUMENTS: Safety—it's everyone's business, 117
SEMICONDUCTORS: Rectifier diodes switch in 100 ns, 148
ENGINEER'S NOTEBOOK: Ribbon cable makes pc-board coils, 122
Microprocessor converts pot position to digits, 123
Op amp complements a-d converter output code, 123

133 New Products

IN THE SPOTLIGHT: Data General coup: chip to chassis, 133
Logic probe includes pulse memory, 139
INSTRUMENTS: Power supply has three floating outputs, 141
SEMICONDUCTORS: Rectifier diodes switch in 100 ns, 148
DATA HANDLING: Add-on memories plug into LSI-11, 154
INDUSTRIAL: 8.4-kilowatt generator is transistorized, 165
MATERIALS: 175

Departments

Publisher's letter, 4
Readers' comments, 6
News update, 8
Editorial, 10
People, 14
Meetings, 20
Electronics newsletter, 25
Washington newsletter, 49
International newsletter, 55
Engineer's newsletter, 126
New literature, 178

Highlights

Cover: Citizens' band collects the crowds, 91

The popularity of CB radios is crowding the channels and causing interference between them—both problems that new regulations and new technology could alleviate. The Federal Communications Commission will soon add more channels, but most technical advances will be delayed till demand for CB gear stops outstripping supply.

Cartoonist Bob Clarke drew the cover.

Rosy employment forecasts may hurt engineers, 67

Predicted shortages of engineers have failed to come true and have damaged the profession by luring too many people into it, argues a member of the National Society of Professional Engineers.

Optical isolators have analog uses, too, 105

Despite their nonlinearity, several kinds of optically coupled isolators can confer noise immunity on analog as well as digital circuits. But the right circuit techniques must be used.

Dependable designing with power devices, 111

Even the newcomer to industrial design can build reliable power-semiconductor equipment if he follows a few simple precepts. Part 1 of this two-part series tells him how to deal with noise and control problems.

And in the next issue . . .

More about high reliability in power-semiconductor equipment: part 2 of a two-part series . . . the why and the how of true rms measurement . . . the unusual usefulness of resistive insulated gates.

EDITOR-IN-CHIEF: Kemp Anderson

EXECUTIVE EDITOR: Samuel Weber

MANAGING EDITOR: Arthur Erikson,
International

SENIOR EDITORS: Laurence Altman,
Ray Connolly, Lawrence Curran,
John Johnsrud, H. Thomas Maguire,
Stephen E. Scrupski

ART DIRECTOR: Fred Sklenar

ASSOCIATE EDITORS: Howard Wolff,
Gerald M. Walker, Alfred Rosenblatt

DEPARTMENT EDITORS
Aerospace/Military: Ray Connolly
Circuit Design: Don Blattner
Communications & Microwave:
Richard Gundlach
Components: Lucinda Mattera
Computers: Stephen E. Scrupski
Consumer: Gerald M. Walker
Industrial: Margaret A. Maas
Instrumentation: Andy Santoni
New Products: H. Thomas Maguire
Michael J. Riezenman
Packaging & Production: Jerry Lyman
Solid State: Laurence Altman

CHIEF COPY EDITOR: Margaret Eastman

COPY EDITORS: Everett C. Terry, Ben Mason

ART: Charles D. Ciatto, *Associate Director*
Patricia Cybulski, *Assistant Director*

EDITORIAL SECRETARIES: Janet Noto,
Julie Gorgogione, Penny Roberts

FIELD EDITORS
Boston: Lawrence Curran (Mgr.), Pamela Leven
Los Angeles: Larry Waller (Mgr.)
Midwest: Larry Armstrong (Mgr.)
New York: Ron Schneiderman (Mgr.)
San Francisco: Bernard Cole (Mgr.)
Judith Curtis
Washington: Ray Connolly (Mgr.)
Frankfurt: John Gosch
London: William F. Arnold
Paris: Arthur Erikson
Tokyo: Charles Cohen

McGRAW-HILL WORLD NEWS

Director: Ralph R. Schulz
Bonn: Robert Ingersoll
Brussels: James Smith
London: James Trotter
Madrid: Dom Curcio
Milan: Andrew Heath
Moscow: Peter Gall
Paris: Michael Johnson, Richard Shepherd
Stockholm: Robert Skole
Tokyo: Mike Mealey

PUBLISHER: Dan McMillan

DIRECTOR OF MARKETING: Pierre J. Braudé

MARKETING ADMINISTRATION MANAGER:
Wallis Clarke

CIRCULATION MANAGER: Nancy L. Merritt

MARKETING SERVICES MANAGER:
Tomlinson Howland

RESEARCH MANAGER: Margery D. Sholes

There are few consumer-electronics success stories as dramatic as the takeoff in citizens' band radio sales. Spurred by the gas shortage and truck-driver need for information on gasoline supplies, CB sales have soared as the radios themselves have become indispensable companions for those quixotic contemporary American folk heroes—drivers of the big highways rigs.

Dick Gundlach, our communications and microwave editor, says that he gave little thought to how widespread CB use was before he started to prepare the nine-page report that starts on page 91. "But while out on the road doing interviews, I started to do an 'ear' count, a tally of the number of CB antennas sported by the long-distance trucks. In one 90-minute drive through wintry Minnesota countryside, about 70%, or five out of every seven trucks, was CB-equipped."

Dick, by the way, took the plunge into CB himself, and wished he had taken his set with him so he could benefit from the truckers' tips on road conditions, traffic obstacles, and the like. But he could not have reciprocated—legally, at least. "My license still has not been sent to me by the FCC, and I sent in my application and \$4 fee some two-and-a-half months ago. I've tried to find out when it will come, even though I realize there's a huge backlog, further compounded by some 550,000 new applications in January, up from 440,000 in December."

The next step in citizens' radio evolution is not firmed up yet, although the latest proposal before the FCC calls for 50 channels for a mix of a-m and single-sideband use. Says Dick: "Commissioner Robert

E. Lee is slated as the dinner speaker for the big CB show—Personal Communications-'76—in Las Vegas this month. I think he may well take advantage of that forum to make the long-awaited announcement that the present 23 channels will become 50."

We have added another page to our continuing coverage of career-related developments. In the Probing the News section this issue, you'll find a thought-provoking article about engineering-manpower predictions and how poorly they have fit actual manpower demand over much of the past decade. The article, on page 67, not only details the discrepancies between prediction and fact, but raises the question of whether such faulty estimating is, in itself, a disservice to the engineering profession.

Part of our career coverage, by the way, caught the attention of the judges of the Jesse Neal Award. Sometimes called the Pulitzer Prizes of the business press, the Neal awards recognize achievements of individual editors. For the second year in a row, *Electronics* editors have been among the winners in the Neal Award competition. New York bureau manager Ron Schneiderman, associate editor Jerry Walker, and senior editor John Johnsrud received a certificate of merit for their contributions to a series of editorials on age discrimination, a career ill that hits EES harder than it does those in other professions.



February 19, 1976 Volume 49, Number 4
92,142 copies of this issue printed

Published every other Thursday by McGraw-Hill, Inc. Founder James H. McGraw 1860-1948. Publication office 1221 Avenue of the Americas, N.Y., N.Y. 10020; second class postage paid at New York, N.Y. and additional mailing offices.

Executive, editorial, circulation and advertising addresses: *Electronics*, McGraw-Hill Building, 1221 Avenue of the Americas, New York, N.Y. 10020. Telephone (212) 997-1221. Teletype 12-7960 TWX 710-581-4879. Cable address: MCGRAW HILL NEW YORK.

Subscriptions limited to professional persons with active responsibility in electronics technology. Publisher reserves the right to reject non-qualified requests. No subscriptions accepted without complete identification of subscriber name, title, or job function, company or organization, and product manufactured or services performed. Subscription rates in the United States and possessions: \$12.00 one year, \$30.00 three years. Canada and Mexico \$14.00 one year, \$32.00 three years. Europe \$35.00 one year, \$87.50 three years. Japan, Israel and Brazil \$60 per year. Australia and New Zealand \$80.00 per year, including air freight. All other countries \$40.00 per year. Limited quota of subscriptions available at higher-than-basic rate for persons outside of field served, as follows: U.S. and possessions and Canada \$25.00 per year; Europe \$40.00; Japan, Israel and Brazil \$85.00; all other countries \$50.00. Single copies \$4.00. Please allow four to eight weeks for shipment.

Officers of McGraw-Hill Publications Company: Gordon L. Jones, President; Paul F. McPherson, Executive Vice President; J. Elton Tuohig, Executive Vice President-Administration; Gene W. Simpson, Group Publisher-Vice President; Senior Vice Presidents: Ralph Blackburn, Circulation; John B. Hoglund, Controller; Ralph R. Schulz, Editorial; David G. Jensen, Manufacturing; Jerome D. Luntz, Planning & Development. Officers of the Corporation: Shelton Fisher, Chairman of the Board; Harold W. McGraw, Jr., President and Chief Executive Officer; Robert N. Landes, Senior Vice President and Secretary; Ralph J. Webb, Treasurer.

Title registered in U.S. Patent Office. Copyright © 1976 by McGraw-Hill, Inc. All rights reserved. The contents of this publication may not be reproduced in whole or in part without the consent of copyright owner.

Subscribers: The publisher, upon written request to our New York office from any subscriber, agrees to refund that part of the subscription price applying to copies not yet mailed. Please send change of address notices or complaints to Fulfillment Manager, subscription orders to Circulation Manager, *Electronics*, at address below. Change of address notices should provide old as well as new address, including postal zip code number. If possible, attach address label from recent issue. Allow one month for change to become effective.

Postmaster: Please send form 3579 to Fulfillment Manager, *Electronics*, P.O. Box 430, Hightstown, N.J. 08520.

When it comes to critical low frequency filtering...

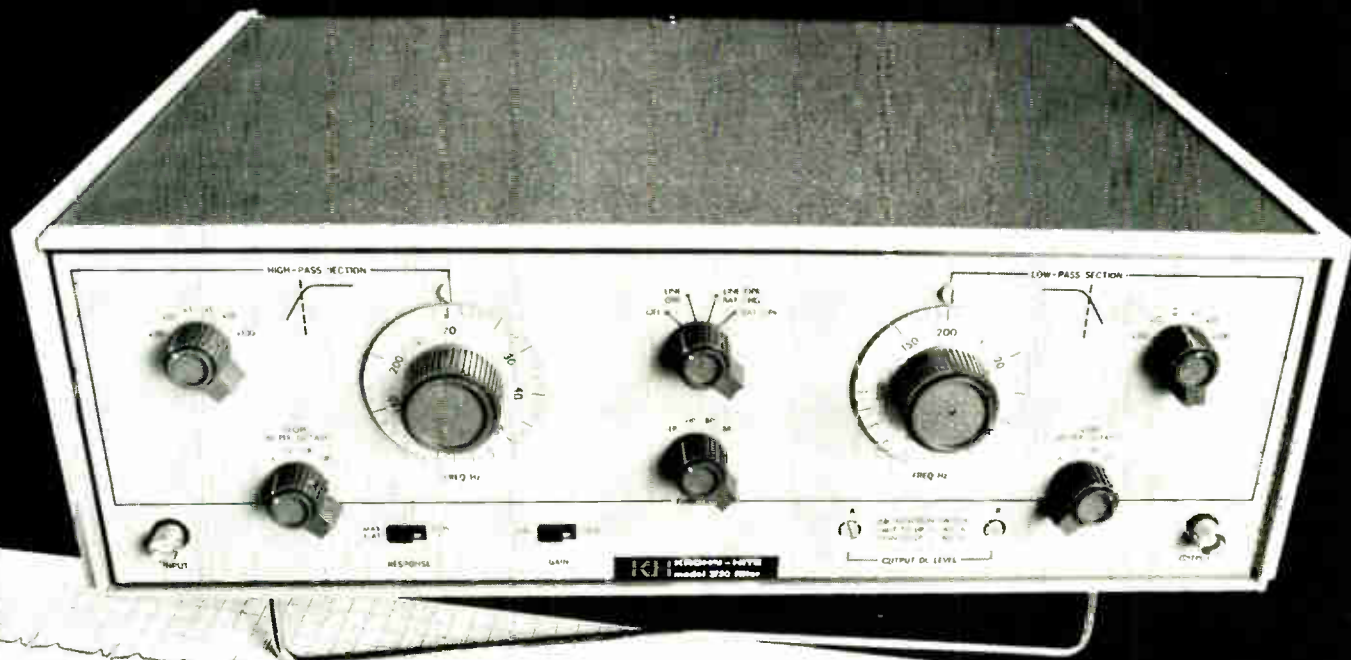

be selective.

Turn to the experts: Krohn-Hite's Model 3750 multi-function filter with variable attenuation slopes lets you custom select operating parameters never before available in one model. Simply turn the selector dials for the filter you need.

Low-pass, High-pass, Band-pass, Band-reject
Frequency Range: 0.02Hz to 20kHz
Attenuation Slopes: 6, 12, 18, or 24 dB Per Octave
Band-pass Gain: Unity or + 20dB
Frequency Response: Butterworth or Low Q

The versatile 3750 meets the requirements of electromedical research, audio testing, psychoacoustics, oceanography, vibration studies, or other low-frequency filtering applications, for only \$995 (optional battery operation available).

Krohn-Hite leads the field with the broadest selection of variable electronic filters to meet all of your filtering requirements from DC to 10MHz.

When it comes to variable filters, it pays to select the best.

For fast action, call us direct or contact your local Krohn-Hite representative listed below.

**KH KROHN-HITE
CORPORATION**

Avon Industrial Park, Avon, Mass. 02322 • (617) 580-1660, TWX 710-345-0831

SALES OFFICES: ALA., Huntsville (205) 534-9771; ARIZ., Scottsdale (602) 947-7841; CAL., San Jose (408) 292-3220, Inglewood (213) 674-6850; CALIF., Denver (303) 750-1222; CONN., Glastonbury (203) 633-0777; FLA., Orlando (305) 894-440; GEO., Atlanta (404) 448-2366; HAWAII, Honolulu (808) 941-1574; ILL., Des Plaines (312) 298-3600; IND., Indianapolis (317) 244-2456; MASS., Lexington (617) 861-8820; MICH., Detroit (313) 526-8800; MINN., Minneapolis (612) 884-4336; MO., St. Louis (314) 423-234; N.C., Burlington (919) 227-3639; N.J., Cherry Hill (609) 424-1060; N.M., Albuquerque (505) 299-7658; N.Y., E. Syracuse (315) 437-6666, Rochester (716) 328-2230, Vestal (507) 785-9947, Elmort (516) 488-2100; OHIO, Cleveland (216) 261-5440, Dayton (513) 426-5551; PA., Pittsburgh (412) 371-9449; TEX., Houston (713) 688-9971, Richardson (214) 231-2573; VA., Alexandria (703) 354-1222; WASH., Bellevue (206) 624-4035; CANADA, Montreal, Quebec (514) 636-0525, Toronto, Ontario (416) 499-5544, Stittsville, Ontario (613) 836-3990, Vancouver British Columbia (604) 278-2009, Halifax, Nova Scotia (902) 434-3402.

Circle 5 on reader service card

Breakthrough.

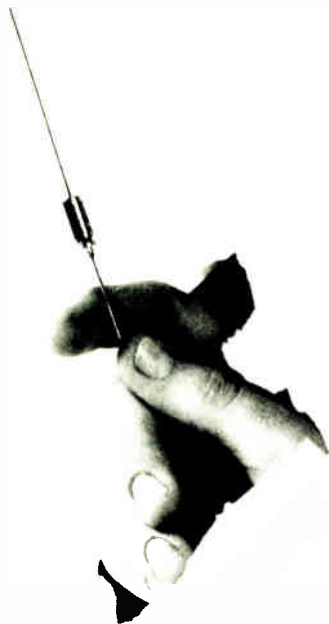

New PuriTan™ all-tantalum capacitor from Tansitor.

The tantalum-cased capacitor
that meets CLR79 specs.

Developed for the most stringent conditions in aerospace applications, the PuriTan all-tantalum capacitor is a major advance in capacitor capability. It meets or exceeds the mechanical, electrical and capacitance requirements of CLR79.

The new PuriTan capacitor solves your problems with:

- Superior AC ripple characteristics
- Reverse voltage capability
- Excellent capacitance stability
- True glass-to-tantalum hermetic seal
- Low ESR
- Low DC leakage

For complete information on the PuriTan all-tantalum capacitor and/or other Tansitor capacitors, call your local Tansitor representative, or contact:

 **Tansitor**
ELECTRONICS
DIVISION OF AEROTRON, INC.

West Road, Bennington, Vermont 05201
Phone: (802) 442-5473
TWX: (710) 360-1782

Specialists in Tantalum Capacitors

TM Trademark of Tansitor Electronics

6 Circle 6 on reader service card

Readers' comments

Fair play for creativity

To the Editor: The very fact that the writer of the letter about patent preassignment agreements [Dec. 25, p. 6] felt it necessary to withhold his or her name shows how repressive it is for a creative person to work for a company demanding such an agreement.

On the other hand, the creative person needs the backup of big business to have new ideas carried through development and production.

Rather than for management to stifle creativity, it could profit greatly by giving recognition and fair royalties to creative personnel.

It is ironic that enforcing such fair play would infringe upon the rights of management to the same degree that not enforcing fair play infringes upon the rights of the individual.

Phyllis B. Chisholm
Hi-Lab
Frisco, Colo.

The time for PM

To the Editor: I disagree with the statement on preventive maintenance, "If it works, let it alone," in Mr. Kush's letter [Jan. 22, p. 6]. According to Murphy and his law, "If anything can go wrong, it will." This applies to any piece of equipment, mechanical or electrical. Therefore a time must be allotted for testing equipment for proper performance—for preventive maintenance, if you will.

The frequency of testing could be based on the mean time between failures for the system being tested. That is, if the system is rated to be reliable for 1,000 hours without a failure, then PM should be performed within this time frame; say, every 900 hours.

In this manner, excessive PM could be avoided, thus enhancing systems performance.

To put it in other words, preventive maintenance is necessary to insure that systems reliability is maintained.

D. D. Dempsey
Fort Gordon, Ga.

Announcing the ideal 12 bit data acquisition module for micro/mini- computers.

ADAC's new ADAM 12 Adaptive Data Acquisition Module is the most cost/effective "front end" system available.

This remarkable module with a throughput rate of 50 KHz contains 16 channels of MUX., high speed sample and hold, 12 bit analog to digital converter and tri-state outputs. All at a low price of \$285 in single quantity.

Even more flexibility is optionally available through the addition of a unique programmable gain amplifier with 4 program selectable gain codes providing resolution to 125 microvolts.

Send for full technical data on the ADAM 12 and other ADAC minicomputer data acquisition and control systems and modules.

ADAC Corporation,
118 Cummings Park, Woburn,
MA 01801. (617) 935-6668.

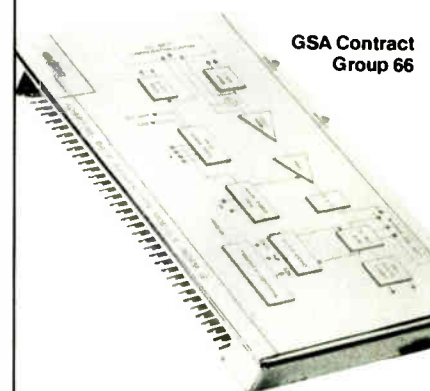

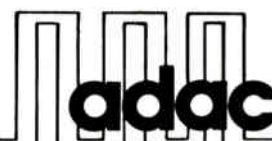
 **adac**

corporation

Circle 196 on reader service card



Any four free with the purchase of one small miracle. Feb. 1-April 30.

Also free, any five of 15 popular programs from our HP-65 User's Library.

That represents \$195.00 worth of software.*

And it points up one thing that sets our HP-65 Fully Programmable apart from all other calculators: our extensive line of software.

Not only do we offer the Application Pacs shown above; we also offer an expanding library of user-created HP-65 programs itemized in catalogs sent periodically to subscribing owners.

You get a year's subscription free. The current catalog contains more than 4,000 programs, grouped according to discipline.

You also get a proven fully programmable calculator with a tested Magnetic Card Reader, five User-Definable keys, 51 preprogrammed functions and operations and a superior editing capability.

Not to mention an uncompromising approach to calculator design, assembly and support—three of the reasons behind NASA's selection of the HP-65 for last

summer's Apollo-Soyuz link-up.

If you've waited for a price break to get your HP-65, your time has come. Here's how to take advantage of this offer: (1) Call, toll-free, **800-538-7922 (in Calif. 800-662-9862)** for an HP dealer near you. (2) Buy an HP-65 from him before April 30, 1976. (3) Send us the free software order form you'll find in the box.

Also, in the box, complete descriptions of the 14 Application Pacs and 15 User's Library programs to help you make your choice.



HEWLETT  PACKARD

Sales and service from 172 offices in 65 countries.
Dept 214B, 19310 Pruneridge Avenue, Cupertino, CA 95014
11/78

Circle 7 on reader service card

*Four Application Pacs @ \$45.00 each; five User's Library programs @ \$3.00 each. User's Library, suggested retail prices—excluding applicable state and local taxes, and special offer good in Continental U.S., Alaska & Hawaii only. Offer void where prohibited by law, regulation or otherwise.

Get the scope you need-Now!

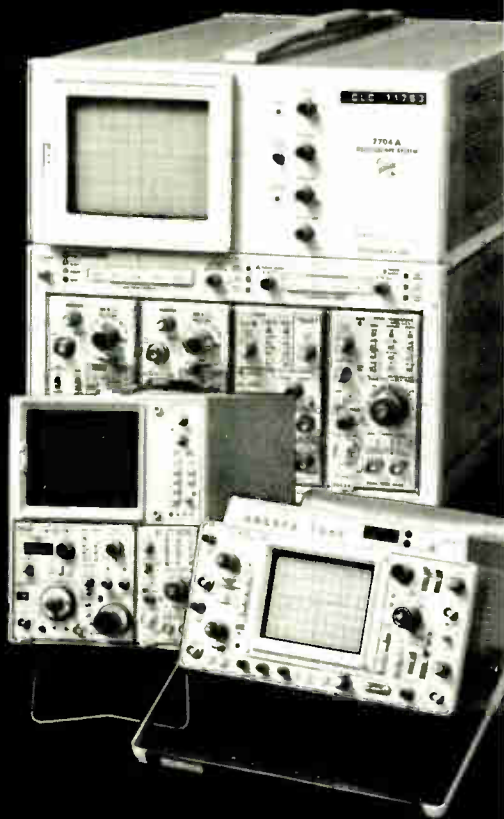

Our "Instrument Professionals" will tell you which scope will do the job best, at the lowest cost, make immediate delivery and guarantee performance.

Write or call for data on our other specialties: Instrument Leasing • Computer Peripherals • Equipment Sales • Instrument Service.

Circle 8 on reader service card

Call  Get our FREE Catalog

Continental Rentals

Div. Continental Leasing Co., Inc.
175 Middlesex Turnpike, Bedford, MA, 01730 (617) 275-0850

Metuchen NJ, (201) 549-8500; Rockville, MD, (301) 881-7997; Dallas, TX, (214) 357-1779; Elk Grove IL, (312) 439-4700; Costa Mesa, CA (714) 540-6566; Santa Clara, CA, (408) 735-8300; Los Angeles, CA, (213) 477-7521

News update

■ The market for intermediate-frequency filters using surface-acoustic-wave technology has not picked up as fast as Crystal Technology Inc., Mountain View, Calif., anticipated in the year since it became the first U.S. company to announce plans to manufacture them [May 1, 1971, p. 25]. A company spokesman says the "market has just been devastated, and no one has been willing to go with any major innovative change." Robert Carlson, vice president for marketing, notes that the \$1.50 price tag on the filters is low enough to begin encouraging color-television makers to use the intermediate-frequency filters by the second half of 1976.

At Plessey Memories Inc., Santa Ana, Calif., however, demand for its i-f filters—using acoustic waves—is "phenomenal." U.S. color-television manufacturers are the prime customers, though the company is also looking for healthy sales in the citizens' band and video-game markets. Industry officials estimated the market for the filters will reach as high as 20 million units within the next three years.

■ The National Semiconductor Corp.'s plans to develop both a watch module and microprocessor using integrated injection logic [April 17, 1975 p. 25] have been shelved, says the company. National engineers found that incorporating minor changes into the design of C-MOS chips allowed those chips to drive the light-emitting diodes in watch modules just as effectively as would I^2L . "If the advantages of I^2L are low power consumption and high density," says an official, "the same thing is offered by n-channel MOS."

In microprocessors, the company says it "would mean a whole new technology." Instead, the company is developing a microprocessor using bipolar technology, but not the relatively slow I^2L . In digital-to-analog conversion, however, National believes that this technology is the one to use, and it may soon introduce a related product.

KITAKAMI

Audio cords & GENERAL MOLDED PRODUCTS....

• Audio cord

KD-501



KD-502



• Phono plug extension cable

KD-601

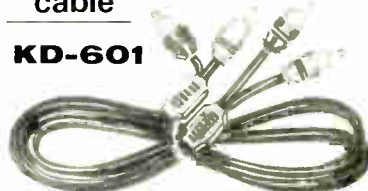

• Headphone cord

KD-701

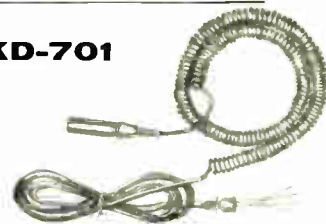

• DIN cord

KD-801

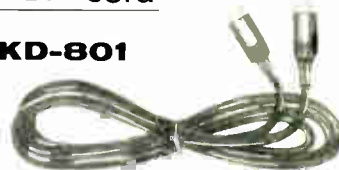

Distributors wanted!

KITAKAMI DENKI CO., LTD.
1407 Hiyoshi-cho, Kouhoku-ku,
Yokohama, Japan. Tel: 044-62-2121
Cable Address: "KDENCO YOKO"
Telex: 3842527 KDENCO J

Circle 197 on reader service card

FMC Corporation

Semiconductor Products Operation
800 Hoyt Street
Broomfield, Colorado 80020
(303) 469-2161



FMC is now a bigger name in power semiconductors.

We're pleased to inform you that FMC Corporation and Brown-Boveri Company have signed a joint marketing and license agreement for their power semiconductor products.

This means we can offer you a complete line of advanced power semiconductors with high-current, high-voltage characteristics, including rectifiers, thyristors and triacs. Ratings are up to 1000 amps and 5000 volts. This is the highest voltage capability offered by any manufacturer in the United States.

Our greatly expanded line of power semiconductors assures you of simplified ordering procedures for devices required in control equipment, welders, power supplies, generators, drives and numerous other services.

For more information just call or mail in the coupon below. We'll send you free brochures describing our product lines along with the name of your nearest FMC distributor or representative.

Yours very truly,

H. D. Wood
Marketing Manager

Name _____ Title _____
Company _____
Address _____
City _____ State _____ Zip _____
Tel. No. _____
Interested in _____
Send additional information on _____

The need to be heard

A serious barrier to communication appears to be developing in the IEEE. A growing number of members of its professional activities committees believe that the IEEE leadership is trying to stifle their attempts to communicate—not only with other members, but with the institute's leadership itself. The tragedy is that what they have to say should precipitate the kind of debate that would make the institute a stronger force in engineering career matters.

Whether the causes for their belief are real or imagined is no longer the issue. The fact that accusations of “censorship” and “laundering” of controversial issues are being made should be enough to persuade the IEEE leaders to reconsider their stand on how to handle critical, even dissident, in-house communications.

Because the professional activities committee chairmen have tended to feel left out, they have begun to communicate informally among themselves and to exchange ideas on how to get the attention of the policy makers at national headquarters. Unfortunately, a “them-versus-us” attitude has developed along with these informal contacts, and they now view their relations with the board of directors as an adversary situation.

It's up to the board to take the initiative in improving communications. The knee-jerk reaction to this type of proposal has been that there are more than adequate opportunities for every member to be heard either through the local sections or through the technical specialty groups. It may be true in theory, but

does not work well in practice; otherwise there would not be the growing frustration among the most active sections about the drift in IEEE's professional activities.

What can be done? A good start would be for the board of directors to reestablish, through IEEE's publishing facilities, a professional activities committee newsletter that would tell all members what's going on at the local sections across the country. This publication, obviously would also do much to cultivate communications between headquarters and the locals.

A couple of conditions would have to be clarified, however. First, the local committees would have to be responsible for getting the material ready for publication, not the headquarters staff. A previous IEEE newsletter was loaded with trivia and proved to be ineffective. Second, headquarters has to keep its hands off the material that is submitted, other than to process it for publication. One of the reasons that the grass-roots chairmen feel alienated is the belief that the New York staff wants to avoid controversy and therefore launders material to make it “acceptable.”

Such a newsletter may not work, either because the sections fail to get behind it despite their complaints to date or because the headquarters staff sabotages the content. But in view of all the changes that have buffeted members in recent years, it is worth a try. If IEEE is to gain the high ranking in professional activities that it has in technical information, it must not put a damper on ideas.

Nobody ever made a 4K static RAM family.

Until today.

Advanced Micro Devices
announces the Am9130 and
Am9140. They do things that
have never been done before.

Look at it this way:

There have always been a
lot of static RAM's. And 4K
RAM's. But there's never been
a 4K static RAM family.

Until today.

Look:

Fully static — no refresh required.

Single 5V power supply.

High speed: Access times to 200 nanoseconds

Two organizations for flexibility: Am9140-4K x 1
Am9130-1K x 4

All input and output logic levels identical to
TTL — full 400mV noise immunity.

Low power dissipation:

700mW maximum (½ power per bit)

350mW typ compared to 2102)

High output drive: 3.2mA @ 0.4V

Full military range available:

— 55°C to + 125°C ambient

DC standby mode reduces power dissipation
by 80%.

Memory status signal indicates when data are
valid, allows improved overall performance,
and simplifies timing. (And if you don't
want to use it, just ignore it. It won't affect
conventional memory operation.)

MIL-STD-883, of course.

Like the picture? Send for the family album.

Advanced MOS/LSI



Advanced Micro Devices • 901 Thompson Place, Sunnyvale, California 94086 • Telephone (408) 732-2400 •
Distributed nationally by Hamilton/Avnet, Cramer and Schweber Electronics.

We sell solutions.

When the man from Honeywell Test Instruments Division comes calling, you may have more and better reasons to see him than you ever realized.

You see, we sell solutions, not instruments. So if your problem can be solved best by a simple plug-in module, that's what he'll recommend.

But if your needs require sophisticated oscillographs, magnetic

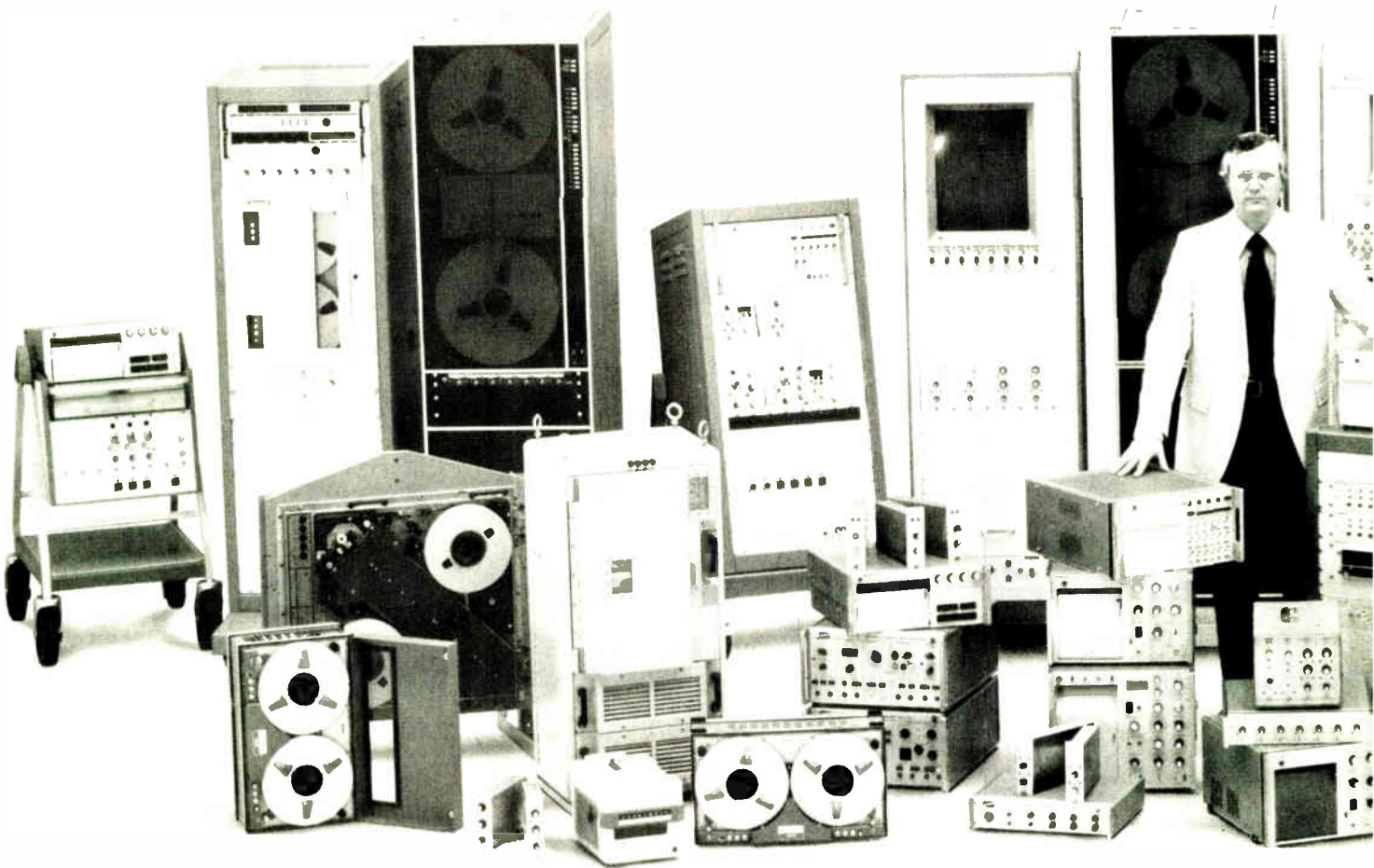

tape recorders/reproducers or custom analog measuring and recording systems, he has the breadth of line and combinations of instrumentation to make exactly the right recommendation. With complete confidence because, in addition to his own expertise, he's backed by the best design, production, application and metrology experts in the instrumentation business.



Honeywell Test Instruments Division — the top trouble-shooters. Call on them when you have any test instrumentation problem. And for a quick look at our complete line of test instruments, be sure to write for our FREE 20-page condensed catalog, Dept. 640, P.O. Box 5227, Denver, Colorado 80217.



Honeywell

MILITARY
APPLICATIONS

AD CONVERTERS

by

MSK

Accuracy

Speed

Size

Repairability

Military

Temp. Range

-55° C to +125° C



- 4 Bit/50 nSec; Low Cost
- Ideal for Radar Scan Converters
- Holds Absolute Accuracy Over Temperatures
- Tracks a 10 MHz Analog Input

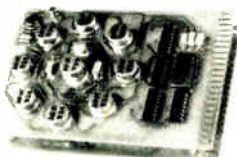

- 9 Bit/200 nSec.
- < 2 Bit Drift Over Temperature
- Insensitive to Clock Frequency

For Further Information Call or Write
M.S. Kennedy Corp.
 Pickard Drive, Syracuse, New York 13211
 Tel. 315-455-7077

People

Schneider named head
of RCA Americom

The company is new, and the title is new, but it really won't be that much different to Philip Schneider, president of RCA American Communications Inc. He's still at RCA Corp., and he's still in the communications-satellite business.

RCA formed RCA Americom last month to operate the company's domestic communications-satellite system. The Federal Communications Commission had ruled that international message carriers should not allow their domestic and international communications operations to cross-subsidize one another, and they must be separated.

Till then, Schneider had been executive vice president of RCA Global Communications Inc., RCA's international communications carrier. Now, in his new capacity, he is back before the FCC, fighting for RCA's right to provide interstate telephone traffic to Alaska via its new Satcom I satellite system. He's up against American Telephone & Telegraph Co., which hasn't launched its own domestic communications satellite yet but recently requested the orbital location that RCA wants.

As the man responsible for the development, marketing, construction, and implementation of RCA's Satcom system while at RCA Globcom, Schneider says: "We would never have designed the satellite as it currently is without Alaska."

The 24-channel Satcom I was launched in December. The system will go into operation "some time in April," says Schneider, and will serve telephone, video and data customers from an operations center in New York City.

The lanky, easy-going executive, who joined RCA in 1961 after tours with Bell Telephone Laboratories and Teleregister Corp., says the RCA service has been carrying network TV and radio over Western Union Corp.'s Westar II domsat. Last September it also began furnishing transmission service for the Home Box Office pay-TV system in New



New launch. Philip Schneider sees RCA providing a "switchboard in the sky."

York City. The HBO-RCA network now covers cable-TV affiliates in 23 cities and is expected to grow with the installation of ground stations in as many as 40 cities by the end of this year.

In addition, as an alternative to terrestrial-communications service, Schneider expects this year to offer major private-line users a new "switchboard in the sky" service. Its main attraction: "You'll pay for it only when you use it," he says.

Abraham at Fairchild looks
to combine I²L, Isoplanar

Yields of bipolar memory devices were a serious casualty at Fairchild Semiconductor during the last half of 1975 as production rates built up. And it can only be surmised that Richard Abraham, Fairchild's new vice president and general manager of bipolar memories, had much to do with correcting the problem.

In the corporate shakeup that came earlier this year [*Electronics*,

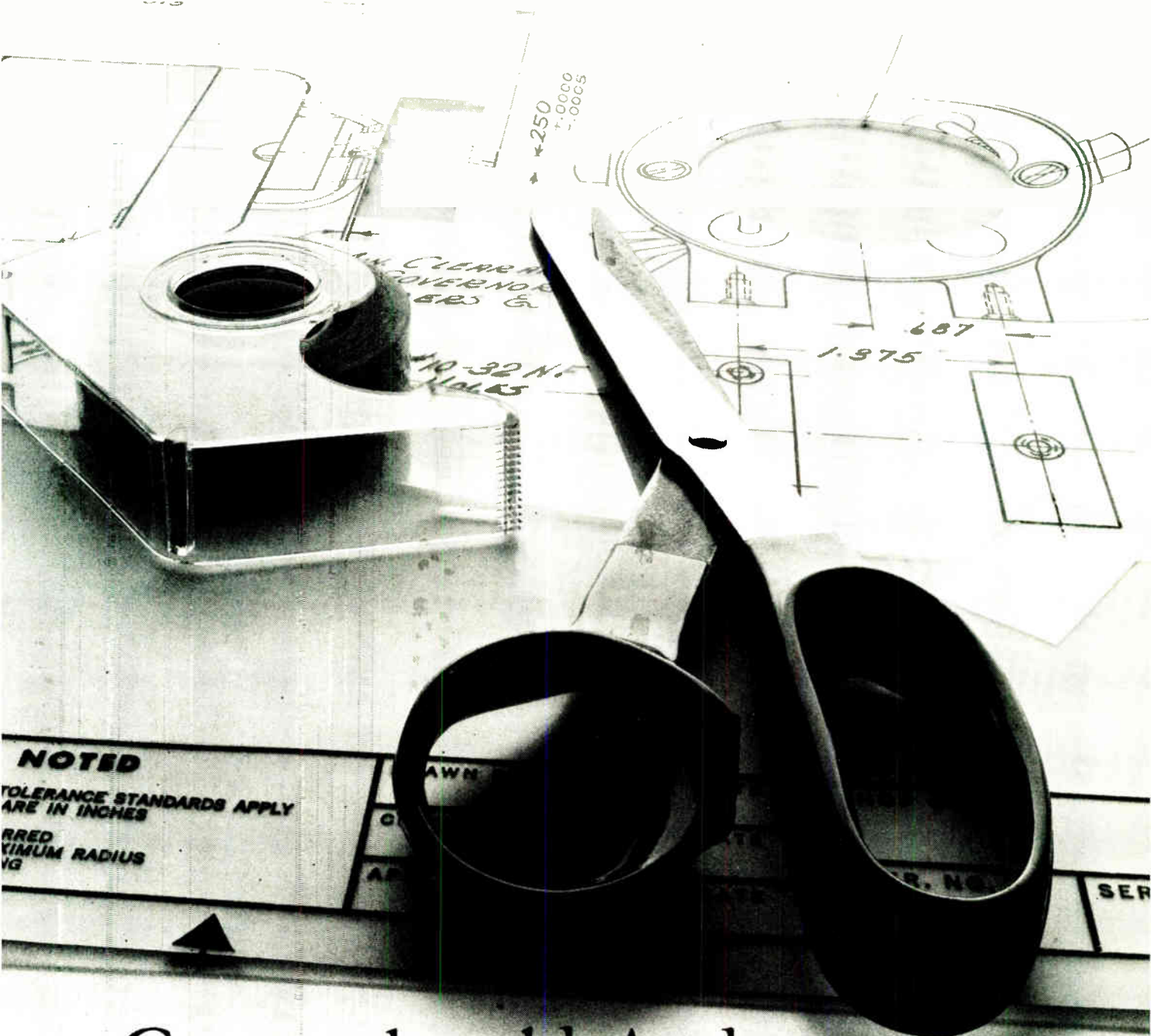

Cut out the old. And cut costs.

You can make drafting revisions a lot quicker with photography and a pair of scissors. Just make a photoreproduction of the original on clear Kodagraph film and scissor out the unwanted detail. Tape the elements you want to a new drawing form and make a reproduction of this composite on Kodagraph matte film. Then simply draft in the new detail.

For more information on how this and other reprographic shortcuts can save you money, write: Eastman Kodak Company, Graphics Markets Division, Dept. R6807, Rochester, New York 14650.

Kodagraph films and papers
Versatility in reprographics



Feb. 5, p. 36], the 46-year-old former head of Motorola's discrete transistor operation has come out a winner. Whereas before he was just another member of the middle-level corporate management in the now defunct Logic and Memory Group, the 6-foot, 2-inch executive now reports directly to Wilfred Corrigan, president and chief executive officer of the Sunnyvale, Calif., semiconductor company. The move, Abraham says, is indicative of "a renewed emphasis on bipolar technology" at Fairchild.

Isoplanar plus. Another indicator is Abraham's present concentration on combining integrated injection logic and the proprietary walled-oxide Isoplanar technology that has enabled Fairchild to dominate the market in 1,024-bit bipolar memories with its 93415 family.

Within the next six months, he says, the company should be in production with two Isoplanar integrated-injection-logic (I³L) products—1,024- and 4,096-bit static RAMS—with performance specifications comparable to Fairchild's present 45-to-120-nanosecond 1-k bipolar Isoplanar RAMS. Further down the line—early 1977, says Abraham—is the just-announced 4-k I³L bipolar dynamic RAM [*Electronics*, Feb. 19, p. 105].

MOS competitor. This will have an operating speed expected to fall below 100 ns and a power dissipation—400 milliwatts active and 80 mW standby—that is no greater than today's metal-oxide-semiconductor RAMS.

"The combination of oxide isolation and integrated injection logic," says the former manager of advanced integrated-circuit development at both Motorola and Texas Instruments, "opens up a number of new applications areas for bipolar memories. Oxide isolation gave bipolar memories a significant performance edge over MOS memories. I²L gives bipolar memories low power and high performance and while n-MOS will always have an edge in cost and density, Isoplanar integrated injection logic will narrow the gap considerably."

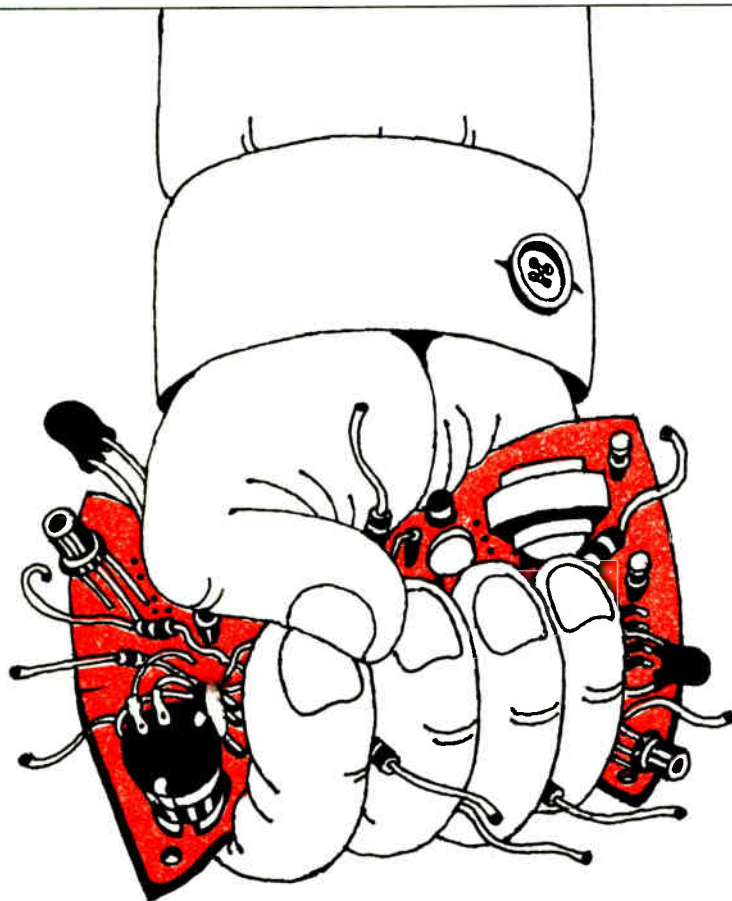

Squeeze your PC board or Hybrid into a Monochip for \$1800.

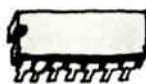

It's really easy. Take your idea or circuit design, no matter what stage it's in and breadboard your system with our \$39 design kit. Then, send us your layout sketch, and in just three short weeks you'll have 50 custom ICs as prototypes.

How can we do it so fast and inexpensively? Monochip is a linear monolithic IC chip carrying up to 300 bipolar components without the last layer of metalization. You can choose from four basic Monochip standards representing different sizes. Then, in your sketch, you simply tell us which components you want connected and we do all the work in three weeks. If you think that's fast, you'll really like the prices and delivery on production units. That's a promise. We're second-sourced, too, so don't worry.

In case you're wondering, Monochip is also great for the first stages of product design. The risk is small, no long development time or hidden charges.

You can get our book of 101 Analog IC design applications for only \$3.00. It contains 124 pages of popular Monochip circuit ideas and some neat design tricks. Just check the coupon below.

interdesign

1255 Reamwood Avenue,
Sunnyvale, CA 94086
Phone (408) 734-8666

My check for \$3 is enclosed for the 101 Monochip applications handbook.

Send me the complete details on Monochip.

Name _____

Company _____ Phone _____

Address _____

City _____ State _____ Zip _____

Not New...Just the Best



ERIE RED CAP

Miniature Ceramic Capacitors

WIDEST SELECTION OF MINIATURIZED CERAMIC CAPACITORS IN THE INDUSTRY!

Erie is in the Red Cap winner's circle because of a well engineered component that's backed by a unique process control system. Combine this with talented, motivated people and you have Erie as the leader in its field. These tiny high quality capacitors are not new . . . but they are the best. Our customers attest to it. Our test laboratories prove it.

Red Cap dielectrics are manufactured by Erie's exclusive Monobloc Process[™] . . . a modern, time-proven ceramic film technology. And tough environmental extremes routinely are endured by our own Jet-Seal, a hard, bright red polymeric protective coating. (The superior aesthetic appearance of Jet-Seal comes to you at no charge.)

Erie Red Caps have it all. 21 temperature characteristics. 1pF to 10uF capacitance range. Ratings from 25 to 500 Vdc. You name the application . . . we've got a Red Cap for the job. All this is due to Erie's total in-house capability . . . from exclusive ceramic formulations to unique packaging. So on your very next buy of ceramic capacitors, do it the easy way . . . specify Erie Red Caps.

Write TODAY for Red Cap brochure 8000 . . . or call our nearby factory representative.

CAPACITANCE
RANGE
1pF to 10uF

21
TEMPERATURE
Characteristics

Voltage Range
25 to 500 Vdc

Encapsulated
by
"JET-SEAL"

Meet or Exceed
Requirements
of MIL-C-20
MIL-C-11015
As applicable

ERIE TECHNOLOGICAL PRODUCTS, INC.
Erie, Pennsylvania 16512

ERIE

Circle 17 on reader service card

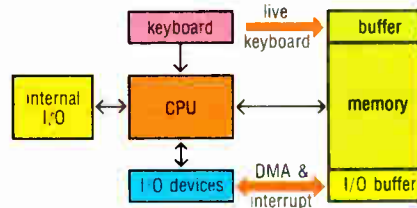

Introducing the HP 9825 with vectored priority interrupt, direct memory access, live keyboard, multidimensional arrays, buffered I/O...

That's big-system computing performance.

The all-new 9825 Computing Calculator: a very versatile, very powerful device for high-speed problem-solving and for interfacing applications. Consider these performance-oriented features:

Vectored priority interrupt allows virtually simultaneous processing of multiple jobs. It's easily programmed to suspend processing, gather or send data and messages to instruments and peripherals, then automatically return to the original job.

Live keyboard lets you interact with the system while a program is running to examine or change program variables—or even perform keyboard calculations.

Up to 400k transfers per second direct memory access provides mini-computer speeds which allow real-time data acquisition and data transfer with high-speed devices.

High-speed, 250k byte tape cartridge with 6-second average access time permits rapid processing of data and loading of programs.

Multidimensional arrays allow you to organize data logically, thus saving program space and execution time. A 20 x 20 matrix can be inverted in 10 seconds.

Buffered I/O increases throughput by providing a programmable software buffer between the program and an external device.

Memory load and record allows you to suspend processing whenever you want and store the complete contents of memory on tape—including data and pointers—for continuation later on.

High level language (HPL) offers you power and efficiency for handling equations, data manipulation,

and input/output operations. Yet it is easy to learn and use.

Other features and capabilities enhance 9825 performance and versatility: for example, upper and lower case alphanumerics on both the display and printer; interfacing to any of eight HP calculator peripherals through three I/O slots, and up to 45 different instruments via HP Interface Buses.

Simultaneous processing of several diverse jobs.

Say you're using a 9825 to control an instrument test stand, and acquiring data from it at speeds in excess of 1000 bytes a second; then printing the results on the new HP 9866B Thermal Line Printer. At the same time, the same 9825 can also be processing and plotting a statistical problem. And through the 9825's live keyboard, you can check the

progress of either program and even change parameters if you desire. It seems the 9825 is doing all these operations simultaneously, thanks to its speed, buffered I/O, and interrupt capability.

Unexpected performance from a computing calculator

All this performance comes in a 26-pound, 5" x 15" x 19" package. Yet, with all its power and computer-like features, the 9825 still retains the friendliness and simplicity of a calculator. You don't have to be a programmer to get performance out of a 9825; nor do you need to be a systems expert to do interfacing applications. When you know all the facts, we think you'll agree the 9825 is a great buy. Write for your free copy of the 16-page 9825 brochure, or call your local HP sales office for more information.

HP computing calculators put the power where the problems are.



Sales and service from 172 offices in 65 countries
P.O. Box 401, Loveland, Colorado 80537

Meetings

Conference on Personal Communications, Electronic Industries Association, Las Vegas Hilton Hotel, Las Vegas, March 30–April 1.

CATV '76—National Cable Television Association Convention, NCTA (Washington, D.C.), Dallas Convention Center, Dallas, April 4–7.

Paris International Electronic Components Show, French Trade Shows (New York), Paris, France, April 5–10.

NBS Seminar on Frequency Standards and Clocks, National Bureau of Standards, Boulder, Colo., April 6–9.

Acoustics, Speech, and Signal-Processing International Conference, IEEE, Marriott Hotel, Philadelphia, April 12–14.

Computer Software Engineering: Reliability, Management, and Design, IEEE, Barbizon Plaza Hotel, New York, April 20–22.

Reliability Physics International Symposium, IEEE, Caesars Palace, Las Vegas, April 20–22.

Electronic Components Conference, IEEE, Jack Tar Hotel, San Francisco, April 26–28.

Optical Computing International Conference, IEEE, Capri, Italy, April 27–29.

Circuits and Systems International Symposium, IEEE, Technical University, Munich, Germany, April 27–29.

Offshore Technology Conference, IEEE, Astorhall, Houston, Texas, May 3–6.

Carnahan Conference on Crime Countermeasures, IEEE, University of Kentucky, Lexington, May 5–7.

Electro 76—IEEE International Convention, IEEE, Hynes Auditorium and Sheraton-Boston Hotel, Boston, May 11–14.

Thin-Trim capacitors

Tucked in the corner of this Pulsar Watch is a miniature capacitor which is used to trim the crystal. This Thin-Trim capacitor is one of our 9410 series, has an adjustable range of 7 to 45 pf, and is .200" x .200" x .050" thick.

The Thin-Trim concept provides a variable device to replace fixed tuning techniques and cut-and-try methods of adjustment. Thin-Trim capacitors are available in a variety of lead configurations making them easy to mount.

A smaller version of the 9410 is the 9402 series with a maximum capacitance value of 25 pf. These are perfect for applications in sub-miniature circuits such as ladies' electronic wrist watches and phased array MIC's.

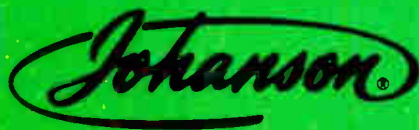

Johanson Manufacturing Corporation
Rockaway Valley Road
Boonton, New Jersey 07005
(201) 334-2676 TWX 710-987-8367

This silicon stays clean for a week...or a year...or...?

Monsanto offers the cleanest silicon slice in the industry. To keep it clean, we're introducing a new package for high quality polished wafers.

It can . . .

- eliminate backside contamination
- prevent wafer degradation
- reduce costs and inventory problems
- improve material handling

The system holds the wafers in FLIP-TRAN™ cassettes which are sealed in a can under a positive nitrogen pressure. This prevents wafer degradation due to particulate matter, water vapor, oxygen and other ordinary atmospheric contaminants. It effectively moves the wafers from our final processing step to your first fabrication step without deterioration. That means you receive and keep a high quality wafer.

And the FLIP-TRAN cassette is designed to interface with a wide variety of automatic cartridges, furnace boats, and other wafer processing containers. Expensive individual handling is eliminated because you can dump-transfer 25 wafers at a time.

Monsanto has consistently provided leadership in the manufacture of polished silicon slices for semiconductor manufacturers – quality materials of the highest order. The cassette system of packaging preserves that quality until the wafers are ready for use in your production line.

Send for more details. We'll send you descriptive literature on this innovative package. Or, if you want more information on our lines of quality silicon, write for more details. Monsanto Electronics Division, Headquarters: 3400 Hillview Ave., Palo Alto, CA 94304. Phone: (415) 493-3300.

Putting Innovation to Work.



Monsanto:
the science
company.

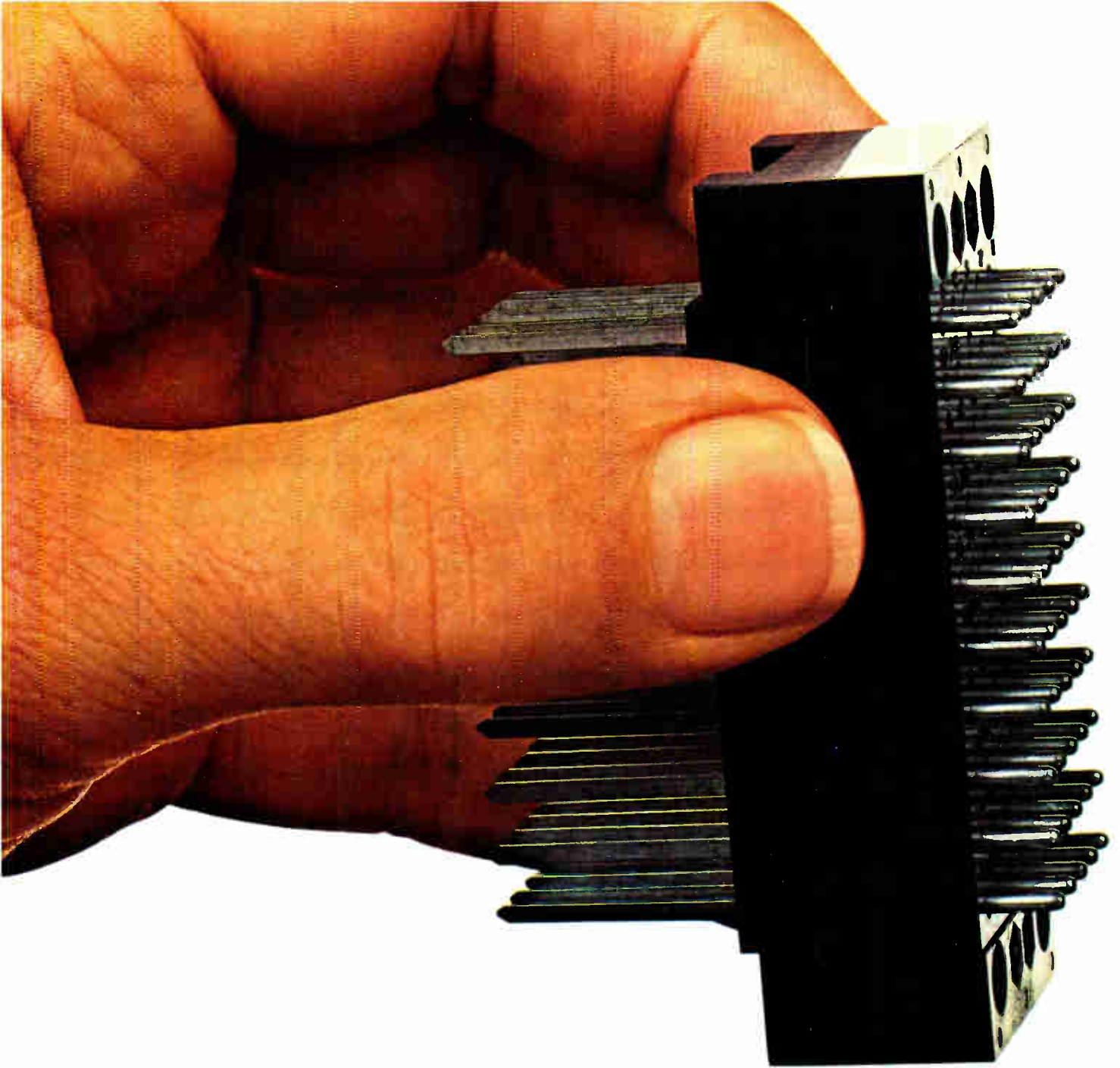

Sylvania gets it all

At some point in your system, all the panels and black boxes must get together, so you can get your system all together.

And Sylvania has that point.

Our new 50-position rack and panel connector.

It's available with either point-to-point or crimp snap-in contacts.

Contacts are on a standard 0.200-in. matrix for automatic wiring applications. The position of each contact is held within a diameter of .020-in. of its true position.

The phenolic molded connector has copper-alloy

contacts with gold or tin plating.

The 50-contact model is available now, off-the-shelf, and additional models will be in production soon.

As with all Sylvania connector products, custom modifications or completely new custom designs are available.

We are able to maintain the highest quality control over all of these connector products because we control the complete operation from molding the plastic through stamping, plating and assembly.

Right up to the finished product.

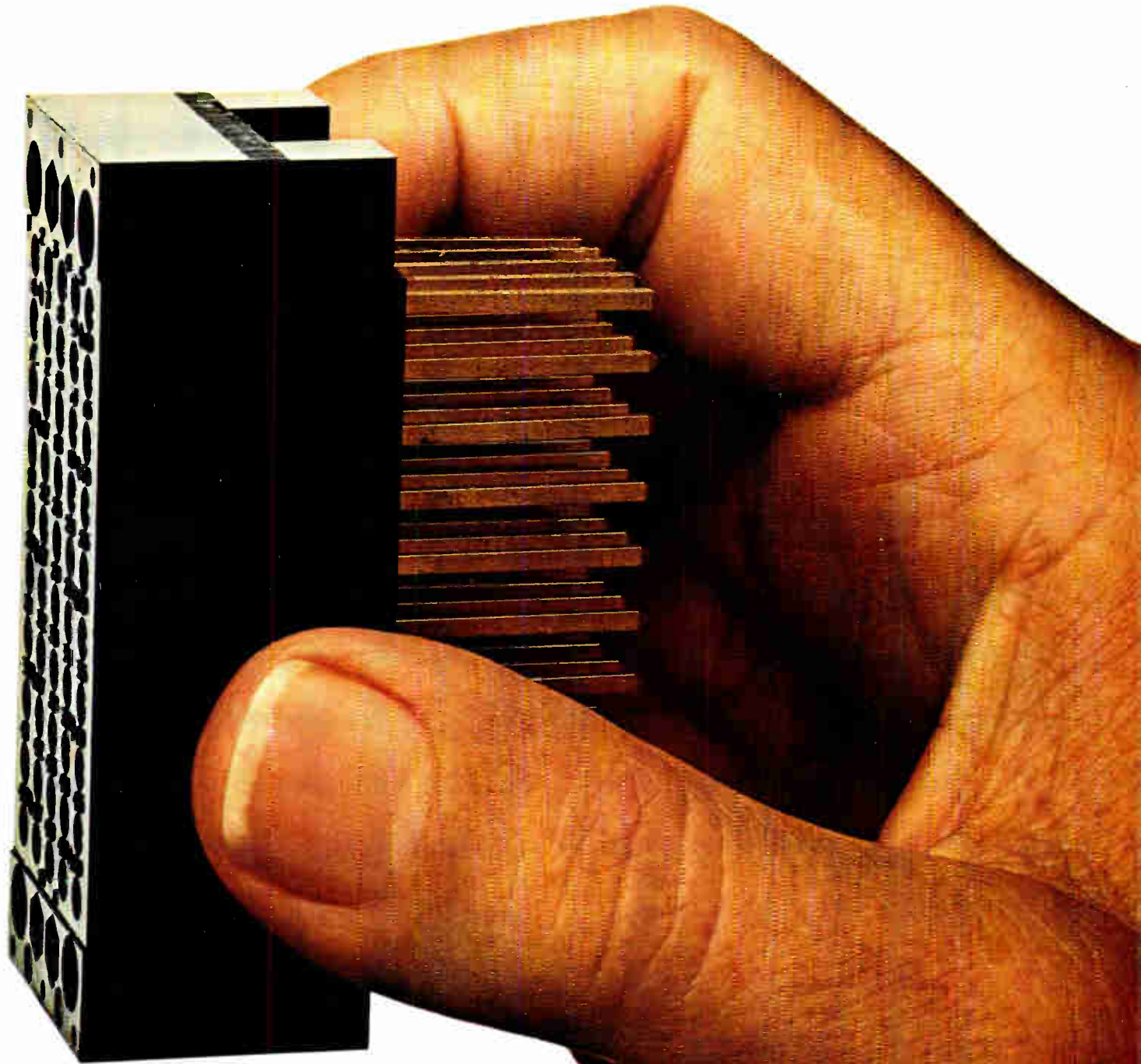

together.

You get the same quality control whether you want our 50-contact connector, your own modification, or something completely special.

We can put it together for you because when it comes to connector technology, Sylvania has it all together.

So get together with us. Call or write: GTE Sylvania, Parts Division, 816 Lexington Avenue Warren, Pa. 16365, 814-723-2000.

We're helping you make it.

GTE SYLVANIA

Circle 23 on reader service card

World Radio History

Hot-molded resistors provide low temperature coefficient and unmatched reliability.

The Resistance Temperature Coefficient of Allen-Bradley hot-molded fixed resistors is typically less than 200 PPM over the entire resistor range shown in the normal equipment operating temperature of +15°C to +75°C. Excellent RTC ratings have always been an Allen-Bradley benefit. And consistency of Allen-Bradley resistors means repeatable results and tight performance patterns. Allen-Bradley resistors offer the **lowest cost—on the board—**where it counts!

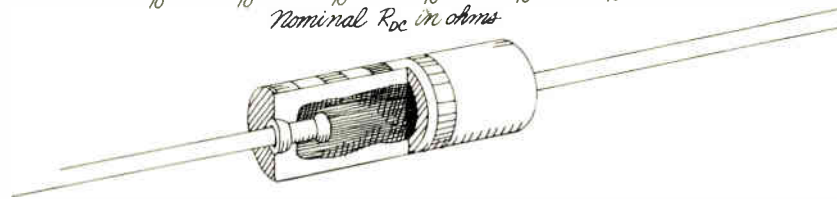
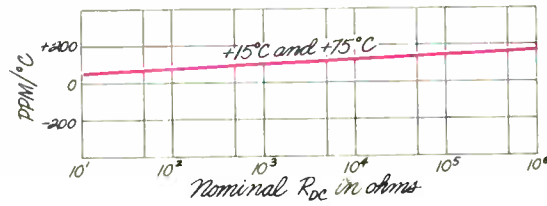

Reliability

is unsurpassed. Over 700 million unit test hours without a single failure.

No coatings

Insulation and resistance element integrally molded into one solid structure.

Pulse handling

characteristics offer outstanding protection against surges and transients.

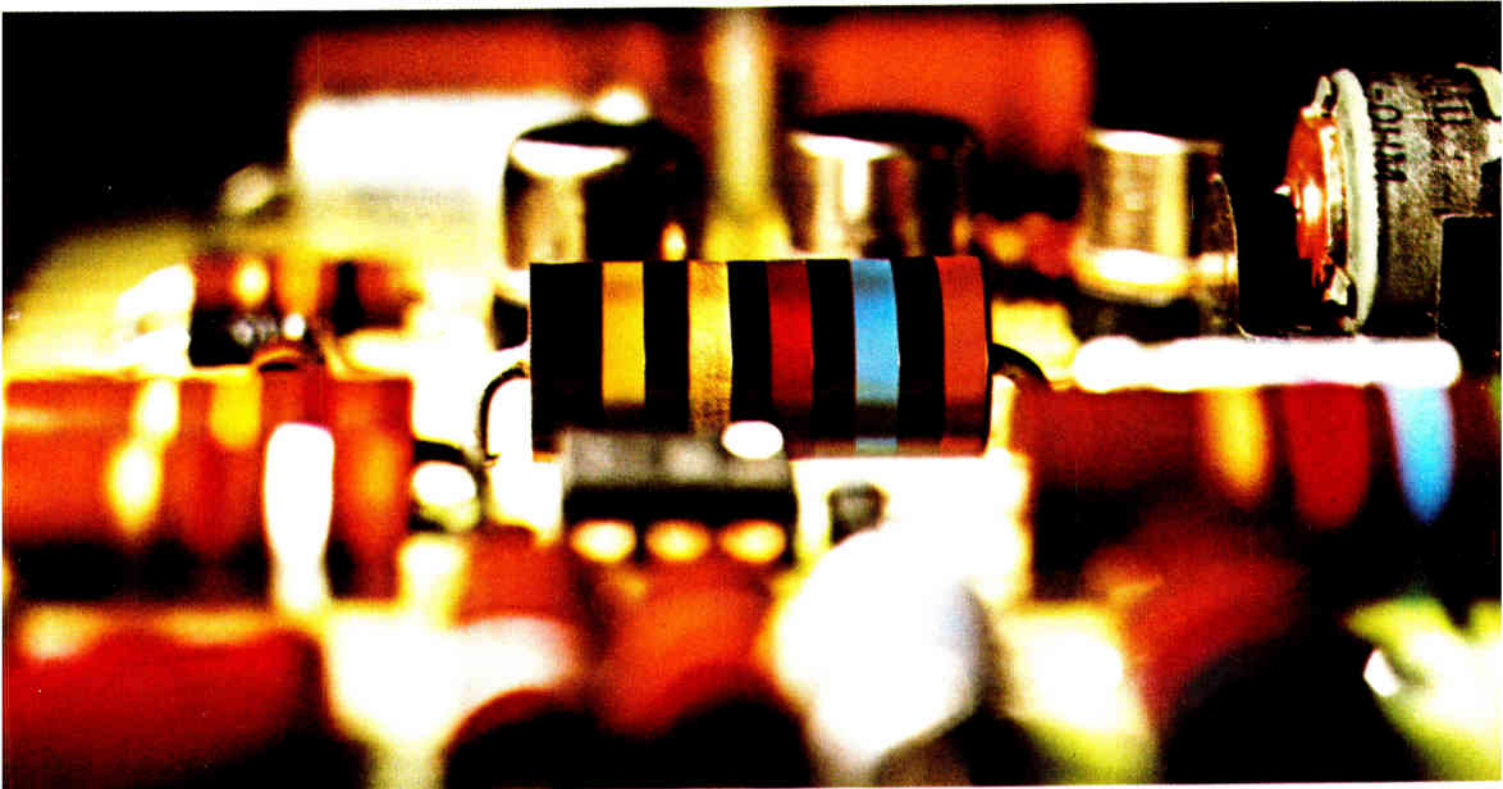

Quality in the best tradition.



ALLEN-BRADLEY

Electronics Division
Milwaukee, Wisconsin 53204

Motorola drops I²L in switch to enhanced MOS . . .

Although Texas Instruments and Fairchild Semiconductor are continuing to pursue injection logic for high-performance digital products, one major semiconductor maker, Motorola Semiconductor, has stopped its I²L work in memory and microprocessors in favor of enhanced MOS. According to Robert R. Heikes, assistant group executive for the Semiconductor division, Motorola has set up a special group, headed by Robert Jenkins, manager of LSI engineering, **to concentrate the company's efforts in high-performance MOS**—including enhanced silicon gate as well as the new MOS techniques, such as V-groove MOS and double-diffused MOS technology.

Recent organizational moves at Motorola also reflect the MOS emphasis. Albert Dulac, head of the MOS Austin, Texas, plant, has been named director of LSI operations, with Colin Crook, manager of LSI systems, and Jenkins reporting to him. Some immediate MOS projects: a 16-k, 16-pin dynamic RAM in sample quantities in a few months and a one-chip 8-bit microprocessor in its final design stages.

. . . as 6800 gains speed, lower prices by summer

By adding depletion loads to most parts in its M6800 microprocessor family, Motorola Semiconductor **plans to double the system's throughput and reduce prices** by the end of the summer. The MC6800D—to be sampled in July—will measure 160 mils on a side, down from 200 mils on the current part, "and could be as much as a factor of two faster," says an official at the firm's LSI operations in Austin, Texas. "Because of the enhanced process we expect the 6800D to go to the full military temperature range."

Clock specs on the microprocessor will be relaxed and Motorola also is readying a monolithic Schottky driver for July sampling. Dubbed the MC6875, the linear part will replace hybrid or multi-package approaches used now, will cost less than \$2.50, and can use an inexpensive 3.58-megahertz TV crystal as its timing source. Other depletion-mode parts will include the system's 128-by-8-bit static random-access memory, 1,024-by-8-bit read-only memory, and peripheral interface adapter.

TI to add 4-, 8-bit processors to 9900 line

Besides full software compatibility with Texas Instruments' 990 minicomputers, **TI's recently announced 16-bit microprocessor will have smaller siblings as well.** In development in Houston are follow-on microprocessors that are architecturally similar, and software-compatible with the n-channel 9900, but—at least externally—able to operate on 8-bit and 4-bit data buses. Samples of an 8-bit version will be available this year; a 4-bit processor, in 1977.

Also in the 4-bit realm, the firm plans to upgrade its p-MOS TMS 1000 microprocessor to n-MOS this year, yielding a part that requires a single 5-volt supply. Beyond that, "we're working on an electrically alterable ROM version of the TMS 1000," a spokesman says.

National, other firms use outside designers

Here's a new one, even for the semiconductor industry. Some major suppliers, feeling the pressure of a fiercely competitive memory market, **have been getting help on key memory products from outside design shops** staffed by well-known designers. For example, all of National

Semiconductor's 4-k RAMs were designed by a task force that included a two-man Bay Area design shop called RAM Power.

RAM Power is headed by Joel Karp and John Reed, both former Intel employees who were responsible for the industry's first 4-k design in the early 1970s. According to a National spokesman, the deal with RAM Power has been so successful that "we've renewed our contract for designs on 16-k RAMs, as well as future bipolar and static memory products."

Another two-man design team, called MOS Aid, has recently been formed in Ottawa, Canada. Specializing in dynamic MOS RAM designs, it is headed by Richard Foss, formerly with the defunct Microsystems International Ltd.

500-V rectifiers due from Unitrode

By closely controlling the gold-doping process and optimizing package designs for low thermal resistance, **Unitrode Corp. has extended the state of the art for high-speed rectifiers.** Its products handle 500 volts at 50 amperes, with a recovery time of 50 nanoseconds, whereas today's best comparable devices, according to the Watertown, Mass., company, handle 450V at 12 A, with a recovery time of 75 ns. Unitrode's gold-doping process is proprietary; engineers will say only that their technique prevents over-doping, which would lead to undesirably high leakage currents. Unitrode has held leakage currents to a maximum of 1 milliampere in its 500-V, 50-A device, as against 25 mA for rectifiers on the market today.

The family is aimed directly at designers of power supplies and will be introduced later this month. It will include 200-, 300-, 400-, and 500-V rectifiers ranging in current ratings from axial-leaded units at 2 and 4 A all the way up to the DO-5-packaged 50-A entry.

TI's first 16-k RAM to have 16 pins

Although Texas Instruments chose not to join the group that formed around a 16-pin package for 4-k RAMs, **its first 16-k versions will have 16 pins.** The first samples, to be shipped late this month, will have a 16-k-by-1-bit configuration that is pin-compatible with Intel, Mostek, and Motorola parts.

Other pin-outs are in the works, however, and users eventually expect 22- and perhaps 20-pin devices from TI, but the parts probably will have different organizations that take more than 16 pins to implement.

Digital multimeter handles 1,000 conversions per second

Using an extension of dual-slope integration, Data Precision Corp. of Wakefield, Mass., has developed a 5½-digit multimeter **that can do a conversion in a millisecond.** The company calls the integrating technique to be used in the model 7500 "quadrphasic," and it entails the integration of the unknown input for 200 microseconds (slower for conversion requirements) to get the fast conversion speed. The instrument then integrates a large reference input for whatever period is required to get within 1% of full scale, at which time the comparator emits a pulse that changes the size of the reference, and slows the clock speed, each by a factor of 100. This greatly reduces the burden on the comparator for the final short period of integration. The model 7500 will cost less than \$3,000.



A little success story with holes in it...

Holes of almost any shape and size. Up to 10,000 holes per square inch, in pieces as thin as 0.10 inch. Holes, slots, and channels, as small as 0.005 inch. And with tolerances as close as ± 0.001 inch.

We're talking about Corning FOTOFORM® and FOTOCERAM® materials. Unique, photosensitive materials that can be precision-etched, machined, cut, milled, chamfered, ground, lapped, polished, sealed to glasses or ferrites. And even metalized.

The real beauty of FOTOFORM and FOTOCERAM materials is they offer you engineering flexibility—the flexibility to do it your way.

And at Corning, your way is the only way. That's why we developed FOTOFORM and FOTOCERAM materials. They may help you write your own success story. We'll help. We're the Fotoform Products Group, Corning Glass Works, Corning, New York.

You ought to get to know us better. Find out more about FOTOFORM and FOTOCERAM materials. Write, under your letterhead, for a free sample depicting the 1776 Bennington Flag and complete specifications to:

FOTOFORM Products Group Dept. E:36
Corning Glass Works, Corning, New York 14830
(607) 974-8583

CORNING
CORNING GLASS WORKS



Write for free sample today!

**We want you
to build
a better power
supply.**



Introducing Unitrode's new high-efficiency power rectifiers.

If you're building switching power supplies, chances are you've had problems with efficiency, voltage or temperature. That's why we came up with our new line of low-cost industrial power rectifiers.

Now you can enjoy advantages like —

Higher efficiencies. Made possible by a very low forward voltage drop (typically .7 volts under maximum operating conditions) and extremely fast recovery times (forward: typically 15ns, reverse: typically 30ns).

Ratings that are second to none. 25 amps in a DO-4, 30 amps in a TO-3, and 70 amps in a DO-5. All three products are available to 150 volts.

Low thermal resistance. Less than 1.5°C per watt for our DO-4, .8°C per watt for our TO-3, and only .6°C per watt for our DO-5.

High junction temperature. Maximum temperature of 175°C for greater system reliability.

Rugged mechanical construction. Designed to dramatically increase the useful life of your particular power supply.

What all these advantages add up to is a lower overall cost for your entire system.

Best of all, our industrial power rectifiers are competitively priced and are available in any volume you need. For complete specs, circle our number on the reader service card, or drop us a line. Unitrode Corporation, 580 Pleasant Street, Watertown, Massachusetts 02172.



\$795 never bought a system DMM like this... until now.

- Fully programmable in function, range and even autorange
- Full remote control up to 12 conversions/sec
- Complete interface capability
- 0.007% Basic accuracy for 6 months

 **DATA PRECISION**®
...years ahead

Until now, you'd pay \$2000 to get what the Model 3400 gives you and even then, you might come up short.

The Data Precision Model 3400, at just \$795, is the world's most accurate systems/lab 4½-digit multimeter. It is the only DMM in this price range designed with digital data interface as a true system multimeter as well as a highly versatile stand-alone unit. It is completely and independently programmable from its rear terminal digital interface for both range, function and even autorange.

The Model 3400 features include TRI-PHASIC[®], the Data Precision exclusive conversion cycle for drift-free overall system performance; up to 12 complete full-scale conversions per second providing printer-compatible data throughput rates; overload protection to 1000 Volts peak on all Volt and Ratio ranges, plus 270V on all resistance ranges; and optimum utilization of 4½ digit resolution through 100% overrange.

And there is still more. The Model 3400 implements "overlap mode" for interlacing MUX advance and sampling, so that system throughput rate equals instrument conversion rate, without MUX settling errors; BCD output is fully printer-compatible; accurate, stable, repeatable 10 μV resolution DC and AC; and it provides full function versatility: DC Volts; AC Volts; Ohms; DC/DC and AC/DC Ratio. IEEE Standard 488 BUS optional.

In the Model 3400, Data Precision has put complete system-implementing control within reach of many new customers. It's just part of our on-going commitment to provide the most accurate and reliable instrumentation at the lowest possible price.

For complete information or a demonstration, contact your local Data Precision representative or Data Precision Corporation, Audubon Road, Wakefield, MA. 01880, (617) 246-1600. TELEX (0650) 949341.



Full one-chip controller sells for under \$10

Four-bit Rockwell device aims at control applications for which today's multi-chip systems would be overkill

The first of a new class of one-chip controllers is here. Getting the jump on its competitors, Rockwell International has developed an under-\$10 microcontroller chip that contains enough on-chip registers, memory, and input/output capability to allow equipment designers to handle many stand-alone and peripheral control applications with a single device [*Electronics*, Feb. 19, p. 132].

Micro. The first of the new PPS-4/1 family from the Microelectronic Device division, Anaheim, Calif., is actually a small microcomputer chip, the A67XX, with 10,752 bits of read-only memory, 384 bits of random-access memory, and 31 input/output ports—more on-chip I/O capability than is available on the single-chip 4-bit controllers originally developed for calculators.

Also adding to the versatility of the PPS-4/1 is its large instruction set—50 instructions all told—and its ability to be used with Rockwell's older general-purpose PPS-4 and the recently introduced two-chip PPS-4/2 systems.

Clearly, the 4- and 8-bit programmable microcontroller chips that are now or will soon be available provide the cheapest solution to a wide range of control applications—in appliances, low-cost instruments such as digital thermometers, in small games and toys, and in industrial

gear that requires a modest amount of data processing, such as gas pumps, scales, and servo gear.

These chips can also be used for peripheral controllers in large microprocessor-based systems, such as point-of-sale and communications terminals. Here they will take the load off the central processors (such as Rockwell's PPS-4 and PPS-8 multi-chip systems) and add capability and flexibility cheaply.

Small but powerful. The ROM, RAM, working registers and I/O ports of the PPS-4/1 chip are arranged to

Development. PPS-4/1 evaluation chip has address and memory lines bonded to pins so prototype programs can be stored in external PROM or ROM. Production version, in a 42-lead plastic package, will have program mask-encoded in an on-chip 10,752-bit ROM.

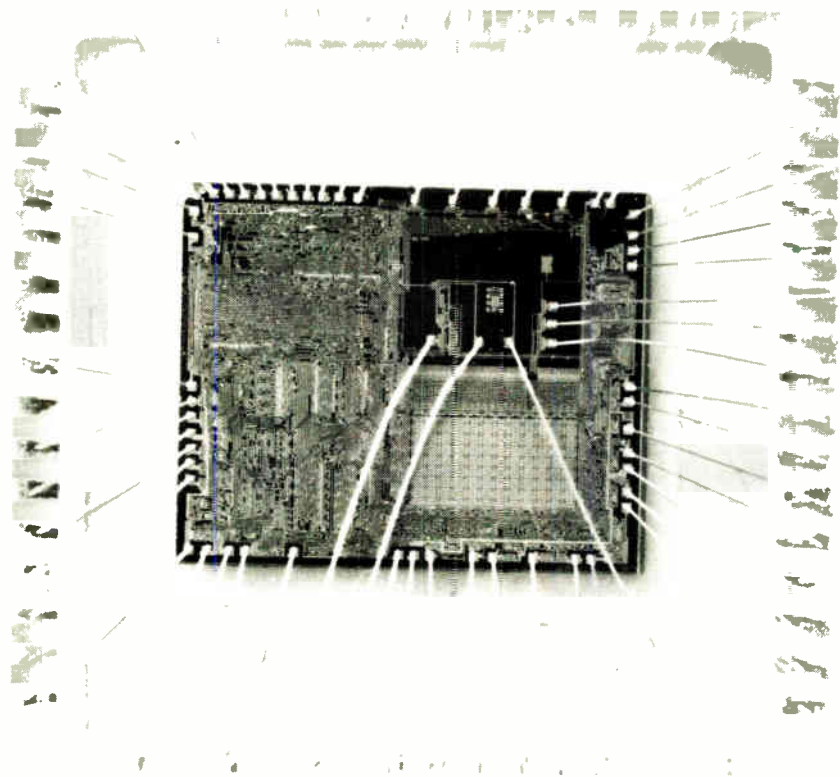

provide a basic microcomputer system. A 1,344-by-8-bit mask-programmable ROM functions as the program memory, while a 96-by-4-bit RAM provides data, parameter, and working storage. Data is processed by the chip's accumulator and five-register arithmetic/logic unit, which together with a carry register perform either binary or decimal arithmetic. Here the accumulator functions as the primary working register, receiving constants via ROM instructions and variable data supplied from or exchanged with the RAM under control of a data-address register. The accumulator also serves as the primary path for 4-bit parallel or serial data.

But what chiefly enables the PPS-4/1 chip to handle the widest variety of applications is its powerful instruction set and I/O structure. In addition to its two 4-bit I/O channels and 10 discrete I/O lines, it has two 4-bit input channels for use simultaneously in testing or comparing data.

What's more, interrupt capability is provided by means of two interrupt-request input lines, one of which can automatically trigger an echo signal or provide priority input and status capability. In addition, the PPS-4/1 is both TTL- and C-MOS-compatible, has a resistor-controlled clock generator, operates from a single 15-volt power supply, and comes in a 42-pin quad in-line plastic package.

Lowest cost. According to James Slager, who's responsible for the system design of the PPS families, "the A67XX chip—unlike others that were first designed as calculator chips—was conceived as the lowest-cost microcomputer circuit element that would still be powerful enough for a wide range of system implementations. Not only can the A67XX be used as a compact stand-alone microcomputer, but it can also be used in conjunction with other A67XX chips in expanded system configurations, or as peripheral controllers with other PPS families, such as our PPS-4/2, PPS-4 and PPS-8 microcomputer families."

The 50-instruction set of the PPS-

4/1 is similar to Rockwell's other PPS-4 sets, enabling a PPS user to move quickly up and down the family, adding equipment features or updating performance. And as with all of Rockwell's microcomputer parts, full software support is provided, as well as a development system, called an assembler. This system combines assembler and emulator functions and helps a user convert high-level assembler lan-

guage into complex machine code.

In addition, Rockwell is making available an evaluation 64-pin chip (P/N A6799), which has its address and memory lines bonded to external pins (see photographs on p. 31); it permits a user to store a program in an external PROM or ROM for real-time development and testing. The prototype device could even be used to implement low-quantity systems quickly. □

Memory

Texas Instruments moves bubbles to pilot production for its products

Texas Instruments has moved magnetic bubble memory devices out of the laboratory and into pilot production in Dallas. It's now supplying samples to its own computer operations and has started talking to outside users to determine preferred organizations for the memory. "We hope to see our equipment incorporating our bubbles out in the market certainly no later than 1977," says C. Morris Chang, group vice president for semiconductor products.

The firm's Digital Systems division originally began working with a 256,000-bit module—sixteen 16,000-bit chips wired together on a ceramic substrate that measured an inch and a half on a side, a configuration that was first operated with a TI minicomputer in 1974. It's since graduated to a single 100,000-bit chip in a ceramic dual-inline package, with the permanent magnets needed to bias the bubbles mounted inside the package. TI apparently held off moving the devices into pilot production until it perfected the 100-k package: "For bubbles to be attractive, the cost should be down in the 20 to 50 millicent/bit range," Chang says, "and to get to that kind of cost, the packing density needs to be at least 100,000 bits."

Few months away. The Digital Systems division has used the new memories in both computers and terminals "in tests in a lab environment until now," says Doss D. Dun-

lop, the vice president heading the division. "But we will put equipment using bubble memories into the hands of internal customers in the next few months. We're now in the stage of defining what products they'll go in."

A likely candidate is a portable data terminal, where their non-volatility and low power consumption make the bubble devices especially attractive. "We can do storage in a portable environment with bubbles. The alternative, a cassette drive, takes a fair amount of power to operate," Dunlop says.

A second application is a disk replacement. "In terms of speed, it fits right in between disk drives and semiconductor memories," Dunlop explains. "There are still some unanswered questions, but we might use it in the same manner as a floppy disk, although it's not a removeable medium like a floppy disk."

Besides shipping samples to internal users, the semiconductor group has engaged mainframe computer makers in discussions aimed at determining requirements for standard products. "We're asking their preferences for organization of the memory," Chang says. "From that consensus, we will try to develop a few standard products based on customer opinions, rather than develop one memory for each customer."

The firm has no plans in the im-

mediate future to offer bubble devices on the open market, however. "Rather than making a big splash in public, we will work with those customers who have indicated a strong interest," he says.

Large market. TI expects to see significant bubble memory business by 1979, with sales of the devices that year to top \$100 million, as bubbles begin penetrating slow-speed memory applications. "By 1985, I would expect to see a \$400 to \$500 million market, but that's just speculation at this point," Chang says. "What we're working toward is to capture a rather major share by 1979." □

Consumer

Electric range holds cooking programs

A microcomputer controls baking, frying, grilling and cooking done on a new electric range from West Germany's AEG-Telefunken. On display last month at a home appliance show in Cologne, the range was developed at the firm's Household Appliance division in Nuremberg and is claimed to be the first European-built electric range to use a microcomputer.

Not surprisingly, AEG-Telefunken used its own recipe for the microcomputer chips—one central processing unit and two read-only memories. They are part of the CP3-F microcomputer system developed at the company's semiconductor facilities in Heilbronn [*Electronics*, Dec. 12, 1974, p. 33]. The two ROMs store some 120 baking and grilling programs that can be used with hundreds of different recipes.

Keyboard control. The three chips are the key components in an electronic unit mounted above the range. This unit, dubbed "Cookbit," has keyboards that replace all the knobs and controls of conventional electric ranges and trigger dozens of oven and cooking-plate functions. The unit also has displays for show-

ing the information that's important in food preparation. The displays are made up of flat-envelope gas-discharge tubes.

AEG-Telefunken's new Cookbit equipment is in a top-of-the-line model in the firm's "Regent" series of electric ranges. The range consists of a four-burner, glass-ceramic cooking section and a broiling/baking section with a pyrolytic self-cleaning facility. The range will go on sale in the spring of next year. No price has been set yet.

With its new range, AEG-Telefunken will be banking heavily on one big selling point—with 120 stored programs for baking, broil-

number would be used for, say, lemon pie, chocolate cake, or doughnuts, while another number may cook fish, sauerbraten, or duckling of a certain weight, says Klaus Fischer, who is in charge of developing electronic systems for household appliances at the Nuremberg facilities. Still other program numbers would be used to prepare, for example, rare, medium or well-done steaks of certain thicknesses.

However, a housewife can also try out "unprogramed" recipes by merely punching in temperatures and cooking times on the keyboards, Fischer adds.

For stove-top cooking, the range



Hausfrau's friend. Programs for cooking, baking and frying are selected via overhead push buttons in AEG-Telefunken's electric range. Microprocessor-based electronic unit stores 120 cooking programs for different dishes—anything from doughnuts to ducklings.

ing, and stovetop cooking, a housewife need not be an accomplished cook or baker. All she need do is follow the cookbook instructions in selecting the ingredients and their amounts, put the food in the oven, and key in the program number given in the cookbook. The Cookbit unit takes care of the time-temperature profiles for each dish.

Of American manufacturers of electric ranges, only Frigidaire division of General Motors Corp. has introduced "computer control" [*Electronics*, Feb. 1, 1973, p. 44]. But in Frigidaire's approach the user programs times and temperatures from the front panel—no cooking programs are stored in memory.

In the AEG unit, one program

has nine cooking cycles for each of the four burners. Each cycle has a specific pair of boiling and simmering levels stored in a random-access memory that's part of the CP3-F microcomputer system's CPU. Electronic timers insure that the power levels of the burners are automatically changed at the right time. □

Communications

AT&T wants laws to bar competition

The American Telephone & Telegraph Co. is lining up its Bell System affiliates and independent tele-

phone companies for a drive to persuade Congress to legislate in favor of a single U.S. telecommunications system. Moreover, AT&T is proposing a rewrite of the 1934 Communications Act that would give state regulators, rather than the Federal Communications Commission, control over interconnection of customer-provided station equipment and terminal facilities, even though the equipment may also be used for interstate service.

The proposals are contained in a 14-page white paper, "The Crisis in Telecommunications: Discussion and Proposed Resolution," being circulated by the company among its affiliates and independent telephone companies. Upon request, it furnished *Electronics* with a copy of the document.

Dated Nov. 4, 1975, the white paper calls for legislation that would provide "indispensable guidance to the FCC and the courts in directing the future of the nation's telecommunications system." Industry sources say the paper is designed to serve as the basis for achieving industry agreement on legislation to be proposed to Congress later this year.

Reaction. Not too many outside the telephone side of the telecommunications industry have seen the document, although a number have heard about it. According to a ranking official at one telecommunications equipment vendor familiar with the plan, "The idea is crazy. Bell is normally very astute, but if they think this plan has a chance in Congress, they are living in the past."

Says Walter Hinchman, chief of the FCC Common Carrier Bureau: "I haven't seen the document but I'm familiar with its contents. To me it sounds suicidal." If the commission is called to testify at the introduction of the kind of legislation that AT&T wants, he is sure the FCC will oppose it.

In addition to calling for "an integrated system of common carrier telecommunications" the AT&T white paper says, "The Congress would find that authorizations to

foster a multisupplier environment for interstate services are contrary to the public interest."

Apparently distressed with earlier FCC actions rejecting as too low several proposed AT&T tariffs designed to compete with the specialized carriers, the company proposal wants Congress to "declare that no charge which is compensatory may be found unjust or unreasonable on the ground it is too low." Any charge that "equals or exceeds the incremental cost of providing the service—i.e., all the added direct costs that are incurred" would be acceptable, according to the white paper. Specialized carriers have contended that AT&T eliminates some of its indirect costs, such as that of equipment already in place, to price new and competitive services below theirs.

Takeovers. The legislation being sought by AT&T would also "require a means of achieving industry restructuring" by permitting unlimited corporate acquisitions. These acquisitions, it suggests, should be exempt from any contrary laws, such as those relating to antitrust.

As an additional roadblock to competition, the AT&T legislative plan "would establish binding standards to be met prior to the FCC's authorization of specialized common carriers." The bill would require a specialized carrier to prove before it is allowed to begin operation that it will not "result in increased charges for basic local telephone service; that its facilities will not wastefully duplicate the facilities of an established carrier; and that its authorization will not impair the technical integrity of the nationwide telephone network." □

Industrial

Microprocessors smarten controllers

Introduced about seven years ago, programable controllers basically have been more reliable and easier-to-assemble solid-state substitutes



Easy fit. Elements of processor-based model 1084 programable controller from Modicon can be plugged into the unit.

for electromechanical relay logic. But the capabilities of the solid-state devices have gradually expanded until now Modicon Inc., Andover, Mass., is introducing a controller designed around microprocessors that behaves almost as if it had been designed around a minicomputer.

In fact, Modicon, which claims to have 60% of the \$20 million-plus annual programable-controller market, is out to tackle process-control applications that have been handled by dedicated minicomputers, according to product market manager Bruce Rusch. He is referring to control systems in such fields as petrochemicals and chemicals.

Up to now, programable controllers have been used to control sequential operations largely in automotive manufacturing and for machine tools. But even here, Modicon's new 1084 control will be able to handle larger and more complex control schemes.

Custom design. The new model relies on custom-designed microprocessors for its computer-like features, Rusch explains. But the unit

What's new in solid state...

RCA offers 11 more Gold CHIP LICs at plastic prices.

Now you can replace ceramic with plastic, and get the reliability of ceramic at plastic prices. Eleven new Gold CHIP standards give you 11 new ways to get the cost and reliability benefits of gold plus Chip Hermeticity In Plastic. In all there are 26 Gold CHIP LICs with the reliability that comes from true hermeticity, plus the economy and ruggedness of plastic. The chip's hermetic—and the metalization and leads are all of non-corroding gold. There's no aluminum with its potential problems.

No problems ordering, either. Just call the Gold CHIP specialist at your nearest RCA Solid State distributor. And give him the type numbers of the circuits you need. That's the easy way to get Chip Hermeticity In Plastic. At plastic prices. Or contact RCA.

Single Operational Amplifiers	CA101AG,* CA107G,* CA201AG,* CA207G,* CA301AG,* CA307G,* CA741CG, CA741G, CA748CG,* CA748G*
Dual Operational Amplifiers	CA747CG, CA747G, CA1458G,* CA1558G*
Quad Operational Amplifiers	CA124G, CA224G, CA324G, CA3401G*
Quad Voltage Comparators	CA139AG, CA139G, CA239AG, CA239G, CA339AG, CA339G
1A N-P-N Transistor Arrays	CA3724G, CA3725G

* New types

Write: RCA Solid State, Box 3200, Somerville, New Jersey 08876; Ste. Anne de Bellevue 810, Canada; Sunbury-on-Thames, U.K.; Fuji Bldg., Tokyo, Japan.



RCA



RCA. Full house in Linear ICs.

retains the features that make the programmable controller preferable to a minicomputer in many industrial applications, he is quick to point out. It can still be programmed with relay ladder diagrams instead of computer programming languages with which many potential users are unfamiliar. Also, it will operate in industrial noise and temperature environments that minicomputers may find too tough.

Up to 10. The new controller has up to 10 Modicon-designed processors, using high-speed Schottky transistor-transistor logic, according to Rusch. The processors are microprogrammed units, containing arithmetic and logic elements, storage registers for partially processed results, and a control read-only memory that contains the microprogram and constants.

Each processor operates independently so that the controller can handle simultaneously such tasks as process control, monitoring fault diagnostics and information storage and display. For example, the 1084 can accommodate ASCII peripherals like card and badge readers, cathode-ray-tube terminals, teletype-writers, and line printers; supervise the operation of other, simpler, programmable controllers; exchange information among controllers, and collect data and provide hard-copy printouts.

Fast processor needed. "We needed an extremely fast processor to handle all the instructions," explains Rusch. "Off-the-shelf single-chip microprocessors were not fast enough, so we developed a custom unit that has a 150-nanosecond cycle time." Commercial microprocessors with a 200-nanosecond cycle time have only recently become available, he points out.

The typical price will range from \$15,000 to \$70,000 depending on features such as whether the controller operates in a stand-alone or supervisory mode. The 1084 has 10,240 input/output points, 10 times the number of any other programmable controller, Rusch says.

In about six months Modicon will have another processor for the 1084

that will make it the first programmable controller geared to trigonometric, logarithmic, and fast Fourier transforms—features that will dramatically increase its process control capabilities, Rusch says. □

Military

Tactical R&D up in fiscal 1977 budget

The \$10.99 billion total sought for fiscal 1977 military research, development, test and engineering may be another record, but it is nevertheless \$1 billion below what Pentagon research chief Malcolm Currie believes is "a fully justifiable program." Convinced that the Soviet Union is driving its military R&D to achieve technological as well as numerical superiority in weapons, Currie and his staff are pushing hard for congressional acceptance of their budget.

Priorities. Despite the 15% boost over last year in the request, Currie says he does "not apologize for it." And, says a Currie staffer, for the fiscal year beginning Oct. 1, "we won't have a lot of extra money because some of the programs moving into engineering development will require a great deal more money." He cites the Air Force and Navy cruise missiles as examples. But, as the Pentagon moves to replace in-house with industry R&D and pushes for more competitive prototyping, the outlook for the electronics industries is improving.

To offset Soviet numerical superiority in weapons, Currie and his staff see improved command and control and communications as a kind of "force-level multiplier," one that can counter to a degree the Russian advantage in force. "Real-time surveillance, target acquisition, and battle control" provided by weapons such as the Airborne Warning and Control System (AWACS) or the Navy's E-2C aircraft with its look-down radar, are worth heavy investment "if they can multiply the individual capabilities of a

large number of less sophisticated and expensive weapons," says the Department of Defense source.

Tactical. Funds for tactical RDT&E are up sharply in the new budget to \$4.23 billion—a 20% jump over a year ago—while strategic systems R&D is up only 3% to \$2.41 billion. The emphasis on tactical systems becomes more evident with a look back at the fiscal 1975 budget, when tactical and strategic R&D outlays totaled a respective \$2.98 billion and \$2.13 billion. The gap between tactical and strategic spending will widen further, according to DDR&E, as projected fiscal 1978 tactical outlays total \$4.72 billion and strategic R&D drops to \$2.36 billion. "Electronics will benefit more than some other technologies like large missiles," observes the DOD source, "since we need more small battlefield weapons and better means to control them."

Remotely piloted vehicles for reconnaissance, target acquisition, or kamikaze-like weapons delivery are getting new emphasis, according to DDR&E. The Army, for example, wants \$7.5 million for RPV advanced development, including \$2 million for field tests of the new multimission Aquila mini-system.

For manned weapons, the Army wants \$26 million for advanced development of its Advanced Scout Helicopter, a highly maneuverable, all-weather vehicle. The Army will spend most of its new money on developing an antisubmarine warfare package for the Advanced Attack Helicopter. It will also include a laser target designator to guide such supporting weapons as the Hellfire and Maverick missiles and cannon-launched guided projectile.

Off-the-shelf. Complementing the RPV and helicopters needed to fulfill this mission are DDR&E programs like the stand-off target acquisition system, funded at \$8.4 million, and the remotely monitored battlefield sensor system known as Rembass, for which \$11.5 million is sought to continue full-scale development. Both systems exemplify DDR&E's interest in using off-the-shelf hard-

What's new in solid state ...

4K RAMs from RCA: Bigger than Intel, smaller than TI.

Everything about our new 22-pin and 18-pin 4K RAMs is standard. Except our chip size. That's something special. Big enough to be reliable, small enough to be price competitive.

With off-the-shelf 4K RAMs backed by our huge MOS experience, RCA is ready to meet your needs now. In high volume. We've backed that commitment with a substantial investment in highly automated memory manufacture. Including even stricter process controls and lot identification procedures than before.

RCA 4K RAMs also have a number of tech-

nology advances that enhance system reliability. Such as clamped bit lines, and active hold-off of unselected Y decoders. Which help reduce soft errors that can cause system downtime.

For more information, contact your local RCA Solid State distributor. Or RCA.

Write: RCA Solid State, Box 3200, Somerville, New Jersey 08876; Ste. Anne de Bellevue 810, Canada; Sunbury-on-Thames, U.K.; Fuji Bldg., Tokyo, Japan.

RCA

30,000

25,000

Compare chip size and simplicity. Our 4K has fewer masking steps which means simple processing, reduced costs, improved reliability.

20,000



15,000

INTEL

18,792 sq.mils

RCA

21,632 sq.mils

TI

28,424 sq.mils

RCA. 70 million MOS units strong.

ware when possible. Sotas, for example, uses moving-target-indicator radars like the AN/APS-94 for mounting in a helicopter.

Computers. Modification of commercial minicomputers for military use beginning in fiscal year 1977 is reflected in the more than \$30 million sought for new field electronic data-processing capabilities. The new battery computer system alone is budgeted for \$12.7 million, including \$10 million for engineering development.

The battery computer system evolved from the Army's unsatisfactory development in the 1960s of the field artillery digital automatic computer system known as Fadac. The new system will respond faster to forward observer fire requests from such new systems as the cannon-launched guided projectile—a weapon that the Defense Department hopes will achieve most kills on the first shot. □

Reliability

Military too strict on microprocessors

Although the price of microprocessors bought off the shelf for commercial use keeps plummeting, their cost for military applications remains high—unnecessarily high, charges a top design engineer at Rockwell International Corp.'s Strategic Systems division. He claims that the specifications on which the military rely are outmoded and call for too many screening and test steps.

Marginal value. "The military should re-examine its mil-spec requirements and eliminate those of little or marginal value," proposes Jack Jurison, who, as project engineer for digital systems at Rockwell's Anaheim, Calif., facility has worked in the field for many years. He was speaking at the Session on Microprocessors at last month's IEEE Winter Convention on Aerospace and Electronic Systems in Los Angeles.

"Many of the screening techniques currently applied to microprocessors were developed more than 10 years ago for determining reliability of discrete components," he says. For example, visual screens can cause a good microprocessor to be rejected as bad when they throw out the device because of an unimportant surface flaw. Moreover, when applied at the manufacturing level, the screening techniques require special handling that often disrupts commercial production lines, adding further to costs, Jurison points out.

Cumulatively, the effect of the specifications and screens on device cost is disastrous, he says. A \$10 commercial processor has its cost doubled by the most preliminary screen, standard Class C; a class B screen roughly triples its cost, while the full-bore military qualification raises total cost five or six times.

Question of price. Asks Jurison: "How much are we prepared to pay for reliability in what is basically a cost/reliability tradeoff? If we are able to back off on the screens, we

can reduce the cost significantly."

On reliability, Jurison cites Rockwell's field experience of 1.5 statistical failures per million hours of operating Rockwell-designed p-channel off-the-shelf commercial devices. Since reliability attains such



Critic. Rockwell's Jack Jurison says the military could save lots of money by using already reliable commercial microprocessors.

Standard chips not likely

Another way to lower the cost of microprocessors to the military is by standardizing on a relatively few basic chips—at least in theory. But it will prove most difficult to achieve in practice, if the lack of agreement evident during a panel discussion at Wincon is anything to go by.

William C. Eppers Jr., acting deputy director of the Air Force's Avionics Laboratory, Wright-Patterson Air Force Base, stated the standardization case for the services. "Proliferation [of chips] is eating us alive costwise. The whole point is to try to tackle life-cycle costs." Maintenance, he says, represents 70% of the life-cycle cost of a typical electronic system. Standardizing on a few chips, or microcomputers using chips, would permit high production volume, lower unit cost, and allow the throwaway advantage that drastically reduces maintenance, Eppers explains.

Among the objections to this philosophy, one in particular was raised repeatedly. This stressed that "freezing" technology at a standard level closes out the rapid advances occurring in semiconductors. "There's a big difference between LSI a few years ago and what can be done now," one panelist said. Another drawback is the many different ways of configuring a chip, notes Donald Calhoun of Hughes Aircraft Co., who presented a paper on applications of a military microcomputer.

Other IEEE members also attacked the whole concept of standardization, which they say seeks to stop the flow of technology at a certain point. "This is not a healthy situation," one remarked, "since it dooms us to an inferior system."

Since the discussion failed to find common ground on the need to standardize, many participants concluded that a definitive program lies far in the future—and likely never will happen.

Good news from Hughes for radio designers—

Now available a 1021-channel CMOS/LSI digital frequency synthesizer



28-pin D.I.P.
ceramic or plastic

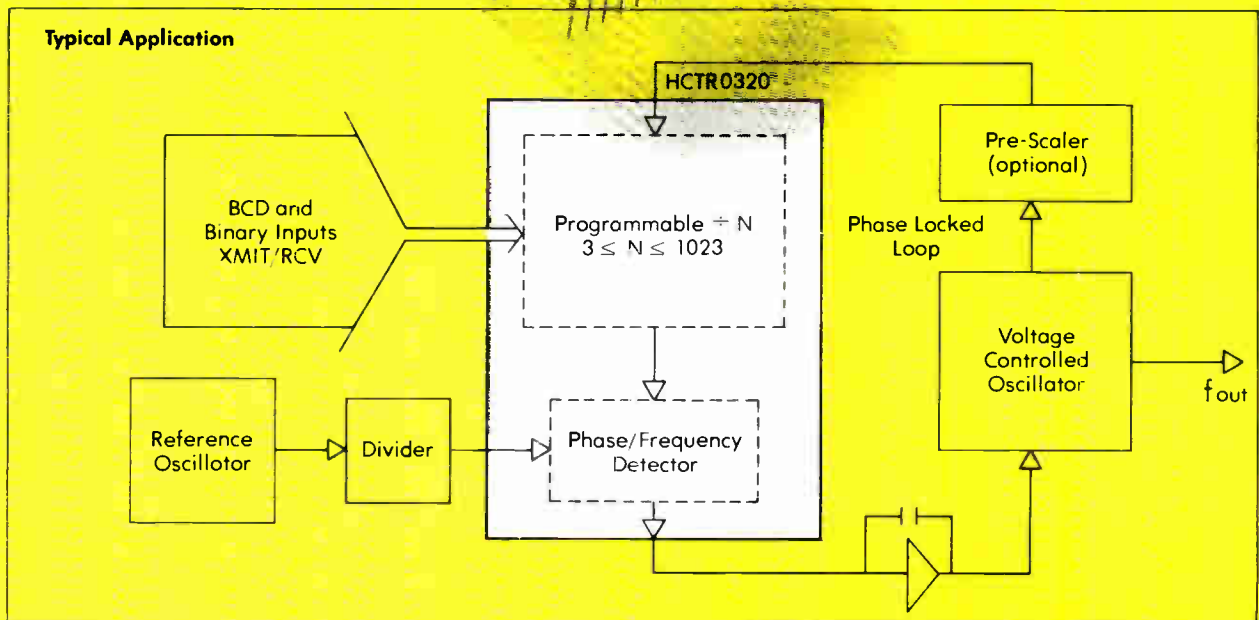

From the largest maker of watch chips comes a digital frequency synthesizer that provides up to 1,021 channels—all from *one* crystal.

It's the HCTR0320 from Hughes. It uses a phase locked loop technique to maintain the frequency of a voltage controlled oscillator at a selectable multiple of a reference frequency. So only one crystal is needed to generate many output frequencies. The fractional error of each output frequency is the same as

that of the reference. And when operated with a 5V supply, this ion-implanted CMOS is TTL compatible, dissipates only 5 mW and will accept up to 5 MHz input frequency.

The HCTR0320, here ahead of its time, is now available for citizen's band, industrial and military applications.

Mail the coupon for information and samples today and see for yourself how it can reduce your equipment costs as well as increase performance—and flexibility, too.



Mail \$19.76 for your sample today

To: Hughes Microelectronic Products Division
500 Superior Avenue, Newport Beach, Ca. 92663
Attn: MOS Dept. (714) 548-0671

Please send me _____ HCTR0320 Frequency Synthesizer(s)
(Send check or money order in the amount of \$19.76 for each sample, including handling and mailing costs)

Please send specifications

name _____
company _____
address _____
city _____ state _____ zip _____

high levels without military screening, "wouldn't it be more cost-effective to take our chances on letting microprocessing fail?" he asks.

In fact, the small size and versatility of the microprocessor device allows designers to "selectively tailor a high degree of redundancy" into a system and thus safeguard critical functions in a way they couldn't hope to do with discrete components, he claims.

While Jurison advocates taking a hard look at what he feels is marginally effective reliability screening, he takes pains to state that the military requirement for testing all devices at elevated temperatures is basic. "All I'm saying is that maybe we can buy cheaper microprocessors and still get reliability." This proposal has been put to microprocessor and microcomputer project people in the Air Force, Jurison says, and "they have shown interest." □

Packaging & production

Nitride film seals at low temperature

For years, semiconductor manufacturers have protected silicon wafers by coating them with a final oxide layer of glass. But, unfortunately, the so-called Silox process does not seal the wafer hermetically. That job requires a material like silicon nitride, which, until now, has required too high a temperature to deposit it on most devices.

Now, LFE Corp., Waltham, Mass., has developed a low-temperature silicon-nitride process [*Electronics*, Feb. 19, p. 25] that it says can supplant Silox. Arthur W. Zafiropoulo, marketing manager for plasma systems, estimates that a typical deposition system would pay for itself within months by allowing manufacturers to substitute hermetically sealed plastic packages for more expensive ones. "One [high-volume] manufacturer of bipolar devices has estimated that he can save \$17 million a year by going to plastic instead of ceramic," he says, but

stresses that such a large saving applies only to a high-volume manufacturer who gets high yields from relatively small dice.

The low temperature is important, Zafiropoulo points out, because passivation, one of the last steps in wafer fabrication, must not disturb the metal and insulating layers deposited earlier. He claims that the process produces extremely pure nitride films at high average deposition rates and uniform thickness and density across the wafer.

Processing. This uniformity is achieved, Zafiropoulo says, not only from using nitrogen instead of ammonia as a reagent, but also because LFE does not premix its reagents as some others do before putting them in the reactor. It introduces silane, or silicon hydride, diluted with argon, separately from the nitrogen in vacuum inside a reactor, where the wafer is heated to about 300°C.

It uses reagents of silane gas and nitrogen, whereas previous processes use diluted silane and ammonia. The secret is in how LFE introduces these reagents into the vacuum-chamber reactor containing the silicon wafers, but Zafiropoulo is not telling precisely how it's done. He says only that nitrogen is dissociated and reacts with silane "by means of a complex mechanism" to form a silicon-nitride film on the heated wafer surface.

He points out that in conventional processes, silicon nitride is deposited at temperatures higher than 750°C—too high for passivation of an entire wafer. This limitation restricts the material to use as a gate dielectric for high-reliability devices and nonvolatile memories.

Fewer contaminants. The process also solves some of the problems that result when ammonia is ionized in the deposition process, Zafiropoulo continues. Chief among them is the introduction of contaminants including hydrogen and oxygen. These impurities may form water vapor with its potential for corroding interconnects or may produce porous nitride films that either don't protect the devices against leakage or have undesirably high etch rates.

LFE has processed "thousands of wafers"—both bipolar and MOS—to demonstrate its system to semiconductor manufacturers, says Zafiropoulo. Yield increases ranged from 5% to 30% through the wafer-probe and final-packaging steps and after burn-in and elevated temperature and humidity tests, he asserts.

He also claims the company already has "a number of orders." A single-reactor system that accommodates one wafer, designed to provide experience with the process, sells for \$20,000; an automated system with multiple vacuum-chamber reactors carries a \$70,000 price tag. The automated units accommodate wafers in cassettes. The wafers journey through an in-line system from one cassette to another to eliminate human handling. Throughput rate is 45 wafers per hour for a silicon-nitride layer 4,000 angstroms thick; thinner layers increase the throughput. □

Solid state

Read-only memory reaches 32-k bits

In the last stages of development at Electronic Arrays Inc. is what will be the largest commercially available n-channel semiconductor read-only memory to date: 32,768 bits. And it uses an amalgamation of techniques—clocking and sensing adapted from dynamic random-access memories and a metal-gate process that uses a self-aligning gate usually associated with silicon-gate techniques.

What this has produced, says the firm's manager of memory product development, Michael R. McCoy, is a static device with an access time in the 200-to-300-nanosecond range and a power consumption averaging 10 microwatts per bit—making it two to three times faster than ROMs a quarter to half the size, but requiring at least two thirds less power. Sample quantities will be available in the second quarter of the year.

To achieve the combination of

Need a simple tachometer system?

For indication only... the 300 Series system.

The 300 Series tachometer has earned a reputation for accuracy unsurpassed by any other analog tachometer. Whether you want to measure how fast, or how many, a 300 Series tach combined with an Airpax magnetic pickup, gear and meter gives you the perfect solution. The price? \$251.65.

For indication and switching... the 300 Series system.

Need under-speed/overspeed protection? The 300 Series switching tachometer will sound the alarm whenever the speed strays beyond your preset limits. With Airpax magnetic pickup, gear and meter your system is complete. The price? \$286.65.

For indication and industrial signal output... the 300 Series system.

The 300 Series tachometer can also be set up to provide industrial signal output, such as 4-20mA. Because of its rugged design, you can use it in almost any industrial environment. The price? \$286.65.

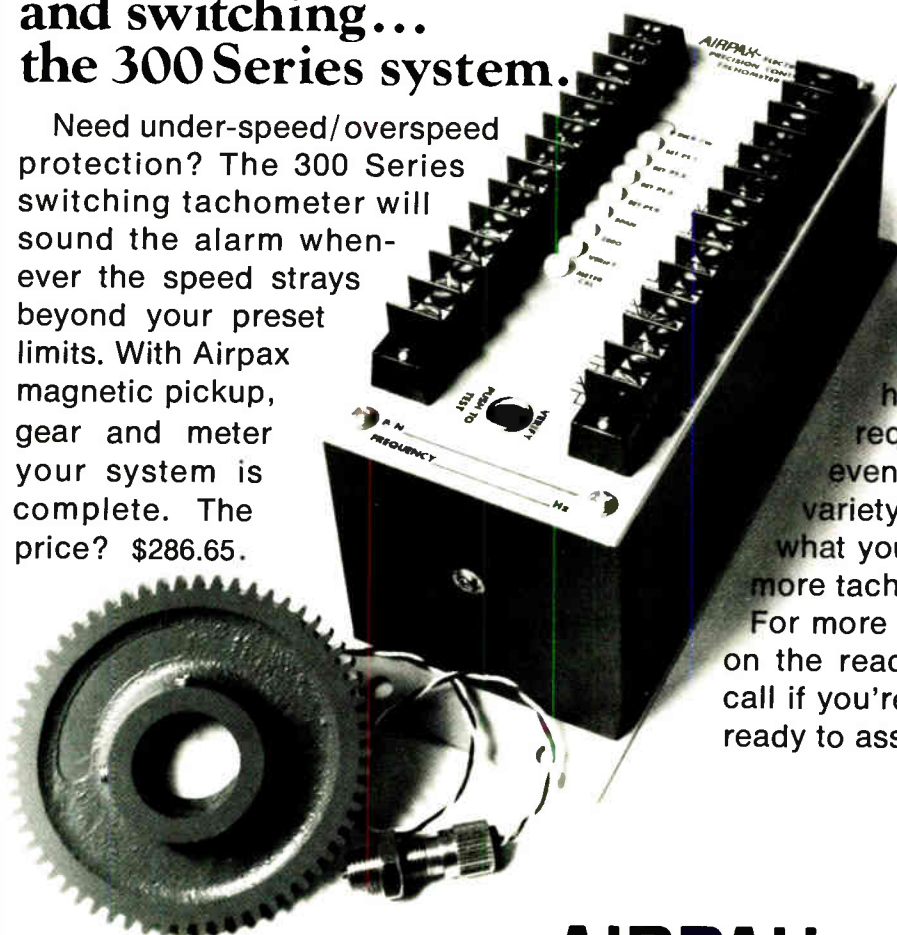

You can order your Airpax 300 Series tachometer to handle whatever functions you require. That's versatility. You can even specify your tach with a wide variety of enclosures. But no matter what your needs are, no one gives you more tachometer for the money.

For more information, circle our number on the reader service card, or give us a call if you're in a hurry. We're standing by ready to assist you.

83

AIRPAX

Controls Division 6801 W. Sunrise Boulevard, Fort Lauderdale, Florida 33313 (305) 587-1100

Other Divisions:

Circuit Breakers and Glass Seals, Cambridge Division, Cambridge, Md.
Broadcast T.V. Equipment, American Data Corp., Huntsville, Ala.

high density, low power, and high speed in the 158-by-255-mil, 28-pin EA3200, the Sunnyvale, Calif., firm's engineers decided that "in terms of cell size and speed it was important to retain metal gates because of their interconnect advantages," McCoy says. "In particular, no yield-reducing contacts are required."

Fewer steps. With silicon gates, such contacts are essential. But silicon gates, because of their self-aligning feature, offer the advantage of fewer masking and processing steps and thus lower costs. What the company's engineers came up with is a self-aligning metal-gate process achieved with a masked oxidation technique.

In the usual metal-gate process the source and drain regions are etched first, followed by a diffusion step. A thick oxide is then grown. The gate areas are etched through the oxide, following which the gate oxide is regrown. "Unlike silicon gate, this is not self-aligning," says McCoy. "The oxide often overlaps, and invariably it's necessary to etch over the source and drain to insure you have contact in those areas."

The source, drain, and gate areas are etched concurrently with the new technique. Then the gate area is masked with nitride, followed by a diffusion step and then the growth of an oxide layer. "Because the gate area has been specifically masked," says McCoy, "there is no overlapping into the source and drain, and only the channel has oxide."

The combination of metal-gate interconnects and self-aligning masked oxidation results in a cell size of only 0.42 square mil, one half the size of cells in 16,384-bit silicon-gate ROMs.

8980A speeds. With just these techniques alone, it would have been possible to build 32-k ROMs, which with 550-ns access times would be at least 200 to 300 ns faster than their 16-k counterparts. "But the main application for ROMs—microcomputer systems such as the Intel 8080A—are down in the 300-ns range," says McCoy.

To get the ROM speed to this

News briefs

Northrop wins Harpoon strapdown guidance

Northrop Corp.'s Electronics division last week received a \$2.5 million contract from McDonnell Douglas Co.'s Astronautics division for initial production of strapdown guidance assemblies for the Navy's Harpoon missile. Harpoon is an antiship missile that can be launched from beyond the horizon by aircraft, surface ships and submarines. Northrop will build the attitude reference assemblies at its Precision Products department, Norwood, Mass., with deliveries to start in January 1977. Each assembly consists of three subminiature rate-integrating gyros and three linear force-balance accelerometers, along with associated pulse rebalance loops to interface with the missile computer.

Shepherd, Bucy move up at Texas Instruments

Mark Shepherd, president of Texas Instruments, Dallas, will move up to board chairman on April 22, succeeding Patrick E. Haggerty who reaches the company's compulsory retirement age of 62 later this month. J. Fred Bucy, executive vice president, will succeed Shepherd as president and remain the chief operating officer of the company.

Marisat placed in orbit

The first maritime communications satellite (Marisat) has been launched and is scheduled to become operational by the end of March. A second Marisat is to be launched in May. Designed to provide ships at sea with full-time, quality communications, the first will serve an area extending eastward from the East Coast of the U.S. to the western portions of the Indian Ocean. The second satellite will cover the mid-Pacific. Shore stations will be interconnected with telephone land-line networks and linked with a control center in Washington, D.C. The Marisat system is jointly owned by Comsat General Corp. (the system manager), RCA Global Communications Inc., Western Union International, and ITT World Communications Inc.

DEC enters word-processing market

Digital Equipment Corp., Maynard, Mass., has entered the word-processing market for the first time. DEC's Datasystem 310W, built around the company's PDP-8/A minicomputer, will sell for \$22,600. It includes the computer, a 45-character-per-second letter-quality printer, a cathode-ray-tube terminal, two floppy disks and a software package that will handle tasks ranging from general correspondence to contract preparation. Jack Gilmore, manager of the word-processing product line, says the 310W is aimed at traditional company data-processing customers whose needs have begun to include word processing.

Upgraded IBM 370/168 coming this summer

IBM Corp. will begin shipments this summer of an upgraded 370/168, which it claims boosts internal computing performance as much as 1.5 to 1.8 times over that of a model 168-3 with a single instruction unit. With the new Attached Processor System (presumably developed by IBM in response to the inroads made into its high-end central processing market by Amdahl Corp.), all data input and output operations are handled by the "host" model 168-3 central processor. But main memory is shared by both the host and the attached instruction processors—increasing the computer's ability to process machine-language instructions.

Westinghouse replaces Xerox computers

Systems Engineering Laboratories Inc., Orlando, Fla., will provide Westinghouse Electric Corp. with up to \$10 million worth of 32-bit computers under a new three-year agreement. The contract replaces the agreement Westinghouse had with Xerox Corp., which recently dropped out of the computer business. The new computers will be part of the systems developed by Westinghouse for energy management by public utilities.

JOIN OUR BME-KAP™ SAVINGS PLAN

SAVE 30% TO 50% ON THE COST OF MONOLITHIC CERAMIC CAPACITORS

This major cost saving is the result of our new BME™ capacitor technology. We've eliminated precious metals entirely from the electrodes and terminations of our BME™ capacitors. No precious metals means lower cost. So now we offer you our complete line of monolithic ceramic capacitors – BME Chips™, BME Radials™ and BME Axials™ – at a genuine savings of 30% to 50%.

This significant reduction is not based on a momentary drop in precious metal prices. This is a long-term solution due to the replacement of precious metals by non-noble metals which are not subject to the same dramatic cost spirals.

SAVE WITH RELIABILITY

Our BME™ capacitors have not sacrificed the inherent electrical and mechanical Ceramolitic® quality. Their reliability can be demonstrated by the extensive test procedures to which they have been subjected. Write to our Applications Engineering Department for complete test reports.

SAVE WITH DESIGN FLEXIBILITY

Now you can seriously consider monolithics to replace micas and tantalums. Our BME™ capacitors feature non-polarity, a wide range of capacitance value, low leakage, high volumetric efficiency, availability in chip, radial and axial packages at prices competitive with mica below 1000pF and tantalum up to 2.2μF.



TYPICAL SELLING PRICES PER UNIT QUANTITIES OF 5000 OR MORE

BME™ "J" DIELECTRIC (COG)	BME-Chip™	BME-Axial™	BME-Radial™
1 thru 100 pF, 5%, 50WVDC	5.1¢	6.8¢	7.5¢
1000 pF, 5%, 50WVDC	12¢	16¢	16¢
BME™ "S" DIELECTRIC (X7R)	BME-Chip™	BME-Axial™	BME-Radial™
.01 μF, 20%, 50WVDC	3.5¢	5.8¢	5.8¢
.1 μF, 20%, 25WVDC	9¢	16¢	14¢
1.0 μF, 20%, 25WVDC	52¢	—	73¢
BME™ "R" DIELECTRIC (Z5U)	BME-Chip™	BME-Axial™	BME-Radial™
.1 μF, +80 -20%, 25WVDC	5.7¢	8.8¢	8.8¢
.47 μF, +80 -20%, 25WVDC	13¢	16.5¢	16.5¢
1.0 μF, +80 -20%, 25WVDC	19¢	27¢	25¢
2.2 μF, +80 -20%, 25WVDC	35¢	—	49¢

JOIN THE USCC/CENTRALAB BME™ CAPACITOR SAVINGS PLAN

Get all the details today. Write on your company letterhead for your concise Savings Plan Price list – your pass book to the lowest monolithic ceramic capacitor prices available. Compare it with anyone else's price list and see.

Remember, USCC/Centralab—Quality, Volume, Savings.

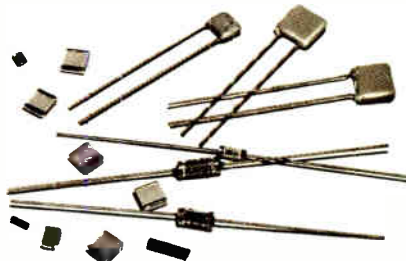

USCC/Centralab

Electronics Division • Globe-Union Inc

4561 Colorado Boulevard ■ Los Angeles, Ca. 90039

(213) 240-4880



OFF-THE-SHELF KEYBOARDS?



This telephone keyboard is, and the others might as well be.

The key legend that makes one



keyboard different from another costs next to nothing. Prototyping?



The Chomerics approach makes small quantities of custom keyboards practical.



Special encoding?
No problem.
Tight schedule?
You've come to the right place. Application: Communications? Lab instruments? Computers? whatever



— Key in to the leader. **CHOMERICS**

77 Dragon Court
Woburn, Ma. 01801
(617) 935-4850

Electronics review

range, McCoy borrows techniques developed for high-performance 4-k dynamic RAMs. "In previous ROM designs, for example, it was common to use a simple buffer amplifier to read out the signal level," he says, "but for a 32-k ROM this would take as much as 300 to 400 ns. This is reduced by half, using a 4-k dynamic sense-amplifier technique to look at the slope of the signal rather than its absolute level."

These dynamic techniques require three power supplies: -12 and ±15 volts, with the ROM clocked on or off via a chip-enable signal. Active power dissipation is 480 milliwatts; standby power is 10 mw. □

Chess mate

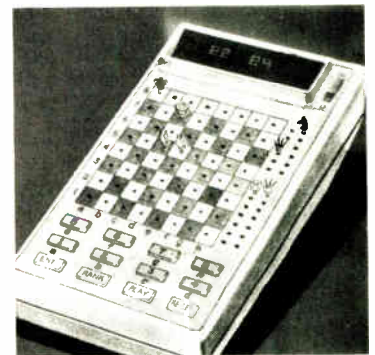

Mostek Corp. of Carrollton, Texas, having won one kind of consumer with a checkbook calculator, is now pursuing a totally different breed—the chess player—with the electronic chess set drawn above.

Demonstrated in breadboard form last week at the 73rd annual American Toy Fair in New York City, the set is a hand-held calculator in which a chess algorithm is stored and into which a player feeds his moves. The calculator, after analyzing the position of the pieces, responds with countermoves indicated on an 8-digit diode display. Basic to the set is an F-8 microprocessor developed by Fairchild Camera & Instrument Corp. but second-sourced by Mostek. Cardinal Industries Inc., a New York City toy manufacturer, plans to hire an assembler for the unit and begin selling it in June at a suggested retail price of \$120.

There's a reason why we're so open about our **Q Series** Open Frame Power Supplies. We want you to know everything about them. Like our one year warranty. And stock delivery. And our socketed semiconductors which makes field spares support a snap.

About our thermal design, the best around, making our heat sensitive parts run cooler and operate longer. And we're the *only* maker of Open Frame Power Supplies where all components operate well within mfrs. specs.

That's why Deltron "Open Frames" save you money three ways: When you buy them. By avoiding costly downtime. And by lasting longer.

We want you to compare Deltron "Opens" with others. In fact, we'll send you our Comparative Engineering Reports matching Deltron against other major mfrs. You'll find as others have that Deltron is unsurpassed for quality and performance.

For some more open talk about Deltron Q Series and a copy of our Comparative Engineering Reports, write or call collect to Deltron, Inc. Wissahickon Avenue, North Wales, Pa. 19454. Telephone: 215-699-9261, TWX 510-661-8061.

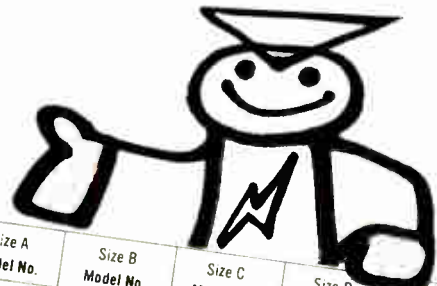

Size A Model No.	Size B Model No.	Size C Model No.	Size D Model No.	Size F Model No.
volts—amps	volts—amps	volts—amps	volts—amps	volts—amps
Q 5—3.0	Q 5—6.0	Q 5—9.0	Q 5—12.0	Q 5—18.0
Q 6—3.0	Q 6—6.0	Q 6—9.0	Q 6—12.0	Q 6—18.0
Q 12—1.7	Q 12—3.4	Q 12—5.7	Q 12—7.0	Q 12—10.8
Q 15—1.5	Q 15—3.0	Q 15—4.8	Q 15—6.3	Q 15—9.5
Q 18—1.3	Q 18—2.6	Q 18—4.0	Q 18—5.2	Q 18—7.8
Q 20—1.3	Q 20—2.6	Q 20—4.0	Q 20—5.2	Q 20—7.8
Q 24—1.2	Q 24—2.4	Q 24—3.3	Q 24—4.8	Q 24—7.2
Q 28—1.0	Q 28—2.0	Q 28—3.1	Q 28—4.2	Q 28—6.0
Dimensions: 4 7/8 x 4 x 1 1/8	Dimensions: 5 3/4 x 4 7/8 x 2 1/2	Dimensions: 7 x 4 7/8 x 2 3/4	Dimensions: 9 x 4 7/8 x 2 3/4	Dimensions: 14 x 4 7/8 x 2 3/4
Price: 1—\$32.00 100—\$26.00 250—\$24.00	Price: 1—\$54.00 100—\$44.00 250—\$41.00	Price: 1—\$67.00 100—\$54.00 250—\$51.00	Price: 1—\$87.00 100—\$70.00 250—\$66.00	Price: 1—\$113.00 100—\$ 91.00 250—\$ 85.00

Some open talk about open frame Q SERIES power supplies

Forward and reverse voltage protection.
Barrier block interface.
Infinite resolution adjustments.
Full interchangeability.
115/230 vac, 47-440 hz.

Socketed IC regulation system.
Filters meet mfrs. ripple ratings.
Glass epoxy PC boards.
Loss of sense protection.
Designed for U.L. Recognized
Component Index.

Socketed power semiconductors.
Iridized aluminum chassis.
Computer grade electrolytics.
Special circuits to protect IC.

For some more open talk
about Deltron Q Series and a copy
of our Comparative Engineering Reports,
write or call collect.

Deltron inc.

What price Zeiss?

The small Epi-Microscope is the best buy anywhere...

... and, for the other five microscopes shown here, too, the price depends entirely on your needs. Whether production line, industrial research, or quality control, Zeiss quality and features always add up to true economy. Zeiss microscopes do more now, can be expanded to do more later, never become obsolete. The Zeiss range of optics and accessories is unequalled.

1. Epi-Microscope. A small and versatile upright incident-light microscope for production, QC and R/D. Rugged and sturdy. Can be mounted on various stands, or attached to machinery in the shop. Switches instantly from brightfield (for regular surface examination) to darkfield (to detect scratches, dirt, small de-

fects). Nomarski interference contrast makes minutest elevation differences stand out. Accepts cameras and TV attachments. Best buy on the market. **Reader service number 90.**

2. Standard KK-08—the Semi-Conductor Microscope. Features Epi-Nomarski optics at production-line cost. Makes it easy to spot pinholes, stacking faults, alignment errors, etching problems, bonding defects, mechanical damages, and many minute irregularities not detectable with any other light microscope technique. 3 x 3" stage with stainless steel plate makes loading and unloading rapid and easy. Can be expanded for research with wide range of accessories, also for photomicrography. **Reader service number 91.**

3. Invertoscope M. The smallest, most compact metallographic microscope. Ideal for fast, routine examinations. Yet has great optical features found in our larger microscopes. Excellent for brightfield and microscopy in polarized light and Nomarski interference contrast, even with Glarex projection screen. Great stability, low price. **Reader service number 92.**

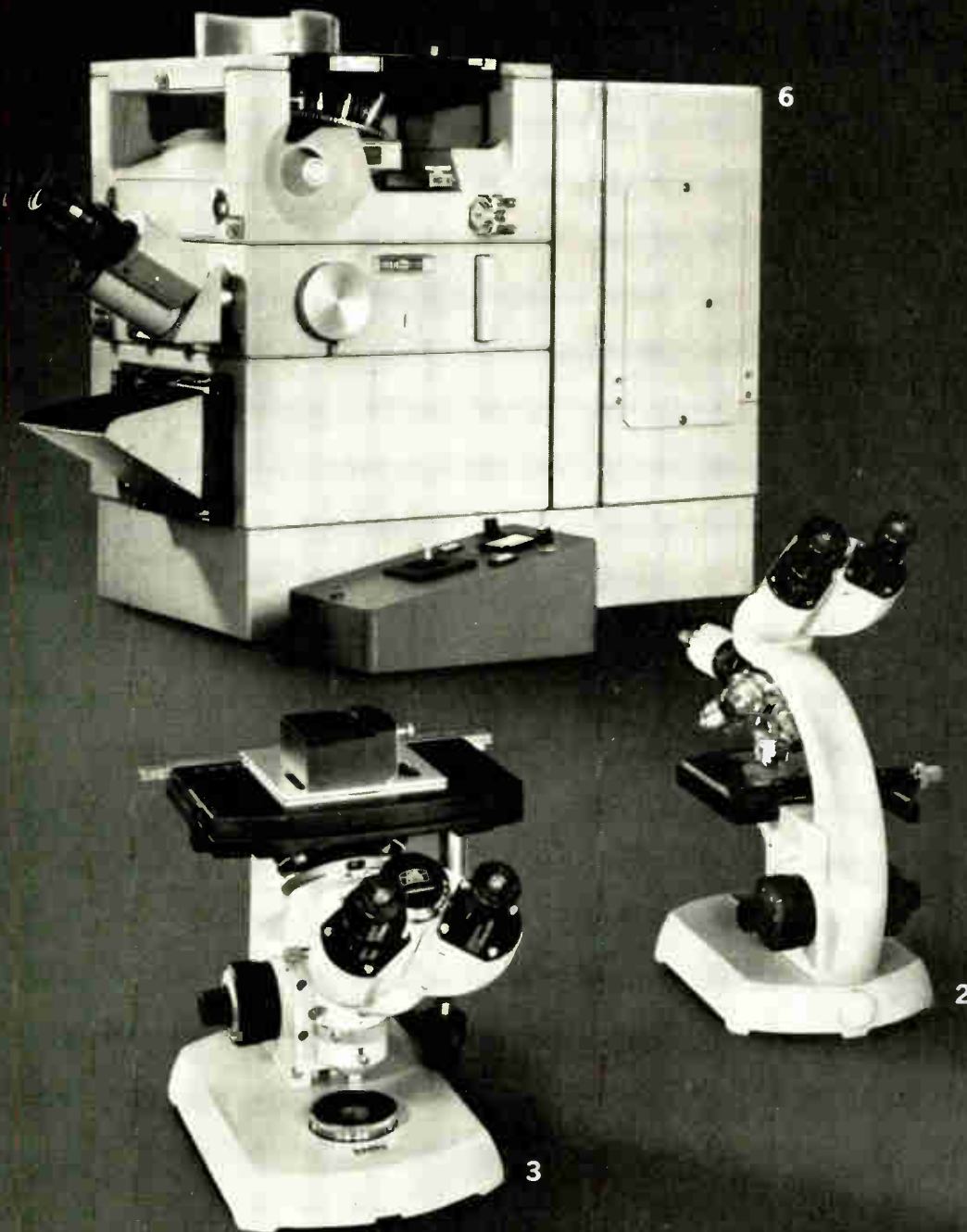

4. Universal Microscope. Recognized as the most universal microscope. With fully interchangeable optics and components for all microscope techniques in reflected and transmitted light, including UV. Accepts all accessories and camera formats, including TV and projection screen. With automatic scanning stage, ideal for photometry and quantitative stereometric image analysis. **Reader service number 93.**

5. Ultraphot IIIB with fully integrated, fully automatic camera systems for 4 x 5" and 35mm, and correct exposure reading from the center of the image field. For all microscope techniques in transmitted and reflected light. Continuous magnification from 2.5x to the limits of light microscopy. Holds 3 lamp housings simultaneously; the flip of a lever selects the illumination source and mode. Ideal for grain-size determinations by either micrometer eyepieces or projector. **Reader service number 94.**

6. Axiomat—a revolutionary modular microscope system. The finest, most stable metallograph ever made. Newly com-

puted optics, topped by a new Epiplanapochromat 125/1.6 with highest resolution ever achieved. Extreme widefield, and built-in zoom system for easy magnification change to the limits of light microscopy. All standard ASTM magnifications. Exceptionally large stage (8 x 17"). Stages remain stationary for utmost stability while focusing is done by moving the objectives — also remote-controlled. Two fully integrated, fully automatic camera systems. Quantitative image analysis by photometer or TV. Modular concept permits different assembly of modules, also for upright microscopy. **Reader service number 95.**

For details write Carl Zeiss Inc., 444 5th Avenue, New York, N. Y. 10018. Or phone (212) 736-6070.

In Canada: 45 Valleybrook Drive, Don Mills, Ont., M3B 2S6. Or phone (416) 449-4660.

Nationwide service

BRANCH OFFICES: BOSTON, CHICAGO, COLUMBUS, HOUSTON, LOS ANGELES, SAN FRANCISCO, WASHINGTON, D. C.

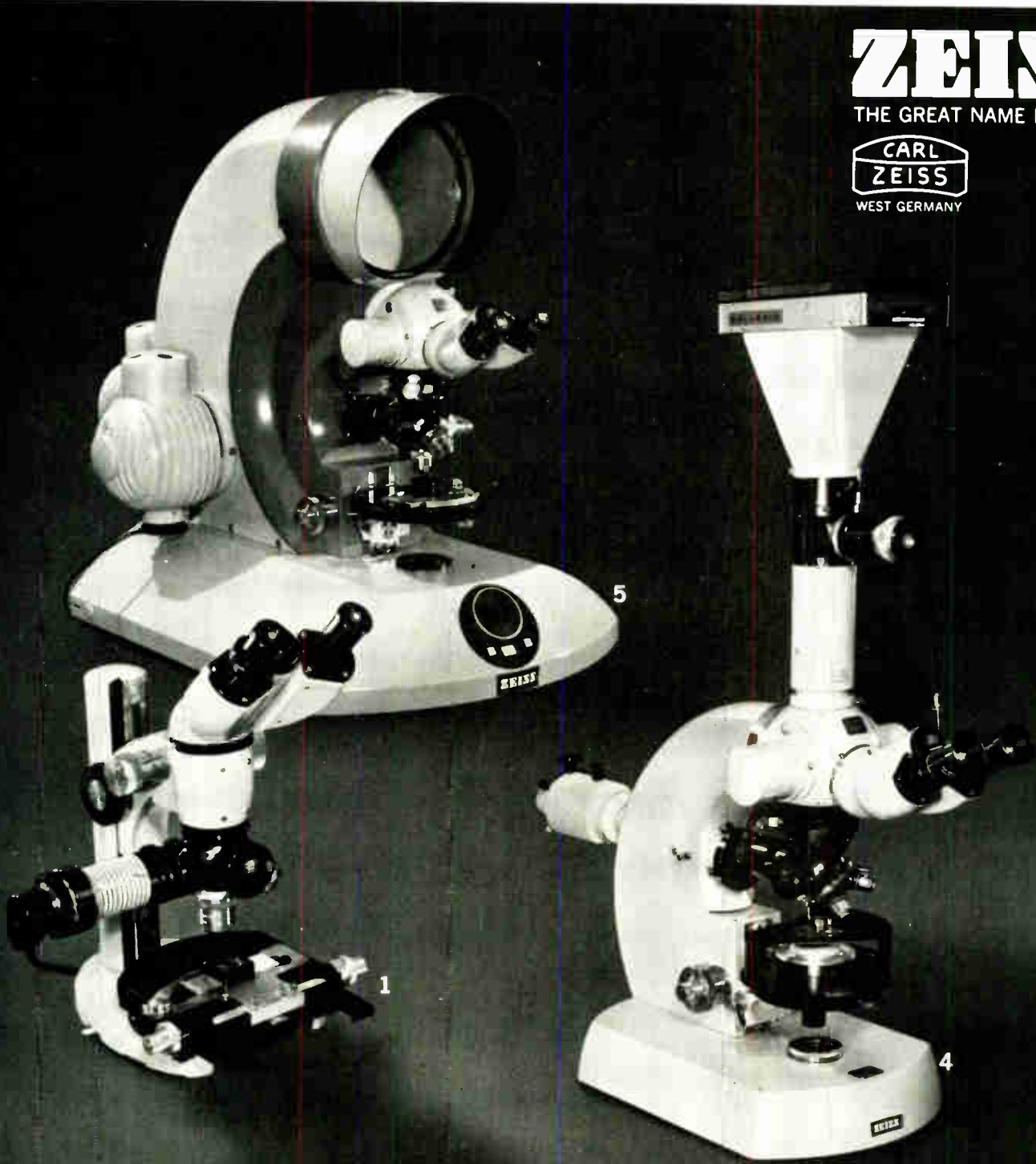

ZEISS
THE GREAT NAME IN OPTICS



STAR PERFORMERS

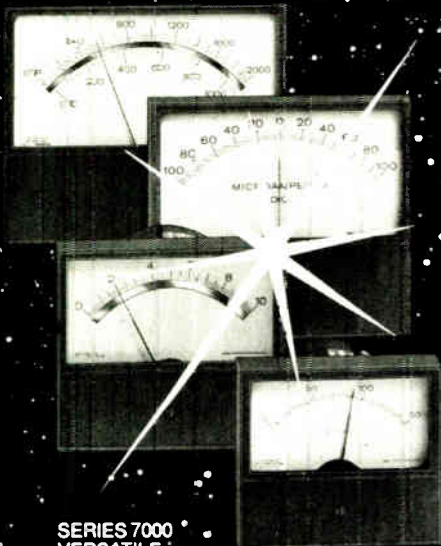

SERIES 7000
VERSATILE

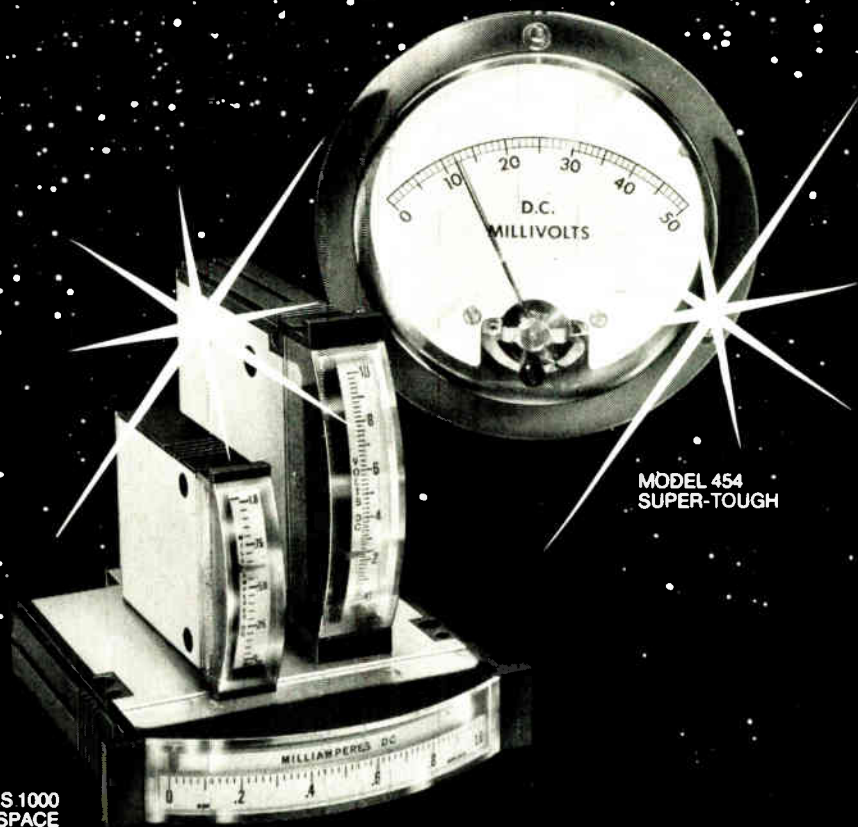

MODEL 454
SUPER-TOUGH

SERIES 1000
SAVES SPACE

api Panel Meters

Get the performance you need — with API panel instruments. Need economy? Small package? Tough case? $\frac{1}{2}\%$ accuracy? LFE has them all.

VERSATILE: Series 7000 can be panel, lens, or bezel mounted. Slide-out scales facilitate modification.

SAVES SPACE: Series 1000 in $1\frac{1}{2}$ " , $2\frac{1}{2}$ " and $3\frac{1}{2}$ " sizes feature rugged polycarbonate case, quick stackable mounting, and famous API quality and styling. Surprisingly economical too.

SUPER-TOUGH: Our new $4\frac{1}{2}$ " round Model 454 is an ideal replacement for glass-window instruments in portable, industrial, and plant uses. Its wrap-around polycarbonate case tosses off blows that would destroy lesser meters. Large clear dial for great visibility.

ACCURATE: Nobody makes more precise panel instruments. We start at a standard 2% rating, with 1% tracking for taut-band ranges. We stop at $\frac{1}{2}\%$ accuracy. You can have anything in between.

There's a LFE distributor or authorized modification center near you to provide quick service on standard or special ranges. Call him. Or call us. We perform. LFE Corporation, Process Control Division, 1601 Trapelo Road, Waltham, Mass., 02154, (617) 890-2000

LFE
CORPORATION

Process Control Division

Fixes for Phoenix to take 5 years, cost \$67.1 million . . .

Even apart from the new engine problems in Grumman's F-14 fighter, the Navy is distressed over the **poor performance of the plane's long-range AIM-54 Phoenix missile**, built by Hughes Aircraft. Yet the Navy hopes to salvage Phoenix with a new five-year R&D program costing \$67.1 million, of which the first \$10.7 million would be spent in fiscal 1977. Operating in a high-density environment, like that of the Mediterranean, the missile cannot discriminate between friend or foe, sources report.

Navigation problems, failure to respond to midcourse and terminal guidance, and a warhead that can't destroy targets unless it hits them directly—all need to be corrected, say Navy officials. First-year funds will be used for tradeoff studies and beginning development of a new on-board digital processor, digital autopilot, target detection sensor, and warhead.

. . . and faulty Sparrow will cost Navy \$28.6 million

Another Navy air-to-air missile, the old standby AIM-7F Sparrow, built by Raytheon Co., has also been having problems, **chiefly in the reliability area and, to a less extent, in target detection**. The Pentagon figures it will take \$28.6 million over three years to fix Sparrow, including \$16.3 million in fiscal 1977 for engineering development of an advanced seeker and to upgrade the missile's electronics complement with state-of-the-art components.

Opposition forms to rewrite of contract renegotiation

Military electronics and aerospace companies are gearing up for a hard battle to kill H.R. 10680 in the Senate this summer—the bill that rewrites the Renegotiation Act **to require Government contractors to figure their profits by division and major product line within a division**. At present it is done on the basis of a company's aggregate Federal business. Recently passed by the House, the new bill would permit the Renegotiation Board to require a contract to be renegotiated if it claimed an excessive profit within one division, or on one product, rather than on a company-wide basis.

Industry contends that the existing system of lumping a company's Federal contracts in a fiscal year permits it to compete for business with an uncertain or limited profit by offsetting it with higher profit margins elsewhere in the company. The new system, they say, would tend to make companies more selective in bidding for Federal jobs and increase their internal accounting costs—a cost that would be passed on the Government.

Broadcast radiation study set by EPA: controls possible

The Environmental Protection Agency is beginning a two-year study of radio and television broadcast and microwave radiation in major U.S. cities **to determine whether environmental controls are required**. Using a van packed with measuring instruments, a small computer for data storage and analysis, and three men, the EPA will survey from 14 to 18 sites in each city. Data acquired by the EPA mobile unit will be combined with research data on health effects being developed within the agency, and the package will then be presented to an inter-agency working group headed by the White House Office of Telecommunications Policy. The seven cities in the survey's first phase include Atlanta, Boston, Chicago, Miami, New York, and Philadelphia. Cities in western states will be surveyed between October 1976 and September 1977.

ITT seeks repeal of international dataphone ruling

ITT World Communications Inc. has gone to a Washington Federal court to prevent development of what it believes will be an American Telephone & Telegraph Co. monopoly in the international record-communications market, **if overseas telephone customers are allowed to use dataphone-type equipment.** ITT Worldcom wants the U.S. Second Circuit Court of Appeals to set aside a recent Federal Communications Commission ruling that AT&T tariffs limiting international customers to voice-only communications are no longer appropriate and that dataphone-type hardware may be used. ITT Worldcom charged that the order would alter the structure of the international data communications market.

Zooming costs doom computerized traffic network

If the experience of the District of Columbia is any measure, the promising computer market for municipal traffic control systems is in serious trouble. The reason: inflated operating costs, largely the result of telephone rate increases, **are making it impossible for cash-starved cities to continue system operations.** The D.C. experimental system, built by Sperry Rand Corp. for the Federal Highway Administration, is being shut down for that reason.

Since D.C. doubled the system's capacity to control automatically traffic flow at 200 of the city's 1,150 intersections with signals, the monthly cost of the telephone lines linking the two computers to 600 traffic-monitoring sensors buried in the streets has climbed from \$675 to \$5,798. And if a pending Chesapeake & Potomac Telephone Co. rate increase is approved in March as expected, the monthly bill will soar to \$21,000. D.C. says it is going to look at new technology to see if it can find a cheaper communications system. The highway administration says that, because of the system's technological success, some 20 other U.S. cities are installing similar ones.

Two in competition for phase shifters for agile radar

Raytheon Co. and Microwave Applications Group are competing for a Westinghouse Electric Corp. subcontract to supply low-cost phase shifters for the multimode Electronically Agile Radar. **Competitive tests are beginning at Westinghouse's Baltimore division.** Each airborne BAR antenna, designed for Air Force use in strategic bombers like the B-1 and B-52, will contain 1,818 individual ferrite phase shifters and account for about 10% of the radar's cost. Westinghouse says the phase shifters are the target of a major cost-reduction effort under its design contract for the Air Force Avionics Laboratory to balance performance and costs.

FCC to speed citizens' band license action

In a move to alleviate a backlog of several hundred thousand citizens' radio license applications, the Federal Communications Commission has approved **a procedure for issuing temporary permits until it can develop and implement a high-speed licensing system.** At the same time, the commission approved a program by its Office of Plans and Policy for a series of planning studies of public need for personal radio communications. The FCC said the studies will not delay a decision on Docket 20120, which proposes to relieve CB frequency congestion by allocation of additional Class D channels.

Sprague puts more passive component families into dual in-line packages than any other manufacturer.

Call Sprague First!

**HIGHER
PACKAGING
DENSITY**

**LOWER
PRODUCTION
COSTS**

plus improved performance and compatibility with DIP microcircuits

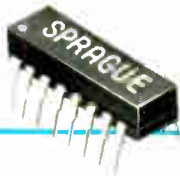

**DIP
MULTIPLE
TANTALUM CAPACITORS**

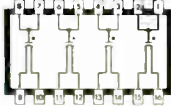

Solid-electrolyte tantalum capacitors with 2 or 4 sections per package. 8- or 16-pin configurations. Standard ratings are 6.8 μF @ 35V, 15 μF @ 20V, 22 μF @ 15V, 33 μF @ 10V. Capacitance tolerance, $\pm 20\%$. Operating temperature range, -55C to $+85\text{C}$. Write for Bulletin 3542 or circle 201 on reader service card.

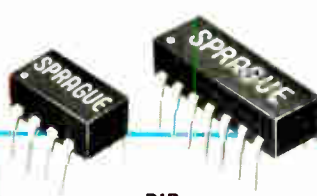

**DIP
MULTIPLE
CERAMIC CAPACITORS**



Monolythic[®] construction . . . alternate layers of ceramic dielectric material and metallic electrodes are fired into a solid homogenous block. 2, 4, 7, or 8 capacitor sections per package. Standard ratings, 18 pF to 0.1 μF @ 100V. Capacitance tolerance, $\pm 20\%$. Write for Bulletin 6242 or circle 202 on reader service card.



**DIP
TANTALUM/CERAMIC
CAPACITOR ASSEMBLIES**

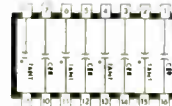

Solid tantalum and Mono-lythic[®] ceramic alternating isolated sections. Choice of 4 or 8 sections per package. Standard tantalum ratings, 6.8 μF @ 35V, 15 μF @ 20V, 22 μF @ 15V, 33 μF @ 10V. Ceramic ratings .01, .047, .1 μF @ 100V. Cap. tol., $\pm 20\%$. Write for Engineering Bulletin 6642 or circle 203 on reader service card.



**DIP
RESISTOR/CAPACITOR
NETWORKS**

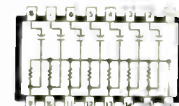

(1 of 3 designs)

Metanet[®] metal-film resistors and Mono-lythic[®] ceramic capacitors in bypassed pull-up, R-C coupling, speed-up, and active terminator networks. Resistor ratings, 100 to 6800 Ω with 125mW power dissipation. Capacitor ratings, 100 pF to .01 μF @ 100V. Write for Engineering Bulletin 6612 or circle 204 on reader service card.



**DIP
MULTIPLE
METAL-FILM RESISTORS**

Noble metal film resistors encased in protective glass. Choice of 7 or 8 resistors per 14- or 16-pin package. Resistance values, 50 Ω to 100,000 Ω . Power dissipation, 125mW. Standard resistance tolerance, $\pm 5\%$. Operating temperature range, -55C to $+70\text{C}$. Write for Bulletin 7042 or circle 205 on reader service card.

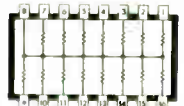

**DIP
PRECISION RESISTOR
NETWORKS**

(1 of 5 designs)

Noble metal film resistors in pull-up, pull-down, interfacing, and terminating configurations, for applications requiring repetitive resistance patterns. 14- or 16-pins. Up to 28 resistors per package. Individual resistors from 50 to 100,000 Ω . Dissipation, 125 mW. Write for Bulletin 7042 or circle 206 on reader service card.



**DIP
MULTIPLE
PULSE TRANSFORMERS**

(1 of 2 designs)

Four transformers in 16-pin package. All cores have exclusive protective coating. Inductance values from 10 to 100 μH . ET product values of 5 volt- μsec . Choice of four turns ratios . . . 1:1, 2:1, 3:1, 4:1. Operating temperature range, 0 C to $+70\text{C}$. Write for Engineering Bulletin 40400 or circle 207 on reader service card.

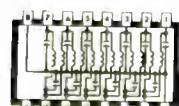

**DIP
TAPPED
DELAY LINES**

Lumped constant delay lines . . . ideal for timing and pulse synchronization circuits. 14- or 16-pin packages with delays of 50, 100, or 150 nanoseconds at a characteristic impedance of 100 Ω . Working voltage, 50VDC. Operating temperature range, 0C to $+70\text{C}$. Write for Bulletin 45004 or circle 208 on reader service card.

Popular Types Now Available OFF-THE-SHELF From Your Sprague Industrial Distributor.

For complete technical data, write for any of the above-mentioned Engineering Bulletins to: Technical Literature Service, Sprague Electric Company, 35 Marshall Street, North Adams, Mass. 01247.

THE BROAD-LINE PRODUCER OF ELECTRONIC PARTS



Buss Fuses Specialize Too!

WITH A COMPLETE LINE OF CIRCUIT
PROTECTION DEVICES AND MOUNTINGS
TO MEET MILITARY SPECIFICATIONS*

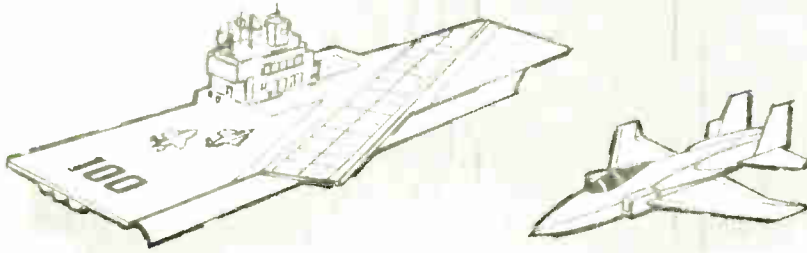
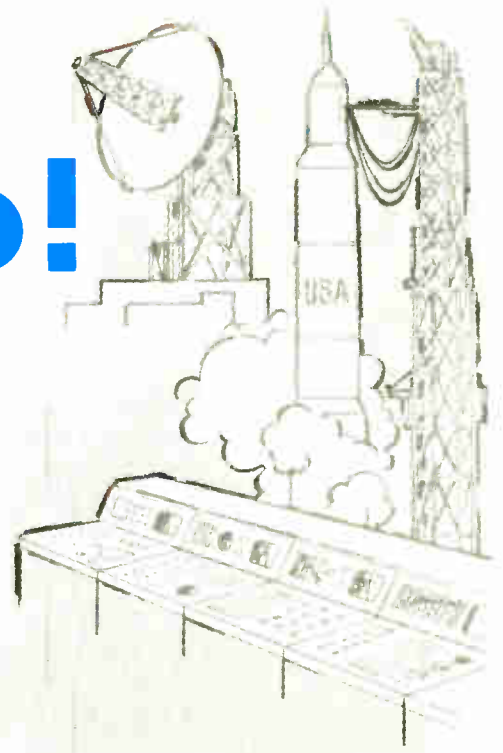

FHN55W

FHL10U

FHN20G

FHL17G1

FHN42W

FMO1

F02A

F02B

F01A

F09B

F09A

F77A

FH21AM

FC21AN

Whatever your military requirement calls for in the way of electronic circuit protection — BUSS offers an extremely broad line of product capabilities — time-delay or quick-acting fuses — instrument type fuses — fuse blocks — fuse clips — extractor post type, open fuse indicating and non-indicating fuse-holders, plus aircraft limiters and limiter blocks. All precision engineered and tested to meet rigid military specifications.

For the full list of BUSS circuit protection products listed under MIL Specs, ask for BUSS Form MIL — See for yourself.

***Military Specifications**

- MIL-F-15160C
- MIL-F-15160E
- MIL-F-19207B
- MIL-F-21346A
- MIL-F-23419B
- MIL-F-5372C
- MIL-F-5373C



BUSSMANN MANUFACTURING
a McGraw-Edison Company Division
St. Louis, Missouri 63107



Japanese work on self-coupled laser to play stylus-recorded video disks

Although many researchers have investigated the interaction produced by the coupling of two semiconductor lasers, a Japanese team is apparently the first to self-couple a single laser successfully. The effects they have discovered are likely to be used soon with video disks and other types of optical memories. The team at the Japanese government's Electrotechnical Laboratory is now extending its investigations to try to demonstrate that optical playback of video disks is feasible.

The team found that when the infrared laser's output is reflected back to the source, both the output and terminal voltage are appreciably increased—the latter by several millivolts. The experimental laser, called Scoop for self-coupled optical pickup, is a continuous-wave multiheterostructure gallium-aluminum-arsenide device with stripe geometry 7 micrometers long and 200 μm long.

Experimenting. Threshold current is about 180 milliamperes, and the near field pattern of light emission is a single spot over the working range of the pumping current. The beam path is about a meter long—several times the distance the beam can remain coherent.

The increase in beam output is greatest when the laser's pumping current is below the lasing-current threshold, but at this low pumping current, the return must be at least 10% for the effect to be observed. A mirror reflects about 30% of the infrared output back to the laser.

The results have convinced the researchers that the optical effects can be attributed solely to the returned light. In the experimental setup, they used a 20 \times microscopic objective, a beam splitter, a mirror-dynamic chopper arrangement, a variable attenuator, and a beam splitter to help them study and dramatize the effects.

In a practical application, the lens would be replaced by a length of Selfoc optical fiber, which transmits light and also has lens characteristics. The photodetector would be included only if used as a sensor with higher sensitivity than the terminal voltage of the laser could provide. The beam splitter and variable attenuator would be unnecessary.

The team now plans to use the la-

ser with the hill-and-dale-type video disks made by Germany's Telefunken AG, which are normally recorded and played back with a stylus. However, for an effective demonstration, the team will have to develop a servo tracking system to keep the laser beam in the spiral groove of the rotating disk and may have to metalize the disks to provide enough reflectivity. □

Around the world

UK study advocates proven bipolars in space

Designers of European spacecraft for the 1980s should stick to off-the-shelf Schottky transistor-transistor logic or other bipolar circuits and avoid custom large-scale integration. That's the conclusion of a European Space Agency (ESA) report on improving the reliability of electronic subsystems in space. Other conclusions to be drawn from the study, intended to govern the design of digital subsystems for command and control functions, are:

- Integrated injection logic looks promising because of its low power and high packing density, but not enough production experience or failure data has been generated yet.
- MOS technology, though production-proven, shouldn't be used because it is 10 times more likely to fail from radiation and several times more likely to pack up in high temperatures than bipolar logic.
- Custom LSI should be used only where absolutely necessary because one year or more is needed in production to prove its reliability, it is subject to inherent catastrophic failure, and it is too expensive if made reliable.
- Standard circuits designed into space subsystems should be sorted first by military-standard specifications and then by a failure-predicting standard similar to the British post office's stringent D-4000.

Cambridge Consultants Ltd. in the UK, which conducted the study, has designed and proposed a dual fail-safe (DFS) design for which it has jointly applied for a patent with ESA. The company claims that the DFS design is more economical and reliable than triple modular redundancy, used by NASA in the U.S.

Swedish load sensor weighs trucks on the road

A strain gage developed in Sweden can be welded in place. The device, called the Aton, is being welded to truck axles to weigh loads—front or rear axle, gross or net—at the press of a button while on the road. The weight is displayed on the dashboard.

The Aton will be manufactured by Amlab AB. The makers claim a maximum error of $\pm 1\%$. The sensor consists of a steel strip, 20 millimeters long, 0.15 mm thick, and 2 mm wide, that is bent under high pressure into a slight S in the horizontal plane. An electromagnet above the gage energizes it with electric pulses and in the off phase detects the vibrations they set up. The frequency, about 1.5 kHz, increases with the weight on the axle. The sensed signal is frequency-modulated and transmitted to an Intel 4040 microprocessor for conversion into units of weight that are shown on a Monsanto digital display.

Here's why REI can rent you what you want when you want it



Our inventory. It's the biggest in the industry, with over 8,000 items of electronic test equipment in stock and ready to go. And it's getting better all the time, because we add more state-of-the-art equipment every month. This means we can deliver one special instrument... or a dozen... within hours of the time you place your order.

Now, more than ever, renting makes sense... to stretch your equipment budget, to fill temporary needs, and to avoid the long delivery lead times associated with purchasing. And renting from REI makes even more sense... because we're better equipped to fill your needs than any other rental company.

REI is backed by the tremendous resources of the PepsiCo organization, which gives us the financial strength to keep on hand whatever test equipment you may need. And renting from us helps *your* financial strength,

too. Since you pay only for the time you have your instruments, you'll never have to spend your money on idle equipment.

Send for our catalog today for a description of our rental, rental/purchase and leasing plans, and for our low rental prices. Or call the instant inventory center nearest you for immediate assistance.

Rental Electronics, Inc.,
99 Hartwell Avenue, Lexington, Mass. 02173.
Please send me your free instrument rental catalog:

Name _____ Title _____

Company _____

Address _____

City _____ State _____ Zip _____

Tel. Number _____

Rental Electronics, Inc.

A PEPSICO LEASING COMPANY

Burlington, MA (617) 273-2770 • Gaithersburg, MD (301) 948-0620 • Oakland, NJ (201) 337-3757 • Ft. Lauderdale, FL (305) 771-3500
Des Plaines, IL (312) 827-6670 • Dallas, TX (214) 661-8082 • Mountain View, CA (415) 968-8845 • Anaheim, CA (714) 879-0561
Rexdale, Ontario (PLC Leasing Ltd.) (416) 677-7513

Circle 54 on reader service card

World Radio History

International newsletter

Japanese predict record electronic growth this year

Electronic production in Japan will set a record this year, and growth will continue steady, predicts the country's Electronic Industries Association. Production in 1976 will total \$14.187 billion, a 16.4% increase over the level last year and 5.2% higher than in 1974, the best previous year, says EIA-J. Most categories are growing, except receiving tubes, black-and-white television picture tubes, industrial instruments, and thyristors. The last two categories reflect lack of capital investment.

Components are growing fastest—up 25% over last year to \$4.253 billion. Passive components lead with an increase of 20% to \$2.321 billion. Integrated circuits will be 24.2% higher to \$491.2 million. Discretes will follow with an increase of 21.9% to \$633.5 million. And paced by color production, picture tubes will rise 17.3% to \$807.4 million.

Germans allocate \$1 billion to space from 1976 to 1979

A space program that will cost nearly \$1 billion from 1976 to 1979 has been approved by the West German government. **Nearly two thirds of the money is earmarked for joint European ventures—among them, the German-headed Space-lab project.** The program aims to push new technologies, to help improve long-range weather forecasting, and to expand the assortment of German and European space-related telecommunications hardware. More than previous space programs, this one emphasizes practical applications, but leaves room for basic research.

Peripherals to lead 1980 computer sales in Western Europe

Peripherals—including printers, keyboard terminals, and intelligent terminals—will account for more than \$5 billion of an \$8 billion Western European computer market in 1980, predicts a market study in the UK. However, **the share of equipment from the U.S. will fall from 80% to 60%**, forecasts Mackintosh Consultants Co. The reduction is attributed to government policies and new companies capitalizing on advance in microprocessor technology and custom large-scale integrated circuits.

The printer market will climb from \$337 million to \$1.4 billion, and keyboards and interactive intelligent terminals will account for \$425 million. As in the computer market, West Germany will continue to lead, but the United Kingdom, now third, is expected to replace France in second place by the end of the decade.

Danes to test advanced phones in Jutland

Several versions of an advanced telephone have been developed by ITT's Danish subsidiary, Kristian Kirks Telefonfabrikker, in cooperation with a regional Danish phone company, Jydsk Telefon A/S. Jydsk, which operates phone service in the Jutland Peninsula, plans to introduce 10,000 trial sets there early next year.

The most advanced phone, equipped with a small display, can operate as a computer terminal. A phone can also be programmed with the 10 numbers called most frequently so that touching just two identifying buttons will put through a call. The called number can be flashed on the screen so that if it's either wrong or busy, the caller needn't pick up the phone. The keyboard of numbers and letters can also function as a miniature calculator, flashing the results on the screen. Although the phone was developed partially by the ITT subsidiary, the Danes hope to sell production licenses outside the country.

Minicomputer runs navigation system for small aircraft

A small minicomputer-based air-navigation system is being marketed worldwide by the UK's Marconi Elliott Avionic Systems for executive-type aircraft, military jet trainers, and military and civil transports. The market for the 19-pound AD620, priced at \$10,000, is estimated at 4,000 during the next 10 years. The company has already sold an undisclosed number to the West German air force.

Pilots can encode Tacan and VOR/DME beacons in the systems, as in larger conventional systems. **In addition, if the aircraft gets out of range of a line-of-sight radio beacon, the AD620 automatically reverts to dead reckoning** according to previous radio inputs and wind velocity. The cockpit control unit, which measures 1½ by 4 by 6 inches, handles the aircraft's sensor inputs and cockpit displays in addition to beacon inputs. The system's AD2770 minicomputer, developed for military airborne Tacan operation, uses transistor-transistor logic. One version contains 10 printed-circuit boards, and the other has 15, depending on the number of turning points or way points desired. Memory capacity is expandible from 2,000 digit words to 24,000 words. Instruction-cycle time is 8 microseconds.

Phased-locked loop is key to Motorola stereo decoder chip

Motorola Semiconductor plans next month to start sampling an improved stereo decoder chip based on a phase-locked loop. The device, designated the TCA 4500A, bests Motorola's current decoder chip, an industry standard, particularly for auto radios. **The phase-locked loop rejects the 57-kilohertz and 114-kHz interference from European "roadside information" broadcasts.** Transition from stereo to mono is linear, eliminating abrupt changes when signals are weak, and the chip provides some gain instead of the usual insertion loss.

Two firms rush electronic trend in teletypewriters

A trend toward electronic teletypewriters in Europe is picking up momentum. **West Germany's Siemens AG has introduced its model 1000, and Philips in the Netherlands has announced plans to show its version next May.** The Siemens model 1000, announced on the heels of the LO 2000 from ITT subsidiary Standard Elektrik Lorenz AG [*Electronics*, Feb. 5], operates almost noiselessly, unlike electromechanical systems.

In its printing unit, the symbols are mounted on 56 spokes of a rotating plastic disk that moves into the write position within a few milliseconds after the key is depressed. Large-scale integrated MOS circuits and other electronic devices help reduce the model 1000 to two thirds the size of a conventional machine. Like SEL's LO 2000, the Siemens model has no dialing disk, but signals other stations through figure keys.

Hitachi gets high speed/power ratio in 1-k bipolar RAM

High speed of a new 1,204-bit bipolar memory from Japan's Hitachi Ltd. is attributed to silicon-dioxide isolation and use of the 100 crystal plane. **Sample shipments of the HM 2110, which is compatible with emitter-coupled logic, have already begun, and quantity shipments, including exports, are to begin in April.**

The memory, only 56% as large as memories made by pn-diode isolation, is equivalent to two U.S. models: the F10415A recently introduced by Fairchild Semiconductor and the MC10146 soon to be marketed by Motorola. Oxide isolation is used only at the sides of the elements, and diode isolation is used at the bottom. The standard HM 2110 has maximum access and cycle times of 35 nanoseconds. The HM 2110-1, priced at a premium, also has a maximum cycle time of 35 ns, but its access time is 25 ns.



From those wonderful folks who brought you the best high-priced testers.

The best low-priced tester.

Introducing the GR 1795 logic circuit tester. The first tester to give you the full diagnostic capability of our GR 1792 series of testers. For about one-third the cost.

This means that for the price of a pretty ordinary tester, you can now get one that will run our powerful CAPS Computer-Aided Programming Software.

So you get all the trouble-shooting speed and accuracy of our big systems.

You get our latest look-ahead probe with pulse-catching capability and automatic programming for different logic families.

And you get a diagnostic clip, fast floppy disc storage, and the same device adapter we use on our big machines.

So what don't you get with the 1795?

Simple. You don't get CAPS simulation and programming capability.

For set-up, you have to program on either an existing 1792 or a separate GR 1797 Programming Station, or use our Programming Service.

Or, you can buy our alternate model GR 1795-LTM.

Instead of CAPS, the LTM uses our new Learner/Tester Mode for set-up and trouble-shooting. It's far more accurate than other schematic/operator-guided probing techniques since it stores full data per node instead of making transition counts. And, it allows you to move up to full CAPS diagnostics at any time.

Now that this kind of performance is available in a low-cost system, big-time testing capability can come to a lot of places it's never been before. Like service depots, to reduce board float. Or small companies on small budgets. Or large companies with multi-station applications.

The new GR 1795 and GR 1795-LTM.

The first low-cost testers that are as good as a GR tester.

GenRad, Inc. (formerly General Radio), Test Systems Division, 300 Baker Avenue, Concord, Mass. 01742, 617-369-8770.



GenRad

The difference in software is the difference in testers.

Circle 57 on reader service card

World Radio History



AMP Circular Plastic Connectors. Stronger, lighter, more versatile, more reliable than metal.

And lower in cost.

No matter where you go, you won't find a more versatile line of circular plastic connectors. From mating plugs to panel-mount or free-hanging receptacles. From square flange to feed-thru pressure bulkhead receptacles. They're available with many types of contacts and arrangements as well as 35A power contacts. And in popular shell sizes.

Why plastic connectors are better than metal ones.

Besides offering greater versatility, AMP gives you

high-strength, glass-filled nylon connectors that are as reliable as metal ones—but cost much less. In some ways, they're even more rugged. Because AMP circular plastic connectors are resilient. Yet, up to lighter. And nonconducting.

AMP automatic machines. For high-speed termination.

The contacts—you pay only for the ones you use—are supplied in continuous strip form. So termination is possible at volume production rates. And at the lowest possible cost to you.

AMP is at the core of reliable circular plastic connectors.

We can handle virtually all your requirements. No matter what industry you're in. And no matter where in the world you're doing business. To prove it, call (717) 564-0100 for information that deals with your specific needs. Or write AMP Incorporated, Harrisburg, Pa. 17105.

AMP is a trademark of AMP Incorporated.





Photo: © AMP

AMP

INCORPORATED

Circle 59 on reader service card

Pick a Plug-in Scope For



Future Expandability

With a 7000-Series plug-in laboratory oscilloscope, you're investing in the current state of the art while assuring your measurement viability for tomorrow. Whether your field is digital circuit design, applied physics research, or communications systems development, you can customize a 7000-Series oscilloscope system for your particular application and continually update your system to keep pace with technological advances.

The 7000-Series offers you superior performance, flexibility, and expandability. It gives you a wide choice in measurement parameters, ranges, and techniques so you can tailor the optimum system for your specific needs. And it continually adds new capabilities and techniques to the growing 7000-Series family of mainframes, amplifiers, and time-bases.

For example, the 7000-Series has recently expanded to make possible:

Easier, more accurate timing measurements with the 7B80 Series. The 7B80/7B85 Delta (Δ) Delay Time Bases allow you to display the main sweep with two intensified zones, both delayed sweeps displayed at their faster rate, and digital crt readout of time delay or Δ time delay—all in one powerful crt format. Your timing measurements are now more accurate and convenient; you can view both analog and digital information at a glance.



Faster single-shot signal measurements with the 7844 Dual Beam Oscilloscope. The 7844 offers you true dual beam performance at 400 MHz, so now you can view and photograph multiple events that couldn't be captured together before.

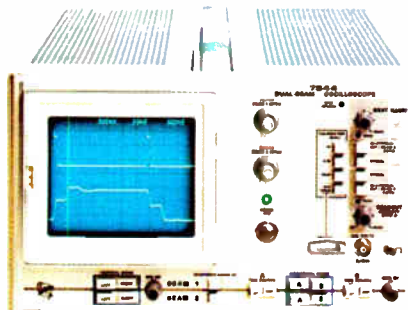

Faster and more versatile storage measurements with the 7633 Multi-mode Storage Oscilloscope. The 7633 gives you 100-MHz storage and multiple storage modes—bistable, variable persistence, and fast mesh transfer. With the 7633, you can store at writing speeds as fast as 1000 cm/ μ s.

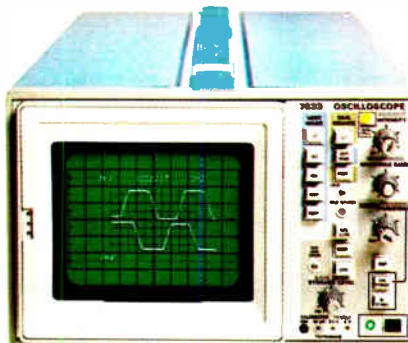

And the 7000-Series will continue to expand to incorporate the most advanced technology for your most sophisticated oscilloscope measurement needs.

But that's not the whole expandability story. With the 7000-Series oscilloscope system—truly more than an oscilloscope—you can make broad-based measurements beyond the conventional oscilloscope: sampling to 14-GHz equivalent band-

width; spectrum analysis to 1800 MHz together with time domain capability; digitally accurate, oscilloscope-controlled measurements of amplitude and time. And you'll be able to add more measurement capability like this as the 7000-Series continues to expand to the edge of technology.

Whether you work in the time domain, the frequency domain, or the data domain, the 7000-Series represents a commitment to your future.

The 7000-Series helps you defer obsolescence because it expands as new technology changes measurement needs. We are continually developing new measurement technology and adapting it for your convenience in the 7000-Series family.

For a catalog describing all the 7000-Series instrument mainframes and their plug-ins, call your local Tektronix Field Engineer, or write Tektronix, Inc., P.O. Box 500, Beaverton, OR 97077. In Europe, write Tektronix Limited, P.O. Box 36, St. Peter Port, Guernsey, Channel Islands.

**The 7000-Series . . .
more than an oscilloscope**



TEKTRONIX®

committed to
technical excellence

Tektronix' new 7B80/7B85 Delta (Δ) Delay Time Bases are being used in the 7904 oscilloscope to measure pulse width in a minicomputer interface circuit.

For Demonstration circle 60 on Reader Service Card. World Radio HisFor Technical Data circle 61 on Reader Service Card.

When you can buy all this for a total of \$701*

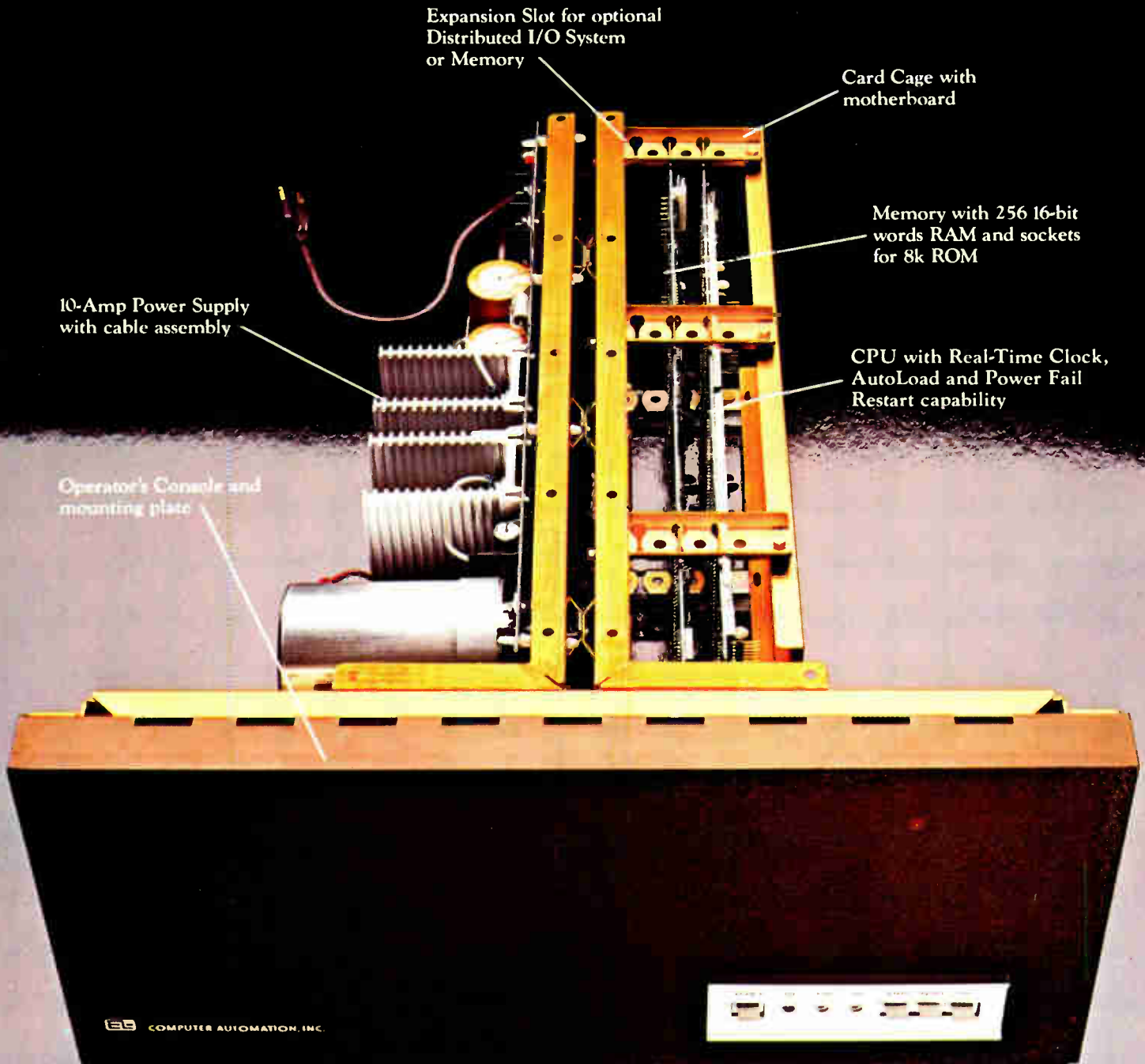

The ALPHA™ LSI-3/05 Millicomputer.
The lowest priced, 16-bit, full-scale, packaged computer in the world.

...building your own just doesn't add up.

Sum and substance. An unbeatable combination even for our competition, so you needn't feel too badly.

Especially when you consider everything we've got going for us.

Specialization, of course.

OEM computers — *low-cost* OEM computers — are our only business. The NAKED MINI[®] people, remember? And when you do only one thing, you do it better.

Experience, too. Over 10,000 up-and-running, field-proven computers successfully integrated into all kinds of sophisticated OEM products.

Also, some things Henry Ford would have appreciated. Buying in volumes most OEM's can't manage. Building the same way.

Where all that gets you is on the down-hill side of the learning curve...where we get our pay-off and you get the lowest-priced, most reliable computers around.

That explains why we can, but not necessarily why you can't. Here's the rest of the rationale:

The chip shot: a hit or a myth?

The fallacy of the micro-processor is that a chip set isn't a computer. Even if you got your chip sets *free* you still couldn't build a computer equivalent to our ALPHA LSI-3/05 for \$701.

Price out the subassemblies shown in the picture and see what we mean. CPU, memory, card cage, power supply and console. All of that design and development time. Amortized over maybe a few hundred systems?

Heart of the ALPHA LSI-3/05 shown at left is this NAKED[™] MILLI central processor and memory for \$395*

ComputerAutomation will build thousands of ALPHA LSI-3/05 systems.

Then there's the packaging and fabrication. Cable assemblies, too.

Just think about the procurement activity alone. The lead time. Getting our picture?

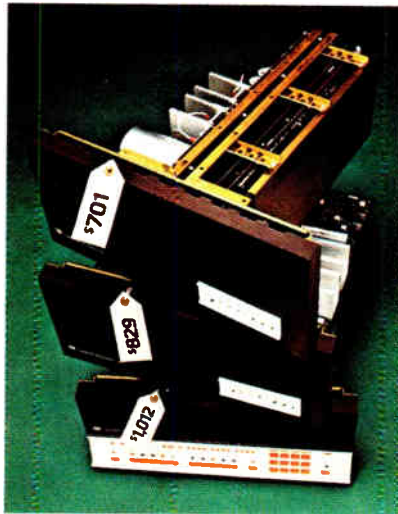

The ALPHA LSI-3/05 is offered in three series featuring a choice of card cages, consoles, memories and power supplies.

Computers vs. computerization

How do you talk to a computer?

Mostly with money, it turns out. Interface money. And mostly a lot of it.

Interfacing a computer to one or two peripheral devices can easily cost as much or more than the computer itself.

Which is why we invented the Distributed I/O System. An optional interfacing system that simultaneously interfaces up to 32 peripherals and special devices, serial or parallel in any combination, for less than \$200* per interface.

What you see is not exactly what you get

Here's what else you get when you buy an ALPHA LSI-3/05 millicomputer:

- 95 powerful instructions
- Individually vectored interrupts
- Direct Memory Access
- Memory expansion to 32K
- Maxi-Bus interchangeability for easy upward expansion to our full line of compatible minicomputers

Plus full-fledged mini-computer software.

From the people who brought you the NAKED MINI

The people with the largest line of compatible computers in the world.

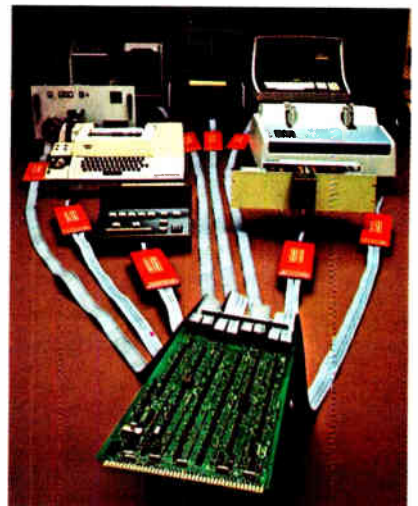

Maxi-Bus compatible ALPHA LSI-3/05 achieves unprecedented cost-effectiveness with ComputerAutomation's new Distributed I/O System.

The people with the lowest-priced computers in the world.

The people with the first and only Distributed I/O System in the world.

The people who've been simplifying OEM build versus buy decisions for years.

ComputerAutomation
NAKED MINI Division

U.S.A. 18651 Von Karman, Irvine, CA 92715
(714) 833-8830

EUROPE Hertford House, Denham Way, Maple Cross, Rickmansworth WD3 2XD, Hertfordshire, England; Telephone: Rickmansworth 71211

All prices shown are for lots of 100 (U.S.A. only)

Patent Pending

For further information circle 62

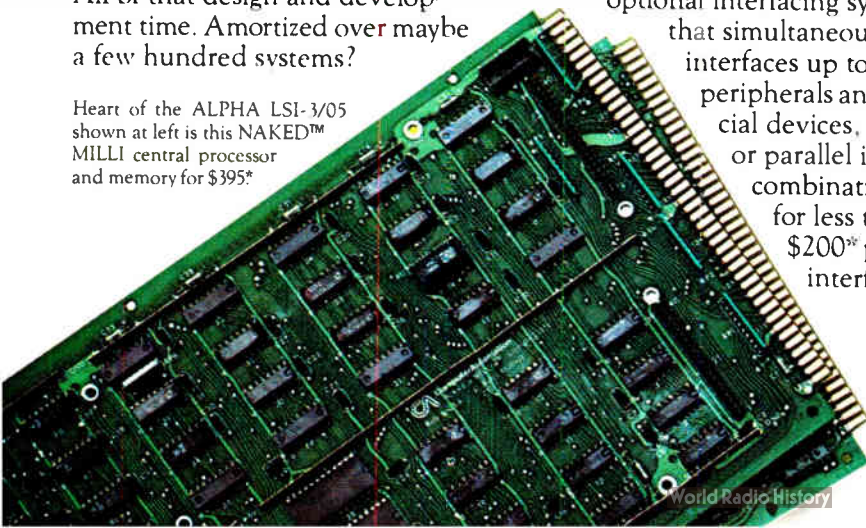

KEITHLEY OFFERS: A 3½-DIGIT MULTIMETER. 4 EXCLUSIVE FEATURES. \$315.



The Keithley 168 Digital Multimeter gives you every key performance feature offered by other first-line 3½-digit DMMs.

But only the Keithley 168 gives you 4 extra features—all useful and all at a competitive price. Compare our 3½ with the others and you'll come to an inescapable conclusion: the 168 is the best buy in 3½-digit DMMs.

For \$315: a superior DMM

For openers, you get a rugged, reliable, easy-to-read, general-purpose, 5-function DMM with more ranges than you'll normally need. Measure from 100 microvolts to 1000 volts dc, 100 microvolts to 500 volts ac, 100 milliohms to 20 megohms, 100 nanoamps to 1 amp, ac or dc. Basic accuracy is 0.1%. All modes fully overload protected. The 168 brings Keithley quality to general-purpose measurement.



4 extra features, no extra cost.

- *Automatic ranging* gives you the most accurate reading, with decimal in the right place, faster than you could do it with switches. Saves you time every time you make a measurement.
- *HI-LO Ohms* lets you turn on a semiconductor junction to see if it's good or measure an in-circuit resistance without turning on a semiconductor.
- *2-terminal input* for all measurements on all functions. You can't get it wrong. Terminals accept banana plugs, alligator clips, spade lugs or bare wire.
- *Lighted function indicator* so you know precisely what you're measuring, instantly.

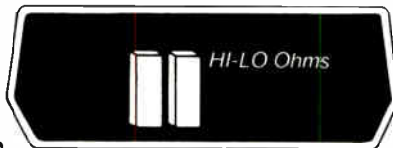

Surprise: more valuable features.

That's not all. We've packed even more value into the 168. Optional battery pack that you buy now or add later. Patented A-D converter to simplify circuitry. No-nonsense, full-year guarantee on parts, workmanship, and specs—including accuracy. Convenient calibration instructions right inside the cover. Light weight for easy portability.

Full complement of accessories.

Use these optional accessories to make your Keithley 168 DMM even more versatile: Wide-range RF probe. Test lead sets. Clamp-on ammeter. 50-amp shunt. High-voltage probe. Carrying case. Rack mount kit.



Now the logical choice.

The 168 is out-front in value. And it's backed up by our reputation for quality. Don't you wish all decisions were this easy?

Ordering a 168 is easy, too. Just contact: Keithley Instruments, 28775 Aurora Road, Cleveland, Ohio 44139. (216) 248-0400. Europe: D8000 München 70, Heiglhofstrasse 5, West Germany. (089) 7144065.

DMMs for all your needs.

We know you have a variety of measurement requirements. So we offer a growing family of DMMs to meet your application and price objectives. Send for our Selector Guide.

180: 4½-digits, 30 nV sensitivity.

190: 5½-digits, high-stability, outstandingly low price.

171: 4½-digits, wide ranging 5-functions.

616: dc, 3½-digits, down to 0.1 picoamp full scale!

160B: dc, 3½-digits, high-sensitivity, low price.

KEITHLEY
The measurement engineers.

Circle reader service #64 for a demonstration, #65 for technical data.

**ACCUTEST WATCH CIRCUIT TEST SYSTEM
TERADYNE MODEL J193**

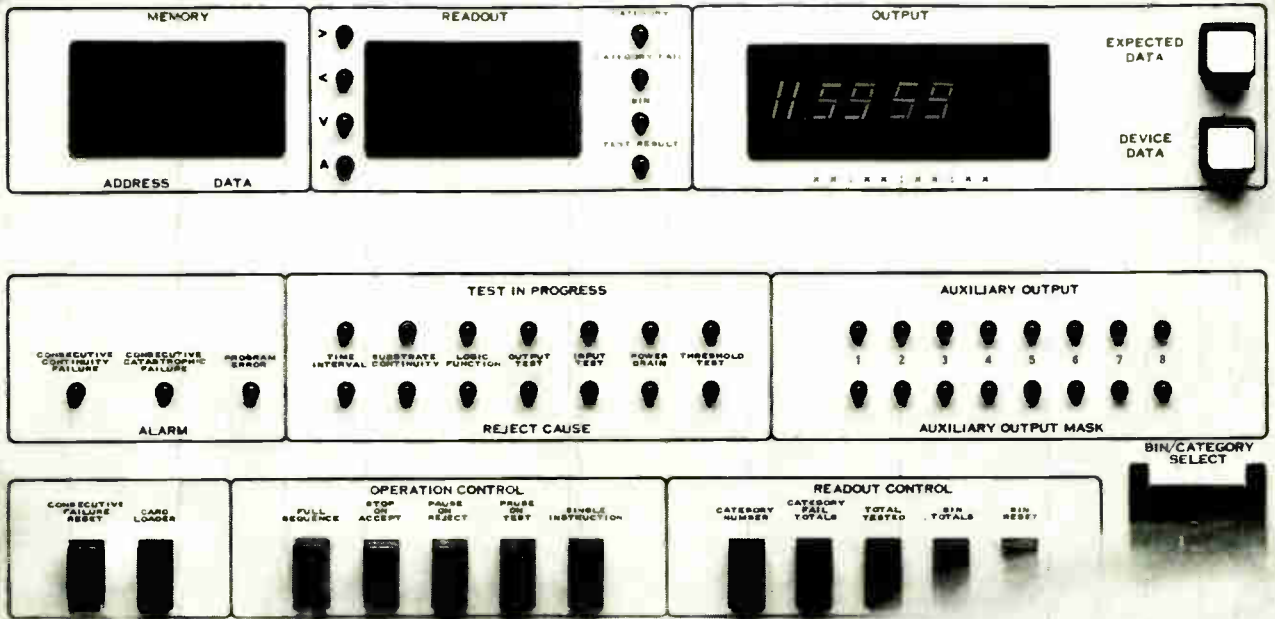

THE TIME MACHINE

Teradyne has a test system built specially for people who check the time thousands of times a day.

Teradyne's new J193 Watch Circuit Test System performs a variety of functional, parametric, and time-base tests on semiconductor timekeeping circuits. These include watch, clock, and timer circuits and modules.

Capable of testing devices with as many as 57 pins, the system can handle up to 48 outputs and 16 control inputs as required. It can also provide three device bias supplies and six clock functions that can be applied to any pins.

A Dedicated Keyboard.

The main advantage of our programming keyboard is that you needn't be a programming wizard to use it. Virtually all test plans are generated, easily edited, and entered using the keyboard, which can be kept in tamper-proof security away from the testing area. The J193 allows you to think in terms of what you want to test without first having to translate it into test-system terminology.

Test programs can be stored on magnetic cards using the card loader. And, as you would expect, the system interfaces to most wafer probers and automatic handlers.

High Throughput. High Yield.

Whether you're a watch maker or a semiconductor manufacturer, you can count on the J193 to eliminate bad parts before they cost you an extra cent of time, expense, or damaged reputation.

The J193's completely optimized design means that the system throughput is limited only by the speed of the devices being tested. And you receive that high throughput at the lowest possible cost.

That's yield. And that's important.

If your time is money, find a minute to write Teradyne. Teradyne, Inc. 183 Essex Street, Boston, Massachusetts 02111. In Europe: Teradyne, Ltd., Clive House, Weybridge, Surrey, England.

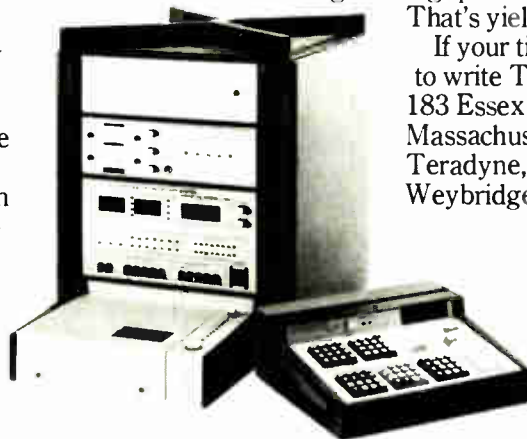

TERADYNE

CHICAGO (312) 298-8610/DALLAS (214) 231-5384/NEW ENGLAND (617) 458-1256/NEW YORK (201) 334-9770
SUNNYVALE (408) 732-8770/LONDON (0932) 51431/PARIS 265 72 62/ROME 59 47 62/MUNICH (089) 33 50 61/TOKYO (03) 406-4021

World Radio History

Manpower predictions draw fire

Years of forecasting engineering shortages have played havoc by creating oversupply, job analysis indicates

by Gerald M. Walker, Associate Editor

Are some manpower studies that depict a shortage of engineers incorrect? Yes, and they endanger engineering careers, says one engineer who has done extensive statistical research into those studies.

To improve their professional and economic standing, engineers have to put a stop to those supply and demand predictions that promote a belief in engineering shortages but in fact contribute to an oversupply. This conclusion was drawn by Milton Alpern, a consulting structural engineer in Massapequa, N.Y., following an analysis of engineering job status over the 10 years from 1963 to 1973.

Alpern has been virtually a lone voice in the National Society of Professional Engineers in trying to call a halt to what he sees as the erosion of all engineers' careers. He wrote his report as a member of the society's manpower task force, and since completing it in September 1974, he has been trying with only middling success to end what he labels the myth of shortages.

No existing studies break out separate figures for EES. But experts believe that supply and demand statistics for all engineering disciplines for the most part follow the same trends.

Much of Alpern's thinking has been the result of his comparison of statements about demand made by the Engineering Manpower Commission, a research arm of the Engineering Joint Council, with actual measures of demand prepared by employment specialist Deutsch, Shea, and Evans Inc. When the predictions and the index were put side by side, the results were startling.

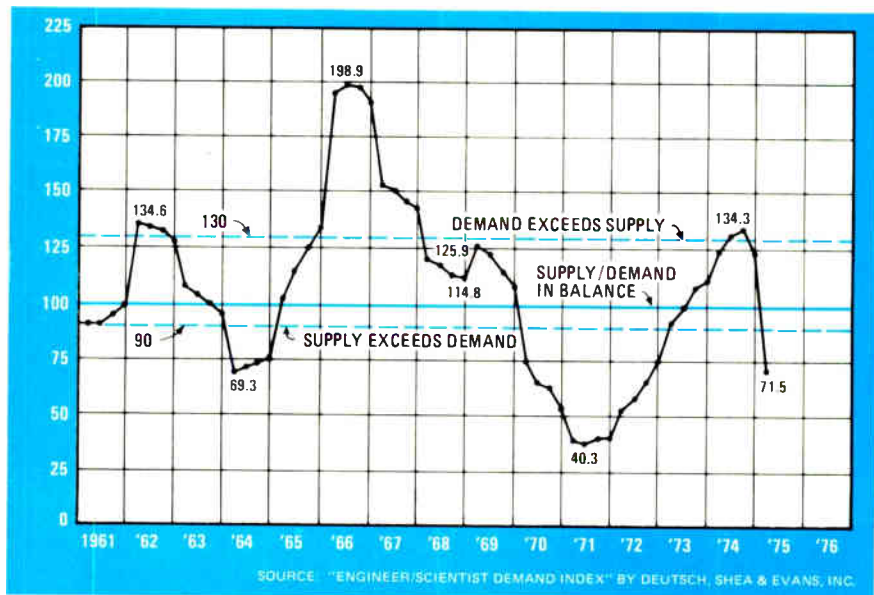

The ups and downs. Demand for engineering manpower, as measured by Deutsch, Shea, and Evans index, fell way below the supply-equals-demand range after 1969.

For 40% of the time studied, demand was less than "normal" as defined by Deutsch, Shea, and Evans, Alpern states. "Despite this, almost all of the writing that has appeared in the EMC documents regarding forecasts of engineer supply and demand have almost continuously stated outright that there will be a shortage of engineers in the near or far future, or have been heavily slanted to give that impression."

He points out that in reporting engineering shortages to high-school guidance counselors through its publications, the commission was wrong 77% of the time from 1963 to 1974. "I am convinced," Alpern charges, "that the commission has taken this tack to ensure an oversupply of engineers. All the evidence points to it."

Recently, he managed to con-

vince others that there was cause for doubt and concern. At the society's winter meeting in Albuquerque, N.M., in January, its board of directors passed a motion that it "publicly state that there is serious evidence to doubt the credibility of the Engineering Manpower Commission's repeated forecasts of engineering shortages in the past, and therefore in the future, and that any predictions of engineering demand are unwarranted and inappropriate for high-school guidance purposes. Further, all NSPE relevant policies should be revised accordingly."

What kind of evidence has Alpern been going on? The following is a brief summary of a few of the 32 statements that he analyzed. In July 1964, the commission predicted ". . . all sectors reported that their employment of engineers . . .

Probing the news

would rise steadily during the decade ahead. . .” But the Deutsch, Shea index values showed demand during the decade actually fluctuating, with unemployment existing for at least half of the time.

A bulletin issued in November 1969 and entitled “The Prospects of Engineering Graduates, 1969,”

stated: “Every indication available to the Engineering Manpower Commission is that employment prospects for new engineering graduates continue to be excellent, at continuing rising salaries. No evidence of significant softening of demand was apparent in the June 1969 data.”

The index at the time was about 110—close to the “normal” 100—and a recession in engineering demand lasting three and a half years

was about to begin. Thus, there was no accuracy in this prediction, comments Alpern. He points out that in 1970, when the engineering job market was becoming more and more dismal, the reports began to reflect only “a slowdown in the long-term growth” of engineering employment.

Then in 1971, when the index was at 42, a report labeled “Job Prospects of 1971 Graduates” stated, “. . . statistics compiled by the Engineering Manpower Commission from 196 schools indicate that engineers and engineering technicians at all levels . . . were largely successful in finding jobs or carrying out other plans.” It concluded, “. . . there is every indication that the U.S. economy will continue to generate a firm demand for new engineering graduates in the foreseeable future.”

In the year and a half since he completed his study, Alpern reports, the commission has continued to cling to the general tenor of the statements above. Yet at a meeting last year of industrial and college leaders, John Alden, its executive secretary, admitted that the ability to project future manpower supply and demand is poor—so poor that it’s not possible to predict whether total engineering employment is growing or contracting, let alone speculate on the hiring or firing of particular specialties or industries.

The simplest solution to the problem of predicting engineering supply and demand, Alpern believes, is to stop trying to forecast because the results have done more harm than good. And, he adds, engineers should challenge others who make these predictions to produce substantiation. “If somebody is good enough to predict engineering demand, they should be able to do the same for the stock market and make a fortune.”

As for the future, he recommends that engineers follow the physicians of America in establishing a true profession—cutting out the subpar engineering schools, putting a “quality filter” on the incoming engineering students, policing the quality of present practitioners, and gaining preeminence in certifying the safety of products and engineering projects. □

BAUSCH & LOMB StereoZoom® microscope

The overwhelming choice of electronics manufacturers... worldwide!

That's the truth. More manufacturers of electronics instruments and components use Bausch & Lomb StereoZoom microscopes than any other brand. And it's easy to understand why when you consider StereoZoom's unparalleled zoom magnification, high resolution optics, proven dependability over nearly two decades, and extreme ease-of-use—all at an economical price.

Write for a free StereoZoom catalog today and discover why StereoZoom is the number one stereomicroscope in the electronics industry.

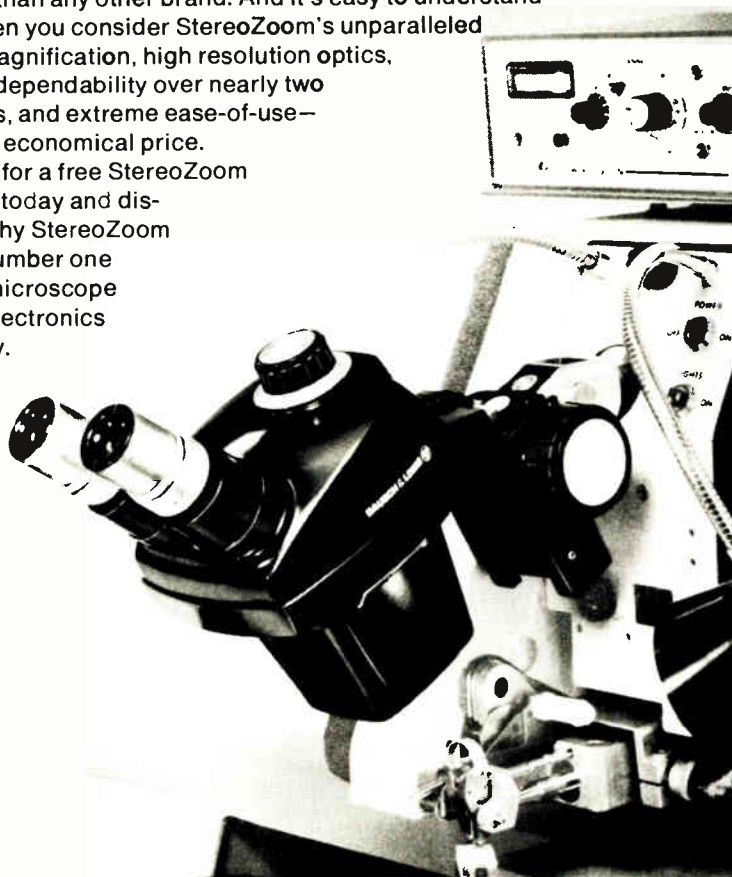

Bausch & Lomb, Scientific Optical Products Division,
62303 North Goodman Street, Rochester, N.Y. 14602.



If you're thinking about integrated circuits for communications products, you should be thinking about Micro Power Systems.

Micro Power Systems is one of America's leading producers of custom integrated circuits. Our business is helping original equipment manufacturers exploit the advanced semiconductor technologies to improve performance and reduce costs.

During the past five years, we have helped design and produce numerous proprietary LSI circuits for our customers in the fields of digital time-keeping, instrumentation,

medical electronics, and communications.

We now possess a unique capability for development and production of specialized ICs for use in communications equipment. If you have an interest in any of the following circuits, or related devices, we urge you to contact us immediately:

- Digital and phase-lock loop frequency synthesizers
- Integrated audio and transmit circuits

- Completely integrated CB radio receivers
- Integrated scanning monitor circuits
- Pocket pager RF and decoder ICs

Our knowledge of the custom LSI approach can help you to evaluate its potential benefits in your own terms. If your need is immediate, we invite you to contact Rich Koury or Dan Hauer at (408) 247-5350.

We sell more than circuits. We sell solutions.



3100 Alfred Street, Santa Clara, California 95050

Components

Thick films roll on

Sometimes considered a transitional technology, thick films are finding their niche in military, medical, and consumer products

by Lucinda Mattera, Components Editor

Having weathered a challenge from thin films, thick-film technology is finding no end of circuit jobs in its second decade of use. Thanks to hybrid applications with thin films, multilayering, improved resistor inks and other materials, and advances in laser scribing and trimming, thick films look as if they are here to stay.

Sales for thick-film resistor networks are growing at the healthy rate of 10% to 20% a year. While improvements in thick-film materials have paced much of this progress, Jack Cole, chief engineer of micro-circuit engineering at the Helipot division of Beckman Instruments Inc.,

Fullerton, Calif., points out, "It's a maturing technology, and more and more people are learning what it can do." Lyle Pittroff, product-marketing manager for hybrid micro-circuits at the Helipot division, agrees, noting that, although "hybrids are talked about as an interim technology, they just keep on going."

Control. Mixing thick and thin films on the same substrate is tricky, cautions Pittroff. "Everything on one chip depends on extremely good process control," he points out. Although thick-film resistors are only about half as accurate as thin-film ones, they offer the advantages

of quick turnaround and easy modification, making them substantially cheaper than thin-film devices, says Cole.

Later this year, Zenith Radio Corp., Chicago, which has been using thick film since mid-1972 in many of its television receivers, will start putting thick-film components in its audio products, as well as new black-and-white TV receivers, says Len Dietch, vice president for TV engineering at Zenith. "We're doing printed-circuit-board layouts now to favor concentrations of resistors—we're doing the layouts with thick films in mind," he notes.

Other potential future applications include electronic tuner-address systems, as well as substrates for potentiometers and switch-stator parts, says Dietch. Thick-film parts are "more stable than phenolics in the presence of humidity," he adds.

Cost advantages. For Burr-Brown Research Corp., Tucson, Ariz., the cost advantages of thick film become especially important for its operational amplifiers and data converters. When an accuracy within 50 parts per million per degree centigrade is not required, thick-film resistors are at least 50% cheaper than thin-film resistors, says William Olshewski, a designing engineer who is chairman of the company's hybrid-technology task force.

Along with new developments in resistor inks, the advent of laser techniques for scribing and breaking substrates, as well as for trimming resistors, have made thick films more competitive, says John Colglazier, president of CTS Microelectronics Inc., Lafayette, Ind. With the laser, tolerances of 0.5%, or even

Cut to size. Thick films, such as this high-voltage divider network, have moved into more and more products as processing steps, from laser trimming to materials, have evolved.

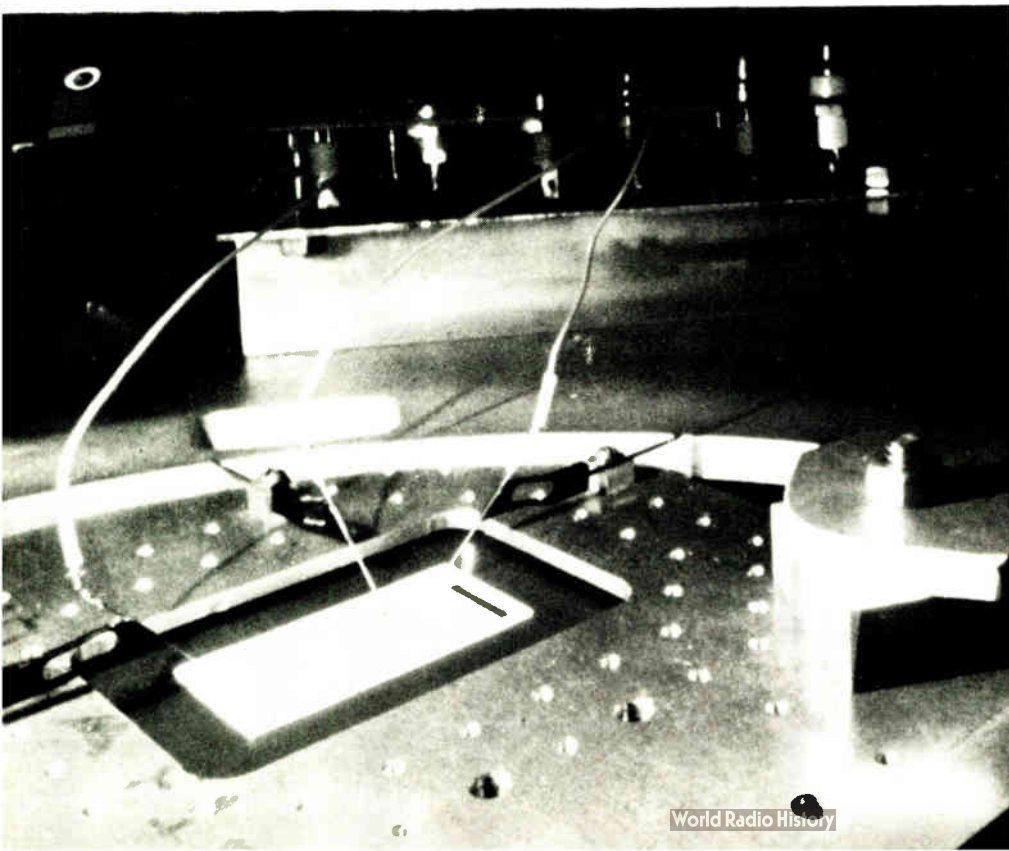

0.1%, are possible—tolerances that were not economically achievable with sand-trimming, he says.

Advantages of thin film have been narrowed to packing density alone, says Paul Schwartz, vice president and general manager of General Instrument Corp.'s Hybrid Microcircuits division, Hicksville, N.Y., "If you have to get extremely tight packing densities, in some cases—but only in some cases—there is an advantage to using thin-film resistor arrays, or thin-film technology."

Opinions about multilayer hybrids are mixed. Multilayer hybrids are suitable for small-quantity jobs, like the space program, in which low yields are no problem, says Jack Heller, marketing manager for Circuit Technology, Farmingdale, N.Y. For good reliability and reasonable yields, it's best to limit the number of layers to three, he cautions.

Another manufacturer making multilayer hybrids—ILC Data Device Corp., Bohemia, N.Y.—has increased its business by more than 50% from 1974 to 1975. Customers who want very high packaging densities are turning to multilayer hybrids, says Bruce Beller, manager for custom hybrids.

Complications. On the other hand, Stanley F. Ribich, manager of microelectronics for Allen-Bradley's Electronics division, Milwaukee, doesn't foresee any growth in ceramic multilayer hybrids. Multilayer hybrids are "inherently expensive to produce—they require additional operations, added inspections, and a very tough electrical inspection."

However, significant improvements in thick-film materials are on the way. Sometime this year, David P. Anisfeld, product-marketing manager, for the Electronic Materials division, Photo Products department of the DuPont Co., Wilmington, Del., expects resistor materials that can be used with non-precious metals. "Products are either on the market or being brought on the market that will provide two-to-four-fold improvement in printing speeds, processing capabilities down to 20 to 30 minutes in furnaces, and laser-trimming speeds approaching 2 to 3 inches per second," says Anisfeld. □

FREE!

COMPLETE CIRCUIT CARD WITH ANY

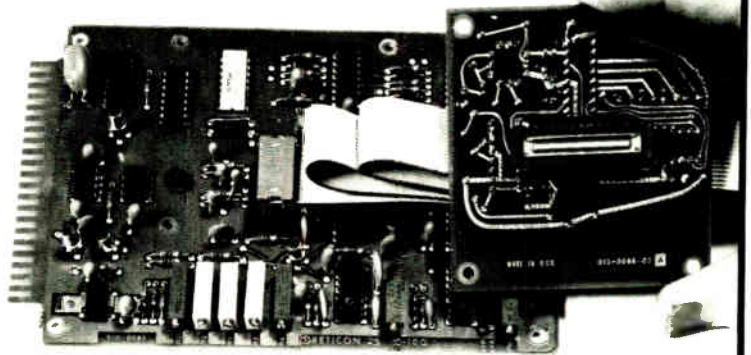

SOLID STATE IMAGE SENSOR

Of course, as with most "freebies", there is a catch to it.

Our "C" series solid state image sensors offer 128, 256, 512, 768 and 1024 elements in a single ceramic DIP with an optical quality quartz window. They require a two or four-phase clock drive and will provide analog video at up to 400:1 dynamic range. That is, if you are an expert in both analog and digital design.

However, when you purchase one of these arrays (in the U.S., at single-unit prices.) and get our RC100 series card set with it free, you'll be on the air with a complete operating system the day you get it. All you need is a power supply and an oscilloscope to admire the results. Up to 400:1 dynamic range, 2 KHz to 2MHz scan rate and a sampled and held "box car" video output.

You can mount the array with its detachable card directly behind a lens remoted from the motherboard without any reduction in the dynamic range and end up with a complete page reader, facsimile or non-contact measurement and inspection system.

And here is the catch! You'll like our approach so much, you'll be buying our arrays in large quantities before you know it. And you won't get any more "freebies". You'll have to build or buy the card yourself.

We know what we're doing when we invest over \$300 in you.

RETICON[®]

910 Benicia Avenue
Sunnyvale, California 94086
(408) 738-4266 • TWX: 910-339-9343

Testing

4-k RAM users check on reliability

Most problems have been worked out by manufacturers; pattern sensitivities, however, cause difficulties

by Larry Armstrong, Midwest bureau manager

Despite semiconductor manufacturers' best efforts to weed out faulty parts before they leave the factory, much of the burden of screening, testing, and preconditioning of 4,096-bit random-access memories has been assumed by the users. They've purchased sophisticated electrical testers, they're subjecting the parts to extensive power-on burn-ins for up to two weeks, and they've designed and redesigned printed-circuit-board layouts around 4-k vagaries.

On the whole, though, users are pleased with the performance of most semiconductor vendors and their parts. "But generally speaking, you must keep on top of suppliers relative to workmanship, or they have a tendency to back off," warns Harold Totty, principal design engineer at Control Data's Corp.'s Small Systems division, with facilities in La Jolla, Calif.

The main problems with 4-ks—which manufacturers and users agree have largely been solved—include too-long refresh times, full-range temperature specs, single-cell shorts caused by small or partial pinholes in the protective oxide layers, and sensitivity to noise.

Fixes. Based on Hewlett-Packard Co.'s experience with "almost every 4-k RAM around," Robert Frankenberg, responsible for testing memories used in the HP2000 mini-computer, believes many of the problems of reliability and workmanship have been solved by improvements in the manufacturers'

processing and testing, as well as by parallel improvements in user tests.

But most users are still grappling with pattern sensitivities. Some sequences of 1s and 0s tend to cause "soft" errors, errors that don't repeat. The problem also occurs in core-memory systems.

Says HP's Frankenberg on pattern sensitivity: "This is not just a one-supplier thing. It's true of almost every 4-k type we've tested. It's industry-wide. We've discovered a number of very effective tests, but unfortunately the test sequences are rather long," he continues. As a result, it is difficult for a semiconductor manufacturer to do them on a production line. "So we've incorporated them into our testing process where we have more time to test, as well as test more parts at one time, than the manufacturer can," Frankenberg explains.

Each 4-k type, he says, has a "weakest link" relating to its design that reacts to particular patterns. But a weak link common to most designs, he says, appears to be the

use of polysilicon rather than metal fanouts from each individual memory cell. Thus far, only a few companies have opted for the metal-fanout approach [*Electronics*, Feb. 19, p. 32]. That's because metal sense lines have greater capacitance than equivalent polysilicon sense lines, and therefore reduce the signal to the sense amp. This either results in a poor signal-to-noise ratio and sensing errors over temperature or it requires a more sensitive, more costly, and less reliable sense amp that draws more power.

Metal fanouts with poly would seem to be a good design practice, Frankenberg says, not only because of the much lower resistivity generally, but fewer variations in resistivity along the line. "It's much more difficult to control resistivity in poly than in metal. Variations in poly resistivity in lines out to sense amps, address buffers or clock drivers where there are high currents usually manifest themselves as pattern sensitivities." In the newer 4-k RAMs, he says, many of the pattern-

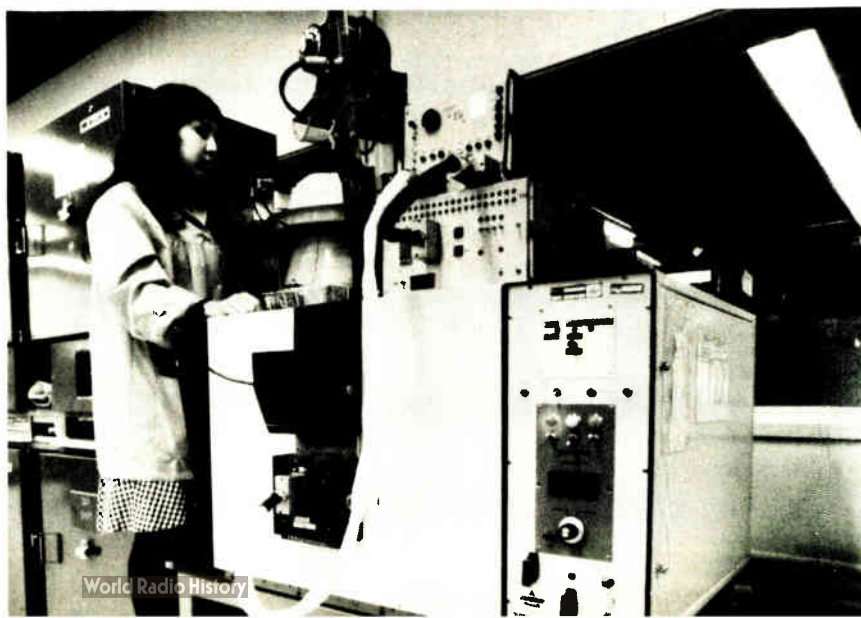

Hot box. Oven for burn-in tests at Intel Corp. can accommodate anywhere from 5,000 to 10,000 sockets at a time.

IN 1970, WE SAID WE WERE GOING TO TAKE OVER IN DIGITAL VOLTMETERS.

At the time, it was not an industry-shaking announcement. In fact, there were a few laughs from our competitors.

Technology-for-technology was still king and everybody bought all the digits, resolution, accuracy and features they could squeeze out of their budget.

We listened. We made some predictions.

A change was on the way.

While our competitors were touting bigger and bigger boxes and more and more digits, we were designing the new DVM for a different electronics industry.

A little while later, we introduced the Fluke 8000A digital voltmeter.

In 1972, it seemed awfully small in comparison to our competitor's behemoths. It only had 3½ digits. It looked different.

The industry's reaction caught everyone by surprise.

Except us.

You could say the Fluke 8000A is just now getting its legs and becoming the performer we always intended it to be.

It's had to. Because of our foresightedness, a whole new segment of the DVM market emerged. Suddenly, everyone was building a low-cost DVM.

Others now ask you to compare them to us.

But they're sort of selective about what they ask you to compare.

Problem is that the average DVM lets you down in one performance area or another.

Not the Fluke 8000A.

It's got overload protection for all ranges. Twenty-six ranges of volts, amps and ohms. Normal mode rejection of 120 dB with an unbalance resistance of one kilohm. Auto zero. The best accuracy statement of any 3½-digit DVM—0.1% accuracy ± 1 digit.

It also performs, day after day. We'll guarantee one year of accuracy on all key parameters. Every unit comes with a one-year, no-nonsense warranty. If something does go wrong, we've got over 30 Fluke service centers that'll guarantee quick



They laughed.

turnaround on your repairs.

And while those other DVM's have been scurrying to catch the 8000A, we've been improving and adding important, new options. Options that add additional measurement capability to the basic 8000A. There's a low-ohms model with 0.001-ohm resolution. A high current

model for measurement up to 20 amps. A milliamp-second model. An analog meter model for peaking and dipping measurements. A high voltage probe for 1 KV to 40 KV measurements, RF probes for ac measurements to 500 MHz, a clamp-on ac current transformer for 2 to 600 A measurements, rack mount kits, test lead kits, dust covers and carrying cases.

So look at everything. Features. Performance. Reliability. Options. Price.

There's a reason the 8000A is the world leader in DVM sales.

And to all those people out there who are claiming this and that about which DVM you should own, ask them why the 8000A leads in sales at \$299.*

They won't laugh it off.

For data out today, dial our toll-free hotline, 800-426-0361.

John Fluke Mfg. Co., Inc., P.O. Box 43210, Mountlake Terrace, WA 98043

Fluke (Nederland) B.V.,
P.O. Box 5053, Zevenheuvelenweg 53,
Tilburg, Netherlands.
Phone: (013) 673-973 Telex: 52237

**Domestic price only.*

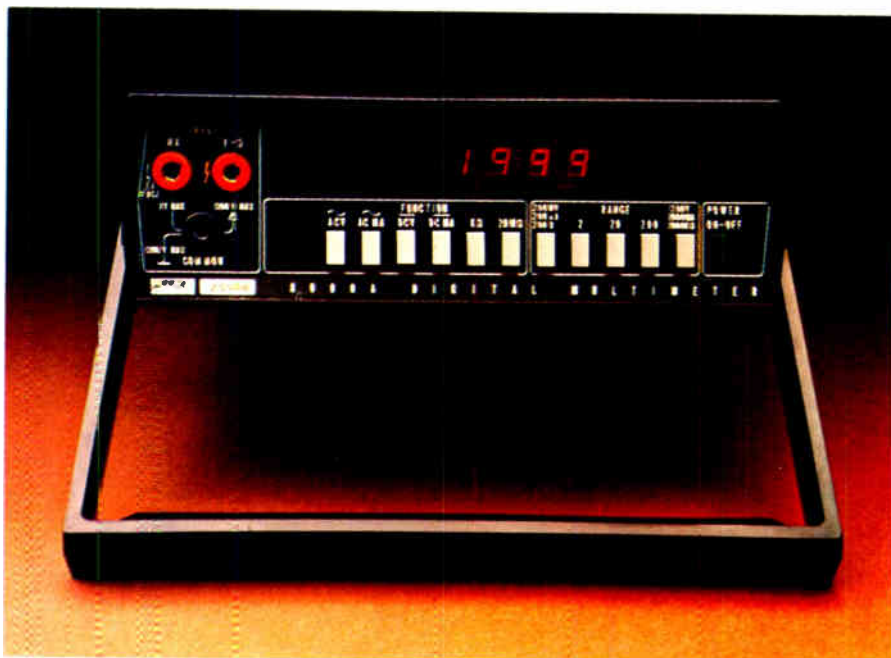

STILL THE LEADER. 8000A DVM. 

Thinking about custom hybrids? Collins has a lot to offer.

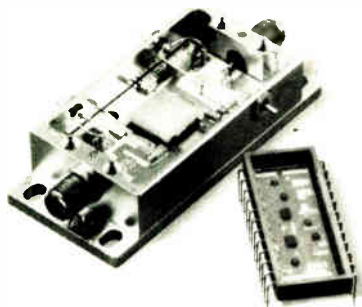

If you are considering hybrids, consider Collins. Our capabilities include:

For Conventional Hybrids:

- Thick Film
- Thin Film
- Laser Resistor Trim
- Low and High Density
- Multiple Packages
- Beam Lead

For RF Hybrids:

- Microstrip (UHF and Microwave)
- Up- and Down-Converters
- Power Amplifiers
- Low Noise Amplifiers (LNAs)
- Local Oscillators
- Integrated RF Systems

They are proven in Aerospace and Aviation Applications. We meet MIL-STD-883/MIL-M-38510.

Our capabilities include Analog/Digital Auto Test at Temperature, Custom Design Implementation, and Design Specification.

Our production facilities are among the most advanced in the world. Collins has, in its more than 12 years of hybrid experience, built over 4,000 hybrid designs. They're all in our database.

Our technical teams are eager to work with you.

Put us to your test.

Call: Marvin Steffen, Marketing Manager, at (214) 690-5937.

Or write: Hybrid Microelectronics Marketing, Collins Radio Group, Rockwell International, Dallas, Texas 75207.



**Rockwell
International**

...where science gets down to business

Probing the news

sensitivity problems relating to design are being solved.

Incoming test procedures that users have devised are stringent. At minicomputer-maker Prime Computer Inc., for example, incoming 4-ks are screened for electrical faults by being inserted in a test board, heated to 50°C, and then exercised via a disk operating system with virtual memory in a way they would function in an actual system. Following that, the good RAMs undergo a two-week burn-in at 70°C in the refresh mode and are then cycled back to the 50°C electrical screen mode. "Naturally, we get some fallout with these techniques," says Robert P. Berkowitz, manufacturing vice president for the Framingham, Mass., minicomputer maker, "but it's in the same range as the other ICs we use."

As for noise immunity, in some plants it is a problem while other users have taken the noise-immunity problems of many RAMs in their stride. Many have gone through several pc-board layout iterations, giving special care to ground networks, methods to maintain constant voltage distribution, and decoupling techniques. "The RAMs we use are rather unforgiving about noise," says one user. "They're much more sensitive than the TTL and Schottky [circuits] we use with them."

shipping both two- and four-layer 4-k populated boards in its computers for a year without noise-immunity problems. Multilayer boards with ground planes provide noise suppression for the system, Berkowitz explains.

The 4-k RAM also turned out to be much less tolerant of supply-voltage variation than the 1-k predecessor. Mostek Corp., however, announced in January a 4-k part with a 200-nanosecond access time that will tolerate power-supply variations of up to 10%—the first standard RAM to deviate from the traditional 5% spec. And TI solved its earlier problems with supply variations by adding a 25-volt, high-temperature stress test to its repertoire of outgoing tests.

Generally, users are loath to name names or talk numbers when they talk about reliability, particularly in the matter of 16-pin vs 22-pin parts. Burroughs Corp. has found, however, that it's tested 300 16-pin 4-k pieces for 3,000 hours in controlled voltage and temperature reliability tests with absolutely no failures. According to J. Reese Brown, senior staff engineer in the Electronic Memory Systems organization, Piscataway, N.J., the firm has had less success with 22-pin 4-k devices, experiencing some infant mortality with these. He confirms that one of the problems was operation at full temperature, particularly when the devices are being refreshed, and says "we got together with the manufacturer, showed him what we found, and the problems—which were design problems—have already been corrected."

Good efforts. Another user, Control Data's Small Systems division, though "reasonably pleased" with one supplier's devices, has had some "basic workmanship problems." These are of a "type easily prevented, and the supplier has taken appropriate corrective action," says Totty. Testing of a batch of 2,000 250-nanosecond 4-k RAMs caused "catastrophic" failures of five devices, he explains, with wire bonds actually lifting and foreign materials found floating.

Up to now, CDC has received 21,000 300-nanosecond 4-k RAMs and has compiled reliability records on them. Of 17,237 parts, a 3.5% rejection rate resulted, which is average, say industry sources. At the board level, 70 of 10,872 failed. And at the system level, 6 of 4,000 plus failed for a 0.16% rate. From the field, only one card failure has been reported.

Now, the CDC division is testing the 250-ns RAM that will go into all of its systems that are produced after April.

Of the 2,000 parts tested so far, 21 have failed, which includes the five "catastrophic" failures. Control Data tests all 4-k RAM at operating temperature, ac/dc, then burns them in for 96 hours at 125°C. Another ac/dc test is performed before a 72-hour burn-in, followed by still another. □

HOW THE LEADER IN DIGITAL VOLTMETERS PLANS TO STAY THERE.

A while back, we got a head start on everybody else in DVM's. People bought more of our instruments than they did the competition's.

Nothing has changed.

We still have the lead because we discovered a few things about the test and measurement field. We learned some things about developing new DVM's for the changing electronics industry.

Above all, we learned, don't offer a DVM unless it truly has value for the guy on the bench.

That means value across the board.

Five-range AC/DC volts to 1200V	only Fluke
Six-month calibration cycle	only Fluke
10,000-Hour demonstrated MTBF	only Fluke
Environmental capability specified and defined	only Fluke
Full line of accessories offering HI volts to 40 KV, RF to 500 MHz, current to 600A	only Fluke

There's not much competition.

Not just one feature that's unique or one lock-out spec, but an entire package that makes complete sense and offers you total value all the way around. Take specs, for example. We publish very conservative specifications. No one else does, but we think it's important that the instrument gives all the specs we've guaranteed. And then a little more. We feel that you ought to get better performance than you expected when you buy a Fluke instrument.

So what should you expect in a DVM?

First, an initial low cost. But also a low cost of ownership.

The Fluke 8600A sells for \$549.*

But, even more important, the 8600A has a demonstrated 10,000 hours MTBF. We've fully defined and specified environmental capabilities. And the calibration cycle is 6 months.

That's going to save you a bundle in cost of operation.

Without any sacrifice in specs.

Guaranteed six-month accuracy specs at 15°C to 35°C with an extremely low



A running start helps.

temperature coefficient. Five ranges each of ac and dc volts to 1200V with 0.02% dc and 0.2% ac accuracy. Five ranges each of ac and dc current to 2A with 0.1% dc and 0.3% ac accuracy. Six ranges of resistance to 20 megohms with 0.1% accuracy. AC bandwidth to 100 kHz.

Autorangeing through all ranges plus individual range selection. Continuous

overload specified for all ranges/functions with overload indication.

Features for flexible operation.

Environmental capability specified and defined. Automatic zeroing. Low 7-watt power consumption for reliability. And a full line of accessories including 40 KV high voltage probe, 500 MHz RF probe and 600 A ac current probe. A self-contained rechargeable battery option.

And remember, those are conservative specs for the 8600A. At \$549.

A genuine value from Fluke.

Which suggests we plan on being the leader in DVM's for a long time coming.

No matter how much it upsets our competitors.

For data out today, dial our toll-free hotline, 800-426-0361.

John Fluke Mfg. Co., Inc., P.O. Box 43210, Mountlake Terrace, WA 98043

Fluke (Nederland) B.V., P.O. Box 5053, Zevenheuvelenweg 53, Tilburg, Netherlands.

Phone: (013) 673-973 Telex: 52237

**Domestic price only.*



THE INDUSTRY STANDARD. 8600A DVM. FLUKE

Communications

Britain to get wired city—via telephone

by William F. Arnold, London bureau manager

The "wired city," which a few years ago seemed to be the communications wave of the future, hasn't been plugged in yet. Interconnecting a cable-television system to provide a host of interactive services proved to be simply too costly.

However, British post office officials are confident that they have found a cheap and easy way to do the job. They hope to link the entire United Kingdom, and possibly the world, through existing telephone systems to an impressive array of information services.

Called Viewdata, their system ties a TV set equipped with a decoder to a telephone so that the user can access through an alphanumeric keyboard one of a virtually unlimited number of "pages" of information from remote data banks. Not only could a home viewer use a remote computer to work out mathematics problems, for example, but businessmen are being promised new classes of telephones and private-wire communications among far-flung corporate offices—all with a hard-copy option.

Trials scheduled. Pilot trials with about 500 receivers are to be conducted next year, and public market trials are to be conducted later in the year. If those milestones are passed satisfactorily, public service would begin in 1978. Among the unknowns yet to be explored are the size of the market, prices, and the services offered, says Roy Bright, Viewdata commercial manager.

The post office is lining up "information providers" for each of the 19 categories to be used in the trials.

Among the services to be offered are news from Reuters and stock quotations. Other promising categories are education, money and insurance, houses and mortgages, jobs and careers, and holidays and travel. A husband could send a message through Viewdata to his wife, who, alerted by a red light, could switch on the TV set and read the message.

Cost to the home owner for 30 pages of information is expected to be about double the price of a local three-minute call, in addition to the price of a Viewdata-equipped TV set. Bright estimates that a black-and-white Viewdata terminal will be about \$200. However, in a business, a terminal might replace many telephones because a visual display unit is combined with a telephone.

A color model and a portable model are planned in a later stage. The hard-copy option, possibly through a cassette recorder, would follow later in the program. Post office officials now plan to sell the business terminals and let home viewers purchase Viewdata sets from retail outlets. The sets would be installed by post office personnel.

Business to benefit. Even though the outlook for the home service is bright, the business prospects are even better. Viewdata promises executives and professionals like doctors up-to-date information literally at their fingertips. What's more, Bright says, they could feed information into the system for their colleagues. Privacy could be restricted by using encoded cards similar to those used to draw money from



Screen test. British post office's Viewdata system links television terminals with telephone lines to display data for subscribers.

banks. Companies or institutions with in-house exchanges could set up their own Viewdata systems. This idea was shown in February with a post-office-sponsored link between ITT's European headquarters in Brussels and a British office.

Viewdata computers are to be arranged in networks so that each would serve about 300,000 subscribers in an area, explains Sam Fedida, who originated the Viewdata concept. He is manager of computer applications at the post office research center in Marthsham, Suffolk. A medium-size minicomputer could handle 200 simultaneous subscribers, and a 20-megabyte disk could store 20,000 pages, he says.

Hardware. Not unexpectedly, semiconductor houses readying Teletext decoders [*Electronics*, Feb. 5, p. 68] are leaving room to add chips for Viewdata. The post office considers the two services complementary. They share common standards of 960-character pages, each with 40 characters in 24 rows, but the Teletext "magazine of the air" is now limited to about 800 pages per TV channel, whereas Viewdata is constrained only by the amount of computer storage available.

A Viewdata decoder would use about a third as many large-scale integrated circuits as a Teletext decoder, including the random-access memory and the character generator. High-density integrated injection logic or conventional bipolar technology could be used in a chip for the rest of the circuitry, including the timing circuit, keypad, processor, row counter, and the like. □

CAN THE LEADER IN DIGITAL VOLTMETERS TAKE OVER IN COUNTERS?

Well...

We've seen some surprising changes.

Last time we checked, for instance, we were sitting in the number two spot.* Not too bad for a company that didn't begin building counters until 1973.

But, then again, we had an advantage. We knew what to do. We knew what it would take to be a leader in counters.

Give the guy on the bench, or building a system, a top-performing, Fluke-quality counter at a price a few hundred bucks less than he expected to pay. An honest bargain is always a big seller.

Frequency Extension Options

520 MHz Prescaler

Covers frequency range of 50 to 520 MHz, using a scaling ratio of 4. Sensitivity is 15 mV rms (AGC). Maximum allowable input is 5 V rms (fuse protected). VSWR less than 2:1 into 50 ohms for levels less than 1 V rms.

1000 MHz Prescaler

Covers 50 to 1000 MHz using a scaling ratio of 8. Sensitivity is 15 mV rms, and maximum allowable input is 5 V rms (fuse protected). VSWR less than 2.5:1 50 ohms for levels less than 1 V rms.

1250 MHz Prescaler

Covers 50 to 1250 MHz using a scaling ratio of 8. Sensitivity is 20 mV to 1000 MHz, increasing to 40 mV rms at 1250 MHz. Maximum input 5 V rms (fuse protected), and VSWR less than 2.5:1 for levels less than 1 V rms.

We know frequency.

For example, a bench/systems box at \$995** with the same programming potential of counters selling \$130 to \$305 and even \$640 more.

That \$995 bargain is our 1953A Programmable Universal Counter/Timer. What does \$995 buy? Here's a good example of how we're changing the counter market. The 1953A is designed for both bench and systems use in frequency, ratio, period(s), time interval and gateable totals measurement. The basic box has a frequency range from DC to 125 MHz at sensitivities to 30 mV. Nine-digit LED display. Full triggering control.



Counters!

But you can see. Take a look at the unit pictured in this ad—you're going to see a lot more on the front panel.

And there are options. Time base options. Frequency extension options. System interface options. We're going to have to send you information for you to get a complete idea of what this counter can do.

But it all starts with the \$995 unit.

An honest bargain from Fluke.

And, meanwhile, when someone asks

if we're going to take over in counters, we just smile, shrug and keep on building those great Fluke counters.

After all, we've only been at it 3 years.

	Time Base Options	
	TCXO	Oven-Stabilized
Frequency:	10.00 MHz	10.00 MHz
Aging Rate: (constant temperature)	$<\pm 3 \times 10^{-7}/\text{mo.}$	$<\pm 1 \times 10^{-7}/\text{mo.}$
Temperature Stability:		
20°C-30°C	$\pm 2 \times 10^{-7}$ typ.	$\pm 3 \times 10^{-9}$ typ.
0°C-50°C	$<\pm 5 \times 10^{-7}$	$<\pm 1 \times 10^{-8}$
Line Voltage: ($\pm 10\%$ change)	$<\pm 5 \times 10^{-8}$	$<\pm 3 \times 10^{-9}$

We know time.

For data out today, dial our toll-free hotline, 800-426-0361.

John Fluke Mfg. Co., Inc., P.O. Box 43210, Mountlake Terrace, WA 98043

Fluke (Nederland) B.V., P.O. Box 5053, Zevenheuvelenweg 53, Tilburg, Netherlands.

Phone: (013) 673-973 Telex: 52237

*Source available upon request.

**Domestic price only.



THE SURPRISING NEWCOMER. 1953A COUNTER. 

Memories

Static RAMs are on the move

New 16,384-bit devices may be grabbing the headlines, but novel design approaches are vastly upgrading their older, smaller cousins

by Bernard Cole, San Francisco bureau manager

All the shouting about the dynamic random-access memories is drowning out the quiet evolution in static 1-k and 4-k RAMs. The changes are opening a new range of markets—and, because the 4-k static is cheaper than its 1-k counterpart, the new parts not only excite the old markets but can penetrate some of the territory of dynamic and core memories.

All this means that life has become more complicated for the designer of memory systems. Up to now, if he wanted to go all out for speed, he used 1,024-bit static bipolar random-access memories, such as Fairchild Semiconductor's 93415, which got him down to 35 to 100 nanoseconds. If low cost and ease of use were more important, there were a number of 2102-type static n-channel metal-oxide-semiconductor RAMs, like those from Intel Corp., with speeds in the 500–600-ns range. At the sacrifice of some ease of use, designers first had the choice of 1103-type 1-k n-MOS dynamic RAMs with access times around 200 ns, then the more recent 4,096-bit RAMs with similar access times and even lower costs. Now, 16,384-bit RAMs are on the way.

But before the 16-k RAMs get to the market in volume, system designers will be offered the fruits of new static 1-k and 4-k memory design, which will further blur the distinctions between high-speed bipolar and n-MOS and between static and dynamic devices.

Consider, for example, Intel Corp.'s new 2115. A 70–120-ns depletion-load n-MOS static 5-volt RAM, it is pin-for-pin and functionally interchangeable with Fairchild's

bipolar 93415, with the additional advantage of requiring almost 300 milliwatts less power. According to Dave House, memory-applications manager at Intel, standard silicon-gate MOS processing was used to fabricate the 133-by-136-mil IC. The field regions on the 16-pin device were not implanted and a conventional diffused phosphorous source-drain was adopted. Only the depletion load used ion implantation.

"To achieve the static bipolar performance, we combined depletion load with on-chip substrate bias generation," he says. To reduce device-body effect and parasitic junction capacitance, a negative substrate voltage is generated on chip to eliminate the requirement for an additional pin and an external power supply, and the back-bias circuit consists of a self-starting oscillator driving a charge pump that is capacitively tied to the substrate.

Not far behind Intel are National Semiconductor, Fairchild Semiconductor, Signetics Corp., and Advanced Micro Devices, among others, with their own fast 1-k static n-MOS rams.

Static 4-k. Also in development and approaching the sampling stage at many of these companies are a number of static 4,096-bit n-MOS RAMs. Using many of the same techniques it developed for its 2115, Intel is already sampling a 1-k-by-4-bit RAM in an 18-pin package. Called the 2114, it is also a 5-v device, and access time from address will range from 200 ns up to 450 ns, with a power dissipation over that range of about 500 mw. While the main mission of the part is to open up the saturated 2102 market,

House believes that it will also have an impact on a portion of the dynamic 4-k RAM market, especially on users scared away by the apparent complexity of the dynamic memories.

Other semiconductor makers have even more ambitious plans for their new static 4-k RAM designs. National Semiconductor will be sampling three 5-v, single-power-supply device in June: the 4-k-by-1 MM5257 and the 1-k-by-4 MM5255 in 18-pin packages and another 1-k-by-4, the MM5256, in a 22-pin package. According to Mauri Morin, National's director of memory products marketing, the speed distribution on these parts ranges from 150-ns to 250 ns.

Using similar static storage and pipelined peripheral-circuit techniques, engineers at Advanced Micro Devices have built 1-k-by-4-bit and 4-k-by-1-bit static 5-v RAMs in 22-pin packages. Access times are 150 to 200 ns and typical power dissipation is 350 mw. When deselected, says Joseph Kroeger, manager of AMD's MOS applications, the supply voltage can be dropped to 1.5 v reducing the power by over 80% to 70 mw.

What is really unusual about AMD's 192-by-197-mil static 4-k parts—the AM9140 and AM9130 [*Electronics*, Feb. 19, p. 105]—is the use of a novel memory static-output signal. It simplifies the timing and boosts the speed of some systems configurations using AMD 4-k statics down to about 100 ns. It means, Kroeger says, the memory can be used at its actual operating speed rather than at the worst-case access and cycle times. □

WHAT WE DID FOR DIGITAL VOLTMETERS, WE'RE DOING FOR COUNTERS.

O.K. Wake up out there.

Fluke has got a frequency counter design specifically for communications—the 1920A. It sells for \$860.*

We wouldn't bother you if it wasn't worthwhile.

Let's face it. We've had to forge some new ground to get a good footing in the counters marketplace. When you're coming up fast on the leaders, like we are, you can't afford any ho-hum instruments. Each counter gets a little better. And, of course, the guy at the bench benefits.

That's how it is with the 1920A counter.

Some advanced LSI/MOS circuitry gives the unit exceptional specifications. And makes it a little more portable. There's a 9-digit LED display, sensitivity to 15 mV, AGC standard, and a frequency range of 5 Hz to 520 MHz. Optional internal prescalers to 1000 MHz and 1250 MHz cover the UHF television, 900 MHz telecommunications, and beacon bands.

Frequency Extension Options
1000 MHz Prescaler
Covers 50 to 1000 MHz using a scaling ratio of 8. Sensitivity is 15 mV rms, and maximum allowable input is 5 V rms (fuse protected). VSWR less than 2.5:1 at 50 ohms for levels less than 1 V rms.
1250 MHz Prescaler
Covers 50 to 1250 MHz using a scaling ratio of 8. Sensitivity is 20 mV to 1000 MHz, decreasing to 40 mV rms at 1250 MHz. Maximum input 5 V rms (fuse protected), and VSWR less than 2.5:1 at 50 ohms for levels less than 1 V rms.

A few extras take you higher.

Direct and prescaled inputs are color-coded to match their corresponding function switches to facilitate operation. The display incorporates full leading zero suppression, automatic annunciation, overflow, and a self-check mode which lights all digit segments.

Then there are some features we're really proud of—exciting to find in an \$860 unit.



But you knew that, anyway.

Measurement delays have been eliminated. A rapid-access gate free runs in the absence of input signals. It's in position to open the gate for the selected gate time as soon as a signal is sensed. An auto-reset circuit initiates a new measurement every time any front panel switch is activated. The first measurement obtained is always correct.

In addition to normal frequency measurements, there's a burst function.

The unit measures RF bursts of greater duration than the selected gate time. To avoid erroneous reading, the display is automatically reset to zero if the burst width is less than the gate time selected.

An optional resolution multiplier coherently multiplies audio tone signals by 1000, providing a resolution of 0.001 Hz in 1 sec.

But now that we've got your attention, the 1920A really doesn't seem so surprising, does it? Really, it's something you sort of expect, when you come to think about it.

Another great instrument from Fluke.

As far as we can tell, it means two things. A promise to you that Fluke is giving their full attention to counters.

And a lot of worry for our competitors.

For data out today, dial our toll-free hotline, 800-426-0361.

John Fluke Mfg. Co., Inc., P.O. Box 43210, Mountlake Terrace, WA 98043

Fluke (Nederland) B.V., P.O. Box 5053, Zevenhevelenweg 53, Tilburg, Netherlands.

Phone: (013) 673-973 Telex: 52237

**Domestic price only.*



FOR COMMUNICATIONS. 1920A COUNTER. 

BEFORE YOU GO BACK TO THE BENCH, TAKE A LOOK AT WHAT YOU SHOULD FIND THERE.

Fluke spends a lot of time paying attention at test and measurement benches across the industry.

Out of what we hear, we develop new products.

Not just DVM's. Not just counters. But also frequency synthesizers, automatic test systems, signal generators, calibrators, logic board testers, power supplies, data loggers, digital thermometers, ac and dc standards, and differential voltmeters.

A company that listens so carefully, probably has what you've been looking for.

Smart, but friendly.

The Fluke 6010A Signal Generator incorporates a microprocessor for free-form entry of frequency in Hz, kHz, or MHz. The unit stores and recalls up to

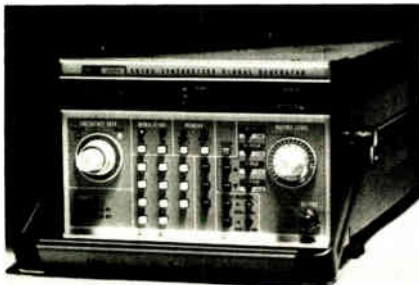

6010A Signal Generator

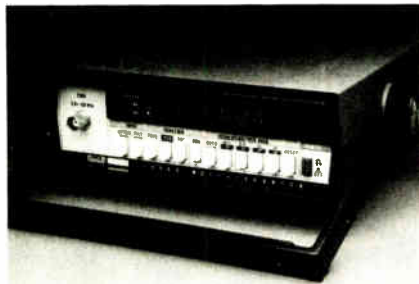

1900A Counter

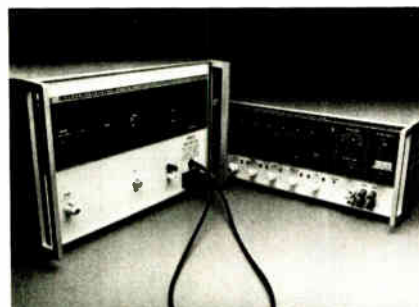

5200A AC Calibrator and 5205A Power Amplifier

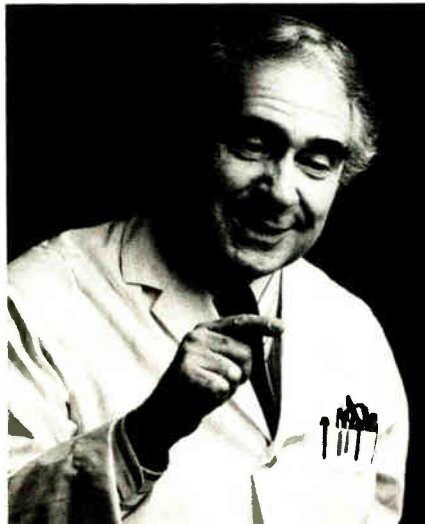

"I'll take one of those... no, that one! And one of those, too!"

ten frequencies, modulation, and attenuator settings by pushing a single button—a feature unique in signal generation.

The microprocessor plays a part in several other operations, including automatic range selection and automatic justification. You can automatically justify the frequency entry on the 7-digit LED readout to give the greatest possible resolution.

But for all its sophistication, the 6010A is friendly. It's easy to use. For example, you've got continuous tuning with the Frequency Edit control—the bright digit denotes the tuned decade. The bright digit can be incremented and decremented with complete carryover and borrow capability across a 10 Hz to 11 MHz coverage.

Put this intelligent, amiable fellow to work for you for only \$2495*.

Keep up the standards on the bench.

From Fluke. A fully programmable ac cal setup with range, stability and accuracy that's hard to beat for the price.

Together, the 5200A Precision AC Calibrator and the 5205A Precision Power Amplifier can calibrate ac devices up to 1200 volts rms. The frequency range is dc to 1.2 MHz. DC output of ± 1600 volts is available. Maximum output current is 200 mA. It will drive a 1500

pF capacitance load. Long-term stability is 200 ppm/ 6 months, midband accuracy is 0.02% overall, and response is a fast 0.5 sec.

Both instruments are short-circuit proof, fully guarded and interlocked. Phase lock availability and quadrature output are standard features.

The system interfaces easily with almost any system. Field installable serial and parallel isolated programming options are available. This unbeatable team goes to work for you for \$8990*.

Basic counting.

A new Fluke multi-function counter, the 1900A features autoranging in both frequency and period modes, with 20% hysteresis to eliminate annoying range switching. There's leading zero suppression and autoreset in all functions for easy and correct readings every time. A large 6-digit LED display with automatic range of 5 Hz to 80 MHz. Exceptional sensitivity of 25 mV (typically 15 mV). Event counting to 10^6 counts. Signal input conditioning. Frequency. Period. Totalize.

At only \$375*, you could say we've stayed close to the basics.

Shhhhhhhhhhh.....

Are you doing NMR or microwave spectroscopy? Be quiet about it. Use the new Fluke 6160B Frequency Synthesizer with the best signal-to-noise ratio available and a guaranteed spurious spec of greater than -83 dB. A range of 1 to 160 MHz with 1 Hz resolution, and from 1 to 20 MHz the spur spec is -100 dB. BCD programmable frequency control. Switching speeds less than a millisecond. Modular construction for custom tailoring to your needs. And all of this quiet costs \$5895*.



6160B Frequency Synthesizer



8400A, 8375A, and 8800A Digital Voltmeters
5½-digit DVM extravaganza.

Whatever you need in a DVM—Fluke has it. We're the leader.

Let's say you need resolution to 5½ digits. Look at these three instruments.

The 8800A is a $\pm 0.005\%$, 200,000-count bench DVM with 1 μV sensitivity. It's light and small, has full guarding and autoranging, and sells for \$985*. Accuracy is a guaranteed $\pm 0.01\%$ for 90 days over a temperature span of 18° to 28°C. Five ranges of dc volts from +200 mV to +1200V. Four ranges of ac volts from 2V to 1200V. True 4-wire resistance measurements on all ranges, 200 ohms to 20 megohms, with 3.3V maximum open post voltage. 10,000-hour MTBF. And overload protection of at least 1000V on any ac or dc range, 250 V rms or dc on any ohms range—the best in the industry. A wide range of accessories includes high-frequency probes, high-voltage probe and clamp-on ac current probe. An isolated printer output option is available.

For systems applications, Fluke offers the 8375A. Standard unit measures 5 ranges of dc volts and 4 ranges of true-rms ac volts. Basic dc accuracy is $\pm 0.003\%$. Basic ac accuracy is $\pm 0.1\%$. Resistance measurements are made in 7 ranges from 10 ohms to 12 megohms with 100 micro-ohms sensitivity. Fluke's patented Recirculating Remainder A-to-D conversion technique with autozero circuit provides reliable long-term accuracy and linearity. A quick check of all measurement functions is provided by the unique self-test feature. Field-installable systems options include remote control, data output and dc external reference.

The 8400A is the same basic box as the 8375A, with some different features. To the capabilities of the 8375A add $\pm 0.002\%$ basic dc accuracy, plug-in ac, resistance and ac or dc ratio options,

switched filter for dc, ac resistance and ratio, automatic settling or time-out delays and serial or parallel data output.

Both instruments, the 8375A and 8400A, offer full autoranging, auto-polarity, 20% overranging, pushbutton selection and 10,000-hour MTBF.

Both sell for \$2195*.

Got a fault in your logic?

Find it fast with the TRENDAR 200 IC TESTCLIP™. This complete pocket-size test set replaces the three commonly-used logic-checking devices—logic probe, logic status display clip, and hand-held IC comparator—for half the price. Using FAULTRACK®, a universal trouble-shooting procedure, board imperfections, solder defects and faulty IC's are easily found and displayed. Testclip automatically tests digital IC's in-circuit at megahertz rates. It automatically locates IC faults and board faults, and displays power status, logic states, toggling, and failures by pin number. Logic levels from 4.5V to 10V are tested automatically without adjustment. Waveform and timing integrity is insured by intimate contact of reference and test IC's. Minimized circuit load high-Z and low-C inputs insure



TESTCLIP

against upset circuit behavior. No calibration or routine maintenance. DTL, TTL, C-MOS, and HTL compatible versions available. Operates anywhere; portable case carries 36 reference IC's.

The TRENDAR 200 IC TESTCLIP, with carrying case, manual, Logic Probe Extension, 10 reference IC sockets and 40 programming pins is \$395*.

Digital thermometers, with options.

Fluke's new series 2100A digital thermometers offer temperature range of -320°F to +3200°F with 0.1° resolution in three models.

And they've got options for maximum versatility.

Like an analog output in four offset ranges, both linearized and isolated. The linearized feature gives direct temperature readings on a strip chart recorder with no interpolation. And because it's isolated, there's no worry about ground loops.



2100A Digital Thermometer

The 2100A has a digital BCD output that monitors six thermocouple types (J, K, E, T, R and S) and two millivolt ranges: 40 and 400 mV. The unit operates from line, 12V dc or self-contained battery pack (7 hours off-line). And you can expand up to 100 points with the 2150A option.

In addition, these units are rated for a minimum 10,000-hour MTBF, have excellent noise rejection and come in tough, all-metal cases. Prices for the three basic models are \$795* (2100A-03, single-point type), \$995* (2100A-10, multi-point type), and \$1095* (2100A-06, multi-thermocouple type).

*Domestic price only.

For data out today, dial our toll-free hotline, 800-426-0361.

John Fluke Mfg. Co., Inc., P.O. Box 43210, Mountlake Terrace, WA 98043

Fluke (Nederland) B.V., P.O. Box 5053, Tilburg, The Netherlands.

Phone: (013) 673-973 Telex: 52237

TEST AND MEASUREMENT INSTRUMENTATION. FLUKE

For information on the 8400A circle 111
 For demonstration on the 8400A circle 112

For information on the 8375A circle 113
 For demonstration on the 8375A circle 114

For information on the 8800A circle 115
 For demonstration on the 8800A circle 116

For information on the test clip circle 117
 For demonstration on the test clip circle 120

For information on the 2100A circle 121
 For demonstration on the 2100A circle 122

NOW CHOOSE FROM HIGH-VALUE DELCO

MAJOR PARAMETER LIMITS

TYPE	V _{CEO}	V _{CBO}	min h _{FE} @ I _C	Package*
DTS-4061	600V	—	8 @ 15A	TO-3
DTS-4059	600V	—	5 @ 15A	TO-3
DTS-4041	400V	—	8 @ 15A	TO-3
DTS-4039	400V	—	5 @ 15A	TO-3
DTS-4026	600V	—	150 @ 5A	TO-3
DTS-4025	400V	—	150 @ 5A	TO-3
DTS-4010	250V	—	150 @ 5A	TO-3
DTS-1010	120V	—	200 @ 10A	TO-3
DTS-1020	120V	—	500 @ 10A	TO-3
DTS-2000	—	40V	2000 @ 600 mA	TO-92*

*TO-92 package modified. TO-3 devices packaged in solid copper cases.

INDUCTIVE SWITCHING CAPABILITY OF THE DTS-4039, 41, 59, 61 DARLINGTONS

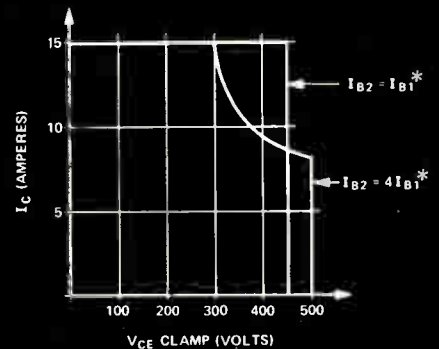

* WITH I_C = 8A I_{B1} = 1A
WITH I_C = 8A I_{B1} = 2A

MOTOR SPEED CONTROL INVERTER OUTPUT WITH DELCO DARLINGTONS

APPLICATIONS DATA AVAILABLE UPON REQUEST

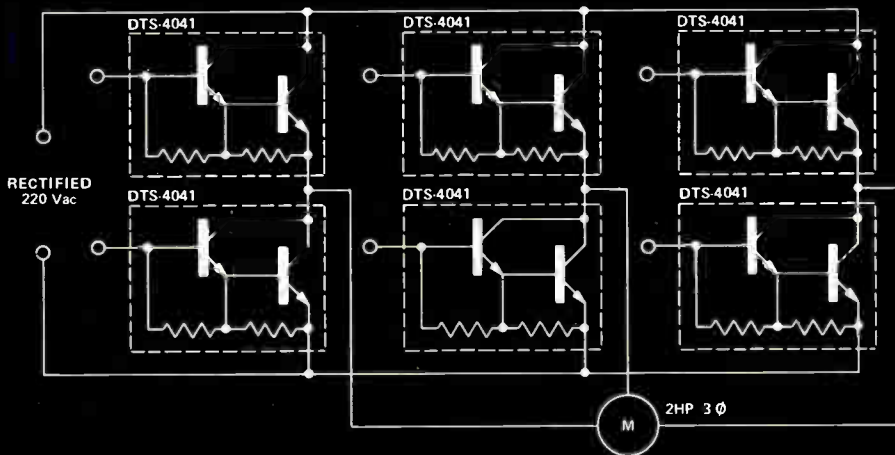

We've added three new ways to save you money on NPN triple diffused silicon power Darlington. Delco Electronics' new DTS-4010, 4025 and 4026 are high powered yet practically priced and give you exceptional energy handling value.

Delco power Darlington's triple diffused mesa construction gives them outstanding peak power handling capability (as shown in the graph of clamped inductive switching). The reverse biased switching data shown illustrates the high energy handling capabilities of these units.

And Delco Darlington can be purchased with t_{out} grouping for improved current sharing in parallel operation.

The planar DTS-2000 is a TO-92 Darlington

and is applied in driver circuits designed for the referenced 2 and 10 hp induction motor speed controls. Five low voltage power supplies in the control circuit for this application use our DTS-1010, 120 V_{CEO} Darlington.

All Delco Darlington bring you the space saving design flexibility you expect from Darlington, PLUS Delco's proven high energy handling capability.

Select any Delco Darlington up to 600 V_{CEO} and contact your Delco distributor for complete application and device data, prices and prompt delivery.

Specify Delco Darlington for power at practical prices.

TEN HIGH-ENERGY, DARLINGTONS.

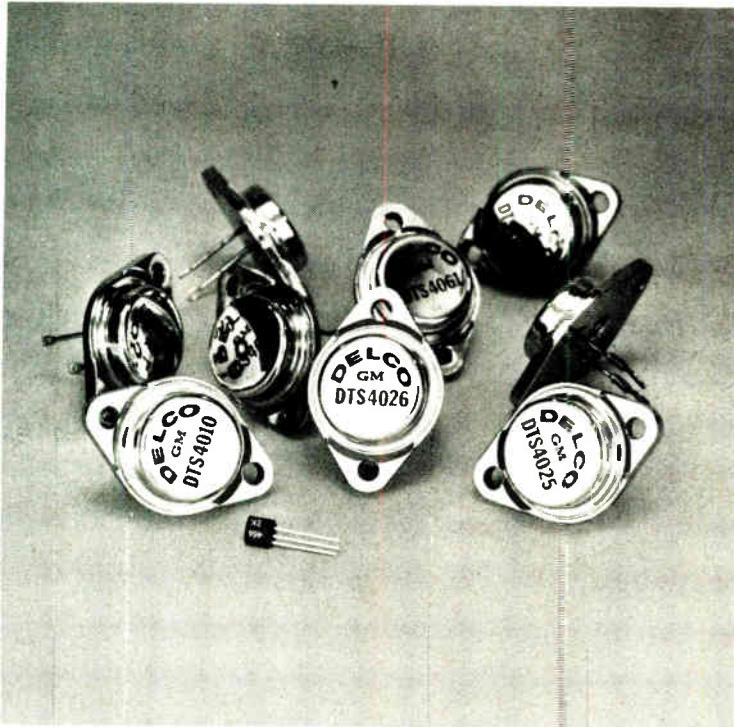

**NOW AVAILABLE FROM THESE DISTRIBUTORS
IN PRODUCTION QUANTITIES.**

ALABAMA, Birmingham
Forbes Distributing Co., Inc.
(205) 251-4104

ALABAMA, Huntsville
Powell Electronics
(205) 539-2731

ARIZONA, Phoenix
Sterling Electronics, Inc.
(602) 258-4531

CALIFORNIA, Gardena
Bell Industries
Electronics Distributors Div.
(213) 321-5802

CALIFORNIA, Goleta
R.P.S. Electronics, Inc.
(805) 964-6823

CALIFORNIA, Los Angeles
Kierulff Electronics, Inc.
(213) 685-5511

CALIFORNIA, Los Angeles
R.P.S. Electronics, Inc.
(213) 748-1271

CALIFORNIA, Palo Alto
Kierulff Electronics, Inc.
(415) 968-6292

CALIFORNIA, San Diego
Kierulff Electronics, Inc.
(714) 278-2112

CALIFORNIA, San Diego
R.P.S. Electronics, Inc.
(714) 292-5611

CALIFORNIA, Sunnyvale
Bell Industries
(408) 734-8570

COLORADO, Denver
Kierulff Electronics, Inc.
(303) 371-6500

CONNECTICUT, Norwalk
Harvey Electronics
(203) 853-1515

FLORIDA, Clearwater
Diplomat/Southland
(813) 443-4514

FLORIDA, Miami Springs
Powell Electronics/Florida
(305) 592-3260

ILLINOIS, Elk Grove Village
Kierulff Electronics, Inc.
(312) 640-0200

ILLINOIS, Skokie
Bell Industries
Electronics Distributors Div.
(312) 282-5400

INDIANA, Indianapolis
Graham Electronics Supply, Inc.
(317) 634-8202

MARYLAND, Baltimore
RESCO/Baltimore
(301) 823-0070

MARYLAND, Beltsville
RESCO/Washington
(301) 937-5890

MASSACHUSETTS, Billerica
Kierulff Electronics, Inc.
(617) 935-5134
(617) 667-8331

MASSACHUSETTS, Newton
The Greene-Shaw Co., Inc.
(617) 969-8900

MICHIGAN, Livonia
Pioneer/Michigan
(313) 525-1800

MINNESOTA, Minneapolis
Stark Electronics Supply Co.
(612) 332-1325

MISSOURI, Kansas City
Walters Radio Supply, Inc.
(816) 531-7015

MISSOURI, St. Louis
LCOMP-St. Louis
(314) 647-5505

NEW JERSEY, Cinnaminson
Wilshire Electronics/Philadelphia
(609) 786-8990 (215) 627-1920

NEW JERSEY, Clifton
Wilshire Electronics/New Jersey
(201) 340-1900 (212) 244-8930

NEW MEXICO, Albuquerque
Sterling Electronics
(505) 345-6601

NEW YORK, Binghamton
Harvey Electronics
(607) 748-8211

NEW YORK, Buffalo
Summit Distributors, Inc.
(716) 884-3450

NEW YORK, Farmingdale
Wilshire Electronics/Long Island
(516) 293-5775

NEW YORK, Freeport
Milgray/New York
(516) 546-6000

NEW YORK, Woodbury
Harvey Electronics
(516) 921-8700 (212) 895-9260

OHIO, Cincinnati
United Radio, Inc.
(513) 761-4030

OHIO, Cleveland
Pattison Supply Co.
Industrial Electronics Division
(216) 441-3000

OHIO, Dayton
Pioneer/Dayton
(513) 236-9900

PENNSYLVANIA, Philadelphia
Almo Electronics
(215) 698-4000

PENNSYLVANIA, Pittsburgh
CAM/RPC Electronics
(412) 288-2600 (412) 782-3770

SOUTH CAROLINA, Columbia
Dixie Radio Supply Co., Inc.
(803) 253-5333

TEXAS, Dallas
Sterling Electronics
(214) 357-9131

TEXAS, Houston
Harrison Equipment Co., Inc.
(713) 652-4700

TEXAS, Houston
Sterling Electronics
(713) 627-9800

WASHINGTON, Seattle
Kierulff Electronics, Inc.
(206) 763-1550

IN CANADA: ONTARIO—Toronto
Zentronics Ltd.
(416) 787-1271

OVERSEAS: EUROPEAN INQUIRIES:
European Parts & Accessories

Marketing Group
General Motors Continental
Plant 2, Noorderlaan, Postbus 9
B-2030 Antwerp, Belgium

ALL OTHER OVERSEAS INQUIRIES:
General Motors Overseas
Operations

Parts & Accessories Dept.
767 Fifth Avenue
New York, N.Y. 10022
(212) 486-4412

Delco Electronics Regional Sales Offices
Union, New Jersey 07083
Box 1018 Chestnut Station
(201) 687-3770

Van Nuys, California 91404
Box 2968
(213) 988-7550

General Sales Office
700 E. Firmin, Kokomo, Ind. 46901
(317) 459-2175

Delco Electronics



Division of General Motors

for the BEST in... ANALOG FILTERS

DUAL HI/LO

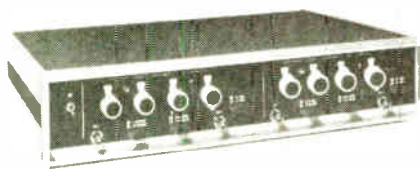

Higher Performance
Lower Cost

Model 452 rolloff: 24dB/octave/channel
Model 852 rolloff: 48dB/octave/channel

- Higher Dynamic Range
- Lower Noise
- Frequency Range:
0.01 Hz to 111 KHz
- Frequency Selection:
Digital, with 3 Digit Resolution
- Cutoff Frequency Accuracy: $\pm 2\%$
- Responses: Butterworth and Linear Phase
- Functions: Low Pass, High Pass, Band Pass, Band Reject
- Dynamic Range: 90 dB
- Passband Gains: 0, and 20 dB

Model 452 from \$1175
Model 852 from \$1725

DATA CLEANER



Anti-Aliasing
Multi-Channel

- Local, Remote and On-Card Programming of Cutoff Frequency
- Up to 16 Independent Channels in 5 1/4" Panel
- Cutoff Frequency Range: 0.01 Hz to 150 KHz
- Rolloff: 48dB/octave/channel
- Responses: Butterworth and Bessel
- Functions: Low Pass, High Pass, Band Pass, Band Reject
- Dynamic Range: 80dB
- Passband Gain: 0dB

FOR DATA ACQUISITION
AND SIGNAL PROCESSING

System 816 Main Frame \$1600
Filter Cards from \$750

BUDGET

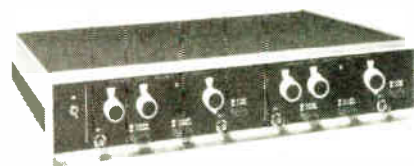

Wide Range
Low Cost

Model 432: 1 Hz to 110 KHz
Model 442: 10 Hz to 1.1 MHz

- Low Cost
- Rolloff: 24dB/octave/channel
- Frequency Selection: Digital, with 2 Digit Resolution
- Cutoff Frequency Accuracy: $\pm 5\%$
- Responses: Butterworth and Linear Phase
- Functions: Low Pass, High Pass, Band Pass, Band Reject
- Dynamic Range: 80 dB
- Passband Gains: 0, and 20 dB
- Low Noise

Model 432 \$825
Model 442 \$895

Prices U.S.A. Domestic subject to change without notice

ROCKLAND

Rockland Systems Corporation 230 Westlack Road West Nyack, N.Y. 10994 • (914) 623-6666 • TWX 710-575-2631

86 Circle 86 on reader service card

World Radio History

We thumbs prefer **Cherry** thumbwheel switches

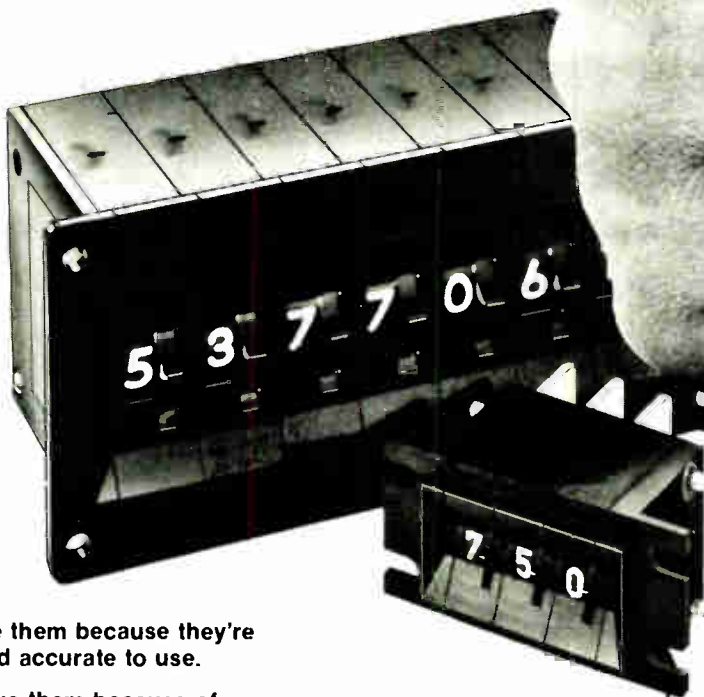

"We like them because they're easy and accurate to use.

You'll like them because of selection, features and price."

You'll also like Cherry quality. The kind of quality you always hope for . . . but that is only realized when a company (like Cherry) has total in-house manufacturing capabilities. To make sure the thumbwheel or leverwheel switch you order is the finest available. Anywhere. Combine this dedication to quality with the broadest line and lowest prices, and you'll understand why our customers say "thumbs up" to Cherry thumbwheels.

NEW! The smallest thumbwheel switch of them all.

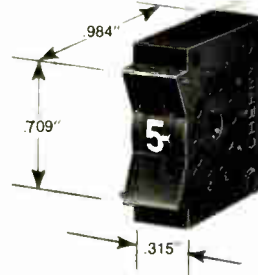

The new T-50 sub-subminiature thumbwheel that takes only 8mm x 18mm front panel space . . . just 32mm depth back of panel.

For complete data and specs: TWX 910-235-1572 . . . or PHONE 312-689-7700 . . . or circle reader service number.



ELECTRONIC DATA ENTRY KEYBOARDS



PLASMA-LUX GAS DISCHARGE DIGITAL DISPLAYS

CHERRY ELECTRICAL PRODUCTS CORP.

Sunset Avenue • Waukegan, Illinois 60085

FEATURE ARTICLES FROM *ELECTRONICS* AVAILABLE IN REPRINT FORM

No of
copies
wanted

New reprints

- _____ R-600 World market report 1976
24 pp \$5.00
- _____ R-526 How reliable are today's com-
ponents 16 pp \$3.00
- _____ R-524 Special report on bipolar
large-scale integration 12 pp
\$3.00
- _____ R-522 Special report on power semi-
conductors 12 pp \$3.00
- _____ R-514 Eight ways to better radio re-
ceiver design 6 pp \$3.00
- _____ R-512 Design of circuits for dan-
gerous environments 4 pp
\$3.00
- _____ R-510 Bipolar integration advances
with I²L microprocessor 8 pp
\$2.00
- _____ R-508 Designing microprocessors
with standard-logic devices
12 pp \$3.00
- _____ R-506 The case for component
burn-in 7 pp \$2.00

Charts

- _____ R-516 Electronic symbols (chart)
\$2.00
- _____ R-211 Electromagnetic spectrum
(16-page report and chart)
\$4.00
- _____ R-213 Electromagnetic spectrum
(chart) \$2.00
- _____ R-326 Optical spectrum (6-page re-
port and chart) \$3.00
- _____ R-327 Optical spectrum (chart)
\$2.00

Books

- _____ R-520 Microprocessors—Electronics
Book Series \$8.95
- _____ R-11 Computer-aided Design 135
pp \$4.00
- _____ R-032 Active Filters 88 pp \$4.00
- _____ R-031 Circuit Designer's Casebook
182 pp (U.S. only) \$5.50
(foreign) \$12.00

Other Reprints

- _____ R-518 Special issue—productivity
\$4.00
- _____ R-434 Designing automated systems
with the new standard inter-
face 12 pp \$3.00
- _____ R-432 An update on communi-
cations satellites 8 pp \$2.00
- _____ R-430 Choosing the right bipolar
transistor model for com-
puter-aided design 20 pp
\$3.00
- _____ R-428 Designing with low-cost la-
sers 6 pp \$2.00
- _____ R-504 U.S. forecast 1975 20 pp
\$3.00
- _____ R-502 European forecast 1975
20 pp \$3.00
- _____ R-500 Japanese forecast 1975
16 pp \$3.00
- _____ All three forecasts \$7.50
- _____ R-426 Special issue—technology up-
date 1974 \$4.00
- _____ R-424 Microprocessor applications
28 pp \$3.00
- _____ R-422 A microprogrammable mini-
computer 8 pp \$2.00
- _____ R-420 Computerized text-editing
and typesetting 8 pp \$2.00
- _____ R-418 Computer analyses of rf cir-
cuits 8 pp \$2.00
- _____ R-416 Optical waveguides look
brighter 8 pp \$2.00
- _____ R-414 The ion-implanted n-channel
process 6 pp \$2.00
- _____ R-412 Liquid cooling of power semi-
conductors 6 pp \$2.00
- _____ R-410 Special report on passive
components 16 pp \$3.00
- _____ R-408 Bringing sight to the blind
8 pp \$2.00
- _____ R-406 Designing with the new logic,
C-MOS and bipolar 16 pp
\$3.00
- _____ R-328 Special issue—pervasiveness
of electronics \$2.00
- _____ R-324 Semiconductor memories are
taking over data-storage ap-
plications 16 pp \$3.00
- _____ R-322 Special report: new displays
complement old 10 pp \$2.00
- _____ R-320 Special report on designing
with flat cable 14 pp \$3.00
- _____ R-318 Special report on auto elec-
tronics 16 pp \$3.00
- _____ R-316 Hybrid circuits solve tough
design problems 16 pp \$3.00
- _____ R-312 Leadless, pluggable IC pack-
ages reduce costs 7 pp \$2.00
- _____ R-310 Penetration color tubes are
enhancing information dis-
plays 6 pp \$2.00
- _____ R-308 Program for transition from
nonlinear to linear transistor
model 6 pp \$2.00
- _____ R-306 Charge-coupling improves its
image, challenging video
camera tubes 8 pp \$2.00
- _____ R-209 Semiconductor RAMs land
computer mainframe jobs
15 pp \$2.00
- _____ R-207 Technology gap starts to
close for computer peripher-
als 16 pp \$3.00
- _____ R-205 Bridging the analog and dig-
ital worlds with linear ICs
16 pp \$3.00
- _____ R-203 East Europe market report
16 pp \$2.00
- _____ R-113 Optoelectronics makes it at
last 34 pp \$4.00
- _____ R-107 Wanted for the '70s: easier-
to-program computers 24 pp
\$4.00
- _____ R-104 The new concept for memory
and imaging: charge-coupling
12 pp \$2.00
- _____ R-023 Special report on tomorrow's
communications 32 pp \$3.50
- _____ R-15 Special report on LSI pack-
aging 18 pp \$3.00

Payment must accompany your order

Make check or money order pay-
able to Electronics Reprints. All
orders are shipped prepaid by
parcel post. Allow two to three
weeks for delivery.

Back issues now available:
1960 to 1969, \$5.00 each
1970 to 1973, \$3.00 each
1974 to 1975, \$4.00 each

USE THIS PAGE AS YOUR ORDER FORM

Cost of orders \$ _____
Plus 10% handling charge \$ _____
TOTAL AMOUNT ENCLOSED \$ _____

Mail your order to:
Janice Austin
ELECTRONICS REPRINTS
P.O. Box 669
Hightstown, N.J. 08520

SEND REPRINTS TO

Name _____

Company _____ Dept. _____

Street _____

City _____ State _____ Zip _____

crystal clarity...

super speed...

competitive cost...



that's the
AILTECH
360 frequency synthesizer

10 kHz to 180 MHz spectrally pure, DIRECT SIGNALS from the AILTECH 360 Frequency Synthesizer result from a totally new and patented technique providing:

- **Direct Synthesis** — at Costs Comparable with Slower, Indirect Synthesizers.
- **Clean Signals** — Spurious More Than 100 dB below output.
- **Quiet Signals** — Phase Noise Floor— 138 dB/Hz below output.
- **High Speed** — Less than 20 μ sec Switching Time.

ECM, Communications, radar, automatic test... whatever your application... the AILTECH 360 offers complete flexibility. Modular construction permits easy frequency extension or restriction of system to specific frequency slots, and the 360 can be frequency programmed with less than 20 μ sec switching time.

We're sure you'll appreciate the difference when you see the 360 in operation. Just call or drop us a line. We'll arrange for a complete demonstration at your convenience.

EAST COAST OPERATION
815 BROADHOLLOW ROAD
FARMINGDALE, NEW YORK 11735
TELEPHONE: (516) 595-6471
TWX: 510-224-6558



WEST COAST OPERATION
19535 EAST WALNUT DRIVE
CITY OF INDUSTRY, CA. 91748
TELEPHONE: (213) 965-4911
TWX: 910-584-1811

INTERNATIONAL OFFICES: FRANCE — La Garenne-Colombes, Telephone 7885100, Telex 842-62821 • GERMANY — Munich, Telephone (089) 5233023, Telex 841-529420
UNITED KINGDOM — Crowthorne, Telephone 5777, Telex 851-847238 • JAPAN — Tokyo, Telephone (404) 8701, Telex 781-02423320 (Nippon Automatic)

Gitchyseff an SFG.

**That's a synthesizer/
function generator, cousin—
the first one ever.**

Our new Model 171 combines the accuracy and stability of a synthesizer with the versatility of a function generator. This means you can generate sine, square, triangle, TTL pulse and dc outputs with synthesizer accuracy. Frequency range is 0.01 Hz to 2 MHz.

Sometimes all you'll need

to use is the generator dial, which is accurate to 3% of full scale. But for more precise operations, you'll want the synthesizer's 4½-digit accuracy which is 0.01% of setting. Synthesizer stability is ±0.002% from 0 to 50°C.

Now we all know that your average synthesizer goes for two grand or better. But the Model 171, which is also a function generator, goes for

just \$795. Which means you could have two of our SFGs for the price of an ordinary synthesizer and have some bucks left over. Gitchyseff a couple. WAVETEK, P.O. Box 651, San Diego, California 92112. Phone (714) 279-2200, TWX 910-335-2007.

WAVETEK®

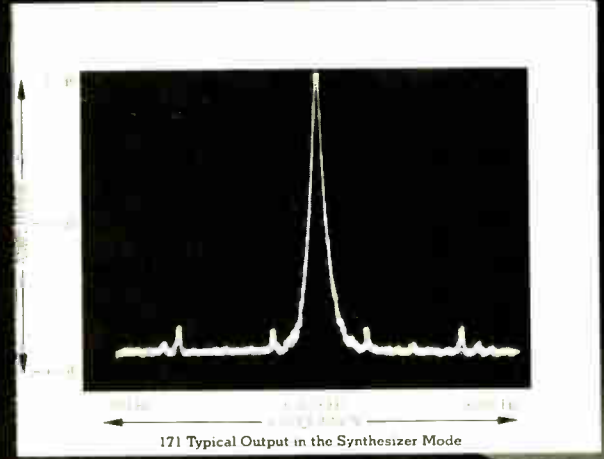
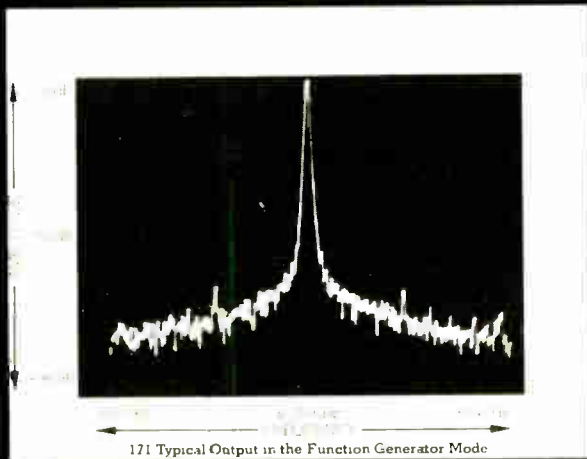

Actual spectrum analyzer photographs showing the improved waveform characteristics in the synthesizer mode.

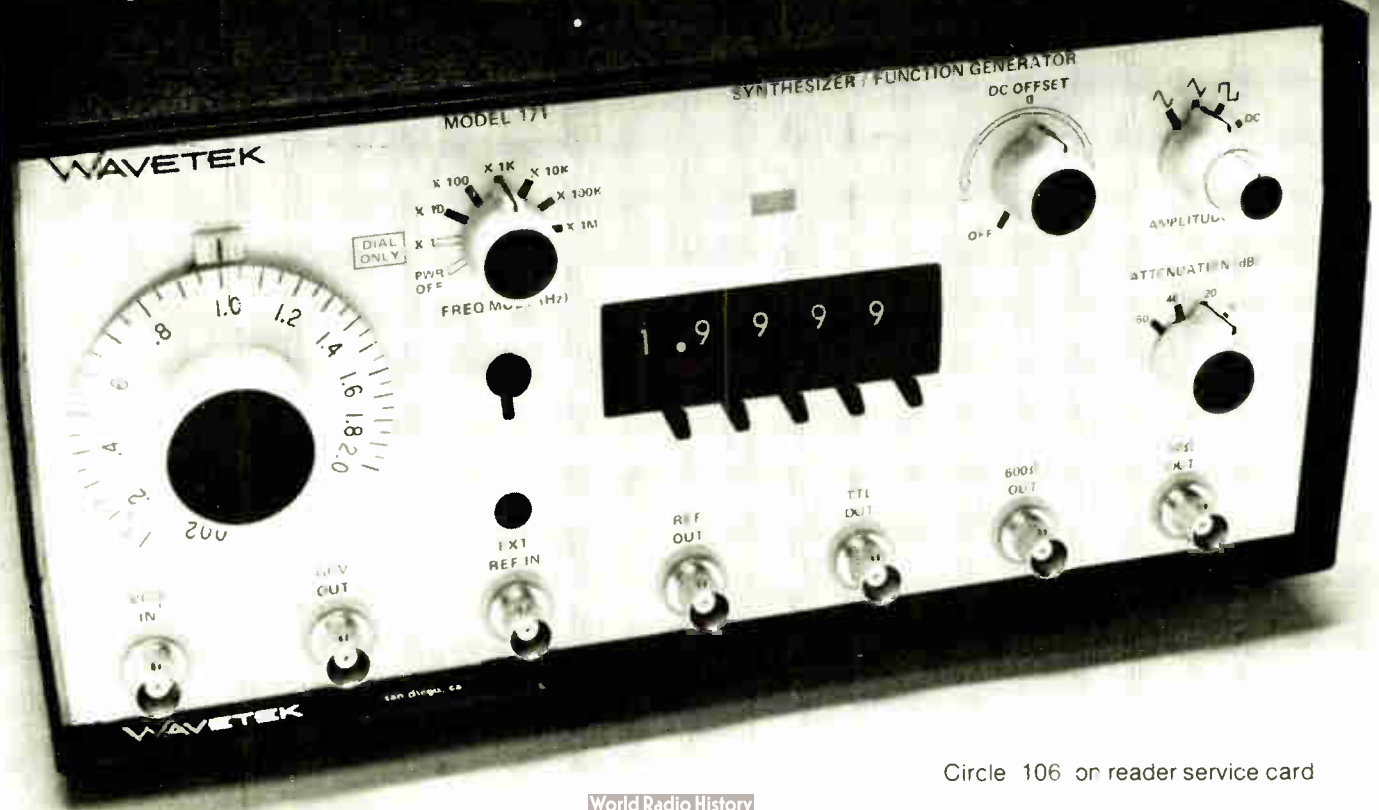

Circle 106 on reader service card

Citizens' band clamor gives headaches to FCC, designers

by Richard Gundlach, *Communications & Microwave editor*

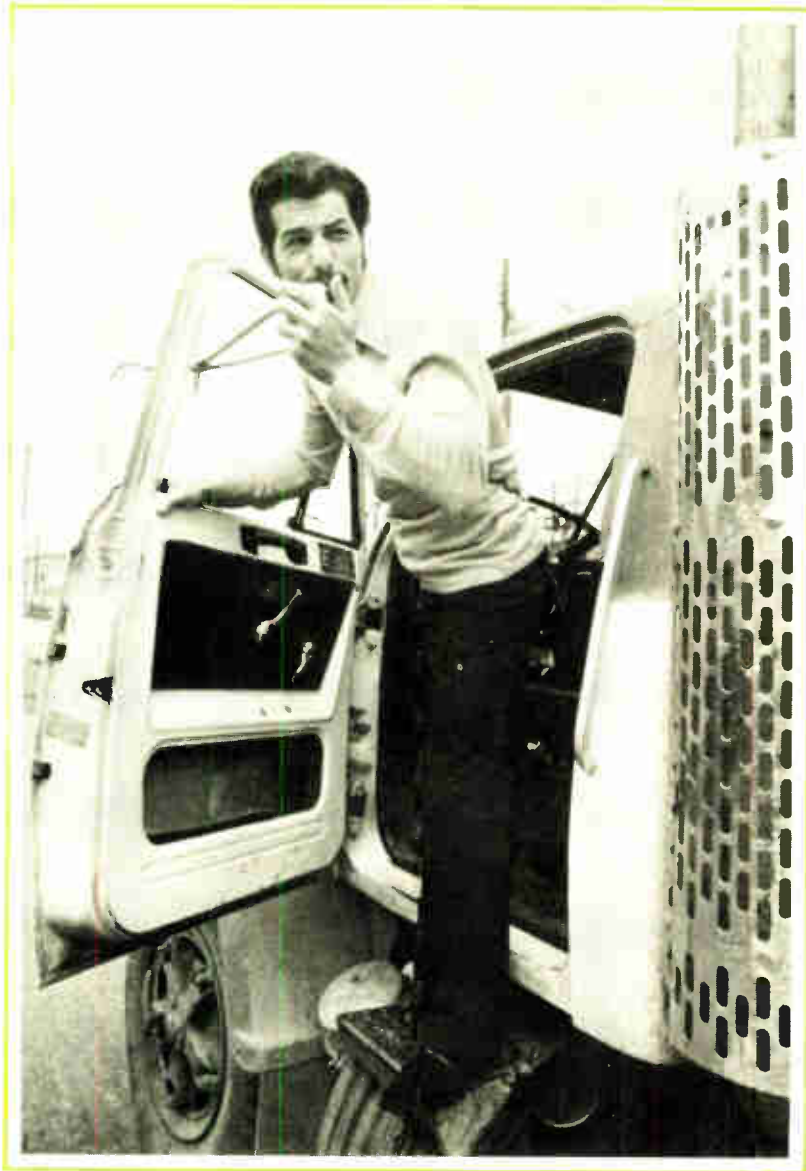

□ It took 16 years from the inauguration of citizens' band radio to accumulate the first million licenses, the first eight months of 1975 for the next million, and only three more months for the third million. Today more than six million licensed and unlicensed users crowd the scant 23 channels allotted by the FCC. In another year, there may be double that number competing for space in the 27-megahertz CB spectrum.

The staggering explosion in popularity has overwhelmed the 50-odd set makers and has caused a booming market in stolen sets. But the user who can hang onto his transceiver finds that popularity is creating its own headaches. Although a good many set owners treat their sets like auxiliary car radios and rarely transmit, there are enough citizen broadcasters for crowded channels and interference to have become major problems. The Federal Communications Commis-

sion probably will allocate more channels soon (see "CB and the FCC"), and interference may fall victim to the technological advances that are beginning to appear in the still developing field of CB-set manufacturing.

The boom started with the gasoline shortage of 1973-74. Long-haul truck drivers bought sets to keep each other informed of the whereabouts of gas supplies. When the highway speed

limit was cut to 55 miles per hour, the sets took on a new role: a warning system about speed traps manned by "Smokeys" or "bears," as highway troopers are called in the colorful CB lingo.

Set makers think the long-haul trucking market, which has been about 65% of the sales, is close to saturation. But the entertaining channel chatter has attracted a rather large following among motorists in automobiles and light trucks, and there is considerable

CB and the FCC

Commonly called citizens' band, Class D of the Citizens' Radio Service was established late in 1958, when the Federal Communications Commission reallocated a portion of the 11-meter amateur band for personal or business communications over distances of 15 miles or less. The FCC set up 23 channels in the 26.965-megahertz-to-27.255-MHz region. One of the channels is reserved for emergency calls, another for calling and the rest for general purpose.

Transmitter power is limited to 4 watts into the antenna for amplitude-modulation and 12-W peak envelope power for single sideband. The range of an a-m transmission can be as much as 25 miles in rural areas and as little as three miles in the noisier urban sprawl. SSB transmitters usually reach half as far again as their a-m counterparts. The FCC requires the transmitted frequency to be within 0.005% of the nominal frequency, and modulation not to exceed 100%.

Operators must have FCC licenses (no test required), but this is a requirement honored as much in the breach as in the observance. Estimates are that there is one unlicensed user for every licensed one—but the FCC really can't do anything to the nonlicensed offenders should its small enforcement staff happen to catch them. It can, however, move against licensed users who violate regulations, which is no inducement to applying for a license.

Right now, the biggest problem for the FCC (other than moving the millions of recent license applications) is finding a way to relieve the channel congestion created by the burgeoning army of CBers. There have been several proposals made:

- Docket 20120 proposes an immediate expansion of the allocation of channels from 23 to 70, with increasing

emphasis on SSB and eventual elimination of a-m. Industry talk has it that the decision will be an expansion to 50 channels with continued emphasis on a-m, in an announcement timed for the Personal Communications Show of the Citizens' Radio section of the Electronic Industries Association, starting March 30 in Las Vegas.

- Docket 19759 proposes a new CB radio service in the 220-MHz region for fm transmission, but there is strong opposition. The armed forces use that frequency band to operate tracking stations and radar installations; Mexico and Canada fear interference with adjacent very-high-frequency TV transmissions, and members of the Amateur Radio Relay League don't want to share their domain with what most "ham" operators consider undisciplined users. "I do get upset when CB manufacturers push for occupancy of other frequency bands—like 220 MHz, which is now occupied by 'ham radio' operators and where the possibility of interference with TV signals is very great—and not really give a darn to look elsewhere," says Harry Dannals, league president. "I don't see why the FCC doesn't make use of some of the old class-A frequencies up at 460 MHz for this type of Citizens' Radio Service." No commission action is expected before 1977, but there must be some decision before the world Radio Administrative Conference in 1979, which will discuss spectrum allocations.

- Docket 20351 proposes that all CB transmitters (and certain other radio services) have a selective calling system, known as the Automatic Transmitter Identification System. Transmissions would be specially encoded to activate only similarly equipped receivers, with each code probably identifying a different geographic area. It looks as though this proposal will lie in permanent limbo.

growth potential here, manufacturers think.

No matter what their vehicle, motorists use CB radios to break the boredom of their driving, to get weather and accident warnings, and to call for breakdown assistance and other emergency help. Commuters can call home when delayed by traffic (or, better yet, learn about the delays and how to avoid them). Farmers and other outdoor workers and sportsmen rely on CB to spring them from their isolation, and fleet owners use it to communicate with their vehicles.

Even with the limited power ordered by the FCC, the transceivers can be useful. The U.S. Department of Transportation and some safety and law-enforcement agencies think citizens' band may provide a nationwide highway communications network. The Missouri Highway Patrol already has sets in its patrol cars, and its troopers are learning of accidents much faster.

Such governmental support and the fact that auto makers are beginning to view CB radio as a highly saleable option may make the sets as common as windshield wipers in cars of the 1980s. But such a proliferation of users would cause even heavier channel crowding and interference.

About 90% of the sets sold under U.S. labels are assembled in the Far East, often with American components. Right now technology is relegated to providing what's needed to pass FCC tests and to anticipating the

changes needed for the projected increase in the number of channels. Prices for the current 23-channel amplitude-modulated sets range from \$125 to \$250, with another \$100 for single-sideband capability (see "SSB—a powerful option"). There is a whole shopping list of options to choose, and most CBers want them all, even though the sets will operate without some of them perfectly well. Set manufacturers commonly call their options "bells and whistles."

FCC approval of 27 additional channels would help relieve the crowding problem, as would the less likely decision to eventually eliminate a-m transmission in favor of the now-optional SSB mode. But regulatory decisions won't solve the biggest problem facing CB users: interference, both man-made and natural.

For example, noise pollution from automobiles has become so heavy that the FCC is studying the problem—which stems in part, paradoxically, from technological advance. High-efficiency alternator diodes and electronic ignition systems have magnified electromagnetic interference levels. These fast turn-on devices generate a much broader spectrum of spurious signals that interfere with the motorists' sets.

Noise caused by adjacent-channel interference is another serious problem, as is increasing solar storm activity. Every 11 years, sun-spot cycles peak. These—and less severe peaks within each cycle—cause CB trans-

SSB: a powerful option

The audio signal in amplitude modulation varies the amplitude of the carrier, producing two additional sidebands, one higher than the carrier frequency, and the other lower. Only the sidebands carry information, so the power put into the carrier is lost.

Single-sideband transmission eliminates the carrier and one sideband, although the carrier must be reinserted at the receiver to recover the message being transmitted. SSB has several advantages:

- Theoretically an SSB system can give an effective gain of up to 9 decibels over a-m, which is equivalent to increasing transmitter power eight times.
- Since no carrier is transmitted, heterodyning from nearby carrier frequencies and the accompanying noise are eliminated (in an SSB-only service).
- With the receiver bandwidth halved, the signal-to-noise ratio is improved.
- Two different stations can operate on the same channel frequency, one on the upper sideband and one on the lower. This doubles the channel capacity without increasing the spectrum.

However, since there are no exclusive channels for SSB, the many a-m transmissions cut into the advantages. Stability also is a problem with SSB sets. The re-

ceiver must be kept tuned within 50 hertz of the transmitter frequency if the message is to be understood word for word, although the meaning usually can be grasped if the receiver is within 100 Hz. That can be expensive, since a good crystal with a frequency drift of ± 10 parts per million from -30°C to 70°C would be needed for long-term stability.

However, some manufacturers think extra tolerance and stability is economically feasible in a transceiver with a single-crystal phase-locked-loop synthesizer chip. The savings in crystals would offset the cost of a better crystal with the extra tolerance and stability. Frank Rose, chief of the FCC's technical standards branch, feels such sets—which really would not need a clarifier control—would go a long way in making SSB more attractive to the average CBer.

Although the SSB-only service is unlikely in the U.S. in the near future, there is international precedent. The International Telecommunications Union, an arm of the United Nations in which all member countries participate, has proposed conversion to SSB-only in the maritime service by 1982. There is every reason to believe that this concept will be carried into point-to-point land communications as well.

missions to skip thousands of miles with little attenuation. The resulting signal-to-noise degradation contributed to a decline in popularity during the high point of the last cycle in 1969, many manufacturers believe. There is no consensus on the market effect of the 1980 peak. Interest may be so great that the sun-spots won't dampen enthusiasm. But no one really knows.

Even at the low point of the sun-spot cycle there still is troublesome interference from adjacent channels. An extra-strong signal from a CBer on a nearby channel can overload a nearby receiver and severely desensitize it.

With the mushrooming number of users, on-channel noise may replace adjacent-channel interference as the number-one noise headache. The FCC allows a 0.005% frequency tolerance in transmissions on the same channel. Other transmissions usually are beyond the range of the user's rig, but the slightly varying frequencies will heterodyne together, raising numerous beat frequencies that take on the characteristic of white noise. This effectively raises the background noise level. White noise is random and can't be removed, so it sets the level of theoretical maximum receiver performance. But spikes of white noise and peaks of noise from other sources can degrade performance even more.

Getting rid of noise

There are three measures now in use against noise reduction: automatic noise limiting, noise blanking, and squelch. Noise-limiting circuits detect the threshold of incoming noise and prevent a series-diode clamp from passing the signal until it reaches the preset level. Noise-blanking circuits try to eliminate noise spikes before they reach high-gain stages, where stretching and nonlinear conditions can add to the problem. Many engineers feel more effective noise-blanking systems are

essential. Squelch circuitry opens up the audio path when no carrier is present. This silences the speaker and eliminates the annoying hiss of background noise.

Technology can provide a technique for the recognition, processing, and elimination of noise. Already proved in more expensive military equipment, such circuits automatically adjust noise thresholds, while signal-enhancement circuits are boosting the signal-to-noise ratio. Although such adaptive processing techniques will reduce sensitivity a bit, it's easily tolerated in the short-range CB communications.

Large-scale integrated-circuit technology can pack the circuitry for adaptive processing onto a single chip. IC designers can afford to use hundreds of transistors to accomplish the signal processing, which was not economically feasible with discrete components. High-speed, high-density technologies like integrated injection logic, which combines analog and digital functions on the same chip, will help bring digital techniques to CB sets. And LSI makes it possible to apply adaptive circuits, using microprocessors, to improve noise performance under changing ambient conditions.

A major sign that technology will play an important role in the development of new CB sets is the growing interest in digital frequency synthesizers using phase-locked-loop techniques. These circuits can generate all the needed channel frequencies from a single crystal-controlled reference oscillator that determines the accuracy. They are essential if the almost-certain allocation of 27 more channels is to be covered inexpensively.

As it stands, set manufacturers are using all-crystal synthesizers, and they're having trouble getting enough crystals [*Electronics*, Feb. 19, p. 76]. A standard arrangement is a 14-crystal synthesizer, with six in a common bank and four each for receiver and transmitter

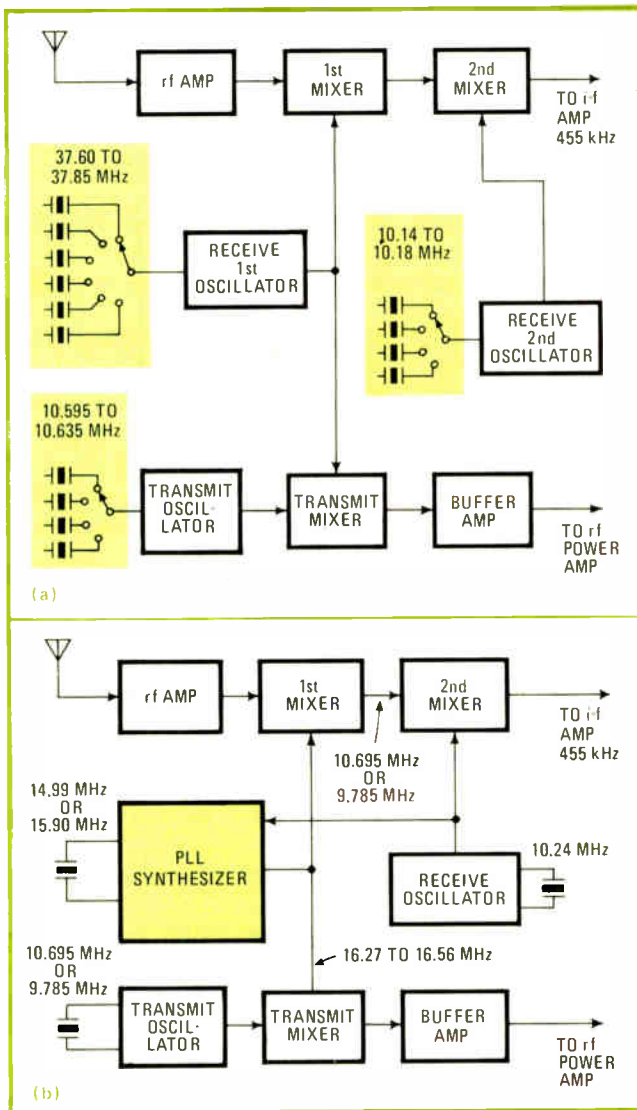

1. Cutting crystals. Phase-locked-loop synthesizers generate the 23 CB frequencies with a single crystal, whereas a typical crystal-synthesized CB transceiver would use a common bank of six crystals and two separate banks of four crystals each.

functions (Fig. 1). By heterodyning these carefully selected crystals, the frequencies for the 23 existing channels are generated. But a PLL synthesizer can lock in on any of the CB frequencies from a reference source controlled by a single crystal. Moreover, it requires no more crystals to generate all 50 of the anticipated expanded allocation of channel frequencies—in fact some models can generate upwards of 70 channel frequencies. The present all-crystal synthesizers can generate about 30 channels, but it will take more than 14 crystals to get all 50 channels.

Locking it up

Many versions of the PLL synthesizer are available, from one-chip LSI versions using one to three crystals to three-chip versions that need only one crystal (Figs. 2 and 3). The trend is towards one-chip LSI with all necessary functions, such as channel programming and a code converter that also drives a digital readout directly.

One of the first U.S. manufacturers on the scene was the Microelectronic Products division of Hughes Aircraft Co., in Newport Beach, Calif. It has adapted the complementary-metal-oxide-semiconductor PLL synthesizer originally designed for a military portable transceiver for use in CB sets [*Electronics*, Jan. 8, p. 31].

A number of Japanese firms plan to supply PLL synthesizer chips, including Matsushita Electric, Mitsubishi, Nippon Electric, Nippon Precision Circuits Ltd. (a subsidiary of watchmaker Seiko), Toshiba, and Hitachi. And several U.S. semiconductor houses have developed PLL synthesizer chips for the CB market.

E. F. Johnson, the Waseca, Minn., pioneer in CB radio, has designed its own custom PLL synthesizer chip, which is being produced by Motorola and National Communications Power Inc., Mountain View, Calif., put together its PLL synthesizer with inexpensive off-the-shelf transistor-transistor-logic ICs and a multiple-sourced read-only memory (Fig. 4).

Some companies have gotten it all together. For example, Nitron of Cupertino, Calif., and set maker SBE of Watsonville, Calif., co-developed a chip with all the components necessary for frequency-generation and selection. In some of the other PLL synthesizers these functions must be performed outboard of the chip. Access to the SBE-Nitron chip is by channel number—the onboard memory can hold a total of 80 channels' worth of information.

Both Motorola and Signetics have put together several CB radio circuits to complement their PLL synthesizer chips for single- or dual-conversion transceivers. Motorola offers an audio-processor module, and a combined second mixer, intermediate-frequency amplifiers, and detector—along with automatic-gain-control amplifiers for both rf and intermediate-frequency stages.

Multipurpose chips

Signetics used double-diffused MOS technology in its 16-pin, 100-channel-frequency synthesizer because D-MOS has a 20-megahertz capability not achievable with n-channel MOS or C-MOS. The firm also has developed several other ICs (Fig. 5). These include a D-MOS field-effect-transistor switch for use as a voltage-controlled oscillator and a dual-gate D-MOS FET that can be used as a radio-frequency amplifier or an oscillator/mixer.

It also has a 7-watt audio power amplifier with thermal shutdown, and a monolithic IC, designed for a-m receivers up to 50 MHz, that includes an on-chip rf prestage with agc, a balanced mixer, a separate oscillator, and an i-f amplifier with agc. Half of a dual low-noise preamplifier is used in a loop filter circuit, and the other half as a microphone preamplifier.

Signetics also is offering a bipolar monolithic compandor IC [*Electronics*, Feb. 19, p. 153] that compresses the audio before modulating the carrier and expands the demodulated audio, if necessary. This makes it possible to raise the average modulation without affecting the limit. To boost the range effectively, Signetics engineers see two approaches to compression. One is a standard amount of compression that gives some increase in "talk power," without requiring an expander in the receiving set to understand the message. The other

switches the compandor to a mode with even greater compression, which requires a receiver with similar companding capability.

Present modulation devices in CB transceivers are diode limiters and other techniques that limit the average modulation to at least 12 decibels below peak. Signetics engineers believe it will be possible to boost the average modulation by at least 6 dB with their new compandor, effectively giving the user that much more transmitting power. But the FCC must approve use of the compandor, and there may be questions about over-modulation producing spurious signals on the band.

Selecting the channel

An expansion from 23 to 50 channels requires re-thinking of channel-selection techniques. There are a number of possibilities, and most CB manufacturers are hedging their bets because they are concerned about making the right final selection.

The standard device right now is a 23-position rotary switch, which clicks each time a user moves into a new channel—so counting the clicks takes the place of looking at the channel indicator when switching. It would be difficult to keep track of the clicks with a 50-position switch, but a 25-position switch with an upper/lower mode is a possibility, as is a two-switch arrangement, one for the 10s and one for the 1s.

A different approach is continuous automatic incrementing with some memory added so that the last-selected channel will return when the set is turned back on. Automatic stepping with a depress-and-hold arrangement could step up or down to each channel frequency at a preset rate. A speed control would allow a varying step-rate, so that moving from channel 1 to channel 50 needn't take too long.

Another possibility is keyboard entry, along the lines of a model developed by SBE (Fig. 6). "Our keyboard entry system can't produce any channel frequency that is programmed into our ROM," says Steve Snell, the firm's chief engineer. Users can rewire switches to get access to illegal frequencies—and they have been known to do so with CB radios.

The SBE model uses a 3-by-4 matrix of numbers, each of which is scanned for key closures. To prevent mistaken recognition of a keybounce as two key strokes, the circuit is scanned several times. The key must be closed at least 5 milliseconds, and if the closure still registers after several scan cycles, that number is entered in the address decoder, which selects the proper programming for the channel from the read-only memory after two numbers are entered.

Of course, with a keyboard, motorists must take their eyes off the road to hit the right key. And they must divert their attention after entering the two numbers to verify the channel selection on a display. Some CB manufacturers think this will militate against acceptance by most users.

But before a channel-selecting technique can vie for consumer approval, it must gain acceptance by the FCC—which now says "the frequency selector shall be limited to a single control." Queries from set manufacturers have led to reevaluation of the rule, and it may

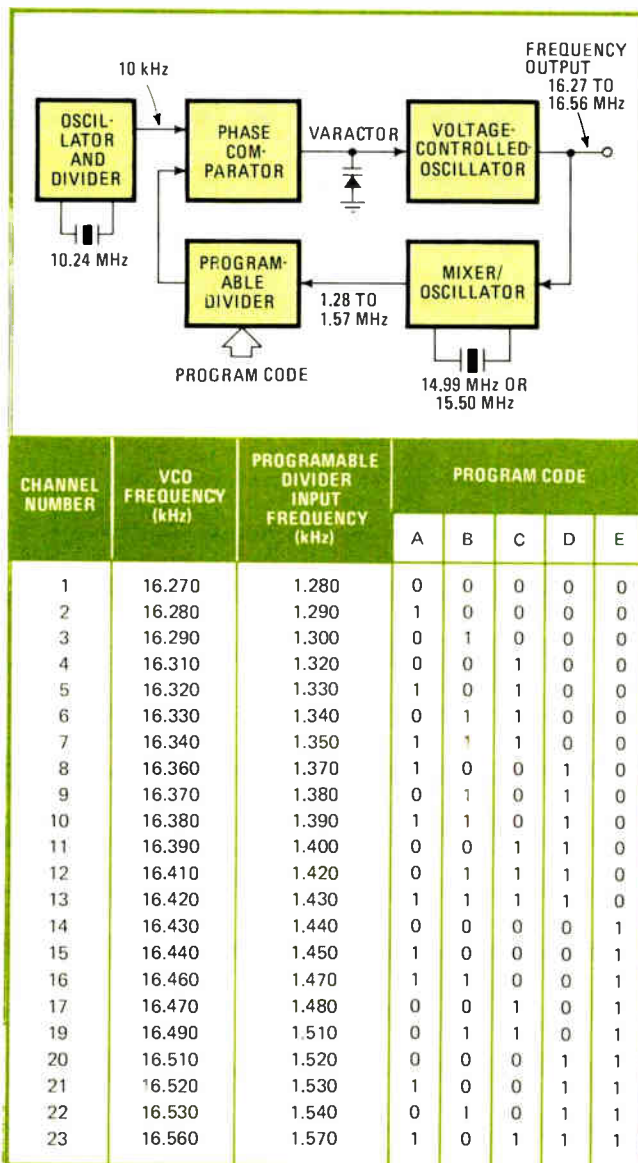

2. BCD data programs synthesizer. Toshiba's three-chip PLL synthesizer uses the new clocked complementary-MOS technology. The 8-bit programmable divider accepts a program code in BCD format from the channel selector. The reference oscillator and divider will accept an input frequency of either 5.12 MHz or 10.24 MHz.

be modified to specify only one location for the controls. The commission's main concern is that only the correct frequencies can be produced by users.

The first generation of expanded-channel CB radios will have many clever ways to display the selected channel—from magnified dial numbers to digital displays using rotating tapes, light-emitting diodes, or liquid-crystal displays. However, LED displays may be difficult to read in daylight in vehicles. Although LC displays are more visible in bright light, they're also more expensive.

Some manufacturers think that building a keyboard, a display, or both into the microphone is the way to go (Fig. 7). Other firms, however, are quick to point out that many CBers do more listening than talking, so they don't have the microphones in use much of the time.

Technological attention may be fixed on PLL synthesi-

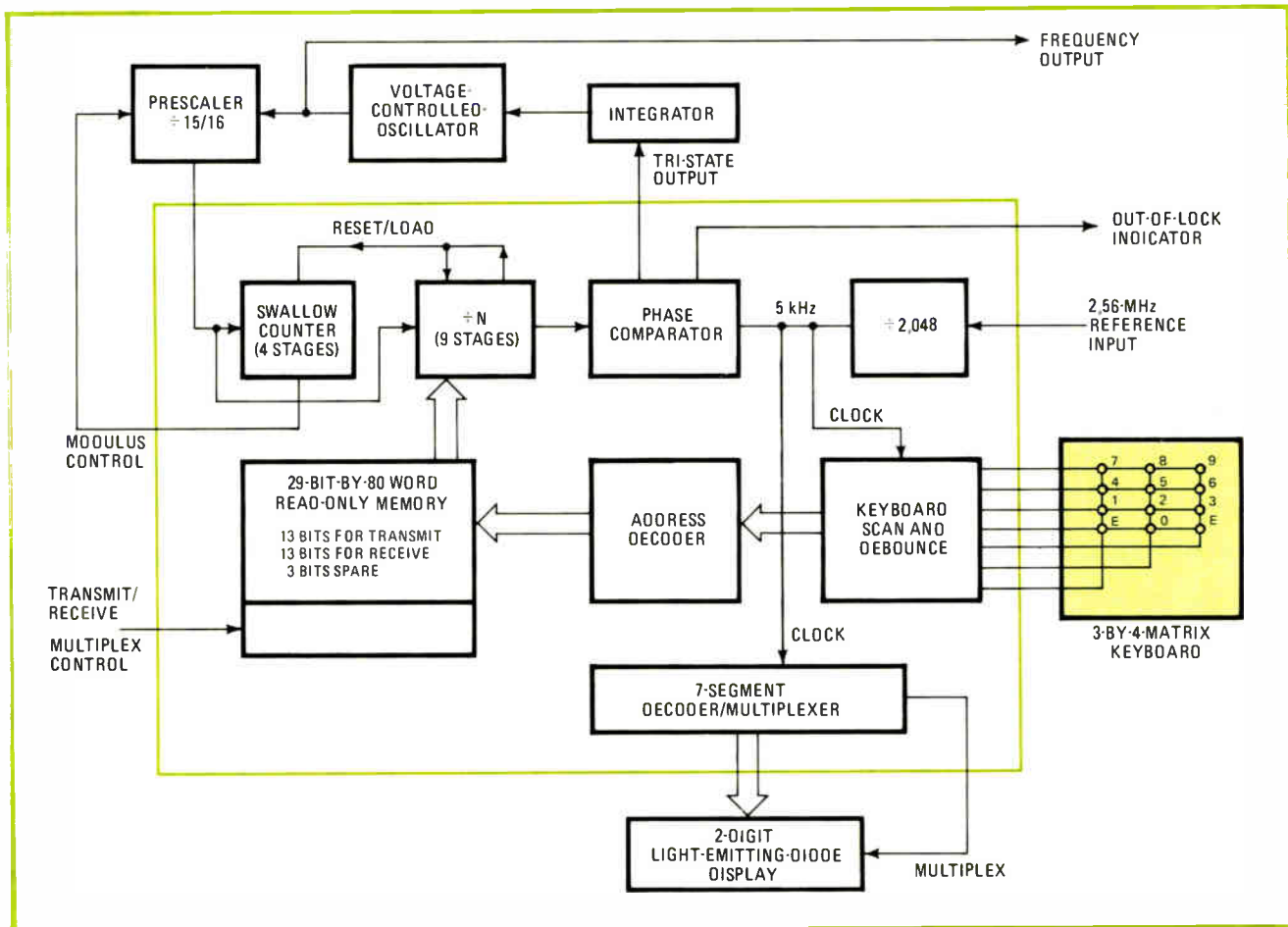

3. Keyboard entry. The 3-by-4 arrangement of contacts provides 12 unique combinations. After the enter key is depressed and released, information contained in the last two digit keys will be entered and displayed. Keyboard logic will accept closures that last longer than 16 milliseconds, thereby eliminating the effects of contact bounce and noise. The ROM stores frequency information for up to 80 channels.

zers, but, with so many CB users on the air, interest in receivers (see "Typical specs") with good adjacent-channel rejection, good overload characteristics, and low cross-modulation products is bound to grow. It's difficult to pinpoint how much of a problem cross-modulation is, but as the CB spectrum becomes even more congested—especially in urban areas—it will become one of the limiting factors on a set's usefulness.

Land-mobile techniques apply

Some of the techniques used in land-mobile radios are beginning to be applied to citizens' band. Eliminating the rf preamplifier, for example, eliminates a cross-modulation source. High-gain rf stages cause the mixer to overload more easily, producing nonlinear effects and thus increasing cross-modulation products.

There are other technological advances that point to the demise of the rf stage. With junction-FET mixer gains of 10 dB and noise of less than 5 dB, an rf stage is no longer needed to mask higher mixer noise. And today's J-FETs have more than 70 dB of spurious rejection, so no rf stage is needed for additional local oscillator isolation. Also, the J-FET mixer is capable of taking a lot more rf signal before cross-modulation becomes a real problem. Another reason for eliminating the rf stage is that 1-microvolt sensitivity is not needed for the short

range of citizens' band communications.

Communications Power Inc. has gotten rid of the rf stage, put in a J-FET mixer, and added a p-i-n diode attenuator that doubles as a receive/transmit switch. Dave Wisherd, the firm's vice president, says that cross-modulation is at least 80 dB down instead of the 50 dB or so expected with conventional techniques and standard mixers. The firm uses an eight-pole filter right after the mixer for extremely good rejection of adjacent-channel interference. "It costs more to do this, but using the same filter for both a-m and SSB is a good trade, economically," Wisherd says.

Conversion: double vs single

Many of today's CB transceivers use double conversion techniques—two mixer stages and two separate intermediate frequencies—although multiple mixing creates more spurious frequencies and reduces the signal-to-noise ratio. "Usually, when manufacturers opt for double conversion over single conversion, they are simply realizing that a higher frequency provides an additional measure of image-frequency rejection," Wisherd says. But, as he points out, image frequency is predictable—twice the frequency away from the carrier frequency. If there is no one using the image frequency, image rejection becomes a minor problem.

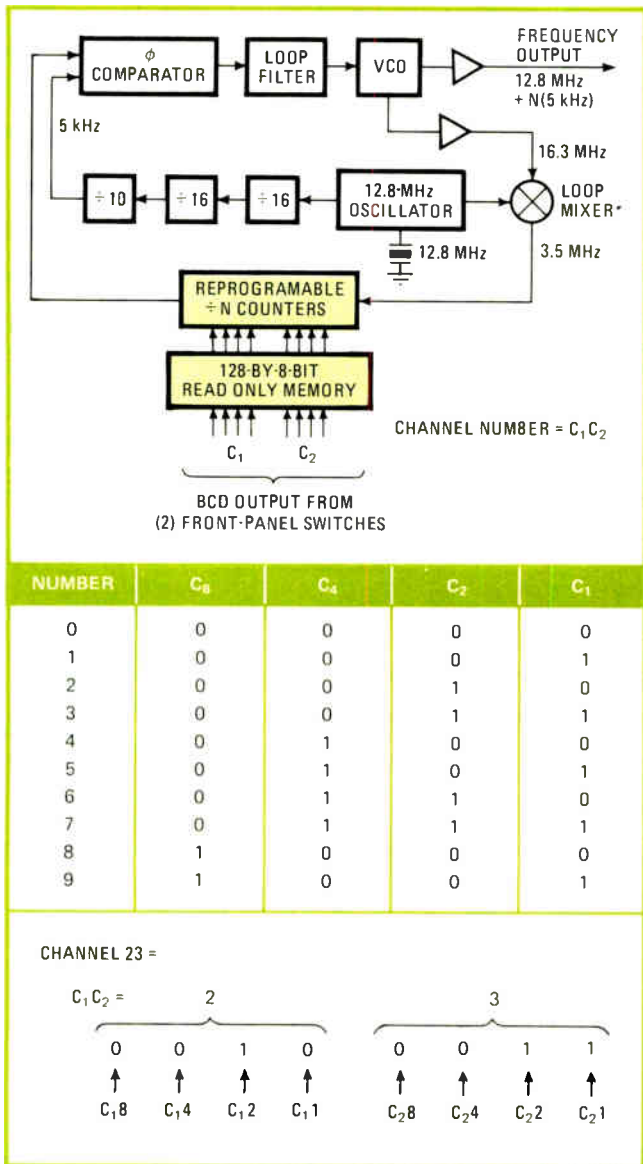

4. Off-the-shelf synthesizer. Communications Power Inc.'s synthesizer uses multiple-sourced TTL ICs and a MOS RAM. Two front-panel switches provide binary-coded-decimal outputs corresponding to each digit of the channel number selected. Each decimal is binary-coded, not the entire number. C_{1,1}, C_{1,2}, etc. are the "bits" of C₁, the first digit in the channel number. C_{2,1}, C_{2,2}, etc. are the "bits" of C₂, the second channel number as shown. The actual radio operating frequency is equal to N(5 kHz) + 12.8 MHz, where 12.8 MHz is a fixed heterodyne offset and N is a BCD number that determines the divide ratio for the programmable counter.

Although single-conversion with a higher i-f has advantages, Hugh Barnes, engineering manager for E. F. Johnson's CB products, says his firm's top-of-the line models use single conversion with 4.3 MHz because "it's difficult to do effective noise blanking at lower frequencies." It's not as easy to achieve the necessary coincidence between noise pulse and activation of the series gate that blanks it, at the lower frequencies.

The transmitter is the only part of the CB set that matters for FCC type-acceptance. Transmitter technology has remained fairly conventional, but Commu-

nications Power Inc. has beefed up the radio-frequency power-output stage.

Aiming at the top-of-the-line a-m/SSB market, CPI uses a 10-watt emitter-ballasted rf transistor. Although it's much larger than needed, it's rated to withstand second breakdown into infinite voltage-standing-wave ratios caused by a broken or disconnected antenna. To satisfy the FCC's dissipation limit for the output transistors, the firm has designed the rf-output stage to work into a fixed-load line.

The transmitter also has an unusual modulation scheme (Fig. 8). Most CB sets use high-level modulation, in which a transformer modulates the voltage to the final rf and driver stages with diode shaping to get linear modulation. Since this model needs a highly linear transmitter capable of good peak envelope power for the SSB portion, CPI uses the same circuitry for a-m. "We just turn on a diode to reinsert the carrier for double sideband," says company vice president Wisherd. "This way, it's a full a-m modulator, not just a compatible a-m modulator that reinserts the carrier after the filter to produce carrier and one sideband."

The switchable-mode, eight-pole crystal filter also minimizes spurious frequencies. Should overmodulations occur, the filter suppresses any frequencies generated that lie outside of the a-m passband.

What's ahead

Although technology can advance the state of the art in citizens' band, much of what happens in the next few years depends on how the FCC decides to relieve the channel crowding. That it will decide to relieve it, with an immediate expansion of the present range, is the only prediction industry observers make confidently. Other possibilities, including fm transmission and restriction of the a-m to SSB transceivers, are up in the air at the moment.

Electronics pegs the 1976 market at a conservative \$500 million in U.S. factory sales—and manufacturers are reminded every day that it would be bigger if they could produce or import enough sets. The sellers' market has a dampening effect on technological change, so the sets will remain pretty much the same until competition forces innovation.

However, many CB-set manufacturers are speculating about what is ahead. Hugh Barnes of E. F. Johnson pretty much sums up present thinking of the manufacturers: "CB sets will reflect a good, better, still better, and best pricing structure in the near future, with prices starting about \$129.95 and ending about \$259.95 for some time to come. As competition gets heavier, manufacturers will try to put more and more features they think the consumer wants into the sets, but prices won't come down much."

The firm's Washington, D. C., representative, Stuart Meyer, thinks when change does come it will be in the form of a dual-mode transceiver. "A-m at 27 MHz will work well in the rural areas," he says, "but a service using fm transmission in the vhf band will be needed in congested urban areas."

CPI's Dave Wisherd doesn't see any ultra-high-frequency CB sets in the future: "They'll be very expensive,

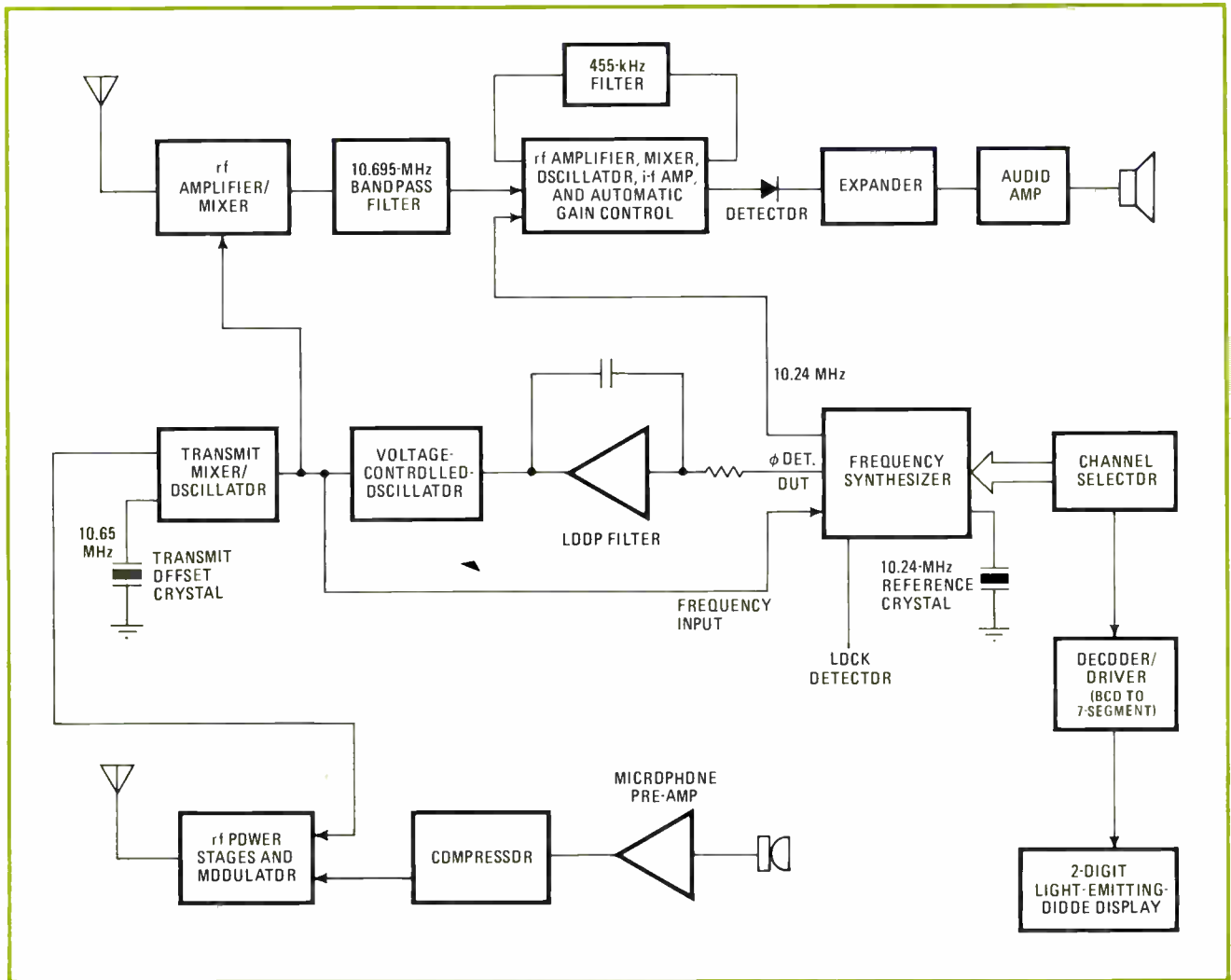

5. **CB circuits on chips.** Signetics has put together several circuits including a 16-pin dual in-line D-MOS PLL synthesizer, a D-MOS FET used as the VCO, and a D-MOS IC that functions as an rf amp mixer or oscillator/mixer. It has introduced a compandor circuit, half functioning as an expander, the other half as a compressor. Another dual IC is used as a microphone preamp and loop filter amp.



6. **Selecting channels with push-button ease.** SBE's phase-locked-loop synthesizer accepts keyboard inputs at a random and asynchronous rate, where all inputs are neglected except for the last two digits punched in before the enter button is pressed.

7. **More than a mike.** Several CB-set manufacturers are contemplating putting a channel display using a LED or LCD readout along with an up/down channel selection switch into the microphone. Next step may be to include a keyboard for selecting the channels.



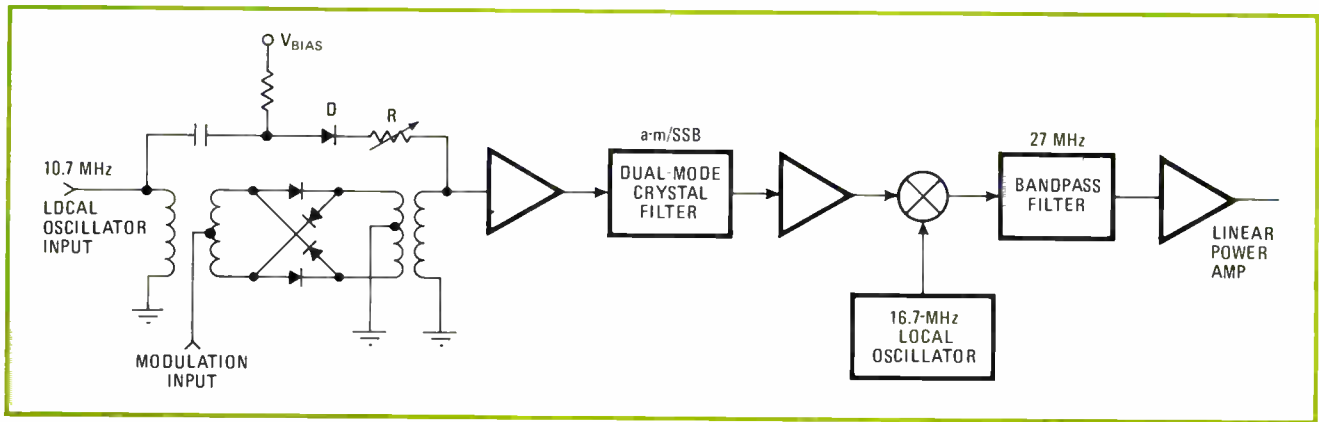

8. Double Duty. The modulation scheme Communications Power Inc. uses in its a-m/SSB CB sets doesn't require an extra crystal filter. For a-m, the carrier is reinserted around the balanced modulator when diode D_1 is turned on. R_1 adjusts the modulation percentage.

since the fm uhf radios haven't much commonality with a 27-MHz a-m rig, and it's so different to use." He does think there is a good possibility of restricting the 27-MHz frequency channels to SSB operation for an effective doubling of channels with the same frequency allocations. The PLL synthesizer and a better crystal will make economically feasible 100-hertz stability, which he thinks will be adequate. However, not all set makers agree with him that a received transmission 100 Hz away from the transmitting frequency will be adequate for understandability.

CB manufacturers do generally agree that sets are going toward in-dash installations, as they move into the largely untapped automobile market. Detroit will play a big part in what happens. Several U.S. CB-set makers have already held discussions with car makers, and two Japanese companies—Japan Industry Ltd. and Panasonic—have in-dash units that include a cassette stereo player, an a-m/fm multiplex radio, and a 23-channel citizens' band transceiver.

In-dash mounts can reduce theft rates, but there may be installation problems in the already limited space behind the dashboard. One CB-set manufacturer thinks installation cost will soar to close to the cost of the set. The solution may be in technology, most set makers think.

"I see putting the main part of the radio in the trunk, with a control head (which could be something like the Princess telephone handset) with channel selector and microphone up front convenient to the driver," says Ray Edwards, chief engineer of the Pathcom's Pace Communications division in Harbor City, Calif. "The handset could be detached and stowed in the glove compartment for further theft protection."

Dave Wisherd agrees. He sees the microprocessor as the key to doing this inexpensively. In the control head, the microprocessor would organize all channel information and other data, which could then be sent serially over a single wire to the shift register, which would be in the trunk module.

This module would provide a parallel format to control all necessary radio functions. "It'll provide the future CBR with a whole host of functions performed digitally such as monitoring preset channels periodically and reading out VSWR, power output, etcetera—simply

with keyboard control," he says.

The promise of a volume market should provide the impetus to produce an LSI chip with just about all the functions for a CB radio. With semiconductor manufacturers already eyeing the volatile market, plus the interest of such high-technology set manufacturers with land-mobile, military and commercial communications expertise as GE, Motorola, and RCA, there is always the possibility that technological innovations may occur faster than anticipated.

There are certain to be many casualties among the present 50 set manufacturers before the marketplace shakes out. Consumer preference is a big question mark, because of radically different operating conditions. In low-density rural areas with little channel crowding or interference, the lower-cost 23-channel sets should be adequate. On the other hand, for the high-density urban areas, higher-performance 50-channel sets are a must. What may finally emerge to meet the needs of mobile America are both types, with technological advances bringing them close together both in performance and in price. □

Typical specs

The FCC only checks the transmitter portion of CB radio before type acceptance. However, the receiver portion often determines how well the set will function in today's crowded, noisy environment. Although cost is a pretty good indicator of a set's performance, the many options offered boost the price without a corresponding increase in performance. A sampling of CB manufacturers' literature gives an indication of standard receiver specifications.

Sensitivity (for a 10-dB signal-to-noise ratio)	
a-m	0.5 to 1 microvolt
SSB	0.25 to 0.5 μ V
Image rejection	greater than 60 dB
Adjacent channel/reflection	-50 dB
Selectivity	
a-m	-50 dB min. at \pm 10 kHz
SSB	-50 dB at \pm 2.3 kHz
Spurious and cross modulation rejection	650 dB min.
Audio output	2-5 W, with under 10% distortion

Counter inverts period to measure low frequency

by Matthew L. Fichtenbaum
General Radio Co., Concord, Mass.

Measuring the frequency of a low-frequency signal directly is a slow process, since enough signal cycles must be counted to give the needed resolution. Measuring the signal's period instead can give the needed information in only one period, but computation or circuitry to convert period to frequency is necessary. The circuit described here finds the reciprocal of the measured period by means of standard binary and binary-coded-decimal counters.

The concept underlying the technique is illustrated in Fig. 1. Four counters are required. Counter A measures the period of the unknown signal by counting the number of clock pulses, N , during a cycle. The number N programs counter B, which is a programmable divide-by- N unit. Counter C creates a burst with a fixed number of pulses K .

This burst is applied to counter B, which computes a number K/N , thus taking the reciprocal of the period, N , and producing a number of pulses proportional to the unknown signal frequency. Finally, counter D accumulates these pulses to display the frequency.

The application determines the clock frequency and the counter lengths.

1. Clock frequency is defined by the highest frequency to be measured, and the resolution with which it must be measured. For example, if 1 kilohertz must be measured to 1% accuracy, 100 clock pulses must

occur in 1 millisecond (one signal period). This defines a clock frequency of 100 kHz.

2. The lowest frequency to be measured has the longest period, which defines the lengths of counters A and B. In this example, a low-frequency limit of 10 hertz would require a counter capable of counting 0.1 second (period of 10 Hz) \times 100 kHz, or 10^4 clock pulses. Fourteen bits would suffice.
3. The size of counter C depends on the length of the pulse burst. The period of a 10-Hz signal results in a count of 10^4 in counter A. If K/N is to be 10, then K , the number of pulses in the burst, must be 10^5 . A 17-bit counter is required. The actual frequency of the burst does not enter into the end result; to speed calculation, the burst frequency should be as high as is convenient.
4. Finally, counter D must count to the highest frequency measured, 1,000. This requires 10 bits, or 3 BCD decades if the frequency is to be displayed.

Control logic, to implement the sequencing required, must of course be provided.

Figure 2 shows how the technique may be used in a tachometer capable of measuring shaft speed from 10 to 200 revolutions per minute, with 2% resolution at 200 rpm. The four steps above give the circuit parameters.

1. At 200 revolutions per minute, the signal period is 0.3 second. To measure the speed to 2%, 50 clock pulses must be counted in this time, so the clock frequency must be 166.7 Hz.
2. At 10 rpm, the signal period is 6 seconds. Counting clock pulses for this time results in $6 \times 166.7 = 1,000$ counts, so counters A and B are each 10 bits.
3. The pulse burst must give a quotient of 10 with 1,000 counts, so it must be 10,000 counts long. Therefore K is 10^4 , and counter C thus requires 14 bits.
4. Counter D, the display register, must count up to the

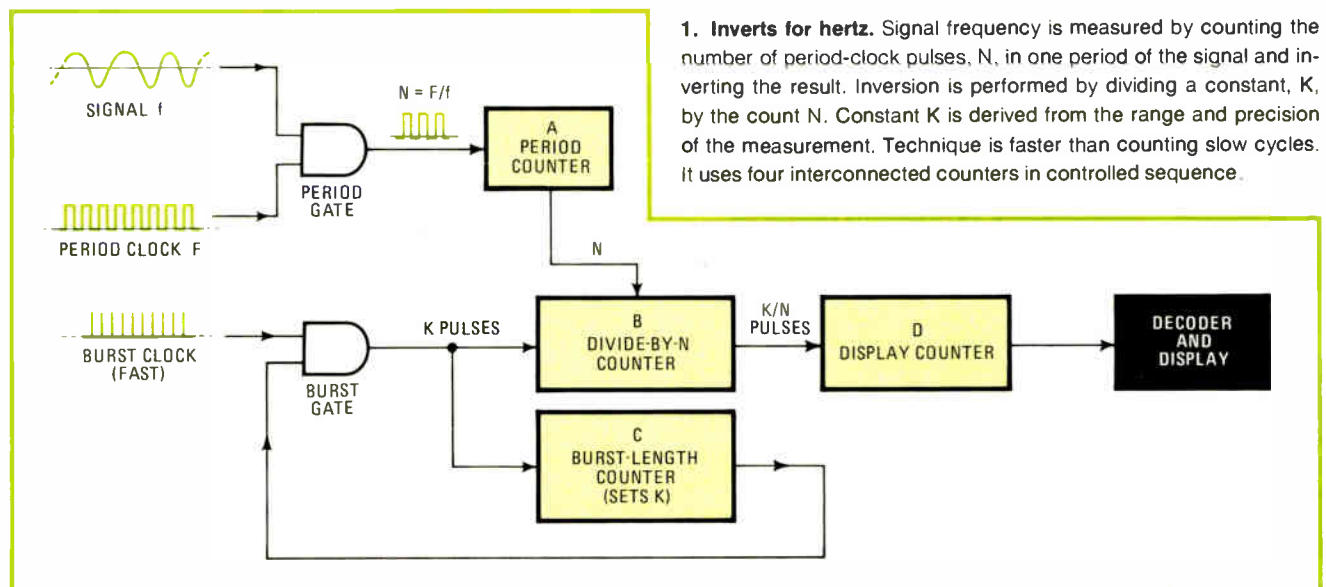

1. **Inverts for hertz.** Signal frequency is measured by counting the number of period-clock pulses, N , in one period of the signal and inverting the result. Inversion is performed by dividing a constant, K , by the count N . Constant K is derived from the range and precision of the measurement. Technique is faster than counting slow cycles. It uses four interconnected counters in controlled sequence.

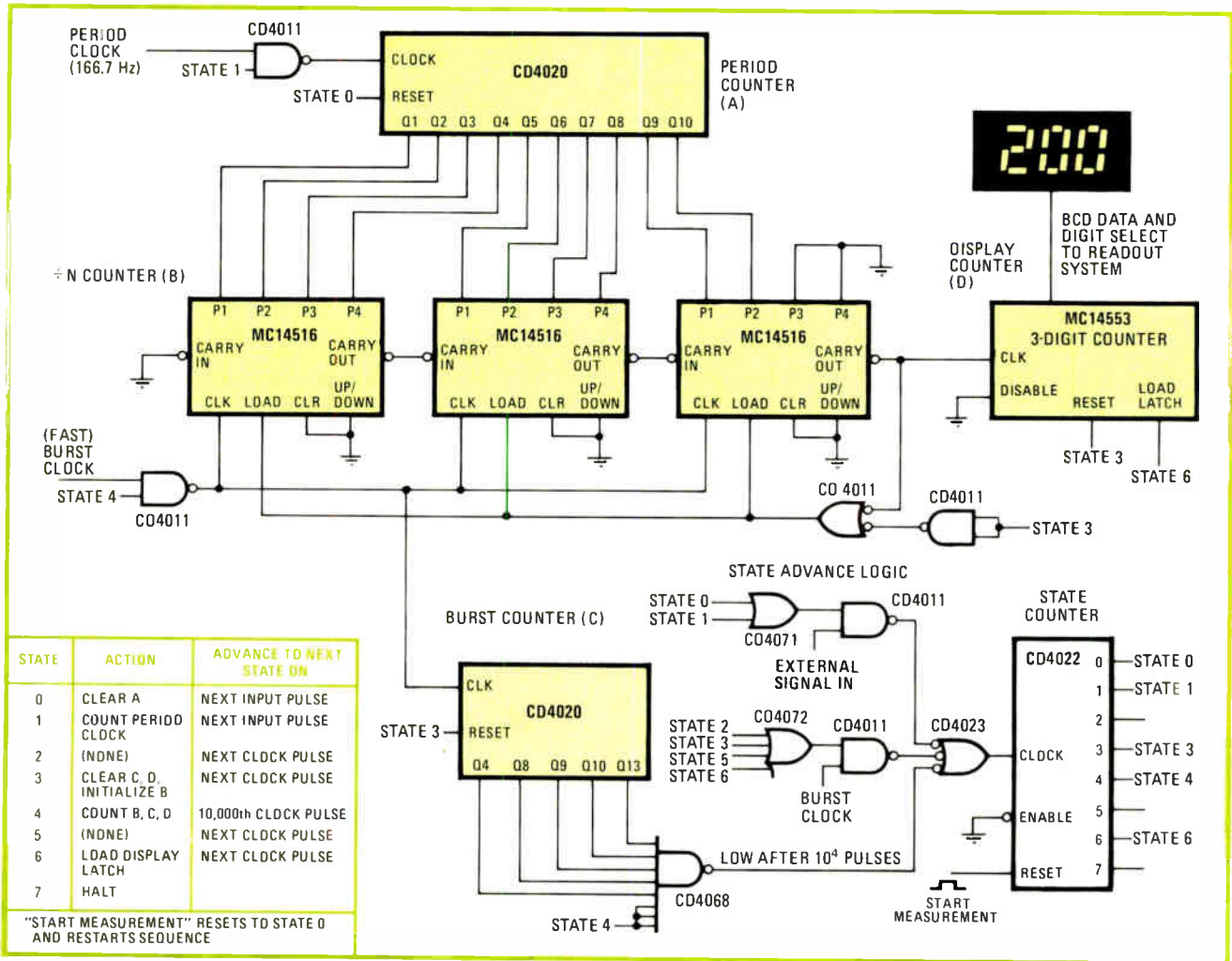

2. Measuring frequency. Implementation of arrangement in Fig. 1 uses C-MOS devices. A fifth counter, the CD4022 divide-by-8, sequences the steps of the procedure, as shown in the table. This measurement system is fast because it counts clock pulses for only one period of the signal frequency, instead of counting many cycles of signal. Precision of measurement is high because clock rate is high.

maximum of 200. Three BCD decades will suffice. For the low frequencies involved, complementary-MOS devices are adequate. The control logic consists of a CD4022 divide-by-8 counter with individually decoded outputs. Each output corresponds to a step in the control sequence as follows:-

- Clear period counter A.
- On next signal transition, start counting clock pulses in counter A.
- On next signal transition, stop counting A.
- Clear counters C and D.
- Enable counters B, C, D to compute frequency.

- After 10,000 pulses, stop counting.
 - Load output latch to update BCD display.
- A network of gates selects the proper signals to advance the sequencer from state to state.

For easier implementation, the length of the pulse burst may be chosen to be an exact power of 2. This simplifies the logic around counter C.

The final display is equal to K/FT , where K is the length of the burst, F is the period-clock frequency, and T is the signal period. Scaling either K or F changes the displayed result accordingly and provides an easy way to change the units of the displayed answer. □

Hexadecimal encoder debounces keyboard

by Ralph Tenny
Texas Instruments Inc., Dallas, Texas

Programs and instructions for microprocessors are commonly written in hexadecimal machine code (0, 1, . . . 9, A, B, . . . F), but must be fed into memory in binary code. In the 16-key encoding keyboard circuit described here, the unique application of two eight-input priority encoders provides the user with key lockout—if he accidentally presses two keys to one encoder simultaneously, only the higher value is encoded, and oper-

Let's talk about the easy way for you to spot microprocessor hardware problems.

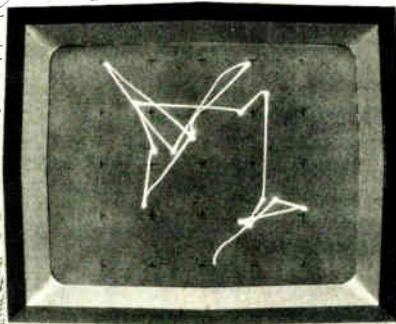
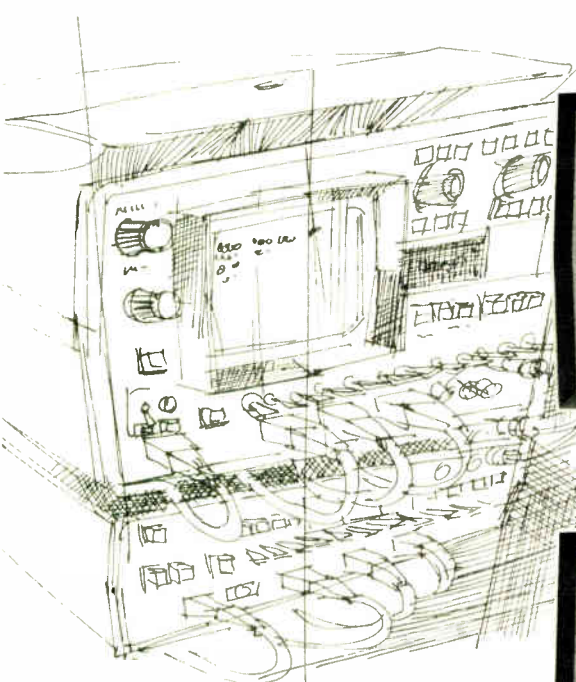

HP's 1600S Logic State Analyzer, in the MAP mode, lets you examine the unique "fingerprint" of every logic system.

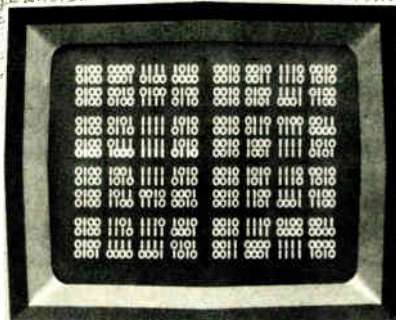

In the TABLE mode, the 1600S displays up to 16 32-bit words. These words could be combinations of addresses, instructions or states of the control lines.



We've probably both spent hours at the simulator to prove we had good software and then discovered

the hardware won't play — what do we do? You know the traditional answer. Dig out the scope, get out the program printout, and brace yourself for hours of grinding, point-by-point checks. But I can tell you that doesn't have to be the case. Especially now that HP has introduced some new tools that can really cut down your troubleshooting time.

HP's Logic State Analyzers can really take a lot of pain out of your troubleshooting procedures. You'll find wiring errors, defective components, and even solder splashes; and you'll find them a lot more quickly than ever before.

Let me give you an example. We had an eight-bit microprocessor system with start-up problems. The clocks were running and phased right, and the address lines toggled, but the machine didn't function. So, we

set up an HP 1600S Logic State Analyzer to look at both the Address and Data buses. It was then we noticed that only "zeros" were being fetched from memory. Knowing the ROM was good, we then added several control lines to the display and the problem showed up immediately. The "Enable" line never went high. A quick look at the "Enable" driver showed the input was ok, but no output. Obviously, the gate was defective.

I don't know how long it would have taken to find that one without HP's Logic State Analyzers, but I know it would have taken us a lot longer.

Call your local HP field engineer. He'll give you all the details on the 1600S (priced at \$6800*) including spec sheets and application notes detailing the use of mapping for troubleshooting minicomputer and microprocessor systems. He'll tell

you about the seminars that HP has arranged around the country and tell you when one will be held in your area and how you can attend. You ought to go to one, because you'll discover an exciting new concept in digital troubleshooting.

*Domestic U.S.A. price only.

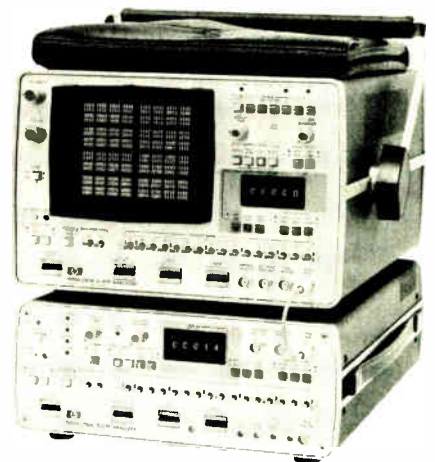

086/5
HEWLETT  PACKARD

Sales and service from 172 offices in 65 countries.
1501 Page Mill Road, Palo Alto, California 94304

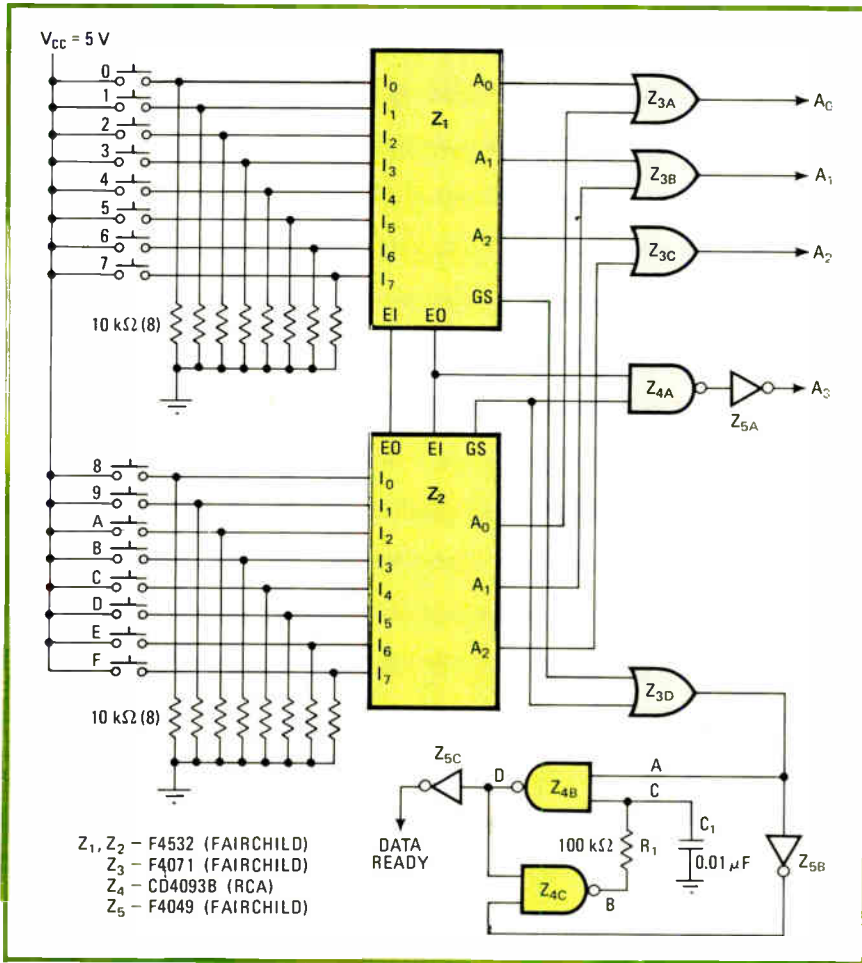

1. Encodes and debounces. Pressing any one of the 16 hexadecimal-digit keys produces the corresponding 4-bit binary output through the two priority encoders Z_1 and Z_2 . Key debounce is provided by the Schmitt trigger delay latch Z_{4B}/Z_{4C} , as illustrated in Fig. 2. This keyboard is a convenient interface to microprocessors or other binary devices for which instructions may be written in hexadecimal code.

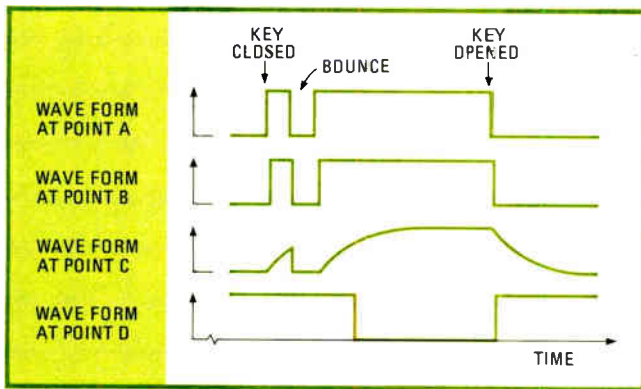

code; if two keys in the same subgroup are pressed, the code output corresponds to the highest-priority key depressed. Lockout between subgroups is accomplished by cross-coupling the enable-input (EI) and enable-output (EO) pins, so that the output code is decided by which subgroup is accessed first. Encoding for the fourth bit is accomplished by an AND gate between the low-order enable-output and the high-order group-select (GS). The composite output code then consists of the subgroup output bits ORed together for the lower three bits, and the fourth bit output.

The keys are debounced by delay latch Z_{4B}/Z_{4C} . The basic ingredients of the latch are the CD4093B Schmitt trigger elements and an RC delay (R_1 and C_1) in the feedback loop of the latch. The debounce wave forms in Fig. 2 show that a key must stop bouncing before the latch feedback, delayed by a time $0.85 R_1C_1$, locks in the key action. Release of a key immediately resets the latch, with the input bypassing the delay loop. It is imperative that a Schmitt trigger be incorporated in the delay latch, but the use of C-MOS holds down the size and cost of the capacitor. The values of C_1 and R_1 are determined by the bounce characteristics of the push-button keys. The 0.01 microfarad and 100 kilohms shown in Fig. 1 will debounce almost any key. □

ation of one encoder automatically disables the other.

Another unique feature of the circuit is a delay latch, which debounces the keys. Only when the key contacts have settled down to a steady closed or open position can the microprocessor read the code.

As Fig. 1 shows, the circuit accepts the hexadecimal input over 16 keys and translates it into 4-bit binary outputs for parallel feed to a computer. The priority encoders provide the basic encoding.

The keys are arranged in two groups, 0 through 7 and 8 through F. Each subgroup is encoded in 3-bit binary

Designer's casebook is a regular feature in Electronics. We invite readers to submit original and unpublished circuit ideas and solutions to design problems. Explain briefly but thoroughly the circuit's operating principle and purpose. We'll pay \$50 for each item published.

The **RIGHT** Flexible Disk Drives and Systems Are Made At Remex.

The **right** flexible disk drive has format flexibility — accepting IBM format, soft sectored and 32 hole hard sectored disks in the same unit — while addition of a sector generator option permits creation of alternative hard sectored formats.

The **right** drive offers unit select for up to four drive daisy chain — overlap seek — DC/DC conversion, eliminating outside negative voltage requirements — and separate data and clock outputs at the interface.

The **right** drive has fast throughput with 6 ms track to track access.

The **right** drive has a unique high reliability design — die cast frame — supported lead screw head positioning — operator interlock for media protection — and a foolproof write enable feature.

The **right** flexible disk system is custom designed for the exact requirements of the quantity buyer — one to four or more drives — formatting of both IBM and hard sectored media interchangeably — double density electronics where required — interface to any mini/micro computer — packaged in rack mount or desk top configurations according to application — and software ranging from simple driver to a complete operating system.

The **right** flexible disk system is made by REMEX — the only flexible disk drive manufacturer with both the total capability to design, manufacture and maintain custom systems for individual applications — and the total commitment to the specialized needs of the quantity systems buyer.

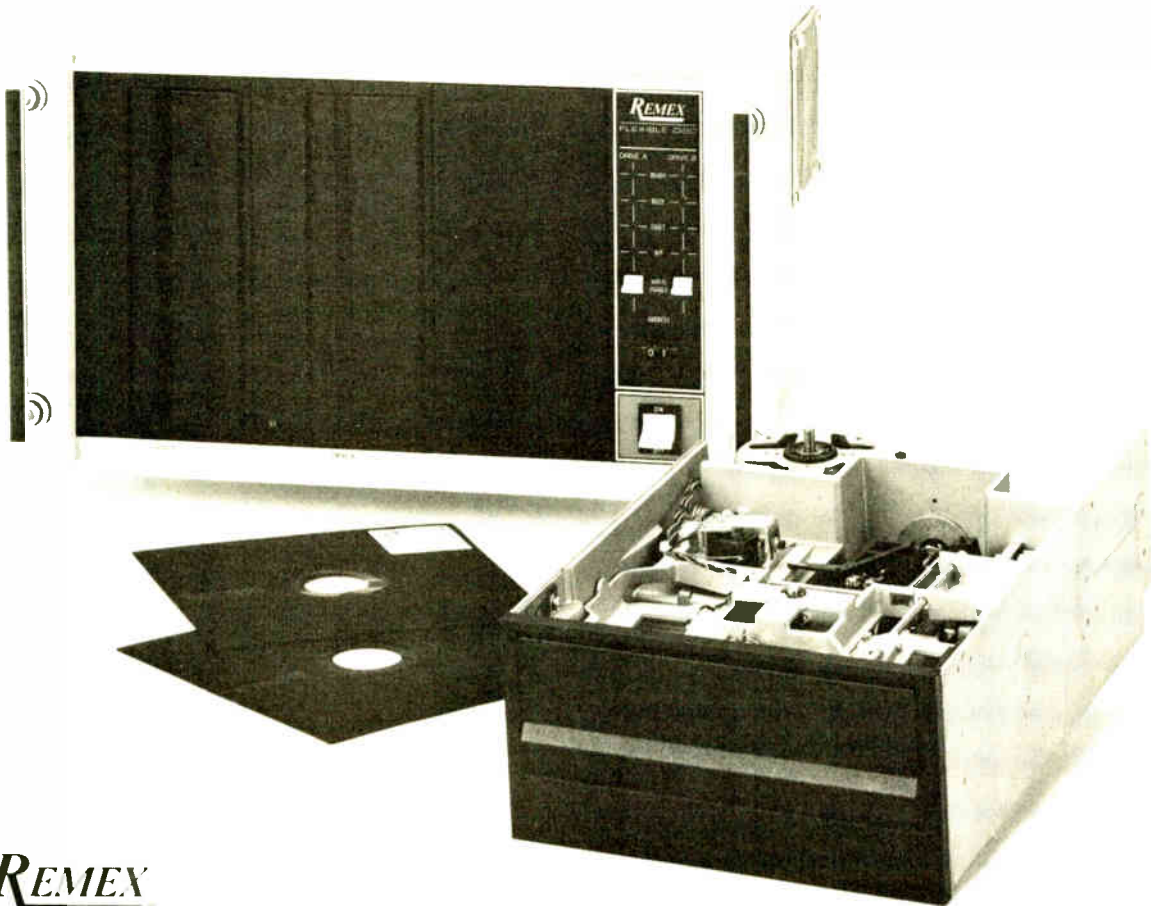

REMEX



**Peripheral
Products**

Ex-Cell-O Corporation
Circle 104 on reader service card

1733 E. Alton Street, P.O. Box 11926, Santa Ana, California 92711,
(714) 557-6860, TWX (910) 595-1715. In Europe and the U.K.: SpA, Microtecnica,
Via Madama Christina 147, Torino, Italy 10126.

Optical isolators yield benefits in many linear circuits

by Mark Hodapp, Hewlett-Packard Co., Optoelectronics division, Palo Alto, Calif.

□ For eliminating noise and breaking unwanted ground loops in digital circuits, optically coupled isolators have earned a well deserved reputation. It is perhaps less well known that optical isolators also can do a fine job in analog circuits. Although the optical isolator is not strictly a linear device—the output is not necessarily linearly proportional to the input—with the right circuit techniques, the isolator's advantages can be applied to such linear tasks as sensing circuits, patient-monitoring equipment, adaptive controls, power supplies, and audio or video amplifiers.

A number of isolators are suitable

Four kinds of isolators are appropriate for linear work—the phototransistor coupler, the photodiode coupler, the transistor-amplifier coupler, and the logic-gate coupler. All of these have an infrared or near-infrared light-emitting diode as their input stage, but their outputs are different, as reflected by their names. Both the transistor-amplifier and logic-gate coupler employ photodiodes as their photodetectors, which are followed by amplifying and/or conditioning circuitry.

For strictly analog circuits, the photodiode and transistor-amplifier isolators are most effective because they are faster and more linear than phototransistor types. In the phototransistor coupler, the collector-base junction of the phototransistor serves as the photodetector, and the capacitance of this junction impairs the rise time of the signal at the collector. Also, amplified photocurrent flows in the collector-base junction and modulates the photoresponse.

In a transistor-amplifier coupler, however, the photodetector and the amplifier are separately integrated devices, so that the coupler's photoresponse is not affected by amplified photocurrent. Also, so long as the bias voltage for the photodiode remains constant, the photodiode's capacitance will not hamper isolator speed. Similarly, the photodiode coupler, which has a very small current gain, usually operates with a separate, though external, amplifier. In contrast, although the logic-gate coupler has a separate photodetector, it is difficult to bias at a stable quiescent point for analog applications—its output is usually either on or off.

However, the logic-gate coupler is ideal for linear circuits in which analog signals are converted to digital at very high speeds. For slower rates, the phototransistor and transistor-amplifier couplers are suitable—and they usually can provide greater noise immunity. Photodiode isolators are seldom used in these linearized conversion circuits because of the output buffer they require.

Examining isolator linearity

To evaluate the linearity of an optical coupler, its transfer function can be expressed as:

$$I_o = K(I_F/I_F')^n$$

where I_o is the isolator's output current, I_F is the input current to the isolator (the forward current through its LED), I_F' is the input current (other than zero) at which K is measured, K is the output current at I_F' , and n is the linearity factor. For a transistor-amplifier coupler, I_o is the collector current of the output transistor, whereas

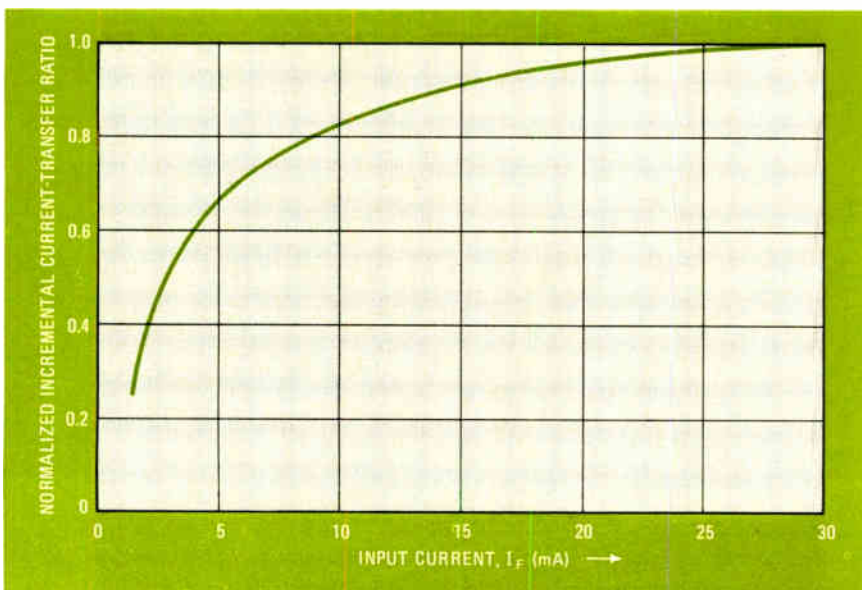

1. Current characteristic. Linearity of optical coupler depends on where its input LED is biased. At low currents, its response is quite nonlinear. But at values of 10 mA or higher, the device's response, depicted here as $\delta I_o / \delta I_F$ becomes more nearly linear.

for a photodiode coupler, I_o is the current flowing into the cathode of the output photodiode.

The linearity factor, n , can also be thought of as the slope of the log-log curve of output current I_o vs. input current I_F . When $n = 1$, the coupler's transfer function is linear, and its current-transfer ratio, which is the current gain expressed as a percentage ($I_o/I_F \times 100\%$), becomes constant. Similarly, when $n = 1$, the device's incremental current-transfer ratio, or the ratio of the change in output current to the change in input current ($\delta I_o/\delta I_F$), is constant and independent of the input current level, as shown in Fig. 1.

A LED's emission is nonlinear, particularly at low input-current levels. For low values of I_F , say, 5 milliamperes or less, n is usually equal to or greater than 2. At higher input currents, the response of a LED becomes essentially linear. Usually, at an I_F value of 10 mA or more, n approximately equals 1.

More than one coupler may be needed

An analog isolation amplifier is used to transfer a low-level ac or dc signal from one ground reference to another in the presence of a large potential difference or induced noise. Since a dc reference must be maintained in a direct-coupled isolation amplifier, the quiescent input current to the optical coupler is normally set at some low level to minimize the device's thermal drift. As a result, two couplers are usually needed for a direct-coupled isolation amplifier, so that each balances out the other's nonlinearity. This balance can be achieved by means of either servo or differential techniques.

On the other hand, an ac-coupled isolation amplifier needs only a single coupler if it is biased properly because there is no need to maintain a dc reference. The isolator's input LED can be biased at some high current level where the isolator's transfer function is more nearly linear.

For the servo-type dc isolation amplifier of Fig. 2, the input current of one isolator is made to track the input

current of a second isolator. To do this, the couplers must be matched—that is, their linearity factors must be equal. Here, a single dual-channel transistor-amplifier isolator is used, and the matching is good, since both couplers are fabricated at the same time.

Building a servo amplifier

The input signal is applied to the noninverting input of amplifier A_1 , which drives the LED of the upper isolator. The LED of the lower isolator is driven by amplifier A_2 , which compares the outputs of the two couplers and forces the forward current through each LED to be equal. The output current of the upper isolator can be written as:

$$I_{C1} = K_1(I_{F1}/I_{F1}')^{n_1}$$

where I_{C1} is the collector current of the isolator's output transistor, I_{F1} is the forward current through the input LED, K_1 is the output current for an input current of I_{F1}' , and n_1 is the linearity factor. Similarly, the output current of the lower isolator is:

$$I_{C2} = K_2(I_{F2}/I_{F2}')^{n_2}$$

where I_{C2} is the collector current of the isolator's output transistor, I_{F2} is the forward current through the input LED, K_2 is the output current for an input current of I_{F2}' , and n_2 is the linearity factor.

The transfer function for the circuit is:

$$V_{OUT} = R_4 \left[I_{F2}'(I_{F1}')^{-n_1/n_2} \left(\frac{K_1 R_2}{K_2 R_3} \right)^{1/n_2} \left(I_{CC1} + \frac{V_{IN}}{R_1} \right)^{n_1/n_2} - I_{CC2} \right]$$

where V_{OUT} is the circuit's output voltage, V_{IN} is the circuit's input voltage, I_{CC1} is the value of the constant-current source for the upper isolator's LED, and I_{CC2} is the value of the constant-current source for the lower isolator's LED. Some simple ways of realizing these con-

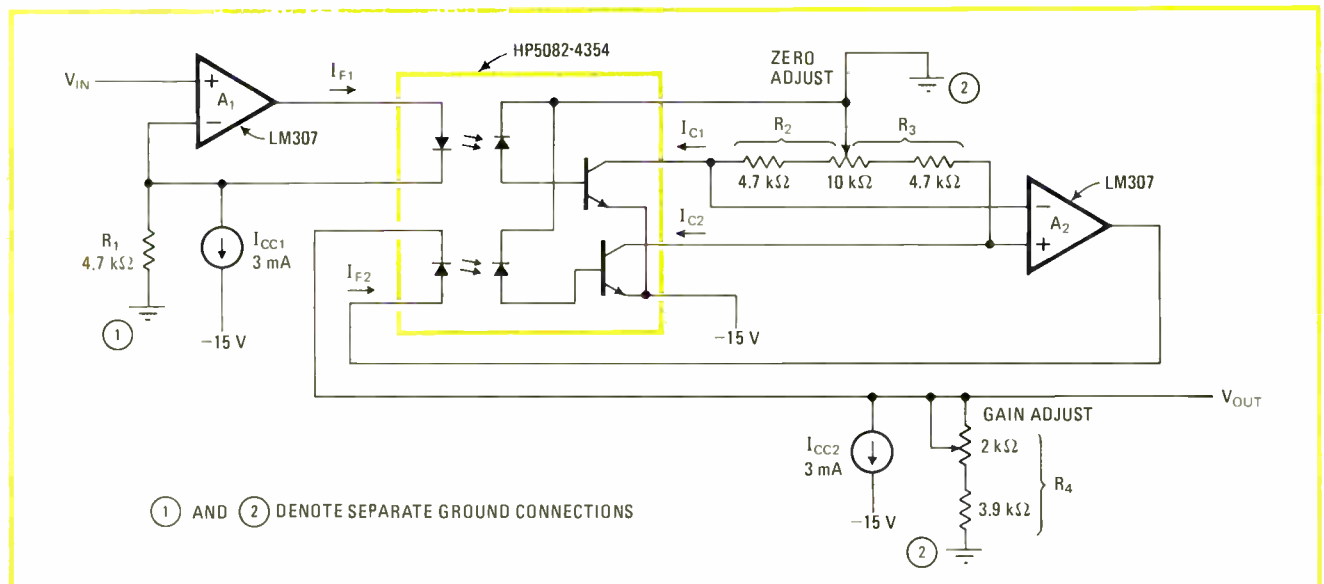

2. Dc servo amplifier. Dual-channel transistor-amplifier coupler provides input-to-output isolation of 500 V for servo-type amplifier. Isolator input currents are forced to track each other, and since the couplers are matched, nonlinearity is virtually eliminated.

stant current sources are shown in "Some biasing basics," p. 110. After the circuit's null point has been adjusted, this transfer function can be expanded:

$$V_{OUT} = R_4 I_{CC2} \left[\frac{n_1}{n_2} \left(\frac{V_{IN}}{R_1 I_{CC1}} \right) + \frac{n_1}{n_2} \left(\frac{n_1}{n_2} - 1 \right) \left(\frac{V_{IN}}{R_1 I_{CC1}} \right)^2 / 2! + \dots \right]$$

When n_1 and n_2 are approximately equal as in these matched couplers, all the higher-order terms of this expression become very small, so that the transfer function is essentially linear.

The output voltage, V_{OUT} , for the servo amplifier can also be written as a generalized proportionality:

$$(1+x)^{n_1/n_2} - 1$$

where x is the ratio of modulation current to quiescent current for the upper coupler's input LED:

$$x = (V_{IN}/R_1)/I_{CC1}$$

The nonlinearity, or linearity error, of the entire circuit can then be expressed as:

$$[(1+x)^{n_1/n_2} - (n_1/n_2)x - 1]/(n_1/n_2)x$$

For this circuit, x is less than or equal to $|0.35|$ and $n_1/n_2 = 1.05$, so that the linearity error can be computed as 0.99%.

Resistor R_1 determines the input range of the circuit. For the R_1 value of 4.7 kilohms given here, current I_{F1} varies between 2 and 4 mA as the input voltage ranges between -5 and $+5$ volts. The circuit's null point is zeroed by adjusting the ratio of resistor R_2 to resistor R_3 . For unity-gain operation, R_4 is varied until $V_{OUT}/V_{IN} = 1$ when V_{IN} is at some value other than zero. Both resistors R_2 and R_3 should be selected to accommodate the worst-case spread between isolator current-transfer ratios.

The bandwidth of the circuit is limited by its oper-

ational amplifiers to about 25 kilohertz. Common-mode rejection is 46 decibels at an input frequency of 1 kHz, and temperature stability is good—gain drift is held to $-0.03\%/^{\circ}\text{C}$, offset drift to ± 1 millivolt/ $^{\circ}\text{C}$. Insulation of the dual-channel coupler is limited by the spacing between its package pins. If separate couplers are used instead, the insulation can be increased to around 2,500 v.

Handling differential dc signals

For a differential-type dc isolation amplifier like the one shown in Fig. 3, the input current of one isolator is increased by the same amount that the input current of a second isolator decreases. In other words, the rise of current gain in one isolator is approximately balanced by a gain reduction in the other. Of course, the couplers must be matched with the same linearity factors, so that their gains change by an equal amount over the same operating range. Again, a dual-channel transistor-amplifier isolator is used.

Amplifiers A_1 and A_2 act as a differential-input pair, while amplifiers A_3 and A_4 form a differential current amplifier. The circuit's output voltage can be written as:

$$V_{OUT} = R_5 [(R_3/R_4)I_{C1} - I_{C2}]$$

where:

$$I_{C1} = K_1(I_{F1}/I_{F1}')^{n_1}$$

for the upper isolator, and:

$$I_{C2} = K_2(I_{F2}/I_{F2}')^{n_2}$$

for the lower isolator. Since the values of resistors R_1 and R_2 are the same ($R_1 = R_2 = R$), then the transfer function for the circuit can be expressed as:

$$V_{out} = R_5 \left[\frac{R_3 K_A}{R_4} \left(1 + \frac{V_{IN}}{R I_{CC}} \right)^{n_1} - K_B \left(1 - \frac{V_{IN}}{R I_{CC}} \right)^{n_2} \right]$$

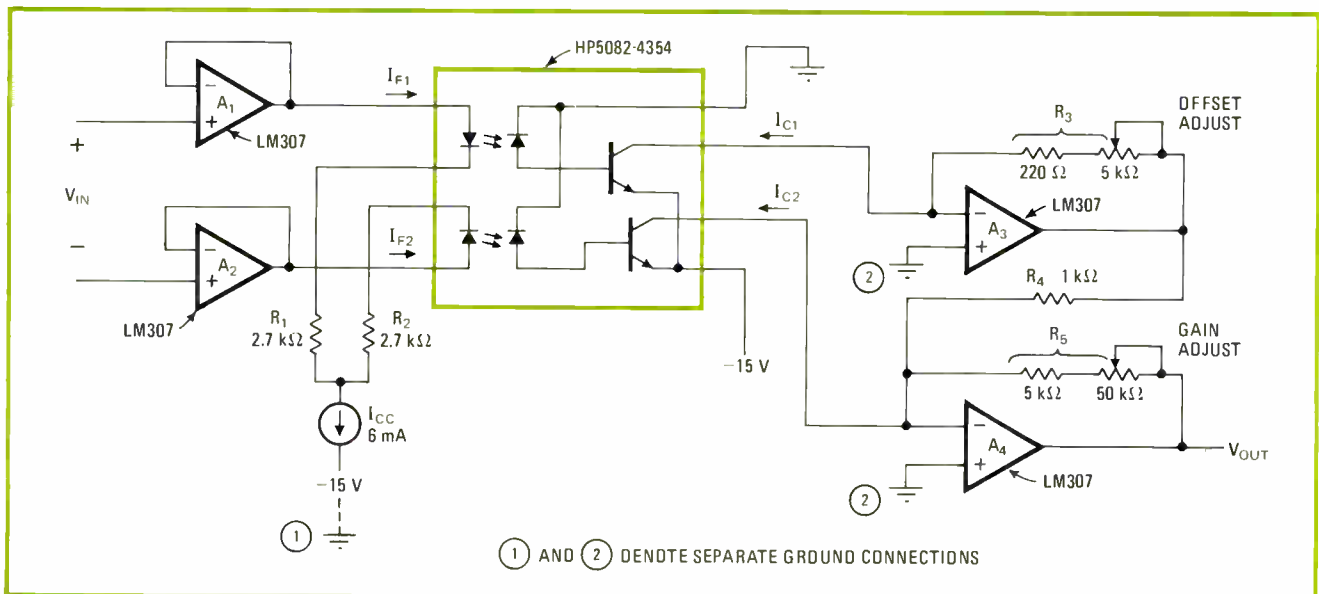

3. Dc differential amplifier. Because of matched characteristics of dual-channel transistor-amplifier coupler, an increase in current gain of one isolator is balanced by an identical gain reduction in the other. Linearity error is held to around 3% over 10-V input range.

where:

$$K_A = K_1(I_{CC}/2I_{F1})^{n_1}$$

and:

$$K_B = K_2(I_{CC}/2I_{F2})^{n_2}$$

and I_{CC} is the value of the constant-current source biasing the input LEDs of the coupler. After the circuit's zero has been adjusted, this transfer function can be written as:

$$V_{OUT} = R_5 K_B \left[(n_1 + n_2) \left(\frac{V_{IN}}{R I_{CC}} \right) + [n_1(n_1 - 1) - n_2(n_2 - 1)] \left(\frac{V_{IN}}{R I_{CC}} \right)^2 / 2! + \dots \right]$$

Since the couplers are matched, n_1 is approximately equal to n_2 , the higher-order terms of this expression become very small, and the transfer function can be regarded as linear.

When expressed as a generalized proportionality, the output voltage, V_{OUT} , for the differential amplifier is proportional to:

$$(1+x)^{n_1} - (1-x)^{n_2}$$

where x is the ratio of modulation current to the quiescent current of the isolators' input LEDs:

$$x = (V_{IN}/R)/I_{CC}$$

The linearity error of the circuit can be computed from:

$$[(1+x)^{n_1} - (1-x)^{n_2} - (n_1+n_2)x]/(n_1+n_2)x$$

For the circuit of Fig. 3, x is less than or equal to 0.351, $n_1 = 1.9$, and $n_2 = 1.7$. The linearity error, then, is around 2.8% when the linearity factors of the isolators are matched to about 12%. If the linearity factors are within 5% of each other, the circuit's linearity error can be reduced to less than 1.5%.

Resistors R_1 and R_2 , which set the circuit's input

range, must have the same resistance value. Here, they limit the current to the isolator's LEDs to between 2 and 4 mA over the input range of -5 to +5 v. Resistors R_3 , R_4 , and R_5 are selected to handle the worst-case spread in isolator current-transfer ratios and to set the circuit's total gain at unity.

As an alternative to a dual-channel transistor-amplifier coupler, a pair of individual transistor-amplifier or photodiode isolators can implement either a servo or differential isolation amplifier. Although it is essential for the couplers to have the same linearity factor (n), they need not have identical output currents (K) for the same input current (I_F'). However, when the K or current-transfer ratio of each coupler is equal, it is easier to zero the isolation amplifier.

In addition, both couplers should exhibit similar behavior as the temperature changes. In the servo amplifier, changes in the current-transfer ratios of the isolators have only a small effect on total gain and offset, so long as the ratio of the isolators' current gains stays the same when the temperature changes.

However, in the differential amplifier, a change in either isolator's current-transfer ratio caused by a temperature change will cause the circuit's gain to change. Such a change in gain can be compensated for by placing a thermistor in the circuit's output differential current amplifier. Output offset, referenced to the input, will be stable as long as the ratio of the isolators' current gains remains constant during temperature changes.

To prevent the capacitance of the photodiode detector in either a photodiode or transistor-amplifier coupler from impeding isolator speed, the photodiode should always be biased on a constant voltage. In a direct-coupled isolation amplifier, the speed of a transistor-amplifier coupler is also limited by the capacitance of the base-collector junction of its output transistor. Similarly, the speed of a photodiode coupler is also limited by how quickly it can operate into its external circuit.

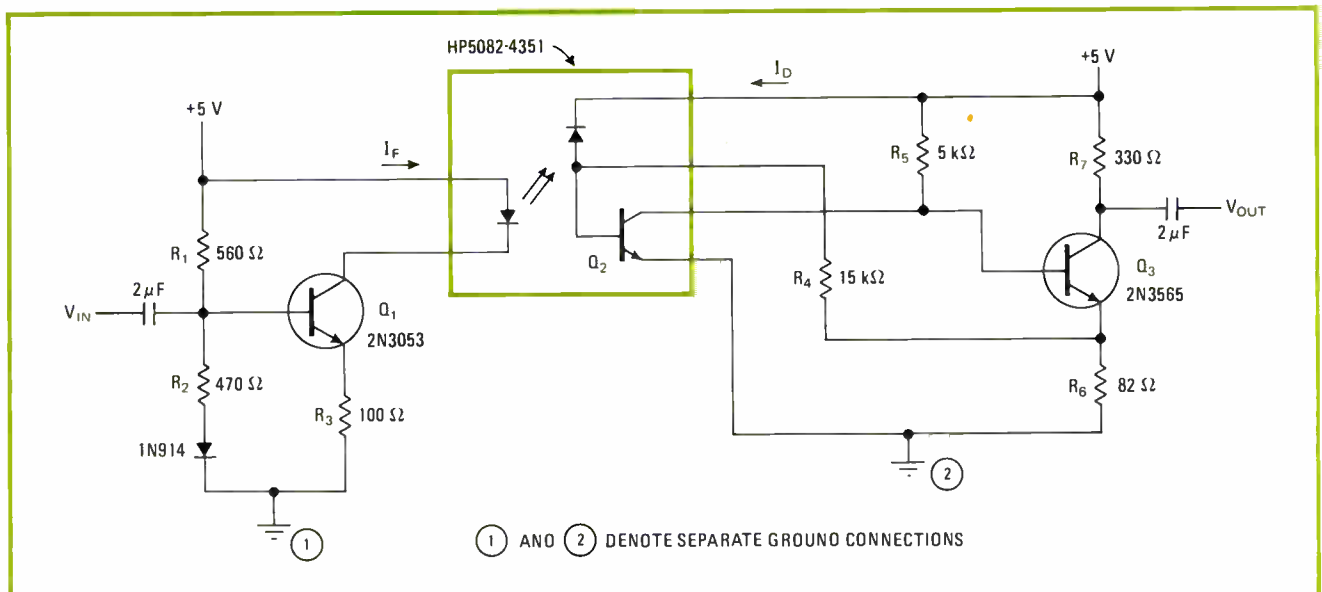

4. Isolating ac signals. For ac-coupled isolation amplifier, optical isolator is biased at high input level, where its transfer function is essentially linear. Here, with single transistor-amplifier coupler, linearity error is typically 2% over 1-V peak-to-peak input range.

For an ac-coupled isolation amplifier, the optical coupler can be biased at a current level higher than that for a dc isolation amplifier. The isolator's incremental current-transfer ratio, therefore, remains fairly constant. The isolator's transfer function is essentially linear ($n = 1$), so that only a single coupler is needed.

Working with the ac analog signal

The ac isolation amplifier of Fig. 4, is built with a transistor-amplifier coupler. The transfer function for this circuit is simply:

$$V_{OUT}/V_{IN} = (1/R_3)(R_4R_7/R_6)(\delta I_D/\delta I_F)$$

where I_D is the photodiode current, and I_F is the forward current through the LED. As long as $\delta I_D/\delta I_F$ is constant, this transfer function is linear.

Transistor Q_1 —along with resistors R_1 , R_2 , and R_3 —bias the isolator's LED at a quiescent current of 20 mA. Resistor R_3 determines the circuit's input range. Here, the LED current varies from 15 to 25 mA over an input range of 1 v pk-pk. Transistors Q_2 and Q_3 form a cascade amplifier having feedback paths through resistors R_4 and R_6 . The circuit's closed-loop gain can be adjusted with resistor R_4 , while resistor R_6 should permit transistor Q_3 to operate at its maximum gain-bandwidth product. Resistor R_5 simply provides a dc bias path for transistor Q_3 , and resistor R_7 limits the maximum excursions of the circuit's output voltage without clipping it.

Linearity error for this circuit is typically 2% over its 1-v pk-pk input range. At the expense of signal-to-noise ratio, the linearity can be improved by reducing the excursions of the isolator's input current. To do this, the value of the resistor R_3 is increased, and an additional resistor is connected between the collector of transistor Q_1 and ground. Its value should return the LED bias current to 20 mA quiescent.

A photodiode coupler is also suitable for building an ac isolation amplifier. But whether the coupler is a

photodiode or transistor-amplifier type, its photodiode detector must be biased at a constant voltage for optimum isolator speed.

In the ac-coupled amplifier, the input diode of the optical isolator is biased at a fixed quiescent current and the circuit's output amplifier has negative feedback for stable gain. Since this circuit has no feedback around the isolator, any parameter that causes the coupler's incremental current-transfer ratio to vary will cause a change in the gain of the circuit. Because the photon emission of the coupler's input diode varies with temperature, the coupler's current gain will also vary with temperature. However, a thermistor can be used in the circuit's output amplifier to compensate for this change in gain.

Exploring various digital techniques

With conventional ac and dc analog-isolation techniques such as those discussed above, the least linearity error that can be achieved with optical couplers is limited to 0.5% to 1%. For better linearity, as well as improved temperature stability, digital techniques are needed.

The analog signal is converted to a digital one, transmitted through an optical isolator, and then converted back again. Since the isolator acts only as a switch, the total linearity of circuit depends primarily on how accurately the analog-to-digital and digital-to-analog conversions are made. The circuit's bandwidth, however, is limited by the isolator's propagation delay.

Figure 5 shows a pulse-width-modulation technique for isolating an analog signal with a logic-gate coupler. The oscillator operates at a fixed frequency (f), and the monostable multivibrator varies the duty factor of the square wave from the oscillator, producing a signal that is proportional to the input (V_{IN}).

The maximum frequency of the oscillator is determined by the required linearity of the circuit and the propagation delay of the optical isolator: $(t_{max} - t_{min}) \times$

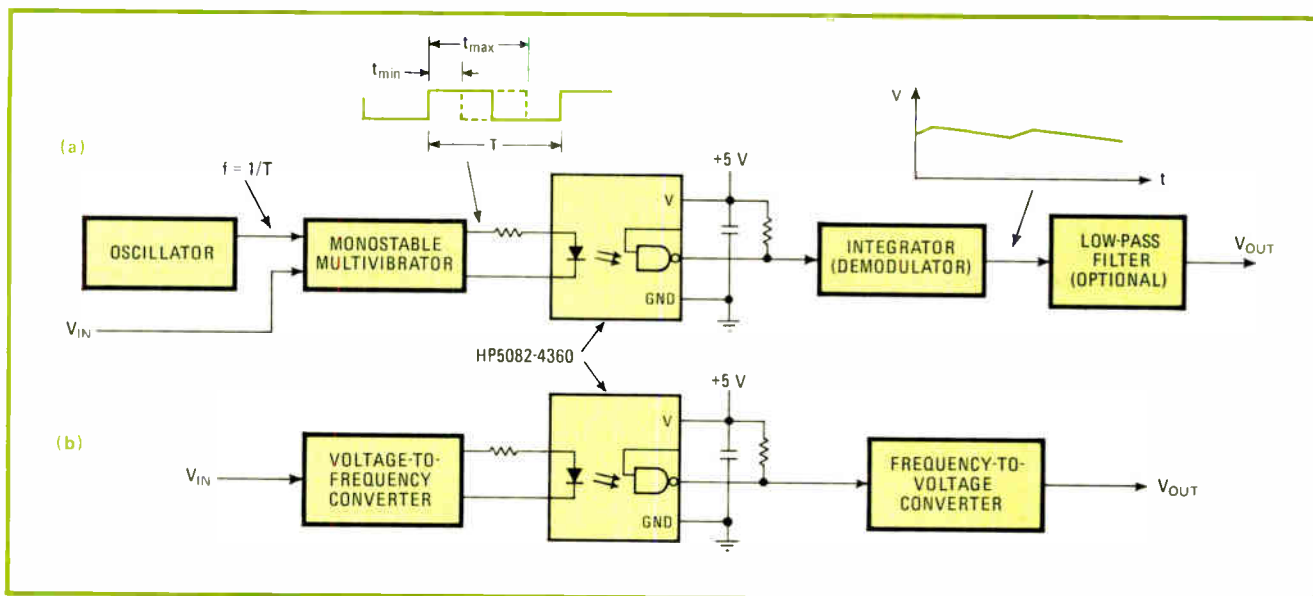

5. Digital yet analog. Logic-gate coupler can be used to transfer analog data that has been converted to digital form. Analog signal can be pulse-width modulated, as in a, or converted into train of pulses whose frequency is proportional to input level, as in b.

Some biasing basics

When an optically coupled isolator is used in a direct-coupled isolation amplifier, its input light-emitting diode must be biased by a constant-current source. Although the regulation of this source is important, the circuit need not be an elaborate design—a simple one will work just as well.

If the supply voltage is stable, the current source can be a mirror-type circuit, built with a pair of npn or pnp transistors, as shown in a. The output current is approximately:

$$I_o = (V_{CC} + V_{EE} - V_{BE})/R$$

where V_{CC} is the positive supply voltage, V_{EE} the negative supply voltage, and V_{BE} the base-emitter voltage of transistor Q_1 .

If the supply voltage is not stable, an LED can be used as an effective, yet simple and inexpensive, voltage regulator. As illustrated in b, the current source can be built with either an npn or pnp transistor. The LED compensates the transistor for changes in temperature because the temperature coefficient of the LED's forward-voltage drop is approximately equal to that of the transistor's base-emitter voltage. Usually, this junction-voltage drift with temperature changes is about -2 millivolts/ $^{\circ}\text{C}$. The value of resistor R can be computed from:

$$R = (V_{CC} + V_{EE} - V_F)/I_F$$

where V_F is the forward-voltage drop of the LED, and I_F is its forward current. The circuit's output current can simply be expressed as:

$$I_o = (V_F - V_{BE})/R_E$$

where V_{BE} is the base-emitter voltage of the transistor.

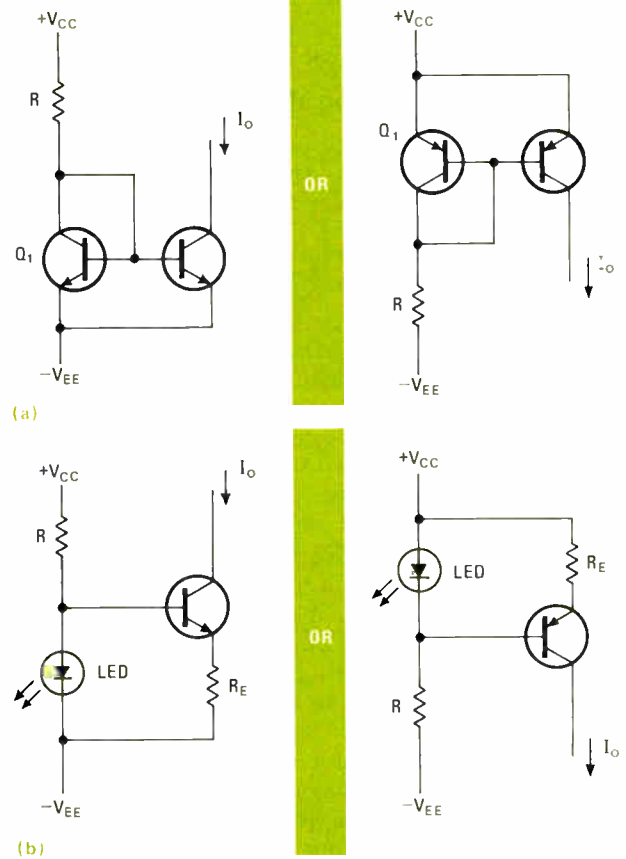

(required linearity) must be greater than or equal to $|t_{PLH} - t_{PHL}|$, where t_{max} is the maximum pulse width of the modulated signal, t_{min} is the minimum pulse width of the modulated signal, t_{PLH} is the propagation delay of the isolator as its output switches from logic low to logic high, and t_{PHL} is the isolator propagation delay for an output transition from logic high to logic low.

After the modulated signal passes through the isolator, it is converted back to the original analog signal by means of a demodulator. Here, the demodulator is the integrator and optional low-pass filter.

Voltage-to-frequency conversion can also be used to isolate an analog signal, as shown in Fig. 5b for a logic-gate coupler. The voltage-to-frequency converter produces an output-pulse train having a frequency proportional to the level of the analog input. The maximum rate at which the pulse train can be transmitted through the optical isolator is limited by the coupler's propagation delay:

$$f_{max} \text{ approximately equals } [1/(t_{PLH} + t_{PHL})]$$

The output signal from the isolator is then converted back to an analog voltage by a frequency-to-voltage converter. The linearity of the complete system is mainly determined by the linearity of the converter circuits.

Frequency modulation, which is similar to voltage-to-

frequency conversion, is yet another technique for transferring an analog signal through an optical isolator. By this method, a carrier frequency (f_0) is modulated by some change in frequency (Δf_0) so that the $f_0 \pm \Delta f_0$ is proportional to the analog input. The original signal can then be reconstructed at the output of the isolator with a phase-locked-loop or similar circuit.

Analog-to-digital converters also enable optical couplers to isolate analog signals. The binary output from an a-d converter drives an optical coupler, and a digital-to-analog converter changes the output from the coupler back to analog form. If the a-d converter has a parallel output format, it can be changed to a serial format by using a parallel-in/serial-out shift register to drive the isolator. When high resolution is needed, this method is useful, as well as economical, since it saves the expense of several isolators.

The rate at which data must be transmitted through the isolator more or less determines which type of coupler is best for a given application. Logic-gate couplers can operate at the highest speeds, attaining frequencies as high as 10 MHz. Transistor-amplifier isolators can achieve data rates as fast as 1 MHz, while phototransistor devices have a top speed of around 100 kHz. Usually, noise immunity must be traded off against speed—the faster the coupler operates, the lower its noise immunity will be. □

Noise and control problems

Designing reliability into equipment having power semiconductors, part I

by Alexander Kusko, Thorleif Knutrud, and John J. Cain, *Alexander Kusko Inc., Needham Heights, Mass.*

□ Power semiconductor equipment faces a tough customer in industrial applications, which demand high reliability despite noisy, dirty, hot surroundings. But it is equal to the demand so long as its circuits are designed to cope with the factors affecting industrial reliability.

The electronic-design engineer inexperienced in this field is likely to fall into a number of traps that can seriously downgrade the performance of his design. And more and more EEs are facing these reliability problems as solid-state power equipment tackles more and more industrial applications. Still, our extensive consulting experience suggests that the newcomer can easily avoid many reliability traps by paying attention to some elementary design precepts. We will review these precepts in this two-part series.

This first part of the series begins by dealing with a problem that invades every aspect of electronic power-circuit design: electrical noise. Then the article concentrates on reliability in the control and logic portion of rectifiers, inverters and choppers that make up most

power semiconductor equipment. Particular points of discussion are feedback control circuits, firing-circuit control, abnormalities in control signals, and the effects of firing circuits on thyristors. The second article, which will appear in the March 18 issue, will address the problems of the power semiconductor circuits themselves.

To be considered highly reliable, industrial power semiconductor equipment must operate without failure or malfunction for 10,000 hours. That means five years of eight-hours-a-day operation or one year of continuous operation.

Very high reliability is the classification given to equipment that lasts 100,000 hours without failure. But the equipment must include redundant subsystems wherever a single subsystem turns out to have a lower reliability rating.

Threat from noise

One of the chief threats to reliability is noise, particularly noise in control and logic circuits. As the number

Rapid transit. A 3-phase, 575-volt phase-delay rectifier supplies power to a 70-horsepower dc motor to drive this 21-passenger, 8,700-pound vehicle at 30 miles an hour on a dedicated guideway. It was part of a West Virginia experiment in personal rapid transit.

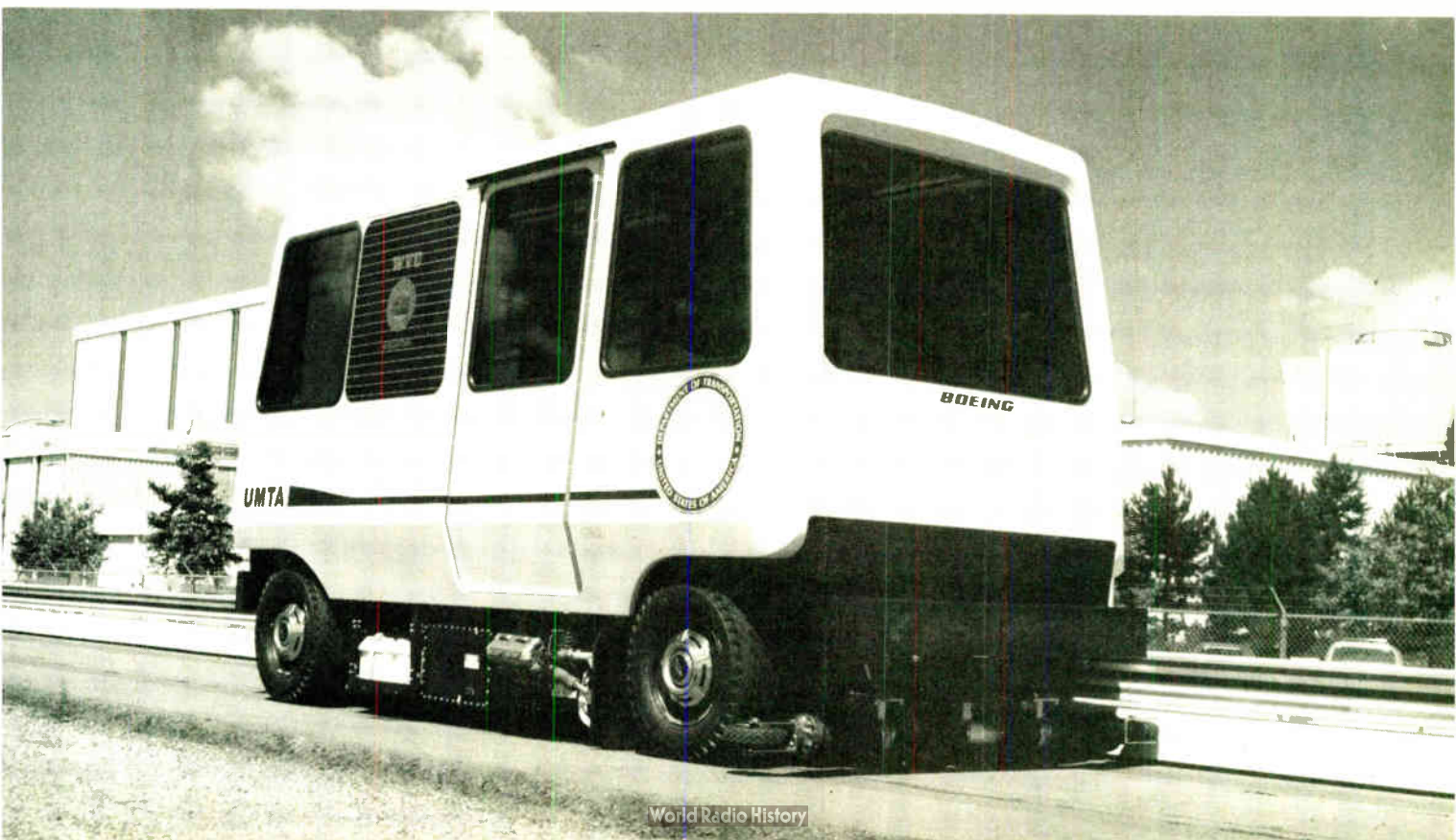

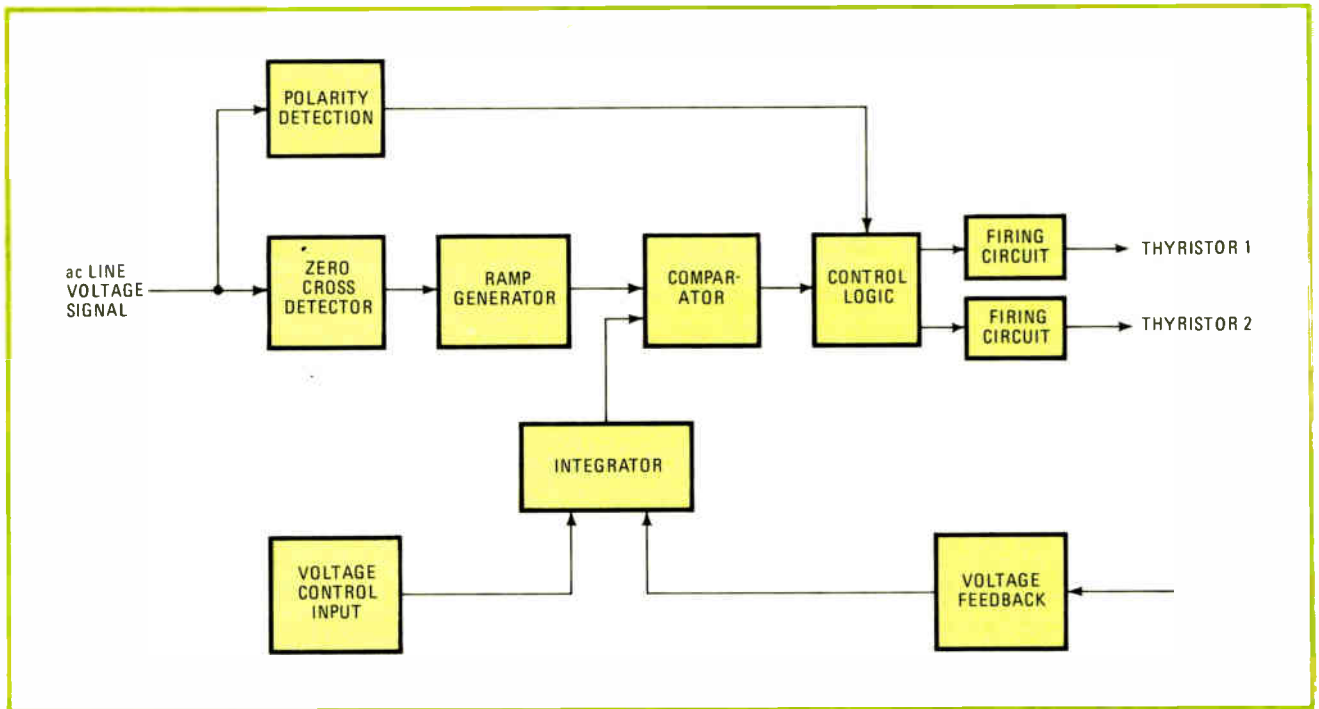

1. **Controlling power semiconductors.** In this ac voltage controller, the ramp generator is synchronized to the line, and the feedback circuit at the comparator crossover point controls the firing angle. A gate network picks one thyristor on the basis of line-voltage polarity.

of power devices, the power level, the operating frequency, and system complexity increase, so does the need for high noise-immunity devices and noise suppression measures.

In control and logic circuits, noise is created chiefly by inductive and capacitance coupling between the power and control circuits. Inductively coupled noise is proportional to the power-current magnitude and the rate of current change (di/dt). It is inversely proportional to the distance between the power and control circuits. Capacitively coupled noise is proportional to the stray capacitance, the rate of voltage change (dv/dt) and the voltage magnitude.

When combined with the less significant noise generated by control-circuit operation, these two noise sources produce a cumulative error signal. The effects can be erratic operation, random equipment shutdowns, repeated blowing of fuses and tripping of circuit breakers, and even destruction of the power semiconductors.

To minimize the effects of noise on control, there are some basic design guidelines:

- High-threshold transistor-transistor logic (HTTL) circuits provide the highest noise immunity, but the most cost-effective choice usually is complementary-metal-oxide-semiconductor logic operated at 12 or 15 volts. C-MOS logic will provide adequate noise immunity when moderate external suppression circuits are included. TTL should be avoided if possible. It has the least noise immunity and requires extensive bypassing, shielding, and a solid-ground system.
- The power lead for each integrated circuit should be bypassed separately with a ceramic or Mylar capacitor. For digital ICs, a capacitor between 0.01 and 0.1 microfarad is adequate.
- Power for analog devices should be supplied through

a resistor-capacitor decoupling network, typically a 27-ohm resistor and a 0.05- μ F capacitor.

- All relay coils should be shunted with suppressors. Ac relays require a metal oxide varistor and/or an RC snubber network, while their dc counterparts need an inversely connected diode.
- Wherever possible, a single-point ground system should tie all devices, subsystems and cable shields together.
- Power and control circuits should be kept as far apart as possible, and there should be some kind of barrier between them, preferably one of steel. Where the interconnection between them runs close to the power circuit, it should be twisted-pair shielded cable.
- Signal transformers should include an electrostatic shield where there is high dv/dt between windings.
- Lastly, circuits must be designed to be inherently immune to noise. For example, level detectors or precision comparators should provide enough hysteresis to eliminate multiple switching, while transistor switches subject to high noise levels should be reverse-biased to hold them in the off state. Differential amplifiers should be used to minimize the noise that affects two different parts of the same piece of equipment (common-mode noise).

Typically power-semiconductor equipment is controlled by a feedback control circuit. The circuit usually contains an operational amplifier integrator that compares transducer feedbacks of voltage, current, frequency, speed, and temperature against some references and uses the resultant output signals to regulate the power circuits.

Three factors are important in determining the reliability of these circuits: selecting the proper transducer, preventing transducer failure from creating unsafe op-

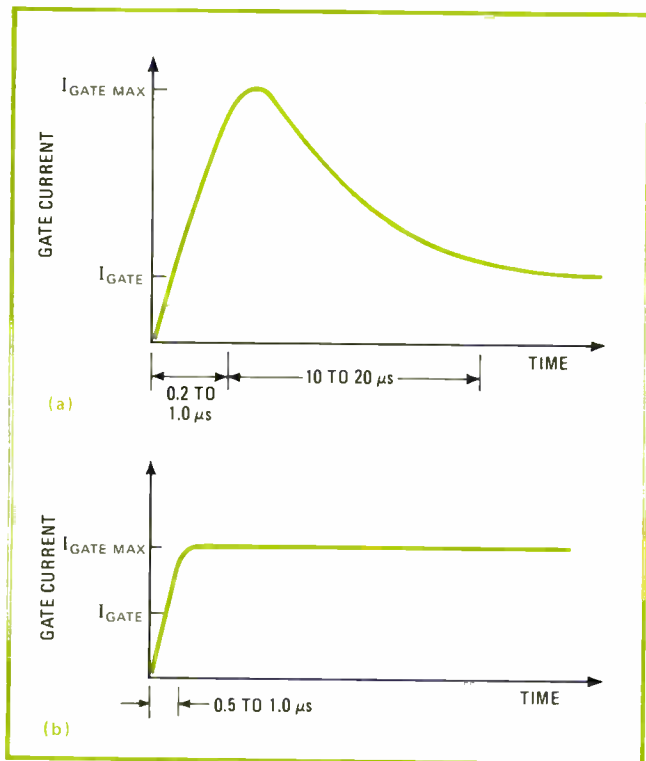

2. Fire away. Hard-firing circuit (a) for a thyristor delivers 3 to 5 times the rated gate current to the device in less than a microsecond. Soft firing (b) is used with the new amplifying or dynamic gate devices. It delivers 1½ to 2 times the rated gate current.

during energization of the equipment and keep them disabled until the internal voltage levels are stabilized.

The circuits must then slowly ramp up the output, thereby limiting the inrush to the load. Quick-acting current-limiting protection also should be provided so that the power current devices can't be overloaded.

Inside the control logic

On response to feedback and operating controls, the control logic supplies switching commands to the firing circuits and to the power semiconductor devices. The logic must be designed to handle all possible states of equipment operation and must be coordinated with the load characteristics.

Generally, equipment using phase control circuits, such as ac voltage controllers and rectifiers, require fairly simple logic because the thyristors are line commutated. The frequency of operation is relatively low, and so when the ac current reverses, it supplies a reverse bias that lasts long enough to turn the thyristors off. But forced commutated equipment, such as choppers and inverters, operate at high frequencies and need an external circuit to supply the reverse bias. In addition, extra care must be taken to prevent commutation failure at the power circuit limits.

Not only must the logic components be selected to perform properly in noisy environments, but they also must include the necessary internal coordination to prevent erroneous logic states and output conditions. The actual organization of the logic and the selection of components will depend upon the type of power semiconductor circuits, the control complexity and the input/output interface requirements.

Simple control systems, such as the ac voltage controller of Fig. 1, typically use analog circuits for most functions. The analog functions in this circuit can be built with op amps and discrete components. The output logic is best handled by HTTL circuits, which have a high output drive suitable for operating the firing circuits.

More complex systems rely heavily on digital circuits. For example, where a phase-locked loop is used to regulate motor speed, a read-only memory and an adder typically will generate the switching patterns necessary for pulse-width modulation of the ac drive inverter. The control logic for cycloconverters, the most complex ac drive system, may even use a small microprocessor-based system.

For all complex systems, the designer must determine the optimum tradeoff among component cost, availability, noise sensitivity, circuit isolation requirements, and the output drive capability.

Usually, C-MOS logic proves to be the best choice for most digital signal processing or pattern-generation applications. But HTTL is better as a buffer between control-logic inputs and outputs requiring high drive capability. In addition, optical couplers can provide ohmic

erating conditions, and minimizing control circuit influence on power circuits during transient conditions.

In selecting a transducer, the most important criteria are high noise immunity and dc isolation from the power circuit. High noise immunity generally demands that a transducer produce a relatively high output voltage from a relatively low source impedance. So transducers with a millivolt output, such as thermocouples and resistance shunts, are to be avoided unless they are extensively filtered and shielded and can tolerate the longer response time that filtering produces. Complex electronic transducers may require external bypassing and shielding to reduce the noise sensitivity of their internal circuits.

Transducers must be isolated from noise, but current and voltage transducers as well as dc transducers are inherently isolated by virtue of their internal transformers. For transducers without built-in isolation, optical couplers can provide the necessary protection against voltage transients.

A transducer failure may result in a maximum output command due to loss of feedback to the regulated circuit. This can lead to unsafe operating conditions such as overspeed of a motor or heater burnout. For maximum safety, therefore, transducer circuits must be designed to be inherently fail-safe. The only alternative is to provide circuits that detect the loss of feedback signal or failure of the transducer and then shut down the equipment.

Transient conditions such as equipment startup and ac power interruptions can produce erroneous signals from the control circuit that result in excessive current through the power semiconductor devices. To prevent damage, it is usually necessary to incorporate circuits that disable the integrator and control logic outputs

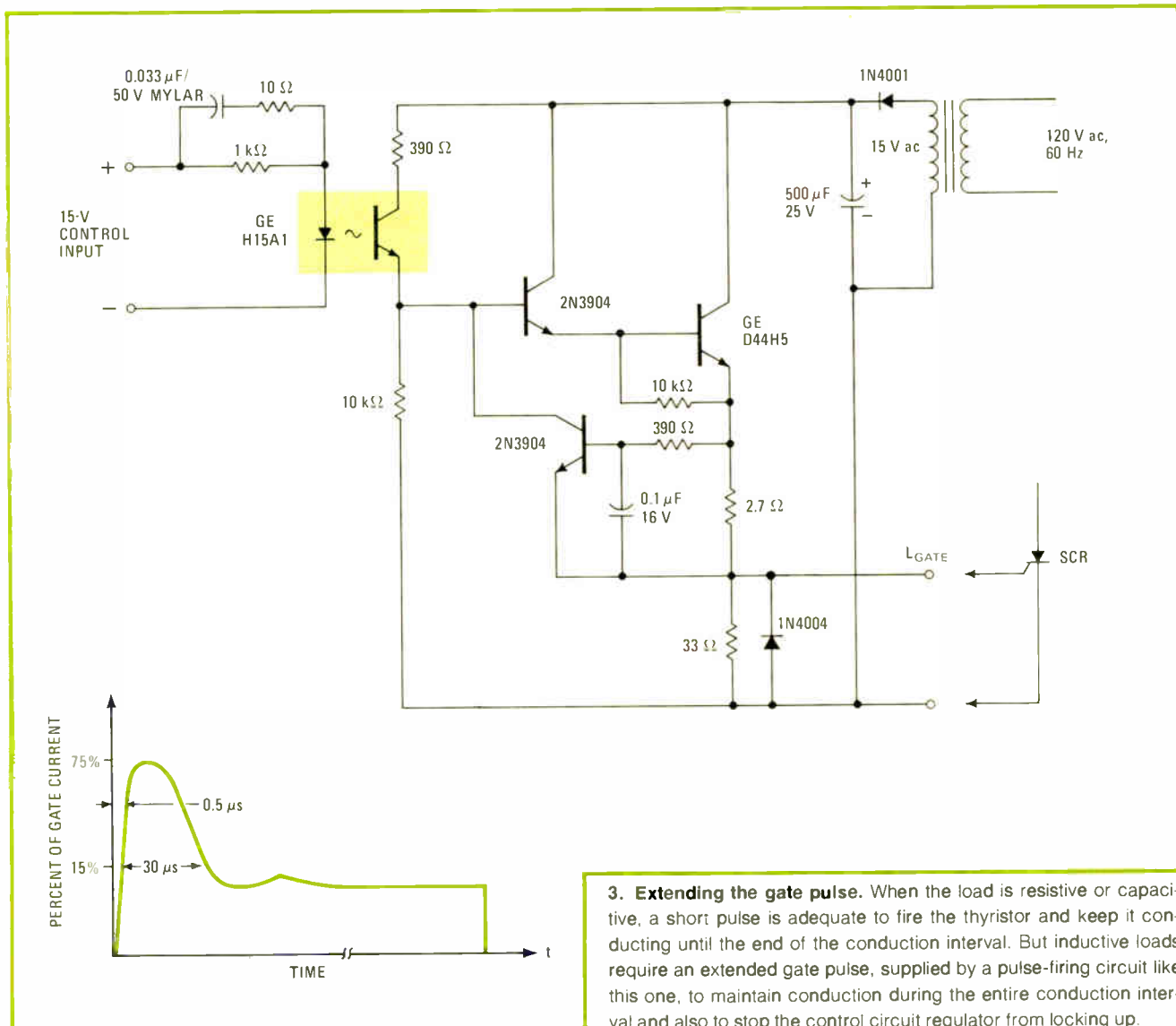

isolation for the inputs and the firing circuit outputs.

With this component mix, the system receives maximum noise immunity on the control inputs and outputs, plus protection against C-MOS failures during testing due to parasitic latch-up. The mix also provides simple interfaces to the input control and output circuits that require high drive currents. It offers the simplest and most cost-effective implementation of the complex logic functions, eliminates ground loops, and permits simple signal interfacing between different dc levels.

Taking care of abnormal signals

To prevent their failure, power semiconductors must receive the proper control signals, no matter what the operating conditions.

Common problems in which control-signal abnormalities can produce power-device failure are: equipment startup and shutdown, supply line interruptions, overloads, and voltage dissymmetry of the power circuit. Proper design can avoid all of these problems.

With equipment startup and shutdown, all power device control states must be maintained in the off state

until voltage levels stabilize. Also, power circuit sequencing must be finished before the actual startup of the power circuit or shutdown of the equipment.

Sequencing is usually required before startup and shutdown for most inverter and chopper circuits. The startup sequence includes a series of commands that charge the appropriate commutation capacitors so that the first thyristors to conduct are the first to be turned off. In the shutdown sequence, all power devices are returned to the off state before deenergization of the power. If any device continues conducting, a fault can develop from the energy left in the power supply capacitor bank.

With supply-line interruptions, the control logic must protect the equipment as long as the interruption lasts. For example, in ac voltage controllers, loss of line synchronization followed by an inrush of current to the transformer or load can cause the power semiconductor to fail. So all firing commands must be locked out until line synchronization is reestablished, and then load power must be returned in a controlled manner.

Inverters present a more difficult problem. After a

supply-line interruption, all conducting thyristors must be switched off and all subsequent firing commands inhibited before the dc supply voltage can drop below the level necessary for commutation.

During overloads, ac voltage controllers and phase-controlled rectifiers are protected by rapidly reducing the time into the cycle at which the thyristor is being fired (that is, the firing angle). Under fault conditions, all firing commands must be inhibited to limit the fault duration to half a cycle.

Limiting overloads and faults in forced commutated inverters and choppers is more difficult. The problem must be sensed and cleared before the current exceeds the capability of the commutating circuit. When a high rate of rise in output current indicates a fault, all conducting devices are switched off as soon as practical.

Voltage dissymmetry is a problem when transformers and motors are driven with power semiconductors. If it becomes significant, dissymmetry will produce a dc voltage component that will saturate the magnetic circuit and thereby overload the power-semiconductor circuit.

To avoid dissymmetry in ac equipment, control signal processing—phase delay, pulse width modulation, pattern generation, and the like—must be symmetric. This requires a common circuit or subsystem for both the positive and negative portions of the ac wave. Also the circuit must have the appropriate logic for controlling the individual power devices. This approach prevents dissymmetry regardless of component tolerance variations, timing differences, and drift during the life of the equipment. It also is economical.

Two kinds of firing up

The firing circuit must provide a gate signal appropriate for the thyristor type and the power circuit. It usually must provide electrical isolation between its control circuit and the thyristor gate terminal. Depending on the thyristor, the gate signal will be hard or soft firing. A hard-firing circuit will supply a peak current equal to 4 to 6 times the rated gate current, while a soft-firing circuit supplies a peak current equal to 1½ to 2 times the rated gate current. Figure 2 shows the two types of firing pulses.

Hard firing is required for the older, center-fire thyristors in order to achieve their di/dt rating. It also insures uniform conduction by the entire device during the initial conduction interval.

Soft firing is used with centerfire thyristors where di/dt is not critical and with the newer amplifying or dynamic gate devices that don't require hard firing to achieve the rated di/dt .

The thyristor circuit and its load determine the time during which the gate signal must be applied. For resistive and capacitive loads, a short pulse fires the device. The thyristor current starts almost immediately and continues until the end of the conduction interval.

For an inductive load, an extended gate pulse (Fig. 3) is necessary to insure that conduction occurs for the required interval and to prevent the control circuit regulator from losing control due to the lagging load power factor. An extended gate-pulse network provides hard

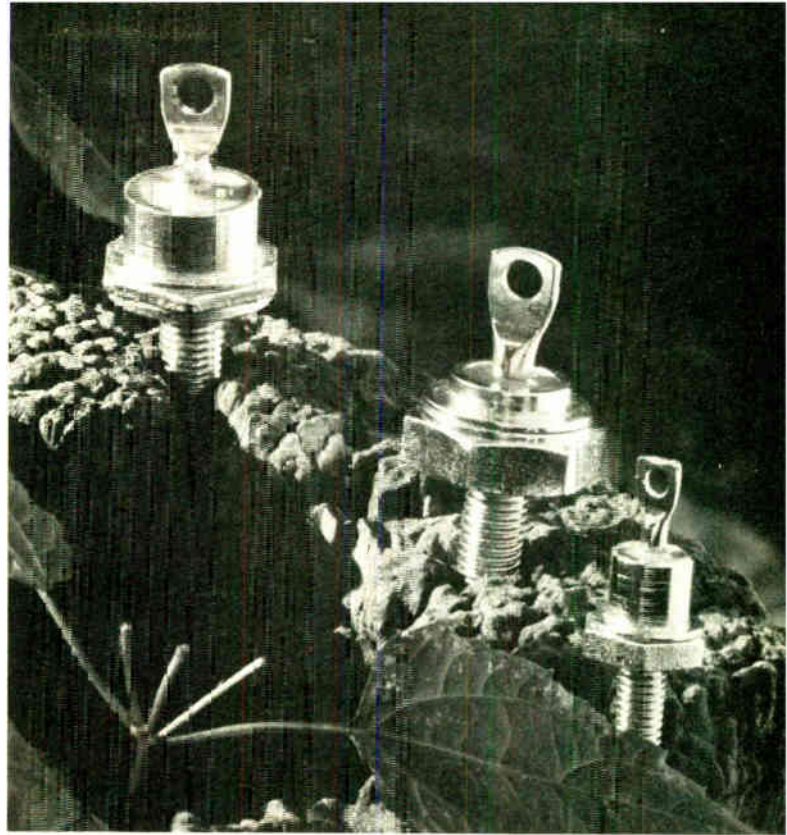

4. Medium-power rectifiers. Typical power semiconductor components are these rectifiers manufactured by Westinghouse Electric Corp., which are available in ratings of 3–70 A continuous current, 50–1,000 V blocking voltage, and 25–1,200 A surge current.

firing followed by a reduced gate current that continues for the duration of the selected interval.

Circuit-induced firing failures

An improperly designed firing circuit can degrade reliability in many ways. If it is near the power circuit, it can become very susceptible to noise. Therefore it must be adequately shielded, bypassed, and grounded, as well as being designed as immune to noise as possible.

When the firing circuit provides dc isolation between the control and power circuits, the switching action of the power circuit produces a high dv/dt condition between the input and output terminals of the firing circuit. The high dv/dt can produce erroneous gate pulses by acting on the interwinding capacitance of the gate-pulse transformer or the feed-through capacitance of an optical coupler (including a printed circuit board).

To minimize the effect, electrostatic shields may be required on gate-pulse transformers. Optical couplers should have a moderate transfer ratio and be immune to capacitance feed-through effects.

Unless the thyristor di/dt capability matches the di/dt imposed by the power circuit, the thyristor may fail. An inadequate gate drive reduces the di/dt capability of the thyristor because conduction is initially limited to a small portion of the thyristor chip. To achieve rated di/dt , the gate drive must be adequate.

Where high reliability is required in severe environments, magnetic-amplifier firing circuits can be used for phase control applications. The amplifier control windings provide ohmic isolation and adequate gain for most regulator and compensation requirements. □

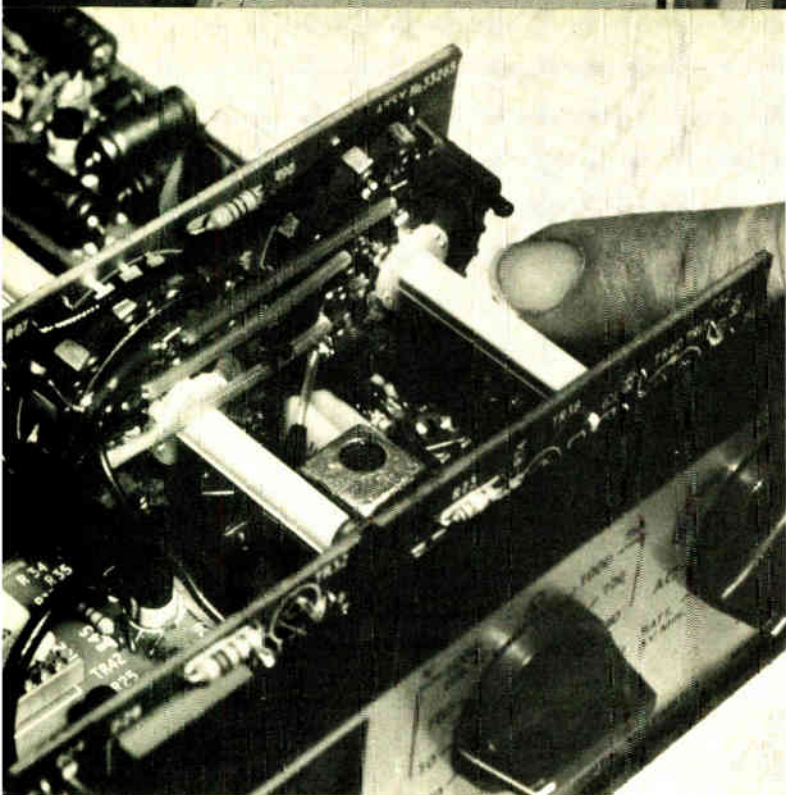

2. Shaft shocks. Front-panel knobs, which often fall off instruments or may be pulled off, are inadequate insulation against shock hazards. This Ballantine digital multimeter has control shafts of plastic instead of metal to provide extra protection.

and other localities that now require a demonstration of a product's safety before it can be sold within their boundaries.

But there is more to providing safety than simply gaining UL approval. "That's just getting a passing grade," observes David Nurse, president of Heath Co., Benton Harbor, Mich. Suppliers must do everything possible to protect users against fire, shock, and casualty hazards, says Henry Littlejohn, product-safety engineer at GenRad Inc., Concord, Mass., and that requires a corporate commitment to safety.

Most major instrument suppliers have set up procedures to be followed in the design of each new product so that it will achieve a high level of safety. But to help instrument designers become more aware of the importance of safety, corporate managers have expressed their interest in adding safety as an independent design parameter. Such direction "pretty well has to come from the top," says Marshall Johnson, corporate safety officer at Hewlett-Packard Co., Palo Alto, Calif. "It has to filter down from a corporate objective," Ballantine's Katzmann adds.

Once this objective is set, "it's important to maintain a good, close, continuous contact with the project engineer," says LFE's Gubisch. Then, safety can be incorporated into designs at the earliest stages—and at the lowest cost.

Once a product is in the field, says Richard Nute, manager of product safety engineering at Tektronix, Inc., Beaverton, Ore., "there's a certain amount of responsibility on the user," both to use the product safely and to consider safety in product selection. Says Donald Mader, engineering group leader in the Electrical department at UL in Melville, N.Y., "today's test-equip-

ment designers and users seem to carefully weigh the many and varied performance specifications of a particular instrument prior to designing or purchasing it. But safety, one of the most important aspects of an instrument, is frequently ignored or taken for granted. Yet if the instrument user takes safety for granted, who will watch out for him?"

The instrument buyer has to perform that function. There are specific, safety-related design features he can look for when evaluating an instrument. Most of them may seem pretty obvious, but almost every instrument now in use lacks at least one.

For example, most instruments today are strong and rigid enough not to collapse under normal operating conditions. But are they all strong enough to withstand foreseeable abuse? In evaluating an instrument, especially one with a plastic cabinet or intended for field service, the engineer should check that the instrument can withstand dropping, connection to high voltages, and exposure to high temperatures or humidity without failing in a way that creates hazards.

Within the instrument case, printed-circuit boards may downgrade its safety unless really firmly mounted. Otherwise they may flex enough to cause a short circuit or mechanical failure when subject to abuse or even normal use, including the plugging in or unplugging of components.

Isolating live parts

An instrument should also be constructed so that no conductors carrying potentially hazardous voltages are accessible to the user while he or she is operating or servicing the unit in the normal course of events. But it isn't always as simple as it seems to provide this kind of protection.

For example, the controls or switches on many instruments have metal shafts. Usually, the plastic knob mounted on the shaft provides sufficient insulation. But slip-on, friction-fit knobs can be removed, accidentally or on purpose, exposing a conductive shaft that passes through a panel to the inside of the instrument, where it may come in contact with current-carrying components.

One way to prevent contact with a potentially live control shaft, used by Tektronix in its model 213 digital multimeter/oscilloscope, is to cover the shaft with a second layer of insulation—a kind of plastic cap that is held captive inside the instrument by the control panel. An alternative preferred by many instrument makers is to use an insulating plastic material for the control shaft itself (Fig. 2).

Nor should electrically live parts be accessible during normal user servicing of the instrument—changing paper in a printer, for example (Fig. 1), or replacing batteries. In evaluating an instrument, the engineer should remember to check out such activities, since they may be performed by a technically unsophisticated user.

Dangerous connections

A hazardous location commonly found on the front panel of test instruments is the input or output connector. Signal sources and voltage or current standards, in particular, are often capable of producing voltages and

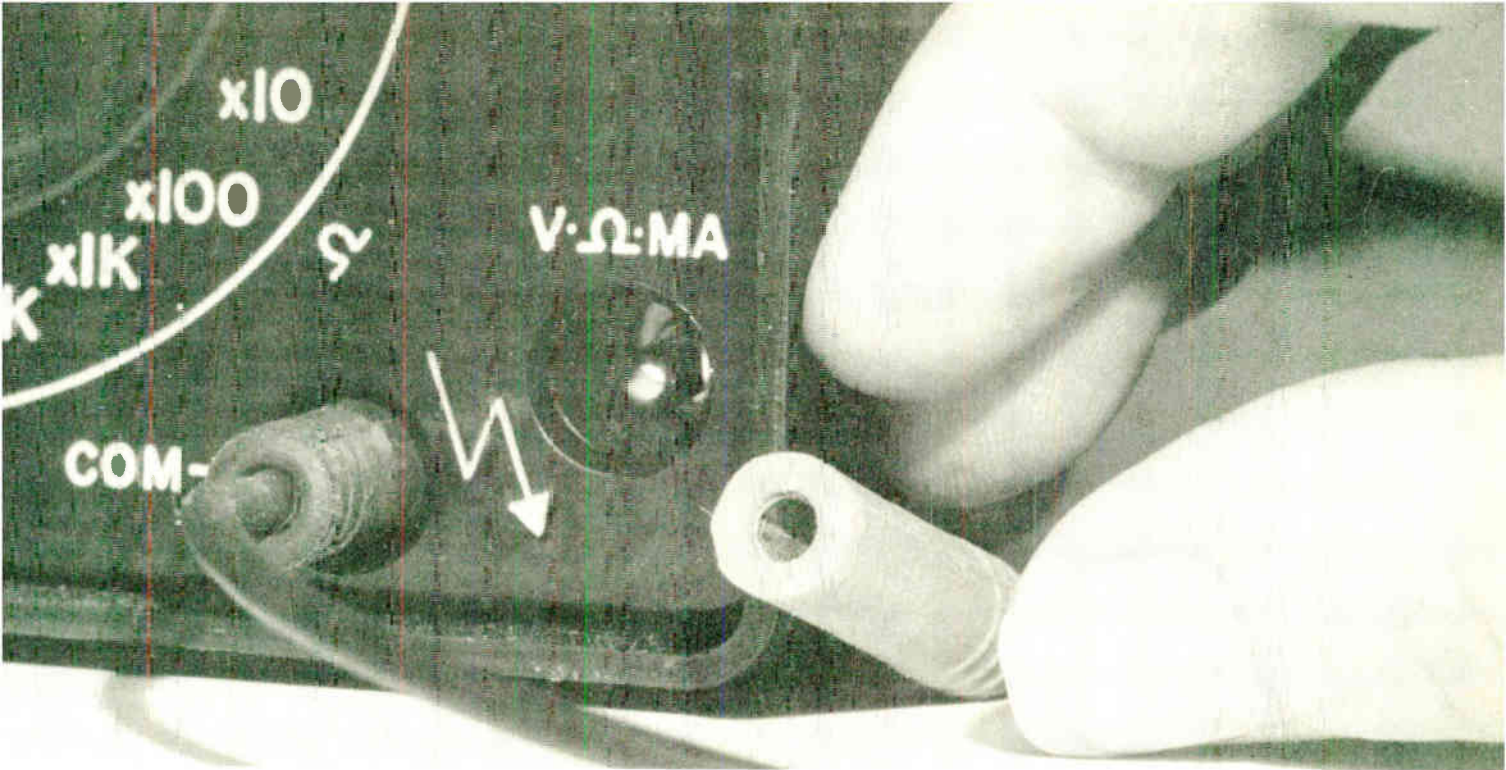

3. Leading question. Leads connected to a measuring instrument are another danger point. Here, on Triplet's model 60 volt-ohmmeter, a recessed male plug mates with an insulated female connector on the test lead, protecting the user even if the lead pulls out of the instrument.

currents at this spot that are high enough to shock an unlucky user.

The connector used must therefore be designed so that the operator cannot contact current-carrying parts. This may sound trivial, but many common connector types—including BNCs—do not meet this requirement. The usual way to provide connector insulation is to use banana jacks or five-way binding posts in place of BNC connectors.

This works well for signal sources that do not require the impedance-matching capability offered by BNC-type connectors, but has a major failing when applied to instruments for measuring, as opposed to generating, signals. In a volt-ohmmeter or digital multimeter, for example, there is little chance of a high voltage appearing at the front-panel connectors. But when the instrument is connected to a circuit under test, high voltages may appear on the leads and mating connector plugged into the unit. If, as often happens, the mating plug pulls out of the meter, a hazardous level of energy may appear on the plug. This is especially dangerous when banana plugs are used because of the relatively large uninsulated surface that then becomes accessible.

There is as yet no widely used method of solving this problem. Locking-type connectors, which would prevent mating units from being disengaged, are generally too expensive and cumbersome to be used in relatively simple and low-cost testers like VOMs. However, an approach adopted by Triplet Corp. in its model 60 VOM has much to recommend it. A banana plug is recessed in the front panel of the instrument, and a mating banana jack is attached to the instrument end of the test lead (Fig. 3). If the jack pulls out of the instrument's front panel, a large rubber boot protects the user from any possible electric shock. While no other manufacturer as yet uses this configuration, its low cost and simplicity

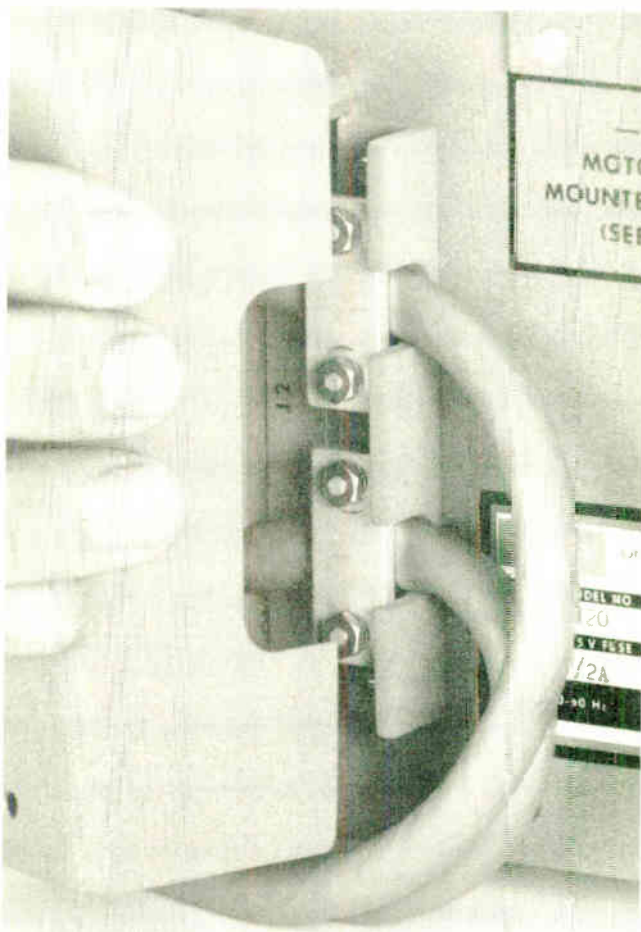

4. Relieved. All wires or cables entering an instrument should have some form of strain relief and push-in relief as shown here, to prevent the cable from transmitting external forces to the internal wiring.

Filling in the details



In-depth criteria for designing or choosing safer instruments—or just about any other product—are available in the form of standards published by American National Standards Institute Inc. (1430 Broadway, New York, N.Y. 10018) and Underwriters Laboratories Inc. (Publication Stock, 333 Pfingsten Rd., Northbrook, Ill. 60062).

Besides issuing ANSI C39.5-1974, which covers electrical and electronic measuring and controlling instrumentation, and ANSI C1-1975, the National Electrical Code, ANSI is the source for international standards from the International Organization for Standardization (ISO) and the International Electrotechnical Commission (IEC). All are listed in ANSI's free catalog. The institute will also order any national standards from foreign countries and even carries some of them in stock.

The proposed instrument safety standard, UL 1244, is only one of hundreds of publications available from UL. UL has also proposed standards in related areas—laboratory equipment, UL 1262, and power supplies, UL 1012. Published standards include printed-circuit boards, UL 796, and plastics flammability, UL 94. The UL catalog also lists product directories to parts and equipment that have met UL requirements.

may soon lead to its adoption as an industry standard.

The instrument buyer should also scrutinize the other end of common test leads—the probe end—for safety. The common straight-shaft, needle-point probe supplied with most voltmeters has a dangerously sharp tip, but this cannot be avoided if the probe is to function properly. However, the instrument maker should provide such a probe with some sort of cap, to prevent injury when the unit is not in use.

Straight-shaft probes also present a shock hazard. It is quite common for a user's hand to slide down the shaft of such a probe and come into contact with the energized probe tip or the circuitry under test. A simple fix for this condition is a shield, or some device like the raised ring often found on soldering irons, to restrain a user's hand from inadvertent contact with the probe tip.

The cables and connectors often used to tie instruments together into systems may also create hazards. As before, no high voltages should be accessible to the user on an interface connector or at the unconnected end of an interface cable. In addition, cables should be tied to the instrument case through some form of strain relief, to prevent forces on them from being transmitted into the instrument where they could damage internal wiring or terminals (Fig. 4). What's more, interface connectors should be designed so that plugging a cable into the wrong connector or misaligning it in the right connector will hurt neither instrument nor user.

Line-cord precautions

Such considerations are even more important where line voltages appear. The power cord itself should have a large enough capacity to handle any foreseeable load from the equipment, including accessories that may be connected to convenience outlets. Moreover, it should be mechanically restrained from being pulled out of or pushed into the instrument case. And, to prevent one wire from being mistaken for another, no low-voltage cable should be made to pass through the same bushing as the line cord.

The plug connected to the power cord should be the proper type for the maximum current and rated voltage of the instrument or, where it can operate at more than one voltage, for the voltage set at the factory prior to shipment. In addition, the plug should conform to any accessory outlets on the instrument if these outlets are either two-wire polarized or three-wire grounded types. In this way, the user will not be deluded into believing that, say, an accessory is grounded when plugged into a three-wire outlet if, in fact, the instrument itself has no provision for grounding.

The design of accessory outlets, too, should prevent a user from coming into accidental contact with a high voltage. They should be mounted so that there is enough clearance around them to permit full insertion of standard plugs. Of course, the connectors used for accessory high-voltage outlets should never be of the same type as those used for low-level signals.

A life-and-death matter

It could literally be fatal if the engineer failed to check out the grounding scheme of an instrument he is considering purchasing. And the first thing he should look at is any connection to earth ground such as a three-wire line cord. This cord should tie every accessible conductive part in the instrument to ground, unless the part is well insulated from other conductive parts and cannot become live as a result of a component failure. If the means for grounding the equipment is through the line cord, the ground contact should be made first and broken last whenever the plug is inserted into or pulled from an outlet.

To maintain the grounding integrity of a supply system, any switch, fuse or circuit breaker that can interrupt the ground lead between the instrument and earth must also simultaneously interrupt all conductors of the supply circuit. And, in a system containing more than one instrument, each unit having a separate supply cord

~LINE 115/230 V $\pm 10\%$ 48-66~ 300 VA MAX

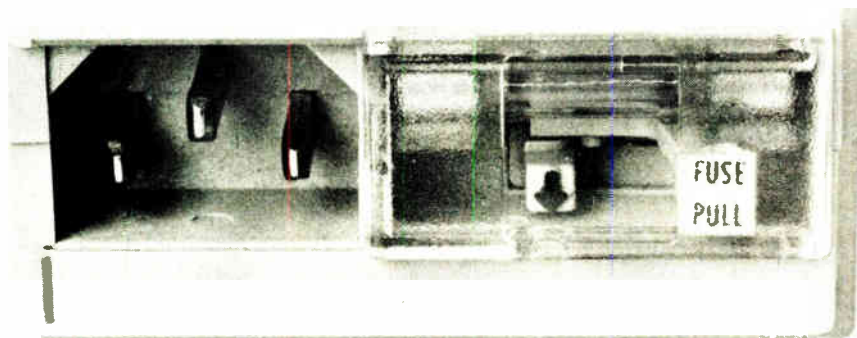

5. Orderly approach. This Hewlett-Packard-designed power module has a power connector that conforms to International Electrotechnical Commission standards and also ensures the ground connection is made first. The line voltage selector switch can be actuated only after removal of the power cord.

should have a grounding-type cord, and all units should be tied to a common ground.

Another set of safety requirements is imposed on instruments that employ line-voltage selectors. The switch that selects different supply-voltage inputs should be constructed so that the voltage setting cannot be changed accidentally, and if the setting can be changed by the user, then the action of changing the voltage selector setting should also change the supply-circuit voltage indicator. The switch that is most often used to meet these demands has a recessed actuator that can be moved only with the aid of a tool like a screwdriver, and the supply voltage is printed on the actuator so that the switch housing covers the unselected voltage level.

Another approach to tap switching, developed by Hewlett-Packard Co., Palo Alto, Calif., is called the power module (Fig. 5). The device has been licensed by HP to Corcom Inc., Chicago, for manufacture and sale to other firms.

The power module consists of a power-input connector, a fuseholder, and a voltage selector in a single housing. The construction of the device is such that a user must remove the line cord before he can change the fuse or the voltage selector. In turn, he must remove the fuse before he can change the voltage selector, as a reminder to him to check for the proper fuse rating for the new voltage setting. In addition, changing the voltage setting permits the proper voltage indication to show through a window, while masking all others.

Care in labeling

Aside from the proper voltage setting, an instrument should have a great deal of other information marked on it. The name of the manufacturer or other organization responsible for the equipment, along with a catalog number or other description, should be plainly visible. This, plus a clearly marked month and year of manufacture—even if in code—helps a technician make repairs or adjustments safely.

Complete operating instructions, a reference to the proper test leads if a set is not provided, and a statement about the proper battery charger or separate power supply to use, if any, should be marked on the



6. Red light. Wherever hazards exist, an instrument manufacturer is responsible for giving customers clear warning. Test instruments should be marked like this Keithley current source to remind the user that output terminals can produce dangerous voltages and currents.

equipment or in a booklet provided with the instrument. The correct fuses and other user-replaceable parts should also be clearly listed.

If any risk of fire, shock, or casualty exists in the use of the instrument, clear warnings to that effect should become visible whenever the hazard is present (Fig. 6). These warnings, even in combination with all of the other safety features discussed, may not make an instrument perfectly safe, but will markedly reduce its chances of injuring anyone. □

Ribbon cable makes coils for printed-circuit boards

by Jim Edrington and F.E. Hinkle Jr.
Applied Research Laboratories, University of Texas at Austin

A microhenry inductor loop made from flexible ribbon cable is easy to mount on printed-circuit boards, and its inductance value is easy to control. This loop is a cross between the familiar wire-coil inductor and a printed-circuit inductor. Since the ribbon-cable loop is three-dimensional, a larger amount of inductance is possible for a given area than a printed-circuit coil can provide. Moreover, the ribbon inductor is much easier to manufacture and control than the usual wire-coil inductor.

Figure 1 illustrates the technique of bending the flexible cable into a semicircle and soldering the ends into a pc board so that the conductors interconnect to form a multiturn coil with a "D" cross section.

The inductance of a "D" cross-section coil may be calculated from the formula for a circular coil, with the

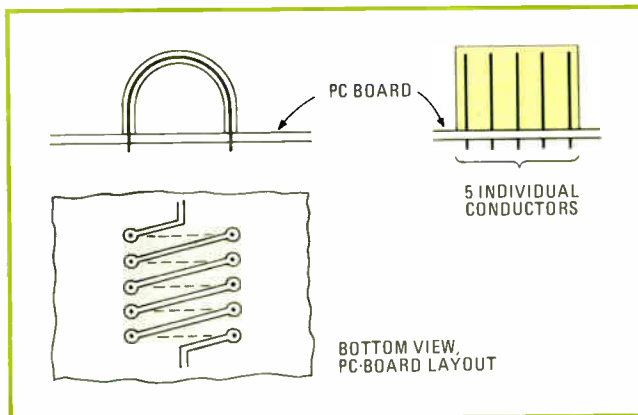

1. Loops good. Flexible ribbon cable is mounted on printed-circuit board, with individual conductors cross-connected in series, to form an inductance coil. One loop can be nested inside another to form a transformer, and individual turns of the loop can be tapped. These coils have the amounts of inductance needed for rf tuning.

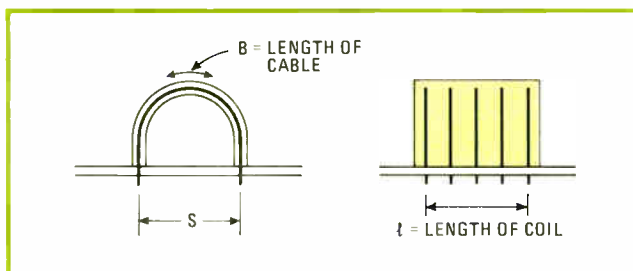

2. Sizing it up. Definitions of dimensions used in text are illustrated. A given ribbon has a fixed number of conductors per inch of ribbon width (coil length), so n and l are equivalent quantities.

effective radius of the "D" coil substituted for the actual radius of a circle. For a single-layer n -turn circular coil with radius a and length l , the inductance in microhenries is

$$L = n^2 a^2 / (9a + 10l)$$

where a and l are in inches.

For a "D" coil with the dimensions shown in Fig. 2, the effective circumference, C , is the length of the ribbon cable, B , plus the pc-board spacing, S . The effective radius can be calculated from

$$r_{\text{eff}} = C / 2\pi = (B + S) / 2\pi$$

Thus, the inductance in microhenries of the coil made with ribbon cable is

$$L = n^2 [(B + S) / 2\pi]^2 / [9(B + S) / 2\pi + 10l]$$

where all dimensions are in inches.

The measured and calculated inductances of an actual "D" coil are plotted versus the length (l) of the coil in Fig. 3. The coil for this test was made of a 2-inch length of Ansley Flexstrip with a pc-board spacing of 1.75 in. With 10 conductive strips per inch, the Flexstrip forms a coil with 10 turns per inch. The calculated values of inductance proved to be close to the measured values over a range of coil lengths from 0.5 to 3.0 in. ($n = 5$ to $n = 30$).

Since flexible cable of this type can be purchased in precut sizes, the manufacture of highly repeatable inductors can be simplified. An impedance transformer can be made by adding a second coil inside the first. A

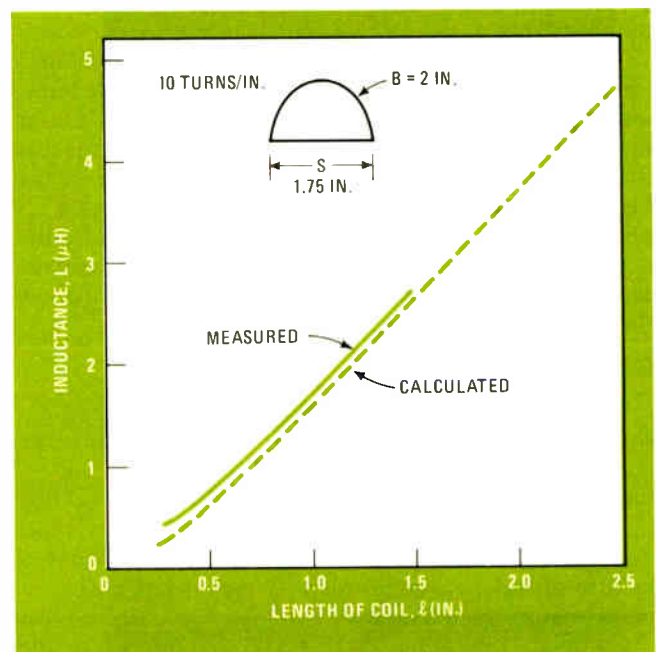

3. Microhenries. Inductance of ribbon-cable inductor is shown as a function of coil length, l . Since ribbon has 10 conductors per inch of width (coil length), abscissa represents 0 to 25 turns.

multiple tapped inductor is easily formed by bringing out any of the turns on the printed-circuit board. Since every turn is terminated on the board, other electrical

components may be wired with the coil. For example, capacitors may be paralleled with the coil to form tuned rf circuits. □

Microprocessor converts pot position to digits

by John M. Schulein
Aeronutronic Ford Corp., Palo Alto, Calif.

A few bytes of program in an 8008/8080 microprocessor, plus a 555 integrated-circuit timer, can convert the position of a potentiometer into a digital value. The arrangement is both economical and convenient when the position data is an input to a system already using the microprocessor, such as an industrial control system or a video game.

As the figure shows, a strobe pulse from the microprocessor triggers a 555 connected as a one-shot multivibrator. The output from the 555 stays high for a period of time that is proportional to the resistance of the pot. To measure this time period, the processor increments an internal register for as long as its input (D7) from the 555 remains high.

When data on the pot position is required, the microprocessor program calls up the POTPOS subroutine, which uses four flags, the accumulator, and the B register. In this subroutine, as the table shows, the processor:

1. Sets register B to 0.
2. Triggers the 555.
3. Increments register B.
4. Inputs the status of the 555 to bit D7 of the accumulator.
5. Sets a sign flag minus if status is high.
6. Jumps back to step 3 if flag is minus.
7. Returns to main program if flag is not minus.

Upon return to the main program, register B contains a number that measures the 555 output pulse duration and hence is a digital representation of the pot position.

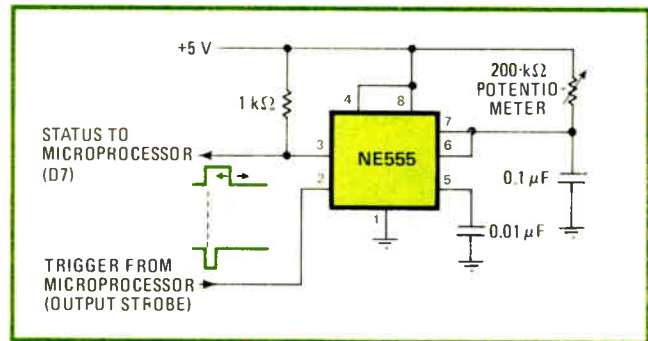

PROGRAM SUBROUTINE

```
POTPOS: MVI B, 0
        OUT TRIGGER
CONT:   INR B
        IN STATUS
        ANA A      (SETS SIGN FLAG)
        JM CONT
        RET
```

NOTE: Register B contains the pot position on exit.

Where is the pot? Potentiometer position is digitized by one-shot multivibrator and subroutine for the 8008/8080 microprocessors. When program calls subroutine, processor triggers one-shot and measures output pulse duration (which is proportional to resistance of pot). Register B stores this value for use in computation of next step in a TV game, process control, etc.

When the hardware and software are used on an 8008 system with a 2.5-microsecond clock, the B register digital output varies from 2 to 65 Hex, i.e., has 100 different values, as the potentiometer is varied across its range. The values of the pot and the timing capacitor can be modified to suit the speed of the processor and the desired range of the digitized output. □

Op amp complements a-d converter output code

by Eugene L. Zuch
Data Systems Inc., Canton, Mass.

In many cases where an analog-to-digital converter has data outputs that are complementary-coded (highest level represented by 00 . . . 0), the interfacing requires uncomplemented coding (highest level represented by 11 . . . 1), and vice versa. Conversion from one form to the other can of course be done with logic inverters, but

if the input analog signal is bipolar, a single operational amplifier can perform all of the inversions.

The approach also works with minicomputers, some of which require complementary input coding while others require uncomplemented coding.

Uncomplemented coding is shown in column 3 of the table, which illustrates the offset binary coding of a ± 5 -volt bipolar analog signal. A 12-bit a-d converter is assumed here, so the least significant bit is $10 \text{ v} \div 4,096$, or 0.0024 v. In this code the all-0s level (000000000000) corresponds to an analog value of minus full scale, or -5 v ; the all-1s level (111111111111) corresponds to plus full scale less 1 LSB or $+4.9976 \text{ v}$.

In the case of complementary coding, shown in column 1 of the table, the reverse is true. All-0s corre-

The 100 NSEC fully static 4K RAM is here now

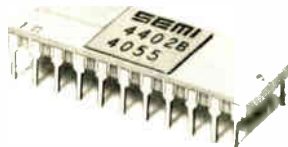

100 nsec. access time. The SEMI 4402B is the fastest 4K RAM available today. Now you can build a 150 nsec. access memory system with 4K chip density, and minimum worry about soft bit errors.

Fully static. You can design systems without losing valuable time for refresh, or wasting board space with costly refresh circuitry. The simpler timing requirements mean an easy interface design.

Data protection. Brownout protection or battery backup features can be added to your memory, since the 4402B retains data at low voltage and power levels.

The SEMI 4402B, at 100 nsec. access and 300 nsec. cycle time is available now for immediate delivery. Contact your local EMM SEMI sales office, representative or distributor today.

EMM SEMI

A subsidiary of Electronic Memories & Magnetics Corp. • 3883 North 28th Avenue, Phoenix, Arizona 85017
(602) 263-0202

EMM OFFICES: WESTERN REGION, Regional Office, San Francisco (408) 247-9711, Los Angeles Area (213) 644-9881, Orange County Area (714) 639-5811; EASTERN REGION, Regional Office, Boston (617) 861-9650, Chicago Area (312) 297-7090, New York Area (516) 423-5800, Cleveland Area (216) 842-8920; INTERNATIONAL OFFICES, European Headquarters, United Kingdom (01) 751-1213, West Germany (089) 714.30.40.

REPRESENTATIVES: Gentry Associates, Orlando (305) 894-4401, Huntsville (205) 534-9771, Burlington, N.C. (919) 227-3639, In Canada: Cantec, Toronto (416) 457-4455, Montreal (514) 620-3121, Ottawa (613) 225-0363. In Sweden: Svensk Teleindustri, QB-890435. In Great Britain/Ireland, MEMAC Whitchurch (029 664) 366/7/8. In Netherlands/Belgium, Famatra, Benelux 076-133457. In Norway, Henaco A/S (02) 15 75 50. In Japan, Nissoho Electronics (03) 544-8396.

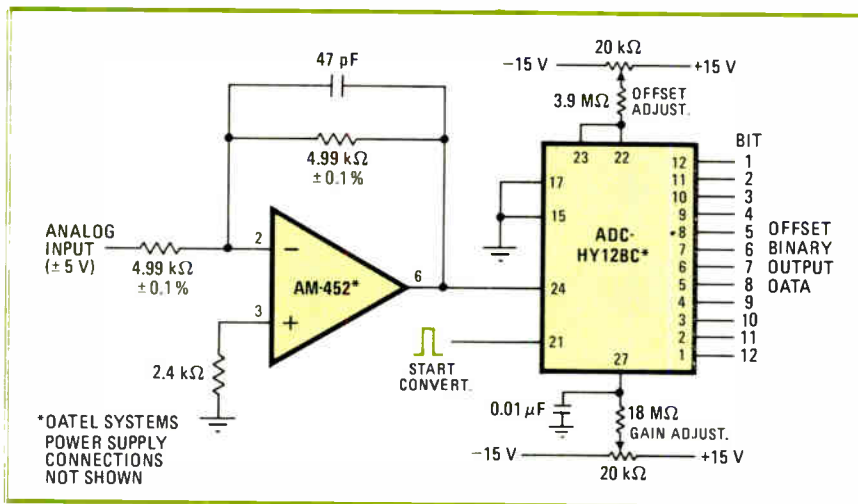

Exchanging complements. Inversion of bipolar analog signal by op amp, prior to analog-to-digital conversion, yields uncomplemented offset binary coding of output data. This technique is useful in interfacing hybrid data converters to microprocessors, minicomputers, and the like.

CODING TABLE				
Scale	Input voltage (± 5 V full scale)	Column 1	Column 2	Column 3
		Complementary offset binary coding	Complementary offset binary with inverted analog	Offset binary coding
+ Full scale	+ 5.0000 V		1111 1111 1111	
+ Full scale - 1 LSB	+ 4.9976 V	0000 0000 0000	1111 1111 1110	1111 1111 1111
+ 1 LSB	+ 0.0024 V	0111 1111 1110	1000 0000 0000	1000 0000 0001
0	0.0000 V	0111 1111 1111	0111 1111 1111	1000 0000 0000
- Full scale + 1 LSB	- 4.9976 V	1111 1111 1110	0000 0000 0000	0000 0000 0001
- Full scale	- 5.0000 V	1111 1111 1111		0000 0000 0000

sponds to +4.9976 v while all-1s corresponds to -5 v. Thus the codes in column 1 and 3 are simply the logic complements of one another.

The obvious way to go from one code to the other is to add a logic inverter to each output line. This is relatively inexpensive, requiring only two hex inverters for 12 output data lines, but it may often be quite inconvenient because 12 data lines must be connected to 12 dual in-line pins on a circuit board. And if the data output from the converter is tri-state, two strobe connections must be handled in addition to the data lines.

For bipolar operation, the inverting-op-amp method requires connection to only one pin of the a-d converter, the analog input. The gain of the inverting amplifier must be set close to -1, although small variations can be taken care of by the a-d converter gain adjustment. The circuit of Fig. 1 shows a fast integrated-circuit op amp connected to the input of a fast hybrid 12-bit a-d converter. After the amplifier is connected, the converter is calibrated for offset and gain, as is normally done for the coding of a bipolar signal (i.e., offset binary coding). Because the ADC-HY12BC converter normally has complementary offset binary coding, use of the inverting amplifier in this case results in offset binary coding.

The table shows how the coding transformation works. Starting with the complementary offset binary coding in column 1, inversion of the analog input in effect rotates the coding about the analog 0 axis, as shown in column 2. Now, column 2 is almost identical with column 3, except that column 2 is 1 LSB higher in analog value than column 3. In other words, 00 . . . 0 in col-

umn 2 corresponds to minus full scale plus 1 LSB, while 00 . . . 0 in column 3 corresponds to minus full scale. But this difference in analog value is easily taken care of by the offset adjustment of the a-d converter.

The technique works in both directions, from offset binary to complementary offset binary or the reverse. It also works between two's-complement coding, in which the most significant bit is complemented from its value in offset binary coding, and complementary two's-complement coding. (Most newer modular or hybrid a-d converters have an output that is the complement of the MSB output for use in two's complement output coding.)

In applications of the op-amp inversion technique, the settling time of the inverting amplifier must be added to the conversion time of the a-d converter. In the circuit shown, the settling time of the AM-452 amplifier is 3 microseconds to 0.01%. Added to the 8-μs conversion time of the ADC-HY12BC, this gives a total conversion time of 11 μs.

The conversion technique is useful in interfacing a-d converters to microprocessors, minicomputers, or other digital-input devices. Most of the earlier modular a-d converters used uncomplemented coding, but many of the newer converters, such as the new low-priced hybrid units, use complementary coding. The change derives from the popularity of the quad current switch technique and the use of a monolithic successive-approximation register inside the converters. □

Engineer's Notebook is a regular feature in Electronics. We invite readers to submit original design shortcuts, calculation aids, measurement and test techniques, and other ideas for saving engineering time or cost. We'll pay \$50 for each item published.

Designers foresee dazzling possibilities . . .

No sooner was the trend to single-chip microcontrollers spotted here last month than digital-system designers began writing in to say why they can't wait to get hold of them. Remember, these single-chip controllers are complete little computers. Unlike the more general-purpose microprocessors, they contain just enough logic, memory and input/output ports to handle a limited number of control functions by themselves, both in consumer products like appliances and in some industrial gear like gas pumps.

But the real importance of the low-cost microcontroller, at least according to the designers we've been hearing from, may be in a **totally different type of application—as peripheral controllers in large microprocessor-based systems, providing cheap and flexible local processing while taking the load off the central processor.**

. . . in combining microcontrollers and microprocessors

A point-of-sale system is the perfect example of how a special-purpose microcontroller would work with a general-purpose microprocessor. The microprocessor would perform the main processing functions—the central bookkeeping, inventory, pricing, merchandise management, and so on—while a host of microcontrollers would handle the peripheral processing right at the various terminals—verifying credit cards, and handling price recognition and cash-register transactions. Not only is a great load removed from the central microprocessor, allowing it to operate faster and more efficiently, but now **a system can be updated by simply changing a controller program** instead of having to tamper with the more complex central program.

A penny-wise guide to IC design

At less than 3 cents a design, the best IC design aid may be a new little book called "101 Analog IC Designs," by the staff of Interdesign Inc., Sunnyvale, Calif., an IC house headed by Hans R. Camenzind. The \$3 book gives **circuit diagrams for amplifiers, oscillators, phase-locked loops, timers, voltage regulators, comparators**, and so on. It's aimed primarily at potential users of Interdesign's Monochip ICs, but would be useful to anyone considering setting up a small custom-IC development program.

Does your SCR have enough drive?

Firing a silicon controlled rectifier doesn't depend only on the voltage and current levels of the trigger pulse—the pulse width matters, too, points out J.D. Balenovich, who is with the reliability, quality, and applications engineering group of Westinghouse Power Semiconductor division, Youngwood, Pa. In high-frequency or high-current applications, when the trigger pulse is at most 20 microseconds wide, the gate drive amplitude must be increased possibly three to five times over its nominal value. **Generally, the gate trigger current required at a junction temperature of -40°C is around twice that needed at 25°C , whereas at 125°C it is about half the 25°C level.** So, before you assume that your gate drive is ample, make sure you're aware of all the nominal firing conditions, including the junction temperature that corresponds to the holding current.

—Laurence Altman

NI 2001 Programmable Calculating Oscilloscope



**Just 11 keys let you
program your
scope controls to
automate complex
signal analysis.**

Requires No Special Programming Language — or Experience.

It's no surprise that industrial and scientific users of test and measurement instrumentation are acclaiming the NI 2001. More than just a better instrument for the acquisition, processing and manipulation of electrical data, its innovations make it an entirely new generation of instrumentation. It ushers in a new era of ease and accuracy in analyzing signal data because it combines all the capability of a digital oscilloscope and micro-processor in a single mainframe. It eliminates interfacing requirements, computer instructions and requires no programming experience.

Only a demonstration can prove how unbelievably versatile the NI 2001 really is. No other instrument gives you the freedom and convenience of *programmability*. With the exception of time base, all front panel controls for mode and display, as well as the entire 81-key interactive keyboard can be programmed. The 11 keys of the keyboard's PROGRAMMING section, shown here, let you automate complex signal analysis. You merely press the PROGRAM key, perform the desired sequence once and press the END key. The NI 2001 will then repeat the sequence whenever the RUN key is pushed. You can store up to 200 instructions with complete editing freedom for additions or corrections. You can pause and review during any



data sequence or perform an operation a step at a time, editing as you go. And, as special-purpose plug-ins become available, like FFT for instance, you can include them in your programs too.

The programmability of the NI 2001 combined with its capability for conditional branching further emphasizes its versatility. Predetermined conditions can be programmed, which when met will allow the NI 2001 to perform decision-making functions. And with options, it can output a control pulse to extend its application as a controller for an experiment or ongoing process.

Programming is just one of a host of features you'll find only in the NI 2001. Get complete details and discover how you can make waveform analysis easier than you dreamed possible. Send the reader service card or write Norland Instruments Dept. E-1.



NORLAND INSTRUMENTS
A Subsidiary of Cordis Corporation

Norland Drive
For: Atkinson, Wisconsin 53538
Tel. (414) 563-8456 U.S.A.

World Radio History For Demonstration Circle 248 on reader service card

Only TRW/IRC offers you complete resistor choice.



You get exactly the resistor you need for your application.

No compromises. No "favorites." Just quality.

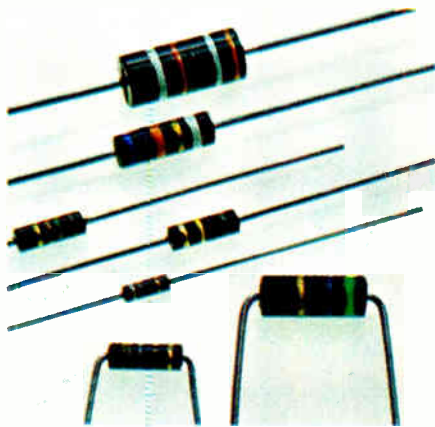

Carbon comp.

Billions used in consumer, industrial, military applications. TRW/IRC carbon comp. capability ranges from standard commercial types through established reliability RCR's, to ultra-high range (10^{11} ohms). Where you're using carbon comp.'s in automated assembly, TRW/IRC packaging options can help cut the cost of interfacing with your machines. Card packs, lead tape reels, cut and formed leads... we'll be glad to explore the potential economies with you.

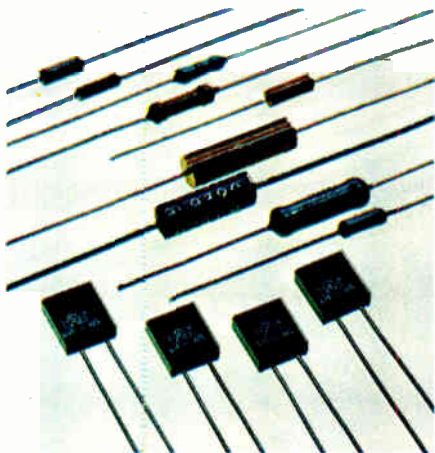

Metal Film

TRW/IRC has brought the state of the art in thin-film to a performance level equaling high-stability wirewounds. Capabilities include resistors with tolerances to $\pm 0.01\%$ and ± 3 PPM T.C. ... high-rel units... precision subminiatures... and, of course

the popular RN's. You can also look at alloy films offering high-temperature and high-voltage capability at low cost.

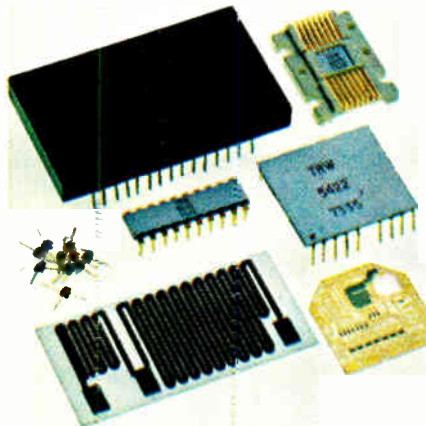

Resistive Networks

Advanced resistor technology here. These IC compatible, precision tantalum-film circuits provide inherent: low noise, excellent stability, and hermetic performance without hermetic cost. Tolerances from 5% to 0.05% available in custom designs. TRW/IRC also offers the industry's most complete line of discrete fixed resistors.



Wirewound

The line starts with molded wirewound resistors—"space-savers" that bridge the cost-performance gap between composition resistors and precision wirewounds. It proceeds to standard, non-insulated types

for appliance/automotive use...to precision subminiatures offering high power density... to low cost fusible, flameproof units for consumer and industrial applications... to tubular and flat power wirewounds with ratings to 250 W.



Metal Glaze™

This is TRW/IRC's thick-film technology—for all types of low power resistor applications. Metal Glaze is widely accepted for its built-in power handling reliability, resistance range, and cost effectiveness. Numerous standard and special designs—precision, semi precision, flameproof, high-rel, high-voltage.

All types...all technologies... one source

To wrap it up, TRW/IRC offers you the most complete line of fixed resistors in the business, with many of the popular types available from one source—your local TRW/IRC distributor. Having a direct pipeline to each of our plants, he can give you fast delivery.

Contact your local TRW sales office for application assistance, custom designs, and special engineering help when you need it. TRW/IRC Resistors, an Electronic Components Division of TRW, Inc. Plants at Boone, N.C., Burlington, Iowa, and Philadelphia, Pa. Write TRW/IRC Resistors, 401 N. Broad St., Philadelphia, Pa. 19108. Or call (215) 923-8230.

TRW IRC RESISTORS

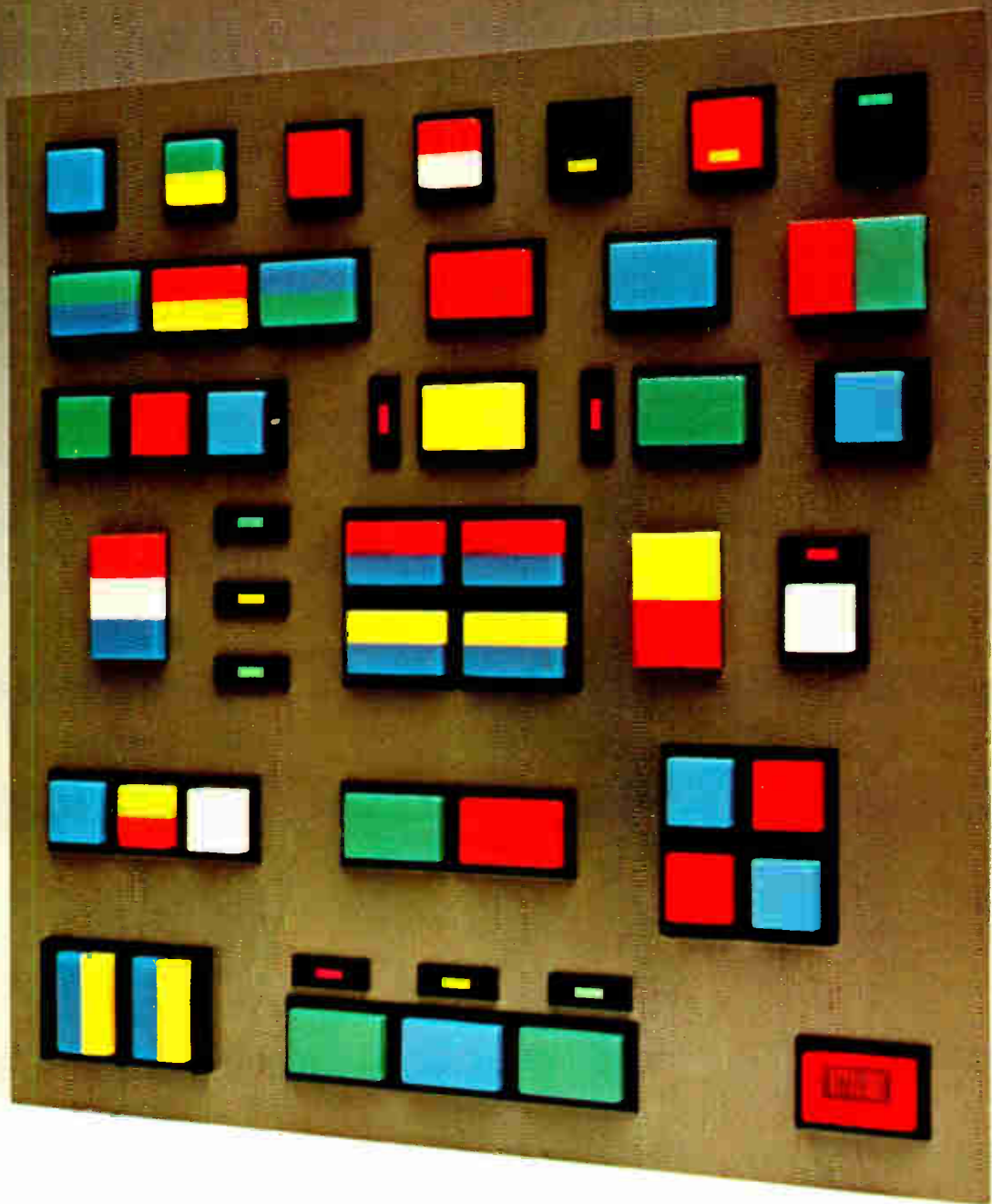

The first good-looking pushbutton that looks

Until recently, if a pushbutton looked good, its electrical flexibility usually didn't. And if it offered electrical flexibility, it usually didn't offer much in the way of looks.

Then MICRO SWITCH introduced the AML (Advanced Manual Line) pushbuttons and indicators. The most comprehensive line ever designed.

AML devices have been designed for appearance by industrial designers. Button height, bezel size, and the compatibility of the square and rectangular shapes combine to "harmonize" your panel. Because the AML line is so broad, you won't have to end up with different looking units to perform different functions.

Displays range from split-screen and hidden-color to a unique, three-segment lens cap indica-

tor, all with transmitted or projected illumination, and a choice of lamps including a T-1¾ wedge base lamp, neon and LED.

The AML units have been designed to look good to electrical engineers, too.

Particularly in flexibility. Three different electrically rated switches in the same size housing. You can choose solid state pushbuttons that operate at 5V or 6-16V with a built-in regulator, sink (TTL) and source (CMOS). Electronic control from logic switching to 3 amps, 120 VAC. And power control up to 10 amps at 120 VAC.

All AML units have been designed to offer the same shallow depth, to provide a unique



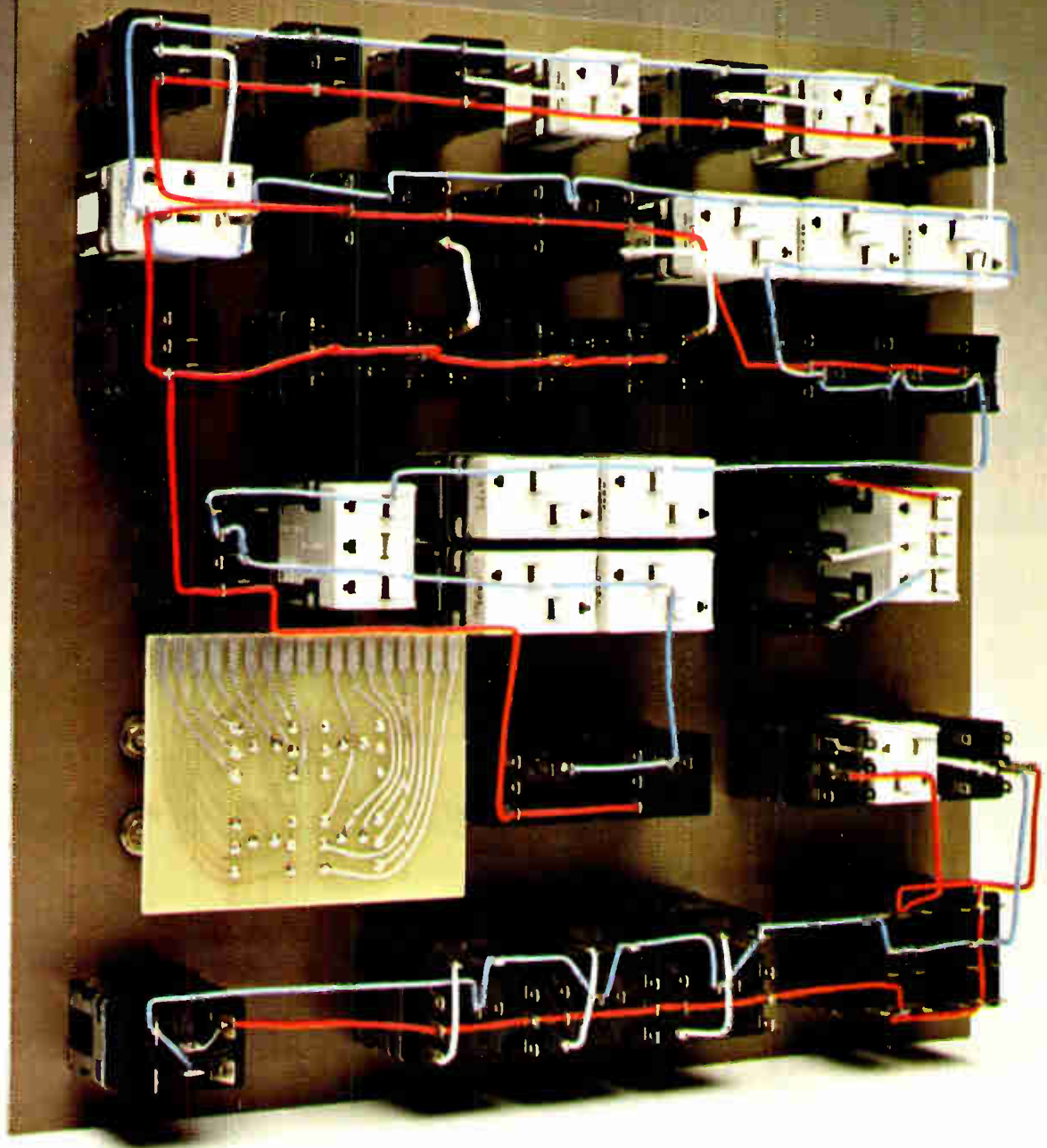

just as good when it's time to wire it.

single level termination. Which means easier wiring and a neat, "clean" appearance. You can either snap them in place from the front, or sub-panel mount them, using individual, strip or matrix mounting hardware.

There's no problem with international acceptance, either. Every AML device is designed to meet the requirements of IEC, CEE24, UL and CSA standards.

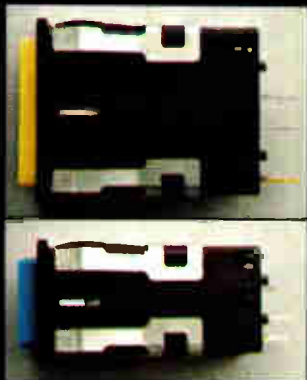

But we believe there's more to building better panels than just offering better pushbuttons

and indicators. That's why we have MICRO SWITCH personnel available to help you solve your specific panel design problems on a personal basis. For more information, write for our "Control Panel Layout Design Guide." Or call your nearest MICRO SWITCH Branch Office or Authorized Distributor.

Either way, you'll end up with one thing. A pushbutton that works as well as it looks.



MICRO SWITCH

FREEPORT, ILLINOIS 61032

A DIVISION OF HONEYWELL

World Radio History

Circle 120 for Data, 121 for Salesman call

Recover 80% of your costly parts cleaning solvents

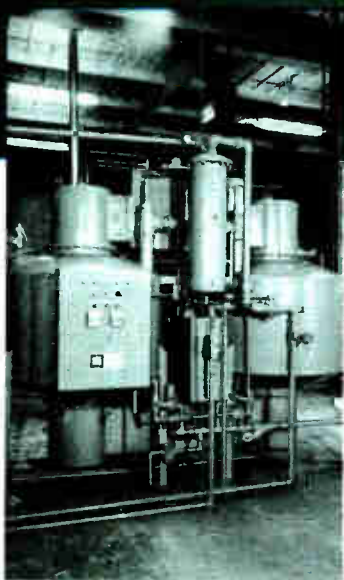

—with Baron-Blakeslee's new "Solvent-Miser"™ Solvent Recovery System

Reduce your parts cleaning costs by recovering 80% or more of your chlorinated or fluorinated solvents. And, while realizing these savings, you also reduce undesirable solvent emissions as required by OSHA and EPA.

Baron-Blakeslee's new "Solvent-Miser" is an efficient carbon adsorbing system that takes solvent-laden air from the parts cleaner and literally "squeezes out" the solvent for re-use. The secret of its efficiency lies in our ability to collect the maximum amount of this solvent-laden vapor. And with 44 years of experience in the design

and construction of vapor degreasing systems—Baron-Blakeslee knows how to keep solvent vapors contained. Fully automatic, the "Solvent-Miser" System can be added or ordered on new units.

Why not have a Baron-Blakeslee engineer survey your cleaning operation? Stop wasting costly cleaning solvents. For details—WRITE TODAY.



Baron-Blakeslee

1620 SOUTH LARAMIE AVE., CHICAGO, ILLINOIS 60650
Nationwide Manufacturing & Distribution Facilities
OFFICES IN ALL PRINCIPAL CITIES

Data General coup: chip to chassis

by Lawrence Curran, Boston bureau manager



Minicomputer maker markets a chip set, single-board microcomputer, and a system complete with software from the NOVA family

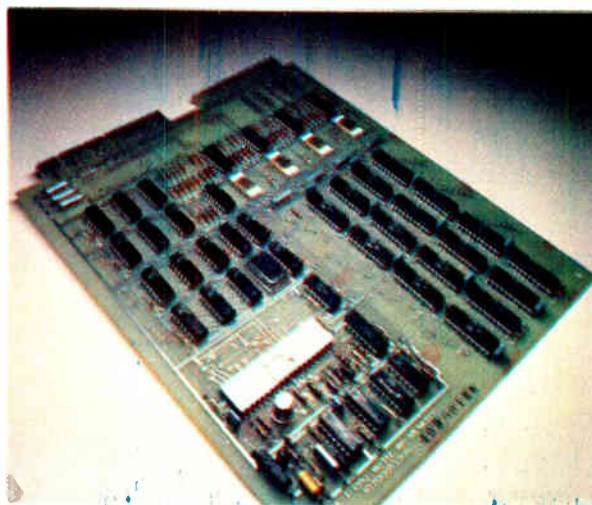

All the way. In addition to a chip set that includes its own microprocessor, Data General is marketing a single-board microcomputer (right) as well as a full-chassis system in its microNOVA line. The system is shown connected to a data-entry console.

Ever since some of the more sophisticated microprocessors have invaded the minicomputer's OEM stronghold, semiconductor makers and minicomputer vendors have been eyeing each other warily. But now for the first time a minicomputer maker has confronted the challenge head on. Data General Corp. has not only designed and built its own semiconductor microprocessor but has also made it the basis for a full family of microcomputers.

Called the microNOVA, the family consists of a chip set, a single-board microcomputer, and a full-chassis system—not to mention the substantial software support that a full 16-bit microcomputer requires and that comes from the company's seven years of experience with more than 20,000 installed Nova systems.

Edson de Castro, president of the Southboro, Mass., company, has been convinced for some time that integration downward was essential if minicomputer makers were to

keep their low-end prices competitive. Data General had to make its own microprocessor, he says, "because we were faced with a choice of doing that or effectively withdrawing from the low end of the OEM business."

The 16-bit microprocessor chip, which measures 225 by 244 mils, is being produced in the company's Sunnyvale, Calif., semiconductor facility. But even though Gardner Hendrie, Data General's manager of systems engineering, says the

THE MIRACLE OF SILICON GULCH

In the beginning there was the Op Amp. And it was good. Unfortunately, it had high bias current and was slow. So, we created the LM108, with Super Beta. Super Beta reduced the high bias current. But it was still slow. So we developed the LM118. A beautiful thing, with feed-forward, large BW and slew. Well, that made it faster. But it left us with the bias current problem all over again.

Then a long silence enveloped the Op Amp world. Everyone waited. There was even some talk that linear was dead.

Months passed. Then, a wondrous event.

National succeeded in putting Bipolar and JFET together on a single chip.

Hallelujah!

The result is called BI-FET.

BI-FET is the first major new linear process in a decade. Easily the biggest thing to hit linear since the original Op Amp.

BI-FET has ion-implanted, ultra-matched, super fast, low noise and high voltage JFETS plus Bipolar, on the same chip. The best low input current, high speed, low noise, low drift combination ever.

And BI-FET features low offset voltage and offset voltage drift. Both coupled with offset adjust that doesn't degrade drift or common mode rejection.

The LF156 was designed for high slew rate, wide bandwidth and an incredibly fast setting time.

2mV maximum offset,
5 μ V/C maximum drift.

10 pA maximum offset current and 50 pA maximum bias current.

100 Hz noise of .01 pA/ $\sqrt{\text{Hz}}$ and 15 nV/ $\sqrt{\text{Hz}}$.

12V/ μ sec. slew rate.

5 MHz bandwidth.

The LF156 is the most accurate, high speed amplifier in the industry: 1.5 μ sec. settling time to 0.01%.

And, if that's not fast enough for you, why don't you try our LF157 Series.

Or for very low current drain there's nothing better than our LF155 Series.

Whichever one you choose BI-FET Op Amps pack a lot of performance in a small package, at low cost. Only \$2.50 in quantities of 100 and up for commercial TO-99.

BI-FET. Bipolar and JFET together, forever. Amen.



BI-FET

NATIONAL SEMICONDUCTOR 

National Semiconductor Corp., 2900 Semiconductor Drive, Santa Clara, Calif. 95051; Scottsdale, Ariz. (602) 945-8473; Mountain View, Calif. (415) 961-4740; Sherman Oaks, Calif. (213) 783-8272; Tustin, Calif. (714) 832-8113; Miami, Fla. (305) 446-8309; Chicago, Ill. (312) 693-2660; Indianapolis Ind. (317) 255-5822; Lenexa, Kan. (816) 358-8102; Glen Burnie, Md. (301) 760-5220; Burlington, Mass. (617) 273-1350; Farmington, Mich. (313) 477-0400; Minneapolis, Minn. (612) 888-4666; Englewood Cliffs, N.J. (201) 871-4410; Syracuse, N.Y. (315) 455-5858; Dayton, Ohio (513) 434-0097; Dallas, Tex (214) 233-6801.

What's on the chip

Data General had two main objectives in designing its 40-pin, 16-bit CPU: to come up with a single chip that would use the latest MOS technology to implement the Nova instruction set, and do it in a way that made use of the company's experience as a minicomputer builder.

Gardner Hendrie, manager of systems engineering, elaborates on them this way: "We wanted to optimize an MOS process to implement this system, not simply use available TTL or adapt someone else's MOS process."

Accordingly, the chip has a classical register file and makes use of programmable logic arrays that are dedicated to run Nova software. The chip is microprogrammable with masks. Further, the chip is optimized to work with dynamic RAMs, with their need for refreshing, so all refresh circuitry is built into the CPU chip, as is all the RAM timing circuitry and a real-time clock.

The CPU chip also includes registers housing a hardware stack pointer and frame pointer. The latter has appeared previously only in higher-performance machines such as Data General's Eclipse series and the Hewlett-Packard 3000, Hendrie says.

And even though Data General has yet to earn its reputation as a micro-processor producer, Hendrie is confident the chip is producible in volume because it uses the same silicon-gate n-channel process with which the company has been successfully building its 4-k RAMs in Sunnyvale.

chip uses only loose design rules, the company still has to demonstrate that it can economically build a large, complex chip with good yields (see "What's on the chip," above).

The chip set includes the 16-bit silicon-gate MOS central processing unit in a 40-pin package and either 4,096-bit dynamic RAMs (also made in-house) or 2,048-bit programmable read-only memories, or a combination of both, plus associated support chips. For example, there's a bipolar bus-driver chip to drive the heavy loads encountered in the larger memory of the board-level micro-computer. An input-output control chip designed and made by Data General is offered separately.

John Scanlon, a marketing specialist, maintains the chip set puts Data General "at the high end of the chip market, and we're bundling it with a lot of software support." The chip set incorporates the full Nova instruction set.

The input-output control chip represents a significant design undertaking. Scanlon says it contains functions that required some 50 TTL chips in the earlier Nova lines, and they're all incorporated in the single chip in a 40-pin package. It includes such functions as: 16-level program interrupt, 64-device program addressability, full busy/done inter-

rupt synchronous logic, data-channel-bus handshaking, full 15-bit count data-address registers, and all power-down and power-up circuitry.

At the board level, Data General is offering a 7½-by-9½-inch micro-computer that Scanlon thinks will compete with General Automation's 110 and 220, Computer Automation's 3/05, and above all Digital Equipment Corp.'s LSI-11. It has the basic chip set, including 4,096 words of memory (16 chips of 4 kilobits each), on-board buffering, and interfaces to printers and CRT displays, plus an interface to Data General's diskette subsystem. Additional RAM storage is available in 4,096- or 8,192-word boards.

The full-chassis system can handle traditional OEM mini-computer functions, or it can serve as a program or interface development system similar to Intel's Inteltec or Motorola's Exorciser, but with full 16-bit capability. It's available with 9 or 18 board slots and with an optional calculator-sized hand-held programmer's console for remote data entry. A typical boxed chassis will contain 16,384 words of memory, a dual-diskette subsystem, and an asynchronous terminal, such as a teletypewriter. The chassis is expandable to 32,768 words of memory

Dynatrac[®] 3 lock-in analyzer can measure noisy signals up to 200 kHz.

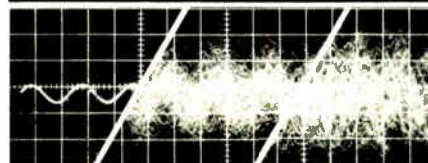

This unique new tool measures amplitude, phase, and frequency of signals obscured by noise, from picovolts to volts at frequencies from .1 Hz to 200 kHz and selectable bandwidths from .001 Hz to 100 Hz.

And, unlike conventional lock-in amplifiers, no phase adjustments are required.

There are many applications (with new ones turning up all the time) in which Dynatrac 3 picks up where the performance of vector voltmeters, phase meters, lock-in amplifiers, wave analyzers, transfer function analyzers, bridge balance null detectors, and noise meters leave off.

To get the complete Dynatrac 3 story (and tell us about your measurement problems), contact Ithaco, Box 818-EIR, Ithaca, N.Y. 14850. Or call (607) 272-7640, TWX 510-255-9307.

ITHACO

Stay current with small lamp data from General Electric. It's free.

Check these 6 halogen cycle lamps GE has added to its low-voltage line.

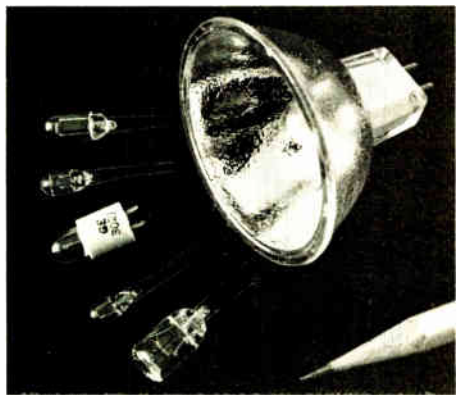

General Electric now offers over 27 halogen cycle lamps that pack high light output in small packages. (In addition, GE offers 8 sealed beam halogen lamps primarily for aircraft applications.) Bulb diameters range from $\frac{3}{16}$ " to $\frac{1}{2}$ ". Lengths from .520" to 2.25". Voltages from 3.5 to 28. O.V. And candlepower from 2.15 cd up to 250 cd.

They're ideal for you if you're designing applications such as optical systems, instrumentation, illuminators, fiber optics, card readers, displays and aircraft navigation. A variety of terminals are offered.

For updated technical information circle the number below or write GE for Bulletin #3-5357.

These GE wedge base miniature lamps offer you savings in time, money and space.

These lamps are ideal for applications such as indicators, markers and general illumination where space is at a premium. Their wedge-based construction makes them easy to insert and remove. They don't require bulky, complicated sockets. And because the filament is always positioned the same in relation to the base, you get consistent illumination from lamp to lamp.

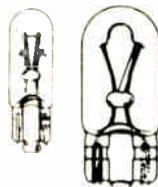

You can choose from over 25 types of GE wedge base lamps. Voltages range from 6.3 V to 28 V. Candlepower from 0.03 to 12 cd. Bulb sizes range from subminiature at 6mm to a heavy-duty bulb at 15mm.

To send for updated wedge base lamp technical information, circle number below or write GE for Bulletin #3-5259.

These three free GE catalogs include important data changes that could affect your present design. Send for yours today.



#3-5169

June '75 Miniature lamp catalog features 40 pages and 500 data changes for complete 500-lamp line.



#3-6252R1

Feb. '75 Sub-miniature lamp catalog features 24 pages and 91 changes for more than 210 lamps.



#3-6254R

Dec. '74 Glow Lamp catalog features 8 pages and 50 changes for 83 Glow Lamp Indicator and Circuit Component lamps.

For up-to-date technical information on any of these items write: General Electric Company, Miniature Lamp Products Department #3382-M, Nela Park, Cleveland, Ohio 44112.

GENERAL  ELECTRIC

New products

and, says Scanlon, will include Data General's disk operating system, standard software editors, a macro assembler, Fortran IV compiler and a relocatable loader. "In essence," he says, "the user will have mini-computer software."

Don McDougall, manager of product marketing, points out that a major question voiced by OEMs has been where they can grow with Data General in complexity, either up or down. "This line should answer that clearly," he says. McDougall notes that OEMs are "much concerned" about any company's commitment to all levels of its business and about its breadth of product line. The microNOVA line should erase any doubts about Data General's full-line commitment, he maintains.

The microNOVA family's key specifications include these instruction execution times: load accumulator, store accumulator, each 2.9 microseconds; add, 2.4 μ s; subtract, 2.4 μ s; multiply, 41.3 μ s, and divide, 59.1 μ s. The 4-k RAM has an access time of 160 nanoseconds, which Hendrie describes as conservative. Those specifications are slightly faster than the same execution times in the Nova 1200, and company officials stress that the chip set accommodates the full 16-bit multifunction instruction set for any machine in the Nova line.

Field support. Scanlon feels the closest any other company comes to the microNOVA line is Texas Instruments Inc., with its model 990 minicomputers that use a 16-bit TI microprocessor [*Electronics*, Nov. 13, 1975, p. 36]. But he stresses that Data General has more minicomputers installed, an important factor in field service support and software familiarity.

Scanlon doesn't expect Data General to be slugging it out for chip-set orders with semiconductor microprocessor manufacturers. He thinks most customers for the microNOVA line, including the chip sets, will be current Data General customers.

Data General Corp., Route 9, Southboro, Mass. 01772. Phone James Buchanan at (617) 485-9100 [338]

Microcomputers. How to make the make-or-buy decision.

<u>MAKE</u>	\$
CPU CHIP	_____
CLOCK CIRCUITRY	_____
CRYSTAL	_____
LATCHES	_____
MEMORY	_____
MISC. TTL CIRCUITRY	_____
MEMORY + I/O CONTROL	_____
ETCHED BOARD	_____
ENGINEERING DESIGN	_____
SYSTEM SOFTWARE DEV.	_____
DIAGNOSTIC SOFTWARE DEV.	_____
PROTOTYPE ASSEM. + TEST	_____
PURCHASING	_____
INCOMING INSPECTION	_____
INVENTORY	_____
DOCUMENTATION	_____
PLANT SPACE	_____
PRODUCTION PERSONNEL	_____
PRODUCTION EQUIPMENT	_____
TESTING EQUIPMENT	_____
PER UNIT TOTAL	\$ _____

<u>BUY</u>	\$
LSI-11	<u>634*</u>
16-BIT, 4K OF RAM,	
8 1/2" x 10" BOARD	
PER UNIT TOTAL	\$ <u>634</u>

When you're through comparing costs — which should wind up about the same — consider these additional facts:

Make your own micro and you waste up to a year just developing your product for market. Buy an LSI-11 and you don't.

Make your own micro and you have to maintain your own field service for it. Buy an LSI-11 and you don't.

Make your own micro and you get a dedicated machine you have to chuck next time you improve your product.

Buy an LSI-11 and you don't.

Make your own micro?

Buy an LSI-11.

For the complete story, call 800-225-9480 (Mass. 617-481-7400 ext.6410). Or write: Components Group, Digital Equipment Corp., One Iron Way, Marlborough, MA

01752. Canada: Digital Equipment of Canada, Ltd. Europe: 81 Route de l'Aire, 1211 Geneva 26, Tel. 42 79 50.

*In 100's. Prices apply to U.S.A. only.

digital
COMPONENTS
GROUP

5V @ 25 AMPS

only 1.68" high

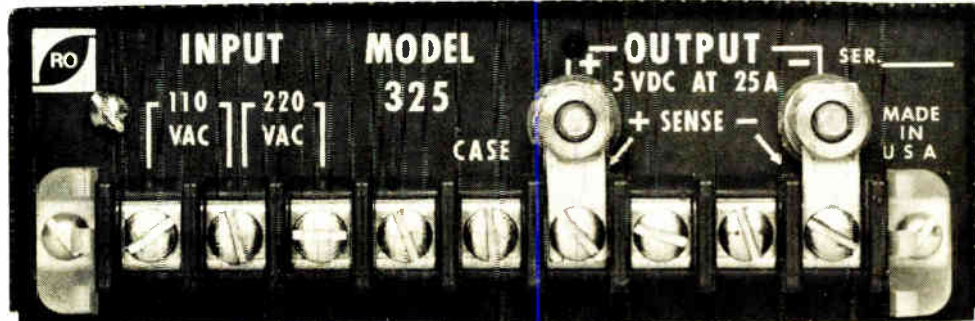

ACTUAL SIZE

The Newest Switcher from the Oldest Manufacturers of 20Khz

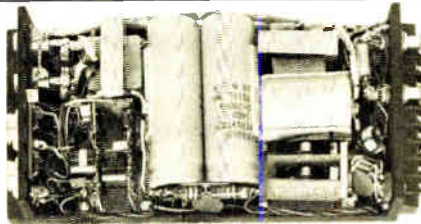

FEATURES

- 70% minimum efficiency
- low profile 1.7 inches
- 1.3W per cubic inch
- 115/230 VAC input without any strapping changes
- fully protected
- full power out at 80°C case temperature
- brownout protection to below 95 or 190 VAC in
- self-recovering overvoltage protection which does not turn off TTL loads
- parallelable by simply strapping the outputs together
- 5 year warranty
- \$299 in 100 piece quantity

RO Associates is proud to introduce its latest entry in the 20 kHz high efficiency switchers. We are the leaders in switching power supplies based on the number of units shipped within the last eight years. All units are fully burned in and thermally cycled over a period of four days under elevated temperatures which eliminates infant mortality failures. Like all other RO power supplies, a heatsink surface is supplied and the full output can be obtained as long as the case temperature is maintained at 80°C or less. The low profile of less than 1.7 inches allows use in spaces where no other power supply can be placed. All magnetics are vacuum impregnated or encapsulated in epoxy, and only teflon wire and sleeving is used throughout the unit.

This new series is unique in that there are four plug-in boards which contain all the low level circuitry and is considered field repairable. Please write for a complete catalog of all of our switching power supplies.



RO ASSOCIATES, Incorporated/3705 Haven Ave./Menlo Park, California 94025/[415] 322-5321/TWX 910-378-5929

Logic probe has pulse memory

First in family of digital troubleshooting instruments, priced at \$125, speeds design, testing of systems that have a variety of logic types

by Andy Santoni, Instrumentation Editor

Digital logic systems often combine a variety of logic families on a single board to take advantage of the distinctive features each has to offer. A system may be built with complementary-MOS circuits to minimize power consumption and contain transistor-transistor-logic chips to perform functions requiring higher speed, or it may contain some combination of TTL, C-MOS, and high-threshold logic.

The model 545A logic probe from Hewlett-Packard Co., the first in a series of new digital troubleshooting instruments from the firm [*Electronics*, Feb. 5, p. 26], can speed testing and designing systems containing most positive logic families: TTL, DTL, RTL, C-MOS, HTL, or MOS. Its price, \$125, is only slightly higher than that of similar instruments that can test only one logic form.

Two modes. The model 545A provides in-circuit functional indications in either of two modes. When the logic-level switch on the instrument's barrel is set to TTL, the logic thresholds are 2.0 volts +0.4, -0.2 v for a logic high and 0.8 v +0.2, -0.3 v for a logic low.

When the switch is set for the C-MOS mode, logic levels depend on the supply voltage: a logic high is greater than 0.7 times the supply voltage and a logic low is less than 0.3 times the supply voltage, and each of these levels has a tolerance of ± 0.5 v dc.

Power supply voltage can fall between 4 and 15 v dc in the TTL mode and between 3 and 18 v dc in the C-MOS mode. The unit is protected against overloads up to ± 25 v dc for one minute, and maximum current drain is 70 milliamperes.

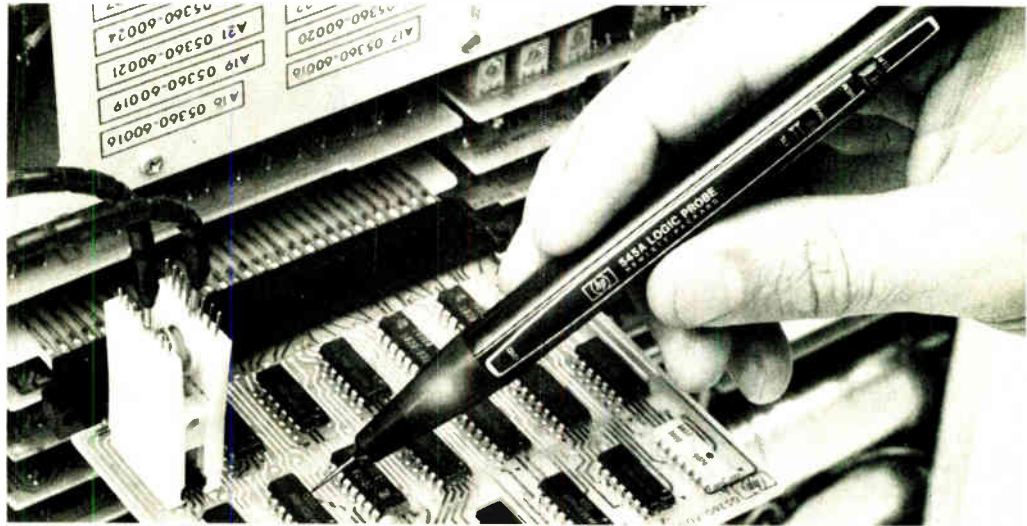

The probe also has an independent built-in pulse memory and display to catch intermittent pulses. When a logic change occurs after the probe tip has been placed on a circuit point and the memory has been reset, the memory circuit retains and displays the pulse until the reset button is again pressed. Use of the pulse memory has no effect on normal operation of the probe.

The single-lamp indicator near the probe tip shows the state of the circuit under test and can be seen from almost any angle. Its interpretation is straightforward. A bright lamp indicates a logic high, a logic low is indicated by a lamp off, and mid-level brightness indicates an open or a bad logic level.

Pulse-stretching is provided so that short, fast pulses are slowed down enough for the operator to see. The minimum input pulse width is 10 nanoseconds when the probe's ground lead is connected to the ground of the system under test,

and typically 20 ns without a ground-lead connection. Maximum pulse repetition rate of the input signal is 80 megahertz in the TTL mode and half that—40 MHz—in the C-MOS mode.

When pulse trains are present at the probe tip, the model 545A's indicator blinks at a constant rate of approximately 10 hertz. This simplifies the detection of a high-repetition-rate signal. If the logic probe were to track the pulse train's level changes, the indication would appear the same as that of a bad level or an open: mid-level brightness.

The probe requires input currents of 15 microamperes or less, source or sink, and has an input capacitance of 15 picofarads or less. Overload protection is provided to ± 120 v continuous from dc to 1 kHz and ± 250 v for 15 seconds over the same frequency range.

Inquiries Manager, Hewlett-Packard Co., 1501 Page Mill Rd., Palo Alto, Calif. 94304 [339]

At last! An EPROM that's going nowhere.

Once our EPROM is on board, it's there for keeps. You don't have to take it off to erase, program or reprogram. All it takes is a single high-voltage programming line, while all the other lines remain at TTL levels.

Instead of stocking a mass of different boards, now you can inventory a few common ones and personalize them later.

This on-board programmability is a huge advantage for our S6834, the latest member of the AMI microprocessor family.

Another version, the S5204A, gives you the same bonus as a second source to National's MM5204. But it's a lot faster.

Both AMI parts have other features that mean a big difference in your system's performance. You get the benefit of a dense 512x8-bit organization. The 575 ns access time makes it speed compatible with the AMI 6800. And the P-Channel SiGate process delivers an EPROM you can trust.

In fact, every spec makes our EPROM worth pinning down:

512x8-bit organization
Single high-voltage pin for programming
All I/O lines TTL compatible for read and program operations
Less than one minute programming time for all 4096 bits
575 ns access time
UV light erasable
Static operation: no clocks
Three-state data outputs
Standard power supplies: +5V, -12V
P-Channel Silicon Gate process
Hermetic package

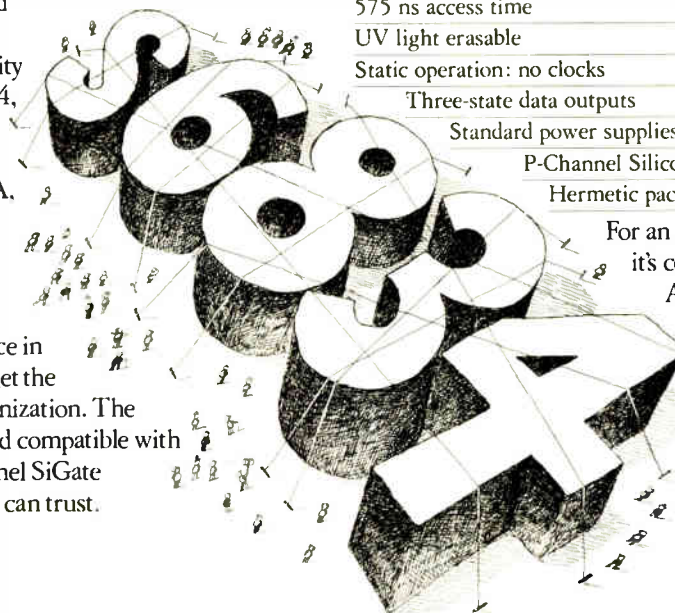

For an EPROM that's going nowhere, it's certainly got a lot going for it.

And it's available now from your local AMI sales office, distributor or representative. Give him a call. Then welcome our EPROM on board.

it's
standard
at **AMI**
AMERICAN MICROSYSTEMS, INC.

Our EPROM is here to stay:

SALES OFFICES

Manhattan Beach CA • (213) 379-2452
San Jose CA • (408) 249-4550
Altamonte Springs FL • (305) 830-8889
Elk Grove Village IL • (312) 437-6496
Norwood MA • (617) 762-0726
Livonia MI • (313) 478-9339
Minneapolis MN • (612) 559-9004
Monsey NY • (914) 352-5333
Cleveland OH • (216) 292-6850
Ambler PA • (215) 643-0217
Richardson TX • (214) 231-5721

DISTRIBUTORS

ALTA ELECTRONICS:
Utah—Salt Lake City (801) 486-7227

ARROW ELECTRONICS:
Minnesota—Bloomington
(612) 888-5522

CENTURY ELECTRONICS:
New Mexico—Albuquerque (505) 292-2700
Utah—Salt Lake City (801) 487-8551

INTERMARK ELECTRONICS:
Washington—Seattle (206) 767-3160

SCHWEBER ELECTRONICS:
California—Costa Mesa (213) 924-5594
and (714) 556-3880

Connecticut—Danbury (203) 792-3500
Florida—Hollywood (305) 927-0511
Georgia—Atlanta (404) 449-9170
Illinois—Elk Grove Village (312) 593-2740
Iowa—Cedar Rapids "Lorenz Sales"
(319) 393-0100

Maryland—Rockville (301) 881-3300
Massachusetts—Waltham (617) 890-8484
Michigan—Troy (313) 583-9242
Minnesota—Edina (612) 941-5280
New Jersey—Somerset (201) 469-6008
New York—Rochester (716) 461-4000
Westbury (516) 334-7474

Ohio—Beachwood (216) 464-2970
Texas—Austin (512) 837-2890
Dallas (214) 661-5010
Houston (713) 784-3600

Canada—Mississauga, Ont. (416) 678-9050

SEMICOMP CORP.:
California—Newport Beach
(213) 971-5253 and
(714) 833-3070

STERLING ELECTRONICS:
Arizona—Phoenix (602) 258-4531
Louisiana—Metairie
(504) 887-7610

Massachusetts—Watertown (617) 926-9720
New Jersey—Perth Amboy (201) 442-8000
New Mexico—Albuquerque (505) 345-6601
Texas—Dallas (214) 357-9131
Houston (713) 627-9800

Virginia—Richmond "Meridian" (804) 335-6521

R. V. WEATHERFORD CO.:
Arizona—Phoenix (602) 272-7144

California—Anaheim (714) 547-0891
Glendale (213) 849-3451
Palo Alto (415) 493-5373
Pomona (714) 623-1261
San Diego (714) 278-7400

Colorado—Englewood (303) 761-5432
New Mexico—Albuquerque (505) 842-0868

Texas—Dallas (214) 243-1571
Houston (713) 688-7406
Washington—Seattle (206) 243-6340

REPRESENTATIVES

ARNESON ASSOCIATES:
Oregon—Beaverton (503) 643-5754
Washington—Seattle (206) 762-7664

BARNHILL FIVE:
Colorado—Denver (303) 426-0222

BENEKE & McCAUL:
Missouri—Grandview (816) 765-2998

CANTEC REPRESENTATIVES, INC.:
Ontario—Ottawa (613) 225-0363

HADDON ASSOCIATES:
California—San Diego (714) 565-9445

HECHT, HENSCHEN & ASSOCIATES, INC.:
Arizona—Phoenix (602) 275-4411

LOWREY & ASSOCIATES:
Michigan—Brighton (313) 227-7067

PRECISION SALES COMPANY:
New York—Syracuse (315) 458-2223

REP, INC.:
Alabama—Huntsville (205) 881-9270
Georgia—Tucker (404) 938-4358

AMI
AMERICAN MICROSYSTEMS, INC.

New products

Instruments

Supply has three floating outputs

Low-cost unit combines fixed, variable sources for breadboarding circuits

Every engineer would like to equip his or her own work bench with a couple of power supplies just to avoid the time and trouble involved in searching for the right instrument or checking one out of the stock-



room. A combination of a 5-volt supply for digital circuits and a bipolar supply adjustable up to 20 v for analog circuits would cover most breadboarding and troubleshooting needs.

The Heath model IP/SP-2718 is a three-output power supply with enough current capability to meet many applications, plus a low enough price—\$140 wired or \$79.95 in kit form—to justify making them available to many engineers.

The IP/SP2718 combines a 5-v dc fixed output with two 0-20-v dc variable outputs in a single, compact unit. The three outputs are floating so that they can be connected in any combination for a wide variety of output voltage and current values.

The fixed supply provides 5 v $\pm 5\%$ at up to 1.5 amperes. The supply is regulated for less than 2% voltage variation from no load to full load and less than 0.15% output-voltage variation for line volt-

age changes as large as 10 volts.

The variable supplies are continuously adjustable from 0 to 20 v at up to 500 milliamperes. There is less than 0.1% variation in output voltage from no load to full load and less than 0.2% variation for line voltage changes of 10 v.

The two variable supplies can be made to track each other so that one will follow the other at any specified voltage difference. When the difference is set to zero and the low side of one output is connected to the high side of the other, the level of a bipolar supply can be set on a ganged pair of controls.

Ripple and noise are less than 5 mV rms on any output.

All outputs are protected against short circuits and are current-limited. A switchable front-panel meter can monitor the voltage or current at any of the outputs.

The supply operates from 100 to 135 or 200 to 270 v lines, 50 or 60 Hz. It measures 4½ inches high, 10¾ inches wide, and 9 inches deep. Shipping weight for either the kit or wired version is 12 pounds.

Heath Co., Benton Harbor, Mich. 49022 [351]

Synthesizer system has low per-channel price

While many fairly inexpensive frequency synthesizers have come onto the market over the past few years, these precision instruments are still far from cheap. So if an application, such as a frequency-agile system or an advanced frequency-division multiplexer requires many synthesizers, the price is still quite high. One way to reduce the cost of these units is to use a multichannel synthesizer system such as the system 51. Covering the frequency range from dc to 3 megahertz with a constant resolution of 1 hertz, the system 51 consists of a controller and from one to four mainframes, each of which holds up to 12 synthesizer channels. The channels employ a direct synthesis technique which allows them to respond to programing changes

Low-cost (under \$1500) IC testers

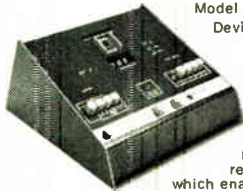

Model 1234 Linear IC Tester.
Devices tested: Monolithic
or Hybrid Operational
amplifiers.

Tests performed:
E_{OS}, I_{B-}, I_{B+}, DC
open loop gain, DC
CMRR, oscillation
detection.

Remarks: 3-digit direct
reading digital display
which enables go-no-go testing

Model 1248 Digital IC Tester.

Devices tested: 14 and 16
pins, TTL, DTL and
CMOS @ 5V. Tests per-
formed: Fixed pattern
functional test.

Remarks: Performs
2²⁰ inspections per test
in from 1 to 5 seconds. No
comparison with a "good"
IC is necessary. 4-digit display
gives absolute test results. Can
also be used to check continuity
of resistor network.



Model 1249
Digital IC Tester.

Devices tested:
TTL, DTL @ 5V, HTL @
15V, CMOS @ 5V,
10V, 15V.

Tests performed: Same as
1248. Remarks: Interfaces with
manual and automatic handlers. Multiple
voltages for CMOS.



Electro Scientific Industries
13900 N.W. Science Park Dr.
Portland, Oregon 97229
503-641-4141



Circle 142 on reader service card

FREE burglar — fire alarm catalog



over 500
systems,
detectors,
controls,
sounders,
tools, locks,
supplies

TO PROTECT HOMES, BUSINESSES, INDUSTRY

Huge selection of hard-to-find security
equipment from stock. 96 fact-filled pages
loaded with 100's of highest quality profes-
sional alarm products, technical notes,
diagrams.

ONE-STOP SUPERMARKET SELECTION INCLUDES:

ultrasonics, radar, infrared, undercarpet
mats, magnetic contacts, smoke & heat de-
tectors; Controls: Alarms: bells, sirens,
phone dialers, lights, guard panels. Large
selection of tools, relays, wire, holdup
alarms, books. Fills need for industry, alarm
cos., businesses, homes, institutions. Order
your copy today.



mountain west alarm
4215 n. 16th st.
phoenix, az. 85016
(602) 263-8831

New products

in only 1 microsecond, but a time
delay in the controller increases the
system response time to 5 μ s. Each
mainframe includes a power supply
and a crystal-controlled master
clock. Provision is also made for us-
ing an external clock such as a ces-
sium-beam standard.

Each channel has three outputs: a
sine wave and a complementary
pair of TTL-level square waves. The
sine wave has a fixed amplitude of
1 volt rms at a source impedance of
50 ohms. Harmonic components are
at least 40 decibels below the funda-
mental, while nonharmonic compo-
nents are at least 50 dB down
through 2 MHz and 40 dB down
from 2 to 3 MHz. Phase noise in a
30-kilohertz band excluding 1 Hz
centered on the carrier does not ex-
ceed -50 dB from 1 Hz to 2 MHz, and
-40 dB from 2 to 3 MHz. The square
waves have the same phase-noise
specification as the sine wave.

The controller can be operated lo-
cally, by means of front-panel
switches, or remotely—by a com-
puter, for example—using 25 TTL-
compatible lines which are brought
out to a rear-panel connector.

Pricing on the system 51 starts at
\$27,500 for a 12-channel system.
Delivery time is 120 days.

Rockland Systems Corp., 230 West Nyack
Rd., West Nyack, N. Y. 10994. Phone Dave
Kohn at (914) 623-6666 [353]

eight inputs can be used to trigger
the analyzer. Features include a
glitch-detector mode, an adjustable
display rate, and provision for exter-
nal clock input (up to 5 megahertz).
The model 80 sells for \$595 includ-
ing a set of probes.

Digital Broadcast Systems Inc., Brentwood
Lane, Madison, Ala. 35758. Phone (205)
837-2183 [354]

Digital capacitance meter measures up to 199.99 μ F

Able to measure capacitances up to
199.99 microfarads in seven ranges,
with a resolution of 0.01 picofarad
on the lowest range, the model 475
capacitance meter also measures
dissipation factor from 0.0000 to
1.9999 to within an accuracy of
0.0005. Basic capacitance-measuring
accuracy is within 0.1%. The instru-
ment makes four-terminal measure-

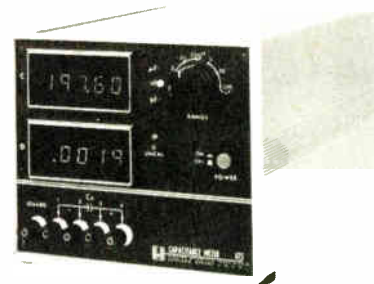

Logic analyzer handles up to eight channels

The model 80 logic analyzer is an
eight-channel instrument that can
be used with an oscilloscope to dis-
play the logic and timing relation-
ships of up to eight synchronous or
asynchronous signals. Any of its

ments at a test frequency of 1 ki-
lohertz. Provision is made for the
application of a dc bias voltage
through rear-panel terminals to test
diodes or electrolytic and tantalum
capacitors. The model 475 is priced
at \$2,200.

Electro Scientific Industries Inc., 13900
N.W. Science Park Dr., Portland, Ore.
97229. Phone (503) 646-4141 [355]

Meters measure inductance at 1-MHz test frequency

Two series inductance meters—one
analog, the other digital—are
noteworthy for their ability to make



150ns 4K RAMs.

Now in volume production.

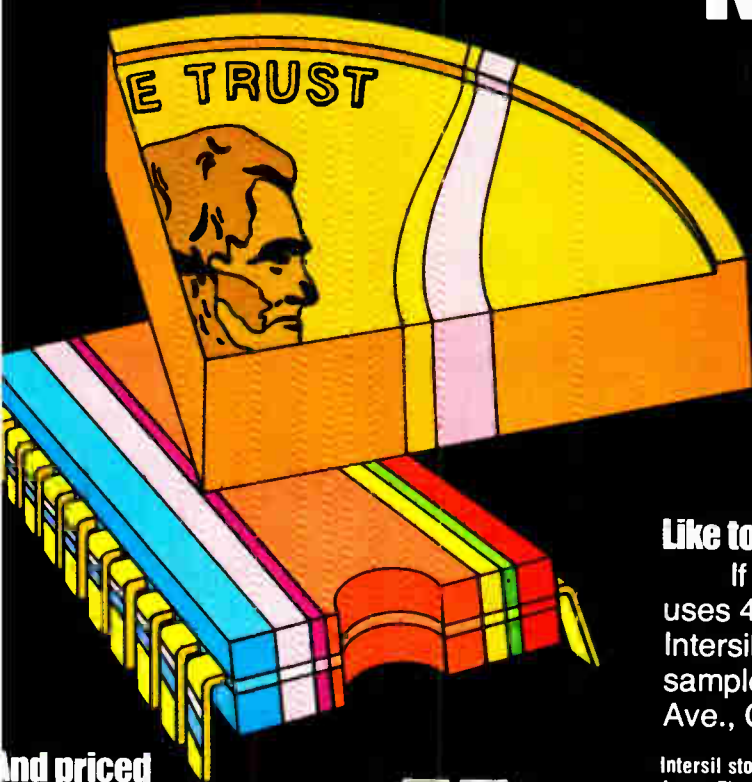

And priced under 1/2¢ per bit.

Others in family below 1/4¢ per bit.

Intersil meets all price competitors with their IM7505A 4096 × 1 MOS RAM

family, the pin-for-pin replacements for the 22-lead Motorola MCM6605s. The IM7505A-1, with its 150ns access speed, is the highest performance dynamic 4K memory in volume production at any price. Cost of the 300ns IM7505A is down to 1/4¢ per bit in 100+ quantities... even lower in higher volume. Comparable price reductions on the "-1" and "-2" versions make this truly the best all-round 4K RAM family you can find.



Like to know more?

If your prototype or production system uses 4K MOS RAMs, call your nearest Intersil sales office for data sheets and/or samples. Intersil, 10900 North Tantau Ave., Cupertino, CA 95014

Intersil stocking distributors

Arrow Electronics
Century Electronics
Elmar/Liberty Electronics
Kierulff Electronics (Mass.)
Marshall Ind. (L.A., San Diego)
R.A.E. Ind. Elect. Ltd. (Van. E.C.)
Schweber Electronics
Semiconductor Specialists
Sheridan Assoc. (PA)
Southland (Fla.)
Weatherford
Zentronics (Canada)

Intersil area sales offices

Boston (617)273-2055
Chicago (312)986-5303
Dallas (214)387-0539
Los Angeles (213)532-3544
Miami (305)971-6160
Minneapolis (612)925-1844
New York (212)567-5585
San Francisco Bay Area (408)984-2170
Upstate New York/Canada
(315)468-3368

Representatives in all major cities.



**Intersil
means
memory**

4096 × 1 MOS RAM	Max. Access	Delivery ARO 100 pcs	5K/ma	Price 100+
IM7505A	300ns	OTS	2 wks	\$ 9.99
IM7505A-1	150ns	OTS	8 wks	14.99
IM7505A-2	200ns	OTS	4 wks	10.23

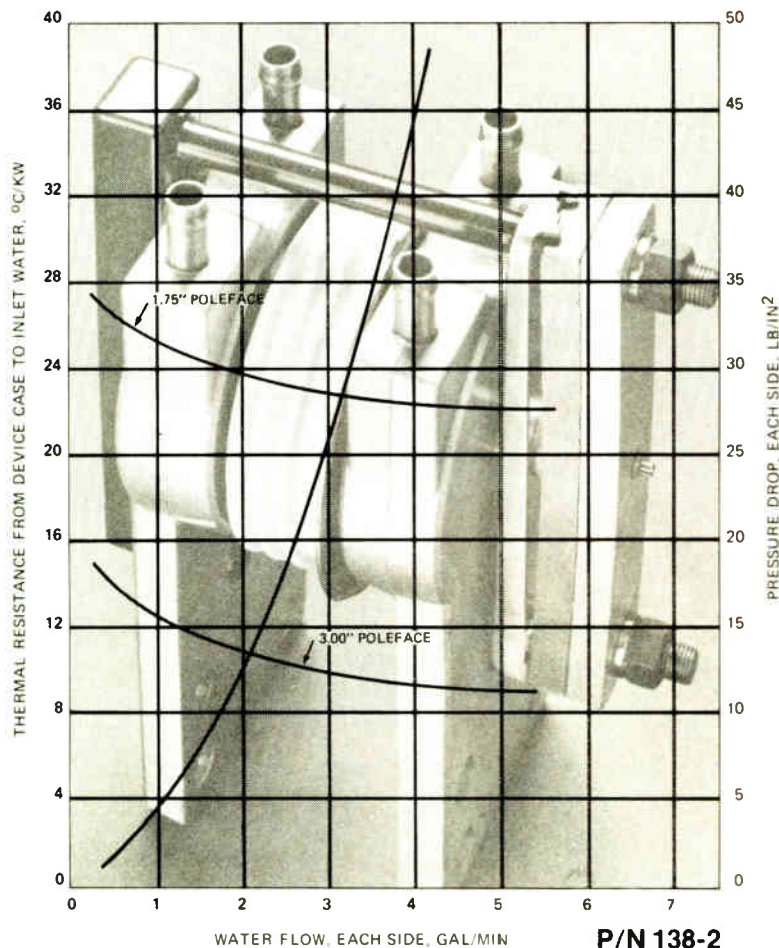

The Best Way to Cool Compression Type SCR's and Diodes

Wakefield's new Series 138 is a super efficient liquid-cooled bus block for use with up to 3 inch diameter compression type SCR's and diodes. Its unique design allows dissipation of 1 KW with less than 10° C temperature rise — performance unmatched by anything else available.

Accommodating Wakefield clamp #144 (6,000 lbs.) or #145 (10,000 lbs.), the Series 138 features low thermal resistance, low water flow and a massive area for mounting to a bus bar. The units are cast aluminum around copper tubes, combining the economy of aluminum with the compatibility of water and copper.

Call or write for full details on the latest of Wakefield's semiconductor coolers.



WAKEFIELD ENGINEERING INC.

AN **EG&G** COMPANY

77 AUDUBON ROAD WAKEFIELD, MA 01880 (617) 245-5900 TWX 710-348-6713

New products



two-terminal inductance measurements at low test currents and at a frequency of 1 megahertz. The analog model 62A has full-scale manual ranges from 1 microhenry to 3,000 μH arranged in a 1-3-10 sequence, while the digital model 62AD has four decade ranges from 2 μH to 2,000 μH full scale. The digital unit has both manual and auto-ranging modes.

The test current for both meters varies from 160 microamperes on the most sensitive ranges to 160 nanoamperes on the top ranges. The digital 62AD has both data outputs and programing inputs so that it can easily be incorporated into an automatic test system. Pricing on the meters is \$1,050 for the 62A and \$1,400 for the 62AD. Delivery time is two weeks.

Boonton Electronics Corp., Parsippany, N. J. Phone Wallace F. White at (201) 887-5110 [356]

120-MHz counter/timer sells for \$279 in kit form

Priced at only \$279 in kit form, the Unic 2001 is a universal counter/timer that can measure frequencies from 1 hertz to 120 megahertz, time intervals from 10 nanoseconds to 5 seconds, and events up to 99,999,999. In its standard form, the counter has a temperature-compensated crystal-controlled time base with an aging rate of 1 ppm per year. Various options



45nS 1K Schottky RAMs.

Now in volume production.



Prices down to 1¢ per bit.

Intersil's IM55S08/18 is a replacement for the 93415/93425 and the 82S08. The bipolar Schottky IM55S08/18 combines PNP inputs, 45nS typical access times and your choice of output: the opencollector IM55S08 or the three-state IM55S18. In addition, an "-A" version guarantees 45nS maximum access time over commercial temperature range.

Packaged in a 16-pin ceramic DIP, the IM55S08/18 is a cent-a-bit in 100+ volume, the IM55S08A/18A is 1½¢ a bit ... but for really low price, try us in larger quantities!

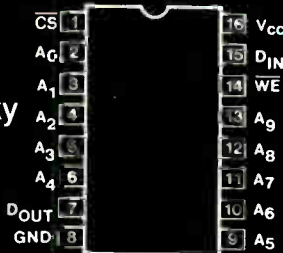

Intersil stocking distributors

Arrow Electronics
Century Electronics
Elmar/Liberty Electronics
Kierulff Electronics (Mass.)
Marshall Ind. (L.A., San Diego)
R.A.E. Ind. Elect. Ltd. (Van. B.C.)
Schweber Electronics
Semiconductor Specialists
Sheridan Assoc. (PA)
Southland (Fla.)
Weatherford
Zentronics (Canada)

Intersil area sales offices

Boston (617)273-2055
Chicago (312)986-5303
Dallas (214)387-0539
Los Angeles (213)532-3544
Miami (305)971-6160
Minneapolis (612)925-1844
New York (201)567-5585
San Francisco Bay Area (408)984-2170
Upstate New York/Canada
(315)463-3368

Representatives in all major cities.

1024 × 1 Schottky RAM	Temp. Range	Max. Access	Delivery 100 pcs	ARD 5K/mo	Price 100+
IM55S08AC	0 to +75°C	45nS	8 wks	12 wks	\$14.99
IM55S18AC	0 to +75°C	45nS	8 wks	12 wks	14.99
IM55S08C	0 to +75°C	70nS	OTS	7 wks	9.99
IM55S18C	0 to +75°C	70nS	OTS	7 wks	9.99
IM55S08M	-55 to +125°C	75nS	OTS	8 wks	19.99
IM55S18M	-55 to +125°C	75nS	OTS	8 wks	19.99

Like to know more?

If your prototype or production system uses 1K bipolar RAMs, call your nearest Intersil sales office for data sheets and/or samples. Intersil, 10900 North Tantau



**Intersil
means
memory**

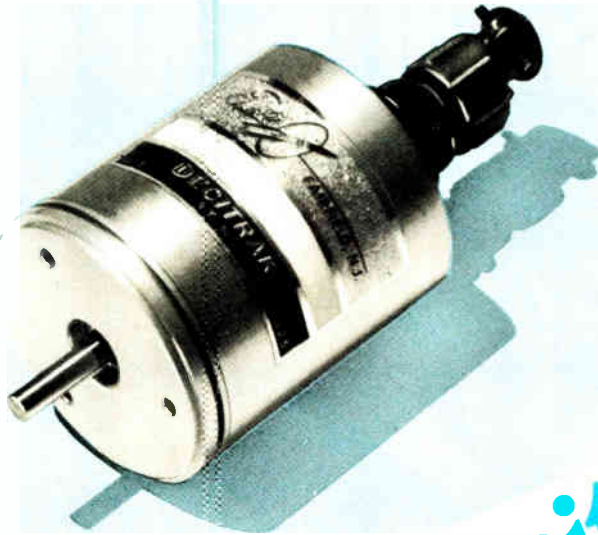

Decittrak[®] decit

OPTICAL INCREMENTAL SHAFT ENCODER

**Low,
Low Cost ...
Rugged Industrial
Design... Wide Ranges
Available Up To 14,400
Counts...**

The ideal, low cost incremental encoder to digitize rotary motion for display and control...up to 14,400 counts per turn...ultra reliable LED light source...only 5VDC required for operation...Bi-directional outputs in sine wave, square wave or pulse format...heavy duty industrial design...And...if you need additional electronics or a system, you can rely on Theta. Our application engineers are ready to help.

LITERATURE:

Write for descriptive literature and your free copy of Digital Solutions to Automatic Control

Theta



3000
INSTRUMENT CORPORATION

Fairfield, New Jersey 07006 • Phone: 201-227-1700

New products

range from the elimination of the time base (at a saving of \$35) to the inclusion of a double-cavity ovenized crystal oscillator (at a price increase of \$125). A wide variety of other options, including special-function cards for the direct display of rpm or gph, is also available. The instrument sells for \$399.95 in wired form.

Beco Inc., P. O. Box 67, Wirtz, Va. 24184.
Phone (703) 483-9258 [357]

Signal generator provides two tones for SSB tests

Covering the range from 250 kilohertz to 80 megahertz, an rf signal generator, model 315, provides two-tone information for testing single-sideband equipment. It is capable of delivering single- or two-tone signals at levels of 0.1 μ v (-127 dBm) to 2 v (+19 dBm) per tone. Signal spacing can be adjusted from 100 Hz to almost 80 MHz.

LogiMetrics Inc., 121-03 Dupont St., Plainview, N.Y. 11803. Phone Murray Feigenbaum at (516) 681-4700 [358]

TOPICS Instruments

Astro-Med, West Warwick, R. I., has announced a lifetime guarantee on the heated styluses used in all of its chart recorders.

Exact Electronics Inc., Hillsboro, Ore., has developed an ASCII interface for its model 605 programable function generator. The new interface is compatible with IEEE standard 488.

Keithley Instruments Inc., Cleveland, Ohio, has announced its model 7802-1SB interface card, which is designed to allow instruments that meet IEEE standard 488 to plug into Keithley's system 1 calculator-based automatic test system.

Weinschel Engineering, Gaithersburg, Md., has expanded its solid-state sweeper line with the addition of the model 436A plug-in unit which covers the range from 18 to 26.5 gigahertz.

MORE PULL in a smaller package?

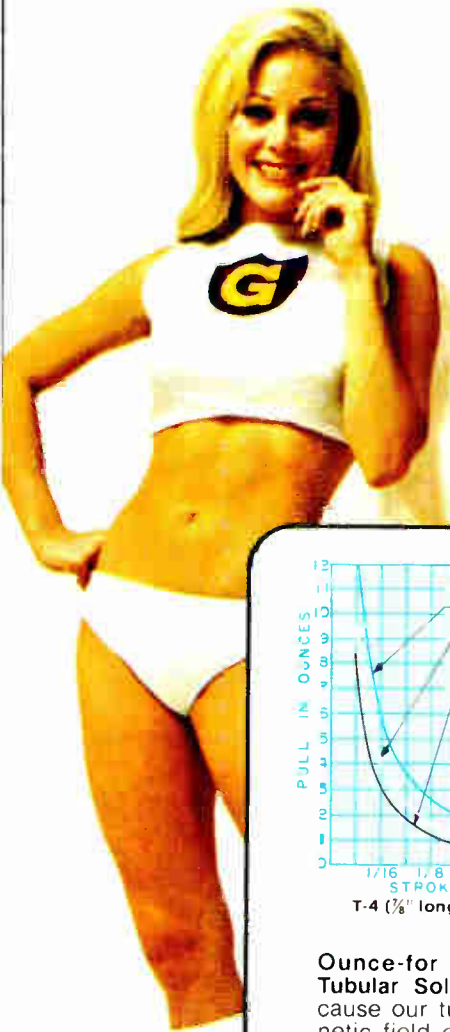

Check these curves.

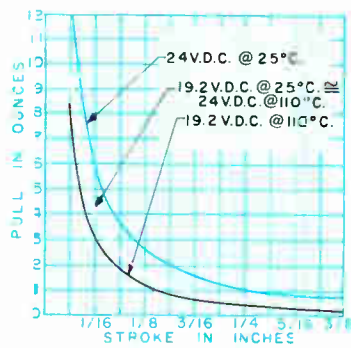

T-4 (7/8" long) Intermittent duty

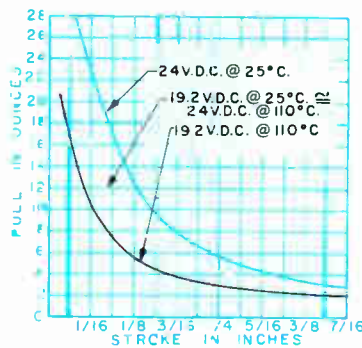

T-8 (1 1/8" long) Continuous Duty

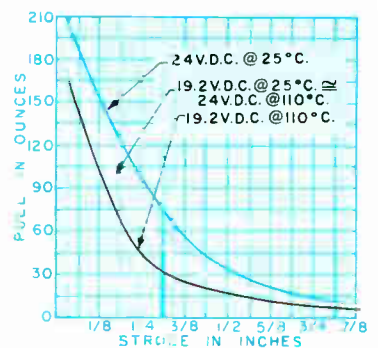

T-12 (1 1/2" long) Intermittent Duty

Ounce-for ounce, inch-for-inch Guardian Tubular Solenoids pack more power... because our tubular designs assure total magnetic field enclosure and result in efficient, powerful operation. More efficient than other DC solenoids. They give you more power in less space, plus UL and CSA recognition.

Easy to design-in. Easy to install. By design.

Guardian Tubulars work in any position. Close tolerance between plunger and bobbin means no possibility of double seating. So they work in your product just the way you want them to work.

Mount them directly into panel by inserting threaded bushing thru installation hole and tightening nut on lock washer. Or, mount with standard bracket.

Either way, Guardian Tubulars install without damage to the solenoid. Look how the

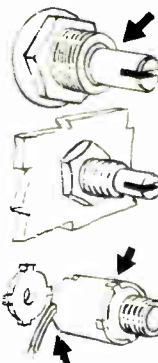

notched tube-steel shell mates with notched end plate. Result? A stronger assembly that takes more torque when installing... with no chance of damage. The leads emerge thru a notch in the steel shell, so they will not, can not be sheared by rotation during installation.

Once you put a Guardian Tubular in your product... forget it. Typical mechanical life is 20 million. That's probably longer than your product's life expectancy... due primarily to the unique Valox® 420 molded bobbin.

Variations and specials? Guardian's got 'em. Any DC voltage from 6 to 240. Push type or pull type operation. Return springs, silencers, termination variations, special mountings... you name it and we'll deliver it with the high quality craftsmanship and low prices that have made Guardian Number 1 in Solenoids—and that keeps us here on top.

Let the Guardian Angel reveal all the pull charts and curves in full size. Send for your free copy of our 72 page catalog.



This mark indicates recognition under the compliance program of Underwriters Laboratories, Inc.



GUARDIAN®

GUARDIAN ELECTRIC MANUFACTURING CO. 1566 West Carroll Avenue—Chicago, Illinois 60607 • 312/243-1100

World Radio History

Circle 147 on reader service card

designed by Grayhill as the world's smallest rotary switch



**10 positions, 1 or 2 poles,
diameter less than .300"**

- Non-shorting...wiping contacts
...rated to make or break 15,000
cycles minimum at logic loads.
- Now available with integral knob
...as well as screwdriver or
shaft operated.
- For communications circuits,
electronic stopwatches, and
other low voltage applications
where size is critical

As the pioneer in switch microminiaturization, we present our Series 75, designed as the smallest the state of the art permits. If you think that small switch means big price...guess again. Here's a lot of switch in a tiny package at a cost that's surprisingly low. Write for Bulletin #237 describing these miniature switches...and consult EEM for more information on Grayhill products.



561 Hillgrove Avenue • LaGrange, Illinois 60525
(312) 354-1040

New products

Semiconductors

Rectifier diodes switch in 100 ns

High speed holds down
temperature, aids efficiency
in radar, other systems

Credit goes to improved production techniques, rather than design changes, for the development of a line of rectifier diodes that can switch 1,000 volts in as little as 100 nanoseconds.

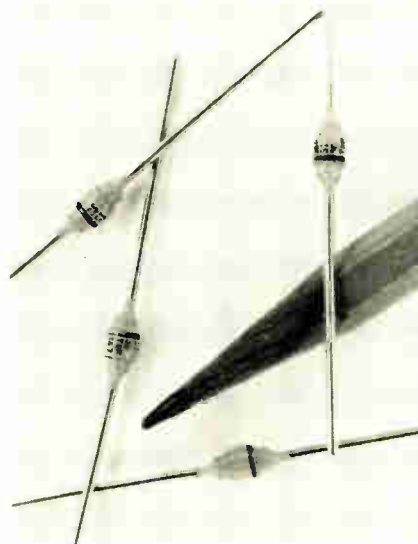

Developed by TRW Semiconductors, the 500X series is an advance on units sold to date by TRW and others, which require up to 700 ns at 1,000 v, says Arthur Forbes, product manager.

Because the basic operating properties of this type of mesa-junction device (and thus its speed) depend on an even deposition of gold on the switch mechanism, the objective was to do a better diffusing job, Forbes says. In the past, the gold doping was diffused onto the junction only at high temperature and "often diffused out so thinly that in operation it migrated and allowed the underlying nickel to come up and lose the device its switching

properties," he adds. To correct this condition, the TRW researchers found new techniques to diffuse the gold doping and seal the completed switch at temperatures under 400°C.

The need for even faster rectifier switching exists because a high speed holds down operating temperatures and contributes to overall system efficiency. The devices have already been tested in radar equipment, for example, where the fast rectifiers operating with a traveling-wave tube increase system efficiency by a critical 2% or 3%, Forbes says. A continuing program to attain comparable operation at 1,600 v should show results by year end, he predicts.

Other specifications for the rectifiers include: 100-v switching in 5 to 7.5 ns, and 500-v in 20 to 30 ns. Maximum current at 25°C is 10 microamperes and at 100°C, 350 μ A. The maximum recommended junction temperature is 160°C.

The rectifiers are packaged in a voidless monolithic glass-metal structure, using no organic materials. Designed in either 3- or 5-watt versions, parts are currently available for sampling. Volume production is scheduled for April 1. The 5-w unit will sell for \$7.50 in lots of 1,000, and the 3-w rectifier for \$4.

TRW Semiconductors, Division of TRW Inc., 14520 Aviation Blvd., Lawndale, Calif. 90260. Call Arthur Forbes at (213) 679-4561 [411]

4-k static RAM has 100-ns access time

The 4402B 4,096-bit fully static random-access memory has an access time of 100 nanoseconds and a cycle time of 300 ns. Believed to be the fastest 4-k static RAM available today, the unit is aimed at communications switching systems, fast mainframe memory systems, and similar demanding applications. The memory requires two power supplies: a V_{DD} supply of +12 volts \pm 5%, and a V_{SS} supply of -5 v \pm 10%. It will retain all of its data even if V_{DD} drops as low as +4 v.



There's virtually no door in metal finishing that OMI can't open

With four operating groups, OMI offers the most extensive source of metal finishing expertise, equipment, processes, chemicals, and supplies anywhere.

There is the Electrochemical Group, manufacturers of Udylite base metal electroplating processes and surface conditioners and Sel-Rex precious metal processes with compatible base metal cleaning and plating systems; the Equipment Group providing Udylite and Sel-Rex plating equipment from laboratory units to fully automatic machines; the Recovery Services Group for precious metal scrap recovery and refining; and the Specialty Chemical Group which manufactures Parker products for paint-base, cold-forming, and specialized metal treatment applications.

What's more, OMI is constantly expanding this capability, opening new doors in metal finishing with pollution control and waste treatment systems to meet ecological requirements, base metal recovery and sludge disposal services, as well as continuous process equipment...we're growing in every direction.

For more information on OMI and how we improve products and make profits grow, write for our brochure "The World of OMI."

Oxy Metal Industries Corporation, 21441 Hoover Rd., Warren, Michigan 48089.

OMI

OXY METAL INDUSTRIES CORPORATION

New snap-in rockers with Cutler-Hammer reliability.

Here's a completely new line of snap-ins, each engineered with the kind of solid dependability you expect in Cutler-Hammer Rockette® switches. Bright metal bezels, illuminated and non-illuminated, A-c and D-c capabilities up to 20 amps.

Sub-panel rockers in a variety of colors, rocker or paddle designs in standard, special, or proprietary models.

Switches snap in and stay in permanently. Speed up assembly time, cut costs.

Flush-mounted rockers in the same wide range of designer-oriented colors and styles. One- and two-pole models.

Illuminated single-pole rockers. Choice of red, green, amber, white, or clear. Hot-stamped legends indicate switch functions.

For more information, call your Cutler-Hammer Sales Office or Switch Distributor.



CUTLER-HAMMER
SPECIALTY PRODUCTS DIVISION, Milwaukee, Wis. 53201

World Radio History

 **Switch to No.1**

Circle 150 on reader service card

**LOW
COST**

\$5.95
(1-999)



Model
CM-1

DOUBLY-BALANCED MIXER

- Wide Bandwidth
DC-500 MHz
- Low Conversion Loss
6 dB Typical
- High Isolation 40 dB Typical
- Miniature Size
0.4" x 0.4" x 0.8"

Extensive design and manufacturing experience combined with high volume, high-reliability capabilities results in the best price/performance/package available.

Send For Application Bulletins



a Division of
Vari-L Company, Inc.

3883 Monaco Pkwy, Denver, CO 80207
Ph: (303) 321-1511/TWX: 910-931-0590

A-8

Circle 151 on reader service card

PINPOINT HEAT

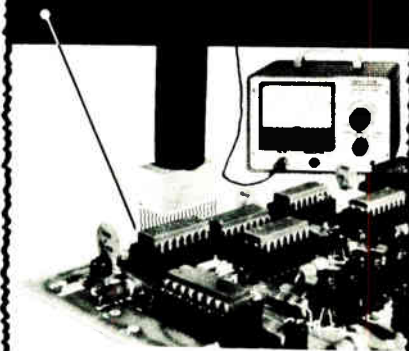

Heat any I. C. or semiconductor component to its rated temperature with a heat probe. Accuracy $\pm 1/2^\circ\text{C}$. Or check the component's temperature with a thermocouple probe. Accuracy $\pm 1^\circ\text{C}$. Model 810 Thermo-Probe does both. Reads out directly in $^\circ\text{C}$ and $^\circ\text{F}$ on a large $4 1/2$ -inch meter.

PRICE \$299.50 F.O.B. South Laguna

Models with other temperature ranges available. For details write to:

MTI MICRO-TECHNICAL INDUSTRIES

P.O. Box 287 South Laguna, CA 92677
714 545-3734 • TWX 910-587-3425 MICRO OHM ELM

Circle 220 on reader service card

New products

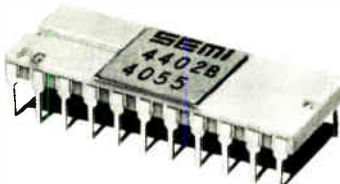
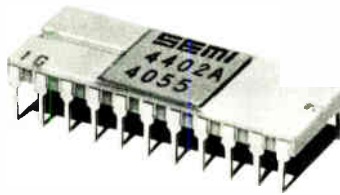

Typical operating power consumption is 450 milliwatts.

A companion memory, the 4402A, is slightly slower—its access time is 150 ns and its cycle time is 350 ns. Both metal-gate n-MOS devices are housed in 22-pin dual in-line packages with pinouts compatible with those of 22-pin dynamic 4-k RAMs. Two other 4-k memories—one that requires only a single 5-v power supply and one organized as 1,024 four-bit words (to make it easier to use in microprocessor systems)—are a few months down the line.

The 4402A sells for \$15.25 in hundreds, while the 4402B is priced at \$22 in similar quantities.

SEMI Inc., 3883 North 28 Ave., Phoenix, Ariz. 85017. Phone Fran Krch (pronounced Kirch) at (602) 263-0202 [415]

IC combines counters, data latches, and output buffers

Intended for use in digital instruments, which often employ decade counters, data latches, and seven-segment output buffers, the MM74C925 combines all of these functions in a single package. Consisting of a four-digit counter, data latches, and a multiplexed seven-segment output capable of driving a four-digit LED display, the IC contains its own free-running oscillator, and thus requires no external clock for the multiplexing circuit. Built with National's high-noise-immun-

**GUIDE TO
DIELECTRIC MATERIALS**



Short form catalog is a useful illustrated guide to product lines and literature. Eighteen different product lines are described. Useful applications and outstanding properties are listed. The catalog contains a reader service card for requesting more detailed information on specific product lines.

Circle 221 on reader service card

**DIELECTRIC MATERIALS
CHART REVISED IN 1975**

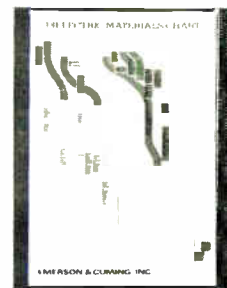

This colorful chart is a standard reference for electronic engineers. Shows Dielectric Constant (ϵ') and Loss Tangent ($\tan \delta$) for many E&C products and common materials plotted on 11" x 16 1/2" graph. For notebook or wall mounting.

Circle 222 on reader service card

**NEW TECHNICAL DATA ON
EPOXY CASTING RESINS**



STYCAST® Casting Resins are described and properties tabulated in this new folder/wall chart. Includes all significant properties of 24 high-performance resins plus notes on curing agents, cure procedures and use. Valuable reference.

Circle 223 on reader service card

Emerson & Cuming, Inc.



CANTON, MASS.
GARDENA, CALIF.
NORTHBROOK, ILL.
Sales Offices
in Principal Cities

EMERSON & CUMING EUROPE N.V., Oevel, Belgium

OUR 4K RAMS ARE SO GOOD, EVEN THE COMPETITION CAN'T RESIST.

Our μ PD411 series of 4K dynamic RAMs is so much better than anything else on the market, even

people who make their own 4K RAMs are buying ours. For their add-on memory systems.

Here's why:

First, speed. While everyone else is only talking about speeds of around 200ns, we're delivering 4K RAMs with speeds down to

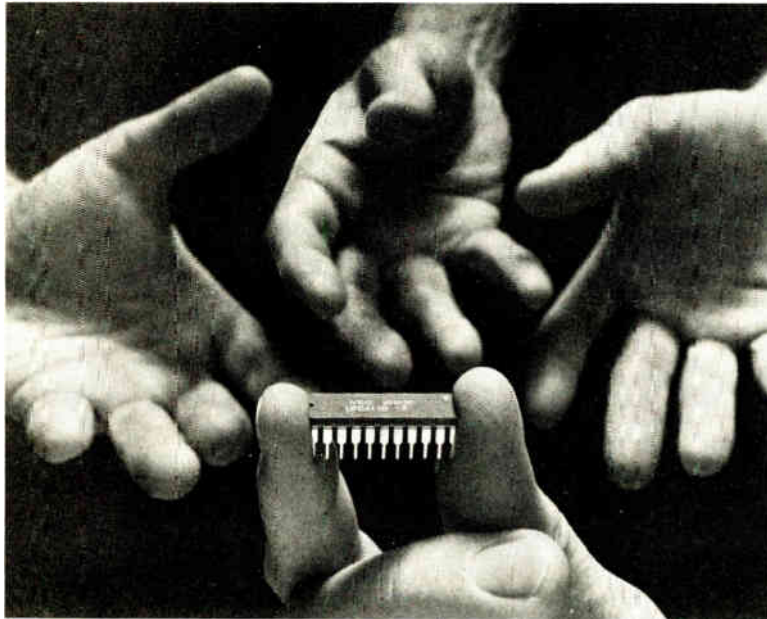

150ns and less.

Second, reliability. Our 4K RAMs are made to the highest standards of reliability in the business. Yields on incoming inspection are honestly amazing. And MTBFs are over 5 million hours.

Third, delivery. We can deliver this state-

of-the-art technology and incredible reliability right now. In whatever volume you want.

So if you need 4K RAMs, take a look at our μ PD411 series — the best 4K RAMs you can buy.

But don't take our word for it.

Ask our competition. NEC Microcomputers, Inc., Five Militia Drive, Lexington, Massachusetts 02173. 617/862-6410.

NEC microcomputers, inc.

WHERE TO BUY IT.

REPS

East

Circuit Sales Co.
Lexington, MA
617/861-0567

Trionic Assoc.
Great Neck, NY
516/466-2300

C.H. Newson
Philadelphia, PA
215/248-3377

Harrisburg
717/233-8576

Baltimore
301/825-0001

Perrott Assoc.
Orlando, FL
305/275-1132

Largo, FL
813/585-3327
Ft. Lauderdale, FL
305/792-2211

Wolff's Sales Serv.
Raleigh, NC
919/781-0164

Space Eng. Sales
Huntsville, AL
205/837-6060

Central

McFadden Sales
Columbus, OH
614/221-3363

Bitronics Sales Co.
Minneapolis, MN
612/835-7744

RF Specialists
Park Ridge, IL
312/698-2044

Merino Sales Co.
Dallas, TX
214/233-6002

R.C. Nordstrom
Lathrup Village, MI
313/559-7373
Benton Harbor, MI
616/429-8560

West

Mike Duffy Assoc.
Denver, CO
303/934-7392

Tri-Tronix
Albuquerque, NM
505/265-8409
Bellevue, WA
206/454-0940

Summit Sales
Scottsdale, AZ
602/994-4587

F.C.M.
Woodland Hills, CA
213/340-1745
El Toro, CA
714/830-3939
San Diego, CA
714/295-6122

Trident Assoc.
Mountain View, CA
415/967-7031

Canada

R.F.Q. Ltd.
Toronto, ONT
416/625-8874
Montreal, QUE
514/626-8324

DISTRIBUTORS

Harvey Elect.
Lexington, MA
617/861-9200

Norwalk, CT
203/853-1515

Fairfield, NJ
201/227-0515

Woodbury, NY
516/921-8700

Intermark Elect.
Seattle, WA
206/767-3160

Santa Ana, CA
714/540-1322

San Diego, CA
714/279-5200

714/453-9005

Sunnyvale, CA
408/738-1111

New products

ity C-MOS process, the circuit has a guaranteed noise margin of 1 volt, and can operate from supply voltages from 3 to 6 v dc. Several variations on the basic circuit are also available. For example, the MM74C927 divides the second most significant digit by six instead of by 10; thus, with a 10-Hz input frequency its display will read in minutes, tens of seconds, and seconds. The IC sells for \$8 in hundreds and is available from stock.

National Semiconductor Corp., 2900 Semiconductor Dr., Santa Clara, Calif. 95051. Phone (408) 732-5000 [413]

10-kV rectifier is only

0.420 inch in length

Measuring only 0.420 inch long and 0.180 in. in diameter, the Semtech type SM 100 silicon rectifier is rated at 100 milliamperes forward current at 55°C and at 10,000 v peak inverse voltage. Other similar units have PIV

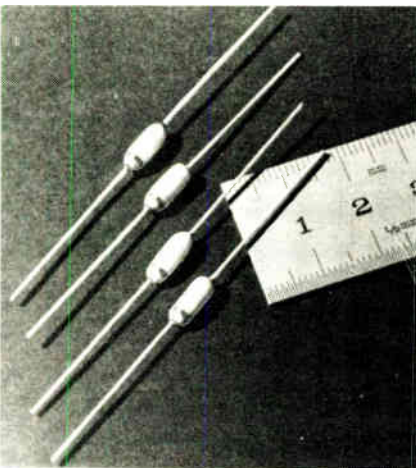

ratings of 4,000, 5,000, and 7,500 v. Made with Semtech's proprietary Metoxilite process, the rectifiers' outer cases consist of metal oxides which are fused directly to the rectifier junction assembly. Originally developed for critical military/aerospace applications, the rectifiers are also suitable for industrial applications and even some consumer products in which very high reliability is essential even in the face of high voltages and extreme

thermal shock. Delivery of the rectifier is from stock.

Semtech Corp., 652 Mitchell Rd., Newbury Park, Calif. 91320. Phone William B. Krause at (805) 498-2111 or (213) 628-5392 [414]

Four-bit ALU

is extremely fast

A four-bit arithmetic logic unit made by a low-power Schottky process is capable of performing a full 16-bit add or subtract operation in only 56 nanoseconds. Designated the Am25LS181, the ALU is a plug-in replacement for the 54LS/74LS181. It can perform 16 binary arithmetic operations on two four-bit words, including add, subtract, double, and compare. The IC is offered in a wide variety of forms and in both commercial and military temperature ranges. Pricing varies from as little as \$4.50 each to as much as \$15.55 each in hundreds. Advanced Micro Devices Inc., 901 Thompson Pl., Sunnyvale, Calif. 94086. Phone (408) 732-2400 [416]

TOPICS

Semiconductors

Motorola Semiconductor Products Inc., Austin, Texas, is into full production on its 4,096-bit MOS dynamic RAM. Housed in a 16-pin DIP, the MCM6604 is now available from stock. . . . **AMS Semiconductor Div. of Advanced Memory Systems Inc., Sunnyvale, Calif.,** has begun shipping production quantities of a new 4-k dynamic RAM that is housed in a 22-pin DIP. The AMS 7280 is TTL-compatible. . . .

Signetics, Sunnyvale, Calif., announces that nine of its low-power Schottky devices have been qualified to MIL-M-38510A. The units are the JB54LS00, -03, -04, -05, -10, -12, -20, -22, and -30. . . . **United Detector Technology, Santa Monica, Calif.,** is offering a kit containing six different types of silicon photodetectors. Priced at \$245, the kit includes a design manual and a special silicon photodetector slide rule.

NEC microcomputers, inc.

Data handling

Memory boards plug into LSI-11

A substantial number of accessory products are being designed for compatible operation with Digital Equipment Corp.'s widely used LSI-11 minicomputer [*Electronics*, Nov. 13, 1975, p. 190], and among the latest are add-on memory boards from Memory Systems Inc. of Hawthorne, Calif.

Andrew Huson, president, says the company will have by mid-March sample quantities of two boards, one with 8,192 words of 16 bits each and the other with 16,384 words. Offering access time of 500 nanoseconds and cycle time of 800 ns, the units are totally compatible with the LSI-11, Huson says. Tentative prices are \$1,450 for the 16-k board and \$875 for the 8-k version in single quantities.

The dynamic-memory modules were designed by Perry Persons and Joseph McGrath of Technical Marketing Inc., Costa Mesa, Calif. For the add-on boards, they chose the same MOS chip that is used in the LSI-11 itself—the Mostek 4096P-11, a 4-k device in a 16-pin package. The add-on memory has 64 of these chips in the 16-k board and 32 in the 8-k version.

For internal timing, four Fairchild Schottky driver ICs are used. No other functions are needed on the boards. They plug directly into the LSI-11 chassis. Power required is either 12 volts at 0.5 ampere or 5 v at 2 A.

Memory Systems Inc., 3341 W. El Segundo Blvd., Hawthorne, Calif. 90250. Phone Andrew Huson at (213) 772-4220 [361]

Serial impact printers can run at 340 lines/minute

Two serial impact printers, the model 103 and the model 503 (shown), can perform bidirectional printing at rates from 70 to 340 lines

per minute. In addition to their high throughput, the printers have a paper-saving high-density mode of printing which, at the flick of a switch, can increase page density by 33%. The result is 88 lines on an 11-inch form instead of the standard 66 lines.

Basically the two printers are very similar, with the 103 aimed at present users of 100 series printers who require complete compatibility with earlier features along with the speed advantage of the new units.

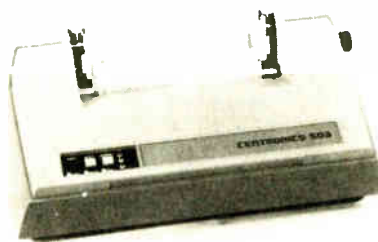

The 503 is configured as a low-cost basic system with all of the features of the 103 available as options. The 103 and 503 sell for \$4,560 and \$3,795, respectively. Delivery time is 45 days.

Centronics Data Computer Corp., 1 Wall St., Hudson, N. H. Phone (603) 883-0111 [367]

Prices slashed for data-acquisition modules

Believing that microcomputers eventually will become as available as op amps, Fred Molinari, president of Data Translation Inc., wants his company to price its data-acquisition modules so that the cost of these essential ingredients in microcomputer-controlled systems won't deter potential users. That's why the DT5701 16-channel module sells for about half the price of its predecessors in Data Translation's Datab II series. The DT5701 will sell for \$175 in quantities of 100.

The key element in the module is a 12-bit analog-to-digital converter, a hybrid device with a settling time of 2 to 3 microseconds—not especially speedy, but sufficient, says

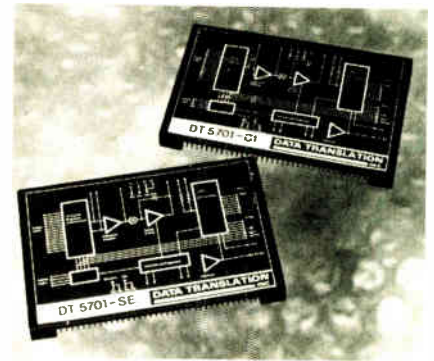

Molinari, to serve 75% of microcomputer needs for data-acquisition modules. In addition, the unit contains a 16-channel multiplexer, a buffer amplifier, a high-speed sample-and-hold amplifier, and all control and programing logic.

The DT5701 is linear to within half a least significant bit from 0°C to 70°C. Accuracy is within 0.03% of full-scale range, and maximum throughput rate is 35 kilohertz. The module is designed to plug into a board, which, in turn, plugs in to the microcomputer system.

Data Translation Inc., 109 Concord St., Framingham, Mass. 01701. Phone Fred Molinari at (617) 879-3595 [362]

8-color CRT terminal sells for \$1,995

The Intecolor 8001 is an eight-color CRT terminal with a keyboard, a 19-inch CRT, four kilobytes of random-access memory, and a 100-piece price of \$1,995. Controlled by a built-in Intel 8080 microprocessor, the terminal has a 25-line-by-80-character format and an RS-232 communications port that can



HUGHES

HUGHES AIRCRAFT COMPANY
CONNECTING DEVICES DIV.

Today we
supply the spark
for America's
defense.

Connections were much simpler 200 years ago. Torch the fuse and the cannon fired.

Supplying the vital spark that makes a modern weapon do its job is a lot more complicated.

That's where we come in. For many years, primes and OEMs for military and aerospace products have depended on us to provide the vital links in their electronic systems—flat cable, etched circuitry, connectors, and total interconnection systems.

Our high-rel connections have to be the best. They're used in systems like Phoenix, Maverick, Lance, Minuteman, AWACS, F-14, F-15, Space Shuttle, Viking, Sonobuoy, F-4, A-7, Condor, Standard Missile, F-18, AAH, Cruise Missile, F-8, Trident, Hobo, Sprint and many more.

To learn how we can serve your interconnection needs, contact Jack Maranto or Dave Cianciulli: Hughes Connecting Devices, 17150 Von Karman Ave., Irvine, CA 92714.

Or call (714) 549-5701.

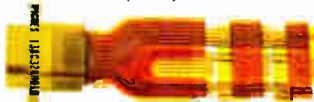

**Hughes
Connecting Devices**

Circle 155 on reader service card
World Radio History

DANA INTRODUCES THE SMART COUNTER.

Series 9000: World's First Microprocessing Timer/Counter.

The Dana Series 9000 is smart enough to make your work a lot easier. Microprocessing controls provide all the features of a premium timer/counter, a reciprocating counter and a calculator. Plus interfacing options and operating capabilities never before available in one instrument.

The Dana Series 9000 Microprocessing Timer/Counter goes so far beyond all other counters it takes a whole brochure just to explain its capabilities. Ask for it. It's the smart thing to do.

Dana Laboratories, Inc., 2401 Campus Drive, Irvine, California 92664, 714/833-1234.



Circle 156 on Reader Service Card for Product Demonstration
Circle 153 on Reader Service Card for Literature Only

New products

handle data rates up to 9,600 bauds. A wide variety of hardware and software options, including extra memory and 64 special programmable characters, is available for the terminal. Pricing starts at \$2,495 in unit quantities, and drops to as little as \$1,695 for large OEM orders. Delivery time is 60 to 90 days.

Intelligent Systems Corp., 2405 Pine Forrest Dr., Norcross, Ga. 30071. Phone (404) 449-5961 [363]

Kit computer can execute most PDP-8 software

Unlike most kit computers, which are supported by a minimum of software, the PCM-12 is designed around the Intersil IM6100 microprocessor—a 12-bit static C-MOS device that is software-compatible with the Digital Equipment Corp. PDP-8E minicomputer. Thus the assembled kit can execute most PDP-8 software including assemblers, edi-

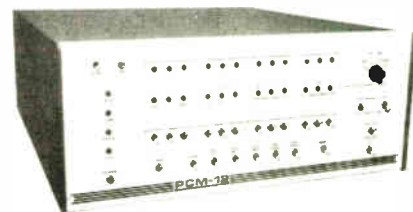

tors, and advanced languages like BASIC and Fortran. Supplied with 4,096 words of 12-bit memory, a control panel, a power supply, interfaces for teletypewriters and cassette recorders, and a cabinet, the kit sells for \$400. Other interfacing modules can raise the price to \$600.

PCM, P.O. Box 215, San Ramon, Calif. 94583. Phone (415) 837-5400 [364]

Graphic plotter draws stepless lines and curves

The 930 series graphics systems are a family of computer/plotters that work in a continuous, rather than incremental, fashion to avoid step

HP's new thermal printer just keeps purring along.

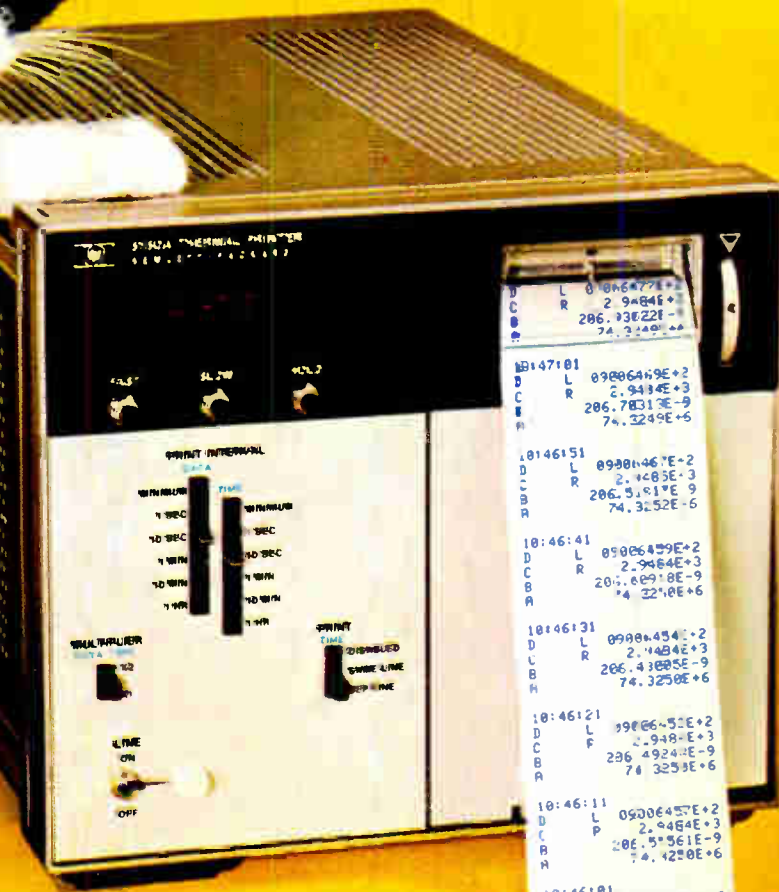

Say goodbye to the clank and rattle of mechanical printers and say hello to quiet, reliable operation. With its thermal printing technique, the new HP 5150A Thermal Printer needs only two moving parts — those that transport the tape.

That's just a beginning. Built-in flexibility and plug-in options mean that, at last, there is a printer that you can custom-tailor to your data printout needs without delay or compromise.

Alphanumeric printout. A full 64-character upper case ASCII printing set, with figures and symbols that read and reproduce clearly. Print speed is three lines per second.

ASCII Interface option. Interfaces to most ASCII coded sources or HP Interface Bus. Full 64-character, 20-column printout.

BCD Interface option. Interfaces with BCD \pm 8421 sources. Prints standard 16-character set, but can draw on the full 64-character complement of the 5150A. Ten or 20 columns.

Scanner option. The 5150A can function as a system controller for up to 13 instruments on the HP Interface Bus, providing automatic data-acquisition capability.

Clock option. With it, an entirely new order of convenience, flexibility and control becomes possible. Simple, front-panel controls let you record the time of day and select the time interval between samples.

Special BCD printouts. Special formats or re-interpretation of BCD inputs can be provided at minimum cost.

The price is right. Only \$875* for the 5150A mainframe.

Plug-in options range from \$125* to 350*. At the price, no other printer matches its

flexibility, quietness and reliability. Write, or call your nearby HP field engineer, for complete technical specifications or a demonstration.

*Domestic USA prices only.

```

D L 0906477E+2
C R 2.9484E+3
B 206.73763E-9
A 74.3252E+6

10:47:01
D L 0906476E+2
C R 2.9484E+3
B 206.73763E-9
A 74.3252E+6

10:46:51
D L 0906476E+2
C R 2.9484E+3
B 206.73763E-9
A 74.3252E+6

10:46:41
D L 0906459E+2
C R 2.9484E+3
B 206.43885E-9
A 74.3252E+6

10:46:31
D L 0906454E+2
C R 2.9484E+3
B 206.43885E-9
A 74.3252E+6

10:46:21
D L 0906455E+2
C R 2.9484E+3
B 206.49244E-9
A 74.3252E+6

10:46:11
D L 0906457E+2
C R 2.9484E+3
B 206.5361E-9
A 74.4250E+6

10:46:01
D L 0906456E+2
C R 2.9484E+3
B 206.62194E-9
A 74.3252E+6

10:45:5
D L 0906455E+2
C R 2.9484E+3
B 206.54314E-9
A 74.3251E+6

10:45:41
D L 0906455E+2
C R 2.9484E+3
B 206.54314E-9
A 74.3251E+6

10:44:41
D L 0906457E+2
C R 2.9484E+3
B 206.73763E-9
A 74.3252E+6
    
```

HEWLETT  PACKARD

Sales and service from 172 offices in 65 countries.
1501 Page Mill Road, Palo Alto, California, 94304

Circle 157 on reader service card 157

Now... AC MEASUREMENTS GO DIGITAL!

- True RMS Volts
 - True RMS Current
 - AC Watts
- ... all in YEW's new 2504 AC DMM!

The new 2504 digital AC instrument offers unexcelled accuracy and versatility for the measurement of sinusoidal and non-sinusoidal waveforms and for measurements at low power factors. Flexible design allows optional purchase of just the measuring functions required while push-button controls provide ease of operation.

The YEW 2504 is the AC DMM. Its 0.25% accuracy and 0.01% resolution, standard analog output, and low cost (Prices start at \$1,590.) make it the ideal instrument for quality control, lab, field maintenance, and instrument calibration applications. Write for details.



Standard ranges (Multirange Model):
30V/60V/100V/150V/300V,
0.5A/1A/2A/5A/10A (15W to 3,000W)
Frequency range: 25 Hz to 1 kHz



YOKOGAWA
CORPORATION
OF AMERICA

5 Westchester Plaza, Elmsford, New York 10523
Telephone: 914-592-6767

60 Years of Measuring & Recording Instrumentation

New products

discontinuities in the straight lines and curves that they draw. The systems include a computer for the creation and maintenance of a data base and for the control of such peripherals as teletypewriters, tape cassettes, tape and card readers, digitizers, and display devices. The system 930/100 has a usable plotting area that measures 31 by 36 inches and sells for \$59,000. The 930/200 has a 54-by-76-inch area and a price of \$75,800. Both units have a resolution of 0.001 inch, a repeatability of 0.003 in., and a maximum plotting speed of 16 inches per second.

Broomall Industries Inc., 682 Parkway, Broomall, Pa. 19008. Phone Richard Stover at (215) 353-4610 [365]

Tape punch runs at 20 characters/second

The model PM-820 is a rugged OEM tape punch that will perforate both roll and fan-fold tape at 20 characters per second. Supplied complete with drive motor, punch cover, and chad container, the PM-820 sells for \$590 in large quantities. Options include drive electronics, spooling, and circuitry to convert binary-coded decimal to ASCII. Delivery time is 30 days.

Data Specialties Inc., 3455 Commercial, Northbrook, Ill. 60062. Phone (312) 564-1800 [368]

Core memories are aimed at microprocessor applications

Stressing its cost-effectiveness for those applications in which loss of data from volatility will present operational problems and increased expense, Ampex has introduced the first in a family of magnetic-core memories designed for use with microprocessors, peripherals, and terminals. The MCM-1000 comes in three sizes—1,024, 2,048, and 4,096 bits—each of which has an access time of 450 nanoseconds and a cycle time of 1,300 ns. Each memory module is completely self-contained

O.K., you guys, back to the old drawing board.

It's a whole new ball game. And just when you'd made all your panel lamp decisions, right? But Monsanto's patented nitrogen doping process for GaAsP on GaP substrates has improved the light-emitting efficiencies of our LED lamps so dramatically that every good designer will want to take another look.

Monsanto has T-1 and T-1 $\frac{3}{4}$ replacement lamps in standard red color (improved significantly over last year's red LEDs) and new bright red which is *unbelievably* bright. Red. Plus green, yellow, and a dazzling new orange. In two lens choices and two lead lengths. And all improved, as you can see on the chart.



Model Number	Color	Size	Luminous Intensity	Viewing Angle
5174B*	Orange	T-1	5.0 mcd	90°
5274B*	Green	T-1	1.0 mcd	90°
5374B*	Yellow	T-1	4.0 mcd	90°
5774B*	Red	T-1	5.0 mcd	90°
5152**	Orange	T-1 $\frac{3}{4}$	40.0 mcd	28°
5252**	Green	T-1 $\frac{3}{4}$	15.0 mcd	28°
5352**	Yellow	T-1 $\frac{3}{4}$	45.0 mcd	28°
5752**	Red	T-1 $\frac{3}{4}$	40.0 mcd	28°

*Also available with 1" lead lengths, low profile (.138" high) lens, and 180° viewing angle.

**Also available with 24° and 65° viewing angles.

Last year there were some sockets that demanded filament lamps, despite their inherent failure-and-replacement problems. *Bright* was needed, and damn the torpedos.

This year you just might find the bright you need in a shake-rattle-and-roll-proof LED lamp. Come and see.

If you can take the time, you just might be able to add a lot of T to your MTBF.

So it's reset to zero, folks, if you want the best indicator lamps (and widest choice of functional differentiation colors) in your gear.

For product information, circle the service number or call your local Monsanto man. Or write Monsanto Electronics Division, 3400 Hillview Avenue, Palo Alto, CA 94304.

Putting innovation to work.

Monsanto:
the science
company.

IF YOU'RE NOT DESIGNING WITH A CSC PROTO-BOARD® LOOK AT ALL YOU'RE MISSING.

Versatility—Use with virtually all types of parts, including resistors, capacitors, transistors, DIP's, TO-5's, LED's, transformers, relays, pots, etc. Most plug in directly, in seconds.

Adaptability—Use in design, packaging, inspection, QC, etc. Works with most types of circuits, in many, many applications.

Expandability—Proto-Board units can be instantly interconnected for greater capacity

Utility—Models are available with or without built-in regulated power supplies (fixed or adjustable).

Variety—A wide variety of models are available with capacities ranging from 630 to 3060 solderless tie-points (6 to 32 14-pin DIP's), to fit every technical and budget requirement.

Speed—Assemble, test and modify circuits as fast as you can push in or pull out a lead. Save hours on every project.

Flexibility—Use independently, or in conjunction with other accessories, such as scopes, counters, CSC Proto-Clip™ connectors, Design Mate™ test equipment, etc. One Proto-Board unit can serve a thousand applications.

Accessibility—All parts are instantly and easily accessible, for quick signal tracing, circuit modifications, etc.

Durability—All Proto-Board models are carefully constructed of premium materials, designed and tested for long, trouble-free service.

Economy—Eliminate heat and mechanical damage to expensive parts. Save money by re-using components.

Visibility—All parts are instantly and easily visible, for quick circuit analysis and diagramming.



Whatever type of electronic circuits you work with, you can do more in less time with CSC's solderless Proto-Board™ systems. As fast and easy as pushing in or pulling out a lead, you can design, test and modify circuits at will. Components plug into rugged 5-point terminals, and jumpers, where needed, are lengths of #22 AWG solid wire. In the same time you took to read this ad, you could be well on your way to assembling a new circuit. For more information, see your CSC dealer, or write for our catalog and distributor list.

CONTINENTAL SPECIALTIES CORPORATION



EASY DOES IT

44 Kendall Street, Box 1942
New Haven, CT 06509 • 203-624-3103 TWX: 710-465-1227
West Coast office: Box 7809, San Francisco, CA
94119 • 415-421-8872 TWX: 910-372-7992
Canada: Len Finkler Ltd., Ontario

© 1976 Continental Specialties Corp.
Prices and specifications subject to change without notice.

160 Circle 160 on reader service card

New products

and includes the timing and control circuits, data and address registers, decoding and drive circuits, a TTL-level interface, and a data-save feature. This prevents loss of data under all possible modes of power turn-on, turn-off, or failure. The MCM-1000 is priced below \$500 in OEM quantities.

Ampex Corp., P.O. Box 33, Marina del Rey, Calif. 90291. Phone (213) 821-8933 [369]

Cassette data recorder designed for systems use

The model JK970 high-speed cassette data recorder is a highly reliable device intended for use in a wide variety of OEM applications. Using a Philips-type digital cassette tape (ISO and JIS standard), the new recorder offers a tape speed of 15 inches per second and start and stop times of 30 milliseconds and 40 ms, respectively. The unit derives its



high reliability from the elimination of many mechanical parts. Its two reel motors and the cassette-setting parts are the only mechanical components. The recorder's drive system reduces the chance of tapes twisting around the capstan and pinch roller, and it minimizes dust accumulation on the tape by bringing only the magnetic head in contact with the tape during operation.

Panasonic, One Panasonic Way, Secaucus, N. J. 07094 [370]

Portable data terminal weighs only 13 pounds

The latest addition to Texas Instruments' "Silent 700" line of data terminals is a portable unit that uses a microprocessor to keep its weight

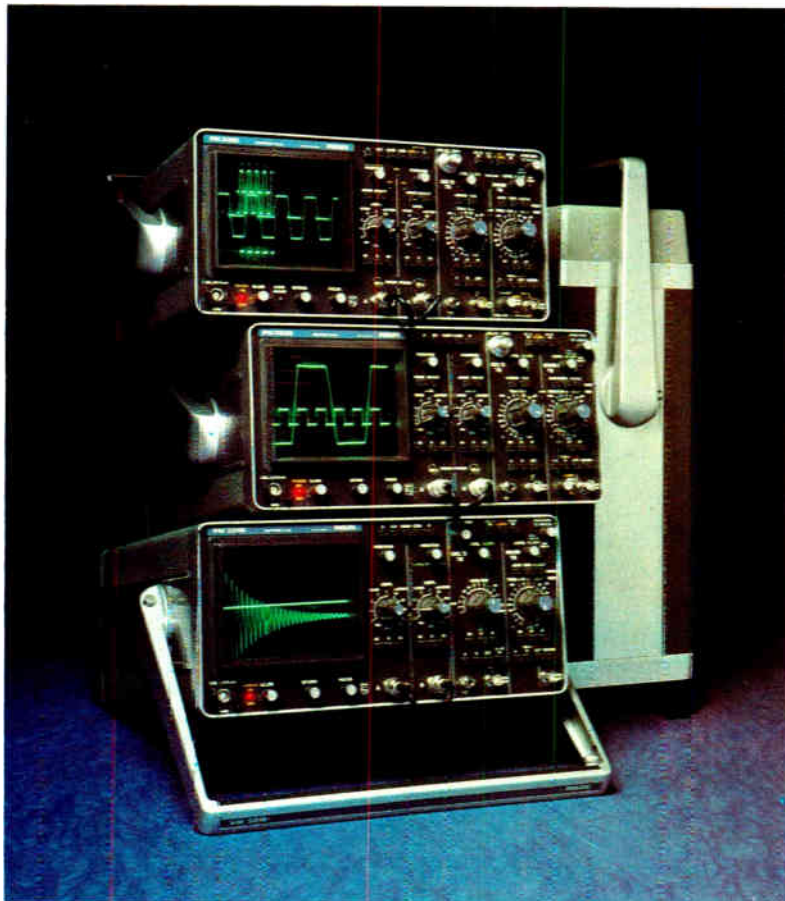

The reasons to buy Philips are ALL IN THE FAMILY!

All the important elements of waveform measurements that you need . . . accuracy, flexibility, ease of use to minimize human error and low cost, are in the Philips family of compacts.

Just as circuits and systems get smaller and faster, so too, do our oscilloscopes.

The 50 MHz model, PM3240, for example, weighs in at a mere 18 1/2 pounds. And because it's used as much outside the laboratory as in, we've given it a logical front panel layout where every control falls naturally to hand. The PM3240 has also been designed to operate from almost any supply, including DC; to have a bright 8 x 10 cm display and good circuit access for short service down-times on the oscilloscope itself.

MOVING UP TO 120 MHz

For higher bandwidth applications, the 120 MHz model, PM3260 is available. This 19.8 pounds light instrument therefore keeps you well ahead of Schottky TTL speeds and at the same time goes on triggering to over 200 MHz to meet the great majority of ECL applications.

Like the 50 MHz model, the PM3260 includes layout features such as clear separation of the main and delayed timebase, as well as operation from DC plus 100 - 240 V supply having frequencies from 46 - 440 Hz.

MULTIPLYING AT 100 MHz

The PM3265 extends all the previous benefits to a bandwidth of 150 MHz and also adds a unique built-in 100 MHz analog multiplying facility. Only with this instrument can you therefore make transient power and dynamic phase measurements on high speed components and circuitry. Moreover, this facility like the rest of the instrument, is extremely easy to use. You simply push the 'A x B' button to obtain the product which can also be displayed together with the B input signal.

Find out more by contacting Philips or utilize our toll free HOT LINE number 800 645-3043. New York State residents call (516) 921-8880 collect.

Philips Test & Measuring Instruments, Inc.

A NORTH AVENUE PHILIPS COMPANY

In the United States:

400 Crossways Park Drive
Woodbury, New York 11797
(516) 921-8880

In Canada:

6 Leswyn Road
Toronto, Ontario Canada M6A 1K2
(416) 789-7188



Electronics/March 4, 1976

PHILIPS

Circle Reader Service #161 for Information
Circle Reader Service #225 for Demonstration

TSD

Touch sensitive digitizer

The direct man-to-computer interface that replaces light pens, joy sticks, skew balls, sparking pens and other interactive devices with your finger.

Imagine being able to communicate directly with a computer by simply pointing at a CRT screen. That's exactly what the Instronics TSD lets you do. By means of transducers located along two sides of a glass plate, the TSD accurately determines the location of a finger or other passive probe and converts the positional information into digital form for computer processing. And because the glass plate is entirely passive, the TSD is safe for use by the general public.

The TSD can be packaged to fit any OEM configuration requirement. It's ideal for use with CRT's, computer controlled projection or display systems, or where computer processing of photographic or graphic material is required.

You should consider the TSD if you're involved in the design of computer systems for medical diagnostics, transportation scheduling and reservations, air traffic control, materials handling, learning systems, inventory control, engineering and design, menu selection, defense and military control.

From Instronics, the company that also makes high accuracy Gradicon digitizers and analytical stereo plotters.

Phone or write today for full details.

INSTRONICS

727 South 23rd Street
Suite 215
Arlington, Va. 22202
Phone (703) 521-7130

International Marketing Office
Stittsville, Ontario K0A 3G0
Canada
Phone (613) 836-4411
Telex 053-4115

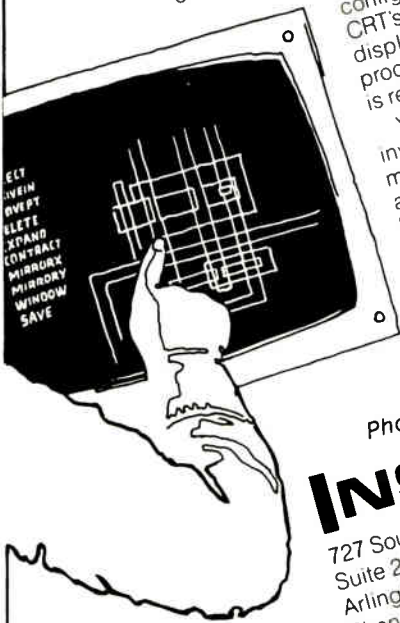

New products

down to just 13 pounds. The model 745 is a full-capability terminal which gives travelers, like salesman, instant access to a central computer by means of a built-in acoustic cou-



pler and any telephone. Priced at \$1,995 in small quantities, the model 745 includes an ANSI keyboard with a calculator-style numeric key pad, automatic paper loading, and thermal printing at 30 characters per second.

Texas Instruments Inc., P.O. Box 1444, M/S 784, Houston, Texas 77001. Phone (713) 494-5115 Ext. 2126 [366]

TOPICS

Data Handling

Texas Instruments Inc., Dallas, Texas, has reduced the prices of six of its handheld calculators. Among the affected units are the SR-51A scientific/statistical calculator, which has been cut from \$149.95 to \$119.95 and the SR-50A scientific machine, which has been reduced from \$99.95 to \$79.95.

Hewlett-Packard Co., Palo Alto, Calif., is conducting a special promotion of its HP-65 fully programable pocket calculator. People who buy the \$795 calculator before April 30 will receive \$195 worth of applications software at no additional cost.

Sycor Inc., Ann Arbor, Mich., has introduced two new intelligent data-entry terminals that are compatible with European (ECMA) standards. The terminals, designated the 310 and 320, have been approved for use with the Honeywell series 62 and Sweda International's 1300 small business systems.

Circle 162 on reader service card

We saw your microprocessor

coming. So we designed an entire family of socket homes for it. Socket cards for card file mounting, and we've even got the card files. Socket boards for LSI mounting in frames, drawers, and racks,

and we've even got the frames, drawers, and racks. Our socket cards, the 3D Series, come with built-in test points, a ceramic monolithic bypass capacitor

at each socket, and solder tab connection to pins on LSI chips. Our socket boards, the 2D Series,

offer a good selection of socket complements, and are compatible with other boards for hybrid installations. We also offer automated wiring service. We're ready for you.



ECCO
PACKAGING/SWITCHES/READERS

1441 East Chestnut Avenue, Santa Ana, California 92701 Phone 714/835-6000
Also stocked and serviced in North America by G. S. Marshall, R-A-E, Zenitronics.

Circle 163 on reader service card

Design with the complete flat cable/connector system.

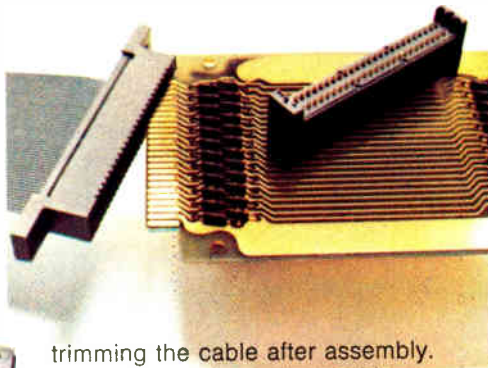

trimming the cable after assembly.

Connector units provide positive alignment with precisely spaced conductors in 3M's flat, flexible PVC cable. The connector contacts strip through the insulation, capture the conductor, and provide a gas-tight pressure connection.

With cable, connectors and assembly tools from one design and manufacturing source, you have added assurance the connection will be made surely, with no shorts or "opens."

And "Scotchflex" now offers you more design freedom than ever. From stock you can choose shielded and non-shielded 24-30 AWG cable with 10 to 50 conductors, and an ever-increasing variety of more than

The 3M DELTA pin and socket connector.

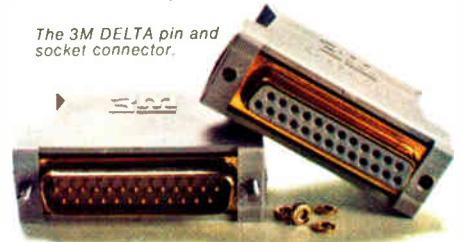

Assembly-cost savings are built in when you design a package with "Scotchflex" flat cable and connectors. But more important, 3M Company offers you the full reliability of a one-source system: cable *plus* connectors *plus* the inexpensive assembly aids that crimp the connections quickly and securely (with no special operator training required).

The fast, simple "Scotchflex" assembly sequence makes as many as 50 simultaneous multiple connections in seconds, without stripping, soldering or

100 connectors to interface with standard DIP sockets, wrap posts on standard grid patterns, printed circuit boards, or headers for de-pluggable applications. 3M's DELTA "D" type pin and socket connectors are now also available. For full information, write Dept. EAH-1, 3M Center, St. Paul, MN 55101.



3M
COMPANY

See our catalog in EEM 2-1034.

3M's "Scotchflex" line.

"Scotchflex" is a registered trademark of 3M Co.

New products

Industrial

8.4-kW generator is transistorized

Ac power unit also offers variable frequency over range from 9 to 250 kHz

While solid-state logic makes quantum jumps in technology almost as a matter of routine, its cousin in the industrial power arena has been a laggard. For example, bulky motor generators or vacuum tubes are still

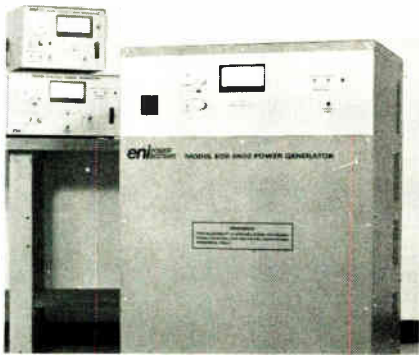

the chief sources of ac power generation for induction furnaces, large ultrasonic transducers, and other industrial applications.

ENI Power Systems Inc., Rochester, N.Y., hopes to change that situation with its transistorized 8.4-kilowatt ac power generator. Not only is the EGB 8400 the first transistorized unit rated at more than 1 kw—it is the first of its size to offer variable frequency, operating over the range of 9 to 250 kilohertz. It is also the first to operate without water-cooling, a feature that has condensed the EGB 8400, together with its power supply and air cooling system, into a 44-by-29-by-30-inch package that weighs only 300 pounds—one third less in weight and size than comparable units.

The variable-frequency feature has proven a major plus. For example, during ultrasonic welding the optimum frequency for maximum power transfer will change as

the metal or plastic melts. Most power generators are single-frequency and cannot adjust for changing conditions. But it's possible to tune the EGB 8400 to the process by adjusting the variable-frequency oscillator while reading the built-in true-average-power meter.

The power meter, which is designed around an analog multiplier and directional coupler circuit, offers accuracy to within $\pm 1.5\%$. With a flick of the switch, the power meter display changes from power leaving the EGB 8400 (forward power) to power absorbed by the generator (reflected power).

The heart of the EGB 8400 is a broadband linear transistor power amplifier that uses more than 90 hybrid-coupled power transistors in the output stage alone. The use of hybrid coupling isolates the output stages; should one transistor fail, the remaining units will continue to supply their outputs. This would not be the case if the transistors were in a standard parallel or series arrangement.

The entire amplifier is driven by a low-level, highly stable voltage-controlled oscillator. Frequency is directly controlled and read out by a two-range oscillator control dial mounted on the front panel. A level control varies the output from zero to full power.

The generator provides maximum power transfer to a 50-ohm load. However, any load impedance (from an open to a short circuit) can be connected without fear of damage or failure.

High-voltage regulators eliminate any voltage spikes or hash on industrial power lines and prevent radiation from reaching the ac line. Input power-line voltage is 120/208 v ac, three-phase, with a maximum draw of 16 kw.

Available with a complete line of accessories that will match it to any induction heating coil, high-voltage corona generator or ultrasonic transducer, the EGB 8400 also has such optional features as frequency lock-loop, watt-second (joule) read-out and control, and remote power

Gas Sensing Semiconductor

FIGARO GAS SENSOR

TGS quickly senses even small amount of gas.

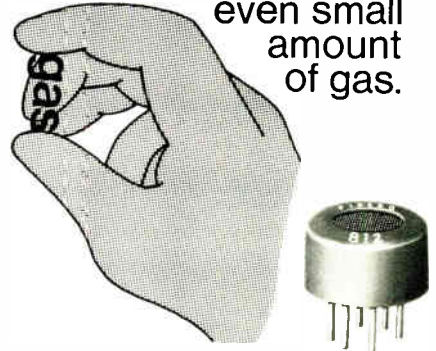

New Models, some with highly sensitive CO sensor, now on the market.

Please contact the address below directly for catalogs and price/delivery information.

FIGARO ENGINEERING INC.

3-7-3, Higashitoyonaka, Toyonaka City, Osaka 560, Japan/Tel: (06) 849-2156

Cable: FIGARO TOYONAKA/Telex: 05286155 FIGARO J

Circle 232 on reader service card

NEW HP-21, 25, 35, 45 & 55 PROGRAM PACKAGES

Business Card Size Fits in Calculator Case

Use your calculator as a "small scale" computer with these convenient new concept high level program packages. Virtually all the \$395.00 HP-80 functions (and some not on the 80) can be performed with Pkg. III, \$3.95. For fields of engineering and science, consider Pkg. II (which requires Pkg. I for full use - try Pkg. I sample) which contains: finding higher order roots via quartic, bisection, Newton's and Lin's programs with checks; complex hyperbolic functions; P(s) multiplied and/or divided by $as + b$, $as^2 + b$, or, $as^2 + bs + c$; translations, P(s-a); 3-D vector summations with direction cosines, dot and cross products with magnitudes and angles; transfer function operations including residue (partial-fraction expansion) evaluation, root-locus plotting, and Routh's criterion.

PKG. I, II, or III, \$3.95 each with case. Specify HP-21, 25, 35, 45 or 55. Instruction book, \$1.95.

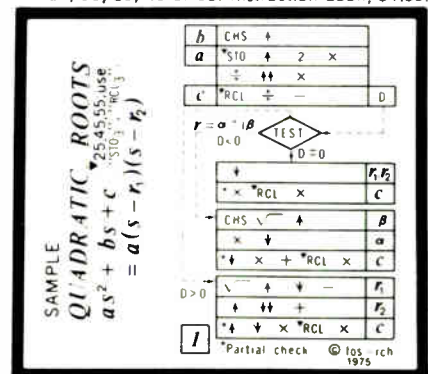

FOS-RCH/PROGRAMS

3120 Castle Oak Avenue
Orlando, Florida 32808
Phone: (305) 299-3857

YOU DON'T HAVE
TO DESIGN OVER-
**there's GPD
in Andover!**



GPD high-current copper TO-3



GPD high-power TO-36

Whether or not you've been buying germanium power devices from Motorola you can get the same transistors from us. We make what you need in 20 package pellet combinations with power dissipations from 1 amp to 75 amps.

Along with more than 50 JAN types, we manufacture these series to give you trouble-free circuitry: AD, ADY, ADZ, ASZ, AUY. They come in the families: 2N5436-2N5440, 2N4276-2N4283, 2N4048-2N4053 and 2N1519-2N1523. They're just some of our many transistors used in military, industrial and commercial systems.

We're not only synonymous with Motorola, but we make custom devices to your specifications. So, don't give up on germanium power when our factory is growing strong.

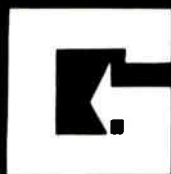

**GERMANIUM
POWER
DEVICES CORP.**

P.O. BOX 65, SHAWSEEN VILLAGE STATION
SHETLAND INDUSTRIAL CENTER, YORK STREET
ANDOVER, MA 01810
(617) 475-5982 TELEX 94-7150

New products

control. Base price is \$11,900; delivery time is 90 days.

ENI Power Systems Inc., 3000 Winton Road South, Rochester, N.Y. 14623 [371]

Solar panel delivers

6 watts per square foot

Made of 3-inch silicon solar cells encapsulated in clear silicone rubber and mounted on an epoxy fiberglass board, the Unipanel is a solar-cell array capable of power densities as high as 6 watts per square foot. Unipanel may be interconnected in various series and/or parallel combinations to meet a variety of de-power requirements. In particular,

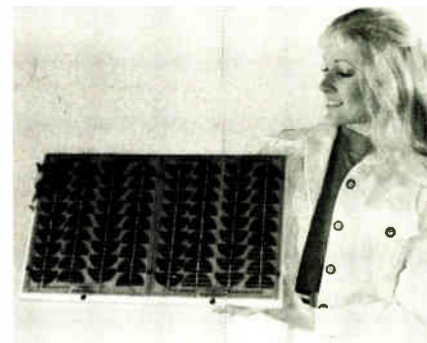

two of them can be combined to form a system with a nominal voltage of 14 volts—an ideal voltage for charging 12-v batteries. The two-panel combination is rated at 16 w and is claimed to be able to deliver a minimum yearly average power of 520 watt-hours per week at an average U.S. location. The system sells for \$760 in unit quantities and \$550 each in lots of from two to nine.

Solarex Corp., 1335 Piccard Dr., Rockville, Md. 20850. Phone Theodore Blumenstock at (301) 948-0202 [373]

Data-acquisition system

works in harsh environments

Designed to withstand unusually harsh electrical and physical environments, the series 6000 data-acquisition and control terminal is compatible with standard mini-

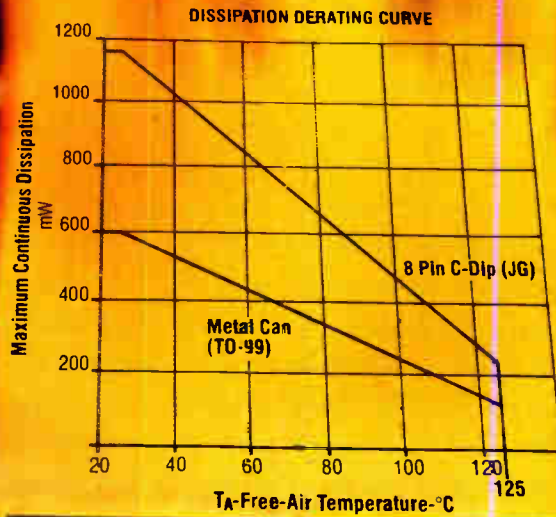
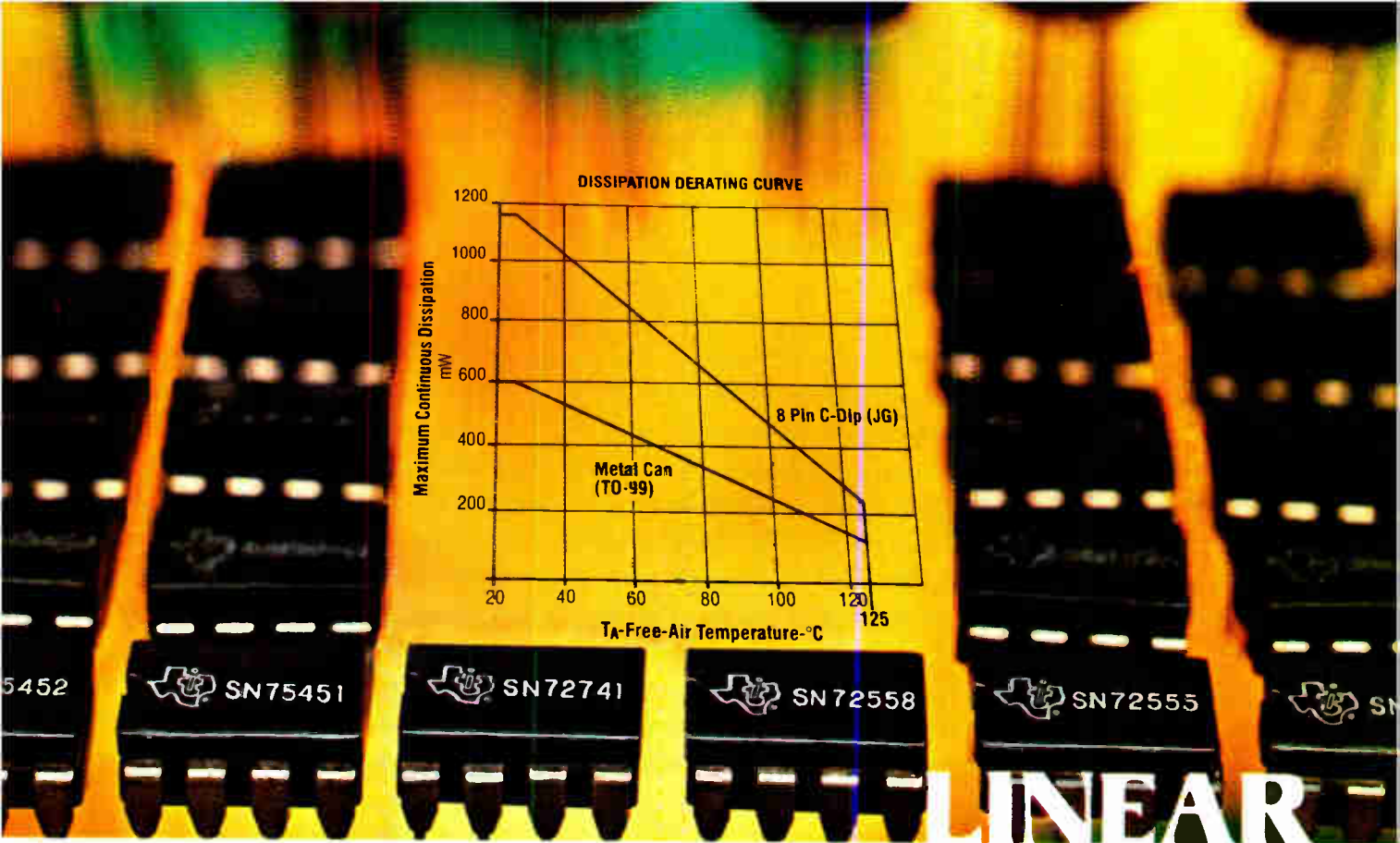

New hermetic dual-in-line package offers superior thermal characteristics... automatic insertion...improves reliability.

Say good-bye to linear circuits in TO-99 cans. Welcome a new packaging milestone. TI's new hermetic 8-pin ceramic dual-in-line linear package.

The innovative JG-package with superior thermal characteristics provides substantially improved device reliability over the old TO-99 can, as the derating curve illustrates. Under identical operating conditions, chip junction temperature in the new 8-pin C-Dip may be as much as 50 C cooler than in a metal can (see box for more details).

As with all dual-in-line packages, the JG-package can be automatically inserted in p.c. boards which will cut

your installation costs. Another saving: The non-conducting ceramic base eliminates the need for insulators.

But you pay no more for all these advantages. TI's linear devices in the JG-package are priced the same as equivalent metal-can functions. Hermeticity and space requirements are the same. The JG-package has also passed all military requirements of Mil-Std-883 and data is available on request.

For more information on the linear circuits available in the new dual-in-line package, contact your nearest authorized TI distributor. Or write Texas

Instruments Incorporated, P. O. Box 5012, M/S 964, Dallas, Texas 75222.



Thermal characteristics (typical operational amplifier)			
PARAMETER	TO-99 PACKAGE	JG-PACKAGE	UNIT
Thermal Impedance (θJA)	210	106.5	C/W
Max. Dissipation @ 70 C	384	744	mW
Max. Dissipation @ 125 C	120	232	mW
Operating Junction Temp.			
T _J @ 500 mW & T _A = 25 C	130	79	C
T _J @ 300 mW & T _A = 70 C	133	102	C
Typical functions available in JG package			
High Performance Op Amp	SNC52101AJG/SN72301AJG		
Differential Comparator	SNC52111JG/SN72311JG		
Universal Timer	SNC52555JG/SN72555JG		
Dual Op Amp	SNC52558JG/SN72558JG		
General Purpose Op Amp	SNC52741JG/SN72741JG		
Dual Peripheral Driver	SNC55451JG/SN75451JG		
Dual Peripheral Driver	SNC55452JG/SN75452JG		

All TI linear products offered in 8-pin Plastic are also available in 8-pin C-Dip-JG

TEXAS INSTRUMENTS

INCORPORATED

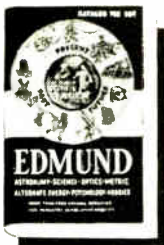

FREE GIANT CATALOG

180 PAGES MORE THAN **4500** UNUSUAL BARGAINS
OPTICS • SCIENCE • ELECTRONICS

1,000's OF HARD-TO-FIND BUYS FOR INDUSTRY

Brand new 180-page easy-to-read edition packed with new products, charts, diagrams, illustrations. On-the-job helps; quality control aids, unique, exclusive items to speed your work, improve quality, cut development and production costs! Loaded with optical, scientific and electronic equipment available from stock for industry, research labs, design engineers, experimenters, hobbyists.

ONE SOURCE FOR ALL YOUR NEEDS

Tremendous variety. Terrific savings. Countless hard-to-get surplus bargains. Many "one-of-a-kinds" nowhere else. Ingenious scientific tools. Thousands of components: lenses, prisms, wedges, mirrors, mounts, all types of accessories. Hundreds of instruments: pollution testing equipment, lasers, comparators, magnifiers, microscopes, projectors, telescopes, binoculars, photo attachments, ecological items, black light equipment and America's largest collection of alternate energy sources: solar, wind, methane.

BUY DIRECT WITH MONEY-BACK GUARANTEE
Edmund ships over 5,000 orders monthly to America's largest industrials — every item guaranteed! You must be satisfied, or return your purchase in 30 days for your money back. Shop the catalog of America's largest Science-Optics-Electronics Mart with confidence! Get your FREE copy without obligation. No salesman will call. Write now for free catalog. Ex"

EDMUND SCIENTIFIC CO.

International Operations Dept.
322 EDSCORP BUILDING
BARRINGTON, N. J. 08007, U. S. A.
TELEPHONE: 609-547-3488, ext. 236
Cable EDSCORP

Circle 168 on reader service card

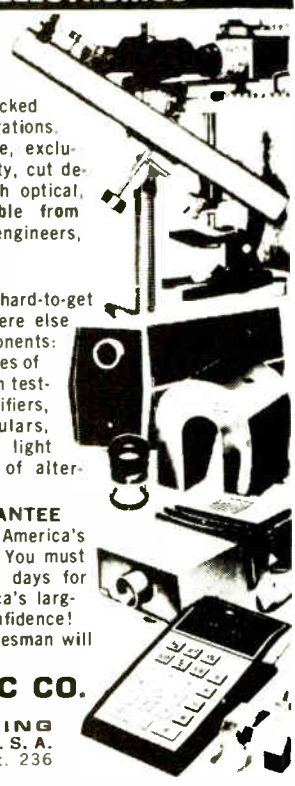
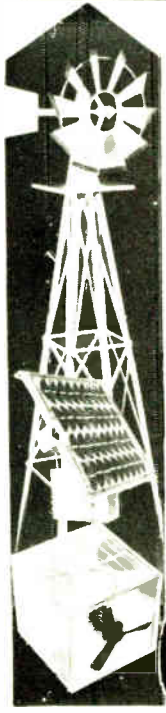

New products

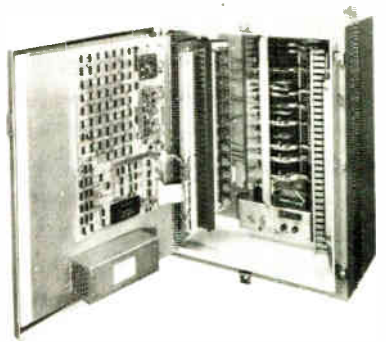

computer UART (universal asynchronous receiver/transmitter) interfaces such as the Digital Equipment Corp. model DL-11D, the Data General model 4023, and the Hewlett-Packard model 12587B. Requiring only a two-wire interconnection between the central minicomputer and each of up to 64 remote terminals, the series 6000 is expected to offer the advantage of very low cabling costs. In addition to direct wiring, the unit can be connected to the computer over voice-grade telephone lines. Prices start at \$2,850, and delivery time is 90 days.

LFE Control System Industries, 2920 San Ysidro Way, Santa Clara, Calif. 95051. Phone D. Ridgeway at (408) 732-9400 [374]

33% more power to the people.

Power/Mate presents Econo/Mate II.

The open frame power supply.

Now Power/Mate brings you 33% more power in the same package size with the second generation of our Econo/Mate series.

The size is the same, the basic components are the same for easy interchangeability. But that's where the similarity ends.

Econo/Mate II adds features like dual AC primary and a plug-in IC regulator for improved regulation.

And Econo/Mate II is tough. Computer design, quality control and Power/Mate's experience helps insure 100,000 hr. MTBF even at this higher power output.

But for all its features, Econo/Mate II is still, most of all, economical. We wouldn't call it Econo/Mate if it wasn't.

Econo/Mate II is in stock, ready for delivery. Send for our free brochure.

Prices start at \$19.95.

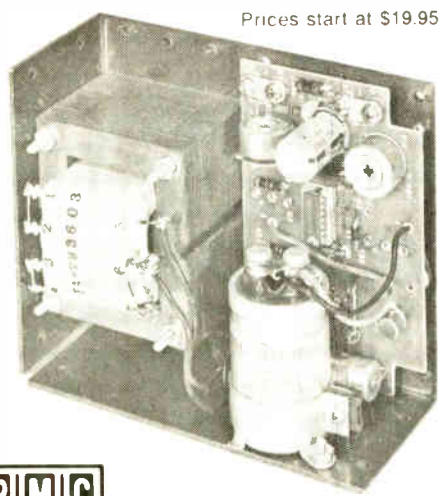

POWER/MATE CORP.

World's largest manufacturer of quality power supplies
514 South River Street/Hackensack, N.J. 07601 / Phone (201) 343-6294 TWX 710-990-5023

Rugged optical encoder resolves 2,500 counts/turn

Offered with resolutions of up to 2,500 codes per revolution (or 10,000, with optional times-four multipliers), the RI/27 family of rotary optical encoders is a line of rugged devices intended for use in the OEM industrial market. The encoders have a maximum operating

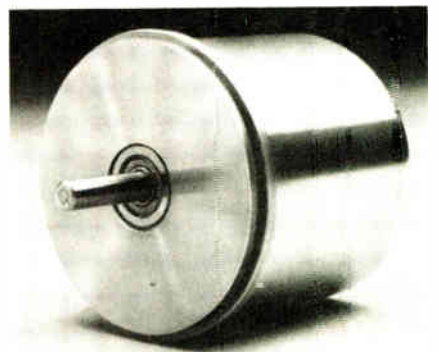

This is a flexible circuit for a heart pacer.

Certainly not if you're a heart patient.

And our customer who builds them feels the same way. He wants a product that heart patients can depend on.

This means reliable components. That's why he's more concerned that we build a dependable flexible circuit than a cheap one.

Not that we can't produce routine circuits just as inexpensively as anyone. We do.

But, when it comes to critical tolerances in super critical applications, we know it's optimum reliability that a customer is looking for.

And BMC delivers . . . everytime.

How do we do it?

Extra care and attention every step of the way. Including expert design advice and assistance. The ultimate in sophisticated artwork creation. Proprietary production techniques and more.

Sometimes this is going to cost you a little more. But, what's a little extra cost if it means your product will keep on ticking a lot longer?

For more information, contact Ed Dugan, Circuits Division (612) 228-6371.

245 EAST 6TH STREET
ST. PAUL, MN 55101
612 - 228-6371

BUCKBEE-MEARS COMPANY

bmc

Would you buy it from the low bidder?



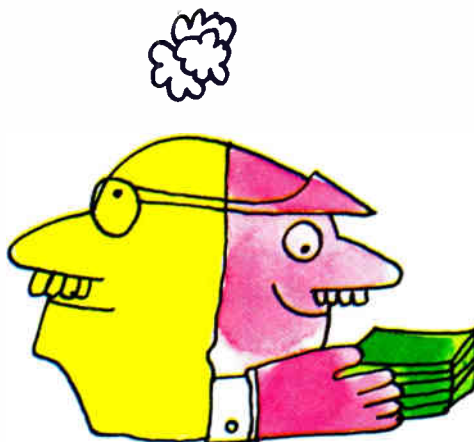

THE IMPORTANCE OF GENIUS AND COMMON SENSE

A company with genius leads. Because head- in-the-cloud thinkers are not inhibited by today. Product technology continually outpaces current performance needs. Time is spent innovating, not duplicating. And when tomorrow finally catches up, the products and services are waiting. Superior Electric has genius.

A company with common sense stays profitable. Because "think tank" ideas are tempered with reality. Products are neither over-optioned nor under-engineered. There's a level-headed utilization of company resources. And a company-wide cost awareness. Superior Electric has common sense.

Superior Electric. Controlling the motions in manufacturing with *SLO-SYN*[®] numerical controls. From economical 2-axis to contouring 4-axis.

Open or closed loop. Program storage, memory files, tool length and

diameter compensation — you choose the options. And with *SLO-SYN* motors and drives. The entire range of *SLO-SYN* synchronous and stepping motors. Matched translator and preset indexer drives. Rotary and positioning tables.

For information on Superior motion systems, write the genius and common sense company:
The Superior Electric Company, 383 Middle Street, Bristol, Connecticut 06010.
Or call 203/582-9561.



Superior Electric

We live up to our name.

New products

speed of 5,000 rpm and a bearing life in excess of a billion revolutions. They can operate over the temperature range from 0°C to 50°C at relative humidities up to 98%. The units have been shock-tested to 50 g and vibration-tested to 10 g.

Itek Corp., Measurement Systems Div., 27 Christina St., Newton, Mass. 02161. Phone Clyde Barnett at (617) 969-7300 [375]

Eight-digit counter can run at 12,000 counts per minute

Intended to replace conventional electromechanical counters, the Minicounter II is an all-electronic device with an eight-digit light-emitting-diode display and a maximum counting rate of 12,000 counts per minute. Available with



or without a reset function, the counter can be activated by switch closures, voltage pulses of from 4 to 50 volts peak amplitude, or pulses from standard TTL, DTL, or C-MOS logic. The model 428 Minicounter II sells for as little as \$45 in hundreds.

Waugh Controls Corp., 9001 Fullbright Ave., Chatsworth, Calif. 91311. Phone (213) 998-8281 for bulletin PB 428.1 [376]

Power-line monitor logs fast ac transients

Just plug the model W115 Power Guard into the same ac line as a computer, and the unit will warn you of possible computer errors caused by transients on the ac line. Whenever a fast transient occurs,

promises, promises,

more than promises, commitment.

Fairchild CCD TV camera *IN PRODUCTION*



mv-201
miniature CCD
television camera

Size: 2"H x 2-1/2"W x 3-3/4"L
Weight: 12 ounces
Price: \$4,500, including camera, lens and power converter

FEATURES

- Completely solid state, including CCD sensor (244 x 190 array)
- EIA Compatible Output
- Records on any EIA/JAL Videotape Recorder
- Uses "C" Mount Lenses
- Low Power Consumption ($\pm 12V$, 4 watts)
- Gamma Correction
- Crystal Controlled Clock Circuits
- Automatic Gain Control (AGC)
- Low Light Performance

mv-201 television camera is the most advanced in a series of cameras developed by Fairchild Imaging Systems using charge-coupled device (CCD) sensors. Fairchild developed charge-coupled devices bring the inherent advantages of solid-state sensors — small size, light weight, low power, and long life — out of the laboratory into the real world by replacing the conventional tube type imaging sensors.

mv-201 television camera operates with standard closed-circuit television receivers and video recorders.

mv-201 television camera's advanced features make it possible to serve a wide range of applications in the military, commercial and industrial sectors.

FAIRCHILD
CAMERA AND INSTRUMENT
CORPORATION
FEDERAL SYSTEMS GROUP

IMAGING SYSTEMS

300 ROBBINS LANE, SYOSSET, NEW YORK TEL:(516) 931-4500 TWX:510-221-1836

Contact Imaging Systems Marketing, Ext. 455

E 3-4-'76

RF-PACKAGES — MICROWAVE SYSTEMS

AUTOTRACK ANTENNA SCR-584 RADAR SYSTEM

360 deg AZ 210 deg EL. 1 mil. accuracy. Missile vel. accel. and slew rates. Amplidyne control. Handle up to 20 ft. dish. Compl. control chassis. ALSO in stock 10 cm. van mounted rad. system. Conical scan. PPL 6 ft. dish. 300 pg. instr. bk. on radar 525



RF SOURCES

CW: 300-535KHz 500W; 2-30MHz 3KW; 4-21MHz 40KW; 24-350MHz 100W; 385-585MHz 1KW; 750-985MHz 10KW; 95-8.8GHz 150W; 1-1.5GHz 110W; 1.7-2.4GHz 10KW; 4.4-5GHz 1KW; 8.8-11GHz 200W. Many more.

UHF: 1 Megawatt 210-225MHz 5μsec 180 PPS; 14KW 400-420MHz 0002DC; 1KW 400-700MHz 002DC

L BAND: 1KW 1-1.5GHz 1DC; 500KW 1.2-1.35GHz 2μsec 400PPS. Many more. Phone or write

S BAND: 1KW 2.4-2.6GHz 75μsec 1200PPS; 250KW 2.7-3.1GHz 8μsec 1600PPS; 500KW 2.7-3.1GHz 8μsec 1600PPS; 1 Megawatt 2.7-2.9GHz 1μsec 1200PPS; 5 Megawatts 2.75-2.85GHz 2.5μsec 400PPS.

C BAND: 225KW 6.275-6.575MHz 4μsec 680PPS; 250KW 5.4-5.8GHz 5μsec 680PPS; 1 Megawatt 6GHz 1μsec 1000PPS. Many more. Phone or write

X BAND: 100W 9.2-9.5GHz 5μsec 1000PPS; 1 KW 8.9-9.4GHz 001DC; 65KW 8.5-9.6GHz 001DC; 250KW 8.5-9.6GHz 0013DC; 400KW 9.1 GHz 1.8μsec 450PPS. Many more. Phone or write

Ku-K BAND: 50KW 16.4-16.6GHz 001DC; 135KW 15.5-17.5GHz 0006DC; 40KW 24GHz 0007DC; 40KW 35GHz 0004DC. Many more. Phone or write

PULSE MODULATORS + H.V.P.S.

245 KW LINE Output 16 KV 16 A. 25 μs 4000 PPS
405 KW FLOATING DECK Output 20 KV 20 A 1 μs to 10 millisecond pulse

500 KW LINE Output 22 KV 28 A. 4/1.75/2.25 μs 2500/550/300 PPS

1 MW HARDTUBE MIT MODEL 9 Output 25 KV at 40 A. 25.2 μs 002 D C

2.0 MW LINE 30 KV 70 A. 1/2 μs 600/300 PPS

3 MW LINE Output 39 KV 75 A. 25/1 μs 500 PPS

10 MW LINE 76 KV 135 A. 2.5 μs 350 PPS

17 MW LINE 17 KV 1000 A. 2.5 μs 150-2000 PPS

SEND FOR FREE 20 PG. CATALOG

X BAND ANTI-INTRUSION SYSTEM

Pulse doppler. Pwr: 7 KW. Range: 20,000 yards. Sector scan or 360°. Type: TPS-21

RADAR SYSTEMS

K BAND MONOPULSE 40KW E-34

KU BAND SEARCH 135KW B-58

X BAND MISSILE CONTROL NIKE AJAX/HERC

X BAND HI-RES. MONOPULSE TRACKER

X BAND FIRE CONTROL 250KW M-33

X BAND WEATHER/SEARCH 250KW AN/CPS-9

X BAND AIRBORNE TRACKER 50KW B-47

X BAND MOBILE TRACKER 40KW AN/MPQ-29

X BAND WEATHER/SEARCH 40KW AN/SPN-5

X BAND ANTI-INTRUSION 7 KW AN/TPS-21

X BAND ANTI-INTRUSION CW DOPPLER AN/PPS-12

X BAND TRANSPONDER 100W AN/DPN-62

C BAND HGT. FDR. 5MW FPS-26; 1MW TPS-37

C BAND SEARCH 285KW AN/SPS-58/D

S BAND HEIGHT FINDER 5MW AN/FPS-6

S BAND SEARCH COHERENT 1MW AN/FPS-18

S BAND ACQUISITION 1MW NIKE AJAX/HERC

S BAND TRACKER 10" DISH 500KW AN/MPQ-18

S BAND MORTAR LOCATOR 250KW AN/MPQ-10A

S BAND TRACKER 250KW AN/MPS-9

L BAND SEARCH 40" ANTENNA 500KW AN/FPS-75

L BAND SEARCH 500KW AN/TPS-10/GSS-1

UHF SEARCH 1MW TPS-28

DRONE CONTROL SYSTEMS

UHF COMMAND SYSTEM AN/URW-14

X BAND DATA LINK AN/UPW-1

X BAND TRACKER AN/MPQ-29

X BAND TRACKER AN/MSQ-51

60 FT. DISH

Complete with Az-El pedestal, ready for installation. Immed. delivery. Write or call.

SPARE PARTS IN STOCK

Nike Ajax, Nike Hercules, M 3, MPS 19, TPS-10, TPS-10D, FPS-6, SPS, SCR 584, HIPAR. Many more. write



**Radio
Research
Instrument
Co., Inc.**

3 QUINCY ST. NORWALK, CONN 06850
(203) 853-2600

Circle 270 on reader service card

New products



the W115 sounds an alarm, records the amplitude and duration of the pulse, and stops a digital clock at the exact time of the transient detection. The Power Guard includes a voltmeter which continuously monitors the ac line, and a strip chart recorder which operates only when transients are detected. Price at \$1,485, the units is available from stock.

Holland Electronics Inc., 970 East 92 St., Brooklyn, N.Y. 11236. Phone (212) 649-7330 [377]

Six-digit stopclock's outputs can be bused

A panel-mounting six-digit stopclock, the DSC-8200 is similar to a digital stopwatch except that it has a full set of logic outputs and controls that allow it to interface with computers, data-acquisition systems, and process controllers. By moving some jumpers on its rear connector, the user can program the instrument to count in hours, minutes, and seconds; or in hours, minutes, and tenths of minutes, or in a variety of other scales including microseconds. Although it contains its own crystal-

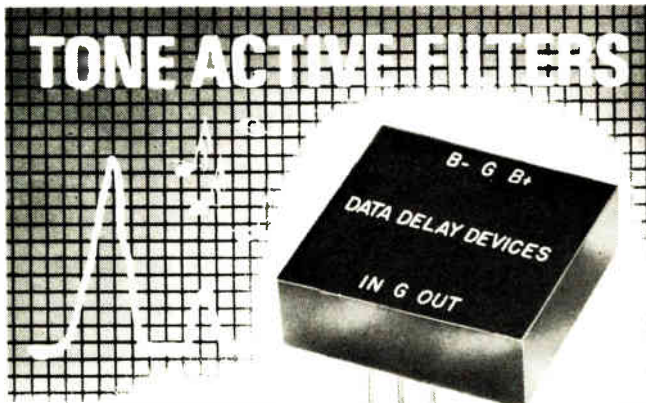

A new family of tone active filters series TAF24 has been developed by DATA DELAY DEVICES.

They have the following specifications:

- 3db (BW) — $\pm 1.5\%$ to $\pm 3\%$ of f_c .
- 20db (BW) — $\pm 10.5\%$ of f_c .
- Gain — 10db ± 1 db.
- Gain stability — $\pm .4$ db from 0°c. to 70°c.
- Power supply — ± 15 Vdc.
- Size — 1.5 x 1.5 x .375

Send for bulletin TAF24

DATA DELAY DEVICES
253 CROOKS AVE., CLIFTON, N.J. 07011 Tel. (201) 772-1106



Introducing RF resistors and terminations the likes of which you've never seen before.



The products:

These are the standards: thousands of variations to custom requirements are easy.

Resistor or Termination	Package	Power Dissipation Watts *	Resistance Ohms **	Frequency GHz	VSWR
T	A	150	50	DC-2.0	1.25:1
T	B	200	50	DC-2.0	1.25:1
T	C	250	50	DC-1.0	1.25:1
T	D	300	50	DC-1.0	1.25:1
R	E	100	100	DC-2.0	1.25:1
R	F	125	100	DC-2.0	1.25:1
T	G	150	50	DC-2.0	1.25:1
R	H	100	100	DC-2.0	1.25:1
R	J	150	50	DC-2.0	1.25:1
R	K	200	50	DC-2.0	1.25:1
R	L	150	50	DC-2.0	1.25:1

*For 100°C case

**Nominal value shown. DC value is nominal $\pm 3\%$.

2-Way Wilkinson Combiner

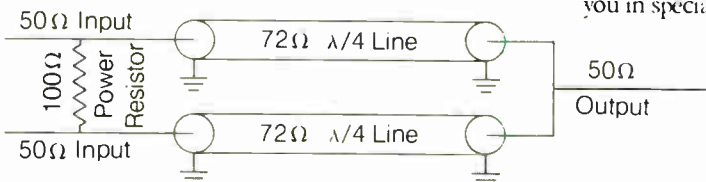

C.T.C. has what it takes.

The package: rugged and reliable.

No other RF/Microwave transistor manufacturer has an in-house packaging capability to compare with ours. No more need for junk packaging. We offer high power transistor packaging techniques with no solder interface for high power dissipation; minimum parasitic inductance; minimum parasitic capacitance; no resonant loops below 4GHz; unmatched long term stability and ceramic seal for the ultimate reliability.

The poop:

No one else offers data sheets like ours: full characterization and all the information you need for easy design. Applications notes and schematics from a staff of expert circuit designers, available to assist you in special problems.

The pricing:

We built leadership in the highly competitive RF and microwave transistor market by having the top performance products, produced in volume and priced to develop the market, not pirate it. The same philosophy goes for these high performance resistors and terminations.

The number to call:

(415) 592-9390. Or write to Communications Transistor Corporation, a wholly owned subsidiary of Varian Associates, 301 Industrial Way, San Carlos, California 94070.

Typical impedance of 50 Ohm termination TA150-50

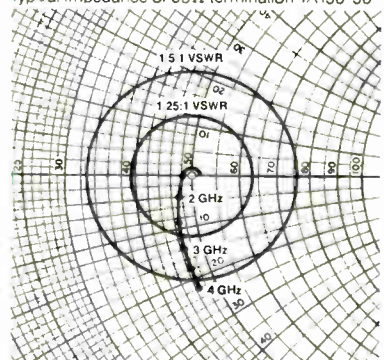

Circle 173 on reader service card

Dialight sees a need:

(Need: The widest choice for your every application.)

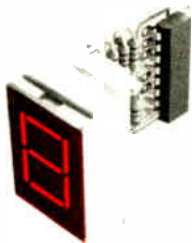

730 SERIES Your choice . . . a red or green LED readout with large 0.625" characters . . . low power, operates with standard IC power supply levels. Comes in plus-minus module. Display uses standard or high brightness LEDs for maximum light output arranged in a seven-segment format. Available with or without on-board decoder/driver. Unique lens design generates bright, highly legible characters.

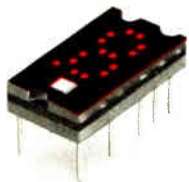

745-0007 LED hexidecimal display with on-board logic operates from 5 to 6 volt supply, low power consumption. Integral TTL MSI chip provides latch, decoder and drive functions. 0.270" character display has wide angle visibility and mounts into standard 14-pin DIP socket.



Dialight, the company with the widest choice in switches, LEDs, indicator lights and readouts, looks for needs . . . your needs . . . and then they develop solutions for your every application. No other company offers you one stop shopping in all these product areas. And no other company has more experience in the visual display field. Dialight helps you do more

with these products than any other company in the business, because we are specialists that have done more with them. Talk to the specialists at Dialight first. You won't have to talk to anyone else. Send for your free new copy of Dialight's current catalog.

DIALIGHT

Dialight, A North American Philips Company
203 Harrison Place, Brooklyn, N. Y. 11237
(212) 497-7600

See Dialight.

New products

controlled timebase, the counter can also be slaved to the power line for especially good long-term accuracy. The DSC-8200 has front-panel start, stop, and reset controls, but these functions can also be controlled by switch closures or TTL-level signals applied through the rear connector. Visual data output is by means of large (0.6-inch) LED displays, while electrical data output is available in parallel binary-coded-decimal form. The counter has a small-quantity price of \$299 for the ac-power version and \$269 for the model that runs on ± 5 v dc.

Datel Systems Inc., 1020 Turnpike St., Canton, Mass. 02021. Phone (617) 828-8000 [378]

TOPICS Industrial

Nova Electric Manufacturing Co., Nutley, N.J., has improved the frequency stability of all of its inverters, frequency changers, and uninterruptible power systems from 0.15% to 0.005% with no concomitant increase in cost.

Jordan Controls Inc., Milwaukee, Wis., has added a new model—the AD-8800—to its line of servo amplifiers for remote positioning control systems. The amplifier is offered in 6- and 12-ampere versions. **Allen-Bradley, Milwaukee, Wis.**, is broadening its line of small, oil-tight pushbutton switches. The new devices include two- and three-position illuminated and nonilluminated devices with pull-to-start and push-to-stop action.

Analogic, Wakefield, Mass., has introduced its Measurometer line of panel-mounting instruments for measurement and control. A key feature of the line is easy programability to read in any desired engineering units. **The Telemotive Division of Dynascan Corp., Chicago**, has developed a digital telemetry and control system that makes it possible to communicate with and remotely control complex materials-handling and/or weighing equipment. System data is suitable for computer input.

New products/materials

Rare-earth magnet powders, ready to be blended, pressed, and sintered into magnetic components, are being offered to users who want to fabricate their own magnetic components and subassemblies. Hicorex brand smerium-cobalt powder sells for \$50 per pound in small quantities, dropping as low as \$14.50/lb in lots of 10,000 lb. Applications areas include instruments, motors, electron tubes, electronic watches, and microphones.

Hitachi Magnetics Corp., Edmore, Mich. [476]

RTV silicone resins can be cured in thick sections and can also be dug out for repair and resealed. Three formulations are available: Eccosil 5122 is the general-purpose resin, 5850 has the best thermal conduc-

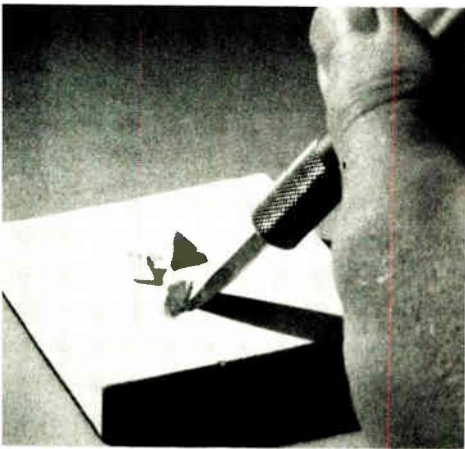

tivity (0.0043 calories per second-centimeter-°C), and 5640 has the lowest density (specific gravity is 0.75). At 200°F all three pourable resins cure in about half an hour.

Emerson & Cuming Inc., Canton, Mass. 02021 [477]

Beryllium oxide components for use in high-power traveling-wave tubes and klystrons are diamond-ground, metalized pieces fabricated to tolerances of ± 0.0001 inch. The BeO collectors, insulators, and support elements sell for from \$5 to \$75.

Ceradyne Inc., P. O. Box 11030, Santa Ana, Calif. 92705 [478]

A temporary adhesive used to hold optical components and semicon-

Dialight sees a need:

(Need: The widest choice for your every application.)

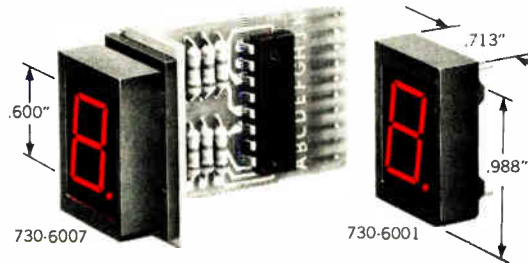

730 SERIES A new 0.600" LED character in super bright red, seven-segmented readout . . . low power . . . draws 10mA/segment or less . . . operates with standard IC power supply levels. Very high contrast ratio . . . visible from 40'. Available with or without on-board decoder/driver, plus or minus bar, and with bezel mounting. In 1000-lot quantities each LED
730-6007 \$6.05. 730-6001 \$2.55.

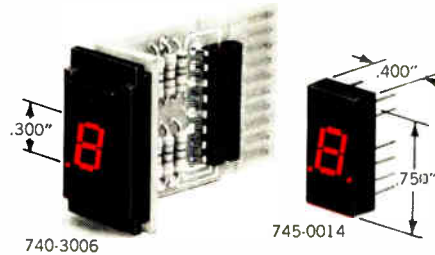

745 SERIES A new 0.300" LED character in a very bright red, seven-segmented readout . . . low power requirements. Standard 14-pin DIP . . . available with left and right decimal with ± 1 , and with and without on-board decoder/driver. Compatible with most TTL and DTL circuits. In 1000-lot quantities each
740-3006 \$6.43. 745-0014 \$2.10.



Dialight, the company with the widest choice in switches, LEDs, indicator lights and readouts, looks for needs . . . your needs . . . and then they develop solutions for your every application. No other company offers you one-stop shopping in all these product areas. And no other company has more experience in the visual display field. Dialight helps you do more

with these products than any other company in the business, because we are specialists that have done more with them. Talk to the specialists at Dialight first. You won't have to talk to anyone else. Send for your free new copy of Dialight's current catalog.

DIALIGHT

Dialight, A North American Philips Company
 703 Harrison Place, Brooklyn, N. Y. 11237
 (212) 497-7600

See Dialight.

The Ten Most WANTED INSTRUMENTS



Brush 260
Oscillograph

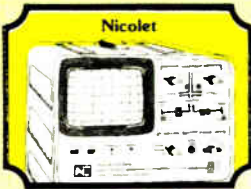

Nicolet
Digital Storage Oscilloscope

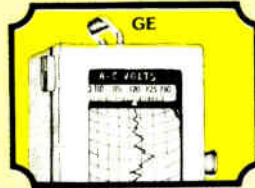

GE
Chart Recorder



Data Research
Transient Voltage Recorder



Esterline Angus
Chart Recorder



Associated Research
Insulation Tester



Kaye
Data Acquisition System



Brush 481
Oscillograph



Biddle
Megger

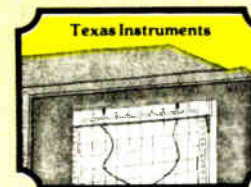

Texas Instruments
Temperature Recorder

RENT'EM FROM GE

Short or long term rentals on over 5,000 most wanted instruments are available from General Electric, shipped the same day. Want your FREE Rental Catalog? Call collect, (518) 372-9900.

GENERAL  ELECTRIC

New products/materials

ductors for dicing, slicing, and grinding is extremely resistant to acid attack. Crystalbond 557 adheres readily to porous and nonporous metals, glasses, and ceramics. Although it will resist attack by hydrochloric, hydrofluoric, and nitric acids, and by aqua regia, it is readily removed by a solution of acetone and methyl ethyl ketone. Priced at \$45 per pound in small quantities, Crystalbond 557 sells for \$30/lb in hundred-pound lots.

Aremco Products Inc., P. O. Box 429, Ossining, N. Y. 10562 [479]

A highly adsorbent desiccant material that changes color as it collects moisture is said to be particularly helpful when the desiccant is used as a drying insert in delicate measuring instruments, for the air drying of transformers, and in similar applications. Natrasorb indicating beads change from blue to pink as they adsorb water. They can hold as much as 40% of their weight in water at which point they can be reactivated by heating. The beads are nondeliquescent and noncorrosive and look and feel dry even when they are saturated.

Multiform Desiccant Products Inc., 1418 Niagara St., Buffalo, N. Y. 14213. Phone John E. Brewer at (716) 881-0100 [480]

Soldering aluminum and aluminum alloys is greatly eased by the use of multicore Alu-Sol 45D solder. The patented material is made of silver-loaded tin/lead solder and four peripherally located cores of a special flux. It contains no bismuth, zinc, cadmium, or aluminum and therefore is very resistant to corrosion. It is also compatible with standard tin/lead solders. Alu-Sol 45D solves the problem of soldering such hard-to-wet aluminum alloys as 6061 and 5052. It also works very well with tin plate, copper, brass, nickel, nickel-silver, and, of course, pure aluminum. It works somewhat less well with steel, stainless steel, and zinc-alloy die castings. Prices are similar to those of standard tin/lead solders. Delivery is from stock.

Multicore Solders, Westbury, N. Y. 11590 [440]

DigiTec creates a 'counter' revolution... with two new revolutionary 'counter' features.

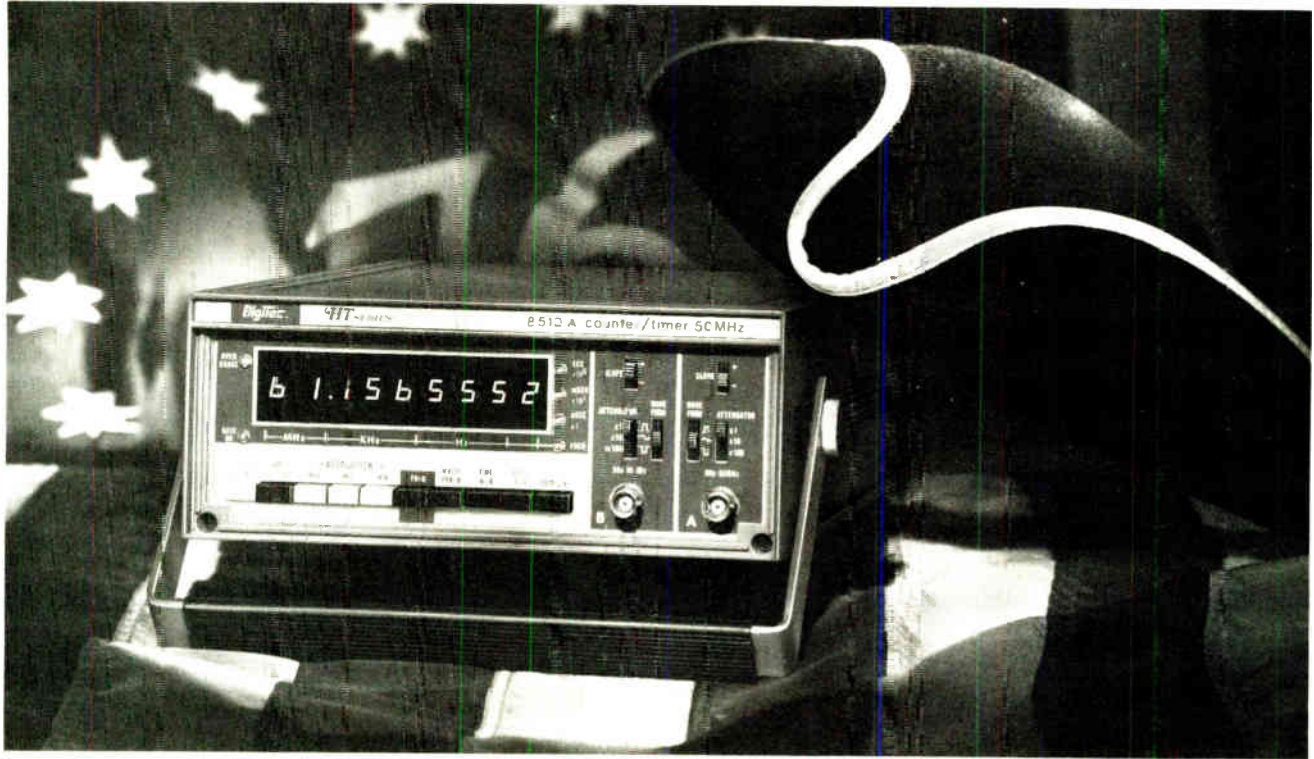

1. **OPTI-RANGING:** DigiTec's exclusive display technique is an improved auto-ranging that actually organizes the data before you see it. With Opti-ranging, there is no need for lights or indicators to indicate MHz, kHz or Hz since the display position is fixed regardless of the time base (resolution) selected.

All our Opti-ranging counters are augmented by a standard LED display of 9 full digits that shows your complete measurement.

2. **INPUT SHUTDOWN:** Another DigiTec exclusive, prevents the display of erratic or erroneous data. Based on the input sensitivity of each instrument, this system shuts down the display if the incoming signal drops below a reliable measurement level. A single zero is displayed to indicate such a condition while preserving maximum measurement confidence.

COMPARE BEFORE YOU BUY!

These counters are not partial-function. All our **UNIVERSAL COUNTERS** feature two separate channels for complete time interval measurements. Each channel has a separate set of input controls, including slope, waveform and attenuators for extra precision.

Every counter is housed in a rugged diecast and extruded aluminum case for lightweight convenience and total protection.

8500A Series Universal Counter/Timers

consist of 4 models for measurements from 5Hz thru 1GHz

Start at **\$725.**

8700A Series Frequency Counters

consist of 3 models for measurements from 5Hz thru 1GHz

Start at **\$625.**

We also offer 15 other counters from which to choose.

DigiTec

UNITED SYSTEMS CORPORATION

918 Woodley Road • Dayton, Ohio 45403 • Ph: (513) 254-6251 • TWX: (810) 459-1728

These instruments available under GSA Contract GS-OOS-27741

Data General users

LET THE SUNSHINE THROUGH

FULL 4231 & 4046 emulation at 1/2 the price!

Our DD-52 Disc System allows your D.G. to operate 30% faster with better usage of your storage capacity for greater system flexibility.

For only \$16,000.00, you can have 54.7 Mbytes of unformatted data storage with software transparency for your RDOS operating system.

Don't be in the dark! DIVA's DD-52 Disc System for greater flexibility and system tailoring.

DIVA, INC.
607 Industrial Way West, Eatontown, N.J. 07724
(201) 544-9000 or 800-631-2141



Circle 178 on reader service card

New literature

Digital instrumentation. A videotape program and textbook, entitled "Digital Troubleshooting," provides training in digital instrumentation. Described as equivalent in coverage to a two-day seminar, the program includes 14 videotapes with a total running time of five hours and 39 minutes and includes a 180-page textbook.

Videotapes and textbooks may be purchased individually. The entire program (14 tapes and one textbook) is available for \$2,200 plus taxes and handling charges. A descriptive brochure and order form is available without charge from Inquiries Manager, Hewlett-Packard Co., 1501 Page Mill Rd., Palo Alto, Calif. 94304. Circle 421 on reader service card.

Proximity switches. Product brochure FY describes two lines of self-contained industrial proximity switches. One is the all-metals-sensitive FY series, which uses the eddy-current-killed-oscillator (ECKO) principle, and the second is the 50FY, which is a magnetically operated Hall-effect device. The 16-page illustrated brochure lists features and advantages of the dc and ac products. It contains two pages of application drawings, simplified ordering guides, and detailed specifications. Write to Micro Switch, division of Honeywell, 11 W. Spring St., Freeport, Ill. 61032 [422]

Panel meters. Electrical-indicating analog panel meters are described in a catalog that covers complete lines for commercial, industrial, military, and aircraft applications. Dixon Instruments, Attn.: Meter Sales, P.O. Box 1449, Grand Junction, Colo. 81501. Phone (303) 242-8863 [423]

Toggle switches. Catalog No. 20 from Machine Components Corp. describes and illustrates a line of X- and X-Y-axis-motion joystick toggle switches. The switches are available with momentary or maintained contacts. Applications include motor controls, X-Y readers, microscope tables, telescopes, and aircraft-pilot

FROM \$20000

**When it comes to graphics...
WE'VE GOT YOUR NUMBER**

Maps, charts, aerial photos...if the information you need is graphical, the Numonics Digitizer can turn it into good, straight numbers. The Numonics Digitizer is desk top size, but offers a 30"x36" working area with resolution down to the closest 0.01". Very economical...and yet it has standard features like big readout and parallel BCD-buffered output. Plus optional direct measuring capability for area and curve length, with or without scaling. As quickly as you set the scale and trace the graphics, we've got your number. Let us tailor our digitizer into a data handling system that's right for you.

Write for more information
The Numonics Corporation
Rte. 202 and Hancock St.,
North Wales, Pa. 19454.
(215) 643-7410

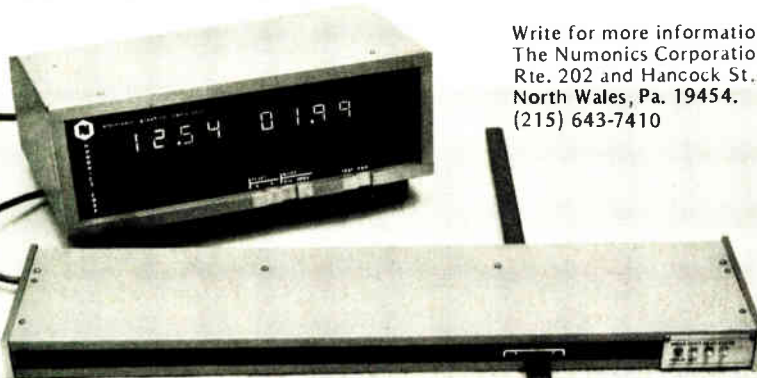

 NUMONICS

New high performance low voltage JAN and JAN-TX zeners

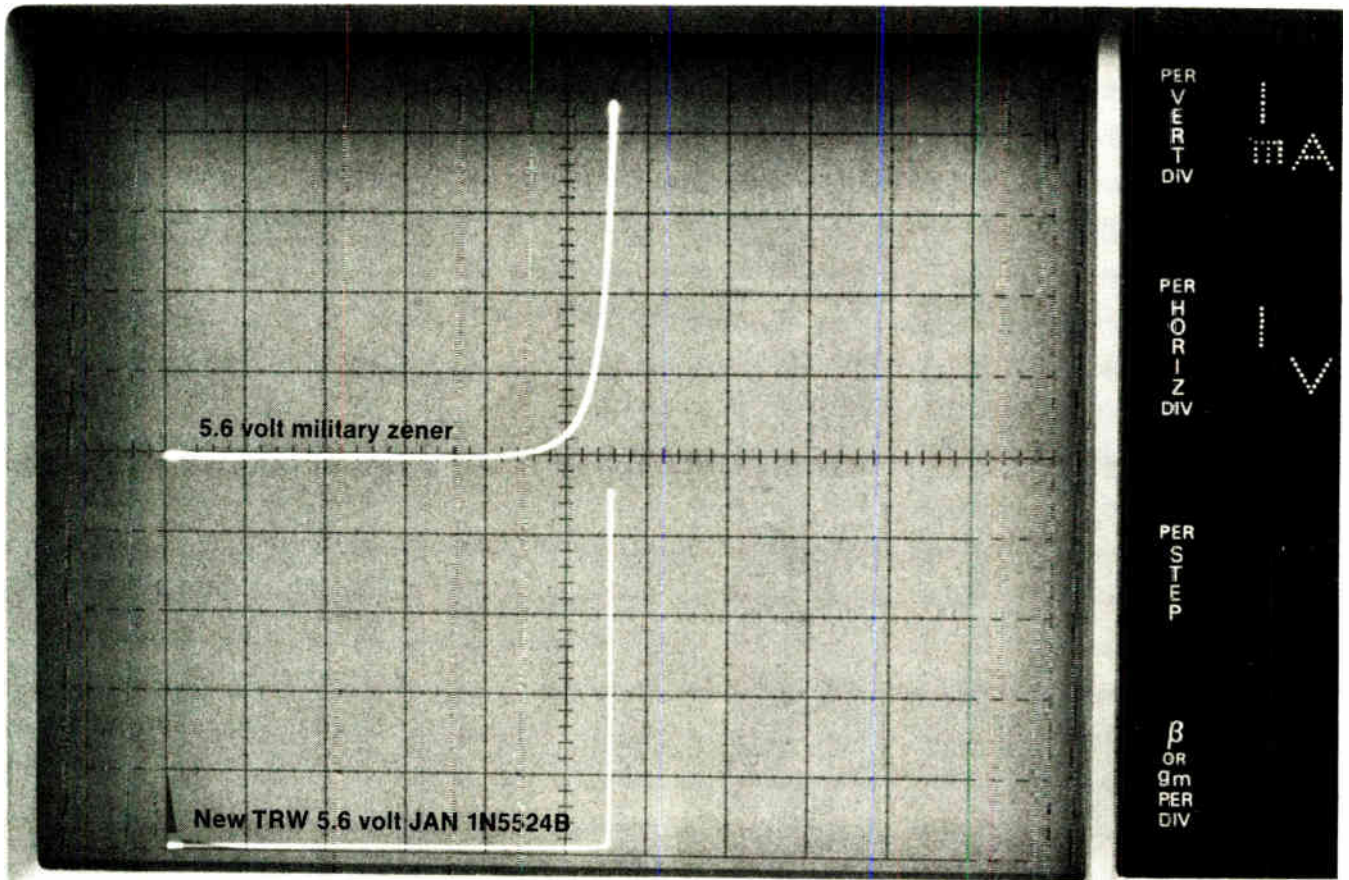

1N5521B through 1N5532B —4.3 volt to 12 volt zeners— now available as JAN and JAN-TX

Now you can get JAN and JAN-TX regular and reference zeners with much sharper knees in the 4.3-12 volt range.

Since the sharper knee gives circuit designers better regulation, TRW's new family of zeners offers a combination of better regulation and lower leakage to provide far more latitude in circuit design. For prices and specifications, call John Power (213) 679-4561, or use the coupon.

TRW Power Semiconductors,

An Electronic Components Division of TRW, Inc.,
14520 Aviation Boulevard, Lawndale, California 90260

- Please send me data sheets on TRW's new JAN and JAN-TX zeners.
- I would like a quote on _____ of _____ volt devices.
(Quantity) (Voltage)
- I am interested in chips with similar specifications for hybrid applications.

NAME _____

COMPANY NAME _____

ADDRESS _____

CITY _____

STATE _____

ZIP _____

TRW POWER SEMICONDUCTORS

Market-Directed® Surveys Provide Inputs Tailored To Your Decision Making

Do you know the size of markets for your products? Do you know if your products are preferred? By whom? And why they're preferred? Do you know if your salesmen reach the buying influences for your products? What proportion are contacted? Which is your best advertising message? What are your industry's marketing trends?

These are a small number of the questions that can be answered for you through actionable research by the unique facilities of McGraw-Hill.

Today's dynamic marketplace requires more market information than ever before.

Studies conducted by McGraw-Hill Research to fill the needs of corporate management, marketing executives, product managers, sales managers and advertising managers are identified as "Marketing Directed Surveys" by McGraw-Hill Research.

These surveys bring you new information about your company, its products, their markets, marketing tools used in the markets, and your advertising program.

For more information about "Market-Directed Surveys," write for our booklet *Answers for Decision Makers in Marketing*, or phone Allen Cobb, Jr., Director of Research (212) 997-6823.

McGraw-Hill Research

McGraw-Hill
Publications Company
1221 Avenue of the Americas
New York, N.Y. 10020



controls. Machine Components Corp., 70 Newtown Rd., Plainview, Long Island, N.Y. 11803 [424]

Using NBS broadcasts. Published by the National Bureau of Standards, NBS Technical Note 668 is a guide intended to help users get the maximum benefit from NBS short-wave transmissions. The guide, which is entitled "The Use of NBS High Frequency Broadcasts for Time and Frequency Calibrations," places special emphasis on the use of wwv and wwvh signals to measure time or set clocks with a resolution of 100 microseconds, and to calibrate frequency to within a few parts in 10¹⁰. wwv broadcasts from Fort Collins, Colo., and wwvh from Kekaha, Kauai, Hawaii. Copies of Tech Note 668 may be ordered from the Superintendent of Documents, U. S. Government Printing Office, Washington, D. C. 20402. The price is \$1.05.

Patent information. A variety of on-line patent-information services that give vital data on patents from 24 countries is offered by Derwent Publications Ltd., Rochdale House, 128 Theobalds Rd., London, WC1X 8RP, England. The computer-based services are described in brochures which are available from the company. [426]

Drafting practices. A comprehensive manual of universal drafting techniques entitled "Manual of Modern Drafting Practices" is a 580-page loose-leaf manual being offered for sale by General Electric for \$95 plus \$2.95 for shipping. Used for more than 40 years by GE, the manual is updated every six months. The semiannual updating service is available for \$40 per year. Quantity discounts are offered. The manual and further information can be obtained from Technology Marketing Operation, General Electric Co., Bldg. 5, Rm. 311, One River Rd., Schenectady, N. Y. 12345 [427]

Solid-state relays. An application note entitled "Solid-state Relays: They're Great When You Use Them Right" discusses the relative

High performance you can really see.

Look to Motorola CRT modules for sharper, brighter displays.

Motorola's 12 and 15 inch CRT modules deliver! 80 sharp characters by 24 lines, with a 7x9 dot matrix display. Video response to 22MHz. Horizontal scan frequency up to 19KHz. TTL separate sync or composite video input. And all at a lower cost than you may now be paying for CRT's with lower performance.

Other screen sizes are 5, 9, 19 and 23 inches. All are optimized for data display applications. All are adaptable for U.S. or European operation. All circuitry is completely solid state. In fact, up to 99% of the module circuitry comes on easily removed printed circuit boards . . . for quick and easy maintenance.

Readable. Economical. Versatile. Serviceable. Why not look us over? Send today for our free Design Kit with complete specs and application notes.



MOTOROLA Data Products

Domestic 455 East North Avenue
Carol Stream, Illinois 60187
312-690-1400 TWX: 910-252-4404

International Airport Center
4250 Veterans Memorial Hwy.
Holbrook, L.I., NY 11741 U.S.A.
516-588-4700 TWX: 510-228-1096

Circle 271 on reader service card

To find a fault fast... "QUIK-FREEZE IT!"

Drops surface temperature
to -50°F. in seconds

Send For
Trial Unit!

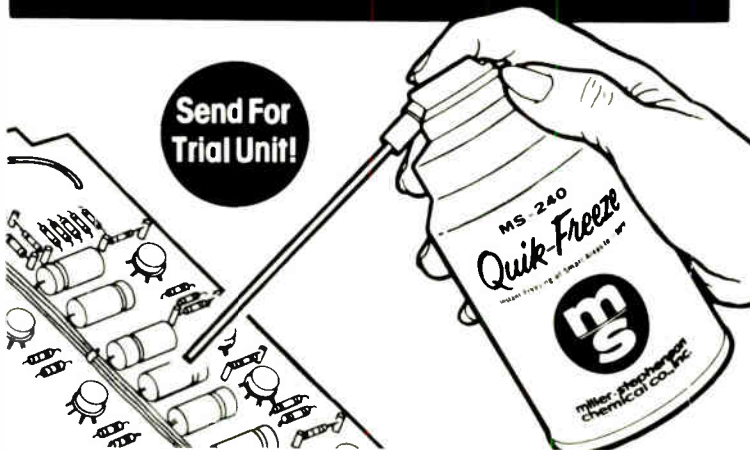

Few things waste more time than locating an intermittent circuit component. Isolate off-again on-again resistors, capacitors, etc., by quick-freezing them during testing. Remember: MS-240 "Quik-Freeze" is not only a circuit cooler, but also a full-fledged freezer. It can drop surface temperature to -50°F. (-45°C.) in seconds. A handy extension nozzle confines the chilling spray to the suspected component. Use MS-240 also to prevent undesirable heat transfer to delicate circuit elements during soldering or welding.

**ms miller-stephenson
chemical co., inc.**

Danbury, Connecticut 06810 • (203) 743-4447

- Enclosed is \$2.00, please send my "Trial Unit" (MS-240).
- Please send FREE literature and prices.

Intended Use

Name Dept./Title

Company

Address

CHICAGO • LOS ANGELES • TORONTO • Dist. in • ITALY • GERMANY • FRANCE
• GREAT BRITAIN • SWITZERLAND • LEBANON • SPAIN • NETHERLANDS

Circle 181 on reader service card 181

TTL Programmable microvolts

\$1595.

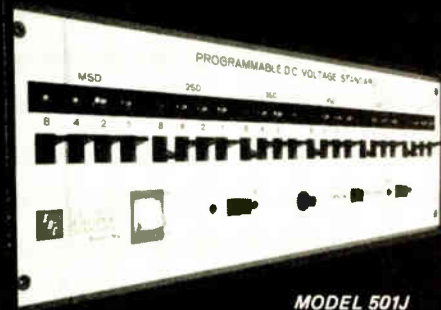

MODEL 501J

The 501J lets you marry your test system to NBS traceable DC voltages for high speed device calibration or signal simulation.

SPEED: 50 μ s switching and settling
RANGES: (f.s.) 100mV, 10V, 100V, 200VDC

RESOLUTION: from steps of 100 nanovolts

ACCURACY: $\pm 0.005\%$ of selected value

PROGRAMMING: TTL logic, BCD; Optional ASCII, Binary and IEEE 488 interface

ACCESSORIES (Field Plug-in): I/O option; \pm converter; Memory; Optoisolators; Ranging amplifier

For engineering or application assistance phone Bob Ross (617) 268-9696

UNIT BLOCK DIAGRAM

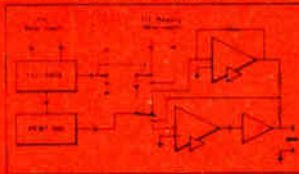

ELECTRONIC DEVELOPMENT CORPORATION
 11 Hamlin Street, Boston, Ma. 02127

Circle 182 on reader service card

Hanover makes markets Afresh every year



28th April - 6th May '76

Hanover Fair

- Refuse collection, disposal and utilization
- Propulsion engineering including installation engines
- Construction equipment
- Building materials and components, prefabricated and system building
- Machinery for building materials and concrete blocks
- Catering, coin-operated machines
- Office and information systems (CeBIT)
- Chemicals, rubber and plastics technology
- Steam and heat
- Iron and steel, non-ferrous metals, foundry products
- Electric lighting
- Production and conversion of electricity
- Distribution of electricity
- Domestic electric installations and equipment
- Specialized electrical processes and processing
- Electronic components and assemblies
- Research and technologies
- Measuring, testing, controlling and automation
- Telecommunications
- Surface treatment
- Cleaning and maintenance of property
- Transport
- Advertizing
- Tools
- Decorative consumer goods

EXPOCLIMA

European Specialised Exhibition for Refrigeration, Air-conditioning Air-handling and Drying

Schenkers International Forwarders, Inc., One World Trade Center, Suite 1867, New York, N.Y. 10048, Tel. 212432-3000

Circle 229 on reader service card

New literature

merits of these relays and conventional electromechanical relays. It suggests when to use each type and tells how to prevent certain common problems in applying SSRs. Copies of Ideafile No. 8 are offered by Heinemann Electric Co., Magnetic Dr., Trenton, N. J. 08602 [428]

Fluke catalog. A 24-page product directory and short-form catalog from John Fluke contains brief descriptions of the company's lines of test and measuring equipment. Included, among other things, are digital multimeters, digital thermometers, ac and dc standards, frequency synthesizers, electronic counters, logic-test equipment, and automated test equipment. Copies are available from John Fluke Mfg. Co. Inc., P.O. Box 43210, Mountlake Terrace, Wash. 98043 [429]

High-voltage interconnections. An expanded family of nearly 200 interconnecting leads and hermetic connectors for high-voltage applications is described in Catalog No. 73-218 from the Capatron division, AMP Inc., Elizabethtown, Pa. 17022. The 48-page catalog includes electrical, mechanical, and materials specifications. [430]

Thermistors. Catalog L-1B includes both product data and applications information on a wide variety of thermistors. The 12-page publica-

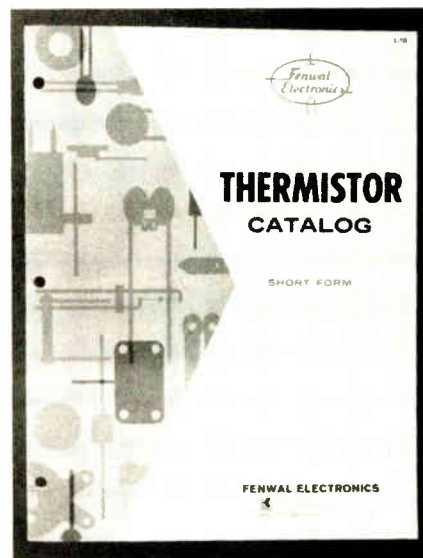

What you must know about Microprocessors.

The microprocessor has permanently changed the methods of designing and building electronic equipment—from process and industrial control to computer-based designs in instruments, communication and consumer/commercial equipment.

But, getting into microprocessors is no snap. As a fundamental departure from the old familiar hard-wired logic techniques, the microprocessor technology has already produced a host of devices competing for the designer's attention, each with its own software and hardware.

This book cuts through the confusion, presenting the design and application potential of this exciting technology in a manner that will appeal to the design engineer who needs to know how to use microprocessors as well as the system analyst who must assess the tradeoffs between micro-

processors and other techniques to accomplish his system goals.

Using articles from the pages of Electronics, this book contains practical and up-to-date information on available microprocessor devices, technology and applications—ranging from the simplest 4-bit p-channel MOS system to the second-generation n-MOS 8-bit processor chips, and the new injection logic and Schottky TTL bipolar processor families needed for the toughest computer-based control applications.

UPCOMING VOLUMES

Others already planned for the Book series: *Thermal Design*, *Mini-computers in Action*, *Large Scale Integration*.

Use form below to order your copy. Prices on 10 copies or more, available upon request.

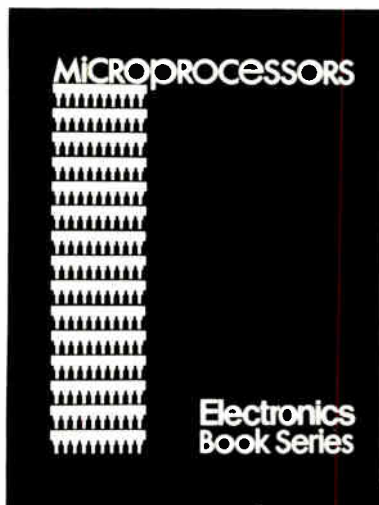

Electronics Book Series

P.O. Box 669 Hightstown, N.J. 08520

Send me _____ copies of "Microprocessors" at \$8.95 per copy.



I must be fully satisfied or you will refund full payment if the book is returned after 10 days free trial examination.

Payment enclosed Bill firm Bill me

Credit Cards Charge My Book To

American Express Master Charge Acct. No. _____

Diners Club BankAmericard No. _____

Date Card Expires _____ Interbank No. _____

1st No's. above name on Mastercharge only.

Name _____ Title _____

Company _____

Street _____

City _____ State _____ Zip _____

Signature _____



Light-Reflecting Electromagnetic Display Components



Visibility-Reliability

Two good reasons for using Ferranti-Packard Display Modules

And there are others. These versatile electro-magnetic modules are economical to apply and operate. Power consumption is negligible. Remanent magnetism provides inherent memory so power is only required to change the display — not maintain it. Drive circuitry is simple and cost is reduced since many modules can be multiplexed on a common data bus and power supply.

The rotating fluorescent discs are the only moving parts — and are rated for over 20 million operations. There are no lamps to burn out — or mechanical linkages to wear. Viewing is by reflected light — so the visibility increases with the ambient light level. This makes Ferranti-Packard Display Modules ideal in brightly lit conditions, indoors or out.

PRE-ENCODED & ALPHANUMERIC DISPLAY MODULES. CHARACTER SIZES FROM 1 TO 18 INCHES

- Ideal for
- Industrial Displays
 - Digital Readouts
 - Traffic Control Displays
 - Score and Bulletin Boards
 - Paging Systems

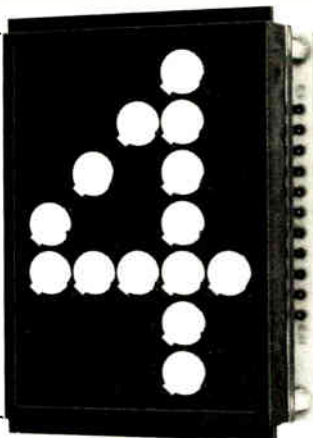

Modules are available in a range of colours and character sizes from 1 inch (2.54 cm) to 18 inches (45.72 cm)

For full information and specifications, contact the Display Components Department.

FERRANTI-PACKARD LIMITED

ELECTRONICS DIVISION,
121 Industry Street,
Toronto, Ontario, M6M 4M3, Canada
Telephone: (416) 762-3661
Telex: 06-22007.

7501E

184 Circle 184 on reader service card

MaX-Y line-up

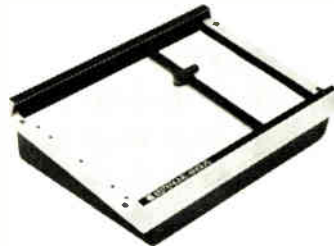
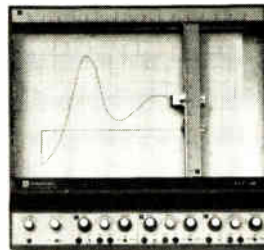

Esterline Angus has the newest and best in X-Y recorders, many models from high speed 2 pen to new stripped down OEM. Maximize your choices: rugged 'XYY' Model 540 zips along at up to 30 ips on each axis. Plots 2 independent variables against time or 3rd variable. Multirange with vernier on all axes. One millivolt/in. sensitivity.

OEM Model 575 contains a unique Y-axis pen shuttle with throwaway fiber-tip pen and pen lift in a single assembly. Slew speeds of 50 ips! Single ranges from 1 mV to 10 V/in. Add-on multirange module available for lab use. Full X-Y catalog: Esterline Angus Instrument Corporation, Box 24000, Indianapolis, Indiana 46224. Telephone 317/244-7611.



Circle 230 on reader service card

Terminal Boards

READI-MADE

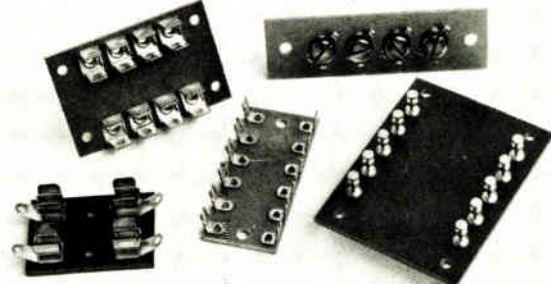

CUSTOM FABRICATED

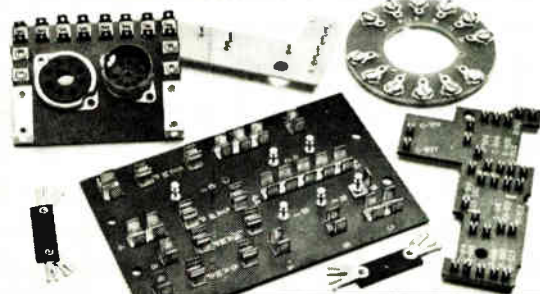

NEW FREE CATALOG ON REQUEST

KEYSTONE ELECTRONICS CORP.

49 BLEECKER ST., NEW YORK, N.Y. 10012 • (212) 475-4600

Circle 231 on reader service card

Varian Introduces The V76 It Remembers Time Is Money

The increasing demands of information processing obviously increases your computer time. And time is money. The V76 is a general purpose, microprogrammed computer system for scientific, industrial and data communications application. It outperforms the high class minicomputers such as the PDP-11/70, ECLIPSE, or the HP-3000.

You save money because of the new low cost 64K memory. The dual-ported semiconductor MOS 660ns memory provides the same performance as an identically configured core memory for one-third the price, or less than seven cents a byte.

With our high performance Cache system you can execute your programs almost twice as fast. Our new Megamap allows you to process up to one million words of on-line data. This combination of large resident memory, Megamap and Cache is a highly cost effective method to process more information, reduce exe-

cuton time and save additional money.

The Varian V76, with an unlimited range of application, and a broad, flexible, high-performance, open-ended selection of computer hardware, firmware and software allows you to design the system that best suits your complex information processing demands.

A network of field service engineers, analysts and a full staff of factory experts are committed to serving you with system configuration, hardware and software specials, installation, operator training and systems management.

Find out about the economy-minded Varian V76 computer system by calling any of our 38 worldwide offices listed below. For a free product brochure write Varian Data Machines, 2722 Michelson Drive, P.O. Box C-19504c, Irvine, CA 92713, (714) 833-2400. In Europe, contact Varian Associates, Ltd., Molesey Road, Walton-on-Thames, Surrey, England, Telephone 28971.

Helping a Fast World Move Faster

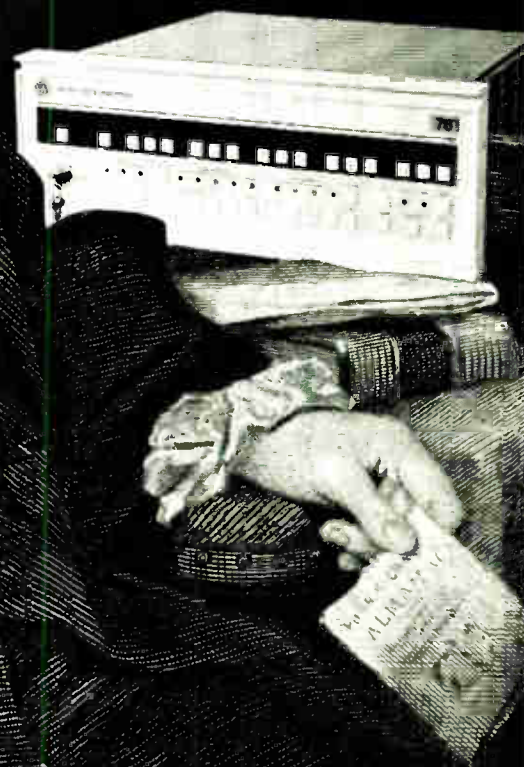

U.S. OFFICES: Los Angeles (213) 499-4438, San Diego (714) 276-9462, San Francisco (408) 736-5630, Seattle (206) 641-4500, Denver (303) 770-2151, Dallas (214) 231-5145, Houston (713) 781-0105, St. Louis (314) 739-8433, Chicago (312) 692-7184, Detroit (313) 645-9950, Cleveland (216) 236-3960, Orlando (306) 259-1592, Atlanta (404) 252-0047, Washington, D.C. (301) 773-6670, Philadelphia (215) 343-2355, New York City (212) 325-5248, Rochester (716) 586-3253, Boston (617) 550-6072.
INTERNATIONAL OFFICES: Brussels (32) 4662000, Darmstadt (06151) 88386, Munchen (089) 8126093, Bensberg (02204) 51966, Amsterdam (020) 15 94 10, Stockholm (08) 820030, Zug (042) 23 25 75, Surrey (093 25) 28971, Toronto, (416) 457-4130, Montreal (514) 332-2840, Vancouver (604) 736-5621, Ottawa (613) 224-6521, Calgary (403) 276-4456, Melbourne 560-7133, Sydney 43-0673, Sao Paulo (011) 2413449, Singapore 2352502, Tokyo 403-7101, New Zealand 697-099, Taipei 559082.

FREE SAMPLE/DESIGN KIT



Free sample/design kit sheds light on how Silikrome® lamp filters put you ahead with more accurate color selection and extended life for miniature incandescent or automotive lamps.

Colorfast and pliant even after 10,000 hours at -160°F to 500°F, these interchangeable, reusable silicone rubber boots can't crack, melt or fade like painted bulbs or plastic caps . . . add 5-6% longer lamp life, too. For your free design kit, contact: APM-Hexseal, 44 Honeck St., Englewood, N.J. 07631; (201) 569-5700



**Color coating:
1. filter,
2. paint or
3. plastic?**

Circle 186 on reader service card

New literature

tion, which can be obtained from Fenwal Electronics, 63 Fountain St., Framingham, Mass. 01701, includes 13 circuit diagrams. [431]

Data converters. More than 100 data-conversion products, such as analog-to-digital and digital-to-



analog converters, and sample-and-hold amplifiers, are covered in a 16-page catalog from Micro Networks Corp., 324 Clark St., Worcester, Mass. 01606 [432]

Interface circuits. The word "interface" has been applied to a variety of functions that are not easily classified. Motorola, therefore, has chosen to put all of its interface integrated circuits into a single, 36-page "Linear Interface" brochure, which contains data on memory interfaces, bus interfaces, instrumentation interfaces, communications interfaces, and computer and terminal interfaces. Copies may be obtained from the Technical Information Center, Motorola Inc., Semiconductor Products division, P. O. Box 20924, Phoenix, Ariz. 85036 [433]

Cylindrical connectors. A line of cylindrical multicontact, coaxial, high-voltage connectors, all of which have a Quick-Lok feature, is described in a short form catalog put out by Lemo U.S.A. Inc., 2015 Second St., Berkeley, Calif. 94710. [434]

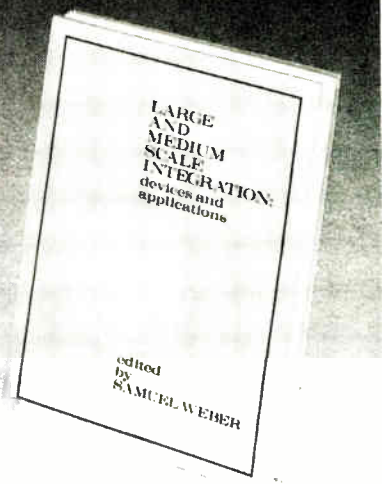

Large and medium scale integration: Keep up with this fast changing technology

Now, in one comprehensive volume, a complete working grasp at large and medium scale integration for electronics engineers engaged in the design of electronic systems, equipment and products.

A wealth of practical working data on large and medium scale integration has been culled from the most important articles in Electronics magazine by Samuel Weber, Executive Editor. Emphasis is on design problems at the system or subsystem level, as well as on the economics of today's design.

Whatever the design problem — from partitioning a digital system to working with a semiconductor company in producing the best LSI design, this book covers the full range of today's important technologies on a practical, rather than a theoretical, level.

It's yours for \$15.00. Keep up.

FREE 10-DAY EXAMINATION

McGraw-Hill Book Company
1221 Ave. of the Americas,
New York, N.Y. 10020



Send me a copy of Large and Medium Scale Integration (068815-X) for 10 days on approval. At the end of that time, I will either remit \$15.00, plus tax, postage, and handling, or return book without further obligation. (Remit in full with this coupon, plus any tax, and McGraw-Hill pays all postage and handling costs.)

Name _____

Address _____

City _____

State _____ Zip _____

Offer good only in the U.S. and subject to acceptance by McGraw-Hill. For prices outside U.S., contact McGraw-Hill Book Co.

23 K138-4018-3

NEW Simpson® INSTRUMENTS

for faster, easier more
economical electrical and
electronic testing and
measuring work



The world famous 260-6
The time-honored,
ever-popular VOM
for universal use



The new 260-6XL
with low-power ohms,
shock-resistant case
and 33 ranges



464

**NEW
DIGITAL
MULTI-METER**
Price/Performance
Breakthrough

NEW Digital Panel Meters 2850

NEW Digital VOM Meter with dB-Ranges 460-db

NEW Frequency Counter-Timer 7015

NEW Ana-Led Panel Meters 7527

NEW Solid-State FET VOM 303-3XL

NEW Electronic Counter 7026

NEW Chroma-Line Color-Pattern Generator 432

NEW Precision Octave Band Analyzer 888

NEW Microwave Leakage Tester 380

NEW High-Frequency Scaler 7020

NEW Low Ohms Probe for use with most VOMs 00735

NEW Amp-Clamp® Clamps-Ons and Line Splitter 294

NEW Sound Level Meters and Calibrator 890

NEW Digital Panel Meters 296

NEW Digital VOM Meter with dB-Ranges 295

NEW Solid-State FET VOM 886

NEW Solid-State FET VOM 884

PLUS . . . over 2,000 stock ranges, sizes and types of analog, digital and AnaLed panel meters . . . a wide variety of meter relays, pryometers and controllers . . . recorders and portable instrumentation . . . and the widest selection of digital and analog test equipment . . . all available for off-the-shelf delivery.



ORDER NOW FROM YOUR LOCAL **ELECTRONICS ELECTRICAL** DISTRIBUTOR



SIMPSON ELECTRIC COMPANY

853 Dunce Avenue, Elgin, Illinois 60120
(312) 697-2260 • Cable: SIMELCO • Telex: 72-2416
IN CANADA: Bach-Simpson, Ltd., London, Ontario
IN ENGLAND: Bach-Simpson (U.K.) Limited, Wadebridge, Cornwall
IN INDIA: Ruttonsha-Simpson Private, Ltd., Vikhroli, Bombay

ASK FOR FULL LINE CATALOG

Circle 187 or reader service card 187



ATTENTION: Systems Designers,

The Electronics Book Series offers you a handbook on the current and revolutionary impact of LSI on digital design. This 220-page book presents a unique opportunity for circuit designers, systems designers, and engineering managers and supervisors to bring their expertise into line with today's LSI design requirements.

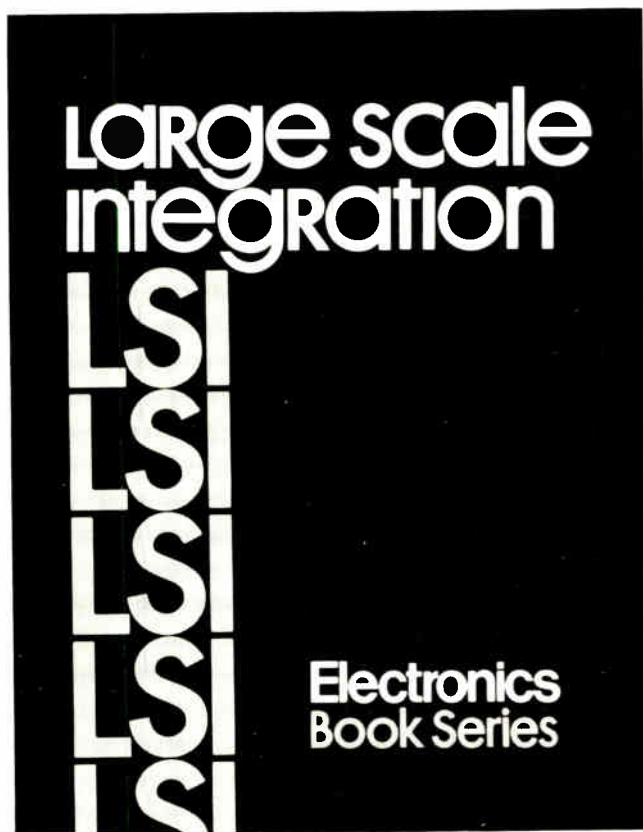

Large scale integration

Like the well-received "Microprocessors"—the first book offered in the Electronics Book Series, also edited by Laurence Altman—"Large Scale Integration" is a compendium of recent articles published in Electronics. Although in some ways it is a companion piece to "Microprocessors" because it explains the new circuits that play in mp systems, it is much more. "Large Scale Integration" deals with the entire range of design applications: main memory systems, peripheral memories, memory controllers, on-line industrial controllers, data acquisition boards, communication systems, calculators, watches, etc.

The content: six general areas

1. LSI technology: the latest MOS and bipolar techniques.
2. LSI devices and performance: memory, logic and interface.
3. LSI design techniques: devices in actual design examples.
4. LSI circuit modeling: hands-on design techniques using computer-aided design.
5. LSI circuit testing: devices and techniques for automatically testing LSI components.
6. Applications: selected to show range of LSI capability—electronic switching, data acquisition, and industrial control.

Some of the specifics:

- Bipolar LSI—its meaning for higher performance.
- I²L—new capability for the system designer.
- Enhanced n-channel MOS—makes memory and logic faster and cheaper.
- C-MOS—the road to low-power LSI designs.
- RAMs: statics, dynamics, 1-k, 4-k—which device for which job.

Circuit Designers, Engineering Managers

- Designing those 4-k RAM boards.
- Taking a look at the big 16-k RAM—its impact on memory design through the seventies.
- What good are the new C-MOS static RAMs.
- How to get the CCD advantage now for the next generation of mass storage systems.
- Merging software and hardware for the optimum balance.
- Analyzing the LSI digital domain—packing the most punch onto a pc board.
- The new breed of LSI in circuit testers—troubleshooting your LSI prototypes pays off in performance.
- CAD for LSI—takes the guesswork out of today's logic design.

The contributors:

Edited by Laurence Altman,
Senior Editor, Electronics

C. M. Hart	W. E. Engeler
Arie Slob	R. D. Baertsch
H. E. J. Wolms	D. M. Brown
Horst Berger	William Davidow
S. K. Wiedmann	Robert Garrow
R. J. Huber	Sterling Hou
K. F. Smith	James Lally
D. R. Hill	Hap Walker
J. N. Fordemwalt	Stephen Scrupski
J. W. Hanson	James Bowers
W. H. Dobelle	Gary Shaw
Laurence Altman	Meir Baran
S. Sheffield Eaton	Andy Santoni
Bernard Cole	Charles House
Clinton Kuo	William Farnbach
Nori Kiagawa	John R. Greenbaum
Ed Ward	Jerry Lyman
Phil Drayer	David Schneider
John Gersbach	Stan Harris
Len Levine	Alan Weissberger
Ware Myers	W. Andriaans
Shep Hume	N. V. Franssen
J. J. Tiemann	



Special Pre-publication Offer:

If your order for "Large Scale Integration" is postmarked on or before April 1, 1976, you need pay only \$7.95 per copy. After April 1, the price will be \$9.95. Take advantage of this 20% discount by using the following order form today.

McGraw-Hill Electronics Book Series
PO Box 669
Hightstown, N.J. 08520

Send me _____ copies of "Large Scale Integration" at the pre-publication price of \$7.95 per copy.

Send me _____ copies of "Microprocessors" at \$8.95 per copy.

I must be fully satisfied or you will refund full payment if the books are returned after ten day trial examination.

Full payment must accompany my order.

Name _____

Title _____

Company _____

Street _____

City _____

State _____

Signature _____

**Electronics
IS THE SOURCE
FOR BOOKS, TOO**



Electronics advertisers

March 4, 1976

ADAC	6	EECO	163	LFE Corporation Process Control Division	48
* Adelys	149	Electronic Development Corporation	182	Micro Power Systems	69
Advanced Micro Devices	11	Electronic Navigation Industries	3rd C	Micro Switch Division of Honeywell	130, 131
* Alltech	11E, 89	Electronics Memories and Magnetics Corporation	124	■ Micro Technical Industries	151
■ Airpax Electronics Inc.	41	■ Emerson & Cuming Inc.	151	Miller Stephenson Chemical Inc.	183
Allen Bradley Company	24	■ Erie Technological Products Co. Inc.	17	■ 3M Electronics Division	164
American Microsystems Inc.	140, 141	Esterline Angus Instrument Corporation	184	Monsanto Commercial Products Co.	21, 159
American Optical Corp. Fiber Optics & Industrial Products Division	193	Fairchild Camera & Instruments	171	Motorola Data Products	183
■ AMP Incorporated	58, 59	■ Ferranti Packard	184	■ Mountain West Alarm Supply Co.	142
■ APM Hexseal	186	Figaro Engineering Inc.	165	‡ National Semiconductor Corporation	134
‡ Baron-Blakeslee	132	■ Fluke Manufacturing Co., John	73-83	* National Semiconductor GmbH	128, 129, 8E
Bausch & Lomb Inc.	68	FMC Corporation Semiconductor Products Operation	9	‡ Nec Microcomputer Inc.	152, 153
■ Bourne Inc.	4th C	FOS-RCH	165	‡ Norland Instruments	127
Buckbee-Mears Co.	169	General Electric Instrument Rental Division	176	Numonics Corp.	178
* Burr Brown Research Inc.	12E	■ General Electric Co. Miniature Lamp Division	136	■ OK Machine & Tool Company	194
‡ Bussman Mfg. Division of McGraw Edison Co.	52	■ General Radio	57	* Oscilloquartz	54
■ Cherry Electrical Products Inc.	87	Germanium Power Devices Corp.	166	Oxy Metal Industries Corporation	149
Chomerics Inc.	44	■ Grayhill Inc.	148	* Philips Industries	46E-47E
Cimarron a Division of Vari-L Company Inc.	151	GTE Sylvania Parts Division	22, 23	* Philips N.V. Pit/T&M Division	2E-3E
■ Collins Radio Hybrid Circuits Division of Rockwell International	74	Guardian Electric Mfg. Co.	147	Philips Test & Measuring Instruments, Inc.	161
Communications Transistor Corporation	173	Hanover Fair	182	* Plessey Microsystems	127
Computer Automation	62, 63	■ Hewlett-Packard	1, 2, 7, 18, 19, 102, 116, 157, 2nd cover	Plessey Semiconductors	132
Continental Rentals	8	Honeywell Test Instrument Division	12, 13	■ Powermate	168
■ Continental Specialties Corporation	160	Hughes Aircraft Company	39, 155	* Procond S.p.A.	147
‡ Corning Materials Division	27	Instronics	162	Projects Unlimited Inc.	193
‡ Cutler-Hammer Inc.	150	‡ Interdesign	16	■ Radio Research Instrument Corporation	172
■ Dana Laboratories	156	Intersil Inc.	143, 145	RCA Solid State Division	35, 37
Data Delay Devices	172	Interswitch	193	‡ Rental Electronics Inc.	54
■ Data Precision	30	* Italtel Siemens	15	RO Associates	138
Delco Electronics Division General Motors Corporation	84, 85	■ Ithaco, Inc.	135	■ Rockland Systems	86
‡ Deltron	45	Johanson Mfg. Corp.	20	* Rohde & Schwarz	1E
■ Diallight Corporation	174, 175	Kennedy Company	64, 65	* Salon Mesucora	54
Digital Equipment Corporation (Components)	137	M. S. Kennedy	14	Schlumberger GmbH	194
Diva Inc.	178	■ Keystone Electronics Corp.	184	* S.E.E.M.	16
‡ Eastman Kodak Company Graphics Division	15	Kitahami Denki Co., Ltd.	8	* Sfernice	52
Edmund Scientific	168	Kronn Hite Corporation	5	Simpson Electric Company	187
				* Sodeco	27

Sprague Electric Company	51
■ Superior Electric Company	170
■ T Bar	191
Tansitor Electronics	6
■ Tektronix Inc.	60, 61
Teradyne Inc.	66
■ Texas Instruments Incorporated	167
Theta Instruments	146
* Thomson CSF	45
‡ TRW/IRC Resistors	128, 129
TRW/Power Semiconductor	179
United Systems Corp. a Sub of Monsanto Co.	177
■ Unitrode Corporation	28, 29
■ U.S. Capacitor Corporation	43
Varian Data Machines	185
Varo Semiconductor Inc.	191
Wakefield Engineering Inc.	144
Wavetek	90
XLO-Remex	104
Yokogawa Corporation of America	158
* Yokogawa Electric	152
‡ Carl Zeiss	46, 47

sealed high density miniature switching

for 12 PDT to 108 PDT with MIL-R-5757 protection against humidity . . . sand . . . dust . . . moisture . . . corrosion . . . splash . . . explosion . . . built to withstand shock/vibration!

HERMETICALLY
SEALED

Tbar[®]
SERIES
881/981
RELAYS



Hermetically sealed glass and metal-to-metal enclosures backfilled for ground support and selected airborne applications. Mates with MS connectors. Pulse operated magnetic latching available. 43 circuits switched in a space as small as 1 3/4" x 4 3/8" x 4 7/8".

Interested? Write or phone T-Bar today for complete facts, prices, quantity discounts.

Tbar[®] INCORPORATED
SWITCHING COMPONENTS DIVISION

141 Danbury Road, Wilton, CT 06897 • Telephone: 203/762-8351 • TWX: 710/479-3216

Circle 191 on reader service card

19¢*

ea.

An integrated bridge rectifier in a miniature dual in-line package

DIB

DUAL IN-LINE BRIDGE

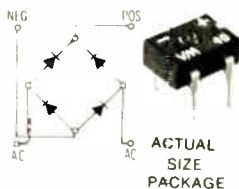

- 4-pin, low-profile DIP
- Leads on standard .10" (2.54 mm) grid
- Compatible with automatic testing, handling and inserting
- 1 Amp at 40°C (I_o)
- 25V to 1000V (V_{RRM})
- Call Lee Miller 214/272-4551, Ext. 206 for more information.

* 100V; 100,000 qty.

Design us in . . . we'll stay there



VARO SEMICONDUCTOR, INC.

P.O. BOX 676, 1000 N. SHILOH, GARLAND, TEX 75040 (214) 272-4551 TWX 910-860-5178

Classified section

FOR EMPLOYMENT AND SALES OPPORTUNITIES

POSITION VACANT

Position Available—Need BS Eng. + U.S. exper. in engineering or technical sales. Fee paid by employer. Over 1,000 U.S. client co's. Est. 1959. Send resume & present salary. Atomic Personnel, Inc., Box 1, 1518 Walnut, Phila. PA 19102.

Graduate Assistantships in Physics can begin during any quarter. Write: Dr. R. Madey, Kent State University, Kent, OH 44242.

EMPLOYMENT SERVICE

Electronics' Industry Newsletter tells you which firms have current employment opportunities, in the field of Electronics, for all types of Engineers, Sales Representatives, Technicians, Executives, Computer Personnel and others. Latest product information is also reported. For information write: Electronics' Industry Newsletter, Dept. 304A, 23573 Prospect Avenue, Farmington, MI 48024.

CLASSIFIED SALES REPRESENTATIVES

Atlanta	... Miriam Curth	404/892-2868
Boston	... H. Buchanan	617/262-1160
Chicago	... Bill Higgins	312/751-3733
Cleveland	... C. Byers	216/781-7000
Dallas	... G. Ambrose	214/742-1747
Denver	... John Ryan	303/266-3863
Detroit	... Mac Huestis	313/873-7410
Houston	... Rick Ofstie	713/224-8381
Los Angeles	Stan Kassir	213/487-1160
New York	... H. Buchanan	212/997-3593
	... D. Hawksby	212/997-3593
Philadelphia	Dan Ferro	215/568-6161
Pittsburgh	Pam Petika	412/391-1314
San Francisco	Mary Kenny	415/362-4600

XEROX 400 TELECOPIER
212/997-6800

Advertising Sales Staff

Pierre J. Braudé New York [212] 997-3468
Paris Tel: 720-73-01
Director of Marketing

Atlanta, Ga. 30309
100 Colony Square, 1175 Peachtree St., N.E.
[404] 892-2868

Boston, Mass. 02116: James R. Pierce
607 Boylston St. [617] 262-1160

Chicago, Ill. 60611:
645 North Michigan Avenue
Robert W. Bartlett (312) 751-3739
Robert M. Denmead (312) 751-3738

Cleveland, Ohio 44113: William J. Boyle
[716] 586-5040

Dallas, Texas 75201:
2001 Bryant Tower, Suite 1070
[214] 742-1747

Denver, Colo. 80203: Harry B. Doyle, Jr.
123 Speer Blvd. # 400
[303] 837-1010

Detroit, Michigan 48202: Robert W. Bartlett
1400 Fisher Bldg.
[313] 873-7410

Houston, Texas 77002: Paul Reiss
601 Jefferson Street, Dresser Tower [713] CA 4-8381

Los Angeles, Calif. 90010: Robert J. Rielly
Bradley K. Jones, 3200 Wilshire Blvd., South Tower
[213] 487-1160

New York, N.Y. 10020
1221 Avenue of the Americas
Warren H. Gardner [212] 997-3617
Michael J. Stoller [212] 997-3616

Philadelphia, Pa. 19102: Warren H. Gardner
Three Parkway,
[215] 997-3617

Pittsburgh, Pa. 15222: Warren H. Gardner
4 Gateway Center, [212] 997-3617

Rochester, N.Y. 14534: William J. Boyle
9 Greylock Ridge, Pittsford, N.Y.
[716] 586-5040

San Francisco, Calif. 94111: Don Farris
Robert J. Rielly, 425 Battery Street,
[415] 362-4600

Paris: Alain Offergeld
17 Rue-Georges Bizet, 75 Paris 16, France
Tel: 720-73-01

Geneva: Alain Offergeld
1 rue du Temple, Geneva, Switzerland
Tel: 32-35-63

United Kingdom & Scandinavia: Robert Ghey
Tel: 01-493-1451, 34 Dover Street, London W1

Milan: Luigi Rancati
1 via Baracchini, Italy Phone 86-90-656

Brussels: Alain Offergeld
23 Chaussee de Wavre
Brussels 1040, Belgium
Tel: 13-73-95

Frankfurt/Main: Fritz Krusebecker
Liebigstrasse 27c, Germany
Phone 72 01 81

Tokyo: Tatsumi Katagiri, McGraw-Hill
Publications Overseas Corporation,
Kasumigaseki Building 2-5, 3-chome,
Kasumigaseki, Chiyoda-Ku, Tokyo, Japan
[581] 9811

Australia: Warren E. Ball, IPO Box 5106,
Tokyo, Japan

Business Department

Thomas M. Egan,
Production Manager [212] 997-3140

Carol Gallagher
Production Manager International [212]
997-2045

Dorothy Carter, Production Manager Domestic
[212] 997-2908

Frances Vallone, Reader Service Manager
[212] 997-6057

Electronics Buyers' Guide

George F. Werner, Associate Publisher
[212] 997-3139

Regina Hera, Directory Manager
[212] 997-2544

NOW IS THE TIME ... TO HIRE A STUDENT THIS SUMMER.

First, it's later than you think, with schools closing on different semester schedules, and students torn between lining-up "sure" jobs now or gambling that something in their chosen field will come along later.

Second, and most important, it's in our industry's best interest to encourage and hold its life-blood by providing practical experience in their future profession.

And, since there'll always be more applicants than openings, you'll be able to select the cream of the crop, then evaluate them with an eye towards hiring, when

as coveted graduates, the job market might well be in their favor.

Because we believe this program is of mutual benefit to both employer and employee alike, we again offer our services as a clearing-house.

Just fill out and return the coupon below, and we'll include your organization in a free listing to be sent to Placement Directors and Department Heads at leading colleges and universities across the nation. They'll post it, and the students will contact you directly.

Free summer help listing

MAIL TO: ELECTRONICS/POST OFFICE BOX 900/NEW YORK/NY 10020

NAME/TITLE (of individual to be contacted)

ADDRESS: (Mailing address of your personnel office)

ORGANIZATION: (Firm, Company, Government Agency or Institution)

TYPE AND NUMBER OF STUDENTS SOUGHT: Electronics Avionics

Technician

Other: (Draftsman, etc.)



3 4 76

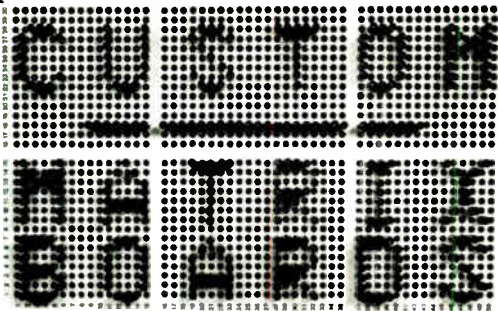

for programming . . .

**NUMERICAL CONTROL EQUIPMENT
PROCESS CONTROL EQUIPMENT
TEST EQUIPMENT**

Spacing between columns = 3mm, 4.5mm, 6mm,
or multiples thereof—Shorting Pins or Diode Pins
SEND YOUR REQUIREMENTS TO US OR CALL :

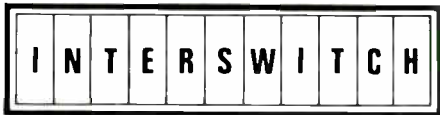

ONE OF THE PURDY GROUP OF COMPANIES
770 Airport Blvd., Burlingame, CA 94010
Phone (415) 347-8217 TWX 910-374-2353 TELEX 34-9373

Circle 193 on reader service card



AO Optics

THE COMPLETE LINE
OF FIBER OPTIC PRODUCTS
FROM AMERICAN OPTICAL
CORPORATION

**FREE
Fiber
Optics
Catalog**

Features the complete AO line of fiber optics products—from Inspection Fiberscopes and Light Guides to Illuminators, Image Conduits, Faceplates and Custom Components. Includes the four newest remote inspection fiberscopes now available.

Describes the principle, technology and techniques used to make flexible light and image transmissions a proven, practical fact. Write today for your FREE copy of the AO Fiber Optics catalog to American Optical Corporation, Fiber Optics Division, Southbridge, Mass. 01550.



Circle 235 on reader service card

**WE'RE
WARNING
YOU...**

. . . it's easy to design instrument panel warning systems with these NEW solid state audio indicators. Six models . . . with .250" (6.4mm) quick-disconnect tabs. Pleasing continuous or pulsing tone . . . 85 dbA at 800 Hz . . . 5 to 50 vdc. Fits 1.125mm opening; adapter ring optional for larger openings. Ask for new free catalog.



Series A1-330

Actual Size

Model A1-301
Adapter Ring
(optional)

**WHERE
TO BUY**

an audio indicator
for every need . . .

- CALIFORNIA, COSTA MESA
MarVac Electronics
- MASSACHUSETTS, SHARON
Adcour
- NEW YORK, ROCHESTER
Ossmann Components
- OHIO, COLUMBUS
Hughes Peters, Inc.
- TEXAS, DALLAS
K. A. Electronics
- UTAH, SALT LAKE
Newark Electronics
- WASHINGTON, SEATTLE
Elwood Industries
- WISCONSIN, MILWAUKEE
Taylor Electric

In Canada:
ONTARIO, WILLOWDALE
Electro Sonic, Inc.



projects[®]
unlimited

Selected distributorships available.

3680 Wyse Road, Dayton, Ohio 45414
Tel. (513) 890-1918, TWX 810-450-2523

WIRE FOR WIRE-WRAPPING



CUT TO LENGTH
STRIPPED BOTH ENDS
AVAILABLE FROM STOCK

OK MACHINE AND TOOL CORPORATION

3455 CONNER STREET, BRONX, NEW YORK, N.Y. 10475 U.S.A.
PHONE (212) 994-6600 TELEX NO. 125091

Circle 194 on reader service card

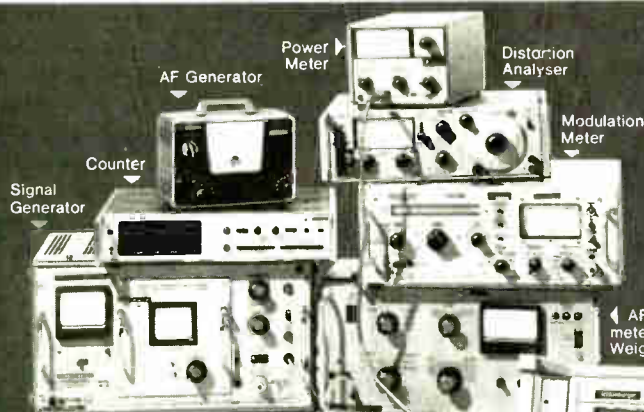

STABILOCK

Compact Radiotelephony Test Set

All functions of these well known laboratory instruments have been combined in the STABILOCK Test Set with an optimum arrangement for checking radio telephone equipment.

The STABILOCK design needs no complicated cabling, the various measuring functions being selected by press-button switching.

The STABILOCK operates with a genuine frequency synthesizer and there are consequently no problems of frequency drift during measurements.

Frequency tuning may also be achieved by remote control.

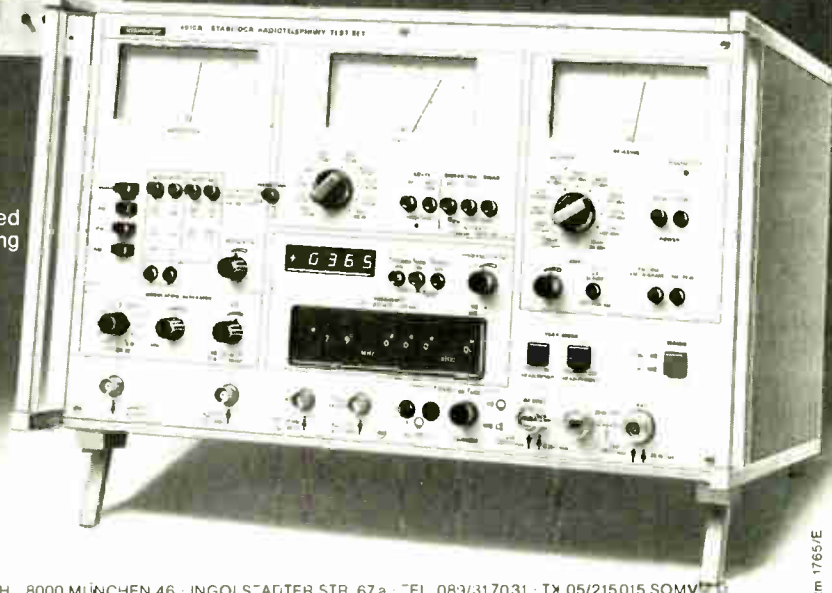

Schlumberger

SCHLUMBERGER MESSGERATEBAU UND VERTRIEB GMBH 8000 MÜNCHEN 46 · INGOLSTADTER STR. 67a · TEL. 089/317031 · TX 05/215015 SOMV

tm 1765/E

194 Circle 283 on reader service card

Tomorrow ideas today.



Using solid-state technology to replace bulky tube-type equipment, ENI's broadband amplifiers are tomorrow ideas available today. ENI's Class A power amplifiers already cover the frequency spectrum of 10 kHz to 1 GHz, with power outputs ranging from 300 milliwatts to over 4000 watts. And we're still climbing. Driven by any signal generator, frequency synthesizer or sweeper, ENI's compact portable amplifiers are completely broadband and untuned. Amplifying inputs of AM, FM, SSB, TV and pulse modulations with minimum distortion, these rugged units are

versatile power sources for general laboratory work, RFI/EMI testing, signal distribution, RF transmission, laser modulation data transmission, NMR, ultrasonics and more. Designed to be unconditionally stable and failsafe (impervious to severe load conditions including open or short circuit loads), ENI power amplifiers will deliver their rated power to any load, regardless of match. For information write: ENI, 3000 Winton Rd. So., Rochester, New York 14623. Call 716-473-6900. TELEX 97-8283 ENI ROC.

ENI

World's Leader in Solid State Power Amplifiers

World Radio History

What Every Designer or Specifier Should Know About RESISTOR NETWORKS!

A wise man once said, "A chain is only as strong as its weakest link". That phrase says as much for electronic circuitry today . . . as it originally did for the value of the individual quality of man. For example, the failure of a single tiny printed conductor path in a resistor network can cause the failure of an entire circuit . . . or system.

Bourns doesn't want that to happen to one of your circuits. For that reason, we want to share some "inside" information about the design and manufacture of thick-film networks . . . so that you can be a more knowledgeable and more selective specifier.

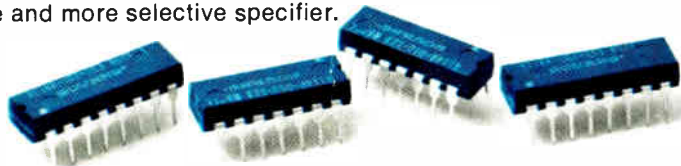
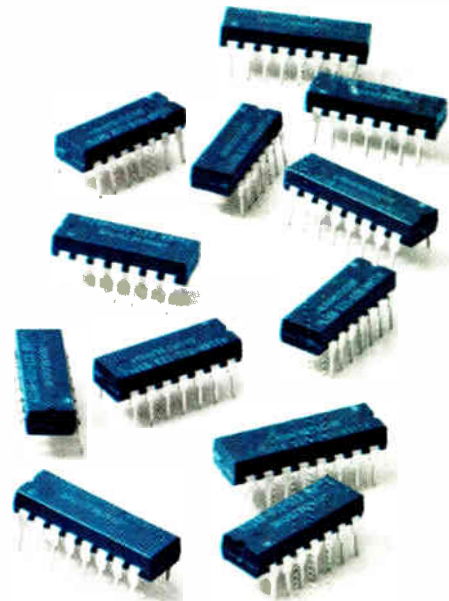

1. Lead Termination Failure

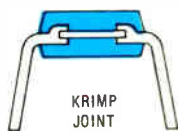

KRIMP JOINT

During Bourns initial design program, customer interviews indicated that commonly used "lap joint" and "butt joint" lead termination designs were subject to failure due to weakening of the solder termination during PC board wave soldering operations, and in-circuit heat cycling and vibration. These design-types depend heavily on solder alone for both mechanical and electrical bonding of leads to the substrate.

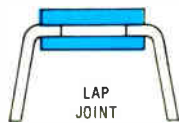

LAP JOINT

With this in mind, Bourns engineers developed the "Krimp-Joint™" lead frame termination design to protect customers from this hazard.

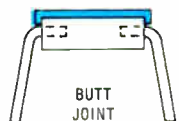

BUTT JOINT

Bourns Krimp-Joint leads are firmly crimped onto the network element, much like a vise grasps a piece of lumber. To "cinch" the electrical connection, a special high temperature, reflow resistant solder is also used.

3. The Packaging

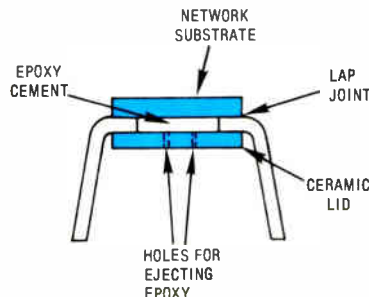

Various types of DIP packaging are utilized of which the molded and "sandwich" types seem most common. One problem that frequently occurs with the sandwich types is delaminating. This happens when air in tiny voids remaining in the epoxy filler (bonds the substrate to the sandwich "lid") expands in hot operating environments to the extent that the package comes apart and fails.

Bourns Krimp-Joint networks are encased in a homogenous molded thermoset plastic package, which is highly heat resistant. Both 14- and 16-pin DIP models are machine insertable, and are available in handy cartridge packages.

4. Power

Bourns uses a high-copper alloy lead material to enhance power dissipation capacity. Other materials — ferrous and brass alloys — do not have comparable performance. Furthermore, there is potential for rust with the ferrous alloy material. The high-copper alloy costs us more . . . but we think your satisfaction is worth it.

5. A Good Coat Is Important

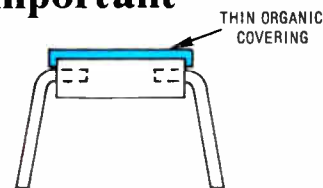

Our little network package must "weather" the homo sapien as well as the electrical environment. Example? Some users report that marking the top of thinly coated networks actually changed internal resistor values. With the tight board spacing found in most equipment cabinets, components occasionally get scraped when boards are inserted and/or removed. Customers report that some thinly protected networks have shorted-out or opened under these conditions. Bourns networks wear a heavy coat of molded plastic to weather the homo sapien climate.

2. Krimp-Joint Eliminates "Edge-Arounds"

"Edge-around" thick-film printing techniques are required by some designs to electrically connect the network circuit — printed on the horizontal surface of the substrate — to pin leads which are always "butted" to the edge of the substrate, or are "lap-jointed" to the opposite side of the substrate. The latter condition exists with lap-joint designs when more complex thick film circuits are executed which require printing on both sides of the substrate (such as resistor/capacitor networks, dual terminators, special application circuits, etc.). Edge-around printing leaves a natural conductor path weakness on the fine edges of the substrate, resulting in the possibility of a very "tenuous" connection. Such connections are subject to failure after exposure to heat cycling, shock, vibration, etc., and can result in an open circuit condition. Sometimes an intermittent condition results, which makes fault diagnosis more difficult.

Since most packages are not tested at full rated power during manufacturing QC, weak edge-arounds sometimes pass final tests . . . and then burn-out (like a fuse), when subjected to full power in an operating circuit.

Bourns Krimp-Joint mechanically contacts both top and bottom surfaces of the resistor network substrate, resulting in a strong, positive connection between pin lead and both sides of a network circuit. No edge-around paths are required.

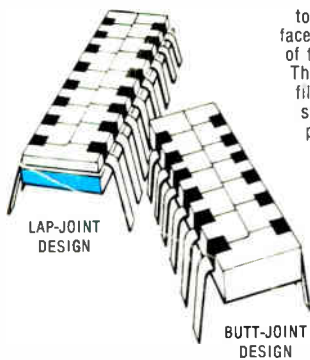

LAP-JOINT DESIGN

BUTT-JOINT DESIGN

EDGE-AROUND CONDUCTOR PATHS

FREE SAMPLES

Try the Bourns "Krimp-Joint" Resistor Network Design. Write to us on your company letterhead telling us

1. current manufacturer's part number you are now using,
2. what resistance values you need . . .

and we will send samples for your evaluation. We'll also include a complete data packet, with a handy cross-reference guide.

