

AUGUST 7, 1975

WHY THE MILITARY IS PUSHING FIBER OPTICS/73

Updated bipolar process finds new life in LSI/101

Choosing a compiler for microcomputer-based systems/107

FOUR DOLLARS A MCGRAW-HILL PUBLICATION

International

Electronics®



THE CONTINUITY MAZE

**TESTING
FINDS THE WAY**

THE BEAUTY OF THE BRAND-REX CABLE YOU BUY IS THE HUNDREDS OF BRAND-REX CABLES YOU DIDN'T BUY.

Brand-Rex keys its business approach on the ability to give you advice. Objective, professional advice. It's an important difference. One we earned the hard way.

It stems from having a broad product line. With the range of materials we process and our broad manufacturing skills, we can offer completely objective solutions to your problems. No preconceived answers restricted by limited capability. The product we recommend results from the conscious elimination of those we don't.

Over the years we have learned to work with 14 different plastics, 7 different circuit identification methods. Ten varieties of metallic shields. Our products meet



applicable UL and CSA standards, and government and industry specifications. We have more UL listings for thermoplastic insulated wire and cable than any other manufacturer.

Our products include everything from simple hook-up and back panel wires, to the more sophisticated ribbon cables and TapeCable®, to highly sophisticated signal, interconnecting, control, data collection and point of sale cables.

What's more, we have an experienced engineering staff with a reassuring record for solving those difficult problems.

So don't think of your Brand-Rex representative as a salesman. Think of him as a problem solving partner with a lot more to offer than just a product. Call him. You'll see.

Brand-Rex Ltd., P.O. Box 26, Glenrothes, Fife, Scotland. Tel. (059-275) 772124.

BRAND-REX LTD.

A PART OF AKZONOB INCORPORATED

True rms volts, amps and watts measurements in just one unit

Specifically developed to solve the perplexing problems of accurate measurement of nonsinusoidal and distorted waves, YEW Type 2504 Digital AC Meter is used in single-phase circuits to measure the true rms value of voltage (30V to 300V, or 100V fixed), current (0.5A to 10A, or 5A fixed) and wattage (15W to 3kW, or 500W fixed), all at an accuracy of $\pm 0.25\%$. Type 2504 incorporates our proven feedback time division multiplier techniques and features superior versatility and simple circuit construction.

Measurement function (W, V-A, or V-A-W) and type of reading (direct or normalized) can be selected from among six different mainframes and type of input (single- or multi-range) can be selected from two plug-in modules. Operation from the front panel is extremely simple and instrument loss is negligible.

Main Specifications

- Types Available: (Mainframe) W, V-A or V-A-W measurements by either direct or normalized (rated input displayed as 1.0000) readout. (Plug-in Input Module) Single-range module; 100V/5A, 500W, Multi-range module; 30V/60V/100V/150V/300V, 0.5A/1A/2A/5A/10A, 15W to 3kW.
- Max. Reading: 11900.
- Units: V, mA, A, W and kW.
- Resolution: 10mV/digit, 0.1mA/digit, 10mW/digit.
- Accuracy: $\pm 0.25\%$ of rdg + 0.05% of range for 50Hz to 60Hz, $\pm 0.5\%$ of rdg + 0.1% of range for other frequency ranges.
- Frequency Ranges: 25Hz to 2kHz for Volts and Amps, 40Hz to 1.2kHz for Watts.
- Dielectric Strength: 2,200V AC between input terminals and case.
- Analog Output: Standard.
- BCD Output and Remote Control: Option.

- *Suitable for complex, distorted waves and low power factor*
- $\pm 0.25\%$ accuracy
- Plug-in flexibility



YEW

• For Electronic Measuring, Recording Instruments:
YOKOGAWA ELECTRIC WORKS, LTD.

Yaesu-Mitsui Bldg., 5-7 Yaesu, Chuo-ku, Tokyo 104, Japan Phone: 274-6511 Telex: J28544 YEW TOK

Overseas Offices: • **YOKOGAWA ELECTRIC (EUROPE) B.V.**, Nederhoven 17-19-21, Buitenveldert, Amsterdam, The Netherlands. Phone: 020-423194 Telex: 44-14094
• **YEWTEC CORPORATION**, 1995, Palmer Ave., Larchmont, New York, 10538, U.S.A. Phone: 914-834-3550, Telex: 710-566-1104

Representatives in Europe: • Belgium: **COMPTOIR COMMERCIAL INTERNATIONAL S.A.**, (03) 32. 78. 64 • France: **TEKELEC AIRTRONIC**, 626-0235 • Finland: **FINN METRIC OY**, 460 844 • West Germany: **NBN ELEKTRONIK**, (08151) 13036 • Italy: **VIANELLO S.P.A.**, 5483811 • Norway: **AS MAXETA**, 53090 • The Netherlands: **TECHMATION NV**, 020-456955 • Spain: **ATAIO INGENIEROS**, 215-35-43 • Sweden: **TELEINSTRUMENT A.B.**, 08/38 03 70 • Switzerland: **OMNI RAY AG**, 01-340355 • United Kingdom: **MARTRON ASSOCIATES LTD.**, Marlow (06284) 5071.



PM 8120 - D.05 m/1cm
500 mm/s - DIN A4 format
16 angles

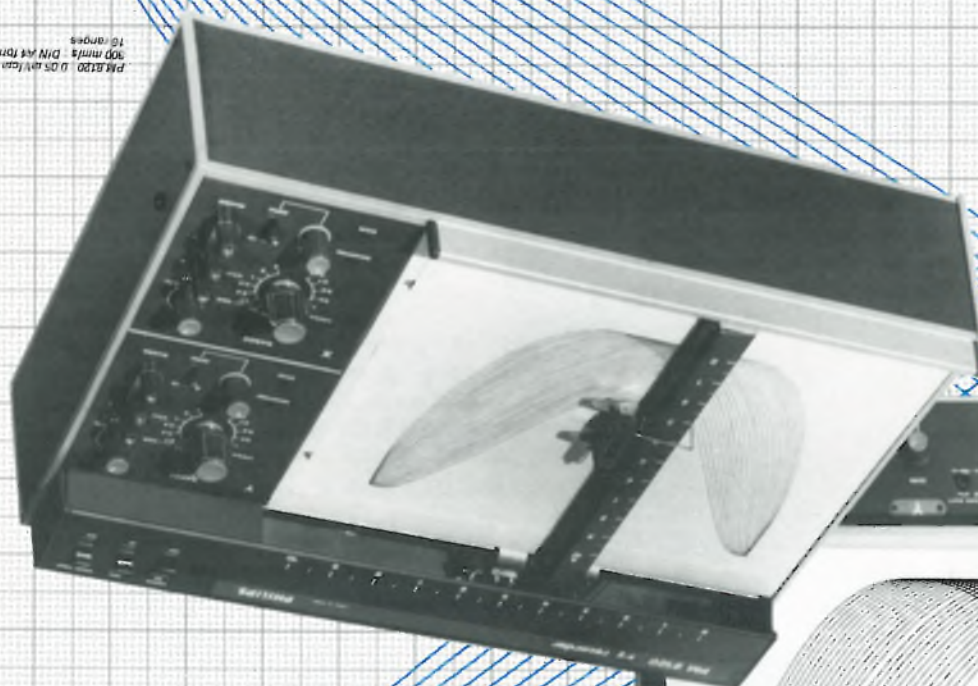

PM 8125 - D.05 m/1cm
500 mm/s - DIN A3 format
16 angles

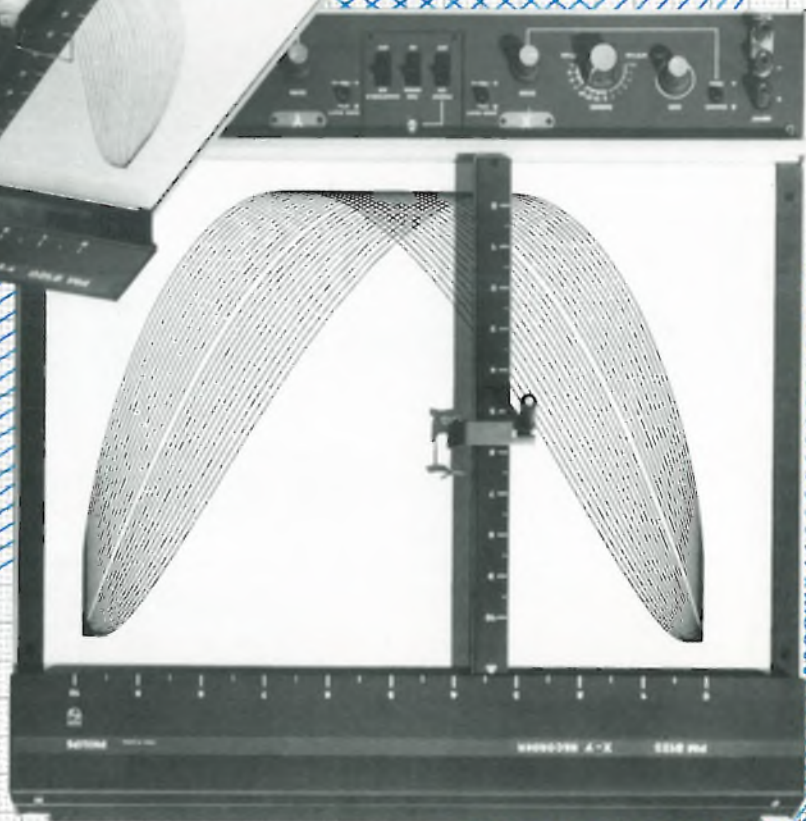

When every detail counts

High 0.05 mV/cm sensitivity, fast 500 mm/s writing speed, big A3 chart size

That's the combination that makes the PM 8125 X-Y A3 chart recorder the right choice for R&D labs, where every detail of the trace is often so important.

The high 0.05 mV sensitivity is adjustable in 14 steps to 1 V/cm, with variable span overlapping each range to give continuous adjustment. Electronic overload protection covers all ranges and the inputs are both floating and guarded to ensure high noise immunity. Most important, the 500 mm/s writing speed enables fast-changing signals to be recorded accurately.

A recording accuracy of $\pm 0.25\%$ and 0.1% reproducibility is ensured by the null balance potentiometric measuring system which has a MOS FET chopper and DC servo system with tachogenerator feedback.

The zero point, which is continuously adjustable over the full recording width, can be conveniently checked at the push of a button, while push-

button selection also provides -100% offset.

Penlift can be remote as well as manual. The writing system employs nylon-tipped felt pens. Standard drawing pens can also be fitted directly.

Electrostatic chart hold-down

A useful feature of the recorder is the electrostatic chart hold-down, which works for any kind of paper and any size up to 250 x 380 mm (Din A3). Quick chart alignment is obtained with pinpoint light guides.

These features add up to make the PM 8125 the ideal recorder for manufacturing and education as well as lab R&D. As illustrated, a smaller format A4 version is also available.

Add-on X_t, Y_t facility

The optional plug-on time base unit PM 9814 is a sweep generator designed to give models PM 8125/20 X_t or Y_t facilities. A wide range of speeds from 0.05 to 20 sec/cm can be obtained with an accuracy

of $\pm 3\%$ and 0.5% linearity.

Comprehensive X-t range

As illustrated below, the Philips program features a comprehensive range of X-t recorders.

Three models have 0.25% accuracy and 0.35 sec response times with a choice of single line, double line or multi-point (up to 12 channels).

Two other compact recorders feature 0.5% accuracy and 0.25 sec response time plus a wide range of options, making them ideal for OEM applications. The compact dimensions and convenient Z-fold paper system also make these instruments ideal for crowded bench work.

The Z-fold chart paper is a feature common to all X-t models, as is the stepper motor chart drive.

For more information on X-Y and/or X-t chart recorders please write to: Philips Industries, Test and Measuring Instruments Dept., Eindhoven, The Netherlands.

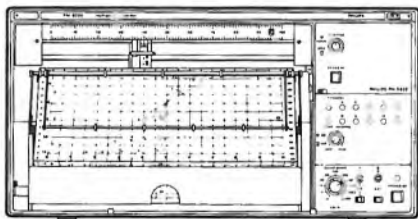

PM 8235 : multi-point recording on 1 to 12 channels using simple pin board programming

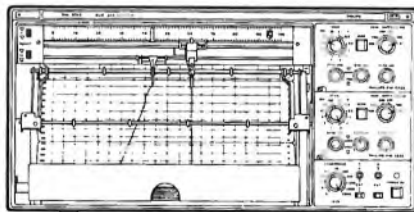

PM 8240/45 : single and double-line respectively : wide choice of input parameters

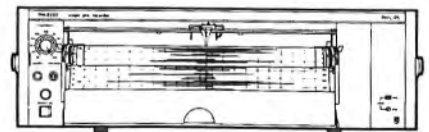

PM 8202/22 : single and double-line. OEM and end user facilities

PHILIPS

Powercube's new 5 volt 10 amp switching regulator offers high efficiency DC-DC power conversion at lower voltages for logic devices. There has never been such a powerful unit available in this miniaturized Powercube package.

This advanced unit operates from raw DC inputs of 18 to 32 volts and is resistance programmable (4 volts to 6 volts at 10 amps). It provides remote sensing to offset line drop and regulates the voltage at the load. This rugged switching regulator features short circuit protection, low heat generation, and can be paralleled for higher power output (up to 100 watts).



Original Powercube Module®

Powercube's new switching regulator delivers system economies by reducing heat sink size, in many instances eliminating fans or blowers, and permits the use of lower capacity batteries. It is engineered to give more than 100,000 hours MTBF at temperatures ranging from -55° to $+100^{\circ}$ C.

Write or phone for complete information on this unique new switching regulator. We have a powerful story to tell.

powerful

5 volt 10 amp switching regulator

*Other voltage and current levels
are available in identical package size;
i.e., +15 volts at 5 amps, +12
volts at 5 amps.*



Actual size 2" x 3" x 1 1/2"



POWERCUBE CORPORATION

214 CALVARY STREET, WALTHAM, MASS. 02154 (617) 891-1830
SUBSIDIARY OF UNITRODE CORPORATION

43 Electronics Review

MILITARY: Air Force receives bids for phased-array radar, 43
Laser gyros gain with new DOD office, 44
FIBER OPTICS: Light signals handle power data, 45
CONSUMER: Electronics adds wristwatch frills, 46
Motorola aims at PL auto-radio tuner, 48
German remote TV control invades U.S., 30
SOLID STATE: American Micro Devices readies oxide isolation, 51
NEWS BRIEFS: 54
MATERIALS: New process closes the GaP, GaAsP gap, 54

1E Electronics International

JAPAN: Prototype infrared detectors have high sensitivity, 1E
WEST GERMANY: Hologram-aimed laser beams solder components, 2E
FRANCE: Program enhances computer time-sharing capabilities, 3E
GREAT BRITAIN: Inexpensive microwave monitor fits in pocket, 3E
Two modular digital panel meters differ in precision, 4E
NEW PRODUCTS INTERNATIONAL: 5E

73 Probing the news

FIBER OPTICS: Military systems efforts advance, 73
COMMUNICATIONS: Data protocol agreement is closer, 76
COMMERCIAL: Wire-line carriers seen dominating 900 MHz, 81
COMPANIES: Plessey Semiconductors plans export drive, 84

87 Technical Articles

SPECIAL REPORT: Automated testing unsnarls continuity skein, 87
DESIGNER'S CASEBOOK: Two instrument ICs sum six inputs, 97
Touch Tone receiver front end provides agc and filtering, 98
SOLID STATE: Improving triple diffusion yields densest ICs, 101
COMPUTERS: Choosing a compiler for microcomputers, 107
INSTRUMENTS: Renting and leasing are economical alternatives, 112
ENGINEER'S NOTEBOOK: Curve tracer can check optoisolator, 116
C-MOS decade divider clocks bucket-brigade delay line, 117

123 New Products

IN THE SPOTLIGHT: Logic-board tester is easy to use, 123
MOS LSI chip runs complex digital clock radio, 124
DATA HANDLING: Color video display used for image analysis, 126
MICROWAVE: S-band magnetron delivers 800 kW of peak power, 130
INSTRUMENTS: Synthesizers are fast and quiet, 134
SUBASSEMBLIES: Low-profile dc-dc converters supply 10 watts, 138
SEMICONDUCTORS: JFETs, bipolar transistors put on same chip, 143
MATERIALS: 147

Departments

Publisher's letter, 6
Readers comment, 8
News update, 10
Editorial, 12
People, 18
Meetings, 34
Electronics newsletter, 39
Washington newsletter, 63
International newsletter, 69
Engineer's newsletter, 120
New literature, 150

Highlights

The cover: Keeping track with automatic testers, 87

The labyrinthine interconnections of equipment built round myriads of complex electronic components can only be checked effectively by automated continuity testers. Their usefulness extends even to hybrid substrates. Cover is by photographer Mitchell Funk.

Military advances in fiber optics, 73

The Army, Navy and Air Force are all making headway with their developmental programs in fiber-optic communications. In fact, the Navy's Aloft avionics system is due for flight testing next year.

3D renaissance sets a bipolar density record, 101

An updated version of the triple-diffusion process packs 17,000 devices onto a single chip. Speeds of 5 to 30 megahertz are fast enough for most minicomputer applications.

Choosing a language for a microcomputer, 107

Microcomputer-based systems intended for many different applications should be programmable by their users in higher-level languages, and the necessary compilers are becoming available. But microcomputers in high-volume systems should still be programmed in assembly language.

And in the next issue . . .

Special report on camera electronics . . .
electronics and industry, part 4: food . . .
fiber-optic communications outside the U.S.

EDITOR-IN-CHIEF: Kemp Anderson

EXECUTIVE EDITOR: Samuel Weber

MANAGING EDITORS: Lawrence Curran, *News*;
Arthur Erikson, *International*

SENIOR EDITORS: John Johnsrud,
H. Thomas Maguire, Laurence Altman,
Ray Connolly, Stephen E. Scrupski

ART DIRECTOR: Fred Sklenar

ASSOCIATE EDITORS: Howard Wolff,
Gerald M. Walker, Alfred Rosenblatt

DEPARTMENT EDITORS

Aerospace/Military: Ray Connolly

Circuit Design: Don Blattner

Communications & Microwave:

Richard Gundlach

Components: Lucinda Mattera

Computers: Stephen E. Scrupski

Consumer: Gerald M. Walker

Industrial: Margaret A. Maas

Instrumentation: Andy Santoni

New Products: H. Thomas Maguire,

Michael J. Riezenman

Packaging & Production: Jerry Lyman

Solid State: Laurence Altman

COPY EDITORS: Margaret Eastman,
Everett C. Terry, Bill Dunne

ART: Charles D. Ciatto, *Associate Director*
Patricia Cybulski, *Assistant Director*

PRODUCTION EDITOR: Arthur C. Miller

EDITORIAL SECRETARIES: Janet Noto,
Julie Gorgoglione, Penny Roberts

FIELD EDITORS

Boston: Gail Farrell (Mgr.), Pamela Leven

Los Angeles: Paul Franson (Mgr.)

Judy Phelps

Midwest: Larry Armstrong (Mgr.)

New York: Ron Schneiderman (Mgr.)

San Francisco: Bernard Cole (Mgr.)

Judith Curtis

Washington: Ray Connolly (Mgr.)

Larry Marion

Frankfurt: John Gosch

London: William F. Arnold

Paris: Arthur Erikson

Tokyo: Charles Cohen

McGRAW-HILL WORLD NEWS

Director: Ralph R. Schulz

Bonn: Robert Ingersoll

Brussels: James Smith

London: James Trotter

Madrid: Dom Curcio

Milan: Andrew Heath

Moscow: Peter Gail

Paris: Michael Johnson, Richard Shepherd

Stockholm: Robert Skole

Tokyo: Mike Mealey

PUBLISHER: Dan McMillan

DIRECTOR OF MARKETING: Pierre J. Braudé

ADVERTISING SALES SERVICE MANAGER:
Wallis Clarke

BUSINESS MANAGER: Stephen R. Weiss

CIRCULATION MANAGER: Nancy L. Merritt

MARKETING SERVICES MANAGER:

Tomlinson Howland

RESEARCH MANAGER: Margery D. Sholes

The trend toward large-scale integration of circuit functions certainly is helping to cut down on the number of wires or conductive paths between components. Yet the number of interconnections in sophisticated electronic equipment remains huge, and finding shorts or opens in those paths is a headache of massive proportions. On page 87, you'll find a report on how automated circuit testers are helping with the continuity maze.

Says Jerry Lyman, our packaging and production editor, who prepared the report: "Interconnections come in many forms, chiefly the plated conductors on printed-circuit boards, backplanes, chassis wiring, cables, and harnesses. To illustrate the complexity of the wiring in modern equipment, the A-6 attack plane has 22,000 to 24,000 points interconnected by cables and harnesses. Backplanes in telephone exchanges have more than 80,000 points, and multilayer printed-circuit boards can have 25,000."

With all the progress in semiconductor fabrication, it's refreshing to discover how many of yesterday's good ideas aren't obsolete. A case in point is the triple-diffusion process for monolithically producing electrically isolated transistors and resistors.

The 3D process, as it is commonly called, is comparatively simple. What's more, refinements in applying the technique have shown that it can be an effective method for obtaining high levels of density and speeds that fit current applications. Indeed, the technique has already brought a record level of circuit

density to bipolar technology.

As in any technique there are design trade offs. Yet the simplicity of the approach is a great asset. Thus the 3D process, which held sway in an earlier age of solid-state design, is not only alive and well, it is entering a new stage of its life. So turn to page 101 for the latest chapter.

Companies that will carefully evaluate whether to rent or buy computers, production machinery, and fleets of vehicles often overlook another significant class of equipment: test and measuring instruments. Yet, when you look at the breathless pace of technology in many areas of testing, it does not make much economic sense acquiring an expensive tester that may end up having a relatively short useful life. All too often, the purchase is postponed until the "new generation" of equipment comes along—and then postponed waiting for yet another "new generation."

There is, however, quite a business growing in the leasing and rental of instruments and test equipment. And the same business trade-offs—avoidance of high initial investment, write-off of monthly fees against operating revenues, preservation of credit lines for company expansion, and the like—apply just as well to the leasing of test equipment as they do a computer or a delivery truck. For a rundown on what to consider before you buy, take a look at page 112.

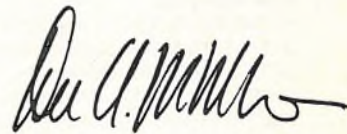

August 7, 1975 Volume 48, Number 16
93,983 copies of this issue printed

Published every other Thursday by McGraw-Hill, Inc. Founder: James H. McGraw 1860-1948. Publication office 1221 Avenue of the Americas, N.Y., N.Y. 10020; second class postage paid at New York, N.Y. and additional mailing offices.

Executive, editorial, circulation and advertising addresses: Electronics, McGraw-Hill Building, 1221 Avenue of the Americas, New York, N.Y. 10020. Telephone (212) 997-1221. Teletype TWX N.Y. 710-581-5234. Cable address: MCGRAW HILL N.Y.

Subscriptions limited to persons with active, professional, functional responsibility in electronics technology. Publisher reserves the right to reject non-qualified requests. No subscriptions accepted without complete identification of subscriber name, title, or job function, company or organization, including product manufactured or services performed. Subscription rates: qualified subscribers in the United States and possessions, Canada, and Mexico \$12.00 one year, \$24.00 three years; all other countries \$25.00 per year, except Japan and Israel \$50.00 per year, Brazil \$40.00 per year, Australia and New Zealand \$60.00 per year, including air freight. Limited quota of subscriptions available at higher-than-basic rate for persons outside of field served, as follows: U.S. and possessions and Canada, \$25.00 one year; all other countries \$50.00. Single copies: \$4.00.

Officers of the McGraw-Hill Publications Company: John R. Emery, President; J. Elton Tuohig, Executive Vice President-Administration; Gene W. Simpson, Group Publisher-Vice President; Senior Vice Presidents: Ralph Blackburn, Circulation; Walter A. Starbury, Editorial; John D. Hoglund, Controller; David G. Jensen, Manufacturing; Gordon L. Jones, Marketing; Jerome D. Luntz, Planning & Development.

Officers of the Corporation: Shelton Fisher, Chairman of the Board; Harold W. McGraw, Jr., President and Chief Executive Officer; Robert N. Landes, Senior Vice President and Secretary; Ralph J. Webb, Treasurer.

Title registered in U.S. Patent Office. Copyright © 1975 by McGraw-Hill, Inc. All rights reserved. The contents of this publication may not be reproduced in whole or in part without the consent of copyright owner.

Subscribers: The publisher, upon written request to our New York office from any subscriber, agrees to refund that part of the subscription price applying to copies not yet mailed. Please send change of address notices of complaints to Fulfillment Manager; subscription orders to Circulation Manager, Electronics, at address below. Change of address notices should provide old as well as new address, including postal zip code number. If possible, attach address label from recent issue. Allow one month for change to become effective.

Postmaster: Please send form 3575 to Fulfillment Manager, Electronics, P.O. Box 430, Hightstown, N.J. 08520.

five important reasons to specify the **KEPCO JQE** power supply

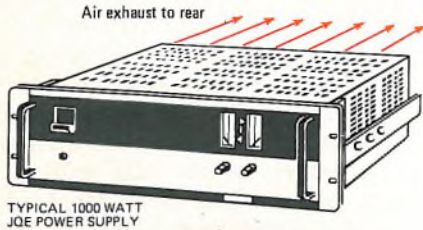

TYPICAL 1000 WATT JQE POWER SUPPLY

- **JQE deliver their rated output right up to +71°C without any derating whatever.** Moreover, they run cool! Internal blowers actually help circulate the air in your system to keep hot spots from developing.
YOUR MECHANICAL PEOPLE WILL APPRECIATE THIS.

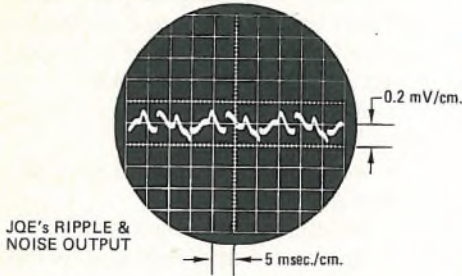

JQE'S RIPPLE & NOISE OUTPUT

- **JQE produce clean d-c,** less than 0.2 mV rms ripple and noise (1.0 mV p-p including spikes up to 10 mHz). The output varies less than 0.0005% for the worst sort of line variation, and long-term drift is less than 0.01%.
YOUR LOAD WILL APPRECIATE THIS.

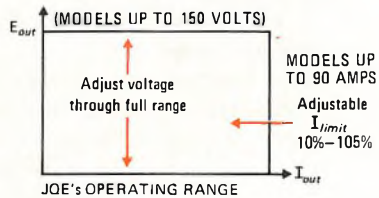

JQE'S OPERATING RANGE

- **JQE are wide-range instruments.** Every JQE can be set from zero to its rated output. What's more, they all have one *additional* volt capacity so that wire drops do not subtract from the voltage available to your load. Buy a 0-15V model to cover the 5V, 6V, 8V, 10V, 12V and 15V loads. A 0-36V model to take care of 18, 24, 28, 32 and 36V jobs.
YOUR BUDGET WILL APPRECIATE THIS.

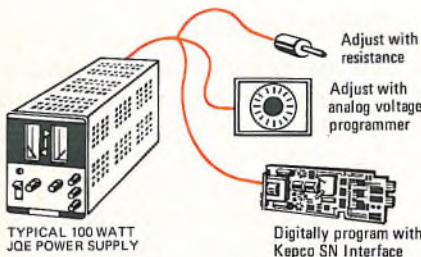

TYPICAL 100 WATT JQE POWER SUPPLY

- **JQE are fully programmable**—by resistance (1000Ω/volt) or by voltage (any gain ratio you choose) or by parallel binary or BCD logic. That means you can easily interface your JQE with a computer control bus. (Use the Kepeco SN Programmer)
YOUR SYSTEM WILL APPRECIATE THIS.

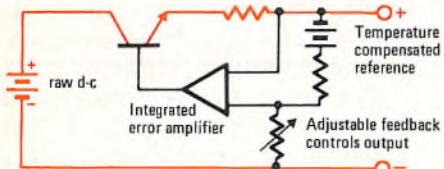

JQE IS AN OPERATIONAL POWER SUPPLY THAT BEHAVES LIKE A LARGE LINEAR AMPLIFIER

- **JQE are linear voltage stabilizers**—which means that JQE are a lot simpler and more reliable than switching machines. (You get a 5-year warranty.) A linear JQE will respond in microseconds to a load shift; will maintain its low output impedance into high frequency pulsed loads; produces no RFI/EMI and doesn't hack up the power line like SCR types.
YOUR NEIGHBORS WILL APPRECIATE THAT.

JQE is a premium quality voltage stabilizer for the no-compromise job

For complete specifications and Applications Notes — contact your nearest Kepco Representative:

ARGENTINA: Coasin, S.A., Virrey del Pino 4071, Buenos Aires, Tel.: 52-5130/52-3185 • AUSTRALIA: Elmeasco Instruments Pty. Ltd., 7 Chard Rd., Brookvale N.S.W. 2100, Tel.: 939 7944 • AUSTRIA: Kontron GmbH & Co., KG, 1140 Wien, Ameisgasse 49, Tel.: 94 56 46 • BELGIUM: C.N. Rood, S.A.N.V., Place de Jamblinne de Meux Plein 37, Brussel 1040 Bruxelles, Tel.: 02/735 21 35 • BRAZIL: Ambriex, S.A., Rua Ceara, 104, 2 e 3º Andares, Rio de Janeiro, Tel.: 264-0461 • BRITISH ISLES: Technation, Limited, 58 Edgware Way, Edgware Middx. HA8 8JP, Tel.: 01-958-5636 • CANADA: Radionics Limited, 195 Graveline Street, Montreal H4T 1R6, Quebec, Tel.: (514) 735-4565 • CHILE: Intermetra Corp. (Coasin Chile Ltda.), Mac-Iver 22, Ofic. 904, Santiago, Tel.: 396713 • CHINA REPUBLIC: Uniworld, Inc., 116 Hsin-Yi Road - Sec. 2, Taipei, Taiwan, Tel.: 320247/320248 • COLOMBIA: Manuel Trujillo Venegas e Hijo, Ltda., Carrera 20, No. 37-33, Apartado Aereo 20702, Bogota 2, Tel.: 45 23 04 • DENMARK: Sophus Berendsen A.S., 10 Amaliegade DK 1256, Copenhagen, Tel.: (01) 148500 • FRANCE: Radio Equipements-Antares S.A., 9, Rue Ernest Cognacq 92301 Levallois-Perret, Tel.: 758.11.11 • FEDERAL REPUBLIC OF GERMANY: Kontron Elektronik GmbH, Industriegebiet 1, 8051 Eching bei Muenchen, Tel.: (08165) 77-1 • INDIA: M/s Industrial Agencies, 111, Mahatma Gandhi Rd., Bombay 1, Tel.: 250741 • ISRAEL: Eastronics Ltd., 11 Rozanis Street, Tel Aviv, Tel.: 475151 • ITALY: Kontron S.p.A., Via Mestre #1, 20132 Milano, Tel.: 2152741/2/3, 4 • JAPAN: Toyo Trading Company Ltd., P.O. Box 5014, International-Tokyo, Tel.: 279-0711 • NETHERLANDS: C.N. Rood B.V., Electronics, 11-13 Cort van der Lindenstraat, Rijswijk (Z.H.) 2100, Tel.: 070-996360 • NEW ZEALAND: W. & K. McLean Ltd., 103-4 Felton Mathew Avenue, Glen Innes, Auckland 6, Tel.: 587-037 • NORWAY: Gustav A. Ring, Ringhuset, Volvat, Oslo 3, Tel.: 0472 23 22 80 • S. AFRICA: Protea Physical & Nuclear Instrumentation Pty. Ltd., P.O. Box 39127, Bramley 2018, Transvaal, Tel.: (2711) 786-1020 • SPAIN: Atajo Ingenieros, S.A., Enrique Larreta 12, Madrid 16, Tel.: 733 05 62/215 35 43 • SWEDEN: Teleinstrument AB, Box 490, S-162 Vallingby 4, Tel.: 08/38 03 70 • SWITZERLAND: Kontron Electronic AG, Bernerstrasse 169 (Sud) 8048 Zurich, Tel.: 01-62 82 82 • VENEZUELA: Coasin, C.A., Edificio Eguski, Av. Habana con Valparaiso, Los Caobos, Caracas 105, Tel.: 72.86.62/82 23.11

KEPCO, INC. • 131-38 SANFORD AVENUE • FLUSHING, N.Y. 11352 U.S.A. • (212) 461-7000 • TWX #710-582-2631 • Cable: KEPCOPOWER NEWYORK

New
Lower
Prices

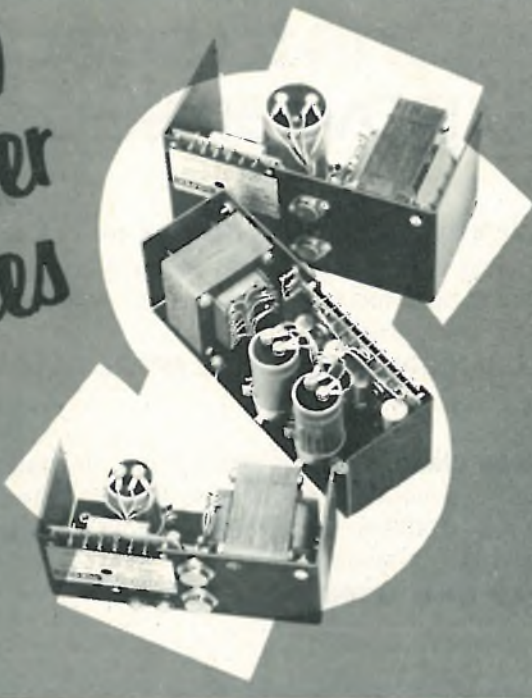

Start Getting Your Money\$worth Out of Power Modules





Now, you can really start getting your moneysworth out of power modules with Abbott's new LOW COST series. Designed to give you 100,000 hours of trouble-free operation (that's 11½ years), these reliable units meet the needs of OEM engineers. Their purchase price is about \$7 per year of service. The model LC series feature:

- 47-420 Hz Input Frequency
- 0.1% Regulation
- +50°C. Ambient Operation
- Single and Dual Outputs
- 1 Day Stock Delivery

These units provide more quality per dollar compared to similar items on the market. See table below for prices on some of our LC models. Many other LC models are listed in our catalog.

If analyzing the many similar power supplies on the market is confusing; if you are concerned about the long-term reliability of those units, then decide on an Abbott power supply for your system. Your best buy in OEM power modules is ABBOTT.

Abbott also manufactures 3,000 other models of power supplies with output voltages from 5 to 740 VDC and with output currents from 2 milliamps to 20 amps. They are all listed with prices in the new Abbott Catalog with various inputs:

60  to DC
 400  to DC
 28 VDC to DC
 28 VDC to 400 
 12-38 VDC to 60 

5V @ 6 Amps	5V @ 10 Amps	12V @ 10 Amps	15V @ 4 Amps	28V @ 1 Amp	±12V @ 1.2 Amps	±15V @ 4 Amps
LC5T6	LC5T10	LC12T10	LC15T4	LC28T1	LLC12T1.2	LLC15T4
\$62	\$73	\$99	\$73	\$62	\$87	\$119.00

Please see your 1975-76 EEM (ELECTRONIC ENGINEER'S MASTER Catalog) or your 1975-76 GOLD BOOK for complete information on Abbott Modules.

Send for our new 60 page FREE catalog.

abbott transistor

INDUSTRIAL PRODUCTS DIVISION

general offices

eastern office

5176 W. Jefferson Blvd./Los Angeles 90016
(213) 930-1040 Telex: 69-1398

1224 Anderson Ave./Fort Lee, N.J. 07024
(201) 224-6900 Telex: 13-5332

8 Circle 8 on reader service card

Readers comment

A simpler algorithm

To the Editor: There is a far simpler calculator algorithm for converting from base 10 than the table-lookup method given in your Engineer's notebook of July 10 [p. 113]. Conversion can be done by first dividing the number by the base until it is less than the base, then repeatedly subtracting and recording any integer part that appears and multiplying back by the base. For example, to get 321_{10} into hexadecimal:

1. Repeatedly divide 321 by 16 to get 1.25390625.
2. Subtract 1 and record it as the most significant digit.
3. Multiply by 16 to get 4.0625.
4. Subtract 4 and record it as the second digit.
5. Multiply by 16 to get 1, which is the last digit.

This method is especially simple on calculators with a constant memory to hold the base.

Cliff Kancler
Sunnyvale, Calif.

Epoxy hermetic?

To the Editor: The last sentence of the article ending on page 30 of the July 10 issue contains the statement: "... the device is hermetically sealed to a ceramic lid with epoxy." We have been monitoring the various attempts to promote epoxy-sealed microcircuits as truly hermetic. We are of the opinion that the only proven truly hermetic seals are metal, glass, and ceramic.

The epoxy seal is probably sufficient for the surface-wave i-f filter discussed in your article, but is inadequate for long-term survival of microcircuits.

D.S. Walker
Sperry Gyroscope
Great Neck, N.Y.

Feeling left out

To the Editor: In the article on low-profile relays [May 1, p. 113], the only thing missing was a mention of the Allied Control line of miniature printed relays, which includes the smallest four-pole double-throw relay available today.

R. E. Delaney
Allied Control Co.
Plantsville, Conn.



More Super-Fast Silicon Rectifiers

Featuring 30 nanoseconds Reverse Recovery Time

A breakthrough in junction technology makes Super-Fast silicon rectifiers possible. These new high speed silicon rectifiers feature low forward voltage drop at higher operating currents and reverse recovery time better than 30 nanoseconds. In addition, these devices have extremely low reverse leakage and high surge ratings. Super-Fast rectifiers use Semtech's proven Metoxilite non-cavity monolithic high temperature construction. Designed for high frequency applications, such as high speed switching regulators and converter circuits. Semtech's Super-Fast silicon rectifiers are stocked for immediate delivery.

LO-V_F Metoxilite

Available as JAN, JAN TX & JAN TXV
to MIL-S-19500/503 (EL)

Types: 1N6073, 74 & 75 (Trr 30ns)

PIV: 50, 100 & 150V
Reverse Current (Max.): 1 μ A DC @ 25°C
Instantaneous Forward Voltage @ 1.5A:
1.0V @ 100°C

Capacitance @ 12V DC (Max.): 24 pF
Single Cycle Surge Current: 35A
Dimensions (Max.): Body .070" D x .165" L
Leads .031" D x 1.25" L

Types: 1N6076, 77 & 78 (Trr 30ns)

PIV: 50, 100 & 150V
Reverse Current (Max.): 5 μ A DC @ 25°C
Instantaneous Forward Voltage @ 3.0A:
1.0V @ 100°C

Capacitance @ 12V DC (Max.): 58 pF
Single Cycle Surge Current: 75A
Dimensions (Max.): Body .110" D x .165" L
Leads .040" D x 1.10" L

Types: 1N6079, 80 & 81 (Trr 30ns)

PIV: 50, 100 & 150V
Reverse Current (Max.): @ 25°C 10 μ A DC
Instantaneous Forward Voltage @ 5.0A:
.8V @ 100°C

Capacitance @ 12V DC (Max.): 230 pF
Single Cycle Surge Current: 175A
Dimensions (Max.): Body .165" D x .165" L
Leads .040" D x 1.10" L

"State-of-the-art"

Types: FF30, FF40 & FF50 (Trr 30ns)

PIV: 300, 400 & 500V
Reverse Current (Max.): 1 μ A @ 25°C
Instantaneous Forward Voltage @ .5A:
1.5V @ 25°C
Capacitance @ 12V DC (Max.): 15 pF
Single Cycle Surge Current: 10A
Dimensions (Max.): Body .070" D x .165" L
Leads .031" D x 1.25" L

Types: 3FF30, 3FF40 & 3FF50 (Trr 30ns)

PIV: 300, 400 & 500V
Reverse Current (Max.): 5 μ A @ 25°C
Instantaneous Forward Voltage @ 1A:
1.5V @ 25°C
Capacitance @ 12V DC: 20 pF
Single Cycle Surge Current: 25A
Dimensions (Max.): Body .154" D x .165" L
Leads .040" D x 1.10" L

LO-V_F DO-4 Stud

**Types: SFF05, 10 & 15 and
*2SFF05, 10 & 15 (Trr 30ns)**

PIV: 50, 100 & 150V
Reverse Current (Max.) IR:
10 & *20 μ A DC @ 25°C
Instantaneous Forward Voltage:
VF @ 10A DC: 1.1V @ 25°C
*VF @ 20A DC: 1.2V @ 25°C
Single Cycle Surge Current: 125 & *250A
Dimensions (Max.): Body .424" D x .405" H

DO-4 Doublers & Center Taps

**Types: SDF05, 10 & 15;
SNFF05, 10 & 15,
& SPFF05, 10 & 15
(Trr 30ns)**

PIV: 50, 100 & 150V
Reverse Current (Max.): IR @ PIV:
10 μ A DC @ 25°C
Instantaneous Forward Voltage VF @ 10A:
1.1V @ 25°C
Single Cycle Surge Current: 125A
Dimensions (Max.): Body .424" D x .405" H

LOV_F DO-5L Stud

Types: STFF05, 10 & 15 (Trr 40ns)

Add "R" to type number
for reverse polarity
PIV: 50, 100 & 150V
IR (Max.) @ PIV:
@ 25°C 0.1mA &
@ 100°C 3mA
VF (Max.) 10A:
@ 25°C .84V; @ 100°C .70V; @ 150°C .63V
VF (Max.) 30A:
@ 25°C .96V; @ 100°C .85V; @ 150°C .78V
VF (Max.) 50A:
@ 25°C 1.05V; @ 100°C .93V; @ 150°C .90V
Dimensions (Max.): Body .64" D x .50" H
Stud ¼ 28 UNF x .43" L

NEW LO-VF DO-5DL Isolated Stud

**Types: STFF05DL,
10DL & 15DL
(Trr 30ns)**

PIV: 50, 100 & 150V
Reverse Current (Max.): IR 20 μ A @ 25°C
Instantaneous Forward Voltage @ 10A:
1.2V @ 25°C
Single Cycle Surge Current: 250A
Dimensions (Max.): Body .64" D x .50" H
Stud ¼ 28 UNF x .43" L

★ ★ ★ ★

1975 NATIONAL SBA SUBCONTRACTOR
OF THE YEAR



**SEMTECH
CORPORATION**

652 Mitchell Road, Newbury Park, California 91320
(805) 498-2111, (213) 628-5392 / TWX: 910-336-1264

CHICAGO: (312) 352-3227
DALLAS: (214) 387-3551
FLORIDA: (305) 644-5404
MARYLAND: (301) 424-6663
NEW JERSEY: (201) 654-4884
SAN FRANCISCO: (415) 494-0113
EUROPEAN SALES HDQ: Bourns AG Zug,
Switzerland (042) 232-242

...a wide range of power and precision wirewound resistors?

● You need a wide range of power and precision wirewound resistors?

- Yes, but I primarily need stable resistors with a low temperature coefficient.

● In calling Sprague you did the right thing! We make resistors up to 50W, with tolerances down to $\pm 0.1\%$, temperature coefficients of less than ± 20 ppm, and a resistive change below 1×10^{-4} after 10000 hours.

- Really?

● Yes indeed, and this is due to our control of raw materials, supervision of the manufacturing process, and selection of the core material and resistance wire. Attention is also paid both to the quality of the end caps and the welding of the

resistance elements, and the wire is space wound to eliminate hot spots.

- That sounds good, but this technology must be expensive.

● Not at all if you consider the CPS factor.
- CPS?

● Yes. The factor $\text{cost} \times \text{power dissipated} \times \text{stability}$, the only true measure of the price of a resistor.

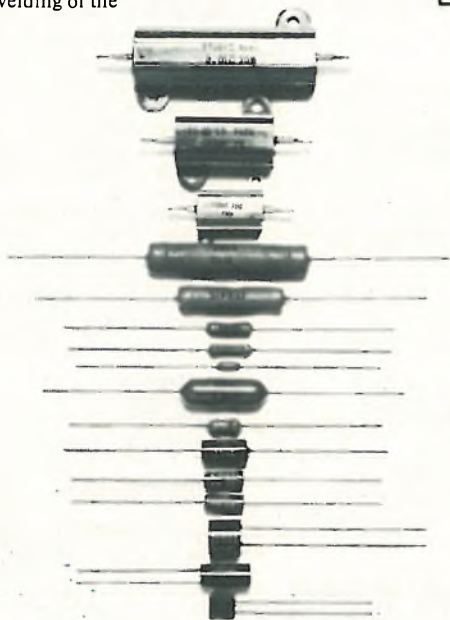

2/75 E

News update

■ Although the National Oceanic and Atmospheric Administration has high hopes for its six prototype data buoys, scheduled to begin monitoring weather and ocean conditions along the Pacific and Alaskan coasts this summer, there's no money in the Federal budget to complete the 36-buoy network until after 1977. "We hope to have the coastal system deployed in the 1980s," says a NOAA official.

As expected, General Dynamics Electronics division, San Diego, won the \$900,000 prototype contract, as well as a pre-production order for five more at \$1.7 million [*Electronics* Aug. 2, 1973, p. 51] using off-the-shelf components, temperature gauges, and other weather sensors. The unit sends uhf data transmissions to landside stations. The data is then used for analysis and interpretation for weather forecasts.

■ A little over a year ago, the General Radio Co. released its first public annual report [*Electronics*, May 2, 1974, p. 30] as a preliminary to going public at a later date. The second public annual report shows an increase in sales from \$43 million in fiscal 1973 to \$49.5 million in fiscal 1974, plus an increase in income from under \$1.2 million in 1973 to \$3.65 million, of which \$2 million is due to a change in reporting inventory.

■ The company still has not set a date for going public because officials feel the equity market is not yet good enough. But a spokesman says he "won't be surprised if it happens in 1976, and next year we'll have 3 years of reports to show." For the past two years General Radio has worked on improving its performance and increasing its efficiency; in a recent move, it has reorganized along marketing lines into three divisions—the Electronic Instrument division for benchtop instruments, a Test System division, and an Environmental and Medical division.

—Howard Wolff

Sprague World Trade Corporation
Chemin François-Lehmann 19, 1218, Geneva, Grand Saconnex, Switzerland
Tel. 98 40 21/44, Telex 27 494

Sprague Benelux, Bruneellaan 47, 9600 Ronse, Belgium, Tel. 055-215302

Sprague France S.à.r.l., 2, av. Aristide-Briand, 92220 Bagneux, France, Tel. 655-19.19

Sprague GmbH, Friedberger Anlage 24, 6 Frankfurt am Main, W. Germany, Tel. 0611-439407

Sprague Italiana S.p.A., Via G.G. Winckelmann 1, 20146 Milano, Italy, Tel. 02-479121

Sprague Electric (UK) Ltd., 159 High Street, Yiewsley, W. Drayton, Middx, England, Tel. W. Drayton 44627

Take this memory test.

Who offers 1K Static RAM's in six speed versions down to 250 nanoseconds?

Who offers three power versions down to 150 milliwatts?

Who makes a 1024 x 1 and three 256 x 4 models?

Who was first with military temperature range parts, including 10% power supplies?

Who was first with Flat Pak, low power, simplified timing and low prices?

Who, alone, offers for free: Power down mode to reduce power

dissipation by 80%, TTL identical input and output levels for easy interfacing and MIL-STD-883 for high reliability?

Time's up.

Now if you didn't have "Advanced Micro Devices" for every answer, you need help.

Start with our brochure. It has everything you need to know about the Am9102, Am9101, Am9111 and Am9112.

What else do you need to know about static RAM's?

Nothing.

Advanced MOS/LSI



Talking to the microprocessor

Time was when a new component could be introduced to designers with simply a specification sheet listing minimum and maximum electrical parameters and a couple of application notes for adapting the component to a particular type circuit.

It's a different story for microprocessors. To be sure, spec sheets and application notes are supplied, but they are not nearly enough, since the key to using a microprocessor is to be able to program it. Moreover, improvements in microprocessors will lie as much in architectural advances as in the electrical performance of the circuitry. And, given the semiconductor industry's aggressive approach to bringing out new devices, these architectural improvements present the danger that the rules for software preparation will

not remain the same but will change constantly.

What's needed is one or two high-level computer languages, such as Basic or Fortran, that have been adapted to microprocessors. For more than a year, Intel's PL/M has been the only high-level language available, but its compiler has been restricted to Intel products. National Semiconductor has hinted at imminent release of its high-level language, called SM/PL, and stirrings in other areas suggest that other new languages—variants of Basic—may be coming soon. Thus, for those languages that are now or will soon be available, compilers are needed to adapt them to a wide variety of microprocessors. And conversely, for the future, designers will need microprocessors that are compatible with the prevalent languages.

Trouble in the 900-MHz market

American manufacturers of mobile communications gear are understandably nervous. The major new land mobile equipment market that seemed certain to stem from the Federal Communications Commission's decision this spring to open up the 900-megahertz market is already being challenged from abroad. The specific challenge comes from Japan's Oki Electric Industry Co., to which American Telephone & Telegraph Co. has just awarded the first contract for 135 mobile radio units to be used in a 900-MHz trial system (see p. 81).

Some U.S. manufacturers are already drawing a dismal parallel between AT&T's move offshore for 900-MHz mobile transceivers and the lost American market for entertainment electronics where imports, many of them from Japan, had captured a staggering 72% share by 1972.

Some communications manufacturers see the threat as more damaging than that faced

by consumer product makers. "In television and comparable areas, the consumer at least could make his own choice between foreign and domestic products," complains one U.S. marketing executive. "But with the 900-MHz market, it is up to AT&T. If AT&T sticks with foreign suppliers, we're dead."

In the end, AT&T may simply be demonstrating to potential American suppliers of 900-MHz hardware that they must learn to compete in the global marketplace. But AT&T at the same time is in effect controlling the development of an entire new U.S. communications market.

It is not pushing protectionism to say that U.S. electronics manufacturers, having in return only nominal entry to Japan's markets, do have cause for concern. America cannot afford to lose to low-cost imports yet another of its high-technology markets. And AT&T should not let itself be caught fostering a loss from which only it will profit.

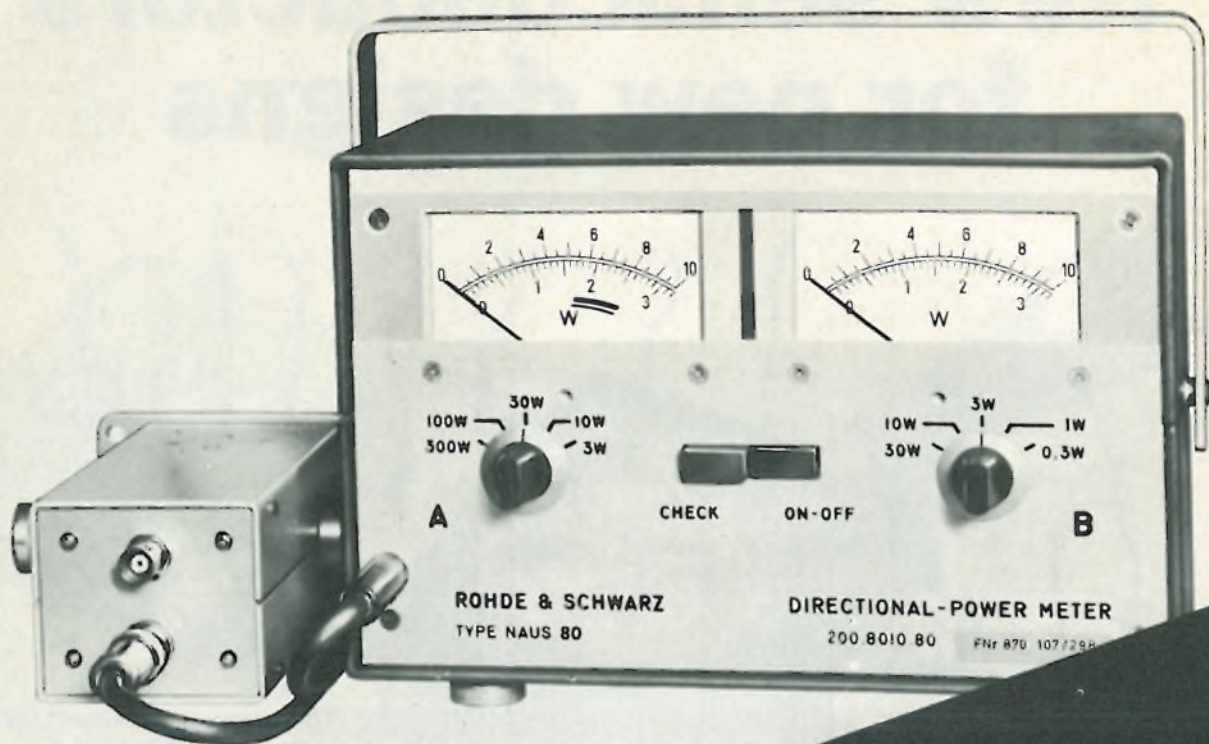

The Perfect Power Meter

**You get
what you want
when you want it.**

The Rohde & Schwarz Model NAUS-80 Power Meter Family was designed with you and your budget in mind and it's stocked in depth to give you quick delivery when you need it.

Just check the items and compare them to your present or planned meter . . . You'll see the R&S NAUS-80's are superior in every way . . . it is the PERFECT POWER METER!

Prove it to yourself . . . send for our complete literature and/or request a demonstration.

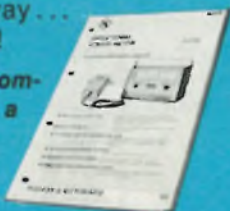

- One head for ALL ranges — 25-1000 MHz; 20 mW-320W (NO PLUG-IN ELEMENTS NEEDED).
- Two meters for simultaneous incident and reflected power readings (VSWR) — Only this method allows tuning optimization.
- High Resolution (linear scale).
- High Accuracy (4% of reading $\pm 1\%$ F.S.).
- 1 kW overload protection (no burnouts).
- One low price for the *complete* instrument — (NO ADD-ONS NECESSARY).
- Five-year warranty on Parts and Labor (no exceptions).
- OFF THE SHELF DELIVERY.



ROHDE & SCHWARZ

14 Gloria Lane, Fairfield, N.J. 07006 ■ (201) 575-0750 ■ Telex 133310

Circle 13 on reader service card

New semiconductors for new designs

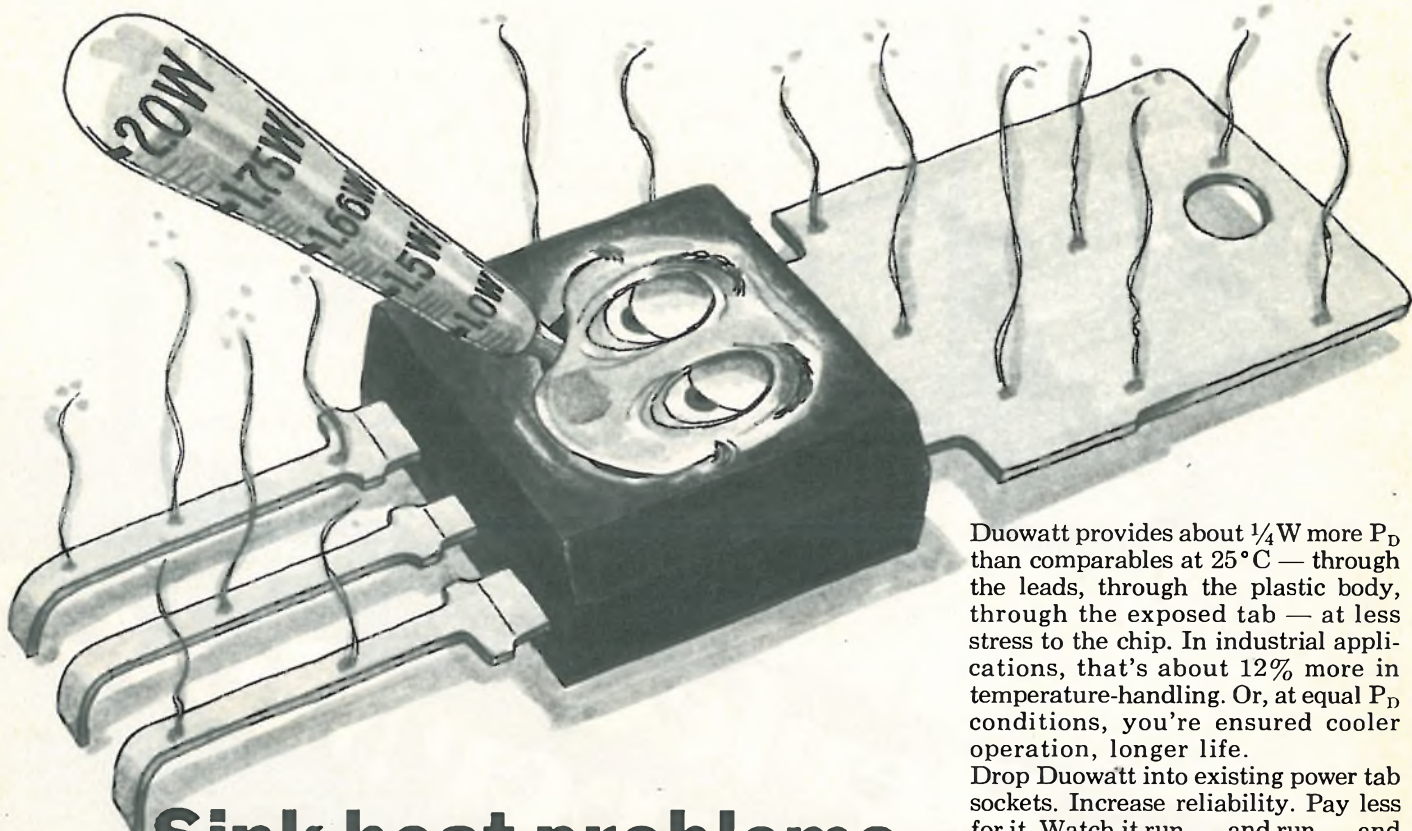

Sink heat problems with 2 watt Duowatt

Duowatt provides about $\frac{1}{4}$ W more P_D than comparables at 25°C — through the leads, through the plastic body, through the exposed tab — at less stress to the chip. In industrial applications, that's about 12% more in temperature-handling. Or, at equal P_D conditions, you're ensured cooler operation, longer life.

Drop Duowatt into existing power tab sockets. Increase reliability. Pay less for it. Watch it run... and run... and run... and run...

At 2 watts, of course.

When we say Duowatt, we mean Duowatt.

Circle 14



Push an ordinary power tab device to 2 watts in free air and you get high θ_{JA} , high stress levels and early demise.

Push a new Duowatt* the same way and you get — the lowest free-air θ_{JA} in the industry — 62.5°C/W ... low stress levels ... and

a real edge in reliability and long life. Besides lower T_J , Duowatt offers second generation epoxy molding providing better impermeability to moisture, lower thermal resistance and higher mechanical strength than sili-

DUOWATT	V_{CE0} Min. V	h_{FE} @ I_C Min.	Price 100- 999	APPLICATIONS
2N6548/49	40	25,000/ 15,000 @ 200 mA	\$0.65/0.35	NPN Darlington Amplifier
2N6551/52/53	60/80/100	60 @ 250 mA	.45/ .50/ .55	NPN GP Amplifier and Driver
2N6554/55/56	60/80/100	60 @ 250 mA	.45/ .50/ .55	PNP GP Amplifier and Driver
2N6557/58/59	250/300/350	40 @ 30 mA	.50/ .55/ .70	NPN HV Amplifier, Low Sat. C.

conet. Plus heavy-duty leads and 2-mil gold wire.

And Duowatt is offered with a device selection already proven reliable in the standard Uniwatt package including monolithic Darlington to 100 V.

* Trademark of Motorola Inc.

† Thermal shock tests on the package ($+150^\circ\text{C}$ to -55°C liquid-to-liquid transfer) over 600 cycles resulted in 0.5% failure rate for epoxy, 3.5% for silicone — a preliminary indication of significant improvement of bond integrity of the one material over the other.

from Motorola,

MHTL—more than just a pretty interface

If industrial systems raise your noise level, quiet down by pairing Motorola MHTL with McMOS. Complement your CMOS designs with bipolar IC's to provide signal conditioning. At the same time meet high-current load demands.

The MC691 Hex Inverter/Translator accepts McMOS inputs and provides high-level outputs.

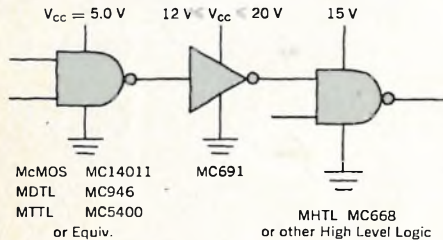

The MC696 Dual Interface Unit, Line Driver/Receiver offers flexible hysteresis capability for design variety. And has low output impedance of ≈ 20 ohms in LOW state.

The MC699 Dual Power "AND" Gate operates at 5 to 20 V supply and also features varying threshold. Its high-voltage, 0.5 A output is a natural for driving relays, lamps and discrete power devices.

MHTL — providing new interference solution to industrial noise problems. Remember — MHTL on the input/output blocks, McMOS in the middle. Result: savings in power dissipation, medium speed operation . . . and noise problems become whispers. Check for specs and a look at the entire MHTL family. We'll send it along — quietly.

Circle 15

MHTL, MDTL, MTTT and McMOS are Trademarks of Motorola Inc.

Number's up for tone-dialing kluges

Days of the telephone tone-dialing kluge are numbered. Countdown for cumbersome pot-coil/discrete combinations is activated by Motorola's new CMOS 2-of-8 Tone Encoder, the MC14410.

This space saving circuit synthesizes standard tone-dialing sinewave signals from digital 2-of-8 code inputs. It's a boon for the usual standard telephones, of course. And, because of the single compact IC package and its insensitivity to RF radiation, it opens completely new opportunities in the regular and hand-held mobile radio

telephones. Other potentials include process control, P-O-S terminals, and credit card verification.

A D/A converter generates sine-wave signals, and an on-chip precision 1 MHz crystal controlled oscillator handles master clocking. Pull-up resistors on row and column inputs are used for mechanical switch interface.

It's \$6.40 at 100-999 for the 16-pin plastic MC14410P, and \$8.32 for the MC14410L. Don't be the last one on the line to call for more information.

Circle 176

Quad buffer clicks in MPU clock circuit

MPU clock specs which constrain clock drivers the most are the 1 MHz rise and fall time requirements as well as logic level demands into the load capacitance within the overshoot restrictions.

One method — and a darned good one — of guaranteeing speed and sat voltage necessary to design clock circuits that meet MPU clock needs is the new MPQ quad transistor buffer. It meets them to a "t": 5 nanosecond minimum t_r and t_f with 40 nanosecond maximum t_{os} (overshoot) duration. 1ϕ and 2ϕ input high and input low voltage specs are, respectively, -0.3 V and $+0.3$ V.

The non-overlapping requirement of the clock signals can be met by the control logic design which drives the buffers.

Various methods of clock circuit driver design are described on the comprehensive data sheet, with circuit schematics, test conditions, waveforms and interfacing detailed. Also included is a section on interfacing MPU with dynamic and slow memories.

100-up price for the versatile MPQ-6842 is just \$3.35.

Circle 175

Readers! Digest the MPU!



An abridgement it's not — but the most complete,

clear comprehensive applications coverage of MPU from organization to design and development.

714 pages of detailed info lead from basic understanding of MPU, its characteristics, organization and use through programming, I/O and family hardware techniques. Peripheral control, system design and development are covered, too. A Q&A section orients to a wide variety of needed supplements.

It guides the experienced, initiates the uninitiated, tells you what-it-is, how-to-do-it.

The best investment of the year for the serious MPU student is only \$25 by check or P.O. to Box 20912, Phoenix, AZ 85036.

total
the semiconductor source.

Presenting the OEM branch of Digital.

It's a complete family of computer tools. And it's growing every day.

Nine CPU's — from our smallest, the LSI-11, to our biggest and newest, the PDP-11/70 — with virtually every meaningful price/performance choice available in between. Choose one of them, and a whole world of possibilities opens up.

Proven operating systems offer real time, time-sharing, and batch capabilities, so you can

choose the system that exactly fits your needs. Also you can hook up any of 60 different peripherals including your choice of 4 different disc drives, 5 terminals, 3 tape systems, 6 line printers — among a host of others.

What's more, you can join a special family called DECUS

(Digital Equipment Corporation Users' Society) and instantly put at your disposal a whole library comprised of thousands of applications software packages.



And then you can start to plan your future. Your next new product, your next PDP-11 or PDP-8 computer. And to help you along the way, our family includes 2400 field service experts

ready to lend a hand when and where you need it. And that means everything from operator training programs that get you quickly up to speed, to the new OEM Referral Program that helps you market your product.

When an OEM chooses a computer company, he makes a big decision with important long-term consequences. The OEM branch of Digital gives you a computer family you'll never outgrow.

To find out more, call or write Digital Equipment Corporation, Maynard, Massachusetts 01754. (617) 897-5111. European headquarters: 81 route de l'Aire, 1211 Geneva 26. Tel: 42 79 50. Digital Equipment of Canada, Ltd.

digital

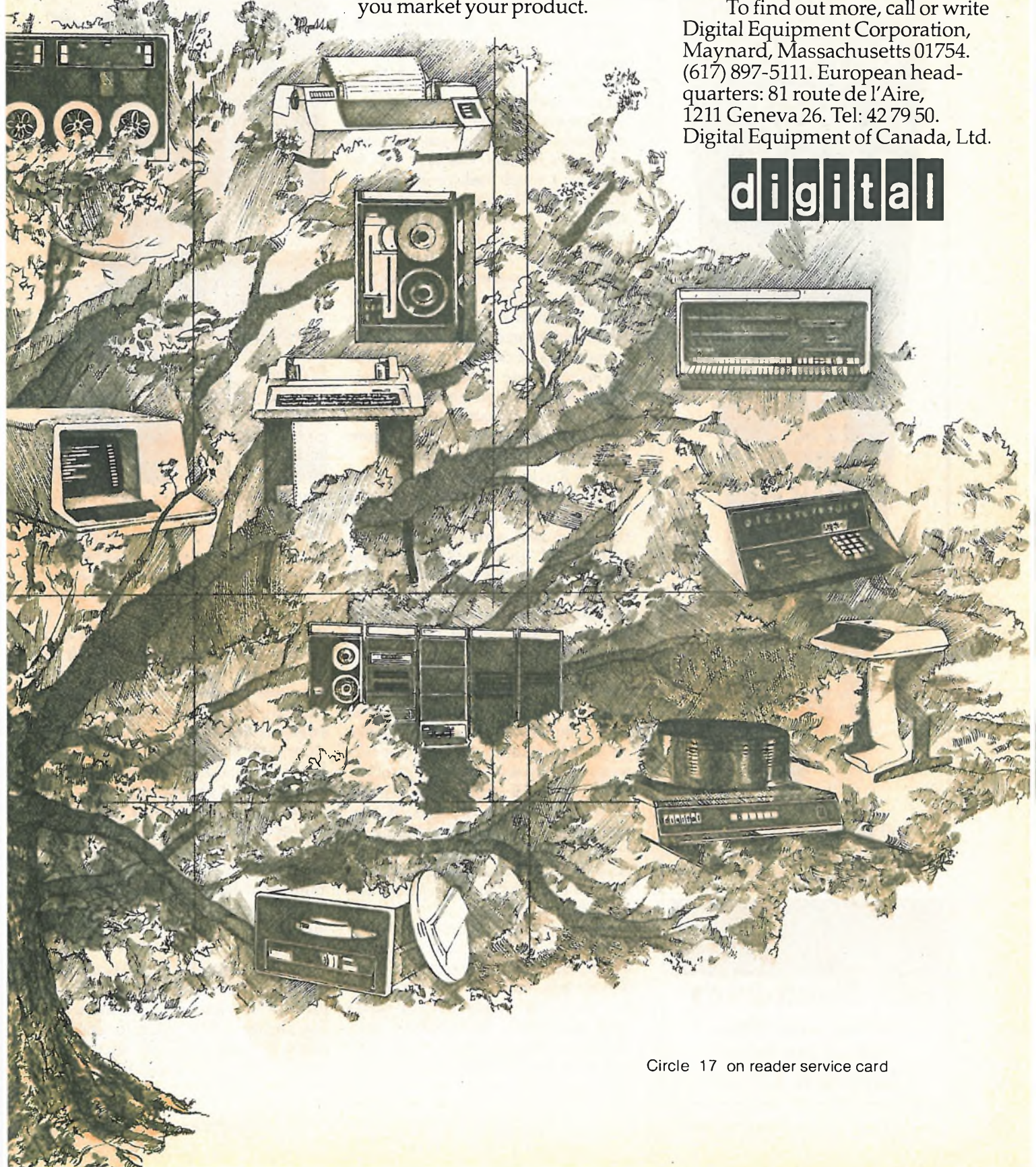

MORE
COMPANIES
BUY
WIRE-WOUND
RESISTORS
FROM
RCL
THAN
FROM
ANYONE
ELSE
ON
EARTH

Write for
catalog



Call our hotline for prompt
service and delivery.
(603) 627-3831

AMF

RCL Electronics

General Sales Office:
700 So. 21st Street
Irvington, N. J. 07111

People

Kovac out to make a name
for Rockwell microprocessors

With the elimination late last month of the Microelectronics Group management layer at Rockwell International Corp.'s Electronics operations (see News Briefs, p. 54), Charles V. Kovac has gained greater visibility as vice president and general manager of the Microelectronic Device division. He says he thrives on that visibility, but he still has a tough task to do in converting the MOS device maker into a supplier of standard microprocessor and memory devices, not just a manufacturer of calculator circuits.

Kovac had reported to Donald A. Mitchell, formerly president of the Microelectronics Group, who has been "reassigned within the corporation," say Rockwell officials, refusing to elaborate further. The move brings Kovac's division a step closer to Donn L. Williams, president of the Electronics Operations, to whom Kovac now reports directly.

Says Kovac, "Donn Williams has been with the organization almost since its inception, so being able to report to him gives me the flexibility and quick-response time needed to run this business."

Personal brand. For some time, though, Kovac has been putting his personal brand on the device division in the effort to expand its business mix and marketing team. Once limited to a handful of salesmen handling major accounts, the division is putting the finishing touches on an organization of 10 representatives, encompassing some 105 salesmen, who will handle microprocessor and memory devices. Kovac got that move going by bringing in Daniel Del Frate as his vice president for marketing and giving him the job of lining up reps [*Electronics*, Jan. 9, p. 14].

More recently, Kovac recruited Richard C. Pinto as vice president for production operations, a step Kovac says helps set the stage for the division's production of standard memories. Both 4,000- and 16,000-bit devices are in the works, and a version of the 1103A is al-



Growth. By 1980, Rockwell's Microelectronic Device division should do \$250 million in sales, according to the goal set by Charles V. Kovac. Calculator business will move down to 20% of the total, while microprocessors and memory will move up to half.

ready on the market. Pinto will also oversee the division's production of devices for the timepiece and automotive markets. His production experience in semiconductors stretches back 18 years, of which 16 were at RCA and the last two at ITT Semiconductors, where he was vice president and general manager.

Pinto has worked with both bipolar and MOS devices, and Kovac says there's a "significant" item in the division's 1976 design and development budget for integrated injection logic, which would be the division's first bipolar-process undertaking.

But even with the marketing, production and rep organizations in place, Kovac knows he still has a big job ahead if he's going to make a mark in memories and microprocessors. "We now have more than



SEMICON COMES TO ZURICH

Plan now to attend the European debut of SEMICON — the world's fastest growing trade fair devoted exclusively to semiconductor processing, materials and equipment.



SEMICON 75 europa

Zurich, November 3-5, 1975

During the past five years thousands of attendees from throughout the world have visited SEMICON trade fairs in the United States. These exhibitions, sponsored by the Semiconductor Equipment and Materials Institute (SEMI), have achieved a reputation and stature unmatched by any other trade fair for semiconductor device manufacturers.

This November, Zürich's popular Züspa Convention Center will be the site of the first SEMICON event ever held outside of the U.S. It will feature exhibits from scores of leading U.S. and European firms, as well as timely technical and business sessions organized by industry authorities.

SEMI officials cordially invite representatives from all European semiconductor companies to attend and participate in this important event. For full details, use the coupon below, or direct questions to I. Willener, SEMICON/Europa Coordinator, 8008 Zürich, Lindenstrasse 33, Switzerland, Telefon 01/32 72 51.

Complete and Return to: SEMICON Europa
c/o I. Willener
8008 Zurich
Lindenstrasse 33, Switzerland

Please send advance programme information and application forms for:

Attendee preregistration Exhibiting

Name _____

Title _____

Company/Organization _____

Address _____

Country _____

Further information may also be obtained from
GOLDEN GATE ENTERPRISES, INC., 1333 Lawrence Expressway,
Santa Clara, California 95051, USA (408) 249-7400

Subminiature capacitors with small mounting areas for printed circuit boards

WIMA FKS 3

FKC 3

FKS 2 min

MKS 3

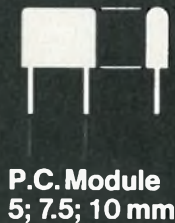

H = 6 to 8.5 mm
in the
capacitance
range
from 1000 pF
to 0.15 μ F

P.C. Module
5; 7.5; 10 mm

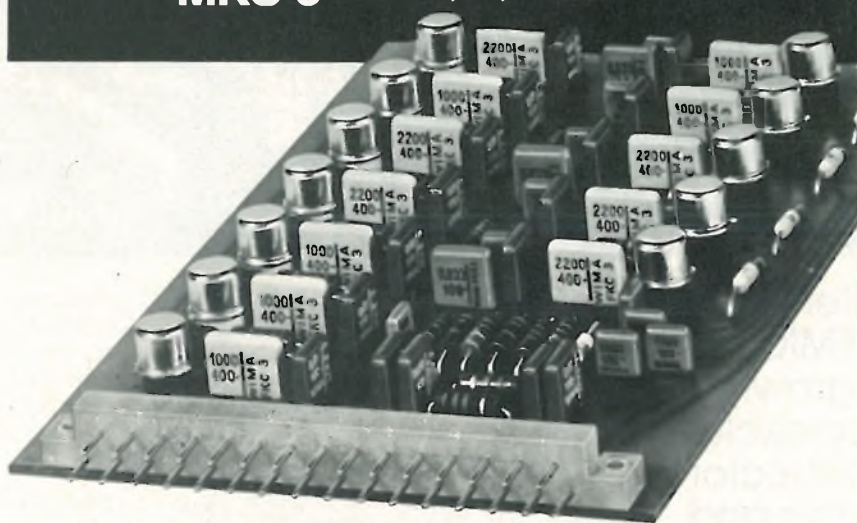

Characteristics:

The design has made better use of the vertical area in order to reduce the mounting area requirement for the capacitor. This facilitates greater packing density and easier mounting on printed boards.

The termination wires are compatible with the standard printed board grid to allow simple insertion. Equally important, the height of the capacitors is compatible with transistors.

These new cast-moulded capacitors are so small that they offer advantages hitherto not obtainable when used on printed circuit boards.



WILHELM WESTERMANN
Spezialvertrieb elektronischer Bauelemente
D-68 Mannheim · Fed. Rep. of Germany
P.O. Box 2345 · Tel.: (0621) 40 80 12

People

30% of the world's calculator circuit business," he asserts, which will account for more than half the division's 1975 sales of some \$80 million. But that business isn't growing anywhere near the heady pace it once set. "Business diversification has characterized our game plan for 1975," Kovac says.

Goals. He's set ambitious goals for the division to achieve by 1980: sales growth to more than \$250 million, and a business mix that has microprocessor and memory devices accounting for more than half of that. Kovac looks for the division's calculator business to account for less than 20% of sales by that time, with a timepiece circuit business that will edge up over 10%. Modem and automotive devices will make up the remainder.

Rockwell isn't plunging headlong into the watch business, although the division is already selling modules incorporating complementary-MOS circuits and liquid-crystal displays. Says Kovac, "At the right time, we'll make a commitment to C-MOS, assembly, and the next-generation display with adequate capacity to serve Rockwell's needs in a deliberate effort. But I don't think the big industry numbers in digital watches will come before 1980." Just to be ready, though, Rockwell has had a module designer from watch-maker Timex, onboard for more than a year.

"I've never been turned down on any reasonable request I've made of Al Rockwell," says Kovac, which could account for his longevity in a volatile business. He's referring to Willard F. Rockwell, the corporation's board chairman headquartered in Pittsburgh.

Indeed, by his own admission, Kovac has come a long way from the days when he spoke the jargon of his aerospace background at the old Autonetics division. Now he looks and talks like someone who's had a big hand in running a successful MOS operation for more than five years, and he exudes a confidence and ebullience that are infectious.



MEASUREMENT COMPUTATION

innovations from Hewlett-Packard

NEWS

INTERNATIONAL edition

AUGUST, 1975

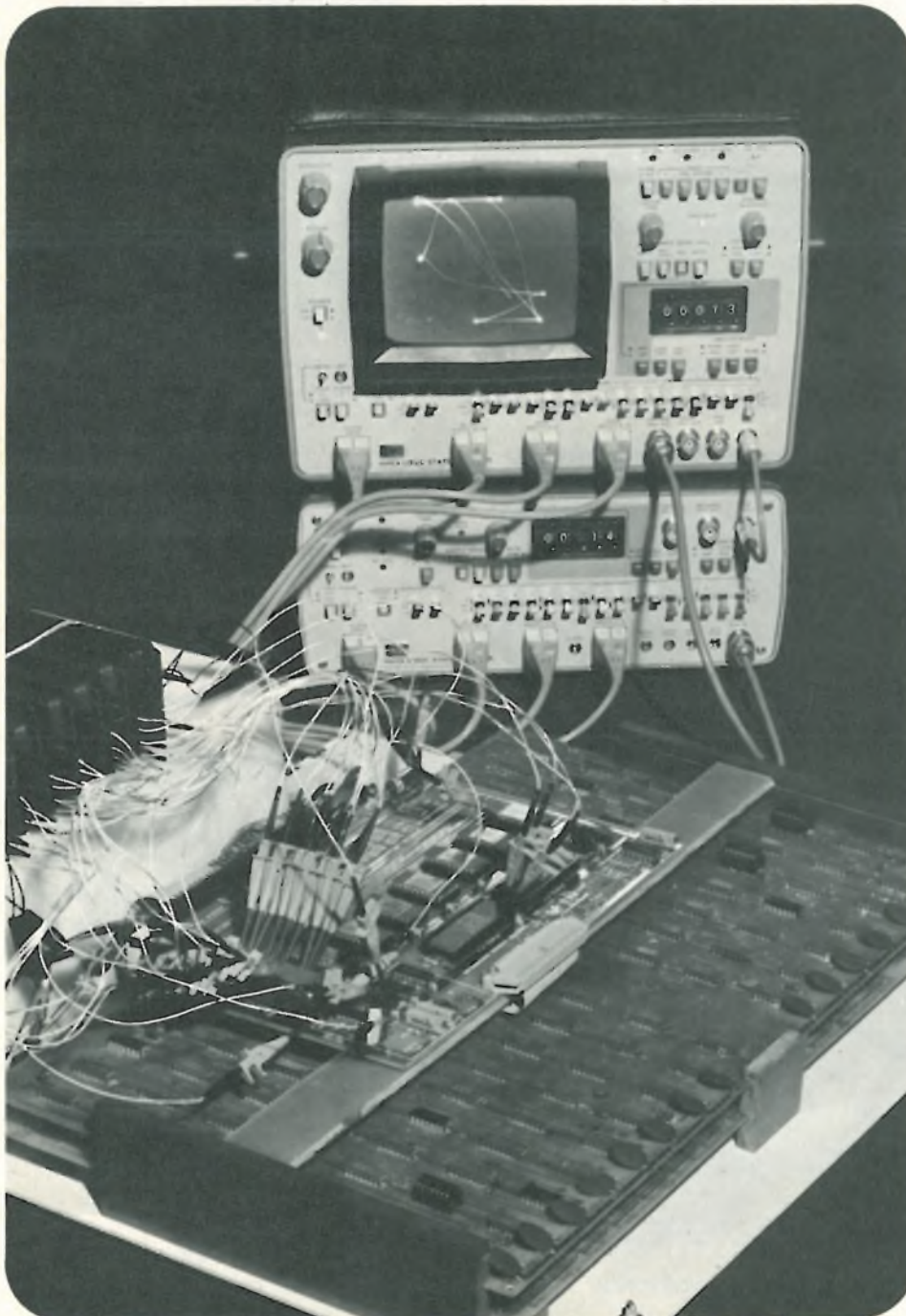

in this issue

New 0.03% accurate
digital multimeter

New fully-ruggedized
signal generator
500 kHz to 1100 MHz

Ultra-fast disc in new
MX/65 DISComputer

New logic state analyzer 'maps' the data domain

To properly troubleshoot complex digital circuits, you need a way to examine the system's functional behavior. That's where the HP 1600A Logic State Analyzer comes in.

It has the unique capability of being able to produce 'maps' of logic-circuit operation which graphically show each address or state as a discrete dot on a screen. The brightness of each dot reveals its frequency of occurrence and the lines between dots are vectors indicating the direction of the state flow.

After familiarization, the maps form recognizable logic patterns, with departures from the norm easily detected.

The HP 1600A also presents a functional picture, in word format (table display), triggered and indexed on digital words. A 16-channel word-format display is standard and this can be in-

(continued on third page)

New HP 2000 ACCESS system supports up to 32 terminals on-line with concurrent remote job entry

With the introduction of the HP 2000 Access System, networking has suddenly become affordable for a large group of applications.

While exercising all of their interactive, on-line processing functions, HP 2000 Access System terminals can operate concurrently as remote job entry stations for large IBM or CDC host computers. The HP system simulates either an IBM HASP-II Multi-leaving Workstation or CDC User 200 Terminal for synchronous intercommunication. Any of up to 32 terminals can initiate data transfers and other remote job entry (RJE) functions to and from the central system, and data can be processed on the HP 2000 System before transmission. Any user may execute applications that can access a paper tape reader, multiple card readers, line printers, magnetic tape drives and disc units.

The system is compatible with the

microprocessor-equipped HP 2640 CRT terminal. With the terminal in the system, a non-technical person can easily format the screen to resemble source documents, then enter data conversationally by filling in blanks. Data entered through all video key stations can be transmitted concurrently to the central host system.

Two versions of HP 2000 Access Systems are available, Model 30 and Model 40. Multiple access for up to 16 terminals is provided by the Model 30. The Model 40 increases the capability to as many as 32 terminals.

Disc storage for both systems can be expanded from the basic disc storage provided (5 megabytes in Model 30 and 15 megabytes in Model 40) to 120 megabytes.

For more information, check A on the HP Reply Card.



An optimum system for manufacturing operations including data collection, inventory control, financial planning and order entry.

New MX/65 DISComputer combines ultra-fast disc with 32K word processor for OEM's

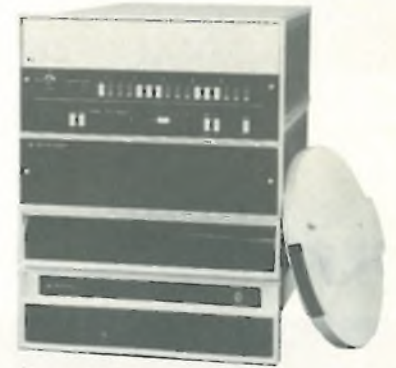

The fastest cartridge disc in the industry, and a versatile 21MX minicomputer combine to form the most powerful DISComputer available.

The new high performance MX/65 DISComputer is a powerful combination of two HP computer components. The unit combines a 15 MByte disc, the HP 12962A, and a 32K word computer, the HP 21MX, into a fully interfaced unit.

The package is available with options to fit nearly any need. Options allow the 12962A ultra fast (25 msec average access time) moving-head disc subsystem to be expanded to 118 MBytes in 15 MByte steps. The micro processor-equipped storage control unit gives the DISComputer automatic error detection and correction to enhance data reliability.

The 4K RAM-based 21MX minicomputer starts at 8K words of memory and can be expanded to 256K words in 4K steps.

The 21MX minicomputer is fully microprogrammable by the user. Its 650 ns semiconductor memory comes in plug-in modules; add memory economically at any time. The 128 instructions in the mini's base set include floating point and extended arithmetic. Memory parity, dual channel port controller (direct memory access) and power fail interrupt are standard features.

Nine powered I/O channels are available in the standard version; up to 36 additional channels can be added without reducing memory space.

To find out more about how to fit the MX/65 DISComputer into your system, check O on the HP Reply Card.

NOW, time interval measurements you couldn't make before

Here's a solution for major problems in high-speed time interval measurements, the 5363A Time Interval Probes. They'll remove some limitations in electronic counter measurements of rise time, propagation delay between 50% points, slew rates, etc.

Trigger point definition is simple and precise. Just dial the thumbwheels to any desired trigger voltage from ± 10 mV to ± 10 V and your counter gets fast rise time 50 Ω pulse when the input reaches the level set. Drift is very low and level calibration is automatic.

Dynamic range is ± 10 V compared to the ± 0.5 V to ± 1.0 V typical of counters. This, plus high sensitivity, lets you trigger close to the bottom and top of signals from most IC families. An ordinary 10:1 probe doesn't extend dynamic range for, while it lets you trigger close to the top of a 5 V pulse, for example, it multiplies the counter's 50 to 100 mV hysteresis by 10 so you can't trigger lower than 0.5 to 1.0 V.

Circuit loading is low because impedance converters at the tips of these active probes provide 1M/10pF input.

Unequal time delays in stop and start channels are equalized by merely turning the Time Zero control.

For automatic system use, order Option 011, Interface Bus compatibility.

To receive data on solutions to time interval problems, check H on the HP Reply Card.



In production line testing the 5363A's high repeatability and pushbutton operation make it ideal for automated time interval measurement systems.

New RF sweeper plug-in emphasizes high performance



HP Model 86222B plug-in for 8620A sweeper, covering 10 MHz to 2.4 GHz, offers useful crystal markers.

For wideband RF sweep testing, Hewlett-Packard now offers an HP 8620A sweeper plug-in that covers 10 MHz to 2.4 GHz in a continuous sweep. The plug-in, models 86222A/B ("B" version adds precision crystal marker system), delivers calibrated RF output from 0 to +13 dBm with full range flatness of ± 0.25 dB. For each key performance characteristic—e.g., frequency accuracy, linearity, stability, residual FM, harmonics, spurious content—the 86222 matches or exceeds any other wide-range RF sweeper. And

no other sweeper can equal the overall performance specifications of the 86222. The 86222B's unique digitally-processed birdie markers (1, 10, 50 MHz) are fully compatible with the HP 8410B Network Analyzer and HP 8755 Frequency Response Test Set, permitting accurate frequency identification.

For a data sheet, check K on the HP Reply Card.

New logic state analyzer

(continued from first page)

creased to 32 channels with the addition of another logic state analyzer, the HP 1607A.

The system can be set to trigger on any unique word and to display the following 15 words for analysis. If, on the other hand, you are attempting to debug a microprocessor program error, you can just as easily display the 15 words immediately preceding the trigger word. Or, you can place the trigger

word anywhere in the 16-word window to reveal what happened both before and after the trigger word.

If your work involves digital circuits, this brochure is worthy of your reading time. For your copy, check C on the HP Reply Card.

New software for HP network and spectrum analyzers cuts linear circuit design time

OPNODE is a new software tool for the engineer with the responsibility for designing and optimizing linear circuits and systems.

With the 92817A OPNODE package on an HP 8542B Automatic Network Analyzer or an HP 8580B Automatic Spectrum Analyzer, you can design improved circuits in less time.

Design parameter inputs (constants, variables or complex equations) are entered via keyboard or cassette tape, and OPNODE outputs the data on the graphics console in the form that you need—tabular, log or linear rectangular plots, Smith chart or even polar plots. Substantial savings in both design and production are benefits derived from more reliable circuit designs. An additional benefit is control of recurring computer-aided design expenses.

OPNODE provides a wide range of capabilities including S-parameter analysis, sensitivity analysis, feedback analysis, optimization and worst case analysis. Up to 40 nodes and 200 components in a circuit can be analyzed in real time, with outputs (including plotting results) provided in from 0.1 to 3 seconds per frequency.

If you are presently using an HP 8542B or an 8580B, you can add OPNODE as a low-cost enhancement. When you consider purchasing either system, OPNODE will provide you additional capability and an even greater return on your investment.

To receive more information on OPNODE, circle P on the HP Reply Card.

Ruggedized RF signal generator offers laboratory performance



Providing AM, FM, or Pulsed RF modulation for a wide range of receiver test applications, the 8640M brings total signal generator performance to environments previously difficult for lab grade instruments.

Field and flight line receiver test applications requiring a precision RF generator now have a solution. HP's Model 8640M Signal Generator provides test signals from 500 kHz to 550 MHz. (1100 MHz; external doubler).

Model 8640M is a highly-ruggedized version of the well-known HP 8640B Signal Generator. It withstands the environmental requirements of MIL-T-21200J, Class II, including salt spray, avionic fuel hazards, and -40°C to $+71^{\circ}\text{C}$ operating temperatures.

Signal quality is intended for testing state-of-the-art receivers. A high-Q, cavity-tuned, solid-state oscillator yields excellent spectral purity with SSB noise >125 dB/Hz at 20 kHz offset. LED digital display resolution of 1 kHz at 500 MHz makes operation ideal for closely spaced channels.

After tuning, the cavity may be phase-locked to the frequency shown on the display. In this locked mode, long term stability is better than $5 \times 10^{-8}/\text{hr}$.

Output power is calibrated from a high level of +13 dBm for spurious response tests, down to -145 dBm for tests at $<0.03 \mu\text{V}$ on shielded receivers. A reverse power protection circuit protects against burnout caused by inadvertent keying of the test transceiver (up to 25 watts).

For more information on this reliable, all-solid-state, general purpose signal generator, check L on the HP Reply Card.

New RF generator with calibrated FM for mobile radio test

Calibrated and metered FM, over the full range 10 to 520 MHz, is featured by the newest (Model 8654B) Hewlett-Packard RF signal generator. Four FM peak deviation ranges are available—0 to 3 kHz, 10 kHz, and 30 kHz over the full 520 MHz range of the generator, and 0 to 100 kHz above 80 MHz. AM specs of the earlier 8654A are preserved.

Frequency settability has been improved with a fine frequency vernier. The instrument's solid-state oscillator drifts less than 1 kHz +20 ppm per 5 minutes after warmup.

Important to transceiver test personnel is a reverse-power protection module, available as option 003. This circuit detects reverse power and instantly isolates the generator output from burnout (up to 25 watts.)

The 8654B is small and portable at $26.7 \times 18 \times 30.5$ cm ($10\frac{1}{2}'' \times 7'' \times 12''$) weighing only 7.9 kg (17 lbs. 5 oz.).

Notice to Owners of 8640A/B RF Generators.

Reverse power protection is now available as Option 003 or retrofit kit (11699A) for HP 8640A/B RF generators.

For detailed technical information, check M on the HP Reply Card.



New compact, solid-state RF generator with calibrated FM is ideal for mobile radio test.

Universal counter plus options tailors to your precise needs

Modular design and a choice of easy-to-install options can be combined to give you a new 8-digit Model 5328A Universal Counter that comes close to meeting your unique needs at minimum cost. The simplest version with no options measures frequency to 100 MHz, single shot time intervals to 100 ns resolution, plus time interval averaging giving 10 ps resolution for repetitive events. The 5328A also measures period, period average, and frequency ratio, and will totalize and scale inputs. Frequency measurement sensitivity is 25 mV rms to 40 MHz and 50 mV to 100 MHz.

Arming capabilities of the basic 5328A allow precise control when a measurement starts—essential for starting time interval measurements on a selected pulse in a bit stream.

Six options are currently available to expand the capabilities of the 5328A:

- Opt 040 expands time interval capabilities and gives 10 ns resolution.
- Opt 030 extends range to 512 MHz with 15 MV rms sensitivity.
- Opt 011 gives full compatibility with the HP Interface Bus.
- Opt 010 increases accuracy and extends calibration intervals.
- Two DVM options measure external DC voltages or internal trigger level settings.

To receive your copy of a technical data sheet, check G on the HP Reply Card.



Option-packed counter comes close to meeting all high-precision frequency and time applications below microwave frequencies.

New triple-output OEM power supply gives brownout protection

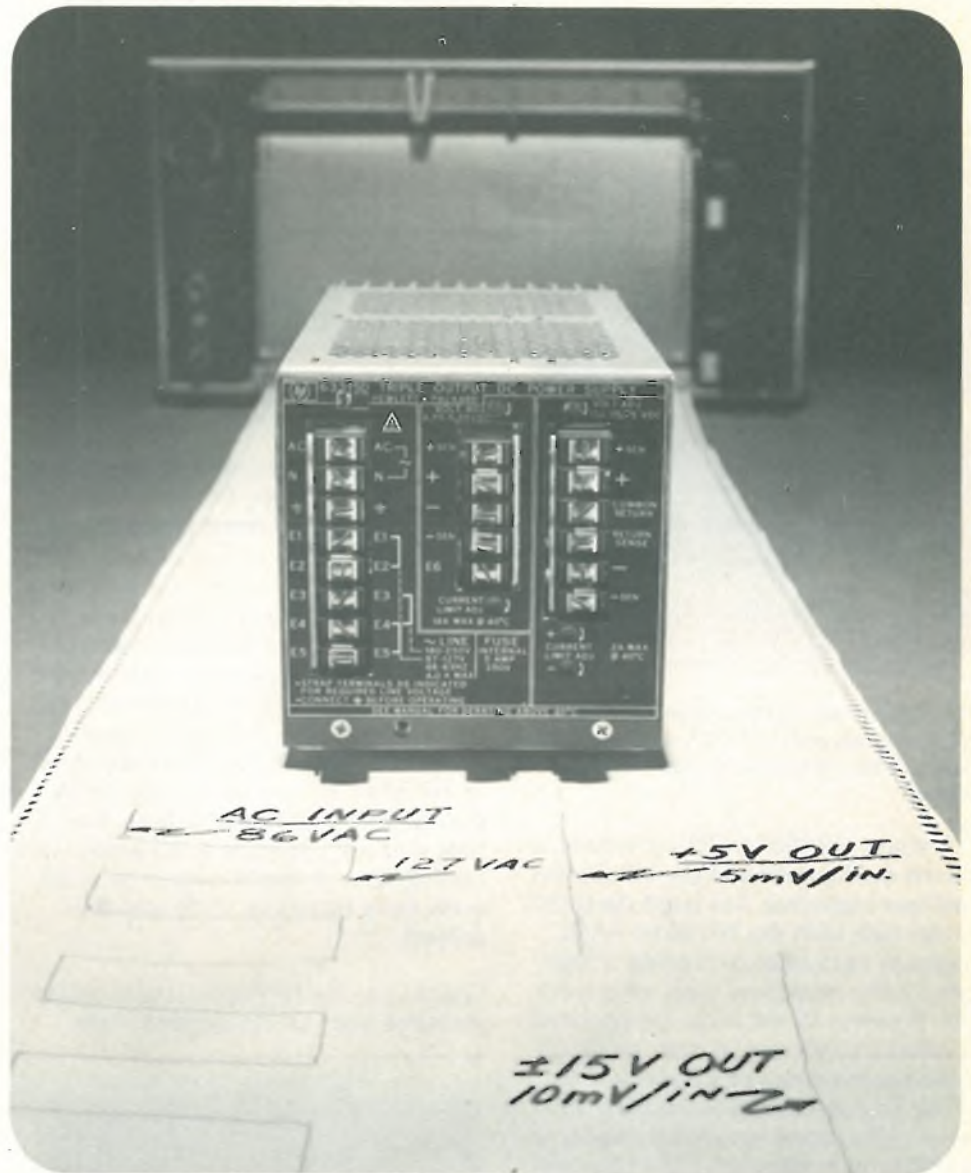

110 Watt Regulated Modular supply is designed for applications requiring the performance, compact size and high conversion efficiency of a switching supply.

Data terminals, mini-computers and other devices with volatile memories are susceptible to loss of data if their power supplies cannot regulate for wide variations or momentary loss of AC input voltage.

HP's new switching supply, Model 63315D, overcomes these problems by maintaining its 5V and $\pm 15V$ outputs "in-spec" for AC line "dips" to 20% and total AC power loss for periods up to 20 msec. The range of input voltages for normal operation is 87 to 127 Vac or 180 to 250 Vac. The unit is also

available for operation from a 48 Vdc input as a DC-DC Converter.

The supply is regulated to 0.12% on all outputs with ripple and noise of 5mV rms, 40mV p-p (20Hz to 20MHz). Outputs are adjustable in the range of 4.75V to 5.25V and 11.4V to 15.75V. Over-voltage, overcurrent, and overtemperature protection are standard.

For details, check I on the HP Reply Card.

NEW CRT subsystem for HP 9830 desktop programmable calculator



9882A subsystem (right) provides CRT and high speed data entry for 9830A calculator (left). Mass memory, below 9882A, has 4.8M bytes memory.

The new HP 9882A CRT subsystem, a special configuration of the HP 2640A intelligent terminal, has been designed to interface with the HP 9830 BASIC language calculator to provide a high speed entry system for users who work with business forms. It can be operated in either a block or character mode for sophisticated data entry applications.

The easy-to-read, 5 × 10 inch, inverse video (black on white) display is available with standard 128-character Roman font. The terminal generates characters with a high-resolution (7 × 9) dot matrix in a 9 × 15 dot character cell.

The microprocessor-controlled operating characteristics of the terminal, combined with its RAM semiconductor memory, provide a smart (dynamically allocated) memory that can store more than 200 lines of data that are viewable 24 lines at a time.

The 9882A comes with 3K bytes of memory, which can be expanded in a 2K byte step up to 5 bytes.

For more information, check N on the HP Reply Card.

New HP Application Note explains causes and measurement of intermodulation distortion in microwave radio systems

Hewlett-Packard's new Application Note 175-1 "Differential Phase and Gain at Work," discusses the causes and measurement of intermodulation distortion in wideband microwave radio systems.

Intermodulation distortion affects the quality of Frequency Division Multiplex (FDM), video and digital transmission signals being passed through the radio system. The various contributors to intermodulation distortion are explained, as well as the special test techniques required to properly display their presence. Nomograms and formulas are provided to allow the user to directly relate intermodulation noise magnitude in FDM/FM systems to specific radio distortion (e.g., differential gain, amplitude flatness) parameters. An extensive bibliography is also provided to assist even more extensive study into the subject.

Check Q on the HP Reply Card to obtain your free copy of Application Note 175-1.

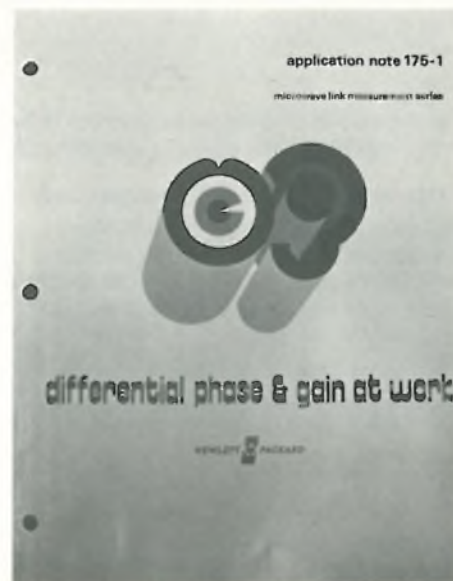

New Cesium Beam Frequency standard, precise and rugged, can take a beating



Remove the lid and you'll see the sturdy construction that enabled the 5062C Cesium Standard to pass the grueling 400-lb hammer blow test.

Now, there's a precision frequency source combining laboratory accuracy with compactness and ruggedness required by military hardware.

The new HP 5062C was designed to meet the specific needs of navigation, communication, guidance and other on-line systems where high performance is required under field environments.

The ruggedness of the 5062C was proven by passing the 400-pound hammer blow test (MIL-S-901) under operating conditions.

Its MTBF has been calculated to exceed 25,000 hours. It maintains 3×10^{-11} accuracy over a wide operating range and requires only 20 minutes of warm-up time even in a -28°C environment.

It is compact: 5¼" high (133 mm); fits standard 19" racks (482 mm); and weighs 50 lbs. (22.7 kg).

Major specifications of the 5062C:

Accuracy	$\pm 3 \times 10^{-11}$
(-28°C to $+65^{\circ}\text{C}$)	
Reproducibility	$\pm 1 \times 10^{-11}$
Stability	$\pm 2 \times 10^{-12}$
Long Term Stability	$\pm 1 \times 10^{-11}$
(for life of Cs tube)	
Short Term Stability	7×10^{-11}
(ave = 1 sec)	

Optional digital display clock and stand-by battery are available at additional cost.

To receive complete technical data, check F on the HP Reply Card.

Digital test simplified with 8 bit \times 32 word generator and HP Interface Bus



High speed, high capacity, high timing stability and unrestricted bit pattern programmability available in highly flexible word generator.

To learn more, check J on the HP Reply Card.

Hewlett-Packard's Model 8016A word generator, now with the HP Interface Bus, is unmatched in its capability to produce complex multichannel data streams for digital design and troubleshooting applications. Using it, you can focus all the powers of both an 8 channel \times 32 bit word generator plus a 50 MHz pulse generator on your testing problems.

You first set up the proper 1's and 0's pattern in the memory. Then, you can adjust the analog pulse parameters of the data waveforms to simulate varying

or worst case conditions. Pulse widths, logic levels, and channel-to-channel delays all are independently variable. Your testing becomes more thorough; it is both functional and parametric. Also, because all of it is accomplished with only a single stimulus instrument, it is thus simpler.

Additional features include strobe channel, RZ/NRZ operation channel serializer, and optional card reader to quickly load data patterns through the HP-IB further simplify your digital testing.

Portable instrumentation recorder gathers data that travels with you

When you have one chance to gather data in the field—data that you will work with later—you can now carry it out with you on the Hewlett-Packard 3960A Portable tape recorder.

When field recording situations are demanding, you need something extra going for you. This compact portable has the performance capability that you need, along with ruggedness.

Capable of operating on either AC or DC, it has a built-in calibration source and high accuracy AC or DC peak meter for input or output monitoring.

Options available allow you to customize your recorder for the kind of work you do. The choice includes voice annotation, DC-AC inverter, remote control, tape/tach servo and others.

Send for complete details on HP's high performance 3960A. Check E on the HP Reply Card.

Rugged recorder with superior tape drive assembly plus outstanding signal to noise ratio.



New portable digital multimeter delivers lab-grade quality and performance at an economical price

The new HP 3465A Digital Multimeter features performance and accuracy that qualify it for lab use. Its 10 mV dc range provides 1 μ V sensitivity. Its ease of operation, light weight, and battery power make it attractive for such cost sensitive applications as production test, service maintenance and education. With its dc/ac/ohms and current measurement capability, it is well suited for CATV, communications and appliance troubleshooting.

Take a look at the front panel. It has all the functions and ranges you'd expect, and more. You get ohms, ac/dc volts, and ac/dc current. The display is a large LED for easy viewing, and extra resolution is obtained with a full scale readout of 19999. Accuracy is $\pm 0.02\%$ of reading $\pm 0.01\%$ of range on dc, meeting the needs for most field or bench applications. The 10 mV dc range and 100 mV ac range provides performance typically found only on more expensive $5\frac{1}{2}$ digit multimeters. The instrument can be powered by any one of four optional power sources: D-cell batteries, the hand-held calculator charger, Ni-cad batteries, ac line.

HP's 3465 uses IC and thin-film technology to combine high sensitivity and accuracy offering wide capability, measurement convenience and user confidence within a reasonable cost.

The standard 3465A is fully equipped with an internal power supply, a battery



New $4\frac{1}{2}$ digit five-function DMM is accurate, sensitive and easy to use.

recharging circuit, and Ni-cad batteries. If you wish to power the HP 3465A from its furnished dry cell batteries, order Option 002. (Option 002 will operate from ac lines when using one of HP's 82002A chargers supplied with most

HP pocket calculators). For ac operation only, order Option 001.

To receive new data sheet on this multimeter, check C on the HP Reply Card.

HEWLETT  **PACKARD**

Europe-7, rue du Bois-du-Lan, P.O. Box 349, CH-1217 Meyrin 1, Geneva, Switzerland, Ph. (022) 41 54 00.
Canada-6877 Goreway Drive, Mississauga, Ontario, L4V 1L9, Ph. (416) 678-9430.

Japan-Yokogawa-Hewlett-Packard Ltd., Ohashi Bldg., 59-1 Yoyogi, 1-chome, Shibuya-ku, Tokyo 151, Ph. 03-370-2281/92.

Elsewhere outside the U.S.A.-195 Page Mill Rd., Palo Alto, California, 94306, U.S.A.

The Scot Pot™ Surprise.



*Amphenol designed a high-performance
precision pot.*

That's no surprise.

But that low, low price. Now that's a surprise.

Performance second to none.

Scot Pot's total performance is better than or equal to any other 10-turn wire-wound miniature precision pot you can buy. One look at the Scot Pot spec sheet tells the story. (Be sure to ask for a copy.) Scot Pot has improved electrical, mechanical, and environmental characteristics. Its performance meets even the most demanding design requirements. All at that surprisingly low price.

Save up to 25%.

And the Scot Pot price-tag is a surprise. A very pleasant one. Because Scot Pot can replace what you're using now—in

form, fit, and function—and save you as much as one fourth the cost.

Scot Pots are available—now.

You can get immediate, off-the-shelf delivery on Scot Pots from your Amphenol Industrial Distributor. He's located close to you—so call him. Or for more information (and a copy of the Scot Pot spec sheet) contact: George Boyd, Amphenol Connector Division, Controls Operation, 2801 South 25th Avenue, Broadview, Ill. 60153. Phone: (312) 261-2000.

*When you can connect it
and forget it...that's quality.*



AMPHENOL

Circle 31 on reader service card

“A boom is on the Are we ready

Seven thoughts on preparing for the next boom in the Electronics Technology Marketplace.

1. *The boom is coming sooner than we think.*

The evidence is all around us. Many segments of the market have already found bottom and are on the way up. Inventory liquidation has been the most rapid in the history of our economy, and the pipelines are almost empty. Federal monetary policy has become extremely stimulative. Interest rates are down, and industry can afford to invest in the instrumentation and modernization it needs. Productivity is increasing. And our most reliable lead indicator—the market—has been booming for six months. No matter what data you look at, it now seems definite that we are in for a *very sharp* economic upturn, and that short of another Arab oil embargo or a drastic tightening of the money supply by the Fed,

nothing can stop it. If you are not planning for an electronics economy that is booming by year-end, you will be 'way too late to take advantage of it.

2. *Be glad you're in the electronics business.*

In terms of *real product demand*, the recession has been slight or non-existent in many sectors of the Electronics Technology Market. For example, a major instrumentation manufacturer just reported on its most recent six months: Incoming orders up 11%, sales up 14%, profits up 21%—compared with the “boom” market of late 1973 and early 1974. Even in the hard-hit semiconductor industry, there is a good deal of evidence that *real product usage* will be essentially flat from 1974 to 1975, and that the apparent boom-bust in bookings and shipments is entirely due to inventory.

Considering that the economy as a whole has experienced its sharpest recession since the '30's, the electronics market has performed extremely well. It will far outperform the economy during the recovery—especially if *we are ready* for the boom.

3. *Start now to build inventories.*

Sound crazy? Consider this: an important part of the boom and subsequent bust was based on product shortages, which led to panic buying, which in turn led to panic production, and thus to inflated inventories. *Let's not do this again.*

It shouldn't take any genius to figure out what products the market would need for a sharp year-end recovery, and it wouldn't be a super-gutsy decision to start now to build toward that level. But let's also be sensible. Ideally, each company should build only toward the market share it can legitimately expect to get. Otherwise, we'll have everybody building to get 50% market share, and it will be August, 1974 all over again.

4. *Get your marketing house in order.*

In the last boom, marketing and sales people spent a major part of their time *killing snakes*—expediting their factories, and hand-holding their customers. Let's not do that again either.

Now is the time to organize and mechanize your marketing and distribution operations, your communications, and your

way. for prosperity?"

service functions so your sales staff can be free to do what it does best—*close orders*. A quick review—painful as it may be—of the problems you had during the last boom should tell you what changes to make.

5. *Unload some old ideas.*

One of the reasons we keep making the same mistakes each time the economic cycle repeats itself is that we keep clinging to our old ideas, articles of faith, corporate dogma, and former solutions. I wish I had a dollar for every knee-jerk statement I've heard about share of market ("we know all our customers"), market coverage ("80% of our business comes from 20% of our customers"), forecasting ("the resistor market will grow 7% per year through 1983"), market development ("we have a planning department for that"), target audiences ("we want to reach the design engineer"), ad budgets ("we spend 2.3% of sales"), etc., etc.

Consider spending some time in a cool, quiet, dark place—rethinking all the things you "know," and tossing out those that are beginning to look a little tired. And you'd better do it *now*—because the business cycles are coming faster and sharper, and the old ideas just aren't good enough anymore. And because in a few months you're going to be too busy to do it at all.

6. *Start now to broaden your markets for 1976.*

One of the important lessons of the 1974-75 downturn is that companies which had broadened their markets during the boom outperformed their competitors in the bust—by *very* wide margins. It doesn't much matter whether the broadening was in customer base, product/service mix, or geography.

One of the best ways to get ready for the next boom is to turn on your marketing operation *now*, and turn it on with the main objective of finding new customers. One way you could do this is to hire more salesmen. Now is the time, because it will take months of training before they can be productive, and also because in six months *everybody* will have decided to hire, and good people will be hard to find.

The other thing you can do is turn on your advertising. Think about that for a moment. Advertising is the cheapest, most efficient way to help new customers *find you*, and you can turn it on in a couple of weeks without any training at all. Besides, you can turn it on now before the market gets cluttered with messages—in six months, *everybody* will be advertising again.

7. *Be glad you're not in my business.*

Do electronics companies cut advertising in a recession? Do they ever. In the first 5 months of 1975, the advertising page pool for which Electronics competes is down a whopping 26% from last year. Our market share is substantially up, but that's small comfort.

Yet when all the smoke clears away, and the 1974-75 recession is studied, we will learn again what every recession of the past has taught us: Companies which maintain or increase their advertising investments in recessions make more profit *during* the recessions, and come out of the recession with improved market share—compared with companies that cut.

In other words, companies which take a long, consistent view of their markets and their marketing objectives do well in good times *and* bad.

And now, a word from the sponsor—

When you decide to broaden your markets by turning on your advertising, the most effective place you can put that advertising is in Electronics.



Daniel A. McMillan III
Publisher

Electronics 
THE SOURCE.

This is the Seventh of a series of editorials on advertising, marketing, and planning in the Electronics Technology Marketplace. Your comments are welcome.

Dialight sees a need:

(Need: The widest choice for your every application.)

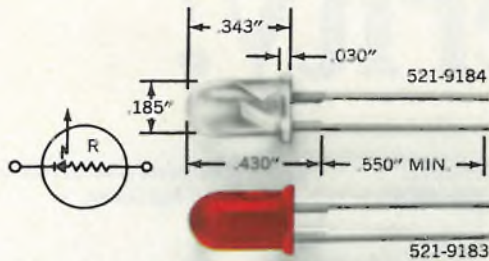

Available in red or clear LED packages with or without a built-in current limiting resistor. Red LED is also made without resistor. Suitable for circuit status indication, alpha-numeric displays and visual indicators. Features long wire-wrappable leads. IC compatible with solid state reliability. High luminous intensity, low power consumption, low cost.

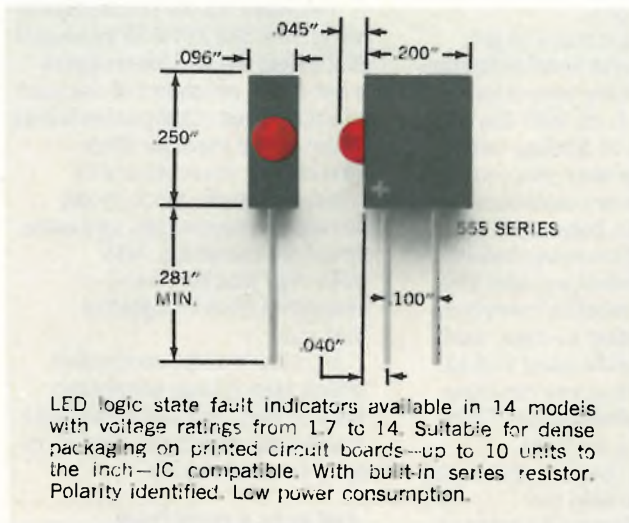

LED logic state fault indicators available in 14 models with voltage ratings from 1.7 to 14. Suitable for dense packaging on printed circuit boards—up to 10 units to the inch—IC compatible. With built-in series resistor. Polarity identified. Low power consumption.



Dialight, the company with the widest choice in switches, LEDs, indicator lights and readouts, looks for needs . . . your needs . . . and then they develop solutions for your every application. No other company offers you one-stop shopping in all these product areas. And no other company has more experience in the visual display field. Dialight helps you do more

with these products than any other company in the business, because we are specialists that have done more with them. Talk to the specialists at Dialight first. You won't have to talk to anyone else. Send for your free new copy of Dialight's current catalog.

DIALIGHT

Dialight, A North American Philips Company
203 Harrison Place, Brooklyn, N. Y. 11237
(212) 497-7600

See Dialight.

Meetings

Symposium on the Simulation of Computer Systems, NBS and ACM, Boulder, Colo., Aug. 12-14.

10th Intersociety Energy Conversion Conference, IEEE, Univ. of Delaware, Newark, Del., Aug. 17-22.

19th Annual SPIE Technical Symposium: Developments in Optical and Electro-Optical Engineering, Past and Future, Society of Photo-Optical Instrumentation Engineers, Town & Country Hotel, San Diego, Calif., Aug. 18-22.

Active Semiconductor Devices for Microwave and Integrated Optics, IEEE and Cornell University, Ithaca, N.Y., Aug. 19-21.

IFAC/75: International Federation of Automatic Control's Sixth Triennial World Congress, IFAC, Massachusetts Institute of Technology, Cambridge, Mass., Aug. 24-30.

NBS Seminar on Frequency Standards and Clocks: Characterization, Usage, and Problem Areas, NBS, Boulder, Colo., Aug. 25-27.

Third International Conference on Thin Films, Hungarian Academy of Sciences et al., Budapest, Hungary, Aug. 25-29.

Fifth European Microwave Conference and Exhibition, Microwave Exhibitions & Publishers Ltd. (Sevenoaks, Kent, England), Congress Centrum, Hamburg, West Germany, Sept. 1-4.

European Solid State Circuits Conference, IEEE, University of Kent, Cambridge, England, Sept. 2-5.

Workshop on Computer Hardware Description Languages and Their Applications, IEEE, City University of New York, New York, Sept. 3-5.

Compeon Fall, IEEE, Mayflower Hotel, Washington, D.C., Sept. 9-11.

First National Conference on Software Engineering, IEEE and NBS, Mayflower Hotel, Washington, D.C., Sept. 11-12.

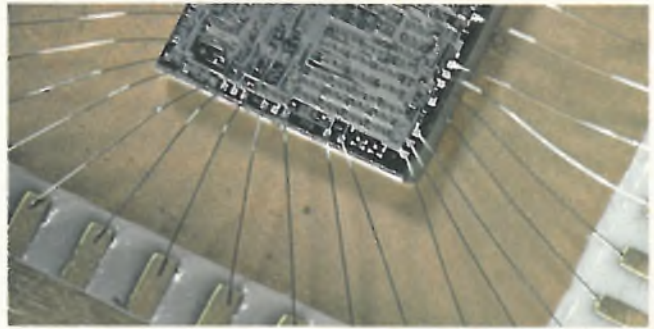

If you're planning a new product, you should know what we know about LSI.



During the past five years, we've helped our customers develop and produce numerous "dedicated" LSI subsystems in the fields of electronic timekeeping, instrumentation, medical and consumer electronics. These efforts have resulted in several outstanding product successes.

The advanced technologies of Large-Scale Integration, no matter how dramatic they may appear to be, aren't for every application.

Knowledge of the tradeoffs, pitfalls and limitations which can compromise LSI implementation is often just as important as projecting its potential benefits.

Knowing these things is our job. Things like cost/quantity tradeoffs, long-term profit analysis of the host product, how to choose the right processes to optimize performance and reliability.

If you're considering LSI, consider Micro Power first. Call us or write for some fact-filled literature on LSI—what it is, how it works, and how we can make it work for you.

We sell more than circuits. We sell solutions.

MICRO POWER SYSTEMS



3100 Alfred Street
Santa Clara, CA 95050
Telephone (408) 247-5350
TWX 910-338-0154

MPS/Japan
21 Mori Bldg.
2-2-5 Roppongi
Minato-ku, Tokyo, Japan
Telephone 586-0371

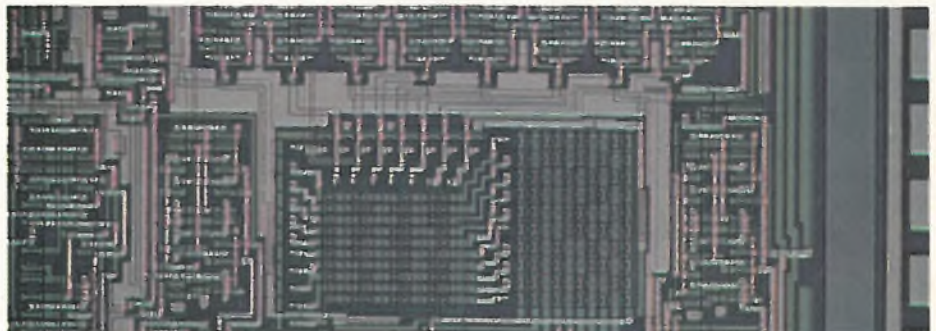

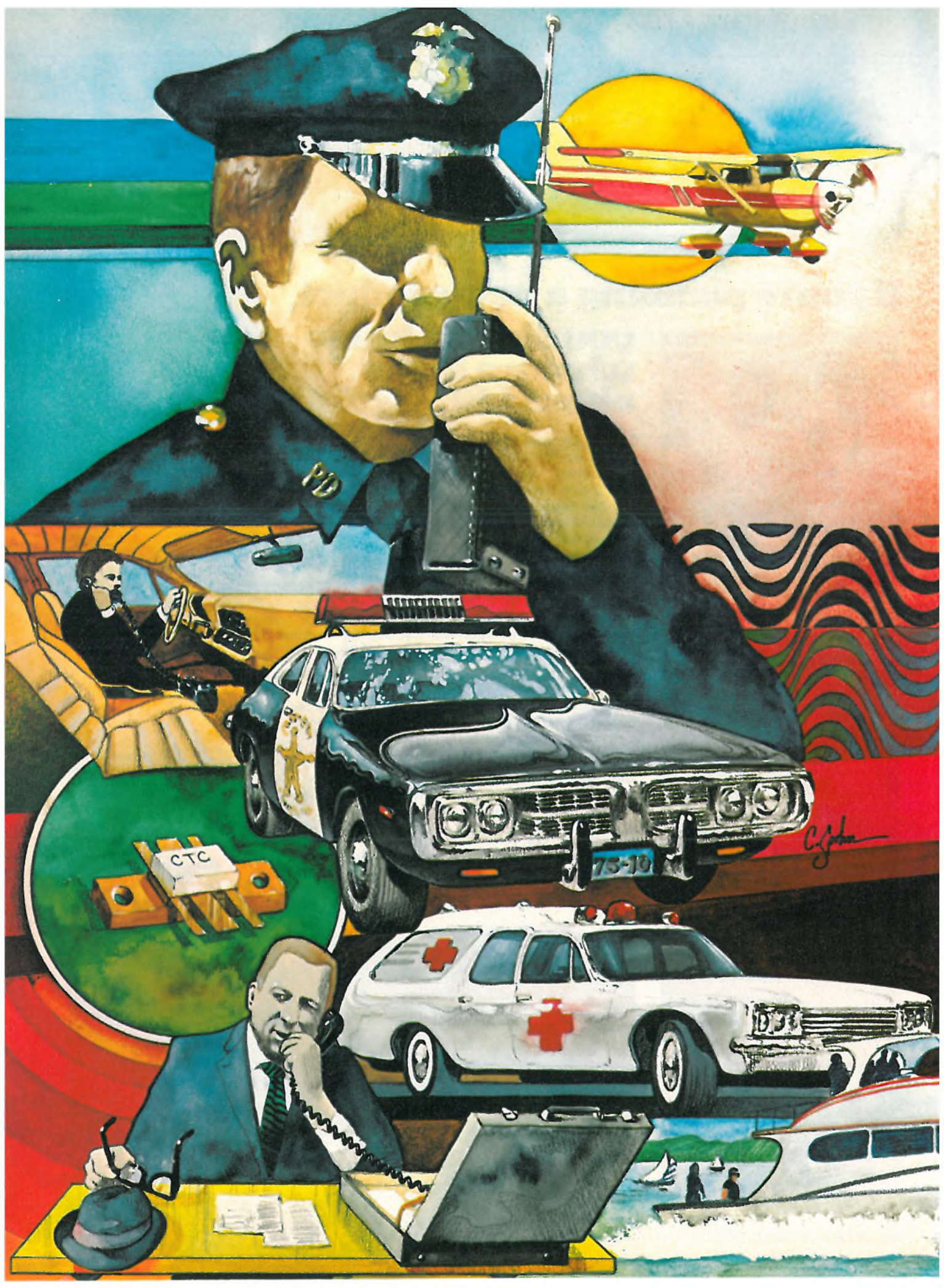

C. John

It takes rugged power to stay on top in land mobile.

All the way from 25 MHz to 1GHz, Communications Transistor Corporation has the power, the prices and the packages to produce the simplest, most rugged, most economical, and by far the most efficient systems in land mobile communications.

While other suppliers are copying the designs we introduced two years ago, we've come up with a whole new packet of power in all four key frequency ranges—HF, VHF, UHF and the major new 900 MHz range. More power, full band, infinite VSWR and like all C.T.C. devices—super rugged. It's the combination that made C.T.C. the powerhouse in land mobile. Now it's better than ever.

Our new devices deliver 80 and 150 Watts at VHF; 75 Watts at UHF; 40 Watts in 900 MHz; and we've even got a 7½ Volt series for hand-held communications at 900 MHz. Send for complete specifications and price lists. Or call collect for immediate requirements. Communications Transistor Corporation, a wholly owned subsidiary of Varian Associates, 301 Industrial Way, San Carlos, California 94070. (415) 592-9390.

$V_{CC}=12.5V f=175\text{ MHz}$

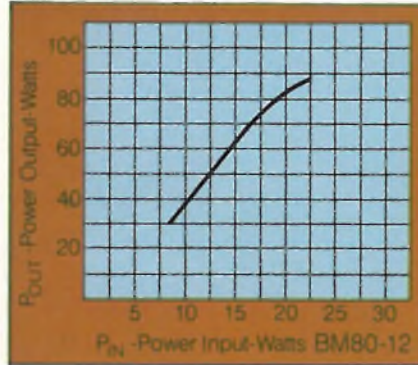

$V_{CC}=12.5V f=175\text{ MHz}$

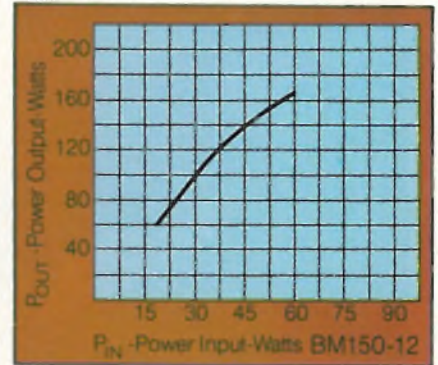

VHF never had it so good. Rugged, efficient, economical.

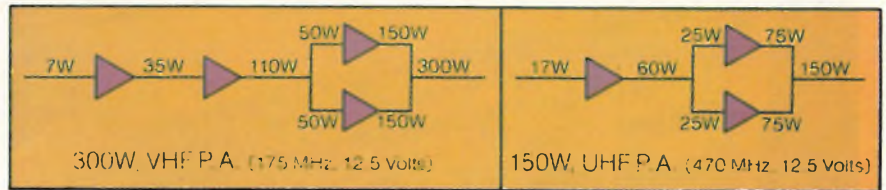

Shorter, more powerful chains in all frequencies.

$V_{CC}=12.5V f=470\text{ MHz}$

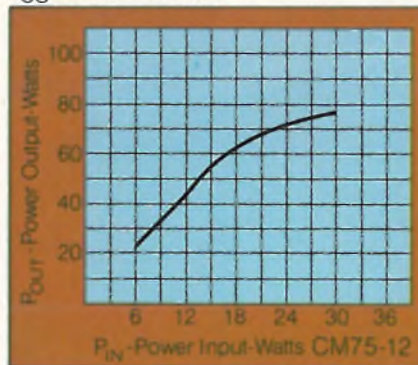

$V_{CC}=12.5V f=850\text{ MHz}$

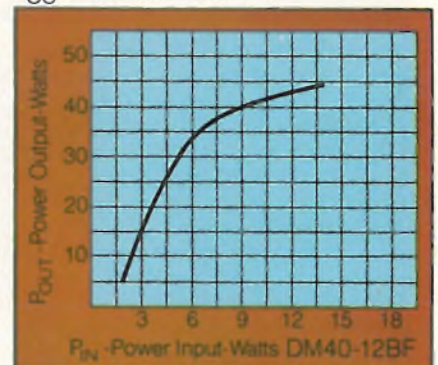

UHF and the newly assigned frequency ranges get their biggest boost from C.T.C.

C.T.C. has what it takes.



Turn to page 7. Important? Sure...

By the time the office copy of ELECTRONICS gets to you, there's nothing left of page 7. It happens. Too often.

How often has ELECTRONICS wound up on your desk dog-eared and abused, with articles clipped out and ripped out? Or days, even weeks late?

How often has ELECTRONICS

never even made it to your desk?

You should be getting your copy of ELECTRONICS right off the press. You need it. Because it's important to stay on top of what's happening in your field. And ELECTRONICS is on top. ELECTRONICS is the Source. It's packed with up-to-date info, the breaking news of the electronic industries in the U.S. and worldwide.

You can get ELECTRONICS where you can find the time to read it—at home. Go to *the Source*, today. Fill out the subscription card enclosed in this issue, and send it off.

Electronics 
IS THE SOURCE.

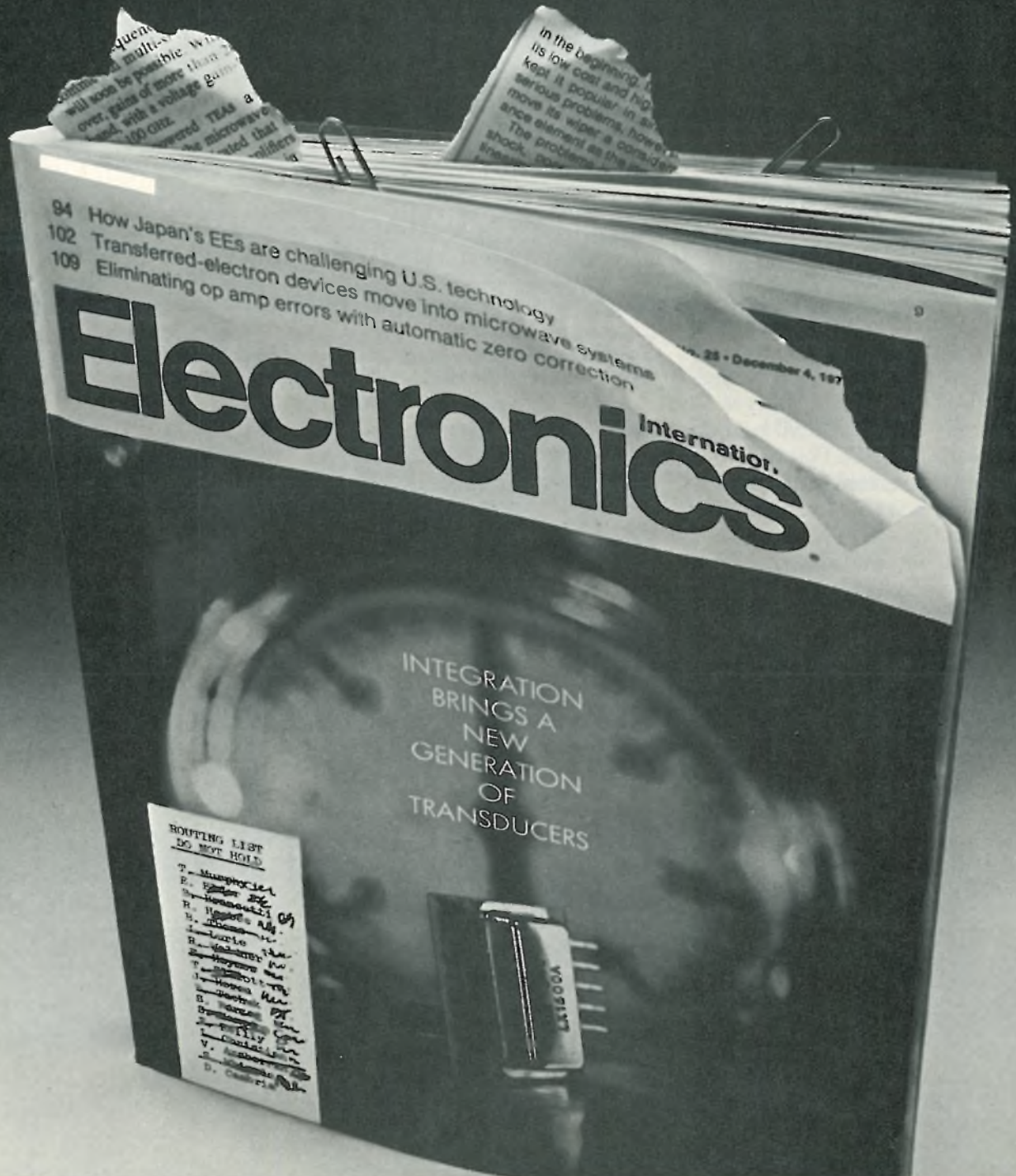

National's Scamp is 8-bit processor at a 4-bit price

National Semiconductor Corp., Santa Clara, Calif., will soon announce a new p-channel MOS microprocessor system. Called Scamp for simple cost-effective applications microprocessor, **it's an 8-bit machine that will sell for the price of most 4-bit processors—about \$15 in quantity.** A system built around Scamp will consist entirely of three ICs—the processor, a 16,384-bit ROM organized into 2,048 8-bit words and a 1,024-bit RAM organized into 128 8-bit words.

High-reliability parts for pacemakers in short supply

Manufacturers of cardiac pacemakers must buy better grades of electronic components to improve pacemaker reliability [*Electronics*, July 10, p. 75], but experts from the Rome Air Development Center, Rome, N.Y., say that **adequate stocks of high-reliability parts are not available.** At a recent National Bureau of Standards conference, Rome officials noted that manufacturers probably use military standard class B parts, or their equivalents. **But Rome officials say pacemaker manufacturers should demand that reluctant vendors add production lines for class A parts, with their failure rates of one in a billion, at least 10 times the mean time between failures of class B parts.**

TI readying 4-bit slice using Schottky process

Aiming squarely at the next generation of fast mini- and midi-computers, Texas Instruments has started releasing details of a **4-bit Schottky microcomputer slice** to some minicomputer manufacturers. The five-chip set, now planned for fourth-quarter introduction, is both micro- and macro-programmable, has a dual-address capability, and can be configured so that it will simultaneously address and control two separate memories. **The high-performance computer uses a unique memory-to-memory architecture that allows the entire memory to be used as working register space.**

Microinstruction cycle time is said to be 100 nanoseconds, and when the set is wired in a 16-bit configuration, **it will perform dual-precision, signed multiply and divide in less than 2 microseconds.** The five chips required to build a complete computer include a micro-macro-programmable 4-bit slice that contains hard-wired algorithms for multiply and divide, micro control element, programmable read-only control memory, field-programmable logic array, and 256-by-4-bit random-access memory.

Lynch, ex-Motorolan, becomes president of Bay Area firm

Patrick D. Lynch, former vice president and general manager for U. S. operations at Motorola's Semiconductor Products division, **has surfaced in Silicon Valley, but not at a semiconductor company.** Lynch last week became president and chief executive officer at Nortron Corp., a \$2 million-a-year company whose main product is an electronic wheel-balancer for autos. Lynch was pushed into corporate limbo at Motorola when John R. Welty succeeded Thomas J. Connors as general manager [*Electronics*, May 15, p. 38]. **Lynch plans for Nortron, of Sunnyvale, Calif., to expand into sophisticated automotive-diagnostic systems built around microprocessors and other semiconductor technology.**

When Honeywell engineers designed the Model Ninety-Six, they had just two objectives: make it the leader and stay on top.

Becoming the leader in its introductory year was an almost unheard-of accomplishment in the field of lab quality magnetic tape recorders/reproducers. It could have been a real temptation for the designers of the Model Ninety-Six to sit back and relax, watching the competition play catch-up.

But they weren't — and aren't — that kind of engineers. From the day the first Model Ninety-Six was shipped more than two years ago, they've never slowed their efforts to make the new leader even more outstanding. Changes have been made to improve reliability and ease of operation. Here are a few of the features that keep the Ninety-Six out ahead of the pack:

- Solid ferrite heads deliver stable, rock-solid data and they're warranted for 3,000 hours at 120 ips.
- A space-saver combination: In 3½ inches of rack space, 14 omniband record amplifiers, 14 record/reproduce monitors, 14 record level amplifier/attenuators and 14 reproduce output level amplifier/attenuators — all front-panel controlled!
- Accepts ¼-inch tapes on 7-inch plastic reels. You don't have to dub your field recorder data before processing.
- High slew rate servomotor gives super spectral purity.
- Selective track record.
Normally, when "record" is selected, all record heads are energized with bias, whether or not data is present. The Model Ninety-Six permits selective energizing of each record track to improve tape utilization.
- Nine bidirectional tape speeds, adjustable fast and search speeds, all solid-state footage counter; super all-electronic shuttle system, E.O.T. sensing without optics, 16-inch reel capacity for the most usable and easy-to-use transport system around.
- Gentlest tape handling. Only the heads touch the tape oxide. No adjustments in tape path. No adjustments when changing reel sizes. 15-minute width change. No pinch rollers; no fixed guides. Low balanced tension is easy on tape and heads.

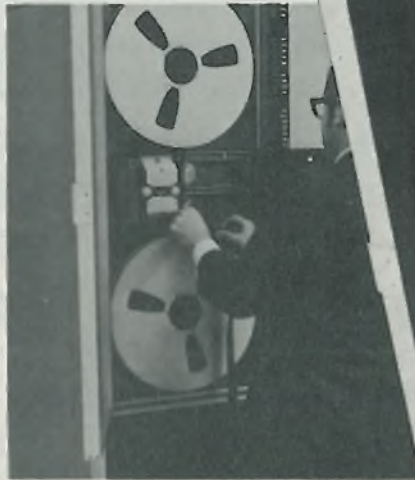

Want complete, up-to-date specifications? Call or write a reel expert: Ed Haines, (303) 771-4700, Honeywell Test Instruments Division, P.O. Box 5227, Denver, Colorado 80217.

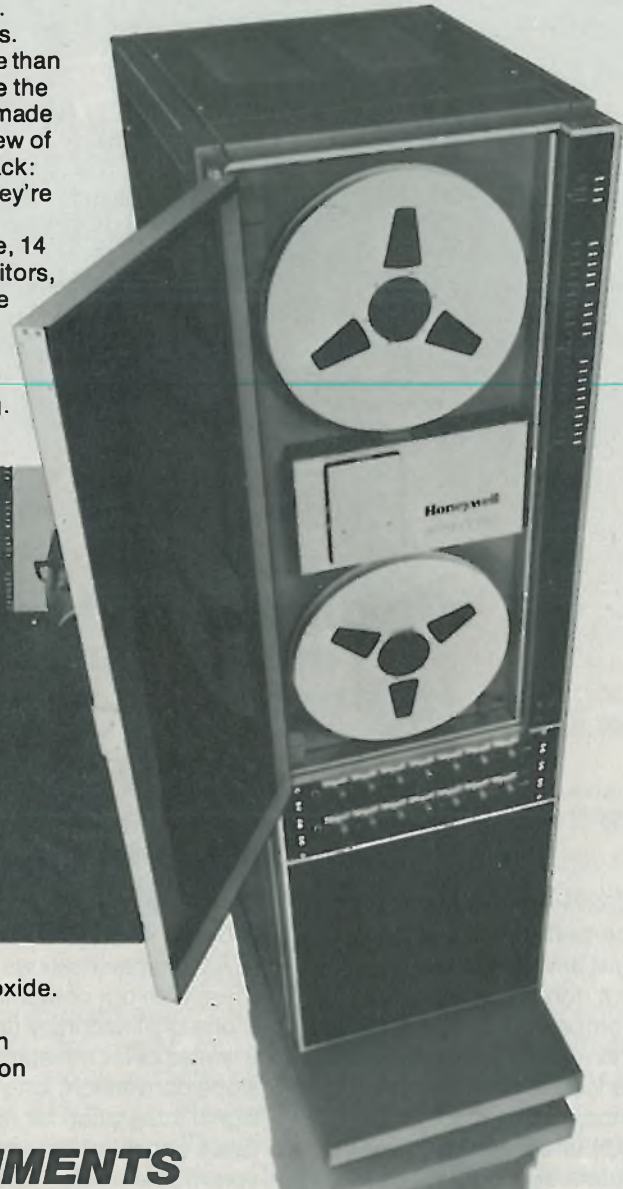

**TEST
INSTRUMENTS
DIVISION**

Honeywell

Air Force receives bids on phased-array early-warning radar

Pave Paws for Electronic Systems division to warn of sea-launched missiles; cost could reach \$100 million

The Air Force last week received proposals for a new long-range ground-based radar that would provide early warning of sea-launched ballistic missiles aimed at the United States. Contractor teams—Raytheon Co. with IBM Corp., General Electric Co. with TRW Inc., and Westinghouse Electric Co. with Bendix Corp., and Aeronutronic Ford Corp.—are competing for the so-called Pave Paws system, which according to one industry estimate might cost \$100 million.

The Electronic Systems division, Hanscom AFB, Mass., will award a contract for Pave Paws early next year. The \$100 million estimate is for two systems, including the site and housing. A completion date is not set, but when completed, the radars will be turned over to the Aerospace Defense Command.

The phased-array radars will face seaward at two sites—Otis Air Force Base, Mass., and Beale AFB, Calif. With a 3,000-mile range and a 240° angle of coverage, the radars will be able to protect the Atlantic and Pacific shores of the U.S. Eventually, the radars will replace the AN/FSS-7 rotating-dish radar systems, now used to detect sea-launched missiles from six sites on the East and West Coasts. These older units are modified height-finder radars originally designed for the Sage system to detect aircraft.

The Air Force decided to switch to a phased-array radar to increase the detection range and for other improved detection and tracking capabilities. However, the Air Force is not saying whether the array should be of solid-state or vacuum-tube design.

Choice. "The contractor has the latitude to select whichever is best to meet the specifications," says Lt. Col. Paul T. McEachern, ESD program director for Pave Paws. The choice will be between a solid-state ultra-high-frequency array with a transceiver in each emitting element, and an L-band system with four to six high-power transmitting

tubes and a space or corporate feed to the individual emitters.

With roughly 2,500 elements and 1-megawatt peak output, a solid-state system would likely be less complex and cheaper than an L-band system, according to one industry observer. The L-band system would require about 5,000 radiating elements, and an output power of 6 to 7 megawatts because of the atmospheric attenuation in this band.

However, an L-band system could provide more accurate angular and amplitude data for tracking, although this is not of primary importance in an early-warning system.

McEachern's deputy program di-

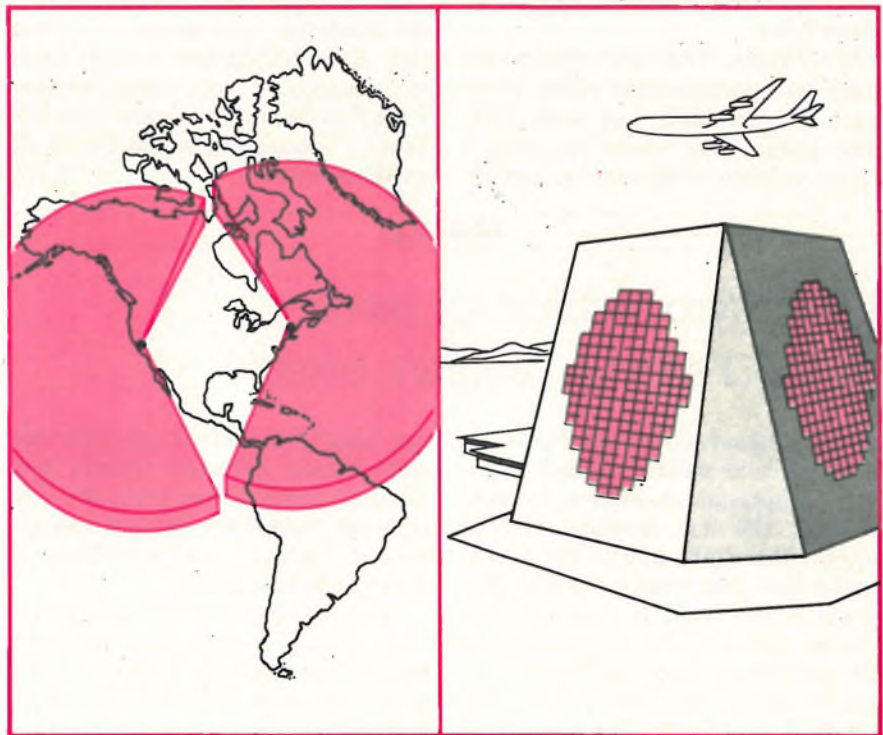

Coverage. Two faces of the Pave Paws (phased-array warning system) radar will provide 240° of coverage from each of two sites. A 10-story building will house the units.

Cobra Dane phased array being readied

Another major phased-array radar system is nearing completion—Cobra Dane, located at Shemya Air Force Base in the Aleutian Islands of Alaska. It is designed to monitor the flights of developmental ballistic missiles and updated missile weapons in the Soviet test range along the Kamchatka Peninsula and the Pacific Ocean, but it will also track space vehicles and provide early warning for the North American Air Defense Command. Developed under a \$38 million, two-and-a-half-year fixed-price contract by the Raytheon Co. Equipment division, Wayland, Mass., Cobra Dane will have a single radiating face with 35,000 dual transmitting-receiving elements, 18,000 of them active and the rest included for future growth. Phase is shifted by p-i-n diodes. Working in the L-band, it will have a 120° beam, a 2,000 mile range, and a peak output of 16 to 18 megawatts. The addition of a computer in October will complete the equipment installation. Raytheon will then test for about five months plus two weeks of joint testing before turning Cobra Dane over to the Air Force, which will operate it for the Aerospace Defense Command. The system is expected to become operational in March 1976.

rector, Richard L. Moore, stresses that the Air Force wants a system built with off-the-shelf components. This can be readily done even for a solid-state system, he says. Individual radiating elements would have to handle peaks of 400 to 600 w. Solid-state transceivers of up to 1,000 w are available. They have been used for communications systems rather than radar, he points out, but these could be applied to Pave Paws.

Two faces. The new system will have two phased-array radar faces, each 65 feet high, and scan 120°. The system will sweep its surveillance volume with narrow, pencil-

shaped beams. Each site will scan a 240° azimuth and from 3° to 85° elevation, with 3,000 miles range, approximately every 6 seconds. A computer, probably about the size of an IBM 370/158, will direct the beam.

In contrast, the present AN/FSS-7 radar system has a range of only 850 miles, insufficient to give early detection of new long-range ballistic missiles. And while an AN/FSS-7 can track only one target at a time, Pave Paws will be able to track multiple targets. A secondary role for Pave Paws will be to support the Air Force's Spacetrack, which tracks all earth satellites. □

Military

Laser gyro technology gains as DOD sets up program office

Before August is over, the Pentagon hopes to have pulled together its tri-service program on laser gyro technology. The first funding level of approximately \$8 million for a two-and-a-half-year demonstration program is not large as military programs go, but the Pentagon's move to coordinate laser guidance programs under the Director of Defense Research & Engineering is good news for a half-dozen industry R&D teams who see the laser gyro as

the strapdown inertial sensor for the next decade. Between aircraft, missile, and shipboard systems, the U.S. military market for inertial navigation systems is now estimated at \$200 million annually.

Officials at DDR&E see the upcoming Aug. 19 meeting between DDR&E's Malcolm R. Currie and Air Force Assistant Secretary Walter B. LaBerge as being the key to completing details of the tri-service effort. The effort so far, they acknowl-

edge, has suffered from "administrative growing pains." DDR&E expects that it will fund this fiscal year a single contractor for pilot production of a laser-gyro system "to get a firm handle on costs and get those costs down." But it's stressed that supporting technology funds will be available to "bring along other competing contractors" with laser-gyro guidance packages, so that the military does not lock itself in with a single contractor.

To a greater extent than conventional inertial-wheel gyros, the strapdown laser systems promise mechanical simplicity, higher reliability, and longer life, plus faster response time. They also are insensitive to high acceleration, vibration, and shock—a prime requirement for missile systems. And elimination of the mechanical gimbals of conventional navigators should cut system costs in half.

The laser gyro operates on the optical frequency-shift phenomenon experienced when an angular turning rate is applied about an axis normal to the geometric plane of a ring laser. In the fundamental two-mode laser gyro, the optical frequencies of clockwise and counterclockwise propagating laser beams differ proportionally to the applied rate. This frequency difference is detected and used as a rate-sensing signal for navigation and guidance.

Leaders. Honeywell Inc., Minneapolis, is widely acknowledged within DDR&E and the industry as the one with the system to beat at this stage. Its strapdown laser inertial navigation system (LINS), completed a series of Air Force flight tests aboard a C-141 transport in May and June at Holloman AFB with favorable results.

"They have solved some of the outstanding technical problems," says one DDR&E specialist, who says the Honeywell LINS has good "bias stability and low scattering."

The Sperry division of Sperry Rand Corp. is also regarded as a major contender, as are Hamilton Standard division of United Technologies, Litton Industries Inc., Raytheon Co., and Rockwell Inter-

national's Autonetics Group.

High performance plus low costs are being stressed by Honeywell. Performance data on its LINS package "has demonstrated long-term repeatability of 0.01 to 0.03 degrees-per-hour consistent with 1-3-mile-per-hour inertial-navigation requirements," says Paul G. Savage. The Honeywell specialist adds, "The ability to achieve these performance levels without thermal controls provides a 2- to 5-minute reaction time for alignment. This is a significant improvement over 15-20-minute reaction times for current inertial equipment."

Goals for LINS set by Honeywell are \$40,000 for the baseline nonredundant system cost in 1975 dollars and a mean time between failure of 2,000 hours. It is aiming for an accuracy of 1-3-mile circular error probability without aids, and a 2-minute reaction time that includes warmup and alignment. However, Honeywell sees LINS as expandable to operate in an aided-inertial mode using Loran, Omega, or the upcoming Navstar satellite system. □

Fiber optics

Light signals handle data on power

Japan's electric power companies are developing communications systems in which data carried on fiber-optic cables will control their power facilities. These cables, which will be threaded through the tunnels containing high-voltage power lines, will replace the point-to-point microwave systems whose signals too often are blocked by the tall buildings of densely populated cities.

Experiments using operational data will begin shortly. In the first experimental phase completed in March, data from a code generator was received free of error over a 2.2-kilometer-long Selfoc cable made by Nippon Electric Co. Measuring 19 mm in diameter and containing four optical fibers, the cable was placed in the same tunnel as a 150-kilovolt power cable in the center of Tokyo. Information was transferred at a

rate of 7.8 megabits per second and, according to the Japanese, was completely unaffected by the energizing of the power cable.

Spearhead. Two of Japan's nine electric power companies are spearheading the effort—Tokyo Electric Power Co. in Tokyo and Kansai Electric Power Ltd. in Osaka, Japan's second largest city. The two are relying on three teams of manufacturers to supply them with equipment. Each group will develop its own cable configurations, modulation and demodulation techniques, and so on.

So far only one team has installed equipment—Nippon Electric Co. and Sumitomo Electric Industries Ltd., who handled the initial tests in Tokyo. This team's charter is to develop optical communications systems for transmitting control data.

The team is using pulse-code-modulated input and output signals for Tokyo Electric and frequency-division-multiplexed signals for Kansai Electric. But in both cases information will be transmitted over the fiber-optic cables themselves by a Nippon Electric method referred to as differential-pulse-position modulation-intensity modulation.

Others. The tasks of the other two teams differ. Hitachi Ltd. and Hitachi Cable Ltd. will specialize in systems for substation control. For Tokyo Electric, they will develop optical communications for controlling protective relays; for Kansai Electric, the communications system will control telemetry systems.

The third team of Fujitsu Ltd. and Furukawa Electric Co. is developing high-speed optical communications for still other applications. These include optical picture-transmission systems and communications allowing the exchange of information among computers.

In Nippon Electric's differential-pulse-position and intensity modulation, incoming signal pulses are grouped to reduce the data that must be transmitted. To illustrate, for each group of four pulses one laser pulse might be generated in one of 16 possible pulse positions to specify the makeup unique to the

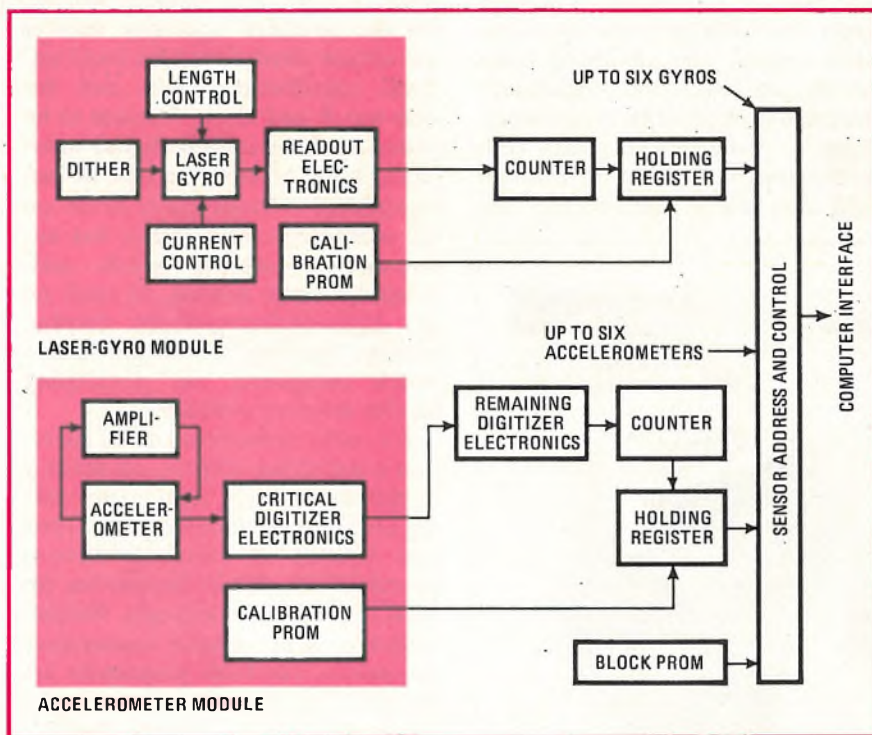

Modular. Honeywell's laser inertial navigation system has separate laser gyro and accelerometer modules, with calibration data stored in programable read-only memories. First flight tests were completed successfully aboard an Air Force C-141.

Electronics review

group. The technique keeps the number of laser pulses and the duty factor relatively low, prolonging the laser's life.

A double heterojunction gallium-arsenide laser in the system has an output of about 3 decibels above 1 milliwatt at a wavelength of 0.8 nanometer. The received signal, after losses in both the fiber and the joints, is at $-42\text{dBm} \pm 0.3\text{ dBm}$. Actually, the fiber has a nominal loss of only 14 dB/km. But since each cable section is only about 550 meters long, losses are introduced at the joints between the sections.

A silicon avalanche photodiode is used for reception. The received signals from a code generator were error-free during the first phase of the experimental tests. □

Consumer

Electronics adds wristwatch frills

No longer a curiosity and certainly beyond the fad stage, the digital electronic watch has established a firm place in the consumer market. What's more, it is moving toward performing new functions made possible by microprocessors. "We are thinking about a wrist instrument, rather than simply a watch,"

Telling time

Watch companies have tried various ways of overcoming the shortcomings in digital displays—LEDs are invisible in bright light, LCDs don't show in the dark. Longines' \$395 Gemini II offers one way out—redundancy. Some LED users have put the display on the side of the watch to cut out bright light. And many of the LCD users have built in a miniature incandescent lamp to light the display. With Gemini II the LCD is viewed for most readings while the LED is turned on only in the dark.



says John Bergey, president of Pulsar division of HMW Industries Inc., which marketed the first solid-state watches with digital displays.

Essentially the wrist-instrument concept boils down to adding such things as communications, calculating and sensing capabilities. The instrument could also receive signals, initially to activate a paging beeper, but later perhaps to process coded signals. The advanced planners also see some form of telemetry transmission as feasible, once longer-lasting or rechargeable power cells are developed. And the instrument could also sense and display the

wearer's pulse and temperature.

"There are many new functions possible with today's technology," comments Scott Brown, director of marketing for Novus, "and the wrist just happens to be a convenient place to carry this instrument."

Functions. New functions are already being added to today's watches. The first features will be for the so-called specialty market for certain consumers who want unusual capabilities. Plans call for stop-watch and alarm features to be added to the standard digital time-piece, both of which could be accomplished without much strain on the technology. And Pulsar has announced an inertial switch, activated by hand motion, to turn on the light-emitting-diode display without pushing a button. Other watch companies are developing similar mercury switches.

An early indication of the direction some of the 40-plus competitors in this hurly-burly market are taking are the announcements by Optel and Uranus of watch/calculators promised for sale in September for \$500 and \$800 respectively. Neither prototype is an esthetic masterpiece as jewelry, but both companies are expecting to sell to "the man who has everything." Calculator buttons rim the face of the Uranus watch. The eight-digit calculator has four functions and LED read out, and the



Fancy. Prototype watch/calculator from Optel shows time and has four-function calculator with liquid-crystal display. Pulsar's inertial switch turns on light-emitting-diode display with flick of wrist.

TEKTRONIX ANNOUNCES

A new concept in portable instrumentation

The TEKTRONIX TM 515 Traveler Mainframe looks like fashionable flight luggage, compact and easy to carry, or slide under an aircraft seat. In reality, it's a five-compartment power module/mainframe that provides power and interface connections for TM 500 plug-in modular instrumentation. Plug in the new (two-wide) SC 502 15-MHz dual-channel oscilloscope, and you have the beginnings of a powerful take-along instrumentation system.

You can optimize a TM 500 system to your needs by selecting from more than 30 plug-in modular instruments. With the TM 515 Traveler Mainframe and SC 502 Oscilloscope as a nucleus, select from DMM's, counters, generators, power supplies, signal processors, and even blank plug-ins for your "home-built" circuits. Intended applications include areas from digital field service to medical, from audio/communications to on-site industrial controls maintenance.

The SC 502 is Tektronix quality, featuring clean triggering characteristics, delay line input, trigger view, trigger holdoff, 1 mV sensitivity, and the capability of working through the rear interface circuit board with other TM 500 instruments. It features a specially brilliant crt designed and built by Tektronix for use in areas of high ambient light. Include a DD 501 Digital Delay alongside the SC 502 and gain the capability of delay-by-events—you can then obtain stable digital displays from electromechanical sources like disc drives that would otherwise be too jittery for accurate viewing on any conventional oscilloscope. Include the DC 505A Universal Counter and DM 502 Digital Multimeter to complete your TM 515 package, and discover the benefits of simultaneous counter and DMM capability with trigger level readout at the touch of a push button.

The TM 500 concept lets you take along on field servicing trips the same instruments you use in the lab or for production testing, thereby enabling you to maintain the same standards on the "outside". The SC 502 Oscilloscope, for example, may be used as a bench instrument in any multiple-compartment TM 500 mainframe, and it offers unique systems capabilities, as well, when operated in a rack in the RTM 506.



Contact your local Tektronix Field Engineer or circle the appropriate reader service number for a demonstration of TM 500 instrumentation or additional technical information on the TM 515 Traveler Mainframe and SC 502 Oscilloscope. For an up-to-date TM 500 Catalog write to Tektronix, Inc., P. O. Box 500, Beaverton, Oregon 97077. In Europe write Tektronix Limited, P. O. Box 36, St. Peter Port, Guernsey, Channel Islands.

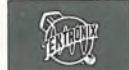

TEKTRONIX®

committed to
technical excellence

For a demonstration circle 47 on reader service card. Circle 46 on reader service card



Liquid Rivets, Bolts, Nails, Staples, Etc.

One drop goes a long way in fastening almost anything to almost anything.

Metals, for instance. And plastics. And ceramics. And rubber.

Eastman 910[®] adhesive bonds fast, too. Almost instantaneously. With only contact pressure.

Tensile strength? Up to 5,000 psi at room temperature.

New Eastman 910 MHT and THT grades hold when the heat is on. Even over 400°F.

For further data and technical literature, write: Eastman Chemical Products, Inc., Kingsport, Tennessee 37662.



Electronics review

"five-function" watch has a solar cell to recharge the battery. Optel's instrument has a 19-button keyboard that looks more like a typical calculator and uses an eight-digit liquid-crystal display to show hours, minutes, and seconds, as shown at the top of page 46.

Marketplace. As for today's marketplace represented at the recent Retail Jewelers Show in New York, the traditional watch companies, such as Bulova, Croton, and Waltham, and the new electronic-watch companies—including semiconductor manufacturers Fairchild and Novus—continue to bad-mouth each other as they attempt to snare control of the digital business. The traditional firms claim the newcomers do not know the jewelry business, and the newcomers snort that the old timers have been left at the post. "Maybe we'll introduce a calculator for \$1.98," growled one old-line watch-company executive, "and mess up the semiconductor industry's calculator market the way they've messed up our watch market." □

Motorola aims at I²L auto tuner

Digital tuning is coming to auto radios, as well as television receivers. Motorola Semiconductor Products Inc. is working on a three-chip integrated-injection-logic synthesizer

that it's proposing to major auto manufacturers and to the auto-radio aftermarket.

"We see a real need to have these three parts out by next June," comments John Comeau, consumer linear-product planner at Motorola's Mesa, Ariz., facility. The three chips are a synthesizer, a controller, and a display driver.

Similar. The synthesizer uses an approach similar to one proposed by Motorola for digital television tuning, a classical frequency synthesizer combining harmonic mixing with a "birdie" counter. This approach requires an on-chip voltage-controlled oscillator, phase-locked-loop feedback, a dc ramp generator, and filtering.

The birdie generator creates a comb of frequency blips, called birdies, that span the fm band. As a user addresses the voltage-controlled oscillator, using thumbwheel switches or a calculator-keyboard-type input, the birdie generator produces the voltage ramp. When the ramp reaches the voltage stored in the voltage-controlled oscillator, the device locks onto the station as the voltage is fed to tuning varactors.

While the frequency synthesizer and display-driver chips will probably be standard, the controller chip will have to be designed to each customer's specifications, Comeau says. "The controller chip is where the bells and whistles are," he adds. It could, for example, contain as many preselected station positions as the

I²L clock chips coming, too

Motorola has an order from Chrysler Corp. for 100,000 digital clock chips using integrated injection logic that would replace complementary metal-oxide-semiconductor chips in high-end auto models.

"It's a put up or shut up order!" declares John L. Webster, manager of product development at Chrysler's Huntsville, Ala., division. "To us, it all boils down to lower cost. So we challenged Motorola to make an I²L clock pin for pin compatible with our C-MOS version."

Chrysler makes about 200,000 digital clocks per year; this model year's C-MOS clock chips come from Stewart-Warner Corp., although RCA Corp. and Solid State Scientific Inc. have filled earlier orders. The I²L chips could go into 1977-model cars.

Chrysler expects Motorola to come up with the first samples within the next few months. "It's a no-risk order for us; there's plenty of supply available in C-MOS," Webster says. "But we want to look at I²L to see if it's as good as it's advertised by its proponents."

Data General announces the one thing that may have kept you from communicating with us.

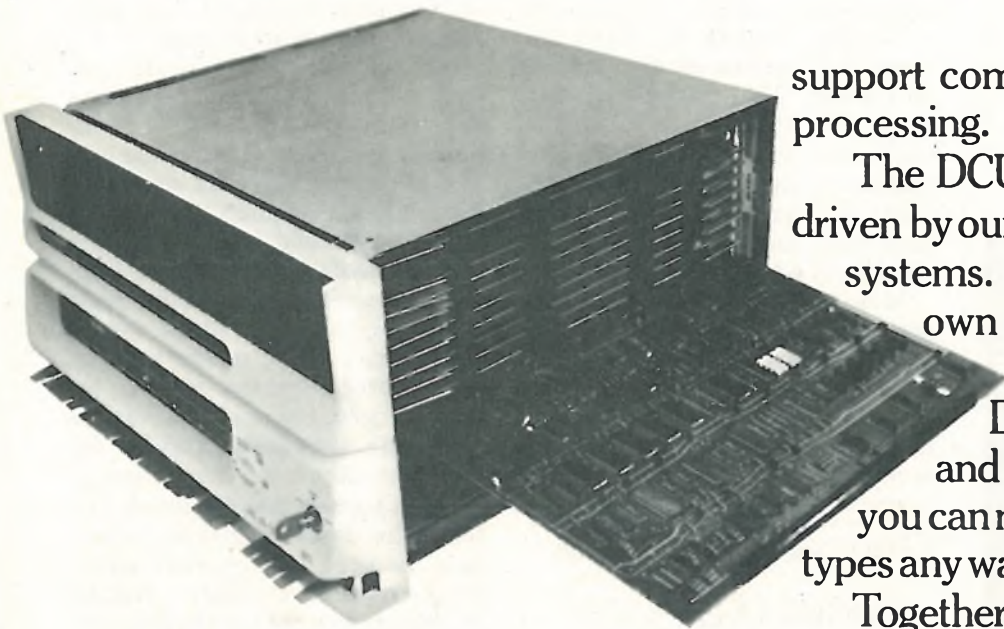

For years, Data General has been the company people have come to for basic communications networks. Because we've always made our computers, peripherals and software completely compatible with each other.

Now you can come to Data General if you want to build big, complex networks.

Because now we have the communications controller board you see here. The DCU/50 (Data Control Unit).

The DCU is designed to work in terminal, switcher, concentrator and front end systems. It takes care of line control and all the character processing. Which leaves the computer free to

support communications message processing.

The DCU is programmable and driven by our real-time operating systems. So you can define your own protocols.

Or you can use our Data General teletypewriter and BISYNC protocols. And you can mix your protocols and line types any way you want.

Together with our high density 16, 8, and 2 line synchronous and asynchronous multiplexers, the DCU gives you direct memory access for extremely high throughput, with minimal systems overhead.

And when you need more speed and more lines, you won't have to throw out anything. You can add on to what you already have.

For example, you can start off interfacing our multiplexers directly to the computer. And later on, plug in the DCU.

Which means no matter how big or small you want your network to end up, you can start off communicating with Data General.

Data General

Data General, Route 9, Southboro, Mass. 01772 (617) 485-9100. Data General (Canada) Ltd., Ontario, Data General Europe, 15 Rue Le Sueur, Paris 75116, France. Data General Australia, Melbourne (03) 82-1361/Sydney (02) 908-1366.

Circle 49 on reader service card

1 / %
 AMERICAN MADE
Tolerance
SCHAUER
1-Watt
ZENERS

Immediate Shipment
Low Prices

ANY voltage from 2.0 to 16.0

Quantity	Price each
1-99	\$1.07
100-499	.97
500-999	.91
1000-4999	.86
5000 up	.82

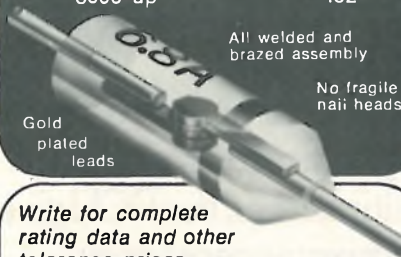

All welded and brazed assembly

No fragile nail heads

Gold plated leads

Write for complete rating data and other tolerance prices.

Buy the kit-
Save a lot



Kit contains a 51-piece assortment of SCHAUER 1% tolerance 1-watt zeners covering the voltage range of 2.7 to 16.0. Three diodes of each voltage packaged in reusable poly bags. Stored in a handy file box. Contact your distributor or order direct.

A \$54.57 value for
ONLY \$24⁵⁰

Semiconductor Division
SCHAUER
 Manufacturing Corp.

4514 Alpine Ave. Cincinnati, Ohio 45242
 Telephone: 513/791-3030

Electronics review

manufacturer wants to offer—so the user could access favorite radio stations just as he is able to do now. The controller will probably offer a signal-seeker search mode for sequentially stepping to stereo stations, or for automatically scanning all stations. With an optional clock chip (see "I²L clock chips coming, too"), the system could be programmed to display time or even engine parameters, if automakers want it to. And the controller chip tells the display what to do.

Motorola is aiming the chip set at manufacturers of radios for intermediate-size cars, Comeau notes. "Our digital radio proposal is targeted for a major part of the volume. And that's the way the pricing is working out." □

German TV control invades U.S.

Convinced that U.S. TV-set makers will soon emulate their European counterparts and go all out for ultrasonic remote control, the German ITT Semiconductor Group's Intermetall GmbH, has set up a marketing office in Chicago.

"Interest among American set producers is strong," says Marijan Lorkovic, Intermetall's product manager for integrated circuits. Talks with one U.S. company are already being held and could lead to a substantial order, Lorkovic adds.

Freiburg-based Intermetall is offering MOS devices for a 30-command ultrasonic digital-control system. By fall, the company will also be offering an MOS-receiver circuit for a smaller nine-command ultrasonic system for medium-priced color sets and high-end black-and-white models. By the end of this year, some 20 TV-set makers in Europe will be installing these devices.

P-channel MOS. The key components in the 30-command control system are a p-channel metal-oxide-semiconductor receiving device, the SAA1025, which is installed in the TV set, and a complementary-MOS circuit, the SAA1024, which is

mounted in a hand-held, battery-powered transmitter. Transmitter commands select up to 16 TV channels, turn the set on and off, and vary volume, brightness, and color saturation in a series of steps.

The system's basic principles are fairly simple. The complementary-MOS transmitter produces the 30 ultrasonic signals by dividing the output of a stable crystal oscillator. This output is applied by an external transistor and transformer to a capacitor-type microphone. A similar microphone in the TV set picks up the signals, feeds them over a preamplifier to the p-MOS receiver, which processes the signals for channel selection and the various operating functions. Unlike the resonant-circuit systems used in other European remote control systems, the digital techniques eliminate the need for expensive inductance-capacitance filters. Neither the transmitter nor the receiving circuitry requires adjustment.

No interaction. To prevent interaction with normal TV-receiver operation, the command signals fall within uncritical frequencies—the 31-to-46-kilohertz gap between the first and second harmonic of the receiver's line-oscillator frequency. A standard 4.43-megahertz crystal is used in the oscillator—a low-cost off-the-shelf device generally used



Push tuner. Remote control from German TV maker Nordmende uses Intermetall's MOS circuits for 16-command control. Channel-selector buttons are on left; on/off, brightness, and other functions are on right.

for color subcarrier applications.

Frequency-division in the transmitter is by two fixed and one variable divider. The latter blanks out any one of 30 pulses from a train of 128 4.43-MHz pulses. The outputs from the last divider stage applied to the microphone are ultrasonic signals between 33.945 and 43.990 kHz. There's a 346.4-hertz separation between adjacent signals.

Each command is activated on the hand-held transmitter by a double-contact button that addresses two sets of control inputs. An integrated decoder converts these inputs into 5-bit words and applies them to the variable divider. Power consumption with the p-channel devices is so low—only 90 microwatts—that the transmitter need not be switched off during standby.

Incoming signals at the microphone are first amplified, then processed and made available as 5-bit code words. The 16 channel-selection code words are converted into one of 16 coded commands that is applied to the set's channel-selection circuitry or program memory.

Other outputs are digital signals that are fed to digital-to-analog converters, to control volume, brightness, and saturation control. Still other outputs provide commands for on/off control and other functions. □

Solid state

AMD readies oxide isolation

There's only one really satisfactory process—oxide isolation—for high-speed bipolar random-access memory. Of the manufacturers who have announced commercial oxide-isolation devices, however, only one, Fairchild Semiconductor of Mountain View, Calif., has been shipping in volume.

But Fairchild is being joined by the small, aggressive Advanced Micro Devices Inc., Sunnyvale, Calif., which has committed itself to sec-

How the dataCon wire wrappers help you ship faster.

To begin with, dataCon's software program — the most complete in the entire wire wrapping industry — ferrets out design errors normally found in your systems test area before wrapping.

What's more, dataCon has people who are experienced in all phases of electronics — they understand your problems and speak your language.

But just as important, wire wrapping is our only business. And by specializing in meeting your needs, whether they be for prototype or production, we can help you ship faster.

dataCon The Wire Wrappers.

The dataCon companies: Experts in automatic and semi-automatic wrapping.
40 Cummings Park, Woburn, Mass. 01801, Tel. (617) 935-7200
6301 DeSoto Ave., Woodland Hills, CA 91364, Tel. (213) 340-1200

Circle 51 on reader service card

There's no RF energy crisis with RCA power tubes.

RCA's combined families of regular and large power tubes not only comprise the broadest line of such tubes in the industry, but they range in power all the way up to 250 kW... and in frequency to 1450 MHz.

Covering almost every major power tube application area, the RCA line also includes a comprehensive array of cavities and circuits. These cavities and circuits are specifically designed to enhance the advantages of RCA's power tubes. Together they achieve a total power package unmatched for reliable high performance.

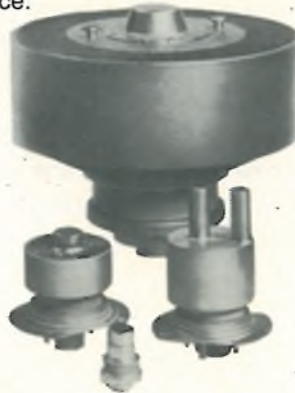

For more information on the entire RCA power tube line, call your RCA Representative or RCA Industrial Tube Distributor, or complete and return the coupon.

RCA Lancaster — where people and technology make the difference.

Manager, Power Tube Marketing
RCA, New Holland Avenue, Bldg. 100
Lancaster, Pa. 17604

____ Please send me the RCA Power, Frequency and Application Chart.

____ Please have an RCA Representative call me. Telephone _____

— This is your mailing label. Please print. —

Name _____

Company _____

Street _____

City _____

State _____

Zip _____

RCA Power Tubes

SCIENCE/SCOPE

Telesat Canada launched its third Anik satellite in May to handle the rapid expansion of telephone, television, and radio service to Canada's northern communities. Its current network of 50 earth stations will be expanded to 70 by mid-year. Compact, transportable earth stations are contributing to the success of oil exploration crews by providing direct telephone service via the Hughes-built Anik satellites to company headquarters and workers' families.

Two Anik-type satellites and 10 earth stations, now being built by Hughes for the Republic of Indonesia as part of a total telecommunications system, will link the 5,000-island nation with telephone, telegraph, television, and teletype.

From the launching of Early Bird 10 years ago to the six Intelsat IV satellites that now encircle the world, transoceanic telephone calls have increased from three million to more than 50 million. In the same period, the cost of a call from the U.S. to Europe has been cut in half. Hughes built both Early Bird, world's first commercial synchronous communications satellite, and the Intelsat IVs for Comsat Corporation, manager of services for the 89-nation International Telecommunications Satellite Organization.

To handle the 200 million transoceanic calls forecast for 1980, Hughes is now building a new series of satellites -- the Intelsat IV-As -- which will have nearly double the capacity of the present Intelsat IVs.

How technology can offset inflation is illustrated by the 25-year record of missile manufacturing at the Hughes Tucson plant. In the early 1950's, the U.S. Air Force air-to-air Falcon -- most advanced of its day -- cost about \$100 per pound. Today, Hughes/Tucson delivers about 16 tons of U.S. Army anti-tank TOW, U.S. Navy air-to-air Phoenix, and U.S. Air Force air-to-ground Maverick missiles each day at an average cost of less than \$50 per pound. In fact, Maverick -- which seeks out its targets with a tiny nose-mounted television camera -- costs just pennies more than \$25 per pound.

Hughes needs satellite communications engineers: 1) BS/MS EE with experience in design of satellite ground control systems, unit design, testing, and integration; telemetry, command, and ranging system experience desirable. 2) BS/MS mechanical engineer with experience in tracking, telemetry, and command equipment design, on-site testing, and product or packaging design of earth station equipment. U.S. citizenship required. Send resume to: Hughes Aircraft Co., P.O. Box 92919, Los Angeles, CA 90009, Atten. Allan Z. St. Jacques. Equal opportunity M/F employer.

A new device for limiting short circuits in AC power systems is being developed by Hughes to meet the electric utility industry's need for more efficient and compact high-voltage transmission equipment. Hughes is building three current-limiting devices (CLD) for the American Electric Power Service Corporation. The CLD prevents short-circuit currents from reaching unmanageable or destructive magnitudes by rapidly inserting a current-limiting resistance into a short-circuited line.

Creating a new world with electronics

HUGHES

HUGHES AIRCRAFT COMPANY

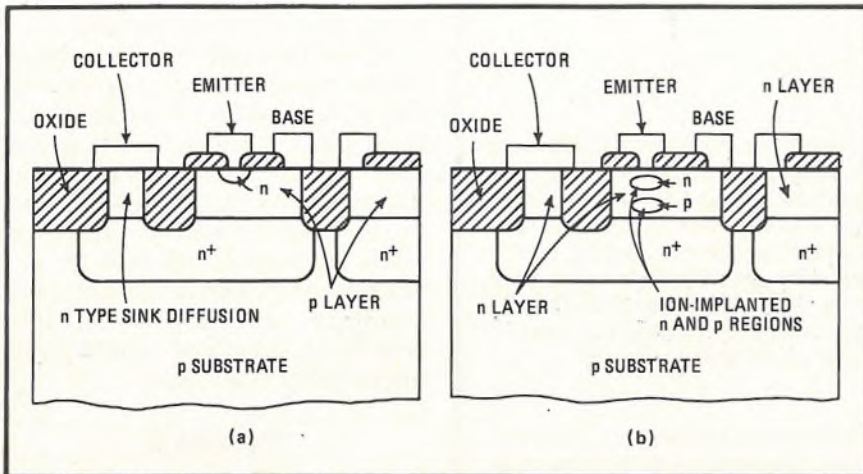

Ion process. Fairchild's Isoplanar I process (left) has p-type substrate with n⁺ diffused channel and p epitaxial layer. In AMD process (right) epitaxial layer is n type and the n and p regions are ion-implanted. The result is that masking steps are cut by 25%.

ond-sourcing Fairchild's lucrative 93415/93415A 1-kilobit bipolar RAM using its own ion-implanted oxide-isolation technique, called Imox. The company claims to be sampling small quantities of an oxide-isolated 1-k RAM that, according to John Husher, AMD's bipolar memory director, requires only one diffusion step and about 25% fewer masking steps.

In Fairchild's so-called Isoplanar-I approach to oxide isolation, n⁺ buried-channel collectors are diffused onto a p-type substrate. Next is grown an epitaxial p layer, which is then covered with a nitride. To form the oxidized region, the nitride layer is masked and etched, with a shallow silicon etch removing parts of the epitaxial layer.

A thick oxide is grown in the etched regions, dividing the wafer into islands of p-type epitaxial silicon that define the extent of all the transistors, diodes and resistors. High-value resistors are made in the epitaxial layers, but for low-value resistors an additional shallow diffusion is needed. Another diffusion-and-masking step is required to establish an n⁺ collector-region contact by means of an n-type sink diffusion through the epitaxial layer. Circuit components are completed by conventional oxide masking and by diffusing the emitters and opening the base and resistor contacts.

In AMD's approach only one dif-

fusion step is required, the one in which the n⁺ buried channel is laid down "and even that one," says Husher, "may eventually be eliminated." By using an epitaxial n layer instead of a p layer, at least one diffusion—one of the most critical in terms of yield loss—is eliminated. This is the one needed to form the n-type sink through the epitaxial layer to the n⁺ buried channel. "Every other step is done with ion implantation," he says, and this reduces the mask steps by 25%.

What this means is that wafers can be made at much lower temperatures—less than 1,000° C compared to the typical range for bipolar devices, including Isoplanar, of about 1,050 to 1,250° C. "Inherent in this," says Husher, "is the possibility of removing the wafer size limitation due to heat warping and going to 4 inches (in diameter) and all the resultant yield improvements."

With AMD's ion-implanted, oxide-isolation, one of the worst problems of bipolar LSI devices—collector-to-emitter shorts—is eliminated. "What happens normally is the emitter punches through the base and shorts the buried channel collectors," he says. "And where you have a very thin epi-layer, as in oxide isolation, the more of a problem this is. With Imox, we can control depths of the devices and control to within very close tolerances all the parame-

CALL ON HUGHES HIGH TECHNOLOGY CONNECTORS FOR THE TOUGHEST JOBS.



C-21 Tighest Sealing Environmental Connector — to 250 psi.

Circle 177



New HAC-PAK™ Round-to-Flat Cable Connector

Circle 178



High density Circular Connector

Circle 179



High density Subminiature Connector

Circle 180

We specialize in connector problems nobody else can crack. If it's simple and easy, anybody can do it, including us. But the tough nut is our specialty.

When you need high density connectors with positive polarization, high contact retention and unmatched reliability, call us. (714) 549-5701. Or write. 17150 Von Karman Avenue, Irvine, CA 92705.

HUGHES

HUGHES AIRCRAFT COMPANY
CONNECTING DEVICES DIV.

We crack the tough ones.

News briefs

June TV sales slip after May gains

First-half sales of television receivers and home radios continue to lag more than 20% behind the comparable 1974 period as June volume dropped after a promising upturn in May, according to new figures from the Electronic Industries Association. May color-TV sales had improved to a point where they were only 11.1% behind May of last year [*Electronics*, June 26, p. 32]. But June sales of 617,937 color-receiver units were 21.3% less than the year before. Monochrome sales, down only 8.5% in May, totaled 470,170 units in June, off 20.7% from a year ago. The June showing put total TV sales in the first half of 1975 at 5,055,215, or 22.4% under last year.

Arinc plans major system change

The nation's largest single user of private-line telephone service, Aeronautical Radio, Inc., Annapolis, Md., this week requested bids to convert its fixed-circuit voice-and-data-communications system for the nation's airlines to a demand-managed system, opening the door to specialized common carriers. Arinc officials estimate annual billings for private-line services exceeds \$57 million.

Rockwell shuffles microelectronics heads

Reflecting top-level concern with slumping calculator sales, Rockwell International Corp. has named Alonzo B. Kight to direct the calculator business. Kight is a corporate vice president, reporting directly to president Robert Anderson. Robert E. Hilchey continues as vice president and general manager of the Microelectronic Product division, Anaheim, Calif., which makes the finished calculators. Charles V. Kovac also remains as vice president and general manager of the Microelectronic Device division, Anaheim (see p. 18). Worst affected by the changes is Donald A. Mitchell, formerly president of the Microelectronics Group, a management level that has been eliminated. Mitchell has been reassigned within the corporation.

Litton puts microwave into standard oven

By integrating a microwave oven with a conventional electric unit, Litton Microwave Cooking Products division of Litton Industries hopes it has come up with a successful marriage. While other units offer both microwave and electric ovens, they are separated, whereas the new Micromatic Model 600 series has the microwave and conventional electric-oven devices in the same cavity. Users will be able to turn on either or both cooking sources. Over two years in development, the units cost \$699 and \$829.

Xerox out of mainframe computers

Xerox Corp., acknowledging a "mistake" when it acquired Scientific Data Systems Inc. in 1969 for \$910 million, is withdrawing from the mainframe computer business. Xerox, which had less than 1% market share in stand-alone digital computers, has had losses from its computer activities over the past few years averaging \$44 million annually.

Texas Instruments sales decline

For its second quarter ending June 30, Texas Instruments, Dallas, reported sales of \$330.9 million, 18% below the quarter of a year ago. First-half sales of \$663.7 million declined 15%. Declining prices and inventory adjustments in calculator operations were cited for the downturn.

Comsat to pay up to \$5 million for CML

Comsat General Corp. says it will pay up to \$5 million to buy the shares of CML Satellite Corp. from MCI Communications Corp. and Lockheed Aircraft Corp. An immediate payment of \$1.5 million has been made to each of the cash-pressed partners, and up to \$1 million more each will be paid if the proposed joint venture by Comsat and IBM Corp. is approved by the FCC and is successful.

ters that contribute to shorting."

While Fairchild has also developed a double-diffused process in which an epitaxial n layer is substituted for a p region, so far it has been applied commercially only in the company's TTL macrologic family. But, says Husher, this approach offers the greatest potential for development in memories, not only standard bipolar and emitter-coupled logic but also Schottky and integrated-injection logic. □

Materials

New process closes the GaP, GaAsP gap

Gallium phosphide has always looked promising for commercial light-emitting diode displays because it draws less power than red gallium-arsenide-phosphide materials and can give off green and yellow colors, too. But it has been too expensive to compete effectively.

However, a British company, Materials Research Ltd., Melbourn, Royston, Herts., is introducing a new process that it claims will make GaP a contender for low-cost displays for calculators, digital watches, and instruments like multimeters.

Coming. Within a year, the company should be able to equal the \$11 to \$12 per-square-inch price of conventional epitaxial gallium arsenide phosphide on gallium arsenide, declares Roland Ware, the company's chief scientist. In contrast, about \$40 per square inch currently charged for comparable GaP materials produced by the company's older "state-of-the-art" Malvern system used by LED makers worldwide. What makes GaP attractive is its efficiency of 2% to 3%, about 10 times better than comparable red GaAsP, Ware points out.

The new Melbourn process grows crystal boules by the Czochralski process. They weigh up to five kilograms, measure three inches in diameter, and can be controlled within 1 millimeter of specifica-

Off the shelf!

CMOS/LSI 4-decade counters.

tions—which should be competitive figures, the company believes. The older Malvern system typically made boules of only 500 grams and about 35 millimeters in diameter but with no precise diameter control.

Already the company has received “strong interest” from major materials users in the United States, Europe and Japan, reports Gordon Blackwell, marketing manager. Most likely the GaP from the new process would first show up in digital watches instead of calculators because GaAsP displays are less entrenched in the newer business, according to Ware.

Improvements. The company improved the GaP crystal growth over the Malvern system with better weight control and by automating the thermal environment to obtain uniformly shaped crystals of high purity. According to Blackwell, the Malvern could produce “pagoda-shaped” crystals, but to control the crystals’ diameters would cause them to crack. Instead, the new Melbourn machine creates the good environment first and then grows the crystals in that, he explains. The company won’t talk about the new tricks, but apparently it involves a computer system to monitor sensor inputs and control the process.

Progress doesn’t come cheap, however. The Melbourn unit will cost about \$220,000 versus about \$66,000 for its older machines. The new machine can also be used to pull gallium-arsenide crystals.

Although GaP crystals can be made in various colors, red GaP isn’t suited for calculator displays, Ware explains. It saturates as the current rises, which means the displays can’t be multiplexed.

In the delicate growth process, GaP is heated to almost 1,500°C under a pressure of 1,000 pound per square inch. The mixture is encapsulated in boric oxide to keep it from evaporating and pressurized to keep the oxide in place. The Melbourn crystal puller weighs three tons, is about 16 feet high and is housed for protection in an explosion-proof room. □

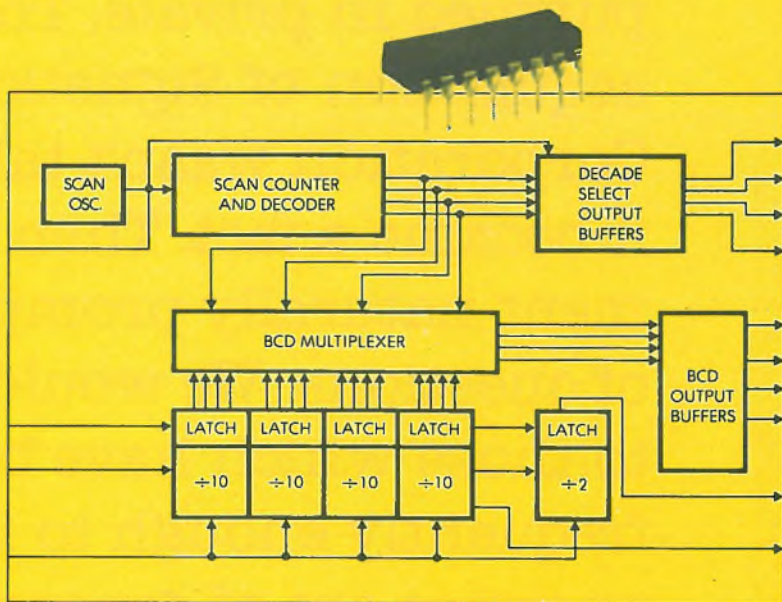

In producing large quantities of digital watch circuits for leading name-brand manufacturers, we’ve naturally become extremely proficient in CMOS counters. Now, with our volume output at a high level we can offer 16-lead DIP CMOS 4-decade up counters right out of stock. Ask for Hughes HCTR6010. It’s TTL compatible, features multiplexed BCD outputs and low power.

A 24-pin version CMOS (HCTR4010) offers both up/down counting, 3½ or 4½ decades and a built-in clock oscillator. Also available from Hughes are PMOS (HCTR0107) and CMOS (HCTR0200) 7-segment counter drivers.

Contact Hughes Microelectronic Products, 500 Superior Ave., Newport Beach, CA 92663. (714) 548-0671, ext. 346.

HUGHES

HUGHES AIRCRAFT COMPANY
MICROELECTRONIC
PRODUCTS DIVISION

Circle 55 on reader service card

An open letter from electronics and

Mergers and acquisitions, like marriage proposals, fare best when pursued in private. The recent acquisition of Signetics by U.S. Philips Corporation wasn't talked about until it became a fact. Then the announcement naturally prompted a number of questions. We would like to reply to those which have been asked frequently enough to indicate that the answers are of general interest to our friends, customers and vendors.

Sincerely,

A handwritten signature in cursive script that reads "Charles C. Harwood". The signature is written in dark ink and is positioned above the typed name and title.

Charles C. Harwood, President
Signetics Corporation

Signetics to the business communities.

(Q) Where does Signetics fit into Philips, anyway?

(A) Signetics is now owned 100% by U.S. Philips Corporation, which is an American company owned by The United States Philips Trust. Consequently, Signetics remains a U.S. corporation. However, it will now benefit fully from the relationship existing between the United States Philips Trust and N.V. Philips Gloeilampenfabrieken, a large public company, active in the manufacture and sales of electronic equipment, electronic components, and other products.

(Q) Will Signetics now be a captive supplier to Philips Europe, Magnavox, or any other Philips interests?

(A) In a word, no. Where appropriate, Signetics will certainly be a normal, competitive supplier to Philips companies around the world. But not as a "captive" supplier, because Signetics' aim is to serve the world market as a component supplier.

(Q) Will Signetics be part of North American Philips and perhaps use the North American Philips sales force?

(A) No. Signetics is completely separate and will operate with its own selling organization.

(Q) Will Philips change top management?

(A) Philips does not plan to, and Signetics' management has committed to remain, and continue functioning in key positions.

(Q) What is Signetics' financial position?

(A) Despite the economic downturn which has affected its profit and loss, Signetics is in a positive cash flow position. Inventories are in solid shape, and we have unused credit lines. We are well-positioned financially, poised for the upturn in business.

(Q) Will Philips be infusing capital into Signetics?

(A) Capital will be invested as needed to meet our primary world-wide growth objectives from sources as will be available and required for a sound financial structure.

(Q) Will Signetics supply the international markets now?

(A) Yes, but keep in mind we are talking about a continuing operation — Signetics is already

supplying the international markets. In fact, we intend to increase sales and services world-wide by also using the N.V. Philips sales and marketing organizations outside the United States.

(Q) Will Signetics customers see many changes now, due to Philips?

(A) Many changes, yes, but not due primarily to Philips. Signetics has been continually developing a variety of new products and technologies — many recent achievements will come on the market very soon: such as the #2650 microprocessor and the #2604, the 4096-bit Random Access Memory. Signetics' sales force is currently being strengthened, but this is in accordance with previously determined plans. Expanded marketing tools, advertising programs, internal changes to improve service to customers and prospects — all these are underway now. Of course, Signetics anticipates a significant plus through Philips' technological contributions and basic research.

(Q) Will there be changes in Signetics' price structure for products?

(A) Certainly not because of the acquisition. Signetics' growth, which has been quite substantial, has resulted from a combination of technology, quality, service, and competitive pricing. Neither Signetics nor Philips foresees any departure from the effort to keep improving in all four areas.

(Q) How will Philips help Signetics?

(A) Philips has a long and intimate understanding of the semiconductor business. They have done an immense amount of research and development in semiconductor devices. Signetics will benefit from this historical work, as well as all future inventions and technological breakthroughs — just as Philips will benefit from Signetics.

signetics

811 EAST ARQUES AVE., SUNNYVALE, CALIF. 94086

INTRODUCING THE WORLD'S FIRST

MEGA

THE INTERDATA 8/32—UNMATCHED LEVELS OF PERFORMANCE IN A MINICOMPUTER SYSTEM.

MEGAMINI ARCHITECTURE: AN ABUNDANCE OF SHEER POWER.

Interdata's new 8/32 Megamini has performance characteristics found only on large scale computers. Like direct addressing to one million bytes. Full 32-bit hardware with performance enhancers such as dual instruction

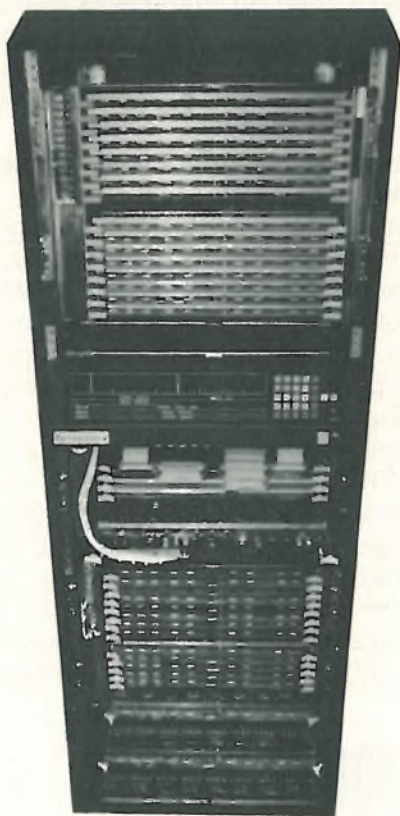

The 8/32 MEGAMINI — with a full Megabyte.

look-ahead stacks, multiple register sets, interleaved 32-bit memory, and fast floating-point hardware. What our 8/32 Megamini means to you is an unequalled combination of power, flexibility, and reliability in a compact package. All at a price that's fully competitive.

MEGAMINI SOFTWARE: POWERFUL, FLEXIBLE, EASY-TO-USE.

Today's hardware must be designed to ease your software effort. You shouldn't have to spend a lot of expensive programming time trying to figure out how to get around minicomputer hardware limitations. With the 8/32 Megamini you don't — because there are none.

For example. The direct addressing capability of the 8/32 Megamini allows you to build programs and data arrays in any size up to the amount of memory you have — no more 64K limits.

It also means we can give you versatile and powerful software to help lower the cost of building your system. Software with a multi-tasking operating system, OS/32MT, with unique multi-user



Multi-Wire Technology — a key to MEGAMINI performance.

MEGAMINITM

COMPARE: THE INTERDATA 8/32 MEGAMINI VS. THE-LESS-THAN-MEGAMINI COMPETITION.

	INTERDATA 8/32	XEROX 550	IBM 370/158	DEC 11/70	DG Eclipse
WORD LENGTH	32 bits	32 bits	32 bits	16 bits	16 bits
INSTRUCTION TIMES (Register to Memory)					
Integer Add	1.25	1.8	.9	1.8	2.5
Multiply	3.54	6.2	2.0	3.9	8.8
Divide	5.8	14.4	9.9	8.3	11.2
Floating Point Add	2.3	6.1	2.4	8.25	5.5
Multiply	3.0	9.1	2.3	11.25	7.2
Divide	5.35	23.3	8.9	12.25	7.9
HARDWARE I/O	Yes	Yes	Yes	No	No
MAX. DMA RATE/SECOND	6MB	4MB	6.7MB	4MB	2MB
DIRECT ADDRESSING RANGE	1MB	1MB	16MB	64KB	64KB
GENERAL PURPOSE REGISTERS	2 stacks 16 each*	4 stacks 16 each	1 stack 16 each	2 stacks 8 each	1 stack 4 each
PRICING (Basic Configuration)					
CPU + 128KB Memory	\$51,900	\$128,700	N/A	\$54,600	\$44,500
CPU + 1048KB Memory	\$179,400	\$478,700	\$1,905,700	\$163,800	N/A

*(6 Additional Stacks Optional)

program development capabilities. Software that has an optimizing macro assembler, MACRO CAL. And software with a sophisticated telecommunications access package, ITAM, that allows you to treat remote communications terminals and computers as if they were simply local devices.

Now, with all of this available, you can concentrate your efforts on the real problem at hand – your application.

THE MEGAMINI: NOT JUST A COMPUTER – BUT A SYSTEM.

The Interdata 8/32 Megamini gives you a full range of peripherals, software and advanced features to choose from in tailoring your system: 166MB disc systems, fast line printers, 1600 BPI tapes and graphic CRT's. Plus software modules like FORTRAN, BASIC, EDIT, AIDS and many more.

FOR MORE MEGADATA, CLIP AND MAIL.

Interdata, Inc., Oceanport, N.J. 07757

- All that power sounds marvelous. Send me more information on the Interdata 8/32 Megamini.
- You may have hit on the solution to my megaproblem. Have a representative call me.

Name _____ Title _____

Company _____

Address _____

City _____ State _____ Zip _____

Telephone _____



Subsidiary of Perkin-Elmer

Oceanport, N.J. 07757. (201) 229-4040 Elec. 8/7/75

MOS 6501 Microprocessor BEATS -EM ALL

~~MOTOROLA 6800
Intel 8080
FAIRCHILD F8
Rockwell PPS8~~

Prove it for yourself!
You Can
Try It!

For



See Us At **WESCON75** Booth 1010

(If you can't make a copy of our documentation, \$10.00 more gets you your very own set!)

HEADQUARTERS—MOS Technology, Inc. 950 Rittenhouse Rd., Norristown, Pa. 19401 (215) 666-7960

EASTERN REGION—Mr. William Whitehead, MOS Technology, Inc., 410 Jericho Turnpike, Suite 312, Jericho, N.Y. 11753 (516) 822-4240

WESTERN REGION—MOS Technology, Inc., 2172 DuPont Dr., Suite 221, Patio Bldg., Newport Beach, Calif., 92660 (714) 833-1600

the first of a low cost high performance microprocessor family

the mcs6501

PRICE!

- LOWEST COST STARTER SET
- LOWEST COST SOFTWARE
- LOWEST COST I/O (M6800 Compatible)
- LOWEST COST DOCUMENTATION
- LOWEST COST PROCESSOR

PERFORMANCE!

- MORE USEFUL ADDRESSING CAPABILITY:
 - TWO REAL INDEX REGISTERS
 - TWO POWERFUL INDIRECTS
- HIGHEST PERFORMANCE (A-H SYSTEMS BENCHMARKS)
- SECOND SOURCE APPOINTED
- READY (RDY) FOR SLOW MEMORY OR DMA

EASE OF USE!

- EASIEST DOCUMENTATION TO USE
- SIMPLE, EASY-TO-FOLLOW INSTRUCTIONS (SIMILAR TO PDP-11)
- EASIEST TO USE DESIGN-IN SYSTEM

COMPATIBILITY!

- ONLY SOFTWARE COMPATIBLE MICROPROCESSOR FAMILY
- PLUG COMPATIBLE WITH M6800

AND THIS IS ONLY THE BEGINNING—
DON'T MISS **MOS** AT **WESCON75!**

Whether it's details, further documentation or actual parts, MOS Technology will be making it all readily available—be sure to see us!

MOS

MOS TECHNOLOGY, INC.
VALLEY Forge CORPORATE CENTER, NORRISTOWN, PA 19401 (215) 966-7950

Washington newsletter

ASW sensors by the on-board avionics of regular aircraft, "make it a natural" for the ASW mission, says a Coast Guard official.

. . . and includes Boeing, Goodyear in phase-2 talks

To consider several possible blimp missions "in detail, with heavy emphasis on costs and comparative economics," Goodyear Aerospace Corp. and Boeing Vertol Co. are negotiating contracts for the second phase of the year-long NASA study. NASA says it has a program budget somewhat under \$500,000.

The separate study by the Center for Naval Analyses, being financed by the Coast Guard, is also studying multiple mission possibilities, including a remote-controlled mini-blimp for surveillance, search and rescue. The Atomic Energy Commission reportedly sees a potential for transporting nuclear reactors by blimp, and the Marine Corps has also expressed strong interest in heavy-lift blimp missions, according to NASA.

Shakeout expected in EFTS hardware

A major shakeout of suppliers of electronic funds-transfer systems is likely after September, when the Federal Home Loan Bank Board is due to recommend "five or six" system configurations for consideration by its 12 district bank centers around the country. The field consists of the usual data-processing giants—IBM, Sperry Univac, Honeywell, Control Data—and many others, all of whom submitted prototype proposals for metropolitan-area EFT systems to the Bank Board in July. Included in the proposals are communications gear, minicomputers, high-speed memories, disk stores, and other peripherals. In addition the Bank Board, which regulates U.S. savings and loan associations, has called for something not being used yet—switching systems to connect savings and loans with retail point-of-sale terminals. Marvin Sendrow, chief of the Board's review team, says vendor estimates of per-system costs range from \$100,000 to \$2 million, depending on the particular services provided and the size of the community served.

The president of the American Bankers Association, J. Rex Duwe, says he expects the first pilot EFTS switch center and data link to be installed by year's end. Possible locations include Los Angeles, New York, Pittsburgh, Cincinnati, and the State of Washington.

Specifications due for rapid transit system in Atlanta

Although Federal funding has been reduced, specifications are coming for some \$47 million worth of communications and control electronics for an Atlanta rapid transit system. Officials at Marta, the Metropolitan Atlanta Rapid Transit Authority, say specs are coming out this week for \$11 million in communications gear, while specs for a \$36-million control system are due by Oct. 15. In April, Marta was informed by the Urban Mass Transportation Administration in Washington that \$800 million in Federal funds through 1981 would be forthcoming, or half of what was originally hoped for. Among other things, Marta has shifted its sights to a semi-automatic rather than a fully-automatic rail system, after San Francisco had so much trouble with its fully-automated Bay Area Rapid Transit system.

What you must know about Microprocessors.

The microprocessor has permanently changed the methods of designing and building electronic equipment—from process and industrial control to computer-based designs in instruments, communication and consumer/commercial equipment.

But, getting into microprocessors is no snap. As a fundamental departure from the old familiar hard-wired logic techniques, the microprocessor technology has already produced a host of devices competing for the designer's attention, each with its own software and hardware.

This book cuts through the confusion, presenting the design and application potential of this exciting technology in a manner that will appeal to the design engineer who needs to know how to use microprocessors as well as the system analyst who must assess the tradeoffs between micro-

processors and other techniques to accomplish his system goals.

Using articles from the pages of Electronics, this book contains practical and up-to-date information on available microprocessor devices, technology and applications—ranging from the simplest 4-bit p-channel MOS system to the second-generation n-MOS 8-bit processor chips, and the new injection logic and Schottky TTL bipolar processor families needed for the toughest computer-based control applications.

UPCOMING VOLUMES

Others already planned for the Book series: *Thermal Design*, *Mini-computers in Action*, *Large Scale Integration*.

Use form below to order your copy. Prices on 10 copies or more, available upon request.

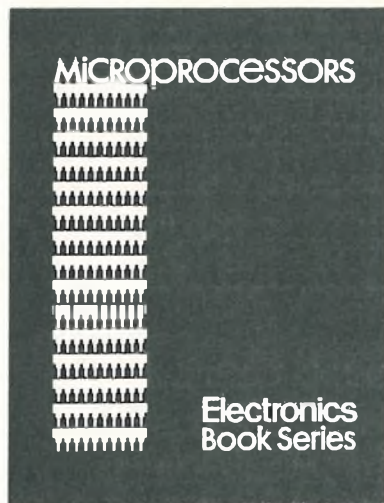

Electronics Book Series

P.O. Box 669 Hightstown, N.J. 08520

Send me _____ copies of "Microprocessors" at \$8.95 per copy.



I must be fully satisfied or you will refund full payment if the book is returned after 10 days free trial examination.

Payment enclosed Bill firm Bill me

Credit Cards Charge My Book To

American Express Master Charge Acct. No. _____
 Diners Club BankAmericard No. _____

Date Card Expires _____ Interbank No. _____

1st No's. above name on Mastercharge only.

Name _____ Title _____

Company _____

Street _____

City _____ State _____ Zip _____

Signature _____

HERMES LOOP ANTENNA

THREE SAMPLE SITES
ON THE NORTH AMERICAN
CONTINENT —

DIFFERENT LATITUDES
DIFFERENT CLIMATE



64°N



42.5°N



32.5°N

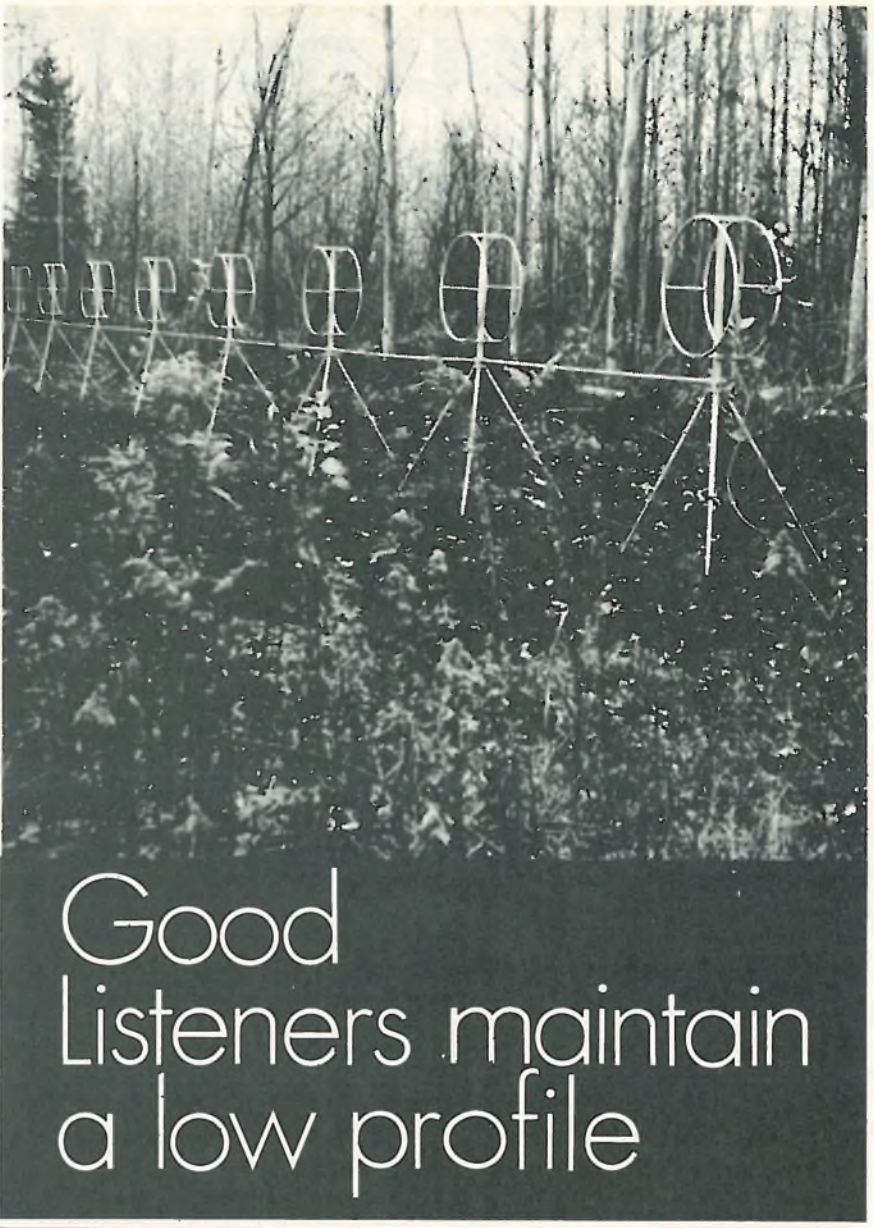

Good
Listeners maintain
a low profile

Even in the solitude of the forest depths, from rooftops, arctic tundra, swamps to sweltering tropics, 'neath snow, sand or ice,

the Hermes Loop antenna keeps an ear to the sky.

The amazing aperiodic antenna does away with vast log periodic and rhombic arrays - those towering antenna farms.

In rosette configuration, the Hermes loop antenna provides an omnidirectional broadband receiving array in space merely 1/100th that of the traditional antenna farm.

More than 53 government agencies around the world have pressed the loop antenna into service.

A new, even more compact version is available.

Only Hermes Electronics makes it.

**2-32MHz
BROADBAND**



ASK US. Send for our Brochure

Hermes Electronics Limited

Suite 315

2020 F Street NW

Washington, DC 20006 USA

202-296 2978

TWX 710 822 1106

August 7, 1975

Electronics

International®

InSb infrared detectors have
high sensitivity: page 1E



Holograms aim laser beams to solder
parts to printed-circuit boards: page 2E

ment they build. **The program, which has not yet been funded, aims to have various technical institutes consult with and advise various companies that encounter problems in converting from mechanical and electrical techniques to more sophisticated semiconductor-based technologies.** Set up by the Ministry for Research and Technology, the beneficiaries include small and medium-size manufacturers of clocks, watches, scales, cash registers, and various other types of office equipment.

Facsimile unit built to bypass European mails

Instead of building a different model for each application, Ultra Electronics in the UK is building a programable electronic control for gas turbines. **The design, which is more efficient and about 30% cheaper than equivalent analog units, was inspired by rising sales of gas turbines for pipeline pumping, industrial applications, and automotive engines.** The company claims prototype units for cars and trucks have been sold in the U. S. to Ford, Chrysler, and General Motors.

At the heart of the design is an Intel complementary-MOS read-only memory, configured 256 by 8 bits, which has charge of eight capacitor memories. Digital circuitry controls the gain of operational amplifiers directly, without analog-to-digital conversion. Every 10 milliseconds, the controller, which can handle 256 instructions, samples as many as 40 analog inputs from sensors for such engine-control parameters as temperature, shaft speed, and power demand.

German consortium to build Intelsat stations for Arabs

Siemens AG is heading a consortium that's to build two Intelsat ground stations in the Arab region—one in Kuwait and the other in Ras-al-Khaimah, a member of the United Arab Emirates. Also participating in the two contracts, signed this month between Siemens and the governments of the two Arab countries, are AEG-Telefunken and Krupp AG. **The two contracts, worth a total of \$16 million, are the first that German firms have won outside of Europe. AEG-Telefunken will supply receiving equipment, and steelmaker Krupp is building the antennas, which are 32 meters in diameter, and related antenna-drive systems.**

The Kuwait station will be installed within the next 18 months and be ready by January 1977 for communications with the Intelsat IV and IV A satellites stationed over the Atlantic. The Ras-al-Khaimah station which will be ready in March 1977, will operate in conjunction with a satellite over the Indian Ocean.

Olympics may launch color-TV industry in Soviet Union

In the same way the 1964 Olympics launched the color-television industry in Japan, anticipation of the 1980 games may have triggered the color-TV countdown in the Soviet Union. That country's state technology-import corporation, Technopromimport, has ordered from Japan a \$4.6 million plant that will have the capacity to turn out enough guns to build 2 million color-picture tubes a year.

Kanematsu-Gosho Ltd., a leading Japanese trading company, negotiated the contract, and it will order the hardware from several manufacturers. The equipment is to be loaded on ships in June or July for delivery to the Soviet Union.

Prototype infrared detectors have high sensitivity

Indium antimonide is sensing element in photoconductive and photovoltaic versions made by Toshiba researchers

Photon techniques definitely have the performance edge on thermal sensing for infrared detection. Two ir detectors of this type measure temperatures at high speeds and are so sensitive they can operate at great distances. The detectors, which can detect infrared signals chopped at rates to about 1 megahertz, are being built into infrared cameras that sense images.

A radiation thermometer, which has several hundred times higher sensitivity than conventional ones, can measure only slight differences in temperature. An array scanner is being used for high-precision temperature control on production lines. And applications are expected in air-pollution observation, medical monitoring and analysis, disaster detection, crime prevention, and research.

Both the detectors, developed at the Toshiba R&D Center, are made of indium antimonide and are mounted on dewar vessels to operate at cryogenic temperatures. One detector is photoconductive, and the other is photovoltaic. Because of the new technology being used, prices are expected to be lower than for other types on the market.

Specific detectivity of both types of detectors approach theoretical values. At 77K, the photoconductive type is rated at 6×10^{10} cm-Hz^{1/2}/w, and the photovoltaic

type at 1×10^{11} cm-Hz^{1/2}/w. Indium antimonide has an extremely high carrier mobility, which gives it its high sensitivity in the infrared range from 3 to 5.5 micrometers.

Photoconductive. The photosensitive area of the photoconductive detector can range from several tens of square micrometers to several square millimeters. A small photosensitive area provides quick response, and a large area gives high sensitivity. A photosensitive area of 0.25 mm² provides a field of view of 120° and a response time of about 1μs.

Sensitivity of the photoconductive detector is proportional to the bias current. The noise characteristics do not always vary linearly, and, above a certain critical value, noise increases rapidly. In sensitivity tests, field of view was 120°, and infrared radiation from a black body was chopped at 1.5 kHz and amplified by a lock-in amplifier.

To fabricate the detector, a p-type indium-antimonide crystal is selected for a long carrier lifetime to

have an impurity concentration of 6 to 9×10^{13} atoms per cubic centimeter, mobility of more than 7,000 square centimeters per volt-second, and a dislocation density of less than several hundred per square centimeter.

To prepare a single crystal, both indium and antimony are melted in vacuum, and the compound is continuously refined as it is pulled through a multizone furnace. After the 16th zone, the desired impurity concentration is less than 2×10^{14} cm⁻³, and hole mobility at 77K is more than 6×10^5 cm²v-s.

After the seed crystal is prepared, p-type single crystals are grown from germanium-doped n-type polycrystals in an atmosphere of high-purity nitrogen-forming gas, including hydrogen. These p-type homogeneous single crystals have a free carrier concentration of less than 1×10^{14} cm⁻³ at 77K, hole mobility of 7,000 cm²/v-s, and dislocation density of less than 10² cm⁻².

After mirror-lapping and cleaning, the elements are mounted with

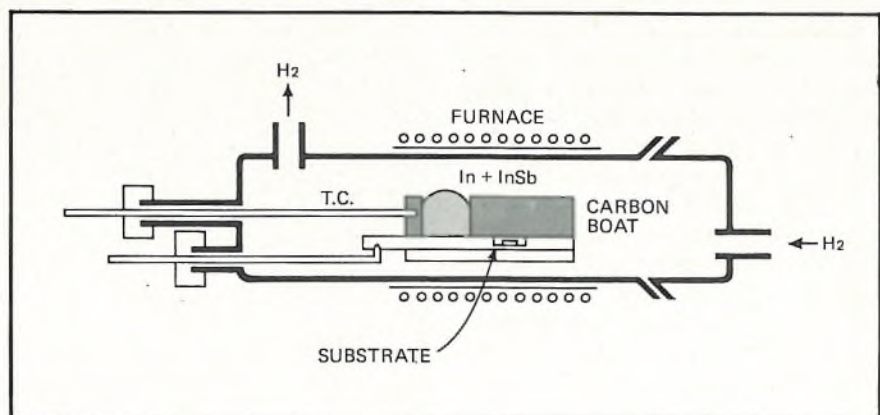

Simplicity. To make photovoltaic detector, Ge-doped InSb p-type substrate in slider contacts n-type In and InSb in carbon boat in hydrogen atmosphere inside furnace.

epoxy resin on a sapphire substrate. Final thickness of the element is less than 50 μm , but if it is made too thin, mechanical distortion lowers the signal-to-noise ratio.

The detector is mounted on a dewar to cool it to 77K. To make an electrode, gold is vaporized on copper, and a gold wire is thermally bonded to it.

Photovoltaic. The photosensitive area of a photovoltaic detector can be 0.1 mm to 5 mm in diameter. It has a sensitivity near the background noise limit with optimum bias at 77K. In a 180° field of view, the specific detectivity at a wavelength of 4.5 μm , chopping frequency of 1.5 kHz, and bandwidth of 1 Hz, ranges from 3×10^{10} to 1×10^{11} $\text{cm}\cdot\text{Hz}^{1/2}/\text{W}$, and if the field of view is reduced, higher sensitivity can be obtained.

To achieve high-yield, high-purity p-type single crystals for the photovoltaic detector, a liquid-phase sliding epitaxial method is used to grow an n^+ layer on a p-type indium-antimonide substrate. The photovoltaic effect of the pn junction diode detects the infrared radiation. Absorption of infrared radiation through the n^+ layer is quite small because of the Burstein-Moss effect, which provides a high quantum efficiency. The fabrication technique eliminates such processes as crystal-cutting, lapping, electrode making, and surface passivation.

The indium-antimonide p-type substrate crystal, doped with germanium, is placed in a carbon slider, a compound of n-type indium-antimonide and indium are put in a boat, and they are set in a quartz tube. The furnace is heated to 400°C in a hydrogen atmosphere and then cooled at about 500°C per hour. When the temperature reaches 250°C, the slider containing the indium melt is placed in contact with the crystal. The slider is then backed away to separate the two substances. When cooled to room temperature, the p-type substrate has an n^+ epitaxial layer about 20 μm thick. Thickness of the epitaxial layer can be controlled by varying the concentrations of the indium antimonide

and the indium melt.

Quantum efficiency is determined by the thickness of the depletion layer, which depends on the p-type substrate concentration, absorption coefficient, and diffusion length of minority carriers. Since a small substrate concentration is desirable, response speed increases with a decrease in element capacity. The

concentration is $p = 10^{15}$ cm^{-3} .

The mesa-type photosensitive area of this element is prepared by using photo-resist. The area is passivated by anodic oxidation to prevent edge leakage. Gold wires are alloyed to both the n^+ layer and substrate by using alloys with low melting points. The detector is then mounted on a dewar. □

West Germany

Hologram aims laser beams to solder several component pins at one time

Although still in the experimental stage, a new laser-based soldering method is paving the way to a high-speed, high-volume system for connecting component leads to substrates or printed-circuit boards. Unlike other laser-soldering methods, the technique, developed by scientists at the development laboratories for production techniques at Siemens AG, uses a hologram. The hologram splits the laser beam into a number of partial beams, each fo-

cused onto a pin so that a number of connections can be soldered simultaneously. This one-shot, multispot soldering technique is the key to the high speed attainable.

"At this stage of development, we cannot yet exactly say what the speed will be," says Heinz-Peter Kraft, who developed the multispot technique, "but once our prototype system is perfected, it should be possible to solder an eight-pin device every three seconds or so." The pro-

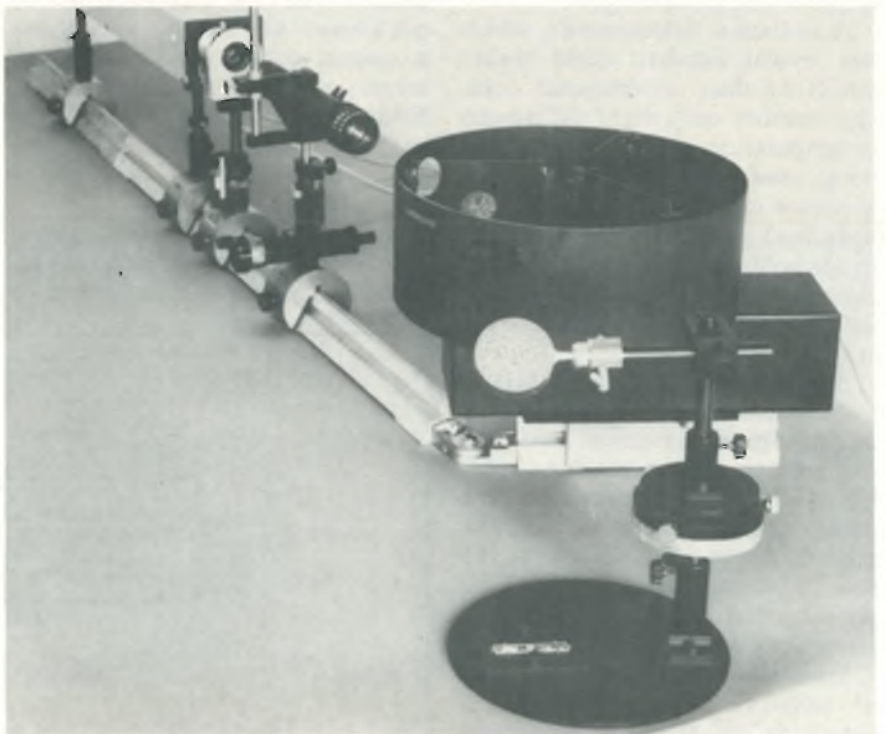

Speedy soldering. Components are soldered simultaneously to pc board by a laser beam that is split by holograms and focused on individual pins by a mirror.

otype should be ready by the end of this year. Siemens may then test it in actual production.

The technique also offers contactless application of heat to places inaccessible or difficult to reach with normal soldering tools. What's more, the precisely controllable laser power and beam width provide uniform and well-defined application of heat.

Source. The energy source in the experimental setup Kraft and his associates have put together in the Munich labs is an yttrium-aluminum-garnet laser. Its beam, 3 millimeters in diameter, is optically expanded to about 30 mm. The beam, now in the form of a plane wave with greater diameter, hits the hologram and is split into partial beams that are deflected by a mirror arrangement onto the pins. But a mirror is needed only for pins difficult to reach directly. On a production line, the system could be vertical.

The beam is expanded to lower its power density and thus to check the development of heat in the holographic plate. To keep the plate cool, it can be exposed to a weak stream of compressed air. The hologram contains information to indicate how the original beam is to be split and at which point each individual beam is to be focused.

Sub-holograms. The hologram consists of closely spaced sub-holograms, each corresponding to one of the partial beams. The hologram reconstructs the soldering points with an efficiency as high as 70%, which includes the losses from beam expansion, reflections on either side of the hologram plate, and the absorption losses within the hologram.

In soft-soldering small components, 5 watts per solder joint will suffice, Kraft points out. So, to solder the leads of an eight-pin device, a YAG laser emitting about 50 W in continuous operation would do. To solder components with fewer or more pins, a correspondingly lower- or higher-power laser would be called for.

The substrates or printed-circuit boards to which components are soldered rest on a plate held at a tem-

perature of around 100°C. This heating lowers the temperature differential between the pins and substrate or printed-circuit board and thus reduces the periods the beams must be focused on the solder joints.

In the prototype system, a feed mechanism will transport the substrates or pc boards and the components to the plate. As the plate rotates, it will move the devices successively under the laser beams for simultaneous soldering. □

France

Time-sharing gets boost from program

A French software specialist has devised a computer time-sharing program that makes project management accessible in a matter of seconds to the layman, as well as the software specialist. Norbert Beyrard, a French mathematician and electronics inventor, has designed the program, called Telor, to handle more data faster than conventional software. Telor is essentially a variant of a network-planning program or a new kind of project-evaluation and review technique (PERT), or critical-path method.

To designers of intricate electronic systems, the program could cut development time radically. Beyrard's software experts explain that the concept can be adapted to optimize the manufacture or construction of any complex device or structure that involves at least 1,000 separate elements or operations. Or, as Beyrard explains it, new computer programs like Telor enable engineers and managers without software skills or a computer to optimize computer capabilities even further than specialists have been able to do in the past.

Algorithm. Beyrard has devised a new algorithm—essentially a modified version of the antecedents method—which allows faster, cheaper preparation of a project-management or PERT program. More important, in the French spe-

cialist's eyes, the concept makes it possible to handle many inter-related factors in a single program. Beyrard explains that, although a typical large batch program might be capable of handling 30,000 to 40,000 vectors, the latest versions of his program, using a time-sharing system linked to a machine such as the IBM 370/68, can tackle at least one million vectors or activities.

The essence of Beyrard's approach is a mathematical method of relating the timing of one operation to all preceding operations on which it depends. Until now, PERT programs have been based on listing and relating the events or stages reached in a project as a result of a number of completed operations or activities. In Beyrard's system, the program lists the activities alone, gives them numbers, and applies the mathematics to them rather than to the events. As a result, what are termed false antecedents are reduced from 50% of the total number of vectors to a figure of only 10%.

Indeed, Beyrard claims that, if combined with an additional system that feeds data corrections to the mass of elements in each program, errors and waste can be cut back so much that the entire program can be prepared 10 times as fast as usual.

Capability of that kind has been increased further in recent weeks by adapting the Beyrard programs to software systems developed by National CSS, a large independent time-sharing house in the U.S., which will be selling the French program. Telor is already being used to manage huge development projects in Africa. □

Great Britain

Microwave monitor fits shirt pocket

Designers have been frustrated in efforts to build an inexpensive lightweight monitor to warn of microwave radiation over a wide frequency range. Effective monitors

have been made, but they don't cover the frequency range, are too bulky, or operate on an expensive thermoelectric principle that boosts their costs above \$2,000, claims a researcher from the University of Newcastle upon Tyne, England.

However, this university research team has used thin-film germanium to develop a pocket-size monitor that could cost less than \$100 and detect excess microwave power at frequencies as high as 100 gigahertz. Workers around microwave-heating, radar, and communications installations could carry the unit, powered by hand-calculator batteries, in their shirt pockets.

To be described at Microwave '75 in September, the unit's thin-film resistance varies with the intensity of the microwave radiation falling on it, says Hans Hartnagel, head of the university's Semiconductor Research Laboratory. This reaction is based on the principle that maximum absorption will occur if the resistance per square of the germanium equals one half of the impedance in free space, he explains.

The group chose polycrystalline germanium because it has a high temperature coefficient of resistivity, good long-term stability, and is easy to fabricate.

For sale. The monitor could be in commercial production in the near future, Hartnagel says. His group is associated with Joyce Loebel Ltd., a subsidiary of Technical Operations Inc., Burlington, Mass., which is discussing possible manufacture of the monitor. The price in mass production could drop below \$50, Hartnagel estimates.

The monitor, 0.75 by 2 by 3 in., has a light-emitting-diode display and two audible alarms, one at the danger point of 10 milliwatts per square centimeter and another at 100 mw/cm². The unit can be adjusted to meet various standards.

Driving the warning system is RCA Corp. complementary-MOS signal-processing circuitry, which produces a pulse whose width varies linearly with the incident power. A C-MOS astable vibrator of fixed period triggers two monostable C-MOS

circuits. The time period of each monostable is controlled by a thin-film detector—one exposed to the microwave radiation and the other shielded from it for reference. This technique cancels errors arising from changes in the ambient temperature, the researchers say. An output pulse results from an AND function, derived by gating the opposite-polarity outputs of the monostables in a NOR gate.

The 1-by-3-centimeter germanium film is prepared by evaporation on a heated substrate to get the needed resistivity. To lower the terminal resistance so that it's compatible with the digital C-MOS circuits, a simple finger pattern is scribed. □

Two modular DPMS differ in accuracy

How can an instrument company in the United Kingdom pit its line of standard digital panel meters in the OEM market against the heavy competition of special-purpose DPMS? To meet that challenge, Exel Electronics Ltd. of Poole, Dorset, has designed two highly flexible semi-custom products that differ in their degree of precision. Replaceable printed-circuit cards enable customers to tailor the instruments to their specific needs.

These cards, called Lexe (Exel spelled backwards) fit into the XL-2000, intended for high-accuracy operations, and the XL-35, which is less precise. The \$305 XL-2000 has an accuracy within 0.01% at a full-scale deflection ± 1 digit and a resolution of 1 part per 20,000, while the accuracy of the \$115 XL-35 is 0.05% of full-scale deflection ± 1 digit over 1 part in 3,000.

Design options include counts of $\pm 1,999$ and ± 999 , operation on line power or 5 volts dc, differential inputs, and ratiometric measurements. The XL-2000 comes in four models rated at 200 millivolts, 2 v, 20 v, and 200 v. The 200-v model has a maximum overvoltage of 350 v, resolution of 10 mv, and an input impedance of 10 megohms. The XL-35

covers 200 v to 200 mv, but other ranges are available.

Functions. The optional Lexe cards are laid out to accept a wide range of active and passive electronic components. Among the functions already conceived are high-voltage and high-current measurement, very-low-current and -voltage measurement using preamplification, six-wire ratio-metry for load-cell or strain-gage uses, and analog high/low comparators for limited settings.

Exel has found that customers usually want their standard instruments changed. David W. Weeks, sales director, points out that the market for standard DPMS is "a lot less than most people think." Except for large corporations such as Rank and Xerox, which make their own units, about 50% of the market has been for specialized industrial weighing and medical applications, he says. A fall-off in sales to the medical profession has knocked the market haywire, but Weeks says Exel retains a healthy share of it.

Options. The design goals were to omit or offer options for as many of the subunits as possible, to maintain relatively low power levels for reliability and analog performance, and to use moderate component-packing densities for added reliability. Among the built-in technical features, chief engineer Alan S. Hooper lists automatic zeroing in both models, placing the main reference at the unit's front end to improve span-drift performance, guarding the analog circuits, and using integrated analog/digital conversion for ratiometric capability and rejection of random and line-induced noise.

Hooper says XL-2000 is largely a compromise between large-scale integration and flexibility. The instrument contains p-channel metal-oxide semiconductor LSI in the counting circuitry, complementary-MOS control logic for low-power operation, and discrete field-effect-transistor operational amplifiers for versatile performance, he says. The less precise XL-35 is built around silicon p-MOS control chips. □

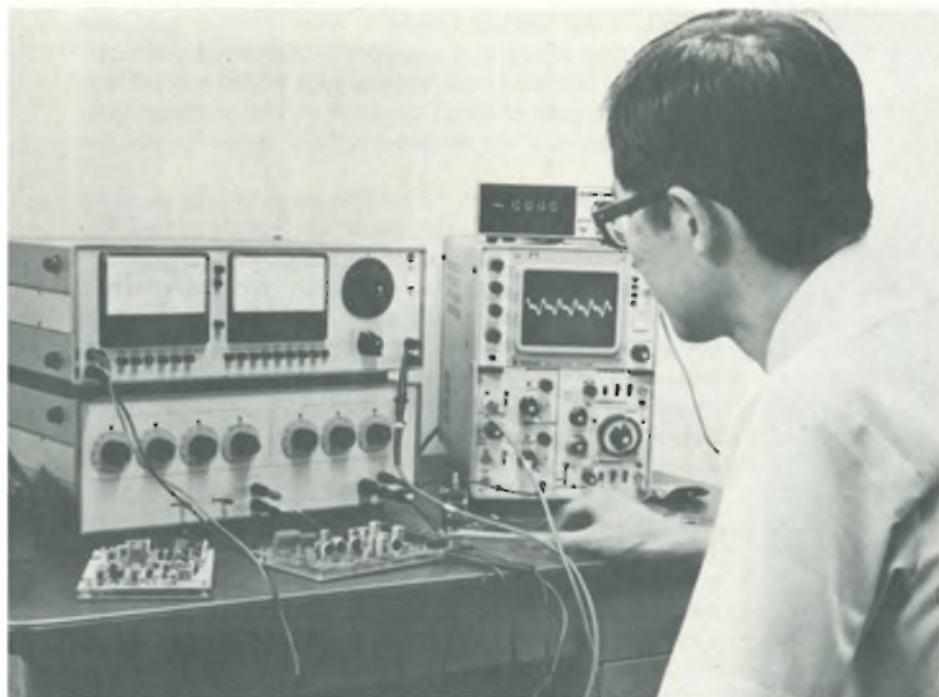

Instruments test low-distortion audio equipment

by Charles Cohen, Tokyo bureau manager

Oscillator distortion is under 0.001% at midband; meter needs no adjustment for signal-level changes

Manufacturers of audio equipment today are developing products with extremely low levels of distortion. Consequently, the test devices that measure distortion and signal-to-noise ratio are also having to improve.

Among recent examples is a combined audio oscillator and distortion meter from Matsushita Communication Industrial Co. Ltd. It allows

distortion measurements down to about 0.001%, as well as level and signal-to-noise ratio measurements in the range from 5 hertz to 150 kilohertz.

The low-distortion oscillator is tuned to spot frequencies with decade switches for the three most significant digits; tuning range is 1 Hz to 99.9 kHz. It has high amplitude stability and quadrature phase output, which makes it suitable for professional applications, including servo-system testing, and use as a variable-frequency-bridge source.

At midfrequencies, the oscillator distortion of the new systems, the V-7220A, is below 0.001%. The frequency-setting network used con-

tributes to this performance, and so does the oscillator amplitude-level control—a particularly important system element, because most devices, from the classical lamp filament to the latest semiconductor devices, contribute nonlinearity and prevent attainment of distortion levels lower than 0.01%.

One early benefit of the oscillator-distortion analyzer combination has been the discovery that many common circuit elements are nonlinear in operation, including solid molded resistors and tapped variable resistors (potentiometers). In fact, the waveform at a tap on a potentiometer may have higher distortion than the input waveform.

The oscillator is basically a phase-shift type using two differential operational amplifiers and two phase-shift networks, each consisting of series-connected resistors and capacitors at the noninverting input of each amplifier. The two amplifiers intrinsically have a phase shift of 360°. The external networks superimpose on this equal and opposite 90° phase shifts at one frequency, and it is at this frequency that the circuit oscillates.

Lead and lag. To go into more detail, the RC frequency-determining circuits are arranged so that at the frequency of oscillation one gives a phase lead of 45°, the other a phase lag of 45°. Input to the inverting input is through a resistor, with an equal-value resistor connected between the inverting input and output for feedback to give a gain of 1. When the same input voltage is applied to the noninverting input through a 45° phase-shift network and to the inverting input through a resistor with feedback stabilization, the output voltage is shifted by 90°.

The RC networks used in this circuit do not have the large loss of a Wien bridge. The change in signal level with small error in network level is about two degrees of magnitude smaller, making it easier to stabilize the circuit.

The amplitude-control circuit holds amplitude constant over the cycle of the oscillator output to pre-

Adret has your requirements
at
its fingertips



LF/VLF programmable generator with wired options 0.01 Hz to 200 kHz

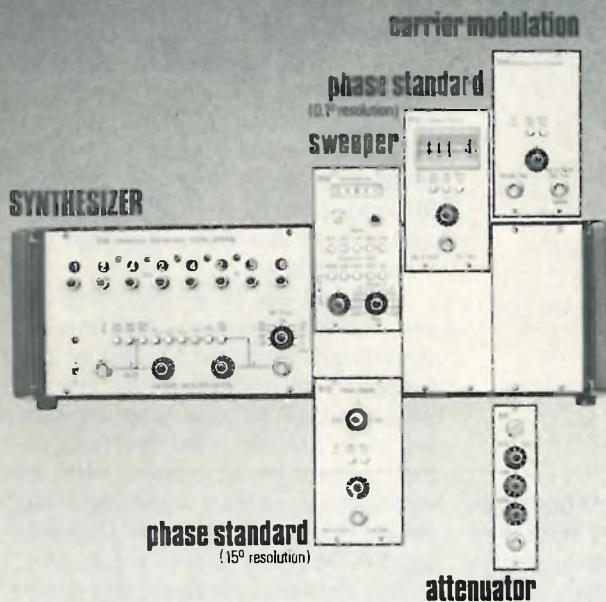

The requirements of the many customers interested in a 200 kHz synthesizer being often quite different, Adret has developed this instrumental system able to suit the specific needs of each user.

The system consists of a mainframe receiving up to 3 among 5 available options which provides both the output signals (sine and square waves) on its front panel and the signals necessary to the various options.



12, av. Vladimir Komarov
78190 Trappes - France
tel. 051 29 72

PSYCHO 319 B

New products international

vent introduction of distortion. At the instant that the output of the second amplifier goes through zero, the peak output of the first amplifier is measured and held. This value is used to control the gain of the second amplifier by means of small in-phase or out-of-phase voltage injected into the second-amplifier input for the entire cycle.

The distortion meter resembles many others in using an RC filter with a large dip at the fundamental frequency, and then measuring total harmonics after removal of the fundamental. However, one innovation is a circuit that measures the ratio of distortion to signal voltage. This eliminates the usual need to adjust the meter for a change in signal level over a 10-decibel range and makes it possible to take readings of distortion as a function of signal level about five to 10 times as fast as usual.

A more significant innovation in the meter is an active filter with a bandwidth large enough to make automatic tracking circuits (which usually increase distortion) unnecessary. For its frequency-determining network, this filter uses a Wien bridge in a modified version that allows the use of an unbalanced single amplifier for lower distortion.

Other benefits derive from putting the Wien bridge at the input to the amplifier, with positive feedback from the amplifier output to the bridge. First, the approximately 10 dB lost in the bridge is restored, so that there's no need to make up the gain in the preamplifier. Paradoxically, too, circuit response is broadened, eliminating the need for automatic tracking circuits. Finally, the quality factor (Q) of the resonance response is increased.

Deep dip. The higher-Q circuit has a deeper dip and is sharper in the region of maximum attenuation. But for a given value of attenuation, say 100 dB, bandwidth is larger because it is further up the attenuation curve from the maximum dip. With sufficiently high Q, maximum dip is set by other values including noise and leakage and does not depend on the value of Q. Actually, this unit incorporates three cascaded Wien-bridge circuits and individual buffer amplifiers, with response set by both local and over-all positive feedback.

At the output of the main active filter, there are low- and high-pass filters that eliminate any hum or high-frequency noise. These are followed by a distortion-meter amplifier with a dc output.

In a separate channel, before the active filter, there is a level-meter amplifier with a dc output that drives a level meter.

Outputs of both the distortion-meter amplifier and level-meter amplifier are fed into separate inputs of the ratio circuit. There, integration of sawtooth waves gives a ratio of the two dc input voltages, which is displayed as a distortion on the meter.

Price of the VP-7220A oscillator is \$1,300; and of the VP-7702A distortion analyzer, \$1,500.

Matsushita Communication Industrial Co. Ltd., 4-3-1 Tsunashima Higashi, Kohoku-ku, Yokohama 223, Japan [441]

New products international



The 1051 digital voltmeter is a 5½-digit unit that measures dc and true rms ac voltages, true 4-wire ohms and 4-wire 4-quadrant ratio—with autoranging as standard. The basic price is 695 pounds. Datron Electronics Ltd., Norwich Airport Industrial Estate, Norwich NR6 6HQ, England [443]

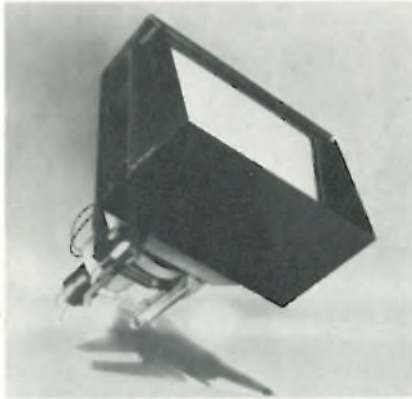

Featuring high brightness, display tube M22-100 is designed to be legible in illuminated surroundings. It has a 22-centimeter flat screen, and the usable display area is 120 by 160 millimeters. AEG-Telefunken. AEG-Hochhaus, 6 Frankfurt 70, West Germany [446]

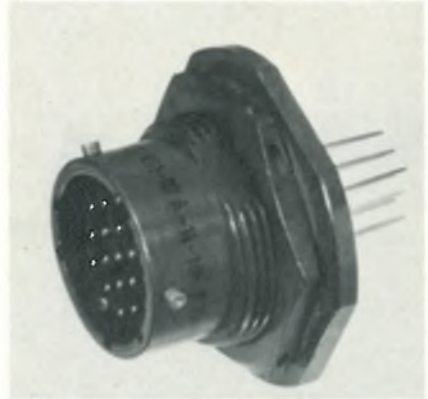

Round connectors type 851/852 have a double locking action: bayonet and push-pull. They can have from three to 61 contacts in any size from 16 to 20. Units are available in ratings of 125°C and 200°C. Souriau et Cie., 13 rue Gallieni, 92100 Boulogne-Billancourt, France [449]

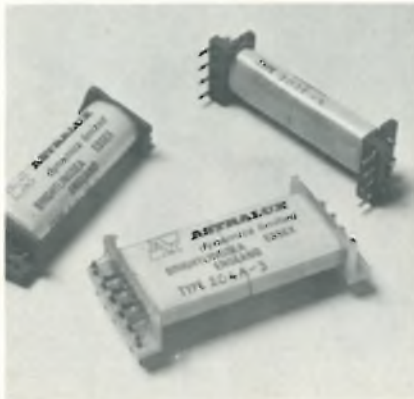

Operating from low drive currents, the 200 series of open-bobbin reed relays is built for industrial switching and telecommunications. Switch ratings range from 250 volts (Form C) to 400 volts (Form A, B). Astralux Dynamics Ltd., Brightlingsea, Colchester, Essex, England [444]

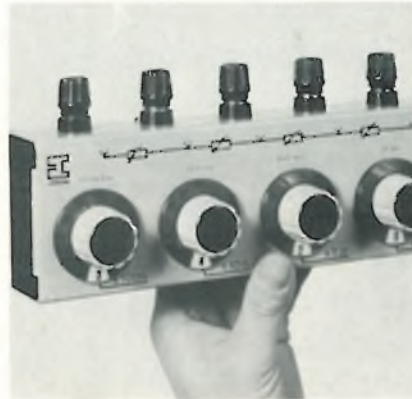

Low-ohm resistance decade, series IWD2000, depends on thin-film networks for its small capacitances. These allow applications up to 100 kilohertz. Maximum current for the $\times 100$ decade is 50 milliamperes. Elementa GmbH, 85 Nuernberg, Hallerstr.8, West Germany [447]



Close control of tip temperature makes the WECP soldering iron suitable for work on heat-sensitive components like MOSFETs. Tip temperature can be set anywhere from 40°C to 400°C. Weller France, ZA des Petits Carreaux, 94380 Bonneuil sur Marne, France 450



Compact delay line for PAL-system color TV receivers has a nominal frequency of 4.433619 MHz and a phase-delay time of 63.943 microseconds. The DL 60 can be soldered into a printed wiring board. Philips, Elcoma Division, P.O. Box 523, Eindhoven, The Netherlands [445]



Built for industrial applications, preselection counter CVS has a maximum count frequency of 20 kHz. Digits in its seven-segment gallium-arsenide LED display are 5 mm high. Unit operates off 220-240 V, 50-60 Hz. Elesta AG, CH-7310 Bad Ragaz, Switzerland [448]

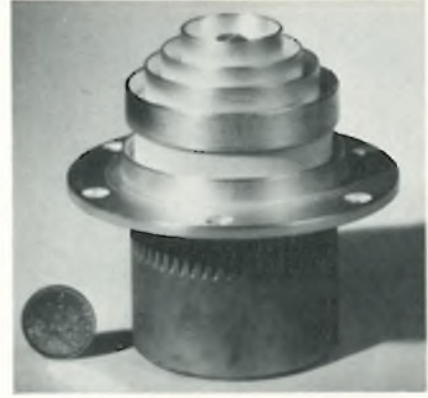

Developed for TV-signal amplification at uhf, the TH 590 (shown above) and TH 392 tetraodes are usable in transmitters or transponders. Each delivers peak-video outputs of 10 kW. Thomson-CSF, Groupement Tubes Electroniques, 92100 Boulogne-Billancourt, France [451]

New products international

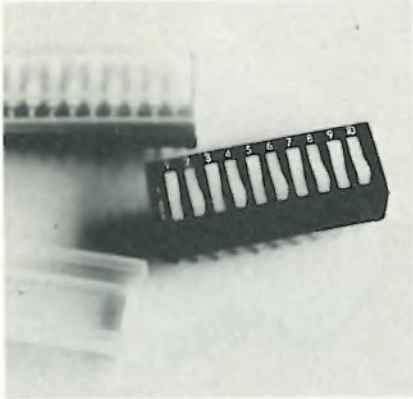

A switch designated the model DIP-10P has contacts that are plated with gold to a thickness of 1.8 to 2.0 μm . Contacts are molded to the housing for high reliability, and lifetime of the unit is 10,000 cycles. Saitama Parts Industrial Co. Ltd., Urawa, Saitama 336, Japan [452]



At the heart of the PM 2513 digital multimeter is an LSI circuit that performs some of the analog functions, the a-d conversion, and digital-signal evaluation. The IC also directly drives the 3½-digit LED display. Philips, P.O. Box 523, Eindhoven, The Netherlands [455]



A multirange resistance meter, the OH470, uses a 40-microampere moving-coil movement with core magnet and sprung jewel mounts. Six ranges measure resistance from 0.1 ohm to 50 megohms. Accuracy is within 2.5%. Chinaglia, 19 Mulberry Walk, London SW3 6DZ, England [458]

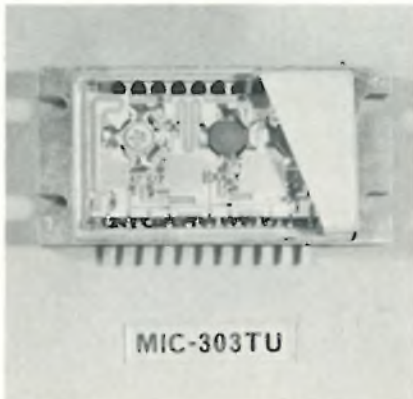

Two ICs are designed for the pre-stage (type MA7702) and final stage (MIC303TU, shown above) of master antenna TV amplifiers. When combined they can be used in boosters as well. Mitsubishi Electric Corp., 2-2-3 Marunouchi, Chiyoda-ku, Tokyo 100, Japan [453]

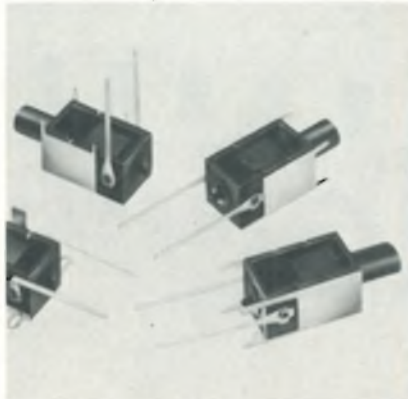

A variable attenuator for cable television maintains a constant 75-ohm input/output impedance. Maximum attenuation is 21 dB, insertion loss is less than 0.5 dB, and the unit covers from 40 to 860 MHz. Egen Electric Ltd., Canvey Island, Essex SS8 0PG, England [456]

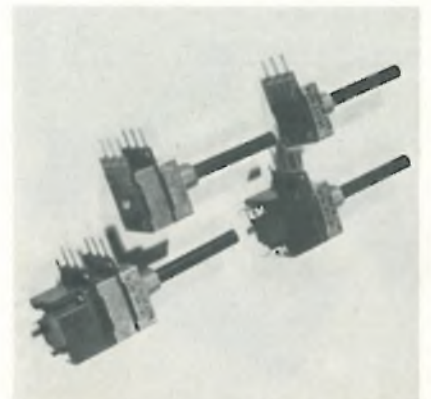

Intended for applications in consumer electronics equipment, the series PR16 potentiometers have resistive tracks that are made by conductive plastic technology, providing low noise and long life. Plessey Resistors, Cheney Manor, Swindon, Wiltshire, England [459]

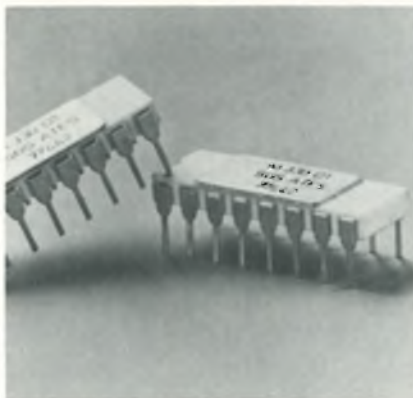

A static random-access memory, the M330, is an n-channel silicon-gate MOS unit that operates from a +5-volt supply. Type A has a maximum access time of 1,000 nanoseconds; type B, 650 ns; and C, 500 ns. SGS-Ates Componenti Elettronici SpA, 20041 Agrate BR, Milan, Italy [454]



Designed to interface 4-volt DTL and TTL devices with high-current, noisy or inductive loads such as relays and solenoids, a driver called PBD 3511 switches 85 V and 300 or 125 mA at a maximum inductance of 2 henries. Aktiebolaget Rifa, Fack S-161, 11 Bromma, Sweden [457]

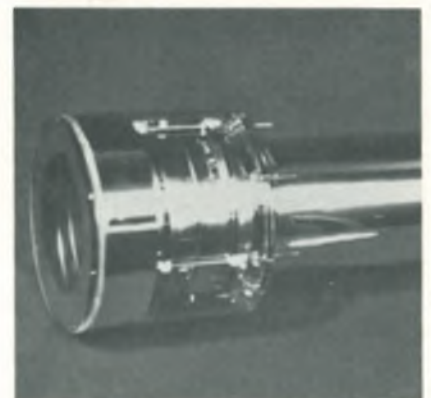

The Image Isocon TV camera tube is designed for systems operating at 20 or more frames per second. It is said to be 14 to 16 dB quieter than the image orthicon, with a greater dynamic range. Electronic Components Division, RCA Ltd., Sunbury-on-Thames, Middlesex, England [460]

Look who just tied the knot.

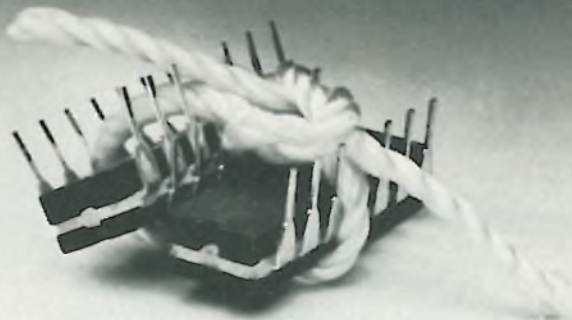

The 54C/74C and the 4000 series.

Actually, it's no great surprise. The 54C/74C and the 4000 series logic families have always been electrically compatible and now many of the functions are even pin-compatible, so you can marry them in your very own system without worrying about a family feud. You'll find mixing these two CMOS series beneficial to you in many ways. First, you'll have more available functions to choose from. So your chances of finding the right one are better. This will minimize the number of CMOS devices you need to implement the logic. And second, you can take advantage of the best personality traits of each series to optimize your system's performance. Key

features such as higher guaranteed noise margin. Greater output drive. And higher speed of specific CMOS functions.

When you're ready to tie the CMOS knot in your system, Harris can help you perform the ceremony. Harris CMOS devices are fully compatible with others in the industry and will perform in your present system without modification. And you can get immediate delivery of both logic families from your Harris Distributor.

For more information on how we can make the CMOS marriage work for you, call our CMOS Application Hot Line at 800-327-8934. Your systems will live happily ever after.

DEVICE	OUTPUT SINK CURRENT	MINIMUM
4002A	$I_{OL} (V_{OL} = 0.4V)$	0.40 ma
4042A	$I_{DN} (V_{OL} = 0.5V)$	0.20 ma
4001A	$I_{OL} (V_{OL} = 0.4V)$	0.30 ma
All 54C/74C	$I_{OL} (V_{OL} = 0.4V)$	0.36 ma
4071B	$I_{DN} (V_{OL} = 0.4V)$	0.40 ma

This illustrates some of the variations in output drive current specified in the 4000 series, and how the 54C/74C fits within the range.

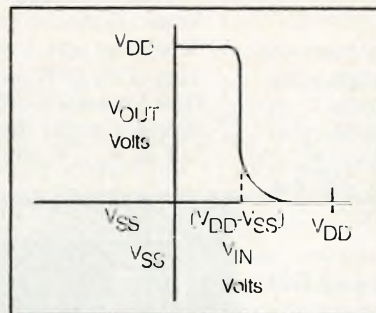

This CMOS transfer characteristic for single level gate functions is for all CMOS logic families. It is the commonality of this characteristic which is the basis of CMOS inter-family compatibility.



HARRIS
SEMICONDUCTOR
A DIVISION OF HARRIS CORPORATION

P.O. Box 883, Melbourne, Florida 32901 (305) 727-5430

EUROPEAN HEADQUARTERS: AUSTRIA: Kontron GmbH, Vienna, 945-046 **BELGIUM:** Harris Semiconductor Inc., Brussels, (02) 428 36 02
INTERNATIONAL REPRESENTATIVES: **BELGIUM:** Belea Spil., Brussels, (02) 649 99 00 **DENMARK:** Ditz Schweitzer A/S, Glostrup, (02) 45 30 44
FINLAND: Finn Metric OY, Tapiola, 460 644 **FRANCE:** Spetelec, Rungis Principal, 686 5665 **GERMANY:** Kontron Elektronik GmbH, Eching bei Munchen, 02165/771 **ISRAEL:** MRBD, Ramat-Gan, 738701/728076 **ITALY:** Erie Elettronica SPA, Milano 6884832/4/5 **NETHERLANDS:** Techmation N.V., Amsterdam, (20) 456955 **NORWAY:** NERA A/S, Oslo, 46 19 50 **SPAIN & PORTUGAL:** Insrumentos Electronicos de Precision, Madrid, 2741007
SWEDEN: AB Elektrotex, Sundbyberg, (03) 289290 **SWITZERLAND:** Stolz A.G., Mutschellen, (057) 54655 **UNITED KINGDOM & IRELAND:** Memec Ltd., Nr Aylesbury, Bucks, (029664) 366

R goes to ground and thus reduces output from A₁.

The level-controlled output from the 74C04 is also applied to a single-stage high-pass filter (A₂) to develop a pure-tone high-group output, and to a two-stage low-pass filter (A₃, A₄) to develop a pure-tone low-group output. These two output signals can then be measured by decoders that follow this front-end circuit. □

Designer's casebook is a regular feature in Electronics. We invite readers to submit original and unpublished circuit ideas and solutions to design problems. Explain briefly but thoroughly the circuit's operating principle and purpose. We'll pay \$50 for each item published.

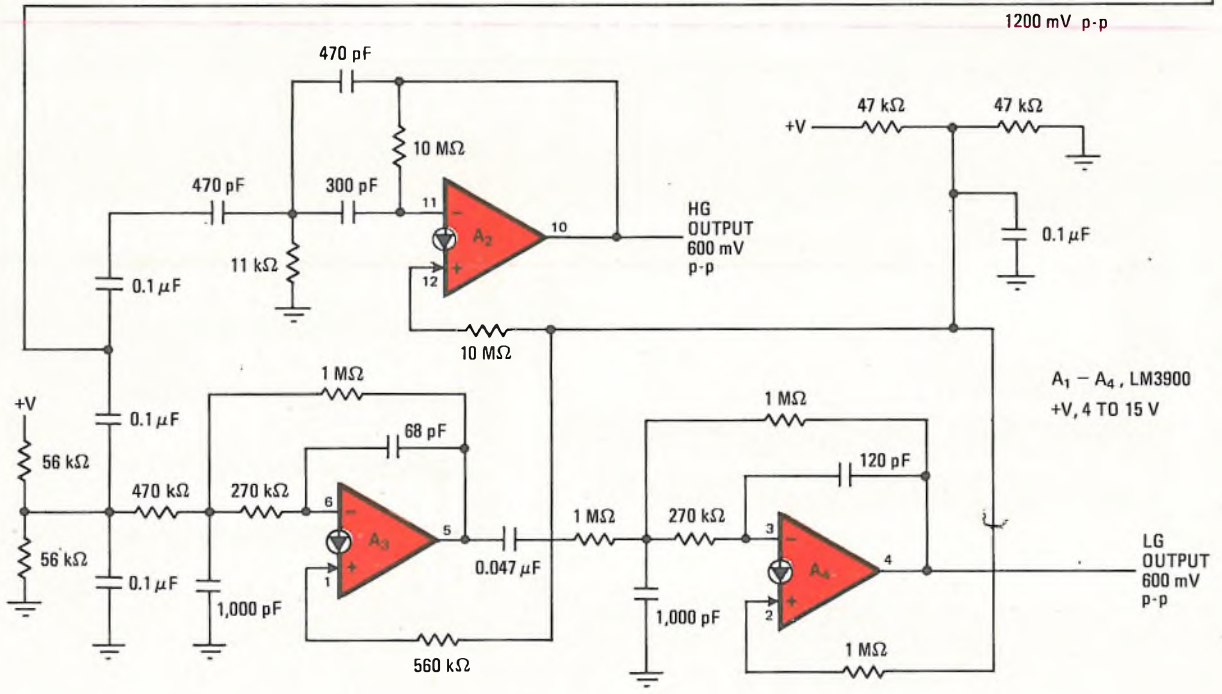
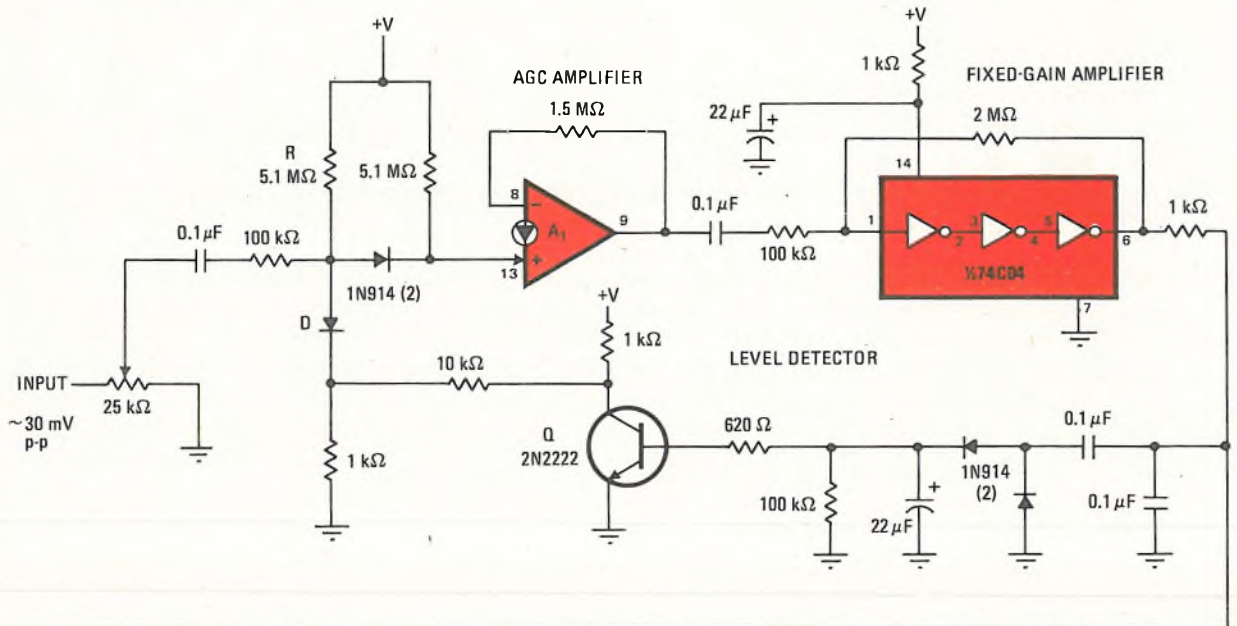
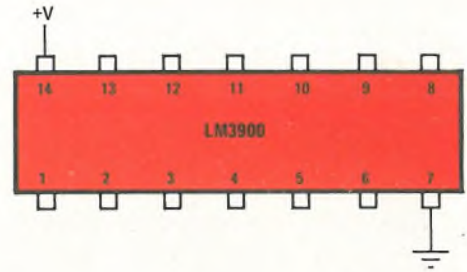

2. Front-end circuit. The two-frequency signal coming in from a Touch Tone phone is boosted or attenuated to a convenient level in agc amplifier, and then is separated into a low-group output and a high-group output by low-pass and high-pass filters. Only two inexpensive and widely available ICs are required to implement these functions. Many operations can be controlled remotely by the Touch Tone push buttons.

Improved triple diffusion means densest ICs yet

Record number of devices being packed on silicon substrates with updated application of the old 3D technology; and new refinements raise speed performances to levels of today's minicomputer systems

by Jim Buie, TRW Systems, Redondo Beach, Calif.

□ A fabrication technique that dates back to an early age in solid-state circuitry is recapturing some of the limelight from newer technologies. It is the triple-diffusion process (hence 3D) that in the early 1960s, as the readiest means then at hand, answered the need for producing electrically isolated transistors and resistors together on monolithic silicon chips. Today, by virtue of its comparative simplicity and in conjunction with newer fabricating refinements, 3D technology can be an effective method for obtaining higher levels of integrated-circuit density and operating speeds suitable for numerous present-day applications. In fact it is already setting new records in bipolar density.

Simplicity, which translates into high yields and low costs, may well be the 3D technology's most attractive feature. Basically it involves three sequential impurity depositions on a prepared silicon substrate. First, after preparation of the substrate by oxidation, come the photo-resist mask and etching steps that delineate the collector areas. Here some new techniques are applied, such as impurity doping with phosphorous-ion implantation followed by a thermal-distribution diffusion. Second and third, the base and emitter regions are created one after the other in similar fashion. Next, intraconnections are made by etching electrode contacts through the protective oxide and by depositing the metal system, such as titanium-aluminum (another innovation, which prevents migration and yet allows very narrow line delineations). Finally the metal itself is etched and the surface is covered with a passivating oxide.

Using just this procedure, an 11-chip computer-cir-

cuit set has been built that features two noteworthy components—one a signal-processing arithmetic unit containing 14,000 devices, and the other a 16-by-16-bit multiplier containing more than 17,000 devices. These 3D chips usher in a new level of circuit capability. What's more, unlike some newer large-scale integration bipolar techniques, the 3D process has become well established in a number of Pentagon programs.

The triple-diffusion process consists of three sequences of entirely non-epitaxial impurity depositions and profile distributions. The major advantage of the technique can be seen in Fig. 1: the pnp transistor and its npn complement can be merged into the same region, while resistors terminate directly on the collector of the assembly, which is a simple extension of the collector region. This feature of coalesced complementary structures having common potential in a circuit not only results in extreme compactness, it reduces the intraconnection complexity.

Good enough

It is this LSI form of the 3D technology that is used for medium-speed device operation, typically 5 to 30 megahertz—not as high as obtainable with epitaxial techniques but fast enough for today's typical minicomputer applications. (Today's 3D practice produces devices with cutoff frequencies of 125 MHz compared to 1-GHz cutoffs for epitaxial structures.) The high complexity possible with the technique more than makes up for the slack in performance. However, faster forms of 3D technology that involve both structural improve-

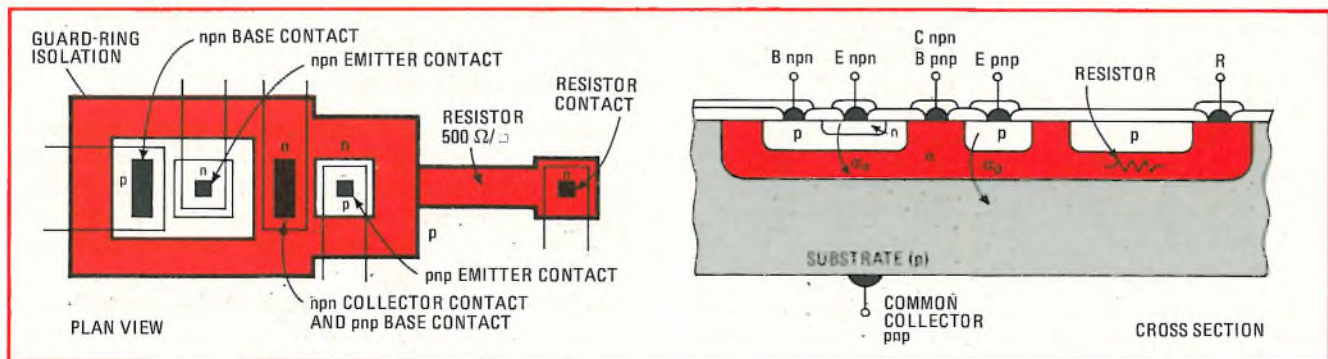

1. Hallmark. Simplicity, perhaps the most endearing quality of the triple-diffusion process, allows the merger of digital structures into tight geometries. The technique may eventually be responsible for chips with 50,000 devices operating in a high-performance LSI system.

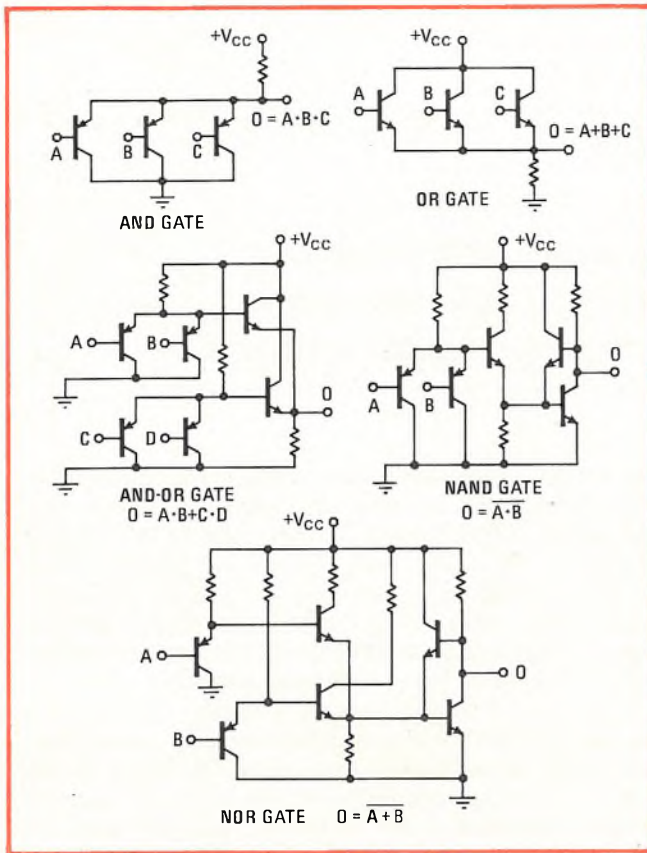

2. All the logic. The triple-diffusion bipolar process permits a designer to implement all the necessary logic directly from the basic structure. Thus, AND gates are wired AND from pnp emitter followers, while ORs are wired OR from npn emitter followers.

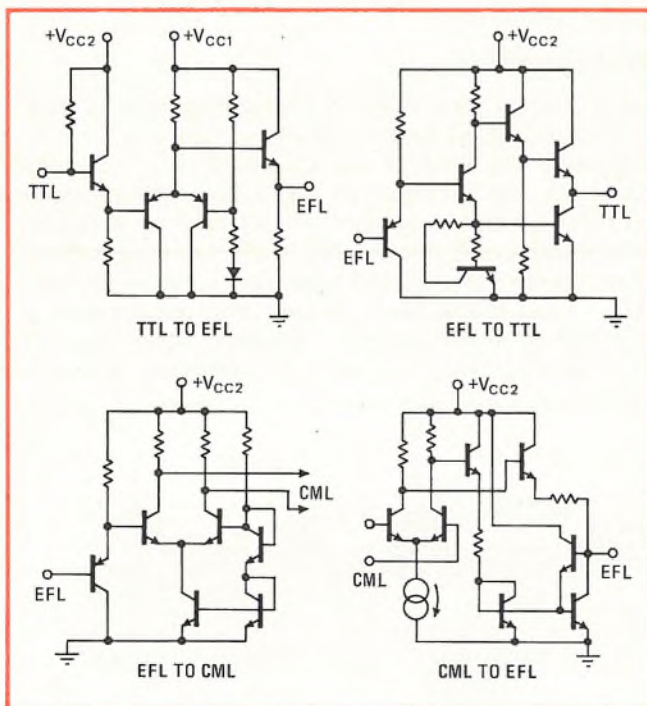

3. Easy in and out. Another significant feature of the 3D process is its easy access to transistor-transistor logic. All logic inputs and outputs are fully TTL compatible and operate from simple 5-volt supplies. In addition, TTL-compatible totem-pole outputs are possible.

ments and new circuit forms are being explored.

A feature of the 3D process that emphasizes its simplicity is its ability to incorporate the p-type silicon substrate as an integrated active-device region—not the weak interaction mode normally processed into IC substrates. Thus, a pnp transistor, for example, is formed from the p⁺ base, n collector, and p substrate (Fig. 1).

A major weakness of the triple-diffused process now becomes evident—conventionally saturated transistor-transistor logic is not immediately available. (It was this limitation that almost sunk the technology back in the mid '60s.) The problem is inherent in the structural simplicity. Since the substrate constitutes one pole of the vertical transistor configuration (and in a sense presents it with an infinite current sink), how can the coupling transistor be operated in the saturated mode, at least in the ordinary sense? The substrate will simply absorb all the base overdrive current.

To deal with this deficiency, designers have provided an extra resistor to source current to the collector of the coupling transistor. Now current is no longer drained infinitely into the substrate (see panel, p. 103).

This substrate action is beneficial in the grounded emitter-saturating transistor. Practically all of the overdrive base current is diverted to the substrate, thereby preventing deep saturation of the transistor. The storage time constant is reduced by this action to only 4 ns into 3D saturated inverters.

Implementing any of the unsaturated circuit forms—such as emitter-coupled, emitter-follower, and current-mode logic—follows directly from the 3D process, and it is these forms that are the bases of today's 3D-improved circuit designs.

Typical circuit elements for 3D-EFL are shown in Fig. 2. The AND gates are wired-AND from pnp emitter followers. The OR gates are wired-OR from npn emitter followers. Grounded emitter inverters are used to complete the necessary logic capability and to restore logic 1 and 0 levels.

Input and output circuits compatible with TTL are shown in Fig. 3. These use a 5-volt power supply and maintain a higher noise margin for chip-to-system interface. Totem-pole outputs are typical for TTL interface with tristate control. Input/output interfaces are shown for TTL, EFL and CML. Large fanout 50-ohm drivers have also been used for on-chip clock buffers and off-chip loads. For these cases, small standard transistors are paralleled in sufficient numbers to divide and distribute the required current.

Long chains—short delays

A particular EFL logic configuration using long cascades of AND-OR gating has worked out especially well in practice. (This has been implemented in a 16-by-16-bit parallel multiplier using the successive add algorithm, where the logic level is not restored until the product output is reached.)

The main advantage of this type of logic chain is the reduction of signal-propagation time: the gate delays obey a summation principle that is less than linear summation and approximately the root-mean-square of the summation time. As an example, for a low-power full-

Clearing the TTL hurdle

For a long time designers couldn't figure out how to achieve true saturated TTL transistors with 3D. The true TTL-coupling transistor operates in a continuous saturated mode, as shown in (a), in the sense that the base-collectors are always forward-biased and independent of whether the logic state of the gate is true or false. Trouble is, the overdrive base current in the triple-diffusion technology is diverted to the substrate by the high forward gain (9) of the 3D substrate transistor action, and this prevents deep saturation.

In fact, the remedy is not difficult: the addition of a bias resistor R_2 solves the problem. As the npnp transistor model in (b) shows, none of the current available at the collector of T_1 can be diverted by pnp action to the substrate, and a current I_2 is therefore fully available for external drive requirements.

Resistor values R_1 and R_2 are selected to maintain a forced beta of four, so for this case only 25% of the current is diverted to the substrate. And, I_1 , of course, performs valuable service of maintaining the continuously saturated condition for T_1 .

Other methods which obtain a reduced saturated condition for T_1 , such as shunting a resistor around the base to collector of T_1 , could also be used, but these result in an increased collector-to-emitter voltage at T_1 with a corresponding loss in noise margin for the gate. Placing a Schottky clamp on the base to collector of T_1 would also avoid the problem but it would also cause a lower noise margin and lower yields because of the more complicated process required.

Taking advantage of this simple bias scheme, two low-power TTL gates have been designed (c) and are now undergoing test simulations. The first is a 1-milliwatt gate and the second is a 5-mW gate. These will implement a universal array type of LSI, called CGA2 (for configurable gate array No. 2).

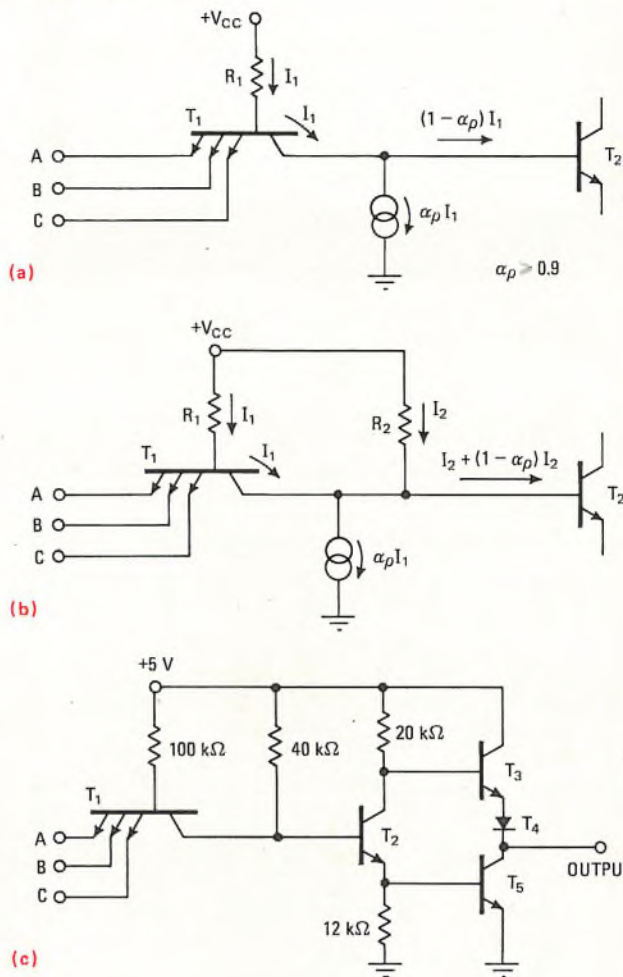

adder EFL circuit exhibiting a single-stage delay time of 14 nanoseconds, a cascade of 32 such stages exhibits less than 100-ns propagation delay. Figure 4 shows the attenuation and propagation delay as a function of the number of cascaded stages.

Recent extensions of 3D-LSI include applying it to the much higher-performing circuit form of current-mode logic. CML extends the frequency range to approximately 30% of the alpha-cutoff frequency— $F_t = 125$ MHz of the devices—and exhibits excellent delay-power products. This is a differential form of logic, but it can also be operated single-endedly by using a dc reference voltage on one side.

CML can be made compatible with EFL, and there are logic advantages in doing this. CML performs register logic exceedingly well but has a more limited capability for combinatorial logic. On the other hand, EFL properties are better for gating. An example of adding combinatorial EFL logic to computational CML D-type flip-flops, with output restored to EFL levels, is shown in Fig. 5. This circuit dissipates 32 mW. The setup time is less than 10 ns and the propagation delay is 25 ns for an 80-picofarad load.

The single most important virtue of a technology lay-

ing claim to LSI status is that it exhibits high yields. A reasonable way to measure the yield and compare this with other competing processes is to construct a graph of chip area versus yield. Using statistical distribution arguments, a defect parameter D_0 can be defined on such a plot that describes the number of defects per unit area. A series of curves drawn for 3D circuits in Fig. 6 over the past three years shows a significant progressive trend toward reduced D_0 , i.e., increased yield. As shown, this is approximately:

D_0 (defects/cm ²)	Year
10	1972
5	1973
3	1974

The yield is plotted for chips passing a functional test at the wafer probe, as this is most descriptive of the results of the wafer-fabrication process. Subsequent dicing, packaging, visual inspection, and final testing have a typical shrinkage of approximately 50% beyond the wafer-probe test. This is largely independent of wafer processing.

At present, most defects are point defects. In general, these cannot be avoided during photoresist contact-printing steps, regardless of the care that may be taken

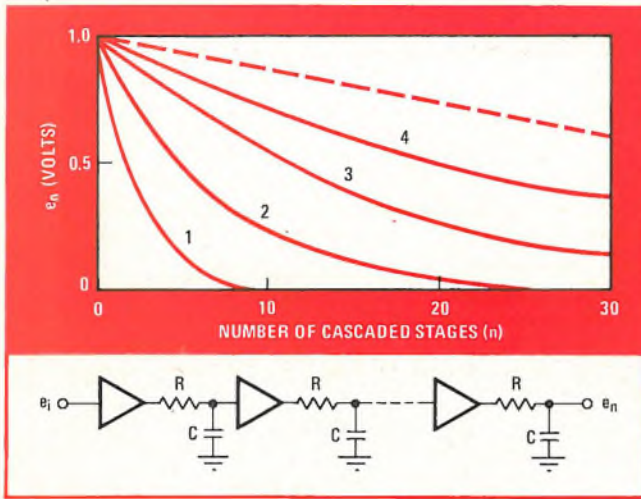

4. Adds up. One feature of 3D technology is the ability of large chains of logic to operate with reduced summation delays. Here a single stage runs at 14 ns, while 2 stages runs at only 100 ns.

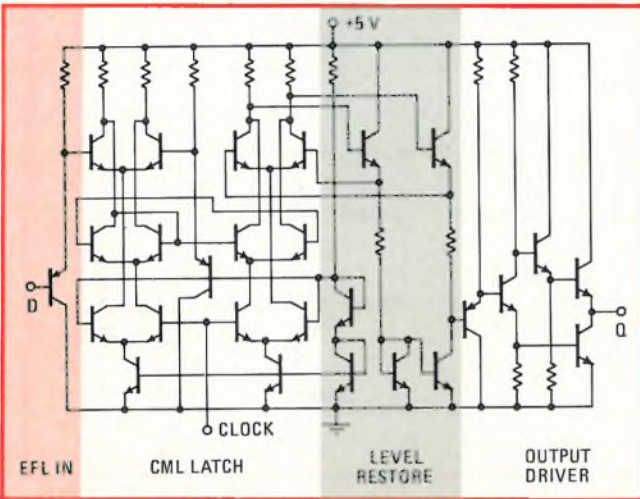

5. Winning duo. It's possible to design emitter-follower and current-mode logic on one chip. This D-type flip-flop boasts fast CML computation registers and efficient EFL combinational registers.

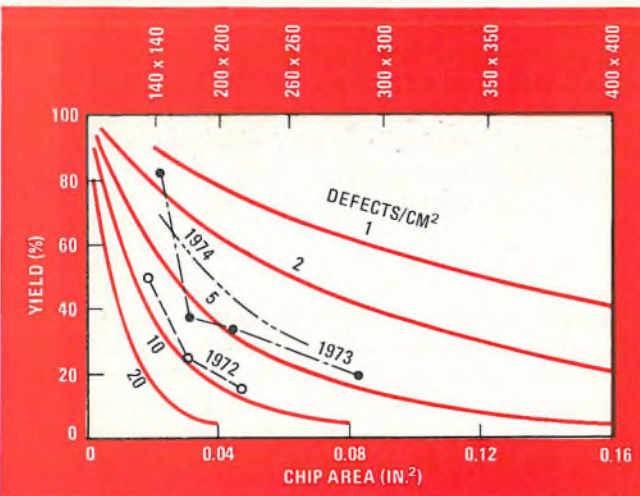

6. High yields. Best news about 3D is its high-yield manufacturing potential. Fewer than three defects per cm^2 are now obtainable, resulting in better than 30% good chips per wafer.

to eliminate them. But experimental work in progress at TRW with projection printing shows a 2:1 decrease in these defects, plus increased producibility.

Realizing the greatest benefits from high levels of LSI requires a maximum effort toward standardization in circuit functions. This is a difficult design problem because circuit functions reflect the design individuality, method of approach, and design goals of the engineer at the system level. How well standard LSI building blocks are realized will depend on the working relationship of the circuit designer and system analyst.

Standardized-function LSI

For digital filtering a few common standardized LSI functions were identified by TRW in a study sponsored by the Air Force. Speed requirements ruled out serial processing in favor of parallel methods. This meant pipelining the processed data through an instruction sequence, which in turn required doing data processing under random-program sequence.

The rule of thumb used in circuit definition was to identify system blocks where all of the main-core electronics are exercised better than 60% of the time. Thus there emerged from this study the concept for a signal-processing arithmetic unit (SPAU) which achieves 70% utilization.

One way to examine the cost tradeoffs of an LSI scheme like the one incorporated in SPAU is to compare its cost with the cost of MSI parts needed to duplicate the function. Figure 7 shows the number and kind required on a one-for-one electronic equivalent basis. A total of 55 MSI chips at an approximate cost of \$747 (MIL-qualified grade) is listed. Comparing this to the projected cost of the SPAU LSI shows a three-to-one improvement in basic device cost. And this says nothing for other potential cost reductions in incoming inspection, handling, printed-circuit-board design, assembly, and so forth.

Another example is shown in Table 1, which lists the savings in terms of the number of external interconnect pins, circuit-board mounting area, total maximum power, and chips. This example examines an existing small- and medium-scale fast-Fourier transform (FFT) design and compares it with a projected LSI design, both having the same electrical specifications.

The savings in these terms were found to be approximately 50%. It is also noteworthy that the power for this example is reduced by 60%. The power reduction is considerable because of the relative efficiency of integrated circuits in conducting internal logic loads, and the low number of off-chip loads, for which ICs require more power to drive.

At this writing, the first fabricated wafers of the SPAU are being completed. This chip has 13,800 devices, dissipates 5.1 watts, and has a chip size of 315 by 351 mils. The clock period is 120 ns, and a typical processing time for an instruction is shown in Table 2.

Two other supporting control chips are under design for hardware-address control: one for general-purpose FFT processing, and a delay line to facilitate address control. All chips are 3D designs using EFL-CML circuits with input-output interfaces compatible with TTL.

SPAUI MSI EQUIVALENTS

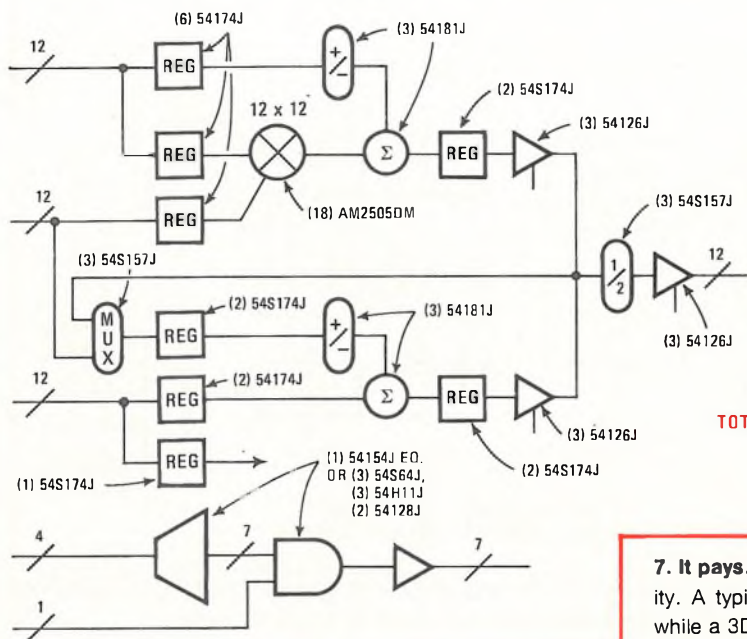

QTY	\$ COST/PKG QTY'S > 100	TYPE	COST \$
8	7.95	SN54174J	63.60
7	20.97	SN54S174J	146.79
6	6.30	SN54S157J	37.80
18	18.00	AM2505DM	324.00
6	24.90	SN54181J	148.50
9	1.97	SN54126J	17.73
1	8.03	SN54154J	8.03
TOTALS			\$747.35

7. It pays. A prime attribute of 3D technology is its low-cost capability. A typical system built with standard MS chips will cost \$747, while a 3D version may cost only one-third as much. This would be in addition to the savings realized from lower assembly costs.

Additional standardized-function LSI chips using 3D have been built. A 16-bit microprocessor is currently in the debugging phase. This machine uses 4-bit slice chips for the programmable address unit and the operand arithmetic unit for a total of two types and eight chips. The 16-bit parallel-hardware multiplier is on a single chip, as is the microprogram-control chip and the I/O chip, for the total complement of 11 chips, exclusive of memory. A block diagram of the CPU is shown in Fig. 8. A typical instruction period is 400 ns.

The I/O chip is made from a type of universal array which features gate-configuration control as well as logic-intraconnection control. The contact mask is programmed for each unique function, but all other masks are common to all chips of this type. Internal four-input gates number 120, there are 60 pads around the periphery of the chip, and there are an additional two gates at each pad position. The total gate complement is: 120 four-input configurable gates; 60 two-input configurable gates, and 60 inverter gates.

The gate configuration means that each gate, at the discretion of the designer, can be configured for AND, OR, AND, NOR, or AND-OR INVERT operations within the logic limit of four noninverting inputs. Upon calculation, it turns out that there are 102 different logic combinations possible for each four-input gate. The purpose of this configuration control is to provide a more powerful logic capability than if the gates were a fixed-logic type like NAND only.

Additional features such as totem-pole or open collectors are provided. Tristate is another option open to the designer. This type of chip is used in an otherwise all-LSI system to pick up bits of logic for housekeeping which may be unique to that particular system. The I/O chip is a good example as far as the mainframe electronics staying the same, but uniqueness is required in

TABLE 1: K-BAND REPORT BACK DEMODULATOR FFT BUTTERFLY ARITHMETIC UNIT COMPARISONS

	MSI/SSI K-BAND BUTTERFLY	LSI/MSI K-BAND BUTTERFLY	LSI REDUCTION
Total maximum external interconnect pins	1,434 pins	628 pins	56%
Nominal circuit-board mounting area (square inches)	59	35	44%
Total maximum power (watts)	50	30	60%
Total parts (DIPS)	76	26	66%

the I/O for different applications of customers.

A review of the trends in industry for more efficient layouts and improved processing technology with respect to yield suggests that LSI is on the threshold of passing over into very-large-scale integration in the near-term future of one to two years. VLSI may be defined as more than 10,000 devices on a chip. Two 3D VLSI chips have already been designed and fabricated—the previously mentioned MPY-1 with 17,000 devices and the SPAUI chip with 14,000.

Beyond LSI

With the increase in the number of devices on a chip (either through higher device-packing density, smaller device geometry, or both), the power per device will have to be decreased and at no additional penalty to performance. The decrease in power should be approxi-

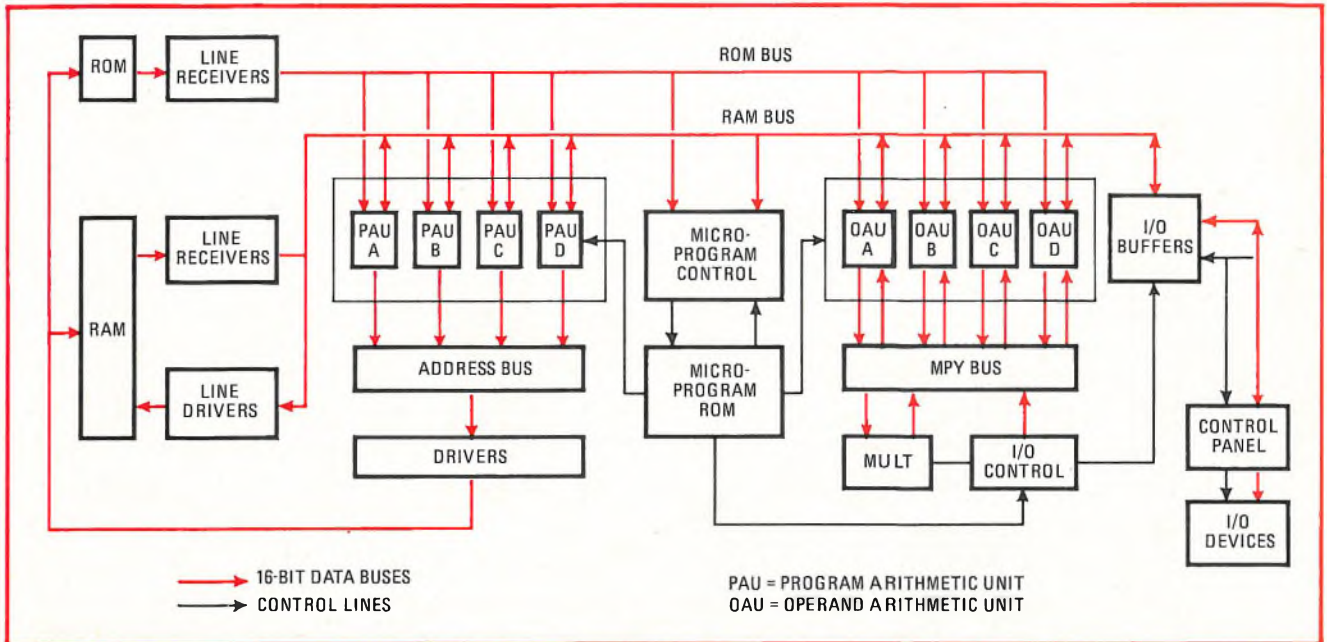

8. Big chip. This microprocessor design amasses almost 20,000 elements on a single chip using the 3D process. Two full-performance central-processing units are included: a programmable address unit and an operand arithmetic unit, as well as control registers.

TABLE 2: TYPICAL SPEEDS OF SPAU SIGNAL-PROCESSING SYSTEM

Load D or T and multiply	t (max)	t (typ)
D register	60 ns	35 ns
Product driver	25	15
Product propagation	168	140
CML R register setup	15	10
Internal clock skew	10	2
	278	207
Time allocated: 360 ns		

TABLE 3: COMPARISON OF PRESENT AND ADVANCED 3D PROCESSES

Parameter	Present 3D	Advanced 3D
Alpha cutoff frequency npnp: MHz	125	500
ppp	40	150
Junction capacitance B-E: pF/mm ²	0.42	0.35
B-C	0.25	0.14
C-S	0.08	0.04
Size (normalized area)	1	0.25
Power (normalized for given speed)	1	0.20

mately the same as the increase of complexity so that the total chip power remains about the same. Advanced 3D designs that have shallower diffused junctions (4.8-3.5-micrometer collectors), smaller lateral spacing factors (from 4 μm down to 2 μm), reduced impurity concentrations, and approximately five times less surface concentration, are on the drawing board and indicate the theoretical improvements shown in Table 3.

As an example of these advantages, consider how they would affect the performance of current VLSI, such as the SPAU chip. Here, the increase in complexity would augment the word length from its present 12 bits up to 24 bits, and power would be reduced from 5 watts to 4w.

Performance on a gate basis would remain the same, but because of greater word length, total operational throughput would be halved. Chip complexity would increase from 14,000 devices to greater than 50,000, and the die size would remain the same.

A concluding argument for continued 3D growth concerns the future development of electron-beam writ-

ing of mask information directly on the wafer chips. To make effective use of the small junction areas that this technology affords, the depth profile will have to be decreased, of course.

At this point the tradeoff factors regarding more complicated processing than 3D will probably not be significant in terms of performance. Thus the continuance of 3D technology for the future as well as the present seems assured.

The 3D process is shown to lend itself readily to different types of circuit technology. At least one type of circuit utilization—the EFL non-threshold cascaded-gate array—has such superlative performance compared to standard methods that its continuance and growth would appear to be certain.

A general standardization of LSI functions is becoming an increasingly important subject. Certain subclasses of major system functions, like FFT processing, will be found in single or few chips. These can have the same degree of cost effectiveness as was earlier observed for ICs over discrettes. □

When to use higher-level languages in microcomputer-based systems

Now that compilers are becoming available for microprocessors, designers must learn to choose between a high-level language that will minimize a system's programming costs and assembly language that will minimize its memory needs

by Jim Gibbons, *Ryan-McFarland Corp., Rolling Hills Estates, Calif.*

□ Unlike other types of computers, microcomputers have seldom been programable by their users. But as soon as they become programable in high-level languages like Fortran or Basic, the users will be free to tailor microcomputer-based systems to their own individual requirements, and the range of microcomputer applications will expand enormously.

The fact is that until now designers have not used microprocessors to build highly flexible systems with many different applications. Rather they have used them to simplify their own job of building complex logic systems intended for high-volume production. For this purpose the compact programs that can be written in the lower-level assembly languages are more than adequate—the undoubted costliness of the process is offset by the high volume of the product and the reduction in memory requirements.

But such an overhead becomes steadily less economical as production runs get shorter. At a certain point it should become much less expensive to use higher-level languages, which make programming quicker and therefore cheaper, even if less efficient in the use of memory.

The obstacle has been a lack of compilers to translate these languages into the machine language of the microprocessor. All microcomputer manufacturers now supply either a cross assembler or a resident assembler or both for programming their products in assembly language. (A cross assembler runs on a large host computer, while the resident assembler runs on the micro-

computer itself in its prototyping environment—Intellec, Exorciser, Imp, Assembler, and so forth.) In contrast, only one compiler—Intel's PL/M [*Electronics*, June 27, 1974, p. 103]—is now commercially available, and only in a cross version. Nevertheless, several manufacturers have announced their intention to develop compilers for other high-level languages that will operate on both host and prototyping systems.

In short, designers will soon have to decide when to use a higher-level language in preference to assembly languages. That decision will have to be made on the basis of the time and cost of completing the project and delivering the product. In fact, when the process of programming a product limits its potential sales, it may very well prove best to deliver an unprogrammed system and a compiler to the end user and permit him to do the programming—just as other computer users do.

Why use compilers?

The efficacy of compilers is a topic which will draw an hour-long dissertation from just about anyone in the field. In fact there is a rich tradition of pros and cons on the subject which are generally accepted if not thoroughly proven. The first argument usually made in favor of using a compiler is that it reduces the cost of programming. The average output of programmers per day is about 10 lines of code, regardless of language. At reasonable salaries and overheads, this can work out to as much as \$10/line programming costs. Since compilers

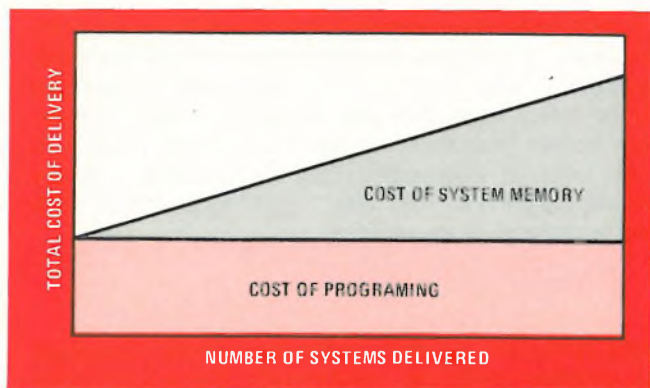

1. **Delivery costs.** The total cost of delivering a number of systems comprises two factors: a constant programming cost and a variable cost of memory, depending on the number of systems produced.

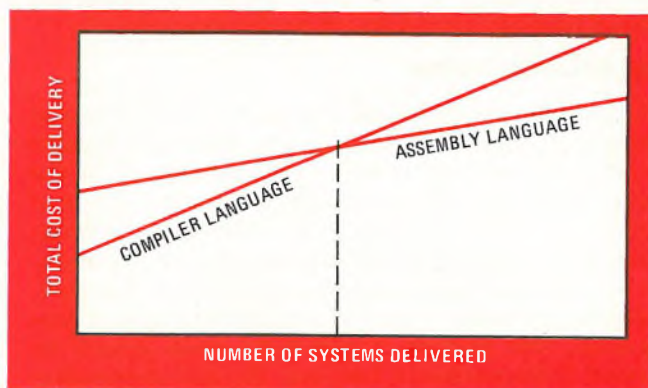

2. **Crossover.** The total system cost will be lower with compiler-language programming if the number of systems is low, while assembly language leads to lower over-all costs for large numbers of systems.

TRADEOFF POINT FOR COMPILER VERSUS ASSEMBLER

Memory cost per bit (M)	Expansion factors (E _C)				
	1.0 or less	1.1	1.25	1.5	2.0
\$.0005	∞	9,750	3,750	1,750	750
\$.001	∞	4,875	1,875	875	375
\$.005	∞	975	375	175	75
\$.010	∞	488	188	88	38
\$.015	∞	325	125	58	25
\$.020	∞	244	94	44	19

$$N = \frac{10(1/16 - E_C/80)}{(E_C - 1) \cdot M}$$

generate several instructions per statement while assemblers generate only one, a line of compiler code obviously will do more work than a line of assembly code. Thus, both time and the cost of developing a program could be reduced by using a compiler.

Another argument is that programs written in compiler language are easier to read and hence easier to debug and maintain than those written in assembly language. Although incomprehensible programs have been written time and again in Fortran and Cobol, by and large they are easier to read than an equally poor program written in assembly language.

Nevertheless, nearly all the microcomputer programs written today are in assembly language, mainly for efficiency—or so it is alleged. The argument goes something like this: "Compilers are inefficient. They generate more machine language than the bare minimum required for a given function and therefore generate larger and slower programs than can be achieved with assembly language. Cost savings on hardware thus not only justify but require the use of assembly language."

It sounds very persuasive. In fact the only possible comeback is to ask, "What specifically are the cost savings, and do they outweigh the added cost of coding?" These factors must be analyzed a bit more closely.

In most cases speed is irrelevant, since today's microcomputers overpower almost all of their applications. The real question is memory cost. Compilers are accused of increasing memory requirements anywhere from 10% to 100% (depending on the particular compiler and accuser). If "efficiency" is in this range, the costs of hardware and software need to be explored.

A question of volume

Given that programs are less costly to develop and maintain in a higher-level language, whereas programs in assembly language make more efficient use of the computer memory, one must compare the total costs of delivery for each. The key is the number of systems which will be delivered with this program. If this number is very high and significant cost savings are envisioned as a result of careful assembly-language programming, the greater programing costs could be justified. If the number is low, then the cost of programing would dominate total system costs. In this case, the use of compilers could be an important technique in reducing the costs of microcomputer-based products.

Two extreme cases will illustrate this point. First, consider a microcomputer system, such as a digital meat scale, that will be programed once and for all during its design phase and will be delivered by the thousands, always with the same program. Here, programing the system in assembly language may be more expensive at the outset, but could prove to be a good investment, being amortized over all the systems delivered. It is also possible that component costs—most likely memory cost—might be reduced.

On the other hand, consider an automated test station, which will require periodic reprograming to accommodate various testing operations. It would be quite unlikely that any component of the system or even the full system would compare in total cost to the cost of preparing, changing, and maintaining the programs. In this instance the same delivered system is operating several different programs. The cost reductions in programing achievable by using higher-level languages would far outweigh the cost of any additional memory required in the system because of "inefficiency" of the compiler.

It would be helpful to have a better idea of what constitutes a "low" or "high" number of systems to be delivered. A simple linear model of the costs of delivery will express the concepts which underlie the two examples given above. The total cost of delivering a program will comprise the fixed cost of programing plus the variable cost of memory in each system delivered (Fig. 1). Since the cost of programing can be directly related to the number of lines written, it can be expressed as

$$L \times P$$

where L is the number of lines and P is the programing cost per line. It has already been stated that P is about \$10 regardless of the language used.

The cost of memory in a single system will be related to L, the number of program lines, B, the number of bits generated by each line of code, and M, the cost per bit of memory:

$$L \times B \times M$$

The total cost of delivering a program in N systems thus will be

$$N \times L \times B \times M + L \times P$$

It is clear from the examples mentioned before that for very large N this cost should be lower when assembly language is used, and that for very small N, this cost will be lower when compiler language is used. Therefore, the two lines must intersect, as shown in Fig. 2. It is this point of intersection that is of interest. It is the boundary between "low" and "high" values of N. This point is defined by the relation

$$N \times L_A \times B_A \times M + L_A \times P = N \times L_C \times B_C \times M + L_C \times P$$

where subscripts A and C refer to assembly language and compiler language, respectively. For a given program, we also know that the total size of the assembly language program and the compiler language program, i.e. the machine language generated by each, will be re-

The hierarchy of computer languages

Computers operate by fetching and executing instructions from their memory. These instructions are nothing more than strings of 1s and 0s arranged by the programmer in such a way as to direct the computer to perform some useful task. They are stored as words in the computer's memory. This most fundamental language—the binary patterns actually fetched and executed by the computer—is referred to as "machine" language.

While machine language is the only language recognized by the computer hardware, it has several disadvantages. First, writing programs in machine language can be very tedious since the programmer must remember the binary instructions recognized by the machine or continually look them up. Second, after these instructions have been written they are extremely difficult to read, making maintenance difficult. And finally, one computer cannot execute the machine language of another.

The first major advancement in computer languages was the creation of "assembly" language. In assembly language, simple mnemonics indicate the operations to be performed, and memory locations are referred to by symbolic names rather than binary addresses. This language still maintains a one-to-one relationship with the machine language, but it is far easier to read and write. "Macro assembly" languages employ the same techniques of mnemonic instructions and symbolic addressing, but the programmer can also develop his own mnemonics, to generate one or more additional instructions.

Since the computer itself recognizes only machine language, assembly language must be translated into binary patterns before it can be executed. A computer program called the assembler performs this task. It accepts assembly language as its input (the "source" code) and produces machine language as its output (the "object" code). While assembly-language programming is far less tedious than machine-language programming, it still requires a knowledge of the architecture and instruction repertoire of the particular computer being programmed.

The strict relationship between programming and the particular computer being programmed was finally broken when higher level languages such as Fortran, Cobol, PL/I and Basic were introduced. Statements in these languages no longer correspond one-to-one with machine language, but rather generate several machine instructions depending on the exact form and syntax of the statement. Programs are shorter, easier to read, easier to write, and related more closely to what the programmer intends to do than to the specific steps the computer will use to accomplish the task. Translation of these languages (from high-level language "source" code to machine-language "object" code) is a somewhat more difficult task than translation of assembly language and is performed by a program called a "compiler."

With a high-level language, a program can be written regardless of the kind of computer that will run it. However, each computer requires its own compiler to translate the program into its own set of instructions.

Another alternative for programming in higher level languages is to use an "interpreter." A high-level language interpreter combines the steps of translation and execution. Machine language is never actually developed. When the program is executed, each line is translated and executed as it is encountered. The translation must be performed each time the line is executed.

Programming languages can most easily be compared by considering a simple example. The one used here is:

$$P = Q + R$$

which means: "Take the data from the memory location called Q, add to it the data in location R, and store the result in location P". Below are solutions to this problem in various languages.

	What the programmer writes	What it means	Translation	Execution
IN MACHINE LANGUAGE:				
(8080)	3A 0300	LOAD ACCUMULATOR FROM ADDRESS 300 (Q)	No translation is required since the programmer writes in the binary patterns recognized by the processor	Machine language instructions are executed by the processor
	47	MOVE THIS TO STORAGE REGISTER B		
	3A 0560	LOAD ACCUMULATOR FROM ADDRESS 560 (R)		
	80	ADD STORAGE REGISTER B TO ACCUMULATOR		
	32 0100	STORE THE RESULT IN ADDRESS 100 (D)		
(6800)	B6 0300	LOAD ACCUMULATOR A FROM ADDRESS 300 (Q)		
	BB 0560	ADD TO THIS THE CONTENTS OF ADDRESS 560 (R)		
	B7	STORE THE RESULT IN ADDRESS 100 (P)		

(Every other microcomputer would have its own unique machine-language program to solve this problem.)

	What the programmer writes	What it means	Translation	Execution
IN ASSEMBLY LANGUAGE:				
(8080)	LDA Q	LOAD ACCUMULATOR FROM LOCATION Q	Assembler program which is executed on the microcomputer or some other computer translates these instructions into the machine language shown above	Machine language instructions are fetched and executed by the processor
	MOV B, A	MOVE THIS TO STORAGE REGISTER B		
	LDA R	LOAD ACCUMULATOR FROM LOCATION R		
	ADD B	ADD STORAGE REGISTER B TO ACCUMULATOR		
	STA P	STORE THE RESULT IN LOCATION P		
(6800)	LDA A, Q	LOAD ACCUMULATOR A FROM LOCATION Q		
	ADD A, R	ADD TO THIS THE CONTENTS OF LOCATION R		
	STA A, P	STORE THE RESULT IN LOCATION P		

(Every other microcomputer would have its own unique assembly-language program to solve this problem.)

	What the programmer writes	What it means	Translation	Execution
IN COMPILER LANGUAGE:				
	P = Q + R	P = Q + R	Compiler program which is executed on the microcomputer or some other computer translates this statement into machine language	Machine language instructions are fetched and executed by the processor

(This statement would have the same net effect on any microcomputer for which a compiler is provided.)

	What the programmer writes	What it means	Translation	Execution
IN INTERPRETIVE LANGUAGE:				
	P = Q + R	P = Q + R	No translation step is required since the interpreter program will do this at the time of execution	This instruction is fetched, translated and executed under control of the interpreter program

(This statement can be executed on any microcomputer which has an interpreter.)

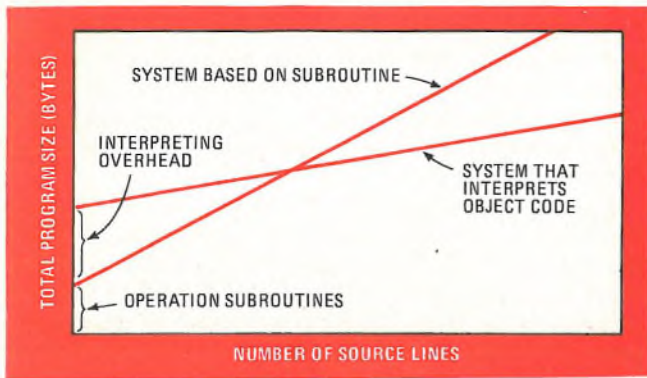

4. Subroutines vs interpreters. Although interpreting systems have a higher overhead, they are more efficient for large numbers of source lines—that is, they result in fewer total program bytes.

that might be written in any higher-level language:

$$P = Q * R + T$$

(Multiply Q by R, add T, and store the results in P.) For a larger machine (some minicomputers and most large mainframe machines), this statement might compile very simply into four instructions:

```
LOAD   Q
MPY    R
ADD    T
STORE  P
```

However, it is not that easy for a microcomputer, since the high-level language statement generates several times more instructions in machine language. For, say, the simplest case—16-bit unsigned binary arithmetic and 16-bit direct addressing—assembly-language programs are shown in Fig. 3(a) for the Intel 8080 and Motorola M6800 microprocessors. Even for the simple case, note that a multiply operation, for example, generates more than 35 bytes of code. With the problem compounded by the more complicated data representations and addressing techniques of most high-level languages, these programs could become much more complex.

One possible solution is to use subroutines for the more complex operations that will probably be repeated. When this is done for the multiply operation, the programs shown in Fig. 3(b) would be generated. However, the support subroutines also shown in that figure would be required as well. (Since subroutines have been introduced anyway, an extra level of subroutines—CALL LOC1—is used in the 8080 version to further reduce the program size.)

What is the tradeoff? Basically, a much smaller program has been generated, but it will run somewhat more slowly because of the transfer of control to the multiply subroutines and the subsequent returns. Also, some system “overhead”—the multiply subroutine—is now inherent in the system. Every compiled program must now include the multiply and other overhead subroutines and will therefore be no longer directly proportional in length to the number of program statements. And, despite the fact that a major portion of the code has been eliminated by the subroutines, it is still not as compact as it was for a large computer.

A second approach can offer much more concise

compilation. The principle is simple. Compile for a somewhat “larger” computer designed for the efficient execution of higher-level-language programs, and then do one of two things: either emulate that hypothetical computer by using an interpreter to translate and execute the compiler’s object code, or microprogram a central-processing unit built from bit-slice components to “be” the computer that’s needed to efficiently execute a program written in the higher-level language.

The major difference in object-code size between this approach and one which relies on subroutines is that the subroutine calls no longer are required. Thus a statement that might be compiled for a subroutine-based execution system as

```
LOAD   DATA1
CALL   OPERA
LOAD   DATA2
CALL   OPERB
```

would not require the subroutine CALL and would be compiled this way for the hypothetical computer:

```
OPERA  DATA1
OPERB  DATA2
```

The definition of the hypothetical computer and its emulation should turn out to be simple. But, if either does prove to be complex, then the definition probably is wrong. In fact, this approach has been used to design Fortran systems for minicomputers that require only 32 operations. Even for a more complex language, complete specification of all required operations and address modes should always be possible in single bytes.

When object-code interpreting systems are compared to subroutine-based systems, the only real differences in the overhead required at runtime are the interpreter’s address-mode routines and decoding section. All of the operation routines are common to both.

Figure 4 shows the relation of total program size, including overheads, to the number of executable source program lines for object-code interpreting and subroutine-based systems. Not surprisingly, the graph indicates that the former, higher-overhead approach is more efficient when large programs must be compiled. It should also be noted that overheads will not necessarily cost as much per byte as object code, since they can be committed to ROMs and purchased in high volume.

Thus, one of the key parameters in selecting a compiler technology must be the expected size of programs to be written in the higher-level language. If the programs are expected to be several hundred lines or more, an object-code interpreting system or one which has been microprogrammed for the correct set of operators will produce the shortest programs.

An extra benefit to compiling for an “ideal” machine and then emulating it is the independence gained for the CPU. The programs generated by such a compiler could be executed on any CPU for which the appropriate interpreter or microcode had been written.

This CPU independence could prove to be the most important technological consideration. The rapid changes in semiconductor technology make it important not to be “trapped” by software. Transferability of microcomputer software is therefore more than just a desirable feature, it is a necessity. □

Renting, leasing are economical alternatives to buying instruments

Conservation of capital, immediate tax breaks, and fast delivery are among the advantages that accrue to renters or lessees of equipment

by Anthony M. Schiavo,
United States Instrument Rentals Inc., San Carlos, Calif.

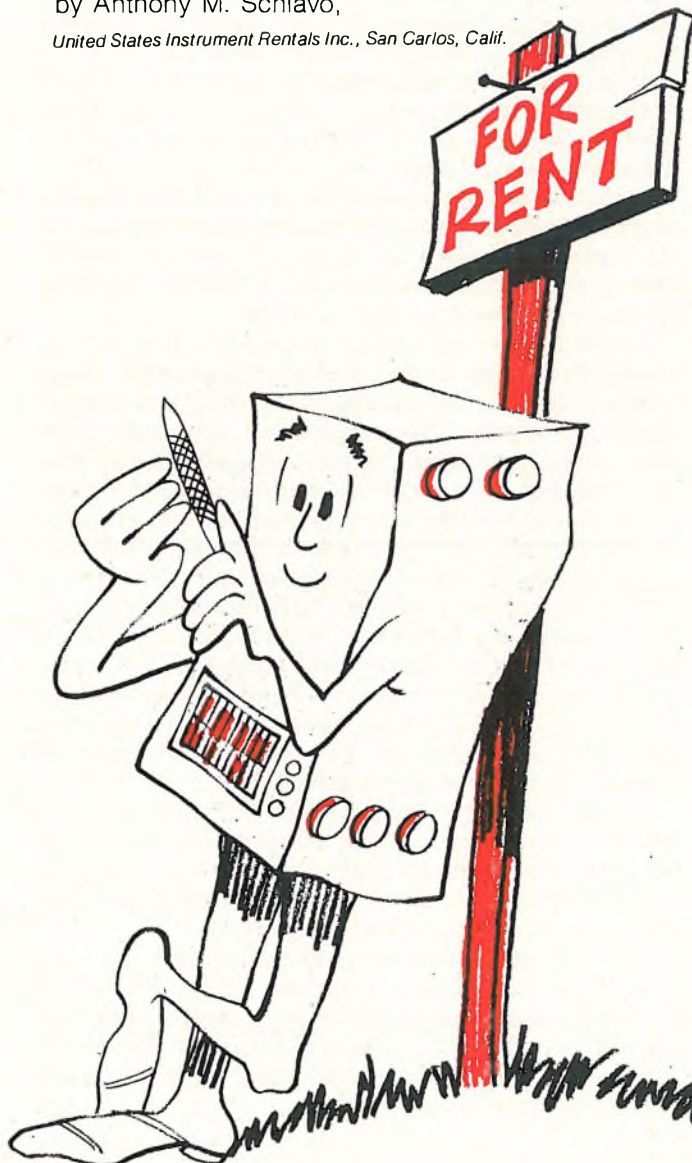

□ Though in good times companies usually buy any test equipment they need, with today's tight budgets other methods of acquisition are becoming more attractive. But it's not always realized that renting and leasing may be more cost-effective than buying even when cash is readily available.

Leasing is a way to finance the purchase of an asset. It involves a contract, usually noncancelable, in which the user agrees to make a series of payments to the lessor in exchange for use of the asset. The sum of the payments over the course of the lease equals or exceeds the price of the asset. Most often, the user is responsible for maintenance and calibration of the asset.

Renting is a much simpler matter, involving a cancelable contract of short duration. Most rentals commit the renter for only a month at a time and permit trade-in or return on short notice at no penalty. In the case of instrument rental, the rental company assumes responsibility for calibration, maintenance, and repair or replacement of equipment, if required.

Renting and leasing each have advantages over buying. In terms of company finances, they convert a capital expense—purchase—into an operating expense, which both postpones the payout of cash and can be deducted from gross income for tax purposes. An added advantage of leasing is flexible payment schedules, while the renter benefits, among other things, from his freedom to return instruments not required at any time and therefore not to pay for idle equipment.

Conserving capital

For companies that are growing, or those that would like to, perhaps the most important aspect of renting or leasing is the conservation of capital. Because a renter or lessee does not put up the purchase price of a new piece of test equipment on a heavy front-end basis, as an owner must, cash is available for investment into other income-producing parts of the business. If the business is growing and prospering, the return on this investment offsets part of the cost of renting or leasing.

If a company has little capital available for new equipment, the advantages of leasing or renting are even greater. To buy an expensive automatic test system, for example, a firm might require a loan, which in turn means paying interest. Renting and leasing not only eliminate these separate interest charges but also preserve a company's credit lines—and with many banks already overextended, the preservation of credit lines may be a very prudent course of action.

The varied payment schedules possible with leasing are especially useful when the instruments to be leased are for use in a new venture that is unlikely to turn a profit for some time. In such cases, it's a good idea to arrange for a decelerated-payment lease, in which fees are low during the first part of the lease term and are higher than those of a straight-line payment lease at the end of the term. As a result, the payments track the ability of equipment used in a new venture to generate profits. Lease payments can generally be arranged on a straight-line, decelerated, accelerated, or V-shaped schedule to meet a user's needs.

Unlike a purchase, a rental generates immediate tax

Quantifying the rent-or-buy decision

Most rent-or-buy decisions must be made in the light of particular situations, making general formulas difficult to propound. However, the accompanying graph should make the task a little easier.

The graph shows the break-even relationship between the cost of renting, the cost of ownership, and utilization. The rental cost is represented by the equipment's monthly rental fee, expressed as the percentage of its list price. Lifetime utilization is the percentage of the equipment's lifetime over which the instrument will be in use.

Ownership costs are a little harder to determine. Anything beyond the original outlay for equipment purchase is often hidden and even when identified is difficult to quantify with any great precision. But a reasonable range for annual ownership costs, expressed as the percentage of the original purchase price represented by each of these costs, is:

- Maintenance and calibration 10-22%
- Depreciation 12-25%
- Property taxes 0-4%
- Storage and other costs 1-3%
- Cost of capital 10-20%

Supposing, for example, that the estimated annual ownership costs of a given piece of equipment total 50% and the expected lifetime utilization is 50%, economics would suggest renting if the monthly rental charge is no higher than 8.3% of the equipment's list price. Alternatively, if the monthly rental rate is 7.5% and the ownership costs total 55% of the equipment's price, rental is

appropriate if the equipment is to be in use less than 61% of its estimated life.

In one actual case, United States Instrument Rentals was approached by a West Coast electronics firm that had a program for developing a product line to be used outside the United States. The firm knew that requirements for the line would be different from U.S. specifications, but since its marketing plans hadn't yet been fixed, neither were its needs.

The firm planned to make a product run every three months, followed by extensive testing. Test equipment needs for the first product run were known, and the firm had the cash to buy the instruments. But it hesitated to buy because of uncertainty over its future needs.

Since the equipment necessary for the first run was known, an exact monthly rental rate (the left-hand margin on the graph) could be determined. And the firm knew it would be making product runs only every third month, for a lifetime utilization rate of 33%.

Use of the graph made it simple for the firm to determine the maximum annual ownership cost that would make buying the preferred alternative. In this case, annual ownership costs would have been higher than this maximum, so that rental was obviously preferable. In fact, after the first production run, the product's specifications were considerably changed, and the test equipment acquired for the first run became unsatisfactory. But since the equipment had only been rented, a switch to more suitable instruments was easily arranged.

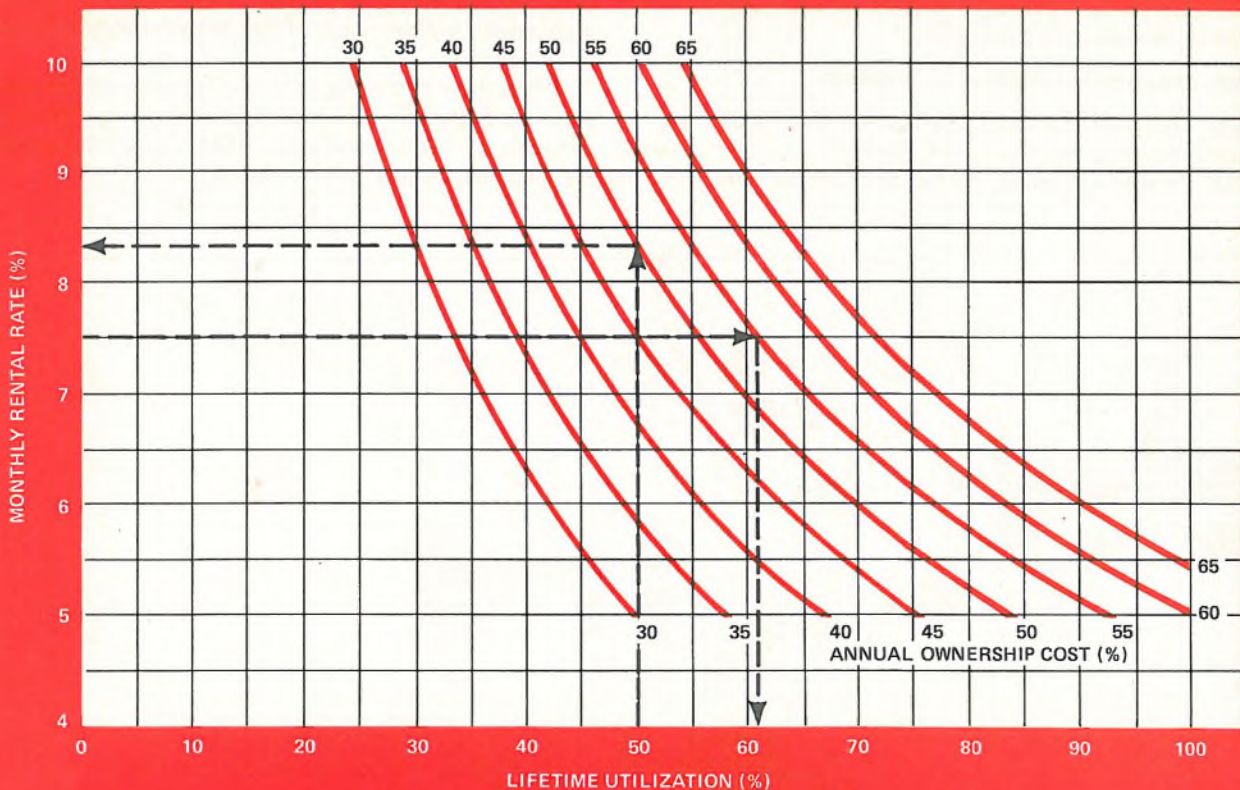

savings because it is an operating expense, deductible from earnings. The fees charged under most leases are tax-deductible, too. If a renter is in the 50% tax bracket, his payments in effect are halved. Though purchased equipment can be depreciated, yielding tax savings, the kind of direct and immediate subsidy that accrues to renters is not possible because of the much longer time period involved.

Other tax advantages

These advantages of renting and leasing become even larger when inflation is taken into account. A dollar saved today through the tax advantages of renting and leasing is worth more than the dollar saved later through depreciation. In the case of leasing, inflation lowers real costs because of the diminishing real value of the dollars paid as a leasing fee, which is fixed under the contract. On the other hand, the buyer loses two ways: the value of the dollars he recovers through depreciation is falling, and the cost of replacing his equipment is rising.

In fact, the owner of a piece of test equipment may have to replace it before it would be fully depreciated. Instruments are generally sturdy enough to outlast their depreciable life, but the rapid changes occurring in technology may make these instruments obsolete much sooner. The user may not yet have recovered enough dollars through depreciation to pay for new equipment, making additional financing necessary.

The best hedge against obsolescence is renting. If new and better or more appropriate instruments become available, the renter can return the equipment being used and replace it with new instruments and a new contract. This is especially valuable to companies working with the latest technologies.

Other reasons for renting or leasing

The ability to return equipment on short notice has a second benefit: renters don't have to pay for instruments they're not using. In the instrument field, where

much equipment is used for short-term assignments or as a backup for operating instruments, owned equipment can spend a good deal of its useful life earning nothing.

Sometimes, of course, projects are long-term and have predictable requirements, and buying may then be the preferable course of action. But it is not always clear from a specification sheet that a given instrument will satisfy all a user's needs. A short rental may be of value in such a circumstance, giving the user hands-on experience with the instrument before deciding to make a costly purchase.

Once an instrument is in use, the owner must calibrate it, maintain it, warehouse it, pay taxes on it, insure it—in short, spend a lot of time, energy, and money providing for it. The renter is free from these obligations. The rental company's staff will calibrate the instrument before shipment and maintain it as required. Companies that maintain full-time calibration and repair labs often find renting a welcome relief when their staffs are heavily burdened.

A small, but sometimes important, advantage of renting is that it simplifies allocating costs among projects. Rental makes it easier to determine what portion of each instrument's cost should be allocated to which contracts. As a result, billing becomes much more equitable for both the renter and the renter's customers.

Most companies that consider renting instruments feel the most important advantage is quick delivery. The rental business is a service business, and the best companies are the ones that provide the best service. To do that, most large rental firms maintain inventory centers in areas with the heaviest concentration of electronics firms. Shipment of a new instrument is sometimes guaranteed within hours of the rental company's receipt of an order.

When the alternative is to buy the equipment needed for a crash project and then wait several months to take delivery, as is often the case, renting is a solution many businesses cannot afford to do without. □



MAGNETIC FIELD MEASUREMENT PROBLEMS? SOLVE THEM WITH THIS NEW, LOW COST, MODEL 615 GAUSSMETER.

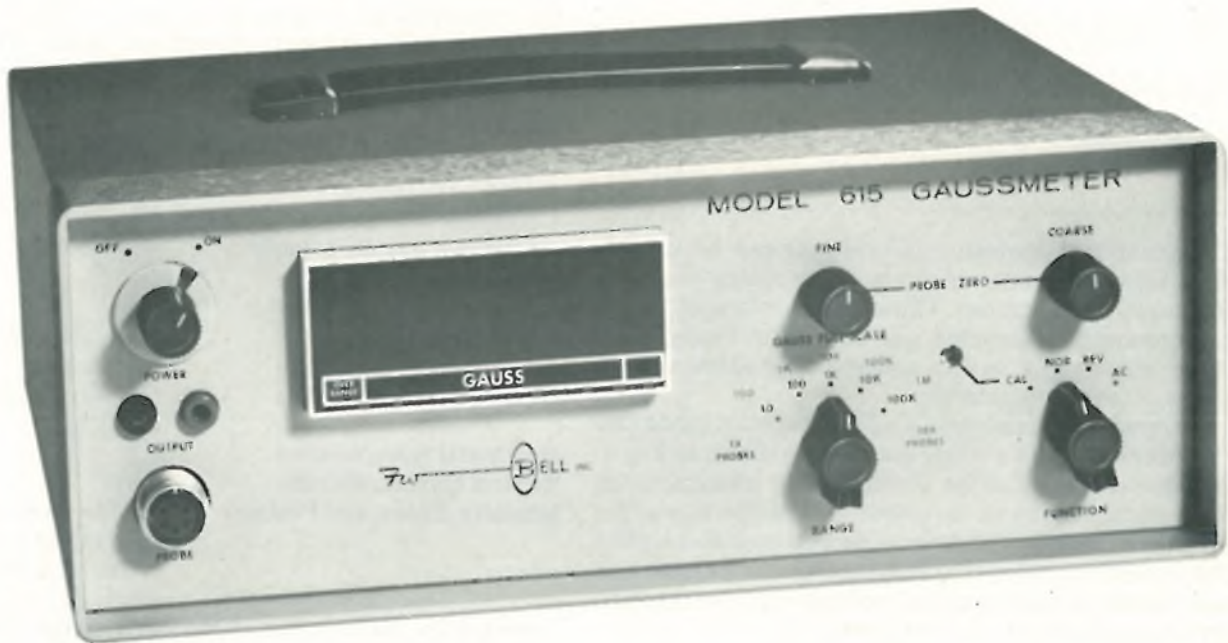

The model 615 Bell gaussmeter is designed to meet the needs of those who need digital operation, high quality and low price. The 615 is the newest addition to well-known, much-used 600 series gaussmeters. The low cost 615 is designed to meet your challenging digital gaussmeter requirements, while maintaining the quality and features of the 600 line. This is possible through F. W. Bell's years of experience in designing and manufacturing excellent gaussmeters.

You get an instrument with a digital read-out and a TTL compatible BCD output. You get a gaussmeter that can use any of the 110 standard magnetic field measurement probes available from F. W. Bell, Inc. These different probes adapt the gaussmeter to the requirements of virtually any application.

F. W. Bell, Inc. has the experience and know-how to offer you the best instruments available. Use the inquiry card to find out how these instruments can benefit you.

Send for our specification sheet before you decide to buy. We invite you to compare our gaussmeters and probes.

Features

- Low cost
- High accuracy 0.5%
- 110 different probes
- High quality
- 10% trade-in discount
- Self calibrating probes

SPECIFICATIONS

Output	Ranges, F.S.
3½ digit	0-10G
BCD	0-100G
100 mV dc F.S.	0-1kG
	0-10kG
	0-100kG
	0-1 MG

Internal Calibration

0.5% of reading

Probes

over 110 STD models available

SEE US AT WESCON!

The
Gaussmeter
People

4949 Freeway Drive East
Columbus, Ohio 43229
Phone: (614) 888-7501
TWX: 810-337-2851



Curve tracer can check optoisolator performance

by Ken Lindsay
Tektronix Inc., Beaverton, Ore.

A conventional transistor curve tracer can be used to check the performance of optoisolators against the manufacturer's specifications. These tests, performed before the component is installed, can save many costly hours of troubleshooting in the prototype, production, and test stages of manufacturing.

An optoisolator consists of a light-emitting diode and a phototransistor in a single package, as shown in Fig. 1. The characteristics of the diode and the characteristics of the transistor can be measured in the same way as for any other diode or transistor. The two optical-coupling characteristics—ratios of transistor collector current and base current to diode forward current—and the isolation can be checked by three procedures.

In the examples, the MCT-2 optoisolator is used as the device under test because it is probably the most widely used isolator. A Tektronix 577 curve tracer was used to perform the tests; however, other instruments can be used in a similar manner.

The isolator may be connected to the curve tracer in the same way as a standard diode or transistor. Since many optoisolators are packaged in a six-pin mini-DIP flatpack, a dual in-line socket and adapter allows easy connection of the device to the curve-tracer terminals. As an alternative, a standard dual in-line IC socket, with banana plugs wired to the terminals, can be used.

The first coupling test is a measurement of the dc collector current-transfer ratio, which is the ratio of dc collector current, I_C , to diode forward current, I_F . The manufacturer specifies a value for this ratio under conditions of I_F of 10 milliamperes and collector-to-emitter voltage V_{CE} of 10 volts. To check this value, connect pin 5 of the device to the collector terminal of the curve tra-

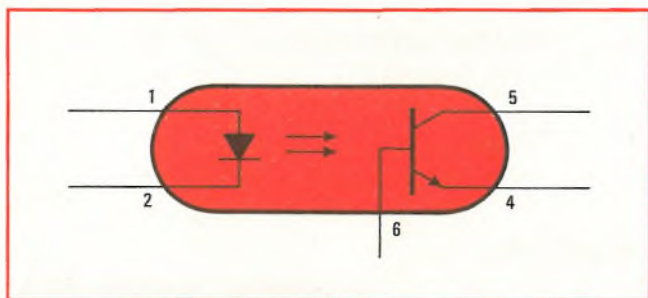

1. **Optoisolator.** Characteristics of the input diode and the output transistor can be checked with a curve tracer, and so can isolation and signal-coupling between the diode and transistor. (Some optoisolators do not provide access to the transistor base lead.)

cer, pins 2 and 4 to the emitter terminal, and pin 1 to the base terminal of the curve tracer so that the step generator drives current through the diode. With no voltage at the terminals, set the controls of the curve tracer as follows:

Collector supply	
Max peak voltage	25 v
Max peak power	0.6 w
Variable collector	0%
Collector-supply polarity	+ (not +dc)
Step generator	
Step offset amplitude	5 mA
Offset multiplier	000 (fully ccw)
Number of steps	Midrange
Any other adjustments	Set for conventional operation
Horizontal volts/division	2 v
Vertical current/division	2 mA
Intensity, Focus, and Position	Set for well-defined spot in the lower left corner of the CRT graticule.

Switch on the voltages at the curve-tracer terminals and set the VARIABLE COLLECTOR % between 60% and 80%. The display obtained should be similar to that shown in Fig. 2. The number of curves displayed depends on the setting of the NUMBER OF STEPS control on the curve tracer.

Rotate the control for VARIABLE COLLECTOR % until the end of the second curve lies at the horizontal center of the screen, as in Fig 2 (disregard the bottom curve representing zero drive current). This display represents a V_{CE} of 10 v (5 divisions \times 2 v/division) and an I_F of 10 mA (5mA/step \times 2 steps). In the example shown, the I_C is approximately 7.7 mA, so I_C/I_F is 7.7/10 or 77%. The manufacturer's specifications guarantee a minimum of 20%, with a typical value of 50%.

For the second test, which measures the base-current-transfer ratio, the setup must be changed slightly. Remove the cable connected to the emitter of the isolator, (pin 4) and connect it to the base (pin 6). This change grounds the base and opens the emitter, which allows the collector-base current to be measured. Change the VERTICAL CURRENT/DIV control to 5 μ A and check that the display is similar to the one in Fig. 3.

According to the manufacturer's specifications, the typical value for dc-base-current transfer ratio is 0.2% with a voltage between collector and base (V_{CB}) of 10 v, and a diode forward current (I_F) of 10 mA. The second step displayed (again, disregard the baseline) represents an I_F of 10 mA, and center screen horizontally represents V_{CB} of 10 v. The base current, I_B , is 9.8 μ A, so the base current transfer ratio I_B/I_F is about 0.1%.

The third and last test must be made with caution. Isolation voltage should be tested only up to the guaranteed minimum rating. If the devices are tested to their maximum, their isolation voltage would have to be

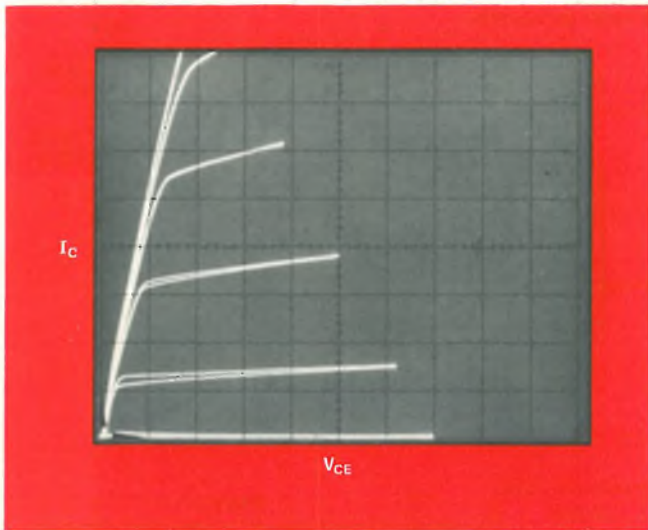

2. Tracer display. Collector current is displayed as function of collector-to-emitter voltage for diode forward currents of 0, 5, . . . 25 mA. Horizontal scale is 2 volts/division; vertical scale is 2 mA/division. Manufacturer rates I_C/I_F ratio at specified I_F and V_{CE} .

exceeded, and it would destroy the device.

To test the isolation voltage of the optoisolator, simply connect the curve-tracer COLLECTOR SUPPLY terminal to any one point on an element of the optoisolator,

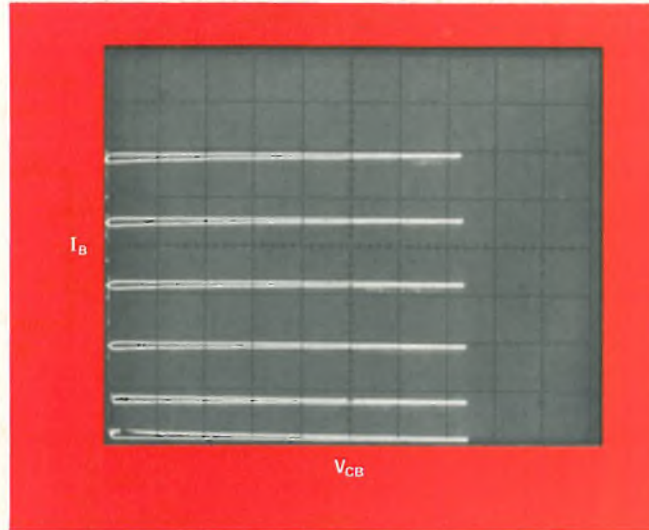

3. Base current. If optoisolator has base lead, base-current-transfer ratio I_B/I_F can be checked as in this curve-tracer pattern. I_F steps are 0, 5, . . . 25 mA; horizontal scale is 2 volts/division; and vertical scale is 5 μ A/division.

such as the diode, and ground one point on the transistor. Then apply the specified voltage and check for any leakage current, which will cause an upward shift of the base line from the zero-current position. □

C-MOS decade divider clocks bucket-brigade delay line

by F.E. Hinkle

The Applied Research Laboratories, University of Texas, Austin, Texas

The bucket-brigade analog shift register is a charge-transfer device that can delay an input signal by a fixed or variable time. A TCA350 MOS bucket-brigade shift register, which has 185 stages, delays the signal by a time $t = 185/2f_c$, where f_c is the clock frequency. The clock frequency must be considerably higher than the signal frequency f_s for sampling and filtering reasons (f_c must be filtered from f_s at the output), so the maximum signal delay is about $10/f_s$. A TCA350 was used to delay 1-kilohertz tone bursts, as illustrated in Fig. 1, for measurements of distortion and insertion loss.

The TCA350 requires two clock-pulse trains of -18 volts; both are at frequency f_c , but they are separated in phase by 180°. [The function of the biphasic clock in the charge transfer process is described in *Electronics*, June 21, 1971, p. 58.] A drain supply of -24 v and an input bias voltage of -8 v are also required. Figure 2 shows the circuit for the shift-register delay line, complete with clock generator and output filter.

In this circuit, an externally generated train of positive pulses at frequency f_p is applied to the 2N4403 transistor switch/level-converter, which produces negative pulses suitable for driving the biphasic clock gener-

ator. The generator, a divide-by-four circuit that uses an MC14017AL C-MOS divider, is biased at -18 v and therefore can drive the TCA350 directly. It generates two non-overlapping pulses at $f_c = f_p/4$, separated by 180°. An MC14009AL C-MOS hex buffer inverts the clock pulses.

The output from the delay line consists of the delayed input signal superimposed on a clock-generated waveform. The output wave that is generated by the clocking pulses has an rms value of 3 v, and its frequency spectrum is integral multiples of f_c . A filter is needed to re-

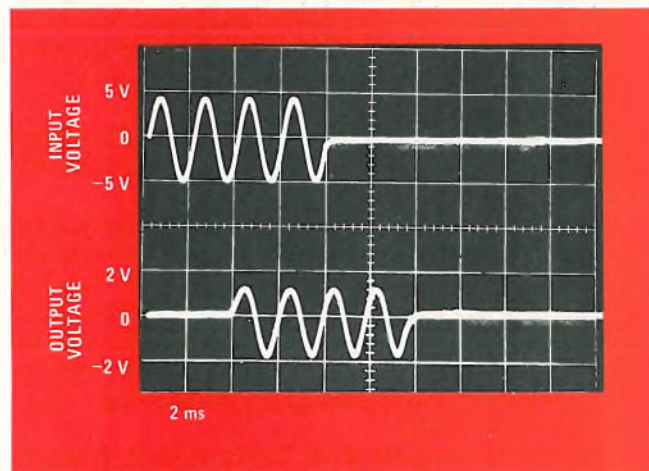

1. Delay. Dual-trace scope photo shows 2-millisecond delay of 1-kHz tone burst in bucket-brigade delay line. Output has been filtered to remove clock-frequency components. Delay is inversely proportional to clock frequency; here $f_c = 46.25$ kHz.

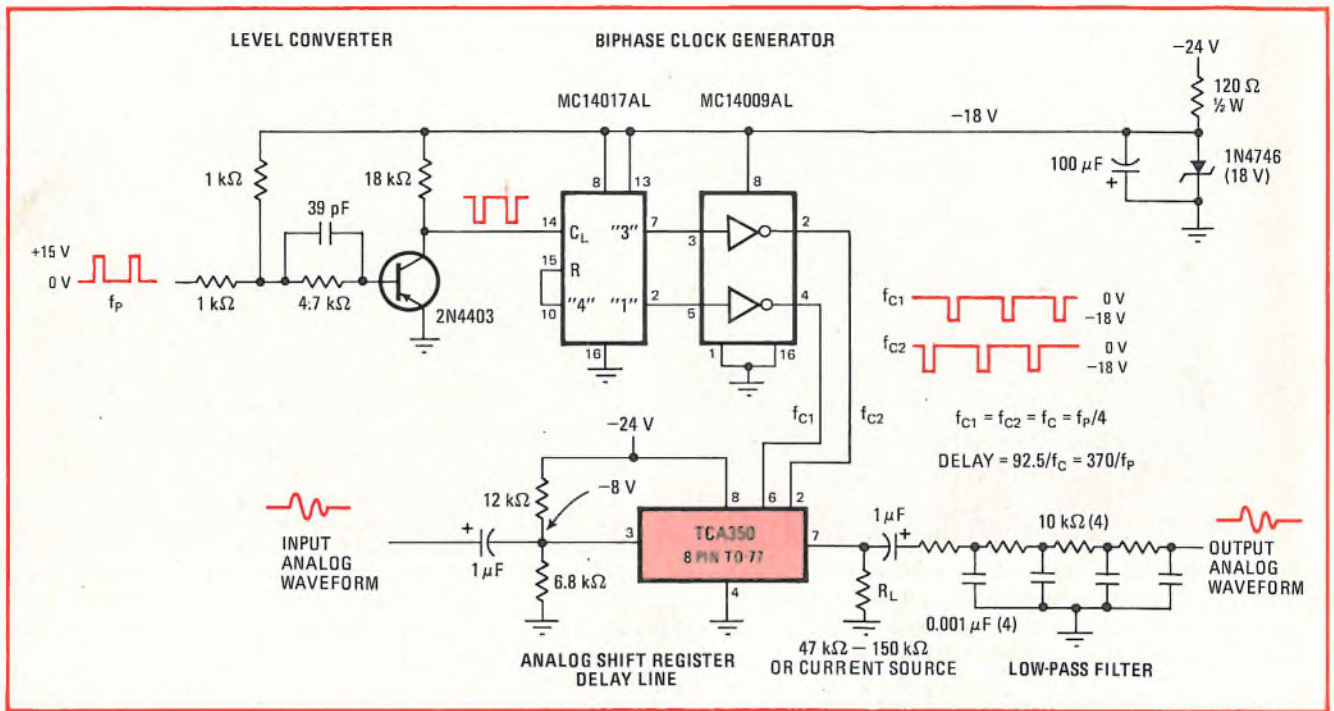

2. Circuit. The TCA350 analog shift register is an MOS charge-transfer device that requires two clock inputs. Clocks of required amplitude and phase relationship are generated by C-MOS divider plus inverters from a conventional input pulse train. Low-pass filter removes clock frequencies from output waveform. Note dc bias at input of delay line. Cascaded shift registers can delay signals for tens of milliseconds.

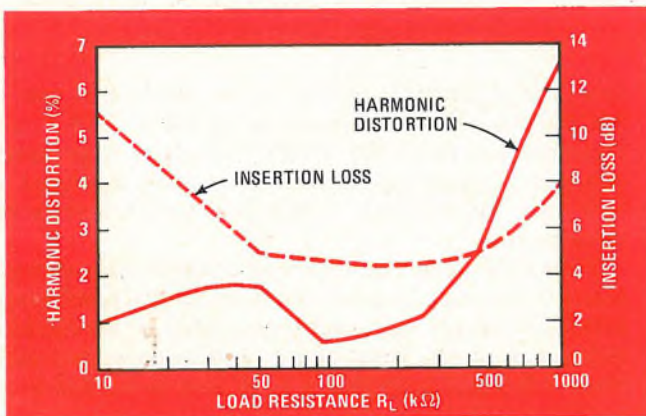

3. Load carefully. Harmonic distortion and insertion loss in circuit depend upon value of load resistor R_L , as shown. Data assumes that $f_s = 1$ kHz, $f_c = 46.25$ kHz, and input signal = 0.77 V rms.

ject the clock frequency and its multiples; the more rejection the filter provides at f_c , the better the wideband signal-to-noise ratio is.

Of course, if f_c is so high that the following system cannot detect it, the filter requirements are not as stringent. For the four-section RC filter shown in Fig. 2, the clock-frequency energy is down about 50 decibels from the maximum allowable output signal within the low-pass filter passband. If a more elaborate filter such as a multipole active filter is used, the clock energy may be reduced even further.

The cutoff sharpness of the low-pass filter determines the maximum amount of delay realizable because a sharp cutoff allows a lower f_c . With the four-section RC filter shown, the maximum delay before signal degradation is about 2 milliseconds. The minimum delay is

about 180 μ s. The longest practical delay is about 18 ms. With such a long delay, however, the signal is less than 500 hertz. Since the delay changes with clock frequency, the worst-case f_c must be determined when calculating the s/n ratio of the delay line.

The usable dynamic range of the shift register also depends upon the filter response and acceptable s/n ratio. The dynamic range of the shift register is greater than 70 dB when a sharp-cutoff filter is used to remove the clock frequency. The analog shift register tracked within 1 dB as the input signal level changed from 3 V to less than 300 μ V. The tracking error was measured in a filter bandwidth of 200 Hz, centered at 2 kilohertz. For input voltages above 3 V rms, the harmonic distortion exceeds 4%. For input amplitude levels of less than 0.5 V rms, the distortion is less than 0.5%. At higher input levels, clipping of signal peaks causes a distortion that is a nonlinear function of the input level.

The output stage of the TCA350 is a source follower that must be terminated in either a load resistor R_L or a constant-current load of about 0.5 milliampere. The relationship between harmonic distortion and load resistance is shown in Fig. 3; note that there is an optimum value for R_L . The distortion curve reflects a 0.2% distortion in the input signal plus the nonlinearity of the bucket brigade. If a current source is used in place of the load resistor, the current should be adjusted for minimum distortion.

Figure 3 also indicates that the attenuation of the input signal varies between 4 and 11 dB as the size of the load resistor is changed. □

Engineer's Notebook is a regular feature in Electronics. We invite readers to submit original design shortcuts, calculation aids, measurement and test techniques, and other ideas for saving engineering time or cost. We'll pay \$50 for each item published.

NAME 3 PRODUCERS OF HIGH VOLTAGE CERAMIC CAPACITORS

If you name ERIE first, you're right on target. For we produce a full line of quality High Voltage Ceramic Capacitors . . . 3kV to more than 30kV . . . in the capacitance value and temperature characteristic to suit your circuit needs. We have all sizes and shapes with the terminal arrangement you want. In fact, you name the application . . . chances are ERIE has a standard unit available. If not, let's talk about it.

You'll find ERIE HV Capacitors in electric utility transformers. Miniature power supplies. CRT displays. Lasers. Lightning arrestors. TV power supplies. Image intensifiers for night vision apparatus. Just about any application where high voltage is involved.

So look to ERIE first. When it comes to High Voltage Ceramic Capacitors, ERIE continues to lead the way. Your letterhead request will get you our new catalog HV/SC-200 . . . or call Customer Engineering at our State College, Pa. plant — 814/237-1431.

ERIE TECHNOLOGICAL PRODUCTS, INC.

Erle, Pennsylvania 16512

Circle 119 on reader service card

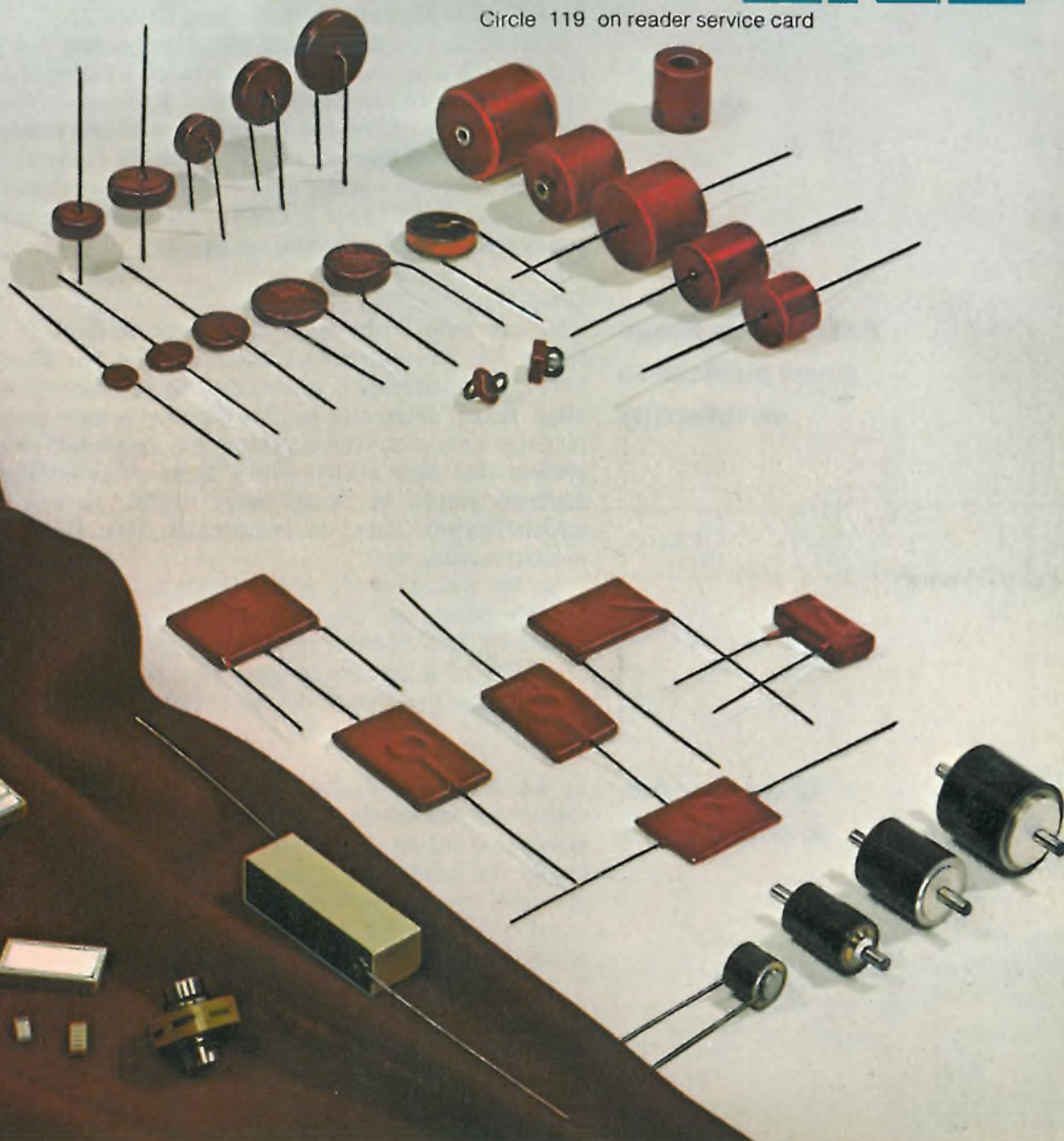

MOS is better than or as good as I²L in some respects

The new bipolar I²L chips may be a challenge to MOS LSI because of their high density, but their smaller gates do not necessarily result in smaller circuits, maintains Robert Crawford, a member of the technical staff at Mostek Corp., Carrollton, Texas. He points out that the MOS circuits have high input impedances that allow them to use long diffused tunnels for multilevel interconnects, while I²L circuits cannot use these tunnels as easily and therefore **may have to use more area for interconnection**. Crawford also points to the greater flexibility of MOS, which can employ wired-OR gates, while I²L is limited basically to NAND gates. Finally, he notes that MOS gates require fewer contacts each.

Additive pc boards evaluated; 10-mil lines can be die-stamped

How reliable are additive or semi-additive processes for printed circuit boards? A recent 62-page report from the Institute of Printed Circuits describes the results of extensive tests on four sets of 12 fully additive boards and eight sets of 12 semi-additive boards. Contributors include both in-house and OEM pc-board producers. For a copy, send \$5.00 to the IPC, 1717 Howard St., Evanston, Ill. 60202.

And while you're thinking about pc boards, did you know that lines just 10 mils wide can now be produced by simple die stamping? Stamped division of Jerobee Industries, Redmond, Wash., says it can supply **chemically milled dies to stamp out 10-mil conductors and 15- to 20-mil spacings on almost any pc substrate** covered by a thin, peelable layer of adhesive-backed copper foil. And a second firm, Rogers Corp. of Rogers, Conn., says it can supply die-stamped boards with 20-mil conductors and 25-mil spacing.

You can help shape a new publication on reliability

You can help both yourself and the Reliability Analysis Center of Rome Air Development Center, Griffiss Air Force Base, New York 13441, by answering a survey they're conducting on LSI, memory, and other recent technologies. To develop a new publication, the center recently sent out forms asking for **comments on devices in use at present and also asking which types of reliability data and analysis methods would be found most useful**. Among the categories are screen/burn-in data, environmental data, life-test data, and failure modes/mechanisms.

So far, RAC says about 400 forms have been returned and the most notable points are the high levels of interest in C-MOS circuits (mentioned by 88% of the respondents) and in methods for predicting the reliability of microprocessors. For a copy of the survey form, write to the center at the above address or call (315) 330-4151.

Chart provides soldering guide

To solder leads to a circular connector reliably, you need to **prepare the solder tool and conductor properly and to be careful over the application of heat**, soldering flux, solder alloys, the soldering technique itself, and finally the joint inspection. Extensive information on these factors is provided in a new wall chart that also shows cross-sectional drawings of standard inserts for Amphenol 97 series connectors. For a free copy, write Wayne Zimmerman, Amphenol Connector division, 2801 South 25th Ave., Broadview, Ill. 60153.

—Stephen E. Scrupski



THE IMPORTANCE OF BEING THICK-SKINNED AND SENSITIVE

Thick-skinned companies are less vulnerable.

Product managers are sticklers on performance.

Quality controllers are uncompromising. Engineers don't yield to technological fads. There's steadfastness in product promotion. And the bottom line is guarded by top management. Superior Electric is a thick-skinned company.

Sensitive companies possess uncommon awareness. Reactions to customer needs are fast and on-target. Concern for the environment is active. Workmanship is a matter of pride. Customers and employees are family. Superior Electric is a sensitive company.

Superior Electric. Controlling the motions in manufacturing with *SLO-SYN*[®] numerical controls. From economical 2-axis to contouring 4-axis models.

Open or closed loop. Program storage, memory files, tool length and diameter

compensation — you choose the options. And with *SLO-SYN* motors and drives. The entire range of *SLO-SYN* synchronous and stepping motors. Matched translator and preset indexer drives.

Rotary and positioning tables.

For information on Superior motion systems, write the thick-skinned,

sensitive company: The Superior Electric Company, 383 Middle Street, Bristol, Connecticut 06010. Or call 203/582-9561.



Superior Electric

We live up to our name.



PROFIT

...a few ways Belden can help you protect your bottom line.

Wire and cable usually cost less to buy than install. And poor performance can cut into profitability deeper than potential penny-per-foot savings on an initial buy.

Here's how Belden can help protect your bottom line performance.

BROAD LINE: We can help you meet toughest environmental and application requirements from an exceptionally broad line of standard wire and cable configurations, or design a special for you if stock answers won't work.

UNIQUE PUT-UP CAPABILITY: Ask about Belden's UNREEL™ packaging concept. A dispensing system that eliminates the reel. And time robbing snarls, backlash, and tangle problems. We have a number of ways to put-up wire that can save you production time and money.

ENGINEERING HELP: There's a Belden Electronic cable specialist near you. He's backed by factory engineering specialists and a Technical Research Center. You won't find a better source for solving cable problems.

HOT-LINE ASSISTANCE: Need a "right now" answer to a cable requirement. Call 317-966-6681. It's a direct-line to Belden's cable engineering facility. A way to get immediate assistance on problems that won't wait.

DESIGN KIT: If you're looking for design help, we have a kit that covers most of the nifty-gritty aspects of performance characteristics, costs, and material capabilities. Send for your kit, today.

GREAT DELIVERY: Belden has increased production capabilities and offers shorter lead times on most cable configurations. Check it out.

Profit protection is part of the Belden cable package. But, find out for yourself: Write: Belden Corporation, Electronic Division, P.O. Box 1327, Richmond, Indiana 47374.

855

... new ideas for moving electrical energy

BELDEN 

Circle 122 on reader service card



Logic-board tester is easy to use

Push-button programming and pseudo-random input signals combine to simplify testing of 128-pin boards at bit rates up to 4 MHz

by Andy Santoni, Instrumentation Editor

Whether in production-line testing or field service, a logic-board test system must be so simple to use that there is no need for highly skilled, technically trained operators. Otherwise, the costs may outweigh the benefits of high-speed automatic testing.

Fluke Trendar's approach to lowering the cost of test-system operation is to simplify the method used to set up the system for each board type. This includes both programming and interface fixturing.

The model 3010A provides eight types of signals that can be programmed onto any of 128 pins to make up the pseudo-random sequences necessary to test a logic board. The number of level transitions at the board's outputs is counted and compared with the output count of a known-good board for go/no-go functional testing.

Fast and slow pulse generators each provide 64 pseudo-random pulse streams ranging from long duty cycles to pulse bursts at the maximum clock rate. Fast, slow, and medium-speed data generators each provide 64 signal sources with pseudo-random data sequences. Nonsimultaneous square waves with descending binary frequencies are available at 24 Gray-code clock sources, and eight pulse streams of the same frequency operating in nonsimultaneous phases are available from the eight-phase clock generator. A reset line provides a one-time pulse for initialization.

The stimuli signals can be strobed into the unit under test at rates from 100 to 4,000,000 words per second, with transistor-transistor logic levels or programed levels from 5 to 15

volts. All signal transitions are non-simultaneous to avoid indeterminate circuit responses and races.

Instead of using computer-language software, the 3010A is programmed by means of a calculator-like keyboard. Each pin may be designated either an input or an output, and for each input pin the test signal type and initial polarity may be selected.

Information is stored in the tester's memory as it is entered on the keyboard. When patterns have been selected for all input pins on the unit under test and the program has been examined and debugged, a magnetic-stripe card the size of a standard credit card is inserted into the tester. The test program can then be written from tester memory onto the magnetic stripe by operating a key switch, and the card becomes the storage medium for the program that corresponds to one unit-under-test type.

Neither pin matrices nor specially wired adapters are necessary to change from one card type to another. The adapter from the 3010A's

front panel connector to the circuit board's mating connector is a simple, pin-for-pin-wired jig.

If a circuit board fails go/no-go testing, the 3010A can be used to locate the faulty component. Since the correct output transition count for groups of output pins, as well as for all output pins, is stored in the tester's memory, groups of outputs can be checked until a defective group count is found. The operator can then probe individual output pins and backtrack along signal paths to locate a defective node.

The rack-mountable model 3010A, which is priced at \$12,900, operates from 117 volts, 60 hertz or, optionally, 100 to 240 v, 47 to 440 Hz. Since the programming panel is detachable, the system can be operated as a complete programming/test station or as a test-only station. A slide-out work-surface shelf is built in, as shown.

Fluke Trendar Corp., 500 Clyde Ave., Mountain View, Calif. 94040 [338]



IC runs complex radio

LSI chip minimizes knobs, switches and wiring; lets OEM give user various sleeping, waking options

by Ron Schneiderman, New York bureau manager



Encouraged by the sales of its metal-oxide-semiconductor clock and clock/alarm circuits for the OEM consumer market, General Instrument's Consumer Products division has expanded the line with a new multifeature n-channel MOS device for digital clock radios. The circuit, which embodies some 16 design and 15 user functions on a single chip, is built specifically for a light-emitting-diode direct duplex drive display. It offers designers of digital clocks many different options in developing a product that meets their company's requirements and product image.

Designated the CK3300, the GI large-scale integrated circuit is 147 mils square. It contains all the logic, contact-noise-elimination functions, control switching, segment drivers, and timing features that are needed to implement several fairly sophisticated functions with clock radios having 4-digit LEDs.

Normally, it's extremely difficult to eliminate radio frequency interference from the digital electronics used in radios. But GI claims that special care taken in LSI design vir-

tually eliminates the rfi problems. Trevor Chatfield, managing director of GI's Consumer Products division, says the largest rfi problem in display-driving has been solved by using a novel technique—half-line cycle anode duplexing, using the half-sine waves produced by two diodes and simultaneously ensuring that all segment-data changes occur during the zero crossings of the line cycle. The technique, says Chatfield, allows brightness to be controlled quite simply, either by using a potentiometer to resistively divide down the line voltage or by using a transformer tap in a two-level scheme.

Segment-driving of the two groups is directly from the IC through 50-ohm switches. This keeps current peaks high, as is necessary for LEDs up to 1 inch high, and also keeps the IC power dissipation down to the 200-to-250-milliwatt level, as is necessary for reliability.

One of the features built into the chip is the combination of several functions in a single switch, which reduces not only the number of knobs and switches in the radio but also the amount of wiring. For instance, simply pushing a button will either turn the radio off or turn it on again if it has gone off automatically but the user is not yet asleep and would like to continue listening.

The alarm may be a buzzer tone or the radio turning on at a preset volume. The first time the alarm turn-off button is pushed, the radio will switch to a low volume. The second time, the radio turns off, and the third time the radio returns to low-volume reception. If, after the

button has been pushed once, the radio is left untouched, it will return to the "wake" volume after five minutes. And if, after the button has been pushed twice, the radio is still left untouched, it will stay off for five minutes, then return to the "wake" volume.

In addition, the "wake" volume, if left alone, will be maintained for 80 minutes unless the radio is returned to radio ON or radio OFF switch position. Changing the switch momentarily from auto to ON or OFF and back to auto will reset the alarm and re-request the alarm for the same time the next day. This cycle can be maintained indefinitely if the button is pushed before the 80 minutes elapses.

Error alarm. The chip also has a standby mode. If a circuit is deployed to change the IC power source to a battery during a line failure, which can be detected by the failure of an oscillator, then the IC will maintain operation to an accuracy of within 30 seconds per hour during the failure, according to GI. On returning to power up, an indicator notifies the user that the displayed time could be in error.

The new GI CK3300 chip also enables a digital clock to automatically turn on any electrical equipment, like a tape recorder, at any precise time setting, to record programs of up to two hours. Another feature is a pre-alarm switch that can, for example, turn on a coffee pot five minutes before alarm time.

According to Chatfield, the device has not yet been priced. Samples will be available in September.

General Instrument Corp., 600 West John St., Hicksville, N. Y. 11802 [339]

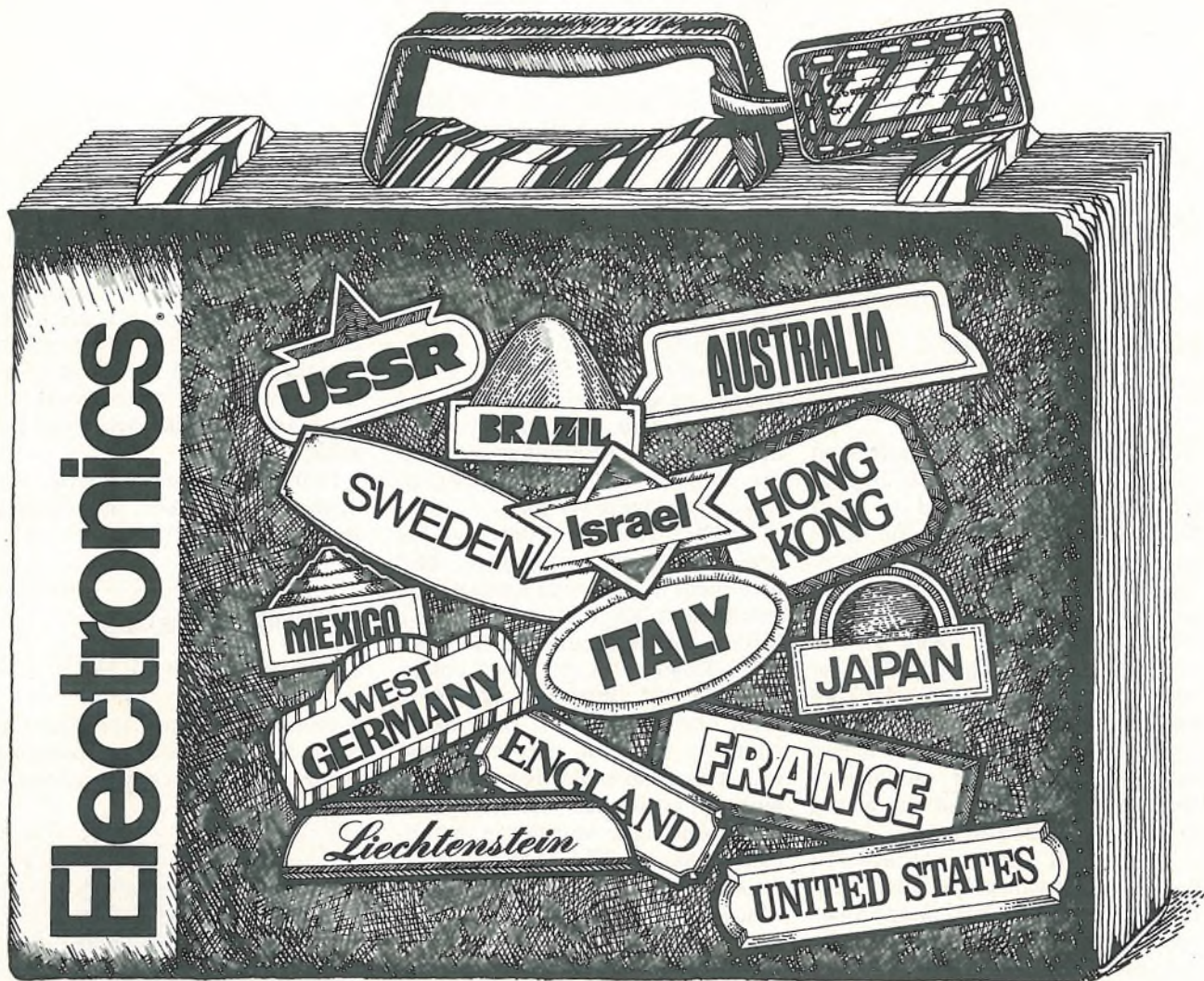

What are your colleagues doing
around the world?

Find out in **ELECTRONICS**.

Go first class. Go to **ELECTRONICS** and you'll find out first hand where the biggest growth potential is today. And where it'll be tomorrow.

ELECTRONICS knows, because its 31 editors, 11 World News Bureaus and 200 correspondents make it their business to stay on top of what's happening in the ETM—the Electronics Technology Marketplace—worldwide. Only **ELECTRONICS** offers readers annual market reports and forecasts on Japan and Europe as well as the U. S.

ELECTRONICS is *the Source*, disseminating information, and establishing and maintaining communications among people in electronics,

wherever in the world those people may be.

We sell over 86,000 subscriptions to 122 countries all over the globe. You should be getting your own copy of **ELECTRONICS** right off the press because the world of electronics—your world—is between the covers of **ELECTRONICS** magazine.

Fill out the enclosed subscription card and send it off. **ELECTRONICS** is the one magazine you can't afford to be without.

Electronics 
IS THE SOURCE.

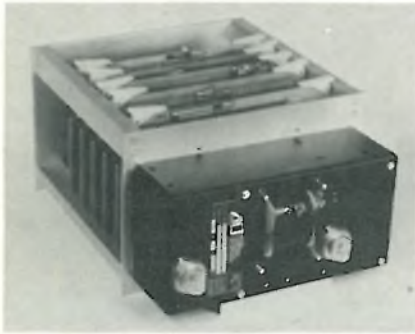

computer products. The package consists of an aluminum card cage with 15 card locations, a universal CPU board, a universal program-able-ROM board, and six connectors. The CPU board contains the central processing unit, the crystal-controlled clock circuitry, 256 words of scratchpad memory, 32 inputs, and 28 outputs. Various additional modules such as extra memory and specialized input/output boards are available. The basic system sells for \$695 and has a delivery time of 30 days.

Applied Computing Technology Inc., 17961 Sky Park Circle, Irvine, Calif. 92707 [363]

\$195 scientific pocket calculator is programable

Selling for half the price of Hewlett-Packard's previous lowest-priced programable pocket calculator, the HP-25 is a six-ounce scientific machine that can store up to 49 program steps in its solid-state memory. Priced at only \$195, the calculator has several features new to the HP line, among them an absolute-value



**NEW!
MINI-BREADBOARD
BUDGET KIT
FOR THE ECONOMY-MINDED
EXPERIMENTER . . .**

**Proto 100
Board**

Patent Pending
Made in USA

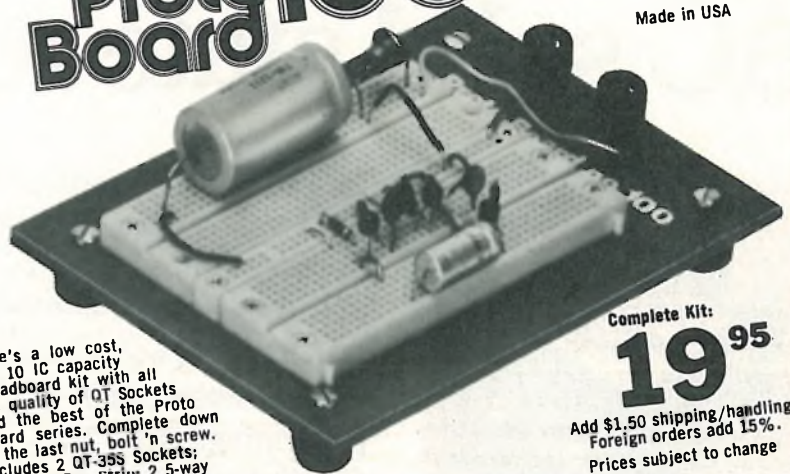

Here's a low cost, big 10 IC capacity breadboard kit with all the quality of QT Sockets and the best of the Proto Board series. Complete down to the last nut, bolt 'n screw. Includes 2 QT-35S Sockets; 1 QT-35B Bus Strip; 2 5-way binding posts; 4 rubber feet; screws, nuts, bolts and easy assembly instructions. Order off-the-shelf today from CSC or local distributor. Charge: BAC, MC, AX. Write for free catalog. Free English/Metric Slide Rule with each order. Dealer inquiries invited.

Complete Kit:

19⁹⁵

Add \$1.50 shipping/handling.
Foreign orders add 15%.
Prices subject to change

**CSC Continental
Specialties Corp.**
Box 1942, New Haven, CT 06509 • 203/624-3103
W. Coast Off.: Box 7809, S. Fran., CA 94119 415/383-4207
Canada: Available thru Len Finkler Ltd., Ontario

Circle 127 on reader service card

LOGIC SERIES No. 2

HOW TO WORK LS INTO YOUR SYSTEM

Send today for your FREE Designers' Guide. Just what the doctor ordered to relieve the power grab with LS. Includes detailed info on existing-system upgrading, and designing the new. Plus 85 data sheets on available LS standard and MIL parts.

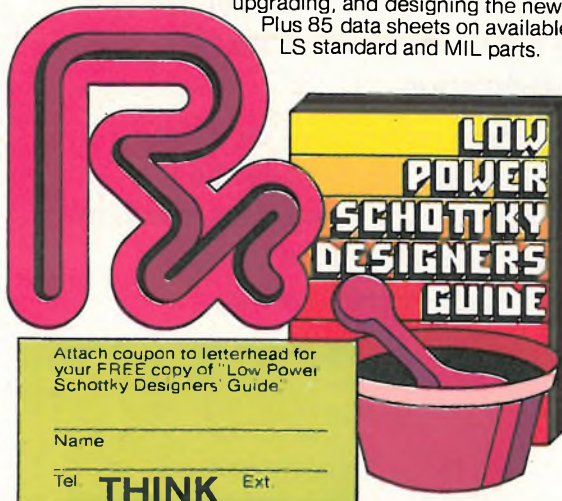

Attach coupon to letterhead for your FREE copy of "Low Power Schottky Designers Guide"

Name _____

Tel **THINK** Ext. _____

Signetics

811 E. ARQUES, SUNNYVALE, CALIF. 94086

An extra margin of safety: our 611 Series AC solid state relays.



U.L. recognized

Life sustaining artificial kidney machines using sensitive low level IC logic to monitor temperature controls demand the utmost in safety and reliability. And that's just how the Teledyne 611 Series of solid state relays are made to perform.

What's more, we've broadened the line to include both ac and dc input ranges and load ratings of 10, 25, and 40 Amps. All versions provide high output transient immunity — 100 V/

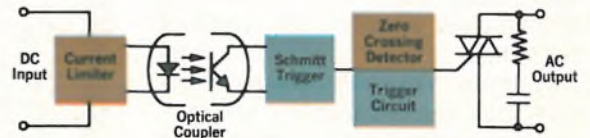

Typical Functional Diagram

μ sec guaranteed minimum dv/dt with 200 V/ μ sec typical. And we've added an optional 600-volt transient withstand capability for ultra-high immunity from false triggering caused by over-voltage transients.

All Teledyne 611s are optically isolated, and feature zero voltage turn-on to reduce RFI. For added safety, we've encased each relay in a rugged, high-impact package with recessed connections that include both quick-disconnect and screw terminals. And in case you haven't heard, we're not the only ones with this package configuration.

All in all, if it's true reliability you want, there's a Teledyne 611 ready to do the job ... in medical electronics, computers, machine tool or process controls. For technical assistance and fast delivery, call us.



Drake-Willock Dialysis System
Photo courtesy of DWS, Inc.

TELEDYNE RELAYS

3155 West El Segundo Boulevard, Hawthorne, California 90250
Telephone (213) 973-4545

New products

function, a pause control, an integer/fraction truncation function, and engineering notation, which is like scientific notation except that it shows only powers of 10 that are multiples of three. The HP-25 can display up to 10 digits in fixed notation but only eight digits in scientific or engineering form. Like earlier HP scientific calculators, the new machine uses reverse Polish notation and a four-register memory stack. It contains 72 pre-programmed functions and operations, including all logarithmic and trigonometric functions, polar-to-rectangular and rectangular-to-polar conversions, and mean and standard-deviation calculations. The calculator comes with a 162-page book of applications programs. Deliveries are scheduled to begin this week.

Inquiries Manager, Hewlett-Packard Co., 1501 Page Mill Rd., Palo Alto, Calif. 94304 [365]

Medium-speed card reader
is highly reliable

Able to process 400 cards per minute, the model 300 card reader uses about half the number of parts of competitive devices and hence has an expected lifetime of 15,000 hours (about five years) with a mean time between failures of 3,000 hours. The machine's use of a single drum to pick cards, transport them past a fiber-optic reader, and stack them not only makes the reader very reliable, it also permits it to read stained and damaged cards at a low error rate. The model 300 sells for \$1,980; delivery time is 60 days.

True Data Corp., 2701 S. Halladay, Santa Ana, Calif. 92705 [366]



Dearest Darlington



For space, and weight saving designs the high gain 2N6282 thru 87 series of STC monolithic NPN and complementary PNP Darlington Power Transistors feature a gain of 100 at 20 Amps, and VCEO sus. up to 100 Volts.

Whatever your power transistor needs you can get the *RIGHT* one.

FROM



SILICON TRANSISTOR CORP. ... THE POWER SOURCE

KATRINA ROAD, CHELMSFORD, MA 01834 (617) 256-3321

Get complete data on these and other STC Power Transistors

Circle 129 on reader service card

ANALOG SERIES No. 1

USE DMOS FETS FOR CLEANEST ANALOG SWITCHING.

DMOS, the key to transient-free switching. DMOS analog switches boost state-of-the-art performance with lowest parasitic capacitances, low on-resistance (30Ω) and high speed (1.5ns). SD210 series for singles; SD5000 for quads.

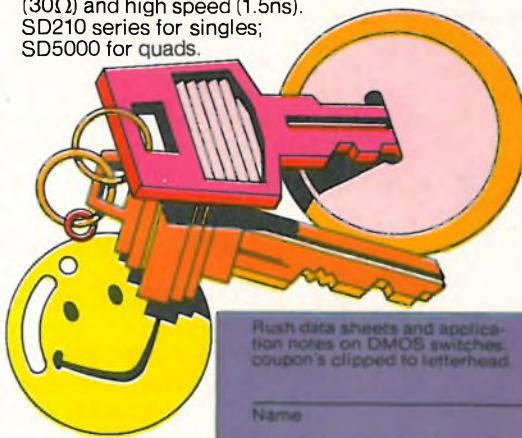

Rush data sheets and application notes on DMOS switches, coupon's clipped to letterhead.

Name _____

Tel. _____

Ext. _____

THINK

Signetics

811 E. ARQUES, SUNNYVALE, CALIF. 94086

Microwave

Magnetron puts out 800 kW

High-power magnetrons producing several hundred kilowatts of peak output power usually weigh about 130 pounds and require liquid cooling. The size and weight make them difficult to handle and install and increase the possibility of damage during installation.

To minimize these problems, Varian uses high-energy-product magnets of the Alnico family in its VMS-1197, an 80-pound forced-air-cooled S-band coaxial magnetron. Also, the high-power dissipating components are located adjacent to the air-cooling heat exchanger and provide a compact form factor.

Designed for remotely tuned systems, the VMS-1197 delivers 800 kilowatts of peak power over the range of 2.7 to 2.9 gigahertz, with duty cycles to 0.0017. A typical time jitter of less than 5 nanoseconds rms makes the tube suitable for moving-target-indicator systems.

To insure a minimum lifetime of 10,000 hours, the VMS-119 has a

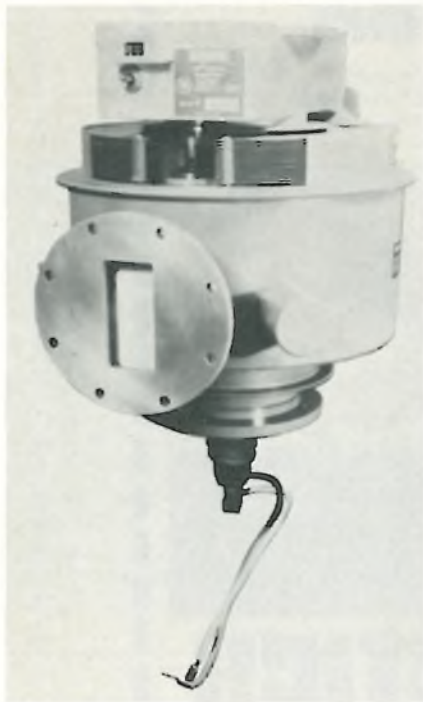

ruggedized filament/heater structure. A number of individual filaments, all in parallel, are used instead of a single filament strand, so that loss of one strand won't end the magnetron's life.

Price of the VMS-1197 has not been set. Delivery time is five months.

Varian/Beverly, Salem Rd., Beverly, Mass. 01915 [401]

Solid-state power amplifier covers 400 to 520 MHz

Intended for use over the 400-to-520-megahertz mobile communications band, models in the

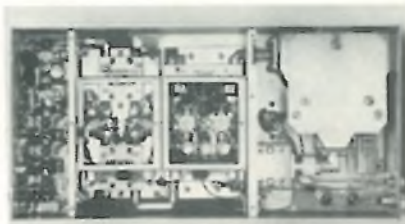

PWA4050 series of solid-state amplifiers come with output-power ratings of from 5 to 200 watts. All models in the series are Class C units that require only 1 milliwatt of input drive to produce full output power. They have an instantaneous bandwidth of 120 MHz and a maximum input VSWR of 2:1 (1.5:1 typical) and can work continuously into any load. Prices range from \$1,650 to \$7,175 depending upon power rating.

Microwave Power Devices Inc., Adams Court, Plainview, N. Y. 11803 [404]

Oscillator produces 5 mW from 8 to 12 GHz

Voltage-controlled oscillator model WJ-2835-25 is a varactor-tuned unit with a minimum power output of 5 milliwatts across the 8- to 12-gigahertz band. Requiring a tuning voltage of from 0 to -40 volts to cover its full frequency range, the oscillator includes a built-in voltage



regulator that keeps frequency-pushing below 0.1% per volt. A proportionally controlled dc heater gives the device a temperature coefficient of less than 30 ppm/°C. The oscillator, which weighs only 12 ounces, also contains a frequency-doubling push-pull rf section and a two-stage isolator. It has an operating temperature range of from -54 to +71°C. Its price is \$1,825 in small quantities. A linearized version, the WJ-2835-26, is also offered.

Watkins-Johnson Co., 440 Mt. Hermon Rd., Scotts Valley, Calif. 95066 [403]

'Drop-In' mixers fit into microstrip circuits

A series of double-balanced mixers that cover the frequency range from 1 to 18 gigahertz are manufactured in a Drop-In form for easy incorporation into microstrip and stripline designs. Called the DMD series, the units have an i-f range of dc to 8 GHz (with dc to 300 MHz standard), a nominal rf VSWR of 2:1, a noise figure of 7.5 dB, and at least 20 dB of



isolation between the rf and local-oscillator ports. Prices start at \$140. A typical multi-octave unit is the DMD4-8 (shown on p. 130) with an rf range of 4 to 8 GHz, an i-f range of dc to 1 GHz, and at least 30dB of LO-to-rf isolation.

RHG Electronics Laboratory Inc., 161 E. Industry Court, Deer Park, N. Y. 11729 [405]

Bandpass filters have only 0.01 dB of ripple

Available with center frequencies from 1.7 to 2.4 gigahertz, the series S1502 bandpass filter has a constant 0.1-dB bandwidth of 20 megahertz and no more than 0.01 dB of in-band ripple. The six-section Tchebyscheff design has a maximum insertion loss of 1 dB and maximum input and output VSWRs of 1.25:1. Stopband attenuation is at least 50 dB for frequencies 40 MHz from the center frequency and at least 70 dB for signals 70 MHz from f_0 . Similar filters for use in other frequency bands can be furnished.

Delta Microwave Inc., 790 Hampshire Rd., Building D, Westlake Village, Calif. 91361 [406]

Multi-throw p-i-n diode switches span 0.2 to 18 GHz

A series of single-pole multi-throw switches spans the frequency range from 0.2 gigahertz to 18 gigahertz. The p-i-n diode devices come in two-, three-, four-, and five-throw versions and are available either with or without integral TTL-compatible drivers. The M87 series is noteworthy for its low insertion loss, and all models meet military stan-



19¢*
ea.

An integrated bridge rectifier in a miniature dual in-line package

DIB
DUAL IN-LINE BRIDGE

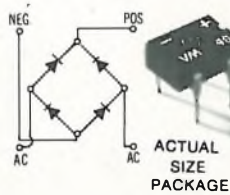

- 4-pin, low-profile DIP
- Leads on standard .10" (2,54 mm) grid
- Compatible with automatic testing, handling and inserting
- 1 Amp at 40°C (I_o)
- 25V to 1000V (V_{RRM})
- Call Lee Miller 214/272-4551, Ext. 206 for more information.

* 100V; 100,000 qty.

Design us in . . . we'll stay there

VARO SEMICONDUCTOR, INC.

P. O. BOX 676, 1000 N. SHILOH, GARLAND, TEX. 75040 (214) 272-4551 TWX 910-860-5178

Circle 131 on reader service card



ANALOG SERIES No. 2

**AT LAST:
HIGH-CURRENT REGULATORS
WITH
SHORT CIRCUIT PROTECTION.**

You've asked for high power capability requiring fewer external parts. Our field-proven 7800 series delivers. Unique voltage regulators with short circuit protection that really works. 7 voltages from 5-24V; TO-220 or TO-3.

Send me full specs on 7800 voltage regulators; coupon's attached to my letterhead

Name _____

Tel _____

Ext _____

THINK

Signetics

811 E. ARQUES, SUNNYVALE, CALIF. 94086

VACTEC brings you BLUE



Unlike our little Japanese friend, photodetectors have always been insensitive to blue. Until now.

Vactec's latest development is a new Blue Enhanced Silicon (BES) photodiode with exceptionally low dark current for efficient response in the blue region (200 - 400 nm). Made in Missouri, U.S.A., it performs equally well in an expensive Japanese SLR camera or in an American-made colorimetric analyzer as well. And you'll like the price, which could be as big a breakthrough as blue sensitivity. Vactec also introduces a new line of PIN photodiodes that operate at high voltages, low noise levels, and fast rise times, with about half the blue sensitivity of the BES photodiode. For larger areas, Vactec offers a complete range of Blue Enhanced Silicon photovoltaic cells up to 1 1/8" diameter.

Vactec now supplies the broadest line of photodetectors in the industry, including:

- silicon solar cells
- hi-speed / low-leakage silicon cells
- NPN phototransistors
- NPN photodarlingtons
- CdS & CdSe photoconductors
- CMOS & bi-polar custom ICs
- opto-couplers
 - a) LED/photoconductor
 - b) LED/phototransistor or darlington
 - c) lamp/photoconductor
- selenium photovoltaic cells

Call or write today:



Vactec, Inc.

**2423 Northline Industrial Blvd.
Maryland Heights, Mo. 63043
(314) 872-8300**

Circle 132 on reader service card



New products

dards for high resistance to hostile environmental conditions.

General Microwave Corp., 155 Marine St., Farmingdale, N. Y. 11735 [407]

Diplexer building blocks
yield broadband multiplexers

By assembling standard diplexer modules into contiguous multiplexers, Acronetics has developed a series of multiplexers in the frequency range from 500 megahertz



to 18 gigahertz. The devices have bandwidths of up to 1 octave per channel with crossover regions equal to $\pm 5\%$ of the crossover frequency. The units have low insertion loss, high out-of-band rejection, and can operate in a MIL-E-5400 Class II environment.

Acronetics, 470 Persian Dr., Sunnyvale, Calif. 94086 [408]

1-2-GHz circulator
occupies only 3.5 in.³

Measuring only 2 by 2 by 0.875 inches, the model 50A1001 circulator spans the frequency range from 1 to 2 gigahertz. Believed to be the smallest such circulator ever built, the unit has a minimum isolation of 17 dB, a maximum insertion loss of 0.6 dB, and a maximum VSWR of 1.35:1. The ferrite device has an operating temperature range of 0 to 50°C and weighs only 12 ounces. Unit price is \$250.

Trak Microwave Corp., 4726 Eisenhower Blvd., Tampa, Fla. 33614 [409]

Your Circuit. Our Hybrid.



If you're thinking of having your circuit made in hybrid packaging, HyComp's experience in thin-film circuitry is your competitive edge. HyComp hybrids are used today in many of the leading industrial and military systems.

D/A and A/D converters, signal conditioners, instrumentation amplifiers, multiple amplifier configurations, S/D and D/S converters, function generators, as well as thousands of custom precision resistor networks . . . are part of HyComp's production each week.

HyComp



HyComp, Inc.
146 Main Street
Box 250
Maynard, MA 01754
(617) 897-4578

Call us at (617) 897-4578 for applications assistance and literature on our standard products. Perhaps we've already made your circuit . . . in our hybrid.

Circle 133 on reader service card

MEMORY SERIES No. 1

THE DO-IT-YOURSELF 2K PROM



Program it on your own home ground. With our big, fast, Field Programmable 512x4 PROM. #82S130/131. Twice the memory for your money: 2048 bits with same pins, same high performance rating as a 1K PROM.

Coupon clipped to letterhead gets you data sheet on #82S130, 131-2K PROM

Name _____

Tel _____

Ext _____

THINK

Signetics

811 E. ARQUES, SUNNYVALE, CALIF. 94086

New products

Instruments

Synthesizers are fast and quiet

50-megahertz units can switch in 200 microseconds without transients

Offered in two styles—a general-purpose laboratory version and a systems-oriented type—the 3300 series programable frequency synthesizer is a relatively inexpensive instrument with a frequency range of 10

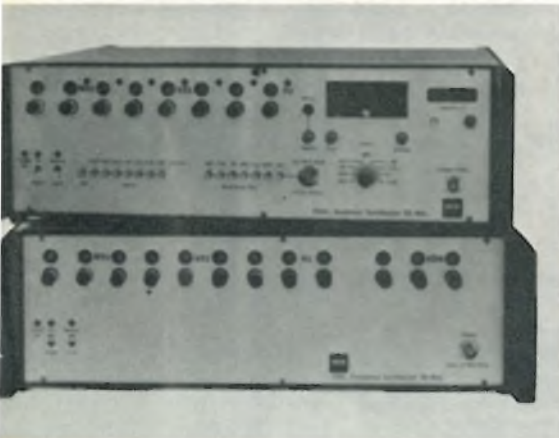

hertz to 50 megahertz, a switching time of 200 microseconds, and a total phase noise measured in a 30-kilohertz band, excluding the 1-Hz band centered on the carrier, of -62 decibels referred to the carrier. The price of the synthesizer is \$3,450 for the systems-oriented model 3310 and \$4,200 for the more versatile 3300.

The 3310 provides for remote programming of both amplitude and frequency and covers its frequency range in 0.1-Hz steps. The 3300 has remote control of frequency only, and its resolution is 1 Hz. However, the 3300 offers internal and external a-m and fm capability, with a search mode for the fm, and has a meter for displaying percentage of modulation and output level. Internal modulation frequencies are 50, 400, 1,000, and 4,500 Hz. The search con-

trol, which sets maximum deviation limits for fm, can be varied in decade steps from ± 1 Hz to ± 1 MHz. Modulation percentage can be varied by means of a front-panel potentiometer from 0 to 90% for a-m and from 0 to 100% for fm.

Both synthesizers offer transient-free remote-control frequency switching by means of TTL-compatible binary-coded decimal signals. Front-panel controls for manual switching are also provided. Frequency drift is less than 2 parts in 10^8 per day and, after 1 month of continuous operation, less than 5 parts in 10^9 per day. A maximum drift of 2 parts in 10^{10} per day is available as an extra-cost option. For even better accuracy, provision is made for phase-locking the synthesizers to an external atomic standard.

Common to both instruments is a maximum output power level of +20 dBm adjustable downwards to -129.9 dBm. The model 3310 provides remote control of attenuation in 0.1-dB steps, while the 3300 provides 10-dB steps plus coarse and fine adjustments.

The signals produced by both units are very clean with harmonics at least 40 dB down and spurious signals at least 80 dB below the carrier. Phase noise in a 1-Hz band located 1 kHz from the carrier is 110 dB down, dropping to 125 dB down 100 kHz from the carrier.

Adret Corp., 1887 Lititz Pike, Lancaster, Pa. 17601 [351]

35-MHz delayed-sweep scope weighs 10.5 lb

Easily portable at 10.5 pounds, the model 335 oscilloscope is a 35-megahertz dual-trace, delayed-sweep instrument with a sensitivity of 1 millivolt per division and a maximum rise time of 14 nanoseconds. (On its three most sensitive gain ranges—1, 2, and 5 mv/div—the scope has a bandwidth of only 25 MHz.) Complete with input delay lines, variable trigger hold-off, and a Z-axis input, the 335 can operate



from a wide range of power sources: 100, 115, 120, 200, 230, and 240 v ac plus 11 to 14 v dc and 22 to 28 v dc. The ac voltages can be at any line frequency from 48 to 440 Hz, and all have a tolerance of $\pm 10\%$. The 335 sells for \$1,825; delivery is from stock.

Tektronix Inc., P. O. Box 500, Beaverton, Ore. 97005 [353]

Compact chart recorder has full 10-inch width

The 3½-inch-high Speedomax XL630 chart recorder uses 10-inch chart paper to read out analytical data at high resolutions. Available in one- and two-channel versions, the recorder can have either right-or-

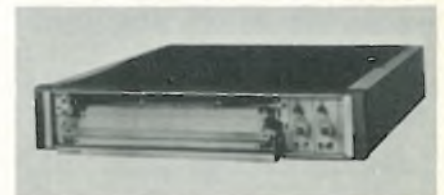

left-hand zero and up to 10 chart speeds. The instrument may be calibrated in either English or metric units and may be specified for rack, panel, or bench mounting.

Leeds & Northrup Co., Mail Station 210, North Wales, Pa. 19454 [356]

Spike/notch filter has simultaneous outputs

A variable-frequency band-pass and band-reject filter has separate, simultaneously working outputs for its spike and notch filters. Thus, if



the filter is tuned to the fundamental frequency of a square wave, for example, the band-pass output will contain the fundamental frequency, and the band-reject output will contain all the harmonics. The filter can be tuned over the frequency range from 0.1 to 10,000 Hz, and its Q factor can be varied from 2 to 100. The model 401 is priced at \$770; deliveries are from stock to three weeks. A. P. Circuit Corp., 865 West End Ave., New York, N. Y. 10025 [354]

Directional power meter spans 25 to 1,000 MHz

Requiring just one power head to cover its full frequency range of 25 to 1,000 megahertz, the NAUS-80A

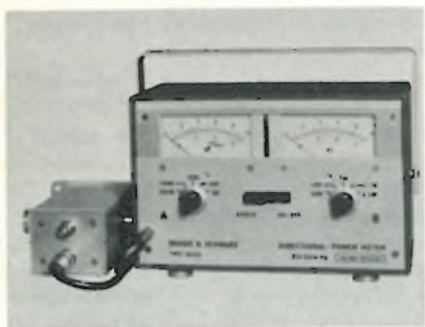

is a directional power meter that can read from 20 milliwatts to 320 watts. Priced at \$750 in the United States, the instrument has a two-meter configuration that allows it to read incident and reflected power simultaneously, thus cutting measurement time to a minimum. Its two meters have linear scales and independent range-setting controls. The portable, battery-operated unit can work for more than 7,000 hours from one set

Look what \$595 buys!

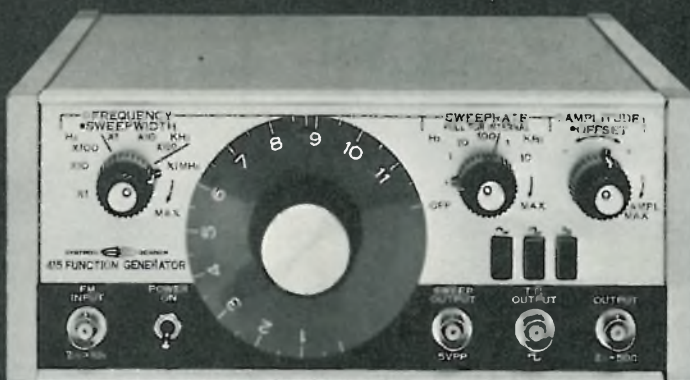

New 11 MHz sweep/function generator

Only Systron-Donner offers a 11 MHz sweep function generator at such an inflation-defying price. Inexpensive, yes, but look at these Model 415 features: **Frequency** in 7 decade ranges from 0.01 Hz to 11 MHz • **Dial accuracy** 1% of full scale typical **Waveform outputs:** sine, square, triangle, ramp and a T'L compat-

ible sync pulse square wave. **Plus:** The same instrument without internal sweep (Model 405) costs just \$495. Of course, it can still be swept externally. For details, contact your nearest Scientific Devices office or Systron-Donner at 1 Systron Drive, Concord, CA 94518. Phone (415) 676-5000.

SYSTRON  DONNER

Circle 135 on reader service card

MEMORY SERIES No. 3

SUPER GIVEAWAY: 6 YEARS OF PROM RESEARCH



FREE for the asking: our PROM reliability report. The kind of hard-nosed data you need on nichrome fusing, and the critical conditions governing rel maximization. A strong evaluation of our PROM research, further supporting RADC findings.

FREE COPY of Signetics PROM Reliability summary attach coupon to letterhead

Name _____

Tel _____

E-t _____

THINK

Signetics

811 E. ARQUES, SUNNYVALE, CALIF. 94086



Make the Most of the Upturn!

Plan now to make the most of the forecasted economic upturn. If you make electronic circuits, we can help. Giants of the industry use our in-circuit test systems to slash testing and troubleshooting costs, increase product yield and improve their profit margin.

These are impressive benefits anytime. Especially when you are planning for increased production. Why get back into the inefficient production turmoil of 1974 when we can help you streamline your manufacturing operation?

One of the many beautiful things about a Faultfinders in-circuit test system is that it does its job faster and more efficiently than the most expert of test technicians, and at far less cost! Its job is to electrically test individual parts of a circuit through probes on each side of the part to be checked. In-circuit test systems are programmed for automatic operation and use multiple-pin fixtures to establish test points.

A most significant feature of our in-circuit test system is the fault printout which supplies complete data for really economical circuit repair. Because our systems test one-part-at-a-time, fault isolation is specific and en-

tirely automatic despite the increased complexity of electronic circuits.

Our test systems operate at a fixed cost, they knock down manufacturing costs and keep them pegged at a reasonable level. They are the best way to combat constantly rising labor costs.

Now is the time to install a Faultfinder test system in your production line.

- *There will be less disruption of your production schedule.*
- *You now have the best tax incentives for capital outlay.*
- *The prime interest rate will never be lower.*
- *Our lead time for test systems and optional equipment is the shortest ever.*
- *Your production line will be operating at maximum efficiency before the orders start stacking up.*

A phone call to any of our Faultfinders offices will bring you more information and a demonstration of in-circuit testing which can prove that you can achieve more profit, better products and a more secure place in the marketplace.



WORLD LEADER OF IN-CIRCUIT TESTING

FAULTFINDERS Inc.

15 AVIS DRIVE, LATHAM, NY 12110 (518) 783-7786

Irvine, CA (714) 549-4901
 Sunnyvale, CA (408) 732-9020
 Park Ridge, IL (312) 696-0335
 Dallas, TX (214) 423-7731

Cicero, IN (317) 984-4903
 Waltham, MA (617) 890-4717
 Alexandria, VA (703) 451-5558
 Faultfinders GmbH, Eschborn, Germany 06196/44008

A1637524

Circle 136 on reader service card

New products

of five D cells. It carries a five-year warranty.

Rohde & Schwarz, 14 Gloria Lane, Fairfield, N. J. 07006 [355]

Self-scanning WWV receiver needs no monitoring

Unlike most radios designed to receive the standard time signals broadcast by WWV and WWVH, the model TF-4 will retune itself to a new frequency if the channel to which it has been tuned fades out. Supplied with standard receiving frequencies of 5, 10, 15, and 20 megahertz, the instrument can either be tuned to any one of them or put into an automatic mode in which it scans for a clear channel and locks onto it. The receiver has a gated tone filter which allows the selection and identification of all six tones broadcast by WWV and WWVH. It sells for \$990 and has a 45-day delivery time.

True Time Instrument Co., 429 Olive St., Santa Rosa, Calif. 95401 [357]

4½-digit multimeter includes 27-MHz counter

The model 4440 digital multimeter is a 4½-digit instrument that measures ac and dc volts, ac and dc amperes, and ohms. As an option, a crystal-controlled time base offers frequency-counting capability up to 27 megahertz. Able to run for 150 hours from a set of disposable alkaline batteries, the meter has a basic price of \$299. Options include a 20-A current shunt, a 36-kv high-voltage probe, and rechargeable batteries.

Valhalla Scientific Inc., 7707 Convoy Ct., San Diego, Calif. 92111 [358]

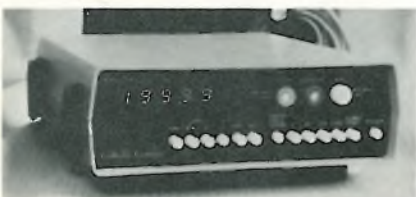

Large and medium scale integration: Keep up with this fast changing technology

Now, in one comprehensive volume, a complete working grasp at large and medium scale integration for electronics engineers engaged in the design of electronic systems, equipment and products.

A wealth of practical working data on large and medium scale integration has been culled from the most important articles in Electronics magazine by Samuel Weber, Executive Editor. Emphasis is on design problems at the system or subsystem level, as well as on the economics of today's design.

Whatever the design problem — from partitioning a digital system to working with a semiconductor company in producing the best LSI design, this book covers the full range of today's important technologies on a practical, rather than a theoretical, level.

It's yours for \$15.00. Keep up.



FREE 10-DAY EXAMINATION

McGraw-Hill Book Company
1221 Ave. of the Americas,
New York, N.Y. 10020

Send me a copy of Large and Medium Scale Integration (068815-X) for 10 days on approval. At the end of that time, I will either remit \$15.00, plus tax, postage, and handling, or return book without further obligation. (Remit in full with this coupon, plus any tax, and McGraw-Hill pays all postage and handling costs.)

Name _____

Address _____

City _____

State _____ Zip _____

Offer good only in the U.S. and subject to acceptance by McGraw-Hill. For prices outside U.S., contact McGraw-Hill Book Co. 23 K138-4018-3

MEMORY SERIES No. 4



THERE'S HARDLY A BIPOLAR MEMORY WE CAN'T SHIP FROM STOCK.

Supermarket convenience: one stop fills all your memory reqs. Take your pick from the industry's broadest line of proven hi-performers. More of the fastest, all the standards—volume stocked now. (MIL, too.)

Clip coupon to letterhead for Bipolar Line Card.

Name _____

Tel. _____ Ext. _____

THINK

Signetics

811 E. ARQUES, SUNNYVALE, CALIF. 94086

FIGARO GAS SENSOR

TGS quickly senses
even small
amount
of gas.

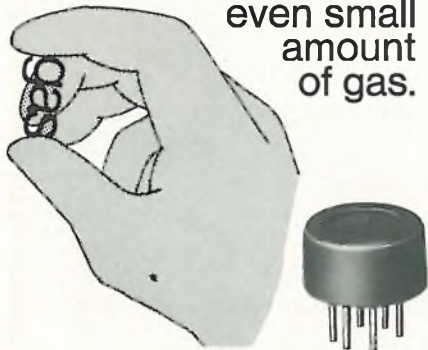

'75 New Models,
some with highly sensitive
CO sensor, now on the market.

Please contact the address below directly for
catalogs and price/delivery information.

FIGARO ENGINEERING INC.

3-7-3, Higashitoyonaka, Toyonaka City, Osaka 560,
Japan/Tel: (06) 849-2156

Cable: FIGARO TOYONAKA/Telex: 05286155 FIGARO J
Circle 138 on reader service card

Primo



UD-876M Uni-directional Dynamic Microphone

The UD-876M microphone is a unidirectional cardioid dynamic microphone intended for the most demanding needs of professional musicians. The dynamic cartridge used in this microphone has been designed with the needs of the performer on stage in mind.

The wind screen provides exceptional rejection of both breath blast and wind sounds.

• For catalog, write to:

PRIMO MICROPHONE INC.

2468 DELTA LANE, ELK GROVE VILLAGE
ILLINOIS 60007, U.S.A. TEL: 312-595-1022
TELEX: 28 3474 PRIMO MUS ELGR

PRIMO COMPANY LIMITED

6-25-1 MURE, MITAKA-SHI, TOKYO, JAPAN
TEL: 0422-43-3121~9
TELEX: 2822-326 PRIMO J

New products

Subassemblies

Dc-dc converters supply 10 watts

Low-profile modular units
accept 9 to 16 volts,
offer 65% to 70% efficiency

Packaged in a modular housing that is only 0.4 inch high, a new series of dc-dc converters can develop up to 10 watts of output power. Moreover, these epoxy-encapsulated series SC units can operate over an input voltage range of 9 to 16 v with an efficiency of 65% to 70%.

All four currently available models provide a 5-v output at a line and load regulation of $\pm 0.2\%$. They are primarily intended for applications in which the primary dc



source is poorly regulated, as with a battery, fuel cell, or motor generator.

The model SC12-5S503 is a 2.5-w unit with a 0.5-ampere output. The model SC12-5S803 is rated at 4 w and 0.8 A, and the model SC12-5S1C03 at 5 w and 1.0 A. All three of these devices measure just 2 by 2 by 0.4 in. The model SC12-5S2003, which has dimensions of 2 by 4 by 0.4 in., is a 10-w unit providing up to 2.0 A of output current.

Current-limiting circuitry assures that the modules are protected against short circuits at their output. What's more, there is no need for derating their output over the full temperature range of -25°C to $+71^{\circ}\text{C}$. And case temperature rises only 15°C to 18°C when the 5- and

10-w models are delivering their full rated output. Additionally, for each model, output ripple and noise are held to 7 millivolts root-mean-square.

In quantities of one to nine, price is \$28.95 for the 2.5-w device, \$30.95 for the 4-w device, \$34.95 for the 5-w device, and \$44.95 for the 10-w device. Delivery is from stock to within two weeks.

Semiconductor Circuits Inc., 306 River St., Haverhill, Mass. 01830 [381]

Hybrid 12-bit d-a converter sells for only \$27

If a two-chip hybrid digital-to-analog converter sells for \$39, then the same two chips plus a voltage reference chip must add up to something over \$40, right? Wrong. Analog Devices' AD563 12-bit d-a converter, which is essentially its two-chip 562 with a built-in reference, sells for only \$27 in hundreds. The current-output device contains, instead of the more usual nichrome resistors, a thin-film silicon-chromium resistor network that gives the converter an over-all gain temperature coefficient as low as 10 ppm/ $^{\circ}\text{C}$. Further, the temperature coefficient of differential nonlinearity is only 1 ppm of full scale/ $^{\circ}\text{C}$.

The converter's input circuits are compatible with DTL, TTL, and both high- and low-level C-MOS. These input circuits are designed to protect the AD563 from failure if active inputs are applied before the converter is turned on. Available in ver-

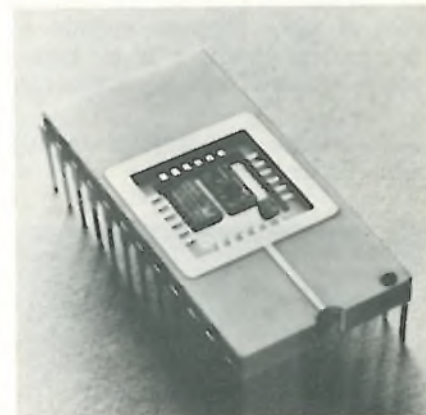

sions for either binary or binary-coded-decimal input coding, the converter contains two scaling resistors and an offset resistor that allow the user to program five output-voltage ranges: 0 to 5 v, 0 to 10 v, ± 2.5 v, ± 5 v, and ± 10 v.

The AD563 is guaranteed monotonic over its entire operating temperature range, be it 0 to 70°C for the J and K versions or -55° to 125°C for the S and T types. The price of \$27 in 100-lots applies to the AD563J. This same unit has a 1-to-24 price of \$42.

Analog Devices Inc., P. O. Box 280, Route 1 Industrial Park, Norwood, Mass. [383]

Rms-to-dc converter

spans 450 kHz, sells for \$19

Selling for only \$19 in hundreds, the 4341 is an rms-to-dc converter with a 3-dB bandwidth of 450 kilohertz, a 1% bandwidth of 80 kHz, and a 0.2% ± 2 -millivolt bandwidth of 20 kHz. Housed in a 14-pin dual in-line package, the converter accepts dc, ac, and mixed input signals and pro-

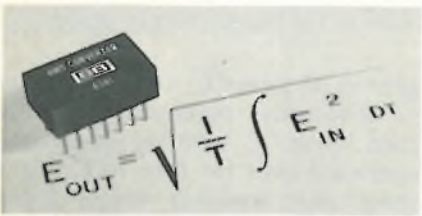

duces a dc voltage output proportional to the rms value of the input. The 4341 uses an external capacitor for averaging the squared input signal. Thus, although dc signals present no problems, very low-frequency ac signals can only be handled with low ripple if a very large averaging capacitor is used.

The converter handles input voltages in the range from -10 to +10 v and produces a dc output between dc and +10 v. The output circuit has a maximum resistance of 1 ohm and can deliver at least 5 milliamperes. For a fixed input signal, the output has a maximum temperature drift of $\pm(0.1 \text{ mV} + 0.01\%$ of output)/°C. The operating temperature

**Three Cheers for
FERRITES
from the Permag Team**

- 1.** With Permag supplying application-rated Indiana General Corp. Ferramics, you'll always get exactly what you need.
- 2.** Complete fabricating facilities. Prototype quantities available. Plus engineering assistance, field testing.
- 3.** Prompt 24-hour delivery. Extensive stock of ferrite parts at all locations. New catalog available. Yea Team!

FERRAMICS FROM PERMAG

YOUR NO. 1 SOURCE FOR ALL MAGNETIC MATERIALS

Consult your Yellow Pages for address and telephone number of Permag near you.

Cable Address: MAGNETS NEWYORK

ALL ACROSS THE COUNTRY

San Francisco Los Angeles Dallas New York Chicago Toledo Atlanta

Circle 139 on reader service card

MEMORY SERIES No. 5

**WE MAKE
ONE FAST RAM
DO THE JOB OF NINE**

Why string up nine 64-bit RAMs, when a single 64x9 package does the same job—at 45ns. Savings? Obvious: less parts to buy, less power to burn. Quantity stock available now. Ask for high-speed #82S09.

Data sheet for 64x9 RAM, the #82S09, available now; attach coupon to letterhead.

Name _____
Tel. _____ Ext. _____

**THINK
Signetics**

811 E. AROQUES, SUNNYVALE, CALIF 94086

MEMORY SERIES No. 10

GIANT 4K PROMS EVEN PRODUCTION CAN AFFORD.

Take the large economy size to prototype OR production. 4096 bits at 60ns secures patterns faster; 512 x 8 organization shrinks board space, boosts reliability—saves parts/assembly costs, speeds the line. #82S115, in volume stock.



THINK
Signetics
811 E. ARQUES, SUNNYVALE, CALIF. 94086

Circle 140 on reader service card



Elgar Frequency Converters will never be out-phased.

Besides providing superbly regulated (.01%) undistorted AC power from 50 VA to 10 kVA, Elgar AC Power Sources (Frequency Converters) provide the potential to change. By simply adding plug-in modules and external interconnections, two or more units can be combined for 2-phase or 3-phase applications. And the frequency can be adjusted from 45 Hz to 10 kHz. Most important, all output functions are programmable. Why not phase out whatever you're using now, and give Elgar Frequency Converters a try? For more information, contact Elgar Corporation, 8225 Mercury Court, San Diego, CA 92111. Phone (714) 565-1155.



140 Circle 167 on reader service card

New products

range of the device is from -25 to $+85^{\circ}\text{C}$.

Burr-Brown, International Airport Industrial Park, Tucson, Ariz. 85734 [385]

12-bit, 4-microsecond a-d converter consumes 2 watts

Selling for only \$229 in small quantities, the ADC-EH12B2 is a successive-approximation analog-to-digital converter which requires a maximum of 4 microseconds to complete a 12-bit conversion. Housed in a standard 2-by-4-by-0.4-inch module, the converter consumes only 2 watts from its $\pm 15\text{-V}$ and $\pm 5\text{-V}$ power supplies. Its maximum temperature coefficient of

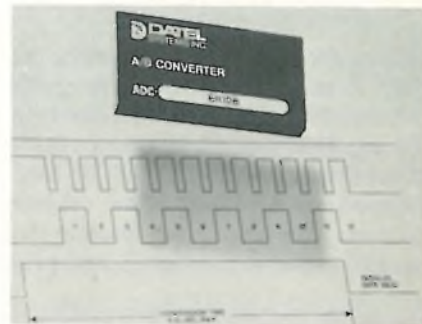

gain is $30 \text{ ppm}/^{\circ}\text{C}$, and its tempo of differential nonlinearity is less than $3 \text{ ppm}/^{\circ}\text{C}$, ensuring monotonic operation over the 0 to 70°C operating range. A slower version of the converter, called the ADC-EH12B1, has a conversion time of $8 \mu\text{s}$ and a price of \$169. Both units have a four-week delivery time.

Datel Systems Inc., 1020 Turnpike St., Canton, Mass. 02021 [384]

Two-wire line protector responds within 50 ns

Designed to supplement, not replace, standard carbon-block and gas-tube protector units normally used to provide lightning protection on drop wires from overhead communications lines, the type 7572 dissipates lower-voltage surges and fast-rising spikes which pass too

Electronics/August 7, 1975



Light-Reflecting Electromagnetic Display Components

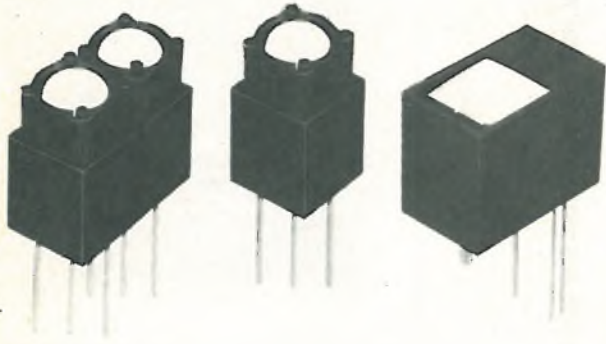

SERIES 32
0.3 inch (7.62 mm)
dual

SERIES 30
0.3 inch (7.62 mm)
single

SERIES 50
0.5 inch (12.7 mm)
single

STATUS INDICATORS

MEMORY — inherent remanent magnetism maintains the display state.

LOW POWER — one milli-watt second set/reset energy. Zero power to retain state. Drive voltages from 3-48 volts.

VISIBILITY — rotating fluorescent discs and flags provide excellent visibility over a wide range of ambient light conditions and wide viewing angles.

RELIABILITY — only one moving part rated for over 20 million operations. No lights or mechanical linkages to wear out. Virtually maintenance free.

FERRANTI-PACKARD STATUS INDICATORS

Ideal for

- Transient Recorders
- Industrial Process Displays
- Contact Status Indicators
- High Density Matrix Displays
- Portable Field Equipment.

Fluorescent discs and flags available in a range of colors.

The electromagnetic operation requires zero energy to maintain status.

Unique memory retention eliminates the need for memory circuits and reduces power supply and circuitry costs. Indicators are fully operational over a wide range of environmental conditions.

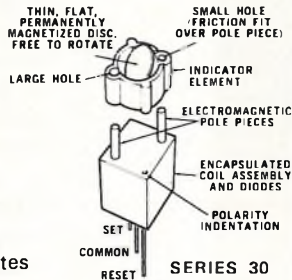

Ferranti-Packard's status indicators are light weight (Series 30, 0.17 oz (5 grams)) and are ideal for mounting on printed circuit boards and high density matrices.

For full information and specifications, contact the Display Components Department.

FERRANTI-PACKARD LIMITED

ELECTRONICS DIVISION
121 Industry Street,
Toronto, Ontario, M6M 4M3, Canada.
Telephone: (416) 762-3661.
Telex: 06-22007.

7304

Circle 141 on reader service card



CONDUCTIVE ELASTOMERIC CONNECTORS

- Alternating layers, 0.005" or 0.010" thick, of conductive and non-conductive elastomers.
- Silver or carbon filled
- Provide electrical contact between two or more circuits
- Eliminates soldering
- No aligning problem
- Easy disconnect
- Offers low profile packaging
- Send for FREE sample.



East Division • 129 Dermody St., Cranford, N.J. 07016 (201) 272-5500
West Division • 427 Olive St., Santa Barbara, Calif. 93101 (805) 963-1867

Circle 168 on reader service card

MEMORY SERIES No. 6

8192 BITS- NO EXTRA PIECES NEEDED.

8K MOS ROM #2608.

Use this big fast memory (1024x8 at 650ns) without costly supportive parts. TTL compatible: no interface required. Static logic: no clocks. Single +5V means no extra power supplies. Volume stock now.

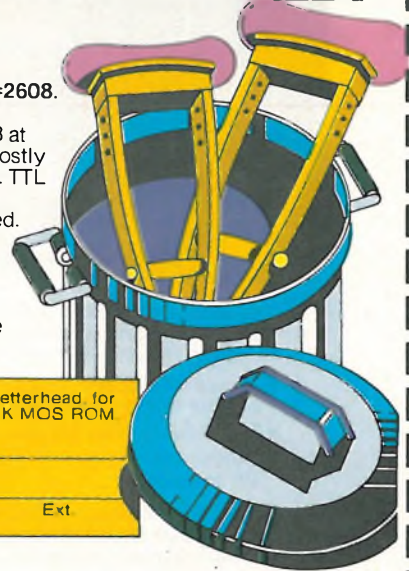

Rush coupon on letterhead, for specs on #2608 8K MOS ROM

Name _____

Tel _____

Ext _____

THINK SIGNETICS

811 E. ARQUES, SUNNYVALE, CALIF. 94086

Circle 169 on reader service card 141

CAPABILITY SERIES No. 2

NEED MIL IC'S? WE CAN TAKE THE HEAT.

All the hottest functions, all from just one source. Pick from 5 hi-rel levels processed to MIL-STD-883A, MIL-M-38510. Unbeatable total package price/delivery: MOS & bipolar memories, 54S, 54LS, 54/54H, 82/82T & analog.



Fasten coupon to letterhead for free Milrel Brochure, & data sheet(s)

for _____
Name _____
Tel. _____ Ext. _____

THINK SINOTICS

811 E. ARQUES, SUNNYVALE, CALIF. 94086

Circle 142 on reader service card

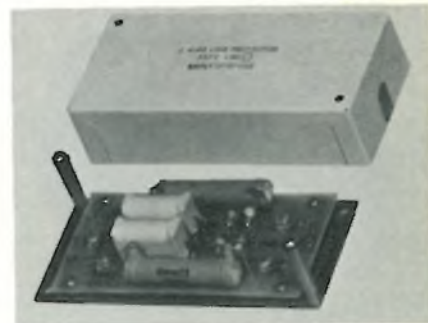

quickly for conventional units to respond to them. Offered in two versions—a dc-blocking type and one that permits dc signaling—the 7572 responds to overvoltage surges within 50 nanoseconds. Both types of line protector include series inductors and shunt varistors, but the dc-blocking type also has series capacitors and shunt diodes for increased protection.

Bayly Engineering Limited, 167 Hunt St., Ajax, Ont., Canada L1S 1P6 [386]

Low-level analog subsystem can withstand 2 kilovolts

The RTP7471 low-level analog input subsystem can measure signals as small as ± 5 millivolts full scale in the presence of common-mode noise transients as great as 2,000 volts dc or peak ac. This high common-mode performance is made possible by using a fully floating input circuit on each of the subsystem's input channels, up to 64 of which can be accommodated. Channels can be selected randomly by a computerized controller at rates up to 8 kilohertz. Also controllable by a computer is the gain of each channel; eight gain ranges, from ± 5 mV to ± 1 V full scale can be selected. Designed to work in power-generating plants and other difficult industrial environments, the RTP7471 subsystem is compatible with Computer Products' RTP7400 line of computer-directed measurement and control equipment. The subsystem has a mainframe price of \$2,750.

Computer Products, 1400 N.W. 70 St., P. O. Box 23849, Fort Lauderdale, Fla. 33307 [387]

DAK SUBMINIATURE TOGGLE SWITCHES

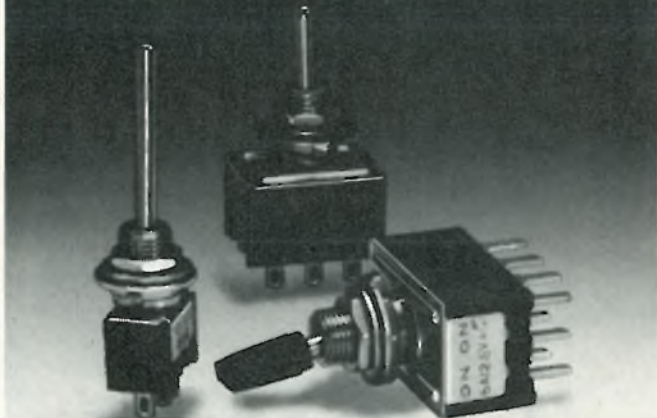

The same Oak quality and dependability you expect and get in rotary and pushbutton switches is now available to you in these Oak toggle switches.

- Single to 4 pole double throw switching
- Three basic lever styles
- Solder tab or PC terminals
- 6 amp rating at 125 VAC
- Silver or Gold plated contacts
- Competitively priced

Stocked for immediate delivery by Oak distributors. Call toll free 800-435-6106 for the name and phone number of your nearest distributor, or write for a catalog.

DAK Industries Inc.
SWITCH DIVISION / CRYSTAL LAKE, ILLINOIS 60014

Semiconductors

JFETs, bipolars on same chip

Ion implantation used to fabricate op amps, analog switches and multiplexers

Using ion implantation as part of a new bipolar-MOS process called Bifet, National Semiconductor Corp. is introducing three families of monolithic devices—op amps, analog switches and analog multiplexers. They incorporate high-voltage, p-channel, junction-field-effect transistors on the same chip with standard bipolar transistors.

The idea of combining JFETs and bipolar transistors on a single chip is not new. Indeed, several companies have actually designed products, but the devices were never very successful.

"The main problem was that because they were built using diffusion techniques these devices were large—50 by 50 mils for a JFET-op-amp front end, for example," explains Jim Solomon, manager of linear design at National. "Also they had very high betas and voltage offsets—about 50 to 100 millivolts—and were rather noisy. In addition there was the problem—a major one in this instance—of matching the JFETs."

With ion implantation, he says, there is uniform doping across the chip, and JFET matching is very close, with voltage offsets in the 3-to-5-mV range and JFET sizes 10 times smaller than purely bipolar devices—about 5 by 10 mils on an op-amp front end, for example.

The advantages of the Bifet process are most apparent in National's new line of 15 op amps: the LF155/155A/255/355/355A for low-supply-current operation; the LF156/156A/256/356/356A for wideband operation; and the LF157/157A/257/357/357A for compensated wideband operation

with a minimum voltage gain of 5.

All three types in the LF series have input bias currents of about 30 picoamperes, input offset currents of about 3 pA, input impedances of 10^{12} ohms; input offset voltages of 1 mV, input offset voltage temperature drifts of 3 microvolts/°C, a common-mode rejection ratio of 100 decibels, and a dc voltage gain of 106 db.

The fastest op amp in the series, the LF157, has a slew rate of 75 volts per microsecond when voltage gain is 5. Settling time is typically only 1.5 microseconds to reach 0.01%.

In the first of its Bifet multiplexer line, the eight-channel LF11305, says Solomon, National offers a device with all the operating characteristics of today's C-MOS switches but without the disadvantages. On-resistance is about 250 ohms, with matching within 2%. Leakage current at 25°C is 30 pA. On-resistance is constant with input and supply voltage. Turn-on time is 1 microsecond, and turn-off time of the device is 0.2 μ s.

National's family of Bifet monolithic quad analog switches—the LF11331/32/33—offers break-before-make action, as well as a constant on-resistance for signals of ± 10 v and 100 kilohertz. In addition, open-switch isolation at 1 megahertz is -50 dB, and there is leakage of less than 1 nanoampere in the off-state. The family is designed to operate from ± 15 -V supplies and swing a ± 10 -V analog signal. A single disable pin turns all switches in the package off. Power dissipation ranges from 570 to 800 mW. Delay time on is 500 ns, and delay time off is 90 ns.

Pricing on the series of op amps ranges from \$6 to \$17.50 each in lots of 100. Price of the LF11331/32/33 is \$2 each in 100-lots. Pricing on the LF11305 multiplexer is not available. The op amps are housed in seven-pin T0-79 cans, and the other devices come in dual in-line packages.

National Semiconductor Corp., 2900 Semiconductor Drive., Santa Clara, Calif. 95051 [411]

Two chips do the work of five in microprocessor

Improvements in circuit design and an increasing willingness to build somewhat larger chips have led engineers at Rockwell International Corp.'s Microelectronic Device division to develop a 4-bit microprocessor at lower cost than the company's ubiquitous PPS-4 parallel processing system. The new entry is the PPS-4/2, which puts essentially the same functions on two chips that are in the PPS-4, a five-chip set.

The new system is aimed at the low end of the 4-bit microprocessor market, where the earlier PPS-4 doesn't compete because of its greater speed and complexity. Applications include \$500 cash registers, as well as credit-verification and other smart terminals.

J. E. Bass, the division's manager of microprocessor development and OEM marketing, says the 4/2 uses

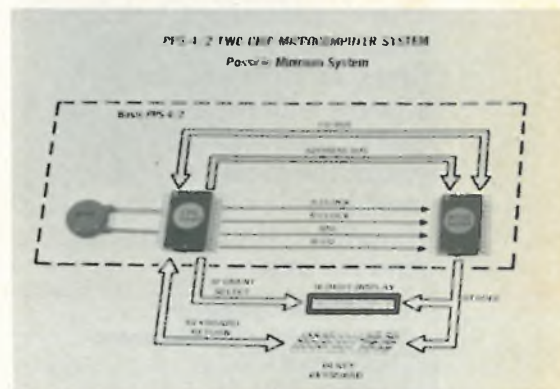

the same instruction set and bus structure as the PPS-4, which has been on the market since mid-1973. But the older design includes separate chips for the central processor, read-only and random-access memories, and a keyboard and display controller for an input device; the 4/2 does the same job with two.

Memory and input/output lines are fabricated on one chip, and the other contains the central processing unit, clock, and 12 external I/O lines to communicate with peripheral devices. There are 2,048 words of 8-bit

A great place to start expanding your company is right here.



Our 16 page book talks about the labor force, about deep water ports, about utilities, temperatures, taxes. There's everything here from financing to flying times, from industries to schools--all the things that make Northwest Florida one of the most profitable, most livable business climates in the country. And it's free.

Gulf Power Company
Manager, Area Development
Department D-8
P.O. Box 1151
Pensacola, Florida 32520
Please send me your book.

Name

Title

Company

Address

City

State

Zip

New products

read-only memory and 128 words of 4-bit RAM on the memory chip, plus I/O lines for communication with the central-processing unit. Bass says the CPU can accommodate 50 instructions, and that, with the two-chip set, the user can implement a low-cost cash register with 64 keys and a 16-digit display. What's more, the 4/2 was developed as Rockwell's next entry in the printing-calculator market.

Bass doesn't expect the PPS-4/2 to impact the applications for the earlier five-chip set because of the latter's greater speed (5 microseconds vs. 4) and bus-driving capabilities. Furthermore, PPS-4 can drive 35 chips while the 4/2 will drive only 10 to 12.

Price of the 4/2 is \$20 to \$30 in quantities of 1,000 to 5,000, and delivery is from stock.

Microelectronic Device Division, Rockwell International Corp., P.O. Box 3669, 3430 Miraloma Ave., Anaheim, Calif. 92803 [412]

Monolithic 8-bit converter is linear within 2 ppm/°C

The AD559 is a monolithic digital-to-analog converter that uses a high-stability thin-film resistor network to achieve a differential nonlinearity temperature coefficient of less than 2 ppm of full scale per degree Celsius. This, combined with initial

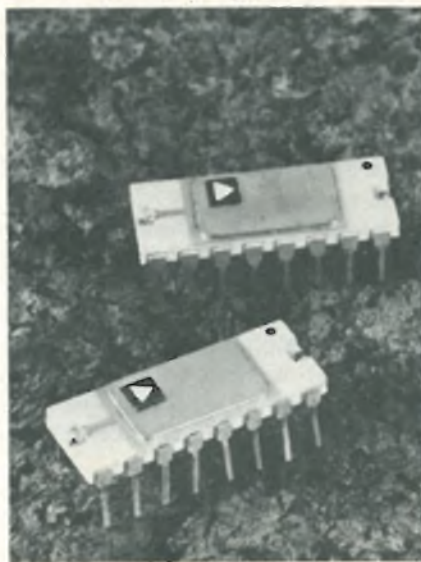

matching to within 0.05%, guarantees monotonicity of the converter over its full operating temperature range of either 0 to 70°C (for the AD559K) or -55 to 125°C (for the AD559S). The units are priced, in hundreds, at \$5.95 and \$8.55, respectively. The AD559 is internally compensated, making the use of an external RC network unnecessary. Delivery of both versions is from stock.

Analog Devices Inc., P. O. Box 280, Route 1 Industrial Park, Norwood, Mass. 02062 [413]

Monolithic 8-bit converter has universal logic inputs

Able to interface directly with MOS (n-channel, p-channel, and complementary), TTL, DTL, ECL, and HTL levels, the monoDAC-08 series of monolithic multiplying d-a converters are 8-bit current-output devices whose outputs can work into any voltage from -10 to +18 v. This high compliance makes an output op amp unnecessary in many applications. Settling time is 85 nanoseconds to within half a least significant bit, and input impedance is high enough to allow the converter to be driven directly by n-MOS and p-MOS random-access memories. The input logic threshold of the device is 1.4 volts above the potential of pin 1, hence, grounding that pin makes the unit DTL/TTL-compatible. To accommodate any other logic family it is necessary merely to connect pin 1 to the appropriate voltage. The monoDAC-08 comes in four versions. Prices range from \$6.50 to \$20 in hundreds. Deliveries of the converter are from distributor stock.

Precision Monolithics Inc., 1500 Space Park Dr., Santa Clara, Calif. 95050 [414]

16-k read-only memory has 600-ns access time

A 16,384-bit MOS read-only memory with a typical active-mode power consumption of 320 milliwatts has a

New products



maximum access time of 600 nano-seconds. Designated the MK28000, the p-channel ROM is pin-for-pin-compatible with the EA 4900. The mask-programable device may be organized as either a 2k-by-8-bit or 4k-by-4-bit memory and is intended for use in point-of-sale terminals, CRT terminals, minicomputers, and mainframes. Housed in a 24-pin plastic package, the MK28000 is priced at \$13.50 in thousands. Mask turnaround time is typically six weeks.

Mostek Corp., 13300 Branch View Lane, Dallas, Texas 75234 [415]

Microprocessor executes PDP-8/E instruction set

The IM6100 is the first production C-MOS microprocessor that recognizes the instruction set of the popular PDP-8/E minicomputer by Digital Equipment Corp. The 12-bit single-chip circuit from Intersil consists of six 12-bit registers, a programmed logic array, an arithmetic and logic unit, and associated gating and timing circuitry. Requiring a single 5-volt power supply, the device has an on-chip crystal-controlled oscillator. Housed in a 40-pin package, the IM6100 sells for \$395 in quantities of 1 to 24 pieces. Intersil Inc., 10900 North Tantau Ave., Cupertino, Calif. 95014 [416]



CONSIDERING Frequency or Time Measurements? CALL ELDORADO!

Eldorado invented direct gigahertz . . . Eldorado invented the 1 ns Time Interval Meter

NANOSECOND INSTRUMENTATION



MODEL 650
1 ns Delay Generator



MODEL 796
1 ns TIM



MODEL 255
1 us TIM



MODEL 784
10 ns TIM



MODEL 421A
1 ns Calibrator

MICROWAVE INSTRUMENTATION



MODEL 988A
20 Hz to 136 MHz
625 MHz to 13.4 GHz



MODEL 989A
20 Hz to 136 MHz
625 MHz to 18 GHz



MODEL 988A
20 Hz to 13.4 GHz

MODEL 970
3 GHz

MODEL 989A
20 Hz to 18 GHz

DC - 1000 MHz INSTRUMENTATION



MODEL 1608
50 MHz



MODEL 1656
600 MHz



MODEL 1657
1 GHz



MODEL 225
15 MHz

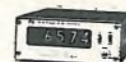

MODEL 224
100 KHz

ELDORADO INSTRUMENTS COMPANY

2495 ESTAND WAY • PLEASANT HILL, CA 94523 • (415) 682-2100

Circle 145 on reader service card

Need a current catalog?

Use your EBG to order the catalogs you need. Last year, 80,000 requests for catalogs were generated through the use of EBG Catalog Inquiry Cards. Put EBG to work for you—and your company.



Electronics
Buyers'
Guide

THE ACTION BOOK



Large and medium scale integration:

Keep up with this fast changing technology

Now, in one comprehensive volume, a complete working grasp of large and medium scale integration for electronics engineers engaged in the design of electronic systems, equipment and products.

A wealth of practical working data on large and medium scale integration has been culled from the most important articles in Electronics magazine by Samuel Weber, Executive Editor. Emphasis is on design problems at the system or subsystem level, as well as on the economics of today's design.

Whatever the design problem — from partitioning a digital system to working with a semiconductor company in producing the best LSI design, this book covers the full range of today's important technologies on a practical, rather than a theoretical, level.

It's yours for \$15.00. Keep up.

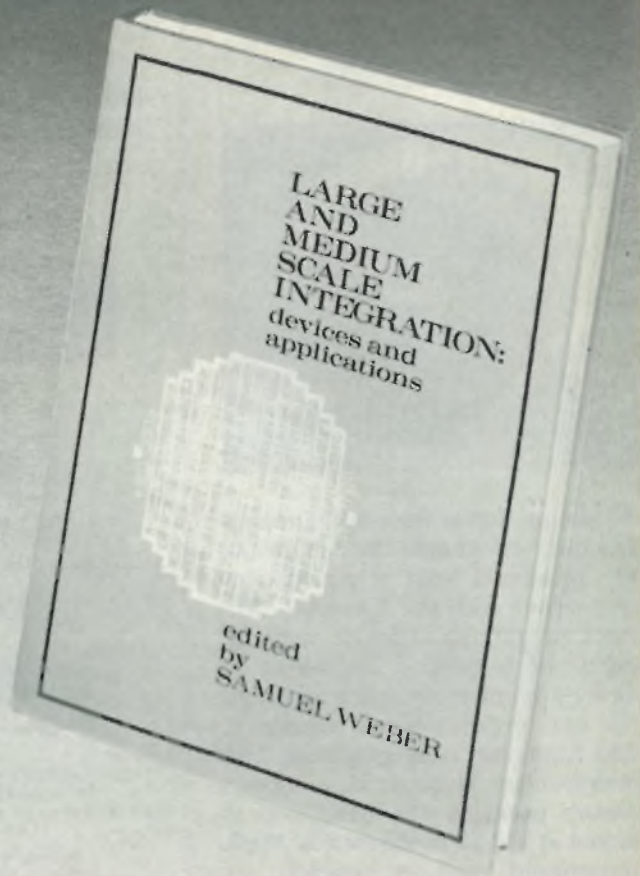

FREE 10-DAY EXAMINATION

McGraw-Hill Book Company
1221 Ave. of the Americas.
New York, N.Y. 10020



Send me a copy of Large and Medium Scale Integration (068815-X) for 10 days on approval. At the end of that time, I will either remit \$15.00, plus tax, postage, and handling, or return book without further obligation. (Remit in full with this coupon, plus any tax, and McGraw-Hill pays all postage and handling costs.)

Name _____

Address _____

City _____

State _____ Zip _____

Offer good only in the U.S. and subject to acceptance by McGraw-Hill. For prices outside U.S., contact McGraw-Hill Book Co.

23 K138-4018-3

New products/materials

A magnification film called 3M LensFilm is a thin, flat, flexible material that can magnify, demagnify, collimate, condense, or diverge light—just as a conventional lens. Made by putting closely spaced



grooves (50 to 200 per inch) into a sheet of cellulose acetate butyrate plastic, LensFilm closely duplicates the effects of a continuous-surface optic. It has potential applications in displays for digital watches and calculators, thermometers, light meters, and test instruments. The material is available in red, green, amber, and blue as well as in neutral density and clear versions, and it can be combined with 3M Light Control Film. The material is offered in lengths up to 12 inches.

3M Co., P. O. Box 33600, St. Paul, Minn. 55133 [476]

A contact cement that sets in less than a minute, Zipbond needs no pre-mixing or post-heating. Unaffected by most chemicals, weather, and temperatures, Zipbond has a low viscosity which allows it to penetrate into tiny spaces. One drop of the material covers one square inch. Instrument Div., Tescom Corp., 2600 Niagara Lane North, Minneapolis, Minn. 55441 [447]

Silver-bearing copper alloys 104 and 107 are high-conductivity metals that resist softening up to 275°F. The materials, which are available in sheet, strip, plate, rod, bar, and tube, will not become embrittled if brazed or annealed in a hydrogen

BAUSCH & LOMB

StereoZoom[®] microscope

The inspector with the perfect record

Almost twenty years on the job and still the industry leader. High resolution optics throughout the entire zoom range, and bright, sharp images over a wide field of view mean less eyestrain, less fatigue, and a lower percentage of errors. And that means tighter production control, less returned product and more satisfied customers.

The Bausch & Lomb StereoZoom Microscope—dependable quality at economical prices. Write for a free catalog today and discover why the Bausch & Lomb StereoZoom outsells all competitive stereomicroscopes in the electronics market... worldwide.



Bausch & Lomb, Scientific Optical Products Division,
62320 North Goodman Street, Rochester, N.Y. 14602.

Circle 147 on reader service card

Own your own holder to hold your own!

Hold your own copies of Electronics in specially designed slipcase holders. They'll keep your Electronics library neat and handy—a permanent information file, issue by issue.

Just complete the coupon and mail to Jesse Jones. He'll process your order upon receipt, postpaid.

ELECTRONICS BOXER
Jesse Jones Box Corporation
2250 E. Butler St., Philadelphia, Pa. 19137

Please send me: boxes @ \$4.25 each; 3 boxes @ \$12.00; 6 boxes @ \$22.00.
My check or money order is enclosed.

Name: _____

Address: _____

City: _____ State: _____ Zip: _____



YOU CAN DO IT YOURSELF...

WITH UNIVERSAL'S MECHANIZED ELECTRONIC ASSEMBLY MACHINES

For over 15 years Universal has been supplying Mechanized Electronic Assembly Equipment to nearly all the leading computer, communications, aerospace, automotive and consumer electronics companies in the world, regardless of their size. We feel we have given them the "in-house" capability to build their products profitably. We can do the same for you with:

- Axial Lead Component Processing Equipment.
- Transistor, DIP and Axial Lead Prepping Equipment.
- Transistor, Disc Capacitor and Axial Lead Taping Equipment.
- Disc Capacitor, DIP, Transistor, SIP and Axial Lead Insertion Equipment.
- As well as Pin Insertion and Wire Termination Equipment.

Universal's Semi-Automatic and Computer Controlled Systems reduce cost, improve quality and give your company the "in-house" production capability to assemble all your electronics . . . you can do it yourself. For details on how to purchase or lease a Universal Electronic Assembly Machine, call or write today.



New products/materials

atmosphere. Electronics applications of the alloys include lead frames, contacts, terminals, commutator segments, collector rings, gaskets, transistor headers, and switches.

The Anaconda Co., Brass Div., P. O. Box 830, Waterbury, Conn. 06720 [478]

A nonstaining epoxy transfer molding compound for capacitor encapsulation has been extensively evaluated in high-volume production and has been found to reduce downtime for mold cleaning by as much as 90%. The material is now available in production quantities.

Furane Plastics Inc., a subsidiary of M & T Chemicals Inc., 5121 San Fernando Road West, Los Angeles, Calif. 90039 [479]

Printed-circuit laminate PC-75 is being offered as a high-performance alternative to the phenolic-paper, epoxy-paper, polyester-glass, and epoxy-glass materials commonly used for printed-circuit boards. Available in unclad, copper-clad, aluminum-clad, seeded and coated, and adhesive-coated versions, PC-75 has high flexural strength, low z-dimension expansion, and high peel strength. Based on an epoxy resin system, the material is relatively nonabrasive and hence causes much less die wear than do laminates that contain glass. The tan-colored material is available in sheets measuring 36 by 48 inches and 36 by 72 in. It is offered in thicknesses of 0.031, 0.047, 0.062, and 0.093 in.

General Electric Co., Midwest Operation, 5504 South Brainard Ave., La Grange, Ill. 60525 [480]

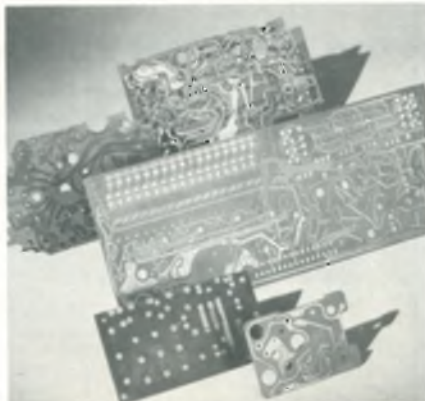

...OR WE CAN DO IT FOR YOU

WITH UNIVERSAL'S MECHANIZED ELECTRONIC ASSEMBLY SERVICES

When you don't have the capacity to do all your own component preparation, assembly or wire wrapping—or when it doesn't pay you to do it yourself—let us do it for you, with no capital investment on your part. Working for you are the industry's most automated facilities including:

- Axial Lead Component Taping, Sequencing and Insertion.
- Transistor Prepping, Taping and Insertion.
- DIP Insertion.
- Pin Insertion.
- SIP Insertion.
- Computer-Aided Design Accessibilities.
- Wire Termination.
- Complete Systems Assembly.
- And, of course, complete testing for all services.

Universal's Mechanized Electronic Assembly (MEA) Division services provide close-tolerance production, on-time delivery and substantial savings in direct labor cost from two locations: Binghamton, New York, and Palatine, Illinois. Write or phone today for full details on what Universal's MEA can do for you.





BUCKEYE CABINETS

Buckeye's classic cabinetry line of aluminum enclosures is colorful, strong and budget priced. Universal 19" front panels, with heights from 12.25" to 28". You can also depend on Buckeye for other instrument-packaging needs: Designer Cases of all types and sizes — Patented card guide modules — PCB racks — Retractable, locking tilt-stands — and the recognized high quality matching instrument knob line.

the **BUCKEYE stamping co.** Write today for free colorful literature!

555 Marion Rd., Columbus, Ohio 43207

"QUALITY PRODUCTS SINCE 1902"



GUIDES • CASES • KNOBS • RACKS

Circle 172 on readerservice card



ERASE P/ROMs WITH MINERALIGHT® S-52 HIGH INTENSITY LAMPS

The S-52 provides complete erasures in approximately six minutes at the suggested working distance of one inch (2.5 cm). At this distance, the effective area of coverage is 2¼ x 6 inches (5.8 x 15.4 cm).

When small quantities of chips are being erased, they can be placed on a simple platform to provide the proper distance from tube to chip surface.

- HIGH ENERGY
- QUICK ERASURE
- OZONE-FREE GRID

Available through your local INTEL distributor or contact —

ULTRA-VIOLET PRODUCTS, INC.

5100 WALNUT GROVE AVENUE, SAN GABRIEL CA 91778
MIS-123-A

Circle 173 on reader service card

You don't have to buy a new car to get an electronic ignition.

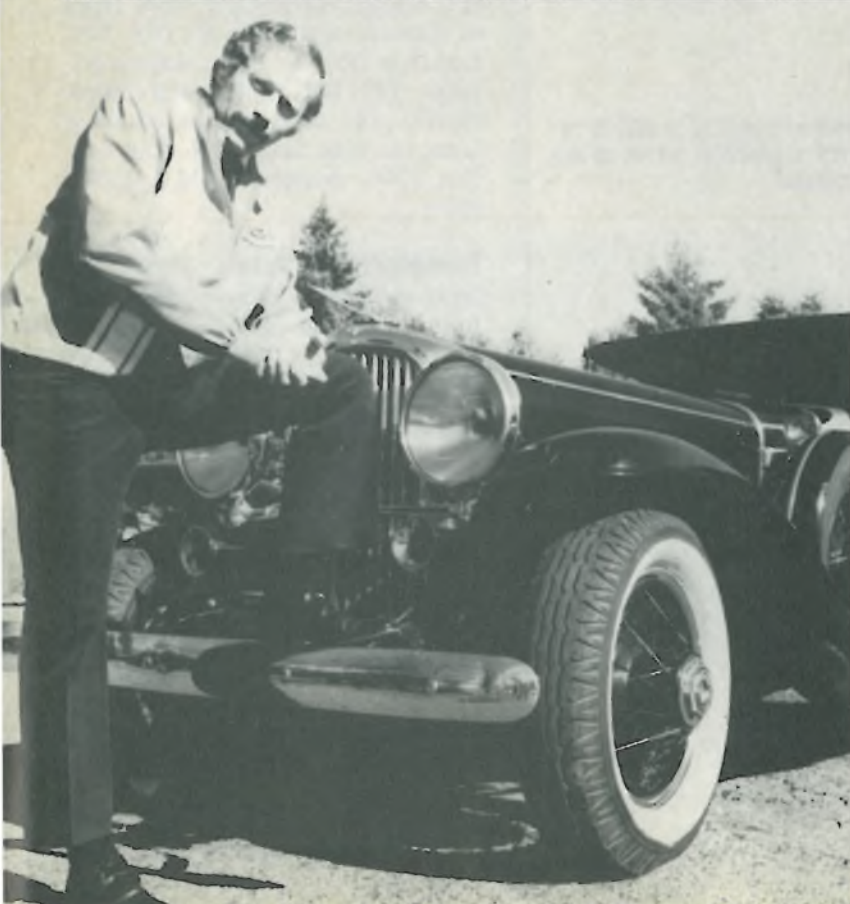

Most of you know the evaluation of automotive electrical systems . . . an evaluation characterized only occasionally by efficiency and performance. I know that, and that's why I use the Delta Mark Ten B CDI on all my cars, new and old. And believe me, you don't have to have a new car to appreciate the best electronic ignition available today. Study these features and you'll know what I mean.

1. Mark Ten and Mark Ten B Capacitive Discharge Ignition Systems are manufactured by Delta Products, Inc., a company with a conscience, and with a proven record of reliability both in product and in customer relations.
2. The Mark Ten CDI's really do save money by eliminating the need for 2 out of 3 tune-ups. Figure it out for yourself. The first tune-up or two saved pays for the unit, the rest is money in your pocket. No bunk!
3. Because the Mark Ten CDI's keep your car in better tune, you actually can save on expensive gasoline.
4. With a Mark Ten, spark plugs stay clean and last longer . . . fouling is virtually eliminated.



No matter what kind of car you drive, it too can use a Delta quality lift.

I want to know more about Mark Ten B CDI's. Send me complete no-nonsense information on how they can improve the performance of my car.

Name _____
Address _____
City _____ State _____ Zip _____



DELTA PRODUCTS, INC.

P. O. Box 1147, Dept. E, Grand Junction, Colo. 81501
303-242-9000

Mark Ten B,
assembled \$64.95 ppd
Mark Ten B, kit \$49.95 ppd

Standard Mark Ten,
assembled \$49.95 ppd
Deltakit® \$34.95 ppd

RF PACKAGES—MICROWAVE SYSTEMS

WORLD'S LARGEST RADAR & MICROWAVE INVENTORY

AUTOTRACK ANTENNA SCR-584 RADAR SYSTEM

360 deg AZ 210 deg EL. 1 mil. accuracy. Missile vel. accel. and slew. rates. Amplidyne control. Handle up to 20 ft. dish. Compl. control chassis. ALSO in stock 10 cm. van mounted rad. system. Conical scan. PPI. 6 ft. dish. 300 pg. instr. bk. on radar \$225



RF SOURCES

CW: 300-535KHz 500W; 2-30MHz 3KW; 4-21MHz 40KW; 24-350MHz 100W; 385-585MHz 1KW; 750-985MHz 10KW; 95-8.8GHz 150W; 1-1.5GHz 110W; 1.7-2.4GHz 10KW; 4.4-5GHz 1KW; 8.8-11GHz 200W. Many more.

UHF: 1 Megawatt 210-225MHz .5μsec 180 PPS; 14KW 400-420MHz .0002DC; 1KW 400-700MHz .002DC
L BAND: 1KW 1-1.5GHz .1DC; 500KW 1.2-1.35GHz .2μsec 400PPS.

S BAND: 1KW 2.4-2.6GHz .75μsec 1200PPS; 250KW 2.7-3.1GHz .8μsec 1600PPS; 1 Megawatt 2.7-2.9GHz .1μsec 1200PPS; 5 Megawatts 2.75-2.85GHz 2.5μsec 400PPS.
C BAND: 225KW 6.275-6.575MHz .4μsec 680PPS; 250KW 5.4-5.8GHz .5μsec 680PPS; 1 Megawatt 6GHz .1μsec 1000PPS.

X BAND: 100W 9.2-9.5GHz .5μsec 1000PPS; 1 KW 8.9-9.4GHz .001DC; 65KW 8.5-9.6GHz .001DC; 250KW 8.5-9.6GHz .0013DC; 400KW 9.1 GHz 1.8μsec 450PPS.

Ku-K BAND: 50KW 16.4-16.6GHz .001DC; 135KW 15.5-17.5GHz .0006DC; 40KW 24GHz .0007DC; 40KW 35GHz .0004DC.

PULSE MODULATORS + H.V.P.S.

245 KW LINE Output 16 KV 16 A. .25 μs 4000 PPS.
405 KW FLOATING DECK Output 20 KV 20 A 1 μs to 10 millisecc pulse.

500 KW LINE Output 22 KV 28 A. 4/1.75/2.25 μs 2500/550/300 PPS

1 MW HARDTUBE MIT MODEL 9 Output 25 KV at 40 A. .25 μs .002 D.C.

2.0 MW LINE 30 KV 70 A. 1/2 μs 600/300 PPS.
3 MW LINE Output 39 KV 75 A. .25/1 μs 500 PPS

10 MW LINE 76 KV 135 A. 2.5 μs 350 PPS.
17 MW LINE 17 KV 1000 A. 2-5 μs 150-2000 PPS

SEND FOR FREE 24 PG. CATALOG

MOD IV HI-RES MONOPULSE TRACKER

Instrumentation radar: freq. 8.5-9.6 GHz. Pwr: 250 KW. .1 mil. accu. Trk. Rng. 50 or 200 mi.

RADAR SYSTEMS

K BAND MONOPULSE 40KW E-34
KU BAND SEARCH 135KW B-58
X BAND MISSILE CONTROL NIKE AJAX/HERC
X BAND FIRE CONTROL 250KW M-33
X BAND WEATHER/SEARCH 250KW AN/CPS-9
X BAND AIRBORNE TRACKER 50KW B-47
X BAND MOBILE TRACKER 40KW AN/MPQ-29
X BAND WEATHER/SEARCH 40KW AN/SPN-5
X BAND TRANSPONDER 100W AN/DPN-62
C BAND HGT. FDR. 5MW FPS-26; 1MW TPS-37
C BAND SEARCH 285KW AN/SPS-5B/D
S BAND HEIGHT FINDER 5MW AN/FPS-6
S BAND SEARCH COHERENT 1MW AN/FPS-18
S BAND ACQUISITION 1MW NIKE AJAX/HERC
S BAND TRACKER 10" DISH 500KW AN/MPQ-18
S BAND MORTAR LOCATOR 250KW AN/MPQ-10A
S BAND TRACKER 250KW AN/MPS-9
L BAND SEARCH 40" ANTENNA 500KW AN/FPS-75
L BAND SEARCH 500KW AN/TPS-10/GSS-1
UHF SEARCH 1MW TPS-28

DRONE CONTROL SYSTEMS

UHF COMMAND SYSTEM AN/URW-14
X BAND DATA LINK AN/UPW-1
X BAND TRACKER AN/MPQ-29
X BAND TRACKER AN/MSQ-51

60 FT. DISH

Complete with Az-El pedestal, ready for installation. Immed. delivery. Write or call.

SPARE PARTS IN STOCK

Nike Ajax, Nike Hercules, M-33, MPS-19, TPS-ID, TPS-10D, FPS-6, SPSR, SCR-584, HIPAR. Many more, write.



**Radio
Research
Instrument
Co., Inc.**

3 QUINCY ST., NORWALK, CONN. 06850
(203) 853-2600

Circle 183 on reader service card

WE SHIP IN 1 DAY

FROM OUR 42000 SQ. FT. FACILITY

MINIS—DEC•DG•CAI

CASC • HP • HIS • IBM • INT • LOCK
MICRO • SEL • TEMPO • UNIVAC
VARIAN • XLO

PRINTERS

MDS 4330	300LPM	\$2950
DP 2440	700LPM	7500
DP 4300	1333 LPM	7500

CARD READERS

DOCUMENTATION	M200	950
	M600	1500
GDI 120, 110A		450

PAPER TAPE

DIGITRONICS	2500	350
CHALCO	5401	350
BRPE PUNCH	21	250

MAGNETIC TAPE

PERTEC	7830	250
	6840	1450
WANGCO	1137	1450

AMERICAN USED COMPUTER CORP

Box 68, Kenmore Sta., Boston, MA 02215
member COMPUTER DEALERS ASSOC.

Circle 184 on reader service card

150

New literature

Thermistors. The newly revised Fenwal Electronics "Capsule Thermistor Course" is a 24-page booklet explaining the workings and applications of thermistors. Consisting of 10 lessons, the booklet contains 14 pages of characteristic curves, references, sensitivity curves, temperature-compensation factors, and similar back-up material. Fenwal Electronics, 63 Fountain St., Framingham, Mass. 01701. Circle 421 on reader service card.

Laser trimming. The relative merits of CO₂ and YAG lasers for trimming thick- and thin-film resistors are discussed in a 16-page booklet entitled "A Comparison of Laser Trimming Systems for Thick and Thin Film Resistors" which has been put out by Apollo Lasers Inc., 6357 Arizona Circle, Los Angeles, Calif. 90045. A comparison of laser and air-abrasion trimming is also included. [422]

Interfacing COS/MOS. An eight-page application note from RCA presents a variety of practical circuits for interfacing COS/MOS circuitry (RCA's version of C-MOS) with a wide variety of other circuitry—both analog and digital. Among the other types of circuitry considered are DTL, TTL, n-MOS, p-MOS, op amps, various displays, 10K ECL, and power-control circuits. The note may be obtained from the RCA Solid State Division, Box 3200, Somerville, N. J. 08876 [423]

Photomultiplier tubes. More than just a catalog, a 20-page publication from EMI Gencom Inc., 80 Express St., Plainview, N. Y. 11803, includes sections on environmental considerations, voltage dividers, the anode circuit, and tube selection. In addition, the publication contains applications information. [424]

Subminiature lamps. Listing more than 1,000 subminiature incandescent lamps, a six-page catalog includes an up-to-date price list and outline drawings. The catalog is available from JKL Components Corp., 2226 Barry Ave., West Los Angeles, Calif. 90064 [425]

Q. Whom do I contact or call to renew my classified ad or make corrections?

A. Write Electronics, Class. Adv. Dept., P.O. Box 900, NY, NY 10020 or call: (212) 997-4392. Give full company name, size of ad, & date or dates it is scheduled to appear.

FEATURE ARTICLES FROM ELECTRONICS

AVAILABLE IN REPRINT FORM!

No. of
Copies
Wanted

No. of
Copies
Wanted

<p>_____ R- 11 Computer-Aided Design\$4.00</p> <p>_____ R- 15 Special Report on LSI Packaging\$3.00</p> <p>_____ R- 18 Reshaping the EE for the Seventies\$1.00</p> <p>_____ R-023 Special Report: Tomorrow's Communications....\$3.50</p> <p>_____ R-027 Consumer Hazards: Why They Happen, How They Can Be Fixed\$2.00</p> <p>_____ R-031 Circuit Designer's Casebook (U.S. Only)\$5.50 Circuit Designers Casebook (Foreign)\$12.00</p> <p>_____ R-032 Active Filters\$4.00</p> <p>_____ R-101 Special Report: The Right Numeric Readout, a Critical Choice for Designers\$2.00</p> <p>_____ R-104 The New Concept for Memory and Imaging: Charge Coupling\$2.00</p> <p>_____ R-107 Wanted for the '70s: Easier-to-Program Computers\$4.00</p> <p>_____ R-110 Automation for Survival and Profit\$2.00</p> <p>_____ R-113 Optoelectronics Makes It At Last (3 part series) ..\$4.00</p> <p>_____ R-203 East Europe Market Report\$2.00</p> <p>_____ R-205 Bridging the Analog & Digital Worlds With Linear ICs\$4.00</p> <p>_____ R-207 Technology Gap Starts to Close for Computer Peripherals\$3.00</p> <p>_____ R-209 Semiconductor RAMs Land Computer Mainframe Jobs\$2.00</p> <p>_____ R-211 Electromagnetic Spectrum Report and Foldout Chart\$4.00</p> <p>_____ R-213 Electromagnetic Spectrum Chart (rolled in mailing tube)\$2.00</p> <p>_____ R-306 Charge Coupling Improves Its Image, Challenging Video Camera\$2.00</p> <p>_____ R-308 Program for Transition from Nonlinear to Linear Transistor Model\$2.00</p> <p>_____ R-310 Penetration Color Tubes are Enhancing Information Displays\$2.00</p> <p>_____ R-312 Leadless, Pluggable IC Packages Reduce Costs..\$2.00</p> <p>_____ R-316 Hybrid Circuit Technology Solves Tough Design Problems\$3.00</p> <p>_____ R-318 Buckling Up for the Bumpy Road to Detroit.....\$3.00</p> <p>_____ R-320 Planar Interconnection Techniques (Designer Must Plan Early for Flat Cable)\$3.00</p> <p>_____ R-322 Special Report: The New Displays Complement the Old\$2.00</p>	<p>_____ R-324 Semiconductor Memories Are Taking Over Data-Storage Applications\$3.00</p> <p>_____ R-326 Optical Spectrum Report and Optical Spectrum Chart\$4.00</p> <p>_____ R-328 Pervasiveness of Electronics Entire Issue of Electronics\$2.00</p> <p>_____ R-406 Logics New Design Tools\$3.00</p> <p>_____ R-408 Bringing Sight to the Blind\$2.00</p> <p>_____ R-410 Passive Components\$3.00</p> <p>_____ R-412 Liquid Cooling Semiconductors\$3.00</p> <p>_____ R-414 Simplified n-Channel Process\$3.00</p> <p>_____ R-416 Optical Waveguides Look Brighter\$3.00</p> <p>_____ R-418 Computer Analyses of RF Circuits\$3.00</p> <p>_____ R-420 Computerized Text-Editing and Typesetting\$3.00</p> <p>_____ R-422 A Microprogrammable Minicomputer\$3.00</p> <p>_____ R-424 Microprocessor Applications\$3.00</p> <p>_____ R-426 Special Issue—Technology Update—1974\$4.00</p> <p>_____ R-428 Laser Becomes a component for Mass-Market Applications\$3.00</p> <p>_____ R-430 Modeling the Bipolar Transistor\$3.00</p> <p>_____ R-432 Users Starting to Hop Aboard US Communications Satellites\$3.00</p> <p>_____ R-434 Standard Instrument Interface Simplifies System Design\$3.00</p> <p>_____ R-500 Japanese Forecast 1975\$3.00</p> <p>_____ R-502 European Forecast 1975\$3.00</p> <p>_____ R-504 U.S. Forecast 1975\$3.00</p> <p>_____ R-506 The Case For Component Burn-in: The Gain is Worth The Price\$3.00</p> <p>_____ R-508 Designing Microprocessors with Standard-Logic Devices\$3.00</p> <p>_____ R-510 Solid State I²L Boosts Bipolar- Microprocessor Integration\$3.00</p> <p>_____ R-512 Design of Circuits for Dangerous Environments\$3.00</p> <p>_____ R-514 Eight Ways to Better Radio Receiver Design\$3.00</p> <p>_____ R-516 Electronic Symbols Chart\$4.00</p> <p>_____ R-518 Productivity—April 17 issue\$4.00</p> <p>_____ R-520 Microprocessors—Electronics Book Series\$8.95</p>
--	---

} 3 FOR
\$7.50

Payment must accompany your order... USE THIS PAGE AS YOUR ORDER FORM

Make check or money order payable to Electronics Reprints. All orders shipped prepaid via parcel post. Allow two to three weeks for delivery.

Back Issues Now Available. 1960 to 1969 \$5.00 each. 1970 to 1973 \$3.00 each.

Mail Your Order To
Janice Austin
ELECTRONICS REPRINTS
P.O. Box 669
Hightstown, N.J. 08520

Amount of Order	\$ _____
Plus 10% Handling Charge	\$ _____
TOTAL AMOUNT ENCLOSED	\$ _____

SEND REPRINTS TO

Name _____

Company _____ Dept. _____

Street _____

City _____ State _____ Zip _____

When you want a small package delivered fast, it's in the bag.



Delta's DASH guarantees delivery on the flight or routing you specify between most Delta cities. Packages accepted up to 50 lbs. with length plus width plus height not to exceed 90"

Bring your package to Delta's passenger counter or air freight terminal at the airport at least 30 minutes before scheduled departure time. Package can be picked up at DASH Claim Area next to airport baggage claim area 30 minutes after flight arrival at destination.

Charges for DASH shipments are nominal. Delta reservations will be pleased to quote actual charges between specific points. Payments accepted in cash, by company check, most general-purpose credit cards, special credit arrangements or on government shipments by GBL.



Rate examples	(Tax included)
Atlanta-Washington	\$21.00
Boston-Miami	\$26.25
Los Angeles-New Orleans	\$31.50
Dallas/Ft. Worth-Los Angeles	\$26.25
San Francisco-Atlanta	\$31.50
Philadelphia-Houston	\$26.25
New York-Tampa	\$26.25
Chicago-Orlando	\$26.25
Detroit-Memphis	\$21.00

For full details, call Delta reservations.

Delta is ready when you are.®

■ Abbott Translator Technical Advertising Agency	8	■ Faultfinders, Inc. D. J. Moore Advertising, Inc.	136
• Adret Electronique Psycho Publicité	6E	■ Ferranti-Packard Huxley-Irwin-Price, Limited	141
Advanced Micro Devices Keye Donna Pearlstein	11	Figaro Engineering Inc. Standard Advertising, Inc.	138
‡ Allen Bradley Company Hoffman, York, Baker & Johnson, Inc.	38	■ Fluke Manufacturing Co., JOHN Bonfield Associates	72
American Used Computer Corporation McDavitt Advertising	150	General Magnetics McCarthy, Scelba, DeBiasi Advertising Agency, Inc.	3rd Cover
Amphenol Connectors Division, Bunker Ramo Corporation Buchen Advertising, Inc.	31	GML Corporation	154
Analogic Corporation Analogic Corporation	41	• Golden Gate Enterprises Associated Ad * Ventures, Incorporated	19
Bausch & Lomb, Inc. Wolff Associates, Inc.	147	Gulf Power Company Ad/Com Advertising, Inc.	144
Belden Corporation Fensholt Incorporated	122	Harria Semiconductor Tucker Wayne & Company	71
Bell, F.W. Urban Marketing, Inc.	115	Hermes Electronics, Limited Public & Industrial Relations Limited	66
‡ Brand-Rex Creamer, Trowbridge, Case & Bastford, Inc.	2-3	■ Hewlett Packard Corporate Marketing Communications	21-30
■ Buckeye Stamping Company, The Wheeler, Kight & Gainey, Inc.	149	■ Honeywell Test Instrument Division Campbell-Mithun, Inc.	42
■‡ MGR/Bussaman Manufacturing Division Media Marketing Service Center, Inc.	68	Hughes Aircraft Company Foote, Cone & Belding/Honig	52-53, 55, 77
California Computer Products Dailey & Associates Advertising	96	■ HyComp, Inc. Fred Molinari Associates	133
■ Clairex Corporation Marquardt & Roche, Inc.	4th Cover	Interdata Shaw-Elliott Advertising	58-59
Communications Transistor Corporation Wylie, Wilson & Munn	36-37	Kathley Instruments Chagrin Valley Marketing Associates	86
■ Concord Electronics Corp. Sound Advertising	82	■ Kepco, Inc. Weiss Advertising	7
■ Continental Specialties Corporation Robert A. Paul	127	‡ Littlefuse, Inc. LF Advertising, Inc.	125
■‡ Cramer Electronics Johnson, Ralpin & Clarke Inc.	83	McGraw-Hill Book Company	80
Datacon, Inc. Henry Sherlock Company	51	Micro Power Systems Associated Ad * Ventures, Incorporated	35
Data General Corporation Scali, McCabe, Slovas, Inc.	49	■ Modular Power Manning/Bowen and Associates	82
Delta Air Lines Burke Dowling Adams, Inc.	152	MOS Technology, Inc. Henry S. Goodsett Advertising, Inc.	60-61
Delta Products, Inc. The William Loughran Company	149	Motorola Semiconductor Products, Inc.	14-15
■ Dialight Corporation Michel-Cather, Inc.	34	■ North Atlantic Industries, Inc. NOAT Advertising Company	78
Digital Equipment Corporation Creamer, Trowbridge, Case & Bastford, Inc.	16-17	Oak Industries, Inc. Switch Division Stral Advertising Company, Inc.	142
Eastman Chemical Products, Inc. Martin Landey, Arlow Advertising, Inc.	48	‡ Omron Corporation of America Frank C. Nahser, Inc.	2nd cover, 1
Eastman Kodak Co.—GMD GD Photofabrication Microelectronic Rumrill-Hoyt, Inc.	79	• Oscilloquartz Young and Rubicam	68
‡ Eastman Kodak Co. Graphics Markets Division J. Walter Thompson Company	19	■ Permag Corporation Schneider, Allen, Walsh, Inc.	139
Eldorado Instruments	145	• Phillips N.V. PIT/T&M Division Brookes Communications Systems SA	2-3
Elgar Corp. Chapman Michetti Advertising	140	Powercube Corporation, Division of Unitrade Advertising Assistance, Inc.	4
■ Erie Technological Products Co., Inc. Altman Hall Associates Advertising	119	Primo Co., Ltd. General Advertising Agency, Inc.	138

■ Radio Research Instrument Corporation Classified Advertising	150
RCA Industrial Tube Products Al Paul Letton Company, Inc.	51
■ RCL Electronics, Inc. Morvay Advertising Agency	18
Rohde & Schwarz McCarthy, Scelba, DeBiasi Advertising Agency, Inc.	13
Schauer Manufacturing Corporation Nolan, Keelor & Stites	50
Samtech Corporation Envision Advertising	9
‡ Siemens Corporation Stiefel-Raymond Advertising, Inc.	32-33
Signalica Corporation Sub. of Corning Glass Works 127, 129, 131, 135, 137, 139-142 Hall Butler Blatherwick, Inc.	
Silicon Transistor BBF Group, Inc.	129
Silliconix Robertson West, Inc.	75
Sprague Electric Company Harry P. Bridge Company	10
■ Superior Electric Co. Keiler, Garrett, Pratt Advertising	121
■ Systron Donner Concord Instruments Fred Schott & Associates	99, 135
Technit TWP Advertising	141
■ Tektronix, Inc. Tektronix Advertising	47
■ Teledyne Relays S. Michelson Advertising	128
Ultra-Violet Products, Inc. Walnut Grove Industrial Advertising	149
United Systems Corp., a Sub. of Monsanto Co. Advertising & Merchandising, Inc.	153
Universal Instrument Corp. Commercial Art Service Graphics	148
Vactec, Inc. Coleman & Associates Advertising	132
Varo Semiconductor, Inc. Warren-Guild	131
Victoreen Instrument Division Dix & Eaton, Inc.	85
Wavetek San Diego Chapman Michetti Advertising	62
Wima, Westermann Oliver-Beckmann GmbH	20
• Yokogawa Electric Works Ltd. General Advertising Agency Inc.	1

Classified & Employment Advertising
F. J. Eberle, Manager 212-971-2557

EQUIPMENT (used or Surplus New) For Sale
Hewlett Packard.....146

■ For more information on complete product line see advertisement in the latest Electronics Buyer's Guide
• Advertisers in Electronics International
‡ Advertisers in Electronics domestic-only edition

Affordable Portable!

- Measures: AC & DC Volts, AC & DC Amps, Resistance
- 26 ranges • 100 μ V resolution
- 1200 Volt overload protection • LSI for reliability
- Plug-in ICs for maintainability
- Rugged LEXAN® case • Integral battery charger
- Weighs only 2 Lbs. (0.9kg)



Model 2120,
3 1/2 digit multimeter.

ONLY **\$295.**

See your local United Systems representative for complete specifications.

UNITED SYSTEMS CORPORATION
918 Woodley Road Dayton, Ohio 45403
Ph (513) 254-6251 Fax (810) 439-1729
a subsidiary of
Monsanto

Digitec

"Information Only" Circle 153 on reader service card
"Demonstration Only" Circle 185 on reader service card

Presenting in your corner: THE ELECTRONICS BOXER!

Why mess around when you can have the ELECTRONICS BOXER clean up your copies—keep them in top condition.

And, it's easy and inexpensive to keep the ELECTRONICS BOXER in your corner. Just complete the coupon and mail. Your order will be processed immediately, postpaid.



ELECTRONICS BOXER

Jesse Jones Box Corporation
2250 E. Butler St., Philadelphia, Pa. 19137

Please send me: boxes @ \$4.25 each;
 3 boxes @ \$12.00; 6 boxes @ \$22.00
My check or money order is enclosed.

Name _____
Address _____
City _____ State _____ Zip _____

BUYING A MINICOMPUTER IS A LOT LIKE BUYING A DRILL.



The other day I wanted to buy a drill. So I got a copy of that handy little magazine. You know the one. Tells all you need to know about different brands, guides you to the best buys.

And I got a great drill.

Then I ran into the same problem at work. Firm needed a minicomputer to streamline accounting procedures.

So I figured I'd choose it the same way I chose my drill, by comparing all the brands. Problem was, how to get all the facts and figures, fast.

Then I heard about GML's "Minicomputer Review," so I got a subscription. Sure enough, it has all the facts and figures. Helped us get a mini just right for us, at the right price.



The accounting department was so happy they gave me a little present.

15 day FREE trial

Examine "Minicomputer Review" for 15 days at our risk. 1975 edition has 300 pages, updated twice a year. If you're not completely satisfied, return it and owe us nothing. Keep it and pay only \$48. Overseas, \$12 extra.

Please rush me my "Minicomputer Review."

name _____

address _____

city/state/zip _____

GML

Mail to: Electronics/GML Corp.,
594 Marrett Rd., Lexington, MA
02173

Advertising Sales Staff

Pierre J. Braudé New York [212] 997-3468
Paris Tel. 720-73-01
Director of Marketing

Atlanta, Ga. 30309: Warren H. Gardner
100 Colony Square, 1175 Peachtree St., N.E.
[212] 997-3617

Boston, Mass. 02116: James R. Pierce
607 Boylston St. [617] 262-1160

Chicago, Ill. 60611:
645 North Michigan Avenue
Robert W. Bartlett (312) 751-3739
Paul L. Reiss (312) 751-3738

Cleveland, Ohio 44113: William J. Boyle
[716] 586-5040

Dallas, Texas 75201: Charles G. Hubbard
2001 Bryant Tower, Suite 1070
[214] 742-1747

Denver, Colo. 80202: Harry B. Doyle, Jr.
123 Speer Blvd., # 400
Denver, Colorado 80203
(303) 893-3863

Detroit, Michigan 48202: Robert W. Bartlett
1400 Fisher Bldg.
[313] 873-7410

Houston, Texas 77002: Charles G. Hubbard
375 Dresser Tower, 601 Jefferson St. [713] CA 4-8381

Los Angeles, Calif. 90010: Robert J. Rielly
Bradley K. Jones, 3200 Wilshire Blvd., South Tower
[213] 487-1160

New York, N.Y. 10020
1221 Avenue of the Americas
Warren H. Gardner [212] 997-3617
Michael J. Stoller [212] 997-3616

Philadelphia, Pa. 19102: Warren H. Gardner
Three Parkway,
[212] 997-3617

Pittsburgh, Pa. 15222: Warren H. Gardner
2 Galeway Center [412] 391-1314

Rochester, N.Y. 14534: William J. Boyle
9 Greylock Ridge, Pittsford, N.Y.
[716] 586-5040

San Francisco, Calif. 94111: Don Farris
Robert J. Rielly, 425 Battery Street,
[415] 362-4600

Paris: Alain Offergeld
17 Rue-Georges Bizet, 75 Paris 16, France
Tel: 720-73-01

Geneva: Alain Offergeld
1 rue du Temple, Geneva, Switzerland
Tel: 32-35-63

United Kingdom & Scandinavia: Keith Mantle
Tel: 01-493-1451, 34 Dover Street, London W1

Milan: Luigi Rancati
Robert Saidel (Middle East)
1 via Baracchini, Italy Phone 86-90-656

Brussels: Alain Offergeld
23 Chaussée de Wavre
Brussels 1040, Belgium
Tel: 13-73-95

Frankfurt/Main: Fritz Krusebecker
Dieter Rothenbach (East European Countries)
Liebigstrasse 27c, Germany
Phone 72 01 81

Tokyo: Tatsumi Katagiri, McGraw-Hill
Publications Overseas Corporation,
Kasumigaseki Building 2-5, 3-chome,
Kasumigaseki, Chiyoda-Ku, Tokyo, Japan
[581] 9811

Australasia: Warren E. Ball, IPO Box 5106,
Tokyo, Japan 100-31
Tel: (03) 667-7397

Business Department

Stephen R. Weiss, Manager
[212] 997-2044

Thomas M. Egan,
Assistant Business Manager [212] 997-3140

Carol Gallagher
Production Manager International [212] 997-2045

Dorothy Carter, Production Manager Domestic
[212] 997-2908

Francesa Vallone, Reader Service Manager
[212] 997-6057

Lisa Hoenig, Secretary
[212] 997-6481

Electronics Buyers' Guide

George F. Werner, Associate Publisher
[212] 997-3139

Regina Hera, Directory Manager
[212] 997-2544

A little simple arithmetic about a Math major.



The cost of a higher education is getting higher. In fact, you could end up spending close to \$20,000 to put your child through college.

So maybe you should consider U.S. Savings Bonds. They're one of the most dependable ways to build funds for an education.

All you have to do is join the Payroll Savings Plan where you work. Then an amount you specify is set aside from your paycheck and used to buy Bonds.

Save your child is 3 years old now. If you buy a \$75 Bond a month through Payroll Savings, by the time he's 18, you'll have \$16,048 tucked away. A solid sum to get him started. See? A little simple arithmetic can add up to a lot.

Make the chances of your child's college education more secure. Join the Payroll Savings Plan now.

Now E Bonds pay 6% interest when held to maturity of 5 years (4% the first year). Bonds are replaced if lost, stolen or destroyed. When needed, they can be cashed at your bank. Interest is not subject to state or local income taxes, and federal tax may be deferred until redemption.



Take stock in America.

Join the Payroll Savings Plan.

Ad Council A public service of this publication and The Advertising Council.

SOLID STATE 3 WIRE SYNCHRO TO LINEAR D.C. CONVERTER



RESPONSE CURVE

MAC 1422-1
MAC 1449-1
MAC 1458-1
MAC 1459-1

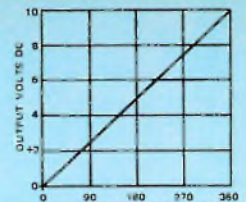
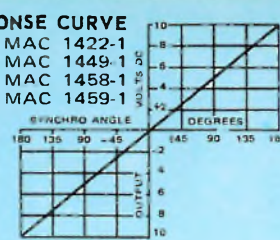

RESPONSE CURVE

MAC 1460-1
MAC 1461-1

FEATURES:

- Develops a DC output voltage linearly proportional to a synchro angle over a $\pm 180^\circ$ range.
- Completely solid state with all of the inherent advantages over a mechanical system such as:
 - High reliability (since there are no moving parts)
 - Light weight—6 ozs.
 - Small size
 - All units hermetically sealed

- Wide temperature range operation
- Output short circuit protected
- Three wire inputs isolated from ground
- Package size may be altered at no extra cost
- Units can be altered to accept different line to line voltages or different operating frequencies at no extra cost
- Not affected by reference voltage or power supply variations.

UNIT	MAC 1422-1	MAC 1449-1	MAC 1458-1	MAC 1459-1	MAC 1460-1	MAC 1461-1
TRANSFER EQUATION	$\pm IV/18^\circ$	$\pm IV/18^\circ$	$\pm IV/18^\circ$	$\pm IV/18^\circ$	$+IV/36^\circ$	$+IV/36^\circ$
ACCURACY (+25°C)	1/2%	1/2%	1/2%	1/2%	1/2%	1/2%
ACCURACY (-25°C+85°C)	1%	1%	1%	1%	1%	1%
L - L SYNCHRO INPUT (VRMS)	11.8	90	11.8	90	11.8	90
FREQUENCY (Hz)	400	400	60	60	400	400
FULL SCALE OUTPUT	$\pm 10V$	$\pm 10V$	$\pm 10V$	$\pm 10V$	+10V	+10V
OUTPUT IMPEDANCE	$<1\Omega$	$<1\Omega$	$<1\Omega$	$<1\Omega$	$<1\Omega$	$<1\Omega$
L - L INPUT IMPEDANCE	$>10K$	$>30K$	$>2K$	$>10K$	$>10K$	$>30K$
REFERENCE VOLTAGE (VRMS)	26	115	26	115	26	115
OPERATING TEMP. °C	-25 - +85	-25 - +85	-25 - +85	-25 - +85	-25 - +85	-25 - +85
D.C. SUPPLY	$\pm 15V$	$\pm 15V$	$\pm 15V$	$\pm 15V$	$\pm 15V$	$\pm 15V$
D.C. SUPPLY CURRENT	$\pm 75MA$	$\pm 75MA$	$\pm 75MA$	$\pm 75MA$	$\pm 75MA$	$\pm 75MA$
BANDWIDTH	10Hz	10Hz	OPT.	OPT.	10Hz	10Hz
WEIGHT	6 oz.	6 oz.	6 oz.	8 oz.	6 oz.	6 oz.
SIZE	3.6x2.5x0.6	3.6x2.5x0.6	3.6x3.0x0.6	3.6x3.0x1.0	3.6x2.5x0.6	3.6x2.5x0.6

A.C. LINE REGULATION

A new method has been developed which allows us to provide a low distortion highly regulated AC waveform without using tuned circuits or solid state active filters of any kind.

The result is a frequency independent AC output regulated to 0.1% for line and load with greater than 20% line variations over a wide temperature range.

FEATURES:

- 0.1% total line and load regulation
- Independent of $\pm 20\%$ frequency fluctuation
- 1 watt output
- Extremely small size
- Isolation between input and output can be provided

Specifications: Model MLR 1476-1

AC Line Voltage: 26V $\pm 20\%$ @ 400Hz $\pm 20\%$

Output: 26V $\pm 1\%$ for set point

Load: 0 to 40ma

Total Regulation: +0.1%

Distortion: 0.5% maximum rms

Temperature Range: $-55^\circ C$ to $+125^\circ C$

Size: 2.0" x 1.8" x 0.5"

Other units are available at different power and voltage levels as well as wider temperature ranges. Information will be furnished upon request.

SOLID-STATE SINE-COSINE SYNCHRO CONVERTER - NON VARIANT

This new encapsulated circuit converts a 3 wire synchro input to a pair of dc outputs proportional to the sine and cosine of the synchro angle independent of a-c line fluctuations.

- Complete solid state construction
- Operates over a wide temperature range
- Independent of reference line fluctuations
- Conversion accuracy—6 minutes
- Reference and synchro inputs isolated from ground

Specifications Model DMD 1508-2

Accuracy: Overall conversion accuracy 6 minutes. Absolute value of sine and cosine outputs accurate to $\pm 30MV$

Temperature Range: Operating $-40^\circ C$ to $+85^\circ C$, Storage $-55^\circ C$ to $+125^\circ C$

Synchro Input: 90V RMS $\pm 5\%$ LL 400Hz $\pm 5\%$

DC Power: $\pm 15V$ DC $\pm 10\%$ @ 50MA

Reference: 115VRMS $\pm 5\%$ 400Hz $\pm 5\%$

Output: 10V DC full scale output on either channel @ 5ma load

Temperature coefficient of accuracy: ± 15 seconds/ $^\circ C$ avg. on conversion accuracy ± 1 MV/ $^\circ C$ on absolute output voltages

Size: 2.0" x 1.5" x 2.5"

Units are available with wider temperature ranges and 11.8V LL, 26V reference synchro inputs. Information will be supplied upon request.

There is No Substitute for Reliability



GENERAL MAGNETICS • INC

135 Bloomfield Ave., Bloomfield, New Jersey 07003 - Tel. (201) 743-2700

Circle 901 on reader service card

Optical switches tailored to fit.

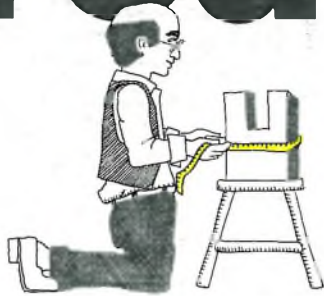

Clairex offers a choice of standard and custom switches with hermetically sealed components.

Don't make your design to fit an optical switch. Let Clairex® make the optical switch to fit your design.

You can get two standard sizes with gap widths of .100 in. or .250 in. Or we'll make them to any width or size you specify.

We seal both the LED and phototransistor in hermetic cases for long life in the harshest environments. Then pretest each switch to make sure it works. The lenses or windows are glass, not plastic, to reduce dust pickup. (Lenses position the light beam more accurately, preventing false signals from stray light.) Outputs are compatible with T²L inputs.

Sensors are either phototransistors or photodarlingtons.

You can forget about friction wear, switching "noise", and contact bounce. The two switch heads are completely isolated. Switching time can be as short as 5 microseconds — impossible with mechanical switches.

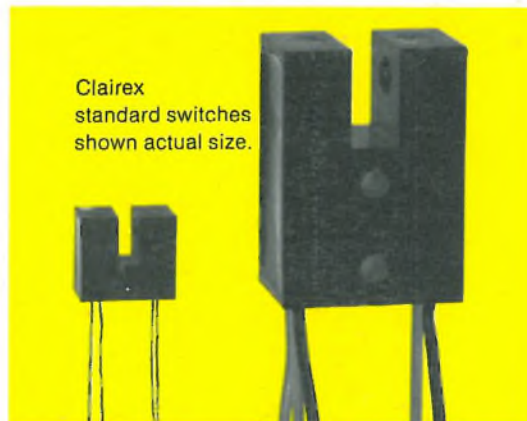

Tell us what you need. We'll develop the solution. With Clairex, you get the best in opto-electronic components — photodarlingtons, phototransistors, photoconductors, opto-isolators. Write Clairex Electronics at 560 South Third Avenue, Mount Vernon, New York 10550. Or phone (914) 664-6602.



CLAIREX ELECTRONICS

Circle 902 on reader service card