

FEBRUARY 20, 1975

Eight ways to better receiver design/87

A low-cost home terminal for two-way cable TV/96

Op amp coupled with zener produces precise reference/101

FOUR DOLLARS A MCGRAW-HILL PUBLICATION

# Electronics®



MATT REYLL  
2022 NE BROADWAY  
PORTLAND OR  
97232

**PRODUCT  
DEVELOPMENT  
PROFILE**

**Scope-multimeter  
takes on  
industrial jobs**



# Why Parylene works where other microelectronic protection fails:

## Controlled conformality

There's a uniform coating of parylene all the way around the half-mil tip of this phonograph needle. That's true conformality, and only parylene gives it, in precisely controlled thicknesses from .002 to 3 mils, in one step. Unlike spray or dip coatings, parylene won't bridge or puddle, or thin out at sharp edges, creating potential failure points. The parylene coating is completely uniform, no matter how dense or intricate the module. And because it's applied at room temperature, there's no component discomfort.



## △200 @ thermal shock protection

This hybrid microelectronics relay has undergone 200 45-minute cycles from -120 to 80°C, simulating earth-orbiting conditions. This X-ray shows all leads remain intact. Parylene protection was at work, on the transformer core and then the whole assembly before packaging (TO-116). There was no appearance of corona up to 5000 V<sub>dc</sub>; leakage was reduced from 10μA to <.001μA at 1000V. RTV encapsulation suffered dimensional mismatch, straining and snapping leads, with 500 V/mil bulk breakdown.

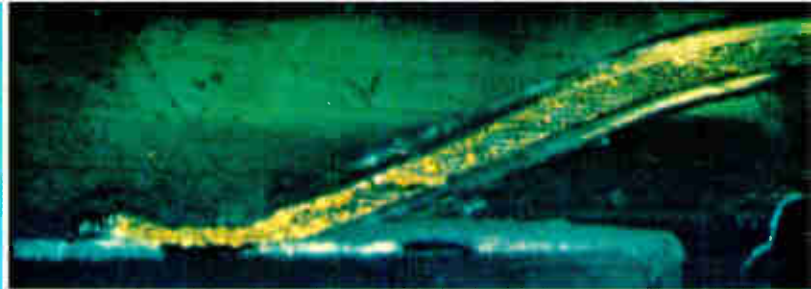
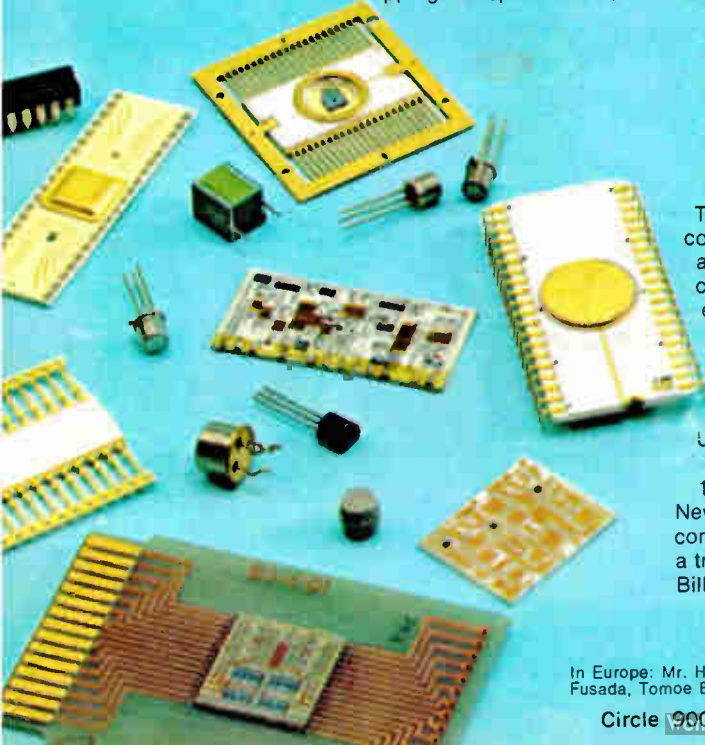

## Crevice penetration in hybrids

This beam lead has a 0.3 mil parylene coating all the way to the weld. Parylene penetrates deep within small crevices, maintaining clearance while putting a coherent coating under beam leaded chips and air bridges. No area is left unprotected, preventing shorts and allowing the designer great latitude in component spacing and sizing. And parylene secures loose debris while preventing breakoff of pigtailed during shock and vibration loadings.

## Lead Strengthening

It took up to 75 grams pull to break these 1 mil wires. Bare 1 mil aluminum wires, for instance, exhibit bond strengths of 3-5.5 grams; coated with 1 mil of parylene, pull strength increases by 60-70 grams.

So wire and bond are stronger, and sideward shorts and loop collapse during extreme g-loads are prevented. Parylene coatings will penetrate the less than 1 mil clearance between beam lead bonded chips and the substrate, giving such strong coating coverage that the chip cannot be lifted without destroying it.

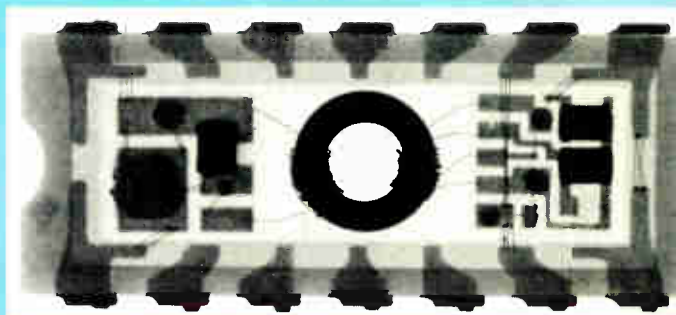

X-ray courtesy NASA Lewis Research Center and Sterer Eng. & Mfg. Co.

## Broad cost effectiveness

These are some of the circuit modules now being protected with a conformal coating of parylene. Because nothing else offers parylene's combined protection against thermal cycling, shock, vibration, humidity, solvents, radiation, ionic contamination. Better barrier protection than liquid coatings like silicones, epoxies, and urethanes. On hybrids you can combine parylene with a hermetic seal for optimum environmental protection . . . and parylene alone will often do the job, and at less cost than hermetic seals. Parylene is compatible with active devices, and meets the tough requirements of MIL-I-46058C.

For long term reliability, parylene provides a cost-effective solution.

Union Carbide invented the parylene system. Various patents apply; commercial use of the patented technology is licensed. Write for our 16-page brochure: Union Carbide Corp., 270 Park Avenue, Dept. RFB-65, New York, N.Y. 10017. For instant communication, and information about a trial run at reasonable cost, call Bill Loeb at (212) 551-6071.



In Europe: Mr. H. Torre, Union Carbide Europe S.A., 5 Rue Pedro-Maxylan, 1211 Geneva 17. In Japan: Mr. N. Fusada, Tomoe Engineering Co. Ltd., Shin Shin Kai Bldg., 14-1 Nimenbashi 3-Chome, Chuo-Ku, Tokyo.

Circle 900 on reader service card

# Give your scope a word trigger

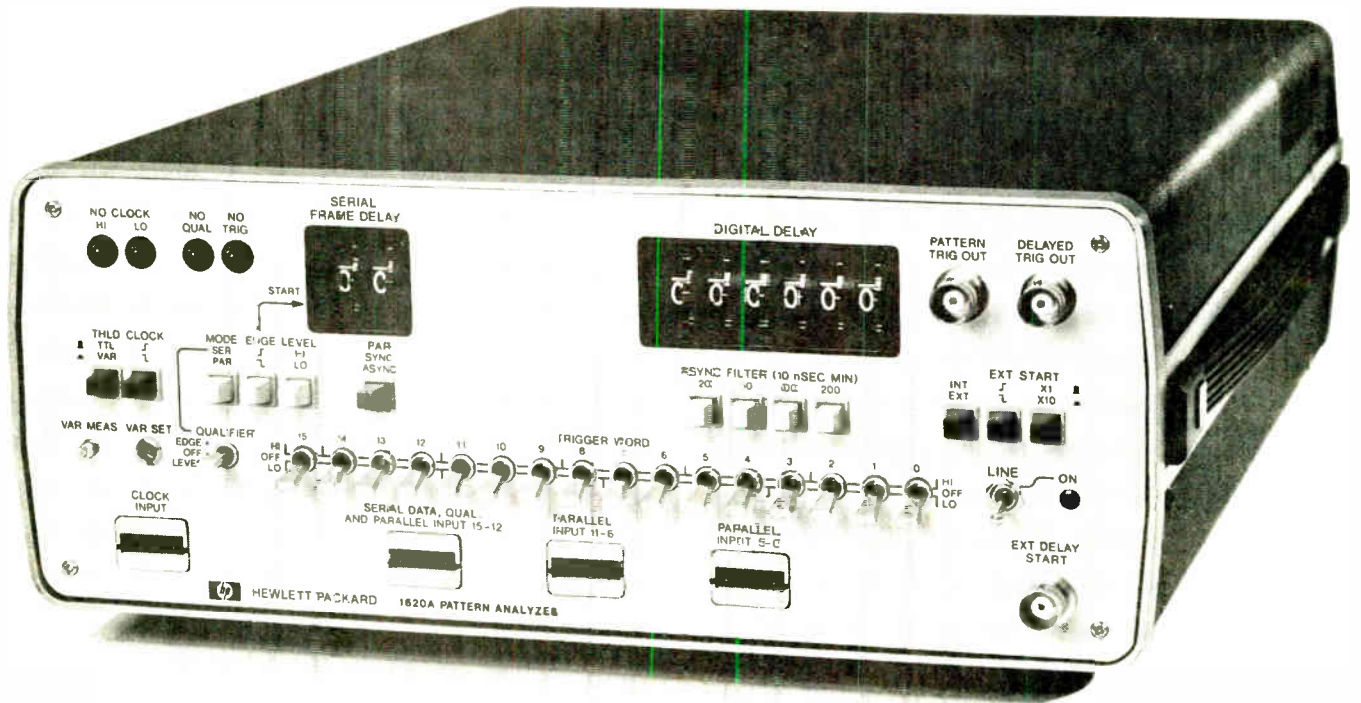
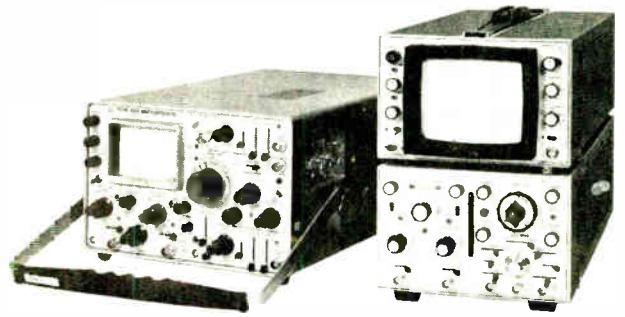

## For easier logic design and debugging

With HP's new 1620A Pattern Analyzer and your present scope you can trigger on any digital word up to 16 bits. Whether your data is serial or parallel, synchronous or asynchronous. You simply preset the trigger word you want, and the pattern analyzer gives you a 2V, 25 nsec pulse when that word appears in the data stream.

The 1620A, with its pattern recognition ability, provides a dynamic window for viewing any digital circuit—at clock speeds up to 20 MHz. You can make real-time measurements on any part of your system... whether you're analyzing the data following the trigger word, another data stream, or some other event at that particular point in time.

You can also delay the trigger point up to 999,999 clock pulses after the word—in either serial or parallel mode. And if you have a long serial word to interrogate, the 1620A,

with its qualifier input, lets you window on any portion of that word.

A threshold-level switch allows you to select TTL input levels or vary the input threshold over a  $\pm 10V$  range for use with other logic families. And a selectable asynchronous filter prevents your scope from triggering on glitches due to differences in pulse timing (skew) among the various channels.

For only \$1,750\* (including probes), you can turn your present scope into a digital troubleshooter and simplify your digital analysis problems. For more information about this newest member of HP's growing digital analyzer family, call your local HP field engineer. He can also give you information on HP's 4-bit AND-gate Trigger Probes for TTL, MOS, and ECL. Priced at just \$95\* each, they give you pattern recognition on four parallel events to trigger scopes, logic analyzers, or other digital test equipment.

\*Domestic USA price only.

HEWLETT  PACKARD

Sales and service from 172 offices in 65 countries.  
1501 Page Mill Road, Palo Alto, California 94304



# HP's New 5 Volt 100 Amp Switching Supply is Ready For the Most Important Test in the World...

# YOURS

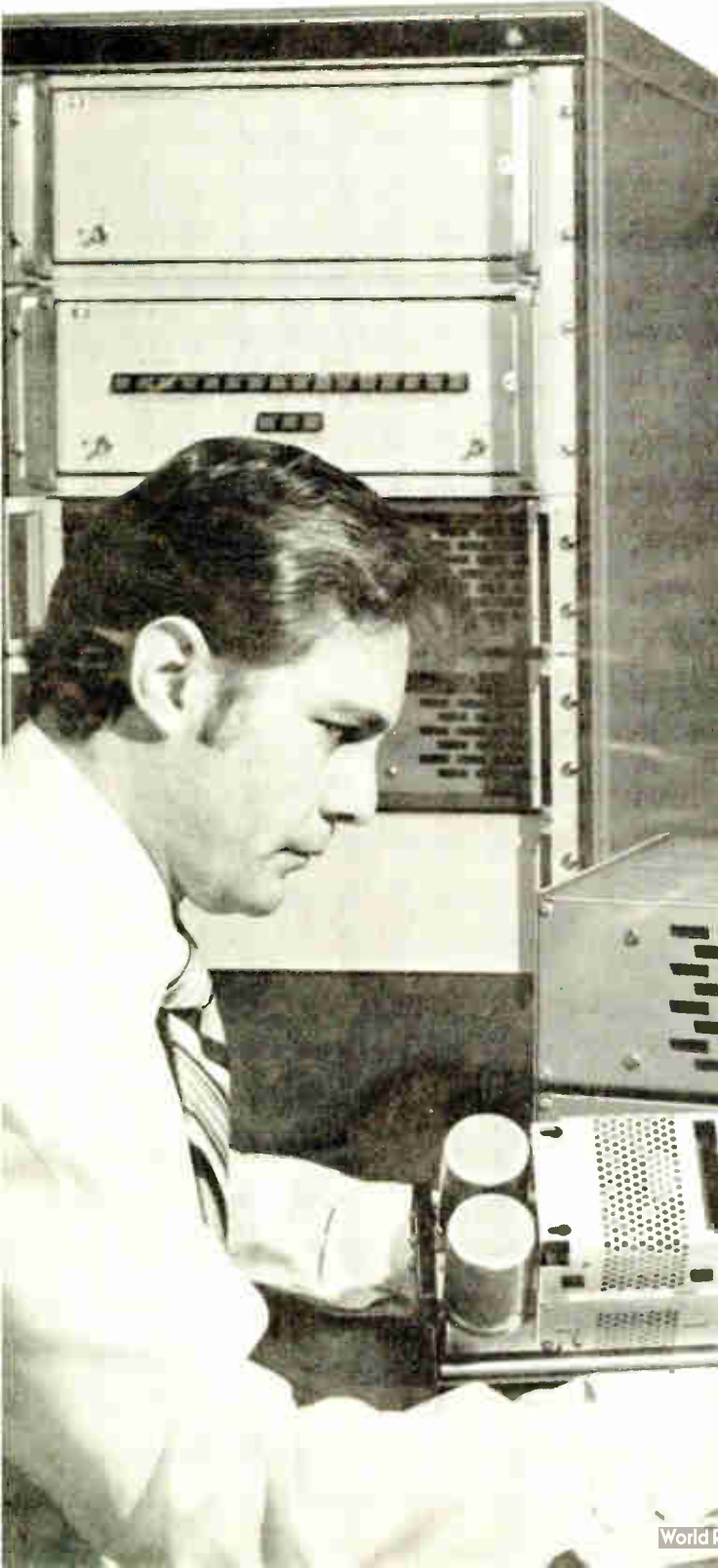

We designed the Model 62605M Switching Supply to give the top performance and reliability demanded by today's OEMs. But, more importantly, you want to know exactly how it will perform for you, in your system. So check designs, examine the modular construction, put it through your own tests. We think you'll find the kind of conservative, sophisticated design and careful attention to detail that adds up to lasting product value.

Of course, the 62605M offers all the benefits of a technologically advanced 20KHz switching supply — high efficiency — small size — low heat dissipation. And, we've added important "standard" features like a soft-start circuit to hold down in-rush current, plus overvoltage and overcurrent protection.

The 62605M operates from 120/220/240 Vac, 48-63Hz, with 70% conversion efficiency. Regulation is 0.1%, with ripple and noise of 20mV rms, 40mV p-p ripple. The supply measures 5"H x 8"W x 12"D, and weighs only 14 pounds.

There's a lot more, so get the complete story including the generous OEM and quantity discounts from your local HP Field Engineer.

Circle 2 on reader service card

HEWLETT  PACKARD

Sales and service from 172 offices in 65 countries.  
1501 Page Mill Road, Palo Alto, California 94304

21501



**29 Electronics Review**

MEMORY: Intel 4-k RAM speeding up to 80-ns access time, 29  
SOLID STATE: Fairchild readies bipolar processors, 30  
4,096-bit RAMs in volume trigger price reductions, 30  
SOLAR CELLS: Thin-film solar cell has 12% efficiency, 31  
COMPUTERS: New Digital Equipment computer adds faster bus, 31  
MILITARY: Army testing in-flight data system, 32  
CONSUMER: Watch market: is 40 a crowd?, 34  
BUSINESS: Bowmar Instrument files for bankruptcy, 36  
MEDICAL ELECTRONICS: C-MOS implant to aid deaf, 38  
NEWS BRIEFS: 38  
OPTOELECTRONICS: Fiber-optic kit aims at industrial applications, 40

**52 Electronics International**

WEST GERMANY: IC controls functions of 8-mm movie cameras, 52  
JAPAN: Brighter LEDs promised by continuous GaAIs growth, 52  
AROUND THE WORLD: 53

**65 Probing the News**

GOVERNMENT: Budget includes increase for defense, 65  
INSTRUMENTATION: European firms in a squeeze, 70  
MANUFACTURING: Automated bonding provides an edge, 74  
AVIONICS: MLS decision triggers brouhaha, 78

**81 Technical Articles**

PRODUCT DEVELOPMENT PROFILE: Tektronix' DMM/scopes, 81  
COMMUNICATIONS: Eight ways to better radio receiver design, 87  
DESIGNER'S CASEBOOK: Optically coupled ringer spares line, 92  
Regulated power supply is adjustable from 0 to 38 V, 93  
Comparator and D-MOS switch rectify small signals linearly, 95  
COMMUNICATIONS: Cost barrier cracked in two-way cable TV, 96  
CIRCUIT DESIGN: Op amp stabilizes zener's reference voltage, 101  
ENGINEER'S NOTEBOOK: Two-color LEDs indicate digital status, 108  
Designing with preferred component values cuts costs, 109

**114 New Products**

IN THE SPOTLIGHT: Microcomputer wields power of a mini, 114  
Test system checks out C-MOS watch circuits, modules, 117  
SEMICONDUCTORS: CCD memory stores 16-k bits, 118  
COMPONENTS: Tubular heaters trigger controls, 125  
PACKAGING & PRODUCTION: Two-in-one system for LSI masks, 130  
MICROWAVE: Power meter measures to 0.5%, 139  
SUBASSEMBLIES: Analog-to-digital converter handles ratios, 145  
MATERIALS: 149

**Departments**

Publishers letter, 4  
Readers comment, 6  
News update, 8  
Editorial, 10  
People, 14  
Meetings, 20  
Electronics newsletter, 25  
Washington newsletter, 49  
Washington commentary, 50  
International newsletter, 55  
Engineer's newsletter, 112  
New literature, 150

**Highlights**

**Cover: DMM/scope fits field engineer's needs, 81**

Latest miniature oscilloscope from Tektronix includes a digital multimeter that doubles its usefulness in the field. This article—one of a series of Product Development Profiles—traces how designers gradually jigsawed the model 213's pieces into a package the size of a small loaf. Cover is by photographer Eric Koniger.

**Budget gives electronics few breaks, 65**

President Ford's budget reduces spending in every area except defense—and Congress may not let him raise spending there. The prospects for nonmilitary electronics suppliers to the Government are even less cheering than last year.

**Eight ways of designing a better radio receiver, 87**

Old design concepts must be exchanged for new ones if today's radio receivers are to extract most benefit from components like vhf crystal filters, p-i-n diodes, and high-power rf transistors.

**Two-way CATV that everyone can afford, 96**

The lack of an efficient, inexpensive terminal has kept two-way CATV out of the home. In a new system, however, a central minicomputer polls remote switches one at a time, keeping both signal intrusion and terminal cost to a minimum.

**And in the next issue . . .**

Impulse bonding as an economical alternative to multilayer boards . . . how the IC revolution is changing data-acquisition systems . . . a low-cost, high-performance silicon temperature transducer.

EDITOR-IN-CHIEF: Kemp Anderson

EXECUTIVE EDITOR: Samuel Weber

MANAGING EDITORS: Lawrence Curran, News;  
Arthur Erikson, *International*

SENIOR EDITORS: John Johnsrud,  
H. Thomas Maguire, Laurence Altman,  
Ray Connolly, Stephen E. Scrupski

ART DIRECTOR: Fred Sklenar

ASSOCIATE EDITORS: Howard Wolff,  
Gerald M. Walker, Alfred Rosenblatt

DEPARTMENT EDITORS  
*Aerospace/Military*: Ray Connolly  
*Circuit Design*: D. J. Blattner  
*Components*: Lucinda Mattera  
*Computers*: Stephen E. Scrupski  
*Consumer*: Gerald M. Walker  
*Industrial*: Margaret A. Maas  
*Instrumentation*: Andy Santoni  
*New Products*: H. Thomas Maguire,  
Michael J. Riezenman  
*Packaging & Production*: Jerry Lyman  
*Solid State*: Laurence Altman

COPY EDITORS: Margaret Eastman,  
Everett C. Terry, Bill Dunne

ART: Charles D. Ciatto, *Associate Director*  
Patricia Cybulski, *Assistant Director*

PRODUCTION EDITOR: Arthur C. Miller

EDITORIAL SECRETARIES: Janet Noto,  
Julie Gorgoglione, Penny Roberts

FIELD EDITORS

*Boston*: Gail Farrell (Mgr.), Pamela Leven  
*Los Angeles*: Paul Franson (Mgr.)  
Judy Phelps  
*Midwest*: Larry Armstrong (Mgr.)  
*New York*: Ron Schneiderman (Mgr.)  
*San Francisco*: Bernard Cole (Mgr.)  
Judith Curtis  
*Washington*: Ray Connolly (Mgr.)  
Larry Marion  
*Frankfurt*: John Gosch  
*London*: William F. Arnold  
*Paris*: Arthur Erikson  
*Tokyo*: Charles Cohen

McGRAW-HILL WORLD NEWS

*Director*: Ralph R. Schulz  
*Bonn*: Robert Ingersoll  
*Brussels*: James Smith  
*London*: Marvin Petal  
*Madrid*: Dom Curcio  
*Milan*: Peter Hoffmann, Andrew Heath  
*Moscow*: Peter Gall  
*Paris*: Michael Johnson, Richard Shepherd  
*Stockholm*: Robert Skole  
*Tokyo*: Mike Mealey

PUBLISHER: Dan McMillan

DIRECTOR OF MARKETING: Pierre J. Braudé

ADVERTISING SALES SERVICE MANAGER:  
Wallis Clarke

BUSINESS MANAGER: Stephen R. Weiss

CIRCULATION MANAGER: Nancy L. Merritt

MARKETING SERVICES MANAGER:  
Tomlinson Howland

RESEARCH MANAGER: Margery D. Sholes

Our series of behind-the-scenes stories detailing the often-tortuous path to final product design—which we call product development profiles—have always rated high marks from readers. And now, we are happy to say, one of them has rated high with the judges of the Jesse Neal Award.

In the August 22, 1974, issue, we ran a profile on variable speech control, an intriguing circuit development that promises to have wide-ranging applications in audio recording jobs. And thanks to the combined efforts of the authors, Jerry Walker, our consumer electronics editor, and Fred Sklenar, our art director, we supplemented the article with a plastic sound sheet. That sheet, when played on a phonograph, dramatically demonstrated the speeded up and slowed down, yet virtually undistorted, reproduction of speech made possible by the technique. For their efforts, Walker and Sklenar won an honorable mention in the Neal competition, which was established to reward initiative by individual editors in the business press.

Coincidentally, in this issue you'll find the latest chapter in the product development profile series—this one on the evolution of the Tektronix line of portable, nearly pocket-size oscilloscopes. The latest in the line, the model 213, combines a scope and a digital multimeter in an amazingly compact package. As our instrumentation editor, Andy Santoni, points out, the unit, weighs under four pounds, although it is "not quite small enough for the average raincoat pocket. Still, to fit a 1-megahertz scope, plus

a true-rms DMM, plus batteries, onto less than 142 cubic inches is an undoubted achievement."

Along the eight-year product development journey were a number of design hurdles: the need to develop small cathode-ray tubes, tiny switches, and special power supplies. And, so far, five different scopes have made it to the marketplace. It's an interesting design story, and you'll find it on page 81.

Every year at this time, in what we feel is a particularly important service to *Electronics* readers, we put together a detailed summary of just what the Federal budget means to the electronics industries. And this year, a close reading of the budget proposals is in order.

That's because with a new President, a resurgent Congress—complete with a House of Representatives that is hosting its largest "freshman class" in recent history—and a serious economic crisis, the budget will be the focal point of debate on how to solve pressing national needs.

You'll find our summary starting on page 65 and, because we feel rather strongly about the imbalanced priorities on which the budget is based, an editorial on page 10. Since electronic technology can help in answering some of our country's current—and longer-range—problems, we would like to hear from any readers who have constructive comments to offer.



February 20, 1975 Volume 48, Number 4  
94,351 copies of this issue printed

Published every other Thursday by McGraw-Hill, Inc. Founder James H. McGraw 1860-1948. Publication office 1221 Avenue of the Americas, N.Y., N.Y. 10020; second class postage paid at New York, N.Y. and additional mailing offices.

Executive, editorial, circulation and advertising addresses: Electronics, McGraw-Hill Building, 1221 Avenue of the Americas, New York, N.Y. 10020 Telephone (212) 997-1221. Teletype TWX N.Y. 710-581-5234. Cable address: MCGRAW HILL N.Y.

Subscriptions limited to persons with active, professional, functional responsibility in electronics technology. Publisher reserves the right to reject non-qualified requests. No subscriptions accepted without complete identification of subscriber name, title, or job function, company or organization, including product manufactured or services performed. Subscription rates: qualified subscribers in the United States and possessions, Canada, and Mexico \$12.00 one year, \$24.00 three years, all other countries \$25.00 per year, except Japan and Israel \$50.00 per year, Brazil \$40.00 per year, Australia and New Zealand \$60.00 per year, including air freight. Limited quota of subscriptions available at higher-than-basic rate for persons outside of field served, as follows: U.S. and possessions and Canada, \$25.00 one year; all other countries \$50.00 Single copies \$4.00

Officers of the McGraw-Hill Publications Company: John R. Emery, President; J. Elton Tuohig, Executive Vice President-Administration; Gene W. Simpson, Group Publisher-Vice President, Senior Vice Presidents: Ralph Blackburn, Circulation; Walter A. Stanbury, Editorial; John D. Hoglund, Controller; David G. Jensen, Manufacturing; Gordon L. Jones, Marketing; Jerome D. Luntz, Planning & Development.

Officers of the Corporation: Shelton Fisher, Chairman of the Board and Chief Executive Officer; Harold W. McGraw, Jr., President and Chief Operating Officer; Wallace F. Traudny, Group President, McGraw-Hill Publications Company and McGraw-Hill Information Systems Company; Robert N. Landes, Senior Vice President and Secretary; Ralph J. Webb, Treasurer.

Title registered in U.S. Patent Office. Copyright ©1975 by McGraw-Hill, Inc. All rights reserved. The contents of this publication may not be reproduced in whole or in part without the consent of copyright owner.

Subscribers: The publisher, upon written request to our New York office from any subscriber, agrees to refund that part of the subscription price applying to copies not yet mailed. Please send change of address notices or complaints to Fulfillment Manager; subscription orders to Circulation Manager, Electronics, at address below. Change of address notices should provide old as well as new address, including postal zip code number if possible, attach address label from recent issue. Allow one month for change to become effective.

Postmaster: Please send form 3579 to Fulfillment Manager, Electronics, P.O. Box 430, Hightstown, N.J. 08520.





This, for example, is a dual-output power supply system comprised of a pair of Kepco JMK Power Supplies, each controlled in both voltage *and* current by type SN Digital Interface Cards.

One power supply, Model JMK 100-1M produces 0-100 volts controlled in 12-bit binary; and 0-1 ampere controlled in 8-bit binary. The other unit, Model JMK 15-6M produces 0-15 volts controlled in 3-digit BCD; and 0-6 amperes controlled in 2-digit

BCD. The two SN Cards that program each power supply are mounted in pairs, each in a type CA-6 dual enclosure. The whole system is assembled in Kepco's RA-24 enclosure, that will occupy only 5 1/4" of space in your 19" rack.

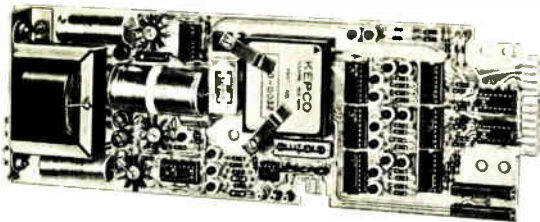

The SN Digital Interface Card accepts your data input on parallel lines, strobed for noise immunity, and stores the data in a buffer register. For isolation, the program is transferred across optical couplers so that your digital signal and the power supply it controls can be up to 1000V apart. The five types of SN Cards offer a choice of BCD or complementary binary programming.

The analog output from the SN Card is in the form of a 0-1V/0-10V range-selected signal\* that is linearly amplified by the companion power supply to produce the desired output. In the illustrated combination of JMK 100-1M and SN-12, the power supply functions as a gain of 10 amplifier, with 12 bits (0.024%) resolution. The JMK 15-6M, programmed by SN-3, functions as a gain of 1.5 amplifier, with 3 digit (0.1%) resolution. The range selector on the SN allows the full resolution to be spread over the lowest 10% of the output.

\*The SN Card also produces  $\pm 10V$  &  $\pm 5V$  outputs to control bipolar power supplies and 0.5V, 1.0V outputs to control current stabilizers.

#### SN CARDS AVAILABLE

MODEL	RESOLUTION	LINEARITY
SN-2	2 BCD	$\pm 0.2\%$
SN-3	3 BCD	$\pm 0.05\%$
SN-8	8-bit	$\pm 0.2\%$
SN-10	10-bit	$\pm 0.05\%$
SN-12	12-bit	$\pm 0.01\%$

These SN Cards are fully self-contained digital programmers, featuring an on-card line-operated power supply. Kepco offers a variety of housings and accessories to accommodate them to various programmable power supplies. As many as eight cards can be accommodated in a standard 5 1/4" x 19" panel.

For complete specifications, write Dept. EX-14

## KEPCO®



KEPCO, INC. • 131-38 SANFORD AVENUE • FLUSHING, N.Y. 11352 • (212) 461-7000  
TWX # 710-582-2631 • Cable: KEPCOPOWER NEWYORK

# When You Buy a Power Supply, Why Not Get the Best?

**IN STOCK**



28 VDC to DC  
(55,463 Hrs.)  
Model C95D

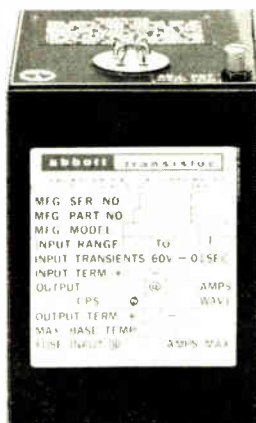

28 VDC to 400 A  
(61,387 Hrs.)  
Model S3D



400 A to DC  
(56,148 Hrs.)  
Model W5D

## Abbott's New Hi-Performance Modules

are designed to operate in the stringent environment required by aerospace systems — MIL-STD-810B and MIL-STD-461A for electromagnetic interference.

**RELIABILITY** — MTBF (mean time between failures) as calculated in the MIL-HDBK-217 handbook can be expected in excess of 50,000 hours at 100°C for all of these power modules. The hours listed under the photos above are the MTBF figures for each of the models shown. Additional information on typical MTBF's for our other models can be obtained by phoning or writing to us at the address below.

**QUALITY CONTROL** — High reliability can only be obtained through high quality control. Only the highest quality components are used in the construction of the Abbott power module. Each unit is tested no less than **41 times** as it passes through our factory during fabrication — tests which include the scru-

tinizing of the power module and all of its component parts by our experienced inspectors.

**NEW CATALOG**—Useful data is contained in the new Abbott Catalog. It includes a discussion of thermal considerations using heat sinks and air convection, a description of optional features, a discussion of environmental testing, electromagnetic interference and operating hints.

**WIDE RANGE OF OUTPUTS** — The Abbott line of power modules includes output voltages from 5.0 volts DC to 740 volts DC with output currents from 2 milliamperes to 20 amperes. Over 3000 models are listed **with prices** in the new Abbott Catalog with various inputs:

- 60A to DC
- 400A to DC
- 28 VDC to DC
- 28 VDC to 400A
- 12-28 VDC to 60 A

Please see pages 307-317 Volume 1 of your 1974-75 EEM (ELECTRONIC ENGINEERS MASTER Catalog) or pages 853-860 Volume 3 of your 1974-75 GOLD BOOK for complete information on Abbott Modules.

Send for our new 60 page FREE catalog.

**abbott transistor**

**LABORATORIES, INCORPORATED**  
general offices eastern office

5200 W. Jefferson Blvd./Los Angeles 90016  
(213) 936-8185 Telex: 69-1398

1224 Anderson Ave./Fort Lee, N.J. 07024  
(201) 224-6900 Telex: 13-5332

## Readers comment

### On stereotyping

**To the Editor:** Methinks RCA is living in the past and needs its consciousness raised. The RCA Home of Future Living exhibit in Disney World's new Space Mountain attraction [*Electronics*, Dec. 26, 1974, p. 58], sounds more like a Home of Past Stereotypes.

As your article points out: "Visitors will see a man conducting a business meeting via satellite in his living room . . . Meanwhile, mom takes a pottery course from a video library. . ." and so on and so on.

Why perpetuate the notion that men should run the world while women find satisfaction in the kitchen or with artsy-craftsy busywork or gabbing on the phone? Such stereotyping does a real disservice to women who too often find their career options reduced by our society's outmoded attitudes. Women who want to be housewives, as many do, will become housewives without any encouragement from RCA. But those who seek professional careers need all the encouragement they can get.

Robert Luchs  
Buchen Advertising, Inc.  
Chicago, Ill.

### Affiliation denied

**To the Editor:** We would like to clarify the implied affiliation between Virginia Polytechnic Institute & State University and E&L Instruments Inc., Derby, Conn., that appeared in the article on a new teaching approach to digital electronics ["Kit offers instant insights," *Electronics*, Jan. 23, p. 70].

The hardware and software were developed by David G. Larsen, instructor in the Department of Chemistry, Peter R. Rony, associate professor in the Department of Chemical Engineering, and Jonathan A. Titus, president of Tychon Inc., all of whom are consultants to E&L. But the fact that a company's products are used extensively at a university doesn't imply endorsement or affiliation.

P.R. Rony, D.G. Larsen,  
and J.A. Titus  
Blacksburg, Va.



Want high-volume component production?

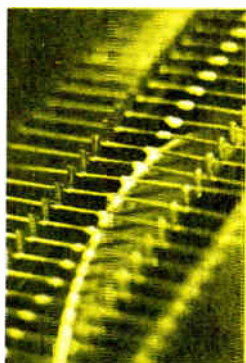

# Consider the capacity of 34 electronic plants in a company called TRW.

The fourteen Electronic Components Divisions of TRW, Inc. can supply virtually any component in almost endless quantities. One of our divisions, for instance, has the capacity to produce 375,000 resistors an hour. Another can produce 15 million connectors a month. If you need a source with high-volume capability, you've just found it in a company called TRW.

## **TRW** ELECTRONIC COMPONENTS

Headquarters: 10880 Wilshire Boulevard, Los Angeles, CA 90024

**TRW**. CAPACITORS

**TRW**. CINCH-MORADNOCK

**TRW**. GLOBE MOTORS

**TRW**. IRC POTENTIOMETERS

**TRW**. IRC RESISTORS

**TRW**. SEMICONDUCTORS

**TRW**. CINCH CONNECTORS

**TRW**. CONSUMER INTERNATIONAL

**TRW**. HOLYOKE WIRE & CABLE

**TRW**. SUPERMET PRODUCTS

**TRW**. CINCH-GRAPHK

**TRW**. ELECTRONIC FUNCTIONS

**TRW**. IRC NETWORKS

**TRW**. UTC TRANSFORMERS

Electronics/February 20, 1975

Circle 7 on reader service card 7

# Only Sprague bantam 4-pin DIP capacitors can give you these advantages . . .



guaranteed max. high frequency impedance



low inductance and low ESR . . .  
4-terminal connection mode option



preferred capacitance values to  
optimize performance when tantalum  
and ceramic capacitors are paralleled



automatic insertion capability



your choice of layer-built ceramic  
or solid-electrolyte tantalum

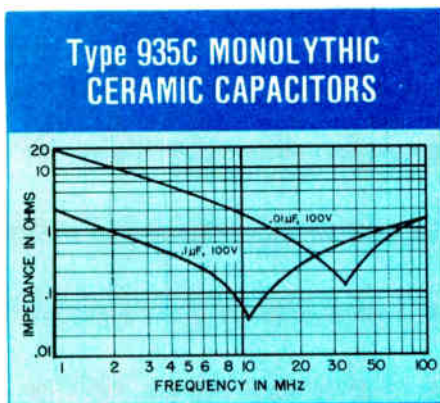

Proven multi-layer construction. COG(NP0) and X7R temperature characteristics. Preferred ratings are .01, .047, and .1  $\mu\text{F}$  @ 100WVDC. Operating temperature range,  $-55\text{C}$  to  $+85\text{C}$ .

Circle 8 on reader service card

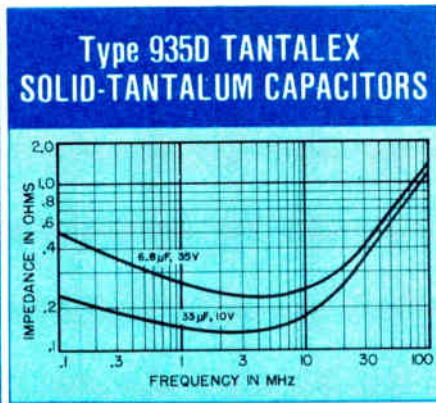

Dual in-line plastic package for mechanical protection and increased reliability. Preferred ratings are 6.8  $\mu\text{F}$  @ 35V, 15  $\mu\text{F}$  @ 20V, 22  $\mu\text{F}$  @ 15V, and 33  $\mu\text{F}$  @ 10V. Operating temperature range,  $-55\text{C}$  to  $+85\text{C}$ .

Circle 215 on reader service card

For complete technical data on Type 935C or 935D Capacitors, write for Engineering Bulletins 6242.3 or 3542.3, respectively, to: Technical Literature Service, Sprague Electric Company, 35 Marshall St., North Adams, Mass. 01247.



THE BROAD-LINE PRODUCER OF ELECTRONIC PARTS

## News update

■ A radar system that automatically tightens auto seatbelts when logic circuits judge a crash to be inevitable has made little progress in the past year. And the easing of seatbelt interlock regulations in the U.S. hasn't helped. The system was developed jointly in Japan by Mitsubishi Electric Corp. and Nissan Motor Co. [Feb. 7, 1974, p. 107]. Nissan has decided it won't need the system in the foreseeable future, but Mitsubishi has developed a production version. It has had an inquiry from the U.S. Department of Commerce and a request for samples from General Motors.

■ Another Japanese development, this one an electrophoretic display that offers a wide choice of colors plus a short-term memory that consumes no power [Oct. 9, 1972, p. 63], has finally moved out of the lab. However, the display isn't going to be a commercial product: it will be used by its developer, Matsushita Electric Industrial Co., as a point-of-sale device to call attention to the company's Panasonic stereo products. The obstacle to commercial introduction is the relatively short lifetime of 10,000 hours, but Matsushita is working to improve that. Meanwhile, it will make custom displays for users satisfied with the present characteristics.

■ Aerospace, electronics, and communications firms won't have to worry about stricter Federal regulations on stock-ownership disclosure—at least not this year. Such a measure was introduced in the Senate last year [Jan. 24, 1974, p. 49], but died after committee hearings. Since then, a steering committee of regulatory agency staff members set up to devise some new rules has done its work. The result is a set of 10 rules, but no action on them is expected in the near future. The original measure was offered in the Senate by Lee Metcalf (D., Mont.) and Edmund Muskie (D., Maine).

—Howard Wolff



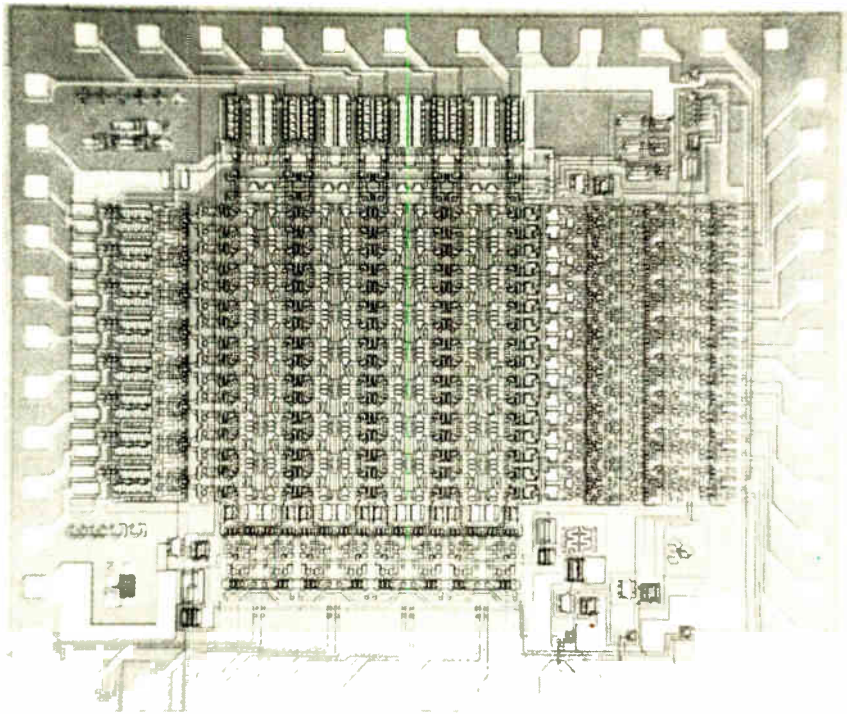

# Here's the world's first 64-bit CMOS Content Addressable Memory.

It'll pay you to remember who makes it.

Not only because this 8 word x 8 bit CAM is a *genuine* breakthrough. But also because it's living proof of all that stuff we've been telling you. About being state-of-the-art CMOS specialists; with the finest, most modern, most productive facility in the industry. The CAM is the first of our new series of CMOS memory devices.

The CAM is a new class of component for computer architecture. It can perform an exact match search, telling whether an input word is or is not stored in the memory. This concept is applicable to pattern recognition systems, air traffic control, signal sorting, data base management, and a variety of radar signal processing and system control applications.

In the interrogate mode, it responds with a match or mismatch answer. Bit mask inputs permit selection of bits to be deleted from the interrogation. It also has conventional read/write capability, and can be used as a 64-bit RAM. In the write mode, information in selected bits can be left unchanged by exercising bit mask inputs. It can also operate in a "learn" mode, storing the input word if the memory shows no match.

Typical interrogate time for an 8-bit word is 110 ns. Read access time is 150 ns. The chip enable feature permits expansion to a memory bank of any desired capacity. Instruction execution time is independent of the number of CAM's. Inputs are CMOS compatible, outputs tristate MOS or TTL compatible.

The CAM is available right now. In 48-pin ceramic dual in-line package. Call or write for prices, samples, and a data sheet.

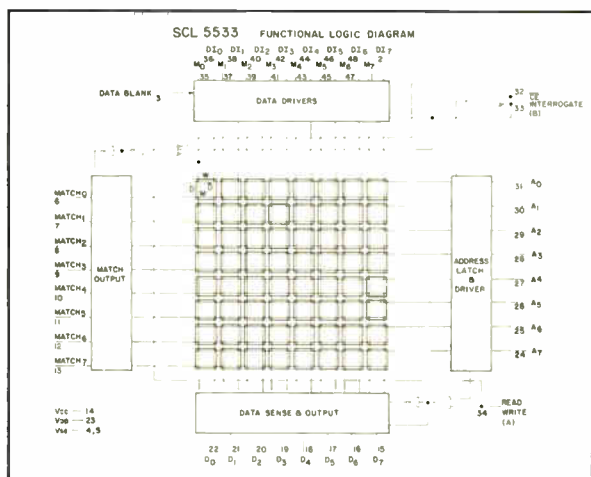

**SOLID STATE SCIENTIFIC INC.**  
Montgomeryville, Pa. 18936/(215) 855-8400/TWX 510-661-7267  
**The CMOS action company.**

East: 215-279-8424  
Midwest: 312-437-8373  
West Coast: 714-546-9621

Electronics/February 20, 1975

Circle 9 on reader service card 9

## What's wrong with the priorities

*The Federal budget submitted by President Ford to the Congress exhibits an extreme case of skewed priorities. With all the alarums and concern about energy, for example, there seem to be very few dollars earmarked for non-nuclear research. The Energy Research and Development Administration, for instance, gets only \$83 million for new energy development in non-nuclear technology. Meanwhile, NASA is getting \$1.7 billion for manned space projects.*

*The Administration is big on taxation to force conservation of fossil fuels, but where is an offsetting commitment to mass transit to give the little guy who commutes an economical alternative to rising fuel costs? Of \$6.9 billion for ground transport, nearly \$5 billion is aimed at highway construction.*

*There's precious little realization on the Administration's part of the value that technology—particularly electronics technology—can have in attacking some of these problems. Of the total energy development budget, we have only:*

- *\$10 million for photovoltaic-cell development*
- *\$20 million for programs aimed at reducing energy consumption in autos and homes*
- *Nothing for promoting communications as a cost-effective alternative to travel.*

*The budget, fortunately, is not the final word*

*on how the nation's tax dollars are spent. It's up to Congress to come up with actual spending laws that reflect its sense of the national priorities. Yet there is little evidence that Congress is any better equipped to deal with the technological aspects of today's problems. What's more, little has been heard from the Government's established science advisory apparatus, and the White House appears to be still wrestling with the role—even the need for—a presidential science advisor.*

*So never has it been more important for engineers to help get the message across to the nation's lawmakers that technology has some worthwhile answers, especially to such problems as energy and the protection of the environment. In addition, technical societies are becoming more active in dealing with the complex interrelationships of technology with society, and engineers should do all they can to support that concern.*

*Talking with congressmen, professional groups, and even local leaders will certainly help right now. But in the long term, many a company and many a fortune is going to be built on the successful application of electronics to national needs. When individuals go out and prove that electronics is an answer, the whole country will be the winner.*



# Advanced MOS.

## Sixteen parts. Seventeen miracles.

Sixteen kinds of 1K static RAM's. The incredible 2102's. Every one is a miracle on a chip.

And now one more miracle: **\$4.95 each.**

**4.95**

100% MIL-STD-883 processing. Free. Plastic, commercial temperature range, 1000-piece quantity. Off the shelf now from Hamilton/Avnet, Cramer and Schweber.

Brought to you by Advanced Micro Devices, the people who took the best of the 2102's and made them better.

If you're paying more than \$4.95 for any part on this chart, stop. Call Advanced Micro Devices.

### Sixteen 1K Static RAM's Under \$5.

Part number	Power @ 5.0V @ 25°C	Access time	Price
2102	300mW	1000ns	\$4.95
2102-1	300mW	500ns	\$4.95
2102-2	300mW	850ns	\$4.95
8102	300mW	1300ns	\$4.95
8102-2	300mW	850ns	\$4.95
4102	300mW	1000ns	\$4.95
7552	300mW	1000ns	\$4.95
7552-1	300mW	500ns	\$4.95
7552-2	300mW	850ns	\$4.95
2802	225mW	1000ns	\$4.95
2802-1	225mW	500ns	\$4.95
2802-2	225mW	850ns	\$4.95
9102	225mW	850ns	\$4.95
9102A	225mW	500ns	\$4.95
91L02	140mW	850ns	\$4.95
91L02A	140mW	500ns	\$4.95

## Military 2102's.

The 2102 is the hottest memory device in the business today.

The only problem is for the military buyer. The 2102 has been out of uniform. Nobody made a Military 2102.

Until now. Advanced Micro Devices' Military 9102. Every one is MIL-STD-883. Every one is guaranteed over the full military temperature range.

We make a high-speed version, too: the 9102A. With 500 ns. access time.

Advanced Micro Devices' Military 9102. It's the best 2102 you can buy.

Specification	The Am9102
Access Time	Guaranteed 850ns (9102DM) Guaranteed 500ns (9102ADM)
*Stand-by Voltage	Guaranteed 1.8V DC Typical 1.0V DC
*Stand-by Power	Guaranteed 64 mW Typical 16 mW
Power Dissipation	303 mW maximum
Power Supply	-10%
Tolerance	TTL Compatible
Logic Levels	Guaranteed 2 TTL loads
Fan-Out	Guaranteed 2 TTL loads

\*Normal data above guaranteed voltage

## LOWPOWER 2102's.

(If you liked what our 9102 did for the 2102, you're going to love our new low-power 9102.)

Our new 91L02 lets you have your cake and eat it, too.

If you replace the 2102 you've been using with our standard Am9102, you'll have a 28% power savings (30mA vs. 70mA).

Now save more.

Replace their standard 2102 with our new low-power Am91L02 for a 57% power savings (30mA vs. 70mA).

Now save even more.

By using our optional power-down feature you reduce stand-by power drain to just 40mW per package!

Now for the really good news. You get all the advantages of low power with absolutely no loss of speed (400ns vs. 400ns); and

absolutely no difference in price.

You also get a choice of commercial or full military temperature range units.

Not to mention MIL-STD-883 at no extra charge.

And immediate delivery.

The 91L02 from Advanced Micro Devices. Remember the name. It's the best 2102 you can buy.

SPECIFICATION	Am9102	Am9102	Am91L02
Power measured at top (Guaranteed, worst case)	70mW	30mW	30mW
Stand-by power	-	30mW	30mW
Power dissipation by dissipation (Guaranteed, worst case)	300mW	30mW	30mW
Commercial version	-	30mW	30mW
Military version	-	30mW	30mW
Speed (Guaranteed over full temperature range)	850ns	850ns	850ns
Commercial & military (9102)	850ns	850ns	850ns
Commercial & military (9102A)	850ns	850ns	850ns
Commercial & military (91L02)	850ns	850ns	850ns

# Advanced Micro Devices

Corporate offices are at 901 Thompson Place, Sunnyvale, California 94086. Telephone (408) 732-2400 or toll free from outside California (800) 538-7904/Southern California: Beverly Hills (213) 278-9700/Mid-America: Oak Brook, Illinois (312) 323-9600/Edina, Minnesota (612) 835-4445/Dallas, Texas (214) 423-1502/Eastern United States: Roslyn Heights, New York (516) 484-4990/E. Syracuse, New York (315) 437-7546/Baltimore, Maryland (301) 744-8233/Wellesley, Massachusetts (617) 237-2774/Britain: Advanced Micro Devices, Telephone 01-730-0855/West Germany: Advanced Micro Devices, Munich, Telephone (089) 53 95 88/Southern Europe: Advanced Micro Devices, S.A. Neuilly, France, Telephone 747-4194/Japan: Advanced Micro Devices, K.K., Telephone (03) 346-0363. Distributed nationally by Hamilton/Avnet, Cramer and Schweber Electronics.

Circle 252 on reader service card

# The first available 256x4 CMOS RAM

Intel's new 5101 1K silicon gate CMOS static RAM is the first easy to use nano-power RAM. It combines high density and ultralow power with a fast, fully static, 256 x 4 modular organization that eliminates clocks, interface circuits and special power supplies while minimizing package count. Now available from stock at Intel distributors, the 5101 is the ideal RAM for upgrading non-volatile, battery back-up and portable equipment memory system designs.

Even at elevated temperatures, the 5101 keeps battery drain extremely low.

At 70°C, maximum standby current is 15 nA per bit, limiting standby power to 75 nW per bit.

Worst case access time (and minimum cycle time) is only 650 ns over the 0°C to 70°C temperature range.

This March, Intel distributors will also stock the M5101 for military temperature range applications. At 125°C, maximum standby current is 200 nA/bit, maximum standby power 1000 nW/bit. Worst case access time for the M5101 is 800 ns over the -55°C to 125°C temperature range.





# Available nanopower M. Intel's 5101.

**AVAILABLE AT  
YOUR INTEL  
DISTRIBUTOR**

**INTEL'S 1K CMOS STATIC RAM FAMILY**

PART NO.	WORST-CASE SPEED*	SIZE	PINS	STANDBY POWER/BIT	AVAIL.
5101	650 ns	256x4	22	75 nW	Now
5101L**	650 ns	256x4	22	75 nW	Now
5101-3	650 ns	256x4	22	1 $\mu$ W	Now
5101L-3**	650 ns	256x4	22	1 $\mu$ W	Now
M5101-4	800 ns	256x4	22	1 $\mu$ W	March
M5101L-4**	800 ns	256x4	22	1 $\mu$ W	March
M5101-5	800 ns	256x4	22	5 $\mu$ W	March
M5101L-5**	800 ns	256x4	22	5 $\mu$ W	March

\*Worst case access times and minimum cycle times are guaranteed over full operating temperature range (-55°C to +125°C for M5101-4, M5101L-4, M5101-5, M5101L-5; 0°C to +70°C for all other types).

\*\*Guaranteed data retention at power supply voltage as low as 2V.

The easy to use 5101 is fully static, chip enable clocking is not required during address transitions. It also interfaces directly with TTL or CMOS and operates with a single +5V supply.

The 256 x 4 configuration is optimum for any memory system organization and is an ideal building block for memory expansion. You get two chip enable inputs, four data inputs, four three-state outputs with output disable control, and read/write control. The output disable pin controls bus states, making bidirectional logic unnecessary in common I/O buses.

The 5101, with its high density and ease of use, is the ideal nanopower RAM for portable instruments and microprocessors, advanced calculators, data collection devices, process controllers, POS, OCR, medical, avionics, ground support—for any equipment demanding long battery life, or non-volatility with battery

back-up. The 5101 silicon gate CMOS RAM is in full production and in distributor stock, along with our other easy to use n-channel static RAMs.

For immediate delivery contact Almac/Stroum, Component Specialties, Inc., Cramer, Hamilton/Avnet, Industrial Components, Inc., Sheridan, and L.A. Varah Ltd.

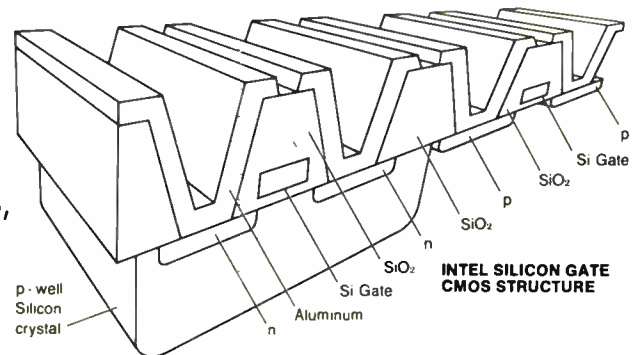

**intel® delivers.**

# RCL

Your  
Dependable  
Source Of  
Supply For  
Precision/Power  
Wire Wound  
Resistors

OFF-THE-SHELF  
DELIVERY  
ON 400  
COMMERCIAL  
STYLES  
PLUS

RBR'S (Mil R-39005)

RWR'S (Mil R-39007)

RB'S (Mil R-93)

RW'S (Mil R-26)

RCL — The major  
source of supply  
for Wire-wound  
Resistors.

# RCL DELIVERS ON TIME!

Call our hotline for prompt  
service and delivery.

(201) 374-3311



## RCL Electronics

General Sales Office:  
700 So. 21st Street  
Irvington, N. J. 07111

## People

### FAA's Cochran moves up to head R&D

Every morning when Jeff Cochran jogs near his suburban Washington, D.C. home, he carries a water pistol loaded with a weak ammonia solution for protection against hostile dogs. Similarly, he believes a little advance planning—"finding out the potentially bad things before decisions are made"—will prove the key to success in his promotion to associate administrator for engineering and development at the Federal Aviation Administration.

Now 54, Jefferson W. Cochran has been a career FAA employee for 27 years, ever since he received his bachelor's degree in electrical engineering from the University of Houston on the G.I. bill. He views his new assignment as chief of FAA R&D as recognition of his extensive field experience with aviation electronics. "I bring a good understanding of what is out there and what is needed," he says of his years as director of the FAA's facility maintenance service.

The proposed new Microwave Landing System and the controversy surrounding it (see page 78) will probably occupy most of Cochran's time. More than one third of the next fiscal year's R&D budget of \$73 million will fund prototype MLS hardware and a brassboard Discrete Address Beacon System that digitally identifies and plots aircraft courses on an air-traffic controller's radar screen. But the most complex R&D program Cochran will oversee may be something else entirely.

"Deciding on a ground-based or air-based aircraft collision-avoidance system is the big challenge that first comes to mind," says Cochran,

with a light southern drawl. A report on a recommended collision-avoidance system, under discussion for more than a decade, is due to Congress by the end of this year.

Also of prime concern are innovations to upgrade air-traffic-control equipment to improve airport safety and air-traffic-controller productivity. About \$10 million is earmarked for automated ATC research. Although the FAA's fiscal 1976 R&D budget is 11% below what was requested, Cochran says it is adequate.



R&D. MLS, DABS, CAS are more than just initials for FAA's Cochran.

However, more "exotic" projects, such as the electronic voice switch and the Aerosat aeronautical radio relay satellites, were heavily cut to make room for MILS and DABS.

Cochran can't help but be aware of the criticism levelled at FAA efforts, particularly in its selection recently of the competitors for the MLS. But with the right kind of planning, "I hope I can catch things before they become problems."

### Gamma-ray detectors are good business for Entine

Your company decides to drop the technology program you've been working on, so what do you do? If you are Gerald Entine, you buy the equipment and inventory, then go into business for yourself.

In Entine's case, this meant leaving Tyco Laboratories where he'd been working since 1969 and setting up a company called Radiation Monitoring Devices Inc., Newton, Mass., to fabricate cadmium-telluride gamma-ray detectors. He did this after Mobil Oil Co. agreed to fund heavily Tyco's development of silicon photovoltaic solar cells [*Electronics*, Dec. 12, p. 14]. Con-



# Avoid that drawn-out feeling.

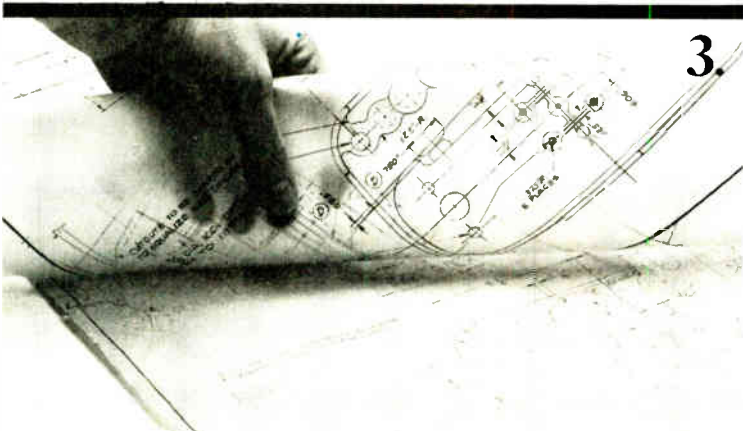
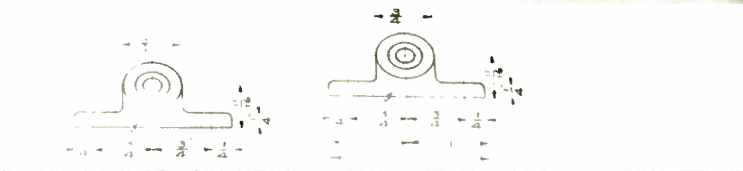
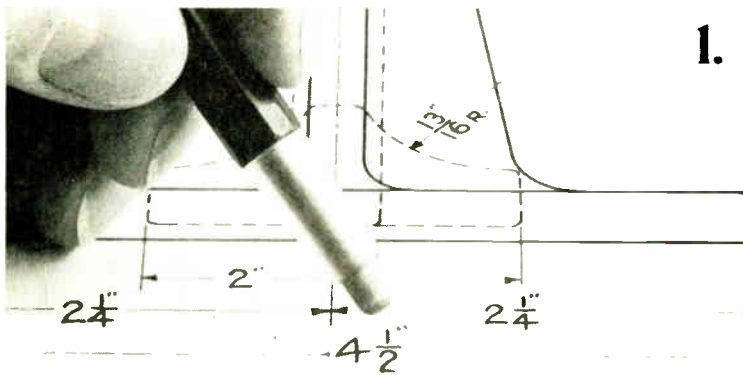

Shortcuts with Kodagraph materials can save hours of drafting time, job after job. **1.** Revising a drawing? Don't retrace the whole drawing. Make a second original on Kodagraph wash-off film. Wet-erase unwanted details. Then draw in the revision. **2.** Need to repeat the same design element a number of times? Don't draw it over and over again. Draw it once. Then make as many Kodagraph film or paper copies as you need. **3.** Restoring an old drawing? Don't redraw. You'll strengthen lines and drop out stains by making photographic reproductions on Kodagraph film. For more information on photoreproduction techniques, write Eastman Kodak Company, Business Systems Markets Division, DP5702, Rochester, N.Y. 14650.

**Kodak products  
for engineering data systems**



# Pulse withstand capacitors for colour T.V.

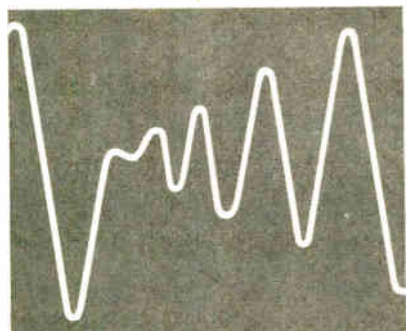
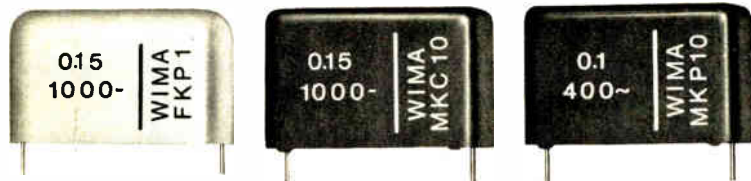

## WIMA FKP 1

Polypropylene film and extended foil electrode capacitors encapsulated in cast resin. Self-healing properties. Suitable for sharp-edged or short rise time pulses in thyristor deflection circuits.



## WIMA MKC 10

Metallized polycarbonate capacitors. Particularly suitable for stringent pulse and surge conditions. Low power factor at high frequencies. Self-healing properties. Plastic case design.

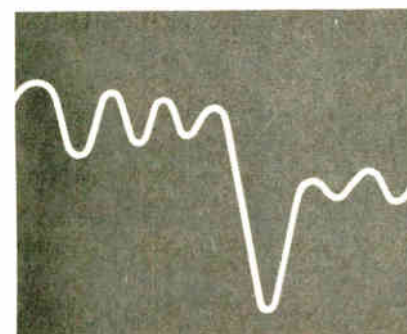

## WIMA MKP 10

Metallized polypropylene capacitors in plastic cases. Self-healing properties. Suitable for both high current and pulse circuits owing to low dielectric losses.

- Other special capacitors in metal cases.
- One year successful field experience in equipment by leading manufacturers.
- Suitable for advanced solid-state equipment.
- For professional electronics.



## WILHELM WESTERMANN

Spezialfabrik  
für Kondensatoren  
D-68 Mannheim 1  
Fed. Rep. of Germany  
Augusta-Anlage 56  
P. O. Box 2345  
Tel.: (621) 40 80 12

Write for our new catalogue.

## People

sequently, the decision was made to drop cadmium telluride.

"I never planned to be an entrepreneur," says the 31-year-old Ph.D. physicist. "But there's a need for the detectors. Only one other manufacturer in the entire country makes them, and I think I can fabricate them to sell for considerably less than they're selling for now."

Now priced around \$3,000, the detectors are used in nuclear medicine and in studies by the Air Force on nose-cone heat shields.

**Down.** Entine contends that if the price were to come down, the detectors, which operate at room temperature, would find a broader range of applications. This would include programs for nuclear-reactor monitoring, preventing thefts of radioactive materials at nuclear facilities, and in satellite spectroscopy.

The Air Force, anxious not to lose a source of the devices, provided Entine with "short-term" funding by ordering 30 devices. Building the detectors is a straightforward process, he says. The difficult part is growing the CdTe crystal. Entine calls this "worse than a black art." Yields are only a few percent because impurities must be less than a few parts per billion, and key impurities are not yet even known.

"But it's one of the easiest semiconductor detectors to work with because it is not affected by moisture, has a long shelf life, and is easy to package," he continues.

Entine is ready to set up 10 crystal-growing furnaces for mass production. He hopes to turn out 1,000 detectors a year, which may make him the largest producer in the world. And he hopes to reduce the price to \$1,000.

**Entrepreneur.** Cadmium telluride is Gerald Entine's stock in trade now.





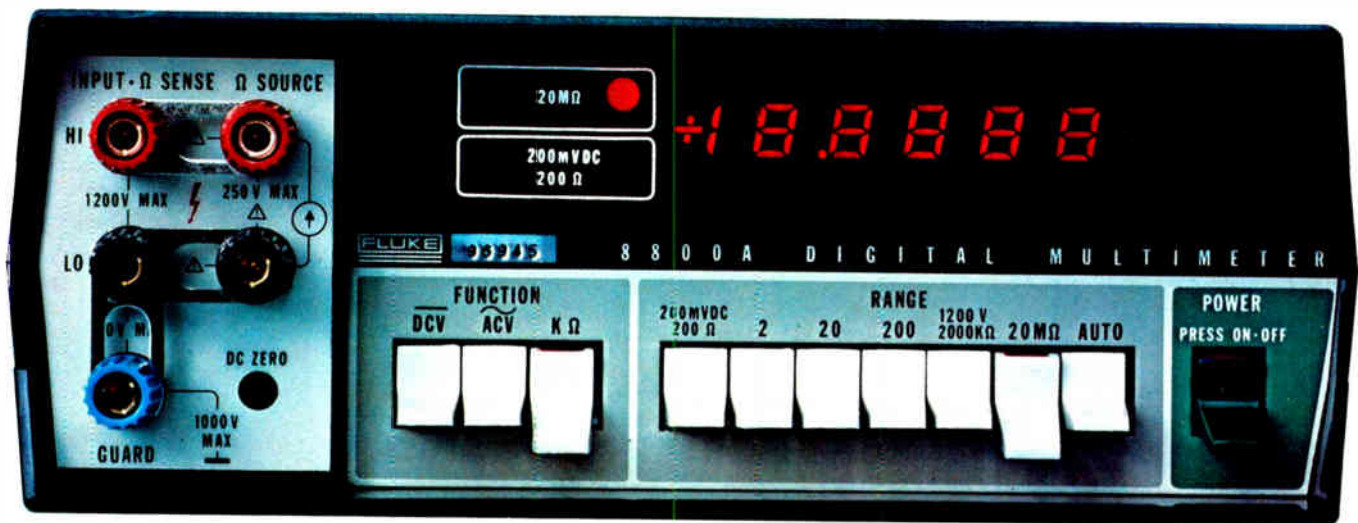

# \$1,099 says no other 5½ digit DMM can perform as well.

## We put our money where our mouth is.

For years people have been calling us "The Voltmeter House."

Today, we hope to convince you that this is no idle chatter.

To the first manufacturer who can show that his 5½ digit bench multimeter selling for \$1099 or less has better all-around specs and performance than ours, we'll pay \$1099 to his favorite charity.

\$1099 is the price of our Model 8800A 5½ digit full auto-ranging multimeter.

If you're ready . . . we'll begin.

**AC input voltage:** Measures four ranges of AC from 2V to 1200V. Most other 5½ digit DMM's are limited to 700V maximum and some to as low as 500V.

**DC input voltage:** Measures five ranges of DC volts from ±200mV to ±1200V.

**True 4-wire ohm measurements on all ranges:** Useful for measuring low value resistance without error caused by lead resistance. Measures six ranges from 200 ohms to 20 megohms.

**Accuracy and resolution:** 1  $\mu$ V resolution with 0.01% accuracy for 90 days over a temperature span of 18° to 28° C.

**High DC input impedance:** 1000 megohms through the 20 volt range. (Computer techs you can measure any voltage up to 20 volts without loading by the multimeter.)

**Offset current:** Less than 15 pA on all ranges. Essential when measuring high source impedance voltages. Most other 5½ digit multimeters don't even spec it.

**Maximum open circuit ohms voltage, 3.3V:** Most DMM's fall into the 9 to 18 volt range. That's not good enough for measuring IC's



when specs say that the measuring voltage cannot exceed 5 volts.

**Overload protection:** It's the best overall protection in the industry. 1200V on any AC or DC range. 250V RMS or DC on any ohms range.

**Mean Time Between Failure:** 10,000 hours, calculated and demonstrated. (unique)

**Unusually low power consumption:** Just 8 watts. One reason why the 8800A is so reliable.

**Size:** Our 8800A is one of the lightest and smallest 5½ digit multimeters around. With bench space at a premium, our box will be appreciated by all technicians.

**Wide range of accessories:** Includes high frequency probes, high voltage probe, clamp-on AC current probe.

It goes on. Our data sheet has the full details.

If you have any doubts whether the 8800A is typical of our line, just check *Electronics* Product Preference Poll (© 1974 by McGraw-Hill, Inc.). Fluke's squarely in the Number 1 spot for "Digital Voltmeters, including Multimeters"!

For data out today dial our toll-free number, 800-426-0361

John Fluke Mfg. Co., Inc., P. O. Box 7428, Seattle, WA 98133  
For a demo circle 162. For literature only, circle 17.

For information on the rest of the Fluke line see our ad in *EEM* or the Gold Book.



# Hewlett-Packard introduces a smaller uncompromising calculator,





# the new HP-21 Scientific. \$125.00\*

Now \$125.00 buys:

- **More power than our HP-35.** 32 pre-programmed functions and operations, including rectangular/polar conversion, register arithmetic and common log evaluation.
- **Smaller size.** 6 ounces vs. 9 ounces for our HP-35.
- **Display formatting.**
- **H-P's unique and efficient RPN logic system.**
- **H-P's quality craftsmanship.**
- **An unbeatable price:performance ratio.**

Here are the details:

**32 pre-programmed functions and operations.** The HP-21 performs all log and trig functions, the latter in radians or degrees. It's our only calculator short of the HP-45 that lets you:

- convert polar to rectangular coordinates, and back again ( $\rightarrow P, \rightarrow R$ );
- do full register arithmetic ( $M+, M-, M\times, M\div$ );
- calculate a common antilog ( $10^x$ ) with a single keystroke.

The HP-21 also performs all basic data manipulations ( $1/x, y^x, \sqrt{x}, \pi$ ) and executes all pre-programmed functions in *one second or less*.

**Full display formatting.** The Display key (DSP) allows you to choose between fixed decimal and scientific notation and lets you control the number of places displayed. (The HP-21 always uses all 10 digits internally.)

When a number is too large or small for fixed decimal display, the HP-21 switches automatically to scientific, so you never have to worry that the calculator will confuse a smaller number with zero.

Finally, if you give the HP-21 an impossible instruction, the Display spells E-r-r-o-r.

**RPN logic system.** Here's what this unique time-and-error-saving logic system means for you:

- You can evaluate *any* expression without copying parentheses, worrying about hierarchies or re-structuring beforehand. Your calculator remembers what's where—automatically.
- You can solve *all* problems your way—the way you first learned in beginning algebra, the way you now use when you use a slide rule.

- You solve *all* problems—no matter how complex—one step at a time. You *never* work with more than two numbers at once.
- You get continuous and immediate feedback. You see *all* intermediate answers *immediately*, because your calculator executes each function immediately after you press the function key. *You watch it happen.*
- You can easily recover from errors. You can back-track when you err, because your calculator performs all operations sequentially.
- You can re-use numbers without re-entering them. Your calculator becomes your scratch pad.

**H-P quality craftsmanship.** One reason Nobel Prize winners, astronauts, conquerors of Everest, America's Cup navigators and over 500,000 other professionals own H-P calculators. Here are four examples of it:

- Every key on every calculator is double injection molded, so the symbol it carries won't wear off. Every function key has a positive click action, so you know for sure the function has registered when you press one.
- There's a moisture barrier under the keyboard to protect the calculator's innards from coffee, tea, milk, what-have-you.
- It's no accident that the OFF-ON switch operates as smoothly as it does. We greased it with silicon when we installed it. It's also no accident that it moves in a horizontal plane. That's to prevent it from moving when you put the calculator into its carrying case or your shirt pocket.
- The heavy gauge plastic case is designed to withstand a long tumble to a hard floor. Incredibly, one H-P pocket calculator once withstood a trip through a snow-blowing machine. The case cracked, but the machine worked.

800-538-7922 (in Calif. 800-662-9862). The numbers to call for a "hands-on" demonstration. We'll give you the name of a dealer near you, and we'll send you detailed specifications of our new HP-21. Challenge it with your problems. See for yourself how much performance \$125.00\* can buy.

**HEWLETT  PACKARD**

Sales and service from 172 offices in 65 countries.  
Dept. 214P, 19310 Pruneridge Avenue, Cupertino, CA 95014  
Circle 19 on reader service card

## REQUIREMENT:

**High stable insulation resistance  
under conditions of high humidity.**

## COMPOUND:

**Plenco 482.**



NORTHERN ELECTRIC COMPANY, LIMITED, the Canadian-based international telecommunications equipment manufacturer, found the answer to this requirement for its wire spring relays used in switching equipment: Our Plenco 482 Phenolic General-Purpose Molding Compound. In addition, only a compound possessing an extremely low mold erosion rate could be considered. Again—our 482 Phenolic.

Northern Electric transfers these relay components in large volume, automatically.

Whatever the type of molding method — transfer, compression or screw injection — whatever the application — it's likely there's a Plenco thermosetting formulation to suit your own particular needs. Plenco experience, too. And service to match.

**PLENCO**  
THERMOSET PLASTICS

PLASTICS ENGINEERING COMPANY  
Sheboygan, Wis. 53081

Through Plenco research . . . a wide range of ready-made or custom-formulated phenolic, melamine and alkyd thermoset molding compounds, and industrial resins.

## Meetings

**Comcon Spring Computer Conference**, IEEE, Jack Tar Hotel, San Francisco, Calif., Feb. 25-27.

**Industrial Applications of Microprocessors**, IEEE, Sheraton Hotel, Philadelphia, Pa., March 11-12.

**Reliability Physics Symposium**, IEEE, MGM Grand Hotel, Las Vegas, Nev., April 1-3.

**Fourth Annual Symposium on Incremental Motion Control Systems and Devices**, University of Illinois Electrical Engineering Department, Urbana, Ill., April 1-3.

**Paris Components Show**, (*Salon des Composants Electroniques*), Porte de Versailles, Paris, April 2-8.

**Southeastcon '75**, IEEE, Sheraton Center, Charlotte, N.C., April 6-9.

**Intercon—IEEE International Convention**, Coliseum and Americana Hotel, New York, N.Y., April 8-10.

**Intermag—International Magnetics Conference**, IEEE, Imperial College, London, England, April 14-17.

**Electronics Production and Test Equipment Exposition**, U.S. Department of Commerce, Stockholm, Sweden, April 7-11; London, April 15-18.

**International Circuits & Systems Symposium**, IEEE, Marriott Motor Hotel, Newton, Mass., April 20-23.

**Reliability Software International Symposium**, IEEE, International Hotel, Los Angeles, April 22-24.

**Society for Information Display International Symposium**, SID, Shoreham Americana Hotel, Washington, D.C., April 22-24.

**International Optical Computing Symposium**, IEEE, Mayflower Hotel, Washington, D.C., April 23-25.

**National Relay Conference**, NARM and Oklahoma State University, Stillwater, Okla., April 30-May 1.



# HARRIS COMPUTERS TEACH, SIMULATE, MANAGE & CONTROL

They're the Useable Systems.

Proved in installations around the world, in sophisticated applications. Millions of dollars worth of Harris Useable Systems.

For example, the Useable SLASH 4VMS. Its powerful VULCAN software simplifies programming. And, its facility to handle huge compilations of data, combined with fast throughput, delivers performance economies.

Useable Systems from Harris. For data base management, complex simulation, or distributed systems. Write Harris Computer Systems,

1200 Gateway Drive, Ft. Lauderdale, FL 33309.  
Europe: Techmation N.V., Gebouw 105/106, Schiphol-Oost, Netherlands.

## HARRIS



COMMUNICATIONS AND  
INFORMATION HANDLING

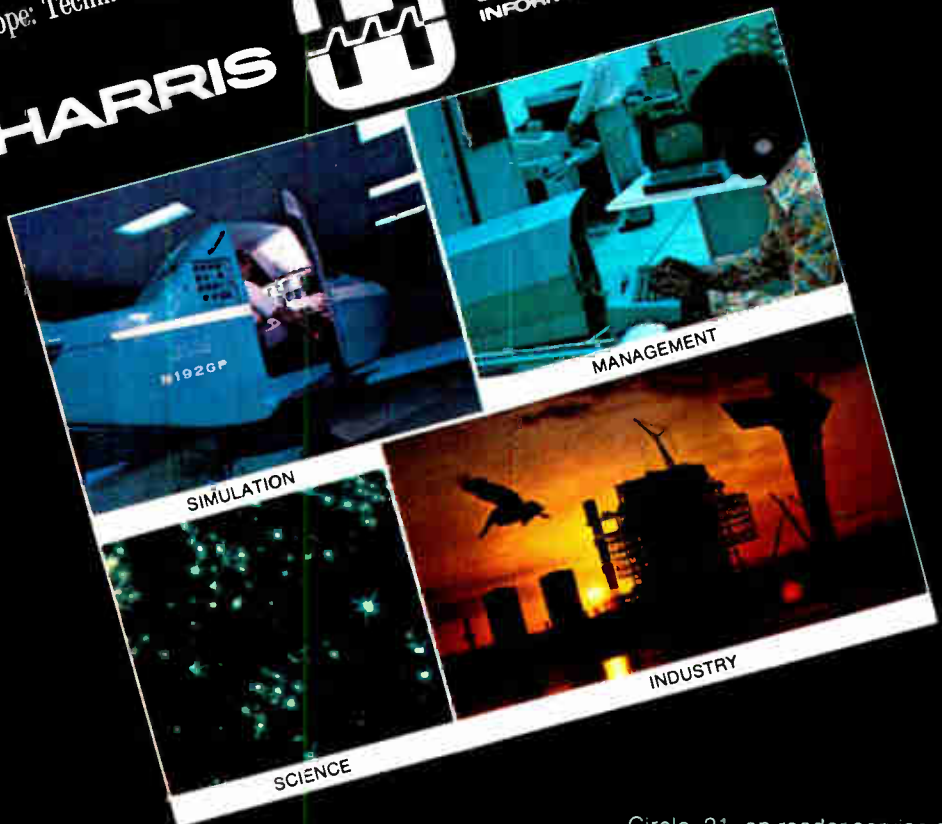

# If you wanted to hook up a computer to a system that exercises electronic calculators, how would you do it?

## Singer Business Machines did it simply, with Digital.



Computer on one end. Exerciser on the other. A single off-the-shelf module and

a bit of cable in between. Simple. Beautiful.

The project manager at Singer designed it. He'd heard about our new M1705 module that contained two complete PDP-8 interfaces on a single card. And he knew just what to do with it. He put it to work on his current project, a computerized testing system for Singer's electronic calculators.

Using our Logic System Design Handbook as a guide, he put together a parallel interface between the PDP-8/e computer and the electronic exerciser he'd designed. Each M1705 module interfaces two exercisers. The entire operation of up to eight exercisers is controlled locally by a single operation at 30 times the speed the operation took by hand.

The M1705 interface saved Singer's project manager a lot of time.

And a lot of trouble. And 40% of the cost of the interface.

If you've got an interfacing problem, we can give you the same kind of support we gave Singer. You'll find standard solutions to most of your problems in the Logic Products Handbook and the Logic Systems Design Handbook. To back up the solutions, we've got the hardware: digital and analog modules, computer interfacing modules, power supplies, cables, accessories, and wirewrap capabilities. Custom design assistance, too. And field specialists to offer advice if you get bogged down.

No one else can say nearly as much.

Which is why you'll probably want to get in touch with Digital next time you have an interfacing problem.

Components Group, Digital Equipment Corp., One Iron Way, Marlborough, Mass. 01752. Digital Equipment of Canada Ltd., Box 11500, Ottawa, Ont. K2H8K8, 613-592-5111. Europe: 81 Route de l'Aire, 1211 Geneva 26, tel. 42 79 50.

**digital**  
**COMPONENTS**  
**GROUP**

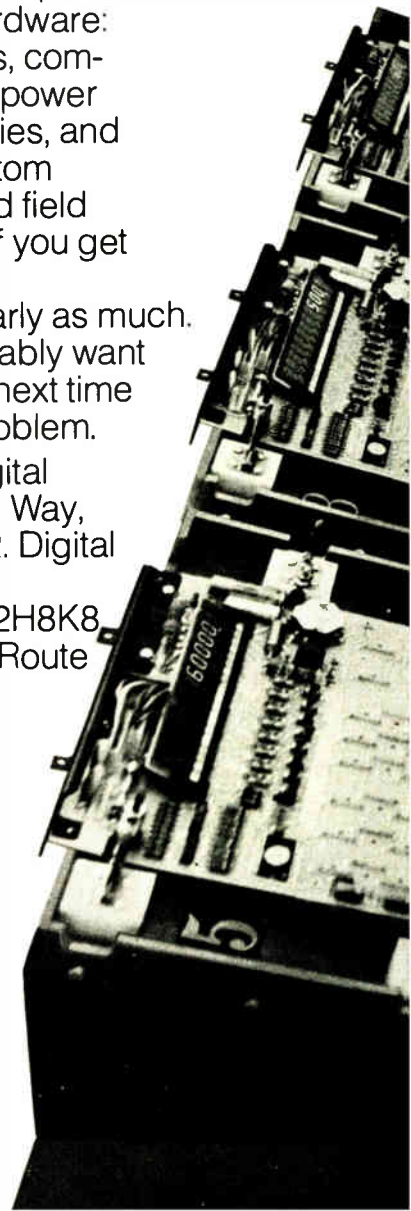





digital pac 86

name tag

digital pac

40000

World Radio History

Pulse handling:  
there's more to  
resistors than  
resistance.

If you're really  
serious about cost,  
be serious about quality.

Experience shows that Allen-Bradley fixed composition resistors can withstand far greater pulse energy levels than resistors manufactured by some other technologies.

For example, a pulse equivalent to the energy from the rapid discharge of a 10 $\mu$ f capacitor charged to 600 volts (1.8 watt-seconds) will have an insignificant effect on Allen-Bradley 1/4 watt resistors.

This performance is characteristic of the hidden values built into all Allen-Bradley composition resistors by our exclusive hot molding process. Quality that can make important differences in your design and procurement decisions.

Ask your Allen-Bradley distributor for "7 ways to tell the dif-

ference in fixed resistors." Or write: Allen-Bradley Electronics Division, 1201 South Second Street, Milwaukee, WI 53204. Export: Bloomfield, NJ 07003. Canada: Allen-Bradley Canada Limited, Cambridge, Ontario. United Kingdom: Jarrow, County Durham NE32 3EN.

A-B Type	Rated Watts	Pulse Energy Capability Watt-Seconds	Equivalent Energy Source
BB	1/8	0.45	2 $\mu$ f @ 670 volts
CB	1/4	1.8	10 $\mu$ f @ 600 volts
EB	1/2	6.4	32 $\mu$ f @ 630 volts
GB	1	16	32 $\mu$ f @ 1000 volts
HB	2	44	32 $\mu$ f @ 1650 volts

EC70

Circle 24 on reader service card

World Radio History



**ALLEN-BRADLEY**  
Milwaukee, Wisconsin 53204



## **\$60 watches using National modules**

National Semiconductor Corp. has opened its drive to break into the high-volume, low-cost electronic watch market with an under \$100 timepiece. **Private-label LED digital watches retailing for about \$60**, shown to dealers at jewelry shows in New York and Texas this month, contain modules made by National.

The company is in volume production with the least expensive of its watch modules, which contains hours and minutes readout and is being sold to private labelers for about \$26 per unit. This is a spectacular—but not unexpected—step for National, which entered the digital-watch market through its Novus division less than six months ago with a line of watches selling for \$125 to \$220 [*Electronics*, Oct. 3, 1974, p. 53].

## **Schottky clamp may add speed to I<sup>2</sup>L circuits**

You've heard of Schottky TTL, but how about Schottky I<sup>2</sup>L? That's what a consensus of bipolar LSI circuit designers at the ISSCC agrees is the way to boost the speed of I<sup>2</sup>L. The trouble with I<sup>2</sup>L in its standard configuration is that, despite an extremely low speed-power product, it is capable of only moderate speed (20 to 100 nanoseconds). But by using a Schottky clamp on the outputs of the gate structure to reduce logic swings, **designers can decrease I<sup>2</sup>L gate delays significantly, much the way they do with TTL**. For example, researchers Horst Berger and Siegfried Wiedmann of IBM's Boeblingen Lab in West Germany, co-inventors of I<sup>2</sup>L, estimate that gate speeds lower than 5 ns are attainable with optimized Schottky I<sup>2</sup>L configurations.

However, the penalty is larger gates. Looking further ahead, Berger and Wiedmann see the possibility of compressing the structure by using a true Schottky collector, obtainable **by replacing one of the diffusions in the I<sup>2</sup>L pnp transistor with metal and thus forming a new pnm transistor**. Although this procedure would require some novel processing techniques, it is exciting to LSI designers.

## **Aligning system aimed at makers of advanced devices**

Cobilt, the Sunnyvale, Calif.-based division of Computervision Corp. of Bedford, Mass., is nearing completion of a new semiautomatic, high-resolution wafer-aligning system **for devices in which extremely small geometries are important**—microwave transistors, magnetic-bubble memories, I<sup>2</sup>L, surface-wave devices, and charge-coupled devices.

The main features of the new model 2020 aligner are single-step capability with 0.125-micrometer resolution; a dual-focus system that permits sharp focus of both wafer and mask with a separation of only 1 to 2 mils; and magnification up to 600 times. **The first production system, built on an order from Texas Instruments, is scheduled for delivery in March.**

## **GI plans to add another processor**

General Instrument Corp.'s Microelectronics division, Hicksville, N.Y., expects to announce **its second microprocessor product next week**—its CP160, a 16-bit unit developed for Honeywell Inc. GI has third-

party sales rights on the device, which follows the company's CP3F [*Electronics*, Dec 12, 1974, p. 33] an 8-bit microprocessor used by West Germany's Olympia Werke AG in its new desktop calculator.

## **AMD to produce Intel's 8080 part**

Advanced Micro Devices will probably be the first second-source for Intel's 8080 microprocessor. The company says its device **will be 40% faster than the 8080 which cycles in 2 microseconds**. The speed improvement, says Ben Anixter, AMD's marketing manager for MOS products, is made possible by the use of triple-ion-implanted depletion.

It took AMD two years to develop the process, which is n-channel, recessed-field-oxide silicon-gate. "Each portion of this conglomeration of processes is not particularly unique," says Anixter. "But the combination gives us extremely cost- and performance-competitive parts." They will be available as samples in June, and in volume by the third quarter. And AMD, until now known as a bipolar and p-channel MOS supplier, **plans also to second-source the Intel 8080 MOS memories**.

## **National's CMP-8 to aim at data-handling market**

In a move away from the original view of microprocessors—general-purpose devices for a broad range of applications—National Semiconductor Corp. is **aiming its CMP-8 at the communications data-handling market**. To adopt this so-called rifle-shot approach to marketing, says Gene Carter, National's microprocessor marketing director, "requires a microprocessor that is optimized for rapid data manipulation rather than arithmetic functions."

The CMP-8 is a single-chip, 8-bit, n-channel silicon-gate MOS device whose parallel central processor is designed to handle 8-bit data words and 16-bit address words. The unit consists of an 8-bit arithmetic and logic section and several registers, including accumulators, index registers, and an interrupt register, a program counter, and a stack pointer. Control is provided by a hard-wired instruction sequencer implemented with programmable logic arrays. **Typically, it takes about 2 microseconds for most communications jobs**.

## **Addenda**

Look for Grumman Aerospace Corp., Bethpage, N. Y., to become the **first recipient of Interdata Inc.'s 8/32 minicomputer**. Four of the yet-to-be-announced 8/32s, a 32-bit, core-based system for basic memory sizes from 128 kilobytes to 1 megabyte, will be used in Grumman's A-6E Intruder weapon-systems trainers to generate flight dynamics, display, tactics and digital radar land mass simulations. . . . Western Electric is getting serious about magnetic bubble memories. There is a pilot line producing them in Reading, Pa., according to Andrew H. Bobeck of Bell Labs, Murray Hill, N.J., inventor of the memory, indicating that the technology has made the transfer from Bell Labs experimental pilot lines to a production pilot line. . . . Motorola will soon announce very-wide-bandwidth, 500-megahertz MECL parts for communications. The MC1601 through MC1604 gates and MC1605 flip-flop use new MECL 20K processing, but have design numbers from the compatible MECL 3 line. **The parts are designed for minimum rise and fall times—less than 1 nanosecond—rather than minimum propagation delay.**

# Here's proof that AZ positive photoresist gives better device yields than negative photoresist.

Shown here is a series of SEM's illustrating the unlimited capabilities of our AZ Positive Photoresist Systems. We want you to see for yourself the excellent resolution, edge acuity, and line width control our photoresists provide in both thick and thin coatings. AZ Systems excel in: contact, proximity and projection exposure; aqueous development and removal; wide processing latitudes; accurate reproducibility of photomask geometries in coatings 0.3 to 2.5 microns thick. All of these factors combine to give you increased yields and profitability. Shipley Company Inc., Newton, MA

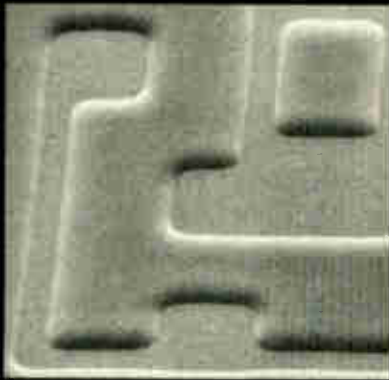

AZ-111 0.8 microns thick on silicon dioxide provides excellent edge acuity, etch resistance and line width control.

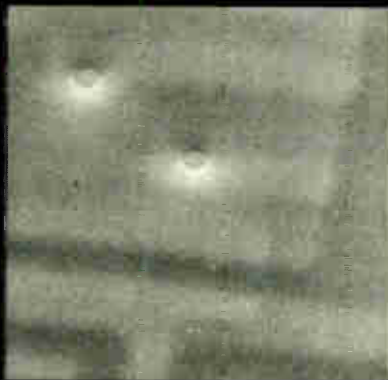

Contact layer coated with 1.8 microns of AZ-1350J is covering 1.5 micron steps. Thick coatings help eliminate pinholes and step breakdown.

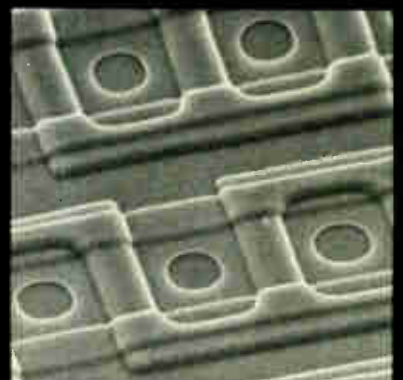

Contacts after etching and resist removal. Note absence of pinholing and sharp edge acuity.



AZ-1350J on aluminum showing excellent step protection through the use of thick coatings.

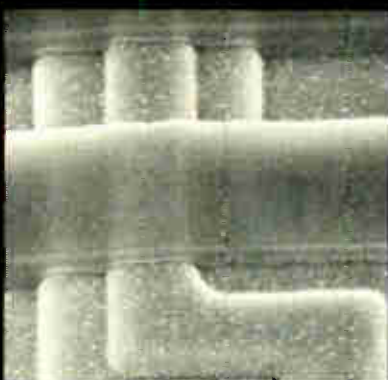

AZ-1350J on aluminum gives excellent edge acuity despite wide thickness variations.



AZ-1350J allows "0" pinholing during etching.



Circle 27 on reader service card



# Now, 4 times the memory on the same size card.

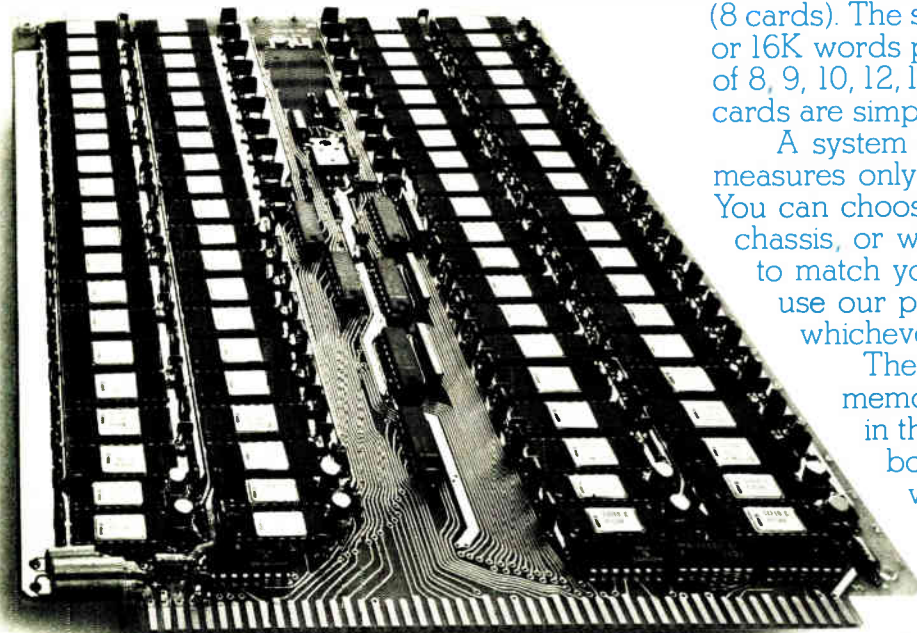

(8 cards). The standard options are 4K, 8K or 16K words per board and word lengths of 8, 9, 10, 12, 16 or 18 bits. For longer words, cards are simply combined.

A system expanded to 256 kilobytes measures only 8.175 x 10.5 x 5.0 inches. You can choose one of our standard card chassis, or we can make a custom chassis to match your requirements. You can use our power supplies or yours, whichever you prefer.

There probably never was a memory system as easy to expand in the field or in your factory. The boards are also interchangeable with our in-10 1103 systems—10,000 of which have already been shipped. Just allow 0.5 inch for each board. The universal control unit provides byte control, module select, address register, optional data register and control and data I/O and automatic refresh capabilities.

But your options on the in-40 and all other important semiconductor memory technologies are really unlimited. Intel also has the customizing expertise that comes from doing work for most of the industry's leading OEM's. And our billion-bit production plant gives quick delivery on standard or custom designs.

Call us if you want to store more words on fewer cards at lower cost.

Intel Memory Systems, 1302 North Mathilda, Sunnyvale, California 94086 (408) 734-8102

Regional offices:

Boston (617) 861-1136;  
Philadelphia (215) 542-9444;  
Dayton (513) 836-2808;  
Dallas (214) 661-8829;  
Los Angeles (714) 835-9642.

The most compact and most expandable low-cost memory system: you'll probably see for years to come is Intel's in-40 dynamic RAM system. It's a true new generation design, available right now in standard models from 16K words to 256 kilobytes or in custom configurations with quick delivery.

Besides highest density, the in-40 assures you higher performance than previous low-cost systems, whether solid-state or core. Built with Intel's newest 4K n-channel MOS RAMs, the in-40 provides an access time of 350 ns, cycle time of 550 ns, low power dissipation and TTL compatibility with very solid margins. One single in-40 memory board stores 16,334 18-bit words or 32,768 9-bit words. One single control unit board runs any system up to 128 kilowords or 256 kilobytes



Memory Options Unlimited

## intel® memory systems

A DIVISION OF INTEL CORPORATION

## Intel 4-k RAM speeding up to 80-ns access

Device is aimed at fastest main-frame memory systems; speed is three times faster than 4-k parts on the market

Today's 4,096-bit semiconductor memories just aren't fast enough for the fastest main-frame memory systems operating at less than 100 nanoseconds. True, the static bipolar and dynamic n-channel MOS 1,024-bit random-access memories try to serve this market. But they are too small, too expensive, and used mainly in peripheral equipment and high-speed buffers.

That is why Intel Corp. has begun development of a high-speed type charge-pumped "pseudo-static" 4,096-bit dynamic RAM, designated the 2106, with an access time of 80 nanoseconds.

Mike Geilhufe, Intel's manager of MOS-memory design, says this speed is not only three times faster than the fastest 4-k parts now on the market, it also matches the speeds of the 7001-style, 1-k n-channel MOS RAMs. And it reaches the lower end of the speed range of the extremely fast 1-k emitter-coupled logic/transistor-transistor logic RAMs.

The new device will be

ECL-compatible, which poses a problem. "Converting the ECL inputs to high-level MOS clocks requires design techniques more common to bipolar than to MOS," says Geilhufe. "This sounds simple, but when you get down to putting it together, it's a bear of a job.

"For example, the device requires only a 600-millivolt differential input which is more similar to bipolar than MOS. But MOS is a voltage-switching logic, not a current switching logic like bipolar. With the latter, a lot of voltage is not needed. What is necessary is a base drive to get a transistor to switch. So we had

to go to extremely sophisticated differential MOS sense amplifiers, which in itself is a problem because MOS does not lend itself to good circuits of this type," he says.

An unusual aspect of this chip's design, adds Mike Markkula, North American marketing manager, is that rather than making it TTL-compatible and then attaching peripheral devices to make it interface with ECL, the 2106 is made ECL-compatible on the chip itself. "This memory will be competing against ECL machines," he says. "If you have a TTL-compatible machine, when you tack on TTL/ECL conversion circuits it costs precious nanoseconds."

Because of the power and speed advantages involved, it was important to come up with a MOS memory that is basically dynamic but appears to be static. To achieve this, a four-transistor dynamic cross-coupled cell is being considered. In this cell, data is charge-stored and sustained by charge pumps, located on the chip, rather than resorting to standard planar-refresh.

"The advantage of such a configuration would be that, as far as the user is concerned, he is looking at a standard ECL RAM," says Geilhufe. The primary difficulty in achieving this, however, is that charge pumps normally require a clock level more nega-

Coming. Intel aims at speed mark for 4-k RAMs with its new 2106.

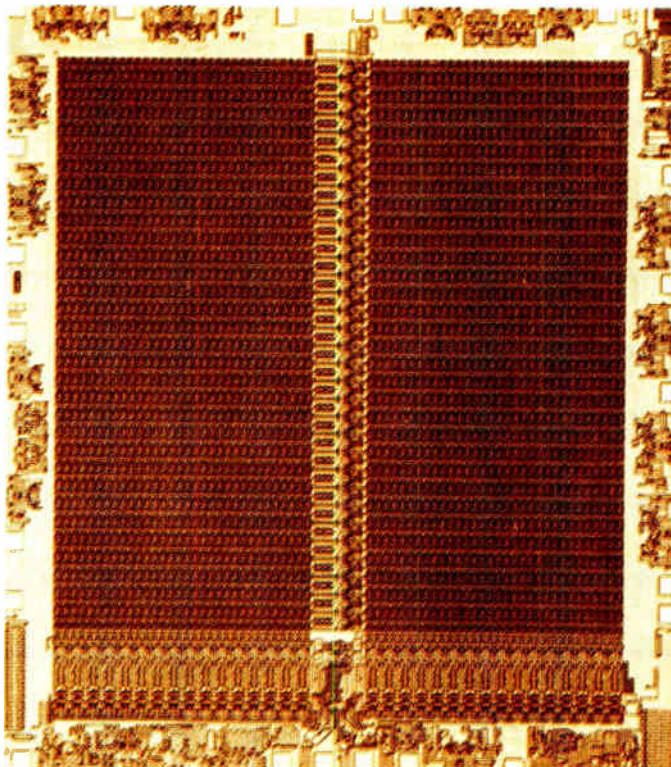



tive than the substrate potential to function efficiently. "Since the charge pump input normally has no diffusion anywhere and no protective devices," adds Geilhufe, "this means that if a signal is significantly more negative than the substrate potential, there is a real chance of blowing something out."

To avoid this, Geilhufe and his coworkers have come up with a modified charge-pump configuration, whereby part of the pump under the gate has a p<sup>+</sup> implant. This makes it possible, he says, to operate with a low-level pump clock voltage that is positive with respect to the substrate potential. The fully decoded 2106 is fabricated by an n-channel silicon-gate process on a monolithic chip of 204 by 237 mils and is assembled in a 22-pin dual in-line package. It has a 150-ns cycle time (write or read with full read-modify-write capability) and operates from +15-volt and -5-v supplies. Operating power is 500 milliwatts. Standby power is 300 mW. □

---

### Solid state

---

## Fairchild readies bipolar processors

Now that semiconductor manufacturers are on stream with n-channel microprocessors aimed principally at the controller market, they're working full tilt on one of the next challenges—bipolar processors for the higher-performance minicomputer market and high-speed process-control market, which are now served exclusively by hardwired logic families. Oddly enough, a company that has been slow in getting into the n-channel metal-oxide-semiconductor controller market is one of the first out with a bipolar design.

Fairchild Semiconductor, which has yet to formally announce its n-channel microprocessor, the F-8, is ready with a family of large-scale integrated computer elements centered around a 4-bit processor slice

built with Schottky/TTL technology. The five-chip family, which makes up all the components needed for a high-performance computer design, includes, in addition to the 4-bit processor slice, a redundancy check generator, a serial/parallel first-in first-out buffer memory, a data-path switch, a 64-bit push-down/pop-up (or p-stack) memory, a data-access register, and a 64-bit random-access memory register companion. In addition, a set of five bipolar memories—RAMs, read-only memories, and programable ROMs—will be supplied to work directly with the processor family of chips.

Already available for sampling are the redundancy generator/checker (the 9401), the 1,024-bit RAM (93425A) and the 1-k PROM (93446). The remaining parts will become available from Fairchild throughout the first half of this year.

**Compatible.** Most surprising is Fairchild's intention to supply this same LSI processor family in a pin-to-pin-compatible complementary MOS design that's built with their buffered oxide-isolated C-MOS technology (called ISO-C). The company is already supplying the first ISO-C LSI C-MOS devices—a programable bit-rate generator (34702) and a 256-bit RAM that will be part of the C-MOS family of processor elements. The other parts, including the 4-bit C-MOS processor slice, will become available in the course of the year.

According to Thomas A. Longo, vice president and group general manager of Fairchild's Integrated Circuits group, "our three LSI processor efforts—the n-MOS F-8 design and the Schottky and C-MOS 4-bit processor-slice families—cover the three principal processor applications areas: the low-end controller market, the high-performance minicomputer and process-control market, and the low-power terminal and remote equipment market." The last market includes the point-of-sale and telecommunication area barely touched by today's designs. "In short," says Longo, "we're serving the cost-conscious n-MOS market, the performance-conscious bipolar market, and the power-conscious

C-MOS market."

In its bipolar design Fairchild uses a shallow low-capacitance diffusion process to come up with an impressively low 6-picojoule-per-gate speed-power product and a 10-pJ product for output buffers. This adds up to gate delays on chip of only 3.5 nanoseconds in dense (50 gates per square millimeter) configurations.

This translates directly into impressive system performance. The 4-bit-processor slice, for example, operates at a 10-megahertz clock rate, accomplishing a microcycle in less than 100 ns, compared to 1 to 2 microseconds for typical n-MOS microprocessor systems. A typical instruction time, which needs 4 or 5 microcycles, can be done in less than 0.5  $\mu$ s—three to four times faster than most n-MOS processors and about 1.5 times faster than proposed integrated-injection-logic designs [*Electronics*, January 23, p. 29]. Like I<sup>2</sup>L designs, the Fairchild system can be operated in parallel, a virtue that leads to shorter instruction cycle times. Indeed, the Fairchild system will have comparable performance to Intel's 2-bit processor slice (the 3000 series), which along with Monolithic Memories' 4-bit slice are the only other available Schottky processor families. □

---

## 4-k RAMs in volume spur H-P price cuts

Hewlett's-Packard's gamble on the use of 4,096-bit random-access memories while the devices were still speculative has paid off. By getting the parts in volume, H-P is now able to cut the prices of the minicomputers in which they are used. But the 4-k RAM H-P finally chose is not the 16-pin version on which it was betting earlier; instead, H-P is going with Texas Instruments' 22-pin package and may switch to a denser 18-pin design later.

Based on an estimated price of \$8 to \$10 per device for TI's 22-pin version by the second half of 1975, H-P



is going into volume production with 4-kilobit and 8-kilobit word modules of medium density. Prices of the 4-kilobit word module are cut to \$900 from \$1,300 and the 8-kilobit to \$1,500 from \$2,150.

**Reductions.** According to Edward R. McCracken, H-P Data Systems division marketing manager, the lower memory prices will result in substantial price reductions in H-P's 21-MX minicomputer configurations. The 32-kilobit system has been reduced 18% to \$11,800 from \$14,400; the 16-kilobit, 15% to \$7,650 from \$9,000; and the 8-kilobit, 10% to \$6,500 from \$6,833.

The shift to TI's 22-pin version follows cancellation of a 4-kilobit RAM order with Mostek Corp. of Carrollton, Texas, for more than 100,000 of its 16-pin parts at an estimated \$1.5 million. McCracken says the decision to cancel came when it became clear that Mostek would not be able to deliver enough parts even to allow adequate testing. TI has thus supplanted Mostek as H-P's supplier, a reversal of the situation last March as Mostek looked to win a big slice of the H-P business when TI had yield problems [*Electronics*, March 21, 1974, p. 70].

In a test program involving about 100 21-MX minicomputers, 370 8-kilobit modules of semiconductor memory and about 6.5 million test hours, McCracken says chip failure rates on the 22-pin TI 4-kilobit RAM were about 0.1% for every 1,000 hours of operation. "By late fall we expect failure rates to be reduced even further to 0.05% per 1,000 hours."

He says H-P is now beginning tests on TI's 18-pin design, but a decision on whether the company will make a major commitment to that part must wait until the end of a three-month cycle. "However, we've received ample test quantities of the new TI chip and the preliminary results look very good," McCracken says. "In addition, our experience with TI's 22-pin part leads us to believe they can do the same thing with the 18-pin version."

If so, he says, it is probable that H-P will reintroduce its two 21-MX

## Thin-film solar cell 12% efficient

A new heterojunction solar cell that offers high efficiency with a possibility of low-cost fabrication has been developed at Bell Laboratories in Holmdel, N.J. Early versions use polycrystalline n-type cadmium sulfide deposited on a single-crystal p-type indium-phosphide substrate. The developers, Sigurd Wagner and Joseph Shay, say they know of no theoretical reason why the device cannot be built completely in thin-film, polycrystalline form, and they are going ahead to find the best thin-film fabrication method. Such methods will be much less costly than present semiconductor processing required to produce the commonly used cells made of single-crystal silicon. Shay and Wagner measured a solar conversion efficiency of 12.5% for their cell—substantially higher than the 7% efficiencies reported for cadmium sulfide-copper sulfide heterojunction devices [*Electronics*, April 4, 1974, p. 99].

In the photo, the thumbnail-size experimental solar cell is shown with a contact grid deposited on the cadmium sulphide layer of the Bell Laboratories-developed device.

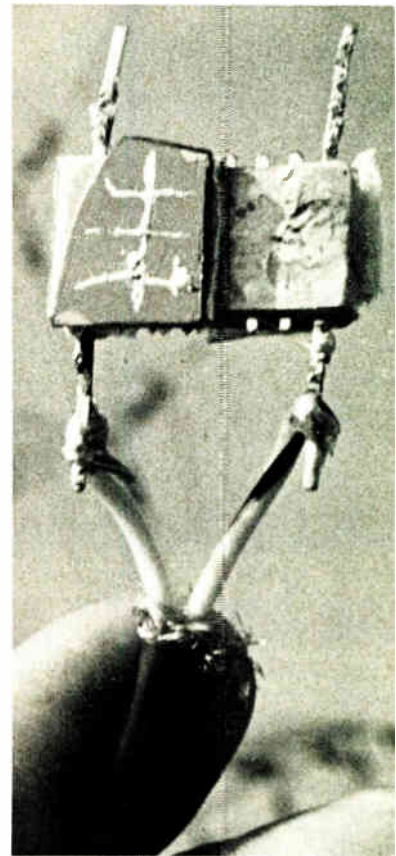

minicomputer models using the TI 18-pin package late in 1975.

The H-P division and other users are evaluating 4-kilobit RAMs from a multitude of suppliers, including Intel Corp., Motorola, Western Digital Corp., Fairchild Semiconductor, American Microsystems Inc., Microsystems International Ltd., and National Semiconductor. Most of these have been ruled out for now because of technical considerations or because parts are not available in suitable quantities. Robert Frankenburg, product marketing manager for the division, says that while the specs for National's 18-pin part "look good, when it comes right down to it, we'll probably go with TI's 18-pin, just because it's available and performs reasonably well."

Meanwhile, Mostek's statement about its problems with the 4-kilobit part is terse. "Mostek experienced minor reliability problems in the

early production of our 4-k RAM," says L.J. Sevin, president. "These have been corrected to all customers' satisfaction. Yields for the MK 4096 have also been a problem, and a major program to improve production is now underway. These two developments, coupled with a large demand for the product, have affected Mostek's ability to meet all customer requirements." □

## Computers

### New DEC computer adds faster bus

A major contributor to the high speed of Digital Equipment Corp.'s PDP-11 minicomputers is the unified bus, a structure that allows memories and input/output devices



**Speedier.** DEC's PDP-11/70 minicomputer uses a special 32-bit internal data path to boost speed. Machine also features a cache memory and new high-speed digital controllers.

to communicate asynchronously with the central processing unit. But when DEC wanted still higher speed, it found the 16-bit "Unibus" was being pushed to its limit and needed supplementing with a new faster data bus.

In the PDP-11/70 minicomputer announced last week, 32-bit buses transfer data at rates of nearly 6 million bytes per second—about six times the top speed of the Unibus. They are used to move data from high-speed bulk memories to cache memory—the first cache in the PDP-11 series—and they do so through a set of control circuits that were also specially developed.

DEC believes the controllers are unique to a computer of this size. Built of transistor-transistor and Schottky logic, each controller fits on one card in the 11/70 CPU. The CPU can handle four of them, and they can each handle up to eight mass-storage devices. The CPU tells the controller to transfer particular data between bulk memory and cache. The controller, which contains addresses stored in registers, executes the instruction which, once given, is forgotten by the CPU.

While some improvements also were made in the 11/70's CPU, it is

essentially similar to the 11/45. This unit was formerly the high-end model in the PDP-11 series with a basic instruction speed of 300 nanoseconds. In developing the 11/70, DEC worried less about what vice president Richard J. Clayton calls "gut-fast specs" and more about optimizing the architecture. A DEC spokesman notes that, "we usually add one 'hot' thing to new PDP-11s, but here we tried to balance everything. The busses are as fast as the processor, which is as fast as the memory. The 11/70 is more complex, interesting, and subtle than other 11s." System prices range from \$55,000 to upwards of \$200,000, depending on options.

**Expansion.** The size of the 11/70's main memory was expanded by a factor of eight over the 11/45, up to two million bytes of core with an average cycle time of 400 nanoseconds. The two-set associative cache memory—the first cache in the PDP-11 series—communicates with the main memory via another dedicated 32-bit-wide data bus. The cache is a 2,048-byte bipolar device, divided into two banks of 1,024 bytes each. It has an access time of 240 ns. Because it is in two banks, DEC says it will have a hit rate—the

likelihood of finding the needed data—of more than 90%.

With the 11/70, DEC is also introducing a major operating system called Interactive Application System which, for the first time in the 11 family, allows time-sharing, real-time, and batch operations to be processed concurrently. IAS is a multi-lingual system that supports ANSI-74, Cobol, enriched Basic, macro assembler, and Fortran VI languages.

Tagged by size and price as a medium-scale computer, the 11/70 can be supplied as a full end-user system with high-speed mass-storage capability, operating systems, and the range of PDP-11 peripherals. As such, DEC believes it offers more than CPUs with similar processing power. Rather, the PDP-11/70 fits a notch above the classic role of the minicomputer but below that of the IBM 370/135.

DEC sees applications for the 11/70 in jobs involving such things as transaction processing, complex scientific problems, and multifaceted jobs like plant control in which the computer directs operations and sets priorities. Handling these problems requires high execution speed, as well as the availability of a large number of programs, all areas DEC has specifically addressed with the PDP-11/70. □

### Military electronics

## Army to test in-flight data system

An airborne reconnaissance system, which could find no takers after the military spent some \$43 million on its development, is getting a new lease on life.

An austere version of the tri-service Joint In-Flight Data Transmission System has been built and tested for the U.S. Army by Northrop Corp.'s Electronics division, Palos Verdes, Calif. And the Army will shortly begin its own tests of a "feasibility demonstration" model

# We make a logic tester for every purpose...

## A family of testing solutions.

Fluke Trendar knows that your logic testing problems come in all sizes. From factory testing thousands of complex boards each month, to nailing one suspect IC in the field. That's why we've developed a family of testers with a model that's sized right for any volume. And with a range of prices to fit any budget.

## High volume production.

Two Trendar testers cover the spectrum of factory needs. The Trendar 2000A, the patriarch of the family, is for big, tough boards. You will find it in a hundred customer installations, where millions of boards have been accurately tested, diagnosed and passed. It provides both single board testing/fault isolation and comparative board diagnostics for maximum speed. For smaller volume, the new Trendar 1010A console offers the same testing power and many of the diagnostic features of the 2000A for well under \$10,000. It provides one pass, go/no-go testing. And, it offers level-programmable drivers

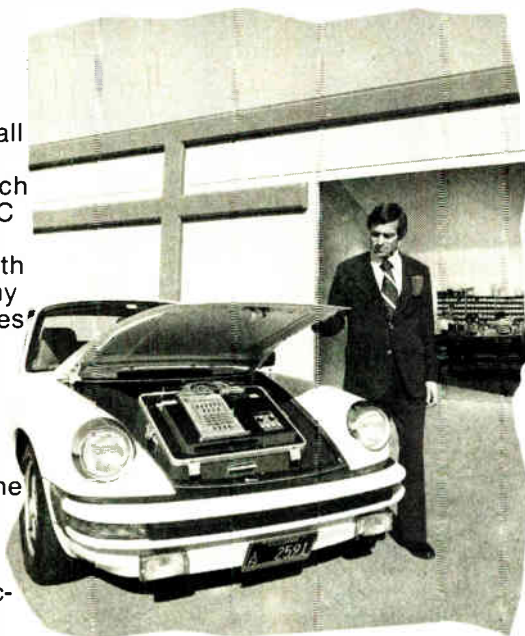

**your plant,  
your pocket,  
or your Porsche.**

and receivers for full CMOS and TTL capability. Faults are isolated by back-tracking logic errors with a built-in probe. The Trendar 1010A is program compatible with the Trendar 2000A . . . an ideal match for low volume production testing or field service applications.

## Portable, too.

The Trendar 1000A is a compatible portable version. Used worldwide in small production and field service facilities, it fits in your Porsche. These testers hold the record for simplest, fastest programming.

## Hand-held testing of IC's in circuit

The smallest family member and one of the most versatile, slashes logic troubleshooting time. TESTCLIP comes in three models to accommodate logic families from 5V TTL/DTL to CMOS and HTL. It acts as a logic probe, logic clip and IC comparator. One of the largest computer companies reports that TESTCLIP cuts troubleshooting costs in half. Another user saves \$1000 per month per technician.

Whatever size you specify, boards passed by Trendars work in the end product. Their initial low cost and high-volume throughput save big dollars.

Call us. Collect. Fluke-Trendar.  
(415) 965-0350.

**FLUKE TRENDAR**

a subsidiary of John Fluke Mfg. Co., Inc.

500 Clyde Avenue, Mountain View, California 94043—415/965-0350  
TWX 910-379-6573. Europe, Fluke (Nederland) B.V., P.O. Box 5053,  
Tilburg, Netherlands. Tel. 013-673973. Telex 52273. U.K., Fluke  
International Corp., Garnett Close, Watford, WD2 4TT, Tel. Watford  
(0923) 33066. Te ex 924583.

Logic testers so sophisticated they don't need a computer

World Radio History

Circle 33 on reader service card



## Electronics review

at the Ft. Huachuca, Ariz., test ground. Development is under the supervision of the Army Electronics Command, Ft. Monmouth, N.J. But no "big buys" are yet contemplated, according to a spokesman.

Renamed the Army In-Flight Data Transmission System, the 200lb. reconnaissance flight package transmits to a ground terminal images gathered by an airborne side-looking radar. Thus, while the aircraft is still on its mission, the terminal can produce a hard copy of the images nearly in real time. Normally, there is a delay before processing while the aircraft returns with recorded data.

The Army formally assumed responsibility for developing the new

tion plane. The original system operated with a variety of sensors, both infrared and visual.

The Aidats system has successfully transmitted radar signals from the aircraft over line-of-sight distances as great as 370 kilometers, more than twice the 150 km originally specified by the Army. The side-looking radar produces an image of the ground as the aircraft flies at some distance to the side of the target. This is an obvious advantage for the military.

Included in the airborne system is the sensor subsystem, which accepts data from the radar, a navigation system, and an aircraft-data-annotation system. The latter two are for correlating sensor images with posi-

tioned removing extensive built-in test equipment, and other sensor-input circuitry, or about 60% to 70% of the system, according to Northrop. Also, the old system had only 5 channels to Aidats' 64, and the new one has twice the output power. □

## Consumer

### Watch market: is 40 a crowd?

Counting on a market that's yet to boom, the number of companies offering electronic watches with digital displays in this country may have passed the 40 mark, almost twice the total in this tough, competitive new field a year ago.

Most of these firms were on hand earlier this month in the bazaar-like atmosphere of the Retail Jewelers of America trade fair in New York. The show provided a good view of the battle shaping up for the U.S. digital-watch market, estimated to be anywhere from 500,000 to 3 million units in 1975.

Whether the new digitals will be the wave of the future or just another timepiece in a market already filled with attractive and accurate analog watches, there was no doubt that digital watches had gained a foothold. The market, at least for the next six months, will hinge on three key factors revealed at the show:

■ Prices. They are dropping. Bowmar Consumer Products surprised the field by showing a two-button light-emitting-diode watch with hours, minutes, seconds, and date at a list price of \$119.60—roughly half the price of other watches with as many features. However, with Bowmar now filing for bankruptcy (see p. 36) the future of this product is in doubt. Swiss American Time Corp., an Otel company, priced its liquid-crystal model at \$124.95. And Timex Corp. finally showed its long-promised LCD men's and ladies' watches, listing them at \$85. Timex had almost a year's delay bringing



**Data in a jiffy.** Northrop Corp. transmission system sends data from side-looking radar, slung below Mohawk OV-1D fuselage, to the ground for processing while plane is in the air.

system in the spring of 1974, after the Naval Air Systems Command dropped out of the effort which it had administered since 1967. Air Force interest was always largely nominal, explains one Navy official, since it pursued other programs which could be operational sooner.

Navy interest began to wane about 1970 when it determined that its reconnaissance aircraft operated so close to aircraft carriers that its effective use of the system would be marginal.

The Northrop tests were conducted with a Motorola Inc. APS-94-D side-looking radar placed aboard a Mohawk OV-1D observa-

tions on the ground. The sensor subsystem digitally modulates a Ku-band carrier on which data is transmitted. A Sperry frequency synthesizer provides up to 64 rf channels, which can be assigned to different aircraft. Power output is 150 watts.

The radar image, which looks like a high-resolution television picture, appears on film 90 seconds after receipt of the data. Numerical position data also appears on the film. Resolution is 32 line pairs per millimeter, or 10 times that of TV.

Modifying the earlier system, which Northrop itself began developing in 1969, cost \$3 million. It in-

# RCA introduces the CCD imager.

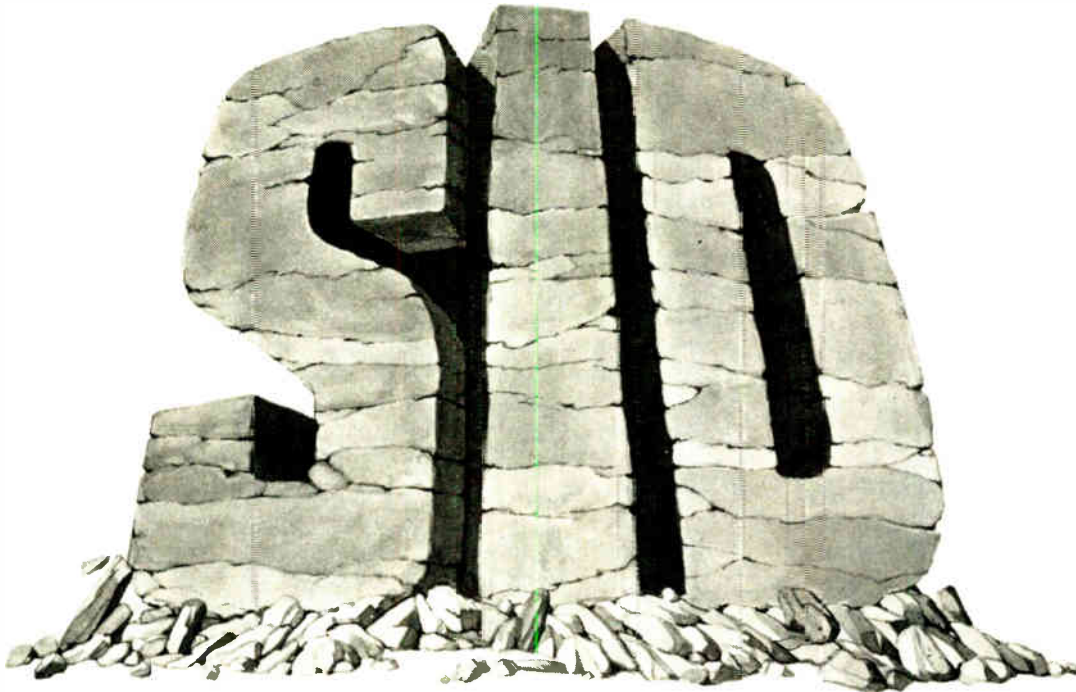

Meet big SID — the solid state technological breakthrough you've been waiting for! A Silicon Imaging Device, RCA's big SID is the first — and largest — Charge-Coupled Device for standard 525-line TV.

Big SID is our premiere device — the first of a new solid-state imager series that holds revolutionary potential for new electronic concepts and designs.

Precisely the kind of major advance

you'd expect from the television pioneer; 512 x 320 elements plus a video preamp all on one "chip" can produce truly useful resolution. Stated in terms of digital memories, to which CCD technology also can be applied, there are 163,840 high-density bits of storage!

Even though big SID is huge by semiconductor standards, it is now possible to build smaller TV cameras

than ever before. When clocked at slightly over a 6 MHz data rate, big SID may be used to generate standard 525-line video which is compatible with monitors and other standard video equipment without modification.

Consider big SID's many desirable qualities:

- Small size and weight
- Solid-state life and reliability
- Sensitivity and spectral response comparable to Silicon-Target vidicons
- Anti-blooming characteristics
- No lag
- Highly linear and stable geometry suitable for mensuration
- Low power consumption
- Solid-state ruggedness — no microphonics

Put big SID to work in your new equipment designs — black and white or color — for surveillance, industrial control, portable audio-visual units, tracking, pattern recognition or "electronic journalism" cameras.

Big SID — RCA type SID51232 — is here.

For more information, see your RCA Representative or write SID Marketing, RCA, New Holland Avenue, Lancaster, Pennsylvania, 17604.

**RCA-Lancaster — where people and technology make the difference.**

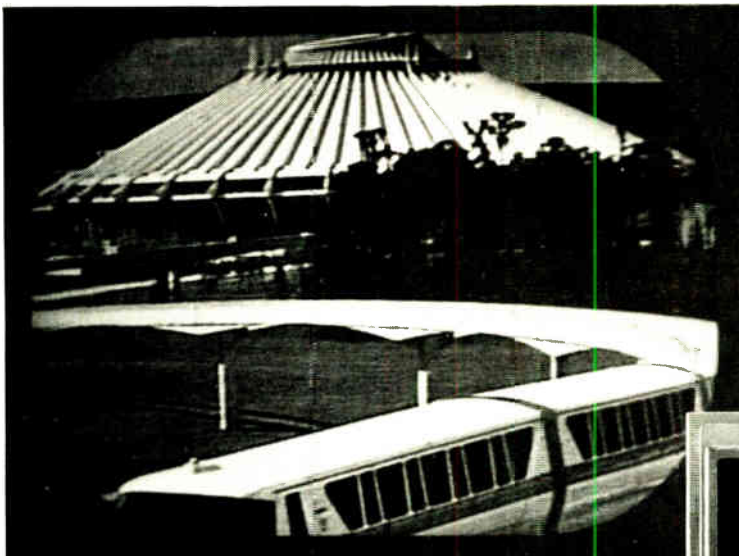

Unretouched photograph of standard 525-line monitor display produced by big SID

Big SID — actual size



# RCA Charge-Coupled Devices



## Electronics review

the watches to market and won't say how they're selling. But with prices dropping, Jerry Allen, vice president of sales at Microelectronic Systems Corp., says, "We've warned our customers not to hold any inventory for the next six months."

■ **Displays.** LEDs and LCDs will continue to appear side by side. Most manufacturers give the volume edge to LEDs for 1975, but there is lots of talk of an LCD "comeback." Comments Edward Miller, marketing manager for Gruen Industries Inc., "Our surveys show the consumers' thrill in turning on LED watches is just about over. The future is in LCDs."

And at least two companies, Computer Time Corp. and Solid State Time Inc., are evaluating easier-to-read two-color electrochromic displays.

■ **New features.** Only Benrus Corp. expressed much interest in high-

density low-powered integrated-injection logic for watches, despite the promise of a one-chip module. Generally, users say that this new approach developed by Texas Instruments does not improve enough on their present two- and three-chip designs using complementary metal-oxide semiconductors.

New features center around overcoming the shortcomings of the LED and LCD displays. For example, to reduce the nuisance of pushing a pair of buttons to turn on the LED displays, companies have come out with a single button that activates two or three switches in succession to get the time (hours and minutes), date, and seconds.

And to help see the time, brightness controls increase intensity of LEDs in bright light or dim them in the dark. For reading the time in the dark, LCD watches are now available with back lighting. □

mar disclosed that Edward A. White, its founder, chairman, president and chief executive, and William D. Mezell, the company's chief financial officer, resigned. Both White, who owns an estimated 38% of Bowmar's stock, and Mezell will continue as consultants.

Meanwhile, Richard Brown, who only joined Bowmar a week before the White and Mezell resignations as head of Bowmar's Consumer Products division, has been appointed acting chief operating officer pending selection of a new president and chief executive. Brown was formerly general manager of Mazda Motors of America Inc. Bowmar, one of the first to market a portable electronic calculator using a single semiconductor chip (made by Texas Instruments), now holds only 12% of the unit market share in the U.S. as against TI's 33%, according to a recent study by Creative Strategies Inc. It ranks fourth with only 8.6% of the U.S. market share in dollars to TI's estimated 23%.

Bowmar stressed its financial difficulties in a preliminary unaudited report just a few days before filing for Chapter XI protection. The company expects to incur a pre-tax loss of about \$23 million and after-tax loss of approximately \$20 million on sales of about \$80 million in 1974. This compares with a pre-tax profit of \$14.7 million and an after-tax profit of \$7.6 million in the fiscal year that ended Sept. 30, 1973, on sales of \$64.8 million.

In the papers filed with the U. S. District Court for the Southern District of New York, Bowmar reported total liabilities of \$48,991,000 and total assets of \$48,870,000.

White blamed the losses on intense price competition as well as unusually large inventory write-downs and receivables adjustments. In addition, the company has been spending heavily on consumer advertising. Also, its effort to develop a semiconductor supplier for its calculator chips by acquiring Integrated Technology Corp. of Phoenix in 1973 set it back \$7 million.

Further setbacks include the closing costs of Bowmar's calculator as-

## Business

### Bowmar Instrument files for bankruptcy as president Edward A. White resigns



**Resigns.** Bowmar president Edward White will continue as a consultant.

Heavy losses and expenditures in the hotly competitive calculator market have caught up with Bowmar Instrument Corp., New York, once the leading marketer in the field. Unable to obtain waivers from its institutional lenders on loan defaults because of larger than anticipated losses, Bowmar filed last week for Chapter XI proceedings of the Federal Bankruptcy Act. This would put it under the protection of the court while it works out new arrangements with its creditors.

A total of \$35 million in loans has been called due by its lenders. One of them, New York Life Insurance Co., filed a \$16 million legal action against Bowmar on its loan. New York Life told Bowmar in December that it would waive the calculator supplier's default but changed its mind when Bowmar's losses were higher than expected.

At about the same time, Bow-



# The beginning of a new day in CCTV cameras with SID.

Big SID  
— actual size



RCA introduces two miniature, *all* solid-state TV cameras with the resolution and features needed to make them genuinely useful for a wide range of applications. Both cameras are designed around RCA's big SID, a 512 x 320 element Silicon Imaging Device based on the revolutionary new CCD (Charge-Coupled Device) technology.

One camera, the TC1150, has a built-in lens with focal length adjustable from 14mm to 38mm. This lens forms part of a unique automatic light control system which quickly adapts over a large range of scene illumination.

The TC1155, on the other hand, accepts standard "C" mount lenses

for even greater flexibility. In addition to achieving maximum sensitivity, low distortion lenses may be employed to take greater advantage of big SID's highly precise, linear and stable image geometry for non-contact measurement.

These cameras are *completely* solid state; they have all the features you'd expect, and possibly some that you wouldn't expect:

- Full 525-line standard video output — no monitor modifications needed
- Small size and weight
- Solid-state life and reliability — no vidicon to replace — no field adjustments necessary

- Sensitivity and spectral response comparable to Silicon-Target vidicons

- Anti-blooming characteristics
- 163,840 picture elements produce high quality, 3 MHz bandwidth pictures

- No lag
- No microphonics
- Low voltage and power requirements

Let big SID and these all-solid-state cameras solve your problems whether in surveillance, industrial control, pattern recognition, military, scientific instrumentation or other applications.

For more information on these and other CCTV cameras and accessories, see your RCA representative or write RCA Closed-Circuit Video Equipment Marketing, New Holland Avenue, Lancaster, Pennsylvania 17604.

**RCA-Lancaster — where people and technology make the difference**



## **RCA** Charge-Coupled Devices

sembly facility in Acton, Mass. Calculator production has since been consolidated in plants in Arizona and Mexico.

The company's shares haven't been traded since Feb. 3, when Bowmar asked the American Stock Exchange to halt trading until it received waivers on its loan defaults. Bowmar's stock most recently was trading at 4%, down from a high of 24¾ in January, 1974.

Still pending, according to Fred Gerard, Bowmar's legal counsel, is Bowmar's antitrust suit against Texas Instruments, filed in December. Bowmar charges TI with deceitful misrepresentation, antitrust violations, conversion of trade secrets, violations of the Robinson-Patman Act and fraudulent patent practices, and asks for damages of \$240 million. □

## Medical electronics

### C-MOS implant to aid deaf

Scientists at Stanford University Electronics Laboratories near San Francisco, Calif., are developing what is, in essence, an artificial ear using a thick-film C-MOS package that could eventually be implanted in a human being.

Aimed at the approximately 200,000 people in the United States who are totally deaf because the hair cells in their inner ear—which convert sound to electrical signals—are missing or defective, the implantable complementary metal-oxide-semiconductor system works by direct injection of electrical signals into the auditory nerve. In effect, the brain is tricked into thinking the real ear is working.

"A number of one-electrode systems have been tried," says one of the scientists, Tushar Gheewala, who described the development at last week's International Solid State Circuits Conference in Philadelphia. "But these have resulted in only low-frequency perceptions, up to

perhaps 300 hertz, much less than is necessary for the brain to decipher a coherent, intelligible signal."

What is needed is a multielectrode neural stimulation system that takes advantage of the way the real ear itself separates auditory signals by means of variously "tuned" hair cells along the inner ear, he says. Working with co-researchers Robert White and Roger Melen, Gheewala has developed a four-electrode 1.25-by-1.25-by-0.25-inch C-MOS package that they believe will deliver information at a rate up to about 4 kilohertz to four groups of nerve-endings in the inner ear.

**Links.** To avoid inserting wires through the skin, the inputs to the implant are delivered via two over-the-air links.

A radio-frequency link couples in about 5 milliwatts of power needed to run the implant. And an ultrasonic link delivers instructions on which electrode to pulse, how frequently, and how hard.

The ultrasonic signals are delivered in digital form from an exter-

nal package that contains a microphone pickup, information coding circuitry, and an ultrasonic transmitter. This package also contains the power transmitter. An ultrasonic signal, Gheewala points out, has good noise immunity and won't cross-couple with the power link.

Electrode-pulsing information is stored in a 32-bit shift register, with eight bits assigned to each of the four electrodes. Serial digital-to-analog conversion takes place by charge redistribution between two equal-valued capacitors and any one of four output capacitors, according to Gheewala. Demultiplexing of the signal is performed by an address switch which selects the appropriate capacitor.

"Physiological evidence indicates that for short pulses the nerve stimulation threshold and response is determined by the total charge delivered and not by amplitude or wave shape," says Gheewala. "Taking advantage of that, we can use this four-electrode demultiplexing system to select any of 256 intensity

### News briefs

#### Philco-Ford plans recall of 10,000 TV sets

Philco-Ford Corp., Blue Bell, Pa., plans to recall more than 10,000 9-inch black-and-white TV sets because of a possible shock hazard. The sets were produced for Philco in Taiwan between May and August of last year.

#### AT&T denies U.S. antitrust charges

American Telephone & Telegraph Co. has filed its first formal response to the Justice Department's antitrust suit, filed last November [*Electronics*, Dec. 12, 1974, p. 76]. AT&T claims it is not violating the antitrust laws and asks the Federal Court in Washington, D.C., to dismiss the suit. AT&T's denial, which was joined by Western Electric and Bell Laboratories, stresses that the Bell System already is operating under a consent decree and final judgment entered with the Justice Department in 1956 as a result of a suit begun in 1949. Moreover, the defendants assert that, since the 1956 consent decree was approved by the Federal Court in Newark, N. J., the court in Washington D. C., where the latest suit was filed, has no jurisdiction.

#### Antitrust suit against IBM is delayed

Judge David N. Edelstein has granted a delay in the start of the Justice Department's antitrust trial against IBM Corp., which was to have started Feb. 18. IBM and Justice Department attorneys, who said they were a month or more behind schedule in preparing documents for the trial, appealed jointly for the delay.

#### Allen-Bradley ends MOS business venture

Milwaukee components supplier Allen-Bradley Co. has sold its majority interest in MOS Technology Inc., Valley Forge, Pa.

# When you buy the ALMA 480B, we throw in 700 programs. Free.



**A library of programs.** Most manufacturers don't say much about programming. We do. There's a library of programs given to every new 480B owner. Over 700 programs that allow you to test DTL, TTL, ECL and bipolar compatible digital devices. And they're ready right now. No waiting until someone feels like getting around to building your program.

**SSI, MSI, LSI, RAM'S and ROM'S.** Hundreds of different devices can be tested. Each, from a program printed on a single piece of paper. All you do is select the appropriate program, set up the machine, turn on the switch, and start testing. When you want to change devices, select the new program sheet and change the program. It's that simple.

**Evaluates and characterizes.** If an IC fails, the 480B doesn't just tell you it failed. It tells you where it failed and the type of failure that occurred. Right down to the pin number.

**Reprogram on the go.** If a number of IC's are failing the specification by a small margin, and that specification is not critical to your application, just adjust the thumbwheel to your minimal requirements. And keep testing.

**A family of digital and linear testers.** The ALMA 550 tests just about any standard or custom linear IC. The ALMA 480B tests just about any digital IC you can find. The ALMA 380C, a low-cost IC tester for almost any digital IC.

## ALMA

Division of Develco, Inc.  
530 Logue Avenue  
Mountain View, CA 94043  
(415) 968-3993



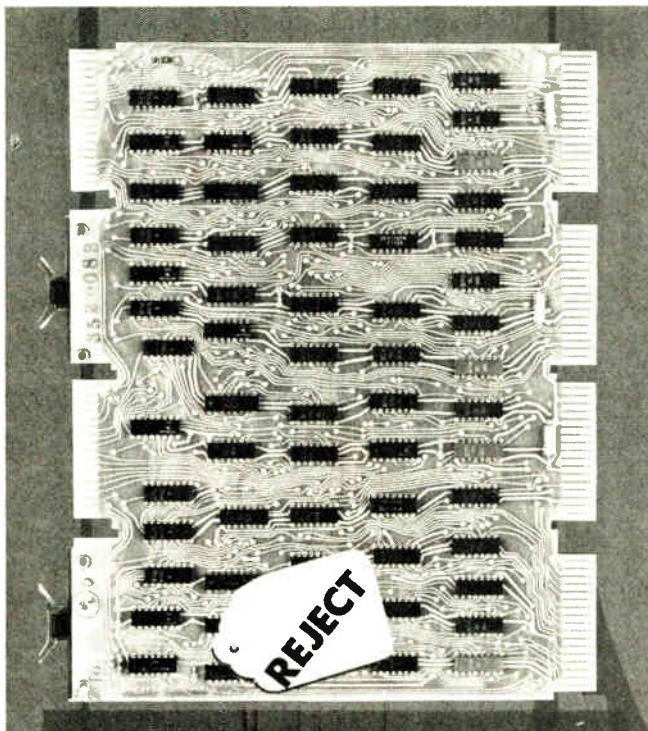

HOW LONG WOULD IT TAKE YOU  
TO REPAIR THIS BOARD?

WITH THE  
**TESTLINE  
AFIT**

CONSIDER THESE FACTS:

1. MAXIMUM REPAIR TIME - 15 MINUTES
2. REMOVE ONLY THE I.C. (OR I.C.'s)
3. MAXIMUM OPERATOR TRAINING - 30 MINUTES
4. NO TECHNICAL SKILLS REQUIRED
5. MAXIMUM SOFTWARE EXPENSE - \$275
6. MAXIMUM HARDWARE EXPENSE - \$9,200

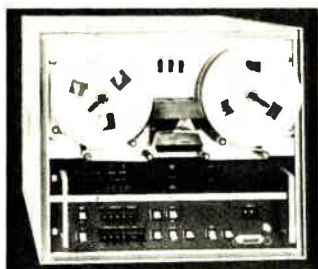

IF THESE FACTS ARE OF INTEREST,  
CONTACT HAROLD CARTER AT:



**Testline Instruments, Inc.**  
North Brevard Industrial Park  
1625 White Drive  
Titusville, Florida 32780

Tel. 305-267-7212

TWX 510-950-3043

## Electronics review

levels for each electrode, up to 4 kilohertz per electrode and 50,000 picocoulombs per pulse."

Since the output for a given channel is stored across a capacitor, the conversion circuit can serve a number of output channels, he says. Once the charge in one output capacitor is set, the conversion unit may be switched to the next storage capacitor and the data stream continued. It is therefore necessary, says Gheewala, to add only one address switch and one output capacitor for each additional output.

"This feature is very important when you consider that 16 channels are likely to be needed for an effective hearing aid," he says. "We are now building about 20 four-electrode units which will be implanted in cats for testing in the spring.

"If all goes well, we will be implanting a 16-channel package we are now fabricating for humans for evaluation by late 1975." □

## Optoelectronics

### Fiber-optic kit aims at industry

By and large, signal transmission over fiber-optic cables has been confined to military uses [*Electronics*, Aug. 22, 1974, p. 69; Jan. 9, p. 29]. But a West German company, AEG-Telefunken, is determined the technology shall go commercial. The company is readying a kit containing all the components an industrial user needs to build a fiber-optic link. Designated the V300P, the building-block system offers 200 kilohertz of bandwidth for data transmissions over a glass-fiber cable up to 60 meters long. The system will be unveiled at the Hanover Fair in mid-April and available in sample quantities right after.

"What we are trying to do," says Hans A. Strack, the man in charge of optoelectronic activities at AEG-Telefunken's semiconductor facilities in Heilbronn, "is to work the market from the bottom up rather

# when it rains...



# ...it works!

© Registered Trade Mark of Morton Salt Company—who makes great products, too.

## If your product must work outdoors this sealed Cherry switch will work!

We built an umbrella *around* a switch . . . by putting our subminiature snap-action switch inside a sturdy housing and injection molding epoxy plastic that encapsulates the switch and leads to seal out dirt and moisture. The result? A switch you can splash, spray, freeze, subject to all kinds of weather.

Because it's watertight and weatherproof. Making it the ideal switch for use in autos, trucks, boats, snowmobiles, power mowers, outdoor vending machines . . . just about any type of product that is subjected to extreme weather, dust, dirt, grit, grease, grime or spray.

The watertight, weatherproof "inside switch" is our good old reliable E62 subminiature, proven over more than a decade in millions of demanding applications. In this new sealed switch design, its stainless steel coil spring mechanism and reliable rock-wipe contact action are protected by a double enclosure plus a rubber boot on the actuator. So that when it rains . . . it works!

**TEST A FREE SAMPLE OF THIS NEW SEALED SWITCH.** Just PHONE (312) 589-7700 or TWX (910) 235-1572, or write on your letterhead.

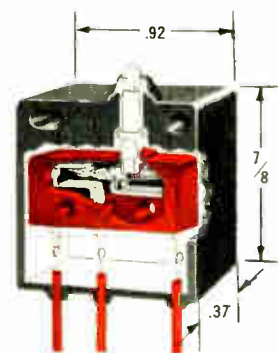

ACTUAL SIZE

We put a switch inside . . . so it's watertight and weatherproof!



**CHERRY ELECTRICAL PRODUCTS CORP.**  
3608 Sunset Avenue, Waukegan, IL 60085

Cherry Worldwide: (Subsidiaries) Hirose Cherry Precision Co., Ltd., Tokyo • Cherry Mikroschalter GmbH, Bayreuth, Germany  
• Cherry Electrical Products (U.K.) Ltd., St. Albans, Herts • (Licensee) G.W. Engineering Pty. Ltd., Sydney



World Radio History

Circle 41 on reader service card



**NEW** Continental Specialties  
**Logic monitor**  
**FASTER THAN A SCOPE!**  
**SAFER THAN A VOLTMETER!**  
**BRINGS ICs TO LIFE!**

Made in USA

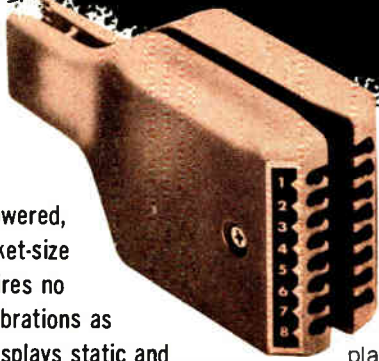

\* Patent Pending

The amazing self-powered, self-contained, pocket-size Logic Monitor requires no adjustments or calibrations as it simultaneously displays static and dynamic logic states of DTL, TTL, HTL or CMOS DIP ICs. Now you can watch your signals work their way through counters, shift registers, timers, adders, flip-flops, decoders, even entire systems! High intensity LEDs turn on when lead voltages exceed the threshold (2V). **No power supply is needed!** The power-seeking gate network locates DIP supply leads and feeds them into the Logic Monitor. Forget about grounds, pin counting or sync polarity.

Simply clip the Logic Monitor to any DIP IC up to 16 pins. Precision plastic guides and a flexible plastic web\* insure positive connections between non-corrosive nickel/silver contacts and the IC leads. Logic levels appear instantly on 16 large (.125" dia.) high intensity LEDs. Logic "1" (high voltage)-LED ON. Logic "0" (low voltage or open circuit)-LED OFF. Yes, now you can see your designs come alive. Order your fast, versatile, accurate, indispensable Logic Monitor today!

"Deliveries starting March 15."

**ORDER TODAY! 84<sup>95</sup>**

Add \$2.50 postage/handling.  
 Foreign orders add 15%.  
 Prices subject to change.



**Continental Specialties Corporation**

Box 1942, New Haven, CT 06509 • 203/624-3103

W. Coast Off.: Box 7809, S. Fran., CA 94119 • 415/383-4207 Canada: Available thru Len Finkler Ltd., Ontario

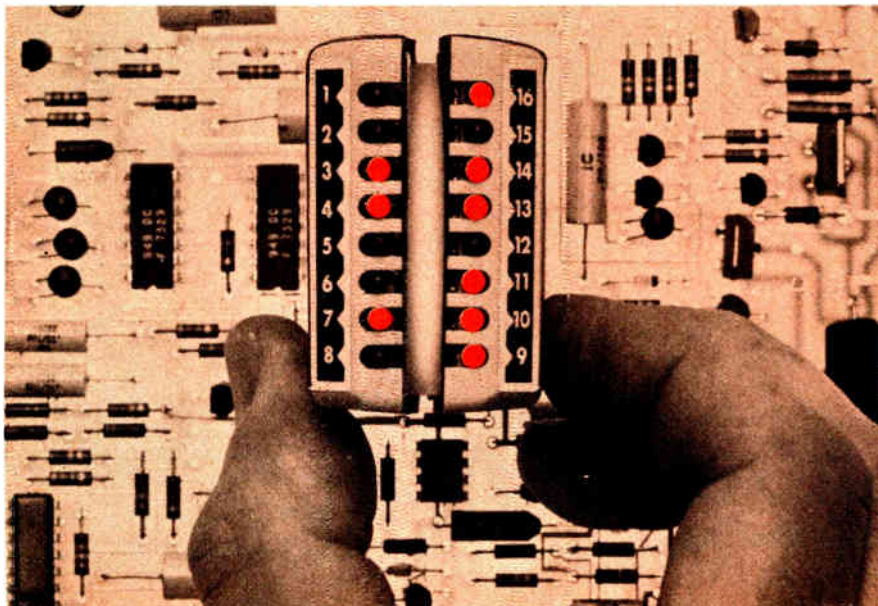

than from the top down.

"It's important to offer a relatively simple system at a cost competitive with a coaxial cable setup and which gives the same interference-free performance."

The price for the V300P package will probably be "around \$200," depending on length and quality of cable. For this, the customer will get a gallium-arsenide infrared-light-emitting diode, a silicon phototransistor detector, the fiber-optic cable, and a 3-decibel optical coupler for matching two cable sections.

With these components, says Strack's associate, Werner Schairer, the user can build a link for signal transmission between, say, computer peripherals, programed instruments, or numerically controlled machine tools and a computer.

**Immunity.** In applications like these, Schairer continues, the cables' immunity to interference from stray electromagnetic fields and the absence of crosstalk between cable strands are decided advantages. The V300P system will be available in different versions, each with emitter and detector specifications that best suit a particular application.

The system's 1.9-millimeter-diameter cable consists of a bundle of 1,000 multimode fibers with an attenuation of less than 0.8 decibel per meter—low enough for a short-haul transmission line, Schairer says. The diode couples 1 milliwatt into the cable.

Looking ahead, Strack's group has already drawn up tentative specifications for a follow-up kit—the V350P—intended for 30-megahertz optical data transmission. It will be suitable for high-bit-rate color-TV-signal transmissions in television studios or for signal distribution within apartment buildings tied to a community antenna. It will have either a fast light-emitting diode or a pulsed laser as an emitter plus either a photo-p-i-n-diode or photo-avalanche diode as a detector. The fiber-optic cable will also have lower attenuation—about 0.3 dB/meter—and will be up to 1,000 meters long. It is likely to debut about a year after the first kit. □



# Now. 1-Kilobyte CCD memory.

The first *production-proven* CCD memory is now here.

Fairchild's CCD450 is a 1024 x 9 byte-serial memory — with *built-in* NMOS input and output transition circuitry.

Compared with MOS memory, CCD simplicity means inherently higher chip densities — and ultimately, lower costs. Because it's fabricated with established NMOS technology, it's easy for the designer to use, too.

Developed by the leader in solid-state memory technology, the 1-Kilobyte CCD450 is the first in Fairchild's new family of CCD memory. And it's ideal for storage use in terminal buffers, display refresh and many other stand-alone terminal applications.

Complete specifications, a technical paper describing the CCD450 and a brief analysis of the projected economic impact of CCD memories are available now with *4-week sample delivery*.

For immediate opportunity to work with this major new memory technology, contact your Fairchild field office or distributor today.

## Fairchild CCD450 Serial Memory:

- Solid-state monolithic.
- Very low power (250 mW max, 30 mW standby).
- TTL compatible.
- Standard 18-pin DIP.
- 4-mode operation: Read, Write, Read/Modify/Write, recirculate.

- 3 MHz data-rate capability.
- Hot Line for additional information: (415) 962-3941

Semiconductor Components Group, Fairchild Camera & Instrument Corp., 464 Ellis St. Mountain View, CA 94040  
TWX: 910-379-6435

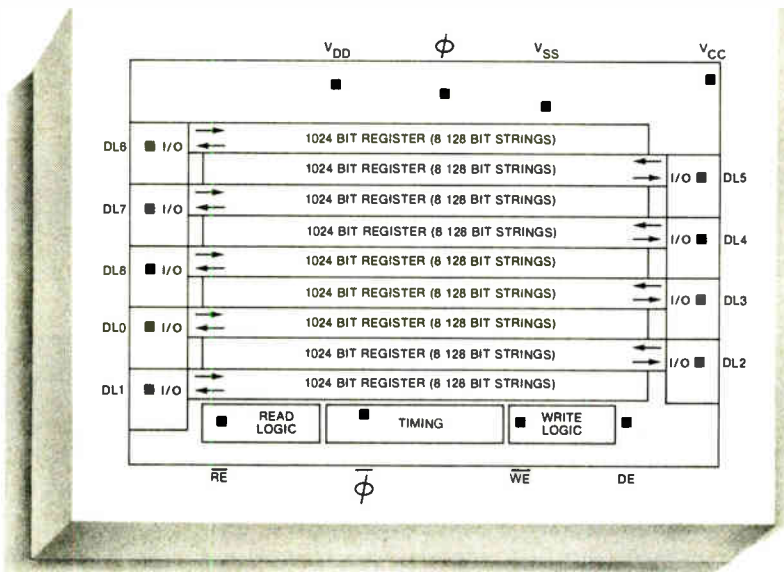

The first production CCD memory is Fairchild's CCD450, 1-Kilobyte serial storage device comprised of nine 1024-bit registers each organized in eight 128-bit strings. The CCD450 utilizes production proven Fairchild CCD buried-channel, ion-implanted barrier structure in the registers and Fairchild's Isoplanar N-channel MOS structure in on-chip timing, charge-detection and interface circuitry.

**MADE IN  
FAIRCHILD**  
**No.1 for memory.**

# 16 channel CMOS MUX.

## No latch up.

## No extra resistors.

### Intersil's new IH5060/5070.

The IH5060 multiplexer is a 16 channel plug-in replacement for the DG506 and HI-506A. The IH5070 is an 8 channel differential multiplexer, a plug-in replacement for the DG507 and HI-507A. Both new Intersil devices eliminate design headaches the others have.

### Floating Body technology solves latch-up problems.

Latch up is eliminated by Intersil's exclusive Floating Body process, which also protects against over-voltages up to  $\pm 25$  volts minimum. It does this by electrically floating the bodies of the N-channel and P-channel MOS-FETs forming the analog gate of the multiplexer.

### Lower ON resistance doesn't attenuate signals.

The Floating Body process does away with need for current-limiting resistors, either off- or on-chip. Result is far lower total ON resistance—400 ohms max for the mil-temp model, 450 ohms max for the commercial. So you get much less system signal attenuation.

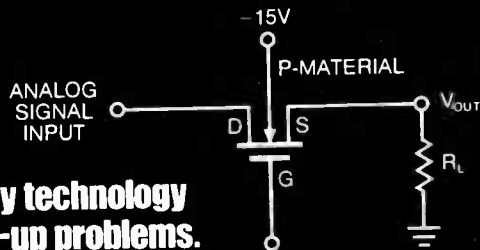

**Figure 1.** In other technologies, when either power supply is off (at ground), even momentarily, and there is an analog signal present, high current flows, causing latch up and possible destruction of the device.

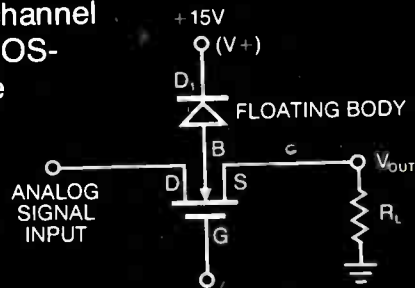

**Figure 2.** Intersil's Floating Body process, U.S. Patent pending, eliminates latch up with a diode between the FET bodies and their power supplies. For a detailed explanation, send for Application Note A006, "A New CMOS Analog Gate Technology."

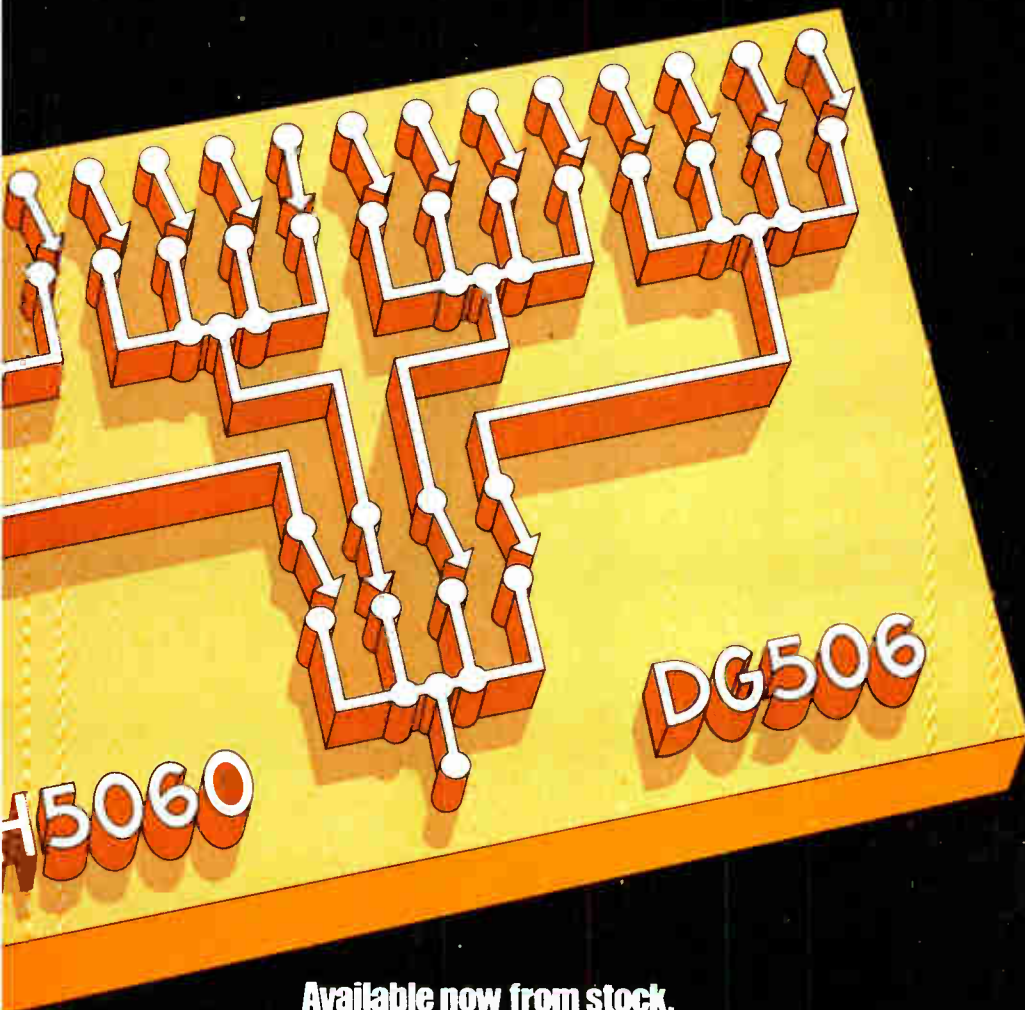

**Available now from stock.**

MUX	Type	Package	Price (100+)	
			-55 to +125°C	0 to +75°C
IH5060	16 channels	28-pin DIP	\$55.00	\$28.00
IH5070	8 dual chs.	28-pin DIP	55.00	28.00

Because they're CMOS devices, supply current drain is the lowest available for this type of product: For mil-temp units, 100 $\mu$ A from the negative supply, 200 $\mu$ A from the positive; for commercial units, 1mA from each supply. And unique Intersil two-tier design reduces circuit output capacitance to less than 40pF, and makes expansion to 32, 64 or more channels very simple.

From the company that makes almost 200 separate types of semiconductor analog gates and over 25 different CMOS switches. Intersil, 10900 North Tantau Ave., Cupertino, CA 95014.

**Part of the distinguished Intersil family of alternate source CMOS switches.**

PART NUMBER	TYPE	R <sub>ON</sub>
DG 181	Dual SPST	30 $\Omega$
DG 182	Dual SPST	75 $\Omega$
DG 184	Dual DPST	30 $\Omega$
DG 185	Dual DPST	75 $\Omega$
DG 187	SPDT	30 $\Omega$
DG 188	SPDT	75 $\Omega$
DG 190	Dual SPDT	30 $\Omega$
DG 191	Dual SPDT	75 $\Omega$



**Get 'em here.**

**Intersil stocking distributors.**

- Arrow Electronics, N.Y., Minn., N.J., Conn., Md./D.C.
- Elmar/Liberty Electronics.
- Kierulf Electronics, Mass.
- Schweber Electronics.
- Semiconductor Specialists.
- Weatherford.

**Intersil area sales offices.**

- Boston (617) 273-2055.
- Chicago (312) 371-1440.
- Dallas (214) 387-0539.
- Los Angeles (213) 532-3544.
- Minneapolis (612) 925-1844.
- New York (201) 567-5585.
- San Diego (714) 278-6053.
- San Francisco Bay Area (home office) (408) 996-5000.
- Upstate New York/Canada (315) 463-3368.

**Representatives in all major cities.**



# Nothing spoils computer data like cardiac arrest

If watts stop flowing in the system, bad things happen – like illogical behavior, like complete lapse of memory. Sorensen STM power supplies assure your computer of a strong heart to guard against these unwanted things.

STMs are more than reliable. Being modular switchers they are twice as efficient as series-pass types, less than half their size, and price competitive. But they have all of the advantages inherent in series-pass design.

There are 40 STMs in the series, from 3.0 to 56 Vdc, in four modular sizes. Our catalog, written especially for heart specialists, tells all about them. Simply circle the inquiry number. Sorensen Company, a unit of Raytheon, 676 Island Pond Road, Manchester, N.H. 03103. (603) 668-4500.

**Sorensen**  
POWER SUPPLIES

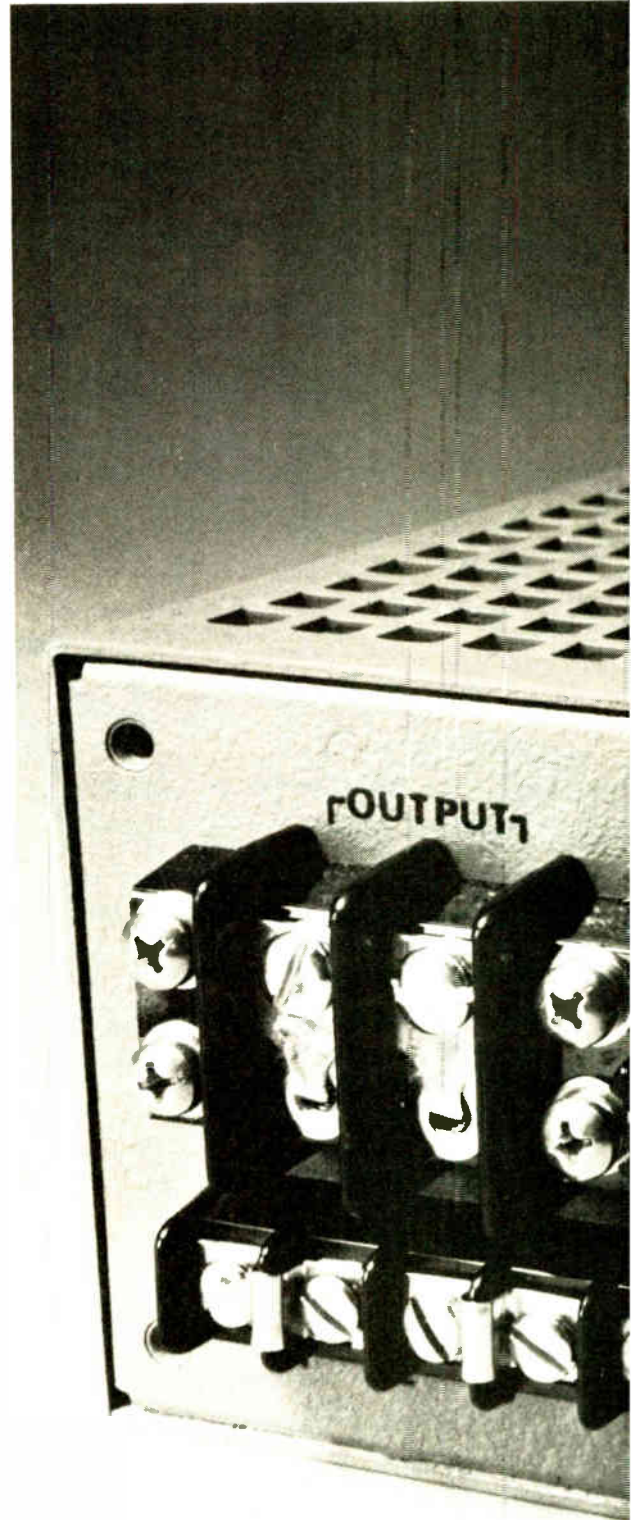

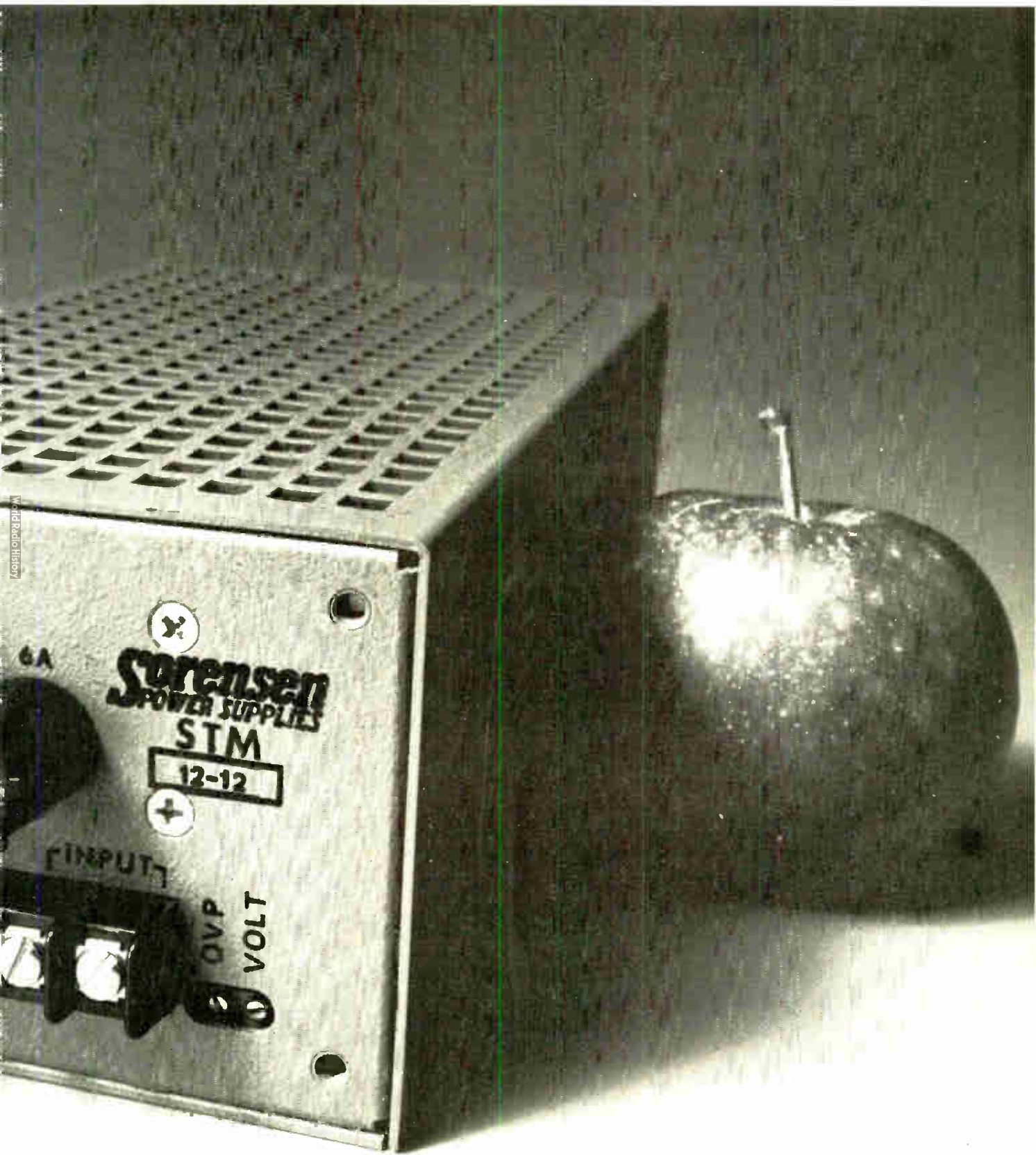

World Pacific History





# For \$1,975 you have no right to expect a signal generator like this.

For \$1,975 you should have to settle for tubes, or for a non-phase-locked generator.

But here's the Wavetek 3000, so you can toss your expectations out the window. This solid state signal generator is not only phase-locked and accurate ( $\pm 0.001\%$ ), it's programmable as well. And it covers the entire range from 1 to 520 MHz in a single band. Yet once we've

Circle 48 on reader service card

received your order, you can expect a signal generator like this one right away... for just \$1,975.

That may not be right, but it sure is reasonable.

#### SPECIFICATIONS

Frequency Range: 1-520 MHz  
 Frequency Accuracy:  $\pm 0.001\%$   
 Resolution: 1 kHz  
 Stability: Less than 0.2 ppm per hour  
 Output Range: +13 dBm to -137 dBm  
 Flatness:  $\pm 0.75$  dB

AM Modulation Range: 0-90%  
 FM Deviation: 0-5 kHz and 0-500 kHz  
 Internal Modulation Rates:  
 400 Hz and 1 kHz  
 Dimensions:  
 12" wide x 5½" high x 13¼" deep  
 Price: \$1,975

**WAVETEK®**  
 INDIANA INCORPORATED  
 P.O. Box 190, 66 North First Avenue  
 Beech Grove, Indiana 46107  
 Tel. (317) 783-3221 TWX 810-341-3226



# Washington newsletter

---

## **Laser weapons would get start in fiscal '76**

Government budget documents show that the Defense Department will buy its first "prototype laser weapons" in fiscal 1976 if Congress approves a \$10 billion program for research, development, test, and engineering. Initial outlays estimated at \$23 million to \$28 million would be needed, according to Pentagon sources. This would come out of a \$570 million R&D account for ordnance, combat vehicles, and related equipment.

Already, according to Air Force researchers, deuterium fluoride lasers have been successfully tested with "very, very high outputs." And Defense officials add that the DF laser will take most of the prototype budget. The DF laser reportedly can "burn through heavy stainless nickel steel at range," which causes Pentagon R&D leaders to encourage its development as a ground-based missile warhead interceptor.

## **Freight rate hike postponed by CAB**

A 35.9% jump in trans-Pacific air freight rates for electronics products shipped to and from U. S. semiconductor makers and others has been shelved for at least a month by the Civil Aeronautics Board. The CAB stayed its order approving the higher rates—from 18.24 to 24.79 cents per revenue ton-mile—for members of the International Air Transport Association one day before they were to take effect [*Electronics*, Jan. 23, p. 30]. The CAB cited "the complexity of the issues involved," including petitions for reconsideration by General Instrument Corp. and members of Wema, a California-based association of U. S. electronics companies.

Earlier court action in Washington by Wema had sought judicial review and a stay of the CAB Order 75-1-46. That action, in Wema's view, was the catalyst in the board's issuance of its own stay 24 hours before it had to respond to the U.S. Circuit Court of Appeals. The CAB action put the Wema court petition temporarily "on ice," says Wema's Washington counsel John Simpson, who calls the proposed increase "a staggering increase for the economically ailing electronics industry."

## **FCC wants to automate radio identification**

Citizens' band radios and other special licensed transmitters operating between 25 and 960 megahertz will have to be fitted with automatic transmitter-identification systems—ATIS—under rules proposed by the Federal Communications Commission in mid-February. Other affected services include maritime, aviation, industrial, land-transportation, public-safety, and Alaska-Public Fixed Stations. ATIS would have to be incorporated in transmitters produced one year after the adoption of final rules. Existing transmitters would not be affected.

"The electronics industries," noted the FCC of its new Docket 20351, "have developed inexpensive but reliable devices that automatically identify a transmitting station. Such devices not only assure the correct identification of every transmission, but could also increase spectrum efficiency when the need for voice identification can be eliminated." The commission invited comments from electronics companies and affected licensees on the ATIS plan, specifically as they relate to its "technical and economic impact." Class D citizens' radio, where many users are unlicensed and don't identify transmissions, is expected to be most affected.

## **Economy affecting truck sales, so rules attacked**

Truck makers and the Government both blame the depressed economy for poor truck and tractor-trailer sales, **but the American Trucking Association is also trying to pin some of it on electronic anti-skid controls and larger brakes.** Lobbyists for the Association have begun a congressional campaign to overturn the National Highway Traffic Safety Administration regulations which require about \$2,500 in increased costs per truck, including \$100 for electronic controls. ATA says the price is too high, and truckers question electronic-system reliability.

## **IBM sees "barrier" to Domsat, asks FCC clarification**

IBM is preparing to ask Federal Communications Commission for **clarification of the language of the FCC opinion that would prevent IBM from controlling CML Satellite Corp., the domestic satellite company that IBM wants to restructure with Comsat General Corp.** [*Electronics*, Feb. 6, p. 40]. Until the request actually goes to the commission, IBM is declining to specify the language that "gives us serious concern." **Unless satisfactorily clarified, IBM said, "that language would be a barrier to IBM's entry into the communications-satellite business, a result we do not believe the commission could have intended."** Comsat General, which now owns one third of CML, and IBM would have paid \$5 million to buy out two other one-third shareholders—MCI Communications Corp. and Lockheed Aircraft—with IBM getting a controlling 55%.

The FCC rejected the plan because IBM's control might "unreasonably foreclose approval of Comsat General's viewpoint" if IBM and Comsat General disagreed on alternatives." In detailing its initial ruling, the FCC said that threat could be eliminated by participation of one or more other partners, leaving no company with a majority interest.

## **System price tag for space tracking now up 50% . . .**

NASA now estimates it will spend \$600 million over a 10-year span for its tracking and data relay satellite system. **That's up \$200 million, or 50%, from original estimates, and the space agency attributes the rise to projected inflation rates and an eight-month delay in releasing the requests for proposals** [*Electronics*, Feb. 21, 1974, p. 31]. RFPs were finally sent off to 52 interested companies in early February, with an April 9 deadline for submission of preliminary system designs.

**Industry insiders say it will ultimately boil down to three teams to bid on the system: Western Union and the TRW Systems group; RCA, General Electric, and Philco-Ford; and IBM, with satellites provided by Hughes and Comsat General.** NASA envisions a three-satellite system that will track and relay information from manned and unmanned space vehicles, beginning in 1980.

## **. . . while agency nears a choice on ground work**

As a hedge against the possibility of further delays in the space-based tracking system, **NASA will choose a contractor next September to refurbish its 28 ground-based tracking stations.** Two companies are vying for the business: DBA Systems, Inc., Indialantic, Fla., and Systems Technology Associates, Falls Church, Va. To do the job, NASA figures on spending some \$5 million for new CRTs, medium-scale computers, disk memories, a-d and d-a converters, and data transceivers, both high-speed and low-speed.

# From the *Quality* DMM Specialists



**At last! True RMS in a  
low cost DMM.**  
(Buy it now...or add it later)

What's so great about true RMS? Well, did you ever have to measure distorted sinewaves? Triangles? Squarewaves? Pulses? Don't bet that you won't have to tomorrow. True RMS is the only *accurate* way to do it. And only Systron-Donner's Model 7224 lets you buy true RMS now or add it later.

The new 20,000-count, autoranging Model 7224 is a quality-built "customer's" DMM. Plug-in boards make it easy to service or to install options at any time. Outstanding features include:

- choice of TRUE RMS or AC averaging
- 0.001 ohm resolution
- autoranging
- large in-line/in-

- plane segmented display with automatic polarity, decimal point and annunciator
- DC/DC ratio option
- 5 ranges DC volts, 7 ranges ohms standard
- optically isolated BCD output
- FAST and SLOW sample rate

Here's how to get details on the first of a new breed of quality DMM's:

In the United States, give your local Scientific-Devices office a call or contact us in Concord. Abroad, contact Systron-Donner GmbH, Munich; Systron-Donner Ltd., Leamington Spa, U.K.; Systron-Donner S.A., Paris (Le Port Marly); Systron-Donner Pty. Ltd., Melbourne.

1 Systron Drive, Concord, CA 94518 • Phone (415) 676-5000

**SYSTRON  DONNER**

For literature circle 51 on reader service card.

For demonstration circle 50 on reader service card.



## IC controls functions of 8-mm movie cameras due soon from Agfa-Gevaert

Just as MOS circuitry has transformed clocks, watches, and tabletop calculators from mechanical or electromechanical into electronic devices, MOS is now beginning to change the design of photographic equipment. Engineers at Siemens AG, together with designers at the German-Belgian photographic-equipment combine Agfa-Gevaert, have developed an IC for cameras.

The Siemens device, the S181, is a low-power circuit for a variety of camera-control functions that were previously handled mechanically. Use of the circuit also makes for a much smaller camera. The S181 is built into three 8-millimeter consumer movie cameras that Agfa-Gevaert plans to introduce this year.

They are the Agfa Movexoom 6 MOS Electronic, to sell for about \$425, the Movexoom 10 MOS Electronic, to be priced from \$638 to \$680, and the sound-film Movexoom Sound MOS Electronic, which goes for about \$766. Each model measures only 15.8 by 9.8 by 4.1 centimeters. The first two will go to market this spring, and the third is due in the fall. All will be built at Agfa's Munich facilities. In the Movexoom 6 MOS, the lens zooms from 7 to 42 millimeters, and in the other two models, from 6 to 60 mm.

Besides the S181 MOS circuit, the Agfa cameras contain two Siemens bipolar ICs, the TCA955, which controls motor speeds, and the TCA965. The TCA965, operating in conjunction with a light-sensitive photoelement, determines the diaphragm opening. One of the tasks of the S181 is to control a four-phase stepper motor that sets the diaphragm opening.

**Controls.** The S181 also controls the film-feed motor in five different modes. In the single-picture setting, the camera takes only one picture when its release button is pushed. In the so-called single-picture-repeat

mode, the camera takes single pictures at a preset rate, which can be varied from one picture each 0.1 second to one a minute.

The so-called title-picture function photographs four frames after the release button is pushed. This function is also advantageous for trick photography. In the setting for 5-second operation, the film-feed motor starts to run for 5 seconds 10 seconds after the release is pushed. In the last mode, 10-second operation, the film-feed motor runs for 10 seconds after a 10-second delay.

The S181, says Günter Katholing, Siemens MOS-products manager, integrates some 1,800 transistors on a chip measuring 3 by 3 millimeters. This high packing density is

achieved through the depletion-load process in which the large-scale load transistors common to standard MOS-fabrication techniques can be replaced by much smaller ones exhibiting depletion characteristics.

These small-area transistors, which perform like constant-current sources, consume far less power than the large-area ones made by standard MOS technology. At the same rise-time values, the power consumption of the transistors is smaller by a factor of five. The process also makes possible MOS circuits that need only one supply voltage. The S181, built by ion-implantation, typically operates on a 7-v power supply and consumes only about 30 milliwatts. □

---

### Japan

---

## Brighter LEDs promised by continuous liquid epitaxial growth of GaAlAs

Brighter diodes could result from a new continuous process for making gallium-aluminum arsenide. The process, now in pilot production by Stanley Electric Co., a Japanese lamp manufacturer, is based on the temperature-difference method of liquid epitaxial growth. This is proving to be a much more efficient method than has been previously used.

But even though the production cost of its liquid GaAlAs diodes is as low or lower than that of diffused gallium-arsenide-phosphide diodes, their total cost is higher because of the high price of the basic gallium-arsenide wafers. Stanley is studying whether or not it can get a premium price for its diodes, which, compared to those of competitors, can be more than six times as bright at the same current or equal in bright-

ness at far less current. If Stanley cannot get a premium price, it must find a less expensive source of GaAs wafers.

Stanley in 1972 received a subsidy from the Research & Development Corp. of Japan to develop a commercial process to produce LEDs by the temperature-difference method, which was developed at the Semiconductor Research Institute in Sendai by two professors from Tohoku University, Jun'ichi Nishizawa and Ken Suto.

**Development.** The method consists of growing p-channel and n-channel epitaxial layers of GaAlAs on a GaAs substrate as it is moved slowly through a hydrogen environment at atmospheric pressure. If the process is commercially successful, Stanley must repay the R&D Corp., but if not, it owes nothing.

In Stanley's process, sliders are pushed in at one end of the apparatus through vacuum locks, traverse under the melt, where epitaxial layers are grown, and come out the other end through vacuum locks. Sliders form a continuous column, and each time a slider is inserted, another is ejected from the far end.

The temperature of the new process is quite a bit lower than the maximum temperature of 1,100°C used in the conventional temperature-cycling process. The lower growth temperature yields a crystal structure with fewer dislocations and other defects.

Aluminum and arsenic to be added to the gallium melt are at one end of a melt container that is held at high temperature, while the wafers on which the epitaxial layer is to be grown are kept cooler in a depression in a slider at the other end of the container. The thickness of the epitaxial layer is proportional to time.

The materials being dissolved in the gallium at the hot end are delivered to the cool end by both temperature-difference and concentration-difference diffusion. The supply is constant, so composition of epitaxial layer is constant.

Diodes now being produced have a p-channel epitaxial layer of GaAlAs that measures about 25 micrometers thick, followed by a n-channel epitaxial layer 10 μm thick. The n layer is much thicker than in diffused diodes. Because the thick n layer has low resistance, the metalization contact can be small to avoid interference with emitter light without reducing efficiency, which makes the diode surface bright all over.

**Brightness.** Brightness of Stanley's small lamp-type LEDs, which have good yields, typically ranges as high as 4,800 footlamberts at a current of 20 milliamperes, and some laboratory units have emitted as much as 9,000 ft-L. In contrast, competitors' catalogs list brightness of 750 ft-L for GaAsP units. Both types of devices emit red at 6,600 angstroms, which is about the optimum

## Around the world

### ITT challenges U.S. 1103s in European market

Armed with its version of the industry-standard 1103 1,024-bit dynamic random-access memory, ITT Semiconductors in the UK is striving to upset the U.S. semiconductor manufacturers' domination of the European market. ITT is the first European firm in the market with a 1-kilobit RAM it claims has been proved in production before it was introduced. The device has a standard access time of 150 nanoseconds, and ITT claims to have eliminated the worst traditional drawbacks of the 1103, including the critical timing relationship between the precharge and chip-enable clocks. Guaranteed specifications include cycle time of 520 ns, typical power dissipation of 0.3 milliwatt per bit, input overvoltage protection, and nondestructive readout.

### Electronic gear simplifies sailboat navigation

Sailboat skippers will soon have their navigation chores eased by equipment from two Continental electronics manufacturers. In Paris, MCB has produced an electronic sensor without moving parts that provides an electronically stabilized display of compass bearings, derived from the east-west axis as well as the north-south magnetic axis. Price is slightly more than \$900. A rival, Oxy Nautica of Switzerland, is offering an electronic compass with moving sensor coils; it displays bearing digitally, and like MCB's product, indicates the course to be followed in a vertical position. The compass, priced at nearly \$1,700, is also part of a \$7,000 autopilot with remote-control override that can be operated from the 12- or 24-volt battery that is standard equipment aboard a sailboat.

### Optoelectronic system measures displacements

An optoelectronic system for measuring mechanical displacements and vibrations, developed by a Swedish manufacturer, will be sold for \$12,500 in West Germany by Johne und Reilhofer of Munich. The Selspot system consists of a camera containing a position-sensitive four-electrode photo-detector that determines positions of light-emitting diodes attached to the moving object to be detected. One camera shows movement in two dimensions, and two cameras give three-dimensional results. Selspot was developed and built by Selective Electronic Co. AB from an idea by a Swedish scholar for measuring movements of human extremities and artificial limbs. In only 1 microsecond, the system determines X and Y coordinates of a LED. As many as 30 LEDs can be switched on, one at a time, at the rate of 322 hertz. Resolution is 1 part in 1,000.

### Machine automatically measures engine blocks

An English firm will soon deliver to an undisclosed Detroit manufacturer a machine that automatically measures diesel-engine blocks. General Motors' Detroit Diesel Allison division is believed to be the purchaser of the 28-ton machine, priced at more than \$250,000. In the machine, which handles 35 engine blocks an hour, digital and analog minicomputers control a hydraulic system that makes 94 measurements by means of inductive transducers. Resolution is said to be 0.0001 inch for the robot, which was produced by Herbert Controls and Instruments Ltd., Letchworth, Hert.

wavelength for viewing.

The LEDs typically have an efficiency of 0.6% to 0.8%, a respectable value for mass-produced diodes. Color and efficiency vary with the percentage of aluminum in the p layer, which can be controlled by the operator.

When the percentage of aluminum is low, the diode efficiency is

high, but eye efficiency is low at the long wavelength at which the light is emitted. Although the diode efficiency is lower with a high percentage of aluminum, it is easier on the viewer's eyes.

Bright GaAlAs diodes previously were made by a liquid-epitaxial process that was not efficient for volume production. □





**A**vailability is one of the most important factors in selecting trimmers. Amphenol can promise immediate off-the-shelf delivery, from its network of strategically located distributors—plus a price that's trimmed to boost your profits.

Whether you need a 3/4" rectangular cermet or wirewound trimmer, "Just Ask and You Shall Receive" our Series 6034 or 3810.

These 3/4" sealed trimmers are available in all pin spacings and styles. The 6034 cermet is an industry standard of excellence. Specifications of the 6034 cermet are: resistance values of  $10\Omega$  to 1 meg.  $\Omega \pm 10\%$ ; infinite resolution; the CRV is 3% of total resistance or  $20\Omega$ , whichever is greater; temperature coefficient is 100 ppm/°C nominal.

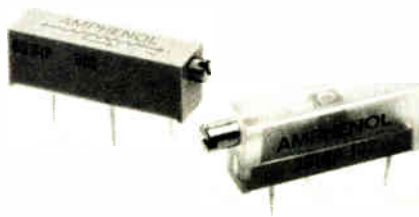

The 3810 wirewound features the unique Vista-Trim top that allows you to see the adjustments you make. Specifications of the 3810 wirewound are: resistance values of  $10\Omega$  to  $20,000\Omega \pm 10\%$ ; resolution 1.78% to 0.22% respectively; temperature coefficient is 50 ppm/°C nominal; ENR 100 $\Omega$  max.

Let us show you how these trimmers can fulfill your specific requirements. For additional information and immediate action, contact the Amphenol sales office in your area or local Amphenol distributor by dialing our toll-free hotline (800) 645-9200. (In New York State) dial collect (516) 294-0990.

**There's a reason to ask for us by name.**



# AMPHENOL

**AMPHENOL CONNECTOR DIVISION**  
2801 South 25th Ave., Broadview, Ill. 60153 Tel: 312-345-9000



## Japanese complain about electronics salesmen in stores

The practice by Japanese consumer-electronics manufacturers of sending their unneeded employees to retail stores as sales helpers has prompted the Consumers Union of Japan to complain to the Fair Trade Commission. **The association charges that these aides do their utmost to induce consumers to purchase their employers' products.** Cited practices include stocking these products in the best locations and misadjusting competitors' products, as well as dragging prospective customers into stores and occasionally fighting among themselves.

The commission is investigating the complaint because **these actions may violate a section of Japan's antitrust law that was originally meant to prevent unfair use of premiums.** The commission says violations may be difficult to prove, however.

About 20 consumer-electronics manufacturers, including Hitachi, Matsushita, Toshiba, and Sony, are now assigning surplus personnel temporarily to retail stores. **One of Sony's labor unions brought this matter to the attention of the Consumers Union.**

## Soviets contract to buy five more switching centers

The Soviet Union's state airline Aeroflot has contracted to buy five more message-switching centers to be located at Alma-Ata, Novosibirsk, Rostov, Sverdlovsk, and Moscow. **These centers are additions to the Soviet segment of the worldwide aeronautical fixed telecommunications network.** Two systems built by the French ITT affiliate Compagnie Générale de Constructions Téléphoniques have already been installed. **CGCT beat out its main rival, Honeywell, for the business and completed an \$8 million package by selling two similar systems for the Hungarian end of AFTN and the nerve center of a new telecommunications service for the Soviet merchant-marine ministry.**

## Foreign bidders on UK exchanges incite protests

Another bitter battle to win contracts for international telephone exchanges in the United Kingdom is expected later this year **when the British post office accepts bids for an automated exchange in the Midlands.** This round is expected to be hot because, although the BPO says it prefers British contractors, it plans to accept bids from foreign manufacturers.

The BPO, which recently awarded Thorn-Ericsson a controversial \$72 million sole-source contract for an automated international exchange in London, plans to order another for London next year. The new awards would total about \$120 million. British companies are protesting the award to Thorn-Ericsson, partially because 60% would be built in Ericsson's Swedish factories. **But the BPO, impressed with Ericsson's performance on an earlier London exchange, says it had no choice if it is to handle increasing traffic.** Plessey, the major contender with \$110 million in existing BPO international exchange contracts, is behind schedule with a London project.

## Takeda-Riken drops Philips scopes because of prices

Takeda Riken Industry Co. has stopped selling Philips oscilloscopes because it says Philips wanted it to sell a new line at prices as low as those in the United States. And Philips is phasing out sales of Takeda-Riken equipment. **Takeda says it could not afford to sell the scopes at**

the prescribed prices, and it was already losing money on older models because of low markup and sales costs.

Takeda also says it has learned that **Japanese users want the latest American design or its equivalent, and European equipment tends to lag American in performance and styling.** Even so, Takeda says it has been able to sell a fair number of Philips oscilloscopes installed in its own equipment. **Because of the Philips move, Takeda now will have to sell through trading companies in individual European countries instead of channeling all sales through Philips.**

## Digital telemetry system operates on telephone network

A new low-cost digital telemetry system that uses transducers to sense various stimuli, such as heat, broken light beams, or water levels, can be used for a variety of applications. **The computer-compatible system, introduced by Westinghouse Brake Signal Co. in the UK, can operate over the conventional switched telephone network.** The telephone lines are connected only when data is being transmitted.

**The three-part system consists of a typewriter-size unmanned central control console and a maximum of 99 stations, each of which can handle 32 sensing transducers.** The console may interrogate the stations periodically, or the system may be programed so that the stations report any disturbance immediately. What's more, **the central console can be interrogated from any dial telephone for status checks, the company claims.** The console is priced at about \$1,200, and each station is \$840 to \$1,400, depending on options.

## Matsushita's kit controls speeds of camera shutters

An electronic circuit that automatically controls the shutter speed of single-lens reflex cameras has been introduced in kit form by Matsushita Electric Industrial Co. **The kit, which contains two packages, is priced at \$20 in sample quantities.** Precision has been increased in this integrated-circuit version of a 1972 system that measures exposure between the time the diaphragm aperture is set and the shutter operates.

**One 14-pin dual in-line package contains a thin-film hybrid IC that includes a monolithic bipolar IC, six field-effect-transistor chips, one bipolar transistor chip, and functionally trimmed thin-film resistors.** A smaller package contains two balanced diodes for logarithmic conversions. Additional external circuits, which Matsushita also makes, are two tantalum capacitors for memory, several bypass capacitors, and a silicon blue photocell for sensing light.

## Orange GaAsP LED needs less power than other colors

A seven-segment orange display that requires less power than red, green or yellow light-emitting diodes has been added to the Siemens AG product line. Shipments are to begin in April for the seven-segment displays, which have symbols 8 and 10 millimeters high, the same as the other colors. **In contrast to the other three diodes, which require about 20 milliamperes per segment to produce a nominal luminous intensity of 0.3 millicandela, the orange one needs only 10 A per segment.** From the same current, the yellow LEDs produce eight times the brightness of the other colors. **The high performance of the yellow LED comes from "the special chemical composition" of the gallium-arsenide-phosphide layer on the gallium-phosphide substrate.**

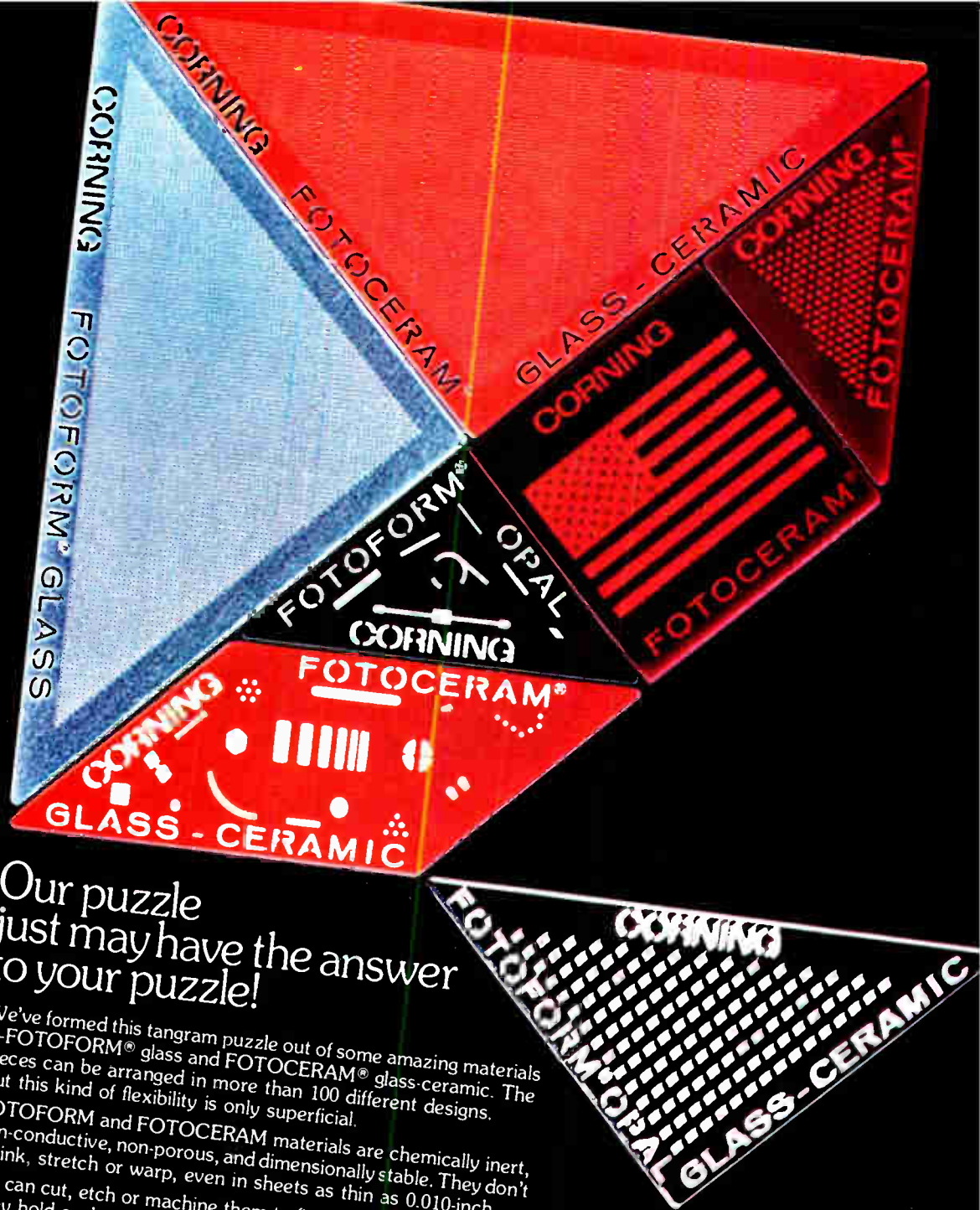

## Our puzzle just may have the answer to your puzzle!

We've formed this tangram puzzle out of some amazing materials —FOTOFORM® glass and FOTOCERAM® glass-ceramic. The pieces can be arranged in more than 100 different designs. But this kind of flexibility is only superficial.

FOTOFORM and FOTOCERAM materials are chemically inert, non-conductive, non-porous, and dimensionally stable. They don't shrink, stretch or warp, even in sheets as thin as 0.010-inch.

We can cut, etch or machine them to fit almost any application. They hold such close tolerances that we can precision-etch 10,000 holes per square inch. Holes of almost any shape, or depressions, or circuit paths. And the finished products can be polished or metalized.

We think FOTOFORM and FOTOCERAM materials have more than 100 industrial applications. Want more information?

Write under your letterhead, tell us the application you have in mind. We'll send you a puzzle just like this one.\* You may solve all of the puzzle designs, and a few production problems as well. \*Limited quantity available.

FOTOFORM and FOTOCERAM materials by  
Fotoceram Products Group

# CORNING

Corning Glass Works  
Corning, New York 14830  
(607) 974-8583

Circle 57 on reader service card



# How to cut corners with

## Cut out the corner coupon.

Linears from the Harris linear family can lower your instrumentation systems costs substantially. Improve performance, lower parts count, reduce design time, and increase system reliability. In the past, the speed and accuracy of most of these linears could only be approached with discrete devices, hybrids, or modules.

Excellent applications for Harris linears include: data acquisition, test equipment, telemetry, medical instruments, and process control.

If you're a systems engineer who's looking for a way to cut corners, without sacrificing quality, speed and reliability, then start cutting with the corner coupon. For immediate action, call your nearest Harris sales office or representative.

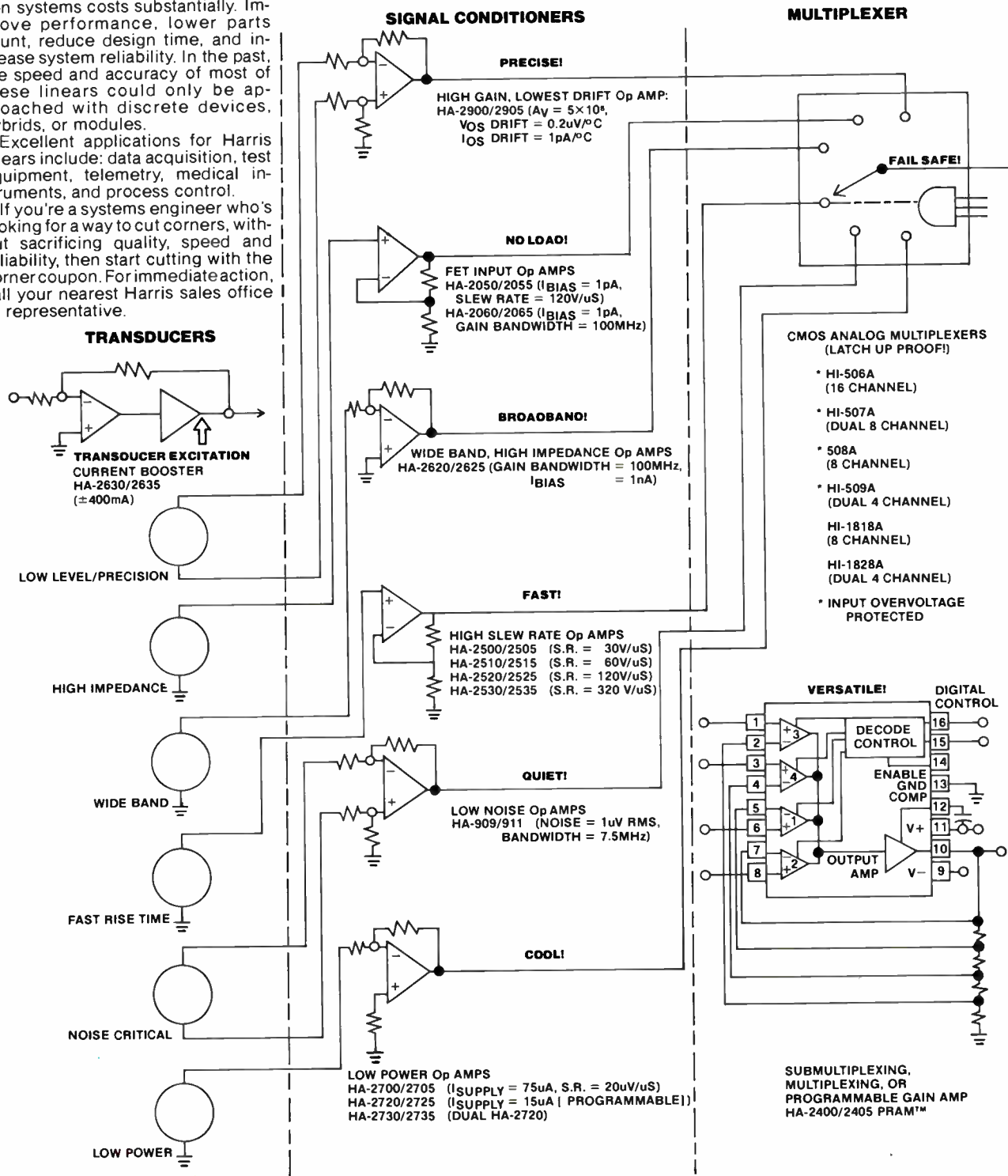

**WHERE TO BUY THEM: OEM SALES OFFICES: ARIZONA:** Scottsdale, (602) 946-3556 **CALIFORNIA:** Long Beach, (213) 426-7687; Palo Alto, (415) 964-6443 **FLORIDA:** Melbourne, (305) 727-5826 **ILLINOIS:** Hinsdale, (312) 325-4242; Schaumburg, (312) 894-8824 **MASSACHUSETTS:** Wellesley Hills, (617) 237-5430 **MINNESOTA:** Burnsville, (612) 432-6111; Minneapolis, (612) 835-2505 **NEW YORK:** Endwell, (607) 754-5464; Melville, L.I., (516) 249-4500 **OHIO:** Dayton, (513) 226-0636 **PENNSYLVANIA:** Wayne, (215) 687-6680 **TEXAS:** Richardson, (214) 231-9031.

**SALES REPRESENTATIVES: CALIFORNIA:** San Diego, (714) 279-7961 **COLORADO:** Denver, (303) 771-4920 **KANSAS:** Olathe, (913) 782-1177 **MARYLAND:** Randallstown, (301) 922-1248 **NORTH CAROLINA:** Raleigh, (919) 828-0575 **OREGON:** Beaverton, (503) 643-1644 **TENNESSEE:** Shelbyville, (615) 684-4544 **VIRGINIA:** Falls Church, (703) 534-1673; Troutville, (703) 345-3283; Virginia Beach, (804) 481-7200 **WASHINGTON:** Bellevue, (206) 454-0300.

# the leading line of linears.

## ANALOG-TO-DIGITAL

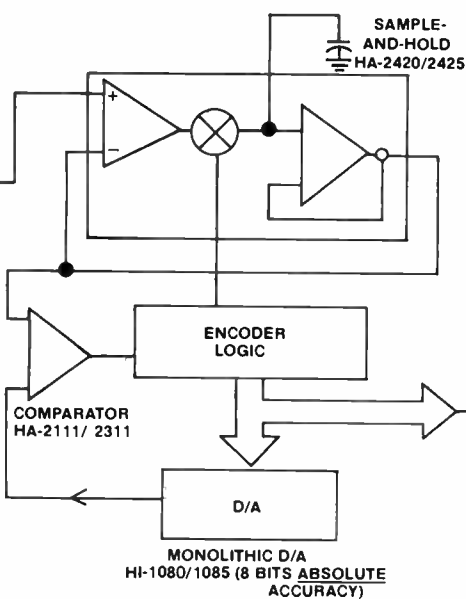

### CMOS ANALOG SWITCHES (NO LATCHUP OR SCR EFFECT!)

HI-200	DUAL SPST	70Ω
HI-201	QUAD SPST	80Ω
HI-1800	DUAL DPST	200Ω
HI-5040	SPST	75Ω
HI-5041	DUAL SPST	75Ω
HI-5042	SPDT	75Ω
HI-5043	DUAL SPDT	75Ω
HI-5044	DPST	75Ω
HI-5045	DUAL DPST	75Ω
HI-5046	DPDT	75Ω
HI-5047	4PST	75Ω
HI-5048	DUAL SPST	30Ω
HI-5049	DUAL DPST	30Ω
HI-5050	SPDT	30Ω
HI-5051	DUAL SPDT	30Ω

## INTERFACE

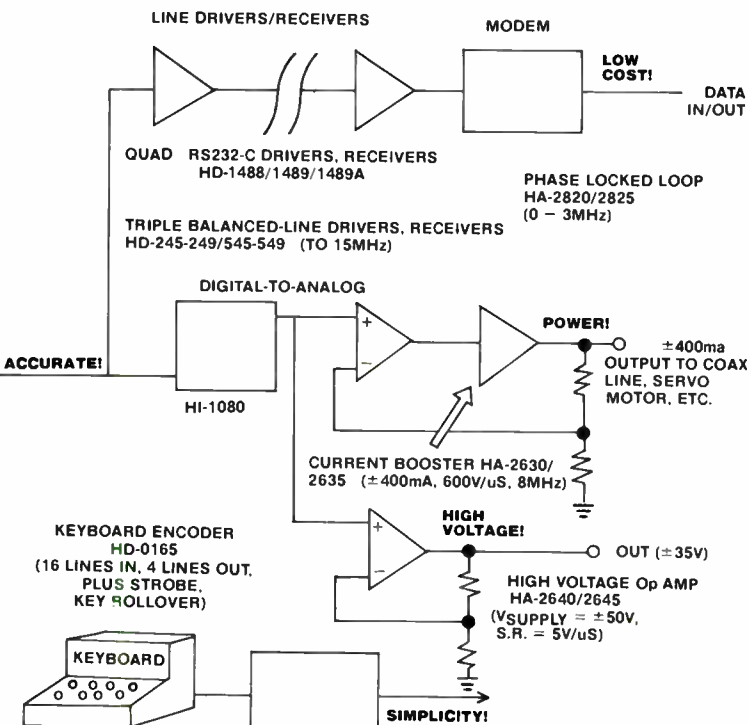

**HARRIS**  
SEMICONDUCTOR  
A DIVISION OF HARRIS CORPORATION

P.O. Box 883, Melbourne, Florida 32901 (305) 727-5430

**Harris Semiconductor**  
P.O. Box 883  
Melbourne, FL. 32901

Tell me more about cutting corners with Harris Linears. I would like more information on the devices checked.

Name \_\_\_\_\_

Title \_\_\_\_\_

Company \_\_\_\_\_

Address \_\_\_\_\_

City \_\_\_\_\_

State \_\_\_\_\_ Zip \_\_\_\_\_

### OP AMPS

- High gain, low drift
- FET input
- Wide Band, High Impedance
- High Slew Rate
- High Voltage
- Low Noise
- Low Power

### MULTIPLEXERS

- CMOS Analog
- Programmable gain amp

- Sample & Hold, gated op amp
- Comparator
- Monolithic D/A
- Line drivers/receivers
- Phase locked loop
- Current booster
- Keyboard Encoder
- CMOS Analog Switches

# Computing calculators where the

**A new "first" in yacht racing.** The sixty yachts racing from Los Angeles to Honolulu are scattered over a wide expanse of the Pacific. And skippers and crews wait anxiously for word of their relative positions in the race. Thanks to an HP 9810 calculator aboard the chief escort vessel, they don't have long to wait. A time tick over the radio begins the roll call for the 60 boats. And less than a minute after completion of the roll the calculator computes and prints each racer's handicap position, distance from LA, distance to finish, average speed, and estimated finish time. The race committee believes this to be the fastest status reporting for regattas of such size.



**Conserving Colorado's most valuable commodity.** In the semi-arid West where rainfall rarely exceeds 20 inches a year, water is the all-important commodity. It's carefully bought and sold, measured and delivered — and never taken for granted. To help make the best use of this precious commodity, the Northern Colorado Water Conservancy District uses an HP-46 calculator to process its water flow data. The calculator's ability to compute the natural log and other transcendental functions speeds water diversion projects, such as the one at Windy Gap which will bring 54,000 acre feet of water per year through the Rockies to Northern Colorado municipalities.





# put the power problems are.

## Mathematics made interesting.

It's like something from a math teacher's dream: students so enthusiastic about learning that attendance soars, discipline problems disappear, and many of the youngsters acquire up to a year of math ability in as little as three months. That's what's happening at a large high school in California where teachers designed an innovative math program based on an HP 9830 calculator and card reader. In a relaxed, open lab atmosphere, students whose abilities range from fourth grade to college level sit side by side—each working at math or programming and advancing at his own pace. With the 9830 replacing "drill and practice," learning has become "fun."

## Keeping ahead of the bulls and bears.

For investors who like excitement, surprises, and plenty of action, there's nothing like the commodity market. Wild price swings in traded commodities are commonplace—and fortunes can be made and lost with each swift change. It's no wonder then that traders, brokers, and analysts subscribe to chart services, such as Commodity Perspective, for timely information on price levels and the number of contracts changing hands. And how does Commodity Perspective, a 40-page weekly, keep abreast of the action? With an HP 9820 Calculator System. For each issue the 9820 prepares detailed charts of 60 of the most current options. It also prints mailing labels, subscription reminders, subscription billing—and keeps books. "Without the HP 9820 System," says publisher Mark Veeneman, "our chart service would not be possible."



LIVE CATTLE		US COINS		COPPER		SUGAR		PORK BELLIES	
APR	FEB	MAR	MAR	MAR	MAR	MAR	MAR	MAR	MAR
125	39.12	3990	522	43.50	53	60			
025		000	526	160	350				
080		30	531	175	510				
02		20	526	160	320				
04		22	529	160	500				
SILVER		CHICAGO		WPG					
MAY	MAR	FEB	APR	JAN					
	290	4265	4345	7300					
		240	310	850					



**STOL control systems analyzed in minutes... instead of days.** Engineers assigned to develop control systems for STOL aircraft must overcome a host of highly complex aerodynamic problems. So control system designers at Boeing have turned to an HP 9830 calculator for help. Now they enter results from wind tunnel tests into the calculator, along with data on the aircraft's mass and inertia. The 9830 quickly computes the static and dynamic derivatives for various trim conditions required to set up a dynamic model of the aircraft for each flight condition. (There are approximately 120 different flight conditions.) The calculator also computes transfer functions and the roots of the characteristic polynomial. And then, using a root-locus plotting program, it designs single-loop control systems. These calculations that once took days are now done in about ten minutes.

## Let an HP calculator put computational power where you need it most—right at your fingertips.

It's unlikely that you race yachts or design STOL aircraft, but you probably have a lot in common with those who do. The chances are that you need fast, economical solutions to your problems—and that's exactly what HP calculators give you. We may even have application programs to match your specific needs. So call your local HP Sales Office for further information on our systems and software. Or write: Hewlett-Packard Co., Calculator Products Division; P.O. Box 301, Loveland, Colorado 80537.



HEWLETT  PACKARD

Sales and service from 172 offices in 65 countries  
P.O. Box 301 Loveland, Colorado 80537

Circle 61 on reader service card

# Turn to page 7. Important? Sure...

By the time the office copy of ELECTRONICS gets to you, there's nothing left of page 7. It happens. Too often.

How often has ELECTRONICS wound up on your desk dog-eared and abused, with articles clipped out and ripped out? Or days, even weeks late?

How often has ELECTRONICS

*never even made it to your desk?*

You should be getting your copy of ELECTRONICS right off the press. You need it. Because it's important to stay on top of what's happening in your field. And ELECTRONICS is on top. ELECTRONICS is the Source. It's packed with up-to-date info, the breaking news of the electronic industries in the U.S. and worldwide.

You can get ELECTRONICS where you can find the time to read it—at home. Go to *the Source*, today. Fill out the subscription card enclosed in this issue, and send it off.

**Electronics**   
**IS THE SOURCE.**







# How do you connect round cable to flat?

Now it's easier than ever to connect round cable to flat. Or flat cable to flat. Or round to round.

Because now Hughes introduces the HAC-PAK Connectors—a whole new connector family offered in three types of contacts: crimp/removable rear-release (non-environmental, environmental or potted); RFI/EMI fixed filter contacts; and fixed solder-tail contacts.

HAC-PAK Connectors are intermateable and intermountable with one another—and with Hughes front-release subminiature rectangular connectors. (W and WSS Series.)

Our exclusive PolarHex™

## It's a snap.

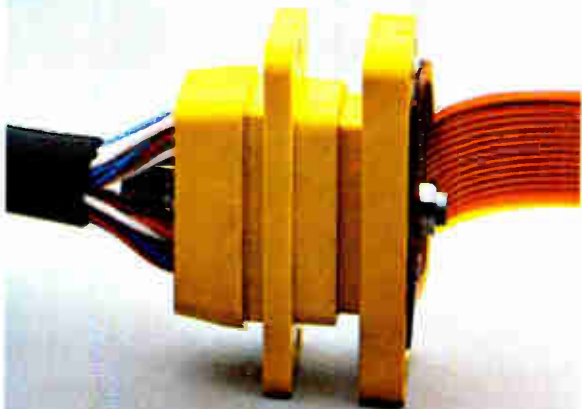

The new Hughes  
**HAC-PAK™ Connector.**  
(MIL-C-28804)

center jackscrew coupling assures alignment, provides positive polarization with a choice of keying positions, and prevents mismatching.

HAC-PAK subminiature connectors have the highest density of number 22 contacts in the industry. (.085" centers.)

To get all the details, make a connection with Ron Ross at (714) 548-0671, or write: Hughes Connecting Devices, 500 Superior Avenue, Newport Beach, CA 92663.

**HUGHES**

HUGHES AIRCRAFT COMPANY  
CONNECTING DEVICES

**We crack the tough ones.**

Circle 63 on reader service card



# How to order a Card-Pak.



When we say we can ship Card-Pak instantly, you can see from our picture why. Each of those boxes contains a knocked down Card-Pak assembly, ready to go. And this is only one of our stockrooms for Card-Pak.

To order one or all of our Card-Paks, just dial (714) 835-6000 collect.

But why should you want what we've so obviously got so much of?

Because Card-Pak is the newest circuit card filing system on the market. And, we modestly think, the best.

It will take up to 56 cards in 19 inches of width. It will take any card between 2x4 and 8x9 inches. It will space those cards any way you like

## And why.

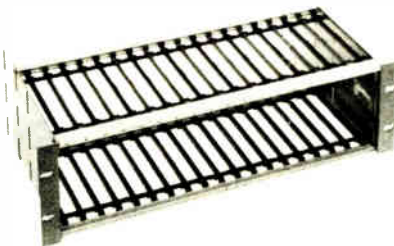

from 3/10 inch up (in .05 inch increments).

It offers a variety of tier arrangements and sizes. As well as versatile provision for connectors. And card handles, card ejectors, and an assortment of identification techniques.

Card-Pak is not cheaply made. It uses parts of precision-molded Noryl, anodized aluminum end plates, and extruded aluminum rails.

And last but not least you can put most Card-Paks together with eight screws. You furnish the screwdriver, we furnish the screws.

We alertly await your call.

## EECO FOR PACKAGING

1441 East Chestnut Avenue, Santa Ana, California 92701

Phone 714/835-6000

Also available from G. S. Marshall nationwide.

**Electronics**/February 20, 1975

## Weapons makers smile—for now

Ford's 1976 budget of \$349 billion includes \$92.8 billion for the Pentagon, but Congress appears to be holding a sharp axe

If anyone is happy with President Ford's spending program for fiscal 1976, it's the nation's military hardware makers. Yet they know that a significant part of the record \$92.8 billion proposed for defense might never emerge as appropriations from the 94th Congress; the Administration's policies and priorities are under sharp criticism from Democrats and Republicans alike.

Central issues in the proposed \$349 billion in outlays for the fiscal year beginning July 1 are Ford's deficit forecast of nearly \$52 billion and the acknowledgement that his proposals would fall far short of pulling the economy out of its deep slump—this, despite the fact that the spending and the deficit will set new records.

**Criticisms.** Infuriating to the large Democratic majority in the new Congress is the Ford budget's strong emphasis on military spending while cutting back on social programs, and allowing for no unemployment-benefit increases despite a forecast jobless rate hovering around 8% for up to two years. Nor does Ford have much support from fiscal conservatives, even in his own party, who are appalled at the deficit plan. It is a figure they fear could easily soar to more than \$70 billion as the Congress refuses to pass Ford's \$11 billion cutback in previously authorized spending, or go along with his proposal to save \$6 billion by putting a 5% ceiling on

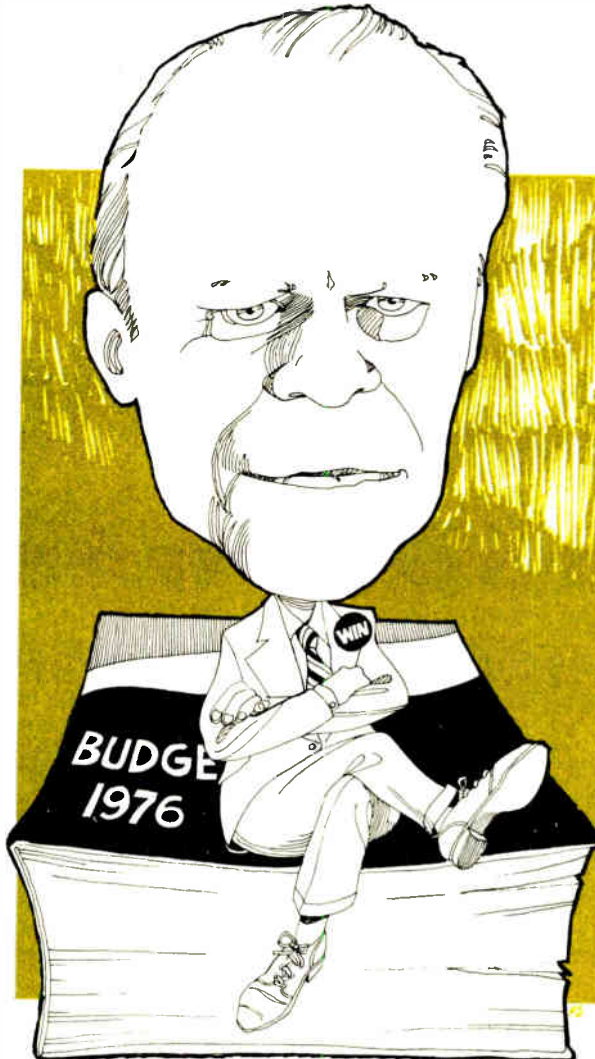

Social Security cost-of-living increases. And there is serious concern among economists that Ford's plan can do little to drop 1975's average annual inflation rate below 10.8%. That high estimate is attributed to the White House energy program.

In short, congressional displeasure with the Ford budget is every-

where. It can be found even among conservative military spending advocates who chair some of the key committees.

Significant is the warning voiced by Senate Armed Services Committee Chairman John Stennis concerning the 18% hike, to \$104.7 billion, in requested defense budget authority [*Electronics*, Dec. 12, 1974, p. 53]. "I wish it could have been less," said Stennis. The request had been put forward by Defense Secretary James R. Schlesinger sternly and "with no apologies."

**The losers.** If military electronics suppliers saw new opportunities in Schlesinger's plans, their counterparts in the market for such social programs as education and law enforcement saw their small, new markets diminished by the White House budgeteers. The Law Enforcement Assistance Administration's proposed \$887 million in outlays, for example, represents an increase of less than 3% on fiscal 1975—insufficient to cover inflation. Some \$485 million of that total is ticketed for states and localities in

the form of bloc grants for local needs. LEAA, the strongest advocate of electronics technology in law enforcement, finds itself next year in a steep decline.

That was clearly signaled by outgoing Attorney General William B. Saxbe, who noted the "long debate over the effectiveness of the LEAA



## Probing the news

program," and concluded that the program "has been a dismal failure."

More interesting to observers of LEAA's parent, the Justice Department, is the \$1.5 million increase for antitrust enforcement, to a total \$18.8 million. "In view of the AT&T and IBM suits," says one corporate attorney in Washington, "this is significant." Justice has always looked on antitrust as an inflation-fighting tool, so there may be more cases coming—perhaps in consumer goods."

Spending for instrumentation and data-processing systems for use in biotechnical research programs at the Department of Health, Education, and Welfare remains flat in the proposed budget at \$11.4 million. So does the Health Services Administration's \$25.1 million for its program of emergency medical services systems.

That program for developing and funding emergency treatment systems as demonstration programs is limited in the new year to awards for 75 feasibility and planning studies, 19 new systems, 14 upgraded systems, and 13 awards for researching new devices, technology, and health-care delivery methods for Americans.

Similarly limited is the Office of Education, from which most funds will go to local school districts to help pay for bricks, mortar, and personnel. Even the new \$7 million outlay proposed for educational television is earmarked for pro-

gramming rather than for television cameras, control equipment, and other broadcast hardware.

## Defense takes up 27% of the budget

A year ago when Defense Secretary Schlesinger laid out his first military budget, he called for fiscal 1975 spending of \$85.8 billion. The 93rd Congress cut that slightly to \$83.2 billion, but Schlesinger says spending for the fiscal year ending June 30 will reach a record \$84.8 billion anyway—largely because of inflation.

Despite continuing inflation, Schlesinger is pushing ahead with his long-range plan to develop a strong conventional force. For fiscal 1976 that means a spending program totaling a record \$92.8 billion, nearly 10% more. That level of outlays plus the additional budget authority the Pentagon wants to set aside for use in future years will push total military funds to 27% of the Federal budget, or \$104.7 billion. Getting all or even most of this past the reform-minded 94th Congress will be Schlesinger's toughest task yet. And his fiscal 1976 budget request has not been helped politically by being coupled with a fiscal 1975 supplemental request for \$522 million in new aid for South Vietnam and Cambodia. The Defense Department has been forewarned of the Congressional mood by the unceremonious dumping of one of its strongest supporters, F. Edward Hé-

bert (D., La.), from the chairmanship of the House Armed Services Committee.

Another 10% increase in the forecast unit cost of the Air Force B-1 bomber in the last six months of 1974 can be expected to fuel the controversy over that program. Each of the 244 bombers proposed to be built by Rockwell International is now expected to cost \$84 million, the Air Force estimates, compared with last June's \$76.4 million tag. Not yet out of prototyping, the B-1's price has skyrocketed 85% from first estimates: \$45.6 million.

**Job issues.** To support its effort to cope with inflation, the Pentagon is counting in part on congressional reluctance to cancel spending programs that could cost jobs in home districts already suffering from high unemployment. Even at the proposed spending level, the Pentagon argues, defense-related industrial jobs will fall to just under 1.47 million, down 25,000 from a year ago, because many of the job-creating contract awards will have no significant economic impact until late in the fiscal year.

If Schlesinger's campaign to get more money succeeds, spending for both procurement and research, development, test, and evaluation accounts will climb by 11%, in line with what the Pentagon sees as close to the inflation factor. With the \$16.5 billion sought for procurement, the military services propose heavy investments in man-carried missiles like Dragon and TOW as well as air-to-air weapons like Sidewinder and Sparrow II to replenish inventories drained by Middle East allies.

Heavy purchases are also sought for Army and Navy helicopters and Air Force and Navy combat planes (see table). The biggest single aircraft outlay proposed is the more than \$2 billion sought by the Air Force for another 135 McDonnell Douglas F-15 Eagles in both fighter and trainer models. Somewhat eclipsed by such big aircraft purchases are significant sums such as the \$21.1 million requested by the Navy to acquire the first of Lockheed's EC-130Q Tacamo IV communications-relay planes. At the other end of the aircraft-procure-

### Lost quarter

In the fall of 1976, the U.S. Government will push back the beginning of fiscal 1977 from July 1 to Oct. 1, and it will have to make the three-month transition through this fiscal no-man's land with a special transition budget. That budget has been submitted to Congress along with the fiscal 1976 budget. The change in the fiscal year will give Capitol Hill additional time to review the President's budget.

In his transition budget, which Congress will treat separately in this session, President Ford proposes a total spending program of \$94.3 billion that will generate a \$9.8 billion deficit. The Pentagon wants to spend \$25.4 billion of that sum, including \$4.7 billion for procurement and \$2.25 billion for RDT&E. As indicated in the table of Pentagon programs, all fiscal 1976 dollar figures include the three-month transition totals.



ment spectrum is the \$39.2 million the Navy is requesting to pick up 146 Beech T-34-C Mentor trainers.

Navy ships are down for big procurement totals, although \$2.3 billion of it is merely to cover prior-year inflation and overruns. Most of the figure for the Litton DD-963 destroyer and General Dynamics' missile-carrying submarine conversions from Polaris to Poseidon is for covering earlier costs. But new starts can be found in the \$1 billion for 10 patrol frigates and the \$1.4 billion for the first Trident-missile sub designed to follow the Poseidon. However, cost-escalation has struck the Trident program, too, and the Pentagon has slowed the proposed procurement schedule from two vessels per year to three every two years.

**R&D gains.** Much of the \$9.6 billion in spending proposed for RDT&E also comes in big chunks. Typical is the \$355 million in Air Force money to get more prototypes of the F-16 lightweight fighter from General Dynamics. Similarly, the Navy is budgeted for nearly \$133 million—six times more than last year—for prototypes of its new carrier-based lightweight fighter formerly known as the VFX. Now called the Air Combat Fighter, the plane looms as a major long-term proposition as the service talks of an eventual purchase of 800 over nearly a decade.

Common to most of the R&D outlays planned for fiscal 1976 is the fact that most of the money is going to development, with a decline in the number of new research starts. In their place are a number of improvement programs to upgrade existing weapons. An example is the Air Force program to spend \$48.3 million over fiscal 1976 and into the first quarter of fiscal 1977 to develop a laser seeker system for the Hughes Aircraft AGM-65 Maverick missile. This, incidentally, reflects the service's unhappiness with the performance of the missile's electro-optics during the last Arab-Israeli war.

Similarly the Navy wants to improve the mid-course command guidance and electronics counter-countermeasures capability of its extended-range Standard missile built by General Dynamics for shipboard use. For that job the Navy wants

## MAJOR REQUESTS FOR WEAPONS PROCUREMENT

(in millions of dollars; quantities in parentheses)

	FY1975	FY1976†	Contractor
<b>Army aircraft</b>			
AH-1S Cobra/TOW	\$ 20.8	\$ 82.4 (60)	Bell Helicopter
CH-47C Chinook	3.0	49.2 (12)	Boeing Vertol
UH-1H Iroquois	18.5	24.8 (48)	Bell Helicopter
<b>Navy aircraft</b>			
A-4M Skyhawk, USMC	9.4	74.5 (24)	McDonnell Douglas
A-6E Intruder	142.6	160.3 (12)	Grumman
EA-6B Prowler	129.1	134.2 (1)	Grumman
A-7E Corsair II	132.6	214.5 (6)	Vought
E-2C Hawkeye	125.2	184.7 (1)	Grumman
S-3A Viking, ASW	560.1	517.4 (41)	Lockheed
P-3C Orion, ASW	152.0	237.8 (15)	Lockheed
F-14A Tomcat	732.7	760.3 (45)	Grumman
*AH-1J Sea Cobra	0	54.9 (22)	Bell Helicopter
UH-1N Iroquois	15.5	36.9 (30)	Bell Helicopter
<b>Air Force aircraft</b>			
A-10 close air support	261.2	567.2 (94)	Fairchild
E-3A AWACS	617.5	774.2 (6)	Boeing
*E-4A AABNCP	82.3	235.8 (3)	Boeing
F/TF-15A Eagle	1,096.0	2,039.3 (135)	McDonnell Douglas
B-1 bomber	445.0	948.5	Rockwell
<b>Army missiles</b>			
Chaparral, surface-air	3.1	59.0	Philco-Ford
Hawk, surface-air	111.9	112.8 (660)	Raytheon
Dragon, antitank	100.3	179.0 (24,443)	Multiple
TOW, antitank	141.7	181.2 (31,004)	Hughes, Emerson
Pershing, surface-surface	10.5	43.5	Martin
<b>Navy missiles</b>			
Poseidon, FBM	39.4	39.7	Lockheed
Trident I, FBM	651.5	1,340.9	Lockheed
** Sparrow II, air-air	103.3	155.6 (980)	Raytheon, GD
** Sidewinder, air-air	32.3	113.9 (2,310)	Raytheon, Philco
Phoenix, air-air	98.0	128.2 (340)	Hughes
** Shrike, air-surface	36.7	56.7 (1,618)	Multiple
* Condor, surface-surface	5.7	102.7 (243)	Rockwell
Harpoon, antiship	151.8	214.8 (365)	McDonnell Douglas
Standard, all models	67.0	134.6 (361)	General Dynamics
<b>Air Force missiles</b>			
Minuteman II/III ICBM	728.7	884.4 (50)	Multiple
AGM-69 SRAM, air-ground	1.5	5.4	Boeing
AGM-65A Maverick, air-ground	73.1	170.0 (7,200)	Hughes
<b>Navy ships</b>			
SSBN conversions, Poseidon	143.6	58.3	Newport News, GD
Trident SSBN	1,378.0	1,440.0 (1)	General Dynamics
SSN 688	545.0	1,011.3 (2)	Newport News, GD
DLGN-38	255.2	398.3 (1)	Newport News
DD-963	464.6	781.4	Litton
PHM Hydrofoil/Missile	108.0	244.3 (2)	Boeing
Patrol Frigate	186.0	1,094.9 (10)	Bath Iron
<b>Other procurement</b>			
MK-48 torpedo	150.5	131.1 (175)	Gould
* Captor torpedo	21.2	43.3 (260)	Goodyear
CIWS (Phalanx)	13.5	44.8	General Dynamics
SLBM phased-array radar	42.5	49.0 (1)	Not selected

## WEAPONS R&D FUNDS

	FY1975	FY1976†	Contractor
<b>Army</b>			
HLH Helicopter	32.8	22.8	Boeing Vertol
UTTAS Helicopter	52.7	110.6	Multiple
AAH Helicopter	60.9	82.9	Bell, Hughes
SAM-D, surface-air	104.8	170.0	Raytheon, Martin
SHORAD missile	17.1	78.0	Not selected
Stinger missile	32.4	22.4	General Dynamics
Tri Tac communications	36.2	66.1	GTE Sylvania
Site Defense ABM	114.9	178.0	McDonnell Douglas
<b>Navy</b>			
Air Combat Fighter (VFX)	20.1	132.8	Not selected
V/STOL aircraft technology	14.3	27.5	Multiple
Sea-launched cruise missile	38.0	143.9	ITT, GD
Surface missile mid-guidance/ECCM	25.2	34.0	Multiple
Aegis surface-air missile	63.0	75.6	RCA
Surface Effect Ship	45.8	55.0	Aerojet General
<b>Air Force</b>			
Advanced Medium STOL prototype	55.8	96.4	Multiple
Air Combat Fighter (F-16)	32.0	355.5	General Dynamics
Laser-guided Maverick	20.8	48.3	Not selected
Advanced ICBM technology	37.3	56.5	Multiple
B-52 Harpoon missile	0.4	17.6	McDonnell Douglas
Air-launched cruise missile	54.6	64.0	Boeing
NAVSTAR global satellite	23.9	87.8	Rockwell, GD

† 15-month funding includes 3-month transition to new fiscal year.

\* First buy or new R&D effort

\*\* Includes Air Force procurement

\$30 million in fiscal 1976 plus \$4 million more for the following year.

### Space and transport: no new programs

Aerospace and electronics contractors whose products fly, orbit or roll found little in President Ford's first budget to boost their sagging morale. NASA Administrator James C. Fletcher is characterizing his fiscal 1976 spending plan of just under \$3.5 billion as one with "no new programs," and an aide complains of "spending power of about one third of our peak year." Meanwhile, planners at the Federal Aviation Administration bemoan their \$250 million ceiling for electronics procurement. That sum buys about 30% less than when it was invoked. Some surface transportation nuggets with electronics content slipped through the White House budget sieve, but only, says one Urban Mass Transportation Administration official, "because they are so small."

**Space cuts.** Five satellite programs disappeared in the NASA budget process, although in the best bureaucratic tradition the agency managed to hang on to nearly all its personnel. Cancelled were the Solar Maximum Mission to measure solar flares and solar winds, as well as the Severe Storm Satellite, a souped-up version of the Synchronous Meteorological Satellite developed by Philco-Ford. Satellite starts delayed indefinitely include the interplanetary Out-of-the-Elliptic program, the Earth-orbiting thematic mapper, and the solar electric propulsion units. According to C. Thomas Newman, agency budget chief, these programs have been rescheduled to fiscal 1977. "It could be worse," Newman believes, noting that NASA managed to squeeze out an inflation offset of more than \$200 million above the agency's benchmark budget ceiling of \$3.2 billion.

Unlikely to agree that it could be worse are proponents of the Large Space Telescope, which was delayed

### Solar energy shines

Solar energy provides one of the few rays of sunshine in President Ford's nonmilitary research and development budget for fiscal 1976. Proposed spending for solar R&D is set at \$57.1 million, which amounts to an increase of 650%. In fact, the five-year plan to spend \$1 billion on solar energy is one of the few Federal R&D proposals to survive unscathed by White House budget cutters [*Electronics*, Oct. 31, 1974, p. 54]. And research on photovoltaic cells is to get \$10 million in fiscal 1976, or 10 times as much funding as it got in fiscal 1975. With few other exceptions the nonmilitary R&D budget, totaling \$7.6 billion, tends to be unexciting. Its 12% increase is barely enough to make up for inflation.

Military R&D obligations, on the other hand, will jump more than 20%, to \$10.6 billion, under the Ford plan, nearly all of which will be spent next fiscal year. The total military and civilian R&D budget request of \$21.6 billion overall reflects a 15% boost from fiscal 1975's \$18.8 billion. Development programs get the lion's share of \$13.3 billion, and experts at the National Science Foundation estimate that 25% to 35% of that sum will be spent on electronics. "Use the higher figure if you include computer buys and other hardware needed to carry out the R&D," explains one NSF source.

The Energy Research and Development Administration, newly formed from the combination of the Atomic Energy Commission and other Federal agencies, is the biggest R&D spender after the Defense Department. Of its proposed \$2.7 billion in obligations, solar R&D proves the biggest winner. R&D dollars for colleges and universities for mission-oriented agency programs will rise barely 5%, to \$2.25 billion, with nearly half generated by the Department of Health, Education, and Welfare. The NSF will contribute \$487 million, up 7.7%, while the Pentagon's \$213 million is up 8%.

indefinitely even though \$5 million in technological development is proposed; that's a \$2 million increase from 1975 funding levels. Also cut were one engine from the Space Shuttle, including the accompanying electronic controls, to offset increased shuttle development costs unacceptable to the White House, says NASA.

**FAA's slippage.** The grim figures for civilian aerospace programs were also reflected at the FAA. Its proposed fiscal 1976 spending program of \$1.14 billion in Federal funds represents a \$306 million decline from the current fiscal year. To offset that, the FAA proposes to dip deeply into trust fund accounts—over \$500 million more than in fiscal 1975—to finance another \$1.12 billion in outlays. The total spending program is \$2.26 billion.

The planned trust fund expenditures include \$73 million for research engineering and development, up \$8.3 million from this year, but labeled "the bare minimum" by one FAA official. The agency has asked for \$96 million in R&D budget authority, but reductions were forced by the White House Office of Management and Budget. Though

no R&D programs have been deleted as budget line items, stretchouts are expected, particularly in air-traffic-control equipment development. For example, a delayed Aerosat, the aeronautical radio relay satellite, is one program casualty of R&D stretchouts.

**PRT's gain.** A personal rapid transit (PRT) demonstration program surfaced in the budget as one of the plus programs at the Urban Mass Transportation Administration, with its \$1.07 billion spending plan showing a \$275 million boost from last year. Of this total, the PRT demonstration is budgeted for \$10 million.

The new PRT would have smaller vehicles, a lighter guideway, and reduced headway between cars compared to the incomplete Morgantown, W. Va., project. Another \$4 million in new UMTA money is earmarked for automated guideway technology. And finally, the Coast Guard wants to buy \$3 million to \$4 million in Loran-C transmitters for the Gulf Coast, with possible West Coast installation scheduled for the future. □

This report was written by Ray Connolly, Washington bureau manager, with assistance from Larry Marion.

MOS/FET, bipolar and CMOS on the same chip...

# The RCA CA3130 is ready to meet MIL-38510/883.

This highly versatile op amp is now available in High-Rel versions. Just a few months after commercial announcement.

So anyone involved with aerospace, military and critical industrial applications can take advantage of this major breakthrough.

Because of the CMOS output stage, a voltage swing to within 10 millivolts of either rail on a single power supply is now possible for the first time. Other principal features are: high open loop voltage gain: 110dB; low input offset voltage: 8mV; low input current: 5pA; very high input impedance: 1.5 T $\Omega$  ( $1.5 \times 10^{12} \Omega$ ); high slew rate: 10V/ $\mu$ s; 2.5mW at 5V supply voltage; 22mA output.

The speed with which RCA converted this breakthrough technology into a High-Rel device illustrates our commitment to High-Rel Linear

ICs. Further evidence of this is the separate organization devoted exclusively to High-Reliability ICs; by our MIL-M-38510 approved production facility in Findlay, Ohio; by the full Class A, B and C processing to MIL-M-38510 and MIL STD. 883.

For the CA3130 High-Rel 8-page spec sheet, and a High-Reliability IC brochure, call your RCA Solid State distributor. Or RCA.

Write: RCA Solid State, Box 3200, Somerville, New Jersey 08876; Ste. Anne de Bellevue 810, Canada; Sunbury-on-Thames, U.K.; Fuji Bldg., Tokyo, Japan.

# RCA



RCA. A full house in Linear ICs.

Circle 69 on reader service card



Instrumentation

## Europeans feel squeeze

Instrument makers caught in vise between American firms and Philips, and tight money

by Arthur Erikson, Managing Editor, *International*

The native test and measurement instrument makers in Western Europe—particularly the smaller ones—face an anxious spring and summer. Sales figures should rise by 10% to 15%, but only because of price inflation; their near-\$575-million home markets don't figure to grow at all in real terms this year.

And, at a time when a no-growth market is making competition rough, U.S. giants like Hewlett-Packard Co. and Tektronix Inc. are becoming keener competitors: the lately-declining dollar gives them an added edge on prices. Philips Gloeilampenfabrieken has also been nibbling away at market shares. "They're coming relentlessly like the German army, with new models all the time," says an industry insider.

Signs of pressure-cooker market conditions are popping up all over Europe. Even in Germany, where most makers say they're up against hard times but figure they can get through until there's an upturn in the market, Siemens AG has put 21% of the workers on instrument lines at its Karlsruhe plant on a four-day week.

In Great Britain, Julian Shaw, product marketing chief for Solartron Ltd. of the Schlumberger Group, expects the liquidity crisis will push a lot of small instrument companies out of business. Already the ailing George Kent Group—not in the small class by any means—has been split in two, and half of it was taken over by the Swiss electrical equipment maker Brown, Boveri & Cie. after a government-created reorganization failed to help. Meanwhile, Advance Electronics Ltd., tight for cash after too-rapid expan-

sion, has gone under the wing of Gould Inc. its Cleveland based company.

It's France, though, where test and measurement people are most sensitized to the perils of the moment. One small company there went into bankruptcy last fall, and the government is trying to mount a rescue effort that would also get three or four houses to join forces.

There's little sign of success so far. The company in bankruptcy, Ferisol, actually had been slipping for five years or so under the autocratic management of its founder, Edmond Geffroy, now in his 80s. Geffroy and his sons are squabbling over how to reorganize the company and the courts have given them until the end of February to work out a plan and get the financing for it. "I wouldn't think of touching it until the family has straightened its problems out," says an executive of a venture-capital firm that has investments in several ambitious French instrument makers.

**Job ahead.** Even when the legal dust settles, the government may find it hard to line up industrialists for its scheme to eventually put together a strong French instrument company by fostering cooperation and mergers among some 140 prospective companies. "Certainly not with me," avows Jean-Claude Asscher, president-director-general of Tekelec-Airtronic, a logical candidate for a nucleus group. "You can't get a race horse by putting lame legs together."

In much the same vein, Fernand Sicard, who heads test and measurement activities for France and Southern Europe at Schlumberger,



**Producing.** Assembly lines still move at Solartron Ltd., but executives expect some small instrument makers to fail.

feels "1975 is not the right time."

Even under flourishing market conditions, Schlumberger—now the largest French broad-line test and measurement house—wouldn't be much tempted to piece small companies into its fairly complex structure. Schlumberger Instruments itself is the result of an amalgam of small companies bought up by the parent group, and it's taken nearly a decade to sort out the operation and get it ready to operate in the black.

"We have had negative cash flow up to now, but we will have positive cash flow by the end of 1975," Sicard says "We've cleaned up our product lines and have new products ready for the market that we developed in 1973 and 1974."

Schlumberger, then, doesn't want in, and officials at the *Institute de Developpement Industriel (IDI)*, a government-controlled venture-capital outfit that's trying to mount the rescue/regrouping effort, admit they aren't counting on signing up Schlumberger for the short term. That leaves Adret Electronique and Schneider Electronique as the most likely partners for a grouping of some sort with Ferisol. IDI believes that a viable company—unless very

What's new in MOS...

# RCA announces the 7001I memory in volume.

What is the company who created CMOS doing in NMOS memories? Putting all of its knowledge in "P" and "N" MOS technologies and its experience in high volume manufacture to work to become an important new source to you.

You told us that although there is already a long list of memory makers you could use another major supplier. One from whom you could expect a steady flow of product in volume. For as long as you need it. Without having to stop to worry about quality problems.

When we decided to enter the field and make memories an important part of the broad RCA semiconductor line, we chose the 7001I 1024-Bit RAM as our starting point. Less than six months after that decision we can accept orders for quantities as high as you can use. And by the time you need 4K memories, we expect to be ready to make the same high volume-high quality offer.

In speed, cycle time, TTL compatibility, package, and every other way the RCA MW7001ID is

interchangeable with any industry standard 7001I. So when the need is there, RCA is ready. We're anxious to set up a program to help you evaluate our product and our production capability.

If you prefer to check out the MW7001ID on your own, you can purchase evaluation quantities through your RCA Solid State distributor. If you really have no immediate need for a new high quality source for the 7001I, watch for the NMOS announcements forthcoming from RCA. When it comes to memories, we're planning to be able to help you in more ways than one.

Write: RCA Solid State, Box 3200, Somerville, New Jersey 08876; Ste. Anne de Bellevue 810, Canada; Sunbury-on-Thames, U.K.; Fuji Bldg., Tokyo, Japan.

# RCA

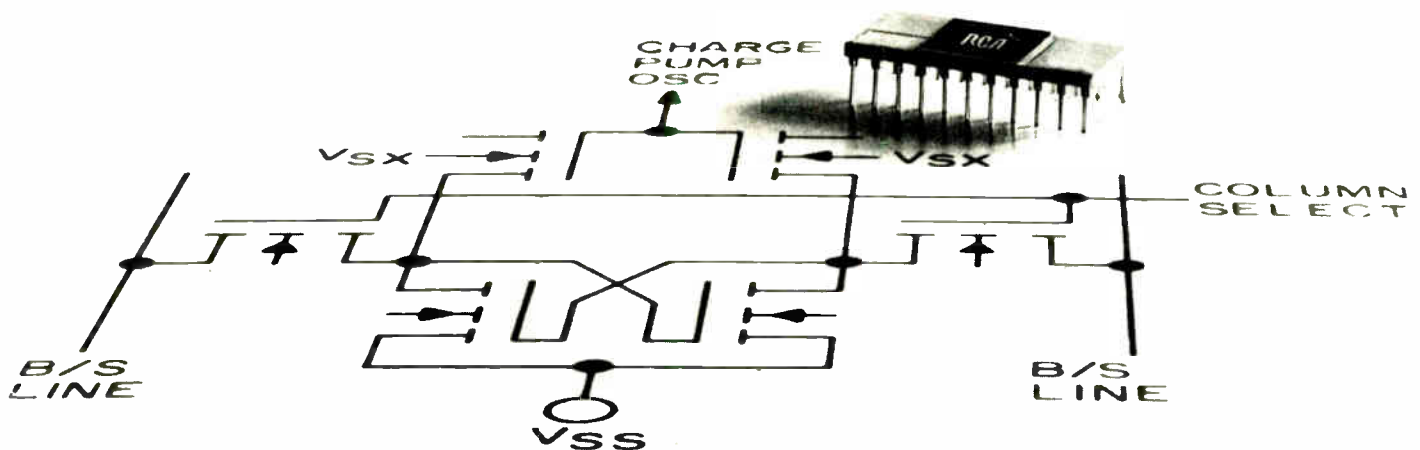

RCA. The first house in CMOS moves into memories.

Circle 71 on reader service card



# THE WORLD'S FIRST CIRCULAR IMAGE SENSOR.

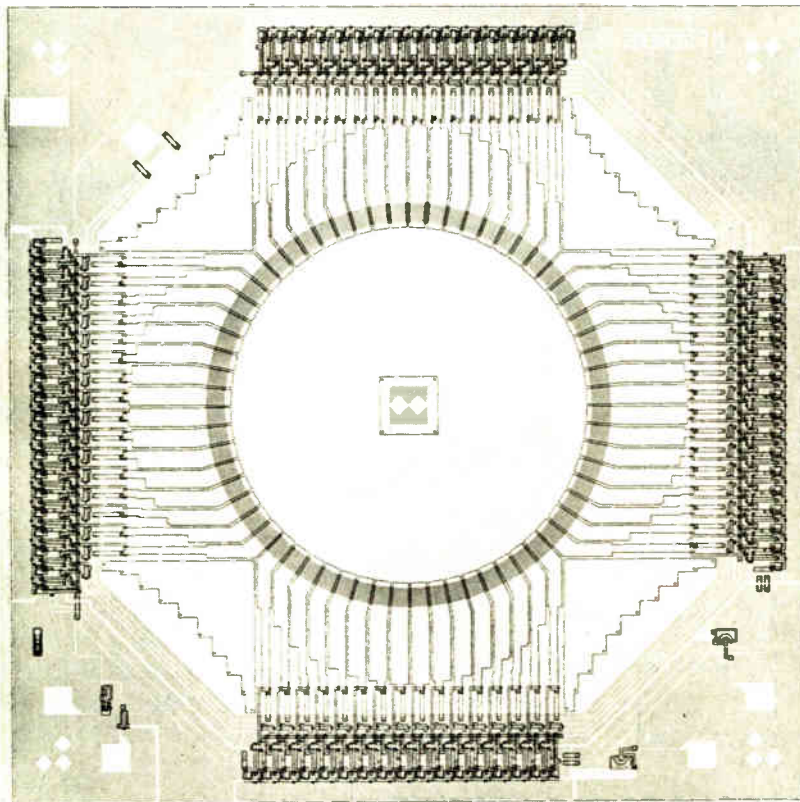

## CIRCULAR?

YES. And with on-chip scanning to provide serial output on a single pin. The 64 sensors of the RO-64 are each 0.1 mm x 0.1 mm in size and are uniformly spaced on a 2 mm diameter circle. The array can be operated at scan rates as low as 30 scans per second or as high as 40,000 scans per second. The device is packaged in a 16 lead ceramic DIP and sealed with an optical quality quartz window. The RO-64 is designed for applications in tracking, automatic alignment, automatic focusing, pattern recognition and many others.

RETICON also continues to offer the most complete line of standard linear and matrix arrays in the industry. Our "C" series linear arrays provide from 128 through 1024 elements of resolution on a single monolithic chip and are considered the standard in facsimile, OCR, and industrial control applications.

Custom devices have been developed for a wide variety of applications from point-of-sale to spectroscopy.

In solid state image sensing, our technical leadership backed by over 60 salesmen and 14 distributors over the world makes RETICON the most viable source.

## RETICON®

910 BENICIA AVENUE • SUNNYVALE, CA 94086  
PHONE: (408) 738-4266 • TWX: 910-339-9343

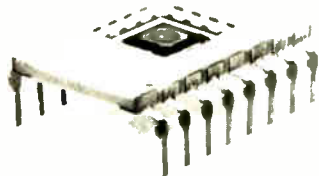

## Probing the news

small—needs at least \$20 million or so in annual sales to stay healthy. That's just about the sales of Ferisol, Adret, and Schneider in 1975.

Whether or not IDI patches something together with Ferisol, the French government will continue to press companies to band together to promote export sales and even to share R&D facilities. Electronics-industry planners in the Ministry of Industry and Research will launch a program later this spring to induce togetherness with hard-cash incentives—how big, they won't say. The idea is to help French companies stand up to foreign competition, particularly American and West German.

**Backing.** Adret's president and director general, Jean Royer, is all for this sort of move. "My reaction is very positive to the government's effort to restructure the industry," he says. Adret has already taken steps to find a partner.

Royer and Martin Birnbaum, his counterpart at Schneider, started exploratory talks about two years ago to "learn to work together," Royer says. The two companies are looking into the possibilities of joining forces at the outset for purchasing and administration. Later, they may move to a trial arrangement that would mesh their R&D activities. Meanwhile, the two companies have set up a joint sales subsidiary in West Germany and expect to have it operating within three months.

This won't be the first joint export effort. Adret has shared one with Tekelec for Eastern Europe for seven years now. Future ones, ministry planners hope, will include joint marketing agreements with companies in other Common Market countries. To avoid antitrust problems, senior French officials plan to plead their case for international partnerships before the Common Market commission in Brussels.

They also want to enlist the Eurocrats' help in finding partners, and the commission presumably will go along. It has a policy that encourages cross-border R&D deals for small firms. □



# TI's golden rule: no gold adder.

A lot of manufacturers give you a little something extra when they sell you gold sockets.

It's called a gold adder. And it can cost you a lot of extra money.

Not so with TI.

TI has a policy of no gold adder.

So when you order low profile solder tail sockets from us, the price we quote is the price you pay.

No matter what the cost of gold.

That's what you *don't* get from TI.

Here's what you *do* get.

- 100 microinch wrought gold contact surfaces for maximum reliability, serviceability, and longevity.

- Universal mounting and packaging.
- Stand-off tabs on the base for solder flush.
- Redundant contact points for low contact resistance, high reliability, and repetitive insertion.
- An optional anti-wicking wafer for better wave soldering.
- And a price that even competes with many tin-plated sockets.

We have a whole family of gold, low profile DIP sockets to choose from — all the way from 8 pins to 40 pins.

But if gold is a little rich for your needs, we offer an identical family of sockets with a tough 200-400 micro-inch plating of tin.

For literature, write Texas Instruments, Mail Station 10-5, Attleboro, Mass. 02703. For the name of your nearest distributor, or for information on our custom connectors, call Connector Systems Marketing, (617) 222-2800, Ext. 268 or 7216.



**TEXAS INSTRUMENTS**  
INCORPORATED

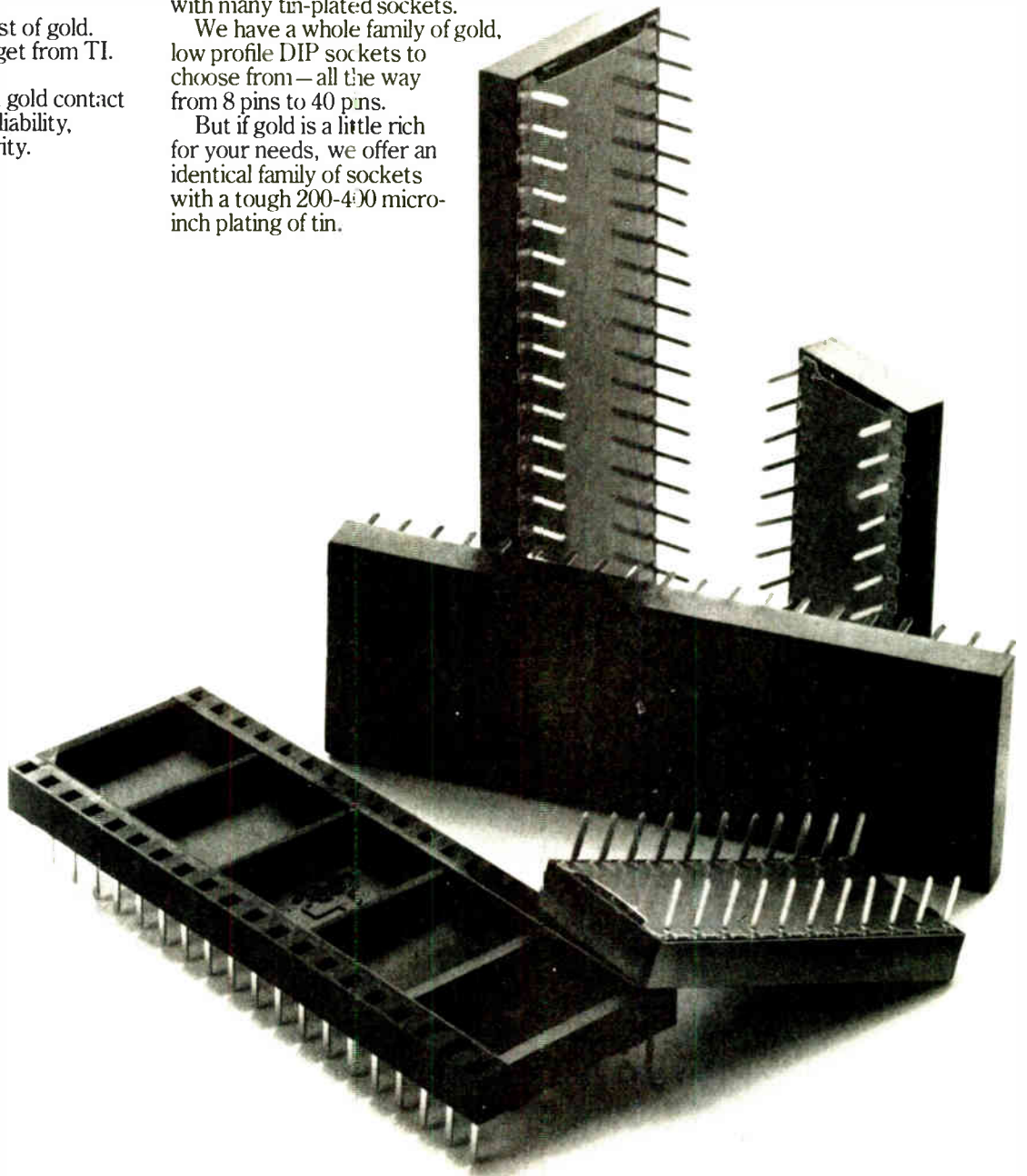

Circle 73 on reader service card

Production

# Automated bonding gives edge

Intermetall finds that by building its own system for transistors it can cut labor costs and boost production while retaining quality

by John Gosch, Frankfurt bureau manager

**Automate or perish.** That dictum has become the West German semiconductor industry's formula for survival in a time of rising labor costs and dwindling profits. And automating the production process is perhaps most vital in transistors, whose prices have declined steadily over the years.

Determined to stay competitive, especially with offshore operations, even in plastic transistors, Intermetall GmbH, the German member of the ITT semiconductor group, has installed a highly automated bond-

ing process. Thus far the effort has paid off, Intermetall says, and the company, in the Black Forest city of Freiburg, is convinced it can continue to come out ahead as labor costs go even higher. Using automatic equipment manufactured in-house, die bonding is now more

than three times faster than in manual operations. More significant, contacting the die in wire bonding processes is more than 10 times faster than before. And only one person monitors two wire bonders.

Horst Knau, Intermetall's plant manager under whose direction the

**Working.** Reel, below, contains frames. Right, chip transport and bonding apparatus are shown. Right below, individual frames are shown. Right below, individual frames move past wire-bonding station at center.

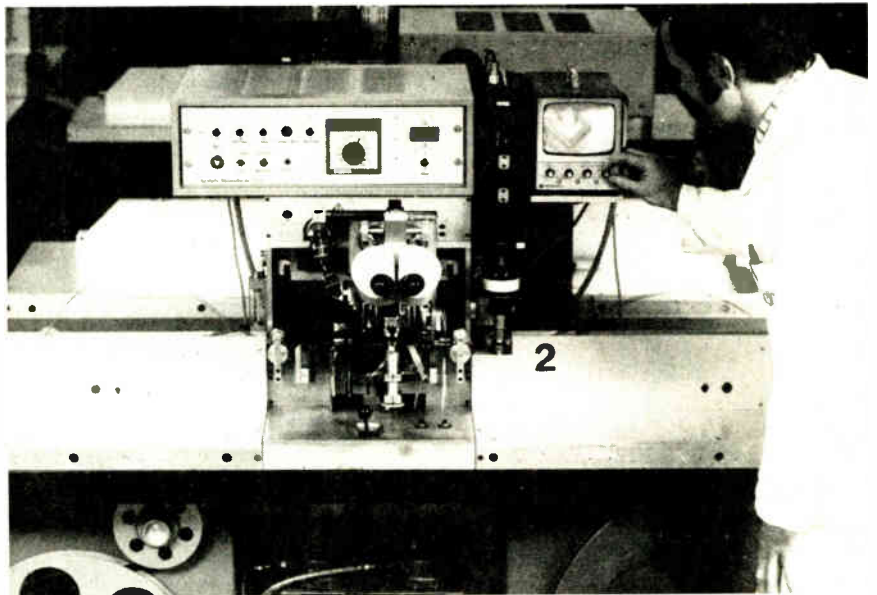
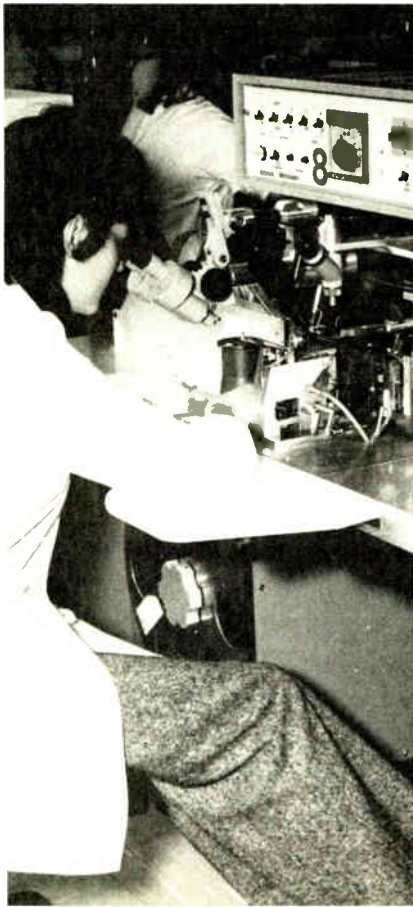
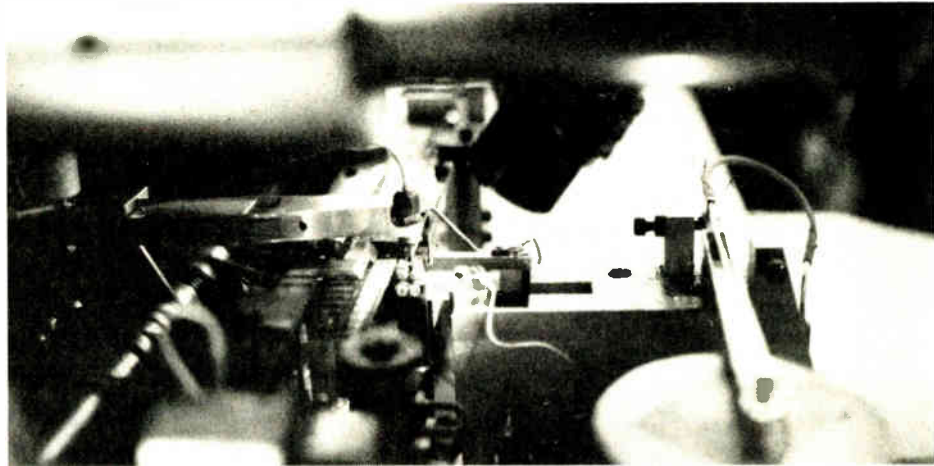



**HD/CMOS**  
is a proprietary  
process which made  
**CMOS** practical  
for custom  
large-scale integration.  
We invented it.

**We sell more than circuits.  
We sell solutions.**

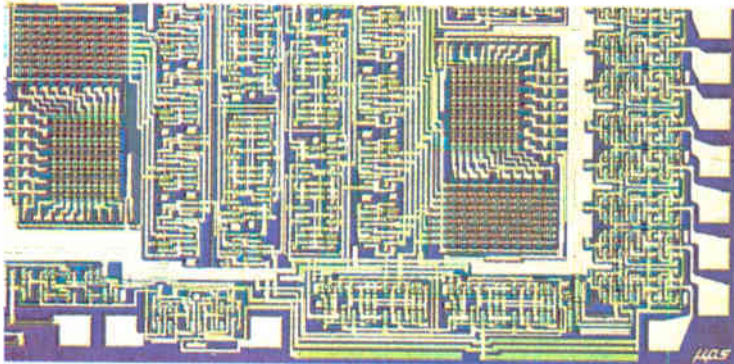

**MICRO POWER SYSTEMS**

3100 Alfred Street, Santa Clara, CA 95050  
Telephone (408) 247-5350



## Probing the news

equipment was developed, says the wire bonder is so fast that two of the new die bonders are needed to serve it. "In the days of hand operations," Knau says, "it was the other way around—one die bonder for two wire bonders." The factor of 10 improvement in speed translates into a transistor handling rate of "well over" 5,000 per hour. The die bonder processes 2,500 per hour.

Not only do the new machines increase productivity and cut labor and fringe-benefit costs, they also help reduce personnel training times. "Whereas it took several months for a girl to become expert in manual bonding, one to two weeks is now enough," he says. And the machine reduces human error.

Intermetall's plant now includes 30 die and wire bonders. With them, the company can produce "well in excess of 100 million plastic transistors a year." Rather than manufac-

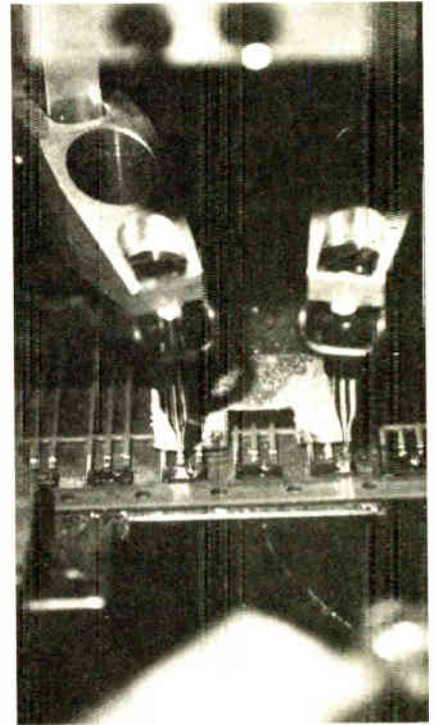

**Base and emitter.** Left bond capillary handles base connections while right one takes care of emitter connections.

# No GO-NO-GO IC checker is so low

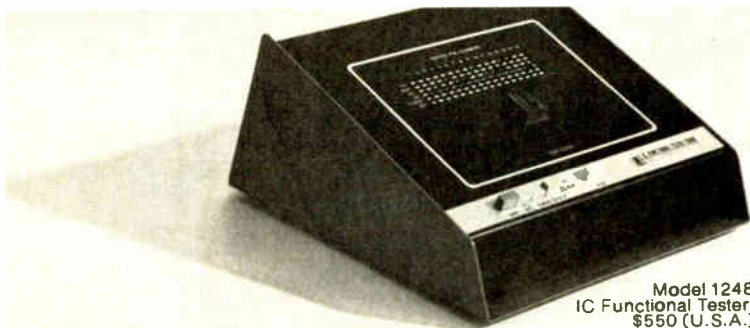

Model 1248  
IC Functional Tester:  
\$550 (U.S.A.)



Searching through your circuitry for bad digital ICs is a waste of time and money. ESI's new Functional Tester quickly identifies bad ICs before they are wired in. It takes less time so it costs less dollars. (And the 1248 sells for under \$600!)

Fast and easy, any assembly worker can obtain a GO NO-GO analysis on 10 or more units per minute. Simply insert the IC—TTL, DTL,

CMOS—in the test socket, push the TEST button and check the digital readout for the proper test code. No comparison with a "good" IC is necessary and changeover from one device type to another takes less than a minute.

Send for our demonstration brochure on this unique IC Functional Tester, or call Stan Gressel at the factory.

Electro Scientific Industries  
13900 N.W. Science Park Drive  
Portland, Oregon 97229  
Phone: (503) 646-4141

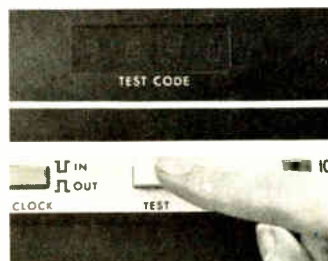

**esi**  
ELECTRO  
SCIENTIFIC

ture and sell the machines to other companies, Intermetall is ready to sell the knowhow involved. Licensing talks have already been held with foreign and domestic semiconductor producers.

The die bonders, which use gold-eutectic mounting techniques, replace versions that used manually controlled stick manipulators. They governed chip pickup, transport to the bonding station, positioning, and bonding. Now all that is left to be automated is chip selection, and Intermetall is working on that. The wire bonders, using thermocompression methods, replace hand-controlled wire positioning and contact-

ing. A mechanical transport feeds the tape containing the frames. Perforations along the tape's edges guarantee accurate placement at the bonding station.

Efficiency is impressive. The die bonder automatically positions a chip on a transistor frame with an accuracy of  $\pm 2$  mils. The wire bonders contact the wires at a better than 20,000 contacts per hour, or six contacts per second. And only 1% to 2% of all bonds do not meet Intermetall's quality standards. □

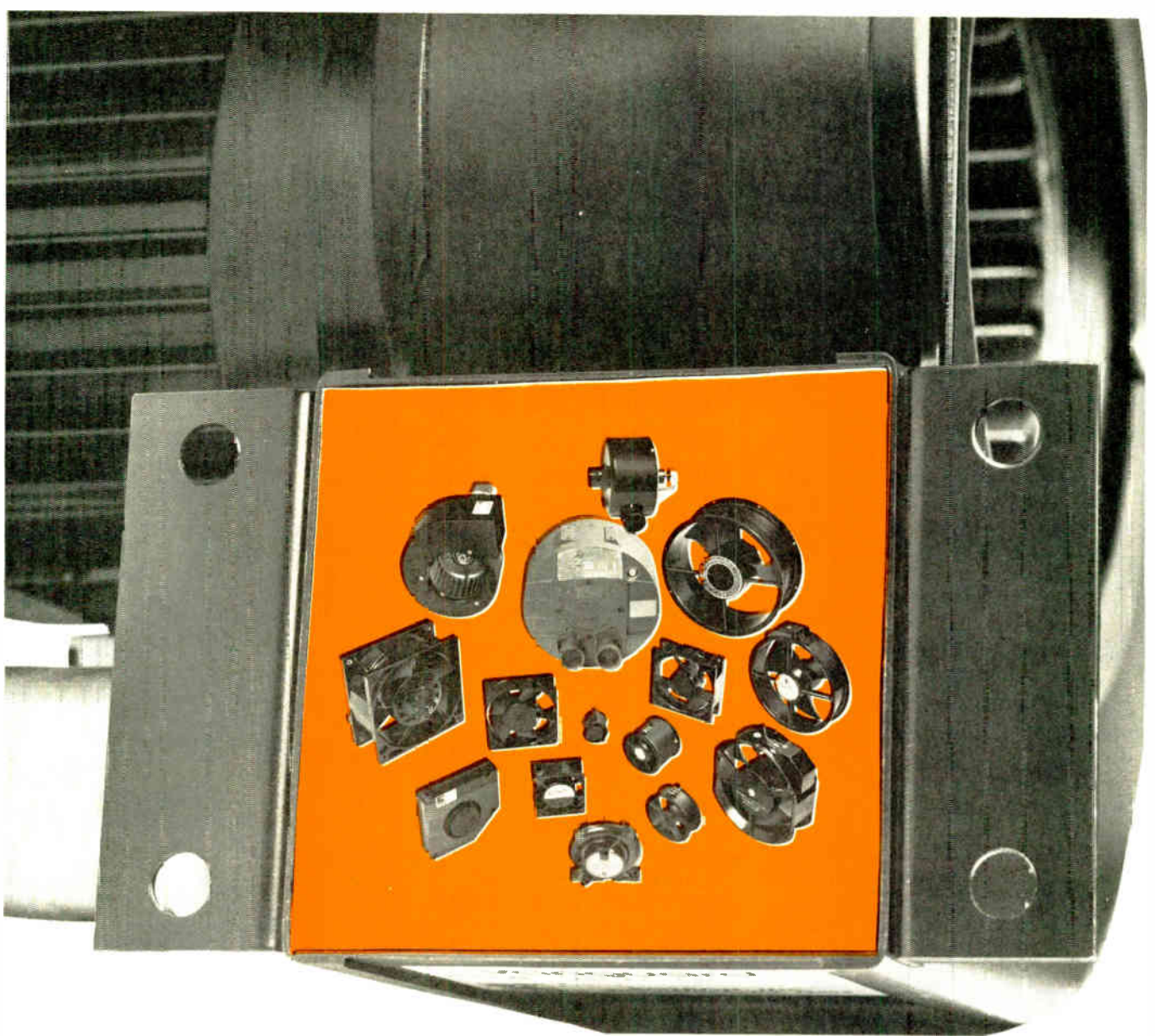

## ***Behind every Rotron fan and blower.. Product Variety***

There's a good reason why there are more than 150 standard model air movers in the Rotron fan and blower line.

It's you.

Your air moving requirements may not be the same as those of someone else. And you yourself may have a number of different air moving needs, calling for different electrical inputs, different housing configurations, various pressures and volumes.

Over the years, Rotron, as the world's leading manu-

facturer of precision air moving devices for electronic and industrial applications, has learned to provide the most meaningful selection of such performance characteristics. You can get just the product you need, when you need it, at a price that's realistic.

Next time you have an air mover requirement, go to the one place you're most likely to find the right answer. In a standard model. Or one specially tailored for you. Rotron will even help you make the choice.

*Why settle for less when the best costs no more?*



**ROTRON INC.**

Woodstock, N. Y. 12498 □ 914 • 679-2401 □ TWX 510-247-9033

Pacific Div. Burbank, Cal 91506, 213•849-7871 • Rotron B.V., Breda, Netherlands, Tel: 79311, Telex 844-54074

10512



Avionics

## Battle of the MLS heats up

FAA choice of scanning beam over doppler has losers claiming foul and hoping for satisfaction from international body

by Larry Marion, Washington bureau, and William F. Arnold, London bureau manager

**Another storm** is brewing in Washington—this time between the Federal Aviation Administration and some electronics companies over the agency's year-end rejection of the doppler technique in favor of the scanning beam approach as the U.S. choice for a standard microwave landing system [*Electronics*, Jan. 9, p. 32]. Both technologies proved "more than adequate" in brass-board testing last year, so proponents of the doppler technology are sniping at FAA selection procedures and alleging staff bias.

Following a five-year, \$50 million competition, a 17-member Government selection committee came down on the side of scanning-beam systems proposed by Bendix Communications division, Baltimore, Md., and Texas Instruments Inc., Dallas. Almost immediately the losing doppler proponents—Hazeltine Corp., Greenlawn, N.Y., ITT/Gilfillan, Van Nuys, Calif., and their subcontractors—cried foul and

mounted an intensive campaign challenging the technical basis for the decision and citing "irrational" procedures. They have tried to upend the decision through a four-member executive committee review, but insiders say their efforts are doomed. And the doppler-seeking British, furious at what they feel is a preordained vote, are campaigning to overturn it.

For the short term, the stakes are \$20 million in FAA prototype system contracts scheduled to be signed in June. But far more crucial in corporate eyes is the four-year development lead that U.S. winners will gain toward capturing big chunks of the estimated \$1.5 billion world market for MLS, the next-generation aircraft navigation system.

Scanning beam and doppler performed well during flight tests, though doppler proponents claim their systems are "proven" and have generated more data. The controversy centers on gray areas: because undisputed advantages did not appear, selection committee members had to base their votes on secondary issues and gut reaction rather than a simple black-and-white choice of a superior technology.

What particularly piques doppler advocates, though, is the FAA's mid-November change in signal format for the scanning-beam system, to a time-reference-signal (TRS) technique rather than the frequency-reference-signal format originally used.

**Members.** Joseph M. DelBalzo, left, is FAA group project manager and chairman of interagency group that picked scanning-beam system. Seymour Everett, right, was lone FAA member to back doppler.

The reason is that the time-reference signal format permits simpler electronics; this lowered costs and improved operational characteristics such as signal-processing speed.

**National interest.** In Washington, U.S. district court Judge June E. Green sided with the FAA, citing the national interest above procedure as a reason for rejecting Hazeltine's Jan. 23 request for an injunction against the FAA to halt further TRS scanning beam work. Whether a newly instituted investigation by the General Accounting Office, and the final executive committee analysis of the choice, support scanning beam or doppler won't be known until April or May. The result of that report may force the FAA to repeat the selection process. "But I don't think it would change the outcome," says the FAA project manager for MLS, Joseph DelBalzo.

DelBalzo dismisses doppler advocates' criticism of the small TRS data base. "We will have more than





enough test data by June," he says, to meet a June 30, 1975 deadline for presenting the American choice to the International Civil Aviation Organization (ICAO). The American TRS scanning beam test system will have a Texas Instruments reflecting antenna, developed by TI with its own funds, for angle guidance; a Bendix antenna for elevation guidance; TI's brassboard electronics for signal processing and amplification; and airborne receivers from Bendix and Collins Radio.

**Cracks.** The doppler camp reacted angrily after the voting procedure and result of the 17-member selection committee became known. Critics of scanning beam pointed to the bloc of four FAA votes for scanning beam, saying DelBalzo and his assistants were biased in favor of the system they nursed. Others claimed FAA voters were afraid to vote against their boss's preference, which he made known to the committee before the vote was taken. And scathing criticism was reserved for the voting—the totals were nine for scanning beam, six for doppler, and two abstentions—which doppler advocates claim is less than the mandated two-thirds majority.

Some criticism of the voting procedures appears justified. DelBalzo himself says he would change it to provide for a secret ballot on the first go-around if he could do it over. But that's all he would change. "As for the two-thirds majority requirement, it just fell through the cracks," he says. "If we had remembered it, it would not have been dif-

ficult to get the necessary votes. It would have been a less than honest vote, though," he adds. And when DelBalzo publicly quizzed his staff members about the reasons behind their vote, a bias did emerge.

"We've had more experience with scanning beam," was the common refrain. FAA staffers appeared unwilling to give doppler the benefit of the doubt. "The committee did not challenge the view that the recommended technique leaves the evaluators somewhat more comfortable [in] . . . dealing with as yet unforeseen issues," says advisory committee chairman Siegbert Poritzky. Doppler advocates assailed this "subjective" evaluation by the FAA staffers even though system performance was so close that subjective views came to play a large role.

Industry and civilian sources also can't get a handle on what the military will do when the scanning-beam decision is ratified by the four Federal agency chiefs. Four of the six military representatives on the selection committee voted for doppler, a black eye for scanning beam since the military has more than five years of operational experience. Arguments that TRS scanning beam ground systems are not suitable for a tactical military environment must await a military decision on frequency use—either C band or Ku band. Also expected is legal action by ITT/Gilfillan.

Meanwhile, the Europeans are joining camps for the three-way clash that's expected at the June ICAO meeting. The British are back-

ing their angry words about the Washington decision with money. And the French and West Germans are building scanning-beam systems unlike the American model. In fact, the French and Germans would like to see the ICAO delay its decision, giving Thomson CSF of France and Standard Elektrik Lorenz of West Germany more time to complete their systems.

The British are most advanced in their battle plan. Plessey Navaid, developer of the basic doppler theory, has received an additional \$360,000 in industry and government funding to help it carry its side into the ICAO meeting.

French and German civil-aviation authorities are in favor of a ground-derived data system, with sophisticated airborne boxes that would land the aircraft based on computer decisions. That way, "the current generation of pilots could be replaced by bus drivers," says one aviation industry source.

International and national pilot associations, along with the FAA, vehemently oppose such systems as unacceptable in the busy general-aviation environment. But the airlines have the last word. The American industry-advisory committee warns the FAA that a failure to sell MLS to the airlines would doom international development. However, if the economy stays sick for the next few years, a ground-derived system might be the most attractive system for the airlines because it could mean less pay for less skilled pilots. □



**Hardware.** Bendix airborne MLS package, above, is similar to one that would be needed for general aviation. At right is Hazeltine's prototype ground MLS system as it was laid out during tests being conducted at Wallops Island, Va.

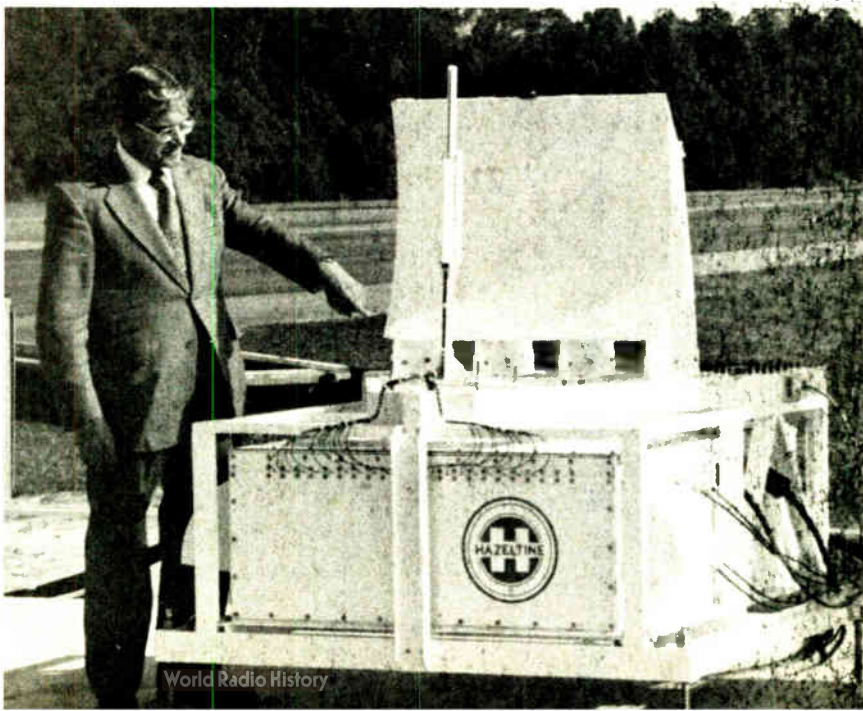

# SIEMENS

## To test linear IC's you can spend \$6,000 or \$100,000. Which makes sense?



It makes good sense to use an inexpensive Computest Model 735 at incoming inspection to identify bad devices. For under \$6,000, the 735 identifies defective linear IC's as rapidly as a \$100,000 "everything" machine.

The Computest 735 tests op-amps, regulators, sense amplifiers, comparators and custom linear

circuits. It sequences through 14 tests automatically, provides simple go-no/go analysis and data logging output to record why the device failed, the failed limit and the failed value.

The Computest 735 makes a lot of sense in your incoming inspection application. We will be happy to tell you why. Contact Cliff Small.

**Siemens Corporation**  
Power Engineering Division  
Computest Products

3 Computer Drive, Cherry Hill, N.J. 08002 (609) 424-2400



### Product development profile

# Tektronix' DMM/scope: a new record in portability

Aiming at the industrial and computer markets, designers of the series 200 miniature oscilloscopes packed ever more performance into the same small volume—then squeezed a digital multimeter in

by Andy Santoni, *Instrumentation Editor*

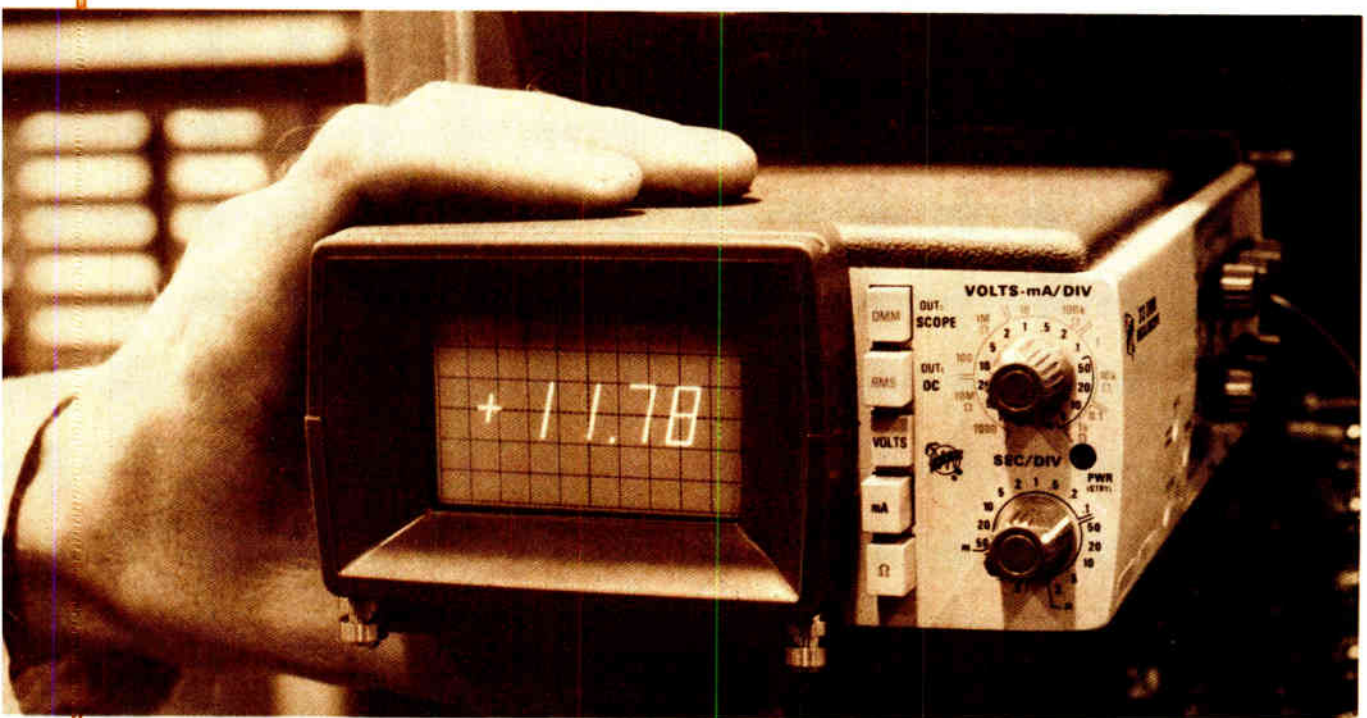

□ A high-quality oscilloscope both portable enough for a field engineer to carry around all day long and small enough to fit in a raincoat pocket: that was Tektronix Inc.'s goal when the company began work on a line of miniature oscilloscopes. The fifth in the series—the model 213 combination digital multimeter and scope—was announced recently [*Electronics*, Feb. 6, p. 123], and, like its predecessors, it meets or betters expectations in both performance and portability.

Weighing less than four pounds, the DMM/scope is housed in a handy package that measures 3 by 5¼ by 9

inches—small enough to hold in one hand, but not quite small enough for the average raincoat pocket (Fig. 1). Still, to fit a 1-megahertz scope, plus a true-rms DMM, plus batteries, into less than 142 cubic inches is an undoubted achievement.

Along the way, Tektronix engineers had to develop small cathode-ray tubes sensitive enough for battery operation, compact multiposition switches, and power supplies flexible enough for battery or line operation. And though linear monolithic ICs today seem a natural choice for high-density circuitry, eight years ago, when



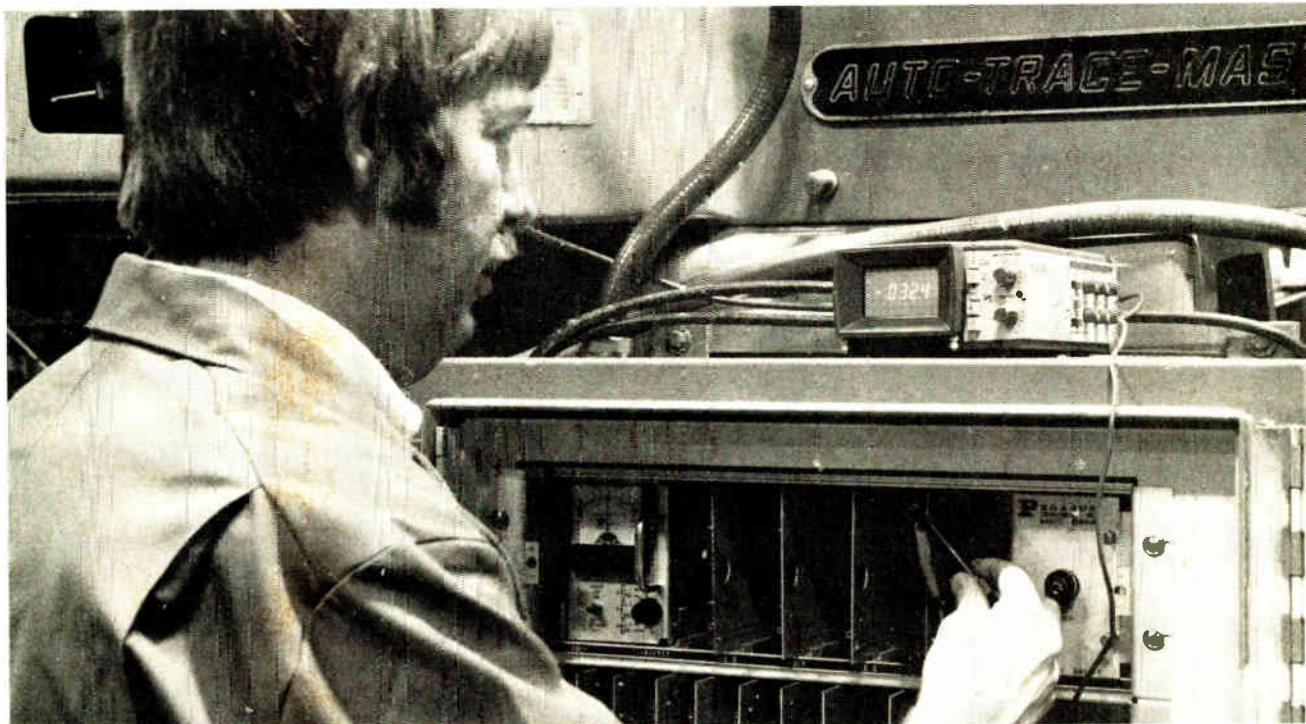

**1. Industrious.** A 3½-digit (2,000-count) multimeter and a 1-MHz-bandwidth oscilloscope are packed into Tektronix' model 213, the fifth 200 series miniscope. Battery operation makes miniscopes ideal for troubleshooting electronic equipment wherever ac-line power or reference to earth ground is unavailable or undesirable

this story begins, they were still a very new technology to apply in oscilloscopes.

It was in 1967 that Howard Vollum, chairman of the Beaverton, Ore., company, first put the idea of a pocket-sized scope to Hiro Moriyasu, then head of Tektronix' advanced circuit and techniques development group and currently manager of calculator engineering, Information Display division. But it was 1971 before the first "miniscope" appeared—the single channel model 211, which has a 500-kilohertz bandwidth. Three miniscopes were added to the line in 1973—the two-channel model 212, the two-channel storage model 214, and the single-channel, 5-MHz model 221—and the single-channel model 213 DMM/scope was added this year (Fig. 2).

The advanced circuit and techniques development group originally began designing a miniscope as a blue-sky effort. Among the engineers involved was David Allen, who was working at Tektronix in the summer of 1967 between semesters at Brigham Young University. When Allen returned to Tektronix after graduation the following year, Moriyasu, eager to get things moving and remembering Allen's experience, assigned him the design project.

Allen finished the last miniscope he'd started the summer before, then settled in to designing a marketable product. At a product planning meeting in June, 1969, a 1971 target introduction date was set, and the miniscope effort changed from a feasibility study to a product development project.

First, design goals were set. Preliminary electrical parameters to be met included a bandwidth of 50-kilo-

hertz and sensitivity of 10 millivolts per division. Input parameter goals were 10-megohm impedance and less than 10-picofarad capacitance. To simplify the layout of the control signal path and the input attenuator switch, circuit design was to include a gain-controlled operational-amplifier input instead of the standard resistive attenuator driving a fixed-gain amplifier.

To be useful in the field, the scope had to be lightweight, small enough to be held in one hand, and easy to use and maintain. To withstand the rigors of portability, the case had to be rugged and the controls and cathode-ray tube be protected against moderate jolts and bumps. And to prevent the user from misplacing a line cord or probe at a test site, those parts had to be integrated into the package.

Since the scope was to be portable and battery-operated, it was to be double-insulated to enable it to make measurements independently of earth ground. Also, of course, it had to be priced low enough to be marketable.

#### **CRT development**

Packing all the components into a small case created problems, most obviously over the cathode-ray tube. There were no small low-cost CRTs available, says Allen that were sensitive enough and had a flat face and internal graticule at a reasonable price. Tektronix also wanted to make its own miniature CRT in order to control the cost and technology of such an important component.

Development began on a tube with an envelope made entirely of ceramic materials—except for the faceplate. This would have been much sturdier and less expensive than a standard all-glass CRT envelope. But Tektronix engineers became uncertain that a working ceramic-envelope CRT could be made in time and at a low enough cost, and discontinued the effort. "It was

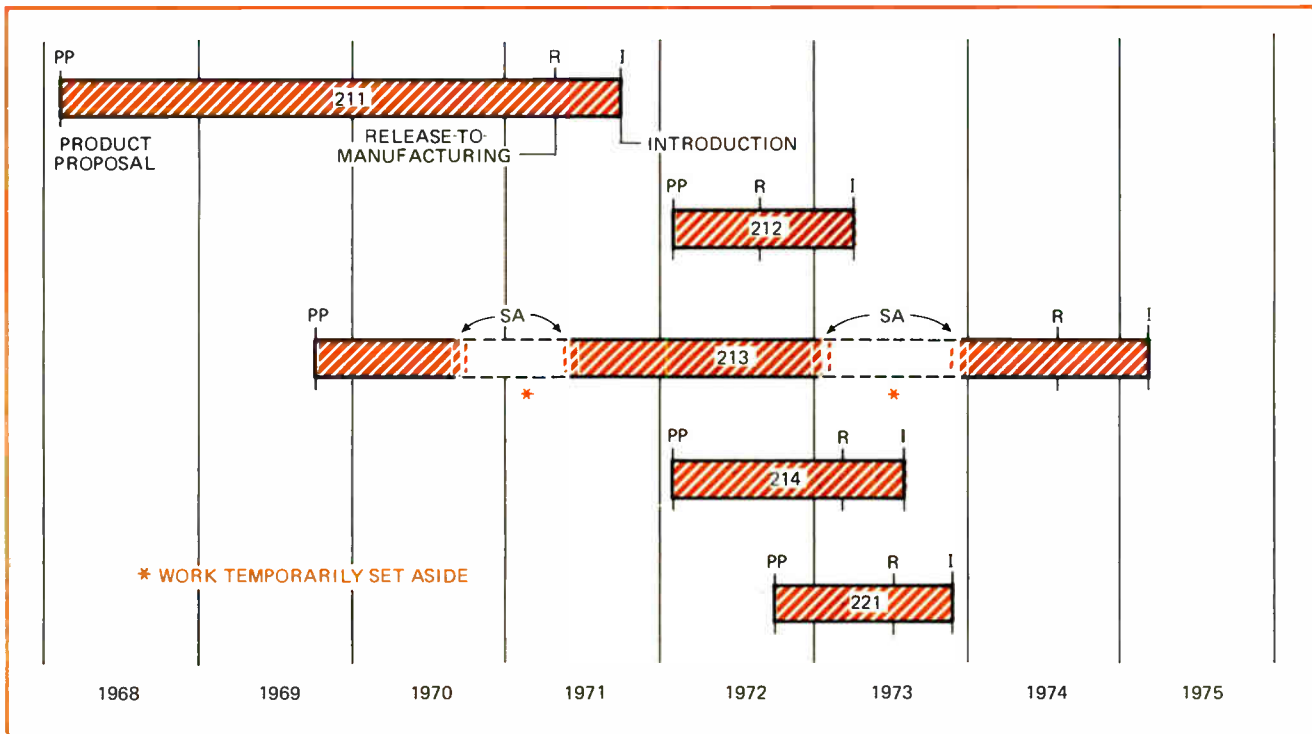

too much of a gamble,” says Allen.

Tektronix also tried developing a CRT that used hybrid deflection—magnetic for the horizontal and electrostatic for the vertical. This design would have allowed the two deflection mechanisms to be placed in the same plane, making the CRT an inch shorter, but it proved to be too expensive, consuming too much power and requiring too much circuitry.

The tube finally used, a unit designed by Tektronix staffer Connie Wilson, uses electrostatic deflection for both horizontal and vertical. It achieves a sensitivity of 17 volts per centimeter, compared with sensitivities of about 25 v/cm in CRTs then commercially available.

### The line on ICs

Integrated circuits then commercially available didn't meet Tektronix' requirements, either. At the time, notes Allen, “there weren't many linear ICs that fitted well into an oscilloscope.”

Tektronix' goal was to integrate the entire vertical amplifier in one IC and the entire sweep circuit in another IC. As part of the 200 series development program, work began on those two parts, along with a third IC for driving the horizontal and vertical deflection plates.

While Allen feared the ICs could not be readied quickly enough to meet the 211 development schedule, the first two parts—the sweep-trigger circuit and the CRT driver—were designed within 10 months. The third, however, took a little longer.

The first vertical amplifier circuit was designed specifically for the model 211. It contained two operational amplifiers that had positive inputs in common and tied to ground, permitting operation only in the inverting mode. Output dynamic range was about 1.5 v around zero, and open-loop gain was about 2,000.

**2. Schedule.** Although a DMM-scope combination was the second miniscope product to be proposed, it was the fifth to be introduced. Along the way, its development was delayed twice: first to concentrate on completing the model 211 and again when the effort of carrying out four design projects concurrently became too great.

“It was what we needed,” says Allen, “but it wasn't universally useful.” He therefore decided to switch to developing a more general-purpose design that would be more economical in the long term. This second device contained two isolated, FET-input op amps with open-loop gains of 100,000 and unity-gain bandwidths of 4-MHz—but its delayed start led to fears it would not be ready in time.

Fortunately, a group within Tektronix' Information Displays division was developing a quad op amp for a graphic terminal. This IC more than met the 211's requirements, and since it was close to completion, Allen chose to run with it instead of the other vertical amplifier circuits. To make this circuit operate in the model 211, the metallization pattern on the die had to be altered. Parts of two of the four op amps were used as constant-current sources for the FET inputs on the other two op amps. The rest of the circuitry was not needed. The result was a simple circuit that performed much like the earliest vertical amplifier design but could be used in a wider range of applications.

The sweep and trigger circuit IC was made by a proprietary Tektronix FET and bipolar manufacturing process. It suffered from unwanted interactions between the two sections, which were eliminated by distributing power and ground separately.

As with many linear IC designs, all three of the 211 circuits had oscillation problems. Two were modified internally to eliminate the problem, but the circuitry external to the CRT driver was modified instead. Next time, says Allen, he would prefer to make all ICs stable



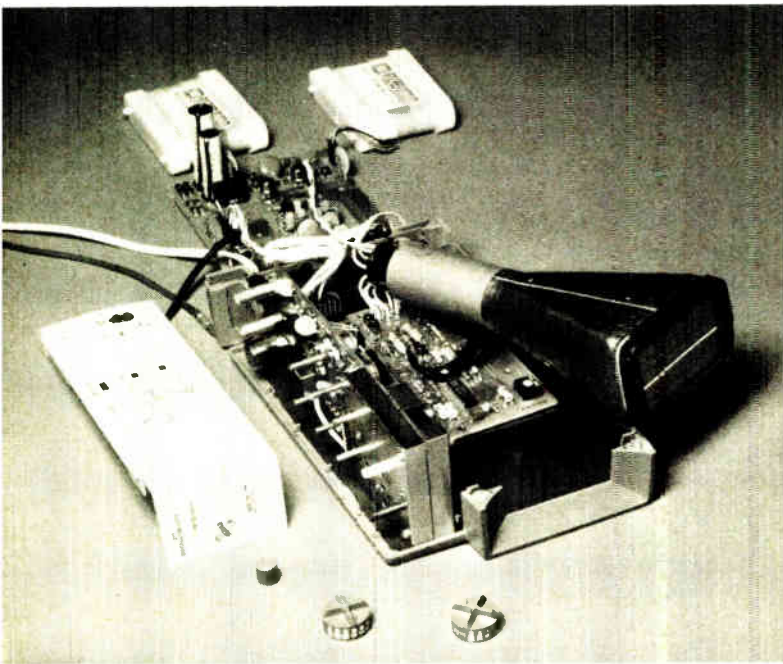

**3. Flexible.** With the bottom cover removed, most components of the model 211 are accessible for testing or repair. The subassemblies of the models 211, 212, and 214 are cabled together so the instruments can operate when in a semi-assembled state. The 221 and 213 plug together without cables; extender boards are available should troubleshooting become necessary at any point.

without external circuitry—a goal much easier to attain nowadays, thanks to the advent of computer-aided design.

As for packaging the ICs, the original goal put small size above every other consideration, but it had to be modified twice to take ease of repair and handling into account also (Fig. 3). The earliest ICs were housed in flat packages that occupied less space than dual in-line plug-in types; but the fact that they had to be soldered to the printed-circuit board would have made IC replacement difficult, so plug-in packages were selected after all. The 16-pin round package that was next designed proved hard to handle because it was so small, and a rather larger 16-pin package was the final choice.

Integrated circuits were an obvious solution to shrink board space requirements. Not so obvious was how to implement sweep speed and attenuation switching when standard selector switches would be too large.

The model 211 would need two multiposition switches that would take as little space as possible and still be low in cost. The solution worked out by Scott Long of Tektronix' switch department was to etch the switch patterns onto the multilayer input circuit board and to clamp the wipers over the board. This simple design uses inexpensive injection-molded plastic housings and requires no discrete wiring to the contacts.

The requirements for small size and battery operation also meant that standard power-supply designs would not be adequate. In the supply designed for the model 211 by Wendell Damm, an electrical designer on the 200 series team, the ac line current was limited by a series capacitor and rectified; then it was used to charge

the 10 internal rechargeable AA nickel-cadmium cells, which also acted as large filter capacitors. The dc voltage was fed to a dc-ac converter multivibrator which was connected to a newly developed small, efficient coaxial bobbin power transformer. This transformer, which supplied the necessary operating voltages to the oscilloscope, had an insulation voltage of 4,000 V dc which, along with its efficiency, would make it ideal for double-insulated applications.

### The finishing touches

From the user's point of view, perhaps the most intriguing part of the model 211's design is its packaging. The job of putting all of the pieces together in the smallest possible box, while maintaining operational simplicity, went to industrial designer Al Hill.

At first, attempts were made to put the controls on the front of the oscilloscope. But, notes board chairman Vollum, "When you hand-hold it, you can put controls in various places." It was decided, then, that the instrument would be right-handed: held in the left hand and with controls mounted on the right side.

The probe and line cord were spooled around the back of the scope to make them easier to carry along, and while both are permanently attached to prevent misplacing them, the probe plugs in internally so that it doesn't have to be unsoldered should replacement ever be necessary. Unfortunately, the hoped-for automatic cord-reel design did not work out because it would have been too bulky and expensive, says Allen.

The first designs for the miniscope case proposed using Tektronix' standard vinyl-clad aluminum. Hill felt, however, that plastic housing could offer the same strength with less weight and smaller size. After convincing Tektronix management that plastic was a viable case material, Hill designed a three-piece, glass-filled ABS housing that measured 3 inches high, 5 inches wide, and 9 inches deep.

The plastic moldings were fairly large and complex for Tektronix, and the die-maker had to make some slight changes in the design to improve manufacturability. Since production began, only details have been changed, and cases presently being manufactured can be retrofitted onto older instruments.

Since the case was not metallic, electromagnetic interference was a possible problem. To prevent it, aluminum, carbon, and silver paints were applied to the inside of the case. Finally, more economical aluminum tape was chosen.

As the pieces came together, most of the design goals were realized. In fact, both bandwidth and sensitivity were better than expected—500 kHz rather than 50 kHz, and 1 millivolt per division instead of 10 mV/div. Size and cost were within range. About the only real disappointments were in the input circuits: input impedance was only 1 megohm and capacitance was over 100 picofarads, and the gain-controlled op-amp input circuit was abandoned in favor of a standard resistive attenuator.

Standard resistive attenuators use fairly complex switches and variable-capacitor networks, which between them compensate the input circuitry for stray ca-

capacitances and inductances and maintain frequency response over the oscilloscope's bandwidth. Trimming a half-dozen compensation capacitors, though, can be a tricky job.

A gain-controlled op-amp circuit could eliminate much of this complicated circuitry by varying the gain of the input amplifier rather than the level of the input signal. Tektronix attempted to design an input circuit that used variable feedback on an op amp to control the circuit's gain. Since the input to a negative-feedback op-amp circuit is a virtual ground, the effects of stray parasitics would be eliminated. But Allen found that at high frequencies, where the op amp's response began to fall off, the circuit did not have enough open-loop gain to require enough feedback to provide this virtual ground, and the circuit became too noisy for use in an oscilloscope.

After the gain-controlled op-amp circuit was discarded, a more standard switched attenuator with an input impedance of 10 megohms was attempted. This circuit could not be relied upon to meet its specifications because the small spacings between circuit-board paths did not have a consistently high enough impedance, especially under humid conditions. Finally, a switched attenuator with an input impedance of 1 megohm, where variations in pc-board impedances would have less effect, was incorporated.

In September, 1969, while development work on the model 211 was just getting up speed, Bill Walker, Tektronix' group vice president in charge of engineering, suggested to Moriyasu that the miniscope should incorporate a digital multimeter, to make it an even more versatile tool (Fig. 4). Work on a DMM/scope began immediately, but was deferred or delayed twice: first it was temporarily set aside to allow completion of the model 211 design, which was released to manufacturing in 1971; then it was continued parallel with the development of models 212 and 214, but had to be halted a second time shortly after the point when model 221 development also began.

### The second and third models

Design work on both the 212 and 214 began early in 1972. Model 212, a two-trace version of the model 211, turned out to be a fairly straightforward design. It resembles the 211 except for the input amplifier board, which now had to contain two channels, and the rear-panel probe carrier, which had to have space for two probes.

The only real problem encountered during the model 212 development project was getting all of the necessary input and control circuitry on one printed-circuit board—and doing it in such a way that the two vertical deflection controls and the horizontal deflection control would be visible to the scope's user. In the end, the two vertical deflection controls were mounted in the same locations as the horizontal and vertical controls in the model 211, and the 212's horizontal deflection control was located near the back of the instrument's side panel. This led to crosstalk problems between the vertical and trigger circuits as signal paths ran the length of the board, but these were eliminated by careful shield-

ing and layout—accounting for printed-circuit runs that aren't connected on one end.

The extra circuitry was fit onto the board first by making the board longer. On the 211, there was about an inch of space between the end of the board and the back of the cabinet which meant about two square inches of pc board space could be squeezed into the 212. Components were mounted on the board standing up rather than lying flat, and they were mounted on both sides of the board. In addition, the four op-amps of the vertical amplifier were now all used, two for each channel, and the amplifiers were redesigned to eliminate the need for current sources.

Model 214, the storage scope, took advantage of these changes. Also, a new, low-current storage CRT, capable of operation from a battery, was developed. Careful design of the cathode cut power consumption from the ½ to 2 w of standard storage CRTs to about 250 mw in the 214 storage CRT. Small push buttons, with extenders to reach the front panel, actuate the storage feature. The instrument was introduced in August, 1973.

While the model 211's bandwidth was 500 kHz, 10 times the 50-kHz design goal, some customers needed response to 5 MHz. The model 221, as the 5-MHz scope was named, required a higher-capacity power supply and more sensitive CRT to operate at higher frequencies. The new CRT achieves a sensitivity of 13 volts per centimeter while using many of the same mechanical parts as earlier units. The power supply, though, was a completely new design, in which the power-line voltage is rectified and used as the power source for an isolated power inverter. The output of the power inverter is used to charge the battery and supply the instrument's internal power supply. This contrasts with earlier designs, which had the battery charger and batteries floating on the power line. The design also permits operation from dc power sources.

New input amplifier circuits also had to be designed

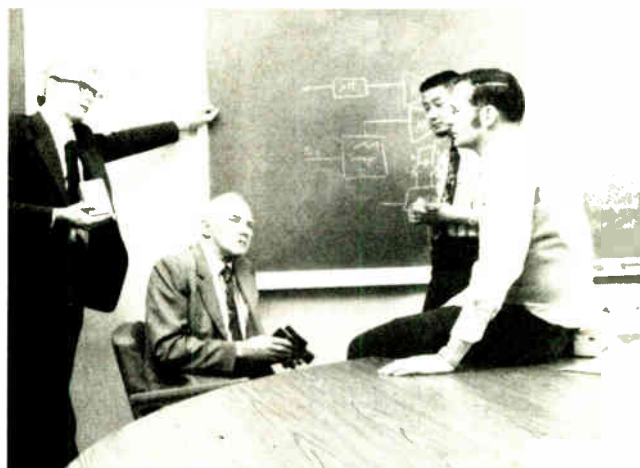

**4. Prime movers.** Tektronix board chairman Howard Vollum (seated left) suggested that the advanced circuit and techniques development group, then headed by Hiro Moriyasu (standing right), work on a small, battery-operated oscilloscope, which led to the 200 series. Bill Walker, (left), group vice president in charge of engineering, first conceived of a DMM/scope combination, and David Allen headed development of the five 200 series instruments.



to operate at the higher speed, and Tektronix decided to go with discrete components because new large-scale ICs would not have been developed quickly enough, explains Allen.

### The DMM/scope

With the 221's introduction in October, 1973, the 200 series design team could again pick up on the DMM/scope. To the user, model 213 is a DMM added to a 211 with double the bandwidth. Internally, however, the 213 is much different from the 211 (Fig. 5).

Because the instrument has current and resistance measuring capabilities, the input circuitry has to perform conversion functions not necessary in an oscilloscope, which only displays voltage waveforms. To handle the input range switching for all three functions, Tektronix abandoned the wafer-type switch of earlier 200-series instruments in favor of a cam switch controlled by a front-panel knob and actuating contacts on the input board. More switch functions can be performed by this design because an increase in the number of switched circuits increases only the length of the cam and board space required, rather than increasing the radius of the board space taken up by the switch.

This flexibility also permits wider pc-board line spacings, so the resistance between runs does not drop so drastically as humidity increases. This was a major factor in improving the 213's input impedance from 1 megohm to 10 megohms, as previously attempted but abandoned for the 211. In the 213, higher input impedance

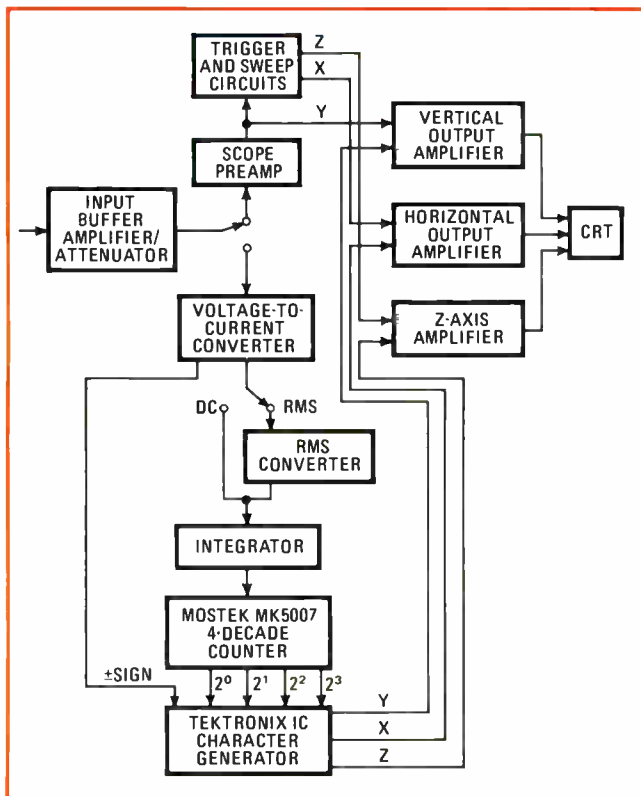

**5. Paths.** In the model 213, an input signal is amplified, then switched to either scope or DMM circuitry. Either the voltage or current waveform, or the numerical value of a voltage, current, or resistance input, can be displayed on a six-by-10-division CRT.

## Product development profiles

Unusually successful products and product lines do not succeed without the perception of a real need, without a well-thought-out and sustained design effort, and without a record of problems either solved or circumvented. Because that kind of development history has ideas to offer other engineers, *Electronics* here offers the latest in its continuing series of "Product development profiles."

The story of Tektronix' 200 series of miniature oscilloscopes begins with the imaginative conception of a "pocketable" scope and ends with a whole range of precise, portable instrumentation that fits an increasingly electronic society's growing need for on-the-spot troubleshooting.

Other articles in the series have covered the HP-35 scientific calculator [*Electronics*, Feb. 1, 1973, p. 102]; the Intel 1103 MOS random-access memory [April 26, 1973, p. 108]; the HP 5345A counter [Feb. 7, 1974, p. 114]; and the Cambridge Research and Development Group's variable speech control system [Aug. 22, 1974, p. 89].

was a must: customers would expect the 213 to have as high an input impedance as other DMMs.

Following the input attenuator, the signal is amplified by an input buffer amplifier, then switched to either the oscilloscope preamplifier or to the DMM circuitry. In the scope mode, it is fed to the trigger/sweep circuits, which drive the horizontal output amplifier, and to the vertical output amplifier. In the DMM mode, the signal is routed to an integrating converter and a Mostek MK 5007 4-decade counter to determine its value in BCD form. A Tektronix-made BCD-to-seven-segment decoder/character generator, the only new Tektronix IC in the 213, provides X-, Y-, and Z-axis outputs to the horizontal, vertical, and blanking amplifiers. Since both DMM and scope inputs are required in the output amplifiers, and earlier 200-series output amplifiers did not have two inputs, new circuits had to be designed. Because of the simplicity of the circuits, discrete components were used for most of the amplifier functions.

The one IC in the output stages is a differential amplifier with potentiometer-controlled gain. This permits dc control of the variable horizontal magnifier rather than routing the signal itself through a potentiometer.

The 213's voltage-deflection factors range in 14 steps from 200 mV/div to 100 V/div over its full-rated bandwidth, and down to 5 mV/div at a 400-kHz bandwidth. As a spin off from its DMM mode, the instrument can also display current waveforms: the 14 deflection factors here go from 5 microamperes to 100 mA/div on bandwidths of dc to 200 kHz on the 5- $\mu$ A/div and 10- $\mu$ A/div scales, dc to 400 kHz for the other scales. Horizontal deflection factors are 2 microseconds to 500 milliseconds per division in 17 steps, and sweep rate can be increased up to five times by a variable sweep magnifier.

As for the 213's DMM mode, the full-scale voltage, current and resistance ranges run from 0.1 to 1,000 V rms or dc, 0.1 mA to 1 A rms or dc, and 1 kilohm to 10 megohms. □

# Eight ways to better radio receiver design

By harnessing the latest accumulation of electronic innovations, lower distortion, better linearity and image suppression attainable; separate stages for agc and amplification provide one of the keys

by Ulrich L. Rohde *Rohde & Schwarz, Inc., Fairfield, N.J.*

□ Radio receiver design, while perhaps the oldest of the electronics arts, is still susceptible to improvement. New components such as very-high-frequency crystal filters, p-i-n diodes, and high-power rf transistors are capable of changing many of the basic, time-honored concepts, enough to yield receivers with lower distortion, better image suppression and better linearity.

The most benefit can accrue to receivers operating in the high-frequency band—2 to 30 megahertz—but many new concepts can be applied equally well to receivers operating at any frequency.

The preliminary step in designing a receiver is the sketching of a block diagram in which expected noise figures and losses (which also produce noise) are assigned for each of the sections. This will allow calculation of the receiver's noise figure. For example, in the block diagram in Fig. 1, if the noise contributions and losses are added up, the cumulative figure is 8 dB.

Each stage also has to be optimized for dynamic range as well as for noise figure. Generally, the broadest dynamic range will be obtained if the gain of the rf and i-f sections is held to a level just sufficient to compensate for the losses. In the block diagram, for instance, the losses—0.5 decibels in the input filter and automatic

gain-control attenuator, 6.5 dB in the mixer, and 4.5 dB in the i-f filter—are compensated by the approximate 11-dB gain of the rf amplifier. But note that the second mixer, because of the vhf crystal filter's minimum bandwidth of  $\pm 3.5$  kHz, is the receiver's most vulnerable stage with respect to overloading; here, higher voltages are concentrated in a narrow bandwidth.

With the block-diagram parameters set, the designer then can move on to the individual stages. This is where the new components allow new design approaches. Let's now consider each of the eight steps that can be taken to improving receiver design.

↑ *Set the intermediate frequency higher than the receiver band to ease image suppression.*

In the past, two or three intermediate frequencies, each lower than the received band, were used in double- or triple-conversion schemes, with the receiver's selectivity being set primarily by the circuits operating at the lowest i-f (often the familiar 455 kilohertz). This was because the components available made it easiest to achieve the necessary selectivity at low intermediate frequencies. However, a low first i-f accentuates the problem of suppressing image frequencies in a receiver. Un-

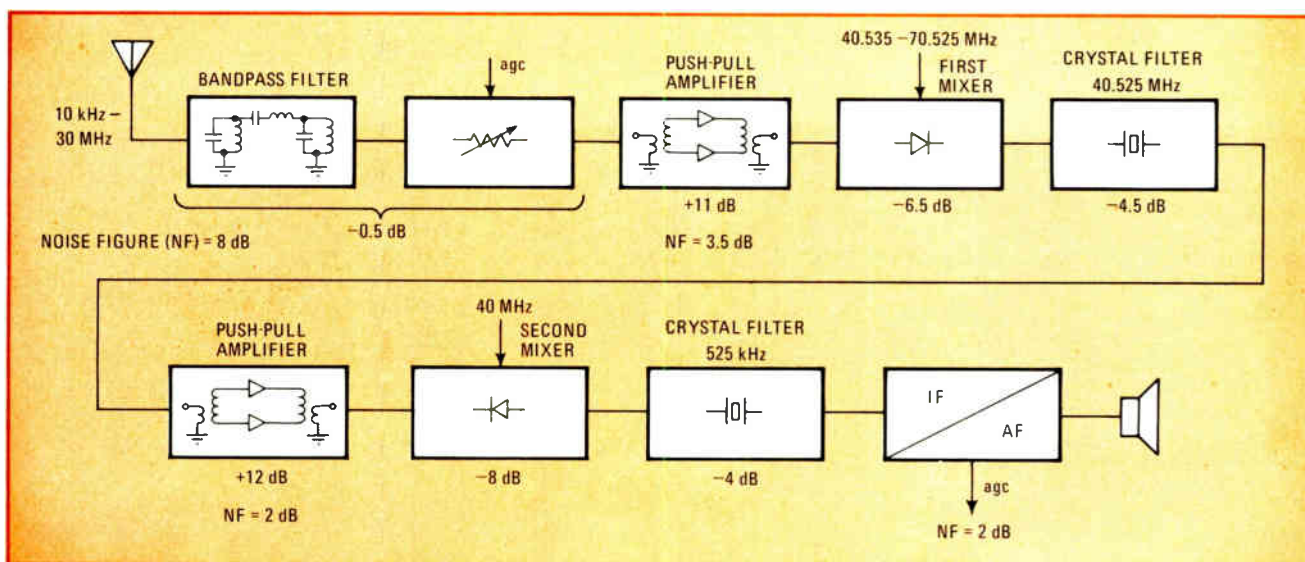

1. **The block.** A receiver's block diagram can be used to analyze the needed gains and to find the receiver noise figure. Stage noise figures, gains, and losses (in dB) are added directly for over-all noise figure. Gains should also balance losses for wide dynamic range.



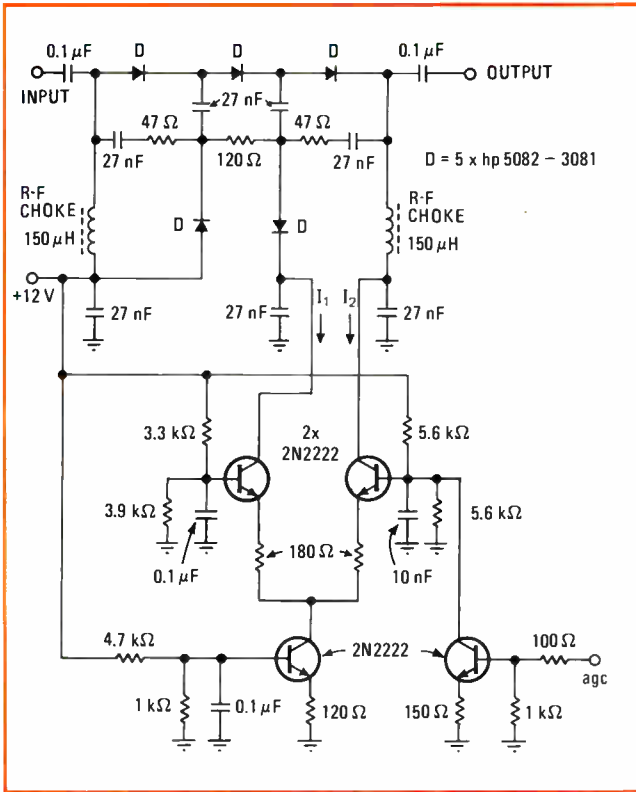

**2. Attenuator.** Five p-n diodes in a double-T configuration act as attenuator. The sum of the transistor collector currents should be maintained constant to hold input and output impedances constant.

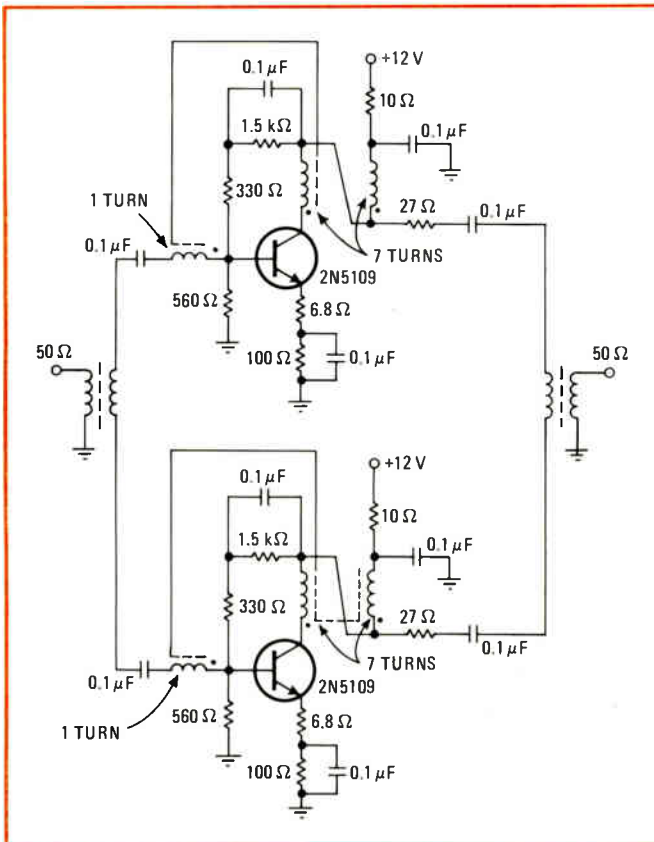

**3. Push-pull.** Two high-power rf transistors can provide an amplifier with good linearity. Feedback from unbypassed emitter resistor, collector-to-base resistors, and collector-to-base transformer linearize the circuit. Curve shows reduction in distortion levels.

wanted incoming frequencies, when mixed with the local oscillator output, can also fall within the i-f band. If a 1-MHz i-f is used, the image suppression, although it may start at 80 dB at the lowest input frequency (2 MHz), will drop to about 30 dB at 30 MHz. For example, for a received frequency of 30 MHz, the image would be 32 MHz—which is near the received frequency—and the input filter has little effect. But at 2 MHz, the image is at 4 MHz, or twice the input frequency where enough selectivity is provided. To reduce the effect of image frequencies that are close to received frequencies, designers have had to turn to tracking bandpass filters at the radio-frequency input, which added to the expense.

The local oscillator also had to be tunable over a range essentially equal to the receiver input range. For a receiver covering 2 to 30 MHz, for example, the tunable ratio has to be 1:15. This ratio calls for a difficult mechanical design to compensate for local oscillator variations in tracking the input frequencies.

Now that vhf crystal filters (30 to 120 MHz) are available for the i-f circuitry, designers can eliminate such problems. If the i-f is set higher than the incoming receiver band, an elliptical low-pass filter with a cutoff, say, of 31 MHz for a receiver of 2 to 30 MHz, can be used to give as much as 80 dB suppression to frequencies above the desired received band. This also makes the image suppression constant, and independent of the received frequency. The same filter will also help reduce the radiated power from the local oscillator, so that several such receivers can be operated close to one another.

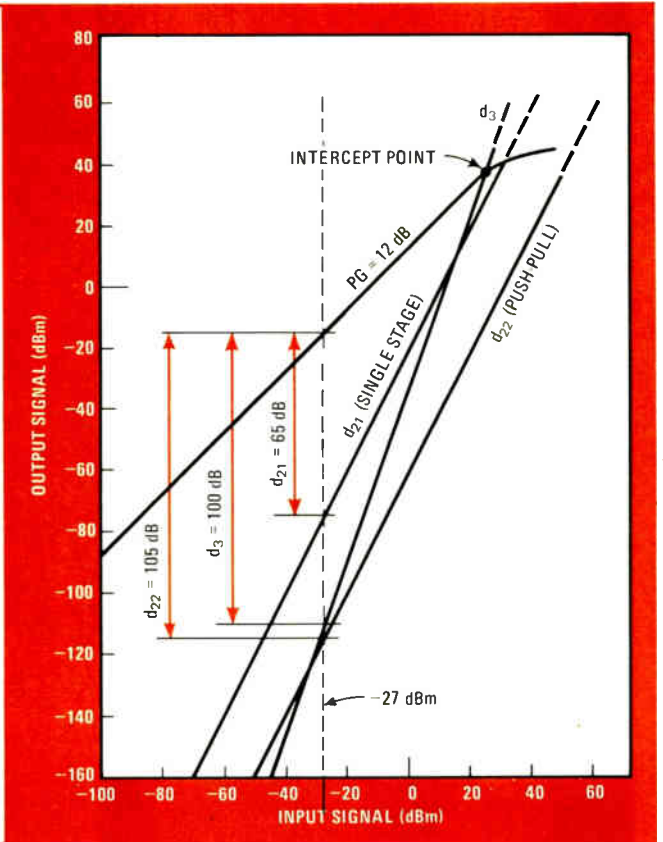

And with the i-f at, say, 40 MHz, the local oscillator need only cover a range of about 42 to 70 MHz (for a receiver of 2 to 30 MHz), a ratio of less than 1:2. This considerably eases the oscillator design task and reduces the possibility of oscillator harmonics mixing with incoming signals to produce unwanted signals in the passband.

**2 Use separate agc and amplification stages to allow more precise control of distortion.**

In the past, vacuum tubes were used for both amplification and agc. But the tube's nonlinear characteristic meant that as soon as an agc voltage was applied, intermodulation distortion appeared. The same is true for bipolar and field-effect transistors. If, however, the two actions are performed in separate stages, each can be optimized. For example, a p-i-n diode attenuator can be placed between the input low-pass filter and the r-f amplifier and used for agc as in Fig. 1. The diode attenuator must provide constant impedance at its ports, since any change in load impedance will disturb the filter's characteristic, and any change in source impedance for the amplifier will change its noise and distortion performance. Figure 2 shows a convenient double-T section p-i-n-diode attenuator which maintains its input and output impedances constant. The differential amplifier provides a current distribution on the two leads into the attenuator to achieve this (the sum of the collector currents must be constant).

**3 Use rf power transistors with heavy feedback in push-pull arrangement to suppress distortion.**

In most earlier receivers, only certain vacuum tubes were considered linear enough for use in class-A rf front ends. Designers accepted the liabilities of vacuum tubes to achieve low intermodulation distortion. Today, high-power linear rf transistors are being produced, which, if run at high dc current and with substantial voltage and current feedback (which is not usually done), can give better linearity than any vacuum tube. Such a circuit, using highly linear uhf power transistors, is shown in Fig. 3 together with its performance curve.

The amplifier, when designed in a push-pull arrangement, can provide almost 40 dB more suppression of second-order distortion products than a single-stage setup. The amplifier gives about 11 dB gain (which is set by the amount of feedback). Actually, the amplifier can give up to about 40 dB more gain without feedback, but the reduction in gain is directly transferred to the dynamic range. Three types of feedback are used: the 6.8-ohm unbypassed emitter resistor provides the current feedback; the unbypassed 330-ohm collector-to-base resistor provides the voltage feedback; and since these two feedbacks will change input and output impedance, a third type—transformer feedback—is used to provide 50-ohm input and output impedance. The result is that the amplifier's standing-wave ratio will be less than 1:1.2 from 100 kHz to almost 200 MHz.

The performance curve, as in Fig. 3, best describes the possibilities of this new type of rf stage. With an input of -27 dBm (a two-tone signal of 20 millivolts each), the gain is 12 dB. At this level, the second order intermodulation distortion (IMD)—( $f_1 \pm f_2$ )—is 65 dB down

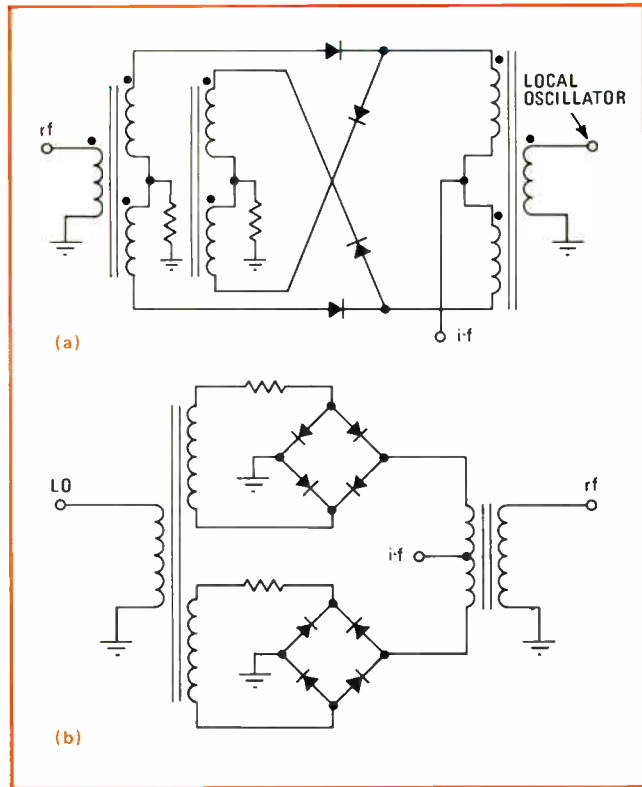

**4. Mixers.** Dynamic range is preserved in mixer at high signal levels by putting resistors in series with push-pull, bridge-connected diodes (a). Transformer in lower circuit suppresses spurious signals.

(single stage) and the third order IMD ( $f_1 \pm 2 f_2$ ) is 100 dB down. The push-pull arrangement will further reduce the second order IMD to -105 dB. The intercept point occurs at an input of about 22 dBm.

**4 Use easier-to-match hot-carrier-diodes in double-balanced, high-level mixers.**

Most designers are aware that push-pull mixers have certain advantages over the single-stage variety (in sensitivity and distortion suppression), but cost has often discouraged their use. Now, reasonably priced, low-noise, hot-carrier (Schottky) mixer diodes are available.

It is worth noting here that double-balanced mixers with FETs have also been recently proposed. Such circuits give excellent suppression of third-order intermodulation distortion, but because the FETs cannot be matched closely enough, the second-order distortion suppression is usually poorer (about 20 to 30 dB less) than can be obtained with hot-carrier diodes. The FETs also introduce a limiting action at a lower signal level than do the hot-carrier diodes.

The main advantage of the hot-carrier mixers is the better matching than is possible with the conventional silicon or germanium diodes. They also will accept higher local oscillator (LO) drive. In addition, these hot-carrier diodes do not show the  $1/f^2$  noise which eliminates silicon diodes at low frequencies.

Special circuits, as shown in Figs. 4(a) and 4(b), have been developed to optimize the mixer performance. In some cases, as many as 16 diodes per section—64 diodes altogether—have been used. The second mixer shown in



the block diagram (Fig. 1) will receive stronger signals than the first one and must, therefore, have a wider dynamic range. This is accomplished as in Fig. 4(a), by putting resistors in series and using two mixer stages in push-pull. The resistors, however, increase losses from 6.5 to 8 dB. The high level mixer of Fig. 4(b) uses a hybrid transformer to suppress spurious signals.

**5 Use low-loss vhf crystal filters in i-f stages for high selectivity and image suppression.**

Until recently, it was not possible to mass produce crystal filters and still obtain high selectivity with low insertion loss. Figure 5(a) illustrates the typical response of today's crystal filters. Since the image suppression from the first i-f to the second i-f depends upon the slope of the filter, 80 dB suppression can be achieved easily. These filters, which recently were selling for \$400 each, have dropped to \$50 in production quantities.

Earlier mechanical filters (of magnetostrictive design) showed rather high IMD at the input because of the non-linear action of the transducer. Modern mechanical filters now use piezoelectric transducers to reduce non-linear action. However, similar effects can also occur with crystal filters if the input transformer uses iron that saturates at low levels. Therefore, a configuration as in Fig. 5(b) should be used to reduce this effect. Actual tests should also be made by applying two signals of 1 volt each to the 50-ohm input of the filter; the spurious signal developed should be more than 80 dB down.

**6 Use a double-conversion i-f with fixed low-pass filters to give variable bandwidth and constant slope.**

It has always been a problem to maintain steep edges in the i-f circuit bandpass characteristic when using narrow-band i-f bandpass filters. However, with a new scheme that twice inverts the incoming signal in the frequency domain, low-pass filters can be used with steep

edges that remain constant regardless of the narrowness of the pass-band. One additional advantage of low-pass filters is that they have a transient time that is half that of the band-pass units. This avoids unnecessary ringing in the filters when pulsed signals are being received.

The concept can be explained from the diagram in Fig. 6. The main selectivity circuit is located in the second i-f, at 525 kHz. The bandwidth of the second i-f (and thus of the overall receiver) is selectable between 150 Hz and 12 kHz. With this method, the bandwidth is selected not by changing the filter, but by changing the frequency offset between two local oscillators.

The 525-kHz signal with, for instance, a maximum bandwidth of  $\pm 6$ -kHz (510 to 531 kHz), is first mixed with a 467-kHz local oscillator signal to produce a signal between 52 kHz ( $525 - 6 - 467$ ) and 64 kHz ( $525 + 6 - 467$ ). This signal is applied to a low-pass filter designed with crystals to give a steep characteristic on the 64-kHz side (this edge will form one of the edges of the eventual i-f bandpass characteristic). This is a fixed-frequency filter and thus can be tuned and set once.

Then the 52-64 kHz signal is returned to the 525-kHz center frequency and mixed with a local oscillator frequency of 583 kHz to bring it back up to 52-64 kHz, but the frequency spectrum is reversed from that of the first situation (frequency components that were at the 64-kHz edge are now 12 kHz below the edge). A filter with a steep slope on the 64-kHz side cuts off the signal components that were on the 52-kHz side in the first step. Finally, the resulting steep-sloped signal is brought back down to 525 kHz and demodulated.

Note that the passband edges are fixed and the bandwidth is narrowed simply by adjusting the offset between local oscillator frequencies. For example, for a 2-kHz bandwidth, the local oscillators would be set at 462 kHz ( $525 + 1 - 64$ ) and 588 kHz ( $525 - 1 + 64$ ). Since the edges are set by the low-pass filter, this gives steep

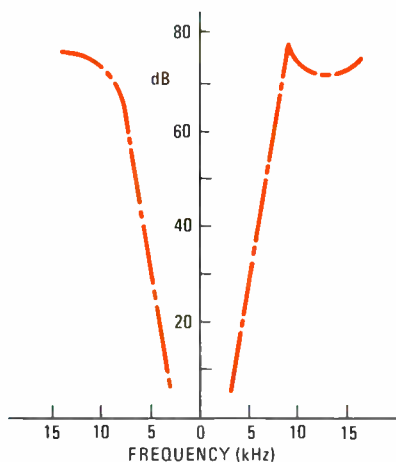

(a)

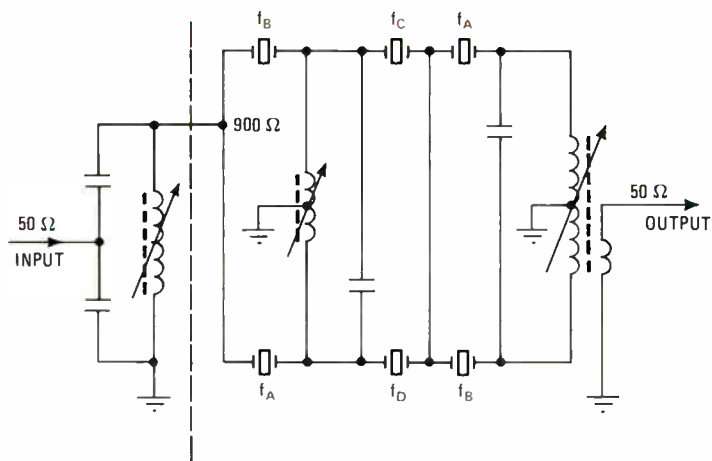

(b)

**5. Filter.** Low losses and steep slopes can be achieved with crystal filters (lower curve is expanded to show detailed performance around center frequency). In the circuit shown here filters with identical subscripts are set for the same operating frequency.

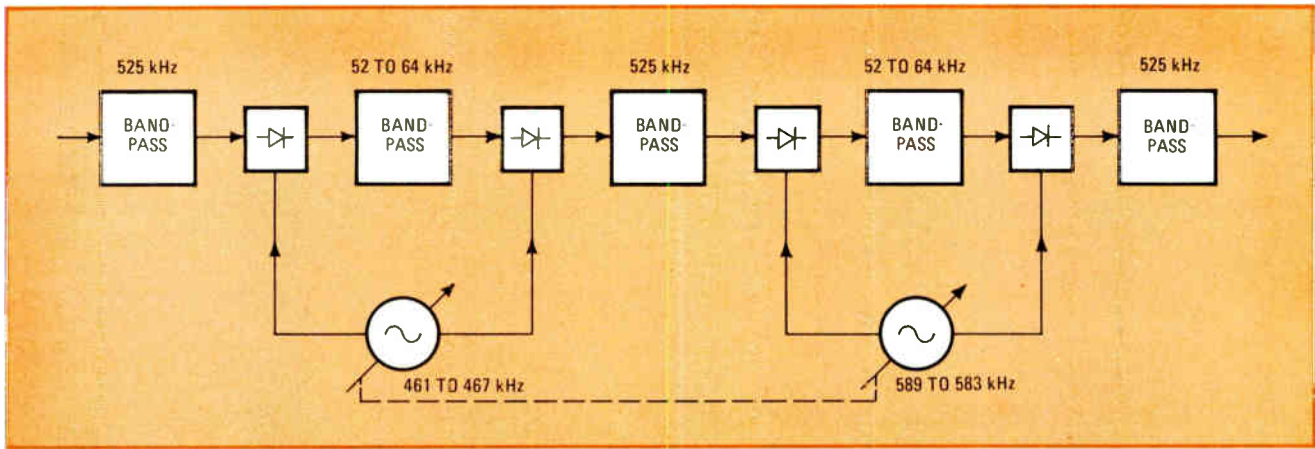

**6. Conversion.** Receiver i-f bandwidth is set by frequency offset between two local oscillators in second i-f. Incoming signal is converted twice to the 52-64 kHz range, where filters with steep 64-kHz edges shape the over-all characteristic.

edges even at passbands as narrow as 150 Hz. This technique also gives a phase or delay characteristic symmetrical with respect to the center frequency. Crystal or mechanical filters normally used in the i-f are of Chebyshev design, which results in nonlinear phase characteristics. However, the low-pass filters can be Bessel-type, which do provide the necessary linearity.

**7** Consider the oscillator sideband noise in determining negative effects on receiver's dynamic range.

Oscillator sideband noise can significantly degrade the receiver dynamic range through an effect called blocking. Oscillator noise can mix with a strong incoming signal, close in frequency to the desired signal, and produce a noise in the i-f passband that interferes with the desired signal (by reducing signal-to-noise ratio). Heavy distortion due to blocking can occur at signal levels well below the 3-dB compression point (another term often used to describe dynamic range). The 3-dB compression point describes the start of cross-modulation and usually occurs at higher signal levels than the blocking effect. For example, as shown in Fig. 7, with sideband noise of 145 dB/Hz, at 20 kHz off the center frequency of

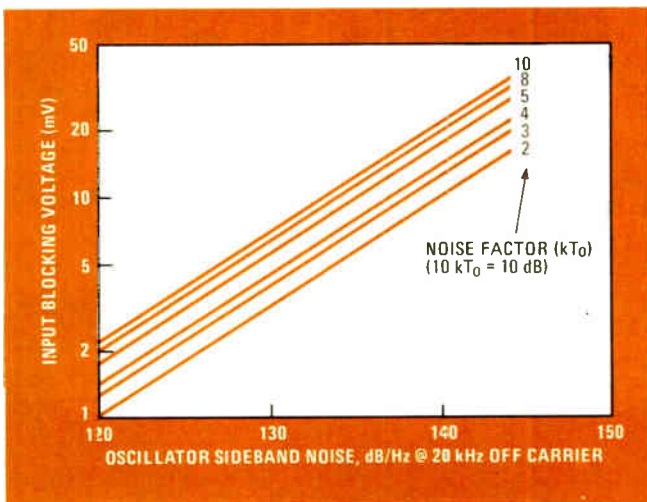

**7. Sideband noise.** Input voltage level that produces 3-dB blocking is related to local oscillator sideband noise, which mixes with incoming signal, and also to over-all receiver noise factor.

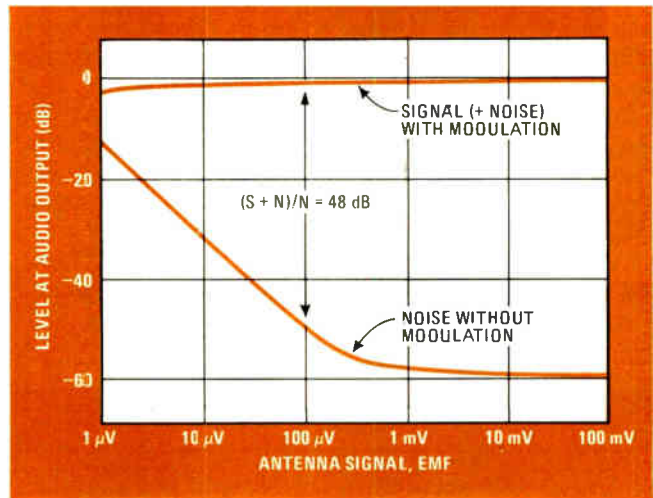

**8. Gain.** Agc circuits increase output signal-to-noise ratio (vertical difference in dB between two curves). When ratio exceeds about 48 dB, input attenuator agc is activated for wide dynamic range.

the local oscillator and with a receiver noise figure of 10 dB, an input voltage of roughly 50 millivolts will cause a 3-dB blocking of the receiver, while the 3-dB compression point may not be reached until the input signal reaches a level as high as 1 volt. Also note that if a synthesizer is used for the local oscillator, spurious signals must also be avoided, because they, like the noise sidebands, will degrade performance.

**8** Use proper agc distribution in the receiver for widest possible dynamic range.

The dynamic range is affected by the lowest signal level at which the agc is applied to the rf attenuator. Agc should be first used in the i-f circuits, until the antenna signal reaches a level equivalent to a signal-to-noise ratio of about 48 dB (see Fig. 8). Then, to protect the second mixer from stronger signals, the attenuator agc should be activated. Too-early activation of the attenuator agc not only reduces the S/N ratio, but may also produce instabilities in the agc circuit. Since the agc circuit is a closed-loop feedback system, it must be carefully analyzed; a Nyquist diagram, for example, should be calculated to optimize its performance. □



## Optically coupled ringer doesn't load phone line

by William D. Kraengel Jr.  
Valley Stream, N.Y.

If passed through an opto-coupler, the ringing signal on a telephone line can be made to operate a remote ringer without overloading telephone-company lines, without interfering with company service, and without degrading operation of the line receiving the signal. The opto-coupler can also be used to operate other equipment, such as a telephone message recorder. The arrangement imposes only a 10-milliampere load on the ac ringing signal and no load at all on the dc voice signals.

In this arrangement, the opto-coupler transfers the ringing signal to the rest of the remote-ringer circuitry and also isolates that circuitry from the telephone line. The output current from the opto-coupler activates a 555 timer that is configured as an astable multivibrator; the audio frequency from the multivibrator, amplified and fed to the remote loudspeaker, then sounds whenever a ringing signal comes in on the telephone line.

As indicated on the circuit diagram, the telephone ringing signal of about 100 volts at 20 hertz has a cycle of 2 seconds on and 4 seconds off. This signal is applied to the light-emitting diode of the opto-coupler through a 1-microfarad capacitor; the capacitive reactance at 20 Hz is about 10 kilohms, which limits the current of the light-emitting diode to 10 mA. The frequency is doubled by the full-wave bridge simply because a 40-Hz gating rate in the sound from the loudspeaker is more pleasing to the ear than a 20-Hz rate.

The 40-Hz output from the coupler is applied to the reset input of the 555 multivibrator. The free-running frequency of the multivibrator is set at a nominal 440 Hz, which is the frequency of the ring-back tone in a telephone, or at whatever frequency is most pleasing to the listener. The frequency can be adjusted by the 250-kilohm resistor. The free-running duty cycle, which would be fixed at 50% by the 1-kilohm resistor, is approximately 35% here because of the 40-Hz modulation of the gating signal.

The output from a 555 timer is sufficient to drive a small speaker through a current-limiting series capacitor with no further amplification. In most applications, however, power-amplification is required. The amplification need only be of the switching type because of the rectangular output of the 555. At current levels below

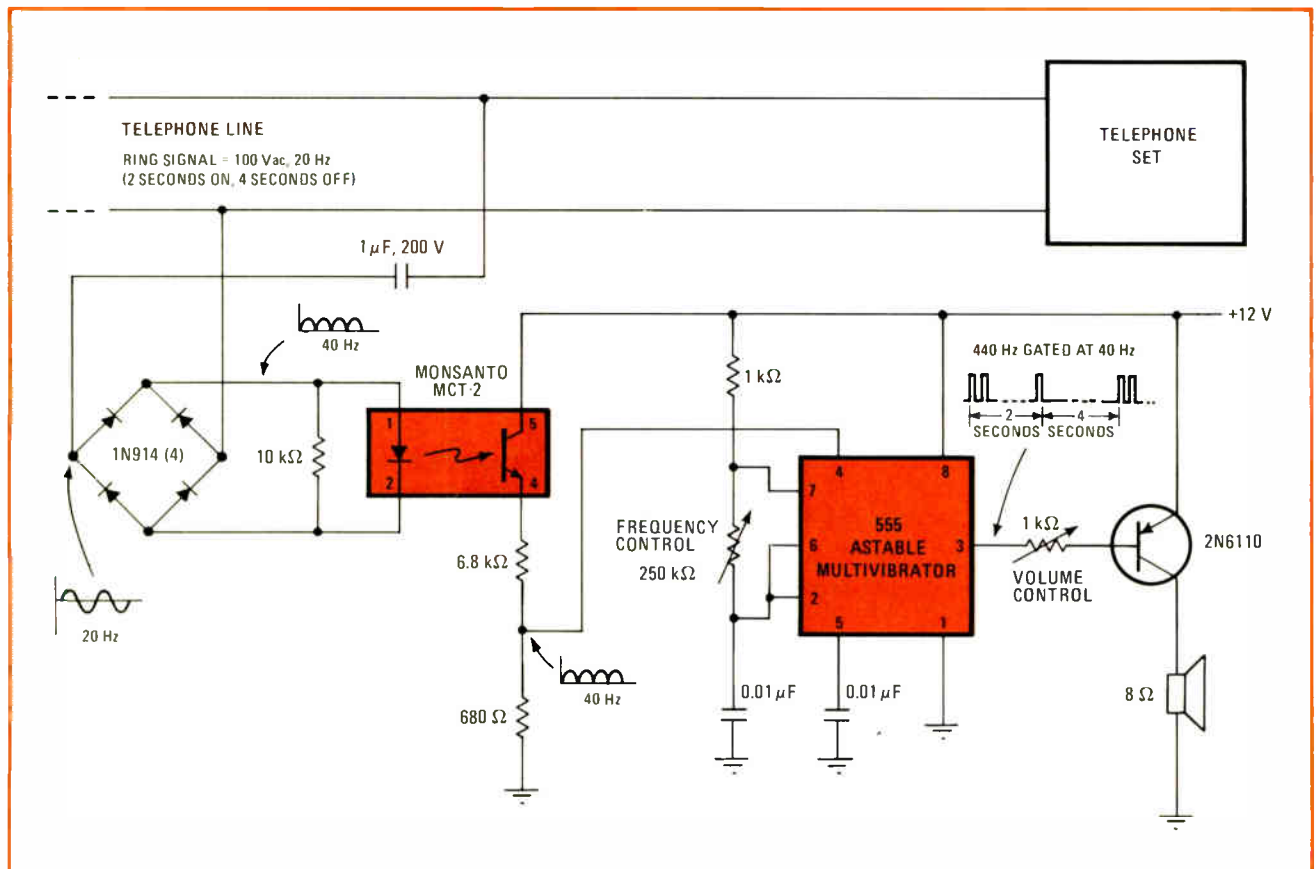

**Remote ringer.** Opto-coupler flashes telephone-ringing signal to remote-ringer circuitry and isolates that circuitry from phone line. Circuit puts 10-mA load on ac ringing signal, and no load on dc voice signals. Frequency and volume at remote loudspeaker can be adjusted.

50 mA, the 555 is more effective as a current sink than as a current source; for maximum efficiency and power output, therefore, a pnp switching transistor is used.

The component values shown produce an output power of about 5.5 w, which is almost the theoretical maximum that can be obtained with a single 8-ohm speaker, a  $V_{CC}$  of 12 v, and a 35% duty cycle. Higher output-power levels can be achieved by greater amplification or lower speaker impedance. At higher levels, multiple speakers can be used in a series-parallel ar-

angement, with each speaker using a matching L-pad for individual level control.

This circuit draws a standby power of about 120 mw from the 12-v dc supply. To reduce standby power to almost zero, a dual opto-coupler can be used. The second isolated and synchronized output is used to gate a triac static switch that turns on the power supply.

Even though this optical-coupling technique avoids severe loading of the line, the telephone company should be consulted before the ringer is installed. □

## Regulated power supply is adjustable from 0 to 38 V

by Frank P. Miles  
Rochester, N. Y.

Through careful biasing of the error-sensing and the output driver for a 723C voltage regulator, a power supply that is variable from 0 to 38 volts can be designed. The stability of the circuit over both time and temperature is excellent, depending only on the internal reference of the chip and being essentially independent of output level. And finally, the circuit requires few com-

ponents; most notably, it requires no zener diodes external to the 723C.

The schematic shows how simple it is to custom-design the supply.  $R_3$  is a 2.5-kilohm potentiometer, chosen to keep the reference current below 5 milliamperes.  $R_1 = R_4$  and  $R_2 = R_5$  for best bias stability and output-range swing. The leakage-limiting resistor  $R_6$  has a value of 47 ohms; it increases the safe operating area of  $Q_1$ .

The maximum output voltage is given by

$$V_{OUT(max)} = (R_2/R_1)V_{REF}$$

where the reference voltage  $V_{REF}$ , a characteristic of the 723C, is typically 7.15 v. Resistor  $R_1$  is picked to be high enough to minimize loading of  $R_3$ , but small enough to avoid bias-current problems at the error-am-

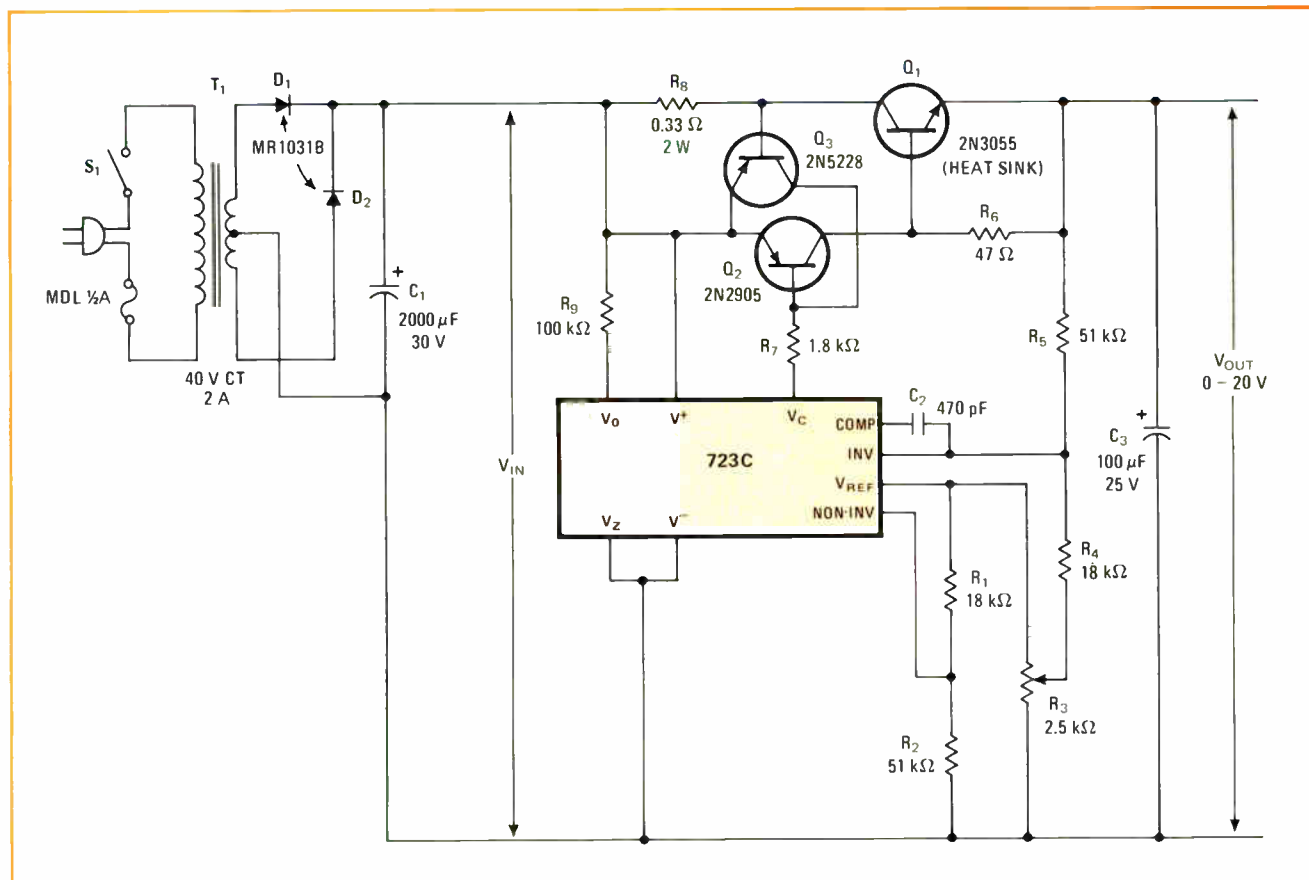

**Regulated power supply.** Setting of  $R_3$  gives output voltage as low as 0 V, or as high as  $V_{IN}$  minus small drop across  $Q_1$ . Value of  $V_{IN}$  must not exceed 40-V limit of the 723C. Components shown here are for 0–20-V, 2-A supply.



# To measure lower distortion than ever before

# -- just push a button

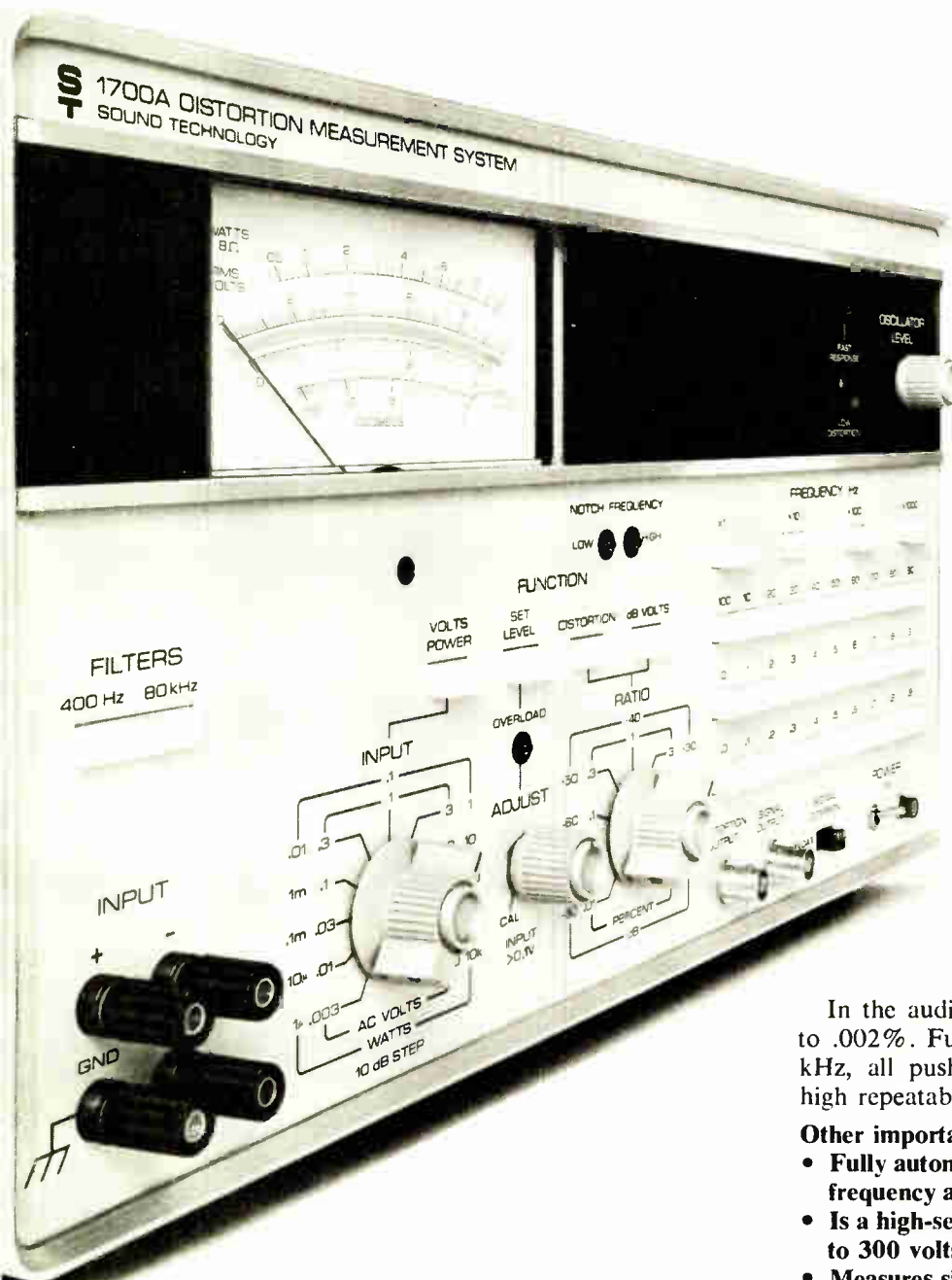

## MEASURE DOWN TO .002%

Here is an important new system for measuring distortion.

This new Sound Tech 1700A is both an ultra-low-distortion signal source and a total harmonic distortion analyzer.

It's an instrument that's fast and easy to use. You can make a measurement in 5 seconds — because both source and measuring circuits are tuned by the same pushbuttons. Even non-technical production personnel can measure with it. And that can save a lot of test dollars in the plant and lab.

## AUTOMATIC NULLING

In the audio range you can typically measure down to .002%. Full frequency range is from 10 Hz to 110 kHz, all pushbutton-controlled for fast selection and high repeatability.

### Other important features:

- Fully automatic nulling — just push a button for frequency at which you want the measurement.
- Is a high-sensitivity AC voltmeter — 30 microvolts to 300 volts.
- Measures signal ratios up to 100 dB.
- Has differential input.
- Reads power in 8-ohm loads.

## ECONOMICAL

The 1700A truly saves on initial outlay, too. It's only \$1625 (other models only \$1340). That's less than the cost of much lower performance oscillators and distortion analyzers.

## MAKE PROFIT HAPPEN — CALL NOW

So don't get caught short. Make profit happen. Call Larry Maguire or Bob Andersen and get full performance data on this important new development.

**S T SOUND TECHNOLOGY**  
1400 DELL AVENUE  
CAMPBELL, CALIFORNIA 95008  
(408) 378-6540

DEVELOPERS OF THE INDUSTRY-STANDARD 1000A STEREO ALIGNMENT GENERATOR AND 1400A ULTRA-LOW-DISTORTION OSCILLATOR

Circle 94 on reader service card

plier inputs. Resistor  $R_2$  is then calculated from

$$R_2 = (V_{OUT(max)}/V_{REF})R_4$$

The other resistors are calculated from straightforward circuit considerations. Resistor  $R_7$  limits the output drive of the 723C to about 10 mA because the internal zener diode is used. Its value, in kilohms, is

$$R_7 \approx 0.1 V_{IN} - 0.62$$

where  $V_{IN}$  is the unregulated voltage out of the rectifier. (The value of  $V_{IN}$  must not exceed the 40-v limit of the 723C.)  $R_8$ , calculated in ohms, provides the proper current-limit point:

$$R_8 \approx 0.65/I_{LIMIT}$$

where  $I_{LIMIT}$  is the maximum output current (in amperes). The pass transistor characteristics and heat sink are also determined by the value of  $I_{LIMIT}$ . Resistor  $R_9$ , calculated in kilohms, maintains zener regulation for low output currents:

$$R_9 \approx 5V_{IN} - 31$$

The output voltage from this supply can be as low as 0 v, or as high as  $V_{IN}$  minus a small drop across the pass transistor. The component values shown in the circuit diagram are chosen for a 0–20-v, 2-A supply. □

## Comparator and D-MOS switch rectify small signals linearly

by Tom Cooper  
TRW Systems, Redondo Beach, Calif.

Rectifying low-level signals with conventional silicon diodes has always been cumbersome. The reason: input signals lower than the diode's turn-on voltage of approximately 0.6 volt result in a nonlinear output that is generally made linear by the addition of one or two operational amplifiers. But if an analog comparator and a two-FET switch are used instead of the silicon-diode-and-amplifier combination, it's possible to rectify waveforms with amplitudes as low as 6 millivolts at frequencies as high as 3 megahertz, while providing an output that can be filtered to yield a dc value directly

proportional to the amplitude of the input signal.

The circuit is shown below. In this precision half-wave rectifier, the input signal is applied to field-effect transistor  $Q_2$  and also to the NE529 high-speed comparator (20-ns propagation delay), which senses the zero crossings of the input voltage. The output from the comparator passes through a level-setting zener diode and drives a high-speed analog switch (2-ns turn-on time) that consists of double-diffused metal-oxide-semiconductor (D-MOS) FETS  $Q_1$  and  $Q_2$ . The comparator and  $Q_1$  drive  $Q_2$  into the on state at each positive zero crossing of the input waveform that is to be rectified, and into the off state at each negative zero crossing.

Because  $Q_2$  is on when the input signal applied to its source terminal is positive and is off when the input is negative, the output from  $Q_2$  is a half-wave-rectified version of the input waveform. □

Designer's casebook is a regular feature in Electronics. We invite readers to submit original and unpublished circuit ideas and solutions to design problems. Explain briefly but thoroughly the circuit's operating principle and purpose. We'll pay \$50 for each item published.

**Half-wave rectifier.** Analog switch  $Q_2$  is driven on and off at the zero crossings of the low-level input signal, producing a precise half-wave-rectified version of the input waveform. Amplitude can be as low as 6 mV and frequency as high as 3 MHz.

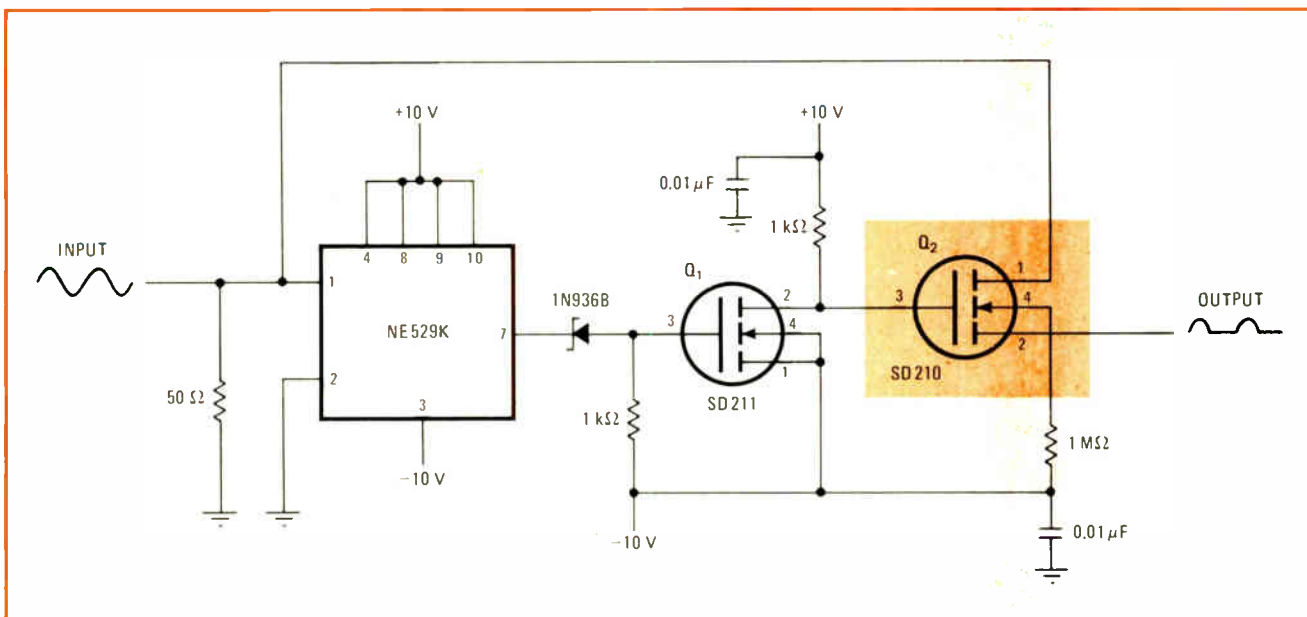

# Cost barrier cracked in two-way cable TV

Remote rf-actuated switch is said to solve interference problem and to pave the way for home services the consumer can afford; test tryouts included 1,000 hookups in Columbus, Ohio, vicinity

by D. Stevens McVoy and Richard Reynolds, *Coaxial Scientific Corp., Sarasota, Fla.*

□ Cable television equipment manufacturers a few years ago were rushing to develop prototype hardware to demonstrate a wide array of novel consumer applications for two-way CATV. These applications included everything from traditional TV fare to such things as automatic utility meter reading, computer-assisted tutoring, home shopping, and a host of other services. Then something put a damper on things: it was recognized that the expense of equipping the consumer market with any of the home terminals then available would be prohibitive. Not only that, but technical problems caused by rf interference were plaguing experimental two-way transmissions. The total effect was to slow down developmental work considerably.

Now a device patented by Coaxial Scientific Corp. (CSC), Sarasota, Fla., promises to remove these roadblocks. CSC's objectives have centered around building a practical and low-cost home terminal system, and minimizing the signal intrusion coming "upstream,"

that is, along the subscriber network to the CATV transmission center. CSC believes that both objectives have been met with the development of the code operated switch (COS).

The COS is a remote switch controlled by command from a minicomputer located in the CATV "headend" transmission center. As illustrated in Fig. 1, the minicomputer commands any COS to open or close, thereby either passing or halting signals from going upstream from that particular network branch. Digital signals from home terminals through the code-operated switches inform the transmission center of what TV channel each subscriber is tuned to. The COS also enables the system to block rf interference, and it makes feasible a relatively inexpensive home terminal using a modified cable converter.

CSC is convinced that the system described here is the breakthrough to successful two-way CATV (Fig. 1). The company has conducted two years of small-scale testing

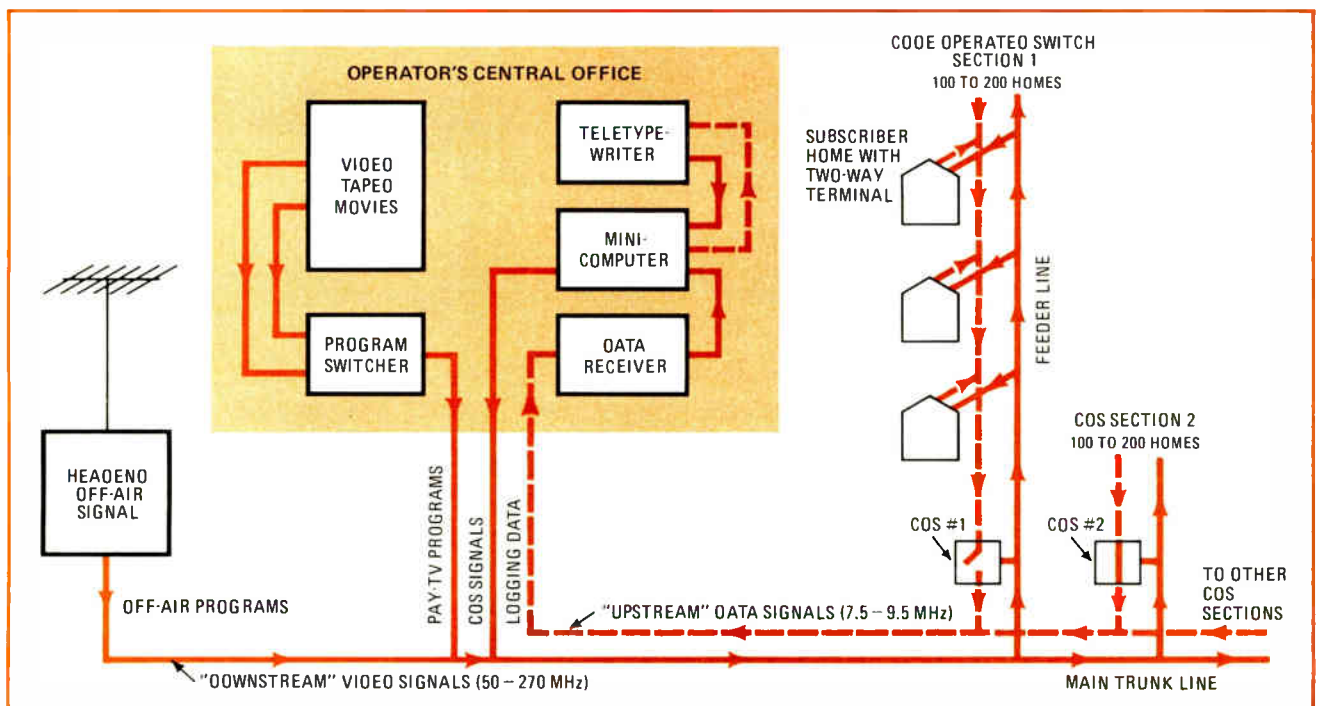

**1. Polling.** In a pay-CATV operation, the minicomputer sends coded digital signals "downstream" on a midband frequency, causing the code-operated switch on a network branch to close. Subscribers' two-way terminals in that branch are then polled.



and 18 months of field operations. The latter included operation of 1,000 home terminals in a pay-TV system.

In an operational system, only one COS is active at any one time; in effect, only one branch out of many is being polled at any one time (Fig. 2). All other COS units are in the off mode. By switching on one COS at a time, signal intrusion problems are greatly minimized.

Figure 2 shows where COSs are placed in a typical CATV plant—generally at the output of each bridger amplifier, which typically serves 100 to 200 subscribers hooked up along two to five miles of cable.

### How It works

Each COS consists of band-splitting filters which separate the downstream (50 to 300 megahertz) frequencies from the upstream (5 MHz to 30 MHz) frequencies (Fig. 3). Downstream signals pass through the COS continuously, without interruption, while the upstream frequencies are either passed or blocked as directed by the minicomputer.

The COS addressor, under the control of a minicomputer at the operator's headend, generates a serial data stream that simultaneously frequency-shifts two crystal oscillators, one normally operating at 10.70 MHz and the other at 10.75 MHz. The frequency difference between the two oscillators for a logical 0 is 50 kilohertz and for a logical 1 is 54 kHz. These two carriers are then upconverted to 113.40 MHz and 113.45 MHz and inserted on the CATV system.

A directional coupler on the downstream line feeds a 113.40-MHz bandpass filter which feeds a two-stage rf amplifier and mixer. The two signals of 113.4 MHz and 113.45 MHz produce mixing products at 227 MHz and at 50 kHz or 54 kHz. The latter product, the one of interest, is separated with a low-pass filter and fed into a resonant discriminator. (This product is 54 kHz or logical 1, as mentioned above.) The output of the discriminator is then fed to a comparator which provides a TTL-compatible data stream to the address decoder. The address decoder recognizes its unique address and produces a logical 1 output when the proper code is received.

An rf switch consisting of a unity-gain amplifier stage is inserted in the upstream path of the COS. This switch is under the control of the address decoder and allows upstream signals to pass through the COS when the proper code has been received. When the rf switch is in the off mode, the upstream signals are attenuated 50 decibels. Each COS also contains an identification transmitter, located prior to the rf switch, that provides positive identification for the minicomputer that the proper COS has been enabled.

Substantial reductions in maintenance costs and significant increases in system reliability now can be realized, thanks to the COS-minicomputer combination. A fault in the cable system, such as a loose connector or damaged cable sheath, is easily isolated by the minicomputer to one small segment of the system, where technical personnel can quickly correct the problem. Also, the cumulative effect of signal intrusion, being largely proportional to the amount of cable plant contributing noise, is reduced by the use of the COS to subdivide the plant. In fact, the code-operated-switch ap-

proach reduces the intrusion problem to the point where it is no longer a serious obstacle.

### Saving terminal costs

Use of the COS opens the way for an inexpensive home terminal. A major expense in a typical interrogation-response home terminal is the rf receiver, decoder, and address-recognition circuitry. But a terminal that simply reports its status, and which operates in the frequency-division-multiplex mode (FDM), does not require this circuitry. Such a FDM terminal requires only a data encoder and rf transmitter circuit. Many terminals operating in the FDM mode, however, occupy too much bandwidth in a nonsegmented cable system. But the COS approach, by segmenting the CATV system into small areas of less than 200 terminals, makes the FDM method practical within those areas.

Home terminals in each COS area are assigned unique rf carriers shifted 20 kHz apart. The carriers are frequency-shift-keyed (FSK) and modulated with status information from home terminals. This approach results in a component cost of approximately \$14 per home terminal (Fig. 4). When combined with a CATV set-top converter, the total package costs only \$60, and the simplicity of the terminal promises lower maintenance costs.

### What's at the movies

During 1973, CSC designed and manufactured 1,000 home terminals to be used by Telecinema, the pay-TV operator in Columbus, Ohio. Telecinema offers first-run movies, without commercials or editing, on three mid-band channels (TV channels between channels 6 and 7). This per-program pay-television operation is unique in that it allows per-program billing and impulse buying without use of telephone orders or special tickets. Since

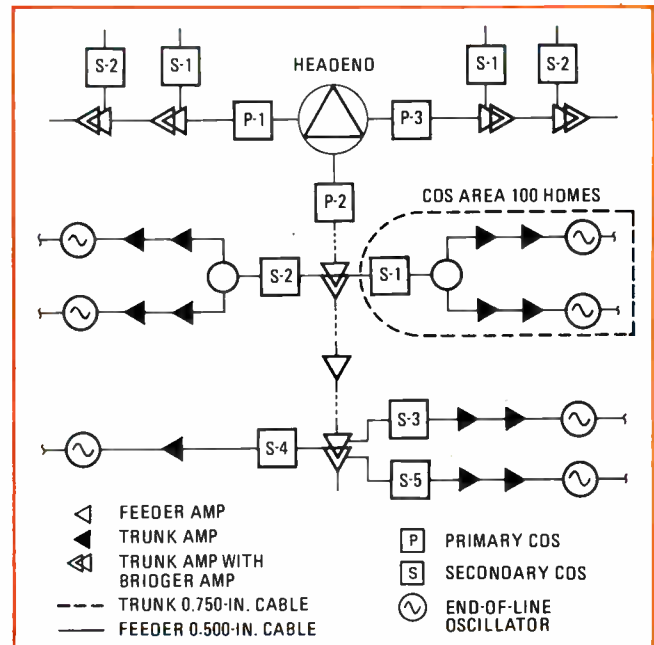

**2. The route.** Code-operated switches isolate segments of the CATV net. Only one branch is turned on at a time to prevent rf noise in other sections from filtering back to the cable trunk. Only 100 to 200 homes per isolated section can communicate "upstream" at a time.

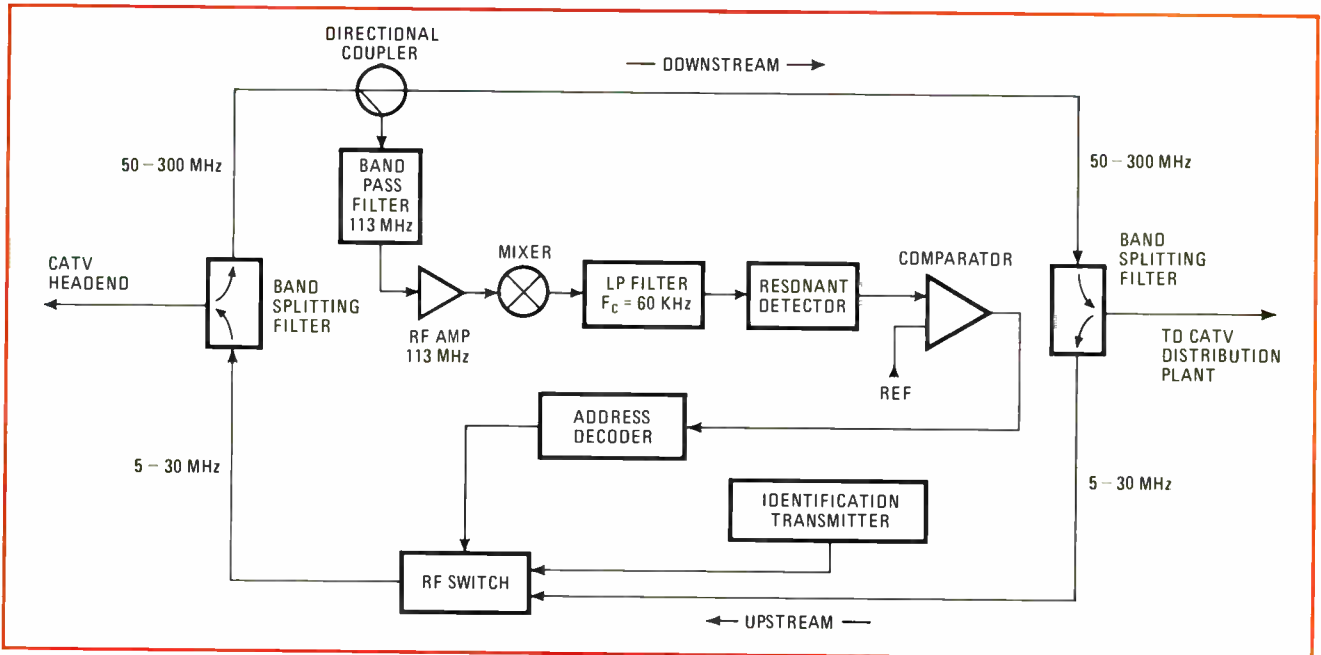

**3. Inside COS.** Each code-operated switch is essentially a band-splitting filter directing "downstream" signals continuously to each home terminal and permitting "upstream" return signals only when commanded by the headend computer. In operation, the "downstream" signals at 50 to 300 megahertz pass continuously, but the "upstream" signals at 5 to 30 MHz only pass through the COS when commanded.

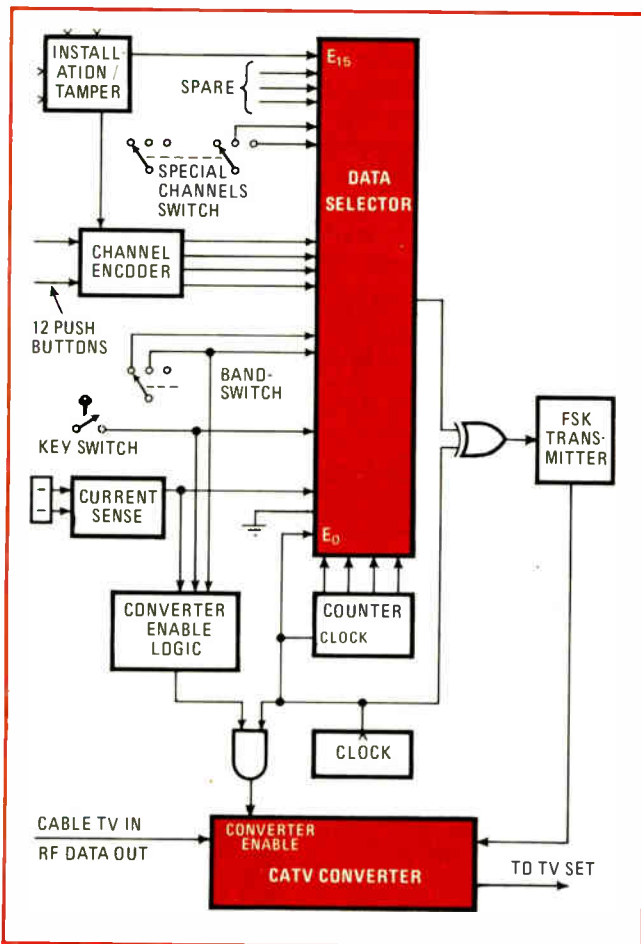

**4. Simple reply.** Because the circuit board added to the home terminal does not have the rf receiver, decoder, and address-recognition circuitry used in other more expensive interrogation/response systems, the cost is only about \$14.

the home terminal acts to monitor the channel position and status of a subscriber's set and reports these facts to the headend computer, it is possible to prepare a subscriber's bill that reflects actual usage of the service.

The home terminal modified by CSC consists of a standard CATV set-top converter of 26-channel capacity with a small board containing the control circuitry (Fig. 5). The CSC circuit board monitors the position of the 26-channel selector, the position of a security key on the front panel of the home terminal, whether the subscriber's television receiver is on or off, and the status of an installation switch.

The data transmission circuitry consists of a parallel-to-serial 16-bit data converter with a Manchester encoder driving a frequency-shift-keyed (FSK) modulator and crystal-controlled transmitter frequency-shifted approximately 3 kHz by switching additional capacitance across the crystal. A clocked 4-bit counter addresses a data selector to provide the parallel-to-serial data conversion. Two of the 16 bits are used as a start-of-message marker, and 14 are available for data.

To allow the subscriber to control the use of pay-television service, a security key is provided on the home terminal front panel and before pay-TV channels can be viewed, this key switch must be on. All other TV channels are available to the viewer in either position of the security key.

The primary winding of a current sense transformer is in series with one side of the ac convenience electrical outlet serving the subscriber's TV set. The secondary winding drives a threshold detector, thereby providing indication of whether the TV set is in use.

To effect Manchester encoding of the serial data, the output of the data selector and the clock output are the inputs to an exclusive-OR gate. Because the serial message is continuously transmitted, a message marker is

necessary to distinguish the beginning of the message. The marker is generated by defeating Manchester encoding during the first data period, cancelling out clock transitions for that period. To continue the marker period without transition for another half period, the next bit is set to logic 0. This provides a minimum of one and a half periods without transition and provides the first transition for data sampling.

### A successful operation

When the subscriber wishes to watch one of the movies, he simply turns on the security key on the terminal and tunes one of the pay channels. At the end of each month, the subscriber receives an invoice similar to a long-distance telephone bill itemizing his charges for the movies viewed during the month.

The results of this 18-month test in Columbus demonstrates that the technology is reliable. Subscribers have accepted the service enthusiastically, paying an average of \$7 per month for first-run movies. This revenue is sufficient to provide an excellent return on investment to the pay-television operator, and as a result Telecinema's parent company, Cablenet International Corp., is planning to expand from the 1,000-subscriber test system to the installation of approximately 10,000 home terminals, and is presently seeking the financing to do so.

Cablenet looks beyond the present movie offering to the introduction of live sports events, special cultural shows, and other special-interest programming. Experimentation has already begun with sports and children's programs produced by Home Box Office, and additional programming will be introduced in the near future.

Using the terminals, Cablenet intends to experiment with education pay television, including college-level instruction for credit, vocational education, and home self-improvement programming such as speed reading. The operator expects that the additional programming to be offered in the future will substantially increase the average revenue per home from the present \$7 level to \$12 a month or more. Since there are few hardware or operating costs associated with providing this additional programming, most of the increased revenue will go directly toward profits for the pay-TV operator.

### Other applications

The establishment of a large-scale network of home terminals for per-program pay-television service is only the beginning. Additional data capacity is available in the CSC home terminal so that various other input devices such as intrusion and fire alarms can be connected at little cost, simply by attaching leads to the circuit board inside. Keyboards for opinion polling, home shopping, and computerized data retrieval are other possibilities—again with only a small amount of hardware. Remote reading of electric and water meters is also economically feasible. Because the incremental hardware cost for adding these services is small, low service charges would be sufficient to support them. And since a large number of terminals will be available in Columbus, the establishment of a profitable business providing one or more of these services is feasible.

## Cable TV specs

A CATV system is based on a high-integrity network of trunk amplifiers and trunk cable coming from the operator's headend transmission center. The trunk is designed to deliver signals to bridger amplifier areas with a minimum of degradation. Bridger amplifiers tap signals from the trunk for use in the bridger service area comprising about 100-200 subscribers connected by two to five miles of feeder cable.

Feeder amplifiers in turn maintain signal levels within the feeder network. The feeder cable system delivers signals to tap-offs located near subscribers' homes. From these tap-offs, signals are routed to home TV receivers on RG type coaxial cables (drops) usually shorter than 150 feet. The tap off takes enough signal from the feeder cable to serve four homes.

Trunk cables are of larger diameter (0.750 inch) aluminum solid sheath for lower attenuation than feeder cable (0.500 inch). Economy dictates smaller cables for the feeder.

Signals flowing in the downstream direction, from the headend to subscribers, use the vhf band from 50 megahertz to 300 MHz; signals in the upstream direction, from subscribers back to headend, use the sub-band from 5 MHz to 30 MHz. Amplifiers in two-way systems actually use an amplifier for each direction with band splitting/combining filters, as shown in the illustration.

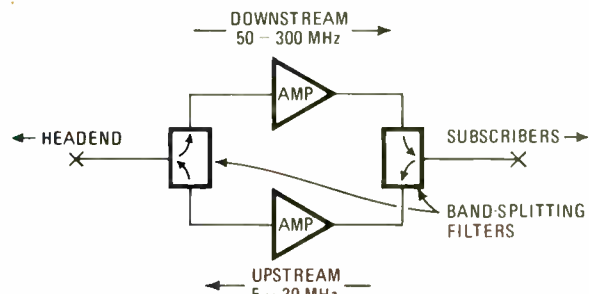

The CSC home-terminal system, not limited solely to cable television systems, can handle a variety of tasks in any broadband coaxial network. A variation of the CSC terminal system is presently being developed for use in motels, for example. The system consists of a home terminal similar to the one in the Columbus CATV system, but considerably simplified and offering fewer television channels. Microprocessor-based systems are under development to allow the installation of a complete pay-television system inside small and medium-sized motels and hotels. In addition to providing pay-television services, the terminal can also communicate room status, maid request, and television theft attempt. A stand-alone microcomputer terminal at the hotel desk connected to the room terminals will provide this information on a printout machine. Development is well along, with test installation anticipated early this year.

The CSC system has educational applications, too. In one situation, using a school's master-antenna TV



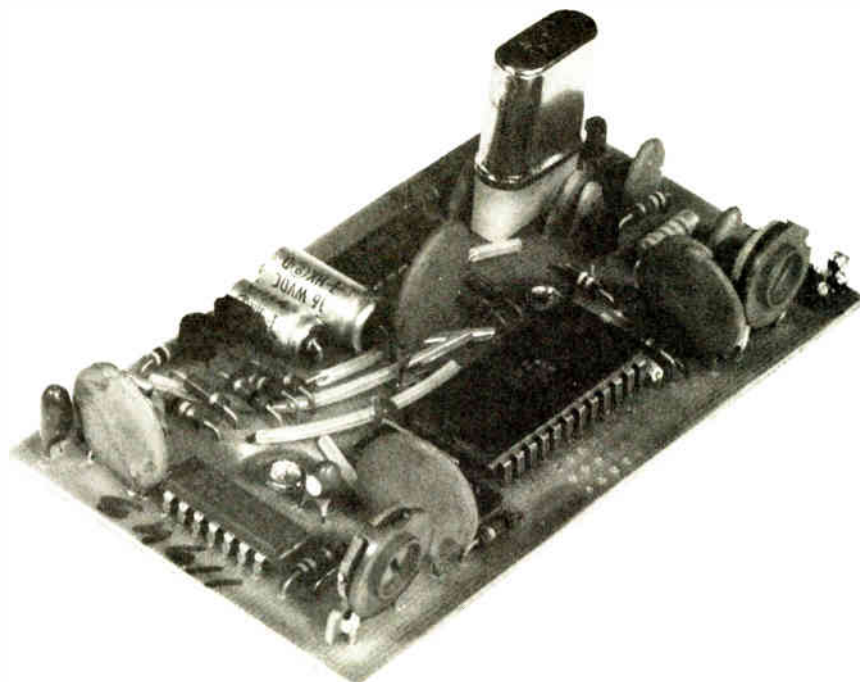

**5. Alteration.** By inserting a 2¼-by-4¼-in. circuit board (top) into a standard cable converter, the operator is able to obtain two-way communication via a frequency-shift-keyed transmitter and data selector designed into the adapter board.

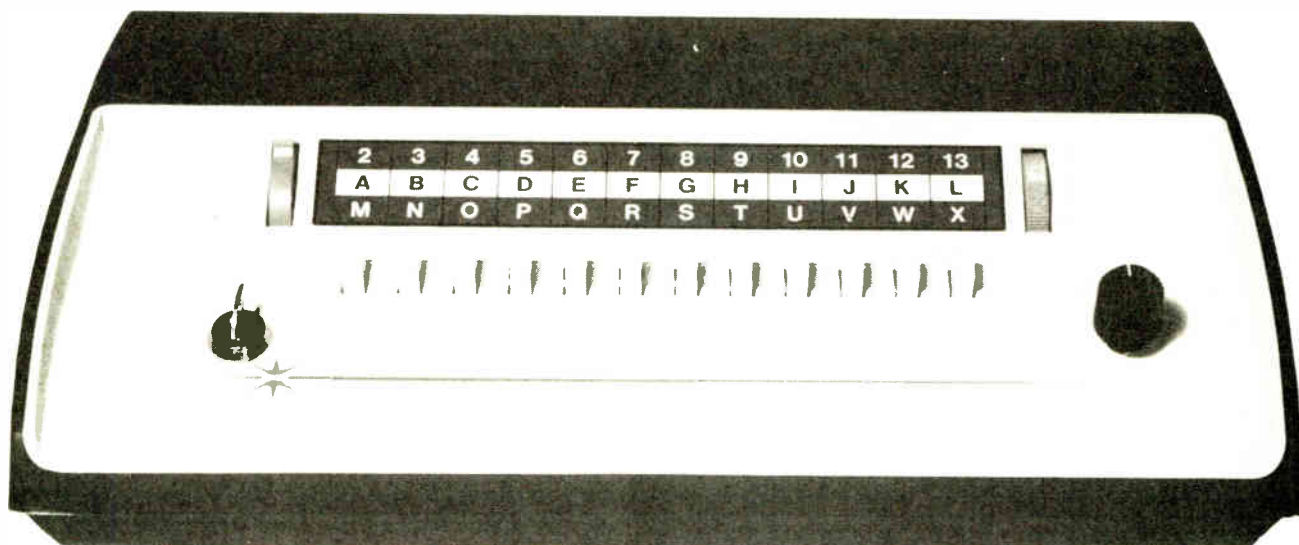

(MATV) system, students have a small terminal equipped with a row of push buttons and an "enter" key. The instructor may use this arrangement to administer multiple-choice tests for grading purposes or for judging student comprehension of his lectures, and get an immediate computer printout of the students' responses. (The same technique can be used for opinion polling of subscribers over a CATV system.)

Television viewing surveys are possible with the CSC terminal, since it monitors the use of all the television channels available to subscribers. In the Columbus system, the computer generates a report every 15 minutes indicating the percentage of TV sets tuned to each of the television channels at that time. However, for a future audience appraisal plan, the CSC system can provide much more detailed and reliable viewing information than the present methods of testing over-the-air viewing because of the much higher percentage of homes sam-

pled at more frequent intervals by the cable network.

The interactive TV system is also useful in industrial, hospital, and business office applications where very inexpensive data-entry terminals are required. CSC terminals combined with a small television monitor, for instance, could provide a complete interactive data link with a local minicomputer for inventory control or accounting purposes. Since the terminal costs would be in the \$100-\$200 range, units could be available at many locations. □

#### ADDITIONAL READING

- D. Stevens McVoy, "A Low-Cost Two-Way Home Terminal for CATV," *TV Communications*, October, 1974.
- John P. Taylor, "Two-way Pay-Cable System Automates Many Functions, Including Monitoring Audiences," *Television/Radio Age*, July 8, 1974.
- D. Stevens McVoy, et al., "Communications System for Data Transmission and Retrieval," Patent No. 3,786,424.
- D. Stevens McVoy, et al., "Communications System Encoder-Decoder for Data Transmission and Retrieval," Patent No. 3,832,690.
- Ernest K. Smith, "Pilot Two-Way CATV Systems," *IEEE Transactions on Communications*, Vol. Com. 23, No. 1, January, 1975.

# Op amp stabilizes zener diode in reference-voltage source

The operational amplifier's isolation characteristics can be used to buffer a reference zener against the supply and load variations that would otherwise downgrade the diode's temperature and voltage stability

by William D. Miller and Richard E. DeFreitas, *Hybrid Systems Corp., Burlington, Mass.*

□ On its own, a reference zener diode can produce a reasonably stable voltage. But in conjunction with an operational amplifier, a reference diode of selected quality can be made to provide a voltage temperature stability as good as 1 part per million per degree Celsius—precise enough for applications like data conversion and instrumentation.

To obtain a zener voltage and temperature coefficient as stable as this, the current through the zener must be kept constant and prevented from fluctuating with changes in power-supply voltage and in load conditions. The op amp does not cancel zener imperfections, but its excellent isolation characteristics can be used to create nearly ideal circuit conditions for the diode, buffering it against both supply and load variations.

A third factor affecting zener current is operating temperature, and of course it also must be kept constant, by appropriate thermal management, which might even involve thermostatic control of the environment or a constant-temperature oil bath.

## Back to basics

The transfer characteristic of a zener diode is shown in Fig. 1(a). Since the curve is not parallel to the current axis in the reverse breakdown region, where a zener is operated, the zener dynamic impedance ( $r_z$ ) is finite,

usually on the order of 10 ohms. Because of this finite impedance, a zener cannot function as a perfect voltage source, supplying the same output voltage no matter what the size of the load. The intrinsic zener impedance and the load impedance always form a voltage divider that attenuates the zener output.

The zener current also influences the zener's voltage-temperature coefficient. Typically, this parameter rises or falls approximately 4 ppm/°C for each milliampere of increase or decrease in operating current. A zener diode, therefore, is most stable when operated at a constant current level. (In practice, the operating current that minimizes the temperature coefficient will vary slightly from device to device.)

The simple single-polarity reference source of Fig. 1(b) illustrates how load and supply variations affect zener current and, hence, zener voltage. Without the load connected, the zener current is 7.5 milliamperes, and the zener voltage is 6 volts. But when the load is put across the zener, it pulls 1 mA from the diode so that zener current drops to 6.5 mA and zener voltage is reduced by 10 millivolts. This output voltage change corresponds to a load regulation of 0.16%, which is too poor for many applications. Also, because the zener current has varied by 1 mA, the zener's voltage temperature coefficient will change by 4 ppm/°C.

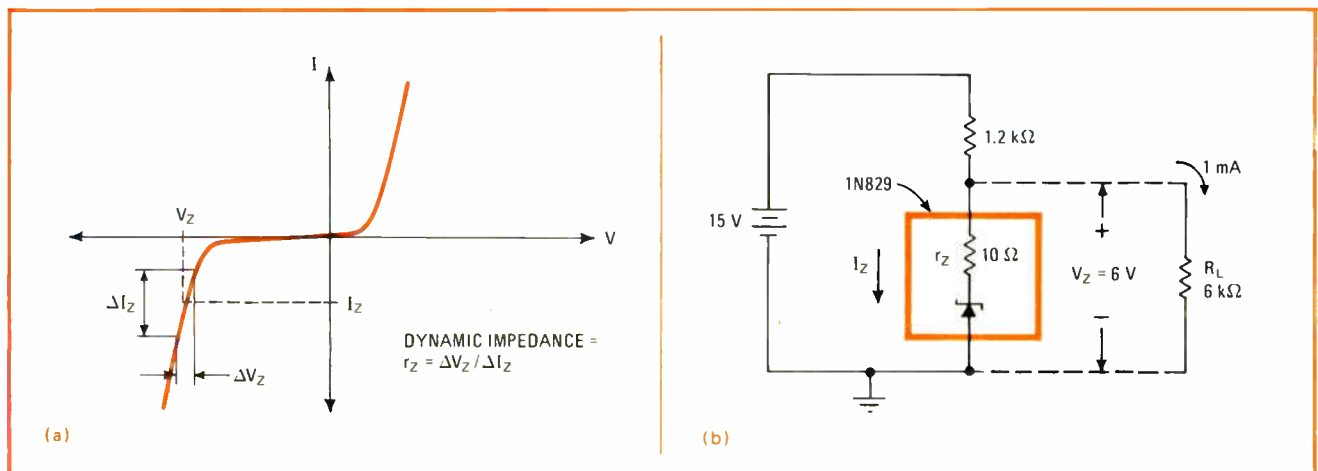

**1. The problem.** Because of the finite slope of the zener diode's transfer characteristic (a) in the reverse breakdown region, zener current is affected by both supply and load variations. In circuit (b), for instance, without the load, the zener current is 7.5 mA, producing a zener voltage of 6 V. When the 1-mA load is connected, however, the zener voltage drops by 10 mV, corresponding to a load regulation of 0.16%.

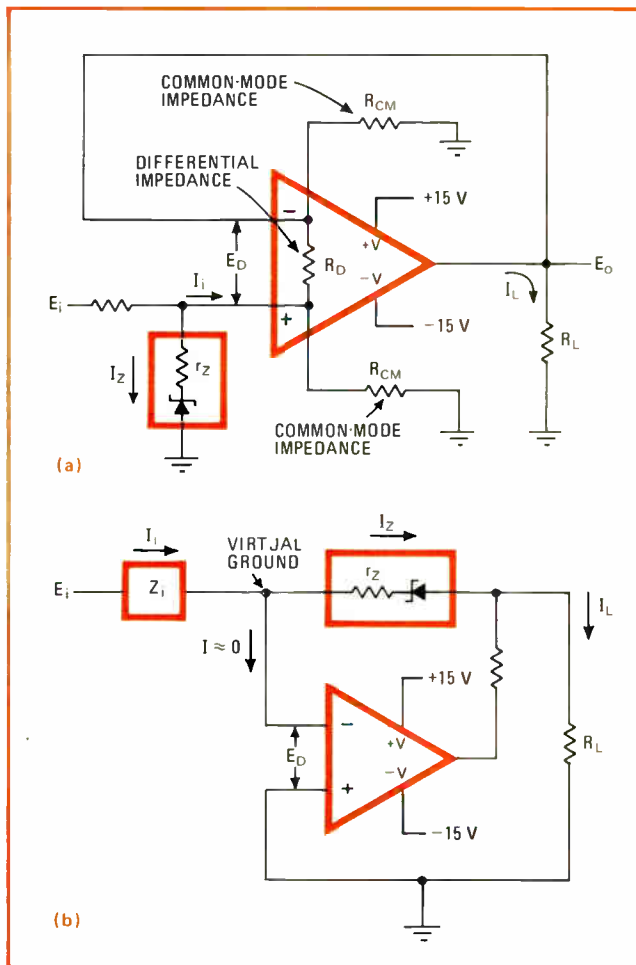

**2. A helping hand.** If a zener is buffered by an op amp, it will be isolated from load fluctuations. For both circuits shown here, the zener current is independent of the load current, which is supplied by the op amp. In (a), the op amp acts as a high-impedance buffer for the zener. In (b), because of the virtual ground, the input current, however derived, determines the zener current. If the input current for either of these circuits is obtained from an op amp, then the zener will also be isolated from supply variations.

In contrast, quite a large change in the supply voltage, about 1.2 V, is needed to produce the same 10-mV output change. But the supply regulation becomes more important if the loading is lighter, say 10 microamperes instead of 1 mA. For example, a 10- $\mu$ A change in the load will produce an approximate output change of only 0.1 mV. However, with a 10- $\mu$ A load, a supply variation of just 12 mV will now cause a 0.1-mV output change.

An op amp, along with an appropriate feedback network, can isolate a zener from the adverse effects of both line and load variations. When a zener is properly buffered, its current will remain essentially constant so that changes in zener voltage and temperature coefficient can be held to a minimum.

### The op amp's advantages

Basically, an op amp is a differential amplifier that rejects equal in-phase signals if they are common to both its inputs. Since power-supply variations are such

signals, they are rejected, and the op amp does not respond to them. Therefore, if the output of an op amp, which is inherently isolated from supply fluctuations, is used to drive a zener, that zener will also be isolated from line variations. The power-supply rejection of today's op amps is very good, frequently 80 decibels or greater.

Isolating a zener from load variations is another matter. To do this, some of the other characteristics of an op amp—such as high gain, low output impedance, and high input impedance—must be exploited. Figure 2 shows two circuit techniques that use these op-amp properties to make zener current independent of loading demands.

In the circuit of Fig. 2(a), the op amp simply acts as a high-impedance buffer for the zener. No matter what the load current is, very little current is drawn by the op amp, so that the zener current remains fairly constant. The current required by the op amp is:

$$I_i = E_D / R_D \quad (1)$$

where  $R_D$  is the op amp's differential input impedance, and  $E_D$  is the voltage between the op amp's inverting and noninverting inputs. This voltage can be expressed as:

$$E_D = E_o / G \quad (2)$$

where  $E_o$  is the output voltage, and  $G$  is the gain of the op amp. Since  $G$  is usually very large, on the order of  $10^4$  or more, differential voltage  $E_D$  is approximately equal to zero, and the output voltage is essentially the zener voltage:

$$E_o = V_Z \quad (3)$$

Substituting Eqs. 2 and 3 in Eq. 1 yields:

$$I_i = E_o / GR_D = V_Z / GR_D$$

which is a very small number. Effectively, differential impedance  $R_D$  appears to be  $G$  times greater than its nominal value, so that it draws  $G$  times less current.

However, it should be noted that the common-mode impedance ( $R_{CM}$ ) of the op amp is what actually limits the input impedance of this circuit. Since impedance  $R_{CM}$  is grounded, it shunts the zener, as well as differential impedance  $R_D$ . Fortunately, for all op amps,  $R_{CM}$  is much greater than  $R_D$ , so that  $R_{CM}$  itself never unduly loads the zener. If zener loading must be kept to a minimum, then a FET-input op amp, because of its exceptionally high input-impedance levels, becomes a logical choice for the amplifier.

This circuit (Fig. 2a) offers a straightforward method of developing a single polarity reference source. However, the circuit of Fig. 2(b) makes possible even tighter control of zener current. Here, the zener diode is placed directly in the feedback loop of the op amp. Furthermore, this circuit (Fig. 2b) is useful for deriving both single-polarity and dual-polarity reference sources.

The high gain of the op amp and the feedback action combine to create a point that is very close to zero volt, or ground potential. This virtual ground permits the input current ( $I_i$ ) to determine the feedback zener current ( $I_z$ ) precisely and independently of the load, regardless



of how the input current is derived. Therefore, because of the virtual ground:

$$I_i = -I_Z$$

Furthermore, the input current is not affected by the level of the output voltage:

$$I_i = E_i/Z_i$$

where  $E_i$  is the input voltage, and  $Z_i$  is the input impedance. Again, as with the circuit of Fig. 2(a), the differential voltage,  $E_D$ , is about equal to zero, because:

$$E_D = E_o/G$$

where  $G$ , the op-amp gain, is very large.

### A single-polarity reference

One way to implement a single-polarity reference source, using the inverting circuit of Fig. 2(b), is shown in Fig. 3. In order to take advantage of the power-supply rejection of the op amp, the zener driving voltage is derived from the op amp by the addition of a small amount of positive feedback, through resistors  $R_1$  and  $R_2$ . The destabilizing effect of this positive feedback is minimal since negative feedback predominates.

The positive feedback factor can be written as:

$$\beta_P = R_2/(R_1 + R_2)$$

which is less than 1. The negative feedback factor is:

$$\beta_N = R_3/(R_3 + r_Z)$$

where  $r_Z$  is the zener impedance. Since  $r_Z$  is small compared to  $R_3$ ,  $\beta_N$  is approximately unity, so that:

$$\beta_N \text{ is greater than } \beta_P$$

The op amp's differential input voltage is given by:

$$E_D = E_o\beta_P - (E_o - V_Z)\beta_N$$

Since:

$$E_D = E_o/G$$

then:

$$\begin{aligned} E_o &= GE_D \\ E_o &= G[E_o\beta_P - (E_o - V_Z)\beta_N] \\ E_o &= GE_o(\beta_P - \beta_N) + GV_Z\beta_N \\ E_o &= (\beta_N V_Z)/[(1/G) - (\beta_P - \beta_N)] \end{aligned}$$

where  $G$  is the gain of the op amp. Since  $G$  is much greater than 1,  $\beta_N$  approximately equals 1, and  $\beta_N$  is greater than  $\beta_P$ , then:

$$\begin{aligned} E_o &= V_Z/(1 - \beta_P) \\ E_o &= V_Z(R_1 + R_2)/R_1 \\ E_o &= V_Z[1 + (R_2/R_1)] \end{aligned}$$

The load regulation for the circuit can be expressed as:

$$\text{regulation} = r_o/[R_L G(\beta_N - \beta_P)]$$

where  $r_o$  is the output impedance of the op amp, and  $R_L$  is the load resistance.

Since the output impedance of an op amp is quite low, ranging from milliohms to ohms, depending on the type of amplifier being used, the op amp acts much like an ideal voltage source, supplying a constant output

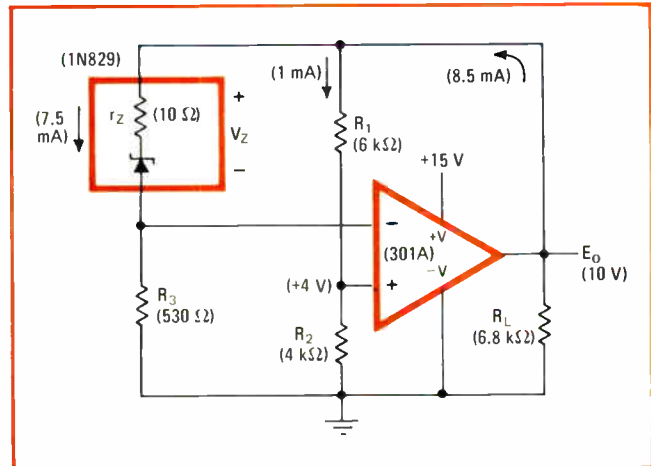

**3. Unipolar reference.** Here, the inverting circuit of Fig. 2(b) isolates the zener from load variations. A small amount of positive feedback permits the zener to derive its driving voltage from the op amp and thus take advantage of the op amp's power-supply rejection.

voltage that is independent of the load. This means that the circuit's voltage regulation can be very good—anywhere between 0.001% and 0.01%, depending on the op amp and zener diode selected. Also, the voltage temperature coefficient of this circuit can be that of the zener itself, as long as the resistors used for the circuit are closely matched.

The op amp chosen must be able to supply all circuit operating currents, as well as the load current. In addition, since the noninverting op-amp input is above ground potential, the common-mode capability of the op amp must be adequate for desired circuit operation. Of course, the op amp's power-supply rejection and offset voltage drift are also important. Typical circuit values and device type numbers are indicated parenthetically in the diagram.

### Dual-polarity references

The requirements of a dual-polarity voltage reference can be even more demanding than those of a single-polarity source, especially if both the positive and negative voltages must be maintained symmetrically about ground. The inverting circuit of Fig. 2(b), because of its inherent virtual-ground point, is particularly adaptable for such an application.

In the dual-polarity source of Fig. 4, a single zener diode is made to generate precise ground-referenced bipolar output voltages. The zener voltage is the difference between the two outputs:

$$V_Z = V_A - V_B \quad (4)$$

where  $V_A$  is the positive output, and  $V_B$  is the negative output. Since the virtual-ground point is the node to which all circuit voltages and currents are referred, the output voltages are merely scaled by resistors  $R_1$  and  $R_2$ :

$$V_A/R_1 = -V_B/R_2$$

Rearranging the terms of this equation yields:

$$V_A = -(V_B R_1)/R_2 \quad (5)$$

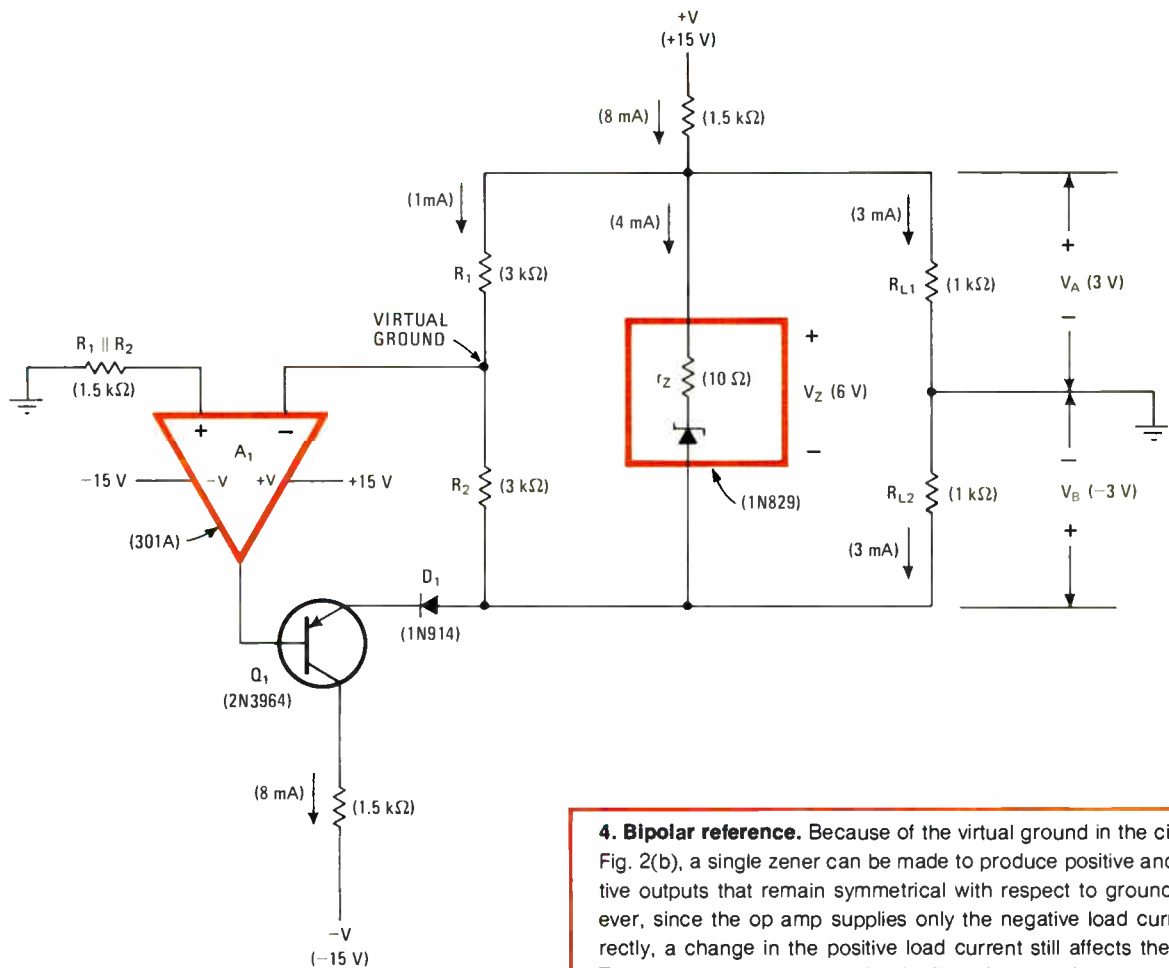

**4. Bipolar reference.** Because of the virtual ground in the circuit of Fig. 2(b), a single zener can be made to produce positive and negative outputs that remain symmetrical with respect to ground. However, since the op amp supplies only the negative load current directly, a change in the positive load current still affects the zener. The resulting voltage reduction is divided equally between the outputs, so the symmetry about ground is preserved. Also, the zener, being driven by the supply, is subject to line variations.

Since  $V_A = V_Z + V_B$  (from Eq. 4), Eq. 5 can be rewritten as:

$$V_Z + V_B = -(V_B R_1)/R_2$$

or:

$$V_B = -(V_Z R_2)/(R_1 + R_2)$$

Similarly, since  $V_B = V_A - V_Z$  (from Eq. 4), Eq. 5 can again be rewritten as:

$$V_A = -(V_A - V_Z)R_1/R_2$$

or:

$$V_A = (V_Z R_1)/(R_1 + R_2)$$

When resistors  $R_1$  and  $R_2$  are equal to each other, positive output  $V_A$  becomes  $+V_Z/2$ , while negative output  $V_B$  becomes  $-V_Z/2$ .

The load current for the negative output is supplied directly by the op amp. Therefore, any variations in the negative load current will not affect the zener's current or voltage. A load variation on the positive output, however, will directly reduce zener current, thereby changing the zener voltage. But, because of the virtual ground created by the op amp, this change in zener voltage is

divided equally between the two outputs, so that both positive and negative outputs remain symmetrical with respect to ground.

With this circuit, however, the zener, being driven directly by the supply and not by the op amp, is not isolated from supply fluctuations. As a rule, though, a supply having adequate regulation for an op amp will pose no problems for the zener.

A current-booster transistor,  $Q_1$ , is included here to permit the use of an op amp having only a moderate output capability. The op amp must be able to sink all of the circuit's operating currents, except for the positive load current, and this can add up to a heavy demand and a costly amplifier. The transistor is an inexpensive way to save money on the op amp. Diode  $D_1$  is included to assure that the amplifier turns on properly. Typical circuit values and device type numbers are noted parenthetically in the figure.

To build a dual-polarity reference that is immune to line fluctuations, as well as load variations on both the positive and negative outputs, requires a second op amp. In the circuit of Fig. 5, amplifier  $A_1$  supplies the negative load current, while amplifier  $A_2$  supplies the positive load current. The zener current then will not be

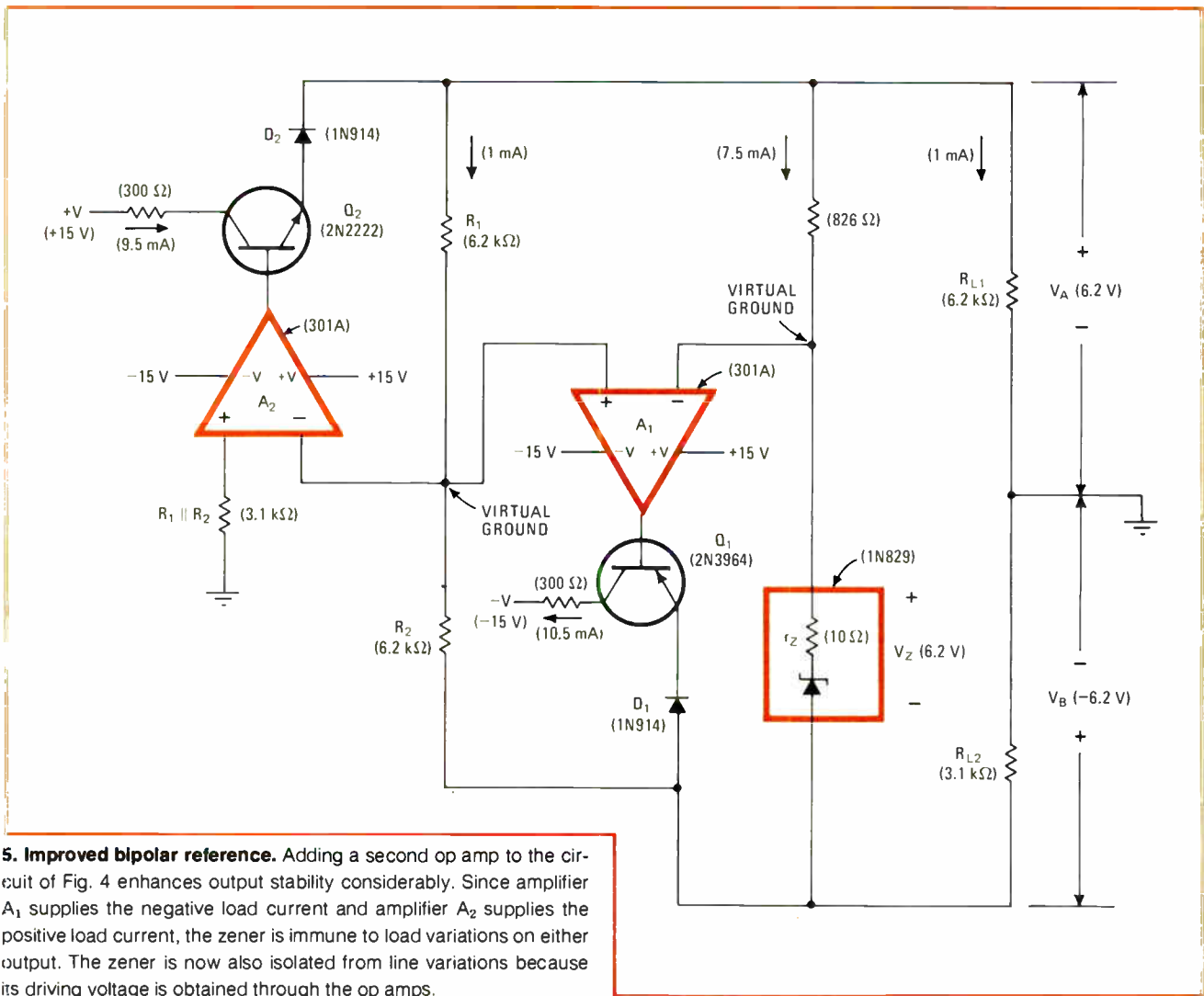

**5. Improved bipolar reference.** Adding a second op amp to the circuit of Fig. 4 enhances output stability considerably. Since amplifier  $A_1$  supplies the negative load current and amplifier  $A_2$  supplies the positive load current, the zener is immune to load variations on either output. The zener is now also isolated from line variations because its driving voltage is obtained through the op amps.

affected by a change in the load for either output. Moreover, since the driving voltage for the zener is derived from the op amps, the zener is isolated from supply variations by the power-supply rejection of the op amps.

Both outputs are maintained symmetrically about ground because each amplifier creates its own virtual-ground point. The negative output voltage is simply an inverted version of the zener voltage:

$$V_B = -V_Z$$

The positive output voltage, on the other hand, is scaled by resistors  $R_1$  and  $R_2$ , permitting it to be an amplified or attenuated version of the zener voltage:

$$V_A = (V_Z R_1) / R_2$$

If resistors  $R_1$  and  $R_2$  are equal, then  $V_A$  is simply  $+V_Z$ . As with the dual-polarity reference of Fig. 4, the two output voltages are related to each other by:

$$V_A / R_1 = -V_B / R_2$$

Transistors  $Q_1$  and  $Q_2$  act as economical current boosters, while diodes  $D_1$  and  $D_2$  provide the gating action necessary for turning the amplifiers on properly. If

chopper-stabilized op amps are chosen for amplifiers  $A_1$  and  $A_2$ , the circuit's thermal and long-term stability will be quite good. Typical device type numbers and circuit values are shown parenthetically in Fig. 5.

Both of the dual-polarity references described here permit a line and load regulation of 0.001% to 0.01% to be achieved. And the temperature stability of both circuits can be as good as that of the zener diode being used. For example, the temperature coefficient of the popular type 1N829 reference diode can be as low as 4 ppm/ $^{\circ}$ C.

Naturally, any reference source must operate in an appropriate thermal environment if circuit stability is to be maximized. Remember that the circuitry associated with the zener diode can dissipate significant amounts of power. An obvious way to minimize the unwanted heat this generates is to choose a low-current reference diode and low-power op amps.  $\square$

**BIBLIOGRAPHY**

- "Silicon Zener Diode and Rectifier Handbook—Theory Design Characteristics and Applications," Motorola Inc., 1961, pp 97-108
- G.J. Deboo and C.N. Burrows, "Integrated Circuits and Semiconductor Devices: Theory and Applications," McGraw-Hill Inc., 1971, pp 558-565.
- J. Milman and C.C. Halkias, "Integrated Electronics: Analog and Digital Circuits and Systems," McGraw-Hill Inc., 1972, pp 501-525.



**Why are other  
computer companies  
refusing to run  
benchmarks against  
the Eclipse?**

Apparently, they've seen some of the results.

Eclipse has been running Fortran benchmarks faster than an IBM 370/155.

And more than twice as fast as the PDP-11/45.

It's even beaten out a Xerox Sigma 9.

And those benchmarks were not ones we designed to make Eclipse look good. We only ran programs that prospects asked us to run.

Not only that, the Eclipse they were run on was using core memory. If we had used semiconductor memory with cache, you can imagine what would have happened.

Eclipse may have caught the competition off guard, but that's just what we expected it to do.

That's why we built Eclipse around a new microprogrammed architecture and an instruction set designed for high level languages and real time operating systems.

And that's why we gave it the fastest Floating Point Processor in the industry.

But making a computer fast is one thing. Getting all that speed out of it is another.

So we also came up with a sophisticated new set of Eclipse software: A Fortran 5 package, and a new Mapped Real Time Disc Operating System with features like virtual overlays and window mapping. (Which you may not have heard about because we just invented them.)

Which means if you don't want to end up with a computer that's been eclipsed, you're going to have to do something about it.

Call (617) 485-5467.

# DataGeneral

The computer company you can understand.

• Data General Corporation Southboro, Massachusetts 01772, (617) 485-9100  
Data Gen of Canada, Data General Europe, 116 Rue de la Tour, Paris 75016 France.  
Data General Australia, Melbourne (03) 82-1361/Sydney (02) 908-1366.

## Two-color LED pair is digital status indicator

by Bill Schweber  
GTE Sylvania, Needham, Mass.

A red-and-green LED pair in a single package, such as the Monsanto MV 5491, can serve as a status indicator for digital levels with a single supply-voltage circuit. The polarity across the LED is reversed by changing the relative potentials at the two LED terminals, rather than by having one of its terminals at ground and putting positive and negative voltages on the other.

An on/off line enables the entire indicator. Transistors  $Q_1$  and  $Q_2$  serve as LED drivers. When the red/green control line is high (and the enable line is high), the output of gate A is low, turning  $Q_1$  off, while gate C's output is high, so  $Q_2$  is on. Current goes through limiting resistor  $R_1$ , and the LED glows red.

When the control line is low, the situation reverses, as does the difference of potential across the LED, which

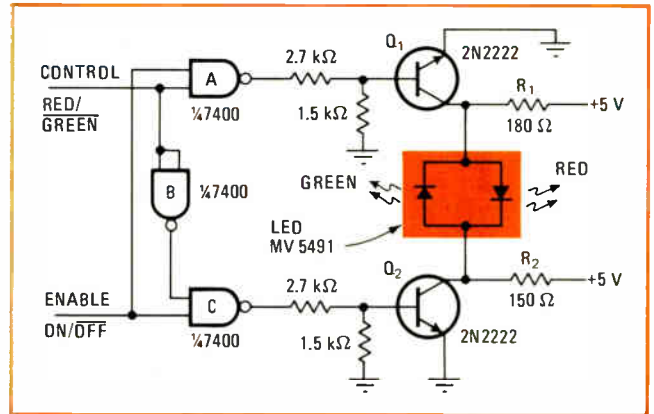

**Logic probe.** A red-and-green LED packaged pair, such as the Monsanto MV 5491, can serve as a status indicator for digital levels.

glows green with  $R_2$  limiting current. Note that  $R_1$  and  $R_2$  are of different values because of the different forward drop across the LED, depending on which way it is biased. Pulling the enable line low causes the outputs of gates A and C to go high, so  $Q_1$  and  $Q_2$  turn on, putting both ends of the LED at the same potential; therefore the LED stays off. □

## TTL IC serves as touch keyboard.

by David Cockerell  
Electronic Music Studios (London) Ltd., London, England

The terminals of a \$2 multiplexer IC can be used as a contactless keyboard to produce binary-coded output. The IC is mounted on a printed-circuit board, and its

terminals are connected to finger-tip-size touch pads. During scanning of the 16 multiplexer inputs, which are actually NAND-gate terminals, a number is generated at the output only when the corresponding pad is touched by an operator's finger.

The transistor-transistor-logic NAND gate in Fig. 1 illustrates the operating principle of this keyboard. If one input of the gate is pulsed high while the other input terminal is allowed to float, the stray capacitance of the floating terminal (typically 3 picofarads) is charged by a current of about 1 milliamperere. This makes the floating terminal also go high, and the two high inputs result in

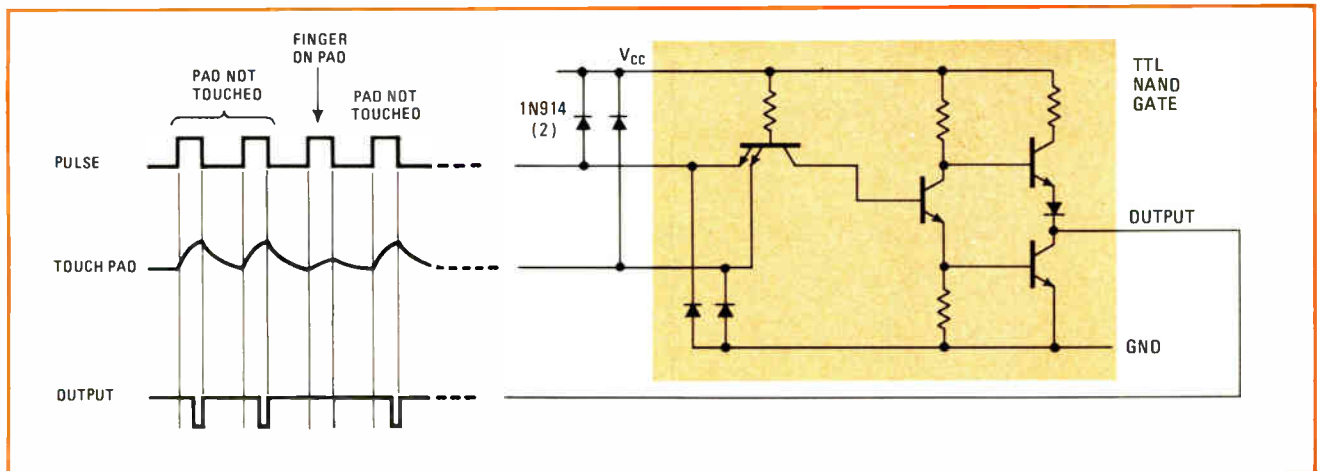

**1. Touch control.** Operator's finger on terminal of TTL NAND gate makes output stay high when other input is pulsed. Output is generated by addition of capacitance from finger—no switches or leads are required. Using this technique, 16-terminal IC can be contactless touch-control keyboard for BCD output. External diodes protect against positive voltage spikes, and internal diodes protect against negative spikes.



a low output. If the operator touches a 30-pF finger to the floating terminal, however, that terminal charges more slowly; it does not have time to reach the threshold voltage (unless the pulse is very long), and therefore the output stays high.

The complete circuitry for the capacitive touch keyboard is shown in Fig. 2. The pulse that strobes the multiplexer also clocks the scanning counter, which delivers A,B,C, and D inputs to both the multiplexer and the parallel-load shift register. During 16 successive clock pulses, the counter scans the 16 possible 4-bit combinations at ABCD, and, at the 4-bit word corresponding to the pad that is touched, the multiplexer produces an output pulse to the shift register. This pulse (into S1 and S0) loads 4-bit word ABCD into the shift register on the trailing edge of the clock pulse.

The shift register can be loaded only if the multiplexer output has been high during the last 20 ns of the clock pulse. This requires that the duration of the clock pulse be more than 20 ns (to let untouched terminals charge up to threshold voltage), but not long enough to let the touched pad charge. A pulse duration of 50 ns has been used successfully.

If the input current to a pad were unusually low, the pulse might have to be longer. Manufacturers of TTL specify only a maximum value for input current, but in fact, the spread in values is less than two to one from one device to another, and is even less between terminals on the same chip. To minimize the effect of this spread without having to adjust each circuit, fixed capacitance of the touch pads should be kept low.

The clock frequency is not critical. It merely must be

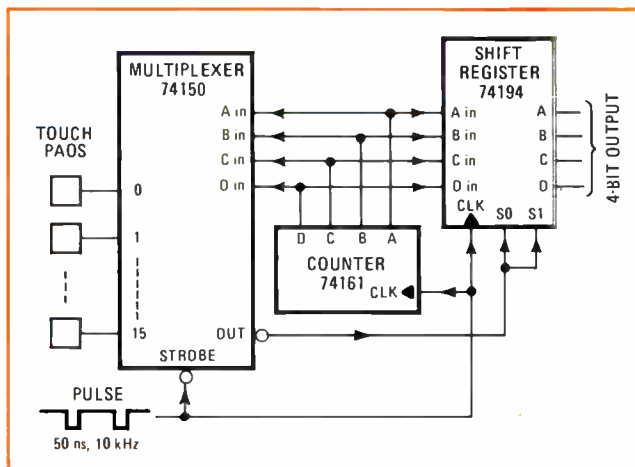

2. **Keyboard.** Complete circuit for contactless touch-control keyboard uses multiplexer, counter, and parallel-load shift register. Pulse that strobes multiplexer also clocks scanning counter into shift register on its trailing edge. Output from register is 4-bit word.

low enough to allow 10-nanoampere inter-emitter leakage to discharge the touch pads between scans. A clock frequency of 10 kilohertz has operated satisfactorily.

The wise designer will add diodes to clamp the pads to  $V_{CC}$  because rubber shoes on nylon carpets can produce some horrifying voltages—as high as 10 kv for a man, and 20 kv for a woman—that can easily destroy the emitter junction of a gate. These diodes, included in Fig. 1, protect against positive voltage spikes. The internal ground-clamping diodes provide protection against negative spikes. □

## Designing with preferred component values cuts costs

by Nathan O. Sokal  
Design Automation Inc., Lexington, Mass.

Designing with a minimum number of component values—so-called “preferred” values—can reduce materials and administrative costs for both manufacturing and engineering functions. The practice is no longer as common as it used to be, but it deserves to be revived now in updated form.

The accompanying tables suggest an order of preference to be followed in selecting values of resistance, inductance, capacitance, zener-diode voltage, field-effect diode current, and the like. Such components are available in sets of values that result from rounding to two (or three) digits the values obtained from  $10^{n/24}$  (or  $10^{n/96}$ ), where n ranges from zero to 23 (or 95) for each decade.

Tables 1 and 2 show the values in each of these series arranged into four columns to indicate the preferred order of component selection. Column one contains the first value and every eighth succeeding value. Column

TABLE 1: TWO-DIGIT SERIES (24 VALUES PER DECADE)			
20% SERIES		10% SERIES	5% SERIES
First Preference	Second Preference	Third Preference	Fourth Preference
1.0			1.1
		1.2	1.3
	1.5	1.8	1.6
2.2		2.7	2.0
	3.3	3.9	2.4
		5.6	3.0
4.7		8.2	3.6
	6.8		4.3
			5.1
			6.2
			7.5
			9.1

two contains values that are half way between two values in column one. Column three contains values that are half way between values in columns one and two, and column four contains all the rest. The order of pref-

## HERMES LOOP ANTENNA

THREE SAMPLE SITES  
ON THE NORTH AMERICAN  
CONTINENT —

DIFFERENT LATITUDES  
DIFFERENT CLIMATE



FROBISHER BAY, CANADA



MARSHFIELD, MASS.

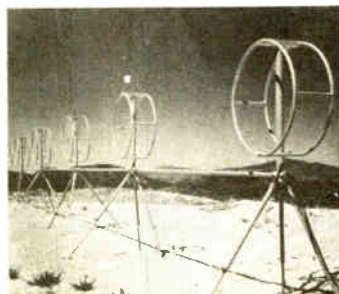

NEAR SAN DIEGO, CALIF.

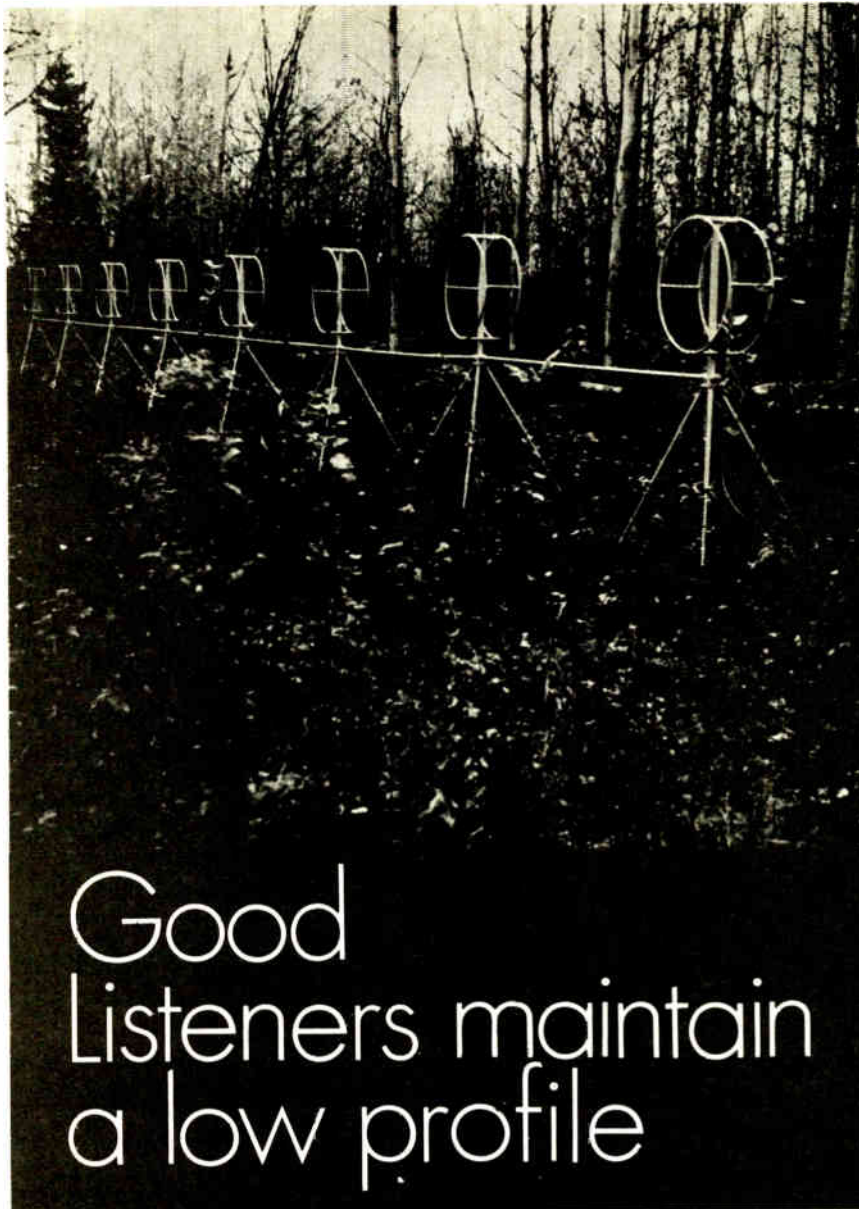

# Good Listeners maintain a low profile

Even in the solitude of the forest depths, from rooftops, arctic tundra, swamps to sweltering tropics, 'neath snow, sand or ice, the Hermes Loop antenna keeps an ear to the sky. The amazing aperiodic antenna does away with vast log periodic and rhombic arrays - those towering antenna farms.

Excellent directional characteristics in rosette configuration, the Hermes loop antenna provides an omnidirectional broadband receiving array in space merely 1/100th that of the traditional antenna farm.

More than 53 government agencies around the world have pressed the loop antenna into service.

A new, even more compact version is available. Only Hermes Electronics makes it.

**2-32MHz  
BROADBAND**



**ASK US** Send for our Brochure

Hermes Electronics Limited  
Suite 315

2020 F Street NW  
Washington DC 20006 USA

202-296 2978  
TWX 710 822 1106



**TABLE 2: THREE-DIGIT SERIES (96 VALUES PER DECADE)**

2% SERIES			1% SERIES
First Preference	Second Preference	Third Preference	Fourth Preference
1.00		1.05	1.02
	1.10		1.07
		1.15	1.13
1.21			1.18
		1.27	1.24
	1.33		1.30
		1.40	1.37
1.47			1.43
		1.54	1.50
	1.62		1.58
		1.69	1.65
1.78			1.74
		1.87	1.82
	1.96		1.91
		2.05	2.00
2.15			2.10
		2.26	2.21
	2.37		2.32
		2.49	2.43
2.61			2.55
		2.74	2.67
	2.87		2.80
		3.01	2.94
3.16			3.09
		3.32	3.24
	3.48		3.40
		3.65	3.57
3.83			3.74
		4.02	3.92
	4.22		4.12
		4.42	4.32
4.64			4.53
		4.87	4.75
	5.11		4.99
		5.36	5.23
5.62			5.49
		5.90	5.76
	6.19		6.04
		6.49	6.34
6.81			6.65
		7.15	6.98
	7.50		7.32
		7.87	7.68
8.25			8.06
		8.66	8.45
	9.09		8.87
		9.53	9.31
			9.76

erence in Table 1 may be familiar to engineers with long memories, but extension of preferred values to include the three-digit series is an update of this concept.

No restriction is placed on the values available to the designer; if a certain value must be used, it can be used. However, when a particular application requires a resistor that can have any value in the range between 100 and 1,000 ohms, for example, a 470-ohm, 20% resistor should be used rather than one rated at 510 ohms with 5% tolerance.

All of the values in Table 1 are available with 5% tolerance. The 5% series are available only with 5% tolerance; the 10% series are available with either 5% or 10% tolerance, and the 20% series are available with 5%, 10%, or 20% tolerance. Similarly, all of the values in Table 2 are available with 1% tolerance. The preferred tolerance (and temperature coefficient spread when a choice exists) is the loosest available one that does the job reliably. The purchasing or manufacturing department can always substitute a smaller tolerance or temperature coefficient if that is advantageous for purchasing or stocking reasons.

Using preferred values results in equipment designs that require a smaller variety of components, and since larger quantities of each component are used, they can be purchased at lower prices. Common use of the preferred values in different projects and equipments also reduces overhead costs in placing and tracing orders for fewer kinds of items, in receiving and inspecting fewer kinds of items, and in stocking and kitting fewer kinds of items for use in manufacturing. Field-service costs are reduced, too, because fewer different items are needed to be distributed, stocked, reordered, and accounted for in field locations.

The standard range of values for components is generally the same in specifications for industry as for the military. As an example, Table 3 shows the standard ranges for carbon-composition resistors. Components selected from the standard range are readily available from more sources and at lower cost than are nonstandard components. □

Engineer's Notebook is a regular feature in Electronics. We invite readers to submit original design shortcuts, calculation aids, measurement and test techniques, and other ideas for saving engineering time or cost. We'll pay \$50 for each item published.

**TABLE 3: STANDARD RANGE OF VALUES FOR CARBON COMPOSITION RESISTORS, MIL-R 39008**

Power rating (watts)	Type	Minimum Resistance (ohms)	Maximum Resistance (megohms)
1/8	RCR05	2.7	22
1/4	RCR07	2.7	22
1/2	RCR20	2.7	22
1	RCR32	2.7	22
2	RCR42	10	22



## How reliable are beam leads?

When, if ever, will beam-lead devices really make it? Not for a while, if you accept the conclusion of a study recently completed by Hughes Aircraft Co. for Rome Air Development Center—"there still are open questions concerning the improved reliability commonly attributed to this technology."

According to RADC's latest Reliability Analysis Center Newsletter, the principal failure mechanisms, based on tests of more than 4,000 commercial beam-lead devices, are: **deplating of gold when improperly protected devices are operated in wet environments**; a gold-silicon interaction that leads to junction shorts; and surface instability of linear devices when the circuits are operated at elevated temperatures.

## Figure out your pay

**Wondering if your pay check is right for your experience and position?** There's a new booklet just out to help you figure what your salary should be. Prepared by the Engineering Manpower Commission of the Engineers Joint Council, the 24-page publication contains a worksheet and **a series of median salary progression charts keyed to degree and year of graduation**. There's also an adjustment table to add or subtract from your median salary for supervisory status, employment field, and geographic region. Once you've worked out the numbers **you'll know if your 1974 salary was better or worse than median pay**. The "kit" costs \$5, prepaid, from the Engineers Joint Council, Dept. PK, 345 East 47th Street, New York, N.Y. 10017.

## Inverting integrator does better in closed loop

When you need an integrator in a closed-loop system, like the automatic-slope-and-gain-control loop of a cable-TV system, **don't automatically decide on a noninverting integrator because you like its high input impedance**. Remember that its amplitude response is peaked, says Roland J. Turner of General Electric Space Division in King of Prussia, Pa. This means the device **has a poor transient response, could start oscillating**, and recovers slowly after a step input.

**An inverting integrator, on the other hand, has a critically damped transient response, so that its settling time is short**. It is also inherently more stable than the noninverting type, and more immune to high-level noise jamming. But what about its low input impedance? Well, it **won't load your signal source if you put a series resistor between source and integrator**. Of course, the maximum value of this resistor is limited by how much signal loss your system can tolerate.

## Methods of testing audio amplifiers

**The performance of audio amplifiers gets harder to measure accurately as it comes closer to the ideal**—really wide bandwidths and minimal distortion. So a free 24-page cookbook, called Standard Audio Tests, should be useful. It describes **simple but precise methods for determining 12 audio amplifier parameters**, including power output frequency response, harmonic and intermodulation distortion, damping factor, and signal-to-noise ratio, using a spectrum analyzer. Write Tektronix Inc., P.O. Box 500A, Beaverton, Ore. 97077. **Stephen E. Scrupski**

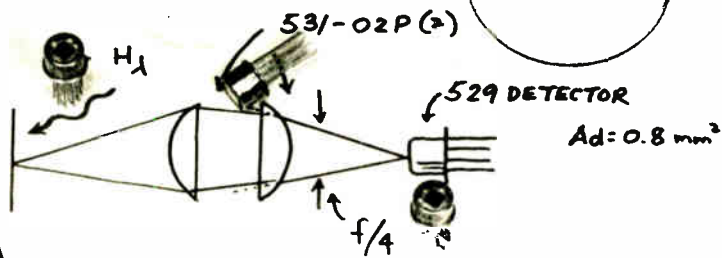

$$P_D = \frac{H_\lambda R T A_d}{4 (f/\#)^2}$$

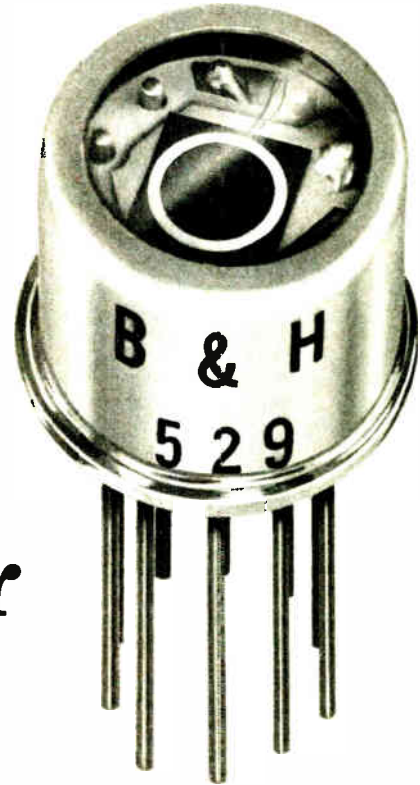

**Announcing A  
Bell & Howell  
Price/Performance  
Breakthrough!**

# Improved Silicon Photo Detectors with integral Amplifier ... now under \$10\*

Bell & Howell can save you some real money on your photo detector circuits. Consider that one of our 529 detectors costs less than the photo diode, op amp, gain determining network and circuit board you'd need to perform the same functions . . . and it's all hermetically sealed in a miniature TO-99 transistor package.

We're tooled up to produce these high reliability units in volume to assure prompt delivery for your production requirements. So figure it out for yourself. When you can get quality units, in a compact size, at a low cost, delivered on schedule, why not contact Bell & Howell now. We'll send you some convincing specifications and prices.

Modification of these units can be made to meet specific requirements on volume orders.

## Performance and Design Features

- Integrated Photo Diode, Op Amp and Gain Network for lowest noise . . . highest stability and reliability
- Sensitivities to  $10^{-12}$  watts
- Lower Dark Offset Voltages
- Spectral Range 0.35 to 1.12 microns
- 7 Decade Linear Dynamic Range
- Programmable Sensitivity and Bandwidth with 2 low value External Resistors
- Bandwidths to 10 MHz
- NEP's to  $10^{-12}$  watts/ $\sqrt{\text{Hz}}$
- Two standard detector active areas,  $0.8 \text{ mm}^2$  and  $5 \text{ mm}^2$

**CONTROL PRODUCTS DIVISION**  
706 Bostwick Ave., Bridgeport, Conn. 06605 (203) 368-6751



**BELL & HOWELL**

Circle 113 on reader service card

\* for quantities of 1000

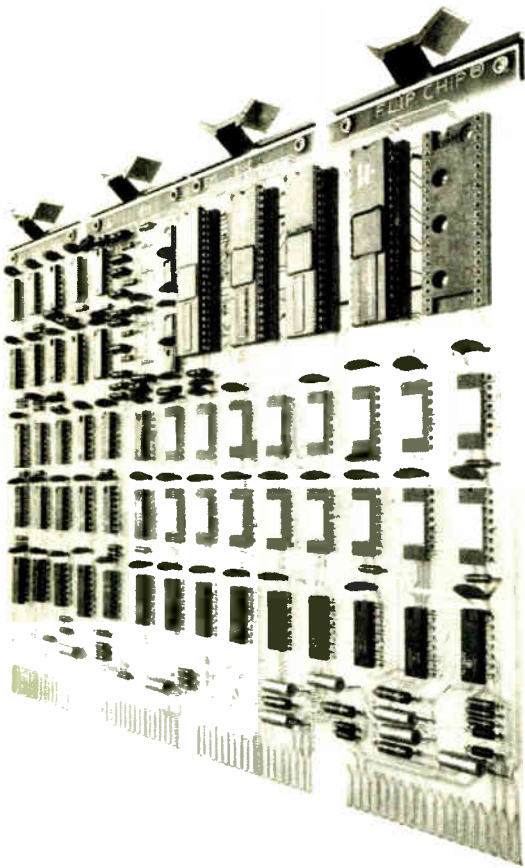

# Microcomputer wields power of a mini

Four-chip LSI-11, with 16-bit processor and 4,096 words of memory on one board, joins DEC PDP-11 family; beats 11/05 speed

by Stephen E. Scrupski, Computer Editor

"It combines the performance of a minicomputer with the size and cost of a microcomputer." That's how Digital Equipment Corp. attempts to define its LSI-11 microcomputer, which is, in fact, an addition to the company's PDP-11 minicomputer family.

The LSI-11 is a complete 16-bit processor, with 4,096 16-bit words of semiconductor random-access memory on a single printed-circuit board measuring 8½ by 10 inches. The computer is compatible with other PDP-11 computers and runs the basic instruction set of the PDP-11/40, which ranks about midway up the family hierarchy in computing power (below only the 11/45 and the new 11/70 system). Execution speed of the LSI-11, the company says, is faster than that of the 11/05, which does register-to-register additions in 3.6 microseconds.

The LSI-11 uses four n-channel MOS LSI chips developed by Western Digital Corp. [*Electronics*, Oct. 31, 1974, p. 25]: a data chip, a control chip, and two microprogramed read-only memories called Microms, which contain the actual instruction set. The basic board (see photo) has one empty socket, which will take an optional fifth LSI chip to

allow floating-point calculations. A 16-bit parallel bus handles input-output functions and the computer can directly address up to 32 kilowords of external memory (either semiconductor RAM, ROM, or core).

The LSI-11 microcomputer family actually comprises several boards:

- The KD11-F processor module (shown in the photo).
- DLV-11 serial line unit, which has a 40-pin MOS UAR/T chip for asynchronous serial interfaces.
- The DRV-11 parallel-line interface module.
- The MSV-11A RAM, a 1,024-by-16-bit random-access memory.
- The MSV-11B RAM, a 4-k-by-16-bit random-access memory.
- The MRV-11AA programable ROM of 4-k by 16 bits.
- The MMV11-V 4-k-by-16-bit core memory with a 1.2- $\mu$ s cycle time.

The Microms also store several features that make the system easy to use, according to DEC. For example, it holds an ASCII console routine that eliminates the programmer's panel, and thus the most unreliable part of most minicomputers—the electromechanical switches. The ASCII routine allows the programmer to debug a program using a key-

board and cathode-ray-tube display. An octal debugging routine also is stored in the Microms, thus eliminating the need to load the routines from an external source, such as paper tape.

The LSI-11's power-fail/restart feature allows it to sense when the ac line voltage drops below a marginal value. In the few milliseconds remaining before power fails completely, it can enter a power-down routine that stores data on disks so that when power returns, the machine will be ready to continue its operations. A real-time clock allows the machine to be synchronized with external operations, and a special input allows synchronizing the clock with inputs from a 60-hertz ac line and others up to about 50 kilohertz.

A backplane also is available to tie four boards together in a four-slot cage assembly. The company says it will announce, on March 30, a "boxed" version of the LSI-11, which will have a cabinet and power supply. The LSI-11 main microcomputer board (KD11-F) will sell for \$634 in quantities of 100.

Components Group, Digital Equipment Corp., One Iron Way, Marlborough, Mass. 01752 [338]



**Now! The readable  
7/8-inch dial...  
a fitting mate for our 7/8-inch pot!**



### **The New Spectrol Model 16 Dial**

**Interchangeable with competitive 7/8-inch dials — and much easier to read — it's a fitting mate for our Model 534, the industry's best low-cost multi-turn pot. Call or write for more information.**

**Spectrol**

**SPECTROL ELECTRONICS GROUP**

**UNITED STATES Spectrol Electronics Corporation 17070 E. Gale Avenue, City of Industry, Calif. 91745, U.S.A. • (213) 964-6565 • TWX (910) 584-1314**

**UNITED KINGDOM Spectrol Reliance Ltd. Drakes Way, Swindon, Wiltshire, England • Swindon 21351 • TELEX: 44692**

**ITALY SP Elettronica spa Via Carlo Pisacane 7, 20016 Pero (Milan) Italy • 35 30 241 • TELEX: 36091**

Circle 115 on reader service card



# There's more behind a carbon film resistor than carbon

Particularly if the resistor comes from Piher. There's 25 years experience for a start.

Which is why we are one of the world's leaders in the carbon film resistor field.

With an output of 10 million resistors *per day*, they are obviously in demand. Everywhere.

Which is why we have opened a manufacturing plant in the USA to help satisfy North American

needs, quickly, and help give a bigger share of European production to European markets.

Find out about the Piher resistor range

— and all the other products that have made us a leader in component technology.

Fill in the magazines reader reply card, or write direct to the office in your area for our technical literature. We're worth knowing.

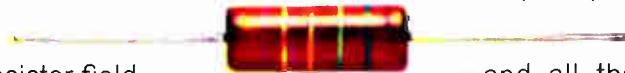

USA - PIHER Corporation, 399 Washington Street, Woburn, Massachusetts 01801. Tel: 617 935 8750

Germany - PIHER International GmbH, 85 Nurnberg, Tuchergartenstrasse 4, Tel: 0911 533 051

France - PIHER International SARL, 83 Rue Etienne Dolet, 94230, Cachan, Tel: 656 8484

Italy - PIHER International SPA, Via Cenisio 34, 20154 Milan, Tel: 314 532/316 213

UK - PIHER International LTD, Romar House, The Causeway, Staines, Middlesex, Tel: Staines 56157

Spain - PIHER SA, Riera Canado, s/n. Apartado de Correos, 53 Badalona (Barcelona), Tel: 389 03 00

Circle 116 on reader service card



# Tester checks C-MOS watch circuits

Dedicated microprocessor-controlled system permits variety of configurations for different levels of circuit and module complexity

by Bernard Cole, San Francisco bureau manager

To meet the exacting demands of watchmakers, some semiconductor companies have had to use automated testing systems costing \$250,000 to \$500,000 and originally purchased to speed up production of standard circuits. And because test cycles for the complementary-MOS watch circuits require at least 2 to 10 seconds, testing with these large units ties up expensive assembly lines.

In a bid to speed up production, ALMA, a division of Develco of Mountain View, Calif., is introducing a microprocessor-controlled automatic tester, the model 720, dedicated to watch circuits and modules. Tests include continuity, output breakdown voltages, input leakage, static and dynamic supply current, oscillator gain, functional checks, output-drive parametric evaluations, and time intervals.

The model 720, priced at \$30,000 to \$40,000, implements microprocessors in a way that differs from other systems in which they merely replace hard-wired logic. The ALMA tester takes advantage of the full computational and peripheral resources of the Motorola 6800 microprocessor, which controls the pin electronics and also generates test programs and program sequences via programmable interface adapters and the data-bus architecture. Both the control architecture and the interface with the unit under test are bus-oriented for modular expandability. The bus structure, an extension of the Motorola XC6800 microprocessor-family bus, provides real-time system control.

Glenn Patterson, ALMA's director of marketing, says the general archi-

ture is effective in the control of functional and parametric-test electronics for evaluation of quartz-crystal time-keeping circuits. These test requirements include a dynamic range for current-sensing from a few nanoamperes to hundreds of milliamperes, test rates from hertz to megahertz, and more than 64 pins for interfacing with units under test.

The system also permits optimum configurations for different levels of watch-circuit complexity, from 4-digit multiplexed watches to circuits with eight or more parallel digits and such complex features as the capability to test chronometers. A fully equipped 720 includes a console-mounted electronics section, a cathode-ray-tube display with keyboard and hard-copy printout, a control module, a high speed 16-

track, 128,000 byte floppy-disk memory and the microprocessor unit with 8,192-bits of static MOS random-access memory—a configuration optimized for generating engineering evaluation.

Dual-pin cards are provided for signal conditioning and sensing the device under test. The basic system has 24 pins and is expandable in two-pin increments to 64 pins. The pin cards perform both functional and parametric tests in parallel to minimize test time. Plug-in resistors on the cards permit the customer to select the dynamic ranges required for different watch-display technologies such as dynamic-scattering liquid-crystals, field-effect liquid-crystals, and light-emitting-diodes.

Quad digital-to-analog-converter modules provide reference values for driver and current-sensing, comparator, 0 and 1 levels, device-under-test bias supplies and supply-current comparator limits. The standard system contains 12 reference levels, and an optional four additional levels can be assigned for multilevel drive requirements or other unique bias/reference applications.

The dual-pin cards plug into a mother board containing 15 boards (or 30 pins) per row. Space is provided for up to 32-dual-pin cards or 64 pins. An additional row contains the microprocessor, its clock, memory, programmable interface-adapters and reference digital-to-analog converters. An interface board unique to the device under test plugs into the pin electronics to allow pin-scrambling.

ALMA Corp., 530 Logue Ave., Mountain View, Calif. 94043 [339]



Test control. Drawer in system contains microprocessor and associated electronics.



Semiconductors

## CCD memory stores 16-k bits

---

Unit with 64 256-bit shift registers aimed at low-cost applications

---

The race to begin production of the first family of charge-coupled-device memories is heating up considerably. Intel Corp. this month introduced a 16,384-bit CCD serial memory, designated the 2416. This device follows a similar—but smaller—9,216-bit CCD memory introduced last month by Fairchild Semiconductor [*Electronics*, Jan. 9, p. 30].

Organized into 64 recirculating shift registers of 256 bits each, the Intel 2416 is designed for low-cost memory applications requiring average access times in the range of 100 microseconds to 1 millisecond, says Mike Markkula, North American marketing manager. Any of the 64 shift registers can be accessed by applying an appropriate 6-bit address input. The shift registers recirculate data automatically as long as the four phase clocks are continuously applied and no write command is given.

A 1-bit shift is initiated in all registers following a low to high clock transition. After the shift operation, the 64 accessible bits (whether modified or not) are transferred forward into the respective registers, and the contents of the next bit position of each register become accessible. No input/output function, says Markkula, can be performed during the shift operation itself.

The Intel 2416 generates and uses an internal reference voltage that requires some time to stabilize after the power supplies and four-phase clocks have been turned on. After at least 2,000 cycles with power supplies at operating voltages, no special action is needed to keep the internal reference voltage stable.

The 2416, fabricated by means of Intel's high-voltage n-channel silicon-gate MOS process, is available in a standard 18-pin package. Maximum serial data rate is 2 megabits per second. Average access time to any bit is about 100 microseconds at a 64-kilohertz shift rate and 64 microseconds at 1 megahertz. Using standard -12 and +5-volt power supplies, the 2416 has combined read/write cycles. Power dissipation is 200 milliwatts at the 2-megabit data rate.

Die size is about 33,000 square mils. This was achieved, says Markkula, by the addition of a second layer of polysilicon to Intel's standard process, allowing much greater density because it permits the use of three layers of interconnect rather than two. Available now in sample quantities, the 2416 is priced under \$60 each in quantities of 100.

Intel Corp., 3065 Bowers Ave., Santa Clara, Calif. 95051 [411]

---

### 4,096-bit PROM uses only 4 mW in standby

Using a silicon-gate p-channel process with the floating-gate avalanche MOS (Famos) technology, National Semiconductor will be supplying production quantities of a 4,096-bit programmable read-only memory by the end of the month. Previously offered only in a 2,048-bit format by Intel Corp., which developed Famos, the denser part—designated the MM5204—is organized as 512 words by 8 bits. Maximum access time over the temperature range

from 0° to 70°C is 1.5 microseconds.

The MM5204 has a maximum programing time of under one minute, and typical programing time is 20 to 30 seconds, says Bruce Moore, product marketing manager. Operating from power supplies of +5 and -12 volts, the 4-k PROM has Tri-State outputs for easy expansion and is TTL-compatible. Housed in a 24-pin dual in-line package, the MM5204 typically draws about 20 to 28 milliamperes while operating. This is roughly translatable into about 0.1 milliwatt per bit. Most important, Moore says, the PROM uses only 4 mW in its power-down mode. This is achieved by a "power saver" logic input. When a logic 1 or TTL "high" is applied to this pin, it deactivates portions of the chip not in use. Typical applications of the 4-k PROM, says Moore, are code conversion, random-logic synthesis, table lookup, character generation, microprograming, and electronic keyboards. Price is \$75 each in quantities of 1-24, \$60 each for 25-99 units, and \$50 each for 100.

National Semiconductor Corp., 2900 Semiconductor Dr., Santa Clara, Calif. 95051 [412]

---

### Field-programmable ROMs offer fast access time

Two high-speed bipolar read-only memories have large storage capacities and are instantly programmable by the user. The model 82S114 is a 2,048-bit programmable ROM organized as 256 8-bit words, and the 82S115 is a 4,096-bit PROM consisting of 512 8-bit words. Typical access time for each model is 35 nanoseconds. The large-scale PROMs are suitable for bus-organized data systems, specifically for microprograms, hardwire algorithms, character generation, control storage, and sequential control. Features include buffered address lines, on-chip decoding, on-chip storage latches, three-state outputs, and input currents of less than 100 microamperes. In lots of 100, the PROMs are priced at \$65 each. Factory pro-

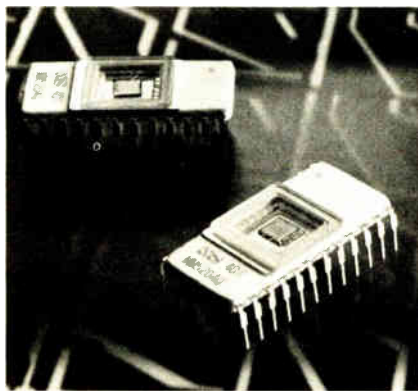

# Compare TI's NEW SR-51....

- Mean, variance and standard deviation.
- Automatic linear regression. ● 20 programmed conversions.
- Percent and percent difference.
- Random number generator.
- 3 accessible memories. And much more for only

**\$224.<sup>95</sup>**

FUNCTION	SR-51	HP 45
Log, ln	yes	yes
Trig (sin, cos, tan, Inv)	yes	yes
Hyperbolic (sinh, cosh, tanh, Inv)	yes	no
Degree-radian conversion	yes	yes
Deg/rad mode selection	yes	yes
Decimal degrees - deg-min-sec	yes	yes
Polar-rectangular conversion	yes	yes
$y^x$	yes	yes
$e^x$	yes	yes
$10^x$	yes	yes
$x^2$	yes	yes
$\sqrt{x}$	yes	yes
$\sqrt[y]{x}$	yes	no
$1/x$	yes	yes
$x!$	yes	yes
Exchange x with y	yes	yes
Metric conversion constants	13	3
% and $\Delta\%$	yes	yes
Mean and standard deviation	yes	yes
Linear regression	yes	no
Trend line analysis	yes	no
Slope and intercept	yes	no
Store and recall	yes	yes
$\Sigma$ to memory	yes	yes
Product to memory	yes	yes
Random number generator	yes	no
Automatic permutation	yes	no
Preprogrammed conversions	20	7
Digits accuracy	13	10
Algebraic notation (sum of products)	yes	no
Memory (other than stack)	3	9
Fixed decimal option	yes	yes
Keys	40	35
Second function key	yes	yes
Constant mode operation	yes	no

More math power for the money. More than log and trig and hyperbolics and functions of  $x$ ... the SR-51 has these and also has statistical functions... like mean, variance and standard deviation, random numbers, factorials, permutations, slope and intercept, and trend line analysis. Check the chart above—compare it. With the HP-45 or any other quality calculator. Then try it—at no risk. We're sure you'll agree that the SR-51 offers extraordinary value.

**Test the SR-51 at no risk. Full refund if not satisfied. Master Charge or Bank Americard accepted.**



TO: Texas Instruments Incorporated  
P.O. Box 22013, M/S 358, Dallas, Texas 75221

Try it 15 days. Return with all accessories if not satisfied.  
Enclosed is my  check,  money order,  company purchase order for \$ \_\_\_\_\_ for the purchase of \_\_\_\_\_ SR-51(s).

Please add state and local taxes where applicable.\*  
Please charge this order to my  Master Charge. Or,  BankAmericard  
My Card Number is:

With the expiration date: \_\_\_\_\_

If Master Charge is used indicate 4-digit Bank Number appearing on card just above your name:

Name \_\_\_\_\_  
Street \_\_\_\_\_  
City \_\_\_\_\_ State \_\_\_\_\_ ZIP \_\_\_\_\_

Authorizing Signature (If billed to Credit Card Must be signed by card holder)

\*AL, AZ, CA, CO, CT, FL, GA, IA, IL, IN, KY, MA, MD, MI, MN, MO, NC, NM, NJ, NY, PA, TN, TX, UT, VA, WA, WI. Offer good only in U.S.

**TEXAS INSTRUMENTS**  
INCORPORATED

© 1975 Texas Instruments Incorporated  
13500 North Central Expressway  
Dallas, Texas

82016



# RF switching to 500 MHz in a TO-5 package

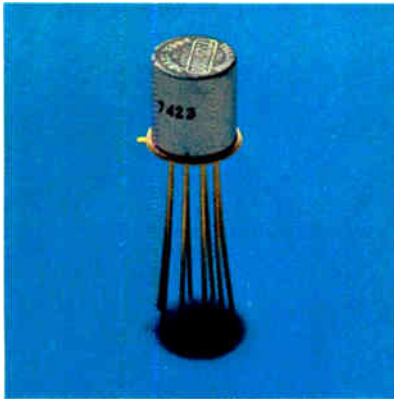

RF circuit and packaging engineers are discovering that Teledyne TO-5 relays make excellent subminiature rf switches for frequency ranges up through UHF. Their reasons are: inherently low inter-contact capacitance and low loss contact circuit geometry. Typical rf performance: Isolation — 45db at 100 MHz, 35db at 500 MHz;

Insertion Loss — 0.2db at 100 MHz, 0.4db at 500 MHz.

And Teledyne Relays offer the widest possible selection: MIL relays in SPDT & DPDT standard, sensitive, and maglatch types, all available with internal diodes; commercial models in DPDT standard and sensitive types, also available with internal diodes. All Teledyne TO-5 relays feature hermetic sealing, gold plated contacts, and all welded construction for high reliability.

For Transmit/receive switching in hand-held transceivers or any low power remote band switching application, Teledyne TO-5 relays are an excellent choice. No other relay offers this combination of rf performance, low coil power dissipation, and small package size.

And they're **in stock** at your local Teledyne Relays distributor. Call your nearest Teledyne Relays office for location of your local representative or distributor.

## **TELEDYNE RELAYS**

3155 West El Segundo Boulevard, Hawthorne, California 90250  
Telephone (213) 973-4545

Burgstrasse 6-8, 62 Wiesbaden, West Germany  
Telephone: 06121-30231/2 Telex: 04-186851 (Trel-D)

Heathrow House, Bath Road, Cranford, Hounslow, Middlesex, U.K.  
Telephone: 01-8972501 Telex: 935008





## New products

graming is available at \$12 per pattern and 50 cents per PROM.

Signetics, 811 E. Arques Ave., Sunnyvale, Calif. 94086

### Timing circuit introduces silicon-on-sapphire line

The first device offered in RCA's projected series of silicon-on-sapphire COS/MOS devices is the TA6778 timing circuit, a ripple-counter circuit for high-speed, low-power (single-power-cell) applications. The voltage range is specified as 1.1 to 5 volts for use as a counter, but the device is designed for operation in watches between 1.45 and 1.6 v using a 4.195-megahertz AT-cut crystal, or between 1.1 and 1.6 v with a 1.048-megahertz SL-cut crystal. Although the design is optimized for a 4-MHz crystal oscillator operating at 1.5 v, the circuit is capable of operating at 80 MHz for a power consumption of 1.6 milliwatts at 5 v. The TA6778 is available in sample quantities. SOS versions of four standard COS/MOS circuits will be available during the second half of 1975.

RCA Solid State Division, Box 3200, Somerville, N.J. 08876 [414]

### Low-cost op amp is programmable

A low-priced, programmable operational amplifier permits tailoring the electrical parameters to the user's needs. Programming is achieved by choice of an external-resistor value or a current source applied to the  $I_{set}$  input pin. This allows optimization of dc characteristics such as input current, power consumption and bias current, and ac characteristics such as open-loop voltage gain, slew rate and gain-bandwidth product. The op amp, type MC3476, operates over a supply voltage range from +6 volts to  $\pm 15$  v. Its low power consumption of 4.8 milliwatts (typical) makes it useful in battery-operated equipment. Other

features include low input offset and bias current (a maximum of 25 and 50 nanoamperes, respectively) and a high input resistance of 5 megohms, typical. The amplifier requires no frequency compensation and has offset null capability and short-circuit protection. Price in a plastic package is \$1.25; in a metal housing, \$1.50.

Technical Information Center, Motorola Inc., Semiconductor Products Division, P. O. Box 20924, Phoenix, Ariz. 85036 [416]

### Low-power op amps have high slew rate

Offering low power consumption at high slew rates, the series 1011 monolithic operational amplifiers are packaged in TO-99 cans with the standard op-amp-lead configuration. Power-supply quiescent current of the units is 150 microamperes, slew rate is 20 volts per microsecond, and output current is 22 milliamperes. These features, to-

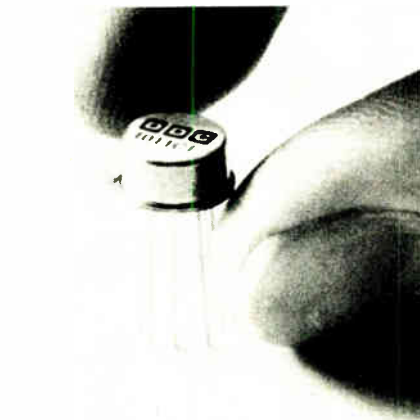

gether with a high open-loop gain of 160 dB, high common-mode rejection, typical low offset voltage of 0.5 millivolt, and an offset current of 5 nanoamperes bias current, make the devices suitable for a variety of high-speed and precision instrumentation applications. The op amps are frequency-compensated internally. Price of the model 1011CT, which is guaranteed for operation from 0 to 70°C, is \$9.45 each; and of the 1011, which operates over the range from -55° to

# We've got them all...



- Flatpacks
- Dual In-lines
- Plug-Ins
- Microelectronic Headers
- Power Packages
- Microwave Modules

They're all from Isotronics... the widest assortment of microelectronic packages you can find anywhere. And they're all manufactured with uncompromising care to meet your high standards of quality. For engineering ability and product reliability in microcircuit packaging, call Isotronics.

the microcircuit  
packaging specialists



## Isotronics

Isotronics, Inc.  
12 Coffin Ave.  
New Bedford, Mass. 02746  
(617) 997-4575 TWX 710 344 1961  
Cable—ISOTRONICS

# CABLE-BILITY WOVEN'S FLAT GOT IT!



## Ribbon Cable IC Interconnects Custom Harnesses

A total source for flat interconnect systems, Woven Electronics offers unlimited design capabilities combining signal/power transmission with specialized functions. Independently insulated conductors give tighter transmission control, more protection, allow easy lead exposure.

Specify sizes, color coding, insulations, custom break-outs without restrictions of other cable forms.

**Cable and ability. Get the best of both from one source.**

## WOVEN ELECTRONICS

P.O. Box 189 Mauldin, South Carolina 29622  
803/963-5131

## New products

+125°, it is \$21.80 per unit.  
ILC Data Device Corp., Airport International  
Plaza, Bohemia, N.Y. 11716 [415]

\$29 sample-and-hold unit has  
5-ns aperture uncertainty

Carrying a price tag of \$29 in small quantities, the SHM-IC-1 is a monolithic sample-and-hold module with an aperture-uncertainty time of 5 nanoseconds, an acquisition time of 4 microseconds (to acquire a 10-volt step to within 0.1%), and a small-signal bandwidth of 2

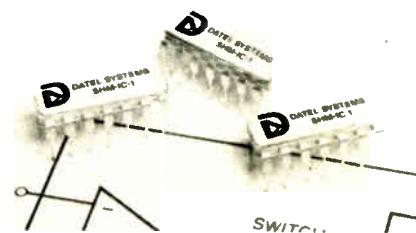

megahertz. The unit is self-contained except for its holding capacitor, which would typically be a 1,000-picofarad unit. The module has a maximum hold-mode feed-through of 0.01% of output, and can operate over the temperature range of 0° to 75°C. Delivery is from stock. Datel Systems Inc., 1020 Turnpike St., Canton, Mass. 02021 [417]

1-GHz counter and 750-MHz  
flip-flop head ECL family

A 1-gigahertz divide-by-four counter and a 750-megahertz type D flip-flop are two of five products that make up Fairchild's F11C00 family of emitter-coupled logic components for instrumentation and communications applications. In quantities of 1,000 pieces, the model 11C05 counter sells for \$54.95 while the 11C06 flip-flop has a price of \$13.70. The other units are the 11C44 phase/frequency detector and a pair of voltage-controlled multivibrators.

Fairchild Camera and Instrument Corp., 464  
Ellis St., Mountain View, Calif. 94042 [418]



# Super grids for superpower tetrodes

There is still nothing like these patented **Pyrobloc<sup>®</sup>** grids for an unmatched combination of performance, size and reliability.

Check out our complete line of highly stable new superpower tetrodes, for broadcast transmitters rated **up to 1 MW!**

- SUPER or HYPERVAPOTRON<sup>®</sup> anode cooling
- Field proven during more than **5 years** of operation
  - Now more than **100 tubes** in use
- Life far in excess of conventional high power tetrodes.

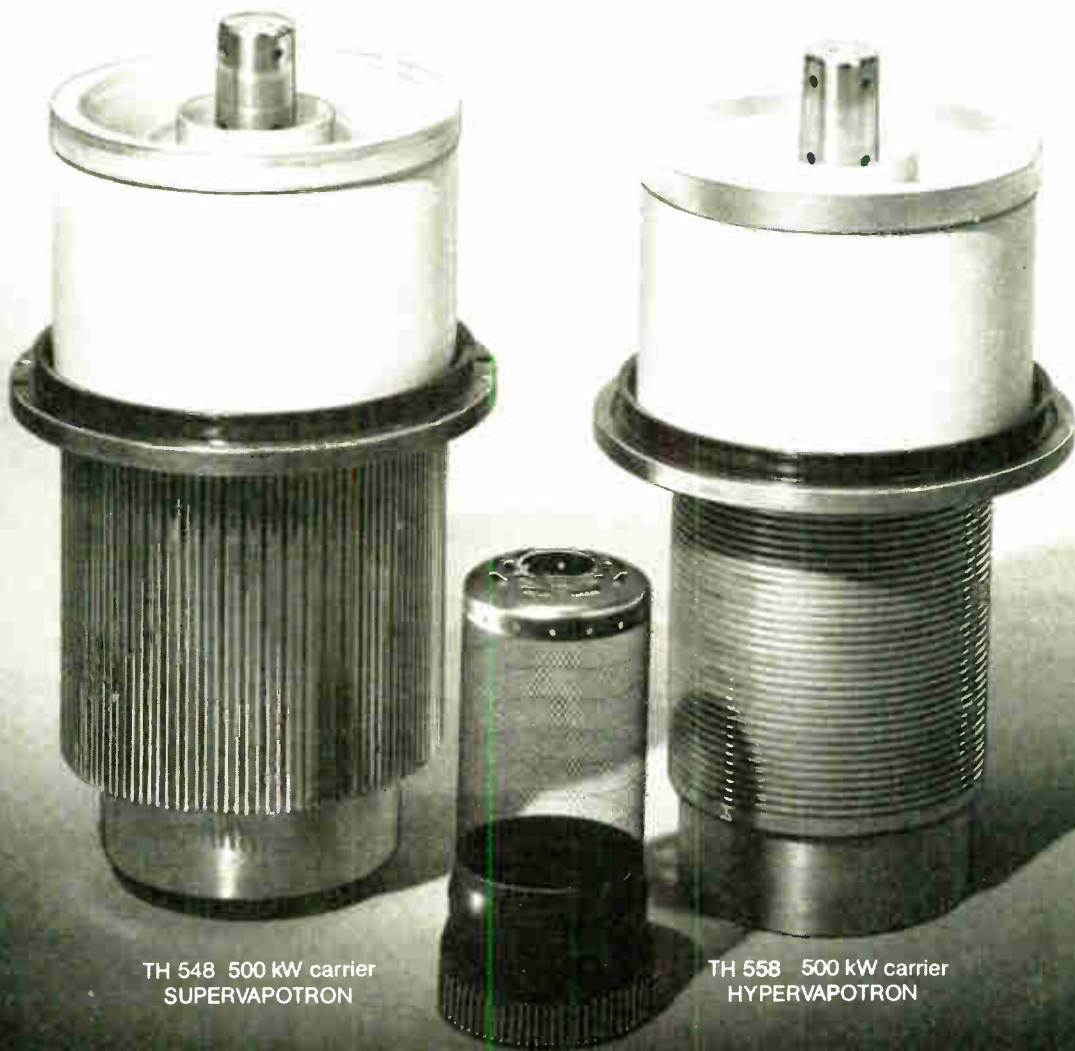

TH 548 500 kW carrier  
SUPERVAPOTRON

TH 558 500 kW carrier  
HYPERVAPOTRON



**THOMSON-CSF**

THOMSON-CSF ELECTRON TUBES, INC. / 750 BLOOMFIELD AVENUE / CLIFTON NJ 07015 / TEL. (201) 779.1004 / TWX: 710989 7149

France - THOMSON-CSF Groupement Tubes Electroniques / 8, rue Chasseloup-Laubat / 75737 PARIS CEDEX 15 / Tel. (1) 566 70.04

Germany - THOMSON-CSF Elektronenröhren GmbH / Am Leonhardsbrunn 10 / 6 FRANKFURT/MAIN / Tel. (0611) 70 20.99

Italy - THOMSON-CSF Tubi Elettronici SRL / Viale degli Ammiragli 71 / ROMA / Tel. (6) 38 14.58

Japan - THOMSON-CSF Japan K. K. / Kyosho Building / 1. 9. 3. Hirakawa-cho / Chiyoda-ku / TOKYO / T 102 / Tel. (03) 264.6341

Spain - THOMSON-CSF Tubos Electronicos SA / Alcala 87 / 7<sup>o</sup> Dcha / MADRID 9 / Tel (1) 226 76.09

Sweden - THOMSON-CSF Elektronrör AB / Box 27080 / S 10251 STOCKHOLM 27 / Tel. (08) 22 58.15

United Kingdom - THOMSON-CSF Electronic Tubes Ltd. / Ringway House / Bell Road / Daneshill / BASINGSTOKE RG24 / OGG / Tel. (0256) 29.155

World Radio History

Circle 123 on reader service card





## microcomputer design

There's more to it than just counting your chips.

Here is some new information to help you win at the product design game. *Microcomputer Design*, a new book by Martin Research, can show you how to cut the chip count on your 8008-based CPU by 20-50%. This is the first major source on cost-effective design with microprocessors. It shows you how to build increased performance and lower cost into your microprocessor system through the efficient use of your chips.

You'll find systems covered from theory to practice — from large to small. Plus important features on . . .

- **What should go into the peripheral, and what goes into the microcomputer.**
- **The most efficient bus structure for the 8008 yet published.**
- **A complete communications controller with keyboard, only 19 chips including 8008, ROM, RAM, and interface.**
- **Over 40 pages on interrupt handling with the 8008.**
- **Most design concepts applicable to any 8-bit microprocessor.**
- **Over 300 pages, dozens of schematics, and an easy-to-use lay-flat format.**

If you are working with microprocessors, you need *Microcomputer Design*. The book won't fit up your sleeve, but when you're designing for high stakes, it's like having an extra ace.

### BLUE-CHIP SPECIAL

Because of the success of our pre-publication promotion, we continue offering one 8008 microprocessor with each book for \$100.00.

Or, try the *blue-chip special* \$110.00 for the book plus one 8008-1, factory-tested for 12.5 microseconds cycle time (60% faster than the standard 8008).

And contact us for information on our economical microcomputer modules, available soon!

With deals like these — *you can't lose.*



Suite 220  
1825 S. Halsted St.  
Chicago, IL 60608  
(312) 829-6932



Send me \_\_\_\_\_ copies of *Microcomputer Design*

With 8008 microprocessor for \$100.00 \*

Blue-chip special book with 8008-1, \$110.00 \*

Book alone, \$75.00 \*

Check enclosed (shipping free).

Purchase order enclosed. Bill my company for goods plus shipping.

Send more information.



Name \_\_\_\_\_

Title \_\_\_\_\_ Phone \_\_\_\_\_

Company \_\_\_\_\_

Address \_\_\_\_\_

City \_\_\_\_\_ State \_\_\_\_\_ Zip \_\_\_\_\_

Signature \_\_\_\_\_

\*USA prices. Illinois: add 5%.

Components

# Tubular heaters trigger controls

Hollow glass resistive units reach temperature peak at midpoint of length

One simple way of protecting devices from overvoltage or over-current conditions is to use a thermally sensitive fuse that is heated by a resistive element. These resistive heaters are usually wirewound ceramic-core devices whose temperature distribution is fairly uniform throughout their length. However, Corning Glass Works has developed a line of resistive heaters that exhibit a nonuniform temperature distribution—the temperature peaks at midpoint in their length, thereby providing highly reliable temperature-triggering.

Corning calls its new devices glass-tube heaters. They are hollow

glass tubes with a tin-oxide resistive film on their outer surface. The glass substrate is what gives the tubes their peaked temperature distribution. The outer tin-oxide resistive film is continuous—it is not trimmed for resistance value so that each part's current density remains uniform across the entire length.

A variety of thermally sensitive control elements can be placed inside the tubes, including: thermal cutoffs, thermally sensitive reed switches, bimetals, fusing alloys, and thermistors or other resistive devices having large temperature coefficients. Initially, the glass-tube heaters are expected to be used as fuse elements in appliances, says Prabodh Shah, a senior market analyst at Corning. Other possible application areas include television, thermostatic controls, automobiles, and circuit protection.

At first, Corning will be selling two standard tube lengths: part number GTH801, which is 0.850 inch long; and part number GTH802, which is 1.000 in. long. Both parts have an inside diameter of 0.168 in. and an outside diameter

of 0.258 in. Nominal resistance values for the 0.85-in. units are 3, 6.5, or 10 ohms, with a tolerance of  $\pm 20\%$ . The 1-in. devices can be either 6.5, 100, or 150 ohms, and tolerance is also  $\pm 20\%$ . At 70°C, continuous power rating is 3 watts for the 0.85-in. version and 4 W for the 1-in. version.

For best results, the control element should actually be in contact with the inner surface of the tube. Since this surface is electrically isolated, the control element can even be packaged in a metal case. Additionally, because the tubes are virtually noninductive, they will not interfere with control elements having a magnetic field.

The graphs given here illustrate the temperature and power characteristics of the glass-tube heaters for one-time applications. When the applied power equals or exceeds the continuous power rating, the tubes will crack and cannot be used again. But in many applications, the control element, together with the tube, will be replaced.

Graph 1 shows the steady-state midpoint temperature versus applied power level, while Graph 2 shows how long the tubes can withstand step power levels.

In quantities of 1,000, the two standard lengths are priced at about 15 cents each, and delivery time is 8 to 12 weeks. Special lengths of 1.49, 1.677, and 1.99 in. are also available. The tubes are supplied with silver-banded ends for mounting in fuse clips or clamps.

Corning Glass Works, Electronic Products Division, Houghton Park, Corning, N.Y. 14830 [341]

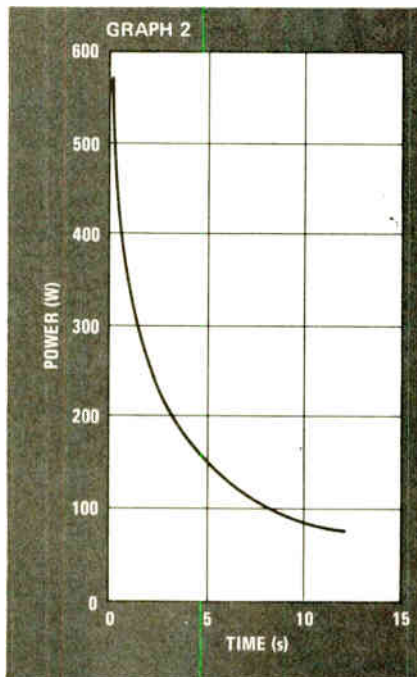
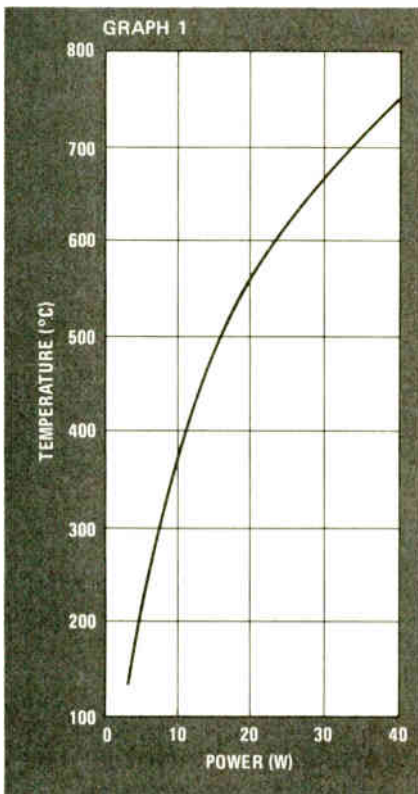

**Heat and power.** For one-time applications, these curves show the temperature (Graph 1) and power (Graph 2) performance of a new line of glass-tube resistive heaters.

## Mercury-wetted relay in DIP can switch 1 ampere at 25 VA

Housed in a dual in-line package, a mercury-wetted reed relay can switch up to 1 ampere at 25 volt-amperes. Boasting a minimum life of 40 million operations, the mercury switch is intended for applications where stable switching characteristics must be maintained over

# Here's a recording swept-frequency-response system you can expand to include:

- narrow-band-wave analysis
- 1/3-octave-band analysis
- level-vs-time recording

## -P2 Sweep Oscillator

- filter-and network-response testing
- loudspeaker, amplifier, and tape-recorder evaluation
- performance tests for microphones, hydrophones, and hearing aids

## -P3 1/3-Octave Analyzer

- speaker testing
- auditorium frequency-response measurements

## -P4 Wave Analyzer

- swept-frequency-response measurements
- distortion measurements
- noise-floor measurements

## -P1A Level-vs-Time Recorder

- reverberation decay measurements
- general level-vs-time recordings



GR's 1523 plug-in approach lets you put together a complete graphic-level measurement system as your needs and budget dictate. Start with the mainframe/recorder and the plug-in that satisfies your immediate measurement requirements, the 1523-P2 Sweep Oscillator, for example. Other plug-ins can be added anytime in the future.

For full particulars call your GR sales engineer.

 **General Radio**

300 BAKER AVENUE, CONCORD, MASSACHUSETTS 01742

NEW YORK (N.Y.) 212 964-2722, (N.J.) 201 791-8990 • BOSTON 617 646-0550 • DAYTON 513 294-1500  
 CHICAGO 312 992-0800 • WASHINGTON, D. C. 301 948-7071 • ATLANTA 404 394-5380  
 DALLAS 214 234-3357 • LOS ANGELES 714 540-9830 • SAN FRANCISCO 415 948-8233  
 TORONTO 416 252-3395 • ZURICH (01) 55 24 20

GR COMPANIES • Grason-Stadler • Time-Data

## New products

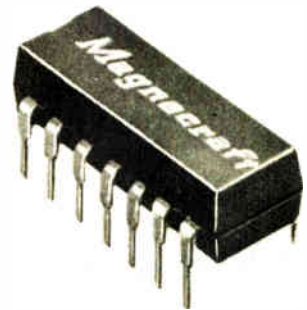

a long period. The unit comes with one form-A contact and with a choice of four coil voltages: 5, 6, 12, or 24 v. Internal diode clamping is available as an option on all models. Magnecraft Electric Co., 5575 North Lynch Ave., Chicago, Ill. 60630 [344]

0.75-watt resistor is only 0.1 inch thick

Measuring only 0.3 inch square by 0.1 in. thick, the model MK 132 precision film resistor can dissipate 0.75 watt at 125°C and can operate at reduced power levels at temperatures up to 175°C. The devices are manufactured in values from 10 ohms to 5 megohms and encapsulated in a

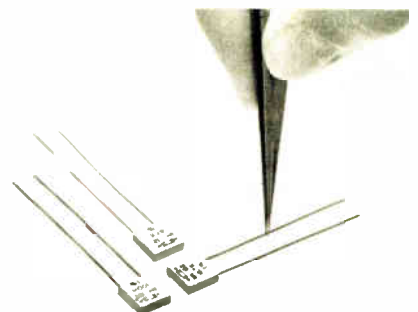

standard CK06 package. Standard resistance tolerance is  $\pm 1\%$ , and maximum temperature coefficient is 50 ppm/°C up to 105°C. This, the company points out, makes the resistor useful in critical analog amplifier and control circuits. Prices, in lots of 1,000 pieces, range from 47 cents to 61 cents each. Delivery time for large-quantity orders is four to



# ECL design just became a three-layer piece of cake.

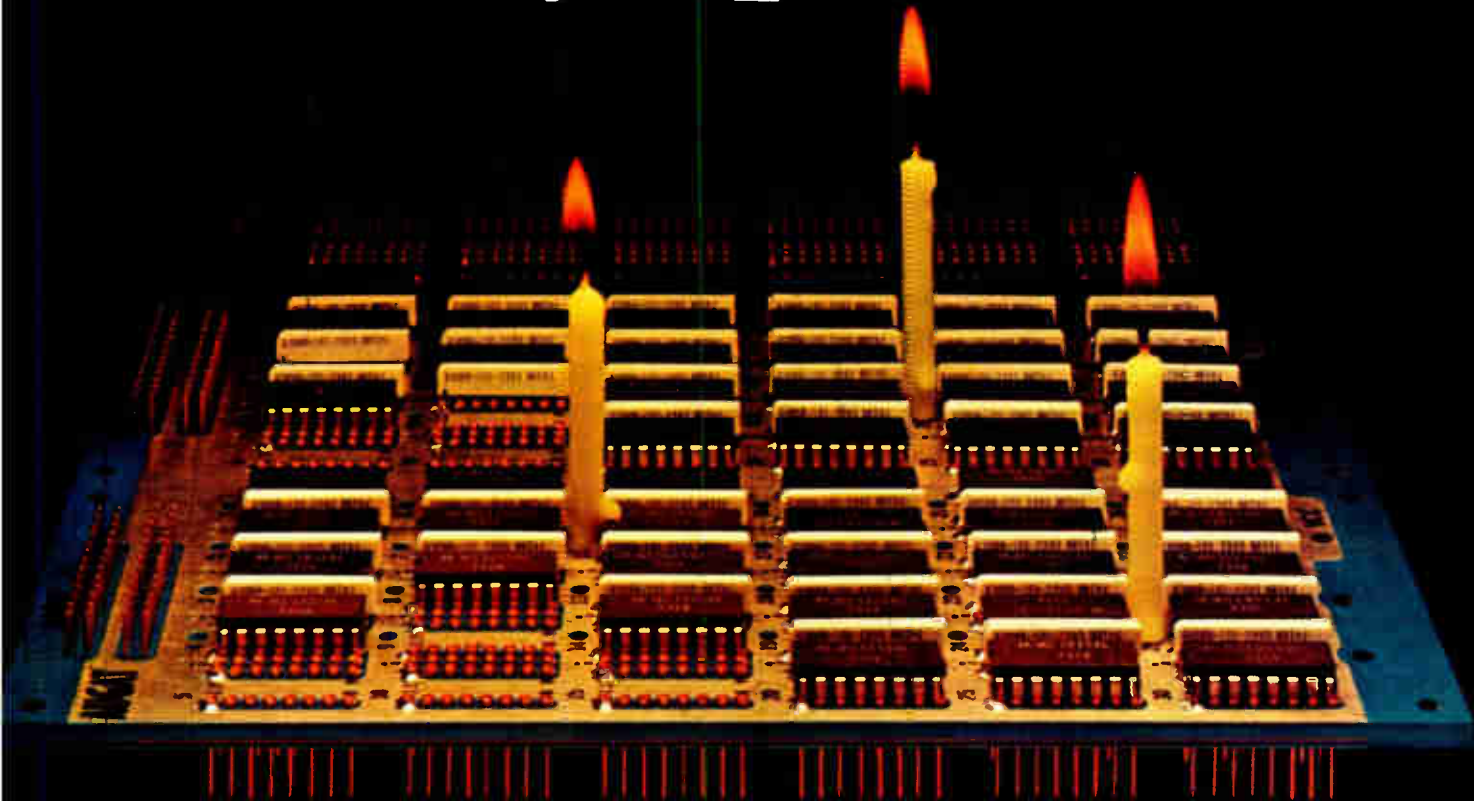

Augat ECL Board with -2 volt bus for terminating single in-line package (SIP) resistor network.

Compared to methods of the past, the Augat series of socket, Wire-Wrap® ECL boards makes ECL design a piece of cake. Even for circuits in the 125 to 500+ MHz range. They can save you 90 percent or more in breadboarding and prototyping time. Tens of thousands of dollars in start-up costs. And many costly hours in field maintainability. With this proven advance in three-layer interconnection technology you don't have to design in controlled impedance interconnections, mess around with transmission lines, or commit power connections for different ECL logic modules. All of which frees you to concentrate on the partitioning of logic functions and the preparation of a wiring list.

And unlike a multi-layer P.C. board, there is no loss in planar density. Two 16-pin ECL and associated pull down and decoupling components fit into one square inch on every Augat ECL board.

The nice thing, too, is that Augat ECL boards are standard catalog items available in any quantity at any time from Augat distributors around the world. You can contact them directly or write Augat, Inc., 33 Perry Avenue, Attleboro, Mass. 02703. Tel. 617-222-2202. TWX 710-391-0644.

# AUGAT®

Registered TM of Gardner-Denver Company

Circle 127 on reader service card

Europe - Augat N.V., Boulevard A. Reyers 103, 1040 Brussels, Belgium, Tel. (02) 7369399.

Japan - Kyakuto Borki Kaisha Ltd., New Otomachi Bldg. 2-1, 2-Chome Otomachi, Chiyoda-Ku, Tokyo 100-91, Japan, Tel. (03) 244-3788



# DELEVAN

# DEPENDABILITY

# DOESN'T

# COST

There's a lot more than meets the eye in Delevan's lineup of miniature RF inductors and transformers. Like the unmatched dependability built into each component. Thanks to a lot of things that go on at the factory. Hard-nosed quality controls . . . complete material analysis . . . advanced in-plant environmental testing . . . automated techniques for winding, soldering and molding . . . and conscientious people who take pride in true "no-fault" production. And of course, the dependable delivery and service you always get from Delevan.

# IT PAYS

Remember . . . the proven reliability of these superior made-in-U.S.A. inductive devices means greater reliability for the products and assemblies *made from them*. Sure, you can save a few pennies by using cheaper components. But this could be expensive in terms of premature failure of the finished product. When your company's reputation is on the line, you can't afford *not to use* Delevan components. Their premium performance more than justifies their use . . . because Delevan dependability pays for itself. Why not prove it to *yourself!*

**Delevan**  **AMERICAN PRECISION INDUSTRIES INC.**  
*Division*

270 QUAKER RD./EAST AURORA, N.Y. 14052  
 TELEPHONE 716/652-3800 TELEEX 091-293  
 OTHER DIVISIONS OF AMERICAN PRECISION INDUSTRIES INC  
 BASCO • OUSTEX

## New products

six weeks. Evaluation samples are available from stock.

Caddock Electronics Inc., 3127 Chicago Ave., Riverside, Calif. 92507 [346]

## See-through trimmer speeds production

A transparent case is being offered as an option on two popular lines of trimming potentiometers so that users can preset the units visually before inserting them in printed-circuit boards. This cuts down the time needed for functional trimming after assembly. The transparent case is obtainable on the 3006 and 3009 0.75-inch trimmers. In large quantities, the 3006 sells for less than 90 cents each; it has a standard resistance range of 10 ohms to 2 megohms and a power dissipation of 1.25 watts at 25°C.

Bourns Inc., 1200 Columbia Ave., Riverside, Calif. 92507 [345]

## Pressure transducers stay accurate from -25 to +75°C

An internal thermostat makes the LX3700 series of pressure transducers very stable over both long periods of time and large changes of temperature. For example, when operated between -25° and +75°C, the units will settle to within 150 millivolts of the specified output value in 30 seconds. After a two-minute warmup, the unit will drift less than 25 mV—even after full-range temperature and pressure cycling. Further, after storage for any length of time, if the transducer is given a two-minute warmup, it will reproduce the performance of its previous powered-up period to a tolerance of 50 mV. The LX3800 series is essentially identical to the LX3700 series except for an outer casing that extends its low-temperature limit to -40°C. Both units cost \$66.67 each in hundreds.

National Semiconductor Corp., 2900 Semiconductor Drive, Santa Clara, Calif. 95051 [347]



# VACTEC Couplers

**For putting it together, VACTEC is second only to RODIN\*.**

Vactec Optical Couplers (T.M. Vactrols) put together incandescent lamps, neon lamps or LEDs with photoconductors or phototransistors in a wide variety of packages and capabilities.

Couplers using photoconductive cells are useful for isolation where speed requirements are in the order of milliseconds. Applications include noiseless switching, noiseless potentiometers, signal modulators for audio, triac firing, and low cost RMS regulators.

Couplers using LEDs and phototransistors or photodarlington provide higher speed for output sensing, input driving, interfacing and coupling, solid state relays, and switching.

VACTEC really does put them together—we make our own photoconductive cells, phototransistors and photodarlington and do the assembly at our only factory near St. Louis. Write for all Vactrol bulletins.

\*Reproduction of The Kiss by Rodin.



**Vactec, Inc.**  
2423 Northline Industrial Blvd.  
Maryland Heights, Mo. 63043 U.S.A.  
(314) 872-8300

Circle 129 on reader service card



# A Good Rental Program Has 25 Sales/Service Centers



## A Great One Has Over 100

Instrument rental...besides the obvious economy and capital dollar savings, service is a big, big factor.

GE has over 100 major city sales/service centers...with the world's largest inventory of test instruments...over 5,000 from many different manufacturers. So, when you need an instrument, call the GREAT Rental Program (518-372-9900 collect) for your nearest sales/service center and a FREE Rental Catalog. We could be the only source you'll ever need.

**Quick-rental\***  
**instruments**

\*Trademark General Electric

**GENERAL ELECTRIC**



## New products

Packaging & production

### 2-in-1 system for LSI masks

Combined pattern generator and image repeater built for low-volume work

The trend among systems companies toward setting up their own semiconductor "model shops" has spurred the development of fabrication equipment specifically for this use. An example is a combination

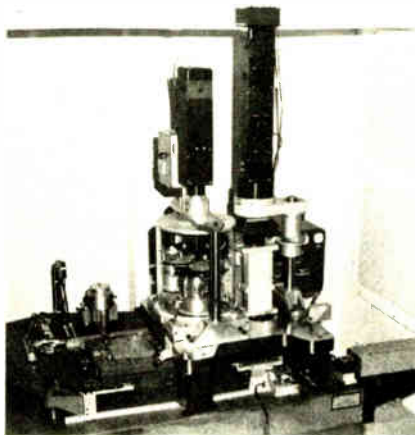

pattern-generator/image-repeater made by Electromask Inc. for users of large-scale integrated circuits who do not need the high-volume throughput of two individual systems. This unit first generates from digital data the complex images for each individual layer in one cell, which are enlarged 10 times and then reduced to the finished size and repeatedly flashed in sequence to make a photomask. The system, plus a small photographic-processing area and computer-aided-design equipment, can produce finished mask sets for fabrication in-house or by an external facility. Further, the capability avoids delays for custom circuits. The model 2500 includes capabilities from image-repeater and pattern-generator systems that Electromask has been supplying, including air bearings, a servo system,

and a laser interferometer for accurate positioning of the plate stage.

As an image repeater, resolution of 0.1 micrometer and absolute accuracy within 0.5  $\mu\text{m}$  are achieved. The absolute accuracy is especially important in surface-wave acoustic devices where dimensions determine center frequency. As a pattern generator, the unit produces accurate rectangles as large as 0.600 inch on a side (0.06 at the image plane), with stage-position resolution of 10 microinches, and stage precision accurate to  $\pm 10$  microinches over an area 5 by 5 in. The aperture can also be rotated through 90°. Stage speed is 2.5 inches per second. The unit is changed from pattern generator to repeater image by moving a single reflector. The equipment is built on a large granite block that provides a stable seismic mass isolated from vibration by three pneumatic mounts. The air bearings which ride on the top and one side, deviate from the flat plane less than 50 microinches. The system is under control of a Hewlett-Packard 2100A computer with peripherals. Use of the computer permits unusual versatility; the unit can save 20% of the image-repeating exposure time by omitting the corners of a mask, making it correspond to the round substrates used for most applications. Likewise, different cells can be placed on the same substrate for large-scale integration or for experimental purposes.

The model 2500 is priced at approximately \$290,000, about two thirds the cost of the individual systems.

Electromask Inc., 6109 De Soto Ave., Woodland Hills, Calif. 91364 [391]

Machine forms, cuts, and ties wire harnesses

A computerized numerical-control machine forms, cuts, and ties wire harnesses at many times manual wiring speeds. The machine, called the Wirewriter, selects wire of a specified color and gauge from a bank of reels, forms it to the re-



**You've got one chance to do a field recording job that demands laboratory performance.**

**With HP's 3960, you can carry it off.**



Not all high performance recorders are big, bulky lab consoles.

One is different: HP's 3960 Portable Instrumentation Tape Recorder.

The compact 3960 goes virtually anywhere. Yet it's still designed to come through when you've got one

chance to get it right. And that's the kind of confidence you need whether you're gathering data across the room or across the desert.

Operable on either AC or DC, the rugged 3960 has a built-in DC calibration source and high accuracy DC or AC peak meter for input or output monitoring. Signal to noise ratio is outstanding. And HP reliability helps insure that what goes in is exactly what comes out.

Ample options are available to let you customize your recorder to exactly the kind of work you do. The choice includes voice channel, DC-AC inverter, remote control, tape speeds and more.

Get complete details on HP's high performance 3960. The portable recorder built to carry it off both in the field and in the lab. Write Hewlett-Packard, 1501 Page Mill Road, Palo Alto, California 94304.

11410

Circle 131 on reader service card

**HEWLETT  PACKARD**

Sales and service from 172 offices in 65 countries.  
1501 Page Mill Road Palo Alto California 94304

World Radio History



# THE DETECTORS

Tough infrared measurement problems are no match for The Detectors . . . Sensors' rugged, reliable, low cost thermopile detectors.

Whatever your application . . . from temperature monitoring, spectrophotometry or pollution monitoring to intrusion and fire detection, horizon sensing instrumentation or laser power measurement, The Detectors are ready to help you solve it.

One of The Detectors has the precise combination of high D\*, convenient resistance range, excellent responsivity, fast time constant and broad spectral response for your specific application.

Learn about the entire Sensors' line of thin film thermopile detectors. Ask for the free brochure now.



**sensors, inc.**

3908 VARSITY DRIVE  
ANN ARBOR, MI 48104  
TEL: (313) 973-1400

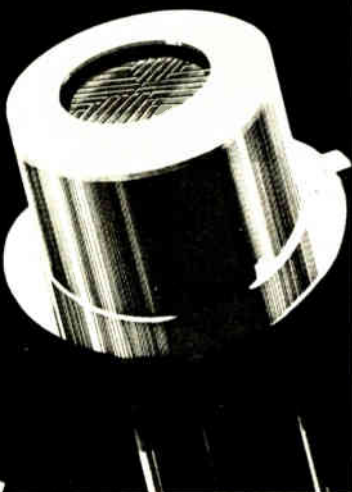

## New products

quired configuration, and cuts it to the required length—all under computer control. Slew speeds range from 20 inches per second for a standard model to 50 in./s for a high-performance machine.

The Wirewriter works in conjunction with special wire-gripping devices called combs, removably mounted onto the harness formboard, which maintains manufacturing integrity through terminal attachment, connector insertion, testing and installation.

In addition to harness-forming, the Wirewriter can produce its own formboard. An accessory plotting pen plots the layout paths and shows where to locate combs and contouring pegs or nails.

The system's modular construc-

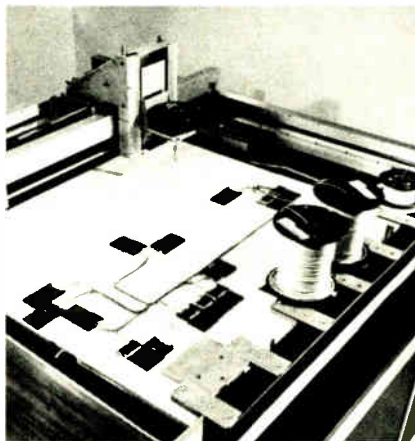

tion makes it adaptable to various needs. Formboards of 4 by 4 feet and 4 by 8 feet are typical.

The machine comes in two versions—numerically controlled by tape and computer-controlled. Prices for the N/C version start at \$35,000. Minicomputer-controlled versions start at \$45,000. Delivery time is 12 to 16 weeks.

Interfacing Enterprises, 10457A Roselle St., San Diego, Calif. 92121 [393]

### Microprocessor improves quality of vacuum coating

The model 3135 vacuum coater system from Varian contains a microprocessor that automatically puts

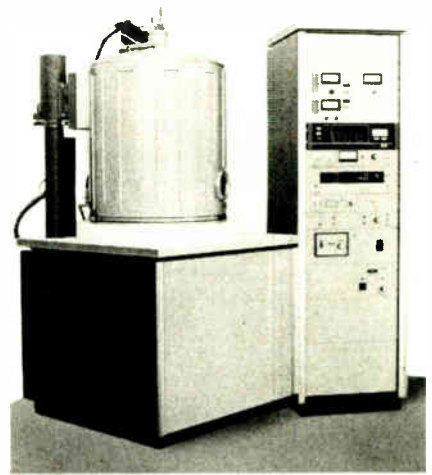

the machine through its entire operating sequence, thus improving process control and repeatability. The system's Q-3500 oil-free pump module provides high pumping speeds and a nearly pure, hydrocarbon-free operating environment. Because the system operates under microprocessor control, variables such as operator skill and response time are eliminated as factors in determining the success of a coating run, although an operator can intervene when necessary. The price of the fully tooled system ranges from \$55,000 to \$60,000, depending upon its configuration. Delivery time is three months.

Varian Vacuum Division, 611 Hansen Way, Palo Alto, Calif. 94303 [394]

### Layered elastomer makes convenient connector

Consisting of alternating layers of conductive and nonconductive elastomers, the Zebra is a flexible connecting device that can be positioned with no alignment problem and which requires no soldering. Since each layer of elastomer is only 0.01 inch thick, the Zebra provides 50 independent conductive paths per linear inch, assuring at least one conductive path per contact with any circuit having contact paths at least 0.02 inch wide and a minimum of 0.02 inch apart. The flexibility of the connector compensates for sur-



# “Scotchflex” Flat Cable Connector System makes 50 connections at a time.



“SCOTCHFLEX” IS A REGISTERED TRADEMARK OF 3M CO.

Build assembly cost savings into your electronics package with “Scotchflex” flat cable and connectors. These fast, simple systems make simultaneous multiple connections in seconds without stripping or soldering. Equipment investment is minimal; there’s no need for special training. The inexpensive assembly press, shown above, crimps connections tightly, operates easily and assures error free wiring.

Reliability is built in, too, with “Scotchflex” interconnects. Inside of connector bodies, unique U-contacts strip through flat cable insulation, grip each conductor for dependable gas-tight connections.

“Scotchflex” offers you design freedom, with a wide choice of cable and connectors. From off-the-shelf stock you can choose: 14 to 50-conductor cables. Connectors to interface with standard DIP sockets, wrap posts on standard grid patterns, printed circuit boards. Headers for de-pluggable connection between cable jumpers and PCB. Custom assemblies are also available on request.

For more information, write Dept. EAH-1, 3M Center, St. Paul, Minn. 55101.

**“Scotchflex” Your systems approach to circuitry.**





**NEW!**  
**ROTARY SWITCHES**

**UP TO 16 POSITIONS**

- SUBMINIATURE
- WATERTIGHT
- 1 OR 2 POLES
- PRESET STOPS
- 50,000 CYCLE LIFE



All Shown  
Actual Size

Nonshorting, low-profile rotary switches with positive detent feature low contact resistance and long life — ideal for hand-held communications or virtually any application that requires a compact, highly reliable, watertight switch.

Contact resistance is 10 to 50 milliohms (max), depending on model. Contact rating for all models is 100 mA @ 120 VAC, and insulation resistance is 10,000 megohms (min) between adjacent terminals @ 100 VDC initial.

Stainless steel shaft is slotted and flatted for screw-driver adjustment or knob. Versatile devices can be PCB or panel mounted. For detailed information, contact TEC or the TEC-REP nearest you.

**DISTRIBUTORS:**

Audio Electronics, Inc., Canada	(416) 495-0720
Bodette Co., Inc., Chicago	(312) 323-9670
Bordewick Co., New England	(617) 859-4915
Century Aero Corp., So. Cal.	(213) 772-1166
Peerless Radio Corp., Florida	(305) 566-5966
Ratel Electronics, No. Cal.	(415) 965-2010



**TEC, Incorporated**  
9800 NORTH ORACLE ROAD  
TUCSON, ARIZONA USA 85704  
(602) 297-1111  
TWX 910-952-1377

**New products**

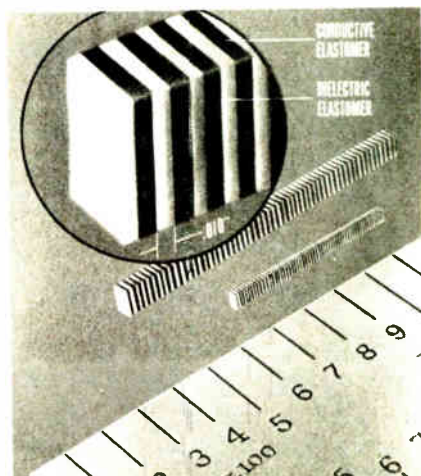

face unevenness and offers a vapor-tight contact seal.

The volume resistivity of the conductive elastomer is 5 ohm-centimeters; for the insulating layers it is  $10^{14}$  ohm-cm. The device's temperature range is  $-60^{\circ}\text{F}$  to  $+350^{\circ}\text{F}$ , and it can operate in relative humidities as high as to 100%. Standard Zebra parts are available from stock. Prices start at 10 cents apiece in large quantities.

Technical Wire Products Inc., 129 Dermody St., Cranford, N.J. 07016 [395

Cases provide at least 60 dB of shielding at 100 MHz

A line of three shielded cases—blank, standard, and custom—provides from 60 to 100 decibels of shielding at 100 megahertz. Even more shielding can be obtained if gaskets are placed between the covers and the case frame, and between the connector flange and the case. The blank case, a simple box without connectors, comes in 13 sizes and sells for as little as \$6.38. The standard series, which comes with

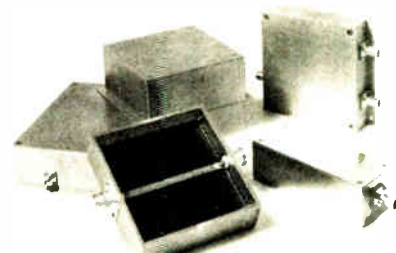

# Systems Supermarket

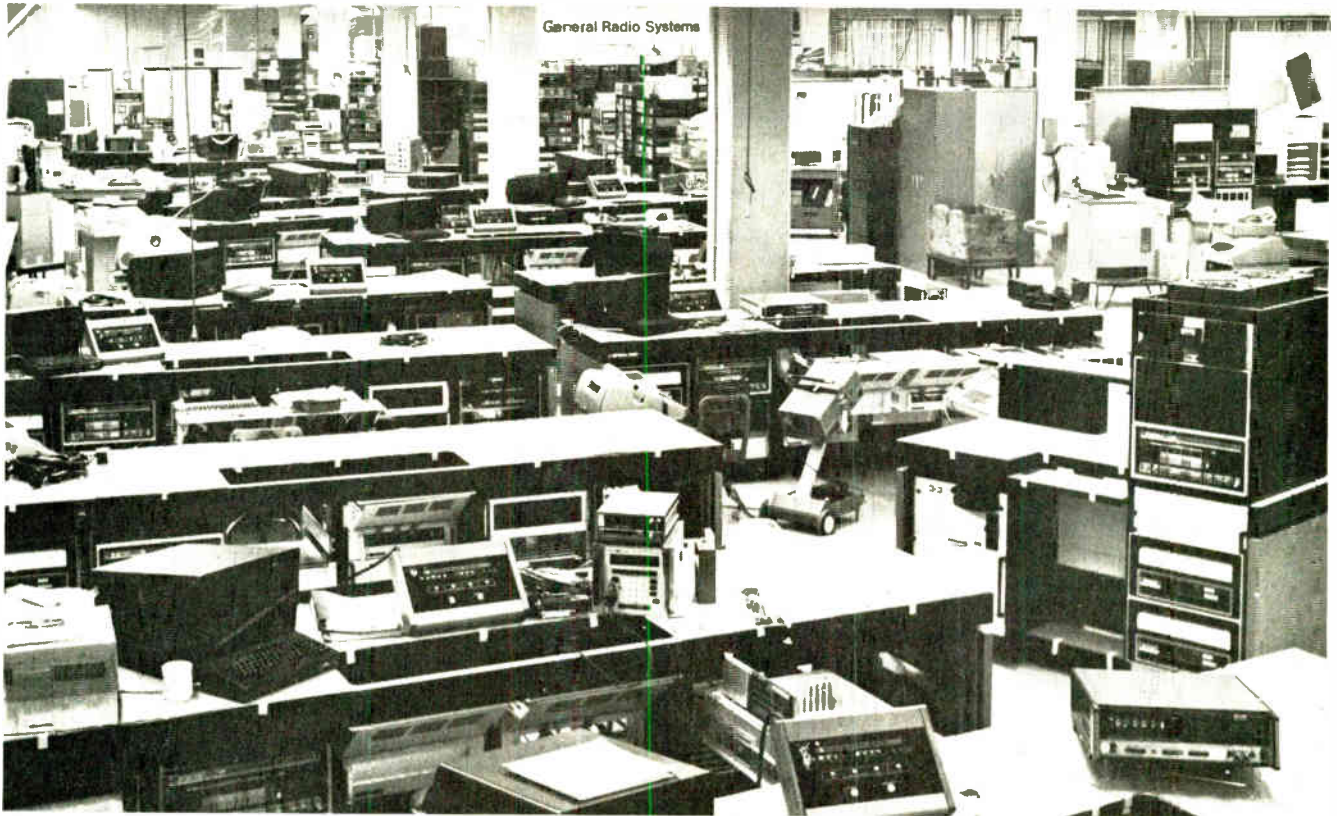

General Radio Systems

If you are in the market for a computer-controlled automatic testing/troubleshooting system, GR is the place to do your shopping. Here you will find a wide selection of automatic systems for testing digital, analog, or hybrid (digital and analog) circuits. And the new CAPS-VII software package that is now available is the current state-of-the-art for testing/troubleshooting software.

For a guide to help you compile your shopping list, request a copy of our new Systems Brochure. It concisely describes and illustrates the several standard GR systems you'll find any day being assembled off the aisles of our systems supermarket.

Photo above shows several systems in production at the Concord plant's Systems Center, one of three such centers.



**1792-D Logic-Circuit Test System**  
For high-speed, parametric digital and analog testing.

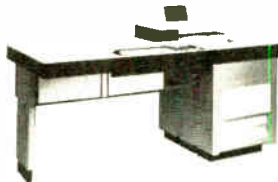

**1790 Logic-Circuit Analyzer**  
A basic functional and diagnostic test system for logic elements.



**2210-A Analog Test System**  
A low-cost dedicated analog test system.

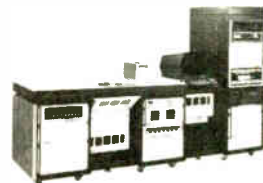

**2210-C Analog Test System**  
A general-purpose analog test system.



**1793 Logic-Circuit Tester**  
A "starter system" — provides rapid digital testing of complex logic circuits at minimum initial cost.



**1792-B Logic-Circuit Test System**  
Designed for the production environment, where low-cost testing and troubleshooting are mandatory.



**2214 Analog Test System**  
A commercial-electronics analog test system.



## General Radio GR Test Systems Division

300 BAKER AVENUE, CONCORD, MASSACHUSETTS 01742

NEW YORK N.Y. 212 964-1722, (IN N.J.) 201 791-8990 • BOSTON 617 646-0550 • DAYTON 513 294-1500  
CHICAGO 312 992-0800 • WASHINGTON, D.C. 301 948-7071 • ATLANTA 404 394-5380  
DALLAS 214 234-3357 • LOS ANGELES 714 540-9830 • SAN FRANCISCO 415 948-8233  
TORONTO 416 252-3395 • ZURICH (01) 55 24 20

GR COMPANIES • Grason-Stadler • Time Data



# the Champ

problem solver

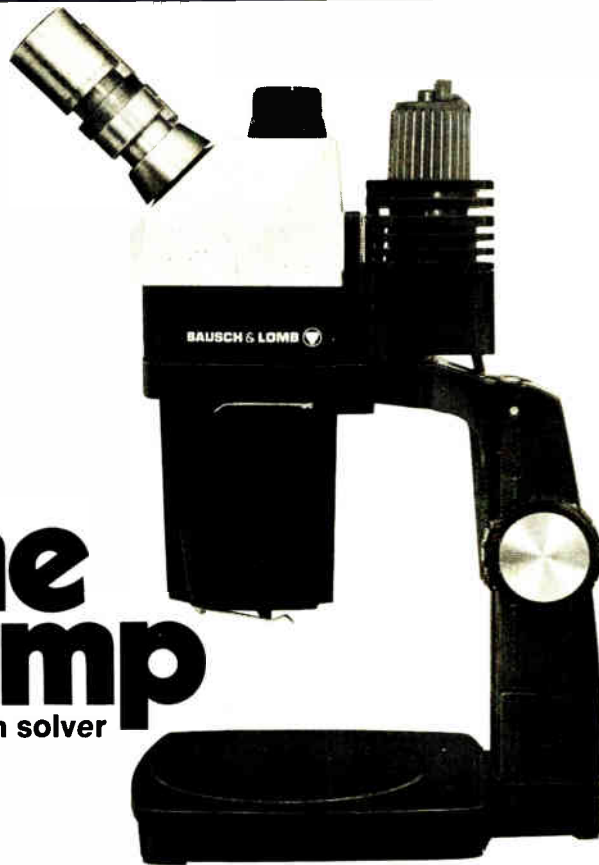

Bausch & Lomb StereoZoom 7 Microscope with Coaxial Illuminator is the answer to your need for full field, full aperture illumination; full color, high contrast imaging and better resolution.

This unique form of incident illumination eliminates surface glare from highly reflective surfaces and also effectively illuminates low contrast objects.

You zoom over a magnification range of 15X through 280X. Field diameter ranges from 0.55 in. through 0.03 in. Working distance is 3.0 in.—0.56 in.

**Send today for our catalog 31-15  
and our FREE DEMONSTRATION offer.**

**BAUSCH & LOMB** 

SCIENTIFIC OPTICAL  
PRODUCTS DIVISION

StereoZoom. Reg. T.M.  
Bausch & Lomb

62314 Bausch Street, Rochester, N. Y. 14602

Circle 136 on reader service card

## Own your own holder to hold your own!

Hold your own copies of Electronics in specially designed slipcase holders. They'll keep your Electronics library neat and handy—a permanent information file, issue by issue.

Just complete the coupon and mail to Jesse Jones. He'll process your order upon receipt, postpaid.



**ELECTRONICS BOXER**  
Jesse Jones Box Corporation  
2250 E. Butler St., Philadelphia, Pa. 19137

Please send me:  boxes @ \$4.25 each;  3 boxes @ \$12.00;  6 boxes @ \$22.00.  
My check or money order is enclosed.

Name: \_\_\_\_\_

Address: \_\_\_\_\_

City: \_\_\_\_\_

State: \_\_\_\_\_

Zip: \_\_\_\_\_

## New products

flange-mounted rf connectors and feedthrough filters, is offered in nine sizes and typically is priced at \$12.15. The custom line is based on the 13 blank case sizes. It is intended for applications in which the size, type, and locations of connectors and feedthroughs must meet special requirements. Prices for the custom series depend upon specific requirements. Delivery takes about 14 days.

Compac, 222 Middle Country Rd., Suite 208, Smithtown, N.Y. 11787 [398]

## Flexible bus system carries high current

Claimed to have a capacity of three times the current of comparable bus systems, a bus strip and clip are also smaller, easier to assemble, and more flexible in their ability to make selective connections from terminal post to bus, according to the manufacturer. The system, which can be assembled to order or provided as separate pieces for assembly by the user, is made of a tin- or gold-plated copper alloy. The bus strip gets both its small size and high current-carrying capability from its low (0.075 inch), wide (0.025 in.) profile. Standard stock strips come with spacings of 0.100, 0.125, and 0.150 inch, but any spacing from 0.100 to 2 inches can be made without additional tooling cost.

Electronics Stamping Corp., 13629 Alma Ave., Gardena, Calif. 90249 [397]

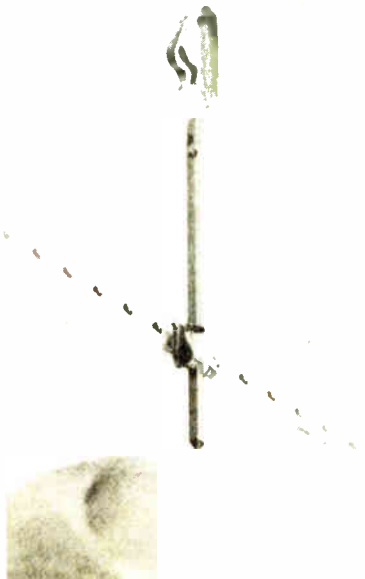

# Electrical Engineering

HMM 124-INT

Visit the  
Hanover Fair  
and you can



# make full use of latest developments

More effectiveness of Electrical Engineering in industry, in the community, in commerce, trade and management: that is just what you are expecting from the 1,620 exhibitors at the Hanover Fair. Within the electrical energy processing section, how does one, for example, meet the rising costs of raw materials? When distributing energy, what can be done for smaller units? How do household installations help the craftsman rationalise his work and in the planning of all types of electrical installation? What progress are the lighting, ultrasonic, micro-miniature welding, spooling and winding machine groups making? Electrical Engineering can find answers to these questions and thousands more, in the form of useful, practical, new developments.

One can make a survey at the Hanover Fair. Here it is not just printed on paper, here you can see the progress which has been made, study and have discussions with experts. Make full use of this compact and accurate information, that only the Hanover Fair can offer you. Make certain that all the new ideas and trends are transferred to your own field and put into action.

## Electrical Engineering Plants and Equipment

Electro-machines  
Transformers  
Static Power Converters  
Primary and Secondary Sources of Current  
Power Capacitors  
High Voltage Switchgear  
Low Voltage Switchgear  
Wires and Conductors  
Cable  
Cable-Line Equipment  
Electro-Mechanical Processing  
Electro-Welding and Soldering  
Electro-Thermal Processing  
Electro-Chemical and Electro-Physical Processing  
Electrical Plants and Equipment for Production and Industry

## Electrical and Electronic Instrumentation and Automation

Individual Units  
Equipment and Systems  
Apparatus and Equipment (according to measuring methods)  
Apparatus and Equipment (according to measuring quantities)

## Electrical Fittings, Household Installations,

Electronic Entertainment  
Installation Devices  
Household Appliances

Radio, Television and Gramophones  
Receiving Aerials  
Electroacoustic Equipment and Accessories  
Audio-visual Devices and Equipment for Commercial Use

## Electronic Components

Active Components  
Passive Components  
Electro-Mechanical Components  
Component Sub-assemblies

Information which cannot be  
obtained elsewhere

starting on Wednesday 16. 4.

**Hanover  
Fair '75**  
April 16-24,

## Lamps, Lighting

Lighting  
Incandescent (Filament) Lamps  
Discharge Lamps

## Telecommunications

Telephony and Telegraphy  
Radio Communications  
Signalling and Security Control  
Timing Devices

## Conferences — Meaningful Complement to the Display

Trade conference deepen and intensify the quality of information obtained at the Hanover Fair. For your particular field the following event has been planned: "ETG Conference 1975".  
General theme: Small and miniature motors.

Organisers: Energietechnische Gesellschaft im VDE, Hannover, together with the Messe-AG.

Dates: Tuesday 22. 4 and Wednesday 23. 4. 75

The complete conference programme and registration documents can be ordered.

Contact the Deutsche Messe- und Ausstellungs-AG, D-3000 Hannover-Messegeleände, Tel. (0511) 8 91, Telex 09 22 728, for the list of exhibitors and any further information you may require.

# Electronics Firms Choose Utah for...

# ENERGY, PEOPLE & PROFITS.

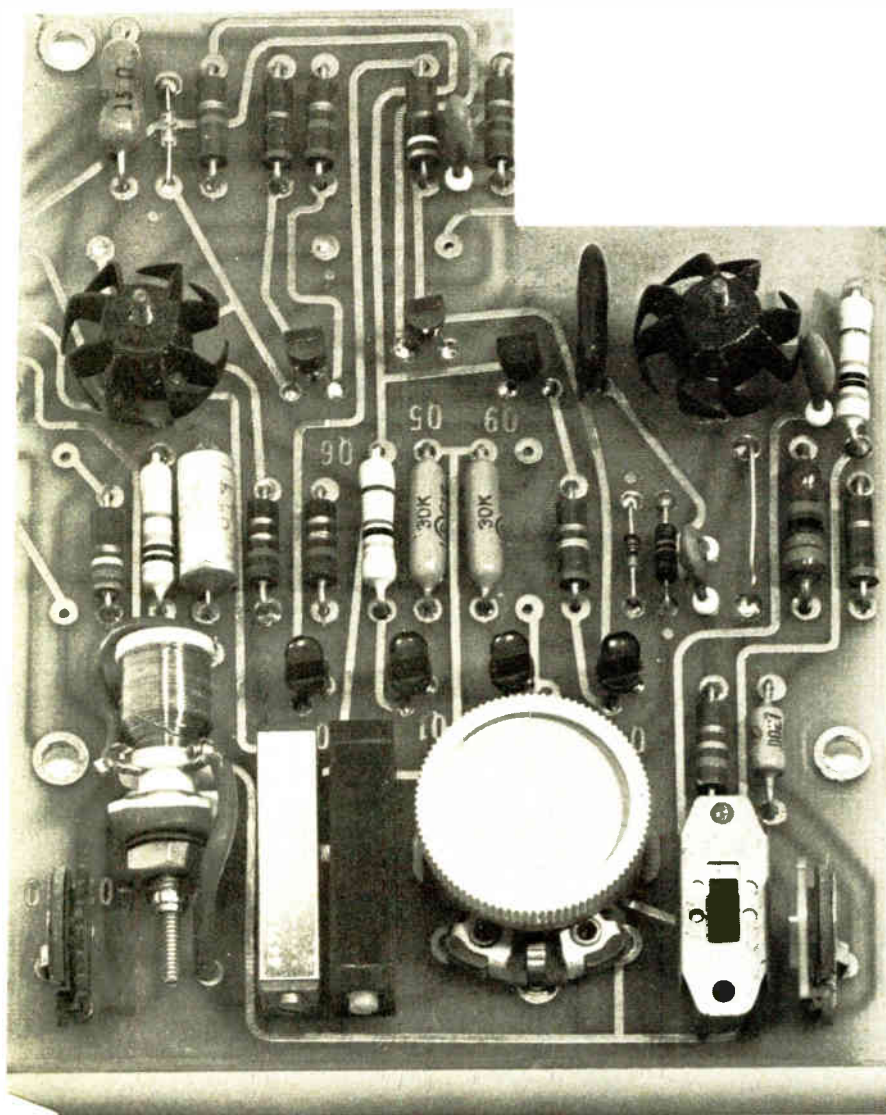

Electronics manufacturers are finding special advantages in locating new plants in Utah. For example:

### Utah is Key Energy Center

The most recent major firm to choose Utah came for "energy" reasons. There are no critical energy problems in Utah now, and probably no area has more going for it in the future. Utah is destined to play a vital role in solving the country's energy needs with its vast coal, oil, oil shale, gas, and uranium resources as well as its hydroelectric power and promising geothermal testing. Utah is a key energy source for all America.

### Utah People Are Productive

Companies that have plants in Utah and other locations have proved the productivity of Utah's labor force by comparative tests. Maybe it's a tradition from the staunch pioneer stock that settled the State. Maybe it's because Utah is still unspoiled industrially. At any rate, Utahns believe in an honest day's work, and they are well educated and easy to train. What's more, Utah has the facilities to train them.

---

### FREE Research Study

A research study of critical cost factors of a hypothetical electronics manufacturer in eleven major cities of the United States, coast to coast, showed a potential 10% higher profit in Utah than the average of all the others.

The survey results are outlined in an easy-to-read 24-page executive summary, available to you for the asking. Just drop your business card in an envelope and mail to:

**John Rencher, Director**  
**Utah Industrial Promotion Division**  
**#2 Arrow Press Square**  
**Dept. E-1**  
**Salt Lake City, Utah 84101**



*A Great Place  
to Work... and LIVE!  
Especially for  
Electronics!*



## New products

Microwave

### Power meter tests to 0.5%

Autoranging digital unit is bus-programable, has an auxiliary analog indicator

In today's cost-conscious environment it isn't enough for an instrument to make accurate measurements. It must be low in price, or else offer the user enough added convenience for his increased productivity to justify its price.

Hewlett-Packard's latest microwave power meter, the 436A, falls into this latter category. An autoranging four-digit machine, the meter has built-in firmware to recognize which of several sensors is connected to its input. The firmware also allows it to read in watts, in decibels referred to 1 milliwatt (dBm) or in decibels relative to a user-settable reference level. In addition, the firmware enables it to switch automatically among its five power-measuring ranges and to zero itself at the touch of a button.

Both a systems-oriented instrument and a convenient bench tool, the 436A is fully programable, yet it includes an uncalibrated analog meter on its front panel to facilitate peaking adjustments. Programming

inputs and digital data outputs may be handled through an HP Interface Bus or by a TTL-compatible binary-coded decimal interface. Both of these features are optional and retrofittable.

The frequency range of the unit is about 100 kilohertz to 18 gigahertz, depending upon the power sensor used. With its low-power sensors, the 436A has five power ranges varying from 10 microwatts (-20 dBm) to 100 milliwatts (+20 dBm) full scale. With high-power sensors, the meter has full-scale ranges from 1 mW (0 dBm) to 3 watts (+35 dBm). Maximum error in the watts mode is 0.5% of reading. In the dB mode it is 0.02 dB + 0.001 dB/°C. Resolution is 0.01 dB.

A novel feature of the 436A is its dB REF button. Push it and subsequent readings will be in dB relative to the level currently applied to the meter. This feature should prove especially valuable in frequency-response testing.

Front-panel readout on the meter is by means of an array of four large (0.375-inch) light-emitting-diode displays. Illuminated annunciators also indicate over- and under-ranging, instrument operating mode, and measuring units.

The meter will be introduced at the IEEE show in New York in April. It has a domestic U.S. price of \$1,800. Delivery time is eight weeks. The HP Interface Bus input/output option adds \$375 to the price, while the BCD input/output interface costs \$275. A typical power sensor, the model 8481A, which has a frequency range of 10 megahertz to 18 GHz and a dynamic range of 30  $\mu$ W to 100 mW, sells for \$400.

Inquiries Manager, Hewlett-Packard Co., 1501 Page Mill Rd., Palo Alto, Calif. 94304 [401]

Transistor produces 200 mW at 2 GHz; 175 mW at 4 GHz

An npn silicon power transistor, designed for use as a linear microwave amplifier, has a typical output power of 200 milliwatts at 2

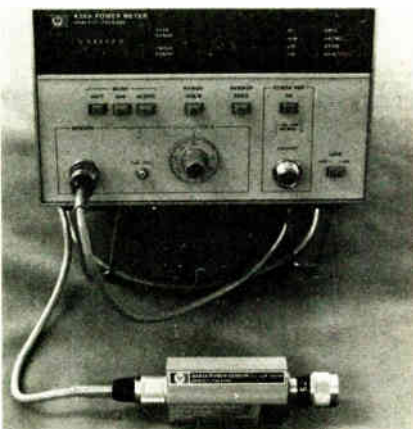

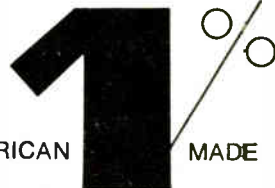

AMERICAN MADE

Tolerance

# SCHAUER

1-Watt

# ZENERS

Immediate Shipment  
Low Prices

ANY voltage from 2.0 to 16.0

Quantity	Price each
1-99	\$1.07
100-499	.97
500-999	.91
1000-4999	.86
5000 up	.82



Gold plated leads

All welded and brazed assembly

No fragile nail heads

Write for complete rating data and other tolerance prices.

Buy the kit-  
Save a lot



Kit contains a 51-piece assortment of SCHAUER 1% tolerance 1-watt zeners covering the voltage range of 2.7 to 16.0. Three diodes of each voltage packaged in reusable poly bags. Stored in a handy file box. Contact your distributor or order direct.

A \$54.57 value for  
ONLY \$24<sup>50</sup>

Semiconductor Division

**SCHAUER**  
Manufacturing Corp.

4514 Alpine Ave. Cincinnati, Ohio 45242  
Telephone: 513/791-3030

# Still only \$2795



**BEST**

## FREQUENCY SYNTHESIZER

- **DC to 2 MHz Range**
- **0.001 Hz Resolution**
- **Full Programmability** BINARY OR BCD
- **No Switching Transients**
- **Direct Digital Techniques**  
NO MIXING OR PHASE LOCKING
- **High Spectral Purity** -70dB SPURIOUS  
-55dB HARMONIC
- **High Stability**  $\pm 2 \times 10^{-4}/^{\circ}\text{C}$  STANDARD  
 $\pm 2 \times 10^{-10}/^{\circ}\text{C}$  OPTIONAL
- **Precision Attenuator**  
0 TO 85dB IN 1dB STEPS PLUS CONTINUOUS CONTROL  
(PROGRAMMABLE ATTENUATION OPTIONAL)
- **High Output Voltage**  
10 VOLTS P-P, 50-OHM SOURCE IMPEDANCE

# ROCKLAND

Rockland Systems Corporation 230 W. Nyack Road, West Nyack, N Y. 10994  
(914) 623-6666 • TWX 710-575-2631

Circle 40 on reader service card

## Fight Them All

Heart Attack, Stroke  
High Blood Pressure  
Rheumatic Fever

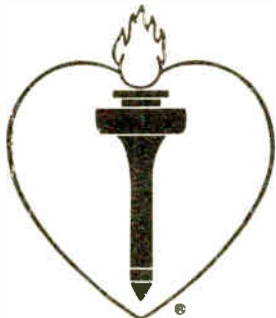

Help your Heart... Help your Heart Fund

## New products

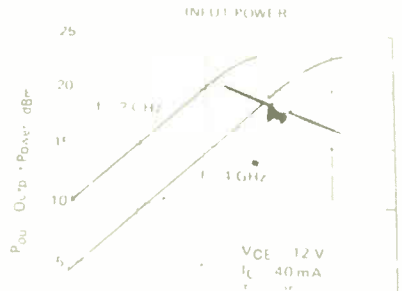

gigahertz and 175 mW at 4 GHz when measured at the 1-decibel compression point. Typical linear power gain of the MS250JE is 10 dB at 2 GHz and 4 dB at 4 GHz. Housed in a type J hermetic strip-line package, the transistor, when used in a 50-ohm system, has an extremely flat gain-versus-current curve. It is well suited for use in the output stages of low-noise amplifiers, telecommunications, and electronic-countermeasures equipment. The MS250JE is priced at \$18 each in lots of 100 pieces. Delivery time is from stock to three weeks.

Texas Instruments Inc., P. O. Box 5012, M/S 19, Dallas, Texas 75222 [403]

Millimeter-wave antenna has 90% beam efficiency

A dual-polarized lens-corrected conical horn antenna that operates between 33 and 40 gigahertz has a nominal half-power beamwidth of  $4^{\circ}$  and a beam efficiency in excess of 90%. Side lobes of the model A858-6/881/884 are 25 decibels down, and VSWR is less than 1.3 across the band. The antenna has a nominal gain of 32.5 dB. It accommodates standard TRG TE<sub>11</sub> circular waveguide components so that switchable linear/circular polarization may also be obtained by the inclu-

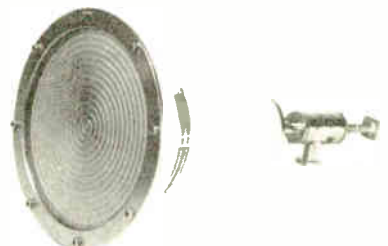



# Introducing the new 4½-digit DPM from WESTON®



Weston, the first to introduce DPM's, completes their third generation product line.

Users of the Weston 2½ and 3½ digit units are well aware of Weston quality. The new Model 1234 provides the same outstanding price/performance, this time with 4½ digits and 10 microvolts sensitivity.

Outstanding accuracy and stability are provided through use of the Weston patented Dual Slope Integration\* technique. Accuracy and stability specifications extend over operating temperatures of 0 to 50°C.

Display readout is a seven segment gas discharge planar packaged in the Weston "industry standard" high impact glass reinforced case.

Basic ranges are 100 mV through 1000V with sample speeds variable to 30 per second. Other standard options are BCD, remote decimal point positioning and line voltage operation for worldwide use. If you have been looking for a 4½ digit DPM, it will be worth your time to take a minute and return the coupon. We will send you everything you need to know about our new Model 1234. For the sales office closest to you, dial toll free (800) 645-9200, or in New York State, call collect (516) 294-0990.

In Europe: Schlumberger Instruments and Systems, 12 Place Des Etats Unis, 92120 Montrouge, France.

Weston Instruments  
614 Frelinghuysen Ave.  
Newark, N. J. 07114

Tell me more about Weston Model 1234 DPM.

I also want to know about

- Weston APM's
- Other Weston DPM's
- Weston DMM's
- Weston VOM's
- Weston Frequency Counters

Name \_\_\_\_\_

Company \_\_\_\_\_

Address \_\_\_\_\_

City \_\_\_\_\_ State \_\_\_\_\_ Zip \_\_\_\_\_

Phone \_\_\_\_\_

Have a salesman call.

**We're either first or best. Or both.**  
**WESTON®**



# enjoy micro-computer advantages

The application of the micro-computer is an exciting business today. It offers a means of getting

greater productivity out of new products...and production lines.

But, the knowledge required to execute designs using micros is mind-boggling. It's a whole new design ballgame, formidable enough to discourage even the most experienced design engineer.

## MYCRO-TEK offers a cost-effective alternative

Utilizing our team of micro-computer specialists enables your company to spend the lion's share of development dollars working directly on the application. You eliminate paying for costly in-house learning curve and false starts.

**...without paying for costly learning curves and false starts.**

With us on your team as consultants, our micro-computer experience and lab equipment is available to

your design department during the critical phases of your product development. As a result, your product is developed rapidly with minimum capital investment in equipment and training costs.

*Sound interesting?* We'd like to provide all the details. Call us—or write for our complete brochure outlining our unique capabilities.



**MYCRO-TEK, INC.**  
MICRO-COMPUTER  
SYSTEMS SPECIALISTS

6631 E. KELLOGG □ SUITE 214  
WICHITA, KS. 67207 □ 316-686-3311

Circle 142 on reader service card

## CUSTOM DESIGNED power supplies to your specs

- Small size • Lightweight • High efficiency • Low output noise • High reliability • Short and overload protection • Plug-in modular construction

TerraCom has developed high performance power supplies for use in critical applications. If your requirement is for a high frequency, low noise, lightweight and small power source, a TerraCom supply is the solution. TerraCom specializes in supplies for use in extreme environments where high reliability and excellent performance are important. Contact TerraCom for successful custom designs of the right supply for your requirement.

**WRITE OR PHONE:**  
for data sheets on  
typical power supplies  
TerraCom  
9020 Balboa Ave.  
San Diego, CA 92123  
(714) 278-4100

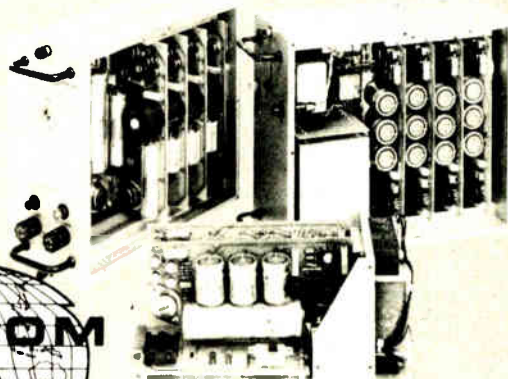
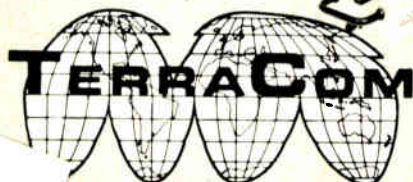

2 Circle 168 on reader service card

World Radio History

## New products

sion of a model A883 switchable polarizer. The antenna is characterized in a 64-page catalog that contains design aids for millimeter-wave systems.

TRG Division of Alpha Industries Inc., 20 Sylvan Rd., Woburn, Mass. 01801 [405]

## Ultraflat directional couplers span 1 to 18 GHz

A series of directional couplers with extremely flat frequency responses are well suited for power-leveling applications. The seven models in the series cover the frequency range from 1 to 18 gigahertz with a maximum deviation from flatness of 0.2 dB for the 1 to 2, 2 to 4, 4 to 8, and 8 to 12.4 GHz units, and 0.3 dB for the 2.6 to 5.2, 1.7 to 4.2, and 12.4 to 18 GHz couplers. The devices, which vary in price from \$125 to \$150, have an average-power rating of 2 watts, and a peak-power rating of 250 w. Delivery is from stock to 30 days.

Weinschel Engineering Co., Inc., Gaithersburg, Md. [404]

## Solid-state oscillators are stable and quiet

A line of solid-state oscillators that cover the frequency range from 0.5 to 18 GHz drift less than 0.05% over the temperature range from -30 to +65°C. The manufacturer claims the oscillators have less a-m

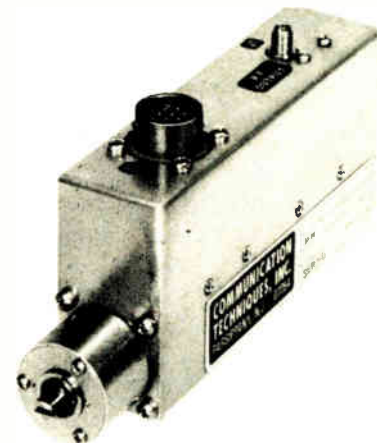

Electronics/February 20, 1975

# Norplex multilayer laminates—the heart of today's high-density circuitry.

In applications where space is critical, multilayer circuits can replace two or more single boards, allowing you to increase circuit density without sacrificing finished exterior dimensions.

Norplex glass laminates and prepregs are available with either epoxy or polyimide resin. They continually meet (and generally exceed) *all* customer specifications. We provide not only the materials but the technical services to go with them,

working closely with you to attain maximum benefits for your product line and increased finished product yield.

We have a separate group devoted exclusively to the manufacture of multilayer materials, working with specialized Norplex-designed equipment for optimum production capability and quality assurance.

No one else can offer you the in-depth experience and technical

expertise of Norplex, where laminate manufacture has been our only business for more than 25 years.

Send coupon for our new brochure which explains the advantages of Norplex multilayer laminates. Or phone: 608/784-6070.

**Norplex laminates**  
by **UOP**

Circle 143 on reader service card

© 1974 UOP

Norplex Division, UOP  
(Universal Oil Products Company)  
Norplex Drive,  
La Crosse, Wis. 54601

Please send me your brochure on  
multilayer laminates.

Name \_\_\_\_\_

Title \_\_\_\_\_

Company \_\_\_\_\_

Address \_\_\_\_\_

City \_\_\_\_\_ State \_\_\_\_\_ Zip \_\_\_\_\_

World Radio History

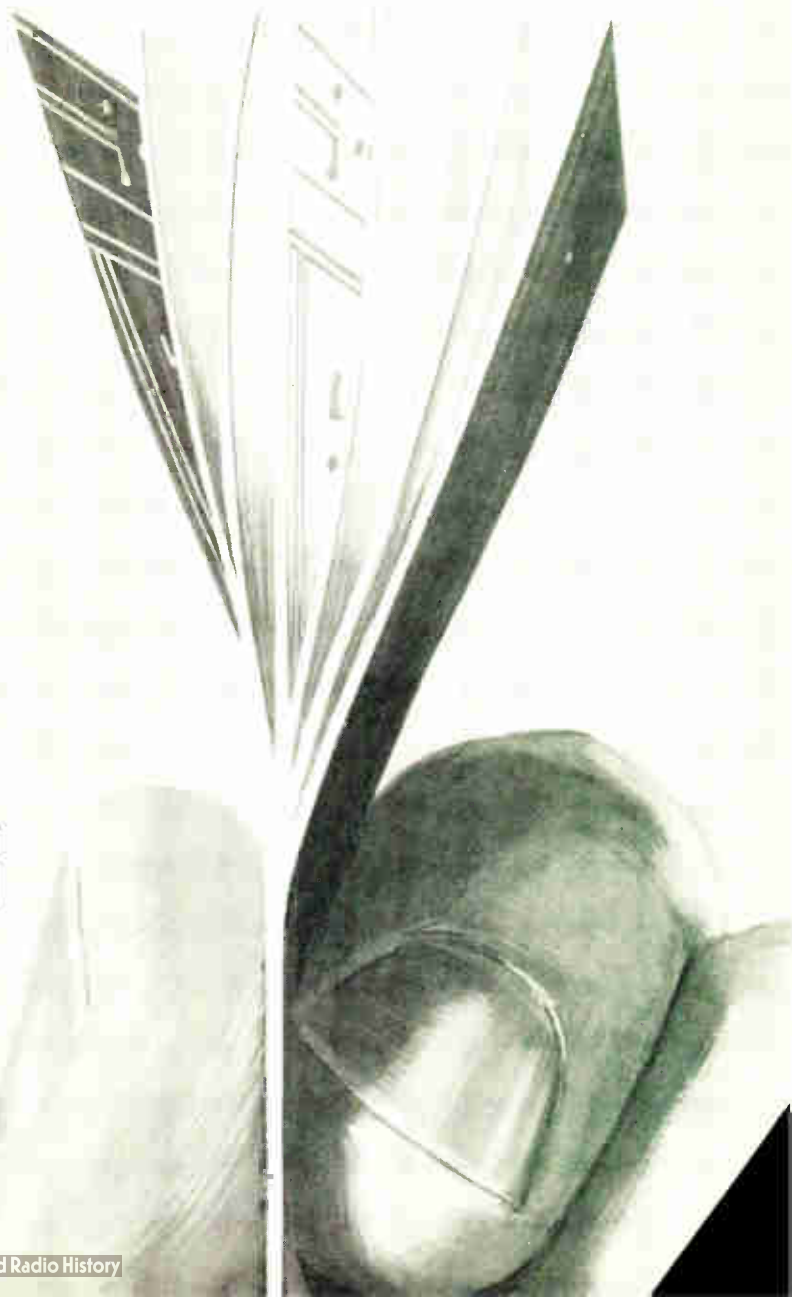



# VERSATESTER I™

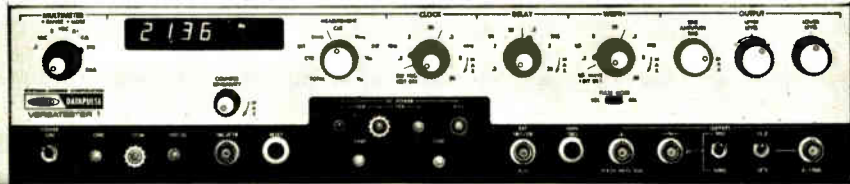

## What is it? A labstrument\*

**VERSATESTER I** □ Generates Pulses, Sine waves and Square waves to 20MHz □ Supplies dc power at +5v, +15v, -15v, ±30V □ Digitally Measures frequency from 20Hz to 20MHz, with autoranging; DC and AC volts, 0-500v; Resistance to 5 Megohms. □ Complete for only **\$1,650!** □ Contact your nearest Scientific Devices Office for specs or demo or Systron-Donner at 10 Systron Drive, Concord, CA 94518. Phone (415) 682-6161.

\*lab-stru-ment \lab-strə-mənt \ n : a complete test lab in one lightweight, portable, 3½" panel height Systron-Donner instrument.

SYSTRON  DONNER

Circle 144 on reader service card

## New products

and fm noise than other available units. Incorporating both fundamental cavity oscillators (series CO) and oscillator-multiplier combinations (series COM), the devices can be easily tuned mechanically, even in the field. Available options include military packaging, improved stability of 0.02% drift, an afc input, internal isolators, fm capability, and auxiliary outputs.

Communication Techniques Inc., 1279 Route 46, Parsippany, N. J. 07054 [406]

Sweeper provides 20 mW from 1 to 18 gigahertz

Sweep oscillator 9514ES/9515ES has a leveled power output of at least 20 milliwatts over the frequency range from 1 to 18 gigahertz. In addition to full-range sweep, the unit provides push-button selection of standard microwave bands. Full-band, marker, and delta f modes of sweeping are possible, making it easy to select the optimum sweep for broad-band or narrow-band testing. A p-i-n diode switch multiplexes the outputs from several solid-state oscillators to a common output to provide the sweeper's wide frequency coverage.

Singer Instrumentation, Palo Alto Operation, 3176 Porter Dr., Palo Alto, Calif. 94304 [407]

Rf power transistors are characterized at 22 V

A family of internally matched broadband microwave power transistors is characterized at 22 volts. The model PH2310 driven by the PH2304 will produce 10 watts of output power over the band from 2.0 to 2.3 gigahertz with an input drive level of 500 milliwatts. The PH2012 driven by the PH2304 will deliver more than 11 watts from 1.7 to 2.0 GHz. The PH2304 sells for \$100 in small quantities, and the other two units are priced at \$175. Delivery is from stock to two weeks. Power Hybrids Inc., 1742 Crenshaw Blvd., Torrance, Calif. 90501 [408]

Vector

PRESENTS **KLIP-BLOKS**

FOR BREADBOARDING

- NO SOLDERING  
...Just Push In
- DIPS, transistors, components patch with ordinary wire
- Buy only sockets needed and — save money!
- Exclusive thru-holes open top and bottom give greater component density. 4 connected contacts per strip with 1 to 24 strips per block -- all on .1" grid. FAST! EASY!

Klip-Bloks snap on Tenth-Tenth Micro-Vectorbord®

Available From Vector Distributors or Factory

Vector

**ELECTRONIC COMPANY, INC.**

12460 E. Gladstone Ave.  
Sylmar, Calif. 91342  
(213) 365 9661 TWX (910) 496 1539



Circle 169 on reader service card



## New products

Subassemblies

# A-d converter handles ratios

Module makes ratiometric conversions and can run from digital logic supply

Operating directly from a 5-volt logic supply, a new series of modular dual-slope analog-to-digital converters can be used to make ratiometric measurements. The units, built by Datel Systems Inc. of Can-

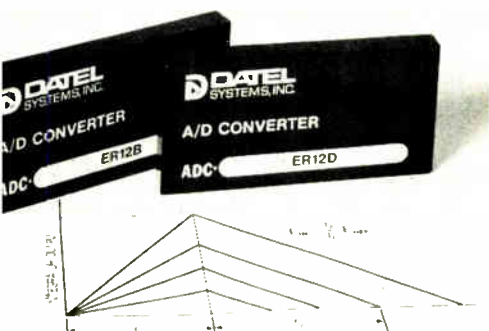

ton, Mass., also have a power output that provides a regulated voltage of  $-5$  v dc at 5 milliamperes.

Applications include instrumentation and computer-controlled systems. The converters are particularly suited to working alongside of transducers at remote locations because they can power the transducers themselves. Also, since the converters can be plugged directly into a digital board and run from the supply there, analog-measurement circuitry can be completely separated from digital circuitry.

The four-wire ratiometric inputs of these series ADC-ER units permit accurate measurements to be made from bridge-type transducers. For ratiometric operation, two of the wires accommodate the signal input, while the other two wires are tied to an external reference voltage, which is at a different common-mode level than the input signal. To operate the converter in a nonratio-

metric mode, these latter two wires are simply connected to its internal reference source.

Five models are available. Two have binary-coded-decimal outputs, either  $2\frac{1}{2}$  digits or  $3\frac{1}{2}$  digits, and three have binary outputs—8, 10, or 12 bits. Total conversion time is 43 milliseconds for the  $3\frac{1}{2}$ -digit BCD model and 77 ms for the 12-bit binary model. All the models measure 4 by 2 by 0.4 inches.

When the signal-integration time is a multiple of the ac line's period, the converter provides a minimum noise-rejection ratio of 40 decibels. An external adjustment permits the unit to be set for line frequencies of either 50 or 60 hertz. There are also external adjustments for zeroing the converter, as well as for adjusting gain and clock frequency. Additionally, a reset-pulse output allows the device's internal counter to be synchronized with an external counter.

When its internal reference is used, the converter is accurate to within 0.05% of reading at 25°C. Accuracy-temperature drift is  $\pm 35$  ppm/°C, while offset-voltage drift is  $\pm 30$  microvolts/°C. Input impedance, across the differential signal wires or between one signal wire and ground, is 100 megohms.

Price ranges from \$79 to \$99, depending on the model, and delivery time is four weeks.

Datel Systems Inc., 1020 Turnpike St., Canton, Mass. 02021 [381]

## 12-bit d-a converter contains thin-film ladder

Unlike many competitive units that use a thick-film ladder network, a new 12-bit digital-to-analog converter is made with a ladder network of thin-film nichrome resistors, giving the device excellent long-term stability. Typically, a nichrome-resistor element changes only 0.1% after 6,000 hours of operation at 125°C.

Manufactured by Hybrid Systems Corp., the new model DAC-12QZ is intended as a pin-for-pin replacement for Analog Devices' DAC-



12QZ, which has been available for some time. The two competing modules are equivalent, both electrically and mechanically.

The Hybrid Systems converter holds linearity error to 0.01% and can slew at 20 volts per microsecond. It can settle to within 0.01% of its final output value within 5  $\mu$ s. Gain stability is 30 ppm/°C, offset voltage drift is 50 microvolts/°C, and differential nonlinearity drift is 10 ppm/°C.

Package size is 2 by 2 by 0.4 inches. Three digital-input codes are available: complementary binary, complementary offset binary, and binary-coded decimal. The unit's output-voltage range can be either unipolar or bipolar:  $+5$ ,  $+10$ ,  $\pm 2.5$ ,  $\pm 5$ , or  $\pm 10$  v. Power-supply requirements are  $+15$  v at 25 milliamperes,  $-15$  v at 30 mA, and  $+5$  v at 35 mA.

The unit is tentatively priced at \$75 each in lots of one to nine. Lead time for sample quantities is from stock to four weeks.

Hybrid Systems Corp., 22 Third Ave., Northwest Park, Burlington, Mass. 01803 [382]

## FET-input op amp has 290-volt output swing

The 3580 series of FET-input operational amplifiers is believed to be the first IC-packaged family to offer output voltage swings as high as  $\pm 145$  volts—that's 290 v peak to peak from a TO-3 can. Further, these units are thermally protected against overloads: if an excessive load is applied they automatically turn off; when the load is removed they turn back on. The family con-

# CMOS RAMs: 2-for-1 sale!

Our 512-bit CMOS RAM sells for about the same price as those other 256-bit RAMs. Two bits for the price of one!

In 100-999 quantities, our silicon-gate S2222A will run you \$15.36 a piece or just 3 cents a bit. 1000-4999 quantities really knock the price down—to \$10.75 each.

The price isn't the only thing that's low. Standby power is less than 20 nano-watts a bit, and operating power 15 microwatts a bit. With that little power, just think what you can do with our RAMs in terminals,

buffers, battery operated systems, portable calculators, time clocks, and military systems.

This is how our dense new CMOS RAM stacks up:

Access time: 400 ns  
Cycle time: 940 ns  
Single supply voltage: +10V  
Standby voltage to sustain data: 3.5V  
Static memory: no refresh  
Temperature range: 0° to 70° C  
Single read/write control line  
Simple memory expansion: chip enable  
16-pin dual in-line package

The S2222, a higher

performance version, is also available with standby power of less than 4 nano-watts a bit, 200 ns access time and 470 ns cycle time.

These days, you need to save every bit you can. Frank Rittiman will show you how. Call or write him at AMI, 3800 Homestead Road, Santa Clara, CA 95051. Phone (408) 255-3651. Or contact your distributor.



**it's  
standard  
at AMI**  
AMERICAN MICROSYSTEMS, INC.

# Here's AMI:

## SALES OFFICES:

1104 Highland Avenue, Suite 1  
Manhattan Beach CA 90266  
(213) 379-2452

1928A Old Middlefield Way  
Mountain View CA 94040  
(415) 969-0610

Altamonte Centre  
249 No. Maitland Avenue, Suite 317  
Altamonte Springs FL 32701  
(305) 830-8889

500 Higgins Road  
Elk Grove Village IL 60007  
(312) 437-6196

1420 Providence Turnpike, Room 220A  
Norwood MA 02062  
(617) 762-0726

29200 Vassar Avenue, Suite 214  
Livonia MI 48152  
(313) 478-9339

Fox Meadows Office Building  
3030 Harbor Lane North, Suite 101  
Minneapolis MN 55441  
(612) 546-3354

20 Robert Pitt Drive, Room 212  
Monsey NY 10952  
(914) 352-5333

Axe Wood East  
Butler & Skippack Pikes, Suite 3A  
Ambler PA 19002  
(215) 643-0217

725 S. Central Expressway, Suite C-5  
Richardson TX 75080  
(214) 231-5721, (214) 231-5285

## DISTRIBUTORS:

ARROW ELECTRONICS:  
Minnesota - Bloomington (612) 888 5522

DIPLOMAT ALTA, INC.:  
Utah - Salt Lake City (801) 486 7227

INTERMARK ELECTRONICS:  
Washington - Seattle (206) 767-3160

SCHWEBER ELECTRONICS:  
California - Costa Mesa (714) 924-5594  
Connecticut - Danbury (203) 792-3500  
Florida - Hollywood (305) 927-0511  
Georgia - Atlanta (404) 449-9170  
Illinois - Elk Grove Village (312) 593-2740  
Iowa - Cedar Rapids "Lorenz Sales" (319) 393-9125  
Maryland - Rockville (301) 881-2970  
Massachusetts - Waltham (617) 890-8181  
Michigan - Troy (313) 583-9242  
Minnesota - Edina (612) 941-5280  
New Jersey - Somerset (201) 469-6008  
New York - Rochester (716) 461-4000  
Westbury (516) 334-7471  
North Carolina - Raleigh (919) 832-8881  
Ohio - Beachwood (216) 464-2970  
Texas - Austin (512) 837-2890  
Dallas (214) 661-5010  
Houston (713) 784-3600

Canada - Mississauga, Ont. (416) 678-9050

STERLING ELECTRONICS:  
Arizona - Phoenix (602) 258-4531  
California - San Carlos (415) 592-2353  
San Diego (714) 565-2441  
Sun Valley (213) 767-5030

Louisiana - Metairie (504) 887-7921  
Massachusetts - Watertown (617) 926-9720  
New Jersey - Perth Amboy (201) 442-8000  
New Mexico - Albuquerque (505) 345-6601  
Pennsylvania - West Chester "West Chester Electric Supply Co." (215) 696-7500  
Texas - Dallas (214) 357-9131  
Houston (713) 623-6600

Virginia - Richmond "Meridian" (804) 335-6521  
Washington - Seattle (206) 762-9100

R.V. WEATHERFORD CO.:  
Arizona - Phoenix (602) 272-7144  
California - Anaheim (714) 547-0891  
Glendale (213) 849-3451  
Palo Alto (415) 493-5373  
Pomona (714) 623-1261  
San Diego (714) 278-7400

Colorado - Englewood (303) 761-5432  
New Mexico - Albuquerque (505) 265-5671  
Texas - Dallas (214) 243-1571  
Houston (713) 688-7406  
Washington - Seattle (206) 243-6340

## New products

sists of three op amps with maximum supply voltages of  $\pm 35$ ,  $\pm 75$ , and  $\pm 150$  v dc. Pricing on them, in

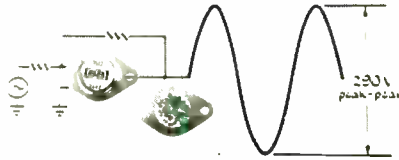

lots of 100 pieces, is \$27, \$43, and \$53, respectively. Small-quantity delivery is from stock.

Burr-Brown Research Corp., International Airport Industrial Park, Tucson, Ariz. 85734 [384]

Instrumentation amplifier is linear to better than 0.002%

Featuring a maximum nonlinearity error of less than 0.002%, a maximum input offset drift of 0.5 microvolt per degree celsius, and a minimum common-mode rejection ratio of 90 dB, the model 606 instrumentation amplifier is intended for medical, aerospace, and industrial applications in which low-level signals must be recovered from noisy environments. The device has a gain-bandwidth product of 10 megahertz, making it fast enough for many data-acquisition applications. Its 75-milliwatt power consumption and small size (2 by 2 by 0.4 inches) make it well suited for portable equipment. In addition to the model 606L, which has a maximum temperature drift of  $0.5 \mu\text{V}/^\circ\text{C}$  and sells for \$98 in small quantities, two lower-cost versions are available.



The 606K has a maximum drift of  $1 \mu\text{V}/^\circ\text{C}$  and is priced at \$85, while the 606J has a drift rating of  $2 \mu\text{V}/^\circ\text{C}$  and carries a \$69 price tag. The units are identical in all other respects than temperature drift. All three models are rated from 0 to  $70^\circ\text{C}$  and are available from stock. Analog Devices Inc., P.O. Box 280, Route 1 Industrial Park, Norwood, Mass. 02062 [385]

\$43 sample-and-hold has 12-bit accuracy at 2.5 kHz

One way to convert fast analog signals to digital form is to use a fast analog-to-digital converter. A



cheaper approach that will often suffice is to use a slower a-d converter preceded by a sample-and-hold amplifier. A moderate-performance general-purpose sample-and-hold module with a single-unit price of \$43 and 12-bit accuracy is suitable for a wide range of such applications. The model 4854 maintains its full accuracy (within 0.01%) at speeds up to 2.5 kilohertz. At 5 kHz, the maximum error increases to 0.05%, and at 10 kHz it's 0.2%. Claimed to be about 10% cheaper than competitive devices with similar specifications, the 4854 has an aperture time of 20 nanoseconds, an aperture-time uncertainty of 2 ns, and a maximum feedthrough of 1 millivolt. The 2-inch-square module has an input impedance of  $10^9$  ohms, an output slew rate of 1.5 v



# RF-PACKAGES—MICROWAVE SYSTEMS

WORLD'S LARGEST RADAR & MICROWAVE INVENTORY

## AUTOTRACK ANTENNA SCR-584 RADAR SYSTEM

360 deg AZ 210 deg EL. 1 mil. accuracy. Missile vel. accel. and slew rates. Amplidyne control. Handle up to 20 ft. dish. Compl. control chassis. ALSO in stock 10 cm. van mounted rad. system. Conical scan. PPI. 6 ft. dish. 300 pg. instr. bk. on radar \$25



## RF SOURCES

**CW:** 300-535KHz 500W; 2-30MHz 3KW; 4-21MHz 40KW; 24-350MHz 100W; 385-585MHz 1KW; 750-985MHz 10KW; 95-8.8GHz 150W; 1-1.5GHz 110W; 1.7-2.4GHz 10KW; 4.4-5GHz 1KW; 8.8-11GHz 200W. Many more.

**UHF:** 1 Megawatt 210-225MHz 5µsec 180 PPS; 14KW 400-420MHz .002DC; 1KW 400-700MHz .002DC

**L BAND:** 1KW 1-1.5GHz .1DC; 500KW 1.2-1.35GHz 2µsec 400PPS

**S BAND:** 1KW 2.4-2.6GHz .75µsec 1200PPS; 250KW 2.7-3.3GHz .8µsec 1600PPS; 500KW 2.7-3.1GHz .8µsec 1600PPS; 1 Megawatt 2.7-2.9GHz 1µsec 1200PPS; 5 Megawatts 2.75-2.85GHz 2.5µsec 400PPS

**C BAND:** 225KW 6275-6575MHz .4µsec 680PPS; 250KW 5.4-5.8GHz .5µsec 680PPS; 1 Megawatt 6GHz 1µsec 1000PPS

**X BAND:** 100W 9.2-9.5GHz .5µsec 1000PPS; 1 KW 8.9-9.4GHz .001DC; 65KW 8.5-9.6GHz .001DC; 250KW 8.5-9.6GHz .0013DC; 400KW 9.1 GHz 1.8µsec 450PPS

**Ku-K BAND:** 50KW 16.4-16.6GHz .001DC; 135KW 15.5-17.5GHz .006DC; 40KW 24GHz .0007DC; 40KW 35GHz .0004DC

## PULSE MODULATORS + H.V.P.S.

245 KW LINE Output 16 KV 16 A. .25 µs 4000 PPS  
405 KW FLOATING DECK Output 20 KV 20 A 1 µs to 10 millisecc pulse

500 KW LINE Output 22 KV 28 A. .4/1.75/2.25 µs 2500/550/300 PPS  
1 MW HARDTUBE MIT MODEL 9 Output 25 KV at 40 A. .25 µs .002 DC

2.0 MW LINE 30 KV 70 A. 1/2 µs 600/300 PPS  
3 MW LINE Output 39 KV 75 A. .25/1 µs 500 PPS  
10 MW LINE 76 KV 135 A. 2.5 µs 350 PPS  
17 MW LINE 17 KV 1000 A. 2.5 µs 150-2000 PPS

SEND FOR FREE 24 PG. CATALOG

## MOD IV HI-RES MONOPULSE TRACKER

Instrumentation radar; freq. 8.5-9.6 GHz, Pwr: 250 KW, .1 mil accu Trk. Rng. 50 or 200 mi.

## RADAR SYSTEMS

**K BAND MONOPULSE 40KW E-34**  
**KU BAND SEARCH 135KW B-58**  
**X BAND MISSILE CONTROL NIKE AJAX/HERC**  
**X BAND FIRE CONTROL 250KW M-33**  
**X BAND WEATHER/SEARCH 250KW AN/CPS-9**  
**X BAND AIRBORNE TRACKER 50KW B-47**  
**X BAND MOBILE TRACKER 40KW AN/MPQ-29**  
**X BAND WEATHER/SEARCH 40KW AN/SPN-5**  
**X BAND TRANSPONDER 100W AN/DPN-62**  
**C BAND HGT. FDR. 5MW FPS-26; 1MW TPS-37**  
**C BAND SEARCH 285KW AN/SPS-58/D**  
**S BAND HEIGHT FINDER 5MW AN/FPS-6**  
**S BAND SEARCH COHERENT 1MW AN/FPS-18**  
**S BAND ACQUISITION 1MW NIKE AJAX/HERC**  
**S BAND TRACKER 10' DISH 500KW AN/MPQ-18**  
**S BAND MORTAR LOCATOR 250KW AN/MPQ-10A**  
**S BAND TRACKER 250KW AN/MPS-9**  
**L BAND SEARCH 40' ANTENNA 500KW AN/FPS-75**  
**L BAND SEARCH 500KW AN/TPS-1D/GSS-1**  
**UHF SEARCH 1MW TPS-28**

## DRONE CONTROL SYSTEMS

**UHF COMMAND SYSTEM AN/URW-14**  
**X BAND DATA LINK AN/UPW-1**  
**X BAND TRACKER AN/MPQ-29**  
**X BAND TRACKER AN/MSQ-51**

**SHORAN Type CPN-2A Freq 290-330 MHz**  
Pwr 30KW consists of trans., recv., monitor, etc.

## SPARE PARTS IN STOCK

Nike Ajax, Nike Hercules, M-33, MPS-19, TPS-1D, TPS-10D, FPS-6, SPS-8, SCR-584, HIPAR. Many more. write



**Radio  
Research  
Instrument  
Co., Inc.**

3 QUINCY ST., NORWALK, CONN. 06850  
(203) 853-2600

Circle 148 on reader service card

## New products

per microsecond, and an operating temperature range of 0 to 70°C. Its price, in lots of 100 pieces, drops to \$29. Delivery is from stock.

Teledyne Philbrick, Allied Drive at Rte. 128, Dedham, Mass. 02026 [383]

\$39 sample-and-hold unit has  $\pm 1$ -ns aperture error

The MP240 sample-and-hold module has a maximum aperture time of 20 nanoseconds, a maximum aperture-time uncertainty of 1 ns, an acquisition time of 5 microseconds (to capture a 10-volt step to within 0.01%), and a 100-piece price of \$39. This combination of performance and price specifications makes the unit ideal for data-gathering systems in which good performance must be obtained at low cost. In addition to its performance specifications, which include a hold-mode

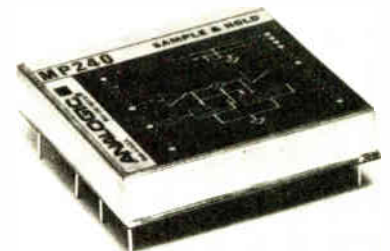

feedthrough of -90 dB and a maximum transfer error of 0.01% at unity gain, the MP240 has the advantage of being a complete system. It includes a high-impedance buffer amplifier, DTL/TTL/C-MOS-compatible switching controls, a proprietary signal-acquisition circuit, and a high-speed output buffer. The MP240 is said to be especially useful for economical wideband-signal data-acquisition systems with throughput speeds up to 20 kilohertz. A 16-channel, 12-bit analog data-acquisition and conversion system will cost OEMs less than \$200 if they use the MP240 along with standard modules, the company says.

Analogic, Audubon Road, Wakefield, Mass. 01880 [386]

# First Ever.

## A Point Plotter Module For Generating CRT Displays.

Easily display digital information on CRTs or pen plotters... from any computer or microprocessor. The DT212 Point Plotter does it all... it interfaces directly to Tektronix, H-P, and DEC scopes... also to analog instrument or control devices.

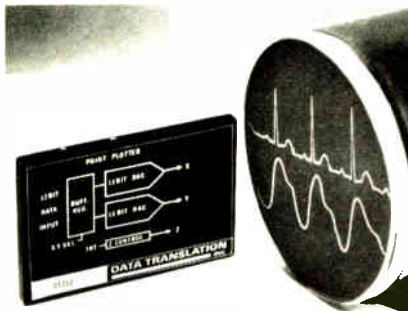

Imagine, for \$245 in 100's you get a complete point plotting system that:

- Displays graphics and alpha- numerics
- Yields more flicker-free data with high speed X, Y, and Z drive
- Provides accurate position placement with dual 12-bit D/A converters
- Interfaces directly to computer I/O

**DATA TRANSLATION  
INC**

109 CONCORD STREET FRAMINGHAM MA 01701

Call us at 617/879-3595 for a complete set of applications data. Or call your local representative below.

78-539-4411	303-934-5505	904-243-6424	504-366-5766	215-337-1573	919-489-1546	713-688-9971
	305-425-5505	305-723-0766	301-953-3724	505-299-7658	216-585-8421	214-231-2573
	305-776-4800	404-939-1674	314-997-1515	201-569-2230	615-584-2614	703-527-3262
		913-649-4000		716-334-2445		206-454-0900

Circle 171 on reader service card

Electronics/February 20, 1975

# NEW and EXCLUSIVE A/D Converter

features

**HIGH SPEED:** 4  $\mu$ sec.  
(250,000 conversions per sec.)

**HIGH RESOLUTION:** 15 bits

**HIGH ACCURACY:**  
0.0065% of FSR

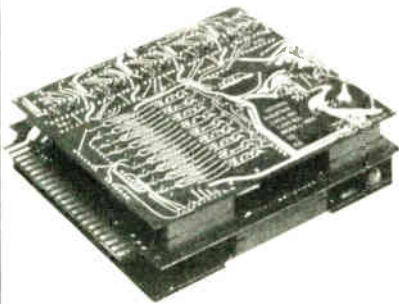

New Model ADC1215F converter from Phoenix Data is available in two basic models: Single-ended and differential.

Phoenix Data's new Model ADC1215F A/D converter has a resolution of 15 binary bits and a total conversion time of 4 microseconds (250,000 conversions per sec.). Accuracy of 0.0065% of FSR is guaranteed in addition to complete monotonicity. Analog dynamic range is in excess of 86 db.

If it's stability, accuracy, speed, or all-around quality you need in Data Conversion, contact Phoenix Data now!



**PHOENIX DATA, INC.**

3384 W. Osborn Rd. Phoenix, AZ 85017  
Ph. (602) 278-8528, TWX 910-951-1364

## New products/materials

A clear, flexible epoxy with properties making it well suited as a cable-junction and connector-potting compound has excellent adhesion to rubber, neoprene, PVC, and nylon. Called TC-447, the two-component formulation is highly resistant to age-hardening, oils, JP fuel, and most common solvents. Cure time is approximately 2.5 hours at 150°F. In addition to the clear TC-447, a similar, but black, formulation designated TC-459 is available for applications where the need to see the connection or cable junction is not a factor.

Techform Laboratories, 215 West 131 Street, Los Angeles, Calif. 90061 [477]

**Synthetic hydrocarbon greases** made from mixtures of synthetic hydrocarbons and lithium soaps are intended for applications in appliances and other lubed-for-life equipment. The Rheolube 723 grease series functions over the temperature range from -40°F to at least +275°F. It is especially valuable where ester-vulnerable plastics are present. Variations on the basic grease include fluorocarbon, molybdenum disulfide, and other additives for high loads, delicate metals, and other special needs.

William F. Nye Inc., P.O. Box G-927, New Bedford, Mass. 02742 [479]

**Liquid polyurethane resins** for casting electrical insulation have the advantage of combining low toxicity with room-temperature curing. The two-component system consists of Vorite prepolymer and Polycin curing agent. When cured, the mixture forms a solid elastomer which shows better resistance to heat and humidity than do conventional polyesters and polyethers. Applications for the material include potting, filling, embedding and encapsulating circuits and components. In addition, the material's small heat rise and good dimensional stability while curing make it suitable for encapsulating toroidal-core transformers, reed and mercury switches, and selenium rectifiers.

Vorite/Polycin, NL Industries Inc., P. O. Box 700, Hightstown, N. J. 08520 [480]

# OPEN THE GATE TO DIGITAL KNOW- LEDGE



**WITH THE NEW  
LR INNOVATOR  
SERIES FROM  
E&L INSTRUMENTS**

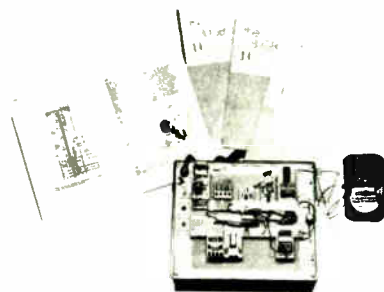

The LR Innovator Series introduces you to a radically new approach to the learning of digital electronics.

You encounter hardware on the very first day. The software (over seven hundred pages — over 90 experiments) is designed for both formal instruction or for self-programmed learning. You learn through the use of the actual integrated circuit chips. The hardware has been designed "open ended." As electronics industry changes and evolves, the Innovator system allows the user full access to new IC technology.

Write today for full details of this exciting new system.

**E&L  
INSTRUMENTS,  
INC.**

61 First Street, Derby, Conn. 06418  
Phone (203) 735-8774



# NOW LOW COST HIGH PERFORMANCE SINEWAVE OSCILLATORS LOW DISTORTION

## the 450 SERIES

### Featuring

- 0.1dB amplitude stability
- 0.1% distortion
- 1 to 20V p-p adjustable
- 100Hz to 10kHz range
- 1% accuracy (adj.  $\pm 5\%$ )
- .02%/°C stability

**Low Profile**  
(1.5" x 2.0" x 0.4")

### Also Available:

- Fixed + Resistive Tuneable Precision Quadrature Oscillators
- Low Cost + Stable freq. include:

## 400 SERIES + 440 SERIES for

stable frequency reference/distortion testing/production testing/resolver excitation/quadrature Mod-Demod/arbitrary reference angle gen./computer controlled oscillator

Frequency Devices Inc. also carries a broad line of active fixed frequency, tuneable and programmable filters.

For further information, please call or write:

S. Ruscio, Sales Manager  
Frequency Devices Inc.  
25 Locust Street  
Haverhill, Mass. 01830  
(617) 374-0761/TWX 710-347-0314



50 on reader service card

## New literature

**EMI filters.** Designer's kit No. 2, consisting of a collection of article reprints on electromagnetic interference and compatibility, catalog information on the company's filters, and a circular slide rule for the calculation of inductive and capacitive reactances, is available from Cornell-Dubilier Electronics, 150 Avenue L, Newark, N.J. 07101. Circle 421 on reader service card.

**Hybrid-computer services.** A brochure describing details of hybrid (analog/digital) computer services and applications is available from Celesco Industries Inc., 3333 Harbor Blvd., Costa Mesa, Calif. 92626, Attention: E. P. Malone. Celesco recently acquired a Pacer 700 computer which can be used for simulation of dynamic systems such as aircraft and missiles. [422]

**Rate-of-return calculator.** A paperboard slide rule that engineers and managers can use to determine the rate of return on an investment can be obtained by writing to Western Electric, R/R Calculator, 16th floor, 195 Broadway, New York, N.Y. 10007. Limit is one free calculator; larger quantities are for sale at \$1 each. [423]

**Stripline components.** A 64-page catalog, No. 749, covers a line of microwave components and assemblies with emphasis on stripline devices. Both active and passive equipment, ranging from low-noise rf amplifiers to directional couplers, are covered. Lorch Devices Inc., 105 Cedar Lane, Englewood, N.J. 07631 [425]

**Motor-lead wire.** A bulletin on two styles of motor-lead wire, types



Introduction  
Description  
Construction  
Specifications

## EMPLOYMENT OPPORTUNITIES

Send New Ads to:  
Electronics  
Class. Adv. Dept.  
P.O. Box 900, N.Y., N.Y. 10020

**DIGITAL DESIGN ENGINEER.** Experience with design and development of digital subsystems. Familiar with TTL, MOS, MSI and control applications of PROM, RAM, and microprocessors. **Scientific Services, Geophysical Institute, Univ. Alaska, Fairbanks, AK 99701.** An equal opportunity employer.

**Q. Whom do I contact or call to renew my classified ad or make corrections?**

**A. Write Electronics, Class. Adv. Dept., P.O. Box 900, NY, NY 10020 or call: (212) 997-4392. Give full company name, size of ad, & date or dates it is scheduled to appear.**

## MULTIPLE RESTRIKE IGNITION



- 500  $\mu$ S REPETITIVE SPARK
- HIGH TOTAL ENERGY INPUT
- FAST RISE TIME
- INSURES PROPER COMBUSTION
- POINTS OR MAG. PICK-UP TRIGGERING
- OPERATES WITH STD. COIL & LIST.
- ADJUSTABLE DURATION CONTROL
- LONGER POINTS & PLUG LIFE
- STD. & MULT. FIRING CONVERSION FLUG
- ONE YEAR FACTORY WARRANTY

LABTRONICS' MULTIPLE RESTRIKE (M-R) IGNITION PRODUCES A HIGH ENERGY REPETITIVE SPARK ON EACH POWER STROKE TO EFFECTIVELY IGNITE THE AIR/FUEL MIXTURE. M-R STATISTICALLY INSURES MORE COMPLETE COMBUSTION - RESULTING IN GREATER ENERGY AND INCREASED EFFICIENCY (FUEL ECONOMY). SEND FOR LABTRONICS' FREE LITERATURE ON THE M-R SYSTEM. BETTER YET, EXPERIENCE M-R AND ENJOY THE PLEASURE AND ECONOMY OF A WELL-PERFORMING ENGINE.

### LABTRONICS, INCORPORATED

1635 HULL STREET • ANN ARBOR, MI 48107

M R System (12v ps.)  
\$795 p.p.d. / cod  
P/N 6129 Mag Amplifier  
\$450 p.p.d. / cod  
Brochure  
Enclosed \$

Name \_\_\_\_\_  
Addr \_\_\_\_\_  
City \_\_\_\_\_ State \_\_\_\_\_

Circle 173 on reader service card



# THE POINTER- METER

## KILLER

NLS's DIGITAL

# PM-3



# \$49.95

In OEM qty.

### Features Include:

- Three full digits; 1 vdc full scale with 0.1% accuracy
- Large LED-0.31" display
- Automatic zeroing
- Low power consumption; 5V @ 0.5W
- MOS/LSI construction
- Unipolar with over-range and negative indication
- Small size: 1"H x 2-1/2"W x 3-1/4"D
- Programmable decimal point

### Options Include:

- Ranges of 10, 100 or 1000 vdc
- Operation as voltmeter/counter
- BCD output; MUX or parallel
- Current measurement
- Ratio operation
- Display dimming/inhibit

For immediate delivery fill in below.

- Special offer of \$78.50 with your check and coupon.  Regular price of \$85.00 C.O.D. or valid purchase order.  
One year guarantee.

Name \_\_\_\_\_

Company \_\_\_\_\_

Address \_\_\_\_\_

City \_\_\_\_\_ State \_\_\_\_\_ Zip \_\_\_\_\_

Add 6% Sales Tax - California Residents

1 3456789101112 ★ 1 3456789101112

PH (714) 755-1139  TWX 910-322-1132  
NON-LINEAR SYSTEMS, INC.  
Box N, Del Mar, Calif. 92014

Circle 216 on reader service card

## New literature

DMD and DTMD, intended for hermetic motor applications is offered by The Anaconda Co., Wire and Cable Division, Magnet Wire, Glen Hill Office Park 8, Glen Ellyn, Ill. 60137 [424]

**Pulse plater.** A data sheet enumerating advantages of using short-duration current pulses instead of simple dc for electroplating a variety of metals is obtainable from Nova Tran Corp., 360 Fourth St., Clear Lake, Wis. 54005. The brochure also includes catalog information on the company's DP 20 series of DigiPlate pulse-plating power supplies, which may be used in the application of gold, nickel, copper, and various alloys. [426]

**Mask saver.** A data sheet from Electromask Inc., 5109 De Soto Ave., Woodland Hills, Calif. 91364, explains how the company's model 7500 mask saver uses a pulsed laser beam to remove defects from chromium and iron-oxide integrated-circuit masks. [427]

**Electro-optical products.** Slits, pinholes, filters, safety goggles, low-power lasers, mirror mounts, and other electro-optical devices are included in a 24-page catalog offered by Energy Technology Inc., P. O. Box 1038, San Luis Obispo, Calif. 93406 [428]

**Eastern European market study.** A forecast and commentary on the 1974-1975 Eastern European Electronics Market sells for \$35 and is obtainable from Fred Glynn/Marketing Research, 2200 Sacramento St., Suite 1206, San Francisco, Calif. 94115. The study, which was put together without the benefit of the large amounts of data normally used for such studies in the U. S. and Western Europe, consists largely of interpolations based on a small number of known facts. The author claims, however, based on a few "predictions" that he has been able to verify, that, with the exception of his figures on Albania, the forecasts are accurate within 25%. [429]

# 2000 pole double throw switch

How do you direct 2,000 low level transducer lines into a back-up computer without changing 200 cables? Easy. T-Bar® 48-pole latching relays. T-Bar makes high density switches and relays . . . designs and fabricates special switching systems . . . reliably and economically. If you switch a lot of lines — all at once or a few at a time — write or phone today for complete T-Bar literature.

## Tbar

INCORPORATED  
SWITCHING COMPONENTS DIV.

1474 Danbury Road  
Wilton, CT 06897  
Phone: 203/762-8351

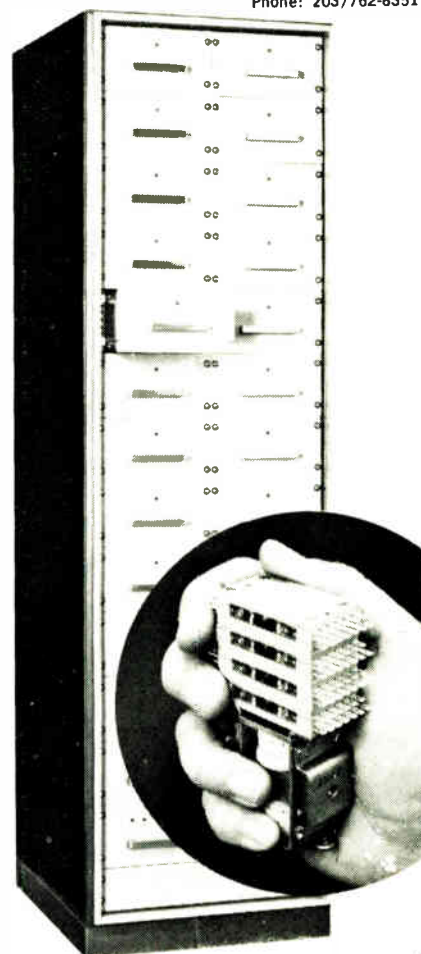

Circle 151 on reader service card

151

# Electronics advertisers

February 20, 1975

<b>Abbott Transistor Labs, Inc.</b> Technical Advertising Agency	6	<b>Harris Semiconductor</b> Tucker Wayne & Company	58-59	<b>Sesocom</b> Bazaine Publicite	7E, 18E
<b>Adelcy</b> C.E.T.I.	17E	<b>Hermes Electronics, Limited</b> Public & Industrial Relations Limited	110	<b>Sfernice</b> Jean Haechler Publicite	30E
<b>Advanced Micro Devices</b> Keye Donna Pearlstein	11	<b>Hewlett-Packard</b> Dancer Fitzgerald Sample, Inc.	18-19	<b>SGS Ates</b> MCann-Erickson	29E
<b>Aerlech Industries</b> Kenneth R. Miller Advertising	156	<b>Hewlett-Packard</b> Tallant/Yates Advertising, Inc.	1	<b>Shiley Company</b> Ingalls Associates, Inc., Advertising	27
<b>Alma/Division of Develco</b> Moorhead Marketing	39	<b>Hewlett-Packard</b> Tallant/Yates Advertising, Inc.	60-61	<b>Siemens A.G. Munich</b> Linder Presse Union GMBH	52
<b>Allen Bradley Company</b> Hoffman, York, Baker & Johnson, Inc.	24	<b>Hewlett Packard</b> McCarthy, Scelba, DeBiasi Advertising Agency, Inc.	2	<b>Siemens Corp.—Electronic Systems Division, Computest Products</b> J.L. Associates	80
<b>American Microsystems, Inc.</b> Wilton Coombs & Colnett Inc., Advertising	146-147	<b>Hewlett Packard</b> Philips Ramsey Advertising & Public Relations	131	<b>Sinclair Radionics Limited</b> Primary Contact Limited	2E-3E
<b>Amplex</b> Cassy and Hull Limited	16E	<b>Hughes Aircraft Company</b> Foote, Cone & Belding	63	<b>Solid State Scientific Inc.</b> Atkin-Kynett	9
<b>Amphenol Connectors Division, Bunker Ramo Corporation</b> Dimensional Marketing, Inc.	54	<b>Intel Corporation</b> Regis McKenna, Inc.	12-13, 38	<b>Sorensen AG</b> Agentur IFF AG	28E
<b>Augat</b> Creamer, Trowbridge, Case & Basford, Inc.	127	<b>Intersil, Inc.</b> Tyser-Fultz	44-45	<b>Sorensen</b> Grover and Erickson, Inc.	46-47
<b>Bausch &amp; Lomb, Inc.</b> Wolff Assoc., Inc.	136	<b>Isotronics</b> Southeastern Advertising Agency, Inc.	121	<b>Sound Technology</b> Frank Burkhard Company	94
<b>Beckman Instruments Limited</b>	9E	<b>Kepeco, Inc.</b> Weiss Advertising	5	<b>Spectrol Electronics Corporation</b> JMR Inc.	115
<b>Bell &amp; Howell, Control Products Division</b> Porter & Mills Advertising	113	<b>Kurz-Kasch, Incorporated</b> David K. Burnap Advertising	155	<b>Sprague Electric Company</b> Harry P. Bridge Company	8
<b>Buckeye Stamping Company, The</b> Wheeler, Kight & Garney, Inc.	156	<b>Labtronics, Incorporated</b>	150	<b>Syston Donner Concord Instruments</b> Fred Schott & Associates	51, 144
<b>Cherry Electrical Products, Corp.</b> Kolb, Tooke & Associates, Inc.	41	<b>Martin Research Limited</b> Clark Associates	124	<b>T-Bar, Incorporated</b> Robert A. Paul Advertising Agency, Inc.	151
<b>Clairrex Corporation</b> Marquardt & Roche, Inc.	4th Cover	<b>Micro Power Systems</b> Associated Ad Ventures, Inc.	75	<b>TEAC Corp.</b> Dentsu Advertising Limited	141
<b>Continental Specialties Corporation</b> Robert A. Paul	42	<b>3M Electronics Division</b> Batten, Barton, Durstein & Osborn, Inc.	133	<b>TEC, Inc.</b> TEC-AD	134
<b>Corning Glass Works, Fluidic Products Department</b> Pierce Brown Associates, Inc.	57	<b>Mycro-Tek</b> Sullivan Higdon, Inc.	142	<b>Teledyne Relays</b> S. Michelson Advertising	120
<b>C.P. Clare International N.V.</b> Markcom	20E-21E	<b>National Semiconductor GmbH</b>	11E	<b>TerraCom</b> Manning/Bowen and Associates	142
<b>Dale Electronics, Inc.</b> Swanson, Sinkey, Ellis Inc.	27E	<b>Non-Linear Systems</b> A & J Associates, Inc.	151	<b>Testline Instruments</b> W.L. Vergason Advertising	40
<b>Data General Corporation</b> Scali, McCabe, Sloves, Inc.	106-107	<b>Oscilloquartz SA, Neuchatel</b> Young and Rubicam	4E, 23E	<b>† Texas Instrument Incorporated</b> Kenyon & Eckhardt Advertising, Inc.	73
<b>Data Translation, Inc.</b> Mark L. Nigberg, Inc.	148	<b>Philips Elcoma</b> intermarco Nederland	13E	<b>Texas Instrument Incorporated—Scientific Calculators</b> Tracy-Locke	119
<b>Delevan Division, American Precision Industries, Inc.</b> Comstock Advertising, Inc.	128	<b>Philips Elcoma</b> Brookes Communications Systems	31E, 54	<b>Thomson CSF</b> Bazaine Publicite	123
<b>Deutsche Messe AG, Hannover</b> Wilkins WPT	137	<b>Philips N.V. PRT/T&amp;M Division</b> Brookes Communications Systems SA	14E-15E	<b>TRW, Electronic Components Division</b> The Bowes Company	7
<b>Digital Equipment Corp.—Components Group</b> Schneider Parker, Inc.	22-23	<b>Phoenix Data, Inc.</b> Craig Miller Advertising	149	<b>Union Carbide Corporation</b> J.J. Lane, Inc.	2nd Cover
<b>† Eastman Kodak Co. Business Systems Markets Division—Engineering Data System Micrographics</b> J. Walter Thompson Company	15	<b>Piher International Limited</b> Scott MacTaggart Advertising	116	<b>Universal Oil Products, Norplex Division</b> Campbell-Mithun, Inc.	143
<b>EECO</b> The Greer Agency	64	<b>Plastics Engineering Company</b> Kutter & Kuttner Inc.	20	<b>Utah State Industrial Board</b> David W. Evans, Inc.	138
<b>EL Instruments, Inc.</b> Langeler-Stevens, Incorporated	149	<b>Preston Scientific, Inc.</b> James Bischof & Associates Advertising/Communications	153	<b>Vactec, Inc.</b> Coleman & Associates Advertising	129
<b>Electro Scientific Industries</b> Commark Group, Inc.	76	<b>Projects Unlimited, Inc.</b> The Parker Advertising Company	155	<b>Vector Electronic Company, Inc.</b> Communications Management Company	144
<b>Fairchild Semiconductor, Inc.</b> Carson/Roberts, Inc. Advertising Division of Ogilvy & Mather, Inc.	43	<b>Radio Research Instrument Corporation</b> Classified Advertising	148	<b>Wandel und Goltermann</b> Werbeagentur	15
<b>Fluke Manufacturing Co., John</b> Bonfield Associates	17	<b>RCA—Solid State Division</b> Marsteller, Inc.	69, 71	<b>Wavetek Indiana</b> Chapman Michetti Advertising	48
<b>Fluke Trendar</b> Moorehead Marketing Agency	33	<b>RCA Electronic Components</b> Al Paul Lefton Company	35, 37	<b>† Weston Instruments, Inc.</b> Schaefer Advertising, Inc.	141
<b>Frequency Devices, Inc.</b> Allied Advertising Agency, Inc.	150	<b>RCL Electronics, Inc.</b> Morway Advertising Agency	14	<b>Wild Heerbrugg</b> Public Relations & Werbe AG	80
<b>General Electric-Instrument Rental Division</b> R.T. Blass, Inc.	130	<b>Reticon Corporation</b> The House Agency	72	<b>Wilma, Westermann</b> Oliver-Beckmann GmbH	16
<b>General Magnetics</b> McCarthy, Scelba, DeBiasi Advertising Agency, Inc.	3rd Cover	<b>Rockland Systems</b> Rolf Johnsen, Inc.	140	<b>Woven Electronics</b> Prentiss Court Advertising	122
<b>General Radio Company</b> Grad Associates	135, 126	<b>Rohde &amp; Schwarz</b>	1E	<b>Yokogawa Electric Works, Limited</b> General Advertising Agency, Inc.	73
<b>Gold Inc./Instrument Systems Division</b> Carr Liggett Advertising, Inc.	156	<b>Rotron, Incorporated</b> Black-Russell-Morris	77		
<b>Harris Corporation</b> Jrce Marketing, Inc.	21	<b>S.A.F.T.</b> U.N.C.C.	25E		
		<b>Schauer Manufacturing Corporation</b> Nolan, Keelor & Stites	139		
		<b>Schlumberger</b>	33E-36E		
		<b>Sensors, Inc.</b> Industrial Marketing Studios	132		

## Classified & Employment Advertising

F. J. Eberle, Manager 212-997-2557

**EQUIPMENT (Used or Surplus New) For Sale**  
Univ. of Alaska, Geophysical Instr. .... 150

For more information on complete product line see advertisement in the latest Electronics Buyer's Guide  
 \* Advertisers in Electronics International  
 † Advertisers in Electronics domestic edition

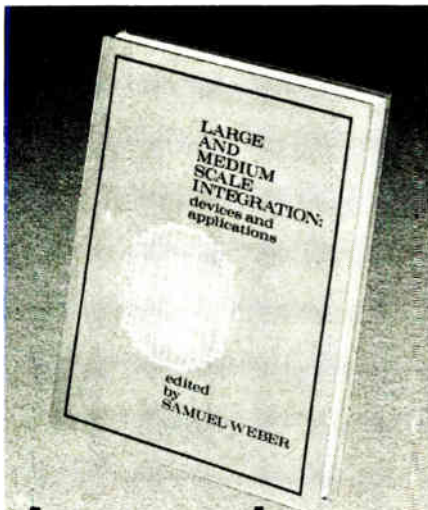

# Large and medium scale integration: Keep up with this fast changing technology

Now, in one comprehensive volume, a complete working grasp at large and medium scale integration for electronics engineers engaged in the design of electronic systems, equipment and products.

A wealth of practical working data on large and medium scale integration has been culled from the most important articles in Electronics magazine by Samuel Weber, Executive Editor. Emphasis is on design problems at the system or subsystem level, as well as on the economics of today's design.

Whatever the design problem — from partitioning a digital system to working with a semiconductor company in producing the best LSI design, this book covers the full range of today's important technologies on a practical, rather than a theoretical, level.

It's yours for \$15.00. Keep up.

### FREE 10-DAY EXAMINATION

**McGraw-Hill Book Company**  
1221 Ave. of the Americas,  
New York, N.Y. 10020



Send me a copy of Large and Medium Scale Integration (068815-X) for 10 days on approval. At the end of that time, I will either remit \$15.00, plus tax, postage, and handling, or return book without further obligation. (Remit in full with this coupon, plus any tax, and McGraw-Hill pays all postage and handling costs.)

Name \_\_\_\_\_

Address \_\_\_\_\_

City \_\_\_\_\_

State \_\_\_\_\_ Zip \_\_\_\_\_

Offer good only in the U.S. and subject to acceptance by McGraw-Hill. For prices outside U.S., contact McGraw-Hill Book Co.

23 K138-4018-3

### Advertising Sales Staff

**Pierre J. Braudé** New York [212] 997-3468  
Director of Marketing

**Atlanta, Ga. 30309:** Warren H. Gardner  
100 Colony Square, 1175 Peachtree St., N.E.  
[212] 997-3617

**Boston, Mass. 02116:** James R. Pierce  
607 Boylston St. [617] 262-1160

**Chicago, Ill. 60611:**  
645 North Michigan Avenue  
Robert W. Bartlett (312) 751-3739  
Paul W. Reiss (312) 751-3738

**Cleveland, Ohio 44113:** William J. Boyle  
[716] 586-5040

**Dallas, Texas 75201:** Charles G. Hubbard  
2001 Bryant Tower, Suite 1070  
[214] 742-1747

**Denver, Colo. 80202:** Harry B. Doyle, Jr.  
Tower Bldg., 1700 Broadway  
[303] 266-3863

**Detroit, Michigan 48202:** Robert W. Bartlett  
1400 Fisher Bldg  
[313] 873-7410

**Houston, Texas 77002:** Charles G. Hubbard  
Dresser Tower, 601 Jefferson St., [713] 224-8381

**Los Angeles, Calif. 90010:** Robert J. Rielly  
Bradley K. Jones, 3200 Wilshire Blvd., South Tower  
[213] 487-1160

**New York, N.Y. 10020**  
1221 Avenue of the Americas  
Warren H. Gardner [212] 997-3617  
Michael J. Stoller [212] 997-3616

**Philadelphia, Pa. 19102:** Warren H. Gardner  
Three Parkway,  
[215] 997-3617

**Pittsburgh, Pa. 15222:** Warren H. Gardner  
4 Gateway Center, [212] 997-3617

**Rochester, N.Y. 14534:** William J. Boyle  
9 Greylock Ridge, Pittsford, N.Y.  
[716] 586-5040

**San Francisco, Calif. 94111:** Don Farris  
Robert J. Rielly, 425 Battery Street,  
[415] 362-4600

**Paris:** Alain Offergeld  
17 Rue-Georges Bizet, 75 Paris 16, France  
Tel: 720-73-01

**Geneva:** Alain Offergeld  
1 rue du Temple, Geneva, Switzerland  
Tel: 32-35-63

**United Kingdom & Scandinavia:** Keith Mantle  
Tel: 01-493-1451, 34 Dover Street, London W1

**Milan:** Robert Saidel  
1 via Baracchini, Italy Phone 86-90-656

**Brussels:** Alain Offergeld  
23 Chaussee de Wavre  
Brussels 1040, Belgium  
Tel: 13-73-95

**Frankfurt/Main:** Fritz Krusebecker  
Liebigstrasse 27c, Germany  
Phone 72 01 81

**Tokyo:** Tatsumi Katagiri, McGraw-Hill  
Publications Overseas Corporation,  
Kasumigaseki Building 2-5, 3-chome,  
Kasumigaseki, Chiyoda-Ku, Tokyo, Japan  
[581] 9811

**Australasia:** Warren E. Ball, IPO Box 5106,  
Tokyo, Japan

### Business Department

**Stephen R. Weiss, Manager**  
[212] 997-2044

**Thomas M. Egan,**  
Production Manager [212] 997-3140

**Carol Gallagher**  
Assistant Production Manager [212] 997-2045

**Dorothy Carter,** Contracts and Billings  
[212] 997-2908

**Frances Vellone,** Reader Service Manager  
[212] 997-6057

### Electronics Buyers' Guide

**George F. Werner,** Associate Publisher  
[212] 997-3139

**Regina Hera,** Directory Manager  
[212] 997-2544

## Only Preston's Amplifiers Deliver "Balanced Precision"!

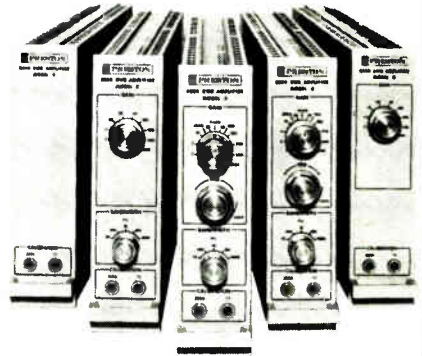

All five models of Preston's 8300 XWB Series Instrumentation Amplifiers deliver exclusive "Balanced Precision" performance! By improving temperature stability and rejection of 'false' input signals, we've slashed the effects of the four biggest sources of instrumentation system errors:

**Common Mode Rejection** — 150 db @ DC, 130 db @ 60 Hz! Preston delivers the highest CMR available to cut 'false' input signals by as much as 80%!

**Temperature Stability** — Gain TC is only 10 ppm/°C and Zero TC is an ultra-low 0.1 μV/°C RTI! That's 2 to 5 times better than any other amplifier!

**Pumpout Current** — Stays below ½ nanoamp over the entire temperature range to reduce errors by more than 90%!

**Overload Recovery** — to within 0.01% in only 30 usec.!

**PLUS** — these other basic advantages:

**Accuracy** — Models available with accuracy from 0.1% to 0.005%!

**Full Power Bandwidth** — from DC to 100 kHz!

**Ten New Options** — including triple output, three- and four-pole Bessel filters, and remote calibrate relay for verified data accuracy.

Get all the details by requesting our 12 page "Balanced Precision" brochure that shows how to determine your instrumentation system's true accuracy! Write to Preston Scientific, Inc., 805 E. Cerritos Ave., Anaheim, Calif. 92805 or call us at (714) 776-6400.

We'll put all our years of experience on the line!

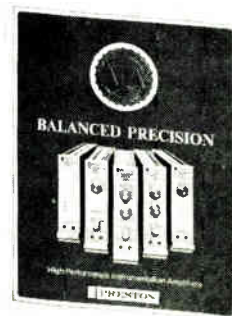

 **PRESTON**



# If you're low man on a company copy, Isn't it time you got your own?

How often has ELECTRONICS never even made it to your desk? How often has ELECTRONICS wound up on your desk dog-eared and abused, with articles clipped out and ripped out? How often has ELECTRONICS wound up on your desk days, even weeks late? And you find yourself reading a January issue in February.

You should be getting your own copy of ELECTRONICS right off the press.

You need it. You want it. You read it because it's important to stay on top of what's happening in your field. And ELECTRONICS is on top. ELECTRONICS is the Source. It's packed with up-to-date information, with the breaking news of the electronics industries

in the U.S. and worldwide.

And you can get ELECTRONICS where you can find the time to read it—at home. Go to *the Source*, today. Just fill out the subscription card enclosed in this issue, and send it off.

**Electronics**   
**IS THE SOURCE.**

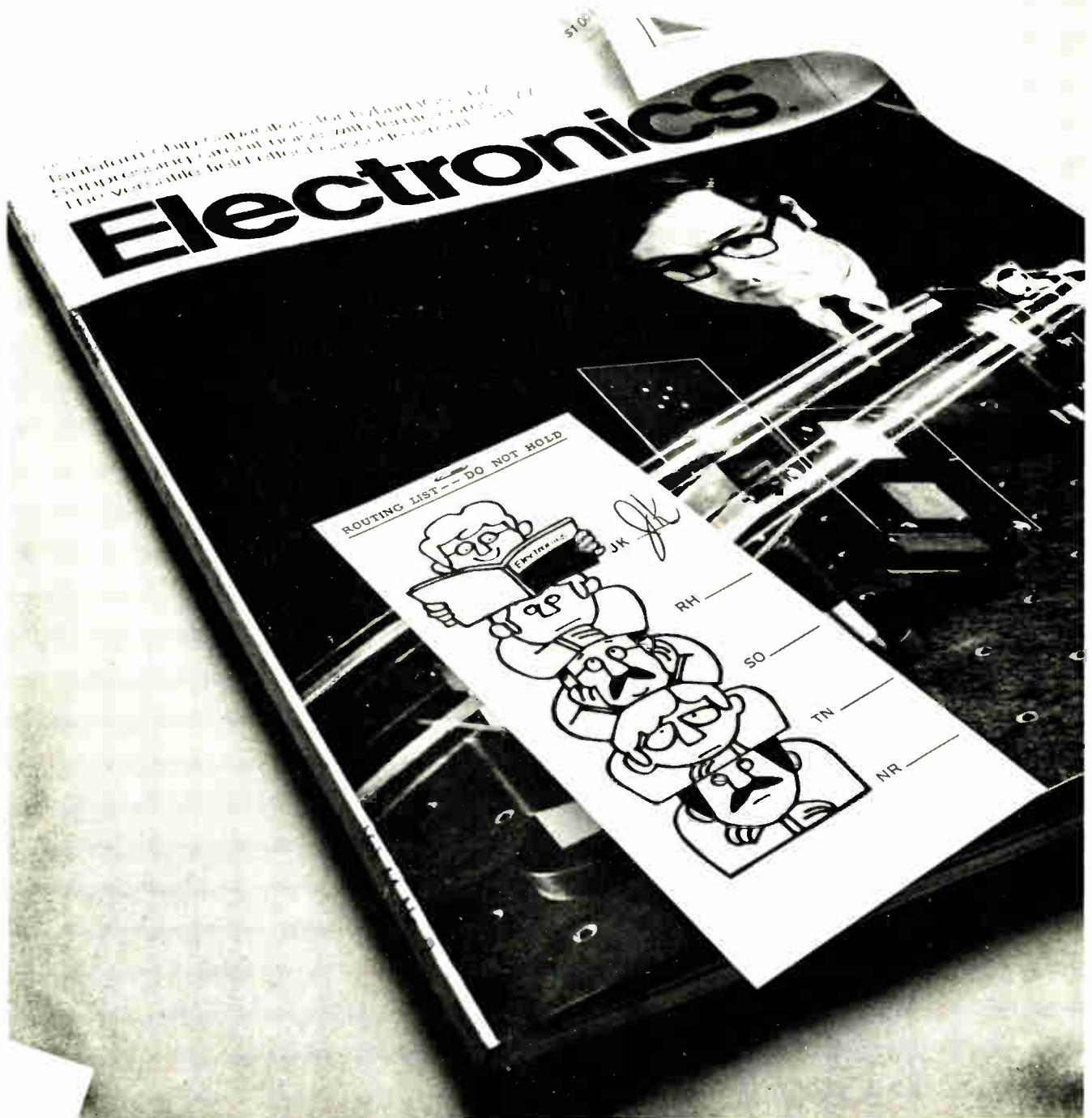

# Payroll Savings.

## The cold, hard, calculating way to get a nice, warm feeling of security.

You can plan your future to the dime. Simply sign up for the Payroll Savings Plan. An amount you specify will be automatically set aside each payday to buy U.S. Savings Bonds.

With Bonds what you save is what you get. Plus interest. Nothing's more secure and dependable.

Ask your payroll people to get you started right away. You'll be richer later. And feel good. And warm. And secure.



## Take stock in America.

Join the Payroll Savings Plan.



The U.S. Government does not pay for this advertisement. It is presented as a public service in cooperation with The Department of the Treasury and The Advertising Council.

new  
C/MOS  
Logic Probes  
Available Now

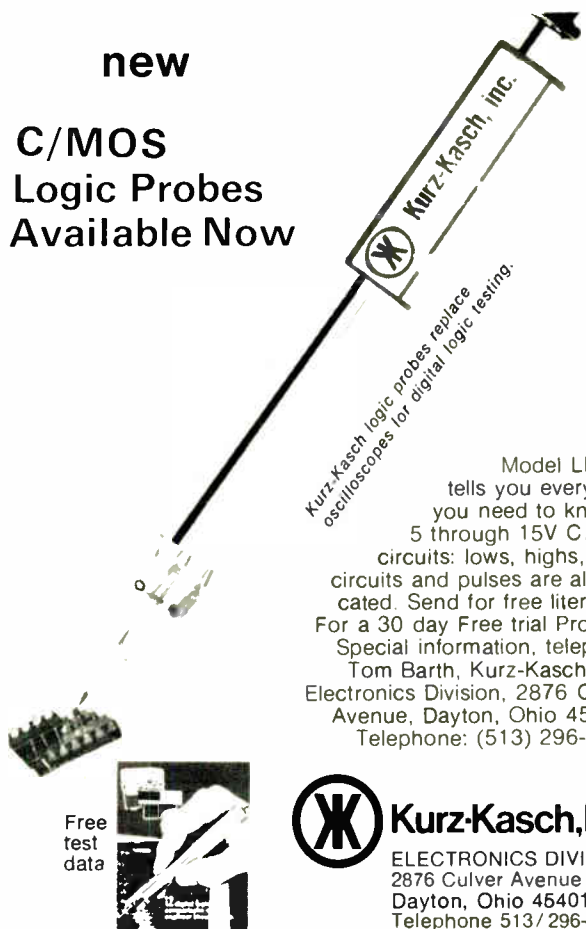

Kurz-Kasch logic probes replace oscilloscopes for digital logic testing.

New Model LP-576 tells you everything you need to know in 5 through 15V C/MOS circuits: lows, highs, open circuits and pulses are all indicated. Send for free literature. For a 30 day Free trial Probe or Special information, telephone Tom Barth, Kurz-Kasch, Inc., Electronics Division, 2876 Culver Avenue, Dayton, Ohio 45401, Telephone: (513) 296-0330.



**Kurz-Kasch, Inc.**

ELECTRONICS DIVISION  
2876 Culver Avenue  
Dayton, Ohio 45401  
Telephone 513/296-0330

Circle 155 on reader service card

## Audio Indicator "Systems"

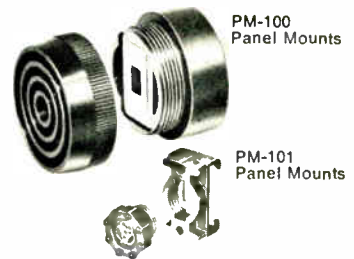

## Speed Up Installation...

add versatility, too!

AI-100 series Audio Indicators

Take your choice. Components . . . or systems.

**AI-100 Series Audio Indicators:** Rugged, reliable, steel encased. Rated at a very noticeable 76 dB at 400 Hz. Four models: AI-101 (3 VDC); AI-103w (3 VDC with third wire collector); AI-105 (5 VDC); AI-112 (12 VDC). Use panel mounts for added versatility. **PM-100:** fits 1 1/8" opening in 1/8" panel. Terminals accept .250" female disconnects, screws, or solder. **PM-101:** for 1/2" openings in 1/8" panels. Bezel, self tap screws, or adhesive mounting. Special mounts made for OEM. What are your needs?



3680 Wyse Road  
Dayton, Ohio 45414  
Tel. 513-890-1918  
TWX 810-450-2523

IN EUROPE  
projects unlimited/  
Europe B.P. 15  
6100 Mont Sur  
Marchienne  
Belgium, Telex 51-390  
Tel (07) 36 84 86

D.I.A.L. 800-645-9200 for the name of your nearest representative. In New York call 516-294-0990 collect.

# Get Your Project Off The Ground

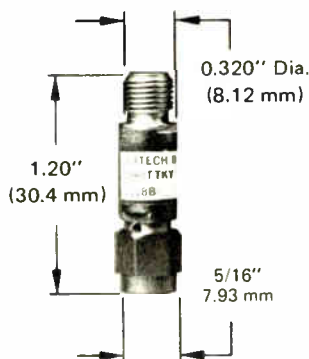

## 1-18 GHz Schottky Detector

(Shown Actual Size)

One wideband Detector with flat frequency response may be all you need for different band applications. Aertech's miniature DOS118B and DOS218B Schottky Detectors weigh only 7 grams and are available off-the-shelf to quickly get your project off the ground.

### SPECIFICATIONS

- $T_{ss}$  . . . . . -50 dBm min. across bandwidth, 100 mA bias, 3 dB video NF, 2 MHz BW.
  - FLAT FREQ. RESPONSE** . . . . .  $\pm 1.0$  dB max.,  $\pm 0.5$  dB typ.
  - Matching & Tracking . . . . .  $\pm 0.5$  dB, typ.
  - Operating Temp. Range . . . . .  $-65^{\circ}\text{C}$  to  $+125^{\circ}\text{C}$
  - Input Connector . . . . . 3 mm SMA (male)
  - Output Connector . . . . . 3 mm SMA (female)
  - Weight . . . . . 7 grams
- Field Replaceable and Reversible Diode Models Available

Frequency GHz	Model	Price
1.0-18.0	DOS118B	\$125.
2.0-18.0	DOS218B	\$120.



10000 YART DR. • SUNNYVALE • CALIF. 94086  
(408) 732-0880 • TWX 910-339-9207

Circle 156 on reader service card

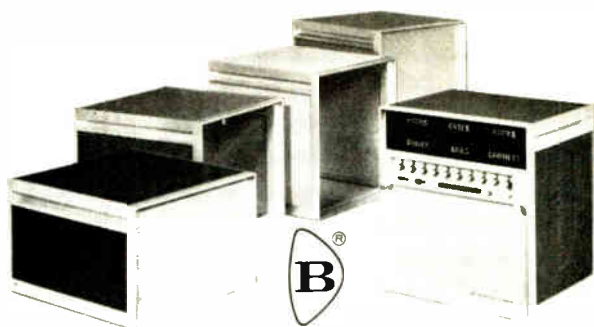

# BUCKEYE CABINETS

Buckeye's classic cabinetry line of aluminum enclosures is colorful, strong and budget priced. Universal 19" front panels, with heights from 12.25" to 28". You can also depend on Buckeye for other instrument-packaging needs: Designer Cases of all types and sizes — Patented card guide modules — PCB racks — Retractable, locking tilt-stands — and the recognized high quality matching instrument knob line.

the **BUCKEYE stamping co.** Write today for free colorful literature!  
555 Marion Rd., Columbus, Ohio 43207  
"QUALITY PRODUCTS SINCE 1902"



**GUIDES • CASES • KNOBS • RACKS**

Circle 175 on reader service card

## The New Brush 2400: the best performing, most versatile wide channel recorder you can buy.

It is available in 2, 3 and 4 channel configurations utilizing combinations of 50 mm and 100 mm channels totalling 200 mm. It had a 99.65% linearity over the full 100 mm channel. Its frequency response is an outstanding 30 Hz at 100 mm, 50 Hz at 50 mm and up to 125 Hz less than 3dB down. It has a full range of plug-in signal conditioners for just about any industrial-scientific-medical application.

For full details on why the new Gould 2400 is the best performing direct writing recorder you can buy, write Gould Inc., Instrument Systems Division, 3631 Perkins Avenue, Cleveland, Ohio 44114. Or Kouterveldstraat 13, B 1920 Diegem, Belgium.



**GOULD**

Circle 176 on reader service card



# SOLID STATE 3 WIRE SYNCHRO TO LINEAR D.C. CONVERTER



## FEATURES:

- Develops a DC output voltage linearly proportional to a synchro angle over a  $\pm 180^\circ$  range.
- Completely solid state with all of the inherent advantages over a mechanical system such as:
  - High reliability (since there are no moving parts)
  - Light weight—6 ozs.
  - Small size
  - All units hermetically sealed

## RESPONSE CURVE

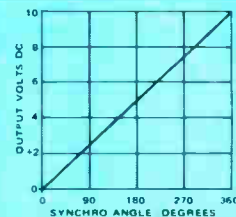
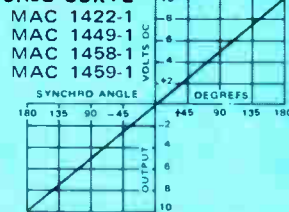

## RESPONSE CURVE

MAC 1460-1  
MAC 1461-1

- Wide temperature range operation
- Output short circuit protected
- Three wire inputs isolated from ground
- Package size may be altered at no extra cost
- Units can be altered to accept different line to line voltages or different operating frequencies at no extra cost
- Not affected by reference voltage or power supply variations.

UNIT	MAC 1422-1	MAC 1449-1	MAC 1458-1	MAC 1459-1	MAC 1460-1	MAC 1461-1
TRANSFER EQUATION	$\pm IV/18^\circ$	$\pm IV/18^\circ$	$\pm IV/18^\circ$	$\pm IV/18^\circ$	$+IV/36^\circ$	$+IV/36^\circ$
ACCURACY (+25°C)	½%	½%	½%	½%	½%	½%
ACCURACY (-25°C+85°C)	1%	1%	1%	1%	1%	1%
L - L SYNCHRO INPUT (VRMS)	11.8	90	11.8	90	11.8	90
FREQUENCY (Hz)	400	400	60	60	400	400
FULL SCALE OUTPUT	$\pm 10V$	$\pm 10V$	$\pm 10V$	$\pm 10V$	$+10V$	$+10V$
OUTPUT IMPEDANCE	$<1\Omega$	$<1\Omega$	$<1\Omega$	$<1\Omega$	$<1\Omega$	$<1\Omega$
L - L INPUT IMPEDANCE	$>10K$	$>30K$	$>2K$	$>10K$	$>10K$	$>30K$
REFERENCE VOLTAGE (VRMS)	26	115	26	115	26	115
OPERATING TEMP. °C	-25 - +85	-25 - +85	-25 - +85	-25 - +85	-25 - +85	-25 - +85
D.C. SUPPLY	$\pm 15V$	$\pm 15V$	$\pm 15V$	$\pm 15V$	$\pm 15V$	$\pm 15V$
D.C. SUPPLY CURRENT	$\pm 75MA$	$\pm 75MA$	$\pm 75MA$	$\pm 75MA$	$\pm 75MA$	$\pm 75MA$
BANDWIDTH	10Hz	10Hz	DPT.	DPT.	10Hz	10Hz
WEIGHT	6 oz.	6 oz.	6 oz.	8 oz.	6 oz.	6 oz.
SIZE	3.6x2.5x0.6	3.6x2.5x0.6	3.6x3.0x0.6	3.6x3.0x1.0	3.6x2.5x0.6	3.6x2.5x0.6

## A.C. LINE REGULATION

A new method has been developed which allows us to provide a low distortion highly regulated AC waveform without using tuned circuits or solid state active filters of any kind.

The result is a frequency independent AC output regulated to 0.1% for line and load with greater than 20% line variations over a wide temperature range.

## FEATURES:

- 0.1% total line and load regulation
- Independent of  $\pm 20\%$  frequency fluctuation
- 1 watt output
- Extremely small size
- Isolation between input and output can be provided

Specifications: Model MLR 1476-1

AC Line Voltage: 26V  $\pm 20\%$  @  
400Hz  $\pm 20\%$

Output: 26V  $\pm 1\%$  for set point

Load: 0 to 40ma

Total Regulation: +0.1%

Distortion: 0.5% maximum rms

Temperature Range:  $-55^\circ C$  to  
 $+125^\circ C$

Size: 2.0" x 1.8" x 0.5"

Other units are available at different power and voltage levels as well as wider temperature ranges. Information will be furnished upon request.

## SOLID-STATE SINE-COSINE SYNCHRO CONVERTER - NON VARIANT

This new encapsulated circuit converts a 3 wire synchro input to a pair of dc outputs proportional to the sine and cosine of the synchro angle independent of a-c line fluctuations.

- Complete solid state construction
- Operates over a wide temperature range
- Independent of reference line fluctuations
- Conversion accuracy—6 minutes
- Reference and synchro inputs isolated from ground

Specifications Model DMD 1508-2

Accuracy: Overall conversion accuracy 6 minutes. Absolute value of sine and cosine outputs accurate to  $\pm 30MV$

Temperature Range: Operating  $-40^\circ C$  to  $+85^\circ C$ , Storage  $-55^\circ C$  to  $+125^\circ C$

Synchro Input: 90V RMS  $\pm 5\%LL$  400Hz  $\pm 5\%$

DC Power:  $\pm 15V$  DC  $\pm 10\%$  @ 50MA

Reference: 115VRMS  $\pm 5\%$  400Hz  $\pm 5\%$

Output: 10V DC full scale output on either channel @ 5ma load

Temperature coefficient of accuracy:  $\pm 15$  seconds/ $^\circ C$  avg. on conversion accuracy  $\pm 1$  MV/ $^\circ C$  on absolute output voltages

Size: 2.0" x 1.5" x 2.5"

Units are available with wider temperature ranges and 11.8V LL, 26V reference synchro inputs. Information will be supplied upon request.

There is No Substitute for Reliability



# GENERAL MAGNETICS • INC

135 Bloomfield Ave., Bloomfield, New Jersey 07003 - Tel. (201) 743-2700

Circle 901 on reader service card

# Clairex phototransistors give you higher sensitivity at extremely low illumination levels...and they cost no more.

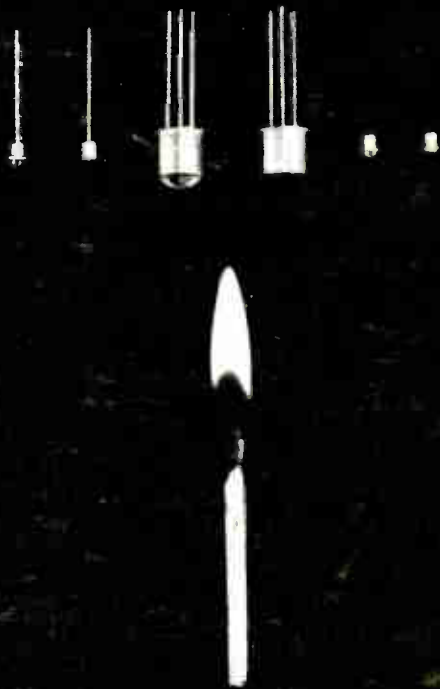
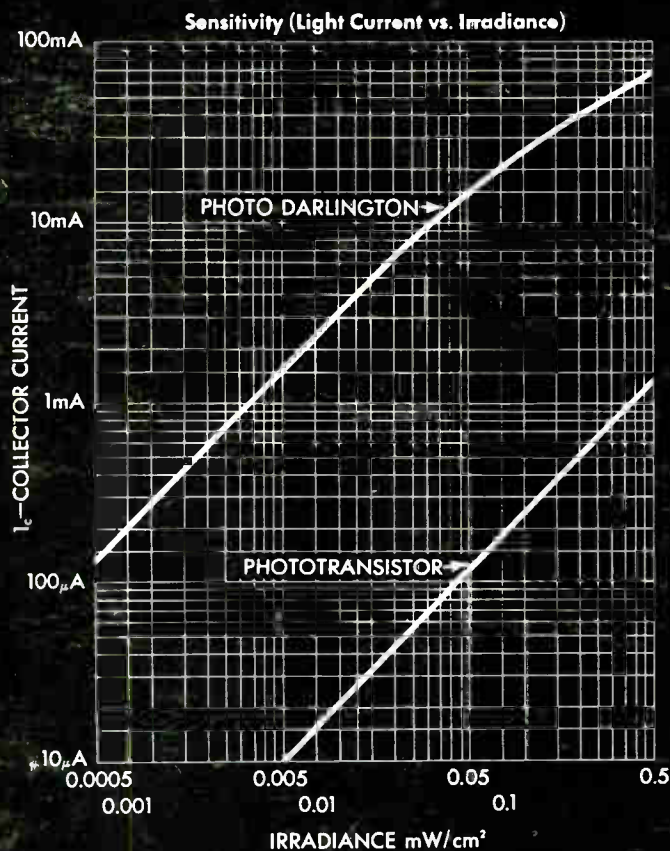

One of our customers is using our phototransistors to detect signals from an LED at distances up to 60 feet.

If you need phototransistors to give you more current at lower light levels, call (914) 664-6602, or write Clairex®, 560 South Third Avenue, Mount Vernon, New York 10550.

## CLAIREX ELECTRONICS

A DIVISION OF CLAIREX CORPORATION

Circle 902 on reader service card

World Radio History