

- 87 Soundsheet: Variable Speech Control
- 96 Scheduling and loading IC test systems
- 104 Designing data acquisition into minis

Where the jobs are  
in the West  
**A WESCON PREVIEW**

# Electronics

Variable Control of Speech Playback



93534  
CS OSBORNE - JR  
1202 W AVENUE H11  
LANCASTER CA

# Dialight sees a need:

(Need: The widest choice for your every application.)

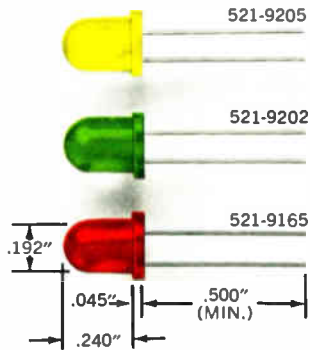

Now available in green, yellow and red. Mini-sized for maximum front panel density and easy panel mounting. High luminous intensity, low cost. Vibration/shock resistant. Solid state for long life. Wide viewing angles. Ideal for applications like panel lighting, film annotation and alpha-numeric displays.

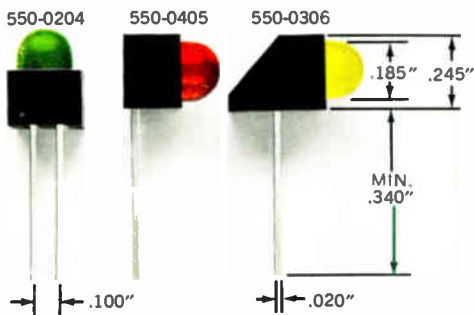

Mix 'em or match 'em. LED logic state fault indicators are available in red, yellow and green, in a variety of shapes, some with a built-in integral resistor. Can be driven from DTL and TTL logic. Designed for easy alignment on PC boards so that multiple functions can be displayed.

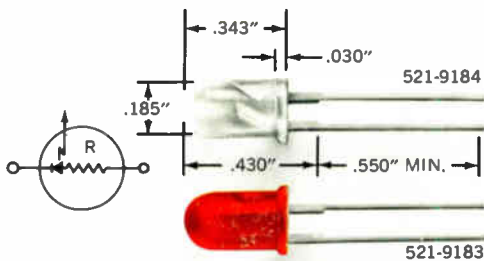

Available in red or clear LED packages with or without a built-in current limiting resistor. Red LED is also made without resistor. Suitable for circuit status indication, alpha-numeric displays and visual indicators. Features long wire-wrappable leads. IC compatible with solid state reliability. High luminous intensity, low power consumption, low cost.

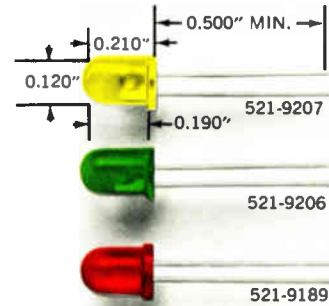

Your choice of green, yellow and red, with axial leads for dense packaging requirements. Wide viewing angle for easy readability. Low power consumption, low cost, IC compatible. 10mA operation for typical brightness. Size is identical to the most popular red LEDs.

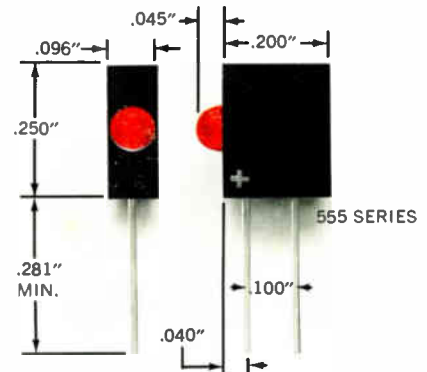

LED logic state fault indicators available in 14 models with voltage ratings from 1.7 to 14. Suitable for dense packaging on printed circuit boards—up to 10 units to the inch—IC compatible. With built-in series resistor. Polarity identified. Low power consumption.

Dialight, the company with the widest choice in switches, LEDs, indicator lights and readouts, looks for needs . . . your needs . . . and then they develop solutions for your every application. No other company offers you one-stop shopping in all these product areas. And no other company has more experience in the visual display field. Dialight helps you do more with these products than any other company in the business, because we are specialists that have done more with them. Talk to the specialists at Dialight first. **DIALIGHT**  
Dialight, A North American Philips Company  
203 Harrison Place, Brooklyn, N. Y. 11237  
(212) 497-7600

# See Dialight.

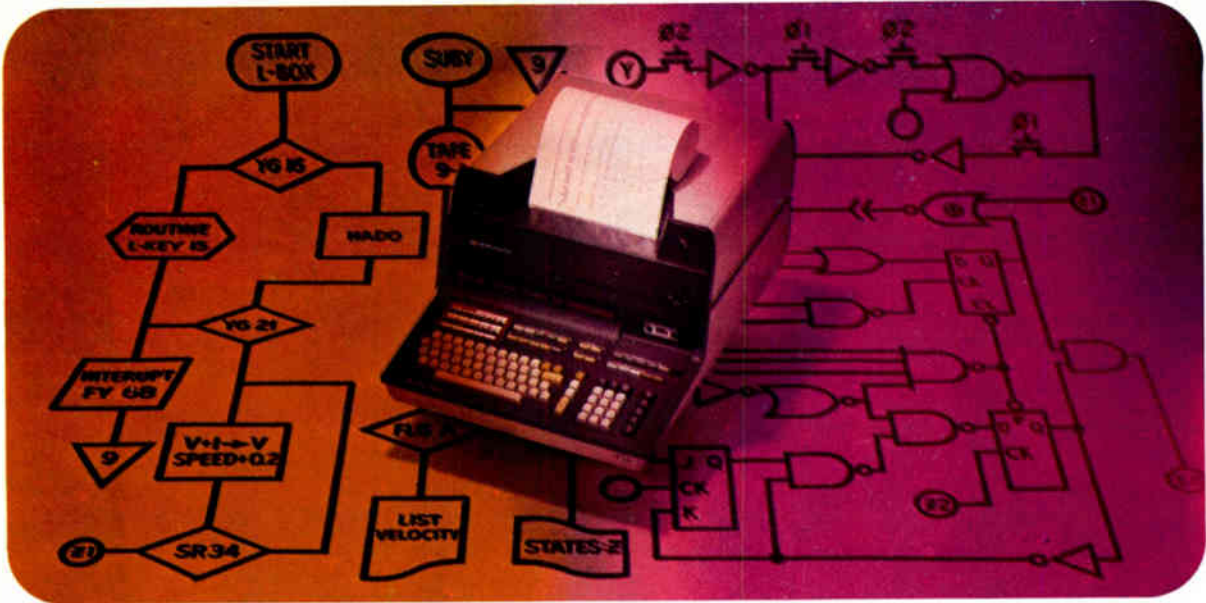

## Simulate Logic Designs Directly From Your Schematic...

And slash your digital development and leadtime costs with the HP 9830 Programmable Calculator. Team the 9830 up with our new Logic Simulation Software and you'll have a potent calculator-aided design system that will verify your digital designs—long before you've spent a nickel on a prototype.

With incredible speed and precision, the 9830 runs through all possible input conditions and associated bit streams, generates the state/time map, then complete logic documentation. Interconnect lists. Truth tables. Timing.

And since the 9830 sits right on your desk, you can interact with your design. Use your experience and training to guide the model to its optimum configuration in a fraction of the time required by other methods.

Combinational or sequential circuits. MOS logic. TTL/DTL logic. No matter what circuit type,

digital simulation with the 9830 adds up to more professional satisfaction for you; more profit for your firm. Not only does it eliminate the drudgery of hand-generated timing diagrams, it also lets you neatly sidestep the slow turnaround time of outside services. Most importantly, it means an end to costly prototype reworks.

You can reap the benefits of an HP 9830 with Logic Simulation Software for just \$332\* per month. For complete details or a demonstration, call your local HP Sales Office, or send us the coupon. We think you'll agree, it's the logical solution to your digital design problems.

\*Domestic U.S.A. price only. Lease, where available, includes service contract.



Sales and service from 172 offices in 65 countries.  
P.O. Box 301 Loveland Colorado 80537

08-10

Tell me more about your HP 9830 CAD Logic Simulation System.

Information only.  Hands-on demonstration.

I work with these families of circuits: TTL \_\_\_\_\_  
MOS \_\_\_\_\_ DTL \_\_\_\_\_ Other \_\_\_\_\_

Name \_\_\_\_\_  
Title \_\_\_\_\_  
Company \_\_\_\_\_  
Address \_\_\_\_\_  
City \_\_\_\_\_ State \_\_\_\_\_  
Zip \_\_\_\_\_ Phone \_\_\_\_\_

Hewlett-Packard Co. P.O. Box 301; Loveland, CO 80537

816C

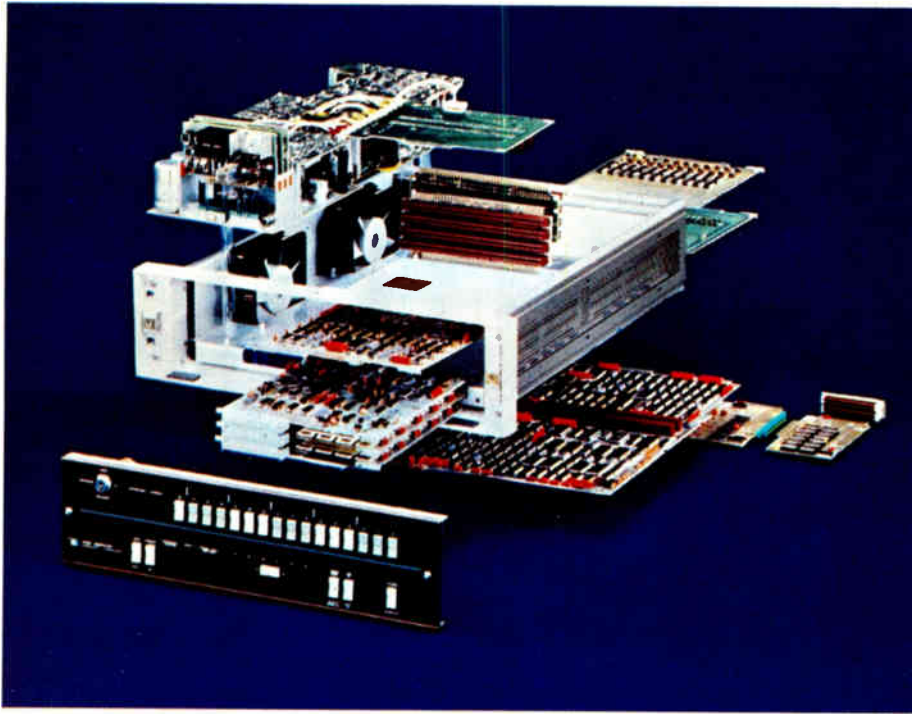

# Piece-by-piece, HP's new 21MX series. Minis no other OEM supplier can offer at any price.

Modular computers that give you all the flexibility you want.  
And all the extras you'd probably order special on other systems.

A basic system costs just \$3927.\* And gives you features like 4K MOS RAM memory, memory parity, 128 instruction set, user microprogrammability, floating point, ROM bootstrap loaders, and a unique front panel.

Call us and find out about the entire 21MX series.  
Before your competitor does. After all,  
he's working for a living, too.

## HP minicomputers. They work for a living.

HEWLETT  PACKARD

Sales and service from 172 offices in 65 countries.  
1501 Page Mill Road, Palo Alto, California 94304

\*In quantities of 50, domestic USA price.

22418

## 29 Electronics Review

LAW ENFORCEMENT: Citizen alarm sends digital codes, 29  
MILITARY: Reconnaissance cameras favor charge-coupled devices, 30  
BUSINESS: Layoff ripples widen in semiconductor industry, 31  
COMPONENTS: Circular connector gets single standard, 31  
INDUSTRIAL: Process control gets new competitor, 32  
SOLID STATE: Microprocessors get new FACE, 34  
INDEX OF ACTIVITY: 34  
NEWS BRIEFS, 36  
AUTOMOTIVE: Congress wants to ease up on seat-belt interlocks, 38  
INDUSTRIAL: Microchip helps identify drugs, 38  
CONSUMER: Bowmar introduces digital LED watch, 40  
Goldmark markets music-teaching aid, 40

## 52 Electronics International

JAPAN: Bucket-brigade IC aimed at audio uses, 52  
HUNGARY: Graphic display may compete in U.S., 52  
AROUND THE WORLD: 53

## 69 Probing the News

AVIONICS: Fiber-optics excites the military, 69  
AIR DEFENSE: Radar sales flying high, 72  
MANUFACTURING: X-ray lithography enters device stage, 80  
ELECTRONICS ABROAD: Ireland attracts offshore plants, 82

## 87 Technical Articles

CIRCUIT DESIGN: Control speeds, slows tape without distortion, 87  
PACKAGING & PRODUCTION: Scheduling for IC tester optimization, 96  
DESIGNER'S CASEBOOK: Timer, doubler form dc-dc converter, 101  
SCR zero-cross trigger limits maximum load factor, 102  
COMPUTERS: Building an analog peripheral inside a minicomputer, 104  
ENGINEER'S NOTEBOOK: Circuit measures optical coupler speed, 109  
Programmable cable tester spots opens and shorts, 110  
Simulating an npn/pnp pair for high-voltage switching, 112  
WESCON: Experienced engineers, technicians scarce in the west, 120  
Professional program emphasizes applications data, 126

## 133 New Products

WESCON 74 PRODUCT PREVIEW:  
Multi-signal generator offers programmable phase, 133  
Thin-film networks: key to converter precision, 134  
Low-cost tester checks out IC memories, 134  
Instrument modules packaged for special markets, 136  
System aimed at low-energy ion implantation, 136  
INSTRUMENTS: Signal source is 'universal,' 151  
SEMICONDUCTORS: Decade divider handles 1.2 gigahertz, 159  
PACKAGING & PRODUCTION: Goldplating is done selectively, 165  
INDUSTRIAL: Adding control to measurement, 179  
MATERIALS: 184

## Departments

Publisher's letter, 4  
Readers comment, 6  
40 years ago, 8  
People, 14  
Meetings, 20  
Electronics newsletter, 25  
Washington newsletter, 49  
Washington commentary, 50  
International newsletter, 55  
Engineer's newsletter, 114  
New literature, 190

## Highlights

### Cover: Fast or slow tapes sound equally clear, 87

When equipped with a new IC-based control, any tape-recorder will play back taped speech at different rates without the usual distortions. Proof that the process works is contained on the special sound sheet facing the article. Cover is by designer Ann Dalton.

### Radar sales surge, 72

Manufacturers in the U.S. and Europe are happily reporting an unanticipated boom in orders for ground-based surveillance systems from many nations in the Third World.

### Maximizing an IC test system's throughput, 96

Constructing a tight schedule for an IC test system and deciding what number of test stations will handle a given load best is not so difficult if you start from the basics—the time needed to position the average device, and the time needed to test it.

### Wescon will be big on new jobs, technology, 120

So great is the need among western electronics firms for process engineers, MOS circuit designers, programmers, and technicians that any who show up at Wescon are likely to receive several job offers—unofficially, of course. Other effects of technological development and change will be found in Wescon's technical sessions (p. 126), with their emphasis on microprocessors and charge-coupled devices, and among the new products on display (p. 133).

### And in the next issue . . .

Designing low-cost receivers for Omega navigation . . . how a microprocessor can benefit a data-acquisition system . . . mini-computers in action, part 9: mini-aided component insertion.

EDITOR-IN-CHIEF: Kemp Anderson

EXECUTIVE EDITOR: Samuel Weber

MANAGING EDITORS: Lawrence Curran, *News*;  
Arthur Erikson, *International*

SENIOR EDITORS: John Johnsrud,  
H. Thomas Maguire, Laurence Altman,  
Ray Connolly, Stephen E. Scrupski

ART DIRECTOR: Fred Sklenar

ASSOCIATE EDITORS: John N. Kessler,  
Howard Wolff, Gerald M. Walker,  
Alfred Rosenblatt

#### DEPARTMENT EDITORS

*Aerospace Military*: Ray Connolly  
*Circuit Design*: Lucinda Mattera  
*Communications & Microwave*:

Stephen E. Scrupski  
*Computers*: Wallace B. Riley  
*Consumer*: Gerald M. Walker  
*Industrial*: Michael J. Riezenman  
*Instrumentation*: Stephen E. Grossman  
*New Products*: H. Thomas Maguire  
*Packaging & Production*: Andy Santoni  
*Solid State*: Laurence Altman

COPY EDITORS: Margaret Eastman,  
Everett C. Terry

ASSISTANT EDITOR: Marilyn Offenheiser

ART: Charles D. Ciatto, *Associate Director*  
Patricia Cybulski, *Assistant Director*

PRODUCTION EDITOR: Arthur C. Miller

EDITORIAL SECRETARIES: Janet Noto,  
Julie Gorgoglione, Penny Roberts

#### FIELD EDITORS

*Boston*: Gail Farrell  
*Los Angeles*: Paul Franson (Mgr.)  
*Midwest*: Larry Armstrong (Mgr.)  
*New York*: John N. Kessler (Mgr.)  
*San Francisco*: Bernard Cole (Mgr.)  
Judith Curtis  
*Washington*: Ray Connolly (Mgr.)  
Larry Marion  
*Frankfurt*: John Gosch  
*London*: William F. Arnold  
*Paris*: Arthur Erikson  
*Tokyo*: Charles Cohen

#### McGRAW-HILL WORLD NEWS

*Director*: Ralph R. Schulz  
*Bonn*: Robert Ingersoll  
*Brussels*: James Smith  
*London*: Marvin Petal  
*Milan*: Peter Hoffmann, Andrew Heath  
*Moscow*: Axel Krause  
*Paris*: Michael Johnson, Richard Shepherd  
*Stockholm*: Robert Skole  
*Tokyo*: Mike Mealey

PUBLISHER: Dan McMillan

DIRECTOR OF MARKETING: Pierre J. Braudé

ADVERTISING SALES SERVICE MANAGER:  
Wallis Clarke

BUSINESS MANAGER: Stephen R. Weiss

CIRCULATION MANAGER: Nancy L. Merritt

MARKETING SERVICES MANAGER:  
Tomlinson Howland

RESEARCH MANAGER: Margery D. Sholes

**W**e think that the best way to communicate to you how a significant advance in audio circuitry really works is to let you hear what it does. So in this issue you'll find a special sound sheet that illustrates with words and sounds how an important new technology—variable speech control—can ease the transfer of spoken information.

The sound sheet is special in several ways. First, it's a first for us. While we've not had the opportunity before to include an aural reproduction right in the magazine, we feel that it's a logical, although unusual, added dimension for technical communication.

Second, it's special because it contains interviews with such observers of the modern scene as Marshall McLuhan and Alvin Toffler. They comment on the impact that variable speech control will have on man's comprehension of spoken data—from the blind "reading" tapes of the daily newspaper to cassette-based learning techniques.

Inserted immediately preceding the article on variable speech control, which starts on page 87, the sound sheet has an explanation of the concept on side one, together with examples of speech played faster and slower than normal without any real loss in intelligibility. As is pointed out there, a tape-recorded talk can be reviewed at twice or three times normal speed—in a half or a third the time the actual talk lasted. On the reverse side are the interviews, followed by another special feature—actual waveforms of the IC-based circuitry in action. You can see the concept at work on an oscilloscope, using the output of your record player.

So turn to page 87 for the article

## Publisher's letter

and the sound sheet. We're sure you'll find interesting reading—and listening—there. Also, we would appreciate hearing any comments you might have about our experiment in adding another dimension—an aural one—to *Electronics*.

**I**t's Wescon time again, and we've put together a preview of what you can expect from the technical sessions (see p. 126), as well as a round-up of some of the interesting products that will make their debut then (see p. 133). What's more, we've added an important extra element to our Wescon coverage this year—an in-depth report on the engineering employment situation.

As Paul Franson, our Los Angeles bureau manager, points out in the report, "there's a subtle difference from past years—in 1974 few well-qualified technical people are available. . . . The openings that exist are for experienced professionals, anti-submarine-systems designers, semiconductor process engineers, computer programmers—and for sub-professionals like technicians."

Then, too, "this year's Wescon site, Los Angeles, is no longer a Mecca for qualified people from outside the area," he points out. That and the uncertain economy means that many engineers would not shift jobs without a 20% raise—10% for cost of living and 10% for relocation. So turn to page 120 and read for yourself why this year it's more the personnel manager, and less the engineer, who is harried.



August 22, 1974 Volume 47, Number 17  
95,289 copies of this issue printed

Published every other Thursday by McGraw-Hill, Inc. Founder James H. McGraw 1860-1948. Publication office 1221 Avenue of the Americas, N.Y., N.Y. 10020. Second class postage paid at New York, N.Y. and additional mailing offices.

Executive, editorial, circulation and advertising addresses: *Electronics*, McGraw-Hill Building, 1221 Avenue of the Americas, New York, N.Y. 10020. Telephone (212) 997-1221. Teletype TWX N.Y. 710-581-5234. Cable address: MCGRAWHILL N.Y.

Subscriptions limited to persons with active professional, functional responsibility in electronics technology. Publisher reserves the right to reject non-qualified requests. No subscriptions accepted without complete identification of subscriber name, title or job function, company or organization, including product manufactured or services performed. Subscription rates: qualified subscribers in the United States and possessions, Canada, and Mexico \$12.00 one year, \$24.00 three years, all other countries \$25.00 per year, except Japan, \$50.00 per year. Brazil, \$40.00 per year. Australia and New Zealand \$60 per year, including air freight. Limited quota of subscriptions available at higher than basic rate for persons outside of field served, as follows: U.S. and possessions and Canada, \$25.00 one year, all other countries \$50.00. Single copies: \$4.00.

Officers of the McGraw-Hill Publications Company: John R. Emery, President; J. Elton Tuohy, Executive Vice President-Administration; Gene W. Simpson, Group Publisher-Vice President; Senior Vice Presidents: Ralph Blackburn, Circulation; Walter A. Stanbury, Editorial; John D. Hoglund, Controller; David G. Jensen, Manufacturing; Gordon L. Jones, Marketing; Jerome D. Luntz, Planning & Development.

Officers of the Corporation: Shelton Fisher, Chairman of the Board and Chief Executive Officer; Harold W. McGraw, Jr., President and Chief Operating Officer; Wallace F. Traubly, Group President, McGraw-Hill Publications Company and McGraw-Hill Information Systems Company; Robert N. Landes, Senior Vice President and Secretary; Ralph J. Webb, Treasurer.

Title registered in U.S. Patent Office. Copyright ©1974 by McGraw-Hill, Inc. All rights reserved. The contents of this publication may not be reproduced in whole or in part without the consent of copyright owner.

Subscribers: The publisher, upon written request to our New York office from any subscriber, agrees to refund that part of the subscription price applying to copies not yet mailed. Please send change of address notices or complaints to Fulfillment Manager, subscription orders to Circulation Manager, *Electronics*, at address below. Change of address notices should provide old as well as new address, including postal zip code number. If possible, attach address label from recent issue. Allow one month for change to become effective.

Postmaster: Please send form 3579 to Fulfillment Manager, *Electronics*, P.O. Box 430, Hightstown, N.J. 08520.

# "New Function Generator a Hit! Most Precise at Lowest Price."

## \$245.



### KH 5800 gains wave reviews.

"Say goodbye to the need for sine wave oscillators. The 5800 is the ideal solo performer for design labs, schools, radio repair shops, and hobbyists."

"Precise mastery of sine, square and triangle wave forms, with typically .3% distortion, raised a crackling of applause among designers and electronic enthusiasts."

"The 5800 has more output power than we'd expected—50 ohm output with 15V p-p—and a frequency range of 0.2Hz to 2MHz."

"Covering the entire audio range in one turn of its 1000:1 tuning dial, the 5800 stunned an audience of audio lab and radio repair men."

"The 5800's push-button simplicity, rep-stocked availability, budget price and quantity discounts drew a standing ovation from vocational educators."

"With its walnut-styled cabinet and convenient carrying handle, the 5800 is a class performer at a budget price."

In stock and available for immediate delivery from any sales office listed below.

## **KH** KROHN-HITE CORPORATION

580 Massachusetts Avenue, Cambridge, Massachusetts 02139 • (617) 491-3211

SALES OFFICES: ALA, Huntsville (205) 534-9771; ARIZ., Scottsdale (602) 947-7841; CAL., San Jose (408) 292 3220, Inglewood (213) 674-6850; COLO., Denver (303) 934-5505; CONN., Glastonbury (203) 633-0777; FLA., Orlando (305) 894-4401; HAWAII, Honolulu (808) 941-1574; ILL., Des Plaines (312) 298-3600; IND., Indianapolis (317) 244 2456; MASS., Lexington (617) 861-8620; MICH., Detroit (313) 526-8800; MINN., Minneapolis (612) 884-4336; MO., St. Louis (314) 423-1234; N.C., Burlington (919) 227-3639; N.J., Haddonfield (609) 795-1700; N.M., Albuquerque (505) 299-7658; N.Y., E. Syracuse (315) 437-6666, Rochester (716) 328-2230, Vestal (607) 785-9947, Elmont (516) 488-2100; OHIO, Cleveland (216) 261-5440, Dayton (513) 426-5551; PA., Pittsburgh (412) 371-9449; TEX., Houston (713) 688-9971, Richardson (214) 231-2573; VA., Alexandria (703) 354-1222; WASH., Seattle (206) 624-9020; CANADA, Montreal, Quebec (514) 636-0525, Toronto, Ontario (416) 444-9111, Stittsville, Ontario (613) 836-4411, Vancouver, British Columbia (604) 588-2619.

Circle 5 on reader service card

# RAYTHEON DC WELDERS ARE ALIVE AND READY TO GO WHERE THE ACTION IS . . .

We have the broadest power range of DC welding equipment available.

If you want to weld the coolest package in town, contact the

Marketing Manager,  
Raytheon Company,  
Production Equipment  
Department, 676 Island  
Pond Road, Manchester,  
N.H. 03103. (603) 668-1600.



## Readers comment

### Critiquing the crowbar

**To the Editor:** The suggested crowbar connection submitted by Mr. [Thomas E.] Skopal of Acopian [*Electronics*, Designer's casebook, May 2, p. 95] does solve the problem of supply transients. But, in my opinion, it generates another problem that far outweighs any advantages. If the connection is made as shown, the load is left unprotected from the possibility of a broken or accidentally disconnected sense lead at the load. This is one of the benefits of crowbar protection if the connection is made on the output leads themselves.

I highly recommend that anyone who uses this connection run a separate pair of leads back from the load and make the connection by using a separate pair of lugs at the load. This is still risky because those leads may break or get left off accidentally.

I think that any load worthy of crowbar protection is probably too expensive to take chances with. I wouldn't use this connection at all.

William L. Blowers  
Photo Research  
Burbank, Calif.

■ *Mr. Skopal replies: Overvoltage-protection circuits are intended to guard the load of a power supply in the event that the supply's regulator fails in a mode tending to significantly increase output voltage. Because such failures usually result in loss of control of the output voltage, the only way to keep the voltage down is by brute-force short-circuiting of the output.*

*Although an accidentally opened sense line will also tend to result in an overvoltage, this condition can easily be prevented without the need to "crowbar" the output. It is only necessary to provide an alternate current path from each sense terminal to its respective output terminal. Low-current diodes are commonly used for this purpose. With output line drops of less than a few hundred millivolts, the diodes do not conduct, but if either sense line opens, its diode will become forward-biased and clamp the output voltage at about half a volt above the setting of the supply. This technique is written up in many*

*power-supply handbooks. Apparently Mr. Blowers was unaware of it.*

### Increasing lamp life

**To the Editor:** In the Engineer's newsletter, "Dimmer lights last longer" [July 25, p. 120], Calvin R. Graf claims to save power by inserting a diode in series with a lamp operating on ac. While it is true that the lamp may last longer and consume less power, the efficiency will decrease, causing a much larger reduction in light output.

The best solution is to use lower-wattage lamps. For cases where dual-mode lighting is needed, the use of the diode is an inefficient but economical solution, and is covered by Patents No. 2896125, 3173031, and 3215891.

Leon A. Ferber  
Perception Technology Corp.  
Winchester, Mass.

### Linking a microprocessor's I/O

**To the Editor:** There were two errors in the schematic for my Designer's casebook, "Interfacing a teletypewriter with an IC microprocessor" [July 25, p. 96]. The upper node of the 750-ohm resistor in the timer's timing network should go to the supply voltage, and not to ground, as shown. And the pin labeled  $\bar{Q}_H$  for the shift register should be this device's clock/inhibit.

Steven K. Roberts  
Cybertronic Systems  
Louisville, Ky.

### Correcting Calspan's address

**To the Editor:** Considerable interest is being demonstrated in our fingerprint reader by persons responsible for controlling access to facilities such as computers, as a result of the article, "Fingerprint file controls access" [July 25, p. 44].

The Albany listing given for the company, however, was not correct. So that we may respond promptly to requests for technical information, we request that you advise your readers that the address of Calspan Technology Products is Buffalo, N.Y. 14221.

Frank G. Woods  
Calspan Technology Products Inc.  
Buffalo, N.Y.



# The last time someone announced 74C, it was a national campaign.

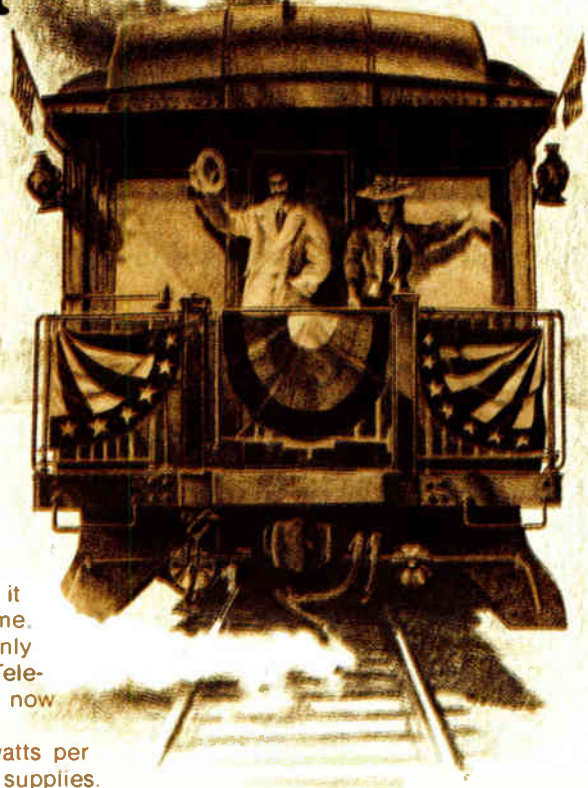

When we saw 74C coming down the tracks, we knew it would be the hottest and most logical CMOS line in a long time. Flags waved, bands played, and thousands of engineers suddenly found CMOS easier to design in. The only thing missing was Teledyne's big production volume and competitive pricing, and now you've got that too.

Here's what Teledyne 74C delivers: A mere 10 nanowatts per gate typical power dissipation. Operation on 3V to 15V power supplies. A big, guaranteed 1V noise margin. Typical noise immunity 45% of the supply voltage. Hefty outputs that drive MOS and bipolar logic (at least two LPTTL loads).

And 74C really simplifies design. 74C logic functions, pinouts and even numbers are identical to 7400 TTL, and every 74C device is compatible with every other 74C device. I/O specs are consistent (no interpreting a pile of data sheets to calculate what's compatible with what). Not to mention drastic cuts in the need for supply regulation, bypass capacitors and noise filtering.

The first batch is available now.

MM74C00	Quad 2-Input NAND Gate	MM74C107	Dual J-K Master-Slave Flip-Flop
MM74C04	Hex Inverter	MM74C160	Synchronous Decade Counter
MM74C20	Dual 4-Input NAND Gate	MM74C161	Synchronous 4-Bit Binary Counter
MM74C42	BCD-to-Decimal Decoder	MM74C192	Synchronous Up/Down Decade Counter
MM74C74	Dual D Flip-Flop	MM74C195	4-Bit Parallel-Access Shift Register

That's our national platform for 74C. But Teledyne's CMOS campaign has just begun. We'll soon be speaking softly about big values in proprietary devices compatible with 74C and custom CMOS for linear and digital applications. All with ultra-low power dissipation and high noise immunity.

 **TELEDYNE**  
**SEMICONDUCTOR**

1300 Terra Bella Avenue Mountain View, California 94043  
(415) 968-9241 TWX: 910-379-6494 Telex: 34-8416

# GET ON BOARD...

## with TANTALEX® Low-Cost Solid Tantalum Capacitors

### Sprague Gives You a Choice ..... for Flexibility in Your Printed Board Designs.



#### DIPPED ...

##### SPRAGUE TYPE 196D

Small size economical capacitors that utilize high-quality tantalum pellet construction. Conformal epoxy resin coating is highly resistant to moisture and mechanical damage. This capacitor has found wide usage in consumer and commercial electronic equipment. Operating temperature range,  $-55^{\circ}\text{C}$  to  $+85^{\circ}\text{C}$ . Available in all popular 10% decade values from  $0.1\mu\text{F}$  to  $330\mu\text{F}$ . Voltage range, 4 to 50VDC. Standard lead spacing, 0.125" and 0.250". For complete data, write for Engineering Bulletin 3545B.

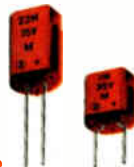

#### MOLDED ...

##### SPRAGUE TYPE 198D

Economically priced, molded-case Econoline™ capacitors. Standard lead spacing, 0.100", 0.200", and 0.250". Tough, flame-retardant, crack resistant case has flattened section and polarity indicator for easy-to-read marking and error-free insertion. Fixed external dimensions allow increased productivity during assembly of PC boards. Designed for severe vibration and shock environment, where lead support alone is not adequate. Operating temperature range,  $-55^{\circ}\text{C}$  to  $+85^{\circ}\text{C}$ . Capacitance values from 0.1 to  $100\mu\text{F}$ . Voltage range, 4 to 50VDC. For complete data, write for Engineering Bulletin 3546.

Call your nearest Sprague district office or sales representative, or write for the bulletins mentioned above to Sprague Electric Company, 35 Marshall Street, North Adams, Mass. 01247.



THE BROAD-LINE PRODUCER OF ELECTRONIC PARTS

## 40 years ago

From the pages of Electronics, August, 1934

### Aviation beacon system

A device that visually interprets the signals of aeronautical radio range beacons which are received through headphones and are relied upon by airmen for directional guidance under conditions of poor visibility, has been developed by W.E. Jackson and L.M. Harding, radio engineers of the Aeronautics branch, Department of Commerce.

According to Rex Martin, assistant director of aeronautics in charge of air navigation, the device includes an indicator which fits into the instrument panel. It is similar to that developed for use with the experimental radio systems for blind landings, and can be used for this purpose. It has two needles, one vertical and the other horizontal.

The vertical needle is the chief indicator. If the aircraft moves off the course defined by the radio beacon, this needle moves accordingly in the same direction. If the plane is exactly on course, this pointer remains in the center of the dial. The horizontal indicator shows the volume of the received signals.

Signals may be received through headphones simultaneously, thus giving visual or aural indication.

### Cathode-ray screen

Improvements in technique have enabled the Allen B. Du Mont Laboratories of Upper Montclair, N.J., to overcome the blackening of the fluorescent screen when the electron beam is allowed to remain stationary on all tubes having the high-intensity screen developed previously by that laboratory.

This means that the life of the screen is materially increased as the darkening caused deterioration of the fluorescent screen and hence loss of light. Furthermore, because of this defect in cathode-ray tubes previously, it has not been practical to use them for certain uses, such as sound recording or indicating meters where the spot or line might remain stationary for a considerable period of time.

# Some data generators can do only **one** thing.

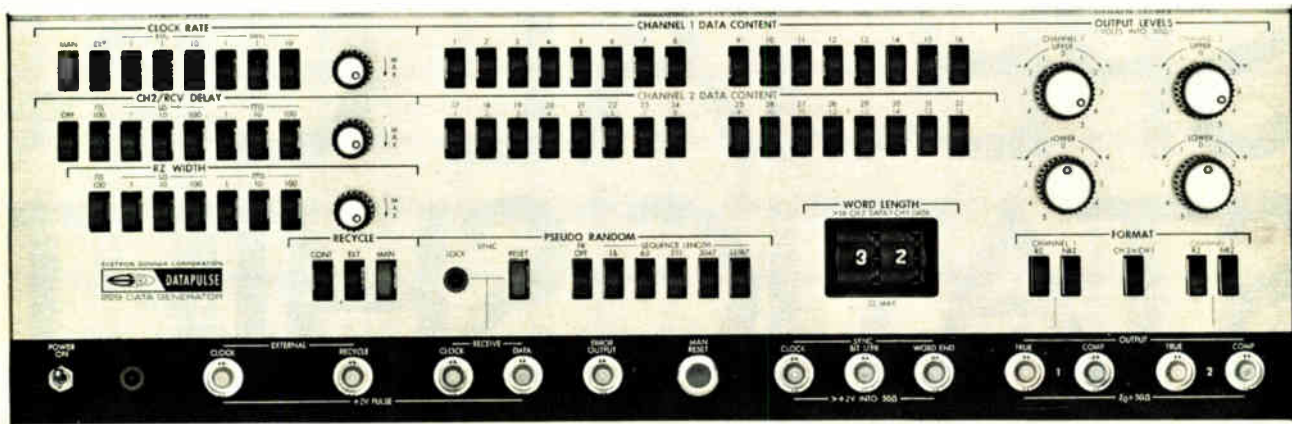

# But S-D's Model 229 offers **all** these capabilities:

## 1. Single/Dual Channels

32/16 bits with variable word length. Variable delay between channels. Data rate to 10 Mbps. Output formats: RZ (with variable width) and NRZ. Adjustable output levels.

## 2. Psuedo-random

sequence generator with word lengths from 15 to 32,767 bits per word.

## 3. Comparator

bit-by-bit error check simultaneous with data generation for full duplex operation with either pseudo-random or programmable data patterns.

All of this capability comes standard on Systron-Donner's Model 229 for \$2,025.00. Remote programming and error display are optional. Applications include testing of tape/disc memory systems and high speed digital communication systems. Get in touch with us and we'll tell you about others especially suited for the 229.

Contact your Scientific Devices office or Systron-Donner at 10 Systron Drive, Concord, CA 94518. For immediate details, call our Quick Reaction line (415) 682-6471 collect.

SYSTRON  DONNER

# 20 million LED digits can't be wrong.

Litronix DL-707 0.3" high digit has same superior features as DL-747 below.

Litronix DL-747 has 0.6" high digits 44% larger in area than digits from any other major supplier.

Mitered corners increase eye appeal.

Light pipe spreads illumination evenly.

Mounted on DIP with standard pin spacing.

DL-747 with cap in place over light pipes.

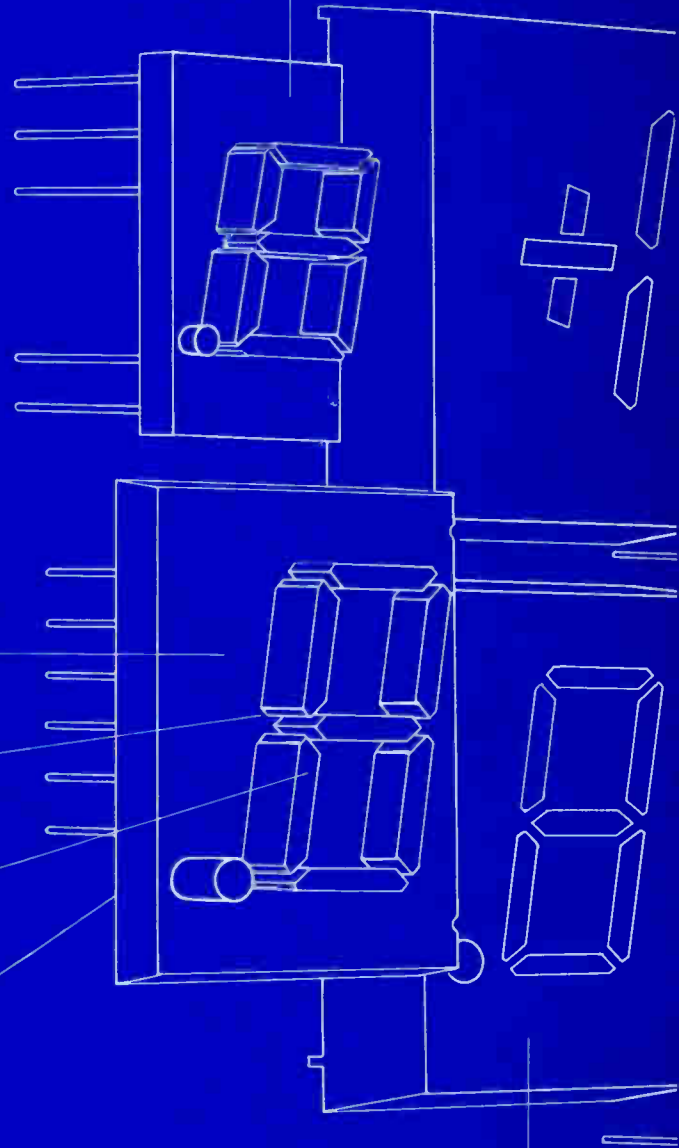

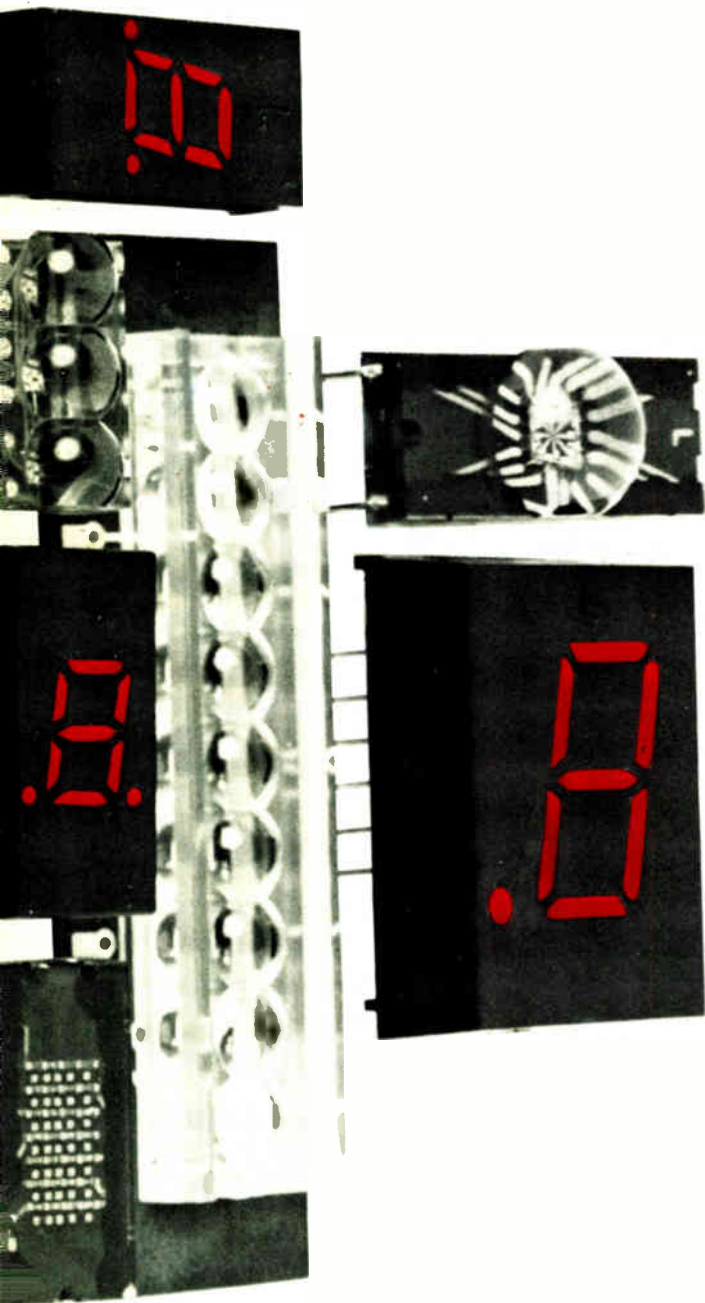

You'll find major advantages in dealing with the world's largest supplier of LEDs—the one that's shipped over 20 million LED digits to date and will deliver many millions more in 1974.

For openers, the Litronix product line is so broad that you can get exactly what you need. Sizes from 0.1" to 0.6". Colors like red and orange today, with yellow and green in volume production soon. Common anode or common cathode. And polarity overflow digits in many sizes.

Perhaps even more important, you're assured of a consistent, reliable product. Litronix doesn't buy any high-technology parts from others. We make everything in-house—starting with the basic GaAsP materials. The result is that we have better overall control: high brightness, proven reliability and assured delivery.

Litronix has two plants in the U.S. and three more overseas to keep the LEDs flowing. Because our volume is large, our prices are very, very competitive.

The drawing at left of our big 0.6"-high DL-747 shows some of the superior characteristics of the popular Litronix 700 Series displays.

Contact us right now for LED displays, LED lamps, opto-isolators, or phototransistors. We know we can meet your needs. Like we say, over 20 million LED digits can't be wrong.

Litronix, Inc., 19000 Homestead Road, Cupertino, CA 95014. Phone (408) 257-7910. TWX 910-338-0022.

**No wonder  
we're No.1  
in LEDs**

# litronix

# MORE POWER MORE BANDWIDTH

Our Model 503L is an ultra-wideband RF power amplifier whose wide range of frequency coverage and power output provides the user with the ultimate in flexibility and versatility in a laboratory instrument. Easily mated with any signal generator, this completely solid state unit amplifies AM, FM, SSB, TV, pulse and other complex modulations with minimum distortion.

Constant forward power is continuously available regardless of the output load impedance match, making the 503L ideal for driving highly reactive loads.

Unconditional stability and instantaneous failsafe provisions in the unit provide absolute protection from damage due to transients and overloads.

This low cost instrument, covers the frequency range of 1.6 to 540 MHz with a linear power output of 3 watts . . . and there's no tuning. Priced at \$995.\*

#### Applications include:

- Laboratory instrumentation
- Communication systems
- Laser modulation
- RFI/EMI testing
- Spectroscopy

\*USA and Canada



For further information or a demonstration contact

ENI, 3000 Winton Road South,  
Rochester, New York, 14623.

Call 716-473-6900.

Or TELEX 97-8283 ENI ROC.

# ENI

The world's leader  
in solid-state power amplifiers.

## People

A 'was' engineer takes over  
RCA's consumer electronics



Vice president. All RCA's Pollack wants to do is cheer his engineers on.

"I was an engineer," comments Roy H. Pollack, recently named vice president and general manager of RCA's Consumer Electronics division in Indianapolis. "And that's what I am, a 'was' engineer. It's been a long time since I've been a practitioner. The thing that I bring to the engineering party here is tremendous respect for legitimate design achievement and criticism of poor engineering. But as far as engineering anything myself, I'm over the hill. All I want to do is cheer our engineers on."

Pollack has the background, as well as a quick-paced, salty-tongued style of speech which should enable him to do a lot of cheering on. He's a long-time RCA manager, having come there in 1950 to do picture-tube engineering and moving early on into solid-state activities.

Leave. For two years he took what looks today like a leave of absence—to head up MOS LSI operations for Fairchild Semiconductor in Mountain View, Calif. But he returned in 1973 to RCA's consumer side of the business—to head up the color and black and white television operation.

Is there a problem in transferring from high-technology semiconductors to mass consumer products?

"In a way, it requires more busi-

ness sophistication to be in the television business," he observes. "LSI ICs are sophisticated products with sophisticated customers—computer manufacturers and the like. TV is a very sophisticated electronic product for least sophisticated customers ranging from small children to the elderly."

An equally significant difference between the semiconductor business and consumer electronics is the impact of Government safety requirements on television-set design and marketing. "I'm made aware of the Government like I never thought possible," Pollack marvels. "Safety is the first order of business, first because we're a responsible company and second because of the Consumer Product Safety Commission and the Bureau of Radiation Health. There's no counterpart of this in the semiconductor business."

Pollack believes that the safety issue will become more important in the color-television industry when the commission issues new standards as it has promised. And contrary to what commission spokesmen have stated, Pollack expects the new standards to be so tough to meet that some set makers will have to get out of the business.

"It will hurt companies with limited resources. The marginal producer which sells on price alone will not be able to handle the increased costs of engineering, testing, and documenting safety requirements."

Giving a U.S. touch  
to Panasonic audio

What's a seasoned American engineer doing as the chief of the audio engineering department at Matsushita Electric Corp. of America? For though Japanese manufacturers of consumer electronics gear often hire American marketing and sales people in the United States, the engineering direction is usually left to technical men from Japan.

Apparently 38-year-old Almon Clegg, who has begun working with Matsushita's highly successful Panasonic line, has a lot to offer. His ex-

# What's going in... in mainframes?

## MOSTEK's 16-pin 4K RAM.

Your mainframe memory system... MOSTEK's 16-pin 4K RAM. A perfect match. Because MOSTEK's 4K RAM gives you the performance, board density and ease of use your system demands. Plus it's available *now*.

Compare performance at the system level. MOSTEK's low capacitance, TTL compatible clocks, combined with superior output drive capability, provide the access time your system requires. Alternate 22-pin designs require high capacitance clocks and additional output buffering, causing system speeds to be lower. MOSTEK's 16-pin multiplexed design reduces the number

of address buffers required without affecting high speed access time. For small peripheral memory arrays the cost savings are substantial — even more so in the case of large mainframe arrays. So look to MOSTEK to meet the high speed requirements of your system.

Want board density? Of course. All memory users — from peripheral and minicomputer manufacturers to the big mainframe people — appreciate the increased density offered by MOSTEK's 16-pin design. (A 50% savings in memory board size over 22-pin alternates.) The result is a more compact, cost effective system.

Interested in ease of use? Again, compare the advantages of MOSTEK's MK4096. Readily available automatic insertion equipment can be used in

board assembly. Voltage pins are on the corners to simplify PCB layout. All inputs including clocks are directly TTL compatible with low capacitance. And the circuit is extremely tolerant of noisy system environments.

Your mainframe, minicomputer or peripheral memory and MOSTEK's 4K RAM. That's what's *going in*.

Want more details? Call your local MOSTEK distributor or representative or contact MOSTEK, 1215 West Crosby Road, Carrollton, Texas 75006, (214) 242-0444. In Europe contact MOSTEK GmbH, TALSTR. 172, 7024 Bernhausen, West Germany, Tel. 798038.

# MOSTEK

Circle 15 on reader service card  
**MOSTEK moves forward...in memories.**

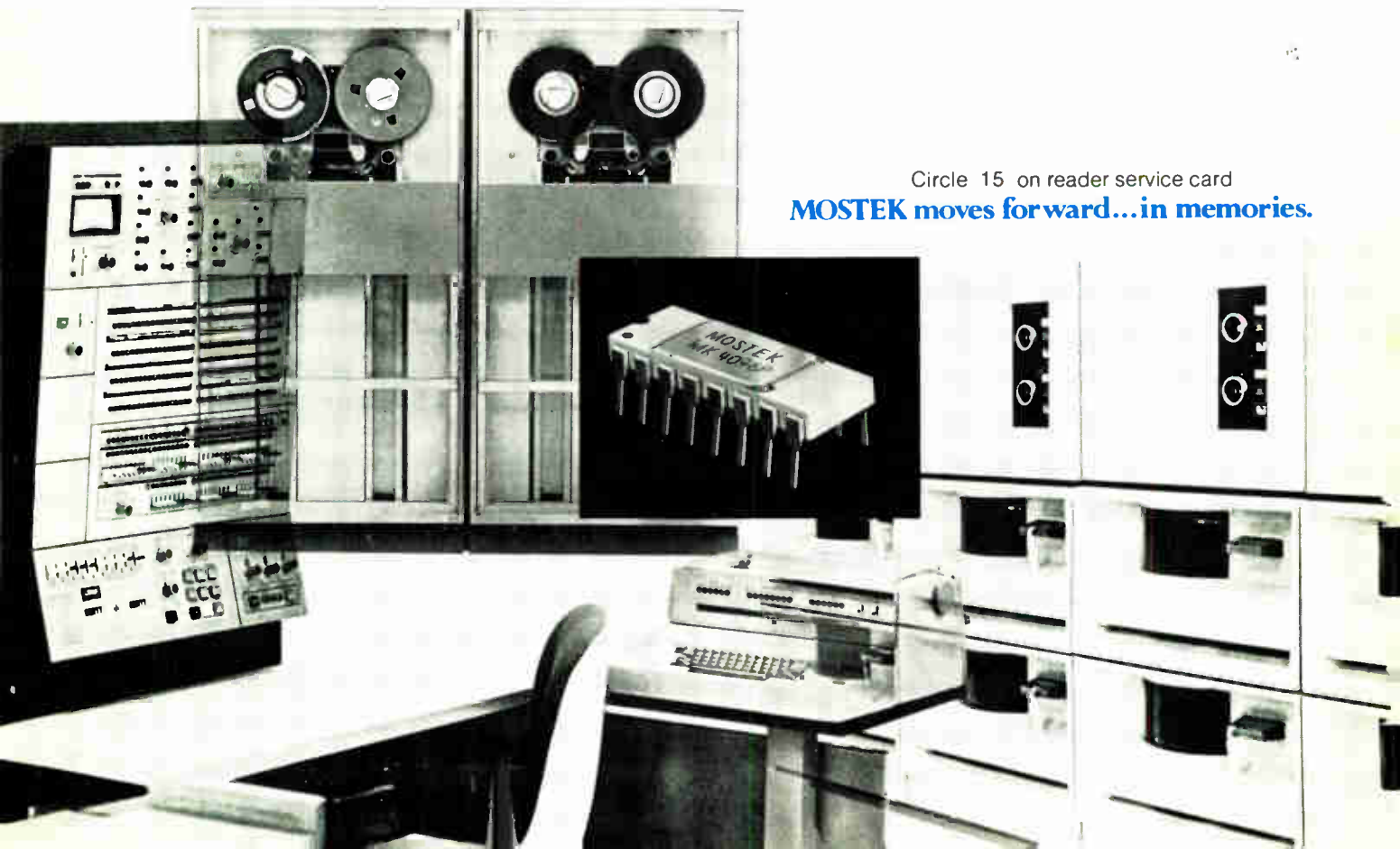

# CABLE-BILITY WOVEN'S FLAT GOT IT!



**Ribbon Cable  
IC Interconnects  
Custom Harnesses**

A total source for flat interconnect systems, Woven Electronics offers unlimited design capabilities combining signal/power transmission with specialized functions. Independently insulated conductors give tighter transmission control, more protection, allow easy lead exposure.

Specify sizes, color coding, insulations, custom break-outs without restrictions of other cable forms.

**Cable and ability. Get the best of both from one source.**

## **WOVEN ELECTRONICS**

P.O. Box 189 Mauldin, South Carolina 29622  
803/963-5131

## **People**

perience includes not only the design of audio equipment, but work in semiconductor applications and industrial electronics as well. Moreover, he's also put in time in consumer retailing and as a college instructor of electronic engineering.

**New products.** At Panasonic in New York, he'll have a dual role. He will feed back suggestions for adapting Japanese-made audio products to American tastes. And he will be in charge of designing some of the new Panasonic products to be manufactured in this country.

Clegg has previously designed patent-applied-for circuits in discrete four-channel, matrix four-channel, and synthesized two-channel while a consultant for General Electric, so he's no stranger to this aspect of audio technology.

The language barrier, a problem Clegg anticipated when joining Panasonic, has not materialized. "This is the first time I've worked for a foreign company, so I wondered whether we could understand each other. But I've hardly recognized a barrier because technology is the common factor."

Nevertheless, he has recognized a difference between the ways U.S. and Japanese engineering staffs operate. "The Japanese structure is more defined than the American. They are more demanding in keeping to procedures," he comments.

The Utah-born Clegg has previously worked for GTE-Sylvania Inc., the Research and Development division of KDI Corp., and the Industrial Products division of General Dynamics Corp.

**Matsushita man.** The Panasonic line gets directions from U.S. engineer Almon Clegg.





**For the past 15 years,  
we've been supplying  
peripherals and component  
equipment to the world's  
largest manufacturer of  
minicomputers.**

**And now we can supply  
them to you.**

# The Components Group of Digital Equipment Corporation.

## We're unbundling the world's most popular minicomputers.

The Components Group will supply proven, reliable computer components to the volume buyer at the lowest possible prices.

Our products are all used by Digital as components and peripherals in the PDP-8 and PDP-11 minicomputer systems, the most popular minis in the world.

But until now, if you wanted Digital components, you had to buy an entire system.

Not any more.

Now, if you order fifty pieces or more, you can buy any of these components completely unbundled. Volume buying will get you price breaks you won't believe — just check out the prices on the next couple of pages.

And you can have our components off the shelf. As our nationwide network of warehouse/depots comes on-line this fall, volume deliveries will be made as fast as we can process your order.



Behind our commitment to deliver stands the entire Digital manufacturing capability — over two million square feet of manufacturing space in the United States, Puerto Rico, Canada and other countries overseas. These are the same facilities that have produced more minicomputers than anyone else, the facilities that manufacture and test the peripherals that support these computers.

To deliver these components quickly and to maintain our high standard of reliability, the Components Group is planning a nationwide network of warehouses. At these depots, products meeting our rigid specifications will be stocked for off-the-shelf delivery.

Our warranty is simple: all hardware is fully warranted for a specified time. If, during this period, any product should prove defective, you simply return it to the nearest depot for fast repair or exchange.

Over the next few years, we expect the cost of computer hardware — especially the cost of the computer itself — to keep going down. Entirely new applications will open up. Volume production of proven components and peripherals enables us to sell at greatly reduced prices. Our low-cost, high-quality products will provide our customers with an opportunity for enhanced profits and a competitive edge in an increasingly price-conscious market.



# Even our newest components are proven products.



Like our computers, our components are designed to deliver maximum performance and reliability.

They are all members of traditional Digital product families, designed to support or complement our well-known computers. And they're all

easy to interface to any other commonly used minicomputer. (If you wish, we'll even design and manufacture your interface in volume.)

Some Components Group products, like our cassette system, remote terminals, and logic modules, are products that we have been manufacturing for a number of years, in quantities to support only our own systems.

Other products, like the PDP-8/A, the DECscope, and the Microprocessor Series of modules are recent price/performance breakthroughs that employ proven, readily available technologies. These products, of course, are also closely related to our traditional computer, terminal, and module products.

All our components and peripherals have been designed for reliability and ease of maintenance, features that are especially important to the volume buyer. Reliability is ensured by pretested quality components





and a minimum of sensitive or moving parts. Maintenance, when necessary, is accomplished by plug-in replacement of modular subsystems.

To provide you with a range of capabilities, product families are being developed. Additional component computers, video terminals, and printers will be introduced in the near future, and will be available in volume from the Components Group.

The component products and peripherals described on the next couple of pages, our introductory line of products, have been selected for reliability and performance. Look them over. They could be the start of a beautiful relationship.



# A display terminal for the price of a teletypewriter.

Video has a lot of advantages. It's fast. It's quiet. And non-computer people find it easy to work with.

But until now, video was pretty expensive.

Now there's DECscope. The world's most inexpensive display terminal.

The keyboard is typewriter-style, so it's easy to use. The scope displays ASCII-standard uppercase characters, each on a 5x7-dot matrix for readability. After displaying 12 lines, the page scrolls upward from the bottom; its speed can be adjusted by the user.

After you've found the information you want, you can take it with you, too. Our optional low-cost copier will deliver hardcopy in 18 seconds; it fits right into the DECscope's desktop cabinet.

Interfacing is with a standard 20mA current loop, or with an inexpensive EIA option for access to the computer over standard



**Under \$950 in quantities of 100.**

telephone lines. Baud rates are switch-selectable up to 9600, for most efficient use of lines.

Installation is easy, just plug it in. The DECscope has few moving parts, so maintenance is simple. And its low heat output means no fans, less noise, and low power consumption.

At such an incredibly low price, the DECscope makes desktop video available to a lot of people who may never have talked with a computer before.

# A reliable cassette system that's cheaper than paper tape.



**Under \$1600 in quantities of 100.**

The TU60 cassette mag tape system was designed for accuracy and reliability. It reads even very low data levels, yet rides right over any noise between the data blocks.

Compared to paper tape, the TU60 is easier to handle, less messy, and a lot more versatile. (Ever try to erase a hole?)

And the TU60 is tough. Its extra-heavy 1 mil tape resists stretching and edge wear, and is spec'd for a minimum of 1000 passes. Reel-to-

reel drive and servo-controlled motors give smooth, easy starts and stops, with no capstans, pulleys or pinch rollers that could damage tape.

With an error rate ten times better than most other cassette systems, the TU60 is a machine you can count on. The read electronics adapt to the tape speed, so power variation or mechanical difficulty won't cause mistakes on the tape.

Other error reducing features include automatic leader detection, single-track low-density recording, and 16-bit cyclic redundancy checking.

Maintenance is rarely necessary. When it is, it's no problem. The top flips open, everything is accessible, and the two main modules can be replaced in minutes.

And look at the price.

So how come you're still using paper tape?

# A low-cost, easy-to-use microprocessor that you can have right now.

Our MPS microprocessor series of modules: the least expensive microprocessor on the market.

We designed the MPS using only standardly-available components with a proven track record. The CPU employs reliable P-channel MOS/LSI silicon-gate technology. We can get it to you now, and we can get it to you without the quirks and bugs that plague a too-new technology.

You can get it on-line fast, too: the MPS interfaces easily. Since its external circuitry is TTL-compatible, you can use it with Digital's broad line of logic modules.

Software development is easier. Control programs are prepared on a small, low-cost PDP-8 minicomputer, using the MPS software-development kit of six basic programs.

Physically, the MPS is a series of four building-block modules and an optional control panel. A basic, fully-operational processor can be assembled from as few as two modules: the CPU and a memory module.

The 8-bit parallel processor can directly address up to 16K words of memory; cycle time is 12.5 $\mu$ sec. Reprogrammable memory (PROM)

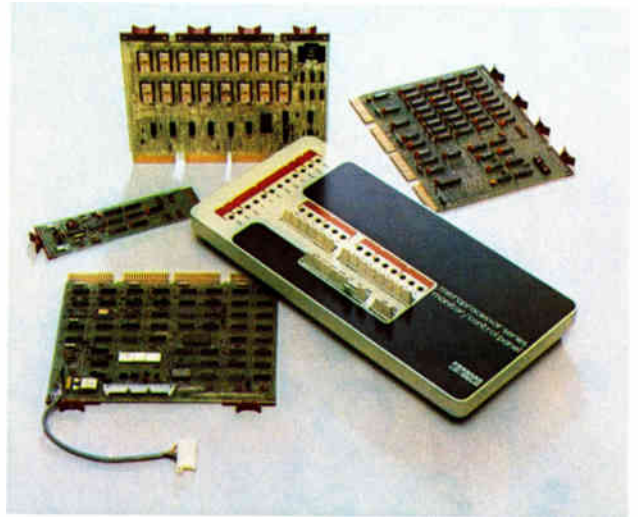

**\$476 in quantities of 100.  
(CPU & 1K RAM.)**

is available in 256-word increments. Read-write memory (RAM) is available in 1K-word increments. An external-event-detection module implements nine levels of priority-arbitration. These include application-defined six-level priority interrupt schemes, AC and DC power-failure detection capability, and the processor-controlled functions of Halt and Restart.

The MPS gives you the convenience of building-block modularity and a design development package that allows you to customize to your application. It's an intelligent solution to low-end processing and control problems.



# The PDP-8/A component computer.

## A no-nonsense, no-compromise computer-on-a-board.

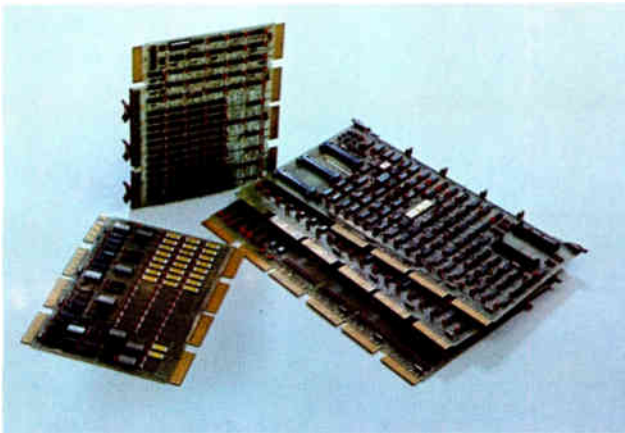

**\$572 in quantities of 100.  
(CPU & 1K RAM.)**

To give you speed and performance at an extremely low price, we've put the world's most experienced minicomputer, the PDP-8, on a single board.

And we've done it using only proven, readily-available, multi-source, MSI semiconductor technology.

The 12-bit PDP-8/A has a cycle time of  $1.5\mu\text{sec}$ , a huge, healthy software library, and the same powerful instruction set as the PDP-8/E. It's fully compatible with most PDP-8 family hardware, operating systems, and high-level

programming languages like BASIC, FORTRAN IV, and FOCAL.

The Omnibus™ backplane makes it easy to interface the PDP-8/A directly to more than 60 PDP-8 options and peripherals. To make your life even easier, we've made the seven most-requested options available on two option boards: serial-line interface, 12-bit parallel I/O, front-panel control, and real-time clock on one board; power-fail/auto-restart, memory extension, and bootstrap loader on the other.

We've employed expandable semiconductor memory to enable you to tailor your memory capacity to your needs, from 1K to 32K words. Choose ROM, RAM, PROM, or ROM/RAM combinations — mix and match to suit your application.

The PDP-8/A will give you minicomputer power at micro-processor prices. We start delivering in quantity in late 1974. We're accepting volume orders now; talk to us.

# Remote terminals for people who think they can't afford remote terminals.

The RT01 and RT02 interactive terminals get around. To the warehouse, the textile mill, the stockroom, the factory floor, and a lot of other places where you might not expect to find the long arm of the EDP department.

Even non-computer people can use them to enter all kinds of data — crane positions, vat levels, logged time, part numbers, whatever — into a remote computer. There's no need for confusing, numerically-coded instructions. RT02 models will prompt the inexperienced operator, spelling out on the display what information is needed next.

The RT01 displays up to 12 digits of data in a numeric Nixie™ display. For non-numeric response, it has programmable status indicators. The 16-key pad will output 30 ASCII characters.

The RT02 costs more and gives you more. A 64-character gas-discharge alphanumeric readout that

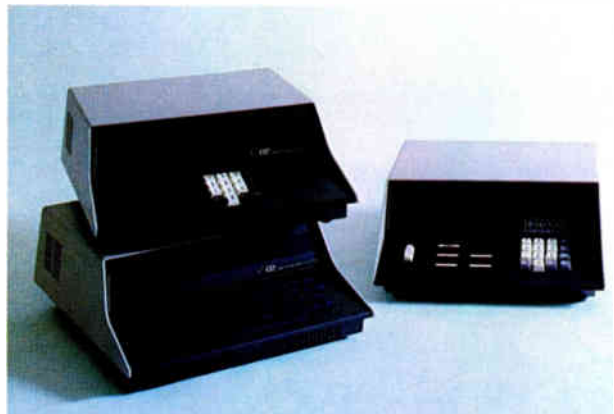

**Starting at less than \$600.**

displays up to 32 characters at once. 16-key or 58-key input. Interactive display prompting.

Both terminals are ASCII-compatible, so you can interface them to any computer with a Teletype™ port. EIA modem interface is also standard.

Both have simple displays and few moving parts for built-in reliability and ease of maintenance.

And look at their down-to-earth prices. These are remote terminals that you can get close to.

# Logic modules and custom interfacing to get it all together.

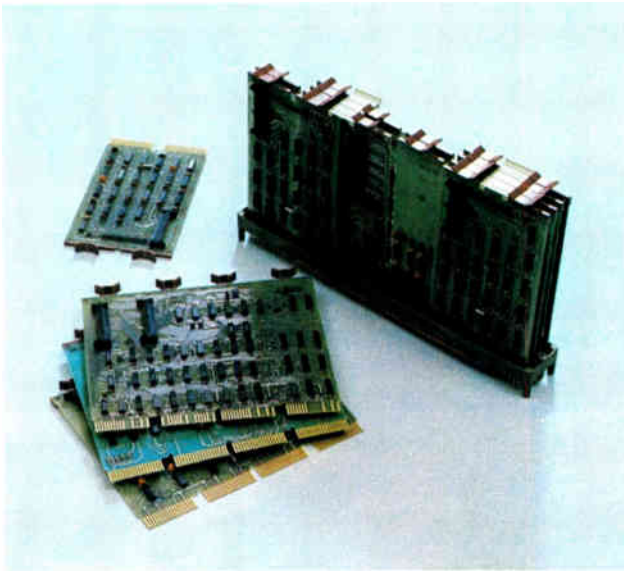

Digital, the world's largest seller of solid-state modules, gives you the widest choice on the market: over 400 pre-tested modules.

**M Series modules.** These high-speed logic modules give you high fanout, large capacitive drive capability and excellent noise margins. In frequencies up to 6MHz.

**K Series modules.** These noise-resistant modules are designed for easy system check-out in industrial control situations where noise-resistance is more important than speed. Though frequencies from DC to 100KHz are typical, we can give you frequencies as low as 5 KHz.

**A Series modules.** For communication between your computer and the outside world, our analog modules give you 10-bit and 12-bit performance in a family of mutually compatible functions — multiplexers, operational amplifiers, sample-and-hold circuits, A/D and D/A converters, reference voltage sources, and multiplying A/D converters.

**DECKit interfaces.** Our DECKits offer you pre-tested, fully-documented interfaces for a number of common interfacing situations. Basically just a few modules and a prewired systems unit, they eliminate design time, breadboarding, and wirewrapping.

**And more.** The Components Group will also supply you, in volume, with custom interfaces, custom modules, and custom variations of our standard terminals. Our Logic Products Handbook and Logic Systems Design Handbook can provide general support and solutions to specific standard problems. We also carry a full line of compatible hardware, power supplies, plug-in-boards, cabinets, racks and related equipment.

**digital**  
**COMPONENTS**  
**GROUP**

**Unbundling the world's  
most popular minicomputers.**

Meet the Components Group now  
— we've got a lot to talk about. Call us direct at

**800-225-9480**

Toll-free from 8:30AM to 5:00PM your time.  
US only. Massachusetts residents, please dial (617) 481-7400.

Digital Equipment Corporation, Components  
Group, One Iron Way, Marlborough,  
Massachusetts 01752.

In Canada: Digital Equipment of Canada  
Limited, P.O. Box 11500, Ottawa, Ontario,  
K2H8K8, (613) 592-5111.

Prices quoted are in US dollars and will vary outside  
the United States.

Not New... Just the Best



# ERIE RED CAP

## Miniature Ceramic Capacitors

### WIDEST SELECTION OF MINIATURIZED CERAMIC CAPACITORS IN THE INDUSTRY!

Erie is in the Red Cap winner's circle because of a well engineered component that's backed by a unique process control system. Combine this with talented, motivated people and you have Erie as the leader in its field. These tiny high quality capacitors are not new... but they are the best. Our customers attest to it. Our test laboratories prove it.

Red Cap dielectrics are manufactured by Erie's exclusive Monobloc Process<sup>®</sup>... a modern, time-proven ceramic film technology. And tough environmental extremes routinely are endured by our own Jet-Seal, a hard, bright red polymeric protective coating. (The superior aesthetic appearance of Jet-Seal comes to you at no charge.)

Erie Red Caps have it all. 21 temperature characteristics. 1pF to 10uF capacitance range. Ratings from 25 to 500 Vdc. You name the application... we've got a Red Cap for the job. All this is due to Erie's total in-house capability... from exclusive ceramic formulations to unique packaging. So on your very next buy of ceramic capacitors, do it the easy way... specify Erie Red Caps.

Write TODAY for Red Cap brochure 8000... or call our nearby factory representative.

CAPACITANCE RANGE  
1pF to 10uF

21 TEMPERATURE Characteristics

Voltage Range  
25 to 500 Vdc

Encapsulated by "JET-SEAL"

Meet or Exceed Requirements of MIL-C-20 MIL-C-11015 As applicable

ERIE TECHNOLOGICAL PRODUCTS, INC.  
Erie, Pennsylvania 16512

Circle 17 on reader service card

# Zip DIP's through incoming tests

If you're still hand-testing your DIP's, you're doing it the hard way. And the slow way. Now you can zip your DIP's through incoming tests ten times faster with our table-top Model 800 high-speed, automatic DIP test handler. Or, for that matter, any one of our other high-speed DIP test handlers and sorters. Why not get all the profitable particulars? Write or call IPT Corporation, 1140 W. Evelyn Ave., Sunnyvale, California 94086. Phone (408) 732-7550.

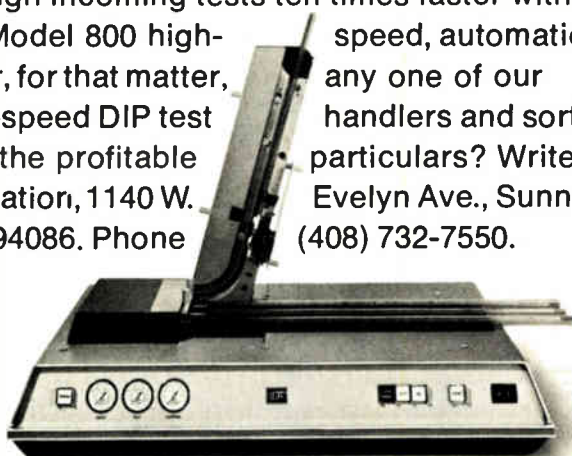

**IPT Corporation**  
High-Speed Automatic Test Handlers

## Meetings

**International Switching Symposium 1974**, VDE, Sheraton Hotel, Munich, Germany, Sept. 9-13.

**Comcon 74, Ninth Annual IEEE Computer Society International Conference**, IEEE, Mayflower Hotel, Washington, D. C., Sept. 10-12.

**Western Electronic Show and Convention (Wescon)**, IEEE, Los Angeles, Sept. 10-13.

**Fourth European Microwave Conference**, Microwave Exhibitions and Publishers Ltd., Maison des Congrès, Montreux, Switzerland, Sept. 10-13.

**European Solid State Devices Research Conference**, Institute of Physics, IEEE, University of Nottingham, Nottingham, England, Sept. 16-19.

**Broadcast Symposium**, IEEE, Washington Hotel, Washington, D.C., Sept. 19-20.

**International Broadcasting Convention**, IEEE et al., Grosvenor House, London, Sept. 23-27.

**International Conference on the Technology and Applications of Charge Coupled Devices**, University of Edinburgh, Centre for Industrial Consultancy and Liaison, et al., Edinburgh, Sept. 25-27.

**Minicomputers in the Factory**, New York Management Center, Delmonico's Hotel, New York, Oct. 7-8.

**Eascon '74, Electronics and Aerospace Systems Conference**, IEEE, Marriott Twin Bridges Motor Hotel, Washington, D.C., Oct. 7-9.

**Tenth Annual International Telemetering Conference**, EIA et al., International Hotel, Los Angeles, Oct. 15-17.

**National Electronics Conference**, sponsored by the National Electronics Conference Inc., Oak Brook, Ill., Hyatt Regency O'Hare Hotel, Chicago, Oct. 16-18.

# Buying a function generator isn't a big deal.



## Using one every day is!

Because there's not much difference in function generator prices, there is often a tendency to specify the "name" brand. But **handle-ability** can be an essential factor. When a basic signal-source goes into your lab, consider first the **day-to-day efficiency** of the instrument and its **effect on the real cost of ownership**.

For example, with sweep width a critical factor in testing network frequency response or developing a response plot, INTERSTATE's F34 allows you to precisely dial the controlled starting and end points. This, coupled with a Sweep Limit Indicator that won't let you dial an invalid output, puts it miles ahead of Wavetek's 134 for accuracy and ease-of-use.

This, and many other human engineering and price/performance differences that exist between the two function generators reflect INTERSTATE's continuing concern for the user, and are factually catalogued in our FREE specifier guide. Check the number below to receive it, or for more direct information, call John Norburg, (714) 772-2811.



**IEC** INTERSTATE  
ELECTRONICS  
CORPORATION

Subsidiary of A-T-O Inc.



"THE \$495 COMPARISON:

INTERSTATE F34, WAVETEK 134 FUNCTION GENERATORS."

U.S. HEADQUARTERS: Dept. 7000, Box 3117, Anaheim, CA. 92803; OVERSEAS SALES OFFICES: AUSTRALIA, Parameters Pty., Ltd.; AUSTRIA, Ing Otto Folger; BELGIUM-LUXEMBURG, Regulation-Mesure S.P.R.L.; FINLAND, Havulinna Oy; FRANCE, Tekelec Airtronic, S.A.; ITALY, Tekelec Airtronic; ISRAEL, Radat International Company Ltd.; JAPAN, Asahi & Co., Ltd.; NETHERLANDS, Tekelec Airtronic, N.V.; NEW ZEALAND, David J. Reid, Ltd.; REPUBLIC OF CHINA, Bons International Co., Ltd.; SPAIN, Telco, S.L.; SOUTH AFRICA, S'electronics (Pty Limited) SWEDEN, M. Stenhardt AB.; SWITZERLAND, Traco Trading Co., Ltd.; UNITED KINGDOM, Euro Electronic Instruments, Ltd.; WEST GERMANY, Tekelec Airtronic GMBH; CANADA, Radionics, Ltd.  
TWX U.S.A. 910-591-1197 TELEX U.S.A. 655443 & 655419

Circle 21 on reader service card

# When we say Brand-Rex Vylink™ wires



*Vylink* is the Brand-Rex trade name for its tough irradiated PVC insulated wire and cable. A thermosetting material, it has superior heat resistance, is unaffected when accidentally touched by a solder iron and has outstanding cut-through, abrasion and chemical resistance – all in addition to vinyl's inherent non-flammability (it meets UL's FR-1 requirements), high dielectric strength and insulation resistance.

Five important processing and operating characteristics of *Vylink* and conventional PVC insulated wires are compared in the following panels. Test procedures and *Vylink*'s properties are detailed in Brand-Rex specification BR-790. Write for your copy to Brand-Rex Company, Willimantic, Conn. 06226. Tel. (203) 423-7771.

## **Heat Resistance**

After 96 hours at 350°F, *Vylink* is unaffected, conventional PVC flows. *Vylink* wire provides far greater protection against current overloads and high temperature environments. It is recommended for shrink-tubing and wave solder cable terminations where wires are exposed to heat guns or solder baths – an excellent low-cost substitute for the premium-priced "high temperature" wires usually used in this application.

## **Solder Resistance**

When a weighted solder iron (1½ lbs. force) is applied to the wire surface, conventional PVC insulation melts almost instantly; *Vylink*, though it may exhibit slight surface discoloration, shows no substantial change – even after several minutes. Regardless of method – hand gun, solder dip, wave soldering – *Vylink* insulation will neither shrink back nor melt. Shorts due to soldering are avoided. Circuit integrity is assured.



# and cables are tough, we prove it.



### Cut-through Resistance

The relative resistance of *Vylink* and conventional PVC insulated wires to penetration may be demonstrated by applying a 90° V cutting edge attached to a weighted plunger perpendicularly to samples of each. To have the specimens cut through in the same length of time, *Vylink* wire must be subjected to at least 5 times the weight. This extra toughness makes thinner insulation walls possible without compromising physical properties. The result — lighter weight, smaller diameter, but equally reliable, cable.



### Abrasion Resistance

In this test, a predetermined weight presses a conventional PVC wire sample against a moving 400 grit, aluminum oxide abrasive tape until the insulation has been worn away and conductor exposed. By comparison, more than half the insulation remains when the same amount of tape abrades *Vylink* insulated wire under identical conditions. This toughness permits the use of thinner insulation which UL recognizes by rating 6½ mil wall *Vylink* wire at 125 volts (UL Style 1472).

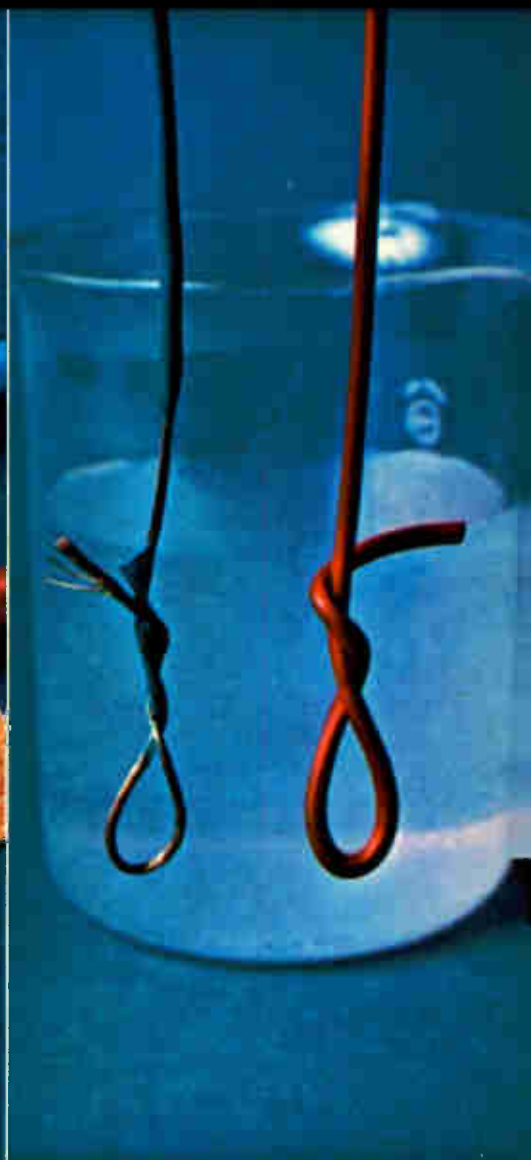

### Chemical Resistance

Electronic bombardment of the specially formulated *Vylink* compound causes a change in the molecular structure and transforms this PVC material from a thermoplastic to a thermosetting plastic. *Vylink*, like all thermosets is generally inert to chemicals and solvents. When *Vylink* and conventional PVC are boiled for two hours in MEK (methyl ethyl ketone), a good solvent for vinyls, *Vylink* is virtually unaffected; conventional PVC is completely dissolved.

## BRAND-REX

4,000 solutions in search of a problem.

Tests were conducted on 16 (26/30) AWG with 1/32" insulation

BRAND-REX CO., A UNIT OF ALCOA INCORPORATED  
Circle 23 on Reader Mail Survey



Stable Trimmers  
Small Duals  
Rugged Pots

If you're really  
serious about cost,  
be serious about quality.

Type FD trimmer. Type GD pot. Ideal variable resistors for CATV attenuators. Or any Bridged-T or L pad application requiring minimum size, stability and long life in severe environments. Exclusive hot-molded composition resistance elements permit peak set-ability. Diameter 1/2

inch (12,70 mm). Immersion-sealed (can be potted). Standard resistance values from 100 ohms to 5 megs and many popular impedance values. Single turn. For complete technical details request Publication 5231 (FD trimmer), Publication 5213 (GD potentiometer), Publication 5221 (FD/

GD attenuators). Allen-Bradley Electronics Division, 1201 South Second Street, Milwaukee, Wisconsin 53204. Export: Bloomfield, New Jersey 07003. Canada: Allen-Bradley Canada Limited, Cambridge, Ontario. United Kingdom: Jarrow, County Durham NE32 3EN.



Actual Size



**Allen-Bradley**

Milwaukee, Wisconsin 53204

Circle 24 on reader service card

## **RCA plan for TV tube plant in China anticipates growth**

Fueling the controversy over whether electronics companies should sell technology to the Eastern bloc nations [*Electronics*, Sept. 27, 1973, p. 42] is RCA's proposal to set up a turnkey TV tube operation in the People's Republic of China. According to William C. Hittinger, executive vice president of RCA's Consumer and Solid State Electronics divisions, the Chinese TV market, although small at present, "could grow dramatically in the next five years."

Like many electronics executives who take the middle ground on the Eastern-bloc technology question, Hittinger feels that rather than have a blanket policy covering all situations, **each case should be decided on its merits**, with guidance from the U.S. Government on national defense issues. RCA is awaiting word from China on its application, which was filed after consultation with the State Department.

## **POS expansion seen tied to Nebraska court ruling**

Hinky Dinky is the new buzz word among the nation's bankers as they watch for expansion of the electronic funds-transfer market. The bankers' interest centers on Hinky Dinky supermarkets, a Lincoln, Neb., chain, **whose right to retain automatic bank-teller systems in two of its stores is now up to the state Supreme Court** following a lower court ruling in its favor. Installed in January, the system linked the two stores to a Nebraska savings and loan association, so that anyone who banked there could pay for purchases at the supermarket simply by giving the cashier a bank credit card with which to withdraw cash from his account via the under-the-counter terminal.

Independent bankers and the state obtained a temporary injunction against the practice and lost in a lower court. Banking officials says that if the Hinky Dinky ruling stands up on appeal, **it will provide a major boost to electronic funds transfer.**

## **Head-up display for helicopters to be developed**

A contract to develop a head-up display for night-flying helicopters is expected to be awarded by the Naval Development Center to EA Industries Corp., Atlanta, the U.S. arm of Marconi Elliott Avionics Systems Ltd. of Britain. The company believes that the contract, though small at about \$200,000, **will lead to sophisticated systems** in keeping with the Defense Department's new emphasis in improving helicopter avionics. One promising technical approach is the use of light-emitting diodes, but it has not yet been decided just how much data should be displayed for the pilot. Marconi already builds the head-up displays for the A-7 fighters.

## **Rockwell expected to market own calculator line**

An announcement is due soon that Rockwell International Corp. will be selling calculators bearing the Rockwell name through retailers. Until now, the company's Microelectronic Products division has been a brand labeler, most notably for Sears and Lloyd's Electronics, but there are murmurs that the Anaheim, Calif., division, **is planning to go the route of its biggest competitors, such as Texas Instruments and National Semiconductor's Novus division.** The move would be in line with

views recently expressed by Donn Williams, president of Rockwell's electronics operations, who maintains that there's not enough profit margin in consumer calculators to justify use of a distributor in marketing the machines [*Electronics*, Aug. 8, p. 75].

## **16k CCD memory designed by RCA to replace drum**

RCA has developed a 16,384-bit charge-coupled-device memory chip for use in an experimental drum replacement. **The CCD demands less power, weighs less, takes up less space than the drum, and accesses four times faster.** The 224-by-240-mil chip was made at RCA's Sarnoff Research Lab for its Electromagnetic and Aviation Systems division in Van Nuys, Calif. The CCD-based system has a capacity of up to 10 million bits, while large drums can handle as many as 100 million.

The chip is organized as two 8,192-bit sections, each consisting of four series-parallel-series registers and input and output translators. An ancillary C-MOS support chip provides clock drive and logic circuitry. Data rate in an 8-megabit drum equivalent would be 2 megahertz for a 2-millisecond average access time, one tenth that of a far larger and heavier drum system that would use 300 watts compared to the 5-W active, 2-W standby of the CCD version.

## **H-P analyzer follows trend to digital market**

Look for acceleration of the trend among instrument makers to aim new products squarely at the digital market. The latest example is Hewlett-Packard's 1620A digital pattern analyzer. No redesigned hand-me-down from early analog days, **it's a selective window that scans bit patterns at data rates up to 20 megahertz** and delivers a trigger signal suitable for an oscilloscope. The analyzer recognizes preset series, or parallel, patterns with up to 16 bits.

Unlike a trigger that depends on a time delay, the pattern-recognition triggering technique does away with the danger of accumulated timing error. Delay can be programmed in a number of ways. The trigger can be delayed up to 99,999 clock periods after pattern recognition. Or if the data is serial, then the data bus may be masked for up to 99 clock edges before scanning begins. The model 1620A is priced at \$1,750; with serial analysis only, the price drops \$650.

## **Addenda**

**Western Digital Corp. has joined the 4k memory race.** The n-channel, silicon-gate part uses the 22-lead Intel/TI pinouts with three-transistor memory cells and a single clock, requires  $\pm 5$  volts, and accesses in 200 to 240 nanoseconds typical, 300 ns maximum. . . . Rockwell Microelectronics has developed a single calculator chip that drives a printer without any ancillary MOS decoders. **The only other semiconductors needed are current-amplifier transistors** to drive the printer solenoids. The first application is a new Seiko printer. . . . Rockwell's C-MOS on sapphire 1,092-bit RAM, exhibit to show 90-nanosecond speed, is working in the lab but is still at least nine months from production. Meanwhile, a number of customers have committed to the company's SOS programmable logic array, with one buying 300 a month.

# Perfect for power supply design.

Unitrode's new ESP Power Switch provides the power transistor and catch diode functions required in switching regulator applications. One convenient package delivers the extra *Efficiency, Speed, and Power* needed to improve response time over regulating components commonly used in power supplies... and at no extra cost.

Unitrode selects and matches its exclusive ESP high speed rectifiers and power transistors to produce a single, plug-in TO-66 package... saving hours of design time.

This new ESP power switch operates with more than 80% efficiency. That's at least 15% better than most switching regulator circuits. Switching rates can be increased from the normal 10-20 KHz to 50 and even 100 KHz. And the ESP power switch can be driven by any IC regulator with no external biasing required.

Since no diode recovery spike is generated, there's less noise and RFI. Circuit designers can use a smaller LC filter, further reducing total power supply size, weight and cost.

For detailed specifications and performance characteristics on both 5A and 15A units, send for our ESP Power Circuit literature. Or, for faster action call Ernie Crocker at (617) 926-0404.



## New Unitrode ESP Switching Regulator Power Switch

Type	Max. Output Current $I_1$	Max. Input Voltage $V_{4-2}$	Typical Efficiency $\eta$	Typical Rise Time $t_{rV}$	Typical Fall Time $t_{fV}$
POSITIVE OUTPUT					
PIC600 PIC601	5A	60V 80V	85% @ 2A	30nSec	50nSec
PIC625 PIC626	15A	60V 80V	82% @ 10A	45nSec	70nSec
NEGATIVE OUTPUT					
PIC610 PIC611	-5A	-60V -80V	85% @ -2A	40nSec	50nSec
PIC635 PIC636	-15A	-60V -80V	82% @ -10A	50nSec	65nSec

\*Measured with  $V_{in} = 25V$ ,  $V_{out} = 5V$ ,  $f = 20$  KHz, Input pulse width =  $10\mu$ Sec  
See Electronics Buyers' Guide Semiconductors Section for more complete product listing

Circle 27 on reader service card

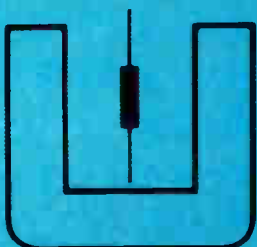

### Available off the shelf

# UNITRODE

580 PLEASANT STREET, WATERTOWN, MA 02172

# The News is

# Major!



## **A 6" tubeaxial fan that moves more air . . . at higher pressures . . . and costs less!**

It's the kind of news you expect from Rotron. An air mover with the extras built in. The Major<sup>®</sup> fan will deliver 150 cfm at a static pressure of .35 inches of water. That's 12% more air than the closest competitor.

The Major stays cooler, too. Its multi-slot permanent split capacitor motor draws less power than a shaded pole, and withstands line voltage variations better. An aluminum venturi and motor housing dissipate heat. And ball bearings add still further to long motor life.

The Major fan mounts interchangeably with other 6" fans. It can also be mounted on less than 6" centers.

Price? About 10% less than you used to have to pay for less performance! Get all the facts on Rotron's new Major tubeaxial fan today by sending for Catalog E2855.

*Why settle for less when the best costs no more.*



**ROTRON INC.**, Woodstock, N. Y. 12498 ☐ 914 • 679-2401 ☐ TWX 510-247-9033  
Pacific Div., Burbank, Cal. 91506, 213 • 849-7871 • Rotron B.V., Breda, Netherlands, Tel.: 79311, Telex: 844-54074

## Citizen alarm sends digital codes from wrist transmitter

Aerospace Corp. is prime contractor for field test next year of system to have 5,000 alarm units

The spirit of Dick Tracy appears to be alive and well at the Law Enforcement Assistance Administration, which next year plans a massive field test of up to 5,000 wristwatch-sized transmitters as personal "citizen alarm" units.

So far, 20 experimental units have been built by Compu-guard Security Systems Inc., Pittsburgh, Pa. The thick-film hybrid integrated circuits basic to the experimental design fit into a watch case 1½ inches in diameter and ½ in. high. When activated, the unit sends out a digitally encoded alarm that can be picked up by a receiver located within a 50-foot radius of it. Prime contractor for the over-all system is Aerospace Corp., El Segundo, Calif.

**Innovative.** Observes George D. Shollenberger, Advanced Technology division manager for LEAA's National Institute for Law Enforcement and Criminal Justice in Washington, "Our citizens' alarm system is our most innovative program. It could provide all Americans with a capability to summon emergency assistance for crime situations, no matter where they take place."

In the forthcoming field test, alarms will be provided to residents of apartment buildings and retail shop owners (see "Schools get alarms too.") Apartments and shops will be equipped with receivers capable of picking up the uhf signals from the transmitters. The receivers

will then re-transmit a signal, containing the receiver's location and, perhaps, the person's identity, to a processor-based teleprinter terminal at a local police station or private security office.

LEAA has been analyzing the system concept to determine just what kinds of information should be transmitted. Aerospace Corp. will also be funding development of pendant necklace transmitters. A request for proposals for the field test is expected in early 1975.

"We are considering using LSI monolithic chips in production models of the miniaturized transmitters," says Romesh Wadhvani,

### Schools get alarms too

Compu-guard Security Systems, developing the wrist transmitters and other elements for the LEAA test, will also supply a complete alarm system next year to five Los Angeles schools. The system will include some 1,500 digital alarm units—both wrist alarms and alarm transmitters concealed in pendant necklaces—as well as classroom receivers, central control stations and printers.

Teachers will be able to summon aid from any point within a school building. When an alarm is activated, a digitally coded signal will be transmitted to receivers dispersed in the hallways and classrooms. These receivers will then re-transmit a signal over the building's existing electrical system to a computerized central station. There, the signal will be decoded to identify the location and time of the alarm, and what type of response is requested.

president of Compu-guard. By as early as next year, the alarm transmitter built with LSI could be incorporated into a functioning electronic watch, he says.

In the present version, there are two hybrid-IC packages inside the watch case, one containing digital electronics, the other the transmitter. To prevent accidental transmission, two stems protruding through the case must be pressed simultaneously before a signal can be transmitted, Wadhvani explains.

When an alarm is being sent, a digital code from an internal shift register is differentially phase-shift-keyed onto a subcarrier at about 20 kilohertz. This is then frequency-modulated onto a uhf carrier. The antenna is a circular band that is etched around the printed-circuit board on which the transmitter rests.

Engineers are grappling with antenna-size and radio-frequency tradeoffs and want units with a range to 500 feet, says Gerald Skinner, Aerospace's program manager for the alarm system. Aerospace's aim is a cost of about \$50 per person for the system.

Shollenberger of LEAA estimates that a transmitter would add only \$2 to the cost of an electronic watch, though this could go down if the chips are mass-produced on a wide commercial scale.

The wrist alarm system is part of LEAA's \$5 million technological development program that includes an electronic cargo security system for trucks, as well as computerized voice-identification systems and low-cost burglar alarms.

Development of the electronic cargo security system, also directed

by Aerospace, is less advanced than the wrist alarm. An RFP was recently issued for five brassboard units to be placed in trucks. However, a decision on which of the five bidders should receive a follow-on contract is not expected soon, according to Aerospace. Trucks would have sensors in doors and seats, in the cargo area, and under the hood. Continuous information on a truck's condition would be transmitted on existing rf equipment. Each truck's location along a predetermined route could be extrapolated from the information, Wadhvani points out. □

**Military electronics**

**Recon cameras favor CCDs**

Delays can be critical when reconnaissance aircraft over enemy territory must return to base to have their cameras' film removed and developed. Hence the Air Force's in-

terest in real-time recon systems—ones that will transmit pictures back to base as they are being taken.

Television, a likely candidate for such systems, is adequate for medium- and high-altitude applications. But for high-speed, low-altitude overflights by aircraft like the F-4, charge-coupled devices "are the only practical answer," observes Harold E. Geltmacher, technical manager of the TV recording and display group at the Air Force Avionics Laboratory's Reconnaissance Sensor Development branch, Wright-Patterson Air Force Base, Ohio.

"The combination of resolution and sensitivity of most imaging tubes is inadequate to get both the resolution and wide field of view that we need," he explains. "And, in a line-scan mode, there is no redundancy in CCDs, so the bandwidth we need to transmit is at a minimum."

CCDs are basic to both EWACS (electronic wide-angle camera system) programs now entering the hardware stage at two contractors. The CAI division of Bourns Inc. in Barrington, Ill., last month moved

into the fabrication phase of its 14-month-old \$1.5 million systems contract. Fairchild's Space and Defense Systems division, Syosset, N.Y., this month will deliver feasibility hardware to prove out its special lens design under a \$100,000 award.

**Panorama.** CAI's lens is similar to that used on today's panoramic cameras. It needs a rotating, "quadruple dove" prism to cut a bow-tie-shaped swath perpendicular to the aircraft direction, and it uses a self-scanning linear CCD imaging array of some 1,600 elements to sense the ground scene.

"In CCD elements, it's a 10:1 reduction over what Fairchild requires, but dwell time decreases by the same factor," says Geltmacher. Dwell time, or integration time, is 250 microseconds per element for Fairchild, and 25  $\mu$ s for CAI.

With the longer dwell time, Fairchild achieves a better signal-to-noise ratio than CAI, and therefore, better resolution. This means that Fairchild's camera can handle rather poorer lighting, according to Geltmacher, though each system has an adequate signal-to-noise ratio for daylight reconnaissance.

Fairchild relies on a "push-broom" technique that, unlike CAI's, requires no moving parts. It does, however, demand more complex optics, and Fairchild is delivering a 140° field-of-view lens that's less than one cubic foot in volume to show the Air Force that it's possible. "Other lenses with this field of view have been two to three feet long and had high distortion," comments James J. Stewart, EWACS program engineer for the Air Force.

Fairchild admits that its bid for the system award was unsuccessful because the Air Force didn't think it could build the lens its approach requires. But it is going ahead anyway, despite the limited funding, because "we see the system as being extremely important to Fairchild and the Air Force," says Joseph Keller, director of marketing for the division. "Film cameras are a big part of our business, but real time is where everything is heading." While the Air Force isn't saying, it's believed that the service will continue

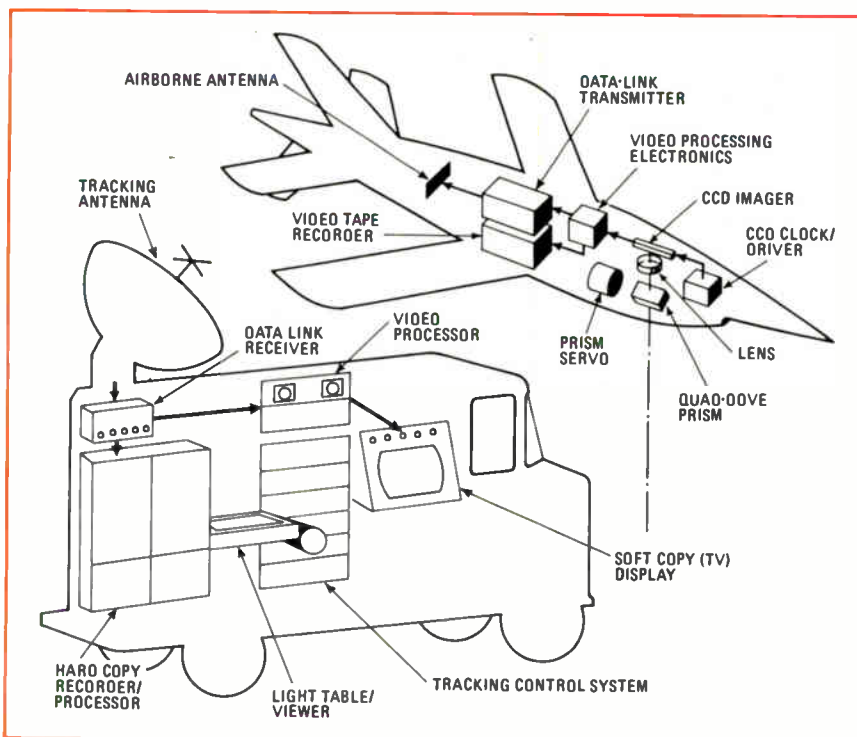

**Recon.** Camera using CCD sensor is only part of electronic wide-angle camera system being developed by the Air Force for high-speed, low-level reconnaissance missions. Tracking van receives signals from the aircraft, processes them, and produces finished pictures.



funding the Fairchild system.

The firm will be using Fairchild-built CCD chips. While the configuration of the 15,000-element array is proprietary, it's likely that Fairchild will use nine or 10 chips of 1,500 to 1,700 elements each. Because of the overlap problems, and the dead space that results from it, the chips will be staggered in two rows and a beam splitter will divide the light.

Both systems, Geltmacher emphasizes, could meet system parameters, which include the ability to resolve 1 foot across 120° at an altitude of 200 ft. Total field of view has to be 140°, and the sensor must fit a space not more than 0.75 ft<sup>3</sup> and cost a maximum of \$20,000 each in lots of 50.

While the optics and CCDs of the Fairchild system are the more expensive, CAI's panoramic approach requires the more on-board processing. Since the scans yield the bow-tie-shaped swaths, some of the information sensed is redundant, Stewart explains. But because only part of the scan will change perhaps not all data need be read out of the CCD chips, simplifying processing.

Besides real-time transmission to ground, the EWACS concept also provides for a backup video tape recorder on-board in the event of jamming or malfunction in the transmission link. Ground facilities include a video-data-link receiver, real-time soft-copy displays, and a CRT hard-copy film recorder. □

---

## Business

---

### Layoff ripples widening in semiconductor industry

Now that business results for the first and second quarters are in, most semiconductor company executives seem agreed: now is the time to trim fat from employment rolls as the growth rate in semiconductor sales cools off. Instead of last year's 40% or more increase in sales, a figure half that or less looks realistic for 1974.

Companies in the San Francisco peninsula's "Silicon Valley" are doing most of the belt tightening. Specific reasons given for the slowdown are that customers are chopping inventories, whereas a year ago they were ordering heavily as a hedge against shortages; there are also fewer long-term contracts; more of the orders that are coming are for immediate delivery, and some orders are being slipped.

At Intel Corp., Santa Clara, because of an across-the-board slowdown in the sales of memory products, employee cutbacks were made in all departments during the first week in August. Intel president Robert Noyce says as many as 100 to 150 were laid off. "However, it's all overhead personnel," he says.

"No production workers were involved."

**Friday.** Fairchild Semiconductor, Mountain View, sent exit notices to technicians, engineers and some others on four consecutive Fridays this summer. Officials admit to laying off 135 of 27,000 employees, but insiders say it is much more than that, perhaps as much as 400.

Raytheon Co.'s Mountain View Semiconductor division laid off about 40 people recently because, says Gene Selven, the director of marketing, backlogs are being rescheduled and softening. Signetics Corp., in Sunnyvale, reports "business is soft" with few orders coming in. But the firm, "rather than get caught like in 1970," hired industrial relations managers two years ago to anticipate slow times and to recommend personnel cuts. To date, Signetics has laid off about 130 workers in administration, management, engineering, and technical and clerical areas. Similar cuts are expected in Signetics' MOS plant in Utah, say some experts.

National Semiconductor Corp. in Santa Clara has "had to react to

high inventories" says vice president and general manager Floyd Kvamme. The firm has been hiring only "selectively" and has laid off some overseas assemblers. At Inter-sil Inc. in Cupertino, there has been a general freeze on employment, except for certain key positions, as well as a 50-person reduction in the 1,000-member workforce.

Electronic Arrays Inc. of Mountain View is suffering a significant slowdown, both because of the general trend in the marketplace and because it was caught in the calculator squeeze. The company was forced to cut its work force of 420 by 10%.

**Elsewhere.** Meanwhile, outside Silicon Valley, layoffs in the semiconductor business are not as drastic. R. S. Carlson, president of Rockwell International's Microelectronics Group in Anaheim, Calif., won't say how many people will be affected at his company but points to declining prices and competitive pressures in calculator devices as forcing "some adjustments to the work force."

And in Texas, Mostek Corp. has laid off 29 at its Carrollton facility—none of them production workers—while Mostek's calculator-making subsidiary Corvus Corp. let 30 go. Texas Instruments in Dallas and Motorola's Semiconductor Products division in Phoenix, on the other hand, report no layoffs and none are expected. The same is true at RCA's Solid State division, Somerville, N.J., and General Instrument Corp., Microelectronics division, Hicksville, N. Y. □

---

## Components

---

### Circular connector gets single standard

The Department of Defense has acted to trim some redundancy from the list of standards for military connectors. Thus, the year-old Defense Materiel Specification and Standards Board has ended a long-standing conflict between two high-

### Connectors first, ICs next?

Recommendations for connector standards made by the special Electronics Panel of the Defense Materiel Specification and Standards Board are only the beginning. The panel's next project, which may have an even wider impact, is to consider developing preferred-parts lists for microcircuits. At present, surprisingly, Department of Defense directives bar such lists.

When those directives were issued in the mid 1960s, however, IC technology was moving so fast that many believed preferred-parts lists would suppress initiative, says panel chairman John Mittino. By now, many ICs on the qualified-parts list are duplicated—often several times over. A list of preferred parts to eliminate this duplication could lower procurement costs. "So long as we don't impact on innovation, we want to do something about this," says Mittino.

Another project will study whether it would be practicable to define electronic subsystems in terms of their interface requirements rather than their internal specifications. This implies a shift to form, fit, and function standards which, industry sources say, would permit modular development of equipment and greater flexibility in its use.

Set up last year to solve standards conflicts among the military services, the Defense Materiel Specification and Standards Board is at quite a high level within DOD. It is chaired by Jacques Gansler, deputy assistant secretary of defense for material acquisition. Its members are representatives of the Director of Defense Research and Engineering, the assistant secretary of defense for installation and logistics, and engineering and logistics representatives from the Army, Air Force, Navy, and Defense Supply Agency. All are of flag rank—generals and admirals—or the civilian equivalent.

density circular connector specs—MIL-C-38999 and MIL-C-81511 [*Electronics*, Aug. 30, 1973, p. 70]. The DOD, following recommendations by the board, or rather its special electronics panel, has declared 81511 obsolete for new designs and called for a phaseover to 38999 as the only standard.

Equipment in the field and in production will continue to use the connectors it has been using. However, equipment in early enough design phases will be required to conform to MIL-C-38999. Decisions on programs further along will be made case by case.

The decision affects a market estimated by some industry sources at \$23.5 million in 1973 and about \$30 million in 1974. However, a lion's share of this market has already been cornered by connectors meeting the now preferred MIL-C-38999 specification. Rather than creating a market impact, the decision helps simplify the business of ordering the high-density unit and keeping it in inventory.

**Service preference.** MIL-C-81511, issued early in 1967, covers connectors similar to those designed to meet MIL-C-38999, published in Oc-

tober, 1966. The Air Force has been using 38999 connectors, originally a Bendix design but now also manufactured by ITT Cannon and Burndy Corp., and the Navy has favored 81511. Amphenol designed an early version of the 81511 connectors; the current, updated model is produced by Deutsch Co. At different times and on different programs, the Army has used both connector styles.

"We looked at a long-standing problem and chose one spec to be adopted as the DOD standard," said John Mittino, chairman of the Electronics Panel. The panel held hearings in April and studied position papers from the Army, Navy, and Air Force along with an industry presentation made jointly by the Electronic Industries Association, the Aerospace Industries Association, and the Society of Automotive Engineers.

Connectors built to MIL-C-38999 offer a number of advantages over MIL-C-81511 types, according to DOD's Harry Meiselman, a panel member who is the panel's liaison with the parent DMSSB. Perhaps the biggest advantage is that the 38999 connector fits more readily into the

military inventory. It uses the same contacts and assembly tools as other circular types. Also, its contacts can accommodate a range of conductor sizes in a single connector shell, a feature totally lacking in MIL-C-81511 connectors.

In addition, Meiselman says, "There are many more 38999 connectors in use, on the order of 35 to 1 in terms of applications." He concedes the MIL-C-81511 connector may offer greater density in some cases. But the two connector styles "are pretty much identical in terms of performance and are virtually interchangeable as far as applications go," says Meiselman. □

## Industrial electronics

### Process control gets new competitor

There's a big new kid on the block in process-control instrumentation—Beckman Instruments Inc., the Fullerton, Calif. supplier of analytical instruments for the chemical, petroleum and petrochemical industries. The move puts Beckman, whose annual sales range around \$200 million, into direct competition with such process-control stalwarts as Foxboro, Honeywell and Taylor Instruments.

Beckman's new line of equipment consists of analog/digital controllers, process-control transmitters, and two- and six-channel recorders. Analog circuitry in the controllers implements process-control functions, while digital circuitry serves for control, housekeeping and indication. The variable-reluctance transmitters include units that measure functions such as differential pressure, absolute pressure, and gauge pressure and level.

An unusual feature of the recorders is that they use pressure-sensitive paper with the stylus underneath instead of above; the writing appears on the paper without a pen or pointer being visible.

The two-channel version includes color-coded plastic bar indicators

# The spec sheets tell you what should happen.

(No load)  
Linear curve you would assume from spec sheet information.

(2 k $\Omega$  load)  
Actual curve with device loaded as specified.

Input Voltage 50  $\mu$ V/DIV

Output Voltage 5V/DIV

## The 577 shows you what did.

When you're designing circuits using linear IC's, you count on spec sheets for the information you need. Generally, gain, CMRR and power supply rejection ratio are given as the ratios of voltage changes measured between discrete points. You assume a "linear" integrated circuit has a linear gain curve (a straight line) with no spurious excursions. But an actual device operating in real-life conditions isn't always linear. Often it produces very irregular curves that may make a big difference in your finished circuit.

These irregular curves are hidden from meters, digital read-outs and go no-go indicators. In fact, a Curve Tracer with its CRT display is the only way to see what is actually happening across the entire operating range of the device you're testing.

The Tektronix 577/178 Curve Tracer will measure and display gain. Offset voltage. Input bias current. Common-mode rejection ratio. And power supply rejection ratio. In addition, the 577/178 displays thermal effects. Popcorn (or flicker) noise. And parameter nonlinearities. And the 577/178 has a storage display to retain curves for comparison or detailed evaluation. Yet it costs only \$3100.

Circle 33 on reader service card

For a demonstration circle 32 on reader service card

To learn about the pitfalls of linear IC performance and measurements write to Tektronix for pamphlet No. A3040, A3061. Tektronix, Inc., P.O. Box 500, Beaverton, Oregon 97005. Or call your local field engineer.

See You At WESCON — Booths 2206-2209



that can be read from 40 feet, rather than the traditional meter pointer. One trace is four times as wide as the other for identification. The six-channel recorder has a similar writing scheme, with thumb-wheel selection to accommodate multiple inputs or calibration signals.

Bill Duncan, product line manager for Beckman's Process Control Instruments division, expects the new line to be a major portion of Beckman's business in three to five years. According to Duncan, the firm entered the control end of the market as they sold increasing quantities of analytical instruments—from chromatographs to pH and infrared analyzers.

"We found that we were supplying more and more complete systems and were buying controllers and other equipment outside," he says. The company concluded it should benefit from that added value by offering the control instrumentation as well.

Duncan estimates that the market segment the firm is addressing is \$100 million to \$150 million per year, depending on how it's defined. Beckman will limit its entry, however.

"We're not going to make minicomputers," he says. "We design our equipment so it is compatible with minis, and can customize it for the customer's mini or large-scale computer." □

**Solid state**

**Microprocessors get new FACE**

Trying to make microprogramming easier for users of its IMP line of microprocessors, National Semiconductor Corp. has developed a new memory and control chip that can be microprogrammed in the field, rather than just at the factory. Called a Field Alterable Control Element, or FACE, the new device enables a user to tailor his microprogram, which generally yields a more efficient and flexible instruc-

tion set, during development in the prototype stage.

Until now, microprogram control of the microprocessors has been done through a factory-programmed control read-only memory, or CROM. Containing a mask-programmed ROM, whose contents are set during the final metalization step in its processing, the CROM chip also has control and sequencing logic. This logic interfaces with the register arithmetic and logic unit (RALU) that is also part of a microprocessor. However, it is the microprogram

control commands in its memory that gives the CROM the ability to direct the RALUs most efficiently and define the instruction set of the system.

**Cumbersome.** Although IMP-8 and IMP-16 microprocessors could be used in a microprogrammable design, users shy away from doing this because the microprogramming requires the CROM to be factory-processed. This could be a cumbersome and time-consuming step, particularly for prototype systems.

The FACE chip retains the RALU

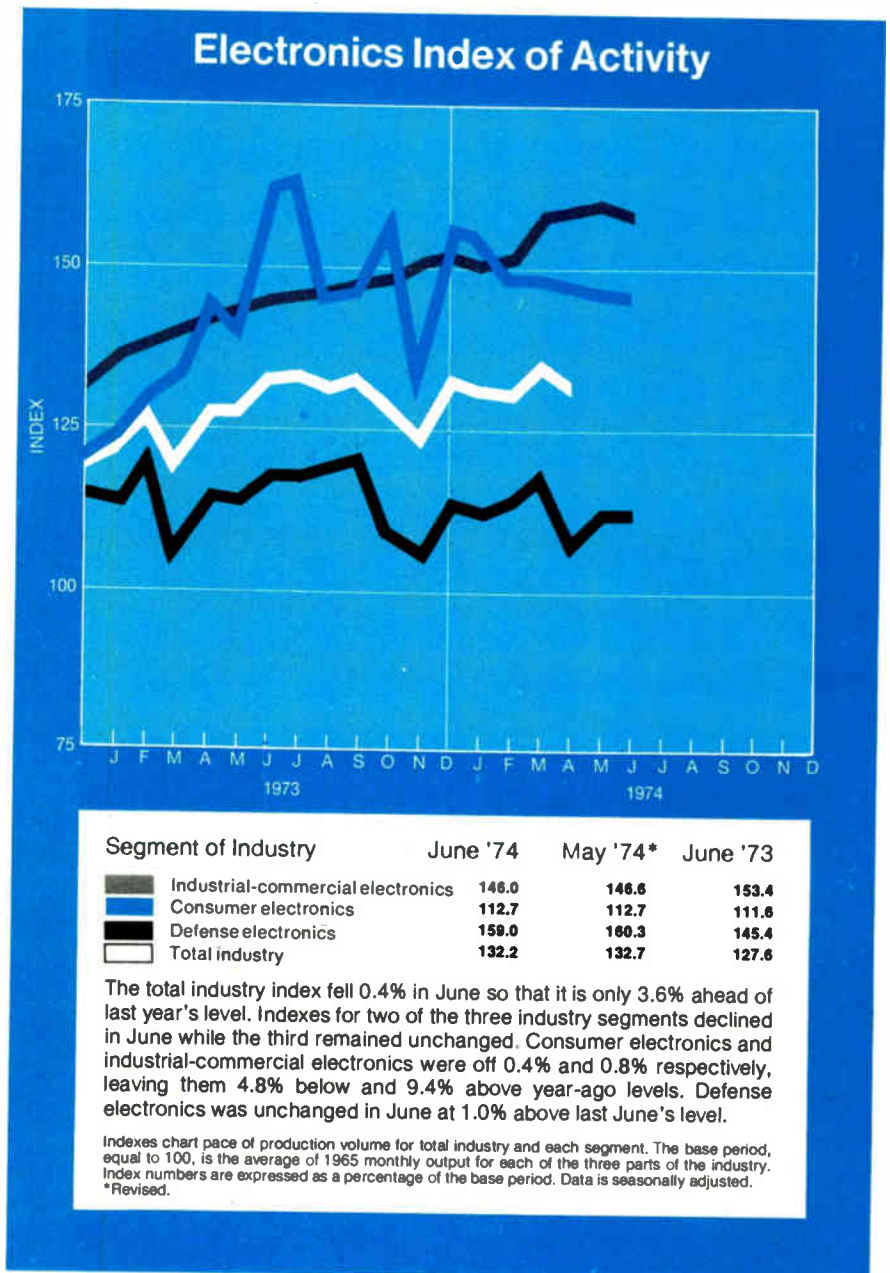

# Some memory systems have more uses than others.



Like Hughes Image Memory Systems.

They give you more detail per dollar than any other image storage technology. Pictures come out clear, clean and bright. In ten different shades of gray.

Hughes memories will store slow-scan pictures, graphics and random vectors, then replay the complete assemblies. Scan rates can be changed and storage time selected.

And because Hughes gives you higher quality memories, we can offer you a wider range of applications. Applications like these:

**RADIOGRAPHIC PROCEDURES:** Our memories store either reference or live images during medical radiographic procedures. Certain techniques like multiple image storage and video mixing, may be used to facilitate rapid diagnosis.

**VIDEO PHONE LINKS:** Now you can have transmission of video data over voice-grade telephone lines and other narrow-band communication channels. Our systems convert the stored picture to slow scan format at the transmitter and reconstitute it at the receiver.

**INFORMATION-RETRIEVAL SYSTEM:** Our systems provide receiver-terminal storage for closed circuit television. The transmission of individual frames of information, rather than a continuous stream of TV pictures, permits time-shared use of the communication channel.

**MEDICAL IMAGING:** Hughes systems assemble slow-scan pictures for TV monitor viewing for use in thermal imaging, ultrasonic scanning and nuclear imaging. The image is built up line-by-line, and may be viewed during the assembly process or after completion.

**COMPUTER-AIDED INSTRUCTION:** Our image memory systems provide high



resolution storage of computer-generated information for use with TV monitors, video projectors and hard-copy devices. The video format of the output signal is particularly useful in classroom settings.

**VIDEO TO SLOW-SCAN CONVERSION:** Hughes systems easily convert video information to slow-scan format to drive electromechanical printers. Information is "frozen" in the memory and extracted at a rate which is synchronous with the printing mechanism.

**TWO-WAY CABLE TELEVISION:** Our systems facilitate interactive use of cable television. With single-frame storage and a simple key set, these systems add a new dimension to the TV communications medium.

**YOUR APPLICATION GOES HERE:** Write 6855 El Camino Real, Carlsbad, CA 92008. Or call (714) 729-9191.



**Creative Image Processing**

Circle 35 on reader service card

interface control and sequencing logic of the CROM chip. But it allows the user to substitute his own microcode in PROM—alterable through fusible links—rather than through the unalterable mask program of the CROM.

FACE, its associated memories and other development aids constitute National's new Microprocessor Development System, which will be sold as a three-board unit, says Philip Roybal, microprocessor development manager at the semiconductor company's headquarters in Santa Clara, Calif.

The microprogram control logic board contains the FACE chip, 512 by 23 bits of bipolar PROM, and an interface cable that connects the board to the CROM socket in a microprocessor system. With this board connected, the RALUs and other processor elements communicate with the FACE in the same way they would do if the CROM were in place.

The second board is a writeable control store, used with the MCL board during microprogram debugging. This board contains 512 by 23 bits of read-write memory, in which the user writes his microcode. The microcode is written in symbolic language, assembled with a micro-assembler, and loaded into the WCS from the processor's main memory through the input/output bus. Control is then transferred to it so that the new microinstructions for the system can be executed and debugged.

During the debugging process, the user can easily alter microcode within the WCS. And then, once he has confidence in his code, he can transfer it to PROM for more lengthy evaluation in a test-bed microprocessor system. It is even possible, Roybal says, to use the MCL board with microcode in PROM in a limited production run to gain experience before committing it to masks for a CROM.

The third part of the Microprocessor Development System is the display and debug unit, a circuit board which manipulates and displays the microprogram control signals being fed back into the proces-

## News briefs

### **NOAA will add remote weather stations**

The National Oceanic and Atmospheric Administration is getting set to install 70 Remote Automatic Meteorological Observing Systems (Ramos) at a cost of about \$2.5 million. Dorsett Electronics division of La Barge Inc., Tulsa, Okla., has received an initial \$826,000 contract for developing and producing 21 Ramos units. An additional 49 units may be ordered later.

Each terminal consists of a 20-foot tower, various exposed weather sensing devices, and two electronics packages—one for communications, the other for generating data. A satellite communications link with a central processing station is planned for some units, while others will communicate over land-based radio. Some units will also be tied into the telephone system for direct contact with the central processor.

### **FBI orders fingerprint systems**

After almost a decade of research and development, the FBI has awarded a \$4.7 million contract for five automatic fingerprint matching systems called Finder to Rockwell International's Autonetics division, Anaheim, Calif., which beat out Calspan Technological Products Inc., Buffalo, N.Y., the only other bidder. [*Electronics*, September 13, 1973, p. 42]

But Calspan officials say that about 50 police agencies have expressed interest in Calspan's system, Fingermatch, which compares fingerprints on file with latent prints retrieved by police.

### **Factory automation may grow dramatically**

Sales of optical pattern-recognition equipment for factory automation may increase 900% from \$1.5 million to \$15 million between 1974 to 1979, says a report from the New York marketing researcher, Quantum Science Corp. Moreover, sales of test equipment may increase 70% from \$181.9 million to \$314.3 million, adaptive controls for machine tools may grow by 390% from \$1.1 million to \$5.4 million, and automatic machine tools, which include numerical and computer-controlled machine tools, as well as robots, may grow 80% from \$296.3 to \$534.4 million. The company also reports that sophisticated software is the biggest need in pattern-recognition and adaptive-control equipment.

### **Dow Corning expands silicon production . . .**

Corning Corp., Midland, Mich., will build a new \$46 million silicon production plant in Carrollton, Ky. The plant will double the company's present capacity for both polycrystalline silicon and semiconductor-grade trichlorosilane. Operation is scheduled to begin in July, 1977.

### **. . . while 3M expands microInterconnects . . .**

3M Co., St. Paul, Minn. is expanding its microinterconnect facility that produces film carrier interconnects [*Electronics*, May 16, p. 89]. It has spent \$2.5 million for production equipment and installed it in its Visual Products division plant, Columbia, Miss.

### **. . . and DuPont is selling its Cerdip facility**

DuPont's Electronic Products division is looking to sell its Cerdip glazed-ceramic-package operation in Danville, Ohio, as the final move in its exit from the semiconductor packaging business. Purchased from Owens-Illinois early last year, the Cerdip line was the only packaging series left at DuPont after the firm stopped making plastic and Multilox multilayer ceramic packages later that year.

### **Stepper motor sales reach \$47 million**

Market researcher ICON/Information Concepts Inc., Philadelphia, says annual sales of stepper motors in the United States are now \$47.5 million, nearly double 1970's figure. Primary applications of these digitally controlled discrete-motion devices have been in computer peripherals, with this area accounting for over 41% of the total.

# THE ODD COUPLER.



If you get a kick out of interfacing between two voltage levels, you're gonna *love* these.

The new NCT 200 and NCT 260 opto couplers from National Semiconductor provide isolation voltages of 2 KV to 3.5 KV (don't you find such a high isolation voltage odd?).

You might also be tickled to learn that the isolation capacitance is 0.5pF... and the typical current transfer ratios 80% (NCT200).

And more couplers are coming in our ever-expanding new opto-electronics line.

Speaking of opto-electronics...

## Our name up in lights.

We knew we could make it in the big time of LEDs and lamps if we just kept plugging away.

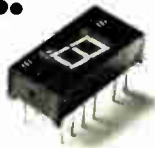

Current highlights include our new NSA series arrays that meet



your 6, 7, 8, 9 (up to 14) digit needs, with or without minus sign, floating decimal and fixed decimal in all the popular combinations.

And a range of new individual single digit LEDs.

And more...with even more coming soon.

For more electrifying details give us a call or write National Semiconductor Corporation, 2900 Semiconductor Drive, Santa Clara, California 95051.

Inquiries will be processed without regard to race, creed or color.



# NATIONAL

National Semiconductor Corp., 2900 Semiconductor Drive, Santa Clara, Calif. 95051, Scottsdale, Ariz. (602) 945-8473, Mountain View, Calif. (415) 961-4740, Sherman Oaks, Calif. (213) 783-8272, Tustin, Calif. (714) 832-8113, Miami, Fla. (305) 446-8309, Chicago, Ill. (312) 693-2660, Indianapolis, Ind. (317) 255-5822, Lenexa, Kan. (816) 358-8102, Glen Burnie, Md. (301) 760-5220, Burlington, Mass. (617) 273-1350, Farmington, Mich. (313) 477-0400, Minneapolis, Minn. (612) 888-4666, Englewood Cliffs, N.J. (201) 871-4410, Syracuse, N.Y. (315) 455-5858, Dayton, Ohio (513) 434-0097, Dallas, Tex. (214) 233-6801

sor system. This unit, says Roybal, allows the user to observe and interact with his microcode, single-stepping through microcycles and altering them as required.

With the user microcode debugged, the user can send it to National which then prepares a custom-masked CROM. The three-board MDS unit will sell for about \$3,000, according to Roybal, and will be available in sample quantities in November. □

### Automotive

## Congress eases seat-belt interlocks

Congress may be pulling out the comfortable cushion of an expanding automobile seat-belt interlock market from under U.S. semiconductor makers. Semiconductor suppliers, however, profess not to be worried, noting that, for most, interlock modules represent only a small part of total sales and that functions still to be performed in an auto require some type of sequential logic module anyway.

The House of Representatives cast an overwhelming 339 to 49 vote in favor of H.R. 5529, which generally waters down the National Traffic and Motor Vehicle Safety Act of 1966. Among other things, it prohibits the Department of Transportation from issuing mandatory motor-vehicle safety standards on seat-belts. The only exception is for a dashboard warning light, which would flash to warn a driver of an unfastened belt. Unlike the present system, the engine could be started with the seat belt unfastened. A similar bill awaits Senate action.

In addition, the House bill contains provisions that would scuttle the electronics potential inherent in air bags and other passive restraints by eliminating a requirement that they become mandatory in 1977 cars.

**Staying cool.** "We're not losing any sleep over it," declares a spokesman for RCA's Solid State division,

Somerville, N.J., regarding the possibility the Senate bill will also pass and the new provisions become law. Like other suppliers, he does not see the auto business suddenly becoming limited so much as redefined. Interlock business may decline but he doesn't expect over-all sales to decline as well. Spokesmen at Fairchild Semiconductor Products group, Mountain View, Calif., and Signetics Corp., Sunnyvale, Calif., which also supply interlock ICs, aren't upset either.

On the user side, John Webster, manager of electronic production development for the Huntsville (Ala.) division of Chrysler Corp., which supplies all the interlocks for Chrysler and some American Motors Corp. cars, shares RCA's calm. "We have other uses for the C-MOS IC used in the interlock system so that business will continue to be good," he says.

Perhaps most disappointed was Stanley Koppel, executive director of the Center for Auto Safety established by consumer activist Ralph Nader in Washington. He is more against the rule making the air-bag system optional than the elimination of the ignition interlock rule. Koppel observed that passive systems are much less irritating than the seat-belt interlock. □

### Industrial electronics

## Microchip helps identify drugs

Police departments may be using trained dogs to sniff out illegal drugs, but it takes a complex piece of electronics equipment to identify those drugs and figure out their concentrations. Usually the equipment—a spectrometer of some kind—is quite complex and must be operated by a person with a high degree of skill.

But by applying a microprocessor and read-only-memory cards, a Pasadena, Calif., company has developed a simplified spectrometer that's tailored just for identifying a



**Detector.** Microprocessor-based spectrometer makes drug tests automatically.

limited range of contraband drugs. And, once the unknown sample is inserted, the Olfax system (as it is called) can run through its paces automatically, without the need for an operator.

With the complication, if not the mystery, of the spectrometer's operation eliminated, Universal Monitor Corp. hopes the system will attract many new and unsophisticated users. Foremost among potential customers are police departments, anxious to obtain positive identification of hazardous drugs quickly. Or the system could be sold to industrial concerns, for use in various stages of their own processes or to monitor specific pollutants.

**Customized.** Rather than being a general-purpose device for identifying a broad range of substances, the Olfax system is set to identify only 16 different drugs. Thus, the electronics, memory, and hardware, as well as the checking procedures, are held to a minimum. For example, a gas chromatograph, often supplied with a general-purpose spectrometer, is unnecessary.

These factors combine to cut the price of the system to \$50,000. This is some \$30,000 less than competitive minicomputer-controlled systems, claims Robert Hertel, director of R&D at Universal.

The Olfax system consists of a quadrupole mass spectrometer from Technology International with a vacuum system and inlet, plus a preprogrammed microcomputer using





If  
you  
think all card  
readers  
are alike...



take a look  
at  
CONRAC

Take a good, long look before you specify... check and compare all the features offered by the CONRAC A-31 Series Magnetic Card Reader. Here are only a few: • Read or write on Standard Magnetic Cards • Industry Compatible Credit Cards— IATA, ABA, THRIFT, NTT • Card remains stationary and visible at all times—minimizing chances of card loss, damage or jamming • Card-in-place switch—insures proper insertion of card before operation • USA designed and made for OEM applications requiring rugged, long life • All this plus more and it's one of the lowest priced. <sup>500</sup>

Write For Descriptive Literature.

**CONRAC** CRAMER DIVISION  
CORPORATION

Mill Rock Road, Old Saybrook, Conn. 06475  
(203) 388-3574

## Electronics review

an Intel 8008 microprocessor chip and a teletypewriter. The 8008 chip was chosen rather than an assembled microcomputer because the system required special input/output circuits.

The microprocessor also helps in the housekeeping chores needed by the spectrometer. This includes such tasks as calibrating and monitoring the unit's critical temperatures and pressures.

**Identification.** To check a drug, a small sample is dissolved in a solvent and injected into the input section. Liquids do not normally need any preparation. Under computer control, the sample is vaporized and introduced into the mass spectrometer. Output data, in the form of characteristic spectral lines, is then compared to line signatures stored in the preprogrammed ROM cards. Material in quantities as small as 10 to 100 nanograms may be detected.

Initially, a light flashes, indicating the presence of a specific drug, such as heroin. But in addition, the instrument can display numerical data, and the teletypewriter can print specific results in numeric or graphic form.

Other substances can be added to the library of compounds, which now includes such street drugs as cocaine, phenobarbital, amphetamine, mescaline, benzocaine, and heroin. In tests in a police laboratory, only one error has occurred in three months, Hertel says. □

## Consumer electronics

### Bowmar introduces digital LED watch

Admittedly suffering from a sag in consumer calculator sales, Bowmar/ALI of Acton, Mass., which at one point had rocketed to the top of the heap in that business, is out to broaden its consumer product line. Bowmar has jumped into the digital-watch business—another competitive consumer market.

The first entry is a man's LED

model that will sell for \$300-\$400. But James W. Clifton, vice president and general manager of Bowmar Arizona Inc., the company's recently built MOS facility, looks for digital watches to retail for \$49 by 1978. "This one," he says of the LED model, "is just the start of a line." To cover all display options, the company is "looking into" liquid crystals and is doing research and development on electrochromics in Canada.

The Chandler, Ariz., MOS facility will make the C-MOS circuits for the watch line. "We've begun processing 3-inch wafers," says Clifton, an ex-Texas Instruments display hand, "and we expect to reach our goal of 15 to 20 good dice per wafer in time to be turning out production quantities by the first quarter of 1975." He says electronic-watch sales haven't taken off as rapidly as predicted earlier because of a shortage of C-MOS.

**Risk.** Bowmar Arizona, meanwhile, represents risk as well as hope for Bowmar/ALI, whose early lead in consumer calculators is generally regarded as having been snatched away by TI. To capture the circuit-making capability considered critical to future good health in the calculator business, Bowmar has had to invest \$7 million in the Chandler plant at a time when it was reporting losses of \$143,000 for the quarter ended June 30. For the same period last year, it reported a \$2.2 million profit. Clifton predicts that p-channel MOS circuits for Bowmar calculators will be coming from Chandler in production volume in November.

Bowmar is not making its own watch chips yet but is buying from two other producers. As Clifton puts it: "If we can buy them cheaper elsewhere, we'll do it." □

### Goldmark markets music-teaching aid

The first consumer electronics product to take the stage at Peter Goldmark's R&D company, Goldmark

## FAST RECOVERY POWER RECTIFIERS

Reverse Recovery ( $T_{rr}$ ) 200ns and 2 $\mu$ s

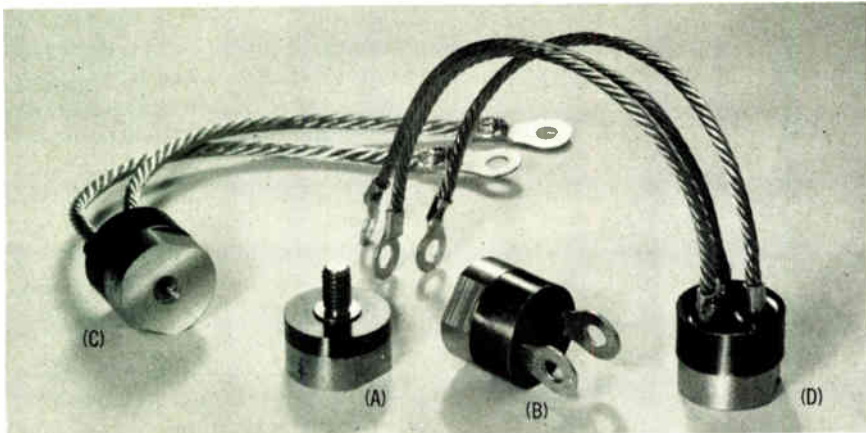

## CUPAC 150

... the power house

CuPac 150 is specifically designed for high frequency-high power applications. CuPac 150 is capable of supplying up to 150 amperes with proper heat sinking. Available as half wave rectifier, doublers, center taps and three phase half wave bridge circuits.

Internally, CuPac 150 utilizes Semtech's Metoxilite rectifiers mounted on an (OFHC) oxygen-free hard copper insert base. Inherent rugged design and reliability enables the CuPac 150 to be used in stringent commercial, industrial, military and space applications.

Body Dimensions: 1.12" D x .70" H (+ stud)

**FAST RECOVERY** — ( $T_{rr}$ ) 200ns. (Fig. A)  
Peak Inverse Voltage: 50, 100, 200 & 400V.  
 $V_F$  (max.) (@ 100A): 1.40V,  $T_j$  @ 25°C; 1.35V,  $T_j$  @ 100°C.

Reverse Current (max.) @ PIV:  
25 $\mu$ A @ 25°C; 1 MA @ 100°C.

**MEDIUM RECOVERY** ( $T_{rr}$ ) 2  $\mu$ s.  
PIV: 50, 100, 200, 400, & 600V.  
 $V_F$  (max.) (@ 100A): 1.22V,  $T_j$  @ 25°C; 1.17V,  $T_j$  @ 100°C.

Reverse Current (max.) @ PIV:  
25 $\mu$ A @ 25°C; 1mA @ 100°C.

## CUPAC 150, LO-V<sub>F</sub>

Peak Inverse Voltage: 30 & 50V.  
Reverse Recovery: 85ns (typ.) & 100ns (max.)

• 1/2 WAVE RECTIFIER

	@ 25°C	@ 100°C	@ 150°C
$V_F$ (typ.) @ 20A	.86V	.77V	.72V
$V_F$ (typ.) @ 60A	.95V	.88V	.85V
$V_F$ (typ.) @ 100A	1.02V	.97V	.93V

• DOUBLERS & CENTER TAPS

	@ 25°C	@ 100°C	@ 150°C
$V_F$ (typ.) @ 10A	.86V	.77V	.72V
$V_F$ (typ.) @ 30A	.95V	.88V	.85V
$V_F$ (typ.) @ 50A	1.02V	.97V	.93V

• 3 PHASE 1/2 WAVE BRIDGE

	@ 25°C	@ 100°C	@ 150°C
$V_F$ (typ.) @ 5A	.86V	.77V	.72V
$V_F$ (typ.) @ 15A	.95V	.88V	.85V
$V_F$ (typ.) @ 25A	1.02V	.97V	.93V

• DOUBLERS & CENTER TAPS Figs. (B) & (C)

Body Dimensions: 1.12" D x .9" H (+ leads).  
**FAST RECOVERY** ( $T_{rr}$ ) 200ns  
PIV: 50, 100, 200 & 400V.  
 $V_F$  (max.) (@ 50A): 1.40V @ 25°C; 1.35V @ 100°C.  
Reverse Current, per leg (max.):  
13  $\mu$ A @ 25°C; 500  $\mu$ A @ 100°C.

**MEDIUM RECOVERY** ( $T_{rr}$ ) 2  $\mu$ s.  
PIV: 50, 100, 200, 400 & 600V.  
 $V_F$  (max.) (@ 50A): 1.22V @ 25°C; 1.17V @ 100°C.  
Reverse Current, per leg (max.):  
13  $\mu$ A @ 100°C; 500  $\mu$ A @ 100°C.

• 3 PHASE 1/2 WAVE BRIDGE Fig. (D)

Body Dimensions: 1.12" D x .9" H (+ leads).  
**FAST RECOVERY** ( $T_{rr}$ ) 200ns  
PIV, per leg: 50, 100, 200 & 400V.  
 $V_F$  (max.) @ 33A: 1.40V,  $T_j$  @ 25°C; 1.35V,  $T_j$  @ 100°C.

Reverse Current, Per Leg @ PIV:  
10  $\mu$ A @ 25°C; 350  $\mu$ A @ 100°C.

**MEDIUM RECOVERY** ( $T_{rr}$ ) 2  $\mu$ s.  
PIV, Per Leg: 50, 100, 200, 400 & 600V.  
 $V_F$  (max.) @ 33A: 1.22V,  $T_j$  @ 25°C; 1.17V,  $T_j$  @ 100°C.

Reverse Current, Per Leg @ PIV:  
10  $\mu$ A @ 25°C; 350  $\mu$ A @ 100°C.

## NEW "STUD"

... Super stud rectifier



Semtech Corporation introduces the DO-5 Stud, a new series of high current silicon stud rectifiers for high frequency applications. Capable of supplying up to 50 amperes with proper heat sinking, the DO-5 Stud has been specifically designed for industrial, military and space applications.

Metoxilite rectifiers are used internally, the base is a DO-5 configuration and terminals offer easy soldering properties.

Body Dimensions: .69" D x .45" H.

**FAST RECOVERY** ( $T_{rr}$ ) 150ns  
PIV: 100, 200, 300 & 400 V.  
IR (@ PIV), Per Leg: 13  $\mu$ A @ 25°C; 500  $\mu$ A @ 100°C.  
 $V_F$  (max.) @ 50A: 1.40V @ 25°C; 1.35V @ 100°C.

**MEDIUM RECOVERY** ( $T_{rr}$ ) 2  $\mu$ s.  
PIV: 100, 200, 300, 400 & 600V.  
IR (@ PIV), Per Leg: 13  $\mu$ A @ 25°C; 500  $\mu$ A @ 100°C.  
 $V_F$  (max.) @ 50A: 1.22V @ 25°C; 1.17V @ 100°C.

## LO-V<sub>F</sub> "STUD"



... Low forward voltage drop.

LO-V<sub>F</sub> stud rectifier is specifically designed for high frequency, high power applications.

**VERY FAST RECOVERY** ( $T_{rr}$ ) 100 ns.  
Peak Inverse Voltage: 30V.  
@ 25°C @ 100°C @ 150°C  
 $V_F$  (typ.) @ 10A .86V .77V .72V  
 $V_F$  (typ.) @ 30A .95V .88V .85V  
 $V_F$  (typ.) @ 50A 1.02V .97V .93V

"We're number 1 because we try harder"



**SEMTECH CORPORATION**

652 Mitchell Road, Newbury Park, California 91320  
(805) 498-2111, (213) 628-5392 / TWX: 910-336-1264

CHICAGO: (312) 352-3227  
DALLAS: (214) 253-7644  
FLORIDA: (305) 644-5404  
NEW JERSEY: (201) 654-4884  
SAN FRANCISCO: (415) 328-8025  
EUROPEAN SALES: (Switzerland) (042) 323-242

# Mod Squad



Sorensen's new generation of modulators—PTM series pass DC power supplies in both single and dual output versions. Now 33 models in the squad—and every one packs *more* power into *less* space than comparable modulators—at low, low cost per watt. New outputs ranging from 12 to 170 watts (2.8 to 29 volts) . . . built-in overvoltage protection . . . low noise and ripple . . . automatic current limiting . . . exceptional operating reliability are the major PTM features. For complete data, contact the Marketing Manager at Sorensen Company, a unit of Raytheon Company, Manchester, N.H. 03103. (603) 668-4500.

## Representative Specifications—PTM

Regulation (comb. line & load)	0.05% + 5 mV (single) 0.02% (dual)
Ripple (PAR)	rms: 1 mV p-p: 5 mV
Temp. Coefficient	0.01%/°C or 1 mV/°C whichever is greater
Prices	\$85 - \$190

**Sorensen**  
POWER SUPPLIES

Communications, Stamford, Conn., is a music student's tape cassette system that adds novel variations to the popular notion of "play along with the professionals."

Actually, the Music Learning System is a joint enterprise with Warner Bros. Publications Inc., the music publisher, and Goldmark, the father of the long-playing record. MLS can be used with any instrument or for voice practice.

A specially designed tape player enables the musician to accompany the sound from a four-track tape control. Of the design of the player, a Goldmark spokesman will say only that special integrated circuitry handles the electronic switching, making MLS a four-track cassette system capable of playing all four tracks in any combination. Usually, such multi-track tape systems play just one track at a time.

Each of the four tracks of the Goldmark system has a different purpose. On the first is an ensemble prerecorded without solo instrument or voice. The second is a soloist track, prerecorded with the instrument alone so the student can hear how the composition could be performed. An Index Voice track, containing electronic signals, voice instructions, and beats coordinated with special MLS sheet music, is the third. Fourth is a track for recording the student's performance for comparison with professional artists.

In practicing, the student would first listen to the ensemble and soloist tracks played together, then play the soloist track alone to hear his particular instrument without the accompaniment. He then goes to the ensemble track and plays along with the professional group.

**Playmate.** Any combination of four tape tracks can be played on music aid.



**If you are  
serious about  
solving EMI  
problems...**

**If not...**

**...this  
Designer's  
Kit is FREE!**



**...it'll  
cost you  
\$35.00**



## **New Designer's Kit on EMI Filters and Systems Engineering Services.**



These Kits are in production now . . . and quantities will be limited.

To reserve your EMI/EMC Designer's Kit #2...write, on your letterhead to Marketing Communications, Cornell-Dubilier Electronics, 155 Avenue L, Newark, NJ 07101 or call (201) 589-7500, extension 480.

This is the most comprehensive package of helpful, useful, and practical information concerning Electro-Magnetic Interference ever offered! To the serious designer, it's free . . . on letterhead request only . . . and for a limited time.

### **This is what it contains:**

- Reactance Slide Rule
- 44 page EMC Solutions brochure
- All Purpose Filter Catalog
- Useful Engineering Data Product Sheets
- Government Interference Restrictions brochure
- Article Library . . . containing reprints of recent technical articles from major publications
- Application Engineering Questionnaire
- And More

**CDE** **CORNELL-  
DUBILIER**

155 Avenue L, Newark, N. J. 07101

CDE — The People to People Company  
— the mark of quality is on everything we make.



See our Filter Demonstration in Booth 2422/3 at Wescon

## **Grumman hose nozzle going great guns**

With Grumman Aerospace Corp.'s financial problems making the front pages of newspapers across the country, it must be nice for company officials in Bethpage, N.Y., to note that their electronic fire hose nozzle is selling like, well, wild-fire. Prototype nozzles, which enable a fireman directing a water stream to control its flow right at the nozzle, are in operation in New York City and Long Beach, Calif. A three-month field trial has just ended in New York while the nozzle is in actual use in Long Beach. According to George Nelson, project engineer for the NPO (nozzle pump operator) system, it is so successful that Grumman is going from hand-wired prototypes into full automated production. New York City is expected to be a major customer, and Grumman has received letters of intent for 27 more NPOs from other cities.

## **Six TRL parts out, 5 to 10 more due**

Proving that it's possible to teach an old logic new tricks, Motorola Semiconductor has introduced six parts using its TRL (transistor-resistor logic) circuitry. A modification of conventional TTL that can produce very dense and complex bipolar circuits, TRL's gate structure adds input resistors to a Schottky transistor [Sept. 27, 1973, p. 29]. Motorola says that both 160- and 400-gate arrays are on the market—the latest is the MC8520 deskewing-cuing register—with five to 10 additional parts expected in the next year. The company is also producing custom TRL for applications as different as telephone answering and slot machines.

## **Corvus sailing along with fishing helpers**

A Texas calculator maker has gotten its hook into a big fish and has no intention of letting it get away. The company, Corvus Corp., a subsidiary of Dallas-based Mostek Corp., introduced a line of electronic aids for fishermen last year [Sept. 27, 1973, p. 34] to be marketed by sporting-goods giant Garcia Corp. Since then, despite a strong push into calculators and clocks, Corvus's output of the gear has doubled. "The Garcia business is a good stable 20% to 25% of Corvus, and it helps smooth out the seasonality of our calculator business," says Berry Cash, executive vice president of Mostek. Meanwhile, plastic tooling problems held up deliveries of the top-of-the-line chart-recording fish finder until June, but a new oxygen-temperature probe received an excellent reception "not only by fishermen, but by environmental agencies as well," he says.

## **Ballpoint computer entry device headed to market**

A ballpoint pen that can enter data in a computer is writing itself right into the market.

Developed at Stanford Research Institute [Sept. 27, 1973, p. 30], the pen has been described by its inventor there as able to do "anything a Rand tablet can at a cost of tens rather than thousands of dollars." Xebec Systems Inc., a Sunnyvale, Calif., computer peripherals firm, has been licensed to develop and market the Alphabec-70, as the pen is called. Xebec plans to have the first set of evaluation models in customers' hands by the end of the year, says Kenneth Scott, product manager. He expects the pen to displace many computer processing methods now used in such areas as accounting, banking, and meter reading. The pen is linked to a computer that automatically reads back, both digitally and verbally, the information it has scanned.

## **GI now shipping its n-MOS devices**

General Instrument said a year ago [Sept. 27, 1973, p. 33] that it would start selling a custom n-channel MOS 16-bit parallel-processor-unit chip around January. The metal-gate part actually wasn't ready until May, but at the same time GI started shipping ion-implanted n-MOS memory and peripheral circuits for microprocessors. Still to come are an 18-channel analog multiplexer and a 5,120-bit ROM.

## **Path smooth for MOS oil-truck calculator**

Say "oil" in a crowded room and chances are you'll hear everything from a condemnation of giant oil companies to an explanation of why last winter's gasoline crisis was really the consumer's fault. But say "oil" in the Hatfield, Pa., operation of Emerson Electric Co. and chances are you'll see nothing but smiles. The reason: Emerson makes an MOS-based transaction computer for oil trucks [Sept. 27, 1973, p. 38] that is selling so well, says the company, that it plans to build a bigger system for transport tank trucks. The present device replaces electromechanical calculators and performs such chores as tracking the volume of oil being delivered and printing out a bill based on the per-gallon price.

## **IEEE adding second congressional fellow**

If one is good, figures the IEEE, then two are better. So the organization, happy with its congressional fellow program, plans to have two fellows for the next term of Congress. This year's program, an IEEE response to membership pressure [Sept. 27, 1973, p. 38], saw Ronal E. Larson, a Georgia Tech associate EE professor, working mainly on the House side. He served with an energy subcommittee as an adviser on subjects for which an understanding of electrical engineering is important.

—Howard Wolff

# This is why...

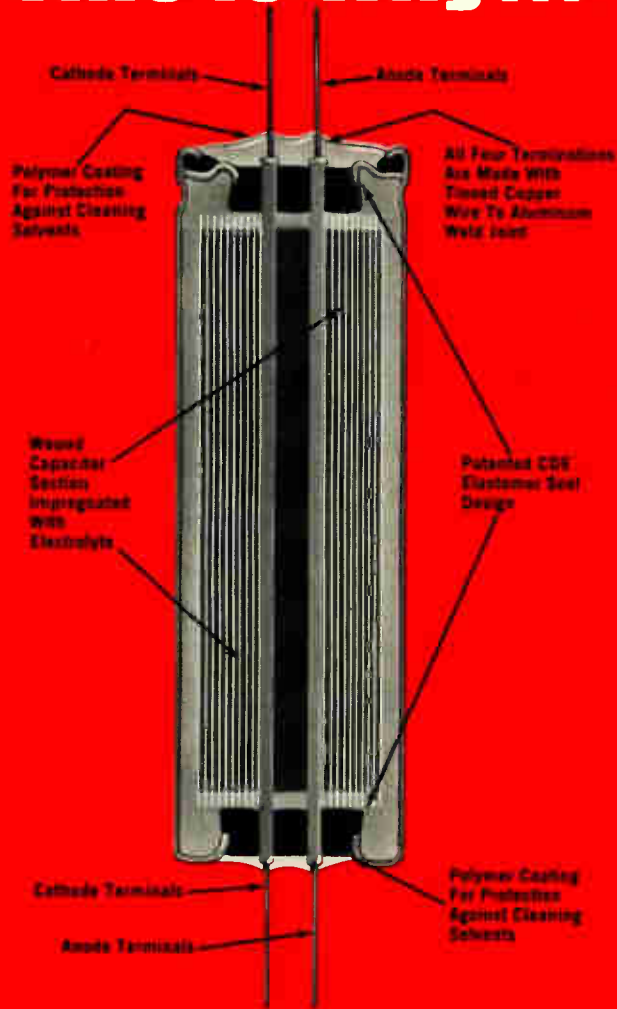

# this is Best...

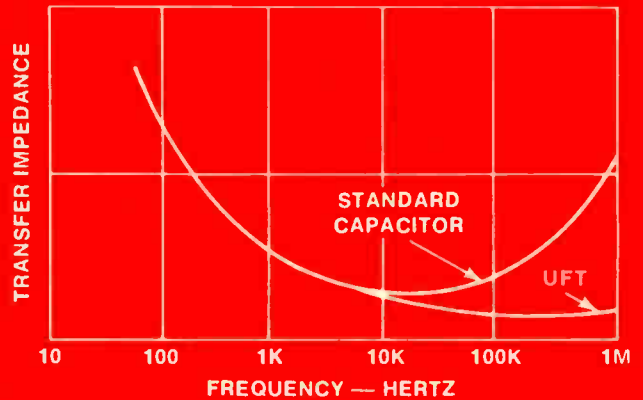

**DESIGNER'S KIT #1** — for those really serious about designing power supplies. Here's what you get: 12 pg. brochure, Designing Switching Regulators, giving theory of operation, detailed description, schematics, curves and component selection ... Application and Designers notes ... Engineering Inquiry and Sample Request Form ... a Library of Article Reprints of recent technical articles describing power supply design ... Construction features of the UFT ... detailed specification brochure ... and more!

**YOURS ON LETTERHEAD REQUEST ONLY!!!**

## FILTER NETWORK...

Provided by Unique Construction Assures Low Inductance at high frequencies

CDE leads the way again...with the development of the most advanced aluminum electrolytic capacitor, the UFT. This 4 leaded construction offers new design freedom... with low transfer impedance at high frequencies. Applications are growing. However, one of the most significant is switching regulators. These high efficiency power supplies have typically been plagued with noise problems. The UFT offers great isolation from ground loops, excellent noise filtering for both source and output voltage... with a transfer impedance that actually decreases above 10 KHz. There's an 8 page data sheet that details all the specs, yours by circling the reader service number. BUT, if you're really serious about designing power supplies, we'll send you our DESIGNER'S KIT #1...yours on letterhead request only.



150 Avenue L, Newark, N. J. 07101

See our Filter Demonstration in Booth 2422/3 at Wescon.

Circle 210 on reader service card

CDE — The People to People Company  
— the mark of quality is on everything we make.



# THE FAMILY THAT PLAYS





# TOGETHER.

Hardware compatibility.

You rarely see it on an RFQ.

Nobody talks much about it.

End users couldn't care less about it.

But the pros know. Volume users who have been the computerization route can tell you all about it.

A lot of them got smart the hard way when somebody sold them stripped-down end-user minicomputers.

They looked a lot like our NAKED MINI®. Stripped down price included. Impressive specs, too. But let's face it, mainly it had a big name on it. Somehow that instills confidence.

But if you're going to put your faith somewhere, it had better be in hardware designed expressly for product computerization. Because you're going to live with it for a long, long time. For better or worse.

What's the difference?

Plug-in interchangeability, for one thing. The NAKED MINI has it. No fine-tuning, adjustments, or calibrations. You pull out the old one and put in the new one. Just like a light bulb.

That's the way it has to be. Volume users can't afford the time and energy it takes to fiddle around with a system out in the field. In the first place, it hurts profits. And in the second, it gives their customers a big, fat pain in their profits, too.

There's an even bigger difference. The entire family of NAKED MINI's are totally compatible. Which means, simply, that when your product changes (and it will), you can easily change to a different machine. Faster or slower. Bigger or smaller. For example, the lowest cost LSI-1, or the twice as fast LSI-2/10, or the four times as fast LSI-2/20.

The mechanical interface is the same on all of our machines. The original programming will still work.

We've always built our machines that way. We always will.

Because we understand the problem.

 **ComputerAutomation**  
Naked Mini. Division

18651 Von Karman  
Irvine, California 92664 (714) 833-8830

Circle 212 on reader service card

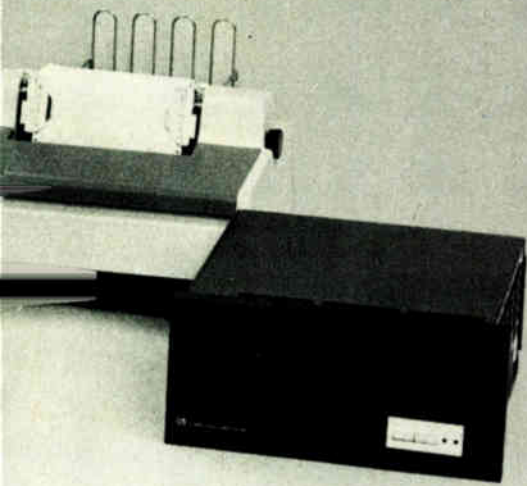

# AIRPAX™

## TYPE 209 E-Frame Circuit Breakers

Airpax Type 209 molded-case circuit breakers are designed for use by the original equipment manufacturer. The hydraulic/magnetic principle provides stable trip points over a wide ambient temperature range. Typical applications include: refrigeration, air conditioning, power supplies, computers, and others.

### Features:

U.L. listed for branch circuit protection.

Current ratings to 100 amperes.  
Voltage: 125V ac, 120/240V ac,  
240V ac, 277/480V ac

Construction: Series, relay, shunt, auxiliary switch.

Termination: Solderless connector, screw or stud terminals.

Time Delays: Instant, short, medium, or long



### Here's the inside story of the Airpax Type 209 Circuit Breaker:

#### Solderless Connector –

Accepts 14-0 copper and 12-0 aluminum wire. (Also available with back connected stud terminals)

**Mounting Foot** – Provides for versatility and ease in mounting.

#### Contact Terminal –

Self-cleaning contacts, sliding under pressure, insure low resistance and long contact life.

**Arc Plate** – Additional arc extinguishing feature.

**Hydraulic-Magnetic Unit** – Accurate protection throughout ambient temperature range.

**Barrier** – Integral part of molded case.

**Arc Chamber** – Ten positioned metal baffles and screen to quickly diffuse and extinguish arc.

**Inertia Wheel** – Prevents nuisance tripping due to inrush currents of 20 times breaker rating without affecting delay curve.

**Handle** – Definite ON-OFF positions. Automatic reset.

**Mechanism** – Positive latching with trip-free construction. Balanced armature. Moisture-resistant finishes.

Airpax Electronics  
Cambridge, Maryland 21613  
Phone (301) 228-4500

# AIRPAX™

Cambridge Division

Want to know more about these compact, competitive Type 209 breakers? Write for Airpax Bulletin 2012.

## **Grumman's F-14 woes aid prospects of lightweights**

**Four new U.S. fighter planes and their potential for multimode avionics systems in a lightweight airframe got a significant lift early in August** after the Senate stymied Grumman Aerospace Corp.'s production of the F-14 Tomcat fighter by rejecting a \$100 million Navy loan to the contractor, calling it a "bailout." And even if the Iranian government, which has 80 F-14s on order, is allowed to lend Grumman the money, congressional sources say that both houses see stronger U. S. defenses if the Pentagon pushes for procurement of larger numbers of less expensive planes like the **General Dynamics' YF-16 and Northrop' YF-17** now in competitive development, as well as the **Air Force's Air Combat fighter and the Navy's Advanced Technology Fighter still on the services' drawing boards.**

Sen. Barry Goldwater (R., Ariz.), long-time friend of the military, proved a key factor in shooting down the loan for the F-14. He complained about its high unit cost, noting that, while it might be better than the F-16 or F-17, it is "not better than three or four of them, which is what we could buy for the same price." **F-14 unit costs for a 334-plane buy will be \$19.8 million, compared to the much lower \$11.1 million per plane for 749 F-15s.**

## **FAA to hold low-bid contractors accountable**

**Burroughs Corp. will not be able to recoup any losses it may encounter on the \$7.6 million Automated Radar Terminal System-II contract** from "add-ons or change orders," say Federal Aviation Administration officials. Administrator Alexander Butterfield, having pledged new management initiatives to prevent cost overruns, disclosed his plan for **new centralized control of FAA programs** at a hearing called by the House subcommittee on Government activities to review the **cancelled \$77 million electronic-voice-switch contract with Philco-Ford Corp.** Philco had underbid its competitors by more than \$13 million, though North Electric had a higher technical rating, FAA officials said at the hearing. Burroughs' major competitors for the ARTS II system bid at least \$18 million [*Electronics*, June 27, p. 29].

The electronic voice switch would have enabled the FAA to operate its own communications system between air-traffic-control centers at substantially less cost than leasing AT&T lines. FAA is reviewing the project to determine whether to scrap the entire concept—Butterfield emphasized at the hearings that the system was not yet needed—or re-bid it. Present indications are that **an inflation-conscious Congress would not approve funding a system in the immediate future that would cost more than \$100 million.**

## **Patent Office drops plans to computerize files**

After 16 years of research and development projects, the Patent Office has **given up trying to computerize its entire file of 20 million ideas.** Costs for a full operational system were estimated at more than \$40 million, says Patent Office Commissioner C. Marshall Dann. Also, according to a recent National Bureau of Standards study, the office's research had been unable to solve technical problems in storing and retrieving the information, and several trillion bits would be needed to computerize the whole file. Dann said the office would **continue computerizing parts of its system**, including trademark files and subject indexes.

## Technology transfer and Comecon, Part 1

Among the many summer events that went virtually unnoticed in a nation traumatized by Watergate was the testimony presented to the Senate late in July by two semiconductor industry leaders—Texas Instruments' J. Fred Bucy and Fairchild Camera & Instrument Corp.'s C. Lester Hogan—on trade and technology transfer with the Soviet Union and its allies. Following are excerpts of the Bucy position, with which this writer generally agrees [Electronics, Aug. 8, p. 52]. *Excerpts from Hogan's testimony will appear in the next issue.* —Ray Connolly

Traditionally, U. S. high-technology firms have secured an effective market share in foreign trade by one of or a combination of three ways: 1) by operating a manufacturing facility in the market to be served; 2) by exporting products into the market; and finally, if the first two are not available, 3) by receiving royalty payments on the products, manufacturing methods, or service.

Note that in each of the three above cases, payment is directly related to each item produced or is derived from participation in market share. In this way, the purchaser of high-technology products effectively finances the innovator's new research and development.

It is quite different for an innovator to sell know-how to an existing competitor or to create a new competitor. After the lump sum payment has been made for a turnkey know-how sale, the innovator of know-how generally will not receive enough future compensation for products produced by the purchaser to compensate him for the loss of market share or to finance sufficiently the needed new technology.

### The exclusivity whipsaw

Let me outline a typical "deal" which the Communist countries want to make with the U.S. high-technology firms. It goes something like this: "We will provide the labor and the building for a production facility. You provide the basic technology know-how, the product design, the manufacturing know-how, the equipment necessary to establish production, and train our engineers and technicians. We will repay you for your investment and your technology with your own products which we will be manufacturing with your know-how in our facility."

There's often the following type of sweetener: "We'll purchase all our product needs from you exclusively while your turnkey facility is being built, and even after it is producing, we will purchase exclusively from you whatever

parts of our requirements we cannot manufacture ourselves."

This "carrot" of an exclusive or closed market is, in my opinion, a rather illusive one. It takes a great deal of gullibility to believe that a Communist country, once it has the know-how to produce integrated circuits, for example, will not increase its capacity enough to fill its own needs. Furthermore, Communist nations use this "come on" as another opportunity to "whipsaw" one company against another and even one country against another. The victims are enticed by the lure of an exclusive market and [also] threatened with exclusion from it.

The only defense the U.S. and its allies have against being "whipsawed" out of their technological lead over the Communist countries, is the revitalization and the strengthening of Cocom [the Coordinating Committee made up of NATO nations, less Iceland, plus Japan]. Indeed, if the United States does not recognize the dangers of technological know-how sales, the "whipsaw" strategies will intensify and cause the final demise of Cocom. There seems to be very little reason why [the semiconductor] industry should make its know-how available to Communist countries. There is certainly no great economic reason for it.

### Market potential

The total semiconductor market in Eastern Europe and the Soviet Union combined is estimated to be about 10% of the free world market, growing to 16% by 1980. However, only a small portion of the total Comecon market would be available to Western manufacturers. The Soviet Union and Eastern European countries largely have adequate capabilities for discrete semiconductor devices.

Their total integrated-circuit market is quite small. By 1975, it is estimated to be less than \$200 million, growing to over \$600 million by 1980. Again, only a small portion of this market would be available to Western manufacturers. [Deducting military requirements and assuming Communist manufacturers serve half the nonmilitary market,] then the available IC market would only be about 2% of the worldwide IC market in 1974, growing to \$360 million or about 7% in 1980.

Thus, the "pot of gold at the end of the rainbow," which is supposed to exist for semiconductor sales, may prove to be a very small container indeed. The loss of this Comecon market will certainly not cause any financial problems for U.S. companies or indeed for the total free world semiconductor industry.

# COMPLETE

# 10 BIT DAC

# ON A SINGLE CHIP!

SIMPLIFIED SCHEMATIC AND PIN CONNECTION DIAGRAM

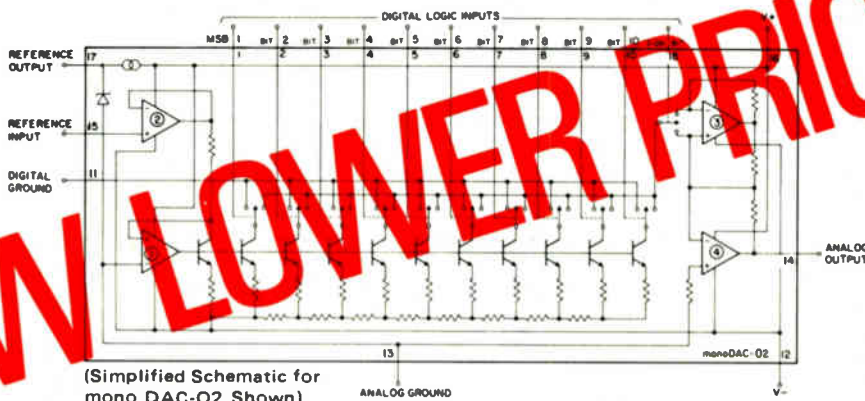

**NEW LOWER PRICES!**

A complete 10-Bit plus Sign D/A Converter on a single chip! No need to add complex external precision voltage references or output operational amplifiers . . . it's all there, tested and ready to go . . . and, every device is *100% tested for monotonicity at 0°, 25° and 70°C* and receives a 72 hour high-temperature *powered burn-in* to insure the ultimate in quality and reliability. The monoDAC-02's flexible Sign/Magnitude coding allows use in both unipolar and bipolar applications and the

logic inputs are compatible with TTL and CMOS levels . . . external reference capability further broadens application versatility. The monoDAC-02 provides fast 1.5 usec settling, low 225mV power consumption and puts it all together in a compact 18-pin DIP . . . and the best part of the story is monoDAC-02's *new, lower prices* . . . they're waiting for you at your Precision Monolithics stocking distributor . . . call him today!

	Resolution	Monotonicity (Guaranteed, 0° to 70°C)	Price @ 100 pcs.
monoDAC-02DDU1	10-bits + sign	7-bits	\$15.00
monoDAC-02CCU1	10-bits + sign	8-bits	\$20.00
monoDAC-02BCU1	10-bits + sign	9-bits	\$30.00
monoDAC-02ACU1	10-bits + sign	10-bits	\$60.00



1500 SPACE PARK DRIVE, SANTA CLARA, CALIFORNIA 95050  
TEL. (408) 246-9225 • TWX 910-338-0528 • CABLE MONO

**AUTHORIZED DISTRIBUTORS:**

NEW YORK METROPOLITAN AREA Harvey Radio, Woodbury, N.Y.: (516) 921-8700 • NEW ENGLAND AREA Gerber Electronics, Dedham, Mass.: (617) 329-2400 • UPSTATE NEW YORK Harvey Federal Electronics, Binghamton, N.Y.: (607) 748-8211 • NORTHEAST Newark Electronics, Woburn, Mass.: (617) 935-8350 • BALTIMORE-WASHINGTON Whitney Distributors, Baltimore, Md.: (301) 944-8080 • PENNSYLVANIA Hallmark Electronics, Huntingdon Valley, Pa.: (215) 355-7300 • Pioneer/Pittsburgh: (412) 391-4846 • MICHIGAN RS Electronics, Detroit, Mich.: (313) 491-1000 • SOUTHEAST Kirkman Electronics, Winston-Salem, N.C.: (919) 724-0541 • EAST CENTRAL Pioneer/Cleveland, Cleveland, Ohio: (216) 587-3600 • Pioneer/Dayton, Dayton, Ohio: (513) 236-9900 • CENTRAL Hallmark Electronics, Elk Grove Village, Ill.: (312) 437-8800 • Minneapolis, Minn.: (612) 884-9056 • St. Louis, Mo.: (314) 521-3800 • TEXAS-OKLAHOMA Sterling Electronics, Houston, Texas: (713) 623-6600 • Dallas, Texas: (214) 357-9131 • SOUTHWEST Sterling Electronics, Albuquerque, N.M.: (505) 345-6601 • Phoenix, Ariz.: (602) 258-4531 • WEST Westates Electronics Corp., Chatsworth, Calif.: (213) 341-4411 • Sunnyvale, Calif.: (408) 733-8383 • Intermark Electronics, Sunnyvale, Calif.: (408) 738-1111 • Denver, Colo.: (303) 936-8284 • Salt Lake City, Utah: (801) 486-3411 • San Diego, Calif.: (714) 279-5200 • Santa Ana, Calif.: (714) 540-1322 • Almac-Strum, Seattle, Wash.: (206) 763-2300 • Portland, Ore.: (503) 292-3534 • CANADA Intek Electronics, Vancouver, B.C.: (604) 324-6831.

## Matsushita designs bucket-brigade IC for audio equipment

Manufacturers of audio equipment are expected to reap the most benefits from a new LSI bucket-brigade device developed by Matsushita Electronics Corp. The device, the MN 3001, is expected to find many applications in audio equipment as a variable or fixed delay line. What's even more significant, perhaps, is that when sales of the MN 3001 begin in November, engineers will be able to develop new, eminently marketable functions.

The device can obtain chorus and tremolo effects in electronic musical instruments. It can also restore the correct pitch of tape recordings played back faster or slower than the correct speed to accommodate the listener's rate of comprehension. (See p. 87 for more on this concept.)

The device can also be used as a variable or fixed delay in communications systems; to build telephone-time or bandwidth-compression systems that employ techniques similar to the tape-recorder pitch-restoration system; in voice-scrambling systems, and as a large-scale digital shift register.

**Commercial.** MN 3001 has been developed for the commercial market by Matsushita Electronics, a jointly owned subsidiary of Matsushita Electric Industrial Co. and Philips Gloeilampenfabrieken of the Netherlands. Key to successful commercial fabrication of bucket-brigade devices, originally developed by Philips Research Laboratory, is Matsushita's proprietary three-level wiring of its silicon-gate MOS devices.

The complete device consists of 512 dual bucket-brigade stages on a single chip measuring 2.80 by 3.68 millimeters. These two identical sections can be connected either in series to obtain the delay of the total of 1,024 stages in one section, or in parallel to obtain double the output voltage available from one section.

All stages in the device are identi-

cal except for the last few stages and the output drivers, which have been designed to qualify the devices especially for use in audio circuits. The basic device samples the input voltage during half the period of the clock frequency. Voltage pulses propagating through the device also have a duty factor of 50%. Such a waveform, though, has a large clock-frequency voltage component and is therefore difficult to filter so

frequency of 100 kHz. Distortion is less than 2% for input voltages as high as 1.7 v rms, and output voltage is 1.13 v. Maximum delay, with a 10 kHz clock, is 25.6 milliseconds for 512 stages. Power drain is insignificant. At the normal operating levels,  $V_{DD}$  of -15 v, and  $V_{GG}$  of -14 v, and load resistor of 47 kilohms, the power drain of 512 stages is only 4 milliwatts.

The bucket brigade consists of

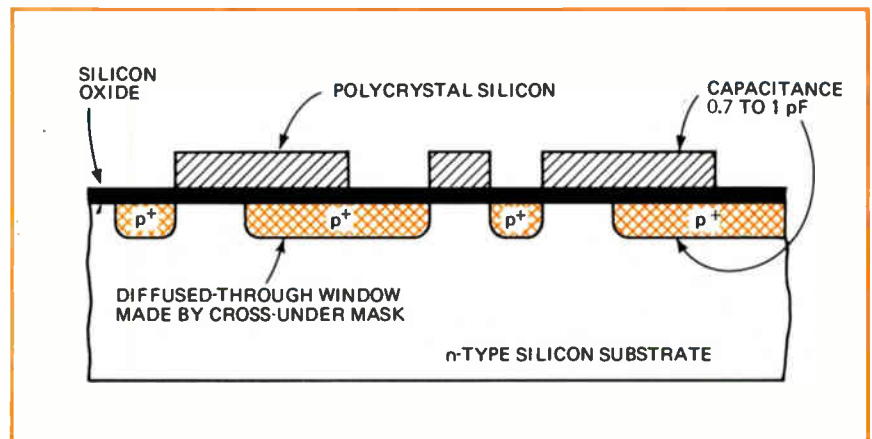

**Bucket-brigade key.** Single region of polycrystalline silicon serves as both gate and electrode of capacitor. Note overlapping cross-under and self-aligned diffusions.

as to obtain the continuous audio waveform needed.

By adding a few more transistors and capacitors, Matsushita engineers have lengthened the output waveform's duty factor to 100%. Pulses delayed by half the period of the clock frequency fill in the intervals between the output pulses of the basic circuit, and the clock-frequency component is eliminated.

The device operates with clock frequencies between 10 kilohertz and 800 kHz. Most devices will operate down to 1 kHz, but they are not guaranteed for operation below 10 kHz. They have good fidelity at frequencies up to one third of the clock frequency.

Response is only down 3 decibels at 30 kHz when operated at a clock

charge-storage capacitors separated by MOS transistors that transfer charges from one capacitor to the next. Intervals of charge transfer are determined by clock pulses. A two-phase clock provides unidirectional flow. Tetrode-MOS transistors increase the isolation between successive capacitors.

Fabricating capacitors is one of the difficulties encountered in making bucket-brigade devices, but Matsushita makes the capacitors without any additional mask steps, which would add significantly to process cost. The first mask step opens windows for cross-under channel diffusion. The p-diffusion is also used to make one electrode of the capacitors. The second step is opening windows for diffusion to

keep source and drain self-aligned with the gate. Matsushita omits the usual mask step to open windows for contacts between polysilicon and diffusion layers. The third step is etching of a polysilicon layer to give a proper pattern for transistor electrodes and interconnections.

In its fourth step, Matsushita makes up for the omitted step. Contact windows for the aluminum wiring are opened up, including windows for aluminum contacts between polysilicon and diffused layers. The fifth step gives the proper pattern to the aluminum wiring, and the sixth and last step removes the glass over the bonding pads to permit bonding the finished chips to the external circuit. □

---

## Hungary

---

# Graphic display may compete in U.S.

For years, export-minded American electronics companies have warned that U.S. restrictions on exports to Eastern Europe would only cause the Communist countries to build up their own competitive industries. Now, it's starting to happen.

At the International Federation of Information Processing (IFIP) congress in Stockholm Aug. 5 to 10, the Computer and Automation Institute of the Hungarian Academy of Sciences displayed for the first time in the West a 24-inch graphic display connected to a Hungarian minicomputer. But more important, Hungarian officials said this display screen will be sent this fall to Control Data Corp. in the U.S.

CDC will evaluate it, and, if it measures up, may start marketing it in the U.S. and elsewhere. The Hungarian unit, known as GD-71, is a medium-price graphic display that the Hungarians say nicely fills a hole in the CDC line.

Hungarian officials made no bones about the effect of U.S. export restrictions, which they say spurred them to produce their own hardware. "We have been developing

## Around the world

### Tiny 20-bit computer churns seismic data

The rush to find new oil reserves in far-flung corners of the world threatens a massive pile-up of seismic data waiting to be processed. But French researchers have come up with a portable large-capacity processor that can handle complicated seismic analyses on the spot. Standard minicomputers, which could be located right at the exploration site are just not adequate, explain Jacques Cretin and Claude Beauducel, two of the team who have built the new machine—dubbed the Geoprocasseur—at the Institut Français du Pétrole just outside Paris. Most minicomputers can not handle seismic data, which usually comes in an 18-bit format.

In partnership with researchers at the Ecole Nationale Supérieure d'Informatique et de Mathématiques Appliquées at Grenoble in the French Alps, IFP has spent four years developing a small computer that can process huge quantities of data as fast as a big computer like the Control Data 6600. What's more, the Geoprocasseur can do it for about one quarter of the price. The machine's designers started from scratch with a 20-bit machine that carries out all the needed processing functions. What's more, microprogramming is one of the key elements in the Geoprocasseur. The machine performs four main functions—fast Fourier transforms, convolution, floating-point conversions, and vector additions.

### Locus terminals process air-traffic-control data

A modular system developed in Great Britain for distributing and processing radar-generated data to individual air-traffic-control terminals may equal or exceed the capabilities of the new centralized U. S. system for medium-sized airports. Marconi Radar Systems Ltd. has devised the Locus-16 system to give each terminal the power to process and generate its own results instead of relying on a huge central computer. The benefits, Marconi says, include the flexibility to meet individual customer requirements and potentially lower cost. The Locus-16 system is being bought in a 29-unit deal expected to be announced shortly by a major United Kingdom authority. The first public display will be at the Farnborough air show early next month.

The system applies intelligent-terminal concepts to delegate some of the computation and generation of display information to the individual terminals. Marconi carries the concept a step further by having each terminal handle its own digitized radar returns, process the necessary data, and the display of information to a controller in forms similar to those of automated systems. What's more, the terminals can be interconnected to trade necessary cooperative information and rely on a central computer to perform protracted calculations and to communicate with other networks.

numerical-control systems for our machine tools, NC-program language, and working with computer-aided component design," one Hungarian said. "We thought we would develop our own CAD software and asked Control Data and ICL [International Computers Ltd. in the UK] for graphic displays. They told us they were not permitted to export.

**Specifications.** The Hungarians did not claim that their display was superior to those of competitors, although it does offer circular-arc generation that is usually found in the high-price range of display units. The display screen is 24 inches in diameter, has a resolution of 1,024 by 1,024 raster points, and its raster

unit measures about 0.35 millimeter. The display has a refresh time of 10 to 100 milliseconds, maximum vector-generation time is 0.16 milliseconds along the full screen diameter, and the maximum length of the vectors that can be represented without flicker is 350 meters. The maximum arc-generation time is 0.25 milliseconds, and the maximum flicker-free arc length is 220 meters.

Among its components are Czechoslovakian-made Tesla transistor-transistor logic circuits and also some Texas Instruments circuits, including some medium-scale integration. The price will be \$60,000 to \$80,000. □

# REI has one question for people who buy electronic test equipment.

## Why?

**When you need it fast . . . rent it.** Purchasing equipment usually involves long delivery lead times. When you rent your electronic equipment from REI it's a safe bet that you can get what you need within 36 hours of the time you call in your order, sometimes sooner. This fast service is possible because we maintain 9 Instant Inventory Centers throughout the U.S. and Canada, stocking millions of dollars worth of equipment.

**When you need it for only a short time . . . rent it.** Need equipment for a short-term project? Rent it from REI. When you don't need it any more, return it to us. It's the easy, low-cost way to use the equipment you need for just the time that you need it.

**When you care about what it costs . . . rent it.** Renting from REI can be less expensive than purchasing. There's no capital investment to adversely affect your company's cash flow. This means you'll get more mileage from your equipment budget. And, since you can treat your monthly payments as an expense in most situations, you'll also achieve tax advantages from renting.

All REI rental equipment is guaranteed to meet manufacturers' specifications and is operationally checked out prior to shipment. Routine maintenance is provided free of charge. Certification and calibration are available upon request. Our flexible arrangements include rental, rental-purchase and leasing packages to give you the use of equipment from one week to three years or more.

Get your free copy of our 1974 catalog that lists virtually every item in our rental inventory. Use reader service card, or write Rental Electronics, Inc., 99 Hartwell Ave., Lexington, MA 02173. For immediate information, call your local REI Instant Inventory Center listed below. Once you rent from REI, you may never buy electronic test equipment again.

## Rental Electronics, Inc.

A **PEPSICO** LEASING COMPANY

Burlington, MA (617) 273-2770 • Gaithersburg, MD (301) 948-0620 • Oakland, NJ (201) 337-3757 • Ft. Lauderdale, FL (305) 771-3500  
Des Plaines, IL (312) 827-6670 • Dallas, TX (214) 661-8082 • Mountain View, CA (415) 968-8845 • Anaheim, CA (714) 879-0561  
Rexdale, Ontario (PLC Leasing Ltd.) (416) 677-7513



**Think about renting.  
It's the smart way to go.**



## **Hard bump ahead for component growth curve**

Europe's components makers are bracing themselves for a hard time next year. Senior strategists at both U.S. and European companies expect a cyclical slump in components business to coincide with both fast rising costs and a general economic slowdown (see p. 31). The result, they say, will be a big drop in sales growth from its zooming 1973-74 levels. Worse still, **one major semiconductor manufacturer forecasts that unit volume sales may even fall below this year's levels.** At the same time, the average sales price is expected to drop fast, as new capacity, launched during the boom of the last two years, begins to outpace failing demand. Some senior insiders are predicting that smaller companies will be in serious trouble and do not rule out the possibility that one or two may be forced out of business.

As in past years, European companies are accusing the U.S. giants like Texas Instruments and Motorola of irresponsible investment policy, but executives at Motorola point out that their company works on a five-year plan, which aims to have those new plants on stream ready to meet the market upswing predicted for 1976-77. **Despite the gloomy forecasts for next year, insiders are looking to a \$2 billion semiconductor market in 1978-79, a \$700 million jump over this year's figure.**

## **UK set makers perplexed over Japanese plants**

Matshushita's announcement that it plans to build a color-TV plant in Wales, coming on the heels of the startup of a Sony plant there, is leaving some British set makers bothered and bewildered over what Japanese intentions really are. "There's no room for two more companies," storms one executive, pointing out that the British color market has gone soft—projected sales are down about a million sets to under 2 million—and not likely to change in the near future, nor can they see Wales as a springboard to European markets where national firms are strongly entrenched.

**One line of thinking holds that perhaps the Japanese misjudged the situation, or that they see Wales as the Taiwan of Europe, and may export sets elsewhere, perhaps back to Japan to beat their own spiraling labor costs.** At any rate, "no one is pleased with the idea," says a company official. Matsushita says the plant will produce 5,000 sets a month when it starts in 1976. **UK components suppliers seem less worried, however, because the Japanese have said they will buy as many local components as possible.**

## **West Germany opts for government control of data net**

West German postal authorities have overridden protests of EDP equipment suppliers and users **by deciding that the federal postal system will have full control over direct-dial digital communications in the country.** The postal ministry will build up lines and facilities for a nationwide electronic data-transmission system at an undisclosed cost by 1980, and a ministry official says that **up to 220,000 terminals are expected to be tied in by 1985.**

**Protests to the plans have centered on the one hand around charges that the ministry will have another price monopoly—in West Germany, the telephone system is also state-controlled and charges to customers are among the highest anywhere.** On the other hand, all equipment at the users' end will eventually be subject to postal approval, raising fears that users will be confined to a narrow choice. Equipment suppliers and users had been pushing for a system in which government

services would be provided on a leased-line basis with a free choice to users on tie-in equipment.

But the postal authorities turned thumbs down on a leasing-based system, saying it would throw its entire business policy in question. German law, it contends, provides for state control of communication systems in all but exceptional cases. **It is still unclear if associations of equipment suppliers and users will go to court to challenge the decision.**

## **Plotter uses ink jets for multi-color display**

A Swedish hard-copy color display system for computer graphics—which uses three jets of colored ink—will go on the market in about a year. The system, developed by a group working under Hellmuth Hertz at the Lund Institute of Technology, **differs from ordinary ink-jet systems in that the entire jet spray is controlled, not just the individual droplets.** This allows for faster ink application: a normal letter-size paper can be printed in complex designs in one minute. Developers have set up Color Jet AB, located in Lund, Sweden, for marketing the system. A price tag of between \$20,000 and \$25,000 for the plotter is being quoted. The Color Jet plotter was shown publicly for the first time at the IFIP congress in Stockholm in early August.

## **Ferranti, Brazil in deal for computer production**

**In a move to balance its importation of technological and production know-how, Brazil is adding Ferranti to the list of companies with which it is setting up joint venture production deals.** The company's Digital Systems division will become equal partner with two Brazilian companies in a new company called Cobra—for Computadores Brasileiros—which will make the Ferranti Argus 700 range of minicomputers and FM 1600 military computers for that country's fast-growing economy. **Ferranti expects that the industrial computers operation will give it a strong export foothold in South America.** One of its Brazilian partners is a government-controlled holding company. IBM already has assembly plant there, and the government reportedly is talking with Fujitsu about a joint venture in commercial computers.

## **Small Fujitsu computer features virtual memory**

The Facom V0 computer just announced by Fujitsu Ltd. **is the first small computer system to feature virtual memory.** When shipments start next February, the computer will compete with Nippon Electric's NEAC System 100, Toshiba's Tosbac 1350, Burroughs L series, and IBM's System Three. Initially, Fujitsu will produce the computer, but after the bugs are ironed out it will be produced by an affiliated company, Usac Electronics Industrial Corp, in which Fujitsu owns 45.7%.

## **AGA lands more orders for IR monitoring system**

The biggest order ever for infrared systems for monitoring copper refining applications has been signed by AGA Infrared Systems of Sweden. The order is for six systems to be installed in a new copper refinery being built by American Smelting Corp. in Amarillo, Tex. Although the contract price was not publicly announced, AGA's systems sell for about \$130,000 each. **The system uses an infrared line scanner that travels back and forth over copper electrolysis baths. Short circuits show up as hot spots on a printout.** The job has traditionally been done by workers patrolling the electrolysis cells. AGA now has five systems in operation and nine on order.

# NOW THERE'S A CHOICE WITH THREE BIG DIFFERENCES

## 120 MHz, 20 lb and a logical layout

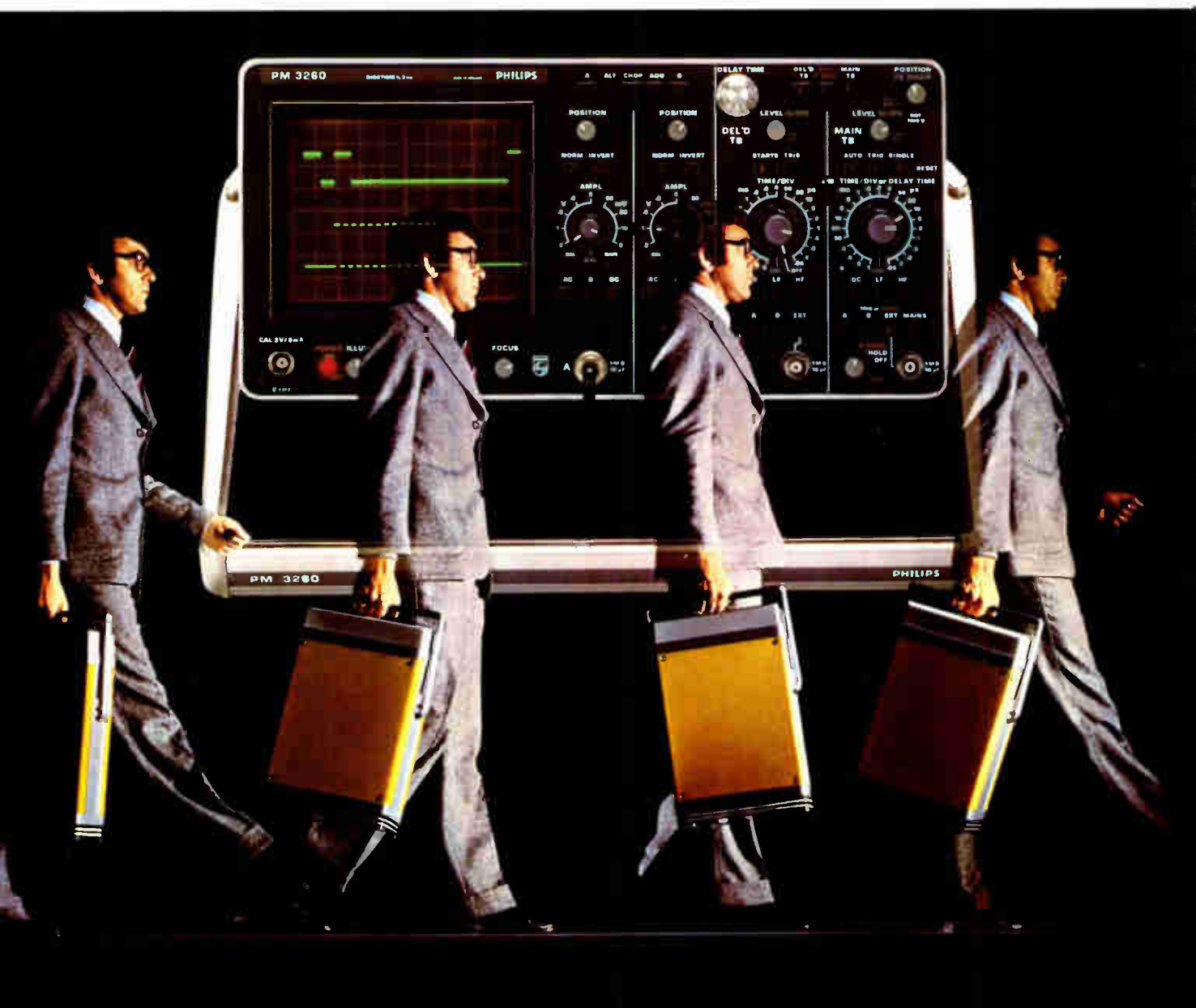

# PHILIPS



## New Philips Oscilloscope has less weight plus more bandwidth and features to get the job done easier

Developing, testing and servicing communications and computing systems is the job - here's how we make it easier :

- by supplying 120 MHz to keep ahead of component developments (like Schottky TTL)
- reducing weight to 20 lb because every pound counts on a service call
- developing a logical front panel layout so that all controls fall naturally to hand
- providing a well defined, bright 8 x 10 div display
- using advanced technologies for optimum reliability
- developing a low dissipation power supply that operates from almost any line voltage and frequency without switching
- and last but not least by including a service conscious internal design that ensures good access and minimal downtime.

Measurements are therefore easier, quicker, and more accurate with this new oscilloscope.

The PM 3260 is also the first in a new family of instruments that

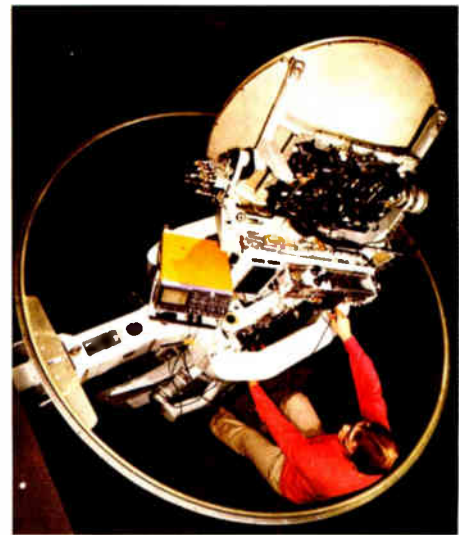
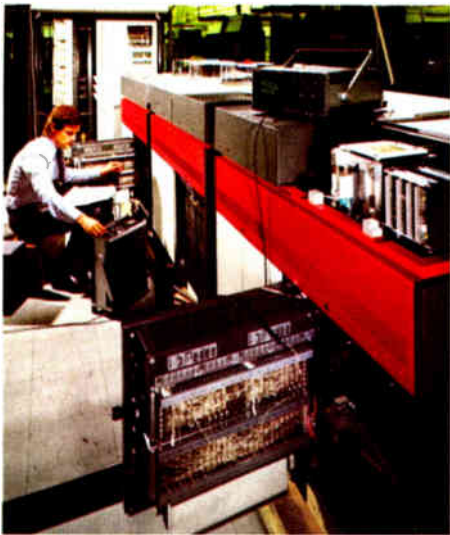

## A few of the many applications for which the new PM 3260 is ideally suited

1. Servicing computer disk memories. It can be seen that the PM 3260 is convenient to operate in both horizontal and vertical positions.
2. Access to telecommunications equipment is not always easy, so the light weight is an advantage, as is the large 8 x 10 div screen and the well-defined, bright display.



3. This marine radar installation is housed in a sphere-shaped housing that is entered using a ladder. The light weight and small dimensions of the oscilloscope are therefore extremely convenient.
4. Servicing computer peripherals such as these magnetic tape drives. Here the very stable triggering of the PM 3260 is a particularly useful feature.

### Brief specification

#### Y-axis

##### Bandwidth

DC - 120 MHz at full sensitivity

##### Input impedance

1 MΩ // 15 pF

##### Display modes

Channel A only, normal and inverted  
 Channel B only, normal and inverted  
 Alternate  
 Chopped at approx. 1 MHz  
 Added

#### X-axis

##### Main time base

1 s/div - 50 ns/div; 1-2-5 sequence;  
 x 10 magnifier extends max. sweep rate to 5 ns/div

##### Modes

Auto; triggered; single

##### Trigger source

Channel A or B; external or mains

##### Delayed time base

0.5 s/div - 50 ns/div; 1-2-5 sequence; x 10 magnifier extends max. sweep rate to 5 ns/div

##### Modes

"Starts"; direct starting, triggered by main time base  
 "Trig", triggered by own trigger circuit after selected delay interval

##### Trigger source

Channel A or B or external

#### CRT

Philips D14 - 240 ; 20 kV PDA tube;  
 GH (P31) phosphor

##### Screen

8 X 10 divisions, each 1 cm, internal graticule

##### Supply

100 - 240 V ± 10 %; 46 - 440 Hz without switching

##### Dimensions and weight

Height : 6.3"

Width : 12.4"

Depth : 16.1"

(excluding handle, front cover and feet)

Weight : 20 lb approx.



# PHILIPS



will include higher and lower bandwidth models.

*The PM 3260 makes widespread use of thin film circuits, incorporating monolithic IC's, in order to reduce weight and the number of adjustment points.*

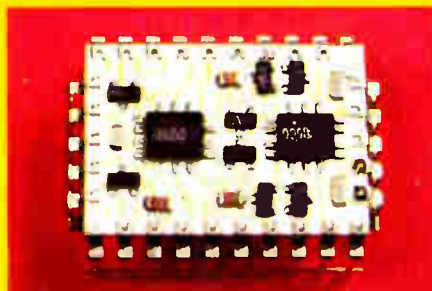

Find out more about this new 120 MHz, 20 lb, logical layout oscilloscope by using one of the attached reply-paid cards. If they have already been used contact your local Philips organisation or write to :  
**Philips Test & Measuring Instruments, Inc.**  
 400 Crossways Park Drive  
 Woodbury, New York 11797  
 Telephone: (516) 921-8880

A flexcircuit for "sunshine" calculators

# We did it for Rockwell.

A better calculator for the money — Rockwell International's aim in the development of its new private label liquid crystal display calculator. To meet this goal, Rockwell designers developed a light-collecting prism for improved display read-out under varying light conditions, including sunlight.

And to facilitate this design improvement, Rockwell employed a Sheldahl flexcircuit. This flexcircuit makes 84 connections between the back-lighted prism-aided liquid crystal display and the calculator's driving logic. Flaps located on each side of the display aperture flex a full 180 degrees to form pressure pads for display connections.

Flexcircuitry's low bulk permits circuits to the upper edges of the display to be routed through limited space between the calculator case and the display ends. The back of the display is left completely open for light entry and prism placement. The flexcircuit has 132 plated-through holes to provide for a matrix that reduces 84 display connections to 28 logic connections.

Rockwell's calculator design is another case where flexcircuitry fits available space and can be produced in volume.

Perhaps Sheldahl flexcircuitry can help in your design problems. Just call or write Sheldahl for further information.

Sheldahl did it for Rockwell International.



**Sheldahl**

Electrical Products Division  
Northfield, Minnesota 55057  
Phone: (507) 645-5633

*The state of the art people in volume flexible circuits.*



# And we can do it for you.

© 1974 G.T.S. Co.

← Circle 60 on reader service card

Circle 61 on reader service card





# John Donohue's "blue line" turns out keyboard switches faster than you can say Oak.

John Donohue, Director of Manufacturing here at Oak, is mighty proud of his "blue line." He ought to be. It's the most sophisticated fully-automated keyboard switch assembly facility in the industry. It was designed with the customer in mind. We wanted to make sure we'd be able to meet his demands for huge quantities of our popular keyboard switches.

And popular they are. We build keyboard switches for everything from miniature calculators to data entry systems to point-of-sale terminals. You can buy them individually or in completely assembled custom keyboards.

If you need low-profile keyboard switches—we have 'em. Our Series 415 switches have a profile of less than  $\frac{1}{2}$  inch. And they're available in either single or double "human engineered" keycaps that dress up any product design.

Series 400 and 475 keyboard switches are built with self-cleaning gold cross-bar wiping contacts. You're assured of trouble-free operation through millions of cycles. And our variety of contact arrangements gives you true design versatility.

We also offer a full selection of lighted and unlighted pushbutton switches plus almost any other type of switch you can put your finger on. Let us know your needs.

Write Lou Roels at Oak for product literature, helpful keyboard design tips and free samples of our keyboard switches.

Or if you prefer, dial 800-645-9200 (toll free) for the name of our local representative (In New York, dial collect 516-294-0990).

**DAK** Industries Inc.

SWITCH DIVISION / CRYSTAL LAKE, ILLINOIS 60014  
TELEPHONE: 815-459-5000 ■ TWX: 910-634-3353 ■ TELEX: 72-2447

"Keep 'em coming, John"

Circle 63 on reader service card

**Beckman Instruments**



**CalComp/Century Data Division**

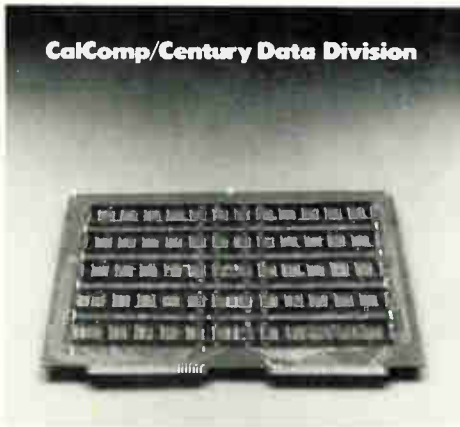

**Litton Digital Data Systems**

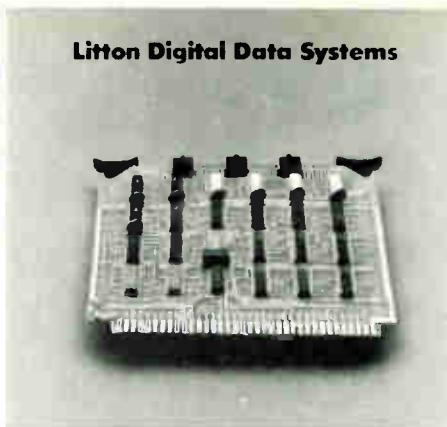

**Lexitron**

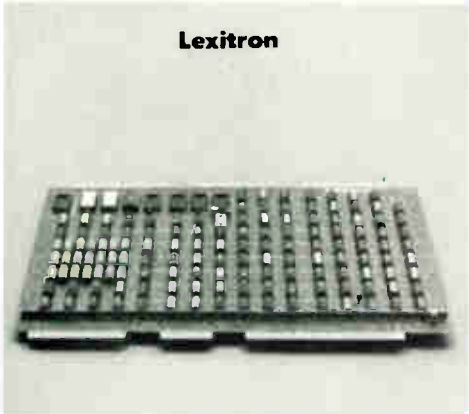

**North Electric Company**

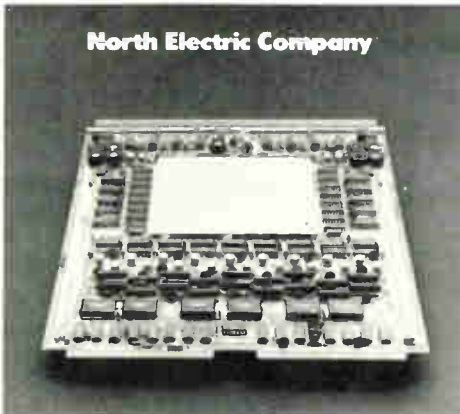

**Western Electric Company**



(Board not released for photography.)

**Econolite**



**Data Source**

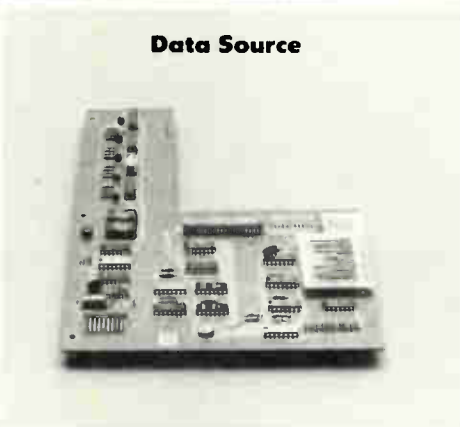

**Diablo Systems Incorporated**  
A Xerox Company

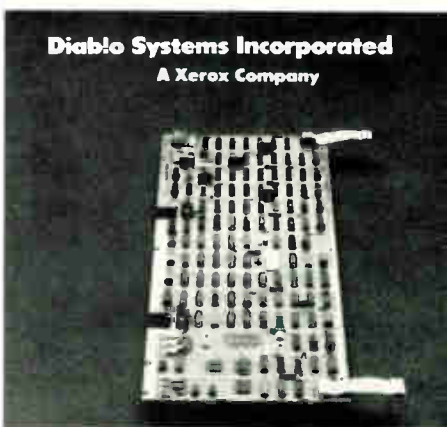

# COMPUTER AUTOMATION'S AUTOMATIC TESTER HAS

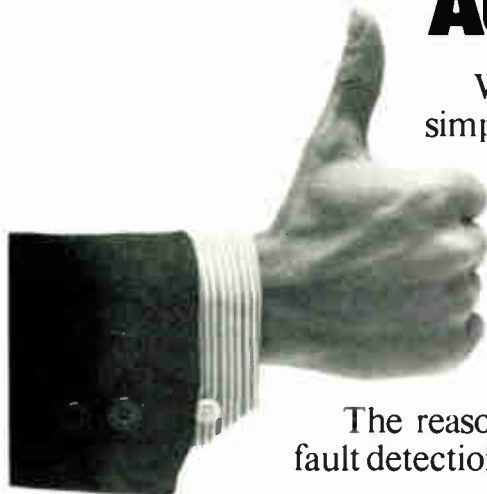

We've listed a few of our CAPABLE tester customers simply to point out something obvious. Companies like these don't buy sophisticated hardware just on the name. Which is a good thing because how many people have ever heard of the CAPABLE tester, anyway?

The fact is, you can't solve testing problems with a name - big or otherwise. So these companies did just what you would do. They looked at all the automatic board testers available. And then they picked our CAPABLE.

The reason is faster board throughput. High-speed, high-volume fault detection and isolation across the entire board range. From simple

**Collins Radio Company**

(Board not released for photography.)

**TRW Data Systems**



**Rockwell International**

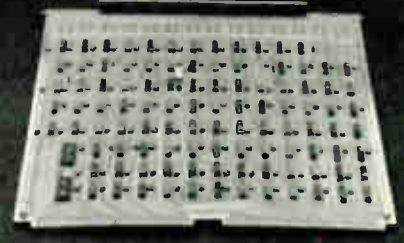

**Diebold, Inc.**



**Tally Corporation**

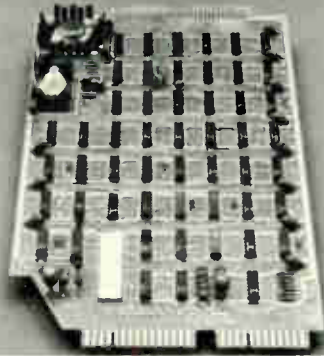

**Computer Machinery**

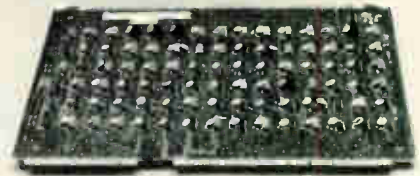

**Ampex Corporation**

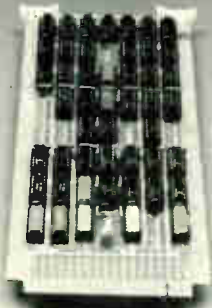

**GTE/Information Systems**

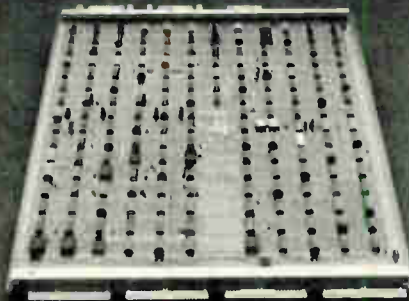

**National Cash Register**

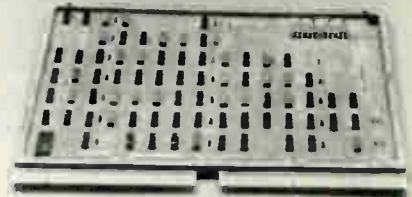

# ACROSS THE BOARD APPROVAL.

to complex modules. Digitals to hybrids. With incredible ease of operation.

And here's the payoff. Actual in-use figures show that CAPABLE can pay for itself in as little as 12 months. Even less in some cases.

If you're more interested in profits than prominence, we can help you now. Later on we'll throw in a big reputation.

18651 Von Karman, Irvine, California 92664

Telephone (714) 833-8830

**Industrial Products Division**

**Computer Automation, Inc.**



# P&B's reputation is important to you when you need Electromechanical Relays.

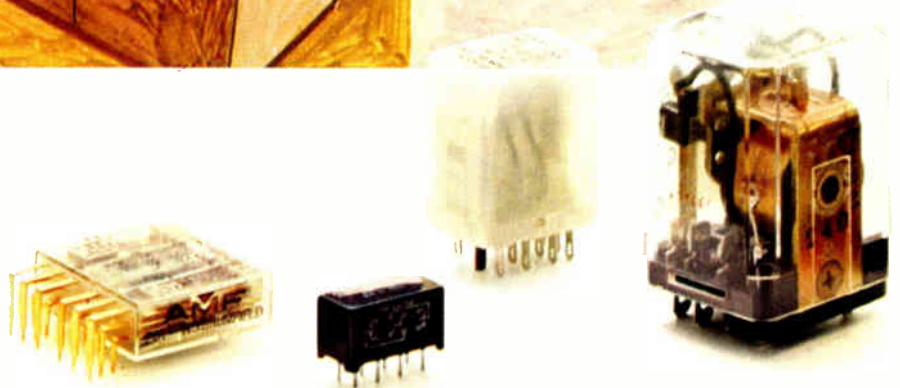

## It's built on cost and quality, broadest selection.

We believe you'll have a hard time matching the cost-to-quality ratio of our relays. You might find lower prices. We don't think you'll find better quality.

Put the two together—competitive prices and outstanding quality—and you have the relays that won't compromise *your* equipment's quality. P&B.

We'll stake our reputation on that.

You get more design options, too, when you bring your relay

application problems to us. We'll show you more different standard electro-mechanical relays than anyone else. Nearly seventy basic designs. More than a thousand different combinations of voltages, contact arrangements, mountings and enclosures. All available from your authorized Potter & Brumfield distributor.

When a standard relay won't meet your requirements, we'll supply one just for your application. We've been doing just that

for thousands of relay users for the past forty years.

For a free 226-page catalog showing all of our relays, call your local P&B representative. Or write Potter & Brumfield Division of AMF Incorporated, Princeton, Indiana, 47670. Telephone 812 385 5251.



Solving switching problems is what we're all about.

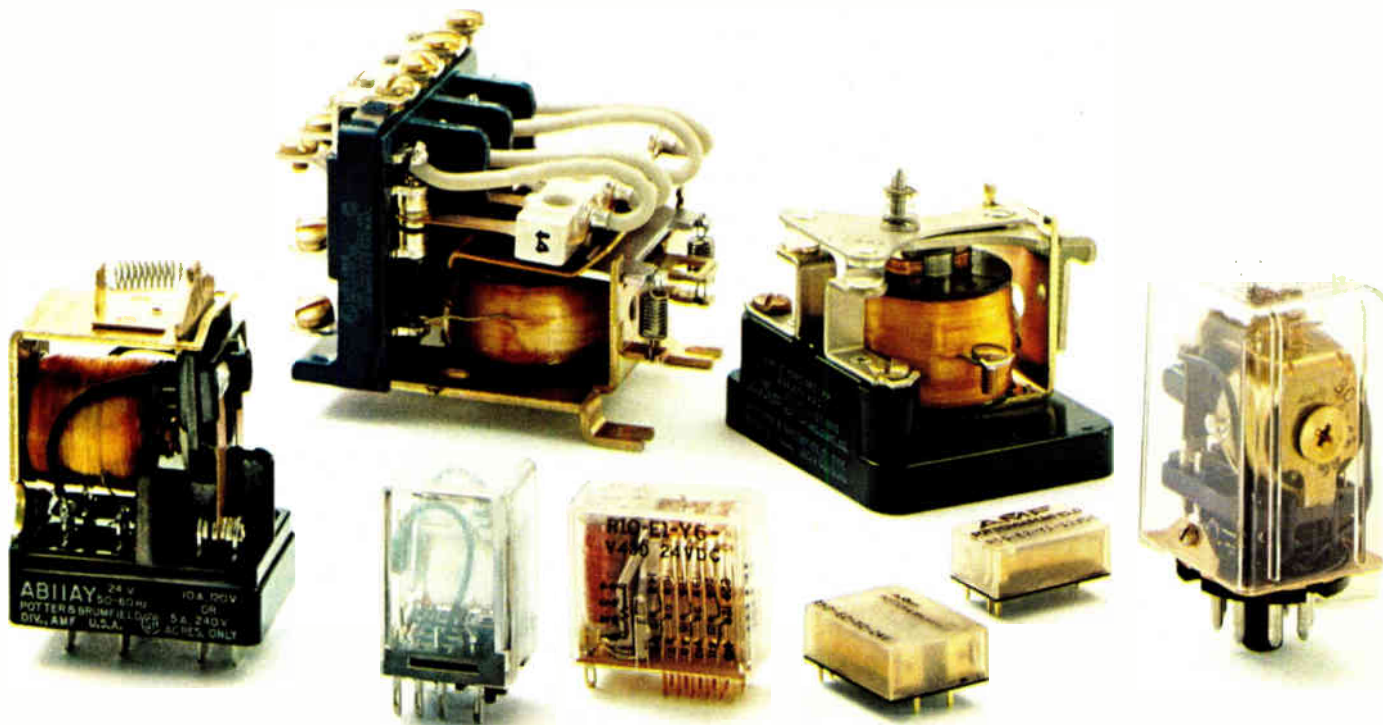

# “We knew the J384 would handle our memory production. Where it surprised us was in engineering.”



Sven Simonsen, one of the founding team at Advanced Micro Devices, Inc. and Managing Director of Bipolar Memory Operations

The J384 is best known as a production test system. But, as Advanced Micro Devices has discovered, it's also an excellent engineering system.

AMD tests its bipolar RAMs on a four-station J384—two on probe, one for QA, and one for an oven and bowl handler. Any one of the stations can be used to generate schmo plots and other engineering evaluation data. Probe-testing is performed at 2MHz, final at 5 MHz, using over a dozen different test patterns.

The system works 24 hours a day, sometimes seven days a week, and downtime is minimal. “It's conceptually simple—no excess baggage and very reliable,” says Sven Simonsen. “Pulses are clean and repeatable, and station-to-station correlation is extremely good.”

What else does Simonsen like about the J384? “The controlled-impedance-cable approach. It lets us check ac parameters like

access time in the oven, at temperature. And on-line changes are easy. We can take a spec sheet to the system and have a clear understanding of what we're doing.”

Simonsen admits that AMD bought the J384 on a lot of faith. “But certainly not blind faith. We had eight other Teradyne systems working for us and had confidence that Teradyne could meet its design objectives on any new machine.”

The J384 is a rugged, economical test system for bipolar and MOS memories. Like all Teradyne systems, it's designed and built to stand up to long, hard use in a factory environment, and is backed by a 10-year circuit-board warranty and the strongest customer-services program in the industry.

For full details, write: Teradyne, Inc., 183 Essex Street, Boston, Massachusetts 02111. In Europe: Teradyne Ltd., 12 Queens Road, Weybridge, Surrey, England.

## TERADYNE

CHICAGO (312) 298-8610 / DALLAS (214) 231-5384 / NEW ENGLAND (617) 458-1256 / NEW YORK (201) 334-9770 / SUNNYVALE (408) 732-8770  
LONDON (0932) 51431 / PARIS 265 72 62 / ROME 59 47 62 / MUNICH (0811) 33 50 61 / TOKYO (03) 406-4021

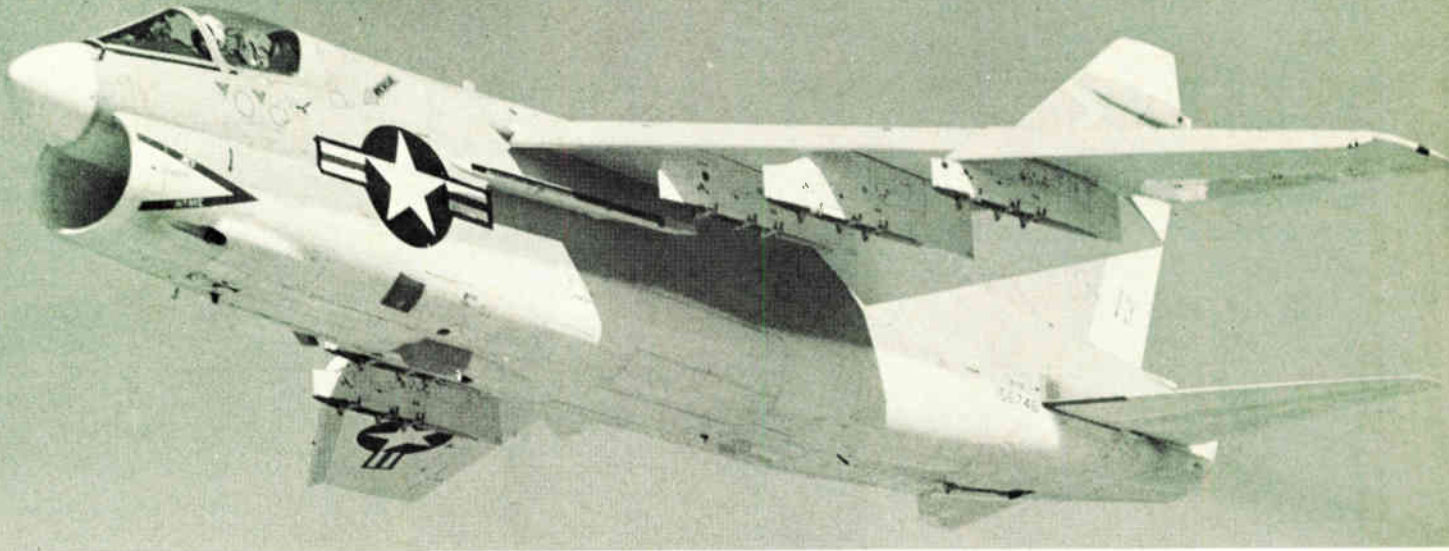

**Flying testbed.** A Navy A-7, like the one shown, will be used in first flight tests of a fiber-optic cabling system.

## Fiber-optics excites the military

Replacement for copper cabling is immune to electromagnetic interference and radiation; avionic flight tests to start next year

by John N. Kessler, Associate Editor

Get rid of most electromagnetic interference, and cut susceptibility to gamma radiation, lightning, and the electromagnetic pulse associated with nuclear explosion, and you've got a giant advance in the art of avionic design. Then add the physical advantages in the areas of weight, cost, and performance, and you're describing fiber-optic cabling, a development that's about to find its way aboard military aircraft.

Although the first test of an aircraft instrumented with fiber-optic cable linking the navigation and weapons delivery systems is not scheduled until the fall of 1975, a fiber-optic data link carrying flight-control signals from the cockpit to the control surfaces was recently flight-tested successfully on a simulator aircraft. This first test of a two-way multipoint fiber-optic data bus used equipment developed by Hughes Aircraft Co., Culver City, Calif., under contract to the Air Force Flight Dynamics Laboratory,

Wright-Patterson Air Force Base, Ohio.

Meanwhile, sources at the Naval Electronic Laboratory Center, San Diego, Calif., which will award the contract for the more fully wired aircraft—an A-7—say that in the 1975 flight test 29 or fewer fiber-op-

tic cables will replace 200 copper wires. Multiplexing will be used, of course, and only minor modifications to the equipment will be made. Adaptor boxes, including light-emitting-diode sources and photodetectors, will interface with each of the systems. But while it will

COMPARISON OF TRANSMISSION CABLES			
Property	Twisted pair	Coax	Fiber optics
Rfi/Emi/noise immunity	No	No	Yes
Total electrical isolation	No	No	Yes
High transmission security	No	No	Yes
No cross talk	No	No	Yes
Low cross talk	No	Yes	Yes
No spark/fire hazards	No	No	Yes
No short-circuit loading	No	No	Yes
No ringing/echoes	No	No	Yes
Temperatures to 450 - 700° C	No	No	Yes
Temperatures to 300° C	Yes	Yes	Yes
200-MHz bandwidth for 300 meters	No	No	Yes
EMP and gamma radiation immunity	No	No	Yes
Low cost	Yes	No	Yes

# Single-Shot Storage to 100 MHz

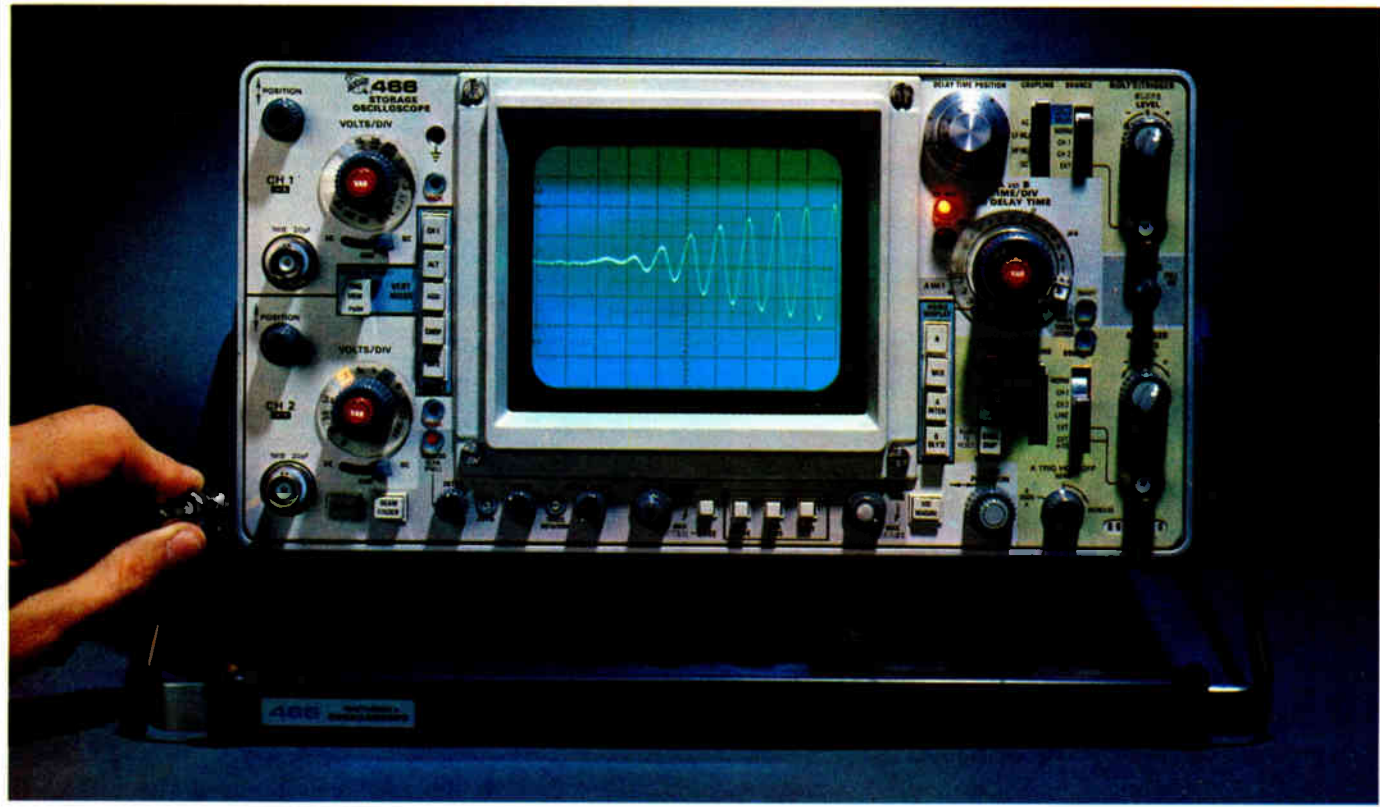

## for DESIGN

The 466 Portable offers the fastest stored writing rate of any Tektronix direct-view oscilloscope—1350 cm/ $\mu$ sec. That's more than enough speed to capture and retain pulses at the upper limit of the scope's 100 MHz bandwidth (5 divisions magnitude for single shot 100 MHz sine wave, or equivalent to storing a 5 division pulse of 3.5 nsec risetime). It provides up to a 5 nsec/division sweep rate through the X10 magnifier and vertical deflection sensitivity to 5 mV/division. You can view and retain fast rise, low repetition rate, single shot or slow moving waveforms. Here are Tektronix' reliable trigger characteristics and CRT's that minimize residual image and burn problems. Now you can view with ease phenomena that could never before be displayed on an oscilloscope.

## for PRODUCTION

The 466's fast stored writing rate offers the production engineer unequalled capabilities. Stored waveforms are brighter—more visible in the high ambient light of assembly areas. Stored waveforms allow personnel to make faster, more accurate decisions and they permit study, comparison to a photo standard, and review by supervisors. Here is an oscilloscope that is essential in computer, aerospace, and many areas of communications. It is designed for minimum training of personnel. And on a dollar per MHz of bandwidth comparison, it is by far your best storage scope buy.

## for FIELD SERVICE

The 466 is the answer to field troubleshooting and calibrations that require the same exacting standards as those originally specified in the lab, production, or engineering. Weighing under 30 lbs., it carries easily. And the 13-position handle provides a versatile support stand. Take an instrument with Option 7 to a missile site or into an aircraft and power it with 12-24 VDC or the 1106. Or use the 1105 battery pack. The 466's 1350 cm/ $\mu$ sec stored writing rate can make the Tektronix 466 your most valuable test instrument.

If the high writing speed of the 466 is not required, the 464 (which is otherwise identical) features 110 div./ $\mu$ sec. 466 Oscilloscope, \$3850. 464 Oscilloscope, \$3300.

Discover what the 466 can mean to you. For a demonstration or more information, contact your local Tektronix Field Engineer, or write Tektronix, Inc., P. O. Box 500, Beaverton, Oregon 97005. In Europe write Tektronix Ltd., Guernsey, C.I., U.K.



For a demonstration circle 70 on reader service card

Circle 71 on reader service card





## Probing the news

be more than two years before there's a complete flight test of a fiber-optic system, the Air Force, Navy, and Army have conducted research on such systems for several years. A strong advocate of fiber-optic systems for aircraft has been Capt. Douglas G. Lockie, electromagnetic compatibility engineer for the F-15 fighter program in the Aeronautical Systems division at Wright-Patterson. The most compelling advantages for fiber-optic cabling he sees are its immunity from radio-frequency interference, electromagnetic interference, electromagnetic pulses, and noise.

Lockie points out further that fiber-optic cabling offers these additional advantages over copper:

- Total electrical isolation.
- No dielectric breakdown.
- No ringing or echoes.
- An order of magnitude reduction in weight.
- Reduced power requirements.
- A slight reduction in the cost of associated avionics.
- A tremendous increase in bandwidth.

The bandwidth for a 300-meter length of fiber-optic cabling is 200 megahertz. For coaxial cable, it's 20MHz, and for a twisted pair, 1 MHz.

Because of the high potential bit rate—megabits vs kilobits—obtainable with fiber-optic cables, signals can be multiplexed so that a single cable can replace many individual copper wires. Also, where shielding is required, in coaxial cable, for example, a 12-lb cable could be replaced with a ½-lb fiber-optic link, says Lockie, because of the latter's minimal shielding needs.

The reduction in absolute power level for an aircraft is made possible because electromagnetic compatibility problems will disappear. Instead of microwatts of power, avionics systems designers will be using nanowatts, says Lockie. The extremely wide bandwidth of fiber-optic cables means that signals in aircraft can be transmitted at a greatly increased data rate—submicrosecond pulses—limited only by the rise and fall time of LEDs and photodetectors interfacing the compo-

nents. This will further reduce power requirements.

**Composite problems.** The key benefit of fiber-optic systems—their freedom from electromagnetic interference—will be compelling now that the Air Force is considering using composites—boron- and graphite-reinforced plastics—instead of metal for aircraft skins. "With composites," says David A. Zann, fiber-optic project engineer with the Air Force Avionics Laboratory at Wright-Patterson, "the shielding effect afforded by a metal skin is greatly reduced."

But while there are many obvious advantages, problems with fiber-optics remain to be solved. Primary among them is the need for complete environmental testing of cables and of cable systems.

Another basic problem is the need for what the military calls "ruggedization"—the need to strengthen fiber-optic links. Andres S. Glista, electronics engineer at the Naval Air Systems Command in Washington, D.C., points out that while the tensile strength of a glass fiber is high, its shear strength is low, and the usual polyvinyl chloride coatings used to strengthen

fibers are very likely to deteriorate at high temperatures.

However, Galileo Electro-Optic Corp., Sturbridge, Mass. (formerly the Electro-optics division of the Bendix Corp.), has programs to develop more rugged cables. Rod Anderson, marketing manager for Galileo, says that fiber-optics with a flint-glass core are stronger than those made with a fused-silica core, and flint glass is cheaper as well as stronger. But the tradeoff is in the attenuation.

The Avionics Laboratory at Wright-Patterson has looked at both high-loss and low-loss fibers, and has opted for the high-loss as adequate for Air Force applications. Besides a hefty cost savings, high-loss cables also feature a higher packing fraction or number of fibers per cable, and a higher numerical aperture, or light-gathering power, than its low-loss counterparts. Both parameters are important for improved signal-to-noise ratios.

In comparing fiber-optics, coax, and twisted pairs, Zann points out that all tolerate vibration, fibers and twisted pairs offer a low cost, while coax trades off that cost for low crosstalk. □

### From fibers to systems

Under contract to the Air Force Avionics Laboratory, Spectronics Inc. has delivered a 15-megabit point-to-point fiber-optic data transmission system with 10 parallel channels. It is a pluggable system, using a 175-foot high-loss cable from Galileo Electro-Optics. The total optical attenuation in the system is 42 decibels. That figure includes a 7.3-dB loss in coupling to the LED at the input, 1.7-dB loss at the detector, and inherent cable loss.

Spectronics has calculated a bit error rate of 1 in  $10^{45}$  for the system. "An error rate of 1 in  $10^8$  seems to be acceptable to the Air Force," notes J. Robert Biard, vice president of research for the Dallas, Texas, firm. Spectronics is now in the tenth month of a two-year contract to deliver an eight-terminal party-line data bus.

Three months ago, Spectronics was awarded another Air Force contract to define the highest data rate available with current components—starting with a minimum of 100 megabits digitally, and a 100-megahertz carrier frequency for fm signals. "It's an attempt to define where the weak link is in the system: the light-emitting-diode driver, the LED, the fiber-optic bundle, detector diode, or preamplifier," he says.

While it's too early to guess at the results, Biard notes that if the fiber optics are eliminated and the source is coupled directly to the detector, the limiting factor seems to be the LED. "But before you get to that theoretical point, you're constrained by the fiber optics. It's a system design tradeoff. Error rate, bit rate, and maximum allowable optical attenuation all must be defined," he says. "The thing that is needed is a fiber-optic bundle intermediate between Corning's and Galileo's." Corning's low-loss fibers (30 dB/km) have a low numerical aperture, making them difficult to couple to LEDs, while the Galileo bundles, which have a high numerical aperture, exhibit losses of 350 dB/km.

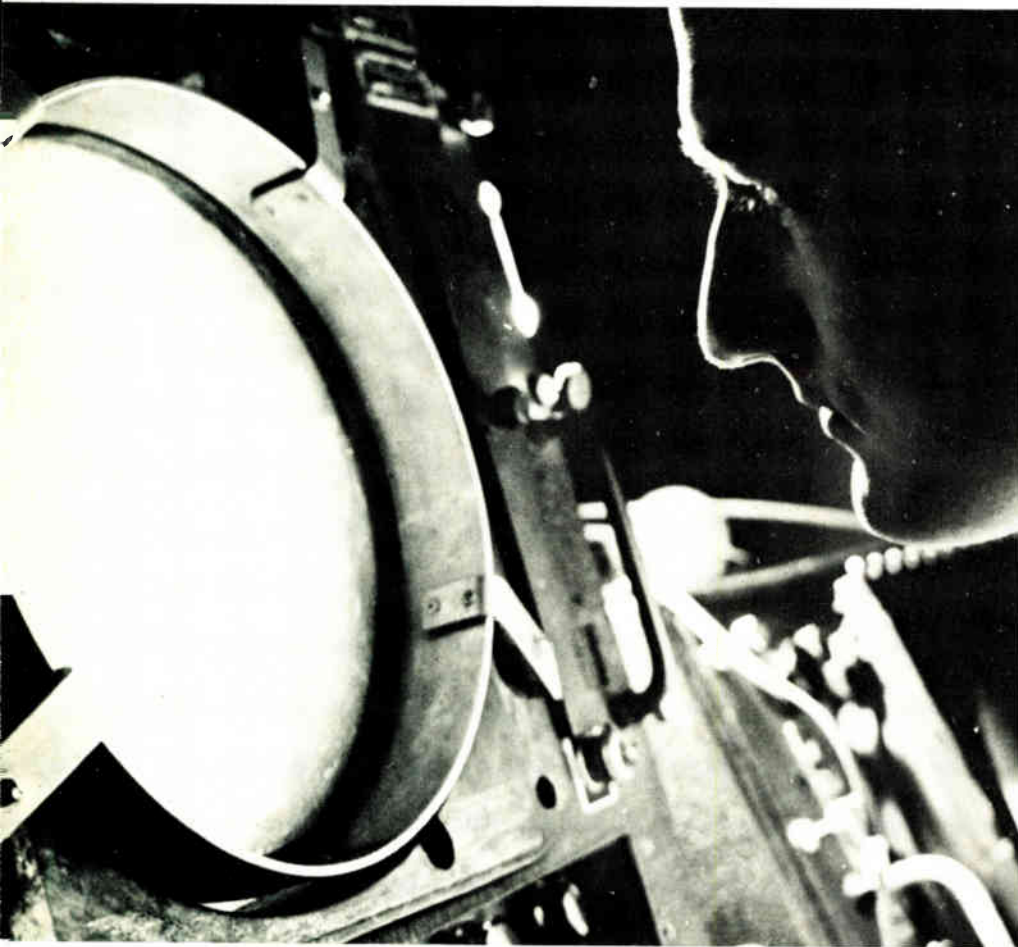

Air defense

## Radar sales are flying high

International competition heats up with Americans,  
British, French, other Europeans reporting boom

by William F. Arnold, London bureau manager

Radar manufacturers aren't exactly sure of the reasons but they report a booming market in ground-based air-surveillance systems. The result is a potential battle among U.S., British, and other European companies in sales and technology all over the non-Communist world. Pacing the boom are air defense systems that some governments may be

buying just to keep up with their neighbors.

"Business is fantastic at the moment," says James W. Sutherland, managing director of Britain's Marconi Radar Systems Ltd. "We're receiving the biggest orders we've ever had." He ascribes the boom to the fact that "business is peaky." In 1968 and 1969 there were big orders

and then "it was relatively quiet for a while. Now in the last nine months business is good again."

**Doing well.** Agreeing is arch rival Thomson-CSF in France. The market is probably better than it has been for years, observes Pierre Samuel, deputy director for surface radar sales. Like most radar managers, he declines to specify sales figures. However, since the cheapest units cost about \$2.5 million, "we're not doing badly," he smiles. And Plessey Radar, eyeing what it calls a boom, has identified 50 customers to whom it hopes to sell its new AR-3D units, according to Allan Carnell, marketing director.

Exactly where the companies are selling remains their closely guarded marketing secret. Evidence indicates that good customers abound in the Middle East, Africa, and parts of Asia, with some companies hinting that they may have some South American deals just about locked up as well. Mostly, these sales are in addition to home sales.

The list of competitors includes, besides Plessey and Thomson, such well-known radar names as Westinghouse, Hughes, Raytheon, ITT Gilfillan, and Texas Instruments in the U.S.; Cossor Electronics, a subsidiary through A.C. Cossor of Raytheon Europe and a leading maker of secondary radar systems in the U.K.; Selenia and CGE-Fiat in Italy; and Philips Signalapparat in the Netherlands.

**Technology.** The marketing strategies by companies are based on some pretty sophisticated technology. Types of radar for both military and civilian uses divide and cross-divide: long-range or short-range, mobile or static, and primary (tracking raw radar returns) or secondary (querying an airplane's transponder for identity, speed, and altitude). More sophistication enters with the use of a computer to process digitized radar returns. Whereas the simplest, and earliest, radars employ an operator to manually track blips, the use of computers takes the systems through various computer-assisted processes to the fully automated type.

Lately, so-called 3-d radars are

# Proven Performance.

<b>Computer:</b>	General Automation SPC-12/20. Step and repeat, mirror image, automatic rewind. Handles variety of formats.
<b>Spindle feed rate:</b>	20-250 ipm. Accuracy to within 2% of setting. Stroke limit adjustable, 0.001-in. increments.
<b>Table travel speed:</b>	400 ipm each axis. Computer-driven, high-torque, high-speed, low-inertia servo motor gives instant acceleration.
<b>Drill hit rate:</b>	200/min. Quality holes on 1/4-in. movement with 3-high stacks and 0.002 chip load.
<b>Spindle motor speed:</b>	15,000-45,000 rpm electric motors; 15,000-60,000 rpm liquid-cooled, frequency-controlled motors; 30,000-80,000 rpm air-bearing frequency-controlled motors.

## The Excellon Mark III. Nobody's equalled it yet.

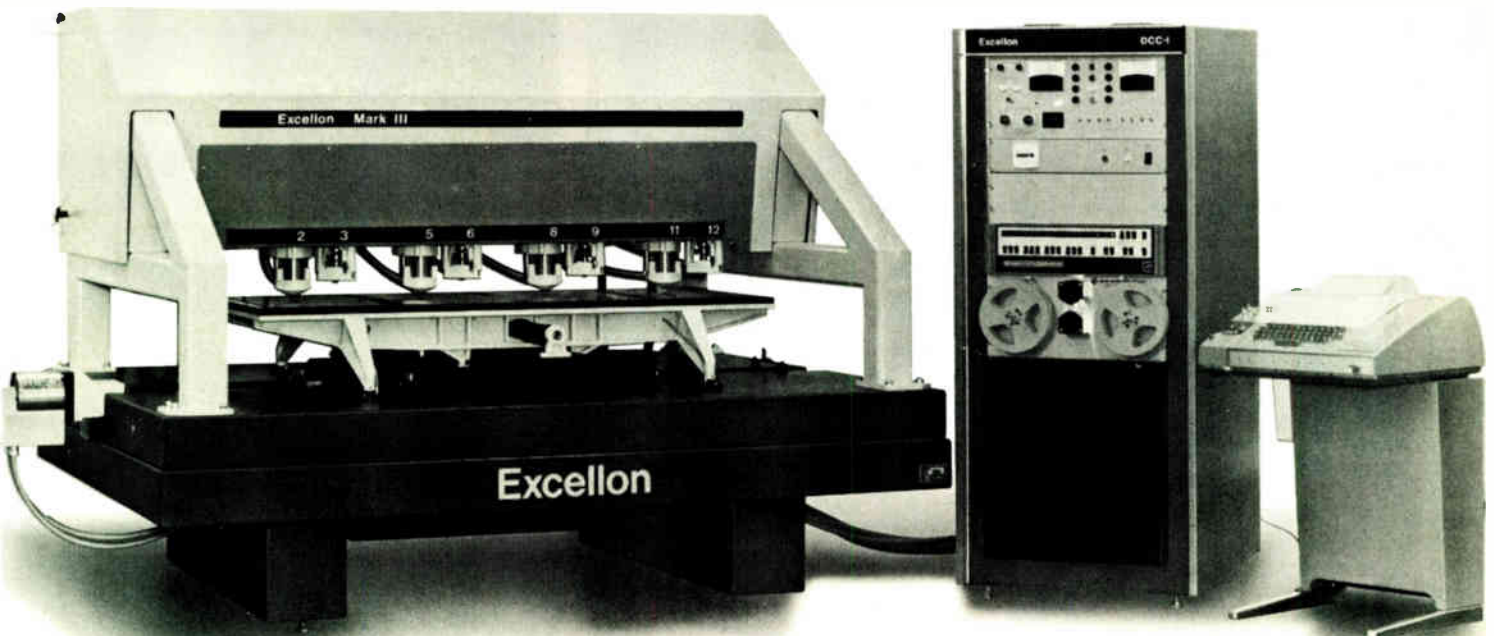

The Excellon Mark III is the most advanced p.c. drilling system in the industry today.

We've had more than our share of advances over the years. The fact is, when we added up the knowledge we've gained from our successes (and failures), we had all the makings of a major breakthrough.

The magnificent Mark III, for instance.

World-wide, the Excellon Mark III is giving unequalled performance with highest production rates possible . . . at the lowest hole costs possible, with high accuracy and clean, smear-free holes.

It has no competition because nobody's equalled it yet. Call or write Dick Hogan, Sales Manager. His number is (213) 325-8000.

### Excellon Automation

A Division of Excellon Industries

23915 Garnier Street

Torrance, California 90509

Phone: (213) 325-8000

Telex: 67.45.62 Cable: Excellon Torrance



Excellon Sales and Service in ENGLAND • FRANCE  
SCANDINAVIA • W. GERMANY • HOLLAND • AUS-  
TRALIA • HONG KONG • TAIWAN • JAPAN

## Probing the news

being targeted as winners, especially with Plessey's ballyhoo of its new AR-3D prototype. These radars give range, bearing, and altitude information from one antenna. Conventional radars get range and bearing from one antenna and need a slower rotating "nodding" antenna to derive altitude. Competing approaches

include stacked beam, frequency scanning, and phase scanning.

Plessey, in choosing frequency scanning for the AR-3D, claims that the unit is far advanced, will give Plessey a solid position in international marketing, and will help restore supremacy in radar technology to the U.K. Essentially, the system combines a new antenna design with up-to-date computer processing so that a pencil beam is

scanned in the vertical plane by varying the transmitter frequency. This happens many times a second as the antenna rotates, and the target's altitude is derived from the frequency of the returned signal. Among other claims, Plessey boasts militarily important performance against ground and rain clutter, chaff, and noise jamming.

Naturally, Plessey's claims didn't go down well in the competitive radar fraternity. Hughes has been making frequency scanned 3-d radar since 1957, says David Gessen. He's manager for advanced products, communications and radar division, ground systems group of the Hughes Aircraft Co., Fullerton, Calif., and he adds that the company was the first in the field and may have most systems in use.

Sharing Gessen's feelings about Plessey is Don Wennerstrom, manager of advanced programs for air defense, ITT Gilfillan, who points out that his company makes a 3-d (AN/TPS-32) for the U.S. Marine Corps. Gessen says that Plessey uses a parabolic center-fed antenna, which Gilfillan has dropped. All in all, he says the AR-3D appears to have medium range, lower power, but pretty much the same performance as ITT's unit. And Thomson's Samuel says that Plessey's bid to take over the technology lead ignores his company's Matador.

No matter what they think of Plessey's unit, however, Hughes and ITT generally agree with the frequency-scan approach. Gessen says that the majority of Hughes's radars use frequency scan—now usually called electronic scan—rather than stacked beam. "We avoid the stacked-beam approach for most applications since it requires a separate receive channel for each beam." This raises cost and lowers reliability, he says. He also says that moving-target indication, a necessity in modern radar, is hard to implement with stacked beams. Both of ITT's 3-d radars, the AN/TSP-32 for the Marine Corps, and the AN/SPS-48 for the Navy, are frequency-scan systems using pencil beams. The elements are planar arrays, which rotate for azimuth, and scan in elevation with serpentine antenna elements.

For the Matador, Thomson-CSF

## 8 CASES FOR SWITCHING TO NATIONAL<sup>®</sup> SCRs



16-1600 Amperes rms  
25-1700 Volts  
Power and Inverter SCRs  
Patented Regenerative Gate

*Call or write for full details*



**NATIONAL ELECTRONICS**

a varian division

geneva, illinois (312) 232-4300

# Norplex multilayer laminates—the heart of today's high-density circuitry.

In applications where space is critical, multilayer circuits can replace two or more single boards, allowing you to increase circuit density without sacrificing finished exterior dimensions.

Norplex glass laminates and prepregs are available with either epoxy or polyimide resin. They continually meet (and generally exceed) *all* customer specifications. We provide not only the materials but the technical services to go with them,

working closely with you to attain maximum benefits for your product line and increased finished product yield.

We have a separate group devoted exclusively to the manufacture of multilayer materials, working with specialized Norplex-designed equipment for optimum production capability and quality assurance.

No one else can offer you the in-depth experience and technical

expertise of Norplex, where laminate manufacture has been our only business for more than 25 years.

Send coupon for our new brochure which explains the advantages of Norplex multilayer laminates. Or phone: 608/784-6070.

**Norplex laminates**  
by **uop**

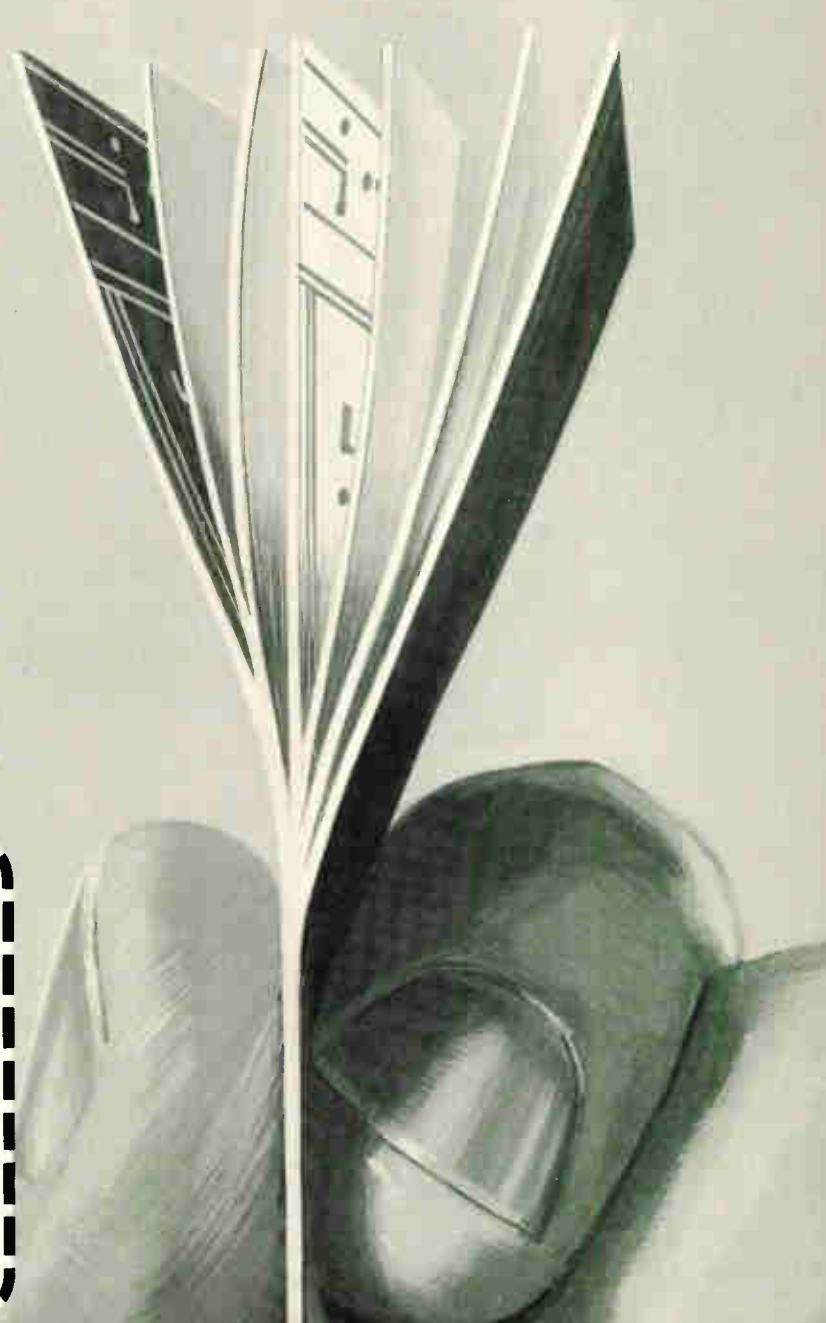

Circle 75 on reader service card

© 1974 UOP

**Norplex Division, UOP**  
**(Universal Oil Products Company)**  
Norplex Drive,  
La Crosse, Wis. 54601

Please send me your brochure on  
multilayer laminates.

Name \_\_\_\_\_

Title \_\_\_\_\_

Company \_\_\_\_\_

Address \_\_\_\_\_

City \_\_\_\_\_ State \_\_\_\_\_ Zip \_\_\_\_\_

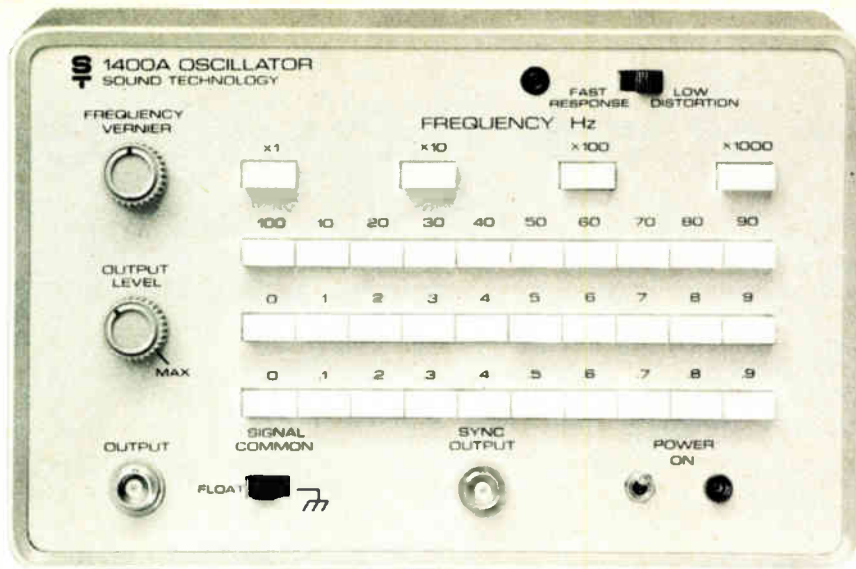

# ULTRA-LOW DISTORTION OSCILLATOR

**10 Hz-110 kHz:** pushbutton tuned for high repeatability, 3-digit resolution. **FLOATING OUTPUT:** selectable by panel switch. **ULTRA-LOW DISTORTION:** typically .001% in audio range (see curve). **FAST SETTLING:** settles to .001% distortion in 5 seconds. Faster alternate mode. **FREQUENCY RESPONSE:** flat within 0.2 dB. **PRICE:** only \$570.

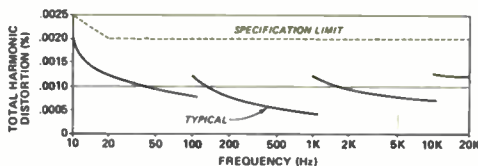

## CALL NOW

Call Larry Maguire or Bob Andersen now for full information on this important new Model 1400A.

**SOUND TECHNOLOGY**  
 1400 DELL AVENUE  
 CAMPBELL, CALIFORNIA 95008  
 (408) 378-8540

Circle 76 on reader service card

## Fight Them All

Heart Attack, Stroke  
 High Blood Pressure  
 Rheumatic Fever

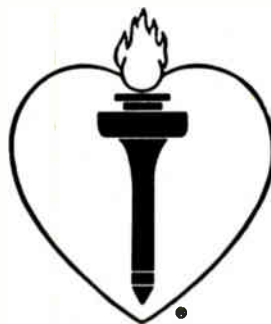

**Help your Heart... Help your Heart Fund**

## Probing the news

uses an unusual phase-scanning technology, a combination of both the conventional stacked-beam system and the more modern frequency-scanning technique. The design is based on a linear array of 40 elements, made up of four diodes each. The scanning function is controlled by a phase-shifter applied at different time intervals to each element. Thus, waves spread out from the array at varying angles, just as stones dropped into a stream one after another at different points along the bank form a wave moving at an angle.

Although Marconi has sold 3-d systems, including five to Saudi Arabia, Sutherland says that "3-d has its place," but that it might be a "matter of fashion." A company "can't try to make a world-shattering step" in technology, he says, as the technology "doesn't happen" that way. "Cost-effectiveness runs through the whole thing," Sutherland declares. For example, a customer might be able to take a conventional antenna, add a height-finder antenna, and get better performance than 3-d.

Raytheon tends to agree with that view. David Barton, a consulting scientist at the company's Bedford, Mass., laboratories, says 3-d radar has limited function compared to Raytheon's multifunction phased-array radar. The result is that the company doesn't see a substantial requirement for 3-d models. Barton explains that phased-array radar performs both search and tracking functions with a single antenna. The conventional 3-d radar, he says, is locked to a fixed scanning schedule and as a result spends more time on empty space than on targets. Multifunction radar with its electronic scan uses a large array of radiating elements that are controlled by phase shifters. Once the beam engages a target, Raytheon's multifunction system assigns monopulse tracking to it.

Raytheon has always produced conventional 2-d equipment, says Barton, but the company has gone to the multifunction phased-array rather than 3-d to meet customer needs. □

# SIEMENS

## IC's – Semiconductor Memories – Core Memory Systems Tested expediently



Do you work with electronic modules or memory systems? Then you should know COMPUTEST. COMPUTEST is a proven equipment series for testing of IC's, complete semiconductor memories as well as core – and disc memories.

The system COMPUTEST contains:  
IC-testers-universal test equipment

and automatic test systems for digital and linear circuits. Semiconductor memory test systems for fast functional control of RAMs, ROMs and shift registers. Or for testing on chips and at the system level. Test systems for automatic checking of production phases in the manufacture of core and disc memory.

Should you be interested in the system COMPUTEST within the extensive test- and check-out-program of Siemens?

Write to  
Siemens Aktiengesellschaft,  
ZVW 133/Ce  
7500 Karlsruhe 21,  
Postfach 21 1080.

# COMPUTEST

## Test- and Check-out System by Siemens

Circle 77 on reader service card

**Announcing  
the most logical  
result of the  
overwhelming  
acceptance of the  
RCA CD4000 series.**

**Lower-cost  
COS/MOS.**



**The learning curve tells the whole story. The more COS/MOS we make, the greater our COS/MOS experience, the lower the cost.**

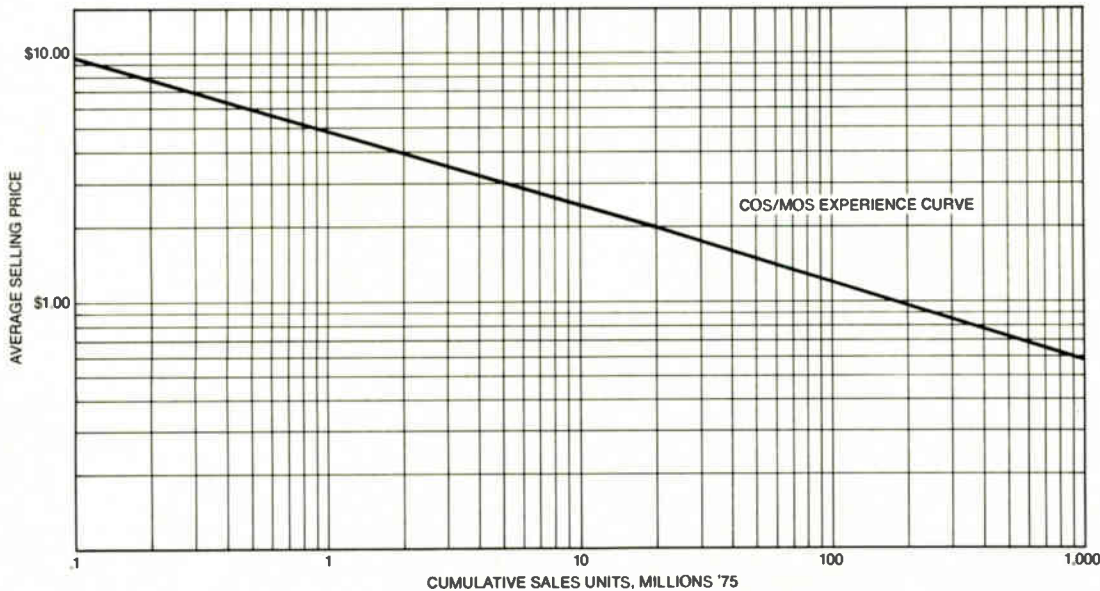

But there are more benefits from the RCA learning curve than volume and price. There's advanced circuit design, meticulous control of quality, the offering of the broadest choice of functions and in-depth applications support.

Should your projects, present and future, demand the design advantages of CMOS; i.e. ultra-low power consumption, high noise immunity, toleration of wide voltage swings—lower cost should make RCA COS/MOS more tempting than ever.

For example, we've recently reduced prices of plastic, commercial ceramic and chip versions of standard COS/MOS by an average of 15%. Popular MSI types have been reduced by as much as 20%.

And we look for this trend to continue as we perfect technologies and production facilities even further.

For a free COS/MOS brochure write RCA Solid State, Section 70H22, Box 3200, Somerville, N.J. 08876. For complete pricing information contact your local RCA Solid State distributor or phone RCA (201) 722-3200 Ext. 2355.

**RCA Solid State**  
The first house in CMOS

Electronics abroad

# Ireland knows what it wants

Republic is shopping among American companies for a semiconductor plant—but wants complete package, not just assembly operation

by John N. Kessler, Associate Editor

Ireland is working hard to woo American electronics manufacturers. But there are major differences between the Irish proposition and that of other countries seeking offshore investment. For one thing, the Dublin government has a pretty specific idea of what it wants and how many jobs it needs. Right now it is seeking an MOS plant—but not just an assembly operation. It wants a completely independent operation requiring management, production, and engineering skills.

Just what are the Industrial Development Authority's operatives offering? The present wage rate is low (about half that of the U.S.) but the IDA hopes that salaries will in-

crease gradually. The real incentives, says the agency, are a diversified labor supply that includes unskilled, skilled, and technically trained workers, engineers, and managers; freedom from income tax on exports for 15 years; cash grants up to 50% for fixed assets; personnel training grants; reduced-rate loans; and ready-built factories—and, of course, a common language.

A cross-section of U.S. electronics firms that have established plants in Ireland since General Electric, one of the pioneers, started its Shannon operation in 1963, brings unanimous enthusiasm. Typical is Molex Inc., a Lisle, Ill., maker of connectors and terminals. The company

outgrew its original 2,500-square-foot Shannon plant, built in 1971, in eight months, and is now completing a 20,000 ft<sup>2</sup> addition to its 17,000 ft<sup>2</sup> facility.

"We couldn't be happier with our location," says Fred Krehbiel, vice president of international operations for the Lisle, Ill., firm. "The IDA knows what you're there for, and it makes every effort it can to see that you're profitable," notes the U.S. executive.

Infotronics of

Boulder, Colo., went to Shannon in 1967, where its facility employs about 100 persons. Fred Brigman, vice president and legal counsel, is happy with productivity and profits. The major incentives for establishing a plant in Ireland, he says, are tax relief, training grants, and a common language.

The story is pretty much the same for Digital Equipment Co.'s operation in Galway. Cyrus E. Kendrick, formerly plant manager there and now starting up a new DEC facility in Phoenix, Ariz., calls DEC's Galway operation "a booming success." This, he says, is the most totally integrated of any of DEC's nine plants. It employs about 600 persons. The managers of the major divisions—financial, engineering, personnel, and business—are all local people, although the plant manager is an American.

Dataproducts has been in Ireland since 1965. Originally, only a manufacturing plant was planned for the Dublin site, but this evolved into a complete independent facility including design, development, manufacturing, and marketing of core memory products, says Graham Tyson, president of the Woodland Hills, Calif., firm.

Some of the chief inducements: grants for equipment, training, and development. These grants have been negotiated with the first mentioned having been "as high as 45% over the years."

Tyson also cites excellent personnel training. The management, "originally American, is now wholly native," he says. □

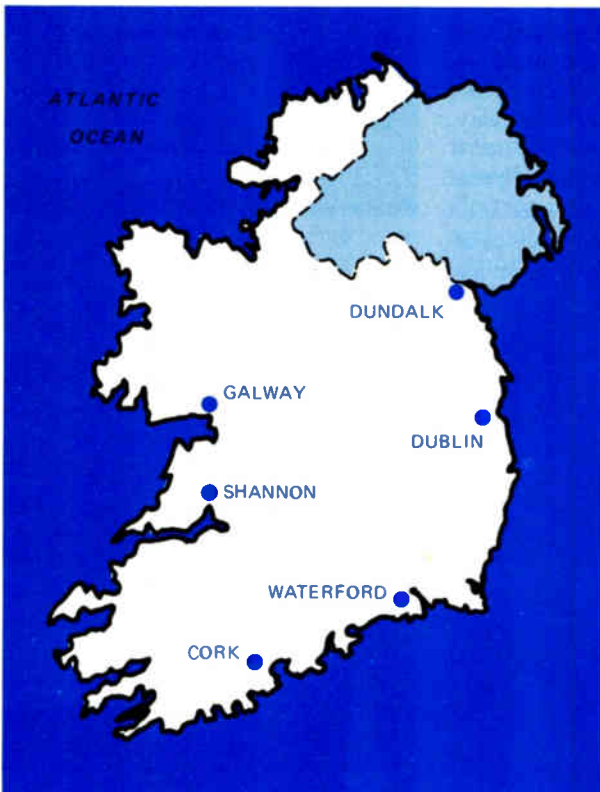

Industrial network. Map shows the six industrial parks set up by Ireland's Industrial Development Agency.



VERTICAL PANEL CABINETS

INSTRUMENTS CASES



SLOPED PANEL CABINETS



**TRIMLINE SERIES  
ELECTRONIC CABINETRY...**  
*Respected For Its Quality  
Remembered For Its Beauty*

Architectural beauty of design that gives a first and lasting impression of quality, an important aid to your sales and marketing efforts.

The underlying mechanical design offers the rugged strength and engineering provisions to mount, protect and service internal electronic components.

Circle 83 on reader service card

Standard modular construction, modification options, the variety of accessories and finishes available, offer unlimited design capabilities for customized individual cabinets, multi-bay or complex console systems at most reasonable costs and shorter delivery scheduling.

Complete Catalog, Drawings and Prices upon request.



**PREMIER METAL PRODUCTS CO.**  
337 Manida Street, Bronx, N.Y. 10474  
Phone: (212) 991-6600

# For built-in reliability, design with "Scotchflex" Flat Cable/Connector Systems.

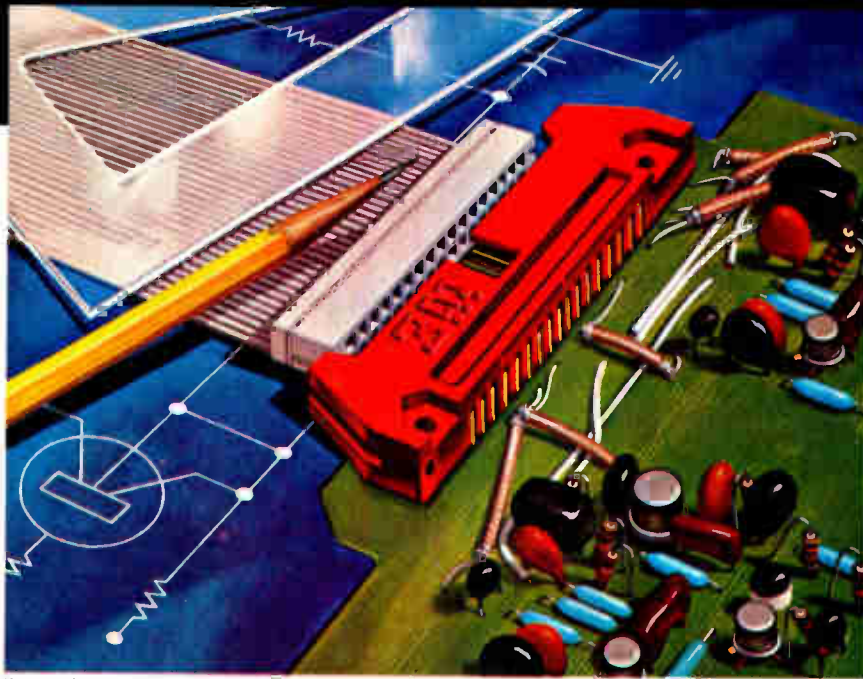

"SCOTCHFLEX" IS A REGISTERED TRADEMARK OF 3M CO.

"Scotchflex" Flat Cable and Connectors can offer you trouble-free packaging for your next generation equipment.

There's built-in reliability for your circuit inter-connects. Our flat, flexible PVC Cable has up to 50 precisely spaced conductors. The gold plated U-contacts are set into a plastic body to provide positive alignment. They strip through the insulation, capture the conductor, and provide a gas-tight pressure connection.

Assembly cost reductions are built-in, too. "Scotchflex" Connectors make up to 50 simultaneous connections without stripping or soldering. No special training or

costly assembly equipment is needed.

Off-the-shelf stock offers you flat cable in a choice of lengths and number of conductors from 14 to 50. Connector models interface with standard DIP sockets, wrap posts on .100 x .100 in. grid, or printed circuit boards. Headers are available to provide a de-pluggable inter-connection between cable jumpers and printed circuit boards (as shown). Custom assemblies are also available on request.

For full information on the "Scotchflex" systems approach to circuitry, write to Dept. EAH-1, 3M Center, St. Paul, Minn. 55101.

**3M**  
COMPANY



---

By processing recorded signals, an IC-based control in a conventional tape player can halve or triple playback rate without distortion; the special sound sheet inserted here demonstrates how it sounds

---

by Murray Schiffman, VSC Project, Cambridge Research and Development Group, Westport, Conn.

□ Keeping pace with the rapid increase in knowledge is a problem in a complex technological society. Radio, TV, movies, and tape-recording and playback units have both alleviated and intensified this situation, causing the audio and audio-visual media to become as important as printed material in the transfer of information.

Unfortunately, in audio presentations, a fixed playback rate often wastes a great deal of the listener's capacity to comprehend. If he were able to control the rate of presentation without distracting distortions, then listening (or listening and viewing) would become as useful as reading for acquiring information.

At last, the Variable Speech Control System provides such a capability. A VSC-equipped tape recorder allows the listener to control the rate of playback, from one-half to three times normal, at will, without the usual "Donald Duck" pitch change at high speed or the garbled rumble at low speed. The benefit to the handicapped, the disadvantaged, and others for whom reading is difficult or impossible is clear. Its potential applications are extensive in education, business, the professions, government, broadcasting, and consumer electronics (see applications table).

Most people read much faster than they speak, and they can assimilate information faster than they can read. Speed readers claim skimming rates as high as 1,000 words per minute. By contrast, speech rates range from 110 wpm to 175 wpm. The average lecturer speaks at about 125 wpm and a professional newscaster at 175 wpm. Thus, there's a wide difference between the rate most people can absorb audio information and the rate at which it is presented. Conversely, it may also be desirable to slow down audio presentation for language training, or where comprehension is difficult.

Although compressed-speech recordings have been produced on the few machines available for this purpose, the choice of rate is still the producer's, not the user's. A more useful playback unit would enable users to control the presentation rate.

A small number of relatively expensive (\$3,000 to \$5,000) rate-variable machines, which are rotating head, reel-to-reel types, have been marketed for a number of years. And the recent development of more sophisticated electronic and simpler electromechanical machines has driven the price to less than \$1,000. Nonetheless, more than 60 million tape recorders for many applications, as well as a variety of other playback units, are purchased each year, and the potential need for rate-variable equipment can scarcely be met by the custom production of a few manufacturers. Now, VSC has been developed to the point that manufacturers can design it into their own standard equipment.

Building the Variable Speech Control system in modular form that could be mass produced was not the original objective. But the idea evolved over a period of years and has resulted in a proprietary, low-cost, universal control-and-processing module that enables any manufacturer, as a licensee, to shift into the production of variable-speed, pitch-restored playback equipment with a minimum of development and redesign.

This objective was crystalized into an intensive development and marketing effort by the realization of a minimum processing technique for the time-compres-

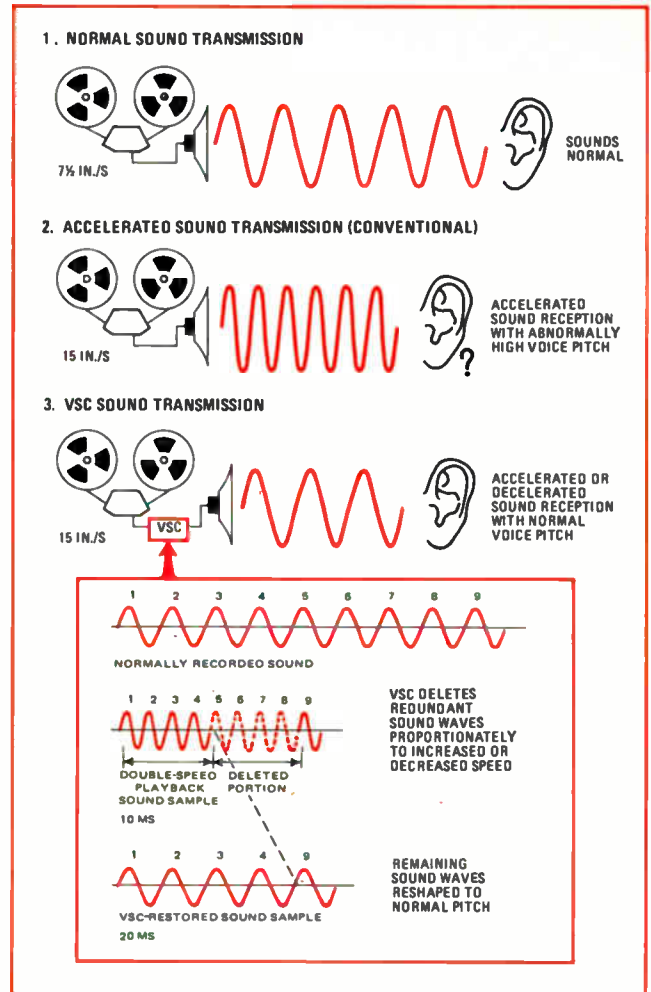

**1. Sampling plan.** Variable Speech Control is based on deletion of a sampling of audio signals and stretching remaining segments to reproduce accelerated sound transmission at near-normal pitch.

sion or expansion of recorded speech. Nearly three years and more than \$1.5 million later, the VSC project has achieved its first-stage goals with the production of dedicated Variable Speech Control ICs, as well as applying for and receiving patents giving broad protection for the rights to provide a basis for non-exclusive licensing and the licensing of major tape-recorder manufacturers.

### VSC unlocks time-sampling

The effect of speeding or slowing recorded speech is well known. Not only is the playback time inversely affected, but the frequency also changes proportionately. As the playback speed is increased or decreased, the change in pitch is quickly perceptible and soon becomes annoying. Once beyond either double or half speed, speech becomes unintelligible. To correct for this distortion, the speech signal waveform must be restored to its original shape and duration.

Since the waveform of speeded speech is compressed into a shorter time frame, "stretching" it back to the original shape while maintaining the speed-up requires that portions of the waveform must be successively deleted to make room for the "stretched" remaining pieces (Figs. 1 and 3a). Fortunately, there is a great deal of redundancy and sufficient duration (100 milliseconds av-



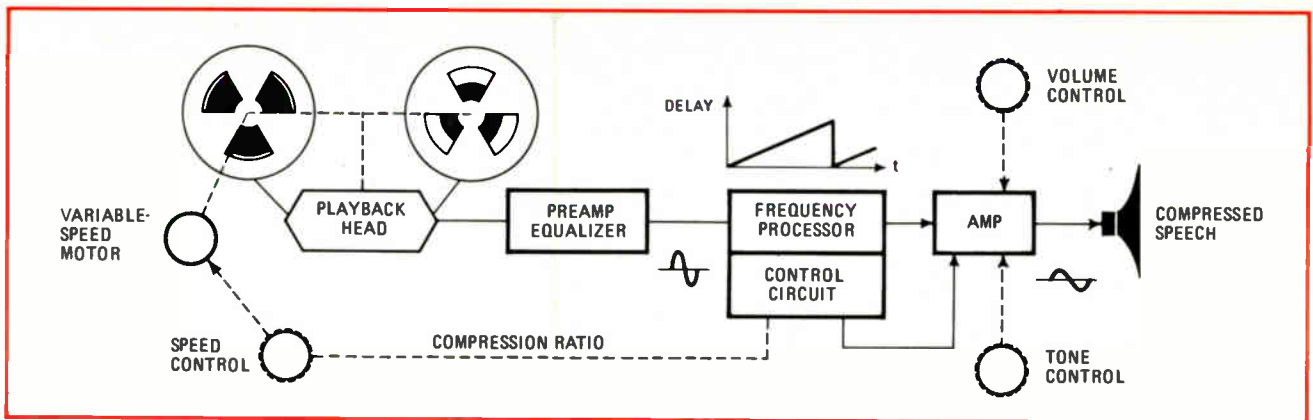

2. **Play It again.** A playback system incorporating time-sampled, time-compression or expansion includes a frequency-processor IC and a control connected between the preamp and the amplifier. Increasing delay applied to speeded speech restores original duration.

erage) in the basic speech sounds (phonemes) for the remaining restored pieces, properly joined, to present a relatively smooth, normal sound, despite the deletions, when played back at higher speed. The key is to delete portions short enough (20 to 40 milliseconds) to avoid significant loss of auditory continuity.

The cut-splice method provides excellent experimental demonstration of this sampling technique. By manually cutting out alternate pieces of normally pre-recorded tape and rejoining the remaining pieces, the resultant shortened composite tape played at normal speed produces compressed speech at normal pitch in greatly reduced time. When slowing down playback, a reverse effect is produced so that the reduced speed causes the waveform to be stretched out over a correspondingly longer period. Thus, restoration requires "compacting" of successive portions of the waveform, producing gaps corresponding to the increased playback time between the restored signal samples. While the speech thus produced is clearly pitch-corrected, the gaps produce audible disturbances when they become long enough—say, more than 5 ms. This effect may be overcome by filling these gaps with redundant speech signal.

Processor and control circuits inserted into the playback audio output chain (Fig. 2) accomplish electronic signal-sampling and restoration. These combine to stretch or shrink the successive playback-signal samples, corresponding to the rate of playback, to restore them to normal. Thus, ever-increasing delay of successive signal segments within a speeded speech sample (Fig. 3a) produces a processed signal sample stretched back to the original duration. Continual repetition of this process produces a composite time-compressed signal.

Conversely, ever-decreasing delay of successive signal samples restores a slowed speech signal sample (Fig. 3b). Continual repetition of this process provides a restored, gap-interwoven, time-expanded speech signal in which the gaps may be filled with redundant signal.

In mathematical terms, the delay transformation is developed as follows: Consider a sine wave  $v = E \sin(\omega t)$  recorded with a tape recorder. If the tape is played back at  $c$  times the original recording rate, the result is

$$v = E \sin(c\omega t)$$

If the signal is then passed through a processor that causes each point of the waveform to experience a cumulative delay of  $c't_{in}$  in passing through the line, then the signal, having been so delayed, becomes

$$v = E \sin[(c - c')\omega t]$$

The original signal can be restored if

$$c' = (c - 1)$$

in that substituting  $(c - 1)$  for  $c'$  above yields the original  $v = E \sin(\omega t)$ , where  $c$  represents the compression ratio corresponding to the speedup. Thus,  $c$  greater than 1 represents time-compression, and  $c$  smaller than 1, expansion.

Or, perhaps it may be useful to express the transformation in more general terms. The restoration may be achieved by progressively delaying the signal entering the processor at time,  $t_{in}$ , by an amount

$$c't_{in} = \int_{t_{in}}^{t_{out}} \frac{f(t)}{t_{out} - t_{in}} dt$$

where  $f(t)$  is the instantaneous processor delay, and  $t_{out} = ct_{in}$ .

### Time-sampling techniques

The only alternate technique applied to the time-sampled, time-compression/expansion of speech depends on fixed input/output rates with respect to the storage channel in order to establish the compression ratio,  $c$ , such that

$$c = \text{input rate/output rate} = R_{in}/R_{out}$$

where  $R_{in}$  and  $R_{out}$  are constant parameters for any value of  $c$ .

This technique has been implemented or proposed for such storage media as:

- A tape deck with rotating multiple-head pickoff, which maintains the normal tape-speed differentially with respect to the speeded or slowed tape, thus yielding normal pitch.
- Dual single-input/single-output processing channels in which samples are processed alternately at a fixed bifrequency read-in/read-out rate. Alternate switched-channel (shift-register) operation is necessary in this



## This is VSC

The 33½-rpm soundsheet accompanying this article gives you an opportunity to hear Variable Speech Control on your own record player. Playing the soundsheet will help you to understand how VSC works in a way that can't be accomplished by the printed word alone.

Side one contains a series of demonstrations comparing audio tapes that have been speeded up and slowed down with and without VSC processing. It also provides a dramatic clue to the potential applications of controlling playback speed.

Side two contains two parts. The first is a group of quotes from prominent observers of communications technology concerning the potential impact of Variable Speech Control that were taped during interviews conducted especially for this soundsheet by Cambridge Research and Development Group.

The second part is a demonstration of VSC characteristics that you can witness by attaching the output of your phonograph to an oscilloscope. The narrator describes what you will see on the scope.

Soundsheet credits: Produced by John Franklin; narrated by Mason Adams; recorded at Audio One, New York; engineer, Rich Peterson; VSC processor, courtesy Crown International. Audio tapes for side one include: "The Environment—Its Engineering Challenges," No. 70-S-03, Soundings, IEEE Continuing Education Service; "Molecules in Space, Men and Molecules," No. 512, the American Chemical Society; "What Causes What In Your Golf Swing—And Why?": Highlights from John Jacobs' Practical Golf, Golf Digest Inc.; "Benefit Approver Development Program," Foundations for Approver Skills, the Equitable Life Assurance Society, Audio-Video Services; "Use of Oral Hypoglycemic Agents," produced by Audio/Scope, a medical-information service of the Upjohn Co.; and "Walking Tour of the American Museum of Natural History," Acoustiguide Inc.

mode of operation to allow for adequate loading time needed in each channel prior to playback.

- Single-input/multiple-output processing channel in which the signal passes through a tapped delay line or tapped shift register whose taps are sampled in sequence at a relative rate inverse to the relative speed of the playback. This is analogous to the rotating multiple-head approach.

- Multiple-input/multiple-output processing channel in which random-access memory provides means for sequential storage and presentation of signal samples, the relative rates of which determine the compression ratio. Such a system switching in dual channels alternately is used to match contiguous samples.

For the most part, the electronic techniques listed above have been implemented with digital storage channels, requiring analog-to-digital and digital-to-analog conversion. In terms of implementation at minimum cost, the second category with its single-input/output processing channel appears to be the most promising. But it has two shortcomings: the dual-channel requirement, and the functional deficiency of a fixed and/or a limited-length sampling period, as constrained by the corresponding storage capacity, and the minimum output rate allowable by the audio bandpass. Alternatively, using variable input/output rates, with respect to the storage channel, produces:

$$c = \text{input rate}(t)/\text{output rate}(t) = R_{in}(t)/R_{out}(t)$$

for corresponding portions

where, although  $R_{in}(t)$  and  $R_{out}(t)$  are now allowed to

vary as a function of time, they are constrained to maintain a constant ratio to one another for corresponding portions of the signal for any elected value of  $c$ . Then a single linearly varied delay channel with simultaneous input/output and a full variable sampling period is also a solution. Thus if, at any time,  $t$ , the instantaneous delay of the line is  $\delta t$ , instead of  $c't_{in}$ , then

$$(c-1)t_{in} = \int_{t_{in}}^{ct_{in}} \frac{\delta \cdot t}{(c-1)t_{in}} dt$$

and, solving,  $\delta = 2(c-1)/(c+1)$

This demonstrates that use of a continuously increasing delay to "stretch" the waveform or a continuously decreasing delay to "compact" it (Fig. 3) is a direct and simple solution. Therefore, the VSC technique can provide a cost-effective solution that overcomes the drawbacks of the fixed bifrequency approach: It requires only one throughput channel, and, by using an analog shift register in the form of a bucket-brigade device for direct processing of the signal, it does away with the need for d-a and a-d conversion.

### Implementing the VSC system

In the dedicated-IC-based system for Variable Speech Control, the tape-head audio output is fed into a programmable MOS analog shift register, the bucket-brigade device, with a capacity of 256 or more bits. There, it is transferred in discrete packets of charge from stage to stage until it emerges. If the shift register is switched at a constant clock frequency, the audio waveform emerges substantially unchanged, 512 clock transitions later. If, however, the clock frequency is repetitively swept monotonically so that its period progresses geometrically from one end frequency to another during bit shifting, each bit of information receives a progressively greater (or smaller) delay.

Thus if the clock frequency is continually decreasing, each successive bit takes longer to pass through the analog shift register than the previous bit. The net effect is that the waveform emerges with the same shape, but it is stretched out in time with all frequency components decreased by the same ratio. In addition, the harmonic relationships are retained so that the quality of the voice is preserved as the pitch is decreased.

For time-expanded speech, exactly the opposite effect takes place, so that the clock frequency is swept from low to high during bit-shifting, thus raising the pitch of the processed speech accordingly. The clocking, drivers, and additional circuitry for timing, splicing, blanking, and amplification are all part of the control ICs.

In the block diagram (Fig. 4), a ramp generator provides a continuously variable sweep input to the voltage-controlled period generator (VCPG). The sweep's slope can vary from positive to negative as a function of the control-potentiometer setting. Output of the VCPG drives an analog shift register driver with a square wave having a geometrically progressing period.

What determines the starting point and slope of the ramp is a voltage produced from the motor-speed control, which is derived from the control potentiometer's setting. As the ramp generator sweeps the Voltage-controlled period generator, the analog shift register

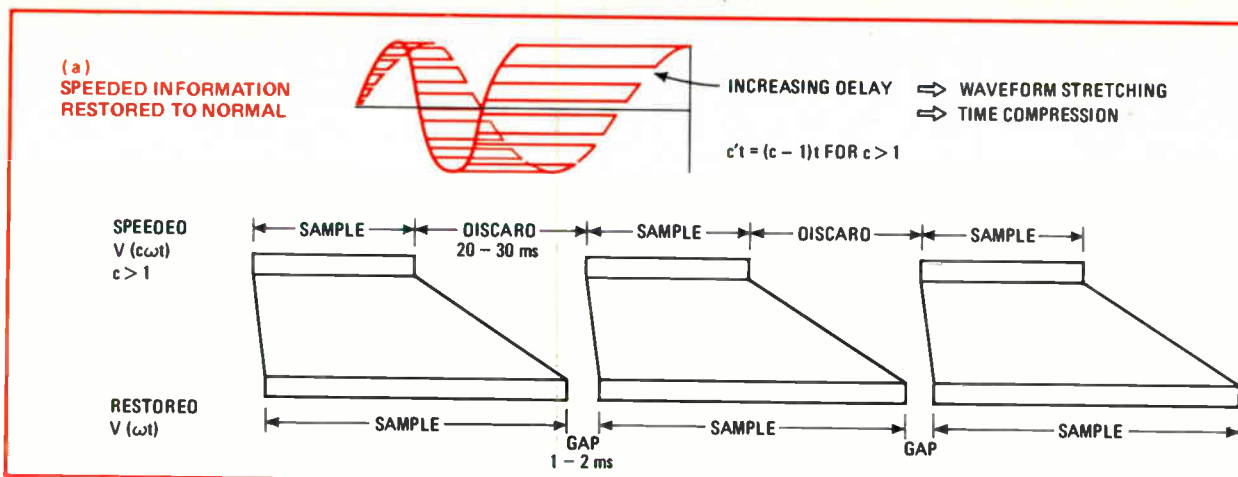

**3. A view of VSC.** Visual presentation shows how normal pitch of speeded playback (a) is restored by deleting 20- to 30-ms sections and stretching the waveform. Slower than normal playback without pitch distortion (b) is accomplished by inserting gaps that, in effect, compress the waveform.

switches at a continuously decreasing or increasing rate in order to effect speech compression or speech expansion, respectively. But, in addition, before the ramp overdrives the VCPG, a comparator sends a signal to the blanking logic, which at the next zero-crossing of the audio output from the shift register, causes the blanking amplifier to be blanked with its dc output maintained to prevent annoying "pops." At the same time, a reset pulse is generated to both reset the ramp generator and start a staircase counter.

During the next 512 transitions of the VCPG (and driver), the counter prevents the blanking amplifier from unblanking. This allows the information from the previous sample, stored in the analog shift register, to be dumped before the next detected audio zero-crossing triggers an unblanking signal, allowing the next sample to pass.

The sweep period of the ramp is a nonlinear function of the control-potentiometer setting, providing the longest possible ramp for each setting as constrained by a 20- to 40-ms discard (or gap) period. The ratio of time compression or expansion depends on the rate at which the clock is swept, and it may be controlled to vary the playback time from less than one-half to more than three times the recording speed.

Although only one bucket brigade is necessary to accomplish this transformation, if two units are summed differentially with their signals inverted with respect to one another, common-mode imbalances associated with the variations in switching and transfer rates are canceled in the subsequent differential-amplifier stages, while providing a 3-dB signal-to-noise gain. In addition, several stages of filtering are needed to reduce the remaining processing and switching transients.

The bucket-brigade device, which contains 512 stages in a 10-pin TO-5 can and operates at 12 to 15 v, is being supplied by the N.V. Philips Elcoma division, Eindhoven, the Netherlands. The control-circuit devices are available to licensees from Interdesign Inc., Sunnyvale, Calif. The production devices are two dedicated bipolar chips containing 200 transistors in 14- and 16-pin dual

in-line packages. Operating range is 9 to 16 v at approximately 30 milliamperes.

The idea of time-compressed speech is not new. Experiments with speeded speech and patents filed on pitch-correction techniques date back to 1924. However, it was not until the late 1950s that an operational time-compression system using the rotating-head technique was implemented and then marketed for about \$4,000. Since then, there has been a great deal of experimenting with compressed speech in anticipation of a simple, lower-cost system.

### Getting VSC on track

Although simple in concept, it was a long hard struggle to develop a viable product and bring it to market. Events leading to the VSC concept began in 1960 when, blinded by glaucoma, Sanford Greenberg had to rely on tape recorders with variable-speed motors to pursue his studies toward a Ph.D. at Harvard. Annoyed by the pitch change, he engaged an engineer on a part-time basis to try to correct the sound electronically. Intrigued by the prospects for such a tape player, in 1964, he enlisted the marketing aid of Kenneth Sherman, a Harvard Business School graduate who had a successful background in product-licensing. When the previous approach proved impractical, Greenberg arranged meetings with key officials at AT&T, RCA, IBM, and other companies in a vain attempt to get one of them to undertake alternate developments. Meanwhile, at Bell Laboratories, Dr. Gerhardt Schroeder had developed a computer-generated simulation of frequency-sampled bandwidth-compressed speech. This technique separated the speech signal into 200-cycle bands through a bank of 36 filters and then recombined these bands at halved frequencies. Playback at double speed produced time-compressed speech.

With the encouragement of Bell Labs, Sherman and Greenberg persuaded Burnell & Co., and subsequently Burnell's filter expert, Bert Norvell, on his own, to pursue the frequency-sampling approach with the idea that one expensive (\$25,000) compressor producing highly compressed tapes could service many inexpensive (\$300 to \$500) expanders.

The surprisingly good quality of a rotating-head-machine recording led to an attempt to produce its electronic analog in the form of a tapped delay-line proces-

(b)  
SLOWED INFORMATION  
RESTORED TO NORMAL

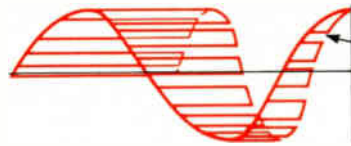

DECREASING DELAY  $\Rightarrow$  WAVEFORM CONTRACTION  
 $\Rightarrow$  TIME EXPANSION

$$= c'(t-T) = (c-1)(t-T) \text{ FOR } c < 1$$

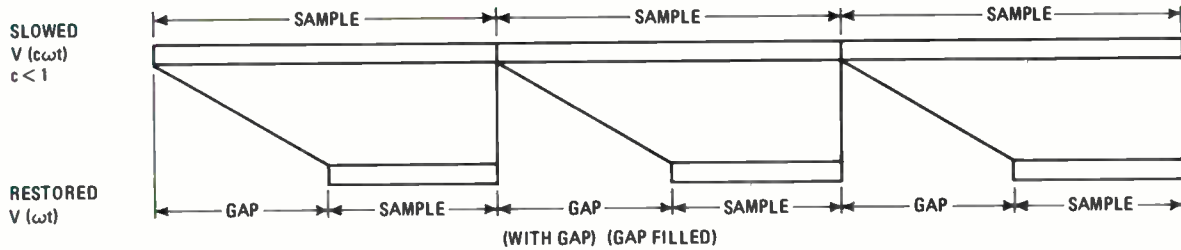

sor, which, it was felt, could yield a compressor/expander for about \$300 to \$400. In 1966, Cambridge Research and Development Group (CRDG) a product-development and licensing company just formed by Kenneth Sherman and his twin brother, Lawrence, assuming all financial responsibility, took over Sherman's agreement with Greenberg to pursue the commercial development of the technique with the ultimate intention of licensing it to a large company.

To help prepare a presentation for this purpose, Lawrence Sherman asked me, as president of Data Technology, to evaluate the proposed tapped-line implementation. I verified the feasibility and cost basis of the approach, but felt that it could be simplified by eliminating the taps. This thought resulted in the concept of the single-input/single-output varied-delay processor. Thus, upon experimental verification of the wave-stretching effect of a varied delay-line using transformers as current-controlled chokes in an LC line, the VSC-development phase of the project began—cost to CRDG to this point, \$37,000.

### Prototype is built

Under a new agreement additionally involving Data Tech and myself with CRDG funding, we set in motion an extensive feasibility study and subsequently developed a discrete-component prototype—a variable-RC delay processor using 160 field-effect-transistor stages. Although this system demonstrated that compression and expansion were being achieved, it had severe noise and conversion problems, which cast serious doubt on the validity of the approach.

Subsequent modification and alignment of the FETs improved the performance of the model sufficiently to produce useful speech compression and expansion. Commercialization was now the objective.

It was clear that the storage medium would be the primary factor in determining system cost, size, and performance. The discrete-component RC FET-storage design in the prototype, while implemented with integration in mind, was not the best way to go. A digital memory with a-d and d-a conversion or a variable continuous line were other possibilities.

Thus the advent of the bucket-brigade analog shift register was a fortuitous development, for it immediately made IC implementation of VSC feasible. Philips, a

developer of the analog shift register, was persuaded to release laboratory samples of its bucket-brigade devices because the Dutch firm was intrigued by the potential market that VSC appeared to offer for its devices. Philips agreed to provide them, despite CRDG's small size. This, in turn, allowed us to demonstrate the viability of the technique by using p-MOS bucket-brigade devices in a breadboard model.

We then hired circuit engineer William Eppler to help develop a successful full-function processor using 16 32-stage bucket-brigade devices in series. These results, coupled with a convincing CRDG marketing presentation, encouraged Philips to expedite development of a 512-stage bucket-brigade device. Substituted for the multiple devices, the new device produced remarkably good results, and Philips' Elcoma division was given the go-ahead to implement a production design. However Philips still wanted significant orders before undertaking serious production at volume prices. At the same time, prospective licensees were insisting on the assurance of sources of production-priced ICs. To break this impasse, CRDG launched an intensive program to demonstrate and market VSC. At this point, the cost to CRDG had mounted to approximately \$200,000.

In anticipation of the availability of an integrated control circuit, a basic, self-contained VSC module using discrete-component control circuits was developed for adaptation to a variety of tape players. This was done to demonstrate the system to prospective licensees and suppliers of the ICs. At the same time we enlisted the guidance of Integrated Circuit Engineering, a semiconductor-industry consulting firm in Phoenix, Ariz., to help us line up contacts with the appropriate IC producers. As an interim measure, we decided to have Interdesign Inc., Sunnyvale, Calif., produce the control circuitry initially in a three-DIP, four-chip preproduction configuration. Interdesign utilized its Monochip approach, a technique in which a standard IC device is customized for specific functional design by masking in the metalization stage.

In the two years that have followed initial introduction, the system has undergone several improvements in the form of machine-interface refinements, Monochip modifications, and dedicated-chip development. Nearly two dozen types of machines have been modified to include VSC. More than 50 companies have visited CRDG

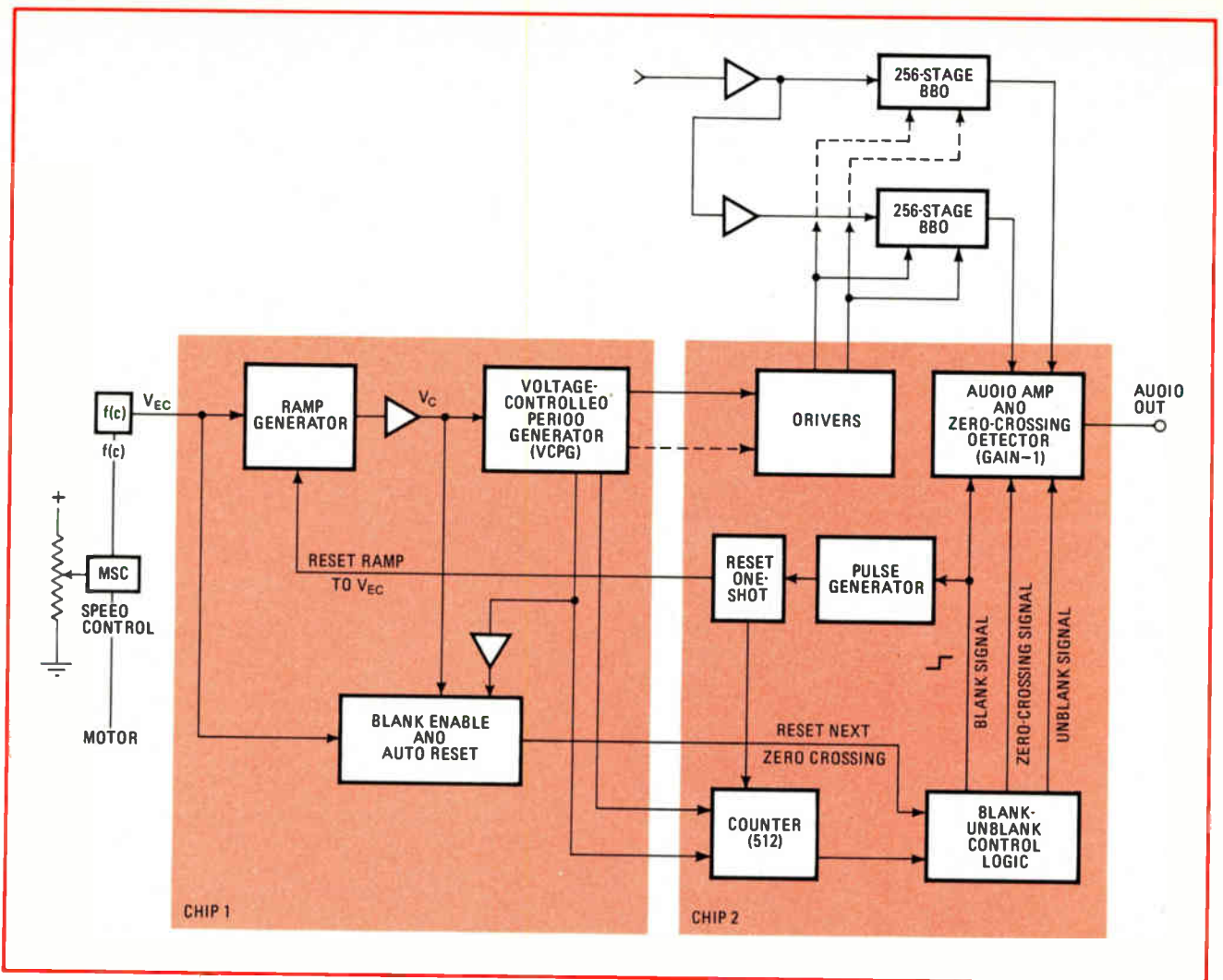

4. **Tape chips.** Functional block diagram of the two-chip Variable Speech Control shows how speed control is linked to the signal-processing circuitry. Ramp generator controls bucket-brigade switching rate via the VCPG to effect compression or expansion.

for licensing discussions. Three agreements have been concluded—Sony Corp. and Matsushita Electric Industrial Co. in Japan and Magnetic Video Corp. in the U.S.

Subsequently, a low-cost cassette recorder for demonstrations was engineered to include VSC. Several dozen units have been produced and sold to prospective licensees and end users. In addition CRDG has carried out successful field tests in training programs at Western Connecticut State College, West Haven, Conn., VA Hospital, Bell Laboratories, and Magnetic Video Corp. The basic U.S. patent was granted in January 1974, and applications have been made in 38 countries. Applications for nine supporting and alternate patents have been granted or applied for in the U.S. and eight foreign countries.

Although the original objectives have been realized, this has not been a smooth or easy development. Serious delays were encountered with respect to the integrated circuits. An unforeseen life problem encountered in the bucket-brigade devices has been resolved only recently. The consequent device-development costs, plus rising prices and increasing demand for ICs further complicated the situation, delaying development of the dedicated-control IC for more than a year

beyond its scheduled completion. Nonetheless, while other sources of supply are being pursued and further refinements are expected, production ICs are now available to licensees for their machine designs. Additional licensees are being sought.

We expect to have consumer-priced machines on the market in the near future. An interesting aspect of VSC ICs to tape-player manufacturers is the potential for them to add features to create various selling points for higher prices. For example, by using from four to six chips or more, rather than three, the manufacturer could install step-up features such as common-mode rejection, gap-filled expansion, dual-channel binaural capability, dynamic noise suppression, amplitude compensation, speed-shift equalization, "smart" sampling triggered by a specific cue, or increased bandwidth for broadcast quality. These features can be added to various tape players, thus providing a line of VSC machines.

The next objective ahead for VSC circuitry will be to integrate the basic system on one low-voltage, low-power chip. Recent experiments have confirmed the feasibility of accomplishing this objective by C-MOS techniques, so the next generation of VSC ICs will be designed accordingly. □

1100101010011010011001011000011

# Synchronous and Asynchronous

10000010 11001010 10011010 0110010



It makes no difference to the MC2260L terminal transmitter. This newest Motorola MOS subsystem for digital data communications operates equally well in either mode. And,

the MC2260L perfectly complements the popular MC2257/59L transmitter/receiver pair it joins in the line, while offering several output functions not provided by the MC2257, such as synchronous transfer, internal clock, and word complete.

Typically, data communications devices of this complexity must be encapsulated in large, non-standard packages, but not with Motorola's approach to these functions. Because the receiver and transmitters are separate units, handling and insertion procedures are kept simple by use of standard dual in-line packages — 28-pin for the MC2259 receiver and the MC2260, 24-pin for the MC2257 transmitter.

Consistent yields from dedicated production facilities allow excellent availability of these types. The same factors help keep prices down. In 100-999 quantities, the MC2257 is \$9.00, the MC2259 is \$10.75, and so is the MC2260. For technical information, including an applications note on the operational aspects of these transmitter/receiver types, circle the bingo number or write to Motorola Semiconductor Products Inc., P.O. Box 20912, Phoenix, AZ 85036. For products, contact any franchised Motorola distributor or your Motorola sales office.

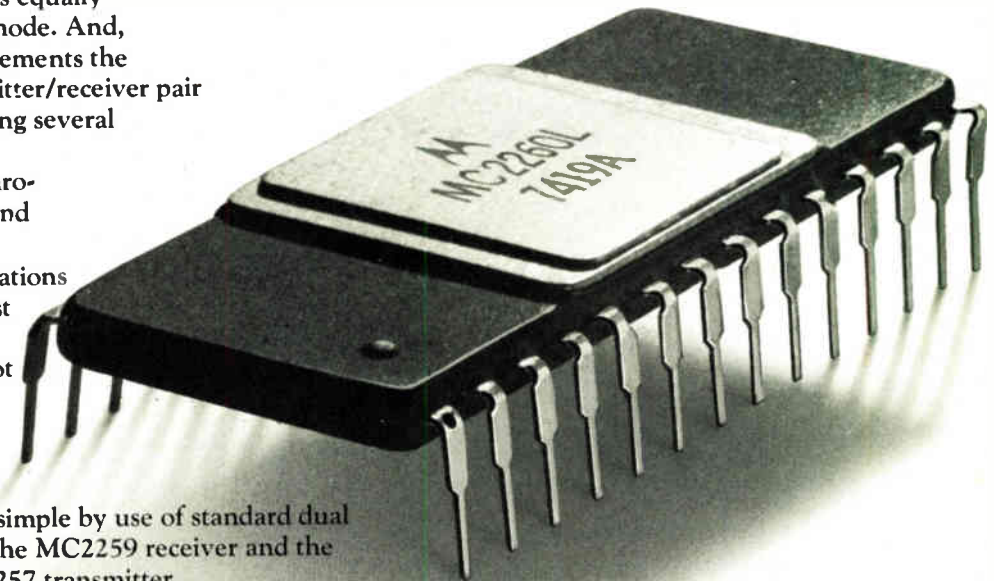

**MOTOROLA MOS**  
— designed for communications systems!



**Efficiency.** Testing rates can be maximized by calculating the best number of test stations to link to a test system for a given mix of units.

## Scheduling an IC tester for maximum throughput

The cost of testing integrated-circuit devices can be reduced if the right number of test stations is used and the testing schedule is properly planned around the average device test and index times

by Beck Chew, *Teradyne Dynamic Systems Inc., Chatsworth, Calif.*

□ Scheduling an integrated-circuit test system can be a very complicated problem. An efficient system must run at maximum throughput yet use a minimum of resources (device handlers and operators). Moreover, not only can test times range from 100 milliseconds to over 10 seconds, but device handling times can vary over roughly the same range, 100 milliseconds to 5 seconds.

The questions that must be answered are:

- How many test stations should be used on one tester?
- If device types are different and have different test times, which should be tested simultaneously?

- What testing modes should be mixed (e.g., wafer sort, final test, high yield, low yield)?

Given a specific amount and mix of product to be tested, the answers to these questions can make a big difference to throughput.

An exact analysis of test system throughput would account for all the variables of different device test times, station setup time, handler access time, and interstation interference caused by queuing for the tester. That level of analysis lies beyond the scope of this article and is best solved by a computerized time-simulation pro-

gram. What follows is intended to provide an understanding of these variables and how each affects throughput and test-equipment utilization.

For simplicity, five assumptions have been made:

- Test time for each device type to be tested has already been reduced to a minimum by proper programing techniques.
- A broad mix of products (long and short test and indexing times) allows intelligent scheduling.
- The lot sizes are large enough to make station setup time insignificant. (In practice, this can be a problem and should be taken into consideration when scheduling product flow.)
- High-quality handlers are in use with insignificant down time. (Some handlers, especially environmental chambers, have severe mechanical reliability problems.)
- All test stations are continuously manned.

### Some definitions

Consider a system designed to test one IC at a time, the case for most systems in use today. The throughput of systems with only one test station is determined solely by the time it takes to move the devices into position (or index them) and the times it takes to test them.

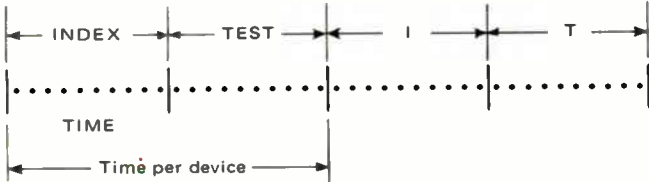

Since the system can handle devices no faster than they can be indexed, the index time sets the theoretical upper limit on throughput. But at this upper limit, no time would be spent on testing the devices, and test-system utilization would be zero.

This is evident from the equations for both parameters. Throughput (TH) in units per time is the inverse of the sum of average unit index time (I) and average unit test time (T), or:

$$TH = 1/(I + T) \quad (1)$$

System utilization (SU) is the ratio of average unit test time to average unit index plus test times, or:

$$SU = T/(I + T) \quad (2)$$

In the above expressions, index time should be fairly constant with any one physical setup. However, test time can vary from almost nothing to the full time required to test a good chip.

ICs are normally tested to first failure, whereupon the test ends. Most device failures are caused by catastrophic defects such as open wire bonds and shorted power-supply lines. So a bad IC usually fails very early in the test sequence—in fact, experience has shown that average bad-chip test times are about a tenth those of good-chip test times. When yield is low, as is often the case with wafer testing, bad-chip test time can significantly affect system throughput. The average test time (T) can be calculated from:

$$T = TG(Y) + TB(100\% - Y)$$

where TG = test time for a good chip, TB = test time

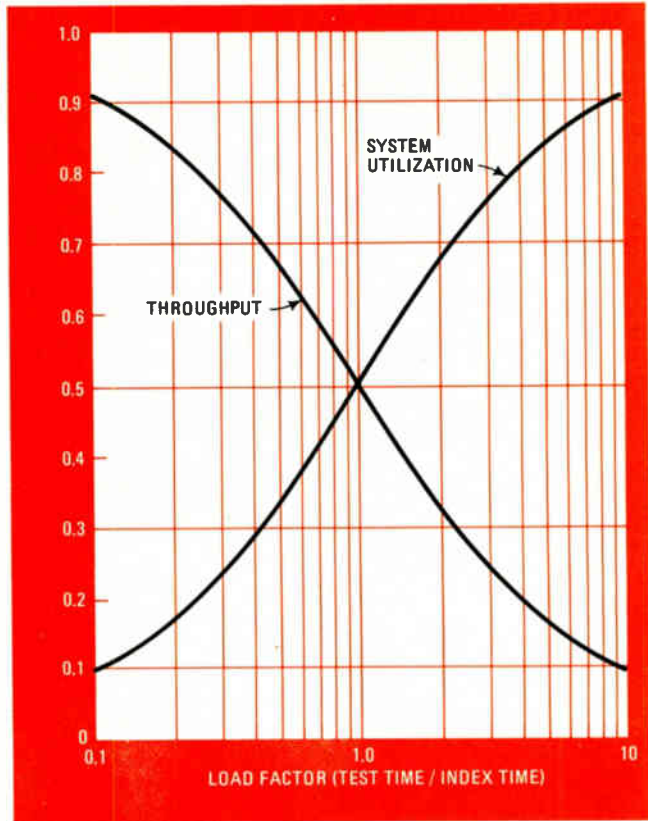

**1. The one-station dilemma.** Throughput, expressed as a fraction of that obtainable if test time were zero, is plotted as a function of the load factor, T/I, or the ratio of test to index time. A low T/I maximizes throughput but reduces system utilization, as the ascending curve shows. Optimization of both throughput and system utilization calls for additional test stations.





index time (station 1) must be added to the denominator of Eqs. 3 and 4.

$$TH = 3/(I_1 + T_1 + Q_1)$$

and

$$SU = 2T_2/(T_1 + T_1 + Q_1)$$

Since the denominators have been enlarged, this situation will deliver lower throughput and lower system utilization than will the loading conditions described for Eqs. 3 and 4.

A second situation that invalidates Eqs. 3 and 4 occurs when the total test time of all stations is greater than the longest index time plus test time of any individual station:

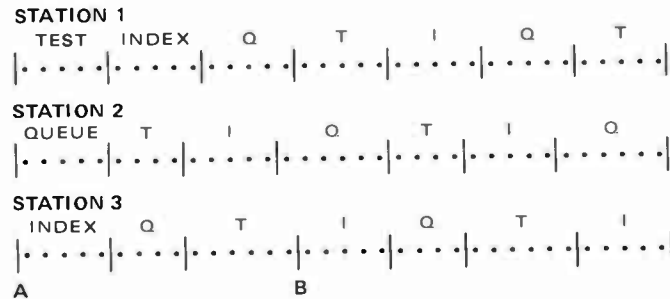

The time from point A to point B is the time required to test three units on a three-station system. Notice that testing is in progress throughout the time interval A-B so that throughput system utilization has become 100% or 1. Therefore in this saturated system:

$$SU = \sum_{i=1}^N T_i/(I+T)_{\max} = 3T/(I+T) = 1 \quad (5)$$

Since therefore  $3T = I + T$ , and combining this expression with Eq. 3,

$$TH = 3/(I+T) = 3/3T = 1/T \quad (6)$$

which shows that the throughput of a saturated system is inversely proportional to the average test time. Thus throughput becomes independent of index time.

Figure 2a shows system throughput versus load factor for one to six stations. For low load factors, where the system utilization (SU) is less than 1, the throughput is plotted according to Eq. 3. For high load factors the throughput is plotted according to Eq. 6. System utilization according to Eqs. 4 and 5 is shown in Fig. 2b.

Note that a low load factor (T/I ratio) is necessary if added stations are to make worthwhile contributions to throughput, as shown in Fig. 2a. The same holds true for system utilization plotted in Fig. 2b.

But if the load factor is too low and system utilization is far less than 100%, then large amounts of system time are being wasted. The general solutions to this problem are to purchase faster handlers, thereby decreasing index times, and to add more test stations.

### How many stations?

The optimum number of stations for the test system will be the number required to satisfy Eq. 5 and so make the system utilization equal to 100%. When testing times are the same at all stations, and so are index times, then

$$\sum_{i=1}^N T_i/(I+T)_{\max} = NT/(I+T) = 1$$

$$\begin{aligned} NT &= I + T \\ N &= (I/T) + 1 \end{aligned} \quad (7)$$

which gives the ideal number of test stations for a saturated system. In practice, actual test times vary widely, but Eq. 7 is still useful as a guideline.

As an example, consider wafer probing. With many types of products, the time required to test one wafer is about 1 minute, which is also the time typically required to change a wafer. When this is the case, one operator can man two probers. One prober will be testing while the other prober is being loaded. Since I is approximately equal to T, two test stations are required.

As a second example, consider a test system that's to be loaded with units having an average test time of 0.2 second, and suppose that automatic handlers capable of processing 7,000 parts per hour are to be used. By substituting  $T = 0.2$  s and  $I = 1/7,000$  hr = 0.514 s in Eq. 8, the best number of stations works out at

$$N = (0.514/0.2) + 1 = 3.57$$

Since N is between 3 and 4, an economic decision must be made. Clearly, three stations are needed. A fourth is only necessary if the cost of using it (including the cost of handler and operator) is more than paid for by the throughput it adds.

The utilization of station 4 will be

$$SU_{3-4} = (TH_4 - TH_3)/TH_1 \quad (8)$$

where  $TH_4$ ,  $TH_3$ , and  $TH_1$  equal throughputs with four, three and one station respectively.

With one station on the tester,

$$\begin{aligned} SU_1 &= NT/(I+T) = 0.2/(0.514+0.2) = 0.28 \\ TH_1 &= N/(I+T) = 1/(0.514+0.2) \\ &= 1.40 \text{ units/s} = 5,042 \text{ units/hr} \end{aligned}$$

With three stations,

$$\begin{aligned} SU_3 &= 3(0.2)/0.714 = 0.84 \\ TH_3 &= 3/0.714 = 4.20 \text{ units/s} \\ &= 15,126 \text{ units/hr} \end{aligned}$$

With four stations,

$$\begin{aligned} SU_4 &= 4(0.2)/0.714 = 1.12, \text{ or } 1.0 \\ TH_4 &= 1/0.2 = 5 \text{ units/s} = 18,000 \text{ units/hr} \end{aligned}$$

Note that Eq. 6 has been used to compute  $TH_4$  because total test time (0.8 s) exceeds the longest index time plus test time. Thus adding station 4 boosts throughput by  $TH_4 - TH_3 = 18,000 - 15,126 = 2,874$  units per hour.

The additional throughput of station 4 can now be weighed against the expense of operating that station. Station 4 utilization will be

$$\begin{aligned} (TH_4 - TH_3)/TH_1 &= (18,000 - 15,126)/15,042 \\ &= 0.57 = 57\% \end{aligned} \quad (9)$$

Note that the 57% utilization factor is also directly obtainable from Eq. 7. Since  $N = 3.57$ , then for four stations the system utilization =  $0.57 = 57\%$ .

$$3.57 - (N - 1) = 3.57 - 3 = 0.57 = 57\% \quad \square$$

# EXPLORE "DOUBLE INTEGRATION" the low-cost path to new Digitizing Product Designs

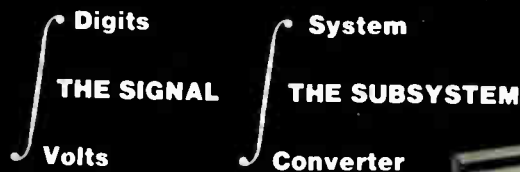

**Compatible integrating conversion modules or complete data-translation subsystems... either way, we'll give you optimum performance, reliability, and "value-added."**

OEM designers everywhere choose ANALOGIC—for advanced technology... for lowest overall system cost... for highest "value added" profits. Here are just 6 of over 100 Analogic products designed specifically for industrial and analytical digitizing:

**1. Integrating A/D Converters.** We make more different price/performance "mixes" than anyone else. The MP2344 uses propriety technology to achieve state-of-the-art performance at low cost. (0.01% accuracy, 3-phase auto-zeroed stability, >100dB CMRR, and 16-bit or 40,000-count bipolar resolution.) Essentially a voltage-to-count (dual-slope) converter, the MP2344 lets you supply the counters, displays, power, and master logic—for maximum value added. For a complete converter system, specify AN2344.

**2. MP2321/2322** low-cost, premium-grade "universal" integrating converters give you *maximum* design freedom... *without* design headaches. 600V CMV range! nA bias current! Drift-free auto-zeroing! "Logic-powered" from +5V DC, with built-in, highly regulated, *isolated* analog supply! Choose 3½ digit BCD, or 12-bit binary. DTL/TTL compatibility with computers, modems, control systems, displays.

**3. Signal Conditioning:** MP221 is a potentiometric, ultra-low-noise, ultra-stable amplifier. Its low-level, performance can't be matched, at *twice* the price. *Not* just low drift, but low *noise*, too: DC to 1 Hz, <0.1  $\mu$ V p-p; DC to 10 Hz, <0.3  $\mu$ V p-p; DC to 100 Hz, <1  $\mu$ V p-p. Noise current, DC to 1 Hz, <3 pA, Drift, <0.03  $\mu$ V/°C!

**4. Power Supplies:** MP3020 *system-grade system-compatible*, DC/DC Converter (5V DC in,  $\pm$ 15V DC out @ 150 mA): very low reflected input noise current; ultra-guarded I/O isolation and noise attenuation; tight static and transient regulation; *exceptional* efficiency.

**5. Complete Subsystems:** The AN5351 is the industry's most complete and versatile load-cell digitizing subsystem. Priced so low that your system profits will soar, it provides: multiple-load-cell excitation; six-wire (auto-tracking) ratiometric input; active multipole filtering; ultra-stable preamplification; autozero/autotare computation; dual-range units conversion; data/result display; count-resolution scaling; over load and limit sensing; data transmission/printout capability; and optimum *industrial-environment* reliability. Buy it, or build it yourself from our modules.

**Choose the Analogic path** of "double-integrated" modules or subsystems—for the most competitive, most profitable end product. Write today for free Design Kit, or call Guy Wilson, at (617) 246-0300.

Analogic, Audubon Rd., Wakefield, Mass. 01880.

**SEND FOR FREE DESIGN KIT**



**ANALOGIC** ■

... The Digitizers



ously variable down to zero. To regulate the output more fully against input voltage changes, resistor  $R_2$  may be replaced by an appropriate zener diode. Diodes

$D_5$  and  $D_6$  are optional—they are used to offset the positive 0.7-V reset threshold of the timer to improve the circuit's output-to-input voltage tracking. □

## SCR zero-cross trigger limits maximum load power

by Richard Eckhardt

*Electronics Consulting & Development, Cambridge, Mass.*

A zero-cross trigger for a silicon controlled rectifier will limit the maximum power delivered to a load if it is made to fire the SCR only on alternate cycles of the ac line input. Such an SCR triggering circuit is useful for driving loads rated at less than 110 volts. There are two advantages to limiting SCR conduction in this way—large amounts of power do not have to be wasted through dissipation, and the load can be powered continuously without the need for a power transformer.

With a zero-cross trigger, the SCR is fired only when the voltage across it is at or near the zero point in the driving ac waveform or pulsating dc waveform. Zero-voltage firing minimizes the generation of noise spikes that may occur when the voltage and current to the load are changed too rapidly.

The zero-cross trigger shown here employs a general-purpose operational amplifier as a comparator. The control-voltage input varies the power applied to the

load by governing the ratio of SCR on cycles to SCR off cycles. To increase the power supplied to the load, the control voltage is made larger.

Some of the pulsating dc voltage produced by the rectifier bridge is applied to the noninverting input of the op amp. The control voltage, which goes to the op amp's inverting input, charges capacitor  $C_1$  through resistor  $R_1$  until the capacitor's voltage exceeds the minimum point of the pulsating dc voltage.

When this happens, the output of the op amp goes negative, switching off the transistor and permitting the SCR to fire. Since the SCR is triggered at the minimum point of the pulsating dc voltage, the SCR turns on only when the ac voltage across it is at or near zero. The output of the op amp remains low until capacitor  $C_1$  discharges through diode  $D_1$  and resistor  $R_2$ .

This capacitor must be charged again by the control voltage before the SCR can be fired again. The charging time of capacitor  $C_1$  determines how many successive cycles of the input voltage are included in the interval between SCR firings.

The circuit's dynamic range is established by the resistance ratio of charging resistor  $R_1$  to discharging resistor  $R_2$ . □

Designer's casebook is a regular feature in Electronics. We invite readers to submit original and unpublished circuit ideas and solutions to design problems. Explain briefly but thoroughly the circuit's operating principle and purpose. We'll pay \$50 for each item published.

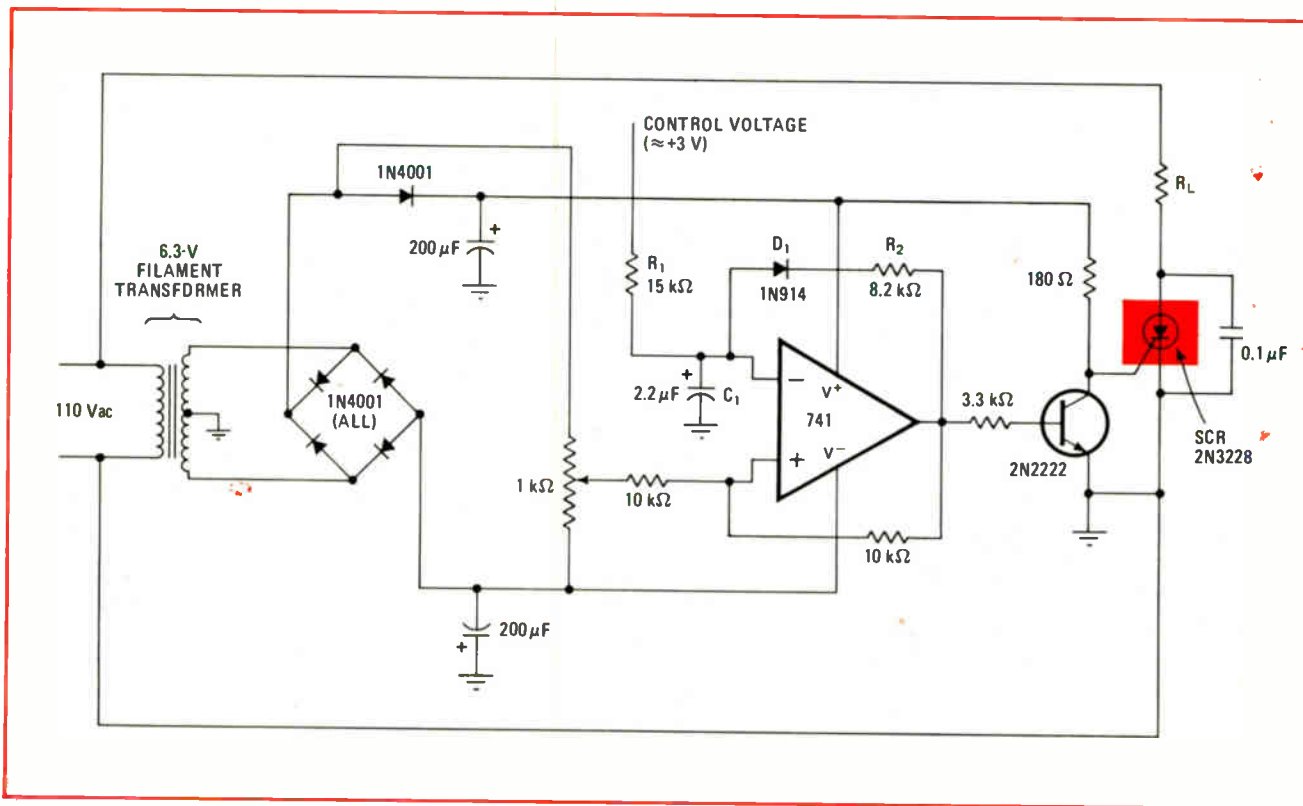

**Power limiting without power waste.** Because this zero-cross trigger fires its SCR only on every other cycle of the ac line, the maximum power delivered to the load can be limited without the need for a power transformer or wasteful power dissipation. The control-voltage input determines the ratio of SCR on cycles to SCR off cycles. The larger the control voltage is, the greater the power to the load.



## Tell it like it is!

Measure the total power density from multiple 300 MHz to 18 GHz sources in a single integrated reading — **only with Narda's NEW isotropic monitor**

Model 8321/8323 Isotropic Probe —  
Frequency Response

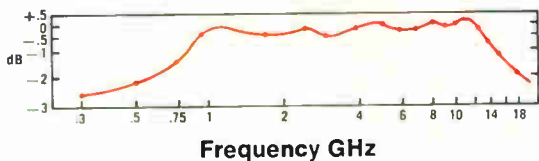

This compact, easy-to-read, radiation monitor accurately measures near and far field power densities over the broad frequency range of 300 MHz to 18 GHz . . . it simultaneously responds to different polarizations and direction of incident power. Read the total power density at any one point from CW, FM, pulsed RF and microwave sources used in communication, radar, ECM and industrial applications.

Write for complete information.

wherever microwaves go... **narda** *Microline*<sup>®</sup>

THE NARDA MICROWAVE CORPORATION • PLAINVIEW, L.I., NEW YORK 11803  
516-433-9000 • TWX: 510-221-1867 • CABLE: NARDACORP PLAINVIEW NEW YORK

"SEE US AT MONTREUX, SWITZERLAND  
MICROWAVE SHOW BOOTH # 155"

"SEE US AT WESCON BOOTH # 2724 & 2725"

Circle 103 on reader service card

# Building an analog peripheral inside a minicomputer chassis

Compact expandable data-acquisition system, which replaces clusters of individual interconnected circuit modules, can be applied by OEM system builders to a wide variety of industrial and laboratory uses

by Fred Molinari and Aaron Fishman, *Data Translation Inc., Framingham, Mass.*

□ The challenge posed by computer-controlled data-acquisition systems today is not so much getting them to work as it is getting their prices down. Peripheral prices may be expected to decrease in proportion to the decreasing costs of the host computers. But usually they don't. Although highly complex devices, computers derive economies largely from mass production. Data-acquisition components, by contrast, tend to be custom designs, manufactured in smaller quantities.

Theoretically, a more-or-less general-purpose data-acquisition front end could greatly lower the system's production cost. Furthermore, if they could be produced in large quantities, many special features usually regarded as extras could be included as standard equipment. And although many users might not need these extra features, the cost penalty of including them would be slight, and users would gain flexibility.

However, reliability can be increased at the same time as prices are reduced if the general-purpose data-acquisition package is made small enough to be mounted inside the minicomputer. There the device can run off the computer's power supply without the requirement for separate chassis hardware, cabling, or interconnecting hardware.

A data-acquisition subsystem within a minicomputer enables the system to implement a wide variety of applications, include wide dynamic-range measurements, extend flexibility in channel-addressing, and expand the number of channels, as well as provide various throughput rates. Thus, the diverse needs of different applications-oriented acquisition hardware can be fulfilled with a standard device that performs the basic data-conversion function and allows the user to configure his specific need without customizing the high-precision circuitry portion.

## How general is general-purpose?

Clearly, the single data-acquisition device should handle as many applications as possible at acceptable cost. If the acceptable cost is pegged too low, performance will be too limited for all but the most simple-minded applications. On the other hand, if it's too high, performance will be adequate for many applications, but the price will be prohibitive for the less sophisticated uses.

How, then, does the system designer establish the price and performance levels of a general-purpose de-

vice? A good approach is to pick a desired parameter, choose a reasonable initial value for it, and then determine how much money can be saved by relaxing the specifications a little. After that, figure out how much extra it would cost to tighten the specifications a little.

Through this kind of thought process, a designer can graph costs against performance levels of several key system parameters. In most cases, these graphs will be highly nonlinear and have sharp breakpoints at those performance values that begin to push the current state of technology.

If the performance levels are chosen in the vicinity of these breakpoints, then relaxing the specifications slightly will not save much money, but tightening them up a little will increase the cost a lot. If the potential applications for the data-acquisition system were fairly uniformly spread across the performance spectrum, such a system would be optimum in its cost/performance trade-offs. But, since this assumption is not valid, at least some spec-juggling will be necessary to come up with the right device for the marketplace.

## Resolution costs

As an example of the development of one of these system specs, consider the crucial parameter of system resolution. As the graph of Fig. 1 shows, costs rise fairly slowly up to 12 bits. Above 12 bits, however, they rise rapidly. The price of a 14-bit system is 70% higher than that of a 12-bit system, but the 12-bit unit is only 10% more expensive than one with 10 bits of resolution. Clearly, 12 bits is the optimum resolution value. Besides, most physical parameters can be covered adequately by a 12-bit converter. In fact, most transducers are hard-pressed to achieve linearities better than 0.05%, and 12 bits corresponds to 0.012%.

Furthermore, many people who are using highly precise analog-to-digital converters today do so, not because they really need the resolution, but because they want to be able to cover a broad dynamic range. The needs of these applications frequently can be met by a 12-bit converter combined with a switchable-gain amplifier. It has been estimated that a 12-bit converter by itself satisfies 80% of the applications that exist today, and it has been further estimated that the bulk of the remaining applications can be satisfied by adding dynamic-ranging capability.

The same sort of thinking is true for speed. Here the

breakpoint occurs at 100 kHz. Above that frequency, further increases in the throughput rate get very expensive. While spending the additional money for a faster system might be justified, one must make sure not to pay a premium for speed that turns out to be unusable. The speed of the system is determined, not only by the conversion speed of the data-acquisition front end, but also by the speed of the computer.

If, for example, the computer takes 20 microseconds to get a conversion into memory, and the front end takes 10  $\mu$ s to make a conversion, then the system needs 30  $\mu$ s to acquire a single data point. Clearly, spending a lot of money to double the speed of the analog-to-digital converter only cuts the over-all data-acquisition time by 16.7%, and it therefore doesn't make much sense to spend a lot of money on a high-speed front end. What's more, microprocessor's cycle time is likely to be five to 10 times slower than that of the mini-computer.

On the other hand, if the converter is tied to a computer that has the ability to operate in a direct-memory-access (DMA) mode, it may make sense to use a high-speed converter because the DMA enables the memories of most minicomputers to be accessed every 2  $\mu$ s. However, a really fast data-acquisition system will need a lot of buffer memory, so the extra cost of such a system is more than merely the cost of its front end.

From such considerations, the designer can generate a set of specs for a general-purpose data-acquisition front end. The system would have a 12-bit a-d converter, a signal-conditioning input amplifier, a sample-and-hold circuit, a system clock, logic-control circuitry, and an input multiplexer (Fig. 2). The multiplexer should be able to handle both single-ended and differential inputs, and, ideally, it should be expandable in its channel capacity.

### The internal analog peripheral

Having decided, at least roughly, on a block diagram and a set of specs for the data-acquisition front end, the designer must decide how it should be built. Advances in semiconductor technology have brought about the option of building the entire unit in a single package small enough to fit onto the interface board found in most minicomputers. This approach saves both money and space, and it can also enhance system reliability by eliminating a lot of cabling and connectors.

Costs are saved by the elimination of a separate chassis, power supply, and set of interconnecting hardware for the front end. Further, line drivers for the cables aren't needed because the cabling is eliminated. A solid-state data-acquisition front end should need no more than about 500 milliamperes of supply current at 5 volts—an amount that most minicomputers can easily supply, since most are designed to accommodate and provide power for controllers that can be plugged into their option slots. The saving in space is also significant.

One problem is getting the system small enough to fit into a minicomputer. Once there, however, the need for miniaturization does not end. If the front end is built in a single package, and if the package is made small enough, there will be space left over in the mini-computer for such nice extras as a DMA interface, a real-

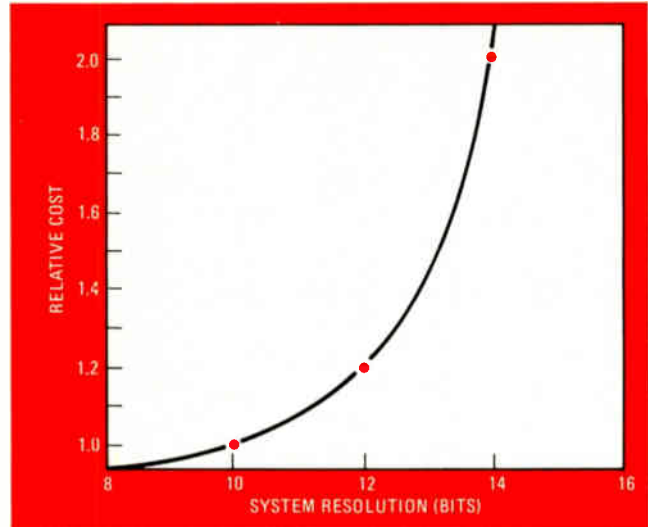

**1. Optimizing resolution.** System costs rise very steeply above breakpoint which, in this case, occurs when resolution climbs above 12 bits. For example, 12-bit resolution costs only 1.2 times as much as 10-bit, whereas 14-bit costs 1.7 times as much as 12.

time clock, and analog diagnostic circuitry for checking out the entire system.

A final reason for going the built-in route is enhanced reliability. It is axiomatic by this time that the connectors are the weakest link in any electronic assembly. By eliminating them, the built-in front end can't help but improve system reliability.

### The fly in the ointment

Of course, nothing in this world is without its flaws. The problem with the built-in analog peripheral is that it is basically an analog device working in a digital—that is, noisy—environment. This problem is by no means without a solution, but it must be borne in mind from the start of the design process.

There are three major sources of noise in a computer: high-frequency clocks, the common +5-v power supply, and the memory if magnetic core. Memory and clock noises can be dealt with by shielding the data-acquisition system all around—packaging it in a metal can. Dealing with power-line noise is a little more difficult. Logic noise on the 5-v lines and grounds will couple into the system if analog signal lines run close to (especially parallel to) the noisy power lines.

A logic-level change of 2.5 V in 10 nanoseconds will couple a 25-millivolt error spike into an analog input line if the two lines have a capacitance of only 1 picofarad between them, and if the source impedance of the analog signal is 100 ohms. Higher source impedances and higher capacitances make the problem worse.

It should be apparent from this example that analog and digital lines must be kept either well separated, well shielded, or both, and that they shouldn't be terminated at adjacent connector pins. Also, analog runs should be kept as short as possible, and they should be surrounded by an analog ground etch with a ground plane etch on the opposite side of the board. The short analog runs minimize the exposure of these runs to stray fields, and the ground shields remove stray capacitance paths.

Twisted-pair analog-input wiring is required to elimi-

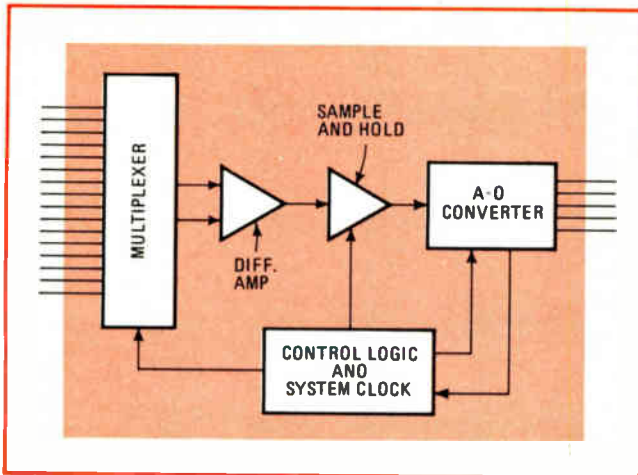

**2. Internal peripheral.** Data-acquisition front end includes expandable multiplexer, sample-and-hold circuitry, and a-d converter. Entire unit can be built into a package small enough to be mounted inside a minicomputer. Provisions for external control are not shown.

nate magnetic pickup. These lines should be routed away from clock lines, memory drivers, and the switching power supply whenever possible. Further, these signal lines should be shielded to eliminate capacitive and electromagnetic pickup.

Since +5 V is normally available at every printed-circuit-board slot in the computer, and since a typical data-acquisition system requires only 80 mA at  $\pm 15$  V, the computer should be able to supply the necessary power. All that's needed is a dc-to-dc converter. However, the design of the converter must guarantee good isolation between the +5-V input ground and the  $\pm 15$ -V output ground to prevent inaccuracies caused by ground loops. Also the dc-dc converter must prevent high-frequency noise on the 5-V line from appearing at the  $\pm 15$ -V output.

The dc-dc converter selected for this application should keep its common-current noise between the input ground and output ground below 300  $\mu$ A peak-to-peak. In addition, the coupling impedance between the input 5 V and the output  $\pm 15$  V should be less than 100 pF in parallel with more than 100 megohms. These specifications guarantee that 2 V of high-frequency noise on the 5-V line will produce less than 100  $\mu$ A of injected noise current onto the  $\pm 15$ -V lines. This noise level can easily be attenuated by the bypass capacitors within the data-acquisition system.

### Internal diagnostics

Once a peripheral on a single card is built inside the minicomputer, diagnostics and trouble-shooting take on a new importance. It is fairly common for a computer to have a digital diagnostic routine for exercising the basic timing, flags, and data paths as a matter of course in the operation of the machine. This is usually not the case in the analog world because diagnosing analog-circuit problems differs radically from digital techniques. When analog circuitry is built into a computer, it becomes highly desirable to emulate, as far as possible, the digital approach to diagnostics.

In the field, for example, it's necessary to have a way of determining if the data-acquisition system is working

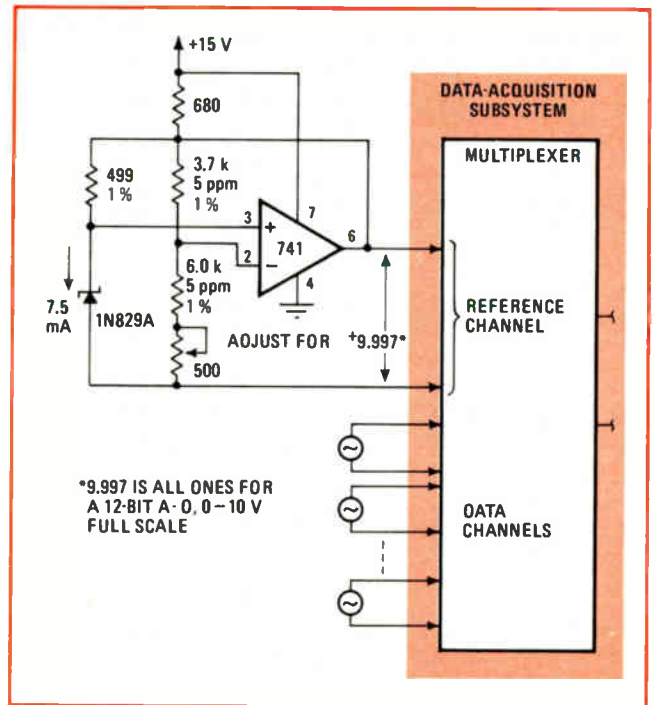

**3. Self test.** Stable reference source hard-wired to one channel of multiplexer can be used to test accuracy of entire system. A precision ramp generator might also be added to check linearity.

correctly. It helps, especially in a new installation, to separate, without disturbing the wiring, noise on the customer's lines from uncertainties in the data being measured. The cost of field service may certainly justify this approach. The addition of a few inexpensive circuits on the controller board can facilitate this type of testing without the need for bulky test equipment.

One way to do this is to dedicate one channel of the multiplexer input as a test channel. A fairly inexpensive precision reference can be hard-wired to that input to check the over-all accuracy and functioning of the system. Figure 3 shows such a reference circuit and its interconnection to the system. Other test circuits could be built in when further qualifications of the analog function are required. One such function might be a ramp generator for checking linearity.

### System operation

The two main periods of interest to a data-acquisition system are the actual time required to sample the analog signal and the time needed to convert the sampled signal to digital form. The first period includes the selection of the desired multiplexer channel and the acquisition and storage of the signal by the sample-and-hold amplifier. The second period is the time required for the a-d converter to complete its conversion; to avoid errors, the sample-and-hold circuit must hold the unknown value constant during this period.

Various techniques that can be used for multiplexer-addressing depend on the need for maximizing system speed and the complexity of software that can be used. A simple system might address the channels sequentially without any need for program control. When this sequential approach is used, it is usually desirable to use a last-channel register as a time-saving device.



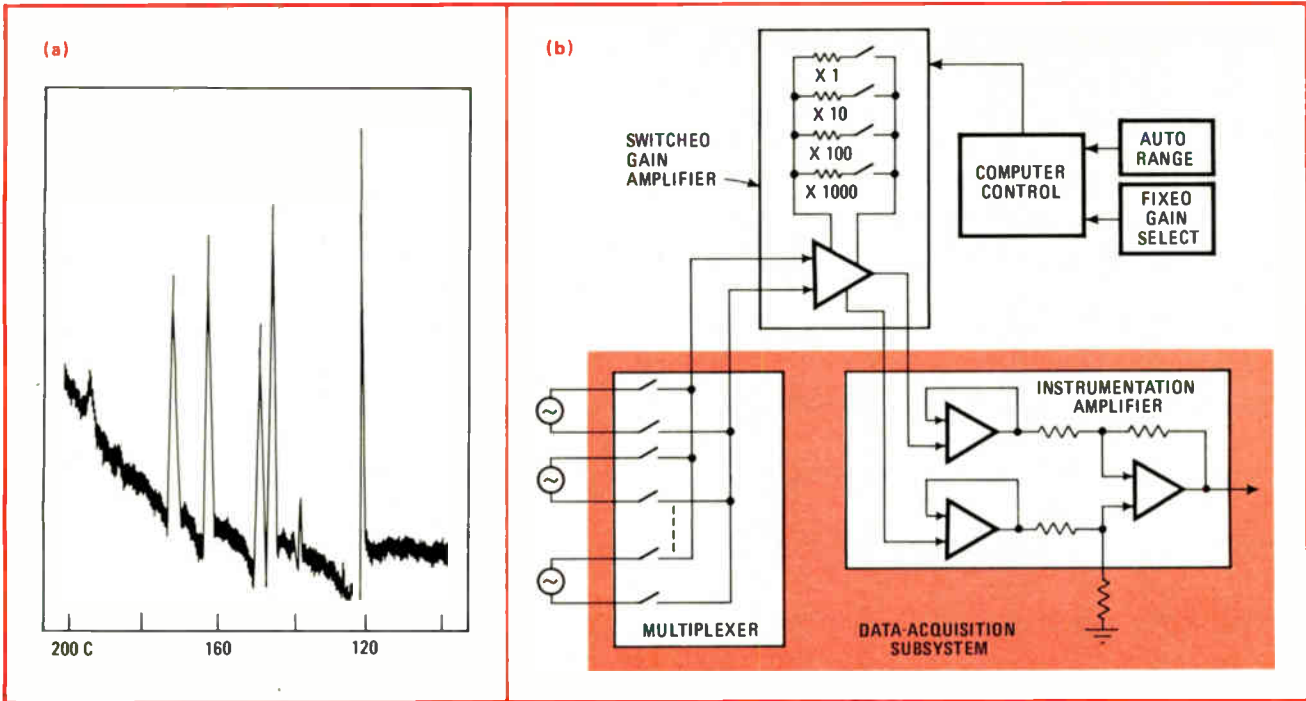

4. **Large and small.** Gas chromatograph output (a) has two ranges of peaks—10 V and 50 mV. Data-acquisition system must be able to digitize both to within 1% or better. Twelve-bit a-d converter with full-scale value of 10 V can only resolve 2.5 mV—5% of 50 mV. Solution is a switched-gain amplifier (b). Simply boosting gain by 10 when studying 50-mV signals allows resolution to within 0.5%.

The last-channel register is useful because, since multiplexer channels are usually sold in batches of 16, if a user needs 23 channels, he buys 32, and nine are not used. To avoid having the system automatically address the unused channels, the number 23 is loaded into the last-channel register. Then, when channel 23 is addressed, the last-channel logic associated with the register will force the multiplexer counter to reset after channel 23 is sampled.

A more flexible channel-addressing technique is random addressing, completely under program control. This eliminates the need for the last-channel register and its associated logic, but it is slower, it requires more software, and it needs more computer memory.

### Trigger

Once a channel is selected, some means must be devised for deciding exactly when to initiate the a-d conversion. For the routine monitoring of slowly varying variables such as temperatures, the system can simply run freely and take one data point at each address.

More often than not, however, external events or processes will determine the time at which acquisition should begin. A good example is a blow-down wind tunnel where a high-velocity wave that might last for only 20 milliseconds is produced. A diaphragm in a large pipe is pumped up until it breaks. The breaking point is unknown, but data-taking must start immediately when the break occurs. This is accomplished by having the pressure-change by the bursting diaphragm produce a trigger pulse, which then starts the data-taking process through an interrupt.

If the data-acquisition system were to run free in this situation, a large memory capacity would be required to recover the desired data, which needless to say, could

raise system costs out of sight. To keep costs down, and to let the system work as effectively as possible, an external trigger is needed. If the system is set up in DMA, the external trigger can start the process with the DMA request, the computer answers it, and it then waits for the next trigger. The process is carried on in the DMA.

The acquisition system can also be triggered internally under program control. This method may not be adequate if time correlation of the input data is important, but a real-time clock can be added to trigger the measurement system at a known accurate rate.

### System flexibility

A general-purpose system must be flexible, and flexibility can be enhanced by an external trigger. Automatic gain-ranging can greatly extend the dynamic range of a system without increasing its resolution and its consequent cost.

An important application in which gain-ranging can be used to advantage is gas chromatography. This electronic tool of chemical analysis produces an electrical output signal in which meaningful information is contained in signals with a peak value of 10 v and also in signals with a peak value of 50 mV (Fig. 4a). To study the 50-mV peaks adequately, the system must be able to resolve approximately 0.5 mV. For a system with a full-scale capacity of 10 v to be able to resolve 0.5 mV, it needs a resolution in excess of 14 bits.

The saving point in this situation is that the system need not be able to resolve a 10-v signal to 0.5 mV. A 12-bit system can resolve a 10-v signal to within 2.5 mV, which is more than adequate; so, for the 12-bit system to also be capable of handling the 50 mV signal, all that's needed is to add a stable switched gain amplifier (Fig. 4b). □

# WHO MAKES THE MOST GLASS PRODUCTS FOR ELECTRONICS?

- CERDIP Sealing Materials . . . we sell the industry standard . . . including the lowest temperature sealing glasses on the market
- Substrates . . . you can choose standard sizes off the shelf, or order special glasses
- Diode Cases . . . we're the largest supplier in the world
- Infra-red Sealing Reed Switch Glass . . . we developed it to give you fast, efficient processing
- Glass Preforms . . . more than 1,200 shapes of IC frames, beads, and other preforms
- CRT Bulbs . . . more than 100 standard shapes, from 1" to 36", plus special shapes and sizes
- Quartz Crucibles . . . O.D. sizes up to 10"
- Chemically Machinable Glass Ceramics . . . for unique shapes and configurations
- Display Materials . . . cell sheets, back plates, mercury capsules and sealing frit, everything for flat panel displays

# CORNING MAKES IT!

We can do almost anything with glass for electronics.  
Got a problem? Write or call:



Electronic Materials Department

**CORNING**  
CORNING GLASS WORKS

Corning, New York 14830  
(607) 974-8866

## Test circuit measures optical coupler's speed

by John R. Torok  
National Semiconductor Corp., Santa Clara, Calif.

Although the performance of optical couplers has improved considerably in the last year or so, the method of measuring their switching times has not. Data sheets for most optical couplers still specify switching time at some unknown LED drive current, making it difficult, to say the least, for a designer to know what the actual switching time is.

Generally, the forward current applied to the coupler's input LED is increased until the collector current of the coupler's output phototransistor reaches some specified value. (This current limit is typically 1 or 2 milliamperes.) Then, the rise and fall times of the collector current are measured at the 10% and 90% points of the specified value.

However, this type of measurement does not accurately define the coupler's switching speed because the output rise and fall times are not referenced to the input current applied to the LED. For example, a 1-microsecond rise time for the output collector current is meaningless if the LED input current must flow for 2  $\mu$ s before there is any output current at all.

A far better indication of coupler speed is device on time, which includes the input-to-output delay time, as well as the rise time of the output current. Likewise, device off time, which accounts for the phototransistor's storage time and the fall time of the output current, should also be determined. These two measurements can be referenced directly to the input current.

Since most couplers having a phototransistor output are driven from TTL signals, the input current to the LED is constant—that is, the input drive can be considered to be fixed and constant with respect to pulse width, pulse amplitude, and duty cycle.

The test circuit for determining a coupler's on and off times is shown in the figure. For this measurement, the base terminal of the phototransistor must be defined electrically, rather than leaving it open, as is usually done. Therefore, a high-value resistor ( $R_2$ ) is placed between the phototransistor's base and emitter terminals. This resistor has only a negligible effect on the coupler's speed and current-transfer ratio.

The input driving-pulse waveform has a peak amplitude of 10 mA, constant to within +10% and -0%, a duration of 8  $\mu$ s, and a maximum duty cycle of 10%. The phototransistor's collector-emitter voltage must also be kept as constant as possible. Here, it is held to 4 V between +10% and -0%.

The apparent load seen by the phototransistor is approximately 25 ohms with the components shown. This load impedance is established by the base-emitter junction

of transistor  $Q_1$ . If desired, the load-impedance value can be increased by inserting a resistor in series with the base terminal of transistor  $Q_1$ .

The coupler's true switching speed can be measured by comparing the input pulse drive voltage with the output voltage at transistor  $Q_1$ . The on time will be the delay between the application of the leading edge of the input pulse and the time when the phototransistor's collector current exceeds 1 mA. The off time will be the delay between the trailing edge of the input pulse and the time when the collector current drops below 1 mA.

The magnitude of the LED drive current, which is set at 10 mA here, can be increased or decreased by simply changing the value of series resistor  $R_1$ . If more drive current is needed, be certain that the input TTL circuitry can sink it.

Resistor  $R_3$  determines the test level of the phototransistor's collector current. The size of this current is computed by dividing the base-emitter (on) voltage (about 0.75 V) of transistor  $Q_1$  by the value of resistor  $R_3$ . Therefore, if the collector current is to be doubled, then the value of  $R_3$  must be halved. Or, in contrast, if the collector current is to be halved, then the value of  $R_3$  must be doubled. In this way, collector-current values

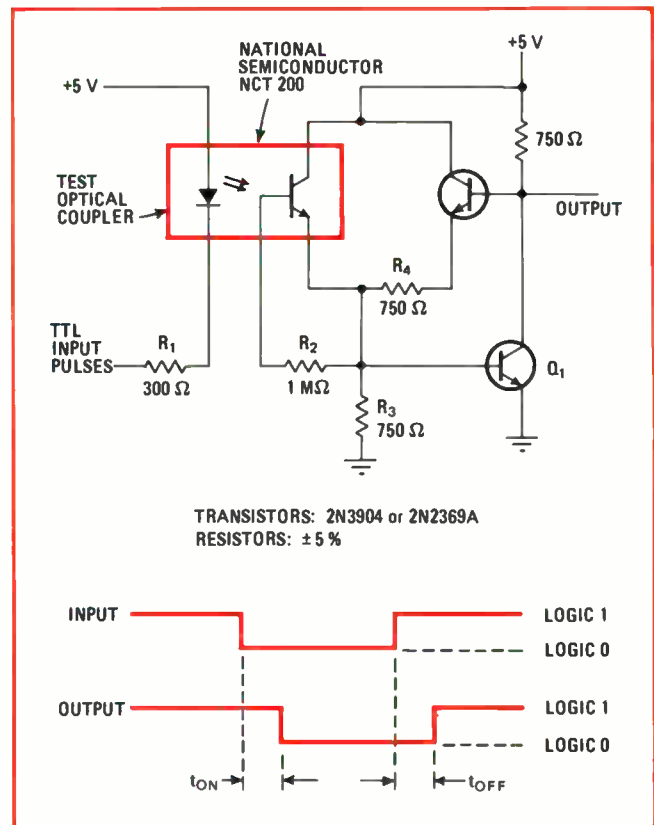

**Speed check.** Test circuit permits the true switching time of an optical coupler to be measured with reference to the input driving current to the coupler's LED. The circuit determines device on time ( $t_{ON}$ ) and device off time ( $t_{OFF}$ ), both of which take the inherent device turn-on and turn-off delay times into account, as well as the rise and fall times of the coupler's phototransistor output current.

can be varied from about 100  $\mu\text{A}$  to around 100 mA. (To assure a logic 1 output level at transistor  $Q_1$ , the value of resistor  $R_4$  must be the same as that of resistor  $R_3$ .)

Besides checking the switching time of an optical coupler, the test circuit is also useful as an interface to a TTL buffer amplifier. □

## Programmable cable tester spots opens and shorts

by D. Bruce Johnson  
Tullahoma, Tenn.

Testing large numbers of cables or cable harnesses can be very costly if 100% quality assurance is wanted. This is especially true in applications where several different cables must be tested simultaneously. Most existing cable testers are intended for checking a large number of circuits and, therefore, are too expensive for testing cables containing 16 or fewer circuits.

But here's a way to build a 16-circuit cable tester that is both fast and reliable, and yet inexpensive. The tester, which is programable, can also be used for checking out cables having less than 16 circuits. It tests for circuit continuity and clearly indicates whether the circuit is open or shorted. All possible circuit combinations are checked for unwanted shorts. The total test time for 16 good circuits is approximately 2½ seconds.

Programing is simple. Wire jumpers are added at the tester's terminals if the cable contains fewer than 16 circuits or if there are any known shorted circuits in the cable. This means that a correctly programed tester only looks for and identifies actual errors in the cable.

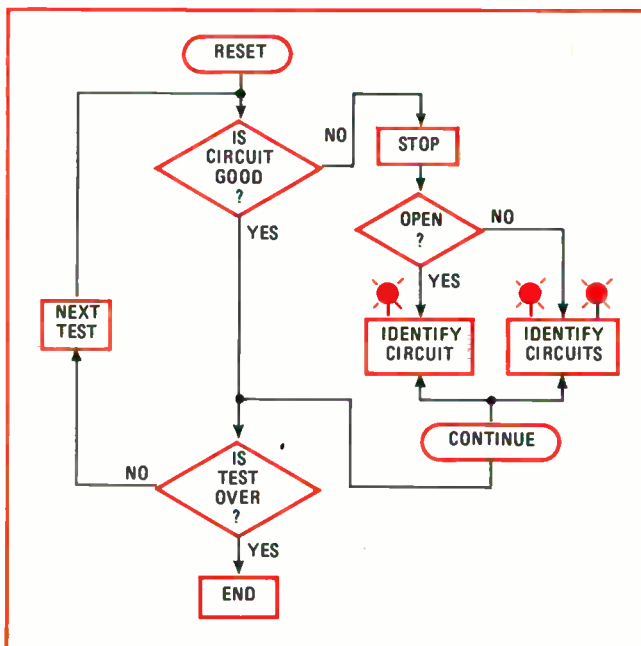

**1. Finding cable faults.** Flow chart summarizes the operation of a programmable cable tester that can check out cables containing 16 or fewer circuits. Each circuit is tested for continuity, and all possible circuit combinations are checked for shorts. The tester is programed simply—by means of wire jumpers at the terminals.

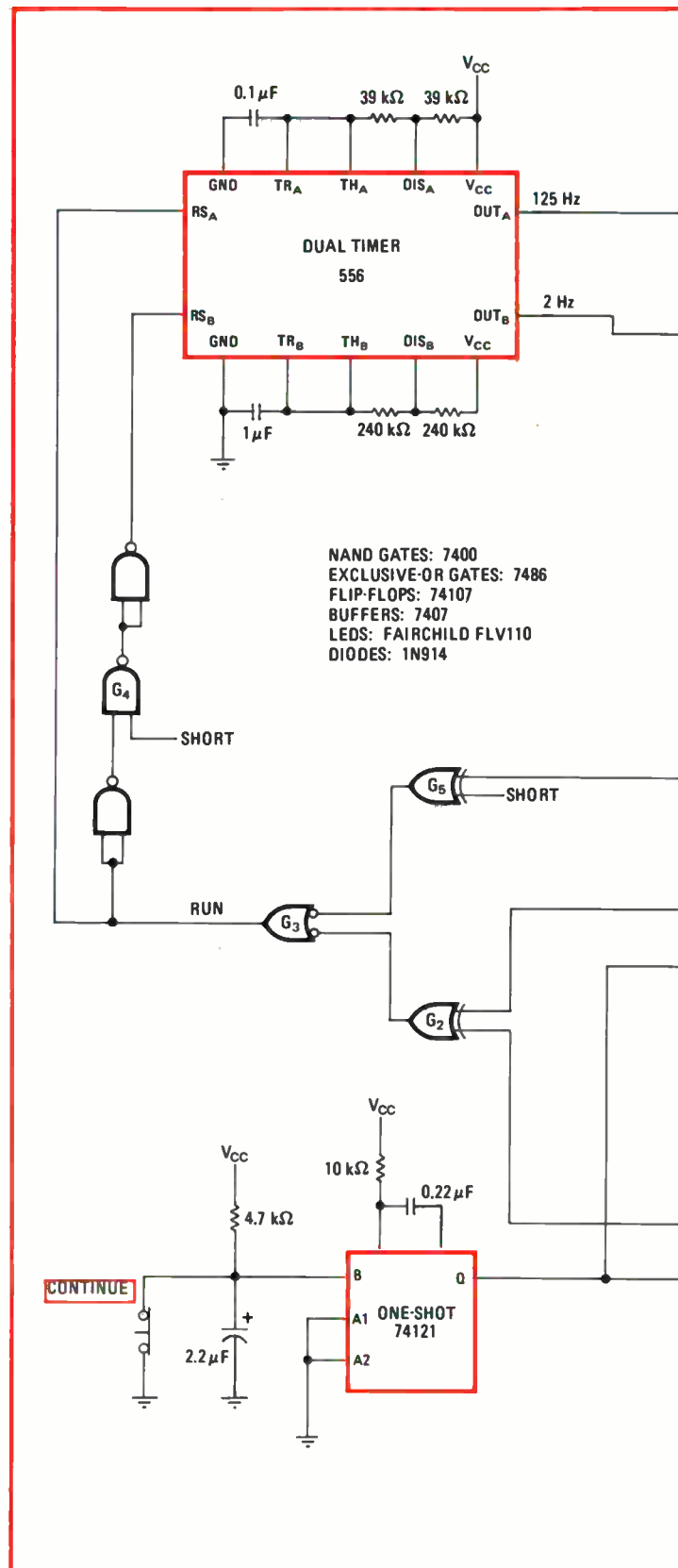

The flow chart (Fig. 1) outlines the operation of the tester (Fig. 2). The left branch of the flow chart indicates that all circuits are tested for continuity, and all possible circuit combinations are checked for shorts. If the cable is faulty, the tester will stop and indicate an

2. **The works.** Cable tester indicates an open circuit by continuously lighting a single numbered LED. If a short is detected, two of the numbered LEDs are lit, and testing is stopped. Testing can be resumed by pressing the CONTINUE push-button switch. A programmed short is noted by two blinking numbered LEDs.

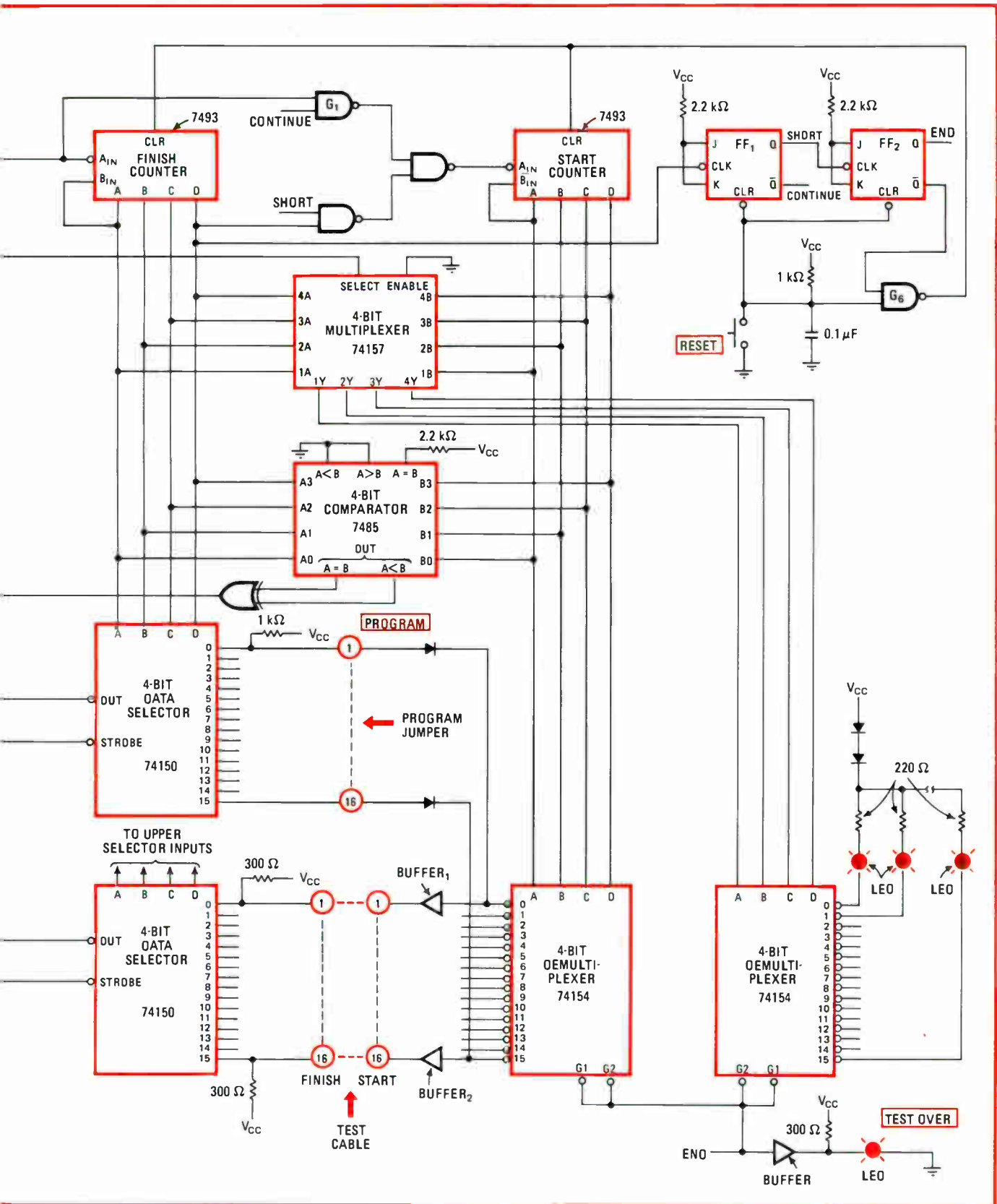

open circuit with a single numbered light-emitting diode, or a short circuit by lighting two numbered LEDs. The right branch of the flow chart shows this process.

Testing can be resumed by pushing the CONTINUE switch or by correcting the error that stopped the test. The RESET pushbutton switch clears flip-flops FF<sub>1</sub> and FF<sub>2</sub>, as well as the START and FINISH binary counters. Both of these counters will log the same pulses because NAND gate G<sub>1</sub> is enabled by the CONTINUE signal (Q output) from flip-flop FF<sub>1</sub>.

The input control signals (A, B, C, D) to the two data selectors and the two demultiplexers are identical for the continuity test. For a counter state of 0000, the 0 output pin of the left-hand demultiplexer is low, as is the output of BUFFER<sub>1</sub>. If circuit 1 of the test cable is good, the 0 output pins of both data selectors are also low. A good circuit will enable exclusive-OR gate G<sub>2</sub>, producing a high output at NOR gate G<sub>3</sub>. This constitutes a RUN signal for the dual timer, allowing this device to be free-running at a frequency of 125 hertz.

As the START and FINISH counters advance, each cable is tested for continuity until all 16 checks are completed. If an open circuit is detected, the RUN signal goes low, disabling the timer and counters. The output of the right-hand demultiplexer that is associated with the faulty circuit will then go low, turning on its associated numbered LED to identify which circuit is open. Pressing the CONTINUE push-button overrides the tester's logic long enough to advance the counters by

one bit, causing the testing to begin again.

When the tester completes all 16 continuity checks, it then goes on to look for all possible unwanted shorts. The 16th clock pulse from the timer returns both counters to their 0000 state and sets flip-flop FF<sub>1</sub>. The START counter will now advance at 1/16th the rate of the FINISH counter. If a short is detected, the Q output of flip-flop FF<sub>1</sub> goes high, changing the test logic by enabling NAND gate G<sub>4</sub> and exclusive-OR gate G<sub>5</sub>. Since the SHORT signal from FF<sub>1</sub> overrides the test logic only when the state of the START counter is greater than or equal to the state of the FINISH counter, there are no redundant error indications of cable shorts.

When a short is found, the lower half of the dual timer is enabled, which places a 2-Hz clock signal on the SELECT input of the multiplexer. The control lines of the right-hand demultiplexer are then alternated between the START counter and the FINISH counter so that two LEDs flash on and off to indicate which two circuits are shorted. At the end of the short test, flip-flop FF<sub>2</sub> is clocked to its set condition, and NAND gate G<sub>6</sub> inhibits the counters. The END signal from FF<sub>2</sub> is buffered to turn on a LED that indicates that the test is over.

If the tester is programed for a planned cable short and that short is missing, the tester identifies one end of the missing short at a time with a single blinking LED. □

Engineer's Notebook is a regular feature in Electronics. We invite readers to submit original design shortcuts, calculation aids, measurement and test techniques, and other ideas for saving engineering time or cost. We'll pay \$50 for each item published.

## Simulating an npn/pnp pair for high-voltage switching

by P.G. Mitchell and K.W. Robbins  
Sperry Research Center, Sudbury, Mass.

High-voltage transistors—those that have ratings on the order of 1,000 volts—are available only as npn devices. Pnp transistors generally have ratings of 400 V or less. This means that the fast switching performance obtainable with a complementary pair of transistors cannot easily be achieved at very high voltage levels. However, it is possible to simulate the performance of a high-voltage complementary pair with two npn devices by using an optical coupler in the drive circuit of one of the transistors.

The circuit in the figure is a high-voltage switch that is controlled by TTL signals at its input and switches 1,000-v signals at its output. Although both of the high-voltage transistors, Q<sub>1</sub> and Q<sub>2</sub>, are npn devices, they operate as a complementary pair.

Transistor Q<sub>1</sub> is optoelectronically coupled to its drive voltage to simulate the operation of a pnp device. The optical coupler acts as a simple single-device voltage-level translator that also provides a voltage-polarity inversion. The base voltage of transistor Q<sub>1</sub> can then follow its emitter voltage during switching. The coupler avoids the low-frequency switching problems associated with capacitive circuitry.

When transistor Q<sub>1</sub> is off, transistor Q<sub>2</sub> is on, and vice versa. During the off time of transistor Q<sub>1</sub>, the capacitor charges to the zener voltage, creating a voltage reservoir that allows Q<sub>1</sub> to turn on hard and quickly through its optical coupler. Transistor Q<sub>2</sub> operates normally as an npn switching transistor.

Rise and fall times of 2 microseconds can be achieved with the components shown. □

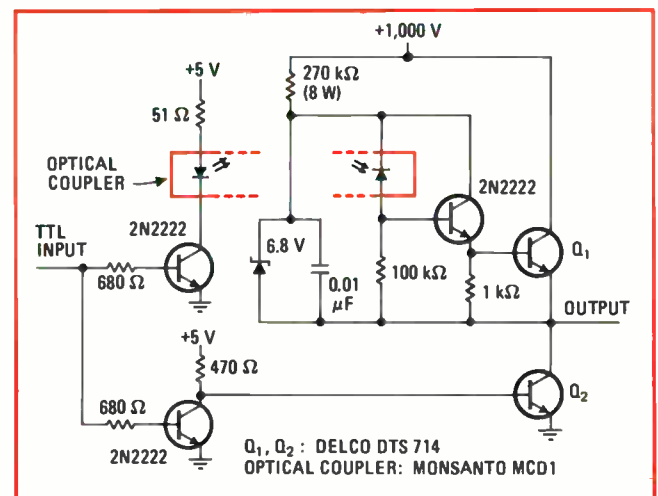

**Optical helping hand.** Complementary high-voltage switching transistors can be simulated with two npn devices by placing an optical coupler in the drive circuit of one of the transistors. The coupler translates and inverts the TTL-level input voltage so that transistors Q<sub>1</sub> and Q<sub>2</sub> conduct alternately. When Q<sub>1</sub> is off, a voltage reservoir is created across the capacitor for turning Q<sub>1</sub> on fast and hard.

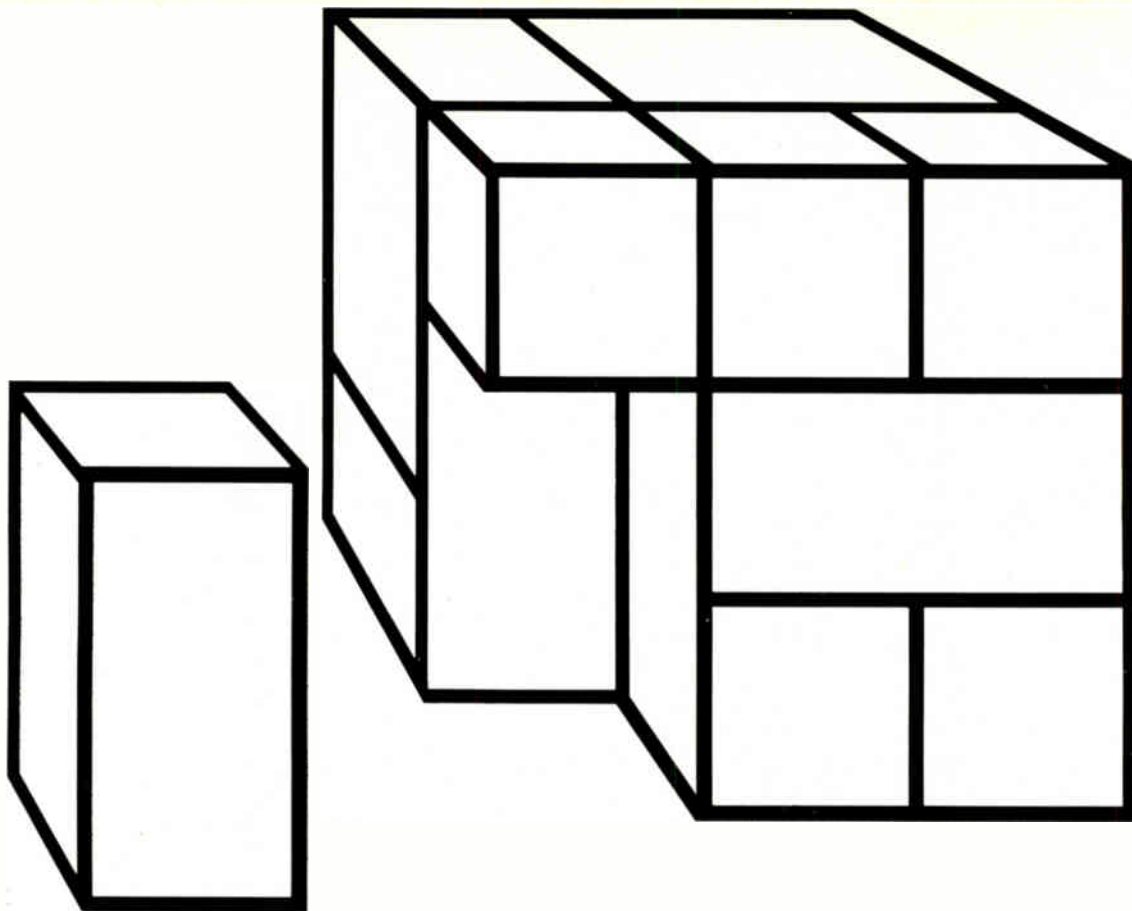

## E-H MODULES FOR SYSTEMS APPLICATIONS

### Building the solution to your measurement problems.

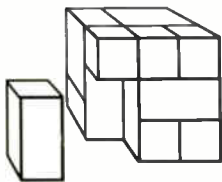

Whether you need one measurement instrument for your systems application or a complete turnkey systems installation—E-H can help. E-H has more experience in building modules for systems applications than any other instrument manufacturer.

E-H pioneered the development of modular, programmable systems elements in 1964 and began building complete test systems in 1967.

Need a programmable pulse generator for an in-house design system? We have eight to choose from, and we'll help you analyze which one is best for your application. E-H is known as the world's leading manufacturer of pulse generators.

Looking for single-shot measurement techniques? E-H opened a new era of single-shot time measurements in 1963 with their Model 142 switching time converter. It's the solution to the problem of making switching time measurements in the sub-nanosecond to one microsecond region in automatic test systems.

Our Model 153 strobing voltmeter makes voltage measurements on fast waveforms at precisely located points in time.

Among the programmable instruments E-H has developed and field-proven for systems use are lines of single-shot measurement modules, word generators, digitizing, and storage modules.

Send for the E-H brochure that has information about modules for systems applications. It will help give you a solution to your systems applications problems.

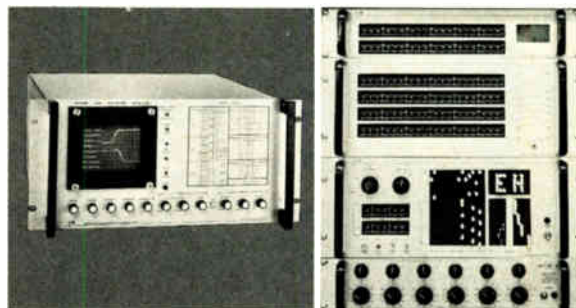

### E-H Research Laboratories, Inc.

515-11th Street, Box 1289  
Oakland, California 94604  
(415) 834-3030



European subsidiary:

P.O. Box 1018, Eindhoven, The Netherlands, (040) 433704

## Four easy pieces make a digital thermometer

If you have the kind of **digital panel meter that has an accessible reference voltage**, you already have the critical element needed for making a direct-reading digital thermometer. The only other major components you need are a pair of thermistors and an op amp. **The voltmeter supplies 15 volts to power the op amp which, in turn, conditions the reference voltage to a value suitable for exciting the thermistor bridge.** The buffering provided by the op amp ensures that the loading of the reference supply by the thermistor bridge does not significantly affect the reference's stability. For precise zero and full-scale direct readings of temperature, a pair of trimmers can be added. Jim Hayes of Analog Devices reports **accuracy on the order of 1°C and resolution of 0.1°C** using a AD2006 DPM, an AD308N op amp, and a Yellow Spring YSI-44211 thermistor.

## How to give the 8008 a thousand input ports

The number of input ports for the popular 8008 microprocessor is **normally limited to six**—but you can make it accept many more than that, says Perry Lyne, a project engineer of Vidar Autodata Inc., Mountain View, Calif. You just take advantage of the fact that the 8008's accumulator can be latched into the lower memory address during the execution of an input instruction. Then, **by decoding this address along with the port select, the number of actual inputs channeled through each port can be increased by as much as 256.** But remember, the accumulator must be set up to enable the decoder properly just before the execution of an input instruction.

## Why use a chip when you can use your head?

Converting between inches and millimeters is no problem if you have a calculator, but Ricardo Snel, an engineer from Brazil, thought up a cute idea that lets you approximate the conversion quickly in your head. **Simply round off that 2.54-centimeters-long inch to a 2.56-cm one.** Since most EEs are familiar with powers of 2, all that needs to be remembered now is that  $1/16 \text{ in.} = 1.6 \text{ mm}$ . It immediately follows that  $1/32 \text{ in.} = 0.8 \text{ mm}$ ,  $1/8 \text{ in.} = 0.32 \text{ mm}$ , and so on. Snel points out that **you won't be off by more than 0.8%** anyway since  $(2.56 - 2.54)/2.54$  is smaller than  $2/250 = 8/1,000$ .

## LEDs make good strobes

If you've only used light-emitting diodes as slow displays or pilot lights, it may come as a surprise that a LED can make a handy light source for a strobe, says Calvin R. Graf of San Antonio, Texas.

**For example, a LED can easily be flashed on and off 60 times per second to synchronize a record turntable to the 60-hertz ac line.** A 6.3-volt transformer steps down the line voltage, and a series-dropping  $\frac{1}{2}$ -watt resistor then sets the proper LED forward voltage. For a red LED, this series resistance is 180 ohms, for a green one, it's 68 ohms. **A silicon junction diode across the LED, in reverse polarity, protects the device during the negative portion of the ac input.** LEDs of any color can be used, provided that the proper series resistance is chosen. **Also, two or more LEDs of the same color can be connected in parallel to get a brighter light source.**

—Laurence Altman



Card-Pak is our new card filing system that comes to you in four parts that takes (in most cases) just eight screws to put together. And we supply the screws.

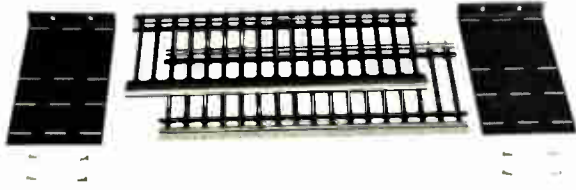

The four parts are dimensioned to your order exactly, for card height, depth, spacing, and total number. Right from stock.

If you want to get fancy, we can give you double-tiered Card-Paks, single-double combos, card identification strips and markers, connector supports, and card handles and ejectors. All from stock.



Our card guides are made of Noryl, not nylon, for dimensional stability, and our metal structures are satin-finished aluminum for durability, rigidity, light weight, and beauty.

Card-Pak is a choice, not an echo. And we'll gladly send you our catalog. Or telephone (toll free) any G. S. Marshall Co. office nationwide.

Card-Pak. From EECO.

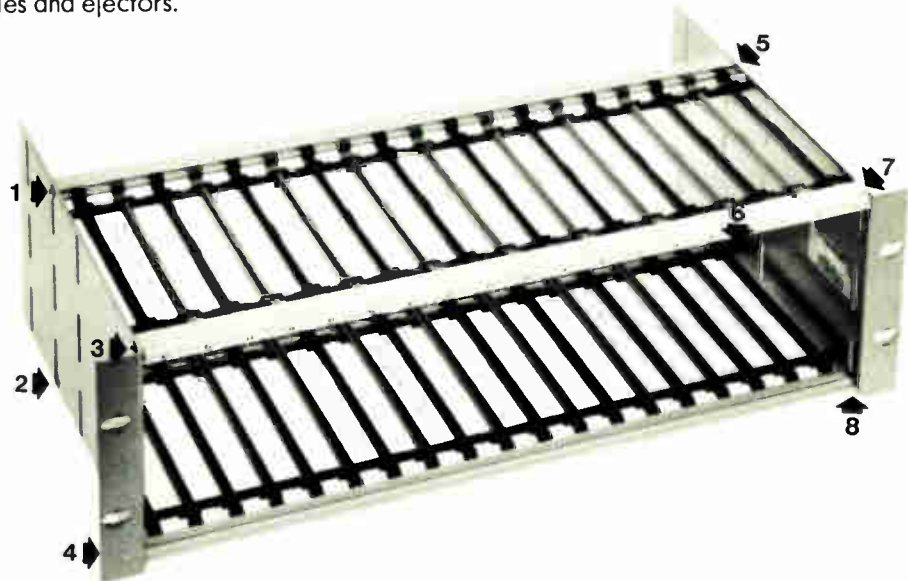

**Eight screws  
and you've got it  
all together.**

CARD-PAK from **EECO**

1441 East Chestnut Avenue  
Santa Ana, California 92701  
Phone 714/835-6000  
Also from G. S. Marshall Company nationwide.

FREE CARD-PAK CATALOG

We'll send it to you if you'll send us the information below.

Name \_\_\_\_\_

Position \_\_\_\_\_

Company \_\_\_\_\_

Address \_\_\_\_\_

# Our family of high the broadest and fast

## Here's proof.

Compare the performance characteristics of these monolithic high slew rate op amps. Device for device, ours offer more. Even the slower slew rates are fast. And nobody tops our fastest. What's more, the slew rates are guaranteed and tested. And where bandwidth limits are critical and you need wide bandwidths at high output levels, these are the op amps for you.

Other advantages are better settling times; space savings because of fewer external components; the best possible DC performance at the highest speeds; and availability in chip form. So, wherever you need high speeds and greater reliability in op amps, look to Harris. For details see your Harris distributor or representative.

PRECISION  
NON-COMPENSATED  
5V/V GAIN STABLE

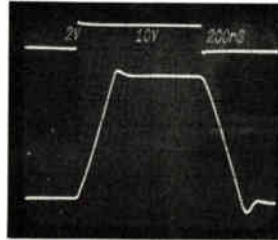

INTERNALLY COMPENSATED  
UNITY GAIN STABLE

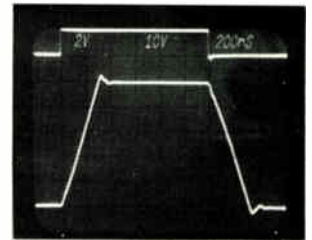

PARAMETERS	LOW SLEW RATE			LOW SLEW RATE		
	HA-2620	HA-2622	HA-2625	HA-2500	HA-2502	HA-2505
Slew Rate	± 25	± 20	± 20	± 25	± 20	± 20
Full Power Bandwidth	400	320	320	350	300	300
Gain Bandwidth Product	100	100	100	12	12	12
Settling Time	1000	1000	1000	330	330	330
Voltage Gain	100k	80k	80k	20k	15k	15k
Bias Current	15	25	25	200	250	250
Offset Current	15	25	25	50	50	100
Offset Voltage	4	5	5	5	8	8
100-999 Units	\$14.95	\$8.95	\$5.95	\$18.50	\$12.95	\$7.50

comparative diagram

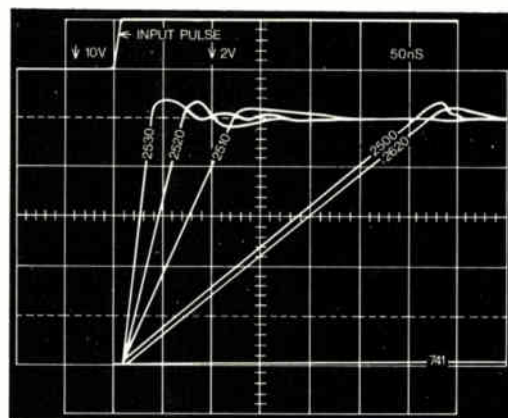

# Slew rate op amps is best in the industry.

**NON-COMPENSATED  
3V/V GAIN STABLE**

**NON-COMPENSATED  
3V/V GAIN STABLE**

**NON-COMPENSATED  
10V/V GAIN STABLE  
INVERTING ONLY**

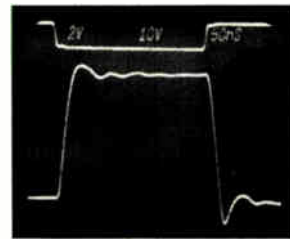
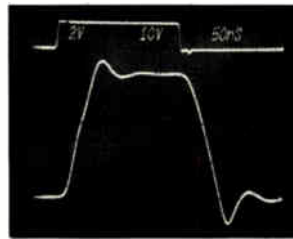
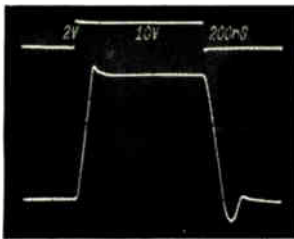

**MEDIUM SLEW RATE**

**HIGH SLEW RATE**

**VERY HIGH SLEW RATE**

MEDIUM SLEW RATE			HIGH SLEW RATE			VERY HIGH SLEW RATE		UNITS
HA-2510	HA-2512	HA-2515	HA-2520	HA-2522	HA-2525	HA-2530	HA-2535	
±50	±40	±40	±100	±80	±80	±280	±250	V/μS (MIN)
750	600	600	1500	1200	1200	4000	4000	kHz (MIN)
12	12	12	20	20	12	70	70	MHz (TYP)
250	250	250	200	200	200	500	500	ns (TYP)
10k	7.5k	7.5k	10k	7.5k	7.5k	100k	100k	V/V (MIN)
200	250	250	200	250	250	100	200	nA (MAX)
50	50	100	25	50	50	20	20	nA (MAX)
8	10	10	8	10	10	3	5	mV (MAX)
\$18.50	\$12.95	\$7.50	\$18.50	\$12.95	\$7.50	\$33.00	\$14.30	



P.O. Box 883, Melbourne, Florida 32901 (305) 727-5430

WHERE TO BUY THEM: ARIZONA: Phoenix—Hamilton, Liberty, Weatherford; Scottsdale—HAR (602) 946-3556 CALIFORNIA: Anaheim—Weatherford, El Segundo—Liberty, Glendale—Weatherford, Long Beach—HAR (213) 426-7687, Mountain View—Elmar; Palo Alto—Weatherford, HAR (415) 964-6443; Pomona—Weatherford; San Diego—Liberty, Weatherford COLORADO: Commerce City—Elmar, Denver—Hamilton, Englewood—Weatherford CONNECTICUT: Oanbury—Schweber, Norwalk—Harvey FLORIDA: Hollywood—Hamilton, Schweber; Melbourne—HAR (305) 727-5430 GEORGIA: Atlanta—Schweber, Norcross—Hamilton ILLINOIS: Elk Grove Village—Schweber, Schaumburg—HAR (312) 894-8824; Schiller Park—Hamilton INDIANA: Indianapolis—Pioneer KANSAS: Lenexa—Hamilton MARYLAND: Baltimore—Hamilton, Rockville—Schweber MASSACHUSETTS: Burlington—Hamilton, Lexington—Harvey, Wellesley—HAR (617) 237-5430 MICHIGAN: Livonia—Hamilton, Troy—Schweber MINNESOTA: Edina—Hamilton, Schweber; Minneapolis—HAR (612) 432-5111 MISSOURI: Hazelwood—Hamilton NEW JERSEY: Cedar Grove—Hamilton, Mt. Laurel—Hamilton, Somerset—Schweber NEW MEXICO: Albuquerque—Hamilton, Weatherford NEW YORK: East Syracuse—Hamilton, Melville—HAR (516) 249-4500; Syracuse—HAR (315) 463-3373, Rochester—Schweber; Westbury—Schweber, Woodbury—Harvey NORTH CAROLINA: Raleigh—Schweber OHIO: Beachwood—Schweber, Cleveland—Pioneer, Dayton—Pioneer HAR (513) 226-0636 PENNSYLVANIA: Wayne—HAR (215) 687-6680 TEXAS: Dallas—Hamilton, Weatherford, HAR (214) 231-9031; Houston—Hamilton, Weatherford UTAH: Salt Lake City—Hamilton WASHINGTON: Seattle—Liberty, Weatherford WASHINGTON, D.C.: HAR (202) 337-3170 CANADA: Mississauga, Ontario—Hamilton, Montreal, Quebec—Hamilton, Ottawa, Ontario—Hamilton

LEGEND FOR HARRIS SALES OFFICES & DISTRIBUTORS: Elmar Electronics (Elmar); Hamilton Avnet Electronics (Hamilton), Harris Semiconductor (HAR), Harvey Electronics (Harvey), Liberty Electronics (Liberty), Pioneer Standard Electronics (Pioneer); Schweber Electronics (Schweber), R. V. Weatherford Co. (Weatherford)

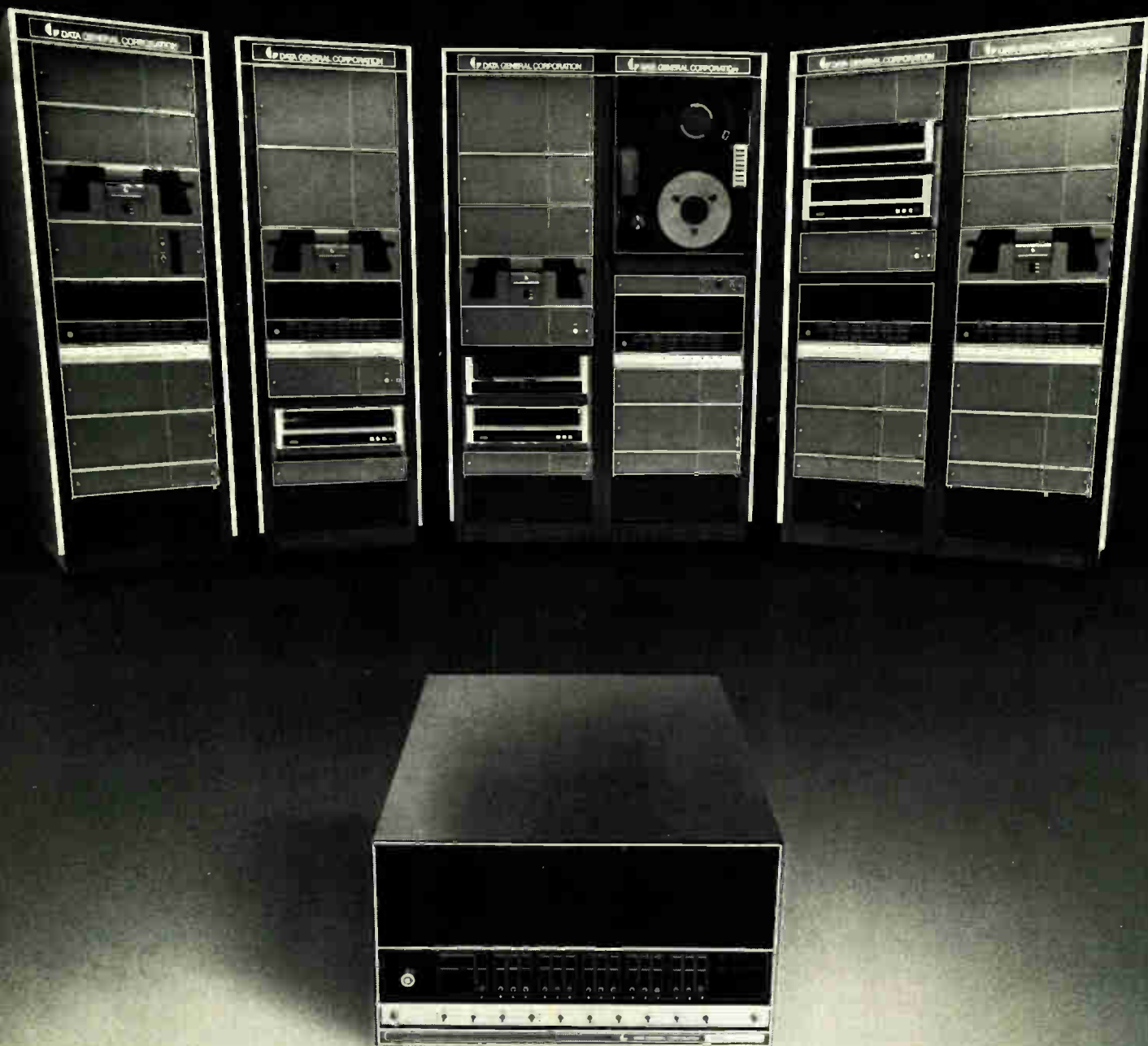

Introducing five Nova 2 systems  
for people who only want one.

Until now, the only way you could buy Nova 2's was five at a time.

Which obviously discouraged people who only wanted one.

So to make sure everyone who wants a Nova 2 gets one, we've come up with five different Nova 2 systems you can buy one at a time.

The smallest is built around our Real-Time Operating System. Which makes it a great little data acquisition satellite.

Next up the line is our Stand-alone Operating System. A small single-user computation system for people who don't need a disc.

Then there's the medium-sized Real-time Disc Operating System you can use to develop software and hardware interfaces, or to build your own medium-sized computation system.

Which is followed by a big Real-time Disc Operating System with more storage and faster output for higher throughput.

And for those who need a system with a built-in backup computer, there's the Dual Nova 2.

So no matter what you want to do, there's a Nova 2 system you can get to get it done.

And 60 days after we get your order, you'll get your system.

# DataGeneral

The computer company you can understand.

• Data General Corporation Southboro, Massachusetts 01772, (617) 485-9100.  
Datagen of Canada Ltd., Hull, Quebec (819) 770-2030/Data General Europe, Paris, France 504-23-44



# Western electronics companies seek experienced engineers, technicians

As Wescon approaches, shortages of skilled programmers, process engineers, and systems designers have personnel directors worried; regional preferences are changing, and big pay hikes are required for relocation

by Paul Francon, Los Angeles bureau manager

□ Employment has traditionally been an ancillary topic at the Western Electronic Show and Convention. It's not usually part of the professional program and not sanctioned by Wescon officials. But there's no getting around the fact that in good times Wescon spawns recruiters and in bad times, hordes of unemployed or nervous engineers are looking as much for jobs as they are for product literature.

This year's gathering Sept. 10-13 at the Los Angeles Convention Center will undoubtedly foster some active recruiting because many western electronics firms are searching for help. But there's a subtle difference from past years—in 1974 few well-qualified technical people are available. The hunt is on not just for bodies to meet, say, exploding needs for the likes of draftsmen in aerospace systems design. The openings that exist are for experienced professionals, anti-submarine-warfare-systems designers, semiconductor process engineers, computer programmers—and for subprofessionals like technicians.

Then, too, this year's Wescon site, Los Angeles, is no longer a Mecca for qualified people from outside the area, while the uncertain economy and a memory of seasons past is persuading others to stay with their present jobs unless pried loose by a 20% raise—twice what was needed before. These factors could all add up to create some harried personnel managers.

This situation is the local result of several more general influences on electronics employment in the West. Among these influences are the changing demands of new and maturing semiconductor technologies, the continued growth of the computer industry versus the relatively static position of aerospace companies, the greater attractions of large companies as employers versus small ones in a period of economic doubt, and a shift in geographical preferences among both companies and individuals away from the smog-dimmed lights of the big city towards smaller cities and even rural atmospheres.

### The digital-IC job picture

The maturation of bipolar circuits and the advent of metal-oxide-semiconductor and complementary-MOS devices is changing the nature of the engineering and technical jobs available with integrated-circuits manufacturers throughout the country, but nowhere is this more evident than in the San Francisco Bay area. There, Fairchild Semiconductor Components Group of Mountain View recently laid off at least 140 technicians and other workers, while Signetics in Sunnyvale laid off 50 across the board. Yet both firms claim they need more engineers.

The reason, suggests Jim Morgan at Corporate Technology Inc., a three-year-old "Silicon Valley" employment service, is that "the people they let go couldn't do" the specialized work that had opened up. High-volume bipolar transistor-transistor logic suffered the biggest cutbacks, he says. The biggest need, he adds, is for process engineers. Semiconductor firms are looking for people who can come in and boost yields, for "if you can increase yields by 5% you can double profits."

"There is definitely a shortage of process engineers," agrees Dennis Prouty, industrial relations manager of

## Guaranteeing the next generation

Who will be tomorrow's engineers and technicians? That question nags at the consciousness of most of today's managers because, as Robert Martin of Hughes Aircraft points out, engineering enrollments are way down. He fears that 1976 "will bring the greatest shortage of engineers in the company's history." Bob Martyn of Tektronix expects that even next year "it's going to be more competitive" because the engineering schools are not supplying enough graduates.

But few companies are doing much to remedy the situation. Motorola's Semiconductor Products division in Phoenix, Ariz., is one of the exceptions.

According to Rod O'Connor, vice president of marketing, the company has met with educators from the three Arizona State universities, looking at the problem and trying to find a solution. "It's quite alarming," he says. "We see the beginnings of the problem already, and it will be critical in a few years. About 53,000 engineers per year are needed now, and only 39,000 are coming out of the engineering schools. The supply will drop to 32,000 by 1975, when requirements will be up even more."

O'Connor blames the situation largely on the poor job business has made of blowing its own horn. "Many kids look at technology as the cause of problems that face the world, not as the solution. We haven't done a good job of talking to them, telling them how technology has given us the highest standard of living in the world." To counter this, O'Connor says, Motorola has produced a film devoted to the contention that technology is good and is making it available to educational groups from universities even down to the grammar school level. The company is also actively talking to the administrations of various educational institutions within Arizona, trying to develop cooperative programs.

Motorola already runs a training program for technicians, because it has problems finding enough technicians, "not the kind that know which end of the American beauty soldering iron is hot, but real professional techs," says O'Connor. But the company also recruits technicians in Idaho and Utah, where training programs are run by state schools. Ironically, the technical program at Idaho University was inspired by American Microsystems' MOS plant in Pocatello, a Motorola competitor.

Fairchild Camera and Instrument Corp.'s MOS division. Three or four years ago, he points out, design engineers were in big demand. But now that those designs have been completed, someone has to make the products. MOS and C-MOS engineers are in great demand, too, he adds. "If we can get them away from other companies, we'll do it."

John Love, employment manager at Lockheed Missiles and Space Co., Sunnyvale, is just as troubled—"everybody is looking for the same kind of people at the same time." In general, he says, Lockheed needs experienced engineers in the microelectronics field where, however, "we're finding very stiff competition."

A typical item on his "needs" list is a senior manufacturing engineer with a BSEE, and four years experience in fabrication. "It's an interesting phenomenon: although there are shortages [of engineers], our people are being pretty selective. We want special skills, and we're not too eager to take experienced people in an-

<p>22 ★ <b>EMPLOYMENT OPPORTUNITIES</b>          Sunday, July 14, 1974          420-411, Times Mirror Square, L.A.</p> <p><b>ASW Engineers</b></p> <p>We are currently in the process of building project teams for long term programs which require engineers with</p>	<p><b>ENGINEERING</b></p> <p>Major NYSE corporation has openings in the following areas.</p> <p><b>Senior Facilities Engineer</b></p> <p>An immediate opening exists for a person with</p>	<p><b>ENGINEERS</b></p> <p><b>MOS/LSI</b></p> <p>Fast growing dynamic MOS/LSI and Test Systems manufacturing company has immediate openings for qualified Engineers in the following areas:</p> <p><b>METALIZATION</b></p> <p>Sr. Engineer responsible for all Wafer metalization to include deposition and etching and the maintenance and operation of high vacuum &amp; C-S systems. BSEE Physics or Chemistry with 3 years</p>	<p><b>Processing Systems</b></p> <p>Designing and analysis of modern signal processing systems and analysis of detection, classification and localization of radiators from passive and active acoustic sensors. Performs preliminary</p>	<p><b>Supervisor</b></p> <p><b>ENGINEER SEMI CONDUCTOR</b></p> <p>BOURNS INC., a manufacturer of electronic components, has immediate openings for experienced supervisors to head up an electronic group designing computerized and automated controls for high-volume production equipment.</p> <p>To qualify, candidates must have BSEE with 3 or more years experience including 1 year supervising an electronics group. Experience must include state-of-the-art knowledge.</p> <p>Qualified candidates are invited to send resume to:</p>	<p><b>PACKAGING</b></p> <p>Will be concerned with process improvement in plastic package area. 13 years in IC assembly with plastic experience desirable. Also concerned with IC package design and development.</p> <p><b>ELECTRONIC DESIGN ENGINEER</b></p>	<p><b>ASW Engineers</b></p> <p>We are currently in the process of building project teams for long term programs which require engineers with experience in the following areas:</p> <p><b>Sonar</b></p>
---------------------------------------------------------------------------------------------------------------------------------------------------------------------------------------------------------------------------------------------------------------------------------	--------------------------------------------------------------------------------------------------------------------------------------------------------------------------------------------	------------------------------------------------------------------------------------------------------------------------------------------------------------------------------------------------------------------------------------------------------------------------------------------------------------------------------------------------------------------------------------------------------------------------------------	-------------------------------------------------------------------------------------------------------------------------------------------------------------------------------------------------------------------------------------------	--------------------------------------------------------------------------------------------------------------------------------------------------------------------------------------------------------------------------------------------------------------------------------------------------------------------------------------------------------------------------------------------------------------------------------------------------------------------------------------------------------------------------------------------------	---------------------------------------------------------------------------------------------------------------------------------------------------------------------------------------------------------------------------------------------------------------	---------------------------------------------------------------------------------------------------------------------------------------------------------------------------------------------------------

other area and retrain them," he says.

Smaller firms in "Silicon Valley" are also clamoring for more workers. Robert Crossley, personnel manager at MOS and linear-circuit maker Advanced Micro Devices Inc., Sunnyvale, says he has 50 openings now for all kinds of jobs. But he is particularly anxious to hire the hard-to-find design, process, and production engineers. Similarly, Massachusetts-based Analog Devices Inc. recently opened a C-MOS facility in Santa Clara only to discover, in the words of president Ray Stata, that "finding each engineer is an excruciating job." Circuit design engineers are particularly scarce, he adds.

Further south, in prospering Orange County near Los Angeles, fast-growing MOS maker Western Digital Corp. is also expanding and looking for people. And president Alvin Phillips is happy to be far away from his San Franciscan counterparts, finding his Newport Beach location ideal. "I think we have considerably less turnover than our competitors up there. There are other semiconductor companies here, but they're 'aerospacious,' not commercial swingers, and people have a reluctance to job-hop."

Others outside "Silicon Valley" find the competition stiffer. "We're all looking in the same fields for the same calibre of people," says Bob Martyn, personnel director at instrument maker Tektronix Inc., Beaverton, Ore., which is looking especially for process engineers. At the south end of Arizona's growing semiconductor business, Jim Burns, general manager of Burr-Brown Research Corp. in Tucson, reports a "devil of a time finding process engineers."

A parallel need for manufacturing and production engineers is also developing among equipment companies moving into high-volume production, says Coleman Colla of employment firm Kemple and Mead, which operates across the country with headquarters in Orange County. Companies need people who are expert in getting the product out and able to accurately predict costs and meet them.

The corporate employment manager at neighboring Beckman Instruments Inc., Fullerton, Calif., agrees: "There's no severe shortage in electronics people. The problem is finding practical people, people who can interface between development and manufacturing."

Of course, the big aerospace firms are always looking for specialists. TRW Systems Group in Redondo Beach, for instance, is finding some shortages in some specialties, but then, says Don McRell, industrial relations manager for the Electronic Systems division, "Our business continually gets more technical and specialized because we're working in the R&D end of it, not the production end." McRell mentions shortages of communications systems engineers, but "super senior communications systems engineers for sophisticated communications have been in short supply since I've been in the business, so that's nothing new." He also needs microelectronics design engineers, "again, state-of-the-art kind of stuff, good rf design engineers, and high-speed digital design engineers."

The need for engineers in the "rf area, people with design capabilities as opposed to those who are managing, or writing proposals" is echoed by Cubic Corp., the San Diego, Calif. makers of instruments, including tracking systems, antennas, and aircraft landing aids. According to Cubic, the big lack is not in recent graduates but in experienced engineers—a complaint familiar from the digital-IC makers.

Hughes Aircraft Co., too, like TRW, is looking for engineers, about 250 at the Culver City site this year and another 400 to 500 next year. "We're pushing the state of the art," says employment manager Robert A. Martin, and "there are very few people who are qualified or dedicated enough to do this in the areas we're particularly interested in, such as lasers, computers, electro-optics, and radar."

### The dearth of programmers

Considerable growth is occurring in Orange County to the south of Los Angeles and particularly among companies in the computer industry. But there, too, employment managers report the people they really want are hard to find, and harder to hire. A spokesman at peripherals manufacturer California Computer Products Inc. in Anaheim points out that his firm is looking for people skilled in the electromechanical field as well as in electronic circuit design, and those skills are rare.

A similar problem exists at General Automation Inc., also in Anaheim. Richard Shlemmer, director of indus-



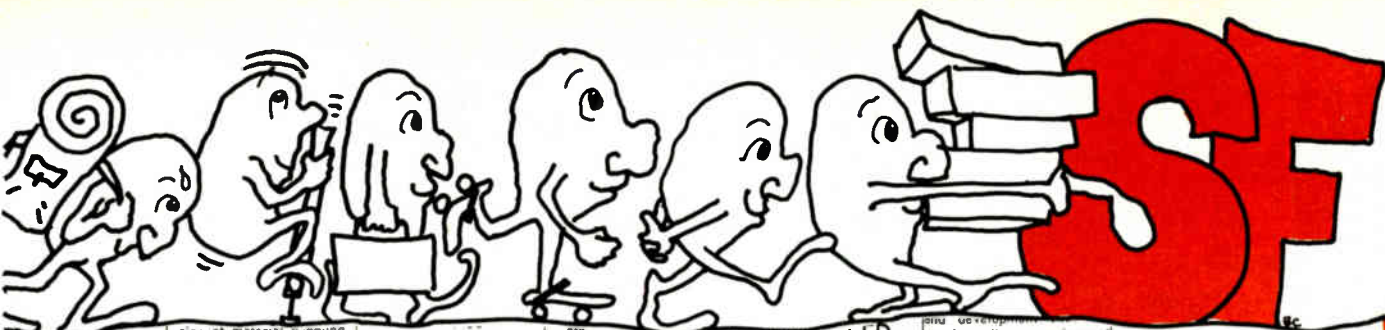

<p><b>Sonar Systems</b></p> <p>Design and evaluation of requirements in submarine sonar system evaluation. Develop technical requirement designs and instrumentation for effectiveness measurement systems. We require 5-10 years</p>	<p>sign of material forging equipment including gravity power and overhead conveyors and mechanical handling devices. Should be able to engineer, estimate and supervise installation of the above for medium to heavy forging operations. Must be able to direct and lead junior employees. Mechanical engineering degree preferred.</p> <p><b>DEVELOPMENT</b></p> <p>Will work in Process Development Group being concerned with N-Charged Silicon Gate Development and a silicon gate implementation. BSEE and minimum 2 years MOS/LSI processing exper. with emphasis on diffusion.</p> <p><b>DIAGNOSTICS</b></p> <p>Will be concerned with semiconductor tester diagnostics and interfacing with process engineering to achieve faster yield improvements. Emphasis on LSI circuit analysis.</p> <p>Must have BSEE and semiconductor device background or an equivalent degree. RECENT COLLEGE GRAD with a strong semiconductor device curriculum and circuit design.</p>	<p>etc. etc. etc. experience in computer systems and related electrical technology plus a BS/MS in EE or physics.</p> <p><b>ASW Systems Design</b></p> <p>Preliminary design of</p>	<p><b>ENGINEER</b></p> <p>Opportunity for product or process engineer experienced in bipolar diffusion, masking and etch. West L.A. area.</p> <p>Send Resume and Salary history to Professional Employment MEMORY PRODUCTS DIV</p> <p>Box L-079, L.A. Times</p> <p>An equal opportunity employer M/F</p> <p><b>ENGINEER</b></p> <p><b>SR. ANALOG DESIGN ENGINEER</b></p> <p>B.S.E.E. required, plus 5 years exp.</p>	<p>an immediate requirement for an experienced electronic engineer with a BSEE plus up to five years experience in solid state circuit design. Experience should include electromechanical design of analog and digital systems using integrated circuits.</p> <p>Duties will be to design digital and analog circuitry of electronic systems for Nuclear Assay Equipment, Neutron Radiography Camera</p>	<p>of requirements in submarine sonar system evaluation. Develop technical requirement designs and instrumentation for effectiveness measurement systems. We require 5-10 years of sonar experience including sonar operations evaluation and digital systems processing, plus a BS/MS in EE.</p>	<p>lation of medium to operations. To direct employee engineering preferred.</p> <p><b>ENGINEERING</b></p> <p><b>Elec Engineer</b></p>
---------------------------------------------------------------------------------------------------------------------------------------------------------------------------------------------------------------------------------------	--------------------------------------------------------------------------------------------------------------------------------------------------------------------------------------------------------------------------------------------------------------------------------------------------------------------------------------------------------------------------------------------------------------------------------------------------------------------------------------------------------------------------------------------------------------------------------------------------------------------------------------------------------------------------------------------------------------------------------------------------------------------------------------------------------------------------------------------------------------------------------------------------------------------------------------------------------------------------------	-------------------------------------------------------------------------------------------------------------------------------------------------------------------------------------	----------------------------------------------------------------------------------------------------------------------------------------------------------------------------------------------------------------------------------------------------------------------------------------------------------------------------------------------------------------------------------------------------------------------	-----------------------------------------------------------------------------------------------------------------------------------------------------------------------------------------------------------------------------------------------------------------------------------------------------------------------------------------------------------------------------------------------------------	---------------------------------------------------------------------------------------------------------------------------------------------------------------------------------------------------------------------------------------------------------------------------------------------------	----------------------------------------------------------------------------------------------------------------------------------------

trial relations at the minicomputer-based systems maker, says the company has no problem finding the few "EE design types" it needs, because many want to get out of nearby aerospace companies into firms with more exciting prospects, but "software types are tough to find, particularly senior programing types." He also adds that "good systems people are hard to find, especially since our automation base is so varied—automobile, production, newspapers, communications, business and science. We need both software and hardware people with experience in some of these specific areas." Shlemmer says that more people seem to be available in the business and scientific segments than in any other.

The general view on programmers is mixed. In Orange County, Microdata Corp.'s manager of personnel, William Graves, says that minicomputer manufacturer has programmers "coming out of our ears." Xerox Corp.'s El Segundo, Calif., operation, where most computer activity is centered, reports software people easier to get than computer hardware people.

But the opposite is true at Honeywell Information Systems Inc., which has operations in Phoenix and San Diego as well as in Waltham, Mass. David Belka, Honeywell information systems manager of manpower resources, believes that computer software is "where the action is," and he adds that Honeywell is seeking software engineers, particularly those with a background in minicomputers.

Belka notes that the changing situation in the computer industry has caught a lot of people unprepared in terms of required skills. The hardware end of the business has slowed down because computers are not changing so much; software is the real emerging area. Consequently, there are very few openings for the many engineers with hardware training but, on the other hand, there are vast opportunities for the relatively few people with software skills.

Up near San Francisco, too, Ampex Corp., which makes computer peripherals and tape products, is short of people with at least three years' experience in the industry, rather than recent grads. Industry expansion is the source of the problem, in the opinion of Robert B. Denison, Ampex' corporate manager for employee relations. "Companies are moving in here so fast," says

Denison, "it's creating more jobs than applications."

Though the Redwood City, Calif. company does little manufacturing there, it does use programmers, and Denison notes that there has been a "talent raid" in this area. "Everybody's having the same problem," and the programmers are profiting as a result by moving from company to company.

But the biggest shortages in Orange County's "computer valley"—home of a myriad of minicomputer, peripherals and other small data-processing companies—are in "subprofessional" workers—technicians, tool makers, draftsmen. "We have a continuing battle finding technicians at all levels," reports Microdata's Graves. Rival Shlemmer at General Automation agrees, "Borderline professionals are tough as nails to find. They're the roughest things to find in our industry." Similarly, Bob Barron, vice president of industrial relations at Pertec Corp., which has data processing manufacturing plants in Orange County and also in the San Fernando Valley area northwest of Los Angeles, reports that shortages of test technicians always seem to be a problem.

Some companies do not give up easily. Further north, the Cupertino manufacturer of general-purpose computers and smart terminals, Four-Phase Systems Inc., has gone to San Diego, Phoenix, and Portland to find manufacturing technicians, says a personnel official.

Down south of Los Angeles, in San Diego, Cubic Corp. is running into the same problem. "Good general machinists of the tool and die type, not simply operators or people limited to one type of equipment, are still hard to find," says J. J. Devlin, corporate manager of industrial relations.

Among IC firms, wafer fabrication workers are at a premium, according to Advanced Micro Devices of Sunnyvale. And even the established aerospace industry is hurting. For, though TRW's McRell says his firm is "really a big model shop" and has experienced no problems in recruiting production workers, Martin at Hughes Aircraft says, "We are continually looking for and have difficulty in getting technologists—electronics technicians, precision machinists, engineering draftsmen." Practically speaking, these very rare types are "not available," and Martin has reached the "pessimis-

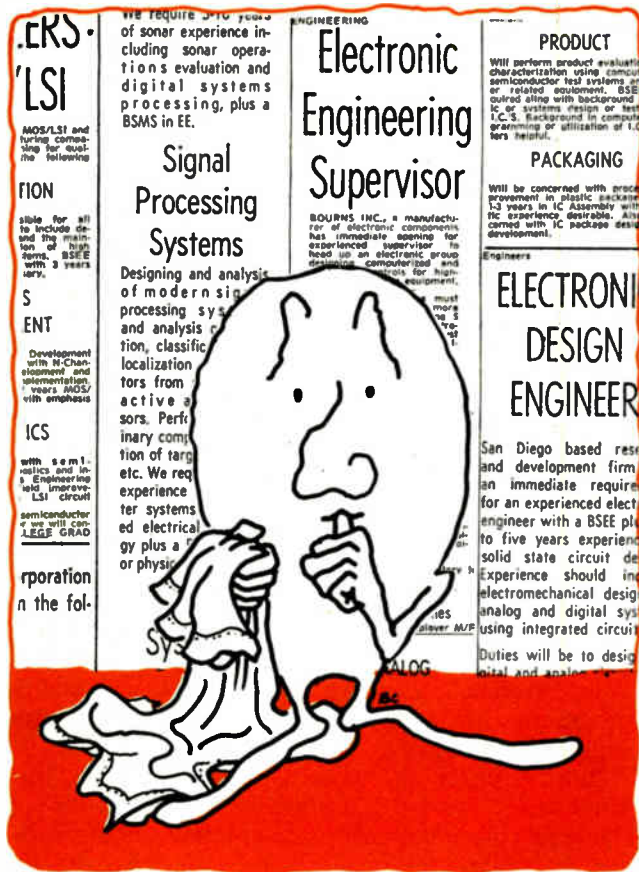

tic conclusion that young people don't want to put forth the effort that's required to be a technically competent specialist."

Frank Chabre, director of management and professional personnel for Collins Radio Co., Newport Beach, adds that, due to the shortage of technicians all over the country, "This area has seen new approaches with recruiting at electronic technical trade schools just as you would a college graduate." In days past, "you recruited these people like production or clerical workers; today, you recruit them just like you would an engineer". Chabre mentions such tactics as providing the prospective employee with a visit to the area and relocating the employee and his family.

### The assembly line

But there are no shortages at the lowest technical levels. As Cubic Corp.'s Devlin observes, electronics assemblers may be hard to find but they're also "not that hard to train. In the time it takes to find qualified people, you can do the training yourself." Similarly, Rockwell Electronics Group in Anaheim, which is experiencing shortages of production workers primarily in "upper technical skill levels," is not yet having problems in the lower-skill production areas, according to Robert V. Underwood, director of personnel.

"There's a lot of competition, but we pay top wages and have excellent benefits to get and keep them," says Shlemmer at General Automation in Anaheim, which, like most other fast-growing firms in areas without a big existing work force, trains its own assembly workers.

In the Bay area, there's a tremendous reservoir of

workers, but they are also very mobile. In more isolated locations, companies may be forced to train their own, but they aren't likely to lose them—at least not to competitors.

Motorola Semiconductor Products division's Ed Glasson, director of employment, says that the company hired 12,000 production workers last year, but a third were rehires. "The work is tedious and difficult, and there's tremendous turnover," he observes. Motorola doesn't have too much competition for the workers in the Phoenix area. Their smaller semiconductor rivals "occasionally cherry-pick us," says Glasson, "but we talk to them and ask if they really want to get into a hiring battle with us."

### The geographical change

The problem of help is more severe for Information Magnetics Corp., located in Santa Barbara, Calif. Though the ideal climate and a university attract many 18- to 23-year-olds, personnel manager Phil Warmanen says 50% of the applicants for hourly paid jobs are rejected on the basis of past job records. "People float from one job to another within the city, and we have a higher turnover than we would like to have. They may quit and do their own thing for a while and then find a job with someone else. We've found that we have to do a lot of training."

Santa Barbara does appeal to professional people, however, as do San Diego, Portland, Denver, Phoenix, and Tucson. Of course, the San Francisco area is the prime magnet, but uncertainty in the market there may prevent local firms from capitalizing on it at present. What is apparent is that Los Angeles is a place not many people want to move to, though nearby Orange County is.

Ten years ago, being located in Los Angeles was a great advantage; now, however, it is a decided disadvantage in hiring, according to Hughes' Robert Martin, who believes "eastern newspapers have brainwashed people—all they think of when you mention LA are earthquakes, smog, and traffic. You can get people from only two areas in the country, New York-Boston and Los Angeles", Martin adds, because "in other areas there just isn't the kind of R&D work being done. In California, if we advertise in San Francisco or San Diego, we don't get responses because people want to live there—they don't want to move to LA."

The reverse is true of Denver and San Diego. "Denver's a delightful place to live," says Martin-Marietta's Boyd. "Most people do the best they can to stay here even if they have to change their type of work".

Devlin feels that Cubic Corp.'s San Diego location is "a help in holding people" due to its "cultural, environmental, and recreational" features, although it is hard to draw them "unless they are aware of what it's like. . . . People will pass up marginally better opportunities to stay here; however, if the offer is big enough, most people will go." National Cash Register Co.'s data-processing operation in San Diego also finds the location a definite plus.

A tendency for many people to want to move to smaller communities, and away from metropolitan areas, is observed by Colla of Kremple and Mead. "A

lot of people want to get away from the big city," he says. "A few years ago, getting people to move to Knoxville would have been a chore, but now we have openings there, and people consider it a good place to live."

A number of firms are taking advantage of this trend. American Microsystems Inc. has a semiconductor processing plant in Pocatello, Idaho. Other companies are looking at Utah, where the Mormon population has a reputation for hard work and productivity. Hewlett-Packard is opening plants in Oregon and Santa Rosa, Calif., in the wine country. Still, ask someone in electronics where he'd really like to live and work, and chances are he'll say San Francisco.

### How to rise above it all

Some companies have few problems in keeping their employees. Hewlett-Packard Co., Palo Alto, Calif., known for its generous benefits, has a turnover rate of about 1%, reports Allan Richardson, corporate manager for employment. The firm, which gets about 150 résumés daily for all professional jobs, has quit hiring altogether since last December, insiders say. Richardson does say that H-P isn't hiring as many engineers as it thought it would this year because of a lowering of production as materials shortages pinched. But the company will be hiring production people and engineers when its new Oregon plant opens up. Richardson is confident H-P will be able to find workers, because of all those job applications and because studies H-P conducted indicate Oregon has a strong local work force.

But for other companies, recruiting has become more difficult. Most like referrals from current and new employees, though they don't feel that wholesale talent raiding is a big problem at present—except among programmers and, according to Hughes Aircraft's Martin, in the big new field of laser technology for the control of nuclear fission. Hughes is a prime target for raids in that field, he says, and we "have lost some key people." But he feels the firm is holding its own. At Bourns Inc., in Riverside, Calif., Kenneth S. Brown, vice president of industrial relations, feels that there is "not much robbing" of talent although he says that if it does get "excessive or super-obnoxious we call the president or the vp of industrial relations of the other company and try to talk them out of playing games."

Along with referrals, newspaper ads and college recruiting are the major tools used. Some companies use employment agencies for specific requirements, but most firms aren't great boosters of the body sellers: "They're expensive, time-consuming, and in most cases, disreputable," says Martin of Hughes. "They flood you with paper, and their job is to sell a body whether that person is good or bad." Rockwell finds they're not a very good source of engineers, and both Cubic and Information Magnetics Corp., Goleta, Calif., note that when they do use agencies, which is rarely, they find it possible to bargain on fees, often managing to drop them substantially.

Some search agencies still try hard, however: "People are really creative when they want to be," says Gordon Hoffman, engineering manager at Mostek Corp., Carrollton, Texas. In the last couple of months, he's run into two different ploys to dig out information on his

**L.A. Times** ENGINEERING  
 Sunday, July 14, 1974  
 224-4111, Times Mirror Square, L.A. 900

**EMPLOYMENT OPPORTUNITIES 2800**

**ASW Engineers**  
 We are currently in the process of building project teams for long term programs which require engineers with experience in the following areas:

**Sonar Systems**  
 Design and evaluation of requirements in marine sonar system evaluation. Develop technical requirements and instrumentation for effectiveness measurement systems. We require 5-10 years of sonar experience including sonar operations evaluation and digital systems processing, plus a BSMS in EE.

**Senior Facilities Engineer**  
 Major NYSE corporation has openings in the following areas.

**ENGINEERS MOS/LSI**  
 Fast growing dynamic MOS/LSI and Test Systems manufacturing company has immediate openings for qualified Engineers in the following areas:

**METALIZATION**  
 responsible for selection to include design and the maintenance of the manufacturing process of high yield production of high purity Aluminum Nitride Chemistry with 3 years exp. necessary.

**PROCESS DEVELOPMENT**  
 Development and implementation of process engineering in 2 years MOS/LSI with emphasis on LSI circuit

**PRODUCT**  
 in product evaluation and test using computerized test systems and off-line equipment. BSEE req. with background in logic design or testing of hardware in computer prior utilization of I.C. Test.

**PACKAGING**

**BEWARE**

engineering staff, as a means to recruit them.

The more recent was a call from what he determined to be a nonexistent trade magazine, offering complimentary subscriptions to key engineering people, which were refused. Earlier, several Mostek staffers received phone calls from a woman who said she was doing a survey on professional achievement for IEEE, Hoffman says. "But when we checked with IEEE, they'd never heard of her." Mostek alerted all its salaried people, and the calls stopped.

A big problem for companies is trying to keep people who have been offered substantial raises. Devlin at Cubic says, "You can't suddenly buy them because that will backfire on you," when others find that a fellow employee has extracted more money by threatening to leave. William C. W. Mow, president of Macrodata Corp., Woodland Hills, Calif., agrees. "I can't hire people at those 15% to 20% raises. My people would go somewhere else to do the same. Some engineers three or four years out of school are making \$22,000. They're pricing themselves out of the market."

A Calcomp spokesman adds, "When you hire a guy, he wants 10% to catch up with inflation, then 10% more to move." The problem is also affecting technicians. Microdata's personnel manager, William Graves, observes some people moving every six months instead of the customary year and a half, just for small salary jumps.

Perhaps the most sought-after prizes are the few women engineers. Xerox notes that it's hard to find them, but Beckman sees more coming out of technical schools. And, of course, minority engineers are also in very short supply. □

# Wescon professional program spotlights hot technologies

Microprocessors and charge-coupled devices come in for close attention, as do marketing and management techniques; emphasis in technology sessions is on practical applications

Practicality has become the keynote of recent Wescon professional programs, and those who attend this year's sessions from Sept. 10 to 13 at the Los Angeles Convention Center will find a wealth of down-to-earth applications information in the sessions that are devoted to technology.

There are 27 sessions in all, most of them dealing with technology and its uses. The proliferation of the technology is acknowledged in a session devoted to new electronics markets in agriculture.

But Wescon has become known for its concern with marketing and management as well, and this year is no exception. Four sessions deal with those subjects.

The only other topic commanding that much attention is the burgeoning world of microprocessors. Three

of the four microprocessor sessions essentially deal with applications information, and the fourth is dedicated to the newer entries in this hotly contested chip-set derby.

Microprocessors, then, come in for considerable discussion in the following survey of key portions of the Wescon professional program. The other pivotal sessions appear to deal with charge-coupled devices, microwave device and radar technology, component and circuit-board testing, and packaging and production.

In addition, there's a session on medical electronics, a tradition at recent Wescon shows, and one on the mushrooming fields of digital communications. But the show's emphasis is readily apparent from the Wescon preview brochure, which labels 11 of the 27 sessions with the word "application."

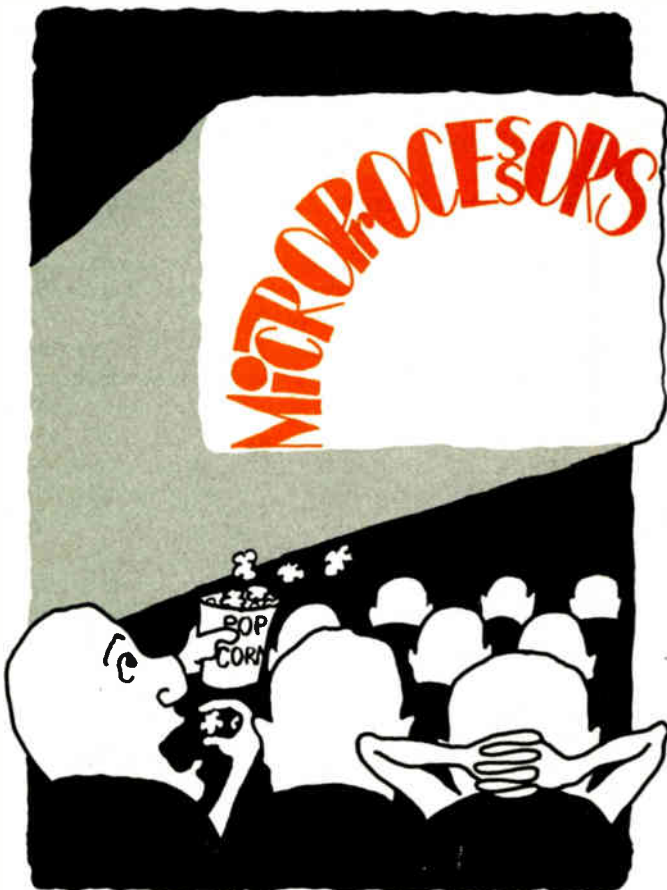

The microprocessor is changing the way the engineer approaches design as radically as did the transistor and the integrated circuit. This time, as Sessions 11, 15, 19, and 23 all make clear, it's the distinction between hardware and software functions that has suddenly become fluid, compelling would-be designers as well as would-be users of the chips to acquire novel programming skills.

The general aim of Session 11, says chairman and organizer David Froelich of IC Update Master, located in Sunnyvale, Calif., and part of United Technical Publications Inc., is to give the would-be user an instant education in the marketplace, which by now includes more than a dozen companies offering not only n-channel MOS microprocessors but also p-channel MOS, C-MOS, and bipolar 4-, 8-, and 16-bit devices.

Details on the ins and outs of particular microprocessors will be given by speakers from Pro-Log Corp., a microprocessor systems design firm in Monterey, Calif., and from National Semiconductor Corp. and Intel Corp., both in Santa Clara. And giving the marketplace overview in "The Microprocessor Market—Now and in the Future" will be Bob Wickham of Creative Strategies Inc., Palo Alto, Calif.

According to Wickham, many users who are traditionally design-oriented shy away from devices that require programming as well as design skills. Consequently, if "they are induced into using microprocessors it will not be from considerations of speed, instruction set, cycle time and other criteria that many of the second-generation microprocessor manufacturers are using as

selling points," he says. Instead, the new user will go to the companies who offer the most software support.

The other criterion of selection, for at least the next two years, will be availability. "A number of new processors are better designed, more efficient than the earlier general-purpose microprocessors—but most will not be on line in large volumes for at least a year," whereas availability covers a multitude of technical sins and omissions, observes Wickham.

Indeed, the gist of Session 15, "Microprocessors—The Second Generation," is that instead of coming out with more general-purpose devices, companies are mostly aiming their second-generation offerings at a particular market segment or providing a unique marketing and servicing approach. Organizer Jerry Metzger, also of IC Update, has keyed this session to "the here and now"—devices and systems that are or will be in production at latest by the first quarter of next year.

National Semiconductor, for one, got interested in giving the user the ability to change a microprocessor's instruction set and thus tailor its architecture to his needs. This "would allow a single processor configuration to be used for a wide variety of applications, and be as efficient at each of them as a special-purpose device," explains Philip Roybal, National's microprocessor marketing manager. The result of this thinking is described in Roybal's paper, "FACE, a Field-Alterable Control Element," which concerns the heart of the company's new Microprogram Development System

Basically, the FACE chip and an associated memory replace the control read-only memory during development of microprograms that will tailor National's IMP-16L, IMP-16P, and IMP-8 to particular applications.

Signetics Corp.'s 8-bit programmable processor takes a different tack. "We are going after that market segment in the middle," says Joseph Kroeger, processor marketing manager at the Sunnyvale, Calif. firm. "It is neither the highest-speed, nor the lowest-cost microprocessor, but it is, we believe, certainly one of the most flexible. It combines a high level of sophistication and a powerful instruction set, with provisions for a very economical interface, which means it can be used effectively over a wide range of different applications."

According to Kroeger, the device's coding efficiency decreases storage space, improves execution speed, and, together with the minimization of external logic support reduces system costs.

Other second-generation systems which will be described in Session 15 include the first C-MOS microprocessor (from RCA Solid State division), an 8-bit Isoplanar device from Fairchild Camera & Instrument Corp., and devices from Motorola, Rockwell Microelectronics, and Intel.

The longer-term implications of microprocessors for both the design and the designers of electronic systems are explored in Sessions 19 and 23, "The Microprocessor Revolution," which are organized by Rudolf Panholzer of the Naval Postgraduate School in Monterey, Calif. Panholzer believes that the "computer turned component may prove to be one of the greatest breakthroughs in electronics" in the 1970s, and he notes that they are already affecting how engineers in the field view hardware and software and how students are

taught to view hardware and software.

Mona Saba of Tektronix Inc., Beaverton, Ore., agrees: "In microprocessors, the difference between what is software and what is hardware is something that changes with the particular application. So, as the microprocessor becomes more pervasive, the dichotomy between software-oriented systems engineers and hardware-oriented design engineers will disappear." She and Jack Grimes, also of Tektronix, are authors of Session 23's "Microprocessors: A Component for All Seasons." Saba predicts, moreover, that "as chip density goes up and the price per bit goes down, very sophisticated microprocessors for \$10 and \$15 are not inconceivable" within the decade.

Fortunately, the logic designer overcomes the first hurdle in dealing with these devices once he realizes that many of the notions and tools applicable to hardware can also be applied to software, points out Bernard W. Jordan, professor of electrical engineering and computer science at Northwestern University in Evanston, Ill., and author of Session 19's "A Teacher Looks at Microprocessors." The principal change in the classroom will be in the teaching of hardware logic design, he says, since this "will have to be expanded to include topics previously considered necessary only to software systems designers."

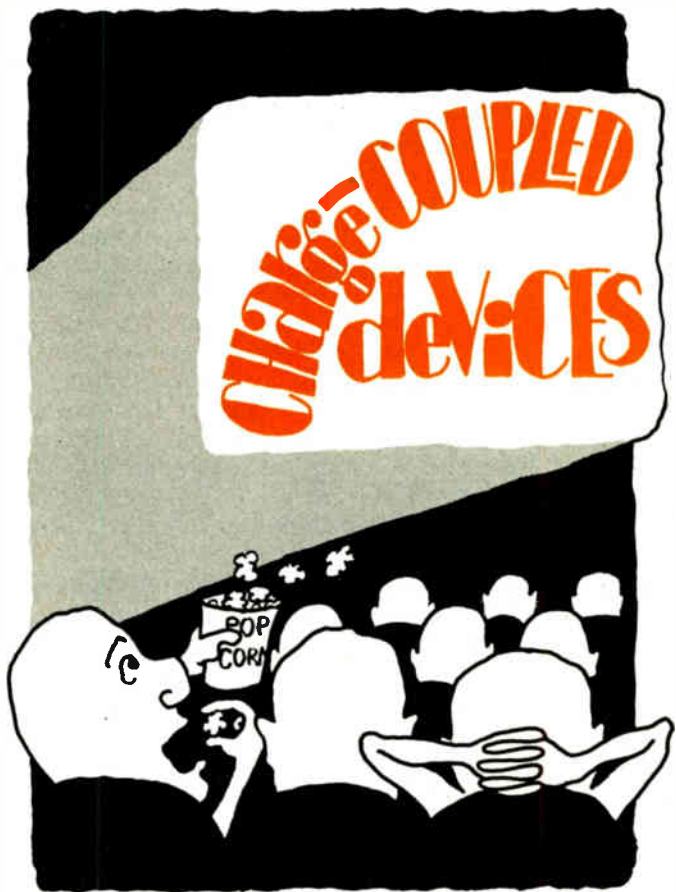

The two Wescon sessions devoted to charge-coupled technology should be required attendance for all designers who are impressed with the potential of CCDs but wonder when products will emerge and for what applications. The answer is that CCDs have reached the

product development stage in all three areas of interest—imaging, memory, and analog signal processing—bringing under the umbrella of LSI semiconductor technology such diverse activities as high-resolution video image sensing, disk and tape memories, and analog time-delay and filtering components.

Those familiar with recent CCD literature must be warned that the CCD sessions at Wescon are composed largely of papers that have appeared elsewhere—at the International Solid-State Circuits Conference, the IEEE Intercon, the National Computer Conference, and a closed-door device research conference on CCDs in San Diego. Nevertheless, they do offer designers a chance to catch up with events and see for themselves how far advanced CCD product development really is.

Imaging is the subject of a strong morning review paper entitled "CCD Image Sensors," in which Allen Solomon of Fairchild Semiconductor, Palo Alto, Calif., describes the details of several CCD image sensors already commercially available—they range from a 500-element linear array suitable for facsimile equipment to a 100-by-100-element array for certain low-resolution video camera applications. Significantly, Solomon describes several higher-order linear and area devices in development, such as the 1,600-element linear sensor described by Bell Labs at ISSCC [*Electronics*, March 21, p. 29], which can resolve a full standard 8-by-11-inch page of type, and an RCA 525-line TV-compatible CCD camera device, which was described at Intercon [*Electronics*, March 21, p. 29]. Not mentioned in Solomon's paper, however, is Fairchild's next entry in the market, a more complex area device—probably in the 256-line range—expected by the end of the year.

In memory, papers by engineers at RCA, Fairchild, and Bell Northern Research (an Intel paper was withdrawn) confirm that the principal thrust of CCD memories is in the medium-speed block-accessed disk and drum equivalents, where the simplicity and small size of a CCD memory element (potentially less than 1 mil<sup>2</sup>) can be exploited in very-high-density (400,000 to 500,000 bits per chip) serial memories for auxiliary computer, microprocessor and terminal applications. Although not stated in any of the papers, the first CCD memory products—block-accessible 16,000-to-32,000-bit chips—may well be available this year from Bell Northern, Fairchild, and others.

The least known but perhaps most interesting developments in CCDs are in the area of analog signal processing. CCD delay lines, multiplexers, and filters are already operating in radar and secure military communications systems. More important to the commercial communications engineer is the application of CCD delay lines and filters to video and telecommunication networks in the form of time delay and equalization components. Both these subjects are treated in an excellent review paper, "Signal Processing Applications for CCDs," in Session 2 by Dennis Buss of Texas Instruments, Dallas [*Electronics*, August 8, p. 98]. Buss, who perhaps among all researchers in the field has the best understanding of CCD technology's signal-processing capability, reviews the various approaches to implementing devices, and discusses how to satisfy system requirements.



For the engineer who considers dc to be any frequency below 1 gigahertz, Tuesday's *the day* at the Wescon professional program. The morning's Session 3, covering microwave and millimeter-wave components, is probably the more generally useful. In the afternoon, Session 7 will cover modern radar technology.

W.K. Kennedy, manager of Watkins-Johnson Co.'s Solid-State division, Palo Alto, Calif., organized the morning session to give users a practical look at how new devices can fit into a system. "What I've felt very strongly in the past is that many papers on microwave devices tend to be theoretical—if someone talks about a Gunn diode, he talks about the theory of why the diode works. But there are a lot of users who want to know not how the device works, in theory, but how it works as a component in a circuit." So Kennedy has asked his authors to hit the practical aspects hard.

Kennedy's session leads off with a late addition, not listed on the preliminary program. Jack Lunden of General Electric's Electronics Laboratory in Syracuse, N.Y., will talk about a new carrier for microwave transistors that replaces wire bonds with more uniform and more reliable metalized conductors. He says he has been able to get 25 watts in L band (1.4 gigahertz) over 600-megahertz bandwidths out of devices mounted on 0.25-by-0.25-inch beryllium-oxide substrates along with their associated chip capacitors. Still in the laboratory development stage, the process is described in detail by Lunden in his paper, "Wirebondless Wideband Microwave Power Transistor Carriers."

The next three papers cover the leading edge of technology in microwave and millimeter-wave compo-

nents—low-noise gallium-arsenide field-effect-transistor amplifiers, Impatt devices, and Gunn-effect devices.

Martin Walker, of Watkins-Johnson Co., Palo Alto, Calif., will describe GaAs FET amplifiers that cover the full 4 to 8 GHz of the C-band and also an X-band unit. The C-band unit, now a commercially available product, offers about 20 decibels gain with a maximum noise figure of 8.5 dB. Walker will also discuss narrow-band applications—GaAs amplifiers as replacements for tunnel-diode amplifiers in military satellites at 7.25 to 7.75 GHz and 7.9 to 8.4 GHz. Their guaranteed noise figure is 6.5 dB, he says.

Circuit applications of Impatt diodes will be covered by N. Bruce Kramer of Hughes Aircraft Co.'s Electron Dynamics division in Torrance, Calif. "The most significant new thing here," says Kramer, "is that we're getting sweep bandwidths of over 15 GHz at 50 to 75 GHz." These devices are aimed at test-equipment-type oscillators. The power generally increases from about 2 milliwatts at the low end of the band to about 30 mw at the high end, according to Kramer. He will also present some results on efforts to reduce the noise output of the devices with proper circuit design.

Though the contrast with Gunn devices is not explicit in the written paper, he says he will make comparisons during his presentation. As examples, he cites Impatt's higher power capability at the higher frequencies and the fact that they can be swept simply by varying the bias current.

Following the Impatt paper, Robert Goldwasser of Varian Associates, Palo Alto, Calif., will discuss Gunn devices. Goldwasser will point out that Gunn oscillators are now practical up to 75 GHz—he says he has achieved 87 milliwatts and 2% efficiency at that frequency. Moreover, Gunn amplifiers have provided 8 dB gain up to 50 GHz. Goldwasser will discuss the Gunn devices primarily as pumps for uncooled parametric amplifiers. The quest here is for higher-frequency pumps, since the noise figure of the amplifier can be reduced if the pump frequency is increased.

Other papers in the morning session will cover microwave varactor-tuned oscillators and broadband microwave mixers that use balanced-line microstrip hybrids.

Anyone ready for still more device information could stay for the first paper in the afternoon radar session. This one, authored by Lt. John Smith and Robert T. Kemerly, Wright-Patterson Air Force Base, Ohio, considers how an X-band phased-array radar might be implemented with solid-state devices. Older solid-state radars used S-band transistors with frequency multipliers to get to X band. But with recent advances in power devices, "it appears that direct X-band power amplification is a viable alternative," according to Smith. The paper covers Impatt and Trapatt devices and bipolar and gallium-arsenide field-effect transistors. "The device that is the closest to meeting our requirements," says Smith, "is the modified Read Impatt. But for reasons of complexity and cost, if the transistors ever make it, that's our bet—to go with the transistors," because of the isolation problems associated with the diodes.

The final paper, too, may draw some interest—it's about synthetic-aperture radars for use in earth-resources monitoring. An airplane transmits the radar

pulses as it flies along, stores the returns, and reads out of the storage a set of data that is related to the whole length of the flight path (the "synthetic aperture"). The secret is to keep track of the phase of the returns along the path, for when this is done, the resolution is equivalent to that of a long antenna. In the paper, authors L.E. Graham and H.C. Rydstrom, Goodyear Aerospace Corp., Litchfield Park, Ariz., describe radar stereo imaging for topographic mapping and the use of the synthetic aperture for sea ice monitoring and in explorations for minerals.

There will also be a comprehensive paper on surveillance radars, by William S. Jones and Louis F. Meren, Westinghouse Electric Corp., Baltimore. It will point out several trends in the area of reduction of the cost of ownership of the systems. "Such techniques as extensive built-in tests and fault isolation, accompanied by redundancy, are permitting a 'heal thyself' approach to design," says Jones.

Two technological trends that complement these efforts, he notes, are digital signal processing and solid-state microwave components. "The digital interface is marching toward the antenna steadily, while solid-state techniques will allow distributed transmitters and receivers—a significant step in achieving lower maintenance costs and a higher rate of availability," he adds.

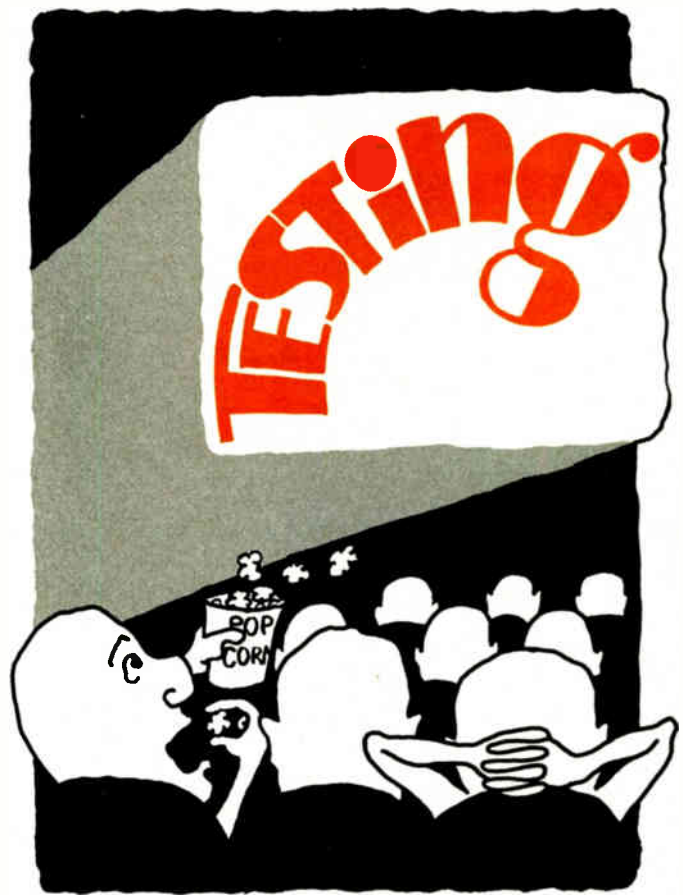

"As microprocessors begin to trickle into the marketplace, how best to test them looms as the really hot topic," says Hughes Aircraft's Roy Nesson, who will chair Wescon's Session 22 on LSI testing. "Test techniques don't rise to the surface by themselves. We

learned that when memory testing was in its infancy. It is meetings such as the upcoming Wescon sessions which provide the necessary cross-pollination" to evolve them.

Hardware emulation is the microprocessor testing approach touted by Bill Mandel of Macrodata Corp., Woodland Hills, Calif. In this method, test-equipment hardware generates several hundred test patterns without interruption, applies them to a microprocessor CPU, and then checks for the correct output, whereas in a software approach only tens of test patterns are obtained from a program. "Hardware emulation outperforms the software approach because it delivers higher testing speeds and enables a tester to deliver longer test pattern bursts to the device under test," explains Mandel. Long test bursts are important in simulating real-time operation of the CPU under test since they reduce the likelihood that the tester will have to go back to the central processor for more test data part way through a sequence.

The speed that's a boon to the performance-conscious designer is a headache to test engineers trying to qualify components. "What makes testing so challenging today, is that engineers are pushing operating speeds toward the design limit of the devices," says William Boggs, E-H Research Labs, Oakland, Calif. He and co-author John Worcester will discuss "New Generation Systems to Solve New Generation Test Problems" at Session 22. Until recently, he adds, "the design limit was about 10 times the minimum cycle time of a device, but now it's more like two to three times." Boggs is pressing for ac testing, which he sees as mandatory for devices which operate at high cycling rates—10 ns or faster. "At such high speeds, slight variations in propagation delay can frequently cause malfunctions when devices are interconnected on a printed-circuit board to form a system."

The C-MOS device, if it's to be rigorously tested, needs much more thoroughgoing treatment than bipolar ICs, according to George P. Nelson, at the Naval Research Laboratories, Washington, D.C. "It may be sufficient to exercise each lead of a TTL circuit, but that's seldom adequate when testing C-MOS," he says. In "Special Considerations for Testing C-MOS LSI," Nelson points out that test patterns must be more extensive for C-MOS and that it is the series-parallel complementary input in C-MOS NAND/NOR gates that's most demanding from the test viewpoint. He also believes that test designers should examine more closely what role test-pattern design plays in valid noise-immunity testing.

How one tests and debugs a printed-circuit board once components are loaded and soldered is becoming critical in cost-effective manufacture. As Inforex's Gerald Kutcher, who is chairing Session 25 on "Automatic Testing of Printed-Circuit Boards," says, "Techniques which only a few years ago were considered exotic are now commonplace, such as the branch-impedance approach for testing both bare boards and boards loaded with components." Branch-impedance testing is a powerful technique for fault isolation because pins engage each node on the printed-circuit board and each branch can be measured as an independent impedance.

Adding computer control to branch impedance testing is one of the themes to be developed by speaker

John Fluke Jr. of John Fluke Mfg. Co., Seattle. Fluke believes that adding a computer will refine the technique and provide precise control of the stimulus signal. He will argue that it can offer an edge over the paper-tape systems now in use.

Mirco Systems Inc.'s recently announced 500 series tester [*Electronics*, July 11, p. 125] manages to increase testing speed by a factor of 100 despite its small size and minimal power consumption. The Phoenix, Ariz., company's marketing vice president, Robert E. Anderson, plans to discuss some of the tester's features—such as its ability to deliver both pseudo-random and programmed test patterns to a unit under test—in his paper "A New Approach to Logic-Circuit Testing." Anderson will point out that though fixed-pattern generators may be sufficient to test simple boards, programmed patterns are frequently necessary to test the more complex ones.

"Users sweat too much about software simulators and fault coverage," says Temon Taschioglou, a marketing specialist at Teradyne Inc., Boston, Mass. Taschioglou is referring to the various software programs that simulate circuits and faults and the question as to how many of the potential faults they actually model. In a paper entitled "A Practical Approach to the Problem of Test Pattern Generation," he will urge adoption of a heuristic approach to testing.



Can ICs in plastic packages be really hi-rel? What snags occur in bonding chips in hybrid circuits? And what are the merits of the additive method of processing printed-circuit boards? These are the subjects of Wescon's three packaging sessions this year, a portion of the program



that has been gaining in strength in recent years.

Large-volume semiconductor users with tough reliability standards—such as military, automotive, and computer equipment makers—still face problems when trying to replace ceramic-packaged circuits with plastic-packaged parts. Such users will have a chance to discuss their experiences in procuring and testing these devices at Session 9, organized by Edward Hakim, research physicist in charge of semiconductor reliability and physics of failure operations for the U.S. Army Electronics Command, Fort Monmouth, N.J. Pointing out that the military has been opposed to using plastic-encapsulated semiconductors, Hakim says, "We've been hesitant because of problems with reliability and procurement specs."

And while plastic-encapsulated semiconductors have achieved adequate reliability in the automobile radio environment, Ken Doversberger of General Motors' Delco Electronics division in Kokomo, Ind., suggests in one paper that appropriate designs and tests are necessary to assure reliability. Also, a program of tests and controls, administered preferably at the vendor's facility, is required to eliminate lot-to-lot variations in reliability, he says.

National Cash Register, Dayton, Ohio, is delving into the question of increasing corporate profits by switching to plastic devices, according to Joseph Pignatiello, manager, quality engineering programs. His paper describes a four-part study of the question. The first part, which has been completed, compares failure rates of plastic- to ceramic-packaged ICs of all types during the board-stuffing and burn-in phases of manufacture. The second stage will be to procure high-reliability ICs—parts that are temperature-stressed to spec by the vendor. NCR's Accounting Computer division, Wichita, Kansas, is committed to buying only high-rel parts, Pignatiello says, and will be monitoring field results. Other areas of concern that will be covered by NCR include field-fail-

ure analysis of plastic-encapsulated bipolar and MOS circuits.

Following the formal presentations, a panel consisting of the speakers and representatives of semiconductor suppliers will engage, with the audience, in what Hakim hopes will be "lively discussions." IC reliability usually triggers such discussion.

Hybrid-circuit makers are treated to a roundtable clinic on semiconductor bonding at Session 17, one of a continuing series of such clinics presented at Wescon, Intercon, and the Northeast Research and Engineering Meeting (Nerem). William Burford of Westinghouse Aerospace and Electronics Systems division, Baltimore, who will chair the session, says likely topics for discussion include problems often encountered in the use of aluminum wire on thick-film gold substrates and bondability of IC chips.

The additive process for printed-circuit manufacture comes under scrutiny at Session 21, with papers presented by manufacturing materials suppliers, board makers, and users. A broad-based overview of the method, which is said to provide lower-cost printed circuits than the older subtractive manufacturing process, is presented by Sam Smookler, general manager of the Photocircuits division, Kollmorgen Corp., Glen Cove, N.Y., while George A. Butter, also of Photocircuits, with Edward V. Klein of Abcor, Cambridge, Mass., will discuss reverse osmosis as a viable means of effluent control for a mass-production printed-circuit facility.

The problem of waste removal from a printed-circuit plant is as difficult as it is timely. John C. Eckhardt of Methode Electronics Inc., Chicago, offers a plan which not only cuts effluents but also lowers over-all costs—combining additive and subtractive processing in a single manufacturing facility. Eckhardt points out that recycling copper removed from boards in a subtractive process for use in the additive assembly area can yield significant cost savings. □

## Wescon's numbers forecast

Wescon officials have sold out the portions of the Los Angeles Convention Center allotted to the Sept. 10-13 show—547 booths in all. That compares with 466 last year in San Francisco and 485 at the 1972 Los Angeles gathering. Attendance is expected to top 30,000, a slight improvement over 1972's number and up from the 27,400 who visited last year's exhibits.

In an effort to speed registration, it will take place, not in the center's main lobby but in Petri Hall, where a scheme like the one used in many banks is expected to shorten the lines.

Another new feature this year for foreign visitors and their prospective customers or suppliers will be an upstairs lounge, sponsored by the U. S. Department of Commerce, where they can meet.

For the first time, too, Wescon will have night sessions. One sponsored by the IEEE and set for Sept. 10 is a panel on engineer pensions; the other is about "psychotronics" and will deal with parapsychology. And for a \$50 registration fee, would-be entrepreneurs can attend a day-long seminar on how to start a new business without venture capital.





A subsidiary of **THOMSON-CSF**

# You are looking at the most advanced cockpit CRTs in the world.

DuMont cockpit CRTs present a pilot with more clearly defined information than any other CRT available. Display precision is visually unaffected by aircraft vibration under exceptionally high brightness conditions, (in excess of 10,000 ft. lamberts). Line widths as fine as 4 mils are available on most standard designs. Our CRTs have already proven themselves in the A-7, A-10 and the F-15.

Specifically designed for military aircraft, our head-up displays are compact, high brightness tubes. Excellent contrast is provided when projected against a 10,000 ft. lambert background of sunlight. In hard mountings they will withstand vibrations exceeding 60G, and up to 90G's with state-of-the-art vibration isolation. Seven differ-

ent head-up displays, all with optically flat faceplates, are available in diameters from 1.85 to 4.25 in.

Dumont head-down displays provide superior brilliance and contrast, and give outstanding performance in raster-scan and dot-matrix applications as well as in random-address, stroke-writing systems. Seven models are available in dimensions from 1.9 x 3.4 to 7.6 x 7.6 inches.

All DuMont cockpit CRTs offer multi-color features with resolutions comparable to high quality monochrome CRTs.

For complete specs and information on the most advanced cockpit CRTs in the world, contact DuMont Electron Tubes & Devices Corporation, 750 Bloomfield Avenue, Clifton, N.J. 07015, (201) 773-2000.

## DuMont



# Wescon 74: a showcase for applications of new technology

Impact of new and emerging electronic techniques on industry and commerce will be a major theme of exhibits at Wescon 74, Sept. 10-13 at the Los Angeles Convention Center. Instruments will be a primary focal point, but exhibitors will also demonstrate applications of microprocessors, IC memories, and hybrid devices. Following are some of the significant devices to be introduced at Wescon.

## Multi-signal generator has programable phase

A **programmable** function generator from Wavetek has what appears to be a new twist: it features two or more signal output channels, with their relative phase programmable and referenced to a sync input or output. Thomas G. Kurtz, Wavetek's instrument sales manager, thinks the instrument will find application particularly in the aircraft industry, where automatic servos, closed-loop systems and timing equipment must be checked: "We've been supplying special function generators with phase-meter capability for some years, but they must be jury-rigged to give variable phase output." The instrument also offers the very low distortion necessary for high-precision applications.

The model 152 Variphase generator also indicates a growing trend in instruments. Like the recently announced Wavetek model 158 and 159 function generators, it is digitally programmed either remotely or from an optional front-panel keyboard. But, unlike earlier programmable instruments, in which the pro-

grammability was simply added to a conventional desk-top instrument, the new units have no knobs and dials. The keyboard can also be used to program other model 152 or 158/9 generators, up to a total of nine.

The standard model of the 152 has two signal output channels and

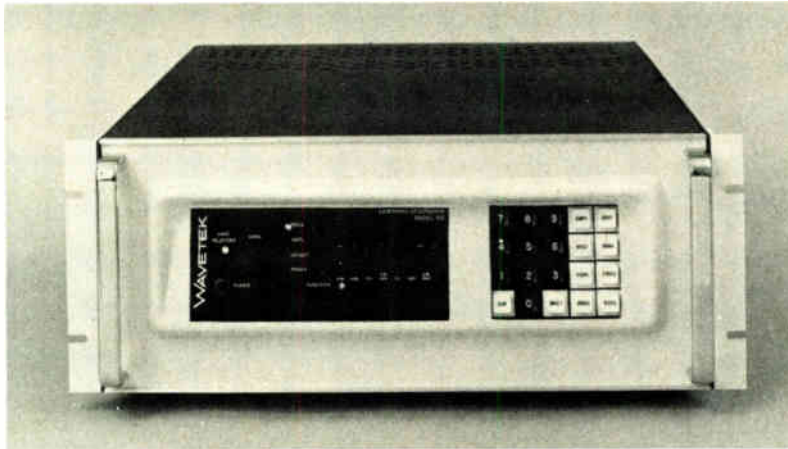

costs \$4,995. A third channel can be added in the same package for \$995, and up to three additional channels can be added in another enclosure. Each channel can be independently programmed for amplitude, offset and waveform. The phase relationship of the sine and square waves is referenced to the sync output and is variable with four-digit resolution. The positive rising edge of the square wave is in phase with 0°

phase of the sine wave. Triangle waveforms and variable-level dc are also available. All waveforms other than triangle and variable phase sine can be inverted.

Frequency range is 1 hertz to 100 kilohertz in five ranges with three-digit resolution. Accuracy is within  $\pm 1\%$  of programmed value plus 0.1% of range up to 10 kHz, and 2% of value plus 0.1% of range above that.

Output level for ac waveforms is 10 millivolts to 9.99 volts peak-to-peak at 100 milliamperes peak output current in three ranges. Dc output is  $\pm 10$  millivolts to  $\pm 9.99$  volts at 100 milliamperes, and output impedance in either case is under 1 ohm. Dc offset is also programmable, to a maximum of 9.99 v including signal.

Total sine-wave harmonic distortion is less than 0.1% (60 decibels down) to 10 kHz, and under 0.7% of 100 kHz. Square-wave rise and fall times are under 3 microseconds for 20 volts peak to peak.

The model 152 is programmed by a serial stream of Ascii-coded characters, with instructions in a 7-bit par-

## New products

allel Ascii code. Optional interfaces are available for H-P 2100 or DEC PDP-11 computers, Teletype, EIA RS-232 or BCD parallel signals.

The instrument will accept input

data at a 1-megahertz byte rate. The output stabilizes within 100 microseconds unless the frequency-range digit is changed, in which case the settling time is 1 millisecond.

The generator can be used in a 19-inch rack, stands 7 in. high, and requires under 150 watts.

Wavetek, 9045 Balboa Ave., San Diego, Calif. 92112 [341]

## Thin-film networks: key to converter precision

Some commercial applications for digital-to-analog converters require that linearity and accuracy hold over months of continued operation at extreme temperatures. Synchros that sense the position of traffic-con-

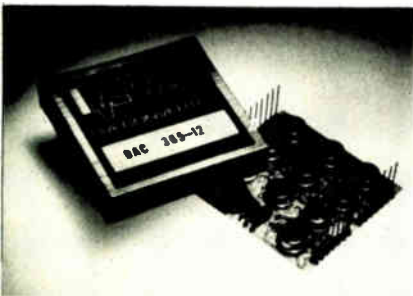

trol antennas, for instance, sit for months in the broiling sun and freezing cold. And CRT displays require good linearity while operating in traffic-control towers exposed to

extremes of weather. With this in mind, Hybrid Systems Corp. has developed a line of ultrastable multiplying digital-to-analog converters, the DAC365 series, that offers low drift and high performance over the full military temperature range of  $-55$  to  $+125^{\circ}\text{C}$  for long periods.

The 2-by-2-by-0.4-inch unit looks like a module, but it uses dynamically laser-trimmed, thin-film nichrome R-2R resistor networks and matched monolithic quad switches made by Hybrid's Microelectronics division. The networks and switches are hermetically sealed in standard transistor-sized metal cans, and the whole unit is built on a printed-circuit board. The thin-film networks, which expand and contract at the same rate as the silicon wafer, are the key to the unit's precision, a spokesman for the company says.

All three versions provide 12-bit resolution; the 365-8 offers linearity within 0.2%; the 365-10, 0.05%; and the 365-12, 0.0125%. Temperature coefficient of linearity for all models is  $1\text{ ppm}/^{\circ}\text{C}$ , while accuracy of linearity is  $6\text{ ppm}/^{\circ}\text{C}$  over the full temperature range.

Both binary and offset binary input codes are offered on all models, and full-scale output is 1-10 volts unipolar and  $\pm 10\text{ V}$  bipolar. Reference in is  $\pm 10\text{ V}$  dc to 1 kilohertz. A stable internal reference is included for applications that do not require the multiplying feature. Settling time is 25 microseconds for a digital change, and  $5\text{ }\mu\text{s}$  for the reference.

Price of the DAC365 is \$125 in single quantities. Delivery time is four to six weeks.

Hybrid Systems Corp., 87 Second Ave., Burlington, Mass. 01803 [342]

## Low-cost tester checks out IC memories

Sophisticated test systems for IC memories give the semiconductor manufacturer the ability to make parametric and functional tests on a wide range of devices. But, since the average system costs about \$250,000, it does nothing to reduce the per-bit cost of a device.

To cut this cost, Pacific Western Systems Inc. has introduced its model 40 production IC-memory tester. Priced at about \$35,000, the model 40 is a dedicated test system designed primarily for use in high-volume production testing of MOS and bipolar random-access memories. Its 14 address lines are capable of testing memories as large as 16,384 bits. It can also be adapted to testing read-only memories, shift registers, and memory boards. What's more, it performs both func-

tional and parametric testing at either the wafer or packaged stage of production. Since the test system has a multiplexing capability, two wafer probers or packaged-device test fixtures may be used simultaneously.

Testing is performed by loading a device-test tape through the tape reader into the controller memory, which then interprets the stored program to direct test routines and maintain test-summary information. The memory unit is composed of four Intel 2102 MOS 1,024-bit static RAMs. Each program is stored on paper tape in Ascii code, and 22 mnemonic instructions form a program.

The function tester is configured to provide 10 test patterns, any of which may be programmed on the

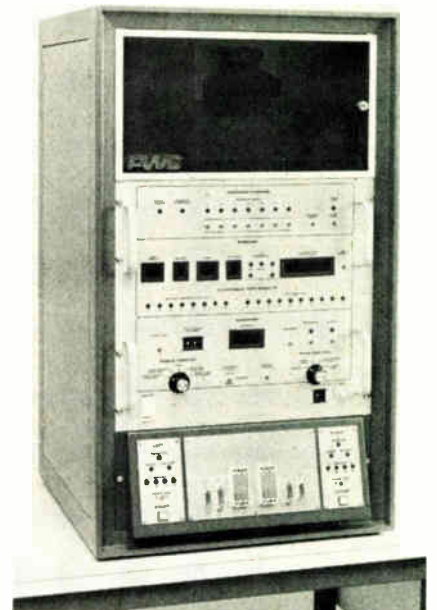



**There's  
something  
very special  
about this line  
of HP XY recorders...**

**the newest addition  
is the fastest most sensitive machine  
we've ever built.**

HP's line of XY recorders is designed to let you choose the right machine with the right options to do the right kind of job for your lab. First: a basic one-pen workhorse. Then, a fast high-performance version. And a two-pen model that doesn't sacrifice speed.

Now, HP introduces a very special combination of acceleration and sensitivity: The Model 7047A.

This is an outstanding XY recorder, the top of the line. Sensitivity of  $50 \mu\text{V}/\text{in.}$

Acceleration in the Y axis of  $3000 \text{ in}/\text{sec}^2$  and  $2000 \text{ in}/\text{sec}^2$  in the X axis. With fully guarded input and 130db common mode rejection.

To meet the demands of the most exacting lab work, the 7047A gives you a switchable input filter, 11 scales of calibrated offset, internal time base and TTL remote control. All as standard equipment.

And like all recorders in the line, the 7047A is built on a strong die-cast aluminum mainframe. Inside, there are no

complicated slip clutches, just tough, continuous duty servo motors that can be driven offscale independently without damage.

This is the best of the best XY recorders ever offered by Hewlett-Packard. Prices start at \$2,850 (domestic USA price only). For complete details on the new 7047A and the other recorders in the HP line, see your HP field representative or write Hewlett-Packard, 1501 Page Mill Road, Palo Alto, California 94304.

11408

**HEWLETT  PACKARD**

Sales and service from 172 offices in 65 countries.  
1501 Page Mill Road Palo Alto, California 94304

Circle 135 on reader service card

## New products

tape. The controller reads the test routine that has been programmed and orders the appropriate test from the patterns available in the function tester. Test speeds in the low range vary from 250 kilohertz to 1.5 megahertz and in the high range from 700 kHz to 5 MHz. Pause time ranges from 2 to 200 milliseconds. Pulse resolution is  $\pm 2$  nanoseconds.

The parametric tester provides for monitoring of continuity, stress, leakage, breakdown, and resistance of the device under test. The results are sent to a display on the front panel and to the grading and summary logic. Devices are graded into

six categories: total reject, total pass, and four grade variations between. Programmable test durations are 4, 10, and 50 ms.

An interface unit, which provides the special test routines that are applied to the device under test, contains active electronics for driving the device pins and comparators for checking the output of the device against an internal reference. The result of this comparison is routed to the test summary storage via the front-panel readout.

An option on the model 40 is a microprogrammable pattern generator that replaces the hard-wired

functional test unit in the model 40 and allows custom test patterns to be loaded through the tape reader and stored in the controller memory. Pattern generation and debugging are accomplished off-line, which allows the system to continue testing for high-volume production while a new test pattern is being generated.

The device measures 22 by 23 by 39 inches and weighs 200 pounds. Power requirements are 115 volts ac, 3.0 amperes typical and 4.0 A maximum.

Pacific Western Systems Inc., 855 Maude Ave., Mountain View, Calif. 94040 [343]

## Instrument modules packaged for special markets

Stressing versatility and compactness, the TM-500 modularized instrument line of Tektronix—less than a year old—now adds up to 32 modules and instruments.

The company is beginning to group selected instruments in a single package, dedicated to a special market sector or application. First use of this concept is in what

Tektronix calls its high-performance package, shown at left. The mainframe, which weighs less than 25 pounds, provides a common power supply and interconnections.

The high-performance package, Tektronix says, fills the requirements of sophisticated research organizations in testing the latest in integrated logic circuits including emitter-coupled logic and fast-triggering devices.

Heart of the package is the PS 505 power supply, shown at the right in the photo. It has a floating output of 3.5 to 5.0 volts dc at 4.0 amperes. Other parts of the package are the TM 504 mainframe (power module); the PG 502, a 250-megahertz pulse generator; the DC 505, a universal counter/timer; and the DM 501, a digital multimeter.

Also put together by Tektronix is a low-cost package for "price-sensitive" areas of the service markets.

One of the newest instruments developed for the TM 500 series is the AF501 bandpass filter/amplifier, which can be used as a manual-sweep spectrum analyzer for sound and vibration signals. In addition to calibration in hertz, the dial is calibrated in cycles per minute, which facilitates direct readout in revolutions per minute. The tuning capability of the bandpass filter enables the user to isolate mechanical signals in dynamic balancing or viewing higher-order disturbances on a CRT monitor. Q is 5 + 1 of 15 + 5. An output pulse synced to the filter (or oscillator) is available for triggering a stroboscope or oscilloscope. The AF501 can also be used as a sine-wave generator covering 3 Hz to 35 kHz, or as an ac-coupled amplifier with gain, variable from 1 to 500, in a 1,2,5 sequence.

Tektronix Inc., P. O. Box 500, Beaverton, Ore. 97005 [344]

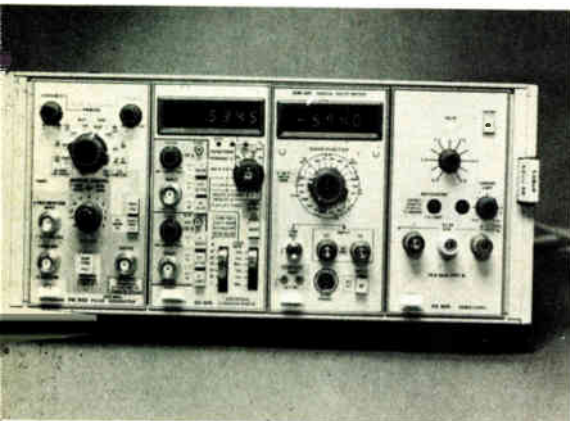

## System aimed at low-energy ion implantation

With increased use of ion implantation in semiconductor processing, a greater variety of implantation systems is emerging. For manufacturers who require relatively low energy levels, Extrion Corp. has developed its model 100, which the company says is compact and

simple to operate, as well as being designed specifically for low-energy implantation.

The model 100 can dope semiconductor devices at selected energy levels from 25,000 to 100,000 electron volts with ions of boron, phosphorus, or arsenic. The system,

which measures 159 by 32 by 77 inches, can process 25 3-inch diameter wafers simultaneously at a rate of more than 200 per hour, depending on the dosage level. The wafers can be placed back-to-back or end-to-end for dual lines.

Extrion, which makes five models

# 85 amp DO-5



The ratings are back and even we're a little amazed at the fantastic results. We knew our upgraded DO-5 was a honey, but an 85 amp rating is (to say the least) a major breakthrough in power semiconductors.

Here's how it tested:

- Dimensions as per JEDEC DO-5 outline.
- Maximum Recurrent Peak Reverse Voltage . . . 100-1600 volts.
- Maximum Average Forward Current, Single Phase Half Wave Rating at 115°C. Case Temperature . . . . . 85 amps.
- Maximum Surge Current (One Cycle) . . . . . 1500 amps.
- $\Theta_{JC}$  . . . . . 0.6

For detailed information, contact:  
FMC Corporation  
Semiconductor Products Operation  
Homer City, Penna. 15748  
(412) 479-8011

**FMC** Special  
Products

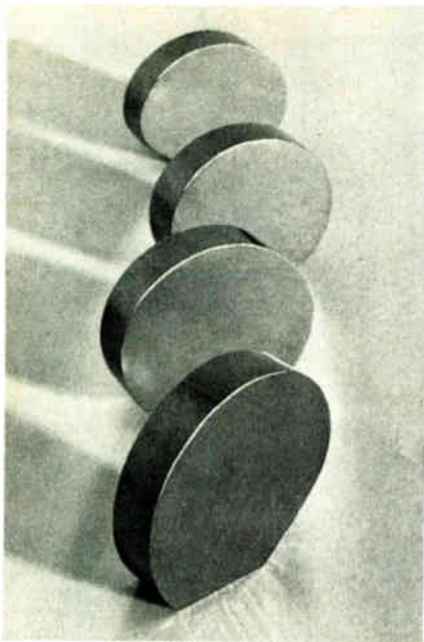

## Our compounds are your right answer for...

### DIODE DISPLAYS, INFRARED DEVICES, ELECTRONIC COMPONENTS

Asarco Intermetallics Corporation offers a wide range of III-V compounds used in the production of light emitting diodes (LED) and photoluminescent displays.

We provide gallium arsenide, gallium phosphide and indium phosphide in both polycrystalline and single crystal form. All polycrystalline materials are available as ingots. Gallium phosphide and indium phosphide are also available in granular form.

Gallium arsenide single crystals are boat grown with typical cross-sections of 19mm x 47mm for a (111) orientation and 33mm x 47mm for a (100) orientation.

You can order single crystals of our III-V compounds as ingots or slices, as cut or polished.

All materials are furnished in small quantities for evaluation or in large volume for production use. For more information contact us at 120 Broadway, New York, N.Y. 10005. Or call 212-732-9500.

# ASARCO INTERMETALLICS CORPORATION

## New products

of higher-energy implantation systems, is introducing a new process chamber in the model 100. The Extract chamber transfers the wafers individually from cassette to implant chamber through a vacuum-lock system. At no time does the operator have to open the chamber, which eliminates pumpdown time and the contamination generally associated with opening the end station to the atmosphere for each loading cycle.

The deviation from implant uniformity is less than  $\pm 1\%$  for 2-inch wafers and less than  $\pm 1.5\%$  for

3-inch types. The beam intensity for boron systems is between 10 nanoamperes and 35 microamperes; for phosphorus, 10 nA to 150  $\mu$ A; and for arsenic, 10 nA to 100  $\mu$ A. The absolute dose accuracy is within 1% at current levels above 30 nA and 5% at levels below 30 nA, the company says.

The model 100 is priced between \$75,000 and \$80,000, depending on the system options. Delivery time is 90 days.

Extrion Corp. P.O. Box 1226, Blackburn Industrial Park, Gloucester, Mass. 01930 [345]

## Programmer controls power supply



Automatic test systems and process control equipment are the primary applications of a series of digital-to-analog programmers developed by Sorensen Co., a unit of Raytheon Co. The programmer converts the digital output of computers, calculators, and intelligent terminals to the analog signals required by Sorensen's line of power supplies used in test and control systems. The series includes three 10-bit binary models with accuracies within 0.5%, 0.1%, and 0.2% respectively, and—as options—a three-digit binary-coded-decimal model and programmers with both negative and positive logic are available.

Each of the programmer's 10 channels has a separate buffer that holds one bit of information, and digital and analog circuits are optically iso-

lated. The buffer allows the computer to strobe information into the digital-to-analog converter that is at the heart of the programmer, freeing the computer to address other peripherals. A manually operated slide switch allows the operator to change the input code from straight binary to BCD.

The programmer has its own power supply, which can give it a range of ac inputs—including 115, 208 and 230 volts—to maintain stability. Digital input ranges from 0-0.8 v on the low end to 2.4-6.0 v. Output of the programmer is designed to program Sorensen supplies up to their full outputs, ranging from 0 to 600 v. The amount of power that the programmer can control ranges from as low as 30 watts to 20 kw. Response time is less than 50 microseconds.

A flag circuit tells the operator when the programmer's power supply goes outside an error range of 2%, and a shutdown line signals the programmer to bring the power supply down to 0 v without affecting the register if there is an error or failure.

A 25-pin connector links the programmer with the computer, which controls the unit with soft-



**New! A 600-watt, 5V, 100 amps switching regulated power supply that has four outputs, measures just 3.9" x 7.5" x 16.12", weighs only 14 lbs., is 75% efficient and costs only \$493.\***

**And LH has 84 other equally exciting models to choose from** — all of them smaller, lighter, more efficient and priced lower than competitive switchers.

**250 to 1500 watts**

LH offers 7 standard wattage ratings — 250, 300, 500, 600, 1000, 1200 and 1500\*\* watts. This is the most comprehensive line of high-efficiency switchers available anywhere.

**4 outputs**

Standard LH switchers are available with single, dual, triple or quad DC outputs. Primary output is fully regulated. 2nd, 3rd and 4th outputs are semi-regulated, but may be fully regulated for \$30 per output.

**Low DC voltage, high power outputs**

Primary voltages are at 5 VDC; 50, 100, 200 and 300\*\* amps. 2nd and 3rd voltages are standard  $\pm 12$ ,  $\pm 15$  and  $\pm 18$ V at 8 amps each; 4th voltage is 24V at 2 amps. Other voltages available.

**Input voltages externally selectable**

110/220 VAC, 47 to 440 Hz, can be selected by simply changing a jumper on the front terminal strip. DC input, 24 to 300 VDC, also available.

**6 case configurations**

All LH switchers use one basic

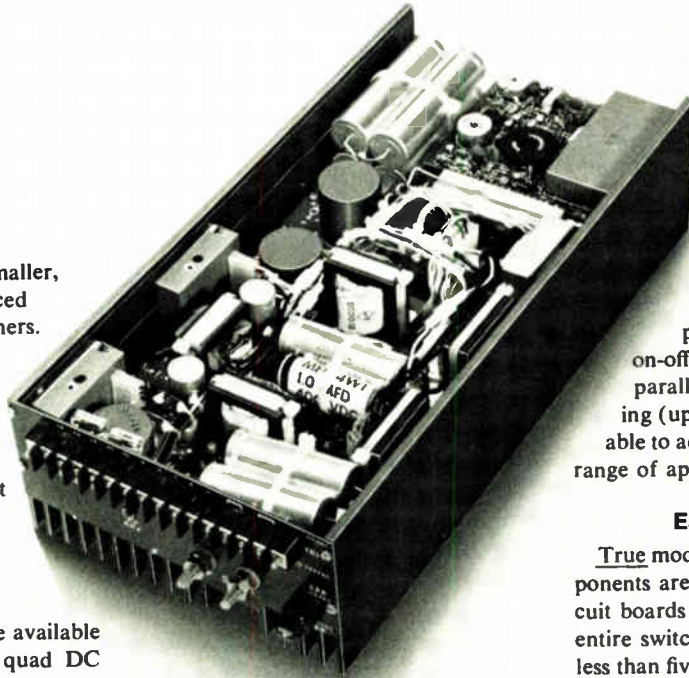

**A number of options**

Over-voltage protection, power fail detection, remote on-off, thermal cutoff, DC input, paralleling, master-slave paralleling (up to 10 units) — all are available to adapt LH switchers to a wide range of applications.

**Easy maintenance**

True modular construction — all components are mounted on just three circuit boards — make servicing easy. The entire switcher can be disassembled in less than five minutes.

proven design and package it in six different case shapes — wide and short or narrow and long — for customer convenience. With a nominal power density of 1.37 watt/cu. in., LH switchers pack more power into a smaller package than any other switchers you can buy.

**80% efficient**

On single output models, over 80% of the primary input power is delivered to the output terminal. On models with dual, triple and quad outputs, efficiency averages 75%.

**Lighter weights**

For example, LH's 250-watt single output model weighs only 7 lbs.; the 1200-watt, quad output unit, just 30 lbs.

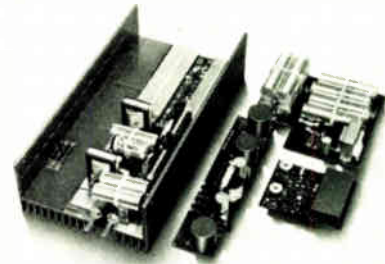

**Priced as low as 63¢/watt**

Watt-for-watt, LH units are the lowest priced switching regulated power supplies you can buy. In 1 to 24 quantity, a 250-watt single output model sells for \$360; a 1200-watt quad goes for \$1245.

**Ask for full-line folder**

The LH rep in your area has a new six-page folder that fully describes the 85 standard LH switchers, and discusses possible options and modifications to meet specific requirements.

Ask him for a copy today.

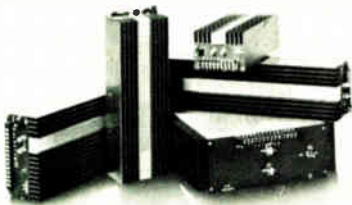

\*1000 pc. qty.

\*\*Available Sept. '74

LH RESEARCH, INC., 2052 South Grand Avenue, Santa Ana, CA 92705 • (714) 546-5279

# Centralab perspectives

FOR USERS OF ELECTRONIC COMPONENTS



**CENTRALAB**

Electronics Division

GLOBE-UNION INC.

5757 NORTH GREEN BAY AVENUE  
MILWAUKEE, WISCONSIN 53201

## To get the latest generation component, engineers are saying Selectashaft®—before they say rotary switch.

**Distributor assembly of this mechanically superior rotary switch gives them instant delivery on over 100,000 custom assemblies and eliminates secondary modification costs.**

If you're specifying or buying rotary switches, your Centralab Selectashaft Distributor would like to let you compare this totally new switch with any old style switch. One sample is all you'll need to see how it can meet custom specifications yet save from 3% to 17% on total cost, depending on switch type and quantity.

Selectashaft is the first name for rotary switch. Electrically equivalent to our famous PA-Series switches, it's the latest generation component. Mechanically superior to any old style rotary, it gives you adjustable torque, better feel and longer life. It uses a new dual ball, side-thrust index, and incorporates an adjustable stop ring instead of the old style stop tabs. There are no modification problems — no bare metal to rust or corrode, no scrap, no loss of warranty and no secondary modification cost. You get everything you need — exact shaft length, end detail and shaft flat angle without modification. And, when you consider the cost savings, the reasons to say Selectashaft — before you say rotary switch — are clear. Ask for a sample and see.



**THIS CATALOG**, available from your Distributor, gives complete specs, dimensional drawings, circuit diagrams and easy ordering instructions. Ask for it. You'll find the answers to your design and delivery problems.

THE SELECTASHAFT SYSTEM consists of preassembled standard rotary switches and a series of individual exact shafts. Factory trained Distributors, using specially designed equipment, assemble these parts to meet custom requirements. You choose from three shaft styles — .250" plain round, .218" and .156" flat. There are 24 shaft lengths, .687" to 2.375" and 24 shaft flat angles in 15° increments. You select from 92 subminiature and miniature switches — 1", 1.325" and 1.500" diameters; diallyl phthalate, phenolic or ceramic sections. You have your choice of knobs, dial plates, index assemblies and hardware. You get the design freedom of over 100,000 possible custom switch combinations.

### ASK FOR SELECTASHAFT ROTARY SWITCHES AT THESE CENTRALAB DISTRIBUTORS:

#### CALIFORNIA

Abacus Electronics  
Mountain View 94040  
415/961-1500

Elmar Electronics Inc.  
Mountain View 94041  
415/961-3611

Kieruff Electronics Inc.  
Los Angeles 90022  
213/685-5511

#### COLORADO

Acacia Sales, Inc.  
Lakewood 80215  
303/232-2882

#### FLORIDA

Electronic Equipment Co.  
Miami 33142  
305/871-3500

Hammond Electronics  
Orlando 32802  
305/241-6601

#### INDIANA

Radio Distributing Co., Inc.  
South Bend 46624  
219/287-2911

Ra-Dis-Co, Inc.  
Indianapolis 46202  
317/637-5571

#### KANSAS

Radio Supply Co., Inc.  
Cambridge 67211  
316/267-5214

#### MASSACHUSETTS

Wilshire Electronics/N.E.  
Cambridge 02138  
617/491-3300

#### MICHIGAN

RS Electronics  
Detroit 48227  
313/491-1012

#### MINNESOTA

Gopher Electronics Co.  
St. Paul 55113  
612/645-0241

#### NEW YORK

Peerless Radio Corp.  
Lynbrook, L.I. 11563  
516/593-2121

Summit Distributors  
Buffalo 14202  
716/884-3450

#### NORTH CAROLINA

Kirkman Electronics  
Winston-Salem 27108  
919/724-0541

#### OHIO

Esco, Incorporated  
Dayton 45403  
513/226-1133

Pioneer-Standard Electronics  
Cleveland 44105  
216/587-3600

Stotts-Friedman Company  
Dayton 45402  
513/224-1111

#### PENNSYLVANIA

Cameradio Electronics  
Pittsburgh 15222  
412/288-2600

Herbach & Rademan, Inc.  
Philadelphia 19134  
215/426-1700

Philadelphia Electronics Inc.  
Philadelphia 19107  
215/568-7444

#### TEXAS

Harrison Equipment Inc.  
Houston 77004  
713/224-9131

Texas Instruments Supply  
Dallas 75235  
214/238-6811

Southwest Electronics Inc.  
Stafford 77477  
713/494-6021

#### WASHINGTON

Aimac/Strom Electronics  
Seattle 98108  
206/763-2300

## New products

ware developed by Sorensen. Address decoders permit multiplexing of up to eight programmers.

Price will be about \$350, and de-

livery time will be 90 days beginning after Sept. 15.

Sorensen Co., 676 Island Pond Rd., Manchester, N.H. 03103 [346]

## Synthesizer offers clean signal



A combination of signal-generator features, remote programmability, and a clean signal is expected to make a frequency synthesizer from Rockland Systems Corp. well suited for communications system alignment and testing. Other typical applications for the model 5500, says the company, include precision sweep-testing of high-Q networks and filters, and as a programmable local oscillator for automated systems.

Covering the frequency spectrum from 10 kilohertz to 40 megahertz, the synthesizer offers stability of 2 parts in  $10^8/^\circ\text{C}$ , and 1 part in  $10^8$  per day aging rate as standard. Two parts in  $10^{10}/^\circ\text{C}$  and 1 part in  $10^9$  per day is optional. Spurious, phase noise, and harmonic-distortion components are down 70, 60, and 30 dB, respectively.

The frequency may be selected by setting the control knobs on the front panel or by remote programming. Interfaces are available for most popular minicomputers and programmable calculators as well as for the Ascii bus, which is gaining acceptance in programmable systems.

LEDs indicate frequency in either mode. Remote or local control is indicated by front-panel lamps.

The output level is 1 volt rms maximum at the 50-ohm port on the front panel. There is a variable attenuator, and an optional 70-dB step attenuator in 10-dB steps is also available. The output is held level within  $\pm 1/4$  dB across the frequency range of the instrument.

The signal may be modulated by internal 400-Hz or 1-kHz signal sources. Alternatively, an external signal may be injected.

A TTL-compatible square wave is provided at a rear-panel connector for synchronizing external systems. Modulation percentage and output level are displayed on an illuminated, dual-scale meter.

Frequency stability is locked to an internal crystal reference. Alternatively, the synthesizer may be locked to an external standard through a rear-panel connector.

Delivery of the model 5500 is expected to begin in December.

Rockland Systems Corp., 230 West Nyack Rd., West Nyack, N.Y. 10994 [347]

## True rms voltmeter resolves 1 $\mu\text{V}$

Featuring a resolution of 1 microvolt, a bandwidth of 1 megahertz, and a price tag of \$1,395, Ballantine's model 3620A ac/dc true rms

digital voltmeter sets a new price/performance standard for the measurement of the true rms value of ac voltages, dc voltages, and mix-

# Leader in Capacitor Dielectrics since 1948!



### All Films — All Gages

- Polyester
- Polypropylene
- Polysulfone
- Polycarbonate

### Metalized — All Modes

- Duomet<sup>TM</sup> (both sides)
- Heavy Edge
- Heavy Metal
- Series Pattern
- Single Side

Write or phone for Free Samples and Literature



ATLAN-TOL INDUSTRIES, INC.

Am-Met Division  
29 Knight Street  
Norwalk, Conn. 06852, U.S.A.  
(203) 853-9494

# NEY

PLAYS  
A  
LEADING  
PART IN  
MANY  
PRODUCTS  
WITH...



## ... LOW ENERGY ELECTRICAL PRECISION CONTACT COMPONENTS.

Like switch assemblies, welded and staked assemblies, wire forms, flat spring contacts, plastic molded brush and contact assemblies, rivet head contacts and complete assembled components. Our series of PALINEY® and NEYORO® alloys have become synonymous with quality in the field of precious metals. Our Design Engineers are always available to assist in the design of parts and/or complete assemblies to your specifications. For our catalog, write The J. M. Ney Co., Bloomfield, Conn. 06002

the precious world of **NEY**

## New products

crystal display, the basic instrument has an analog signal output suitable for driving a chart recorder, and a serial BCD output. Isolated parallel BCD output is available as an option for \$125. For applications involving its incorporation into a computer-controlled automatic test system, the meter has an additional remote programming option that provides optically isolated range and function selection for a cost of \$275.

Crest factors as high as 5:1 can be handled at full scale, rising to 10:1 at mid-scale, and 50:1 at 10% of full scale. (Crest factor is the ratio of the peak value of the input signal to its rms value.)

The 3620A can handle pulse trains with repetition rates as high as 300 kHz, making possible meaningful, precise measurements on such complex waveforms as those encountered in switching regulators, SCR control circuitry, and studies of acoustics. Other anticipated areas of application include vibration studies and biological research.

The meter weighs 6.5 pounds, consumes only 20 watts of prime power, and has a delivery time of stock to four weeks.

Ballantine Laboratories Inc., P.O. Box 97, Boonton, N.J. 07005 [348]

## A-d converters

Using thin-film nichrome resistor networks, a series of three 12-bit analog-to-digital converters developed by Micro Networks Corp. offers high temperature stability. Linearity of the units is within half of the least-significant bit over the full range from -55°C to +125°C. The resistor networks, made in-house, permit close temperature

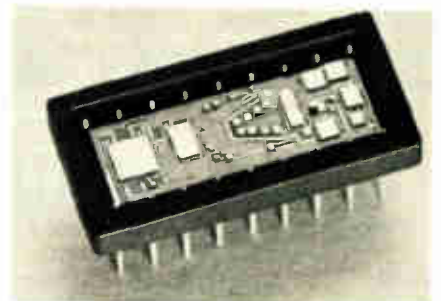

# CELCO makes "Above-Average" YOKES for "Above-Average" CRT Displays

Need a deflected CRT spot as small as 0.00065"?

The CELCO HDQ High-Resolution Deflector for Satellite Photography Read-out was the choice of one of our customers for their "Above-Average" display requirements.

You can get performance like that with a CELCO YOKE optimized on your CRT for your "Above-Average" display. (measured with a CELCO CRT Spot Analyzer.)

Or YOUR "Above-Average" display may require fast Zero-approach settling time, as required in a Fingerprint Scanning job where CELCO HDN Deflectrons are specified to recover to 0.01% in 25 $\mu$ s.

Precision Linearity on the final film plane or work surface, in Integrated Circuit Mask-Generator Displays enables producers of LSI technology to make low-cost computers for all of us. CELCO Special Deflectrons and Linearity Correctors LC123 are being used by several equipment builders for their "Above-Average" displays.

For PEPR, a system for reading Bubble Chamber photographs, developed by a few individuals at MIT and refined and expanded by others at leading universities throughout the world, CELCO was asked to provide special Low Residual Yokes for their project. CELCO produced their HD Deflector with special 0.003% residual, and GFJ irrrotational Focus Coils to help achieve the performance of these "Above-Average" displays. CELCO DAPP2N-7 Amplifiers drive the Dynamic Focus Coil; a CELCO DAPP2N-5 Amplifier was selected by another PEPR group to drive the CELCO B1700 Di-Quadrupole which produced the rotating high-resolution scanning line!

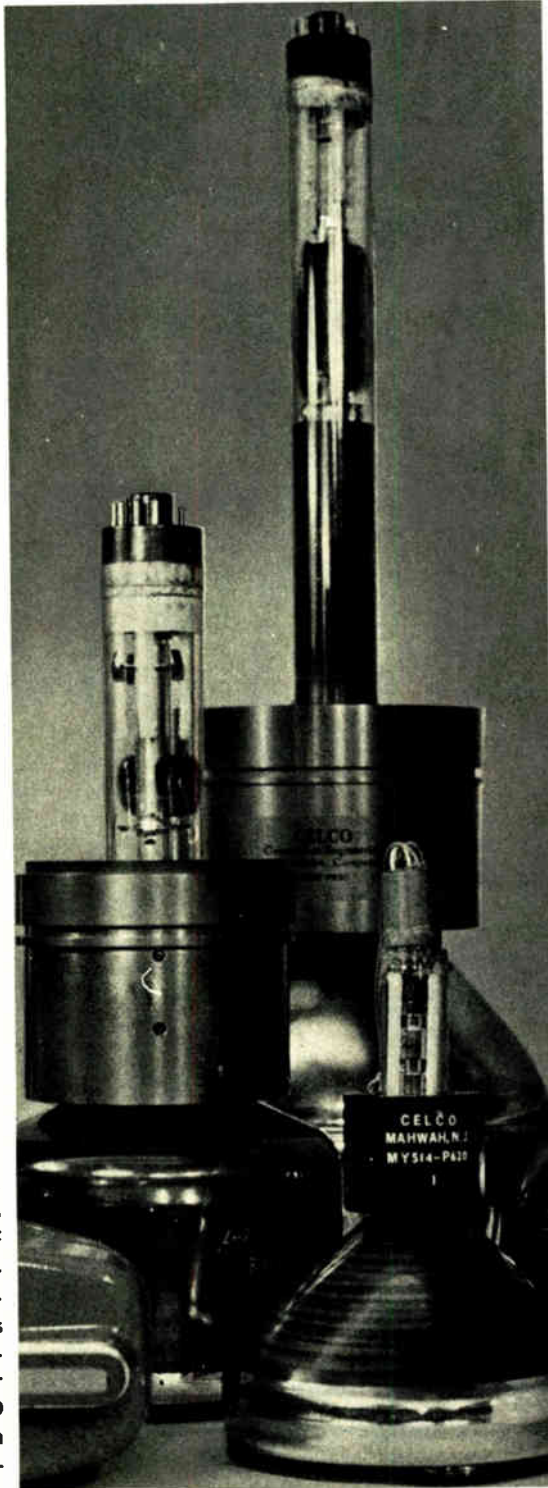

"Above-Average" Recording Storage Tube displays with 1 $\frac{1}{6}$ " neck scan converters and storage tubes need CELCO QY and QD Recording Storage Tube Yokes.

CELCO electronics and magnetics were integrated into a CELCO "DS" Special Display System for Oil Exploration and Data Reduction where "Above-Average" Linearity, Spot Growth, Zero-approach, Bandwidth, and Residual performances were required. Our customer decided to use CELCO's unique display experience to achieve his "Above-Average" display.

CELCO "Above-Average" deflection yokes, focus coils, beam-centering and aligners, astigmatic correctors, and pincushion correctors applied to your specific requirement will help you produce YOUR "Above-Average" Direct-View Display.

REMEMBER CELCO YOKES, whether you want to send a man to the moon, a probe to Jupiter or Mars, investigate chromosomes or trophoblast for cancer research, or build a large format scanner to generate typesetting masters, X-Ray enhancement, or data digitization.

- CELCO CRT Mounts, coil positioners, holders and magnetic shields will enable you to get everything together to achieve your "Above-Average" display.
- Write for CELCO YOKE BROCHURE and your FREE CELCO CRT Display Computer Slide Rule to compute the CELCO YOKE you need for your "Above-Average" CRT Display.

UPLAND CA 714-982-0215  
MAHWAH NJ 201-327-1123

(average is so . . . ho-hum to us.)

"Above-Average" YOKES for "Above-Average" CRT Displays.

CONSTANTINE ENGINEERING LABORATORIES COMPANY  
1150 E. Eighth Street, Upland, CA 91786

70 Constantine Drive, Mahwah, N J 07430



# No need to look further for a reliable R-F power source. MCL has one.



And here's what we built into it:

- solid state circuitry
- short and open circuit protection
- frequency stability  $\pm 0.1$  db
- external pulse or AM modulation
- internal square wave modulation
- low tube cost/operating hour
- qualified to MIL-STD-461 and 810

It has six different plug-in heads

Model	Freq. (MHz)	Pwr. (MIN)
6047	10-50	65
6048	50-200	65
6049	200-500	65
6050	500-1000	65
6051	1000-2000	40
6052	2000-2500	25

You have now ended your search for a stable, reliable 65 watt oscillator. Just call or write for detailed engineering data. Or ask for a demonstration

MCL, INC.,  
10 North Beach Avenue,  
LaGrange, Illinois, 60525.  
(312) 354-4350



Circle 146 on reader service card

## MAGNETIC INSTRUMENTATION

### Gaussmeters • Fluxmeters

Magnetizers • Stabilizers • Demagnetizers  
Automatic Magnet Processing Systems  
Alnico Permanent Magnets • EI Laminations



**Thomas & Skinner, Inc.**

1120 East 23rd Street, Indianapolis, Indiana 46205 • 923-2501

146 Circle 218 on reader service card

## New products

tracking of 1 part per million/ $^{\circ}$ C. Also, devices in the 5200H series are functionally trimmed for offset and gain, eliminating the need for trimming potentiometers and other external components so the user does not have to "tweak" the devices into specification limits.

The converters are housed in 24-pin hermetic glass dual in-line packages measuring 1.25 by 0.79 inch. The three input-voltage ranges are 0 to -10 volts (MN5200), -5 v to +5 v (MN5201H), and -10 v to +10 v (MN5202H).

The units operate from  $\pm 15$  v and 5-v supplies, consuming 700 milliwatts. Micro Networks claims that power dissipation is lower than that of typical 12-bit a-d converters, which require  $1\frac{1}{2}$  to 2 watts. The new units, which provide both serial and parallel output, are complete with internal reference. The converters can operate either in a continuous conversion mode or on command by a "start" convert pulse. The output code is complementary binary.

With a maximum conversion time of 50 microseconds, the units are aimed at high-speed data-acquisition systems. The 5200H series can also be ordered to MIL-STD-883 class B requirements. With its freedom from adjustment plus its long-term stability, it is designed for military and avionics applications, as well as instruments.

Prices of the types MN5200H, MN5201H, and MN5202H are \$375 each in quantities from one to 24 and \$325 each for 25 to 99. Commercial models, for  $0^{\circ}$ C to  $70^{\circ}$ C operation, are priced at \$225 each for one to 24.

Availability of the 5200 types is two to four weeks. For the 883 class B devices, delivery time is six to nine weeks.

Micro Networks Corp., 5 Barbara Lane, Worcester, Mass. 01604 [349]

## Portable recorder

Electrosensitive recorders in some cases use so much voltage, as high as 400-500 volts, that they cannot

## HERMES LOOP ANTENNA

THREE SAMPLE SITES  
ON THE NORTH AMERICAN  
CONTINENT —

DIFFERENT LATITUDES  
DIFFERENT CLIMATE



FROBISHER BAY, CANADA



MARSHFIELD, MASS.

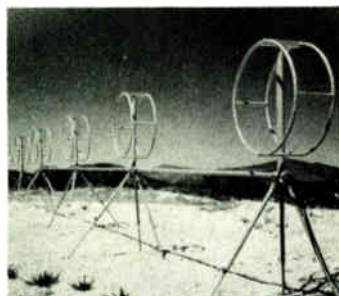

NEAR SAN DIEGO, CALIF.

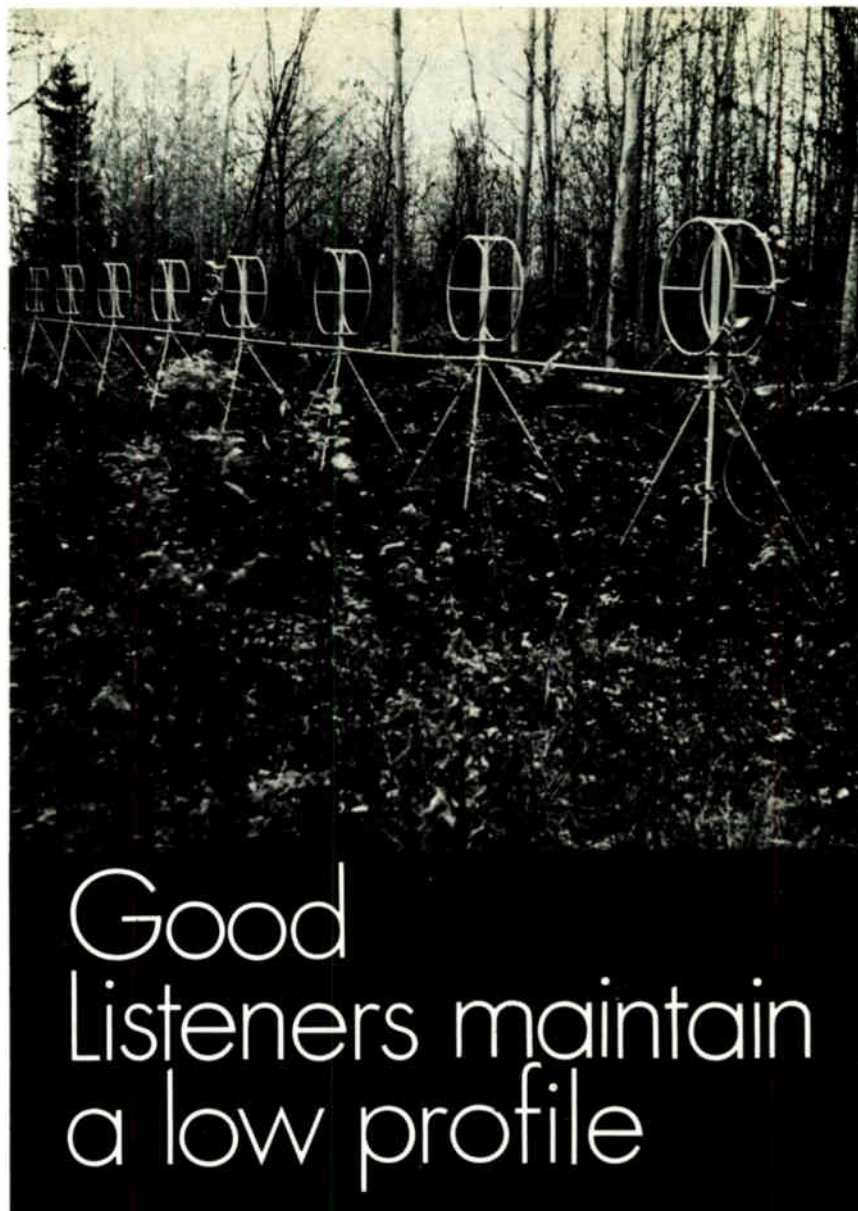

Good  
Listeners maintain  
a low profile

Even in the solitude of the forest depths, from rooftops, arctic tundra, swamps to sweltering tropics, 'neath snow, sand or ice, the Hermes Loop antenna keeps an ear to the sky. The amazing aperiodic antenna does away with vast log periodic and rhombic arrays - those towering antenna farms.

Excellent directional characteristics in rosette configuration, the Hermes loop antenna provides an omnidirectional broadband receiving array in space merely 1/100th that of the traditional antenna farm.

More than 53 government agencies around the world have pressed the loop antenna into service.

A new, even more compact version is available. Only Hermes Electronics makes it.

**2-32MHz  
BROADBAND**



**ASK US Send for our Brochure**

Hermes Electronics Limited

Suite 315

2020 F Street NW

Washington, DC 20006 USA

202-296 2978

TWX 710 822 1106

# One termination method is surer, faster and costs less.

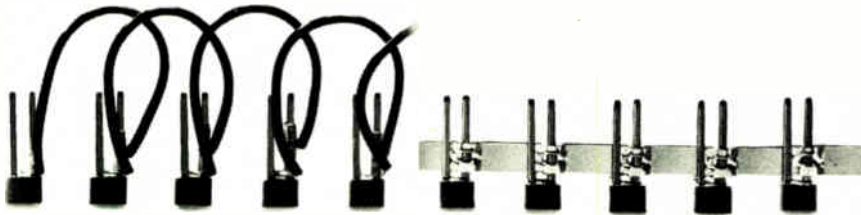

## Obviously.

Engineers nationwide are switching from wire wrap to a new, simpler way of connecting common spaced pins in electronic chassis. The Lear Siegler Pin Bar.

The reasons are clear:

Terminations are surer because each Pin Bar is "spec" built to fit your pins precisely. No chance for human error. Pin Bars mean 100 percent reliable gas tight terminations that will outlast the life of the chassis.

Assembly is faster because each bus terminates all pins at once—with a remarkably simple tool.

That adds up to low cost terminations. Pin Bars can cut your wire wrap costs in half. Typically from 10 cents down to 3-6 cents per pin. One major manufacturer has already demonstrated a \$68 savings per chassis using Pin Bars. You may, too. Write for more information and free Pin Bar samples to:

**LEAR SIEGLER, INC.**  
**ELECTRONIC INSTRUMENTATION DIVISION**  
 714 N. Brookhurst St.  
 Anaheim, Calif. 92803  
 TWX 910-591-1157  
 Telephone: (714) 774-1010



## New products

be made portable. But Astro-Med, a division of Atlan-Tol Industries Inc., says its new DASH 2, a two-channel inkless recorder, requires only 40-50 milliamperes and 6 v to write. This makes it possible to power DASH 2 with small gel-cell batteries that produce 12 v. The unit measures 14 by 8 by 10 inches and weighs 25 pounds.

The low-voltage, low-power electrosensitive paper used by the unit is the key to this performance. The paper is coated, and one layer is vacuum-deposited aluminum ap-



plied to a black base paper. When a stylus or electrode with a charge of 6 v is applied to the paper, the coating is vaporized, opening a window to the black paper underneath.

Four paper speeds of 1, 5, 25, and 50 millimeters per second are push-button-selectable, but any speed between 1 and 100 mm/s may be dialed in. Traces are unaffected by the velocity of the stylus or speed of the paper. Signals as low as 1 millivolt per millimeter and as high as 100 v can be recorded, and each channel has an attenuator with fixed position ranging up to 1 v/mm, or 50 v full scale. There is also an internal calibration source and variable gain control. A position control allows zero position to be set anywhere over the full 50-mm channel width.

A high-torque galvanometer gives a response range from dc to 100 hertz at various amplitudes. For instance, with 50 mm of amplitude the unit can record at up to 35 hertz,



**"When engineers saw they didn't have any knobs, they were scared they'd lose control, but now they're in love with the thing."**

So happy, indeed, that when AMI offered to brief our people on their side of the story, we asked if we could publish some of their comments. They're reproduced here.

The validity of their comments? Each uses Sentry 600, relies on Sentry 600, and has one or more Sentry 600 systems in their department: Ed Carcher, Manager of Product Characterization; George Gray, Manager,

Test; Bill McNeally, Supervisor, Test; Bob Frohman, Supervisor, Systems Software Support; Fred Jenne, Director of Advanced Product Development.

**"You'd need a wall full of knobs to let them do slowly what S-600 does fast."**

**"We have yet to find a device we couldn't test on the Sentry 600."**

**"Field service and support is very good, relatively speaking. Fairchild is the least worst in the industry."**

They know semiconductor testing. And they know the Sentry 600.

The Sentry 600. Just one function-optimized component in the Fairchild Sentry family of six interrelated circuit testing systems.

Optimized for engineering, sophisticated production, and QA/test center operations, the Sentry 600 performs the widest range of tests for the broadest range of components. High speed MOS/LSI, PCB and bipolar testing simultaneously. Complete testing at wafer level and in automatic handlers at full rated device speeds. Finally, and most important to

AMI, extensive peripheral choice for massive data generating capacity. Manipulate. Analyze. Compute.

But don't take our word on it.

Listen to AMI: "When we went to buy a system, we could buy anything we wanted. We were not restricted by what the rest of the company had. We made an evaluation and chose the Sentry 600. It lived up to expectations fully."

AMI's experience: It's a good reason to check into Fairchild Sentry systems. Because it's time you had a semiconductor test system that lives up to your needs and expectations.

Fairchild Systems, A Division of Fairchild Camera and Instrument Corporation, 1725 Technology Drive, San Jose, California 95110. (408) 998-0123

MADE IN TWX: 910-338-0558.

**FAIRCHILD**

Slightly over a year ago, American Microsystems, Inc. ordered their first Fairchild Sentry 600.

Today, nine Sentry 600's are on line at AMI. Number ten is on its way. Each system was carefully evaluated by AMI. And then the next ordered. The result? AMI is now the largest purchaser of Fairchild's Sentry 600. It's a happy association.

**"The thing we hate most about it is the thing we love most about it!"**

**"Without the Sentry I would never even try to get this type of data."**

**"One insertion goes through 50 different tests - we are checking parameters, not making Go/No-Go tests."**

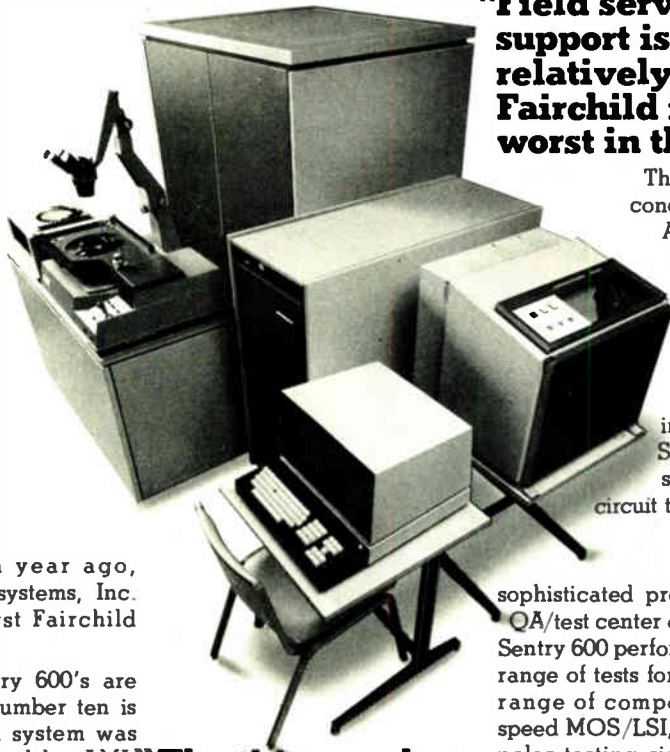

When you  
specify High-Rel Hybrids,  
specify  
**Highbrids**  
from Raytheon/Quincy

Highbrids because they combine high reliability, high performance and high technology in a beam lead or chip-and-wire package.

Highbrids are the *only* hybrids we make at Raytheon/Quincy. Because we're high on the military and medical electronics markets. In fact, that's where 98% of our Highbrids are used.

All our Highbrids are custom engineered and are the most advanced design units available.

So, if you don't know all about Highbrids from Raytheon/Quincy, it's high time you do. Contact Mr. K. Singh at Raytheon Company, Industrial Components Operation, 465 Centre Street, Quincy, Mass. 01810. (617) 479-5300.

**RAYTHEON**

## New products

and with an amplitude of 1 centimeter it can record at 100 Hz. Linearity is within 1% of full scale.

Astro-Med sees applications for the DASH 2 wherever oscilloscopes are used to monitor voltage, such as in electronics laboratories and in the medical, pollution, utility, and seismic fields.

Price of the recorder is \$1,950, and delivery time is 60 days.

Astro-Med, a Division of Atlan-Tol Industries Inc., Atlan-Tol Industrial Park, West Warwick, R.I. 02893 [350]

## CRT display

Designed for medical and electronic instrumentation, a cathode-ray-tube display from Hewlett-Packard offers resolution of 80 to 100 lines per inch, uniform all-over focus despite wide changes in intensity, fast rise-time capabilities, and crisp brightness.

The model 1332A is in a 5¼-inch-high half-rackwidth frame, which contains a display measuring 9.6 by 11.9 centimeters, high-speed X and Y deflection circuits, a wideband blanking Z-axis amplifier, and regulated power supplies. More than 35 standard options make it possible, the company says, to tailor the display to individual applications.

Spot resolution of the 1332A is 0.305 cm (0.012 in.) at high intensity, remaining well focused at all intensities and in all parts of the screen. Thus, says the company, the unit solves such difficult display problems as writing many characters around picture edges while showing significant detail in curves, graphs, or diagrams within the picture. Using an aluminized screen and an accelerating potential of 22.5 kilovolts, the display can produce more than 15 gray shades.

Standard X and Y amplifier rise time is 70 nanoseconds, and 25 ns is optionally available.

U.S. prices for the 1332A begin at \$1,200 for standard units. Current delivery-time estimate is 60 days.

Inquiries Manager, Hewlett-Packard Co., 1501 Page Mill Rd., Palo Alto, Calif. 94304 [338]

# Why The Danameter is selling like hotcakes.

## One-Year Battery Life.

In a digital instrument, you'd expect to fool with a battery regularly, recharging it or replacing it.

Not with The Danameter. The battery will last you at least one year. And even if you find a way to wear it out, you're only talking about 69¢.

## Liquid Crystal Readout.

With an analog voltmeter, accuracy depends on how well you can interpret.

With The Danameter, the liquid crystal display shows precisely the information you require in large digits. It adjusts to all light conditions. Even direct sunlight.

And it's accurate to a degree you never imagined possible in an instrument at this price.

## Automatic Polarity.

You don't swap leads with The Danameter. Because the

digital display shows you instantly whether the polarity is positive or negative.

## Almost Indestructible.

The Danameter has only one function selector. It's recessed behind the molded edges of its cyclac case. You can drop it on concrete. You can kick it down the hall. When you pick it up, it'll be working perfectly.

It's the first true portable instrument of its kind.

## And it's only \$195.

Call your Dana sales rep toll-free at 800-645-9200. In New York, phone 516-294-0990. In Europe, call 02-41 45 50.

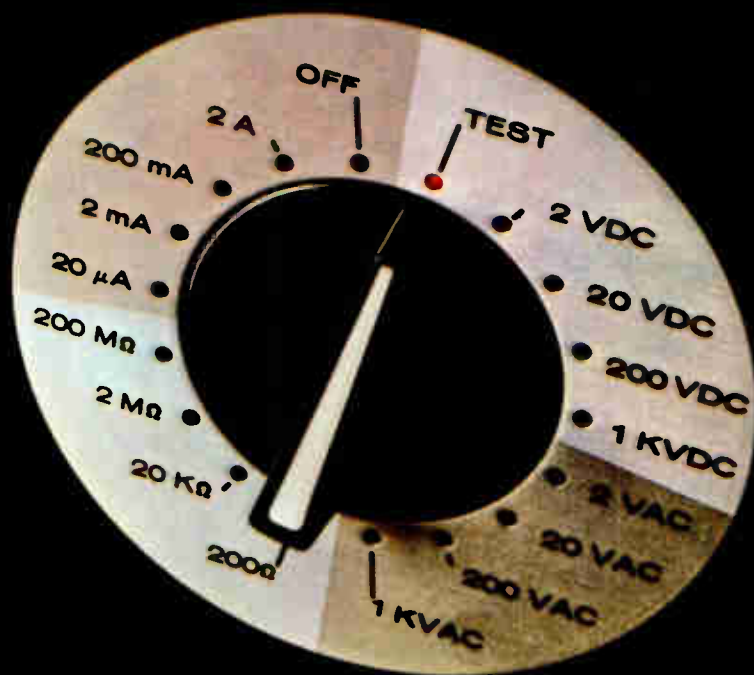

# DANA

Others measure by us.

# The first name in counters is not the counter you name first.

We aren't as well known for our counters as we are for our digital multimeters. But we should be. Because we make some of the best counters available for the money.

The nine models in our 8000B/8100 series feature measurements such as frequency, period, multiple period, time interval, time interval average and totalize modes.

A standard 8-digit display provides high resolution measurements. Models feature 10 nanosecond resolution for single shot time events along with 150 picosecond resolution for repetitive events.

**ATE.** For more accurate waveform parameter testing, the counters feature digitally programmed trigger-level resolution of .05 volts and trigger-level hysteresis compensation.

**Communications.** For low-level, high-frequency measurements, sensitivity as high as one millivolt at 500 MC is featured. Counters also employ a 150 MC direct count capability.

Yet prices start at \$1,390.

So before you talk to the biggest name in counters, talk to the best. Contact your Dana sales representative by calling toll-free 800-645-9200. In New York, phone 516-294-0990. In Europe, call 02-41 45 50.



**DANA**

Others measure by us.

Instruments

## Signal source is 'universal'

Generator delivers function, pulse, sweep capabilities; covers 20  $\mu$ Hz to 20 MHz

A new analog-to-digital generator to be introduced at Wescon by Interstate Electronics Corp. combines a 20-megahertz function generator with a pulse generator and comes close to being a universal signal source over its 20 microhertz to 20 MHz range.

With its broad range of signal capabilities it can be used for analog applications, such as audio sweeping, and also as a source for digital testing. Such multiple capability is becoming increasingly important as digital circuitry breaks ground in areas like consumer products and industrial equipment, which a short time ago were solely analog, Interstate points out.

The model 77 offers two pulse modes. Pulse rate may be set on a duty-cycle basis so that the pulse width remains a constant percentage of the pulse period, independent of the repetition rate. Alternatively, the pulse width may be set so that it stays constant as the repetition rate is adjusted.

Signals available include square wave, sinusoidal, triangle, ramp, ramp and hold, exponential (log) ramp, variable symmetry sine and triangle waves, as well as a dc out-

put. A 1,000:1 planetary-drive dial assembly provides the user with a precise frequency setting. A calibrated four-step attenuator plus a 20-decibel vernier varies the output range from 15 volts peak (open-circuit) down to 3 millivolts. These levels halve when delivered into a 50-ohm load. All waveforms may be inverted and offset. The generator covers 20 hertz to 20 kilohertz and 0.01 to 10 hertz.

A log-linear ramp generator sweeps the frequency over a 1,000 to 1 range. Sweep frequency limits are determined by setting the main dial to the lower limit and the sweep limit cursor to the upper limit.

Sweep time can be varied from 1,000 seconds to 10 microseconds, and the ramp generator provides either a ramp output voltage or an analog output of the generator frequency for driving chart recorders. The ramp signal can also be employed as an independent signal source. Full sync outputs and inputs, plus external control of sweep and the signal, are provided.

Primary operating modes are continuous, triggered, gated, continuous sweep, sweep and hold, and burst. Both the main and squaring amplifiers are available for external use and can be used to convert ECL to TTL signals.

Output transistors and integrated circuits are mounted in sockets to facilitate servicing. The ramp circuit board, mounted on the underside of the instrument, swings out on hinges for easy servicing.

Rise and fall times for rectangular waves are under 15 nanoseconds, and standard pulse width is adjustable from under 30 ns to over 10 milliseconds. The phase angle of triggered and gated waveforms is adjustable, as is the trigger level. Frequency, amplitude and offset are stable within 0.05% in 10 minutes, and 0.25% in 24

hours. Sine-wave distortion is under 0.5% to 100 kHz and 5% to 20 MHz. Sine-wave signal amplitude is flat within 0.1dB to 100 kHz, and is down 2.5 dB at 20 MHz. The model 77 generator is priced at \$1,095, with delivery time in 60 days. The model 74, without log-sweep capability, is available at \$895.

Interstate Electronics Corp., 707 E. Vermont Avenue, P.O. Box 3117, Anaheim, Calif. 92803 [351]

## Miniature oscilloscope has computerized triggering

The model PS940A mini-portable oscilloscope offers computerized triggering, which eliminates the trigger-stability controls associated with general-purpose oscilloscopes. A TTL circuit, being digital, further eliminates the need for front-panel adjustment for a stable trace display. Model PS940A offers a 20-megahertz bandwidth, sensitivity of

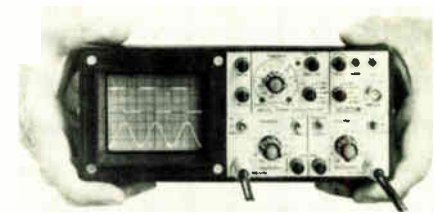

10 millivolts per division, a built-in delay line for use in viewing pulse leading edges, and full dual-trace switching capability. Additional features include algebraic waveform display, as well as ac, low-frequency reject, and high-frequency reject trigger modes. Price of the PS940A is \$1,095.

Vu-data Corp., 7170 Convoy Court, San Diego, Calif. 92111 [354]

## Data coupler expands data logger's capability

The model 215 Miniface data coupler, for Digitrend data loggers, expands the capabilities of the data logger with a strip printer to provide computer-compatible punched pa-



# New and improved General Electric lamps provide for increased design flexibility.

## Two new sub-miniature halogen cycle lamps ideal for miniaturization.

These new T-2, 6.3V, 2.1 amps, 75 hour GE halogen cycle lamps are the smallest of their type (.265") and set industry standards for size and light output (16-20 candlepower). They are the perfect lamps for miniaturization of equipment such as reflectors, housings and optical systems, and they also save on overall cost of your equipment.

In addition, they are less than half the cost of the #1973 quartz lamp they replace. Two terminal configurations are available: #3026 (20 candlepower) has wire terminals; #3027 (16 candlepower) has a new two pin, ceramic base that plugs in to make installation and removal a snap.

These lamps have an iodine additive that creates a regenerative cycle that practically eliminates normal bulb blackening. They will produce approximately 95% light output at 75% of rated life.

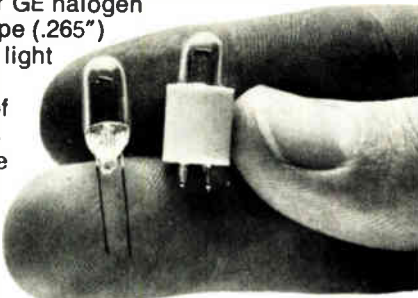

## An expanded line of Wedge Base Lamps for simple, low-cost circuitry.

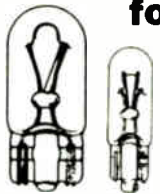

Now you can have greater design freedom than ever before with wedge base lamps. GE now offers six large lamps in its line of T-1 3/4 (.230" max.) all-glass, sub-miniature wedge base lamps. In addition to our three 14V lamps (#37, #73 and #74), we now also offer two 6.3V lamps (#84 and #86) and a 28V lamp (#85).

These lamps are ideal for applications where space is at a premium. Their wedge-based construction allows you to design for low-cost sockets and virtually ends corrosion problems because they won't freeze in the sockets. And the filament, which is always positioned in the same relation to the base, offers more uniform brightness.

## Green Glow Lamp has been improved over previous lamp.



Actual Size

Now our G2B Green Glow Lamp, the only domestic green lamp on the market today, gives a more uniform, purer green light than our previous model. It's bright enough for your circuit component applications. With appropriate current limiting resistors, it can be used for 120/240 volt green indicator service. Or used together with our high-brightness C2A red/orange/yellow glow lamps to emphasize multiple functions with color.

All GE glow lamps give the benefits of small size, rugged construction and low cost — 12¢ each for the G2B, 44¢ each for the C2A in 100,000 quantities.

## Send today for newest literature.

For the most up-to-date technical information on any or all of these lamps, write: General Electric, Miniature Lamp Products Department, #0748-M, Nela Park, Cleveland, Ohio 44112.

**GENERAL**  **ELECTRIC**

## New products

per tape, magnetic tape, teleprinter/punch or modem outputs. The data logger scans, conditions, logs, and registers alarms for outputs from thermocouples, load cells, and pressure transducers. The 215 Miniface provides scanning speeds of 13 points/s with 215A magnetic-tape output, 10 points with 215B



punched-paper-tape output, 1 point with 215C teleprinter/punch output, 110 to 2,400 baud (factory programmable) with 215E output drive for modem, and 6.5 points/s with 215F digital multiplex for printer and 5055 high-speed strip printer. Prices range from \$1,995 for the 215E Miniface to \$5,995.

Doric Scientific Corp., 3883 Ruffin Rd., San Diego, Calif. 92123 [355]

## Core tester checks transformer laminations

The model 305 magnetic-core test set checks the quality of transformer-core laminations. The equip-



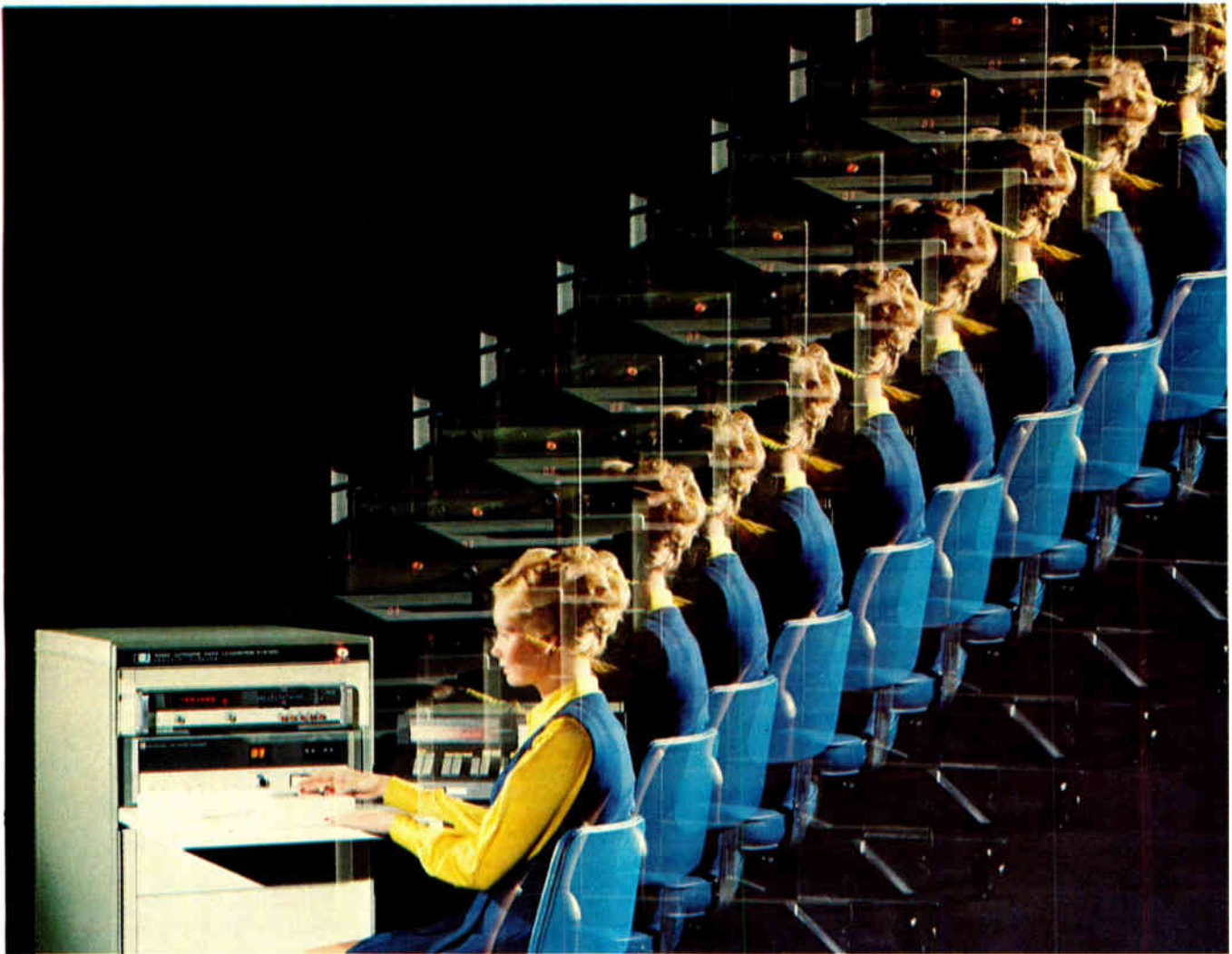

## Multiply your output...

...by adding one HP 3050A Automatic Data Acquisition System.

One 3050A can multiply your production output by as much as ten over manual test methods. Or, it can reduce testing time in R&D while boosting your testing capability. HP's 3050A eliminates most manual operations in AC V, DC V and Ohms Measurements. No more manual switching, no more visual monitoring or manual transcribing, no more data analysis... the unit's multi-channel scanner, DVM, and programmable calculator do all those things automatically. This system makes pass-fail decisions on the spot or prints out your test data, in the units you want, for rapid analysis. You get more efficient, more comprehensive testing while reducing testing errors.

Whether you have a manufac-

turing testing or an R&D application, easy-to-learn algebraic or BASIC programming language lets you program the system for your specific testing needs. You can select up to 100 individual channels, change ranges and functions on the DVM, analyze and store data, and print the results...all under calculator control.

Dry-reed relays and DVM resolution to  $1 \mu\text{V}$  lets you monitor low-level transducer outputs as well as large AC signals and DC levels to 200V. Computational power of the 9820A calculator controller (or optional 9821A and 9830A) allows you to do calculations and data analysis, thus eliminating data reduction tasks. You can convert measurements to engineering or scientific units, linearize and compensate transducer outputs, calcu-

late average values and standard deviation, perform design computations, and more...all automatically. And an optional page printer and X-Y plotter can save you hours preparing tabulated data and graphs.

Couple this capability with the system's operational simplicity—which lets you free skilled people for other tasks—and you can see why the 3050A is finding wide use in testing and data acquisition applications.

Contact your local HP field engineer for information on applying the 3050A to your testing situation. Or, write Hewlett-Packard.

094148

**HEWLETT  PACKARD**

Sales and service from 172 offices in 65 countries.  
1501 Page Mill Road Palo Alto California 94305



# syntronic

## THE RIGHT PARTS AT THE RIGHT TIME

At Syntronic Instruments we make every effort to keep ahead of the times. That means anticipating materials shortages and planning our production to suit your schedules.

Planning starts with our design engineers who help you select and specify the right precision yoke for your CRT display.

For prototypes and production runs we do our own precision machining, our own tooling, our own molding of intricate parts, and of course, our own coil winding and assembly.

Our own computer installation is used for material requirements planning, production scheduling, bill of materials files and explosions and cost accounting functions which support our purchasing and production activities.

As the largest manufacturer of precision yokes and coils we have a highly specialized organization... devoted to getting you the right parts at the right time.



SYNTRONIC INSTRUMENTS, INC.  
100 Industrial Road, Addison, IL 60101  
Phone (312) 543-6444

## New products

ment measures the effective permeability of single laminations in the size range of EE 28-29 to EI-13 (2 mils to 25 mils in thickness). The core lamination is driven through a one-turn primary by a low-duty-cycle series of pulses, and a closely spaced one-turn secondary produces a voltage that is subsequently amplified and metered through a sample-hold circuit. The unit includes a built-in self-check feature.

Mayberry Electronics Co., 1250 Industrial Ave., Escondido, Calif. 92025 [356]

## Frequency comparison is traceable to NBS

A frequency comparator allows comparison of local frequency standards to one part in  $10^{11}$ , traceable to U.S. National Bureau of Standards through radio station WWVB on 60 kilohertz. It can compare any input frequency that is a multiple or submultiple (1-10) of 1 megahertz. Accuracies to parts in  $10^9$  can be obtained by a digital readout in relatively short periods of time. Accuracies to parts in  $10^{11}$  are obtained in six to nine hours by means of an internal strip-chart recorder. Auxiliary outputs include 1 megahertz, phase-locked to WWVB, WWVB time code, auxiliary recorder drive, and WWVB carrier. Price is \$1,295, including antenna.

True Time Instrument Co., 429 Olive St., Santa Rosa, Calif. 95401 [358]

## Simplified logic cuts multimeter/counter noise

Designated the DMC 45, a digital multimeter/counter uses a simplified simulation of two-speed-clock logic to integrate signals for only 100 milliseconds and provides infinite noise rejection to 10 hertz and multiples thereof. The frequency-counting phase-lock circuitry, which enables direct counting, also eliminates the usual 10-second time base below 100 Hz. Measurements are therefore made five to 10 times faster at these low frequencies, ac-



# The new Keithley Model 168 autoranging DMM... ...vive la différence!

There really is a difference in Digital Multimeters, and once you've experienced Keithley's 168 you'll know why we say *vive!* If you're tired of "general-purpose" promises that turn into run-of-the-mill

performances; if you want that bit extra that'll make your job easier, then *vive la différence*... here's the DMM for you! Send for our DMM Selector Guide or call us for demo now. Phone (216) 248-0400.

**AC** VOLTS  
**DC** AMPS  
OHMS

**5 functions**  
100  $\mu$ V to 1000 V dc  
100  $\mu$ V to 500 V ac  
0.1  $\mu$ A to 1 A dc  
0.1  $\mu$ A to 1 A ac  
100 m $\Omega$  to 20 M $\Omega$

### two-terminal input

Simple to connect. You can't get it wrong. Eliminates the word "whoops" from your vocabulary. Saves temper, too.

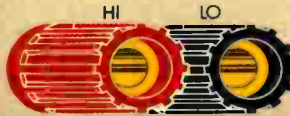

### options & accessories

Rechargeable batteries that you can install anytime. An RF probe for high frequencies. Test leads. A 50-amp current shunt too.

### hi-lo ohms

Select either of two voltage levels, 1 V or 100 mV, for ohms measurements. You can have your PN junctions either way you want 'em... on or off.



**price**  
Enough said? Order one... or two... or three now!

**\$299<sup>00</sup>**



### automatic ranging

You just connect the signal and push the function. The decimal point pops into position automatically and the display is direct reading. That does save time!



See and use the new Keithley Model 168 at WESCON 74, Booths 2808/9.



**KEITHLEY INSTRUMENTS**  
U.S.A. 28775 AURORA ROAD, CLEVELAND, OHIO 44139  
EUROPE 14, AVENUE VILLARAIN, 1009 PULLY, SUISSE



If you could save up to 30% without losing anything by using this new 10mm ceramic trimmer capacitor, wouldn't you want to know it?

That's exactly what we can promise you for many applications. All the performance you need for about a third less than you've been spending.

These new trimmers have five capacity ranges from 3.0pF min. to 30.0pF max. Their operating temperature range is  $-30^{\circ}\text{C}$ . to  $+125^{\circ}\text{C}$ . And they mount interchangeably with other ceramic trimmers for PC applications. Four dielectric types available.

But check them out for yourself. Get the coupon in the mail today.



E. F. JOHNSON COMPANY/Waseca, Minnesota 56093. Dept. 3012

You bet I'd like literature and a free test sample of your new low cost trimmer capacitor if it can do what you say!

Check capacitance (pF) range needed:

- 3.0 to 8.0       3.0 to 12.0       5.0 to 13.0  
 5.0 to 20.0       5.0 to 30.0

\_\_\_\_\_ Please send them directly.

\_\_\_\_\_ Please call me at: \_\_\_\_\_

Name \_\_\_\_\_

Firm \_\_\_\_\_ Title \_\_\_\_\_

Address \_\_\_\_\_

City \_\_\_\_\_ State \_\_\_\_\_ Zip \_\_\_\_\_



**E. F. JOHNSON COMPANY**

## New products



According to the company. Six measurement functions and 32 ranges are offered: dc volts from 10 microvolts to 1,000 v in five ranges; ac volts from 10  $\mu\text{V}$  to 750 volts in five ranges; dc and ac current from 100  $\mu\text{A}$  to 4 A in five ranges; resistance from 0.4 kilohm to 40 megohms in six ranges, and frequency from 10 Hz to 20 MHz in six ranges. The DMC 45 is priced at \$695. Battery packs, depending on desired operating hours, are available at an added cost of \$95 to \$125.

California Instruments Co., 5150 Convoy St., San Diego, Calif. 92111 [359]

## Spectrum analyzer

covers 100 Hz to 25 MHz

The model 236 is said to fill the gap between low-frequency and microwave spectrum analyzers. It provides graphic signal analysis from 100 hertz to 25 megahertz; 100 Hz resolution is obtained on stable narrow-band scans. The unit incorporates self-checking calibration references for both frequency and absolute level. Other features include 1.25-microvolt ( $-105\text{ dBm}$ ) sensitivity, distortion-free dynamic range exceeding 60 dB, automatically programmed and manually controlled sensitivity, and a smoothing filter for noise analysis. The model 236 is priced at \$3,275.

Nelson-Ross Electronics, 5 Delaware Dr., Lake Success, N.Y. 11040 [360]

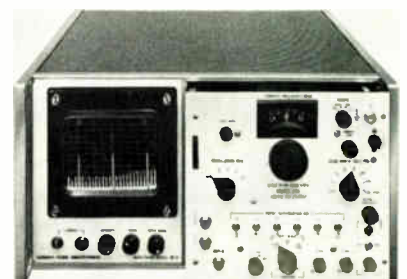

# We improved our micro resist.

New KODAK Micro Resist 747 is the purest, most stringently controlled resist we've ever made.

It's filtered to a value of 0.5 micrometer, and there are less than 10 parts per million of metal ions. (Less than three parts per million each of sodium, lithium, potassium, tin, or gold.) Viscosity and solids are also closely controlled.

And there are processing solu-

tions of equally high quality: KODAK Micro Resist Developer, Thinner, and Rinse. All of which help you get more uniform coatings and better process reliability. And *that* means economy.

There's convenience, as well. This negative-working resist comes in four ready-to-use viscosity grades: 30, 45, 60, and 110 centistokes.

# We couldn't improve our offer.

## Technical assistance.

We'd be pleased to share our experience in microelectronics with you. As a start, why not send for the comprehensive six-page data sheet on KODAK Micro Resist 747? Or have a representative demonstrate it for you. Either way, just use the coupon.



<b>Eastman Kodak Company</b>	PHF
Dept. 412-L, Rochester, N. Y. 14650	
<input type="checkbox"/> Please have a representative demonstrate KODAK Micro Resist 747.	
<input type="checkbox"/> Please send detailed information.	
Name _____	
Title _____	
Company _____	
Address _____	
City _____	State _____ Zip _____
For information on sales outside the U.S. and Canada, contact the International Photographic Division, Eastman Kodak Company, Rochester, N. Y. 14650, U.S.A.	
8-48	

# Quick Operating Fasteners for Electronics

One of these dependable, easy-to-install fasteners may be exactly what you need to solve your fastening problem.

Standard Simmons panel fasteners, latches, pressure hinges, hole plugs and other devices have proved themselves in thousands of varied electronics applications. Most are immediately available from stock in various sizes and capacities, and all can be adapted to your special needs. Quickly. Economically. Write for our 36-page catalog for complete data on all Simmons quick-operating fasteners.

## SIMMONS FASTENER CORPORATION

1745 North Broadway, Albany, New York 12201  
Quality fastening products for industry

**MINI-Q-LOCK** — quick-operating fastener for miniaturized electronics applications where space and weight limitations are important. ▼

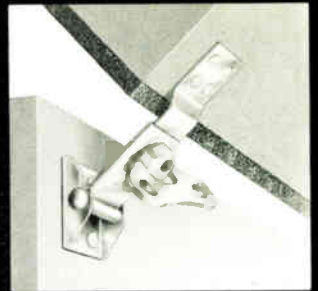
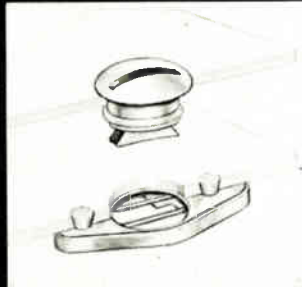

**HINGE-LOCK** — rugged pressure hinge provides strong seal on hinge line of gasketed cases. (Matched hardware with Link-Lock fasteners.)

**QUICK-LOCK** — for removable panels and access doors; locks or opens with a 90° turn. Works with curved sheets or slightly misaligned holes. ▼

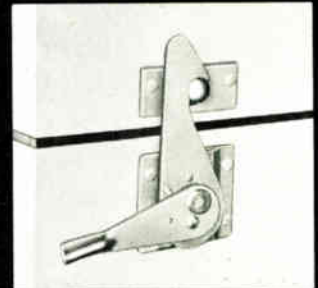
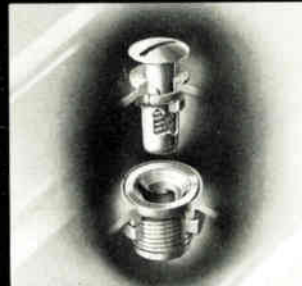

**HOOK-LOCK** — springless, positive-locking latch lies flat on mounting surface; high closing pressure and load-carrying capacity. Impact and shock-proof.

**LINK-LOCK** — ideal for latching where heavy locking pressure is required. High impact resistance. Available in medium and heavy duty. ▼

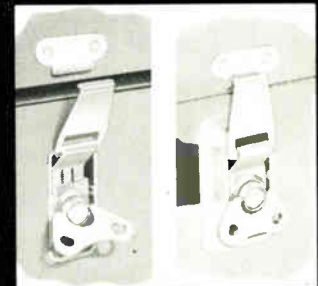
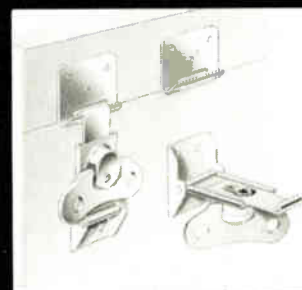

**RECESSED LINK-LOCK** — minimum protrusion, pressure-tight seal. Can be bonded with adhesive or riveted to any sheet, sandwich material or plywood.

**SNAP-IN PLASTIC CLIPS** — provide instant fastening for wire, cables, trim or tubing. Self-adapt to variations in hole size and material thicknesses. ▼

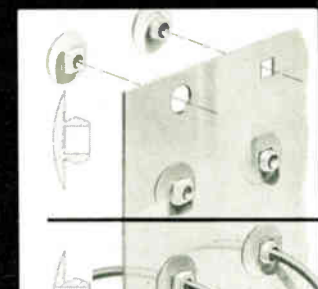

**HOLE PLUGS** (plastic) permit fast, secure, snap-in installation in round, square or unusual-shaped holes. Not affected by climate or temperature.

## New products

### Semiconductors

# Decade divider handles 1.2 GHz

Monolithic device aimed at frequency synthesis in navigation, other markets

A monolithic 1.2-gigahertz decade divider from Plessey Semiconductor opens the aircraft-navigation bands to direct frequency synthesis. The part has twice the capability of the next-higher decade divider on the market, another Plessey part rated to 600 megahertz.

A 1-GHz divide-by-four circuit, also from the English company, held previous frequency honors. But the new decade divider should prove popular, not only for its higher frequency response, but also because it brings the output frequency down to the range of popular ECL 10K and MECL II logic.

Plessey's product comes in three varieties: the SP8665B for 1 GHz, the SP8666B for 1.1 GHz, and the SP8667B for 1.2 GHz. All are specified over the full 0° to 70°C commercial range.

The dividers use emitter-coupled logic, and the outputs are fully compatible with MECL II and become so with ECL 10K by using two resistors. They require a nonstandard 6.8-volt ( $\pm 0.3$  V) power supply to permit the high performance, but as current drain is a constant 80 milliamperes, regulation should be simple.

The dissipation of the part is approximately 550 milliwatts, not much higher than that of the divide-by-four stage. Packaging, surprisingly at this frequency range, is a standard 14-pin dual in-line type.

The device is ac-coupled, and sine-wave input can be as low as 100 MHz. Below this, a rise time under 10 nanoseconds is required for triggering. Input rating is 400 millivolts to 1.2 V sine wave peak-to-peak.

The minimum rated slew rate for square-wave input is 200 volts/s and input impedance is 400 ohms at

low frequency. The clock input is self-biasing.

The clock inhibit input is MECL III-compatible, with a typical inhibit reference level of -1.3 V.

For synthesizer use, no preamplifier is required, of course, but for instrumentation applications, various commercial CATV amplifiers are useful, at least to 1 GHz. Dennis Chant, Plessey marketing manager, sees demand for the part in frequency synthesis for the Tacan and DME (distance measuring equipment) from 960 to 1,215 MHz, and for instrumentation for these and lower frequencies in the new 900-MHz land-mobile bands.

Plessey Semiconductors, 1674 McGaw Ave., Santa Ana, Calif. 92705 [411]

## Signaling circuits based on three-tone sequences

A series of selective signaling devices is based on three-tone sequential-code principles. Designated the '07 series, these monolithic devices are constructed with MOS LSI technology. They include the FX-107, a single-code transceiver with transponder capability, and the FX-207, a multicode transmitter with logic-controlled selection of any one of eight different input codes, providing appropriate binary-coded output. The devices can be used separately or in any combination for selective signaling. Price ranges from \$17.15 to \$20.

Consumer Microcircuits of America Inc., 10727 Indian Head Industrial Blvd., St. Louis, Mo. 63132 [413]

## N-channel RAM accesses in 400 nanoseconds

The 2102-type n-channel 1,024-bit MOS RAM (model AM91028) offers access times down to 400 nanoseconds with maximum power dissipation of 263 milliwatts. In addition to the 400-nanosecond unit, a 500-ns device (AM9102A) and 650-ns model (AM9102) are offered. All versions guarantee power dissipa-

# Procond

Synthetic film capacitors  
Electrolytic capacitors  
Filters  
Push Buttons

PROCOND S.p.A.  
32013 Longarone (Belluno) Italy

telephone (0437) 76145/76355  
telex 44029

Quadrangolo

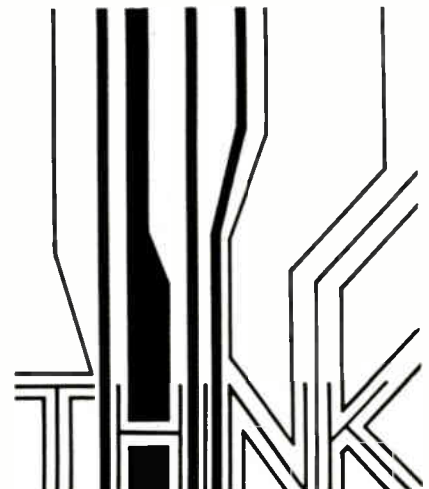

**CONTROL—precise**  
**SIZE—fits**  
**SUPPLY—fast**  
**PRICE—fine**

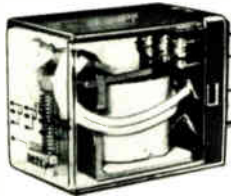

**Miniature Relay Type MPM-100**

- Available for various voltages AC & DC.
- Both 4PDT and DPDT contact switching requiring minimum driving power is available.
- Highly economical.
- Incorporates anti insulation fatigue device which prevents short-circuits.
- Uses UL-approved resin bobbin.

**Digital Line Printer LP-108**

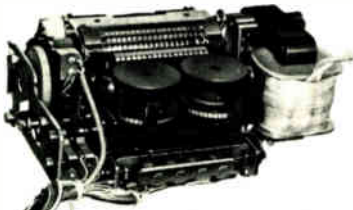

- Compact size with simplified mechanism.
- Up to 18 columns.
- 13 characters per column.
- High reliability.
- Red/black printing.
- Print rate of 2.5 to 3.0 lines/sec.
- Low cost



**Miniature Motor Timer Type UT-500**

- Smart surface design. Plug-in type terminal.
- Economical due to simplified pointerless mechanism.
- Available in a variety of types ranging from 10 seconds to 24 hours, surface-mounted or flush-mounted.

Whichever way you take the measure of TEC control instruments you're getting top value. They work longer; give you more reliable performance for your money.



**TOKYO ELECTRIC CO., LTD.**

14-10, 1-chome, Uchi-Kanda, Chiyoda-ku, Tokyo, Japan

**New products**

tion at 263 milliwatts. The circuits also guarantee the dc standby mode, which reduces power requirements by 75%, and input and output characteristics are identical to those of TTL, with guaranteed fanout of two TTL loads. Price ranges from \$16.95 to \$32.

Advanced Micro Devices Inc., 901 Thompson Place, Sunnyvale, Calif. 94086 [414]

**IC contains all TV audio circuitry needed**

A monolithic integrated circuit, called the LM1808, contains all the audio circuitry required by a television receiver. The LM1808 is a 2-watt i-f circuit with an improved volume control, in which the recovered audio is a linear function of the resistance of the control potentiometer. Thus, a single nonshielded wire can be run from the LM1808 to the front panel for the volume control, eliminating the need for a multiconductor shielded cable.

National Semiconductor Corp., 2900 Semiconductor Dr., Santa Clara, Calif. 95051 [415]

**RAM is designed for bus-structured systems**

Called the model 2606, a random-access memory is an n-channel, ion-implanted device with common, shared, input/output pins. Designed specifically to service bus-structured systems, it is available in a standard 16-pin dual in-line package. Its organization into 256 words of 4 bits each permits the designer to obtain an 8-bit byte with just two of the

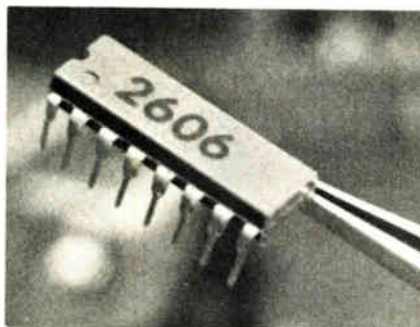

RAMs. (This is to be contrasted with the eight 1,024-by-1 RAMs that would be needed to obtain the same 8-bit byte.) The 2606 requires a single source of 5 volts, which is available from a standard TTL power supply; the use of a single source of power simplifies the problems of power distribution and decoupling. The power dissipated by the RAM is approximately 200 milliwatts. Price is \$10.40 each in 100-lots.

Signetics, 811 East Arques Ave., Sunnyvale, Calif. 94086 [416]

**FET switch driver provides many functions**

A dual field-effect-transistor switch driver with complementary outputs for MOS-interface application may be used in an analog switch driver to provide a variety of switch functions. The model D139 translates low-level TTL, complementary-MOS and DTL logic to high-level logic (FET analog switches and MOS structures). The monolithic device also incorporates bipolar, p-MOS and Schottky technology on a common substrate, and each output can drive one or more p-MOS or n-MOS FETs directly, or drive a junction-FET switch with a few additional circuit elements. Output voltage swing can be as high as 30 v. Maximum switching time is 200 ns, and typical supply current is 1.5 mA, which provides low power dissipation. Pricing in lots of 100 for the plastic-packaged DIP D139CJ is \$6.80 each; the 14-lead ceramic D139AK and D139BK are \$13.40 and \$11.15, respectively. TO-86 type flat packs (D139AL and BL) are priced at \$20.40 and \$18.15 each.

Siliconix Inc., 2201 Laurelwood Rd., Santa Clara, Calif. 95054 [417]

**Uhf power transistor puts out 45 W at 470 MHz**

The MRF621 uhf power transistor, designed for 12.5-volt dc operation from 406 megahertz to 512 MHz, can

# Little trimmers are very big at our house...



**Spectrol**

**We've Got Your Trimmer and We've Got Your Package!**

Whatever you need you can get it right off the shelf from your nearest Spectrol distributor — wirewound or cermet — all available at prices that are right. Call for a quote, ask for free samples, or send for a data sheet.

**Spectrol**

**SPECTROL ELECTRONICS GROUP**

**UNITED STATES** Spectrol Electronics Corporation 17201 E. Galle Avenue, City of Industry, Calif. 91745, U.S.A. • (213) 964-6005 • TWX (810) 684-1334

**UNITED KINGDOM** Spectrol Reliance Ltd. Drake's Way, Salford, Wiltshire, England • Salford 21581 • TELEX: 44882

**ITALY** SP Electronics spa Via Carlo Pizzacane 7, 20016 Pavia/MIlan Italy • 36 36 241 • TELEX: 32001

Circle 161 on reader service card



# Plenco 414.

## It helps Robertshaw do a double job of heat control.

This electrical control for water heaters, by Robertshaw Controls Company, Indiana Division, Indiana, Pa., is a combination temperature-regulating and -limiting device.

Encased in its Plenco phenolic housing and mounted against the water tank, the control senses the temperature of the water by its contact with the outside of the tank. To maintain water temperature one section of the housing (and its associated parts) is used to turn the element on and off. To limit temperature another section of the control will shut off power when the temperature exceeds a predetermined value.

Our Plenco 414 Black Heat-Resistant/Electrical Phenolic Molding Compound is specified for the housing. The molder: Plastics Division, Harvey Hubbell Incorporated, Newtown, Conn.

This Plenco thermoset material is designed for electrical parts that also require the ability to withstand heat. In addition it offers good mechanical strengths, dimensional stability, easy molding, fast cure.

More than likely Plenco has the combination for you.

**PLENCO**  
THERMOSET PLASTICS

PLASTICS ENGINEERING COMPANY  
Sheboygan, Wis. 53081

Through Plenco research . . . a wide range of ready-made or custom-formulated phenolic, melamine and alkyd thermoset molding compounds, and industrial resins.

### New products

be the basis for power-amplifier designs in commercial/industrial uhf mobile-radio applications. The device is rated at 45 w power output at 470 MHz, 12.5 v dc collector supply, with a minimum power gain of 4.8 dB and a minimum collector efficiency of 55%. No degradation in output power occurs when working

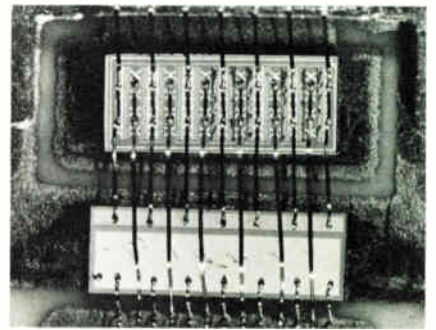

into a 20:1 VSWR at any phase angle. The MRF621 uses an internal MOS capacitor chip for controlled-Q construction. Price is \$39 each for one to 24, and \$34.50 each for 25 to 99.

Motorola Semiconductor Products Inc., P.O. Box 20912, Phoenix, Ariz. 85036 [419]

### Active terminator

combines 14 circuits

A method of terminating emitter-coupled-logic outputs is provided with a device, designated the F10014 active terminator, which combines 14 independent termination circuits in a monolithic package. Each terminator lead serves as a bilateral clamping circuit usable over a wide range of line impedances. Operating from standard -5.2-volt ECL power supplies, each clamping circuit in the F10014 serves as a low impedance that sinks current at logic-high levels, and as a high impedance that sources current at the logic-low levels. The clamping action thus limits overshoot and ringing caused by unmatched impedances in ECL systems. Price is 98 cents in 100 to 999 quantities, and 89 cents in 1,000 quantities.

Digital Products Division, Fairchild Camera & Instrument Corp., 464 Ellis St., Mountain View, Calif. 94042 [420]



### 1. Pneumatic Cable Tie Installation Tool

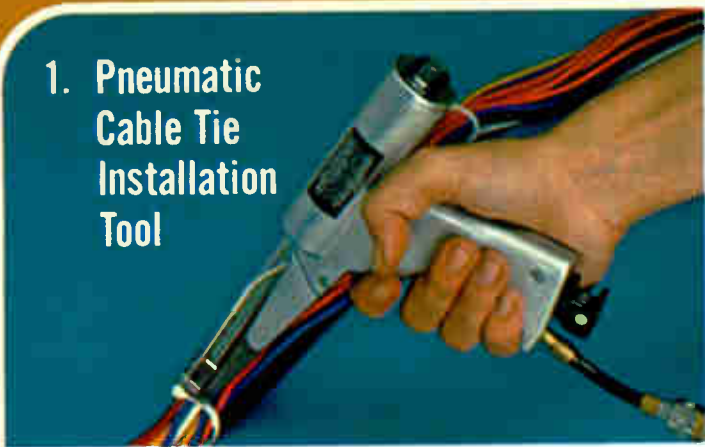

**Fast, Continuous High-volume Production** with new pneumatic cable tie installation tool ■ Lightweight PPTS air tool requires minimum force, reduces fatigue; no training required ■ Installs 36 different PAN-TY® and STA-STRAP® cable tie products ■ Uses standard 70 to 80 psi air to automatically tighten ties to pre-set tension and cut flush ■ No sharp edges—no metal barbs—no twisting ■ Ask for demonstration and lease arrangements

Circle 219 on reader service card

### 2. Fully Pre-insulated Female Disconnects



**Speed Connection with New Fully Pre-insulated PAN-TERM™ Disconnects** by eliminating costly, time-consuming addition of separate insulation ■ Complete line of fully insulated disconnects with full vinyl insulation protects against shorting across exposed disconnect termination ■ No need to stock and handle separate insulating parts ■ Female disconnects for .250 and .187 male tabs; wire ranges #22 to #14 ■ Convenient packaging in handy dispenser box with clear, see-through, snap-open, snap-closed lid ■ Free samples

Circle 220 on reader service card

**4**  
**new ideas**  
from  
**PANDUIT**  
to Save  
Assembly Time

**New PAN-TERM™ Female Disconnects** added to Panduit's extensive terminal line ■ New disconnects with vinyl insulation or non-insulated for .187 and .110 tabs ■ Wire ranges: #22-18 and #16-14 ■ Also available, full selection of disconnects with vinyl and nylon insulation for .250 tabs ■ All packaged in convenient dispenser boxes ■ Free samples

Circle 221 on reader service card

**Secure Small Diameter Wire Bundles in Limited Space** with new miniature adhesive backed mount ■ ABMM-A mount is just 3/4" x 3/4" and accommodates all miniature cross-section PAN-TY and STA-STRAP cable ties ■ Pressure sensitive adhesive backing.

Simply peel off the mount from paper dispenser strip and apply to surface ■ Saves cost and time of drilling holes for fixed diameter clamps ■ Free samples

Circle 222 on reader service card

### 3. Complete Line of Female Disconnects

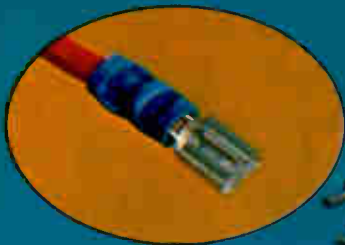

### 4. Miniature Adhesive Backed Mounts on Easy Dispenser Strip



*Full Line of Wiring Components Sold Through Authorized Panduit Distributors*

**PANDUIT** CORP.

Tinley Park, Ill. 60477 • Phone: (312) 532-1800  
In Canada: Panduit (Canada) Limited

Visit PANDUIT at WESCON in Booth 1245-46

# Celanex tunes in the best cost and performance picture.



By injection molding rotor and stator strips in Celanex thermoplastic polyester, instead of slower compression molding in alkyd resins formerly used, South American manufacturers cut finished part costs, speed production and improve performance of these TV tuners.

Among the many advantages of Celanex in this application are its excellent dimensional stability and electrical properties. Its impact strength and resistance to wear. Its moldability and fast-cycling characteristics. And the long shelf-life of parts molded of Celanex eliminate an especially knotty problem caused by the hot, humid Brazilian climate.

No wonder numerous television manufacturers worldwide are tuning in to Celanex thermoplastic polyester. Particularly since it also has the highest flammability rating (VE-O by UL 94 to 1/32") from Underwriters' Laboratories.

Compared to thermosets, metals and other thermoplastics, Celanex can do a lot to improve your products and finished part costs. Let us give you the facts. Write Celanese Plastics Company, Dept. X-609, 550 Broad Street, Newark, N.J. 07102.



*Tuner shown actual size. Molded by Begli Componentes Ltda. São Paulo, Brazil.*

**A TOUGH TEAM FOR TOUGH TIMES:**  
**CELCON<sup>®</sup>**  
acetal copolymer  
**CELANEX<sup>®</sup> NYLON.**  
**CELANEX<sup>®</sup>**  
thermoplastic polyester



  
**CELANESE  
ENGINEERING  
RESINS**

Celanese Plastics Company is a division of Celanese Corporation. Canadian Affiliate: Celanese Canada Ltd. Export: Amcel Co., Inc., and Pan Amcel Co., Inc., 1211 Avenue of the Americas, New York 10036.

Circle 164 on reader service card

## New products

Packaging & production

### Goldplating is done selectively

Technique for connector contacts cuts thickness in nonfunctional areas

In an attempt to find the most economical way of using gold contacts in the connector industry, Viking Industries Inc. has developed a method of electrodepositing gold se-

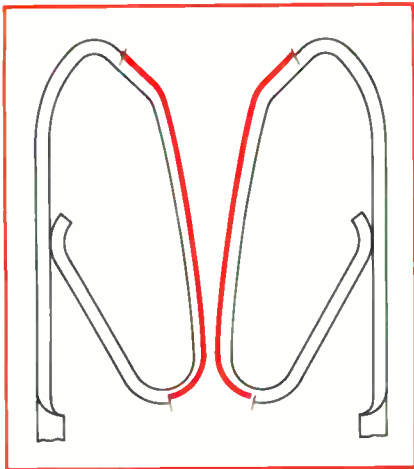

lectively on contact surfaces, as shown above in color.

In this method, called AuTac, the contact is plated after all fabrication is complete, thus avoiding surface damage. The selected area can be plated to any required thickness (in steps of 10 microinches) consistent with performance and cost parameters. The remaining area can be left bare or plated with reduced thicknesses of gold or any other platable material. Significant cost savings are realized not only from the selective deposition, but the plated-thickness tolerance is reduced approximately 50% below that of other methods.

According to Vern Griffin, manager of engineering at Viking Industries, Standard Products division, "Other methods of applying gold to contacts have many drawbacks. For example, with gold spot-welded contacts, there is always a possibility

of damaging the contact, and the gold may break off during mating. In the gold-inlay method, gold must be applied before forming the contact, thus weakening the contact, a disadvantage in itself, not to mention possible gold-contact damage while forming."

By eliminating or significantly reducing the amount of gold on non-functional areas, according to Griffin, a saving of up to \$1.32 for certain military-specification 100-pin connectors can be realized with the AuTac method.

Using this plating method, Viking has developed a line of low-cost edge-board connectors, allowing all areas of the contact-mating surface to be gold-plated 0.000050 thick while reducing the gold thickness of non-critical areas to 0.000010, or eliminating gold altogether.

Viking Industries Inc., 1840 South Elena Ave., Redondo Beach, Calif. 90277 [391]

Molded carrier strips hold contacts for soldering

To ease the task of inserting its Digi-Klip board-to-board contacts, Components Corp. has introduced a molded carrier strip that holds the contacts in place until they are soldered. The carrier, called Digi-Pac, is loaded with five to 44 contacts at Component Corp.'s plant and shipped to the customer for insertion on his boards. The customer can specify the number of contacts in each carrier, and some positions can be left open, avoiding the waste of unused contacts. The carrier holds the contacts in alignment for mass insertion on the mother board, and, after soldering is completed, the carrier can be discarded.

Digi-Klips, which have been available for several years, are formed from beryllium copper wire that is heat-tempered after forming to give it reliable spring-retention properties for use as pressure contacts. Since they are free-standing contacts, without an insulating body—they use the mother board as insulation—they are low in price: two to three cents per connection.

The Digi-Pac carrier uses contacts

## To simplify power/signal distribution systems design

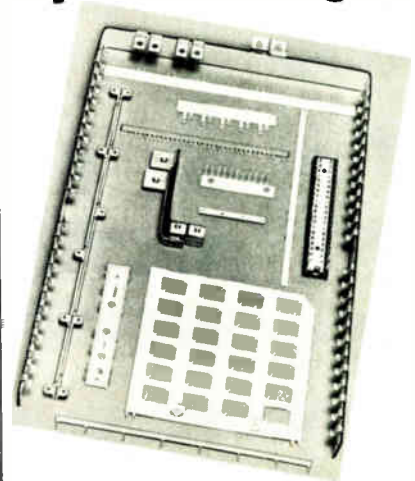

"Omny-Bus"®

Laminar  
**BUS  
BARS**

from  
**METHODE**

Interconnection City, U.S.A.

"Omny-Bus" systems are self-supporting structures built of layers of flat conductors, each insulated and encapsulated into multi-conductor units. An infinite number of designs are possible to conform to chassis, backplane or card cage configurations. They meet applicable UL, Mil-Standard and NASA specifications. And a variety of terminations are available.

Phone or write us for full information about "Omny-Bus" Systems or any of our other interconnection devices—connectors, PC boards, jack panels, backplanes, etc. We produce America's most complete line. Everything from single components to complete wire wrapped assemblies. We're Interconnection City, U.S.A.

 **Methode Manufacturing Corp.**  
1700 Hicks Road  
Rolling Meadows, Ill. 60008  
Phone (312) 392-3500  
TWX 910-687-0760

# Look what \$450 buys!

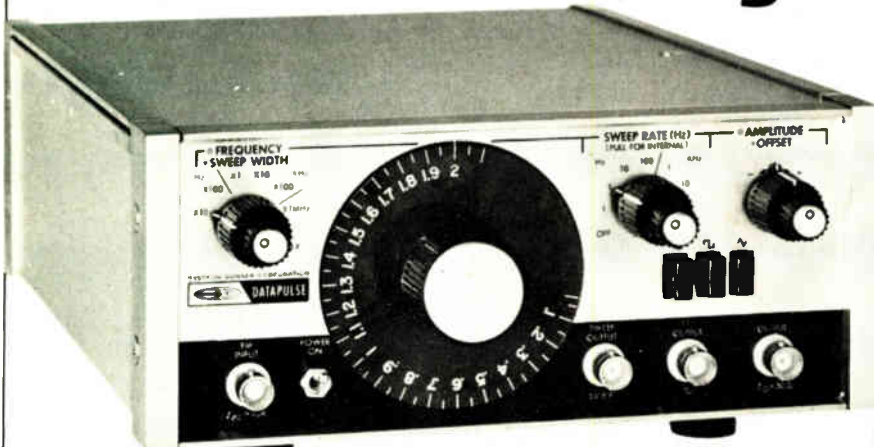

## New 2 MHz sweep function generator

It's the only one at that price... Systron-Donner's Model 411 sweep function generator. Check these features: **Frequency** in 6 decade ranges from 0.02 Hz to 2 MHz—Dial accuracy 2% of full scale typical—**Waveform outputs:** sine, square, triangle, ramp and a T2L compatible sync pulse square wave. **Plus:** Model 411 is the only low cost sweep function generator which allows the operator to set the upper frequency limit to dial accuracy. **Contact:** your nearest Scientific Devices office or Systron-Donner at 10 Systron Drive, Concord, CA 94518. For immediate details call our Quick Reaction line (415) 682-6471 collect.

**SYSTRON**  **DONNER**

Circle 166 on reader service card

Vector

PRESENTS **KLIP-BLOKS**

FOR BREADBOARDING

● NO SOLDERING  
...Just Push In

● DIPS, transistors,  
components  
patch with  
ordinary  
wire

● Buy only  
sockets needed  
and — save money!

● Exclusive thru-holes open  
top and bottom give greater  
component density. 4 connected  
contacts per strip with 1 to 24 strips  
per block -- all on .1" grid. FAST! EASY!

T45-4  
Single  
"Quad"

for  
0.015"  
0.032"  
leads

Patented

Visit WESCON Booth 1014

**Vector** ELECTRONIC COMPANY, INC. 

12460 E. Gladstone Ave.  
Sylmar, Calif. 91342  
(213) 365 9661 TWX (910) 496-1539

166 Circle 223 on reader service card

## New products

intended for insertion on a board 0.062-inch thick. The contacts mount in plated-through holes whose diameters measure between 0.030 and 0.040 in. Plating on the contact is electro-tin, and 30 micro-inches of gold over nickel is available as an option.

Components Corp., 106 Main St., Denville, N.J. 07834 [392]

## Relay test system built for medium-size volume

Relay manufacturers with smaller production volumes customarily use slow, manual test techniques or benchtop machines that cannot do complete checkouts. With these manufacturers in mind, Teradyne Inc. has developed a less expensive version of its K167 automatic relay-test system. Designated the K167B, it is designed for medium-size manufacturers with volume below 20,000 relays a month.

The specifications and performance of the two systems are identical; all tests, such as coil resistance, contact voltage and resistance, contact timing, and sequence tests can be made during a single insertion of the relay. Typical test time is about 1 second, and manual handling time is 3 seconds. The unit is designed to handle mainly signal relays. In the K167B, four-station multiplexing and high-volume dc and ac capabilities are removed from the basic system and instead are offered as options. Teradyne says that, typically, breakdown failures on relays are as low as 2% of all relays made, so high-voltage capability is not crucial. Also, many relays are used in small-current applications.

The system is controlled by a Teradyne M365 computing controller. The operator communicates with the K167B via a data terminal with CRT; a line printer for hard copy output is optional. A magnetic-tape cartridge read/write unit reads programs into the controller's memory and records the data the controller has processed. New jobs can be written and edited during testing.

Hard copy can show lot-summary

# Control Logic Programming

# turn to CTS

## for DIP set-up switches

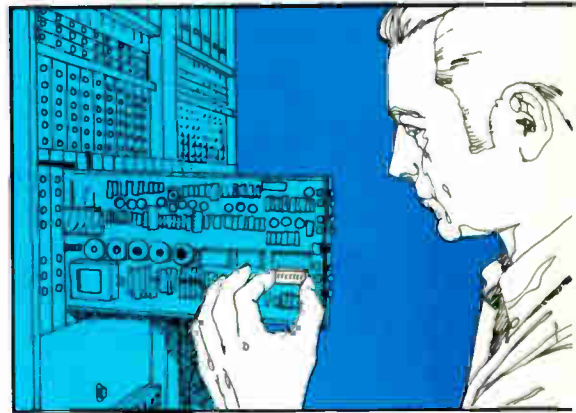
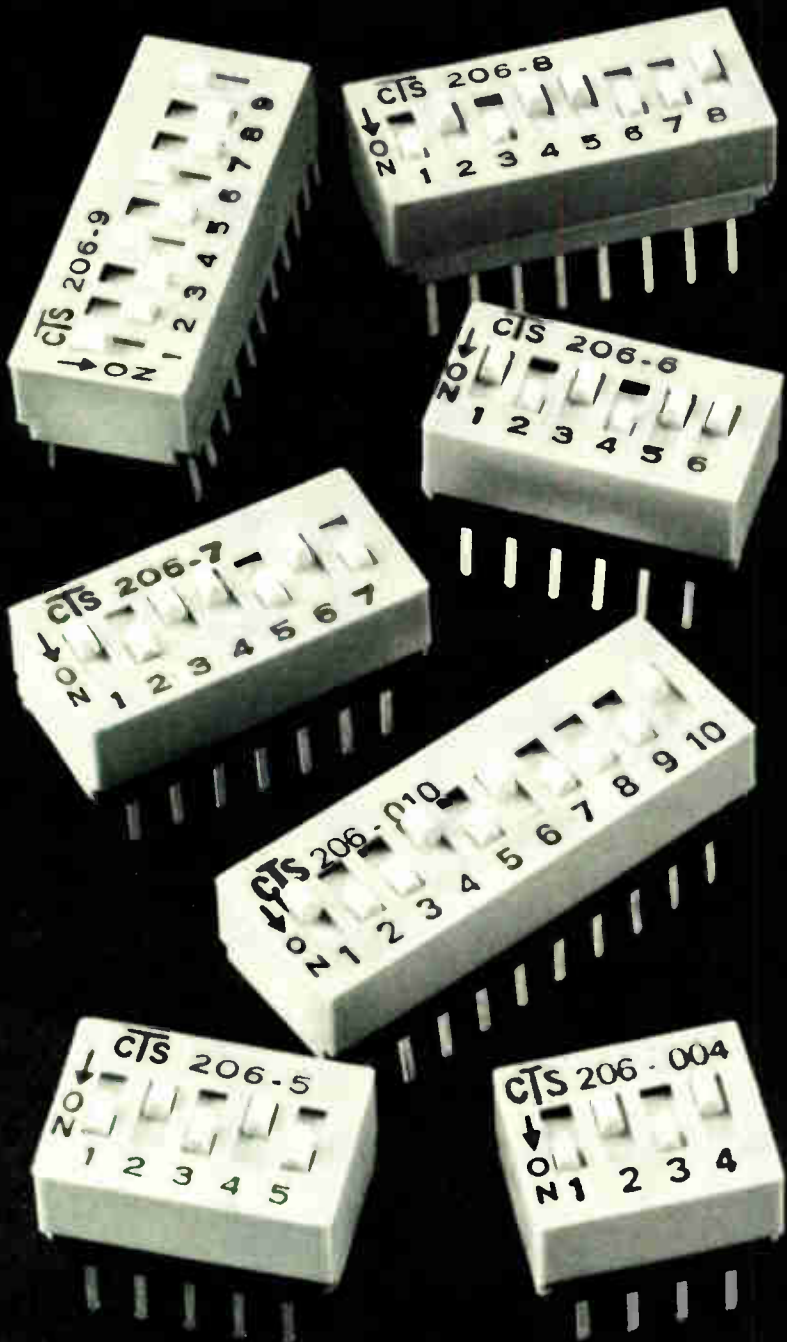

New CTS 206 Series switches will streamline your logic programming. These dual-in-line packages mount on the same PC board as other circuit components, eliminating the need for special mounting hardware/interconnection wiring. Program up to 10 different functions and/or signal levels with one compact switch.

CTS offers 7 different packages with 4 through 10 individual SPST slide switches per package. Automatic insertion saves you time and money. Units have .100" x .300" centers for inserting into either PC boards or standard IC sockets. Gold plated contacts that wipe on make and break assure low contact resistance over long life.

Designed for computer, computer peripheral, communication, test equipment and numerous other programming applications. Use good logic, turn to CTS. Find out more about our new, economical 206 series switch today. CTS Keene, Inc., 3230 Riverside Avenue, Paso Robles, California 93446. Phone: (805) 238-0350.

Circle 167 on reader service card

**CTS CORPORATION**  
Elkhart, Indiana



A world leader in cermet and variable resistor technology.

# IMC MOTOR FACTS

## Get on the Merry-Go-Round (Computer Style)

More and more computer systems engineers are discovering that IMC's Floppy Disc motor is the answer to a low-cost and highly efficient drive system. This synchronous unit has constant speed, good acceleration and works with a minimum of flutter. Literature on request! For further information please call Gene Egan, V.P. Sales—516/334-7070 or write:



Floppy Disc Motor

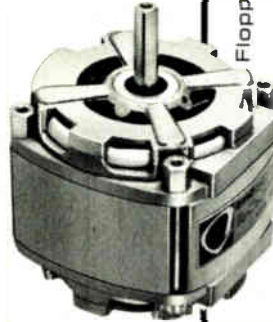

Available in two frame sizes from 3/4" to 5-3/8" diameter.

## IMC MAGNETICS CORP. EASTERN DIVISION

570 MAIN STREET, WESTBURY, NEW YORK 11590

Circle 168 on reader service card

Try it first. Send for a free sample.

# Tempilabel<sup>®</sup>



### Temperature Indicating Labels

The center spot on a Tempilabel<sup>®</sup> turns black when the surface to which it is affixed reaches the specified temperature (from 100° to 600°F).

Tempilabels<sup>®</sup> are available with single spots, or with multiple spots for monitoring safe operating temperatures. They provide permanent temperature records, and are thus useful in designing components and selecting materials.

If you are not now using Tempilabels<sup>®</sup>, fill in the coupon. We'll be glad to send you a sample that you can try in your own plant or laboratory.

### Tempilabel<sup>®</sup>

Division, Big Three Industries, Inc.  
Hamilton Blvd., South Plainfield, N.J. 07080  
Phone: 201 • 757-8300 • Telex: 138662

Send sample of Tempilabel<sup>®</sup>.  
For use at ° temperature.

Name \_\_\_\_\_

Title \_\_\_\_\_

Company \_\_\_\_\_

Street \_\_\_\_\_ City \_\_\_\_\_

State \_\_\_\_\_ Zip \_\_\_\_\_

# Can you spot your limitations?

168 Circle 224 on reader service card

## New products

information, which totals the number of relays tested, the total passed or failed, and the number that failed each test.

Depending on the number of relay contacts tested, which can vary from four to 16, the basic K167B will sell from \$58,000 to \$64,000. The optional multiplexer costs \$2,200 to \$4,600, again depending on the number of contacts, and each additional test station costs between \$11,000 and \$13,400. The high-voltage control card sells for \$800, while the ac and dc cards, which supply 100 volts, cost \$600 each. Delivery time is 20-24 weeks.

Teradyne Inc. 183 Essex St., Boston, Mass. 02111 [339]

## Solder terminals

center automatically

A line of "bullet-nose" solder terminals provides automatic installation and positive centering in the mounting hole of the circuit board. The mounting area of the terminal, which is hollow, is spun closed. When inserted into a board, the chamfered portion under the shoulder centers the terminal in the mounting hole squarely, regardless

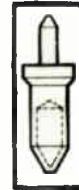

of variations in hole diameter. The shoulder is then held against the mounting surface, and the assembly is pressed against a flat tool face. Pressure causes the hollow "bullet-nose" to flatten out, forming a mushroom effect against the underside of the board, while providing a flow channel for wave soldering. The "bullet-nose" technique eliminates swaging, as well as board and lug cracking, and provides compensation for variations in board thicknesses. These new terminals are interchangeable with conventional



## Take the gamble out of trimmer buying.

Three of the winners in our extensive cermet trimmer line can give you a sure jackpot, because, right now, they satisfy over 90% of all trimmer requirements and board layouts.

Pick the 3/8" square, single-turn, sealed Model 72. Or the 3/4" rectangular, multiturn, sealed Model 89. Or the 3/8" diameter, covered, single-turn Model 91. Each in 19 standard resistance values from 10 ohms to 2 megohms... and in a variety of pin spacings.

Prices are right, too. Models 72, 89, and 91 are respectively just \$0.53, \$1.01, and \$0.41 in the 500-piece quantity.

And after all that, if exceptional setability

and 100 ppm°C tempco isn't enough, think of this: They're all available for immediate delivery from stock at your local Beckman/Heli-pot distributor!

Considering the stakes in your own competitive field, you should look into the quality and performance of Beckman cermet trimmers.

If you need immediate technical literature or the phone number of your local Beckman/Heli-pot representative, call toll-free (800) 437-4677.

**Beckman**

**HELIPOT DIVISION**

## New products

types of solder terminals.  
Sealectro Corp., Mamaroneck, N. Y. 10543  
[394]

Chuck for wafer prober  
is programed remotely

The model TP38 ThermoChuck system for wafer probers can be remotely programed. A monitor indicates when the set temperature is reached, and a dry-atmosphere en-

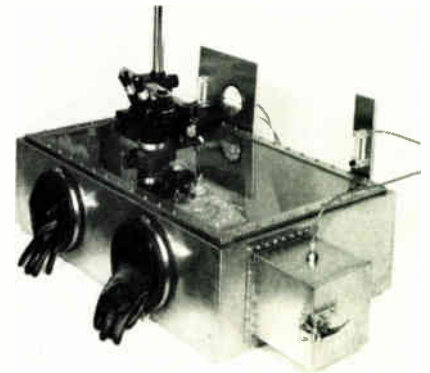

closure eliminates moisture condensation on the wafer at low temperatures. The unit is self-contained, except for a 110-volt power source, and it uses dc proportional control. Accuracy is within  $\pm 1^\circ\text{C}$ ; and stability,  $\pm 0.3^\circ\text{C}$  over the range from  $-50^\circ$  to  $+125^\circ\text{C}$ .

Tempron Corp., 40 Glen Ave., Newton, Mass. 02159 [393]

Ultrasonic bonding system  
offers automatic tuning

The model 4320A ultrasonic generator and model 4310 piezoelectric transducer for ultrasonic wire-bonding applications features integrated circuits, two channels, bond-indicator lights, and automatic tuning. Power and time are continuously variable from 0 to 10 watts and 10 to 300 milliseconds respectively. A low-power-range switch for bonding fine wires is also offered. Operating frequency is 59 kilohertz. A built-in time delay retards the ultrasonic bonding pulse until machine vibrations have stopped. A 20-w gener-

**Team up with  
PERMAG MAGNETS**

The Permagnet team's a winner. Permanent magnets, assemblies, Alnico, and ceramics. What a lineup! 24 hour off-the-shelf delivery. Design and engineering assistance. Complete magnetizing, grinding, and cutting facilities. Call or write for our new catalogs. Permagnet . . . worth cheering for.

Consult your Yellow Pages for address and telephone number of Permagnet near you.

Cable Address  
MAGNETS NEWYORK

YOUR NO. 1 SOURCE FOR ALL MAGNETIC MATERIALS

San Francisco Los Angeles Dallas Boston New York Chicago Toledo Atlanta

**PERMAG**

ALL ACROSS THE COUNTRY

Circle 170 on reader service card

## NEW! PROTO-CLIP® for power on-hands off signal tracing. Eliminates shorting leads ...and costs under \$5!

Bring IC leads up from pc board surface for fast signal tracing and troubleshooting. Great for injecting signals and wiring unused circuits into existing boards. Scope probes and test leads lock onto unique Dynagrip inset for hands off testing.

New plastic construction eliminates springs and pivots. Long lasting resilient plastic insures thousands of operations. Non-corrosive nickel/silver contacts for simultaneous low resistance connections to all IC leads. Narrow throat makes Continental Specialties' Proto-Clip a must for high density pc boards.

If you work with ICs you need a Proto-Clip! Order today!

- 14-pin Proto-Clip \$4.50 each
- 16-pin Proto-Clip \$4.75 each

Available at your local distributor or order directly from Continental Specialties. Distributor inquiries welcomed.



**Continental Specialties Corp.**  
325 East St., Box 1942, New Haven, CT 06509  
Telephone (203) 624-3103

CANADA:  
Available thru Len Finkler, Ltd.,  
Downsview, Ontario

Unique  
DYNAGRIP  
inset keeps  
probes from  
slipping

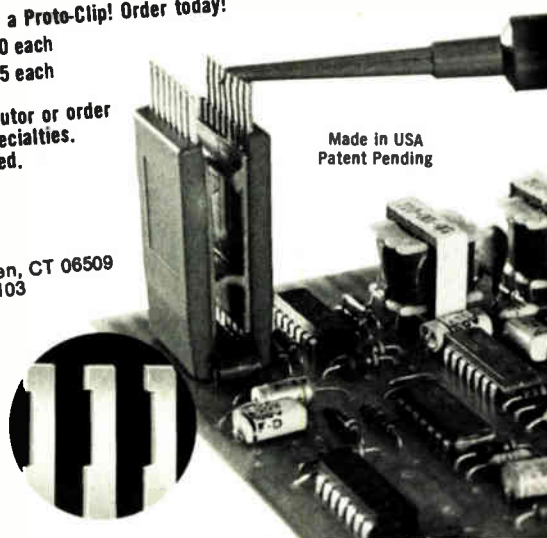

170 Circle 225 on reader service card



# ACDC ANNOUNCES THE GRAND OPENING OF OUR NEW HIGH EFFICIENCY POWER SUPPLY.

We've opened it up to give you an inside look at things like the modular construction that adds to reliability and simplifies circuit check out...the low voltage drop, high speed rectifiers that combine the best elements of reliability, speed and low forward voltage drop...the low impedance output capacitors that reduce high frequency ripple to about 5mV peak-to-peak...and the sealed input EMI filter that minimizes conducted RFI.

These 20KHz inaudible switchers operate from 115/230VAC, 47-63Hz or from 150VDC with 70% efficiency and 0.1% regulation. (100VAC also available).

Overvoltage and overload protection is standard and EMI is minimized by shielding and filtering. (We even offer an optional built-in filter for compliance with Mil-Std 461, CE03). You get low inrush on turn on for soft start and can parallel up to six switchers in master-slave configuration.

There are 10 models in this new series. Five 300 watt models range from 5V at 60A to 24V at 14A. Five 500 watt models range from 5V at 100A to 24V at 23A. They're all in our new brochure. Just circle the reader service number and we'll get a copy to you right away. However, if you would like a copy of our 64-page catalog containing technical data on our complete line, fill-out the coupon company letter-



Name

Company Name

Address

City

State

Zip Code

**acdc electronics inc**

Oceanside Industrial Center Oceanside, CA 92054 (714) 757-1880

# We bridged the forward surge gap. For extra protection.

Our bridge rectifier ratings for DC output and forward surge capacities are substantially greater than those of competitive devices. Even though our physical dimensions are the same.

So, our single phase and three phase bridge rectifiers provide important added safety at normal operating levels.

You no longer have to take the chance of using a marginally rated bridge rectifier and running the chance of expensive down time and replacement costs.

Wagner single and three phase bridge rectifiers as well as center tap rectifiers come in standard size packages. Only our current ratings and forward surge ratings are higher.

B-10 Series. DC rating-30A@75°C Case. Forward Surge rating-400A@ rated load. B-10 Series replaces look-

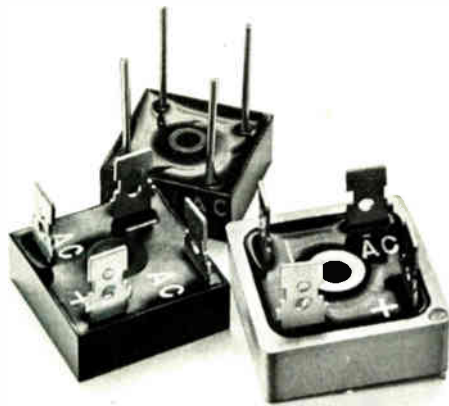

alike bridges rated up to 25A and from 50 to 1,000 PRV per leg.

B-40 Series. DC rating-15A@75°C Case. Forward surge rating-300A@ rated load.

B-50 Series. DC rating-10A@75°C Case. Forward surge rating-300A@ rated load.

For additional information on Tung-Sol® bridge rectifiers, write to: Tung-Sol Division, Wagner Electric

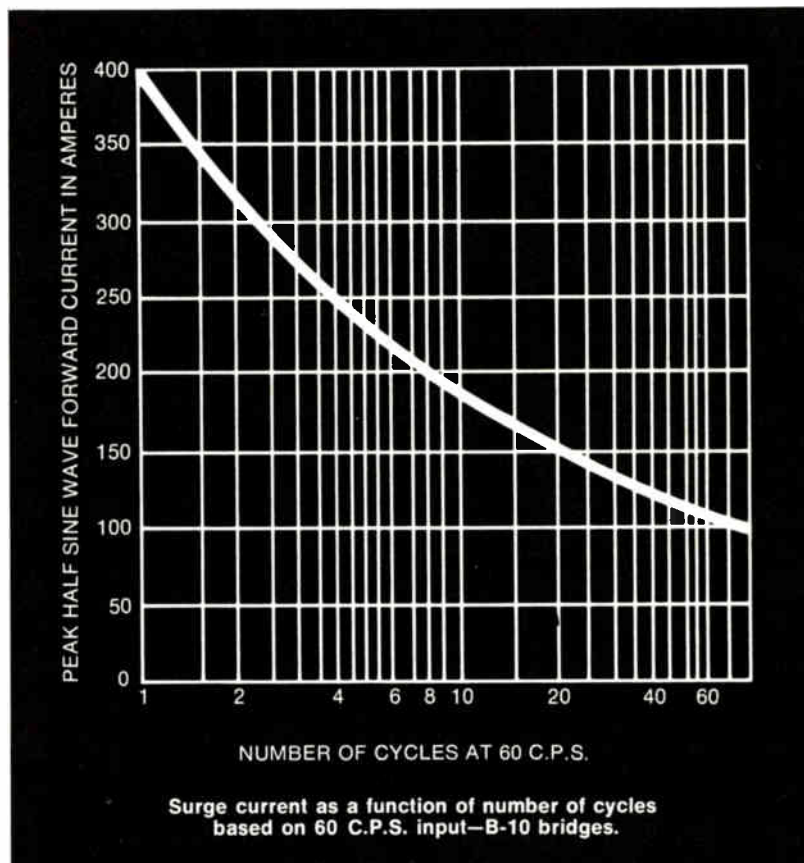

Corporation, 630 West Mt. Pleasant Avenue, Livingston, New Jersey 07039.

Wagner makes other quality products in volume for the electronics industry, including vacuum fluorescent readouts, power supplies and subsystems, silicon rectifiers, resistors, miniature lamps and status indicators. And Wagner offers contract manufacturing.

## WAGNER®

We've got a lot more riding for you.

## New products

ator is available for heavy wire-bonding applications.

Advanced Development Group, Kulicke and Soffa Industries Inc., 155 Commerce Dr., Fort Washington, Pa. 19034 [395]

Modules convert pc prototypes to production

Direct conversion of wire-wrapped printed-circuit prototypes into production-quantity boards is possible with modules that have physical dimensions, power distribution, and

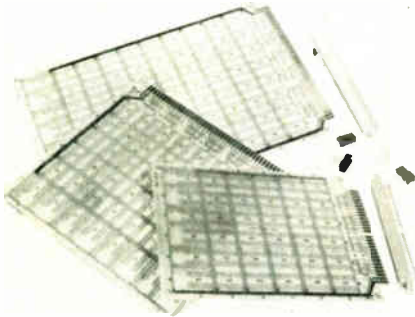

input/output connections that are interchangeable from wire-wrapped to printed-circuit fabrication. Any standard connector of 56 or 86 pins, with pin-to-pin dimension of 0.156 inch, is accepted; special connectors are not required. Price ranges from \$18 to \$40.

Jardon Engineering, 364 E. First St., Tustin, Calif. 92680 [396]

Pin headers can connect pc boards

Designers can build integrated circuits or interconnect printed-circuit boards with 14-, 16- and 24-way high- or low-profile pin headers. The low-profile versions, used with MLC multicolor flat cable, provide a means of board-to-board connection when plugged into standard dual in-line packaging sockets. Discrete components may be soldered across the pin heads of both the low- and high-profile versions to make up such circuits as ladder attenuators, programing plugs, diode matrixes, logic circuits, and oper-

# OUR ANGLE: The FIRST Digital Phase Angle Voltmeter



... This NEW DPAV provides complete analysis of complex AC waveforms at discrete frequencies and displays the results on a high readability 4½ digit display. Parameters measured are Total, Fundamental, In-Phase, and Quadrature voltage plus Phase Angle. Phase angle is displayed directly in degrees from 0° to 360° with a resolution of 0.1°.

The Model 220 operates phase-sensitively at a single factory-set frequency from 30 Hz to 32 KHz. The Model 225 has the capability of operating with two to four pre-specified frequencies. Both models have a total voltage measuring capability from 30 Hz to 100 KHz.

The DPAV can be used on the bench or in Automatic Test (ATE) applications. Remote programming, 10MΩ input isolation auto ranging, and BCD output options allow for complete hands-off operation necessary in automated test consoles. Priced from \$2950.00.

Let our sales engineering representative demonstrate our NEW angle to you. Call toll-free (800) 645-9200 for his name and address.



**NORTH ATLANTIC industries, inc.**

200 Terminal Drive, Plainview, New York 11803 • Phone (516) 681-8600

California District Office: 13418 Wyandotte Street, N. Hollywood, CA 91605 • Phone (213) 982-0442

Circle 173 on reader service card

## Cost Cutter

NEW Electronics Buyers' Guide...

Easy-to-use, single volume source for:

- Data on over 4,000 products
- Over 6,000 company listings and phone
- **EBG EXCLUSIVE:** quick access to over 800 catalogs through a Direct Inquiry Service. numbers

The international world of electronics at your fingertips. Find suppliers...fast...accurately...and locally! For your copy send \$15.00 (USA and Canada only; elsewhere send \$25.00) to address shown below.



## Electronics Buyers' Guide

A McGraw-Hill Publication  
1221 Ave. of the Americas, New York, N.Y. 10020



## BLACK MAGIC™ low cross-talk cable

From Ansley Electronics — an U.L. approved flat data transmission line cable for inter & intra cabinet computer wiring.

It's the only cable engineered for dual-dielectric phenomenon and accurate propagation of high speed pulses. Low "cross-talk" figures and low attenuation preserve pulse waveshape, amplitude and timing. Physically rugged and flat for peripheral intercabling; BLACK MAGIC™ cable can be cold stripped for reliable and low cost installation.

Standard cables have  $Z_0$  at 50Ω, 93Ω and 100Ω. Others available for your custom requirements.

Far end cross-talk on twisted pair (14%)

Far end cross-talk on Black Magic cable (1.6%)

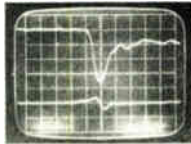

# Ansley

ANSLEY ELECTRONICS CORP.

Subsidiary of Thomas & Betts Corporation

3208 Humboldt St., Los Angeles, Ca. 90031 Tel. (213) 223-2331

Ansley Electronics — The Flat Cable Company

Circle 174 on readerservice card

## Remote viewing at a price competitive models can't even approach.

This new, low-cost FS-100 Fiberscope with a 24" flexible length can reveal hidden flaws, peer into recesses, and trace vibrations to their source. Built with AO quality throughout, this battery-powered unit features a high resolution fiber bundle with a wide angle fixed focus objective lens and an adjustable eyepiece. For further information on the entire Fiberscope line, write or call American Optical Corporation, Fiber Optics Division, Southbridge, Massachusetts 01550. Tel. (617) 765-9711 Extension 2445.

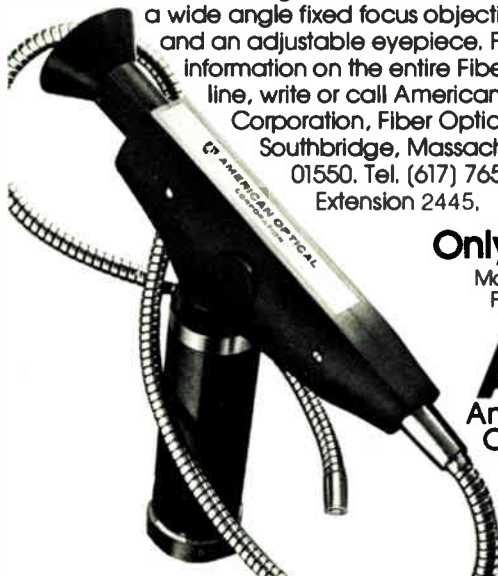

**Only \$295**  
Model FS-100  
Fiberscope

**AO**  
American Optical

174 Circle 226 on reader service card

## New products

ational amplifiers. Once the snap-on cover is in place on the pin headers, potting compound can be injected either through the slot on the low-profile or through the hole on the high-profile version. Prices range from 55 cents to \$1.25 each for small quantities.

Jermyn, 712 Montgomery St., San Francisco, Calif. 94111 [397]

## Toroidal-coil turns counter eliminates wire breakage

For elimination of missing counts, wire breakage, and contact pitting associated with the winding of the fine-wire miniature toroidal coils, the model 303 toroidal-coil turns counter offers a new principle for counting turns. There are no electrical contacts, and extremely light



wire-tension is required. The counter, available in kits, is adaptable to most winding machines and, in particular, to those using an electrical-contact "feeler" that interrupts a current flow when the wire passes through. Prices depend on whether the kits are installed by the user or the company.

Mayberry Electronics Co., 1250 Industrial Ave., Escondido, Calif. 92025 [399]

## DIP handler accepts units with 6 to 20 leads

The type 95½ stick-to-stick dual-in-line-package handler accepts all DIP types—cerdip, ceramic, and plastic—

Electronics/August 22, 1974

# Micaply Ohmega™

## presents new design possibilities for Thermal Printing Circuits.

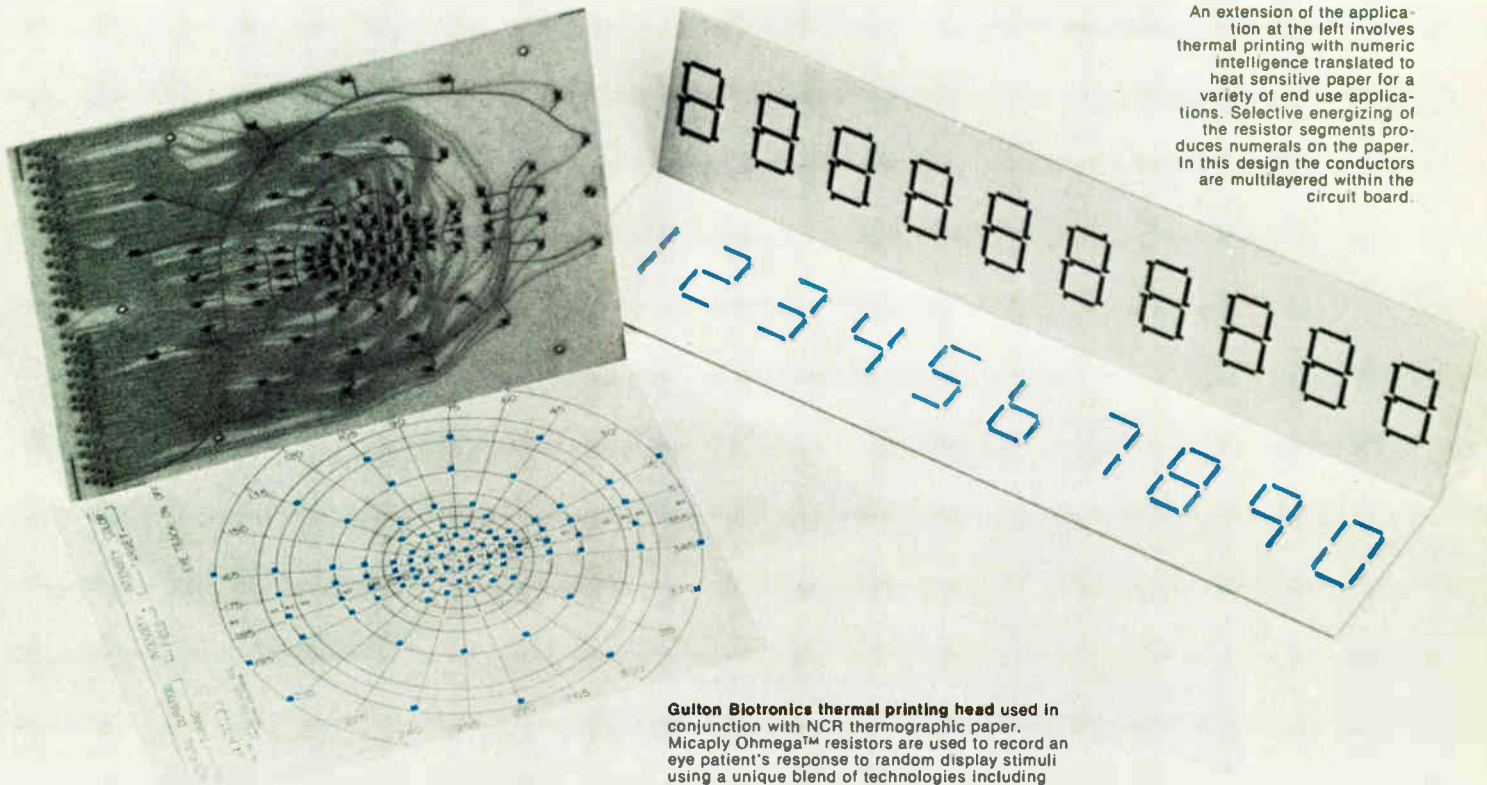

An extension of the application at the left involves thermal printing with numeric intelligence translated to heat sensitive paper for a variety of end use applications. Selective energizing of the resistor segments produces numerals on the paper. In this design the conductors are multilayered within the circuit board.

Gulton Biotronics thermal printing head used in conjunction with NCR thermographic paper. Micaply Ohmega™ resistors are used to record an eye patient's response to random display stimuli using a unique blend of technologies including fiber optics and integrated circuitry.

Circuits like the two shown above are examples of what can be accomplished with Micaply Ohmega™ Resistor-Conductor circuit laminate.

It offers designers a proven epoxy glass substrate with both the resistor and conductor layers completely covering the substrate on one or both sides. Selective etching produces conductors complete with integral thin film type resistors.

When the circuit board and heat sensitive paper are contacted and the resistors energized, patterns are produced on the paper.

Its advantages include:

- Tolerates repeated I<sup>2</sup>R heating without changing resistor value.
- Much lower cost than conventional materials and processing.

- 25 or 100 ohms-per-square sheet resistivity.
- Line widths consistent with thin film micro-electronic techniques.
- Subtractive etching process—no screening, firing, or vacuum equipment required.
- 10" x 36" sheets for processing economy.
- Can be easily drilled and cut.
- Can be multilayered for higher density.
- Resistors can be laser trimmed.

**We offer complete design assistance and circuit production. Contact us for an evaluation of your requirement or a complete literature package. Find out how Micaply Ohmega™ can give you new design flexibility and reduce your circuitry cost.**

First in a series of Micaply Ohmega™ application reports. —Watch for future applications news.

The **Mica** Corporation

See us at  
**WESCON**  
Booth 1015

10900 Washington Boulevard, Culver City, California 90230, (213) 559-4223, TWX: 910-340-6365; Telex: 674999

**Micaply** International, Ltd. Silloth, Cumbria, England, Silloth 571, Telex: 64120, Cable: Micaply, Silloth  
Circle 175 on reader service card

## Self-Sealing Fasteners that fight clean.

Environmental contamination can play havoc with equipment. So play it smart: protect equipment performance with leak-proof hardware that seals tight against air, gas, and fluid pressures over 10,000 psi.

APM makes protection a family affair with Seelskrews®, Seelbolts®, Seelrivits® and Adjust-A-Seels®—the fasteners with the patented

built-in bodyguard under the head.

Contained in a precision-tooled groove under the head, a silicone rubber O-ring compresses with installation to form a positive metal-to-metal seal—vibration can't budge. Usable in any standard dimension hole; reusable again and again.

Write or phone for free literature, price information and samples:  
APM-Hexseal  
44 Honeck St.  
Englewood, N.J. 07631

(201) 569-5700



**APM-HEXSEAL**  
DIVISION OF APM CORPORATION

**THE CLEAN FIGHTERS.**

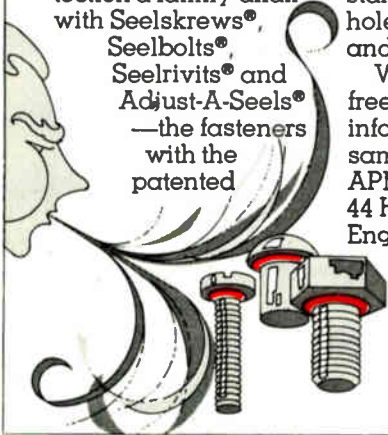

Circle 176 on reader service card

## New products



having six to 20 leads. The handler sorts two, three, or five categories, and production rate is gauged at 7,200 devices per hour at zero test time. Typical test throughputs are: 6,000 with 100-millisecond test time and 5,000 with 220-ms test time. Price range, with custom stick adapters, is from \$8,200 to \$13,000 each, depending on options.

Daymarc Corp., 301 Second Ave., Waltham, Mass. 02154 [398]

Shielding gasket is formed as helical spring

An electromagnetic-interference gasket called Spira is manufactured from thin flat material and is wound in the form of a helical spring. The spiral, which is manufactured from either stainless steel or tin-plated beryllium copper, is bonded to a relatively hard rubber extrusion. Since a relatively wide material is used in the manufacture of the basic spiral, a low-impedance path for electromagnetic current through the microwave frequency range is guaranteed. Different versions of the gasket permit the use of quarter-turn fasteners on covers and provide positive moisture and dirt seals.

Electro-Data Technology, 2808 Naomi St., Burbank, Calif. 91504 [400]



## BAILEY CRYSTAL FILTERS

- Types: Band pass—Single side band  
Band reject—Linear phase
- Center Frequency: 50 KHz to 65 MHz
- Bandwidth Range:  
0.003% (narrow) to 3% (wide) of center frequency
- Selectivity: 1.8 typical
- Spurious Atten: to 90 db
- Ultimate Atten: to 100 db
- Passband Ripple: 0 to 1 db typical
- Insertion Loss: less than 3 db typical

Custom Design and Data Sheets Available On Request

**Bailey** If you buy quality

**BAILEY ELECTRIC COMPANY**  
2545 West Grandview Boulevard  
Erie, Pennsylvania 16512

Our new "spin-seal" conformal-coated axial may well be the industry's long-term answer to a truly low-cost, automatically-insertable ceramic capacitor.

"Spin-seal" uses techniques developed for and currently in use to produce hundreds of millions of metal film resistors. It permits us to manufacture axial ceramics at high speeds while closely controlling uniformity and

handling characteristics necessary for automatic insertion. And at lower cost than molded case styles because more automated production techniques are used.

Right now, we're producing "spin-seal" capacitors in four case sizes with capacitance ranges of 0.027  $\mu$ F to 0.47  $\mu$ F at 50 volts and 0.001  $\mu$ F to 0.22  $\mu$ F at 100 volts. Two tolerances are available:  $\pm 20\%$  and  $+80, -20\%$ . "Spin-seal" capacitors are available with Z5U temperature characteristic. Capacitors with X7R and NPO characteristics are nearing completion.

"Spin-seal" isn't the only new development we're working on in the area of low cost ceramic capacitors.

Watch for the announcement of our new line of dipped-radial ceramic capacitors. Another step in our plan to serve your full ceramic capacitor needs.

**CORNING**  
ELECTRONICS



**Here's our answer  
to holding down the cost  
of ceramic capacitors.**

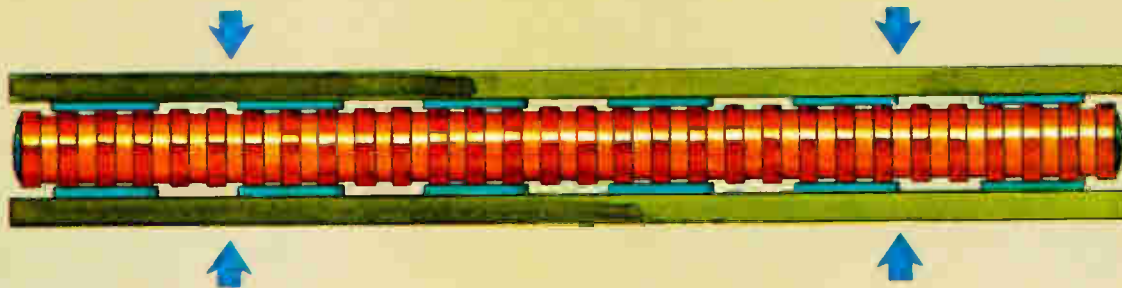

## Our new micrometallized connectors. We made them work under pressure.

By combining micro-circuitry with an elastomer. Then the whole innovative package is placed between parallel planes of any hard board circuitry. So the elastomer can exert equal pressure along its entire length.

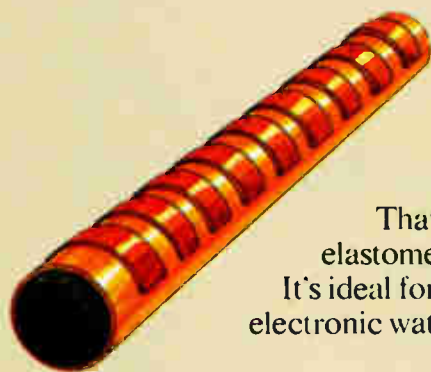

That's our extraordinary elastomer interconnection system. It's ideal for liquid-crystal displays in electronic watches. And for other products that demand advanced connection techniques.

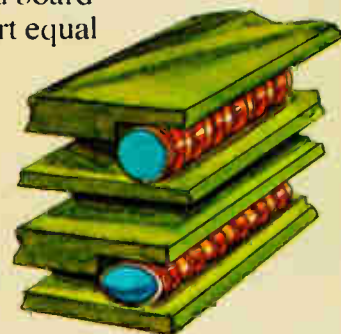

Circuit paths are isolated from one another, and since we offer extremely fine resolution, multiple redundancy to the interconnected components is certain.

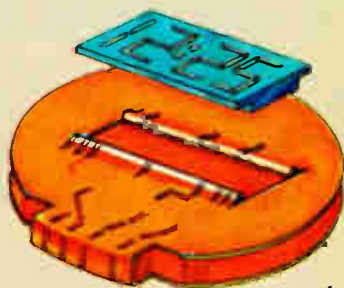

Another advantage is the fact that the elastomer rod can "float" within the micrometallized circuitry for unmatched resistance to shock and vibration. For easy handling and precise location, tabs and sprocket holes are available.

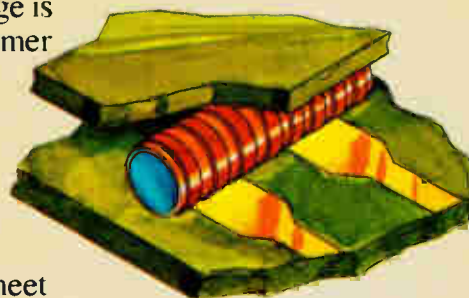

You can also be assured that AMP can meet your microelectronic interconnection needs: AMP Elastomate comes in a wide variety of cross-sections, lengths and circuit-path widths. But best of all, it doesn't take much pressure to make it work efficiently and economically for you. Just call (717) 564-0100. Or write AMP Incorporated, Harrisburg, Pa. 17105.

# AMP

INCORPORATED



# AMP District Offices.

**NEW ENGLAND DISTRICT**  
Suite 107, Riverside Park  
Weston, MA 02193. (617) 891-7500

**NEW YORK DISTRICT**  
25 Commerce Drive  
Cranford, N.J. 07016  
(212) 285-9575 (N.Y.)  
(201) 276-4382 (Cranford)

**MID-ATLANTIC DISTRICT**  
400 W. Swedesford Rd.  
Berwyn, Pa. 19312  
(215) 647-6060

**SOUTH ATLANTIC DISTRICT**  
955 L'Enfant Plaza North, S.W.  
Suite 4010  
Washington, D.C. 20024. (202) 484-9596

**GULF DISTRICT**  
2220 Parklane Drive, N.E.  
Suite 485  
Atlanta, GA 30345. (404) 934-6363

**OHIO DISTRICT**  
Landings Office Bldg.—Suite 207  
3040 Riverside Dr.  
Columbus, OH 43221. (614) 486-0276

**LAKE DISTRICT**  
30555 Southfield Rd.—Suite 440  
Southfield, MI 48075. (313) 645-5590

**ILLINOIS DISTRICT**  
1050 Morse Ave.  
Centex Industrial Park  
Elk Grove Village, IL 60007  
(312) 439-5800

**NORTH CENTRAL DISTRICT**  
4600 W. 77th St.—Rm. 319  
Minneapolis, MN 55435. (612) 920-8210  
TWX (910) 576-2849

**SOUTHWESTERN DISTRICT**  
Frito Lay Tower—Suite 1440  
Exchange Park, Dallas, TX 75235  
(214) 352-4852-4853  
TWX (910) 861-4227

**SOUTHERN PACIFIC DISTRICT**  
1840 S. Wilmington Ave.  
Compton, CA 90220. (213) 537-4490  
TWX (910) 346-7044

**NORTHERN PACIFIC DISTRICT**  
Vallico Park  
10300 N. Tantau Ave.  
Cupertino, CA 95014. (408) 255-3830

# AMP

INCORPORATED

## New products

Industrial

### Adding control to measurement

Dual digital comparator  
provides decision output  
based on preset values

As analog panel meters give way to digital devices in a variety of industrial, medical, and other OEM applications, what may one expect to replace the old meter relay? (The meter relay is essentially a delicate analog panel meter with a pair of adjustable limit switches—one high and one low—which are tripped when they are touched by the meter pointer.)

The answer may well be United Systems Corp.'s model 6860 dual digital comparator, which will be introduced at Wescon. This latest addition to the company's line of Digitec HT (High Technology) instruments is an all-digital device that accepts a BCD input from a measuring instrument and compares it simultaneously with two preset values set by the user by means of front-panel switches. A pair of LED displays—each of which can be either an H or an L—indicates whether the monitored value is above or below each of the preset levels. In addition, relay contacts, which can be connected in a variety of configurations, are provided as decision outputs for feedback control, alarm activation, or other remote signaling applications.

The 6860 is a five-digit bipolar device. Each of the two preset levels is set by means of five thumbwheel switches and a rocker switch for polarity selection.

Unlike meter relays, which are themselves measuring instruments, the dual comparator cannot introduce any errors into a control system. It simply operates on digital data provided by a meter with a BCD output and provides a display and a decision (relay contact) output. In addition, the 6860 differs

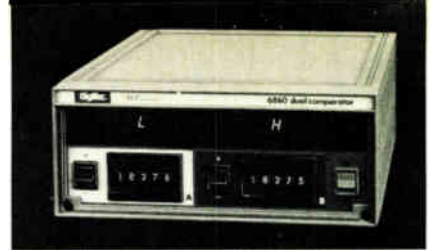

from meter relays in that it need not be a strictly high-low device. It can monitor two high limits or two low ones. For example, if used to ensure that an oven doesn't overheat, the lower of two high limits might be used to turn off the heat while the higher one was used to sound an alarm.

The two comparators can be ganged together to form one 10-digit unit, or the entire instrument can be cascaded with other instruments to get even higher resolution, or to obtain more than two control points, or both.

The 6860 is housed in a 3.5-inch half-rack enclosure. Available from stock, it is priced at \$495 in single quantities.

United Systems Corp., 918 Woodley Road,  
Dayton, Ohio 45403 [371]

Ruby-laser oscillator  
has high pulse rate

The model K15QPTM ruby-laser oscillator, operating in a pulse-transmission mode, achieves narrow pulse widths in the 3-to-5-nano-second range at high pulse-repetition rates. Minimum pulse peak power is 60 megawatts at a repetition rate of 60 pulses per minute. The system consists of an electronics cabinet; the mounting rail; and a water-to-water cooling system, which circulates deionized water through the laser head. Applications include precision satellite ranging, plasma diagnostics, shock propagation, and vibration analysis.

Hadron Inc., Korad Division, 2520 Colorado  
Ave., Santa Monica, Calif. 90404 [375]

Control transformers  
offer 11 power ratings

A line of multitap machine-tool control transformers, the 555 series, includes 11 power ratings from 0.150 kVA to 3.000 kVA. Four taps allow wiring to any of 14 primary

# If you're testing 1K RAM's or 4K RAM's without an MD-100 or MD-104... YOU'RE KIDDING YOURSELF!



**Reliability**—With more than 300 stand-alone MD-100/104 systems in use throughout the world today, Macrodata has set the industry standards for memory testers—and these two systems still provide the only way you can test memories effectively and obtain valid data.

**Pattern Sensitivity**—If one of those "it's no problem" guys has been telling you that a

few hardwired patterns are all you need to test RAM's, watch out! They have decided that RAM's aren't really pattern sensitive, so they don't bother to fully explore worst-case pattern conditions for these devices. They say that it's not necessary, but you know better.

**Pattern Sensitivity Tests**

The adjacent curves are plots of individual device access times at different supply voltages. Each curve represents a different test pattern. Over the specified operating regions of the devices, these shmoo plots show the pattern sensitivities of the 1K and 4K RAM's. For example, while MARCH would make one think that the 4K device is operational, notice that the chip does not work during a portion of its MASEST curve. A MARCH test also indicates that the 1K device passes its access time specification at nominal voltage, but a GAL.PAT II test demonstrates much slower access time characteristics and that the 1K chip does not really pass at nominal voltage.

### Here's Why You Need MD-100/104 Capability

**Example #1:** In a recent test, six devices from separate

and passed until heat produced failure.

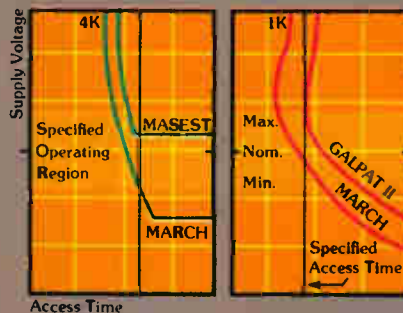

need are fixed patterns to solve your test problems, send your device to us for the moment of truth. If we're right, aren't you just kidding yourself until you get an MD-100/104 on line? For action, call or send for a free brochure today.

lots from the same manufacturer all failed under different unique patterns with identical set-up conditions of voltage, timing, etc.

**Example #2:** In another test, one device passed on all patterns for approximately 10 seconds and then failed due to heating problems. After being rehabilitated by coolant spray, the device again ran

**Example #3:** For typical pattern sensitivity of 1K and 4K RAM's, see the chart of V. vs. Access Time.

**Let's Make A Deal**—If someone tells you that your semiconductor memory is not pattern sensitive and all you

## Macrodata



**Macrodata Corporation**, 6203 Variel Avenue, Woodland Hills, California 91364, Phone: (213) 887-5550, Telex: 65-1345  
 Sales Offices: Northern California Area Tel. (408) 735-9560 • Scottsdale Tel. (602) 966-2179 • Minneapolis Area Tel. (612) 454-2034 • Chicago Area Tel. (312) 297-8746 • Cleveland Area Tel. (216) 461-8333 • Dayton Area Tel. (513) 293-3145 • East Coast Tel. (516) 543-8600 International: West Germany — Munich Tel. (0811) 34 56 00 Telex: (841) 521-5969 • Milan, Italy Tel. 871-988/899-248 Telex: (843) 34314 • Sweden and Norway — Stockholm Tel. (08)-380-370 • Tel Aviv, Israel Tel. 25 55 69 • Tokyo, Japan Tel. (03) 985-5266 Telex: (781) 272-2171 • Buckinghamshire, England Tel. High Wycombe (0494) 36 3 81 Telex: (851) 837236

"PLEASE SEE US AT WESCON BOOTH NO. 1160-1161"

Circle 180 on reader service card

## New products

voltages ranging from 208 to 600 volts. Three secondary taps provide 10 different output voltages from 85 to 130 v. The four primary taps permit connection with the 14 supply-voltages available in most in-plant power systems in North America, Europe, and many other parts of the world. Similarly, depending on the connection of the primary taps, the three terminals on the secondary winding supply the range of motors

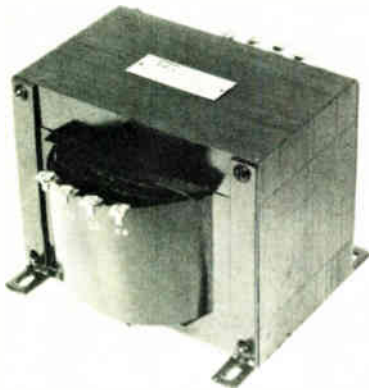

and electromechanical equipment. Applications include machine tools, textile machinery, and materials-handling systems. Delivery of the transformers is from stock.

Frequency Technology Inc., TDC Division, Box 365, Whitcomb Ave., Littleton, Mass. 01460 [376]

## Counter-controller accepts many input signals

Accepting a wide variety of input signals, the series 7129 Digi-Master II counter-controller counts up to a preset number where an output relay is actuated to control a machine or other circuit. Applications are in production and processing, for instance, in winding, packaging, weighing, blending, converting, and cutting to length. With four decades using light-emitting-diode readout, models have one or two preset control levels and operate on 105 to 125 volts ac, 50/60 hertz. Counting speeds depend on the type of input signal: electronic pulses to 10 kHz, Veeder-Root photoheads or pulse generators to 2 kHz, or user switch



closure to 100 counts per second. Price is \$325.

Veeder-Root Co., 70 Sargeant St., Hartford, Conn. 06102 [373]

## Susceptometer provides response of 10 kilohertz

A superconducting susceptometer measures paramagnetic, diamagnetic, or ferromagnetic susceptibility in various applications. The instrument measures susceptibility change in a 0.4-cubic-centimeter sample and 1,000-oersted field with frequency response up to 10 kilohertz. Temperature may be controlled from 300 K to 3 K, and axial magnetic field is variable from 0 to 10,000 gauss. With a superconducting stabilizing shield, the field will drift no more than 1 part in  $10^{14}$  per second. The system also measures magnetization and susceptibility change with changing temperature. With temperature constant, the system measures susceptibility change of a sample caused by



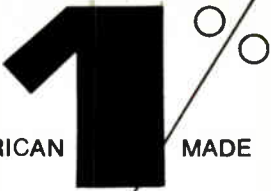

AMERICAN MADE

**Tolerance**  
**SCHAUER**  
**1-Watt**  
**ZENERS**

## Immediate Shipment Low Prices

ANY voltage from 2.0 to 16.0

Quantity	Price each
1-99	\$1.07
100-499	.97
500-999	.91
1000-4999	.86
5000 up	.82

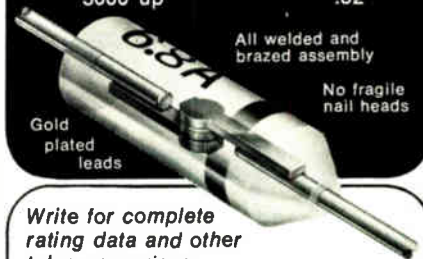

All welded and brazed assembly

No fragile nail heads

Write for complete rating data and other tolerance prices.

## Buy the kit— Save a lot



Kit contains a 51-piece assortment of SCHAUER 1% tolerance 1-watt zeners covering the voltage range of 2.7 to 16.0. Three diodes of each voltage packaged in reusable poly bags. Stored in a handy file box. Contact your distributor or order direct.

A \$54.57 value for  
**ONLY \$24<sup>50</sup>**

Semiconductor Division

**SCHAUER**

Manufacturing Corp.

4514 Alpine Ave. Cincinnati, Ohio 45242

Telephone: 513/791-3030



SEE WHAT  
GARDNER-DENVER  
IS DOING NOW.

## Profit by our experience in solving wire preparation problems

The Gardner-Denver Wire Preparation Unit delivers wire cut to length, stripped one end or both, in any quantity. For low or high volume users. Just set a dial, flick a switch, and profit from more than a decade of our experience in processing all types of insulated wire. This automated machine can be used as an on-line system with a Gardner-Denver Terminal Locator or other semi-automatic wiring equipment, or as a bench unit to process bulk wire. We also have a machine to produce twisted-pairs. De-reelers too. Write for Bulletins 14-111 and AC-35. Gardner-Denver Company, Grand Haven Division, Grand Haven, Michigan 49417.



# GARDNER·DENVER

## New products

chemical reaction and absorption of optical flash, for example.

Superconducting Technology Inc., 1166 Independence Ave., Mountain View, Calif. 94040 [377]

Timing controller works from 1 second to 100 hours

A solid-state timing controller offers on and off times independently adjustable from 1 second to 100 hours or longer. The model CT/LR recycle timer is specifically designed to drive an external relay or con-



tractor in commercial and industrial applications where precise control is required. The unit is available for operation from 12 volts dc or 115 V ac 50/60 hertz and has a SPST-normally open solid-state output rated at 1.5 amperes. Operation from other supply voltages can be provided on request. Price is \$85, with OEM discounts available.

Metrix Manufacturing Co. Ltd., 51 Sheffield St., Toronto, Ont. M6M 3E5, Canada [374]

Inclinometer measures  $\pm 10^\circ$  deflections

An inclinometer, featuring internal voltage regulation and static error band of  $\pm 0.25\%$ , and designated the model 685A, is for aerospace or industrial applications where reliable measurements of deflection of  $\pm 10^\circ$  away from a horizontal reference is required. The model 685A can also be used in road graders, asphalt pa-



vers, and other mobile machinery. The unit provides good stability over a wide temperature range of  $-10^\circ\text{F}$  to  $+175^\circ\text{F}$ . Solid-state electronic circuitry compensates for ambient temperature changes as well as input voltage variations, and performance is not affected when subjected to vibration or shock. The unit can withstand 50 g, and vibration error is  $\frac{1}{2}\%$  for 1  $\frac{1}{2}$  g in the sensitive axis and 4 g in the perpendicular axis. Price is \$195.

Robinson-Halpern, 1 Apollo Rd., Plymouth Meeting, Pa. 19462 [378]

Stereomicroscope studies wafer alignment, masks

Designed for industrial inspection, the model MI stereomicroscope can be fitted to machines, workbenches and other inspection sites, swinging out of the way when not in use. The unit offers two focusable telescoping objectives but no focusing drive, and has a parallel imaging path. Magnification is from  $1.25\times$  to  $40\times$ . Applications are in wafer-alignment and mask-inspection, for example. A typical configuration is priced at about \$400.

Wild Heerbrugg Instruments Inc., 465 Smith St., Farmingdale, N. Y. 11735 [379]



SEE WHAT  
GARDNER-DENVER  
IS DOING NOW.

**Pass!**  
**It's wrapped.**

In less than one second, your operators make permanent, gas-tight electrical connections with Gardner-Denver Wire-Wrap\* Tools. Tool weighs only 13  $\frac{1}{2}$  ounces. Handles 18 through 32 gauge wire. Send for Bulletin 14-1 on Gardner-Denver Wire-Wrap tools, bits, and sleeves. Gardner-Denver Company, Grand Haven Division, Grand Haven, Michigan 49417.

\*Wire-Wrap is a registered Trademark of Gardner-Denver Company.



**GARDNER  
DENVER**

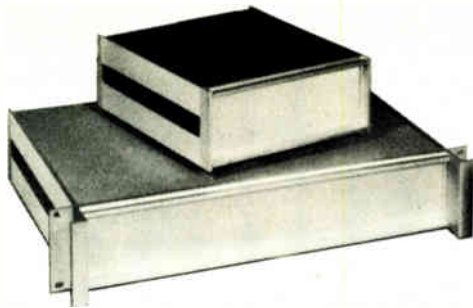

# BUCKEYE CASES

Buckeye bord-pak cases are made of aluminum extrusions and available in  $\frac{1}{3}$ ,  $\frac{1}{2}$ ,  $\frac{2}{3}$  and full rack widths. Full fabricating capabilities and complete electronic packaging needs from Buckeye include: colorful cabinets, 4 sizes of adjustable P.C.B. Racks, patented card guide modules; retractable tilt-stands with feet, and a complete line of matching instrument knobs.

Write today for free colorful literature!  
**the BUCKEYE stamping co.**

555 Marion Rd., Columbus, Ohio 43207

"QUALITY PRODUCTS SINCE 1902"



**GUIDES • CABINETS • KNOBS • RACKS**

"See us at WESCON—Booth 1145-46"

Circle 184 on reader service card



Diacon introduces an adjustable environmental Handler that can store and sort up to 300

semi-conductor packages simultaneously while operating over a temperature range of  $-73^{\circ}\text{C}$  to  $150^{\circ}\text{C}$ . It adapts to any shape feeding stick and can adjust to fit any size package.

It can handle 4200 parts/hour with zero test time and is compatible with all testers. With few moving parts, it is highly reliable. For easy handling of your packages, contact:



**DIACON, INC.**

4812 Kearny Mesa Road  
 San Diego, California 92111  
 (714) 279-6992

## New products/materials

A room-temperature curing adhesive will bond ceramics, metals, glass, and electric components at temperatures to  $2,500^{\circ}\text{F}$ . Called 918 ceramic adhesive, the material offers high-temperature stability, dielectric strength, mechanical properties, and

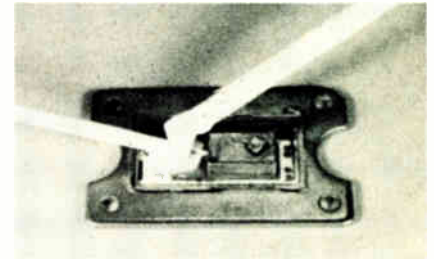

resistance to thermal shock. It is also resistant to molten metals, oxidizing, and reduced atmospheres. Applications include assembly, bonding, insulating, potting, coating and sealing. A trial quart costs \$15.

Cotronics Corp., 37 W. 39th St., New York, N. Y. 10018 [476]

A single-component zirconia-base ceramic coating for use at high temperatures can be applied to a wide range of materials, including ceramics, glass, graphite and quartz. Ultra-Temp 516 comes as a premixed paste that forms a hard, dense coating after being cured at  $500^{\circ}\text{F}$  for two hours. It will resist temperatures up to  $4,400^{\circ}\text{F}$ , and it is a good dielectric with resistivity to  $10^{14}$  ohm-cm and strength to 250 v/mil. Price is \$66 per pint, \$110 per quart.

Aremco Products Inc., Box 429, Ossining, N. Y. 10562 [477]

Eccocoat CC-4 and 258 are electrically conductive coatings that are especially effective on surfaces subject to flexing and stretching. Silver-filled Eccocoat CC-4 produces surface resistances of 0.050 ohms per square inch by 1 mil thick, useful for applications in rf shielding, radar-reflective surfaces, or in heat sinks. Eccocoat 258 is a carbon-based semiconductor with a resistivity of 100 to 120 ohms per square, depending on the thickness of coats.

Emerson and Cuming Inc., Canton, Mass. 02021 [478]

Scotch brand circuit-protection tape

# Look to Ballantine for scopes



**Portable • Dual Trace • X-Y**

<b>1040A</b>	40 MHz, 5 mV Delayed Sweep Only 27 lbs.	\$1200
<b>1066B</b>	20 MHz, 5 mV	\$745
<b>1010A</b>	10 MHz, 5 mV, Only 15 lbs.	\$495
<b>7050A</b>	Electronic Transient Recorder	\$985



**Ballantine Laboratories, Inc.**  
P.O. Box 97, Boonton, New Jersey 07005  
201-335-0900, TWX 710-987-8380

Circle 229 on reader service card

## flameless 1000° heat

Instant, precise heat for  
1001 uses — shrink  
tubing, desoldering, forming,  
bonding, deburring,  
drying, setting adhesives.  
World's most complete line.  
Models from 200-1000°F.

## you can hold in your hand

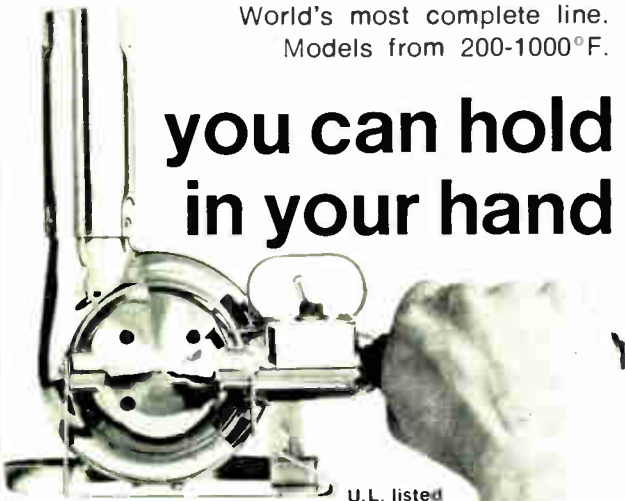

U.L. listed

Send for your free full line catalog page and price list.

**MASTER** appliance corporation  
RACINE, WISCONSIN 53403

In Canada, contact Martin Industrial Sales, P.O. Box 576,  
4445 Harvest Road Burlington, Ontario C1-2

Circle 230 on reader service card

# YEW's POWERFUL FAMILY!



## AC WATTS

And, that's a lot of accuracy, even with low power factors and distorted waveforms. The YEW 2885 is renowned throughout the world as the AC power measuring instrument. YEW's APR-2, on the right is used as a standard by many countries in the world.



## TRUE RMS V-A-W

Accuracy and versatility have generated a reputation for the YEW 2503 True RMS V-A-W instrument that's hard to beat. Distorted waveforms and low power factor hardly phase it at all.



Model 2041

## PORTABLE WATTMETERS

YEW has made more precision analog portables than anyone else in the world . . . and they're usable to 2 KHz and not expensive.

To find out all about YEW's extensive family of power instrumentation, just write or call. We'll be happy to prove why we're #1 in power.

**YEW**

**YEWTEC CORPORATION**

1995 Palmer Avenue  
Larchmont, N.Y. 10538  
Telephone: 914-834-3550

© Yokogawa Electric

60 Years of Measuring and Recording Instrumentation

Circle 185 on reader service card

185

# DIP-ALARM<sup>TM</sup>

Unique, miniature solid state sound device with unlimited applications



- Plugs into DIP sockets or PC boards • Rugged, reliable, loud • Models for 3, 5, and 12 VDC, 35 mA
- Dependable solid state construction means no mechanical contacts, arcing or RF noise. • 76 dB at 400 Hz tone radiates in all directions for positive alarm, warning, fault detection • Use in conjunction with DIP-FLASH<sup>TM</sup> for pulsing operation.



projects<sup>®</sup>  
unlimited

3680 Wyse Road  
Dayton, Ohio 45414  
Tel. 513-890-1918  
TWX 810-450-2523

IN EUROPE  
projects unlimited/  
Europe B.P. 15:  
6100 Mont Sur  
Marchienne  
Belgium; Telex 51-390  
Tel (071) 36.84.86

D.I.A.L. 800-645-9200 for the name of your nearest representative.  
In New York call 516-294-0990 collect.

Circle 186 on reader service card

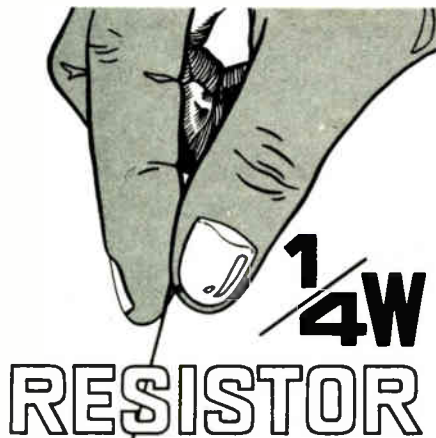

FIXED COMPOSITION  
FIXED CARBON FILM  
SEMI-FIXED (1/8W)

**TAIYO** DENKI  
CO., LTD.

225-3, 7-cho, Nakamachi, Ohtori, Sakai City,  
Japan 593 Phone: 0722 (62) 8281

## Cost Cutter



**New Electronics Buyers' Guide...**  
Easy-to-use, single volume  
source for:

- Data on over 4,000 products
- Over 6,000 company listings and phone numbers
- **EBG EXCLUSIVE:** quick access to over 800 catalogs through a Direct Inquiry Service.

The international world of electronics at your fingertips. Find suppliers... fast... accurately... and locally! For your copy send \$15.00 (USA and Canada only; elsewhere send \$25.00) to address shown below.

## Electronics Buyers' Guide

A McGraw-Hill Publication  
1221 Ave. of the Americas, New York, N.Y. 10020

## New products/materials

1290 is a polyester-backed tape coated with a pressure-sensitive adhesive. Designed for use with 1280 mask line-resolution tape, tape 1290 is resistant to plating and stripping-bath chemicals and protects the section of a pc board beyond the mask line during total immersion. The material also protects boards from damage caused by corrosive chemicals and from plating fumes. Tape 1290, available in 72- and 144-yard rolls, can be cut to any width.

3M Company, Dept. EP4-8, Box 33686, St. Paul, Minn. 55101 [479]

A **silicone elastomer** contains individual, nonconnective, uniformly dispersed, convoluted wires to seal and shield electronic enclosures. Called Elastomet, the material eliminates moisture channels, since each wire, except for its contact points, is entirely surrounded by silicone rubber. There are approximately 900 wire-contact points per square inch of contact surface. Elastomet is available in sponge or solid silicone in strip form and in sheets. Prices start at 25 cents per foot in quantity.

Tecknit, 129 Dermody St., Cranford, N. J. 07016 [480]

A **new chemical etchant** for the manufacture of gallium-phosphide light-emitting diodes offers controlled etching to produce the mesa structure required for LED devices and for LED separation. The etchant is stable and nontoxic, and it does not attack metalizations or SiO<sub>2</sub> silica masks. It is compatible with beam-lead technology and exhibits a high etch rate for all types of crystal. Price is \$25 per gallon.

Transene Company Inc., Route 1, Rowley, Mass. 01969 [409]

A **resin for encapsulation** of electronic devices is designed to retain electrical properties during prolonged continuous exposure to high-temperature environments and excessive moisture. Plaskon Epiall MX-2342 has a low ionic contamination level, good shelf stability, and batch-to-batch uniformity.

Plastics Division, Allied Chemical Corp., 2829 Glendale Ave., Toledo, Ohio 43614 [410]



# These power semiconductor cooling ideas could get you out of a hot spot.

No. 12 of a Series

Semiconductor control of power means lots of heat generation in the semiconductor device. If the inherent power handling and switching capabilities of the device are to be taken advantage of, you've got to get rid

of that heat. But in power applications, the capabilities of discrete dissipators relying on natural convection or unchanneled air movement are soon outstripped. Here are some innovative ways power circuit de-

signers have used IERC liquid-cooled heat sinks, IERC heat dissipators in channeled air environments, and IERC heat dissipators in IERC forced air packages to get themselves out of big-power hot spots.

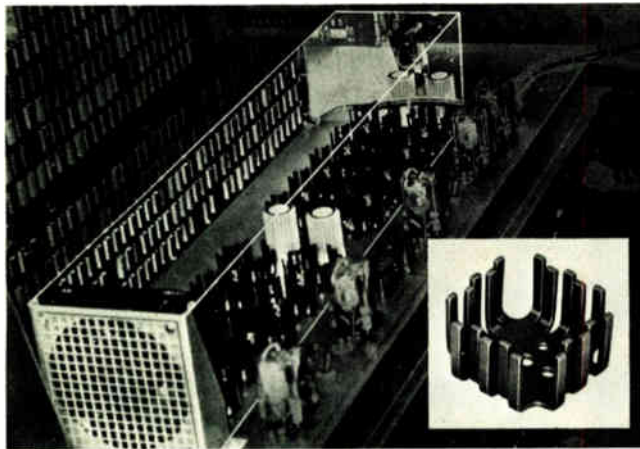

**X-Y plotter designer** put all his hot TO-3 power transistors in one basket to cope with heat problem. Utilizing existing chassis, he mounted devices in UP dissipators, wrapped a shroud around the assembly, and installed a blower. The UP's staggered fingers create turbulence in air stream for maximum efficiency of both the dissipator and air flow, and allowed the designer to meet his design goal of 80°C case rise maximum. He also had room within the shroud to cool his hot resistors.

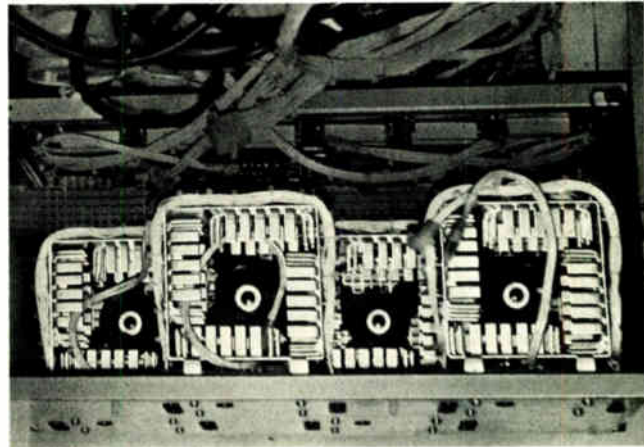

**Dissipate 1280 watts in 530 cubic inches** was the word given to designer of this power supply so he turned to our FAHP4 forced air packages. It took 4 units to do the job at a cost of \$26 (\$6.50 each/1000 pc qty.) plus \$40 for the fans. Average case rise of the 16 transistors was only 75°C.

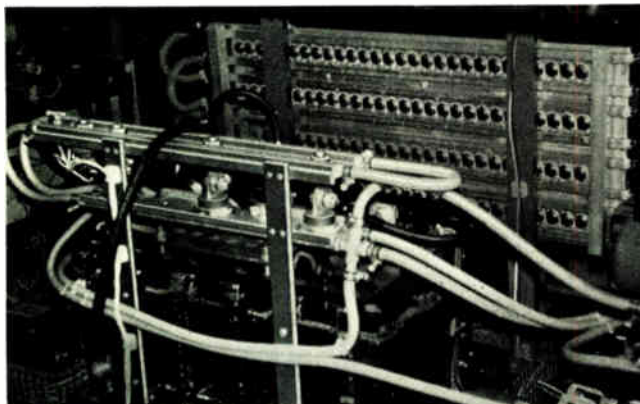

**6000 watts of heat** produced by 125 TO-3 case transistors in an industrial welding machine power supply was raw-power problem solved by IERC E4 liquid cooled sinks. Designer brazed together four standard E4's cut to 36 inches in length and tier stacked two other E4's to cool high power SCR's. Total area of heat sinks used only a fraction of the space required for a blower-cooled system of similar capacity.

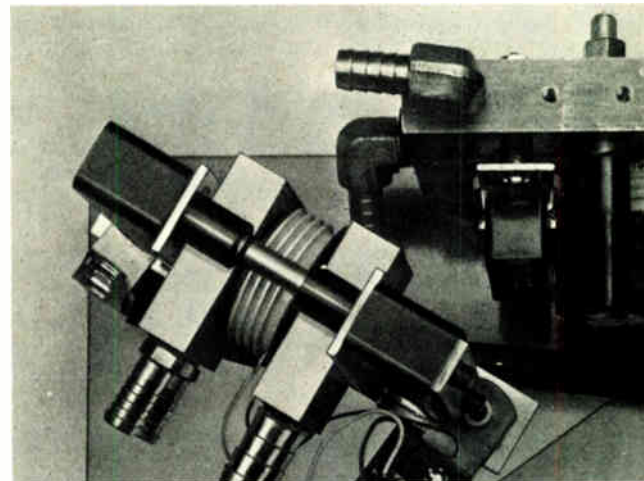

**Fork-lift truck speed control** used SCR's in hocky puck packages to handle thousands of watts in drive power. Big heat problem was solved with IERC liquid-cooled, double-side heat exchangers specially designed to let these big pressure-mount semiconductors dissipate on the order of 1000 watts each with just a 20°C case rise above ambient. Where did the designer get the coolant? He routed vehicle hydraulic fluid through the heat exchangers.



#### For more information

on heat sinks and dissipators for milliwatts to kilowatts, send for the IERC Short Form Catalog today. It covers the most complete line of thermal problem solving devices available anywhere.

# IERC



## Heat Sinks/Dissipators

INTERNATIONAL ELECTRONIC RESEARCH CORPORATION / A SUBSIDIARY OF DYNAMICS CORPORATION OF AMERICA / 135 WEST MAGNOLIA AVENUE, BURBANK, CALIFORNIA 91502

# A BETTER METER.

Data Precision's newest multimeter — the 5½ digit MODEL 3500 — is a second generation instrument that combines the best of both worlds.

More features.  
For less money.

MODEL 3500 incorporates all of the proven circuitry advances that made our 2500 Series the internationally accepted price/performance leader.

Tri-phasic™ auto-zero, Ratiohm™ 2- and 4-wire resistance, and Isopolar™ high stability referencing.

With a 6 month basic DC accuracy of ±0.007% of reading ±0.001% of full scale ±1 LSD, full autoranging from 1 microvolt to 1000V (DC or AC peak) and 1 milliohm through 12 megohms resistance, 20% overranging, DC Ratio, isolated BCD output, remote triggering and remote ranging, it represents the most sophisticated lab-quality multimeter you can buy for less than \$1000.

**\$995.**  
complete

MODEL 3500 features the industry's most reliable, field proven circuit technology packaged behind a big, bright and easy-to-read ½ inch planar gaseous display. And none of the bugs of an unproven design.

MODEL 3500 measures DCV, 1 microvolt to 1000 Volts; ACV, 1 microvolt to 700V RMS, 30 Hz to 100KHz; Resistance, 1 milliohm to 12 megohms; and Ratio.

## AVAILABLE NOW

Contact your local Data Precision representative to arrange for a demonstration.

AL	(205) 533-5896	MA	(617) 273-0198	NY	(S) (516) 482-3500
AZ	(602) 994-9519	MD	(301) 792-8661	OH	(N) (216) 725-4560
CA (N)	(408) 733-9000	MI	(313) 482-1229	OH	(S) (513) 885-4171
CA (S)	(714) 540-7160	MN	(612) 781-1611	OR	(503) 238-0001
CO	(303) 449-5294	MO (W)	(816) 737-0066	TX	(N) (214) 234-4137
CT	(203) 525-7647	MO (E)	(314) 731-2331	TX	(S) (713) 461-4487
FL	(813) 294-5815	NC	(919) 787-5818	UT	(801) 268-3181
GA	(404) 457-7117	NJ (S)	(215) 925-8711	WA	(206) 763-2210
HI	(808) 262-6286	NJ (N)	(201) 863-5660	CAN (W)	(416) 787-1208
IL	(312) 593-0282	NM	(505) 265-6471	CAN (W)	(613) 772-5874
IN	(317) 293-9827	NY (N)	(315) 446-0220	CAN (E)	(514) 731-9328

Data Precision Corporation  
Audubon Road, Wakefield, MA 01880  
(617) 246-1600

 **DATA PRECISION**  
...years ahead



Visit us at WESCON Booth #2705-6  
Circle 188 on reader service card

# The Screaming Yellow Zonker from Watertown.

From deep within the bowels of C&K's production facilities in Watertown, Massachusetts, you can hear the fiendish sound. An unearthly whir. A subliminal roar and a ceaseless *zip, zap, zonk!* It's the sound of C&K's mammoth *switchamajig*. It looks like a reincarnated stone age monster. But it's really a 20th Century miracle worker. It's over 20 feet long, weighs over 8 tons, and is yellow in color—crude bulldozer yellow. With its many protruding tenacle-like air hoses, it looks like Jules Verne's Thing that came from beneath the sea. In reality, it's the world's most sophisticated subminiature switch assembly unit. Into one end goes the various bits and pieces which make up a switch—then, *zip, zap, zonk*—out the other end comes the fully-assembled switch . . . in perfect form.

Our screaming yellow zonker is one reason why C&K is the world's leading manufacturer of electrical switching devices. Once you get to know it, it is a lovable beast.

**C&K Components, Inc.**, 103 Morse Street, Watertown, MA 02172  
Tel: (617) 926-0800, TWX: 710-327-0460

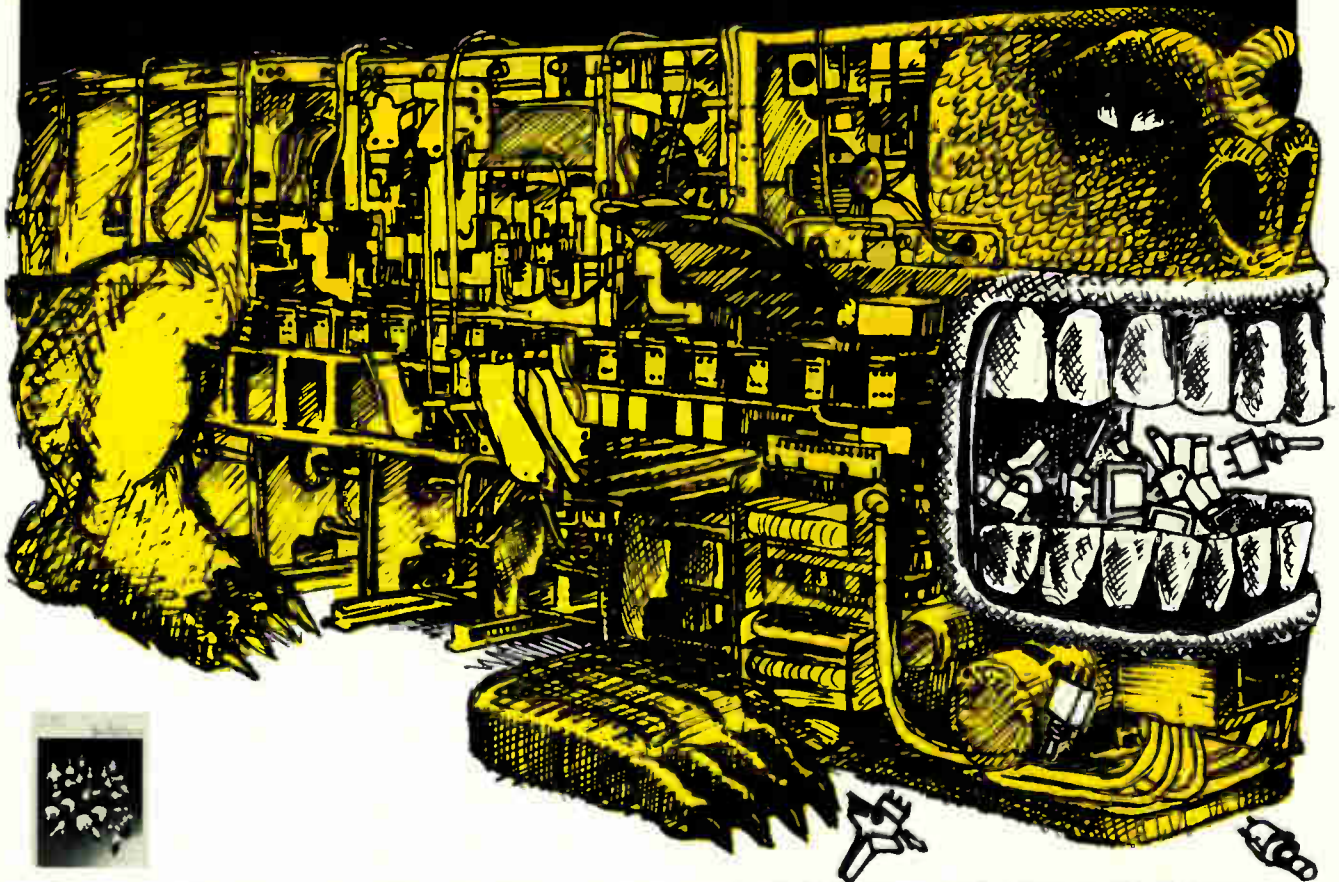

**P.S.** The Screaming Yellow Zonker makes a whole bunch of subminiature switches—toggle, rocker, paddle handle, pushbutton and others—which can be found in C&K's 12-page catalog. Get one quick and see all of the interesting and useful small, super switches that can come out of a zip, zap, zonk!

# THE NO-FUSS VOLTAGE REFERENCE THAT RUNS OFF 5 VOLTS.

The Analog Devices AD580. Two bucks.

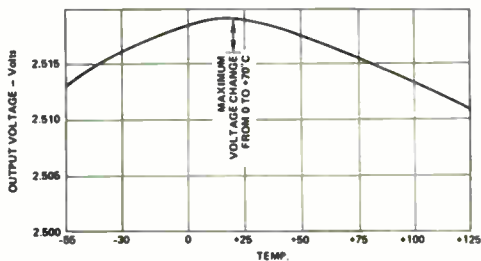

It's a three terminal, bandgap voltage reference that you just plug in—no external components. And it's the only one that works from the same power supply as your logic system—5 volts.

You get a fixed 2.5 volt output for inputs between

4.5 volts and 30 volts. With stability over temperature of 40ppm/°C, and over time of 25μV/month. Or 250μV forever.

The AD580 is an ideal external reference for 8 and 10 bit converters for digital panel meters and any low-power applications.

\$2.00 in hundreds. TO52 package or chip.

Call or write for our data sheet.

Analog Devices Semiconductor. Norwood, Mass. 02062.

East: (617) 329-4700; Midwest: (312) 297-8710;

West: (213) 595-1783.



 **ANALOG  
DEVICES**

Circle 190 on reader service card

## The Quick Way

New Electronics  
Buyers' Guide  
Easy-to-use, single  
volume source for:

- Information on 4,000 products
- Over 6,000 company listings and phone numbers
- **EBG EXCLUSIVE:** quick access to over 800 catalogs through a Direct Inquiry Service

Here is the international world of electronics at your fingertips. Find suppliers . . . fast . . . accurately . . . and locally! If you don't have your own copy, send \$15.00 (USA and Canada only; elsewhere send \$25.00) to address shown below.

## Electronics Buyers' Guide

A McGraw-Hill Publication • 1221 Ave. of the Americas • New York, N.Y. 10020



## New literature

**Digital indicators.** Nationwide Electronic Systems, 1536 Brandy Pkwy., Streamwood, Ill. An eight-page

**Slimline meters  
digital indicators by NES,  
building blocks  
for your  
systems**



catalog details the Slimline series of digital panel instruments, which are only 9/16-inch thick. Circle 421 on reader service card.

**Sensors.** Proximity switches are described in a brochure from Industrial Solid State Controls Inc. 435 W. Philadelphia St., York, Pa. 17405. Specifications and applications are given for the switches, many of which are compatible with standard logic systems. [422]

**Meter-controller.** Nova Tran Corp., 360 4th St., Clear Lake, Wis. 54005, has published a catalog sheet on the AMC 6000 precision ampere-time meter and controller for electroplating operations. [423]

**Converters.** Analogic Corp., Audubon Dr., Wakefield, Mass. 01880. An eight-page primer outlines a basic approach to avoiding common errors in specifying analog-to-digital converters. [424]

**Filters.** Catalogs listing a variety of interference filters for the visual and infrared portions of the spectrum are available from Optical Coating Laboratory Inc., Technical Products Division, Box 1599, Santa Rosa, Calif. 95403 [425]

**Inductors.** JDN Electronics, 239



# INTERNATIONAL TELECOMMUNICATION UNION (ITU)

147 Member countries. Headquarters of the permanent ITU Organs: General Secretariat, CCITT, CCIR, IFRB at Place des Nations, CH 1211 Geneva 20, Switzerland.

# TELECOM 75

2-8 oct. 1975 Geneva, Switzerland  
On the occasion of its International Broadcasting Conference:

## 2nd World Telecommunication Exhibition and World Telecommunication Forum

The World Market for equipment, systems and products. Electronics, broadcasting, telecommunications, data communication specialists and buyers meet for summit discussions.

Intergovernmental/industrial cooperation in CCIR; CCITT; national and international telecommunication networks; sound and television broadcasting; CATV; audio-visual techniques; fixed and mobile radio-communication services; space communications and research; antennae; telephony; telegraphy; data communication; electronics industry.

### Press comments on TELECOM 71 Geneva, June 1971

... A unique chance for systems suppliers *Australian Financial Review, Sydney*; ... Wide array of new hardware *Electronics International, New York*; ... The quality of the exhibits was extremely high ... sure indication of the competition that companies face in selling telecommunication systems *Canadian Electronics Engineering*; ... Proved itself necessary to the communications business *Electronics Actualités, Paris*; ... Japan has participated with her up-to-date technology *Look Japan, Tokyo*; ... A unique opportunity for on-the-spot comparisons which would be difficult to make without numerous trips abroad *Le Monde Diplomatique, Paris*; ... The biggest technical show ever held *The Vietnam Guardian, Saigon*; ... Enormous success *Ya, Madrid*; ... Attracted participants from all over the world ... high degree of competition *IEE News, London*; ... 400 million television viewers saw *TELECOM 71 Diario de Noticias, Lisbon*; ... Great success *Zolnierz Wolnosci, Warsaw*; ... The world as an electronic village *The Times, London*; ... Giant show ... has tremendous potential for improving information exchange ... the exhibitors well satisfied: "We are looking forward to seeing you next time" *Telephony, Chicago*.



### IMPORTANT Please return NOW

TELECOM-75 Secretariat, ORGEXPO,  
CH 1211 Geneva 4, PB 65, SWITZERLAND  
(Phone: 22-21 95 33 Telex: Pallex 22784)

Please rush TELECOM-75 exhibitor application form/visitor information to:  
(Please type or print the entries in this form)

Company/organization: .....

Person and function: .....

Address: .....

Telephone/Telex: .....

Remarks: .....

Electrical/Computer Engineers:  
**Digital Design in R & D Lab**  
 Computer Hardware/Interfaces/Peripherals

BS/MS degree in Electrical/Computer Engineering? One or more years of experience designing interface equipment? Join us NOW and design digital computer hardware, interfaces, peripheral devices and other related equipment in our Ann Arbor laboratories.

Familiarity should include assembly language programs; data transmission methods and conventions; analog signal conditioning techniques (A/D, D/A converters); and microprocessors (Intel). The design of interface equipment linking scientific analytical instruments to scientific computers, as well as the writing of test programs and computer diagnostics, would be your primary responsibilities.

We believe you would enjoy the working atmosphere of our new, well-equipped R&D facility—and our compensation-benefits package is outstanding. Send your resume and salary history in complete confidence today.

**PARKE-DAVIS**

David Misner; Personnel Representative  
 Research Laboratories  
**PARKE, DAVIS & COMPANY**  
 2800 Plymouth Road  
 Ann Arbor, Michigan 48106  
*An Equal Opportunity Employer M/F*

**UHF VHF FM**

**TV-FM-HAM 2 m. ANTENNA**  
 NEW ROLLABLE (with perfect color band-width). Just unroll and stick on wall. Uses no masts, no rabbit ears, no dangerous plugging to AC lines, and NO SIGNAL SPLITTERS since the VHF-UHF-FM terminals (VHF usable for 220 MHz FM) available at the same time. (New 1971 slotted design with U.S. Patent S/N 3577196). Made of decorative foil/plastic yet rugged for use in yacht or RV. Optional: Plain burlap or printed etching on burlap of either desert, galaxy or leaved branch. Antenna size: 18" x 48" unrolled, works behind picture, against metal! Price is only \$15 for model with following gain: (VHF = 9 dB), (UHF = 12 dB), (FM = 6 dB); gains above dipole.  
 Order postpaid AIRMAIL, insured, from

**ANTENNA DESIGN CO.**  
 11621 HUGHES AVE., N.E.  
 ALBUQUERQUE, N.M. 87112

CIRCLE 954 ON READER SERVICE CARD

**RADAR SYSTEMS**  
**TRACKING ANTENNA SYSTEMS**

Nike Hercules, Nike Ajax, M-33, MPS-9, SCR-584, TPS-1E, TPS-2B, FPS-6, FPS-14, FPS-18, FPS-75, UPX-6, MPQ-10A, IBM 705 Computers,  
 HUNDREDS MORE. LARGEST INVENTORY OF RADAR AND MICROWAVE EQUIPMENT IN THE WORLD.

**RADIO RESEARCH INSTRUMENT CO.**  
 3 QUINCY ST., NORWALK, CONN. 07031 853-2600

CIRCLE 956 ON READER SERVICE CARD

**free catalog**

**POTTING APPLICATORS**  
 MANUAL OR AIR OPERATED  
 2½cc 6cc 12cc 30cc  
 FOR POTTING, ENCAPSULATING ETC.

**PHILIP FISHMAN CO., INC.**  
 7 CAMERON ST. WELLESLEY, MASS. 02181

CIRCLE 957 ON READER SERVICE CARD

**PROFESSIONAL SERVICES**

**DiCon Associates**  
**DIGITAL SYSTEMS CONSULTANTS**  
 Experts in Micro-Processors  
 Special Purpose Computer Hardware  
 Schematics Only, or Debugged Products  
 P.O. Box 262  
 Huntington Station, N.Y. 11746

**PROFESSIONAL SERVICES**

**Thorough Patent and Trademark Searches** for Professional Engineers and Research & Development Firms. Patent Consultants, 422E Washington Building, Washington, D.C. 20005. (202) 638-1666.

**POSITION VACANT**

**Television Maintenance Technician:** New learning center in suburban New York SUNY branch needs highly-experienced video repair technician to service television studio. Must know VTR maintenance, color circuitry. Salary competitive. P-6036, Electronics.

**SAME DAY SHIPMENT**  
 Minis & Peripherals  
**PRINTERS**  
 "BRAND NEW"

---

**DATA PRODUCTS**

---

**2440— 700 LPM**

---

**2470— 1250 LPM**

---

**MDS 4320— 300 LPM**

---

ALSO  
 CENTRONICS, POTTER, CDC  
 A. B. DICK, IBM, HIS, UNIVAC

*Send for Free Report "Maintenance of Computers"*  
**AMERICAN USED COMPUTER CORP.**  
 P.O. Box 68, Kenmore Sta., Boston, MA 02215  
 member COMPUTER DEALERS ASSOCIATION

CIRCLE 953 ON READER SERVICE CARD

**SOLD!**

"Please discontinue our ad in 'Searchlight' as we have sold the equipment through this advertising." Can "Searchlight" Serve You?

CLASSIFIED ADVERTISING  
**SEARCHLIGHT SECTION**  
 BUSINESS OPPORTUNITIES  
 USED OR SURPLUS EQUIPMENT

**FREE CATALOG**

**HARD-TO-FIND PRECISION TOOLS**  
 Lists more than 2000 items—pliers, bweezers, wire strippers, vacuum systems, relay tools, optical equipment, tool kits and cases. Also includes ten pages of useful "Tool Tips" to aid in tool selection.

**JENSEN TOOLS**  
 4117 N. 44th Street, Phoenix, Ariz. 85018

CIRCLE 951 ON READER SERVICE CARD

**FREE ALARM CATALOG**

Full line of professional burglar and fire alarm systems and supplies. 96 pages, 450 items. Off the shelf delivery, quantity prices.

**mountain west alarm**  
 4215 n. 16th st., phoenix, az. 85016

CIRCLE 952 ON READER SERVICE CARD

Morristown Rd., Gillette, N. J. 07933, is offering a catalog on its four new lines of miniaturized inductors. [426]

**Attenuators.** A 24-page guide on attenuators from Tech Laboratories, Bergen and Edsall Blvds., Palisades Park, N. J. 07650, includes information on potentiometers, decade resistor units, VU meters, multipliers, and ladder attenuators. [427]

**Metal-film resistors.** Sprague Electric Co., North Adams, Mass. 01247, has reprinted a paper presented at the Electronic Components Conference on "The Reliability of Laser-Trimmed Screen-Printed Metal-Film Resistors." It is available as Sprague technical paper TP 74-7. [428]

**Plastic lamps.** An eight-page catalog describing three series of snap-mount plastic lamps is available from Littelfuse Inc., 800 East Northwest Highway, Des Plaines,

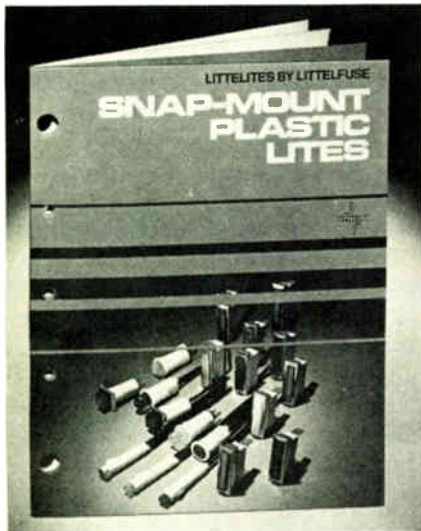

Ill. 60010. The eight-page catalog lists lens styles, housing types and other specifications. [429]

**Coil products.** Endicott Coil Co., 24 Charlotte St., Binghamton, N. Y. 13905. A newsletter, called "Current Windings," describes applications for coil products. [430]

**Thermistors.** An eight-page bulletin describing sizes, types and resistance

## IMC FAN FACTS

### IMC's MINI has a MAXI

When it comes to applications, our Mini-boxer fan can meet a maximum of uses—ranging from the busy ring of the super-market cash register to the soothing melodies of a modern tape deck. Variations of this model include the Ball Bearing, G.P. Sleeve Bearing, Skeleton and Mil Type Miniboxers—all with similar low profile applications. Circle the "Bingo" to get your copy of the Airmover Catalog. For further information please call Fred Taylor, Sales Manager at (603) 332-5300 or write:



50/60 HZ AIRMOVER



3-5/8" Sq. by 1-1/2" deep

## IMC MAGNETICS CORP.

NEW HAMPSHIRE DIVISION

ROUTE 16B, ROCHESTER, NEW HAMPSHIRE 03867

Circle 232 on reader service card

## Select the precision low-noise AC preamplifier that's optimum for the job.

Our 16-page brochure describes the most common factors to be considered in selecting accessory and general purpose preamplifiers. The following areas are covered in detail: • Noise performance • Source impedance characteristics • Output load considerations • Power supply requirements • NASA/AEC/MIL specs (when required) • Environmental considerations.

Product and performance data are provided for precision preamplifiers that provide optimum noise performance with almost any source impedance over the frequency range of 0.01 Hz to 1 MHz. For your free copy of our preamplifier



brochure, circle the reader service number or (for a faster response) fill in the information below and mail this page to: Ithaco Inc., 735 W. Clinton Street, Ithaca, New York 14850. Call 607-272-7640 or TWX 510-255-9307.

Our brochure will help

**ITHACO**

Name	Title		
Company Name	Phone		
Address	City	State	Zip

# Energy Saver



## NEW ELECTRONICS BUYERS' GUIDE . . . EASY-TO-USE, SINGLE VOLUME SOURCE FOR:

- Information on over 4,000 products.
- Over 6,000 company listings and phone numbers — both home and field offices.
- **EBG EXCLUSIVE:** quick access to over 800 helpful catalogs through a timesaving Direct Inquiry service.
- More than 1,400 pages of data.

Here is the international world of electronics at your fingertips. Find suppliers . . . fast . . . accurately . . . and locally! Don't have a copy? Use coupon below, today.

## Electronics Buyers' Guide

A McGraw-Hill Publication  
1221 Ave. of the Americas, New York, N.Y. 10020

Yes, send me \_\_\_\_\_ copies (copy) of the energy saving Electronics Buyers' Guide. I've enclosed \$15.00 (USA and Canada only; elsewhere send \$25.00). Full money back guarantee if not satisfied.

NAME \_\_\_\_\_

COMPANY \_\_\_\_\_

STREET \_\_\_\_\_

CITY \_\_\_\_\_

STATE \_\_\_\_\_ ZIP \_\_\_\_\_

## New literature

values of thermistors has been updated by Keystone Carbon Co., St. Marys, Pa. 15857. Applications and circuit information are given. [431]

**Testers.** Addison Division, Muirhead Inc., 1101 Bristol Rd., Mountainside, N. J. 07092, has published a six-page catalog describing its line of continuity-test instruments, including testers and troubleshooting



equipment for backplanes, harnesses, cable assemblies, and printed-circuit boards. [432]

**Diffusion boats.** Vac-Glass Design, 10 Railroad St., Lawrence, Mass. 01841, has published a catalog that gives data on quartz-diffusion boats. The brochure contains drawings, descriptions, and prices. [433]

**Matched limiter channels.** RHG Electronics Laboratory Inc., 161 East Industry Ct., Deer Park, N.Y. 11729. Two-page application note, designated AP401, discusses dynamic testing of matched limiter channels for monopulse and other applications. [434]

**Cable connections.** A four-page guide from Sigmaform Corp., 2401 Walsh Ave., Santa Clara, Calif. 95050, describes matching heat-shrinkable tubing to CATV cable connections, terminations, and splices. [436]

**Storage systems.** Diva Inc., 607 In-



# "We Design Great Instruments"

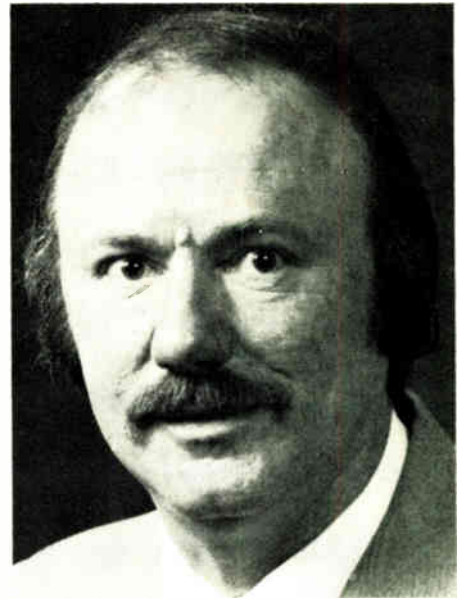

**Jim Luksch, Executive Vice President**  
 Texscan Corporation, 2446 North Shadeland  
 Indianapolis, Indiana 46219 • Ph 317-357-8781  
 TWX 810-341-3184, Telex 272110

Texscan is the world leader in its field. But we've found we may have grown complacent in telling you why.

Here briefly is just one comparison of our product versus competition.

The Wavetek 1801A and the Texscan WB-711 Sweep Generators are almost identical in specs. However, the Wavetek has 688 parts, Texscan 331. The Wavetek cost \$1245. Texscan \$870.

Take a look at the chart below. Fortunately for us, unfortunately for them; it's only one of many examples:

	WAVETEK 1801A	TEXSCAN WB-711
Transistors	88	28
Resistors, Diodes, Capacitors and Inductors	598	294
IC's	2	9
Total Parts	688	331
Price	\$1245	\$870

	Freq. Range	Pwr. Output	Dis-tortion	Flat-ness	Sweep Width	Sweep Rate	Linearity
Wavetek 1801A	1-500 MHz	0.7V RMS	-30 dB*	±0.35 dB	0.2-500 MHz	.01-50 Hz	2%
Texscan WB-711	1-500 MHz	0.7V RMS	-30 dB	±0.25 dB	0.1-500 MHz	0.5-60 Hz	2%

\*typically

**Texscan**  
 THE WORLD LEADER AND  
 COMING ON EVEN STRONGER.

U. S. Sales Offices: Albuquerque 505-298-2575, Bayside (N.Y.) 212-423-7330, Binghamton (N.Y.) 607-748-0509, Blue Bell (Pa.) 215-542-1490, Cedar Rapids 319-363-2489, Cleveland 216-243-8430, Dallas 214-363-5291, Dayton 513-885-4171, Depew (N.Y.) 716-685-4111, Detroit 313-482-1229, Dover (N.J.) 201-366-7518, Hamden (Conn.) 203-288-5246, Hazelwood (Mo.) 314-731-5200, Hazlet (N.J.) 201-264-1851, Honolulu 808-941-1574, Huntsville (Ala.) 205-837-1601, Independence 816-737-1414, Indianapolis 317-257-7231, Los Angeles 213-478-1586, Mt. Penn (Pa.) 215-672-5565, Northbrook (Ill.) 312-882-7140, Orlando 305-859-2160, Palo Alto 415-494-3331, Seattle 206-763-2233, Syracuse 315-454-9314, Ulster Park (N.Y.) 518-372-6649, Winston-Salem 919-722-9671, Waban (Mass.) 617-969-3372, Wheaton (Md.) 301-942-9420. Canadian Sales Offices: Downsview 416-638-0218, Halifax 902-455-0670, Montreal 514-735-4565, Ottawa 613-728-4624, Vancouver 604-732-7317, Winnipeg 204-475-1732. OVERSEAS OFFICES: U K 04427-71138 WGermany0811/695421

# IEE-ELECTRA

## SUBMINIATURE INCANDESCENT LAMPS

- All standard sizes, T 3/4 through T 1 3/4, including NEW T1, 28V
- Choice of wire terminal, screw base, bi-pin, midget flange, sub-midget flange, special midget flange, and midget groove base configurations
- Broad electrical range: 4 to 28 volts; .014 to .2 amps of current; .02 to .6 MSCP
- Special lamps available to customer specifications: special leads; directionally reflectorized; customized filament selection
- Hand-crafted for accurate filament location and superior mechanical characteristics; machined bases for precision fit
- Handblown, seamless and tipless, glass envelope for absolute clarity
- Controlled aging (24 to 36 hours) at rated voltages for filament stabilization and elimination of random failures



IEE is the ONLY source for quality aged and selected lamps AT COMPETITIVE PRICES.

For your every man/machine interface requirement, IEE has a solution. From "the Olympus of Displays," the world's most diversified selection of display products, technologies, and design expertise, IEE offers you your choice of:

- Multiple Message Displays — rear projection; status indicator/annunciators; mini-CRT's
- Dynamic Message Displays — 64 & 256 character dot matrix panels
- Numeric & A/N Displays — line filament; neon; transilluminated;

LED's (with integrated electronics); liquid crystals; gas discharge; fibre-optics

- Subminiature Lamps — LED & incandescent
- Low Profile Switches — completely sealed, illuminated, custom arrays
- Peripheral Accessories — universal mounting hardware; bezels; interface circuitry
- Customized Products & Multi-Function Systems. Never has so much been available to so many from a single source. Hadn't you better write or call today for your copy of IEE's Product Selector?



# the Olympus of displays

Industrial Electronics Engineers, Inc.  
7740 Lemona Ave., Van Nuys, Calif. 91405  
Phone: (213) 787-0311 TWX 910-495-1707

European Office: 6707 Schifferstadt, Eichendorff-Allee 19, Germany.

**DIAL-A-SOURCE: Call toll-free 800-645-9200**  
Circle 196 on reader service card

## New literature

**Industrial Way West**, Eatontown, N. J. 07724. A catalog containing descriptions of a line of magnetic mass-memory systems for minicomputers covers disk drives, floppy disks, and tape systems. [437]

**Modular connectors**. A 16-page catalog describing a modular-connector line using the Hypertac contact design has been released by Hypertronics Corp., 154 Great Rd., Stow, Mass. 01775 [435]

**Interactive terminal**. Termiflex Corp., Box 1123, 17 Airport Rd., Nashua, N. H. 03060, has published a four-page brochure describing some of the inquiry/response applications for the company's hand-held interactive terminal. [438]

**Resistor networks**. A 12-page catalog describing both custom and standard single in-line and dual in-line cermet-resistor networks is offered by CTS Berne Inc., 406 Parr Rd., Berne, Ind. 46711 [439]

**Switch**. A linear slide-selector switch is described in a data sheet from Sonitronic Inc., 32-02 Linden Pl., Flushing, N. Y. 11354. The sheet includes illustrations, specifications, and applications. [440]

**Ferrite components**. Indiana General, 405 Elm St., Valparaiso, Ind. 46383. Catalog 208 describes the company's line of Ferramic components and materials, which include toroids, baluns, E cores, and antenna rods. The first section of the brochure is arranged by application, and the second covers ferrite materials, shapes, and sizes. [401]

**Sockets**. A 16-page catalog giving information on insulated and non-insulated sockets has been published by Sealectro Corp., Mamaroneck, N. Y. 10543. Also listed are the company's Rivet-Loc designs, resistor jacks, and test-point sockets, designed to military specifications. [402]

**Thermocouple wires**. A 24-page catalog describing a line of insulated thermocouple wires, including duplex wires and multipair cable is available from Noral Inc., 23600 Mercantile Rd., Beachwood Commerce Park, Cleveland, Ohio 44122 [403]

**Thermocouples**. Barber-Colman Co. Industrial Instruments Division, 1304 Rock St., Rockford, Ill. 61101. A bulletin on thermocouples and their applications includes information on proper calibration and limits of error, a temperature-conversion guide and tables on pipe, conduit, and wire considerations. [404]

**Digital analyzer**. Macrodata Corp., 6203 Variel Ave., Woodland Hills, Calif. 91364, has published an eight-page illustrated brochure that describes the MD-107 memory/digital logic analyzer, which tests all classes and sizes of digital logic and memory, from chips to systems. [405]

# IEE·MIDAS

## ILLUMINATED MEMBRANE SWITCHES

- Environmentally sealed, transparent mylar membranes
- Extremely lightweight, "wafer-thin," profile — front & rear of panel
- Long life: 1,000,000 cycle life-rated
- No mechanical linkage, springs or buttons
- Quiet, positive, fingertip pressure (4-9 oz.), single pole/single throw, momentary contact switching
- Lowest cost per switch for high density switch requirements
- Optional matrix design (customized or standard), such as 1x8, 3x4, 2x3, 5x6, 7x8, 10x10, etc.
- Displays any graphic data reproducible on film; optional color

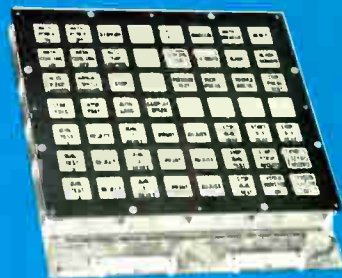

## SPENDING 2 HOURS A DAY BREADBOARDING?

### You could be wasting money!

That's right! If you start using E&L products, you'll save  $\frac{2}{3}$  the time and money you spend using conventional equipment. This time/cost savings means you can amortize sophisticated E&L instrumentation like the Elite 2 (\$1395) in less than 4 months.

Need something a bit less sophisticated? E&L also offers a complete line of less expensive breadboarding instruments to fit your specific requirements.

Write today for our free catalog.



**E&L INSTRUMENTS, INCORPORATED**  
61 First Street, Derby, Conn. 06418 • Phone (203) 735-8774  
See us at Wescon booths 2810 & 2811

Circle 233 on reader service card

From the very beginnings of information display, IEE has been a leader in the innovative design, successful introduction, reliable manufacture, condensed packaging, and effective application of high quality, display devices and integrated systems for commercial, industrial and military use. Based on two decades of experience, and a dedication to quality, IEE today offers:

- the world's most diversified selection of display products
- the design, human factors, and

systems integration expertise to fulfill your most sophisticated requirements.

- the pricing, product availability, and productive capacity to meet your most demanding schedules

- and the ingenuity and sincere desire to help solve your most complex display problems. Information Display is OUR business; why not contact the experts for YOUR solutions?

Call or write today for information regarding introductory offers on prototype evaluation quantities of many of IEE's display products.



## the Olympus of displays

Industrial Electronics  
Engineers, Inc.  
7740 Lemona Ave., Van Nuys, Calif. 91405  
Phone: (213) 787-0311

European Office: 6707 Schifferstadt, Eichendorff-Allee 19, Germany.

**DIAL-A-SOURCE: Call toll-free 800-645-9200**

Circle 197 on reader service card

**This  
Green  
Light  
Says,**

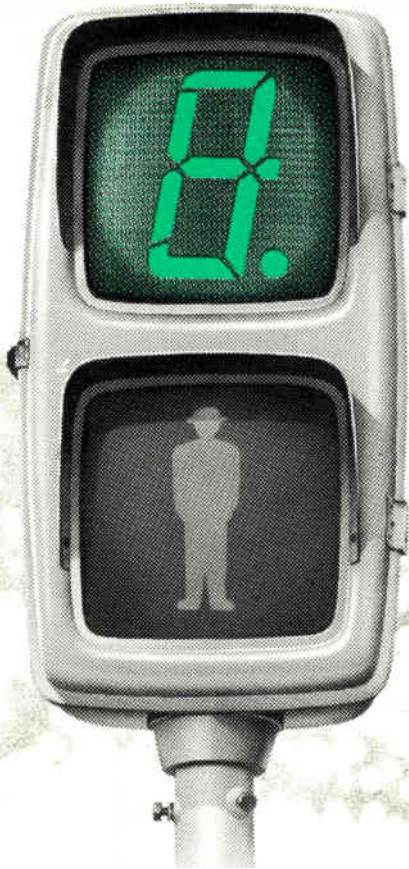

**“Go ahead  
with  
slim trim  
display  
equipment  
ideas.”**



Multi-Digit Display with nine, eleven or thirteen digits. Or the FG type Multi-Digit Display with nine or twelve digits.

Go ahead because Ise lights your way to smaller, snappier equipment with a new wafer-thin multi-digit display. Then in addition to lighting the way, gives you a choice of two displays to work with. The DP-AS

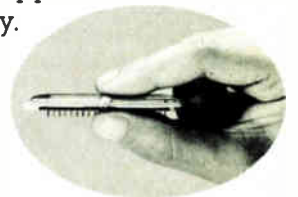

Digits on <FG> models measure a mini 5mm high to help you be as small in your thinking as you want. Both new displays are glass-enclosed all around. And have easy-mounting pin connectors. But mounting isn't the only thing that comes easy with these trimmed-down displays. Reading the indication they give comes easy, also. Because Ise keeps with the past. Gives these new multi-displays the same eye-easy green glow and planer construction that make their forerunners so popular. In addition, they also give you low-voltage advantages for direct LSI drive.



If you've been holding back on a headful of ideas simply because the right multi-digit display wasn't available, it's time to stop.

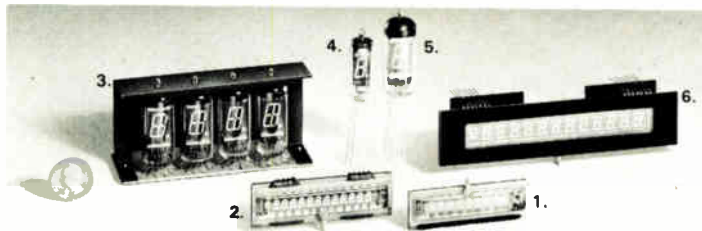

1. FG95A (NEW)
2. FG125A2 (NEW)
3. DMCL12H
4. DG12H1
5. DG19E1
6. DP128AS (NEW)

**The Brighter Side of Electronics**



*Creator of Fluorescent Digital Display:*

**ISE ELECTRONICS CORP.** P.O. Box 46 Ise-city, Mie Pref., Japan  
Tel: (05963) 5-2121 Telex: 4969523

**ISE INTERNATIONAL CORP.** 2-7-7, Higashi-Shinbashi, Minato-ku, Tokyo, Japan  
Sales & Technical Office: Tel: 433-6616~9 Telex: J26546 Cables: "ISEWORLDREP" TOKYO

**ISE CORP. OF AMERICA** 1472 West 178th Street, Gardena, Calif., 90248 U.S.A.  
Tel: (213) 532-0470 Telex: 230674910

Representative: Paris, Munich, Amsterdam, Stockholm, Vienna, Milan, Bombay, Hong Kong, Taipei.

# Electronics advertisers

August 22, 1974

■ <b>ACDC Electronics, Inc.</b> Rose Associates Advertising & Public	171	<b>Cramer Division of Conrac</b> McCarthy, Scelba, DeBiasi	40	■ <b>Hewlett-Packard</b> Phillips Ramsey Advertising & Public Relations	135
• <b>Advanced Micro Devices</b> Keye Donna Pearlstein	6E	<b>CTS Corporation</b> Reincke, Meyer & Finn, Inc.	167	<b>Hughes Aircraft Company</b> Foote, Cone & Belding	35
<b>Advanced Micro Devices</b> Keye Donna Pearlstein	10-11	■ <b>Dana Laboratories</b> Dailey & Associates	150A-150B	■ <b>IMC Magnetic Corp.</b> Monad Advertising Design	168,193
■ <b>Alpax Electronics</b> Welch, Mirabile & Co., Inc.	48	■ <b>Dale Electronics, Inc., A Sub. of the Lionel Corporation</b> Swanson, Sinkey, Ellis, Inc. Advertising	4th Cover	<b>Individualized Instructions, Inc.</b> Jordan Associates Advertising	142
<b>Allen Bradley Company</b> Hoffman, York, Baker & Johnson Inc.	24	<b>Data General Corporation</b> Scali, McCabe, Sloves, Inc.	118-119	<b>Industrial Electronic Engineers</b> Olympus Agency	196-197
<b>American Optical Corp. Fiber Optics &amp; Industrial Prod. Div.</b> Wilson, Haight & Welch, Inc., Advertising	174	■ <b>Data Precision</b> Allied Advertising Agency, Inc.	188	<b>Intel Corp.</b> Regis McKenna, Inc.	18-19
<b>American Smelting and Refining Company</b> Clyne Maxon, Inc.	138	■ <b>Datel Systems, Inc.</b> John Donland Advertising	3rd Cover	<b>International Electronic Research Corp.</b> McCarron, Kane, Inc.	187
<b>AMF/Potter &amp; Brumfield Division</b> Fuller & Smith & Ross, Inc.	66&67	<b>Diacon</b> Rogondino Advertising and Marketing	184	■ <b>Interata Electronics Corp.</b> Chris Art Studio, Inc.	21
■ <b>AMP Incorporated</b> Aitkin-Kynett Co., Inc.	178-179	■ <b>Dialight Corporation</b> Michel-Cather, Inc.	2nd Cover	<b>IPT Corporation</b> Rock Advertising Design	20
■ <b>Analog Devices Inc.</b> Schneider Parker, Inc.	190	‡ <b>Digital Equipment Cor. —Components Group</b> Schneider Parker, Inc.	D1-D12	<b>Iee Electronics Corp.</b> Shinwa International, Inc.	198
<b>Analog Corporation</b> Sommer Agency, Inc.	100	<b>Eastman Kodak Co.— GMD GD Photolabration Microelectronics</b> Rumrill-Hoyt, Inc.	157	• <b>Ieola</b> Werbstudio Equipe	6E
<b>Anslay Electronics Corp.</b> S. Michelson Advertising	174	• <b>Ebauchee SA</b>	8E	■ <b>Ithaco, Inc.</b> Webb & Athey, Inc.	193
■ <b>APM-Hexaal</b> The Sommer Agency, Inc.	176	<b>EECO</b> The Greer Agency	115	■ <b>Johnson Company, E.F.</b> Martin Williams Advertising	156
<b>Atlan-Tol Industries, Inc. —AM-MET Division</b> Michael London Associates	141	<b>E-H Research Laboratories, Inc.</b> Hal Lawrence, Inc.	113	<b>Kelthley Instruments, Inc.</b> Chagrin Valley Marketing Associates	155
<b>Ballantine Laboratories, Inc.</b> MLF Graphics	185	■ <b>EL Instruments, Inc.</b> Langeler-Stevens, Incorporated	197	• <b>Kistler Instruments AG</b> Atelier für Werbung	7E
‡ <b>Beckman Instruments, Inc., Hellpot Div.</b> N.W. Ayer/Jorgensen/MacDonald, Inc.	169	■ <b>Electronic Navigation Industries</b> Hart/Conway Advertising—Public Relations	14	<b>Krohn-Hite Corp.</b> Impact Advertising, Inc.	5
<b>Billley Electric Company</b> Barber/Drullard Division of Barlow/Johnson	176	■ <b>Erie Technological Products Co., Inc.</b> Altman Hall Associates Advertising	17	<b>Lear Siegler, Inc. Electronic Instrumentation Div. —Pin Bars</b> Jansen Associates, Inc. Marketing Services	148
‡ <b>Bourns, Inc.</b> Marlborough Assoc., Inc.	39	• <b>Excellon Industries</b>	39	<b>LH Research, Inc.</b> Van Der Boom, McCarron, Inc., Advertising	139
<b>Brand-Rex</b> Creamer, Trowbridge, Case & Basford, Inc.	22-23	‡ <b>Excellon Industries</b> Graham & Sparkman Advertising etcetera	73	<b>Litronix, Inc.</b> Bonfield Associates	12-13
■ <b>The Buckeye Stamping Company</b> Wheeler Kight & Gainey, Inc.	184	<b>Fabri-Tek, Inc.</b> Midland Associates, Inc. Marketing and Advertising Services	143	<b>Macrodata Company</b> JMR Advertising	180
<b>Celanese Plastics Company</b> D'Arcy-MacManus International, Inc.	164	<b>Fairchild Camera &amp; Instrument (Systems Technology Div.)</b> Rose Associates Advertising and Public Relations	149	<b>Master Appliance</b> Jack Crowe Studio Advertising	185
■ <b>CELCO (Constantine Engineering Laboratory Co.)</b> Stano Advertising	145	<b>FMC Corporation—Semiconductor Products Operation</b> DeSales Advertising, Inc.	137	<b>M C L, Inc.</b> HWH Associates, Inc., Advertising & Sales Promotion	146
■ <b>Centralab Electronics Div., Globe-Union Inc.</b> Action Communicators	140	<b>Gardner-Denver Co.</b> Buchen Advertising Inc.	132-133	<b>Methodo Manufacturing Corp.</b> Sander Rodkin Advertising, Ltd.	165
■ <b>C &amp; K Components</b> Van Christo, Inc.	189	■ <b>General Electric Co., Miniature Lamp Div.</b> Carr Liggett Advertising, Inc.	152	<b>The Mica Corporation</b> Robert A. White Advertising	175
<b>Computer Automation</b> Cochrane Chase & Company, Inc.	46-47, 64-65	<b>Harris Semiconductor</b> Tucker Wayne & Co.	116-117	<b>3M Electro Products Division</b> Batten, Barton, Durstine & Osborn, Inc.	84
■ <b>Continental Specialties Corp.</b> Robert A. Paul	170	<b>Hermes Electronics, Ltd.</b> Public & Industrial Relations Limited	147	<b>Mostek Corporation</b> David W. Evans, Inc./Texas	15
■ <b>Cornell Dubilier Electronics</b> McCarthy, Scelba, DeBiasi Advertising Agency, Inc.	43, 45	■ <b>Hewlett-Packard</b> Richardson, Seigle Roifs & McCoy, Inc.	2	<b>Motorola Semiconductor Products, Inc.</b> E B Lane & Associates, Inc.	95
‡ <b>Corning Glass Works, Electronic Materials Dept.</b> Pierce Brown Associates, Inc.	108	■ <b>Hewlett-Packard</b> Tallant/Yates Advertising, Inc.	153	<b>Narda Microwaves</b> McCarthy, Scelba, DeBiasi Advertising	103
‡ <b>Corning Glass Works, Electronics Products Division</b> Warner, Bicking & Fenwick, Inc.	177	■ <b>Hewlett-Packard</b> Tallant/Yates Advertising, Inc.	1	<b>National Electronics</b> Lea Advertising	74
				■ <b>National Semiconductor Corp.</b> Chiat/Day, Inc. Advertising	37

■ <b>The J.M. Ney Company</b> Cooper Advertising, Inc.	144
<b>North Atlantic Industries, Inc</b> NOAT Advertising Company	173
■ <b>Oak Switch</b> Marsteller, Inc.	62-63
<b>Panduit Corp.</b> Donald L. Arends, Inc.	163
■ <b>Permag Corporation</b> Schneider, Allen, Walsh, Inc.	170
• <b>Phillips Elcoma</b> Intermarco nederland	2E
• <b>Phillips N.V. Pli/T &amp; M Division</b> Broekies Communications Systems SA	54
<b>Phillips TMI</b> Broekies Communications Systems SA	57-60
<b>Plastics Engineering Company</b> Kuttner & Kuttner, Inc.	162
‡ <b>Precision Monolithics, Inc</b> Marlborough Associates, Inc.	51
<b>Premier Metal Products Corp.</b> Commercial Press, Inc.	83
<b>Procond S.p.A.</b> QUADRAGONO	159
<b>Projects Unlimited, Inc., Dayton, Ohio</b> The Parker Advertising Company	186
■‡ <b>Raytheon Company, Industrial Components Operations</b> Equipment Department Provandie Eastwood & Lombardi, Inc.	150
<b>Raytheon Company, Production</b> Equipment Department Provandie Eastwood & Lombardi, Inc.	6
‡ <b>Raytheon Company, Sorensen Department</b> Provandie Eastwood & Lombardi, Inc.	42
<b>RCA—Solid State Division</b> Marsteller, Inc.	78-79
‡ <b>Rental Electronics, Inc.</b> Humphrey Browning MacDougall, Inc.	54
• <b>Rohde &amp; Schwarz</b>	1E
<b>Rotron, Incorporated</b> Black-Russell-Morris	28
<b>Schauer Manufacturing Corp.</b> Notan, Keelor & Sites	181
<b>Semtech Corporation</b> Adgraphix Corporation	41
‡ <b>SHELDAHL INC.</b> Chuck Ruhr Assoc. Advertising, Inc.	61
• <b>Siemens A.G. Munich</b> Linder Presse Union GmbH	52
<b>Siemens AG</b> Linder Presse Union GmbH	77
<b>Simmons Fastener Corporation</b> Skild & Wyse Advertising, Inc.	158
<b>Singer Company, Kearlort Div.</b> Gaynor & Ducas, Inc.	202
• <b>Sodeco—SAIA</b> PR Service	51
<b>Sound Technology</b> Frank Burkhard Company	76
■ <b>Spectrol Electronics Corp.</b> J M R Inc.	161
<b>Sprague Electric Company</b> Harry P. Bridge Company	8

<b>Syntronic Instruments, Inc.</b> Moody & Harrison, Inc.	154
<b>Syston Donner Concord Instruments</b> Fred Schott & Associates	9, 166
<b>Taiyo Denki Co., Ltd.</b> Daipro, Inc.	186
• <b>TEAC Corp.</b> Dentsu Advertising Ltd.	73
■ <b>Tektronix, Inc.</b> McCann Erickson, Inc.	70.33
<b>Teledyne Semiconductor</b> Regis McKenna, Inc.	7
<b>Teletype</b> N.W. Ayer & Son, Inc.	201
<b>Templi Ind. Div. of Big Three Ind.</b> Black-Russell-Morris	168
<b>Teradyne, Inc.</b> Quinn & Johnson	68
<b>Texscan Corporation</b> Bruce Boltum Associates	195
<b>Thomas &amp; Skinner, Inc.</b> Bell-Catterlin & Hedgecock Advertising, Inc.	146
<b>Thomson-CSF/Dumont</b> Raniere, Sasiaw, Mohr and Associates, Inc.	132
<b>Tokyo Electric Co., Ltd.</b> PAL, Inc./Export Advertising	160
<b>Union Internationale</b> Des Telecommunications La Presse Technique SA	191
■ <b>Unitrode Corporation</b> Culver Advertising, Inc.	27
<b>Universal Oil Products,</b> Norplex Division Campbell Mithun, Inc.	75
<b>Vector Electronic Company, Inc.</b> Communications Management Company	166
■ <b>Wagner Electric Corporation</b> Coordinated Communications, Inc.	172
■ <b>Woven Electronics</b> Prentiss Court Advertising	16
<b>Yewtec Corporation</b> Kenmarc Advertising, Inc.	185

## Advertising Sales Staff

**Pierre J. Braudé** New York [212] 997-3468  
London 01-493-1451  
Director of Marketing

**Atlanta, Ga. 30309:** Joseph Lane  
100 Colony Square, 1175 Peachtree St., N.E.  
[404] 892-2868

**Boston, Mass. 02116:** James R. Pierce  
607 Boylston St. [617] 262-1160

**Chicago, Ill. 60611:**  
645 North Michigan Avenue  
Robert W. Bartlett (312) 751-3739  
Paul W. Reiss (312) 751-3738

**Cleveland, Ohio 44113:** William J. Boyle  
[716] 586-5040

**Dallas, Texas 75201:** Charles G. Hubbard  
2001 Bryant Tower, Suite 1070  
[214] 742-1747

**Denver, Colo. 80202:** Harry B. Doyle, Jr.  
Tower Bldg., 1700 Broadway  
[303] 266-3863

**Detroit, Michigan 48202:** Robert W. Bartlett  
1400 Fisher Bldg.  
[313] 873-7410

**Houston, Texas 77002:** Charles G. Hubbard  
2270 Humble Bldg. [713] CA 4-8381

**Los Angeles, Calif. 90010:** Robert J. Rielly  
Bradley K. Jones, 3200 Wilshire Blvd., South Tower  
[213] 487-1160

**New York, N.Y. 10020**  
1221 Avenue of the Americas  
Warren H. Gardner [212] 997-3617  
Michael J. Stoller [212] 997-3616

**Philadelphia, Pa. 19102:** Warren H. Gardner  
Three Parkway,  
[212] 997-3617

**Pittsburgh, Pa. 15222:** Warren H. Gardner  
4 Gateway Center, [212] 997-3617

**Rochester, N.Y. 14534:** William J. Boyle  
9 Greylock Ridge, Pittsford, N.Y.  
[716] 586-5040

**San Francisco, Calif. 94111:** Don Farris  
Robert J. Rielly, 425 Battery Street,  
[415] 362-4600

**Paris:** Alain Offergeld  
17 Rue-Georges Bizet, 75 Paris 16, France  
Tel: 720-73-01

**Geneva:** Alain Offergeld  
1 rue du Temple, Geneva, Switzerland  
Tel: 32-35-63

**United Kingdom & Scandinavia:** Keith Mantle  
Tel: 01-493-1451, 34 Dover Street, London W1

**Milan:** Robert Saidel  
1 via Baracchini, Italy Phone 87-90-656

**Brussels:** Alain Offergeld  
23 Chaussee de Wavre  
Brussels 1040, Belgium  
Tel: 13-73-95

**Frankfurt/Main:** Fritz Krusebecker  
Liebigstrasse 27c, Germany  
Phone 72 01 81

**Tokyo:** Tatsumi Katagiri, McGraw-Hill  
Publications Overseas Corporation,  
Kasumigaseki Building 2-5, 3-chome,  
Kasumigaseki, Chiyoda-Ku, Tokyo, Japan  
[581] 9811

**Osaka:** Ryji Kobayashi, McGraw-Hill  
Publications Overseas Corporation, Kondo  
Bldg., 163, Umegae-cho Kita-ku, Japan [362] 8771

**Australasia:** Warren E. Ball, IPO Box 5106,  
Tokyo, Japan

## Business Department

**Stephen R. Weas, Manager**  
[212] 997-2044

**Thomas M. Egan,**  
Production Manager [212] 997-3140

**Carol Gallagher**  
Assistant Production Manager [212] 997-2045

**Dorothy Carter,** Contracts and Billings  
[212] 997-2908

**Frances Vallone,** Reader Service Manager  
[212] 997-6057

## Electronics Buyers' Guide

**George F. Werner,** Associate Publisher  
[212] 997-3139

**Regina Hers,** Directory Manager  
[212] 997-2544

## Classified & Employment Advertising

F. J. Eberle, Manager 212-997-2557

<b>EQUIPMENT (Used or Surplus New) For Sale</b>	
American Used Computer Corp.....	192
Antenna Design Co.....	192
P. Fishman Co., Inc.....	192
Jensen Tools and Alloys.....	192
Mountain West Alarm Supply Co.....	192
Parke Davis Research.....	192
Radio Research Instrument Co.....	192

■ For more information on complete product line see advertisement in the latest Electronics Buyer's Guide  
• Advertisers in Electronics International  
‡ Advertisers in Electronics domestic-only edition

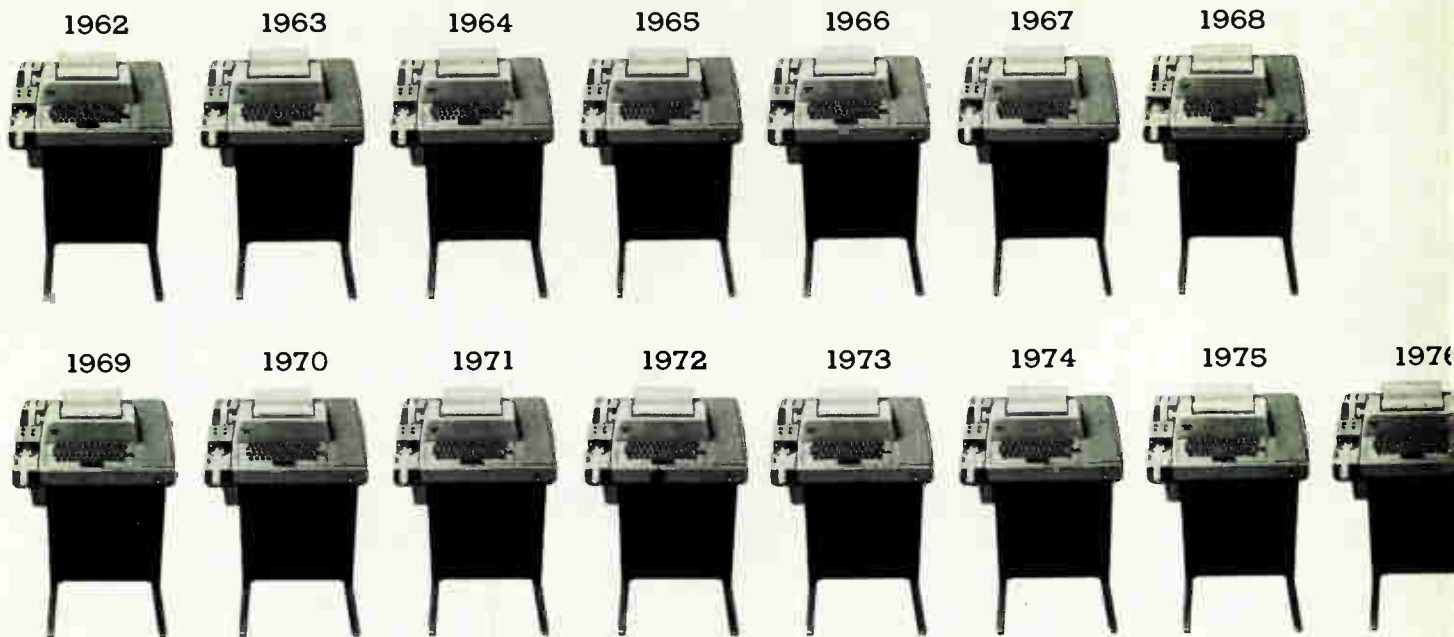

## Just how much longer will the model 33 be around?

The moment economy, reliability and versatility in data communications go out of date, the model 33 will become obsolete. But the more we look at today's business and economic environment, the more it seems the model 33 will live forever.

Because where else can you get so much for so little?

When the model 33 was first introduced, it was a bargain. Today, it's still a bargain. But it's hardly the same machine.

We've got a team of engineers assigned to the model 33 and their job is to keep making it better. Every year, they come up with a number of new features and improvements. Some improvements make the 33 more

dependable and versatile. Others make it easier and more economical to manufacture.

Because of these changes, the model 33s we're building today are standard-duty terminals instead of light-duty units. And our manufacturing changes have enabled us to stay ahead of rising costs.

Since we feel the model 33 is going to be around for a long, long time to come, our parts support, quality service and continued product improvement programs are as strong as ever.

It takes more than manufacturing facilities to build the terminals Teletype® Corporation offers. It also takes commitment. From people who think service is as important as sales. In terminals for computers and point-to-point communications.



**The computercations people.**

For more information about any Teletype product, write or call: TERMINAL CENTRAL, Teletype Corporation, Dept. 53U, 5555 Touhy Avenue, Skokie, Illinois 60076. Phone 312/982-2500. Teletype is a trademark registered in the United States Patent Office.

# Singer can supply any stepper motor you need, even if it's a real oddball.



The motor shown above was specially designed with a head positioning lead screw for a "floppy-disc" computer memory.

You're not designing floppy-disc memory systems right now? Singer-Kearfott still can come up with the right stepper motor for *anything* you have that needs the right stepper motor.

Our single-source capability is based on the most complete line available today. You can choose from either permanent magnet or variable reluctance motors; stepping angles from 1.8° to 90°; maximum stepping rates from 100

to 2000 steps/sec.; and frame sizes from 8 through 40.

All these motors feature high detent torque; stable, continuous/instantaneous response; and precision accuracy. So they're ideal for applications where magnetic or punch-tape drives are used for print-out—business machines,

data processing equipment, communication input-output terminals, etc.

We also supply a universal, solid-state logic driver that's compatible with all Kearfott stepper motors.

The motors and logic driver are in production right now, making them readily available. Only the oddballs take a little longer. So write for our new, comprehensive stepper motor catalog, or phone us about your special requirements.

The Singer Company, Kearfott Division, 1150 McBride Avenue, Little Falls, New Jersey 07424. Phone: (201) 256-4000.



Size 18



Size 23



Size 20



Size 35

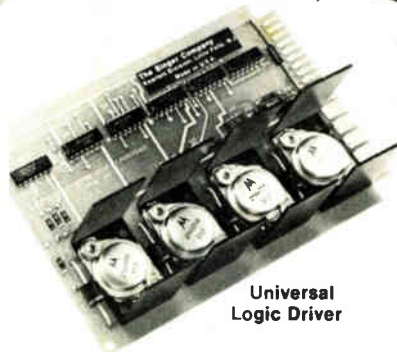

Universal Logic Driver

# SINGER

AEROSPACE & MARINE SYSTEMS



A new winner from Datel Systems . . .

# Two-for-One SALE!

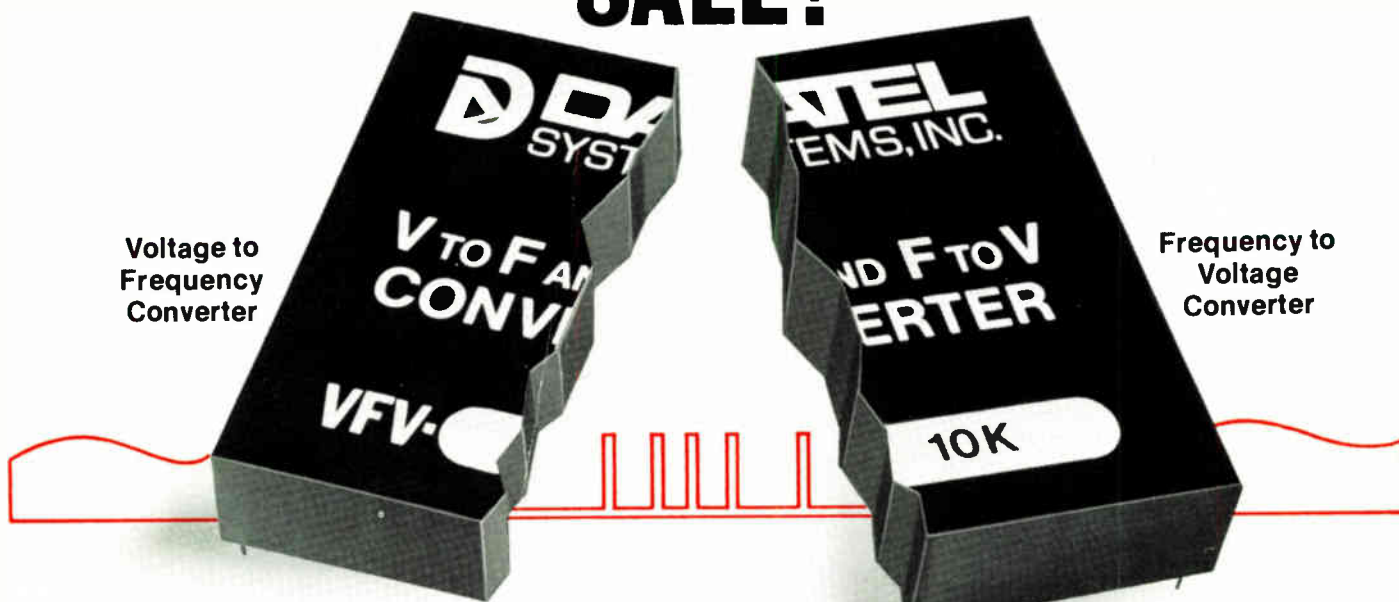

Take your pick.

A voltage-to-frequency or frequency-to-voltage converter.  
We've put them both together in one little module.

Our VFV-10K has a highly linear (50ppm max.) pulse train output (10kHz full scale) and is ideal for analog-to-pulse rate conversion or in data transmission applications. These fast-settling designs will change pulse rate within one cycle of the new frequency and will drive up to 1000pF of capacitive load or 12 TTL loads.

A 100kHz full scale version (VFV-100K) offers greater resolution in the same 2" x 2" x .375" modular package as its 10kHz brother.

#### PROGRAMMABLE I/O

Both the VFV-10K and VFV-100K include a built-in inverter stage so that positive or negative, current or voltage inputs may be used. The digital section provides DTL/TTL or CMOS compatible short-circuit-proof positive or negative pulses.

Use the VFV-10K or -100K for a multitude of signal applications such as those suggested below. At only \$59.00 and \$79.00 each, they're a bargain.

#### Applications

Use a VFV for:

1. Remote isolated analog V/F data transmitter using optoisolators.
2. Linearize a sine wave VCO using an F/V in the feedback loop.
3. Accurate low drift super long term integration using a V/F and a 5 or 6 decade counter. (The total area under the curve is proportional to the total accumulated counts. Wideband noise following integration).
4. Single, scalable frequency meter or tachometer using a F/V and a DPM.
5. Simple analog addition or subtraction for frequency difference or frequency sum.
6. V/F-type analog-to-digital converter and readout. Use a V/F and Datel's DM-3000 universal counter/display/DPM in its clocked-counter configuration.
7. Specified linearity all the way down to zero for wide dynamic range applications.

#### QUICK SPECS

**Input Ranges**  
0 to +10V, -10V, +1mA or  
-1mA min.

**Nonlinearity**  
±.005% max. (VFV-10K)  
±.05% max. (VFV-100K)

**Output Pulse**  
75 usec. wide (VFV-10K)  
7.5 usec. wide (VFV-100K)  
DTL/TTL or CMOS selectable  
logic levels  
12 TTL loads

**Settling Time to .01%**  
Within one cycle of new  
frequency

**F/V Operation**  
500 usec. filter time constant  
(VFV-10K)  
50 usec. filter time constant  
(VFV-100K)

**Stability**  
**Gain**  
20ppm/°C Max. (VFV-10K)  
200ppm/°C (VFV-100K)  
**Zero**  
10uV/°C max. (both models)

**Power**  
±15V at 25mA

**Mechanical and Pinning**  
2" x 2" x .375" DIP spaced

Send today for  
your FREE 72 page  
Engineering  
Product Handbook



**DATEL**  
SYSTEMS, INC.

1020 Turnpike Street, Canton, Mass. 02021  
• TEL (617) 828-8000 • TELEX 924461  
• TWX 710-348-0135

WESTERN REGIONAL OFFICE: SANTA ANA, CALIF.  
714-835-2751

**INTERNATIONAL SUBSIDIARIES**  
W. Germany Datelek Systems, GmbH, 8 Muenchen 71  
Becker-Gundahstr. 1  
TEL. 089/784045, Telex 5212855  
France Datel Systems SARL  
11 Rue Ferdinand Buisson, 75016 Paris, Fr.  
Tel: 603-06-74/603-05-31  
United Kingdom Datel (UK) Ltd., Sealine House,  
Priestley Road, Basingstoke, Hampshire RG-24 9NT  
Tel: Basingstoke (0256) 66721

Circle 901 on reader service card

# Need E-Rel Components?

★  
ESTABLISHED RELIABILITY

★ ★ ★ ★ ★  
ESTABLISHED  
RELIABILITY

MIL-R-39007, MIL-R-39009  
MIL-R-39015, MIL-R-39017  
MIL-R-55182

MIL-R-39007  
MIL-R-39009  
MIL-R-39015  
MIL-R-39017  
MIL-R-55182



## We helped write the book!

Don't spin your wheels when you shift to established reliability from standard military specifications. Dale has the QPLs and the finished goods stock to save you valuable time. We're

### Fast delivery on many styles

offering fast delivery on many established reliability part

numbers for both wirewound and metal film resistors and wirewound trimmers. And we can deliver something else, too: *Experience.* Our work in the Minuteman program led to the formulation of the first specifications for established reliability resistors. Since then our materials improvement and failure rate documentation programs have become models in the industry. Today our AGS resistors have a proven failure rate of .000032% per 1,000 hours. *That's established reliability.* Put it to work for you now. Call 402-564-3131 (wirewound styles) or 402-371-0080 (film styles) or dial 800-645-9200 for the name of your Dale representative.



DALE ELECTRONICS, INC.  
Columbus, Nebr. 68601  
A subsidiary of The Lionel Corporation  
In Canada: Dale Electronics Canada Ltd  
In Europe: Dale Electronics GMBH,  
8Munchen 60, Falkweg 51, West Germany

Circle 902 on reader service card