

- 91 Switching regulators: a big boost for efficiency
- 104 Taking the thick-film route in microwave hybrid ICs
- 113 How to design wideband toroidal transformers

1st  
987 099

# Electronics



1420 N.W. 302 83MAY NOV 74  
 MATT NEILL  
 13022 NE BROADWAY  
 PORTLAND OR 97232

**A new generation joins the IC op amp family**

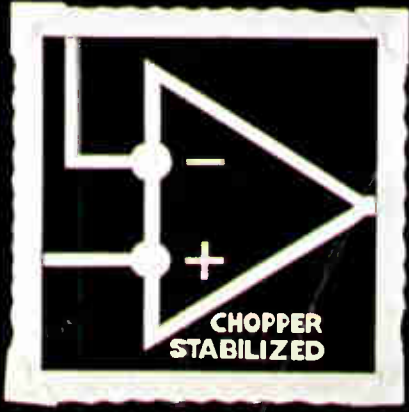



# ENGINEER POWER

Engineering is the big difference in Power Supplies from Electronic Measurements . . . more power per cubic inch, more power per pound, higher efficiency (and less heat), ripple as low as 0.5 mV.

The table shows the 0.1%-regulation SCR models and 1%-regulation EM models, but Electronic Measurements has a full line, bench-type and modular, with single and multiple outputs, from 5V to 500V and from 2.5A to 650A.

And there's more: remote sensing and programming, automatic E/I crossover, stability within 0.05%, full overload protection, rugged construction that's easy to service, and a five-year guarantee.

In Power Supplies, the best is Engineer Power, from Electronic Measurements. For a short-form catalog, use the Reader Service card, or contact Electronic Measurements.

Rating	Price	
	EM	SCR
6V-600A	\$1,600	\$2,000
7.5V-300A	1,200	1,400
10V-250A	1,200	1,400
10V-500A	1,600	2,000
20V-125A	1,050	1,200
20V-250A	1,275	1,500
20V-500A	2,050	2,650
30V-100A	1,050	1,200
30V-200A	1,450	1,800
40V-60A	950	1,100

Rating	Price	
	EM	SCR
40V-125A	\$1,300	\$1,600
40V-250A	1,975	2,500
50V-200A	1,975	2,500
80V-30A	950	1,110
80V-60A	1,200	1,500
100V-100A	1,975	2,500
120V-20A	975	1,300
120V-40A	1,200	1,500

Rating	Price	
	EM	SCR
160V-15A	\$ 950	\$1,100
160V-30A	1,300	1,600
160V-60A	1,975	2,500
250V-10A	950	1,100
250V-20A	1,300	1,600
250V-40A	1,975	2,500
500V-5A	1,300	1,500
500V-10A	1,600	2,000

19" Rack, 20" depth. Voltage and current adjustable over wide range.

See EEM Vol.1-791, 1-792, 1-793 for additional information.



## ELECTRONIC MEASUREMENTS INC.

405 Essex Road, Neptune, N. J. 07753

Phone: (New Jersey) 201 - 922-9300 • (Toll-Free) 800 - 631-4298

Specialists in Power Conversion Equipment

# SURPRISE!



## Free! 100 page optoelectronic designer's catalog.

HP's new 100 page Optoelectronic Designer's Catalog is here! It's absolutely free and comes loaded with detailed specifications and complete application notes on our broad line of optoelectronic products, including our LED displays, LED lamps, high-speed optically-coupled isolator and PIN photodetectors.

Mail the coupon today so we can get your copy on its way to you now.

**HEWLETT**  **PACKARD**

Sales, service and support in 172 centers in 65 countries.  
Palo Alto, California 94304. Offices in principal cities throughout the U.S.

Hewlett-Packard  
640 Page Mill Road, Palo Alto, California 94304

Surprise me with your free 100 page HP Optoelectronic Designer's Catalog.

NAME \_\_\_\_\_

TITLE/POSITION \_\_\_\_\_

COMPANY \_\_\_\_\_

ADDRESS \_\_\_\_\_

CITY \_\_\_\_\_

STATE \_\_\_\_\_

01331



FOR NEW STANDARDS IN MICROWAVE TEST EQUIPMENT, THINK HP

## Uncomplicated microwave testing.

Simplify reflection/transmission measurements by building your test workbench around the HP 8755 Frequency Response Test Set (\$3,200). This setup permits simultaneous measurement of insertion loss and return loss from 100 MHz to 18 GHz. Flatness is  $\pm 0.7$  dB. Dynamic range is 60 dB with only 10 mW of RF drive.

Direct-reading, fully calibrated controls speed work since calibration is maintained as you shift from full response to views of fine-grain detail. Time and temperature drift are eliminated by a modulated system using advanced hot-carrier diode detectors.

Domestic USA prices only

You use time efficiently for measurements, not recalibration. This system is ideal for testing a broad range of microwave devices such as filters, attenuators, amplifiers and frequency translation devices like mixers.

Maintain one setup simplicity over several octaves with the new HP 11692D (dual) and HP 11691D (single) directional couplers (\$1175 and \$650). Directivity is  $>30$  dB to 8 GHz and  $>26$  dB to 18 GHz with  $\pm 1$  dB flatness.

To round out your workbench, complement your HP test set and couplers with an HP 8620 series sweeper. All the details are yours simply by calling your nearby HP field engineer, or writing.

04312

HEWLETT  PACKARD

Sales, service and support in 172 centers in 65 countries.  
1501 Page Mill Road, Palo Alto, California 94304

Circle 2 on reader service card





## 33 Electronics review

CONSUMER ELECTRONICS: Field-effect LCDs make watch debut, 33  
MILITARY ELECTRONICS: Navy buys dogfight simulator, 33  
DISPLAYS: LEDs may light military displays, 34  
MEDICAL ELECTRONICS: New pacemaker is rechargeable, 35  
AEROSPACE ELECTRONICS: Floating ball rivals North Star, 36  
COMMERCIAL ELECTRONICS: 3M videocopier melds techniques, 36  
GOVERNMENT ELECTRONICS: Shock hazard tester from NIH, 38  
SOLID STATE: A-m radios offered chips, 40  
Acoustic device deflects laser, 40  
ECONOMICS: DOD cuts only 7% in first budget round, 42  
NEWS BRIEFS: 44

## 56 Electronics International

WEST GERMANY: Clockmaker turns to TV for 4-MHz crystals, 56  
SWITZERLAND: UN ground station for disaster airlift, 56  
AROUND THE WORLD: 57

## 69 Probing the News

SPACE ELECTRONICS: Europeans reach accord, 69  
COMMERCIAL ELECTRONICS: Lower prices open doors for OCR, 73  
COMPANIES: Oak prunes, plants—and grows, 76  
Teradyne changes bad news to good, 80

## 85 Technical Articles

SOLID STATE: Chopper-stabilized IC op amps are efficient, 85  
CIRCUIT DESIGN: Switching regulators—the way to power, 91  
DESIGNER'S CASEBOOK: Binary input determines pulse frequency, 98  
Automatic gain control operates over two decades, 99  
MICROWAVE: Thick-film technology boosts microwave hybrids, 104  
CIRCUIT DESIGN: Designing toroidal wideband transformers, 113  
ENGINEER'S NOTEBOOK: Op-amp circuit makes five dc checks, 117  
Measuring inductances below 100 nanohenries, 118  
Electronic dice ease tough decisions, 118

## 125 New Products

IN THE SPOTLIGHT: Chopper circuit put on op amp chip, 125  
COMPONENTS: Connector offers dense interface, 127  
DATA HANDLING: Word processor uses chip set, 133  
INSTRUMENTS: Pulse generator tailored to MOS logic, 139  
SUBASSEMBLIES: Display-correction modules go commercial, 145  
MATERIALS: 150

## Departments

Publisher's letter, 4  
Readers comment, 6  
Meetings, 8  
40 years ago, 13  
People, 18  
Electronics newsletter, 29  
Washington newsletter, 53  
Washington commentary, 54  
International newsletter, 59  
Engineer's newsletter, 121  
New books, 153  
New literature, 154

## Highlights

### Cover: Chopper-stabilized IC op amp is born, 85

Chopper stabilization, newly applied to a two-chip op amp, makes it outperform its nearest rival by a factor of 10. The device is also cheaper than a hybrid module and easier to handle than a discrete assembly. An equally new one-chip version is also described on page 125. Cover is by Art Director Fred Sklenar.

### 11 European countries reach space accord, 69

At a meeting in Brussels, European science ministers at last settled on a \$1 billion space program. It includes a new satellite launch vehicle, the Spacelab sortie module, and a satellite system for marine navigation.

### Switching regulators can be quiet, 91

Fast-switching low-noise power semiconductors, plus careful filter design, will yield a switching regulator that is both highly efficient and almost free of noise.

### Thick-film ICs make good microwave devices, 104

Though thin-film hybrid circuits are widely used for microwave applications, thick films can deliver just as good performance in the 1–4-GHz range—and in addition are easier and less expensive to fabricate.

### And in the next issue . . .

Wescon preview . . . how to design for reliability in consumer electronics . . . a digital instrument for analyzing high-speed transients.

EDITOR-IN-CHIEF: Kemp Anderson

EXECUTIVE EDITOR: Samuel Weber

MANAGING EDITORS: Lawrence Curran, *News*;  
Arthur Erikson, *International*

SENIOR EDITORS: John Johnsrud,  
H. Thomas Maguire, Laurence Altman  
Ray Connolly

ART DIRECTOR: Fred Sklenar

ASSOCIATE EDITORS: John N. Kessler,  
Howard Wolff, Gerald M. Walker

### DEPARTMENT EDITORS

*Aerospace*: William F. Arnold  
*Circuit Design*: Lucinda Mattera  
*Communications & Microwave*:  
Lyman J. Hardeman  
*Computers*: Wallace B. Riley  
*Consumer*: Gerald M. Walker  
*Industrial*: Alfred Rosenblatt  
*Instrumentation*: Michael J. Riezenman  
*Military*: Ray Connolly  
*New Products*: H. Thomas Maguire  
*Packaging & Production*: Stephen E. Grossman  
*Solid State*: Laurence Altman  
*Special Issues*: Harry R. Karp

COPY EDITORS: Margaret Eastman,  
Everett C. Terry

ASSISTANT EDITOR: Marilyn Offenheiser

ART: Charles D. Ciatto, *Associate Director*  
Patricia Cybulski, *Assistant Director*

PRODUCTION EDITOR: Arthur C. Miller

EDITORIAL SECRETARIES: Janet Annunziata,  
Julie Gorgoglione, Penny Roberts

### FIELD EDITORS

*Boston*: Gail Farrell  
*Los Angeles*: Paul Franson (Mgr.)  
*Midwest*: Larry Armstrong (Mgr.)  
*New York*: Alfred Rosenblatt (Mgr.)  
*San Francisco*: George Sideris (Mgr.),  
Judith Curtis  
*Washington*: Ray Connolly (Mgr.),  
William F. Arnold  
*Frankfurt*: John Gosch  
*London*: Michael Payne  
*Paris*: Arthur Erikson  
*Tokyo*: Charles Cohen

### McGraw-Hill WORLD NEWS

*Director*: Walter A. Stanbury  
*Bonn*: Robert Ingersoll;  
*Brussels*: James Smith;  
*London*: Marvin Petal;  
*Milan*: Peter Hoffmann, Andrew Heath;  
*Moscow*: Axel Krause;  
*Paris*: Michael Johnson, Richard Shepherd;  
*Stockholm*: Robert Skole;  
*Tokyo*: Mike Mealey

PUBLISHER: Dan McMillan

ADVERTISING SALES MANAGER: Pierre J. Braudé

ADVERTISING SALES SERVICE MANAGER:  
Wallis Clarke

BUSINESS MANAGER: Stephen R. Weiss

CIRCULATION MANAGER: George F. Werner

MARKETING SERVICES MANAGER:  
Tomlinson Howland

The Probing the News story, on page 69 is more than just a report of a momentous agreement arrived at in Brussels. Rather, it's the telling of what could be the key chapter in a book that man has been aching to complete for generations: a book describing true international cooperation that crosses the traditional lines of groups, blocs, and alliances. And it all might happen in space.

For with the accord among science ministers representing 11 European nations, not only is Europe solidly in the space business with three cooperative projects worth perhaps a billion dollars, but one of those projects will be accomplished with the United States. Thus, with the U.S. and Russia planning a joint space effort and with the newly created European Space Agency planning to join the post-Apollo program of NASA by building the Spacelab sortie module, it can be truly said that space is at last becoming international.

The article, by Richard Shepherd of McGraw-Hill's Paris bureau, outlines the work that will be done, the organization that's being set up to do it, and the delicate negotiations and compromises required.

**H**eadline grabbers—like the semiconductor memories and microcomputers that are pacing advances in the digital area—are by no means the only examples of solid progress in solid-state devices. There has been tremendous, if quiet, progress in linear developments, particularly operational amplifiers. Innovations such as superbeta and field-effect input transistors were two that have warmed the hearts of design engineers whose goal is precision.

Now, another most welcome trend is the availability of chopper-stabilized op amps in IC form, two of which are described in this issue. They have come a long way from the old vacuum/mechanical chopper monsters, which were used for 30 years for top performance before being replaced by hybrid solid-state module types. In this issue, we present two almost simultaneous steps forward in the development of the chopper-stabilized op amp art. One is a two-chip device from Texas Instruments (p. 85), the other a truly monolithic one-chip device from Harris Semiconductor (p. 125).

**M**any and varied were the companies laid low by the recession of the late 1960s and early 1970s, but the success and survival stories are just beginning to emerge. Two Probing the News articles—on pages 76 and 80—take a look at a pair of electronics firms that have made it and then some, but in different ways.

In what may be called a tale of two companies, Chicago bureau manager Larry Armstrong tells how Oak Industries appears to have anticipated the severe slump when in 1967 it decided to lop off activities that it considered no longer fruitful, and broaden its base to one that is now healthy and vigorous. On the other hand, Teradyne Inc. of Boston was hit hard, but used the opportunity to tighten up. Gail Farrell of our Boston bureau tells how it was done.



August 16, 1973 Volume 46, Number 17  
91,376 copies of this issue printed

Published every other Thursday by McGraw-Hill, Inc. Founder: James H. McGraw 1860-1948. Publication office 1221 Avenue of the Americas, N.Y., N.Y. 10020; second class postage paid at New York, N.Y., and additional mailing offices.

Executive, editorial, circulation and advertising addresses: Electronics, McGraw-Hill Building, 1221 Avenue of the Americas, New York, N.Y. 10020. Telephone (212) 997-1221. Teletype TWX N.Y. 710-581-5234. Cable address: MCGRAWHILL N.Y.

Subscriptions limited to persons with active, professional, functional responsibility in electronics technology. Publisher reserves the right to reject non-qualified requests. No subscriptions accepted without complete identification of subscriber name, title, or job function, company or organization, including product manufactured or services performed. Subscription rates qualified subscribers in the United States and possessions, Canada, and Mexico \$9.00 one year, \$12.00 two years, \$16.00 three years; all other countries \$25.00 per year, except Japan \$50.00 per year and Brazil \$40.00 per year, including air freight. Limited quota of subscriptions available at higher-than-basic rate for persons outside of field served, as follows: U.S. and possessions and Canada, \$25.00 one year; all other countries \$50.00. Single copies: United States and possessions and Canada, \$1.00; all other countries, \$1.75.

Officers of the McGraw-Hill Publications Company: John R. Emery, President; J. Elton Tuohig, Executive Vice President-Administration; Gene W. Simpson, Group Publisher-Vice President; Senior Vice Presidents: Ralph Blackburn, Circulation; John B. Hoglund, Controller; David G. Jensen, Manufacturing; Gordon L. Jones, Marketing; Jerome D. Luntz, Planning & Development.

Officers of the Corporation: Shelton Fisher, President; Wallace F. Traendly, Group President, McGraw-Hill Publications Company and McGraw-Hill Information Systems Company; John J. Cooke, Senior Vice President and Secretary; Ralph J. Webb, Treasurer.

Title registered in U.S. Patent Office; Copyright © 1973 by McGraw-Hill, Inc. All rights reserved. The contents of this publication may not be reproduced either in whole or in part without the consent of copyright owner.

Subscribers: The publisher, upon written request to our New York office from any subscriber, agrees to refund that part of the subscription price applying to copies not yet mailed. Please send change of address notices or complaints to Fulfillment Manager; subscription orders to Circulation Manager, Electronics, at address below. Change of address notices should provide old as well as new address, including postal zip code number. If possible, attach address label from recent issue. Allow one month for change to become effective.

Postmaster: Please send form 3579 to Fulfillment Manager, Electronics, P.O. Box 430, Hightstown, N.J. 08520.



# A more functional generator for \$495.

The new Krohn-Hite Model 5200 linear sweep/function generator gives you more versatility and performance for your money. If that's a sweeping statement, we stand ready to prove it! Model 5200 generates basic sine, square, triangle and ramp waveforms that you can manipulate with sweeps and triggers from 0.00003Hz to 3MHz. For even more versatility, the new Model 5300 adds an exponential ramp for logarithmic sweeping at only \$695. For fast action, call the Wavemakers at (617) 491-3211, TWX 710-320-6583, Krohn-Hite Corporation, 580 Massachusetts Ave., Cambridge, Mass. 02139.

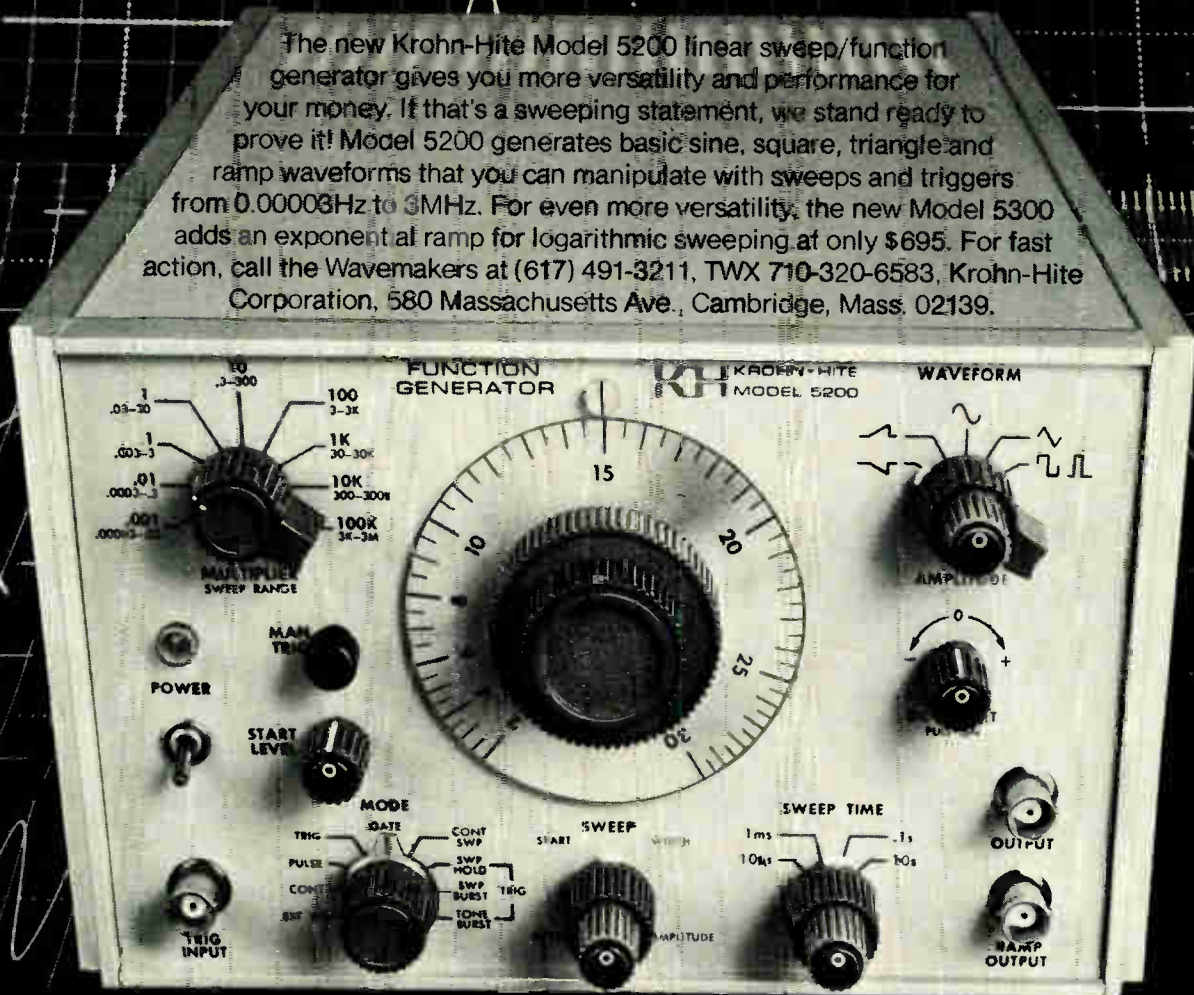

**KH KROHN-HITE CORPORATION**

SALES OFFICES: ALA., Huntsville (205) 534-9771; CAL., Santa Clara (408) 243-2891, Inglewood (213) 674-6850; COLO., Littleton (303) 795-0250; CONN., Glastonbury (203) 526-8800; FLA., Orlando (305) 894-4401; HAWAII, Honolulu (808) 941-1574; ILL., Des Plaines (312) 298-3600; IND., Indianapolis (317) 244-2456; MASS., Lexington (617) 861-8620; MINN., Minneapolis (612) 884-4336; MO., St. Louis (314) 423-1234; N.C., Burlington (919) 227-2581; N.J., Bordertown (609) 298-6700; N.M., Albuquerque (505) 255-2440; N.Y., E. Syracuse (315) 437-6666, Rochester (716) 328-2230, Wappingers Falls (914) 297-7777, Vestal (607) 785-9947, Elmont (516) 488-2100; OHIO, Cincinnati (513) 261-5440, Dayton (513) 426-5551; PA., Pittsburgh (412) 371-9449; TEX., Houston (713) 468-3877, Dallas (214) 356-3734; VA., Springfield (703) 321-8630; WASH., Seattle (206) 261-5440; CANADA, Montreal, Quebec (514) 636-4411, Toronto, Ontario (416) 444-9111, Stittsville, Ontario (613) 836-4411, Vancouver, British Columbia (604) 688-2619.



No matter  
what shape  
your waves  
are in . . .

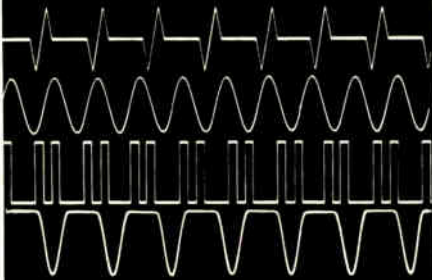

Intronics gives  
you their true  
RMS value.

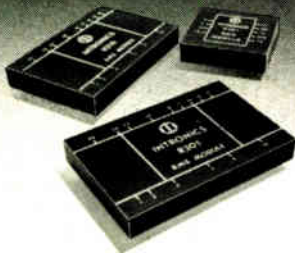

$$E_1(\text{RMS}) = \sqrt{\frac{1}{T} \int_0^T (E_1)^2 dt}$$

And you'll get to keep more than two thirds of what you would expect to pay for true Root Mean Square measurements. Intronics' RMS Operator Modules accept any arbitrary input waveforms—sine, distorted sine, square, random and complex. They perform the actual operations of squaring, averaging and square rooting. And they provide an output which is a smooth, continuous function of the input without breakpoint type non-linearities. Intronics' RMS Modules provide accuracies to 0.05%, precise measurements from DC to 1 MHz, response time as fast as 2 msec, and DC calibration.

You no longer need to settle for the insufficient accuracies of averaging and peak value devices, or the high cost of a true RMS voltmeter. Specify Intronics' RMS Modules. It's the best way to avoid worries about the shape of things.

  
**intronics**

57 Chapel Street, Newton, Massachusetts 02158 U.S.A.  
617-332-7350, TWX 710-335-6835

Overseas Call:  
Brussels, Belgium 35-97-91 Tel- Aviv, Israel 53459  
Helsinki, Finland 11-123 Milan, Italy 719-518  
Paris, France 9077844 The Hague, Holland 678380  
Munich, Germany 524181 Maidstone, England 54224

## Readers comment

### More on MOS vs CCDs

To the Editor: As a result of a number of comments and questions about my article, "The tradeoffs in monolithic image sensors: MOS vs CCDs," [*Electronics*, May 24, p.106], I should like to comment:

- The difference in CCD and MOS image sensors as to noise, imaging, and overload properties make each type of device more suitable for different classes of applications. For instance, the desirable performance parameters are quite different for image sensors used in manufacturing-process control, optical character recognition, and commercial-broadcast television.
- Although the general device comparisons presented in the article are useful for introducing the principles underlying performance limitations, manufacturers' specifications should be consulted to ascertain the specific performance of a particular product. Space limitations prohibited treatment of such details as the influence of blooming, signal-to-noise ratio, and photo-response.
- The dynamic range of typical MOS image sensors was erroneously stated to be 20 to 1. This error probably resulted from 10 "f" stops being interpreted during typesetting as  $2 \times 10$  instead of  $2^{10}$ .

Roger Melen  
Stanford Electronics Laboratories  
Stanford, Calif.

### A 'not' in robot programing

To the Editor: While I am pleased that Mr. [Alfred] Rosenblatt included Synchro-Trans in his article, "Robots handling more jobs on industrial assembly lines" [*Electronics*, July 19, p.93], I have not, nor would I ever, say that "The Synchro-Trans robots are difficult to reprogram, compared with Versatran and Unimate machines. . . ." It appears that the correct version should read, "The Synchro-Trans robots are *not* difficult to reprogram. . . ."

The ability to change programs and set stops in a simple straightforward manner is a major sales feature—especially for the small shop.

R. W. Reinhardt  
Synchro-Trans Corp.  
Detroit, Mich.

## The Elegant Capacitors



For elegant applications. Zero temperature coefficient  $\pm 10$  ppm/ C ( $-55$  C to  $+85$  C) with .01% accuracy—now 25% smaller in size.

Precise specs from precise craftsmanship. That's what you'll find in all capacitors by EAI. Polystyrene. "Mylar." Polycarbonate. Polysulfone. Polypropylene. Plain and metallized films. Hermetically sealed. RC networks, also. Matching tolerances from 5% to 0.005%.

Plus a growing list of other elegantly crafted etceteras—and fast, fast delivery.





Electronic Associates, Inc.  
185 Monmouth Parkway  
West Long Branch, New Jersey 07764  
Tel. (201) 229-1100

**Distributors**

**Arizona:** Hamilton/Avnet, Phoenix (602) 269-1391  
 Kierulff, Phoenix (602) 273-7331  
**California:** Hamilton/Avnet, Mountain View (415) 961-7000  
 San Diego (714) 279-2421  
 Hamilton Electro, Culver City (213) 870-7171  
 Kierulff, Palo Alto (415) 968-6292  
 San Diego (714) 278-2112  
 Wesco Electronics, Los Angeles (213) 685-9525  
**Colorado:** Hamilton/Avnet, Denver (303) 534-1212  
 Kierulff, Denver (303) 343-7090  
**Florida:** Hamilton/Avnet, Hollywood (305) 925-5401  
**Georgia:** Hamilton/Avnet, Norcross (404) 448-0800  
**Illinois:** Allied, Chicago (312) 421-2400  
 Hamilton/Avnet, Schiller Park (Chicago) (312) 678-6310  
 Kierulff, Rosemont (Chicago) (312) 678-8560  
**Kansas:** Hamilton/Avnet, Prairie Village (Kansas City) (913) 362-3250  
**Maryland:** Hamilton/Avnet, Hanover (Baltimore) (301) 796-5000  
 Pioneer, Rockville (301) 427-3300  
**Massachusetts:** Electrical Supply, Cambridge (617) 491-3300  
 Gerber, Dedham (617) 329-2400  
 Hamilton/Avnet, Burlington (617) 273-2120  
 Kierulff, Needham Heights (617) 449-3600  
**Michigan:** Hamilton/Avnet, Livonia (313) 522-4700  
**Minnesota:** Hamilton/Avnet, Bloomington (612) 854-4800  
**Missouri:** Hamilton/Avnet, Hazelwood (St. Louis) (314) 731-1144  
**New Jersey:** Arrow, Saddlebrook (201) 256-7331  
 Hamilton/Avnet, Cherry Hill (609) 662-9337  
 Cedar Grove (201) 239-0800  
 Haddonfield (609) 429-1526  
**New Mexico:** Century, Albuquerque (505) 265-7837  
 Kierulff, Albuquerque (505) 247-1055  
**New York:** Semiconductor Concepts, Hauppauge (516) 273-1234  
 Hamilton/Avnet, Syracuse (315) 437-2642  
 Westbury, L.I. (516) 333-5812  
 Arrow, Farmingdale (516) 694-6800  
 Summit, Buffalo (716) 884-3450  
**North Carolina:** Pioneer, Greensboro (919) 273-4441  
**Ohio:** Arrow, Dayton (513) 253-9176  
 Kierulff, Dayton (513) 278-9411  
**Texas:** Hamilton/Avnet, Dallas (214) 638-2850  
 Houston (713) 526-4661  
 Kierulff, Garland (Dallas) (214) 271-2471  
**Utah:** Hamilton/Avnet, Salt Lake City (801) 262-8451  
**Washington:** Hamilton/Avnet, Seattle (206) 624-5930  
 Kierulff, Seattle (206) 763-1550  
**Canada:** Prelco, Montreal (514) 389-8051  
 Ottawa (613) 237-6150  
 Electro Sonic Ind. Sales, Toronto (416) 924-9301  
 Hamilton/Avnet, Montreal (514) 735-6393  
 Toronto (416) 677-7432  
 Ottawa (613) 725-3071  
 L. A. Varah, Vancouver, B.C. (604) 736-6411  
 Future Electronics, Montreal (514) 735-5775  
 Ottawa (613) 232-7757  
 Toronto (416) 677-7820

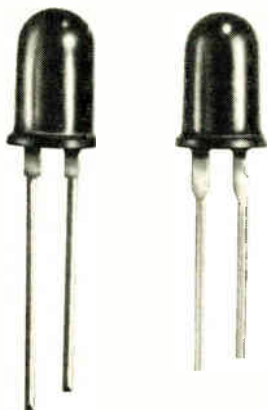

5082-4850  
17¢

RL-4850  
17¢



MV-54  
10¢



RL-54  
10¢



5082-7730  
2.95



MAN-7  
2.70

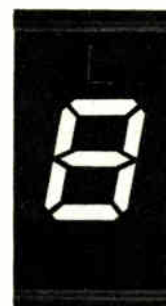

DL-707  
2.70

# WHAT'S THE DIFFERENCE?

Let's not even get into a discussion about visual differences. Let's talk about prices. It's an understatement to say LED prices are coming down. Some people would like to make it an overstatement. When you react to 10 and 17 cent prices for lamps and \$2.70 for displays as if it's news, you haven't been talking to Litronix. We all know that published prices for 100K and million pieces are meaningless. These kinds of prices depend on your specs and requirements.

Note: Prices indicated are published prices as of June 1, 1973.

Litronix is one of the leading LED suppliers. We shipped over \$15 million in LEDs in the last 12 months. Our product line crosses over every other manufacturer in the business and we can deliver in any volume. Everything from infrared diodes and opto-isolators to lamps and displays. Technology-wise our brightness specs and low power options are unsurpassed.

Why are we a leader? In the first place, we manufacture our own high quality materials—ingots and wafers.

We even supply materials to other LED manufacturers.

Second, we have the engineering and manufacturing capability to handle any need. A company of 3,000 people totally devoted to LED manufacturing.

So don't let the headline prices fool you. The big deal you thought you were getting might turn out to be not so big after all.

**Before you buy, check with Litronix.**

the bright guys  
**litronix**

Litronix, Inc. • 19000 Homestead Road • Cupertino, California 95014 • (408) 257-7910 TWX: 910-338-0022

# Eavesdrop on a signal.



## Directional Couplers 10 MHz-12.4 GHz

The new Singer Directional Couplers eavesdrop in the 10 MHz to 12.4 GHz range with three exceptional units — 10-1000 MHz, 1-4.2 GHz and 3-12.4 GHz. They tune in so that output in the coupled arm accurately reflects the signal in the main line without disturbing the characteristics of the input signal.

And with better than  $\pm 0.3$  dB flatness over a 10-1000 MHz range to provide accurate monitoring of power and frequency.

Flatness and directivity optimized for sweeper leveling applications.

Single couplers are available as directional

detectors.

A dual Directional Coupler specifically for reflectometer measurements with directivity of 33 dB minimum in the 10-1000 MHz range.

All couplers have stainless steel connectors for durability and consistent performance.

And finally, the price. Starting at \$195, it is as low as our quality is high.

For more information contact the Singer Company, Palo Alto Operation, 3176 Porter Drive, Palo Alto, CA 94304, Telephone (415) 493-3231.

**SINGER**  
INSTRUMENTATION

Circle 8 on reader service card

The new  
**ROTASWITCH®**  
**820 Encoder**  
is so small it  
fits in a space  
this size.

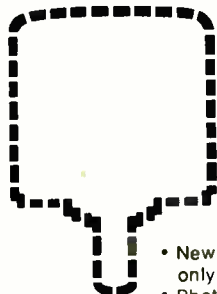

See!



- New 820 Series ROTASWITCH Encoder is only 1" in diameter; size 11 servo housing
- Photoelectric type, uses LED sources
- Single or quadrature, sine or TTL compatible  $\square$  output
- Up to 500 pulses per revolution
- High quality components for top dependability
- Low cost (\$150.00 in single quantities)

Complete specifications in Bulletin 820. Write or call

DISC Instruments, Inc. 102 E. Baker St., Costa Mesa, Calif. 92626, Phone (714) 979-5300

Disc Instruments Division  
Finnigan GmbH  
Dachauer Strasse 511, 8 München 50, Germany  
Phone: (0811) 142291 (2)

Disc Instruments Division  
Finnigan Instruments Ltd.  
Paradise, Hemel Hempstead, Herts, England  
Phone: (0442) 57261

See DISC Encoders At ISA International Show, Booth 556, Houston, Texas, October

8 Circle 158 on reader service card

## Meetings

**Preparation and Properties of Electronic Materials:** AIME, Stardust, Las Vegas, Aug. 26-29.

**European Microwave Conference:** IEEE, IEE, Brussels University, Belgium, Sept. 4-7.

**Western Electronic Show & Convention (Wescon):** Wema, Civic Auditorium and Brooks Hall, San Francisco, Sept. 11-14.

**Indian Electronics Trade Fair:** Trade Development Authority, Taj Mahal Inter-Continental, Bombay, Sept. 15-17.

**Third European Solid-State Device Research Conference:** IEEE et al., Munich Technical University, West Germany, Sept. 18-21.

**International Conference on Engineering in the Ocean Environment:** IEEE, Washington Plaza, Seattle, Sept. 25-28.

**International Exhibition of Industrial Electronics (Elettronica 2):** Turin, Italy, Sept. 29-Oct. 8.

**National Electronics Conference:** IEEE, Regency Hyatt O'Hare Hotel, Chicago, Oct. 8-10.

**Electronic and Aerospace Systems Convention (Eascon):** IEEE, Sheraton, Washington, Oct. 8-10.

**Optical Society of America Annual Meeting:** OSA, Holiday Inn—Downtown, Rochester, N.Y., Oct. 9-12.

**International Telemetry Conference/USA:** ITC, Sheraton Northeast, Washington, D.C., Oct. 9-11.

**Canadian Computer Show and Conference:** CIPS, Exhibition Park, Toronto, Oct. 16-18.

**American Society for Information Science Annual Meeting:** ASIS, Hilton, Los Angeles, Oct. 21-25.

**Connector Symposium:** Connector Study Group, Cherry Hill Inn, Cherry Hill, N.J., Oct. 24-25.

Electronics/August 16, 1973



# Micro-mini pc connectors can have contacts on .025-inch centers.

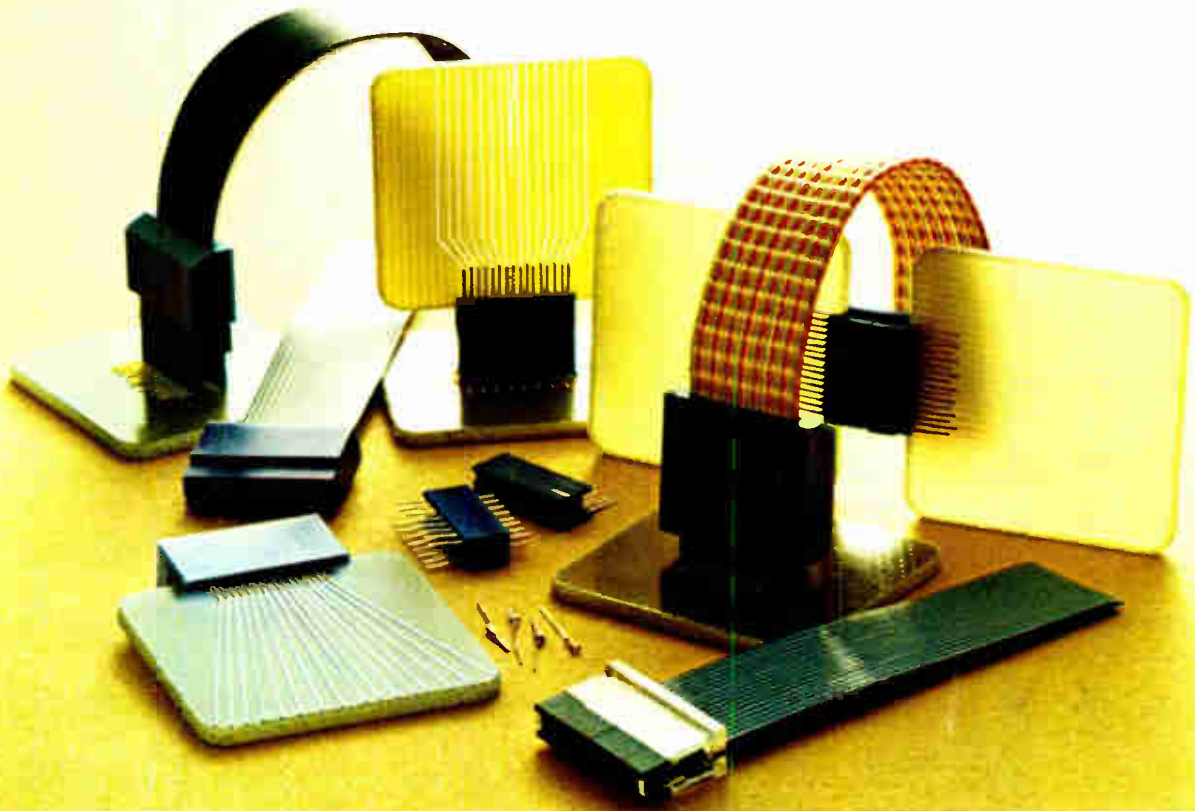

AMP chevron-shaped-contact connectors are specially designed to ensure the maximum density—and reliability—demanded in next generation microelectronic packaging designs. Chevron contact tails are suitable for .050-inch centerlines on double-sided boards or can be easily arranged to suit .025-inch centerline spacing on single-sided boards. They are available in a wide range of connector configurations for board-to-board, board-to-wire and board-

to-flat cable interconnection, including transmission cable to match 75 ohm impedance.

The unique receptacle contacts have chevron-shaped springs for positive, redundant contact with mating pins. Connectors are easily “stacked” or modularized, and

built-in misalignment allowance compensates for wide mounting tolerances. Gold over nickel plating on beryllium copper contacts provides maximum performance reliability in the most critical environments.

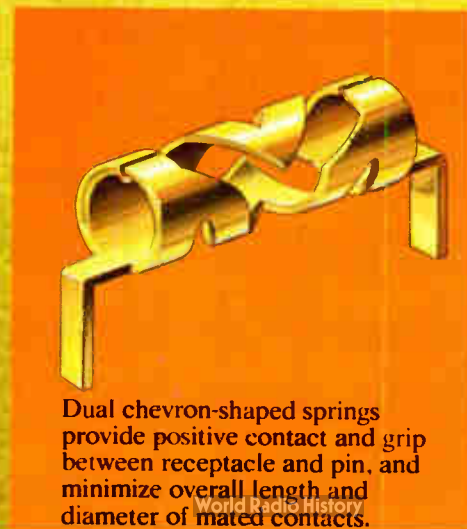

Dual chevron-shaped springs provide positive contact and grip between receptacle and pin, and minimize overall length and diameter of mated contacts.

# AMP has the pc connector to meet your density and design requirements.

We offer a wide variety of printed circuit connector types and configurations... in standard and special designs that let you match packaging design parameters to required standards of reliability and economy. Connectors include high-density types for microelectronics, as well as one or two-piece edge, posted, mother/daughter board, or special header types.

Choice of contact styles include bifurcated leaf, cantilever, tab or fork type, each in crimp snap-in form or eyelet style for solder termination. Posted types can also be provided for automatic point-to-point or wrap methods.

The AMP line of connectors offers many innovative designs for board interconnection of high density rectangular connectors. MSI, LSI and LED substrate circuitry, including liquid crystal display packages.

Only a representative sample of versatile and reliable AMP pc connectors are shown on these pages. We'd like to acquaint you with the product to fit your specific needs. Talk to an AMP Sales Engineer about your connector requirements.

*TERMI-TWIST connectors can be mounted on a chassis or in open-frame and slotted-plate panels, and can be used in almost any panel arrangement with single- or double-sided pc boards.*

*Two-piece connector with blade-type contacts ensures maximum electrical conductivity: receptacle housing accepts crimp snap-in contacts or posts for point-to-point wiring.*



*AMP modified fork connector provides high reliability at low applied cost for board-to-wire and board-to-board applications.*

*80-position edgemount connector provides practical pluggability for leadless liquid crystal display substrate.*

*Special lightweight automotive pc connector offers unique latching system for positive wire retention and back loading design to simplify wire or contact replacement.*

*This one-piece edge connector with bifurcated leaf-type contacts offers firm wiping action and redundant points of contact.*

*Multi-tap connector combines a pc board edge connector and a terminal block with individual screw/clamp terminals or FASTON tabs for quick connect/disconnects.*



# All you need for cable-to-board connections.

With flat or round cable, AMP can give you just the connector you need to get on or off a printed circuit board.

## Flat cable-to-board.

These AMP connectors and headers are all you need to take advantage of the savings in weight and space, and the opportunities for eliminating wiring errors and reducing costs which flat flexible cable can provide.

### Two-piece cable-to-board.

Another way to go from cable to board. A spring retention clip holds mating sections firmly together.

### "Daisy chain" connections.

The AMP termination technique allows daisy-chain or branch connections without the need for cutting cable. Just machine-attach contacts across the width of cable, fold cable back on itself, and insert it into the connector housing.

### Cable-to-post.

Single or double-row connectors let you plug flat cable to posts on printed circuit boards. Standard housings are available with as many as 70 positions.

### One-piece cable-to-board.

This double-row bifurcated contact connector mates directly with pads on edge of single- or double-sided pc boards. It can be supplied with or without mounting ears for fastening to pc board or to rack.

### Cable-to-header.

With this new AMP Latch connector, you can terminate all leads on multiconductor flat cable simultaneously. Without prestrapping or soldering. It will also accommodate ribbon cable woven cable...even discrete wires.

### Cable-to-strip receptacle.

With this one, you don't even need a connector housing. Contacts, after attachment to cable, fit directly into a DIP-type receptacle.

## Round wire cable-to-board.

All it takes is a gentle pull to separate our miniature rectangular connector from its pc board header. And it only detaches when you want it to, because of positive locking pawls built into the connector housing.

A full selection of circuit configurations on .165-inch centerlines lets you design for maximum miniaturization.

In 1 through 36 positions.

Integral cantilever springs inside every socket of AMP miniature rectangular connectors ensure positive electrical and mechanical contact. Yet insertion/extraction forces average less than one pound per circuit.

## Engineering backup...worldwide.

Some 900 application, service and sales engineers are prepared to assist you with every design and production application involving AMP pc connectors and interconnection systems. At your domestic manufacturing plant, or wherever you use AMP products and machines throughout the world. You'll find AMP manufacturing and service facilities in 16 major international markets. In the United States, district offices are located in Weston, MA, Cranford, NJ, Berwyn, PA, Washington, DC, Atlanta, GA, Columbus, OH, Southfield, MI, Elk Grove Village, IL, Minneapolis, MN, Dallas, TX, and in Compton and Cupertino, CA.

For more information on chevron-shaped connectors, circle Reader Service Number 150. For information on flat cable connectors, circle Reader Service Number 151. Information may also be obtained by contacting the AMP office in your area. Or by writing AMP Incorporated, Harrisburg, Pa. 17105.

**AMP**  
INCORPORATED

# AMP International locations.

## ARGENTINA

AMP S.A. Argentina  
4 de Febrero, 76, Villa Zagla—SAN MARTIN  
Buenos Aires, Argentina

## AUSTRIA

AMP Austria  
Branch of AMP Deutschland G.m.b.H.  
Markgraf-Ruediger Str. 6-8  
1150 Vienna, Phone: 924191/92

## AUSTRALIA

Australian AMP Pty. Limited  
155 Briens Road  
Northmead, N.S.W. 2152 Australia  
Mailing Address:  
P.O. Box 194, Baulkham Hills, N.S.W.  
2153 Australia  
Phone: 630-7377

## BELGIUM

AMP Belgium  
Branch of AMP-Holland N.V.  
Rue de Brabant 62-66  
Brussels, Phone: 19.36.07

## BRAZIL

AMP do Brasil Ltda.  
Rua 7 de Abril 355  
Sao Paulo, Brasil, Phone: 335204

## CANADA

AMP OF CANADA LTD.  
20 Esna Park Drive  
Markham, Ontario  
Phone: 416-499-1251

## FRANCE

AMP de France  
29, Chaussee Jules-Cesar  
Boite Postale No. 39  
95301-Pontoise (Val d' Oise), France  
Phone: 464-92-20  
464-92-30

## GREAT BRITAIN

AMP of Great Britain Limited  
Terminal House  
Stanmore, Middlesex, England  
Phone: 01-954-2356

## GERMANY

AMP Deutschland G.m.b.H.  
Amperstrasse 7-11  
607-Langen, B.FFM.,  
West Germany, Phone: (06103) 7091

## HOLLAND

AMP Holland N.V.  
Papierstraat 2  
's-Hertogenbosch, Holland  
Phone: (04100) 25221

## SWEDEN

AMP Scandinavia AB  
Datavagen 5  
175 00 Jakobsberg, Sweden  
Mailing Address:  
Fack  
S-175 20 JARFALLA 1  
Sweden, Phone: 0758/104 00

## MEXICO

AMP de Mexico, S.A.  
Apartado Postal 179, Naucalpan de Juarez  
Edo. de Mexico  
Phone: Mexico City 576-41-55

## ITALY

AMP Italia S.p.A.  
Via Fratelli Cervi 15  
10093-Collegno (Torino), Italy  
Phone: 785-656

## SPAIN

AMP Española, S.A.  
Apartado 5294  
Pedro IV, 491, 495  
Barcelona 5, Spain  
Phone: 307-75-50

## JAPAN

AMP (Japan), Ltd.  
No. 15-14, 7-Chome, Roppongi  
Minato-Ku, Tokyo, Japan  
Phone: 404-7171

## 40 years ago

From the pages of *Electronics*, August 1933

The *Detroit Times*, one of the Hearst newspapers, is now making use of the photo-electric halftone engraver on its "rush" work. This machine, invented by Walter Howey of the Hearst organization at New York, was described in *Electronics* for November, 1932.

The photo-electric engraver at Detroit gave an especially good account of itself during the recent earthquake disaster in California. Photographs of earthquake scenes were sent to Detroit over the telephone wires by facsimile. Within ten minutes of the time of receipt of photo-facsimile, regular two-column cuts were made and ready.

The **Procter & Gamble Company**, Cincinnati, manufacturers of Ivory Soap, Crisco, Chipso and similar products, had a problem which threatens every business using oil-burning boilers. Where the fire accidentally goes out in such boilers, the oil may flow over and is likely to cause an explosion when the flame resumes.

Procter & Gamble has provided against this contingency by the use of a Photronic cell mounted in a pipe, leading directly into the fire-box. The device is removed far enough from the furnace so as to keep it cool and prevent the cell from being damaged by the heat.

In case the fire goes out, the light fails. The cell then opens its sensitive relay which in turn opens a power relay. This de-energizes the starter coil, allowing the starter to drop to the stop position, which shuts down the blower motor and closes the electrically operated valve. In a jiffy the flow of oil to the burner is discontinued. Hence there is no danger of oil accumulating in the boiler and the likelihood of an explosion is prevented. All this takes place in a fraction of the time that it takes to tell it.

Usually the flow of oil into boilers is shut off by some sort of thermal relay, when the fire fails. But this particular photo-cell installation is more positive in its action than the usual fuel cut-off, for it is bound to shut off the fuel when the light goes

out. The system operates unfailingly the instant the beam is interrupted.

**Clinton W. Hough**, president of Wired Radio, Inc., New York City, makes use of a photocell to get a direct reading of the wind's velocity from the anemometer on his Riverside Drive apartment.

Ordinarily, in weather bureaus and other places where the familiar four-cupped anemometers are used, counters record the total rotations and then the speed of the wind must be calculated. To avoid this, Mr. Hough has arranged a photocell to be operated by a small lamp each time the anemometer shaft rotates. The pulsating current generated by the photocell is then amplified and carried to a coil-wound frequency meter, which is calibrated to read directly in miles per hour the speed of the wind.

**Dr. Nevil Monroe Hopkins**, research and development engineer, 111 East 10th St., New York City, has developed a method for confidential voting by means of black and white disks held in the hands of the voters, while a photocell measures the total reflection of light from the white sides of the disks, signifying "yes." Dr. Hopkins has applied for patents on the method, which can be extended to infra-red light, so that the audience of voters sits in literal darkness and cannot see what each other's vote is. By measuring the output of the photocell with a meter, however, the percentage of voters holding up their disks with the white side front, can be quickly read off. The method is designed for secret voting in confidential canvasses, psychological tests, opinions, etc.

Before conducting the vote, the audience is first "balanced up" by measuring the light from faces, clothes, etc., for a zero line. Then a top reading for 100 per cent of white disks is made. Any percentage of "yes" votes will then be indicated by the position of the meter between these two points. Allowance is made for rows of voters further from the photocell by having them hold up larger disks.

# AMP

INCORPORATED



# YOU CAN

## EIGHT FUNCTION CALCULATOR ARRAY WITH MEMORY

## FIVE FUNCTION CALCULATOR ARRAY WITH MEMORY

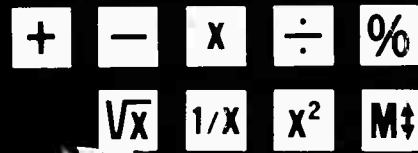
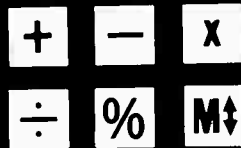

Eight-Function, Five-Function, The "T-Totaler" - all the grand arrays from MOS feature:

- Displays up to 8 digits and mathematical sign during entry of operands
- Displays intermediate calculations as well as final result
- Performs chain calculations involving sequential algebraic entry
- Permits fixed or floating decimal point
- Internal memory for "M" operation
- Internal clock generator
- Direct LED segment drive optional
- Auto-clear
- Low battery detector
- Display blanking
- Supplied in a 28-lead DIP

*MOS TECHNOLOGY, INC.—Continually coming up with new methods and more answers. So today, more than ever, YOU CAN COUNT ON US!*

**Need Details? We've A Data Sheet That Delivers. Simply Write Or Phone.**

**HEADQUARTERS** — Applications Mgr.: Mr. Julius Hertch;  
MOS Technology, Inc., Norristown, Pa. 19401

**CENTRAL REGION** — MOS Technology, Inc., 838 S. Des Plaines  
St., Chicago, Illinois 60607 • (312) 922-0288

**EASTERN REGION** — Mr. William Whitehead, Suite 307 — 88  
Sunnyside Blvd., Plainview, N.Y. 11803 • (516) 822-4240

**WESTERN REGION** — MOS Technology, Inc., 2172 Dupont Dr.,  
Suite 221, Patio Bldg., Newport Beach, Calif. 92680 • (714) 833-1600



# COUNT ON US



## T-TOTALER ARRAY

**FIVE FUNCTION CALCULATOR ARRAY WITH MEMORY PROGRAMMED FOR AUTOMATIC ACCUMULATION—ACCEPTS ENTRIES ITEM BY ITEM, PRICE BY PRICE, PROVIDES FOR TAXES, DISCOUNTS, MARK-UPS**

**T + - x**

**÷ % M↕**

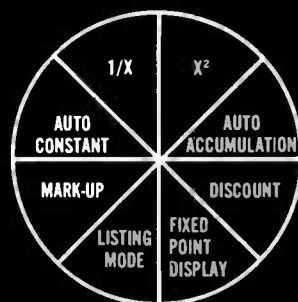

Qty	Item	Price	Total
2	Ties	1.98	3.96
1	shirt	4.60	4.60
3	socks	1.25	3.75
			12.31
			.23
	10% disc.		1.08
	Tax 6%		.66
	Total		11.74

2 x 1.98 T +  
4.60 T +  
3 x 1.25 T +  
10% T -  
6% T +

WE'VE TURNED  
A TECHNOLOGY  
INTO A  
COMPANY



**MOS TECHNOLOGY, INC.**

VALLEY FORGE CORPORATE CENTER, NORRISTOWN, PA. 19401 (215) 666-7950

an affiliate of  
**ALLEN-BRADLEY**



# The new Digital Processing Oscilloscope...

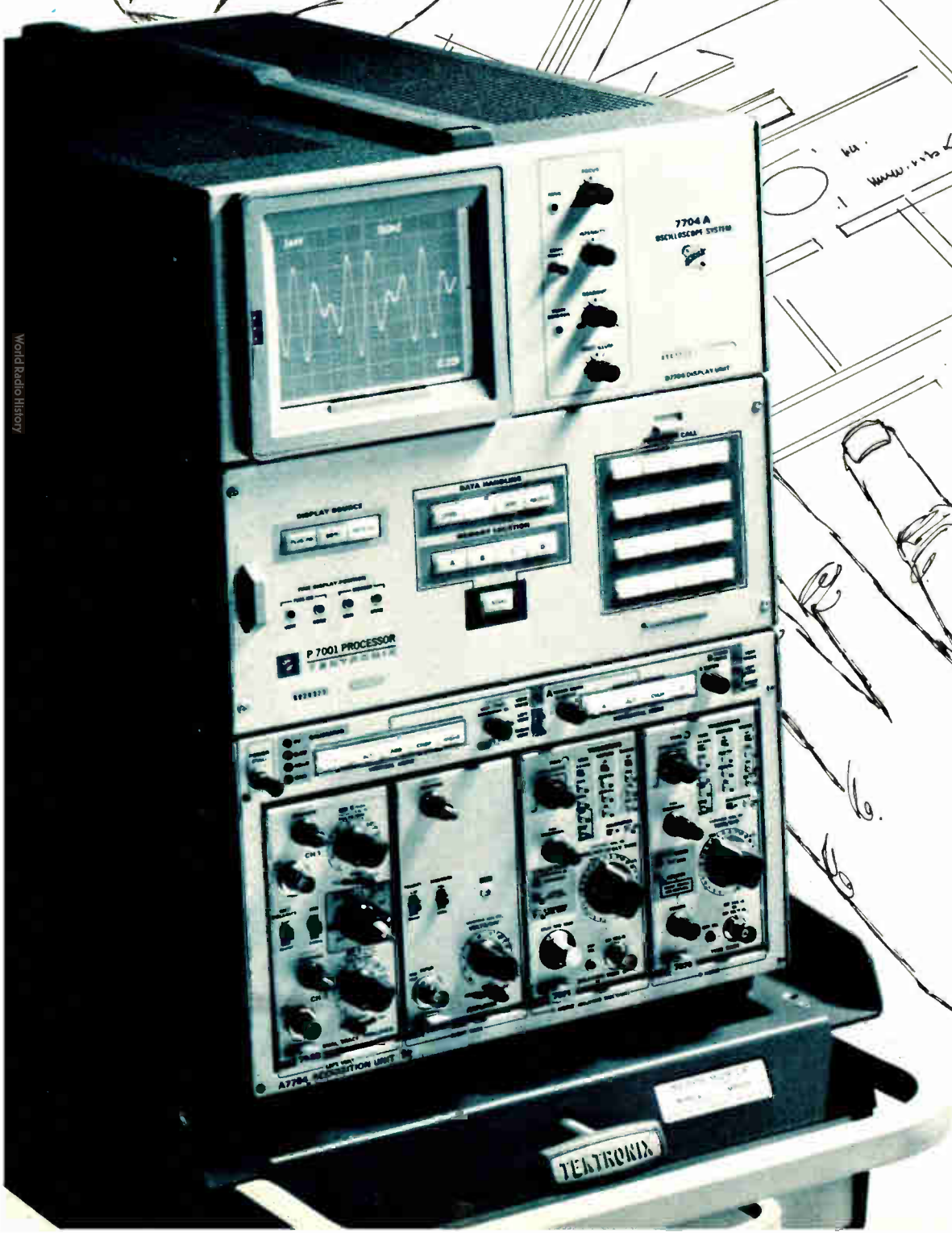

World Radio History



# ...with the world's best signal acquisition system

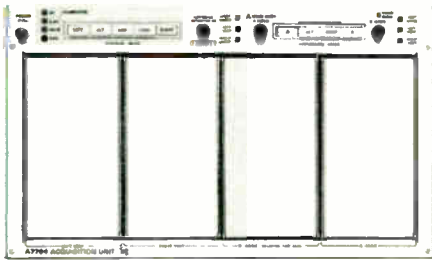

Based on the TEKTRONIX 7704A laboratory oscilloscope, the **Digital Processing Oscilloscope** takes full advantage of more than thirty acquisition plug-ins. These 7000-Series plug-ins are designed and manufactured by the acknowledged leader in analog signal processing technology. They, and the **DPO Processor** bring previously unavailable efficiency to *digital processing* of analog signals.

The broad variety of single- and dual-channel amplifiers, time bases, digital units, counters, DMM's spectrum analyzers, samplers, and time domain reflectometers enable this system to capture signals with amplitudes from microvolts to kilovolts and frequencies from DC to 14 GHz. Additionally, spectrum analyzers permit digitizing frequency-domain signals.

With this vast acquisition capability exists the ability to capture your signals. If your measurements are in the electronics field the **Digital Processing Oscilloscope** can operate on your signals directly. If you work in the physical energy field the use of suitable transducers will

permit your measurement to be processed.

To those harried by measurement problems, the **DPO** is the most necessary invention since the yardstick; combining the waveform viewing capability of a 200-MHz oscilloscope with the processing capability of a minicomputer. To learn the *better measurements story* send for the **Digital Processing Oscilloscope Brochure**, check the reader service box or contact your local Tektronix field engineer.

Tektronix, Inc., P.O. Box 500A, Beaverton, Oregon 97005. In Europe write Tektronix LTD., P.O. Box 36, St. Peter Port, Guernsey, C.I., U.K.

## Amplifiers

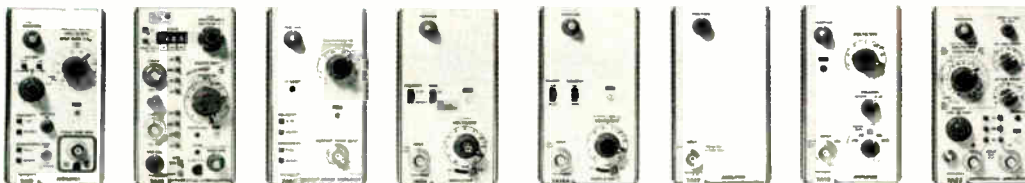

## Dual-Trace Amplifiers

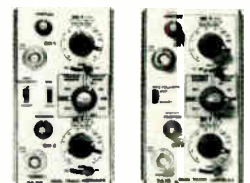

## Time-Bases

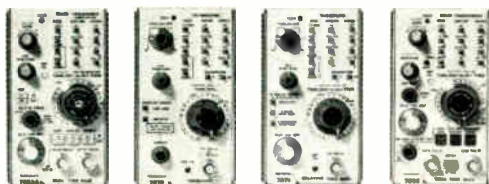

## Digital Plug-ins



## Spectrum Analyzers



## Sampling Plug-ins

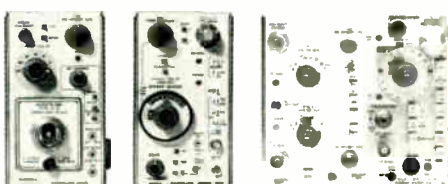

## TDR

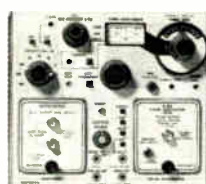

**TEKTRONIX®**  
committed to  
technical excellence

## If you want to hurt the 240L RF Power Amplifier

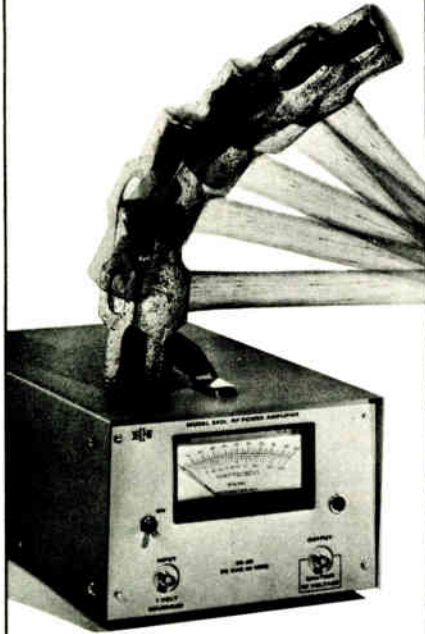

...you've got to do more  
than short circuit its output.

As a matter, of fact, this *brand new* instrument will deliver more than 40 watts of Class A linear power and up to 150 watts of CW and pulse power to any load impedance (from an open to a short circuit). Immune to load damage and unconditionally stable the 240L covers the frequency range of 20 KHz to 10 MHz with a flat 50 db gain. Completely *solid state* the 240L will faithfully reproduce input waveforms from any signal or function generator in its range.

If you need a transducer drive source for ultrasonics, RFI/EMI, biological research, electro or acousto optics the 240L was designed for you.

Solid state reliability is here at \$1450.00.

For further information or a demonstration contact ENI, 3000 Winton Road South, Rochester, New York 14623 (716) 473-6900 or TELEX 97-8283

# ENI

The world's leader  
in solid-state power amplifiers.

## People

### Lehmann revamps connector concept

Ed Lehmann, new marketing vice president at the Amphenol Industrial division, is trying to do away with the traditional approach to selling connectors. "In the past, we built a connector and offered it for sale," says Lehmann, who is re-orienting the market goals of the Chicago-based division of Bunker Ramo Corp. "We didn't always tell the customer how to put the wire on. Today, we're viewing more and more of the connector market as a total interconnect requirement—not only the components, but also installation and termination of the devices," he says.

Why? Because when the design concept is integrated with the application concept, economies of scale are possible, says Lehmann. This means, he says, involving the connector manufacturer at the beginning of the design cycle instead of waiting to order the connectors piecemeal at the last minute, which is the widespread practice.

It is up to the connector manufacturer and designer to do a better job. "We must establish greater communications with the people that are putting things together—the manufacturing and production people at the user companies. We should be asking 'how can we, the manufacturer, improve the effectiveness, reduce the cost, reduce the assembly time, increase the reliability, and provide the right materials?'"

**Tradeoffs.** Also, manufacturers should not close their minds to the total needs of the marketplace by building only one approach to a component problem, he adds. "It's difficult, when you have an existing design, to offer variations, especially when, as far as marketing is concerned, different designs will work equally well," he says. "Whether it's round cable vs flat cable, or edgeboard vs pin-and-socket, the manufacturer should be prepared, not just to protect his design, but to offer both approaches."

Lehmann is out to establish Am-



**Integrator.** Ed Lehmann integrates interconnect design with application.

phenol as what he calls the industry's "thought leader," and his business plan calls for acceleration of new-product development. The plan is already in operation. He cites the division's work in bright tin-lead-contact plating, zero-insertion-force connectors, and a modular-connector kit for breadboarding and prototyping work. "Maybe the volume it brings will support our investment," he says, "or maybe not. But we're establishing a reputation that's important to us."

Since markets outside the U.S. and distribution markets are two of the fastest growing segments of the electronics industry, Lehmann comes to the Industrial division well prepared to handle its growth. In a career that's been marked by changes within Amphenol every two or three years—"You can never hit a moving target," he grins—Lehmann counts tours of duty both as marketing vice president for distribution at the Amphenol Sales division, and as director of European marketing for the Amphenol Components group in Brussels.

Before joining Amphenol in 1961, he worked in Electronic process con-



# MOSTEK WILL WORK WITH YOU. ASK HAMMOND.

"It was paramount that precise wave shape integrity be closely maintained. Although not commonly required by most MOS circuits, Mostek achieved this result and their unique design competence and process control procedures made possible a practical mass production program."

A comment from Harwood Moore, vice president, Engineering, of Hammond Organ Company about our performance in a very cost-sensitive consumer area.

One of the most challenging aspects of Hammond's design and cost parameters demanded ladder

network tolerance not ordinarily encountered in MOS manufacturing. In order to assure the stairstep accuracy needed by Hammond, the MOS device channel width on the chip became very critical. It was known that these channels would widen slightly, altering the desired wave form. Therefore, it was necessary to control this physical parameter as closely as possible. Moore continues: "Our communication with Mostek has been excellent and we now use six chips developed especially for us. We insist on and are proud of our high reliability standards. MOS devices from Mostek are not only compatible with these standards, but have exceeded our initial goals." Words we like to hear whether from industrial or consumer quarters. When you think MOS, think Mostek. Bring us your ideas . . . we'll work with you. Just ask Hammond.



**MOSTEK**®

1215 West Crosby Road  
Carrollton, Texas 75006  
(214) 242-0444  
TWX 910-860-5975  
TELEX 73-0423

© Copyright 1973 by MOSTEK Corporation

At HAMMOND ORGAN CO., Chicago, Illinois: Harwood Moore, Vice-President Engineering for Hammond Organ Co., and on the right, Dr. Robert Proebsting, Senior MOS Design Engineer for MOSTEK Corporation, looking at one of Hammond's new organ models using MOSTEK's LSI circuitry

## Megohmmeter and Hipot?

**YES!** For true integrity in HV bench-testing of electrical or electronic equipment —you need both! Megohmmeter to test insulation resistance (IR) . . . Hipot to test dielectric strength.

### HIPOTRONICS OFFERS

a full line of high resistance megohmmeters — sixteen models with ranges to 20,000,000 megohms and high current capability for testing insulation resistance to ASTM specification D-257, MIL, and UL standards.

### HIPOTRONICS ALSO OFFERS

a full line of AC/DC hipots — twenty-seven models with ranges to 10KV AC and 25 KV DC for non-destructive measurement of leakage current, corona discharge, AC and DC insulation strength.

### HIPOTRONICS GUARANTEES

complete high voltage — high resistance capability for thorough testing of switches . . . motors . . . coils . . . chokes . . . insulation . . . transformers . . . cables . . . electrical/electronic assemblies . . . harnesses . . . and more.

For more information write or call our marketing department for brochures HP7101 and HP7107.



BREWSTER, N. Y. 10509  
Phone: (914) 279-8091



trol at the ITT InteleX division. A Canadian by birth, Lehmann holds a BS in mechanical engineering from McGill University. He is an avid shutterbug, fisherman, and musician. Moreover, he builds his own classical guitars.

Briton banks on his own originality

Any Westerner who can sell \$2 million worth of his own calculators to Japan is not quite an ordinary man. Clive Sinclair, founder and managing director of Britain's Sinclair Radionics Ltd. of St. Ives, Huntingdon, has done just that.

The calculator he is selling in Japan is Sinclair's Executive [*Electronics*, Electronics International, July 3, 1972], well known now for being only 3/8-inch thick and weighing 2 1/2 ounces. It is that small because Sinclair designed the calculator so that the chip, furnished by Texas Instruments Ltd. or General Instruments Microelectronics Ltd., can be pulse-driven instead of being run continuously.

Sinclair is 32 years old and self-taught. He left school at the age of 17, and at 21, he began selling his own radio-construction kits by mail order. In the mid-1960s, he added hi fi. By 1967, annual sales totaled more than \$250,000, and by mid-1972, before the calculator was introduced, sales had reached \$2 million a year. Currently, sales are running at about \$7.5 million a year, about 75% of which comes from calculator sales.

**View from the top.** This unusual man does business from an unusual corporate home, a six-story, 19th-century, former flour mill on the bank of the River Ouse, north of Cambridge. From one of his windows on the top floor, the managing director can look over miles of fen country; from another over the roofs of the old market town of St. Ives. Or he can look down and check that his two Rolls-Royces are still in the mill yard.

Although the calculator is his

*Continued on page 24*

Circle 20 on reader service card

## NEW 1000:1 SWEEP GENERATOR

(It's a function generator too!)



The VIC 965A is a new sweep generator covering a wide 1000:1 continuous frequency sweep range and combines the functions of a sweep generator, and a function generator in one small compact unit only 3 1/2" high and 12" wide. It provides a wider sweep frequency range, greater stability, and accuracy than commonly available. Five frequency ranges, 0.035 Hz - 35 Hz; 0.35 Hz - 350 Hz; 3.5 Hz - 3500 Hz; 35 Hz - 35,000 Hz; and 350 Hz - 350,000 Hz.

The upper and lower frequency limits may be set (screwdriver) to cover a lesser range

than the 1000:1 range normally covered. The generator can be manually tuned, can be swept with a SINGLE SWEEP UP, SINGLE SWEEP DOWN, and AUTOMATIC continuous sweep. The sweep rate is determined by a digital dial providing a wide range of sweeps either linear in Hz/sec or log in Oct/min. Both linear and logarithmic D.C. voltages proportional to frequency are provided at the back of the unit. For more details contact: Vibration Instruments Company, 1614 Orangethorpe Way, Anaheim, California 92801 — 714/879-6085.



VIBRATION INSTRUMENTS CO.

20 Circle 160 on reader service card

Electronics/August 16, 1973





## For the really tough applications, OEM's like VIDAR choose HP.

How do you record millions of telephone calls daily, process this data, and bill millions of customers monthly — without any errors? The VITEL division of VIDAR tackled this problem and solved it with their unique new telephone message metering system.

To record the raw data, VIDAR needed a magnetic tape drive with proven reliability at a competitive price. That's why VIDAR chose HP's 7970E Tape Drive. They needed the best of both worlds and knew that HP quality was the result of 33 years of experience in engineering and mass production techniques that lower costs and improve reliability.

The VITEL system records "one-shot" data at a telephone company central office to provide accurate usage

Circle 21 on reader service card

information. For instance, one system in a major metropolitan area handles 3.6 million telephones in over 100 offices. The system replaces mechanical message registers to bring a new level of accuracy to customer billing procedures.

But OEM's like VITEL want — and need — more than rugged construction, reliable performance, and competitive pricing.

They want a broad range of data rates. Like 200,556,800 cpi NRZI, or 1600 cpi phase-encoded recording that's ANSI IBM compatible. And flexibility, like 7 and 9 track, multi-density, NRZI and PE; all in one read-only tape drive.

Plus OEM Specials. Like 50-Hz 230-volt operation. Or personalized labels or logos. Even different paint on

the front panel. And how about OEM discounts, and a one-page OEM agreement written in plain English.

For the full story call your local HP sales engineer or write: Hewlett-Packard, 1501 Page Mill Road, Palo Alto, California 94304; Europe: P. O. Box 85, CH-1217 Meyrin 2, Geneva, Switzerland; Japan: Yokogawa — Hewlett-Packard, 1-59-1, Yoyogi, Shibuya-ku, Tokyo, 151.

**HEWLETT**  **PACKARD**

2/231

HP sales, service and support in 172 cities in 63 countries.

## Tektronix TM 500 Series puts it all together

Tektronix has taken a new approach to test and measurement instruments. The TM 500 Series is modular, multifunctional, synergistic, cost effective, and more. It includes the features you've been looking for.

Presently, the TM 500 Series includes 24 general purpose plug-in test instruments. All new ways to think of Tektronix. Digital counters to 550 MHz. Signal sources ranging from below 1 mHz to above 1 GHz. Pulse generators to 250 MHz. Digital multimeters with 4½ digit LED readout and temperature measurements from -55° C to +150° C. Plus signal processors, power supplies, and CRT monitors.

All the modules are interchangeable. So you can make combina-

tions of instruments to meet your particular needs. When new instruments are introduced (and many will be soon), you simply plug them into the power unit. You can use a single compartment (TM 501), a triple compartment power unit (TM 503), or two 503's combined for a standard rackmount installation.

Connections between modules and/or external equipment are made through the power unit rear interface board and optional rear panel connectors. Approximately 30 input-output lines are available in each compartment for special set-ups you might want to make. This intracompartament interface feature also permits multifunction applications resulting in a synergistic effect. Instruments working

together perform more functions than the same instruments working independently. Many modules include serial BCD so information can be transferred directly to a computer or calculator.

The TM 500 is compact too. A three-compartment power unit is only 6"x8.7"x15.3". That means the TM 500 is two to six times smaller than comparable instruments. So you save bench space. And it's light weight, easy to carry. A package including a general purpose counter, multimeter, and power supply weighs 14 to 18 pounds!

Cost? All TM 500 plug-in modules are competitively priced with instruments of comparable capabilities. Because TM 500 instruments share the fixed costs of

# Modular, compact, synergistic, multifunctional, versatile, cost effective and more.

Circle 22 on reader service card

For a demonstration circle 161 on reader service card



power supplies, cabinets, etc., they consistently provide the lowest cost per test/measurement function. And, because the instruments are modular, cost of maintenance is lower too.

For complete details, contact your Tektronix Field Engineer. Or write or phone for our new 12 page, full color brochure and 24 data sheets. They show why the TM 500 is the finest test and measurement series available today. Tektronix, Inc. P.O. Box 500, Beaverton, Oregon 97005. In Europe, write Tektronix Ltd., Guernsey, C. I., U.K.

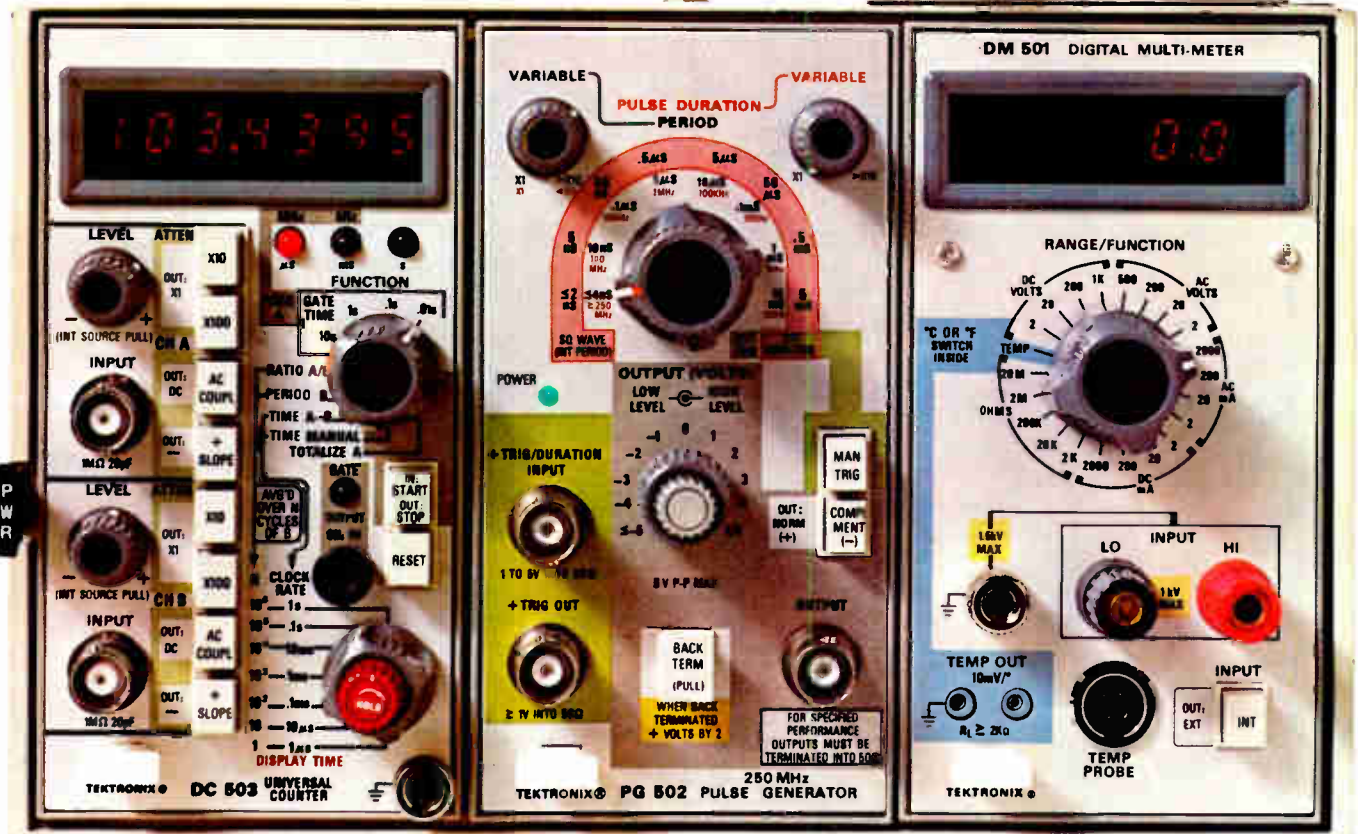
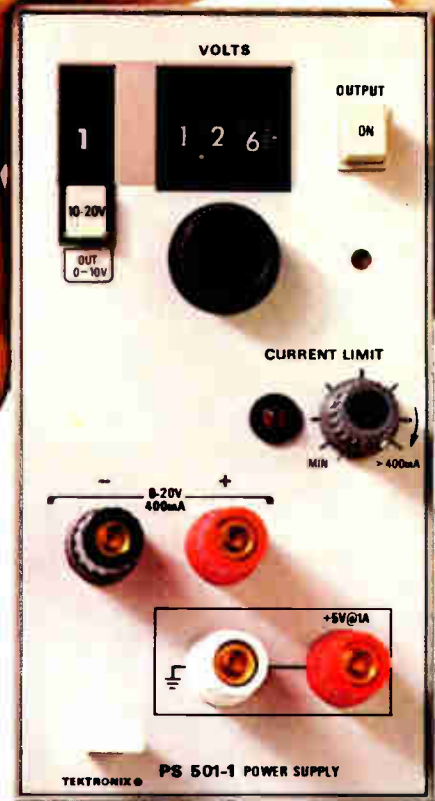

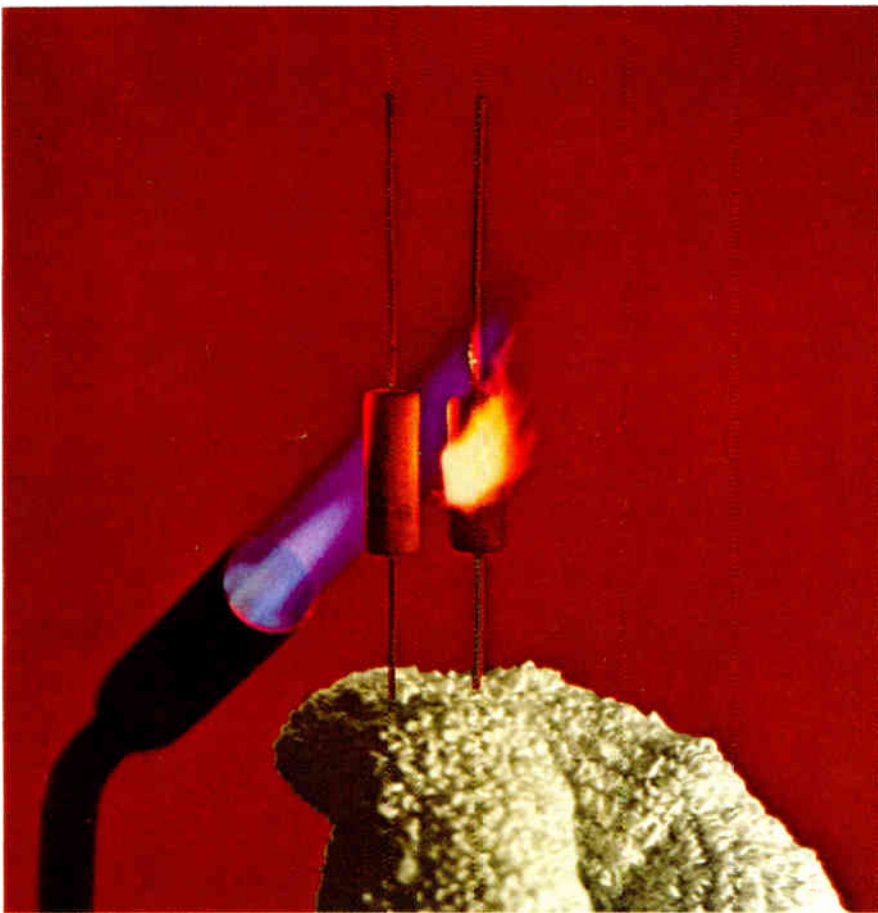

## OTHER RESISTORS DO A **SLOW BURN** UNDER SPRAGUE'S TORCH TEST!

CERON® CERAMIC-INSULATED FLAME-PROOF WIREWOUND RESISTORS are a *new* development to meet the need for a *truly* non-flammable resistor in electronic equipment. Unlike some other so-called "flame-proof" resistors, which open-circuit before burning when subjected to high overloads, new and exclusive Sprague Ceron® Resistors are absolutely inert in the presence of heat or flame. They will not ignite under any degree of overload. *Actually, they will not burn even when placed directly into an open torch flame!* This is clearly indicated in the photograph above, which dramatizes the protective qualities of the flame-proof Ceron® coating as compared with that of a

conventional silicone-coated resistor.

The special coating is completely resistant to standard industrial cleaning solvents. Totally inorganic, it is also immune to attack by fungus. It provides excellent protection against thermal shock, humidity, and vibration. Dielectric strength, measured in a "V" block, is 500 volts a-c.

Series 380E (standard) and Series 400E (non-inductive) Ceron® Resistors meet moisture requirements of Specification MIL-R-26. Resistance values range from 1 to 60,000 ohms, in wattage ratings from 1 to 10 watts. Resistance tolerances as close as  $\pm 1\%$  are available. Sizes range from  $\frac{1}{8}$ " D. x  $\frac{3}{8}$ " L. for the 1-watt resistor to  $\frac{5}{16}$ " D. x  $1\frac{3}{4}$ " L. for the 10-watt unit.

widest-selling original product, Sinclair is prouder of an older item: an fm tuner based on a phase-locked loop. He thinks he was the first to market one, in 1970. He had pulse-width-modulated audio amplifiers in 1966 and a matchbox-sized radio in 1964. He claims to make the cheapest digital multimeter on the British market. In development is a 2-inch-screen TV receiver with all the circuitry integrated according to his own ideas. And he's developing something he won't talk about in computer hardware.

So far, Sinclair has originated most of his own products, but recently he's built up a team of 25 engineers who are working on new items. The first quality he looks for in a team member is creativity, coupled with expertise in a particular field.

He says the main factor in originality is simplicity, "but simplicity doesn't mean crudity. On the contrary, it often involves subtlety." Sinclair thinks that having to teach himself electronics probably helped develop originality. "Innovation is often a matter of transferring an idea from one field to another. If you teach yourself, you dig into all sorts of nooks and crannies for information, because nobody tells you what to read. So you pick up a wide range of ideas."

**Dropout.** Clive Sinclair left school at 17. Today his company's sales are \$7.5 million.



48R-2118R2

For complete technical data, write for Engineering Bulletin 7250 to: Technical Literature Service, Sprague Electric Co., 35 Marshall St., North Adams, Mass. 01247.



THE BROAD-LINE PRODUCER OF ELECTRONIC PARTS





## YOU'RE LOOKING at the PERFECT SOURCE for CRYSTALS, OSCILLATORS and CRYSTAL FILTERS

ERIE is bursting with a full line of QUARTZ CRYSTALS . . . with deliveries to meet your production schedules. 1 kHz to 200 MHz . . . AT, JT, DT, NT, SL, 5°X, GT.

We have exotic crystals and very simple crystals, low frequency and high frequency crystals. And we manufacture and test to meet or exceed Mil-C-3098 standards. ERIE provides a better crystal because we control our total manufacturing process in-house.

Our broad line of CRYSTAL OSCILLATORS range from low cost TTL dip package types to complex high stability, high reliability oscillators . . . both military and industrial types.

When it comes to CRYSTAL FILTERS, ERIE can design and manufacture the filter best suited to your application. There is virtually no limit to the variety we produce . . . including Monolithic Crystal Filters.

So come to ERIE for a fast, accurate and down-to-earth answer to your frequency control problem. One factor remains constant . . . you'll get a fair, cost-conscious answer. We have the technology and the products to implement effective crystal performance.

WRITE FOR OUR CATALOG  
OR CALL 717/249-2232  
FOR ENGINEERING AND  
PRICING HELP.

**ERIE FREQUENCY CONTROL**  
453 LINCOLN ST., CARLISLE, PENNSYLVANIA 17013  
DIVISION OF ERIE TECHNOLOGICAL PRODUCTS, INC.



Circle 25 on reader service card

# There's more to resistors than resistance



## If you're really serious about cost, be serious about quality.

If you think all resistive components are the same, listen to what these users have to say about Allen-Bradley fixed composition resistors:  
**Buyer**—"A-B has shipped nearly four million parts without a single reject or problem. The quality is superb. I've spent 12 years in production control and purchasing. I've seen the amount of down-time, rework and field retrofit caused by others:"

**President**—"We have used many millions of Allen-Bradley hot-molded resistors. The uniformity of quality from one shipment to the next is truly outstanding!"

**Engineer**—"When we use A-B resistors instead of some other make, it's one less component we have to worry about!"  
"We learned the hard way. The subtle things make the difference. They all

add up to the top quality we want in our products!"

**Purchasing Agent**—"We wish we had more Allen-Bradleys."

Write for Publication RD. Allen-Bradley Electronics Division, 1201 South Second Street, Milwaukee, WI 53204. Export: Bloomfield, NJ 07003. Canada: Allen-Bradley Canada Limited, Cambridge, Ontario. United Kingdom: Jarrow, Co. Durham NE32 3EN.



**Allen-Bradley**

Milwaukee, Wisconsin 53204

Circle 28 on reader service card



## **Mitre digital 2-way CATV system readied for use**

The wired city is moving a little closer to reality as a result of development by Mitre Corp., Bedford, Mass., of a two-way high-speed digital communications system, called Mitrix, for cable television. In nearly two years of tests, Mitre has found that the system can coexist with other services in a CATV network, and **it can operate with virtually any type of terminal, including facsimile machines and CRT-keyboard units.**

Mitrix requires only about 2% of the cable bandwidth, and it offers transmission rates between 70 and 300,000 bits per second. The demonstration system consists of a two-way CATV network, a computerized network-control center to manage traffic, and several subscribers' digital interface units to connect digital terminal equipment to the "receive" cable.

**Mitrix can time-share a maximum of 8,000 minimum rate subscribers and can have 131,072 subscribers in one network.** Mitre says the system is now ready for full-scale development and that the first applications will probably be in large plants and business environments.

## **Specialized carriers create huge market for microwave gear**

**Specialized common carriers will buy \$67.8 million in long-haul microwave equipment this year and \$505 million through 1980.** These figures, based on a market analysis of specialized carriers by Harry Newton, project director for market researcher Frost & Sullivan, New York City, represent about 25% of the total microwave-equipment purchases, including those of the Bell System and other telephone companies, from independent manufacturers.

Newton contends that **an estimated \$30 million will be spent by the specialized common carriers over the next eight years for short-haul—intra-city—communication systems.** But he says this figure could increase dramatically if a company develops cheaper short-haul equipment that would offer an alternative to the regular telephone lines.

## **Bargaining strategy tempers U.S. hopes of Soviet ATC sale**

U.S. optimism that American companies may have the inside track in selling \$1 billion worth of air-traffic-control systems to the Russians [*Electronics*, Jan. 4, p 50] is being dampened. **Observers caution that the Soviets may be playing off several countries' suppliers against each other.** Besides the U.S. companies, the Russians are known to be talking with Britain's Plessey and France's Thomson-CSF. A contract could be let before the end of the year because the Russians are in a hurry to begin upgrading their overcrowded system, say U.S. sources. And the Soviets reportedly asked IBM, Raytheon, Sperry Univac, Lockheed Electronics, Texas Instruments, and Westinghouse to supply proposal information on **the first-phase upgrade of ATC systems, and this is estimated to be worth from \$50 million to \$100 million.**

## **Japan accelerates calculator exports**

Exports of desk calculators from Japan are increasing at a dizzying pace. Preliminary estimates for the first seven months of this year show that **the number of calculators exported has already exceeded the total exported during the 12 months of calendar 1972.** Ministry of Finance statistics for the first six months show that exports during that period were 2.365 million units, worth \$176 million, which is **2.4 times the number of units and 1.52 times the value of calculators exported during the first half of last year.** About half of these calculators, 1.18 million,

went to the U.S. The number of units increased much faster than the total price, indicating that sales of low-price machines grew rapidly.

## **Intersil Cronus-1 electronic watch is set to go**

The electronics and the LED displays for Intersil's Cronus-1 stop watch which was unveiled this week are ready for production, and delivery is pending the plastic housings for the new timer. **The watch, which shows 24 hours, will have a rechargeable battery, quartz-crystal oscillator, a light-emitting-diode display, and a C-MOS chip in a 28-pin dual in-line package.** Cronus-1 is ½ in. wide, 1.4 in. long and about ¾ in. high. It has a continuous display and can go for three months without recharging. A button can be pushed to disengage the LED display and conserve power. **It will sell for \$195.00.**

## **New instruments can display random- logic sequences**

Hewlett-Packard Co., Palo Alto, Calif., and Digimetrics Inc., Dublin, Calif., have started showing customers new oscilloscope-like instruments that display logic-waveform patterns on cathode-ray tubes. However, unlike conventional oscilloscopes, **both displays can be used to analyze random-logic sequences, since neither requires repetitive input sequences.**

The H-P instrument is said to be a version of the recently introduced 5000A logic analyzer, which shows a representation of any 32-bit sequence in a long series of logic operations. Logic states are indicated by light-emitting diodes, and the diode spacings represent clock intervals, rather than actual clock times [*Electronics*, April 26, p.139].

The presentations on Digimetrics' Digiscope resemble logic-system timing diagrams. **Synchronous or asynchronous signals from as many as eight digital channels can be stored in registers** under control of an internal clock. Register storage allows logic states, pulse-transmission times, and glitches (short pulses) to be viewed as though the CRT were a storage tube, as the clock sets the speed of the sweep.

## **New core memories from Data General are denser, cheaper**

Data General Corp. has reduced prices on a new line of core memories, similar to the Nova 2 memory, which can either be bought with new Nova 1200 and Nova 800 minicomputers or can be added to existing Nova systems without modifications. **The cores, made in Southboro, Mass., are strung at Data General's Hong Kong subsidiary.**

The new memories have a denser core configuration—a 15-inch-square printed circuit board can hold 16,384 words with a cycle time of 1,200 nanoseconds. While the new memories have enabled Data General to lower the price of most of its computers, **the savings are most substantial in the larger systems where 16,384 words are now on one board instead of two.**

## **Riley returns to semiconductors**

**Look for Jim Riley, who has been president and chief operating officer first of Signetics Corp., Sunnyvale, Calif., and then Intersil Inc., Cupertino, Calif., to get back in the semiconductor business at Inselek Inc.** Riley, who resigned from Intersil more than a year ago, has acquired an interest in the Princeton, N.J., manufacturer of silicon-on-sapphire components and may well be named chairman of the board. He is also expected to take an active part in the company's operations.



# fail-proof

UNITRODE IS SPECIFIED IN ALL MAJOR  
MISSILE AND SPACE PROGRAMS  
...WHERE THERE IS NO MARGIN FOR FAILURE.

# rectifiers

From HAWK to SAM-D, from MERCURY to VIKING, thousands of Unitrode rectifiers have been operating dependably for millions of hours under the most extreme environmental conditions. In Apollo alone, over three thousand Unitrode components have been used in everything from the Saturn booster and capsule telemetry system to the lunar module and cameras. Some reasons why? Unitrode's unique fused-in-glass construction for monolithic devices that are void-free and bonded, with very high forward and reverse surge capability, mechanical strength and permanently stable electrical

characteristics. And they provide more power in smaller packages. Unitrode also provides the broadest line of power rectifiers from 1A through 20A — over 100 types. Whatever your rectifier application, think of Unitrode for down-to-earth reliability.

For fast action, call Sales Engineering collect at (617) 926-0404. Unitrode Corporation, Dept. 14 Y 580 Pleasant Street, Watertown, Mass. 02172. For the name of your local Unitrode representative, dial (800) 645-9200 toll free or in New York State (515) 294-0990 collect. Check listing below for your nearest Unitrode distributor.

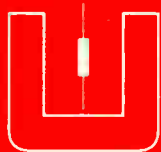

## UNITRODE

Unitrode Flashcard Distributors: ARIZ., Phoenix, KERNITT (602) 777-7321; CAL., Los Angeles, KERNITT (213) 675-5231; Fla. Am., KERNITT (407) 964-4251; San Diego, BERLITT (714) 278-2127; CANADA, Toronto, SCHWIBER (416) 425-2472; CHINA, Denver, KERNITT (303) 343-0296; FLA., Hollywood, SCHWIBER (305) 927-0512; GA., Atlanta, SCHWIBER (404) 448-9170; ILL., Elk Grove, SCHWIBER (312) 723-7240; MD., Bethesda, SCHWIBER (301) 961-7571; Baltimore, J. J. D'AMICO (301) 629-6418; MASS., Weymouth, SCHWIBER (617) 990-8484; MICH., Troy, SCHWIBER (313) 583-5242; N.J., Aspinwall, SCHWIBER (609) 469-8006; N.M., Albuquerque, SCHWIBER (505) 223-2225; N.Y., Rochester, SCHWIBER (716) 429-4220; Wash. D.C., SCHWIBER (202) 634-7474; N.C., Raleigh, SCHWIBER (919) 822-4481; OHIO, Beachwood, SCHWIBER (216) 464-0790; TEX., Carrollton, ASTRATE (214) 377-2471; (Dallas), HAMILTON INNET (214) 634-2824; Houston, HAMILTON INNET (713) 425-2441; Houston, LEMERT (713) 275-1465; UTAH, Salt Lake City, ALBA ELECTRONICS (801) 486-0327; WASH., Seattle, ALBAFF (206) 792-2224

See EEM Section 48X and EES Semiconductor Section for more complete product listing.

# NEW SOLID STATE RELAYS

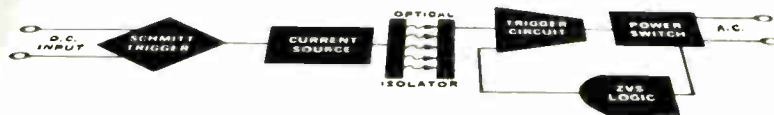
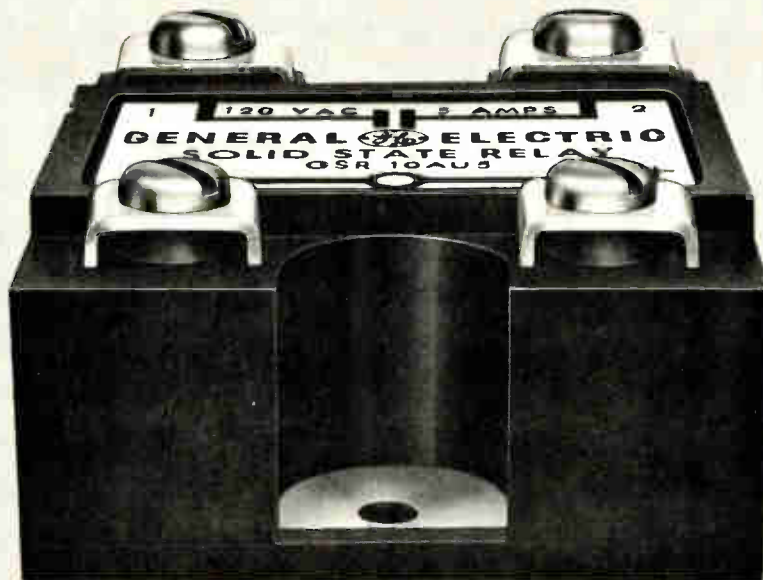

## FROM GENERAL ELECTRIC

All the technology that went into making General Electric a leader in couplers and power semiconductors is in our first solid state relay. Two models, 5 Amp. GSR10AU5 and 10 Amp. GSR10AU10, feature

- 120 V line operation
- Zero voltage switching, 5V max.
- T<sup>2</sup>L operation – 30 to 100° C
- Operates from 6.3 to 140 V RMS
- 1500 V RMS Photon Isolation

AVAILABLE NOW FROM YOUR AUTHORIZED GE DISTRIBUTOR  
SEMICONDUCTOR PRODUCTS DEPARTMENT, SYRACUSE, NEW YORK

GENERAL  ELECTRIC

Circle 32 on reader service card



## Field-effect LCDs may give watches push in the market

At least four companies have developed field-effect LCDs, and Gruen has already begun marketing its watch

**Field-effect** liquid-crystal displays may give the electronic-watch industry a big boost. What is claimed to be the first watch using a field-effect LCD, the Teletime, has been introduced by Gruen Industries, Waterbury, Conn. And president Mitchell J. Teeman predicts a 20-fold increase in the digital electronic watch market this year—from about \$2.5 million to \$50 million.

Meanwhile, the Hughes Aircraft Microelectronics division, Newport Beach, Calif., and Motorola Semiconductor Products division, Phoenix, Ariz., have developed field-effect liquid crystals for watches with a projected life expectancy of five years [*Electronics*, Aug. 2, p. 36]. Rockwell Microelectronics, Anaheim, Calif., also plans next year to produce a watch using field-effect LCDs that will sell for under \$50.

Previous LCD watches have used the dynamic-scattering type display [*Electronics*, April 12, p. 95]. These displays illuminate milky white lettering, created by a flow of current, against a mirror background. Field-effect displays, which absorb light through polarizers, show up dark characters against a diffused white background.

Teeman, speaking at the Retail Jewelers Association convention in New York last month, also said that as research and development costs are absorbed, retail prices will come down 50% in two years—to the point

of direct competition against fine analog watches. Prices of the six Teletime models begin at \$150.

**Watching for a long time.** Supplier of Gruen's LCDs is the Ilixco Corp., Cleveland, Ohio, a company that has been making commercially available field-effect LCDs for two years. Ilixco director of engineering, Tom Harsch, is confident that the display will last for the guaranteed three years, and believes it can last

for 10. Harsch adds that Ilixco's use of high-purity materials which draw low current, plus a thermoplastic seal to maintain purity, assures the long life of the display.

Gruen's field-effect LCDs use a 1.5-volt battery boosted to 7.5 v, 5% of the power at half the voltage needed for a dynamic-scattering LCD. Motorola and Hughes say their LCD operates at 3 v.

The Gruen watches are packaged modularly—there are two main parts, the primary board assembly and the timekeeping module. The timekeeping module contains the LCD and an IC package, which is directly connected to the display. This accommodates most of the interconnections so that only eight remain to be made between the primary board and the timekeeping module.

Two ICs are used. One contains a 32-kilohertz oscillator and count-down circuit that operates the battery, and the other drives the count-down and performs the display's decoder-driver functions. The primary board carries the voltage converter, oscillator subassembly, switch, and battery. □



**Long time.** Field-effect LCDs, such as those used in Gruen's Teletime (above) have longer life than dynamic-scattering LCDs.

### Military Electronics

## Navy buys dogfight simulator for pilots

The fact that training methods for U.S. fighter pilots have changed little since World War II unfortunately became evident in the low kill ratios of the Vietnam War. As a consequence, the U.S. Navy is bent

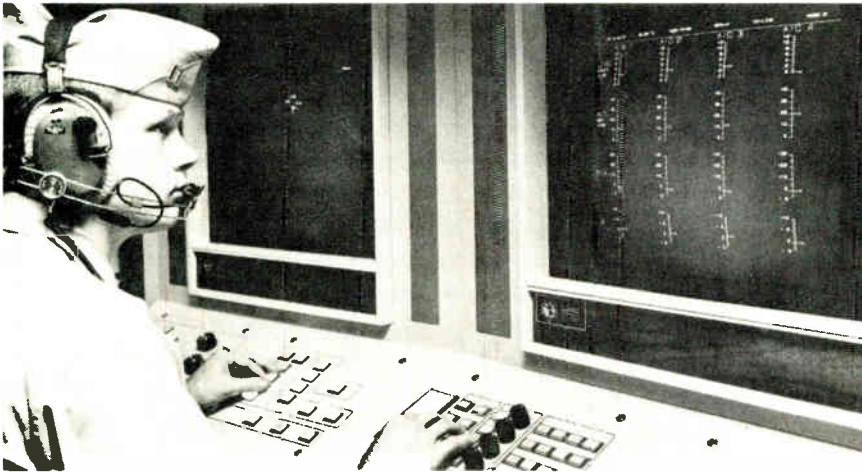

**Dogfight monitor.** A new Air Combat Maneuvering Range, developed by the Cubic Corp., provides real-time monitoring and control of fighters engaged in air combat training.

on improving its methods, and one sign of this is the new Air Combat Maneuvering Range (ACMR), delivered to the service this month for tests.

The system, developed by Cubic Corp., San Diego, Calif., provides real-time monitoring and control of fighters maneuvering in dogfights; actions are recorded for later playback to the pilots, and firings and scores are simulated. Presently, fighter trainees are allowed to fire only one live missile a year because of the cost, providing a severe pass or fail examination.

Cubic's ACMR, set up at the U.S. Marine Corps Air Station in Yuma, Ariz., with a remote display station in Miramar Naval Air Station, near Cubic in San Diego, should also reduce the large but classified number of accidents in training pilots.

The airborne part of the system is a transponder similar in size and configuration to the Sidewinder missile. In fact, the unit, with a strap-down inertial guidance system, replaces a Sidewinder and can be used with any aircraft that has a mounting for the missile—F-4, A-4, F-8, A-7, A-6, F-14, and even the C-130. To the aircraft, the on-board system appears to be a missile, and no modifications are required.

**Solar-powered sites.** The air instrumentation package works with the tracking instrumentation subsystem, six remote sites located in the southern California desert region. The sites, which use solar power, are

located within line of sight of the master station. The system can handle 16 aircraft simultaneously. It has a 40-mile range at altitudes from 5,000 to 50,000 feet and to within 4-ft accuracy of location.

The heart of the system is the control and computation unit consisting of three Xerox Sigma 5 computers that govern the operation of the subsystems. Completing the hardware are two display and debriefing vans, one at Yuma and a remote one at Miramar, either of which can control the pilots. Multiple displays are used, and they may show a third-party view of the two competing aircraft from any angle, a cockpit view from either plane, or numerical data.

Cubic's contract calls for the delivery of one system at a cost of about \$9 million, but Hugh Kohonen, senior staff scientist, expects a total of \$60 million from the program, including possible tracking applications. □

### Displays

## LEDs may light military displays

Flat TV screens to replace cathode-ray tubes have been one of the will-o'-the-wisps of the electronics industries for many years. Now Litton Industries Data Systems division

hopes to replace, not only the CRT, but a 4-by-4-foot digital plotter with a flat screen only a few inches thick. The display, using unique three-color light-emitting diodes, is headed for possible use in Litton's Tacfire system [*Electronics*, Aug. 2, p. 44] under a contract from the U.S. Army Electronics Command and as a cockpit display under a pact from the U.S. Air Force Flight Dynamics Laboratory.

So far, Litton, Van Nuys, Calif., has produced a 6-by-6-inch demonstration model, but expansion to the larger size is only a matter of money and time, the company says. The demonstrator, which displays in red, yellow, and green, uses digitally addressed hybrid modules each 1½ by ¾ in. Litton is taking the entire output of the special LEDs from Texas Instruments and Bowmar of Canada, says Tom O'Donnell, vice president for business development. Colors are selected by current passing through the diode. The colors available are especially appropriate to military applications. Red identifies the enemy, green is for friendly forces, and yellow provides such information as boundary lines.

Since a small module that uses 512 diodes provides 22-line-per-inch resolution, a full 4-ft-by-4-ft panel (the Army's standard size for maps and plotting) would require slightly more than 1 million diodes. The digital addressing used, however, means that only 127 wires are required. Grey scale—brightness—is also available, and if the company were to go to 80 lines per inch, resolution would be equivalent to that of standard video. The present system gives 80-meter resolution on standard Army 50,000-to-1 maps.

A big advantage of the LED display is that it would replace the X-Y plotter, as well as the CRT used in the Tacfire system, and it could be used in such other systems as Awacs (Airborne Warning and Control System), as well. The display should also be far more reliable than CRTs or electromechanical equipment. With a 4-by-6-dot matrix, all numerals and letters can be displayed. Moreover only 60 microseconds are required to update a character or



symbol, much faster than the digital X-Y plotter, and symbols can be flashed to attract immediate attention.

As might be expected, the big problem is cost. O'Donnell says that the LED cost must be brought down to about 10 cents per point, far from the present \$1 per point. At that rate, a single-color display would cost about \$75,000 or \$80,000, and a three-color unit, \$125,000. He says the program is at least two years from practicality, but looks for it to be used in the future. Even if a blue LED is developed, consumer applications are a long way off. □

## Medical Electronics

### New pacemaker is rechargeable

A lightweight, rechargeable heart pacemaker that needs to be implanted in a patient only once appears to be able to be recharged periodically for at least 20 years. In a five-year collaborative effort between two Johns Hopkins University scientists, Robert Fischell, a physicist at the Applied Physics Laboratory, and Kenneth B. Lewis, a cardiologist at the University hospital, designed the unit by applying satellite technology to the intricate problems of monitoring and augmenting weakened hearts. Following successful implantation of units in animals and humans, commercial production is beginning at the licensee, Pacesetter Systems Inc., Sylmar, Calif. The unit costs about \$1,800.

While a conventional pacemaker costs much less—about \$1,000—each unit must be replaced surgically every two years. Nuclear-powered units can last 20 years, but they cost about \$5,000, emit some radiation into the body, and are three times bulkier and heavier than the new unit. Moreover, the wearer can easily recharge the new unit by himself, thus saving expensive and time-consuming visits to a doctor's office.

The pacemaker measures 4.27 by

7.24 by 1.32 centimeters and weighs about 96 grams. With a patient under local anesthetic, the unit is implanted between the skin and muscle tissue in the hollow just under the left collarbone. Through catheterization, the electrode is placed in the right atrium of the heart. Once implanted, the unit causes no inconvenience and permits the wearer to lead a reasonably active life, APL says. As a demand unit, the pacemaker only "fires" if the heart doesn't beat within a prescribed time.

**A battery for a body.** Co-developer Fischell says that there were two big problems in developing the unit. Although they used nickel-cadmium cell technology from APL's space developments, it took the efforts of several manufacturers to get a rechargeable cell that would operate at body temperatures. The other problem was "finding a truly hermetic seal for the electronics so that the body fluid wouldn't damage them." A special alloy was finally selected.

The electronics include a heart-beat wave amplifier feeding a small processor that discriminates when the heart is about to beat, which inhibits the pacemaker. Since the body, as well as the heart, puts out a

lot of signals, the processor must accurately pick up the heart's frequencies, notes Wade E. Radford, APL assistant program sponsor. If the heart does beat, it can't beat again for 400 milliseconds, which "helps our signal-to-noise ratio because we can ignore the noise in that region," he says.

Other electronics are a solid-state clock, various fail-safe circuits, and a telemetry circuit that lets the wearer know that the recharging head isn't in the right position to recharge the cell.

**Recharge in 90 minutes.** To recharge, the seated wearer plugs in a portable recharging unit, puts on a special vest, and places the recharging head where the unit's signal lights direct him. The pacemaker is recharged through the skin for 90 minutes a week, enough to keep up a six-week reserve. An acoustical-coupler option also lets the wearer transmit his heart signs via telephone to a doctor.

Fischell, who says that sales should be good, points out that the worldwide market for pacemakers next year will take 100,000 units. Further refinements may be in the offing for the hybrid electronics package. Although the size of the power cell largely determines the

**Long-lived pacemaker.** Using space technology, Johns Hopkins scientists designed a rechargeable pacemaker that is expected to operate for at least 20 years. The unit sells for about \$1,800.

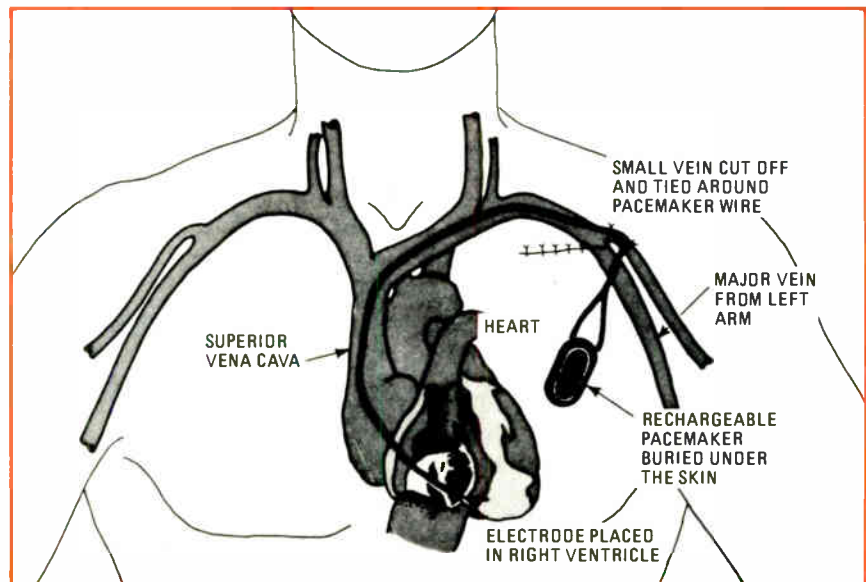

## Electronics review

unit's shape, the electronics could all be placed on a 1-by-1-inch chip, Radford says. □

## Aerospace electronics

### Floating ball rivals North Star—almost

An experimental system that is really a satellite within a satellite promises more accurate and economical navigation for future systems, according to recently released findings by the U.S. Navy. The disturbance-compensation system (Discos), jointly developed by the Applied Physics Laboratory of Johns Hopkins University and Stanford University's department of aeronautics and astronautics, was quietly launched aboard the Navy's Triad satellite last September and had not been made public until late in July.

Although most satellites must be interrogated twice a day to determine their tracks, which can't be

predicted for more than 16 hours in advance, the Discos navigation fixes for Triad, accurate to within a 10th of a mile, can be predicted accurately for two weeks or more in advance.

This means that Discos can provide a stable platform for scientific experiments, reduce the amount of ground-based computer equipment for tracking, and pinpoint satellite positions for possibly months in advance, much like navigation charts of the stars, says Richard B. Kershner, assistant director, at Johns Hopkins APL.

**Cheaper later.** Kershner foresees that Discos will also show up on special scientific satellites to measure the earth's surface, explore the upper atmosphere and its relationship to solar activity, and, as a suspended platform, test the theory of general relativity. But, since the system will cost from \$3-4 million to build, a commercial version seems a long time in the future. Instead, APL is developing a cheaper variation on the same idea, using an eddy-current-suspended slider around a wire to detect drag along the track, the

most difficult disturbance force to predict. This system could handle a once-a-week interrogation cycle at a price tag of \$20,000 "after you've produced a few," Kershner says.

Discos achieved its results by counteracting the drag and radiation forces acting on satellites. The heart of the system is a 2.2-centimeter gold-platinum alloy ball "flying" inside a spherical chamber with 1-centimeter clearance all around. The satellite is on track when the ball is centered in relation to the chamber. The enclosed ball is immune to drag and radiation forces. When drag or solar radiation pressure is about to throw the satellite off track, sensing electronics on opposite "sides" of the chamber detect the changed position of the ball and fire thruster jets that adjust the satellite in relation to the ball.

Although the 15-year-old idea sounds simple, building Discos was "the toughest job we've ever done in the space business," Kershner says. Stanford spent eight years and APL three years working on the concept. Developers found that the satellite had to be very symmetrical around the ball, and the electronics, which measure tiny position changes in picofarads, also must compensate for the "gravitational attraction of the rest of the satellite for the little ball," a weighty matter in space, he says. □

**Keep the ball centered.** The Navy's Discos system operates in the Triad navigational satellite. When the small gold-platinum ball is centered in the chamber, the satellite is on track.

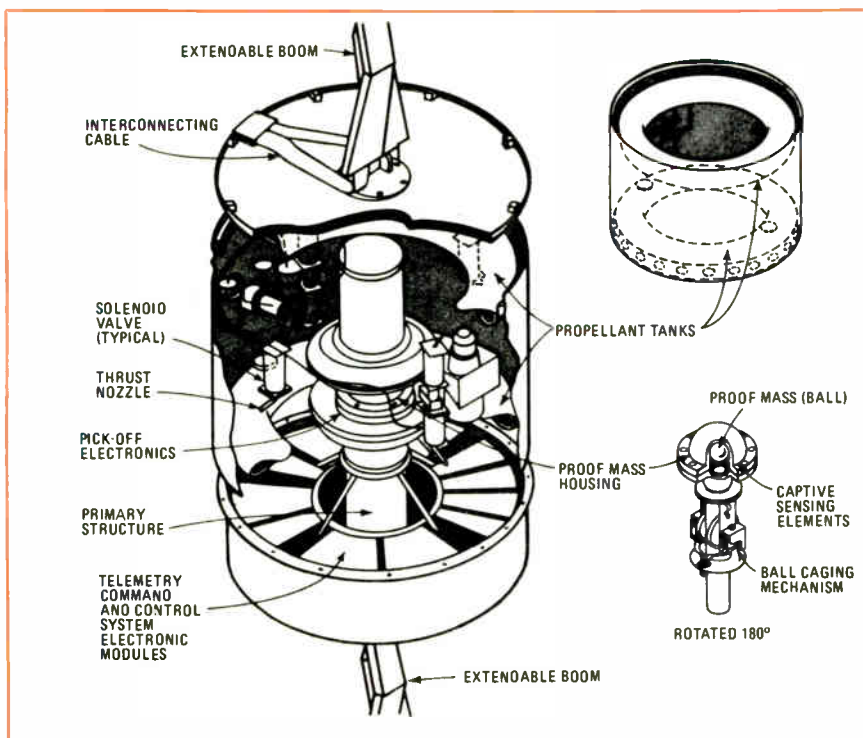

## Commercial electronics

### 3M videocopier melds techniques

The videotape industry and its customers are in a quandary over different types of tapes, widths, and formats. However, Minnesota Mining & Manufacturing Co. has developed a videotape contact-printing technique that combines magnetic and thermal technologies to handle all the variations. Dubbed STAM—for sequential thermal anhyseretic magnetization—the process was introduced in St. Paul this month. The adjustable high-speed helical video-



# Interchangeable CPUs. That's modularity.



SUE's basic CPU gives you a minicomputer that's high in flexibility yet low in cost. Other CPU models provide additional arithmetic or math capability to satisfy specific application needs.

These all slide easily in and out of the chassis. Without any wiring. In fact, you can change CPUs at your plant (or even in the field if need be) in about 60 seconds. So a SUE system can change and grow as fast as your customer's needs change and grow.

**The component computer.** And you're not limited to one CPU at a time. SUE's multiprocessor capability lets you hook up as many as four on a single Inibus. Just choose the combination of processors that suits the system best.

That's because SUE (the System User Engineered mini-computer) is the first of its kind: a component computer for systems. Its modular processors, memories and controllers all plug together in almost any combination to solve your application problems.

That includes I/O controllers, but you'll never

need more than two basic types with SUE: one bit serial, one word parallel. These will adapt to any I/O device.

#### **Wider choice of peripherals.**

We offer a full line of peripherals to go with SUE: IBM compatible 5440 disk drives, printers from 100 cps to 600 lpm, magnetic tapes, cassettes, punched card devices and paper tapes. Anything your system needs.



**Complete software tools.** To make your programming burden lighter, we offer a full set of software tools: sort/merge, DOS, assemblers, utilities and other programming aids.

And we're the only company we know of that unconditionally warrants all our software for a full year.

**Built for systems builders.** SUE's built-in flexibility makes it fit your systems now, makes it easily changeable later on.

You can be sure we'll be here later on, too. Which is one more advantage of dealing with an established, reputable company like Lockheed Electronics.

Let's talk. Call (213) 722-6810, collect, or write us at 6201 E. Randolph St., Los Angeles, California 90040.



# That's SUE.

**Lockheed Electronics**  
Data Products Division

Boston 861-1880 • New York metro (215) 542-7740 • Philadelphia 542-7740  
Washington (703) 525-3600 • Atlanta 266-0730 • Detroit 557-5037 • Chicago 833-4600  
Dallas 231-6163 • Houston 682-2617 • San Francisco (408) 257-3357

tape duplicator does away with the need for backward-running tape recorders for mirror-image master tapes.

"Our idea was to get away from the mirror master, and this takes us through that step automatically," says Jack G. Bondus, STAM marketing manager. "It's very much a field-convertible system," he continues. "It can be adjusted to many different widths and formats, and it can copy onto iron, high-energy iron, and chromium-dioxide tapes."

At the heart of the system, a metal intermediate-transfer belt is coated with a proprietary magnetic material. Unlike present duplicators that print tape-to-tape by contact, the 3M double-transfer process thermally picks up images from the belt and transfers signals from the belt to the copy tape by using magnetic, or anhysteretic, stimulation. Audio and control tracks are electronically re-recorded because contact duplication systems do not have flat frequency responses.

**Technologies combined.** A combined magnetic-thermal approach avoids the shortcomings of either approach used singly, Bondus says. Contact-printing systems that copy magnetically from a mirror-image master tape, such as those of Matsushita and Ampex, cannot copy onto high-performance tapes. The 3M high-energy copy tapes have coercivity—a measure of relative bias and erase field strengths—of 500 to 650 oersteds.

In its combination of the two approaches, 3M passes the magnetic belt with its 2,000-oersted coating around a cylinder heated to above the Curie temperature of the belt's magnetic layer, erasing signals from the tape's previous rotation, and preparing it to record signals from the master tape. As the belt moves over a cooling cylinder, it comes in intimate contact with the master, and the recorded signals are thermally transferred from the master to the belt. The belt, now serving as a carrier of the mirror-image signals, revolves to a copy station where signals are magnetically transferred from the belt to the copy tape.

Prices range from \$35,000 for a

STAM contact printer designed specifically for in-cassette duplication of 3/4-inch U-Matic videocassettes at 37 1/2-inches per second to \$98,000 for reel-to-reel models that handle tape widths up to 1 inch and operate at 75 inches per second. However, 3M plans higher-speed units. □

### Government electronics

## Shock-hazard tester developed by NIH

The National Institutes of Health has developed an automatic shock-hazard tester that will cut down the risk of electrical shock to patients connected to electronic monitoring equipment. Whereas conventional testing methods are slow, cumbersome, and not always accurate, NIH's prototype tester lets a trained technician check out a piece of equipment in 12 seconds and, by interpreting the data, also predict when a shock might occur.

"Our concept here is to bring automatic test equipment into the hospital," says Walter Friauf, chief of the electrical and electronics engineering branch of NIH's Biomedical Engineering and Instru-

mentation branch. He says the portable tester can be safely taken into critical areas, such as intensive-care units, from which intricate patient monitors can't be removed for testing. The probability of shock, he says, is proportional to the square of the inspection interval.

Because three-wire grounds aren't always reliable, the tester spots either bad ground wires or excessive current leakage. The assumption is that in the interval between inspections the equipment will remain safe so long as either the ground remains or the leakage does not become excessive. The tester has five digital readouts: resistance to ground wire (power on and off), leakage with power off, power on with normal polarity, and power on with reverse polarity. With the simple entry-recording format, a technician can spot trends and fix potential hazards, Friauf says.

**Enter solid-state.** The tester uses solid-state logic elements in a sequencer composed of clocks and a counter. The sequencer paces through 30 steps, each step controlling a power circuit for measuring currents and resistances. Two voltage-to-frequency converters and five counters and readouts are used for the digital displays. A 1-kilowatt isolation transformer is incorpo-

**Invented at NIH.** This tester can be used by a technician to check out a piece of medical equipment in 12 seconds to determine and predict shock hazards.

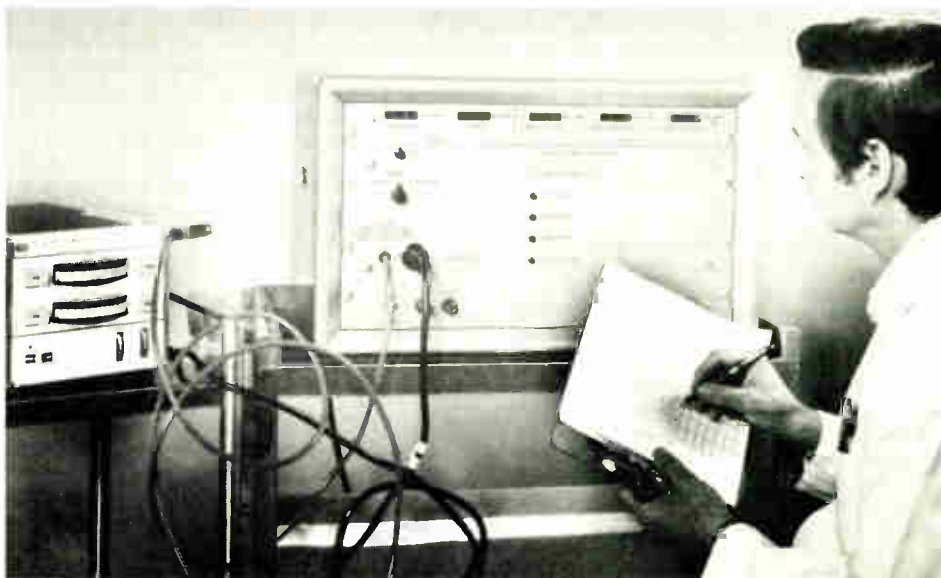



# PL/M

## A NEW HIGH LEVEL SYSTEMS LANGUAGE THAT ANYONE CAN USE AND UNDERSTAND

**A New High Level Language for the MCS-8 Microcomputer** PL/M is a new high level language concept developed by Intel to meet the special needs of microcomputer systems programming. For the first time, programmers can utilize a true high level language to efficiently program microcomputers. It is an assembly language replacement that can fully command Intel's 8008 CPU and future processors to produce efficient run-time object code. While programming time and costs are drastically reduced, training, documentation and program maintenance are also simplified. The user application programs and standard systems programs can be transferred to future computer systems that support PL/M without reprogramming.

**PL/M Allows the Programmer to Concentrate on the Problem** PL/M is derived from IBM's PL/I, a very extensive and sophisticated language that promises to become the most widely known and used language in the near future. The general structure of PL/I is well suited to efficient implementation on the Intel MCS-8 microcomputer system. PL/M is a subset of PL/I with emphasis on those features of PL/I that accurately reflect the nature of systems programming requirements. PL/M was designed by Intel to provide additional developmental software support for the MCS-8 microcomputer systems. It permits the programmer to concentrate more on his problem and less on the actual task of programming than is possible with assembly language.

**PL/M is an Efficient Language** Tests on sample programs indicate that a PL/M program can be written in less than 10% of the time it takes to write the same program in assembly language without reducing efficiency. The main reason for this savings in time is the fact that PL/M allows the programmer to define his problem in terms

natural to him, not in the computer's terms. Consider the following program which selects the largest of two numbers. In PL/M, the programmer might write:

```
If A > B, then C = A; else C = B;
```

Meaning

"If variable A is greater than Variable B, then assign A to Variable C, otherwise, assign B to C."

A corresponding program in assembly language is twelve separate machine instructions, and conveys little of original intent of the program.

**Features of the PL/M Language** The system programmer has at his disposal a language that is specifically oriented to systems design, yet is easy to learn, and is written in a terminology with which he is already familiar. Because of the ease and conciseness with which programs can be written and the error free translation into machine language achieved by the compiler, the time to program a given system is reduced substantially over assembly language.

The PL/M compiler is written in ANSI standard Fortran IV and thus will execute on most machines with little alteration. Debug and checkout time of a PL/M program is much less than that of an assembly language program, partly because of the inherent clarity of PL/M, but also because writing a program in PL/M encourages good programming techniques. The structure of the PL/M language enables the compiler to detect error conditions that would slip by any assembler.

It will be available this coming July from Tymshare, GE, Applied Logic Corporation and directly from Intel. Intel Corporation, 3065 Bowers Avenue, Santa Clara, California 95051, (408) 246-7501

```
      .MODEL SMALL
      .STACK 1000
      .DATA
      A DB 10
      B DB 20
      C DB ?
      .CODE
      START:
      MOV AX, A
      MOV BX, B
      CMP AX, BX
      JG  THEN
      MOV C, A
      JMP  END
      THEN:
      MOV C, B
      END:
      HLT
```

### PL/M Coding

Program Development  
Time: 15 Minutes  
Number of Bytes  
of Program: 114

**PL/M vs ASSEMBLY LANGUAGE** As an example of comparative programming effort between PL/M and assembly language, this program to compute prime numbers was written twice, first in PL/M, and then in assembly language. The PL/M version was written in fifteen minutes, compiled correctly on the second try (an "end" was omitted the first time) and ran correctly the first time. The program was then coded in Intel MCS-8 assembly language. Coding took 4 hours, program entry and editing another 2 hours, debug took an hour to find an incorrect register designation, the kind of problem completely eliminated by coding in PL/M. Results of this one short test show a 28 to 1 reduction in coding time. This ratio may be somewhat high, overall ratio in a mix of programs is more on the order of 10 to 1. The hand coded version produced 110 8-bit bytes of program, the PL/M version: 114 bytes. In this example, in order to gain 28 to 1 in coding time, the user had to sacrifice 3% in generated code efficiency.

```
      .MODEL SMALL
      .STACK 1000
      .DATA
      A DB 10
      B DB 20
      C DB ?
      .CODE
      START:
      MOV AX, A
      MOV BX, B
      CMP AX, BX
      JG  THEN
      MOV C, A
      JMP  END
      THEN:
      MOV C, B
      END:
      HLT
```

### Assembly Coding

Program Development  
Time: 7 Hours  
Number of Bytes  
of Program: 110

intel  
delivers.

rated to make the tester electrically safe.

Friauf says NIH built the tester in the hope that industry would pick up the idea and produce it commercially. "Parts cost us about \$1,500," he says. Even so, that makes it better than manual methods, some of which are a hazard to the person making the test. With the new tester, however, a technician simply snaps an alligator lead to the instrument chassis, plugs the instrument into the tester and the tester into the wall, and takes his readings. □

---

**Solid State**

---

## A-m radios offered chips by Signetics

Few markets have been as hard for monolithic integrated circuits to crack as a-m broadcast receivers. There are so few transistors in most a-m radios that set manufacturers see little profit in developing new designs around integrated circuits merely to shave already low semiconductor costs.

Signetics Corp. is more hopeful. It intends to capture the a-m radio market with a new monolithic front end—the radio-frequency and inter-

mediate-frequency sections of a radio. The Sunnyvale, Calif., manufacturer designed the NE546 chip to replace only the transistors and the interstage resistor-capacitor networks directly between the transistors, leaving the tuning components, coil networks, second diode detector and audio stage of the conventional discrete-component design essentially unchanged.

**Costs less, does more.** Signetics' design won't require set manufacturers and their passive-component suppliers to scrap their enormous investment in value engineering and tooling to produce support circuitry in huge volumes at low cost. The new circuit is also designed to be sold at a lower cost—50 cents in large volume—than the transistors and interstage networks it replaces. The small-quantity list price, however, will probably be pegged around \$2 when the circuit is formally announced in a month or two. As a sweetener, performance will be better than the conventional stages, promises Jack Mattis, linear marketing manager.

Production has started, and one auto company has already placed a volume order at much less than \$2 apiece, Mattis says. His primary sales targets are the American, Japanese, and European manufacturers of auto radios, portable and home a-m radios, and front ends of the a-m/fm radios usually built into stereo players. These represent a potential market for 25 million front-end circuits and another 25 million monolithic audio amplifiers (which enter the picture because, coupled to the new front ends, these amplifiers enhance over-all performance and eliminate the need for a bulky audio transformer).

To accomplish all this, Chandru Idnani, senior engineer at Signetics, went back to the type of full super-heterodyne design employed in the pretransistor era in radios with about 10 vacuum tubes. On the one chip are a cascode rf amplifier, a local oscillator, a differential amplifier

operating as a mixer, an automatic-gain-control circuit incorporating the first diode detector, and an i-f amplifier. Idnani also worked in a voltage regulator to ensure stable operation over a supply range of 9 to 15 volts, thus compensating for the frequent fluctuations in auto-battery voltages.

Idnani adapted the basic super-heterodyne structure to the types of networks that a-m set manufacturers usually use in the front end. Although such networks generally operate with only three or four discrete-transistor stages, Idnani found it necessary to use 13 transistors, 10 diodes, and 19 resistors. However, he notes, the payoff is a circuit that is inherently stable enough to assure good yields in volume production.

The NE546 is compatible with the NE540, a monolithic audio amplifier previously announced by Signetics. When the two are used in combination, the sensitivity, signal-to-noise ratio, and fidelity on a typical a-m radio improves "an order of magnitude," Idnani asserts. Improvement was measured after an auto radio's transistor stages were replaced with the two chips. □

---

## Acousto-optic device deflects laser

Researchers at RCA Laboratories, Princeton, N.J., say they've developed a highly efficient acousto-optic crystal deflector for laser beams that promises to replace the cumbersome electromechanical systems generally in use. The experimental scanner is an anisotropic Bragg device constructed from a crystal of paratellurite (TeO<sub>2</sub>). Program manager Istvan Gorog says that the deflector occupies a volume of only a half cubic centimeter, dissipates 50 milliwatts, and operates in the frequency range of 35 to 100 megahertz.

**High resolution.** With the crystal, RCA has built a laser-beam scanner that operates at TV rates but projects a picture with three to four times the detail of conventional TV. In the horizontal direction, the crystal-

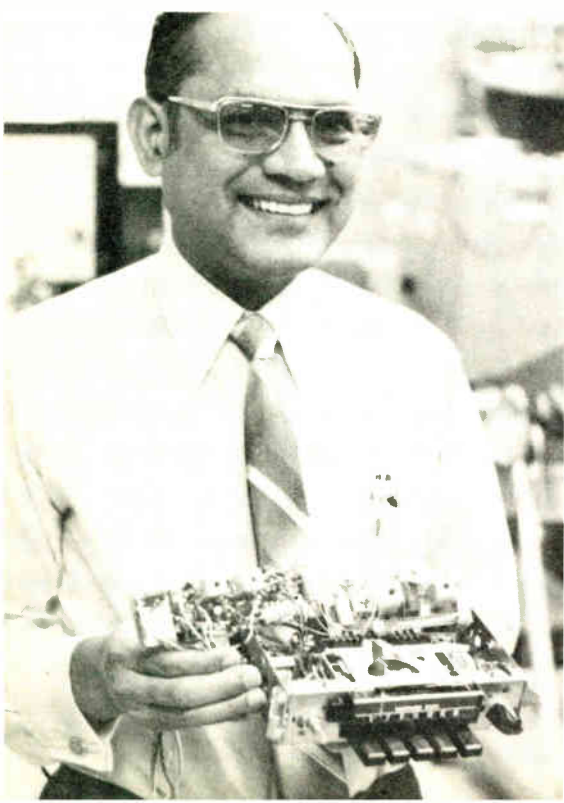

---

**Chip designer.** Chandru Idnani designed an a-m radio on a chip that is compatible with existing car radios.



# You won't find a Synchron<sup>®</sup> Motor that meets your specifications.

# But we'll build one (or 100,000) that matches your specifications. Exactly.

Synchron motors are made in five major styles. Speeds from 900 rpms to one revolution per week. Torque from 8 through 98 oz-in at one rpm. Hundreds of output options.



And we'll build it at a competitive price.  
And we'll deliver it on time.

And we'll make sure it will perform in accordance with your specs. (Every motor we make is tested before it leaves the factory.)

But most of all, we'll be sure *you* are completely satisfied. It may be a strange way to do business, but we've been doing it for so long we don't know any other way.

**Call or write for complete Synchron motor specifications and the name of your Hansen representative.**

**MALLORY**



HANSEN MANUFACTURING CO.  
a division of P. R. MALLORY & CO. INC.  
Princeton, Indiana 47670

We make every Synchron motor as if *our* name were on your product.

driven laser can easily scan up to the 15,750 lines per second of conventional TV. Scan rate is limited by the retrace time of 10 microseconds. A conventional oscillating galvanometer-driven mirror directs the beam vertically.

"The tellurium-dioxide crystal is much cheaper and considerably more compact than the electro-mechanical systems employing rotating and oscillating components," Gorog points out. Other types of crystals, such as lead molybdate, had been worked with before, he continues, but "this is the first acousto-optic deflection method that's close to a real application." He predicts that "in a short time" the new, but still experimental, deflector could be applied in both image-generating and recording systems employing lasers.

In developing the deflectors, Gorog and his associates, Peter V. Goedertier, Joseph D. Knox, and Igal Shidlovsky, were able to overcome the severe dips in efficiency at mid-frequency ranges that had plagued earlier work with anisotropic deflectors. (Anisotropic-crystal properties depend on the direction of propagation of both the sound and light waves.) In part, this was done by producing high-purity material and devising a proprietary cold-press bonding technique for attaching transducers to the TeO<sub>2</sub> crystals. As a result, the deflectors have efficiencies, when operating at television rates, of as high as 90%.

**Solid-state scan.** Acousto-optic deflector made of paratellurite is tried out in this argon-laser camera system aimed at Joseph Knox, one of the crystal's developers at RCA.

In addition to high efficiency, the new deflector can be fabricated with relative ease because it does not require the beam-steering mechanism of other crystal deflectors. Moreover, resolution of 1,000 TV lines can be achieved with a deflector having an aperture of only 0.5 centimeter.

This small aperture size facilitates diffraction-limited operation, Gorog says. And it makes the deflection system more compact and permits a scanner to be built from relatively simple optical elements of only average quality, he says. □

## Economics

### DOD cut only 7% in first budget round

Submerged by Watergate, the Pentagon's fiscal 1974 budget request is drifting through Congress largely intact. Although it is unlikely that the final Defense appropriation will surface for the President's signature before Christmas, the spending authorization, which sets an upper limit for appropriations committees, cleared the House before the August recess with only limited damage to procurement and R&D requests—a 7% cut that leaves the Pentagon with \$20.4 billion.

On the Senate side, the Armed Services Committee also trimmed \$1.5 billion from the Nixon request,

although it specified where cuts should come—including some \$494 million in tactical air power—while the House left \$950 million of its reductions to the judgment of Pentagon management. Those House cuts on the floor were in addition to the \$625 million cut in committee. Overall, the initial private consensus of military and defense-industry sources is that its critics in the 93rd Congress have thus far proved themselves unable to deliver on earlier threats to significantly slash the Nixon program [*Electronics*, Feb. 15, p 68].

**Visibility.** The procurement and R&D cuts thus far have been largely limited to programs with high visibility because they are either experiencing technical difficulty or seeking major spending increases. The Navy's F-14 interceptor, being built by Grumman Aerospace, and the Air Force's F-15 tactical fighter, contracted to McDonnell Douglas, are typical of programs with problems. So is the Air Force B-1 strategic bomber under development at Rockwell International. The F-14, for example, got all the money sought in the House for a 50-plane buy, but the Senate committee approved only \$197.6 million of the Navy request, withholding action on the remaining \$505.4 million until DOD comes up with a new contract. Both the House and Senate rejected a request by Deputy Defense Secretary William P. Clements Jr. for money to check out alternatives to the plane [*Electronics*, July 5, p. 50].

The F-15, whose \$1.1 billion request included \$918.5 million for 77 planes, had its procurement money cut to \$587.6 million for 39 planes in the House because of problems with engine development. The B-1 bomber, which the Air Force acknowledged has fallen behind schedule, lost \$100 million in the Senate from its \$473.5 million request for development money, and it is almost certain to be cut back further in the final appropriation process, say committee sources in both houses. Beyond questions of the program's need, the B-1 is subject to challenge from the bomber version of the General Dynamics F-





# Protected:

Our new 16-channel analog multiplexer — the only monolithic multiplexer with internal overvoltage protection. Features performance characteristics previously unavailable, and it's pin-for-pin replaceable with the DG-506.

Designated the HI-506A, this new Harris 16-channel multiplexer combines DI/CMOS (dielectric isolation) processing and unique circuit design to provide on-board protection against analog input overvoltage. Therefore, in the event of overvoltage in one channel, there is no output error when other channels are being addressed. This same protection

circuit eliminates latch-up as well as unpredictable operational characteristics that could result from transient voltages originating in either the signal or supply. A second similar protection circuit provides the device with the necessary safeguards against static charges. In addition, break-before-make switching eliminates undesirable channel interaction.

Applications include data acquisition, telemetry systems, process control and general analog switching. The device is available in volume now for off-the-shelf delivery. For details see your Harris distributor or representative.

#### Features:

**Internal overvoltage protection, both analog and digital**

**No channel interaction with power loss**

**Break-before-make switching**

**DTL/TTL and CMOS compatibility**

**Supply current 4mA at 1 MHz toggle rate**

**Power requirement 7.5 mW disabled**

**Power requirement 7.5 mW enabled**

**Access time 500 ns**

**Power supply ±15V**

**Signal range ±15Vdc**

**Supplied 28-pin DIP**

HI1-506A-5 100-999 units

0°C to +75°C \$28.60

HI1-506A-2 -55°C to +125°C \$57.20

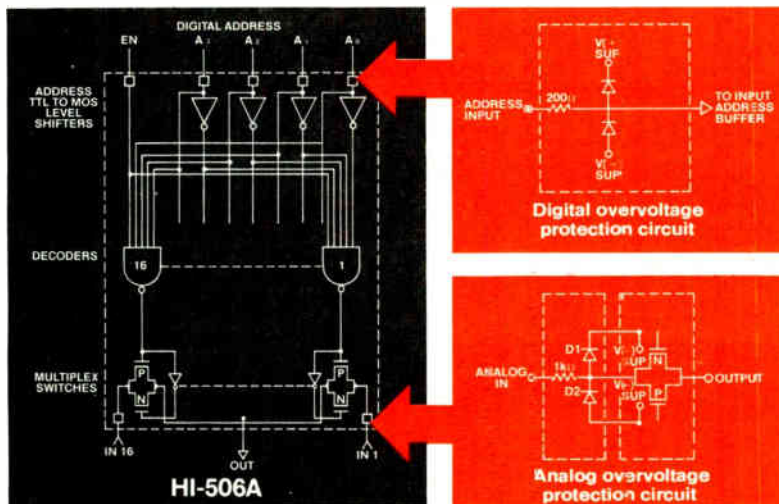

# Harris



**HARRIS SEMICONDUCTOR**  
A DIVISION OF HARRIS-INTERTYPE CORPORATION

P.O. Box 883, Melbourne, Florida 32901  
(305) 727-5430

WHERE TO BUY THEM: ARIZONA: Phoenix—Liberty, Weatherford; Scottsdale—HAR (602) 946-3556 CALIFORNIA: Anaheim—Weatherford, El Segundo—Liberty, Glendale—Weatherford; Long Beach—HAR (213) 426-7687; Mountain View—Elmar; Palo Alto—Weatherford, HAR (415) 964-6443; Pomona—Weatherford; San Diego—Weatherford, Western COLORADO: Denver—Elmar, Weatherford WASHINGTON, D.C.: HAR (202) 337-3170 FLORIDA: Hollywood—Schweber, Melbourne—HAR (305) 727-5430 GEORGIA: Atlanta—Schweber ILLINOIS: Chicago—Schweber, Schaumburg—HAR (312) 894-8824 MARYLAND: Rockville—Schweber MASSACHUSETTS: Lexington—R&D, Waltham—Schweber W-Ilesley—HAR (617) 237-5430 NEW MEXICO: Albuquerque—Weatherford NEW YORK: Melville—HAR (516) 249-4500; Syracuse—HAR (315) 463-3373, Rochester—Schweber, Westbury—Schweber OHIO: Beachwood—Schweber; Dayton—HAR (513) 228-0636 PENNSYLVANIA: Wayne—HAR (215) 887-6680 TEXAS: Dallas—Weatherford, HAR (214) 231-9031, Houston—Weatherford WASHINGTON: Seattle—Liberty, Weatherford.

LEGEND FOR HARRIS SALES OFFICES & DISTRIBUTORS: Harris Semiconductor (HAR); Elmar Electronics (Elmar); Harvey/R&D Electronics (R&D); Liberty Electronics (Liberty); Schweber Electronics (Schweber); R. V. Weatherford Co. (Weatherford), Western Radio (Western).

111, which both houses have voted to continue in production another year with nearly \$173 million for another 12 planes.

**Slowdowns.** The Air Force took other cuts in tactical programs at the hands of the House and Senate committees, losing \$50 million of its \$142.4 million for Fairchild Industries' A-10 close-support plane. It also lost \$42 million of its \$209.5 million request for the Boeing E-3A Advanced Airborne Warning and Control System.

As far as the Air Force is concerned, over-all congressional sentiment seems to favor more buys of established weapons and stretching out some of the newer efforts where costs are not yet established.

**Ships.** If there was reluctance to pursue major new aircraft programs in the Congress, the mood did not carry over into Navy ship projects like the Trident missile submarine follow-on to Poseidon. It received the full \$1.5 billion sought in the House and survived a cut-back effort in the Senate committee. However, the Senate did cut \$29.3 million sought for advance procurement of a control ship, a mini-carrier designed to handle helicopters and V/STOL fixed-wing aircraft. And the House cut nearly \$150 million for conversion of Polaris-missile submarines to the newer Poseidon. The Navy's \$72.8 million in R&D money for high-speed, surface-effects ships remains intact so far, even though the amount is more than double last year's \$32 million.

Army projects, like the Navy's, also survived any broad cutbacks, save for Senate-committee reductions of \$25.7 million in the \$401.5 million sought for the Safeguard antiballistic-missile system and \$19.5 million cut from the All-Weather Forward-Area Air Defense System. Coming through unscarred after the first round of the funding process were the Raytheon SAM-D missile with \$194.2 million; the Utility Tactical Transport Helicopter with \$108 million; the Heavy Lift Helicopter with \$60 million; the Advanced Attack Helicopter with \$49.3 million; and Litton's Tacfire artillery-control system with \$40.6 million. □

## News Briefs

### Instrument trade drops

U.S. exports of aeronautical, nautical, and navigational instruments dropped to \$112 million in 1972 from \$126 million in 1971, while imports rose from more than \$2 million to more than \$20 million, according to new Commerce Department figures. The change left the U.S. with a \$91.6 million net trade balance in the category—most of which is electronics—down 15% from 1971. The largest decline in exports came in aircraft flight instruments, which dropped to \$29 million from nearly \$44.7 million a year earlier. However, exports of airframe-equipment instruments increased by nearly a third to \$28 million in 1972.

### Fleet-defense system to be tested

The first public demonstration of the AN/SPY-1 phased-array radar for the U.S. Navy's multimillion-dollar Aegis area-defense weapons system is scheduled for this month at RCA's Government and Commercial Systems division, Moorestown, N.J. Next month, the system will be sent to the West Coast for installation aboard the Navy's test ship, the U.S.S. Norton Sound.

The system's array modules each includes 32 ferrite phase shifters, and a key element in the system is the RCA-developed phase-shifter driver, the first high-current, hybrid, integrated, pulsed-control circuit ever built, according to the company.

### CDC merges two networks

Control Data Corp. is merging its former communications-network competitor, Service Bureau Corp., into its Cybernet data-communications network. CDC acquired SBC as part of the settlement of the company's antitrust suit against IBM. The first part of the merger will be on an executive level; a technical merger will occur when engineers are able to link the incompatible IBM and CDC computers. CDC has no present plans to replace the IBM computers, which CDC was authorized to use free for six months after the settlement.

### Air Force to get modified F-111 radars

Texas Instruments will modify three AN/APQ-146 terrain-following radars, originally produced for the Air Force's F-111 interceptor, for use aboard the B-1 manned strategic bomber, now in development at Rockwell International. TI will modify the radars under a \$1 million-plus subcontract from Boeing Aerospace Co., which is responsible for B-1 avionics subsystems integration on the Air Force Aeronautical Systems division program.

### Cherry is private-labeling calculators . . .

Cherry Electrical Products Corp., Waukegan, Ill., has eased its way into calculator manufacturing and is now producing private-label units for Unicom, SCM, Summit, and Olympia. The company, a major switch maker, moved into keyboard manufacture before making the jump into calculator assembly, a \$6 million business which is expected to raise sales by 40% next year to over \$24 million.

### . . . and Sharp introduces LCD midget

With a retail price projected at about \$110, Japan's Sharp Corp. plans to introduce a four-function handheld calculator with an eight-digit liquid-crystal display in the U.S. this October. The EL-805 runs for more than 100 hours on a single penlight battery and provides a display two or three times larger than those presently used on handheld units. The 805 also uses C-MOS circuitry, and is packaged entirely on a glass substrate.



# Test your memory.

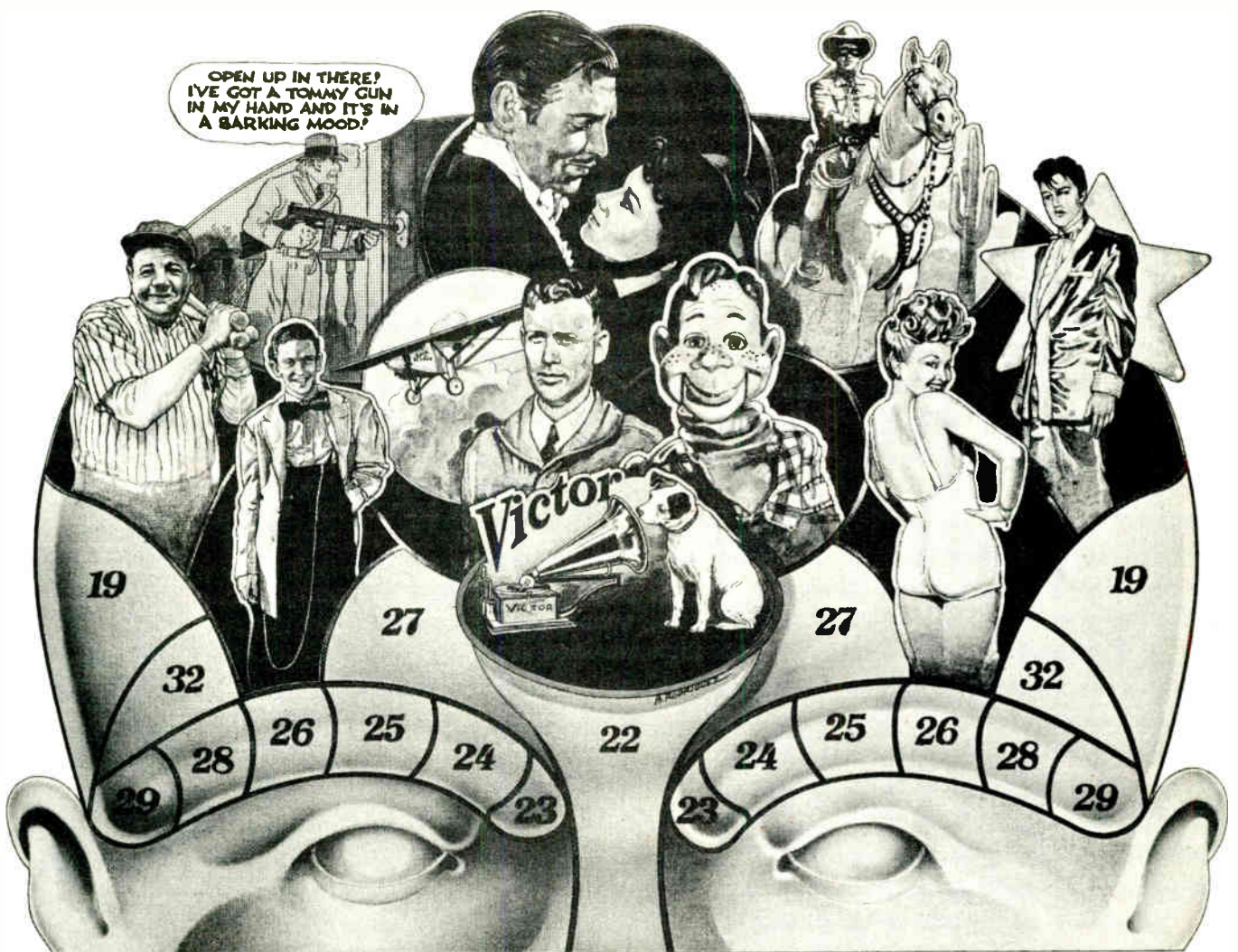

# Introducing

## 3 modular systems that cover the entire field of memory testing.

The Rangers are a new series of Sentry compatible testers developed to meet the growing needs of the semiconductor memory market — RAMS, ROMS, and Shift Register memories. To get an idea of how fast this market is growing, take RAMS as an example. The forecast predicts they will quadruple in size every two years, and double in volume every year.

Today's data rates of 10MHz will go to 20MHz by tomorrow. This pattern rate will continue to evolve until a theoretical limit is reached. And maybe that's 100MHz. The Rangers were designed to keep pace with this fantastic growth through both advance technology and an easily integrated modular architecture.

Meet Ranger I. This is the core unit to the Ranger family. A dedicated functional pattern exerciser. It will handle any of today's memories at a 20MHz test rate. Design philosophy is independent data and sequence algorithm, continuous, non-skip, pattern execution, with selection of any of 10 partitionable programs. Thirty N type programs or ten N<sup>2</sup> type programs.

A powerful mini-controller (not just a simple shift register) processes the macro and micro instructions. Programming can be done from either the front panel or by magnetic tape cassette. Ranger I is production oriented with a memory test feature that sorts memories according to rows and columns.

For the engineer who has to develop new patterns and play with them, Ranger provides all hardware controls... loop, toggle between any RAM address, three Vcc levels to work with, polarity, and many front panel Sync jacks.

BY TECHNOLOGY RANKING, THE DEVICES RANGERS CAN TEST.

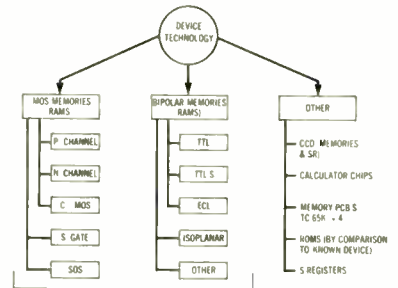

ALL KNOWN RAMS  
SIZE TO 4K MOS, 2 K BIPOLAR (TODAY)  
BY 1975 16K MOS, 4K BIPOLAR  
ULTIMATE CAPABILITY 65K \* 4

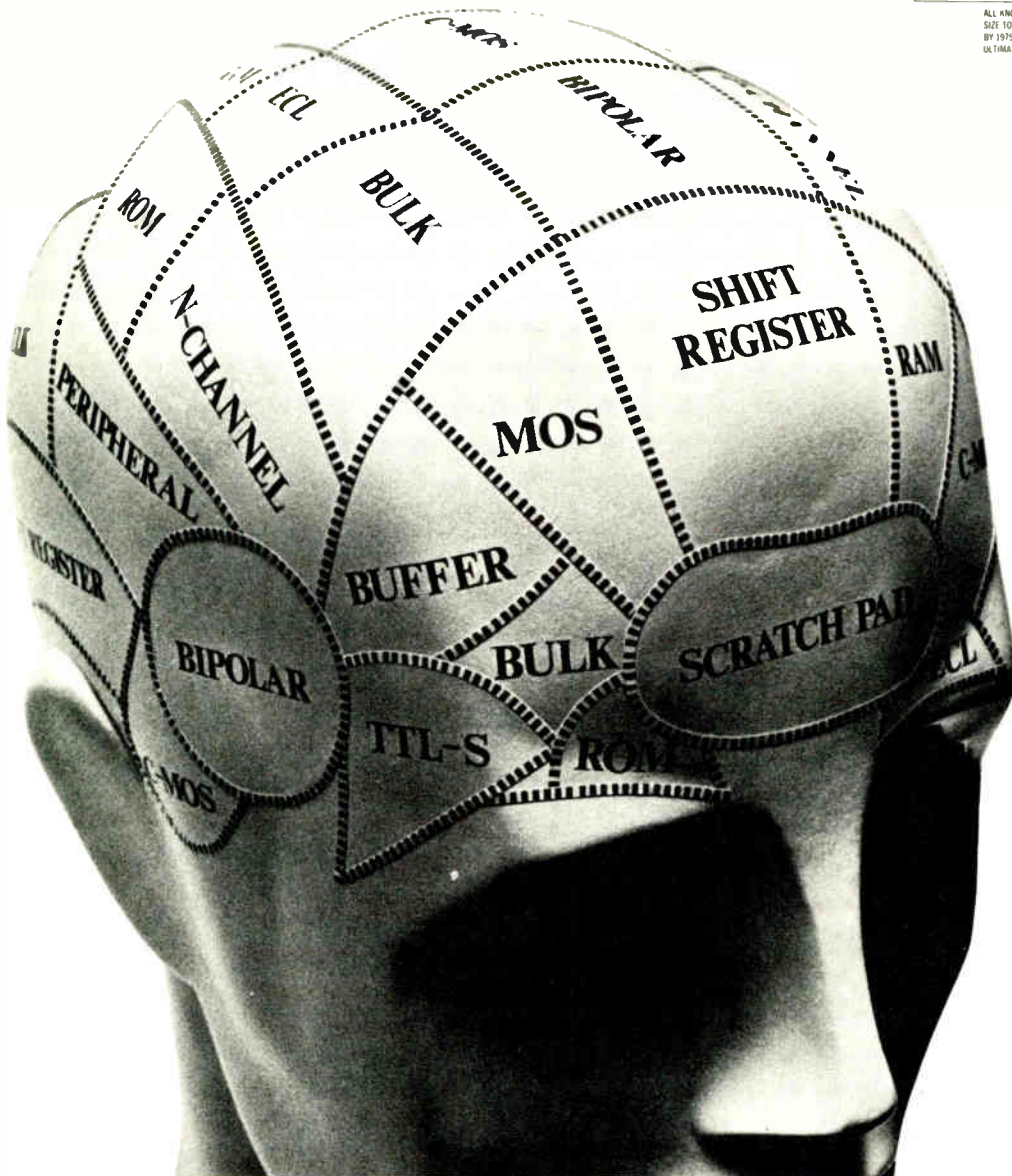



# the Rangers.

## Ranger II. A more versatile memory tester with programmable pin electronics and timing generators.

Meet Ranger II. Besides the wafer testing, incoming inspection and engineering evaluation capabilities of Ranger I, Ranger II is programmable with pin electronics and timing. It's multiplexed to separate stations and can do margin testing. Parametric testing is optional.

## Ranger III. A computer controlled, functional and parametric system for mass production volume testing.

If you are a memory producer, Ranger III provides quality control and extensive data manipulation. It will tell you exactly where you stand at each step of the manufacturing process.

Ranger III uses a powerful computer — the Sentry FST-1. The test oriented language (FACTOR) and an extensive backup of software and peripherals will handle multiple Rangers providing ultra-high throughput. Especially when performing parallel, functional, and parametric testing.

## The Ranger Family was designed to complement the Sentry Series.

The Rangers were developed as extensions to the Sentry Line. Much of the hardware like power supplies, PMU, pin electronics, timing and computer has been proven with other Sentry systems. Any of the Rangers can be easily added to Sentry products enabling protection of your investment. With Ranger, you can test your complex logic and memories with the most powerful system available today.

For more information, write for details, or call us collect: (415) 493-5011. Our TWX: 910-373-1204.

### RANGER CAPABILITIES.

RANGER I.	RANGER II.	RANGER III.
<ul style="list-style-type: none"> <li>• 20 MHZ FUNCTIONAL PATTERN RATE.</li> <li>• MICROPROGRAMMED CONTROLLER.</li> <li>• MACRO SEQUENCE CONTROL OF UP TO TEN (10) SETS OF HARDWARE PARTITIONABLE PROGRAMS.</li> <li>• PATTERN GENERATION WITH TWO INDEPENDENT ATTRIBUTES, DATA EQUATION AND SEQUENCE ALGORITHM.</li> <li>• CONTINUOUS — NON SKIP — PATTERN EXECUTION OF SUCH COMPLEX PATTERNS AS PING PONG, STAR AND CORNER DISTURB AND OTHER CUSTOM PATTERNS.</li> <li>• LINKAGE TO CPU, SENTRY OR OTHER PERIPHERAL INTERFACE.</li> <li>• DEDICATED PERFORMANCE BOARDS WITH PREPROGRAMMED TIMING AND LEVELS FOR GIVEN UNIT UNDER TEST.</li> <li>• TOPOGRAPHICAL SCRAMBLING.</li> <li>• (OPTIONAL) MAGNETIC TAPE CASSETTE AND KEYBOARD PROGRAM ENTRY.</li> <li>• EXTENSIVE PROGRAM GENERATION AND SENSITIVITY ANALYSIS (SCHMOO PLOTS) USING THE SENTRY 600.</li> </ul>	<p>RANGER I CAPABILITIES PLUS</p> <ul style="list-style-type: none"> <li>• PROGRAMMABLE TIMING.</li> <li>• DEDICATED PIN ELECTRONICS WITH PROGRAMMABLE LEVELS.</li> <li>• CASSETTE WITH PROGRAMMING IN HIGHER LEVEL LANGUAGE.</li> <li>• MULTIPLEXING TO 2 STATIONS (TIME MULTIPLEXED, INDEPENDENT PROGRAMS).</li> <li>• MARGIN TESTING: CLASS PLAN WITH VARIABLES TIMING, PATTERN, SUPPLY VOLTAGES, INPUT/OUTPUT LEVELS.</li> <li>• PARAMETRIC TESTING (GO/NO-GO ONLY) OF VOLTAGE LEVELS AND CURRENTS.</li> </ul>	<p>CONSISTS OF</p> <ul style="list-style-type: none"> <li>• RANGER 2'S MULTIPLEXED TO AN FST-1 COMPUTER.</li> <li>• COMPLETE PARALLEL TEST CAPABILITY: FUNCTIONAL AND PARAMETRIC TESTS EXECUTED ON BOTH RANGERS.</li> <li>• SOFTWARE FOR CONTROL OF BOTH RANGERS.</li> <li>• SOFTWARE DATA CAPABILITY: PARAMETER DISTRIBUTION DATA LOGGING FAILURE ANALYSIS MANUAL ANALYSIS BINNING SCHMOO PLOTS BACKGROUND/FOREGROUND</li> </ul>

### ARCHITECTURE AND FEATURES.

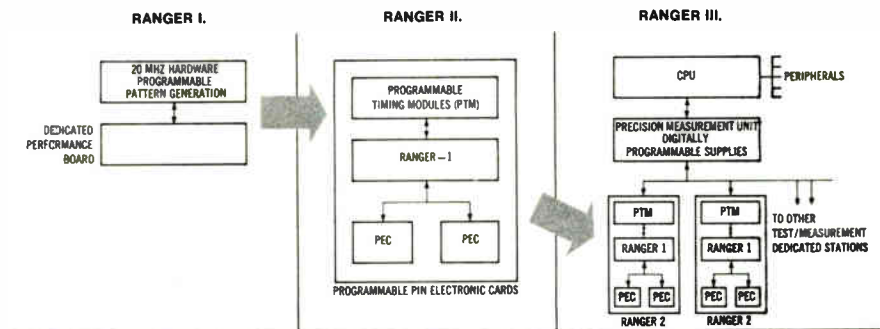

1. 20 MHZ FUNCTIONAL EXERCISER AND MASTER CONTROL WITH SEQUENCING CAPABILITY FOR UP TO 10 PROGRAMS.
  2. 3 ADJUSTABLE SUPPLY VOLTAGES FOR TTL, ECL AND MOS MEMORY CHIPS.
  3. PERSONALITY CARDS WITH INPUT DRIVERS, OUTPUT SENSORS AND TIMING FOR RAMS, ROMS AND SHIFT REGISTERS.
  4. PATTERN LIBRARY WITH PATTERNS STORED ON PROM'S.
- OPTIONAL: CASSETTE WITH INTERFACE.

- ALL THE CAPABILITIES OF THE RANGER I, PLUS:
1. PROGRAMMABLE TIMING.
  2. PIN ELECTRONICS WITH PROGRAMMABLE LEVELS.
  3. MULTIPLEXING TO 2-STATIONS.
  4. MARGIN TESTING.
- OPTIONAL: GO/NO-GO PARAMETRIC TESTING.

- ALL THE CAPABILITIES OF THE RANGER II, PLUS:
1. COMPLETE PARALLEL TEST CAPABILITY: FUNCTIONAL AND PARAMETRIC TESTS EXECUTED ON BOTH RANGERS.
  2. SOFTWARE FOR CONTROL OF BOTH RANGERS, PRODUCTION AND ANALYSIS CAPABILITIES INCLUDING: PARAMETER DISTRIBUTION, MANUAL ANALYSIS, BINNING AND SCHMOO PLOTS.

### RANGER PRICE/PERFORMANCE ANALYSIS.

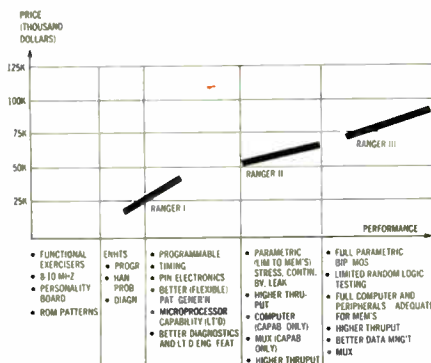

**FAIRCHILD**  
SYSTEMS TECHNOLOGY

Fairchild Systems Technology 3500 Deer Creek Road  
Palo Alto, California 94302

Please send me more information on:

Ranger I  Ranger II  Ranger III

Name \_\_\_\_\_

Title \_\_\_\_\_

Company \_\_\_\_\_

Street \_\_\_\_\_ City \_\_\_\_\_

State \_\_\_\_\_ Zip \_\_\_\_\_

Phone \_\_\_\_\_ Ext. \_\_\_\_\_

# Fairchild Systems

Fairchild Systems Technology, a division of Fairchild Camera & Instrument Corporation.

# MECL 10,000

## All things to all designers?

No, of course not. MECL 10,000 wasn't originally intended to be a general purpose logic family. It just worked out that way, at least for applications where speed is a requisite. What began as a logic family for mainframe computers has rapidly evolved into a standard logic for *all* high speed uses. Today's applications range from digitally tuned FM sets to instrumentation, minicomputers, peripherals, and sophisticated data communications. Applications are growing as designers recognize the various competitive advantages that a MECL 10,000 design provides. As a designer, are you interested in . . .

## Flexibility and system savings

Conventional two-sided PC-boards may be used . . . cost saving wire-wrap techniques are possible . . . no special line driver circuits are required . . . noise problems are reduced . . . wire-ORing reduces system cost . . . complementary outputs minimize system gate and package count.

These are a few advantages of MECL 10,000 — *designed for not adapted to* high speed applications. And speed performance is not limited as in the case of saturated logic designs.

## Function and package choice

Check the table. With the four new additions 10K now offers 52 func-

tions, and 40 new functions are in various stages of planning, design and processing.

*Now there is a package to meet every requirement.* For economy designs, the new plastic package offers costs ranging 5 to 10% below ceramic prices. And 10K is also available in hermetic flat packages for MIL-TEMP and high PC-board function density requirements.

## Reliability

Patterns of high reliability are beginning to take form. Figures such as estimated failure rate of 0.013%/1000 hours for circuits operating at 125°C. Presently, reliability tests are generating approximately 2.4 million device-hours per month with expansion to approximately 3.5 million device-

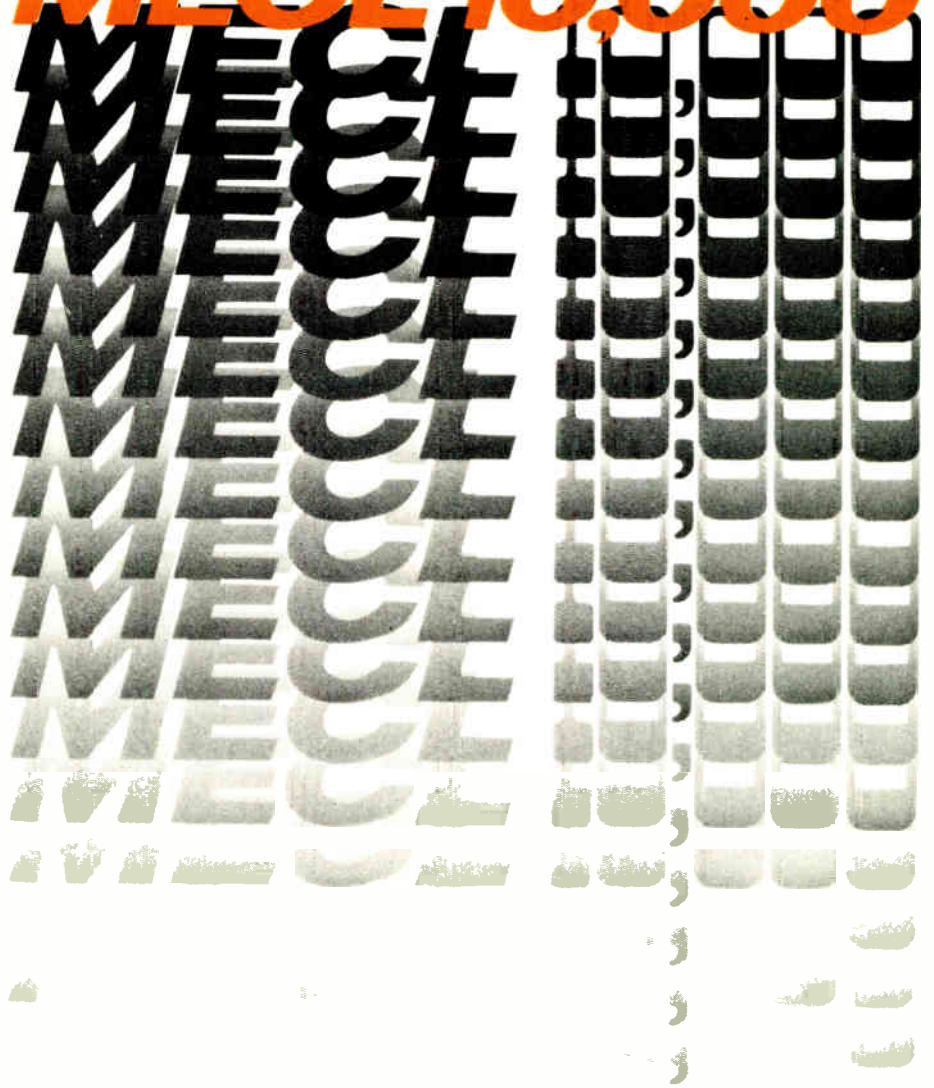



# All things to all designers?

hours per month, all dedicated to providing greater reliability at lower costs.

## Availability

MECL 10K has not experienced the large scale shortages of other logic families. Motorola's carefully engineered production capacity build-up, began in 1972, has accelerated in 1973 and present delivery quotes range from "off-the-shelf" to approximately 5-6 weeks. And new capacity is planned for the ever increasing demands.

## Design assistance

Application notes, detailed data sheets, comprehensive data book, and a MECL System Design Handbook provide the answers to design problems. And a team of application engineers is constantly available for design assistance.

## All things to all designers?

Only you as a designer can answer that question. Perhaps MECL 10,000 can be applied to your new design, or to upgrade the performance of older equipment. For your information we have prepared a design file including three new useful application notes:

AN-700 Simulate MECL System Interconnections With a Computer Program

AN-701 Understanding MECL 10,000 Specifications

AN-709 MECL 10,000 Arithmetic Elements

And to make evaluation a little easier we have included an evaluation certificate allowing you to

Function	Commercial (-30°C to +85°C) Ceramic DIP	Commercial (-30°C to +85°C) Plastic DIP	Military (-55°C to +125°C) Ceramic DIP	Military (-55°C to +125°C) Ceramic Flat Pack
Quad OR/NOR Gate	MC10101L	MC10101P	MC10501L	MC10501F
Quad NOR Gate	MC10102L	MC10102P	MC10502L	MC10502F
Quad AND Gate	MC10104L		MC10504L	
Triple 2-3-2 OR/NOR Gate	MC10105L	MC10105P	MC10505L	MC10505F
Triple 4-3-3 NOR Gate	MC10106L		MC10506L	MC10506F
Triple Exclusive OR/NOR Gate	MC10107L	MC10107P	MC10507L	MC10507F
Dual 4-5 Input OR/NOR Gate	MC10109L	MC10109P	MC10509L	MC10509F
Dual 3-Input/3-Output OR Gate	MC10110L	MC10110P		
Dual 3-Input/3-Output NOR Gate	MC10111L	MC10111P		
Triple Line Receiver	MC10114L		MC10514L	
Quad Line Receiver	MC10115L	MC10115P	MC10515L	MC10515F
Triple Line Receiver	MC10116L		MC10516L	MC10516F
Dual 2-Wide OR-AND/OR-AND-INVERT Gate	MC10117L	MC10117P	MC10517L	
Dual 2-Wide 3-Input OR-AND Gate	MC10118L		MC10518L	
4-Wide 4-3-3-Input OR-AND Gate	MC10119L		MC10519L	
4-Wide OR-AND/OR-AND-INVERT Gate	MC10121L	MC10121P	MC10521L	
Triple 4-3-3-Input Bus Driver	MC10123L			
Quad TTL-To-MECL Translator	MC10124L		MC10524L	
Quad MECL-To-TTL Translator	MC10125L		MC10525L	
Dual MECL-To-MOS Translator	MC10127L			
Dual Bus Driver	MC10128L			
Quad Bus Receiver	MC10129L			
Dual D Latch	MC10130L			
Dual D Flip-Flop	MC10131L		MC10531L	MC10531F
Dual MUX W/Latch (Common Reset)	MC10132L			
Quad Latch	MC10133L			
Dual MUX W/Latch (Separate Select)	MC10134L			
Dual J-K Master-Slave Flip-Flop	MC10135L		MC10535L	
Universal Binary Counter	MC10136L		MC10536L	
Universal Decade Counter	MC10137L			
64-Bit RAM (64 x 1) (90 ohm Drive)	MCM10140AL			
4-Bit Universal Shift Register	MC10141L		MC10541L	MC10541F
64-Bit RAM (16 x 4)	MC10145L			
64-Bit RAM (64 x 1) (50 ohm Drive)	MCM10148AL			
12-Bit Parity Generator/Checker	MC10160L		MC10560L	
Binary to 1-8 Line Decoder (Low)	MC10161L			
Binary to 1-8 Line Decoder (High)	MC10162L			
8-Line Multiplexer	MC10164L	MC10164P	MC10564L	
Priority Encoder	MC10165L			
Dual 4-Line Decoder (Low)	MC10171L			
Dual 4-Line Decoder (High)	MC10172L			
Quad 2-input MUX W/Latch	MC10173L			
Dual 4-to-1 Multiplexer	MC10174L		MC10574L	MC10574F
Quint Latch	MC10175L		MC10575L	
Hex D Flip-Flop	MC10176L			
Look Ahead Carry Block	MC10179L			
Dual High Speed Adder/Subtractor	MC10180L			
4-Bit Arithmetic Logic Unit	MC10181L	MC10181P	MC10581L	MC10581F
High Speed Dual 3-Input/3-Output OR Gate	MC10210L			
High Speed Dual 3-Input/3-Output NOR Gate	MC10211L			
High Speed Triple Line Receiver	MC10216L			
High Speed Dual D Flip-Flop	MC10231L	MC10231P	MC10631L	MC10631F

Shaded blocks indicate new introductions.

MECL and MECL 10,000 are trademarks of Motorola Inc.

sample any six MECL 10,000 devices of your choice at 50% off list prices.

For performance proof, write to Motorola Semiconductor Products

Inc., P.O. Box 20912, Phoenix, Arizona 85036 and ask for MECL Design File #3. Only an evaluation will prove MECL 10,000's value to you.



**MOTOROLA MECL**  
... new logic capabilities for the 70's!

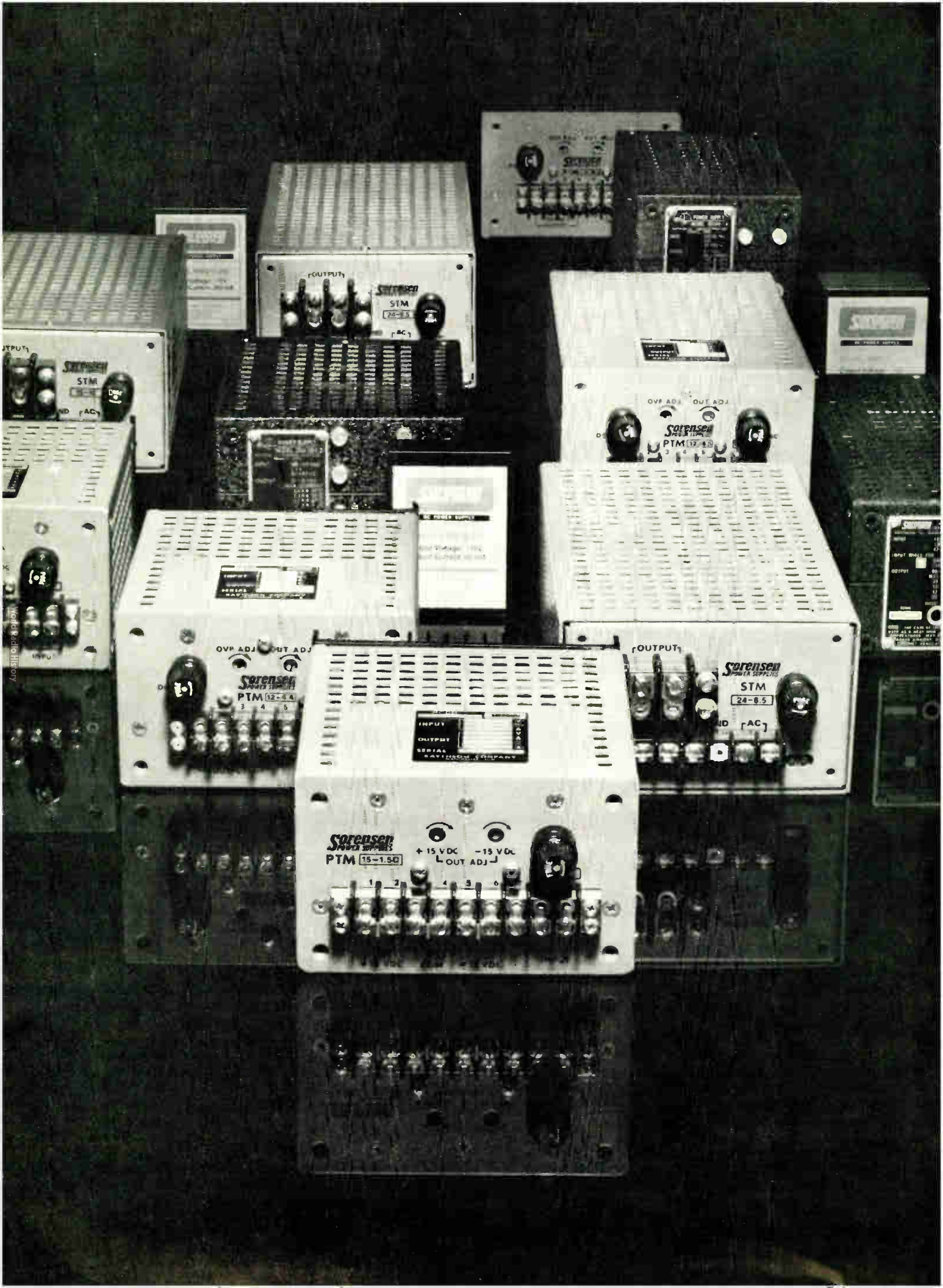

World Radio History



# The Sorensen Modulares. A powerful line-up.

Sorensen Modulares give you maximum choice. Plus dependability and efficiency. No matter what your power requirement, count on Sorensen. From the advanced switching-transistor STM series to the miniature encapsulated MMs, there's a Sorensen modular to meet your system specifications and your most rigid performance demands.

## Single Output

**STM Series** — 40 models. Switching-transistor modulares that provide twice the efficiency of series-pass competitors in half the space — and eliminate need for external cooling. STMs feature built-in overvoltage protection; computer-optimized filtering; 0.05% voltage regulation; output voltages range from 3.0 (min.) to 56 (max.) Vdc.

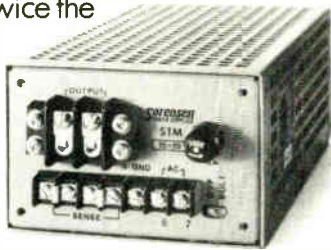

**PTM Series** — 12 models. All solid-state series-pass modulares that achieve state-of-the-art power density; deliver more power per cubic inch than comparable competitive units, at lower cost per watt. Features include built-in overvoltage protection; highest quality components; adjustable automatic current limiting; 0.05% + 5mV voltage regulation; low ripple and noise; six voltage levels to 100 watts.

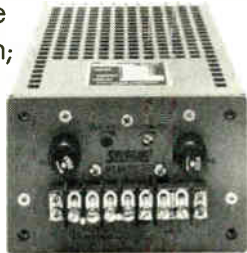

## Dual Output

**PTM DUALS Series** — 9 models. Dual output versions of PTM series, with the same advanced design and construction. Compact, solid-state series-pass modulares with built-in overvoltage protection; feature tracking accuracy to 0.2%; voltage regulation — .02%; transient response — 50  $\mu$ sec. Series includes +5, -12 volt model for CMOS applications.

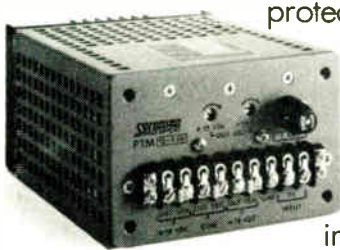

## Miniature

**MM Series** — MMS (single) MMD (dual) MMT (triple) — 15 models, 4 package sizes. Designed for maximum reliability

in microminiature electronic applications. All MM encapsulated modulares feature built-in overvoltage protection; excellent voltage regulation; single outputs from 5 to 28 Vdc; dual outputs of  $\pm 12$  or  $\pm 15$  Vdc.



**Other dependable Sorensen power supplies**

**QSA Series** — 29 models. Modular, wide range, convection-cooled power supplies feature excellent operating specifications plus a wide range of accessories. Models provide outputs from 3-330 volts and up to 300 watts. Top choice for multi-output systems.



## Lab/Systems Power Supplies

**SRL Series** — 14 models. Low voltage, regulated, solid-state DC power supplies. Rack-mount style featuring excellent stability, fast response time over the full load range, built-in overvoltage protection. Power ranges from 0-60 Vdc and 100 Amps.

**DCR Series** — 37 models. High performance, all-solid-state power supplies featuring the lowest cost per watt on the market. 10 voltage ranges from 20 Vdc to 30,000 Vdc; 7 power levels from 400 to 20,000 watts. Ideal combination of economy, reliability and performance.

SORENSEN CATALOG/73 provides fully detailed specifications for all models of Sorensen modular and lab/systems power supplies. Write for your copy. Sorensen Company, a unit of the Raytheon Company, 676 Island Pond Road, Manchester, N.H. 03103. Tel. (603) 668-4500. Or TWX 710-220-1339.



# Sorensen POWER SUPPLIES

"See us at WESCON"

# Name it and it's yours.



We only screwed up one thing when we introduced our Model 146. Its name. We considered "the generator for the man who has everything." We even entertained such wild possibilities as "the alpha-omega machine." But in desperation, we finally settled for "The Multi-function Generator." Not a bad name, but it just doesn't do justice to the instrument. Read the next paragraph and see if you don't agree that the 146 deserves a better tag.

#### What the 146 is and does.

The Model 146 is two complete generators in a single package. You can use either one independently, or you can use one to control the frequency and amplitude of the other. The instrument's unique calibrated dial system allows center frequency, sweep width, amplitude and frequency modulation limits to be set — and read — *without* an oscilloscope. We realize you don't *have* to have a 146 for frequency modulation, amplitude modulation or frequency shift keying. But without one, you'll need at least *two* function generators, *plus* an oscilloscope. Probably the best words to describe the 146 are versatility and convenience.

Circle 52 on reader service card

#### What you should do.

Put your feet up on the desk for a few minutes and let your imagination run amuck. You're bound to come up with something more appropriate than "multi-function generator." Then, simply fill out the coupon (or a reasonable facsimile) and mail it to us. If we think the name you send in is the best one, we'll send you a Model 146 "whatchamacallit" **ABSOLUTELY FREE!** You have nothing to lose but a postage stamp and you stand to win an incredible laboratory signal source valued at \$1,495. So hurry. Enter today.

#### Contest rules

1. Enter as often as you please, but each entry must be mailed in a separate envelope.
2. Entries must be postmarked no later than midnight September 15, 1973. All entries become the property of Wavetek and cannot be returned.
3. Entries will be judged on the basis of neatness, originality and aptness of thought. Wavetek reserves the right to supervise the judging and the decision of the judges is final.
4. Only one Model 146 will be given away and the winner will be notified by mail. The winner grants to Wavetek the right to publish his entry and to use his name and photograph for advertising and promotion.
5. Anyone in the United States and Canada may enter except employees (and their families) of Wavetek, its advertising agency and independent sales representatives. Odds of winning depend on the quality of the entry and the number of entries received. Void where prohibited. Federal, state and local laws apply.

I name it:

Name \_\_\_\_\_

Company \_\_\_\_\_

Address \_\_\_\_\_

City \_\_\_\_\_ State/Zip \_\_\_\_\_

**WAVETEK®**

P.O. Box 651, San Diego, California 92112  
Telephone (714) 279-2200, TWX 910-335-2007



## **RFPs planned soon for computerized car diagnostic units**

Industry soon will be asked to participate in developing a prototype system that will inspect motor vehicles' safety and emission controls and diagnose their defects, if any, **following a \$1.4 million award this month by the Department of Transportation** to the District of Columbia government. The award, the first of a series that will fund operating systems in several states, promises to open up a multimillion dollar market in computerized car inspection. RFPs are already in the mill for the pilot D.C. system, which is to become operational by March 1974. A DOT official observes that the winning company should have a big edge over competitors when the states pick their system contractors.

**Under Federal law, DOT must fund from five to 10 states for operating systems at an estimated cost of \$5 million to \$10 million each.** Each system will be built around a general-purpose minicomputer that uses terminal and sensor inputs for visual and performance monitoring. The D.C. project will handle a few thousand cars a year, the state systems about 100,000. The printout from the diagnostic system will also tell the car owner why his car failed.

## **EMP survivability test programs set by Air Force, Army**

The Air Force and Army are stepping up efforts to test how well air and ground electronics can survive the electromagnetic-pulse effects of nuclear warhead bursts. **EMP simulators, developed in large part to test the feasibility of laser countermeasures for missile defense** [*Electronics*, Nov. 6, 1972, p. 51], **are scheduled for use on avionics under a multimillion-dollar program** developed by Air Force Special Weapons Center, Kirtland AFB, N.M.

A similar test effort is being developed at the Army's Harry Diamond Laboratories, Adelphi, Md., part of which has been contracted out to Rockwell International's Autonetics division. The classified Autonetics program calls for "examples of engineering methods and practices, analytical and experimental tools, and new techniques for applications" in EMP, and covers antenna models, components degradation analyses, filter applications as terminal protection devices, and laboratory simulation of EMP using current injection.

## **Commission urges more electronics to fight crime**

A strong recommendation that "every police agency immediately establish" 24-hour command and control centers with two-way radio contact with field units was made to the Justice Department by the National Advisory Commission on Criminal Justice Standards and Goals. In its report last week **the commission also zeroed in on the usefulness of digital communications and called on the Law Enforcement Assistance Administration to begin competitive development of pilot systems.**

These recommendations should carry some weight after the three-year authorization to LEAA on Aug. 6 to grant up to \$3.25 billion to the states. Also, Attorney General Elliot Richardson has stated his interest in using more technology in the judicial system. But, while endorsing information systems, the commission cautions that **state systems should be coordinated to avoid duplication of records and equipment** and to ensure privacy. The commission, made up of state and local office holders, law enforcement officials and citizens, entitled its conclusions "A National Strategy to Reduce Crime."

## Design-to-cost: the EIA view

In the never-ending debate over weapons system costs, effectiveness, reliability, compatibility, and numerous other ilities, there is one defense official who likes to recount the story of the Russian admiral who was anxious some years ago to enhance the Soviet image as a major sea power. It was a time when one of the largest elements of the Russian navy was no more than a relatively harmless fleet of single-screw, small-gunned destroyers. What the admiral did was retrofit these ships fore and aft with new, medium-range anti-ship missiles, providing the navy with a significant new capability that cast a pall over NATO. The admiral, it seems, had grasped the principles of cost-effectiveness.

Something akin to that way of thinking is evident in the Electronic Industries Association's recent response to the Director of Defense Research and Engineering's call for help in implementing the Pentagon's design-to-a-price policy. "Modification of existing equipment may be a more cost-effective way of satisfying a new functional requirement than new design until studies indicate a new design round is justified," wrote EIA's Government Production division in a 15-page letter to Jacques S. Gansler, DDR&E's assistant director for electronics. Following a meeting with Gansler last fall, the EIA division has come up with a series of 19 recommendations that it believes will help the Pentagon in its latest effort to find a way out of "the defense cost dilemma."

### Going commercial

Gansler, who has yet to respond to EIA's letter, is known to be interested in finding out where successful commercial electronics products and practices—including warranties—can be applied to hold down costs [*Electronics*, March 1, p. 49]. EIA makes it clear it has received the message. In addition to calling for policy changes that will make possible the procurement of commercial hardware for military systems—a practice beginning to be applied number of DOD data-processing projects—the EIA recommends that the Pentagon learn from commercial practice by (1) writing specifications to cover end results, not details, and (2) using redesign tradeoff studies when equipment is to be introduced gradually into the field and for procurement follow-ons.

On the subject of warranties, EIA's pitch was somewhat softer. Noting that "warranties pose a difficult problem under current contracting procedures," the association said "the degree to

which industry will warrant defense products—particularly under the type of constraints explicit in 'design-to-cost'—is going to be largely a function of the degree to which the producer can control . . . the operating and maintenance environments." There are many in industry who are convinced that these conditions can never be met.

### How airlines fly

Nevertheless, the contractors' call for a program of common electrical and mechanical interfaces, like that of Aeronautical Radio Inc. for the nation's airlines, should have distinct appeal. "One of the basic concepts of the Arinc operation with the airlines," EIA observed, "is that the common interfaces in an aircraft be absolutely defined, thus permitting the various airlines to buy their aircraft components from sources of their own selection. The same principle must be applied to military platforms if the proliferation of designs of Tacans, altimeters, transceivers, etc. is to be stopped. Within any given generation of technology, there is no reason why the military must design a new piece of equipment for each platform. A program with teeth in it has to be established . . ."

To many outside the Government—and indeed to some inside it—there is certain to be suspicion of the EIA recommendations and, considering some of the past and present procurement disasters in weapons procurement, the basis for those suspicions is not unreasonable. The EIA proposal, for example, that seeks greater "industry participation in the translation of operational needs into system parameters" will surely sound to some like setting the fox to watch the chickens. But the idea of limiting the tenure of such a group "from about two weeks to a maximum of six months" for any given system specification—since a longer period "would be indicative of a weak or questionable system concept"—should help allay those fears. So should EIA's argument that industry assistance in preparing specifications would mean that bidders supplying "industry participants would have to 'live with' the results of their efforts," as would the participating representatives of the military end user when they return to their commands.

At the very least, EIA's proposals deserve serious consideration within DOD where the procurement process is in deep trouble. As DDR&E's John S. Foster, Jr., succinctly put it before his departure earlier this year, "We are running out of money."  
—Ray Connolly



# ac, dc, volts, amps, ohms

## 25 ranges

## \$595 complete

## 5-day delivery



**INTRODUCING** Systron-Donner's all-function 7004A Digital Multimeter  Measures dc and ac voltage, dc and ac current and resistance  New improved circuitry expands AC response to 100 KHz  New color-coded pushbuttons help distinguish functions  New carry case option  New simplified calibration  Optional battery pack with recharger (\$95) mounts internally  1,000 megohm input impedance on 3 lowest ranges  0.01% dc accuracy. For lab, field or systems use (with DTL/TTL compatible BCD outputs, \$45 additional).

Contact your local Scientific Devices office for more 7004A details or: Concord Instruments Division, 10 Systron Drive, Concord, CA 94518. In **Europe**: Systron-Donner GmbH Munich W. Germany; Systron-Donner Ltd., Leamington Spa, U.K.; Systron-Donner S.A. Paris (Port Marly) France. In **Australia**: Systron-Donner Pty. Ltd. Melbourne.

**We made a good DVM better!**

SYSTRON  DONNER

**The Systron-Donner Instruments Group:**

Concord Instruments  Computer Systems  Datapulse  Kruse Electronics  Microwave  Trygon Electronics

## Clockmaker looks to color TV for 4-MHz crystals

Normally when a company has a hot-selling item, there's little reason to phase out its production. But what's normal for most firms isn't so for Staiger, a Black Forest clock manufacturer that went to market with quartz and IC-based household clocks two years ago.

Now, with sales of its 32-kilohertz quartz clock booming and with domestic and foreign retailers clamoring for stepped-up deliveries, the company has decided to discontinue that line and turn to another.

"What prompted the switch," says Staiger's sales manager, Lothar Roetzschke, "was that the quartz supplier couldn't meet our demands for more 32-kHz crystals." So, figuring what's good for a color-TV set must also be good for a clock, Staiger turned to a 4-megahertz quartz crystal—for which there is no supply problem because enough manufacturers are producing it. In TV sets, 4-MHz crystals are used in the color-subcarrier circuitry.

**Pluses.** The high-frequency quartz, says Roetzschke, will render the company's new clockworks superior to their predecessors in two respects: in temperature stability and in resistance to shock and vibration. This, together with the high accuracy inherent in quartz timepieces, makes the 4-MHz clockwork suitable for applications far beyond just household clocks. Examples that Roetzschke cites are timepieces that must operate in environments prone to shock, vibration, and variable temperature, as in automobiles, ships, aircraft, and industrial-control equipment.

The switch to a higher frequency has also meant turning to a new integrated-circuit technology. Replacing the bipolar IC in the 32-kHz units is a C-MOS device. As Reinhard Jaeckle, Staiger's chief of development, points out, only with C-MOS can a high-frequency oscilla-

tor be driven with tiny power cells. This technology gives a running time of more than a year before the cells need replacing, Jaeckle says.

**In use.** The 4-MHz quartz and the C-MOS device are the key electronic components in Staiger's new clockwork, designated CQ2002. It will enter production this fall and will be used in desk-type clocks featuring a data indicator and a buzzer that can be set to come on for five seconds every minute—tone for five seconds, no tone for 55 seconds—the kind of timepiece sometimes found on executive's desks. This clock will go to market at the end of this year and will be followed by CQ2002-equipped wall and mantelpiece clocks next spring.

The CQ2002 will be produced for other domestic and foreign clock manufacturers as well. Its factory price will be 49 deutschmarks (about \$21.50), but Roetzschke says that figure is sure to come down

with increasing production. At room temperatures, the CQ2002 has a time deviation of no more than 1 minute per year, which is the same accuracy as that for its two predecessors, the 16-kHz CQ2000 and the 32-kHz CQ2001 version.

The 4-MHz quartz is an AT-cut crystal, ground into a plane-parallel disk about 0.75 inch in diameter. It is designed so that its amplitude of oscillation is highest at the center and becomes smaller towards the edges until it is practically zero in a narrow peripheral zone. This structure allows the disk to be clamped at its edge by spring bands without affecting the oscillations at the center. Such support, then, makes the crystal more shock- and vibration-resistant than a 32-kHz crystal, which cannot be mounted the same way because it oscillates with nearly constant amplitude over the whole area. The CQ2002 resists shocks of more than 500 grams. □

---

### Switzerland

---

## Earth station for UN airlifts can be landed almost anywhere

When an earthquake, a typhoon, a guerrilla war, or other disaster devastates a developing country, good communications with the outside world are essential for effective rescue and relief operations. The trouble is, a developing country's communications network—when there is one—is almost sure to get knocked out of service by a disaster.

Trying to get back on the air by repairing what was there is at best chancy. Much better, insists William B. Pierce of the International Telecommunications Union, would be a transportable earth station that could be flown in and set up fast on

the spot. Geneva, he points out, is just a single hop via an Intelsat-4 synchronous satellite to nearly every developing area. And Geneva, of course, is headquarters for both the United Nations Development Program and for the International Red Cross, two organizations that figure to get involved when developing countries need massive help.

**Outlook.** Chances look good for Pierce's project. He is one of a group of electronic engineers assigned by ITU to help developing countries improve their telecommunications networks. And since ITU is also a Geneva-based United Nations agency, it



was only natural that UNDP turned to ITU for a first look at portable satellite stations. Pierce put together the main parameters; then ITU had Nippon Electric Co. and Technology Resources SA, a Paris-based communications consultant, develop detailed specifications. Technology Resources expects to deliver the document this month.

ITU's specifications call for hardware that can be shipped in the luggage compartment of a passenger jet like a Boeing 707 or a McDonnell Douglas DC 8. That requirement imposes limits of just under 5 metric tons and 37 cubic meters. What's more, individual packages that make up the shipment must be sized so that three men can set up the station and get it on the air within 18 hours. Once on the air, the station has to be available 99.5% of the time for the next 30 days.

For starters, ITU figures it would work with a 5-megahertz slot in the appropriate Intelsat-4 bird. That space is enough for two voice-plus-teletypewriter channels in the standard 6-gigahertz up frequency and the 4-GHz down frequency.

**On the air.** As for power, the specifications call for a 100-watt output for the transmitter, which will be paired with a Cassegrain antenna 15 feet in diameter. The receiver: an uncooled parametric amplifier mounted very close to the antenna feed horn. To boost the safety margin for getting a message through, there will be delta modulation with a single channel per carrier. This modulation method can stand much higher error rates than pulse-code modulation.

With the preliminary design blocked out, the next step is getting a commitment of some \$350,000 to build a prototype. Pierce is optimistic about UNDP getting the money into its budget. But the development agency is not the sole possible source. "We have had feelers from a large U.S. foundation," reports Pierce, "and a large country as well." After the prototype, ITU would like to see three or four full-fledged stations built at a cost of some \$200,000 a copy. □

## Around the world

### Test of aircraft fiber optics

Financed by the Ministry of Defence, Marconi-Elliott Avionics Ltd. is experimenting to see whether fiber-optic links can replace electrical cables for transporting digital data in the troublesome electromagnetic environment in airplanes. M-E has built a complete link, transmitter, and receiver system, which will be flight-tested shortly by the Royal Aircraft Establishment in a Comet transport. The equipment will carry two-way data between two airborne computers, part of the navigation computation and display system.

The M-E experimental equipment uses standard gallium-arsenide emitters working at a 0.9-micrometer wavelength, plus silicon photodiode receivers. Clock rate is 5 megabits per second, and pulse width a few tens of nanoseconds. A fiber link connecting a transmitter and receiver is actually a bundle of about 100 glass fibers, so that if some break the channel is not lost. A bundle is about 1/8 inch in diameter, including sheathing, and looks like an ordinary electrical cable. The fiber-link run in the Comet will be about 80 yards long.

### Gas display uses dc drive

Gas-discharge, 35-dot alphanumeric displays have not caught on much in Europe, and what volume market exists is supplied by Burroughs and Mullard. Now Ferranti Ltd. is joining in. Ferranti's technology is developed, but the module format will depend on customer reaction.

Unlike the others, Ferranti drives its module with direct current. That is, once the neon-argon gas cell that forms the dot is switched on it stays on steadily until switched off. The advantage, says Ferranti, is that power dissipation is much less than with pulse driving, and no external memory is needed to rewrite the display at every cycle. The snag is a slightly more complex construction—each cell needs its own internal resistor, which functions as a built-in memory so that when a cell is switched on it stays on. Further, the resistors ensure that all the cells switched on actually come on.

Ferranti's cells are 18 mils in diameter, and they spread 30 cells to the inch along both axes. Thus, a five-by-seven character is approximately 1/6 by 1/4 in. The biggest panel built so far has 15 rows of 20 characters.

### Rf test system isolates minicomputer

Minicomputer control of low-level radio-frequency measurements has been conspicuous by its absence, because the clock and other pulse currents in the computer constitute a noise source that interferes with the measurements. This is the opposite of the usual situation, where special precautions must be taken to keep environmental noise from interfering with the computer. Engineers at Matsushita Communication Industrial Co. have solved the problem by designing a split test system with the minicomputer outside the screen room that contains the equipment being tested and the radio-frequency test instruments.

The system was designed in response to a pressing need from the parent company, Matsushita Electric Industrial Co.—one of the world's largest manufacturers of the proliferating breed of cassette-recorder—multiband-radio combinations. Perhaps the most important part is a CRT terminal used to flash instructions to the operator inside the screen room to adjust the set being tested. An automatic manipulator is provided for volume-control adjustments, but manual intervention is relied upon for band changing, tuning, function-switch settings, and all other adjustments to cope with the large variety of mechanical configurations of different sets. The console also allows the engineer setting up the system to type in parameters or view curves.

With an unskilled operator manipulating panel knobs and the computer controlling measurements, all data can be taken in two hours—about one 10th the time required by a skilled technician or engineer doing the same tests manually. Matsushita says it is willing to sell the system to other companies, as well as to its own divisions. But at something like \$230,000 a copy domestically, it doesn't expect to sell more than three or four a year.

# 191 FLAVORS OF BECKMAN DIPS



All 191 flavors of RESNET™ DIPs offer system compatibility because we use the same packages you use for I.C.s; plus you get ceramic dependability at plastic prices.

Whether you're inserting resistors automatically or by hand — call your local Beckman/Helipot representative and ask how you can save money using RESNET DIPs. He stocks locally for immediate delivery.

If you need immediate technical literature or the telephone number of your local Beckman/Helipot representative, call H.E.L.P. (Helipot Express Literature Phone) toll-free (800) 437-4677.

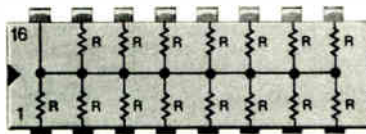

898-1 (16 resistors)  
Price (1,000-4,999) \$8.85

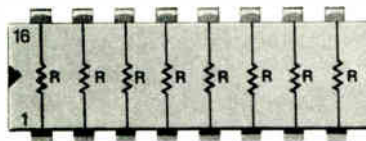

898-3 (8 resistors)  
Price (1,000-4,999) \$7.76

**STANDARD RESISTANCE VALUES**  
(± 2% or ± 2Ω)

62*	110	330	1.0K	2.2K	6.0K	15.0K
68	160	470	1.5K	3.3K	6.8K	22.0K
100	220	680	2.0K†	4.7K	10.0K	

\* Standard in 898-3 only.  
† Standard in 898-1 only.

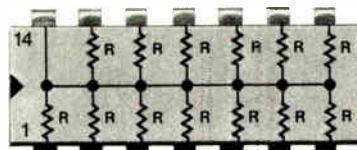

899-1 (13 resistors)  
Price (1,000-4,999) \$8.81

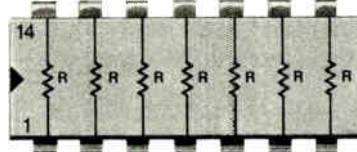

899-3 (7 resistors)  
Price (1,000-4,999) \$7.72

**STANDARD RESISTANCE VALUES**  
(± 2% or ± 2Ω)

22	62	180	510	1.5K	4.3K	11K
24	68	200	560	1.6K	4.7K	12K
27	75	220	620	1.8K	5.1K	13K
30	82	240	680	2.0K	5.6K	15K
33	91	270	750	2.2K	6.0K	16K
36	100	300	820	2.4K	6.2K	18K
39	110	330	910	2.7K	6.8K	20K
43	120	360	1.0K	3.0K	7.5K	22K
47	130	390	1.1K	3.3K	8.2K	
51	150	430	1.2K	3.6K	9.1K	
56	160	470	1.3K	3.9K	10K	

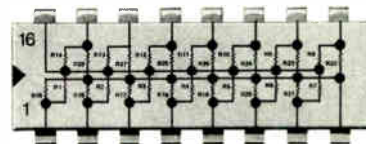

898-5-R220/330  
Pulse squaring TTL terminator.  
Price (1,000-4,999) \$1.45

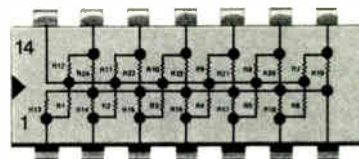

899-5-R220/330  
Pulse squaring TTL terminator.  
Price (1,000-4,999) \$1.35

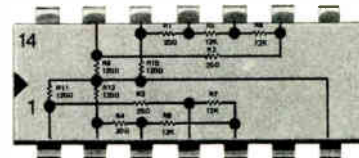

899-19  
DIP interface network providing resistors for μA711 core sense amplifier configuration.  
Price (1,000-4,999) \$1.18

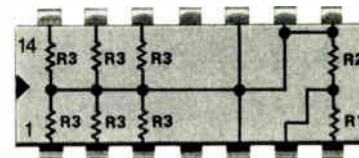

899-40  
DIP network provides six line terminators and the threshold setting divider for the Intel 3208A sense amplifier.  
Price (1,000-4,999) \$1.35

**Beckman**  
HELIPOT DIVISION



## UK chip promises minicomputer on one board

A British maker of computer peripherals has breadboarded a micro-processor chip that makes possible a minicomputer on a single board measuring 10 by 14 inches that the company says has roughly the power of a Digital Equipment Corp. PDP-11. Computer Electronics Ltd., of Saffron Walden, Essex, has fitted several full boards with smaller boards in MSI TTL to stand in for the new chips. The company is now seeking money to turn the breadboard into LSI MOS. Computer Electronics says such a computer could be produced cheaply enough in volume to become a standard in numerous peripherals. The micro-processor would have so much power that the company says **the surplus capacity in a half-dozen or so peripherals could be used as a central processor**, eliminating the need for a separate CPU. The company is working on software to implement the proposed operation.

The breadboarded processor has 16-bit fully parallel operation with cycle time of 1 microsecond. It has eight general-purpose registers, including one stack pointer and the program counter. There are 93 instructions. **The microprocessor can directly address a maximum of 65,536 words and can also address 8-bit bytes or single bits.** A full board will have capacity of 16,384 words of storage, plus an address register, a real-time clock, and communications channel.

## Germany evaluates data test link to U. S. via Intelsat

Can the time difference between Europe and the U. S. be exploited to **tap unused computer capacity during slack periods over a transatlantic communications-satellite link?** To answer that question, AEG-Telefunken has conducted a large-scale experiment in data transmission from its Constance facilities through Intelsat-4 to a terminal near Washington, D.C. The 12-day, round-the-clock experiment, was supported by West Germany's Science Ministry and Postal Administration, as well as Comsat Laboratories and the Intelsat organization.

During the tests, **randomly generated characters originating at Constance were recorded at the U.S. terminal 0.23 seconds later with no trouble at all**, despite the high data throughput rate and the transmission path's high susceptibility to interference. The terminals used in the experiment have a new error-control process that AEG-Telefunken says "is so good that an error can slip through only once in 100 days, even when a transmission-path distortion is encountered every 10 seconds." Results of the test are now being evaluated by the post office to determine what further steps must be taken to implement a commercial transatlantic computer system.

## Mitsubishi to make n-MOS memories by selective oxidation

Mitsubishi Electric Co. will use its selective-oxidation process (SOP), with a silicon-nitride mask to produce its upcoming line of n-channel MOS memories. That process is being used to produce thick-field oxide regions for all silicon-gate MOS and about half the aluminum-gate MOS the company produces. **The 4,096-bit memory will have a chip size about 80% the size of the one used in the U. S. by Intel Corp.**

The nitride layer is used only for masking the wafer while growing a thick layer of oxide over the field region. Mitsubishi says **it achieves a fine pattern with SOP because it etches patterns in the nitride layer by a gas-plasma process** [*Electronics*, Electronics International, June 7].

By optimizing the thickness of the oxide layer underlying the nitride

## International newsletter

---

layer to prevent over-etching and by optimizing both the thickness of the nitride layer and the temperature at which oxidation is performed, engineers say they prevent damage to the silicon wafer that has plagued others who have unsuccessfully tried nitride masking.

### **Automatic network will monitor air quality in Bavaria**

Germany will soon set up its first fully automatic air-quality-monitoring network. Ordered by the Bavarian environmental protection agency and **to be designed and installed by Dornier AG, the network will eventually have about 65 measuring stations scattered over Bavaria.** Data on hydrogen sulfide, carbon monoxide, sulfur dioxide, hydrocarbon, nitrous oxide, and dust, together with meteorological information on wind, temperature, humidity, radiation, and rainfall, will be transmitted to a control center in Munich via conventional telephone lines. **All measuring functions, including calibration, will be handled automatically and by remote control from the Munich center.** The condition of any measuring instrument can be checked at any time through special channels.

### **Import outlook spurs Fujitsu computer advances**

Impending liberalization of computer imports some time during 1975 is the driving force behind the announcement by Fujitsu Ltd. of its **Facom 230-8 series with virtual memory. All but the smallest model have p-MOS main memories.** The new series spans the range from the IBM System/3 through the 370-145 and 158. Virtual memory capacity is 512 megabytes. Deliveries of all models are to begin in October 1974.

The new machines upgrade the Facom 230-5 series by adding virtual-memory capability, IC main memories, higher-speed disks and drums, and associative memory. **All existing programs can be used without modification on the 8 series,** although older software can not take full advantage of the technology advances. Fujitsu did not extend the 8 series to its top models, the 230-60 and 230-75, which would benefit more from software advances than revision in hardware. Moreover, the 60 and 75 are to be replaced by the M-1 through M-4 series being developed in cooperation with Hitachi Ltd. under government subsidy.

### **British Airways buys Ferranti gear for reservation net**

British Airways—the national airline formed by amalgamating British Overseas Airways Corp. and British European Airways—is the first major customer for Ferranti's new real-time control computer, the Argus 700. **BA will use 20 Argus 700-Ts, the smallest models, in main reservation offices to control data flow between more than 600 Ferranti terminals and two IBM 370/168 computers** that will form the hub of its next-generation seat-reservation system. The computer complex, to replace the IBM-360-based system inherited from BOAC and the Univac-based system inherited from BEA, is to begin operation by the end of next year.

Ferranti's 700-series computers are **16-bit machines built for programming in a high-level language, preferably Coral-66,** a real-time derivative of Algol. The smallest and the middle-sized machines, the 700-T and 700-E, use the same TTL processor, with 750-nanosecond core storage. The 700-T has a capacity of 24,576 words, and the 700-E has a capacity of 64,512 words. The biggest machine, the 700-S, has an ECL processor and a capacity of 256,000 words of 500-ns core store. All machines use separate microprogramed input/output processors.



# 4 Turns for \$1.46

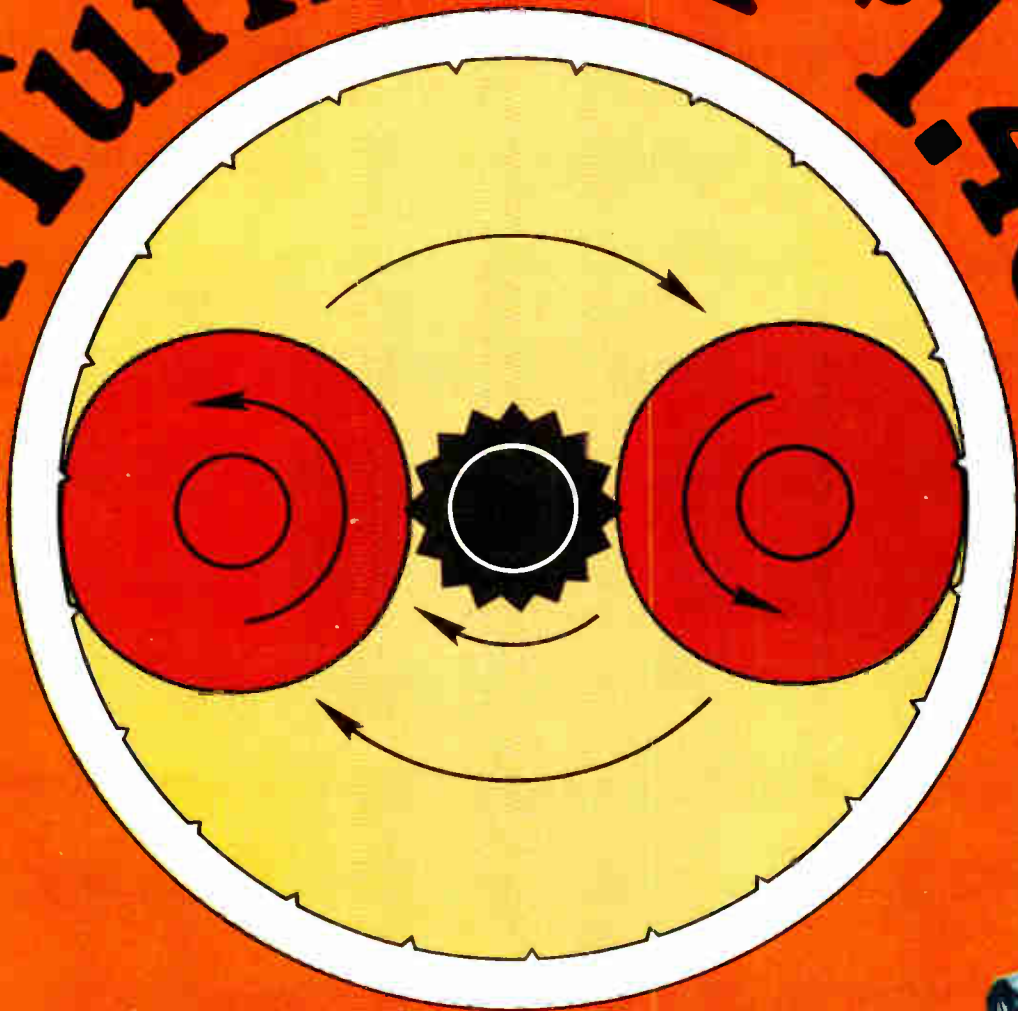

MODEL  
3339



## Meet a model of setability... *the smallest low-price multi-turn potentiometer on the market.*

You can be four times as sure of balancing critical circuitry with this cermet trimmer, Model 3339. Why? An ingenious drive mechanism (patent 3,614,703) gives you four mechanical turns to traverse the element.

**And that element!** Cermet provides the temperature coefficient ( $\pm 100$  ppm/ $^{\circ}$ C) and total resistance stability you need for temperature extremes ( $-55^{\circ}$  to  $+150^{\circ}$ C if need be). Choose your resistance—10 to 2,000,000 ohms. Count on quality. Model 3339 has

a high temperature plastic housing, sealed for extra protection.

**Top-Adjust Style: \$1.46, in 1,000-piece quantity**  
(Side adjust style Model 3339W; a few cents more)

Call, or write, your nearest Bourns sales office for more data on this multi-turn in a single-turn package. (Top-adjust size: .30" dia. x .25" high. Side-adjust size: .31" x .32" x .38" high)

**Available from your Bourns distributor.**



BOURNS, INC., TRIMPOT PRODUCTS DIVISION • 1200 COLUMBIA AVE., RIVERSIDE, CALIF. 92507

# Total resistor capability spoken here

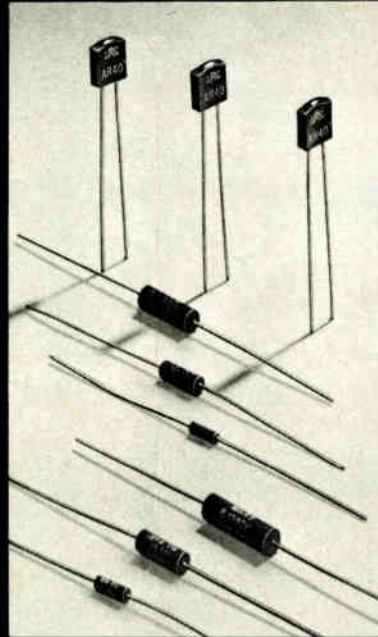
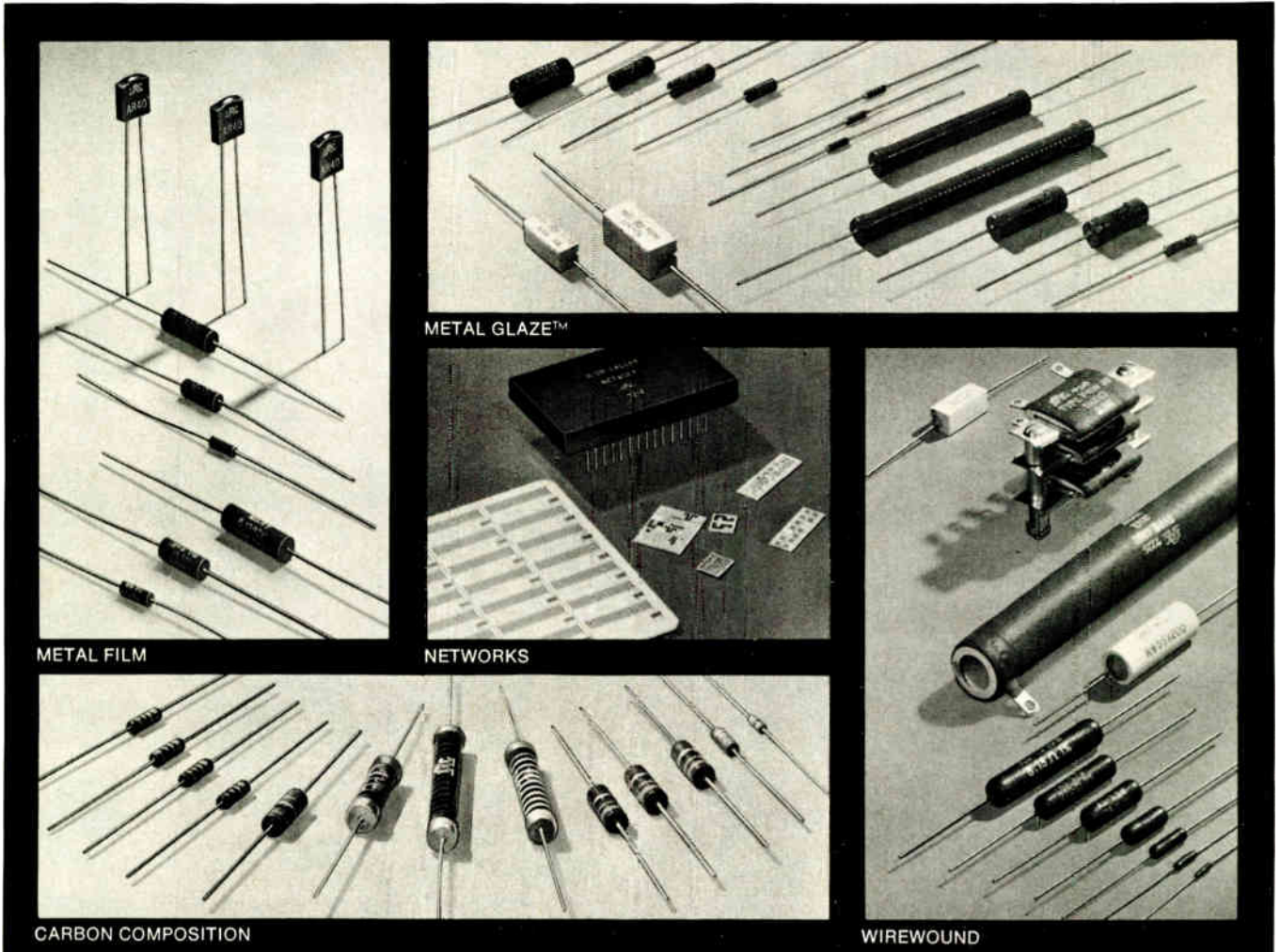

METAL FILM

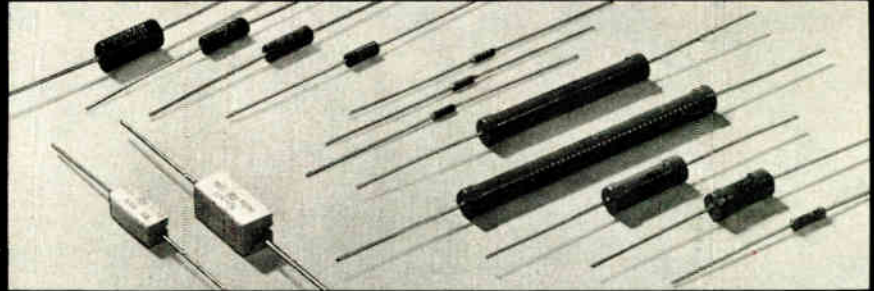

METAL GLAZE™

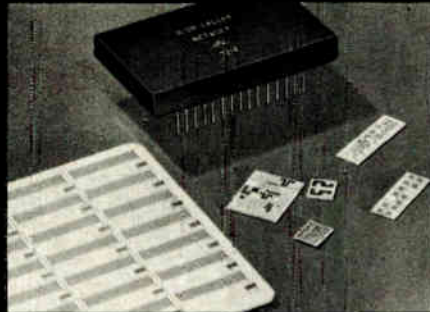

NETWORKS

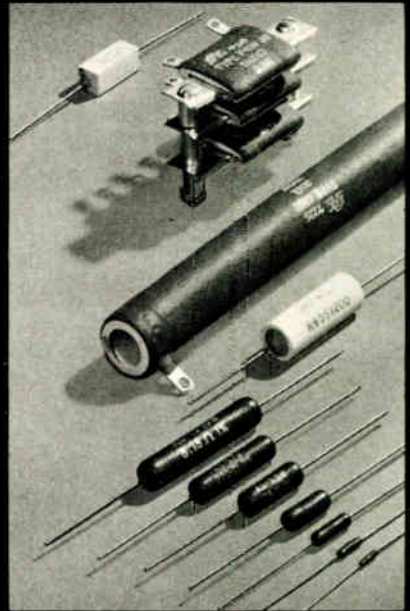

WIREWOUND



CARBON COMPOSITION

## TRW/IRC Carbon Composition Resistors

Used by *billions* in consumer, industrial and military applications, TRW/IRC carbon composition capability ranges from standard commercial type through established reliability RCR's, to ultra-high range ( $10^{11}$  ohms). Where you are using carbon comp.'s in automated assembly, TRW/IRC packaging techniques can help cut the cost of interfacing with your machines. Card packs, lead tape reels, cut and formed leads . . . we'll be glad to explore the potential economies with you.

## TRW/IRC Metal Glaze™ Resistors

This is TRW/IRC's thick-film technology—for every type of low power resistor application. Metal Glaze is widely accepted for its built-in power handling reliability, resistance range, and cost effectiveness. Available in numerous standard and special designs—precision, semi-precision, flameproof, high-reliability, high-voltage.

## TRW/IRC Wirewound Resistors

The line starts with molded wirewound resistors—"space-savers" that bridge the cost-performance gap between composition resistors and precision wirewounds. It proceeds to standard, non-insulated types for appliance/automotive use . . . to precision subminiatures offering high power density . . . to ceramic, flameproof units for TV and computer applications . . . to tubular and flat power wirewounds with ratings to 250 W.

## TRW/IRC Metal Film Resistors

TRW/IRC has brought the state-of-the-art in thin-film resistors to an equal performance level with high-stability wirewounds. Capabilities here include resistors with tolerances to  $\pm 0.01\%$  . . . high-reliability units to MIL and aerospace specs . . . precision subminiatures . . . and standards, of course. You can also look at alloy films offering high-temperature and high-voltage capability at low cost.

## TRW/IRC Resistive Networks

Advanced resistor technology here. These IC compatible, precision tantalum-film circuits provide inherent low noise, excellent stability, and hermetic performance without hermetic cost. Tolerances from 5% to 0.05% are available in custom designs. TRW/IRC also offers the industry's most complete line of discrete fixed resistors.

## All types . . . all technologies . . . from one source

To wrap it up, TRW/IRC offers you the broadest line of fixed resistors in the business, with extensive, nationwide distribution. All available from one source—your local TRW/IRC distributor. With a direct pipeline to each of our plants, he can give you fast delivery. Contact your local TRW/IRC sales office for application assistance, custom designs, and special engineering help when you need it. TRW/IRC Fixed Resistors, 401 N. Broad Street, Philadelphia, Pa. 19108 — (215) 922-8900 • Greenway Road, Boone, N.C. 28607 — (704) 264-8861 • 2850 Mt. Pleasant Street, Burlington, Iowa 52601 — (319) 754-8491.

# TRW<sup>®</sup> IRC RESISTORS



# LOW COST IC D/A'S...made easy!

8 & 10-bit Models  
Internal Reference  
100% Power Burn-In  
Specs guaranteed 0° to 70°C  
Available From Stock  
From \$9.95\*

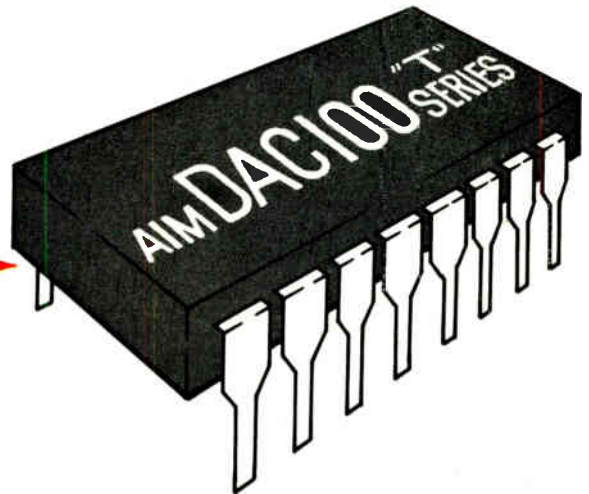

## COMPLETE FAST CURRENT OUTPUT DAC IN A 16-PIN DIP!

At last — an I.C. D/A converter that's easy to apply! The aimDAC 100 series provides its own internal reference voltage for low full-scale tempco and high supply rejection without complex external circuitry — and the fast current output settles in 250ns for use directly in high-speed A/D converters. Need a voltage output? Just add an op-amp — the tracking feedback resistor's already in the package! (Use our monoOP-01 High Speed Op Amp for total settling in less than 1.0µsec!)

Every aimDAC 100 guarantees its critical linearity and tempco over the entire 0° to 70°C temp range — and all devices are 100% burned-in for maximum stability and reliability. Military temperature range models and MIL-38510 processing are available, too.

Best of all, aimDAC 100's are available from stock — try one and see how easy I.C. D/A conversion can be!

\* 100 pc. quantity

### AIMDAC 100 "T" SERIES

Application	Guaranteed Max. Linearity 0° to 70°C	Guaranteed Max. Tempco 0° to 70°C	Price @ 100 pcs.	Model*
10 BITS	0.05%	60 ppm	\$26.00	aimDAC 100 ACT1(T2)
10 BITS	0.1%	60 ppm	\$17.00	aimDAC 100 BCT1(T2)
8 BITS	0.2%	60 ppm	\$12.00	aimDAC 100 CCT1(T2)
8 BITS	0.3%	120 ppm	\$ 9.95	aimDAC 100 DDT1(T2)

\* T1 models contain internal feedback resistor for +10V, ±5V operation  
T2 models contain internal feedback resistor for +5V, ±2.5V operation



1500 SPACE PARK DRIVE, SANTA CLARA, CALIFORNIA 95050  
TEL. (408) 248-9225 • TWX 910-338-0528 • CABLE MONO

#### AUTHORIZED DISTRIBUTORS

NEW YORK METROPOLITAN AREA Harvey Radio, Woodbury, N.Y.: (516) 921-8700 • NEW ENGLAND AREA Gerber Electronics, Dedham, Mass.: (617) 329-2400 • UPSTATE NEW YORK Harvey Federal Electronics, Binghamton, N.Y.: (607) 748-8211 • NORTHEAST Newark Electronics, Malden, Mass.: (617) 321-3930 • BALTIMORE-WASHINGTON Whitney Distributors, Baltimore, Md.: (301) 944-8080 • PHILADELPHIA Hallmark Electronics, Huntingdon Valley, Pa.: (215) 355-7300 • MICHIGAN RS Electronics, Detroit, Mich.: (313) 491-1000 • SOUTHEAST Kirkman Electronics, Winston-Salem, N.C.: (919) 724-0541 • EAST CENTRAL Pioneer/Cleveland, Cleveland, Ohio: (216) 587-3600 • Pioneer/Dayton, Dayton, Ohio: (513) 236-9900 • CENTRAL Hallmark Electronics, Elk Grove Village, Ill.: (312) 437-8800 • Minneapolis, Minn.: (612) 925-2944 • St. Louis, Mo.: (314) 521-3800 • TEXAS-OKLAHOMA Sterling Electronics, Houston, Texas: (713) 623-6600 • Dallas, Texas (214) 357-9131 • SOUTHWEST Sterling Electronics, Albuquerque, N.M.: (505) 247-2486 • Phoenix, Ariz.: (602) 258-4531 • WEST Westates Electronics Corp., Chatsworth, Calif.: (213) 341-4411 • Sterling Electronics, San Carlos, Calif.: (415) 592-2353 • Intermark Electronics, San Carlos, Calif.: (415) 592-1641 • Denver, Colo.: (303) 936-8284 • Salt Lake City, Utah: (801) 359-0531 • San Diego, Calif.: (714) 279-5200 • Santa Ana, Calif.: (714) 540-1322 • Almac-Stroum, Seattle, Wash.: (206) 763-2300 • Portland, Ore.: (503) 292-3534.



**Mary Lou, Martha, Mollie and Judy  
are sold on the AO STEREOSTAR® Zoom Microscope.**

## Here's why.

The AO STEREOSTAR Zoom stereoscopic microscope was specifically designed for convenience, working ease and optical performance. Zoom controls are located on both sides for convenience. It eliminates awkward reaching when changing magnification. The high resolution optical power pack may be rotated 360° to accommodate most any assembly or inspection situation. Full optical equipment offers a magnification range of 3.5x through 210x. Working distance of 4.0 inches is maintained at all magnifications in basic models, and if that's not enough, add a 0.5x

auxiliary lens to make it 5.7 inches. STEREOSTAR Zoom microscope assures a wide field of view, up to 2.25 inches with the 10x high eyepoint eyepieces. It also features an extremely efficient illuminator that stays cool even after long hours of continuous use. See for yourself. Contact your AO dealer or sales representative for a convincing demonstration.



**AMERICAN OPTICAL  
CORPORATION**

SCIENTIFIC INSTRUMENT DIVISION • BUFFALO, N.Y. 14215



# Signetics MOS

## DEVICE SELECTOR

### INSTRUCTIONS

Set arrow in lower window at Register Length, Bit Capacity, Character Size or Function.

Read Device Type and Specification in upper windows.

### SIGNETICS MOS DEVICE SPECIFICATION

TYPE	V <sub>SS</sub>	V <sub>DD</sub>	V <sub>GG</sub>	V <sub>BB</sub>	PROCESS	PKGS.
2580	+5	0	-12	-	P-SG	N, I

SHIFT REGISTERS	REGISTER LENGTH	ORGANIZATION	SPEED (MHz)
STATIC — METAL GATE	16	16 x 2	1.0
	25	25 x 2	1.0
	32	32 x 2	1.0
	50	50 x 2	1.0
	100	100 x 2	1.0
	100	100 x 2	3.0
STATIC — SILICON GATE	50	50 x 2	1.5
	100	100 x 2	1.5
	200	200 x 2	1.5
	32	32 x 6	2.0
	40	40 x 6	2.0
	80	80 x 4	1.5
	240	240 x 2	1.5
	250	250 x 2	1.5
	256	256 x 2	1.5
	128	128 x 2	1.5
132	132 x 2	1.5	
1024	1024 x 1	1.5	
DYNAMIC	100	100 x 2	3.0
	512	512 x 1	2.5
	1024	1024 x 1	2.5
	512	512 x 1	3.0
	1024	1024 x 1	3.0
	256	256 x 4	8.0
	512	512 x 2	8.0
1024	1024 x 1	8.0	
MEMORIES	BIT CAPACITY	ORGANIZATION	ACCESS TIME (ns)
RAM STATIC	256	256 x 1	1000
	256	256 x 1	1000
	1K	1024 x 1	1000
	1K	1024 x 1	500
RAM DYNAMIC	1K	1024 x 1	310
	1K	1024 x 1	180
	2K	2048 x 1	330
ROM	1K	256 x 4	750
	1K	128 x 8, 256 x 4	750
	2K	256 x 8, 512 x 4	750
	1K	256 x 4	950
	1K	128 x 8, 256 x 4	950
	2K	256 x 8, 512 x 4	950
	4K	512 x 8	700
8K	2048 x 4	700	
CHARACTER GENERATOR	CHARACTER SIZE	ORGANIZATION	ACCESS TIME (ns)
CHARACTER GENERATOR	7 x 5	64 x 7 x 6	600
	5 x 7	64 x 6 x 8	600
	9 x 9	64 x 9 x 9	700
SPECIAL CIRCUITS	FUNCTION	ORGANIZATION	SPEED (MHz)
RECEIVER-TRANSMITTER	UAR/T	8 BIT	0.32
FIRST-IN, FIRST-OUT BUFFER	FIFO	32 x 8	1.0

### PACKAGE DESCRIPTIONS

A Package: 14-Pin Silicone DIP  
 B Package: 16-Pin Silicone DIP  
 I Package: Ceramic DIP  
 K Package: 10-Pin TO-100  
 N Package: Silicone DIP  
 T Package: 8-Pin TO-99  
 TA Package: 8-Pin TO-99  
 V Package: 8-Pin Silicone DIP  
 XA Package: 18-Pin Silicone DIP  
 XC Package: 22-Pin Silicone DIP  
 Y Package: 24-Pin Ceramic DIP

© 1973, PERRYGRAF Div. Noshua Corp., L.A., Cal. 90064 Printed in U.S.A.

# FREE

Pick up a FREE MOS SELECTOR SLIDECHART and dial yourself the broadest MOS line in the industry. On one side, you choose a function (say, an 8k ROM), set the pointer, and read off all the major specs. The reverse side, a cross-reference guide, instantly converts any of 114 "Brand X" devices to the Signetics part number. Makes ordering our MOS as easy as getting and using them.

From Signetics you get everything you want, with no blue sky. Super. So's the slidechart. Send. Get. Quick.

CLIP COUPON TO YOUR LETTERHEAD. SAVE TIME & TROUBLE.

Signetics/MOS Selector  
 811 E. Arques Ave., Sunnyvale, Calif. 94086

I deserve to have a FREE MOS SELECTOR SLIDECHART, and I shall use it well and sincerely.

Name	Title
Company	Mail Stop
Address	
City	State
Zip	Phone

Signetics Corporation. A subsidiary of Corning Glass Works.

# Signetics

**SCHOTTKY TTL:  
A MILLION UNITS  
DELIVERABLE  
NOW.**



**Available in quantity today: A broad line of Schottky TTL parts, including functions never before available in Schottky.**

**Our Schottky TTL Family:** 39 SSI and MSI devices available now, 8 more on the way. These super, high speed devices can be used to upgrade existing TTL systems or to design the next generation TTL system. Completely compatible with standard 9300 and 7400 TTL series, and 3 times as fast (3 ns typical gate propagation delays, 125 MHz typical input clock frequency for J-K flip-flops, 90 MHz typical input clock frequency for counters and registers).

**TTL Today:** Our total TTL family is the most complete mix available anywhere. Schottky for super speed, Standard 9300 and 7400 at super prices, low power 93L MSI for reduced power consumption.

**For the Design Engineer** Schottky means an increase in overall system speed by a factor of 2 or 3, with a minimum of redesign and increased power. By using Schottky TTL devices, for example, critical path delay problems can be reduced or eliminated, processing time can be reduced, computer and peripheral control systems can communicate faster. Our Schottky TTL family is not only broad and diversified, but includes some unique complex MSI functions, such as:

- *93S05 Variable Modulo Counter.* This low cost 4-bit counter can be programmed, without external components, for division by 2, 5, 6, 7, 8, 10, 14, or 16. Typical count rate is 100 MHz.
- *93S10/93S16 Synchronous Counters* bring the most popular counter function up to Schottky speeds of 90 MHz and clock-to-output delays of less than 9 ns.
- *93S43 Super high speed 4-bit by 2-bit multiplier* performs #2s complement multiplication without correction at very high speeds. (For example two 12-bit numbers can be multiplied in 125 ns.)
- *93S62 9-bit Parity Generator/Checker.* Will generate a parity bit for an 8-bit word in 20 ns. Two 93S62 devices will generate a parity bit on a 16-bit word in 29 ns.

Also outstanding is our *93S46 6-Bit Identity Comparator.* Compares two 6-bit words in less than 10 ns with one device; or compares two 12-bit words in less than 15ns with just two devices.

**Contact** your friendly Fairchild distributor or your neighborhood Fairchild Regional Sales Office.

**SUPER AVAILABLE SCHOTTKY DEVICES**

<u>TTL/SSI</u>		Prices 100-999
<b>NAND Gates/Hex Inverter</b>		
9S00 (54/74S00)	Quad 2-Input NAND	.86
9S03 (54/74S03)	Quad 2-Input NAND (O/C)	.86
9S04 (54/74S04)	Hex Inverter	1.05
9S04A	High Speed Hex Inverter	1.05
9S05 (54/74S05)	Hex Inverter (O/C)	1.05
9S05A	High Speed Hex Inverter (O/C)	1.05
9S10 (54/74S10)	Triple 3-Input NAND	.86
9S20 (54/74S20)	Dual 4-Input NAND	.86
9S22 (54/74S22)	Dual 4-Input NAND (O/C)	.86
9S133 (54/74S133)	13-Input NAND	.86
9S134 (54/74S134)	12-Input NAND (3-State Output)	.86
<b>AND Gates</b>		
9S11 (54/74S11)	Triple 3-Input AND	.86
9S15 (54/74S15)	Triple 3-Input AND (O/C)	.86
9S41	Quad 2-2-3-3 Input AND	.86
<b>NAND Buffer/Driver</b>		
9S40 (54/74S40)	Dual 4-Input Buffer	.86
9S140 (54/74S140)	Dual 4-Input Line Driver	1.12
<b>AND-OR-Invert Gate</b>		
9S64 (54/74S64)	4-2-3-2 Input A-O-I	.86
9S65 (54/74S65)	4-2-3-2 Input A-O-I (O/C)	.86
<b>AND-OR Gate</b>		
9S42	Dual 4-2 Input	.86
<b>Dual D-Type Flip-Flop</b>		
9S74 (54/74S74)	Positive Edge Triggered	1.73
<b>Dual JK Type Flip-Flop</b>		
9S109	Positive Edge Triggered JK	1.95
9S112 (54/74S112)	Negative Edge Triggered	1.95
9S113 (54/74S113)	Negative Edge Triggered	1.95
9S114 (54/74S114)	Negative Edge Triggered	1.95
<b>TTL/MSI</b>		
<b>Arithmetic Operators, Comparators, Multipliers</b>		
93S41 (54/74S181)	4-Bit Arithmetic Logic Unit	14.00
93S42 (54/74S182)	Carry Look Ahead For ALU	3.25
93S43 (25S05)	2s Complement Multiplier	12.00
93S46	High Speed 6-Bit Comparator	4.75
93S47 (71S60/81S60)	High Speed 6-Bit Comparator (O/C)	Sept.
93S62 (82S62)	9-Bit Parity Generator/Checker	7.60
<b>Counters, Registers, and Latches</b>		
93S00 (54/74S195)	4-Bit Parallel Access Shift Register	Oct.
93S05	High Speed Variable Modulo Counter	10.50
93S10	Edge Triggered, Fully Synchronous Decade Counter	7.25
93S16	Edge Triggered, Fully Synchronous 4-Bit Binary Counter	7.25
93S174 (54/74S174)	Hex D-Type Flip-Flop	Sept.
93S175 (54/74S175)	Quad D-Type Flip-Flop	7.40
93S194 (54/74S194)	4-Bit Bidirectional Shift Register	7.15
<b>Decoders/Demultiplexers</b>		
93S137	1-of-8 Decoder With Input Latches	Oct.
93S138 (54/74S138)	1-of-8 Decoder/Demultiplexer	Oct.
93S139 (54/74S139)	Dual 1-of-4 Decoder/Demultiplexer	Oct.
<b>Multiplexers</b>		
93S12	8-Input Multiplexer	6.50
93S153 (54/74S153)	Dual 4-Input Multiplexer	4.75
93S157 (54/74S157)	Quad 2-Input Multiplexer	4.75
93S158 (54/74S158)	Quad 2-Input Multiplexer	4.75
93S253 (54/74S253)	Dual 4-Input Multiplexer With 3-State Outputs	Nov.
93S257 (54/74S257)	Quad 2-Input Multiplexer With 3-State Outputs	Nov.
93S258 (54/74S258)	Quad 2-Input Multiplexer With 3-State Outputs	Sept.



# The T317 Incoming-Inspection Department

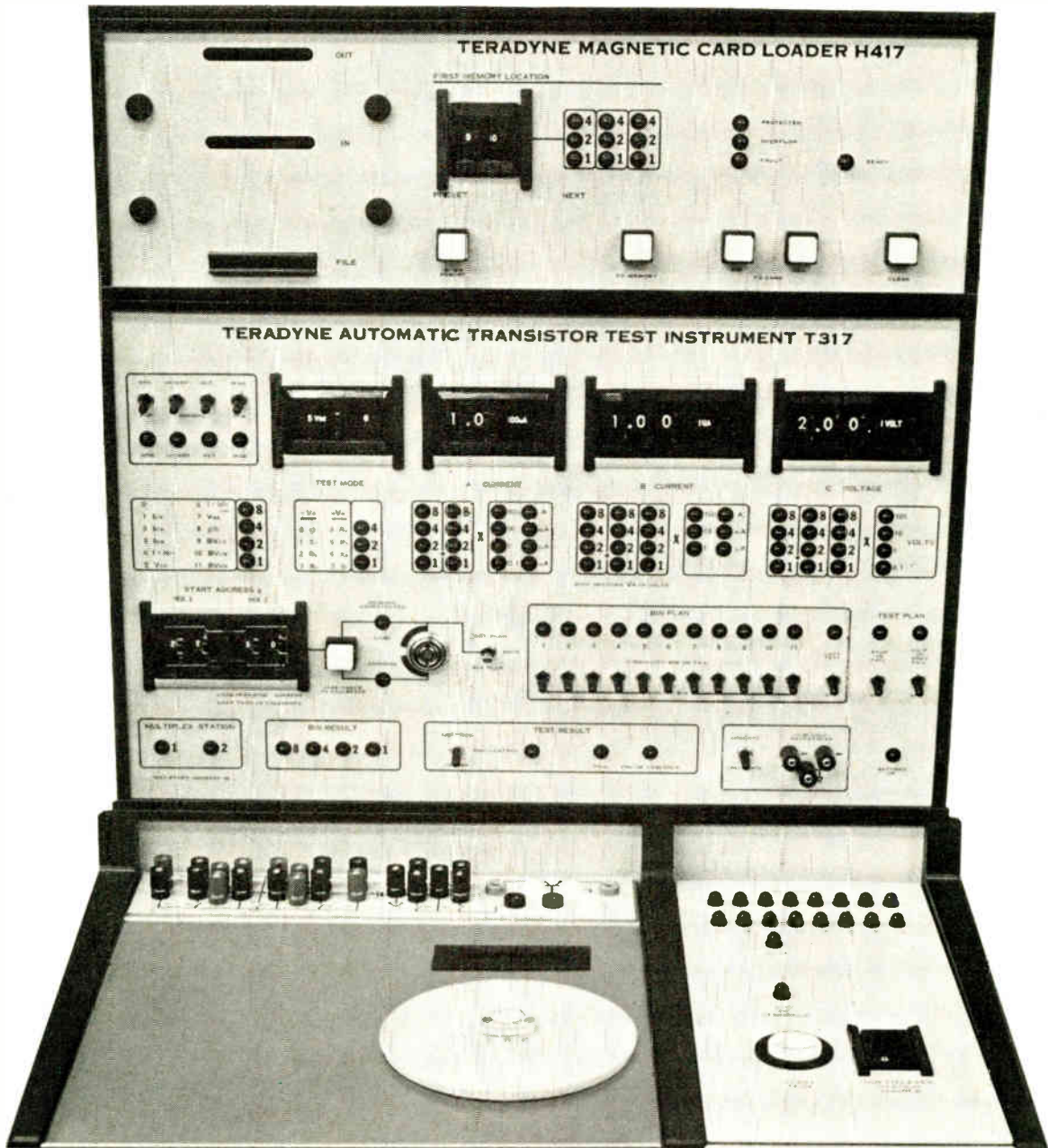

Our new T317 tests transistors, diodes, SCRs, FETs, zeners, triacs, and arrays.

It can multiplex up to three different jobs simultaneously, and it interfaces to handlers and probers.

It stores programs by built-in semiconductor memory or by a magnetic card programmer.

It is powerful enough for production-line testing, but is priced low enough for incoming inspection.

Learn more. Get a fact-filled brochure by writing: Teradyne, 183 Essex St., Boston, Mass. 02111. In Europe, Teradyne Europe S.A., 11 bis, rue Roquépine, 75 Paris 8<sup>e</sup>, France.

## TERADYNE

CHICAGO (312) 298-8610 / DALLAS (214) 231-5384 / NEW ENGLAND (617) 458-1256 / NEW YORK (201) 871-4052 / SUNNYVALE (408) 732-8770  
LONDON (093-28) 61111 / PARIS 265 72 62 / ROME 59 47 62 / MUNICH (0811) 33 50 61 / TOKYO (03) 406-4021



# Probing the news

Analysis of technology and business developments

## European space pact

Eleven nations to collaborate on three projects: launcher, U.S. post-Apollo work, and marine-navigation system

by Richard Shepherd, McGraw-Hill World News

Europe is heading back into the space business with a \$1 billion collection of new projects that could keep contractors, including electronics firms, happy for at least another 10 years. That was the message from a meeting in Brussels late last month when science ministers from 11 European countries abruptly shelved their differences and agreed on a new space program.

Three projects got the green light:

- The ministers agreed to go right ahead and build a new satellite-launch vehicle, the L3S.
- The Europeans will join the U. S. post-Apollo program by building the Spacelab sortie module.
- A new marine-navigation-satellite system will be launched.

The ministers rounded off their day's work by deciding to put the whole program in the hands of a new organization, the European Space Agency, which is expected to set up shop by April 1 of next year.

**ESRO staff.** In fact, most of the work will be handled by the existing staff of the European Space Research Organization, which has been accumulating an increasingly strong reputation for its tight management of a series of scientific-satellite projects. ESRO, which will become the nucleus of the ESA, is already busy with plans to hire space experts from the defunct European Launcher Development Organization, killed off only a few months ago after a long series of launcher failures.

The relaunching of European space hopes was an all-or-nothing affair—agreement could be reached only by including everybody's favorite project. The French won support from the Germans for the

launcher project in exchange for agreeing to back German enthusiasm for the Spacelab. The British gave token support for the launcher and Spacelab in return for acceptance of a marine-navigation-satellite system. "It is an extremely delicate agreement," points out a French space official. "It only needs one country to drop its share, and everything will collapse."

**Launcher is key.** The key element of the new European space program is the projected L3S launcher. Without it, the French will agree to nothing at all, and without it, the Europeans will have to rely exclusively on American launching facilities. It is also by far the most expensive project on the list—with a price tag of more than \$550 million. But the French point out that European telecommunications programs, international or global navigation systems, and other applications will create a market for 30 to 50 geostationary satellites between 1980 and 1990. The French contend that these markets, as well as export business, will justify the cost of L3S.

The L3S will be a 150-foot three-stage rocket, weighing 200 tons—something like the old U. S. Titan 2 or Atlas-Centaur launchers. It will put payloads of up to 750 kilograms into orbit at a maximum altitude of 36,000 kilometers. And with so many misfires and nonstarters staining European launcher history, the French are playing safe this time. L3S will be less sophisticated than the Europa 3 rocket—an ELDO equivalent that never got further than the design stage. When it takes off for the first time in 1979, L3S will be about 15 years behind U. S. technology, but it will be Europe's

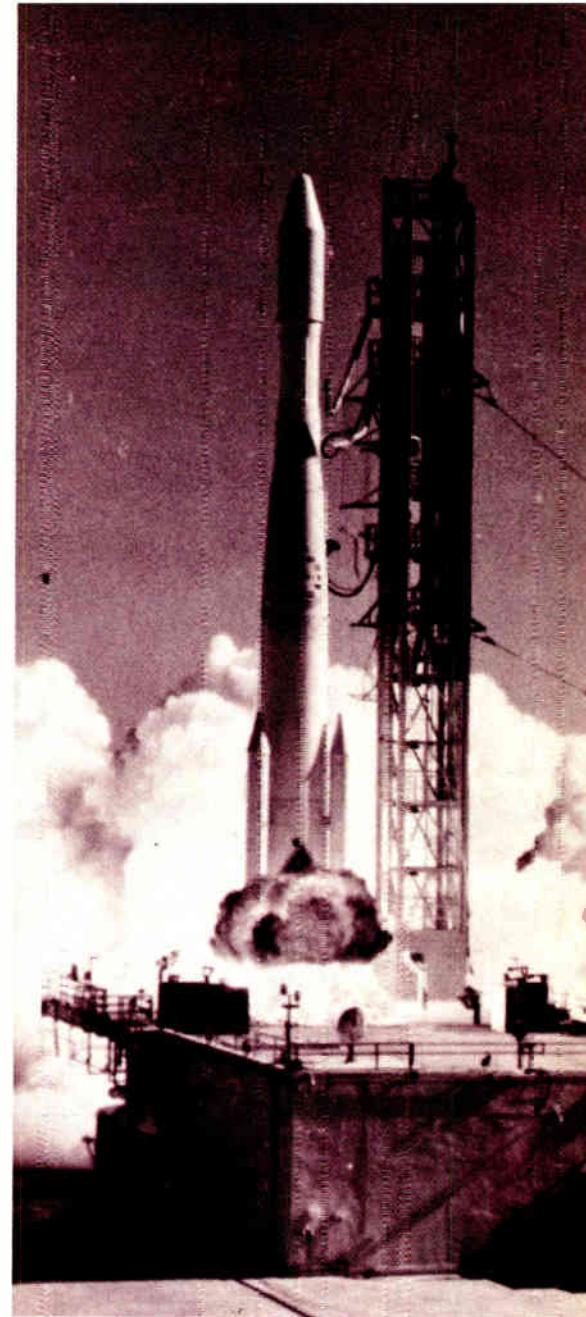

**Foreshadowing.** This is the launch of HEOS-1 (for highly eccentric orbiting satellite) during December 1968.

best. Four 60-ton-thrust Viking rockets will power the first stage, a single Viking will fire the second, and the third stage of the launcher will burn a combination of liquid hydrogen and oxygen.

France wanted the L3S so badly that it agreed to put up 60% of the cost, and its European partners managed to squeeze out an additional 2.5% before bargaining ended. In return, the French are making sure that they keep a tight grip on the construction program. The French Centre National d'Etudes Spatiales will run the launcher project itself, thus taking most of the project's control away

## Probing the news

from ESA, which will manage the rest of the space program.

At the industrial level, CNES will nominate Société Nationale Industrielle Aérospatiale as prime contractor. Main subcontractors will be the Société Européenne de Propulsion, which is expected to get an order for about \$170 million to build the motors for all three stages; missile and military hardware specialist Matra, and liquid-oxygen supplier l'Air Liquide. One of the biggest foreign subcontractors will be German engineering group MAN, which will get orders for work on the motors. In addition, CNES officials say every country sharing L3S costs is guaranteed orders of at least 80% of the value of its contribution.

**May be losses.** To keep a curb on the problem of cost escalation, the ministers undertook to keep the price of the L3S launcher within strict limits—even if contractors have to incur losses.

The Spacelab will be Europe's contribution to the post-Apollo space-shuttle program planned by NASA. The vehicle will be a 15-ton sortie module flying piggyback on a recoverable Space Tug. The plan is for the lab to become spaceborne in 1979 on the Space Tug's third trip, when the first European scientist is expected to get a flight. What's more, the Europeans hope to get NASA to sign an agreement tying the American space program to using Spacelab or its successor as the sole manned craft during the period 1980 to 1985.

Behind the political bustle over Spacelab and the launcher program, ESRO is in the middle of a major switch from an essentially scientific and strictly European setup to much heavier emphasis on applications satellites and to closer cooperation with the U.S. Even before the three new projects landed on its plate after the Brussels meeting, ESRO had a busy schedule ahead.

During this summer, ESRO is hoping to select a U.S. company—probably Comsat or RCA—as its partner in the Aerosat air-navigation satellite project. Now, the project is snagged over the American airlines' continued refusal to consider a uhf

SHARING THE COSTS			
TOTAL COST	L3S \$550 MILLION	SPACE LAB \$380 MILLION	MAROTS \$60 MILLION
WEST GERMANY	19.35%	52.55%	20.0%
BELGIUM	5.0	4.20	1.0
DENMARK	0.5	—	—
SPAIN	2.0	2.8	—
FRANCE	62.5	10.0	15.0
UNITED KINGDOM	2.5	6.3	56.0
SWITZERLAND	1.15	1.05	—
NETHERLANDS	1.0	2.0	—
ITALY-SWEDEN NORWAY	6.0	21.10	8.0

system, even though ESRO insists that it would cost the airlines nothing, at least at first. If the snag can be ironed out through a compromise solution now under discussion, ESRO hopes to put the first of two 350-kilogram geostationary satellites into parking orbit over the Atlantic in 1977.

**Fall award.** In October, ESRO plans to award a contract for the development of the Meteosat spacecraft. This will represent ESRO's share in the Global Atmospheric Research Program, in partnership with American, Japanese, and Russian satellites. Launch date is set for the end of 1976 for a single geostationary spacecraft, which eventually would become part of the global observation network known as World Weather Watch.

The marine-navigation-satellite system (Marots) ties in with the ESRO European communications-satellite project. The combined system is designed to provide satellite links for a significant portion of intra-European telephone, telegraph, and teletypewriter traffic in the 1980s and also as a link system for the European Broadcasting Union's Eurovision relay. For a start, contracts will go out toward the end of this year for the construction of an Orbital Test Satellite, which will be used to evaluate communications techniques and spacecraft requirements. To satisfy the British, the European science ministers agreed in

Brussels that the OTS project could be converted to a marine-navigation system, which could be either an addition or a replacement for the original ESRO program.

At the same time, ESRO is pushing ahead with new scientific projects. Four scientific satellites are on the pads right now as follow-ups to the seven successful launchings up to the end of last year. ESRO has been hurrying to build its capability in applications satellites. It has more than doubled its staff working on applications projects over the past year or so and has reduced by about a third the numbers working on scientific craft.

There has been a big change in spending patterns, too. Expenditures on scientific programs last year were almost double the applications budget of about \$27.6 million. This year, that share has more than doubled to around \$60 million, out of a total budget of \$120 million.

Next year's budget was expected to rise to about \$160 million, but the newly formulated programs have changed all that. Now ESRO—or ESA—spending will leap to more than \$200 million next year. When the ESA program reaches its peak in about 1976-77, annual expenditure will soar to between \$300 million and \$360 million at today's prices. At that rate, the ESA is likely to become about the most expensive European organization outside of the Common Market. □



# You supply the transducers and the computer...



## System 620 takes care of the rest

### A WORD FROM OUR AMPLIFIER-PER-CHANNEL

There's one of us for each channel. We isolate transducer signals right at the source. This means lower noise, less crosstalk, higher CMR, high input impedance, and continuous analog outputs for each channel. If one of us gets zapped by a tidal wave input, the rest don't feel a thing. You can set our gain from 0.1 to 1,000 in the field with our plug-in gain modules.

### OUR HIGH LEVEL MUX CHIMES IN

I'm FET & fast. I'm addressed sequentially or at random. Then I zip data to our programmable gain amplifier. It's your turn, amp.

### OUR ADC SPEAKS HIS MIND

I'm responsible for the 50KHz throughput with 12 bit digital output while my slower brother can output 14 bits at 20KHz. And my sample & hold amplifier insures accuracy with dynamic signals.

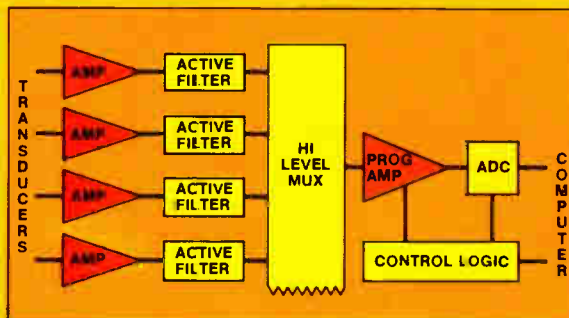

### OUR CONTROL LOGIC DEMANDS EQUAL TIME

Using DTL/TTL logic, I'm the one that makes it so easy to interface your computer with System 620.

### OUR ACTIVE FILTER SPEAKS UP

Anyone in the know will tell you that the place to filter is *after* amplifying the signal. No wonder I'm so active. I limit the signal bandwidth, which reduces noise and eliminates signal components which produce aliasing errors. It's easy to set my bandwidth from 1Hz to 1KHz in the field with my little plug-in module. System 620 puts the cart (that's me) after the horse, where it belongs.

### LET'S HEAR FROM OUR PROGRAMMABLE AMP

I'm fast too. And my gain is also under computer control. I can increase the input sensitivity of System 620 by 1, 2, 4, 10, 20 or 40. This allows our input amplifiers to accommodate maximum signal levels, while your computer programs me for best signal to noise ratio.

### IN UNISON !!!

Imagine, 64 amps & filters, a MUX, a programmable amp, an ADC & control logic in a 7-inch rack cabinet for less than \$150/channel. And expandable to 256 or 2048 channels. No wonder we're multiplying like rabbits in installations everywhere.

**NEFF**  
INSTRUMENT CORPORATION

1088 E. Hamilton Rd., Duarte, Calif. 91010  
Tel. (213) 357-2281 TWX 910-585-1833

Circle 71 on reader service card

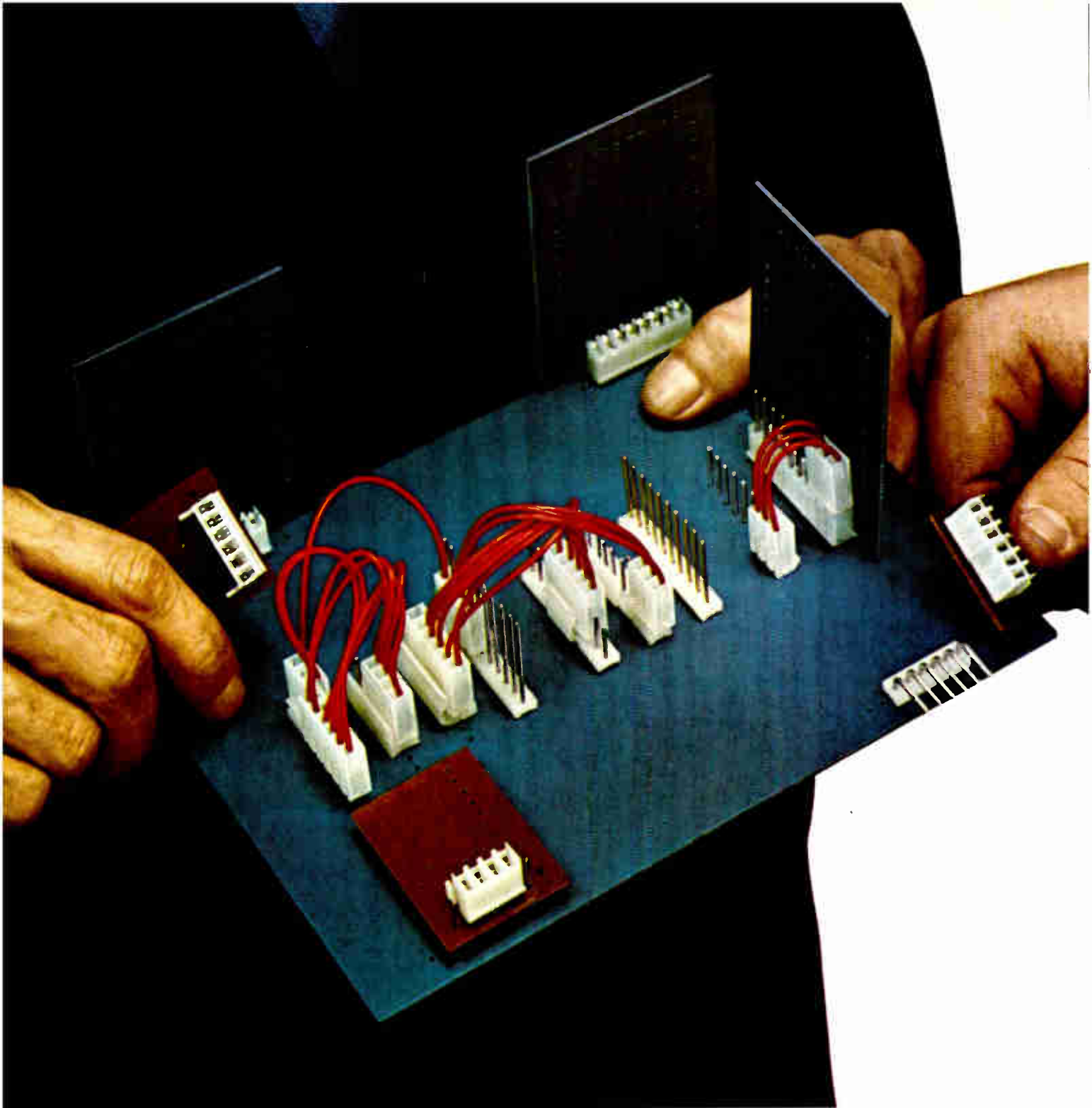

**KONEKTCON® MAKES THIS EASY!** It's the Molex system that solves the most complex board-to-board, board-to-component, chassis-to-board interconnection problems. It's economical. Reliable. Quick. Versatile. Uses only four basic connectors. Unique rigid square wire male terminals permit stacking of multiple board connections to the same circuits. Molex vibration assembly method stakes up to 300 terminals per minute for wave soldering. Preassembled round male

terminal wafers also available for 2 to 18 circuits. Three female terminal assemblies provide incomparable flexibility: cable-to-board; board-to-board, parallel; board-to-board, perpendicular; and board-to-chassis. Plus a variety of options, including a 3-circuit power transistor. For technical specs call (312) 969-4550. Or write: Molex Incorporated, Lisle, Illinois 60532.

*...creating components that simplify circuitry*

Circle 72 on reader service card

World Radio History





Commercial electronics

# Optical page reader prices tumble

As costs dip well below \$100,000, new applications beckon—  
even many keypunch operations are targets for recognition systems

by Alfred Rosenblatt, New York bureau manager

As prices come down, the optical page reader is on the verge of making important new inroads into communications and data-processing while continuing healthy growth in newspaper and other publishing applications. Conceptually, there's probably no easier way to convert a page of typewritten information into digital format for computer storage or processing than for a machine to do it automatically. In practice, however, optical character-recognition (OCR) systems have been prohibitively expensive. Until the last year or two, most systems sold have been sophisticated, extremely fast, and priced at upwards of \$200,000.

But OCR is being overtaken by progress in electronic components. The use of such devices as monolithic self-scanned photodiode arrays for scanning pages of information, fast minicomputers to control the recognition and formatting processes, and higher levels of integrated circuitry that produce cheaper equipment, to say nothing of clever design innovations, are

forcing OCR prices down sharply.

"Page readers for use in remote or branch-office locations as batch data-entry terminals should be available in two or three years for under \$10,000," predicts Charles Latta, manager for OCR sales to original-equipment manufacturers at Control Data Corp., Minneapolis. "And a complete system with a computer and magnetic-tape store should sell for about \$20,000."

Such prices may seem on the low side to others, but they're indeed in the ballpark. Marvin Weiss, vice president for R&D at Compuscan Inc., Teterboro, N.J., puts the reader price up between \$10,000 and \$15,000—boosted there, he explains, by the need for some modicum of intelligence to allow for such things as on-line correction of reading errors. As prices drop, applications are expected to blossom, and OCR is already a threat to many keypunch operations, says Frank Kirby, marketing manager at Optical Scanning Corp., Newtown, Pa.

OCR is also being included in gen-

eral-purpose multimedia data-entry systems such as those produced by Scan-Data Corp., Norristown, Pa., and Cummins-Allison Corp., Glenview, Ill.

**Opportunities beckon.** An increasingly important application of OCR is expected to be in communications systems, where the conventional teletypewriter can be replaced by a page-reader that scans the original typed information. Large potential customers are newspapers and printing plants, where typed pages of news stories, text for classified advertisements or pages for books are converted into digital data that can be fed either into communications links or into automatic phototypesetters [*Electronics*, July 5, p. 65].

One company, Datatype Corp., Miami, Fla., has even developed a special typing ball for newspaper and similar applications, which

**Easy readers.** Optical page readers from Optical Scanning Corp. (below) and Decision Inc. (right) typify the new, lower-priced OCR systems reaching the market.



## Probing the news

types bar-code symbols under each character; hence, the page reader can be cheap—about \$15,500—because it reads bar codes and doesn't have to recognize characters. Also for the newspaper field, Hendrix Electronics, Manchester, N.H., recently announced a machine to read OCR-A font. It reads 150 characters per second and costs \$14,500.

Until now, most sales—by companies such as IBM Corp., Armonk, N.Y., Recognition Equipment Corp., Dallas, and CDC to various OEMs—have been generated by high-throughput systems priced at \$250,000 and up to large, centralized operations such as credit-card houses, banks, and insurance companies. Also included are the experimental high-speed letter-sorting systems installed by the U.S. Postal Service [*Electronics*, Nov. 6, 1972, p. 67]. These operations need speeds of thousands of documents per hour to process customers' bills and pay-

ments. Sales are now \$150 million per year in the U.S., plus \$100 million overseas, and they are growing at a 10% to 15% rate, estimates a CDC source.

But even the big manufacturers are developing lower-priced units. IBM, for instance, will soon be shipping its model 3886, which will be priced at about \$120,000 for a stand-alone system, with a reduction of \$10,000 to \$15,000 for one that operates into a System/370 computer. REI and CDC are also developing lower-priced systems, although they decline to reveal any details.

Adding impetus to the use of OCR in communications is the U.S. Army's Communications Systems Agency, Fort Monmouth, N.J. Currently, the agency is evaluating proposals for an Automatic Message Entry and Address system—a replacement for a teletypewriter—to be used in the Army's Autodin network. These units would convert telegrams typed on standard message forms into standard ASCII dig-

ital code, thereby eliminating the retyping and paper tape now necessary. The goal is for an \$18,000 reader to handle standard OCR-A font; a \$20,700 reader for both OCR-A and -B, and a \$28,232 multi-font reader. "Validation" models will be procured from at least three companies, says an Army spokesman, before the Army orders production lots running to at least 500 systems.

Actually, such a data-entry application is not new, even though the price goals certainly are. The U.S. State Department has been using model 170 systems from Compuscan for about a year to transmit telegrams from offices in Washington, London, Paris, and Bonn, says Compuscan's Weiss. Model 170s are pegged at about \$60,000. And the U.S. Navy is completing installation, begun more than a year ago, of 14 System 70 page readers from Cognitronics Corp., New York. Eventually, Weiss predicts, such OCR terminals will have both send and receive capabilities, instead of

HP COUNTERS PROMISE A LOT — AND DELIVER IT ALL.

# The counter system that

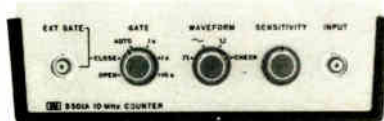

**5301A — 10 MHz Module:** 10 Hz to 10 MHz range. Direct counting and totalizing to over 10 MHz. Automatic or manual gating. Input waveform selector. External gate control. \$145.

The heart of HP's versatile frequency/time/volts/ohms measurement system is the sophisticated six-digit HP 5300A mainframe (\$395) which contains basic counting circuitry. Snap this mainframe onto the bottom module you need and it instantly becomes one of six feature-loaded instruments — each with traditional HP quality and ruggedness... each operating

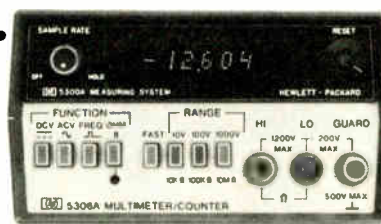

**NEW 5306A — Digital Multimeter/Counter Module:** Six-digit frequency readings to 10 MHz. Five full digits of AC/DC volts, ohms. Floating, guarded input. Automatic zero adjust. Up to 10 readings/sec. Overload protection. \$450.

from power line or optional battery pack.

Best of all, once you have the mainframe, it's the low cost way to build a complete workshop of first-line instruments.

It's the one system that truly does stay on top of your needs — and your budget.

Send for a free detailed brochure on HP's 5300 Series Counters.



**5303B — 525 MHz Counter Module:** DC to 525 MHz range, burst or CW frequency. 50 $\Omega$  or 1 M $\Omega$  input. Automatic gain control. Fuse protected front end. Optional high stability time base (FCC Type-Approved). \$800.



**Battery Pack Module:** Sandwiches in between any mainframe/module combination. Permits up to 5 hours of continuous operation. Battery level indicator. Recharge while in use. Carrying handles and shoulder strap. \$195.

02306

All prices domestic U.S.A. only.



relying on separate printers.

**Price goals feasible.** Are the Army's price goals difficult to meet? They shouldn't be, says Robert L. Price, a systems engineer at Optical Scanning Corp. The throughput the Army requires for its telegrams is relatively slow, it uses only one form, and it doesn't need the reformat-and-editing capability required by a business user, he points out. Optical Scanning recently introduced an OCR machine—the Opscan 37—which sells to the end user for about \$46,000 with a magnetic-tape and editing terminal that allows an operator to key in characters the machine finds difficult to read [*Electronics*, June 21, p. 42].

"The basic architecture of the system leads to its low cost," says Price. "Instead of implementing recognition functions in hardware, we save hardware cost by using software." The recognition algorithm may be slower in software than in hardware, but it's fast enough, he points out.

Also exemplifying the ingenious engineering being introduced into

OCR equipment is the OCR 7600, introduced by a newcomer to the field, Decision Inc., Oakland, Calif. The unit will sell in OEM quantities for only \$30,000. Such options as magnetic tapes, IBM 3886 interface, and editing terminal are extra. Speed of the unit is 600 characters per second, or about twice that of IBM's 3886, says Richard Dove, director of marketing. The basic system recognizes the OCR-A font, but a floppy disk that's part of the system can store programs for recognizing such other alphanumeric fonts as OCR-B, Courier, typewriting, computer printing, and handwritten numerics.

Decision uses a proprietary "topological-analysis technique, which is software-implemented and hardware-augmented." The company also aims to reduce costs by eliminating hardware, Dove says. Major recognition decisions are made at the software level by a modified Data General Corp. Nova minicomputer, which serves as the recognition processor and controller.

Thirty kilobytes of core are used for recognizing OCR-A characters, and up to 64,000 kilobytes are needed for more complex fonts. Price of such a versatile system may also be double.

Dove points out that technical innovations that can help to keep costs down, include:

- A simpler paper-handling system that can stack paper on the scanner upside down and read each page from the bottom. This eliminates complex mechanisms for restacking the pages in proper sequence.
- Standardization of most parts, including optics, motors, and ICs.
- Use of photodiode arrays, rather than flying-spot scanners, lasers, or photomultiplier tubes for document scanning. The light source is a simple light bulb.

The Decision scanner is a 128-diode array from Reticon Inc., Mountain View, Calif., which also supplies the arrays to CDC, Recognition Equipment, Compuscan, Dest Data Corp., Sunnyvale, Calif., and Inforex Corp., Burlington, Mass. □

# stays on top of your needs.

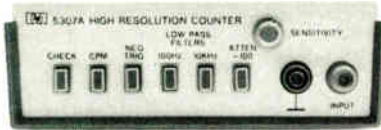

**NEW 5307A — High Resolution Module:** Range, 5 Hz to 2 MHz and 50 to  $1 \times 10^7$  counts/minute (CPM). Measures frequency and RPM much faster than conventional counters... 0.0001 Hz or 0.001 CPM resolution in less than 1 second. \$350.



**5304A — 10 MHz Timer/Counter Module:** DC to 10 MHz range. 100 nsec. time interval accuracy. Unique "Time Interval Holdoff" ignores input ringing or contact bounce. Two DC coupled amplifiers with attenuators, slope, polarity and gain control. \$325.

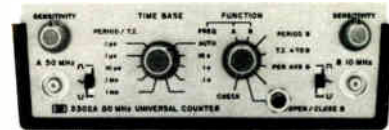

**5302A — Universal 50 MHz Counter Module:** 10 Hz to 50 MHz range. Automatic or manual gating. 100 nsec. time interval accuracy. Period, period average, ratio and totalize functions too. Input waveform selector. \$275.

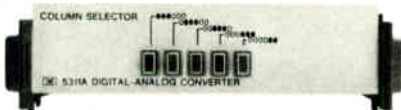

**Digital-to-Analog Converter Module:** Sandwiches in between modules—even with battery in place. Permits high resolution analog plots of digital measurements. Galvanometer and potentiometer recorder output. \$295.



Sales, service and support in 172 centers in 65 countries. Palo Alto, California 94304. Offices in principal cities throughout the U.S.

Companies

# Oak prunes, plants—and grows

Component maker weathered recession by reducing military and TV-tuner business, and broadening base away from electronics

By Larry Armstrong, Midwest bureau manager

It may look that way in retrospect, but Oak Industries Inc. didn't really forecast the recession of the late 1960s. However, the firm rode it out more or less unscathed because Oak planners had in 1967 come up with the solution to a more serious problem: how to ensure the continued growth of the old-line manufacturer of electronic/electrical components through the 1970s.

So while the recession that felled some mighty companies also hit what was then Oak Electro/netics Corp., virtually all Wall Streeters agree that Oak's drop in sales was probably caused by management's conscious, planned reduction of its military and low-margin television-tuner businesses. And along the way to building a broader base, the company changed its name to Oak Industries Inc.; entered the security,

materials, and gas-appliance-controls businesses through acquisition; and, most recently, started its own cable-TV division.

"Today, 83% of our business is in electronic components and gas- and electrical-appliance controls," says E. A. "Nick" Carter, chairman and chief executive officer of the Crystal Lake, Ill., firm, "so we're a long way from our objectives. We're still trying to change the image and makeup of the company, and it's going to be a long and well-planned program."

The Components group, includ-

ing Oak Switch, Marco-Oak, Lamps Inc., McCoy Electronics, and tuner manufacturer Selectronics, logged 50% of the nearly \$1 billion in the firm's total 1972 sales—down from 58% in 1970, and 100% in 1967. The Controls group last year accounted for an additional 34%. "I expect the dollar value to increase, but the percentage, in relation to the rest of our business, will change dramatically," Carter predicts.

"Dramatically" is a strong word, but Carter, often still reflecting the inherent conservatism of the components business, doesn't use it lightly.

**Hierarchy.** Top men at Oak are, clockwise from right, Carl J. Bradshaw, president of CATV division; Frank A. Astrologes, Oak's president; and E. A. "Nick" Carter, chairman and chief executive officer.

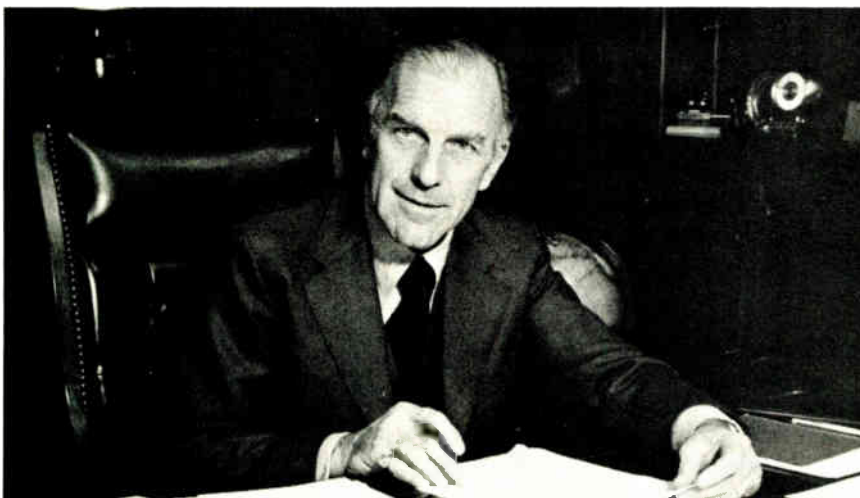



Oak's two rapid-growth areas, admittedly receiving the most emphasis from management, are CATV and materials. "We would anticipate that these two will equal at least 50% of our total volume—and maybe more—within five years," he says.

**Oak roots.** In the 1960s, Oak was rooted in TV tuners, switches, crystals, crystal filters, potentiometers, and illuminated products. "Reducing our dependence on the TV industry was the most significant for us," adds Frank A. Astrologes, president. "We knew that we had to get out of that terrible position, which was often feast or famine." So Oak has pruned its tuner operations from \$25 million to \$18 million—from 45% in 1967 to around 20% today. "What we've done is stopped trying to be all things to all people in the TV industry, and we've concentrated our efforts on the big four or five TV-set manufacturers," Astrologes explains.

Oak also had produced a sizable relay line for the military, but the company had managed to broaden the line to 50% commercial by the time the military put the squeeze on, he recalls. "At that time, all the relay manufacturers ran to the commercial field. It was ridiculous to stay in that market and expect to make a profit," he says. "We gradually withdrew, ending up with a single relay, the W-type industrial relay." Oak wrote off the military relays and sold the last of the commercial ones, except the W-type, in March.

The Materials group was the first acquisition in 1967. It is currently the most profitable and the one offering the greatest potential for reducing Oak's dependence on the electronics industries. "We had decided that the materials area had enough connection with our electronic/electrical knowhow that we should be there, particularly in Teflon and laminate materials," Astrologes says, "and so that was our initial breakout."

The group develops, among other things, circuit boards and laminates, flexible circuitry, and Teflon and Teflon products for insulation.

Oak entered the budding cable-television business in 1971 at the plea of Sterling Manhattan Cable

Television Corp., which asked Oak to develop a quality set-top converter for the CATV industry. With that product, the Gamut 26, and its solid-state successor, the V-26, Oak quickly captured what it estimates to be 75% to 80% of all converter installations in the U.S. From that small beginning stemmed what is now the Oak CATV division—the firm's most innovative group in terms of new products and the roots for Oak's long-term growth.

"We entered an industry that was even more lacking than most in credibility," says Carl J. Bradshaw, the 42-year-old division president, who holds law degrees from the Universities of Minnesota and Michigan, plus Keio University in Tokyo. "We want to carry over the honesty and credibility gained in the components group to the CATV industry."

**Cross-fertilization.** Bradshaw is also responsible for bringing a couple of other professional and competent firms to the infant industry. He explains: "We believe that the terminal-equipment field is one of the most interesting and growth-oriented. Still, there are others that are growth-oriented, and, frankly, the industry needed new blood. So I looked at the areas in which I thought additional competition was needed, and I went out of the field and joint-ventured with them." The results were the formation last summer of Heller-Oak Cable Finance Corp. and this May, of Myers-Oak Communications Construction Corp.

Heller-Oak was established with Walter E. Heller International Corp., with an initial financing capability of \$50 million. Unlike other finance companies, Bradshaw points out, it does not seek equity positions in cable companies, and it lends at normal commercial finance rates—"not extraordinary interest rates, no 15% to 20% under-the-table kicker. You don't even need to buy Oak equipment to get Heller-Oak financing," he adds. L. E. Myers Co., the largest contractor specializing in the construction of transmission lines and distribution systems for electric utilities, is well equipped for competition, through Myers-Oak, for the projected \$200 million in overhead and underground-trunk



**New Time Code Translator/Generator** — Precision unit provides *simultaneous* and *independent* generation and translation of any time code format.

All modular plug-in design and wire-wrap interconnection eliminates "mother boards" for easier maintenance and field modification. Seven-segment gas discharge displays present outstanding readability. Days, pulse rate and parallel outputs are standard.

MOXON/SRC CIRCLE 77



**New Computer Compatible, Programmable DC Power Source.**

Automatic systems use. Output 100V @ 0.5A or 50V @ 1A. 16-bit binary or 8-4-2-1 BCD. Hi speed — over 10 kHz. Noise and ripple 800 uv p-p max. Load transient recovery 30 μsec. Data circuit interface selection, programmable current limiting. Hi AC/DC isolation w/guard shield. Data line isolation.

MOXON, SRC DIV. CIRCLE 166



**\$84.00 Isolated Miniature Power Supplies.**

Compact Model 3564 exceeds specifications of high priced supplies. Low 0.1pF AC and 10,000 megohms DC isolation (due to fiber glass front panel, precise component placement and multi-shielded XFMR). Ripple 75uV p-p. Front panel 10-turn pot. adjusts output 0-25VDC, 0 to 200mA.

SRC/MOXON CIRCLE 167



**Moxon Inc/SRC Division**  
2222 Michelson Drive  
Irvine, California 92664  
Phone: (714) 833-2000

# Send us your photos.



## We'll send you ours.

### Video Image Processing from CVI

Colorado Video offers a complete high quality line of video image processing instruments. Capabilities of these precision instruments span the video field:

- synthetic color
- image subtraction
- contrast expansion
- computer input
- differentiation
- outlining
- computer-processed image display
- shading correction
- edge enhancement

To obtain your free CVI synthetic color photo and a video image processing brochure, simply mail us a black and white photo with your letterhead.

# cv*i*

Colorado Video, Incorporated  
P.O. Box 928  
Boulder, Colorado 80302  
(303) 444-3972

## Probing the news

and feeder-CATV systems to be built this year.

The same spirit of innovation that pervades the division's joint ventures also has animated its product development. Earlier this summer, Oak introduced the module concept to pay-TV by means of a 31-channel varactor converter, expandable to 32, 33, or 36 channels. The converter is designed to be retrofitted to Oak's pay-TV system, called ESP for expandable scrambled programming. That double unit, in turn, can be sent to the factory for the addition of authorization buttons when two-way cable-TV becomes a reality. "This is the first time that any system for home use has been designed to be sent back to the factory for updating, instead of obsolescence," Bradshaw claims.

The division also has announced a 31-channel remote converter, a low-cost 19-channel unit in both converter and pay-cablevision formats, and recently introduced a CATV-amplifier line made by Teleng Ltd., of South Ockendon, Essex, England, that will be sold, serviced, and warranted by Oak.

And in late 1971, Oak Security Inc. was formed around three acquisitions, and the corporation developed for the security industry services in consulting, guards, central stations, training, publications, and hardware evaluation.

In cooperation with a local cable company, Oak Security introduced the nation's first CATV security system. The experimental setup offered two-way cable subscribers nine levels of emergency, intrusion, and fire security—all monitored by a central station. "I think we've pretty much found out what we wanted," Bradshaw comments, "and we're not expanding it to a full-blown arrangement."

"We've run an experiment, so we can understand what the market's going to be when it comes," he continues. "We've developed and patented a transmitter that's excellent for upstream transmission for security and an economical head-end device to read it." Oak's done its homework and is waiting for the market to develop. □



# Pushbuttons that stretch your budget and your panel.

If your panel suffers from a lack of dollars or space, here's our solution: Series 3 medium-priced pushbuttons and indicators.

They offer versatility that until now was available only in much higher-priced devices. For instance, there's a choice of low-energy, electronic-duty reed switches or 5-amp, double-break power switches. Strip, matrix or individual mounting is available. As are six lighted display colors and momentary or two-level alternate action.

Buttons? Choose from four styles, including one that's similar in appearance to a keyboard button.

Added up, this makes the Series 3 perfect for jobs such as computer peripheral equipment, business machines, communications systems or most any control panel.

For more information, contact your MICRO SWITCH Branch Office or Authorized Distributor (Yellow Pages, "Switches, Electric"). They'll bend over backward to help you.

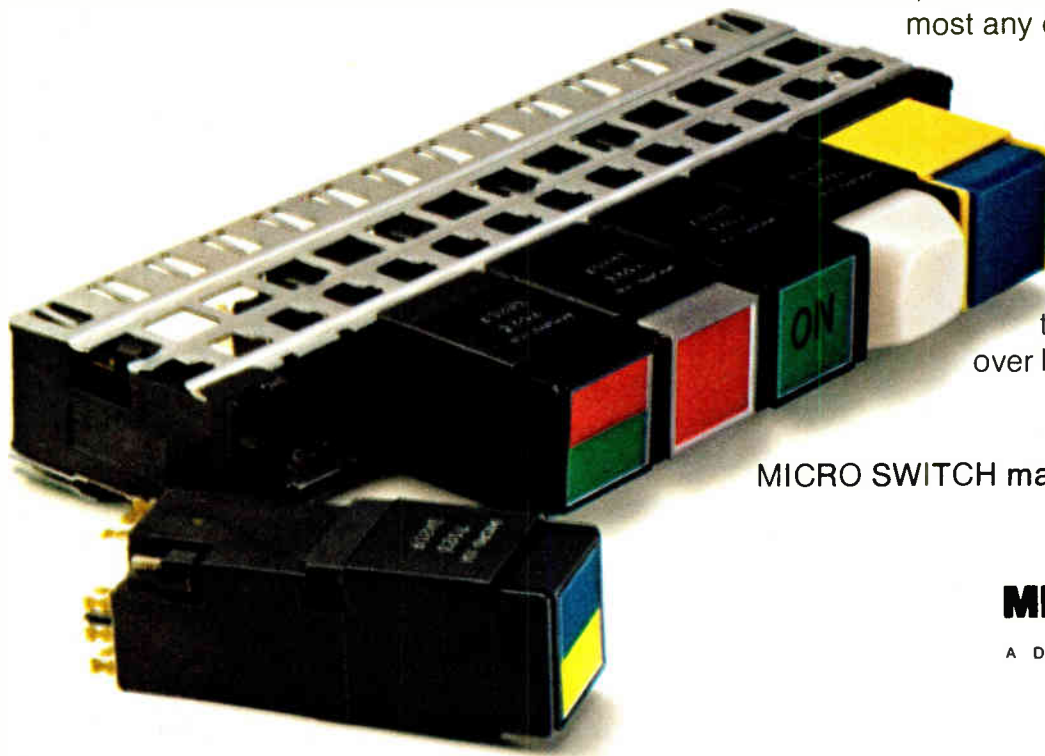

MICRO SWITCH makes your ideas work.

**MICRO SWITCH**  
FREEPORT ILLINOIS 61032  
A DIVISION OF HONEYWELL

MICRO SWITCH products are available worldwide through Honeywell International.

Companies

# Teradyne: from bad news to good

Tester company used red-ink days of the recession to make changes in management, production, and sales to embark on period of growth

by Gail Farrell, Boston bureau

A little more than two years ago, Teradyne Inc., which had been consistently profitable since its founding in 1960, found itself at low ebb. Semiconductor manufacturers had almost entirely stopped buying capital equipment during the recession, and by 1971, sales by this Boston automated-test-systems maker were down by one third to \$13.1 million—and its ledgers were awash in the red ink of a \$1.25 million loss. To make matters even worse, the relative importance of automated semiconductor testers, the mainstay of its sales, was declining.

Yet today, sales are growing faster than ever, bookings so far this year have more than doubled, and president Alexander V. d'Arbeloff predicts the tester market "won't saturate until well into the 1980s." With anticipated sales of over \$30 million this year, Teradyne claims it

will be number three in the testing business, behind Hewlett-Packard and Tektronix.

It would be easy to say Teradyne's turnaround was simply caused by the economy—but that's only part of the story. Equally important were the management, production, and sales decisions the company made and acted upon during the worst of the recession. For, as one corporate official puts it, "A bad year presents the best opportunity to make changes, and, as long as the company can pay its rent, to get its house in order and prepare for the next round."

One highly visible change that took place during the third quarter of 1971, when the company dropped \$375,000 on \$3 million sales, was the appointment of cofounder and vice president d'Arbeloff to the office of president. While not an un-

known quantity in that he had run the day-to-day operations in the past, he had been overshadowed somewhat by the flamboyant former president and present chairman of the board, Nicholas DeWolf.

At the same time, Teradyne decided to diversify its product line and reorganize its marketing and engineering functions into seven product groups. Until 1969, semiconductor manufacturers had accounted for almost 90% of sales, but when they stopped buying in June 1970, the whole company suffered. "In late 1970 and 1971, we realized the hole we were in," d'Arbeloff recalls, and the result was a series of new products in the areas of pc-board testing, backplane testing, laser trimming, connectors, and automotive-parts testing—each of which is profitable.

**Sales diversified.** Now, little more than half of Teradyne's business is with the semiconductor industry, although, in absolute terms, such sales have more than held even. Sales to semiconductor users, which were "really a cushion for us in the bad time from June 1970 on," says marketing manager Frederick Van Veen, have more than doubled, and new customers have surfaced. In fact, Teradyne's largest customer is now in Detroit—not Silicon Valley—buying testers for seat-belt interlock circuitry.

Even before the economic crunch, the company had been changing its sales methods, gradually switching to direct-sales offices from reps, and increasing its sales force. When the going got rough, d'Arbeloff decided to continue this expansion, opening offices across the country—New England and Europe already had

**Happy.** Teradyne president Alex d'Arbeloff, left, and board chairman Nicholas DeWolf. The president's management philosophy discourages formation of a tight hierarchy.

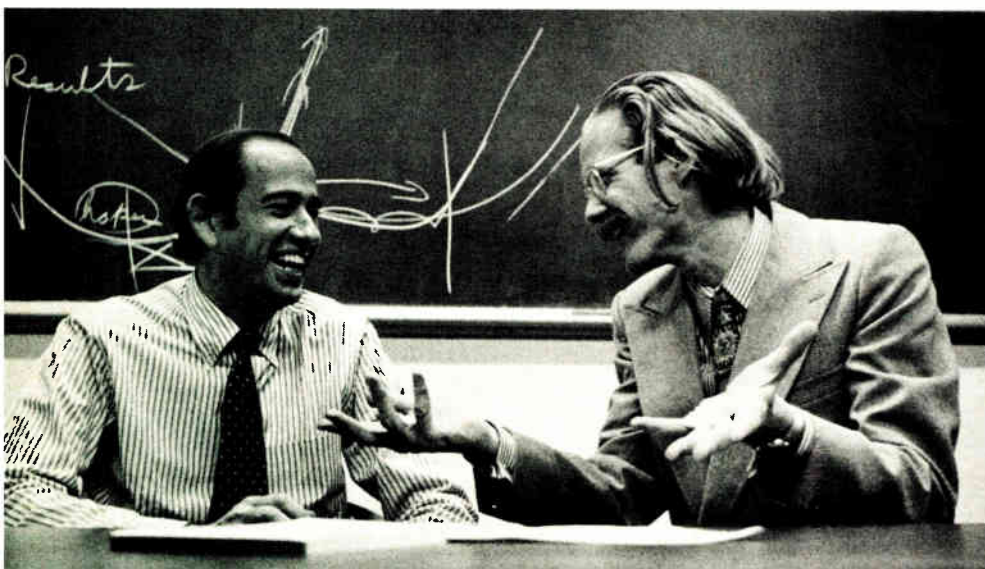



# PROBLEM:

cramming more power distribution cable into less space.

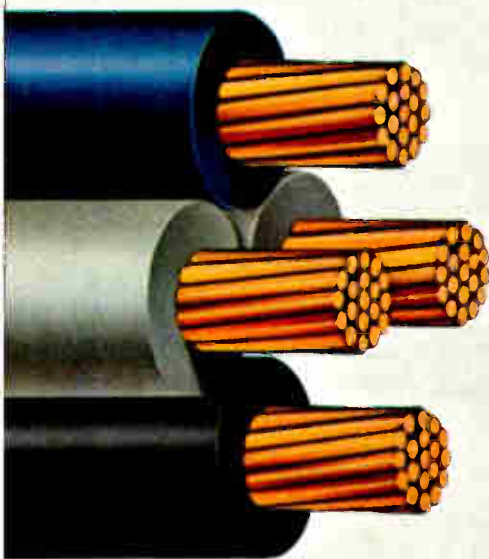

## SOLUTION: a cable that's flat instead of round.



Now you can pack more power distribution cable into less space than you ever thought possible. By using Brand-Rex's new *flat* PVCA cable. A vinyl-insulated aluminum strip you can stack, run in trays or ducts, bend at any angle for branching or to follow any contour.

UL-recognized for 105°C, 100 volt operation, PVCA has passed the UL vertical flame test. And its outer jacket is highly resistant to oil and grease.

Standard terminals, including center tap, are readily available for fast, economical, air-tight, water-tight connections and splices. Yet new PVCA costs *less* than the conventional cable it replaces.

For a fact folder that outlines in detail all the special problems this new concept in flat power distribution can solve, write to Brand-Rex Company, Willimantic, Conn. 06226. Or call: 203/423-7771.

# BRAND-REX

4,000 solutions in search of a problem.



# A flameless heat tool for every need: Master makes them all

Master offers you the world's most complete line of flameless heat tools. Each one is precision built for rugged dependability and versatile performance. And every Master heat tool features a complete line of attachments for every production need.

Heat Guns and Blowers are available in U.L. and L.A. approved models. CSA approved in Canada. In Canada, contact Martin Industrial Sales, P.O. Box 576, 4445 Harvest Road, Burlington, Ontario.

Send for your free 12-page catalog and price list on the world's most complete line of flameless heat tools.

**MASTER**  
appliance corporation  
Racine, Wisconsin 53403

## Probing the news

direct-sales offices. One-third of Teradyne's sales are overseas, and an office in Japan has been recently opened to handle an expected tripling of sales there this year.

Taken together, d'Arbeloff says, all these changes "created an upsurge. When an industry or company has problems, as we did in 1971, there is a tendency for morale to go down and for people to get discouraged, but we haven't lost a single good person."

**Loose rein.** Of his own role as president, d'Arbeloff says, "I don't think an individual should have that much impact; instead I try to create an environment where people can thrive. I think I have been stressing as little hierarchy—as little structure—as possible."

He has managed to avoid building up the sometimes heavy layer of middle management generally considered mandatory for a company whose sales are climbing the way Teradyne's are. D'Arbeloff admits this can cause a little confusion, but he says the best way to manage creative individuals is to give them clear goals, interesting projects, a share of the company's success, and freedom of action—something he says is "hard to come by in most organizations."

Managers of the seven product groups report directly to him, as do managers in the recently reorganized production department. Formerly, all production was pooled, but now the department is split into four parts, each with its own test group. Says a spokesman, "We've made sure the operating elements are of a size that don't require formal structure: I think this sets the stage for the next level of growth."

And Teradyne fully expects to continue on an upward trajectory. Just-released figures for the second quarter show sales of \$9.1 million and income of \$792,000—up considerably from comparable 1972 figures of \$4.7 million sales and \$175,000 income. An official notes that the markets for both automatic test equipment and connectors are growing rapidly, so Teradyne is "not limited by the market, but by our ability to respond to it." □



## Figure of merit

SN62088 - 66.67

740 - 1.5

108 - 0.1

118 - 0.07

770 - 0.04166

101 - 0.00333

741 - 0.0002

725 - 0.000133

$$\text{Figure of merit} = \frac{\text{SR}(\text{V}/\mu\text{s, typ})}{I_{\text{IN}}(\text{nA, max}) \times V_{\text{IO}}(\text{mV, max})}$$

(@ 25 C)

# OP AMPS

**SR = 25V/μs     $I_{\text{IN}} \leq 5 \text{ nA}$      $V_{\text{IO}} \leq .075 \text{ mV}$**

## Highest performance yet. TI's new SN62/72088

Texas Instruments now offers a unique chopper-stabilized op amp with superior performance – at both high and low frequencies.

The new SN62/72088.

Using a formula of slew rate divided by input current times input voltage, the 62088 attains a figure of merit 44 times higher than the next best device.

It may well set the standard for high performance op amps for some time to come.

The SN62/72088 will allow you to replace bulky modular devices or large, complex, discrete circuits with a single 14-

pin dual-in-line plastic package. Standard sockets, layouts and automatic insertion speed board design and assembly time.

The SN62/72088 is fabricated using a combination of technologies – including bipolar,

junction field effect and P-channel MOS transistors.

The circuit design includes an internally compensated high frequency wide-band amplifier and a null amplifier of bipolar design with JFET inputs; also three linear amplifiers, a clock generator with multiple counting and decoding stages and several analog switches fabricated with MOS devices.

For data sheets please specify by type number and write: Texas Instruments Incorporated, P. O. Box 5012, M/S 308, Dallas, Texas 75222.

### SN62088 Characteristics Typical Values

40 microvolt input offset voltage  
400 pico amp input current  
100 pico amp input offset current  
130 dB voltage gain  
3 MHz unity-gain band-width  
25 volt per microsecond slew rate  
80 dB common-mode rejection



**TEXAS INSTRUMENTS**  
INCORPORATED

84111

# Buying a function generator isn't a big deal.



## Using one every day is!

Because there's not much difference in function generator prices, there is often a tendency to specify the "name" brand. But **handle-ability** can be an essential factor. When a basic signal-source goes into your lab, consider first the **day-to-day efficiency** of the instrument and its **effect on the real cost of ownership**.

For example, with sweep width a critical factor in testing network frequency response or developing a response plot, INTERSTATE's F34 allows you to precisely dial the controlled starting and end points. This, coupled with a Sweep Limit Indicator that won't let you dial an invalid output, puts it miles ahead of Wavetek's 134 for accuracy and ease-of-use.

This, and many other human engineering and price/performance differences that exist between the two function generators reflect INTERSTATE's continuing concern for the user, and are factually catalogued in our **FREE** specifier guide. Check the number below to receive it, or for more direct information, call John Norburg, (714) 772-2811.



**IEC** INTERSTATE  
ELECTRONICS  
CORPORATION

Subsidiary of A-T-O Inc.



"THE \$495 COMPARISON:

INTERSTATE F34, WAVETEK 134 FUNCTION GENERATORS."

U.S. HEADQUARTERS: Dept. 7000, Box 3117, Anaheim, CA. 92803. OVERSEAS SALES OFFICES: AUSTRALIA, Parameters Pty., Ltd.; FINLAND, Havulinno Oy; FRANCE, Tekelac Airtronic, S.A.; ITALY, Tekelec Airtronic; ISRAEL, Radat International Company Ltd.; JAPAN, Asahi & Co., Ltd.; NETHERLANDS, Tekelec Airtronic, N.V.; NEW ZEALAND, David J. Reid, Ltd.; REPUBLIC OF CHINA, Bons International Co., Ltd.; SPAIN, Telco. S.L.; SWEDEN, M. Stenhardt AB.; SWITZERLAND, Traco Trading Co., Ltd.; UNITED KINGDOM, Euro Electronic Instruments, Ltd.; WEST GERMANY, Tekelec Airtronic GMBH. CANADA: Radionics Limited. TWX U.S.A. 910-591-1197. TELEX U.S.A. 655443 & 655419

Circle 84 on reader service card

World Radio History



## Chopper-stabilized IC op amps achieve precision, speed, economy

A two-chip design combines high-voltage JFET processing with an MOS chopper-stabilized circuit in a standard 14-pin dual in-line package to provide the performance needed for today's data-acquisition systems

by Mike Callahan, *Texas Instruments, Dallas*

□ Designers have long sought an operational amplifier that would deliver high precision and fast operation, yet would come in an easy-to-use integrated-circuit package. Now—for the first time—a chopper-stabilized circuit has been built into an IC op amp, fabricated on two chips, which achieves precision and speed, as well as the economy associated with ICs. The 088 (Fig. 1) is being offered in a standard 14-pin dual in-line package that can be mounted on printed-circuit boards along with other ICs.

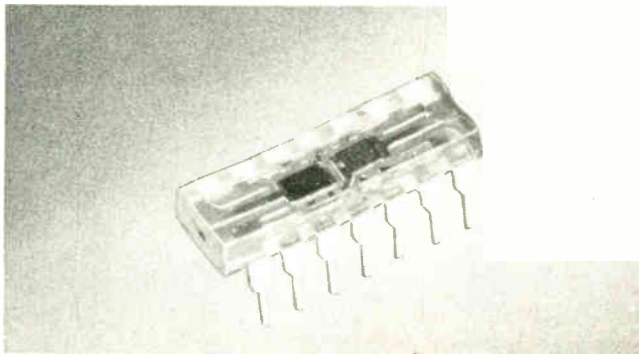

**1. New standard.** The first chopper-stabilized op amp offered in a 14-pin dual in-line package is a two-chip design with low input parameters, high gain, and high slew rate. High-voltage JFET process teams up with MOS chopper circuit for over-all optimization.

The standard IC format is much less expensive to use than the bulky, high-priced modules or messy jerry-rigged discrete assemblies that were formerly necessary to achieve the high performance needed for such applications as sample-and-hold circuits and analog-to-digital converters. The 088 delivers performance an order of magnitude better than that of its nearest competitor when expressed as a combination of high slew rate, low input current, and low offset voltage—the key parameters.

The combination of low input current, voltage offset, and minimum offset drift contributes to high accuracy. The high output, coupled with a fast slew rate and short settling time, maximizes speed of measurements.

The high level of input performance was achieved by a chopper-stabilized circuit technique. True, chopper stabilization is not new, but it has never before been applied to IC op amps. Chopper stabilization divides the signal path into a high-frequency portion, which is amplified directly, and a low-frequency or dc portion, which is chopped and fed back against the input to can-

Chopper stabilization of an integrated operational amplifier is a significant step forward in linear-IC development. Another all-monolithic approach to chopper-stabilized op amps is described on page 125.

Device	Slew rate (V/ $\mu$ s)	Input current (nA)	Input-offset voltage (mV)	Figure of merit (nA $\cdot$ ns) <sup>-1</sup>
741	0.5	500	5	0.0002
101A	0.5	75	2	0.00333
108A	0.1	2	0.5	0.1
725A	0.005	75	0.5	0.000133
770	2.5	15	4	0.04166
531	30	500	5	0.012
740	6	0.2	20	1.5
118	70	250	4	0.07
088	25	5	0.075	66.67

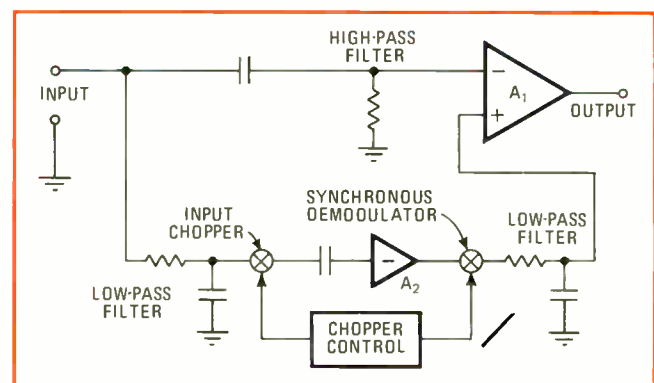

**2. Two paths.** In one path (upper), high-frequency components are amplified directly, and in a second path (lower), the dc signal is chopped and fed back against the input.

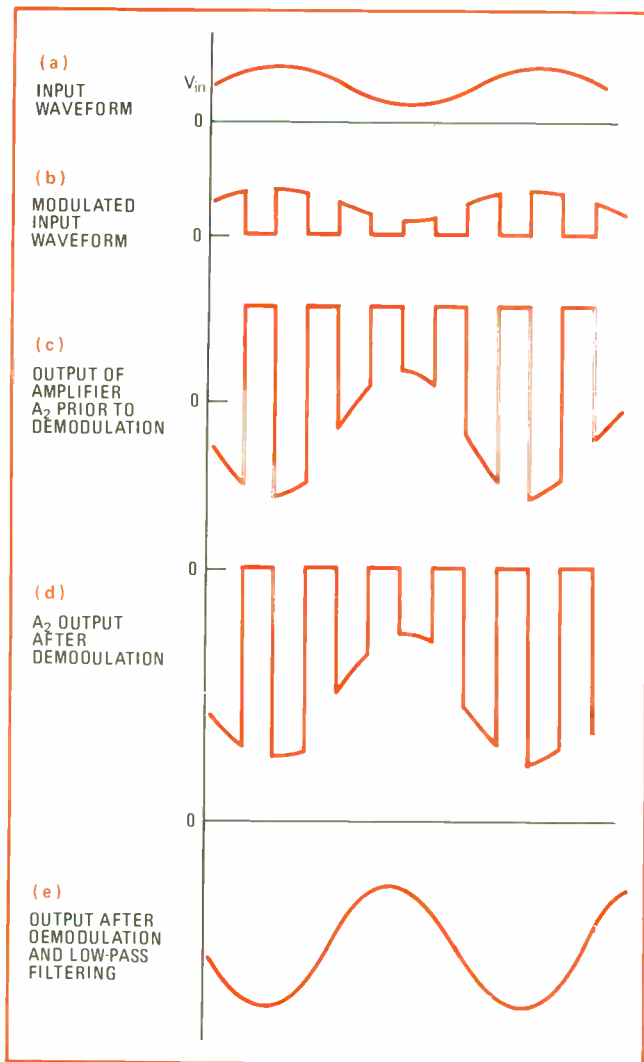

**3. Making waveforms.** The dc and low-frequency input to chopper channel (a) is converted to the wavelike (b), whose ac signal is capacitively coupled to  $A_2$  (c). The dc level is restored in (d), while final signal shape (e) is summed at the terminal of  $A_1$ .

cel the dc-voltage offset and minimizes the drift.

On one chip, a pair of high-voltage junction-field-effect transistors is used in the input of the main amplifier to achieve the fast slew rate and low-input current characteristic of FET input devices. This is the first commercial use of high-voltage JFETs on the same chip with conventional bipolar transistors. The high-voltage process results in JFETs with breakdowns of 40 volts, compared with 7 V for ordinary JFETs. The technique eliminates the need for such performance-degrading elements as lateral pnp devices in level-shifting networks.

A second MOS chip containing the chopper circuit is added to the package to correct for the initial offset voltage and offset drift. In this manner, the best advantages of FETs are obtained without offset problems.

The performance of the two-chip unit is impressive. Input current is only 5 nanoamperes maximum, while input offset voltage is a low 30 microvolts. Rise time is 65 ns, and offset drift is a  $0.6 \mu\text{V}/^\circ\text{C}$ . At the same time, the device, catalogued SN62088, has an impressive 130-decibel voltage gain and a respectable output slew rate of  $25 \text{ V}/\mu\text{s}$ .

### How good is good?

Table 1 compares the 088 with other available IC operational amplifiers in terms of the key performance parameters of slew rate, maximum input current, and maximum input-offset voltage. The table shows that most IC op-amp designs fall into one of two categories—those that have good dc characteristics (offset parameters, drift, and gain) or those that have good ac characteristics (slew rate, bandwidth, and rise time).

Designs that are optimized for good dc parameters but have compromised ac performance include the 725, 770, and 108. The latter two amplifiers utilize super- $\beta$  transistors to obtain low input currents but consequently sacrifice slew rate and bandwidth (see "The op-amp dilemma," p. 87). Some designs that favor ac performance but compromise dc performance are the 531,

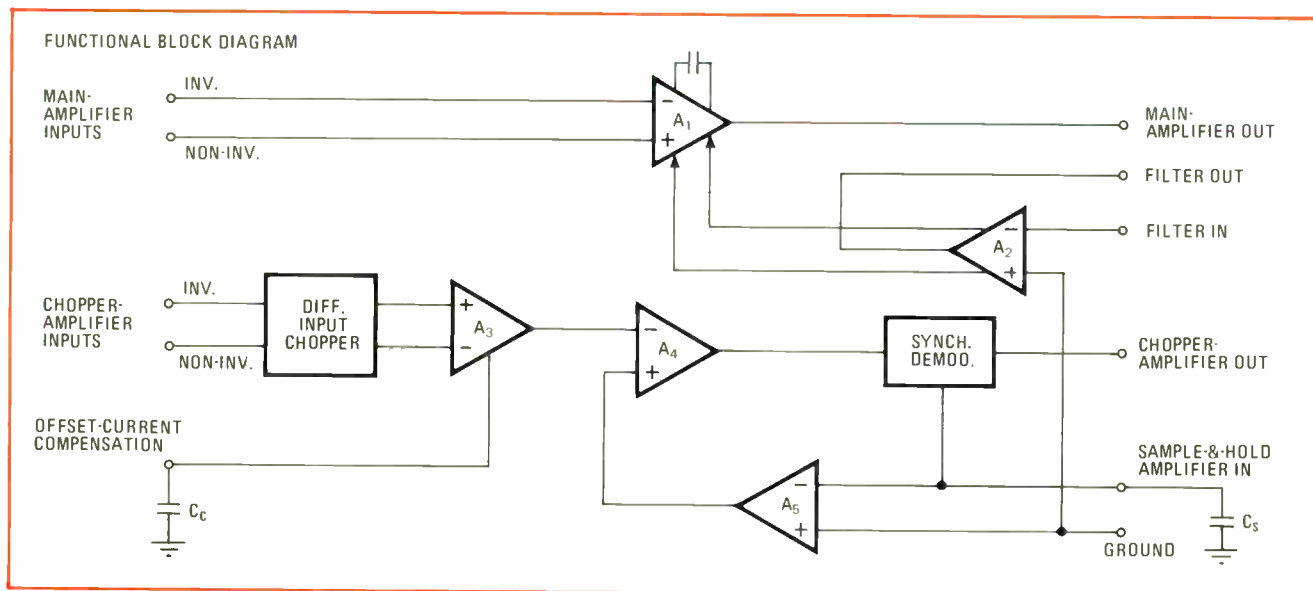

**4. Laying it out.** The main amplifier,  $A_1$ , of the chopper-stabilized device is a direct-coupled wideband amplifier with JFET inputs. The chopper channel has a differential-input chopper, plus amplifiers  $A_2$ ,  $A_3$ , and  $A_5$ , synchronous demodulator, and sample-and-hold.



## The op-amp dilemma

Generally speaking, optimizing the dc characteristics of an op amp means compromising ac performance and vice versa. Ac performance here is defined as encompassing slew rate, bandwidth, and rise time. Dc parameters are input-offset voltage, input current, input-offset current, gain, input-offset drift, and others.

The reason no existing amplifier has both excellent ac and dc characteristics may be clarified by considering the various IC technologies available to implement typical design techniques. A single matched pair of bipolar transistors can give excellent offset voltage and fairly low input currents if the collector currents are kept low. This low operating current, however, prevents the amplifier from being very fast because  $f_T$  of transistors is reduced when operating current is reduced. In addition, insufficient current is available to charge both the compensation capacitor and nodal capacitances quickly enough.

Super- $\beta$  transistors as input transistors allow lower input current but still do not solve the speed problem. Super- $\beta$  input transistors, with gains in the 2,000-6,000 range, offer an order-of-magnitude improvement in current gain over that of ordinary transistors. Indeed, input currents less than 5 nA can be easily met with operating currents of less than 10  $\mu$ A, but excellent ac performance cannot easily be obtained. This is because necessary level-shifting must still be done by the wide-base, low-frequency, lateral pnp transistor.

Darlington, quasi-Darlington, or emitter-follower stages (see figures) can be used along with super- $\beta$  input structures to keep input current reasonable and operating current moderately high for fast ac performance, but this usually results in high offsets and offset drifts.

A useful technology to obtain low currents and fast slew rate is the integrated FET. It is able to solve these two problems because a FET has no fixed relationship between input current and operating current, as does a

bipolar transistor. Whether a junction FET or a junction-protected MOS FET, this component has only reverse-bias junction leakage for input current. Therefore, the first stage may be operated without large input currents at a current high enough to obtain the desired ac performance. The main problems posed by FETs are offset voltage and offset-voltage drift, problems that are best solved with chopper-stabilized circuits.

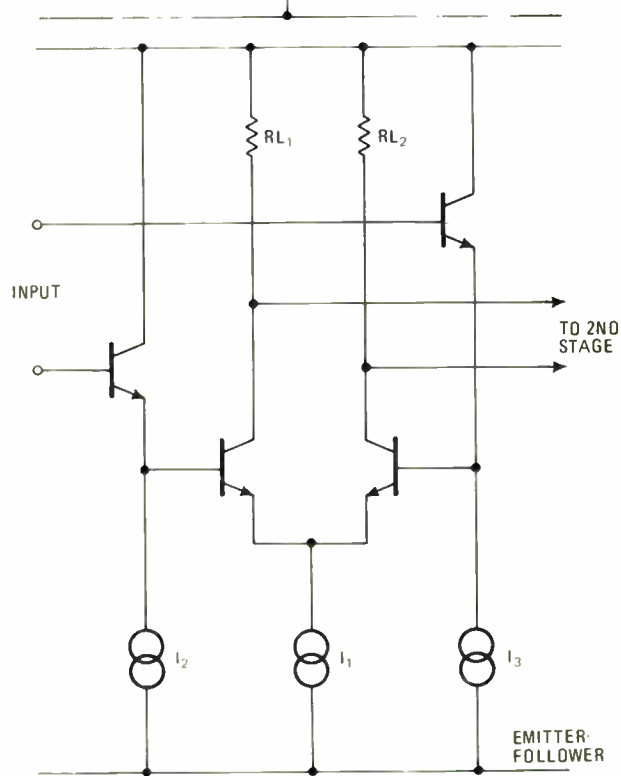
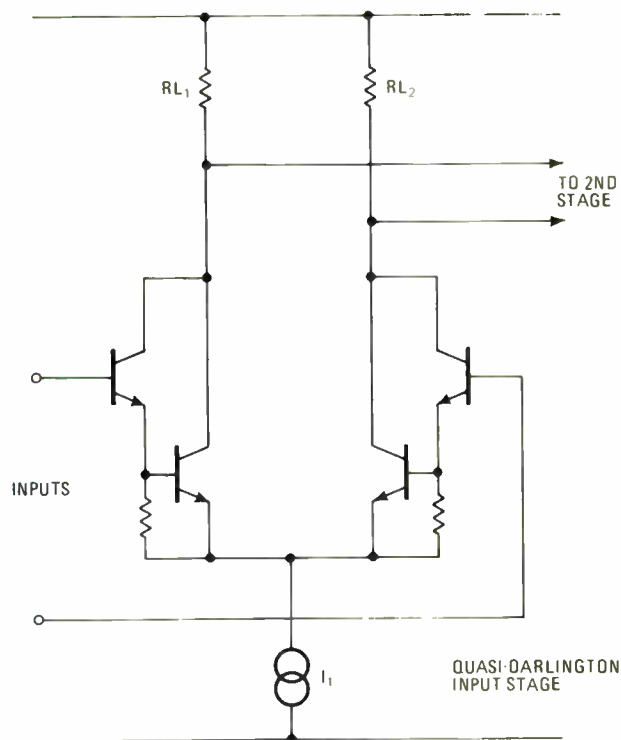
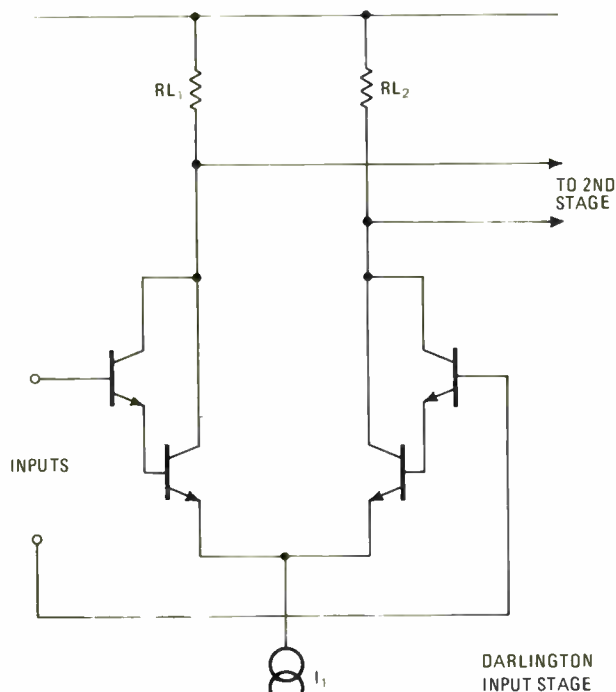

the 118, and the 740. The 740 uses JFET input transistors and obtains good slew rate and input current, but poor offset voltage.

To compare various commercially available op amps on a quantitative basis, the table includes a figure of merit (FM) derived from both dc and ac characteristics.

$$FM = \frac{\text{Unity-gain slew rate}}{\text{input current} \times \text{input-offset voltage}}$$

Input current is in nA (maximum), and noninverting unity-gain slew rate is in V/ $\mu$ s (typical). To maximize the figure of merit, a design must have good performance in all three categories, but typically, most of the devices listed do well in one or two, but not in all three. The exception is the 088, which offers more than an order of magnitude greater performance than the amplifier with the next highest figure of merit and more than two orders of magnitude better than the runner-up.

### How chopper stabilization works

Chopper stabilization is a circuit technique that reduces over-all input error. It normally involves two signal processing paths as shown in Fig. 2. The high-pass filter in the upper path allows high-frequency components to be amplified directly by amplifier A<sub>1</sub>. The lower path is the chopper channel, which accepts only dc and low-frequency signals. An input switch periodically chops the signal by shunting it to ground. The result is a pulse train modulated with the low-frequency input signal; this may be ac-coupled to a second amplifier, A<sub>2</sub>, where it is amplified.

To reestablish the proper dc level to this signal, it is demodulated in synchronism with the input chopper. The demodulated signal has the chopper spikes removed by the output low-pass filter and is summed with the high-frequency components at the noninverting input terminal of A<sub>1</sub>. Thus, the low-frequency components are modulated, amplified, demodulated, and summed by the main amplifier. Any dc signals are thus converted to ac and then amplified. Since the dc and low-frequency signals are processed by modulation, both high- and low-frequency amplifiers may be ac-coupled, preventing any dc errors from these amplifiers from appearing at the true input. This in turn means that input current and offset voltage are substantially reduced.

The operation of the chopper channel may be explained further by referring to Fig. 3, which exhibits the waveforms of the chopper-stabilized op amp of Fig. 2. The input to the chopper channel (a) consists of a dc and low-frequency component (any high-frequency components are rejected by the input low-pass filter). The shorting action of the chopper converts the input signal to that shown in Fig. 3b. The ac signal is capacitively coupled to the inverting amplifier A<sub>2</sub>, whose output is shown in Fig. 3c.

Notice that, since A<sub>2</sub> is ac-coupled, the waveform in Fig. 3c does not have proper ground reference. This dc level is restored as shown in Fig. 3d by a demodulator switch, acting in synchronism with the input chopper. The output low-pass filter removes the high-frequency switching components and passes the dc and low-frequency signals. This amplified, inverted version of the input signal, shown in Fig. 3e, is summed at the noninverting terminal of the main amplifier, A<sub>1</sub>.

### Designing the op amp

To obtain chopper-stabilized performance and utilize technology with few external components, a departure was made from conventional chopper-stabilized amplifier design. The over-all circuit layout chosen is shown in Fig. 4, where the two signal-processing paths characteristic of chopper-stabilized operation are shown. The main amplifier, A<sub>1</sub>, is direct-coupled. It is designed primarily as a fast, wideband amplifier with JFET inputs.

The chopper channel (path 2) consists of a differential-input-chopper (DIC), amplifiers A<sub>2</sub>, A<sub>3</sub>, A<sub>4</sub>, and A<sub>5</sub>, a synchronous demodulator (SD), and a sample-and-hold circuit. Amplifiers A<sub>3</sub>, A<sub>4</sub>, and A<sub>5</sub> are all MOS and therefore may have significant offset voltages.

There are two phases to the chopper loop: one senses the offsets of the MOS amplifiers and stores it on the sample/hold capacitor, C<sub>s</sub>; during the next cycle, the offset of A<sub>1</sub> is amplified by A<sub>4</sub>, A<sub>3</sub>, and A<sub>2</sub> as an error signal. Amplifier A<sub>2</sub> performs two functions: first, it acts as a low-pass filter to remove switching spikes caused by the SD, and second, it converts the single-ended error voltage into a differential error current. It is this differential current source that corrects the offset of the main amplifier, A<sub>1</sub>.

This technique senses offset voltage of the main amplifier, amplifies this error term, and then uses active differential feedback to reduce offset voltage and offset-voltage drift. Low-frequency gain is increased by the gain of the chopper channel (about 60 dB). The offset-voltage connections to A<sub>1</sub> are performed at a 1-kHz rate at terminals similar to offset-adjust terminals on a 741-type amplifier. Since this nulling technique does not use any inputs of A<sub>1</sub> (as the conventional technique does), full differential capability of the amplifier may be realized.

This differential capability gives the user a significant advantage over the inverting-only amplifier. Since the offset correction is effectively continuous, offset-voltage drift with respect to time and temperature are also improved. Low drift, coupled with high initial accuracy, means that this amplifier is especially well suited to remote applications, where periodic adjustment is difficult, and to standard instrumentation applications

TABLE 2: PERFORMANCE PARAMETERS OF 088

Offset voltage	35 $\mu$ V
Input current	500 pA
Unity-gain slew rate	25 V/ $\mu$ s
Offset-voltage temperature drift	0.6 $\mu$ V/ $^{\circ}$ C
Voltage gain at dc	130 dB
Rise time (10-90%, 40-mV step, unity gain)	65 ns
Settling time (unity gain, 10-V step, to 0.1%)	1.9 $\mu$ s
Unity-gain bandwidth	3 MHz



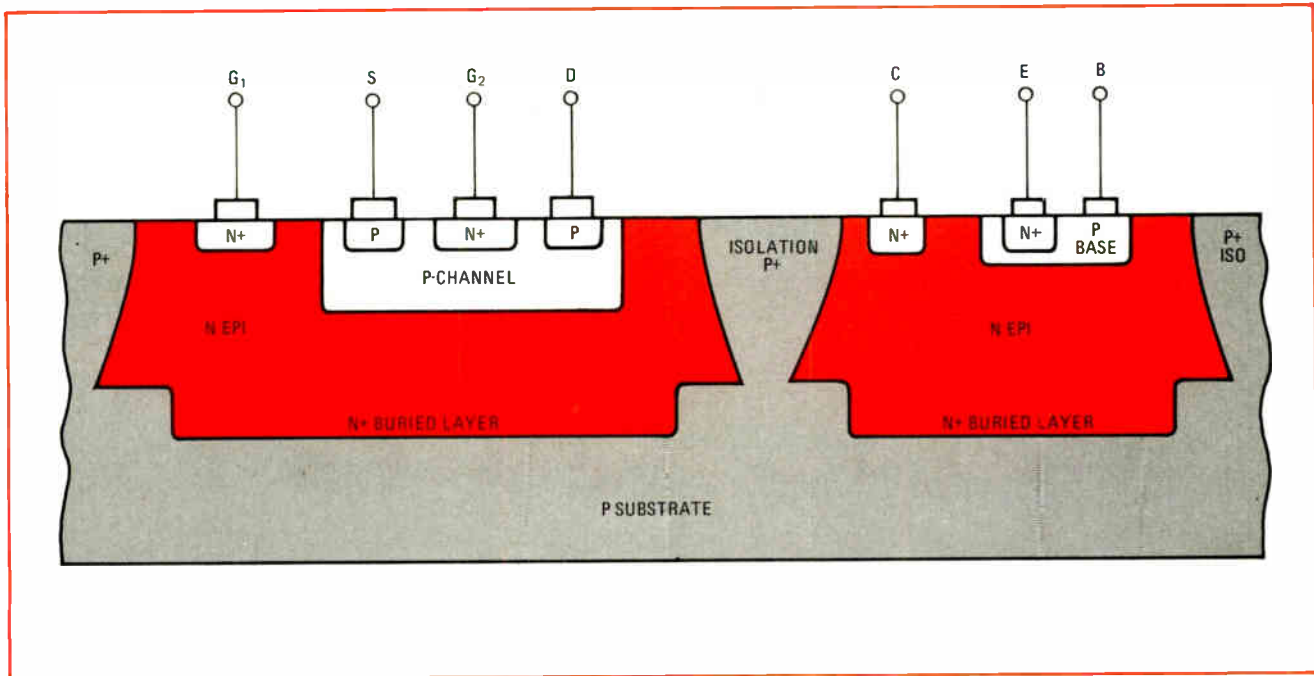

**5. One more step.** The high-voltage JFET process has an extra lightly doped p-diffusion for the channel. It's doped lightly so that it can be pinched off at a reasonable voltage and so that it forms a good contrast in conductivity to the heavily doped emitter diffusion.

where initial offset adjustment is undesirable.

The features of the SN62088 realized by this two-chip design approach are shown in Table 2. The small size, enabling the device to be packaged in a standard 14-pin DIP makes the device, unlike conventional-module op amps, suitable for use with existing automatic-insertion equipment. Moreover, since the 088 has full differential capability, inverting operation, noninverting operation, and differential operation are all possible.

#### What the chips are like

In the 088, one MOS chip, 108 by 73 mils on a side, provides a variety of functions, both digital and analog, not normally associated with op amp designs. The digital section contains a clock generator, a countdown flip-flop chain, decoding, five analog switches, and switch drivers. These switches are used for input-chopper, demodulator, and sample-and-hold. The analog portion consists of three all-MOS amplifiers, typified by low gain, high offset, and low-frequency response. These disadvantages are not detrimental to circuit performance, however, because the offset is self-corrected, the requirement for gain is moderate, and the MOS amplifiers only operate in the low-frequency chopper channel. The great virtues of MOS processing are the high packing density it allows in digital circuitry and the good bilateral switches it can yield.

The other chip, 75 by 90 mils, contains the bipolar transistors and JFETs that make up the basic op-amp circuit. Again, this is the first commercial integration of high-voltage JFETs with standard bipolar transistors. Previous JFETs in ICs were either laboratory curiosities or were made by standard processes to fabricate one of two kinds of JFETs—one similar to a 1/2-inch p-channel resistor that has a breakdown voltage of about 7 V or one with an epitaxial channel, (n-channel), which has a very high breakdown voltage, but which unfortunately

has its gate in common with the substrate. Because of this structure, it is unsuitable as an input element of an op amp.

If the p-channel JFET made by standard processing were used as the input transistor of an amplifier, the circuit design would have to include some sort of a voltage-clamp circuit to keep the transistor from breaking down. This implies that the level-shifting must be done by lateral pnp transistors, which are slow and have a low-frequency response.

The JFET used in the 088, on the other hand, has a breakdown voltage greater than 40 V, so that required level-shifting may be accomplished by the JFET itself, a relatively wideband component. This allows the small-signal transient response to be very fast, typically 65 ns.

The JFET structure, shown in Fig. 5, requires one more diffusion step than conventional ICs—a lightly doped p-type region, which is used for the channel. This region is very lightly doped so that it may be pinched off at a reasonable voltage and so that the heavily doped emitter diffusion, which is used as a gate, will not cause a low breakdown voltage from gate to drain. Note that standard base diffusion is added in the contact areas of the source and drain to facilitate ohmic contact.

Together with the JFET input structure, the main amplifier has three gain stages with internal frequency compensation. The first stage accomplishes the required level-shifting, but it has low gain to prevent a large capacitance from being reflected to the input by the Miller capacitance effect. A low-input capacitance is very important with a JFET op amp because of its high input impedance, typically greater than 1,000 megohms. The other two gain stages, designed to be very fast, have high gain. This amplifier is completed with a complementary emitter-follower stage to buffer the gain stages from the external load.

The characteristics of the 088 make it suitable for a

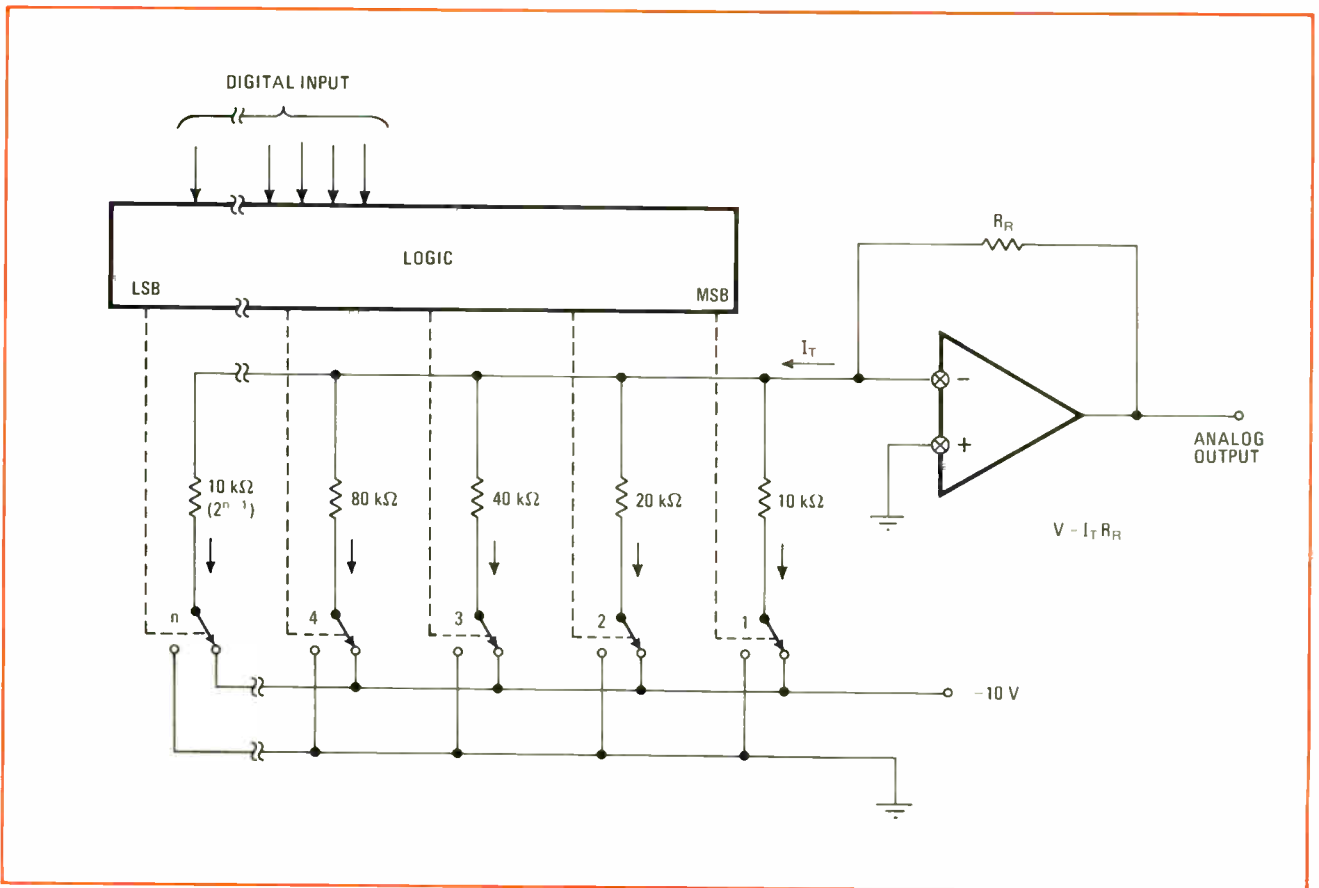

**6. Accurate conversions.** Because the digital information may be processed very quickly with chopper-stabilized op amps, this digital-to-analog-converter circuit enhances the total conversion speed of data-acquisition system.

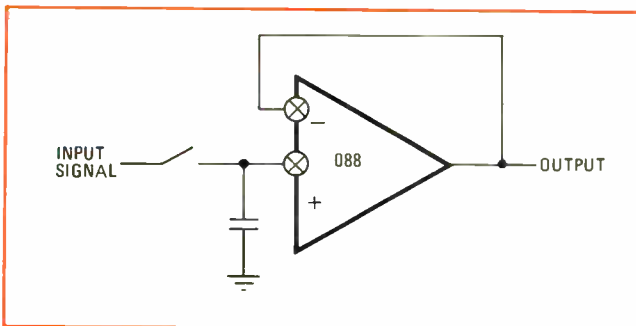

**7. Sample and hold.** Performance of this standard sample-and-hold-circuit is enhanced by the 088 because the high-slew-rate device responds to fast changes at the input and settles quickly. Settling time of  $2 \mu\text{s}$  results in 10-times improvement over 741 systems.

broad range of applications, especially those that require extreme accuracy, excellent long-term stability, high input impedance, low input current, fast settling time, and fast slew rate.

### Applications

The d-a converter shown in Fig. 6 is a case in point. This basic configuration is suitable, whether the binary-weighted resistors (shown) or an R-2R ladder network is used. Because the digital information may be processed very quickly, the conversion speed of the total system is normally restricted by the amplifier as it performs a current-to-voltage input transformation. Thus, the amplifier should have very low input currents so that no sig-

nificant error occurs to the least significant bit.

Consider the converter to have 18 bits of digital information, and the most significant bit to be 5 mA. The input current of the op amp should be considerably smaller than that of the least significant bit, which in this case is 40 nA. The 088 is an excellent choice for this application because of its low drift, its low input current, and its high speed.

Another application for which the 088 is especially well suited is the sample-and-hold (Fig. 7), or peak-detect-and-hold. Requirements of these types of circuits are fast acquisition time, low input current, and low offset voltage. The circuit shown here is in a unity-gain configuration, although it could be generalized with gain resistors in the feedback loop. The amplifier must be able to respond to fast changes at the input and settle to the required system accuracy in a minimum of time.

Because of the fast settling time of the 088 (less than  $2 \mu\text{s}$  for accuracy to 0.1% for a 10-v step) the aperture time of this circuit is very small—more than an order-of-magnitude improvement over that of the 741-type amplifier. □

### Closing the loop

Readers who are interested in discussing the 008 may call applications specialist Dale Pippenger at (214) 238-3865 during business hours the week of Aug. 20.



# Switching regulators: the efficient way to power

The switching regulator, which offers the advantages of high efficiency, small size, and cool operation, can be made to supply a low-noise output through careful filter design and prudent semiconductor selection

by Robert S. Olla, *Diablo Systems Inc., a subsidiary of Xerox Corp., Hayward, Calif.*

□ Although switching regulators make power supplies that are two to three times more efficient than the dissipative type, while remaining cost-competitive, many designers believe they are noisy and avoid using them. But with today's wide selection of fast-switching low-noise power semiconductors, reliable switching regulators can easily be built that are almost free of noise. What's more, careful filter design will also enhance semiconductor performance. For example, a switching-regulator power supply can provide an output of 2 to 200 volts at 5 to 50 amperes, holding regulation to 0.01% and ripple and noise voltage to 1 millivolt.

Besides having lower noise, switching regulators are more reliable than dissipative regulators because they operate at lower temperatures. This also extends the life of the supply, since its components do not age as quickly. Other advantages are its smaller size and lower weight, while, as fringe benefits, its higher operating fre-

quencies permit inductors and transformers to be less bulky and its lower temperatures allow smaller heat sinks.

## The basic switching regulator

As shown in Fig. 1a, a switching regulator basically consists of three sections: a switch, a pulse generator, and a filter. The voltage source,  $E_i$ , may be any dc voltage requiring regulation, like a battery or the output of a rectifier. Generally,  $E_i$  must be at least twice as large as the desired output voltage, and the input power must be large enough to supply the output power needed.

The switch is usually a transistor or thyristor power device, which is switched between its saturation and cutoff regions. The pulse generator does this on/off switching by varying its output pulse rate or pulse width as a function of line and load conditions. When pulse-width modulation is used, the generator produces a

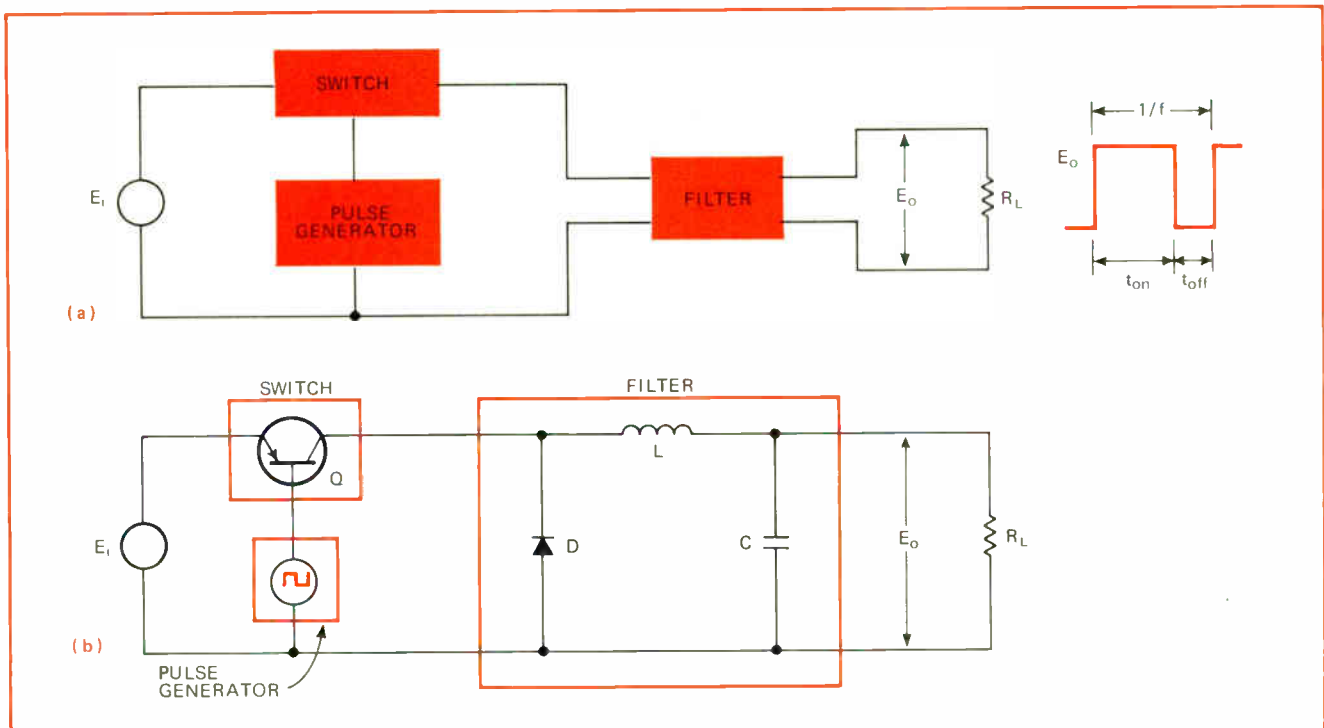

1. **Elementary regulator.** Block diagram (a) of basic switching regulator outlines the principal circuit sections, which are then detailed in (b). Input voltage  $E_i$  can be any unregulated dc source. Regulator operating frequency is determined by the rate at which the pulse generator turns the transistor switch on and off. The filter and commutating diode average the pulses from the switch to some dc voltage.

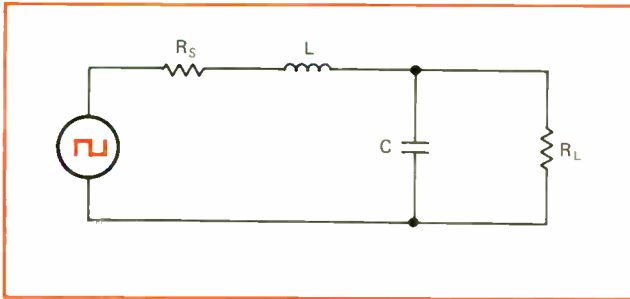

**2. The right filter.** Series-parallel RLC filter works best in regulator applications because its inductor and its capacitor can be chosen, almost independently, to optimize regulator performance. The inductor influences overshoot, transient response, and load current, while the capacitor establishes noise and ripple characteristics.

nonsymmetrical square wave that has a frequency usually on the order of tens of kilohertz.

The filter is perhaps the single most important section of the switching regulator. To a large extent, it determines the regulator's efficiency and transient response, as well as ripple and noise voltages. In addition to averaging the pulses from the switch, the filter must remove the high-frequency components of these pulses. Regulator output voltage,  $E_o$ , can be expressed by:

$$E_o = t_{on} E_i / (t_{on} + t_{off}) \quad (1)$$

with:

$$t_{on} + t_{off} = 1/f \quad (2)$$

where  $f$  is the pulse generator frequency.

For regulator applications, the RLC filter (Fig. 1b) is the best choice because it permits high power efficiency to be achieved. For instance, even though the transistor switch is off, the inductor's induced voltage continues to charge the capacitor through the commutating diode, thereby increasing efficiency. Moreover, during light load demands, the energy stored in the capacitor supplies the load, while during heavy load demands the energy stored in the inductor supplies the load. This means that both  $L$  and  $C$  can be chosen for optimum regulator performance. (Of course, their values must be kept within reasonable limits.)

Besides storing energy for the regulator, the inductor limits the regulator's transient response as well as the peak load (capacitor) current. The capacitor, on the other hand, primarily determines the regulator's ripple and noise voltages. Both the inductor and the capacitor, therefore, are critical components and, needless to say, must be selected carefully.

### Filter considerations

The RLC filter that is best for switching regulator applications can be represented by the series-parallel RLC circuit of Fig. 2, where  $R_s$  is the source resistance of the pulse generator. The circuit must be prevented from oscillating because of the power losses that will result. To avoid this underdamped condition when there is no load:

$$R_s^2/4L^2 \text{ must be greater than } 1/LC \quad (3)$$

or, with a load:

$$1/4R_L^2 C^2 \text{ must be greater than } 1/LC \quad (4)$$

If  $R_s$  is small and  $R_L$  large, the circuit will oscillate. Since  $R_s$  is fixed under light or no-load conditions, the first inequality may not be met, making it necessary to

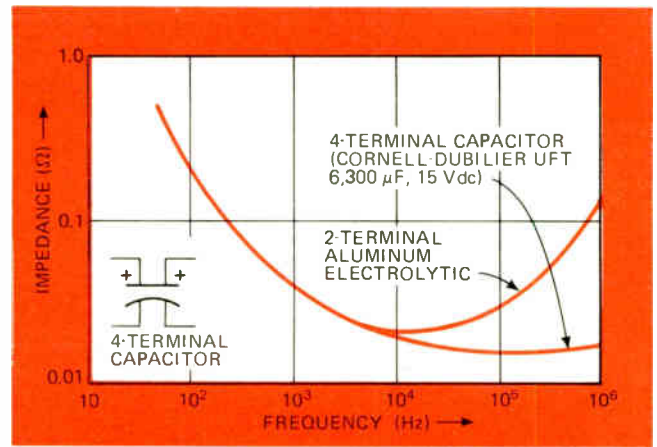

**3. Special capacitors.** Four-terminal capacitors are ideal for regulator circuits, providing good noise filtering and isolation from ground loops. The graph shows how a special capacitor exhibits low impedance even at high frequencies, while the impedance of a conventional capacitor increases beyond 10 kilohertz. These four-terminal units can be used at the regulator's input and output.

find a minimum  $R_L$  that meets the second inequality. Because the load seldom goes to zero, the load alone may be large enough to prevent oscillations. If it is not, the power supply should be preloaded.

The transient overshoot of the regulator can be found from classic inductor and capacitor relationships:

$$dt = L(di)/e_L = C(dv)/i_C$$

where  $di = i_C =$  capacitor current,  $dv$  is capacitor voltage, and  $e_L$  is inductor voltage. The change in capacitor voltage is the transient overshoot:

$$\Delta E_o = dv = L(\Delta i)^2 / C e_L$$

For increasing loads:

$$\Delta E_o = L(\Delta i)^2 / C (E_i - E_o) \quad (5)$$

For decreasing loads:

$$\Delta E_o = L(\Delta i)^2 / C E_o \quad (6)$$

Similarly, the regulator's transient response, or recovery time, can be computed. For increasing loads:

$$t_r = 2L\Delta i / (E_i - E_o) \quad (7)$$

For decreasing loads:

$$t_r = 2L\Delta i / E_o \quad (8)$$

Since the load current increases in a linear fashion, the value of inductor  $L$  can be expressed as:

$$L = (E_i - E_o)t_{on} / 2(I_{pk} - I_o) \quad (9)$$

where  $I_{pk}$  is the peak load current and  $I_o$  is the rated load current. Other considerations (besides value) for selecting inductor  $L$  include core size, core shape, core material, gap size, and the number of wire turns. For predictable and stable results,  $L$  should have a fairly linear inductance.

Choosing the filter capacitor is equally important for a well-designed switching regulator—a poor selection will result in a regulator that is plagued with noise problems. The capacitor's value depends on the output ripple voltage permitted:

$$C = (E_i - E_o) / 4\pi^2 f^2 L E_r \quad (10)$$

where  $C$  is expressed in farads,  $L$  in henries,  $f$  in hertz, and  $E_r$  is the maximum allowed peak-to-peak ripple voltage. The capacitor's voltage rating should be at least 1.2 times larger than  $E_o$ .

There are even special four-terminal capacitors that are intended mainly for switching regulator appli-

cations. They are low-inductance devices exhibiting excellent high-frequency characteristics. Figure 3 compares the impedance of a four-terminal capacitor with that of a quality two-terminal aluminum electrolytic capacitor. At high frequencies, the four-terminal device is clearly superior for regulator applications because of its lower impedance. Also, four-terminal capacitors provide good isolation from ground loops and good noise filtering for both the source and output voltages.

### Picking the semiconductors

Choosing a commutating diode for the filter is a relatively simple task—a matter of simply looking through manufacturers' data sheets. In addition to safely handling all peak currents, the diode must have a short recovery time, a small forward voltage drop, and a peak inverse voltage rating that is at least twice as large as the input voltage.

The diode's recovery time is important because of its influence on output noise. After the switching transistor shuts off, the diode conducts, charging capacitor C. When transistor Q turns on again, diode D is still in its conducting state and shorts Q to ground for a little while. This double conduction dissipates power in both transistor Q and diode D and is a prime source of noise.

Like selecting a commutating diode, choosing a switching transistor also involves going through manufacturers' data sheets. The transistor must provide sufficient peak and average current-handling capabilities, as well as a safe collector-emitter breakdown voltage rating. (This voltage is generally 1.2 times larger than  $E_i$ .) Additionally, the transistor's saturation voltage should be as small as possible when collector current is at its maximum.

Switching time is the most important transistor specification. Maximum efficiency is achieved when the transistor is either saturated or in cutoff. However, since

transistors cannot switch instantaneously, a considerable amount of power (say 10%) can be dissipated during the switching time. Keeping switching times small compared to the period of the switching frequency will minimize these switching losses.

The switching frequency should be high enough to keep the values of inductor L and capacitor C small, but not so high that transistor Q and diode D become expensive. Typical operating frequencies range from 10 to 50 kilohertz. The source voltage should be from two to five times larger than the output voltage, keeping in mind any high-voltage constraints that apply.

### Design procedure

Designing the simple regulator circuit of Fig. 4 will illustrate how to use the equations just given. For this example:  $E_i = 5E_o = 25$  volts,  $E_o = 5$  v,  $I_o = 2$  amperes, and  $f = 20$  kHz.

Before calculating component values, some other important circuit parameters must be found. From Eqs. 1 and 2, the on-time of transistor Q can be computed:

$$t_{on} + t_{off} = 1/f = 1/(20 \times 10^3) = 5 \times 10^{-5} \text{ seconds}$$

$$t_{on} = E_o(t_{on} + t_{off})/E_i = E_o(1/f)/E_i$$

$$t_{on} = (5)(5 \times 10^{-5})/(25) = 10^{-5} \text{ seconds}$$

Another important consideration is the regulator's peak current, which is usually 5% to 20% greater than  $I_o$ . The smaller the peak current becomes, the larger the transient response is. In this case, let the peak current be 5% larger than  $I_o$ , so that  $0.05(2 \text{ A}) = 0.1 \text{ A}$ . The change in load current becomes:

$$\Delta I_L = 2(I_{pk} - I_o)$$

$$\Delta I_L = 2(2.1 - 2) = 0.2 \text{ A}$$

The value of inductor L can now be computed from Eq. 9:

$$L = (E_i - E_o)t_{on}/2(I_{pk} - I_o)$$

$$L = (25 - 5)(10^{-5})/(0.2) = 10^{-3} \text{ H}$$

The value of capacitor C can also be computed. Using

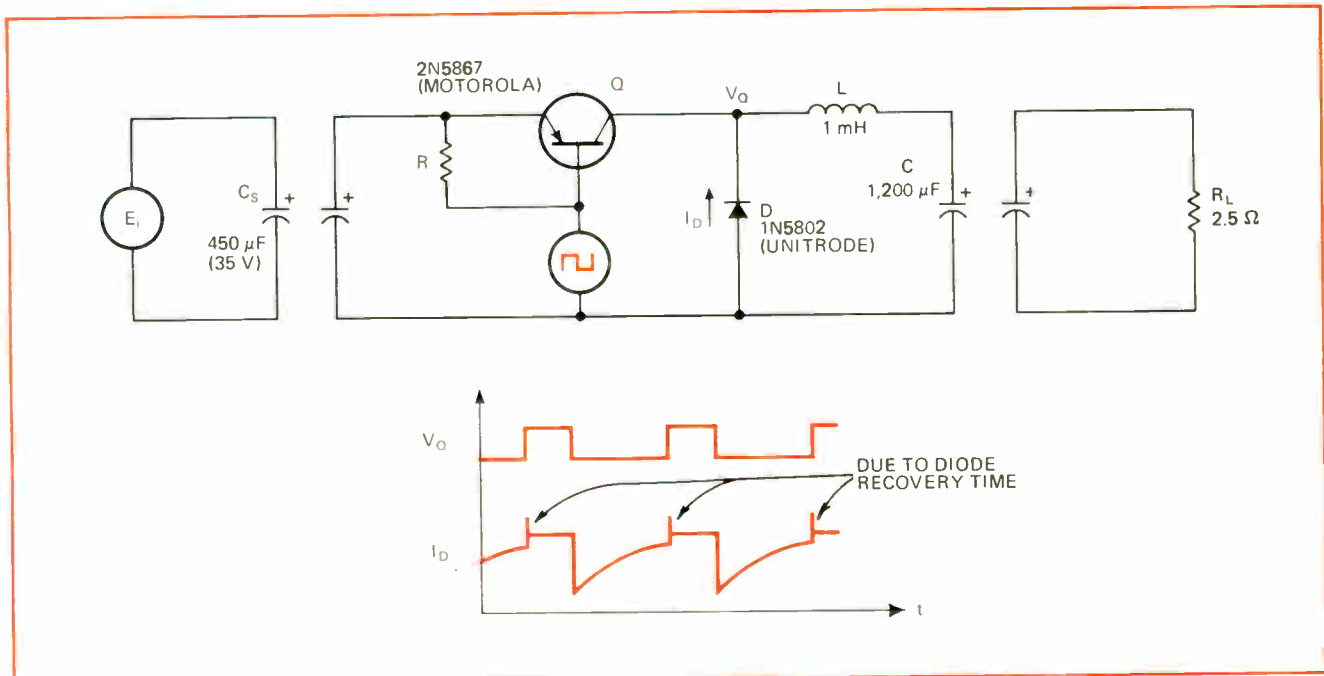

4. **Typical design.** Once the desired regulator characteristics are known, values for the filter's inductor and capacitor can be computed quite easily. The transistor and the diode are selected from manufacturers' data sheets. Capacitor  $C_s$  limits input ripple.



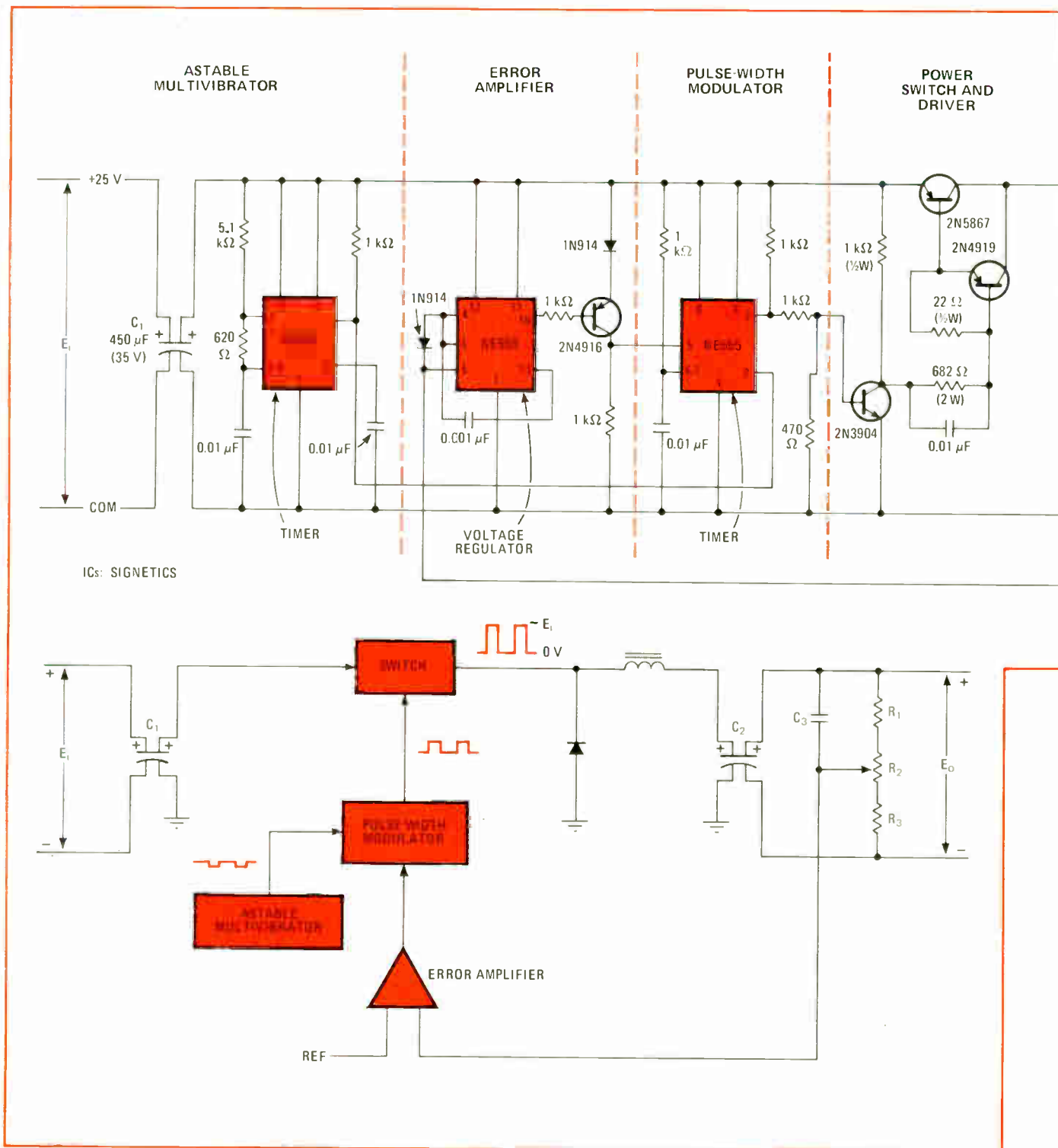

**5. Complete circuit.** Basic regulator of Fig. 4 is shown here with its associated timing and pulse-generating circuitry. The block diagram illustrates how the over-all regulator works. The multivibrator determines switching frequency, and the error amplifier adjusts the pulse width of the modulator to maintain regulator output voltage at the desired level. The output resistor divider provides the sensing voltage.

Eq. 10 and restricting output ripple to a typical value of 1 millivolt yields:

$$C = (E_i - E_o) / 4\pi^2 f^2 E_r$$

$$C = (25 - 5) / 4(9.85)(4 \times 10^8)(10^{-3})(10^{-3})$$

$$C = 1,200 \text{ microfarads}$$

Once L and C are known, the circuit's stability can be determined. To account for the source impedance as

well as all lead resistances and their associated losses, let:

$$R_s = 2 \text{ ohms}$$

The load resistance is:

$$R_L = E_o / I_o = (5 \text{ V}) / (2 \text{ A}) = 2.5 \text{ ohms}$$

Now the circuit's quality factor can be checked with the inequalities of Eqs. 3 and 4. For the no-load condition:

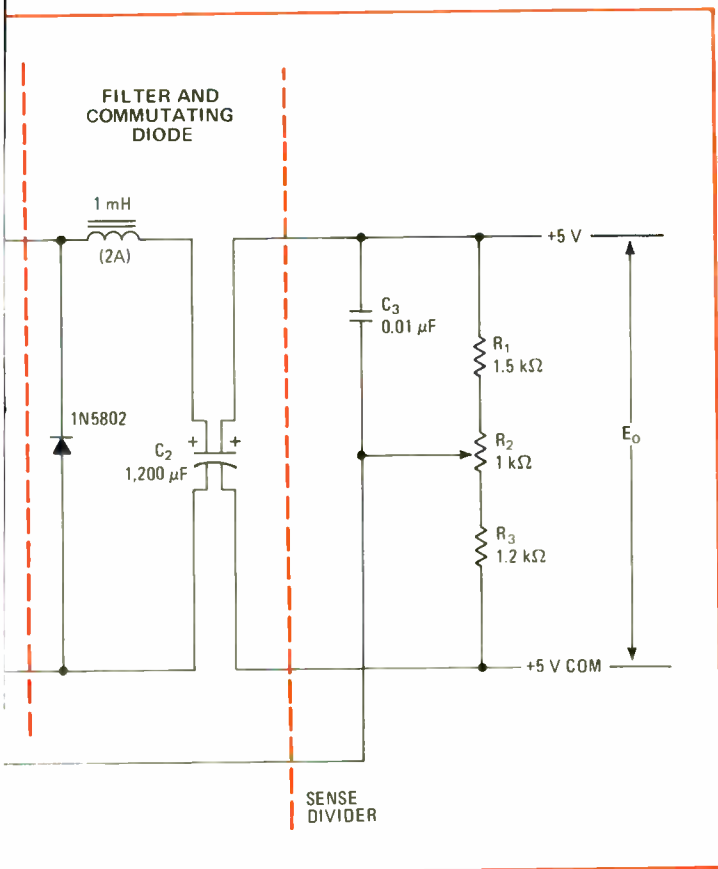

$CR_s^2/L$  must be greater than 4  
 $(1.2 \times 10^{-3})(2)^2/(10^{-3}) = 4.8$   
 4.8 is greater than 4

Since this inequality holds, the regulator will not oscillate when there is no load. With a load present:

$L/R_L^2C$  must be greater than 4  
 $(10^{-3})/(2.5^2)(1.2 \times 10^{-3}) = 0.13$   
 0.13 is not greater than 4

which is an oscillatory condition, although the circuit will not oscillate under full load or even half load. If it were to operate with no load, then the last inequality would have to be solved for a minimum  $R_L$ .

The regulator's transient response can be calculated by assuming that load current increases from half load to full load (from 1 to 2 A). From Eq. 7, the recovery time for an increasing load is:

$$t_r = 2L\Delta i/(E_i - E_o)$$

$$t_r = 2(10^{-3})(1)/(25 - 5) = 10^{-4} \text{ seconds}$$

For decreasing loads, Eq. 8 applies:

$$t_r = 2L\Delta i/E_o$$

$$t_r = 2(10^{-3})(1)/5 = 4 \times 10^{-4} \text{ seconds}$$

Overshoot can be found from the same conditions just used to compute the transient response. For increasing loads (Eq. 5):

$$\Delta E_o = L(\Delta i)^2/C(E_i - E_o)$$

$$\Delta E_o = (10^{-3})(1)^2/(1.2 \times 10^{-3})(25 - 5) = 40 \text{ mv}$$

For decreasing loads (Eq. 6):

$$\Delta E_o = L(\Delta i)^2/CE_o$$

$$\Delta E_o = (10^{-3})(1)^2/(1.2 \times 10^{-3})(5) = 160 \text{ mv}$$

As shown in the figure, a capacitor,  $C_s$ , is placed across the input to keep the source voltage free of high-frequency ripple. If this ripple voltage is to be held to

50 mV or less, as is usually the case, then:

$$C_s = I_{pk}t_{on}/E_r$$

$$C_s = (2.1)(10^{-5})/(50 \times 10^{-3}) = 420 \mu\text{F}$$

A type 2N5867 pnp power transistor can act as the switch for the regulator. Its collector-emitter breakdown voltage is 60 V, its maximum saturation voltage is 1 V, its average collector current is 5 A, and its switching rise time is 0.7 microsecond. When no switching signal is present, resistor R will turn off the transistor.

A high-efficiency fast-recovery diode, a type 1N5802, makes an excellent commutating diode for the regulator's filter. It offers a peak inverse voltage rating of 50 V, handles average currents of 2.5 A, withstands peak currents of 35 A, has a forward voltage drop of 0.875 V, and switches in only 25 nanoseconds.

### The complete regulator

All the components for this basic regulator circuit are now determined. A complete switching regulator, one that includes all the necessary pulse-generating and timing circuitry, is illustrated in Fig. 5, along with its block diagram. It includes the basic regulator just designed.

As indicated, there are five major sections: an astable multivibrator, an error amplifier, a pulse-width modulator, a power switch and driver, and a filter and commutating diode. The multivibrator, which employs an IC timer, determines the regulator's switching frequency. The error amplifier is an integrated voltage regulator that contains its own precision internal reference; it establishes a feedback path from the output. Like the multivibrator, the modulator makes use of an IC timer, but this one is wired as an adjustable monostable multivibrator. The power switch is a complementary Darlington pair. Four-terminal capacitors are used at both the regulator's input and output.

The block diagram sums up how the regulator works. The multivibrator triggers the pulse-width modulator approximately every 50  $\mu\text{s}$ , turning the switch on and off. The modulator's pulse width is determined by the output of the error amplifier. The filter averages the voltage output from the switch to some dc level.

The voltage divider formed by resistors  $R_1$ ,  $R_2$ , and  $R_3$  samples the output voltage. This voltage is then compared, by the error amplifier, with a reference voltage, permitting an error voltage to be generated. The error voltage increases the modulator's pulse width if the output voltage is low with respect to the reference voltage. If the output voltage is higher than the reference voltage, the error voltage decreases pulse width.

Capacitor  $C_3$  bypasses the resistor divider for ac voltages, resulting in lower output ripple. □

### BIBLIOGRAPHY

- A.E. Richmond. "Calculus for Electronics." McGraw-Hill Book Co., New York, 1958.
- Egon Brenner, and Javid Mansour. "Analysis of Electric Circuits." McGraw-Hill Book Co., New York, 1959.
- Phillip Cutler. "Electronic Circuit Analysis (Vol. 1: Passive Networks)." McGraw-Hill Book Co., New York, 1969.
- Jerry Eimbinder (ed.). "Designing with Linear Integrated Circuits." John Wiley & Sons Inc., New York, 1969.
- Michael English. "Need to Design A Switching Regulator?" Electronic Design, Jan. 4, 1970, pp.106-111
- RCA Designer's Handbook. "Solid State Power Circuits." Technical Series SP-52, Somerville, N.J., RCA Solid State Division, 1971.
- Cornell-Dubilier Electronics. "Aluminum Electrolytic Capacitors, Low Inductance Type UFT (Class 210.68)." Division of Federal Pacific Electric Company, September, 1972.
- R.S. Olla. "Designing Switching Regulators." Cornell-Dubilier, 1973.
- Triad Distribution Division. "Inductors—Toroidal and Power."

# Memory lag got you down?

## Relief is 4 easy steps away.

**Step 1.**

Think about  
the company.

**Step 2.**

Pick exactly  
what you need.

**Step 3.**

Know what to expect.

**Step 4.**

Call for Intersil.



## Think about the company.

You know us. Technology leader in bipolar RAMs. A top supplier in P/ROMs. The company with a wider range of memory performance, and more production techniques—bipolar TTL, CMOS, N-channel and P-channel MOS—than any independent solid-state memory manufacturer.

Look here:

## Pick exactly what you need.

	Memory Type	Description	Read Access Time, Max. (nSec)	Power Dissipation, Max. (mW)
RAMs	IM5501	16x4 TTL Static	60	500
	IM5503	256x1 TTL Static, 1 C/S	80	625
	IM5503A	256x1 TTL Static, 1 C/S	60	625
	IM5508	1024x1 TTL Static, 1 C/S	85	625
	IM5523	256x1 TTL Static, 3 C/S, Tri/St	80	625
	IM5523A	256x1 TTL Static, 3 C/S, Tri/St	60	625
	IM5533	256x1 TTL Static, 3 C/S	80	625
	IM5533A	256x1 TTL Static, 3 C/S	60	625
	IM7501	256x1 P-Ch MOS Static	1000	300
	IM7511	256x1 P-Ch MOS Static	750	250
	IM7512	256x1 P-Ch MOS Static	1200	160
	IM7552	1024x1 N-Ch MOS Static	1000	300
	IM7552-1	1024x1 N-Ch MOS Static	500	300
P/ROMs	IM5600	32x8 TTL Static	50	500
	IM5603A	256x4 TTL Static	60	500
	IM5610	32x8 TTL Static, Tri/St	50	500
	IM5623A	256x4 TTL Static, Tri/St	60	500
Shift Registers	IM7712	1024x1 P-Ch MOS Dynamic	3MHz	200
	IM7722	1024x1 P-Ch MOS Dynamic	3MHz	200
	IM7780	80x4 P-Ch MOS Dynamic	2.5MHz	355

## Know what to expect.

### Coming Up

IM7733	1024-bit N-Ch MOS Static S/R, 4MHz Freq.
IM6523	256-bit CMOS RAM, 20mW Active Pwr, .25mW Stby
IM5604	2048-bit TTL P/ROM, 80nS Access
IM6508	1024-bit CMOS RAM, 60mW Active Pwr, .30mW Stby
IM5605	4096-bit TTL Static P/ROM, 90nS Access
IM7507	4096-bit N-Ch MOS Dynamic RAM, 400nS Access

## Call for Intersil.

Intersil stocking distributors. Elmar/Liberty Electronics. Schweber Electronics. Semiconductor Specialists. Weatherford.

Intersil area sales offices. Boston (617) 861-7380. Chicago (312) 371-1440. Los Angeles (213) 370-5766. Minneapolis (612) 925-1844. New York (201) 567-5585. San Diego (714) 278-6053. San Francisco Bay Area (home office) (408) 257-5450.

Representatives in all major cities.

# Intersil

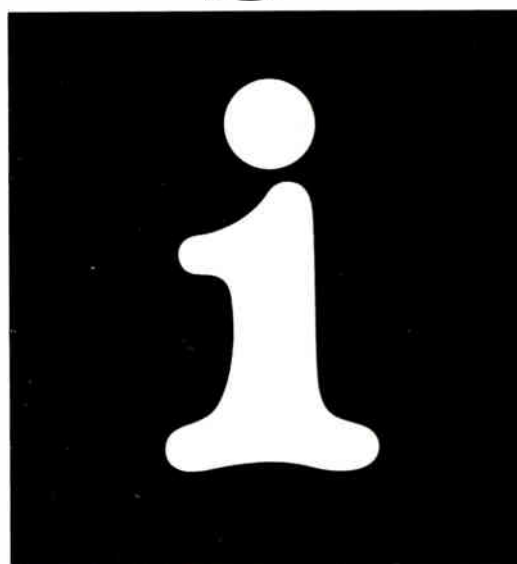

## Binary input determines pulse-generator frequency

by Mahendra J. Shah  
University of Wisconsin, Madison, Wis

A digitally programmable pulse generator for computer-controlled test systems and real-time control systems can be put together quite economically. The generator's output frequency is linearly related to the input binary number, and its output-pulse width can be varied over a 20:1 range by manually adjusting a potentiometer.

The circuit consists of: a low-cost 8-bit digital-to-analog converter having a current output; an integrated one-shot and its reset circuitry (transistor  $Q_1$ , resistors

$R_1$ ,  $R_2$ , and  $R_3$ , and capacitor  $C_1$ ); an op-amp integrator (including emitter-follower  $Q_2$ , resistor  $R_4$ , and capacitor  $C_2$ ); and a zero-crossing comparator (transistor  $Q_3$ , diode  $D_1$ , and resistor  $R_5$ ).

With transistor  $Q_1$  off and transistor  $Q_2$  on, the output current from the converter linearly discharges capacitor  $C_2$  to almost zero, turning transistor  $Q_3$  off. This causes  $Q_3$ 's collector voltage to rise toward the 5-volt supply level, firing the one-shot and causing its  $Q$  output to go high. Reset components  $R_2$ ,  $R_3$ , and  $C_1$  differentiate this output transition, producing a positive pulse at the base terminal of transistor  $Q_1$  and turning this device on.

For the interval (recovery time  $T_R$ ) that transistor  $Q_1$  remains on, capacitor  $C_2$  charges to its maximum voltage. Transistor  $Q_1$  then turns off, permitting the cycle to repeat. Meanwhile, the one-shot completes its timing cycle and generates a pulse of width  $T_P$ .

**Digitally variable.** Pulse generator offers adjustable output frequency and output pulse width; pulse frequency changes linearly with the binary input. When transistor  $Q_1$  is off and transistor  $Q_2$  on, converter output current discharges integrator capacitor  $C_2$  until transistor  $Q_3$  turns off. This triggers the one-shot, producing an output pulse and turning on transistor  $Q_1$  so that capacitor  $C_2$  can charge up.

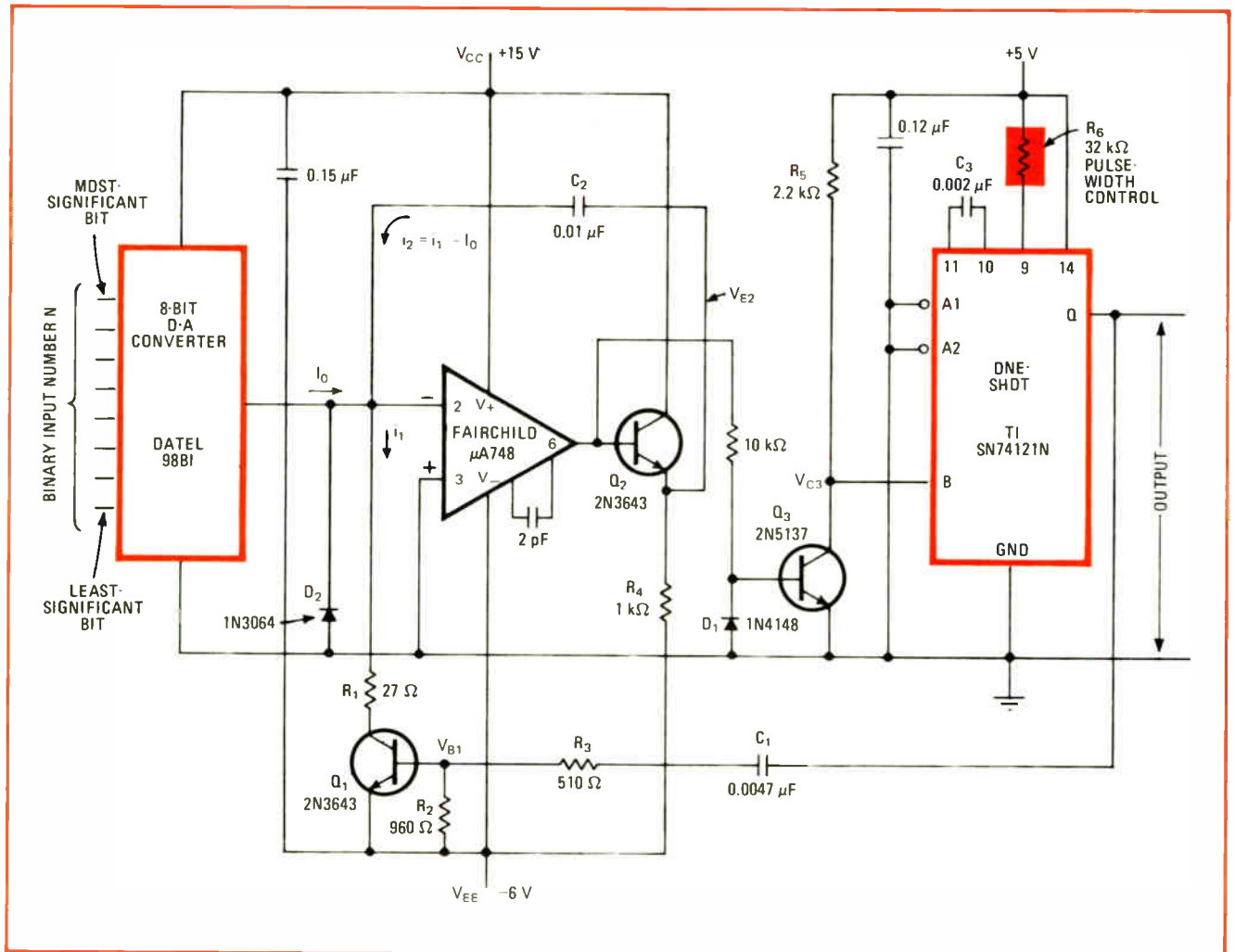

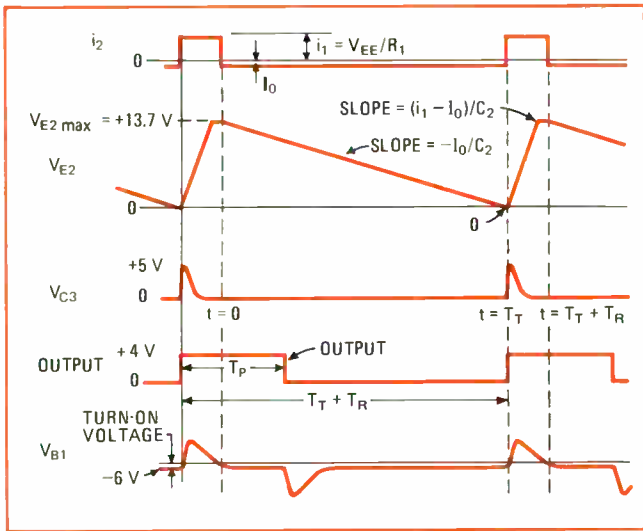

The length of reset interval  $T_R$  depends on the threshold voltage of transistor  $Q_1$ , the desired output-signal amplitude, and the time delay provided by resistors  $R_1$ ,  $R_2$ , and  $R_3$ , and capacitors  $C_1$  and  $C_2$ . The total output period is given by:

$$T_T = C_2 V_{E2max} / I_0$$

where:

$I_0 = kNV_{CC}$   
 where  $k$  is a constant (0.68 micromho), and  $N$  is the input binary number. The output-pulse frequency can be written as:

$$f = 1 / (T_T + T_R)$$

When the recovery time is much smaller than the total period, as is the case here, the output frequency for the

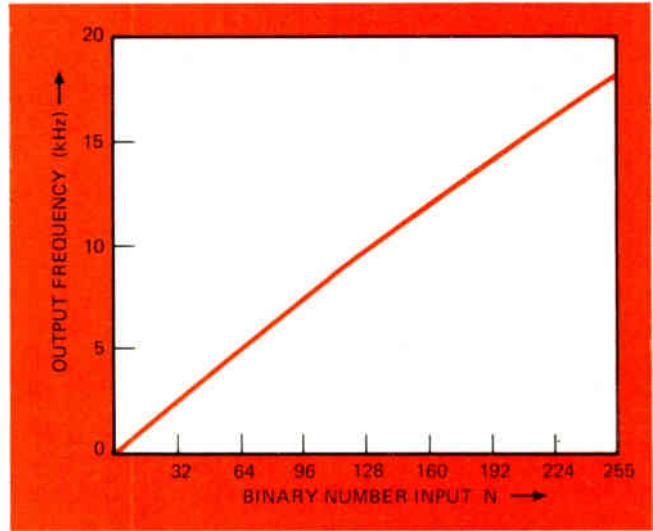

pulse generator can be approximated by:

$f = kN / C_2$   
 which is linear with respect to input number  $N$ , as indicated by the plot. Output-pulse width is variable and is given by:

$$T_P = 0.69R_3C_3$$

The largest value of  $T_P$  is limited by the one-shot's recovery time, as well as by the fact that  $T_P$  should be greater than the recovery time but smaller than the total period.

Diode  $D_1$  prevents the base-emitter voltage of transistor  $Q_3$  from exceeding its reverse breakdown rating. Diode  $D_2$  protects the d-a converter from possible damage from a large negative voltage at its output. □

## Automatic gain control operates over two decades

by Carl Marco  
 Martin Marietta Corp., Orlando, Fla.

A voltage-controlled junction-field-effect transistor permits an automatic-gain-control circuit to maintain a constant output voltage over a two-decade input-voltage range. The resulting agc circuit is intended for use in a radar seeker device to prevent amplifier overload as the target gets closer. Inputs can range from 40 millivolts to 4.1 volts peak-to-peak, but the output remains a nominal 0.2 v pk-pk.

As shown in the diagram, the JFET is located in the gain-control loop of noninverting amplifier  $A_1$ . The gain of this amplifier can be represented by:

$$A_V = 1 + R_F / R_I$$

where  $R_I$  is the series combination of the 1-kilohm resistor plus the FET's drain-source (channel) resistance:

$$r_{ds} \approx r_{ds(on)} / (1 - V_{GS} / V_{GS(off)})$$

For the FET used here,  $r_{ds(on)}$  is 25 ohms maximum and

$V_{GS(off)}$  is -10 v maximum. The channel resistance, therefore, stays linear for about half the range of  $V_{GS(off)}$ , but tends to become nonlinear at voltages above  $1/2 V_{GS(off)}$  because of the FET's departure from square-law behavior at high gate-source voltages. Amplifier gain can then be rewritten as:

$$A_V = 1 + (110 \text{ k}\Omega) / [(1 \text{ k}\Omega) + (0.025 \text{ k}\Omega) / (1 - |V_{GS}| / 10)]$$

$$A_V = 1 + 110 / [1 + 0.025 / (1 - |V_{GS}| / 10)]$$

The voltage divider formed by resistors  $R_1$  and  $R_2$  attenuates (by around 20:1) input signal amplitude to prevent distortion at the output. Since the inverting input of amplifier  $A_1$  tries to track its noninverting input, the positive input is the one that determines the FET's drain-source voltage. This channel voltage must be kept small to force the FET to remain in its triode region of operation. A shift in the FET's operating region would introduce large amounts of distortion.

Amplifier  $A_2$  is connected as a half-wave rectifier. When  $A_1$ 's output swings positive, diode  $D_1$  conducts, shunting  $A_2$ 's feedback resistor ( $R_3$ ) and bringing the junction of this resistor and diode  $D_2$  to zero. When  $A_1$ 's output goes negative, diode  $D_2$  conducts so that amplifier  $A_2$  has a gain of -1 and a positive output.

Resistors  $R_4$ ,  $R_5$ , and  $R_6$  provide full-wave rectifica-



tion for  $A_1$ 's output signal. Since the resulting rectified signal is supplied from a high-impedance source (and not buffered as is usually done), it is a current drive signal that can feed amplifier  $A_3$  directly. When the circuit is balanced, the current through resistor  $R_7$  is equal in magnitude but opposite in polarity to the full-wave rectified current.

The voltage divider, composed of zener diode  $D_3$  and precision resistors  $R_8$ ,  $R_9$ , and  $R_{10}$ , determines the signal level applied to amplifier  $A_3$ . This amplifier performs as a comparator/integrator, supplying the very large dc gain needed for the circuit's closed-loop feedback. Capacitor  $C_1$  prevents  $A_1$ 's output from oscillating, while resistor  $R_{11}$  allows filter capacitor  $C_2$  to be added without creating a "virtual" ground at  $A_3$ 's input.

Capacitor  $C_2$  prevents ac ripple from modulating the FET's gate voltage and producing distortion. Its value is chosen by trading off circuit-response time against the amount of filtering. Only a small change in  $A_3$ 's input current causes the circuit to adjust itself, producing whatever agc voltage is required to maintain an output of 0.2 v peak-to-peak.

When input-signal amplitude increases, the drive current to amplifier  $A_3$  also increases, causing  $A_3$ 's output

to go more negative. This raises the FET's channel resistance and decreases  $A_1$ 's gain, thereby maintaining the output level at 0.2 v pk-pk. An input voltage of 4.1 v pk-pk or higher cuts off the FET, making the voltage gain of  $A_1$  equal to unity. Amplifier  $A_1$  then tracks the input, attenuating it by a factor of 20. At an input level of 4.1 v, output distortion is only 1.1%.

For an input below 40 millivolts, the drive current to  $A_3$  becomes negative so that  $A_3$  provides a positive output, back-biasing diode  $D_4$  and bringing the FET's gate-source voltage to zero. The gain of amplifier  $A_1$  is then at its maximum value ( $1 + 110/1.025 = 107$ ), permitting the circuit to track the low-level input and producing an output of  $5.35 V_{in}$ .

The circuit's output-voltage level can be increased to 0.4 v pk-pk, for an input voltage range of 80 mv to 8.2 v pk-pk, by changing the voltage division at the comparator input—resistor  $R_7$  is connected between resistors  $R_8$  and  $R_9$ , rather than between resistors  $R_9$  and  $R_{10}$ . However, this change increases output distortion to 4.4% at the 8.2-v input level. □

Designer's casebook is a regular feature in Electronics. We invite readers to submit original and unpublished circuit ideas and solutions to design problems. Explain briefly but thoroughly the circuit's operating principle and purpose. We'll pay \$50 for each item published.

**FET in the driver's seat.** Automatic-gain-control circuit employs voltage-controlled JFET as the variable control element. The FET's channel resistance determines gain of amplifier  $A_1$ , in response to error voltage produced by comparator  $A_3$ . Amplifier  $A_2$  and the surrounding diode/resistor network perform as full-wave rectifier. The output is maintained at 0.2 volt for inputs from 40 millivolts to 4.1 v.

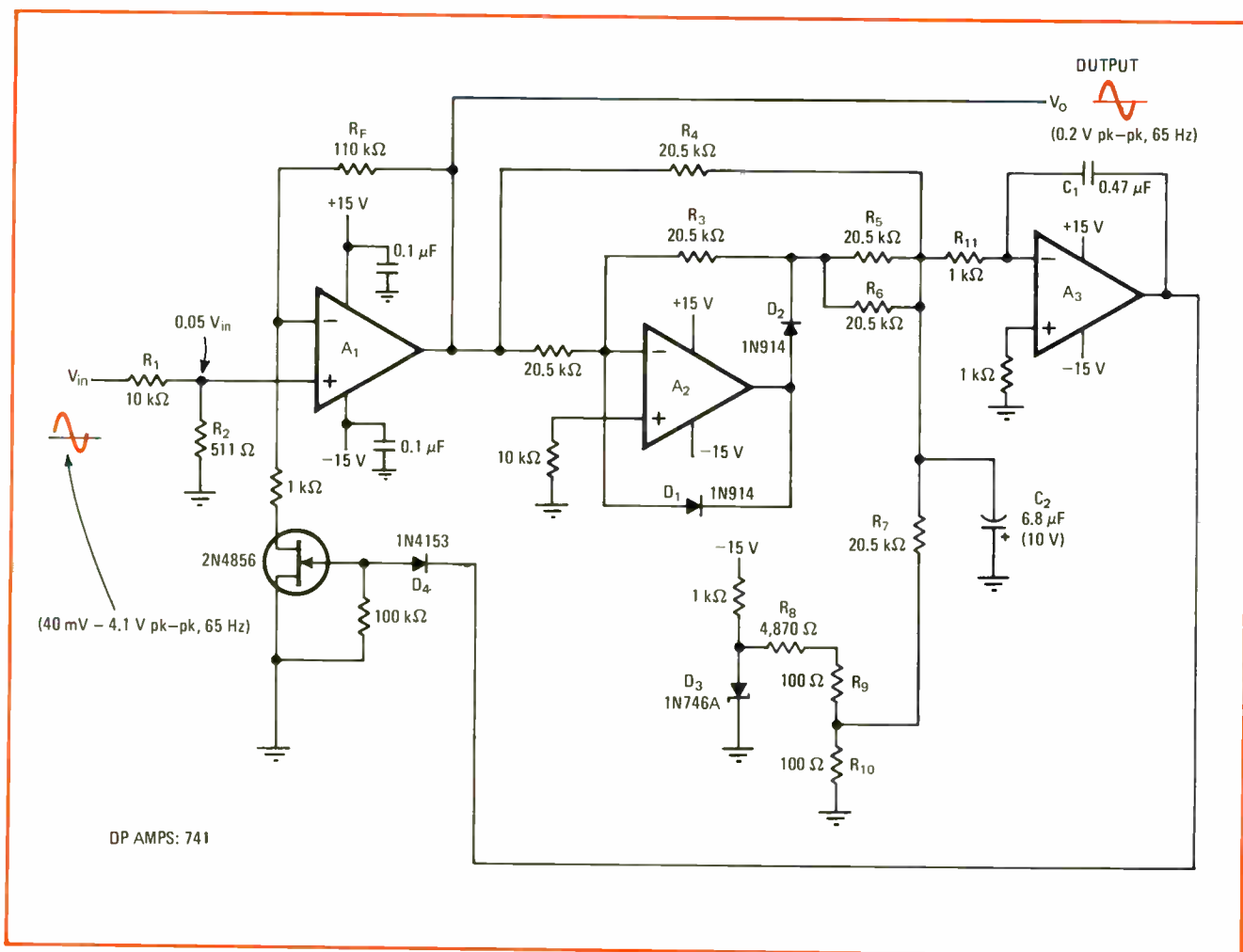

Meet our new series of  
high-frequency problem solvers . . .

# High-Performance VHF/UHF FET Family

Remember the U310? Some people call it the SuperFET. We introduced it a year ago: worst-case 75Ω input match VSWR of 1.25:1. Figure of merit  $2.35 \times 10^9$  typical. Third order intercept point of +29 dBm.

Now we've extended the U310 technology to produce an entire family of high-performance N-channel junction FETs. They're ideal for VHF/UHF applications such as the two circuits shown below:

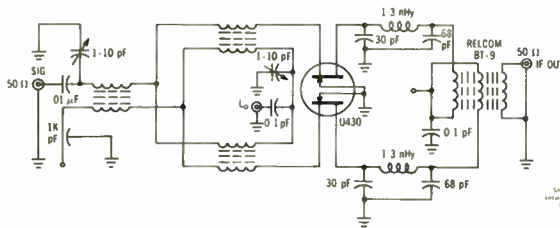

Single-balanced active mixer—100 dB dynamic range,  
+2.5 dB conversion gain, +32 dBm intercept point, 50-250 MHz.

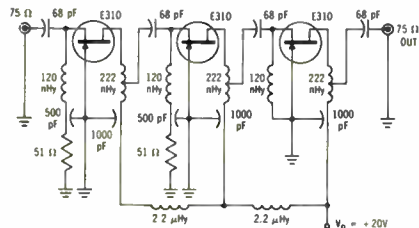

Wideband amplifier—225 MHz center frequency,  
1 dB bandwidth of 50 MHz, 24 dB gain.

U310 family characteristics include:

- High power gain (common gate)—16 dB at 100 MHz, 11 dB at 450 MHz.
- Noise figure = 3 dB typical at 450 MHz.
- High transconductance = 10,000 to 20,000 μmhos.

Select the right FET for your application from this array:

Type	Package	Feature	Applications	Price (1K units)
E308	Epoxy TO-106	$V_D = -1.0$ to $-6.0$ V $I_{DSS} = 12$ to 60 mA	High-frequency, small signal VHF or UHF source followers, amplifiers, mixers, or oscillators	\$ 0.57
U308	Metal TO-52			\$ 3.70
E309	Epoxy TO-106	$V_D = -1.0$ to $-4.0$ V $I_{DSS} = 12$ to 30 mA		\$ 0.75
U309	Metal TO-52			\$ 4.45
E310	Epoxy TO-106	$V_D = -2.0$ to $-6.0$ V $I_{DSS} = 24$ to 60 mA		\$ 0.75
U310	Metal TO-52			\$ 4.45
U310 family dual FETs have $V_D$ , $I_{DSS}$ , and $g_m$ parameters matched to 10%. Packages designed for easy insertion into printed circuit boards				
E430 Dual	Epoxy Si-105	$V_D = -1.0$ to $-4.0$ V $I_{DSS} = 12$ to 30 mA $g_m = 10$ to 20 mmho	VHF/UHF balanced mixers and cascode amplifiers	\$ 1.70
U430 Dual	Metal TO-99			\$ 9.95
E431 Dual	Epoxy Si-105	$V_D = -2.0$ to $-6.0$ V $I_{DSS} = 24$ to 60 mA $g_m = 10$ to 20 mmho		\$ 1.70
U431 Dual	Metal TO-99			\$ 9.95

Get the complete story on this advanced high-frequency FET family.  
For application notes and technical information

## write for data

Applications Engineering: (408) 246-8000 Ext. 802



### Siliconix incorporated

2201 Laurelwood Road, Santa Clara, California 95054

# We helped one perform an

Indirectly, of course.  
Here's what happened.

Our customer, a manufacturer of electronic medical equipment, needed to build 50 prototypes of his new electronic coagulator (a surgical knife that cauterizes blood vessels as it cuts).



The coagulator used a +12V supply, and the customer chose to use in his system the 78XX or the about-to-be-announced National LM340-12 fixed voltage regulator.

The problem was that our

competitor couldn't deliver the 78XX in time, and our LM340 wasn't ready yet.

So our Field Applications Engineer Gene Cloud biased up an LM309K with two resistors that could be eliminated from the board when the LM340-12 became available, without having to change the board.

So our customer got his prototypes done on time.

It was no big deal. It was all in a day's work for one of our Field Applications Engineers.

## **We make house calls.**

Our Field Applications Engineers (FAE's) are our consultants-at-large to the electronics industry.

They're not salesmen. When an FAE visits you he visits you to help solve problems, not to take an order.

They think on their feet. Like when Gene Cloud improvised a make-shift substitute for an unavailable part.

And they're pretty independent. Oh, we pay their salaries, but they're more like independent consultants than our employees. If you have a need that National can't satisfy, our FAE will recom-



# of our customers appendectomy.

mend a competitive product without batting an eye.

**Our operator in  
Denver, Salt Lake, Phoenix  
and Albuquerque.**

Our featured FAE this month, Gene Cloud, got his bachelors from Texas A&M, and his masters from Arizona State.

Before joining NSC he spent four years at Motorola, where he progressed from engineer trainee to group leader on TTL Research & Development, and finally to senior design engineer MOS-LSI using computer aided design.

An order-taker he's not.

## **More about our LM 340's.**

They're our new fixed voltage regulators, and they're terrific.

The height of simplicity (no additional circuits to perform the function), short-circuit proof, and virtually indestructible (can't be destroyed by having inadequate heat sink).

LM340's have an excellent match of coefficient of expansion and contraction. They'll withstand thousands and thousands of temperature cycles. This

results in excellent reliability.

Available in plastic and TO3 package in all temperature ranges, and in +5, 8, 12, 15 and 24 volts (also available in negative voltages, our LM320 series).



## **Hot off the linear press.**

Have you noticed the trend to multiple linear IC's in one package?

National first introduced its LM3900 quad current mode amplifier, and now has the LM339 quad comparator and LM324 quad op amp. The result is more performance at lower cost, with the added plus that all these devices are designed for operation on single power supplies like the LM340. Think what a creative FAE can do with these to solve your problems.

For further information on any of our new things, or any of our old things, write National Semiconductor Corporation, 2900 Semiconductor Drive, Santa Clara, California 95051.

Or, to heck with the expense, call (408) 732-5000.

# **National/linear**

# Hybrids for microwave gear get boost from thick-film technology

When their numerous advantages are fully exploited, thick films require less expensive production equipment than thin films, provide higher yields, and allow greater tolerance in fabrication processes

by O. J. Digiondomenico and Ted M. Foster, *Westinghouse Electric Corp., Baltimore, Md.*

□ For microwave applications, hybrid technology has achieved reliability levels 100 times greater than the discrete-circuit approach. What's more, circuits built with thin and thick films are smaller in size, lower in cost, and offer easy reproducibility. Armed with these advantages, hybrid microwave technology has left the developmental stage and now is well into the production phase.

So far, thin films have been widely accepted—thanks largely to this technique's capability for laying down precise conductor geometrics—while the advantages of thick films have not been fully harnessed. Yet thick films can deliver the high performance needed for devices operating in the 1–4-gigahertz frequency range—and can add a few bonuses as well. These extras include a more than doubling of production rates, an increased yield through continuous-run fabrication, and a

higher tolerance to dust, contamination, and surface imperfections.

## Laying down thin film

Most often, thin-film deposition on a ceramic substrate is done in a vacuum chamber such as the one shown in Fig. 1, by evaporating or sputtering conductive, resistive, or dielectric material on a carefully cleaned substrate. The vacuum prevents oxidation and allows the molecules of material being deposited to travel to the target with minimum collisions with gas molecules.

In the case of evaporation, the material to be deposited is heated by a resistive heating unit until the molecules acquire the thermal energy necessary to leave the surface at a suitable speed to ensure deposition. Sputtering differs from evaporation in that an electrical field accelerates the positive gas ions toward a cathode that is covered with the material to be deposited. An ion striking the cathode causes a molecule to be ejected and deposited on the substrate.

Both evaporation and sputtering are relatively expensive and are even more costly when the hybrid is to be a microwave circuit. For example, consider the case of metalizing a substrate for 1-gigahertz operation. Because the current density beneath the surface of a conductor falls off exponentially, about three skin depths are required if the resistive loss is to be kept low.

One skin depth is defined as the distance between the surface and the level beneath the surface at which the current has diminished to  $e^{-1}$  of its surface value. At three skin depths, the current is down to  $e^{-3}$  or about 5%, which is negligible, so that current flow can be thought of as confined to a layer that is three skin depths thick. (Skin depth varies with frequency as  $1/f^{1/2}$ , where  $f$  is the frequency.) For devices operating at 1 GHz, three skin depths equal about 8 micrometers. This is 10 to 100 times thicker than the conductor layer used at lower frequencies.

To build up this thickness, a lot of material must be sputtered or evaporated because only a fraction of what is propagated actually lands on the substrate. The rest coats the walls of the vacuum chamber, and when the material is gold, costs can really run high—\$100 to \$200 for a single deposition covering one side of 20 substrates.

A second disadvantage of evaporated films for micro-

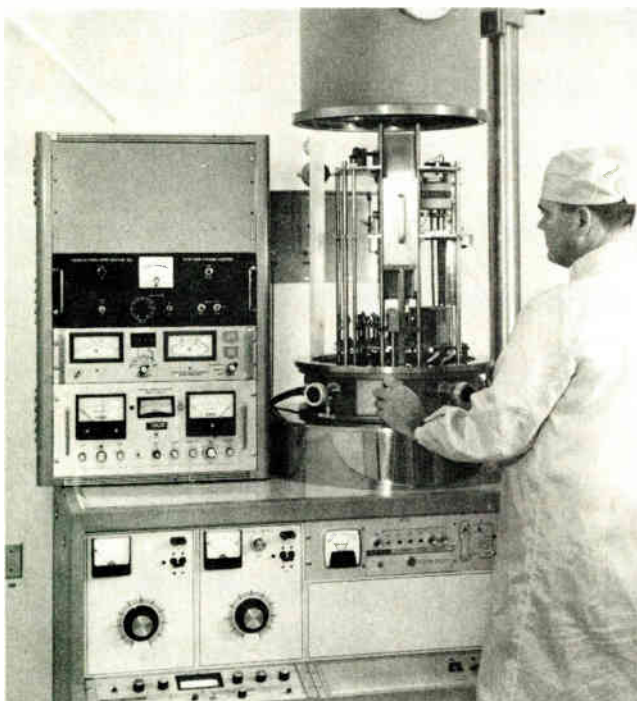

1. **Elegant.** Vapor deposition system—typical of the costly equipment required to deposit thin films, a process challenged by thick-film technology—contains fixturing to manipulate substrates and masks without breaking the vacuum. Film-thickness monitoring equipment is mounted in the rack cabinet to the left.



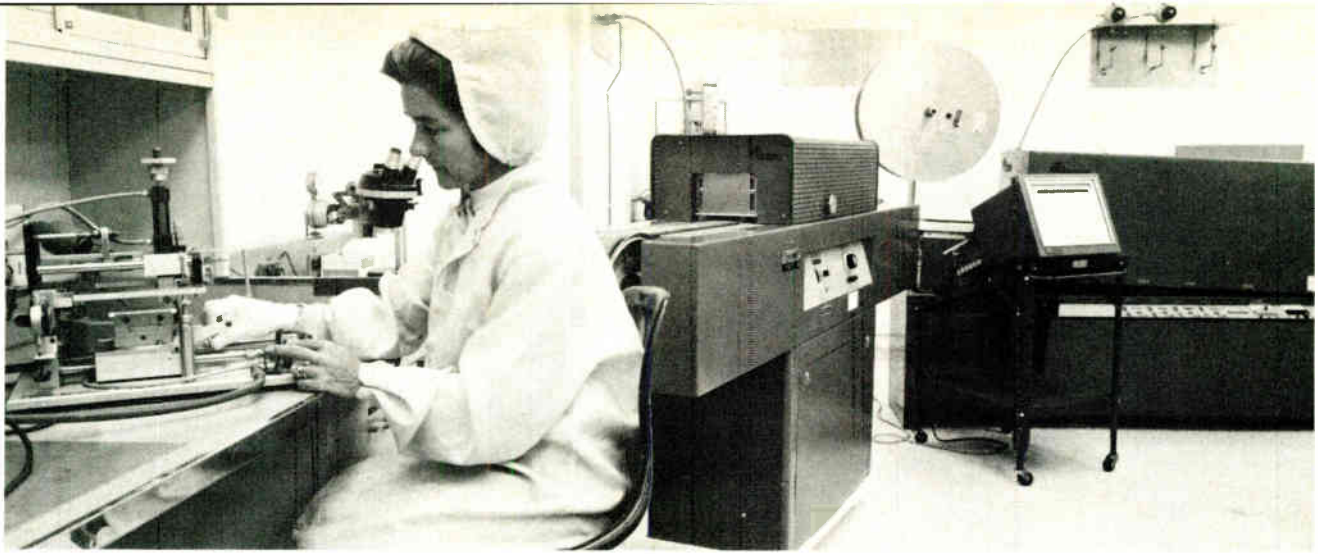

wave circuits is that their resistors and capacitors require very smooth substrates to prevent discontinuities in the resistive and dielectric layers that develop due to microscopic peaks and valleys in the substrate's surface. Such discontinuities can degrade performance.

At low frequencies, these discontinuities pose little problem because a glaze can be applied to smooth out the surface roughness. But this won't work at microwave frequencies, because the glaze is too lossy, and microstrip performance will suffer considerably. The alternative is to use polished alumina or sapphire substrates for thin-film microwave fabrication, but this is an expensive route.

On the other hand, thick films don't require very smooth substrates because the conductive, resistive, and dielectric layers are a good deal thicker than the variations in the substrate surface. Thus, the designer may use inexpensive substrates.

Another problem is that thin-film fabrication is essentially a batch process, which is highly vulnerable to loss and, thus, low yield. Vacuum pumps work for several hours to reduce the pressure to the point where evaporation can begin. However, if anything goes wrong, the whole batch can be ruined. On the other hand, the thick-film process is normally a continuous-run operation open to inspection after each stage: printing, drying, and firing. Therefore, adjustments to the process can be made before a large number of substrates are ruined.

As for throughput, thin-film batches are relatively small, resulting in a low production rate. A typical \$20,000 vacuum chamber produces 50 to 100 substrates with thick evaporated metalization in an eight-hour shift, and these substrates will still require etching to define the circuitry. However, a typical \$10,000 thick-film setup, consisting of a screen printer and belt furnace, can produce 250 to 500 substrates, with resistors and conductors already defined, in an eight-hour shift.

Thin films require careful attention to cleanliness. All dust particles and chemicals that might affect adhesion or performance must be removed, and this requirement means thorough cleaning without residue. And if cleaned substrates are not processed promptly they must be cleaned all over again. What's more, since the substrate must remain contamination-free throughout the fabrication process, the air in the thin-film production area must be well filtered, the substrates handled

**2. Squeezing by.** Thick-film pastes, which become conductors, resistors, and capacitor dielectrics, are pressed through the stainless-steel mesh in thick-film printer at left. Meshes as fine as 500 lines per inch enable line and space definitions as small as 4 mils. The circuit then enters the dryer (center) and then the furnace (right).

on laminar-flow clean benches, and personnel handling the substrates must wear laboratory coats, hats, and gloves so that they don't introduce dust particles into the substrates' environment. This all adds up to a great deal of expense.

Thick films are more tolerant about cleanliness problems for two reasons. First, film adhesion is less susceptible to substrate contamination because much of the contamination is burned away in the firing process as the glass fuses with the substrate at the high firing temperature. Second, thick films are many times thicker than most particles and are not severely affected by them. But a single dust particle will cause a break in the surface of a thin film.

### Laying down the lines

At microwave frequencies, energy is often coupled between adjacent conductor lines. With line width and spacing critical, it is crucial that the film technology provide precise dimensions, a requirement that screen printing of thick film can meet.

Thick films are printed by forcing a metal-glass paste through a screen onto a substrate with a squeegee (Fig. 2). For the first step, the screen, made of stainless steel wire, is coated with a photographic emulsion, which fills the mesh. Then artwork defining the desired circuit is held against the emulsion in a vacuum frame, and the emulsion is exposed to an intense light. When the emulsion is developed, areas not exposed are removed, leaving unfilled mesh.

Next the screen is stretched tightly and mounted on a frame, which is then mounted over a substrate on a printer. The paste is spread on top of the screen and wiped across it with a squeegee at a controlled rate and pressure. This wiping forces the paste through the open mesh onto the substrate.

The substrate is then dried by placing it in an oven for about 10 minutes at 175°C. After drying, the substrate is passed through a precisely controlled furnace by conveyor belt. The temperature in the furnace rises slowly to a plateau at a temperature chosen to fuse the metal particles and the glass with the substrate, typi-



cally 750°C to 1,000°C. A gold paste, for example, might be fired at 875°C for 6 minutes.

Lines laid down by the thick-film process depend on the size and the spacing of the wires that form the screen mesh. Screens with as many as 500 wires per inch are available for fine-line printing. In practice, at least

### Microstrip: a slow starter

Microstrip seems a natural for hybrid fabrication because its open-face construction facilitates both deposition of film on the substrate and attachment of discrete components. But despite the fact that both stripline and microstrip configurations were available to microwave designers in the early 1950s, the use of stripline grew rapidly, and microstrip was almost entirely ignored.

One reason is that stripline, having a balanced double-ground-plane configuration, is more easily adaptable to coaxial systems. In addition, excellent dielectric materials along with special metal-to-dielectric bonding processes developed rapidly, offering the microwave designer a transmission-line medium with low microwave losses and uniform dielectric constant. What's more, the stripline approach lends itself readily to reproducible designs, and it was promptly put to work producing mixers, electronic switches, and filters for antennas and antenna-feed systems.

The approach does have one major disadvantage. Since it is a double-ground system, perfect symmetry must be maintained if propagation is to be only by the minimal-loss transverse electromagnetic mode (TEM). And, unfortunately, stripline is extremely susceptible to a parallel-plate mode in which a difference of potential exists between the two ground planes. One can eliminate this undesirable lossy mode by placing closely spaced ground-plane shorting pins in close proximity to the center conductor. Nonetheless, the susceptibility to unwanted-mode generation presents a handicap where one wishes to attach devices such as diodes, transistors, and capacitors to the center conductor.

Microstrip, on the other hand, is an open-faced configuration, and component attachment is simple. Also, being an unbalanced system, the parallel-plate mode cannot exist. But its mode of propagation is not pure TEM. In fact, for the nonceramic materials available two decades ago with low loss and low dielectric constant, so much of the electromagnetic energy was propagated in the air space outside the dielectric medium that radiation losses became very severe. This was probably the principal reason for the limited application of the microstrip approach in the 1950s.

During the mid-1960s, advances in the low-noise and power-transistor state of the art and in device-packaging techniques prompted designers to have another look at the microstrip approach as an open-faced transmission-line system. By then, insulating materials were available with much higher dielectric constants. The two primary ones were sapphire and 99.5% alumina ceramic. The effect of the higher dielectric constants was to confine more of the propagating energy in the insulating region between the center conductor and the ground plane. This reduced radiation and brought about the much lower-loss microstrip systems used today.

two mesh openings are required for lengthy lines because of the difficulty in aligning circuit artwork with mesh openings over long distances. Thus, line widths as narrow as 4 mils can be printed routinely with a tolerance of  $\pm 1$  mil, which fulfills most requirements. But there are circuits that require line widths and gaps to be controlled to  $\pm 0.25$  mils or less for proper performance. For instance, interdigital filters, such as the S-band version shown in Fig. 3, require gap tolerances of  $\pm 0.25$  mil to control coupling between the elements and, hence, the filter response.

Some parallel line couplers and filters require tolerances of  $\pm 0.1$  mil. Here's where conventional thick-film screening won't do the job. But there is no need to revert to expensive thin film because it is quite practical to screen-print and fire a fine-grain conductive layer over the entire substrate and then use photolithography to etch the desired pattern. With proper care in the etching process, line widths and gaps can be controlled to  $\pm 0.1$  mil. In practice, precautions are taken to ensure a thin and uniform photoresist layer, a precise image exposed on the photoresist, and a carefully timed etch process.

Holes required for transistor placement, rf grounds, and dc returns are punched through the ceramic prior to firing. And since the variations of the hole positions and dimensions produced by subsequent firing are predictable, there is little problem in meeting required tolerances.

Holes can also serve as grounding points on the substrate, as can the substrate edge. The procedure here is to screen a thin paste onto the substrate and let gravity or a vacuum draw the material into the holes and over the edges. Then the substrate is dried and fired. Both the viscosity and the thermal expansion coefficient of the paste are carefully selected so that flow is uniform over the surfaces and adhesion survives the thermal stresses during the cool-down after firing or in a later temperature cycle. Often a second application is neces-

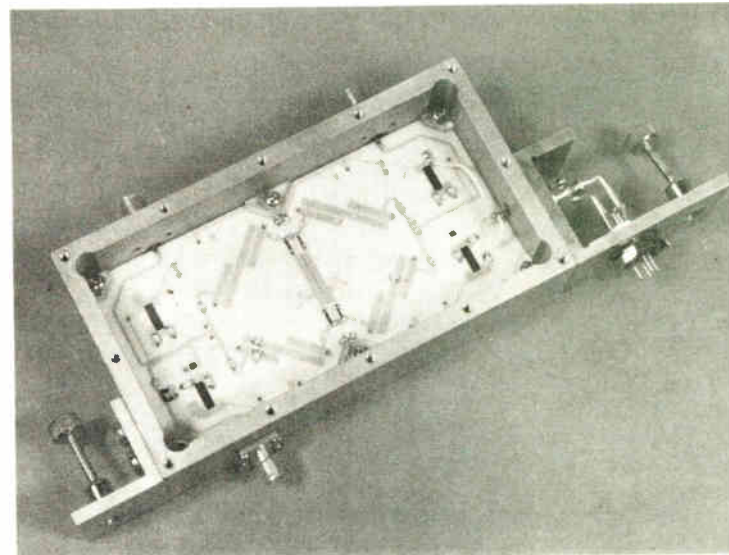

**3. Tight tolerance.** Thick-film S-band interdigital filter requires spacing between conductors to be controlled to 0.25 mil. And some parallel-line couplers require gap tolerances controlled to 0.1 mil. But screening and firing a fine-grain conductor layer, followed by an etch process, avoids the need to turn to thin film.

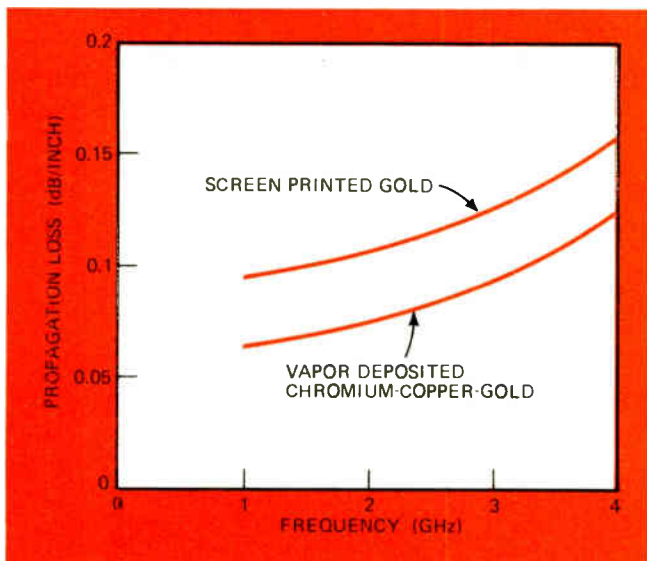

**4. All is not lost.** Screen-printed thick-film gold conductors show higher losses than rival thin-film alloy, but in most microwave hybrid applications, the difference is not significant because critical signal paths are kept short. Measurements were taken on a 50-ohm microstrip line, 8 inches long.

sary to achieve a film thickness sufficient for low-loss requirements.

### Conductor pastes

There is a whole range of thick-film pastes—conductive, resistive, and dielectric—and they vary in type and proportions of metal, glass binder, and solvent used. Popular conductors are gold, silver, platinum, and palladium, either alone or in various combinations. Despite the high cost of gold and its tendency to dissolve in tin-lead solder, it is the best choice for microwave application because of its low loss and long-term stability. However, soldering must be performed with care, often with the aid of indium-alloy solders. They help prevent removal of gold from the substrate during the soldering operation.

Thick-film conductors adhere quite well to a substrate. As an example, a typical conductor pad can withstand a pull of 20 pounds per 100 square mils. However, drying temperatures must be raised slowly to prevent the solvent from leaving small bubbles in the conductor film as it evaporates.

Although thick-film conductors have slightly higher propagation loss than the thin-film type, the difference is small and in most cases unimportant (Fig. 4) because line lengths are usually quite short. Part of the difference is due to the fact that copper has higher conductivity than gold. For critical applications where low loss is required, copper can be deposited in thick-film form by using a nonoxidizing atmosphere in the furnace during firing. The loss measurements displayed in Fig. 4 were made on a 50-ohm transmission line, 8 inches long over a frequency range of 1–4 GHz. The thick-film conductor is gold, approximately 12 micrometers thick. The thin-film conductor is a three-layer composite, approximately 8 micrometers thick: 500 angstroms chromium, 500 angstroms gold, 8 micrometers copper, and 500 angstroms gold. The chromium layer aids adhesion to

the substrate. The second layer, gold, prevents interaction between the chromium adhesion layer and the main copper conductor layer. The top gold layer protects the copper from oxidation.

### Thick-film resistors and capacitors

Resistive pastes are composed of various combinations of metals and metal oxides combined with glass binders and organic solvents, with resistivities ranging from 1 ohm/square to  $10^8$  ohms/square or more. Resistors can be printed either before or after the conductor paths are printed, but are usually printed last so that they don't have to undergo a second firing, which may cause an erratic change in resistor value. Once resistors are dried and fired, they can be trimmed, if necessary. Trimming can be accomplished either by removing resistor material with abrasive powder carried by a jet of compressed air or by burning away resistor material with a laser. Resistor can be trimmed to tolerances of 0.1% or better.

Thermal stability of thick-film resistors is excellent, thanks to the glass, which helps hold ohmic values steady even at elevated temperatures and high humidities. After an initial resistance change that occurs within the first few hours after firing, the resistance remains constant within 0.1% to 0.2% indefinitely.

Long-term measurements of resistors typically show changes of only 0.15% after 24,000 hours. Also, a bake at 150°C for 1,000 hours produces a change of less than 0.15%. Resistors moisture-tested under load to MIL-STD 883 have shown changes of only 0.15%. The temperature coefficient of resistance of thick-film resistors can be as low as 25 ppm/°C over a temperature range of 50°C to 150°C, which is a good deal better than most other resistors.

Thick-film dielectric pastes serve admirably in hybrid microwave applications. Those with low dielectric constants insulate conductor crossovers where high capacitance is undesirable. Other pastes with higher dielectric constants are used for capacitors. Pastes with dielectric constants of approximately 10 are useful because the capacitance required for low impedance at microwave frequencies is only 50 to 100 picofarads; surface area is

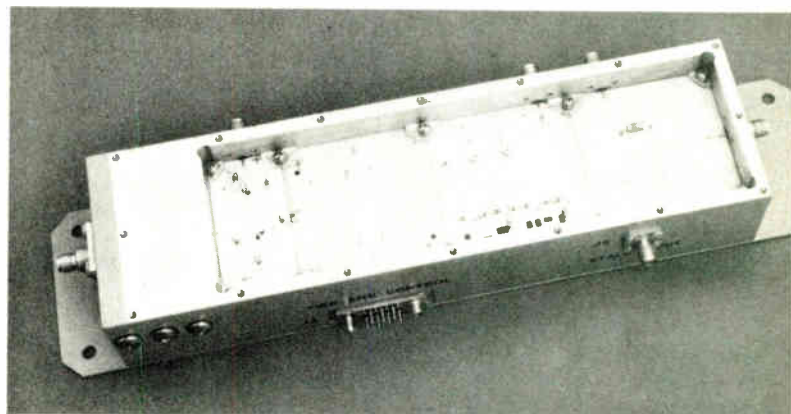

**5. Thick-film radar.** Microwave receiver covers the frequency range of 1,215 to 1,365 MHz. Sections, from left to right, are monitor coupler, two stage rf amplifier, sensitivity-time-control attenuator, and balanced mixer. The coaxial diode protector is in the housing to the left. Going thick film yielded a 2:1 reduction in cost.



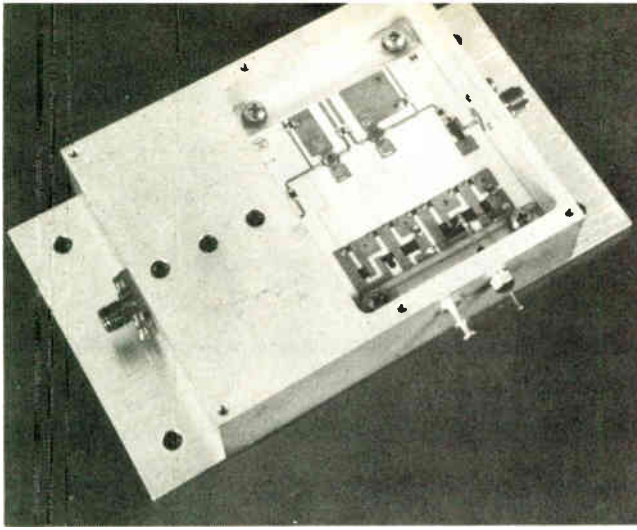

**6. Successor to a paramp.** High-performance amplifier with coaxial protective limiter has 25-dB gain and a noise figure of 2.75 dB maximum over the range of 1.2 to 1.4 GHz. Two-stage amplifier is mounted on the 2-by-2-inch high-dielectric substrate secured in the housing. Screened conductors are high-conductivity thick-film gold.

about 0.1 inch square. One low-noise hybrid microwave amplifier using thick-film bypass capacitors was found to have better performance than a similar amplifier using discrete capacitors because the thick-film capacitors provide a large-area, low-impedance path to ground. But thick-film capacitors don't adapt as well to inter-stage coupling as to bypassing because the tolerance requirements are usually tighter. What's more, if the areas are large or registration is poor, perturbations may be introduced in the rf transmission path.

Yields of thick-film capacitors are good and will approach 100% if a double-print technique is followed. By printing and drying the dielectric layer twice before firing, there is a very low probability that a pinhole in one layer will coincide with one in a second layer. Reproducibility of a particular capacitance value depends a great deal on film thickness, but it is unimportant for bypass applications because the capacitance must merely exceed some minimum value to be usable.

### Putting it together

Component-attachment techniques for thick and thin film don't differ very much. Components with metal terminations or leads can be attached by soldering, welding, or conductive epoxy, whereas bare-chip devices can be attached by using heat, ultrasonic energy, or epoxy. Wire-lead attachment can be accomplished by the familiar thermocompression or ultrasonic bonding.

Most microwave integrated circuits are active devices packaged by the device manufacturer, and so they are well protected for handling. Soldering can be performed conventionally with small irons, or reflow-soldering paste may be used. Another technique is microwelding, which works best for small leads, such as beam leads. Here, a controlled amount of energy is applied to the lead with two electrodes. Care is taken to apply just enough energy to form a reliable bond, but not so much as to destroy the lead.

Substrate mounting is very important for some hybrid microwave circuits because often the ground plane on the back of the substrate is part of the circuit. If energy enters the region between the ground plane and the mounting enclosure, circuit performance may be ad-

versely affected by undesirable coupling of stray energy from input to output.

Of the several ways to mount the substrate in its enclosure, two popular methods are corner clamps and soldering. Clamps make it easy to remove a substrate for repair, but care must be taken to ensure a reliable, uniform connection between the ground plane and the enclosure. Or the substrate may be soldered in place, but there is a danger that thermal stress will later break the bond. Of course, once soldered, removal and replacement is a lot harder than with corner clamps. Substrate clamping is satisfactory for most applications. Over 1,200 microwave modules with a total of 3,000 clamped substrates have been made and tested successfully, and no clamp failures have occurred in 1 million device hours of operation.

### Putting thick film to use

A subsystem which makes full use of the thick-film techniques is the integrated microwave receiver shown in Fig. 5, which is designed to operate over the frequency range of 1,215 to 1,365 MHz. Going to thick film resulted in a 2:1 reduction in cost, compared with traditional discrete-component fabrication, and size was reduced considerably. The receiver has the flexibility to allow its use with a wide variety of L-band radars. Performance characteristics are better than those possible in non-integrated receivers. The receiver is packaged in an environmentally sealed, rf-shielded enclosure, and solid-state design techniques were teamed with hybrid fabrication methods to create a single subsystem.

This unit contains a coaxial diode receiver protector, monitor coupler, sensitivity time control (STC) attenuator, two-stage rf amplifier, and a balanced mixer. The control circuits required for the STC attenuator are contained in the bottom cavity of the housing.

The receiver rf circuits occupy four high-dielectric substrates (99.5% alumina). The transmission-line patterns are screened and fired by using high-conductivity, thick-film gold ink. Then the semiconductor devices, in miniature hybrid packages, are bonded in place by thermocompression. Maintenance is simplified because any of the four substances can be removed individually for repair or for circuit updating.

The coaxial receiver protector, which is a diode limiter, is an integral part of the receiver housing and is noise-matched directly to the microstrip circuitry. It requires no external bias or triggers, and it operates rapidly for signal levels up to 10 kilowatts peak and 10 watts average. The monitor coupler is a 20-dB parallel line coupler, into which a monitor signal can be applied for transmission through the receiver. The STC attenuator provides voltage-controllable, variable attenuation from 0 to 50 dB, with a linearity of  $\pm 2^\circ/\text{dB}$ . This device is designed to yield a linear dB/volt relationship with the drive signal.

The amplifier substrate contains two low-noise transistor stages with a noise figure of 3 dB and a gain of 20 dB. The over-all noise figure, including the diode limiter, is 4.5 dB. The 1-dB compression point of the amplifier is +13 dBm (20 milliwatts).

The results achieved with the L-band receiver spurred development of a solid-state L-band amplifier



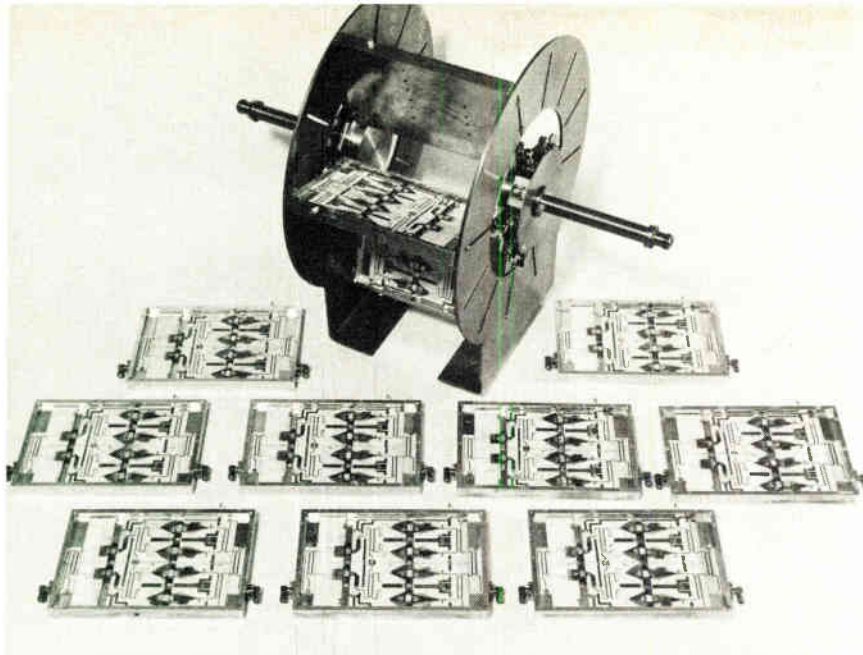

**7. High-power ferris wheel.** Each circuit module in the foreground (above) contains four 25-watt hybrid amplifiers. The outputs of each of the modules are combined to develop 100 watts. Twelve of these units are then combined to deliver 1-kilowatt peak power.

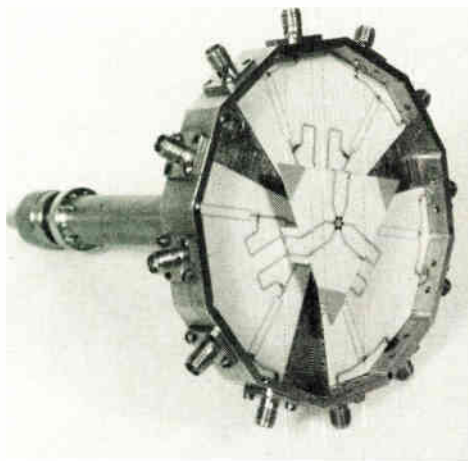

**8. Divider/combiner.** Input signal is divided into 12 equal parts by unit (left) to drive 12 100-watt amplifiers. A similar device combines the outputs from the 12 amplifier subsections. N-way design holds loss in combine or divide mode to 0.5 dB maximum.

to serve as a direct replacement for a parametric amplifier in an existing system. The main objective here was to achieve a significant increase in reliability. The unit that was developed, shown in Fig. 6, contains a two-stage, low-noise transistor amplifier preceded by a coaxial limiter similar to the one in the L-band receiver.

The low-noise amplifier comprises two transistor stages mounted on a high-dielectric 2-in.-square ceramic substrate. Again, screen techniques applied the high-conductivity thick-film gold ink to form the transmission-line circuit. Resistive inks were added to form the resistors. Since the thick-film hybrid approach minimizes the number of components requiring bonding, over-all reliability is greatly enhanced.

Another feature of this unit is the screen-printed attenuator that follows the output-transistor stage. Its purpose is to isolate this stage from its terminating load. Once fired, the resistive paste is laser-trimmed to form a "pi" attenuator at very little additional cost. The coaxial diode limiter, which is again an integral part of the housing, is noise-matched directly to the microstrip amplifier. An over-all maximum noise figure of 2.75 dB is achieved over a 15% bandwidth (1.2–1.4 GHz).

A total of 64 of these units has been delivered to the customer, and the device has accumulated up to the present time in excess of 750,000 operating hours. There

have been no failures. This is a demonstrated mean time between failures of 338,000 hours with a 90% confidence factor.

The power amplifier pictured in Fig. 7 is another example. It is a breadboard, 1-kw peak-power, L-band amplifier. By incorporating the unique thick-film power divider/combiner arrangement shown in Fig. 8, the 1-kilowatt peak power level, with 1-millisecond pulse widths, is achieved with an over-all amplifier efficiency of 30%. Actually, four 25-watt transistors are combined through appropriate circuitry to produce each of the 100-w amplifiers shown in Fig. 7. Then, 12 of the 100-w amplifiers are combined by using a coaxial power divider (shown in Fig. 8) to produce the full kilowatt output, including all combining losses.

As is evident, the list of microwave components and subsystems to which the thick-film technique have been applied is rather extensive. What's more, to illustrate the technique's broad range of usefulness, the approach has also proved applicable to the design of a 13-bit Barker code-compression board—which contains a 30-MHz hybrid i-f limiter/amplifier module, followed by a surface-wave decoder and a hybrid i-f amplifier and detector—and a phase-shifter driver, used to provide the proper current pulse to drive a 5.5-GHz ferrite phase shifter for phased-array-radar applications. □

# THE CHEAPEST MINICOMPUTER VS. THE CHEAPEST SOLUTION

Before you buy a minicomputer, do yourself a favor. Make a very fundamental decision. Do you want the cheapest machine you can find or the cheapest total solution to your problem?

We think it's the latter.

Because the cheapest machine is just that. It's raw hardware at a rock bottom price. And virtually every minicomputer supplier offers a product like this. Including us.

But your goal should be to get the lowest cost total solution for your problems. And paying less now could cost you more later if the machine you buy has been designed for rock bottom price alone. Be careful. You should look beyond raw iron. You need a computer package that saves you money at both ends. One that's been designed with the total solution in mind. A powerful blend of hardware, systems software, and extensive peripherals.

You also should look for a supplier that has built his business on fulfilling this need. That's us.

### **The world's most powerful mini.**

We've developed the most effective minicomputer package you can buy: the SPC-16. Six different models to choose from and the *most powerful* instruction set available anywhere.

The SPC-16 does more things in less time with less memory. That's why it can actually save you money on your total system.

And we've recently enhanced the capability of our SPC-16 family with a number of new products including:

Multi-user BASIC, and the real-time, multi-programming capability of our RTOS-16 operating system. And our new extended FORTRAN IV.

New peripherals like a low speed line printer, head per track disk and a floppy disk.

High speed floating point processor,

8K memory board, heavy duty process I/O boards, A/D and D/A converters and digital I/O boards.

And completely new asynchronous communications multiplexer system.

Here's another reason for choosing us:

### **We've already had our tryouts.**

Today all the big mini manufacturers are announcing that they're "in the systems business."

We've been in it from the start.

And while everybody else was churning out iron, we were building systems and piling up applications know-how.

We got involved with our customers' problems. We listened and we learned. Then we rolled up our sleeves and went to work.

As a result our people don't have to be retrained for this new approach because it isn't new at all. Not to us.

Over the years we've supplied systems to solve some very tough problems in the automotive industry, in production machine control, in electrical testing and communications. And this experience has built a fund of systems expertise no mini manufacturer can match.

There's a good chance we already have a system that fits your needs. If not, we have the know-how to design it for you. Or *with* you.

In fact, we can probably utilize our experience to solve your system problem faster than others can deliver a bid.

### **Read all about it.**

If you're determined to reduce systems cost, we have a book for you. It's titled "The Value of Power." It covers everything you'll need to know to make the right decisions, for the right reasons, to end up with the right system for your specific needs. It's free.

Write for a copy. The address is 1055 South East Street, Anaheim, California 92804. Or phone (714) 778-4800.

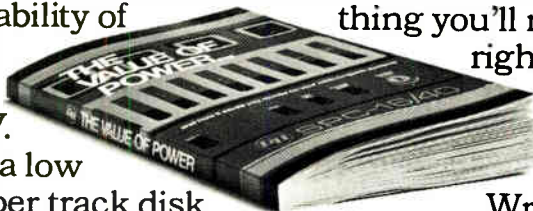

# General Automation



# We've got designs on the analog CMOS market.

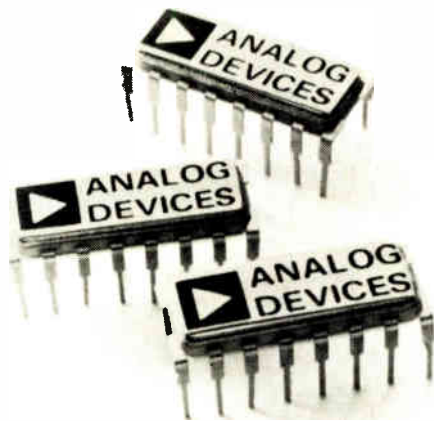

## They begin here.

With CMOS switches and multiplexers that have an ultra-low standby power dissipation of only  $30\mu\text{W}$  (max) at  $\pm 15\text{V}$ . And they're TTL, DTL, and CMOS compatible. So you get maximum flexibility in your logic design without sacrificing the benefits of low-power CMOS. Each comes in a 16-pin DIP and will operate in the military and commercial temperature ranges.

First there's the AD7510 quad switch. It's got four independent analog switches with ON resistance of 70 ohms, and leakage currents of 200pA. So it's ideal for sample and hold circuits, D/A converters and numerous other switching functions. AD7510. Priced from \$13.00/1-49 units.

Then there's the AD7501. And the AD7502. Simple eight channel and differential four channel multiplexers respectively. And they deserve that respect — with an ON resistance guaranteed

**Analog quad switches.  
Analog multiplexers.  
 $30\mu\text{W}$ .**

below 300 ohms, and leakage currents of only 100pA (typical). They'll do anything from analog data multiplexing to digital CMOS multiplexing. AD7501 and AD7502. Priced from \$28.00/1-49 units.

We can send you samples and data sheets. Or, if you have a special linear circuit design that could use a CMOS solution, just give us a call.

## And there's more to come.

We design, make and sell more analog circuits than anyone else: modular and IC. Analog CMOS is just a logical extension of this experience. And in the future we'll show you imaginative uses for analog CMOS, as well as FET and bipolar technology, to give you the special and often unique performance you're looking for. At the price you're looking for.

Analog Devices, Inc., Norwood, Mass. 02062



## Call 617-329-4700

for everything you need to know about analog CMOS.

# Designing toroidal transformers to optimize wideband performance

Broadband circuits, now widely used in mobile radios and CATV equipment, often require efficient impedance-matching transformers; the development and testing of a vhf unit illustrates an effective design approach

by Herbert L. Krauss and Charles W. Allen, *Virginia Polytechnic Institute and State University, Blacksburg, Va.*

□ Toroidal transformers, which are often needed in circuits with more than octave bandwidths operating at frequencies to several hundred megahertz, are widely used but little understood. Recently, an experimental test system requiring a bandwidth of 150 kilohertz to 100 megahertz needed to have the 50-ohm input and output of its wideband vhf amplifier matched with a 200-ohm transmission line. The development of a toroidal transformer that would do this matching uncovered certain design principles and construction techniques that could easily be extended to other applications of the device.

A similar need arises, for instance, in amplifiers for mobile radio and cable television systems. There it is often necessary to transform the relatively low input and output impedances of bipolar transistors by a factor of 4 or 6 in order to obtain the 50- or 75-ohm impedance required for transmission lines.

## Transformer model

A wideband model for a toroidal 4:1 impedance matching transformer was first investigated by Ruthroff<sup>1</sup> and, more recently, by Pitzalis, Horn, and Baranello.<sup>2</sup> This transformer consists of a twisted-wire-pair

transmission line wound on a ferrite core (Fig. 1).

Its analysis makes use of equivalent circuits that describe operation in both high-frequency (Fig. 2a) and low-frequency (Fig. 2b) ranges. At higher frequencies, the permeability of the ferrite core decreases, and conventional transformer action becomes less effective. Nevertheless, the two windings are coupled as a transmission line, and the device still behaves like a transformer, provided the length of the transmission line is kept well below half a wavelength.

In the high-frequency circuit, the insertion power loss (neglecting transmission-line loss) is:<sup>1</sup>

$$\frac{P_i}{P_o} = \frac{[2 R_s (1 + \cos \beta l) + R_L \cos \beta l]^2 + \left[ \frac{R_s R_L + Z_o^2}{Z_o} \right]^2 \sin^2 \beta l}{4 R_L R_s (1 + \cos \beta l)^2} \quad (1)$$

where

$P_i$  = available power from the source

$P_o$  = output power

$R_s$  = source resistance

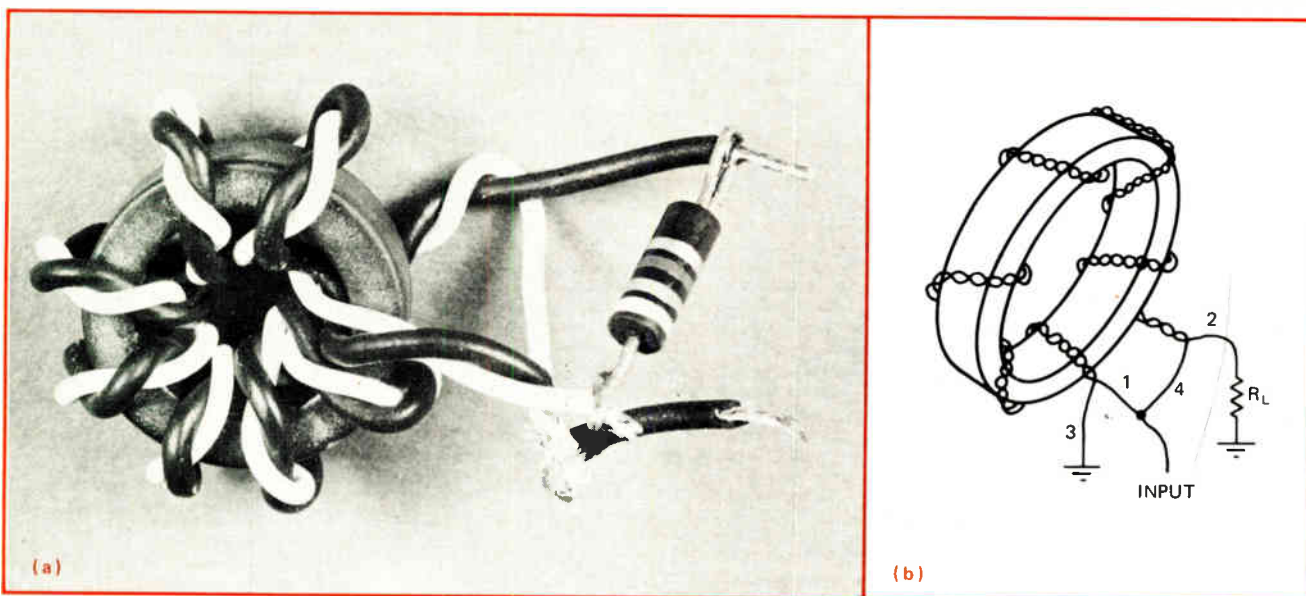

1. **Broadband transformer.** Toroidal transformer can operate at frequencies from a few kilohertz to several hundred megahertz. Twisted-wire-pair configuration shown transforms impedance in a ratio of 4:1. Modified design yields slightly higher transform ratio.

$\beta$  = the transmission line's phase constant

$l$  = length of the transmission line

$R_L$  = load resistance

$Z_0$  = line characteristic impedance.

For the low-frequency circuit, where the permeability of the core material has a dominant effect on the transformer's performance, a straightforward analysis (ignoring core loss) yields:

$$P_i/P_o = (R_s^2 + 4X_m^2)/4X_m^2 \quad (2)$$

where  $X_m$  is the primary magnetizing reactance.

Maximum power transfer for these networks is obtained when

$$R_L = 4R_s \quad (3)$$

and

$$Z_0 = 2R_s \quad (4)$$

The core magnetizing inductance is:<sup>4</sup>

$$L_m = X_m/\omega = 4.0 N_p^2 \mu_r (A_c/L_c) \quad (5)$$

where

$N_p$  = number of primary turns

$A_c$  = effective cross-sectional area of the core

$L_c$  = average magnetic path length in the core

$\mu_r$  = permeability of the core

$\omega$  = frequency in radians.

In the above equation, when  $A_c$  is measured in units of square centimeters and  $L_c$  in centimeters, then  $L_m$  is in units of nanohenrys.

A composite parameter  $A_l$ , which is defined by  $A_l = 4\mu_r (A_c/L_c)$ , is listed by some core manufacturers to simplify Eq. 5 such that:

$$L_m = N_p^2 A_l \text{ nanohenrys} \quad (6)$$

The lower cutoff frequency,  $f_1$ , can be determined by setting Eq. 2 equal to 2.0 (3-dB point), giving

$$f_1 = (R_s \times 10^9)/(4\pi N_p^2 A_l) \text{ Hz} \quad (7)$$

This relationship determines the number of turns

needed for a specified low-frequency response. The upper cutoff frequency for an optimally matched transformer can similarly be obtained from Eq. 1 and occurs when the line length,  $l$ , is approximately 0.3 wavelength. If possible, to minimize losses due to mismatch, this length should in practice be kept shorter than about 0.125 wavelengths.

### Transmission-line considerations

The choice of the transmission-line characteristic impedance must satisfy the conditions of Eqs. 3 and 4. Several popular types of transmission lines exist, including twisted-pair, coaxial, and stripline.<sup>4</sup> Twisted-pair lines are most commonly used, especially where minimal winding space is available. To obtain uniform characteristic impedance along the line, it is advisable to use a tight twist, which can be conveniently achieved by means of a twist drill or lathe. When a loosely twisted line is wound on a core, the wires tend to have uneven spacing and introduce impedance variations that degrade high-frequency performance.

The measured effect of twist count (twists per centimeter) on the characteristic impedance is shown in Fig. 3 for several wire sizes and types of electrical insulation. The phase velocity on these lines is also given. Note that the tighter twists tend to reduce the value of  $Z_0$ . Other details concerning the construction of these and other types of transmission lines having lower characteristic impedance have been discussed by Pitzalis<sup>5</sup>, Hejhall<sup>6</sup>, and Mueller<sup>7</sup>. Pitzalis and Couse<sup>4</sup> have shown that minor deviations of  $Z_0$  from the value predicted in Eq. 4 can be tolerated.

### Selecting core permeability

As noted previously, the desired insertion-loss bandwidth depends upon core specifications, number of winding turns, and transmission line length. The desire to have a short transmission line, along with other mechanical considerations such as available winding area, generally restricts the number of turns on the core. As a

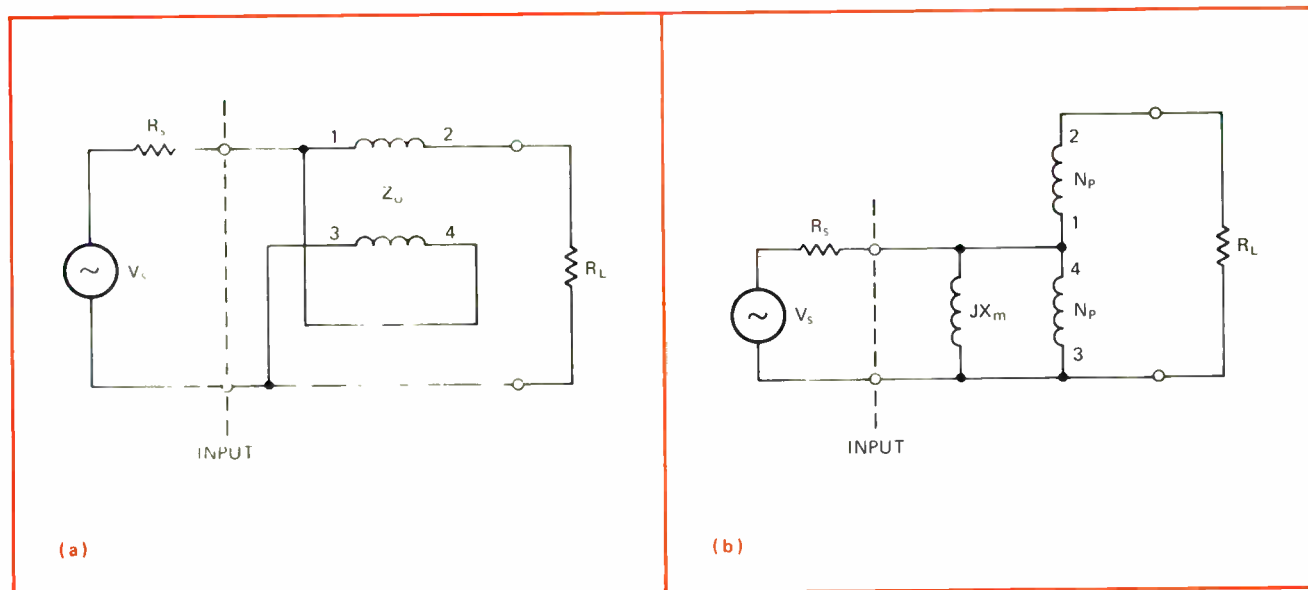

2. **Transformer model.** High frequency model of toroidal transformer (a) describes performance at frequencies above which the permeability of the core ceases to be effective. Low-frequency equivalent circuit (b) describes operation that depends heavily on core permeability.



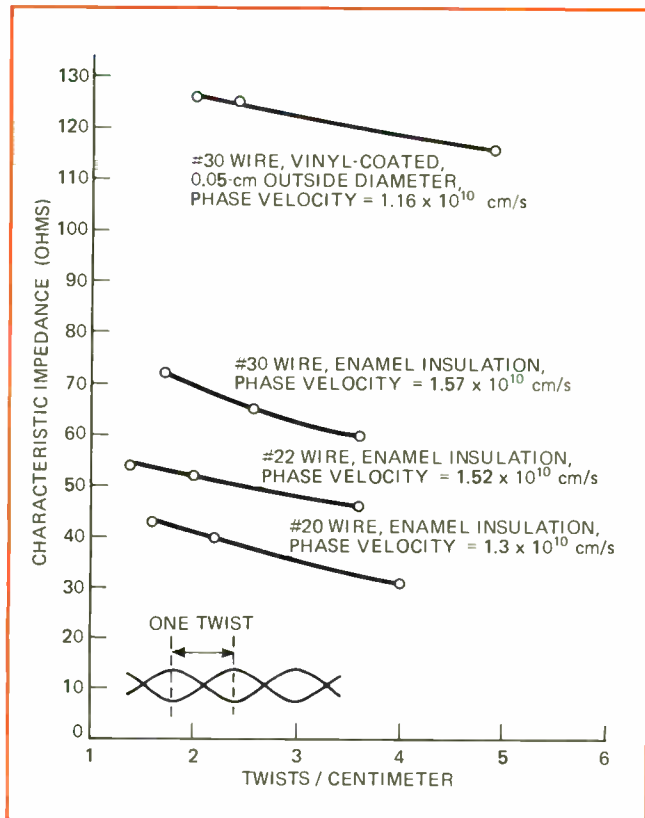

**3. Doing the twist.** Measured data shows effect of twist count (twists per centimeter) on the characteristics impedance of twisted-wire-pair transmission lines. Notice that tighter twisting tends to reduce value of characteristic impedance.

practical rule of thumb, the maximum allowable number of turns can be estimated as

$$N_{pmax} = 0.8 A_c / \pi d^2 \quad (8)$$

where  $A_c$  is the core winding area and  $d$  is the outside diameter of wire used to make the twisted-pair line.

Generally, then, to obtain the lower cutoff frequency with a minimum number of turns, the factor  $A_1$  in Eq. 7 should be large. The value of  $A_1$  is for the most part dependent upon core permeability; thus high- $\mu$  cores are desirable. Care should be exercised in the choice of

a core, however, since the permeability of the higher- $\mu$  cores ( $\mu_0$  greater than 1,000 or so) tends to be widely temperature-dependent.

### Higher impedance ratios

Usually, when higher impedance transformer ratios are desired, multiple cores are constructed with transformation ratios of 2:1, 3:1, and 4:1, and then these are cascaded together to get higher ratios.<sup>5,8</sup> But it is also possible, by adding a third winding on a single core, to extend the 4:1 impedance transformation ratio to as much as 6:1.

Thus, after the two-wire transmission line has been constructed for a conventional 4:1 transformer, a third wire can be tightly wound about the existing two-wire twists as shown in Fig. 4. This forms a short three-wire transmission-line section, and the wire length for a desired transformation ratio is:

$$l_3 = l (\sqrt{R_L/R_s} - 2) \quad (9)$$

where  $l_3$  = length of three-wire section, and  $l$  = length of two-wire line before the addition of the third wire.

The line is then wrapped on a ferrite core. Unfortunately, the response of these transformers at higher frequencies tends to decrease when impedance ratios higher than 6:1 are attempted.

### Theory tested

The design and performance of the 50:200 ohm transformer with a minimum 3-dB insertion-loss bandwidth of 150 kHz to 100 MHz is outlined below:

1. Given :  $R_s = 50\Omega$ , and  $R_L = 200\Omega$ ; then  $Z_o = 2R_s = 100\Omega$ . It was found experimentally that a twisted-pair transmission line consisting of two #30 vinyl-coated wires (see Fig. 3) would have  $Z_o = 100\Omega$  and a phase velocity of about  $1.16 \times 10^{10}$  cm/second.
2. The required number of core winding turns was calculated. Two Ferroxcube Corp. ferrite cores were available in style 266T125. Both cores have good temperature characteristics, and data is as follows:

Model 4C4	Model 3D3	Units
$A_1 = 55 \pm 20\%$	$A_1 = 330 \pm 20\%$	mH/1,000 turns
$\mu_0 = 125 \pm 20\%$	$\mu_0 = 750 \pm 20\%$	
$A_c = 0.183$	$A_c = 0.183$	cm <sup>2</sup>

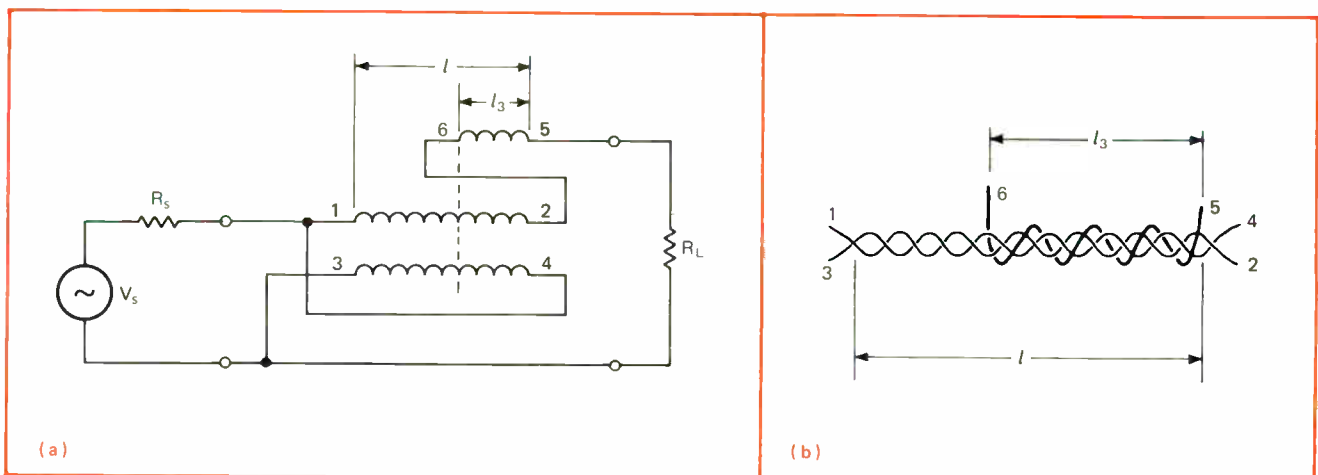

**4. Upping impedance ratios.** If a third winding is added to the transformer, impedance transformation ratio can be extended from 4:1 to as much as 6:1. At higher frequencies, however, the amplitude response of the three-wire transformer begins to decrease.

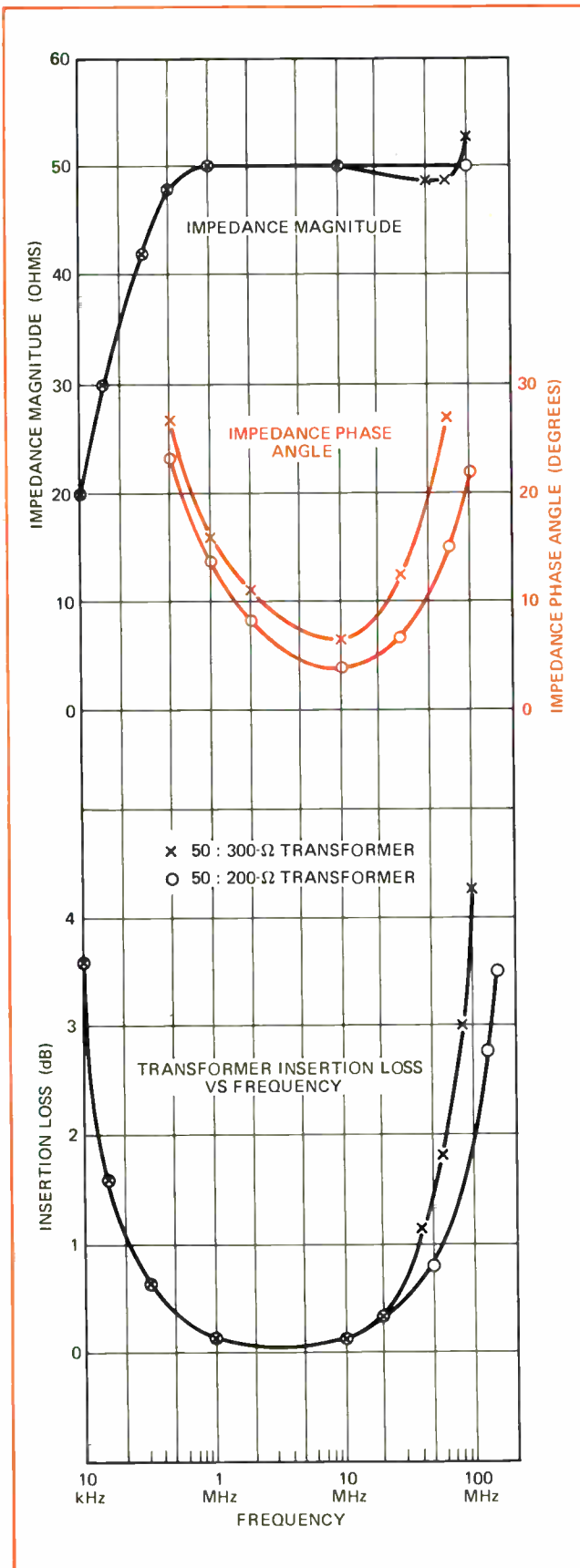

**5. Measured performance.** Input impedance and transformer insertion loss are plotted for the 50:200-ohm and 50:300-ohm transformers. As shown bandwidth for the higher-impedance-ratio transformer is decreased due to greater insertion loss above 20 MHz.

The maximum number of winding turns is calculated from Eq. 8:

$$N_{pmax} = \frac{0.8A_c}{\pi d^2} = \frac{0.8(0.183)}{\pi(0.05)^2} \approx 16$$

For the model 4C4 core,  $A_1 = 44$  (guaranteed lowest value) and from Eq. 7

$$N_p = \sqrt{\frac{R_s \times 10^9}{4\pi f_1 A_1}} = \sqrt{\frac{50 \times 10^9}{4\pi(1.5 \times 10^5)(44)}} \approx 25$$

This exceeded  $N_{pmax}$ , so the number of turns required when using the model 3D3 core with  $A_1 = 264$  (guaranteed lowest value) was calculated:

$$N_p = \sqrt{\frac{50 \times 10^9}{4\pi(1.5 \times 10^5)(264)}} \approx 10$$

Thus, the model 3D3 core is satisfactory.

- Using the phase velocity data, the maximum permissible line length was calculated. Since  $v_p = f\lambda$ , where  $\lambda$  is the transmission-line wavelength at frequency  $f$ , then at 100 MHz

$$0.125 \lambda = 0.125(1.16 \times 10^{10} \text{ cm/s}) / 100 \text{ MHz} = 14.5 \text{ cm}$$

Ten turns of the transmission line were wrapped with this length of line. The design was tested; its input impedance and insertion-loss characteristics vs frequency are plotted in Fig. 5.

- A 50:300-ohm transformer was made from the above design by constructing a three-wire section as shown in Fig. 4. The length of this section is

$$l_3 = 14.5 \left( \sqrt{\frac{300}{50}} - 2 \right) \approx 6.5 \text{ cm}$$

Changes in the performance of the transformer resulting from this modification are also given in Fig. 5.

Impedance data for frequencies above 0.5 MHz was obtained with a radio-frequency vector impedance meter, but an electronic voltmeter was used for frequencies below 0.5 MHz. Insertion loss was determined with a vector voltmeter. Input-impedance measurements of open- and short-circuited lines were used, along with a Smith chart to determine transmission-line characteristic impedances and phase velocities. The ends of the transmission line were soldered to the center of a 5-by-5-cm copper sheet to provide a good short-circuit termination at vhf.<sup>9</sup> □

#### REFERENCES

- C. L. Ruthroff, "Some Broadband Transformers," Proc. IRE, vol. 47, pp. 1,337-1,342, August 1959
- O. Prizalis, R. E. Horn, and R. J. Baranello, "Broadband 60-W HF Linear Amplifiers," IEEE Journal of Solid-State Circuits, Vol. SC-6, No. 3, June 1971
- "Magnetic Design Manual," Ferrocube Corp., Saugerties, New York, 1971
- O. Prizalis and T. P. Cause, "Practical Design Information for Broadband Transmission Line Transformers," Proc. IEEE, pp. 738-739, April 1968
- O. Prizalis and Thomas P. Cause, "Broadband Transformer Design for RF Transistor Power Amplifiers," U.S. Army Technical Report ECOM-2989
- R. C. Hejhall, "Solid State Linear Power Amplifier Design," Motorola AN-546, Motorola Semiconductor Products Inc.
- O. Mueller, "Low Distortion Wideband Transistor Power Amplifier," 1972 International Symposium on Circuit Theory, North Hollywood, Calif.
- "Solid State Power Circuits," RCA Technical Series SP-52, pp. 482-488, Harrison, N.J., 1971.
- H. J. Reich, P. F. Ordung, H. L. Krauss, and J. G. Skalnick, "Microwave Theory and Techniques," p. 151, D. Van Nostrand Co., 1953

## Single op-amp test circuit makes five dc checks at once

by Jerald Graeme  
Burr-Brown Research Corp., Tucson, Ariz.

The five primary dc characteristics of an operational amplifier can be tested simultaneously by one circuit, so that multiple tests are avoided as well as the need to switch the test circuit. The test circuit permits measurement of open-loop gain, offset voltage, input bias current, quiescent current, and output-voltage swing. The various output signals generated by the circuit can be monitored separately or processed and combined to produce a single pass/fail indication.

To find the open-loop gain, the ac portion of summing junction signal  $e_j$  is measured. This signal is an amplified replica of the op amp's input signal,  $e_i$ , which is, in turn, related to output signal  $e_o$  by:

$$e_j = 100e_i = 100(V_{OS} + e_s/A)$$

where  $V_{OS}$  is the op amp's offset voltage, and  $e_s$  is the input signal voltage. With a peak-to-peak detector, the ac portion of  $e_j$  can be converted to a gain-related dc voltage suitable for pass/fail examination by a voltage comparator. (A square-wave test signal is used here because it is simple to generate with a single op amp, but a sinusoidal test signal could be used instead.)

Input offset voltage  $V_{OS}$  is measured from the dc portion of output signal  $e_j$ . As with the open-loop gain measurement, a comparator can be used to provide a pass/fail indication. If  $e_j$  is not filtered for this type of monitoring, the amplitude of its ac component may introduce some error. Generally, however, the high gain

and moderate offset-voltage levels of most general-purpose op amps produce an ac component that is an order of magnitude smaller than the dc component, allowing filtering to be eliminated to speed up testing.

Op-amp input bias current,  $I_B$ , can be determined through the simple current-to-voltage converter formed by amplifier  $A_1$ . The flow of input bias current through resistor  $R_1$  creates a dc voltage at the output of  $A_1$  for comparison against a specified related level. To avoid measurement errors due to  $A_1$ , this amplifier's offset voltage should be nulled and its input bias current should be much less than that to be measured.

Although this bias-current test checks only one of the two input bias currents, it is generally adequate as long as an extremely low input-offset current is not a requirement. Moreover, if a transistor mismatch at the input of the op amp being tested is severe enough to create an excessive input-offput current, then the mismatch would very likely also create a high offset voltage that would be detected by the  $V_{OS}$  monitor.

In a manner similar to the way bias current  $I_B$  is measured, quiescent current  $I_Q$  is monitored by amplifier  $A_2$ , which develops a voltage from the positive supply current drain of the amplifier under test. This voltage is due partly to feedback current  $i_f$ , as well as to  $I_Q$ . However, since  $i_f$  is known for a given feedback resistor and output voltage swing, its effect can be corrected by offsetting the monitor limit.

Output voltage swing can be checked against the level of the input signal since the amplifier under test is basically a unity-gain inverter. If the output voltage cannot swing over the full range of the input signal, a large error signal will be produced at the  $e_j$  output, and the gain monitor can detect this failure. If comparator monitors with OR gating are used, a single pass/fail output indication can be implemented. □

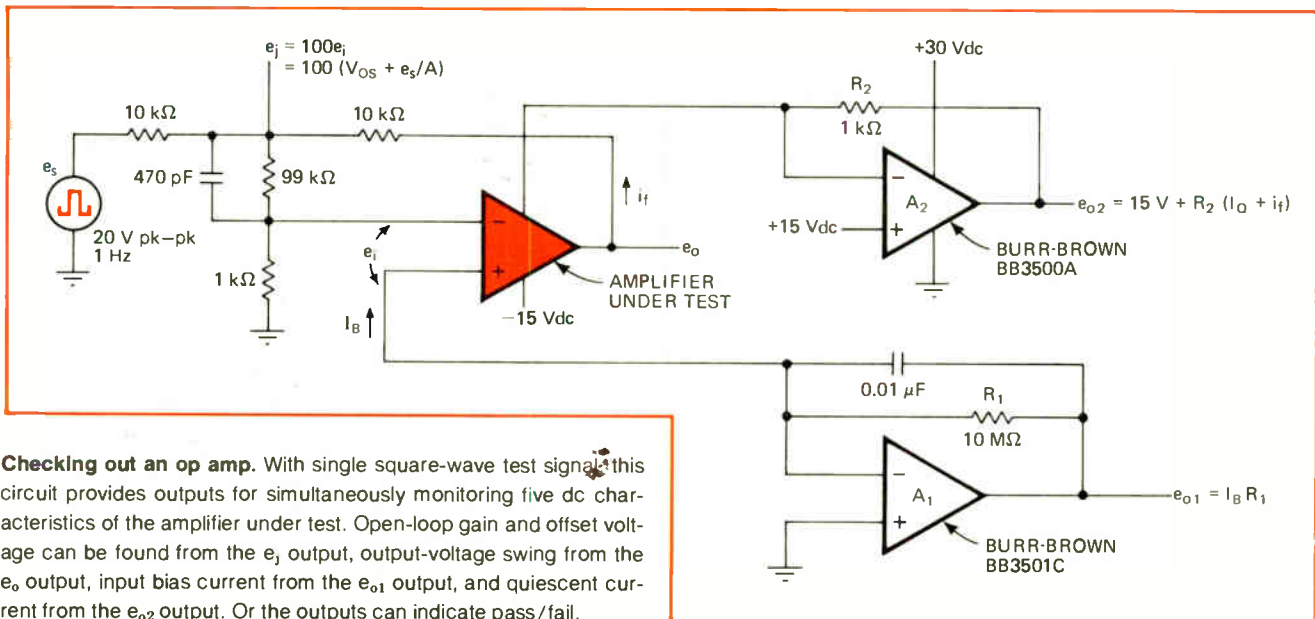

**Checking out an op amp.** With single square-wave test signal, this circuit provides outputs for simultaneously monitoring five dc characteristics of the amplifier under test. Open-loop gain and offset voltage can be found from the  $e_j$  output, output-voltage swing from the  $e_o$  output, input bias current from the  $e_{o1}$  output, and quiescent current from the  $e_{o2}$  output. Or the outputs can indicate pass/fail.



---

## Measuring inductances below 100 nanohenries

by Gunther Dabrowski  
*Rohde & Schwarz, Munich, West Germany*

---

You can measure very small inductance values by taking advantage of the fine resolution your existing inductance meter has when operating on its most sensitive range setting. For example, the instrument's most sensitive range setting may be only 0.1 microhenry. But, with the help of a special jig, this same meter can be used to determine inductances to within approximately 1 nanohenry.

The photographs show a typical inductance meter and the special low-inductance adapter jig. The jig consists of a single copper band loop, wound on a Teflon disk (50-millimeter diameter) and mounted on supports

with banana plugs that can be plugged directly into the meter's measuring terminals.

The copper loop is cut and provided with two small holes. If a short piece of wire is plugged into these holes, the loop is closed and will have an inductance of just about 100 nH. The exact inductance value can be read with the meter.

By pushing the jig more or less deeply into the terminals of the inductance meter, you can change slightly the inductance of the jig so that you can adjust the inductance value exactly to one of the calibration lines on the meter scale. (The insulated knurled knobs on the instrument's front panel can be used as mechanical stops.)

After the meter has been properly peaked for a loop inductance of 100 nH, the short circuit is removed, and the unknown inductance plugged in as shown. The meter is now peaked again; it will indicate a somewhat larger inductance reading. The value of the unknown inductance is the difference between the two meter readings. This technique generally provides a measurement accuracy to within 1 nH. □

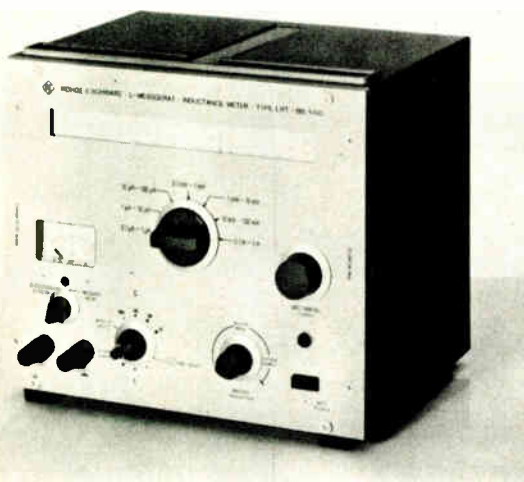

**Extending meter range.** With a special jig, small inductances can be measured with a standard inductance meter. The technique exploits the instrument's resolution at its most sensitive range setting. Measurements are made by taking the difference between two readings.

---

---

## Electronic dice ease tough decisions

by Glen Miranker\*  
*Yale University, New Haven, Conn.*

---

A pair of electronic dice can help you make decisions. Many people in management positions are often faced with decisions that appear to be impossible to make, based on the information provided them. In an attempt to decide among the choices that confront them, some flip a coin, thus using a statistical method to select one of two courses of action.

\*Now with IBM Corp., Yorktown Heights, N.Y.

Generally, however, there are more than two possible choices, and then a pair of dice is better, allowing you to choose one out of up to 36 separate alternatives.

A die face can be considered as shown in (a); a table of the desired states is also given. The two tables of (b) indicate how a standard binary counter can be modified slightly to produce these desired states. In fact, if the counter is reset at a "normal" count of six and the "modified" zero state is detected and decoded properly, a popular type 7493 four-bit binary counter will do.

The wiring scheme of (c) will serve as a single die—with seven incandescent bulbs representing the die face. Naturally, if you build two of these circuits, you will have a pair of dice.

All that remains to be done is to clock the counters to some random state to simulate a roll of the dice. The leftover flip-flops and inverters can be used to do this, as

shown in (d). Just about any capacitor value will do, provided it produces a pulse repetition rate of less than 10 megahertz. A capacitance of 1 microfarad is fine, although you may want to use a larger value so that the clocking of the counters is readily apparent. The clock

rate, however, should be rapid enough to allow the dice to go through several dozen states. □

Engineer's Notebook is a regular feature in Electronics. We invite readers to submit original design shortcuts, calculation aids, measurement and test techniques, and other ideas for saving engineering time or cost. We'll pay \$50 for each item published.

**Manager's helper.** A statistical decision maker—a pair of electronic dice—can be simulated by logic gates, a binary counter, and a series of miniature lamps. Desired states (a) for seven-bulb die face can be realized by modifying a four-bit binary counter as noted by the table in (b). Hookup for single die is shown in (c), while circuit (d) makes use of leftover logic gates to simulate a roll of the dice.

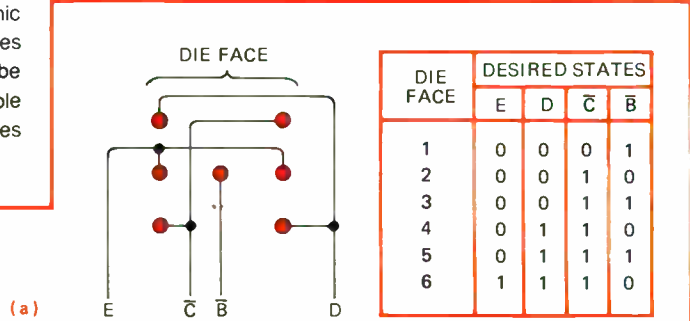

(b)

PULSES AFTER RESET	NORMAL COUNTER OUTPUT STATES		
	D	C	B
0	0	0	0
1	0	0	1
2	0	1	0
3	0	1	1
4	1	0	0
5	1	0	1
6	1	1	0

(b)

DIE FACE	MODIFIED COUNTER OUTPUT STATES		
	D	$\bar{C}$	$\bar{B}$
3	0	1	1
2	0	1	0
1	0	0	1
6	0	0	0
5	1	1	1
4	1	1	0
RESET	1	0	1

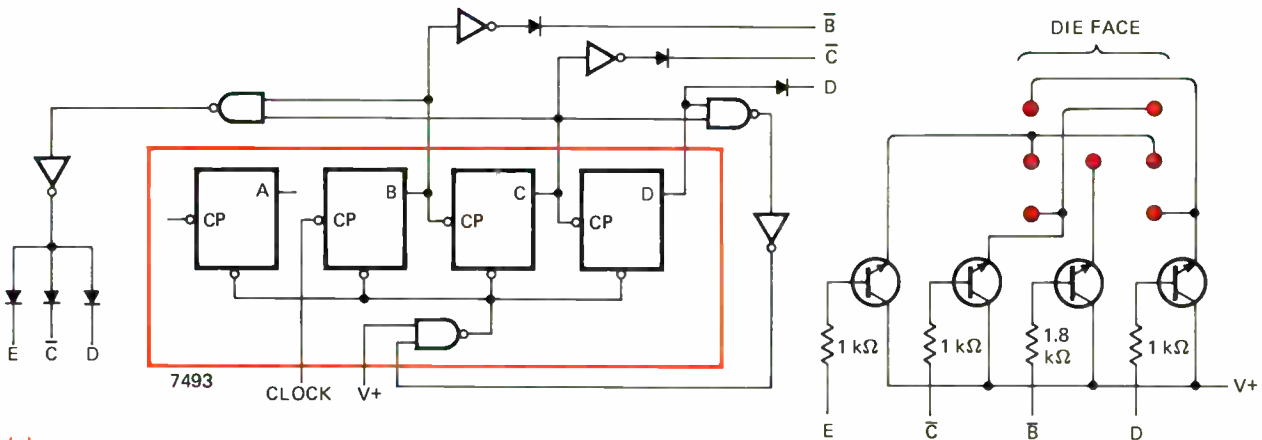

NANDS: 7400  
 INVERTERS: 7404  
 DIODES: 1N914  
 TRANSISTORS: 2N5129  
 BULBS: 6 V, 50 mA; ONE LEAD TO GROUND

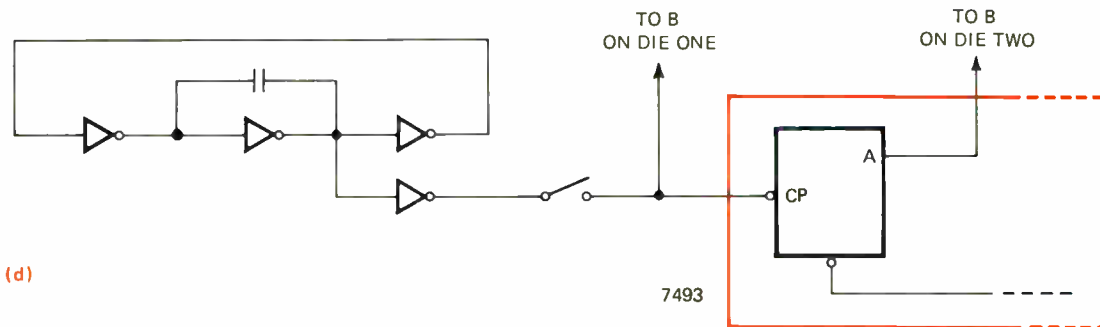

# One-stop memory source

Whatever you need in memory, chances are you'll find it here. Arrays, stacks, complete single-card memories, megabit systems. Standard or custom designs. Wide temperature core or semiconductor. EMM is the one-stop memory source.

Take our Micromemory 3000, for instance. It's a complete TTL compatible memory on a single card—up to 8K by 18 bits with a 650 ns cycle time. You can put them together to get any system capacity you want. And the Micro-Ram 3000 is a compatible 200 ns semiconductor memory on a single card. Standard multi-card chassis, including power supply and other options, are available.

Then there's the Micromemory 2000. Also a total system on one card with edge connections that allow it to be treated just like a logic circuit. Not quite as high performance. Even lower cost. It operates from plus five volts input only.

Or if your need is for large mass memories, consider the Micromemory 6000. It is a multiple board module with 16K sense. In its basic configuration of 16K by 40 or 32K by 20, it uses only two boards.

And there are more to come. But we won't talk about them now because they're still in field test. After all, we promise only what we can deliver, and we deliver only proven hardware.

If you'd like to know more about our proven hardware, and how it can fit your needs, call Phil Harding at (213) 644-9881. Or contact your local EMM sales office.

**EMM** ELECTRONIC  
MEMORIES  
**COMMERCIAL PRODUCTS**  
A Division of Electronic Memories & Magnetics Corporation  
12621 Chadron Ave., Hawthorne, Calif. 90250



EASTERN REGION: (617) 861-9650; CENTRAL REGION: (312) 297-7090; WESTERN REGION: (213) 477-3911



# Engineer's newsletter

---

## Four comparators that are better than four comparators

Increasingly convinced that a set of four is often better and cheaper to use than four independent units, **designers are turning more frequently to the quad device—four devices in one DIP.** A relatively recent entry into the quad club, which by now includes quad transistors and diodes, operational amplifiers, voltage regulators, and line drivers, is the comparator. This device is a natural in industrial and consumer systems needing a number of differential voltage comparisons. For instance, one new quad comparator, Motorola's MC3302, can operate from a single power supply anywhere from 2 to 28 volts dc and **enables different voltages to be compared very near ground potential even when operating from a single supply voltage.** The voltages can even be combined to get an AND output function.

## An analog input to a DMM? Read on

A digital multimeter will take a stable reading from a changing input signal if you place a sample-and-hold circuit in front of it. Adding a sample-and-hold module to a 4-digit DMM can **increase the maximum allowable rate of input-voltage change from, say, 1 volt per second to 1 V/microsecond.**

## More power to the transistor

Transistor switches are now becoming available for many of the high-power jobs normally handled by bulky and expensive SCRs. Typical ratings of some new TI units are impressive. Conduction-cooled and measuring only 7 by 3.5 by 1.6 inches, **these switches can handle 150 amperes and 100 volts, 200 A and 100 V, and 60 A and 400 V.** A 100-A, 500-V device is in the design stage. All operate from dc to 10 kilohertz and—most important for many new systems—they can all be driven from standard DTL or TTL circuits.

## Soldering aluminum made practical

If you like the light weight and corrosion resistance of aluminum but are deterred from using the metal because it's so difficult to solder, you should check out Alcoa's X69 flux and X807 solder, which make aluminum **almost as easy to work as copper.** The solder, which melts at 570°C, can be applied by dip, iron, or furnace. Since the conductivity of aluminum is lower than copper's, you have to use wire two gauge numbers larger than usual. Even so, you get a **50% reduction in weight.**

## Handbooks on data communications, ground support

Datacom system designers should look into a new "Communications Handbook" from Microdata Corp., Dept. C, 17481 Red Hill Ave., Irvine, Calif. 92705, which **covers the design end of the booming data-communications business from A to Z.** Especially good is a section giving cost/performance tradeoffs and efficiency-boosting design tips for switched telephone networks.

And for those working on **ground-support systems that must meet specifications for high-intensity rf environments,** the Naval Air Systems Command has in loose-leaf form a new "Electromagnetic Compatibility Design Handbook for Avionics and Related Ground Support Equipment" that gives the story on grounding, shielding, bonding, testing, safety, and the rest. Called NAVAIR AD 115, it can be gotten from Freeman Associates Inc., Ayattsville, Md.

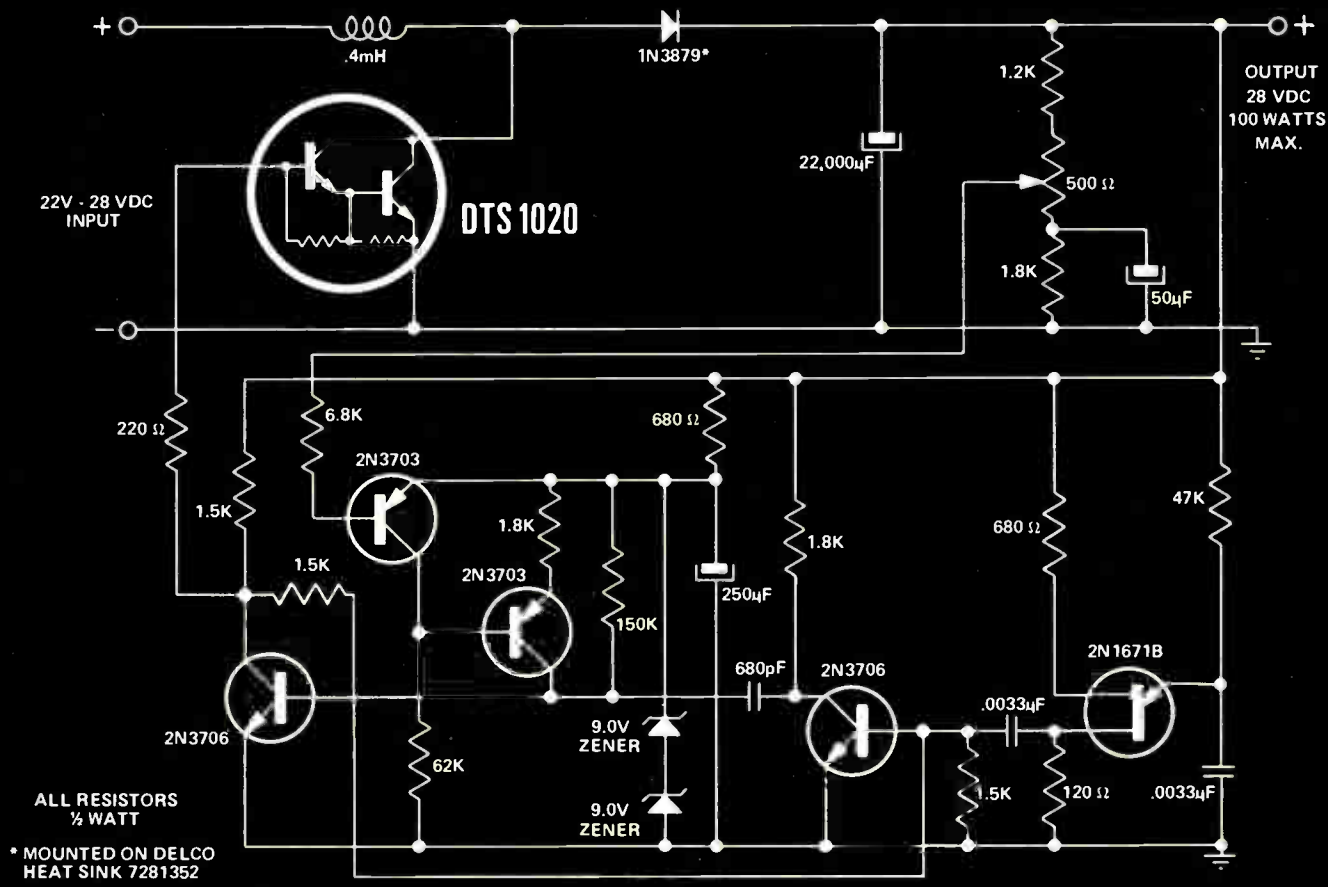

**SWITCHING REGULATOR**

	$V_{CE0}$ @ 0.1 mA	$V_{EBO}$ @ 50 mA	$V_{CE(SUS)}$ @ 500 mA	$h_{fe}$ @ 1 MHz ( $V_{CE} = 10V,$ $I_C = 200 mA$ )	$h_{FE}$ ( $V_{CE} = 5V,$ $I_C = 10A$ )	$V_{CE(SAT)}$ @ 5.0 A	$I_C$	$P_T$ @ 75°C
<b>DTS-1010</b>	120V	7V	80V	12	200	1.8V	10A	100W*
<b>DTS-1020</b>	120V	7V	80V	12	500	1.5V	10A	100W*

\*100 percent tested at 2.5A, 40V.

# The Kokomoans now give you Darlington Switching Power.



Use a Darlington in place of an ordinary transistor, and you'll realize an additional magnitude of gain plus increased switching power. Use a Delco silicon power Darlington (DTS-1010 or DTS-1020) and you'll also realize a gain in dependability.

Delco's Darlington's are triple diffused mesa units housed in copper TO204MA cases and built for ruggedness. The design gives them high energy capability—the ability to handle surges of current and voltage simultaneously. They are ideal for switching inductive loads in circuits subject to transients or fault conditions.

Design a switching regulator circuit around a Delco Darlington or use it in any 60-100 volt

application to reduce circuit size, weight, and cost. In addition, the Darlington space saving feature allows you more design flexibility. Unlike an ordinary transistor, it's only energy-limited, not beta-limited. You can exploit its full energy capability in your circuit.

Call your nearest Delco distributor. He has them in stock and he's got the data on high energy switching for small spaces.

For details on the switching regulator circuit, ask for Application Note 49.

## Now available from these distributors in production quantities.

ALA., BIRMINGHAM • Forbes Distributing Co., Inc. (205)-251-4104  
 ARIZ., PHOENIX • Sterling Electronics (602)-258-4531  
 CAL., LOS ANGELES • Kierulff Electronics, Inc. (213)-685-5511 • Radio Products Sales, Inc. (213)-748-1271  
 CAL., PALO ALTO • Kierulff Electronics, Inc. (415)-968-6292  
 CAL., SAN DIEGO • Radio Products Sales, Inc. (714)-292-5611  
 CAL., SAN DIEGO • Kierulff Electronics, Inc. (714)-278-2112  
 CAL., SUNNYVALE • Cramer/San Francisco (408)-739-3011  
 COLO., DENVER • Cramer/Denver (303)-758-2100  
 CONN., NORWALK • Harvey/Connecticut (203)-853-1515  
 FLA., MIAMI SPRINGS • Powell/Gulf Electronics (305)-885-8761  
 FLA., ORLANDO • Powell/Gulf Electronics (305)-859-1450  
 ILL., ROSEMONT (Chicago) • Kierulff Electronics (312)-678-8560  
 ILL., SKOKIE (Chicago) • Bell Industries (312)-282-5400  
 IND., INDIANAPOLIS • Graham Electronics Supply, Inc. (317)-634-8202  
 MD., BALTIMORE • Radio Electric Service Co. (301)-823-0070  
 MASS., NEEDHAM HEIGHTS • Kierulff Electronics, Inc. (617)-449-3600

MASS., NEWTON • The Greene-Shaw Co. Inc. (617)-969-8900  
 MICH., FARMINGTON • Harvey-Michigan (313)-477-1650  
 MINN., MINNEAPOLIS • Stark Electronics Supply Co. (612)-332-1325  
 MO., NO. KANSAS CITY • LCOMP-Kansas City, Inc. (816)-221-2400  
 MO., ST. LOUIS • LCOMP St. Louis, Inc. (314)-647-5505  
 N.J., CLIFTON • Wilshire Electronics/New Jersey (201)-365-2600, (212)-244-8930  
 N.Y., BINGHAMTON • Harvey/Federal (607)-748-8211  
 N.Y., EAST SYRACUSE • Cramer/Syracuse (315)-437-6671  
 N.Y., ROCHESTER • Cramer/Rochester (716)-275-0300  
 N.Y., WOODBURY • Harvey/New York (516)-921-8700, (212)-582-2590  
 OHIO, CINCINNATI • United Radio, Inc. (513)-761-4030  
 OHIO, CLEVELAND • Pattison Supply (216)-441-3000  
 OHIO, DAYTON • Kierulff Electronics (513)-278-9411  
 PENN., PHILADELPHIA • Almo Electronics (215)-676-6000  
 PENN., PITTSBURGH • RPC Electronics (412)-782-3770  
 S.C., COLUMBIA • Dixie Radio Supply Co., Inc. (803)-253-5333

TEXAS, DALLAS • Adleta Electronics Co. (214)-741-3151  
 TEXAS, FORT WORTH • Adleta Electronics Co. (817)-336-7446  
 TEXAS, GARLAND • Kierulff Electronics, Inc. (214)-271-2471  
 TEXAS, HOUSTON • Harrison Equipment Co., Inc. (713)-224-9131  
 UTAH, SALT LAKE CITY • Cramer/Utah (801)-487-3681  
 VA., RICHMOND • Meridian Electronics, Inc., a Sterling Electronics Company (703)-353-6648  
 WASH., SEATTLE • Kierulff Electronics, Inc. (206)-763-1550  
 CANADA, ONT., SCARBOROUGH • Lake Engineering Co., Ltd. (416)-751-5980  
 ALL OVERSEAS INQUIRIES:  
 General Motors Overseas Operations  
 Power and Industrial Products Dept.  
 767 Fifth Avenue, New York, N.Y.  
 10022. Phone: (212)-486-3723.

**Kokomoans' Regional Headquarters.**  
 Union, New Jersey 07083,  
 Box 1018, Chestnut Station,  
 (201) 687-3770.  
 El Segundo, Calif. 90245,  
 354 Coral Circle, (213)  
 640-0443.  
 Kokomo, Ind. 46901, 700 E.  
 Firmin, (317) 459-2175  
 (Home Office).



**Delco Electronics**

DIVISION OF GENERAL MOTORS CORPORATION.  
 KOKOMO, INDIANA



MARK OF EXCELLENCE



# OUR ANGLE: Low Cost D/S and S/D Modules

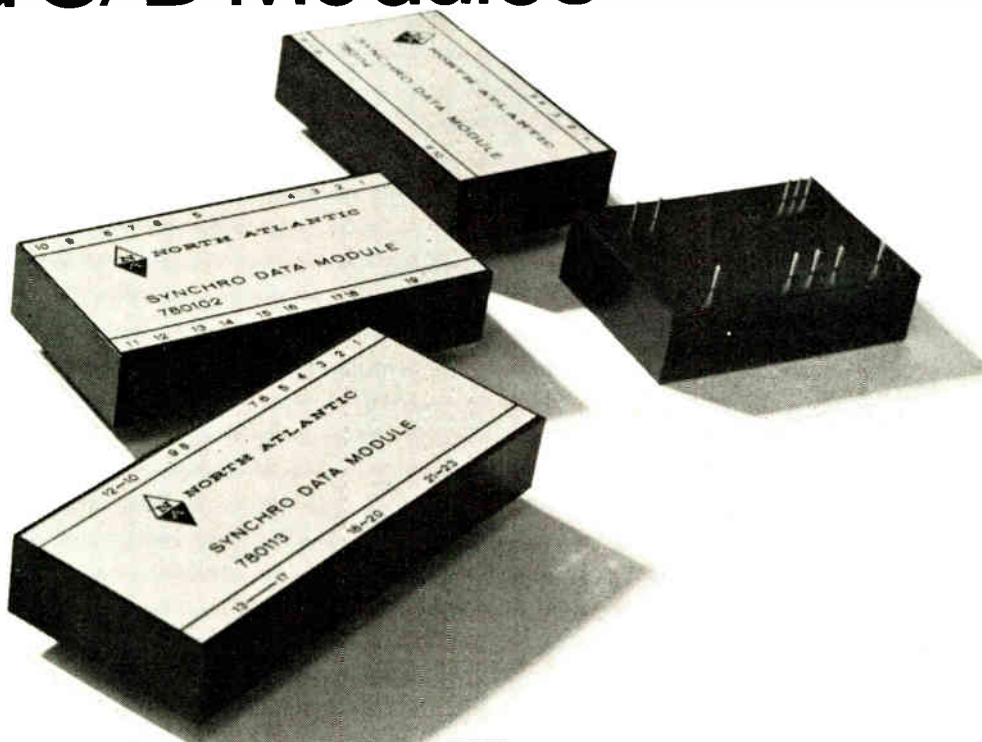

**TYPICAL S/D MODULE SETS**

FUNCTION	LINE-LINE	FREQUENCY
S/D or R/D	11.8V	400Hz
R/D	26V	400Hz
S/D or R/D	90V	400Hz
S/D	90V	60Hz

**TYPICAL D/S MODULE SETS**

FUNCTION	LINE-LINE	FREQUENCY
D/S or D/R	11.8V	400Hz
D/R	26V	400Hz
D/S or D/R	90V	400Hz
D/S	90V	60Hz

How does a choice of 14-bit resolution, 60 or 400 Hz data frequency, high accuracy, 11.8V to 90V line-line voltages and all kinds of self-protection circuitry look from your angle?

North Atlantic's Series 780 is available now. Only 5 modules make up a complete S/D or D/S converter, and any set nests in an area less than 21 square inches.

S/D specifications include 3 minutes  $\pm 0.9$ LSB accuracy, and continuous tracking with low velocity errors. D/S specifications include 4 minute accuracy, 1.25 VA output and 25  $\mu$ sec settling time.

Key performance specifications for both converters include 14-bit (.022 $^\circ$ ) resolution over 360 $^\circ$ , 0-70 $^\circ$ C operation and 4000 $^\circ$ /sec data rates. Both units are DTL and TTL compatible.

To shrink your prototype schedule, we offer an interconnecting PC board. Or, if you plan to integrate a converter directly onto your own PC cards, we can supply proven mylar artwork.

Any set of modules — \$650. Order a set today. North Atlantic sales engineering representatives are located throughout the free world.



**NORTH ATLANTIC** industries, inc.

200 Terminal Drive, Plainview, New York 11803 Phone (516) 681-8600  
California District Office: 13418 Wyandotte Street, N. Hollywood, CA 91605; Phone (213) 982-0442

## Chopper circuit put on op-amp chip

Input structure of operational amplifier uses pair of n-channel MOSFETs; low offset conditions make device suited to precision control systems

by Laurence Altman, Solid State Editor

The chopper-stabilized amplifier, with its low input parameters for precision applications, has been used in one form or another for about 30 years, but it is only recently that this performance-boosting technique has been successfully applied to operational amplifiers in integrated form. First, Texas Instruments developed a two-chip chopper-stabilized op amp in a 14-pin dual in-line package (see page 85). Now Harris Semiconductor has developed the first single-chip monolithic device in a standard TO-99 can.

The specifications of the HA-2900 will make it one of the best all-around IC op amps now available, both for the ordinary sample-and-hold and analog-to-digital converter applications and as the first monolithic op amp that's suitable for the more demanding precision jobs: amplification of very-low-level dc

signals for thermocouples, biomedical instrumentation, and precision integrators. Indeed, with its low input bias current, precision integrator circuits built with the HA-2900 op amp will be especially useful for dual-slope a-d converters, active filters, and industrial control systems of all kinds.

The input specs of the 2900 underline its usefulness in precision applications where normally the offset input parameters of the op amp would degrade the precision of the measurements and therefore inhibit the system's ability to acquire data. Offset voltage of the device is only 50 microvolts at 25°C, compared to 500  $\mu\text{V}$  for standard version 725A and 108 op amps (see table). This, together with the low offset voltage drift (0.1  $\mu\text{V}/^\circ\text{C}$ ), means that systems using the 2900 can detect dc voltages 100 times smaller than systems designed with most general-

purpose IC amplifiers, making the device an excellent choice for general low-level applications.

Equally impressive is the offset current of 0.1 nanoampere. This value compares favorably with that for op amps built with junction field-effect transistor inputs, which suffer from fairly high offset voltage. It is also smaller than the popular general-purpose amplifiers shown in

**Unique.** First monolithic op amp with chopper stabilization has MOSFET inputs on the same chip with bipolar devices. Table compares the HA-2900 with other IC op amps.

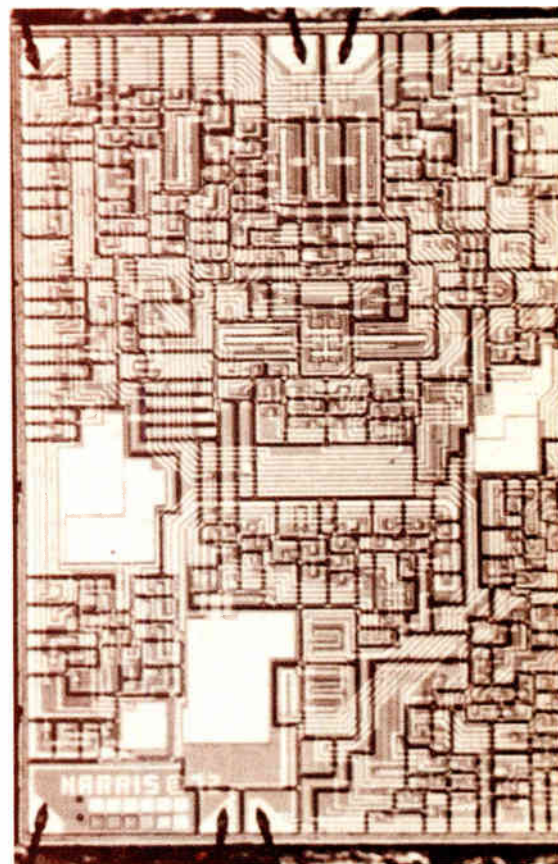

GUARANTEED PARAMETERS FROM $-55^\circ\text{C}$ TO $+125^\circ\text{C}$							
Parameter	725 A	108 A	727 (Preamp)	121 (Preamp)	088	2900	Units
Offset V at $+25^\circ\text{C}$	500	500	10,000		75	50	$\mu\text{V}$
Offset V drift	1.0*	5	1.5	1.0*	0.6	0.1	$\mu\text{V}/^\circ\text{C}$
Offset current at $+25^\circ\text{C}$	5	0.2	15	0.5	0.3	0.1	nA
Offset-current drift	90	2.5	2.0 (typ)	20		1.0	$\text{pA}/^\circ\text{C}$
Open-loop gain	$5 \times 10^5$	$4 \times 10^4$	60	20	$1 \times 10^3$	$5 \times 10^8$	V/V
Bandwidth (for unity gain)	.05	0.5	.002		3	3	MHz (typ)
Slew rate (unity gain)	.005	0.25			25	2.5	$\text{V}/\mu\text{S}$ (typ)

\*After external zero adjustment.



# How to multiply your draftsmen's time.



---

Shortcuts from Kodak turn drafting hours into minutes—on job after job.

---

Routine redrawing chores take a lot of valuable board time. Kodak can show your draftsmen how to restore drawings, make revisions, and handle repetitive elements—without redrawing. You'll save hours of drafting time and save money, too.

It's easy, because it's done photographically! We'll explain how to do it and help you select the proper Kodagraph films and papers for your particular work. And we can show you how, with an automated Kodak

processor, you can get reproductions back to your draftsmen faster, to save even more time.

There are other ways that Kodak can help multiply your draftsmen's efficiency. Microfilming your drawings will make them more accessible, save filing space, provide security, and give you other benefits, too.

---

Get the details.

---

For additional information write: Eastman Kodak Company, Business Systems Markets Division, Dept. DP874, Rochester, N.Y. 14650.

**Kodak products for drawing reproduction.**





the table on page 125 and makes the 2900 desirable for sensitive, precision systems. Indeed, the combination of low input parameters, together with an open loop gain of  $5 \times 10^8$ , a bandwidth of 3 MHz (typical), and a fairly respectable slew rate of 2.5 volts per microsecond typical, is what marks this device as a major advance in the design of general-purpose operational amplifiers.

**Mixing the process.** The achievement of a single-chip chopper-stabilized op amp depended on Harris' ability to combine MOS and bipolar processing on the same chip—another first in op-amp design. The input structure contains a pair of n-channel MOSFET transistors. The extremely low input-current requirements of MOSFETs are ideal for op-amp designs, but they have never been used before because they are difficult to fabricate on a chip containing bipolar devices and because the low-current feature is accompanied by high offset voltage. It is here that the chopper-stabilization circuit comes in, being used to null the offset voltage.

The advanced processing techniques, allowing npn, pnp, and n-channel MOSFETs on one chip, result in an LSI linear device with 252 active elements on a monolithic substrate with low offset voltage and current plus high gain.

Another feature of the 2900 is that, unlike most chopper-stabilized operational amplifiers, it has fully differential inputs and can be used in all standard operational amplifier applications, with the added advantage that its low offset voltage eliminates the need for external trimmer pots. The device maintains a low drift rate through the entire temperature range with negligible long-term drift rate. The result is elimination of the major obstacle to achieving good system error budgets and simplified calibration.

The HA-2900 comes in a TO-99 package and is available in three temperature ranges. Hundred-up prices for each are: HA-2905 (0° to 75°C), \$55.00; HA-2904 (-25° to 85°C), \$71.50; and HA-2900 (-55° to 125°C), \$88. Delivery is immediate from any Harris distributor.

Harris Semiconductor, Division of Harris Intertec Corp., Melbourne, Fla. 32901 [338]

## New products

### Components

## Connector offers dense interface

Three zero-insertion-force devices in U shape can provide 228 circuit contacts

As manufacturers pack more and more functions onto ceramic substrates, the number of connector pads begins to limit the number of functions the card can handle. Accordingly, the Amphenol Industrial division of Bunker Ramo Corp. has developed a zero-insertion-force connector that allows insertion of ceramic substrates or conventional printed-circuit boards from either the top or through an open end on one side of the connector. Two rows of cantilever-beam-type contacts are closed by turning an activating cam rod a quarter-turn.

"This means that the card can be slid into two opposing connectors," points out senior product manager Mike Corrigan. Such versatility of board termination will allow, for example, a single substrate or pc board with tabs on three sides to be inserted into a U-shaped configuration made of three of the new connectors. Corrigan predicts that widest use for the device will be in computers, where high-density packaging is desirable. Amphenol's first major customer for the connector is Sperry Univac, where it is used in both military and commercial computers. "The market is small now, but it should grow to a \$4-5 million total—about 5% of the EDP market for connectors—by 1977," he says.

In addition, the connector's inherent zero-insertion force is an advantage. The abrasive characteristics of ceramic substrates damage conventional connector contacts with even occasional insertion/removal cycles, as well as damaging the microelectronic circuits, Corrigan says. And the combination of both high-density-contact connectors and

high-contact-engagement forces makes insertion or removal of conventional circuit boards extremely difficult.

Amphenol's cam actuation uses a 30% glass-filled polycarbonate rod that runs the length of the connector. A slotted, teardrop-shaped extension of the rod enables a screwdriver to position the contacts and also gives a visual indication of the contact's open or closed position. Despite its name, the connector has a slight wiping action of 0.003 to 0.005 inch as it is cammed onto the board, Corrigan estimates.

The 244 series zero-insertion-

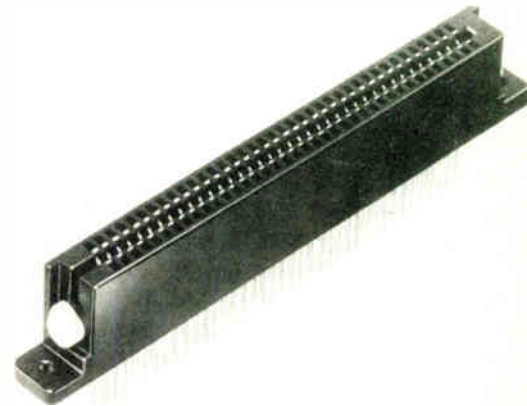

force connector accepts substrates or boards with a thickness of 0.062 in.  $\pm 0.008$  in. It is available now with 38 contact positions for 76 independent opposing circuit contacts with solderless wrap termination. Current rating is 3.0 amperes; operating voltage is rated at 600 v ac. Contacts are plated with 30 millionths of an inch of gold and have a contact resistance of 10 milliohms maximum at rated current; insulation resistance is 5,000 megohms minimum.

Price of the connector is about 10 cents per contact in quantities of 1,000.

Amphenol Industrial Division, 1830 S. 54th Ave., Chicago, Ill. 60650 [341].

### Resistive active filters

cover from 1 to 50 kHz

The 736/746 series of six-pole resistive active filters is available with either Butterworth or Bessel response

# Dialight sees a need:

(**Need:** Find a very small fault in a very large system.)

# See Dialight.

All printed-circuit boards need a fault indicator; that's why Dialight has developed such a broad family. These tiny LED devices signal where and when a fault occurs in a complex electronic circuit — and this can reduce downtime to a minimum. With some Dialight fault indicators, you can get as many as 10 units in just 1" of space. These devices, which come in a variety of sizes, are designed to operate from 1.6 to 14 volts and are available with both axial and right angle leads. They

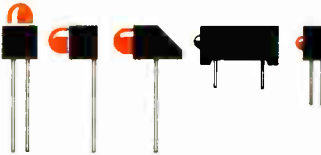

can be driven directly from DTL or TTL logic and can also serve as logic-state indicators, binary data displays, or just as indicators, as in this p-c board furnished by Struthers-Dunn, Inc.\* But Dialight's fault finders are only a small part of their fast-growing family of light-emitting diodes. Additional opto-electronic devices are extensively used in cartridges, lighted push-button switches, optoisolators, and readouts, all supplied by Dialight. A wide variety of discrete LEDs further adds to the broad family.

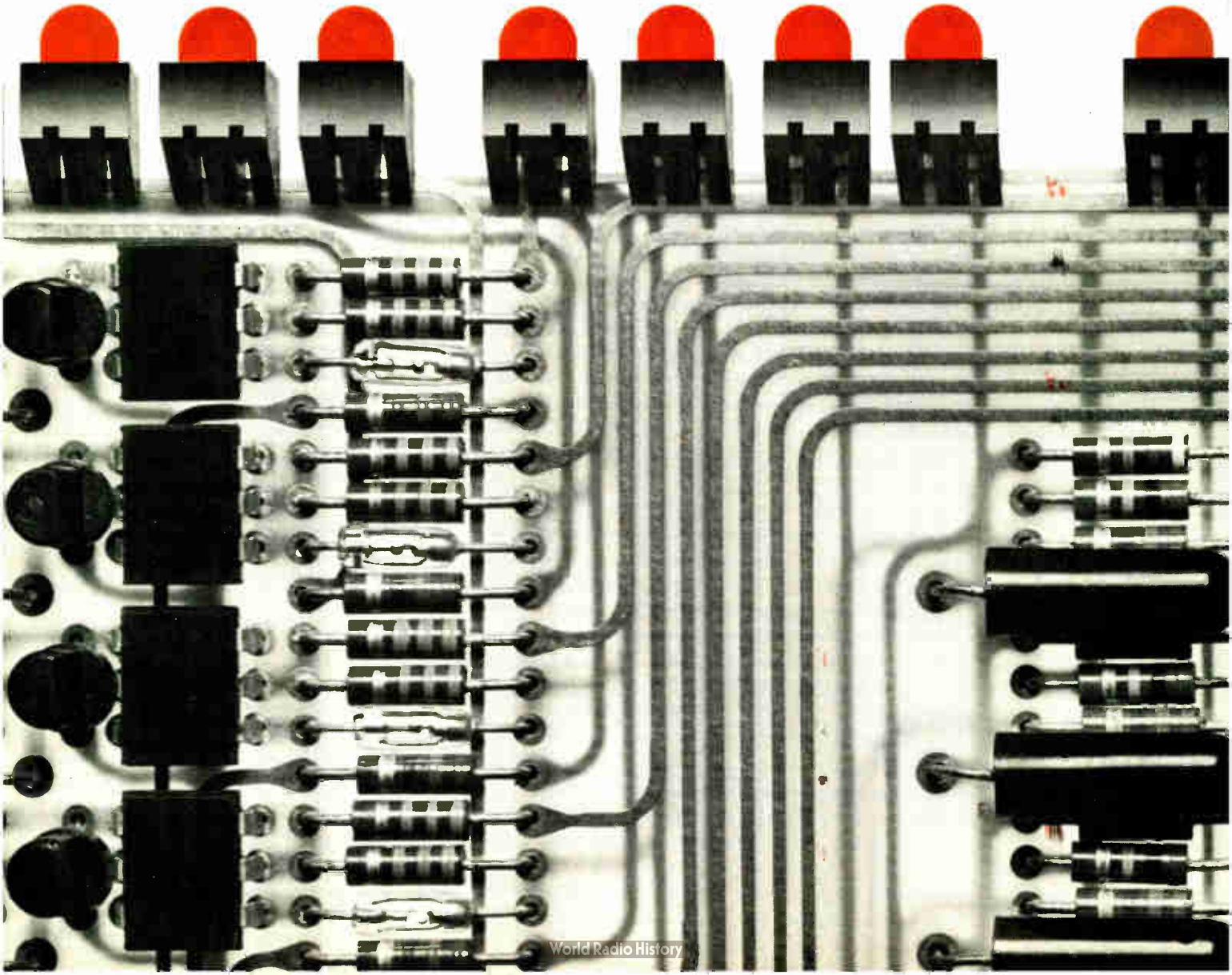



Dialight is a company that looks for needs . . . and develops solutions. That's why we developed the industry's broadest line of switches, indicator lights and readouts using LEDs. No other company offers you one-stop shopping in all these product areas. And no one has more experience in the visual display field. Dialight can help you do more with them. Talk to the specialists at Dialight first. You won't have to talk to anyone else. We can help you do more with LEDs than anyone else because we've done more with them.

Here are a few products in this family: **1.** Ultra-miniature indicator lights **2.** Datalamp cartridges **3.** Bi-pin LED lamp **4.** Opto-isolators **5.** LED solid state lamps **6.** Logic state fault indicators

\*Used in their VIP Programmable Controller

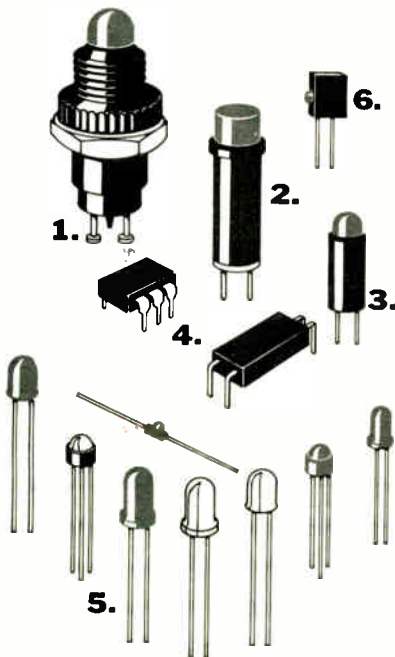

Please send data on your LED products.

NAME \_\_\_\_\_  
 TITLE \_\_\_\_\_  
 COMPANY \_\_\_\_\_  
 ADDRESS \_\_\_\_\_  
 CITY \_\_\_\_\_ STATE \_\_\_\_\_

**DIALIGHT**

Dialight Corporation, A North American Philips Company  
 60 Stewart Avenue, Brooklyn, N.Y. 11237 (212) 497-7600

Circle 129 on reader service card  
**Electronics/August 16, 1973**

## New products

and in four overlapping ranges covering bands from 1 hertz to 20 kilohertz for the 736 and from 1 Hz to 50 kHz for the 646. All are filtered down to 3 decibels at the corner frequency. Dc gain is within unity by  $\pm 0.02$  decibel, with output offset drift of 10 microvolts/ $^{\circ}$  C. Drift of 0.01%/ $^{\circ}$  C is available on special order. The low-end cutoff frequency in each range can be extended by one decade, increasing offset voltage and drift slightly.

Six identical external tuning resistors, one for each pole, control frequency cutoff, and a potentiometer trims the offset; precision resistors can be used if cutoff frequency is already determined.

The 736/746 series can be used in most situations requiring low pass such as data transmission, test instrumentation, and frequency analysis applications where signal fidelity and adjustable cutoff frequency are needed. The series performs equally well in fixed-frequency applications. Price of the 736 is \$95 each for 1-9 units, and \$65 for 100 units; the 746 costs \$105 for 1-9 units and \$75 for 100 units. Delivery time is stock to two weeks.

Frequency Devices Inc., 25 Locust St., Haverhill, Mass. 01803 [343]

## Capacitors are available on pressure-sensitive tape

For easier, more accurate mounting, the CP series of subminiature capacitors for microelectronics applications is available on pressure-sensitive tape. The T-version capacitors are provided in alignment, adhering



to the tape, and may be placed where needed with the tape pressed down to hold them in place; the units are then soldered, and the tape stripped off. The tape is sulphur-free, will not stain, and will withstand 325 $^{\circ}$  for an hour and soldering temperatures for a few seconds. Price is 75 cents each in quantities of 10,000 and 35 cents in 100,000-quantities.

Voltronics Corp., West St., E. Hanover, N.J. 07936 [344]

## Slide-action switch offers 10 positions

The model GDS slide-action switch in a dual in-line package, offers 10 positions from 0 to 9 and measures 1.34 inch by 0.39 inch by 0.47 inch, not including the contacts. The unit also provides a 0.275-by-0.43-inch display and is designed to last over 1,000,000 switching operations at 48 v ac. The GDS-1 can be plugged

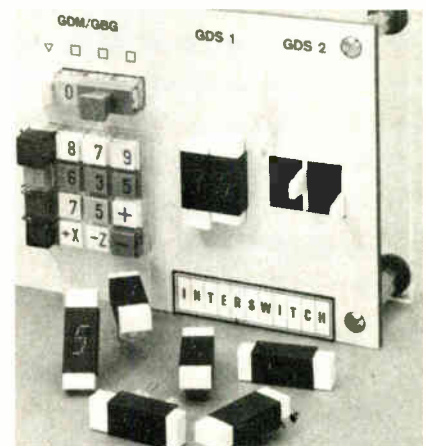

into a pc board through two 0.39-inch holes on the front panel, and the GDS-2, once mounted on a board, can be installed on a front panel from the rear.

Interswitch, 770 Airport Blvd., Burlingame, Calif. 94010 [345]

## Module accommodates 18 resistors on one substrate

A thick-film resistor module is designed for applications where many resistors are needed for installation



Careful there . . .  
you're likely  
to start  
something.



Just a  
"flutter" of pressure  
. . . and SNAP!

Less than 2 grams of force actuates this Cherry snap-action miniature switch. Outside, the external aluminum actuator is purposely  $2\frac{3}{8}$ " long to provide this unusually low operating force. Inside, an extra internal actuator further reduces operating force while maintaining solid contact mating pressure for reliable performance.

The "flutter force" switch is only one of Cherry's E22 series of unique miniatures. All are rated 3 amps, 125 VAC. All are also available in gold "crosspoint" configuration for low energy solid state circuits.

**A switch in your hand is worth two in the tree, so . . . SNAP UP A FREE SNAP-ACTION SAMPLE.**

Just TWX 910-235-1572 . . . or PHONE 312/689-7704 and ask Frank to give you facts on miniature switches . . . or circle appropriate reader service number.

**E22-75HX**  
5 grams LIGHT  
FORCE actuation  
Circle No. 168 for  
Free Sample



**E22-55HX**  
3.5 grams LIGHTER  
FORCE actuation  
Circle No. 169 for  
Free Sample



**E22-85HX**  
Less than 2 grams  
"FLUTTER"  
FORCE" actuation  
Circle No. 170 for Free Sample



**CHERRY** 

**CHERRY ELECTRICAL PRODUCTS CORP.**  
3600 Sunset Avenue, Waukegan, Illinois 60085



Cherry affiliates worldwide • Hirose Cherry Precision Co., Ltd., Tokyo • G. W. Engineering Pty. Ltd., Sydney  
Cherry Electrical Products (U.K.) Ltd., St. Albans, Herts • Cherry Mikroschalter GmbH, Bayreuth, Germany

## New products

in a small space. As many as 18 resistors have been placed on the 1/2-inch substrate, and the company says that still more can be accommodated, depending on the power rating of the resistors and the pin layout. Resistor values ranging from 25 ohms to 10 megohms with tolerances as low as  $\pm 1\%$  can be built in the 780 series; custom matching can be achieved to within  $\pm 0.5\%$ . A typical 16-resistor module is priced at less than 52 cents in production quantities.

CTS Microelectronics Inc., 1201 Cumberland Ave., Lafayette, Ind. 47902 [346]

Relays require only 40 mW to switch to 2-ampere loads

A low-profile, flatpack series of micro-miniature relays, called the 72N series, is an all-welded family that requires only 40 milliwatts of power

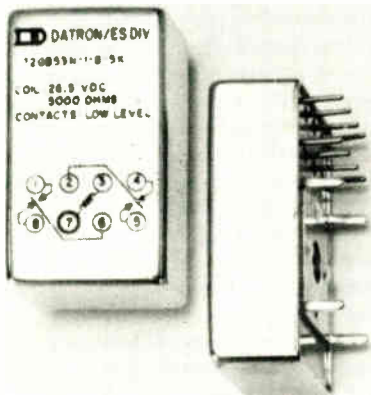

to switch a dry circuit to 2-ampere loads. Mounting configuration includes plug-in leads, so the relay may be plugged directly into a circuit board without bending and handling of leads.

Datron Systems Inc., Electronic Specialty Division, 18900 N.E. Sandy Blvd., Portland, Ore. 97220 [347]

Proximity switch provides turret head

Designed with a turret head that can be indexed to any of five positions, a solid-state proximity limit switch detects ferrous and non-fer-

rous materials. The unit is available in two versions: a model with a 1/2-inch sensing range that can be imbedded in metal without loss of sen-



sitivity, and a model with a 3/4-inch sensing range.

R.B. Denison Inc., 103 Broadway, Bedford, Ohio [348]

Toggle switch requires no backup installation nut

A subminiature toggle switch is now available with an optional U Special Bushing, which requires no backup nut for installation. A shorter-threaded bushing above a thicker nonthreaded flange is used instead, and this means much faster panel installation. The unit is available in more than 35 configurations in single-, double-, triple-, and quadruple-pole versions, all double-throw.

C&K Components Inc., 103 Morse St., Wattertown, Maine 02172 [349]



**everything  
you've wanted  
to know  
about extended  
capability  
nickel-cadmium  
batteries...**

Here's a book with more information on nickel-cadmium batteries. This new handbook supplements the first Nickel-Cadmium Battery Application Engineering Handbook with new application information on extended capability batteries. To find out how you can order this comprehensive engineering handbook circle the number below on the reader service card, or write: General Electric Company, P. O. Box 114, Gainesville, Florida 32601. 453-25

**But didn't  
know where  
to look**

GENERAL  ELECTRIC



# EITHER OF OURS WILL COVER FIVE OF THEIRS.

5 volt powered, 5 ranges—from 20mV through 200V full scale, the Model 253 changes ranges almost as fast as you can change your mind. Without rewiring. More OEM delights: the 253 comes standard with BCD output, 200-volt overload protection, autopolarity, and big, bright LED digits. All of this fits into a neat, small ANSI cutout, 3.32" x 1.14".

And if you want line power, it's optional. Ratio, too.

Our 256 is the 253 with 1/2" Sperry readout and character serial BCD output. Saves a few bucks.

Both models are covered by a strong warranty that guarantees these DPM's even if you've peeked inside to see how cunningly everything's packaged.

Prices are \$95 for the 253 in OEM quantities, and less for the 256. For complete details on the 5V DPM's that do everything an OEM wants, call John Welte collect at (714) 540-4914. Or write Newport Laboratories, Inc., 630 East Young Street, Santa Ana, California 92705.

## NEWPORT



In Europe: Newport Laboratories B.V., P.O. Box 7759, Schiphol-0, Holland, Tel: 020-45-20-52



Data handling

## Word processor uses chip set

Logic for low-priced, versatile text editor provided by microprocessor

Still another company has jumped into the proliferating word-processing industry, with a machine based on a microprocessor. Editext: Word Processing Inc. of Burlington, Mass., has introduced as its first product a text-editing machine, the Editext:



80, built around Intel's 8008 microprocessor.

At \$8,000, the machine is well below the price of minicomputer-based systems, and Editext claims the 80's capabilities are well above those of competitively priced systems whose main function is secretarial. While the unit can perform the standard letter-typing functions, it is also expected to be used in applications that require heavy editing, such as in publishing houses and technological groups, and in the production of manuals.

Configuration of the Editext: 80 includes a heavy-duty IBM Selectric typewriter, a 3M tape cartridge with a special transport, and the preprogrammed microprocessor that provides logic to perform editing tasks. Outboarded onto the processor are 10,240 words of read-only memory and 1,024 words of random-access memory.

Unlike most other word processors, which require constant interaction between operator and machine, the editing and printing

functions are separated in the 80. The operator has merely to type the text and enter the editing instructions before the power phase begins. The Editext performs without supervision the final printing, incorporating all commands.

There are only eight editing commands—replace, move, delete, underline, indent, format, center, and erase. These can be entered in any sequence. The company claims that these commands are sufficient to edit the most complex documents. Once characters per line and lines per page are specified, entire paragraphs can be added or deleted without changing the page format or affecting the numbering of pages.

Since the processor is limited in capacity and cycle time, the two tape-storage units are controlled separately with hard-wired TTL. Once it is signaled by the processor to start, the controller does all the work, bypassing the processor to access the memory directly. To do this, Editext has direct-memory channels similar to those in computers. The processor sets up the beginning location in the tape, but the channels advance the memory. After the transaction is completed, the processor commands a check to assure that the tape is finished, and other commands can be sent.

The Editext: 80 uses a 3M tape cartridge with a capacity of 150 pages, and typical page length is 55 lines. A tape drive can search the tapes at 45 lines per second. An internal directory is automatically maintained at the beginning of each tape, and a complete index can be printed out. The operator merely has to key in the document number to retrieve it.

Delivery time is 90 days.

Editext: Word Processing Inc., 20 Ray Ave., Burlington, Mass. [361]

## 'Universal' microprocessor helps design digital systems

Microprocessors, sets of a few chips that form small computers, look like the answer for many users who need to develop digital systems, espe-

cially ones to process relatively low volume. But most microprocessors require a lot of software and firmware development, a wasteful and expensive proposition if the user has to keep ordering new masks made up for read-only memories.

To help overcome this problem, a number of companies are now developing universal microprocessors that can be used for program and hardware development. The units act like complete microcomputers, but have added capabilities. Applied Computing Technology, which earlier introduced such a unit for Intel chip sets, now has developed one for the Rockwell Microelectronics PPS-4 microprocessor. ACT calls the PPS-4MP an Assembler—it assembles programs and emulates the desired chip set.

The unit uses random-access memory to emulate the ROM that would be installed in a microprocessor used in controller or computer applications. The system will set a routine in programable ROMs from programs developed and stored in the Assembler, or it will produce tapes for mask-programmed ROMs. As a computer, it's a 4-bit machine, with 8- and 16-bit instruction words. Fifty instructions are included, and 16,384 8-bit words can be directly addressed in ROM or read-write memory emulating ROM, or 8,192 4-bit words in RAM. Indirect addressing doubles capacity.

One 12-bit program-counter register, two program-stack registers, and an 8-bit instruction register are included. Two levels of direct nesting and unlimited indirect nesting are available. Instruction cycle time



## New products

is 5 microseconds for a single-word instruction, and the time is the same for two 4-bit binary numbers. The system can handle a total of 48 input and 48 output ports, plus a Teletype channel. The unit's operating system storage is 2,048 8-bit words, with PROM expansion to 14,336. It uses Rockwell circuits for all applicable functions.

With increasing use of microcomputers, ACT sees programing aids such as the Assemulator becoming standard devices.

ACT will also perform the programing for users designing custom systems. The basic PPS-4MP costs \$6,950.

Applied Computing Technology, 17815 Sky Park Circle, Irvine, Calif. 92707 [362]

### Word processor prints

240 words a minute

A computerized editing and typing system, called the model CTS, is desk-size and geared to high-volume production. The word processor can format typed-in pages automatically and will scan the 26 pages in its storage cassette at a rate of 12,000 characters per second to locate a particular document already stored on tape or to pinpoint and make needed corrections. It then types out an error-free document automatically at 240 words per minute. Price is \$8,995, but a variety of rental, purchase, rental-purchase, and third-party lease plans will be available.

Litton Industries, Royal Typewriter Division, 850 Third Ave., New York, N.Y. 10022 [363]

### Front-loading disk drive

handles to 96 million bits

A 200-track-per-inch front-loading disk drive, called the model 206, is configured with either one removable cartridge for 48 million bits of data capacity, or one fixed plus one removable cartridge for 96 million bits. The unit connects to all commonly used minicomputers and is designed to provide total system



storage capacities up to 394 million bits by daisy-chaining up to four drives. Price is about \$3,800.

Electronic Memories & Magnetics Corp., 12621 Chadron Ave., Hawthorne, Calif. 90250 [366]

### Add-on memory doubles

IBM 360/67 storage

An add-on main memory that doubles the storage capacity of some IBM System/360 model 67 computer processors is called the 360/CORE 67. It is expandable from a minimum of 262,000 bytes to a maximum of 2 megabytes of main storage. Expansion increments duplicate IBM-supplied memory for the Model 67 Mod 1 processors up to 1 megabyte of storage. Cycle time for the add-on memory is 750 nanoseconds.

Cambridge Memories Inc., Concord, Mass. [364]

### Modules improve computers' industrial-system operation

Three new modules, designed for Digital Equipment Corp.'s Universal Controller interface, reduce the number of intermediate devices required between the interface and the process transducers. The modules plug into the controllers used in PDP-8- and PDP-11-based industrial data-acquisition and control systems to add direct analog input



and direct ac input to the existing capability. Price is \$1,100.

Digital Equipment Corp., Maynard, Mass. 01754 [365]

### Memory combines

tapes and disks into one unit

A minicomputer memory is designed to integrate tapes and disks into a single peripheral. Addressed



and controlled through one mini-computer input-output slot, the CartriFile 211 provides a combination of random-access and bulk data storage and incorporates a sealed moving-head disk. Price with a PDP-11 computer interface is \$5,995. OEM and quantity discounts are available.

Tri-Data Corp., 800 Maude Ave., Mountain View, Calif. 94040 [367]

### Batch terminal includes

150 cards/minute reader

Designated the model 88-6, a remote batch terminal provides a 150-cards-per-minute reader, a 132-column 165-characters-per-second printer, control panel, display panel, and terminal-control unit. The 88-6



is compatible with the IBM 2780 line discipline. Other features are: dual 400-character buffers, two- or four-wire communications at 1,200, 2,000 or 2,400 bits per second, automatic error recovery with extended retry,

# How an Applicon Graphic System improves design, cuts cost.

The AGS 700 is an automated design/drafting system capable of reducing unit design costs by 30-70% and producing time savings up to 10:1. More than fifty U.S. and overseas corporations are already realizing savings of hundreds of man-hours and thousands of dollars. For example:

**An electronics equipment manufacturer** saves fifty-two manhours on one size PC board and seventy-nine

manhours on another. Figuring conservatively at \$10 per manhour, he estimates savings of more than \$157,200 in designing 240 boards.

**A computer/controls company** reports reducing design and revision time from 119 to 83 manhours per board. At an average savings of \$432 per unit. Handling 700 PCBs per year, this company's estimated savings equal \$302,400.

**A major controls manufacturer** realizes savings of 90% on engineering change turnaround

alone – because the AGS 700 manipulates computerized drawings almost instantly.

Applicon Graphic Systems are already demonstrating their profitability in many applications: electronics, architectural, mechanical, diagramming, mapping. Accepting input by several techniques, they enable designers and draftsmen to interact quickly and powerfully with their drawings to produce improved designs at faster rates and greatly reduced costs.

For more information, mail the coupon below.

APPLICON, INCORPORATED EL - 1  
154 Middlesex Turnpike  
Burlington, Mass. 01803

Please send complete data about  
Applicon Graphic Processing directly to:

NAME \_\_\_\_\_  
TITLE \_\_\_\_\_  
COMPANY \_\_\_\_\_  
STREET \_\_\_\_\_  
CITY \_\_\_\_\_  
STATE \_\_\_\_\_ ZIP \_\_\_\_\_

**APPLICON**  
INCORPORATED

Circle 135 on reader service card







When it comes to  
**TRANSIENT  
 VOLTAGE  
 PROTECTION**

*Signalite* wrote  
 the book!

**And, It's Yours FREE!**

**It's all part of the SIGNALITE  
 TRANSIENT VOLTAGE PROTECTION KIT!**

Including a 28-page book entitled, "Gas Discharge Devices For Use In Transient Voltage Protection and Electrical Energy Transfer." Part I, Transient Voltage Protection, details sources of voltage transients, operation and construction of protectors, comparison of various transient protection devices, pulse breakdowns, V & I characteristics of protectors in AC & DC circuits, follow-on current, etc. Part II, Electrical Energy Transfer, details various devices, applications and glow-to-arc transitions. Included in the Signalite Transient Protection Kit are specification bulletins on Signalite's UNI-IMP, the fastest surge arrester in existence... COMM-GAP, a high quality, low cost protector with a wide range of applications... TWO ELECTRODE & TRIGGERED SPARK GAPS... AC/DC LINE PROTECTORS... plus an Applications Engineering Worksheet so that the Signalite Application Department can help in the design of your protection circuitry.

*Signalite*  
 DIVISION OF GENERAL  
 INSTRUMENT CORPORATION

1933 Heck Ave., Neptune, New Jersey 07753  
 Area Code 201-775-2490 ■ TWX 201-775-2255

329

**New products**

and EBCDIC transparency. Lease price is \$545 per month.

Data 100 Corp., 7725 Washington Ave. S., Minneapolis, Minn. 55435 [368]

Disk memory provides to 400 million bits of storage

Designed to plug directly into a PDP-8/E Omnibus, the model 240 disk cartridge memory system can accommodate up to eight disks, providing a maximum of 400 million

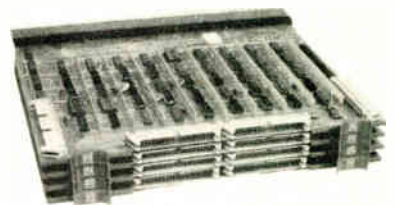

usable bits of on-line storage. The controller works with either the 5440 top-loading or 2315 front-loading drives. OEM price is \$2,500.

Data Systems Design, 1122 University Ave., Berkeley, Calif. [369]

Thermal printer is aimed at calculator market

A thermal printer for use in calculators and other equipment requiring printed tapes provides a 5-by-5 dot matrix print head. The model TP 3100 can produce any programmed combination of 64 alpha-



numeric characters and symbols. Printing capacity is up to 18 columns on 2½-inch-wide thermal paper.

Bowmar Instrument Corp., 8000 Bluffton Rd., Fort Wayne, Ind. 46809 [370]

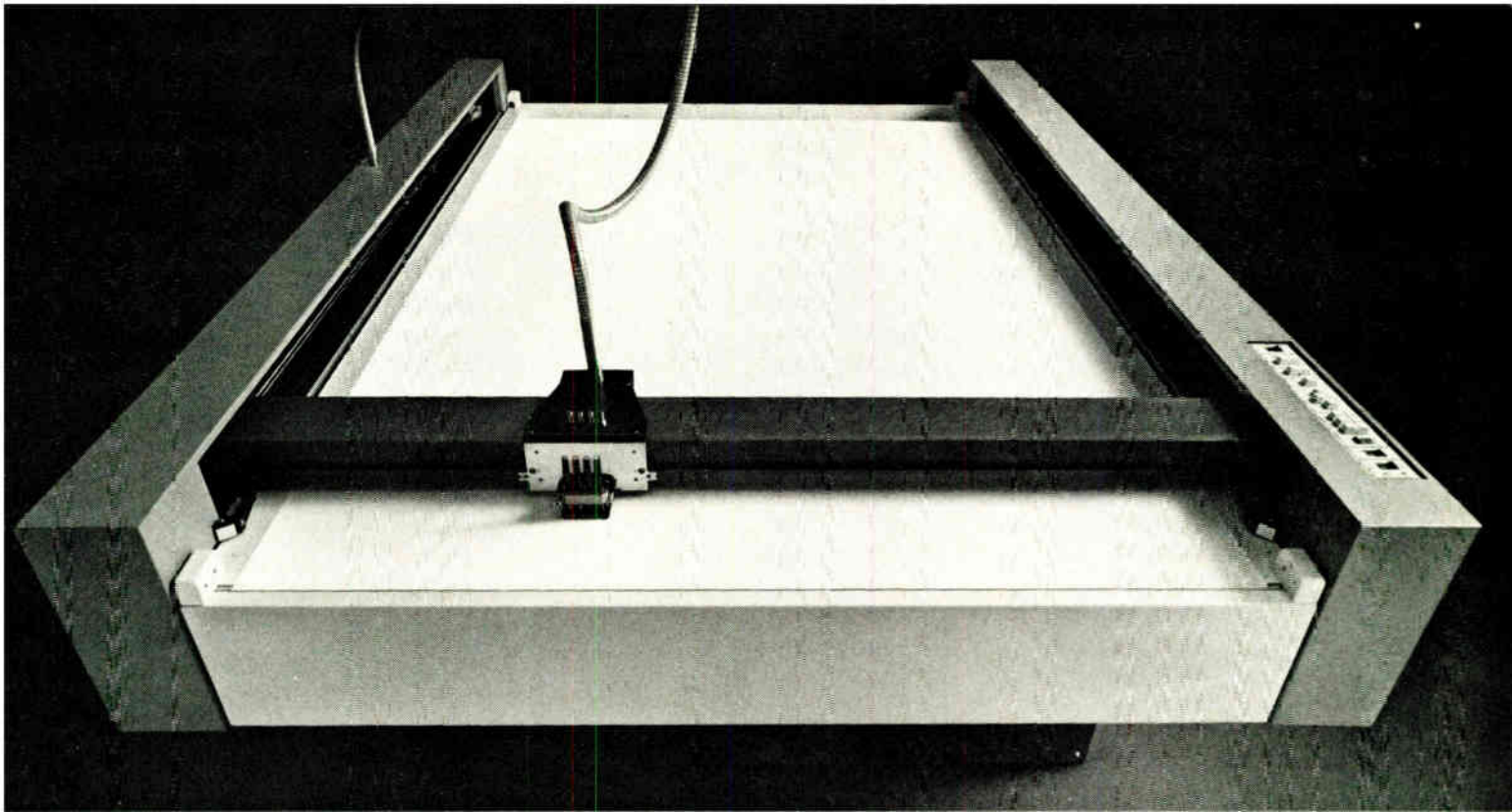

## The four-fingered fast-drawing kid is coming to town.

We call it the 748. It's big. And it's fast.

Its 4 inking pens move at speeds over 40 inches a second. That's faster than ink flows, so we had to figure out a pressure inking system that lets the ink catch up to the pens.

If you make integrated circuits or maps. Or if you have precision drafting needs, this is the new tool.

The 748's plotting area is 48"x82". It can scribe

coated materials and cut strippable film. At peak speeds!

The quality of its line is not impaired by its incredible speed. And like all CalComp flatbed plotters, the new 748 offers easy-to-use software for most computers.

We service it in 29 countries. But the way we've made it, you won't be calling us very often.

Do call us to see it. Our number is (714) 821-2011. Or

write California Computer Products, Inc., EM-M6-73, 2411 West La Palma Avenue, Anaheim, California 92801.



**CALCOMP**



# THE UNINTERRUPTIBLE

## STRAIN

by Michael Cricketon

It seemed harmless enough at the time. A rather simple experiment. Hooking two uninterruptible power sources together. Of course, that was before anyone knew about the kvat factor.

The first indication that anything was amiss came from Poughkeepsie, New York. During the night every electrical device began operating at full power. It didn't seem to matter whether the switches were on or not. Dishwashers sprayed, toasters toasted and popped, automatic garage doors opened and closed. Most alarming of all were the lights. At 2 AM, Poughkeepsie was bathed in billions of candlepower.

The phenomenon was soon repeated all across the country, with a multitude of results, some amusing, many tragic. A plush Los Angeles hotel suddenly found all its heated waterbeds were approaching the boiling point. A computer in Wilmington, Delaware, succeeded in printing out the numerical value of infinity. The continuous glow of every incandescent bulb in the nation caused America to become a nation of insomniacs. Except in Las Vegas, where the problem wasn't even noticed.

### A Nation of Insomniacs.

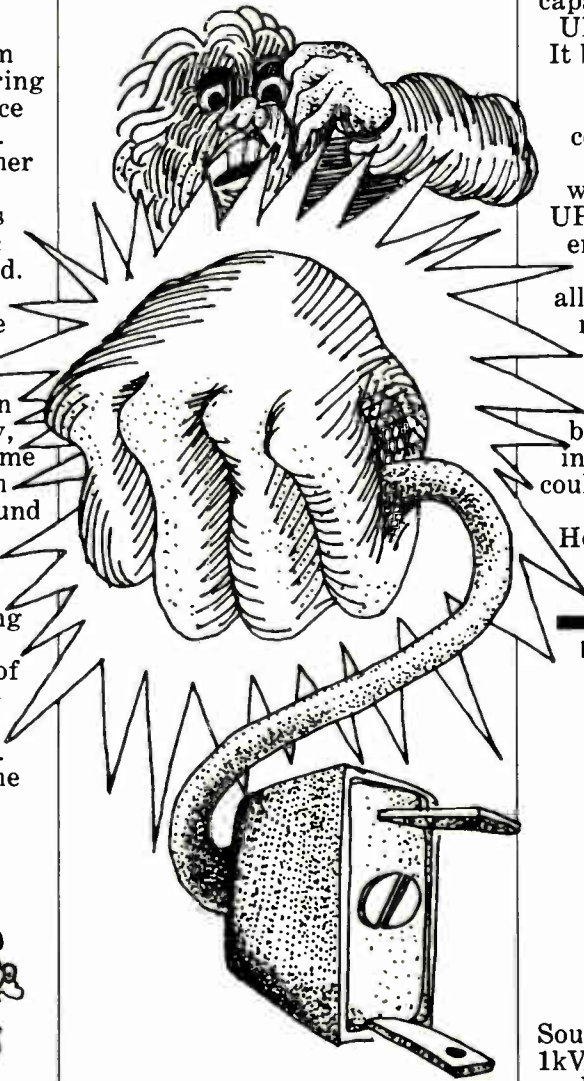
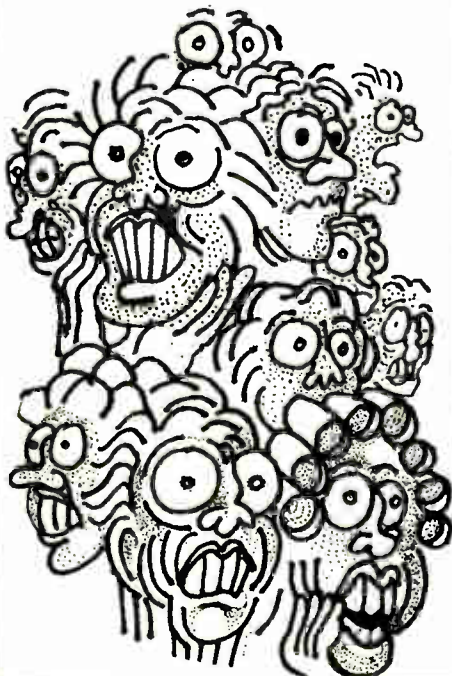

Fortunately, the sleepless nights were turned to advantage by a dedicated group of scientists. They soon traced the problem to the two inter-connected UPS's. Connecting them together at first glance would seem no different than linking two batteries pole to pole. The difference was in the purpose of the devices involved. The purpose of an uninterruptible power source is to provide a continuous supply of power under all conditions, even during electrical failures.

When each UPS found it was unable to supply the other with power, it searched for a place to store the unused kva's. The system contained minimal inductance and practically no capacitance at all. Therefore each UPS did the only thing it could. It began storing its power in the dimension of time in kvat's.

This put each UPS in direct contact with all the power that had ever been used and ever would be. In kvat potential, the UPS's were decidedly on the low end. Thus they became a drain.

A drain for all the power in all of time. Trillions of kilowatts rushed through the UPS's and out over the world's electrical networks. Left unchecked, all energy would have eventually been focused into a single blazing millisecond. But before that could happen, a brilliant scientist took bold and decisive action. He disconnected the UPS's. The uninterruptible strain was interrupted at last.

### Elgar The Uninterruptible.

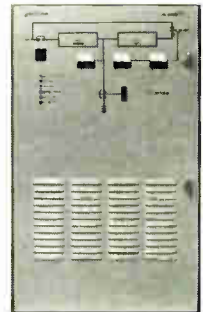

Elgar Uninterruptible Power Sources are available in .5kVA, 1kVA, 2.5kVA, 5.0kVA, and 10kVA models. They supply 40db line transient reduction,  $\pm 2\%$  voltage regulation and up to ten minutes of instantaneous reserve in case of power failure. Ideal for IBM Systems 3 and 7, DEC PDP/8, PDP/11, Burroughs 1700, and Data General Super Nova. For complete information, call Wally Foy collect (714) 565-1155. Or write Elgar Corporation, 8159 Engineer Road, San Diego, California 92111





Instruments

## Pulser tailored to MOS logic

Test generator puts out 16 V from each of two channels; also checks other circuits

Designed with today's MOS logic and tomorrow's even faster MOS circuits in mind, a pulse generator developed by Hewlett-Packard has two outputs, each of which puts out pulses as high as 16 volts, and a

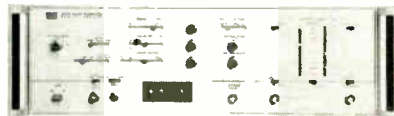

repetition rate that reaches up to 50 megahertz.

Combining the outputs of the model 8015A yields 30 v, from +15 to -15 v. Graduated level controls precisely adjust pulse top and baseline individually, obviating the need to set levels with a scope or digital voltmeter. Individual slide controls for top and baseline eliminate offset control—pulses of any amplitude up to 16 v are set within the desired window of +16 to -16 v.

Each output has a normal/complementary switch, and each has selectable source impedance, 50 ohms or 1 kilohm, to deal with reflections and varying loads. Thus the 8015A is suited to testing C-MOS, low-threshold MOS and most high-threshold MOS, as well as TTL, HTL, and discrete circuits. Repetition rates range from 1 hertz to 50 MHz (30 MHz for 32-v operation) to handle a wide variety of applications including faster MOS.

Transition times are variable from 6 nanoseconds to 0.5 s, the faster times useful with IC logic families and the slower times in trigger level detection and process control applications. Verniers separate control transition times of leading and

trailing edges, which may differ by 100:1 in either direction.

By using the 8015A's B delay mode, non-overlapping two-phase clock signals can be assured. Channel B is delayed with respect to A, so pulses never overlap; the distance between the two pulses can be adjusted with the delay control. By combining the A+B and the B delay modes, three-level signals may be generated, to simulate special codes or to test charge-coupled devices.

Single pulses may be commanded by the operator. To minimize gating problems such as drift and jitter, counted burst is offered as an option. Thumbwheels predetermine how many pulses, from 1 to 9,999, will be delivered on command. Unlike conventional gating, in which pulses within a gate signal vary with pulse rate, the counted pulse burst number is constant.

The 8015A, which will be demonstrated at Wescon in San Francisco, Sept. 11-14, is priced at \$1,750 in the U.S. The counted burst option adds \$350. A single-output model of the generator sells for \$1,350.

Inquiries Manager, Hewlett Packard Co., 1501 Page Mill Rd., Palo Alto, Calif. 94304 [351]

## Function generators provide independent sawtooth unit

Three function generators incorporate an independent, yet integrated, sawtooth generator. The models 505, 515, and 525 offer built-in capabilities to generate sine, triangular, and square waves, sawtooth waveforms, pulses, low-duty-cycle pulses, tone bursts, swept sine, swept triangular, and swept square waves, swept prb, haversines, and



monopulses. Each of the units additionally provides a built-in wide-band summing amplifier; its integrator and sawtooth generator can be operated separately or together. Price is \$645 for the 5-MHz model 505, \$845 for the 10-MHz model 515, and \$1,045 for the 20-MHz model 525.

Ailtech, 19535 E. Walnut Dr., City of Industry, Calif. 91748 [353]

## High-voltage megohmmeters provide variable output

Three models of a heavy-duty industrial megohmmeter are available for testing the insulation resistance



on such electrical equipment as switchgear, circuit breakers, generators, transformers, wire and cable, motors, regulators, and connectors. The models HV2.5, HV5, and HV10 feature continuously adjustable outputs from zero to 2,500 v, 5,000 v, 100,000 v, and 200,000 v respectively.

Hipotronics Inc., Brewster, N.Y. 10509 [354]

## Continuity tester designed for field, bench checkout

The model 1060 OEM continuity tester which is battery-operated and suited for field or bench checkout, is



The U. S. Government does not pay for this advertisement. It is presented as a public service in cooperation with The Department of the Treasury and The Advertising Council.

# If you can't manage now, how are you going to manage later?

Money's tight. You feel pretty lucky if you can stretch your paycheck enough to meet all the everyday expenses. It's harder than ever to save a buck. And how are you going to take care of the future, when you've got enough trouble just taking care of the present?

But, you *can* manage to save—by joining the Payroll Savings Plan where you work. It's a sure way to get started on a nest egg that you can depend on in the future.

The amount you designate will be automatically set aside from your paycheck and used to buy U.S. Savings Bonds, *before* you get your check, and *before* you can spend it.

So, join the Payroll Savings Plan and start on your "secret stash" today. And then just relax and don't worry about tomorrow. You'll manage.



Now E Bonds pay 5½% interest when held to maturity of 5 years, 10 months (4% the first year). Bonds are replaced if lost, stolen, or destroyed. When needed they can be cashed at your bank. Interest is not subject to state or local income taxes, and federal tax may be deferred until redemption.

**Take stock in America.**  
Buy U.S. Savings Bonds.

## New products



designed to permit all semiconductor junctions to react as open circuits. Fused to protect live circuits from overloading, the unit tests adjustable nominal shorts (impedance of less than 15 ohms), adjustable nominal opens (impedance of more than 15 ohms), a semiconductor junction, or low, open voltages of nominally 1.5 volts. It has an audio-visual alarm.

Litton Automated Business Systems, OEM Products Division, 600 Washington Ave., Carlstadt, N.J. 07072 [355]

### Volt-amp-wattmeter

holds error to 0.1%

A precision digital volt-amp-wattmeter for true-rms measurement uses a time-division multiplier to provide accuracy on both sinusoidal and distorted ac waveforms



over a wide frequency range. The model 2503 measures from 3 to 600 V, 0.1 to 5 A, and 300 mW to 18 kW.

Yewtec Corp., 1995 Palmer Ave., Larchmont, N.Y. 10538 [356]

### Counter measures

from 20 HZ to 18 GHz

The model E01-351C microwave counter, for operation in hostile environments encountered in ground-

support, flight-line, shipboard, and portable applications, automatically measures frequencies from 20 hertz to 18 gigahertz, using an electronically tuned YIG filter. Manual adjustment for tuning a cavity or phase-locking an oscillator are not required; the operator need only connect the unknown frequency to the appropriate input connector,



and the correct frequency is automatically displayed.

EIP Inc., 3130 Alfred St., Santa Clara, Calif. 95050 [357]

### Logic probe tests TTL,

DTL, and RTL circuits

The model LS-1 battery-operated logic probe, for testing TTL, RTL, and DTL circuits, has light-emitting diodes mounted at the tip: a red LED for logic high and a green LED for logic low. Both LEDs stay off in the absence of logic levels and when there is an open circuit. Pulse trains are indicated by both lights on. The unit is battery-operated, has a logic-high threshold of 2 V and a logic-low threshold of 0.8 V. Price is \$77, including battery.

Signal Laboratories Inc., 187 N. State College Blvd., Orange, Calif. 92668 [358]

### Portable impedance bridge

eliminates calculations

Fast, accurate measurements requiring no calculations are provided by the model 315A portable universal impedance bridge. A five-digit readout with automatic lighted floating decimal indicates the value of the device under test. The parameter and its magnitude are also displayed. The instrument measures resistance from 0 to 12 megohms, capacitance from 0 to 12 micro-

# First with the MOS.

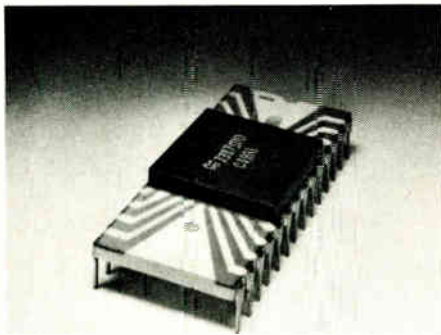

**A very calculating chip.** Our S2144, or "Golden Gate" chip as we call it, is a small miracle. It's an 8-digit calculator chip that drives LEDs or Panaplex displays. A few of the product attributes are: 4 function, 8-digit display • automatic constant in all functions • selectable arithmetic or algebraic mode • automatic round-off • chain operation • switch or key decimal setting • floating decimal on entry, and fixed or floating decimal on results. • products and quotients of sums and differences.

As we're always on the leading edge of this technology, what's happening in MOS is happening right here.

Ask your nearest AMI distributor or contact us for complete details. We'll give you the MOS for your money.

American Microsystems, Inc., 3800 Homestead Road, Santa Clara, CA 95051. Phone: (408) 246-0330.

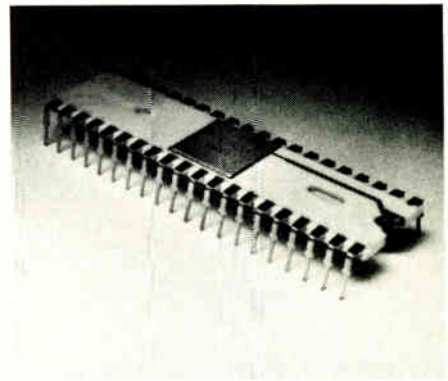

**It's a wizard at the keyboard.**

The S9021 dynamic keyboard encoder has 90-key, 4-mode capability. Like most AMI products, it gives you a great deal of flexibility in application. Its other features are: • TTL compatibility • N key rollover/lockout select for error-free operation • optional serial output • teletypewriter standard ROM pattern.

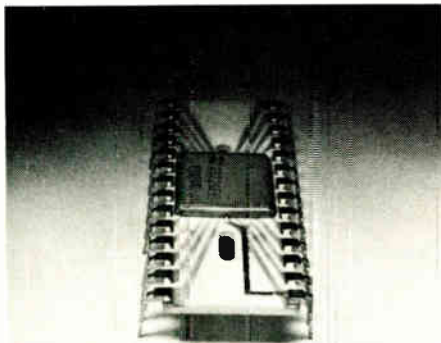

**A very nice ROM,** although surprisingly dense. Our 16K S8996 is the densest ROM you can find at the moment. It's a pin-for-pin replacement of 8K ROMs made by AMI, Signetics, TI and GI. It even has 4-bit programmable chip select, so you can put 16K ROMs in a system and program them to recognize their own select code. Other features include: TTL compatibility • output storage register for data retention • Ion implant for maximum speed at low power.

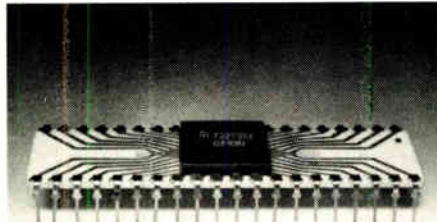

**We've got rhythm.** The S8890 Rhythm Generator is made for use in complex electronic organs. It generates percussion instrument trigger signals and saves you money because a single LSI circuit contains both the Rhythm ROM and Counter. This is another example of AMI's product range and broad engineering capabilities. And the beat goes on. The Rhythm Generator has: 64 bit voice pattern length • 10 voice pattern length selection for each instrument • 9 different percussion instrument drive signals • 5 ROM programmable voice pattern bit lengths • internal oscillator with extended frequency control • beat number display outputs (tube interface).



**Our Liquid Crystals** give you the right time and the right face. The 23550 is a 3½-digit transmissive clock display. Our S1736 chip drives it directly. In our Liquid Crystal clock duo, you'll find: • large characters (.65 inches high) and wide viewing angle (160°) • very low LCD power requirements (10 mw) • 12-24 hour option • alarm with "snooze" capability • AM and PM display.

**AMI**  
AMERICAN MICROSYSTEMS, INC.



# VIDEO analogue to digital converter systems for Colour TV and Radar

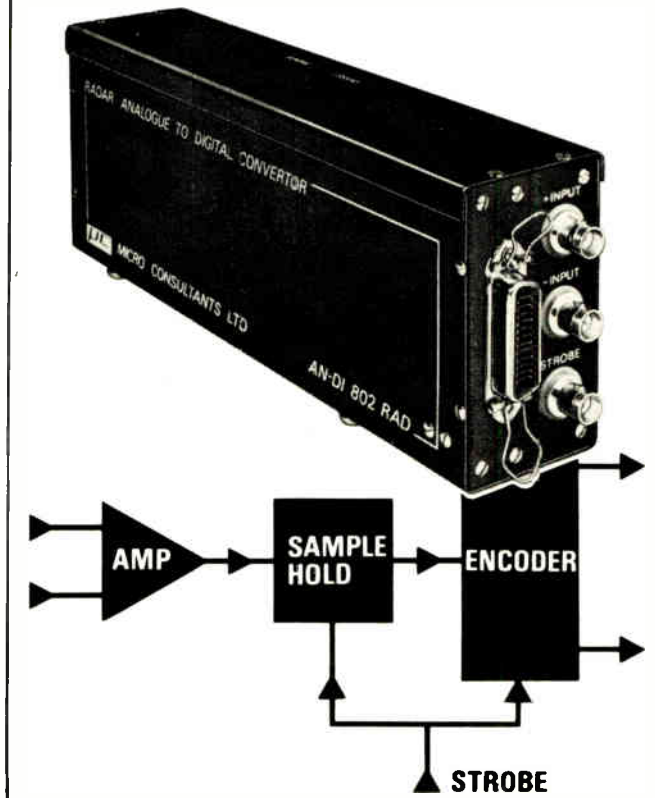

## **AN-DI 802 RAD 'C'**

<b>Resolution</b>	8 bits
<b>Throughput</b>	15 MHz
<b>Input</b>	$\pm \frac{1}{2}$ volt 50 $\Omega$ or 75 $\Omega$ diff.
<b>Sample Aperture</b>	100 picoseconds
<b>Output</b>	Parallel MECL balanced line drivers
<b>Size</b>	3.6 x 2.0 x 9.5 inches

## **AN-DI 1002 VID**

<b>Resolution</b>	10 bits
<b>Throughput</b>	4 MHz
<b>Input</b>	$\pm 1$ volt 50 $\Omega$ or 100 K $\Omega$ diff.
<b>Sample Aperture</b>	20 nanoseconds
<b>Output</b>	74 TTL
<b>Size</b>	3.6 x 2.0 x 9.5 inches

Also available is the DI-AN 1002 RAD, this is a complementary DIGITAL TO ANALOGUE CONVERTOR. Features include 15 MHz updating, 100 volt per  $\mu$ sec slew and < 100 pico volt second switching noise.



## **WESCON - STAND 1355/56**

If you can't make it, contact us for a demonstration, the week following exhibition

**MC MICRO CONSULTANTS LTD**

Interface House, Croydon Road, Caterham, Surrey, England  
Tel. Caterham 47201 (5 lines) Telex 946643

## **New products**

farads, and inductance from 0 to 1,200 henries, with resolutions of 0.1 m $\Omega$ , 0.01 pF, and 0.01  $\mu$ H. Full-scale accuracies are: within 0.05% for

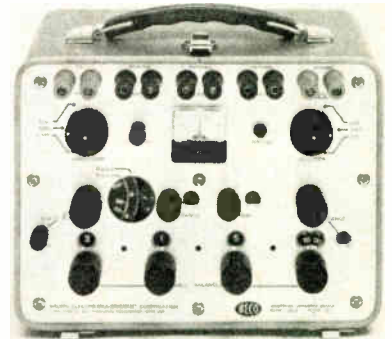

resistance, 0.2% for capacitance, and 0.2% for inductance. The 315A is battery-powered, but the company offers an ac-power option. The basic instrument is priced at \$545.

Brown Electro-Measurement Corp., 11060 118th Pl. N.E., Kirkland, Wash. 98033 [359]

Field-strength meter has rise time of less than 2  $\mu$ s

A field-strength meter, model R-35A, available with a peak and an average detector, is priced at about \$2,000. The detector is selectable by a front-panel switch. The



peak detector, with its rise time of less than 2 microseconds, makes possible the measurement of impulse noise and signals. The average detector, on the other hand, is more suitable for measuring carriers and other continuous-wave signals, the company points out.

Randtech Corp., 14 Division St., Amsterdam, N.Y. 12010 [360]

# AERTECH A2S800 SERIES IS SECOND SOURCE FOR HP 5082-2800 SERIES SCHOTTKY (HOT CARRIER) DIODES

DELIVERY – STOCK TO 30 DAYS

## FEATURING

- FAST SWITCHING
- LOW THRESHOLD
- HIGH BREAKDOWN
- PLANAR PASSIVATED

## APPLICATIONS

- HIGH LEVEL DETECTION
- SWITCHING AND GATING CIRCUITS
- ANALOG-TO-DIGITAL CONVERTERS
- MIXERS
- RING MODULATORS

### AERTECH MODEL

A2S835  
A2S810  
A2S811  
A2S900

### HP MODEL

5082-2835  
5082-2810  
5082-2811  
5082-2900

*Aertech*  
CORPORATION

825 STEWART DR. • SUNNYVALE • CALIF. 94086 • (408) 732-0880 • TWX 910-339-9207

# Raytheon Semiconductor now puts your linears in one place.

## No gimmicks. Just op amps, voltage regulators, wideband amps, comparators, sense amps, line drivers and receivers, memory drivers, and low level audio amps.

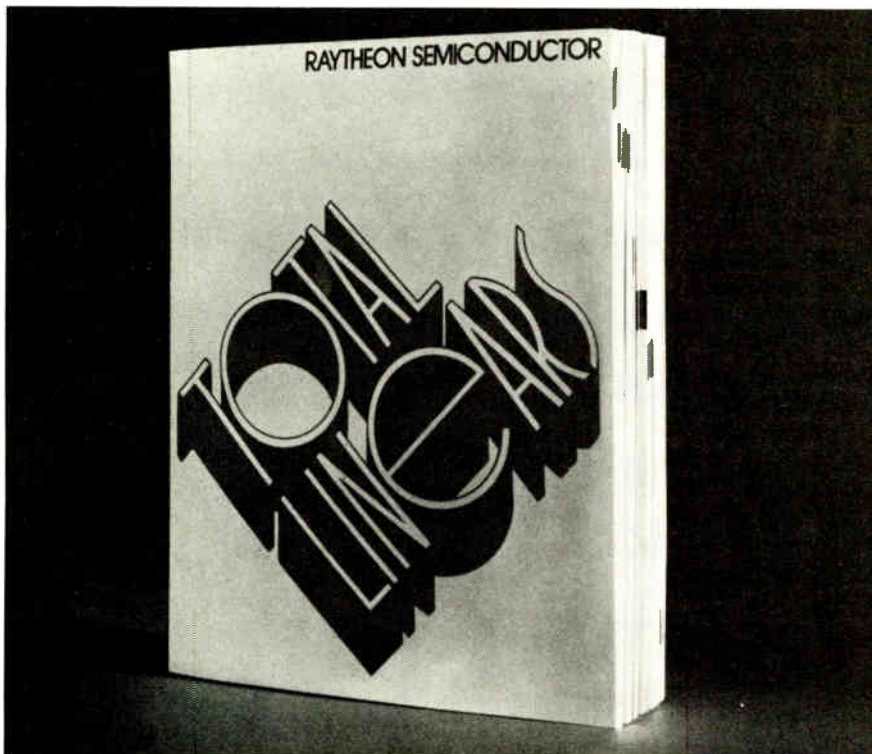

Just send us your request on your company's letterhead. We'll put Total Linears at your fingertips. Your Linear House: Raytheon Semiconductor, 350 Ellis Street, Mountain View, California 94042.





### Subassemblies

## Display modules go commercial

Low-priced units correct CRT pincushion distortion in medium-cost systems

Expensive modules have been used for years in such precision applications as military systems, cockpit displays, and phototypesetting to take care of pincushion distortion in cathode-ray-tube displays. The distortion is caused by variations in the distance the beams must travel from the gun structure to the edges and corners of the CRT.

Until now, users of medium-priced display terminals have simply put up with this distortion because there was no economical way to correct it—even the least expensive correction modules cost \$250, and prices escalated quickly from that minimum, resulting from rigid specifications for accuracy, operating-temperature range, and ruggedness. However, Intronics of Newton, Mass., has developed a series of CRT geometry-correction modules, designated C200, that are aimed at the commercial market. With prices starting at \$120, which Intronics claims are the lowest on the market, and its less stringent specifications, it is feasible for use in displays with prices beginning in the \$5,000 range.

Designed for CRTs with either magnetic or electrostatic deflection systems, the C201 and C202 accept horizontal and vertical input-voltage signals and generate, respectively, output current or voltage signals corrected for pincushion distortion. Both modules operate over deflection angles from 20° to 70°, and accuracy ranges from within 0.5% at 70° to within 0.25% at 40°. Small-signal bandwidth of both is 10 megahertz, while full-power bandwidth is 1 MHz. Slew rate is 30 V per microsecond, and settling time to within 1% of final position after a

10-v step is 1 microsecond.

Size and cost were shaved by using a transconductance-multiplier technique. Instead of a direct-computation method, the C200 generates a hyperbolic tangent similar to that needed to correct for pincushion, and it bypasses all the square-rooting that is usually required to compensate for the CRT's geometry.

Also available in the same series is the FC101 CRT focus-correction module, which has 800-kHz full-power output frequency and full-scale typical accuracy to within 1%.

Price of the C201 is \$120; of the C202, \$145; and of the FC101, \$55. Delivery time for all modules is two weeks.

Intronics, 57 Chapel St., Newton, Mass. 02158. [381]

### Op amp handles signals as low as 100 nanovolts

An operational amplifier designated the model 9821 has been built for low input noise; the unit is specifically for use in preamplifiers handling signals as low as 100 nanovolts. Measuring 1.125 inch square by 0.5 inch high, the unit provides a 3-nv/square-root-hertz maximum input noise voltage and a 30-nv rms output noise for a 100-Hz bandwidth centered about 1 kilohertz. Other specifications include a 120-decibel minimum open-loop gain, 0.3 v/microsecond minimum slewing rate, a 1-megahertz minimum gain bandwidth product, and  $\pm 10$  v at  $\pm 10$  milliamperes output swing. Operating temperature range is from -55° to +100°C. Price for 1 to 2 pieces is \$49. For 3 to 9 units, it is \$44; and for 10 to 29 pieces, \$40.

Optical Electronics Inc., Box 11140, Tucson, Ariz. 85734 [382]

### Xenon lamp system suited to character recognition

A high-intensity xenon lamp system, called the VIX-150, extracts 200,000 candlepower from 150 watts

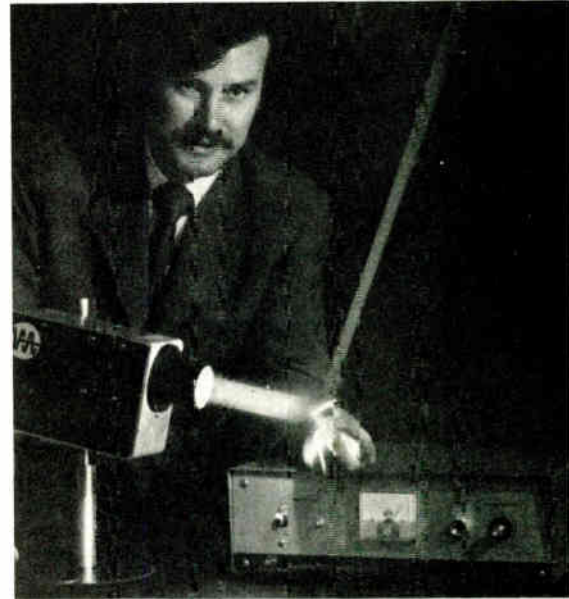

of power. The lamp's color temperature is 5,100° Kelvin. According to the company, the lamp is a re-packaged version of xenon lamp X6207, with added capabilities for new applications. These include optical character recognition, medical devices such as sterilizers, photographic systems, and sun simulation. Cost of the lamp is \$175, while the system, which includes a lamp holder, power supply and cooling system, is priced at \$945.

Eimac Division, Varian Associates, 301 Industrial Way, San Carlos, Calif. 94070 [383]

### Building-block relay handles up to 30 contacts per unit

A solid-state relay utilizes a building block concept for the expansion of poles up to 30 contacts per relay. The CR120 type S uni-pole relay is designed around seven basic components, which permit the user to assemble any desired contact con-

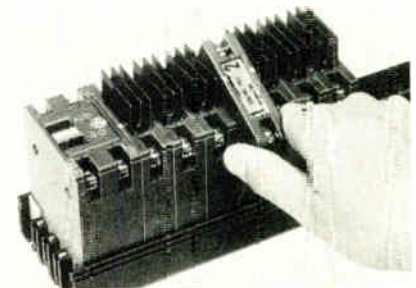



General Electric's New  
PowerUp-15\* Battery

**RECHARGES  
IN 15 MINUTES**



**THINK  
OF THE  
POSSIBILITIES**

When charged at room temperature for 15 minutes with an approved charger, General Electric's new PowerUp-15\* battery delivers 90 percent of its rated capacity.

The battery is charged with a unique Voltage/Temperature Cutoff system which features straight forward charger control circuitry.

Ideal for portable industrial power tools, photographic equipment, portable communications devices . . . anywhere portable electric power is needed fast.

And you get all the advantages of time-proved GE nickel-cadmium rechargeable batteries.

For more information, write General Electric Company, Section 452-04, Schenectady, N. Y. 12345, or circle reader service card.

\* Trademark of General Electric Company

**GENERAL  ELECTRIC**

## New products

figuration at the time of installation. Thus, the unit can satisfy virtually any application requirement. The unit also offers snap-together design. Just one function is performed by each block, so replacement costs are kept to a minimum.

General Electric Co., Building 6, Room 207, Schenectady, N.Y. 12345 [385]

Voltage regulator is  
rated at 100 watts

A 100-watt hybrid silicon voltage regulator capable of a line regulation of 0.10% and load regulation of 0.15% is designated the model

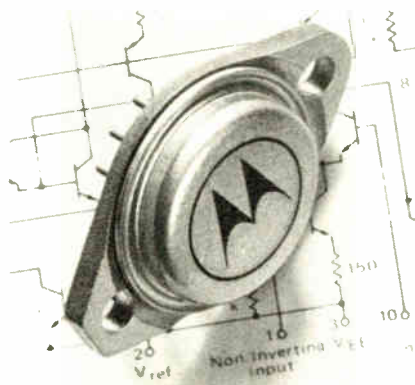

MPC1000. The unit is a 10-ampere positive or negative series device capable of operation with input voltages as high as 60 volts. Output voltage can be adjusted from 2 to 35 volts. Output currents of 20 A can be obtained without external pass transistors. Price ranges from \$14.95 for 1 to 99 pieces, to \$11.50 for 100 to 999 pieces.

Motorola Inc., Semiconductor Products Division, Box 20924, Phoenix, Ariz. 85036 [386]

Signal conditioner-amplifier  
is packaged in small module

Called the Scamp model 1,800, a signal conditioner-amplifier package also includes an isolated power supply. The modules are small, and 30 of them can fit into a standard 3½-inch-high rack adaptor. The unit is suitable for portable field applications, as well as general laboratory and testing uses. It is available

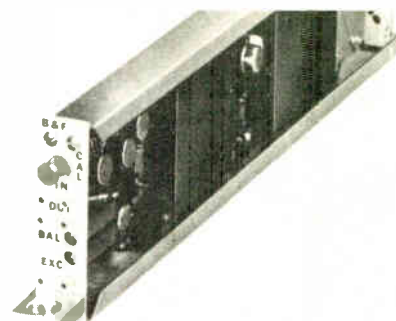

for operation from 28 v dc or 12 v dc.

B & F Instruments Inc., Cornwells Heights, Pa. 19020 [387]

FET amplifier features  
range of  $\pm 20$  to  $\pm 150$  V

An FET modular operational amplifier features a rated output voltage range from  $\pm 15$  to  $\pm 140$  volts at 10 milliamperes. The model 171 works with supplies ranging from  $\pm 20$  to



$\pm 150$  volts. And since the devices have a high power-supply rejection of  $7 \mu\text{V/V}$ , there is no need for an expensive, highly regulated supply. Moreover, asymmetrical supplies may be used, adding yet more flexibility. Price is \$69 on \$79, depending on type.

Analog Devices, Rte. 1 Industrial Park, Box 280, Norwood, Mass. 02062 [388]

Ac power source ensures  
uninterrupted voltages

Containing its own built-in batteries, battery charger, and dc-to-ac inverter, the model 1202 power source ensures continuity of frequency-stable 60-hertz, 115-volt ac

# The Avantek GPD amplifying device.

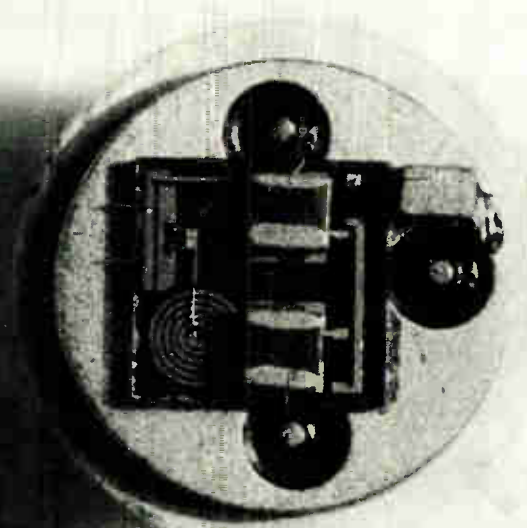

**Big on  
performance.**

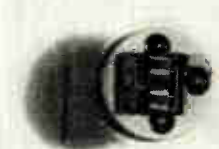

**Small on  
size and price.**

Imagine, a complete 5-400 MHz transistor amplifier, featuring over six octaves of flat bandwidth, thin film sapphire construction, complete cascadability and a miniature TO-12 package, for \$30 and under.

The Avantek GPD has to be the best miniature amplifier buy available today. Check the prices below and consider the performance per dollar. You're probably paying too much right now even if you are building your own.

Find out more about the Avantek GPD by phoning your regional sales office or the factory direct. Or, use the readers' service number below and receive a complete data sheet and our 18-page applications brochure, *Designing with GPD's*.

Avantek, Inc. Eastern Regional Office, Falls Church, Virginia (703) 533-2260 Central Regional Office, Shawnee Mission, Kansas (913) 362-9511 Western Regional Office, Santa Clara, California (408) 249-1354 Corporate Headquarters, Santa Clara, California (408) 249-0700.

Model	Frequency Response (MHz) Minimum	Gain (dB) Minimum	Flatness (dB) Typical	Noise Figure (dB) Typical	Reverse Isolation (dB) Typical	Power Output for 1 dB Gain Compression (dBm) Typical	Avantek Intercept Point for 1M Products (dBm) Typical	VSWR (50-ohms) Typical In	VSWR (50-ohms) Typical Out	Input Power Volts DC	Input Power Current (mA) Typical	Storage Temperature (°C)	Weight (grams)	Price (Qty. 1-99)
GPD-401	5-400	13	1.0	4.5	-20	-2	-8	2.0	2.0	15	10	-65 to +200	1.0	\$30
GPD-461	Same as GPD-401, except three external capacitors are required to establish low frequency roll-off													
GPD-402	5-400	13	1.0	6.0	-20	+6	+18	2.0	2.0	15	24	-65 to +200	1.0	29
GPD-462	Same as GPD-402, except three external capacitors are required to establish low frequency roll-off													
GPD-403	5-400	9	1.0	7.5	-20	+15	+26	2.0	2.0	24	65	-65 to +200	1.0	30
GPD-463	Same as GPD-403, except three external capacitors are required to establish low frequency roll-off													

**Avantek . . . years ahead today**

Avantek, Inc., 3175 Bowers Avenue, Santa Clara, California 95051. Phone (408) 249-0700. TWX 910-339-9274 Cable: AVANTEK



# New Multi-Octave Double Balanced Mixers

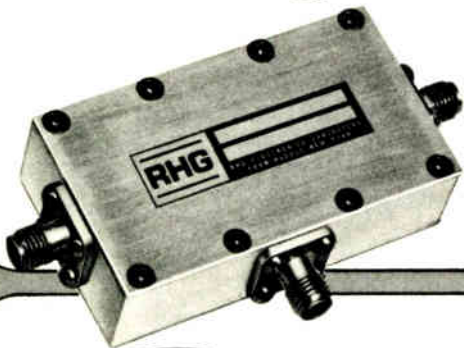

Now Available  
RF to 18 GHz  
IF to 2.3 GHz

0.5 to 12 GHz  
COVERAGE  
IN A SINGLE MIXER  
UNIQUE DOUBLE  
BALANCED MICROWAVE  
CONFIGURATION\*

Excellent noise performance is maintained over several octaves along with low IM distortion and high isolation.

#### MULTI-OCTAVE • OCTAVE MODELS

Model No.	Freq. (GHz)	NF (db)	Price
DM 1-4	1.0 to 4.0	7.5	\$325
DM 1-8	1.0 to 8.0	8.5	345
DM 1-12	1.0 to 12.0	10.0	425
DM 5-12	0.5 to 12.0	10.0	450
DM 1-18	1.0 to 18.0	10.0	595
DM 1-2	0.8 to 2.2	7.2	295
DM 2-4	1.8 to 4.2	7.5	295
DM 4-8	3.7 to 8.2	8.2	325
DM 8-12	7.8 to 12.2	10.0	345
DM 12-18	11.8 to 18.2	10.0	495

#### NOTES:

1. LO-RF isolation 20 db.
2. Based on 1.5 db IF N.F.
3. RF & LO VSWR: 2.0:1.
4. LO injection: +5 to +10 dbm.

Mixers are available with or without built-in low noise preamplifiers — one group of hundreds of standard RHG waveguide and coaxial mixer-preamplifiers.

Write for technical performance curves and detailed data sheets. \*U.S. Pat. #3,652,941

**RHG** **RHG ELECTRONICS  
LABORATORY • INC**

161 EAST INDUSTRY COURT • DEER PARK  
NEW YORK 11729 • (516) 242-1100 • TWX 510-227-6083  
for Reliability, Innovation and Service

## New products

sine-wave voltage to critical loads, despite temporary interruptions of commercial ac power. Applications are in digital control systems and minicomputers. The unit supplies an output of 250 volt-amperes continuously, with commercial ac power present, and will supply 250 VA for a minimum of 10 minutes or 150 VA for 20 minutes when no ac input is present. Price is \$975.

Wilmore Electronics Co. Inc., Box 2973, W. Durham Sta., Durham, N.C. 27705 [384]

D-a converter is for military,  
rugged industrial jobs

A 100-nanosecond 13-bit thick-film hybrid digital-to-analog converter is designated the model SDAC. It is

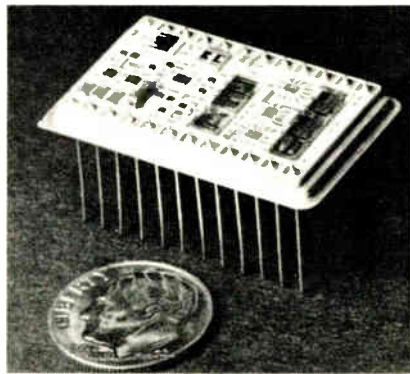

packaged in a hermetically sealed 24-pin double dual in-line metal can and features pin-programmable voltage,  $\pm 2$ -mA output. Designed for severe environments, the unit is processed to MIL-STD-883 level C,

with level B processing available for applications requiring extreme reliability. Price starts at \$350.

ILC Data Device Corporation, 100 Tec St., Hicksville, N.Y. 11801 [389]

Voltage-to-frequency  
converter has high linearity

The model 801A voltage- or current-to-frequency converter offers a linearity to within 0.005%. Signals may be summed at the input, allowing either offset or threshold adjustments over the entire scale. This may be coupled with variable voltage scaling. The combination gives the unit flexibility, which at its logical extreme allows matching the input to the signal-producing transducer characteristics. Price is \$69 for 1 to 9 pieces.



Dynamic Measurements Corp., 6 Lowell Ave., Winchester, Mass. 01890 [390]

# think small

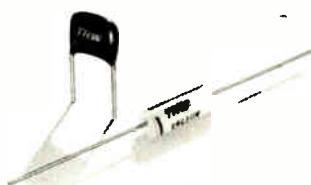

... with TRW metallized film capacitors. For example, metallized polycarbonate ultra-miniatures (Type X463). Real problem solvers in precision circuitry where stability with small size is essential. Capacitances: .001 to 10.0 mfd in 50, 100, 200, 400 VDC. High IR, low DF, fully rated from  $-55$  to  $+125^{\circ}\text{C}$ —with less than  $1\frac{1}{2}\%$  capacitance change. Rugged, plastic film case. For similar performance in a metal enclosed unit, ask about Type X482. And for real space savings in a rigid pre-molded case, check the X440.

And then there are X601PE subminiatures in metallized Mylar\* construction with dipped epoxy coating. Capacitances: .01 to 10.0 mfd—in 100 and 200 VDC. Temp.:  $-55$  to  $+100^{\circ}\text{C}$  (to  $125^{\circ}\text{C}$  with derating). Tough, self-healing. Great for high-density PC's, humid environ-

ments, precision applications. (Metallized Mylar units also available tape-wrapped or metal enclosed.)

One other thing. We figure you can't make quality capacitors and me-too capacitors under the same roof. Because sooner or later, one operation will goof the other one up. So we take the quality route. Count on it.

Write for catalog or application engineering assistance. TRW Capacitors, an Electronic Components Division of TRW, Inc. Box 1000, Ogallala, Nebraska 69153. (308) 284-3611.

\*Du Pont T.M. for Polyester Film

## TRW<sup>®</sup> CAPACITORS

# NEW SHORTER CASE! SCHAUER 1-WATT ZENERS

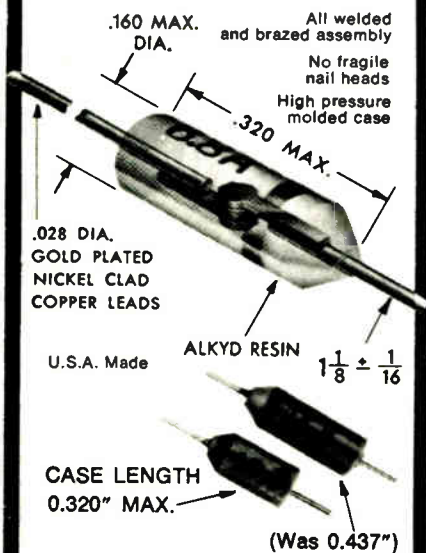

**SAME LOW PRICES FOR  
1% TOLERANCE ZENERS  
ANY VOLTAGE  
FROM 2.0 TO 18.0**

Quantity	Price Each
1-99	\$1.07
100-499	.97
500-999	.91
1000-4999	.86
5000 up	.82

**IMMEDIATE SHIPMENT**  
Send for rating data and  
20%, 10%, 5% and 2%  
tolerance prices.

Semiconductor Division

## SCHAUER

MANUFACTURING CORP.

4514 Alpine Ave., Cincinnati, Ohio 45242  
Telephone 513/791-3030

## New products/materials



**Two solder creams** both contain silver and are part of the line of standard tin-lead creams; all creams are suspended in an activated rosin flux. Material XM 27330, which has a eutectic melting point of 354°F, is suitable for soldering silver and gold-plated surfaces. Material XM 27328 has a 430°F melting point and is lead-free.

Multicore Solders, Westbury, N.Y. [476]

**A screen-printed resist ink**, ER 3038, for use with etchants having a pH of 8.0 or higher, is for printed-circuit-board applications. The material is resistant to the alkaline etchants used in circuit production, but it can be removed in caustic solutions.

Colonial Printing Ink Co., 180 East Union Ave., East Rutherford, N.J. 07073 [477]

**Silicon etchants**, for use in semiconductor technology, are based on compositions containing reagent, nitric, hydrofluoric, and acetic acids. The acetic acid moderates and controls the etch rate. The etchants are available from \$7 per gallon and up.

Transene Inc., Rte 1, Rowley, Mass. [478]

**A lightweight castable ceramic**, called Ceramacast 520, hardens after being mixed with water to produce castings with high thermal insulation values at temperatures to 3,300°F. The alumina-based material has a thermal conductivity of 8.0 BTU/ft<sup>2</sup>/hr/°F/in. at 3,000°F. Density is 0.048 lb per cubic inch as cured, or about half that of aluminum. Price is \$25 per quart or \$50 per gallon.

Aremco Products Inc., Box 145, Briarcliff Manor, N.Y. 10510 [479]

**Three-inch-diameter sapphire** substrates and silicon-on-sapphire epitaxial wafers require fewer masking steps than silicon-only wafers, so that the cost of wafer production is reduced. These substrates are also more durable than conventional ones. Moreover, they will not warp and may be stripped and reused.

Union Carbide Corp., Materials Division, 8888 Balboa Ave., San Diego, Calif. 92123 [480]

**Ceramic adhesive and coating 901** is made from high-purity refractory fibers, which are asbestos-free, and inorganic binders that cure at room temperatures and are applied by brushing, dipping or spraying. The material air-dries to a hard surface and has a melting point of 3,200°F. Applications include potting compounds. Price is \$15 per quart.

Cotronics Corp., 37 W. 39th St., New York, N.Y. 10018 [409]

**A one-part conductive copper-based paint** for printed-circuit-board manufacture has a cured resistivity of less than 1 ohm per square at an applied thickness of 2 to 3 mils. X-coat 332 may be brushed, sprayed, or rolled on.

Electro Kinetic Systems Inc., 2500 E. Ridley Ave., Chester, Pa. 19013 [410]

**A conductive coating system** called compound 4950 is a flexible, one-component base containing silver that bonds to polyimide film. It may be used for repair of flexible printed circuits, or as the actual printing medium for MOS circuits. Moreover, it may be screened, brushed, or sprayed on.

Chomerics, 77 Dragon Ct., Woburn, Mass. 01801 [391]

**Apco 80 and Apco 103** are solvents designed for dissolving cured epoxies and polyurethanes without damage to critical components—a help in reclaiming and repairing expensive circuit components. Immersing the part in the solvent makes the resin flake off; if the flakes are filtered out, the solvents can be reused.

Applied Plastics Co., 612 E. Franklin Ave., Box 277, El Segundo, Calif. 90245 [392]



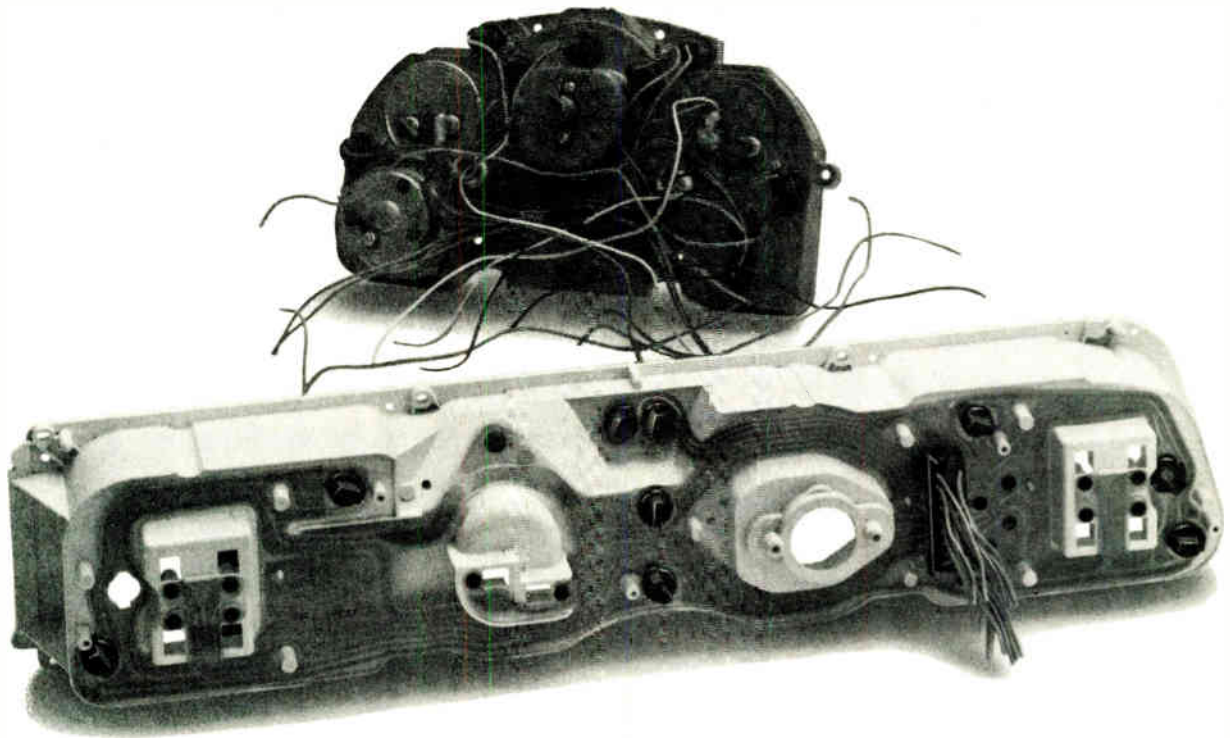

## We did it for Ford.

Take the complicated and make it simple. That's good engineering.

And that's exactly what Ford Motor Company engineers did with the help of the Schjeldahl flexible circuit on the automobile instrument cluster you see in the foreground above.

One flexible circuit eliminates the cable harness "rats nest" of wires on traditional instrument clusters. It eliminates wiring errors. The conductors can go only one place and be connected in only one way.

It's simpler because light sockets, instruments and external connectors pick up their electrical connections directly from the flexcircuit pads. No mating connectors are necessary.

Because it is flexible, Ford stylists are not limited to flat surfaces in designing instrument clusters as they could be with conventional printed circuit boards. The circuit you see above, for instance, flexes into 10 different planes while making all electrical connections. That's using flexcircuitry as it should be used.

To turn good engineering into reality, Ford engineers needed a reliable sophisticated flexible circuit that could be produced at the rate of thousands per week.

Schjeldahl did it for Ford.

 **Schjeldahl Company**

Electrical Products Division  
Northfield, Minnesota 55057  
Phone: (507) 645-5633

*The state of the art people in volume flexible circuits*

# And we can do it for you.

CLASSIFIED ADVERTISING  

**SEARCHLIGHT SECTION**  
 BUSINESS OPPORTUNITIES  
 USED OR SURPLUS EQUIPMENT

**IMMEDIATE DELIVERY**  
 Minis & Peripherals  
**DEC—HIS**  
**SEL—HP—MOHAWK**  
 CPU, Card, Printer, Tape, Disk  
**BRAND MOHAWK 4320 PRINTERS**  
 NEW **TELETYPE 35 & 37**  
 For Sale/Rent  
**617/261-1100**  
*Send for Free Report "Maintenance of Computers"*  
**AMERICAN USED COMPUTER CORP.**  
 P.O. Box 68, Kenmore Sta., Boston, MA 02215

CIRCLE 952 ON READER SERVICE CARD

**free catalog**  
**POTTING APPLICATORS**  
**MANUAL OR AIR OPERATED**  
 2½cc 6cc 12cc 30cc  
 FOR POTTING, ENCAPSULATING ETC.  
**PHILIP FISHMAN CO., INC.**  
 7 CAMERON ST. WELLESLEY, MASS. 02181



CIRCLE 956 ON READER SERVICE CARD

**HELP!**

**Q. How do I reply to a box number ad?**

**A. Address an envelope with the box number indicated in the ad, c/o Electronics, Class. Adv. Dept., P.O. Box 900, NY, NY 10020**

**Q. Whom do I contact or call to renew my classified ad or make corrections?**

**A. Write Electronics, Class. Adv. Dept., P.O. Box 900, NY, NY 10020 or call: (212) 997-6585 or 6586. Give full company name, size of ad, & date or dates it is scheduled to appear.**

**AUTOTRACK MOUNT**

**AUTOTRACK SCR-584 RADARS**  
 360 degree azimuth, 210 degree elevation sweep with better than 1 mil accuracy. Missile velocity acceleration and slewing rates. Amplidyne and servo control. Will handle up to 20 ft. dish. Supplied complete with control chassis. **ALSO** in stock 10 cm. van mounted radar system. Conical scan. PPI. 6 ft. dish. Ideal for S band telemetry, weather, haloon trk. missile trk. rocket trk. ECM range. Write for complete data. 600 pg. instr. bk. avail. at \$25 ea.

**1 MEV LINEAR ACCELERATOR**  
 Dual Mode, Ion or Electron, RF Drive, 300 KHZ at 45 KW. Includes control console, RF unit, accelerator, etc.

**MOD IV HIGH RESOLUTION TRACKER**  
 Instrumentation radar: freq. 8.5-9.6 GHz, Pwr: 250 KW, .1 mil tracking accuracy. 6' Fresnel lens antenna with 4 horn monopulse feed. Tracking range 50 or 200 miles. Formerly used as range safety radar at Cape Kennedy.

**PULSE MODULATORS**  
 245 KW LINE PULSER Output 16 KV at 16 amp. .25 microsec at 4000 PPS.  
 405 KW FLOATING DECK PULSER Output 20 KV at 20 amp. 1 microsec to 10 milsec pulse.  
 500 KW LINE PULSER Output 22 KV at 28 amp. 4/1.75/2.25 at 2500/550/300.  
 1 MW HARDTUBE MIT MODEL 9 Output 25 KV at 40 amp. .25-2 microsec at .002 D.C.  
 2.0 MW LINE PULSER Output 30 KV at 70 amp. 1/2 microsec at 600/300 PPS.  
 3 MW LINE PULSER Output 39 KV at 75 amp. .25/1 microsec at 500 PPS.  
 10 MW LINE PULSER Output 76 KV at 135 amp. 2.5 microsec at 350 PPS.  
 17 MW LINE PULSER Output 17 KV at 1000 amp. 2-5 microsec at 150-2000 PPS.

**HV POWER SUPPLIES**  
 6.3 KV @ 5. Amp; 20KV @ 1.3 Amps; 35KV @ 1.5 Amps; 28KV, 70MA; 12KV @ 800MA; 18KV @ 2.25 Amps; 17.5KV @ 1.8 Amps.

**RECON DRONE CONTROL RADARS**  
 X Band systems autotrack and search complete with plotting boards. Fully mobile van mounted. Gives PPI, slant range, altitude data. Ground to air control links and beacons also in stock AN/MPQ-29 & AN/UPW-1

**RADAR DATA MICROWAVE LINK**  
 Freq. 7.1-7.9 GHz, Pwr. 100 MW., 4 channels. Transmits video, pulse, synchro, and voice information. Mfr: Motorola.

**SPARE PARTS IN STOCK**  
 Nike Ajax, Nike Hercules, M-33, MPS-19, TPS-1D, TPS-10D, FPS-6, SPSB, SCR-584, HIPAR

**RADAR & RF PKGS.**  
 3ghz 40kw Pulse RF pkg  
 24ghz 40kw Pulse bomb toss system  
 16ghz 100 kw Pulse B-58 search radar system  
**X BAND SEARCH 40 KW PULSE WEATHER RADAR**  
**X BAND AUTOTRACK 250KW PULSE M-33** compl w/ plot boards  
**X BAND BEACON 400 W PULSE AN/DPN-62**  
**X BAND AUTOTRACK 50KW PULSE B-47** fire control complete  
**C BAND WEATHER RADAR 250 KW PULSE**  
**C BAND HEIGHT FINDER** AN/FPS-26 5 megawatt output  
 AN/TPS-37, 1 megawatt output.  
**C BAND 1 MEGAWATT AUTOTRACK** 10ft dish mortar locator MPQ-21  
**C BAND 285KW PULSE Search AN / SPS-5**  
**S BAND AUTOTRACK 500 KW PULSE 10' DISH**  
**S BAND 1 MEGAWATT COHERENT AN / FPS-18**  
**S BAND 1 MEGAWATT PULSE NIKK ACQ.**  
**S BAND 5 MEGAWATT HEIGHT FINDER AN/FPS-6**  
**S BAND BEACON 1 KW PULSE**  
**L BAND 500KW PULSE AN / TPS-ID / E**  
**L BAND 5 to 20KW PULSE**  
 400mhz 1KW CW AN / FPS-23  
 225mhz 1 MEGAWATT PULSE AN/TPS 28  
 2-30mhz 100KW PULSE  
 CW 950-5ghz 150 WATTS  
 CW 1.5mhz-10 5ghz 5 WATTS  
 CW 7.4 GHZ 2 KW  
**AN / GPG-1 SKYSWEEP TRACKER**  
 3 cm. auto. tracking radar system. Comp. pkg w/ indicator sys. Full target acquisition & auto tracking. Input 115v 60 cy new. In stock for immed. del. Entire sys. 6' x 3' x 10'. Ideal for infrared tracker, drone tracker, missile tracker. R & D.

**HUNDREDS MORE IN STOCK LARGEST RADAR INVENTORY IN WORLD.**  
 WRITE FOR CATALOG ON YOUR LETTERHEAD

**Radio-Research Instrument Co. INC.**  
 3 Quincy St., Norwalk, Conn. 06850 • 203-853-2600

CIRCLE 951 ON READER SERVICE CARD

**Job-seekers...**  
 be the first to know  
 with McGraw-Hill's  
**Advance Job Listings**

By having our new weekly ADVANCE JOB LISTINGS sent First-Class (or by Air Mail, if you prefer) to your home every Monday you can be the first to know about nation-wide openings you qualify for both in and out of your field.

This preprint of scheduled employment ads will enable you to contact anxious domestic and overseas recruitment managers BEFORE their advertisements appear in upcoming issues of 22 McGraw-Hill publications.

To receive a free sample copy, plus information about our low subscription rates (from one month to 12), fill out and return the coupon below.

**ADVANCE JOB LISTINGS / P.O. BOX 900 / NEW YORK NY 10020**

PLEASE SEND A SAMPLE COPY OF ADVANCE JOB LISTINGS TO:

**McGraw-Hill**

NAME \_\_\_\_\_ ADDRESS \_\_\_\_\_

CITY \_\_\_\_\_ STATE \_\_\_\_\_ ZIP \_\_\_\_\_

E 8/16/73

## New books

**Biomedical Instrumentation and Measurements**, by Leslie Cromwell, Fred J. Weibell, Erich A. Pfeiffer, and Leo B. Usselman, Prentice-Hall Inc., Englewood Cliffs, N.J., 446 pp., \$16.95.

To a person starting out in a new field, a good over-all view of what is going on in that area can be the most valuable and yet the most difficult kind of information to get. Although the adventurer may not yet be knowledgeable enough to ask all the right questions, he needs to get a lot of right answers.

For engineers entering medical electronics, this volume provides the desired perspective. It covers the entire field of medical-electronic measurements, while omitting such related but separate areas as electrosurgery. Any book that attempts to cover an entire field like medical instrumentation must be superficial in at least some of its treatment, and this one is no exception. Nevertheless, for descriptions of current practices in medical electronics, and as an introduction to pertinent medical terminology, the book can be of great value to the electronics technologist who is just getting his feet wet in medicine.

The book becomes somewhat disappointing when it leaves the description of practices and delves into the technical considerations that lie behind them. These portions seem to be written on a level more suited to a technician than an engineer. For example, the chapter on electrodes raises more questions than it answers. We are told in this chapter that silver-silver-chloride electrodes are very stable. But we are not told what stability means in this context, nor why this particular combination of chemicals leads to high stability.

Despite this shortcoming, the book and its appendices on medical terminology are a welcome addition to the scanty literature in this field. An engineer who wants to learn what modern electrocardiography is all about, or who wants to learn how a body plethysmograph measures intra-alveolar pressure in the lungs could get his answers from this volume.

—Michael J. Riezenman  
Instrumentation Editor

JAPAN makes  
8,000,000 color TV sets  
a year.

SANKEN supplies  
100,000,000  
color-TV diodes  
a year.

## SANKEN COLOR-TV DIODES

### Fast Recovery Diodes

	HF-1 Series	UF-1 Series	SB-2 Series	TD-13	TD-15	S-34	SF-1
PRV	400~1000V	400~1000V	500~1000V	1300V	1500V	500V	1500V
DC Output Current	0.6A	0.25A	1.0~1.5A	1.0A	1.0A	0.8A	0.03A
Reverse* Recovery Time	0.8 $\mu$ sec.	0.3 $\mu$ sec.	1.0 $\mu$ sec.	1.0 $\mu$ sec.	1.0 $\mu$ sec.	0.3 $\mu$ sec.	0.3 $\mu$ sec.

\* @  $I_F = 2\text{mA}$

### Silicon High Voltage Diodes for Multiplier Assembly

	HVT-18	HVT-30S
PRV	12,000V	18,000V
DC Output Current	15mA	15mA
Reverse Current	1.0 $\mu$ A	1.0 $\mu$ A
Reverse* Recovery Time	0.5 $\mu$ sec.	0.5 $\mu$ sec.

\* @  $I_F = 10\text{mA}$



ELECTRIC CO., LTD.

## SANKEN ELECTRIC COMPANY, LTD.

1-22-8 Nishi-Ikebukuro, Toshima-ku, Tokyo, 171 Japan  
Tel: 986-6151 Telex: 0272-2323



# Silicon Avalanche Integrated Bridge Rectifiers



**Where space and reliability are major design considerations.**

Varo's IBR features: 200V, 400V and 600V PRV with 250V, 450V and 650V min. avalanche voltages at 10A and 25A ( $I_{O}$ ). Fast recovery versions; (200ns,  $t_{rr}$ ), 15A and 36A ( $I_{O}$ ), 3 $\phi$  full-wave bridges also available.

The electrically isolated case (circuit-to-case, 2kV min.) and

less than 1°C/W thermal impedance ( $Z_{\theta JC}$ ) allow operation at full rated load to 100°C ( $T_C$ ). The controlled avalanche characteristics permit the use of lower PRV safety factors in design considerations.

Three mounting options; press-fit, stud and TO-3 outline flange are available.

**\$2.50** ea., 10A, 200V, TO-3 outline (1000 qty.)

**Also from Varo:**

**EBR, Epoxy Bridge Rectifiers:** with 100, 200, 400 and 600V PRV; 1, 2 & 6 Amp ( $I_{O}$ ). *Controlled avalanche and fast recovery series.*

**Design us in; we'll stay there**



**VARO**

**VARO SEMICONDUCTOR, INC.**

P.O. BOX 676, 1000 N. SHILOH, GARLAND, TEX. 75040, 214/272-4551, TWX 910-860-5178

**ALLIED ELECTRONICS**, Chicago, Ill. 312/421-2400. **THE ALTAIR CO.**, Houston, Tex. 713/781-5300; Richardson, Tex. 214/231-5166. **BELL INDUSTRIES**, Menlo Park, Cal. 415/323-9431; Skokie, Ill. 312/965-7500; Bellevue, Wash. 206/747-1515. **BLUFF CITY DIST. CO.**, Memphis, Tenn. 901/725-9500. **BRIDGEFIELD SUPPLY**, Chesterland, Ohio 216/729-9451. **CRAMER ELECTRONICS**, Nationwide; Newton, Mass. 617/969-7700; **ELECTRONIC PARTS CO.**, Denver, Colo. 303/744-1992. **MILGRAY ELECTRONICS**, Freeport, N. Y. 516/546-6000; Hyattsville, Md., 301/864-1111; Cherry Hill, N. J., 609/424-1300. **WESTATES ELECTRONICS**, Chatsworth, Calif. 213/341-4411.

*In Canada:*

**ELECTRO SONIC**, Toronto, Ont. 416/924-9301. **R.A.E. IND. ELECTRONICS**, Vancouver, B. C. 604/687-2621. **PRELCO ELECTRONICS, LTD.**, Montreal, Quebec 514/389-8051. **WESTERN RADIO SUPPLY**, Hamilton, Ont. 416/528-0151.

Circle 154 on reader service card

## New literature

**Control circuit.** An application note entitled "Measurement of Power and Characteristic Values of a Phase-slicing Control Circuit" is available from Norma Messtechnik, Box 88, A-1111 Vienna, Austria. Note SD 4603/2 E is an English version and SD 4603/2 D is the German version. Circle 421 on reader service card.

**Power supply.** The full line of OEM dc power supplies manufactured by Powertec Inc., 9168 DeSoto Ave., Chatsworth, Calif. 91311, is described in a 44-page catalog providing specifications, general information, and illustrations. [422]

**Resistor networks.** A range of standard and custom thin-film resistor networks, substrates, and hybrid circuits is detailed in a folder being offered by LRC Inc., 11 Hazelwood Rd., Hudson, N.H. 03051 [423]

**Optoelectronics.** Optron Inc., 1201 Tappan Circle, Carrollton, Texas 75006. A condensed catalog of optoelectronic products includes parameters, photographs, package configurations, and dimensional drawings on products such as silicon phototransistors, light-emitting diodes, and encoder assemblies. [424]

**Transistor.** Silicon Transistor Corp., KSC Semiconductor division, Katrina Rd., Chelmsford, Mass. 01824, has published a 40-page catalog of silicon and germanium power transistors. [425]

**Process control.** Moore Industries Inc., 8158 Orion Ave., Van Nuys Calif. 91406. A 12-page catalog describes 26 electronic process-control instruments and 53 options. It includes specifications, illustrations, and general applications information. [426]

**Switches.** A six-page foldout catalog featuring the PB-400 series of modularly constructed miniature printed-circuit push-button switches is being offered by Standard Grigsby, 920 Rathbone Ave., Aurora, Ill. 60507 [427]



**YOU'RE WHISTLING IN THE DARK...**

if you think that heart disease and stroke hit only the other fellow's family.

**GIVE... so more will live  
HEART FUND**



*Contributed by the Publisher*

# Electronics advertisers

August 16, 1973

## Advertising Sales Staff

**Pierre J. Braudé** [212] 997-3485  
Advertising Sales Manager

**Atlanta, Ga. 30309:** Joseph Lane  
100 Colony Square, 1175 Peachtree St., N.E.  
[404] 892-2868

**Boston, Mass. 02116:** James R. Pierce  
607 Boylston St. [617] 262-1160

**Chicago, Ill. 60611:**  
645 North Michigan Avenue  
Robert W. Bartlett (312) 751-3739  
Paul L. Reiss (312) 751-3738

**Cleveland, Ohio 44113:** William J. Boyle  
[716] 586-5049

**Dallas, Texas 75201:** Charles G. Hubbard  
2001 Bryant Tower, Suite 1070  
[214] 742-1747

**Denver, Colo. 80202:** Harry B. Doyle, Jr.  
Tower Bldg., 1700 Broadway  
[303] 266-3863

**Detroit, Michigan 48202:** Robert W. Bartlett  
1400 Fisher Bldg.  
[313] 873-7410

**Houston, Texas 77002:** Charles G. Hubbard  
2270 Humble Bldg. [713] CA 4-8381

**Los Angeles, Calif. 90010:** Robert J. Rielly  
Bradley K. Jones, 3200 Wilshire Blvd., South Tower  
[213] 487-1160

**New York, N.Y. 10020**  
1221 Avenue of the Americas  
Warren H. Gardner [212] 997-3617  
Michael J. Stoller [212] 997-3616

**Philadelphia, Pa. 19102:** Warren H. Gardner  
Three Parkway,  
[212] 997-3617

**Pittsburgh, Pa. 15222:** Warren H. Gardner  
4 Gateway Center, [212] 997-3617

**Rochester, N.Y. 14534:** William J. Boyle  
9 Greylock Ridge, Pittsford, N.Y.  
[716] 586-5040

**San Francisco, Calif. 94111:** Don Farris  
Robert J. Rielly, 425 Battery Street,  
[415] 362-4600

**Paris:** Alain Offergeld  
17 Rue-Georges Bizet, 75 Paris 16, France  
Tel: 720-73-01

**Geneva:** Alain Offergeld  
1 rue du Temple, Geneva, Switzerland  
Tel: 32-35-63

**United Kingdom:** Keith Mantle  
Tel: 01-493-1451, 34 Dover Street, London W1

**Milan:** Robert Saidel  
1 via Baracchini Phone 86-90-656

**Brussels:** Alain Offergeld  
23 Chaussee de Wavre  
Brussels 1040, Belgium  
Tel: 13-73-95

**Stockholm:** Brian Bowes  
Office 17, Kontor-Center AB, Hagagarten 29,  
113 47 Stockholm. Tel: 24 72 00

**Frankfurt/Main:** Fritz Krusebecker  
Liebigstrasse 27c  
Phone 72 01 81

**Tokyo:** Tatsumi Katagiri, McGraw-Hill  
Publications Overseas Corporation,  
Kasumigaseki Building 2-5, 3-chome,  
Kasumigaseki, Chiyoda-Ku, Tokyo, Japan  
[581] 9811

**Osaka:** Ryji Kobayashi, McGraw-Hill  
Publications Overseas Corporation, Kondo  
Bldg., 163, Umegae-cho Kita-ku [362] 8771

**Australasia:** Warren E. Ball, IPO Box 5106,  
Tokyo, Japan

## Business Department

**Stephen R. Weiss, Manager**  
[212] 997-2044

**Thomas M. Egan,**  
Production Manager [212] 997-3140

**Carol Gallagher**  
Assistant Production Manager [212] 997-2045

**Dorothy Carter,** Contracts and Billings  
[212] 997-2908

**Frances Vallone,** Reader Service Manager  
[212] 997-6057

## Electronics Buyers' Guide

**George F. Werner,** Associate Publisher  
[212] 997-3139

**Regina Hera,** Directory Manager  
[212] 997-2544

* AEG Telefunken	2E	Micro Switch Division of Honeywell N. W. Ayer & Son, Inc.	79
* AEROCOM	6E	Molex Incorporated	72
Jacster Enterprises, Inc.		Total Communications Service	
Aertech Industries	143	MOS Technology, Inc.	14-15
Kenneth R. Miller		Henry S. Goodsett Advertising, Inc.	
Allen-Bradley Company	28	Mostek Corporation	19
Hoffman, York, Baker & Johnson, Inc.		Kaufmann Advertising, Inc.	
American Microsystems, Inc.	140-141	Motorola Semiconductor Products, Inc.	48-49, 84A-84D
Wilton, Coombs & Colnett, Inc.		E B Lane & Associates, Inc.	
American Optical-Scientific Instrument Division	64	National Semiconductor Corp.	102-103
Wilson, Haight & Welch, Inc.		Chiat/Day, Inc. Advertising	
AMP Incorporated	9-13	Neff Instruments Corp.	71
Aitkin-Kynett Co., Inc.		Larry Courtney Company	
Analog Devices, Inc.	112	Newport Labs	132
Schneider Parker Guy Inc.		Hall Butler Blatherwick, Inc.	
Applicon Incorporated	135	North Atlantic Industries, Inc.	124
Johnson, Raffin & Lingard, Incorporated		Diversified Corporate Services, Inc.	
Avantek, Inc.	147	Oxy-Metal	5E
Witmer & Berridge Adv./Design Associates		Reinhardt Publicite	
Beckman Instruments, Inc., Hellip Div.	58	Philips Elcoma	61
N. W. Ayer/Jorgensen/MacDonald, Inc.		Tag Intermarco	
Bourns, Inc.	61	Philips N. V. Pit/T & M Division	58
Marlborough Assoc., Inc.		Marsteller International S. A.	9E, 11E
Brand-Rex	81	Plessey Capacitors	
Creamer, Trowbridge, Case & Basford, Inc.		Roles and Parker Ltd.	
California Computer Products	137	Precision Monolithics, Inc.	63
Dailey & Associates Advertising		Marlborough Associates, Inc.	
Cherry Electrical Products Corp.	130	Radiometer Copenhagen	10E
Kolb/Tookey and Assoc., Inc.		Raytheon Semiconductor	144
Chicago Dynamic Industries, Inc.	156	Durel Advertising	
Burton Browne Advertising		RCA Electronic Components	12E
CIT Alcatel	16E	Al Paul Lefton Company, Inc.	
Promotion Industrielle		RCA Ltd.	50-51
Colorado Video, Inc.	78	Marsteller Ltd.	
O'Connell-Colburn, Inc. Creative Business Communications		Rheinisch-Westfaelische Verlag Werbewirtschaft	7E
Communication Associates, Inc.	14E	Verlag Werbewirtschaft	
Caroe Marketing, Inc.		RHG Electronics Laboratory, Inc.	148
Dale Electronics, Inc., A Sub. of The Lionel Corporation	4th cover	Samuel H. Goldstein	
Swanson, Sinkey, Ellis, Inc., Advertising		Rohde & Schwarz	1E
Delco Electronics Division, General Motors Corp.	122-123	Sanken Electric Co., Ltd.	153
Campbell-Ewald Company		Global Advertising Co., Ltd.	
Dialight Corporation	128-129	Schauer Manufacturing Corp.	150
Michel-Cather, Inc.		Notan, Keelor & Slices	
Disc Instruments, Inc.	8	Siemens Aktiengesellschaft	56
Jansen Associates, Inc.		Linder Presse Union GmbH	
Eastman Kodak Company, Business Systems Markets Div.	126	Signalte, Inc.	136
J. Walter Thompson Co.		MSD Advertising Agency, Inc.	
Electronic Associates, Inc.	6	Signetics Corp., Sub. of Corning Glass Works	65
Gerald Clarke, Inc.		Hall Butler Blatherwick, Inc.	101
Electronic Measurements, Inc.	2nd cover	Siliconix	
Hill Advertising Agency		Robertson West, Inc.	
Electronic Memories and Magnetics	120	SINGER INSTRUMENTATION- ALFRED DIV.	8
R & M Advertising		N. W. Ayer/Jorgensen/MacDonald, Inc.	
Electronic Navigation Industries 18		Sorenson Company, A Unit of Raytheon Company	50-51
Hart Conway Co., Inc.		Provandie Eastwood & Lombardi Inc.	
Elgar Corporation	138	Sprague Electric Company	24
Chapman Michetti Advertising		Harry P. Bridge Company	
Erie Technological Products Co., Inc.	25	SRC Division/Mxon, Inc.	77
Altman Hall Associates Advertising		Ron Jenner & Company	
Fairchild Semiconductor, Inc.	66-67	Syston Donner Concord Instruments	50, 156
Carson/Roberts, Inc., Adv., Div. of Ogilvy & Mather, Inc.		Bonfield Associates	
Fairchild Systems Technology	45-47	TEAC Corp.	8E
Hall Butler Blatherwick, Inc.		Dentsu Advertising Ltd.	
General Automation	110-111	Tektronix-IDD	26-27
Chiat/Day, Inc., Advertising		Young & Roehr, Inc.	
General Electric Company, Battery Products Dept.	131-146	Tektronix Inc.	16-17, 22-23
Robert S. Cragin, Inc.		McCann Erickson Inc.	
General Electric Co., Semiconductor Products Dept.	32	Teledyne Relays	63
Advertising & Sales Promotion Syracuse Operation		S. Michelson Advertising	
G. T. Schjeidahl Co.	151	Teradyne, Inc.	68
Chuck Ruhr Assoc. Advertising, Inc.		Quinn & Johnson, Inc.	
Hansen Mfg. Company	41	Texas Instruments Incorporated, Semiconductor Group	83
Keller-Crescent Co.		Tracy-Locke Advertising, Inc.	
Harris Semiconductor	43	Thermotron Corporation	156
Tucker Wayne & Company		Enterprise Advertising	
Hewlett-Packard	1	TRW/Capacitors	149
Richardson, Seigle, Rolfs & McCoy, Inc.		Gray & Rogers, Inc.	
Hewlett-Packard	21	TRW/IRC Resistors	62
Richardson Seigle Rolfs & McCoy, Inc.		Gray & Rogers, Inc.	
Hewlett-Packard	2	Unifrode Corporation	31
Richardson, Seigle, Rolfs & McCoy, Inc.		Impact Advertising	
Hewlett-Packard	74-75	Varo Semiconductor, Inc.	154
Richardson, Seigle, Rolfs & McCoy, Inc.		Warren-Guild	
Hipotronics, Inc.	20	Vibration Instruments Co.	20
Kenmarc Advertising, Inc.		Jansen Associates, Inc.	
Intel Corporation	39	Wavetek San Diego	52
Regis McKenna, Inc.		Chapman Michetti Advertising	
Interall Inc.	96-97		
Tycer Associates			
Interstate Electronics Corporation	84		
Chris Art Studio Inc.			
Intronics	6		
Impact Advertising Incorporated			
Krohn-Hite Corporation	5		
Impact Advertising, Inc.			
Lambda Electronics Corporation	3rd Cover		
Michel Cather, Inc.			
Ltronix, Inc.	7		
Regis McKenna, Inc.			
Lockheed Electronics Company	37		
McCann-Erickson, Inc.			
Master Appliance	82		
Klau-Van Pietersom-Dunlap, Inc.			
Micro Consultants Ltd.	142		
Geoffrey Dadd Ltd.			

## Classified & Employment Advertising

F. J. Eberle, Manager 212-971-2557

EQUIPMENT (Used or Surplus New) For Sale	152
American Hite Computer Corp.	152
Fishman, Philips Co., Inc.	152
Radio Research Instruments Co.	152

\* For more information on complete product line see advertisement in the latest Electronics Buyer's Guide  
\* Advertisers in Electronics International only  
‡ Advertisers in Electronics domestic edition only





Beautiful  
New Babies

# BOTH TRULY REMARKABLE

CDI's New Baby: Series SL, Linear Slide Switch (Pat. Pending)



**Positions: ANY NUMBER DESIRED up to 100 (unique feature)**

### APPLICATIONS: CONTROL FUNCTIONS REQUIRING RAPID POSITION SELECTING

- CATV channel selecting
- High & Low limit switches
- Process equipment controls
- Computers & peripherals
- NC applications
- Many others

### OTHER REMARKABLE FEATURES:

Mounts EITHER left/right OR up/down (versatile).  
Single or multiple position selectors.  
Solder lugs or dip solder termination for p.c. use.  
1 or 2-Poles, or coded outputs available.

### ELECTRICAL CHARACTERISTICS:

200 megohms min. insulation.  
1000 volts min. dielectric strength.  
2 amps @ 115 VAC current carrying capability.  
125 ma @ 115 VAC current breaking capability.

CDI earns its reputation every day for Consistently High Quality, Consistently Good Delivery, Designing to Your Needs.



## CHICAGO DYNAMIC INDUSTRIES, INC.

PRECISION PRODUCTS DIVISION

1725 Diversey Blvd., Chicago, Illinois 60614, Phone (312) 935-4600 TELEX 25-4689

Circle 156 on reader service card

## From stock - ALL NEW THERMOTRON TABAI SERIES ovens

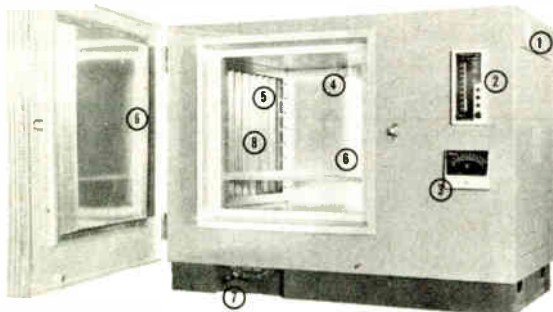

LOOK AT THE FEATURES THAT ARE INCLUDED IN THE PURCHASE PRICE OF THIS ALL-NEW OVEN SERIES:

1. OVERHEAT PROTECTOR
2. SOLID STATE TEMPERATURE CONTROL WITH BOTH MANUAL AND AUTOMATIC SETTING
3. TEMPERATURE INDICATOR
4. INTERIOR LIGHT (ON MOST MODELS)
5. ADJUSTABLE AIR BAFFLES FOR BEST POSSIBLE GRADIENT
6. AVAILABLE IN STAINLESS OR COLD-ROLLED STEEL WITH HIGH TEMPERATURE FINISH
7. EXHAUST VENTS
8. FORCED AIR CIRCULATION

(SEND FOR COMPLETE CATALOG)

**IMMEDIATE,  
OFF THE SHELF  
DELIVERY**

Available in 3 Ranges:  
+ 70° F to + 392° F  
+ 176° F to + 572° F  
+ 212° F to + 822° F



**THERMOTRON  
CORPORATION**

Kollen Park Drive / Holland, Michigan 49423 / 616 392-1492

West Coast:  
8934 Mason Ave.,  
Chatsworth California 91311  
Phone 213 882-5030

156 Circle 173 on reader service card

# \$395



## Measure 103.807 Hz automatically in 1 sec.

- \* AGC \* Autoranging to 2 MHz in 1 sec. \* Auto-  
matic frequency readings to 0.001 Hz in 1 sec. \*  
6 digits standard, 2 optional \* 25 mV sensitivity
- \* Leading zero suppression \* 5 high stability  
oscillator options \* Rechargeable battery option
- \* 5-day delivery

For Model 6220 literature, contact your local Scientific Devices office or Systron-Donner at 10 Systron Drive, Concord, CA 94518. Phone (415) 682-6161. Europe: Munich, W. Germany; Leamington Spa, U.K.

**SYSTRON DONNER**

Circle 174 on reader service card



Do you face  
a make or buy  
decision on  
power supplies?

# BUY LAMBDA'S LZ SERIES THE ONLY FIELD REPAIRABLE P-C MOUNTABLE POWER SUPPLY.

Available in 3 package sizes,  
in 26 single output and 19 dual output models  
from \$35, up to 28 volts, up to 1400 mA.

## COMPETITOR COMPARISON CHART

Lambda-Pak	Competitors' Model		Lambda-Pak	Competitors' Model		Lambda-Pak	Competitors' Model	
YES	NO	Fully repairable	YES	NO	Wide input voltage range—105-132 Vac	YES	NO	single and dual (tracking) outputs
YES	NO	Continuously adjustable voltage	YES	NO	Short circuit proof	YES	NO	Designed for series operation
YES	NO	Multivoltage rated	YES	NO	Vacuum impregnated transformer	YES	NO	Stocked and distributed from Los Angeles, Montreal, Chicago and New York
YES	NO	Foldback current limiting	YES	NO	Three different power packages			

### LZ SERIES SINGLE OUTPUT MODELS

MODEL	VOLTAGE VDC	CURRENT mA	PRICE
LZS-10	5	450	\$35
LZS-11	12	195	35
LZS-20	15	300	55
LZS-30	5	900	65
LZS-33	15	400	65
NEW LZS-34	5	1400	95

### LZ SERIES DUAL TRACKING OUTPUT MODELS

MODEL	VOLTAGE VDC	CURRENT mA	PRICE
NEW LZD-12	+15V	50	\$35
LZD-21	+5	300	55
LZD-22	+15	90	40
LZD-23	+15	150	55
LZD-31	+5	500	65
LZD-32	+15	220	65
NEW LZD-35	+15	300	95

For additional voltages, send for Lambda's 1973 catalog supplement L 3.

**1-DAY DELIVERY  
60-DAY GUARANTEE**

## LZ SERIES AVAILABLE IN 3 NEW MODELS



**Regulation** 0.15%—line or load; models LZS-10, LZS-30, LZS-34, LZD-21 and LZD-31 have load regulation of 0.15% + 5mV; model LZD-12 has line or load regulation of 0.25%.

**Ripple and noise** 1.5mV RMS.

**Temp. Coefficient** 0.03%/°C

**Tracking accuracy** 2% absolute voltage difference (dual output models only) 0.2% change for all conditions of line, load and temperature

**AC input** 105 to 132 Vac, 57-63 Hz

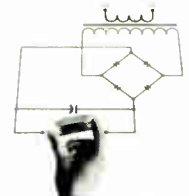

**WHETHER YOU MAKE OR BUY...**

**LAMBDA ELECTRONICS CORP.**

MELVILLE, NEW YORK 11746 515 Broad Hollow Road Tel. 516-694-4200  
ARLINGTON HEIGHTS, ILL. 60005 2420 East Oakton St., Unit Q Tel. 312-593-2550  
NORTH HOLLYWOOD, CALIF. 91605 7316 Varna Ave. Tel. 213-875-2744  
MONTREAL, QUEBEC 100C Hymus Blvd., Pointe Claire, Quebec 730 Tel. 514-697-6520  
PORTSMOUTH, HANTS, ENG. Marshlands Road, Farlington Tel. Cosham 73221  
VERSAILLES, FRANCE 64a 70 rue des Chantiers 78004 Tel. 950-2224

# Technology Marketing Inc. asked us to prove our network capability.

## Now it's your turn.

Respected computer systems developers like Technology Marketing Incorporated are making good use of Dale's thick film network capabilities. The network above is used to set threshold voltage and provide termination for two sense windings in a P.C. layout compatible with 7500 Series memory sense amplifiers. It has been used effectively in high volume production memory and computer systems developed by Technology Marketing Inc. Standard or Special, Dale can provide the resistance function you need...in the quantities and at the price you require. Make us prove it.

### Models immediately available for these and many other standard functions:

- MOS/ROM pull-up/pull-down
- Open collector pull-up
- "Wired OR" pull-up
- Power driver pull-up
- High speed parallel pull-up
- TTL unused gate pull-up
- TTL input pull-down
- Digital pulse squaring
- Line termination
- Long line impedance balancing
- LED current limiting
- ECL output pull-down resistors
- TTL input

**Power Rating:** 1/8 watt max./resistor; 2 watts/package (single in-line); 1-1/2 watts/package (DIP).

**Resistance Range:** 10 ohms to 1 Meg., depending on tolerance.

**Tolerance:** 1%, 2%, 5%, 10%, 20%.

**T.C.:**  $\pm 200$  ppm/ $^{\circ}$  C.

**Packaging:** Flame retardant epoxy coating or sandwich-type ceramic construction.

Double width and discrete networks also available in standard or special designs.

*For complete information, call your Dale representative or phone 402-371-0080.*



DALE ELECTRONICS, INC., 1300 28th Avenue, Columbus, Nebraska 68601  
A subsidiary of The Lionel Corporation • In Canada: Dale Electronics Canada Ltd.