

Triple varactor chip for a-m electronic tuning 60

Color control comes to plasma displays 66

Bipolar LSI gains on MOS 76

# Electronics®

**Cutting the  
cost of  
electronics  
production**

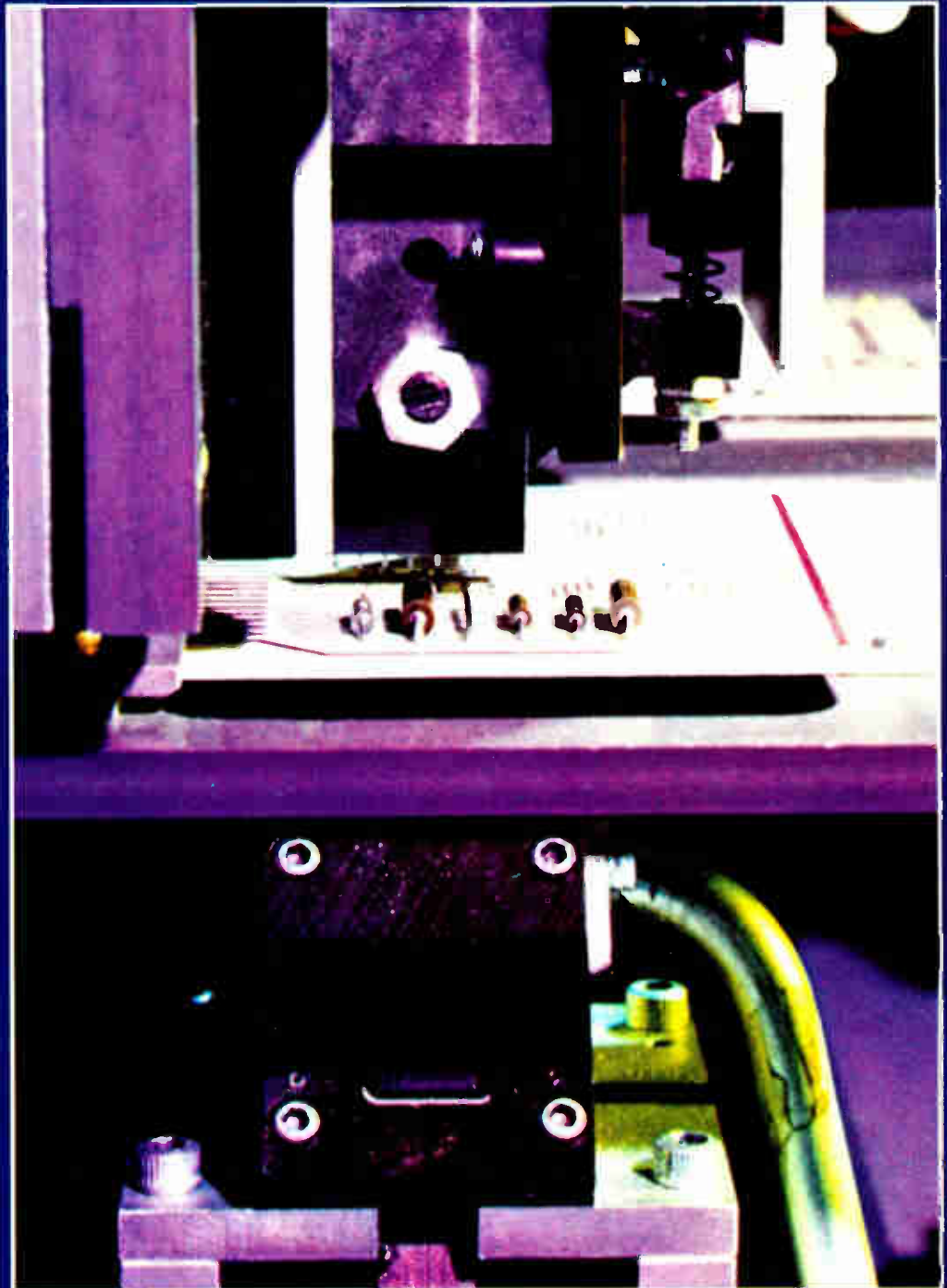

When we started a revolution  
in Valley Forge,  
a part of it was to build a new  
customs house!

A customs house—manned, equipped, ready to serve!  
You'll find it at MOS Technology where we've put together  
some of the best brains in the business along with the most  
sophisticated equipment to get your job done! You've got  
specs, need custom LSI's? We've got the personnel and the  
computerized design and computer-controlled testing to  
give you the arrays you want—quality, reliability and  
economy included! After all, if we, at MOS, could start a  
revolution, and turn a technology into a company, you can  
be sure we'd build ourselves an exceptional customs house  
from which to conduct the whole business!

We've Turned  
A Technology  
Into A Company

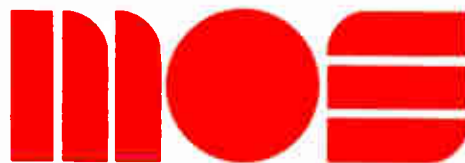

**MOS TECHNOLOGY, INC.**  
VALLEY FORGE INDUSTRIAL PARK, VALLEY FORGE, PA. 19481 • (215) 666-7950

*A Proud Affiliate  
of Allen-Bradley Co.*



#### EASTERN REGIONAL OFFICE

REGIONAL SALES DIRECTOR — Mr. William Whitehead, 88 Sunnyside Blvd., Suite 307, Plainview, New York 11803 • Phone: (516) 822-4240 • ALABAMA, N. CAROLINA, S. CAROLINA, TENNESSEE, MISSISSIPPI — Currie Aerospace Associates, P.O. Box 1424, Huntsville, Alabama 35807 • Phone: (205) 536-5650 • FLORIDA, GEORGIA — Currie Aerospace Associates, 2907 McCoy Road, P.O. Box 13229, Orlando, Florida 32809 • Phone: (305) 855-0843 • NEW ENGLAND STATES — Victor Associates, 280 Worcester Road, Framingham, Massachusetts 01701 • Phone: (617) 879-5710 • NORTHERN NEW JERSEY, NEW YORK (WESTCHESTER COUNTY, LONG ISLAND) — Falk Baker Associates, 383 Franklin Avenue, Nutley, New Jersey 07110 • Phone: (201) 661-2430 • NEW YORK (EXCEPT WESTCHESTER CO.) — Ossmann Component Sales Corp., 280 Metrc Park, Rochester, New York 14623 • Phone: (716) 442-3290 • DELAWARE, MARYLAND, WASHINGTON, D.C., VIRGINIA, W. VIRGINIA — Bernard White & Company, Inc., 7 Church Lane, Baltimore, Maryland 21228 • Phone: (301) 484-5400

#### CENTRAL REGIONAL OFFICE

REGIONAL SALES DIRECTOR — Mr. Alan Matral, 10400 W. Higgins Road, Suite 631, Rosemont, Illinois 60018 • Phone: (312) 298-2035 • ILLINOIS, INDIANA, WISCONSIN — Coombs Associates, Inc., 1001 E. Touhy, Des Plaines, Illinois 60018 • Phone: (312) 298-4830 • OHIO, KENTUCKY, W. PENNSYLVANIA — McShane, Inc., P.O. Box 523, 123 W. Washington, Medina, Ohio 44256 • Phone: (216) 725-4568 • MICHIGAN — R. C. Merchant & Co., 18411 W. McNichols Road, Detroit, Michigan 48219 • Phone: (313) 535-6000 • MINNESOTA, N. DAKOTA, S. DAKOTA — Mel Foster Company, Inc., 228 S. Cedar Lake Road, Minneapolis, Minnesota 55405 • Phone: (612) 374-2612 • MISSOURI, KANSAS, NEBRASKA, IOWA — Harlan J. Weisler & Assoc. Inc., 2050 Woodson Road, St. Louis, Missouri 63114 • Phone: (314) 428-3934 • TEXAS, OKLAHOMA, ARKANSAS, LOUISIANA — Norwell Associates, 10210 Monroe Drive, Dallas, Texas 75220 • Phone: (214) 357-6415

#### WESTERN REGIONAL OFFICE

REGIONAL SALES DIRECTOR — Mr. Jack Turk, 2172 Dupont Drive, Patio Bldg., Suite 221, Newport Beach, California • Phone: (714) 833-1600 • ARIZONA, NEW MEXICO — Toward Engineering Associates, P.O. Box 15268, Arcadia Station, Phoenix, Arizona 85018 • Phone: (602) 955-3193 • CALIFORNIA, NEVADA — Bertrand & Zoolalian, Inc., 7340 Florence Avenue, Suite 305, Downey, California 90241 • Phone: (213) 927-4406 • Hunter Associates, 1208 Fox Plaza, San Francisco, California 94102 • Phone: (415) 626-8576 • COLORADO, UTAH, WYOMING — R. G. Enterprises, 1107 S. Pearl Street, Denver, Colorado 80210 • Phone: (303) 744-2464 • WASHINGTON, OREGON, IDAHO, MONTANA — A. Tudor & Assoc. Inc., 2605 Western Avenue, Seattle, Washington 98121 • Phone: (206) 682-7444

#### INTERNATIONAL SALES REPRESENTATIVES

ARGENTINA — T. R. C. Electronica, S.A.C.I. el., Cangaio 4450, Buenos Aires, Argentina • Phone: 88-4044 5 6 • ENGLAND (WALS, SCOTLAND, IRELAND) — Impectron Limited, 28 31 King Street, London W3 9JH, England • Phone: 01 922 5388 • FRANCE — Bureau de Liaison, 113 Rue de l'Université, Paris (7e), France • Phone: 551 9920 • GERMANY (NETHERLANDS) — International Micro Electronics, Inc., Arabellahaus 1838, Arabellastr. 5, 8000 Munich 81, Germany • Phone: 72 321 • INDIA — Electronics Enterprises, 46 Karani Building, New Charni Road, Bombay 4, India • Phone: 375375 • ISRAEL — Electronics, 110, 75 Haifa Road, P.O. Box 21029, Tel Aviv, Israel • Phone: 38352 • ITALY — Specialized Corporation, Piazza Spolorno 3, 20159 Milano, Italy • Phone: 632 435 • JAPAN (HONG KONG, KOREA, TAIWAN) — Takachiko Koheki Company, Ltd., 1-7, Chome Kohjimachi, Chiyoda-Ku, Tokyo 102, Japan • Phone: 263-3211 • SWEDEN (DENMARK, FINLAND, NORWAY) — Thure F. Forsberg, Forshapatan 58, P.O. Box 79, Forsta 1, Sweden • Phone: 647040 • SWITZERLAND — Ernst M. Egli, Ingenieur-Bureau AG, Witikonstrasse 295, Zurich (CH 8053), Switzerland • Phone: 53 38 11

# Testing digital IC's?

8013A, \$625

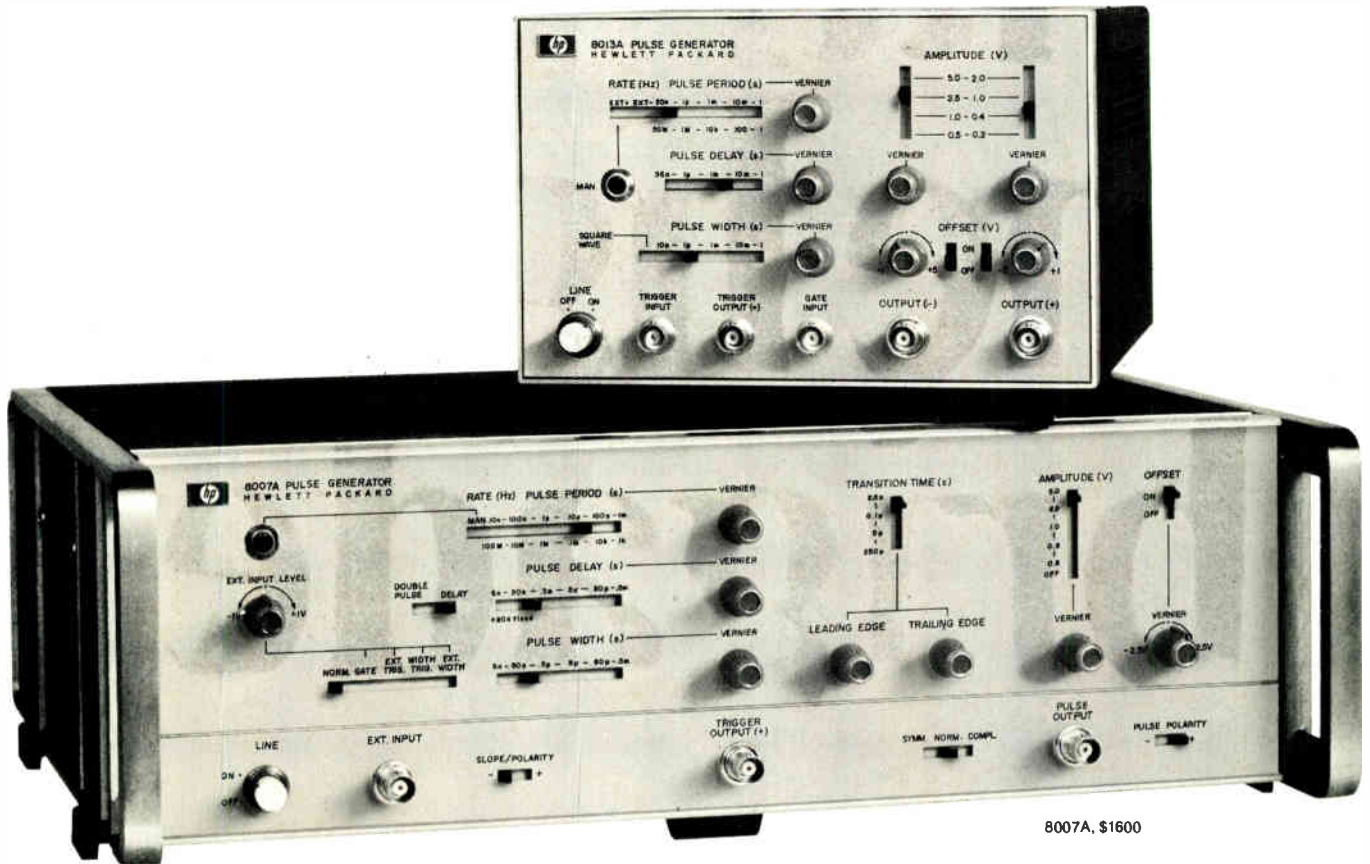

8007A, \$1600

## HP's new pulsers give you the most capability per dollar

If digital IC's are your big interest, HP's new 8000-Series pulse generators are for you. You not only get **versatile capability**, but you **save money** as well! These new pulsers offer you a choice of price/performance packages to meet your needs, within your budget—whether you're working with computers, communications, telemetry, or any other digital system.

The new 8007A gives you rep rates from 1 kHz to 100 MHz, **variable transition times** (2.5 ns to 250  $\mu$ s),  $\pm 5$  V amplitude, and  $\pm 2.5$  V dc offset—all for **\$1600**. With the 8007A, you can design and test the fastest of today's digital devices—ECL IC's and bi-polar memories—and have "speed to spare" for tomorrow's advances.

If you don't need 100 MHz, you can save. For only **\$875**, you can get the new 8012A, which gives you rep rates from 1 Hz to 50 MHz. Like the 8007A, it offers **variable transitions** from 5 ns to 0.5 s, with  $\pm 5$  V amplitude and  $\pm 2.5$  V dc offset.

If you don't need variable transitions, you can save even more. Our 8013A gives you rep rates from 1 Hz to 50 MHz with a fixed transition time of < 3.5 ns,  $\pm 5$  V with dc offset, and dual outputs—all for **\$625**.

All three of these new pulsers give you pulse-shaping capabilities, allowing control of NRZ or RZ waveform parameters with the output width determined by the input waveform width. Normal external triggering and gating are also supplied.

The 8007A also gives you a double-

pulse mode, and all three models have square-wave capabilities. And the 8013A offers simultaneous positive and negative outputs, with  $\pm 5$  V amplitude across 50  $\Omega$  ( $\pm 10$  V open-circuit or with high-impedance internal source).

**Other HP pulse generators**, listed in the catalog, begin as low as **\$225**.

For further information on any of these new 8000-Series pulsers, contact your local HP field engineer. Or write Hewlett-Packard, Palo Alto, California 94304. In Europe: 1217 Meyrin-Geneva, Switzerland.

081/11

**HEWLETT**  **PACKARD**

SIGNAL SOURCES

# Charge of the light brigade



Here are the LEDs you can order by the brigade full. HP's indicator lights—unbeatable for brightness and wideangle visibility. Use them on circuit boards—their tough leads will keep them firmly in place. Or mount them on a front panel; they just clip on. In fact, you can put them anywhere you want a small, tough bulb that needs only 2 volts DC to light the way.

Price? 65¢ in 10 K quantities. And they're available in any quantity you want. Call your local HP office for the exact figures and specs on the 5082-4440. Or write Hewlett-Packard, Palo Alto, California 94304; Europe: 1217 Meyrin-Geneva, Switzerland.

HEWLETT  PACKARD

SOLID STATE DEVICES  
Circle 2 on reader service card

---

## 27 Electronics Review

COMMUNICATIONS: Which path to the Wired City? 27  
COMPANIES: Raytheon to market British oscilloscope line, 27  
COMMERCIAL ELECTRONICS: Magnetic bubbles, liquid crystals combine in police system, 28  
SOLID STATE: Double mesa means double protection for triacs, 28  
COMMUNICATIONS: Computer CATV link brightens CAI's promise, 29  
COMPUTERS: Sorter developer sought, 30; Computing calculator with thermal readout, 32; Wanted: ultrafast printer, 32  
COMPUTER-AIDED DESIGN: \$200,000 system does the job, 32  
GOVERNMENT: Standards for interfaces, peripherals proposed, 34  
CONSUMER ELECTRONICS: Reel-to-reel programmer for audio fans, 34  
INSTRUMENTATION: Amorphous thermometer called radiation resistant, 36  
FOR THE RECORD: 36

---

## 59 Technical articles

CONSUMER ELECTRONICS: Matched-varactor chip brings electronic tuning to a-m radios, 60  
DISPLAYS: Plasma display changes color as current input changes, 66  
CIRCUIT DESIGN: Designer's casebook, 71  
SOLID STATE: Coming up fast from behind—denser bipolar devices, 76  
PACKAGING & PRODUCTION: New wiring and insertion methods cut costs of electronic production, 80 (cover)  
CIRCUIT DESIGN: Relaxation oscillators provide compact drive for injection lasers, 88

---

## 91 Probing the News

SPACE ELECTRONICS: Planning a Grand Tour, 91  
INTERNATIONAL: Europe ahead on optical switching, 94  
MILITARY ELECTRONICS: Small group challenges Loran giants, 97  
CONSUMER ELECTRONICS: Audio firms dominate EIA show, 98

---

## 103 New Products

IN THE SPOTLIGHT: Ion implanter is fully automatic, 103; Color CRT monitor has high resolution, 104  
INSTRUMENTS: Low-priced synthesizer is programmable, 107  
SUBASSEMBLIES: Modules provide building blocks for power supplies, 111  
PACKAGING & PRODUCTION: Semi-automatic wire-wrapper, 115; New pc material, 116; Timing system for plating, 117  
COMPONENTS: Active filters are tunable, 119; Lever locks DIP in test socket, 121

---

## 125 Electronics International

WEST GERMANY: Programed driving gets a road test in West Germany, 125  
INTERNATIONAL: Aeronautical satellites open to world participation, 125  
JAPAN: Laser and holograph team up for computer input tablet, 126; Kanji display, 127  
GREAT BRITAIN: Putting aircraft flight data into one TV display, 127  
WEST GERMANY: The big Olympic event: worldwide broadcasting, 128

---

## Departments

Publisher's letter, 4  
Readers comment, 6  
40 years ago, 8  
People, 10  
Meetings, 13  
Electronics Newsletter, 17  
Washington Newsletter, 49  
International Newsletter, 123

# Electronics

EDITOR-IN-CHIEF: Kemp Anderson

EXECUTIVE EDITOR: Samuel Weber

MANAGING EDITORS: Robert Henkel, *News*;  
Arthur Erikson, *International*

SENIOR EDITORS: John Johnsrud,  
H. Thomas Maguire, Stephen E. Scrupski

ART DIRECTOR: Fred Sklenar

ASSOCIATE EDITORS: William Bucci,  
Richard Gundlach, Howard Wolff

## DEPARTMENT EDITORS

*Aerospace*: Jim Hardcastle  
*Circuit Design*: Lucinda Mattera  
*Communications & Microwave*:  
John N. Kessler  
*Computers*: Wallace B. Riley  
*Consumer*: Gerald M. Walker  
*Industrial*: Alfred Rosenblatt  
*Instrumentation*: Owen Doyle  
*Military*: Ray Connolly  
*New Products*: H. Thomas Maguire  
*Packaging & Production*:  
Stephen E. Scrupski  
*Solid State*: Laurence Altman

COPY EDITORS: William S. Weiss,  
Margaret Eastman

ART: Charles D. Ciatto, *Associate Director*

PRODUCTION EDITORS:  
Susan Hurlburt, Arthur C. Miller

EDITORIAL ASSISTANT: Marilyn Offenheiser

EDITORIAL SECRETARIES: Claire Goodlin,  
Vickie Green, Bernice Pawlak

## FIELD EDITORS

*Boston*: James Brinton (Mgr.), Gail Farrell  
*Dallas*: Paul Franson (Mgr.)  
*Los Angeles*: Lawrence Curran (Mgr.)  
*New York*: Alfred Rosenblatt (Mgr.)  
*San Francisco*: Stephen Wm. Fields (Mgr.),  
Roberta Schwartz  
*Washington*: Ray Connolly (Mgr.),  
Jim Hardcastle, Larry Armstrong  
*Frankfurt*: John Gosch  
*London*: Michael Payne  
*Paris*: Arthur Erikson  
*Tokyo*: Charles Cohen

## McGRAW-HILL WORLD NEWS

*Director*: Walter A. Stanbury; *Atlanta*: Stan Fisher; *Chicago*: Mike Sheldrick; *Cleveland*: Arthur Zimmerman; *Detroit*: James Wargo; *Houston*: Robert E. Lee; *Los Angeles*: Michael Murphy; Gerald Parkinson; *San Francisco*: Margaret Drossel; *Seattle*: Ray Bloomberg; *Washington*: James Canan, Herbert W. Cheshire, Seth Payne, Warren Burkett, William D. Hickman; *Bonn*: Robert Ingersoll; *Brussels*: James Smith; *London*: Marvin Petal; *Milan*: Peter Hoffmann, Andrew Heath; *Moscow*: Axel Krause; *Paris*: Stewart Toy, Michael Johnson; *Stockholm*: Robert Skole; *Tokyo*: Mike Mealey

PUBLISHER: Dan McMillan

ADVERTISING SALES MANAGER: Pierre J. Braudé

ADVERTISING SALES SERVICE MANAGER:  
Wallis Clarke

BUSINESS MANAGER: Stephen R. Weiss

CIRCULATION MANAGER: George F. Werner

RESEARCH MANAGER: David Strassler

MARKETING SERVICE MANAGER:  
Tomlinson Howland

## Publisher's letter

Besides writing articles for *Electronics* (see page 88), Forrest Mims flies rockets, assists blind children, and studies politics. Although Mims majored in political science at Texas A&M, he has always been an experimenter. Sent to Vietnam as an Air Force intelligence officer in 1966, Mims took his rocketry and laser experiments along with him. Tinkering with miniature guidance systems, he needed a bit of open space to test them out. The best launching site he could find in populous Saigon was the infield of the race track. Actually, he was merely following precedent—the Viet Cong had used the same place, with real rockets, during the Tet offensive.

Mims' interest in laser ranging systems led him to develop a mobility aid for the blind. He tried out a prototype with children at the Saigon School for the Blind, with results he describes as "good." Incidentally, the drive circuits he built for those aids are described in this issue's article.

After Vietnam, Mims spent two and a half years at the Air Force Special Weapons Test Center at Kirtland Air Force Base in New Mexico, letting his interest in his experiments overshadow his chosen career. But now, either despite of or because of his interest in science, he plans to combine his political science and physical science experiences, by writing about the relationships between government and science. First, however, he's going to finish the book he's now working on. (It's all about GaAs lasers.)

Our Frankfurt-based field editor, John Gosch, has been doing his bit to maintain both the "inter-

national" and the "technology" parts of our contents page subtitle, "The International Magazine of Electronics Technology." Besides his regular reporting on new developments in Germany, Switzerland and the East bloc countries, Gosch keeps his eyes open both for contributions to our technical articles pages and for the in-depth news stories that we run in our Probing the News department. This issue, he hit with copy in both sections.

Like our other overseas editors, Gosch is fluent in the language of the country in which he is based. And he is a trained engineer. So when, on one of his trips to Hamburg, he stopped in at Valvo, the big components subsidiary of Philips Gloeilampenfabrieken, he knew that the work on electronic tuning for a-m radios would make a good technical article (see page 60). Then, his bilingual talents came into play when the manuscript arrived and had to be translated into English, a chore which was eased considerably by his engineering and writing expertise.

Another trip to Hamburg, this time to the Philips' research laboratories there, resulted in the story on the unusual optical data switching system (see page 94). Actually, there were two trips, because Gosch spotted the development while in the labs on another story and had to keep after the developers for two more weeks to get the details of how the system worked.



July 19, 1971 Volume 44, Number 15  
89,678 copies of this issue printed

Published every other Monday by McGraw-Hill, Inc. Founder: James H. McGraw 1860-1948. Publication office 330 West 42nd Street, N.Y., N.Y. 10036; second class postage paid at New York, N.Y., and additional mailing offices.

Executive, editorial, circulation and advertising addresses: Electronics, McGraw-Hill Building, 330 West 42nd Street, New York, N.Y. 10036. Telephone (212) 971-3333. Teletype TWX N.Y. 710-581-4235. Cable address: MCGRAWHILL N.Y.

Subscriptions limited to persons with active, professional, functional responsibility in electronics technology. Publisher reserves the right to reject non-qualified requests. No subscriptions accepted without complete identification of subscriber name, title, or job function, company or organization, including product manufactured or services performed. Subscription rates: qualified subscribers in the United States and possessions and Canada, \$8.00 one year, \$12.00 two years, \$16.00 three years; all other countries \$25.00 one year. Limited quota of subscriptions available at higher-than-basic rate for persons outside of field served, as follows: U.S. and possessions and Canada, \$25.00 one year; all other countries \$50.00. Air freight service to Japan \$60.00 one year, including prepaid postage. Single copies: United States and possessions and Canada, \$1.00; all other countries, \$1.75.

Officers of the McGraw-Hill Publications Company: John R. Emery, President; J. Elton Tuchig, Senior Vice President—Services; Donald B. Gridley, Group Vice President; Vice Presidents: Ralph Blackburn, Circulation; John R. Callahan, Editorial; William P. Giglio, Administration; David G. Jensen, Manufacturing; Jerome D. Luntz, Planning & Development; Joseph C. Page, Marketing; Robert M. Wilhelm, Finance.

Officers of the Corporation: Shelton Fisher, President; Joseph H. Allen, Group Vice President—Publications and Business Services; John J. Cooke, Senior Vice President and Secretary; Ralph J. Webb, Treasurer.

Title registered in U.S. Patent Office; Copyright 1971 by McGraw-Hill, Inc. All rights reserved. The contents of this publication may not be reproduced either in whole or in part without the consent of copyright owner.

Subscribers: The publisher, upon written request to our New York office from any subscriber, agrees to refund that part of the subscription price applying to copies not yet mailed. Please send change of address notices or complaints to Fulfillment Manager; subscription orders to Circulation Manager; Electronics, at address below. Change of address notices should provide old as well as new address, including postal zip code number. If possible, attach address label from recent issue. Allow one month for change to become effective.

Postmaster: Please send form 3579 to Fulfillment Manager, Electronics, P.O. Box 430, Hightstown, N.J. 08520.

# OUR ANGLE: angle position indicators that do more and cost less

## SHOULDN'T YOU TAKE A NEW READING ON THIS COST-PERFORMANCE ANGLE?

For better ways to measure synchro and resolver data, North Atlantic offers the best of both worlds: budget prices for the popular API-8025; superior performance and increased capability of the new 8525. • Both are interchangeable without any mechanical or wiring modifications. North Atlantic's solid-state 8525 offers an accuracy of  $0.05^\circ$  (3 minutes). Following a  $180^\circ$  step input, it synchronizes a five-digit NIXIE readout in  $\frac{1}{2}$  second flat. And it tracks at up to  $1000^\circ$  per second. Where cost can be traded against performance, the proven electromechanical API-8025 . . . a recognized indus-

MODEL 8525



MODEL 8025

try workhorse . . . is available with its 6 minute accuracy,  $25^\circ$ /second slew speed, and many options. • Input of the 8525 is any 60 or 400Hz resolver/synchro data from control instrumentation. The patented servo design eliminates all inertia and improves dynamic performance many times over. Its digital outputs are especially suited to the computer-oriented requirements of today's automatic test systems. The 8525 . . . priced at \$1885 . . . and the API-8025 priced at \$995 actually cost less because they perform more functions per dollar. And with greater reliability. ®

For complete information on the cost-performance angle, please write or phone now.

**NORTH ATLANTIC**  
*industries, inc.*

200 TERMINAL DRIVE, PLAINVIEW, NEW YORK 11803  
cable: noatlantic / twx: 510-221-1879 / phone: (516) 681-8600

## WHICH DEFLECTION YOKE FOR YOUR DISPLAY ?

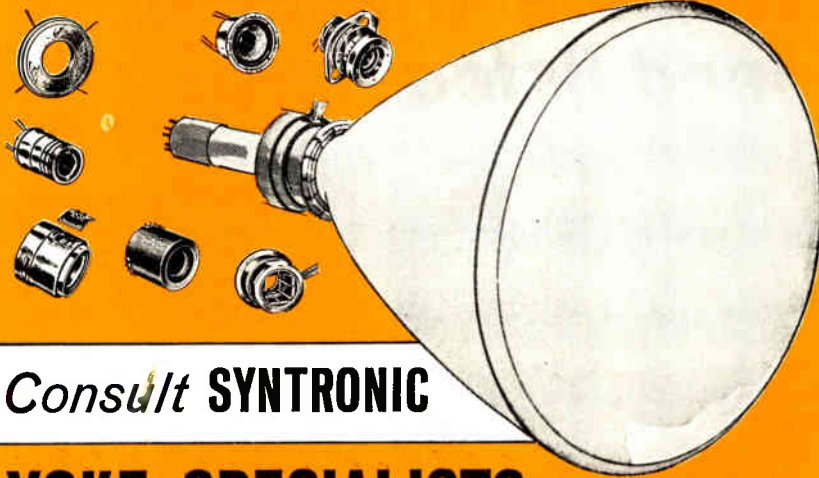

Consult **SYNTRONIC**

## YOKE SPECIALISTS

Syntronic's team of experts knows more about yoke design, engineering and quality control than anyone else. A solid 10-year record of leadership—acknowledged throughout the industry. Benefit from it.

*syntronic* **INSTRUMENTS, INC.**  
100 Industrial Road, Addison, Illinois  
Phone: Kingswood 3-6444

Circle 141 on reader service card

# the grabber.

Our plunger action Mini-Test Clip is designed specifically for reaching into densely packaged miniaturized circuitry to make rapid, reliable tests.

- Gold plated copper contact hook makes positive connection, and won't damage lead wires.
- Specially designed tip slides down over square wire-wrap pins for solid contact.
- Integrally molded wire assures greater reliability and eliminates time-consuming assembly.
- Molded nylon probe provides complete insulation to point of connection.
- Four models offer widest selection of connecting plugs. Write for complete information and prices.

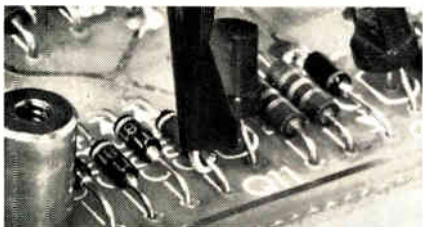

**POMONA ELECTRONICS**

1500 E. Ninth St., Pomona, Calif. 91766 • Telephone: (714) 623-3463

## 40 years ago

From the pages of *Electronics*, July 1931

The outstanding feature of the Chicago visit was the several demonstrations of the Sanabria television system, marked as it was by intense illumination (due to the Taylor lamp) over a six-foot screen, and beautiful mechanical work (by Sanabria himself). What the demonstration lacked in showmanship it made up technically. The universally expressed opinion was that Sanabria's television was the best seen to date; that his 45-line picture had good detail and that Sanabria himself was a young man whose feet were squarely on the ground. The lamp of low cost, high intensity and reasonable life, the work of Taylor, a young man of promise, is a most important part of the system.

June *Electronics* chronicled the transmission of radio phone communication across the English channel by means of a directive wave of the order of 18 centimeters, a wavelength far below those used commercially for communication up to this time. The experiment was

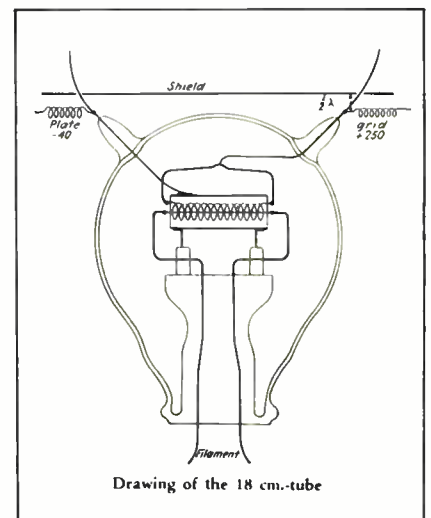

performed by the International Telephone and Telegraph Company, transmission and reception taking place at historic Calais and Dover, about 22 miles.

Through the courtesy of Dr. Irving J. Saxl, *Electronics* is enabled to publish for the first time in this country, and most probably in any country, a diagram of the tube used in this pioneer work.





# Cannon flexible circuitry and connectors do it all—for less.

ITT Cannon does the whole job—from circuitry design thru termination. We take any etched circuitry project from conception to graphic production, chemofacture and assembly. Then we put the right terminations on it—from the broadest line of connectors in the industry—standard rectangulars and circulars to special high density types. And we'll terminate it by welding, soldering or crimping—whichever method meets your specific application. What's in it for you? Savings. Costs reduced as much as 50%. Weight reduced as much as 60%. Over-

all volume by as much as 80%

Add Cannon quality and reliability, complete design freedom and you see why our flexible circuitry systems meet the varied requirements of the communications, automotive, computer, appliance and aerospace industries.

For technical data, write for our FDG brochure. ITT Cannon Electric, a division of International Telephone and Telegraph Corporation, 666 E. Dyer Rd., Santa Ana, California 92702. (714) 557-4700.



**CANNON** **ITT**

Circle 9 on reader service card

# A-B breakthrough will change your thinking about photo resistors.

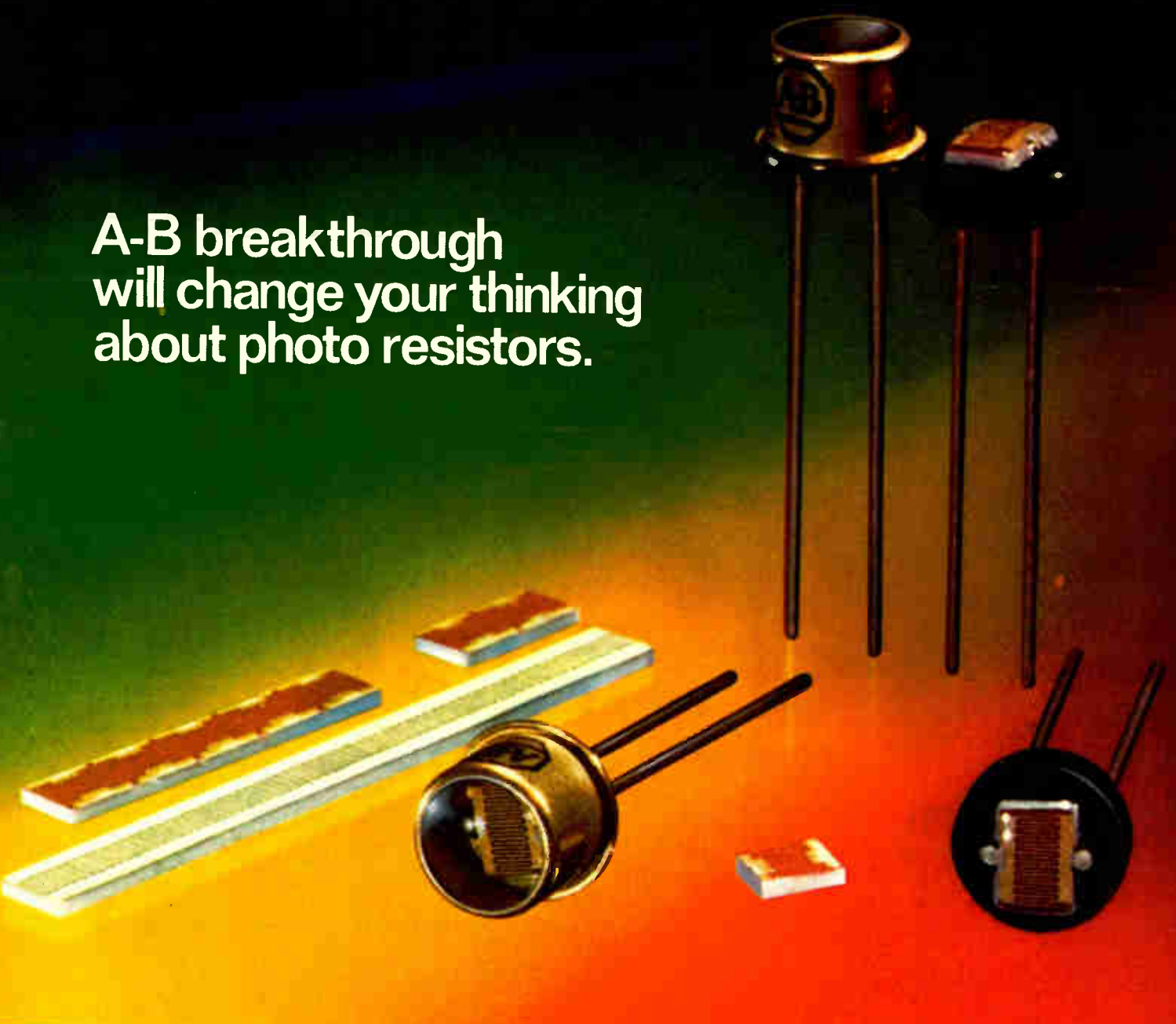

Allen-Bradley's unique electroding process gives new material and surface topography improvements. And superior photodetector response and speed. It means a whole new generation of miniaturized cadmium sulfide and cadmium sulfoselenide photodetectors for hybrid applications. Custom styles to fit

your needs. Chips. Bars. Arrays. And leaded devices for circuit board applications. Temperature limit 85°C. Response as fast as 10 milliseconds at 10 footcandles. Three spectral sensitivities. Standards available as PHOTOCHIPS, multi-cell PHOTOCHIP ARRAYS or single-channel PHOTOBAR detectors, and PHOTO-

CHIPS in TO-18 metal or TO-98 plastic packages. All with traditional A-B quality and service. Large-area custom devices are our specialty. Request Publication 5910. Write: Allen-Bradley Electronics Division, 1201 South Second Street, Milwaukee, WI 53204. Export: Bloomfield, N.J. 07003. Canada: Galt, Ontario.



NEW DIMENSION ELECTRONICS  
**ALLEN-BRADLEY**



*Now you can  
make a sales  
trip to Japan  
for \$400....  
...and talk to  
15,000 buyers  
in their  
native tongue!*

The vehicle? Nikkei Electronics — the Japanese version of Electronics Magazine published in Japanese for consumption in Japan only.

Nikkei Electronics will be published bi-weekly by NIKKEI/McGRAW-HILL INC. — a joint venture of NIKKON KEIZAI SHINBUN and McGRAW-HILL INC. Nikkei Electronics will be published entirely in the Japanese language including advertisements.

- If you sell, or want to sell your products in Japan, you can talk to 20,000 buying influences in their native tongue for just \$400 a page.
- If you are already advertising in any of the unaudited lesser media in Japan, here is your opportunity to consolidate your schedule in the one strong medium, make a dominant impression and save advertising dollars.

If you are interested in advertising in Nikkei Electronics contact your local Electronics salesman or any of the Electronics sales offices in the U.S. and Western Europe.

*Nikkei Electronics*



A Nikkei/McGraw-Hill Publication.

## Meetings

**International Conference on Amorphous and Liquid Semiconductors**, University of Texas; University of Michigan, Ann Arbor, Aug. 8-13.

**Joint Automatic Control Conference, IEEE**, Instrument Society of America; Washington University, St. Louis, Aug. 11-13.

**Western Electronic Show and Convention (WESCON)**, Western Electronics Manufacturers Association, IEEE; Brooks Hall/Civic Auditorium, San Francisco, Aug. 24-27.

**Geoscience Electronics Symposium**, IEEE; Marriott Twin Bridges Motor Hotel, Washington, Aug. 25-27.

**London International Symposium on Network Theory**, IEE; City University, London, England, Sept. 6-10.

**Conference on Computers for Analysis and Control in Medical and Biological Research**, IEE; University of Sheffield, England, Sept. 7-9.

**Conference on Displays**, IEE; University of Loughborough, England, Sept. 7-10.

**Petroleum & Chemical Industry Technical Conference**, IEEE; Marriott Motor Hotel, Atlanta, Ga., Sept. 12-15.

**International Conference on Engineering in the Ocean Environment**, IEEE; Town & Country Hotel, San Diego, Calif., Sept. 14-16.

### CALL FOR PAPERS

**Ultrasonics Symposium**, IEEE; Carillon Hotel, Miami Beach, Fla., Dec. 6-8. Sept. 1 is deadline for abstracts to Dr. H. Matthews, Sperry Rand Research Center, 100 North Road, Sudbury, Mass., 01776.

**International Solid State Circuits Conference**, IEEE; University of Pennsylvania/Sheraton Hotel, Feb. 16-18, 1972. Oct. 1 is deadline for abstracts to A.V. Brown, T.J. Watson Research Center, Box 218, Yorktown Heights, N.Y.

# ME-2



## SCANBE'S NEW DUAL IN-LINE SOCKETS

- ◆ Accepts flat or round leads
- ◆ Tapered entry channels
- ◆ Replaceable pins

At first glance, Scanbe's new ME-2 Dual In-Line Sockets may appear to be like all others. Appearances can be deceiving. Our new ME-2 includes many exclusive features and offers Scanbe's quality, precision and performance. When it comes to customer benefits, Scanbe's ME-2 socket is a leader not a follower.

Also, custom P.C. board designs using ME-2 sockets to fit your application, software programs and solderless services can complete your hardware system from one source... Scanbe. Write or call for catalogs, price and delivery.

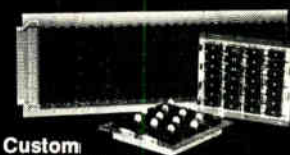

Custom  
PC Board



**MANUFACTURING CORP.**  
A CANOSA COMPANY  
3445 Fletcher Avenue  
El Monte, California 91731  
Phone: (213) 579-2300

**Main memories  
get 45,000,000 bits  
of 1103 MOS RAM.**

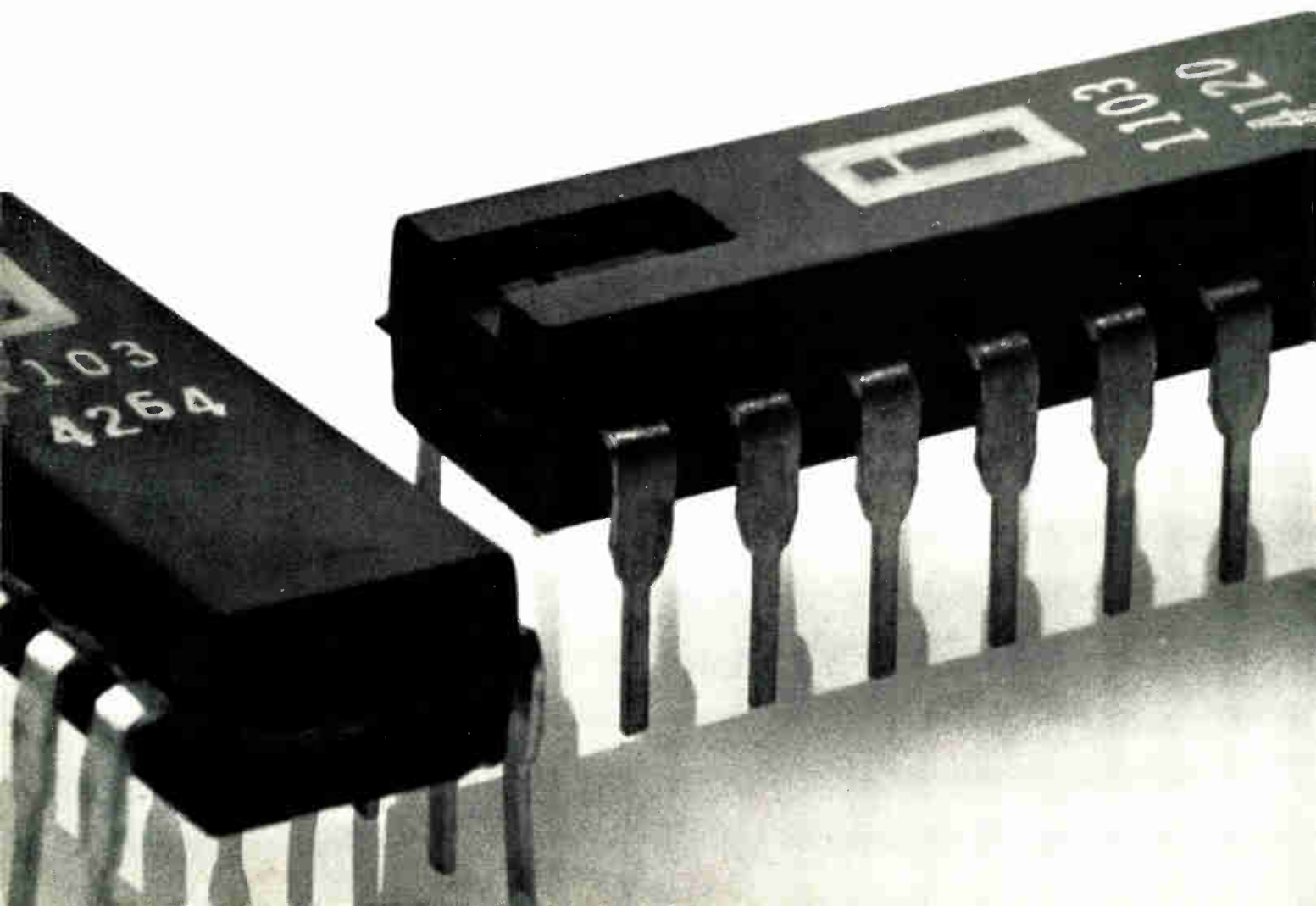

As of June 21 Intel has delivered 45,000,000 bits of the 1103 MOS RAM for use in main frames, mini-computers, data terminals, controllers and scientific calculators.

We can't reveal the buyers as yet, but when you hear their names (perhaps at FJCC) you'll recognize some of the leading figures in the computer industry.

And the RAM they have tested and selected is Intel's 1103, the 1024-bit silicon-gate MOS RAM that's in production in a big way. Deliveries of the 1103 in June alone will total 17,000,000 bits. So if you're thinking of designing with semiconductor memory, don't overlook Intel's 1103. It's the RAM to reckon with.

The 1103's specifications have improved recently. Read cycle time is 480 ns, down from 540 ns. Pre-charge to data out has improved from 390 nsec to 310 nsec. As before, all AC and DC parameters are guaranteed from 0°C to 70°C.

For immediate delivery of the 1103 call your local Intel distributor, Cramer Electronics, Hamilton Electro Sales, Industrial Components, or Electronic Marketing. In Europe contact Intel at Avenue Louise 216, B 1050 Bruxelles, Belgium. Phone 492003. In Japan contact Nippon IC, Inc., Parkside Flat Bldg. No. 4-2-2, Sendagaya, Shibuya-Ku, Tokyo 151. Phone 03-403-4747.

Intel Corporation is in a brand-new production facility at 3065 Bowers Ave., Santa Clara, California 95051. Phone (408) 246-7501.

Circle 15 on reader service card

intel<sup>™</sup>  
delivers.

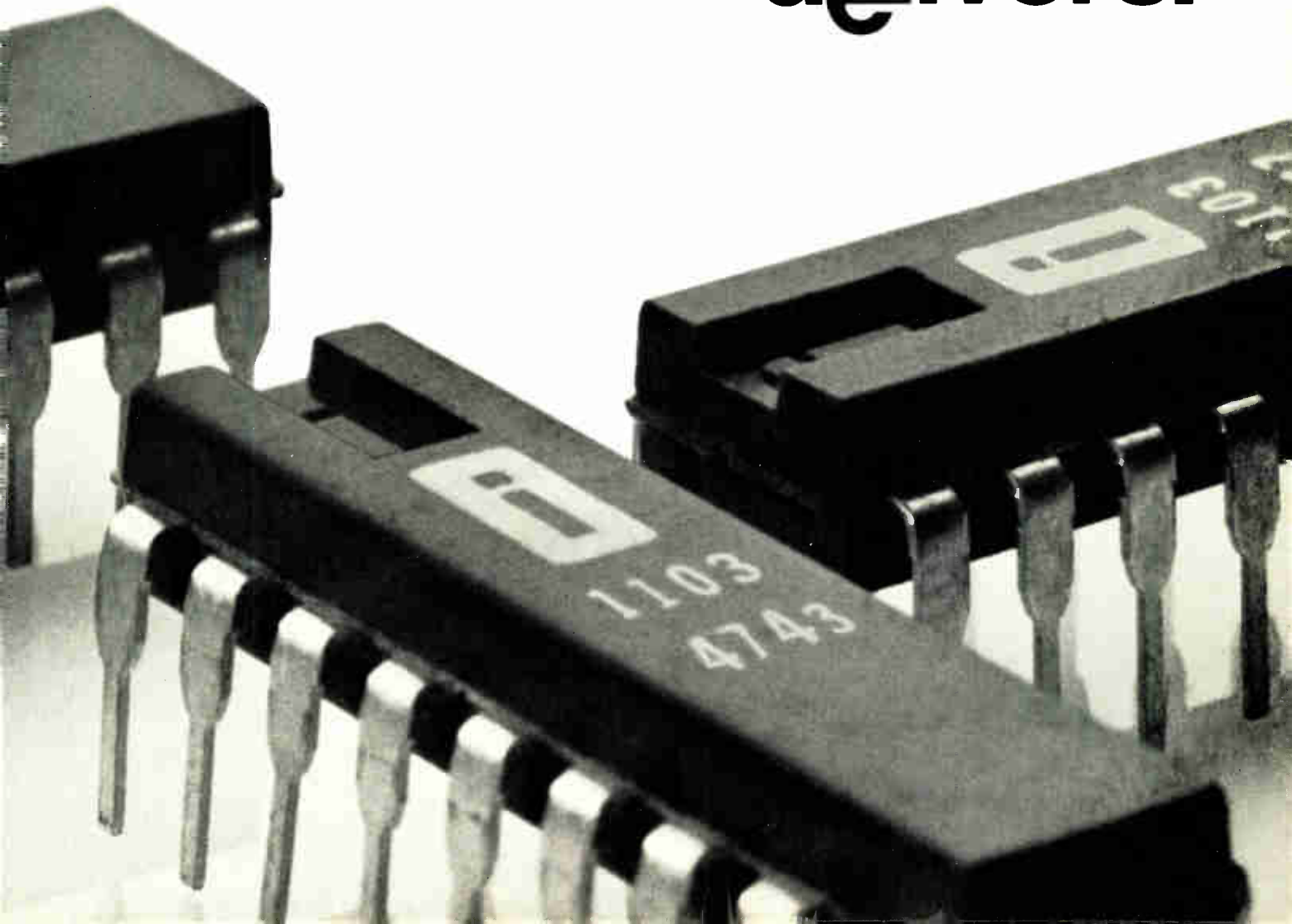

# Our low-inertia dc motor isn't one to throw its weight around.



The rotor of our motors is completely hollow.

So our motors have little weight to start with.

So it starts instantly. Or stops. Or positions. In fact, it can go from dead stop to 2,000 rpm in less than one millisecond. The fastest response of any motor of similar size.

It can handle rate-step requirements (from 1 to 500 steps per second). Or be used stalled, as a torque motor, without damage.

Which makes our motor ideal for use in incremental tape capstan drives, line printer drives, machine tool positioning and industrial automation. Several models are available.

With capacities from 15 to 135 oz/in of torque and pulse torques of 10 times larger. Also, options such as special shafts and inertias, forced air cooling adaptations, and integral tachometers.

For additional information, call your MICRO SWITCH Branch Office (Yellow Pages under "Switches, Electric"). Or write for our Product Brochure VM.

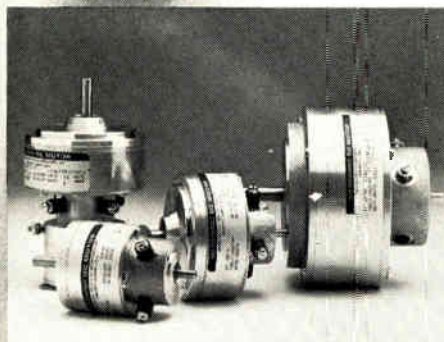

**MICRO SWITCH**

FREEPORT, ILLINOIS 61032

A DIVISION OF HONEYWELL

MICRO SWITCH products are available worldwide through Honeywell International.

---

# Electronics Newsletter

---

July 19, 1971

## FCC pondering 1-to-1 cable ratio for cities

With the success of cable telecommunications systems depending in large part on the FCC recommendations expected about Aug. 1, FCC chairman Dean Burch has tipped his hand on the subject. Burch told cable television system operators in Washington that the commission will require a one-to-one ratio of public service channels for each broadcast channel in major urban markets, adding that "we are contemplating a requirement that the capacity for two-way nonvoice communications be built into every new system." Burch warned the cable industry that if its response to his plea for an enlightened approach "is one of moving broadcast signals around the country in order to make a buck" then "we'll draw our own conclusions."

Burch's recommendation that cablecasting build from its base of imported distant broadcast signals and "turn itself into a vehicle of maximum service" upset over-the-air broadcasters, who have enlisted the aid of the White House. President Nixon has responded by naming a high-powered commission to study the total communications picture, including the balance between cable and over-the-air systems.

## Industry cool to Wired City plan . . .

An Arthur D. Little Inc. proposal to wire a city of 10,000 to 20,000 with an experimental broadband telecommunications system to predict future urban demand for services and their costs is reportedly losing support among the 20 companies expected to participate [*Electronics*, May 24, p. 32]. Insiders say sponsors were distinctly cool to the Cambridge, Mass., consultant's informal suggestion that it receive up to 10% equity in a special corporation as its fee. Moreover, supporters are concerned with possible antitrust implications of such a venture, as well as with cable TV industry disagreement with Little's cost projections (see p. 27). Nevertheless, Little says it's still proposing Phase 2 of its program—site selection, engineering, and implementation plans—to the participants, and exploring means of financing.

## . . . as NAE concept is called similar

Entitled "Communications Technology for Urban Improvement," a 218-page study just delivered by the National Academy of Engineering to the Development of Housing and Urban Development, recommends six pilot projects for consideration by the Government. Industry sources see strong similarities between the A. D. Little Wired City concept and the NAE report—which is still looking for sponsors now that HUD has effectively backed out of communications technology support.

The NAE study lists, among others, a \$968,700 pilot program from a community information service center that would give citizens a dial-for-information service to six operators with CRT consoles linked to minicomputers of the Honeywell H316 or Digital Equipment PDP-11 class.

## NR gets \$900,000 to develop small inertial navigator

First major step toward the development of a very small, low-cost inertial navigator for aircraft and medium-range missiles has been taken by the Air Force Avionics Laboratory. North American Rockwell's Autonetics Division has been awarded a 14-month, \$900,000 contract to build an experimental demonstration system called Micron. It will be a bit larger

---

# Electronics Newsletter

---

than the final system, which is expected to be less than 6-by-6-by-6 inches and under 10 pounds.

The final system would include a computer and the electrostatically suspended gyroscope that Autonetics has been working on since 1959. More than \$5 million in company funds has been spent on the gyro, which uses the mass-unbalance-modulation principle. Micron is a strap-down system, which means that it has no gimbals and all inertial sensors are fastened directly to the aircraft or missile frame. This results in a mechanically simpler navigator, but one that requires more computer capability.

## First isoplanar RAMs emerge from Fairchild

The first commercial isoplanar, random access memory ICs have rolled off the Fairchild Semiconductor line in Mountain View, Calif., and are now in the hands of customers. The bipolar part will be available off the shelf by mid-August, says the company.

Fairchild's introduction of the isoplanar technique [*Electronics*, March 1, p. 52] was greeted skeptically by competitors, who wondered if such devices could be produced. Now, C. Lester Hogan, president of Fairchild Camera & Instrument, calls the first RAM—a 256-bit model with 70-nanosecond cycle time—the analog to the first planar transistor. And Fairchild expects to make the big move to a 1,024-bit part with a 40-nanosecond cycle time in about four months.

## Cloud appears on calculator horizon

A company that started off with a big bang to challenge Japanese supremacy in electronic calculators—International Calculating Machines Inc.—may be on the brink of disaster because the market for its product “just blew out,” according to a source at ICM's first and only customer to date. ICM was started [*Electronics*, Feb. 15, p. 37] by the Systems division of Electronic Arrays Inc., Woodland Hills, Calif. Caltype Corp., a Los Angeles office machine wholesaler, was the first customer for the ICM 816, which was to retail for \$395. A Caltype source says that price was outdated two months after the agreement to supply 2,000 machines a month. In fact, the unit was selling for as low as \$139.50 in the San Francisco area a week ago.

A spokesman for Electronic Arrays says Caltype couldn't meet payments for machines delivered and adds that the ICM 816 inventory of “a few thousand” was a source of ready money to help Electronic Arrays through a tight cash situation. “We have to protect our mainstream MOS business,” this source says, hinting that a significant agreement with an OEM or assistance from a partner will be required to save ICM. Both avenues are being explored.

## Ampex to produce IBM compatible memories

The Ampex Computer Products division, one of the newest memory chip makers [*Electronics*, May 10, p. 43], has decided to become a plug-to-plug compatible supplier for IBM semiconductor memory systems. The division also will design and make arrays “with special requirements for any customer doing a system designed around a special device,” says division general manager Eugene Prince.

While the bulk of the work will be for Ampex products, Prince expects to provide replacement semiconductor memory systems that are plug-interchangeable with those for the IBM 370/135 and 370/145 when enough of those machines get into the field.



# The *Thrust* in Linear Circuits

Plus news from Texas Instruments about

---

Schottky TTL – Growing line, full availability

---

MOS/LSI – Specs on industry's broadest line

---

Optoelectronics – New P-DIP couplers

---

Power transistors – Increased reliability

---

Transistors – Two new Darlington

---



# Linear circuits: 40 new functions announced this year.

## TI has the capability—across the board.

Your choice of linear ICs at TI is growing fast. In the past six months we've introduced 40 new functions—that's more than one per week. And more are coming.

Now a broad, economical, dependable selection, TI's current line includes 12 operational amplifiers, 10 voltage comparators, 5 video amplifiers, 2 communications circuits and 37 consumer circuits. And there are 32 functions in our related interface circuits line. Check the product list under the foldout. Prices are competitive and delivery is immediate—from distributor stocks or from TI's big in-house inventories.

### Op amps — top performance, all packages

TI has carefully structured a broad line of op amps.

It's a useful, accommodating line. Suppose you want state-of-the-art super betas. TI has two brand-new ones—the SN52108/72308 and the SN52108A/72308A. High performance devices, they are ideal for applications requiring extremely low input offset voltages. They join the two super betas — SN52/72770 and SN52/72771—recently announced by TI.

As for precision op amps, your choice includes the internally compensated, general purpose SN52/72741; the SN52/72558, SN52/72747—dual 741s— and the SN52/72748—an extended bandwidth, general purpose device. The SN52101A/72301A are pin-for-pin replacements for the LM101A/LM301A, while the general purpose, internally compensated SN52107/72307 are direct replacements for the LM107/LM307.

Rounding out your op amp choice are the popular, general purpose SN52/72702 and SN52/72709.

And TI's package selection is industry's widest: 8- and 14-pin plastic DIP; 14-pin ceramic DIP; TO-5; ceramic and metal flatpacks.

### Voltage comparators — a 10-device choice

In voltage comparators, TI gives you a choice of

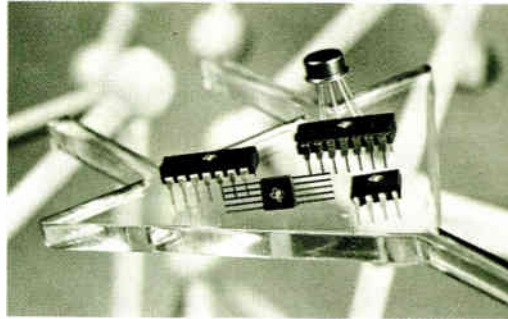

singles and duals from industry standards to supercomparators.

Singles include the SN52/72710 as well as new super comparators: SN52/72510 and SN52/72810, each featuring high gain and low offset voltage. The SN52/72510 is a single comparator with strobe.

The SN52106/SN72306 are pin-for-pin replacements for the LM106/LM306.

In duals, you can select the SN52/72711 or the SN72720 differential comparators; or any of the new supers—SN52/72811, SN52/72514 and SN52/72820. A replacement for the MC1514/MC1414, the SN52/72514 has greatly improved performance. Like a response time of 30 ns. And soon: SN52/72506, a dual 52/72106.

### Video amplifiers — a full bandwidth range

TI offers a complete range of video amps (see table). The new SN55/7512 is the only monolithic video amplifier having offset null capability. And TI's new SN55/7514 outperforms competition with a typical gain of 300 and an 80-MHz bandwidth. The SN55/7511 offers the best gain-bandwidth product.

TI Video Amp	Bandwidth
SN55/7511	3 MHz
SN55/7510	40 MHz
SN55/7512	80 MHz
SN55/7514	80 MHz
SN52/72733	200 MHz

### Consumer circuits

For color TV, AM/FM radios/phonos and other consumer applications, you can satisfy your requirements with TI's line of 37 consumer circuits. If your application still requires special features, consult us on our custom capabilities.

For linear circuits brochure, circle 283; for consumer circuits brochure, circle 284.

TI Operational Amplifiers					
Type	Features	Input Offset Voltage (Max) mV	Input Offset Current (Max) nA	Input Bias Current (Max) nA	Slew Rate at Unity Gain (Typ) V/ $\mu$ s
SN52/72702	Wide BW, General Purpose	5	500	10,000/15,000	1.7
SN52/72709	General Purpose	5/7.5	200/500	500/1500	0.3
SN52/72741	Internally Compensated General Purpose	5/6	200	500	0.5
SN52/72747	Dual SN52/72741	5/6	200	500	0.5
SN52/72748	Extended BW, General Purpose	5/6	200	500	0.5
SN52/72558	Dual 741 in 8-pin package	5/6	200	500	0.5
SN52101A/SN72301A	Precision Op Amp	2/7.5	10/50	75/250	0.5
SN52107/SN72307	Internally Compensated General Purpose	2/7.5	10/50	75/250	0.5
SN52/72770	Super $\beta$	4/10	2/10	15/30	2.5
SN52/72771	Super $\beta$ , Internally Compensated	4/10	2/10	15/30	2.5
SN52108/SN72308	Super $\beta$	1/10	0.4/1.5	3/10	0.25
SN52108A/SN72308A	Super $\beta$	1/0.73	0.4/1.5	3/10	0.25

# Integrated Circuits: you'll find your broadest choice—by far—at TI.



### TI's full line-up of linear ICs

LINEAR CIRCUITS		COMPUTER INTERFACE CIRCUITS	
<b>OPERATIONAL AMPLIFIERS</b>		<b>SENSE AMPLIFIERS</b>	
SN52/72702	Wide bandwidth, gen. purp.	SN7520/SN7521	Dual-channel with complementary outputs
SN52/72709	General purpose	SN7522/SN7523	Dual-channel with open-collector output
SN52/72741	Internally compensated, gen. purp.	SN7524/SN7525	Dual (two independent sense amps)
SN52/72747	Dual SN72741	SN7526/SN7527	Dual with register output
SN52/72748	Extended bandwidth, gen. purp.	SN75234/SN75235	Dual with inverted outputs
SN52/72558	Dual 741 in 8-pin package	SN7528/SN7529	Dual with preamplifier outputs as test points
SN52101A/72301A	Precision	SN75238/SN75239	Dual with test points and inverted outputs
SN52107/72307	Internally compensated, gen. purp.	<b>PERIPHERAL DRIVERS</b>	
SN52/72770	Super $\beta$	SN75450	Dual positive-AND
SN52/72771	Super $\beta$ , internally compensated	SN75450A	Improved dual positive-AND
SN52108/72308	Super $\beta$	SN75451	Dual positive-AND
SN52108A/72308A	Super $\beta$	SN75451A	Improved dual positive-AND
<b>VOLTAGE COMPARATORS</b>		SN75452	Dual positive-NAND
SN52106/72306	Single differential comparator with dual strobes	SN75453	Dual positive-OR
SN52/72506	Dual differential comparator with strobes	SN75454	Dual positive-NOR
SN52/72510	Single differential comparator with strobe	<b>LINE DRIVERS AND RECEIVERS</b>	
SN52/72514	Dual differential comparator with strobes	SN75100	Dual differential line receiver
SN52/72710	Single differential comparator	SN55/75109	Dual differential line driver
SN52/72711	Dual-channel differential comparator with strobe	SN55/75110	Dual differential line driver
SN72720	Dual differential comparator	SN75150	Dual EIA line driver
SN52/72810	Single differential comparator	SN55/75107	Dual differential line receiver
SN52/72811	Dual-channel differential comparator with strobe	SN55/75108	Dual differential line receiver
SN52/72820	Dual differential comparator	SN75154	Quadruple EIA line receiver
<b>VIDEO AMPLIFIERS</b>		<b>MEMORY DRIVERS</b>	
SN52/72733	Amplifier with adjustable gain (200 MHz BW @ gain of 10)	SN75303	150-mA 2 x 4 transistor array
SN55/7510	40 MHz bandwidth	SN75308	600-mA 2 x 4 transistor array
SN55/7511	High gain-bandwidth product amplifier (gain of 3000 @ 3 MHz)	SN75324	400-mA with decade inputs, dual sink/source
SN55/7512	Amplifier with offset null capability	SN75325	600-mA, dual sink/source
SN55/7514	80 MHz bandwidth		
<b>COMMUNICATIONS CIRCUITS</b>			
SN56/76502	Logarithmic amplifier		
SN56/76514	Balanced mixer		
<b>CONSUMER CIRCUITS</b>			
<b>Audio amplifiers</b>			
SN76001	1W audio at 9V and 8 $\Omega$		
SN76003	3W audio at 30V and 16 $\Omega$		
SN76005	5W audio at 35V and 16 $\Omega$		
SN76013	3W audio at 24V and 8 $\Omega$		
<b>Dual channel and stereo</b>			
SN76104	Stereo multiplex decoder		
SN76105	Stereo multiplex decoder		
SN76110	Stereo multiplex decoder		
SN76131	Stereo preamplifier		
SN76149	Stereo preamplifier		
<b>Chroma circuits</b>			
SN76242	Chroma sub-carrier regenerator		
SN76243	Chroma amplifier		
SN76246	Chroma demodulator		
SN76630	Chroma demodulator with PAL switch		
<b>Complex TV functions</b>			
SN76532	TV jungle (suitable for horizontal deflection with tubes)		
SN76533	TV jungle (suitable for horizontal deflection with semiconductors)		
<b>Regulators for varactor tuners</b>			
SN76550	33V at 5mA		
SN76552	22V at 5mA		
SN76553	12V at 5mA		
<b>IF circuits for radio and TV</b>			
SN76600	1st and 2nd video IF stages		
SN76603	RF/IF amplifier		
SN76619	RF amplifier/FM detector		
SN76640	Sound IF/limiter, slope detector, audio driver, voltage regulator		
SN76641	IF limiting amplifier		
SN76642	Sound IF/detector		
SN76643	Sound IF/detector		
SN76650	1st and 2nd video IF with keyed AGC		
SN76653	SN76650 with inverted AGC		
SN76660	Sound IF/amplifier limiter, balanced coincidence detector, d-c volume control		
SN76665	Sound IF/amplifier limiter, detector, attenuator, audio driver, voltage regulator		
SN76670	SN76660 with open-collector output		
SN76675	FM IF amplifier limiter, detector and audio preamplifier		
SN76676	FM IF amplifier limiter		
SN76680	SN76660 with audio driver and voltage regulator		

For data sheets, specify device number and write to Inquiry Answering Service, Texas Instruments Incorporated, P.O. Box 5012, M.S. 308, Dallas, Texas 75222.

## 3 ns Schottky TTL Immediate delivery on TI's entire line of Schottky TTL ICs.

Availability is now excellent on TI's entire line of 3 ns at 20 mW Schottky-clamped TTL ICs.

Advanced, highly automated production facilities have been placed into Schottky TTL production to keep in-house inventories up and distributor stocks filled—assuring on-time delivery of this fast-growing line.

Recent announcements in the Schottky line have expanded your choice to 16 functions. The latest additions are two new dual J-K edge-triggered flip-flops—the SN54S/74S113 and SN54S/74S114. Plug in either and you upgrade present systems to 100 MHz.

Also in the Schottky family are two quadruple 2-input NAND gates, a hex inverter, two triple 3-input AND gates, a triple 3-input NAND gate, two dual 4-input NAND gates, two 4-wide, 4-2-3-2 input AND-OR-INVERT gates, a dual 4-input NAND buffer, a dual 4-input 50-ohm line driver/NAND buffer, a dual D-type flip-flop and a dual J-K flip-flop.

In addition to being readily available and faster than any other TTL family, the Schottky-clamped family provides many other benefits. For example, a 125-MHz typical J-K flip-flop input clock frequency. Compatibility with nearly all saturated digital devices. Switching times virtually insensitive to variation in power supply or temperature. For data sheets, circle 285.

## MOS/LSI

# TI offers most comprehensive MOS catalog line.

TI's standard line of MOS/LSI circuits is your biggest, most comprehensive choice. There are 64 separate functions—each produced in volume for quick delivery and maximum economy.

TI's static shift registers have speeds from DC to 3 MHz, complexities to 500 bits, at an average small quantity price of 2¢

per bit. Dynamic registers have speeds to 10 MHz, complexities to 1000 bits, at an average small quantity price of 0.8¢ per bit.

In read only memories, TI offers speeds from 350 ns to 1  $\mu$ sec (fully decoded) and complexities from 1024 to 4096 bits. Prices in small quantities are from 0.9¢ per bit to 0.25¢ per bit.

Access times for TI random access memories range from 280 to 750 ns, with very low power dissipations. Complexities from 256 to 2048 bits, prices average 0.8¢ per bit in small quantities.

Package choice includes 14- to 40-pin plastic, 16- to 40-pin ceramic, TO-100 and TO-8.

For data sheets, circle 286.

SRs	Organization	Bits	MHz	Logic	$V_T$	Power			$\phi$	Clock Swing	Pwr (mW at 1 MHz)		Pkg
						$V_{SS}$	$V_{DD}$	$V_{CC}$			Pkg	Per Bit	
TMS 3000 LR	Dual 25	50	0-1	stat	High	+14	0	-14	2	+14 to -14	240	4.8	TO-100
TMS 3001 LR	Dual 32	64	0-1	stat	High	+14	0	-14	2	+14 to -14	270	4.2	TO-100
TMS 3002 LR	Dual 50	100	0-1	stat	High	+14	0	-14	2	+14 to -14	185	1.9	TO-100
TMS 3003 LR	Dual 100	200	0-1	stat	High	+14	0	-14	2	+14 to -14	280	1.4	TO-100
TMS 3012 JR/NC	Dual 128	256	0-1	stat	High	+14	0	-14	1	+14 to 0	380	1.5	CDIP/plastic
TMS 3016 LR	Dual 16	32	0-1	stat	High	+14	0	-14	2	+14 to -14	130	4	CDIP
TMS 3021 LR	21-bit	21	0-1	stat	High	+14	0	-14	2	+14 to -14	140	7	TO-100
TMS 3028 LR	Dual 128	256	0-1	stat	High	+14	0	-14	1	+14 to 0	380	1.5	TO-100
TMS 3101 LC/NC	Dual 100	200	0-2.5	stat	Low	+5	0	-12	2	+5 to -12	270	1.35	TO-100/plastic
TMS 3102 LC/NC	Dual 80	160	0-2.5	stat	Low	+5	0	-12	2	+5 to -12	216	1.35	TO-100/plastic
TMS 3103 LC/NC	Dual 64	128	0-2.5	stat	Low	+5	0	-12	2	+5 to -12	170	1.35	TO-100/plastic
TMS 3112 JC/NC	Hex 32	192	0-1	stat	Low	+5	0	-12	1	0 to +5	255	1.33	CDIP/plastic
TMS 3113 JC/NC	Dual 133	266		stat	Low	+5	0	-12	1	0 to +5	260	1.0	CDIP/plastic
TMS 3114 JC/NC	Dual 128	256		stat	Low	+5	0	-12	1	0 to +5	260	1.0	CDIP/plastic
TMS 3304 LR	Triple 66	198	0.01-5	dyn	High	+14	0	-14	2	+14 to -14	100	0.5	TO-100
TMS 3305 LR	Triple 64	192	0.01-5	dyn	High	+14	0	-14	2	+14 to -14	100	0.52	TO-100
TMS 3309 JC/NC	Dual 512	1024	0.01-5	dyn	High	+14	0	-14	4	+12 to -12	90	0.09	CDIP/plastic
TMS 3314 JC/NC	Triple (6014)	192	0.01-2	dyn	High	+14	0	-14	2	+14 to -14	210	1.1	CDIP/plastic
TMS 3401 LC/NC	Single 512	512	0.02-5	dyn	Low	+5	0	-12	2	+5 to -12	70	0.17	TO-100/plastic
TMS 3402 LC/NC	Single 500	500	0.02-5	dyn	Low	+5	0	-12	2	+5 to -12	70	0.17	TO-100/plastic
TMS 3406 LR	Dual 100	200	0.01-2	dyn	Low	+5	0	-12	2			0.4	TO-100
TMS 3409 JC/NC	Quad 80	320	0.05-5	dyn	Low	+5	0	-12	1	0 to +5	250	0.8	CDIP/plastic
TMS 3412 JC/NC	Quad 256	1024	0.01-6	dyn	Low	+5	0	-12	1	+5 to -12	100	0.1	CDIP/plastic
TMS 3413 LC/NC	Dual 512	1024	0.01-6	dyn	Low	+5	0	-12	1	+5 to -12	100	0.1	TO-100/plastic
TMS 3414 LC/NC	Single 1024	1024	0.01-6	dyn	Low	+5	0	-12	1	+5 to -12	100	0.1	TO-100/plastic
TMS 3417	Quad 64	256	0.05-5	dyn	Low	+5	0	-12	1	0 to +5	210	0.8	CDIP/plastic
TMS 3419 JC/NC	9 x 128	1024	0.01-3	dyn	Low	+5	0	-12	1	0 to +5	600	0.6	CDIP/plastic

RAMs	Organization	Decode	Logic	$\phi$	$V_T$	Access (ns)	Cycle Time (ns)	Refresh (ms)	Power Supply				Power Dissipation		Package	Pins
									$V_{DD}$	$V_{SS}$	$V_{CC}$	$V_{BB}$	Total	mW/bit		
TMS 1101 JC/NC	256 x 1	yes	stat	—	Low	750	800	NA	-10	+5	-10		480	2	CDIP, plastic	16
TMS 1103 NC	1024 x 1	yes	dyn	3	Low	300	580	2	0	+17	-10		300	0.3	Plastic	18
TMS 4000 JC/NC	16 x 8	no	stat	—	High	80	150	NA	-12	0	-12		120	1	CDIP/plastic	40
TMS 4003 JC/NC	256 x 1	no	stat	—	High	60	120	NA	-18	0	-12		300	1	CDIP/plastic	40
TMS 4020 JC/NC	1024 x 2	yes	dyn	2	Low	320	640	2	-16	0	+2		300	0.15	Plastic	24/22
TMS 4022 JC/NC	1024 x 1	yes	dyn	2	Low	650	1000	2	-20	0	+2		180	0.18	CDIP/plastic	24/22
TMS 4023 JC/NC	1024 x 1	yes	dyn	4	Low	500	900	2	-20	0	+2		80	0.08	CDIP/plastic	24/22
TMS 4025 JC/NC	1024 x 2	yes	dyn	3	Low	280	640	2	-16	0	+2		160	0.08	Plastic	24
TMS 4026 NC	64 x 4	yes	stat	—	Low	1000	1500	NA	-5	+5	-15		650	2.5	Plastic	28

ROMs	Organization	Bits	Access (ns)	$V_T$	Power			Power (mW at 1 MHz)	CDIP/Plastic Pkg No. of Pins
					$V_{SS}$	$V_{DD}$	$V_{CC}$		
TMS 2000 JC/NC	Programmable Logic Array	3840	3000	Low	+5	0	-12	350	40
TMS 2200 JC/NC	Programmable Logic Array	5482	3000	Low	+5	0	-12	350	28
TMS 2300 JC/NC	256 x 10 ROM	2560	550	Low	+5	0	-12	300	24
TMS 2400 JC/NC	64 x 7 x 5 ROM	2240	700	High	+14	0	-14	350	28
TMS 2403 JC/NC	USASCH II 7 x 5 CG	2240	700	High	+14	0	-14	350	28
TMS 2404 JC/NC	EBCDIC 7 x 5 CG	2240	700	High	+14	0	-14	350	28
TMS 2500 JC/NC	256 x 10 or 512 x 5 ROM	2560	350	Low	+5	0	-12	270	24
TMS 2501 JC/NC	64 x 7 x 5 USASCH II CG	2500	350	Low	+5	0	-12	270	24
TMS 2600 JC/NC	256 x 8 or 512 x 4 ROM	2048	900	High	+12	0	-12	200	24
TMS 2601 JC/NC	Test Pattern	2048	900	High	+12	0	-12	200	24
TMS 2602 JC/NC	USASCH II-to-Selectric, Selectric-to-USASCH II	2048	900	High	+12	0	-12	200	24
TMS 2603 JC/NC	EBCDIC-to-USASCH II	2048	900	High	+12	0	-12	200	24
TMS 2604 JC/NC	USASCH II-to-Selectric and EBCDIC	2048	900	High	+12	0	-12	200	24
TMS 2605 JC/NC	Quick Brown Fox	2048	900	High	+12	0	-12	200	24
TMS 2700 JC/NC	256 x 12 ROM	3072	900	Low	+5	0	-12	350	28
TMS 2800 JC/NC	256 x 4 ROM	1024	900	High	+12	0	-12	180	16

# New semiconductors expand your broad choice at TI.

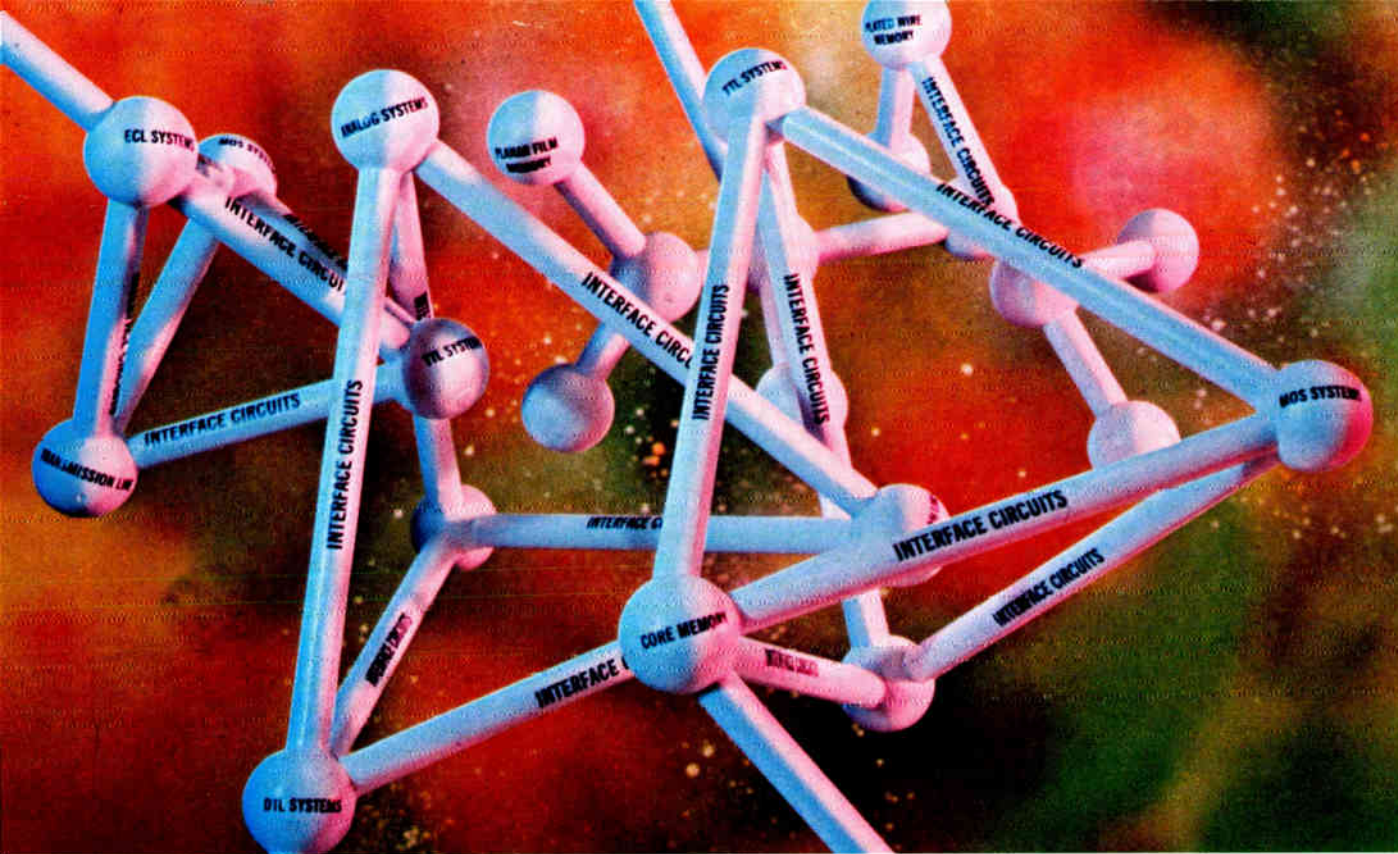

## The thrust in computer interface — more circuits to do more jobs.

Thirteen new interface circuits have been announced by TI in the past few months: 4 sense amps, 2 line circuits, 2 memory drivers, and 5 general purpose drivers.

TI's total computer interface IC line—broadest in the industry—now includes 32 separate functions. And it's still growing and improving. These compatible functions are specifically designed to reduce costs, connections, package counts and design time—while increasing interface performance. Here's the latest wrap-up:

### Sense amps — now, inverted outputs

Just added to TI's sense amp selection are four new devices having an output gate which provides an inverted output. Designated SN-75234, 235, 238 and 239, they are general purpose functions having identical pin-outs and features as the popular SN7524, 25, 28 and 29. In addition, they are internally-compensated.

Completing your current choice of 14 sense amps are the SN7520, 21, 22, 23, 26 and 27.

### General purpose drivers — new, improved models

Significant advancements have recently taken place in TI's choice of general purpose peripheral drivers. Three new devices have been added—the SN75452, SN75453 and SN75454—while the new SN75450A and SN75451A represent distinct improvements over previous versions, including

logic input clamping diodes and improved output breakdown voltage. Each features a minimum transistor collector-emitter breakdown voltage of 30 V.

### New memory drivers shrink PC boards

Two new TI memory drivers can reduce PC board area as much as 20% when replacing discrete circuitry.

The 600-mA SN75325 is designed primarily for use with 2½ D and 3 D core memories. The 600-mA SN75308 is an eight-transistor array for two-dimension memory systems.

TI's IC memory line also includes the 400-mA SN75324 with on-chip decoding and the 150-mA SN75303 monolithic transistor array.

### Line circuits for cooler MODEMS

Most EIA-compatible ICs suffer severe heat build-up problems, but TI's SN75150 dual line driver and SN75154 quad line receiver cool that headache. *Both meet all EIA RS-232-C specs completely.* The SN75150 can endure sustained shorts to ground or any voltage up to ±25 V.

And broadening your choice are the SN75107/SN75108, SN75100 and SN75109/SN75110 for data transmission applications.

For complete information on any TI interface circuit, circle 283 on the Reader Service Card.



### Optoelectronics

New optical couplers in low-cost, reliable 6-pin plastic DIP.

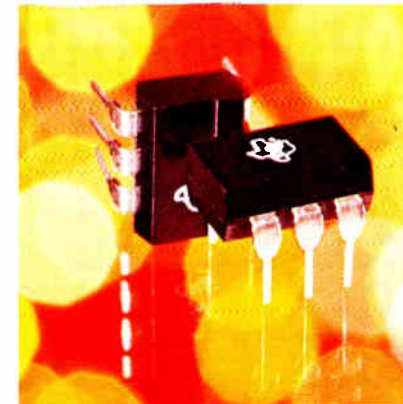

TI's two newest optically coupled isolators are in a new 6-pin dual-in-line plastic package—which pays off for you in lower component costs and lower assembly costs.

These two new couplers—TIXL111 and TIXL112—can be handled with the same automated assembly equipment and can use the same sockets and PC board design as the most popular IC packages.

TI's new TIXL111 has an input-to-output voltage of ±1.5 kilovolts and is DTL/TTL compatible. Price is \$3.35 (100-999).

The TIXL112, with ±500 volts isolation, is industry's lowest priced coupler. Only \$1.70 in 100-999 quantities.

The new couplers are suitable for use as solid-state relays, for voltage isolation, as interface devices between systems, and as line driver/receiver combinations.

For data sheets on the TIXL111 and TIXL112, circle 287 on the Reader Service Card.

### Power transistors

Nine new HV types have glass-passivated chip for greater reliability.

You'll get superior performance from all of TI's new high-voltage transistors. A glass passivated

	V <sub>CE</sub>	Continuous Collector Current	Package
2N3902	400 V	2.5 A	TO-3
2N3583	250 V	1 A	TO-66
2N3584	330 V	2 A	TO-66
2N3585	440 V	2 A	TO-66
2N3540	440 V	2 A	TO-66
2N3439	450 V	1 A	TO-5
2N3440	300 V	1 A	TO-5
2N5157	700 V	3.5 A	TO-3
2N5241	400 V	5 A	TO-3

chip (see drawing) provides a protected collector-base junction that increases reliability and lowers leakage. It also better equips each device to handle inversion.

And this unique chip combines with the collector guard ring to heighten temperature stability. The 2N3902, for instance, will pass such reliability requirements as MIL-S-19500/371 which calls for 300 V<sub>CE</sub> at 150°C reverse bias test for 48 hours.

TI's new high-voltage power transistors are useful in direct rectified line operations as inverters, converters, amplifiers and switches.

For data sheets on all nine, circle 288 on the Service Card.

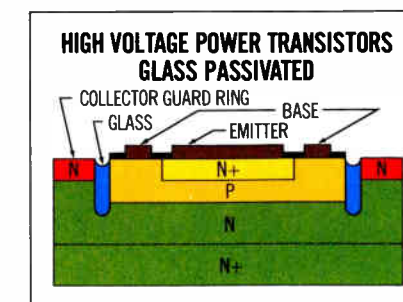

### Transistors

Darlington connections boost h<sub>FE</sub> to new highs for single package devices.

At best, a single, volume-produced bipolar transistor can produce a maximum h<sub>FE</sub> of 1000. That's just the *minimum* for TI's new 2N5526. And for our new 2N5525, the minimum h<sub>FE</sub> is 5000.

Both are NPN Darlington-connected epitaxial planar silicon transistors. Each has high input

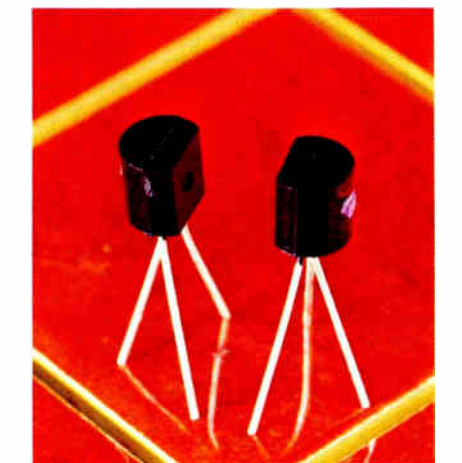

impedance to prevent circuit loading; high gain over a wide range of collector current up to 200 mA; plus all the cost-, labor- and space-saving advantages inherent in using one package instead of two.

You can put these benefits to work in such applications as high gain-low noise audio preamps; complementary output pair drivers; remote control amplifiers where space is critical; high gain DC amplifiers; strain gauge amplifiers; and sensing amps for power supplies.

For data sheet, circle 289 on the Reader Service Card.



For more information on any TI product, call your local TI sales engineer or authorized distributor. Or write Inquiry Answering Service, Texas Instruments Incorporated, P.O. Box 5012, M.S. 308, Dallas, Texas 75222.

**TEXAS INSTRUMENTS**  
INCORPORATED

# How to live within your budget!

Money for new test equipment is tight. Every dollar has to stretch as far as possible without hurting performance.

If you're looking for a 15 to 50-MHz scope—like the 422, 453A or 1700—you owe it to your company to try Hickok. Because, with a Hickok scope, you get quality performance while saving money.

With Hickok, you receive:

- dual and single channel models
- 25-MHz bandwidth
- stable triggering beyond 50 MHz
- 10-mV sensitivity
- built-in delay line

The value-priced 5000A and 5002A are the results of Hickok's experience in producing more than 20,000 scopes for reliable operation in rugged military environments. These performance-packed scopes are ideal for lab applications: clean pulse response; 4 screen width horizontal and 3 screen height vertical deflection; sharp, bright trace. And for field use, lightweight, compact design.

These are features usually found on models costing up to \$2100. And this brings us back to economy—the 5000A single channel scope is \$595 and the 5002A dual channel is \$845. Call Hickok to take a look at these scopes in your lab.

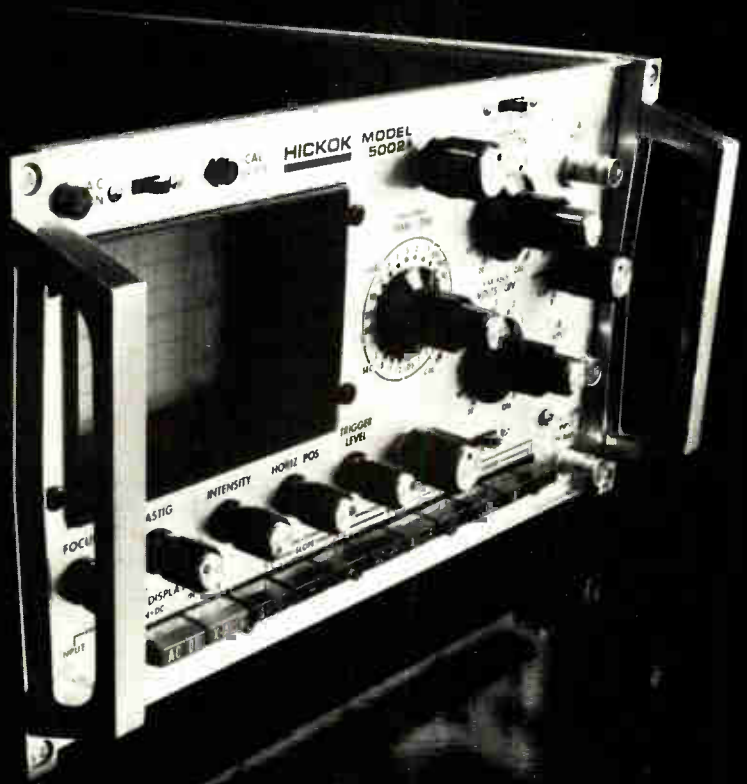

**HICKOK**  
the value leader

Instrumentation and Controls Division  
10514 Dupont Ave. • Cleveland, Ohio 44108  
(216) 541-8060

# HICKOK

MOSTEK announces

# A breakthrough in counter/display circuits!

5002

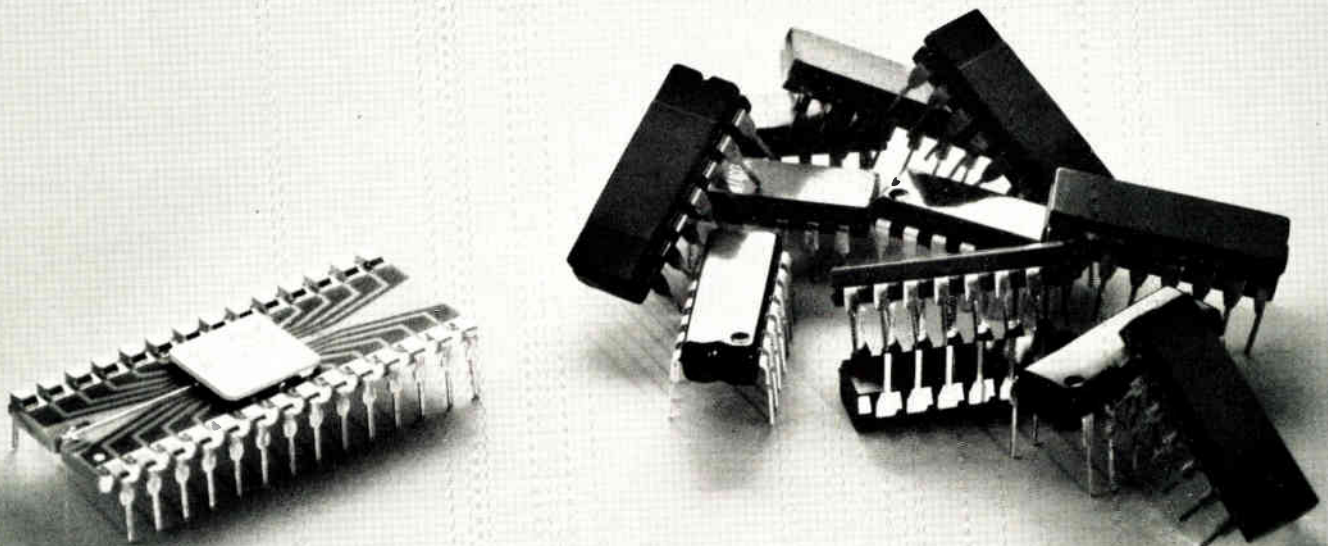

## Now...MOS replaces TTL

Four digits of counting/display logic in one package . . .  
same single +5V supply but 1/100th the power!

Our new MK 5002 P gives you all the logic you need for your counting/display systems: four decade-counters, four quad-latches, seven-segment decoder, multiplex logic, BCD outputs, leading-zero suppression. All of this in one package, with one +5V power supply and less than 20mW of power!

Our point is this. If you're now using TTL, better take a look at what MOSTEK's MOS technology can do for you. We've designed an entire instrument system on a single chip. We've replaced 12 ordinary TTL packages with a single 5002 and given you more performance

over a broader power range. (You can operate from +5V supply, or your 6V, 9V or 12V batteries, for instance.) And the cost of our 5002 is lower than TTL—even at today's prices.

Whether your application is in frequency counters, digital voltmeters, digital timers or event counters, for example, you need to consider the advantages of our new breakthrough circuit . . . made possible through MOSTEK's ion-implantation process. Call for detailed information to Gordon Hoffman or Dave West at (214) 242-1494. Or contact your nearest Sprague representative or distributor.

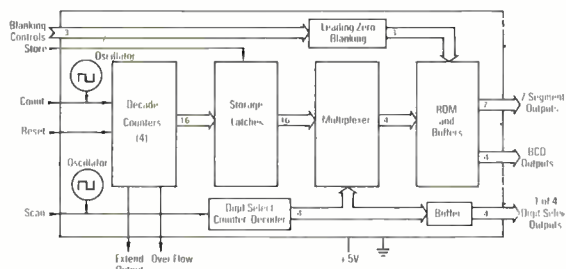

The  
Calculator-on-a-Chip  
Company

An affiliate of Sprague Electric Company  
1400 Upfield Drive  
Carrollton, Texas 75006

# Electronics review

Significant developments in technology and business

## Cable TV men agree to disagree on Wired City

Study by Little on costs of frequency vs space multiplexing networks draws fire at cable group meeting

**Which way to the Wired City?** Can a two-way broadband, switched network be achieved best by replacing frequency-division multiplexed systems now in use for one-way entertainment services with space-division multiplexing? The questions raised by the consulting firm of Arthur D. Little Inc. are generating much heat but little light—conditions that mark many of the issues considered by cable broadcasters.

The issue, raised at the National Cable Television Association's annual meeting, and its answer will affect today's \$177 million equipment market and its predicted growth to \$448 million by 1976. Of these totals, an estimated \$100 million and \$240 million, respectively, will go for such electronics as head-end equipment, amplifiers, bridges, line extenders, customer dropoffs, and television set converters. Industry sources estimate that such hardware accounts for about 20% of the cost of a turnkey CATV system, with cable taking another 20% and the remainder going for labor.

The effort to draw cost comparisons between branching FDM systems and the admittedly more costly SDM concept estimates was presented to the cable operators by Little's John P. Thompson, whose views were immediately challenged

by several system operators. Most outspoken was Irving B. Kahn, head of TelePrompTer Corp., the largest system operator.

At issue was Thompson's presentation noting that Little estimated investment-per-subscriber in a typical 12-channel, one-way FDM system as \$125 on the basis of a 20,000-terminal system in an urban area with 50% saturation. A new 24-channel basic system "would cost \$135," Thompson said, "and a new 24-channel, two-way system \$140."

Upgrading three such FDM systems to give "full viewer feedback" in a two-way operation would raise investment per subscriber to \$285, \$280, and \$255, respectively, Thompson said, excluding new head-end equipment costs of "about \$50,000." A new SDM 24-channel, two-way system, including broadband switching, would require a subscriber investment of \$370, according to the Little estimate.

In challenging the data, Kahn declared that FDM system investment now runs to half the figures cited by Little, while costs of SDM would be more than double the \$370 estimate. Other cable men said space-division multiplexing could be more than three times the Little study estimates.

While Thompson said there has been no definitive look at the technical aspects of broadband SDM systems, and urged it be studied in a pilot operation before proceeding with expansion by frequency-division multiplexing, TelePrompTer's Kahn argued that FDM "broadband is here. It will be commercially available by the end of the year and

retrofitting can be done with commercially available hardware."

The space-division multiplexing proponents say its greater capacity likely will be required if cable television is to be used for such community services as two-way computer-assisted education and instruction, rural medicine, transit information, and crime prevention. SDM, it is said, permits a more flexible system—it can piggyback a large number of fm broadcast signals, for example, and cuts spacing between amplifiers—and is less likely to be put out of commission than a single-cable FDM system. But FDM, say its supporters, can carry more than 25 channels—some say as many as 36—and when laid down as a two-cable system, has all the capacity needed.

### Companies

How to get into scopes via the Atlantic

Raytheon's entry into the rough-and-tumble oscilloscope field in the middle of a recession occasioned an almost universal question: "Why now?"

The answer is that Raytheon will market a foreign line of instru-

**For openers.** Raytheon's Richard Kirkland, Anthony Johnson unpack.



ments—from Britain's A.C. Cossor Ltd., a wholly owned subsidiary—with a high price-performance ratio. Moreover, Raytheon declares that it will be happy to corner 5% to 6% of the U.S. scope market through Cossor, which already grosses more in Britain than any other scope maker.

Anthony P. Johnson, national sales manager of the Raytheon instruments operation, Bedford, Mass., also figures that recession psychology can be turned to advantage, especially with the firm's CDU-150 general-purpose scope.

That instrument is the child of the British military's late-1960s procurement of the XT-531. The 531 is being used throughout the British armed services, and carries nomenclatures of both the North Atlantic Treaty Organization and the U.S. General Services Administration. Cossor is producing hundreds of the military-grade scopes each month—after beating out the likes of Hewlett-Packard, Tektronix, and British firms in design competition.

"British labor costs are only about a third of those in the United States," says Johnson, "And since we have a multi-thousand-unit contract already, our parts-cost leverage is high. Thus, we can build excess XT-531s, label them CDU-150s, and sell them to the public in this country for \$1,495."

Though some U.S. scopes with similar performance come within \$200 of this figure, no stateside price competitor is as rugged. And if they've been designed to withstand Mil-Spec environmental tests, they cost 30% to 50% more.

The CDU-150's electrical specs are good, too; it's a dc-to-35 megahertz dual-trace scope with built-in time base, 10-nanosecond rise time, and 5 millivolt-per-centimeter sensitivity.

"So with money tight, we are trying to convince customers that we can offer a general-purpose scope, capable of taking quite a physical beating, at a low price and without performance tradeoffs," Johnson says.

"Our kind of customer is the computer service engineer who often

drives hundreds of miles with his scope in the trunk. When he takes it out, it must work."

---

### Commercial electronics

---

#### Bubble/crystal data system proposed for police cars

A system using a pair of the newest technologies—bubble-domain memories and liquid crystal displays—is being proposed to help solve one of the oldest law-enforcement problems: getting stored information instantly to policemen in the field.

The proposal is being made by the Autonetics division of the North American Rockwell Corp. to the U.S. Law Enforcement Assistance Administration as well as to several state and local police agencies. The system would consist of a small digital patrol-car computer into which police officers would enter data, such as a suspect's name or driver's license number, to be matched against entries in the unit's data bank.

The display, operating at millivolt levels, is called ideal for mobile use because liquid crystals reflect ambient light—sunlight by day, a dashboard lamp at night. The bubble memory is considered highly suitable for this application because of its capacity potential and nonvolatility. And, unlike other law-enforcement systems that require the policeman to radio information to a central computer for a data search [*Electronics*, April 27, 1970, p. 115], the Autonetics version, with its on-board computer, would operate in real time.

The size of both the memory and display would vary according to the law enforcement agency's requirements. In some cases, it would be sufficient to store and indicate data for a simple "want" on a person or vehicle; in others, a physical description requiring a larger memory and display capability may be needed.

The memory could be controlled and updated from the station house

via the car's radio link. Autonetics says the entire system could operate off the car battery without any trouble.

The Anaheim, Calif., company says it has already demonstrated bubble-domain memories with a density of  $2.5 \times 10^6$  bits per square inch in an experimental substrate. Autonetics estimates that about 9 billion bits of data could be stored in an area of about one cubic foot at a cost ranging from 0.001 to 0.003 cent per bit. Power consumption, says Autonetics, would be on the order of watts.

Autonetics also says it can handle liquid crystal displays' susceptibility to changes in temperature. The company claims to have built suspended liquid crystal displays that operate over a temperature range of less than  $-50^\circ\text{C}$  to more than  $+100^\circ\text{C}$ . This range, says an Autonetics spokesman, is "far wider than capabilities ever expected for liquid crystal materials and much more than adequate to meet the requirements."

Many specific system details remain to be worked out. Autonetics envisions a two-phase program: development of a prototype unit using existing MOS circuits for the memory to demonstrate the effectiveness of the principle, then a three-to-five-year period in which to start manufacturing bubble-memory units in production numbers.

Current research is being funded by the company and is aimed at developing improved material for bubble-domain memories and devices that generate, control, and detect bubble propagation. Similar work is being conducted with liquid crystals.

---

### Solid state

---

#### Double mesa is key to triac chip process

A firm that claims to be the largest producer of triac chips in the world, Hutson Industries of Dallas, has developed a technique for making thyristors that is said to make chip



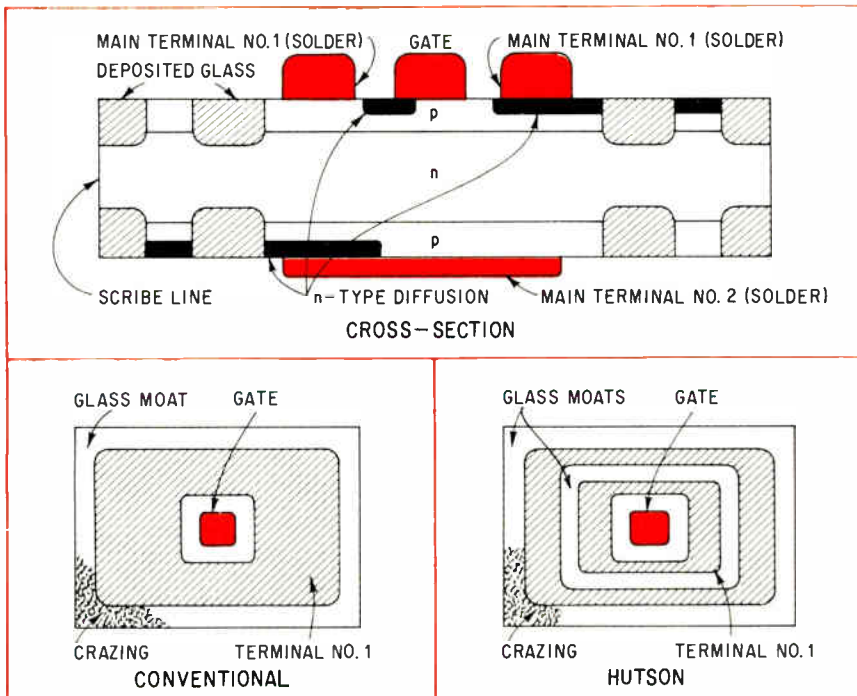

**Double protection.** Hutson Industries triac, which it says will make chip devices as easy to use as discretes, protects part with double mesa. At top is cross section of the chip, showing scribe through outer glass moat. At bottom left is conventional one-moat, one-mesa layout, while at right is the two-moat, two mesa approach. Company calls its process Di-Mesa.

triacs almost as convenient to use as conventional discrete devices. Hutson calls the process Di-Mesa, from the double mesas used to protect the part.

Though unpackaged semiconductor chips in hybrid or other circuits provide the ultimate solution to the problem of reducing device packaging costs, most are rather fragile and must be handled with great care if they're not to suffer damage or contamination. Glass passivation increases resistance to damage, but it also introduces another problem: tiny edge cracks that can grow under thermal stress and result in device contamination. This is especially troublesome in triacs, which are very sensitive to impurities.

In glass passivation thyristors, it's usual to isolate the junction by depositing glass in a moat surrounding the active area. But when the devices are separated by scribing through the glass, the stresses required cause minute cracks in the glass; under later thermal cycling, the glass can separate, permitting water or other substances to con-

taminate the junction and destroy the properties of the thyristor.

Hutson's solution is to etch two moats around the device, forming two mesas. After glass has been deposited in both moats, the devices can be separated as usual by scribing through the outer glass ring; cracks that may appear cannot transport contaminants to the junction. Hutson also coats the whole face of the device with the glass except where connections must be made for further protection.

After this, according to Paul E. Wible, Hutson's marketing head, the chip is very rugged. "It forms a truly discrete part. We don't sell a vial of chips with an 80% AQL. We sell them just like any other discrete product, with 100% testing before they go out the door."

The chips are coated with solder so that they can be reflow-soldered into place by the user, eliminating the need for delicate welding operations and the possibility of "purple plague," the gold-aluminum compounds often formed in conventional bonding. Both flip-chip and "right-side-up" mounting are pos-

sible, and Hutson has preforms available for connections and mounting. The solder, 90% lead and 10% tin, is softer than the common eutectic usually used in electronics, and also provides self-annealing for less cumulative damage from thermal cycling than is usual with the eutectic.

## Communications

### Computer CATV link offers CAI promise

Computerized community information networks and computer-aided instruction in the home may be made available by a system that picks up computer-generated display frames distributed over cable TV networks. Dubbed Ticcit (time-shared, interactive, computer-controlled, information television) by its developer, the Mitre Corp., the engineering model of the system utilizes a commercial television receiver and cassette video tape recorder. A standard 12-button telephone puts it into the private, interactive mode, enabling a subscriber to phone for specific information.

The current test and demonstration program delivers 60 displays per second over a single CATV channel in Reston, Va., where there are six terminals equipped with the cassette VTR and coupler-decoder device necessary to capture and refresh the data. [*Electronics*, April 12, p. 57]. In its present form, the Mitre-developed device comprises an ordinary TV tuner, a function switch to allow independent operation of the TV receiver and VTR, and an address decoder. The VTR serves as the refresh memory: when the control device disables the take-up and supply reel mechanism, the helical scan record/playback heads will record a single 1/60-second display frame and then play it back continuously.

Mitre officials estimate that the eventual cost of the system will be 10 cents per user hour for community information services with 6,000 subscribers, or 50 cents per user hour for computer-aided instruction



**Cable power.** Mitre's Ticcit, a cable TV system in which the user interacts directly with a remote computer, is used by a class in Reston, Va., where Ticcit is receiving a tryout.

servicing up to 200 students, not including the cost of source programming. (Present-day CAI technology costs \$3 to \$10 per student hour, whereas even student-teacher contact in higher education runs an average of \$3 per hour.) Mitre estimates that the coupler-decoder, in production quantities, will sell for about \$17. And manufacturers of cassette VTR project prices as low as \$400 within five years.

While Mitre uses an IBM 360/50 for running Ticcit software and a Honeywell 516 to drive its Data Disk TV character generator, the co-inventor, Kenneth Stetten, says that Ticcit is designed to be controlled by a minicomputer with 64,000-word minimum storage and the data base stored on disks. Mitre's transmitted picture frames contain only every other line of a standard TV picture, reducing vertical resolution by 30%, but allowing Mitre to send 60 frames a second instead of the usual 30. Each frame is preceded by a one-line, 16-bit digital address consisting of black and white bars—an encoding scheme that lets Ticcit address up to 32,000 different subscribers, Stetten says.

In the public mode, users select frames by dialing a three-digit "sub-channel" address on the coupler-decoder unit. If that address matches the address of the transmitted frame, the VTR records that frame, and then plays it back continuously. In the private, dial-up mode, the computer incorporates the unique address of the subscriber's terminal in the display

frames it sends. The coupler-decoder device will only activate the record mechanism for that terminal with the matching address.

Mitre hopes to continue its work with Ticcit using an expected \$475,000 award from the National Science Foundation, of which about \$150,000 would go to the University of Texas for the development of software for junior college courses in freshman English, math, and computer sciences. Ticcit was developed using Mitre independent R&D funds, and an earlier NSF award was used to analyze the target courses and educational level for the technology, and operating costs.

## Computers

### Bright promise beckons sorter developer

One of the more interesting computer peripheral developments in recent years was a sorting machine, announced as a product in the autumn of 1969 by Astrodata Inc. of Anaheim, Calif. Designed to reduce execution time of many programs by as much as half, the sorter, despite some deficiencies, appeared to have tremendous market potential. But Astrodata ran into financial difficulties—it is bankrupt and reorganizing under Chapter 11—and is seeking to license patents for its machine, which never got into full-scale production and marketing.

The company believes that the

sales potential of the sorter, which does a job ordinarily handled by a software routine, could be realized as soon as it can be made to work efficiently in the environment of a computer system. It's connected to a central processor, from which it accepts a load of about 2.5 million bytes of data, organized into multiple-byte records. It can sort this data completely and return it to the processor in roughly one minute, whereas the usual software routine takes many minutes.

In its present form, the machine, which measures 72 by 85 by 35 inches, contains a magnetic drum and a collection of IC comparators. The unsorted data, in a typical application, after having been collected on a magnetic disk, would pass from the disk into the computer memory, through an input-output channel, and then to the sorter through another channel. When the sorter is finished, it returns the sorted data through a third channel into memory, while a new load passes through the second channel into the sorter. This two-way passage requires a two-channel hookup.

In general, several such sorted loads would be accumulated on another disk on still another channel, and would have to be merged after the basic sorting job; the Astrodata sorter can't do the merging.

This sequence displays one of the sorter's main deficiencies: The data being sorted has to make several passes through the memory and various channels before it's ready, in completely merged form, for further processing. These numerous passes keep the computer from other tasks and tie up four I/O channels, whereas a software routine would require only two.

Another major problem is that the machine sorts records as if they were big binary numbers. But if the records are to be sorted on some field other than the most significant bits—or if they are in ASCII or binary-coded decimal or some other code—they must be converted in the CPU time saved.

Redesign of the comparison circuitry to handle different codes, or

# 500-MHz Real-time Oscilloscope System

*with 1-Gigahertz Direct Access*

- 1 GHz @ 5 V
- 500 MHz @ 10 mV
- 8 x 10 cm display
- 500 picosecond delayed sweep
- 20 cm/ns writing speed
- Compatible with all 22 7000-Series plug-ins

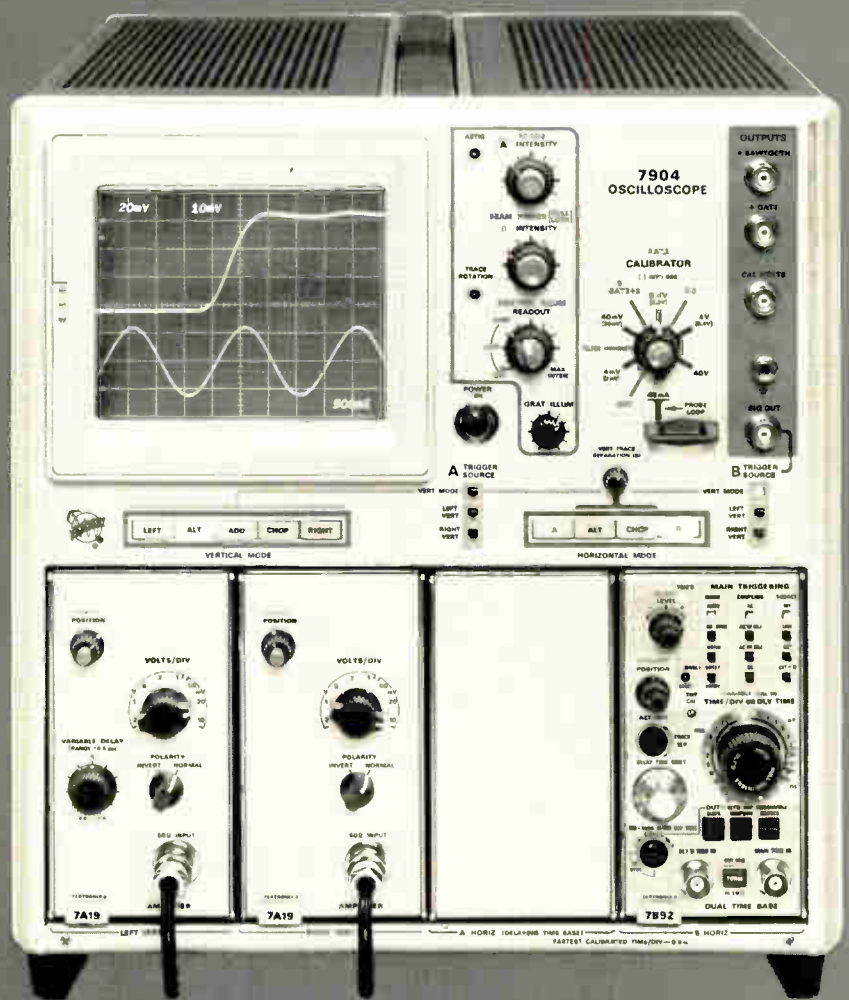

The new Tektronix 7904 Oscilloscope is power packed. With 7A19 Amplifier plug-in it offers a phenomenal real-time bandwidth of 500 MHz at 10 mV/div. And the ultra-high CRT bandwidth makes possible direct access offering 1-GHz bandwidth at a deflection factor of 5 V/div.

The new 7B92 Dual Time Base is in a class of its own. It has sweep rates to 0.5 ns/div, triggering to 600 MHz and a display mode that allows you to view the intensified delaying sweep and delayed sweep simultaneously.

Now you know why the amazing 7904 was the center of attraction at the 1971 IEEE Show.



## TEKTRONIX®

committed to progress  
in waveform measurement

Instrument prices: 7904 Oscilloscope \$2900, 7B92 Dual Time Base \$1400, 7A19 Amplifier \$500. For more information call your nearby field engineer or write: Tektronix, Inc., P.O. Box 500, Beaverton, Oregon 97005.

U.S. Sales Prices FOB Beaverton, Oregon

Circle 31 on reader service card

to sort on selected fields, is not hard to do—nor is it hard to conceive a way to use the sorter with, say, a disk controller instead of through channels. In this mode the sorter might be made to look to the controller like another disk.

But no controller on the market is capable of adding a unit like the sorter. To design one, and to redesign the sorter to go with it, would take a year or more of effort by a team of experienced engineers, with plenty of money behind them. And some critics suggest that the machine's cost would have to be cut to perhaps a few percent of its cost (in six figures) to be marketable.

---

### Computing calculator features thermal print

Not only are more and more minicomputers being marketed in calculator's clothing, but there is a discernible movement of instrument makers into the programable calculator field.

Following coincidentally the purchase by Tektronix of the Cintra Corp., maker of the Statistician 911 [*Electronics*, Aug. 17, 1970, p. 126] is Hewlett-Packard's debut of its Series 9800, Model 10 computing calculator.

Besides being characterized by Thomas L. Kelly, general manager of H-P's calculator division, as "the most powerful calculator we've ever built," the Model 10 brings to the market an interesting feature: an optional thermal-print readout developed by Hewlett-Packard especially for it.

Capable of four lines a second, the readout has full alphanumeric capability, a calculator first. Though the company isn't ready to divulge details, it says that the readout "definitely isn't a Texas Instruments type" and apparently represents a new concept.

The calculator itself is built in modular form, and is designed to take functional block plug-ins to increase its calculating power. The basic machine, which has a 10-digit light-emitting diode readout with floating decimal, is supplied with 51

registers capable of handling 500 program steps. It can perform all the basic arithmetic functions, including square roots and reciprocals, with the program mode being available from a single keyboard setting.

Beefing up the Model 10 are other options and plug-ins, presently totaling 11. Robert Watson, the engineering manager principally responsible for developing the new machine, points out that the circuits of these external block modules are direct extensions of the internal memory. Using programable read-only memories in each block for maximum flexibility, including an n-channel 4,000-bit MOS read-only memory designed for the machine by Hewlett-Packard, these additional options give the user functions not normally associated with calculators.

Plug-ins boost calculating power to a maximum of 111 registers and 550 programs, making the Model 10 just about the most powerful machine still going under the name of calculator.

With the math block alone the machine can solve 17 simultaneous equations as well as all log, trip, and transcendental functions found on slide rules. A total of 28 functions are available, including a "do loop" function ordinarily found only on large computers.

---

### Wanted: printer to do 30,000 lines/minute

Want to build a printer that can blaze out 30,000 lines a minute? There's a customer available—the Lawrence Livermore Radiation Laboratory in Livermore, Calif., recently divorced administratively from the original Radiation Laboratory in Berkeley.

Radiation Inc. built such a printer for Lawrence about eight years ago for \$350,000, and it's been running ever since in the laboratory's computation department. But the faithful old printer, having churned out some 100 billion lines, at a cost of half a million dollars per year just for paper, is getting rather shaky,

and Sidney Fernbach, the department head, is thinking about asking for bids for a successor. He's willing to settle for about the same speed, but he figures it'll probably cost more than the old one, since the price of almost everything else has gone up. But he won't help any prospective bidders by disclosing how much he's willing to pay.

As for Radiation, it does not seem particularly anxious to build a replacement printer. A spokesman at the Systems division, Melbourne, Fla., asserts the company easily has the technology to duplicate the machine but adds: "Today's hourly rates, and building just one unit, could result in a final price that scares away the customer." The job would have to be profitable, he adds.

For printer builders who are about to rush to the drawing board, here's how the Radiation version works. A web of special paper from a large, 12-inch-wide roll passes under a row of styluses. Electrical impulses generate tiny arcs from the styluses to a grounded metal drum under the paper; each arc burns a black spot on the paper. These spots combine to create alphanumeric and special characters in a 5-by-7 dot matrix—120 characters per line, 6½ lines per inch—in a format resembling that produced by conventional printers.

However, most commercially available printers run at 600 to 1,000 lines per minute, and the fastest, IBM's model 3211, puts out 2,000.

These printers by way of comparison, skip from page to page at about the speed that Lawrence's paper moves while it is printing.

---

### Computer-aided design

---

\$200,000 system does job for custom MOS firm

Computer-aided design systems for LSI arrays are expensive. Some firms have spent \$5 million or more [*Electronics*, Jan. 18, p. 93] to tie into huge computers and to develop software. So when a fledgling in the cus-

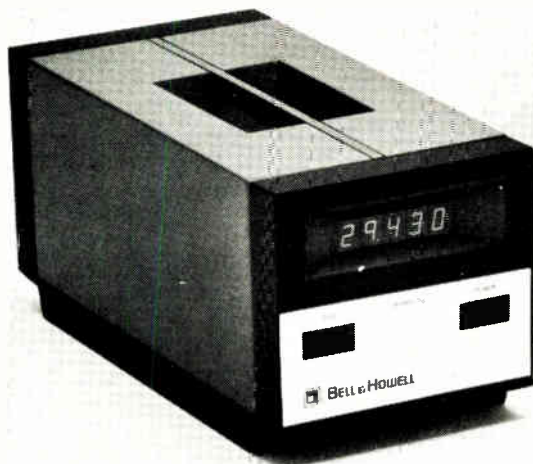

## Bell & Howell & a Change in the Weather

"Well, they've done it again." "Who?" "The guys in the back. Look." "What is it?" "A digital barometer."

"So?"

"So, you realize that in this great electronic age, weather bureau types are still eyeballing a big glass tube of mercury to get barometric pressure?"

"Even at big airports?"

"Even at big airports."

"My that's comforting. And with ours?"

"Says here it's easy to use. That to get any kind of accuracy on standard mercury manometers, you've got to know column temperature, amount of gravitational correction relative to where you are, and you've got to keep cleaning the mercury and the column.

Ours you just plug in and read. Nothing to interpret or interpolate."

"Accurate?"

"0.025%. And it records any pressure change in about a second."

"What else?"

"It's portable. Only six by six by twelve inches."

"Is that a big deal?"

"How'd you like to haul about four feet of old glass tube around in the field upright all day?"

"I see what you mean."

"Boy, they really did a number. Because it's digital you can feed it directly into a computer for storage or computation. And it's compatible with remote data links. (Not only that, they've come out with a secondary pressure standard version that reads out in psi.)"

"Where would they use the things?"

"Oh, meteorology labs, private weather bureaus like TV and radio stations have, federal weather bureaus, marine installations, altimeter and airspeed calibrations. And it's rack mountable for OEM's."

"Anybody else got one like it?"

"Looks like we're all alone. And it's going to sell for around \$3K to boot."

"Guess we better run an ad. Coupon?"

"Don't think we'll have room. Tell 'em to write for the 4-461 Digital Barometer and the 4-462 Digital Secondary Pressure Standard. Bell & Howell Instruments Division, 360 Sierra Madre Villa, Pasadena, California 91109."

**INSTRUMENTS DIVISION**

 **BELL & HOWELL**

© Copyright 1971 Bell & Howell

tom silicon gate MOS/LSI business says it has a CAD system that embodies just a little more than \$200,000 in hardware and software costs, it's worth a close look. That's approximately what General Digital Corp., Newport Beach, Calif., has spent in gearing itself for custom chip development with CAD [*Electronics*, May 24, p. 17].

Alvin B. Phillips, founder and president of General Digital, says, "We're in the custom silicon gate MOS business and we needed a customer-responsive CAD system that works as well and as fast as anyone else's, but ours is a hell of a lot less expensive." General Digital is following a trend with its system by adopting an interactive cathode ray tube on which the designer can optimize circuit layout, and by choosing a camera for mask pattern generation rather than rubyliths.

Richard Sitrine, General Digital's vice president for research and development, points out, though, that one of the big differences in the system is the use of a relatively inexpensive pattern generator—\$40,000 vs. \$200,000 to \$250,000 for some such digitally controlled units—driven by a Digital Equipment Corp. PDP-11 computer to expose mask patterns on a glass master.

Sitrine breaks the General Digital system into three basic parts: one he calls the Applicon system, a second is the Gyrex Products pattern generator, and the final portion is a David Mann step-and-repeat camera. The Applicon portion, named for a CRT-oriented mask layout system by Applicon Inc., of Burlington, Mass., is responsible for interfacing the computer with peripherals and encompasses a digitizer, interactive CRT terminal, the computer, a drum plotter, extra tape cassettes plus disk and core storage to augment the PDP-11's memory, and interface electronics to drive the Gyrex pattern generator. All the hardware and software in the Applicon portion of the system carries a price tag of about \$85,000.

The Gyrex pattern generator costs \$40,000 and the step-and-repeat camera plus aligner adds another \$80,000 for a total system cost

of approximately \$205,000. Sitrine says General Digital can live with just one step-and-repeat camera because the company is making hard masters, and far fewer of those have to be made than with the more wear-prone emulsion masters.

Eventually, General Digital plans to have a number of circuit designers developing the input data for the Applicon system, which combines Applicon's own software and proprietary programs developed by General Digital to adapt that system to its needs, especially the program to drive the pattern generator.

Sitrine says the beauty of the system is that it enables the user to enter data into the system easily; compose, edit and optimize cell placement in a block diagram form; then have the software convert the block data into precise cell geometries that are exposed on the mask by the pattern generator.

---

### Government

---

#### NBS proposes standards for interfaces, peripherals

A proposal that would require standard peripherals and communications interfaces on all data processing equipment purchased by the Federal Government after 1973 is being forwarded by the National Bureau of Standards, the Federal Government's chief technical adviser.

Ruth Davis, director of the NBS Center for Computer Sciences and Technology, says the proposal is an important part of a standards plan now being reviewed by officials of the Commerce Department and the White House Office of Management and Budget. She expects the review to be completed and the plan to be approved within two months.

The standard peripherals interface is coming in for special attention because of Congressional concern over the high cost of peripheral equipment, she notes. A General Accounting Office study in 1968 indicated that the Federal Government could save as much as 40% on

peripheral equipment purchases if gear produced by all manufacturers could be freely interconnected with the mainframes that the government already is operating.

For a second opinion on the center's peripherals interface standards plans, the director says she is turning to the National Academy of Science's computer sciences and engineering board. If the NAS approves development, work would begin this year.

Meanwhile, the center is cooperating with the International Standards Organization toward developing a standard interface [*Electronics*, Oct. 26, 1970, P. 115]. And it's also gearing up for a computer standards program that would affect such diverse areas as computer networks and system performance measurement. The latter program is handicapped, however, because the value of standards still hasn't been determined.

To determine those values, the center is proposing a reporting system that would require all Federal computer users to report what standard devices they are using and what kinds of savings result. In the meantime, the center is reviewing responses from agency computer experts to a questionnaire asking what standards they consider most important.

---

### Consumer electronics

---

#### Programmer picks spots on reel-to-reel tapes

For the audiophile who has everything, the Califone-Roberts division of Rheem Manufacturing Co. has come up with something else—a digital programmer that cues reel-to-reel tape so that any 16 selections can be played in any order.

The Los Angeles firm plans to market the device—called Professional Selector—in the second quarter of 1972.

The prototype uses 80 integrated circuits and 37 discretes to perform logic functions. The system comes in three sections—the computer to code

# C-LINE PROGRAMMABLE UNIUNCTION TRANSISTORS

guaranteed stability  
from  $-55^{\circ}\text{C}$  to  $+125^{\circ}\text{C}$ ...

PUTs you a step ahead in design flexibility.

Unitrode offers the only 100V PUT type and the only type with guaranteed stability from  $-55^{\circ}\text{C}$  to  $+125^{\circ}\text{C}$ . We also offered the first PUT in a hermetically sealed TO-18.

With Unitrode's Programmable Uniunction Transistors (PUTs), you're freed from the restricting fixed values of conventional UJTs. Simply by varying external resistor values, you can program  $E_{ta}$ ,  $R_{BB}$ ,  $I_P$  and  $I_V$  to meet your particular needs in timing, pulse, sweep and sensing circuits, oscillators and SCR triggers. The highest voltage, hermetic package and greatest temperature stability are three good reasons for specifying Unitrode PUTs. Three more are nano-amp leakage for long interval timing, low cost, and a strong applications engineering staff ready to help. PUT more design freedom at your fingertips; order any of six types directly off the shelf.

For fast action, call Sales Engineering collect at (617) 926-0404  
Unitrode Corporation, 580 Pleasant St., Watertown, Mass. 02172.

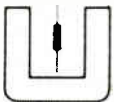

**UNITRODE** quality takes the worry out of paying less.

Unitrode Corporation, Inquiry Processing Dept. 8C  
37 Newbury Street, Boston, Massachusetts 02116

Please send free samples of PUT checked below (including data sheet).

Check for Sample	Unitrode Type No.	Forward Voltage Rating Volts max.	Peak Point Current $\mu\text{a}$ max.	Valley Point Current $\mu\text{a}$ min.	Check for Sample	Unitrode Type No.	Forward Voltage Rating Volts max.	Peak Point Current $\mu\text{a}$ max.	Valley Point Current $\mu\text{a}$ min.
<input type="checkbox"/>	2N6119 <sup>1</sup>	40	2.0@10V <sup>3</sup>	70@10V <sup>4</sup>	<input type="checkbox"/>	2N6138	100	10@10V <sup>5</sup>	40@10V <sup>6</sup>
<input type="checkbox"/>	2N6120 <sup>2</sup>	40	0.15@10V <sup>3</sup>	25@10V <sup>4</sup>	<input type="checkbox"/>	U13T3	100	2.0@10V <sup>5</sup>	70@10V <sup>6</sup>
<input type="checkbox"/>	2N6137	40	10@10V <sup>5</sup>	40@10V <sup>6</sup>	<input type="checkbox"/>	U13T4	100	0.15@10V <sup>5</sup>	25@10V <sup>6</sup>

1. Formerly U13T1 2. Formerly U13T2 3.  $R_G=1M\Omega$  4.  $R_G=10K\Omega$  5.  $T=55^{\circ}\text{C}$ ,  $R_G=10K$  6.  $T=125^{\circ}\text{C}$ ,  $R_G=10K$

NAME \_\_\_\_\_ TITLE \_\_\_\_\_  
COMPANY \_\_\_\_\_  
ADDRESS \_\_\_\_\_  
CITY \_\_\_\_\_ STATE \_\_\_\_\_ ZIP \_\_\_\_\_

the tape and program playing sequence, a power supply, and a translator to control the player. Its cost, including a tape player, will be in the \$2,000 area.

Before the user can program his music, he must run through the entire reel and, using a 10-digit keyboard on the programmer, encode each blank space before each recorded selection.

From the keyboard, he then punches out the code number that immediately appears on a set of RCA Numertron display tubes. Simultaneously, another readout shows the total number of selections, from one to 16, made in the program. And another readout shows him which number is being played.

The computer has a 16-word, eight-bit memory and uses 7400 series transistor-transistor logic ICs for counting and memory. The translator takes the code signal from the computer and drives the tape player on fast forward or rewind until it zeroes in on the beginning of the selection. This type of control requires a tape player with a constant-reading head, because the code is recorded on the audio track.

According to Roberts, the programmer may find its first application in education. For example, it could be used to run language tapes, cuing questions and responses at the instructor's command. And Roberts doesn't exclude the possibility of making a cassette version should the reel type go over well with schools and audio buffs.

---

### Instrumentation

---

Amorphous thermometer called radiation-resistant

A conventional metal resistance thermometer can't survive radiation because, bombarded by neutrons, its crystalline structure breaks down and its resistivity changes. The result can be readings off by two or three Kelvins. So scientists at Los Alamos, N.M., Scientific Laboratory are making thermometers out of

quickly cooled amorphous materials—alloys of palladium, silicon, and chrome. The idea is that without a crystalline structure to be disrupted, radiation does not represent a danger.

The researchers are using what they call a splat technique to cool the molten alloy  $7 \times 10^9$  Kelvins per second and to prevent formation of a well-defined crystal structure.

The process begins when the alloy is heated in an eyedropper-like tube. A globule of the molten alloy is forced out of the tube and, as it falls, intersects a light beam causing two copper anvils to slam shut and splatter the drop between them. The drop, which now looks like a piece of solder flicked off a hot iron, is used in thermometers.

The Los Alamos scientists haven't run radiation tests, but they're hoping that the material will withstand radiation up to  $10^{18}$  nvt (the time interval of neutron flux). This is what it would be exposed to in the nozzles of nuclear rockets.

But in thermal tests, reports Charles Tallman, ranges of 4 K to approximately 700 K are possible. Above 700 K, the material begins to go crystalline.

Tallman has other plans for the material. Since its resistance changes also when it's stretched, he's also working on a radiation-proof strain gage.

---

### For the record

---

**String of firsts.** IBM says it will deliver a machine called the System 370 model 195 beginning in the spring of 1973. The new machine essentially is identical to the present 360/195 except for the additional instructions and other enhancements that distinguish the 370 series from the 360 lines. The company will also field-convert 360/195s; it will take five days because considerable rewiring will be necessary.

Meanwhile, the first 360/195 is just going on line at McDonnell-Douglas Automation Co. in St. Louis. McDonnell-Douglas is calling it the "model 195" without specifying either 360 or 370; if the com-

pany is perhaps a little confused over just which series it belongs to that's understandable since McDonnell-Douglas already has more than 100 IBM computers.

Finally, the first 370/145, IBM's semiconductor-main-memory machine [*Electronics*, Oct. 12, 1970, p. 125], is to be shipped shortly from the company's Endicott, N.Y., plant. It's going to Stanford University, and is about a month ahead of schedule—a far cry from the woes IBM experienced in getting its early 360s out the door in 1965 and 1966.

**Eyeing Soniscan.** The Sangamo Electric Co. of Springfield, Ill., is dickering with GTE Sylvania Inc. of Needham, Mass., for Sylvania's Soniscan magnetoacoustic memory [*Electronics*, Aug. 31, 1970, p. 33]. Although neither agreement nor announcement of terms is expected until late August following a GTE board meeting, Sangamo's subsidiary, Microsonics Inc. of Weymouth, Mass., probably would take charge of further Soniscan development.

The Navy, hoping to use Soniscan in its advanced airborne digital computer, retains its interest in the memory system, said to be capable of packing densities of 5,000 bits per cubic inch and a cost in production of 0.1 to 0.2 cent per bit. But Sylvania is said to have encountered problems in accessing Soniscan data, though Microsonics' engineers—with a heavy background in magnetostrictive and acoustic delay lines—feel they can solve them.

**Point the way.** Sperry Rand's Flight Systems division, Phoenix, Ariz., will build the first digital guidance and control system for short takeoff and landing (STOL) aircraft under the terms of a \$2.3 million NASA contract awarded recently [*Electronics*, March 1, p. 22]. Built around a digital computer similar to the one proposed for the demised supersonic transport, the STOL approach and landing avionics system will consist of guidance, digital flight control, flight director, and display subsystems. It is scheduled to be flight-tested in March 1973 on a modified de Havilland Buffalo.



# the p.c. holes per penny game stops here:

The most economical  
way to drill 1 to 12 hole sizes  
at 40,000 to over 300,000

*precision* holes per hour is  
with Excellon's rugged new

**OPEN-END**

## **MONOMATIC/7**

printed circuit drilling systems  
with *automatic drill changing!*

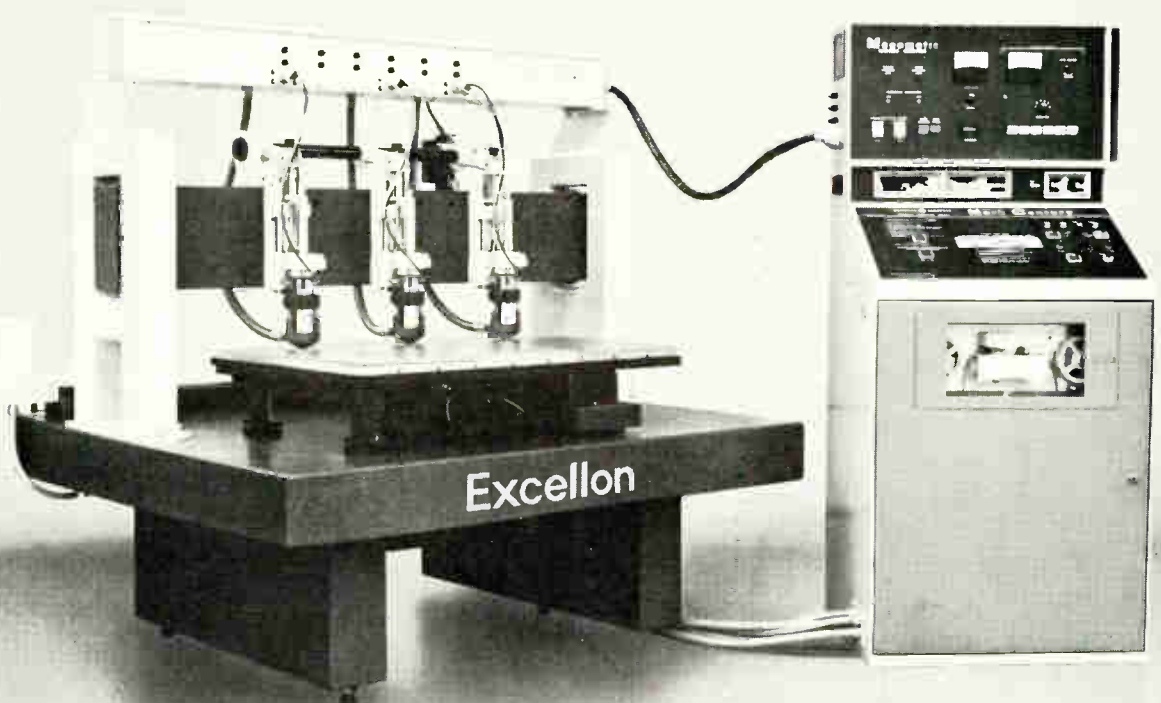

(for details, see next page) —————>

Circle 37 on reader service card

Economical;  
 1 to 7 quiet spindles;  
 @ up to 200 hits/minute.  
 And built to grow  
 with continuous development...

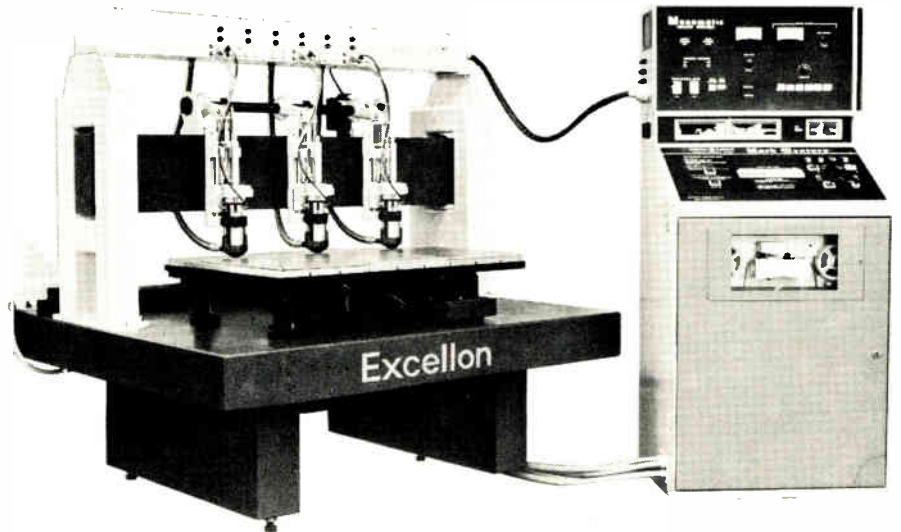

# OPEN-END Excellon's MONOMATIC/7

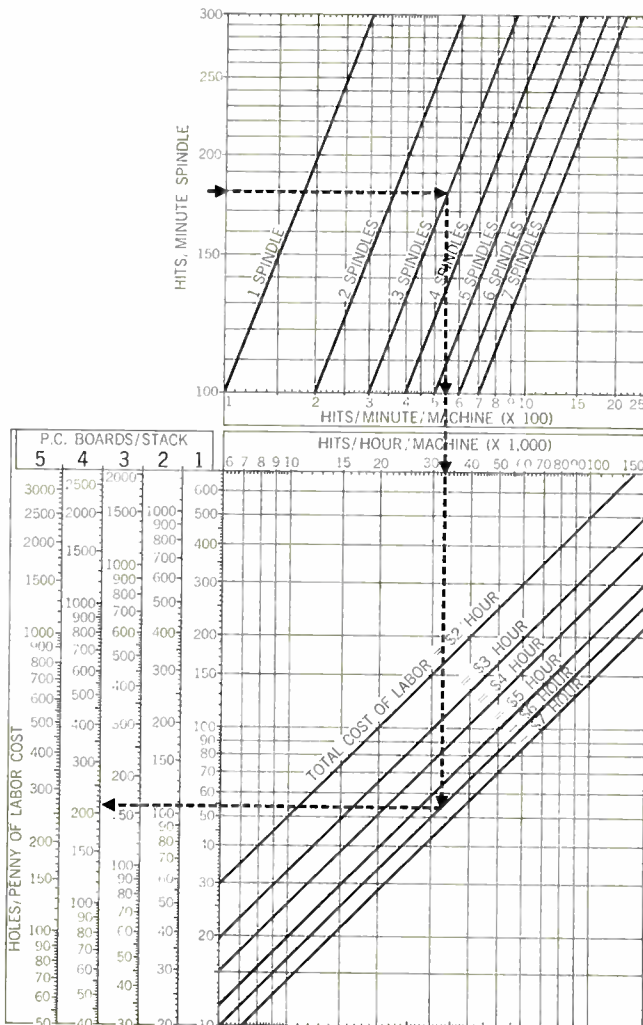

Get your full-size copy of this nomograph on request.

MONOMATIC/7 numerically controlled drilling systems are turning in some astonishing production figures (see nomograph, left) which obsolete all prior ideas about hole productivity. With ten *major* variables\* in the "holes per penny" equation, it is not realistic to quote hole costs without these accompanying parameters. Some idea of MONOMATIC/7's performance, however, can be projected from this *conservative* example: With three active spindles at 180 hits/minute/spindle, a \$6/hour operator can drill 4-board stacks at a rate of *over 200 holes per penny of labor cost*... at 129,600 holes per machine hour! Clean, burr-free holes to  $\pm 0.001$ " accuracy. Add the cost of a 3-spindle MONOMATIC/7, prorated to *your* writeoff schedule, to get a true look at the future of p.c. drilling.

### the "open-end" concept...

MONOMATIC/7 systems were developed to deliver high drilling rates in continuously varying production assignments, and to interface with predictable tooling evolutions in years to come. Seven spindle positions are provided by the basic frame. Any or all of these positions may be fitted with active spindles for varied drilling assignments and varied board geometries. At this time, silent air-bearing electric spindles operating from 45,000 to 80,000 RPM are recommended for most applications, with infinitely variable feed rates assuring optimum chip load.

\*The ten major variables: (1) Hole quality; (2) machine hit rate; (3) board thickness vs smallest hole size; (4) board size; (5) no. of hole sizes/board; (6) holes/board; (7) no. of boards/run; (8) labor rate + overhead; (9) hourly equipment cost; and (10) future equipment applications.

Add a 3rd spindle and extension table to a standard 2-spindle machine.  
Result: **50% more production for 12.5% more investment.**

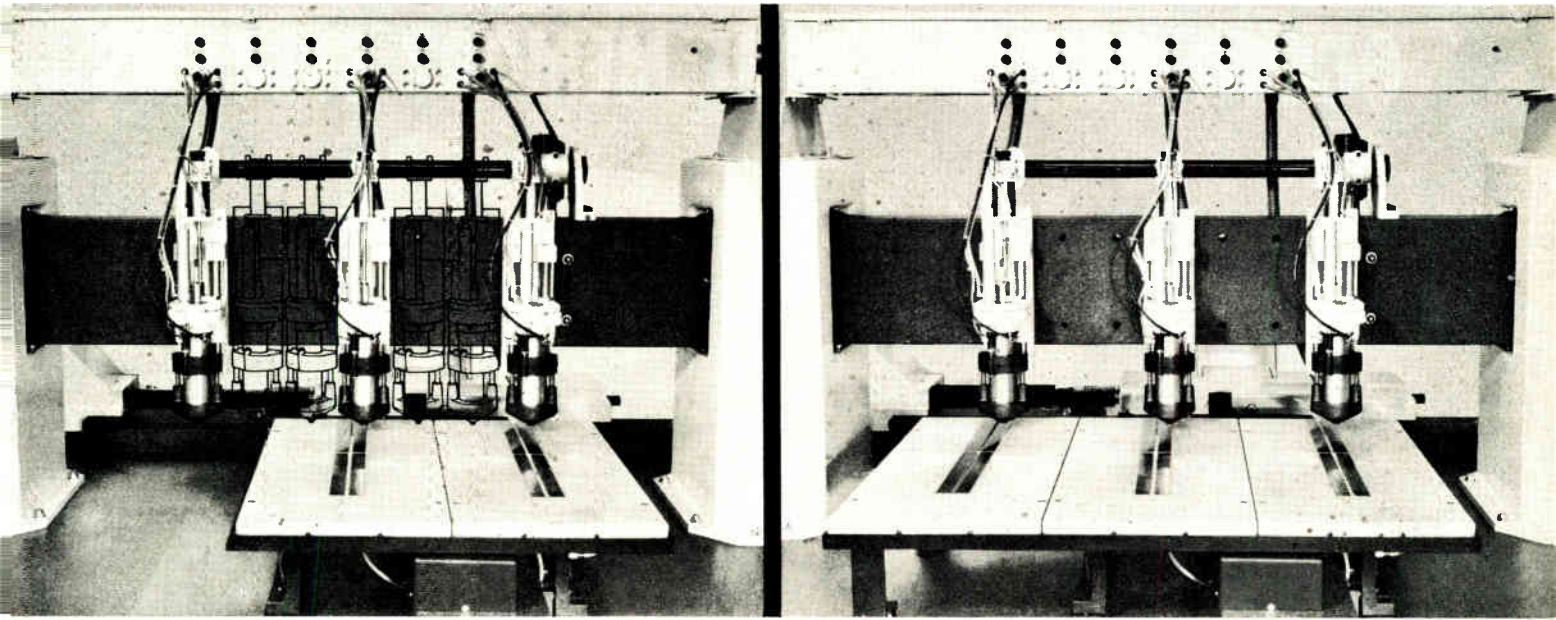

#### the add-on work table ...

The basic machine also provides a 25½" x 25½" (drilling area) work table, which can be expanded to 38¼" x 25½" by a self-aligning add-on table extension. Basic table travel is 25½" in both X and Y axes, permitting a single spindle to cover the entire drilling area. The extension table permits 12.75" travel (left-right) and full travel (in-out) to drill three 12.75" x 25.5" stacks with three spindles. With appropriate spindles and tooling plates, up to seven 4.25" x 25.5" patterns can be drilled simultaneously at 336,000 holes/hour in 4-board stacks.

#### granite construction because ...

MONOMATIC/7 machines utilize the great rigidity, mass and dimensional stability of granite in the fixed spindle beam, surface plate, support, and X-Y axis ways. This stability permits the 175-inch-per-minute travel and variable feed rates up to 250-inch-per-minute for sustained high hit rates. Air-bearing shoes "float" the work table on the surface plate and granite ways with so little friction that *virtually all servo power is available for fast acceleration and traversing.*

#### TYPICAL CONFIGURATIONS

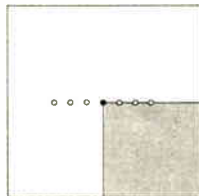

1 Spindle, 1 Stack 25.5" x 25.5"

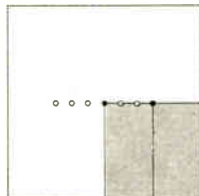

2 Spindles, 2 Stacks 12.75" x 25.5"

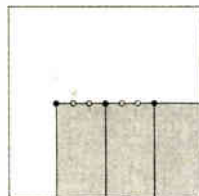

3 Spindle + Extension Table,  
3 Stacks 12.75" x 25.5"

● Active Spindle  
○ Inactive or Vacant

#### and now, automatic drill-changing ...

Up to twelve hole sizes can now be drilled automatically by each spindle, because *the long-sought automatic drill changer has been developed by Excellon.* Special functions in the N/C program can substitute sharp drills for dull, return each drill size to an indexing drum as its pattern is completed, substitute the next drill size, and continue uninterrupted. No extra spindles are needed. No drilling area is sacrificed. *And multi-size drilling rates are virtually as high as single-size.* (More details on this "open-end" feature will be announced in the near future.)

#### Excellon passes along savings ...

By every measure MONOMATIC/7 systems are the best drilling value ... but there is more to come: Where delivery can be scheduled to eliminate inventory of long-lead parts at Excellon, this very real saving is passed along to you! Normal payout via production savings is already fast; this makes it faster.

Let's talk about it.

Where variety is the problem, versatility is the answer.

# Excellon



EXCELLON INDUSTRIES

23915 GARNIER / TORRANCE, CALIFORNIA 90505

Phone: (213) 325-8000

Telex: 674562 - Cable: EXCELLON Torrance

ENGLAND • Excellon International • Arkwright 18, Astmoor Industrial Estate, Runcorn • Cheshire, England • Phone: Runcorn 66545 • Telex: 627496 ■ FRANCE/BELGIUM • Electro-Outil • 31, Rue du Gouverneur-General-Eboue • Issy-Les-Moulineaux (Seine) • Paris, France • Phone: 736-16-50 • Telex: 25045 ■ SCANDINAVIA • Edvard Schneider AB • Malmkillnadsgatan 54 • Stockholm 3, Sweden • Phone: 23 24 20 • Telex: 17434 ■ THE NETHERLANDS • Excellon Europa N.V. • Vijfhuizen 158, Vijfhuizen • Netherlands • Phone: 02508-456 • Telex: 41478 ■ GERMANY/AUSTRIA • Excellon Europa GmbH • 6368 Bad Vilbel b Frankfurt • Alte Strasse 37 • Deutschland • Phone: 06193-85794 • Telex: 416101 ■ ITALY • Franco & Puccio • Via Mauro Macchi, 70-20124 Milano, Italy • Phone: 2042245 ■ SPAIN • Antonio Casas, S.A. • Carretera Sta. Cruz de Calafel Km 10 Apartado de Correos (P.O. Box) No. 16 • San Baudilio de Llobregat • Barcelona, Spain • Phone: 2910262 ■ ISRAEL • Talviton Electronics Ltd. • P.O. Box 3282 • Tel Aviv, Israel • Phone: 444572 • Cable Address: TALVITKO ■ AUSTRALIA • Astronics Australasia Pty Ltd. • 161-173 Stort St. • South Melbourne, Victoria • Telex: AA30492 ■ FAR EAST • Nippon S.T. Johnson Sales Co. • No. 3-5, Uchikanda-3 chome Chiyodaku • Tokyo, Japan • Phone: Tokyo (252) 1251-65 • Telex: 02223367 • Cable: NPOHEATING Tokyo

# THE DESIGNER'S CHOICE

## ecom<sup>®</sup> SERIES F CORE MEMORY SYSTEMS

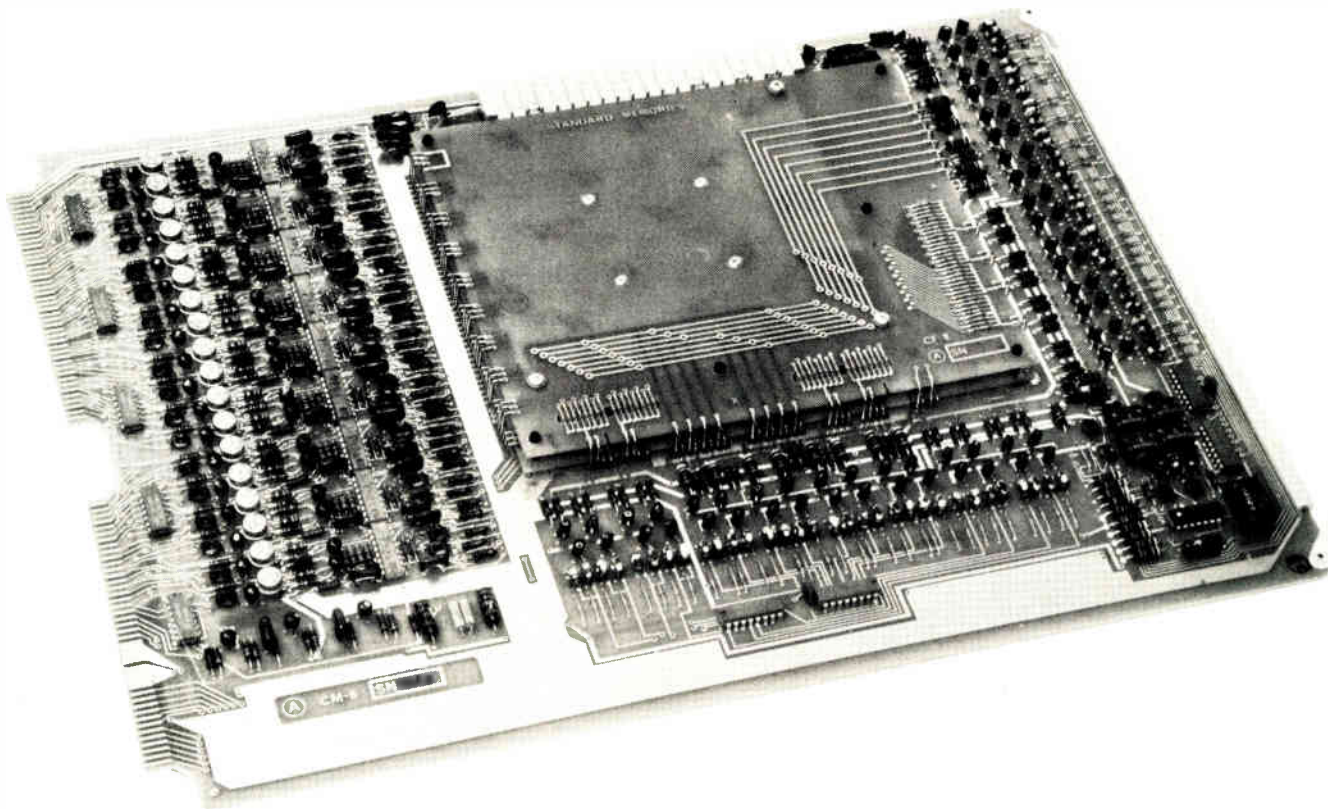

### FLEXIBILITY

- Available as a digital stack module in any capacity from 4K x 8 through 4K x 18
- Available as a packaged system yielding 4K x 8 to 16K x 18 in a 5¼" height enclosure or 16K to 65K in a 12¼" enclosure

### SPEED

- 750 nanosecond full cycle time

### PROVEN DESIGN

- Hundreds delivered over the past 12 months

### DELIVERY

- From stock to 60 days

### REMEMBER

- No speed/cost trade-off. Call or write immediately for the best price in the business for your configuration.

5¼" enclosure



12¼" enclosure

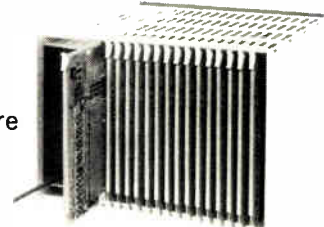

**STANDARD MEMORIES**  
INCORPORATED  
A Subsidiary of Applied Magnetics Corporation

#### EAST COAST OFFICE

Standard Memories, Inc.  
569 River Road  
Fairhaven, New Jersey 07701

Walt Waldron  
201-842-3160  
TWX 710-722-5763

#### WEST COAST OFFICE

Standard Memories, Inc.  
15130 Ventura Blvd.  
Sherman Oaks, California 91403

Jack DeVine  
213-788-3010  
TWX 910-405-1738

# HONEYWELL'S PORTABLE 5600.

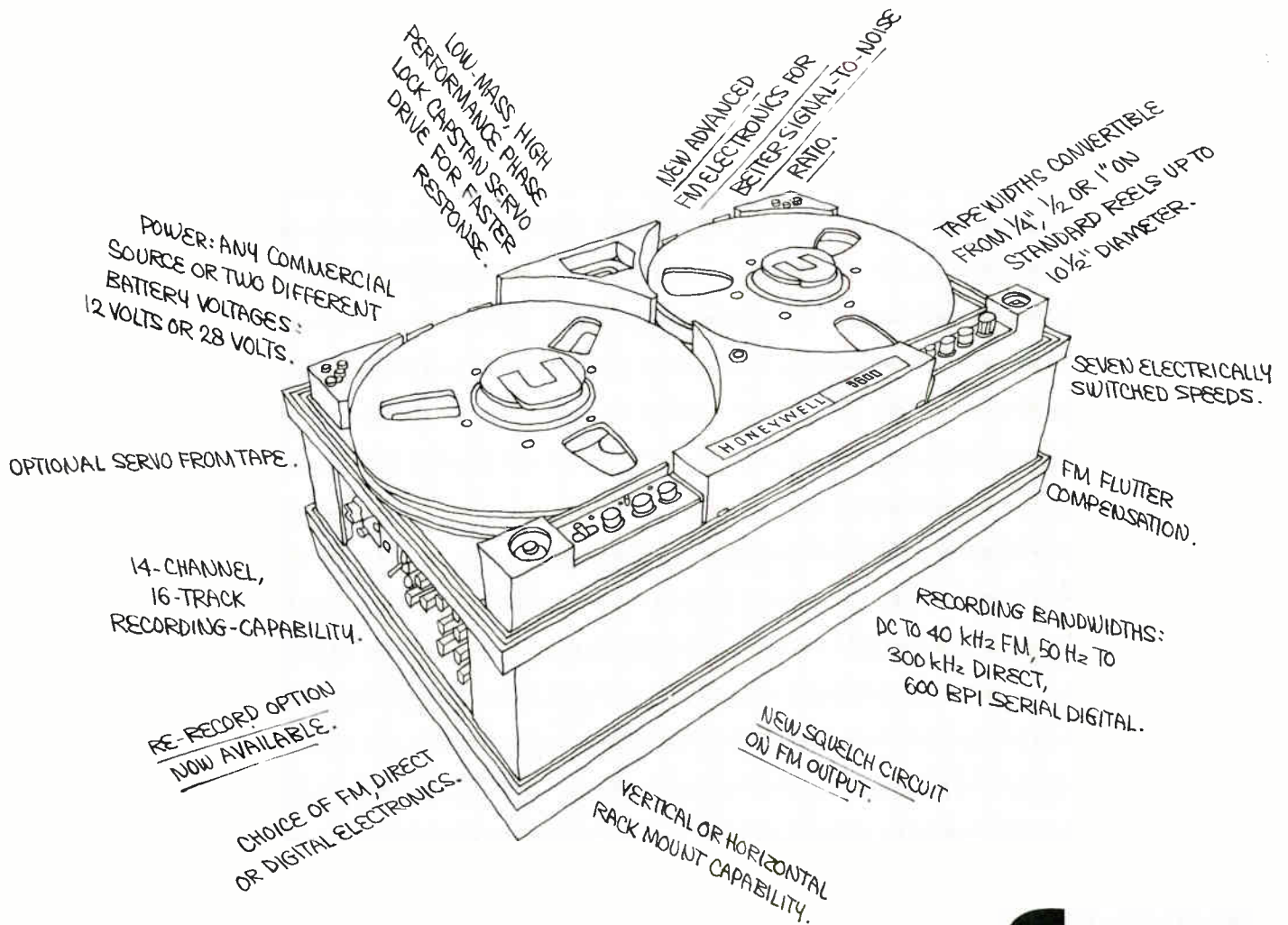

# even more for your money.

The new, advanced portable magnetic tape recorder offers greater performance, more features and greater versatility than any other recorder in the same price category.

And that's just half the story. Let one of our representatives tell you the rest. Call your local Honeywell office for a demonstration. Contact C. S. Corbin, 303-771-4700 — X692. Or complete and mail the coupon. Today.

**Honeywell**  
The Automation Company

E-7

Yes! Have someone contact me with more information on the 5600.

NAME \_\_\_\_\_

FIRM \_\_\_\_\_ POSITION \_\_\_\_\_

ADDRESS \_\_\_\_\_

CITY/STATE/ZIP \_\_\_\_\_

MAIL TO: Honeywell, Test Instruments Division, MS218,  
P. O. Box 5227, Denver, CO 80217.

# Tubeless, Tireless

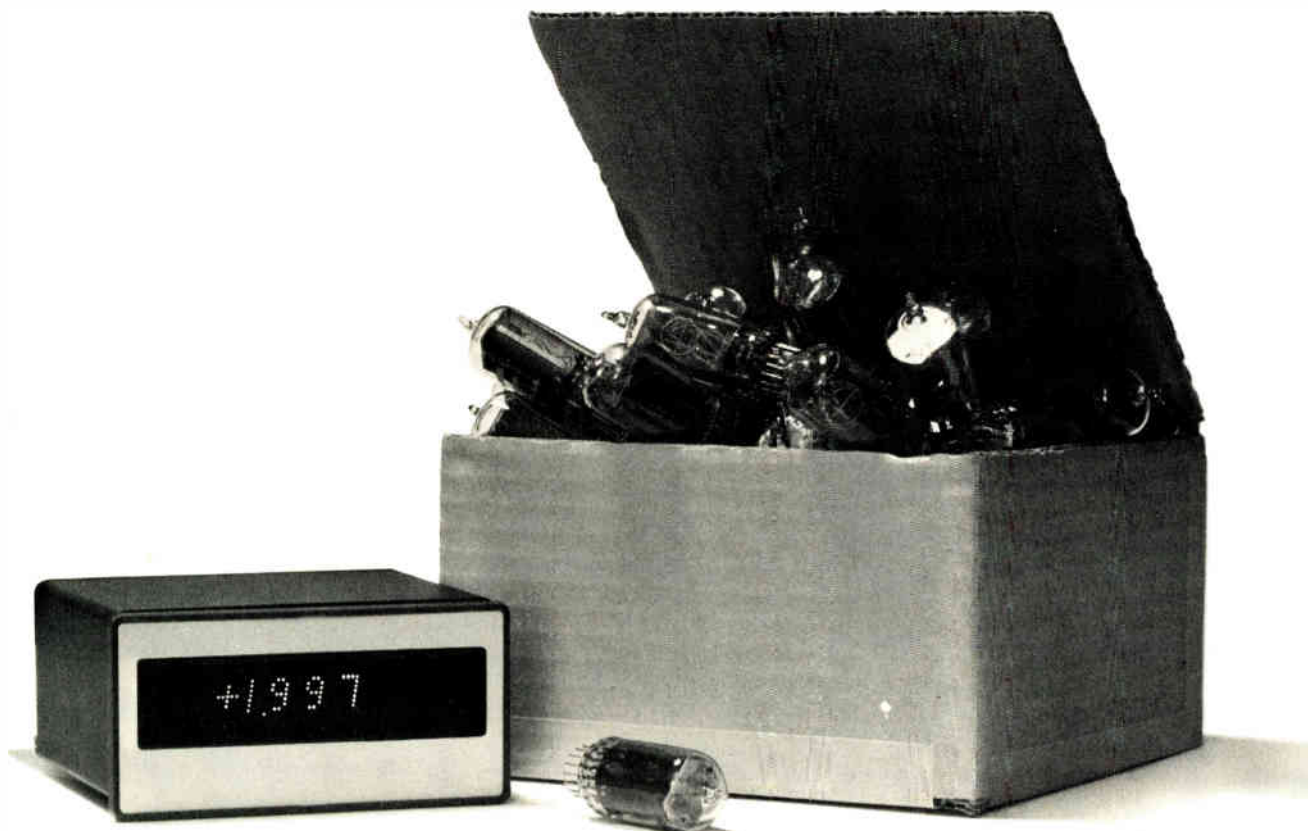

HP's new 3431A panel meter has no tubes to burn out; its shaped-character LED display will perform tirelessly, almost forever. To further increase its reliability, Hewlett-Packard has "designed out" many components, replacing them with proprietary LSI and MSI circuits. And the 3431A's solid-state power supply helps reduce power requirements to only 5 watts. As a result, electrical and thermal stress is minimized, for longer life. Battery operation is optional, allowing portable applications.

Size, too, is minimized by the 3431A's advanced circuitry. It measures only 1.7" high by 3.5" wide by 2.9" deep—including power supply.

All others are 25% to 650% larger in volume.

The 3431A is also the best-looking DPM available. Its display is brighter and easier to read than tube or bar-type displays — and cannot give erroneous readouts. Its pop-out front panel covers all mounting fixtures and adjustment controls, and can be painted or silk-screened with any color or nomenclature.

The 3431A is the new performance leader. Accuracy is  $\pm 0.1\%$  rdg,  $\pm 1$  digit, with 1 mV sensitivity. The operating temperature range is 0° C to 60° C. Exclusive HP features include full scale and 10% FS autoranging signals, 55 ms zero-to-FS response

time, sample rate display, and remote digital control of sample rates.

Any way you look at it, the 3431A is your only choice in DPM's, if you're looking for instrument quality. Yet it costs only \$225, in quantities of 100. For full details, contact your local HP field engineer, or write Hewlett-Packard, Palo Alto, California 94304. In Europe: 1217 Meyrin-Geneva, Switzerland.

091/11

HEWLETT  PACKARD  
COMPONENTS



For New Sources of Quality Products Visit The Tenth . . .

# JAPAN ELECTRONICS SHOW '71

Osaka  
Oct. 1-7

## JAPAN ELECTRONICS SHOW

1971 OCTOBER 1-7 OSAKA  
1972 LATE IN SEPTEMBER TOKYO

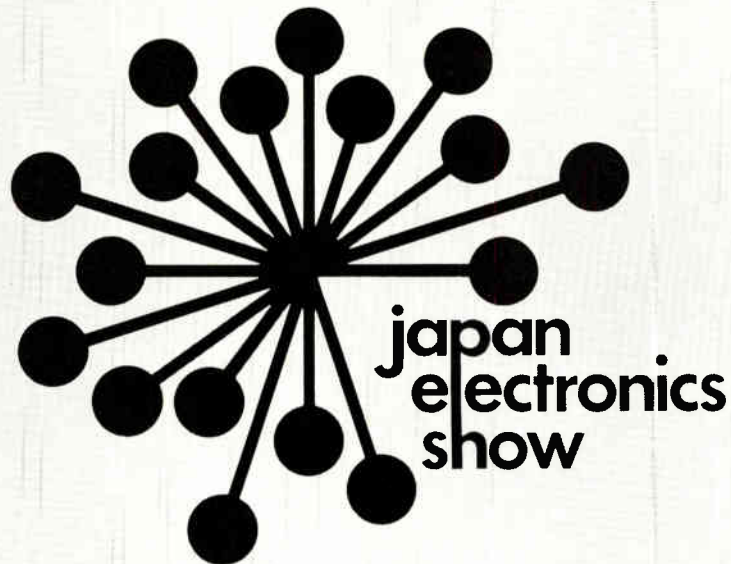

### ***Welcome Your Participation And Your Visit !!***

Invitation to application for 1971 Japan Electronics Show (JES) has been closed. This year, latest electronics products and components will be displayed by approximately 300 domestic makers and more than 100 participants from overseas including France, Germany, United Kingdom, Austria, Switzerland, U.S.A. and Korea.

In 1972, JES will hold the exhibition late in September in Tokyo. Participation in this JES all-round electronics show by manufacturers in all countries of the world is invited.

Sponsored by **ELECTRONIC INDUSTRIES ASSOCIATION OF JAPAN**

Conducted by **JAPAN ELECTRONICS SHOW ASSOCIATION**

2-2, Marunouchi 3-chome, Chiyoda-ku, Tokyo, Japan



For New Sources of Quality Products Visit The Tenth . . .

# JAPAN ELECTRONICS SHOW '71

Osaka  
Oct. 1-7

## Look to Hitachi for large capacity semiconductors.

If large capacity is what you're looking for, large capacity is what you get in Hitachi semiconductors.

Rectifying diodes available up to 800 amp.

Thyristors up to 1,000 amp.

To perform beautifully in any conceivable role.

For more information, write in care of nearest address.

### Large Capacity Thyristors (press pack)

Type Series	V <sub>BO</sub> /V <sub>RM</sub> (peak) (V)	I <sub>b</sub> (avg) (A)	I <sub>FM</sub> (peak) (Ap)	T <sub>j</sub> (max) (°C)	Remarks
CA01	2,000-2,500	1,000	17,000	125	General use
CC02	800-1,300	800	15,000	125	
CH03	1,800-2,500	400	8,000	125	
CH03V	800-1,300	400	8,000	115	Fast turn-off type 50 (30) μs

### TRIAC's for consumer electronics

Type Series	V <sub>DRM</sub> (V)peak	I <sub>T</sub> (A)RMS	P <sub>GM</sub> (W)peak	V <sub>GT</sub> (V)DC	I <sub>GT</sub> (mA)DC	T <sub>j</sub> (°C)max	Housing
FU12	100-400	3	1	2	30	110	M-332 (Plastic)
FT06	100-400	6	5	3	50	100	TO-66 (Metal)
FS03	200-400	10	5	3	50	100	Stud base
FS04							Flat base (Metal)
FS06							TO-66 (Metal)
FR01	200-400	16	5	3	50	100	Stud base
FR02							Flat base (Metal)
FQ01	200-400	20	5	3	50	100	Stud base
FQ02							Flat base (Metal)

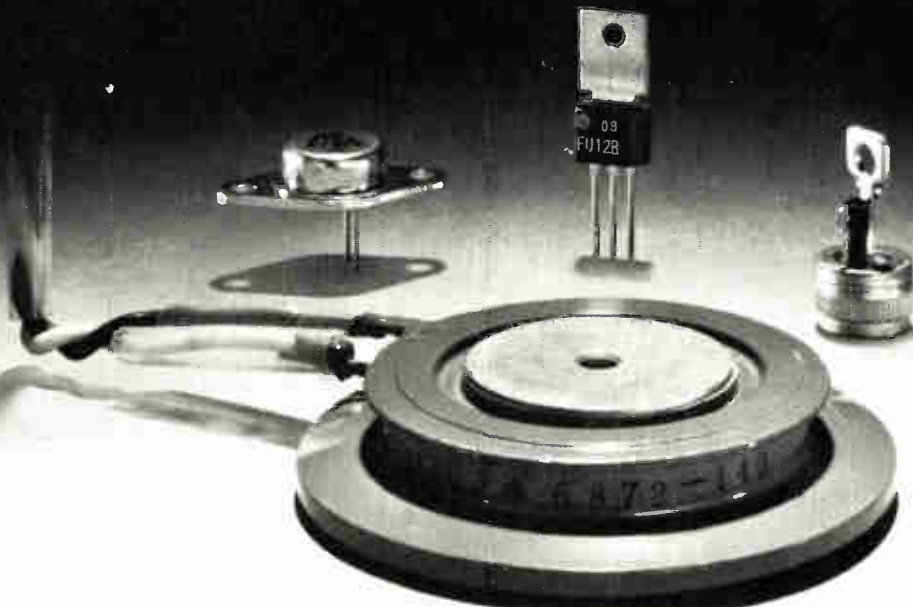

# HITACHI

Head Office (Section XH-E): 6-2, 2-chome, Otemachi, Chiyoda-ku, Tokyo 100 Düsseldorf Office: 4000 Düsseldorf, Graf-Adolf-Strasse 37, West Germany Tel. 10846 London Office: Winchester House, 77 London Wall, London E.C. 2 Tel. 588-3275 Hitachi America, Ltd.: New York: 437 Madison Avenue, New York, N.Y. 10022 Tel. (212) 758-5420 San Francisco: 100 California Street, San Francisco, Calif. 94111 Tel. (415) 981-7871 Los Angeles: One Wilshire Building, 624 South Grand Avenue, Los Angeles, Calif. 90017 Tel. (213) 624-0891 Nissei Sangyo GmbH (Deutschland): Düsseldorf, Am Wehrhahn 41, West Germany Tel. 36 09 03 Nissei Sangyo Co., Ltd., Taipei Office: Nanking Bldg., No. 165, Sec. 2, Nanking East Rd., Taipei 104 Tel. 570704





For New Sources of Quality Products Visit The Tenth . . .

# JAPAN ELECTRONICS SHOW '71

Osaka  
Oct. 1-7

## Zero In On Your Computer Needs Today — With Toko's Splitsecond Memory System



Now heading your way—a brand new breed of memory system hot on the computer market. It's Toko's high-speed, woven plated-wire memory system, HS 150. Dual-designed to operate on the non-destructive readout mode, it can be used partly for random access, read-write memory and partly for read-only memory.

General Specifications:

- Memory Capacity 16K Byte  
(2K words of 72 bits)
- Read Access Time 125 nanosecond
- Read Cycle Time 150 nanosecond
- Write Cycle Time 300 nanosecond

Toko's advanced electronics technology has developed other top-quality computer components, such as memory stacks pulse transformers and delay lines.



For further information, just call or write

**TOKO, INC.**

Head Office: 1-17, 2-chome, Higashi-Yukigaya, Ohta-ku, Tokyo, Japan New York:  
Toko New York Inc. 350 Fifth Avenue, New York, N.Y., 10001 U.S.A. Tel: 565-3767  
Los Angeles: Toko, Inc. Los Angeles Liaison Office 1830 West Olympic Blvd., Los  
Angeles, 90006 Cal. U.S.A. Tel: 380-0417 Düsseldorf: Toko, Inc. Europe Liaison  
Office 4 Düsseldorf, Kölner Straße 246, Düsseldorf, W. Germany Tel: 78-7064

Circle 135 on reader service card

## O.E.M. Buy Direct and Save

### TRANSFORMERS

Miniature input-output and power supply types, line matching and oscillation types, pulse and modulation types.

### MICRO MOTORS

Precision D.C. motors for everything from VTRs to mini cassette decks.

### PANEL METERS

More than 30 types from which to choose.

### WRITE TODAY!

For catalogs, full details.

Orient Electronics, Ltd.  
Yoyogi P.O. Box 38,  
Tokyo 151, Japan



ORIENT ELECTRONICS, LTD.

Circle 136 on reader service card

## Primo

### CONDENSER MICROPHONE UNI-DIRECTIONAL CMU-503



For Using  
1. Broadcasting 2. Studio recording

#### SPECIFICATIONS

● Directivity: cardioid ● Sensitivity:  $-67\text{dB} \pm 1.5\text{dB}/\mu\text{bar}$  at 1KHz ● Impedance: 600 ohms  $\pm 10\%$  ● Signal to noise ratio:  $53\text{dB} \pm 3\text{dB}$  (Equivalent self noise  $-21\text{dB} \pm 3\text{dB}$ )  
● Maximum in put level: 134dB distortion: 0.7% ● Attenuator:  $-10\text{dB}$  ● Tone control: M - flat, V -  $-6\text{dB}$  at 100 Hz ● Power supply: DC SYSTEM, DC - Battery, Marolly H7D/A (or Everedy E126) ● Operation hours: 200 hours (continuous) ● Dimensions:  $21\phi \times 145\text{mm}$  (mic.) ● Cable length: 6m (with cannon 3p connector)

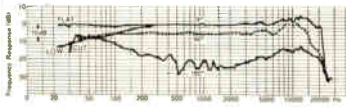

For catalog write to:

#### PRIMO COMPANY LTD.

CHICAGO ILLINOIS OFFICE:  
530 W. SURF. ST., CHICAGO ILLINOIS 60657  
TEL. 312-472-6142

TELEX: 25-4225 PRIMO MUS COILLUSA

HEAD OFFICE:  
25-1, 6-CHOME, MURE, MITAKASHI, TOKYO, JAPAN  
TEL. 0422-43-3121-7

CABLE: "PRIMO MUSASHINO MITAKA"  
TELEX: 2822-326 PRIMO MUS

Circle 137 on reader service card

## Here is a truly reliable, multiple switch assembly with a soft touch.

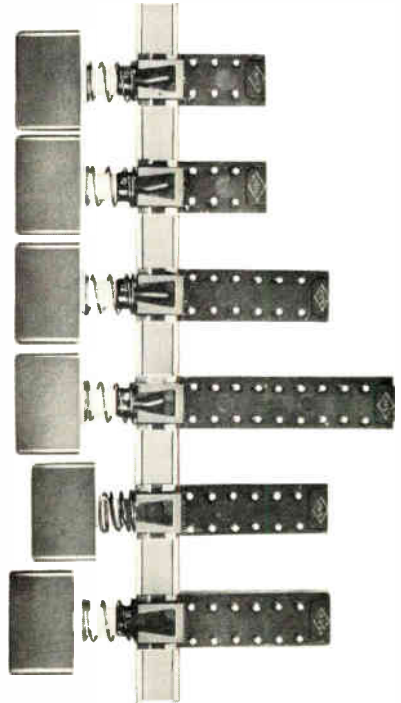

#### SPECIFICATIONS:

- Rating: 0.3A, 125V AC
- Contact Resistance:  
20m $\Omega$  or below at 1A-2.5V DC
- Insulation Resistance:  
100M $\Omega$  or more at 500V DC
- Insulation Withstand Voltage:  
One minute of 500V AC
- Switching: Non-shorting mechanism
- Switch Spacing: 10, 15, 17.5, 20m/m
- Number of Switches: 1 ~ 10
- Terminal Spacing: 4m/m

#### OTHER PRODUCTS:

- SWITCHES
- FUSE HOLDERS
- PLUGS
- JACKS
- CONNECTORS
- SOCKETS
- CORD ASSEMBLY
- OTHER COMPONENTS



For further information, please write to:  
**SHOWA MUSEN KOGYO CO., LTD.**  
No. 5-5, 6-Chome, Togoshi, Shinagawa-ku,  
Tokyo, 141, Japan.  
Cable: "SHOWAMUSEN TOK"  
Phone: 785-1111  
Telex: 246-6301 "SHOWAMUSEN TOK"

Circle 45 on reader service card

45



For New Sources of Quality Products Visit The Tenth . . .

# JAPAN ELECTRONICS SHOW '71

Osaka  
Oct. 1-7

**Go ahead,  
dream  
your impossible dream....**

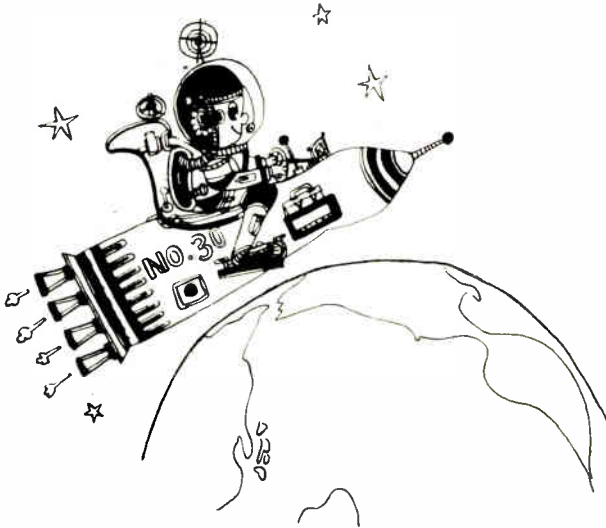

Stopped by the need for a permanent magnet better than any that now exists? Maybe Hitachi Metals can help. At our magnetic and electronic materials research center and other laboratories, our experts are hard at work making magnets do more things than anyone thought possible. Developing new magnetic materials such as rare-earth cobalt, and finding new uses for magnets. No one knows what they'll come up with next. But it just might be the answer to your impossible dream.

Devotion to improvement, added to integrated production backed by years of experience, is behind the quality of Hitachi magnets. Quality that means cast magnets designed and finished to close tolerances. Featuring high coercive force; big energy product; magnetic field uniformity and stability. And cast in any shape—no matter how intricate. Here are some typical examples.

Type	Residual Induction (Br) gauss	Coercive Force (Hc) oersteds	Energy Product (B×H) max. ×10 <sup>-6</sup>
Hi-MAG (ALNICO-5-7)	13,000-14,500	700- 800	6.8- 8.2
YCM-8B (ALNICO-8)	8,800- 9,600	1,380-1,550	4.8- 5.5
YCM-8D (ALNICO-8)	7,500- 8,300	1,700-1,850	5.5- 6.5
YCM-8E (ALNICO-8)	7,500- 8,500	2,000-2,150	5.5- 7.0
YCM-9B (ALNICO-9)	10,000-11,000	1,350-1,500	9.0-11.0

For full details about Hitachi magnets, write.



**HITACHI**  
Hitachi Metals, Ltd.

Head Office: Chiyoda Bldg., Marunouchi, Tokyo, Japan

**Hitachi Metals America, Ltd.**

New York (Head Office): Magnet Materials Sect., 437 Madison Ave., New York, N.Y. 10022, U.S.A. Tel. 212-758-5255  
Chicago: 2200E, Devon Ave., Des Plaines, Ill. 60018, U.S.A. Tel. (312) 299-0031  
Detroit: Suite 375, 24300 Southfield Road, Southfield, Michigan 48075, U.S.A. Tel. (313) 557-7142  
Los Angeles: Suite 870, 1901 Ave. of the Stars, Los Angeles, Calif., 90067 U.S.A.

## NOBLE COMPONENTS

▲ LINEAR MOTION VARIABLE RESISTORS (Single & Tandem) FOR TV AND Hi-Fi EQUIPMENTS  
Travel Length—30MM, 45MM & 60MM AVAIL-  
ABLE

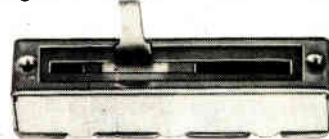

▲ VARIABLE RESISTORS FOR 4 CHANNEL Hi-Fi AMPLIFIER Dia meter — 16MM & 24MM



PC LUGS ON THE ABOVE RESISTORS ALSO AVAILABLE

— MAIN PRODUCTS —

- \* VARIABLE RESISTOR
- \* ELECTRONIC SWITCH
- \* CAPACITOR
- \* FIXED RESISTOR
- \* COIL & IFT
- \* POWER RESISTOR
- \* CDS SINGLE CRYSTAL
- \* AUTOMATION EQUIPMENT & ATTACHMENT



ALL ROUND ELECTRONIC COMPONENTS MANUFACTURER  
**TEIKOKU TSUSHIN KOGYO CO., LTD.**  
335, Nishinaka-machi, Kariyado, Kawasaki, Kanagawa, Japan  
Phone: Nakahara (044) 42-3171 Cable: TEITSU-KAWASAKI  
Telex: 3842-155

Circle 138 on reader service card



**HOPE has the largest waiting room in the world**

From the day they are born to the day they die, over half the people on earth never see a doctor.

Project HOPE's medical teams teach and heal . . . they go to all points of the compass . . . at home and abroad . . . wherever they are needed . . . wherever there are the lame, the blind, the sick, the hopeless . . . wherever the generosity of the American people makes new missions possible.

People are waiting.



Dept. A, Washington, D.C. 20007



For New Sources of Quality Products Visit The Tenth . . .

# JAPAN ELECTRONICS SHOW '71

Osaka  
Oct. 1-7

## AUTOMATIC SORTERS for electronic components

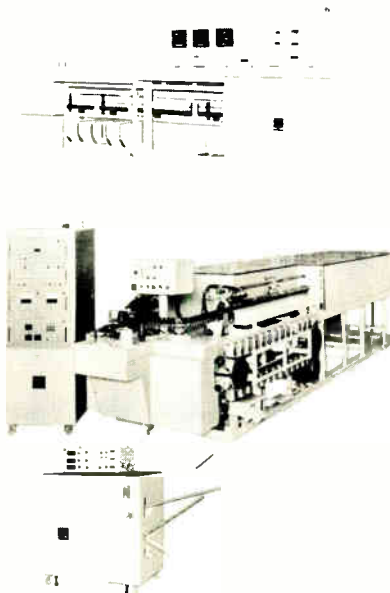

### CS-1

for film capacitors  
Speed: 1 pc/sec or 2 pcs/sec  
Testing items: Disconnection  
Withstand voltage  
Insulation  
Capacitance (0.001 $\mu$ F - 0.5 $\mu$ F)  
Tan  $\delta$

### CS-2ES

for electrolytic capacitors  
with AGING DEVICE (20 min.)  
AUTOMATIC COUNTING and  
BAGGING DEVICE at the final stage  
Testing items: Short, Disconnection,  
Leakage current,  
Capacitance (1 $\mu$ F - 1,000 $\mu$ F)

### RS-150

for DRY CELLS UM-1, -2 or -3  
Speed: 180 pcs/min.  
Voltage: 1.40 ~ 1.80 V  
Current: 2.0 ~ 12.0 A  
Insulation test available on request

## CKD CHUKYO ELECTRIC COMPANY, LTD.

Tokyo Office: 1-21-1, Nishi-Shinjuku, Shinjuku-ku, Tokyo 160, Japan  
New York Office: 155 East 55th Street, New York, N.Y., 10022, U.S.A.  
Phone: (212) 832-3888

Circle 139 on reader service card

# Your Heart Fund Fights

HEART ATTACK  
STROKE  
HIGH BLOOD PRESSURE  
INBORN HEART DEFECTS



## Micro-miniature Digital Indicator

### "MINITRON"



#### FEATURES:

- Long life
- Seven-segment readout
- Low-current

#### SPECIFICATIONS:

- Digits displayed: 10 digits, 0 to 9 and decimal point
- Rated voltage: 6V AC, 5V DC
- Power consumption: 40mW per element at 5V DC
- Life: Longer than 100,000 hours
- Operation temp.: -50 to 70°C
- Dimensions: 0.86" (H) x 0.45" (W)  
Thickness: 0.35"  
(including lead section of 0.12")

#### ● Exclusive Distributor:

### MITSUI & CO. (U.S.A.) INC.

Head Office: (General Machinery Dept.)  
Pan American Bldg., 200 Park Ave., New York, N.Y. 10017  
Phone: 973-4600  
Los Angeles Office: (Machinery Dept.)  
611 West Sixth St., Los Angeles, Calif. 90017  
Phone: (213)-680-1000

#### ● Manufacturer:

**FUJI ELECTRONICS CO., LTD.**  
Kawasaki, Japan

## IC TYPE SM-0007 CHECKER

Possible to test all DTL, TTL . . . NAND GATE IC with GO/NO-GO TEST. Absolutely unnecessary to prepare program for testing.

Inserting into the socket to be tested IC and this simple function completes the testing.

SM-0007 for planned idea and low cost! We have available checker for Flip-Flop IC.

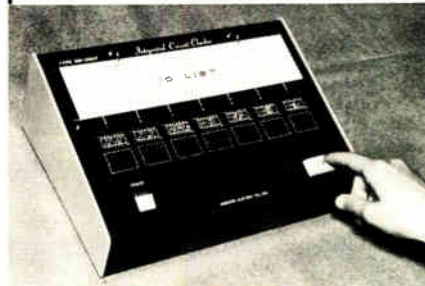

## LOGIC TYPE HL-1 TESTER

Applicable to all logic systems, a completely new tester... capability exceeds other testers... much easier to operate than an oscilloscope.

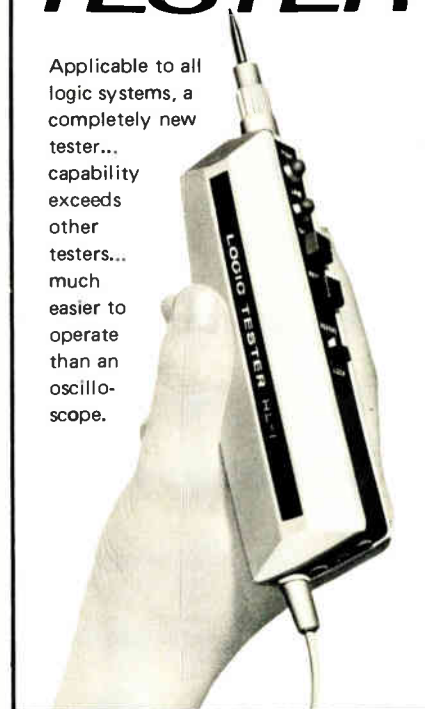

### KOKUYO ELECTRIC CO., LTD.

1-36-15, OOKAYAMA, MEGURO-KU, TOKYO, JAPAN.  
CABLE ADDRESS "INSTKOKUDEN TOKYO"  
PHONE TOKYO 03 (723) 3181

# 2048 Bit Kit

**Introducing the MM6305,  
a 2048 bit field programmable ROM.**



Last month we introduced a 1024 bit field programmable ROM. This month we outdid ourselves.

The new 6305 uses the reliable fusible-link technology requiring only 90 mA for programming. Believe it or not, no special equipment is required, *any* test equipment can do it. Or, if you like, we'll sell you a portable programmer that you can throw in a suitcase and plug into any electrical outlet.

Our new MM6305 is designed to be pin-for-pin compatible with our 1024 and 2048 mask programmable ROMs. That means you can be busy working on that prototype or preliminary design with one of our programmable ROMs while we're

booming ahead on your volume ROM requirements. That will cut weeks off your design cycle, dollars off your costs and get your boss off your back.

Think what you can do with this large bit capacity. Cut preliminary logic design to a few hours, utilize maximum flexibility in microprogramming techniques, develop and checkout higher accuracy look-up tables on the spot.

A few other good things about the MM6305 include an access time of 40 nsec, .25mW/bit power dissipation, and it's DTL/TTL compatible. It is organized 512 words by 4 bits with full address decoding included on the chip. Want to know the price? It's a low 5¢ a bit in small quantities — available NOW, in full mil temperature range (MM5305) and 0° to 70°C (MM6305).

## MM6305 Highlights

40 nsec access time  
.2 mW/bit  
512 words by 4 bits  
16 pin DIP  
Programmed by ANY test equipment

*Pick a winner, write, call, TWX or telex for full data. Do it quick!*

## Monolithic Memories



Monolithic Memories, Inc., 1165 East Arques Avenue, Sunnyvale, Ca 94086  
(408) 739-3535 TWX: 910-339-9229 Telex 346 301

**U.S. REPRESENTATIVES:** ALABAMA: Col-Ins-Company, Inc., Huntsville (205) 881-1835; ARIZONA: Howe & Howe Sales, Inc., Phoenix (602) 264-7971; CALIFORNIA: DeAngelo, Rothman & Company, Whittier (213) 945-2341; William J. Purdy, Burlingame (415) 347-7701; COLORADO: William J. Purdy, Littleton (303) 794-4225; FLORIDA: Col-Ins-Company, Orlando (305) 423-7615; ILLINOIS: Carlson Electronic Sales, Chicago (312) 774-0277; INDIANA: Robert O. Whitesell, Indianapolis (317) 359-9283; KENTUCKY: Robert O. Whitesell, Louisville (502) 893-7303; MARYLAND: J. R. Daniel & Company, Lutherville (301) 825-3330; MASSACHUSETTS: Circuit Sales, Inc., Lexington (617) 861-0567; MICHIGAN: Robert O. Whitesell, Detroit (313) 358-2020; MINNESOTA: HMR, Inc., Minneapolis (612) 920-8200; NEW JERSEY: R. T. Reid Assoc., Teaneck (201) 692-0200; NEW YORK: Mar-Com Associates, Syracuse (315) 437-2843; NORTH CAROLINA: Col-Ins-Company, Raleigh (919) 834-6591; OHIO: Robert O. Whitesell, Cincinnati (513) 521-2290; PENNSYLVANIA: J. R. Daniel & Co., Glenside (215) 887-0550; TEXAS: Data Marketing Associates, Dallas (214) 358-4646; Data Marketing Associates, Houston (713) 686-9627.

**INTERNATIONAL REPRESENTATIVES:** ENGLAND: Analog Devices, Ltd., 59 Eden Street, Kingston-Upon-Thames, Surrey, London. Phone: 01-546 6636, Telex: 27383. FRANCE: Radio Equipments, 9 rue Ernest Coganaco, 92 Levallois, Peret. Phone: 737-54-80, Telex: 62630. GERMANY: Neumuller & Co. GmbH, 8 Munchen 2, Karlstrasse 55. Phone: 592421, Telex: 0522106. INDIA: Flash Enterprises, 72-B, Miller Road, Bangalore-1B. Phone: 72660, Cable: Flaent. ISRAEL: S.T.G. International Ltd., 52 Nachlat Benyamin St., P. O. Box 1276, Tel-Aviv. Phone: 53459, Telex: 033-229 Tel-Aviv. JAPAN: Marubeni-Iida Co., Ltd., 3, Hommachi 3-Chome, Higashi-ku, Osaka 530-91. Phone: Osaka (271) 2231, Cable: MARUBENI OSAKA, Telex: OS-3261, OS-3262, OS-3297; Marubeni-Iida Co., Ltd., 6-1, Ohtemachi 1-Chome, Chiyoda-ku, Tokyo. Phone: TOKYO (216) 0111, Cable: MARUBENI TOKYO, Telex: TK2326, TK2327, TK2328. NORWAY: Henaco A/S, Cort Adeleers Gate 16, Oslo. Phone: 56 51 85. SWEDEN: AB Svensk Teleindustri, Valla torg 53, 121 69, Johanneshov. Phone: 08-91 0440. SWITZERLAND: Omni Ray AG, Dufourstrasse 56, 8008 Zurich. Phone: (051) 47 8200, Telex: 53239.

---

# Washington Newsletter

---

July 19, 1971

## High costs of Mk. 2 avionics may hurt B-1 advocates

Congressional opponents of the Air Force's proposed B-1 bomber program intend to use updated cost overrun figures on the F-111's Mark 2 avionics package as a key argument in their effort to kill the B-1. (Early versions of the B-1 are slated to get the "austere" version of the avionics package known as Mark 2B.) Critics not only dispute the USAF contention that a new manned bomber is required but add that the Mark 2 cost spiral demonstrates that the service cannot accurately forecast costs. Latest Air Force cost estimate for the contract with North American Rockwell's Autonetics operation is \$646 million, plus \$209.5 million for spares and support costs, making a total of \$855.5 million that contrasts with an original 1966 Air Force estimate of \$172 million. Nevertheless, the service believes it can get its B-1 with modified Mark 2 avionics by arguing that the package now is workable.

## Comsat promoting broadcast satellite over AT&T effort

Communications Satellite Corp. is privately pushing for Federal Communications Commission approval of its second domestic satellite filing instead of its two-satellite system. The former would serve television and radio broadcasters and other users [*Electronics*, Jan. 4, p. 33], while the latter, which was filed first, would be for the exclusive use of AT&T. Sources at Comsat say the company now sees a bigger market in a broad domestic satellite service, and therefore pushed its service potential at the recent National Cable Television Association meeting in the capital.

Along with most other industry sources, Comsat officials believe the company is unlikely to get FCC approval of both its applications when a decision comes—presumably before the year's end. And if the joint filing with AT&T is turned down, AT&T is expected to go it alone later.

## Economics, politics make joint use of Aerosat unlikely

Changes in the aeronautical communications satellite program are dimming hopes that Aerosat would also serve the maritime community, say Federal Aviation Administration sources [*Electronics*, April 26, p. 31]. Despite support from the White House Office of Telecommunications Policy, hardware manufacturers and the French government, economics and international politics will probably rule out its use by ships.

The idea assumed that satellite circuits would be leased from industry and that industry would add excess capacity to its satellites to serve the maritime community, the sources point out. But now that the program is becoming an international venture [see p. 125], they add, the satellite will probably be jointly owned by the U.S. and European governments. And tight government budgets will require the spacecraft to be launched by a smaller Thor-Delta rocket, restricting the Aerosat system to fewer channels, which would be for aeronautical use only.

## NASA to ask industry for fast recorder

NASA is predicting that the toughest development item in its new High Energy Astronomy Observatory program will be a data recorder. Richard Halpern, HEAO program manager at NASA headquarters, says the tape recorder will require a high—20 kilobits per second—data rate and a long life-time, so that, unlike most other electronics items aboard the 10-ton craft, it will not be purchased off the shelf.

Meanwhile, NASA is asking industry to submit proposals for the two

---

# Washington Newsletter

---

spacecraft before August 27, in preparation for the selection of a system manager in early 1972. Value of the contract is expected to run between \$190 million and \$250 million, a sum that Congress is expected to appropriate because of the scientific community's strong support for the program.

## **Air Force drops target ID scope from F-15 fighter**

Another avionics system has been eliminated from the McDonnell Douglas F-15 fighter—the airborne telescope known as Tiseo for target identification system, electro-optical [*Electronics*, Feb. 1970, p. 37]. The Air Force says its decision was due not, as rumor had it, to any need to reduce costs or hold down overall plane weight to meet structural fatigue requirements, but to the expectation that pilots in the single-seat aircraft would not want to hold their heads down to the Tiseo scope when in combat. In any case, the service adds, “we have enemy identification IFF equipment.”

Other limitations of the Tiseo were its 2° field of view and 30° sweep angle, restricted in a supersonic environment, and its optical character, which made it unusable at night or in a cloudy sky. For instance, an enemy aircraft could defeat Tiseo's lock-on and track capability by ducking into a cloud bank, officials conceded. Nevertheless, USAF officials say “the Tiseo has great possibilities, but more in the air-to-ground role” when installed on two-place aircraft, and the service plans to use it on some of its McDonnell Douglas F-4Es.

## **Bell Labs to study how to identify origin of 911 calls**

AT&T has consented to commit Bell Labs resources to the problems of automatic number and location identification, say National Academy of Engineering sources. NAE earlier had applied pressure to the Bell system through AT&T vice president Kenneth G. McKay, a member of NAE's Committee on Telecommunications, to study what NAE calls 911/ALI—how to identify the calling number and listed location when that number is addressed to a 911 emergency center. Bell will spend one to two years studying the problem and writing the specifications for a generic system that will be usable with telephone equipment everywhere and be made available to its member companies.

The Chicago Police Department has been talking with Illinois Bell, which appears the closest of the Bell companies to location identification—it has a completely computerized cross index of phone numbers and locations for Chicago. In a coup that may prove embarrassing for Bell, however, independent phone companies in Nebraska have submitted a \$150,000 proposal to the Law Enforcement Assistance Administration for the installation, demonstration, and evaluation of 911/ALI for 80% of that state's population.

## **CDC touts STAR computer to NASA**

Control Data Corp. is trying to persuade NASA's Langley Research Center to buy one of its string array or STAR computers, on the grounds that the pipeline processor would be the most cost-effective way of adding power to the Hampton, Va., facility. The company, which has been a systems consultant to Langley since 1965, points to the fact that computing facilities there are now being taxed by the operational use of NASA's differential maneuvering simulator, a sophisticated system that can be used to simulate docking maneuvers and air combat.

# Look at it from every angle.

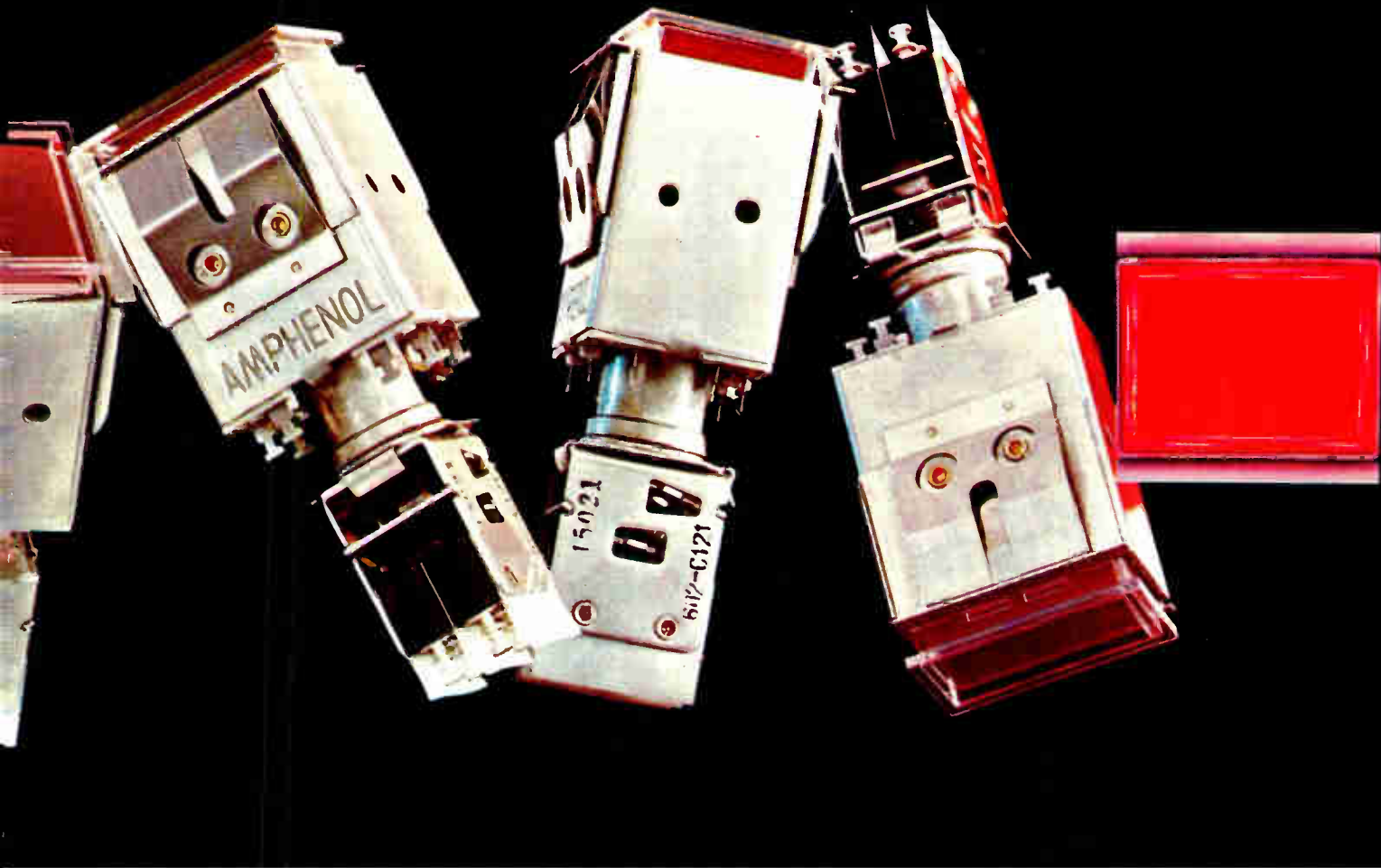

## You can't beat the quality or the price.

This switch is from Amphenol's new line of four-lamp push-button panel controls and matching indicator lights. Examine it thoroughly. Notice the careful attention given to its construction.

And each module in the Series 602 line gives you complete freedom of design in circuitry and display. Mounting is quickly accomplished from the front of the panel. Operator indicator module permits independent lamp illumination and provides for momentary or alternate action.

Display possibilities? Lateral, longitudinal;

single-, three-, and four-section screens with a wide variety of color arrangements. Also, a wide variety of mounting options are awaiting your specifications. Long and short barriers, long and short side flange mounts, and optional spacing barriers.

Take another close look at the new Amphenol Series 602, then ask us about the price. That's really worth looking at—from any angle. We'll send you a full line catalog too. Amphenol Controls Division, Bunker Ramo Corporation, 120 South Main Street, Janesville, Wisconsin 53545.

**BUNKER  
RAMO**

# AMPHENOL

# And now, from the ROM capital of the world..

## ...4096 and 3072 bits.

With seven ROMs, we were already on top in the read-only-memory market.

Our two newest ROMs will keep us on top for a long time to come.

Each is worthy of special note.

The MM4232/MM5232 is a 4096 bit static ROM organized in either a 512 word x 8 bit or 1024 word x 4 bit configuration controlled by a mode control input. With an access time of 1 microsecond. It features two mask programmable chip enable lines (CE<sub>1</sub> and CE<sub>2</sub>), a clever innovation which provides logic control up to 16K bits *without external logic*.

Our other new ROM is the MM4241/MM5241 Vertical Scan Character Generator. A 3072 bit static read-only-memory organized in a 64 x 6 x 8 format with an access time of 750nS. The MM4241AAN/MM5241AAN is a standard 5 x 7 font available off-the-shelf.

Both of our newest ROMs use standard supplies (+5, -12V) and are bipolar compatible at the inputs and outputs. In addition, both have been designed with Tri-State™ logic outputs. (Another innovation, and one which gives you wire OR'd capability without loading common

data lines or reducing the 750nS access time.)

Finally, both the MM4232/MM5232 and MM4241/MM5241 are mask programmable. Thereby allowing you to submit your own programs for processing in a paper tape or punched card format.

That's a look at our two newest ROMs. For more details on them, our other seven read-only-memories, our line of standard code converters and look-up tables, or a handsome picture postcard of the ROM capital of the world, contact us today.

National Semiconductor Corporation,  
2900 Semiconductor Drive, Santa Clara,  
California 95051. Phone (408) 732-5000.  
TWX: (910) 339-9240. Cable: NATSEMICON.

Note: MM42xx refers to -55°C to +125°C temperature range devices; MM52xx to -25°C to +70°C

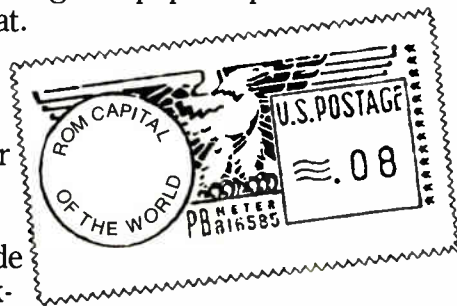

## National



# Stop electronic noise pollution.



Use Bendix EMI filter connectors. There are more to choose from than ever before. They'll suppress radiated and conducted noise, without the use of shielded leads or conventional filter networks. Each contact is surrounded by its own ferrite filter. You'll save weight. Save space. Save money, too.

Various filters are available to meet your frequency and attenuation requirements. You can intermix them within the connector package, too, yet the connector remains intermateable and intermountable with our standard Pygmy<sup>®</sup> series (MIL-C-26482), JT and LJT series (MIL-C-27599 and MIL-C-38999). This design versatility is solid assurance there's a Bendix configuration that's sure to meet your requirements.

More information about stopping electronic noise pollution? Write for our new brochure. It tells all about Bendix EMI filter connectors. The Bendix Corporation, Electrical Components Division, Sidney, New York 13838.

**Bendix**  
  
**Electronics**

# Xerox Oscillographic Papers: 31 B.C. (Before Copiers)

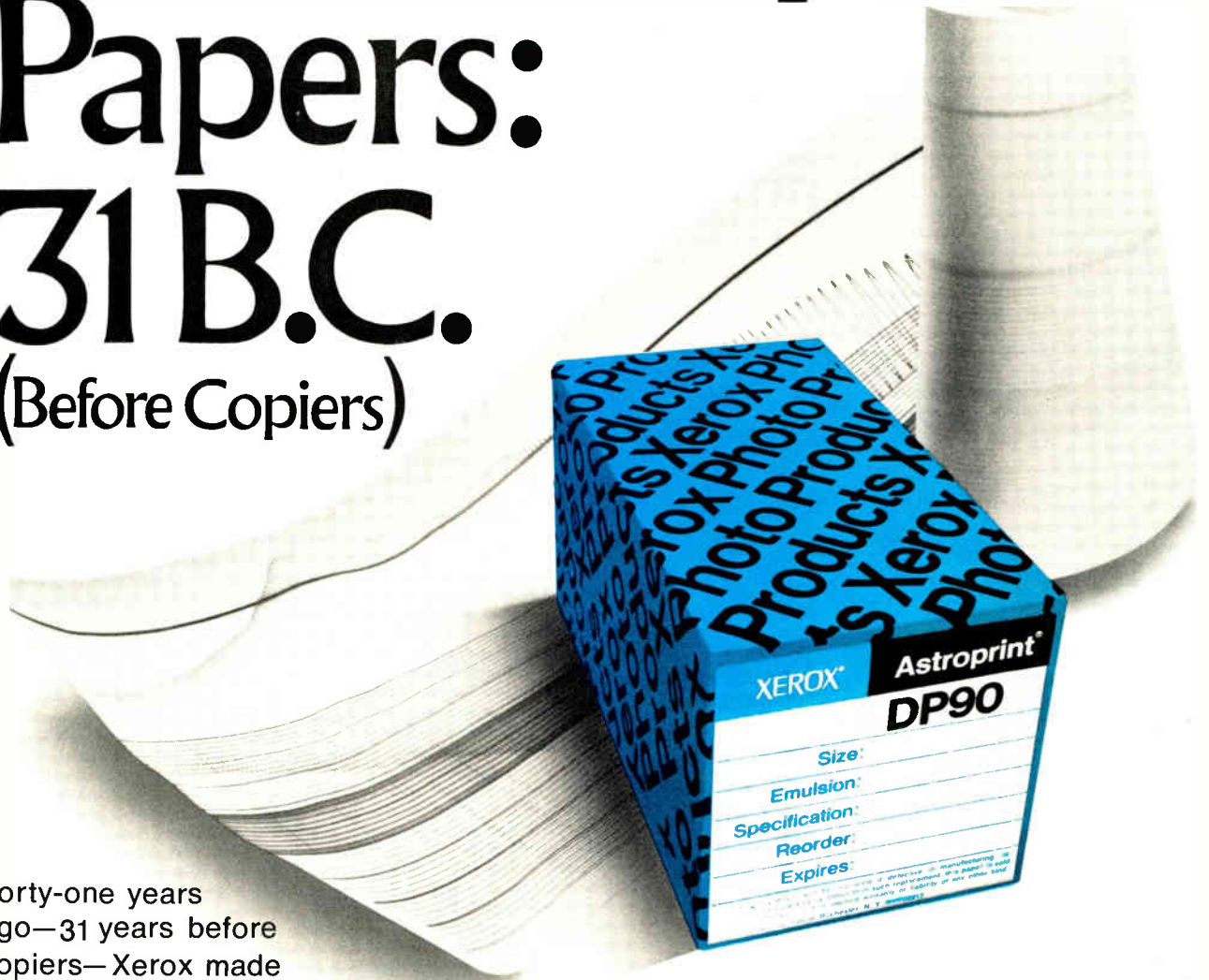

Forty-one years ago—31 years before copiers—Xerox made great oscillographic papers.

And we've been improving them ever since. You can order them direct from your local Xerox Product Specialist listed in your telephone directory for fast shipment from our Regional Supply Centers—our way of helping you save time and money, while solving storage and delivery problems. Check performance, price and service benefit that's yours with Xerox Astroprint DP90. Xerox Corporation, Business Products Group, Department HL, Rochester, New York 14603.

**XEROX.**

Xerox and Astroprint are registered trademarks of Xerox Corporation

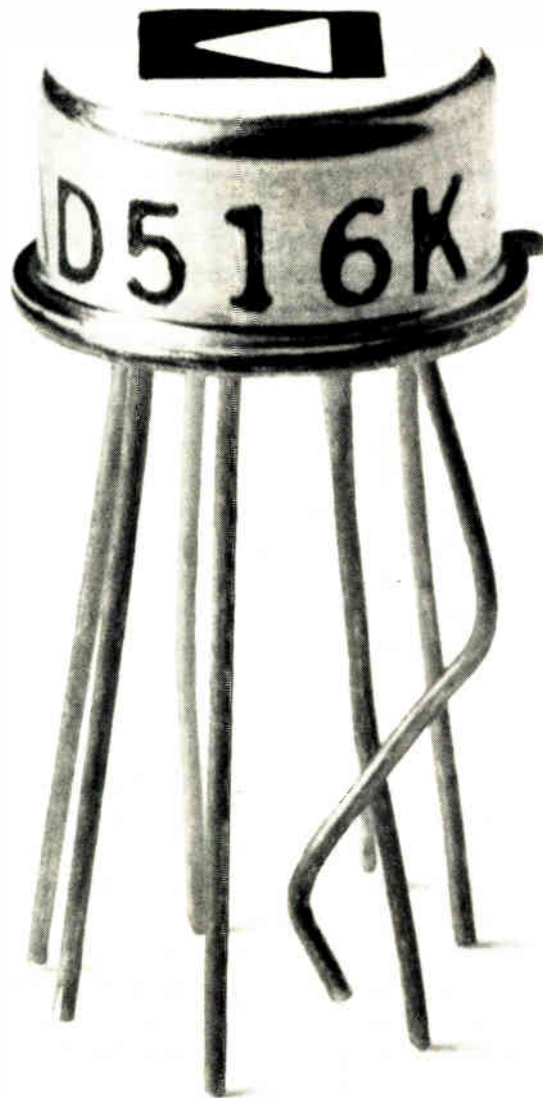

## “Quite frankly, other linear I.C. devices need not feel threatened by us.”

We're not competing as miniature low cost devices, we're competing as circuits—a new family of linear FET op amp circuits that are equal to any, better than most, and in many cases unique in the industry. Read these guaranteed min-max specifications.

*AD-503* Bias current 10pA; offset voltage 20mV (trimmable to zero); gain 50K; slew rate 4V/μsec; offset voltage drift 25μV/°C.

*AD-506* Internally laser-trimmed version of the 503 holds offset voltage to 1mV; eliminates requirement for external Vos trimming.

*AD-513* Single capacitor external compensation; slew rate to 20V/μsec; settling time 3μsec to 0.1%; 5MHz gain bandwidth; (with feed-forward compensation: slew rate to 50V/μsec; gain bandwidth to 30MHz); bias current 20pA; offset voltage 20mV.

*AD-516* Internally laser-trimmed version of the 513 holds offset voltage to 1mV; eliminates requirement for external Vos trimming.

*AD-511* Bias current 5pA; offset voltage 1mV; gain 25K; economical replacement for C-118, 20-008, 20-108, 140801, and 501/P501 amplifiers.

That's the nucleus of the FET op amp family. Then there are the multipliers, converters, instrumentation amplifiers, and dual transistors. Like the op amps, these circuits are ready to use, typically with no need for outboard components. All are manufactured completely by us using the most advanced techniques and equipment. Send for the family album—a 20 page in-depth description of the products and how they are made, including handy selection guides. Free. Analog Devices, Norwood, Mass. 02062. (617) 329-4700

 **ANALOG DEVICES**

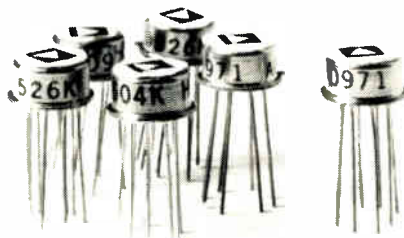

# Everything about this MOS/LSI packaging concept is economical, including our connector. And you can rely on that.

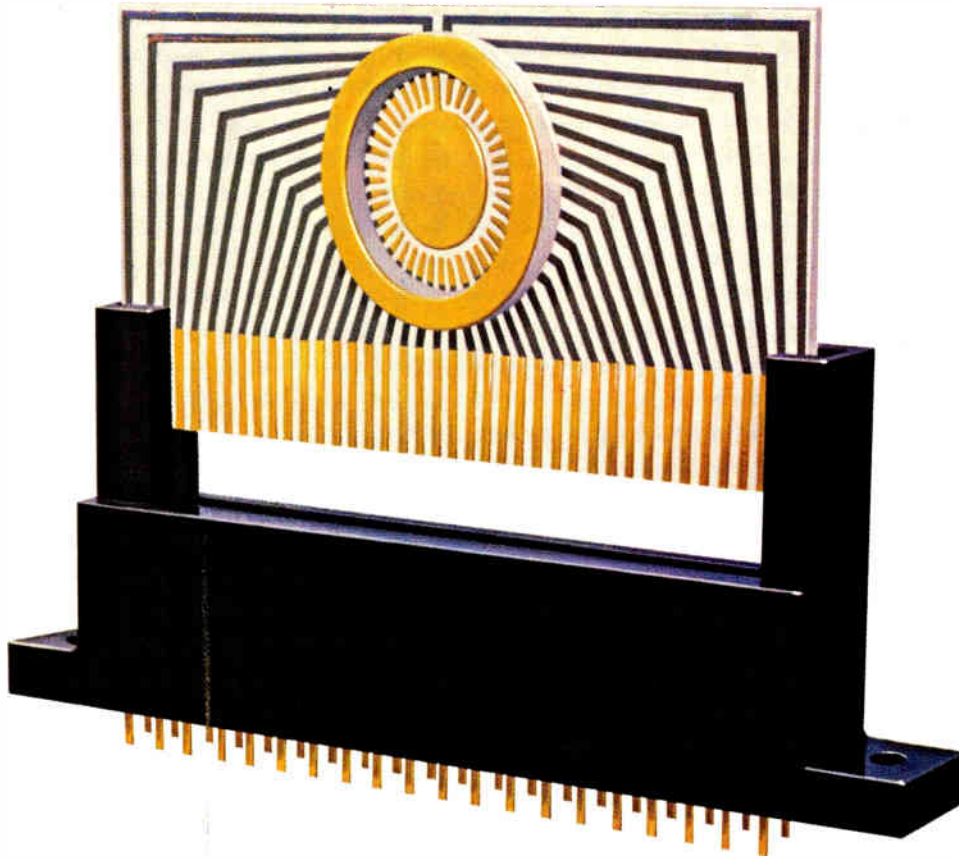

Our edgemount connector is specifically designed to help you take advantage of the economy and flexibility in leadless IC substrate packaging.

You get *all* the substrate advantages: low initial cost, greater packaging density, easy insertion/extraction, quick replaceability. And the low per line cost of our connector matches the package's economy. Now, that's cost savings all the way.

Can you depend on it? Yes. Because our connector is designed to give reliable, uniform contact with every pad across the substrate. In addition, posts are rigidly

molded in the block on .050" staggered centers, with no exposed bent metal.

For specs and information on this connector and new substrate packaging concepts, write:

**AMP Incorporated, Industrial Division,  
Harrisburg, Pa. 17105**

**AMP**  
INCORPORATED

Manufacturing and Direct Sales Facilities in: Australia,  
Canada, France, Great Britain, Holland, Italy, Japan, Mexico,  
Puerto Rico, Spain, Sweden, United States and West Germany.

## Technical articles

---

### **Tune your a-m radio electronically with matched-varactor chip: p. 60**

Owners of high-priced fm receivers and uhf/vhf tv sets know all about the advantages of varactor-diode tuning, but it's yet to appear in the humble a-m radio. Emerging from the laboratory, however, is a triple diode on a single chip. By dividing the a-m band into three frequency ranges, and using a segment of the triplet to cover each range, the wide capacitance ratios required for tuning across the broadcast band can be achieved easily, say authors Gerhard Jonkuhn and Carl Heinrich Lembke, leading to economical electronic tuners for a-m sets.

### **Current changes add color to plasma display: p. 66**

Plenty of interest was generated when the Burroughs Corp. introduced a self-scanning display panel consisting of gas-filled, phosphor-coated cells. Now it should become even more interesting with a multicolor display capability, says author Rudolph A. Cola. It's done by using a phosphor coating sensitive to ultraviolet light and a variable current source: when the cell discharge contains a large ultraviolet component, the phosphor emits light that can be continuously varied from green to red by the input current.

### **New bipolar ICs challenge MOS in the density derby: p. 76**

One of the oldest and most rigid lessons in the designing-with-ICs primer is: for speed, use bipolar; for density, MOS. But it soon may be junked, asserts author John DeFalco, because of new bipolar techniques being developed. With very thin epitaxial layers and new isolation techniques, bipolar ICs can achieve MOS densities, leading to large-scale integration and much lower costs.

### **Automated electronics production lines cut costs: p. 80 (cover)**

Integrated circuits make designing electronic systems easier. But building the hardware is another story, and it's often a tale of rising prices due to higher labor costs, says author Stephen E. Scrupski. Manufacturers are increasingly turning to better and faster machines for automating their assembly operations, with computers playing a key role in cutting costs.

The cover: Here, on blushing infrared film, is the head of USM Corp.'s new dual in-line package insertion machine. Typical of the automation aids coming to electronics production lines, the machine is computer controlled to give higher speeds and greater flexibility than numerically controlled units.

### **Relaxation oscillator drivers for injection lasers: p.88**

Thyristors do a good job of driving injection lasers, but for very compact, low-power configurations, says author Forrest M. Mims, the designer could do better with relaxation oscillators. He'll find that a four-layer diode or a single transistor operated in the avalanche mode can take up less space, cost less, and be far more efficient than an SCR.

### **And in the next issue . . .**

Hall-effect devices in IC form . . . single-transistor storage cell for high-density RAMS . . . English-language program for automatic test equipment . . . high-performance communications amplifier is simple to design . . . unions for EES?

# Matched-varactor chip brings electronic tuning to a-m radios

Now it's feasible to build economical varactor tuners for the a-m band by dividing the broadcast range into three frequencies and using individual segments of a triplet on a single chip to tune across each

by Gerhard Jonkuhn and Carl Heinrich Lembke, *Valvo GmbH, Hamburg, West Germany*

□ The variable capacitance diode tuner is a familiar component in higher-priced fm radios and uhf/vhf television sets. But they've yet to appear in a-m radios, for the much wider capacitance ratios required to tune over the broadcast band have proven difficult to achieve with a single varactor diode.

In developmental work, several diode sections, combined with switching diodes, have been used to achieve the large capacitance variations required. However, to insure accurate tracking, these diodes have to be identical, and matching has been far too costly for commercial applications. Now, with development of a technique for putting several varactor diode sections on a common substrate [see "Making it go," p. 63] and the know-how acquired in development and mass production of tuning diodes for the other applications, economical, accurate varactor tuning for a-m radios is a lot closer.

This design approach breaks the tuning diode into three separate segments to achieve synchronous tracking over the a-m broadcast range. The resulting device actually is a triple diode, or triplet, that consists of three identically fabricated diode sections on a common, plastic-encapsulated silicon chip measuring 0.056 square inch. The interconnected cathodes of the three diode

sections are brought out by two leads to minimize interaction in the circuit; the anode of each partial diode is accessible via a separate lead. Leakage capacitance between anodes is negligible.

Combining several diodes on a common chip during the manufacturing process significantly minimizes the costs of choosing discrete diodes that have very closely matched capacitance-vs-inverse-voltage characteristics. The diodes, by sharing a common chip, have almost identical characteristics, and thus provide frequency tracking.

The key considerations in fabricating an a-m tuning diode are its capacitance variation; the shape of its capacitance-vs-inverse-voltage ( $C_V$ -vs- $V_R$ ) characteristic curve (shown in Fig. 2); and, in the case of a multi-element combination, its match with other diodes in that combination.

These three characteristics have to meet specific requirements. First, the capacitance variation must be large enough to cover the a-m broadcast range. Second, the diode's  $C_V$ -vs- $V_R$  characteristic curve shape must insure negligible modulation distortion. Finally, if several diodes are combined to operate synchronously, they all must have the same  $C_V$ -vs- $V_R$  characteristic curve to

**1. Triplet.** The 0.056-square-inch, plastic-encapsulated chip shown here on the lead frame during production has three separate and identical varactor diodes. The diodes share a common cathode, but it is necessary to bring out each anode lead separately.

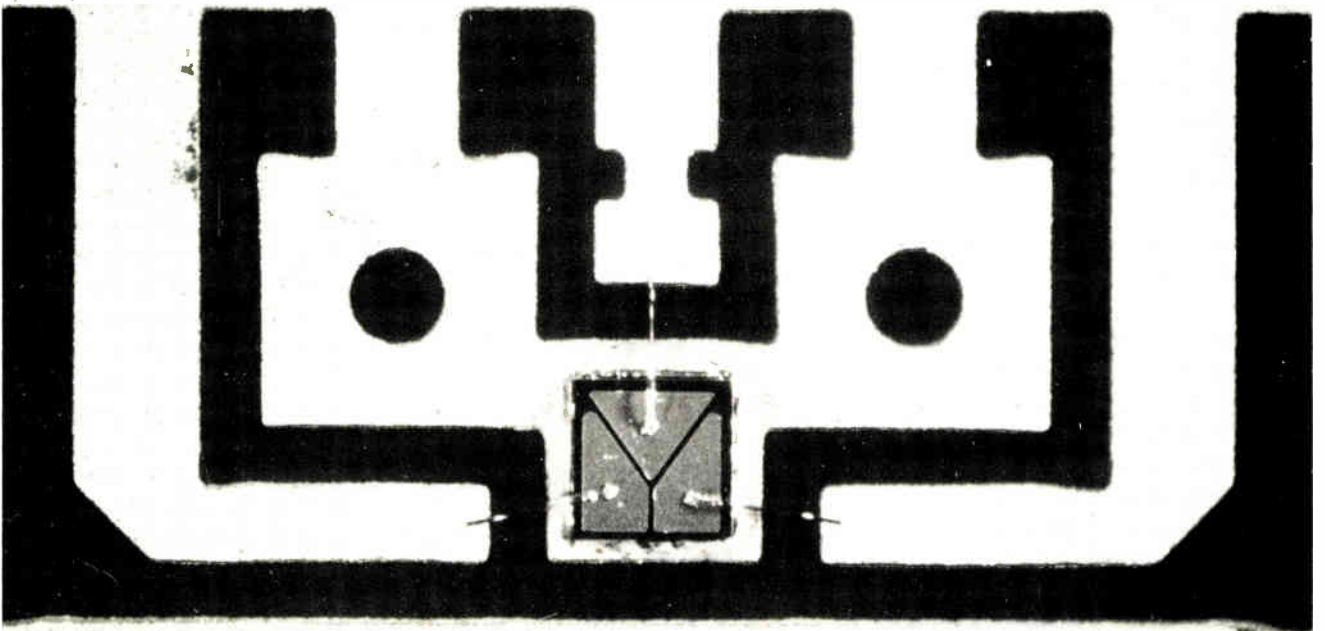

achieve good frequency tracking. For this triplet, the several sections can be frequency-tracked to within 1% over the whole tuning range, but deviations of up to 2% are tolerable.

In addition, the circuitry has to meet certain demands to achieve accurate tuning. In a basic a-m diode-tuned, parallel resonant circuit (Fig. 3) the dc tuning voltage, variable between 1 volt and 30 v by a tuning potentiometer, is effectively applied across the variable-capacitance diode  $C_D$ . Because capacitor  $C$  is much larger, the resonant circuit—consisting of  $C_D$ , coil  $L$ , and of the circuit's parasitic capacitance  $C_P$ —can be tuned.  $R_S$  acts as a decoupling resistor; capacitor  $C$  provides ac ground for the circuit without shorting out the dc tuning voltage. The dc tuning voltage must be very stable—voltage variations would lead to capacitance changes and hence to frequency variations.

The resistor must be small in value lest the voltage drop across it (due to the different inverse diode currents) create relatively large and unequal voltage drops across the diodes, causing a tracking problem.

Using the frequency limits (535 and 1650 kilohertz) of the medium-wave band of the a-m broadcast range, the frequency variation ratio at the receiver input is 3. The required variation in tuning capacitance,  $C_{var}$  is therefore:

$$C_{var} = \frac{C_{max}}{C_{min}} = \left(\frac{f_2}{f_1}\right)^2 = \left(\frac{1605}{535}\right)^2 = 9$$

However, the required tuning capacitance ratio also must consider the circuit capacitance  $C_P$  in parallel with the diode. Hence, the required capacitance variation now becomes:

$$C_{var} = \frac{C_{Dmax} + C_P}{C_{Dmin} + C_P}$$

Thus, when the resonant circuit's parasitic capacitances are considered, the actual capacitance ratio of the tuning diode must be much higher than 9.

**2. Voltage tuned.** The voltage-variable capacitance,  $C_D$ , determines the resonant frequencies of the tuned circuit in the a-m radio.

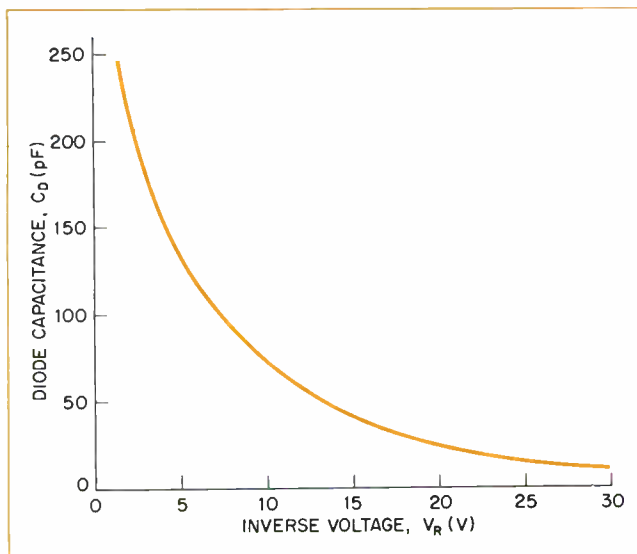

For example, consider a capacitance  $C_D$  of approximately 30 picofarads—a typical value often encountered in these circuits—and keep the same value for  $C_{Dmin}$ . Solving the previous equation for  $C_{Dmax}$ :

$$\frac{C_{Dmax}}{C_{Dmin}} = \frac{C_{var} C_{Dmin} + (C_{var} - 1)C_P}{C_{Dmin}}$$

Plugging these values ( $C_{var} = 9$ ;  $C_P = C_{Dmin} = 30$  pF) into the equation for  $C_{Dmax}$ , the value of  $C_{Dmax}$  is 510 pF.

A compromise must be made in establishing the values for  $C_{Dmax}$  and  $C_{Dmin}$ : large capacitance values require large chip areas which push up diode costs considerably because of lower yields. The value chosen for  $C_{Dmin}$ , on the other hand, can't be too small compared with  $C_P$ ; otherwise the capacitance ratio required to tune the entire frequency band would be too high, and the tuning characteristic at the high-frequency end also would be adversely affected. For yield purposes, the capacitance values for one section of a typical a-m triplet range from 230 to 280 pF for  $C_{Dmax}$  at an inverse voltage of 1 v, and less than 13 pF at an inverse voltage of 30 v. In this case, two triplets must be used in parallel.

**Strong-signal problem.** Because the diode's capacitance changes with dc voltage, a large incoming signal effectively superimposed upon the dc tuning voltage causes momentary diode capacitance variations. The shape of the capacitance-vs-inverse-voltage curve strongly affects the large-signal behavior of the tuned circuits. As the input-signal amplitude increases, the capacitance variations can lead to a shift in center frequency of the tuned circuit, as well as a deformation in their resonance-curve shape. Thus, accurate tuning is not possible in extremely strong-signal conditions.

How a large input signal affects the circuit's resonance curve (Fig. 3) depends on the shape of the diode's  $C_D$ -vs- $V_R$  characteristics curve. Deformations of these resonance curves result from a diode being operated at a point of inflection of an irregularly shaped characteristics curve.

If, however, the characteristic has a continuously

**3. Diode curve.** Shape of the capacitance-vs-inverse-voltage curve strongly affects the large-signal behavior of the tuned circuit.

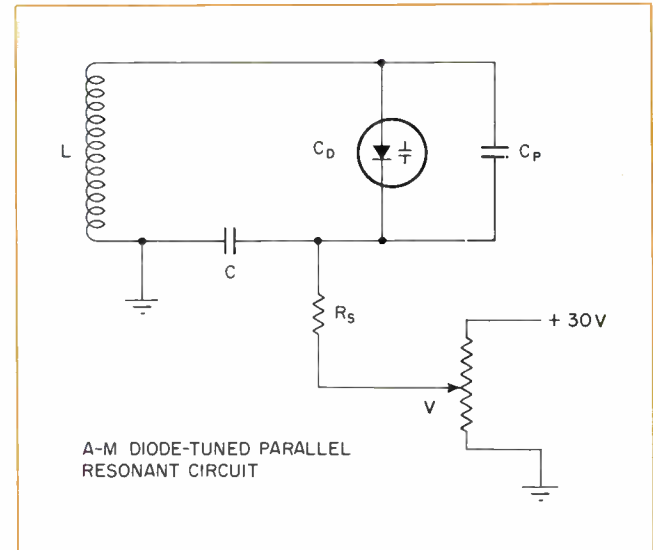

**4. Shaping up.** Diode fabrication procedures influence the C-vs-V characteristics as shown in these curves—on top is the homogenous diode and below is the epitaxial diode curve.

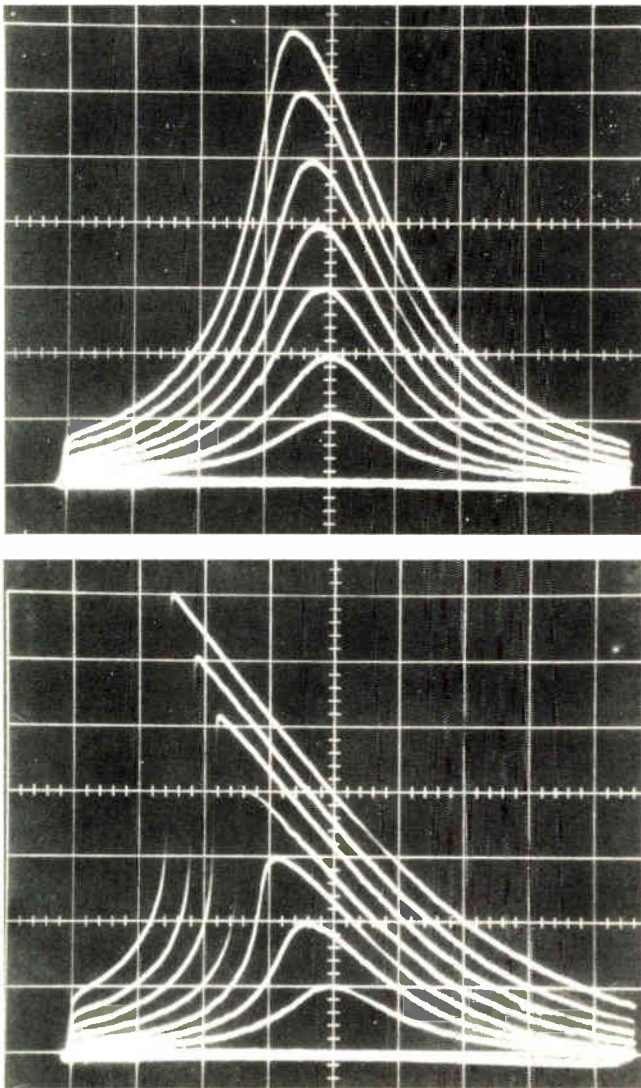

curving shape (hyperbolic, for example) over the operating region, hardly any deformations in the shape of the resonance curves occur.

Large input signal voltage can also introduce excessive signal modulation distortions. Experiments have shown that here, too, diode characteristic curves with a continuously curving shape produce less modulation distortion than irregularly shaped curves with one or more inflection points.

In the vicinity of powerful transmitters, a car radio's antenna may pick up signals of up to several volts. For that reason, too small a value of inverse voltage should be avoided lest forward-biasing of the diode occur and lead to modulation distortion in the diode's tuning range. However, evaluations indicate that no significant problems will occur if circuit parameters are properly chosen.

Ordinary home and automobile receivers contain two or three tuned stages requiring good frequency-tracking characteristics in the tuning diodes. Good tracking is obtained if the capacitance values (as a function of tun-

**5. Three-point tracking.** By adjusting the oscillator frequency, the rf stage can be made to track the incoming frequency at three points (a), but the stage gain will be maximal at three points (b).

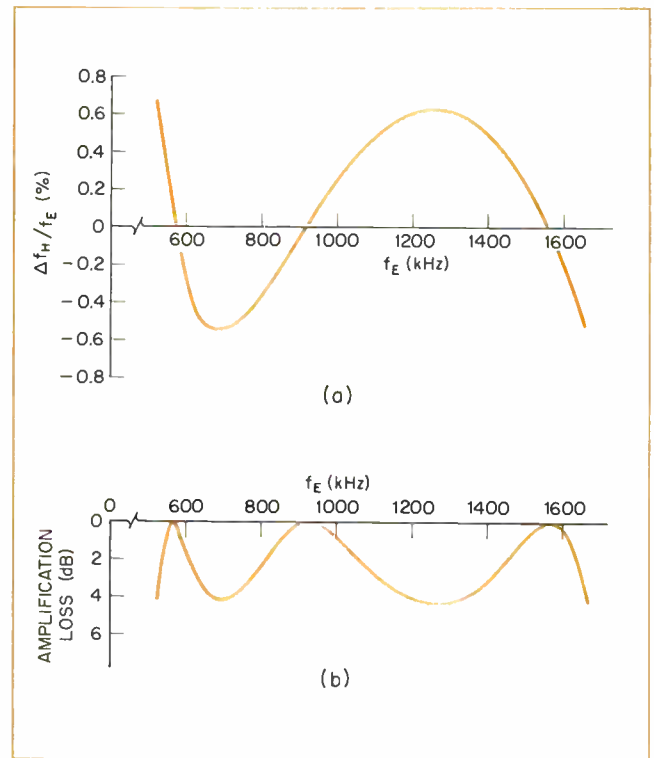

ing voltage) of all diodes in all stages remain equal or if they differ from one another by a constant factor. But with suitable circuit design techniques and alignment methods, resonance frequency of the rf stage,  $f_{i,r}$ , can be made to equal the incoming frequency  $f_E$ , at three points by adjusting the oscillator frequency,  $f_o$ , so that  $f_o - f_E = f_{i,r}$ . (Figure 4 shows the deviation of the rf tuning circuit's frequency with respect to the incoming frequency with the rf and oscillator stages having identical diodes.) Moreover, poor tracking also results in loss of signal amplitude because the gain is maximal only at the tracking points.

Constant deviations of capacitance ratios between diodes in a multi-element package, such as triplet, can be compensated by adjusting the inductances in the stages. Frequency-tracking errors have less effect at the upper end of the tuning range, (minimum capacitance) because the diode's capacitance is only a part of that of the total circuit. At the low end, however, the diode's capacitance constitutes virtually all of the tuning capacitance, so the same percentage of error has a much larger effect on the tuning.

**New ground rules.** In designing diode-tuned circuits, several rules differ from those involving conventional variable-plate capacitors. For example, because the maximum capacitance variation and the maximum capacitance values that can be achieved with varactor diodes are limited, several diodes may have to be used in a stage so that parasitic capacitance doesn't become the frequency-controlling element at the high-frequency end. Other differences occur in alignment and placement of the dial indicator.



6. **Good connections.** There are various ways of connecting a triplet's diode sections in parallel, depending on the number of tuning stages.

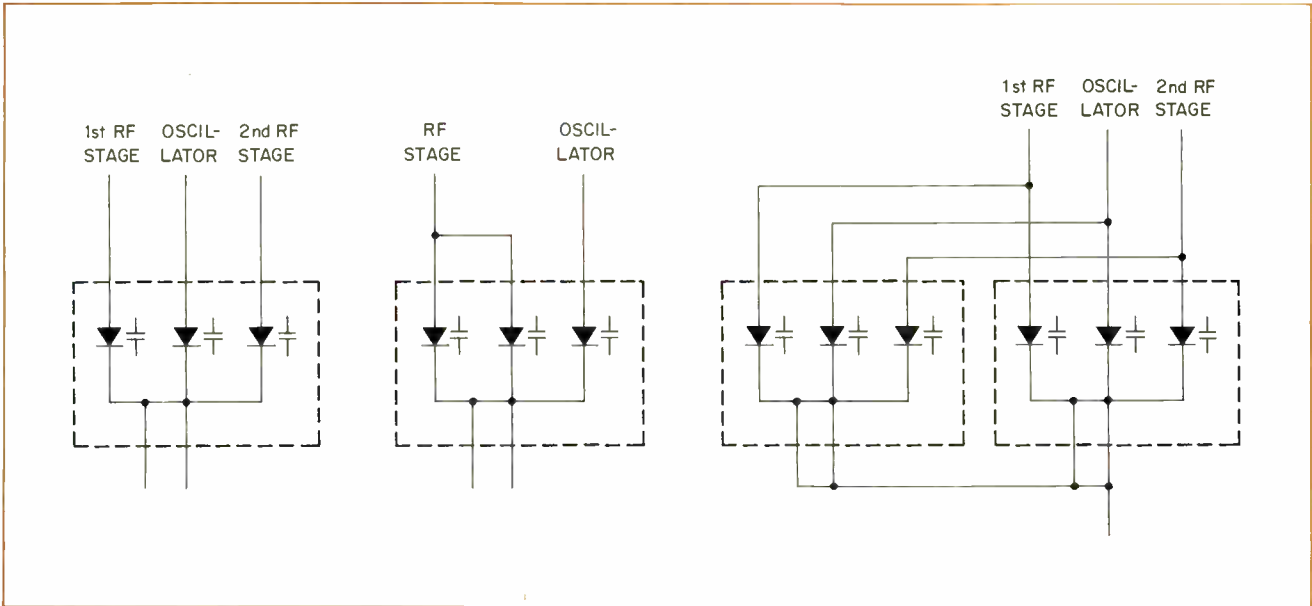

## Making it go

Manufacturing the triplet starts with an  $n^+$  silicon material upon which an  $n$ -type epitaxial layer is grown. The diode configurations are etched out after covering that layer with an oxide film. P-type material is diffused through the newly formed windows. Subsequently the p-n junction is produced in the diffused zone.

The doping concentration in the epitaxial layer follows the impurity-concentration profile that shows the trend of variation in the number of impurity spots per unit volume as a function of the thickness of the epitaxial layer. The high doping level in the performance curve affects both the initial capacitance of the diode and its breakdown voltage.

The diode's capacitance variation is a function of the change in width of the depletion layer; this takes place

partially between the p-type and the n-type layers. The capacitance depends on the depletion width which, in turn, is a function of the inverse voltage applied across the p-n junction, and of the impurity concentration of the epitaxial layer. As the inverse voltage increases, the depletion layer moves toward the  $n^+$  silicon layer, and this width increases.

This decreases the diode's capacitance; on the other hand, the opposite occurs for decreasing inverse voltages. The depletion layer in this situation moves toward the p-type layer, resulting in a capacitance increase. Thus, the operating principles of the diode are similar to those of a parallel-plate capacitor with a plate surface area equal to the etched area in the oxide layer, and a spacing between plates equal to the depletion-layer width.

**Making triplets.** Capacitance variation is a function of depletion width, dependent on voltage across p-n junction and dopant level.

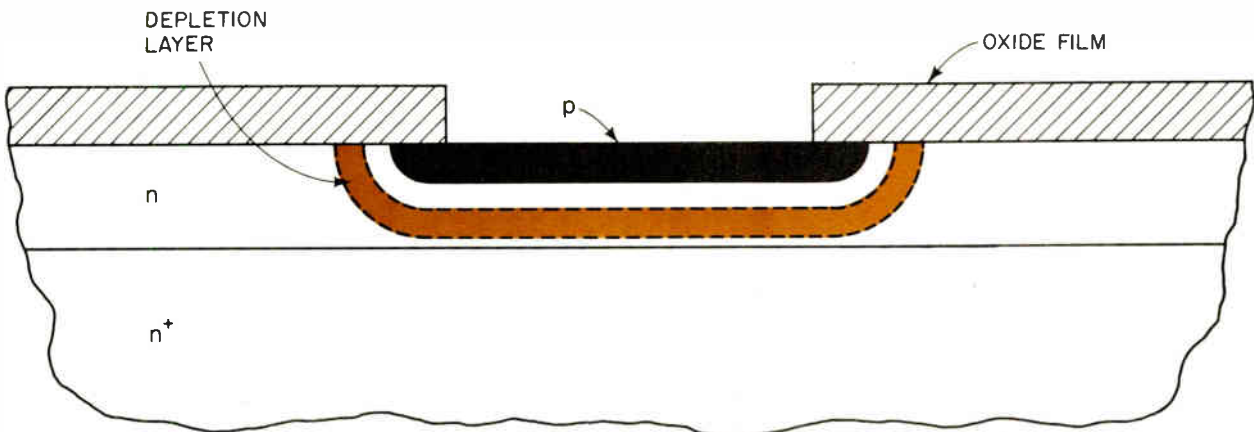

Parallel circuit capacitance,  $C_P$ , cannot be allowed to take any arbitrary value. For a required variation of the effective tuning capacitance, and for a given maximum and minimum value of the diode capacitance,  $C_P$  can be calculated from:

$$C_P = \frac{C_{D_{max}} - C_{var} C_{D_{min}}}{C_{var} - 1}$$

For a combination of  $C_{D_{max}}$  and  $C_{D_{min}}$  values—230 pF and 13 pF respectively—the maximum parallel value of circuit capacitance that can be tolerated and still tune over the a-m broadcast range can be calculated:

$$C_P = \frac{230 - (9 \times 13)}{9 - 1} = 14.1 \text{ pF}$$

Although  $C_P$  shouldn't surpass that value, in actual circuit design it's difficult not to exceed it. It's even more difficult if the receiver has long- and short-wave bands in addition to the more standard medium-wave broadcast band. In that case additional capacitance of the band switches used in such receivers further increases the total circuit capacitance. The designer can either connect several diodes in parallel or cover each tuning range in two bands. Figure 6 illustrates possible methods of connecting the diodes in parallel depending on the number of tuning stages in the receiver.

**Two-step tuning.** In a receiver with two tuned stages, the oscillator stage can be tuned with only one diode section because that stage requires a smaller capacitance variation than the rf stages. This is because the oscillator frequency is above the incoming frequency by an amount equal to the intermediate frequency. The two remaining diode sections in the triplet then are parallel-connected and used for tuning the rf stage. Oscillator design, though, must take into account the effect of the padder capacitor  $C_S$ ; this component is necessary for frequency tracking and also limits the effective capacitance variation of the diode.

In most cases  $C_S$  is approximately equal to  $C_{D_{max}}$  so that, for a capacitance variation ratio of 4.3,  $C_P$  can be about 19 pF.

In receivers with three tuned stages, each stage has a parallel-connection arrangement involving two or more diode sections—each from a different triplet. By using one diode section from each triplet for each stage, this arrangement insures that capacitance deviations between diode sections of different triplets do not adversely affect frequency tracking.

**Divide and conquer.** The other technique for getting an otherwise unachievable capacitance variation range with just a single diode is to simply divide the frequency band to be covered in half and deal with each half separately. The medium-wave range, for example, might be split into two subranges, one from, say, 535 kHz to 950 kHz and the other from 900 kHz to 1650 kHz.

Alignment is another consideration in diode-tuned a-m receivers. The basic circuit arrangement shown in Fig. 7 has worked well in the laboratory and also should succeed on the production line. Prior to the alignment procedure, coil inductance in the oscillator stage is preset to its nominal value. After that, the coil is left unchanged through the entire procedure. The value of the padder capacitor,  $C_S$ , should have as tight a tolerance as possible.

To eliminate the need for presetting the oscillator coil outside the circuit, the varactor diode in the oscillator stage first is short-circuited. The oscillator coil is set and then adjusted so that the circuit resonates at a frequency calculated using the nominal values of the coil and padder capacitors; circuit and coil capacitances  $C_{P0}$ ; and trimmer capacitor,  $C_{T0}$ . Since  $C_S$  is very much larger than the sum of  $C_{P0}$  and  $C_{T0}$ , and since it is also very accurate, any deviations in the value of  $C_P$  can be neglected.

The alignment procedure starts by setting the upper and lower frequency limits of the oscillator stage. With

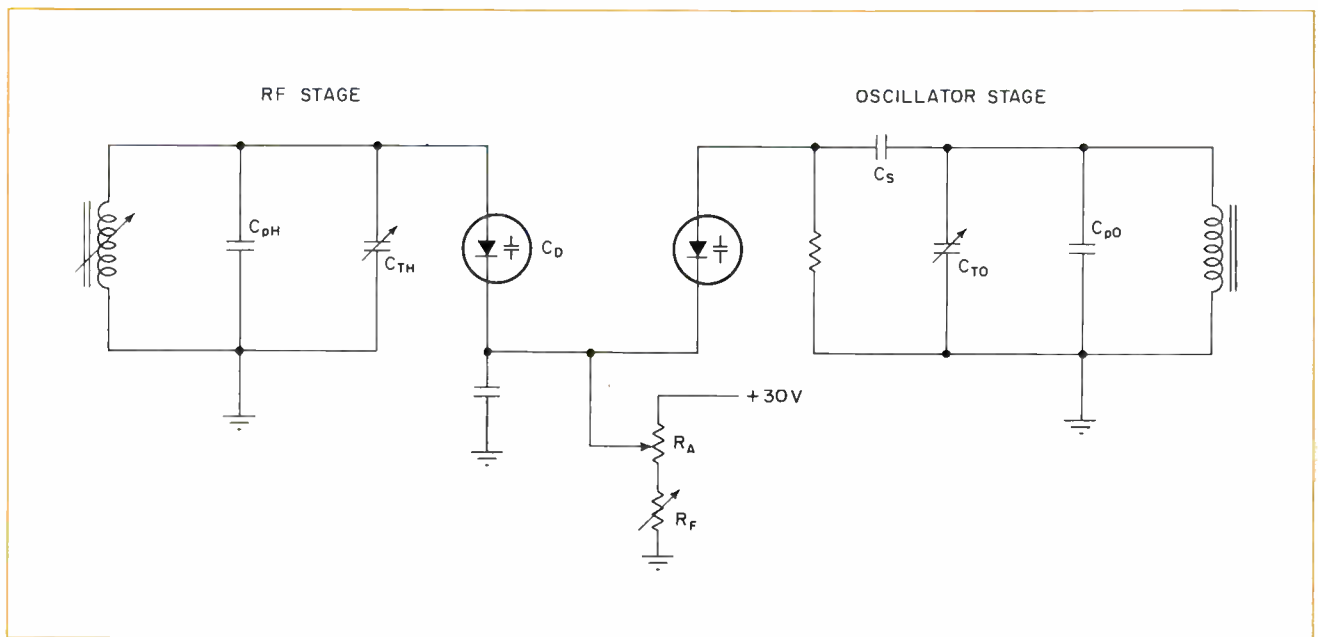

7. **Proposed alignment.** With the tuning pot emitter R set for maximum voltage, the high frequency limit of the oscillator stage is set by trimming capacitor C, the low-frequency limit with variable resistor  $R_F$ . This arrangement makes aligning the triplet varactor tuner quite simple.

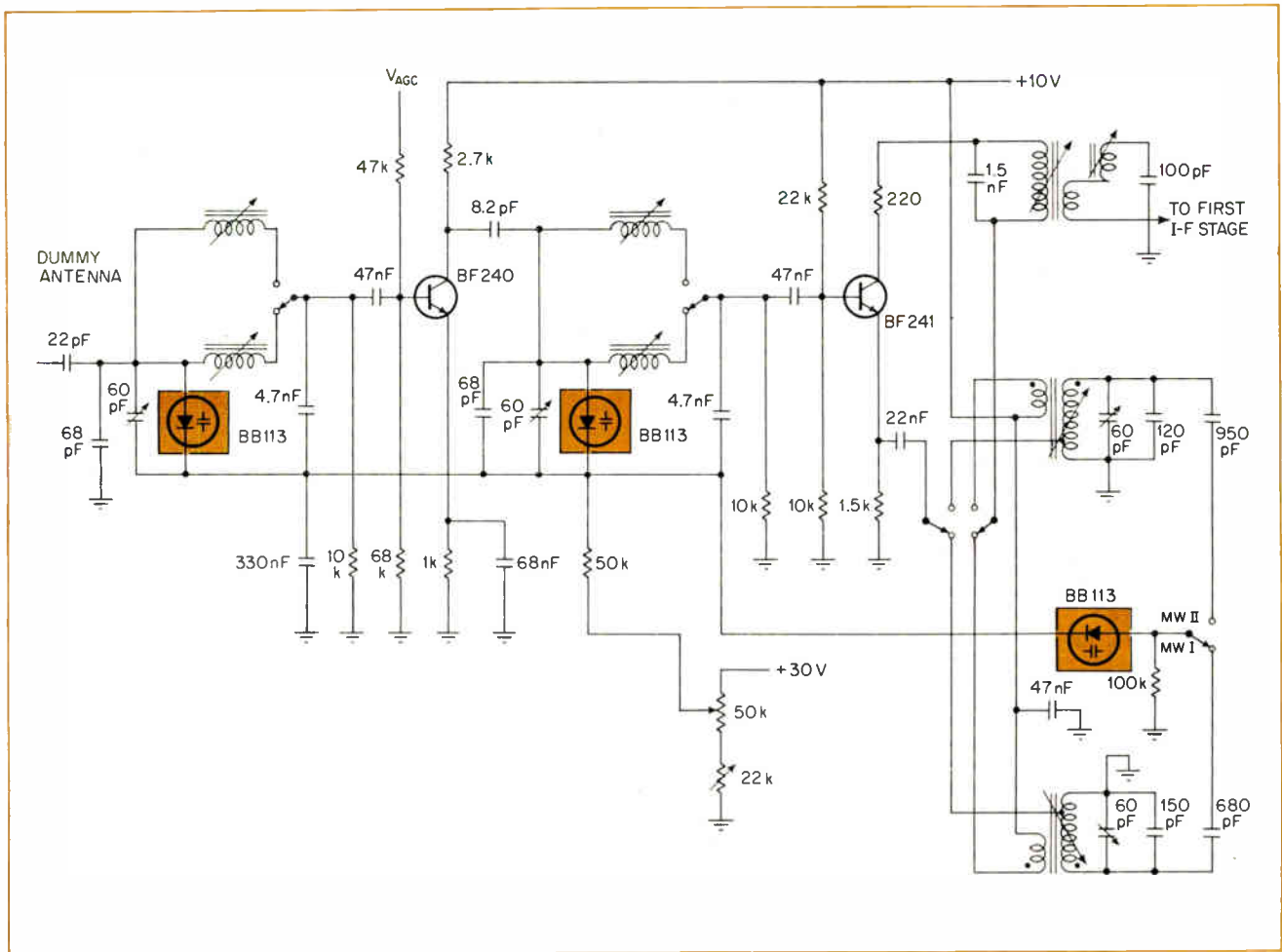

**8. Auto tuner.** In this application for a-m tuning diodes in a car radio, the front-end circuitry of a typical auto receiver uses a split medium-wave band requiring three triplet-diode chips, type BB113. Each tuned stage uses one diode section from each of the three chips.

tuning potentiometer  $R_v$ , adjusted for maximum voltage, the upper frequency is set by adjusting trimming capacitor  $C_{T0}$ . Similarly, with  $R_v$  set at maximum resistance, the oscillator's lower frequency is fixed by potentiometer  $R_F$ .

The rf stage is aligned using conventional methods. The upper tracking frequency is set by adjusting capacitor  $C_{TH}$ ; the lower tracking frequency by adjusting the coil. For each setting the tuning potentiometer must be readjusted so that the oscillator frequency is equal to the sum of the particular resonance frequency and the selected intermediate frequency. These coil and potentiometer adjustments in the rf stage must be repeated alternately until there remains no interaction between them.

The number of adjustment positions in this alignment procedure isn't any greater than that encountered in aligning conventional rf stages. However, the procedure does offer an additional advantage—the oscillator alignment can be performed in just two steps.

In application, radio receiver designers can use one of several methods for frequency indication: the tuning potentiometer's angle of rotation, the tuning voltage, or the oscillator frequency.

If the potentiometer's angular rotation is used, the dial would be accurate only near the alignment points

of the frequency range. To a certain extent, the same would be true if the inverse voltage applied to the tuning diodes were used. Deviations between the indicated and the actual (tuned) frequency at the end points can vary from set to set because the capacitance curves of diodes in different triplets differ slightly as a result of normal production spreads.

**Dial indicator types.** The oscillator frequency technique offers a more accurate approach. With this frequency, a dial indication can be obtained either digitally, using a counter, or by an analog method. The oscillator frequency is converted into a dc voltage proportional to that frequency. Indication is done with a suitably calibrated moving-coil instrument. The obvious drawback of this approach, however, is that this type of tuner would be expensive, particularly for a car radio.

The car radio example is well taken, because an automotive receiver represents one of the best showcases for the benefits of varactor diode tuning in a-m radios. There, the diodes would eliminate moving parts in the receiver's tuned stages; save space on the dashboard; and most important to automakers, provide greater flexibility in locating the receiver. It could be mounted in the rear of the car, far from interference sources, with only a remote tuning control placed within the driver's reach. □

# Plasma display changes color as current input changes

The minimal address and drive circuitry characteristic of self-scanning displays also proves capable of eliciting stepped or continuous color variation in a new version of the design

by Rudolph A. Cola, *Burroughs Corp., Electronic Components div., Plainfield, N.J.*

□ A readout of any color from red through yellow to green can be obtained from a new display panel simply by feeding a varying amount of current into a matrix of gas-filled, phosphor-coated cells. The concept derives directly from the earlier commercial Self-Scan panel, a monochrome device designed around a self-scanning dot matrix. But the added color range is bound to expand the Self-Scan's applications still further—in alphanumeric display terminals, point-of-sale recorders, and aircraft instrument panels, to mention only a few.

For displays of more than 10 and fewer than 1,000 characters, the original panel is already cheaper than either cold-cathode indicator tube arrays or cathode ray tubes. But the only means of displaying several colors till now was the bulky CRT—and that's where the multicolor Self-Scan should score. Also, it shares the basic design's economy in driving and addressing circuits and is only 1¼ inches thick.

Like the monochrome version, described in detail on page 68, the multicolor panel consists of six major parts.

These are, from back to front, a rear glass cover, a set of horizontal scanning anodes, a set of vertical cathodes, an opaque insulating center sheet containing a rectangular array of gas-filled cells forming rows and columns, a set of horizontal display anodes, and a front glass cover.

In the course of operation, gas discharges occur at every intersection of the cathodes and the rear scanning electrodes, not simultaneously but column by column across the display. Through apertures in the cathodes, each column of discharges primes the gas in the corresponding column of cells in the center sheet. This gas may or may not discharge depending on the state of the front display anodes. These anodes lie at right angles to the primed column of cells, and carry a signal synchronized with the scanning rear discharge, thus lighting up some anode-cell intersections and not others. By this means, characters visible through the front glass cover are built up by conditional discharges in the gas cells.

Basically, four differences exist between the multi-

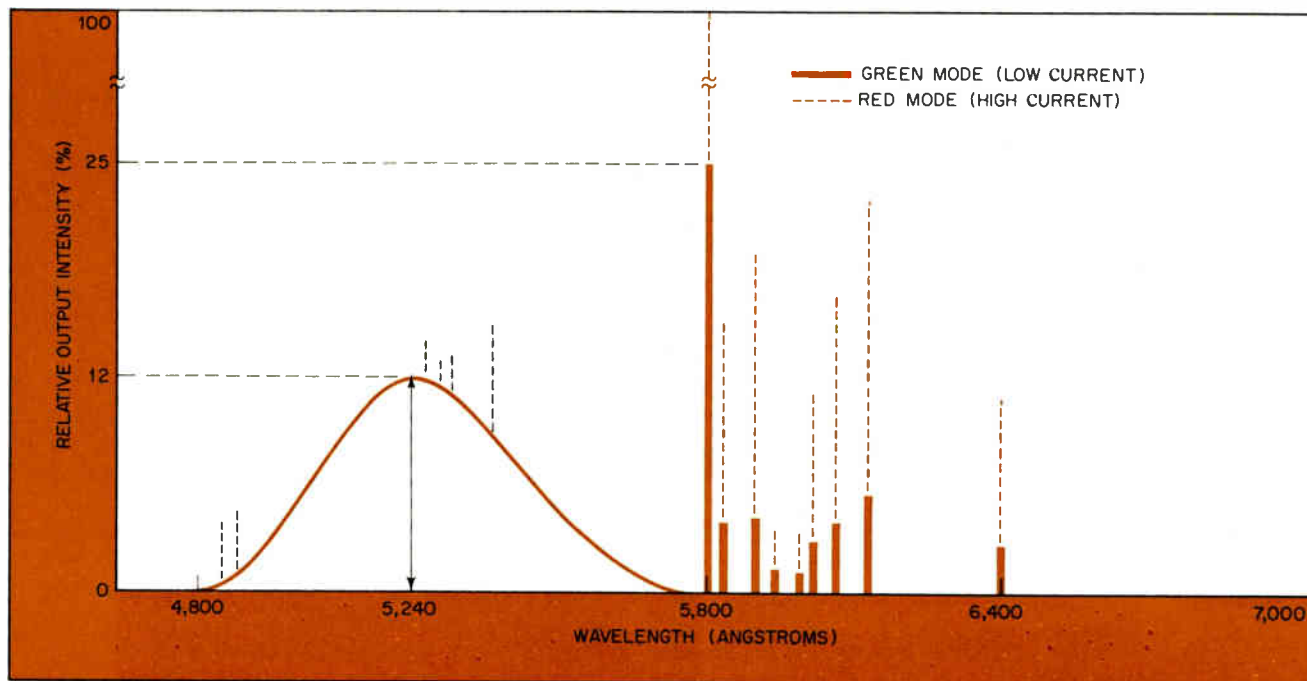

**1. Two-level emission.** Light emitted by a single cell in the color panel includes one broad band with a peak in green, from the ultraviolet-stimulated phosphor, and many individual red and yellow lines direct from the gas mixture. As more current is applied, the broad band remains nearly constant, but the gas, as shown by the dotted lines, emits more and more strongly, even producing a little greenish light.

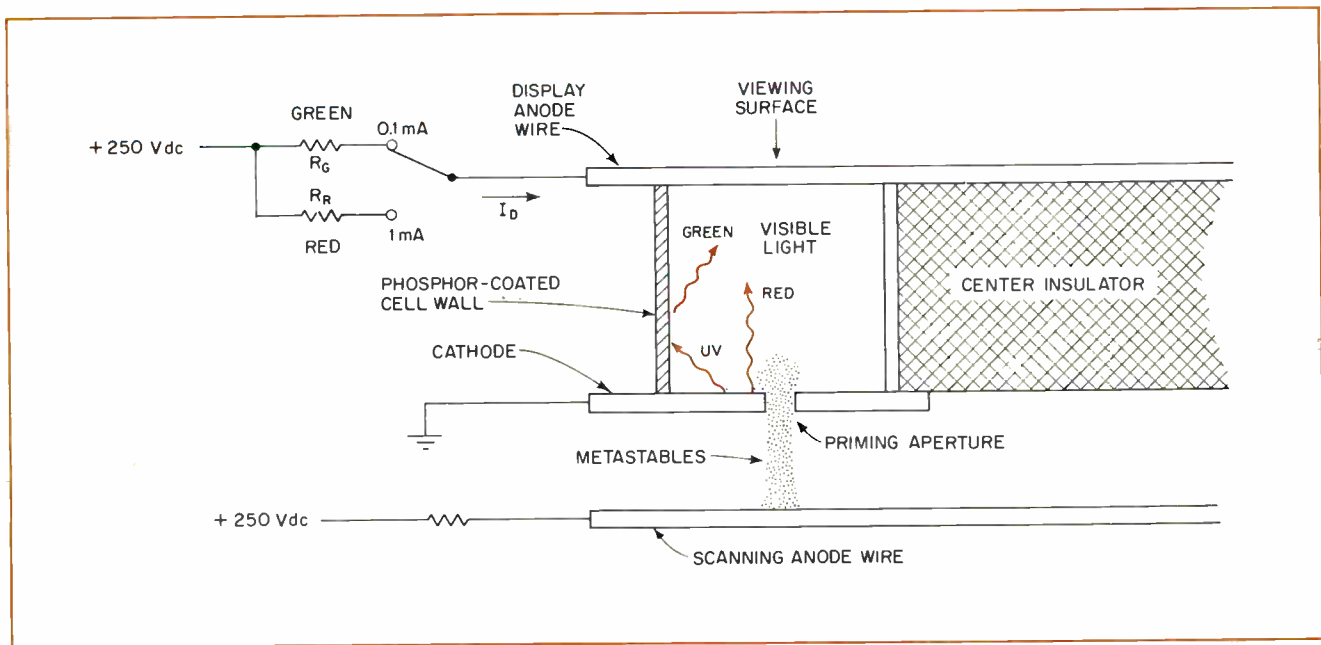

**2. Linearity vs. saturation.** The phosphor reaches its saturated light output at relatively low radiation levels, corresponding to low applied current, while the neon emission is approximately proportional to current over a wider range.

color display panel and the monochrome version:

- The walls of the gas-filled cells are coated with a phosphor that is sensitive to ultraviolet light.
- The control circuits include a variable current source for the cell current.
- The front glass cover is translucent not transparent.
- The cover has an opaque black coating covering its entire rear surface, except for circular areas directly in front of the discharge cells.

When the discharge in the cells contains a large ultraviolet component, the phosphor emits visible light that can be one of several colors—green, in the phosphor chosen for the prototype. The variable current source permits the color also to be varied continuously from green to red. And the translucency of the front cover, plus the opaque black coating, overcome a variation in color that otherwise would occur when the panel is viewed from different angles.

If the front cover were transparent, as in the basic panel, a low-intensity red discharge would be visible at the rear of every cell, when that cell is discharging in the green mode. This discharge alters the color of the phosphor glow. Further, a parallax effect makes it visible only to an observer directly in front of the panel; as he moves to one side, it disappears, just as the water at the bottom of a well is visible to someone looking directly into the well but not to one seeing only the top opening of the well from one side. Thus the color of the glowing phosphor, if viewed through a clear front panel, would seem purer from an angle than from directly in front.

The translucency of the front cover diffuses the light from the low-intensity red discharge at the rear of the cell throughout all the light from the phosphor; and the black coating makes the angled view, seen only through the uncoated areas over the cells, seem the same color.

In a monochrome panel, most of the ways of achieving a color, other than the familiar red-orange of neon and neon-based mixtures, involve coating the cell walls

with one of several different kinds of phosphors and using a gas that emits mainly ultraviolet light when excited. Then colors can be varied to a degree if filters are placed in front of the panel. But they cannot be varied continuously over any range, and the variation cannot be controlled electronically. Also, since the gas mixtures that emit strongly in the ultraviolet part of the spectrum and weakly in the visible part generally have higher breakdown voltages than mixtures containing neon, they need costlier driving circuits than neon displays.

A more versatile and less expensive approach takes advantage of neon's dual discharge, in both the ultraviolet and visible ranges. In the multicolor Self-Scan, the cell walls in the panel are coated with a zinc orthosilicate phosphor, which emits green light under ultraviolet rays. The total emission, shown in Fig. 1, includes a broad continuous band, with a peak intensity at 5,240 angstroms, from the phosphor, and many individual emission lines, between 5,800 and 6,400Å, from the neon. At low current levels, enough ultraviolet light is emitted to saturate the phosphor, producing a green color. (The diagram doesn't show the wavelengths of the ultraviolet emission, which haven't been definitely determined but are most likely either or both of the bands between 1,192 and 1,470Å or 2,947 and 3,595Å.)

**Color change.** As current increases, the visible neon emission becomes stronger. First the strong line at 5,850Å, corresponding to yellow, becomes intense enough to override the green light from the phosphor; then, at higher currents, the longer wavelengths at the red end of the spectrum become noticeable. Meanwhile, because of saturation, the output from the phosphor increases hardly at all, even though the ultraviolet bombardment of it increases just as the yellow and red does.

This variation is illustrated in the graph in Fig. 2. The intensity of the light emitted by the neon is a nearly linear function of the anode current, and at low current levels is less than that of the phosphor. However, the

## Self-scanning basics

Built round a unique glow scanning process, the Self-Scan panel display shows alphanumeric in a 5-by-7 dot-matrix array of gas-filled cells with only about a tenth of the drive and addressing circuitry that a nonscanning device would require. And the panel is only 1/4 inches deep [*Electronics*, March 2, 1970, p. 120].

The exploded sectional view shows the panel's construction. Scan anodes, cathode conductors, display cavities, and display anodes are all sandwiched between a front and rear glass cover, and hermetically sealed in a common envelope, which is filled with a neon-based gas mixture at low pressure.

In operation, the glow starts at the reset cathode at one end of the display, producing metastables, or neon atoms raised to an energy level that's not quite enough to ionize them. These atoms diffuse along the grooves in the rear glass cover which lie at right angles to the cathode conductors and in which the scan anodes lie. On the way they collide with atoms of the trace gases in the mixture, ionizing them and producing free electrons that are accelerated by any electric field present in the gas. As the electrons accelerate, they collide with other atoms, producing more ions in an avalanche effect. Finally, ions capture these electrons and return to their low-energy states. The energy released by this return is radiated, in the case of neon, in the form of ultraviolet and visible light. (Note, however, that this light occurs at the rear of the panel and is visible only as a matrix of pinpoints from the front.)

A three-phase clock times the passage of the metastables along the scan anode grooves. Clock phase 1 is connected to cathodes 1, 4, 7, 10 etc., phase 2 to cathodes 2, 5, 8, 11 etc., and phase 3 to cathodes 3, 6, 9, 12, etc., down the panel.

After the reset pulse, the metastables have drifted only as far as cathode 1, so clock phase 1 initiates a discharge at this cathode and not at 4, 7, or 10. New metastables generated by the discharge diffuse further along the grooves, so that by the time of clock phase 2 another discharge is triggered at cathode 2 (and not at cathodes 5, 8, 11, etc.). The same phenomenon is repeated during phase 3.

Then phase 1 returns—but this time it triggers a discharge only at cathode 4, which has received metastables from cathode 3, but no discharge at cathode 1, which is too far from cathode 3 to have received new metastables. In

this way the glow propagates along the entire length of the panel, at the rear of each cathode, at a rate of approximately 70 scans per second. Metastables that permit the reset cathode to discharge diffuse from two pairs of electrodes called the keep-alive anode and cathode, at which a continuous discharge is maintained. The process is roughly analogous to the scanning of a CRT if the entire face of the tube could be scanned in a single sweep.

Meanwhile, some metastables also diffuse through the small apertures in the cathodes toward the front of the display and prime the gas in the display cavities. To produce visible dots at the viewing surface, the appropriate display anodes are addressed in time with the glow scan, and cause a gas discharge in that row of display cavities which is primed. During one complete glow scan down the rear of the panel, each dot in the desired message is illuminated on the display side of the panel. Successive scans light up and extinguish the dots fast enough for the display not to seem to flicker to the human eye.

Because the characters are displayed as a 5-by-7-dot matrix, there are seven scanning anodes and seven display anodes (corresponding to the seven rows of dots) and five cathode conductors per character (corresponding to the five columns of dots) plus two more cathodes for the space between characters. Thus in a 16-character display there are 111 cathodes—seven for each of the 16 characters, less two (because there is no need for cathodes "between" the last character and the nonexistent 17th position), plus one (the reset cathode).

The scanning is controlled by two flip-flops connected as a ring counter, shown below. To start the scan, the reset input sets both flip-flops to the logic 1 state; this turns on transistor  $Q_{(R)}$ , through which the reset cathode is grounded, initiating a discharge at that point. Clock pulses then advance the flip-flops through the cycle of three phases—they are connected so as to bypass the fourth phase that would occur in straight binary operation and correspond to a new reset pulse. The reset pulse, externally controlled, occurs only at the end of one scan, to initiate the next.

A character generator controls the levels of the display anodes synchronously with the clocking of the scan. Data to be displayed is stored in a buffer memory and read out through the character generator as the scan proceeds.

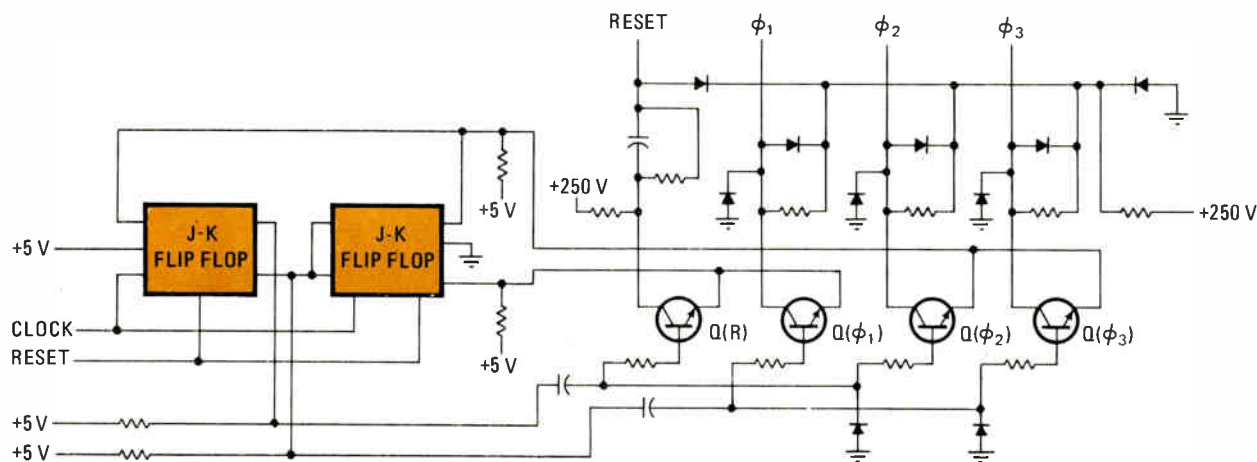

**Ring counter.** These two flip-flops generate the three-phase clock signal that controls the scanning of the discharge along the display. Their interconnections bypass the fourth phase of straight binary operation, corresponding to the reset pulse.

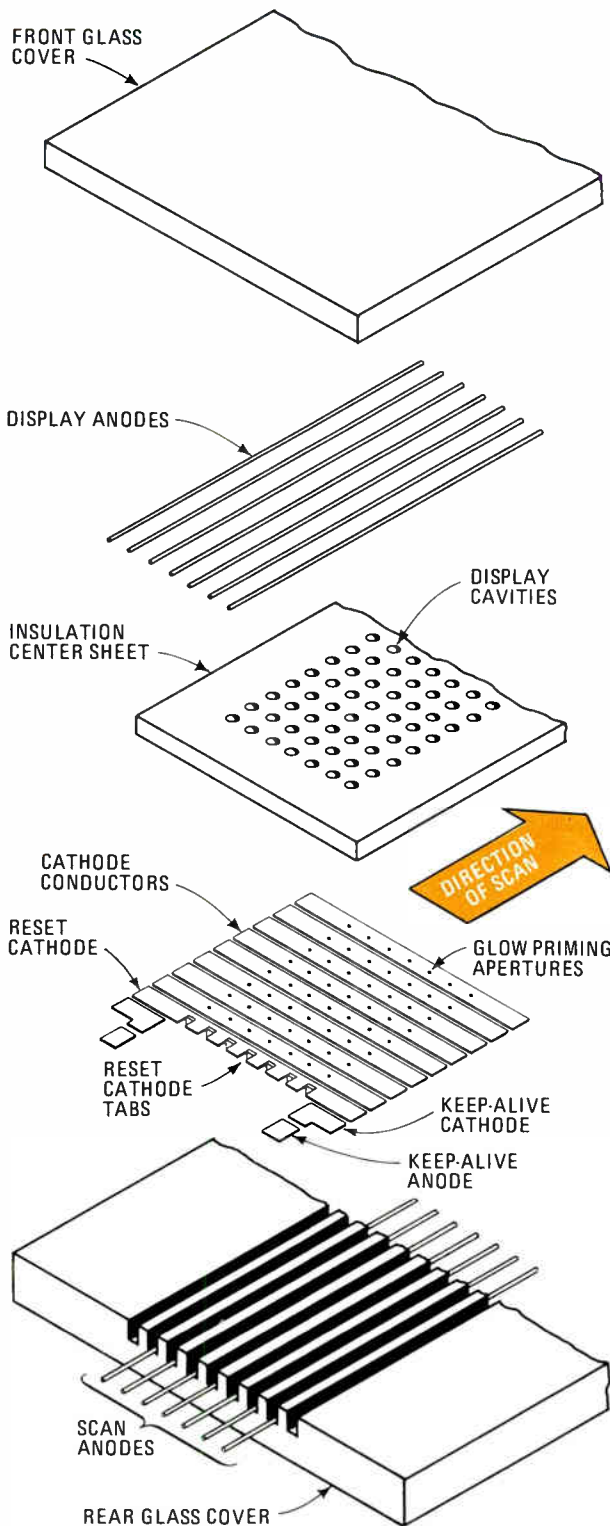

**Club sandwich.** Cathode conductors and scan anodes, in the rear half of the display panel, generate ionic discharges that scan along the length of the panel. Metastables leak through the small holes in the cathodes into the display cavities, where, if an appropriate signal is present on the display anodes, they trigger discharges that are visible from the front of the display.

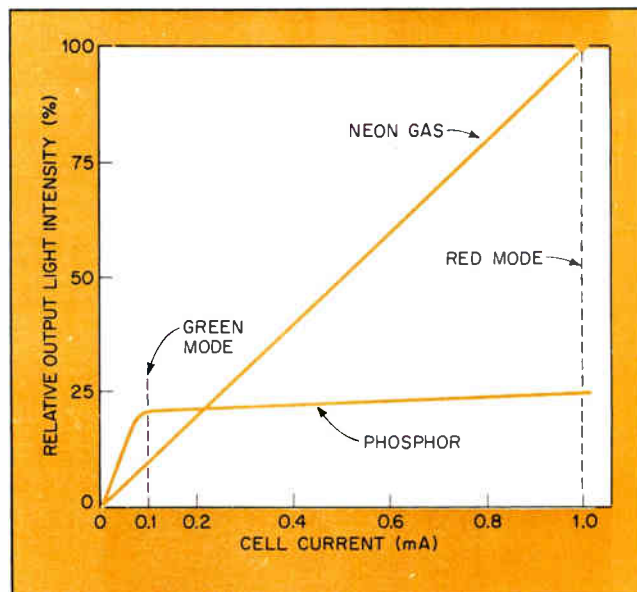

**3. Simple color change.** Cell color is a function of anode current, controlled by switching between external anode resistors.

phosphor saturates at only 0.1 milliamperes per cell, while the visible neon radiation increases past 1.0 mA. At this level, the measured light intensity from the neon is considerably greater than that from the phosphor. But since the human eye doesn't respond readily to changes in light energy and is less receptive to red light than to green, the two colors appear to be balanced.

Control of current magnitudes to produce red or green displays is quite simple, as Fig. 3's cutaway view of a single cell in the display panel shows. During one clock period, a particular cathode is grounded, and all seven scan cells associated with this cathode become ionized and begin to discharge. Metastable atoms of neon, generated in the ionic plasma, diffuse through the cathode aperture into the cell cavity, priming the display cell. When the primed cell discharges, with the switch on the 0.1-mA position, the small visible radiation from the neon is masked by the light from the phosphor, so that the output color is green. In the 1-mA position the luminosity of the neon dominates.

**Color control.** The prototype has only the two current magnitudes, but it would be very simple to add some resistors and switches to produce a stepped color change, or a potentiometer to produce a continuous variation.

Controlling the current to the anode has useful properties besides simplicity of color control. In the straightforward design, the information to be displayed determines which cells discharge and which remain dark, while a separate control determines the color of the discharging cells. More complex circuitry could display the desired information in one color and light up the background cells in a different, contrasting color.

Other color ranges can be obtained besides the red-green one by choosing the right phosphor coating material. And the phosphor coating process itself is so simple, and the means of current variation so inexpensive, that conceivably they could be applied routinely to all models in the line of Self-Scan panels, along with the translucent and black-coated front glass. □

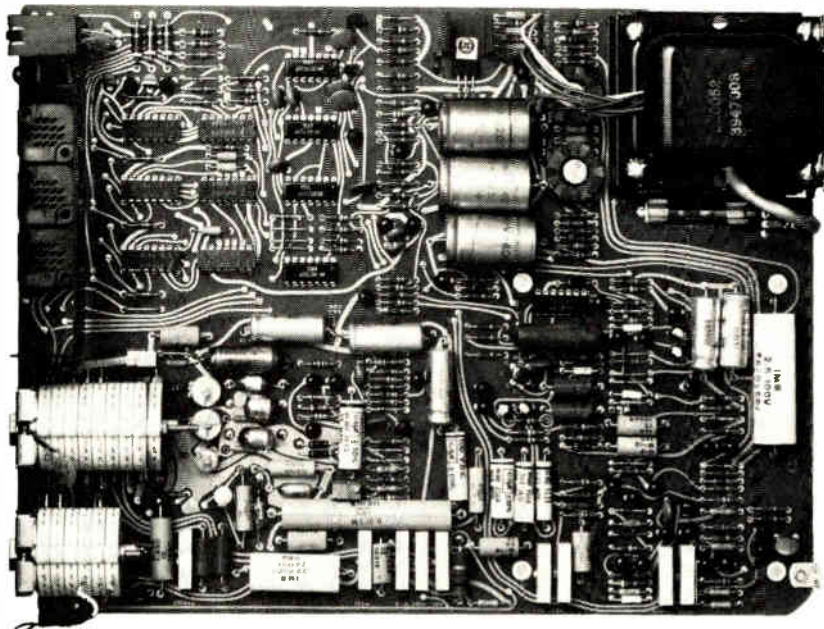

**This board contains over  
250 components.**

**Compatible FREON can  
economically clean the assembled  
board...residue-free.**

Put an end to costly piecemeal cleaning. FREON cleaning agents are compatible with most materials of construction, including polycarbonates. You can clean completely assembled boards without damage to substrates, components or markings. Remove all rosin-based flux and other contaminants at the same time. Get clean, dry, residue-free boards.

**Flux Removal.** A typical cycle for cleaning p.c. boards in a four-stage vapor defluxer is (1) gross removal of flux and contaminants in boiling FREON (below 118°F), (2) liquid rinse in FREON, (3) spray rinse, (4) final vapor-rinse in vapors of freshly distilled FREON.

**Low Solvent Replacement Cost.** FREON cleaning agents are constantly

recovered and purified for reuse. In a properly designed and operated defluxer, solvent losses are minimal.

**Purity.** FREON cleaning agents are electronic grade materials and chemically stable. No stabilizers or inhibitors are required.

**Safety.** FREON cleaning agents have a low order of toxicity. They are nonflammable and nonexplosive and do not require any special safety equipment.

**See what a difference a properly designed FREON cleaning system can make in your cleaning costs. Write for more information about FREON and cleaning and defluxing systems. Du Pont Company, Room 22448A, Wilmington, Del. 19898.**



**FREON**  
cleaning agents

FREON is Du Pont's registered trademark for its fluorocarbon cleaning agents.



# Designer's casebook

## Fast ECL-to-TTL interface shifts data for 80¢ per bit

by R.R. Osborn  
New York, N.Y.

A single integrated circuit, a few resistors, and one capacitor are all that's needed to build an ECL-to-TTL interface that operates at the speed of emitter-coupled logic—and total component cost is only about 80¢ per bit. Normally, converting the 0.8-volt swing of ECL to the 2-v swing needed for transistor-transistor logic requires at least four active devices for amplification and level shifting. Commercially available interfaces operate with a delay of about 19 nanoseconds and cost approximately \$1.60 per bit.

The circuit of (A) allows ECL to be used wherever its high-speed performance is most advantageous; the TTL takes over for all other functions where its low cost and ready availability are beneficial. The interface, which operates in the emitter-coupled mode, employs hot-carrier diodes  $D_1$  and  $D_2$  to prevent transistor saturation. This eliminates transistor storage time so that the circuit performs at ECL speed.

Transistors  $Q_1$  and  $Q_2$  act as switches, while  $Q_3$  is a constant-current source. With a high ECL signal present,  $Q_1$  is on and  $Q_2$  is off. The constant current from  $Q_3$  is directed to ground by  $Q_1$ , and resistor  $R_1$  pulls  $Q_2$ 's collector to the supply potential (5 v in this case).

When a low ECL input is applied,  $Q_1$  turns off and  $Q_2$  turns on.  $Q_2$  then switches the constant current to  $R_1$  and the TTL gate. Diode  $D_1$  prevents  $Q_2$  from saturating by clamping the collector to  $-0.7$  v. ( $D_1$  can be eliminated if the TTL gate has an input clamping diode.)

The operation of the right-hand side of the circuit is

**Logic shifting.** Circuit (A) translates 0.8-volt ECL data to 2-V TTL data at the speed of ECL.  $Q_1$  and  $Q_2$  switch constant current of  $Q_3$ . With  $Q_1$  off,  $Q_2$  switches  $Q_3$ 's current to  $R_1$  and the TTL gate.  $Q_2$  cannot saturate because of  $D_1$  clamp, thus eliminating transistor storage time and increasing operating speed. Interface (B) offers alternate supply arrangement. Circuits (C), (D) and (E) are TTL-to-ECL interfaces.

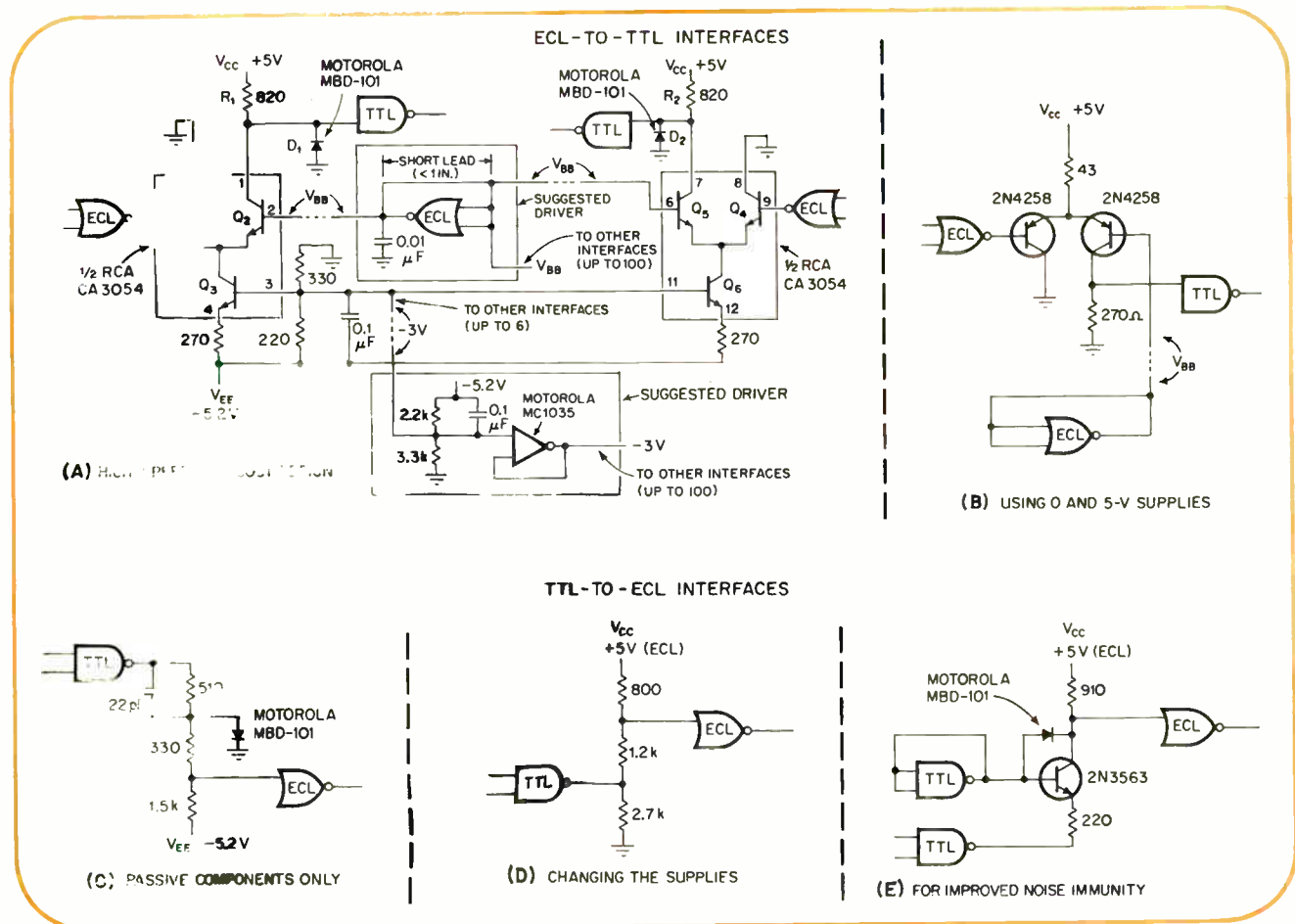

identical. With a high ECL input,  $Q_4$  conducts,  $Q_5$  is off with its collector tied to 5 v through  $R_2$ , and  $Q_6$ 's constant current is grounded. With a low ECL signal present,  $Q_4$  switches off, and  $Q_5$  carries the constant current of  $Q_6$  to  $R_2$  and the TTL gate. Diode  $D_2$  stops  $Q_5$  from going into saturation.

Two recommended driver configurations also are illustrated. Each one can be used for as many as 100 additional interface circuits. Therefore, the number of ECL-to-TTL conversions easily can be extended to 100 data bits.

Usually, an ECL gate is powered with supply voltages of  $V_{EE} = -5.2$  v and  $V_{CC} = 0$  v. If it is necessary to use  $V_{EE} = 0$  v and  $V_{CC} = 5$  v, the interface of (B) can be employed, though two precautions must be observed: the ECL gate must be carefully decoupled from any TTL noise on the 5-v power line, and the  $V_{CC}$  supply must be

a low-impedance quiet source to counter a 0-decibel noise rejection from the positive supply to the logic outputs.

Diagrams (C), (D) and (E) show suggested TTL-to-ECL interfaces. Circuit (C) uses only passive components; its 22-picofarad capacitor can be omitted if stray capacitance is low or if high speed is not essential. The diode provides a 0.7-v reference when the TTL input is high.

Both (D) and (E) employ a 5-v supply as the  $V_{CC}$  voltage for the ECL gate. Circuit (E) is recommended for improved noise-immunity performance due to the high collector impedance of the transistor, which functions as a ground-base amplifier. The TTL gate that is coupled back on itself provides a TTL threshold level. As with circuit (A), the hot-carrier diode prevents the transistor from saturating, thereby improving speed.

## Tunable active filter maintains constant Q

by Roger Melen  
Stanford University, Palo Alto, Calif.

With a potentiometer at each end of a three-stage, state-variable filter's middle section, the resonant frequency of the circuit can be tuned without significantly altering circuit Q. The active bandpass filter shown has a Q of about 30 and a resonant frequency that can range from 150 to 1,500 hertz with a Q variation of less than 5%.

Leaving the dual potentiometer aside simplifies calculating the filter's resonant frequency ( $f_0$ ) and bandwidth (B):

$$f_0 = \frac{1}{2} \pi R_1 C_1 = \frac{1}{2} \pi R_2 C_2$$

$$\text{and } B = \frac{1}{2} \pi R_3 C_1$$

where  $R_1 = R_2$ , and  $C_1 = C_2$ . The gain (A) and Q of the filter are equal since  $Q = f_0/B$ :

$$A = Q = R_3/R$$

where  $R = R_1 = R_2$ .

Putting the potentiometer in the circuit just adds a voltage divider that decreases current flow through  $R_1$ ,  $R_2$ , and  $R_3$ . The smaller current causes an apparent simultaneous increase in the values of these resistors.

As the potentiometer setting is varied, both the filter bandwidth and resonant frequency are tuned. However, circuit Q remains approximately constant because both R and  $R_3$  change in the same direction and with the same proportional magnitude.

The filter's operating frequency range can be shifted by changing the capacitors. The tunable bandwidth, however, will not be appreciably altered unless the potentiometer and the two 10-ohm resistors also are different. Uses include signal recovery tasks.

**Potting down Q.** Depending on setting of dual potentiometer, tunable filter can resonate anywhere within a frequency decade (from 150 to 1,500 hertz) with little change in circuit Q or gain. Potentiometer divides interstage voltage so that current through  $R_1$ ,  $R_2$  and  $R_3$  drops, simulating proportionate resistance increases. Resonant frequency shifts but Q remains constant (less than 5% variation).

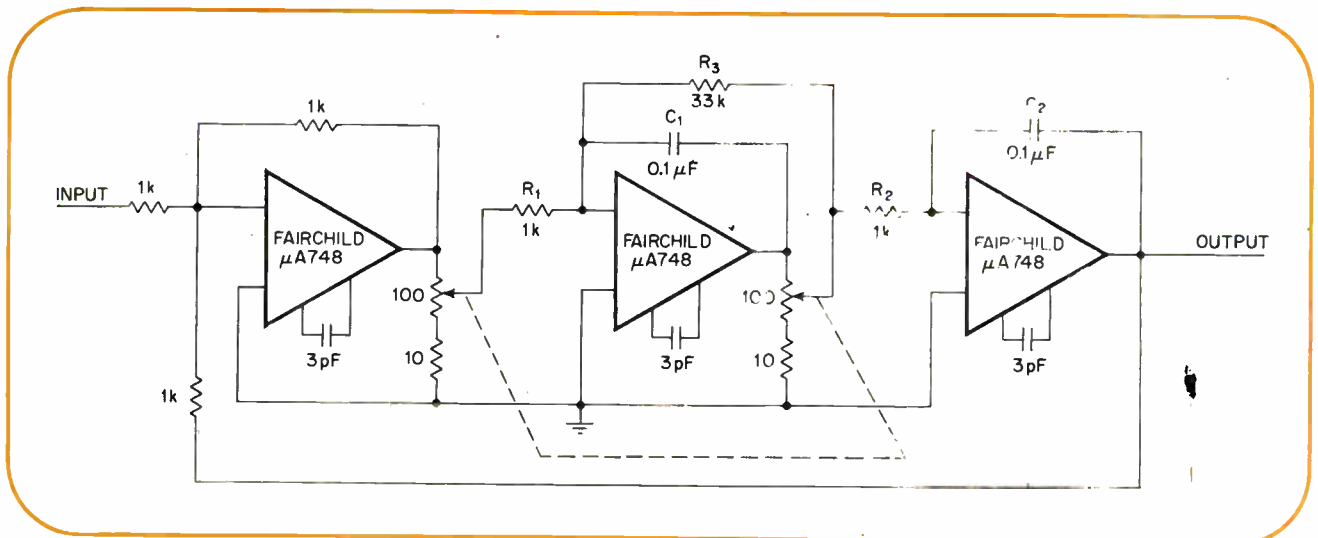

# Detector measures phase over full 360° range

by Charles A. Herbst  
Fort Lee, N.J.

Because it halves the phase difference between two input signals, a digital differential phase meter can perform measurements over a full 360° range. Moreover, the circuit is easy to build and calibrate.

The circuit detects the average phase (time) difference between any two sine, square, triangle, or pulse inputs with the same frequency. It can handle frequencies from 100 hertz to beyond 1 megahertz over an amplitude range of about 0.5 to 10 volts peak-to-peak. Total parts cost is low since only five IC packages are needed.

One input signal,  $e_a$ , acts as a reference, while the other,  $e_b$ , is the test signal from the network under measurement. Both signals are clipped and squared by comparators  $A_1$  and  $A_2$ , resulting in logic-level pulses that are buffered and inverted before being applied to flip-flops  $FF_1$  and  $FF_2$ .

The flip-flops perform as binary counters, dividing the input frequency by two so that the phase difference

between  $e_a$  and  $e_b$ , also is divided by two. This division extends the measurement range of the circuit from 180° to 360° (since the four-gate exclusive-OR phase comparator sees 90° rather than 180°, or 45° instead of 90°).

Any phase difference between the outputs of  $FF_1$  and  $FF_2$  is converted into a train of width-modulated pulses by the digital phase comparator. These pulses then are time-averaged into an analog current by the low-pass filtering action of the meter circuit. The value of the analog current represents the phase difference between  $e_a$  and  $e_b$ .

With a divide-by-two counter, the circuit can measure phase differences up to 360°. Using a divide-by-four counter would extend the circuit's measuring range to 720°, but at the expense of resolution and accuracy.

The offset switch,  $S_1$ , creates a midscale zero-phase position on the meter so that the initial direction of the relative phase shift of the network under test can be determined. The calibration switch,  $S_2$ , sets the flip-flops to zero and applies noncoincident inputs to the exclusive-OR phase detector during a full-scale meter calibration check.

This digital phase meter uses TTL integrated circuits: two type 710 comparators, two type 7400 NAND gate packages, and one Texas Instruments SN7473 dual flip-flop. The circuit also employs an ammeter with a full-scale deflection of 100 microamperes.

**Measuring phase.** Comparators  $A_1$  and  $A_2$  clip and square inputs  $e_a$  and  $e_b$ . After being buffered and inverted, the signals then are halved by flip-flops  $FF_1$  and  $FF_2$ . Dividing signals by two also divides their phase difference, extending range of circuit (A) from 180° to 360°. Four-gate exclusive-OR phase comparator modulates pulses, which then are filtered for analog output (B) to deflect meter.

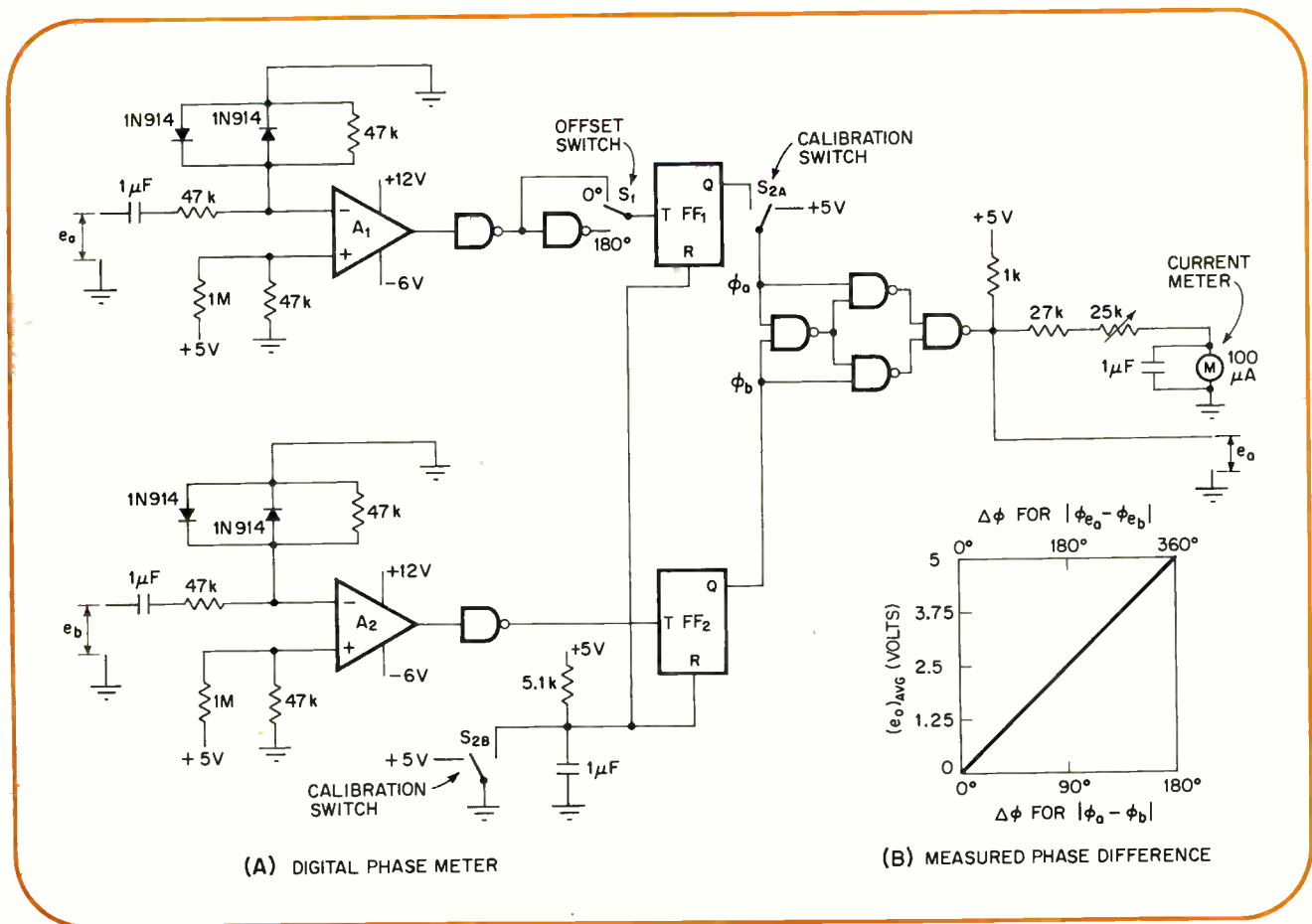

# Counting by halves simplifies odd-order symmetric counter

by Edward J. Murray  
Philco-Ford Corp., Willow Grove, Pa.

Odd-order countdown chains (such as divide-by-three and divide-by-five schemes) frequently involve intricate designs because there are no readily available devices. Using logic propagation delay and feedback to produce half-counts solves the problem. If the output of an  $n + 1$  counter (where  $n$  is odd) is fed back to either the input clock or its inverse, the counter can move half a clock phase during each transition of its output flip-flop. The resultant circuit output is an  $(n + 1) - 1 = n$  count that is symmetric.

For example, a symmetric divide-by-three counter (A) can be realized with two flip-flops connected as a simple divide-by-four counter. Both outputs of the last flip-flop are fed back to select the appropriate clock phase. The configuration actually consists of a divide-by-1.5 stage followed by a divide-by-two stage, thus producing a symmetric divide-by-three counter.

The  $Q_1$  output of  $FF_1$  provides the unsymmetric di-

vide-by-1.5 count, which is used to toggle  $FF_2$ . The  $Q_2$  output of  $FF_2$  supplies both the symmetric divide-by-three count and the gating needed to determine what clock phase will be used. When  $FF_2$  changes state, clock phase also changes.

The very narrow (less than 100-nanosecond) pulses present in the trigger signal  $T_1$ , are due to logic propagation delay. The first positive clock transition after time  $t_1$ , causes  $Q_1$  to go high and  $Q_2$  to go low so that the input clock toggles  $FF_1$  directly. Each transition of  $FF_2$  produces a phase change at the toggle of  $FF_1$ , causing spikes due to signal delay through the flip-flops.

A symmetric divide-by-five counter (B) from a divide-by-six configuration operates similarly. Further extensions of the basic circuit principle also are possible. The logic modules used are made by Texas Instruments.

Applications for an odd symmetric counter include deriving a square wave from a master clock, full-duplex modems, multiplexers, special-purpose processors, multifrequency wave generators, and center-sampling systems. In general, these counters can be used whenever a square wave is needed for time-sharing equipment or for split-phase operations that must be synchronized to a variable master clock.

Designer's casebook is a regular feature in Electronics. We invite readers to submit original and unpublished circuit ideas and solutions to design problems. Explain briefly but thoroughly the circuit's operating principle and purpose. We'll pay \$50 for each item published.

**Countdown.** Transitions of last flip-flop change phase (by half counts) of input clock, which controls toggle of previous flip-flop(s). Output of odd-order countdown scheme is symmetric square wave because final stage "divides evenly." Divide-by-three counter (A) can be extended into divide-by-five configuration (B) by adding another flip-flop and appropriate toggle controls.

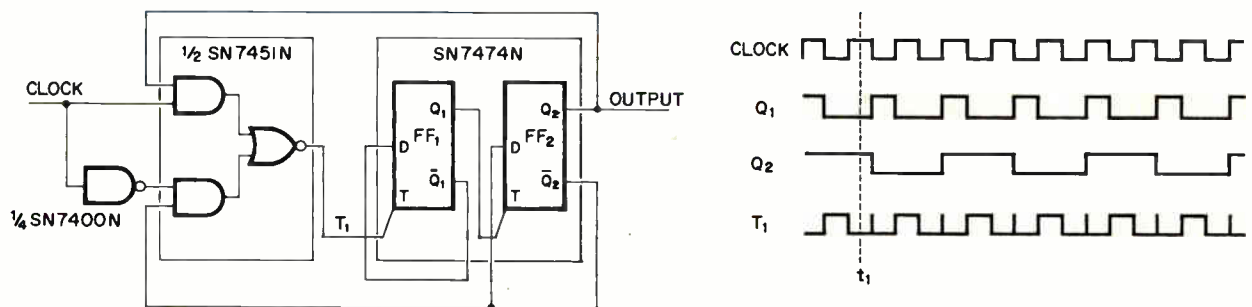

(A) DIVIDE - BY - THREE COUNTER

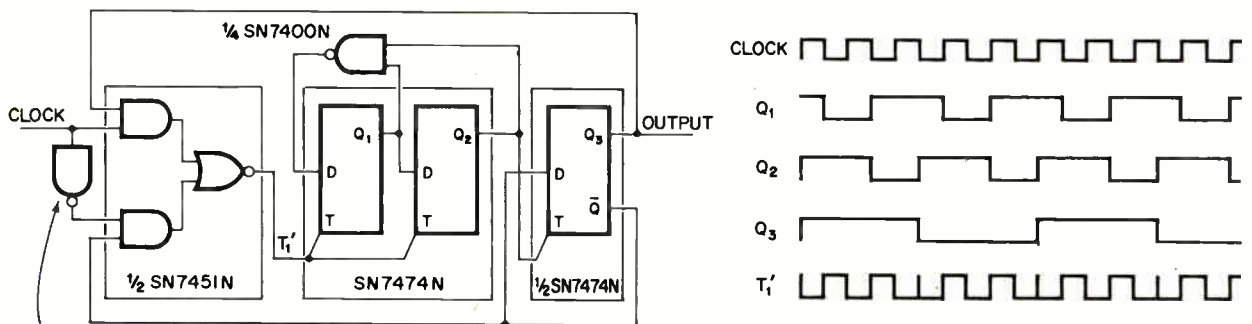

(B) DIVIDE - BY - FIVE COUNTER

# ANYONE IN THE FIELD CAN MAKE ALTERATIONS IN MINUTES WITH LOW COST DATAPAC ROMS

Datapac Read-Only Memory Systems are unique in their design to let you easily change individual bits, words or an entire memory in the field. Datapac ROMs are available in a wide choice of models, sizes and configurations. Capacities from 1K to 1 Megabit. Word lengths to 80 bits. Speeds as fast as 200 Nsec Cycle and 75 Nsec Access. Off the shelf delivery — 50,000 hrs. MTBF. Mil Spec compatible. And 1.5¢ per bit. Write today for our FREE brochure containing the complete Datapac story.



**DATAPAC INCORPORATED**

3839 S. Main St., Santa Ana, Calif. 92702, Tel. (714) 546-7781  
Circle 75 on reader service card

**"#1 in the field"**

# Coming up fast from behind—denser bipolar devices

Because it's now possible to diffuse very thin epitaxial layers, and because new methods of isolating transistors have been developed, bipolar ICs today can achieve MOS component densities

by John A. DeFalco, Honeywell Information Systems Inc., Framingham, Mass.

□ Better techniques for isolating bipolar transistors are being developed that result in denser, easier to build, and therefore cheaper integrated circuits. They not only open up the possibility of bipolar large-scale integration, but also pose a very real threat to MOS technology: 1,000- and 2,000-bit bipolar memories suitable for large computer mainframes are already in the works at several semiconductor laboratories.

The processes include: collector and base diffusion isolation methods, developed at Bell Laboratories and further investigated at IBM; the Trimask structure developed at Bell; the Isoplanar process developed at Fairchild, and the V-ATE process recently announced by Raytheon [*Electronics*, June 7, p. 35].

**Standard buried collector.** A look at the limitations of the old bipolar devices, which have changed very little since being introduced in the early 1960s, will yield greater understanding of the evolution and ingenuity of the new bipolar techniques.

The traditional structure, shown in cross section in Fig. 1, has an n+ buried collector diffused into a p-type substrate, and is commonly called the standard buried collector (SBC). The collector is made of a low-resistivity material, which provides low-saturation resistance, and takes the form of an n-type epitaxial layer. To isolate the various transistors, p-type material is diffused through this epitaxial layer at the transition boundaries, and makes contact with the p substrate.

In the SBC structure, the substrate and the p-type isolation diffusion form a diode with the n-type collector that is always reverse-biased, since the p substrate side is connected to the most negative circuit potential. The base diffusion is p-type while the emitters are n+. The same n+ diffusion also provides ohmic contacts to the device collector.

This simple structure has served the semiconductor industry well for ten years. And while this longevity is a testimonial to its success, the limitations of this early device restrict its utility for new designs.

Its worst drawback is the inherent parasitic capacitance between each transistor's collector and ground. This capacitance is a result of the p-n junction isolation, which has a capacitance associated with the reverse-biased junction. The size of this capacitor depends on several factors:

▪ The resistivity of the material used, which is a function of the device's requirements in the way of junction

breakdown voltages and current-carrying capability.

▪ The thickness of the epitaxial layer, which is a function of manufacturing capabilities and required junction breakdown voltages.

▪ The area of the transistor's collector, which derives largely from the current-carrying capability required of the device.

Obviously, the transistor can switch only as fast as this stray capacitance can be charged and discharged, and this fixes the speed-power product of the device for any given current and voltage.

Another basic limitation of the SBC process results from the fact that all diffusions are three-dimensional, and spread outward as far as they spread downward. To allow for this outdiffusion, additional space must be provided between the emitters, collectors and bases. In the case of the isolation diffusion, the outdiffusion sideways is almost equal to the epitaxial thickness, and allowance for it must be made in laying out an integrated circuit. The result is that the transistors become uneconomically large for complex circuits.

The epitaxial layer in the SBC process is crucial for determining device speed and component density. The thinner it is, the less the collector-substrate capacitance, and the faster the device speed for a given drive power. Conversely, to maintain a given speed the power may be reduced. Again, the thinner the epitaxial layer, the less the outdiffusion, and the more the component density can be increased. And while the junction breakdown levels do fall off with shallower diffusions, they are still compatible with the range of digital circuit applications.

Epitaxial thicknesses in the range of 7 to 10 microns are typical for SBC processing. If these thicknesses are reduced to 1 to 3 microns, other circuit advantages occur in addition to smaller stray capacitances and greater component density. For one, when transistors are formed in shallow epitaxial layers their inverse gain ( $\alpha$ ) increases.<sup>1</sup> This inverse gain is the current gain when collector and emitter are interchanged (that is, the collector base junction is forward-biased and the emitter-base junction is reverse-biased). The increase in gain occurs because of the greater proximity of the buried collector to the base region, which improves the injection efficiency of the buried collector when it is biased as an emitter.

This high gain can be used to reduce the transistor

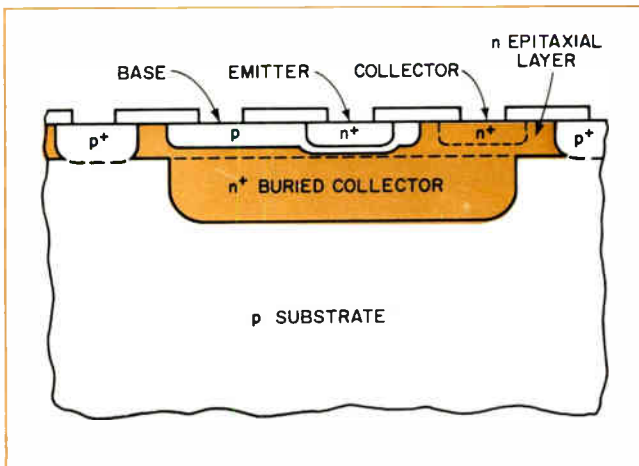

**1. The old way.** The standard buried collector (SBC), although the backbone of bipolar device construction, isn't perfect: parasitic capacitance appearing at each transistor's collector to ground limits operating speed. Also, isolation diffusions give large devices.

storage time if the basic circuit shown on Fig. 2(a) is used. For devices with an  $\alpha^{2\infty 1}$  of about 0.8, the result is a 30% to 40% reduction in storage time.

This high inverse gain makes additional circuits possible—for example, the emitter follower driver shown in Fig. 2(b). It's a simple means of obtaining an active TTL load in which the inverse current flowing from  $R_2$  to  $E_2$  is high enough to keep  $Q_2$  in the off position when  $Q_1$  is on. In addition, when  $Q_1$  is off,  $Q_2$  can function as an emitter follower driver. Another example is the TTL circuit, shown in Fig. 2(c), which has an increased noise immunity by virtue of hysteresis.

Experimental gates built by Bell Labs using shallow epitaxial layers of 2- to 3- $\mu$  manufacturing tolerances and 1- $\mu$  epitaxial thickness have achieved propagation delays of 5 nanoseconds at 1-milliwatt power dissipation using a 1.5-v supply. And some of the work in shallow epitaxial structures has gone beyond the experi-

mental stage, since Motorola and Signetics have each recently announced availability of 10,000 Series emitter-coupled logic families with 3- $\mu$  epitaxial layers, that achieve 2-ns delays at 25-mw power dissipation.

**Collector diffusion isolation.** The ability to grow shallow epitaxial layers also enables designers to consider different techniques for providing device isolation, which will save considerable chip area into the bargain. One of these techniques, called collector diffusion isolation, is shown in Fig. 3.<sup>2</sup>

The first two process steps in CDI are similar to the standard buried collector process—an n+ buried layer is diffused into a high resistivity p-type substrate. At this point a shallow (1- to 2- $\mu$ ) p-type (instead of n-type) epitaxial layer is grown over the entire wafer surface. Then n-type collector contacts are selectively diffused through the p epitaxial layer to make contact with the buried layer along its periphery. An additional p-type base diffusion, requiring no masking, is the optional next stage in the process; it improves the quality of the transistors, but at the expense of a process addition. Finally, emitters are diffused, contact holes opened, and aluminum added.

As in the standard buried collector process, isolation in the collector diffusion method takes the form of a reverse-biased p-n junction, but here no actual isolation diffusion has been performed. Instead, the collector contact diffusion serves to accomplish the isolation, eliminating process steps and saving chip area.

The CDI process involves either one or two fewer steps, since no masks are required for isolation or base diffusions. Since masking operations account for most of an IC's cost, the CDI structure is cheaper than an SBC device of the same area. It has also been determined that CDI transistors have greater current-carrying capability than SBC devices of equal size, so that a device of minimum size may be almost always used.<sup>3</sup>

The small device size possible with the CDI process is exemplified by the gate shown in Fig. 2(d). It occupies

**2. The new way.** Thin epitaxial SBC process yields circuit advantages. In (a), a high  $\alpha$ , reduces transistor storage time. In (b), an active TTL load is obtained, and in (c), increased noise immunity results.

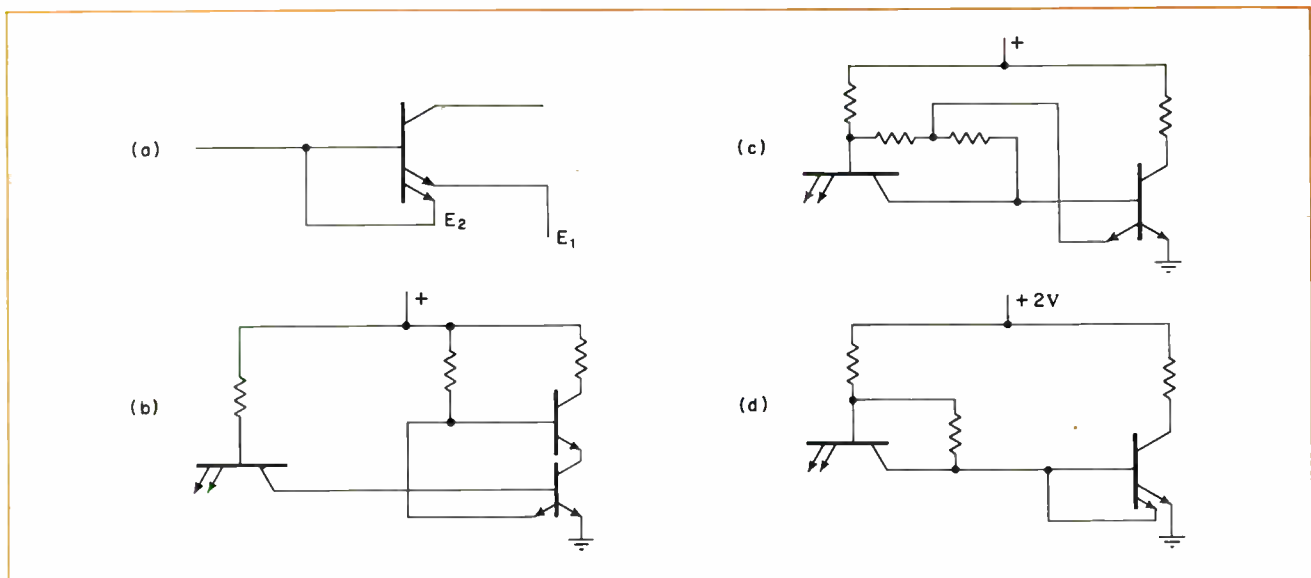

# New wiring and insertion methods cut costs of electronic production

Better and faster machines for automating the assembly of electronic equipment are now available that effectively counter rising labor costs; computers, too, are starting to speed up production rates

by Stephen E. Scrupski, *Packaging and Production Editor*

□ Integrated circuits have made it easy to build equipment—on paper. The trouble comes when the circuit and block diagrams must be converted into working hardware economically. Since an increasing share of the cost of producing electronic equipment in the United States is due to labor, automation, or at least mechanization, of assembly tasks is attracting more and more attention.

Equipment production actually has two stages—prototype and full production—and the role of automation is different at each stage. In building prototypes and early production models, the need is for fast but flexible methods of producing interconnections. Wrapped-wire connections to individual integrated circuits, after their insertion in sockets, have gained in usage over the past few years [*Electronics*, Aug. 31, 1970, p. 56]. Now newer methods of machine-controlled, point-to-point wiring are being introduced that may offer advantages over wrapped wire both when phasing a circuit board into production and later, when converting it into a multi-layer printed circuit board.

**1. Multiwire.** In the Photocircuits process, insulated wire is laid into adhesive on printed circuit board with a four-headed machine, which can simultaneously wire up to four boards measuring 15 by 20 inches. Control program is developed from engineer's wiring lists.

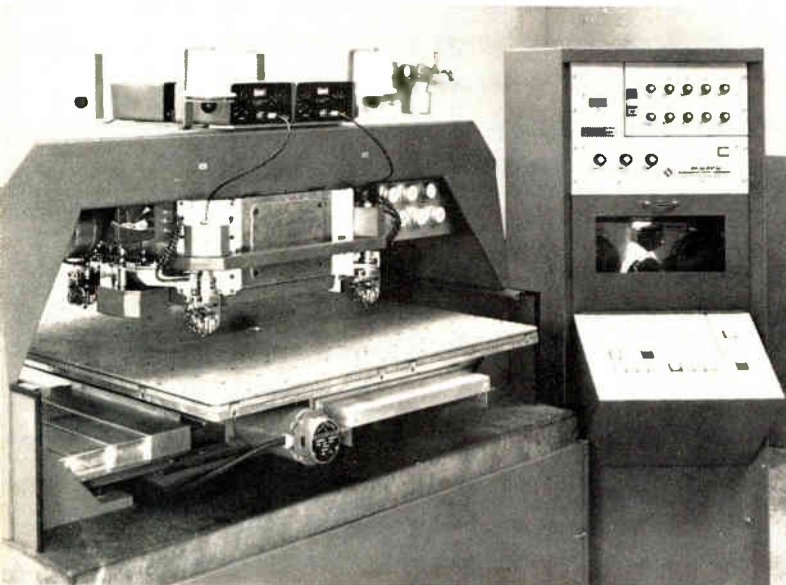

In full production, one of the major bottlenecks is getting all the components on the board in preparation for soldering. Here, new computer-controlled insertion machines are coming along that will speed production and lower costs.

Of course, there is nothing more automatic than etching out all interconnections at once on a printed circuit board. But once made, printed circuit boards cannot be redesigned, and a redesign, no matter how minor, means scrapping the board, remaking masks and producing new boards. However, changes can come about because the designer wants to take advantage of a newer integrated circuit that does more in the same space or simply because an error was found. Servicing and field changes to update equipment also are an important part of the economic picture, and some designers are even avoiding multilayer boards altogether in favor of fast changes in the field. It's to eliminate the waste of time and money involved in changing multilayer layouts early in the production process that equipment manufacturers resort to discrete wiring interconnection methods.

Three new methods of machine-controlled, point-to-point wiring not only do away with the need for the sockets that dual in-line packages require for wire-wrapping but, since no wrapped wire posts protrude, present the same low-profile packaging as the printed circuit board and so can be mounted as close to one another as pc boards can be. All three route insulated wire across the pc board in X-Y fashion, but there the resemblance between them ends. These three, along with two older methods of point-to-point wiring, are summarized on p. 85. The chart is based on a compilation made by Jack Staller, president of Microsystems Technology, Burlington, Mass., a manufacturer of computer-controlled, semi-automatic, wrapped wiring machines.

The first method—Multiwire, developed at Photocircuits division, Kollmorgen Corp., of Glen Cove, N.Y.—routes the wires by pressing them into an adhesive coating. Crossovers can be safely made because of the insulation on the wire. Wires are terminated in a plated-through hole made by drilling through the end of the wire while it's held in place and through the board, and then following up with the normal plating process. Instructions for X-Y routing are developed by means of software at Photocircuits that converts from-to wiring lists into a numerical control tape.



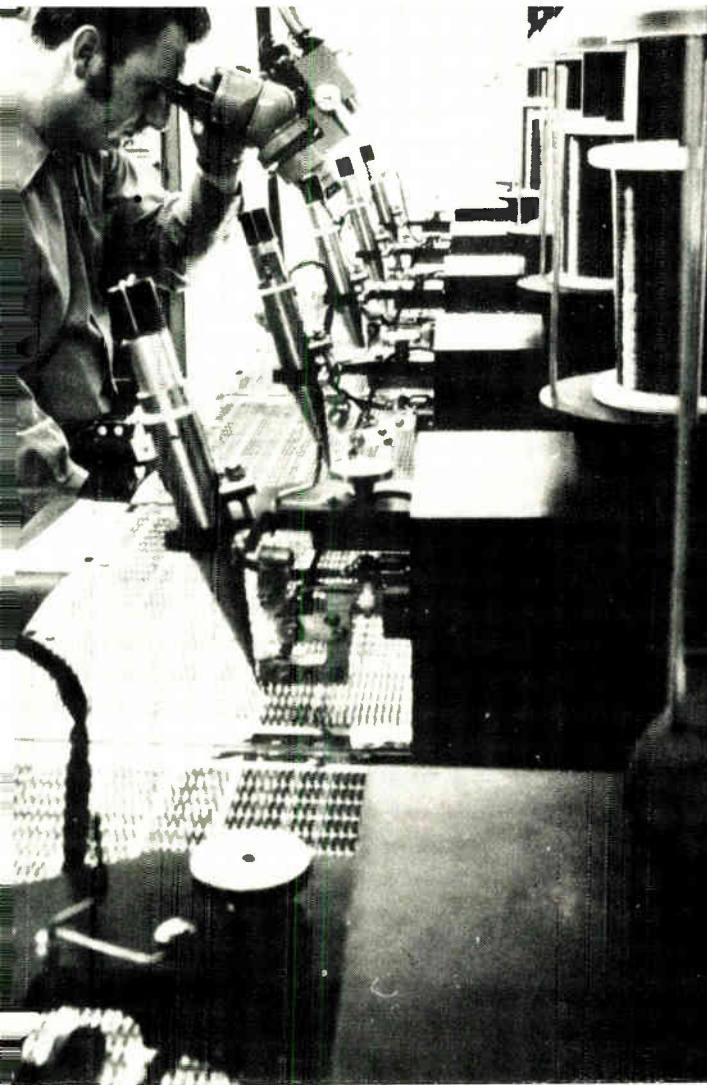

**2. Infobond.** Six-headed reflow soldering machine is operated from numerical control tape. Machine is in use at Inforex Inc. to wire circuit boards in production quantities. Operator monitors wiring process, and intervenes if automatic tests show bad solder joints.

A second method is being offered by two companies—Infobond Corp. of Burlington, Mass., and Weltek division, Wells Electronics, Inc. of South Bend, Ind. In this method terminations are made to solder-coated pads by heating the wire, burning off the insulation, and reflowing the solder to complete the connection. The wire is then tested for strength with a pull test, and also for electrical continuity. If it fails either test, the bonding head repeats the cycle.

A third method is called Stitch-wire by Accra-Point Arrays of Santa Ana, Calif., and Micropoint by Micro Technology of Westlake Village, Calif. It makes connections by welding, rather than soldering, directly through the insulation.

Multiwire is offered as a service by Photocircuits, and machines are not available for outside users. Photocircuits, a major printed circuit board maker, quotes the following cost comparisons between a 5-by-7-in. multilayer board with 30 dual in-line packages and its Multiwire counterpart. A two-sided board with plated-through holes would entail tooling costs (layout, master

artwork, reduction and drill tape preparation) of \$700. Unit board costs would range from \$70 each for only five boards to \$25 each for 25 boards. Total cost of five boards would therefore be \$1,050, while for 25 boards it would be \$1,325. Multiwire, on the other hand, would take a tooling cost of only \$322 while unit board costs would be \$62 for five boards and \$37 for 25 boards. Consequently, total costs would be \$632 for five boards and \$1,247 for 25 boards. The cost thus favors low-quantity use typical with prototypes.

Average delivery time would be cut in half with Multiwire—from the six to eight weeks for printed circuit boards to about three to four weeks for Multiwire. And changes can be made simply by changing the numerical control tape rather than re-making the artwork.

One user of Multiwire says it was this low-cost and fast-change capability that made him use it for his prototype and early production models. He also points out that Multiwire reduces debugging time. With boards wrapped with a hand-gun, he notes, there are as many sets of mistakes to be found as there are boards, so that each board must be debugged before the system can be completed. But with Multiwire, he says, all boards are identical, any error appears on every board, and correcting one board corrects them all.

He is also pleased with the close resemblance of Multiwire to the printed-circuit board format: plated-through holes are used for component mounting, and the board has the same low profile and thus can be mounted on the same spacing in the back plane or mother boards as can pc boards. The spacing of wires—25 mils—also is close to that on pc boards, giving greater assurance that the circuit will perform similarly when converted to pc board construction.

One potential Multiwire user, however, is concerned about the possibility of the wire's insulation breaking

**3. Close-up.** Infobond wires are routed in X-Y pattern on pc board and reflow-soldered to plated pads. Pads are linked to other side of board by plated-through holes. The narrow connection between hole and pad restricts flow of heat during later soldering of ICs.

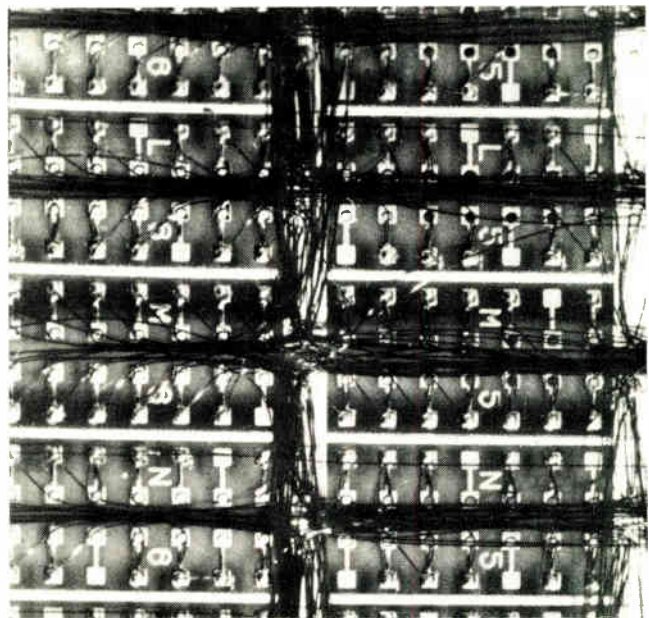

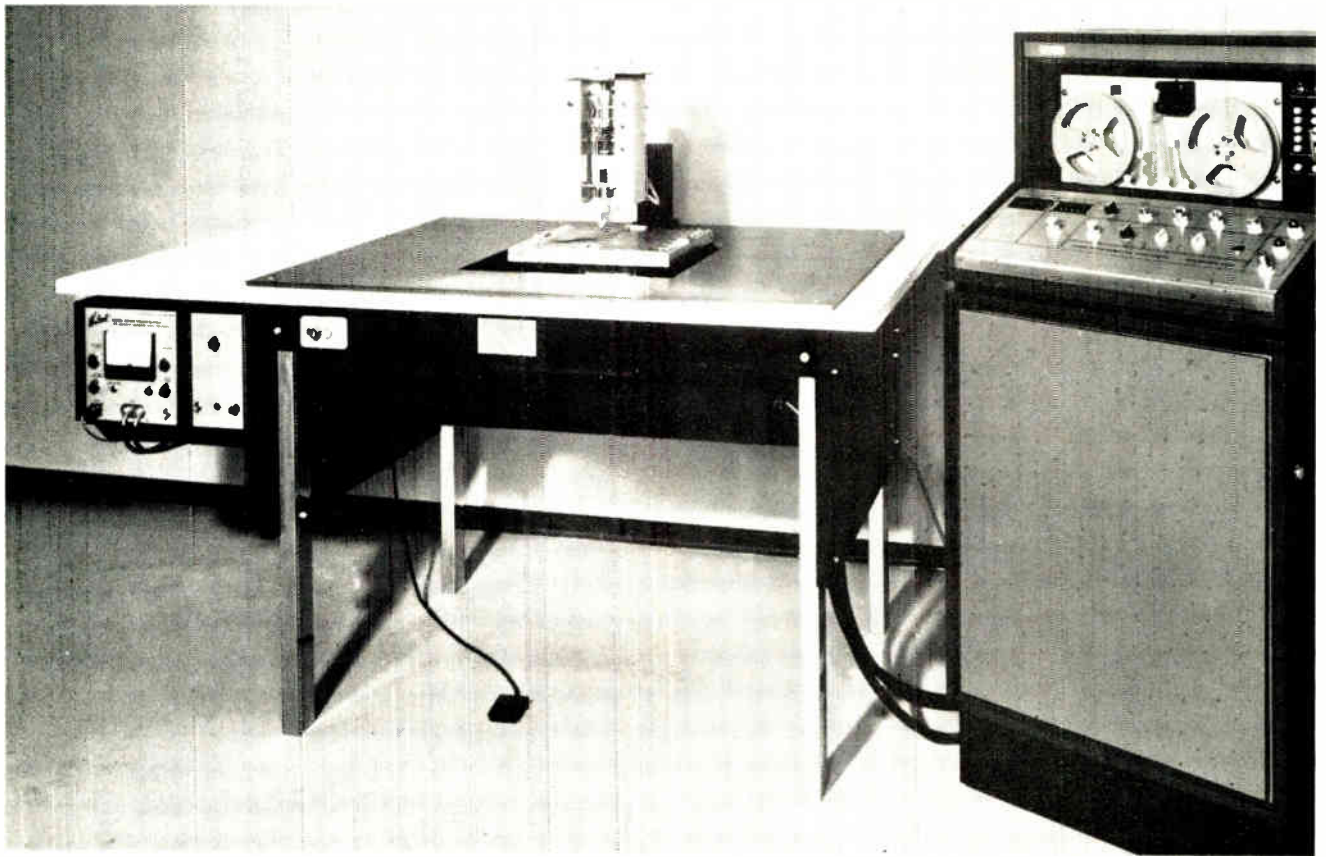

4. **Tiers.** Weltek's through-insulation electronic reflow system is operated from numerical control tape. Multiple-head versions can be built, too. This machine sells for \$29,500, although a manually operable version also is available for \$4,000.

down when it crosses either another wire or a previously applied etched copper lead on the board. While he hesitates, however, actual users say they haven't run into any problems of this kind.

Infobond was formed by Inforex Inc., Burlington, Mass., as a separate entity to offer the wiring service that Inforex uses in its own data entry equipment, but the machine may also be offered for sale soon. (Inforex' data entry system uses four to six 12-by-12-inch boards, holding 250 ICs each.) According to Robert Guidera, Infobond president, Inforex and IBM entered into a license agreement in May that permits IBM and its subsidiaries to use the process.

In the Infobond process, unlike Multiwire, the wires are not "glued" down, and their tendency to rise off the back surface of the board could create problems. Infobond says that the program can be ordered so that shorter wires are applied last, to hold down the longer runs that were applied earlier. However, Inforex uses covers on the backs of the boards, which prevent such problems and also add to the board's stiffness.

The process starts with a standard board with the ground and power connections already included as etched wiring. Plated-through holes link the component side of the board to the wiring side, on which there are pads plated with solder to receive the wire. Dual in-line packages are mounted by bending the leads into a dog-leg pattern and then soldering them. (Inforex uses a lead-forming machine to prepare the packages and a fixture for soldering—after the board has been wired,

the operator loads the DIPs into a frame, turns the frame over and places it on the board, and then with a flat-tipped soldering iron solders all leads on one side of a package simultaneously.)

Weltek's process is called Tiers, short for through-insulation electronic reflow system, and is handled by machines that are available to outside buyers. A numerically controlled single-head machine sells for \$29,500, a single-head lab model for slightly under \$4,000. Ray Larson, Weltek president, says that machines with four to six heads could sell in the \$40,000 to \$75,000 range, depending on the automatic options desired.

Larson characterizes Tiers as "not a panacea—an answer to all wrapped-wiring problems—it's merely a new process that would enable circuit people to reduce the size of back panels by a factor of 2:1 with a consequent savings in wire cost (sometimes a factor of 20:1) and savings in hardware." However, he adds, "the process does require compatible hardware and the full cooperation of the equipment user in designing his pc boards, pads, etc., so that they are fully compatible with the Tiers process."

One user of the Tiers soldering heads is Sycor, Ann Arbor, Mich., makers of computer peripherals. Sycor's director of manufacturing, William Ince, says that he has been using the machine to make magnetic read-only memories since June 1969, adding another six-head machine a year later. However, Ince says that Sycor hasn't yet applied the machines to IC interconnection or back panel wiring because they have

been preempted by the heavy ROM production schedule.

University Computing Corp., Dallas, Texas, is using a similar point-to-point reflow soldering machine to interconnect 160 DIPs, 80 on each board side, for use in its computer terminals. The boards measure 6½ by 9 inches. The company says the process costs 75% less than other point-to-point wiring methods and is even 35% less costly than printed circuit boards, considering that it allows engineering changes to be made in the field. As in Infobond, the DIPs are 14- and 16-lead devices, and are soldered to each side of the board after their leads have been bent to lie flat against the solder pads.

The Stitch-wire machine from Accra-Point Arrays (Apac) sells for about \$3,000 for a manual version and \$26,000 for an N/C version; Apac also offers a wiring service. Apac president H.V. Hilker says that he can get down to about 6.5 cents a wire, in quantity, whereas the lowest he has heard quoted for wrapped wire is about 7 cents a wire. The Stitch-wire system uses 30-gauge wire, and the weld offers a 5½-pound pull strength. Hilker says that the process is rugged and, because it can handle the DIP in several mounting configurations, it is more versatile than the others (even though it does require a special terminal for welding).

Micro Technology, a division of Sterling Scientific In-

dustries, also offers point-to-point wire-welding machines, but on a lease basis. Micro Technology will lease the machine for \$150 a month, plus a charge based on the number of terminations made per month. This charge could go as low as 1 cent in high-quantity usage, the company says. The machine is manual and could be run by an experienced operator at rates of 350 to 400 terminations an hour.

One user of the Micro Technology machine is Instruments Systems Corp., Huntington, N.Y., which has been using it for about eight months to build prototype boards for airborne applications. Gerome Pazer, ISC program manager, says that its main advantage is that the boards have the same densities as will result from the final multilayer pc boards. In addition, since the machines are in-house, he can turn around on a circuit layout in just a few hours. Overall, he claims he can cut three to four months off system development time.

Wrapped wire still is being used by many designers for the quick turnaround situations, and in the past year, there has been a rapid growth in the availability of wiring services. There are now four types of companies offering the services: large systems houses seeking contract wiring business to avoid idle machines; independent houses, who do contract wiring as their main business; manufacturers of the wrapping equipment, who, faced with a slowdown in sales of capital equipment,

**5. Memory maker.** Four-headed reflow-solder machine at Sycor, Inc., Ann Arbor, Mich., produces read-only memories based on magnetic E-cores. The machine uses Weltek heads and power supplies, plus an X-Y positioning system that is produced by Universal Instruments. Sycor added improvements to the cycling speed of the heads and also a broken-wire detection feature. The memories are used in the company's intelligent computer terminals, over 1,500 of which have been delivered. The memory board itself is shown in Fig. 6.

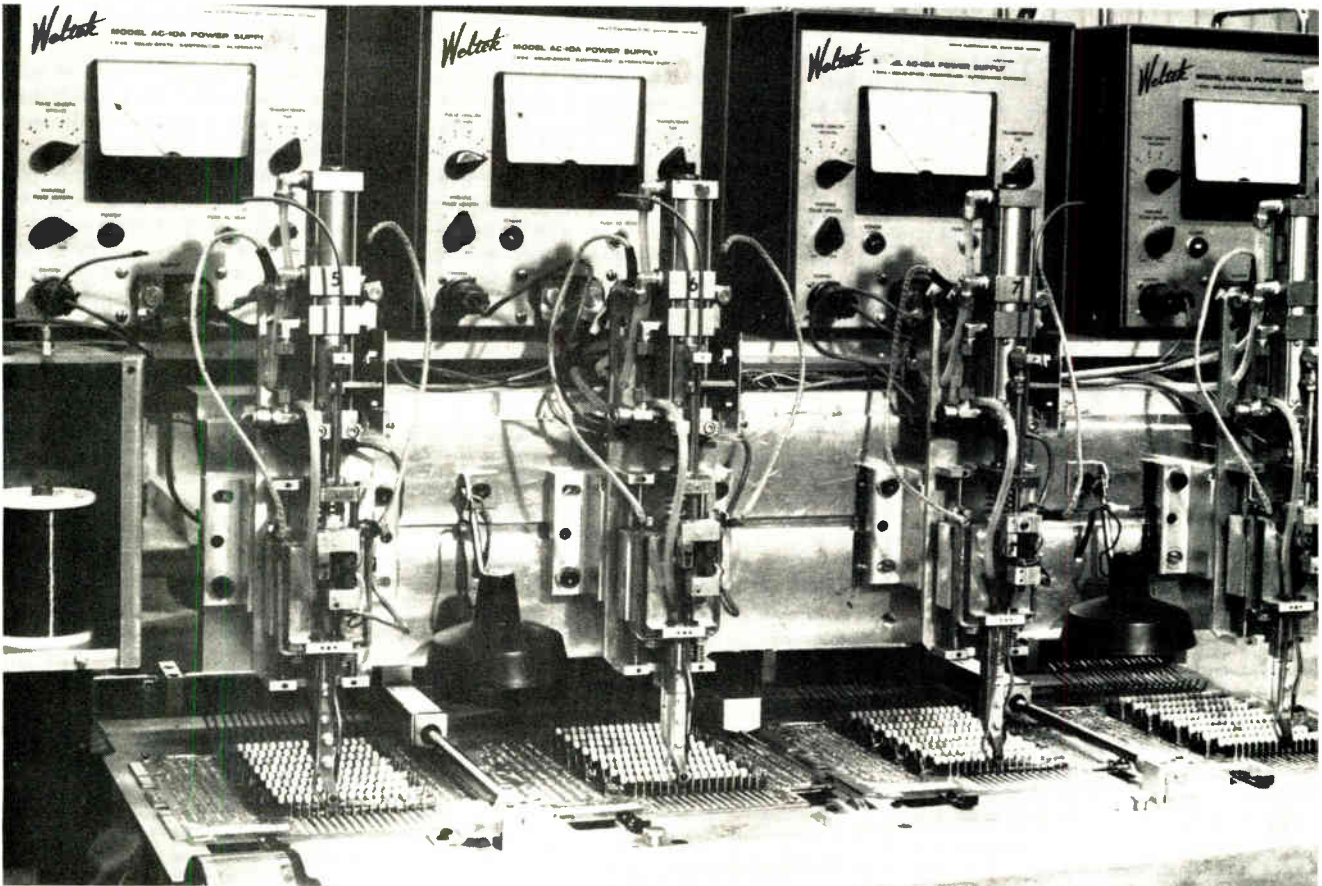

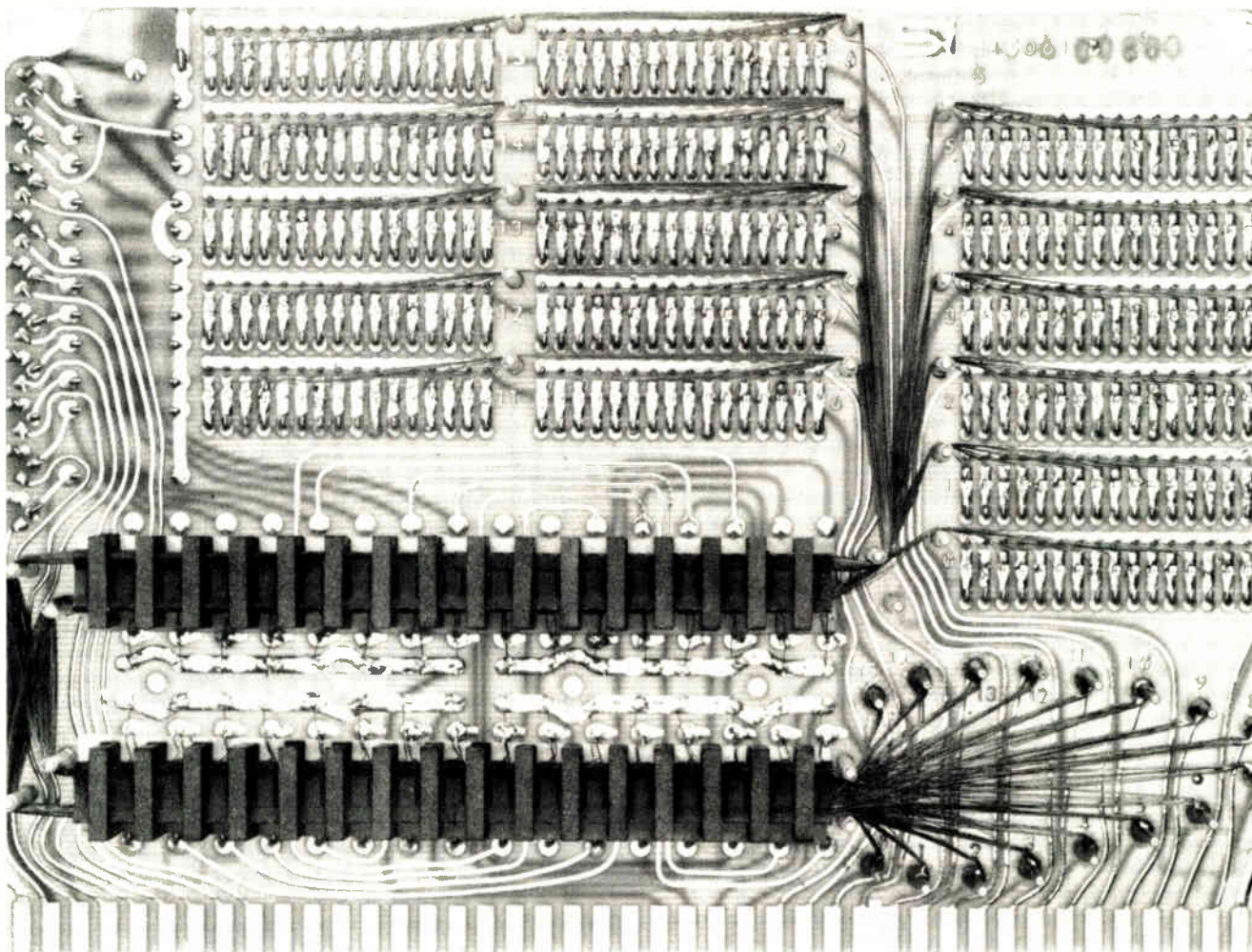

**6. Magnetic ROM.** Sycor read-only memory, made with machine in Fig. 5, stores 8,192 bits in magnetic E-cores. Wire lies in troughs in the memory cores, and pole pieces are added later. Each wire is soldered to one of 256 pads after being routed around insulated posts.

are taking contracts for wiring as an economic necessity; and finally connector manufacturers who have broadened their horizons and now see themselves as total packaging system suppliers rather than component suppliers.

As an example of what automation can do, consider the example of a company that has gone from zero to \$16 million in sales in a year and a half—Peripheral Business Equipment Corp. of Santa Ana, Calif., a division of Pertec Corp. PBE makes key-to-tape units and tape-to-microfilm recorders.

When they were starting, says manufacturing engineer Michael Kazarian, they realized that about 80% of their labor and materials costs were associated with components on pc boards, so they decided that automatic assembly would have to be a way of life. They now have a dual-center-distance, axial-lead-component insertion machine, a sequencer, and a pantograph insertion machine for DIPs, and are considering the addition of a computer-controlled DIP insertion machine.

The firm uses about four million ICs a year—a typical unit has 1,500 axial-lead components and 600 DIPs, and they are turning out 100 such machines a week. About 90% of the DIPs are 14-lead versions, and 10% are 16-lead types and 24-lead MOS packages. Only the MOS devices are manually inserted, because they cost in the

\$200 range, and Kazarian says he is not about to trust them to an insertion machine. Moreover, the chance of damaging the MOS circuits with static electricity makes him additionally reluctant to machine-insert them.

The company illustrates another fact of electronics manufacturing life today—a young company, if it has the capital, can take advantage of automated equipment now on the market, while larger companies already have a heavy investment in older machines and much of their production is based on hand assembly.

However, centralized computer control of the whole production line is still a long way off for electronics manufacturers, although advances are being made. Machines have evolved through the numerically controlled stage, where they are primarily serial processors, waiting for and then executing each command, to computer control, where the computer's look-ahead capability can set up subsequent steps and thus overlap cycles. For example, in the new computer-controlled DIP insertion machine developed by USM Corp., Beverly, Mass., the actual insertion head is the same as in the N/C version, but the computer allows several DIPs to queue up as they wait for insertion rather than having them remain in their feed sticks until then.

In addition, a computer can control several insertion machines simultaneously. At Universal Instruments

## A guide to automated point-to-point wiring

### Wire-wrapping

A plated, solid-copper wire is stripped, then wrapped with high tensile force around rectangular, hard, sharp-cornered posts. 24- to 30-gauge wire is usable. Six wraps around post give 24 gas-tight joints in parallel. Developed by Bell Laboratories for high reliability, long life. Most widely used posts are 0.025 inch square, 0.45 in. square, and 0.031-by-0.062 in. rectangular. Connectors, posts, wires, hand guns, and semiautomatic and automatic wiring machines are available. Quickly programed and readily changed in factory and field. Each post usually holds three wires (three levels). Minimum operating centers for posts is 0.100 in., though 0.075-in. post centers are being worked on. The term "Wire-Wrap" is a trademark of Gardner-Denver Co., Quincy, Ill.

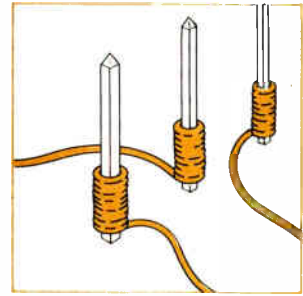

### Termi-point

A spring clip forces solid or stranded wire against a plated post to form a gas-tight joint. Clip strips insulation in the process. Developed by Amp Inc. (Termi-point is trademark) to permit use of stranded wire and easier removal of terminations than possible with wrapped wire. Three levels of wiring commonly used. Lower level clip can be snapped off with special tool, and upper clips can be slipped down on the post. Connectors and pins available only from Amp Inc. Automatic wiring machine available from Amp on lease, and various suppliers will supply hand Termi-point gun mounted on machines for semi-automatic operation. Hand guns also available. Minimum operating centers usually 0.100 in., 0.075 in. possible.

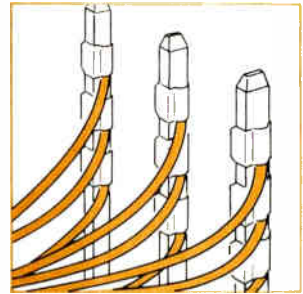

### Multiwire

Insulated wires are routed by numerical control and pressed into uncured catalytic thermosetting adhesive surface on printed circuit board substrate. Heat and pressure embed wires into the surface and cure the adhesive. Terminations are provided by drilling through wire at desired points, and then metalizing wire ends, joining them to edge of plated-through hole conductor. Developed by Photocircuits div., Kollmorgen Corp. for fast turnaround boards with insulated crossovers (equivalent of multilayer boards). Wire is 34 gauge with polyimide insulation. Photocircuits provides wiring service working from customer's interconnection and component location information. Minimum operating centers are 0.025 in. for wires, 0.050 in. for drilled holes.

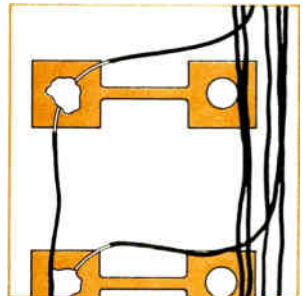

### Automatic reflow soldering

Polyurethane insulated wire, 38 gauge, is stitched under numerical control and reflow-soldered to plated pads on board. Automatic wiring head feeds wire, pulses heat to melt insulation and reflow solder on pad, cools to form connection, performs pull test and continuity check, and cuts wire when net is completed. Components must be bonded by reflow to opposite side of board (no mass-flow soldering possible). Service offered by Infobond Corp. Machines offered by Weltek. Fixtures for fast manual attachment of components have been developed. Minimum operating centers usually 0.075 in., 0.050 in. possible.

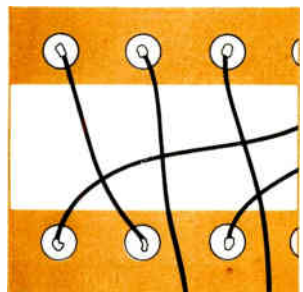

### Automatic welding

Similar to Infobond and Tiers, except wires are welded to points on the pc board. Weld is made through insulation. Wire is usually nickel, termination points usually nickel or stainless steel. Insulated wire is fed through center of pencil electrode. Other electrode is brought to contact terminal on other side of board. Pull tests and continuity tests can be made. Originally developed by Jet Propulsion Laboratory for high reliability and quick turnaround of small aerospace assemblies. Machines available from Accra-Point Arrays and Micro Technology. Minimum operating centers 0.050 in.

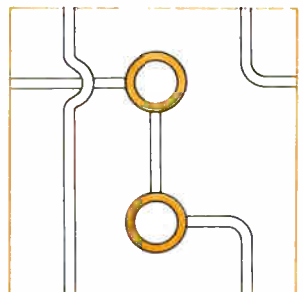

## Intent to insert

One of the newest integrated-circuit packaging concepts was designed right from the start for automated insertion. It's General Electric's Minimod [*Electronics*, Feb. 1, p. 44], which has an etched copper lead frame connected to the chip and carried by a sprocketed polyimide strip. The strip is shipped in 25-foot lengths on reels so that the user can mount it on his own automatic test and insertion equipment. When it was announced, however, there were no machines commercially available that would handle the Minimod strips. GE began talks with several machinery manufacturers and now at least two—Kulicke & Soffa, Fort Washington, Pa., and Universal Instruments, Binghamton, N.Y.—say they soon will have the machines ready.

Albert Soffa of K&S says his company is designing a complete line of tools to handle the Minimods and is now giving quotes on them. In June, it demonstrated a semi-automatic machine, shown below, at the Consumer Electronic Show in Chicago. He calls the Minimod "the machine designer's dream" because of its easy handling of the strips and the close tolerances it holds on the sprocket holes.

The insertion of dual in-line packages with more than 18 leads is extremely difficult to automate; the probability of having all the leads line up with the holes in the pc board is small because the leads can be bent out of position, or might not even have been applied to the package within the proper tolerances. With the Minimod, however, there is no loss in accuracy of lead positioning up until the point of insertion.

At Universal Instruments, John Hohl, vice president, says that machines using pantograph, numerical control and computer control will soon be available to cut, form, insert, and clinch the Minimod leads into a pc board. Of the patterns now being run by GE, Hohl says that two versions—with four and 14 leads—will be handled by his machine, since these are the ones most commonly used at present.

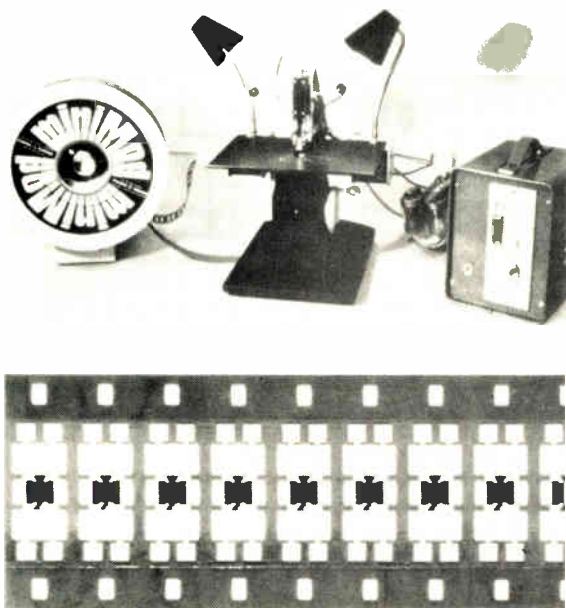

Corp., Binghamton, N.Y., for example, a General Automation SPC-12 minicomputer controls several DIP insertion machines or even a mixture of machines, including an axial-lead component inserter and a component sequencer, which prepares axial-lead components for insertion by taking them off individual rolls of tape and placing them on a single roll.

A computer also allows closer monitoring of the production rates, supplying documentation on insertion rates, malfunctions, and rejected parts. Walter Haug, USM product manager, even predicts it will be possible for managers to keep track, in real time, of whether they are making or losing money on the production line.

USM Corp. and Universal Instruments are in fact the two major manufacturers of computer-controlled component insertion machines in the U.S. USM has just announced its machine, while Universal introduced a computer-controlled dual in-line package insertion machine about a year ago and recently brought out a new version.

Just how much can be saved with machine insertion of components is shown by a comparison offered by USM's Haug, who says that a typical manual insertion rate for DIPs is 125 an hour (numbers higher than this have been given, but such numbers do not take into account normal interruptions during the operator's workday). At a labor-plus-overhead cost of \$5 an hour, this gives a DIP insertion cost of 4 cents for each device.

With the USM computer-controlled machine, Haug says that 4,000 components can be inserted each hour. Thus, with the same labor-plus-overhead of \$5 an hour, the cost per DIP insertion is one-eighth of a cent. Going a little further, Haug says that if the company inserts, say, six million DIPs a year for a period of two years, the manual insertion cost is \$480,000. With USM's \$50,000

**7. Stitch-wire.** Point-to-point, numerically controlled welding of wires is done with Accra-Point Arrays machine. Wire, 30-gauge, is threaded through stationary welding head while other welding point is placed beneath the board. Board moves in horizontal plane as wire is welded to each terminal through the insulation. Technique has been used in minicomputers and airborne equipment.



computer-controlled machine and with \$15,000 of labor-plus-overhead costs, the total cost with the machine is \$65,000, giving a savings over two years of \$415,000.

The USM machine handles up to 20 different DIPs in the stick carriers, and uses a PDP8E for control. In its basic configuration, the machine can store the locations of 400 DIPs. This number can be raised with tape or disk storage.

The Universal Instruments computer-controlled machine, which sells for \$48,000, handles 24 sticks, holding DIPs with 14, 16 or 18 leads. Thickness of the DIP can be between 0.080 and 0.180 inch (an important factor because although many circuits use the DIP lead configuration, package thicknesses actually vary widely). DIPs can be spaced as close as 0.100 inch between lead rows.

The machine is conservatively rated at 3,000 DIPs an hour. Of course, the actual insertion rate depends on the board layout—if the DIPs are widely spaced, the X-Y table needs more travel time, and the insertion rate will drop. But since most boards are designed with DIPs on

**8. Micropoint.** Close-up of wires welded to tops of terminals on the back of logic board made by Micro Technology. Wire is welded through insulation. Spacing of pins for ICs allows variety of dual in-line package sizes, with all leads on 0.100 centers.



**9. DIP inserter.** Universal Instruments computer-controlled dual in-line package insertion machine runs at about 3,000 DIPs an hour, using a General Automation SPC-12 minicomputer for control.

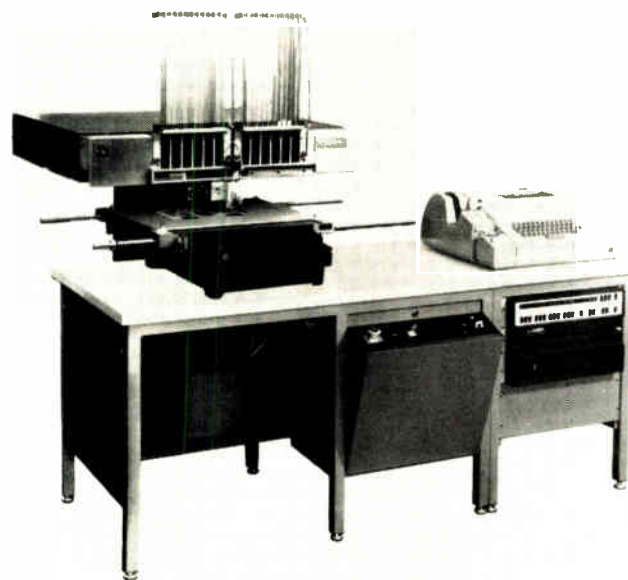

less than 1-inch spacings, 3,000 an hour is a practical rate, according to Universal.

However, even if the manual insertion-rate were 300 DIPs an hour using some type of aid, the labor-cost saving with the machine would be in the neighborhood of 1 cent per DIP. Thus for each million DIPs inserted, the savings would be in the neighborhood of \$10,000, and at an annual insertion rate of one million DIPs, it would take five years to pay off the machine.

But there's more to the comparison than just the savings in insertion labor, says Matt Thompson, manager of the electronic assembly division at Universal. He claims that even bigger savings, though it's difficult to estimate them, lie in the elimination of human error and debugging time. □

## EQUIPMENT MANUFACTURERS

### Multiwire:

Photocircuits division  
Kollmorgen Corp.  
31 Sea Cliff Ave.  
Glen Cove, N.Y. 11542  
516-676-8000

### Automatic reflow soldering:

Infobond Corp.  
Middlesex Turnpike  
Burlington, Mass. 01803  
617-273-0600

Weltek division  
Wells Electronics, Inc.  
1701 South Main St.  
South Bend, Ind. 46623  
219-287-5941

### Automatic welding:

Accra-Point Arrays  
2005 South Ritchey St.  
Santa Ana, Calif. 92705  
714-835-8666

### Micro Technology

Division of Sterling Scientific Industries  
5388 Sterling Center Drive  
Westlake Village, Calif. 91361  
213-889-1470

### Computer-controlled DIP inserters

Universal Instruments Corp.  
E. Frederick St.  
Binghamton, N.Y. 13902  
607-772-1710

USM Corp.  
Balch St.  
Beverly, Mass. 01915  
617-927-4200

# Relaxation oscillators provide compact drive for injection lasers

In highly miniaturized, low-current laser systems, pulsers built with a four-layer diode or a single transistor can do the job for less money and space and at greater efficiencies than thyristors

by Forrest M. Mims, *Albuquerque, N.M.*

□ Injection lasers are modest in size and power demands but are more than generous in the jobs to which they can be applied. Available from a number of manufacturers, these first cousins to light-emitting diodes are finding increasing popularity with designers of ranging systems and intrusion alarms, and are contenders for applications in optical communications and memory systems.

The traditional means of driving an injection laser is with a silicon-controlled rectifier. However, for highly miniaturized, low-current laser systems, the designer can select another driving source—diode relaxation oscillators—that can give him higher efficiencies and lower costs than SCRs.

At room temperature, typical injection lasers require current pulses of from 5 to 40 amperes with a half-current width of less than 200 nanoseconds. Such pulses are easily produced by discharging a small capacitor through the laser diode via an SCR. Unfortunately, an SCR must be operated in an inefficient, high-resistance mode to provide this fast switching.

A typical SCR may have a resistance of only a fraction of an ohm when on; but since its total rise time may be as high as 1 microsecond, it can turn on only partially before the capacitor completely discharges, thereby presenting a resistance as high as 5 or 6 ohms when operated in a fast-switching mode. This high on-resistance reduces efficiency, and greatly increases the discharge voltage necessary to obtain a laser operating current. In fact, typical SCR pulsers require over 200 volts for proper laser operation.

While the SCR retains its flexibility advantage as a switching element for injection laser pulsers, relaxation oscillators, built with either a four-layer diode or a conventional transistor operated in the avalanche mode, offer superior performance in the miniaturized applications where current requirements fall below 50 A. Furthermore, these circuits often are more economical, since appropriate transistors cost less than \$1, while SCRs sell for as much as \$12.

A simple relaxation oscillator, employing a four-layer diode,  $D_1$ , as a current switch, is shown in Fig. 1.  $C_1$  charges through  $R_1$  until  $D_1$ 's breakdown voltage is reached.  $C_1$  then discharges through  $D_1$  and the laser diode.  $D_2$  protects the laser from the possibility of reverse current.

$C_1$  is approximately 0.01 microfarad. The value of  $R_1$  determines the oscillator's frequency. Injection lasers typically operate at a 5-kilohertz rate, which corresponds to an  $R_1$  value of 5 kilohms. The bias voltage is set to some value greater than the breakdown voltage of  $D_1$ . Four-layer diodes are available with a wide range of breakdown levels between 8 and 100 volts.

Since the circuit's peak current may exceed the maximum allowable for a particular laser diode, a dummy load of 0.1 ohm should be used in the laser's place to monitor the pulse parameters. (A suitable dummy load can be made from 10 1-ohm resistors in parallel.) For this monitoring, an oscilloscope with a frequency response fast enough to track a 50-ns pulse should be used.

A significant feature of this circuit is its small size. The pulser, along with a 24-v battery and a collimating lens, were installed in an aluminum cylinder measuring only 4.5 by 0.5 in. The completed assembly, designed for use in an experimental eyeglass-mounted mobility aid for the blind, projects a beam with a divergence of 3 milliradians. It's built with a Motorola M413054 four-layer diode that has a 22-v breakdown voltage. The cir-

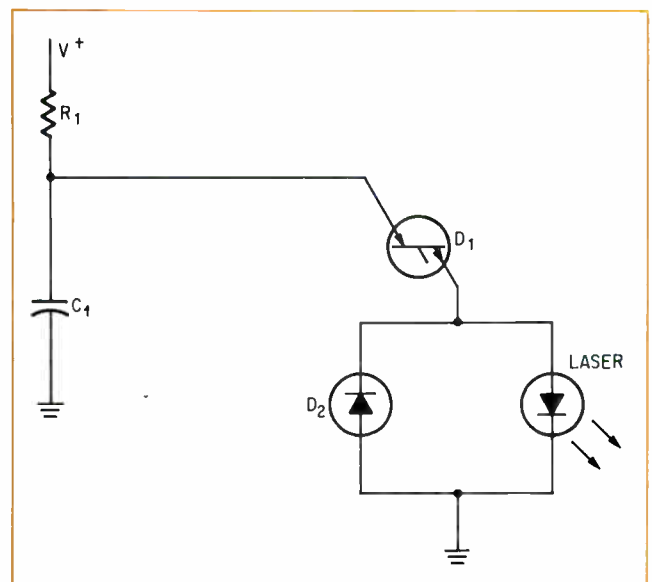

**1. Diode drive.** Inexpensive circuit delivers narrow pulse of current to injection laser. When  $C_1$  voltage exceeds breakdown level of four-layer diode,  $D_1$ , capacitor discharges, firing laser.



cuit pulses an RCA TA7606 laser with a peak current greater than 5 A in a 50-ns pulse and at a repetition rate of 2 kHz. In general, pulses as large as 12 A are possible with the four-layer diode oscillator.

The transistor oscillator, as can be seen from Fig. 2, is similar to the diode pulser. Capacitor  $C_1$  charges through  $R_1$  until the voltage across the capacitor equals  $Q_1$ 's breakdown voltage ( $BV_{cex}$ ).  $C_1$  then discharges through  $Q_1$ , the laser, and  $R_2$ . With available transistors,  $BV_{cex}$  ranges between 45 v and 300 v.

The circuit also can be built with an avalanche transistor rather than a switching transistor operating in the avalanche mode. While the former costs quite a bit more than a switching transistor, an avalanche device is less likely to burn out in this type of circuit. It also has a well-defined breakdown level, and can handle higher currents. A switching transistor can deliver a maximum peak current to the laser of 25 A, but with an avalanche transistor, it is possible to attain a peak current level of

more than 50 A.

The values of  $C_1$  and  $R_1$  in the transistor pulser are of the same order of magnitude as  $C_1$  and  $R_1$  in Fig. 1.  $R_3$  is approximately 7.5 kilohms.  $D_1$ , which protects the laser from reverse current, should be mounted as close as possible to the laser to minimize induction in the leads joining the two components.  $R_2$  limits the current through the laser and permits current monitoring.

Since pulses as high as 50 A are possible, it's particularly important to know in advance what the peak current will be. The current may be calculated, but if the laser is to be operated at or near the peak, it's safer to follow the procedure outlined for the four-layer diode pulser and monitor the current output with a 0.1-ohm dummy load.  $R_2$  should have a value of from 0.1 ohm to 1 ohm. If used when determining peak current, it must be left in the circuit when the laser is installed.

Besides being less expensive than the four-layer-diode pulser, the transistor circuit has another advan-

## Trading off lasers

Next year the tiny injection laser will celebrate its tenth anniversary: it was announced almost simultaneously by scientists at GE, IBM, and MIT in the fall of 1962. While the word "laser" conjures images of shoebox-size mainframes, hollow glass tubes, and high-voltage pulsers, this particular laser is little more than a light-emitting diode with special characteristics.

Commercial injection lasers fall into the single-heterostructure category. A p layer of gallium arsenide is epitaxially grown on an n layer. On top of the p-type material is an epitaxial p+ layer of aluminum gallium arsenide.

Light emission occurs when electrons, injected into the diode by a forward bias, cross the potential barrier formed by a p-n junction. To cross the junction, the electrons first must be stimulated to higher-than-normal energy states. After crossing the junction, the electrons fall back to the ground state and, in a process fundamental to light generation, give off excess energy in the form of photons.

So far, this progression applies to both injection lasers and LEDs. The laser is unique in that it has two parallel, facing mirrors, usually formed during fabrication by cleaving the GaAs along its natural crystalline planes. These mirrors form the optical cavity necessary for laser operation. Photons generated at the junction bounce between the end mirrors, in the process forming a standing wave that stimulates the in-phase emission of still more photons that have just crossed the junction. The result is a beam of quasi-coherent light. Spectral width typically is less than 200 angstroms, and can be less than 50 angstroms.

Injection laser beams lack the coherence exhibited by light from other types partly because the injection laser's high gain encourages simultaneous multiple modes. An injection laser beam's divergence also is relatively poor; at a typical 20°, it's much greater than the divergence of beams from other types of lasers. That's why injection lasers are finding their primary applications where divergence and

coherence can be traded off for low cost, low-voltage drive requirements, and small size.

Since an injection laser requires a current density of many thousands of amperes per square centimeter, very narrow pulses (under 200 ns) and low duty cycles (typically 0.01% to 0.1%) are required for room-temperature operation. For most efficient operation, the current pulse should have a fast rise time because injection units have a definite threshold for laser action. Any portion of a current pulse that flows before the threshold is reached contributes only to device heating.

Not all injection lasers are limited to pulsed operation. Both Bell Laboratories and RCA Laboratories have built experimental versions of double heterostructure injection lasers that operate continuously at room temperature [*Electronics*, Aug. 31, 1970, p. 37]. These lasers have two additional layers of (AlGa)As, one grown on the original (AlGa)As layer, and the other on the bottom layer of GaAs. These additional layers boost efficiency, permitting operation at a much lower current density.

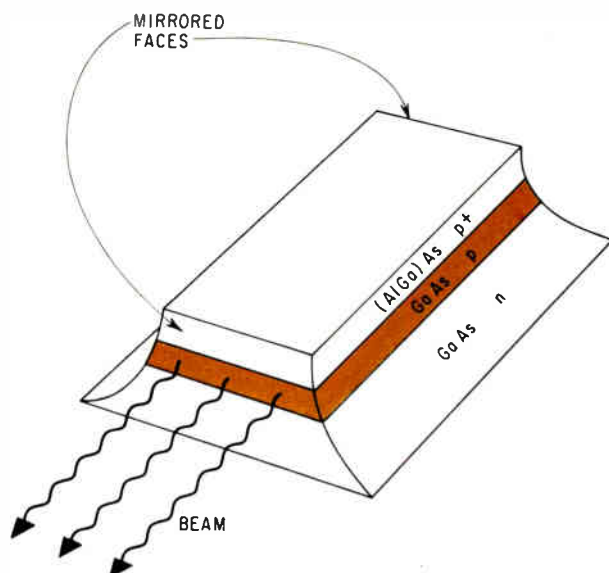

**Laser structure.** Single heterostructure injection laser is basically GaAs diode with built-in optical cavity. Infrared radiation, generated at p-n junction by forward current, resonates between mirror-like walls, formed during diode fabrication. Output beam has very narrow spectral width.

## Where to get laser diodes

Just a few companies sell injection diodes, although several others, including Bell Laboratories and IBM, are developing components for sale or for their own use.

The units listed here are single-diode lasers; specifications refer to room-temperature operation. The manufacturers also offer custom and off-the-shelf injection-diode arrays. In general, these arrays put out more power. For example, Laser Diode's LD200's, which come in TO-5 cans,

have a minimum peak-power output of 200 watts.

Although it doesn't offer discrete diodes, Electro-Nuclear Laboratories Inc. of Menlo Park, Calif., sells a complete injection-laser system, the 492, which includes power supply and current pulser. Made in a package measuring 6 by 4 by 2 inches, the system has a peak-power output that's adjustable to 5 w, and a repetition rate of 1.28 kilohertz. Price is \$695.

—Owen Doyle

Company	Serial number	Typical peak output power (w)	Repetition rate (kHz)	Pulse width of drive current (ns)	Output wavelength (Å)	Threshold current (A)	Price (small quantities)
Laser Diode Laboratories Inc. Metuchen, N. J.	LD22	6	5	100	9,050	8	\$ 28.00
	LD23	12	5	100	9,050	15	\$ 39.00
	LD24	25	5	100	9,050	20	\$ 70.00
RCA Somerville, N. J.	TA7606 <sup>1</sup>	2	1	200	9,050	4	\$ 18.85
	TA7607 <sup>1</sup>	6	1	200	9,050	7	\$ 50.70
	TA7608 <sup>1</sup>	6	1	200	9,050	7	\$ 20.30
	TA7609 <sup>1</sup>	13	1	200	9,050	10	\$ 55.00
	TA7610 <sup>1</sup>	13	1	200	9,050	10	\$ 23.20
	TA7705 <sup>1</sup>	50	0.1	100	9,050	75	\$ 74.95
Texas Instruments Inc. Dallas, Texas	TIXL28	7	1	800	9,000	12	\$ 44.00
	TIXL29	6	3	300	9,000	25	\$ 15.50

1. RCA soon will change the designations of its injection diodes to 40,000-series numbers. TA prefix signifies developmental products.

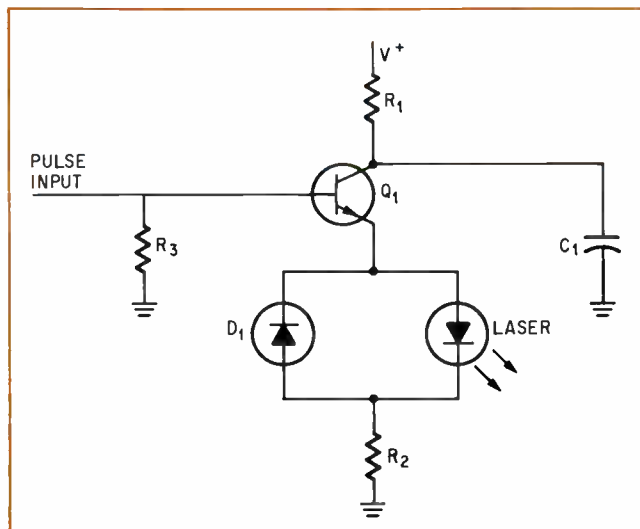

2. Transistor drive. In operation, circuit is almost identical to Fig. 1 pulser. Main difference is that the transistor circuit can be triggered externally—by pulsing base of  $Q_1$ , an avalanche or switching transistor. Photo shows typical short-rise-time pulse delivered to laser.

It can be externally pulsed. If the bias is set to some value below  $Q_1$ 's breakdown voltage, the transistor will turn on and discharge  $C_1$  only when a positive pulse is applied to the transistor's base.

The main advantage of the four-layer-diode circuit is its efficiency—on resistance is less than 1 ohm compared with up to 5 ohms for a transistor. But even with a transistor, the relaxation oscillator is an extremely efficient pulser. Figure 2 shows the pulse from an avalanche transistor driver. With the relaxation oscillator, the total rise time (base line to peak) is approximately 25 ns. For an SCR pulser the figure is closer to 100 ns.

Like SCR pulsers, the relaxation oscillators can drive LEDs as well as injection lasers. Quite similar in structure to LEDs (see "Trading off lasers," p. 89), injection lasers are used where the need is for a point source of radiation with a relatively high peak power. The beam from an LED diverges about 10 times as much as one from an injection laser. Individual injection lasers can deliver as much as 60 watts, whereas LED outputs amount to only hundreds of milliwatts. LEDs, however, are a much less expensive light source. □

### Bibliography

An excellent review of SCR pulsing techniques is found in RCA application note AN-4469, "Solid State Pulse Power Supplies for RCA GaAs Injection Lasers."

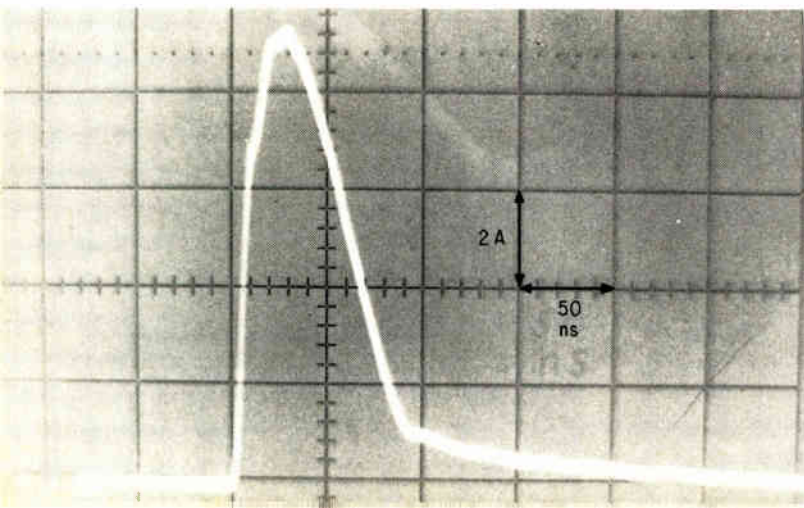

# Probing the news

Analysis of technology and business developments

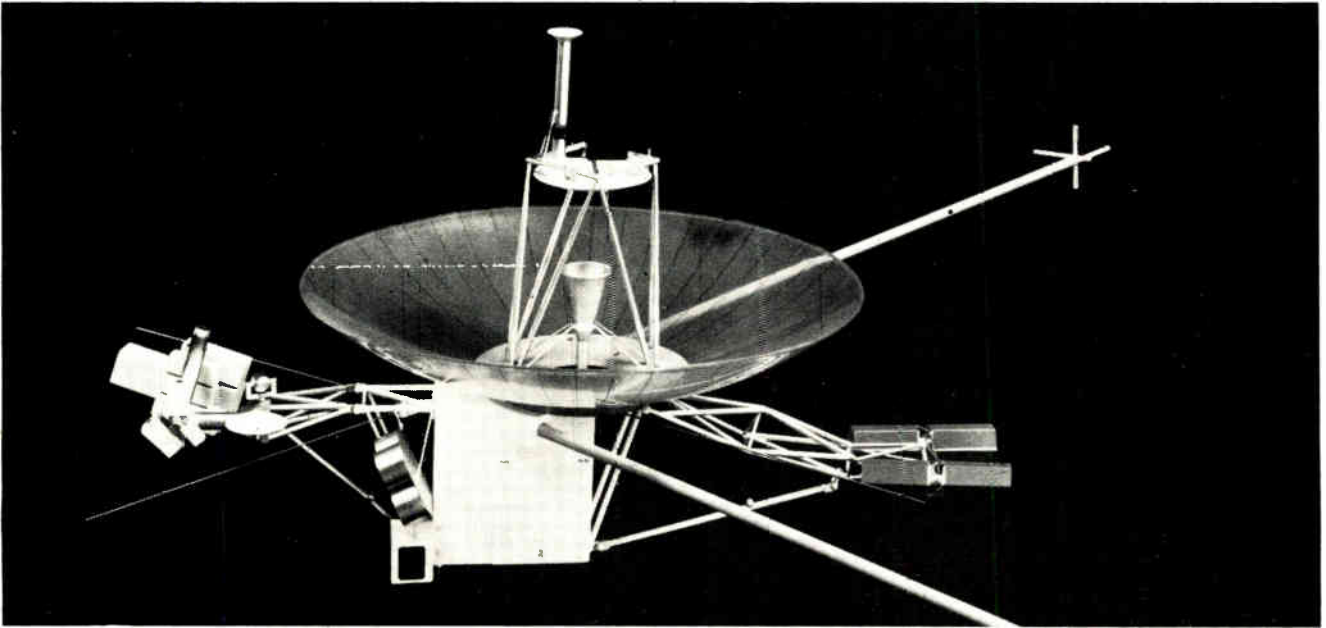

## Planning a Grand Tour

Congress debates the value of the present four-part Grand Tour, NASA envisions alternatives, and industry stands alert for new contracts

by Lawrence Curran, Los Angeles bureau manager

The next potential plum in planetary exploration is the proposed Grand Tour of the outer planets, which could begin as early as 1976. And even though Congress has yet to decide how large that plum will be—or even if there will be one at all—industry and NASA are already eyeing it hopefully.

Both Capitol Hill and NASA sources in Washington concede, however, that the Grand Tour will remain vulnerable for several years in Congress because of its high price tag (an estimated \$750-900 million), NASA's continuing austere budget, and uncertainty in the scientific community over the priorities in exploring the outer planets.

As envisioned by officials at the Jet Propulsion Laboratory, Pasadena, Calif., which hopes to direct the Grand Tour, the most ambitious mission envelope would include two launches to Jupiter, Saturn and Pluto (JSP), and two more to Jupiter, Uranus and Neptune (JUN). The first JSP tour has a 1976 launch tar-

get, the second a 1977 target, and each would last 10 years. Both JUN spacecraft would be sent aloft in 1979 on similar 10-year missions. The vehicle most likely to make the fly-by flights to gather data on the planets and their satellites in each mission set is JPL's own design for a thermoelectric outer planet spacecraft (TOPS) [*Electronics*, March 30, 1970, p. 108], although JPL would not build the actual craft.

**Alternatives.** Faced with fiscal realism, however, NASA planners have to consider alternatives to the full mission, such as intensive single-planet explorers followed by a fly-by tour of three outer planets. Unless NASA is forced to go with existing spacecraft, such as TRW Systems group's Pioneer probe, this alternative wouldn't have much impact on technology, because the TOPS spacecraft [see photo] is the likely candidate to fly any of the outer planet missions. But if individual planet exploration doesn't supplement, but instead is substituted for, a Grand

Tour mission, there may be no lucrative TOPS spacecraft prime contract. NASA's present position, however, is that it will cost more to explore each planet one at a time.

The four firms most frequently mentioned by NASA, JPL, and industry sources as likely to bid on the spacecraft prime contract if the program remains viable are: the Boeing Co., Hughes Aircraft Co., Martin-Marietta Corp., and North American Rockwell Corp.'s Space division. Warren Keller, program manager for the Grand Tour at NASA headquarters in Washington, says the TOPS spacecraft "will soak up several hundred million" of the program's \$750-900 million estimated cost. Harris M. "Bud" Schurmeier, deputy assistant director for flight projects at JPL, says the prime system contractor "would pick up where JPL leaves off on TOPS, doing the detailed design, fabrication and test" under JPL's direction.

But the fiscal 1972 line item for missions to outer planets is already

in trouble. NASA requested \$30 million to get started on the outer planet exploration. The Senate cut it down to \$10 million, and the House restored it. If that cut is sustained in a House-Senate conference, the 1976 and 1977 JSP missions would probably be cancelled [*Electronics*, July 5, p. 35]. Still, NASA headquarters sources say that if they can get \$20 million through Congress this year, "we can give the 1976 probe a pretty good try."

It's more likely, though, that NASA's fall-back position from the two JSP and two JUN Grand Tours would encompass a 1977 launch to Jupiter to do a more detailed exploration than could be done during a fly-by, then follow with the 1979 JUN grand tour. "This is one of the options that's being considered," says JPL's Schurmeier, "and we hope to get it resolved this fall." That's when the Space Science Board of the National Academy of Sciences will meet to hammer out its outer planet scientific objectives.

No matter which mission envelope is ultimately chosen, the TOPS spacecraft is the likely vehicle to carry out fly-by, orbiter, or planetary entry probe missions. JPL has designed it as a multimission spacecraft powered by four radioisotope thermal generators that would deliver 500 to 550 watts. There would be little new technology in the TOPS concept for a Grand Tour mission, either in the spacecraft's subsystems or in the scientific instrumentation. The big challenge will be to make systems reliable enough to function for 10 years.

**Getting the Picture.** Donald Rea, JPL's assistant director for science, terms the television requirements "the most challenging task" for the Grand Tour missions: "We'll probably want to or have to fly a new vidicon, and we're looking at silicon vidicons and silicon intensifier vidicons."

He doesn't foresee any other major sensor development problems, anticipating that the other instruments flown will be space-proven. "But there's some concern about the radiation environment of Jupiter and also of the radioisotope thermal

generators," he notes. "We'll want to know how much shielding and redundancy will be needed, and in which instruments. Calibration is also a problem. We're not sure how scientific instruments will be calibrated for 10-year missions."

Rea is excited about exploring both the interplanetary and the interstellar media during Grand Tours, with imaging and occultating experiments of the planets and their satellites, "six of which are about the size of Mercury and our moon, and shouldn't be short-changed," he says.

**Approaches.** The overall TOPS spacecraft design, plus critical subsystems, have engineers at JPL and in industry doing both their homework and some friendly jousting with each other. JPL engineers, for example, have to live with a JPL system level decision to make the television camera in the science package double as the sensor for planetary approach guidance. But at North American Rockwell's Space division in Downey, California, Paul Rupert argues for an approach guidance sensor separate from the scientific instrumentation because of trajectory correction problems. "The big problem is that we don't know precisely enough where the planets are," Rupert says. Rupert is lead engineer for sensor development on the Grand Tour project there. North American Rockwell is building a breadboard of an approach guidance sensor for the Grand Tour, and hopes to be at work calibrating the system within a year.

Richard Stanton, senior engineer in JPL's Guidance and Control division, agrees with Rupert up to a point. Says he, "Technically, separate science and approach guidance instruments would be the best way of guaranteeing success. But the science sensor has sufficient sensitivity to sense stars, so we can potentially use it. Besides, if we can save \$10 million by combining the sensors, we'll probably do it that way."

Other companies besides the four most often mentioned as spacecraft prime contractors are watching to see how the Grand Tour fares in Congress. General Electric is known to be doing at least subsystem-level studies, and TRW's Systems group stands ready to propose its Pioneer

probe vehicle for less ambitious outer-planet exploration.

A TRW spokesman contends JPL has opted for three-axis stabilization to get better images than a spin-stabilized spacecraft could provide during a fly-by, but he doubts the value of high-resolution photos of, say, the cloud cover of Jupiter. He adds that three-axis stabilization dictates the need to have the STAR (self-testing and repairing) computer aboard the spacecraft, to detect and immediately correct such things as the beginning of spacecraft tumble.

Meanwhile, JPL engineers continue to refine the STAR computer's design [*Electronics*, March 30, 1970, p. 108] and that of the centralized data handling system in which STAR will function. JPL in the past year has built a prototype of the STAR derivation to go aboard TOPS. It's called the control computer subsystem, and its task is to monitor all subsystems and adjust them if they're not functioning properly.

The centralized data handling system in which the control computer subsystem will function is also advancing into the hardware stage. It consists of a programable, adaptive, computer-aided telemetry system, which is called the measurement processor subsystem—a two-billion bit data storage system consisting of a buffer, single-speed tape recorders, science instrument interface units, a ground command decoder, a central timing source, and control computer subsystem.

**On the boards.** Richard Easton, cognizant engineer in charge of the measurement processor subsystem in JPL's Astrionics division, says the JPL plan is to breadboard both the measurement processor and the control computer in the next year with the custom TTL devices being built by Harris Semiconductor.

In addition, Texas Instruments is developing an analog tree-organized multiplexer to be used in the measurement processor's data multiplexer. It, too, should be built with the actual units within the next year. Easton says that tape recorders that function for 10 years could be one of the bigger challenges in the centralized data system for TOPS, but observes, "I'm generally optimistic about the whole system. □

75 MFD/30 VOLT DC CAPACITORS

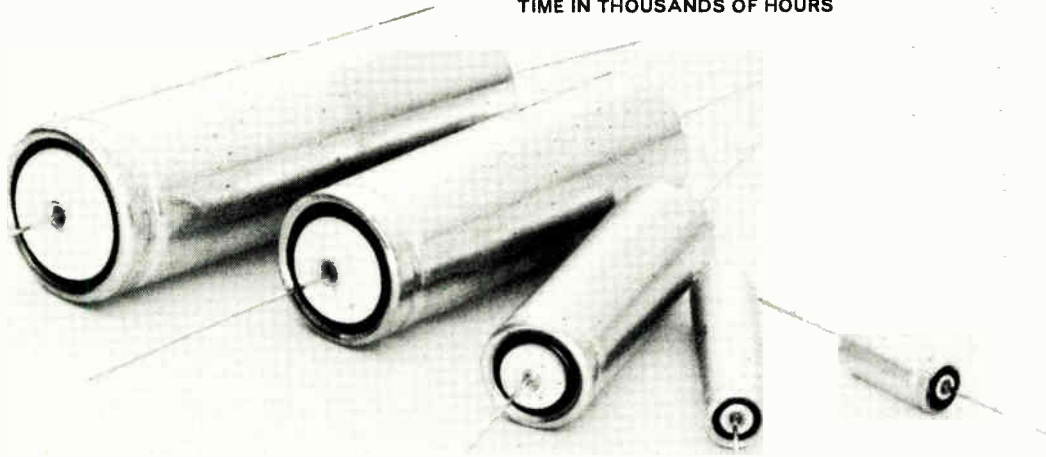
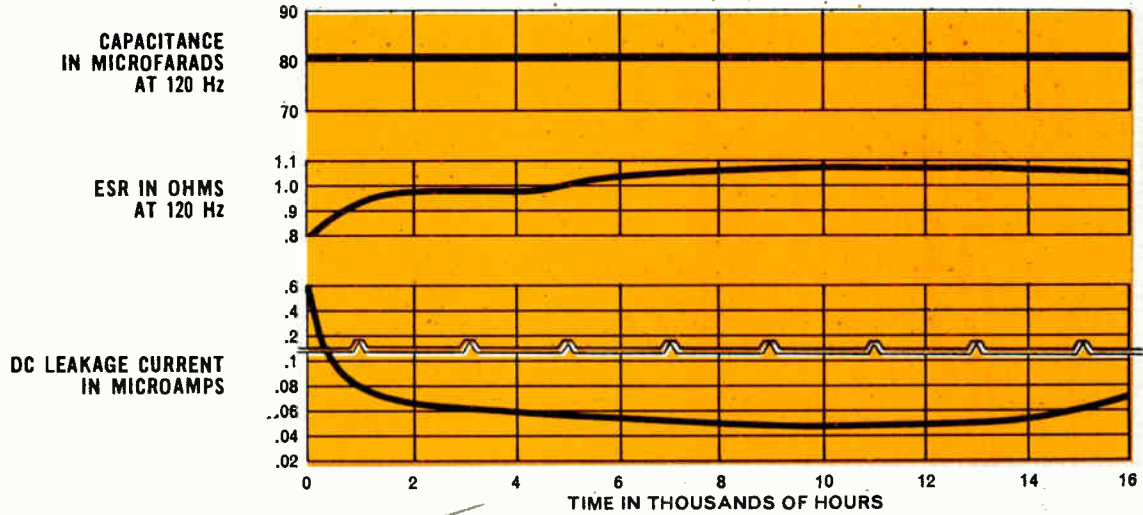

# Our new TCG capacitor has curves you can't resist.

The curves tell at a glance the typical life story of one of our new TCG aluminum electrolytic capacitors. But there's more to a TCG than life curves. There are 45 case sizes, with safety vent protection where required; capacitances from 2 to 22,000 mfd; voltages from 3 to 450 VDC; and a  $-40$  to  $+85^{\circ}\text{C}$  temperature range.

Add to these a high C/V in a small package. Plus outstanding electrical and physical characteristics. And you've got our new TCG. Find out more by writing for Bulletin 4-307. Eighteen pages of data . . . and some curves that will open your eyes. Popular ratings available from authorized Mallory distributors.



**MALLORY CAPACITOR COMPANY**  
 a division of P. R. MALLORY & CO. INC.  
 Box 372, Indianapolis, Indiana 46206; Telephone: 317-636-5353

Electrical and electronic components • sequence timers • metallurgical products • batteries

International

# Europe ahead on optical switching

Pulse-code-modulated switching systems have already arrived in Europe—and now Germany has gone a step further

by John Gosch, Frankfurt bureau

**American firms** are losing their grasp on technological leadership to Europe in some key areas of communications. For some time the leader in digital switching for telephone networks, Europe has taken another step forward—in optical data switching, which so far hasn't gained backing in the U.S.

Even though this country's nationwide data communications networks are still a ways off—operating targets are scattered over the next few decades—a lot of work is going into designing the hardware to sell to carriers. But systems that switch pulse-code-modulation signals, which are the backbone of the digital network planned by AT&T, have gotten short shrift in the U.S.; Bell doesn't have such a switching system on the drawing boards yet. Others, like the Data Transmission Co., aren't planning to use pulse-code modulation at all.

Europe, on the other hand, has pioneered with electronic PCM switching systems. It already has three experimental PCM switching systems in operation. The latest—the "National" exchange in London—handles 240 digitized voice channels. In optical data switching, West German engineers at the Philips Research Laboratories, Hamburg, have built an experimental four-channel switching system that uses lasers, photodetectors, luminescent diodes, and phototransistors. They're even designing a 2,000-channel system that could be ready for an in-house demonstration by the year's end.

Postal administrations, which run the communications in European countries, aren't likely to move to optical switching in the near future

because of their big investments in present switching systems, acknowledges Bernhard Hill, the principal researcher behind the Philips system. But one application for optical switching that may not be too far off, he says, is in private data networks linking computers and peripheral devices.

Even that market, however, depends on how well the 2,000-channel version performs. The major advantage optical switching systems have over electronic versions is their simplicity, says Hill. "The net structure is uncomplicated, and the number of structural elements is very low." Potentially these systems are the cheapest of any. Another advantage Hill cites is the absence of crosstalk, which is a problem even in electronic systems. And optical systems, like electronic versions, can also be made smaller and expanded much more easily than can elec-

tromechanical systems.

To Hill's knowledge, no one else has a working experimental optical switching system. Several years ago Bell Laboratories in Murray Hill, N.J., looked at an experimental network in which the switching element was a pnpn diode accessed by a deflected light beam. But at that time a deflector would have required high switching voltages, and since other switching techniques were more cost-effective, Bell dropped the project after a year.

**Routing.** In the Philips system, a laser is used to access information, and phototransistors, photodetectors, and IR luminescence diodes also participate in the switching process. The new digitally controlled light deflector, which provides access in less than 1 microsecond to the switching matrix [*Electronics*, Feb. 1, p. 103 or 5E], consists of Kerr cells and birefringent prisms

**Data exchange.** In proposed 2,000-channel optical switching system, PCM signals are stored in shift register, then routed to appropriate channels as laser scans matrix.

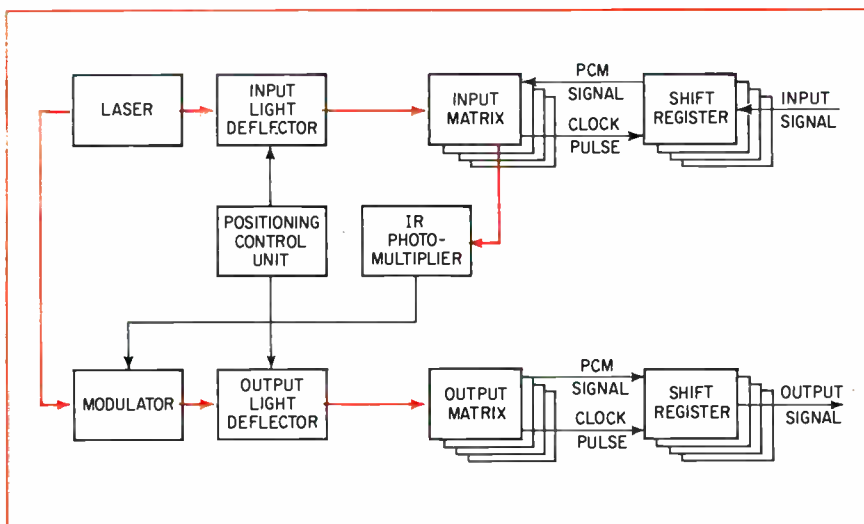

that in combination deflect the laser beam to various positions determined by the input voltage.

Switching accuracy of the deflector is one tenth of the laser beam's spread, so that deviation would be no more than one tenth of a millimeter for a one millimeter-diameter beam. With that small a deviation, there's no chance that the beam will miss a point on the switching matrix, say the Philips developers. And because the contrast between the laser beam and light from the surrounding area is 300 to one, there's also no chance that other light sources will inadvertently initiate switching.

In the basic four-channel system, the laser's output is passed through a beam splitter. One beam is sent to the input (accessing) deflector, the other to the output deflector, both being controlled by a digital positioning unit. Switching matrices, which include photodiodes and detectors, are divided into input and output portions.

When a signal comes in on a channel, information is fed to the positioning control unit, which deflects the laser beam so that it strikes the channel's photodiode. The photodiode, then routes the data along a common, electrical transmission line to the light modulator. There the information modulates the second beam, and the output light deflector directs the optical signal to the appropriate photodetector, where it is demodulated and sent out in electrical form. With such a basic system, any pair of incoming and outgoing channels can be connected by simple space-division multiplex techniques.

**In time.** For linking several information-carrying channels simultaneously, time-division multiplex methods are employed: laser beams scan the photo devices in each matrix in sequential fashion, momentarily connecting every channel in the input matrix to the appropriate output channel in the output matrix. The operation of the two light deflectors is synchronized, and the information transfer is carried out by pulse techniques.

In a commercial setup, Hill says, the signals for the light-beam-positioning control unit would come from a process computer with a

memory that would contain all the matrix position numbers of channels to be connected. The computer, in turn, would work in conjunction with the telephone exchange dialing circuitry.

The number of channels such a system would switch will depend on the bandwidth of each channel and on the light deflectors' switching speed. If that speed is, for example, 5 MHz and if the channel width is 5 kHz, the number of information-carrying channels that could be switched simultaneously would be 500, according to the scanning theorem.

**Upwards.** The total system capacity would of course be much higher than the number of channels switchable at any one time. With the light deflectors now being developed at the Hamburg labs up to 1 million different deflection directions can be obtained. That's also the number of channels that each matrix in a system using such deflectors could include. And if more than two light deflectors are operated in parallel, systems of even higher capacity could be built.

The 2,000-channel exchange system on which Hill and his people are currently working uses essentially the same principles as the basic version just described, but it differs in several important engineering details [see diagram on p. 94]. For one thing, a shift register associated with each incoming and outgoing channel temporarily stores information. Further, the input matrix incorporates a component combination consisting of a photodetector, an infrared luminescence diode, and a phototransistor for each channel. Finally, instead of the common transmission line of the basic version, it has an optical path set up between a common infrared photomultiplier and an IR luminescent diode in each channel.

In this configuration, the information is read into the incoming channel's shift register—a bipolar type designed for 50-MHz operation—at a low bit rate. When the laser beam assigned to the input matrix is directed towards the photodetector of the incoming channel, a phototransistor feeds a clock pulse to the shift register, causing it to release its information content to the lumines-

cent diode at a very high bit rate. The diode's emitted light, modulated by the PCM electrical signal, is picked up by the IR photomultiplier, which then passes the information to the light modulator. There, the information is put onto the output laser beam, and is deflected onto the appropriate photodetector in the output matrix. After demodulation, the information is fed into the outgoing channel's shift register. Again, a phototransistor, activated by the laser beam, initiates shift register operation.

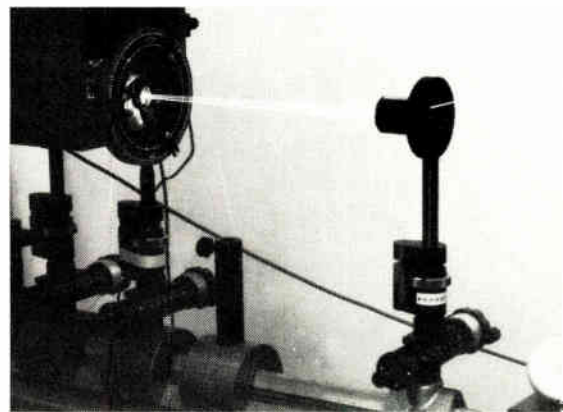

**Light switch.** Optical systems similar to four-channel experimental version could route data over phone lines.

Because the shift registers time-compress and store the input data, many channels can exchange information without any increase in the switching speed of the light deflectors being necessary.

The prime advantage of this version over the basic one, Hill says, is that it can accommodate channels with a wider bandwidth. In the basic version, the photodiodes, being physically connected to the common transmission line, introduce parasitic capacitances which limit the channel frequency range. In the more advanced system, however, the photo elements are electronically decoupled through the use of the optical path.

It should be relatively easy, Hill says, to design a compact IC containing the shift register, the photodetector, the IR luminescent diode, and the photo-controlled transistor associated with each incoming channel. The same is true, of course, for the shift registers, and the optoelectronic devices associated with each outgoing channel. □

# If you've forgotten about electroluminescence, **unforget!**

## **OVONIC DISPLAYS**

has developed

### **ELECTROLUMINESCENT LAMPS WITH HALF-LIFE OF 15,000 HOURS**

(blue-green to yellow spectrum)

<b>Voltage/Frequency</b>	<b>Brightness</b>	<b>Half-Life</b>
115V/400Hz	20 Ft. L.	15,000 Hrs.
90V/10KHz	47 Ft. L.	500 Hrs.
250V/60Hz	15 Ft. L.	Being Tested

**AND**

**—in final stages of development—**

### **RED ELECTROLUMINESCENT LAMPS**

(based on naturally red phosphor)

For application assistance, Ovonic EL specifications, test samples, pricing or just discussion, call or write Mr. Peter Tarrant, Marketing Manager,

**OVONIC DISPLAYS** / Division of Energy Conversion Devices, Inc.

333 Park Street Troy, Michigan 48084 Phone (313) 588-7510



Military electronics

# Small group challenges Loran giants

How a team of long-time Loran experts enabled a tiny company to vie with Litcom, Teledyne for a big Government contract

by Paul Franson, Dallas bureau manager

**Though only a year old**, and though it has never flown equipment, a tiny Austin, Texas, firm managed to beat out seven other experienced companies and snare a \$596,000 Army contract to develop a family of new Loran (long range navigation) systems.

But even if the Advanced Products Laboratory, a subsidiary of Applied Devices Corp. in Greenwich, Conn. is a newcomer, its principals are old hands at Loran, and are banking on their heavy experience to win the production contract in ten months. Their competition is tough. It includes Teledyne Systems Co., Northridge, Calif. and the Litcom division of Litton Industries, Melville, N.Y., both of which got simultaneous development contracts of \$611,000 and \$605,000 respectively, and both of which are also experts in Loran technology.

Gordon T. Graves, president of Advanced Products and J.L. Drayer, director of engineering, should know. Each has worked on Loran systems at Teledyne and at Litton. Back in May 1970, when Applied Devices decided to set up a new subsidiary specializing in navigation and position locating systems, it approached Graves, who drew on his experience to suggest that the new facility concentrate first on Loran.

Accordingly, a source at Teledyne isn't surprised that Advanced Products won the award. "Gordon Graves and Larry Drayer both came out of Teledyne and essentially bid a Teledyne system against us in this procurement," he says. "Their system was attractive, and they've done a decent simulation of their hardware, but they've never flown anything before," he adds.

Though he won't discuss the Teledyne system, he says that the three proposals are rather different.

Litcom describes its system as relying on "proven design," although some work is going into developing a new central processor using MSI and an expandable memory. "The Army can put our system up in the air, do studies against it, and come up with the specs for their new systems," says a company source.

**Strategy.** Advanced Products, however, is relying on state-of-the-art technology, such as MOS/LSI and light-emitting diodes, plus new architecture and some new circuitry to cut the costs of its system and improve reliability and performance. "We felt that Loran was a good bet for us because the equipment on the market was deficient in performance and reliability and cost too much," reports Graves. He expects the production contract to call for 2,000 to 3,000 units.

Comparing the most advanced Loran receivers, which use TTL in distributed arithmetic architecture, with the Advanced Products system, he notes. "Our designs depend on large-scale calculator-type chips and

RAMs and ROMs." The Advanced Products system will use 130 chips as against the 1800 or 2,000 of present Loran receivers, says Graves. "The LSI chips cost more, but not that much more," he maintains. "And design, inspection, and assembly costs are much lower." Graves is shooting for "an MTBF of 2,000 hours for our equipment as opposed to the figure of 500 we've heard for present equipment."

To improve performance, the company has several technical schemes up its sleeve. It boosts signal strength by using multiple strobes, permitting the receiver to employ statistical sampling techniques, and making it less susceptible to noise. It reduces interference by using an adaptive limiting technique that compares the received signal code to the known Loran format. And when the ground wave signal is inadequate because the object to be positioned is too far away from the transmitting station, the skywave signal is employed.

The total result of these changes, says Graves, is to double the 500- to 600-mile range at which present receivers are useful. □

## Land, sea, and air

With more money available as the war in Southeast Asia winds down, companies like Teledyne Systems have noticed there are more contracts around for Loran.

Recently Teledyne won an Army contract for engineering models of a manpack Loran set, built six of them, and is expecting an RFP for the production contract. It also got a Department of Transportation contract to demonstrate a Loran location system for emergency surface vehicles. In addition it teamed with Teledyne Ryan Aeronautical Co. in San Diego, and completed negotiations with the Air Force to combine Loran and Omega in a navigational receiver. Now it is bidding on a Coast Guard contract for a low-cost merchant Loran receiver.

Consumer electronics

## Audio firms dominate EIA show

Four-channel, Dolby, cassette, and 8-track gear abounded at biggest exhibition, but the stands were noticeably short on video playback and recording hardware

by Gerald M. Walker, Consumer Editor

**Backed** by a strong sales rebound in nearly every product category, the consumer electronics industry late last month strutted its stuff in the largest-ever Electronic Industries Association consumer show. Nearly 300 companies filled booths for the fifth annual show at Chicago's McCormick Place, and the big show-stopper was four-channel stereo.

The EIA took advantage of the occasion to welcome exhibitors with sales figures showing a 51.4% year-to-year gain through April for phonographs and 12.6% for tape equipment, while TV makers learned that sales of color sets jumped 38.5% and monochrome rose 19.2% over 1970. But though both audio and video sectors showed impressive gains, hi-fi dominated the gathering.

Conspicuously present were the throngs of high fidelity component manufacturers and mass producers rushing to show new four-channel stereo equipment, a sector whose anticipated takeoff point was supposed to be 1972 [*Electronics*,

**Be seated.** Dot position in Motorola quad unit determines listener's perspective.

March 1, p. 73]. Dolby noise reduction units for recorders and fm tuners also were very much in evidence, as were cassette players for cars and cartridge systems for home use. Conspicuously absent at most television booths were the widely heralded videotape recording and playback units that had been expected to soar this year to form a booming new market.

**Quad sound.** Consumers can now get into the four-channel swim, one way or another, for as little as about \$50 for a simple decoder to as much as \$700 for a full receiver. More than a score of companies have decided that the sales potential is too great now to wait until the conflict between discrete four-channel programming and coded matrixing is sorted out. Either approach is available now from a variety of companies, though the recorded library is still rather thin and only a few fm stations are planning quadrasonic programs.

Not only were the high-fidelity producers such as H.H. Scott Inc., Maynard, Mass., Harmon-Kardon Inc., Plainview, N.Y., and Fisher Radio Corp., Long Island City, N.Y., showing new quadrasonic playback equipment, but the big guns in mass consumer electronics, including RCA Consumer Electronics division, Indianapolis, Ind., and Motorola Consumer Products division, Chicago, were also knee-deep in the action, as were a raft of Japanese firms.

An important shot in the arm for cassette advocates is being provided by the spread of the Dolby B-type system, designed to suppress hiss on recording tape. The Dolby process, which involves coding of tape and

fm broadcasts, and decoding at the player, is licensed to some 25 firms and will make the stereo cassette a serious high-fidelity medium, according to Ray Dolby, founder of the British-U.S. company. Besides the tape decks with built-in Dolby decoders selling in the \$200 to \$300 range, stereo units that will process Dolby fm broadcasts as well as tape were announced by both Fisher and Harmon-Kardon.

While the cassette is being groomed as a medium for top-quality hi-fi systems, it is also making new inroads into the audio entertainment field, heretofore dominated by 8-track cartridges. For example, Teac Corp. of America, Santa Monica, Calif., which has stressed high-priced players for audio buffs, now has a car cassette unit with an automatic load mechanism and a continuous auto-reverse capability.

**On the track.** Not to be outmaneuvered, 8-track makers have made a renewed bid to get their units into homes, thanks to the interest peak in four-channel sound. More than a dozen firms were showing quad-8 units either as complete four-channel ensembles or conversion packages with a Q-8 player, two-channel amplifier, and two speakers.

In the videotape field, a few companies showed TV-tape units. Only Admiral Corp., Chicago, displayed a receiver with a built-in Cartrivision player. JVC America Inc., Maspeeth, N.Y., and Akai America Ltd., Compton, Calif., showed videotape recorders designed for home use, while Motorola put an Electronic Video Recording player in its futuristic entertainment room. □



HEWLETT  PACKARD  
POWER SUPPLIES

**take a  
close look  
when you  
specify a  
power  
supply...**

There's a lot to consider when you specify a power supply, and HP gives you a lot. Take selection for example. HP offers well over 100 models ranging from 10uV to 4000V, from 1uA to 2000A . . . plus a selection of options that satisfy most applications. Performance is another major consideration. At HP, we don't practice "specsmanship". We present specifications conservatively and completely, so you get the performance you expect. And, every model is backed by a comprehensive operating and service manual detailing every aspect of the supply from operation to maintenance. But it doesn't end there . . . if you need assistance, we have an international network of 220 offices to serve you. And it's all based on a concept of quality and reliability — your assurance that you are getting the best value. Hewlett-Packard, New Jersey Division, 100 Locust Avenue, Berkeley Height, New Jersey 07922, Telephone (201) 464-1234.

**DC POWER SUPPLY SELECTION GUIDE**—this 36-page guide is factual and informative . . . clearly lists all the specs, features, options, prices, etc. on every HP power supply . . . makes it easy to find the right model for any application. Write for your copy.

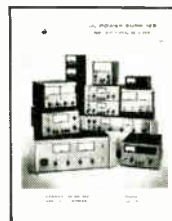

21103

Circle 99 on reader service card



6259B DC POWER SUPPLY  
HEWLETT - PACKARD 0-10V 0-50A

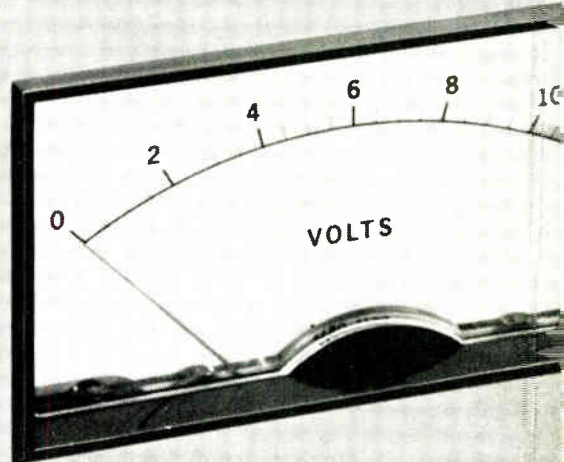

# CTS *has the answer in*

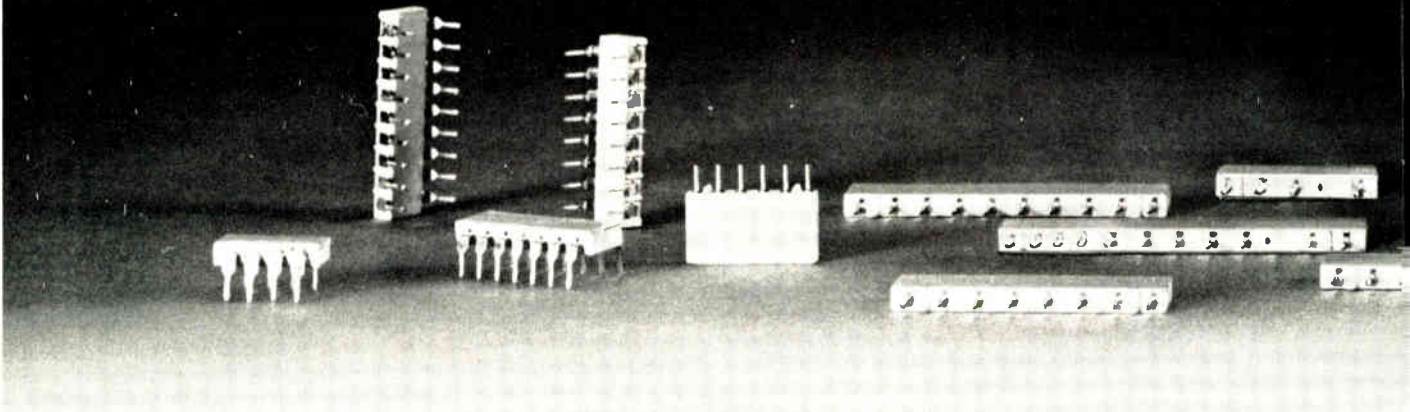

You name it—we have the exact cermet resistor network size and characteristics you need. Here's the choice you get right now: our *750 line* includes: .100" centers with 4, 6 & 8 pins; .125" centers with 2, 4, 6 & 8 pins; and .150" centers with 4 through 13 pins. And we're working on new designs right now!

All compact, extremely stable and highly reliable. Recently we packed even more circuitry into our *760 series*, giving you a choice of four popular space-saver packages: 8, 14, 16 and 18 flat lead styles. Packed with up to 17 resistors per module with flat leads standard (round leads on request).

# *cermet resistor networks.* So ask us!

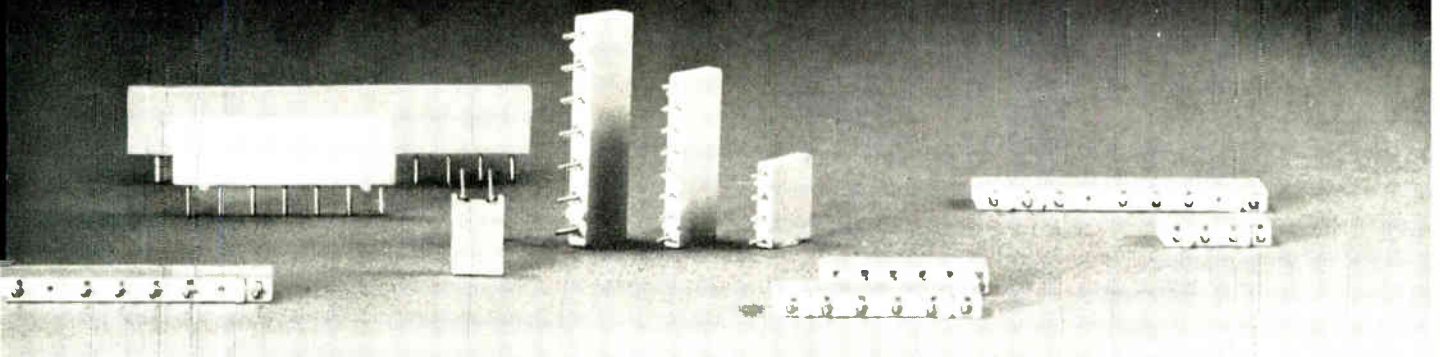

Our broad line provides an infinite number of circuit combinations, all with excellent TC, load and temperature characteristics supported by millions of hours of reliability testing. Ask your CTS sales engineer for data. Or write CTS of Berne, Inc., Berne, Indiana 46711. Phone (219) 589-3111.



ACTUAL SIZE



**CTS CORPORATION** *Elkhart, Indiana*

A world leader in cermet and variable resistor technology.

# Centralab offers immediate delivery on functional modules



Centralab, the industry leader in thick film microcircuitry, now has combined its recent advances in packaging and chip hybrid technology to bring you five new functional modules available for immediate delivery from stock. These modules are sealed in ceramic packages with 14 swaged terminal pins universally spaced .600" row-to-row and .100" apart to facilitate printed circuit board mounting.

Module	Function	Rating	Suggested Applications
FM-1110	Power driver	1 amp @ 60v steady state	Interfacing with relay/solenoid coils, magnetic cores, lamps, etc. in computers, control consoles, test equipment, digital systems, etc.
FM-1203	Dual driver	300 ma @ 28v steady state	
FM-1403	Quad driver	300 ma @ 28v steady state	
FM-2100	MOS clock driver	200 ma with up to 30v shifts	To drive all popular MOS circuitry in calculators, computers and other digital systems.
FM-3100	Programmable multivibrator	Output pulse widths 200 ns to 12 $\mu$ s	Delay, timing and pulse shaping in computers, control circuits, test equipment and other digital systems.
*FM-4100	RC clock oscillator	500 kHz to 6 mHz	Time base, square wave generators and tone signalling controls for computers, test equipment, etc.
*FM-5100	Overvoltage crowbar	Trip voltage 4.5 to 12.5v, < 1 $\mu$ sec response	To protect voltage sensitive devices such as IC's, MOS devices, etc.
*FM-5111	Overvoltage crowbar	Trip voltage 12.5 to 20.5v, < 1 $\mu$ sec response	
*FM-5120	Electronic fuse	Trip current 1 amp @ 40v, < 1 $\mu$ sec response	DC electronic equipment and systems where precise, fast current disconnect is required.
*FM-6110	Power operational amplifier	250 ma peak output current with supply voltages $\pm$ 15 vdc	Servo systems, test equipment, power supplies, etc.

## DESCRIPTION

**FM-1110, 1203, 1403: Single, dual and quad drivers**  
Designed to accept standard DTL and TTL logic levels and to drive loads which require high power. Consist of single or multiple NAND/NOR gates and high gain amplifiers.

**FM-2100: MOS clock driver**  
Designed to accept standard DTL and TTL logic levels and universally drive MOS circuitry. Consists of a three input AND function followed by a power inverter.

**FM-3110: Programmable monostable multivibrator**  
A flip-flop which, when triggered by an input pulse, generates an output pulse of prescribed width, with control through interconnection of appropriate package pins.

**\*FM-4110: RC clock oscillator**  
An RC astable multivibrator and an output buffer stage capable of providing a square wave output at a predetermined fixed frequency. It can operate down to 5 Hz with the addition of external capacitors.

**\*FM-5110, 5111: Overvoltage crowbar**  
A high speed electronic voltage sensing element and switch designed to protect voltage sensitive electronic devices by shunting out the supply voltage when high transients or other overvoltage conditions are experienced on the supply line.

**\*FM-5120: Electronic fuse**  
The electronic equivalent of a fuse which features accurate threshold levels, high speed and reset capabilities. Available in a variety of current threshold levels.

**\*FM-6110: Power operational amplifier**  
An operational amplifier designed to provide output capabilities far beyond those obtainable with equivalent monolithic IC's.

**\*These modules are scheduled for introduction in 1971.**

We welcome inquiries on any variation of the above modules and can provide rapid turnaround on samples and production quantities of custom modules. For design assistance or other information, write Sales Manager, Microcircuits, Centralab. Standard modules are also available through Centralab Distributors.



**CENTRALAB**

Electronics Division  
GLOBE-UNION INC.

5757 NORTH GREEN BAY AVENUE  
MILWAUKEE, WISCONSIN 53201

M-7115

## New products

# Production-line ion implanter is fully automatic

by Stephen E. Scrupski, Packaging and Production Editor

System offers preprogrammed doping of 120 three-inch device wafers per hour with boron or phosphorous

The transition from laboratory to production line has been a fairly fast one for ion implantation. Device designers accept it as an alternative to diffusion methods of forming semiconductor junctions because it creates much shallower junctions. They also applaud the elimination of high-temperature bake cycles that can result in a shift of junctions. And in MOS manufacture, ion implantation can produce self-aligning gate structures that have lower parasitic capacitance than diffused devices and thus offer higher-frequency performance.

The process came of age this month with introduction of the P-554 ion-implantation processor by Ortec Inc. The production-oriented system, priced at \$75,000, can operate unattended throughout its pumpdown and implantation cycle. It provides preprogrammed doping, with uniformity within 2% and repeatability within 1%. Using the 18-wafer chamber shown in the photo, and an exposure of 10 seconds per wafer, a throughput of 120 three-inch wafers per hour is possible. Larger chambers will be available soon.

The beam of positive ions (either boron or phosphorous, p- and n-type dopants) is accelerated to an energy of 5,000 to 150,000 electronvolts and is swept across a wafer in a

raster-type scan with a beam spot about 0.5 centimeter in diameter. Masking can be done with the photoresist used in diffused devices, or—for MOS structures—the aluminum gate can serve to stop the ions from entering the semiconductor. After each wafer is doped, a mechanical shutter closes and the tray is indexed to the next wafer.

**Press and wait.** Because the doping process is preprogrammed, the operator need only load the wafer tray, press the start button, and wait to remove the tray when all wafers have been covered. In the tray, the wafers are handled face down to prevent dust from collecting on the surfaces.

During the cycle, the doping and scanning rates are monitored and any deviation from a preset limit causes a shutter to close and a warning indicator to come on. The system also can be equipped to accommodate printout equipment that automatically records each dose.

The system uses a dual-filament gun that permits continued operation if one filament burns out. A 90° permanent-magnet separator eliminates undesired particles from the ion beam, and in the final stage of the scan, the beam is deflected slightly off axis so that neutral particles pass in a straight line and are trapped.

In addition to monitoring the implantation process, the system has automatic detection and interlocks to protect against power failure, malfunctioning of the vacuum or cooling systems, or operator error. The high-voltage section is interlocked; opening of the doors shuts

down the source power and shorts the high voltage to ground, discharging the capacitance.

Another feature that the company says aims at the production floor is the use of refrigeration to cool the vacuum system, rather than liquid nitrogen, which is inconvenient to use but has been a standard in laboratory implanters.

Overall cabinet size is 9 feet long, 4 ft. wide, and 6 ft. high. The company says delivery time is three to four months.

The system is a new area for the company in terms of its product line. Ortec was formed to produce semiconductor detectors for nuclear energy, which led to similar electronic instruments, and then to instruments related to plasma physics and X-rays.

Ortec Inc., an EG&G company, 224 Midland Rd., Oak Ridge, Tenn. 37830 [338]

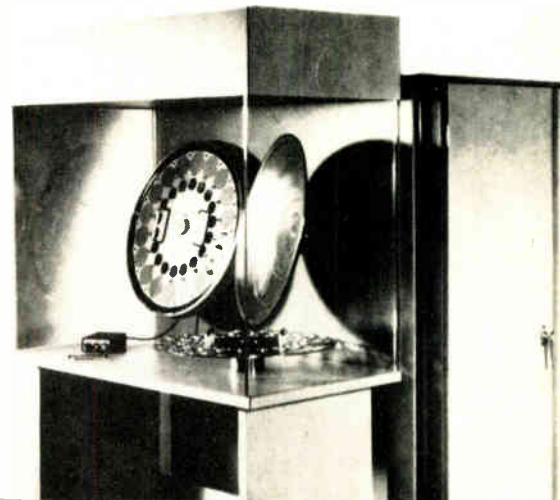

**Load and lock.** Semiconductor wafers are put in tray for implantation of impurity ions to form junctions. Cabinets hold controls.

Displays

# Color CRT monitor has high resolution

by Wallace B. Riley, Computers Editor

Beam penetration of 2-layer phosphor screen during scan is controlled by a switch that operates at 15  $\mu$ s

**Resolution** in the standard color display cathode ray tube is limited by the spacing of the holes in the shadow mask. A novel design that eliminates the mask yields higher color resolution in CRT monitors. Initial marketing target for the monitors is computer terminal makers, who need only add a controller to the monitor. The color enhancement is also expected to be attractive to builders of interactive graphic displays.

The monitors, made by CPS Inc. of Sunnyvale, Calif., are based on a CRT with two phosphor layers instead of one; these layers produce color when penetrated by a beam. However, the heart of the system is a special switch, actually a power supply for the CRT's voltages, that controls the beam. It is made by CPS and also is available separately.

Speed is the key factor in the color switch. It can change the high-voltage output for the CRT's accelerating electrode from one level to another in 15 microseconds, including settling time; this fast switching makes possible a color change in the middle of a sweep or scan of the screen. Only one other high-voltage supply on the market has anywhere near the capability of the CPS color switch, according to Fred Martin, vice president of marketing at CPS, and the competitive supply's specifications show a 175-microsecond switching time. With it, all elements of a whole frame would have to be a single color.

**Versatile switch.** Voltages for the cathode, the focusing grid, and the filament—everything in the CRT except the deflection signal—also are provided by the CPS color switch. Deflection drives and coils are included in the monitor when sold as a package.

The color displayed on the monitor's screen is controlled by varying the energy of the electron beam that strikes the screen; the energy is a function of the voltage on the accel-

erating electrode. A low-energy beam penetrates only the first phosphor layer, which glows red. But a high-energy beam penetrates both layers, and generates a green glow from the second layer. Intermediate energy levels generate orange or yellow. Of course, when the beam penetrates both layers with maximum energy, both red and green colors are produced; but the red phosphor saturates quickly and the eye is more sensitive to green than to red, so that the green swamps the red as viewed.

The two-layer tube itself, although not in wide use, is commercially available from several suppliers; the main source of supply for CPS is GTE Sylvania, and the company has also experimented with two-layer tubes from Thomas Electronics Inc.

One reason the experiments have not yielded commercially available color displays up to now is the difficulty of switching the high-voltage supply quickly with a low power dissipation in the supply—a problem that CPS has licked.

**Four levels.** The switch itself has an output range of 6 to 16 kilovolts, and can produce any four voltage levels within that range that are at least 2 kV apart. For the color CRT application, its outputs typically are 7, 9, 11, and 13 kilovolts, for red, orange, yellow, or green displays respectively.

The switch, known as the CPS-7000, is available by itself in several versions depending on speed required and the number of levels in the output; prices range from \$1,900 to \$3,600. The display monitor, containing the switch, sells for \$7,000 to \$13,000, depending on the switch used and the quantity ordered.

CPS Inc., 722 East Evelyn Ave., Sunnyvale, Calif. 94086 [339]

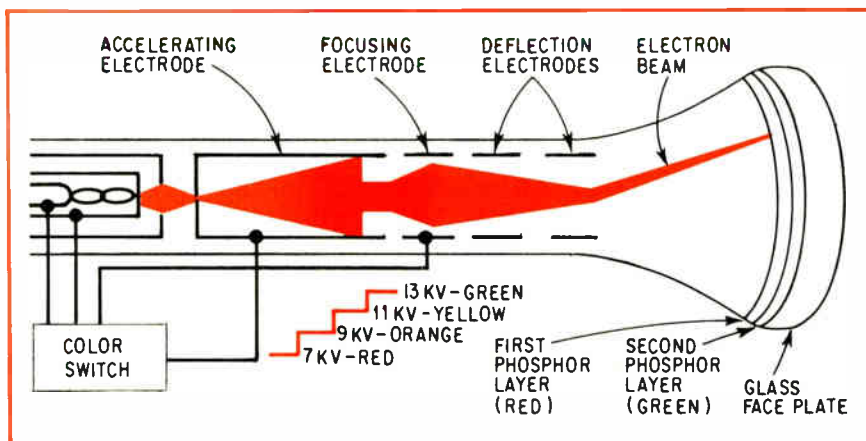



# A funny thing happened on the way to the bench.

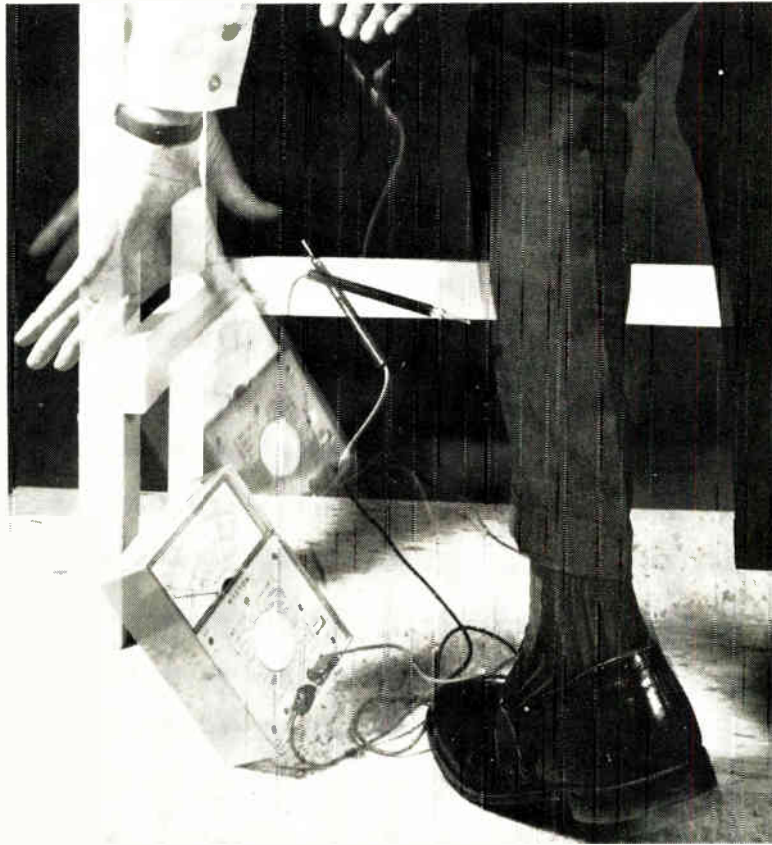

Photo courtesy Electronic Engineer

This Weston VOM will come through a five-foot fall and continue to work. We engineered our new 660 series VOMs to be virtually indestructible. And we back up this claim with a written warranty.

In addition to sparing you the embarrassment and inconvenience of a broken instrument, we've designed in all the features you expect in a modern VOM—plus a few more that may surprise you, considering that you pay no more for industry's smallest precision multitester.

For example: all models have diode-protected meter movements, with full

circuit overload protection optional. All are equipped with a custom taut-band mechanism, self-storing handle, polarity reversal switch, externally replaceable fuse, and a single range selector switch.

Basic accuracy is 2% on DC and 3% on AC ranges—an accuracy they'll maintain in extreme environments because they're *temperature compensated*, too.

The 660 series drop-proofed line includes a 35-range general-purpose VOM, a VOM with resettable relay for 220-volt circuit overloads, and a high-

accuracy version of each. There's also a high impedance unit with four push-button selectable modes and 37 ranges designed especially for semiconductor troubleshooting, but rugged enough for any field servicing need as well.

See your Weston distributor, or write for details on these "bouncing" new baby VOMs with more of everything... except price.

**WESTON®**  
WESTON INSTRUMENTS  
614 Frelinghuysen Ave., Newark, N.J. 07114  
a Schlumberger company

# A very uncomplicated new OEM recorder with just one thing going for it...

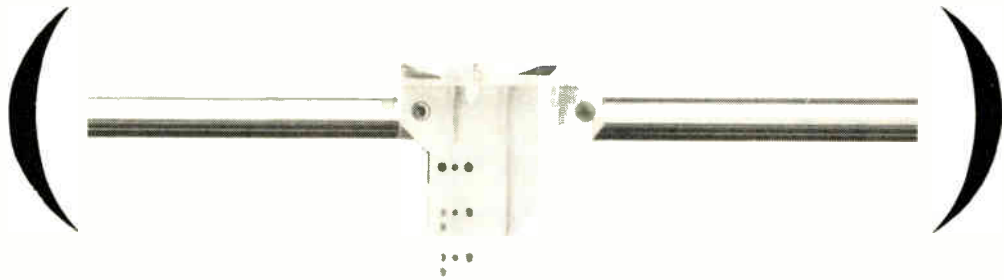

You'll like what you see in our new approach to dedicated OEM strip chart recorders. First, we eliminated all those complicated moving parts from the writing mechanisms. No more pulleys, cables and slip clutches. Instead, there's just one simple moving part—the slider/pen assembly. That's because a linear servo motor keeps the pen going magnetically ... and very reliably.

When you see the HP Model 7123, you'll notice how the low power servo system makes the recorder smooth, precise and trouble-free. You could drive it off scale around the clock without noise or danger.

Even with all that, you've got a lot more going for you with the 7123. Like a swing-out chart paper drive for quick reloading and reinking. The viewing/writing area is slanted so you can make notes right at the disposable pen tip. And you can work without worrying about a lot of circuit adjustments. They're simply not needed anymore.

Since it's an OEM machine from the ground up, the 7123 has options

for everybody. Select any chart speed and voltage span in English or Metric scaling. In all, nearly 50 options will customize the recorder exactly to a specific application.

You'll probably be most intrigued by an option we call electric writing. Normally, the ink system works like a cartridge fountain pen. But electric writing is designed for people who don't even want to mess around with that. A highly stable electrosensitive paper that gives you a crisp, clear trace without ink.

Available in full rack or half rack versions, the 3½ inch high 7123 makes totally unattended operation a reality. Simplicity, reliability, precision and even electric writing. With all that going for you, you can turn it on Friday and forget about your work all weekend.

To see the uncomplicated new 7123 and its matching price and OEM discount schedule, call your nearest HP sales office. Or write, Hewlett-Packard, Palo Alto, CA 94304; Europe: 1217 Meyrin-Geneva, Switzerland.

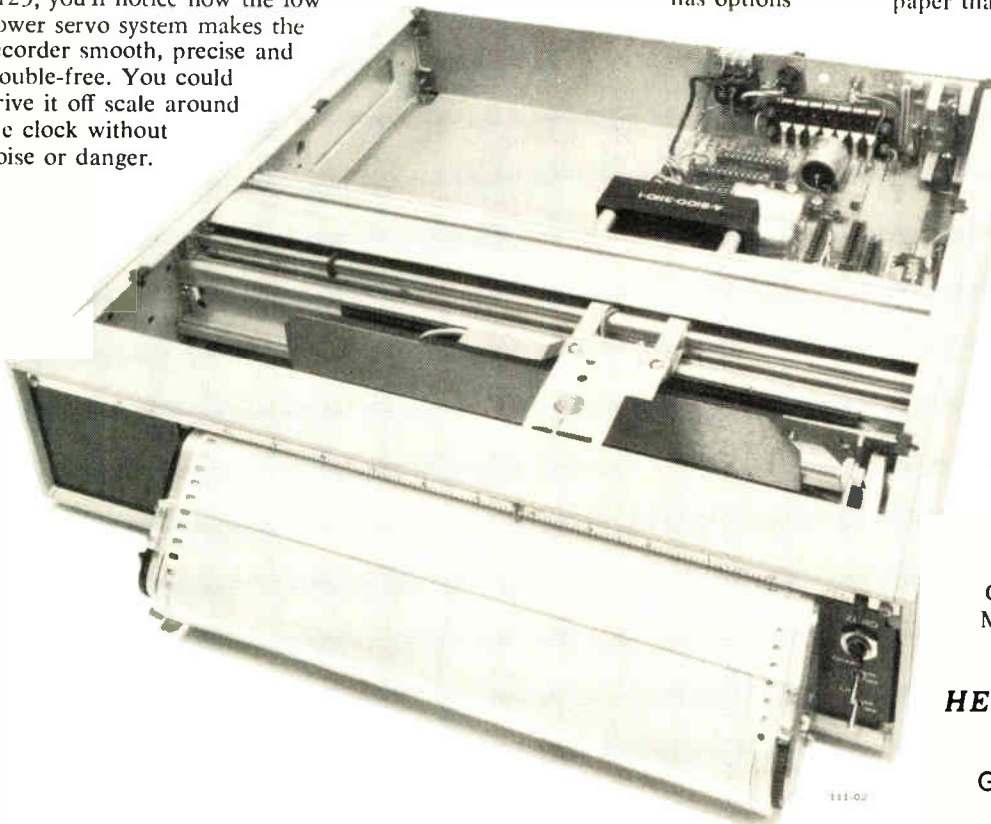

HEWLETT  PACKARD

GRAPHIC RECORDERS

## New products

### Instruments

# Synthesizer is programable

Direct method employed in unit priced at \$2,450; MSI helps keep cost low

Where stability and purity are necessities, the direct method of frequency synthesizing is preferred. But it's expensive, so engineers have had to trade off by going to indirect devices, such as phase-locked loop

signal generators. In an attempt to eliminate that cost-technology tradeoff, Rockland Systems Corp. has put together a programable frequency synthesizer for fall delivery that will sell for \$2,450 and use the direct method.

Leland Jackson, vice president of engineering at Rockland, attributes the low cost to use of off-the-shelf medium scale integration, some custom MSI, and "radically new techniques." And, adds Jackson, "sometimes a small company can run with a technology faster. In this case, it's digital filters."

The signals are digitally generated, then converted to analog output. The basic frequency is derived

from a single internal crystal reference, and others by mixing and filtering the reference signal. To change the frequency, the model 1500 switches instantaneously after a 0.5 microsecond delay. The result is that no jitter or settling time is involved.

But while the programing and remote control are easy, the signals pure, and the price low, the 1500 does have one limitation. It is the low frequency range, 0.0001 hertz to 2 megahertz, compared to the 50 MHz available in more expensive instruments. Rockland is counting on the attractive price to make up for the handicap, and is aiming the unit at measurement and testing appli-



Automatic ranging frequency counters models cf-251 and cf-252 select correct measuring range and decimal point position in readout, depending on operator's choice of highest accuracy or fastest speed of measurement. Measuring range goes up to 100 MHz. Price is \$695 for 251, \$895 for 252. Dixon Inc., Box 1449, Grand Junction, Colo. [351]



Universal counter timers series 6150 provide four frequency ranges: 50 MHz, 200 MHz, 512 MHz, and 3 GHz. Other ranges are available by adding or exchanging internal plug-in pc cards. Expandable design permits upgrading of resolution from basic 100 ns to 10 ns. Price starts at \$1,195. Systron Donner Corp., Galindo St., Concord, Calif. [352]

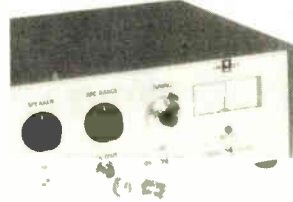

Frequency modulated transmitters T-10 series measure from 125 to 1500 microstrains over typical temperature range of  $-40^{\circ}$  to  $+175^{\circ}$  C. Units withstand immersion in hydrocarbons and common fluids and exposure to salt spray and steam. Range is 100 feet line-of-sight. Inmet Inc., 987 Pinetree Dr., Indian Harbour Beach, Fla. 32937 [353]



Circuit analyzer called Omni-Tester 900 checks complex wiring by tape controlled operation. Device measures continuity, insulation resistance, ac/dc dielectric strength. Tapes can be produced manually or automatically, and control console accommodates up to 1,000 test points. Tele-Sciences Inc., 351 New Albany Rd., Moorestown, N.J. [354]

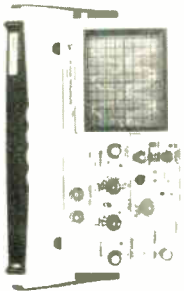

Portable oscilloscope model 434 offers split-screen storage in small package with 8- by 10-cm CRT. Features include dual trace with 25 MHz bandwidth, deflection factor of 1 mv/div to 10 v/div in 13 steps, and fastest sweep rate of 20 ns/div. Price is \$2,150, and it drops to \$1,585 for model without storage. Tektronix Inc., P.O. Box 500, Beaverton, Ore. 97005 [355]

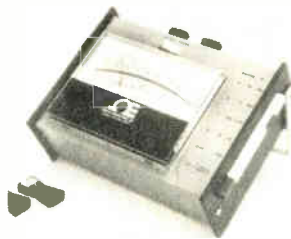

Portable thermocouple readout meter is driven by high-gain amplifier, and contains a built-in ice point reference allowing temperatures to be read to within  $1^{\circ}$  C. Basic meter range is  $-100$  to  $+175^{\circ}$  C, and response time is less than two seconds. Any type  $\tau$  thermocouple can be used. Price is \$245. Omega Engineering Inc., Box 4047, Stamford, Conn. 16907 [356]

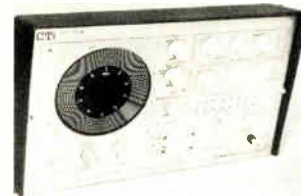

Distortion analyzer model DTS-531, for firms servicing data communications equipment, identifies types of distortion accompanying the signal. LEDs display pattern on monitoring console and show magnitude of distortion from 0 to 98%. Standard data rates go up to 4,800 baud. Communications Technology Inc., 1900 York Rd., Timonium, Md. [357]



Digital ratiometer type 2330-570 displays ratio of two dc voltages over a ten-to-one change in the reference voltage. Accuracy of the  $3\frac{1}{2}$  digit device is 0.1% of reading  $\pm 1$  digit over a reference voltage range of +0.5 v dc to +2.0 v dc. Internal voltage divider permits higher ranges. Price is \$199. Digilin Inc., 1007 Air Way, Glendale, Calif. [358]

# Looking for Bit Errors?

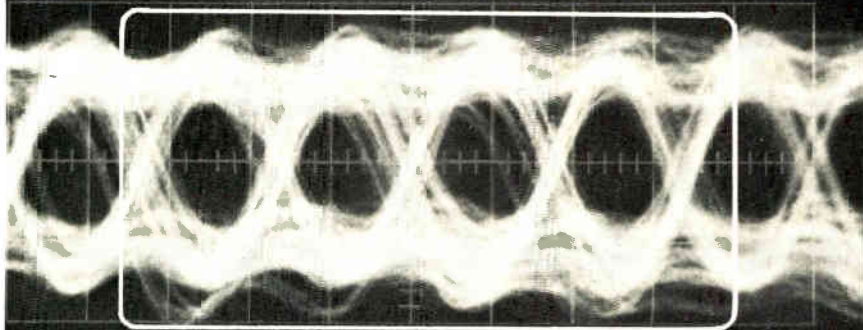

Actual Eye Pattern



## Here they are!

Kingsley Roby of our engineering staff uses the DCS Model 4660 Link-BERC (Link-Bit Error Rate Calculator) to check out our own 10 mega-bit PCM equipment. Why not let him help you check your T-1, T-2, standard IRIG or special digital transmission links?

With selectable bit-blanking, clock-phasing, bit error rate intervals and standard internal calibration . . . analyzing your link will be a lot easier and less time-consuming than complicated computer or pulse generator / scope lash-ups. Also remember your printer (or one we will supply) can be connected to Link-BERC to provide a hard copy record of system bit error rates.



Model 4660 Link-BERC

Call us or circle the reader service number for a free application brochure and a demonstration at your facility.

Day/Address	Hour/Min	Bit Errors
00		
01	0102	000
02	0105	110
03	0107	000
04	0109	190
05	0111	190
	0113	000



**DATA-CONTROL SYSTEMS, INC.**  
 Commerce Drive, Danbury, Connecticut 06810  
 203 743-9241

## New products



**Direct.** Frequency synthesizer gets its basic signal from a crystal reference, derives others by mixing and filtering.

cations including communications systems, computer-controlled frequency generation, sweeping and hopping; and laboratory frequency standards. The company says it expects the instrument to be used with automatic and semiautomatic test equipment, also in radar and sonar signal generation.

The 1500's direct-method synthesis requires no mixing or phase locking, and it can run off a 1 MHz external standard. The basic machine can be programmed four ways: universal interface accepts BCD, binary, contact closures, or transistor-transistor logic levels. In the binary mode there are no switching transients, and amplitude and phase continuity are maintained when frequency is changed. The frequency range has a selectivity of 9 decimal digits in 0.001-Hz steps.

Stability is  $\pm 2 \times 10^{-8}/^{\circ}\text{C}$  with  $\pm 2 \times 10^{-10}/^{\circ}\text{C}$  optionally available. Spectral purity is -70 dB below fundamental to 1 MHz spurious and -60 dB below fundamental to 1 MHz harmonic. The unit also offers synchronous loading of 46-bit parallel words or four 12-bit bytes, determined by one control bit.

The model 1500 comes with a rack adapter and programming connector. Two options are available: a high-stability reference priced at \$750 additional and a remotely programmed attenuator (0 to 85 dB in 1 dB steps plus continuous control) at \$250 additional.

The device measures 3½ by 17 by 14 in. in its case and fits into a 19 in. rack. Weight is 15 pounds. Delivery will begin this fall, and small quantities can be ordered from stock. Rockland Systems Corp., 131 Erie St. East, Blauvelt, N.Y. 10913 [359]

# All Relays Are Not Created Equal!

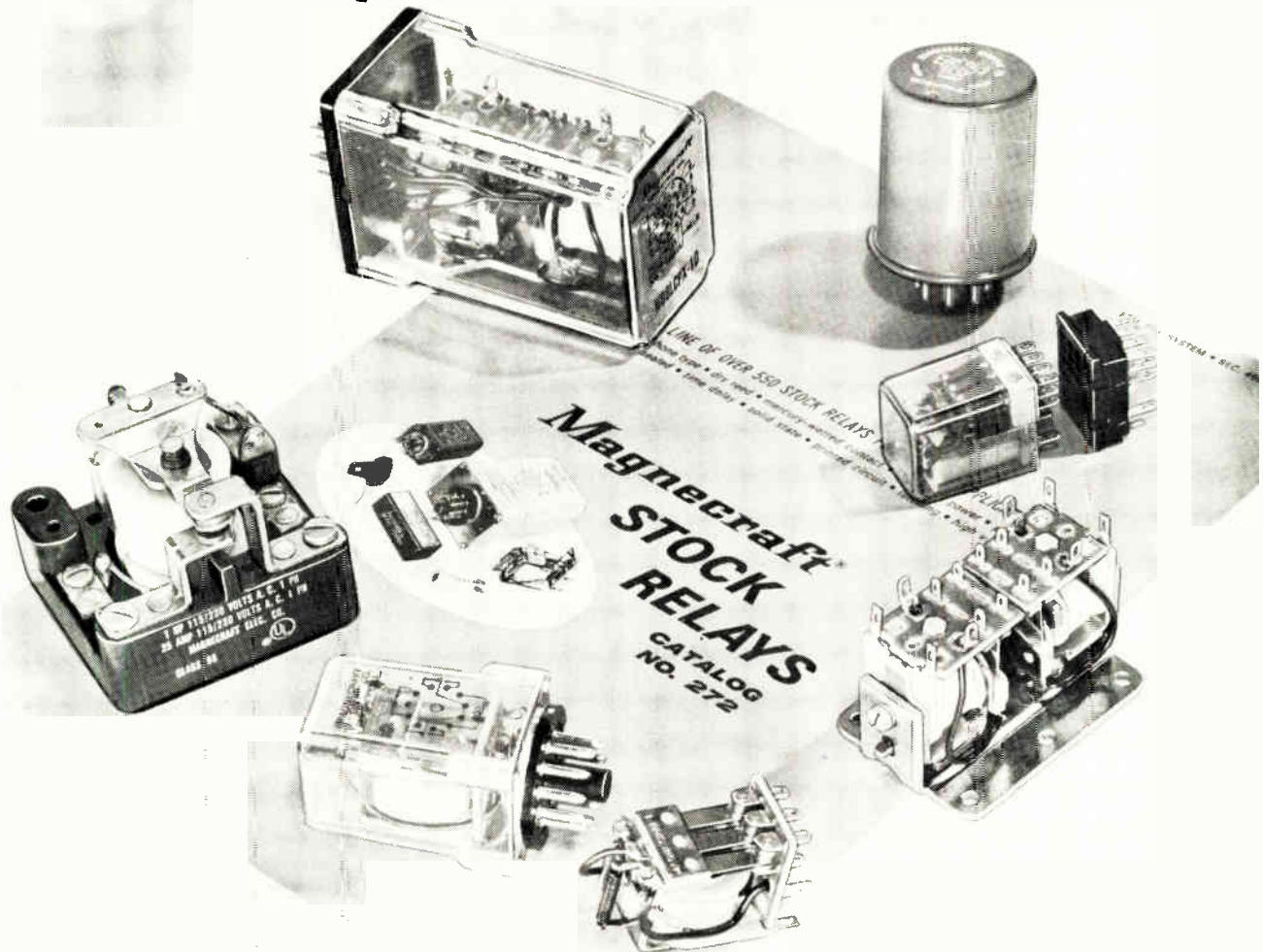

## Magnecraft Creates Better General Purpose & Power Relays.

Magnecraft relays are not created equal, because they are created to be better. Created better than its competitors, created better than the most demanding requirements, created better because reliability is important. We are then in the best position to help solve your switching and control needs, not just sell you a relay.

Magnecraft's general purpose and power relays, used in so many applications, incorporate a rugged hinge pin design armature suspension system, molded nylon coil bobbins, and glass melamine terminal boards, to insure electrical stability and mechanical stability over a longer life. These two classes of relays are available in hundreds of variations: Up to 50 amp contacts; Up to 6PDT, in latching versions; Auxiliary contacts; Many types of enclosures, plastic see-thru, metal dust covered, and metal hermetically sealed; Many types of terminations, such as solder lug, octal style plug-in, and terminal board plug-in are available: and of course all standard coil voltages. The variations listed are in stock for immediate delivery, not just on special order. When your design calls for a general purpose or a power relay, turn to Magnecraft with confidence.

Our 20 years experience has enabled us to do more than just build a good relay. We can help you solve your switching and control problems. Your first step is simple. Send today for Stock Catalog #272 listing over 550 different relays stocked by Magnecraft and its nationwide network of distributors.

**Magnecraft<sup>®</sup> ELECTRIC COMPANY**

5575 NORTH LYNCH AVENUE • CHICAGO, ILLINOIS 60630 • 312 • 282-5500 • TWX-910 221 5221

# This Brush Multipoint recorder is 16 times faster than conventional multipoints. And you can change its mode by turning a dial.

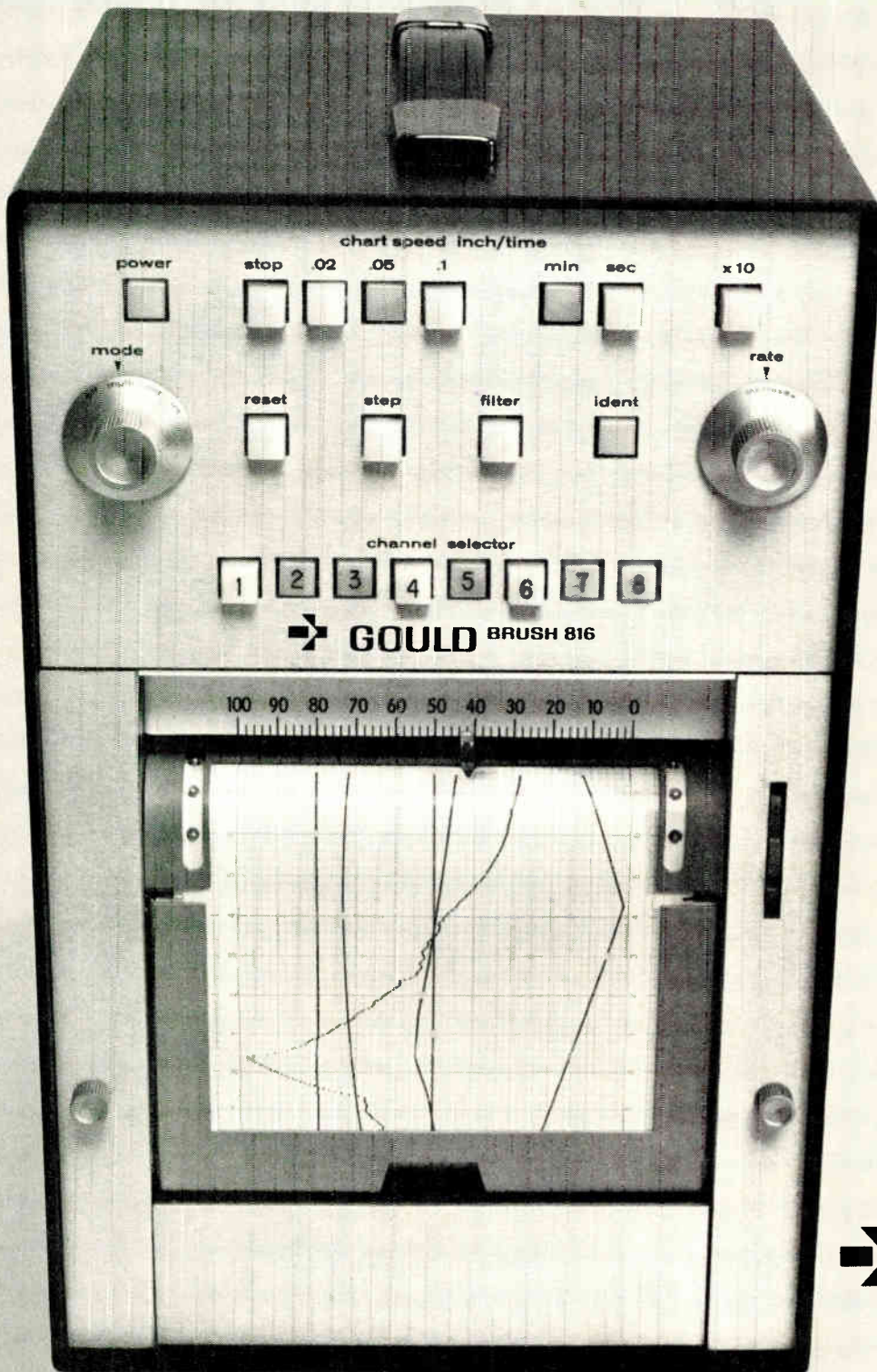

High speed. And exceptional versatility.

These are two big reasons why the Brush 816 Multipoint Recorder goes right to the head of its class.

It scans and displays up to 8 channels of data 16 times faster than conventional multipoints. And that means maximum information at lowest cost per channel.

The dial at upper left gives you fingertip selection of operating mode; *multipoint* sampling, *intensified* sampling (for channels of high dynamic content), or *continuous* single channel recording. Presentation is rectilinear on a 4½" grid while traces are clear and easy-to-read. Paper is stack-to-stack Z-folded and tucks neatly into a catch drawer below the writing table. And there's a pushbutton choice of 12 chart speeds.

The 816 adapts to a wide range of data sources and handles both high and low level inputs. A series of optional signal conditioners provides almost unlimited input flexibility.

Typical applications include: temperature dispersion vs. flow; pressure distribution within a vessel; structural stress analysis; dye dilution studies; chemical analysis; patient monitoring; machine or automotive dynamics. And many more.

At first chance, take a good look at the Brush 816 Multipoint Recorder. You'll get so much more . . . but you won't pay more to get it. Write: Brush Division, Gould Inc., 3631 Perkins Avenue, Cleveland, Ohio 44114, or Rue Van Boeckel 38, Brussels 1140 Belgium.

 **GOULD BRUSH**

Subassemblies

## Modules build power source

Preregulators, generators, output circuits permit user to design, change his supply

The power supply market is largely custom: a new piece of equipment triggers the design of a new power supply—which may account for the existence of 80,000 or more so-called "standard" designs on the

market at the present time.

But the picture could change as the Powercube Corp. brings out its Cirkuitblock modules. Out of a series of three basic module types—preregulators, power generators, and output modules—it should be possible to supply almost every internal power need from off-the-shelf blocks. "This brings some of the economies of volume to the power supply business," says president Chester L. Schuler. Moreover, from experience gained in the space program, Powercube can supply up to 100 watts out of as few as two 2-cubic-inch modules. Several of the smaller modules are being used aboard NASA satellites and probes.

The simplest Cirkuitblock system uses a power generator hooked to the ac line, and an output module that delivers the desired unregulated voltage and current to the system.

Powercube's power generators, six of which accommodate 10 to 100 volt dc inputs and two which work on ac, use rectified or dc-to-dc converted current to produce a square wave output of about 30 kilohertz and 40 volts peak to peak. This output is common to all the power generator modules. What's uncommon is the 80% to 95% efficiency with which it's generated. In some supplies, transformer excitation losses alone can greatly reduce the degree

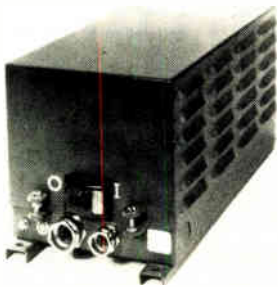

SCR static inverter model 200 VA is designed for small loads, features regulated sine wave output with  $\pm 5\%$  voltage control and  $\pm 1\%$  frequency control. Unit has nominal dc inputs of 24, 32, 125, or 250 v, and applications include navigation and communications. Solidstate Controls Inc., 600 Oakland Pk. Ave., Columbus, Ohio [381]

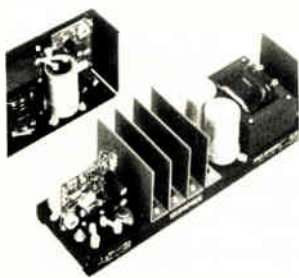

Regulated dc power supplies called OEM series are offered in six basic sizes, each with voltage ratings of 5, 6, 12, 15, 18, 20, and 24 v dc, providing 42 different voltage/current ratings. Input is 115 v ac  $\pm 10$  v, 57-63 Hz; regulation, line  $\pm 0.25\%$ . Prices range from \$24.95 to \$299. Power Tec Inc., 9168 DeSoto Ave., Chatsworth, Calif. [382]

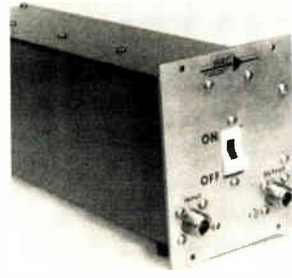

Wideband amplifier ARC-10HB for laboratory use operates into an infinite vswr, features instantaneous bandwidth of 300-500 MHz and power output adjustable from 5 to 10 w. Applications include antenna and component testing, EMI susceptibility testing. Price is \$1,485. Amplifier Research Corp., Box 7, New Britain, Pa. [383]

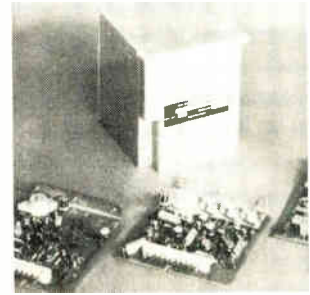

Regulated dc power supplies models C70 3925 201 and 202 deliver multiple output voltages, and function together to form a single power supply for avionic and military applications. Features include low heat dissipation, maximum operational altitude of 70,000 feet. Singer General Precision Inc, McBride Ave., Little Falls, N.J. [384]

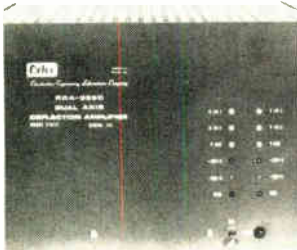

Deflection amplifiers models RDA-1260 and RDA-0960 provide 12-ampere change through 25 microhenry deflection yoke in less than 6  $\mu$ s. The 1.8 MHz bandwidth allows use of single deflection system for positioning and character writing in most applications. Four power supplies are included. Celco, Pacific Div., 1150 E. 8th St., Upland, Calif. [385]



Digital display assembly called Digicator includes bezel and color filter, mounts into front panels by two screws. Lamps are replaceable from the front. Unit is available with seven-segment numeric, hexadecimal, and alphanumeric characters. Price is \$1.98 per decimal digit in 100,000 quantities. Discon Corp., N.E. 4th Ave., Pompano Beach, Fla. [386]



Trembler switch measures 0.125 in. diameter by 0.687 in., and is designed for low-current applications. The miniature unit is available in ranges from 1.5 g to 7 g with a tolerance of  $\pm 0.2$ g. It senses motion in a plane that's vertical to its axis, is sealed to withstand potting stresses. Cole Instrument Corp., 2034 Placentia Ave., Costa Mesa, Calif. [387]

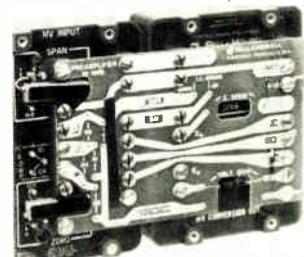

Pre-amplifier model 19-101B converts dc signals in the millivolt range to level required for use in precision computing, controlling, indicating, and recording devices. The transistor-chopper-stabilized, high-gain device has 0.5% overall linearity. Price is \$309. Bell & Howell Co., Control Products Div., Bostwick Ave., Bridgeport, Conn. [388]

# Best Buy

in 1% Tolerance  
1-Watt Zeners  
**SCHAUER**  
Immediate Shipment



## Low Prices

ANY voltage from 2.0 to 18.0

Quantity	Price each
1-99	\$1.07
100-499	.97
500-999	.91
1000-4999	.86
5000 up	.82

Write for complete rating data and other tolerance prices.

## Buy The Kit!

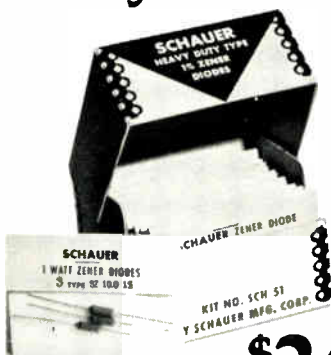

A \$54.57 value for only

**\$24.50**

Kit contains a 51-piece assortment of SCHAUER 1% 1-watt zeners covering the voltage range of 2.7 to 16.0. Three diodes of each voltage in reusable poly bags. Stored in a handy file box. Contact your distributor or order direct.

Semiconductor Division

### SCHAUER

Manufacturing Corp.

4514 Alpine Ave. Cincinnati, Ohio 45242

Telephone: 513/791-3030

## New products

of efficiency in the equipment.

The output modules all work from the common 30-kHz 40-v peak-to-peak input, and from this can generate regulated or unregulated single or dual outputs, at 4 to 200 v, 0.3 to 10 A. Users can hang output modules on power generators until they reach the maximum wattage capability of the generator in the system.

The unregulated output modules have something more like an ordinary power supply schematic with a high-frequency, low-loss transformer input, rectification, choke-capacitive (L-C) filters and a zener diode voltage limiter. Regulated units use a simple transistor regulator and attain line and load regulations of as little as 100 mv peak to peak at 300 v output.

Where the regular line of power generators can't meet certain Mil-Spec input requirements, Powercube offers switching preregulators to place before the power generators. These handle the varied forms of power used in military applications, offer overvoltage and surge protection, and in addition do some regulation to make for an even smoother output.

Powercube describes the module line as a "tree," with a squat trunk of preregulators and eight main branches—power generators—from each of which can spring 38 different output modules.

"Now it's possible to sit down and block out a supply and live with the design," says N. Edward Chapman, marketing vice president. "Even system changes that once might have reverberated back to the original power supply transformer can be accommodated just by changing an output module. Circuitblocks can be used for breadboarding as well as for the final system." This should cut down on engineering time and simplify debugging as well as purchasing procedures, he adds.

The price is \$40 to \$60 per module in 25-unit lots. In thousand-unit lots, it is \$25 to \$30 per module. Delivery is stock to 6 weeks.

The Powercube Corp., a subsidiary of the Unitrode Corp., 214 Calvary St., Waltham, Mass. 02154 [381]

CLASSIFIED ADVERTISING

## SEARCHLIGHT SECTION

BUSINESS OPPORTUNITIES  
USED OR SURPLUS EQUIPMENT

RADAR SYSTEMS GROUND AND AIRBORNE. AUTOMATIC TRACKING ANTENNA SYSTEMS. NIKE AJAX. NIKE HERCULES. M-33. MSQ-1A. MPS-19. MPS-9. SCR 584. TPS-1D. TPS-28. FAA-ASR-2. AIRBORNE SYSTEMS. APN-84. APN-102. APS-20. APS-27. APS-45. DPN-19. DIGITAL COMPUTERS. IBM 650. IBM 704.

LARGEST INVENTORY OF RADAR AND MICROWAVE EQUIPMENT IN THE WORLD.  
**RADIO RESEARCH INSTRUMENT CO.**  
3 QUINCY ST., NORWALK, CONN. 06850 (203) 853-2600

CIRCLE 966 ON READER SERVICE CARD

### Radiation Devices Co.



OEM'S - BROADCASTERS  
UNIVERSITIES - SERVICE COMPANIES

Review Our Economical Line of Instruments, Accessories, and Signal Processing Components Spanning The Frequency Range From D-C to 2 GHz. To Get Best Value For Your Electronics Dollar. Brochures and Application Notes Are Available Upon Your Request.

RADIATION DEVICES CO., BOX 8450, BALTIMORE, MD. 21234

CIRCLE 967 ON READER SERVICE CARD

### WHAT IS THE MYSTERY OF FINANCIAL SUCCESS

Mystery uncovered in NEW ROADS TO OPPORTUNITY AND WEALTH, a booklet just published. Interested in a lucrative business of your own? Profit by sending for and reading it. FREE, No Obligation. ELES INTERNATIONAL, John R. Sauer, President P.O. Box 22458, Denver, Colorado 80222.

CIRCLE 968 ON READER SERVICE CARD

**New VACUUM PENCIL**

for picking up miniature parts

\$7.50 ea

**PHILIP FISHMAN COMPANY**  
7 CAMERON ST., WELLESLEY, MASSACHUSETTS

CIRCLE 969 ON READER SERVICE CARD

Don't forget the

## BOX NUMBER

When answering the classified advertisements in this magazine don't forget to put the box number on your envelope. It's our only means of identifying the advertisement you are answering.



# How to get the RF transistor they said couldn't be designed, designed.

Gentlemen:  
I need a custom transistor to meet the following specifications:

Frequency \_\_\_\_\_ Watts-out \_\_\_\_\_  
Volts \_\_\_\_\_ Anticipated quantity \_\_\_\_\_  
Additional Comments \_\_\_\_\_  
\_\_\_\_\_

NAME \_\_\_\_\_  
TITLE \_\_\_\_\_  
FIRM \_\_\_\_\_  
ADDRESS \_\_\_\_\_  
CITY \_\_\_\_\_ STATE \_\_\_\_\_ ZIP \_\_\_\_\_

 **Communications Transistor Corporation**  
An affiliate of Eimac/Varian  
301 Industrial Way, San Carlos, California 94070

And built. In quantity. Communications Transistor Corporation specializes in solving design problems that have baffled others.

The range of our standard line (see chart) gives you some idea of the range of our capabilities. But 90% of our sales are of custom products. So these standard products are hardly the limits of our capabilities; merely the guidelines.

Send us the specs for the transistor they said couldn't be designed. We'll get to work designing it.

Series	Frequency	Power Chain	Supply
A-12	25-50MHz	3, 25 & 70W	12V
A-28	30-80MHz	3, 25 & 70W	28V
B-8	175MHz	2 & 5W	8V
B-12	175MHz	3, 25, 40 & 70W	12V
B-28	175MHz	3, 25, 40 & 70W	28V
C-8	470MHz	2 & 5W	8V
C-12	470MHz	3, 12, 25 & 40W	12V
C-28	400MHz	3, 12, 25 & 40W	28V
D-28	1GHz	3, 10 & 20W	28V

CTC's standard products: A guide to our capabilities; but hardly the limits.

## Communications Transistor Corporation

301 Industrial Way, San Carlos, California 94070 (415) 591-8921

**NEW**  
**BOURNS**  
MODEL  
**3861**

**RV6** ...and more to come

**VARIABLE RESISTOR**

**...NEWEST ADDITION TO THE GROWING FAMILY OF BOURNS PANEL CONTROL UNITS!**

NOW LISTED ON QPL FOR MIL-R-94C, RV6 STYLE, the new Model 3861 with its hot molded carbon element is the ideal answer when your requirements call for long, dependable control life . . . when frequent adjustment is needed . . . or for any RV6 Mil-Spec application. Advantages of the Model 3861 include: metal bushing and case; 1/2 watt power rating at 70°C; resistance to 5 megohms; and, tolerance of  $\pm 10\%$  . . . and a price of \$1.15 each in 2500-piece quantities.

Also, take a look at the other members of the Bourns Panel Control family — many are cermet for added stability and higher power requirements:

**Model 3852**

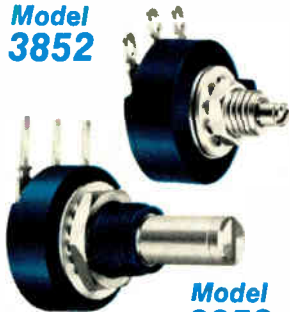

**Model 3859**

3/4" dia., metal bushing, locking or non-locking, rated 2 watts at 70°C, resistance to 5 megohms, and tolerance of  $\pm 10\%$ . The price: 81 cents each in 2500-piece lots.

3/4" dia., plastic bushing or quickly installed snap-in version, 2 watts at 70°C, resistance to 5 megohms, tolerance  $\pm 10\%$ . In 2500-piece quantities, just 66 cents each.

**Model 3862**



1/2" dia., rated 1 watt at 125°C, resistance to 5 megohms, tolerance  $\pm 10\%$ . Price each in 2500-piece quantities, \$1.18.

Complete technical data on these units is available from the factory or your local Bourns Trimpot Products distributor . . . write today!



**BOURNS, INC., TRIMPOT PRODUCTS DIVISION • 1200 COLUMBIA AVE., RIVERSIDE, CALIF. 92507**

## New products

Packaging and production

# Wire-wrapper sells for \$10,000

Semi-automatic machine  
includes tape controller;  
CAD software is available

After a dramatic sales increase attributed largely to purchase of a semi-automatic wire-wrap machine, a West Coast company decided there was a substantial market among medium-sized companies for

a machine that could sell in the \$10,000 range.

That's what led to the introduction of the WWM-300 by Standard Logic Inc., whose principal activities have been dual in-line packaging of ICs, a wiring service and computer-aided documentation to back up the hardware assemblies, and fabrication of MOS and core-memory systems.

Bruce Billington, marketing vice president, points out that the WWM-300 sells for \$2,800 to \$4,000 lower than most semi-automatic machines. For \$10,000, the user gets a fully operational system including the tape controller, an extra in some machines. The system includes a

positioning table with a pointer that moves at 420 inches per minute vs the 100-400 in./min of most competitive machines; the tape controller and spoolers for the tape reader; a readout that shows the X and Y position and wire number to be used; plus a 40-hole wire bin, with indicator lights to tell the operator which wire type comes next.

"It has all the ingredients you need to operate," comments Billington. The WWM-300 can accommodate panels or boards measuring up to 24 by 40 inches.

Standard Logic will provide either of two software packages with the machine. For \$1,000, the customer gets the conventional "from-

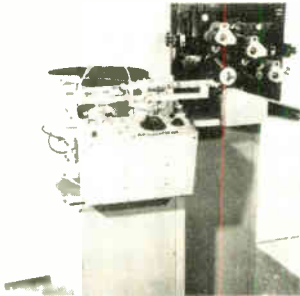

Printing machine model U-1200 color-bands pin and socket contacts in three colors simultaneously. Operation is at the rate of 240 units per minute, and automatic feed system consisting of vibrating bowl and interchangeable in-line tracks handles most sizes. Change over is easily made. Markem Corp., 150 Congress St., Keene, N.H. [391]



Circuit board drill is designed so that one to four spindles can be precision mounted and spaced to suit application. Optional interface to tape punch allows unit to produce its own tape directly from artwork. ASCII or EIA code is available, and projection scope has digital readout. Price is under \$20,000. D.A.C., 725 Reddick Ave., Santa Barbara, Calif. 93103 [392]



Thick-film screen printer provides repeatable substrate printing through a single-blade squeegee maintaining parallelism to substrate holder to within 0.001 in. X and Y alignment is adjustable by micrometer control knobs, and automatic carriage system is available for high-volume production. Sel-Rex Corp., River Rd., Nutley, N.J. [393]



Male rack and panel connectors for military, commercial, industrial applications are available in 50- and 104-pin versions. Tip positioning of contact tail is held to within diameter of .020 in. of true position. Units accommodate wire-wrapping machines. Price is 8-12 cents per contact. GTE Sylvania, 730 3rd Ave., New York, N.Y. [394]



Thermal chuck model TP 3001 for probing hybrid circuits, semiconductor wafers and chips is for use with Electroglas probes. Models for other probes are available. Temperature is presettable, remotely programmable with 1°C accuracy, 1°C repeatability, covers range of -50° to +200°C. Temptrox Inc., Hillside Ave., Needham, Mass. 02194 [395]

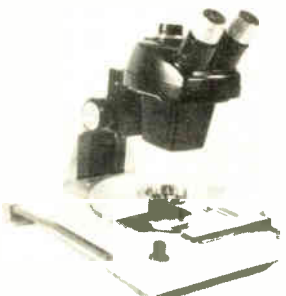

Miniprober model MP-0701 is suitable for pilot-line testing of semiconductor wafers and chips, and also for failure-analysis work in opened packages. Manual station has eight probe heads, each independently adjustable in X-Y and Z using 8:1 ratio in its joystick control. Price is \$1,150. Wentworth Laboratories Inc., Route 7, Brookfield, Conn. 06804 [396]

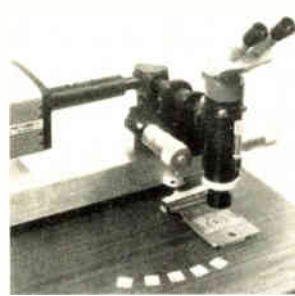

Trimming system model 660 uses YAG laser with continuous wave and Q-switched operation. The manual unit has micrometer-driven X-Y beam sweep and collinear binocular microscope. It trims thick- and thin-film IC resistors and conductors. It can be adapted to scribing processes. Coherent Radiation, 932 E. Meadow Dr., Palo Alto, Calif. [397]



Socket panel 8136-w for 60 or 72 DIPS, 14- or 16-lead, have gold over nickel, plated contact assemblies, wire-wrap termination. Male connectors provide 120 contacts, with .100 in. spacing between pins and rows. Mating female connectors are available. Price is \$75-\$150 depending on style, quantity. Augat Inc., 33 Perry Ave., Attleboro, Mass. [398]

## New products

to" wiring software package, or for \$3,500 he can obtain a CAD package that takes the finished system from completed logic design to finished wire hardware, with documentation that includes an extensive error diagnostic check and implementation analysis.

The WWM-300 uses the gun sight pointer technique; the pointer moves in the X and Y axes, and the operator aligns the wire-wrapping gun over the pin where the pointer stops. Billington says this has become the dominant method in semi-automatic wire wrapping, because it does away with operator fixation and fatigue, which can be caused by a machine with a stationary pointer and a moving table.

The low price is possible because Standard Logic makes most of the machine's components, including the tape controller, which fits into the same cabinet as the wire bin and power supplies. Only the tape reader, cabinet and positioning bench are bought outside. "This

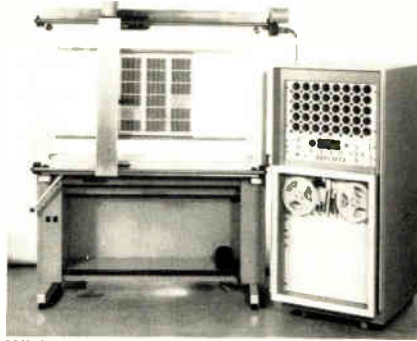

**Wiring system.** Console, left, holds wire bins, display, controller, and power supply.

gives us a good handle on all our manufacturing costs," says Billington.

The company has also cut the positioning bench costs by eliminating a gear box and adopting Teflon-coated lead screws without sacrificing durability, Billington says. The display, an option with most competitors, allows the operator to check quickly the absolute X and Y positions that represent the distance from the zero reference point in both axes to the nearest 0.01 in. The

wire number is punched into the paper tape before the start of a job, and transferred into a holding register for display.

The WWM-300 is aimed at the digital system manufacturer, such as firms manufacturing minicomputers or disk controllers—essentially any company making computer interface equipment, Billington explains. A leasing arrangement is also being worked out.

Standard Logic Inc., 1630 S. Lyon St., Santa Ana, Calif. 92705 [399]

### Pc board material combines strength, ease of fabrication

Makers of consumer electronics equipment have been shifting from paper phenolic to glass polyester for printed circuit boards because the latter provide greater strength. However, they have had to face a new kind of problem—glass polyester is harder to machine, and the

# New Linear-IC Tester from an old pro.

General Radio has developed a linear-IC tester with features that only an instrument-maker with over a half century of component-measurement expertise could offer. It's our new 1730 Linear-Circuit Tester that tests op amps, comparators, voltage followers, and regulators to *manufacturers'* specs. In fact, over 15 parameters can be easily tested in a GO/NO-GO or measurement mode at the push of a button — including gain-bandwidth product, slew rate, and output impedance. Then there's programming; it takes only seconds to set or reset a complete series of parameter limits by means of self-locking slide switches on a removable memory panel. The inexpensive memory panels (only \$25 each) represent hard-wired programs that can be stored as a permanent library. There's more to a 1730, of course. Prices start at just \$5950; test results (both GO/NO-GO and quantitative measurements) are readily available for

automatic data logging; versatile device-adaptor modules hold almost any conceivable type of linear device; parameter test limits can be expanded for non-standard or evaluation tests. Also, the 1730 is compatible with computers and mechanical handlers, and GR's worldwide service organization will be there if you need it, whether 5 or 50 years from now.

A lot more will be said for the new 1730 Linear-Circuit Tester when you talk to Will Swope, one of the Component/Network Testing people at GR. Call Will collect at 617-369-4400 or write to him at 300 Baker Avenue, Concord, MA. 01742. In Europe write to Postfach 124, CH 8034, Zurich, Switzerland. Prices are net FOB, Concord, MA.



**General Radio**

NEW YORK (N.Y.) 212 964-2722 (N.J.) 201 791-8990 / BOSTON 617 646-0550  
CHICAGO 312 992-0800 / WASHINGTON, D.C. 301 881-5333  
LOS ANGELES 714 540-9830  
TORONTO 416 522-3395 / ZÜRICH (011) 55 24 20  
GRASON-STADLER 617 369-3787 / TIME/DATA 415 327-8322

fabrication processes reduce tool life.

Two pc boards introduced by Westinghouse Electric Corp. were designed to meet the need for a strong board that also is easy to fabricate. The two lines—econofab and econofab heavy duty—have received Underwriters' Laboratories SE-O flame-retardant approval.

The heavy-duty version has a strength close to glass polyester but with the same fabrication qualities as paper phenolic. It is priced competitively with glass polyester, and Westinghouse says it is stronger, has better electrical characteristics, and provides the same ease of fabrication as flame-retardant paper phenolic boards. According to Westinghouse, engineering tests have shown that it is flatter and more rigid than the paper phenolic products commonly used.

Both types of pc board are designed to be produced in high-volume quantities, so the company says that delayed shipments, a common

industry problem, will be virtually eliminated by introduction of the two new lines.

Westinghouse Electric Corp., Pittsburgh, Pa. 15222 [340]

### Timing system controls 12 pc board plating processes

Several steps are involved in making plated-through holes in printed circuit boards—pre-etching, sensitizing, deposition, electroplating, with cleaning steps in between—and each step may require a different amount of time in its particular tank. To help keep track of this and similar processes, Catoptrics Inc., New Hyde Park, N.Y., is introducing a set of remotely powered, corrosion-proof timers.

With the power control unit in a remote, clean area, only low voltages are brought into the plating area, increasing operator safety, while only the timer modules need

to be sealed against the corrosive fumes in plating rooms. The single power control module can handle up to 12 timing modules, supplying each with 6 volts and 4.9 v. It also supplies voltages to accessories and coordinates operation of the system.

A timer cycle is begun with its start button; a light on the module flashes to indicate the end of the cycle. An optional bell module can be obtained to ring a bell for 30 seconds and an optional relay module will give a contact closure for control purposes at the end of the cycle. Up to 12 relays, one for each timer module, are available for control.

Three timing ranges are available for a module: 1 second to 1 minute, 5 s to 5 min, and 10 s to 10 min. Reset time is 0.1 s.

A basic system, with five timers, is priced at \$181.60, including the power control unit. A full system with 12 timers and the bell and relay modules is priced at \$561.25.

Catoptrics Inc., 159 Robby La., New Hyde Park, N.Y. 11040 [400]

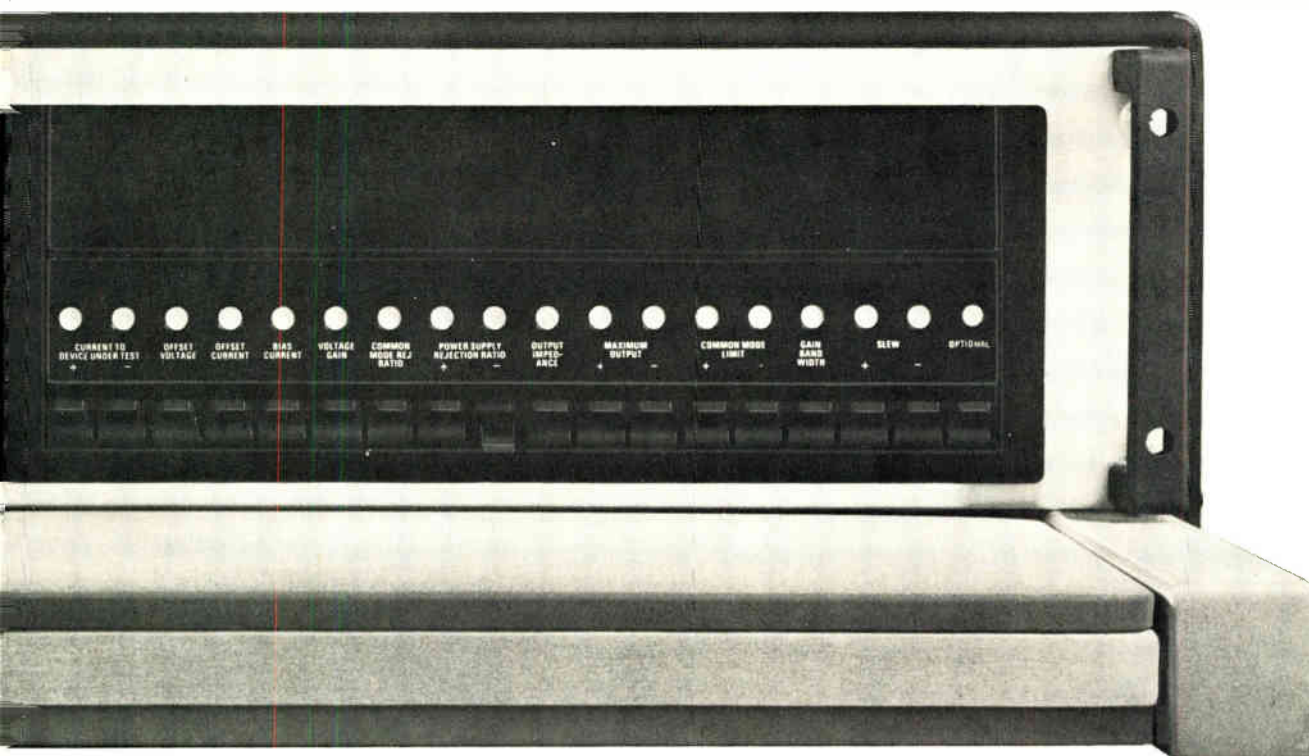

# RAYTHEON SEMICONDUCTOR. OUR RAY III IS THE FASTEST FULL LINE OF TTL PRODUCTS YOU CAN GET.

RAY III has 33 logic functions for superfast TTL circuit designs in both industrial and military applications. There are 22 gates with speeds down to 4 nanoseconds. There are 8 flip-flops with speeds down to 10 nanoseconds. And there are complex MSI arrays that add, decode, generate and check parity.

RAY III is available off-the-shelf. It provides the functions, the speed, the power savings, and the flexibility necessary for fast circuit design.

We've got the process nailed down. DC and AC specs are tight over the entire operating temperature range. We pro-

vide the guaranteed specs you need for no-guesswork system design. And RAY III is compatible with all DTL and TTL logic levels, power supplies, and design rules. RAY III saves power. Up to 20% per gate at high operating frequencies.

RAY III has proven acceptance. In computer central processors and airborne computers. In digital tests and measurement instruments. In minicomputers, multiplexers, computer graphics, and peripheral logic.

We're continuing to expand our broad line of superfast TTL products. We have a new technical team. And new develop-

ment programs providing new design tools. We're the first source for SUHL. We have 57 functions in RAY I and 42 functions in RAY II TTL products. Available in all standard industry packages. And there are more RAY III MSI arrays and logic functions being developed.

Get more information on the fastest complete line of TTL available. Ask your nearest Raytheon Semiconductor franchised distributor for the "RAY III" design manual. Or stop by Raytheon Semiconductor, 350 Ellis Street, Mountain View, California 94040. (415) 982-9211.

**RAYTHEON**

## PERIOD.

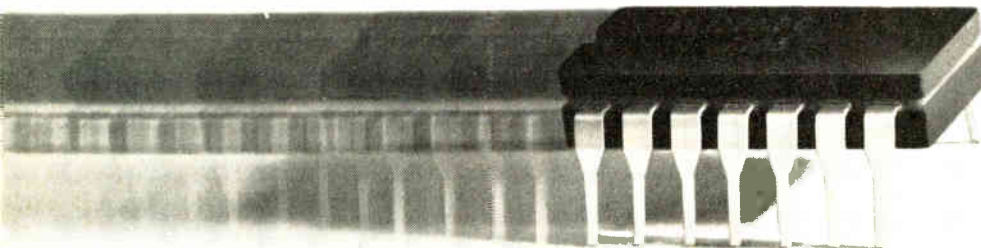

Components

# Active filters are tunable

Cutoff frequencies of 4-pole, lowpass units are selectable; line covers 0.1 Hz–20 kHz

When active filters became widely available in the early 1960s, they were welcomed by engineers who had been forced to design low-frequency filters using huge, lossy chokes and equivalent resistors and

capacitors. Equal results could be achieved with less than a handful of semiconductors and other small parts. Still, a company might or might not carry an active filter with the needed passband characteristics or the appropriate cutoff frequency—and lots of active filters wound up as custom developments.

Now Analog Devices Inc. is offering the series 730 tunable active filter line: four-pole, lowpass filters with cutoff frequencies selectable by the user. The series covers 0.1 hertz to 20 kilohertz in four overlapping ranges—0.1 to 20 Hz, 10 to 200 Hz, 100 to 2,000 Hz, and 1,000 to 20,000 Hz—and has either Butterworth (amplitude flatness in the passband) or

Bessel (time-delay flatness) response.

C. Peter Zicko, marketing manager for analog products says the tuning method is simple. The user picks the cutoff frequency of his filter by switching in sets of four matched resistors outboarded to the 730. Resistor value decides frequency, and resistor tolerance establishes the absolute accuracy of the selection. "We generally recommend that 1% resistors be used," he says, noting that this makes it easy to achieve 3% accuracy in cutoff frequency selection. A nomograph is all the user needs to pick resistors, and hence frequency.

It is here that Analog took the

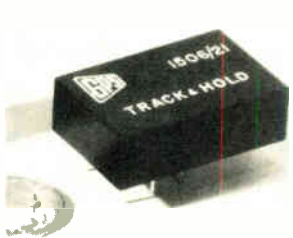

Track-and-hold module SH1506 traces input with gain of unity until commanded to hold. Output is then isolated from input and held at that instantaneous value. At 25°C and rated power supply, gain is 1.00, and frequency response of the solid state device is 5 kHz. Price is \$125 for 1-9 units. GPS Corp., 14 Burr St., Framingham, Mass. 01701 [341]

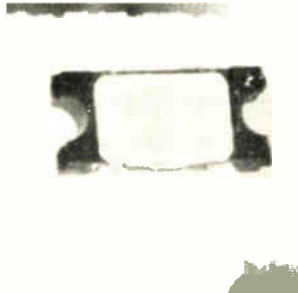

General-purpose switch series 2SS is based on Hall-effect chip. Size is 1/10 in. wide and 2/10 in. tall. Switching speed is up to 10,000 operations per second in temperatures of -40° to +70°C. Applications include limit, control, synchronizing, and position-sensing functions. Micro Switch Division, Honeywell Inc., 11 W. Spring St., Freeport, Ill. 61032 [342]

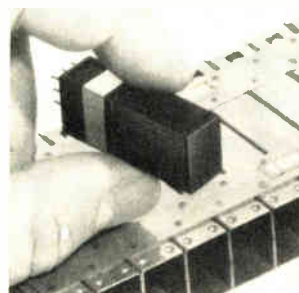

Subminiature fiber optic readouts, series FRO, feature power requirements of 100 mw per character. Applications include readout for ambient light environments such as aircraft cockpits. Character height is 0.457 in. Illumination is provided for readout up to 15 feet. Price is \$10 in 1,000 quantities. Shelly Assoc. Inc., Reynolds Ave., Santa Ana, Calif. [343]



Decimal-to-ASCII encoder called Data-Dial converts manual calibration instruments to automatic data logging by replacing each knob on instrument panel with one containing its own digital output circuitry. Thin cable delivers logic, power supply lines to knobs. Electro Scientific Industries Inc., N.W. Science Pk. Dr., Portland, Ore. [344]

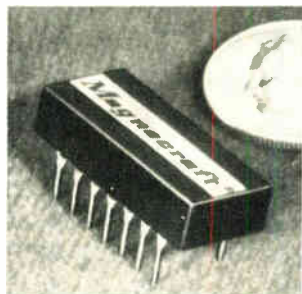

Relay class 505QC is housed in a 14-pin DIP, with switching, latching and timing built into one package. Latching is achieved by shorting two pins. The user adds a resistor/capacitor network to existing circuitry for timing functions. Price is \$19.51 each in 100-lots. Magnecraft Electric Co., 5575 N. Lynch Ave., Chicago, Ill. 60630 [345]

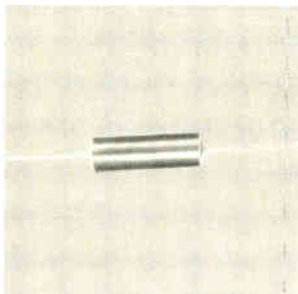

Fuse resistor series F500 acts as precision wire-wound resistor and as fusing element. Devices provide protection for semiconductors, eliminate fire hazard and circuit board damage, and reduce number of discrete components needed. Units operate within range of 0.2 to 200 ohms. RCL Electronics Inc., 700 S. 21st St., Irvington, N.J. 07111 [346]



Double-balanced mixer model M6KC, RFI shielded, is in hermetically sealed package. Operation is over frequency range of 5-400 MHz and isolation is typically 35 db, conversion loss 6 db. Price is \$12 each in quantities of 100. Applications include up-down frequency conversion, phase detection. Relcom, 2329 Charleston Rd., Mountain View, Calif. [347]

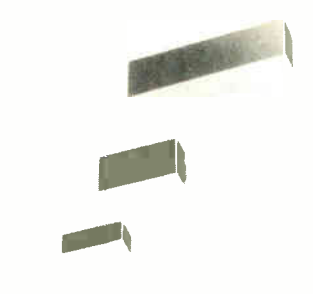

Miniature nanosecond delay lines in three series are compatible with dual in-line packaging and are designed for 10 equally spaced taps if required. Delay ranges from 5 to 100 ns, and pulse distortion characteristic is 5%. Devices conform to military standards. ESC Electronics Corp., 534 Bergen Blvd., Palisades Pk., N.J. 07650 [348]

# BUSS QUALITY

## SMALL DIMENSION FUSES AND FUSEHOLDERS

For The Protection of All Types of Electronic and Electrical Circuits and Devices...



includes dual-element "slow-blowing", single-element "quick-acting" and signal or visual indicating types... in sizes from 1/500 amp. up.

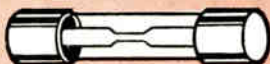

HKA lamp-indicating, signal activating holder.



HMR RF shielded holder for 1/4 x 1 1/4 in. fuses.



HKP panel mounted holder for 1/4 x 1 1/4 in. fuses.



TRON Rectifier Fuses For the Safe Protection of Solid State Devices.

Provide extremely fast opening on overload and fault currents, with a high degree of restriction of let-thru current. Many types and sizes available. Ampere ratings from 1/2 to 1000 in voltage ratings up to 1500.



Circle 142 on reader service card

# UniversatILITY

50 WATTS OF POWER OUTPUT

Microdot's Model 445 VHF-UHF Power Oscillator combines the best of all worlds — general purpose power source for universal applications with versatility of functions.

Typical applications include:

- Power meter calibration
- NMR testing
- Laboratory transmitter
- High attenuation measurements
- High power transistor testing
- Power amplifier and laser modulator drive
- Susceptibility testing to MIL standards



Fully-loaded and compact, the Model 445 includes such convenient features as:

- Eight plug-in heads for frequency coverage from 10 KHz to 2500 MHz
- Fully-protected against mismatch
- Modulation capabilities for square wave, pulse, AM and FM
- Low residual AM and FM

Call Microdot today for more details on the oscillator with UNIVERSATILITY. They'll know exactly what you mean.



**MICRODOT INC.**  
INSTRUMENTATION DIVISION

19535 East Walnut Drive, City of Industry, California 91744 ■ (213) 965-4911 or (714) 595-7541

Circle 120 on reader service card



tradeoff between tunability and performance. "The cutoff frequency of filters tuned in-house is specified as  $\pm 2\%$ , and typical figures are lower. While 3% is a conservative figure for the tunable 730's and adequate for most applications, we did exchange that 1% for tunability," says Zicko.

Most users will be more interested in the cost savings obtained. Initial cost is lower at \$69 in lots of one to nine, a saving of about \$6 over Analog's pre-tuned filters, and of more over those that once had to be tuned to fit the applications.

Adding to the saving is the fact that users can stock filters in anticipation of varieties of applications, then tune them to fit by adding the appropriate resistors. The time gained by removing the sampling, specifying, ordering, and engineering steps should cut overhead. Zicko says the parts and labor involved in tuning one of these filters could run

well below a dollar.

Passband gain is held near unity at  $\pm 0.02$  decibel, with output offset drifts of 50 microvolts per degree centigrade maximum. The offset can also be trimmed. Noise is rated at 75  $\mu\text{V}$  rms over the full bandwidth of 20 kHz and, since the filters are this quiet, Zicko is confident they'll find markets in data transmission and a/d conversion, test instruments, frequency analysis and other applications where an adjustable cutoff frequency is needed.

Analog Devices Inc., Rte. 1 Industrial Park, P.O. Box 280, Norwood, Mass. [349]

Lever locks DIP in socket, prevents damage to leads

Designed for easy insertion of dual in-line package leads when setting up for hand-test and burn-in, a test

socket built by Textool Products Inc. eliminates virtually all pressure on the leads.

The socket, called ZIP-DIP, uses a locking lever that clamps DIP leads after insertion of the IC into the top half of the socket and releases the package upon completion of the test. Ramps and bevels guide the leads into the socket, where contacts exert uniform pressure on all leads, compensating for different widths and for bent leads.

When the lever is actuated, the center plate of the socket moves about 1/32 of an inch, squeezing the two halves of each contact uniformly around each lead and assuring good electrical contact.

The line consists of five models that accept DIPs with 16, 18, 22, 24 or 40 leads. In quantities of 100, prices range from \$2.59 to \$8.55.

Textool Products Inc., 1410 Pioneer Dr., Irving, Texas 75060 [350]

**FNA FUSETRON**  
Fuse 13/32 x 1 1/4 in. slow-blowing, Visual-Indicating, Alarm-Activating. (Also useful for protection of small motors, solenoids, transformers in machine tool industry.)

**BUSS MIC-13/32 x 1 1/4 in.** Visual-Indicating, Alarm-Activating.

**BUSS GLD-1/4 x 1 1/4 in.** Visual-Indicating, Alarm-Activating.

**BUSS GMT and HLT holder.** Visual-Indicating, Alarm-Activating.

**BUSS GBA-1/4 x 1 1/4 in.** Visual-Indicating.

**BUSS MIN-13/32 x 1 1/2 in.** Visual-Indicating.

**BUSS Grasshopper Fuse.** Visual-Indicating, Alarm-Activating.

**BUSS ACH** Aircraft Limiter, Visual-Indicating.

**The Complete Line of Signal-Indicating Alarm-Activating Fuses**  
For use on computers, microwave units, communication equipment, all electronic circuitry.

**SUB-MINIATURE FUSES**  
Ideal for space tight applications, light weight, vibration and shock resistant. For use as part of miniaturized integrated circuit, large multi-circuit electronic systems, computers, printed circuit boards, all electronic circuitry.

**TRON Sub-Miniature Pigtail**  
Fuses—Body size only .145 x .300 inch. Glass tube construction permits visual inspection of element. Hermetically sealed. Twenty-three ampere sizes from 1/100 thru 15.

**BUSS Sub-Miniature GMW**  
Fuse and HWA Fuseholder  
Fuse size only .270 x .250 inch. Fuse has window for visual inspection of element. Fuse may be used with or without holder. 1/200 to 5 amp. Fuses and holders meet Military Specifications.

BUSSMANN MFG. DIVISION,  
McGraw-Edison Co., St. Louis, Mo. 63107

For fuses and fuseholders of unquestioned high quality for every protection need . . .

SUPPLIED THE ECONOMICAL WAY  
THRU DISTRIBUTORS

**BUSS QUALITY**  
FUSES

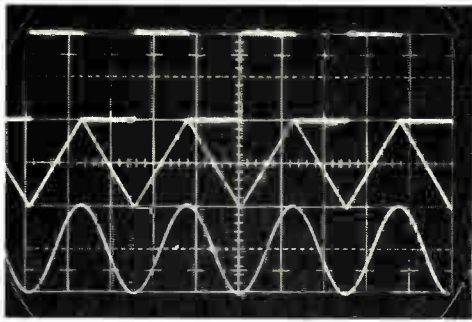

Sine, square & triangle

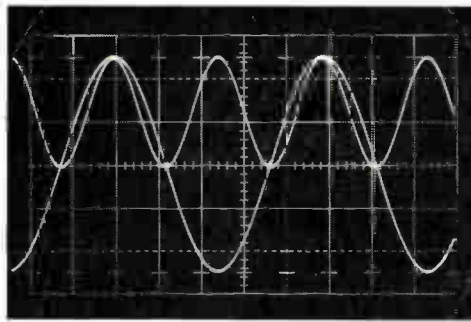

Sine squared

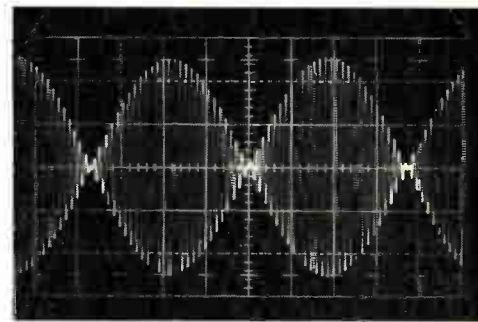

Suppressed carrier modulation

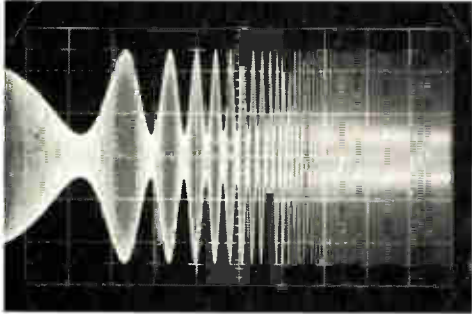

AM log swept envelope

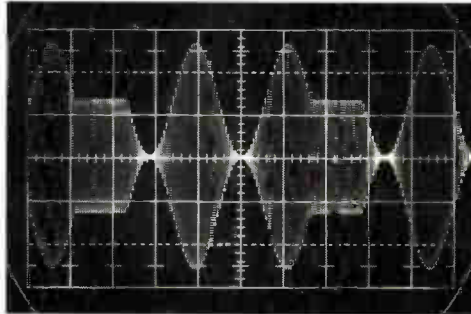

Tone burst AM

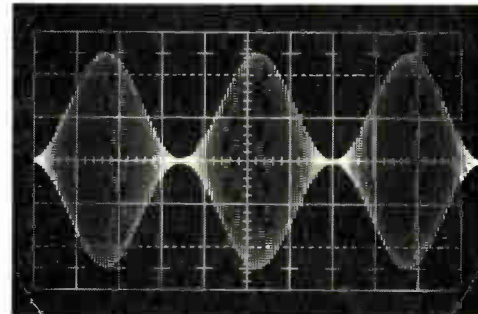

Sine wave amplitude modulation

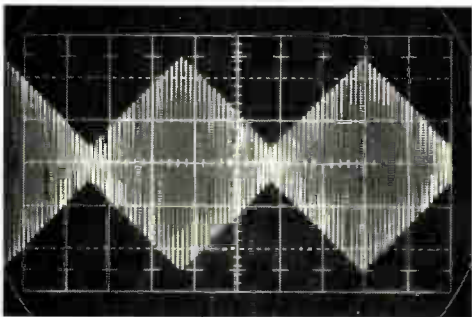

Triangle amplitude modulation

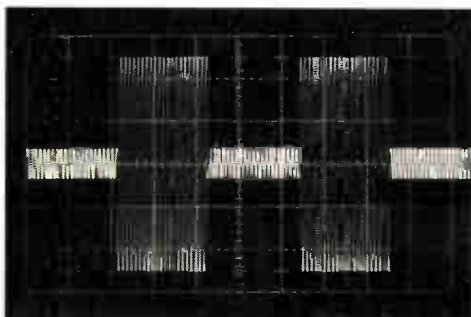

Square amplitude modulation

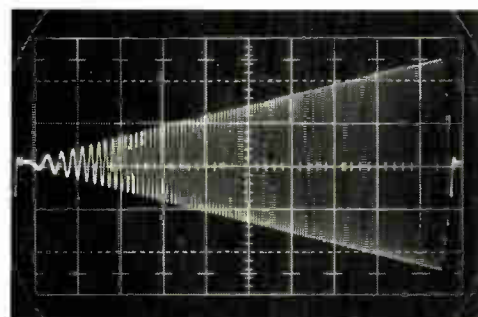

Swept AM - FM

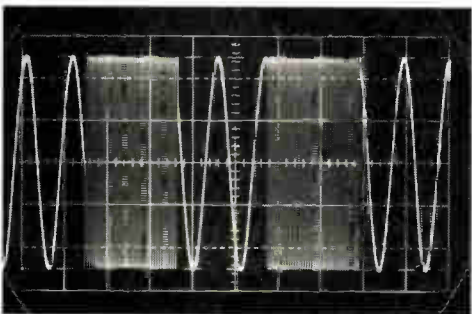

Frequency shift keying

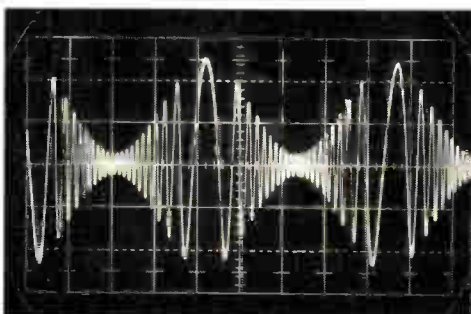

Linear AM - FM (sine wave)

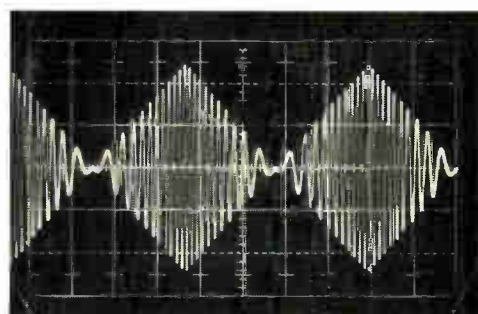

Linear AM - FM (triangle)

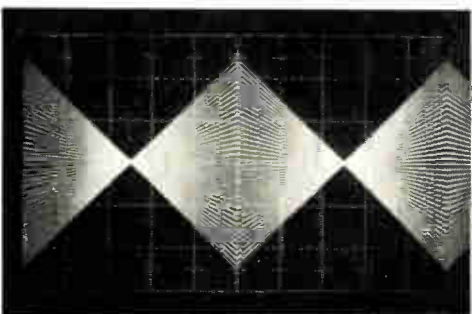

Ultra low frequency AM



Model 135 LIN/LOG Sweep Generator



Model 136 VCG/VCA Generator

How do these waveforms grab you, generator fans?

See more pictures like these at WESCON Booths 1124-26

Circle 122 on reader service card

**WAVETEK®**

P.O. BOX 651, SAN DIEGO, CALIFORNIA 92112  
PHONE (714) 279-2200 TWX 910-335-2007

---

# International Newsletter

---

July 19, 1971

## GEC decides to drop bipolar IC production

GEC Semiconductors Ltd. (formerly Marconi-Elliott Microelectronics Ltd.) is pulling out of bipolar IC production. Henceforth, the only commercial monolithic ICs it will make will be custom MOS arrays. This activity will be transferred to GEC's Hirst Research Center at Wembley so that the plants at Witham near London and Glenrothes in Scotland can be closed. The company blames falling orders and high price levels; new bipolar orders in the March-to-May quarter fell by 55% from the already-low previous quarter.

GEC's best consistent sellers have been a DTL array, supplied mainly to other GEC companies, and until recently ECL to Siemens AG in West Germany, but it got into 74-type TTL too late to be successful. Its market share was too small to significantly boost its prospects of remaining in bipolars. Inevitably, the decision raises the question of how long the other less-viable bipolar makers in the U.K.—Ferranti Ltd., Mullard Ltd., Transitron, and SGS—will continue to absorb losses, and in the longer term whether the British market will support several native companies supplying custom MOS products despite the fierce pressures of intensive foreign competition.

## Japan cabinet shuffle said to presage easing of computer curbs . . .

The recent Japanese cabinet shakeup has strengthened the possibility that computers may be among the industries open to foreign investment before the end of the year. Indeed, Prime Minister Eisaku Sato swiftly met with Kakuei Tanaka, his new Minister of International Trade and Industry, to urge serious consideration of removing computers from the list of industries to remain barred from foreign capital participation. Under the previous minister, a decision was said to have been made to place computers on the negative list with the specification that the restriction would be liberalized at a later date [*Electronics*, July 5, p. 109].

Tanaka, sources say, plans a series of meetings with electronics industry leaders to outline the government's wishes. Although MITI officials still are said to strongly support continued protection of the industry, international political realities are applying pressure to Japan's position vis-à-vis entry of foreign capital.

## . . . and technology exchange program gets consideration

Japanese electronics companies are mulling over a plan to begin a technological exchange program with their West German counterparts. The pact, says the Electronic Industries Association of Japan, would entail a swap of Japanese know-how in consumer electronics in return for German expertise in the industrial sector. For starters, the Japanese probably would provide television production advice, while the Germans would help with the technology for producing the PAL broadcast system. The Germans are supposedly interested in learning production techniques for color tubes smaller than their current 20-inch minimum.

## Schneider subsidiary is spinning off

Schneider Electronique is splitting off from its parent Schneider Radio-Television to go independent—with a boost from the French government and considerable outside capital. Sources say the split is being made so that Schneider's professional electronics section can develop faster and more economically. The result likely will be a rapid expansion of the

---

# International Newsletter

---

Schneider line of digital measuring instruments and, to a lesser degree, the low-priced Schneider desk calculators. The government's year-old industrial development institute is putting up a minority share of the capital for the new firm and will provide management counsel. Other minority shares will be held by Schneider Radio-Television (already partly owned by Philips), by a venture capital group known as Societe Europeenne pour le Development Industriel, by Philips itself, and by private investors. The new company is expected to be set up officially in September.

## Rotterdam officials weigh computerized ship navigation

Officials of the Port of Rotterdam are considering implementing a radar-based ship navigation and location system under computer control. The proposal is part of a \$28 million plan to update the radar net that controls traffic in the 27-mile channel linking the Dutch port with the North Sea. The modernization would boost the number of radar stations along the channel from seven to nine and make the system very nearly automatic. Pilots would carry aboard ship a tone-coded transponder operating at 9 gigahertz; it would feed the ship's identity into the computerized control system. **Instead of getting positions from shore-based controllers by voice radio, pilots would read positions off a digital display built into their portable radio sets.** Philips has worked out the details of the system, which can accommodate up to 200 ships at a time, and could get the go-signal soon.

## Mullard tube pushed for night vision gear

Engineers at Britain's Mullard Ltd. feel their channel-electron-multiplier tubes for image intensification, already in preproduction, show important potential advantages over established three-stage cascade intensifiers, and eventually may replace them in standard military night-vision equipment. Mullard's channel tubes have a 0.75-inch-diameter picture area in a tube measuring 1.75 in. in both diameter and length, much smaller than a cascade tube, and small enough to be used in a possible night-viewing goggle system. **Moreover, with only one stage, the Mullard unit probably will cost about one-third less than the cascade tube.**

Mullard engineers believe they have been more successful than U.S. companies doing similar work, primarily because they opted for electrostatic image inversion and focusing rather than the fiber optic inversion and proximity focusing used in the U.S. The Mullard tube's gain is 100,000 at 1,200 V plate voltage, and uses a 40-mil-thick plate with 15-micron-diameter channels mounted close to the phosphor viewing screen. The electron lens is between the plate and input photocathode.

## Dassault speeds output of its Eole transponders

Electronique Marcel Dassault is stepping up production of its Eole transponders to fill an order for 500 units by mid-August. The French government's space research center has ordered the 2.2-pound transponders for use in the joint U.S.-French Eole weather satellite experiments; they will be carried into the stratosphere by balloons and will inform the satellite of their position every 90 minutes to chart stratospheric winds for the first time. **Meteorologists hope the data will help them make accurate weather forecasts at least a week in advance.** NASA will launch the satellite Aug. 17; the balloons go up Aug. 21.

## Programed driving gets a road test in West Germany

Computer would call the turns at each intersection to ease driver navigation and speed traffic flow

**For those drivers** who can't read a map, help is on its way—although slowly. Siemens AG is testing an automobile navigation system, in which a computer tells a driver which turns to make from his point of origin to his final destination. It also figures out what speed will hit green lights as often as possible along the way.

For determining such speed and direction information, the computer uses goal and location data originating at the car. It processes that data using stored information on obstacles like construction sites and then sends its results back to the car, where it is displayed on a small dashboard light panel. The key elements in the car-computer data exchange are stationary transceivers along the road, inductive loops in the road bed, and transmitting and receiving equipment on the car.

**Fast flow.** Once introduced on a wide scale, such "programed driving" not only will help drivers find their way around, but solve many traffic problems in large cities. For example, traffic through a city could be distributed by directing cars headed for the same destination along different routes. This would make for faster and greater traffic through-flow. Also, because drivers are given recommended green-light speeds, there's minimum waiting at

traffic lights, fewer idling cars, and less air pollution.

In the Siemens technique, now being tested in the company's Munich factory grounds, the driver sets a small thumb-wheel-operated counter on the dashboard to a number that represents his destination. During the trip, a small transmitter installed on the car continuously sends out the number in the form of coded pulses. When the car passes by roadside transceivers, the pulses are picked up by an inductive loop in the roadbed and sent over cables to the computer. The car-mounted pulse transmitter in the test version operates at around 37.5 kilohertz. A typical roadside transceiver is mounted on a small pole and is slightly larger than an ordinary parking meter.

The computer determines the origin of the transmissions by a transceiver-identifying signal that accompanies the destination pulses. It then figures out the route the driver should follow from his point of origin. Using information on the green or red status of traffic lights at that and subsequent intersections, the computer also determines how fast the driver should go to optimize green lights.

The direction and recommended-speed data, also in pulse form, is sent back over the same cables to the same transceiver. The receiver in the Siemens system is also a laboratory version and operates around 67.5 kilohertz. To provide sufficient time for the information exchange to take place at any vehicle speed, the car's transmitter and receiver are installed at the front end and at

the rear end, respectively.

Programed driving, once it is perfected, would not be restricted to city drivers and city traffic, Siemens says. Company officials see the day when nationwide computer and data pickup systems would automatically direct a driver from, say, Munich's Karlsplatz to the Place de la Concorde in Paris. The systems would tell a driver which Autobahn or Autoroute to follow, which border crossing point is the least congested, and even which rest areas along the way have parking space available.

While the technical realization shouldn't be too difficult, the expenses involved would be quite large, the firm says. Company marketers figure that a system covering the whole of West Germany would cost up to \$6.5 billion, about twice as much as the Bonn government's annual budget for road construction.

---

### International

---

Aeronautical satellites open to world participation

The realities of international politics and the shortage of funds in its upcoming budget are forcing the U.S. Government to turn a sharp about-face on its decision to go it alone on transoceanic aeronautical services satellites. As a result, European, Asian and U.S. officials will attempt to hammer out plans this summer for an international venture to build and operate Atlantic and Pacific sat-

ellite systems, despite cries by American industry that they have been sold out by the Department of State.

At a preliminary meeting held in Washington last month, European space officials and representatives from Japan, Spain, the Netherlands, Australia, the Philippines, Canada, and the U.S. agreed that an international program for aeronautical satellites was desirable. They then agreed to hold a ministerial-level conference in Madrid beginning August 3 to work out the details of the venture. The Europeans take the credit privately for convincing the Americans that the high cost of two similar systems made cooperation the only sensible solution. "We were amazed and astounded to see how similar our independent research had been," said an official of the European Space Research Organization close to the negotiations.

**Questions.** David Israel, Director of the Federal Aviation Administration's Office of Systems Engineering Management, says that two major issues will have to be resolved at the meeting: Whether the satellite systems will be owned or leased and how the production of the systems will be distributed.

Israel says that the initial U.S. decision to lease satellite services over the Pacific by the end of 1973—a timetable that would have foreclosed European and Japanese participation—will probably be reversed for several reasons. One key reason, he states, is that European Space Research Organization members, particularly Germany and France, have made it clear that "they will build a satellite over the Atlantic themselves if they have to." Since the Europeans have the votes in the International Civil Aviation Organization to veto U.S. satellite plans and both the Department of State and Office of Management and Budget feel that a joint program would represent the lowest cost to the U.S., "You finally come to the conclusion that a joint program is the way to go," he says.

Working out an international program, however, means that the late 1973 deadline for satellite service

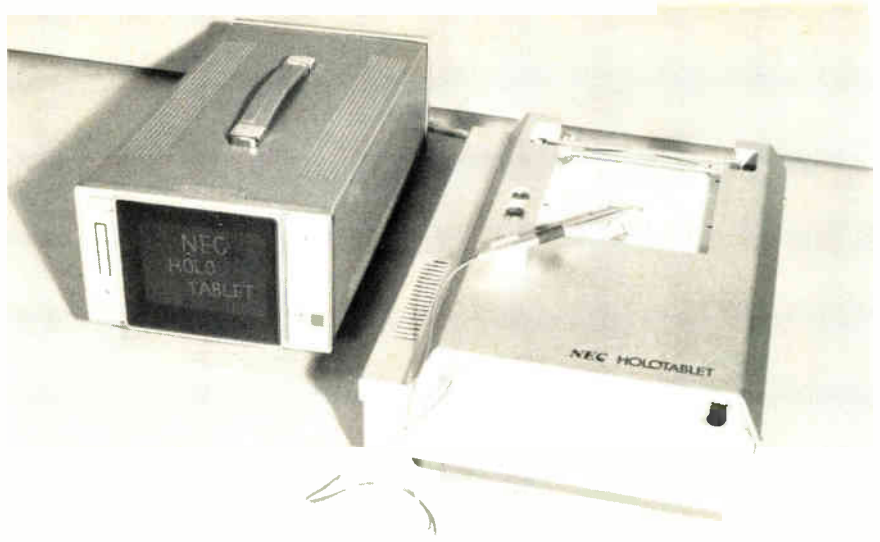

**Penmanship.** Linkage ties ball point pen to a laser pen below writing surface, where holograph generates positional data. Coding speed is  $10^4$  positions per second.

spelled out by the White House Office of Telecommunications Policy will have to be slipped. OTP's schedule, which called for the issuance of requests for proposals in July, will probably be replaced by a joint schedule that could call for issuance of a joint RFP by October 1, Israel says. Both European and FAA sources have long been skeptical that the OTP schedule could be met.

**Need.** The International discussion of the aeronautical services satellites comes at a time when airlines are becoming increasingly negative about the need for the systems. Whipsawed by declining demand and increasing operating costs, the airlines are fearful that they will be called upon to pay for communication satellite services they do not believe they need. As a result, the International Air Transport Association has labeled the L-Band Satellite scheme "premature." It has said it will resist the levying of user charges by all legal means at its members disposal.

---

## Japan

---

### Laser and holograph team up for computer input tablet

A holographic input device that uses a laser stylus to translate diagrams into simple binary code for instantaneous transmission is being put on market by Nippon Electric Co., Ltd.

NEC researchers say its Holotablet is the first holographic computer input device ever developed and add that commercial models, priced at

about \$3,000, will go on sale in Japan this summer and in overseas markets before the end of the year.

With the use of holography, says Teiji Uchida, manager of the Quantum Device Research Laboratory at NEC, researchers were able to eliminate the complicated analog-to-digital converter and coordinate measuring devices commonly found in graphic data tablets.

In NEC's device, operators use a normal ball point pen to draw their diagram on paper, and a pantograph link moves a laser pen in identical patterns over the hologram plate. The laser light is funneled to the pen by a fiber optic light guide. The hologram plate is divided into a matrix of 0.25 mm squares. Total size is 128 by 128 squares.

**Coding.** As the laser beam moves across this matrix, the hologram divides it into sets of diffraction beams. These first-order beams vary in horizontal diffraction according to the structure of each hologram square and hit photodetectors: seven detectors for Y coordinates, and seven for X coordinates. Striking various combinations of these cells, the beams generate a binary code for digital output, which goes to an amplifier. In the prototype, tracing speed of  $10^4$  positions per second was achieved with resolution of 2 lines/mm.

Eventually, NEC says, it plans to develop a finer matrix system, with sections reduced to 0.1 mm square. A 20-bit photodetector would be used.

Eight function keys are located on the hologram tablet for operating the device with companion systems. Each of the keys, which can be acti-

vated by touching them with the tip of the ball point pen, are located along the bottom edge of the tablet.

---

## Kanji spells display for computer project

To Japan's Oki Electric Industry Co. Ltd. fell the task of developing a Chinese-character display for the national computer project—and a formidable task it was. Called kanji, the characters are used in written Japanese, and a display based around them is a requirement for natural man-machine communications and many other computer-aided tasks. But there's more to the display than just kanji—engineers found that the unit's capability should include, in addition to 2,500 kanji, another several hundred characters, including Japanese phonetic syllabaries, the roman alphabet, and symbols.

Oki completed a prototype dot display and associated hard-copy printout in 1968: it was used at the Foreign Ministry for data retrieval and proved its value of an input/output device. Experience with this prototype provided data for an improved model that has just been completed. Moreover, Oki also developed a prototype vector-type display.

**Characters.** Oki's dot display uses a transfer-type read-only memory with a U/I-shaped core to generate the large number of kanji and other characters. The improved version has provisions for 3,240 characters, of which 200 to 300 are syllabary, alphabet, and symbols, while the remainder are kanji. Each character consists of an 18-by-18 dot matrix, adding up to a required capacity of about 1 million bits.

The transformer type of memory is especially suited to applications where a relatively small number of memories with a large number of patterns is required because there is no tooling charge. Peripheral circuits are extremely simple, making for stable operation, and cost, including peripherals, is moderate. Character memory and other con-

trol circuits are used in common with the display. Characters measure 4 mm by 4 mm, and have the same 18-by-18 dot pattern as the display.

The display is designed for 16 horizontal lines of 32 characters each on a 16-inch cathode ray tube. Sweep is a modified television type that provides four lines per millimeter for writing, but skips spaces between lines. The refresh memory contains 512 words, which are needed for one complete display; it refreshes 38 times per second.

In some applications, the input can be eight-level paper tape, in which case two consecutive positions are used for a single character. At each position, six levels are used for information, one is used for parity, and the eighth is unused. The words in the refresh display include the 14 bits from the paper tape, a fifteenth for parity within the display, and two more to give horizontal and vertical line segments for forms, making a total of 17 bits. Horizontal line segments at successive characters can connect, but vertical line segments on successive lines of characters can not—the sweep skips spaces between lines.

**Prints.** The dot kanji display printer also is designed to make hard copies. The copies are made by electrostatic printout by horizontal rows of pin electrodes; the paper moves to provide vertical sweep.

The printer reads out one horizontal row of 18 dots from the matrix pattern of one character during the display's horizontal flyback time. Though the printout operates about two orders of magnitude slower than the display, it still can print 640 characters per second, or more than one page per second.

The prototype dot display consisted of one character generator, one display console, and one hard-copy printout. The improved unit, however will be able to operate up to six display consoles and hard-copy printouts from each character generator.

Oki also developed a vector-type kanji display, and a comparison of the two types, according to the company, shows that both the dot and

vector displays give more than sufficient quality for practical use. The vector unit can get along with about 20% less character memory capacity. However, the pattern generator, cathode ray tube peripheral circuits, and control circuits are simpler for the dot display. Furthermore, print-out of hard copy is much easier with the dot unit.

The vector display facilitates changing the size of the characters, and makes it possible to go from a display with horizontal lines of characters to one with vertical lines. The vector unit also is easier to combine with a graphic display.

---

## Great Britain

### Putting aircraft flight data into one TV display

So far airborne computers and head-down cockpit displays are performing strictly military functions. Eventually, however, they are bound to be used to improve ordinary avionic functions in civil aircraft. The Royal Aircraft Establishment at Farnborough has a team looking into ways of easing the pilot's job by the computer processing of routine information before it gets to the cockpit and then displaying it in ways made possible by computer generation.

Most of the RAE effort is concentrated on finding out how best to use a head-down display: What sort of data to put on it, and how to get it there. RAE has embodied its initial ideas in simulation programs that can be demonstrated in three ways: on a 7.5-inch stroke writing CRT, a 7.5-in., 625-line TV raster tube, and the latter superimposed on a moving-map display. Britain's commercial avionics companies—Elliott Flight Automation, Ferranti, and Smiths—are co-operating with RAE and eventually will probably use some of the ideas.

**Graphs.** Project leader Geoff Carr says the advantage of the electron beam tube display is that it can bring together the data normally displayed all around the cockpit.

Furthermore, a computer can work on the inputs from the aircraft motion sensors and pass data to the display in a form of more immediate value to the pilot than the data on present conventional distributed readouts. For instance, in one mode Carr's display shows the plane's past, present, and future fuel consumption in a graphical form that makes it immediately clear whether the plane will be able to get to alternate airports if its destination is weatherbound. A flick of a switch brings the graph up on the display.

**Variety.** Margaret Treadgold, who is responsible for display development, foresees half a dozen different data displays called up by a switch, including a reference table of route check points and cross-checking of the accuracy of the various navigation data inputs by reading them all out simultaneously. Mostly, though, the display will probably show navigation data in a fairly regular format like this:

- The plane represented by a small plan diagram in the middle of the screen, surrounded by a distant circle representing perhaps a 10-mile radius.
- A dotted "confidence circle" close around the plane, representing the possible degree of error in the calculation of its position.
- A pair of parallel lines representing the desired flight path, one on each side of the plane and in line with it, and swinging to right or left as the plane gets off the path.
- The next way point, represented by a small box, appearing as it comes within the 10-mile circle and steadily approaching the plane.
- A line along the plane's axis across the diameter of the distant circle, indicating the deviation of the actual flight path.
- A dotted line extending from the way point box, indicating the course change necessary at that point.

**Bearing.** Alphanumeric data can be grouped around the distant circle. One item devised by RAE is a portion of a bearing scale over the top of the circle, moving to right or left as with a rim-read disk compass. Together with the axis line, this will indicate heading bearing. Carr says

other data that can be accommodated on the small screen includes latitude and longitude of the plane and of the next way point, distance and time to the next way point, expected time of arrival there, and the course from that point. There might also be room for items like speed and fuel remaining.

All the items can be updated automatically or on demand, or varied using a row of keys along the screen's lower edge that change function automatically when the display changes.

RAE has worked out its system using a Ferranti Argus 400 computer with an 8,192-word, 24-bit memory. Carr says that established computer technology seems all right for the job, although developing computers to meet likely international aviation standards may be expensive.

---

### West Germany

---

The big Olympic event:  
worldwide broadcasting

While it won't show in the record books, communications electronics will earn a gold medal at the 1972 Summer Olympics in Munich for size, complexity, and cost. Siemens AG, Munich, which has the contract to provide planning and hardware for most of the Olympic communications systems, estimates it will spend in the neighborhood of \$17 million on the mammoth communications project.

Among other things, the large West German electronics manufacturer will build an instant reference network of two 4004/45 computers and 72 remote terminals with CRT displays. These will provide information on all Olympic-game results back to 1896 plus personal and performance records on all athletes, coaches, and trainers expected to participate at Munich. This information will be scattered around Munich, Kiel and Augsburg, where Olympic competition is being held. Also, a closed-circuit television network for journalists, with over 3,000 receivers, will have 15 channels, two

of them displaying the latest results.

But the major communications effort for the Olympics has gone into planning worldwide television and radio transmission. The television center at the main Olympic site in Munich is being planned by Deutsches Olympiazentrum Radio-television (DOZ), a company formed by the two major West German television networks. Karl-Heinz Schulte, head of TV transmission planning of DOZ, estimates a total cost of hardware and personnel for the television and radio transmission will run about \$28 million.

**Gear.** A total of 26 outside broadcasting vans, plus 12 studios with two cameras each, will be tied to a central switching room near the Olympic Stadium. "We will have 45 incoming video lines and about 3,000 audio lines, including inter-communication and telephone lines coming from these locations," explains Schulte.

From this menu, the switching center will select up to 16 video and some 400 audio offerings for simultaneous transmission to the 60 participating TV networks throughout the world. Events not transmitted live are shuttled to a VTR center where tapes are made.

DOZ will transmit what it calls its "world television program" each day from 9 in the morning to 11 at night during the 16 days of competition. Many countries outside Europe plan to condense the DOZ world program into a shorter two-three-hour transmission. This would be done at the television center by TV journalists and technicians from the various countries. For countries with no broadcast journalist present, the DOZ-produced daily highlights are available by satellite. The U.S. is the only country which will have totally separate coverage. ABC will select and transmit its own programs and will have its own studios.

**Proxy.** Nations with only a few journalists can make use of the so-called "off-tube complex"—a room containing 60 color TV monitors. From here a broadcast journalist can switch his monitor to any of the incoming offerings and begin commenting as if he were at the scene.



**When Only Excellent is Adequate TURN to Grayhill**

**WHAT'S NEW ABOUT THIS SWITCH?**

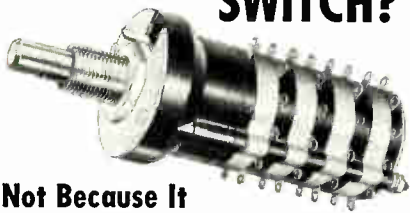

**It's Not Because It**

- 1) is explosion proof.
- 2) has up to 12 positions/deck.
- 3) could have up to 6 poles/deck.
- 4) comes in shorting or non-shorting versions.
- 5) is available in sealed, military or standard versions.

No...These are Standard Grayhill Rotary Switch features.

**IT'S NEW BECAUSE**

one or more positions may be ISOLATED from normal shaft turning techniques. It has its own built-in shaft turning SAFETY feature.



For details on this and other Switches Ask for Catalog



523 Hillgrove Avenue  
LaGrange, Illinois 60525  
Area Code 312, Phone 354-1040

**The Difference Between Excellent and Adequate**

Circle 145 on reader service card



**YOU'RE WHISTLING IN THE DARK...**

if you think that heart disease and stroke hit only the other fellow's family.

**GIVE ... so more will live HEART FUND**



*Contributed by the Publisher*

**First LOOK at the SPECS...**

**then take a DOUBLE LOOK at the NEW LOW PRICES!!!**

Precision thin film resistor ladder networks for as little as \$8 for hermetically sealed mil spec units...and even less for commercial quality!!!

**BOTH R-2R VOLTAGE DIVIDERS and CURRENT DIVIDERS**

PACKAGE: 16 LEAD DIP (.690 × .250) and FLAT PACK (.375 × .250)  
TEMPERATURE RANGE: -55° C to +125° C  
T. C. TRACKING: < 1 ppm/° C  
LADDER RESISTANCE VALUE (R) : 500\*, 5K, 10K, 25K or 50K

\*Current divider ladder only.

**APPLICATION RESISTORS INCLUDED**

MODEL NO.	DESCRIPTION	PRICE (1000 UP)	RATIO ACCURACY
HC 1000	12 Bit Voltage Divider	\$16.60	0.012%
HC 1050	12 Bit Current Divider	16.60	0.012
HC 1005	10 Bit Voltage Divider	14.00	0.05
HC 1055	10 Bit Current Divider	14.00	0.05
HC 1010	8 Bit Voltage Divider	9.00	0.2
HC 1060	8 Bit Current Divider	9.00	0.2

**LADDER RESISTANCE VALUE (R) : 10K WITH NO APPLICATION RESISTORS**

HC 100	12 Bit Voltage Divider	15.50	0.012
HC 105	10 Bit Voltage Divider	12.50	0.05
HC 110	8 Bit Voltage Divider	8.00	0.2

For fast action contact nearest sales rep.

- LEXINGTON, MASS.**  
Contact Sales Inc. (617) 861-1550
- NORRISTOWN, PA.**  
Denco-Data Engineering Co. (215) 272-1444
- MOUNTAINSIDE, N. J.**  
JJS Assoc. (201) 233-4562
- SYRACUSE, N. Y.**  
W. H. Zimmerman Inc. (315) 474-4889
- CEDAR RAPIDS, IA.**  
Lorenz Sales Inc. (319) 366-0774
- RICHARDSON, TEX.**  
Thornton Electronic Sales Co. (214) 231-6891
- PASADENA, CAL.**  
Mar-Land Enterprises (213) 681-9440
- CUPERTINO, CAL.**  
Trident Assoc. (408) 245-7884

Custom networks also available, for further information contact: Norm Palazzini at (617) 897-4578

**HyComp**

HyComp, Inc.  
146 Main Street, Box 250  
Maynard, Massachusetts 01754



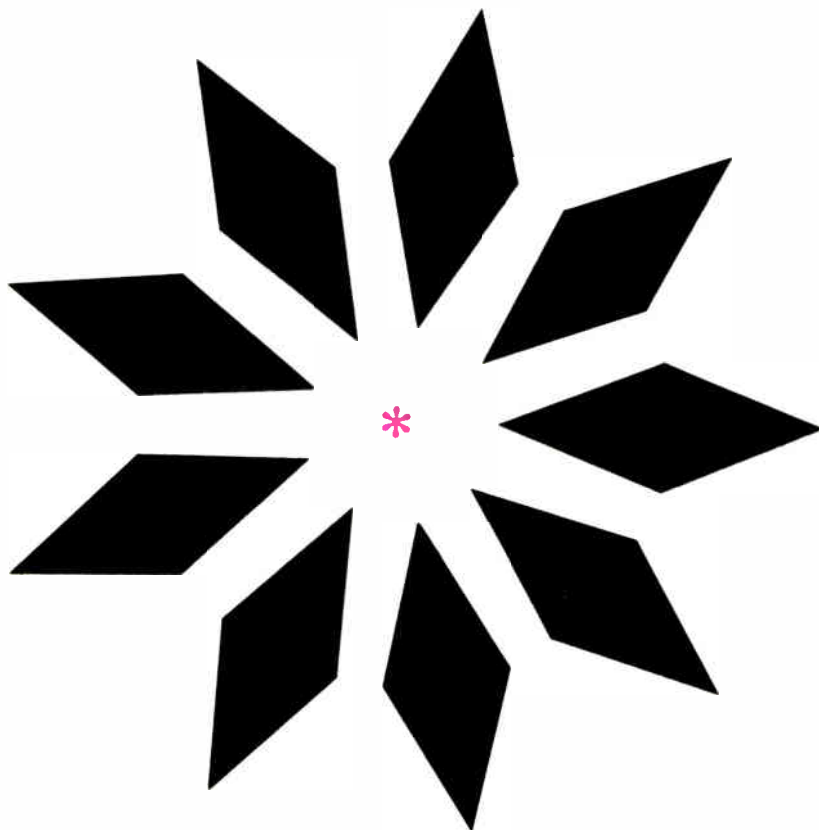

# Complete HF Receive Antenna capability in a 50 meter circle

How Hermes did away with vast rhombic or log-periodic antenna farms shoed away by a shrewd array ...

Take 1 meter diameter loops 4 meters apart and get an omni directional broad-band receiving array. covers 2 - 32 MHz

optimum beam characteristics for both long and short range communications.

Rosette configuration of linear arrays gives a number of overlapping high gain beams all available simultaneously.

**\* Using less than one hundredth of the real estate.**

Aperiodic Loop Systems are shrewd enough for restricted space, quick set up, roof mountable, or just below ground level.

Governments and military agencies use them.

Give up the antenna farm. ASK US

## Hermes Electronics Limited

Suite 315  
2020 F Street N. W.  
WASHINGTON  
D.C., 20006  
Telephone 202 296-2978  
TWX 710-882-1106

## Advertising Sales Staff

**Pierre J. Braude** [212] 971-3485  
Advertising Sales Manager

**Atlanta, Ga. 30309:** Charlton H. Calhoun, III  
1375 Peachtree St., N.E.  
[404] 892-2868

**Boston, Mass. 02116:** William S. Hodgkinson,  
James R. Pierce, 607 Boylston St.  
[617] 262-1160

**Chicago, Ill. 60611:** Ralph Hanning,  
Kenneth E. Nicklas, 645 North Michigan  
Avenue, [312] MO 4-5800

**Cleveland, Ohio 44113:** William J. Boyle,  
[716] 586-5040

**Dallas, Texas 75201:** Richard P. Poole  
1340 Republic National Bank Building  
[214] RI 7-9721

**Denver, Colo. 80202:** Richard W. Carpenter  
Tower Bldg., 1700 Broadway  
[303] 266-3863

**Detroit, Michigan 48226:** Ralph Hanning,  
2600 Penobscot Building  
[313] 962-1793

**Houston, Texas 77002:** Richard P. Poole,  
2270 Humble Bldg., [713] CA 4-8381

**Los Angeles, Calif. 90017:** Robert J. Rielly,  
Bradley K. Jones, 1125 W. 6th St.,  
[213] HU 2-5450

**Minneapolis, Minn. 55402:** Kenneth E. Nicklas,  
1104 Northstar Center [612] 332-7425

**New York, N.Y. 10036**  
330 W. 42nd St.  
Warren H. Gardner [212] 971-3617  
Michael J. Stoller [212] 971-3616

**Philadelphia, Pa. 19103:** Jeffrey M. Preston,  
6 Penn Center Plaza  
[215] LO 8-6161

**Pittsburgh, Pa. 15222:** Jeffrey M. Preston,  
4 Gateway Center, [412] 391-1314

**Rochester, N.Y. 14534:** William J. Boyle,  
9 Greylock Ridge, Pittsford, N.Y.  
[716] 586-5040

**St. Louis, Mo. 63105:** Kenneth E. Nicklas,  
The Clayton Tower, 7751 Carondelet Ave  
[314] PA 5-7285

**San Francisco, Calif. 94111:** Don Farris,  
Richard R. Butera, 425 Battery Street  
[415] 362-4600

**Paris:** Alain Offergeld  
17 Rue-Georges Bizet, 75 Paris 16 France  
Tel 720-73-01

**Geneva:** Alain Offergeld  
1 rue du Temple, Geneva, Switzerland  
Tel 32-35-63

**United Kingdom and Scandinavia**  
**London:** Keith Mantle, Brian Bowes  
Tel Hyde Park 1451  
34 Dover Street, London W1

**Milan:** Robert Sadel, Roberto Lauren  
1 via Baracchini Phone 86-90-656

**Brussels:** Alain Offergeld  
22 Chaussee de Wavre  
Brussels 1040 Belgium  
Tel 13-65-03

**European Special Project Manager:** Oliver Ball  
Tel: Hyde Park, 1451, London 34 Dover Street

**Frankfurt/Main:** Fritz Krusebecker  
Elsa-Brandstroem Str. 2  
Phone 72 01 81

**Tokyo:** Masaru Wakeshima, McGraw-Hill  
Publications Overseas Corporation,  
Kasumigaseki Building 2-5, 3-chome,  
Kasumigaseki, Chiyoda-Ku, Tokyo, Japan  
[581] 9811

**Osaka:** Akihiko Kamesaka, McGraw-Hill  
Publications Overseas Corporation, Kondo  
Bldg., 163, Umezae cho Kita-ku [362] 8771

**Australasia:** Warren E. Ball, IPO Box 5106,  
Tokyo, Japan

## Business Department

**Stephen R. Weiss, Manager**  
[212] 971-2044

**Thomas M. Egan,**  
Production Manager [212] 971-3140  
**Dorothy Carter,** Contracts and Billings  
[212] 971-2908

**Frances Vallone,** Reader Service Manager  
[212] 971-6057

## Electronics Buyers' Guide

**George F. Werner,** Associate Publisher  
[212] 971-3139

**Regina Hera,** Directory Manager  
[212] 971-2544



**COMPUTER AUTOMATION, INC.**

895 West 16th Street, Newport Beach, California 92660. Phone (714) 642-9630. TWX 910-596-1377

Description

Cost per unit

1EA	<b>ALPHA 16-BIT MINICOMPUTER</b>	<b>\$3550.00</b>
	4K WORDS OF MEMORY	N/C
	HARDWARE MULTIPLY/DIVIDE	N/C
	VECTORED PRIORITY INTERRUPTS	N/C
	TWO DIRECT MEMORY CHANNELS	N/C
	122 INSTRUCTION SET (500 WITH MICROCODES)	N/C
	BLOCK I/O	N/C
	KEYLOCK CONTROL CONSOLE	N/C
	AUTOMATIC I/O VIA STD DMC'S	N/C
	STANDARD SOFTWARE: CONVERSATIONAL	N/C
	ASSEMBLER, ONE OR 2-PASS ASSEMBLER,	
	RELOCATABLE LOADER, DEBUG, UTILITY,	
	DIAGNOSTICS, MATH & EDIT ROUTINES	
	<b>TOTAL</b>	<b>\$3550.00</b>

## \$3550 and down.

Our new ALPHA™ 16 is the first low-cost computer that's still a low-cost computer by the time you get it. That's because it gives you for free the kind of features that are extras with everybody else. For \$3550 we're talking about a fully-parallel, stored program, general purpose 16-bit computer — 1600 nanosecond full cycle and 4K 16-bit words of memory expandable to 32K. Plus all the standard features shown above. In addition, you get the most powerful instruction set in the industry — 122 basic instructions (including numerous multi-function instructions and unique immediates, Long Shifts, Jumps, and Memory-to-Register arithmetic). On top of this, a complete line of

peripherals and options, plus FORTRAN, BASIC, and Cross Assemblers are available. Finally, our list price of \$3550 usually goes even lower. Since that price is for a quantity of one. For larger quantities, OEM Discounts and Bonus Discounts reduce our starting price still further. (Incidentally, ALPHA 16 with 2K words is only \$3050 and down, and our 8-bit ALPHA 8 with 4K bytes goes for only \$2800 and down.) Send today for details on ALPHA. The best mini-computer at the lowest price in the industry.



**COMPUTER AUTOMATION, INC.**  
895 West 16th Street • Newport Beach, California  
92660 • Phone (714) 642-9630 • TWX 910-596-1377

# Electronics advertisers

July 19, 1971

<b># AEROCOM</b>	15E	<b>Gould, Inc./Brush Instruments</b>	110	<b>Orient Electronics, Ltd.</b>	45
Grant Advertising, Inc.		Carr Liggitt Adv., Inc.		KB&L Advertising, Ltd.	
<b>Airco Speer Electronic Components</b>	10	<b># Grayhill, Incorporated</b>	D-1	<b>Ovonic Displays</b>	96
Hazard Adv. Co., Inc.		Carr Liggitt Advertising, Inc.		John H. Rosen Advertising	
<b>Allen-Bradley Company</b>	12-13	<b>Hermes Electronics, Ltd.</b>	D-2	<b># Philips Gad Elcoma</b>	12E
Hoffman-York, Inc.		Public & Industrial Relations Limited		Tag-Intermarco delamar Agency	
<b>AMP, Incorporated</b>	58	<b># Hewlett-Packard</b>	2	<b># Philips N.V., Pit/T &amp; M Division</b>	2E
Aitkin-Kynett Co., Inc.		Lennon & Newell, Inc.		Marsteller International S. A.	
<b>Amphenol Controls Group,</b>		<b># Hewlett-Packard, Colorado Springs Division</b>	1	<b>Pomona Electronics Company</b>	8
<b>Bunker Ramo Corporation</b>	51	Talant/Yates Adv., Inc.		Buxton Advertising Agency	
Marsteller, Inc.		<b># Hewlett-Packard, Loveland Division</b>	42	<b># Primo Company, Inc.</b>	45
<b># Analog Devices, Inc.</b>	55	Talant/Yates Advertising		General Advertising Agency	
Kalb & Schneider, Inc.		<b># Hewlett-Packard, New Jersey Division</b>	99	<b># Racal Electronics Limited</b>	6E
<b># Anritsu Electric Co., Ltd.</b>	19E	McCarthy, Scelba and DeBiasi Adv. Agcy. Inc.		Saward Baker & Co. Limited	
Diamond Agency Co., Ltd.		<b># Hewlett-Packard, San Diego Div.</b>	106	<b>Raytheon Semiconductor</b>	118
<b># Asahi Glass Co., Ltd.</b>	18E	Phillips Ramsey Advertising		Durel Advertising	
Asia Advertising Agency, Inc.		<b># Hickok Electrical Instrument Company</b>	25	<b>RCA Electronic Components</b>	4th cover
<b>Beckman Instruments, Inc.</b>		Key Marketing Associates		Al Paul Letton Company	
<b>Electronic Instrument Div.</b>	56	<b>Hitachi, Ltd.</b>	44	<b># Rohde &amp; Schwarz</b>	5E
N. W. Ayer & Son, Inc.		Densu Advertising		<b>Scanbe Manufacturing Corp.</b>	13
<b>Bell &amp; Howell—Electronics &amp; Instruments Group</b>	33	<b>Hitachi Metals, Ltd.</b>	46	Warren C. Wilson & Associates	
Coordinated Communications, Inc.		Asia Adv. Agcy., Inc.		<b>Schauer Manufacturing Corp.</b>	112
<b>Bendix Corporation, Electrical Components Div.</b>	53	<b>Honeywell, Test Instrument Division</b>	41	Notan, Keelor & Stites	
MacManus, John & Adams, Inc.		Campbell Mithun, Inc.		<b># Showa Musen Kogyo Co., Ltd.</b>	45
<b>Bourns, Inc.</b>	114	<b>HyComp, Incorporated</b>	D-1	General Advertising Agency, Ltd.	
Marlborough Assoc., Inc.		M. W. Friedman Associates		<b>Standard Memories, Inc.</b>	40
<b># Busstrom Mfg. Division of McGraw Edison Company</b>	120-121	<b>Intel Corporation</b>	14-15	M B Advertising Agency	
Henderson Advertising Company		Bonfield Associates		<b>Syntronic Instruments, Inc.</b>	8
<b>Centralab, Div. of Globe Union, Inc.</b>	102	<b># ITT Cannon Electric</b>	9	Burton Browne Advertising	
The Brady Co.		MacManus John & Adams, Inc.		<b>Teikoku Tsushin Kogyo Co., Ltd.</b>	46
<b>Chukyo Electric Co., Ltd.</b>	47	<b>Kokuyo Electric Co., Ltd.</b>	47	Diamond Agency Co., Ltd.	
Kariyusha Advertising, Ltd.		International Promotion, Inc.		<b># Tektronix, Inc.</b>	31
<b>Collins Radio Company</b>	7	<b>Magnecraft Electric Company</b>	109	Dawson, Inc.	
John G. Burnett Advertising		Marketronics, Inc.		<b>Texas Instruments Incorporated, Components Group</b>	19 to 24
<b>Colorado Video, Inc.</b>	D-4	<b>Mallory and Co., P. R. Mfg. Division</b>	93	Albert Frank Guenther Law, Inc.	
Communications Transistor Corporation		Aitkin-Kynett Company		<b>Toko, Inc.</b>	45
Hall Butler Bliatherwick, Inc.	113	<b>Microdot, Inc. Instrumentation Division</b>	120	Hakuhodo, Inc.	
<b>Computer Automation</b>	D-3	Spectra Advertising		<b>UNISEM Subsidiary of United Aircraft Corporation</b>	57
Cochrane Chase & Company, Inc.		<b># Micro Switch Division of Honeywell</b>	16	Schaefer Advertising Inc	
<b>CTS Corporation</b>	100-101	N. W. Ayer and Son, Inc.		<b>Unitrode Corporation</b>	35
Reincke, Meyer & Finn, Inc.		<b>Mitsui &amp; Co., Ltd.</b>	47	Impact Advertising, Inc.	
<b>Data Control Systems, Inc.</b>	108	General Advertising Agency, Inc.		<b>Wavelek</b>	122
Technical, Industrial & Scientific Marketing, Inc.		<b>Monolithic Memories</b>	48	Chapman Micheli Advertising	
<b>DATAPAC</b>	75	Muris McKenna, Inc.		<b>Weston Instruments, Inc., Newark Division</b>	105
Ehnyart & Rose Advertising, Inc.		<b>MOS Technology, Inc.</b>	2nd cover	Arndt, Preston, Chapin Lamb & Keen, Inc.	
<b>Dixson, Inc. Electronic Instrument Division</b>	6	Henry S. Goodsett Advertising, Inc.		<b>Xerox Corporation</b>	54
Lowery Business Publications		<b>Mostek Corporation</b>	26	Hutchins Advertising Company, Inc.	
<b>DuPont de Nemours &amp; Company, Freon Division</b>	70	Continental Communications, Incorporated			
N. W. Ayer & Son, Inc.		<b># National Semiconductor Corp.</b>	52		
<b>Elco Corporation</b>	11	Chiat Day, Inc. Advertising			
Mori Barish Associates, Inc.		<b>Nikkei Electronics</b>	13		
<b>Electronic Industries Association of Japan</b>	43	North Atlantic Industries, Inc.	5		
Asian Advertising, Inc.		He me Associates, Inc.			
<b># Erie Technological Products Company, Inc.</b>	3rd cover	<b># Nortronic Company, Inc.</b>	16E		
Altman Hall Associates Advertising		Fischbein Advertising, Inc.			
<b>Excellon Industries, Inc.</b>	37-38-39	<b># Olympus Optical Co., Ltd.</b>	11E		
Elgin Davis, Inc.		Fuji Agency			
<b>General Radio Co.</b>	116-117	<b># Onan Division of Studebaker Corp.</b>	17E		
GRAD Associates		Campbell Mithun, Inc.			

## Classified & Employment Advertising

F. J. Eberle, Manager 212-971-2557

<b>EQUIPMENT (Used or Surplus New) For Sale</b>	
<b>E.L.E.S. International</b> .....	112
<b>Philip Fishman</b> .....	112
<b>Radiation Devices Co.</b> .....	112

■ For more information on complete product line see advertisement in the latest Electronics Buyer's Guide  
 # Advertisers in Electronics International

# Narrow-Band TV



If you don't need motion in your TV pictures, but need:

- Low-cost, long-distance, transmission over standard voice-grade phone lines
- Tape recording on standard 1/4" audio tape
- Hard-copy printout
- Magnetic disc image storage (multiple pictures or color too)
- An interconnection to a computer

Investigate our 201-series Video Converters, which compress the bandwidth of standard TV signals to as low as 500 Hertz, and our 220-series Video Converters which utilize a unique disc memory technique to re-convert to conventional 525-line TV format.

# CVI

COLORADO VIDEO, INCORPORATED • P.O. Box 928 • Boulder, Colo. 80302 • (303) 444-3972 Video Data Acquisition • Processing • Display • Transmission

July 19, 1971

# Electronics

## Reader service

**Use these handy post-cards for more detailed information on products advertised, new products, new literature.**

Circle the number on the Reader Service postcard that corresponds to the number at the bottom of the advertisement, new product item, or new literature in which you are interested.

Please print clearly. All written information must be legible to be correctly processed.

If the cards have already been used, you may obtain the needed information by writing directly to the manufacturer, or by sending your name and address, plus the Reader Service number, to Electronics Reader Service Department, Box 444, Hightstown, N. J. 08520.

All inquiries from outside the U.S. that cannot reach Electronics before the expiration dates noted on the Reader Service postcard must be mailed directly to the manufacturer. The manufacturer assumes all responsibilities for responding to inquiries. Electronics merely provides and clears requests for information from inquirer to manufacturer.

Correct amount of post must be affixed for all mailings from outside the U.S.

### Multi-product advertisements

For information on specific items in multi-product advertisements which do not have a specific Reader Service number indicated, write directly to manufacturer for information on the product in which you are interested.

### To subscribe to or to renew Electronics

Fill in the subscription card adjoining this card. You need to send no money. Electronics will bill you at the address indicated on the card.

15

14

\*For employment inquiries fill in home address. July 19, 1971 Card Expires September 19, 1971

Name \_\_\_\_\_ Title \_\_\_\_\_

Company\* \_\_\_\_\_

Address \_\_\_\_\_

City \_\_\_\_\_ State \_\_\_\_\_ Zip Code \_\_\_\_\_

1	22	43	64	85	106	127	148	169	190	211	232	253	274	295	316	337	358	379	400	421	442	463	484	960
2	23	44	65	86	107	128	149	170	191	212	233	254	275	296	317	338	359	380	401	422	443	464	485	961
3	24	45	66	87	108	129	150	171	192	213	234	255	276	297	318	339	360	381	402	423	444	465	486	962
4	25	46	67	88	109	130	151	172	193	214	235	256	277	298	319	340	361	382	403	424	445	466	487	963
5	26	47	68	89	110	131	152	173	194	215	236	257	278	299	320	341	362	383	404	425	446	467	488	964
6	27	48	69	90	111	132	153	174	195	216	237	258	279	300	321	342	363	384	405	426	447	468	489	965
7	28	49	70	91	112	133	154	175	196	217	238	259	280	301	322	343	364	385	406	427	448	469	490	966
8	29	50	71	92	113	134	155	176	197	218	239	260	281	302	323	344	365	386	407	428	449	470	491	967
9	30	51	72	93	114	135	156	177	198	219	240	261	282	303	324	345	366	387	408	429	450	471	492	968
10	31	52	73	94	115	136	157	178	199	220	241	262	283	304	325	346	367	388	409	430	451	472	900	969
11	32	53	74	95	116	137	158	179	200	221	242	263	284	305	326	347	368	389	410	431	452	473	901	970
12	33	54	75	96	117	138	159	180	201	222	243	264	285	306	327	348	369	390	411	432	453	474	902	971
13	34	55	76	97	118	139	160	181	202	223	244	265	286	307	328	349	370	391	412	433	454	475	951	972
14	35	56	77	98	119	140	161	182	203	224	245	266	287	308	329	350	371	392	413	434	455	476	952	973
15	36	57	78	99	120	141	162	183	204	225	246	267	288	309	330	351	372	393	414	435	456	477	953	974
16	37	58	79	100	121	142	163	184	205	226	247	268	289	310	331	352	373	394	415	436	457	478	954	975
17	38	59	80	101	122	143	164	185	206	227	248	269	290	311	332	353	374	395	416	437	458	479	955	976
18	39	60	81	102	123	144	165	186	207	228	249	270	291	312	333	354	375	396	417	438	459	480	956	977
19	40	61	82	103	124	145	166	187	208	229	250	271	292	313	334	355	376	397	418	439	460	481	957	978
20	41	62	83	104	125	146	167	188	209	230	251	272	293	314	335	356	377	398	419	440	461	482	958	979
21	42	63	84	105	126	147	168	189	210	231	252	273	294	315	336	357	378	399	420	441	462	483	959	980

# Electronics

## Reprint service

Reminder: The Post Office now requires your ZIP CODE on all mail. Please include your ZIP CODE number when filling out your reply card.

First class  
Permit no. 42  
Hightstown, N. J.

### Business reply mail

No postage stamp necessary if mailed in the United States

Postage will be paid by

# Electronics

Reader service department  
Box 444  
Hightstown, N. J. 08520

## Only Electronics editorial matter listed on this page available in reprint form:

You may order any of the below listed reprints by key number. Discounts on quantities over 10.

Bulk reprints of editorial matter can be ordered from current or past issues. The minimum quantity is 500 copies. Prices quoted on request; call 609-448-1700 Ext. 5494, or write to address below.

### Reshaping The EE For The Seventies

24 pages. \$1.00

Key no. R-18

### Special Report on New Look in LSI Packaging.

Parts I & II. 16 pages. \$2.00

Key no. R-15

### Electronics Markets (1971). U.S.A. & European Combined Forecasts.

46 pages. 2 fold-out charts. Bound. \$5.00. Key no. R-13

### Computer-Aided Design.

148 pages. \$4.00.

Key no. R-11

### Active Filter Chart & Infra-Red Detector Chart.

2 Electronics 1969 Special Guide Charts. \$1.00 includes both 4-color charts. Key No. R-033

### Active Filters.

96 pages. \$4.00.

Key no. R-032

### Circuit Designers Casebook.

217 pages. \$4.00.

Key no. R-031

### Consumer Hazards: Why they Happen, How they Can Be Fixed.

14 pages. \$2.00. Key no. R-027

### Special Report: Tomorrow's Communications.

32 pages. \$3.50. Key no. R-023

### Special Report on Ferrites.

16 pages. \$2.00. Key no. R-017

### Special Report on The Transistor: Two Decades of Progress.

48 pages. \$3.00. Key no. R-016

### Special Report on Gallium Arsenide.

7 parts. 32 pages.

\$4.00. Key no. R-012

### Special Report on Large Scale Integration.

54 pages. \$3.00.

Key no. R-010

### Field Effect Transistors.

Parts I, II, and III. 64 pages.

\$4.00. Key no. R-64

### 1970 Electronics Index to Technical Articles and Authors.

\$1.00.

Key no. R-32

To order reprints or for further information, please write to:

Electronics Reprint Department  
P.O. Box 669  
Hightstown, N.J. 08520

Only orders with cash, check, or money order will be accepted. **No invoicing will be done.**

# ERIE EMI Filters

WORLD'S BROADEST LINE OF MINIATURE CERAMIC FILTERS  
AND FILTER SYSTEMS

**FIRST**— in subminiature  
design capability

**FIRST**— in total in-house  
production capability

**FIRST**— in Quality and  
Volume Production

**FIRST**— to develop a complete  
line of subminiature  
EMI Filters

ERIE's stature as undisputed world leader in subminiature high performance Ceramic EMI Filters has been earned by our ability to apply 35 years of sophisticated ceramic and related technology to developing superior EMI Filters. Virtually all other presently known ceramic EMI filters are a copy of an Erie design. Yet, no firm has been able to equal Erie's combined in-house filter capability and proprietary ceramic technology.

Today these miniature filters "do their thing" in noise pollution control, eliminating extraneous noises and emissions from air waves.

There's an application for reliable Erie filters in your communications, aerospace, aircraft and industrial equipments. We'll be happy to help solve the problem.

Write for our new EMI Filter brochure  
ERIE TECHNOLOGICAL PRODUCTS  
Erie, Pennsylvania 16512



**ERIE** TECHNOLOGICAL PRODUCTS, INC. • Erie, Pennsylvania 16512

Circle 901 on reader service card

# GaAs lasers go commercial at new low prices!

RCA GaAs laser diodes have now reached a level of product maturity; many developmental types have been assigned commercial numbers; and they are priced lower than ever—as low as \$6.95 (at 1000-level) for type 40858.

RCA GaAs lasing devices are available as diodes, stacks, and arrays. They feature high peak and average power outputs at exceptionally low drive currents. They are also available in 800 to 900 nanometers in GaAlAs for improved match to image intensifiers. A wide range of custom designs can be provided to meet system needs.

You will find that RCA lasers offer design advantages in data-link communications, fuzing devices, intrusion alarms, ranging equipment, target designation equipment, night-vision systems, and many other infrared systems. Put the competitive advantages of RCA lasers to work in your application.

RCA also offers a line of matching P-I-N Photodetectors for use with laser systems.

For further information see your local RCA Representative or RCA Distributor. Or write: RCA, Commercial Engineering, Section 70 G-19 /US8, Harrison, N. J. 07029. International: RCA, Sunbury-on-Thames, U.K., or P.O. Box 112, Hong Kong.

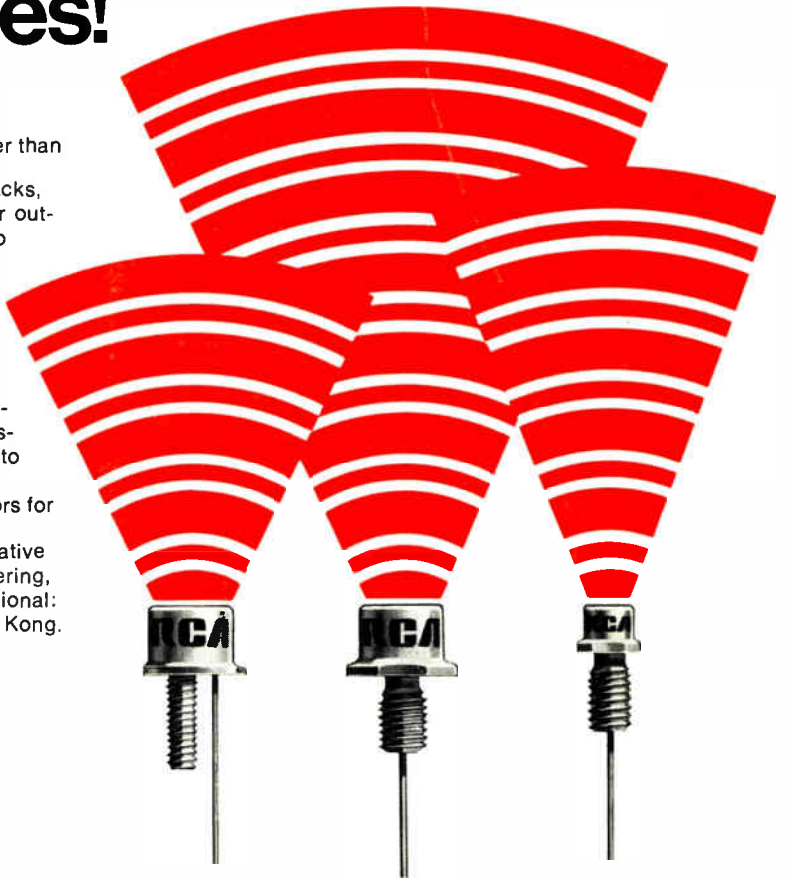

## RCA Solid State

### Single diode lasers

- efficiency—3%
- wavelength—905 nanometers
- pulse duration—0.2  $\mu$ s (max.)\*
- case polarity—negative (Reverse-polarity types available)

Type	Pkg	Power Output (W) (min.)	I <sub>FM</sub> (A)	Source Size (mils)	Duty Factor %
40855	OP-3	0.7	10	3x0.08	0.1
40856	OP-3	1.0	10	3x0.08	0.1
40857	OP-3	2.0	10	3x0.08	0.1
40858	OP-3	3.0	25	6x0.08	0.1
40859	OP-3	5.0	25	6x0.08	0.1
40860	OP-3	5.0	20	6x0.08	0.1
40861	OP-3	7.0	40	9x0.08	0.1
40862	OP-3	10.0	40	9x0.08	0.1
40863	OP-3	10.0	30	9x0.08	0.1
40864	OP-3	12.0	75	16x0.08	0.1
40865	OP-3	15.0	75	16x0.08	0.1
40866	OP-3	15.0	60	16x0.08	0.1
TA7864	OP-12	25.0	75	24x0.08	0.02
TA7763	OP-12	25.0	100	24x0.08	0.02
TA7705	OP-12	40.0	250	55x0.08	0.005
TA7787	OP-12	60.0	250	55x0.08	0.005

\*Except 0.1  $\mu$ s max for TA7705 and TA7787

### Laser arrays

- wavelength—905 nanometers
- series wired
- duty factor—0.02%
- pulse duration—0.2  $\mu$ s (max)
- case polarity—negative (Reverse-polarity types available)
- package—OP-4A

Type	No. of Diodes	Power Output (W) (min.)	I <sub>FM</sub> (A)	Source Size (mils)
TA7687	10	25	25	100x0.08
TA7687A	10	50	25	100x0.08
TA7688	15	35	25	150x0.08
TA7688A	15	75	25	150x0.08
TA7690	30	75	25	160x40
TA7690A	30	150	25	160x40
TA7692	60	150	25	160x60
TA7692A	60	300	25	160x60

### GaAlAs laser diodes and arrays

Type	Center Wavelength (nm)	Peak Power Output (W) (min.)	I <sub>FM</sub> (A)	Source Size (mils)	No. of Diodes	Pkg
TA7867	850 $\pm$ 50	3	25	6x0.08	1	OP-3
TA8127	850 $\pm$ 50	7	40	9x0.08	1	OP-3
TA8101	800 $\pm$ 20	85	40	150 x 0.08	12	OP-4A
TA8105	850 $\pm$ 30	85	40	150 x 0.08	12	OP-4A
TA8106	800 $\pm$ 20	170	40	160 x 40	24	OP-4A
TA8107	850 $\pm$ 30	170	40	160 x 40	24	OP-4A
TA8131	800 $\pm$ 20	300	40	160 x 60	48	OP-4A
TA8132	850 $\pm$ 30	300	40	160 x 60	48	OP-4A

### Stacked-diode lasers

- wavelengths—905 nanometers
- series wired
- package—OP-12
- pulse duration—0.2  $\mu$ s (max)
- case polarity—negative (Reverse-polarity types available)

Type	No. of Diodes	Power Output (W) (min.)	I <sub>FM</sub> (A)	Source Size	Duty Factor %
TA7764	3	25	40	9.5x9.5	0.02
TA7964	2	30	75	16x4	0.04
TA7765	2	50	100	24x4	0.02