

Computer plans high-density pc board layout 76

A program-it-yourself read-only memory 91

Everyman's frequency standard: the TV color burst 96

Electronics®

SPECIAL REPORT

The challenge of LSI testing

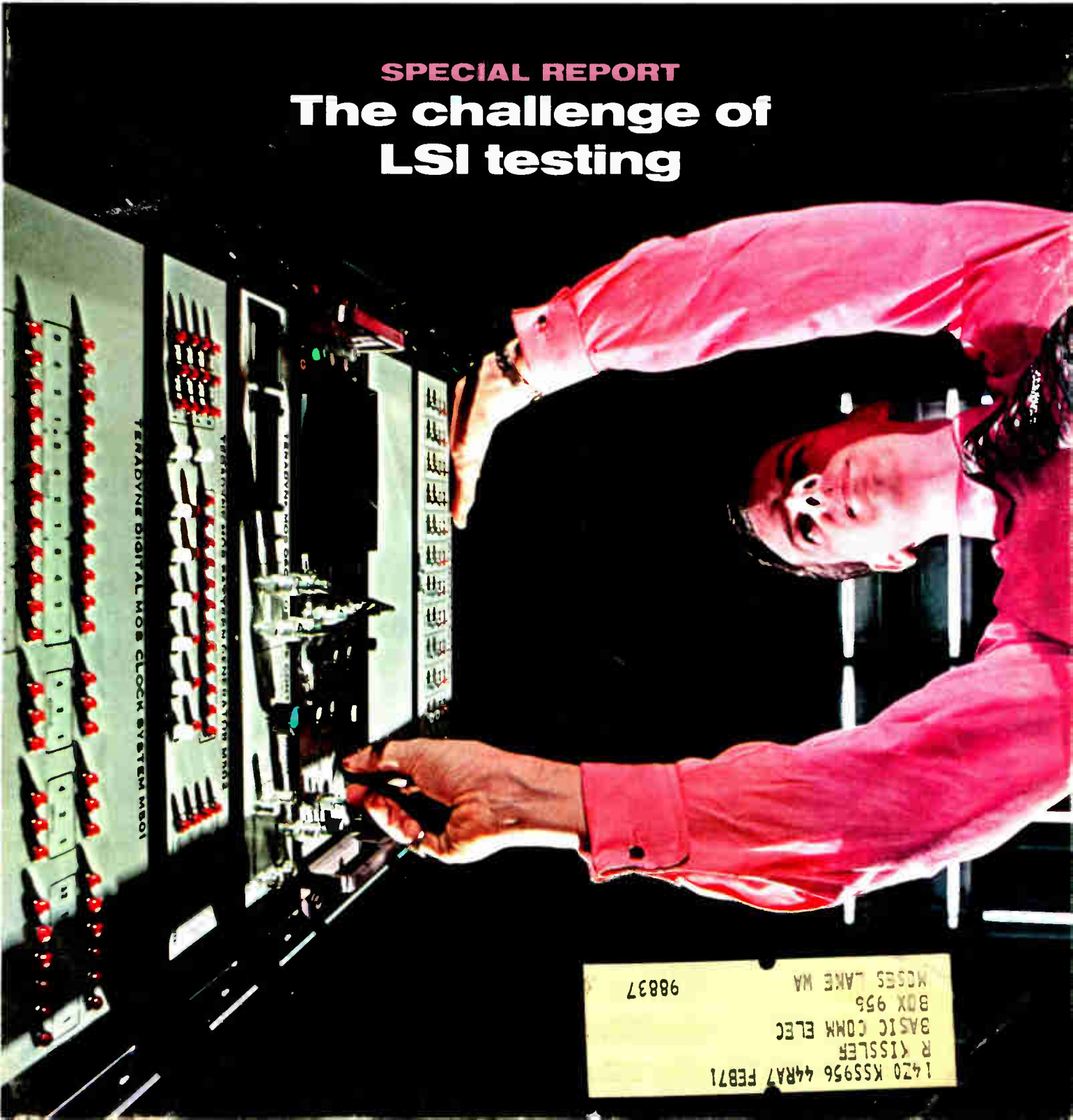

1420 KSS956 44RA7 FEB71
 R KISSLER
 BASIC COMM ELEC
 BOX 956
 MOSES LAKE WA 98837

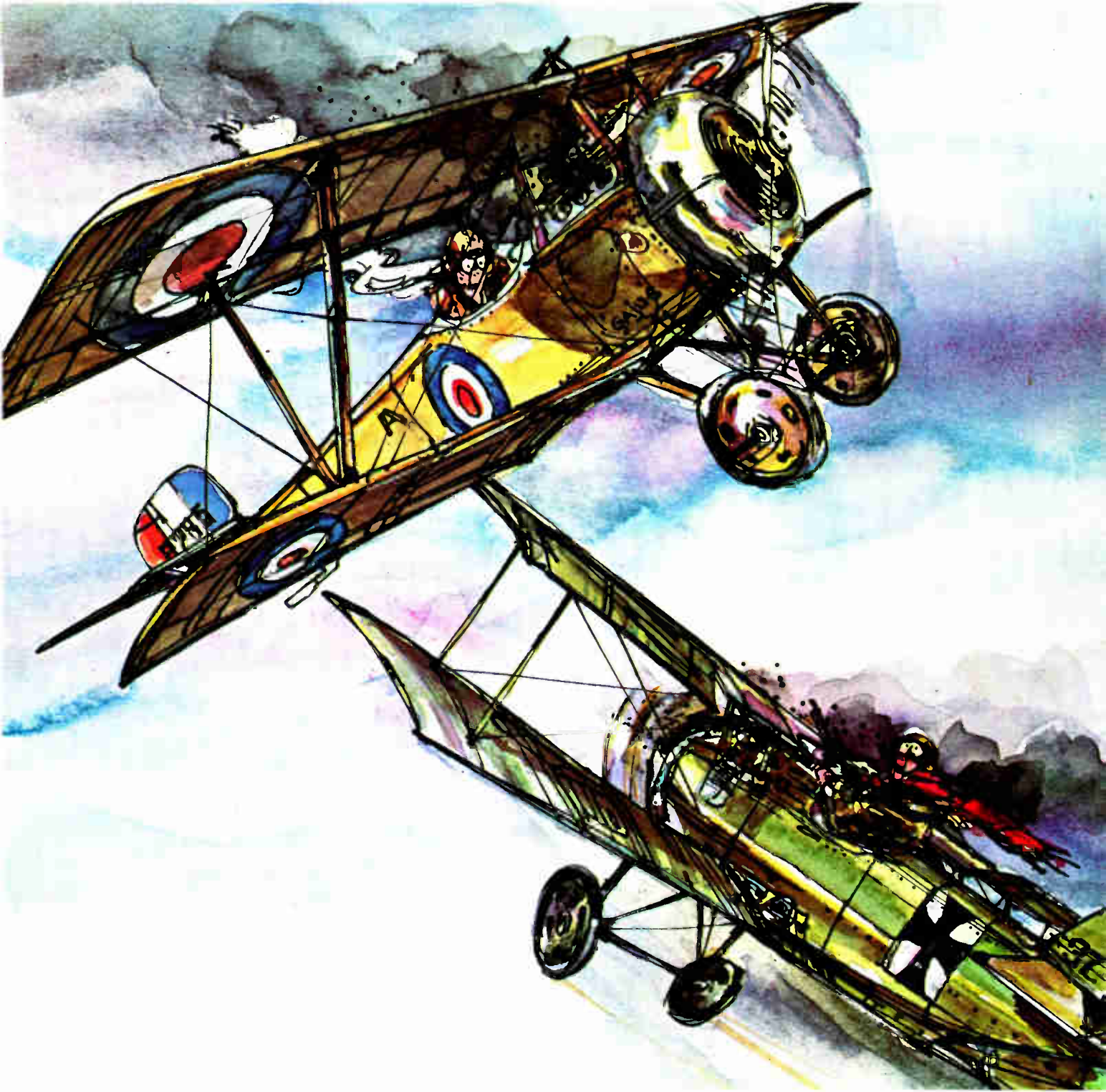

No place for a field failure

When you're in a "dog fight" with your competitors, critical failures in MOS LSI could shoot you down. With so much at stake, shouldn't you call in the ace of aces in MOS technology?

That's AMI. Our reliability record has been flawless. That's why we continue to furnish MOS LSI circuits for jumbo jets and the space programs,

including the moon shots, orbiting satellites and deep-space probes.

Why take a chance? Don't fly blind with unproven MOS LSI or with suppliers who haven't demonstrated their ability under fire. Call us today —and we'll show you how our mastery of MOS can give you the competitive edge.



AMERICAN MICRO-SYSTEMS, INC.

3800 Homestead Road, Santa Clara, Calif. 95051 (408) 246-0330

'Masters of MOS'

Circle 900 on reader service card

These amplifiers make your test equipment— and your budget—look good.

Hewlett-Packard's new wideband RF amplifiers improve the sensitivity of your scopes, spectrum analyzers, counters, network analyzers — anywhere you need low-noise, high-gain amplification.

As a result of HP's hybrid thin-film microcircuit technology, these amplifiers bring you superior perform-

ance and high reliability at low cost.

The table below gives frequency ranges, prices and performance of the six basic configurations. Dual channel versions of the preamps can also be supplied to improve the performance of 2-channel instrumentation.

They're ready for delivery now. A call to your HP field engineer will

bring you the details of how these amplifiers can help enhance the test equipment you're using now. Or write to Hewlett-Packard, Palo Alto, California 94304; Europe: 1217 Meyrin-Geneva, Switzerland.

HEWLETT  PACKARD

04021A

HEWLETT-PACKARD 8447 SERIES LAB AMPLIFIERS

	HP 8447A Preamp	HP 8447B Preamp	HP 8447C Pwr. Amp.	HP 8447D Preamp	HP 8447E Pwr. Amp.	HP 8447F Preamp/Pwr. Amp.
Frequency Range	0.1-400 MHz	0.4-1.3 GHz	30-300 MHz	0.1-1300 MHz	0.1-1300 MHz	0.1-1300 MHz
Nominal Gain	20 dB	22 dB	30 dB	26 dB	22 dB	48 dB
Gain Flatness	±0.5 dB	±1 dB	±1 dB	±1.5 dB	±1.5 dB	±3 dB
Noise Figure	<5 dB	<5 dB to 1.0 GHz <6 dB, 1.0-1.3 GHz	<11 dB	<8 dB	<11 dB	<8 dB
Output Power @ 1 dB Gain Compression	>+7 dBm	>-3 dBm	>+17 dBm	>+7 dBm	>+14 dBm	>+14 dBm
Price	\$550	\$600	\$450	\$650	\$700	\$1175



Circle 1 on reader service card

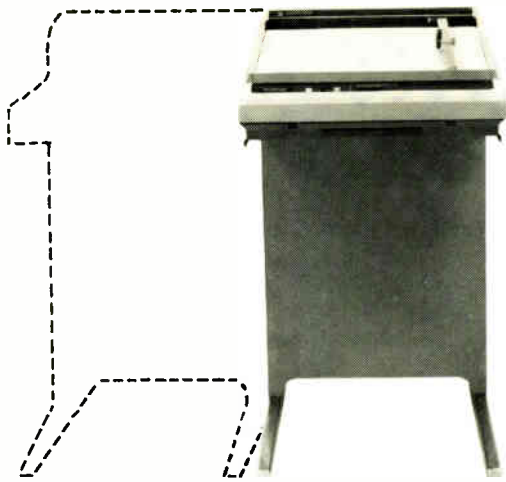

Picture your terminal (even if it's IBM) with our \$3,300 graphic plotter.

At last, everybody can see their time-share data plotted in smooth, clear graphs. Hewlett-Packard's Model 7200 Graphic Plotter will add a new visual dimension to any terminal in the business. Now, even if you're partial to IBM's 2741, you can have instant graphic solutions to every type of engineering or mathematical problem.

There's no special operation or programming knowledge needed. You control the program. Plot numerical data in points, lines, curves, circles, ellipses, bar graphs or pie charts. Or, manipulate and expand computer data

and plot in finished graphic form. You get smooth lines—not the staircase drawn by the incremental recorder.

Use the HP 7200 simultaneously with your time-share terminal or silence the terminal and use the plotter alone. Because it goes to work when the data comes in, there's no time lag.

Simple manual controls allow you to set the graph limits to fit any pre-printed grid. HP's Autogrip electrostatic holddown firmly grips any graph paper up to 11x17 inches.

You can arrange to add a graphic plotter to your existing time-share

terminal by contacting Hewlett-Packard. Buy it at \$3,300. Rent it. Lease it. Or lease to buy.

We can match a 7200 with any EIA ASCII terminal in the business... or even IBM's 2741. So now, everybody can be the arty type. For details, contact Hewlett-Packard, Palo Alto, California 94304; Europe: 1217 Meyrin-Geneva, Switzerland.

HEWLETT  **PACKARD**

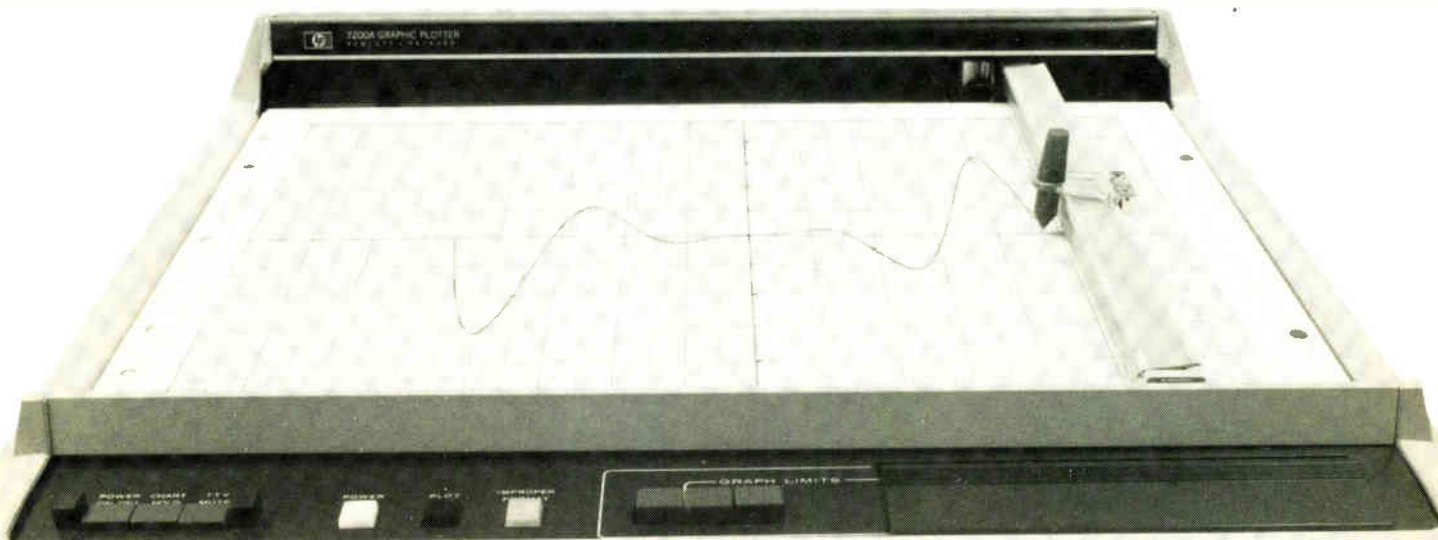

35 Electronics Review

DISPLAYS: Gas plasma panels getting gray scales, 35
INDEX OF ACTIVITY: Total hits five-year low, 36
LASERS: Material could open door to laser communications, 36
ECONOMICS: Increase of 8% in sales foreseen, 37
MILITARY ELECTRONICS: Tri-Tac to pick up speed, 37
COMMUNICATIONS: Three firms to develop personal transceivers for police, 38
MEETINGS: Spring Joint, Naecon due for letdown, 38
MEMORIES: Litton picks up on MOS, 40; Ampex to go bipolar, 43
INDUSTRIAL ELECTRONICS: Fabrication changes mean more power, 43
COMMERCIAL ELECTRONICS: NASA funds automated attendance system, 44; Automated fingerprint study, 46
AVIONICS: Cockpit display features moving window, 46
SPACE ELECTRONICS: Development contracts awarded for Gbit laser, 48
FOR THE RECORD: 50

67 Technical Articles

SPECIAL REPORT: Meeting the MOS/LSI challenge: a special report on testers, 68
DESIGN AUTOMATION: Computer takes over job of laying out dense pc boards, 76
CIRCUIT DESIGN: Designer's casebook, 80
COMPUTERS: With a speech pattern classifier, computer listens to its master's voice, 84
SOLID STATE: ROM can be electrically programed and reprogramed and reprogramed, 91
INSTRUMENTATION: Frequency standard hides in every color TV set, 96

105 Probing the News

CONSUMER ELECTRONICS: Solid state invades Detroit, 105
COMMUNICATIONS: Western Union: still a live wire, 113
MILITARY: Piracta spells digital avionics, 117

121 New Products

SJCC PREVIEW: Intelligent terminal, 121; Low-cost tape drive, 122; Medium-speed printer, 124
DATA HANDLING: \$650 printer, 127; Bipolar ROM, 129; Graphics terminal, 130; Lightweight printer, 132
INSTRUMENTS: Fairchild invades bench-tester business, 135; Multimeter measures ac and decibels, 136
PACKAGING & PRODUCTION: Leadless inverted device carrier applied to ICs, 141
SEMICONDUCTORS: Drivers developed for numeric displays, 145; Bipolar memory has 15-ns access time, 146

155 Electronics International

JAPAN: Plated-wire memories challenge cores, 155, and semiconductors, 156
FRANCE: Drawing a bead on infrared radiation, 156
JAPAN: Fujitsu glows over plasma displays, 157
CANADA: Satellite will push technology to open up northern areas, 157
GREAT BRITAIN: ICL breathes new life into its 1900 series computers, 158
WEST GERMANY: Focusing on water pollution, 158

Departments

Publisher's letter, 4
Readers comment, 6
People, 14
40 years ago, 18
Meetings, 22
Electronics Newsletter, 25
Washington Newsletter, 57
New Literature, 150
International Newsletter, 153

Title R registered U.S. Patent Office; © copyright 1971 by McGraw-Hill Inc.
All rights reserved, including the right to reproduce the contents of this publication in whole or in part.
Volume No. 44, Number 10

Electronics

EDITOR-IN-CHIEF: Kemp Anderson

EXECUTIVE EDITOR: Samuel Weber

MANAGING EDITORS: Robert Henkel, News;
Arthur Erikson, International

SENIOR EDITORS: John Johnsrud,
H. Thomas Maguire, Stephen E. Scrupski

ASSOCIATE EDITORS: William Bucci,
Richard Gundlach, Howard Wolf

DEPARTMENT EDITORS

Aerospace: Jim Hardcastle
Circuit Design: Lucinda Mattera
Communications & Microwave:
John N. Kessler

Computers: Wallace B. Riley
Consumer: Gerald M. Walker
Industrial: Alfred Rosenblatt
Instrumentation: Owen Doyle
Military: Ray Connolly
New Products: H. Thomas Maguire
Packaging & Production:
Stephen E. Scrupski

Solid State: Laurence Altman

COPY EDITORS: William S. Weiss,
Margaret Eastman

ART: Fred Sklenar, Director
Charles D. Ciatto, Associate Director

PRODUCTION EDITORS:
Susan Hurlburt, Arthur C. Miller

EDITORIAL ASSISTANT: Marilyn Offenheiser
EDITORIAL SECRETARIES: Claire Goodlin,
Vickie Green, Bernice Pawlak

FIELD EDITORS

Boston: James Brinton (Mgr.), Gail Farrell
Dallas: Paul Franson (Mgr.)
Los Angeles: Lawrence Curran (Mgr.)
New York: Alfred Rosenblatt (Mgr.)
San Francisco: Stephen Wm. Fields (Mgr.),
Roberta Schwartz
Washington: Ray Connolly (Mgr.),
Jim Hardcastle, Larry Armstrong
Frankfurt: John Gosch
London: Michael Payne
Paris: Arthur Erikson
Tokyo: Charles Cohen

McGraw-Hill World News

Director: Walter A. Stanbury; Atlanta: Stan
Fisher; Chicago: Mike Sheldrick; Cleveland:
Arthur Zimmerman; Detroit: James Wargo;
Houston: Robert E. Lee; Los Angeles: Michael
Murphy; Gerald Parkinson; San Francisco:
Margaret Drossel; Seattle: Roy Bloomberg;
Washington: James Canan, Herbert W.
Cheshire, Seth Payne, Warren Burkett, William
D. Hickman; Bonn: Robert F. Ingersoll;
Brussels: James Smith; London: Marvin Petal;
Milan: Peter Hoffmann; Moscow: Axel Krause;
Paris: Stewart Toy; Tokyo: Mike Mealey

PUBLISHER: Dan McMillan

PLANNING & DEVELOPMENT MANAGER:
Donald Christiansen

ADVERTISING SALES MANAGER: Pierre Braudé

CIRCULATION MANAGER: George F. Werner

RESEARCH MANAGER: David Strassler

PROMOTION MANAGER: Tomlinson Howland

ADVERTISING SALES SERVICE MANAGER:
Wallis Clarke

The cover reads "The challenge of LSI testing," but the challenge of presenting that special report (see page 68) in an eye-stopping way was what faced our art director, Fred Sklenar, about the time the IEEE show rolled around. We think he and photographer Manny Rubio met the challenge in a strikingly dramatic way.

In case you're wondering, the Teradync testing machine is not about to fall over. Rubio—a veteran sports, nature, and industrial photographer—put a wide-angle lens on his camera, put his camera on the floor and shot straight up.

And our Los Angeles bureau manager, Larry Curran had the challenge of putting the report together. His in-depth reporting chronicles the problems at the interface between MOS/LSI tester makers and users. Over the past few months, the makers and users of the testers, spurred on by the overriding common goal of turning out circuits that work, have been seeing eye to eye a lot more. We think you will feel as we do, that this report is the final word—at least for right now—on where MOS/LSI testing is and where it is going.

We've added a few new names to our masthead recently and would like to present three new staff members to you. Ladies first.

Lucinda Mattera, who received her bachelor's in electrical engineering from New York's City College, joins us after four years experience on other electronics mag-

azines, where she was, among other things, circuit editor. She is doing the same for us, overseeing the Designer's Casebook and our circuit design department. Previously, Lucinda worked for five years designing electromechanical components. She helped design potentiometers, and some of her work has flown in the F-111.

Our new editorial assistant, Marilyn Offenheiser is a graduate of New York University, where she majored in advertising. She is on her way to the top in the sport of judo. She started only two years ago but is already running a 160-student judo school in northern New Jersey and has her third brown belt.

Jack Kessler, new communications and microwave editor, gets his leisure time kicks sailing across blue water. And he keeps sailing on in journalism. Jack was an electronics magazine news editor for two years and had spent most of a decade at Bell Labs, writing in the technical information department and editing on the Bell Labs' Record. He earned his BA in English at the University of Pennsylvania, and did graduate work at Rutgers, studied science writing at MIT and boned up in physics at UCLA. And somewhere in there, the reporter's blood surging, he covered a wire service police beat in Los Angeles.

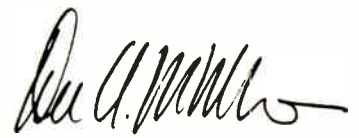

May 10, 1971 Volume 44, Number 10
91,609 copies of this issue printed

Published every other Monday by McGraw-Hill, Inc. Founder: James H. McGraw 1860-1948. Publication office 330 West 42nd, N.Y., N.Y. 10036; second class postage paid at New York, N.Y., and additional mailing offices. Executive, editorial, circulation and advertising addresses: Electronics, McGraw-Hill Building, 330 W. 42nd Street, New York, N.Y. 10036. Telephone (212) 971-3333. Teletype TWX N.Y. 710-581-4235. Cable address: MCGRAWHILLN.Y.

Subscriptions limited to persons with active, professional, functional responsibility in electronics technology. Publisher reserves the right to reject non-qualified requests. No subscriptions accepted without complete identification of subscriber name, title, or job function, company or organization, including product manufactured or services performed. Subscription rates: qualified subscribers in the United States and possessions and Canada, \$8.00 one year, \$12.00 two years, \$16.00 three years; all other countries \$25.00 one year. Limited quota of subscriptions available at higher-than-basic rate for persons outside of field served, as follows: U.S. and possessions and Canada, \$25.00 one year; all other countries \$50.00. Air freight service to Japan \$60.00 one year, including prepaid postage. Single copies: United States and possessions and Canada, \$1.00; all other countries, \$1.75.

Officers of the McGraw-Hill Publications Company: John R. Emery, President; J. Elton Tuohis, Senior Vice President—Services; Donald B. Gridley, Group Vice President; Vice Presidents: Ralph Blackburn, Circulation; John R. Callahan, Editorial; William P. Gislio, Administration; David G. Jensen, Manufacturing; Jerome D. Lutz, Planning & Development; Joseph C. Page, Marketing; Robert M. Wilhelm, Finance.

Officers of the Corporation: Shelton Fisher, President; Joseph H. Allen, Group Vice President—Publications and Business Services; John J. Cooke, Senior Vice President and Secretary; Ralph J. Webb, Treasurer.

Title © registered in U.S. Patent Office; © Copyright 1971 by McGraw-Hill, Inc. All rights reserved. The contents of this publication may not be reproduced either in whole or in part without the consent of copyright owner. Subscribers: The publisher, upon written request to our New York office from any subscriber, agrees to refund that part of the subscription price applying to copies not yet mailed. Please send change of address notices or complaints to Fulfillment Manager; subscription orders to Circulation Manager, Electronics at address below. Change of address notices should provide old as well as new address, including postal zip code number. If possible, attach address label from recent issue. Allow one month for change to become effective.

Postmaster: Please send form 3579 to Fulfillment Manager, Electronics, P.O. Box 430, Hightstown, N.J. 08520.

PETP FILM CAPACITORS



EASIER THAN EVER TO FIT
YOUR BOARD & BUDGET.

BROAD LINE GETS BROADER.
8 LOWER CAPACITANCE VALUES
(100 pF thru 390 pF @ 200 V).

Type 192P Pacer® Polyester Film Capacitors are mass-produced to beat the space/cost squeeze in commercial and industrial applications. Extended-foil PETP film sections with metal end caps provide best possible non-inductive construction. End caps also act as moisture barriers. Ideal for automatic insertion on printed wiring boards. Expanded line includes capacitance values from 100 pF to .47 μ F. Voltage range, 80 to 600vdc. Write for Bulletin 2066C.

Technical Literature Service
Sprague Electric Company
35 Marshall Street
North Adams, Mass. 01247



THE BROAD-LINE PRODUCER OF ELECTRONIC PARTS

When You Buy a Power Supply, Why Not Get the Best?

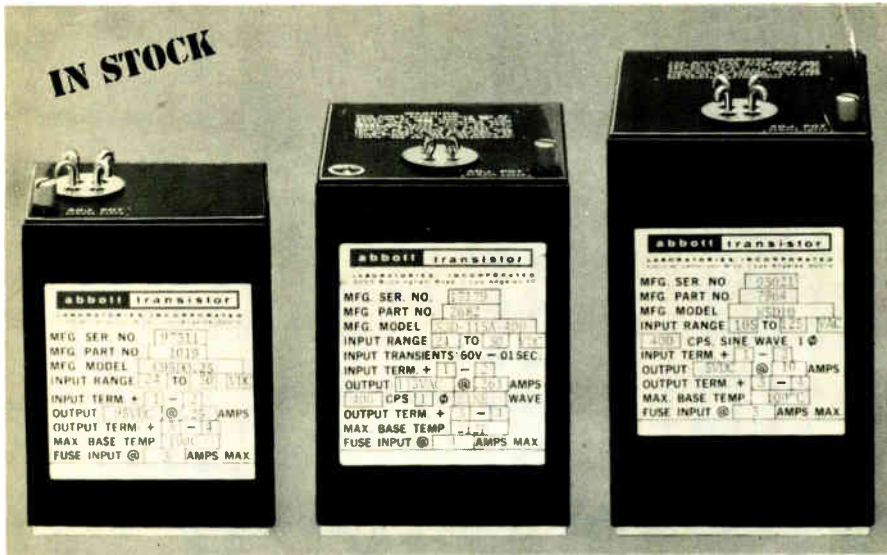

28 VDC to DC
(55,463 Hrs.)
Model C95D

28 VDC to 400 A
(61,387 Hrs.)
Model S3D

400 A to DC
(56,148 Hrs.)
Model W5D

Abbott's New Hi-Performance Modules

are designed to operate in the stringent environment required by aerospace systems — (per MIL-E-5400K or MIL-E-5272C) and MIL-STD-461 for electromagnetic interference.

RELIABILITY — MTBF (mean time between failures) as calculated in the MIL-HDBK-217 handbook can be expected in excess of 50,000 hours at 100°C for all of these power modules. The hours listed under the photos above are the MTBF figures for each of the models shown. Additional information on typical MTBF's for our other models can be obtained by phoning or writing to us at the address below.

QUALITY CONTROL — High reliability can only be obtained through high quality control. Only the highest quality components are used in the construction of the Abbott power module. Each unit is tested no less than **41 times** as it passes through our factory during fabrication — tests which include the scru-

tinizing of the power module and all of its component parts by our experienced inspectors.

NEW CATALOG—Useful data is contained in the new Abbott Catalog. It includes a discussion of thermal considerations using heat sinks and air convection, a description of optional features, a discussion of environmental testing, electromagnetic interference and operating hints.

WIDE RANGE OF OUTPUTS — The Abbott line of power modules includes output voltages from 5.0 volts DC to 3,650 volts DC with output currents from 2 milliamperes to 20 amperes. Over 3000 models are listed **with prices** in the new Abbott Catalog with various inputs:

- 60A to DC, Regulated
- 400A to DC, Regulated
- 28 VDC to DC, Regulated
- 28 VDC to 400A, 1 ϕ or 3 ϕ
- 24 VDC to 60A, 1 ϕ

Please see pages 930 to 949 of your 1970-71 EEM (ELECTRONIC ENGINEERS MASTER Catalog) for complete information on Abbott modules.

Send for our new 68 page FREE catalog.

abbott transistor

LABORATORIES, INCORPORATED
5200 W. Jefferson Blvd./Los Angeles 90016
(213) 936-8185 Cable ABTLABS

1224 Anderson Ave./Fort Lee, N.J. 07024
(201) 224-6900

Readers comment

Perspective on projection

To the Editor: Guenther O. Langner's article on light-gated cathode ray tubes [Dec. 7, 1970, p. 78], and particularly his panel on scoring the displays, was misleading for several reasons. First, equipment on a drawing board or in a laboratory was compared with gear that is commercially available. Second, though the topic was large projection displays, anything from a size hardly larger than a home TV screen up to a giant 40-by-30-foot picture was treated equally. Third, price was not a consideration.

The only existing, truly large, real-time display in the world, the Eidophor projector, which can display 40-foot pictures, was qualified as "one attempt to use the deformation principle." Because conversion of any display information to the TV format was not taken into account, Eidophor was further given bad ratings for applications other than the television projections.

K. Eckstein
Eidophor Ltd.
Glarus, Switzerland

▪ *Mr. Langner replies: I have always been and am still truly impressed by the technical achievement which condenses in the Eidophor projector. No doubt, for very-large screen TV projection, no real challenge to the Eidophor can be envisioned for the near future. For bright (above 20 foot-lamberts) pictures of several hundred square feet, the hardware costs of the Eidophor are probably below \$100 per square foot of projected image, even less than that of a 1,029-line TV monitor.*

The fact remains, though, that the Eidophor projector, from the standpoint of technical complexity, can be better compared to instrumentation such as a scanning electron microscope or an electron-beam milling machine rather than a cathode ray tube display. As seen from the frame of reference chosen in the article, which evaluated technologies rather than products on

New S-D expandable counters.

The most sensible new approach in counter design since 1960!

New 6150 series expandable universal counter-timers.

S-D developed this line to handle almost every counter/timer requirement—bench and systems. Four basic models cover frequency ranges of 50, 200, 512 MHz, and fully automatic 3 GHz. Buy for current requirements and upgrade frequency range at any time. These instruments were designed from scratch for **programmability**: single line or binary, total control including attenuators, and analog or digital trigger level control.

You can add most expandable features by inserting a new PC card. S-D's expandable counter protects you against obsolescence for years to come.

6150 options and features: Choice of 100 nsec or 10 nsec TIM resolution—choice of five oscillators—four types of BCD output—up to 9-digit readout—versatile remote programming—3½" height in full rack width—10mV rms resolution to 0.1 Hz.

6050 series frequency counters.

For those who want to measure frequency in a low cost, lightweight instrument, available with a battery power source, the answer is S-D's new 6050 series. You have a choice of four basic frequency ranges to 3 GHz. Like the counter-timer series, all units are expandable.

6050 series features: Automatic operation right up to 3 GHz—small 3½" height in ½ rack width—10 mV rms sensitivity to 200 MHz, 50 mV to 3 GHz—resolution to 0.1 Hz—expandable to 9 full digits—programmable options.

Call your Scientific Devices man today for a demo or contact Concord Instruments Division, 888 Galindo Street, Concord, CA 94520. Phone: (415) 682-6161.



	50 MHz	200 MHz	512 MHz	3 GHz
Frequency Model:	6050	6051	6052	6053
Counters	Price: \$ 770	\$1050	\$1550	\$2295
Universal Model:	6150	6151	6152	6153
Counters	Price: \$1195	\$1475	\$2150	\$2995

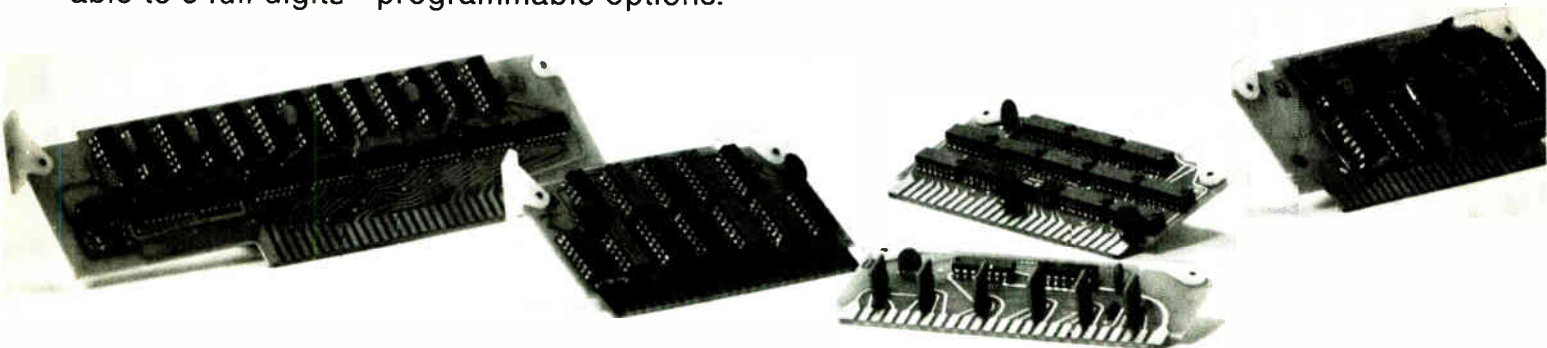

SYSTRON  DONNER

HOW FAST CAN WE GET?

Give us a try — **66** Bourns distributor locations throughout the nation ready to deliver this exceptional new TRIMPOT® potentiometer off the shelf in all ranges of resistance from 100 ohms to 2 megohms.

Take a look at these prices and give us a call.

1-9	10-24	25-49	50-99	100-249	250-499
\$1.40	\$1.30	\$1.21	\$1.19	\$1.15	\$1.08

ALABAMA

Electronic Wholesalers, Inc.
Huntsville, 205 539-5722

ARIZONA

Kierulff Electronics
Phoenix, 602 273-7331

CALIFORNIA

Westates Electronics Corp.
Chatsworth, 213 341-4411

Hamilton Electro Sales
Culver City, 213 870-7171

Liberty Electronics Corp.
Inglewood, 213 776-6252

Elmar Electronics, Inc.
Mountain View, 415 961-3611

Hamilton/Avnet
Mountain View, 415 961-7000

Kierulff Electronics
Palo Alto, 415 968-6292

Spectronics
Ridgecrest, 714 375-8484

Electronic Supply Corp.
Riverside, 714 683-8110

Western Radio
San Diego, 714 239-0361

COLORADO

Hamilton/Avnet
Denver, 303 433-8551

Kierulff Electronics
Denver, 303 343-7090

CONNECTICUT

Connecticut Electro Sales
Hamden, 203 288-8266

DeMambro Electronics
Milford, 203 878-6521

Cramer Electronics, Inc.
North Haven, 203 239-5641

FLORIDA

Cramer Electronics, Inc.
Ft. Lauderdale, 305 566-7511

Gulf Electronics
Miami, 305 887-6541

Hamilton/Avnet
Hollywood, 305 925-5401

Hammond Electronics, Inc.
Orlando, 305 241-6601

GEORGIA

Jackson Electronics Co.
Atlanta, 404 355-2223

ILLINOIS

Allied Electronics Corp.
Chicago, 312 421-6800

Hamilton/Avnet
Schiller Park, 312 678-6310

F-J-R/Midwest
Rosemont, 312 678-8560

INDIANA

Fort Wayne Electronics
Supply, Inc.

Fort Wayne, 219 742-4346

Graham Electronics Supply, Inc.
Indianapolis, 317 634-8486

KANSAS

Hall-Mark Electronics, Inc.
Kansas City, 913 236-4343

MARYLAND

Pytronic Industries, Inc.
Baltimore, 301 539-6525

Hamilton/Avnet
Baltimore, 301 796-5000

Washington, 202 935-5600

Schweber Electronics
Rockville, 301 427-4977

MASSACHUSETTS

DeMambro Electronics
Boston, 617 787-1200

Electrical Supply Corp.
Cambridge, 617 491-3300

Cramer Electronics, Inc.
Newton, 617 969-7700

MICHIGAN

Harvey Radio Company
Romulus, 313 729-5500

MINNESOTA

Lew Bonn Co.
Edina, 612 941-2770

MISSISSIPPI

Ellington Electronic Supply, Inc.
Jackson, 601 355-0561

MISSOURI

Hamilton/Avnet
Hazelwood, 314 731-1144

Hall-Mark Electronics Corp.
St. Louis, 314 521-3800

NEW JERSEY

General Radio Supply Co., Inc.
Camden, 609 964-8560

Hamilton/Avnet
Cherry Hill, 609 662-9337

Eastern Radio Corp.
Clifton, 201 471-6600

NEW MEXICO

Electronic Parts Co., Inc.
Albuquerque, 505 265-8401

NEW YORK

Standard Electronics, Inc.
Cheektowaga, 716 685-4220

Cramer/Esco, Inc.
Hauppauge, 516 231-5600

NEW YORK (Cont.)

Milo Electronics Corporation
Syosset, 516 364-1111

Cramer-Eastern
East Syracuse, 315 437-6671

Hamilton/Avnet
Syracuse, 315 437-2641

Federal Electronics, Inc.
Vestal, 607 748-8211

Schweber Electronics
Westbury, L. I., 516 334-7474

Harvey Radio Company, Inc.
Woodbury, L. I., 516 921-8700

Woodbury, L. I., 516 921-8700

NORTH CAROLINA

Electronic Wholesalers, Inc.
Winston-Salem, 919 725-8711

OHIO

Hughes-Peters, Inc.
Cincinnati, 513 351-2000

Pioneer Standard Electronics, Inc.
Cleveland, 216 432-0010

Hughes-Peters, Inc.
Columbus, 614 294-5351

Pioneer/Dayton
Dayton, 513 236-9900

OKLAHOMA

Hall-Mark Electronics
Tulsa, 918 835-8458

PENNSYLVANIA

Pytronic Industries, Inc.
Montgomeryville, 215 242-6700

Powell Electronics
Philadelphia, 215 724-1900

Cameradio Company
Pittsburgh, 412 391-7400

Pittsburgh, 412 391-7400

RHODE ISLAND

Wm. Dandreta & Co.
Providence, 401 861-2800

Providence, 401 861-2800

TEXAS

Hall-Mark Electronics Corp.
Dallas, 214 231-6111

Hamilton/Avnet
Dallas, 214 638-0900

Harrison Equipment Co., Inc.
Houston, 713 224-9131

UTAH

Standard Supply Co.
Salt Lake City, 801 355-2971

Salt Lake City, 801 355-2971

WASHINGTON

Liberty Electronics/Northwest
Seattle, 206 763-8200

Seattle, 206 763-8200

WISCONSIN

Taylor Electric Co.
Mequon, 414 241-4321

Mequon, 414 241-4321

Readers comment

the market, the ratings could hardly have come out substantially differently.

Medical electronics safety

To the Editor: After reading the article on medical electronics gear in hospitals [Feb. 1, p. 54], I found myself amazed at the dangerous situations patients are placed in. As in so many instances these days, perhaps Federal legislation is necessary to alleviate these safety problems. Therefore, I hope the article has stimulated others, as it has me, into taking the actions needed to improve these conditions.

Harold Fitzgerald
Hope College
Holland, Mich.

Mistaken identity

To the Editor: In Electronics Newsletter [March 29, p. 17] it's stated that "The largest monolithic MOS RAMs on the market are 1,024-bit devices, such as those produced by Intel, Mostek, and American Micro-systems." Could you possibly be confusing American Micro-systems with Advanced Memory Systems and its AMS 6001, the first monolithic 1,024-bit MOS RAM on the market?

Jerome D. Larkin
Vice president, marketing
Advanced Memory Systems Inc.
Sunnyvale, Calif.

■ Yes.

Lights on

To the Editor: In my Designer's casebook [April 12, p. 88], two important connections were omitted in the diagram. There should be a lead across the filament of each flashlight bulb connecting the cable shielding to the cable center conductor. The bulbs will not indicate without this wire shunt. For dc signals the filaments would be shorted. However, because the antenna is handling rf signals, the filaments operate normally. Each lead should be about 2 inches long.

James E. Taylor
Xerox Corp.
Rochester, N.Y.

YOUR BOURNS TRIMPOT PRODUCTS DISTRIBUTOR

HOW LOW CAN WE GET?

We looked at the competition, then built a better potentiometer, the Model 3006, a low cost cermet unit for PC board use.

Here's how we did it:

GAVE IT MORE POWER

$\frac{3}{4}$ watt at 70°C

MADE IT SURER

superior setability: longer element, 15 turns and 16 independent wiper contacts to make sure

SEALED IT TIGHTER

to Mil-R-22097

BUILT IT LOWER

only $\frac{1}{4}$ " off the board

PRICED IT LOWER

only 81¢ in 25,000 piece quantity, much lower for more

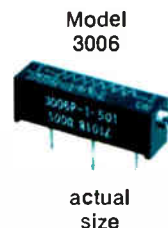

Send for full data on the 3006, and we'll send along dramatic proof of how tough a little unit it really is.





**For less than \$5,000 we give you
the best little computer around.**

**For \$1,700 you get the same computer
with its clothes off.**

The Naked Mini.TM

You're looking at the first official portrait of an entirely new minicomputer concept. The NAKED MINITM.

It represents a major breakthrough in minicomputer thinking. Specifically, it means that someone in the minicomputer industry has finally broken through the \$2000 barrier. With no sacrifice in computer power. It means that the computer has at last become a true component. To be buried inside your OEM product.

For the systems designer, it means an opportunity to get full computer power and greater design freedom at a drastically reduced price.

In all industries, the NAKED MINI opens up new application areas, with general purpose minicomputers replacing hard-wired circuitry.

The premise behind the NAKED MINI is actually rather simple: sometimes you need computer performance but not a whole computer system.

Let's say you need a large volume of minicomputers but in your product you already have the power, controls, and mounting hardware.

In the past, you could either buy a full-blown minicomputer or build your own scaled-down version. With the former choice, you obviously ended-up with redundant parts. And selecting the latter always cost you a lot more than you bargained for.

Well now you have a third option. Computer Automation's NAKED MINI. The computer with its clothes off. Everything that really counts — memory and processor — without the

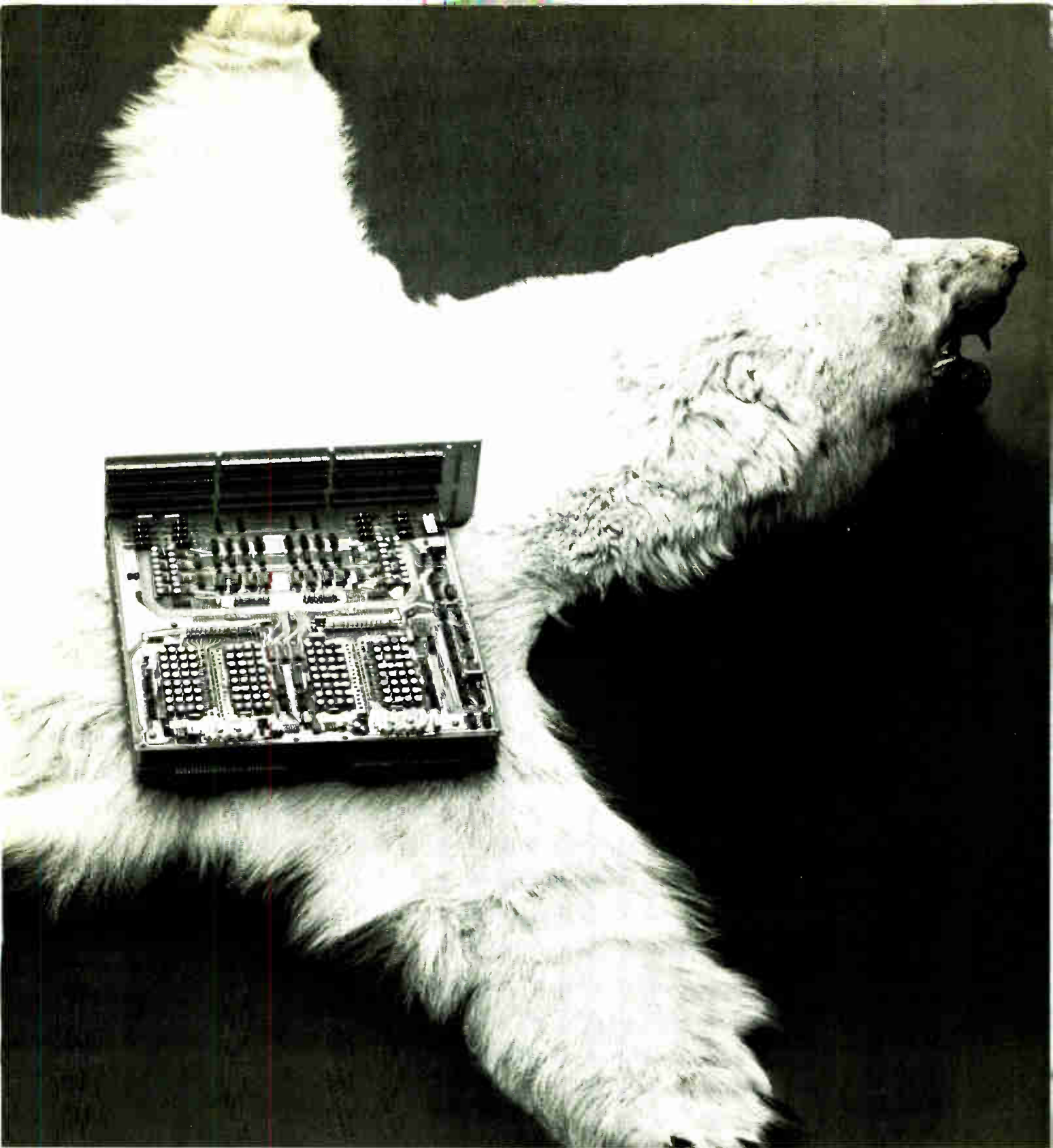

ancillary components that you already have in your system.

At this point you're probably skeptical. "I'm going to get a do-it-yourself kit . . . a processor only . . . a handful of cards and components without even a memory."

To the contrary, the NAKED MINI is a fully-operational computer. An integral unit designed for maximum useability and interfaceability. Fully tested and fully warranted. You get all the computer power of a stand-alone system. Without all the cost.

Functionally, the NAKED MINI is identical to our existing machines. Its low cost has been achieved without sacrificing any of the previous line's superb features.



Circle 11 on reader service card

The 16-bit NAKED MINI still gives you hardware multiply/divide as a standard item. Moreover, all machines offer direct memory channels, vectored interrupts, and 32K addressability. Because the software and I/O interface are compatible, all of the options and programs for our present machines are useable with the NAKED MINI.

The NAKED MINI with 4K of expandable memory is priced from \$1700 (\$2400 for the 16-bit unit) in 200-unit quantities. First deliveries are scheduled for this November.

In summary, the NAKED MINI gives you the same horsepower and computer flexibility as our packaged machines. But at the price of a component. For full details, write or call today.

COMPUTER AUTOMATION, INC.

895 West 16th Street • Newport Beach, California
92660 • Phone (714) 642-9630 • TWX 910-596-1377

High Energy Silicon for the 70's.

For Audio Amplification.

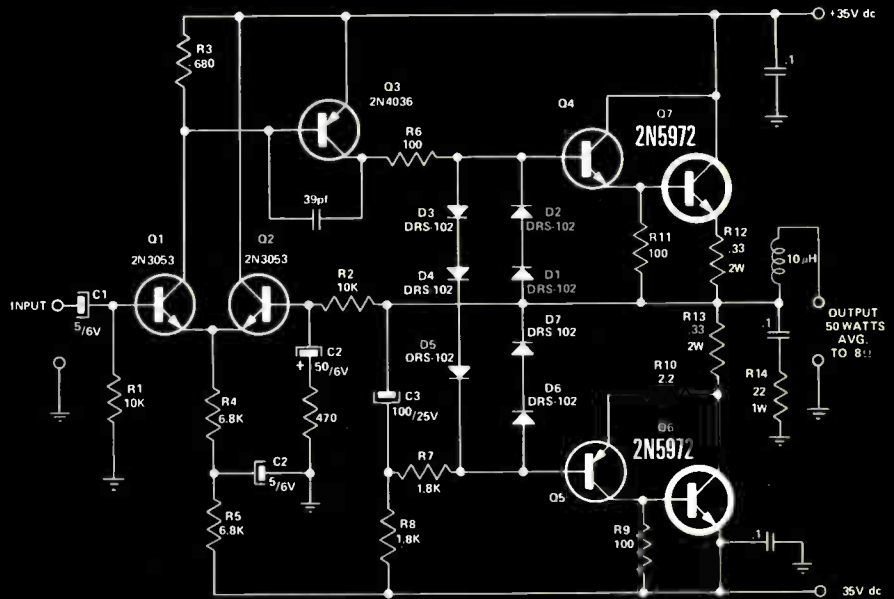

For Switching.

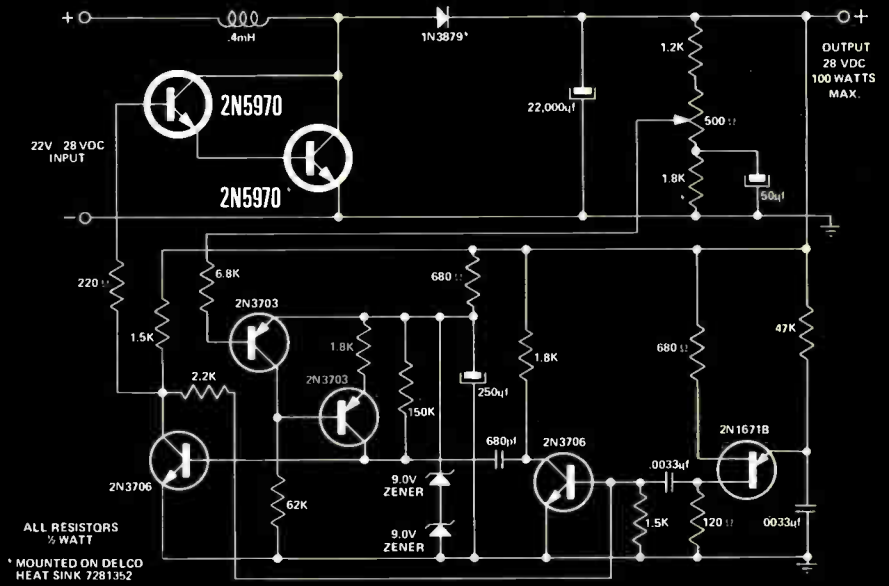

TYPE	I _c Cont. Amps.	I _c Pulsed Amps.	V _{CE0} Volts	V _{CEX} Volts	V _{CE0} (SUS) Volts	h _{FE} (min.) @ I _c =5A	h _{FE} (min.) @ I _c =15A	V _{CE} (sat.) Volts @ I _c =10A, I _B =1A
2N5970	15	20	60	80	60	20	10	2.0
2N5971	15	20	60	80	60	50	20	1.5
2N5972	15	20	80	100	70	25	10	1.8
2N5973	15	20	100	120	80	25	10	1.8

Pulse Energy Test — @ V_{CE}=40V, I_c=4.5A
t_p=10 ms, duty cycle ≤ 4% ALL TYPES=1.8 Joules

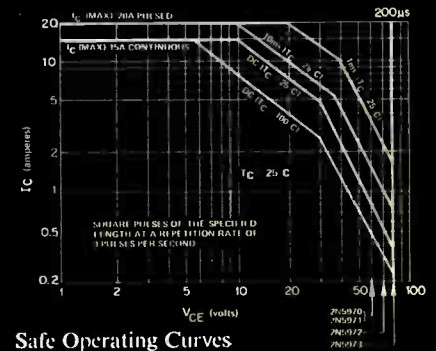

NPN Triple diffused silicon power transistors in TO-3 Solid Copper cases.

Delco's New 2N5970 Series Transistors: 15 Ampere, Medium Voltage Fast, Versatile, Strong.

These high energy workhorses have built an excellent reputation for linear power amplification as well as for high efficiency switching.

The 2N5970 series offers switching capability up to 120V and 15 Amperes at rates of up to 50 kHz. They provide an optimum balance of energy handling capability and speed for maximum protection against failure from circuit fault conditions. When used for amplification the 2N5970s' linear transconductance over wide current ranges gives them superior performance.

As usual, Delco houses the high energy silicon elements in solid copper TO-3 cases for maximum thermal capacitance and low thermal resistance (1.17° C/W max.) to assure extra reliability in the toughest applications.

They're ideal for voltage regulators, power amplifiers and high efficiency switching circuits. The 28

volt shunt regulator shown is amply handled by the 2N5970 (V_{CEX} of 80 Volts). In the direct coupled audio amplifier, the 2N5972 displays its excellent frequency response, gain linearity and transconductance.

For fast shipment of small or large quantities of Delco's 2N5970 series, call your nearest Delco Electronics Distributor.

Application Notes 42 and 43 provide the data on the circuits.



Delco Electronics

DIVISION OF GENERAL MOTORS CORPORATION, KOKOMO, INDIANA

Available from these Delco distributors:

ALA., BIRMINGHAM • Forbes Distributing Co., Inc. (205)-251-4104
ARIZ., PHOENIX • Cramer/Arizona (602)-263-1112 • Sterling Electronics (602)-258-4531
CAL., LOS ANGELES • Kierulff Electronics, Inc. (213)-685-5511 • Radio Products Sales, Inc. (213)-748-1271
CAL., PALO ALTO • Kierulff Electronics, Inc. (415)-968-6292
CAL., SAN DIEGO • Milo of California, Inc. (714)-232-8951
COLO., COLORADO SPRINGS • Walker Electronics (303)-636-1661
COLO., DENVER • Cramer/Denver (303)-758-2100 • Denver Walker Electronics (305)-935-2406
FLA., MIAMI • Mountain Electronics Subsidiary of Avnet, Inc. (305)-634-4556
FLA., WEST PALM BEACH • Mountain Electronics, Subsidiary of Avnet, Inc. (305)-833-5701
ILL., ROSEMONT (Chicago) • Kierulff/F-J-R (312)-678-8560
ILL., SKOKIE (Chicago) • Merquip Electronics (312)-282-5400
IND., INDIANAPOLIS • Graham Electronics Supply, Inc. (317)-634-8486
MD., BALTIMORE • Radio Electric Service Co. (301)-823-0070
MASS., NEWTON • The Greene-Shaw Co., Inc. (617)-969-8900
MICH., ROMULUS • Harvey/Detroit (313)-729-5500

MINN., MINNEAPOLIS • Stark Electronics Supply Co. (612)-332-1325
MO., KANSAS CITY • Walters Radio Supply, Inc. (816)-531-7015
MO., NO. KANSAS CITY • ECI Semiconductors, Inc. (816)-221-2400
MO., ST. LOUIS • Electronic Components for Industry Co. (314)-647-5505
N.J., CLIFTON • Eastern Radio Corporation (201)-471-6600
N.M., ALBUQUERQUE • Cramer/New Mexico (505)-265-5767 • Sterling Electronics (505)-247-2486
N.Y., BINGHAMTON • Harvey/Federal (607)-748-8211
N.Y., NEW YORK • Harvey/New York (212)-582-2590
N.Y., WOODBURY • Harvey/New York (516)-921-8700
OHIO, CINCINNATI • United Radio, Inc. (513)-761-4030
OHIO, CLEVELAND • Pattison Supply (216)-441-3000
OHIO, DAYTON • Kierulff/F-J-R (513)-278-9411
OKLA., OKLAHOMA CITY • Radio, Inc. (405)-235-1551
OKLA., TULSA • Radio, Inc. (918)-587-9123
PENN., PHILADELPHIA • Almo Electronics (215)-676-6000
PENN., PITTSBURGH • RPC Electronics (412)-782-3770
S.C., COLUMBIA • Dixie Radio Supply Co., Inc. (803)-253-5333

TEXAS, DALLAS • Adleta Electronics Company (214)-742-8257
TEXAS, FORT WORTH • Adleta Electronics Co. (817)-336-7446
TEXAS, HOUSTON • Harrison Equipment Co., Inc. (713)-224-9131
UTAH, SALT LAKE CITY • Cramer/Utah (801)-487-3681
VA., RICHMOND • Meridian Electronics, Inc., a Sterling Electronics Company (703)-353-6648
WASH., SEATTLE • Kierulff Electronics, Inc. (206)-763-1550
WASH., TACOMA • C & G Electronics Co. (206)-272-3181
CANADA, ONT., SCARBOROUGH • Lake Engineering Co., Ltd. (416)-751-5980
ALL OVERSEAS INQUIRIES:
General Motors Overseas Operations Power and Industrial Products Dept., 767 Fifth Avenue, New York, N.Y. 10022. Phone: (212)-486-3723.

Regional Headquarters, Union, New Jersey* 07083, Box 1018 Chestnut Station, (201)-687-3770 ■ El Segundo, Calif. 90245, 354 Coral Circle, (213)-772-5181
■ Chicago, Illinois* 60656, 5151 N. Harlem Avenue, (312)-775-5411 ■ Kokomo, Ind. 46901, 700 E. Firmin, (317)-459-2175 Home Office
■ *Office includes field lab and resident engineer for application assistance.



JUST OFF THE PRESS!

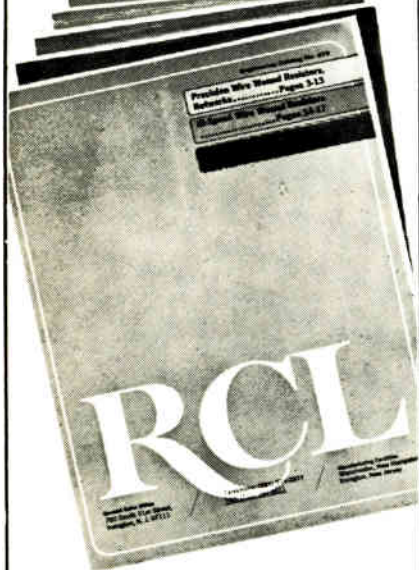

RCL's NEW 1971 RESISTOR ENGINEERING GUIDE

the industry's most extensive and most accurate compilation of engineering information on wire-wound resistors

PRECISION/HI-SPEED POWER/WIRE-WOUND RESISTORS

including: beryllium oxide core power resistors . . . 22 special temperature coefficients from -50 PPM to +6000 PPM . . . sub-miniature precision resistors . . . ladder and summing networks.

Write for your free copy today!

RCL

ELECTRONICS, INC.
700 South 21st Street
Irvington, New Jersey 07111

People



Caceres

There's plenty of talk about improving communication between physicians and medical electronics companies, but Dr. Cesar A. Caceres, the new president of the Association for the Advancement of Medical Instrumentation, intends to act on it. "Instead of just feeding standards to industry," he contends, "we need to consult medical electronics companies at the specification design stage. The industry-group interaction is necessary so that the end user—the physician—will get reliable, low-cost products—not just research equipment."

AAMI has proved more than adequate for bringing the industry together with hospitals and practicing physicians; its membership rolls are split evenly among the three groups. "AAMI is prompting this cooperation without exposé tactics and has been getting good results," Caceres adds. "For example, it has stimulated a group of manufacturers to write specifica-

tions for cardiac pacemakers." Under Caceres, AAMI will slant its journal more toward applications and away from its current research orientation. It will continue its series of seminars on hospital safety, and will start providing posters and filmstrips for teaching safety. The group is considering a national conference on device safety in 1972.

Caceres acquired his applications bent as head of the Public Health Service Medical Systems Development Laboratory. There, he devised a software package to recognize patterns in electrocardiographic wave forms and to write out interpretations for use by physicians.

More recently, he has been concerned with installation of multitest facilities to augment professional medical laboratory services and to diminish unit costs to the physician; he formed and headed George Washington University's Department of Clinical Engineering, and designed its new multi-phase health screening system.

Currently, Caceres is medical director for Health Audio-Data Inc., a Washington, D.C., computerized multitest facility. He also heads Clinical Systems Associates Inc., a consulting group in clinical engineering.

For thousands of bankers everywhere, Gerald M. Lowrie is a preventive measure. "We hired him specifically to keep bankers from making a mess with their computers," says one official at the American Bankers Association, where Lowrie works as executive director of the Banking Professions group.

Lowrie, a former IBM computer salesman turned banking analyst, and his predecessors at the ABA, obviously have done their job well. Over the past decade, banks, which Lowrie calls the "last major industry to embrace computers," have become the largest single group using data processing equipment.

"Banks are the leading edge of most things that are happening in

"Choosing the right digital voltmeter"

Product Manager, Charles Newcombe gives you some inside tips on choosing the appropriate digital voltmeter for your task.

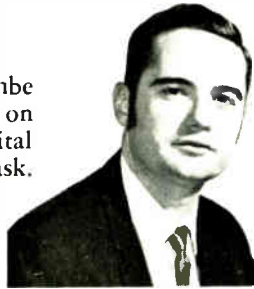

"The single most important point to remember in choosing a digital voltmeter is *credibility*. That is, you must have confidence in the measurements made. When a Fluke voltmeter records a measured volt, you know you have received an accurate reading . . . you can believe, brother.

"Next, get yourself a DVM with the accuracy and stability needed for a given job. Fluke digital voltmeters are available in seven different models with certified guaranteed accuracies down to 0.004% and sampling rates up to 400 per second. Fluke voltmeters are so stable they seldom require recalibration more than once a year. And they are designed to work in a wide range of environmental conditions. As a matter of fact, Fluke off-the-shelf DVM's meet or exceed many military specifications.

"Get yourself a DVM that won't always be out of service for maintenance or repair. Fluke DVM's use our unique recirculating remainder analog-to-digital conversion circuitry. It uses far fewer components than other methods. So, as the parts count goes down, the reliability goes up. And as a bonus feature, power drain is low, so we can give you true battery portability.

Our DVM's are burnout proof, which is just another neat little trick to minimize downtime.

"Don't handicap yourself with digital voltmeters that can't be updated in the field as your needs change. Fluke meters let you drop-in circuit boards at anytime to expand measurement capabilities or tailor the instrument to systems application. Our wide range of options includes such things as millivolts (with 1 microvolt resolution), 4 wire ratio, AC-AC ratio and 4 terminal ohms. Isolated digital or printer output, and isolated remote control with memory were designed for direct computer interface— not just add on adaptability.

"Buy a new voltmeter with all the circuit refinements and convenience features that make it a genuine pleasure to use. Fluke meters give you autopolarity, autoranging, pushbutton function and range selection, and floated and guarded circuitry. All Fluke DVM's have an extra digit for 20 to 60 percent overranging.

"Don't fall for the price fallacy. When we introduced Fluke digital voltmeters a few years back, we offered them at a price that curled our competitor's hair. We did it by engineering the complexity out of the instrument. We did it by not taking the 'me too' path.

"We've got a full measure of new information on the complete line of Fluke DVM's. We'd like to send you a copy. Call us here at the factory, or better yet, contact your nearby Fluke man."

Here's one of our two new voltmeters. The Model 8200A is a fast systems DVM featuring 400 samples per second, 60% overranging, autoranging and remote programming. Accuracy is 0.01%. Prices begin at \$995.



Here's the other, the new Model 8400A with the big accuracy spec, 0.004% for 90 days, 0.01% per year. Base price is \$2450.



Fluke, Box 7428, Seattle, Washington 98133. Phone: (206) 774-2211. TWX: 910-449-2850/In Europe, address Fluke Nederland (N.V.), P.O. Box 5053, Tilburg, Holland. Phone: (04250) 70130. Telex: 884-50237/ In the U.K., address Fluke International Corp., Garnett Close, Watford, WD2, 4TT. Phone: Watford, 27769. Telex: 934583.

get close
to a
good
thing in...
indianapolis

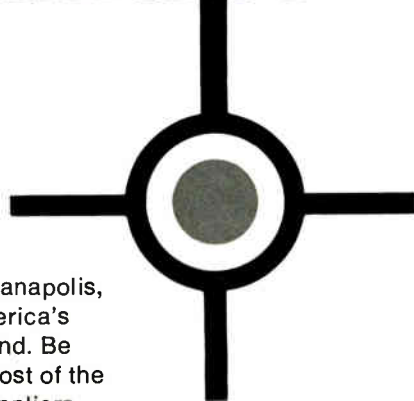

Get close to a good thing in Indianapolis, the middle of America's economic heartland. Be within hours of most of the nation's major suppliers and markets and minutes from our own highly diversified industrial and commercial facilities. Over 100 available site locations give your company access to an outstanding transportation system that includes . . .

- 7 Interstate Highways
- Complete City-circling Interstate
- Inner-city Interstate Loop Under Construction
- 18 U.S. and State Highways
- More than 100 Major Truck Lines
- 5 Major Rail Carriers
- Inner-City Rail Belt—100 Miles of Inner-city Track
- Air Facilities For Major Passenger and Cargo Jets

Get close to 81 of the top 100 U.S. markets today. For information on Indianapolis, for assistance on sites and buildings and for computerized site selection data, write *John Hardy, Area Development Director, Dept. 721* or call 317-635-6868 collect.

Indianapolis Power & Light Company

25 Monument Circle • Indianapolis Indiana 46204

People



Lowrie

computers today," he says. He cites the use of management information systems, on-line terminal oriented computers, and large-scale systems as examples.

Because of his background, Lowrie also served for the past two-and-a-half years as staff director of ABA's Monetary and Payments Systems committee, which has just released a report mapping out the steps that must be taken if banks are to cope with the 44 billion checks the ABA predicts will be written in 1980. The recommendations call for extensive use of electronic systems to transfer large sums of money between banks and increasing reliance on giant credit card authorization networks, which will eventually be expanded to capture transaction data.

"In the next couple of years, you will see a lot of these things," Lowrie predicts. "The technology and inventiveness needed are already here." The largest stumbling block for electronic payment systems, he claims, is convincing the total banking community that they are really needed.

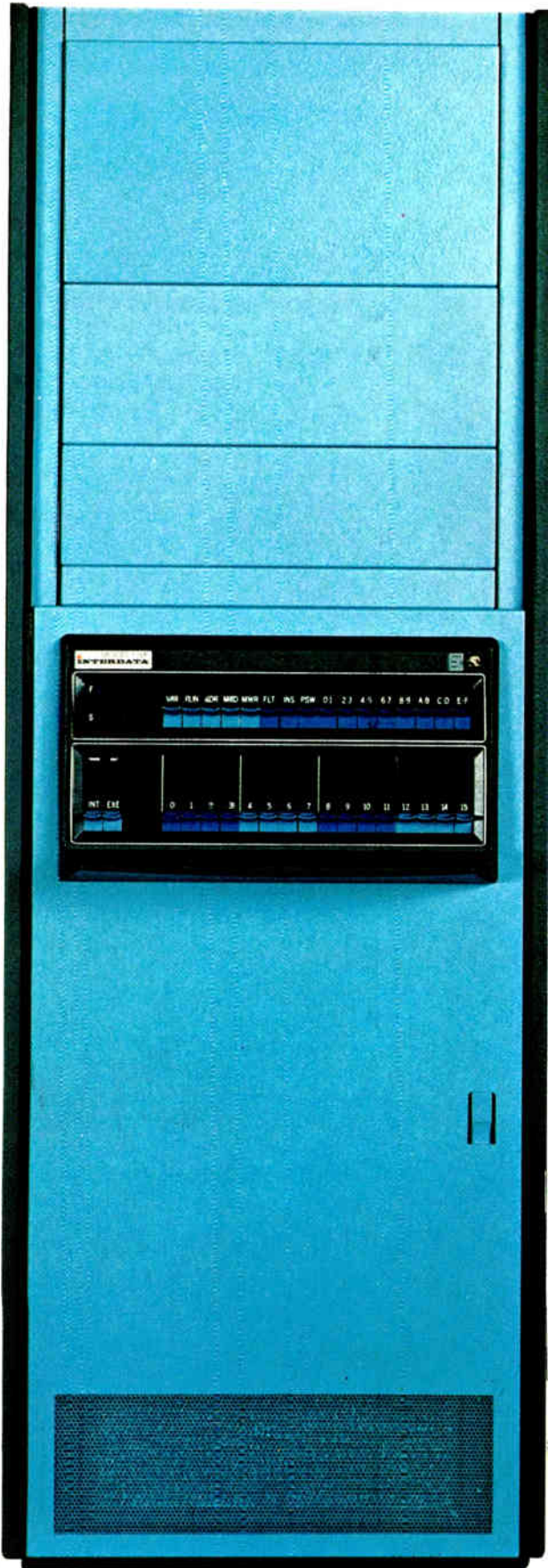

Price: \$10,500*

Performance:

The Interdata Model 5 minicomputer makes the power of a systems computer available to the OEM.

Why it can do the job. The Model 5 optimizes throughput with its comprehensive I/O package. Programmed block I/O. Automatic I/O. Cycle-steal selector channel I/O. Plus masking capability for immediate interrupt and low overhead automatic service.

Its software is systems oriented. A Real Time Operating System (RTOS) for multiprogramming, simultaneous I/O operations, interrupt acknowledgement and automatic scheduling. And a Basic Operating System (BOSS) for single task system control.

What makes it so efficient. The Model 5's fast floating point arithmetic operations save subroutine storage and linkage. Store and restore operations are reduced by 16 general purpose registers. And greater core efficiency is realized through its 16-bit and 32-bit instructions.

Why it's easy to work with. The Model 5 cuts coding and debugging time because its powerful set of 113 instructions include many which are multi-functional. Of its 16 general purpose registers, 15 can be used as index registers. All core memory is directly addressable. And programming is made easier by the automatic interrupt, supervisor call instructions and floating point arithmetic.

Why interfacing is so simple. The Model 5 can control up to 256 devices, yet has only 27 I/O lines for you to worry about. And you can get general purpose I/O boards and low-cost daughter boards to conveniently modify many existing controllers.

How it assures high up-time. The Model 5 optional system protect package keeps you on the air with memory parity, privileged instructions, memory protect and power fail/auto-restart.

How you can find out more. About the Model 5, its complete line of peripherals or the other members of the Interdata family of minicomputers. Call or write Interdata, 6 Crescent Place, Oceanport, New Jersey 07757. (201) 229-4040.

*Quantity discounts available. 20 units, for example, cost only \$8,400 each.

The Interdata Model 5

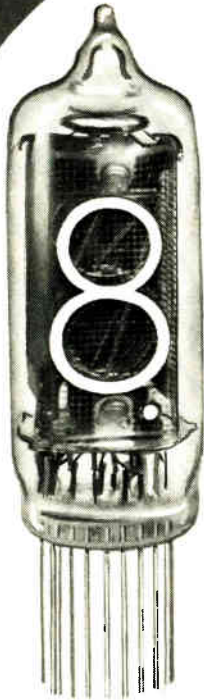

**Tight
Spots?**

**Tight
Budgets?**

**HERE'S A NEW
NATIONAL® READOUT
TUBE FOR BOTH
TIGHT SPOTS and
TIGHT BUDGETS!
THE NL-1222**

SEND FOR DATA FROM:

NATIONAL ELECTRONICS, INC.
a varian subsidiary

Geneva, Ill. 60134, phone 312-232-4300

40 years ago

From the pages of *Electronics*, May 1931

Electronics believes that designers should accept the inherent advantages of midget [radio] construction; should realize the desires of many thousands of listeners who care not for distance; should design a receiver for 90 per cent reproduction and about 10 per cent sensitivity and selectivity. Such a set would be a dignified addition to the receiver group. Whereas a set hitting only about 40 per cent on everything has no place in modern radio.

Dr. Arthur H. Compton, in a lecture recently given at the College of the City of New York, announced that the University of Chicago would shortly undertake an extensive study of the problem of releasing atomic energy. The solution to this problem, according to Dr. Compton, would create a limitless reservoir of power, and would bring undreamed-of changes to civilization.

If **Dr. Einstein** is right and space is "curved," then the Einstein theory is of special curious interest to broadcast listeners who want to hear their favorite radio programs repeated a second time.

For "curved space" means that every radio program will, years hence, return to earth, after having made the circuit of the universe. Such radio waves, even though weakened by their long journey, should return intact—although soprano voices will probably be found an octave or so lower.

The Supreme Court of the United States on April 27, refused to review a lower court decision in the famous "Clause 9" case, in which the DeForest Radio Company won a permanent injunction against the Radio Corporation of America. . . . The DeForest Company asked for an injunction, under Section 16 of the Clayton Act, to enjoin RCA from carrying out or enforcing certain provisions of the standard license contract made by RCA with some 25 manufacturers of radio receiving sets.

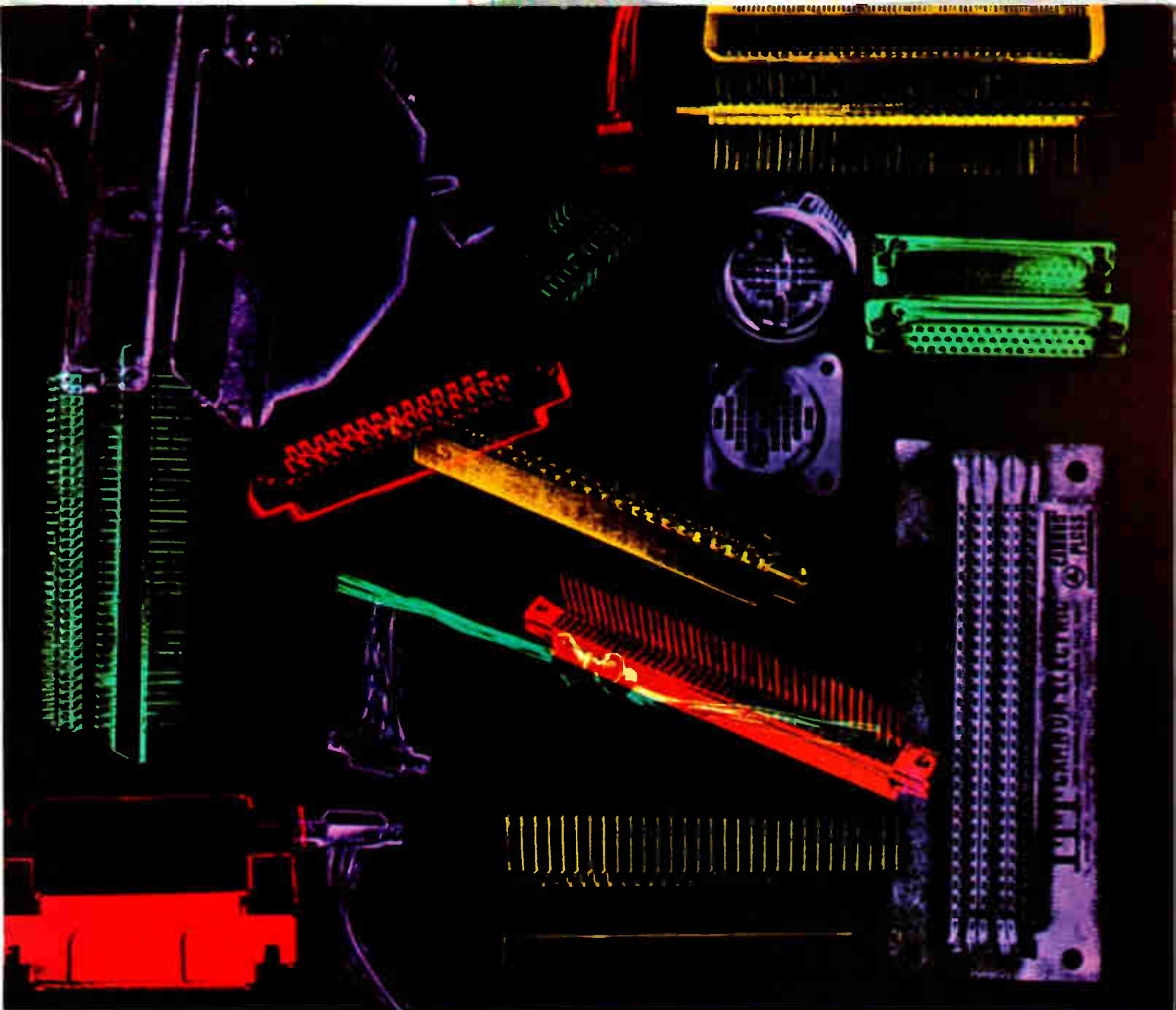

There are more reasons to buy Cannon than other EDP connectors. One is DL.

ITT Cannon now offers you a full line of EDP connectors. Printed circuit, input/output, flexible cable, microminiature—you'll find them all at Cannon. And some you won't find anywhere else. Like our exclusive DL's—multiple-wire rectangular connectors with cam-actuated spring contacts. They feature low cost, low mating force and low contact wear. Their crimp and wire-wrapping terminations make them ideal for I/O, cord-to-cord, and cord-to-panel applications.

Other input/output connectors you'll be interested in are our low cost Burgun-D subminiature rectangulars, and CL's (circulars combining low mating with high contact force).

Some of the other reasons why Cannon means

EDP are: low-cost, versatile backplane assemblies; bottom preloaded plate connectors; MIL-C-21097 edgecard connectors; low-cost circulars; FLEX-LOC cable connectors; and microminiature rectangulars, circulars and strip configurations, including the 50MIL for memory core applications.

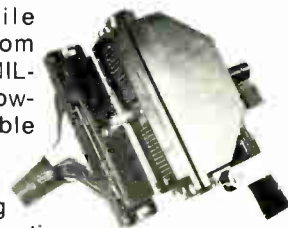

We've just shown you some of the reasons for connecting Cannon with all your EDP requirements. For others, contact ITT Cannon Electric, International Telephone and Telegraph Corporation, 3208 Humboldt Street, Los Angeles, California 90031 (213) 225-2151.

CANNON ITT

Circle 19 on reader service card

IC panels: by the piece... or

AMP gives you two ways to go for building the IC panels you want, economically.

Make them yourself.

We'll supply all the mounting components you need. Miniature spring sockets, IC receptacles, DIP headers and strip receptacles. And high-speed machines to apply them in your plant.

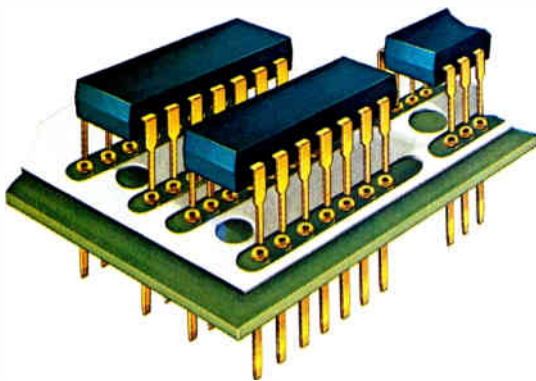

Miniature spring socket • inner spring exerts constant pressure on lead end for maximum retention and conductivity • wide bell-mouth for easy entry • low profile • flare lip for stop • accepts DIP leads and round leads .010" to .040" diameter • available with wrap-type or TERMI-POINT* clip-type posts, also solder version.

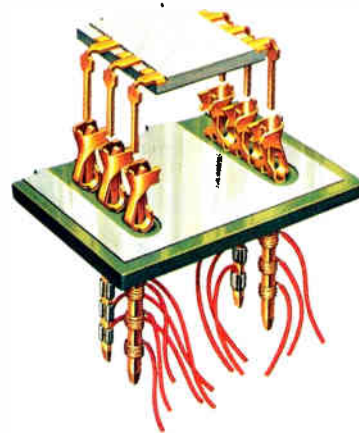

IC receptacles • accepts .022" round leads and .022" x .040" rectangular leads • has wide contact lead-in—unique anti-overstress feature assures good contact • available with wrap-type or TERMI-POINT clip-type posts • solder version available.

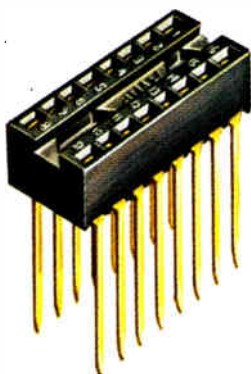

DIP headers • ideal for low-cost, high density packaging • built-in overstress design • bell-mouthed entry for easy insertion of IC's • 14 and 16 leads • available with wrap-type or TERMI-POINT clip-type posts • solder version available.

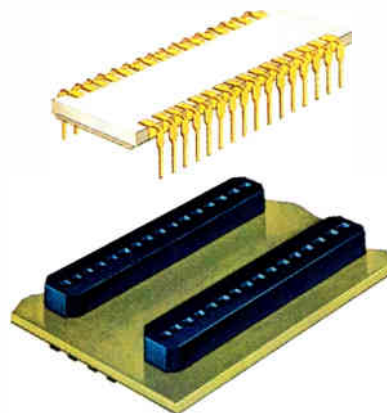

Low profile DIP header and DIP strip receptacles • only .150" high • housings are self-containing for solder operation • header accepts standard 14 and 16 pin DIP's • strip receptacle available in 4 position through 22 position DIP patterns.

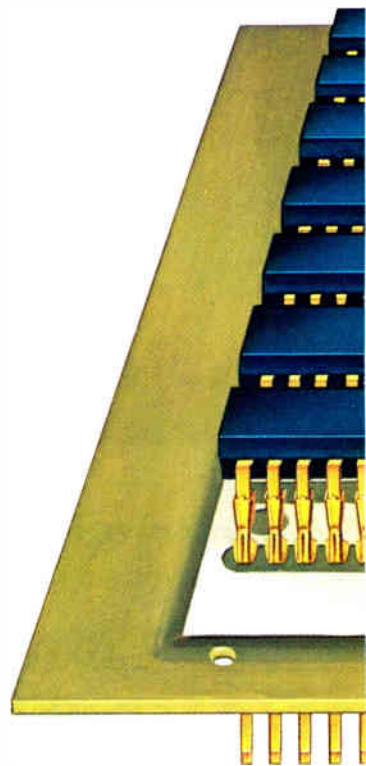

*Trademark of AMP Incorporated.

by the boardful.

Have us make them for you.

Finished IC panels made to your specifications and ready for you to insert IC packages.

Fact is, we can take your IC panels to the final step and supply them pre-wired with wrap-type point-to-point wiring, or our own TERMI-POINT clips.

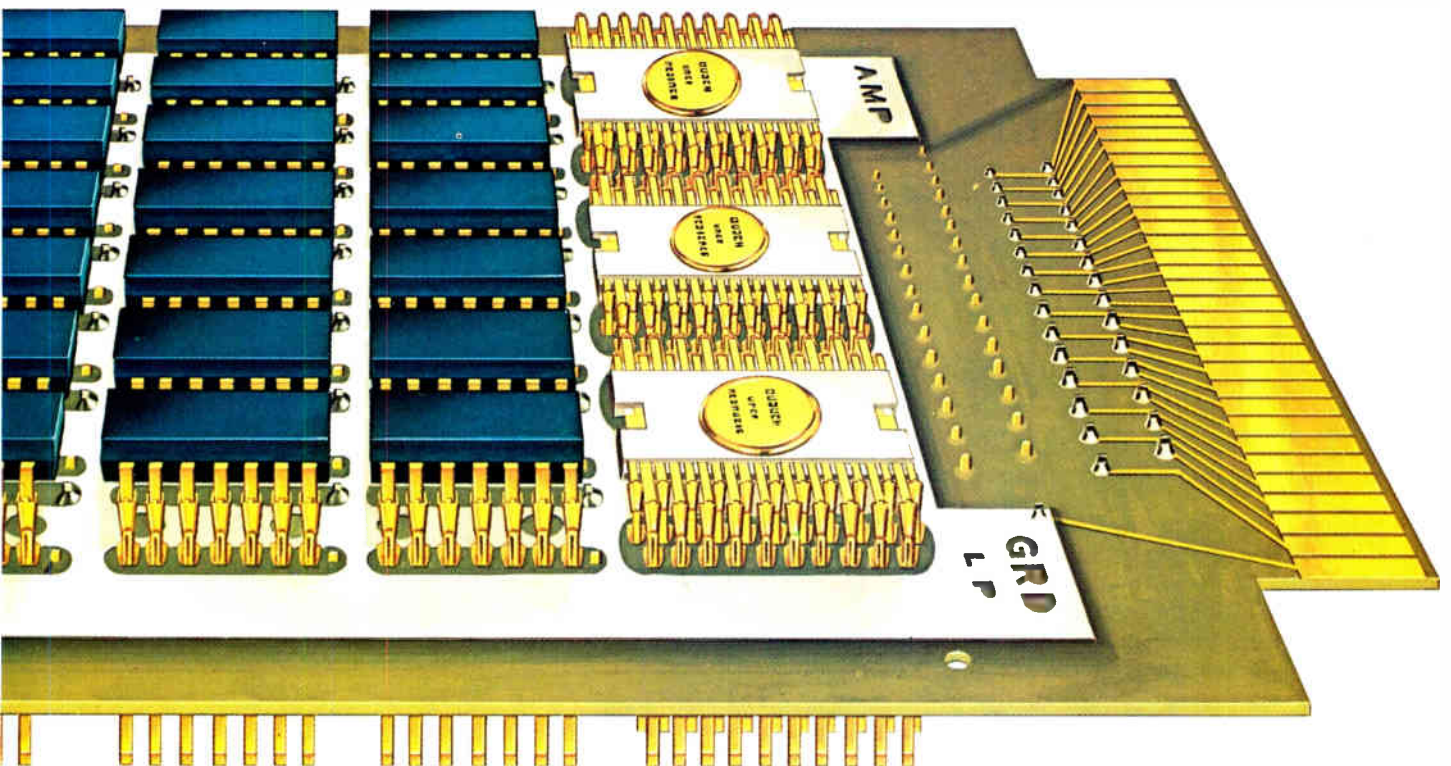

Either way you get all the reliability you need plus the benefits of AMPECONOMATION . . . high-speed AMP automated application machinery that gives you the greatest number of reliable connections at the lowest installed cost.

For details that can help you make a choice write:
AMP Incorporated, Harrisburg, Pa. 17105

AMP
INCORPORATED

Manufacturing and Direct Sales Facilities in: Australia, Canada, France, Great Britain, Holland, Italy, Japan, Mexico, Puerto Rico, Spain, Sweden, United States and West Germany.

Programmable 1-ns Digital Delay Generator



The Berkeley Nucleonics' Model 7040 is a new breed of time delay generator:

- It is programmable.
- It may be triggered internally or externally up to a 5-MHz rep rate.
- It is adjustable in delay from 1 ns - 999.999 μ s in 1 ns increments.
- It is accurate to 100 ps.
- And its price is \$2950.

Whenever highly precise time delays are required, the Model 7040 will do the job. It is ideally suited for the following applications: calibration of time interval counters, time-to-amplitude converters and oscilloscope sweeps; radar range simulation, cable fault location and delay line testing. The Model 7040's programmable feature gives you an important new building block for automatic test systems and production testing of IC's.

Berkeley Nucleonics has been developing and manufacturing precision pulse generators for eight years. These instruments have become standards in the nuclear research industry for testing linearity, stability and resolution of amplifiers and analog-digital converters. The Model 7040 is a product of the company's continuing interest in the development of pulse generators with precision parameters. For additional information about the Model 7040 as well as the rest of the product line, write or phone:

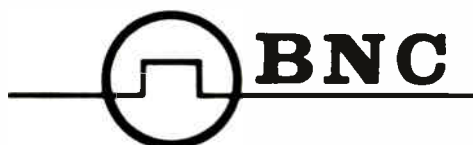

Berkeley Nucleonics Corporation

1198 Tenth Street • Berkeley, California 94710 • Phone: (415) 527-1121

Meetings

Calendar

Spring Joint Computer Conference, IEEE; Convention Center, Atlantic City, N.J., May 18-20.

Power Industry Computer Applications Conference, IEEE; Statler Hilton Hotel, Boston, May 24-26.

Electric & Electronic Measurement & Test Instrument Conference, IEEE; Skyline Hotel, Ottawa, Ont., Canada, June 1-3.

Conference on Laser Engineering & Applications, IEEE; Washington Hilton Hotel, Washington, June 1-4.

Symposium on Applications of Ferroelectrics, IEEE; IBM Research Center, Yorktown Heights, N. Y., and Holiday Inn, White Plains, N. Y., June 7-8.

Conference on Aerospace Antennas, IEEE; London, June 8-10.

International Conference on Communications, IEEE; Queen Elizabeth Hotel, Montreal, June 14-16.

Cost Engineering Symposium, American Association of Cost Engineers; Hotel Bonaventure, Montreal, June 19-23.

Temperature, its Measurement and Control in Science and Industry, American Institute of Physics, Instrument Society of America, National Bureau of Standards; Washington, June 21-24.

Pollution Engineering & Equipment Exposition and Conference, McGraw-Hill Inc., Technical Industry Expositions, Inc.; Conrad Hilton Hotel, Chicago, June 22-24.

Design Automation Workshop, IEEE; Shelburne Hotel, Atlantic City, N.J., June 27-July 1.

Design Automation Workshop, Association for Computing Machinery, IEEE; Shelburne Hotel, Atlantic City, N.J., June 28-30.

International Symposium on Electromagnetic Compatibility, IEEE; Bellevue Stratford Hotel, Philadelphia, July 13-15.

Power Engineering Society Summer Meeting and International Symposium on High Power Testing, IEEE; Portland Hilton Hotel, Oregon, July 18-23.

Conference on Nuclear & Space Radiation Effects, IEEE; New England Center for Continuing Education, Durham, N.H., July 20-23.

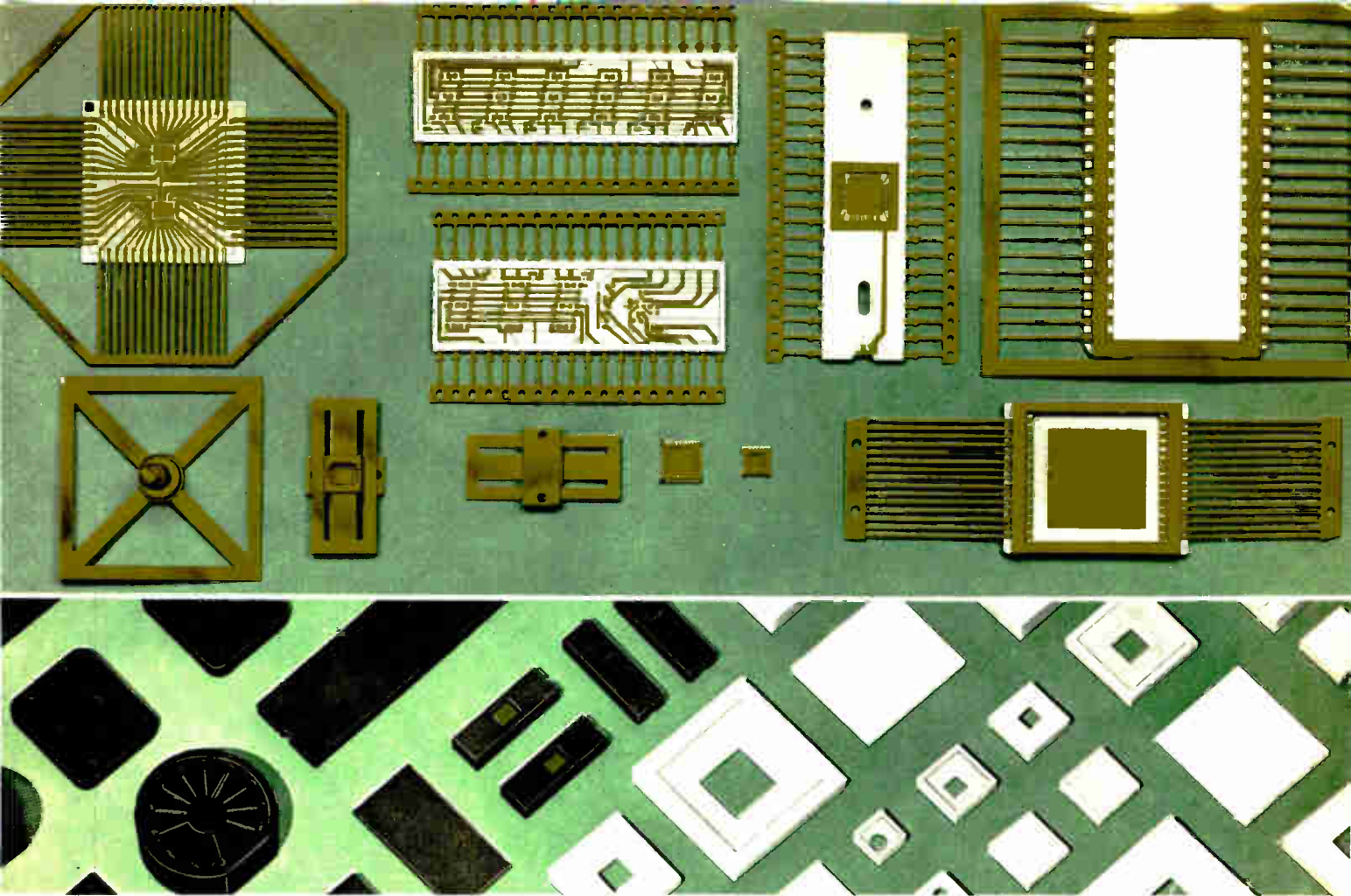

AlSiMag[®]
BRAND

CERAMICS

cover the broad spectrum of
RELIABLE
ELECTRONIC PACKAGING

Leadership in this field is well established with the major electronics firms. Head to head conferences and prompt production of prototypes have often proved to be the best stepping stones to progress.

COMPOSITE PACKAGES. All ceramic, standard and custom made. Includes hybrid, light emitting diode, MOS, high power transistor (both stud mounted and flange mounted), and high density leadless packages.

COMPOSITE SUBSTRATES. Custom made. All ceramic construction. Maximum circuit density and high reliability are attained by vertical stacking of planes. Single source responsibility on multi-layer components for multi-chip attachment.

BLACK CERAMICS. Widely used to protect light-sensitive semiconductors. American Lava offers a wide variety of custom made ceramic components in alumina and other materials. Bases and lids available with glass and gold.

RING FRAMES AND BASES. Pioneer in alumina ceramics of this type and construction. Many open designs may save you time and expense.

CHIP SUB-MOUNTS. Custom made in metallized alumina. Many open designs available for diode and transistor applications.

CODE IDENT. NO. 70371

American Lava Corporation **3M**
COMPANY

PHONE 615/265-3411 • CHATTANOOGA, TENNESSEE 37405, U.S.A. A SUBSIDIARY OF

For service, contact American Lava representatives in Offices of Minnesota Mining and Manufacturing Company in these cities (see your local telephone directory): Boston: Needham Heights, Mass. • Chagrin Falls, O. • Chicago: Elmhurst, Ill. • Dallas, Tex. • Indianapolis, Ind. • Laurens, S. C. • Los Angeles, Calif. • Metropolitan New York: West Caldwell, N. J. • Up-State New York and Canada: Phoenix, N. Y. • Orange, Conn. • Philadelphia, Penn. • St. Louis: Lee's Summit, Mo. • Salem, Va. • S. San Francisco, Calif. • Tempe, Ariz. • International: c/o American Lava Corporation, Chattanooga, Tenn. 37405, U.S.A., TELEX 558432

70th
YEAR
OF
CERAMIC
LEADERSHIP

Circle 23 on reader service card

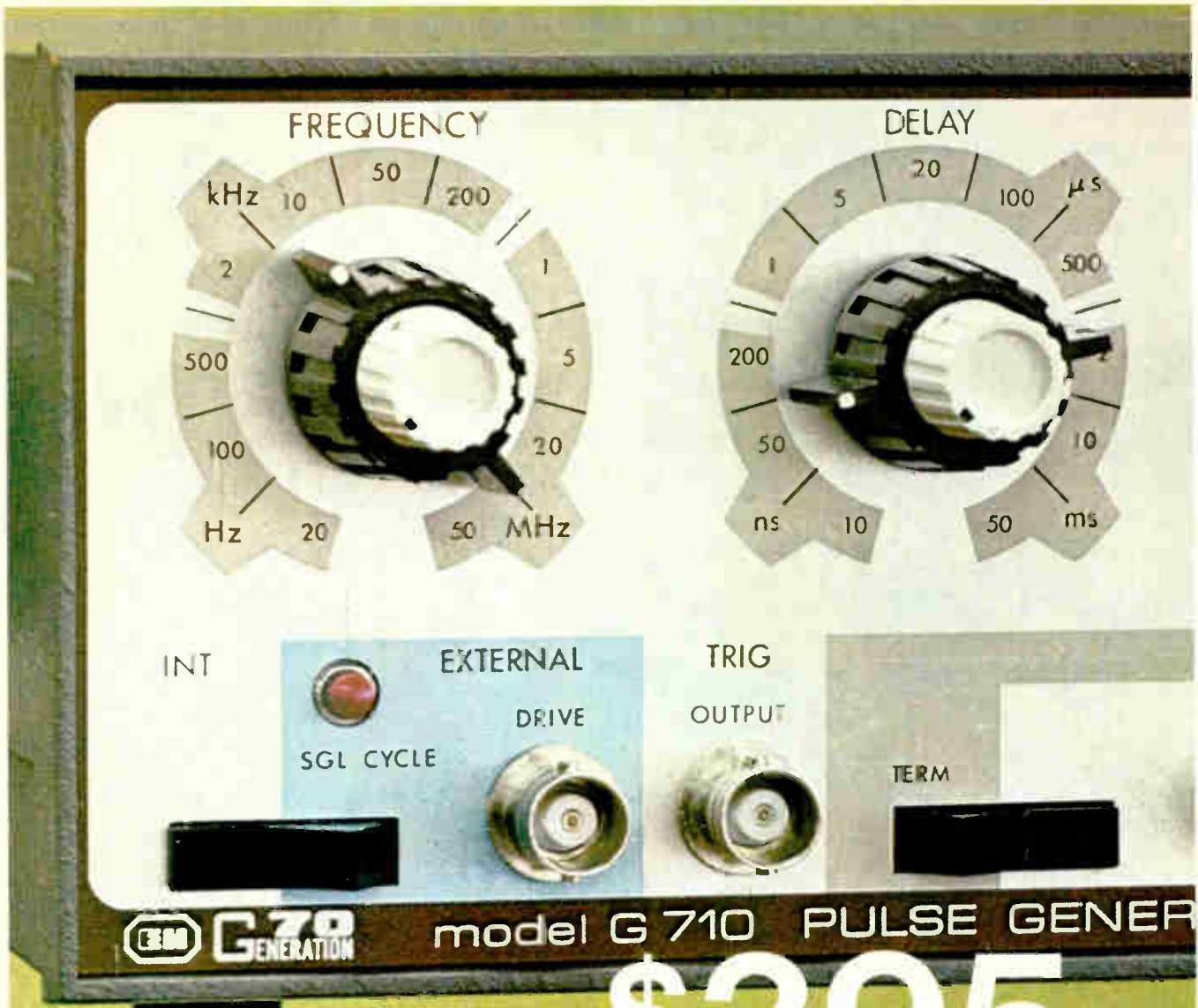

\$395

Dear Sir:

You boys from E-H Research Laboratories talk big. Now, prove it. Here is my purchase order. Please ship me _____ Model G710 50 MHz pulsers for only \$395 each. I understand the E-H Model G710 pulser from your new GENERATION 70™ line offers dual outputs with amplitude to 5V into 50 ohms, rise and fall times of 5ns, duty factor greater than 50%, external triggering and waveform distortion less than 5% peak-to-peak. I want a 5-Day Free Trial and a One-Year Guarantee.

Name _____	Title _____
Company _____	
Address _____	Telephone _____
City _____	State _____ Zip _____

515 11th Street • Box 1289, Oakland, California 94604 • (415) 834-3030

If you don't want to cut up your magazine, just a purchase order to E-H or to an E-H Representative will do.



Electronics Newsletter

May 10, 1971

Boeing to plunge into TTL business

Boeing, which has been working hard in recent months to diversify its aerospace operations, is doing more than just wetting its feet with its new electronics products organization. In one somewhat surprising move, it is plunging into the hotly competitive TTL integrated circuit business.

Sometime this summer, the group plans to introduce a line of high voltage (12 to 80 V) logic circuits developed originally for special in-house needs. The airplane maker also plans to introduce at the same time a low-cost telephone scrambler about the size and shape of a standard dictionary. It will be equipped with more than 8,000 different codes said to be insensitive to normal detection and decoding devices.

The Boeing electronics group also will develop and build the general-purpose computer and sequencer for the Mariner Venus-Mercury spacecraft—the first time the company has handled such a job in-house. Boeing will build two of the unmanned spacecraft under a \$47 million NASA contract for launching in 1973 [*Electronics*, Feb. 15, p. 118]. Though it will do 75% of the work at its Kent, Wash., plant, Boeing expects to subcontract to outside companies about \$8 million worth of electronics hardware for the planetary craft.

A-d conversion plan called better, cheaper

The first new analog-to-digital conversion technique in years has emerged from Data Precision, of Wakefield, Mass., an affiliate of Gordon Engineering Inc. Its promise: to drastically lower costs while improving considerably accuracy and drift. Based on a medium-speed technique, working at about a microsecond per bit, the so-called Triphasic convertors would use about two-thirds the usual parts—and less costly parts at that—plus an inverse feedback error cancellation technique.

Since errors as a result of normal operation are canceled during conversion, no fine adjustment is needed; this lowers production costs and makes an instrument built with the converter easier to use. It also improves specs: drift over a six-month period is $\pm 0.007\%$ of output. It's estimated that Triphasic convertors will cost from a third to half as much as convertors with equivalent—or lesser—accuracy.

High-density bipolars to go into memories

Raytheon's Semiconductor division in Mountain View, Calif., has developed a very-high density bipolar IC process—300,000 to 500,000 transistors per square inch—that it claims offers "an order of magnitude improvement over existing bipolar techniques." Memory products made with the technique are expected by the end of the year.

The process, developed for the division's beam-lead work, is reminiscent of mesa fabrication because material between transistors is etched away, leaving an air gap to provide isolation. This permits tighter packing than the reverse-biased pn junction in normal bipolar structures or the oxide in Fairchild's Isoplanar method [*Electronics*, March 1, p. 52].

Electronics R&D to rise 11% in '71

Electronics companies expect to spend 11% more this year than in 1970 on research and development. A survey conducted by McGraw-Hill's Department of Economics during March and April also indicated that

Electronics Newsletter

the firms plan to increase their R&D in 1974 by 34% over this year's estimates.

U.S. industry overall expects to spend \$19.4 billion on R&D this year, according to the McGraw-Hill survey. Though this is up 6% from 1970, the increase probably reflects just the hikes in labor and materials costs associated with R&D. In 1970, total R&D actually declined for the first time since McGraw-Hill started the survey nearly 20 years ago; it is estimated at \$18.33 billion, down from \$18.37 billion spent in 1969.

While electronics is not a reporting category, reports from the sector closest to it—electrical machinery and communications—indicate an expenditure of \$5.33 billion in 1971. This is up from \$4.8 billion in 1970 and \$4.29 billion in 1969, the McGraw-Hill survey reports.

Piezoelectric display joins cockpit race

A numeric display touted as more reliable than standard emissive displays and the new liquid crystal readouts is being developed by Kollsman Instrument Corp., Syosset, N.Y. The Kollsman display relies on the light-absorbing effect of ceramic piezoelectric elements; like liquid crystal, it is reflective and gets brighter as more light is shined on it. But its material has greater temperature stability than liquid crystals, says Kollsman, operating from -55 C to +75 C.

When the piezoelectric elements are butted against a flat plate on the front of the display, ambient light passing through the glass is absorbed by the ceramic; the display appears dark. To define a number, a signal applied to the proper "light frustrating" segments makes them contract and move far enough away from the glass—5 to 10 microns—so that the light no longer passes into a ceramic. The light is reflected and the segment appears white.

North American seeks new electronics fields

Watch for North American Rockwell Corp.'s Electronics Group to begin acquiring outside companies with expertise in a variety of technologies. Among those technologies: digital data collection and transmission, including data memories; communications and peripheral equipment; instrumentation; process control; aircraft avionics; shipborne electronics; and rf communications.

Addenda

If the Pentagon orders France's Crotale missile system, the Northrop Corp. will produce it under a license deal just signed with Thomson-CSF, the French firm that developed Crotale's guidance system. The U.S. Army is currently testing the mobile defense system against low-flying aircraft [*Electronics*, March 29, p. 31] . . . At least three companies—Cutler-Hammer's AIL division, Lockheed Electronics, and the Whittaker Corp.—plan to propose air traffic control systems built around mini-computers when the FAA asks for bids on the ARTS-2 system for low-to medium-density airports in late May. Their entries could spell trouble for Sperry Rand's Univac division, which now has a scaled-down version of its ARTS-3 automated radar terminal system under evaluation at the Knoxville, Tenn., airport. . . . A line of inexpensive modular data-entry equipment—including CRT displays, small processors, and peripherals—will be introduced in June by Sanders Associates. Dubbed the series 800, the line will have TTL in its processor electronics, as well as MOS/LSI memories.

The *Thrust* in Optoelectronics

Plus news from Texas Instruments about

MOS/LSI: Big choice in display system components

TTL ICs: MSI decoder/drivers

Hybrid ICs: Two new 1-amp voltage regulators

S/C memories: New 2048-bit RAM array

Linear ICs: New op amps, memory drivers

Thyristors: More power for less cost—in plastic

Transistors: First diode-protected MOSFETs



Optoelectronics:

TI has the capability—across the board.

From 1 mA silicon sensors which could sit neatly on the head of a pin to television image tubes which use 2.4 million photodiodes to set new standards for spectral sensitivity—that's the scope of TI optoelectronics.

And whether your work is at one of these extremes, or somewhere in between, you'll find TI easy and profitable to deal with. Easy because no one offers you more choices in standard products, or a broader custom capability, or more opto manufacturing know-how. Profitable because opto devices are 20 times more reliable than electromechanical parts and cost less over the life of your system...and when you need speed, they're 1000 times as fast.

Biggest sensor and emitter choice

One of your toughest design jobs is to match sensors and emitters for optimum cost-effective performance. You want standard parts if you can find them.

TI is the best place to look. We've got 22 types of emitters in 11 different packages and 47 types of sensors in 12 packages. Some manufacturers specialize in low-power devices, others in high.

TI has both—and nearly everything in between. In emitters, we go from the miniature TIL23 at 0.4 mW to the TIXL16 at 200 mW, nineteen types in all. Plus TI makes three types of laser diodes with up to 7 watts peak power. In sensors, TI offers 31 types of photodiodes and phototransistors, with sensitivity ranging from 40 μ A to 7.0 mA, and 16 types of signal photodetectors and photodetector modules. It's the biggest standard line in the industry. Add to that a custom capability to produce infrared detectors for the electromagnetic spectrum from 1 to 30 microns and you see some of the potential TI has to help you optimize your designs.

Custom sensor and emitter arrays

TI sensors and emitters are available mounted in printed circuit boards to your specifications for cus-

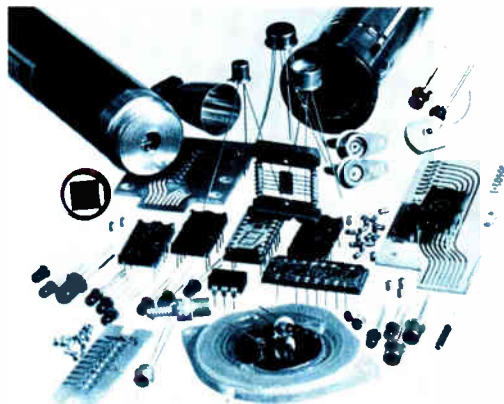

tom arrays or matrices. These complete units can be designed for tape readers, position indicators, pattern and character recognition, shaft encoders and many other special applications. Almost any configuration can be manufactured, and arrays are delivered tested and ready for installation. We can supply sensor arrays only, emitter arrays only, or sensor/emitter combinations. Components can

be matched for improved performance when required.

If you're working in areas where devices must be accurately spaced on centers too close for discrete packages and too far apart for an economical monolithic approach, TI's beam-lead phototransistor arrays may be the answer. They're available in X-Y and linear matrices mounted on ceramic substrates.

Optically coupled isolators — now in low-cost plastic

TI's optical couplers have long been electrically compatible with IC logic. Now, with the announcement of couplers in dual-in-line plastic packages, they are mechanically compatible as well...helping you cut costs from design to delivery. The new P-DIPs can be handled with the same automated assembly equipment and can use the same sockets and PC board design as the most popular IC packages. TI couplers—with response from DC to 100 kHz, high shock and vibration immunity, bounceless action, and speeds to 2 μ sec—provide input/output isolation of up to 1500 V. Nine types are available, in four package types in addition to the P-DIP.

For more information on industry's biggest optoelectronic line, including an outstanding visible display capability (see special story opposite on fold-out), circle 260 on the Reader Service Card, or contact your TI sales engineer or local authorized TI distributor.

Optoelectronics
from Texas Instruments



TIOPTO PRODUCT SPECTRUM

Alphanumeric Displays

Numeric Displays

Visible Light Emitting Diodes

Thermal Printing Devices

Avalanche Photodetectors

Beam-lead Phototransistor Arrays

Custom Sensor/Emitter Arrays

Industrial Phototransistors

Infrared Detectors

Silicon Photoamperic Detectors

Silicon Sensors

TIVICON™ Television Image Tubes

Optoelectronic Materials

Gallium Arsenide Laser Diodes

Gallium Arsenide Light Sources

Optically Coupled Isolators

Optically Coupled Pulse Amplifiers

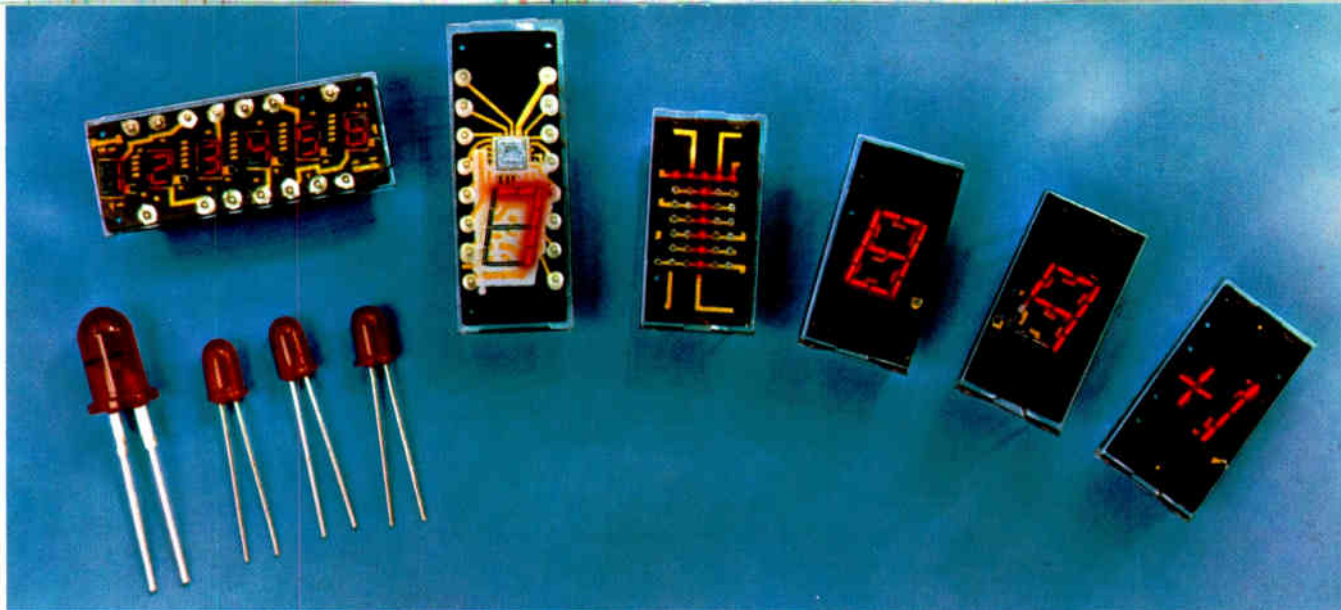

The thrust in data display is OPTO — low cost, low current, simple and small.

Optoelectronic displays are making it tough on tubes and tungsten. Costs are lower. Less power is needed—eliminating high-voltage power supplies in many applications. Drive electronics are simplified. Size and weight are reduced. And on the human engineering side, readability is better, too. The flat emitting plane of opto readouts greatly widens viewing angles...and there's less susceptibility to washout from high ambient light.

When all these good reasons make opto displays right for your application, TI is the logical place to buy them. TI produces all of its own Group III-V materials (gallium arsenide, gallium aluminum arsenide and gallium arsenide phosphide). TI has more high-volume semiconductor production experience than any other manufacturer. And when it comes to combining opto technology with digital logic, who's better equipped than the digital logic leader? It adds up to the best performance, delivery and price you can find anywhere. Plus a fast-growing, flexible standard line and top custom capability.

Six new DIP displays

Your opto display component choice has been greatly expanded by recent TI announcements. Among them is the new TIXL360 7-segment numeric device with a row of six digits in a single dual-in-line package. Intended for small calculators where the display is multiplexed, it has 0.1-inch characters with a pitch of 0.172 inch. Packages can be stacked end to end for an unlimited number of digits.

TI's new TIL302 and TIL303 are seven-segment numeric displays (also A, C, E, F, H, J, L, P, and U) with 0.25-inch characters. Both are in 14-pin DIPs. TIL303 has the decimal on the right.

TIL304 is a useful new overflow unit which shows plus or minus one when used with the TIL302 and 303.

A new alphanumeric display, TIL305, uses 35 diodes in a 5 x 7 matrix. All characters, digits and matrix-accommodated symbols are produced.

And coming soon is the next generation visible display. It's a new hybrid which includes a 0.25-inch 7-segment-with-decimal display, a decade counter, latch, decoder and current source driver—all in the same 16-pin dual-in-line package. Low power consumption, increased reliability (fewer external connections), and lower assembly costs will make it ideal for industrial controls, aircraft displays and portable instruments.

Breakthrough—the 35¢ VLED

TI has announced a breakthrough price on visible light emitting diodes—made possible by a new, highly-automated production line. TI's TIL209 now costs only 35¢ in 25,000 quantities (49¢ in 100-4,999 quantities). It comes in a molded red plastic package with an integral dome-shaped lens. An epoxy filler diffuses the emitted light, creating a uniform light source throughout the dome structure. Output is 15 microwatts at 20 milliamperes. The TIL209 is replacing tungsten lamps in home appliances, stereos, and cameras.

TI's new TIL210—a larger version of the 209—is ideal for panel-mounted indicator lights in computer systems, data-processing equipment and communications systems.

More new developments

TI's opto display innovations extend in many directions. Like a thermal printer, fully compatible with IC logic, which produces 30 characters per second... silently, without impact on heat-sensitive paper. And in the not-so-far future, liquid crystal displays. TI's liquid crystal R&D promises low power consumption, low-voltage (12 V) drive, simple color changes, MOS compatibility—and a low cost-per-digit that will open up more applications than any earlier technology.

For data sheets on the complete TIOPTO line of display components and VLEDs, circle 261 on the Reader Service Card.



New economy semiconductors expand your broad choice at TI.

Thyristors

New high-performance SCRs, triacs in low-cost plastic.

With twenty new SCRs and two new triacs, TI now offers your widest choice of plastic-package thyristors.

Three SCR series are available (see chart). The 12-amp TIC126, the 8-amp TIC116 and the 5-amp TIC106.

In the TIC106 series a big 70-mil silicon wafer handles a 5-amp current at 80°C case temperature—*that's three times better than competition.* This larger chip also re-

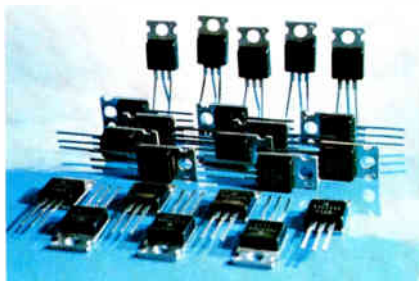

sults in a peak gate power dissipation capability of 1.3 watts—*twice that of competition.*

And they're all in TI's new high-performance plastic package (TO-66). This new package design provides lower leakage, more moisture resistance, increased stability, and high resistance to thermal shock and vibration. They are direct replacements for competitive types and are plug-in substitutes for most TO-66 metal-can units—no adapters needed.

Prices are 20% less than metal can equivalents.

The two new triacs are also in low-cost high-performance plastic. The TIC226B has a repetitive peak off-state voltage of ± 200 V, and the TIC226D is rated at ± 400 V.

Fast, on-time delivery is assured by big volume production on TI-designed, automated assembly lines.

For data sheets on the 22 new thyristors, circle 268 on the Reader Service Card.

Transistors

First diode-protected MOSFETs offer high gain and high output impedance.

In FM tuners, top-line color TV sets and other such applications, you can now economically replace vacuum tubes with TI's three new dual-gate MOSFETs. The 3N201, 3N202 and 3N203 each have a 10-kilohm output impedance at 200 MHz, making circuit performance independent of transistor-to-transistor variations. Each is protected from excessive input voltages by integrated back-to-back diodes between gates and sources which eliminate precautionary handling procedures.

In addition, these new MOSFETs have a typical 12,000 micromhos gain, a low feedback capacitance of 0.03 pF max., and a typical low noise figure of 2.8 decibels. All together, these characteristics add up to the performance you want at considerably lower cost.

Use the 3N201 in VHF pre-amplifiers where linear, low-noise amplification is needed. Use the 3N202 as a VHF mixer and in TV tuners; the 3N203 in tuned high-frequency amplifiers. **For data sheets on these low-cost, pacesetting MOSFETs, circle 269 on the Reader Service Card.**



TYPE	VOLTAGE (peak)	CURRENT (amps)
TIC106Y	30	5
TIC106F	50	5
TIC106A	100	5
TIC106B	200	5
TIC106C	300	5
TIC106D	400	5
TIC116F	50	8
TIC116A	100	8
TIC116B	200	8
TIC116C	300	8
TIC116D	400	8
TIC116E	500	8
TIC116M	600	8
TIC126F	50	12
TIC126A	100	12
TIC126B	200	12
TIC126C	300	12
TIC126D	400	12
TIC126E	500	12
TIC126M	600	12
TIC226B	± 200	8
TIC226D	± 400	8

Simplified semiconductor selection



Here's quick relief from the confusions and risks involved in selecting from the tens of thousands of discrete semiconductors available today. It's TI's *Preferred Semiconductors and Components Catalog* — containing detailed specs and application data on 322 popular devices that will meet the big majority of your needs.

They've been pre-selected by computerized demand analysis from TI's 1,500 "standards" and 13,000 "specials." Included are small-signal and

power transistors, diodes, thyristors, rectifiers, regulators, light sensors and resistors. All are known, proven and in wide use. All are in volume production, available from TI distributor and factory stocks. All are recommended for new or existing designs.

Result: you'll save time and money, reduce inventories and testing, and get faster delivery. For your copy of TI's *Preferred Semiconductors and Components* catalog, circle 270 on Service Card.

TEXAS INSTRUMENTS
INCORPORATED



Georgia Department of Industry & Trade,
Industry Division, Dept. EL-4, P.O. Box 38097,
Atlanta, Georgia 30334

Please send me free information on Georgia's unique
profit opportunities.

Name _____ Title _____

Company _____

Address _____

City _____ State _____ Zip _____

People.

Hire a Georgian and you hire an individual. Dedicated. Determined. He wants a good life for himself and his family. And he's prepared to work hard for it.

And Georgia has prepared him to do it. With 25 technical training schools turning out thousands of skilled people for industry. Free.

There's so much to tell about Georgia, that we've retained the Fantus Company to pull all the profitable facts together for you. Plus, a summary of our technical training program, and up-to-date labor supply information on 400 Georgia towns, are available free. Just send us the coupon. We'll give you the facts.

Georgia, the unspoiled.

**TELEDYNE RELAYS
REPRESENTATIVE
LIST**

AUSTRALIA Austronic Engineering Labs., 452 Victoria Street, Brunswick, 3056, 387-1477
AUSTRIA Omni Ray AG, Mollargasse 54, Vienna VI
BELGIUM Uni-Office, Inter'l Centrum, 5E Verdieping, Kamer 522, Rogierplein, Brussels
ENGLAND Souriau Lectropon, Ltd., Shirley Avenue, Vale Rd., Windsor, Berks, Slough 27629, Telex 85184456
FRANCE Technique et Produits, Cite des Bruyeres, Rue Carle Vernet, 92 - Sevres, 626-02-35, 626-24-38, Telex 84225997
GERMANY Omni Ray GMBH, Nymphenburgerstr. 164, 8 Munich 19, Telex 841524385, Telephone # 0811-513-2059
HOLLAND, LUXEMBURG, Uni-Office, N.V., P.O. Box 1122, Rotterdam, Holland, 13 22 20 Telex 84421484
ISRAEL, STG International, Ltd., 52 Nachlat Benyamin St., P.O. Box 1276, Tel Aviv, 53459
ITALY Tekelec Airtronic, Viale Romagna 14, 20133 Milano, 73-85-674
NORWAY Nordisk Elektronik (NORGE) A/S, Elkemhuset, Middelthunsgate 27, Oslo 3
SO. AFRICA Impectron, P.O. Box 10262, Vogas House, 123 Pritchard St., Johannesburg
SPAIN Hispano Electronica, S.A., Comandante Zorita, 8-Madrid 20
SWEDEN Nordisk Elektronik AB, Postfack, Stureplan 3, Stockholm 7, 08/24 83 40, Telex 85410547
SWITZERLAND Omni Ray AG, 8008 Zurich, Dufourstrasse 56, Telex 84553239

We're Shrinkers

...of relays:

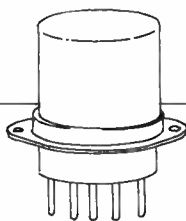

The Round Relay
Early '50s

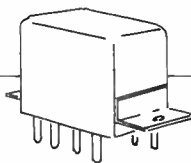

Full Size Crystal Can
Mid '50s

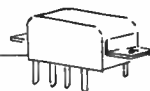

1/2-size Crystal Can
Early '60s



TO-5
Late '60s



Centigrad
'70s

And the tiny TO-5 is our claim to this fame . . .

Miniaturization of electro-mechanical relays has been the goal of the relay industry since the era of the "giant" Crystal Can — the earliest attempt at miniaturization . . . Teledyne Relays is the recognized pioneer and leader in the development of reliable miniaturized innovations in the electro-mechanical relay field . . . Always looking for optimum solutions to tough problems, we have continued to shrink more and more requirements under the TO-5 cap as the demand for more applications accelerates.

To meet the requirements of the military and defense markets, the first TO-5 was developed — the basic 412 relay . . . Though revolutionary at the time, the first TO-5 bears little

resemblance to the infinitely more complex and reliable family of TO-5 electro-mechanical relays available today to meet every industrial and technological application . . .

As the requirements grew, so grew TO-5 in its capabilities . . . Yet it continued to shrink in size. Following the first success came the Sensitive Relay . . . Then to broaden the selection, the extremely miniature TO-5 Magnetic Latching Relay was introduced with gratifying results . . . But there was even more to come, for to meet the needs of the military/aerospace electronic markets, diodes for internal arc suppression were placed inside the TO-5 case.

When market research indicated that more than 50% of relays in use were being driven from transistors,

we felt it made sense to place the transistor drivers inside the relays . . . But just when we thought this completes the package of a true family of general purpose relays, our "header shrinkers" came up with the low profile .100 grid relay — the Centigrad, which seems to be the ultimate in little relays. Only .225 high, the Centigrad is the perfect answer to any packaging density problem. The TO-5's shrinking history is also a history of growth, for we can offer a wide range of basic military, industrial, and hybrid relays, whatever your requirement . . . And watch what we are doing with solid state!

Write or call for complete data on your TO-5 Relay requirements . . . We are at your service.



TELEDYNE RELAYS

3155 West El Segundo Boulevard, Hawthorne, California 90250 • Telephone (213) 679-2205

Gas plasma panels getting gray scales

Work under way at Bell, Zenith, Burroughs could lead to use in Picturephone, flat TV, cockpit readouts

Close on the heels of color in gas plasma display panels [*Electronics*, March 15, p. 31] come proposals from Bell Labs, Zenith Radio Corp., and Burroughs Corp. for adding gray scale and hence images to the displays. At present, individual points in the panels are either on or off, limiting them to alphanumeric and to graphic or vector displays that could be put together from short orthogonal segments; the segments, in turn, are a series of adjacent points in the display panels.

As for commercial possibilities,

some applications are obvious. Among them: Picturephone, cockpit displays, and flat-screen TV—although Zenith says it has been able to obtain only four to six gray levels instead of the 16 to 32 it requires for TV. And now Owens-Illinois Corp. is believed ready to offer commercially its Digivue panels, which, although they do not yet have a gray scale, could quicken interest in all such panels [see below].

Bell Labs has designed a panel consisting of three individually driven layers with two optical attenuating films between them. The cells in the three layers all produce light of the same intensity. But the light from the rear layer passes through both attenuating layers, that from the middle layers through one, while light from the front layer is directly visible. This provides a

binary weighting to the three layers, so that eight different tints—or “gray”—are available, including total blackness (all three layers off) and full brightness (all three on). Bell Labs uses the usual neon-based mixture of gases in the triple panel, producing a reddish glow for display.

The panels are about 6 x 6 inches, and contain a matrix of 250 by 250 points spaced 23 mils between centers. By sharing some of the addressing and driving functions, the three layers require only about 50% more circuitry than a single layer.

Zenith's approach is different: the various light-intensity levels are attained by altering the number of light pulses produced in a given period of time. The technique depends on the use of a discrete or inherent capacitance in series with a bidirectional switch. Either the switch or the capacitor can be the light source; in the plasma display panel the individual light-emitting cells act as switches, and are themselves capacitive because a charge is stored on their walls between discharges.

An individual cell's capacitance is precharged with an addressing pulse that causes the cell to discharge just once; the pulse's length or amplitude may be modulated to control the amount of precharging. This pulse is followed by a sustaining voltage with a complex wave-shape, rather than the conventional sinusoid sustaining voltage; it causes additional discharges to occur twice, four times, or six times during a single cycle, depending on

Going commercial

Owens-Illinois is about to open a 34,000-square-foot factory near Toledo, Ohio, for the production of the original plasma panels, called Digivue, in commercial quantities. Up to now the panels, invented at the University of Illinois [*Electronics*, March 31, 1969, p. 133], have been produced only in pilot-line quantities and sold for experimental purposes. The new plant at first will make two sizes: 2 by 8 inches for a single line of characters, with dots spaced 33 to the inch, and a large 8½-inch-square panel with 60 dots per inch, capable of displaying a full page of information. Other sizes and resolutions will be brought out as production capability and demand develop.

Eventually, a multicolor display will go into quantity production, as will equipment now in development for making hard copy, rear projection, and external write-in using light pens and similar devices.

The panels are expected to be used in teaching machines, for which they were originally invented at Illinois, as well as for aviation cockpit displays, airport schedule displays, financial data terminals, and telephone message centers.

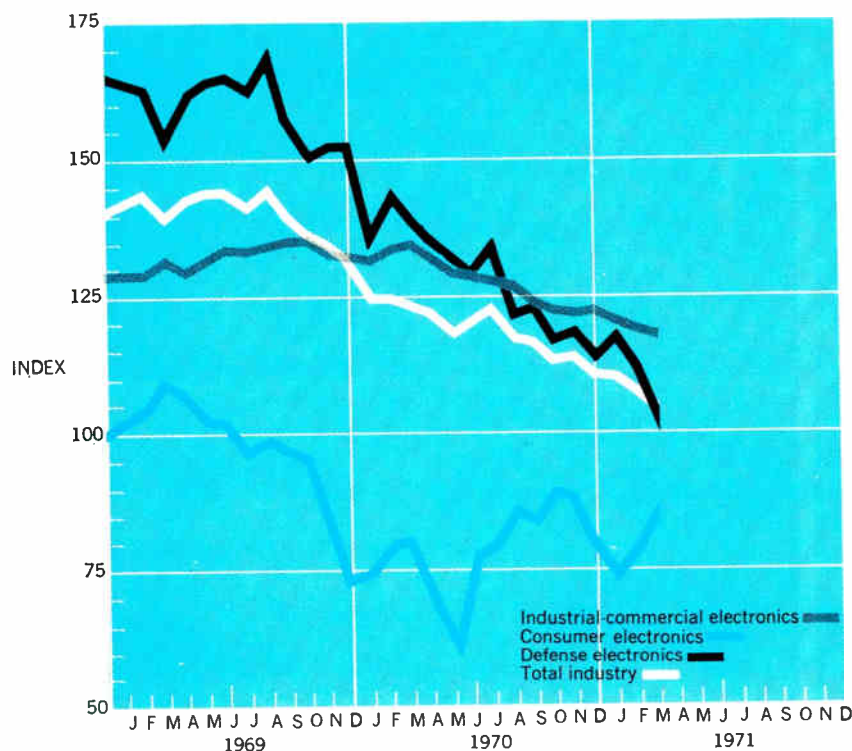

Segment of Industry	Mar. '71	Feb. '71*	Mar. '70
Consumer electronics	86.4	79.6	80.3
Defense electronics	104.1	112.1	140.6
Industrial-commercial electronics	118.7	119.3	135.3
Total industry	105.0	108.3	128.4

Electronics Index of Activity

May 10, 1971

The total industry index for March dropped from February's downward revised 108.3 to 105—the lowest level since October 1965. What's more, it was 18.2% below March 1970.

For the second consecutive month, the consumer sector was the only gainer, increasing 8.5% from February's revised 79.6. It was also the only component of the index to show an increase over 1970—up 7.6% for the month. Defense, down 7% in March to 104.1, hit its lowest point since September 1965, when it stood at 103.9. The drop from March 1970 was a substantial 26%. Industrial-commercial sagged to its lowest point since October 1967, settling at 118.7.

Indexes chart pace of production volume for total industry and each segment. The base period, equal to 100, is the average of 1965 monthly output for each of the three parts of the industry. Index numbers are expressed as a percentage of the base period. Data is seasonally adjusted.
* Revised.

the capacitance precharge level. Or the discharges may not occur at all if the precharging is omitted. This gives a total of four gray or tint levels in the panel, corresponding to zero, two, four, or six discharges during a cycle. One cycle is typically 60 microseconds, the time to display a single television line.

A third approach has been tried at Burroughs, using the company's Self-Scan display panel. The scan is triggered not by the conventional clock, but by the beginning of a separately controlled raster scan of the information to be displayed—a transparency in the experimental model. This raster scan also provides the information that phase-modulates the current provided to the individual display. This modulation determines the timing of a secondary discharge in the front part of each cell after it has been primed by ions leaking through a

small hole from the rear cell. There, a primary discharge occurs on every scan. If the discharge in the front part is initiated only a short time before the rear discharge quenches itself as the scan moves away, it produces a less-intense visual impression than would be present if the front-layer discharge were permitted its maximum duration by an early initiation—hence, a gray-scale effort.

Lasers

Bendix forecasts 10-dB/km loss with its fiber

The hope for early exploitation of the laser's tremendous information-carrying capacity could be hanging on a glass fiber only microns in diameter. The Bendix Corp.'s Mosaic Fabrications division in Sturbridge, Mass., has drawn very high-

purity fibers that it is confident will have transmission losses below 20 decibels per kilometer, a figure it hopes to reduce to 10 dB/km. The 20-dB figure was first achieved by Corning Glass Works last year, following Nippon Electric's disclosure of transmission losses in optical fibers of 50 to 150 dB/km [*Electronics*, Sept. 28, 1970, p. 129].

The Bendix fiber consists of a core, which can range in diameter from 2 microns to 2.4 mils, inside an overall diameter (including a cladding) of 2 to 2.5 mils. The wavelength for transmission can vary, but Bendix researcher Steve Drucker suggests that the solid-state laser that emits at about 0.9 microns looks best.

Engineers at ITT's Standard Telecommunication Laboratories are enthusiastic about fiberoptic waveguides—they foresee "commercially operating fiberoptic tele-

phone and television transmission systems operating within five years." But Bell Laboratories researchers are more cautious. "An attenuation value of 20 dB/km is low enough that some system possibilities might be considered, but to say that a commercial system right now could be built around this is too strong a statement," says Rudy Kompfner, associate executive director of Bell Labs Research, Communications Principles division.

Interest about fiberoptic wave-lengths is worldwide. Experimental programs are being pursued at the GTE Laboratories in Bayside, N.Y., by the British Post Office's Research department in Dollis Hill, and by the Ministry of Posts and Communications in the USSR. The reason is that if an optical communications system is successfully deployed, it could theoretically carry 100 million simultaneous two-way telephone calls and still have 80% of its bandwidth available for guard space, Picturephone, and TV signals. How soon such a system will be needed depends on many factors. For example, if only 1% of the Bell System's customers went over to Picturephone service, it would increase the transmission needs of the network by 100%. And S.E. Miller, director of Bell Labs' guided wave research laboratory, believes that an optical intercity communication system would be feasible if it could carry in the range of 500,000 two-way telephone calls.

Half a million calls would require a data transmission capacity of 60 billion bits per second, and the fastest optical modulator so far has a capacity of only 1 billion bits per second. It's the one developed by Gerard White, a member of technical staff at Bell Labs, using a lithium tantalate crystal and electronically multiplexing four 250-megabit channels. Bell also has a promising laser: its aluminum-gallium-arsenide double hetero-junction device that operates continuously at room temperature off a flashlight battery [*Electronics*, Aug. 31, 1970, p. 31].

Economics

8% increase seen in sales this year

Against a background of their worst month in more than five years, the electronics industries are maintaining a more or less optimistic outlook. The Index of Activity [see p. 36] dropped in March to its lowest level since October 1965, but McGraw-Hill's latest Capital Spending Survey shows that electronics executives expect both sales and spending to rise 8% in 1971.

At the same time, manufacturers reported an actual operating rate for 1970 of only 77%. That figure isn't likely to improve quickly unless production can improve faster than capacity—but capacity itself is expected to increase 7% this year on top of last year's 7% rise.

The industries expect expansion to eat up 71% of their capital spending dollar during 1971, with the rest going for modernization and replacement of equipment. However, it's interesting to note that expansion is expected to account for only 58% in the 1972-74 period.

Military electronics

Tri-Tac program due for speedup

Armed with a strong sense of urgency and \$8 million left from the defunct Project Mallard, the Pentagon's communications chief is about to ask industry to begin work on a major new tactical communications trunking and switching system.

Stressing the urgent need for a joint service system, Louis DeRosa, assistant to the Secretary of Defense for telecommunications, plans to set a blistering pace for the development of Tri-Tac hardware [*Electronics*, Nov. 23, 1970, p. 38], so that the system may be deployed between 1975 and 1977.

Maintaining the pace, however, hinges on two things: Congressional approval, and the timely development of key components. E.F. Paroulek, DeRosa's technical assistant, points out that until Congress allows the reprogramming of the Mallard funds, there is no money for the Tri-Tac program. Even then, DeRosa will still have to go up Capitol Hill again and secure the \$10 million in fiscal 1972 money he is requesting.

Paroulek says the component most critical for Tri-Tac development is a wideband switch, called the A switch, designed for both digital and analog traffic. Industry was first briefed on the Pentagon's requirements on May 6 and will get a formal request for proposals sometime this summer. DeRosa's office hopes to award a contract for the \$10-million to \$20-million development item before year's end. Ultimately, Paroulek says, 100 to 200 of the mobile switches, small enough to be toted in a 2½-ton truck, will probably be bought.

In keeping with a Federal development trend, the Pentagon will not specify either space division or time division multiplex technology, but will ask industry to determine what should be used to meet the Defense Department requirements. The switch, to be built around a programable medium-scale processor, will continuously monitor all circuits and, if the quality on any one becomes unacceptable, will automatically switch over to another channel. Each of the modularly constructed units will serve as circuit switches for 300 to 800 lines. An additional module will be developed to provide store and forward capabilities, Paroulek says.

Within the next two years, DeRosa's office will also ask industry for bids on a multiplex module that will concentrate network traffic and for a modulator-demodulator for use with existing radio sets. Eventually, the radio sets and input-output gear will be replaced by common triservice gear, he says.

To get maximum support for his program, DeRosa has organized it

IN DIGITAL PANEL METERS

WHAT SETS ANALOGIC APART?

Specs.

More specifications than most other companies. Tighter specifications than most other companies. Specifications that are met on a continuing basis. Analogic's specifications are conservatively stated, never overstated, and are designed into the product, not the result of test "fall ins."



Precision, Versatility and
Maximum Accuracy
in Minimum Size DPMs.

Analogic AN2500 Series Digital Panel Meters offer the greatest input/output versatility available today at a price that permits OEM utilization while offering laboratory instrumentation precision.

- Truly miniature in size: 2" H x 2 3/4" D x 3 1/2" W, (saving critical behind-panel space.)
- Twice as accurate as competitive units.
- 0.05% basic accuracy and better than 0.004%/°F tempco for superb resolution and rock solid display.
- Operating temperature range: -10°C to +60°C (extended temperature ranges available.)
- Floating differential input amplifier provides input impedance in excess of 1000 megohms.

The AN2500 series of DPMs range from two digit unipolar to three digit bipolar plus "1" over-range with automatic polarity indication. They are priced low enough, from \$179 (unit price)*, to permit systems engineers to meet both performance and cost objectives.

*Substantial OEM discounts available.

For immediate information call Al Grant, (617) 246-0300, or write for definitive data sheets and detailed short form catalog. Analogic Corporation, Audubon Road, Wakefield, Massachusetts 01880.

ANALOGIC 
...The Digitizers

Electronics review

along lines recommended by Congress. Instead of assigning one military service to serve as executive for the program, he has set up a Tri-Tac program office staffed by all three services that reports directly to his office. The lack of Air Force and Navy support, Army sources point out, was the death blow for Mallard.

Communications

Three firms to develop personal police radio

Personal transceivers designed solely for law enforcement are almost within hailing distance, and the companies involved may come as a surprise to some people. Phase 1 development contracts from the Justice Department's Law Enforcement Assistance Administration have been awarded to GTE Sylvania Inc., Buffalo, N. Y., Martin Marietta Corp., Orlando, Fla., and Teledyne Electronics, Newbury Park, Calif. Conspicuously absent are GE and Motorola, which didn't bid.

LEAA officials are not committed to financing phase 2, the production phase of the project, but do expect to award multiple contracts for tooling up for mass production if development is successful.

Though the LEAA generated the specifications and 75% of the money, the actual contracts were awarded by the Air Force Systems Command's Aeronautical Systems division at Wright-Patterson Air Force Base, Ohio, which also will probably do much of the evaluation of the entries. The companies are committed to supplying four to six prototypes, to the LEAA, and two to four to the Air Force.

Last September's RFP specified that companies should have the desire and capability to engineer and manufacture the transceivers in quantities of 10,000 per year. It also suggested that the price of a fully equipped transceiver, after production has begun, should not exceed \$650 in lots of 10 or more.

Teledyne, with the smallest

award (\$56,733 from LEAA and \$14,239 from the Air Force), apparently opted to pick up most of the development cost in-house.

A spokesman for Martin Marietta, which received \$200,875 from the LEAA and \$100,117 in Air Force money, said that their radios "will be based on an inductorless technology which eliminates 95% of the coils usually used in radios of this type." The technique, developed under an earlier military contract, substitutes capacitors and resistors built from current micro-miniaturization technology, the spokesman added.

Sylvania received \$382,167 from the LEAA and \$108,974 from the Air Force.

The radios will be designed for high-noise ambient conditions and are to be worn at shoulder level. They are compact enough to allow the user to sit in a car, run, and fight hand to hand.

The four LEAA radios will be in different frequency configurations: one will receive and transmit at around 150 megahertz, another at around 450 MHz, the third will receive at 150 MHz and transmit at 450 MHz, and the last will receive at 450 MHz and transmit at 150 MHz. Each will be manually tunable to four channels within each of the four frequency bands. The Air Force modification specifies a wideband front end, vhf-only transceiver; it must transmit and receive at several channels between 138 and 174 MHz.

Meetings

Quiet days in Dayton and on Boardwalk

The Boardwalk at Atlantic City will be less crowded than usual next week when the Spring Joint Computer Conference opens in the New Jersey seashore resort. And things are also likely to be slack in Dayton, Ohio, where the National Aerospace Electronics Conference (Naecon) is scheduled to open.

Only about 190 exhibitors will

SAVE
\$\$\$

GAIN
performance

**over any other 50-MHz,
 plug-in oscilloscope.**

50-MHz oscilloscope with:

5-mV dual-trace amplifier and delaying sweep **\$2200**
 5-mV dual-trace amplifier and single time base **1900**
 5-mV single-trace amplifier and single time base **1650**

AND LOOK AT THESE BONUSES:

- 3 plug-in compartments and mainframe mode switching
- 6-1/2-inch CRT — 50% larger than 8 x 10 cm CRT's
- time bases have 5 ns/div sweep rate
- amplifiers and time bases accurate within 2%
- high writing-rate CRT gives a brighter trace

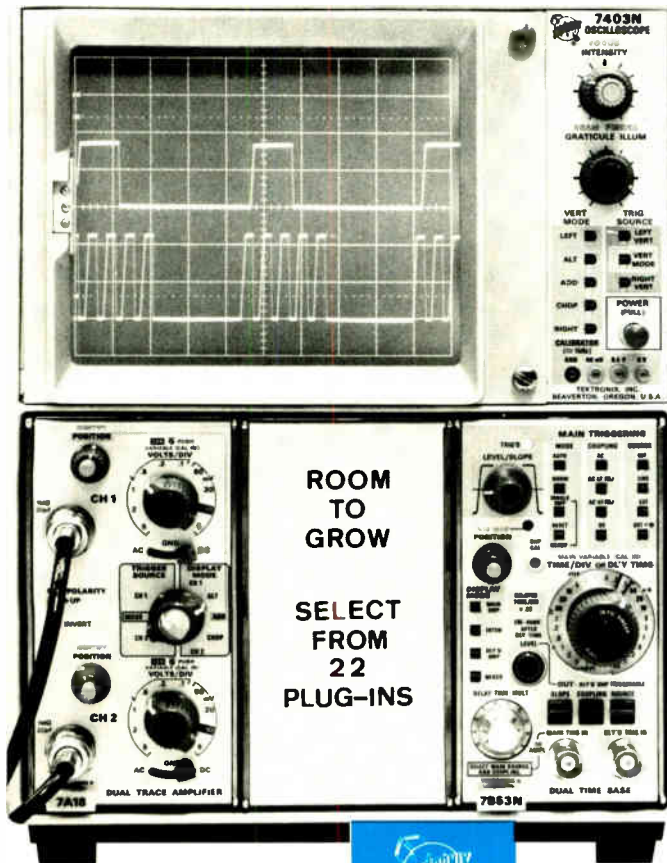

If you wish, select a plug-in for the second vertical compartment to give you 10 μ V/div at 1 MHz or 1 mV/div at 55 MHz or 1 mA/div at 55 MHz or another dual-trace unit for 4-trace capability, etc., etc. Plug-in prices start at a low \$250. Call your nearby Tektronix field engineer today for a demonstration.

7403N Oscilloscope	\$950
7A18 Dual-Trace Amplifier, Option 1	\$500
7A15 Single-Trace Amplifier	\$250
7B53N Dual Time Base	\$750
7B50 Time Base	\$450

U.S. Sales Prices FOB Beaverton, Oregon

Available in U.S. through the Tektronix lease plan.

TEKTRONIX®
 committed to
 technical excellence

AIR TRAFFIC CONTROL



TOTAL ELECTRONIC
SYSTEMS CAPABILITY.
SPECIALISTS IN
TIME/FREQUENCY,
RADAR AND
DATA SYSTEMS
OFFERING RAPID
GROWTH.

SIERRA 
RESEARCH CORPORATION
an equal opportunity employer
P.O. BOX 222, BUFFALO, N.Y. 14225

Electronics review

be showing their wares at the Spring Joint, down radically from the 350 of a year ago. Absent will be almost all the major mainframe computer makers. IBM, Honeywell, Control Data Corp., Xerox Data Systems, and NCR either will not be there or will be represented by other than their main computer divisions. Only RCA will make the trip, showing off for the first time in public its RCA 3 virtual memory computer system introduced last September. The company will also unveil new video and remote data terminals, and a software package for on-line computer control of all manufacturing operations, including production and inventory control, which the company claims cost a million dollars to develop.

Other new products being shown include small and low-cost impact and thermal printers and a group of bipolar and MOS read-only and read-and-write memories [see page 121].

The fact that the large computer makers are absent from the show may have had its influence. Comments one small Massachusetts manufacturer of peripherals: "If IBM and Honeywell aren't showing, why should I?" However, the main reasons cited for not exhibiting are the oft-heard ones these days of no money, or not enough money to support both advertising and attendance at shows.

At Naccon, whose business supporters rely so heavily on contracts emanating from the nearby Wright-Patterson Air Force Base, things are likely to be even quieter. Only eight exhibitors have signed up, compared with the 29 of last year. And the attendance won't come near the 1,600-plus of 1970.

Memories

Litton touting MNOS
that's electrically alterable

Nitride-isolated MOS memories are nothing new [*Electronics*, April 14, 1969, p. 50], but ones that work well, are reproducible, and have good yields are. Litton Systems Inc.

claims it has developed just such devices, and in fact is looking to license its silicon nitride process for quantity production, according to Yukun Hsia, one of the developers. To back up the claim, the company recently delivered two 256-bit MNOS random-access memories to Wright-Patterson Air Force Base, which funded the work.

The RAM is not incorporated in a production system at Litton at this time. Richard Shively, manager of the digital equipment, says the company is pursuing a number of possibilities, and is in "rather advanced stages [of serious discussions] with a couple of people."

Hsia claims Litton has licked the nitride layer problems that have always limited single-chip density of these devices to a mere 256 bits and also prevented the addition of decoding circuits to the chip. Now Litton's nitride researchers are busy debugging a 1,024-bit unit, expect to build a 2,048-bit part in six to nine months, and can incorporate full decoding capability right on both chips.

Litton and others (Sperry Rand, Westinghouse, Hughes) got into the silicon nitride approach to memory early because, though expensive, it offers advantages other semiconductor memories can't match. For starters, it's electrically programmable and electrically alterable (re-programmable). Most field-programmable memories are not electrically alterable—either they can't be re-programmed at all or they require such complicated methods as strong doses of ultraviolet light to do the job—and this means delay in program time and expense in program changes and debugging. For another, MNOS RAMs also are non-volatile. Besides, nitride memories have nondestructive readouts, and NDRO is what's so attractive about plated wire. Finally, MNOS storage cells have only one transistor, compared to three to six transistors for other MOS cells, and this spells high packing-density potential—less than 1 mil² is the conservative estimate, giving a factor of 3 to 5 area advantage over standard MOS.

Litton's current devices have

Bell & Howell & The Light Fantastic

It tips the scale at around seventy pounds. So you can take it anywhere. That's the light part.

Now the fantastic. It's a high performance, seven speed, seven channel recorder/reproducer that comes in for a bit over \$1k a channel.

It's the CPR-4000. Designed by the boys in the back to placate the sales engineers. "Give us a mag tape system with practically everything, for practically nothing," they begged. And the boys in the back did pretty well.

From the top, the seven speeds are electrically selectable (15/16 through 60 ips). It takes 1/2" tape on 8" reels.

The heads have an edge track voice channel and don't require a touch worth of alignment or adjustment after first installation. In fact, those heads are so darn good, we'll guarantee you 1,000 hours of head life.

Dual capstans keep the tape away from any motion disturbances, give minimum flutter, constant tape tension and a uniform head to tape contact. It doesn't have any solenoid actuated pinch rollers like you normally find around. So that cuts down power consumption and gives you more precise tape guidance and better short wavelength recording.

But probably the best feature is an automatic load, automatic feed option. Not only is that faster, it cuts out the mess ups and wipe outs.

And of course, the CPR-4000 has the latest in IC circuitry, is all modular, has solid state plug-in record/reproduce amplifiers, comes direct or FM and is just the nice new ticket for over a hundred lab, mobile or remote facility applications.

The light fantastic. You can get one now. (The specs don't take that long, though.) Just write Bell & Howell, Instruments Division, 360 Sierra Madre Villa, Pasadena, California 91109.

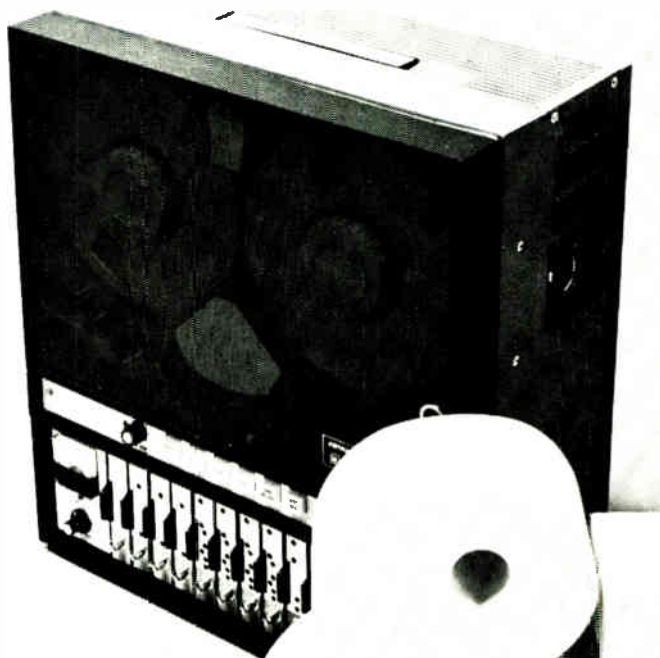

INSTRUMENTS DIVISION



BELL & HOWELL

SCIENCE/SCOPE

A laser cloth-cutting system -- described as "the first major advance in apparel manufacturing since the invention of the sewing machine" -- was demonstrated recently by Genesco, Inc., world's largest apparel company, and Hughes, the system's developer. Benefits to the \$50-billion industry will include lower costs, faster deliveries, quicker response to fashion changes, sharp reduction of large, risky inventories (now exceeding \$3-billion), and better values for the consumer.

The laser beam cuts garments one at a time from a single layer of cloth with amazing speed and much greater accuracy than the old method, which cuts them from many layers. The new system consists of a computer which stores programmed cutting instructions, a positioning device, the laser, and a conveyor. Hughes scientists investigated 42 cutting methods for Genesco -- including blades, water-jets, and thermal, chemical, and fracture methods -- before they chose the laser.

The mission of the three Orbiting Solar Observatory satellites Hughes will build for NASA's Goddard Space Flight Center is to gain a better understanding of how energy is transported from the sun's photosphere into its corona. Key task is to learn the secrets of the chromosphere, where the unexplained solar flares erupt. It is an irregular layer of gases extending outward from 3,000 to 10,000 miles and varying in temperature from less than 10,000°C to more than 100,000°C. The new satellites will require a spatial resolution capability nearly 20 times greater than that of earlier OSOs.

TV-like images of the terrain below, produced on cockpit displays from thermal radiation of ground objects, will enable U.S. Air Force B-52 crews to fly "blind" night or day. The FLIR (Forward-Looking Infrared) system, which Hughes is developing under contract with Boeing's Wichita, Kans. division, is one of the sensors to be installed in the B-52 under the EVS (Electro-Optical Visual Sensors) program.

The Law Enforcement Assistance Administration, Department of Justice, has contracted with Hughes for a 13-month research study of police problems in handling crowds and demonstrations. Systems engineers are reviewing the causes and results of past disturbances to gain a better understanding of patterns and responses. Purpose is to recommend tactics, equipment, and training for future command-and-control systems adapted to the specific requirements of civilian police departments.

Hughes needs radar systems engineers with systems analysis and synthesis experience. EE degree required. Also: software/programmer specialists with experience in software systems, real time applications, and technical data management systems. U.S. citizenship required. Please write: Mr. R. S. Roth, Hughes Aircraft Company, P.O. Box 3310, Fullerton, CA 92634. An equal opportunity employer.

The earthquake resistance of buildings, bridges, and dams can be determined before construction by making modal vibration tests of models with an automated computer-controlled system developed by Hughes. MODAPS (for Modal Data Acquisition and Processing System) can test virtually any structure with resonant frequencies ranging from 0.75 Hertz to 800 Hertz. The new system cuts testing costs 50 percent.

Creating a new world with electronics



Circle 42 on reader service card

writing voltages in the order of 30 volts, but the company expects its 2,048-bit models to sport write voltages in the respectable 20- to 25-v level. Litton is also shooting for 1-microsecond write times and 0.25-microsecond read times with its memories.

Ampex going bipolar with its arrays

When Ampex Corp. bought a semiconductor plant, customers and competitors of its Computer Products division, a major core supplier, wondered which technology would be used in its new semiconductor arrays. They can record Ampex in the bipolar column—at least initially. The arrays will be made in the Santa Monica, Calif., facility just purchased from Varadyne Inc.

The division has been buying both bipolar and MOS memory components from Intel Corp., Intersil Inc., and Fairchild's Semiconductor division for the three semiconductor memories it has announced to date: the ASM-10, -20, and -30 [*Electronics*, Nov. 23, 1970, p. 36]. But H. Frederick Koehler, chief engineer in the division for core and semiconductor memory products, says Ampex is starting with a bipolar storage array "because MOS plays into the heart of the core area"—in memories with access times from 600 nanoseconds to about 1 microsecond.

For this reason the division's first device, the ASD-10, will be a 256-bit by one-word bipolar random access memory component with an access time faster than 200 nanoseconds, Koehler says. The part has been designed, and the first test masks are in hand. It will probably show up in a memory system early next year. Koehler declines to elaborate on the system, admitting only that Ampex is "looking at combinations of core and semiconductor memories, with a semiconductor cache, and we're going to be very much in the end-user business in systems."

But the division is also looking for more MOS process people.

Koehler expects to have an MOS process at Santa Monica by the beginning of next year, though he's not certain yet whether it will be p- or n-channel. "If I had to make the decision today," he says, "we'd be looking at a 1,024-bit dynamic silicon-gate p-channel part similar to the Intel 1103, but I don't have to make that decision now, so we could conceivably be in n-channel parts."

Industrial electronics

Fabrication changes soup up power devices

Power hybrid assemblies—for use in anything from dc motor drives to controls that actuate protective gas bags in automobiles—have been limited to 40 to 50 watts because they couldn't handle high voltages. Now International Rectifier, applying advanced passivation to silicon-controlled rectifiers in such assemblies and using new interconnection techniques, is getting much higher power in smaller device packages.

The firm is delivering power hybrids rated at 230 volts that handle 12.5 kW in a new line dubbed PACE/pak.

David Cooper, International Rectifier's director of engineering, will even predict the possibility of new units able to handle 800 amperes in a three-phase, 440-V system—capabilities that are orders of magnitude higher than those of available thick-film hybrid assemblies. He says that the usual thick-film hybrid, with a beryllium oxide or alumina substrate, has more voltage drop in 1 inch of interconnect at 40 A rms than there is on the SCR junction, and this limits its voltage capability.

The company has adapted a semiconductor planar process to making power devices using silicon nitride and glass passivation. This allows the use of unpackaged SCR junctions. "Above about 500 or 600 volts," Cooper explains, "oxide passivation breaks down. We need nitride or nitride and glass, which

Hughes is more than just electronic devices and components. It's equipment too.



Gas lasers and laser trimmers, welders and drillers (RS 293)



Microcircuit production equipment (RS 294)



Numerical control systems (RS 295)



Semi-automatic wire terminating and harness laying equipment (RS 296)



N/C positioning tables and systems (RS 297)



FACT automatic circuit testers (RS 298)

HUGHES

HUGHES AIRCRAFT COMPANY
INDUSTRIAL ELECTRONICS GROUP
BUILDING 100, MAIL STN. C-512
CULVER CITY, CALIFORNIA 90230

Circle appropriate Reader Service (RS) numbers.

USING



Follow through with high density packaging... fast, computer-aided assembly and wiring techniques...and noise-free power distribution...

LOGICWARE

starts with your...

- ...freehand logic diagram
- or
- ...pin and string lists
- or
- ...from-to pin list
- or
- ...(you name it)

LOGICWARE

uses...

- ...logic cards
- or
- ...wired IC sockets
- or
- ...planar PC boards
- or
- ...combinations

(whatever is best for your project)

LOGICWARE

includes modular concepts for economical changes or system additions.

Send for the latest LOGICWARE "literature kit"



E E C O

ELECTRONIC ENGINEERING COMPANY of Calif.
1441 East Chestnut Avenue, Santa Ana, California 92701
Phone (714) 547 5651 • TWX 910 595-1550 • Telex 67 8420

Electronics review

can carry us all the way up to 3,000 volts or higher if the device can withstand the internal coronas at the voltage."

The big difference in the interconnect technique is the incorporation in the package of metal lead frames, which enhance its voltage capability. A typical "sandwich" structure for one of the International Rectifier assemblies has the SCR junction mounted on a tungsten or molybdenum buffer plate (which prevents thermal fatigue of the SCR), the buffer plate mounted to the metal lead frame, and the frame bonded to the thick-film passive portions of the circuit. Under the thick-film elements is a beryllium oxide or alumina substrate that provides a good thermal path

Good things. Smaller package with more power is made possible by semiconductor planar process for power devices. Old method is at top.

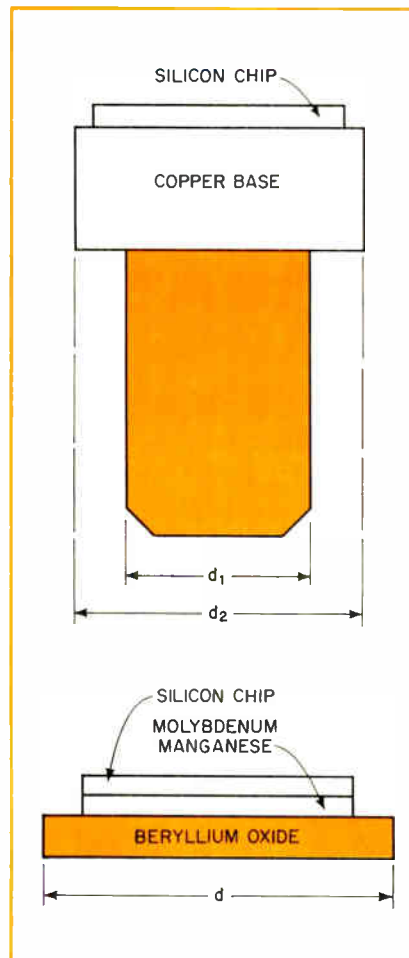

to an underlying copper or aluminum heat-sinking plate, from which the circuit is electrically isolated. The active devices in the hybrid assembly are encapsulated in a high-temperature, moisture-resistant epoxy.

In this way, the heat from the high-power SCRs in the assembly is passed along a path that widens from the junction down, providing good heat dissipation. Cooper says thick-film techniques alone might allow fabrication of 10- to 12-amp DC motor drives but his combination of nitride and glass SCR passivation with metal lead frames can deliver a 3-horsepower motor drive carrying 55 to 60 A and 240 v rms.

And by eliminating the packaging around the individual components, including the SCRs, the International Rectifier assemblies have been considerably reduced in size compared to the units with discrete components they'll supplant. For example, a 2-hp, 230-v single-phase full-wave-controlled bridge assembly designed for motor controls is just 1 by 1½ by 1 inch, not much larger than commercially available 25-w audio amplifiers.

There will be eight or 10 devices in the new line within a year, "covering 90% of the usage of SCRs and diodes in drives and power supplies in the world," Cooper says. They run the gamut from fractional-horsepower motor drives through pulse-charging doublers to series-regulated bridges.

Commercial electronics

NASA funds JPL project with eye on school market

As space budgets dried up, NASA centers around the country sought other outlets for their talents. Through its Technology Application Office, the space agency encouraged those pursuits and provided funds. Now one such development operation has resulted in a working system in California.

Put together by the Space Technology Applications division of Jet

Propulsion Laboratory in Pasadena, the system has automated attendance accounting at John F. Kennedy High School in Sacramento. Vasel Roberts, project engineer, explains that the pilot project is designed to demonstrate the system to other schools, a number of which are interested. The \$600,000 development cost provided by NASA included an extensive survey of high schools to determine their needs. Future systems, to be built by private industry for up to 3,800 students, would cost \$60,000 to \$70,000 apiece, he says.

The system consists of small keyboard units, rather like adding machines, and a varian 6201 computer. Each of the school's 76 classrooms has a keyboard, connected by cable with the computer. JPL says the present system's maximum capacity is 128 classrooms and 3,000 students.

Each student has a four-digit code number. Instead of calling roll, the teacher punches the numbers of absent students on the keyboard, then pushes an "absent" button. If an absent student subsequently appears, the teacher re-punches his number and pushes a "tardy" button. For security, the teacher cannot enter information without first punching his own identification number.

The computer prints out a list of all absent and tardy students during the first period, giving each student's name, number, sex, class, and home telephone number. In subsequent periods, only changes in student status are printed.

The system is expected to save each teacher up to 40 minutes daily by eliminating the roll book and the cards filled in for absent students. In addition, it produces an average daily attendance summary for each month. In California, this is used as the basis for state funding. "Done manually, these monthly reports take days or even weeks," says Roberts.

The division is one of two in JPL's two-year-old Civil Systems Project Office. The other is the transportation division, formed recently to direct a "people mover"

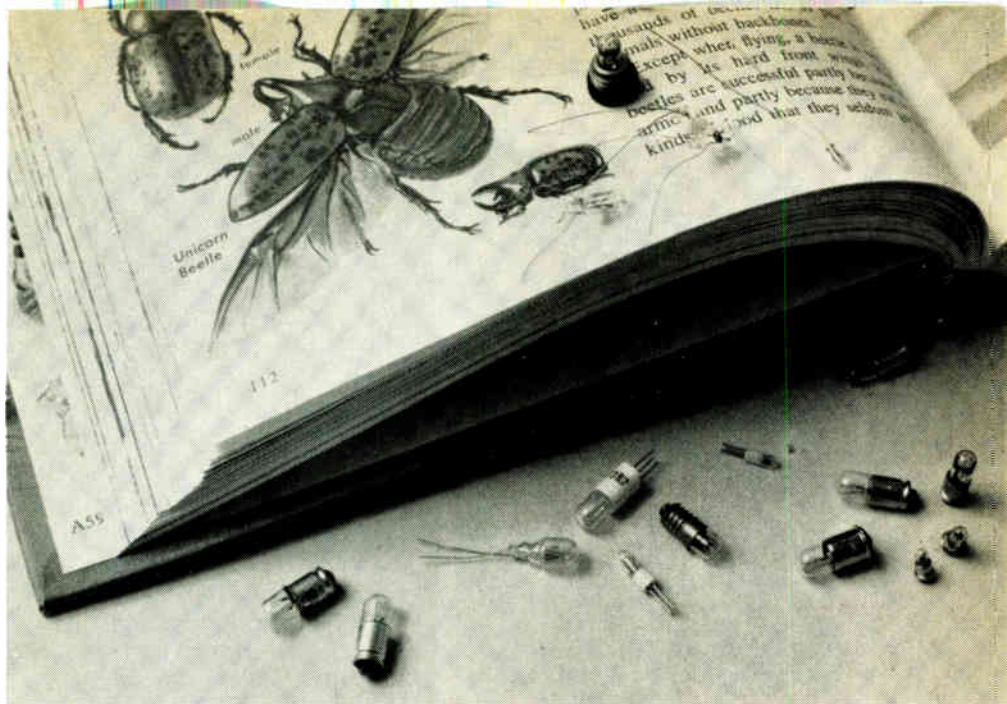

Our sub-miniature lighting-bugs come in all shapes and sizes. In fact, Chicago Miniature offers more species than any other manufacturer. For instance, T-3/4, T-1, T-1 1/4, T-1 1/2 and T-1 3/4 sizes with standard wire terminals, flanged and bi-pin base and a variety of others are ready to ship from stock.

But, variety is only half the story. Important things like selecting the proper glass composition to meet specific requirements, choosing lead wire material for optimum sealability and conductivity, and maintaining a highly efficient vacuum to assure luminous efficiency. These are just a few of the design considerations we take into account.

Also, all T-3/4 and T-1 sub-miniature lighting-bugs are aged for a minimum of 16 hours, then individually measured for candlepower. This aging and selection process was pioneered by Chicago Miniature

and it means, you get a more reliable lamp for your Lighted Switch, Aircraft Panel, Instrument Panel Indicator, or whatever your application.

Write for information on our complete line of sub-miniature lamps.

For application assistance contact your Chicago Miniature Sales Representative.

For off-the-shelf delivery contact your local authorized Chicago Miniature Electronic Distributor.



CHICAGO MINIATURE
LAMP WORKS
4433 N. Ravenswood Ave.,
Chicago, Illinois 60640
(312) 784-1020

a GENERAL INSTRUMENT company

THE LIGHTING BUGS

Our sub-miniature lighting-bugs.

Check list FOR PRECISION MAGNETIC SHIELDS ENCLOSURES



CO-NETIC PRECISION
MAGNETIC SHIELDS
FOR
PHOTOMULTIPLIER
TUBES

Send for
Bulletin PM-2

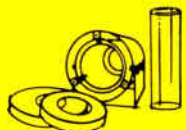

MULTI-CAPABILITY
MAGNETICALLY
SHIELDED
CHAMBER

Send for
Bulletin 196



PERMANENTLY
EFFECTIVE CRT
MAGNETIC SHIELDS

Send for
Bulletin 191

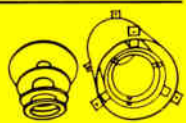

HIGH MAGNETIC
FIELD ENVIRON-
MENTAL SHIELD

Send for
Bulletin 192



MAGNETIC SHIELDS
FOR MODULAR
DEVICES

Send for
Bulletin 193



MULTICELL
MAGNETIC
SHIELDING
ENCLOSURE

Send for
Bulletin 194

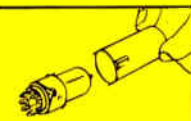

CO-NETIC SHIELDS
FOR MINIATURE
VACUUM TUBES

Send for
Bulletin VT-1

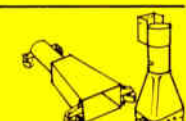

RECTANGULAR
CRT MAGNETIC
SHIELDS

Send for
Bulletin 198

SEND TODAY FOR THE ABOVE
BULLETINS

MAGNETIC SHIELD DIVISION PERFECTION MICA COMPANY

(home office)

740 Thomas Drive
Bensenville, Illinois 60106
(312) 766-7800

(west coast office)

1325 East Esther Street
Long Beach, Calif. 90813
Long Beach (213) 591-5638—39
Los Angeles (213) 775-8079

Electronics review

transit plan funded by the Department of Transportation for the city of Morgantown, W. Va. The office's budget for the year ending June 30 is around \$4.5 million; it has about 120 employees.

In addition to the high-school system and the DOT contract, the office is working on several projects with the National Institutes of Health, the office's first client and still a significant customer, with annual funding of around \$5,000,000. NIH projects include biomedical image processing, chromosome studies, and various medical studies. As an illustration of the transfer of space technology involved, the biomedical image processing is a fallout from JPL's computer enhancement of photographs telemetered for space.

Automated print system could have wide impact

How do you quantify the impact of converting from manual to automated fingerprint identification? The answer is being sought by North American Rockwell Information Systems Co. (Narisco), in Anaheim, Calif. Not only may the FBI's award of an \$80,000 contract to Narisco for the study prove significant to all enforcement agencies, but it may open new markets in consumer credit-verification systems.

Narisco's president, Sidney L. Hasin, says the study will aim at a clear definition of system performance, an analysis of costs, and an evaluation of how to effectively integrate optical scanners, computers, transmission systems, and storage techniques.

Hasin says that the systems study will indicate how many bits are needed to define fingerprint characteristics and how that information on any one print can be electronically differentiated from the information on any other print. He points out that such information could be transmitted by analog techniques, such as facsimile or slow-scan video, or by having fingerprint readers at law enforce-

ment stations across the U. S. that would digitize a print and send that information to the FBI's headquarters, on switched or dedicated telephone lines.

Edward O. Ethell, vice president, business development, North American Rockwell Electronics Group, says his division intends to exploit his company's expertise in rapidly coding, sorting, and matching one set of data against another. And while the first applications of such systems will be for the FBI and police agencies, similar problems exist in the area of credit verification, automated bank accounting and billing, and the identification of persons having access to secure areas.

The FBI's fingerprint file contains about 200 million sets of fingerprints on more than 80 million persons, including a criminal file of nearly 20 million persons, according to Narisco. The company says that "as many as 30,000 inquiries from law enforcement agencies are processed daily against the criminal file alone." The turnaround time at present is said to be three days. This includes recording, classification, name search, fingerprint and record searching, record updating, and response back to the requesting agency.

But last November an experimental fingerprint reading system was developed for the FBI by Cornell Aeronautical Laboratory Inc., Buffalo, N.Y. This equipment optically scans a fingerprint, converts it to an electronic signal, filters, edits, and records the minutiae that make each print unique. The efficiency of this equipment and other possible alternatives to it will be evaluated by Narisco, says Hasin.

Avionics

Moving window key to Navy cockpit display

A moving "window" on the world below is the key to a new type of cockpit display system being designed by the instrumentation

division of the Ampex Corp., Redwood City, Calif. The system is being developed under contracts from the Naval Air Development Center and the Naval Air Systems Command [*Electronics*, April 26, p. 18].

What the Navy wants is a display system that will present the pilot with a map of the area over which his aircraft is centered at any moment in flight. This not only provides a navigation aid, but gives the Navy a means of updating maps.

The system's ground equipment consists of an optical line scanner, a disk recorder, and a video tape recorder. According to Thomas W. Ritchey, senior engineer on the project, optical scanning was preferred to TV because pieced-together TV photos give edge distortion. The scanner moves across an existing map, taking in segments that are 9 by 4 inches.

The scanned segments are transferred to a video disk recorder, which adds video blanking and frame information. In effect, the transfer turns the map into a complete video picture. When the picture of a map section is complete, it is passed along to a video tape recorder—a 2-inch transverse scan machine similar to Ampex's commercial studio units. During this second transfer, address information is added—on the track used in studio operation for tape cuing—so that the section is uniquely identified.

The airborne equipment consists of a cartridge VTR; a four-segment disk recorder; and a 5-inch, 600-line color CRT display being developed by Hughes Aircraft Co. The system is controlled by the onboard navigation computer, which supplies polar coordinates and heading information to an address correlator that has to think in advance—it has to know what map sections the pilot will need some time in the future, find them, and relay them to the disk from the onboard VTR so that they can be transferred to the display at the proper time.

The trickiest part of the system

the Giant Killer strikes again...



New Heath SM-105A

\$350.00*

ASSEMBLED & TESTED

- 10 Hz to over 80 MHz range
 - Advanced design — new Texas Instruments 74S Series superspeed Schottky TTL
 - 5-digit LED readout
 - Wide range input without adjustment
 - 1 megohm input
 - Crystal clock
- *Send for free SM-105A spec sheet... and watch the giants fall!*

SM-105A SPECIFICATIONS — Sensitivity: 100 mV RMS to 50 MHz; 250 mV RMS, 50 MHz to 80 MHz. Frequency Range: 10 Hz to 80 MHz. Input Impedance: 1 Megohm shunted by less than 15 pF. Overload: 50 V RMS from 10 Hz to 40 MHz; from 40 MHz to 80 MHz derate linearly to 2.0 V RMS. Maximum DC input is ± 50 V. Time Base: 1 MHz ± 2 Hz. 0° C to 40° C ambient, ± 10 ppm. Readout: Five 7-segment light-emitting-diode displays. One single light-emitting-diode for overrange. Overrange: Flashing, 40 ms on, 60 ms off. Power Requirements: 120/240 VAC, 12 watts. Dimensions: 9 $\frac{1}{4}$ " D x 6 $\frac{3}{4}$ " W x 2 $\frac{1}{4}$ " H. Net Weight: 3 $\frac{1}{2}$ lbs. Shipping Weight: 6 lbs.

FREE HEATH SCIENTIFIC INSTRUMENTATION CATALOG

Investigate these and other new ideas in Spectroscopy, Digital Instrumentation, Lab Equipment and Test Equipment. Send for your FREE catalog now.

HEATH COMPANY, Dept. 520-28
Benton Harbor, Michigan 49022

HEATH
a Schlumberger company

Please send free Heath Scientific Instrumentation Catalog

Name _____

Address _____

City _____ State _____ Zip _____

*Mail order prices; FOB factory.

Prices & specifications subject to change without notice. EK-296R

Check these two winners before you buy a loser!



Digital Multimeter Model 414 Digital Multimeter Model 330

You can buy DVM's almost anywhere at almost any price, but you'll never get more for your money than what you get with our *low-cost* Model DM 414 or our *very low-cost* Model 330 — and here's why:

The basic DM 414 offers 6 ranges of DC volts, 7 ranges of resistance, and 6 ranges of DC current for as little as \$795. It measures DC volts from $1\mu\text{V}/\text{digit}$ to 1000V., resistance from 1 milli Ω/digit to 10 Meg Ω (4-wire Kelvin), and DC current from 1 nA/digit to 1 A. Eleven additional ranges are also available as options — a total of 30 ranges to measure just about anything that needs to be measured in engineering, production, or laboratory work. Other available options include: AC volts from $10\mu\text{V}/\text{digit}$ to 1000 V. AC current from 1 nA/digit to 1 A., auto-ranging, display storage, BCD output, and rack mounting. All of this in one handsome, compact, unbreakable enclosure that measures only 8½-inches wide and 4½-inches high.

But suppose you are looking for something for a few hundred dollars? Throw away that VTVM catalog. You can have all the advantages of a digital multimeter and still pay less than \$400 for our remarkable Model 330. The DM 330 has full multimeter capability — measuring DC volts, AC volts, DC current and K ohms. It is far superior to the old VTVM's in performance and convenience and it is priced at \$399. The DD 330 provides the same performance except for AC volts and sells for just \$369.

That's why we say, check our low-cost DVM's before you buy. It's easy to pay more, but hard to get more for what you pay. For data sheets, just use the reader service card.

DYNASCIENCES
CORPORATION

9601 CANOGA AVENUE
CHATSWORTH, CALIFORNIA 91311
TELEPHONE: (213) 341-0800
TWX 910-494-1951 • TELEX 67-3382

Electronics review

is in the circuitry that positions a given map segment on the CRT—this is the electronic window control Ampex has developed. The on-board disk holds four map segments: the window picks a portion of the one selected for display and centers it on the CRT. Then, as the craft flies out of the bounds of the segment, the display picks up the next one from the next track on the disk, and a new map segment is recorded in place of the outdated one. The disk can record and play back independently and simultaneously.

The design definition phase of the project is being completed, and Ritchey hopes to be building a test system by this fall.

Space electronics

Lockheed, McDonnell
designing Gbit laser

The Air Force has selected two giant aerospace contracting firms to make a preliminary design of a system to transmit data via laser between satellites at a rate of 1 gigabit per second. The contracts went to McDonnell Douglas and Lockheed, and are for systems that would fly in 1975 [*Electronics*, March 1, p. 17].

While both companies have working systems, neither has met all the specs of the Space and Missiles Systems Organization proposal. Lockheed, however, is closer since Romaine F. Whitmer, manager of the electronic sciences lab at the Lockheed Palo Alto Research Center, says that he has achieved the 1 Gbit-per-second rate with a continuous-wave neodymium YAG laser. McDonnell Douglas is believed to be at 200 megabits per second with a mode-locked system.

Whitmer says that before the weight and power specifications—100 pounds and 140 watts for the transmitter—set by Samsco can be met, improvements have to be made in detector efficiency. "A neodymium YAG laser emits light at 1.06 microns, and detectors at the wavelength are only about 0.1%

WE'LL TAKE 58 TTLs WITH 812 LEADS AND CHANGE IT TO ONE 40 LEAD PACKAGE . . . WITH OUR NEW GENERATION OF MOS/LSI TECHNOLOGY

No matter how low the price of TTL gets to be, you can get the MOS for your money when you convert your present digital boards to **custom MOS/LSI**. With GDC's integrated systems-oriented approach to custom MOS/LSI ranging from logic design through mask fabrication to **volume production**, we can help you reduce costs even for annual requirements as low as a few thousand pieces.

With our **unique CAD** we can **interface** with you to partition your TTL logic, run the **simulation program**, generate and verify test patterns, and execute a mask design layout from our extensive **library of standard MOS logic cells**. Optimum cell placement and interconnect for minimum area is accomplished on a **CRT interactive graphics system** and when the design is complete, you get the hard copy of the plot, and we **automatically digitize** the composite and run our **digital mask-pattern generator**.

A short time later, you receive your pilot quantities of packaged MOS/LSI devices fully tested for your evaluation. Our processes utilize the latest in MOS technology for high performance, yields, and reliability for both the **low threshold silicon gate** and **high threshold p-channel processes**.

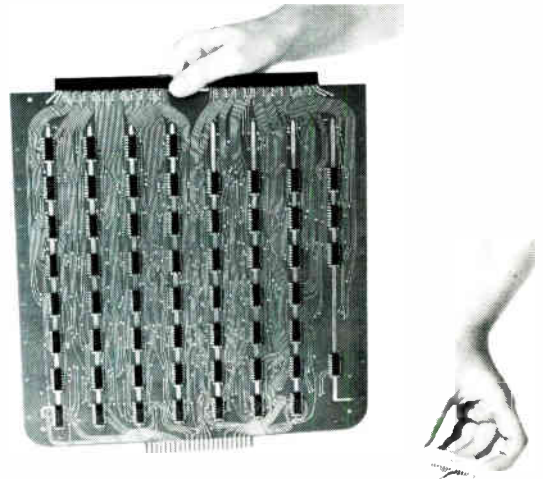

WHY NOT VISIT US AND SEE OUR ENGINEERING AND MANUFACTURING CAPABILITIES FOR YOURSELF. WE'LL PROUDLY SHOW YOU OUR BRAND NEW MULTI-MILLION DOLLAR 35,000 SQUARE FOOT BUILDING IN NEWPORT BEACH. IT'S PROBABLY THE WORLD'S FINEST FACILITY FOR THE PRODUCTION OF MOS/LSI WITH ENOUGH DIFFUSION TUBES AND EQUIPMENT CAPACITY TO TURN OUT A HALF-MILLION CHIPS PER MONTH. COME AND SEE WHY WE EXPECT TO BECOME ONE OF THE INDUSTRY LEADERS IN CUSTOM MOS/LSI. IF YOU CALL OR WRITE, WE'LL BE GLAD TO SEND YOU OUR LITERATURE.

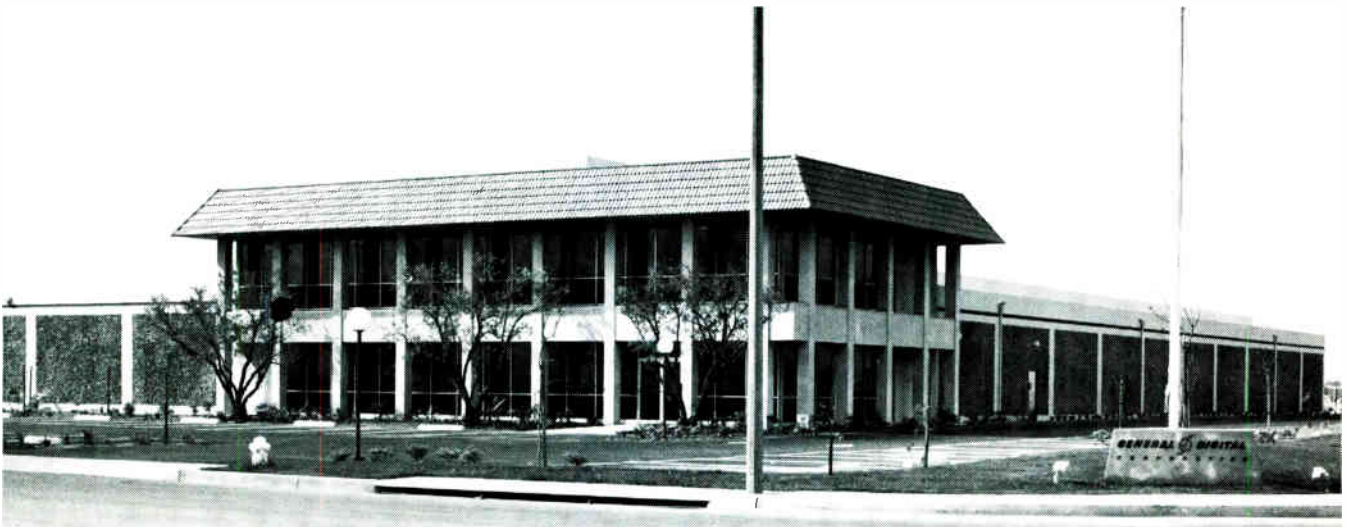

GENERAL DIGITAL

C O R P O R A T I O N

19242 RED HILL AVENUE • P.O. BOX 2180 • NEWPORT BEACH, CALIFORNIA 92663 • (714) 557-3550

INDUSTRIAL CATALOG
Area Development Dept.
NORTHERN NATURAL GAS COMPANY
2223 Dodge Street
Omaha, Nebraska 68102



Sir: Please send Sources of Supply information on:

NAME _____ TITLE _____

COMPANY _____

ADDRESS _____

CITY _____ STATE _____ ZIP _____

Sam Hawkins will track down anything you want for \$100 an hour.

He's a private eye. And sometimes it takes him days to get a solid lead. But you don't have days to find that gizmo, ratchet or cog you need for that special creation of yours. And you certainly don't want to spend \$100 an hour. So forget about hiring a private eye. Ask us. We may be able to find what you need fast. **And it won't cost you a penny.**

Our Northern Plains* Industrial Catalog service can locate whatever it is you need to make whatever it is you've designed work. It tells you things like who makes it, and where to find it. If you'd like to find whatever it is you haven't been able to find, just describe it. Before you know it we'll track it down, from an exotic manufactured part, to a sophisticated sub-assembly.

*Iowa, Kansas, Minnesota, Nebraska, South Dakota, Upper Michigan and Wisconsin.

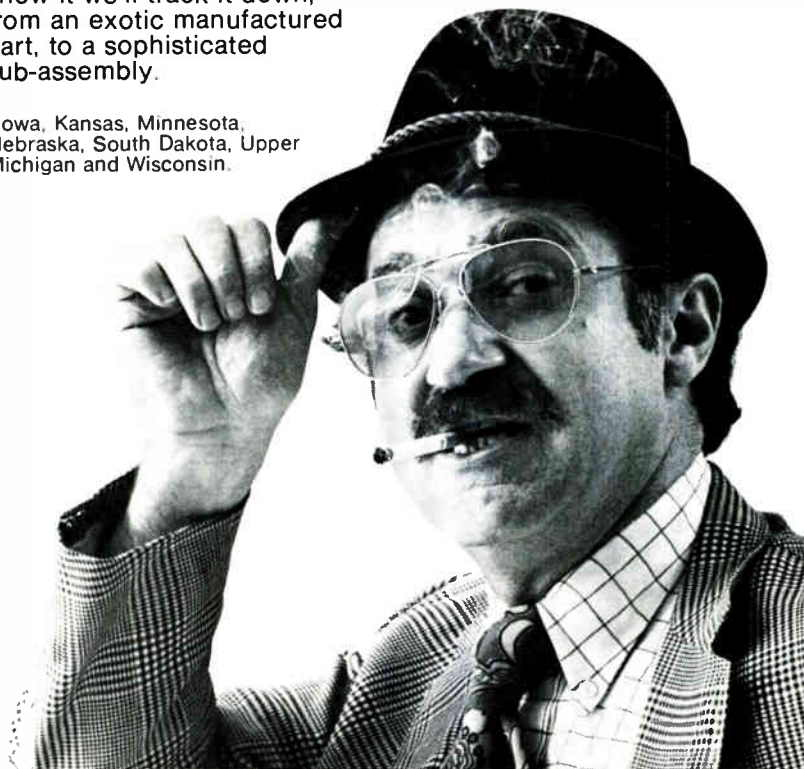

Electronics review

efficient," he says. One alternative is to double the laser frequency to 0.53 microns because at that wavelength the detectors are 30% efficient, but since the doubler is only 10% efficient, the net gain is not very high. "And besides, the doubler adds to system complexity and weight, and we have to weigh in at 100 pounds," says Whitmer. The other alternative is to develop new detectors with 5% efficiency.

For the record

IC beam. The Air Force is interested in generating IC masks by having a computer-controlled electron beam "write" them—interested enough to award a \$449,000 contract to Radiant Energy Systems Inc., Newbury Park, Calif. The 27-month contract from the Aeronautical Systems division at Wright-Patterson Air Force Base calls for the subsidiary of Hugel Industries Inc. to build and evaluate such a system.

Viatron loses. The embattled Viatron Computer Systems Corp. has lost its battle to file for Chapter 11 bankruptcy. Instead, the U.S. District Court has upheld the Securities and Exchange Commission's petition to force the company into a Chapter 10 proceeding, under which a court-appointed trustee can dig more deeply into a company.

Missed. Roy Pollack's departure from RCA as manager of IC operations left an emotional hole but not an operational one, says William C. Hittinger, vice president and general manager of RCA's Solid State division. Highly regarded technically in his 20-plus years at RCA, Pollack has moved to the West Coast as vice president and group director for MOS operations at Fairchild Semiconductor. Fairchild had been trying to lure Pollack away for almost two years.

Moving up to replace him is a 22-year RCA veteran, Barnard V. Vonderschmitt, who has been in the semiconductor operation at Somerville, N.J., since 1957.



Family portrait.

Take a good look at one of America's first families—the Mallory family of aluminum electrolytic capacitors. And you'll see quality, experience and dependability.

THE FP. "Pop" has been around quite awhile and is still going strong. It's got a twist mount, solder lug terminals, -30 to $+85^{\circ}\text{C}$ temperature range, 80 to 60,000 mfd capacitances and voltages from 3 to 475 VDC.

THE TC. "Mom's" got temperature ranges of -40 to $+85^{\circ}\text{C}$, -30 to $+85^{\circ}\text{C}$ and -20 to $+65^{\circ}\text{C}$; capacitances of 5 to 3,000 mfd; and voltages from 50 to 500 VDC.

THE TCW has axial leads and all-welded construction. It operates from -40 to $+85^{\circ}\text{C}$, in capacitances from 2 to 20,000 mfd and voltages from 3 to 450 VDC.

THE TT is a miniature axial lead capacitor with beautiful performance from -40 to $+85^{\circ}\text{C}$. The TT goes from 1 to 4600 mfd, in voltages from 3 to 150 VDC.

THE MTA has axial leads and all-welded construction—in a good-looking molded plastic case. It operates in a range from -30 to $+85^{\circ}\text{C}$, with 3 to 4500 mfd capacitances and voltages from 3 to 100 VDC.

THE MTV is the latest addition to our aluminum electrolytic, molded-plastic-case family. It's all-welded, with a single-ended vertical mount. And has an operating range of -30 to $+85^{\circ}\text{C}$, capacitances from 5 to 1400 mfd and voltages from 3 to 100 VDC.

Take the time to meet a great family. Write for our Family Portrait Bulletin. Or see your authorized Mallory distributor.



MALLORY CAPACITOR COMPANY

a division of P. R. MALLORY & CO. INC.
3029 E. Washington St., Indianapolis, Indiana 46206; Telephone: 317-636-5353

Electrical and electronic components • sequence timers • metallurgical products • batteries

**The new PDP-16.
Some people think
it's a computerized
machine controller.**

It is.

**Some people think
it's a special-purpose
computer or maybe
some kind of a pre-
processor.**

They're right, too.

**And some people
think it's a design
breakthrough that
will revolutionize the
computer industry.**

**They're the right-
est people of all.**

The PDP-16 is the first functional computer. Each configuration is specially designed to fit the user's application. You get just enough computer to do what you want done.

How do we know what you want done?

You tell us.

You explain, in English, exactly what you want the PDP-16 to do. Then we put the information into our big PDP-10, and our specially-developed Chartware program goes to work. Chartware and the PDP-10 design your special PDP-16. They figure everything out, up to and including the wire wrap program and the cost per unit for whatever quantity you want. Then we assemble the PDP-16, test it to make sure it does what you want it to do, and there you are. A functional computer. At a very reasonable price.

So how come nobody ever did that before?

Because, until now, it was cheaper to buy a general-purpose computer than to design a special-purpose one. But now there's the PDP-16. Thanks to Chartware and the PDP-10, the PDP-16 offers the engineer a tremendous saving in design time and virtually eliminates debugging.

But what about specifications?

The word length of a PDP-16 is the word length you need: 8-bit, 12-bit, 16-bit.

The memory of a PDP-16 is the memory you need: up to 1K of hard-wired read-only memory, 16 or 256 words of scratch pad memory. If you don't need any memory, you won't get any.

The program capabilities of the PDP-16 are the programs you need, up to 150 program steps.

The specifications of a PDP-16 are the specifications of the job you want done.

That's the real breakthrough. With the PDP-16, you no longer have to fit the problem to the computer. You can finally design a computer to fit your problem.

What's the catch?

The catch is, you have to order ten or more. In OEM quantities, the PDP-16 will control your instrument, machine, or process for considerably less cost per unit than a stripped-down mini.

And what's the price?

Generally speaking, a PDP-16 will cost between \$800 and \$3000, depending on the configuration and on the number of PDP-16's ordered. If you tell us your application, we can tell you exactly how much the PDP-16 will cost in the quantity you want to order.

So write. We can tell you a lot more.

Digital Equipment Corporation, Main St., Maynard, Mass. 01754, (617) 897-5111

digital

The Magn

HP's got a great new idea in counters: buy one that just fits your specific application — without paying for extras you'll never use. Yet make your choice from a family of six counters with a wide range of unique features, at prices so low you'll wonder how we did it.

You'll get all the things you expect from our 5326 and 5327 family of counters: totalizing, frequency, ratio, period and time interval measurements, in a range of 50 MHz or 550 MHz.

In addition, they let you perform tasks no counters could handle before.

For instance, you can now do IC logic timing testing simply and economically with 15 picosecond resolution. HP's unique time interval averaging mode makes it possible! (Request HP Application Note 129 for the story.) Price is just \$1195 for a 50 MHz unit and \$1795 for the 550 MHz model with this powerful time interval capability.



ificent Six.

For just \$355 more you can get a counter with a DVM built in. So you can do things like measure rise times more rapidly, simply and accurately than with a scope. And you can check external dc voltages with it, too. Add a \$60 HP 11096A Probe if you need rf voltage measurements.

Want programming capability? Our options will permit remote control of all front panel functions, including trigger levels and attenuators.

Computer interface is easy and costs less than ever.

Suppose you just want the basics? Our frill-free models will supply them with trouble-free, simple operation. They'll cost you \$950 for 50 MHz, \$1495 for 550 MHz.

Your HP field engineer has the 5326/27 data sheet that tells the complete story about these precise new counters. Or write to Hewlett-Packard, Palo Alto, California 94304; Europe: 1217 Meyrin-Geneva, Switzerland.

00102



HEWLETT  PACKARD

Counters that promise a lot and deliver it all.

Circle 55 on reader service card

Drive FET analog switches from DTL without interface drivers?

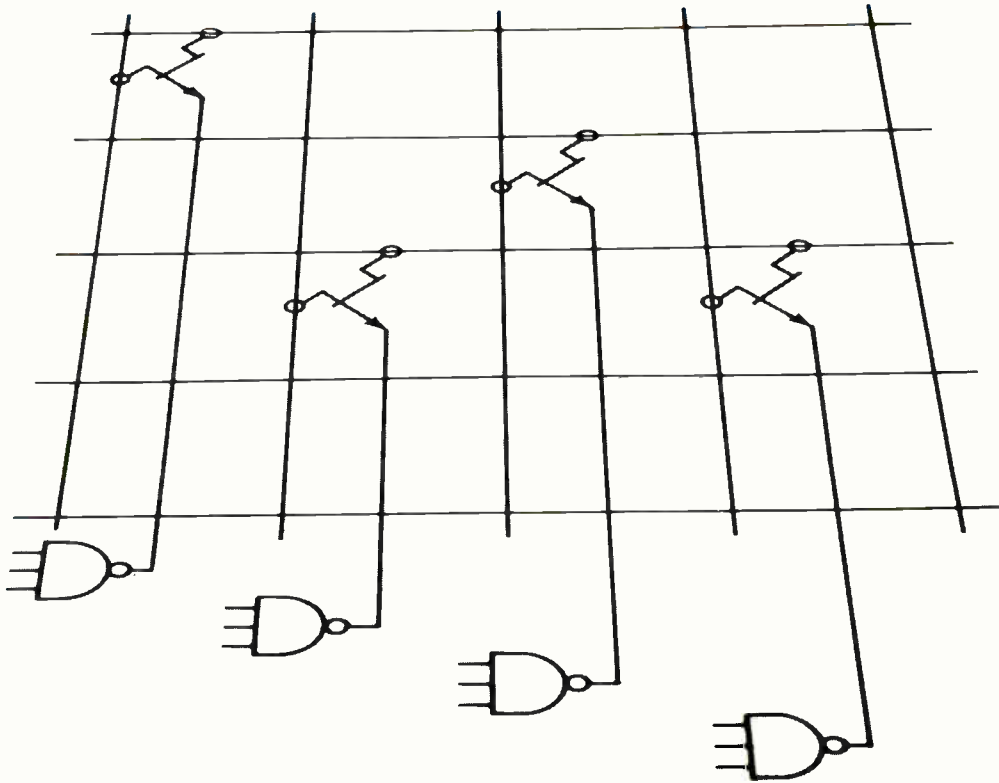

Sure.

Where low cost is a prime requirement, such as in an audio crossbar system or other small digital multi-point switching system, control the Siliconix U306 directly from DTL logic.

Think of it. No interface drivers between analog switches and low level logic in many applications. This is just one example of how Siliconix products and applications know-how can save you money.

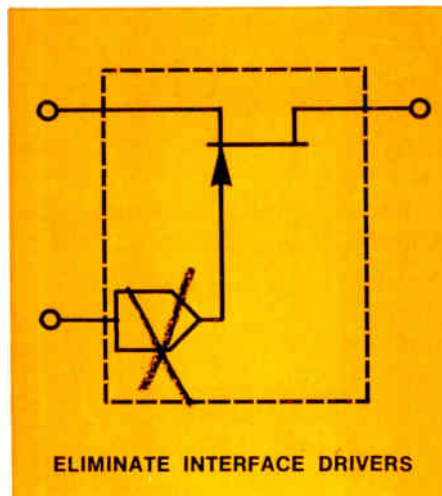

Siliconix has an entire line of switching FETs (p-channel, n-channel, JFET, PMOS, CMOS) plus drivers (where needed) and integrated driver-switches that give you the advantage of low cost, high quality and reliability.

Find out what Siliconix can offer you. A 2Ω FET with an OFF leakage of 200pA maybe? Call your Siliconix representative for more information on our broad line of MIL-spec metal hermetic can or low-cost epoxy switching FETs.

You'll be glad you did.



Siliconix incorporated

2201 Laurelwood Road • Santa Clara • Calif. 95054
Phone (408) 246-8000 Ext. 201 • TWX: 910-338-0227

New York: Sy Levine (516) 796-4680 New England: Al La Croix (617) 769-3780 St. Louis: Jim Spicer (314) 291-3616 Minneapolis: Ed Koelfgen (612) 920-4483 Southern California: Dave Ferran (213) 420-1307 Northern California: Chuck Brush (408) 246-8000 In Europe: Siliconix Limited, Saunders Way, Sketty, Swansea, Great Britain. Siliconix GmbH, 7024 Bernhausen, Postfach 1340, W. Germany. Siliconix 9, Ave d'Arromanches, 94-Saint-Maur, France.

Washington Newsletter

May 10, 1971

NASA aims at optical computer for spacecraft

A highly parallel optical computer, capable of processing entire images at a time, could be in space before the end of the decade if work at NASA's Goddard Space Flight Center continues at its present pace. Goal of the early experimental work is to program a spacecraft to look for and identify specific targets and transmit the images to earth, rather than sending back continuous, undigested masses of photos as picture-taking satellites now do.

By translating images into Fourier transforms, the development, dubbed the Opdic computer, would permit onboard screening of images. An onboard digital computer could be programmed to look for specific target signatures by scanning the two axes of the Opdic's output plane or to spot which changes in the images being received are large enough to warrant transmission back to earth. The Fourier transforms would reach earth in less time or bandwidth than the output of a TV scanning system needs. A miniature gallium arsenide laser is being developed for the system, but presently a helium-neon laser is being used in bench tests with film.

Westinghouse is now developing photon sensors that will translate the Opdic's output plane from an optical to an electrical signal, and Conductron recently delivered an electro-optical interface unit that will permit TV signals to be processed by the system. Proposals are now due from industry on two other components for Opdic: an optical-to-optical interface and a set of optical filters.

Bank study endorses nationwide charge card networks

The "cashless society"—and with it a large market for electronics hardware—has moved closer as the result of recommendations by the influential American Bankers Association. In its study, which took two and a half years and cost \$500,000, ABA's monetary and payments system committee says the authorization networks now being set up by separate bank charge card plans should be linked to provide a nationwide facility. An eventual byproduct of this process, automatic entry of the transaction, would ultimately turn such links into point-of-sale terminals.

The panel is also telling ABA members that it would be a "costly mistake" not to develop a paperless or electronic method for clearing and distributing payments among banks, to keep up with the increasing number of checks—a total expected to double between now and 1980 to 43 billion annually. The first step would be to establish electronic, automated clearing facilities at the local level. Next, the local facilities would have to be connected on a regional basis, and finally they would be linked through a nationwide network.

Minicomputer to interface FBI files, local police . . .

The FBI is expected shortly to issue a request for proposals from industry for a message-switching minicomputer to go online on Nov. 1, when the bureau's National Criminal Information Center is scheduled to absorb the massive criminal-history files from the Law Enforcement Assistance Administration's Project Search.

The minicomputer will be plugged in to the front end of the FBI's pair of new IBM model 360/65 machines. It will handle the 60,000 daily transactions between NCIC and the 100-plus state and local law enforcement agencies, 37 of which presently are computer-to-computer links.

Washington Newsletter

The minicomputer will be the first of several message-switching units that FBI sources say will become necessary as five to six million more criminal-history files are added to NCIC over the next three to five years.

**... while LEAA
looks to link files
and patrol cars**

Experiments which also would make the NCIC files partially accessible to the officer "on the beat" are being funded by LEAA, through block grants to state and local law enforcement agencies. One of the more advanced efforts is going on in Kansas City, whose police department is talking with three firms, including IBM and GTE Sylvania Inc., for an in-the-car total inquiry and response system. As part of that city's automated law enforcement response team, the units would query the Kansas City data base, which would automatically route any inquiries it couldn't answer to NCIC. IBM would supply an as yet unannounced teleprinter unit, and Sylvania would probably modify its digicom 300 system, a CRT communications system, which, along with a semiautomated vehicle location system, is scheduled for October delivery to Oakland, Calif., under a \$254,000 contract.

No matter how automated the patrol car becomes, an officer on the beat will have access to NCIC data only "to support probable cause and to protect himself," says an FBI official. This means that only three of the eight NCIC files are being opened to patrolmen.

**Engineers will seek
representation
on NAS board**

The National Academy of Engineering has delayed, at least for a year, any move to break off from its parent organization, the National Academy of Sciences. But some NAE members still say a break is inevitable. What the NAE is trying to do now is gain three seats on the NAS nine-man board of governors, which is currently made up entirely of Academy of Science members, and which sets the budgets and policies of NAS's operating arm, the National Research Council.

NAE members feel that many of the issues studied by the National Research Council are oriented to science rather than engineering, and that, due partly to their lack of representation in the NAS board, engineers haven't been able to get the council to approve work they feel should be done. Bitter words have been exchanged by both academies over the past year, and they are expected to get bitterer still between now and next April, when members meet to vote on revising the makeup of the board.

**New school to train
better managers
of Pentagon R&D**

David Packard's pet project for getting better people in charge of Pentagon R&D programs is off and running in high gear. Applications far exceeded the 65 openings for the first class of the new Defense Systems Management School at Fort Belvoir, Va. The five-month training program will begin in August, with graduates moving into major systems projects early next year.

Deputy Defense Secretary Packard wants the school to have equal status with the National War College and the Industrial College of the Armed Forces, and to attract bright, professionally qualified officers at the colonel and commander level, who will aim their military careers toward the management of major R&D efforts. He insisted on a location near the Capitol to keep the students and instructors close to the pressures surrounding top-level Pentagon managers.

For basic industrial connectors



think of us as your hardware store.

Plugs, sockets, connectors, hardware and accessories—for relays, tubes, cable connections, sound systems or whatever—a whole raft of things you'd never expect from us. They've been in our industrial product line for many years. In fact, it's the broadest line available anywhere. So next time you need something

in basic black, think of us as your connector hardware store. Drop us a line and we'll send you our latest 32-page II-1 Catalog along with the name of your closest Amphenol distributor. Write to Amphenol Industrial Division, The Bunker-Ramo Corporation, 1830 South 54th Avenue, Chicago, Illinois 60650.



AMPHENOL

DO YOU FACE A MAKE OR BUY DECISION ON POWER SUPPLIES?

If you build,
send for this
brochure.

If you buy,
send for this
catalog.

12 MARCH 1971 CATALOG SUPPLEMENT

**LAMBDA
POWER HYBRID
VOLTAGE REGULATORS**
The world's first... 22 models... 5 volt 5 amp model
@ \$20 in quantities of 100

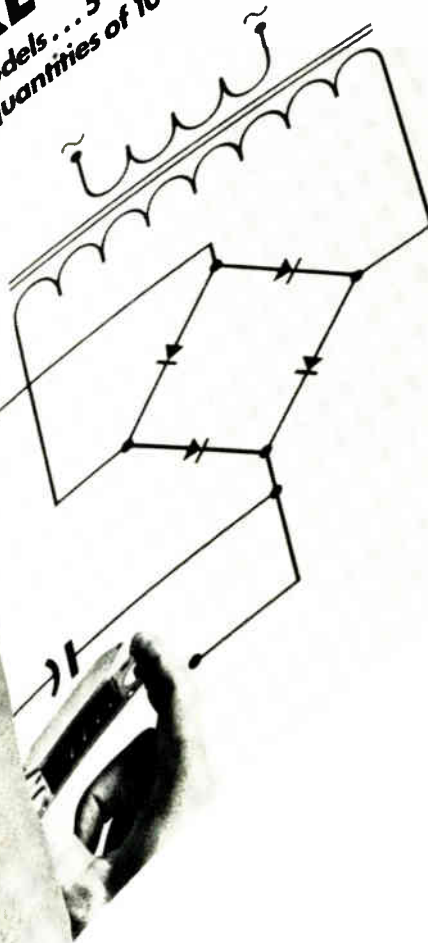

Whatever your decision, you can benefit from a revolutionary new Lambda development—The Power Hybrid Voltage Regulator. If you buy, Lambda offers you the industry's largest line of power packages, including many models that incorporate The Power Hybrid Voltage Regulator. If you build, it's available as a component. It will save you money at every step from design through production and field service and give you all these performance features:

- Up to 5 amps DC output
 - Up to 28 volts DC output
 - Up to 85 watts dissipation
 - 0.2% regulation, line or load
 - .007%/C° temperature coefficient
 - Short circuit and overload protection
 - Thermal protection
 - Remote programming
 - Remote sensing
 - Increased power handling capability with external regulation transistor
 - Increased current output when used as a driver for series regulation transistors
- Write today for this brochure... or this catalog... or both.

**LAMBDA
ELECTRONICS CORP.**

A Veeco Company

515 Broad Hollow Road, Melville, L.I., New York 11746. Telephone: 516-694-4200. TWX: 510-224-6484. CABLE: LAMBDATRON, MELVILLE, N.Y.

There are two ways to get away from real-time control problems. Ignore them. Or get a Honeywell 1600.

Let Honeywell take a load off your mind. When it comes to real-time data acquisition and control, we have more to offer than anyone. And our Series 1600 systems start as low as \$12,900 — complete with computer, interface, and operating software.

There is a variety of field-proven systems, peripherals, and communications sub-

systems (which tie together a hierarchy of 1600's). There are plenty of analog and digital subsystems, too, that handle up to 2,048 analog inputs and 4,096 digital inputs and outputs.

There is a powerful foreground/background monitor. A real-time executive. And functional software packages for data

acquisition and DDC.

There are attractive quantity discounts plus world-wide sales and continuing field support that you know you can count on.

Find out why Honeywell is your best way to get away from real-time and control problems. Write: Honeywell Information Systems, MS(061), 200 Smith Street, Waltham, Mass. 02154.



The Other Computer Company:

Honeywell



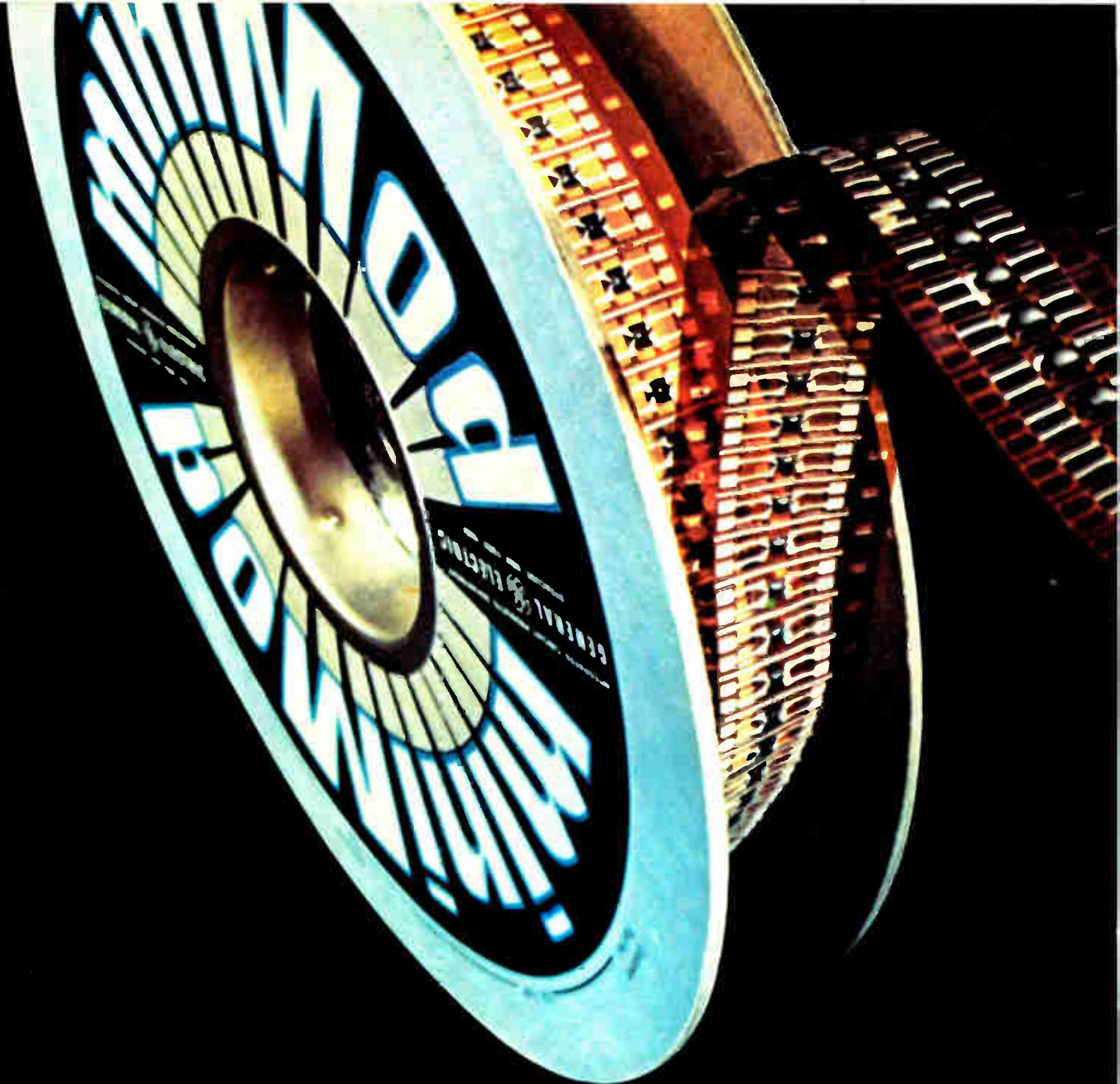

General Electric's new



Tomorrow's IC package today

Dramatic new
interconnection technique
means smaller,
more reliable IC's

Some time ago, General Electric research scientists came up with two great ideas for integrated circuit manufacturing. These ideas looked so good to us that we set about turning them into practical devices that you could use. And now, we've put these ideas into production.

The first idea is called multibond™. It's an exciting interconnection technique in which all bonds to the chip are made at once by reflow soldering. No individually-bonded wires; no lead frames; no thermo-compression. It results in a network of external lead connections that is both stronger and more reliable than that formed by individually-attached leads.

And it made possible our second idea. That's miniMod™—our new

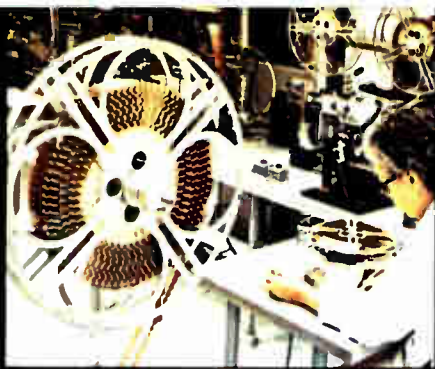

packaging concept for integrated circuits. Inside the miniMod package, the IC chip and its metallized lead pattern are supported on a strip of 35 mm polyimide film. Chip, leads and film are then encapsulated to form a tiny, rugged integrated circuit that is available individually or on reels. That's right—reel-to-reel IC's for the high-volume user.

General Electric's miniMod package offers a new dimension in the mechanization of IC installation and use. They can be tested quickly—right on the strip and can be molded or hermetically sealed into DIP, hybrid or other package configurations. For the low volume user, miniMod provides a very small IC package of high quality and reliability that permits simple, standard assembly techniques.

To turn our developments into reality, we've now introduced two new integrated circuits in the miniMod package. The industry-familiar 741 op amp has become the GEL1741 featuring high gain amplification and short circuit protection. And our GEL1494 Accu-Switch™ is a regenerative threshold detector with controlled hysteresis. It's great as a Schmitt trigger while offering

greater stability. These are just the first two products in our new miniMod package. There are many more on the way.

The photos above show operation of a miniMod IC mounting system developed for low-volume PC board or hybrid use, a typical miniMod hybrid application and typical high-volume handling equipment. In addition, we've worked with several manufacturers of production equipment, and they're now ready to discuss specific production needs with you.

For more information about GE's new miniMod IC's or how to use them, write General Electric Company, Integrated Circuit Products Department, Section 770-01, P.O. Box 131, Liverpool, New York 13088.

GENERAL  ELECTRIC

Circle 63 on reader service card

NOW

...two 128 bit bipolar RAMs,
one ECL compatible,
the other TTL, operating
at 15 and 20 nanoseconds

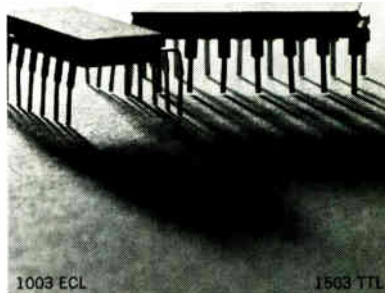

from AMS.

AMS, first to announce 10 nanosecond 16 and 64 bit RAMs now introduces the 1003 and 1503. Organized 128 x 1 and packaged in 16 pin DIPs, these high performance devices operate at only 3 milliwatts per bit. And they are available off-the-shelf at all of the AMS distributors listed below.

For the fastest 128 bit memories available, specify the AMS 1003 or 1503. Call your local AMS representative or write for complete information.

Other AMS bipolar products include: 16 and 64 bit devices; 32 x 8/9, 128 x 8/9, 512 x 8/9 and 4K x 1 Modular Memory Cards.

Advanced Memory Systems, 1276 Hammerwood Avenue, Sunnyvale, Ca 94086 (408) 734-4330

AMSTM

Powell/Philadelphia
S. Island Road/Box 8765
Philadelphia, Pa. 19101
(215) 724-1900

Powell/Washington
10728 Hanna Street
Beltsville, Md. 20705
(301) 474-1030

Powell/Huntsville
Box 488, Fayetteville
Tenn. 37334
(615) 433-5737

Powell/Florida
2049 W. Central Blvd.
Orlando, Fla. 32814
(305) 423-8586

Powell/California
411 Fairchild Dr./Box 997
Mountain View, Ca. 94040
(415) 964-0820

Powell/California
7423 Van Nuys Blvd.
Van Nuys, Ca. 91409
(213) 988-3330

Apollo Electronics, Inc.
101 Binney Street
Cambridge, Mass. 02115
(617) 868-3120

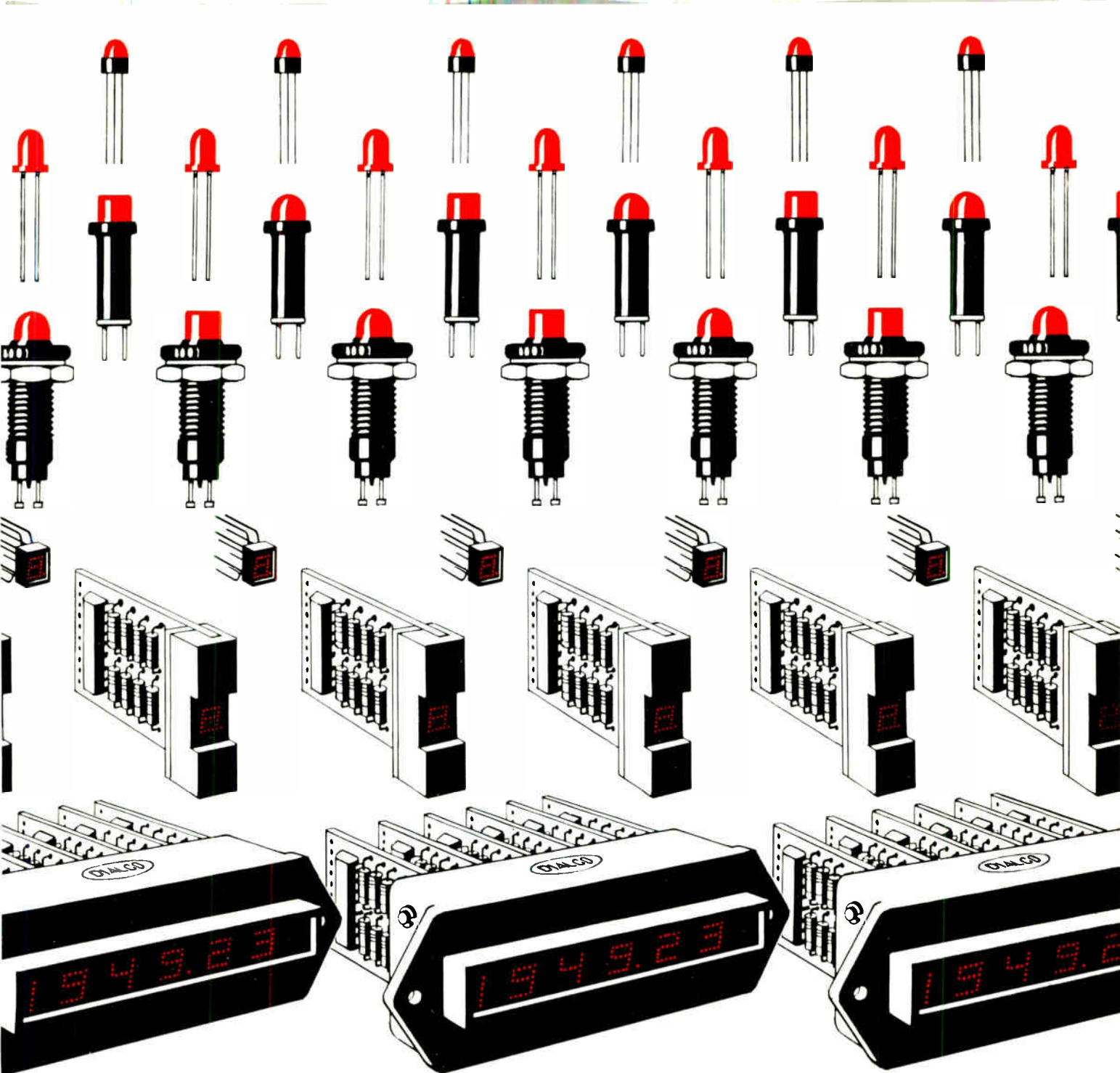

Dialight announces **DIODE-LITE™** the industry's broadest line of LED light sources, indicator lights and readouts.

Here is every component or package you might need to capitalize on the long life and reliability of LEDs: DIODE-LITE light sources . . . indicator lights utilizing DIODE-LITES in cartridges and complete assemblies . . . illuminated pushbutton switches . . . readout modules in .125", .205" and .600" character heights . . . these modules incorporated in readout packages complete with decoder/drivers . . . and finally, display assemblies of 2 to 10 read-

out packages mounted in a bezel frame with window. All are attractively priced. All are available off-the-shelf from Dialight or through selected distributors.

No one else offers you one-stop shopping in LED visual display. And no one has more experience in the visual display field. That's important too. Write today for our Data File on DIODE-LITES and compare it with anybody else's.

DIALIGHT

DIALIGHT CORPORATION, A NORTH AMERICAN PHILIPS COMPANY • 60 STEWART AVENUE, BROOKLYN, N.Y. 11237 • (212) 497-7600

Circle 65 on reader service card

The Allen-Bradley cermet corps: versatile standard packages containing R/C circuitry designed to your needs.

The need: compact R/C networks in DIP's for terminator applications in new generation computer designs. To meet the circuit board space crunch, Allen-Bradley combines resistors and capacitors in a package compatible with automatic insertion equipment. These cermet networks save space and attachment costs. Packaged in dual in-line molded packs that lock out the environment and

match your IC's. Lead frames with built-in stand-offs are weldable or solderable. Volume production available.

SELECTED SPECIFICATIONS

TOLERANCES	Absolute to $\pm .5\%$
TRACKING	Excellent
RESISTANCE RANGE	10 ohms to 10 megs, standard; 1 ohm to 100 megs, special
CAPACITANCE RANGE	To 60,000 pF per cm ²
TCR	As low as ± 100 ppm/ $^{\circ}$ C
CALIBRATION	Abrasive or laser
LEAD SPACING	100 mil standard

Investigate the advantages of Allen-Bradley cermet R/C networks. For information write: Marketing Department, Electronics Division, Allen-Bradley Co., 1201 South Second Street, Milwaukee, Wisconsin 53204. Export office: 1293 Broad St., Bloomfield, N. J. 07003 U.S.A. In Canada: Allen-Bradley Canada Ltd., 135 Dundas Street, Galt, Ontario.

Actual Size

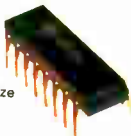

EC71-4 © Allen-Bradley 1971

NEW DIMENSION ELECTRONICS
ALLEN-BRADLEY



Circle 66 on reader service card

Technical articles

Special report on the challenge of MOS/LSI testing: page 68 (cover)

The tie that binds test gear manufacturers and MOS/LSI vendors is the need to produce reliable, economical MOS. But they didn't always follow the same path to that end. Now both sides are starting to agree that universal test systems are unrealistic. Instead the trend is toward building more specialized equipment that tests special devices, says author Lawrence Curran.

Computer-aided design unravels pc board wiring: page 76

If you've encountered headaches in designing and laying out tightly packed printed circuit boards, asserts author Robert Campagna, you'll be pleased to know that an analgesic is available. It's a set of computer programs that can locate holes in boards, thread connections, and decide optimal routes, effecting considerable cost and time savings.

Hands off! Let your voice control a computer: page 84

Everybody's talking about computers, and soon they'll be talking to them, too, say authors James W. Glenn and Myron H. Hitchcock. One step in that direction is a voice pattern classifier that analyzes speech to produce and process a digital code for computer command. Though limited now, it could form the basis for aircraft control and computer-aided education systems.

Read-only memory is electrically programmable: page 91

Thanks to a special storage element, a semiconductor read-only memory can be programmed (and reprogrammed) by electrical signals, rather than by a fixed mask at fabrication. Called Famos (for floating avalanche-injection MOS), the technology yields other benefits, too, says author Dov Frohman-Bentchkowsky: a 2,048-bit chip in production now is fully decoded, is TTL compatible, and can be operated in the static and dynamic decoding and sensing modes.

Looking for a stable reference signal? Try your color TV: page 96

The major television networks bring you more than Westerns and situation comedies: they also broadcast a high-resolution, 3.58-megahertz color subcarrier signal. It can be taken right from a color TV receiver, says author D.D. Davis, and used as a reference for calibrating other signal sources.

And in the next issue . . .

Special report on displays . . . what's going on in Japanese computers . . . receiver control by computer . . . designing an active RC bandpass filter the easy way . . . solid state sensor for low-light level detection.

Meeting the MOS/LSI challenge: a special report on testers

Test gear makers and MOS/LSI vendors are starting to resolve differences and are developing a consensus that universal systems are impractical; trend is to specialized equipment for specific devices

by Lawrence Curran, *Los Angeles bureau manager*

□ Despite the differences that often divide MOS/LSI tester manufacturers and array vendors, the two groups have a common goal: insuring that the devices leaving the assembly line really work. They have long been split on how to achieve that goal economically. However, considerable evidence is emerging that the two sides are starting to think along the same lines at last.

For one thing, a consensus of LSI tester makers and vendors indicates that it's impractical to aim for universal testers that try to accommodate all arrays. Instead, many companies on both sides are making a clear delineation between the different testing needs of logic arrays and memory devices, and between diagnostic and production testing. And LSI vendors are starting to get a firmer grip on just what capabilities they want in their testers, with some even calling for the standardization of certain basic tester components and test parameters.

But perhaps the most important common ground between tester manufacturers and semiconductor makers is that resolution of the test system dilemma is essential to the development of the MOS industry. "Selling untested devices," asserts William Mow, president of Macrodata Co., a Chatsworth, Calif., test system firm, "throws the test burden on the systems manufacturer. The end result of this is increased failures in end products, reduced performance of the system, and general disillusionment by the end user with the MOS industry as a whole."

Common ground isn't always easy to find in this highly competitive, highly volatile milieu. Tester makers must anticipate rapid technological advancement to produce systems that will be ready to exercise the newest arrays. They must decide whether to build around one vendor's needs or develop a general-purpose line. And they must choose between building a universal test machine or going to specialized gear. The LSI vendors, facing tremendous volume demands for economical arrays that really work, know that the critical decision on which tester to buy, or whether to build one in house (Fig. 1), represents a substantial capital outlay in itself and could make the difference between profit and loss in a particular line. Their test gear must do the job.

This sort of pressure has led to strong denunciations on both sides—with the tester makers accusing

the vendors of either not knowing what they want or of wanting too much, and the vendors replying that testers are too expensive and technologically far behind their devices [*Electronics*, Feb. 1, p. 62, March 1, p. 65]. In fact, the only thing both groups seemed to agree upon was that, given the largely custom nature of the MOS/LSI business, standardization of test equipment and test procedures would be impossible to attain.

One factor that's helping to clear the air is a better grasp of the direction the MOS market is taking. There's a growing feeling that memories will dominate the MOS market, and that specialized testers should be developed to concentrate on them. And since memories must be put through a variety of data patterns at frequencies now settling at about 5 megahertz, the emphasis is on getting speed out of the tester's pattern-generating memory. This, in turn, has triggered a trend away from having an on-line computer in the test system—its core memory can't generate data patterns fast enough to provide satisfactory throughput.

But in addition to changing equipment architecture, MOS memory testing also may greatly alter price structures. Already, Macrodata has knocked the pins from under the \$50,000 price floor typical for other memory testers by introducing its MD-100 (Fig. 2), an incoming inspection machine that sells for less than \$15,000 [*Electronics*, April 12, p. 127].

One Macrodata official, a little tired of the acceptance hassle he almost always faces when the MD-200 general-purpose tester is delivered to customers, is delighted to have a tool that allows him to ignore the "Gee, wouldn't it be nice if . . ." penchant of semiconductor manufacturers who always seem to want more than is designed into a tester. He has to listen to the device manufacturers who may want to buy the much larger and more versatile MD-200, which carries a price tag up to \$250,000 and is intended to do complex device characterization testing. But the MD-100 has only one-third the components of the 200 and no general-purpose minicomputer. It's intended for incoming inspection—go/no-go functional testing—of MOS or bipolar memory arrays at up to 5 MHz. Macrodata also uses the 100 internally; in fact it helped out its big brother by catching and rejecting 20% of the 64-bit bipolar RAMs that had been causing

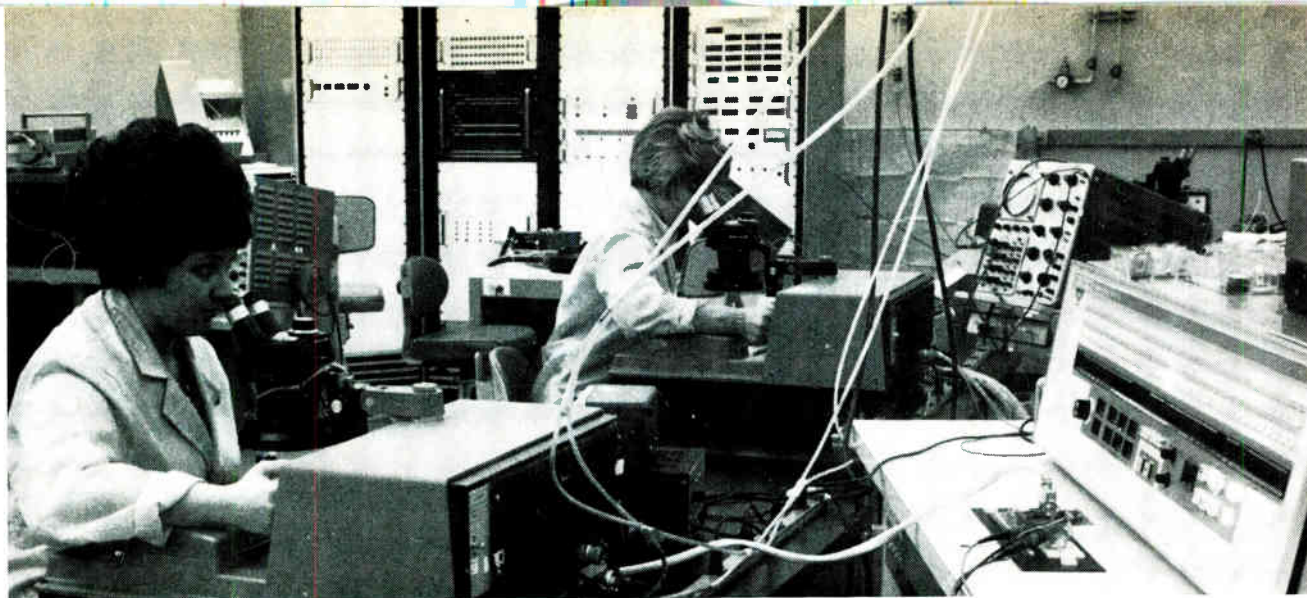

1. In house and out. North American Rockwell Microelectronics Co. put together its own system (foreground) for diagnostic and functional testing of MOS memories and logic arrays at 1 MHz. Shown in background is 2-MHz tester purchased from Non-Linear Systems Corp.; it's expected to go on-line soon.

problems in building the MD-200.

Macrodata officials believe that if they can place MD-100s in enough MOS/LSI memory user's plants, more device manufacturers will be convinced of the need for more thorough testing before they ship their arrays. Indeed, the first order for the MD-100 came from a device manufacturer interested in getting a better handle on his production. And Macrodata will sell interface electronics to link the tester with computer-controlled wafer probers for production line testing.

Macrodata's decision not to try to live with one kind of tester to answer the needs of all MOS/LSI manufacturers probably is the right one, according to the consensus of most LSI manufacturers. Hardly any of them think it's wise to buy a "universal" tester—one that accommodates bipolar and MOS arrays, and both general logic and memory components—because the devices are so different.

Lester S. Penner, director of General Instrument Corp.'s Semiconductor Products Group, Hicksville, N.Y., says logic and memory arrays are "very different types of devices with decidedly different testing requirements." The result, Penner believes, is that memory testers can be implemented more easily than random logic machines. He says that while random access memories may require very long bit patterns and many combinations of things, such as power supply, voltage levels, and clock amplitudes—as many as 100,000 test conditions—the tests fall into a quasi-periodic sequence. Because they aren't random, the tests can be implemented in hardware by using shift registers and counters—and without a computer—Penner points out. But with random logic, the test pattern must be completely flexible, with all variables under program control, he says.

"You can get away without a computer for memory testing, but you need it for checking random logic," the GI official asserts. And while Robert Schreiner, marketing manager for MOS at Fairchild Semiconductor, Mountain View, Calif., says his division needs a "super-flexible tester like the Fairchild Sentry 400,"

he thinks it's impractical to use a high-priced machine to test read-only memories and shift registers. For these devices, Schreiner says, the best approach is a simple, special-purpose box. "We now need a low-cost—say, \$20,000—register tester," he adds.

At National Semiconductor Inc., Santa Clara, Calif., Clark W. Davis, MOS design manager, cites major differences in MOS and bipolar machines—for example, transient and propagation delay testing, both of which are done in MOS but not bipolar. Another difference is the higher speed required for bipolar LSI. Davis explains that "at a 5-MHz rate, you can test MOS in production, but not bipolar. A 256-bit bipolar RAM, for example, has to be tested at a rate of 100 nanoseconds or under [10 MHz]." Davis thinks there's a place for both the large, general-purpose tester and the small, dedicated machine. "If you build custom devices, you've just got to have a general-purpose tester, but if you're testing RAMs, and you know what the worst-case bit pattern is, you should use a dedicated tester. The same is true for serial shift registers."

One of the biggest problems tester houses face in trying to build units that exercise both bipolar and MOS parts is "the conflict between the high-voltage swings you need for MOS and the fast speeds needed for bipolar," says John Cocking, vice president of a new tester firm, Comaltest Inc., New Hyde Park, N.Y. "We've found that if you want a positive voltage pulse of 20 volts, it's very difficult to get a rise time of under 30 nanoseconds," he notes. "But as soon as you get down to 5 V, rise times of 3 or 4 ns are straightforward." Cocking says Comaltest, which recently introduced its first tester [*Electronics*, April 26, p. 81] can deliver 20-V pulses with 12-ns rise times, "but from 30 to 12 is a long, hard fight."

Nor do many test equipment manufacturers believe it's sensible to test too many kinds of devices on one machine. The trend is toward using both large (and usually expensive) general-purpose, computer-controlled systems to test random logic, particularly when the LSI manufacturer is characterizing his de-

VICES, and to highly dedicated, less-expensive memory testers that don't require the flexibility of a computer in the system, especially for incoming inspection or production testing.

An attempt to develop a universal tester would be unrealistic, says Baden Parker, manager of test equipment operations at General Digital Corp., Newport Beach, Calif. "Most people couldn't afford such a tester if we could build it," Parker notes. General Digital's recently introduced MOS/LSI test system, the Spartan 770 [*Electronics*, March 15, p. 119], is not designed to test bipolar parts at all, Parker stresses. "The nearest thing to a universal test system is the test-center approach that loosely couples free-standing systems," Parker says. "A universal tester would be too complex and costly."

Concurring is a spokesman for Teradyne Inc., a Boston tester manufacturer. "A truly universal test system would cost more than anyone would pay," he asserts. He describes the company's J283 SLOT machine system [*Electronics*, March 2, 1970, p. 115] as a "broad system" that can handle production testing of bipolar arrays and static MOS, but its 100-kilohertz data rate is not suited for dynamic MOS memories; for that job, he says, the company's 5-MHz J277 is the choice.

The general feeling among suppliers of MOS/LSI test gear is that with their market just beginning to mature, most of them have taken a fresh design approach to their systems, rather than adding onto equipment originally intended for bipolar LSI tests.

It's the contention of Macrodata president Mow that \$75,000 to \$100,000 is too high a pricetag for machines that do incoming inspection of memory arrays. And memories, he maintains, will make up the bulk of the semiconductor market by 1975. Hence the MD-100, with its basic price of \$13,750. Mow doesn't think the large, general-purpose systems can test memory units efficiently: they fail on throughput.

"And even conservative estimates indicate more than \$100 million in semiconductor business by 1975; the device manufacturers are talking about a \$300 million to \$400 million market," he says. "At least 50% of the total LSI business will be in memories, and most data terminal companies today have problems with their MOS RAMs because they couldn't test them."

At Redcor Corp., Woodland Hills, Calif., Ben Barber, product manager for MOS testers, shares the opinion that it's not practical to try to build a tester for all varieties of devices—even all MOS devices. Random logic, shift registers, and ROMs can be tested on one type of machine, Barber maintains. But the volume of data required to test RAMs requires another kind of tester, in his opinion, "and a dynamic RAM has to be refreshed every 2 milliseconds."

Redcor introduced its PAFT 4 memory tester, with a 2-MHz data rate, about six months ago, but Barber says Redcor has reached the point where officials "are stepping back and asking 'how far do we have to go?' The memory business will be a big business, especially the RAM business. We can build machines that will test devices at 10 MHz, but we're not sure anyone can pay for them."

Minicomputers and memory testers

Innovator. Minicomputers, asserts Macrodata president William Mow, can't provide enough patterns fast enough to test MOS memories. His solution: a microprogrammable bipolar pattern generator, as used in the company's MD-100 memory exerciser.



One of the problems in using minicomputers to generate patterns for testing MOS memories, says Macrodata president William Mow, is that the tremendous number of patterns required can cause severe slowdowns in overall test time. Surveys indicate 200 to 512 patterns per channel are sufficient to test most MOS random logic devices, Mow asserts, but 100,000 patterns aren't enough for MOS memory testing: a very simple walking 1s and 0s test can require more than 2 million patterns. And in a general-purpose, minicomputer-controlled test system with a memory cycle time of 1 microsecond and 12 bytes of data per word, says Mow, if the user wants to test 24 channels, loading the buffer memory alone would require 4.198 seconds per die for a 1,024-bit RAM.

"This is a simple transfer from main memory, assuming you have a main memory of more than 4 million words," Mow continues. "Without a memory that large, you have to generate the patterns via algorithm, which means that overhead carry of 4.198 seconds per die increases exponentially, and this calculation is independent of execution time and buffer memory size."

Macrodata's solution is the microprogrammable pattern generator in the MD-100, which uses high-speed bipolar logic "oriented toward throughput rather than optimizing processing time," Mow says. It can generate those 2 million patterns for a 1,024-bit RAM "faster than present devices' operating frequency," Mow says. The MD-100 can test the Intel 1101 256-bit MOS RAM for a walking 1s and 0s pattern—foreground and background—in 130 milliseconds.

Mow says the pattern generator can substitute for the interim buffer storage in the larger, general-purpose testers, and allows elimination of the general-purpose minicomputer, cutting the component cost in the 100 to one-third that of the MD-200 general-purpose tester. What's more, "Almost all the overhead cost of the software is gone," Mow maintains.

Barber contends that it would take too much time to test all possible RAM data patterns and their combinations. He believes test engineers will work out the patterns most likely to produce failures in a RAM and ask for those in a production tester. Redcor believes the major device makers will buy high-speed, sophisticated machines for engineering diagnostic testing determinations of the patterns RAMs are most likely to fail, and then buy another line of machines that freezes those patterns for production testing. Barber believes the price of the memory tester for engineering diagnosis will be \$100,000 or more.

Standing almost alone in contending that an MOS/LSI tester can suffice for essentially all digital circuits is Xintel Corp. in Chatsworth, Calif. The firm

LSI test system manufacturers

Company	Types of testers		
Adar Associates Inc. 85 Bolton St. Cambridge, Mass. 02140 (617) 492-7110	Bipolar and MOS logic and memory	General Digital Corp. 19242 Redhill Ave. Newport Beach, Calif. 92663 (714) 557-3550	MOS logic and memory
Comaltest Inc. 124 South Eighth St. New Hyde Park, N.Y. 11040 (516) 488-2525	MOS logic and memory	LSI Testing Inc. 2280 South Main St. Salt Lake City, Utah 84115 (801) 487-5828	MOS logic and memory
Datatron Inc. 1562 Reynolds Ave. Santa Ana, Calif. 92707 (714) 540-9330	Bipolar logic MOS logic and memory	Macrodata Co. 20440 Corisco-St. Chatsworth, Calif. 91331 (213) 882-8880	MOS logic and memory
Educational Computer Corp. East Eagle Road Strafford, Pa. 19077 (215) 687-2600	MOS logic and memory	Non-Linear Systems Inc. P.O. Box N Del Mar, Calif. 92014 (714) 755-1134	Primarily MOS logic
E-H Research Laboratories Inc. 515 11th St. Box 1289 Oakland, Calif. 94604 (415) 834-3030	Bipolar logic MOS logic and memory	Redcor Corp. 21200 Victory Blvd. Woodland Hills, Calif. 91364 (213) 348-5862	Primarily MOS logic and memory
Fairchild Camera & Instrument Corp. Systems Technology Division 974 East Arques Ave. Sunnyvale, Calif. 94086 (408) 735-5221	Bipolar logic MOS logic and memory	Teradyne Inc. 183 Essex St. Boston, Mass. 02111 (617) 426-6560	Bipolar and MOS logic and memory
		Xintel Corp. 20931 Nordhoff St. P.O. Box 665 Chatsworth, Calif. 91311 (213) 882-8811	Bipolar and MOS logic and memory

doesn't say its Spectrum 1 machine can test linear ICs, but Rod Mack, director of marketing, maintains it can handle any digital circuit on the market. Xintel officials surveyed dozens of LSI suppliers, and concluded that to test everything from bipolar resistor-transistor logic, through emitter-coupled logic, through all the various MOS processes, they had to boil the test requirements down to three critical categories—voltage and current levels, clock timing, and data patterns.

Says Mack, "People often build testers that serve a limited market because they don't understand the absolute requirements for testing. A tester has to be able to provide the levels, timing, and data patterns for all LSI devices, and do both parametric and functional testing." The device fabrication process—bipolar, p- or n-channel MOS, or C/MOS—determines the voltage and current levels, and timing and frequencies required to exercise them, he maintains. Then the device organization—shift register, ROM, RAM, or general logic—dictates the test data patterns.

Mack feels that Xintel, as a new company, is "not hampered by the need to consider how we can modify or add to existing equipment. Otherwise our hardware and software approaches would be limited by previous experience. Some existing testers still depend on the closing of reed relays to make parametric measurements," Mack points out. "This greatly limits parametric measurements on dynamic MOS devices and

also limits machine throughput," Mack declares.

The Fairchild Systems Technology division, Mountain View, Calif., was on the scene earlier than Xintel and also backs a universal digital LSI tester. Fairchild's approach is to invest in the central processor for data management and incorporate appropriate test heads for different devices. "One mainframe with special heads allows you to have interchangeable programs and is more flexible to use," asserts Floyd Horwitz, national sales manager.

Officials of other tester firms, such as Adar Associates, Cambridge, Mass., believe one kind of tester can handle many functional exercises on most bipolar or MOS/LSI devices, but that trying to perform many parametric tests with the same machine is unwise. Attempting to test quickly for all the parameters on a device data sheet will lead to compromise, usually in the number of data patterns injected into a memory component being tested, asserts W. Brad Turner, head of Adar's application engineering department. He maintains that this will let bad devices out the door. "Some memories are pattern sensitive," Turner explains. "While they work well with a simple read-write checkerboard, they can't take a walking 1s and 0s pattern. Trying to be all things to all circuits in one box means you're going to lose test performance somewhere."

In planning ahead, tester suppliers must be concerned with the ability of their gear to handle in-

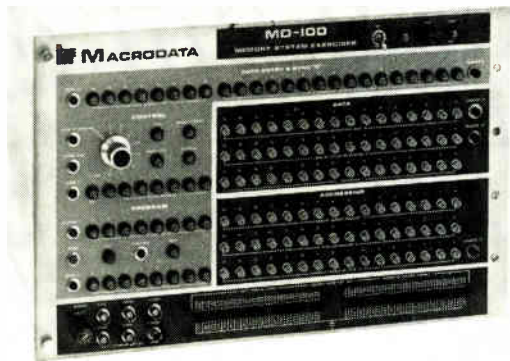

2. Breaking the price barrier. Macrodata's MD-100 is designed for incoming inspections of MOS memories. By focusing on one application, company was able to bring tester's pricetag down to below \$15,000.

creased LSI speeds. Many feel their equipment will have to be ready to handle MOS shift registers and memories operating at 10 MHz, or in a range from 5 to 10 MHz, but maybe not for three years. Again, memory components appear to be leading the way in MOS technology, as well as potential broad use; hence the smart test system designers are homing in on the particular problems presented by memories.

That's why tester manufacturers can't afford to introduce hardware that has little growth capability, or that could become obsolete very quickly as newer, faster systems reach the market. Ray Sonners, chief engineer at North American Rockwell Microelectronics Co., Anaheim, Calif., puts the galloping technology problem in perspective when he says, "A year or so ago, we talked about MOS shift registers at 500 kilohertz, and now we're up to 5 MHz. If frequencies keep going up, your big tester box is obsolete to do only one job."

James Flath, manager of wafer fabrication at Intel Corp., Mountain View, Calif., says tester suppliers should plan for MOS device speeds of 5-8 MHz three years from now. Most firms are doing it already, with many of the newer MOS test sets pegged at data rates around 5 MHz, putting Flath's estimate a little on the low side. National Semiconductor's Davis sees speed requirements in excess of 10 MHz in three years, as does a Fairchild Semiconductor test engineer, who anticipates the high-speed n-channel MOS coming onstream then.

What speed ahead?

The consensus among tester firms indicates that the critical areas that will have to be speeded up to handle faster LSI parts will be the pattern-generating memories that deliver the test patterns to the device, and the drivers and comparators at the test head. Here, they're hand-in-hand with their customers: they depend on the very LSI vendors whose devices they're trying to test to come up with faster RAMs for the pattern-generating memories.

Tester manufacturers usually design their pin electronics cards with the fastest circuitry they can find. Much of it is high-speed bipolar logic, such as ECL. At Non-Linear Systems Inc., Solana Beach, Calif., which recently delivered a MOS/LSI tester to NRMEC [*Electronics*, Feb. 15, p. 132], Wilber Bailey, a project engineer, believes 10-MHz devices are "some way off," but notes that the firm is working toward the higher speed.

Bailey believes that to increase speed, the driver/comparator circuitry must be kept close to the test head to avoid cable capacitance encountered with remote setups, and rise times of the drivers will have to be considerably improved. Faster rise times will bring noise problems, he says, but these can be solved. General Digital's Parker agrees. He'd like to see propagation delays in the comparators (Fig. 3) fall to 5 ns, and he's closely watching developments in Schottky TTL and ECL with an eye toward improving clock resolution in the Spartan 770's memory system.

Adar's Turner also homes in on the driving and sensing circuitry. Adar uses ECL for all critical applications, such as sense-logic and strobe-positioning circuitry, in the Doctor 32 and 64 systems. Says Turner, "We have to stay ahead of the art in order to test to the limit of the art."

LSI Testing Inc., Salt Lake City, Utah, is trying to stay ahead by offering options. The 4024/4036 tester (Fig. 4) has a 2-MHz data rate as standard, but 5 MHz is available as an option.

Fairchild Systems Technology's Horwitz sees the local memory or data pattern memory as the speed limitation now. When faster RAMs become available economically, he says, today's units will be replaced. Concurring are Xintel's Mack and William Boggs, systems sales manager of E-H Research Laboratories, Oakland, Calif. Mack points out that the Spectrum 1's 5-MHz data rate reflects the top speed of the bipolar RAMs in the data pattern memory.

Most tester manufacturers say they'll get better speed out of their present equipment when the improved RAMs and higher-speed components for the driver/comparators become available; most current hardware is modular. But Adar's Turner feels total system redesigns eventually will be needed because the computer mainframe will become a drag on performance.

Ultimately, tester makers may get a speed break from the device makers: they may not require 100% testing of MOS memories and shift registers at maximum frequencies, as they do now. There may be a move afoot to follow the example of manufacturers of high-frequency bipolar devices and test only samples from each production lot. Only the easier-to-test, low-frequency parameters that imply satisfactory high-frequency performance may have to be measured. "Nobody has the guts yet to ship a part not completely tested at maximum frequencies," says GI's Penner, "but this could be coming."

Adds National's Davis: "If we're going to continue to do propagation delay testing, we have to test in excess of 10 MHz"; he'd like to talk customers out of that kind of testing. He points out that with TTL

parts, only a few critical paths are tested, not the whole chip, and he would like to do the same with MOS parts. "We test the whole chip now because the machines that give us the throughput we need can do it."

Michael Levine, manager of MOS test equipment engineering at Texas Instruments Inc., Dallas, adds, "MOS is still in its growing phase and we need extra power. Later we'll be able to standardize testing more. Maybe MOS will get to the point, like bipolar, where users won't feel the need to test at high speeds."

LSI vendors essentially agree that their test sets should include a computer for test flexibility and system control. But their views on the functions they want the computer to perform vary. And those who have experience in testing high-speed devices point out that an on-line minicomputer can limit data rates, especially in memory arrays. Some users, such as Fairchild Semiconductor, like having a computer in the system because it allows different tests to be performed on different test heads in the same machine. (Fairchild, however, is unusual: the Sentry 400 used in its MOS operation is tied into an IBM 360.)

Others want it for data-logging of results in engineering diagnostic testing. TI's Levine, who uses TI-built testers in the MOS operation, says the computer allows him to set up various conditions for a multiplicity of parts. But the system may still have to use high-speed data-pattern-generator memories for high-speed tests.

The use of high-speed data-pattern memories to deliver the 2-MHz to 5-MHz data rates needed for faster, dynamic MOS parts is becoming a trend among newer testers. Test engineers at Fairchild Semiconductor also want the computer for flexibility, not for speed. At National Semiconductor, Davis says a minicomputer isn't really needed. "What you need is a miniprocessor—a machine that has memory and the ability to do some simple data manipulation. You need something in between a fast memory and a computer."

Among tester manufacturers, even Teradyne, the pioneer in computer-controlled equipment, recognizes the move away from an on-line minicomputer that fetches data patterns from a core memory when high-speed testing is required. The company's J277 (shown on the cover and in Fig. 3), to be on the market within a few months, is a full-clock rate, 5-MHz test system for dynamic MOS/LSI. Under control of Teradyne's M365 computer, says a company spokesman, it can allow infinite pattern length in testing, and should be able to meet the requirements of any MOS devices as they develop. The computer or controller is being used to generate test patterns and dumps them into a buffer or accumulator, which, in turn, presents them to the device in a burst.

Adar's Turner sums it up by emphasizing that the computer shouldn't be tied to the device under test. "That's having the tail wag the dog," he notes. "It adds another layer or two of read or cycle time, slows the test process, and generally limits test speed to something below the state of the art. A computer should twist the knobs, flip the switches,

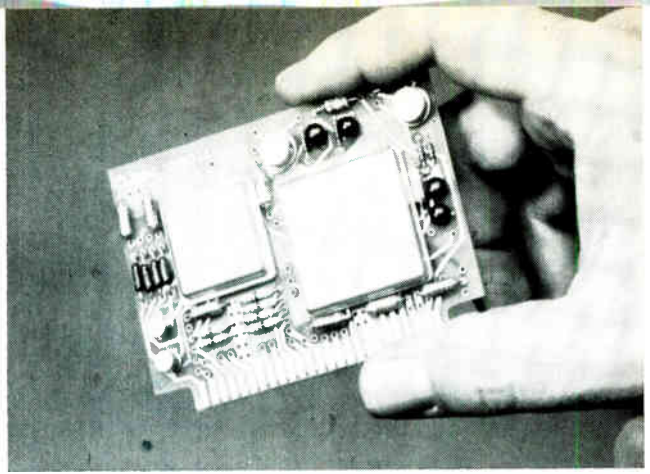

3. **Speed source.** General Digital's hybrid driver/comparator module provides the company's Spartan 770 test system with 5-megahertz data rates for dynamic MOS memory testing.

handle the housekeeping, log the data, and keep its hands off the device."

Another point of agreement among most tester manufacturers is that the computer-controlled system grew up at a time when dc parametric tests predominated in the bipolar device world. The set measurements required large numbers of sequential tests done on various device pins. But in MOS, functional testing predominates, says General Digital's Parker. Here a large, internal, high-speed data pattern memory (40 channels with 1,024 bits per channel in the Spartan 770) is loaded and dumped one or more times to the device under test.

Dramatic cost savings are possible if a general-purpose minicomputer and its software development costs can be removed from the test system for the kind of repetitive functional tests usually required for MOS/LSI memory arrays. Macrodata, for example credits elimination of the minicomputer in its MD-100 memory tester and substitution of a pattern-generating multiprocessor for much of the 100's price saving over the general-purpose MD-200 (see "Minicomputers and memory testers," p. 70).

But for the larger testers that are being used more for device characterization than for production testing, the computer still performs valuable off-line functions. Sam Duran, product manager for testers at Datatron Inc., Santa Ana, Calif., notes that even if hardware pattern generators are used (as in Datatron's 4400 machine) "device makers still want to know yields, when and where failures occurred, and they want to analyze this information: they want to do data logging."

Most device manufacturers are in accord in wanting to separate engineering diagnostic testing from production testing—probably with different machines. Indeed, some play down the importance of engineering diagnostic testing; they say it's desirable but not of paramount importance.

At Electronic Arrays Inc., Mountain View, Calif., Michael McCoy, manager of advanced product development, wants his tester to do both engineering diagnostic and production testing of both wafers and packaged parts, but he's in the minority. Others believe it would be too costly to have both capa-

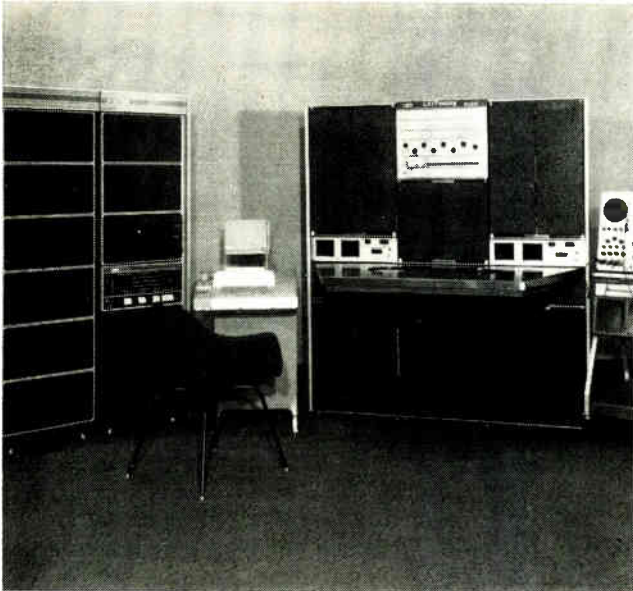

4. Versatile. LSI Testing Inc.'s 4024/4036 system has two test heads and 2-MHz data rate as standard; two more test heads and a 5-MHz rate are optional. Firm says system can simultaneously test two completely different devices at different pattern levels.

bilities in the same machine. At Mostek Corp., Dallas, Kenneth Davis, manager of test systems, says he's looking for a production tester he can use on both wafers and packaged devices. TI wants separate testers for production and engineering, but doesn't have them now in its Houston MOS operation. Levine says the company is planning a smaller version of the versatile machine in use now for production testing; he regards wafer and packaged device testing procedures as very similar, and envisions very few or no problems in using the same tester or testing system for both.

National Semiconductor's Davis wants his testers to do both wafer and finished-parts testing. He also would like an engineering diagnostic capability for debugging programs—but not necessarily in a production tester, where all he really has to know is how many devices failed each test. But on an engineering machine, he wants to know the failure modes, plus a listing of how many dice failed each test, and the ability to measure actual parameters and do program debugging. A source at Intel Corp. says engineering diagnostic ability in a tester "is nice but not essential." He wouldn't sacrifice production capability to have diagnostics in the same machine.

And at GI, Penner says separating engineering diagnostic testing from production testing is a matter of logistics. "With its own dedicated testers," he says, "manufacturing can schedule its own tests better." But he wants wafer probe and final packaging capabilities in production test equipment, although he needs more wafer probe capacity than final test capacity because there may be only a 25% yield at wafer probe, but, of course, all dice must be tested.

The want list

Thus, in general, MOS/LSI manufacturers at least are formulating pretty definite ideas about what they want. The tester users are asking for functional, parametric, and dynamic testing of at least 40 leads under program control with a variety of voltages available. They'll be asking for propagation delay measurements in dynamic tests of 1 to 2 ns in a few years. They want flexibility in their testers, and they want cooperation from their suppliers in making changes in testers.

Some of them are asking for some degree of standardization in pin electronics cards among tester manufacturers. Others seek easier interfacing with wafer probers and device handlers. One LSI vendor questions whether the latter should be done by the tester houses, but he wants someone to address the problem. Still others would like to have simpler software interfacing, easier-to-use languages, and flexible word lengths from 300 to 2,000 bits.

Other features sought in newer testers are the ability to work with random storing of addresses and then order them again later; users want to pick and choose those addresses at a high rate. One LSI vendor says this is a function of intelligent local storage. "Local storage is no good if you have to go back to the mainframe to fill it up again," he says; "I want a dedicated miniprocessor."

But though tester manufacturers and LSI vendors clearly have been getting a better grip on general configurations, capabilities, and functions, outright standardization of test equipment and procedures is still a long way off. That's due largely to the custom nature of the MOS/LSI business.

LSI users select one or two sources for their proprietary products, all of which may have peculiar test requirements, especially MOS logic arrays. And though memories show more signs of some degree of standardization in test patterns, the custom nature of the devices again mitigates against universally acceptable test procedures and equipment.

Adding to the potpourri is the proliferation of process technology: p- and n-channel, C/MOS, silicon gate, and ion implantation, plus combinations of these. There are an "enormous number of products," says GI's Penner, "and each manufacturer likes his own test conditions." McCoy of Electronic Arrays also points to the "tremendous amount of products available" as mitigating against standardization "because the users demand different voltage levels." He sees no hint of parts standardization in the near future, although he does hold out some hope for standardized power supplies, logic levels, and input-output voltages and currents.

But even with second-source products, National Semiconductor's Davis says that with circuit differences and process differences, worst-case tests for one part will not necessarily serve as worst-case tests for the second-source part. Intel's Flath also calls the different voltage levels for MOS parts made by different processes the biggest bar to standardization—he

doesn't think there will be much parts or testing standardization within three to five years.

Charles Irwin, NRMEC's manager of test and reliability engineering, says, however, that there may be some light dawning at the end of the voltage-level standardization tunnel, at least for random logic arrays. He boils it down to a need for -30 or 40 V to $+30$ or 40 V in testers. However, he notes, that much voltage swing in a system introduces noise, and he doesn't think tester builders recognize the cross-channel noise problem until they get pretty far downstream in their designs.

Naturally, tester manufacturers also aren't hopeful that standardization in voltage levels, timing, and data patterns can be worked out and reflected in their machines. Some of them are settling on certain parametric tests they'd like to see become standard, however. Most of them mention stress, leakage, breakdown voltage, and power supply levels as the categories they think can become standard. They think worst-case leakage parameters can be standardized, and they report that most device manufacturers want to be able to check for threshold breakdown voltage to monitor process variations.

General Digital's Parker says these are the most frequently mentioned tests device manufacturers want, and he'd like to see them standardized. "I'd like to say that we can foresee these becoming standard tests for all devices, but we don't have enough information to say it will happen," he notes. Macrodata's Mow would add a probedown or continuity test to the list—a check to see that all probes come in contact with device pads. He also suggests "various permutations of clocks, voltages, and frequency in bursts" to the parametric test list.

But Xintel's Mack doubts that data patterns will ever be standardized. He says there will be typical patterns, such as walking 1s and 0s, "but from the standpoint of the tester, if you can get away from thinking of what the device leads are—inputs, outputs, clocks, or chip selects—and think in terms of applying a set of voltages as specified by some data pattern and some timing criteria, a standard tester can be developed if the data pattern capability exists."

Very possibly the best statement about the hope for standardization comes from Teradyne president Nicholas DeWolf, who asserts: "Standardization will come out of the marketplace. The company with the best equipment and methodology will find in retrospect that it has introduced standards to the industry. The feeling at Teradyne is that a committee approach, such as through the IEEE, for example, would lead only to the least offensive standards rather than the most effective ones."

DeWolf's comment carries over into another area that has haunted test set makers—competition from in-house test builders at the semiconductor companies. Tester manufacturers generally feel the market's acceptance of independent test instrumentation builders will blunt the competition from in-house tester groups. They can't evaluate the in-house efforts, but in competition with other known independents, the tester firms can size up rival designs.



5. Flexible. Teradyne's J277 dynamic MOS/LSI test system is controlled by Teradyne M365 computer and allows infinite pattern length. Thus, says the company, it should be able to accommodate any devices as they are developed. It operates at 5 MHz.

They still run up against in-house competition often, however. As Kay Smith, president of LSI Testing, relates, "The biggest problem we have is the in-house tester group." In a semiconductor company, he says, it's easy for engineers to justify to management the costs of building an in-house tester instead of going outside "because they can hide costs."

Xintel's Mack says in-house groups have the advantage of a good understanding of their company's products and problems. Although Xintel has yet to announce a firm order, he says his competition is evenly divided between in-house and independent tester companies. However, tester suppliers are split over the impact of the business recession on the amount of competition provided by in-house groups. Datatron's Duran says the slowdown caused many companies to look inside for a solution to their tester needs, but this will be a temporary situation.

However, a Teradyne spokesman says that while most of the company's competition traditionally has come from in-house groups, and that while more than half the testing done today may be done on in-house equipment, the business slump has changed things. "The engineers who would have made up the in-house cadres of test experts," he says, "have been thinned out in layoffs." Further, he observes, "the overhead-conscious IC houses now are leaving test system design to those who make it their profession—companies like us." □

Contributing to this article were Owen Doyle and Alfred Rosenblatt in New York; James Brinton in Boston; Stephen Wm. Fields in San Francisco; Paul Franson in Dallas, and Gerald Parkinson, McGraw-Hill World News, Los Angeles.

Computer takes over job of laying out dense pc boards

Improved layout program can locate holes in printed circuit boards, thread connections through them, decide on best routes and run them along diagonals; designer need complete at most 1% to 3% of layout

by Robert Campagna, *GTE Sylvania Inc., Needham Heights, Mass.*

□ Designing and laying out a tightly packed printed circuit board is liable to cost more money and cause more headaches than any problems with materials or chemical processing. But the early computer programs that were intended to take over the job of routing the wires usually handled the routing in an inefficient X-Y fashion or completed no more than a small part of the job.

Now available are better programs than can lay out connections along diagonal lines and designate plated-through holes wherever necessary. They also leave at most only 1% to 3% of the interconnections to be completed manually.

Such a set of programs is presently being used to design small, densely wired two-layer boards for use in airborne equipment. Each board holds up to 24 flat packs and requires 200 to 300 connections. One layout, which cost \$2,000 when arrived at manually, was designed by the computer in one third the time for one quarter the cost. The programs can also handle wire-wrapped boards and less dense boards of discrete analog components.

The system works on an IBM 360 model 40 or larger models in the series. The programs are written in Fortran and Cobol, except for a few assembler routines in the routing program. (The routing program can also be run on an XDS Sigma 7, where its execution time averages 80 minutes per board of about 250 connections compared with 6 minutes on an IBM 360/85.)

Inputs to the system are: the logic design, which can be described free form (some other programs restrict placement of input data to certain columns); a library of available types of ICs; and a physical description of the board with dimensions, approximate location of IC packages, and edge connections.

In operation, the system first audits and checks the logic design input to insure against clerical errors in connections (it notes each connection both at the input and the output gates). It also checks all leads on a logic device, to insure they are properly specified. Gates are next assigned to ICs, and the ICs are assigned to locations on the board. The results then are used to assign external signals to connector pins and to create a list of the points that have to be interconnected.

The lines that are common to several pads or

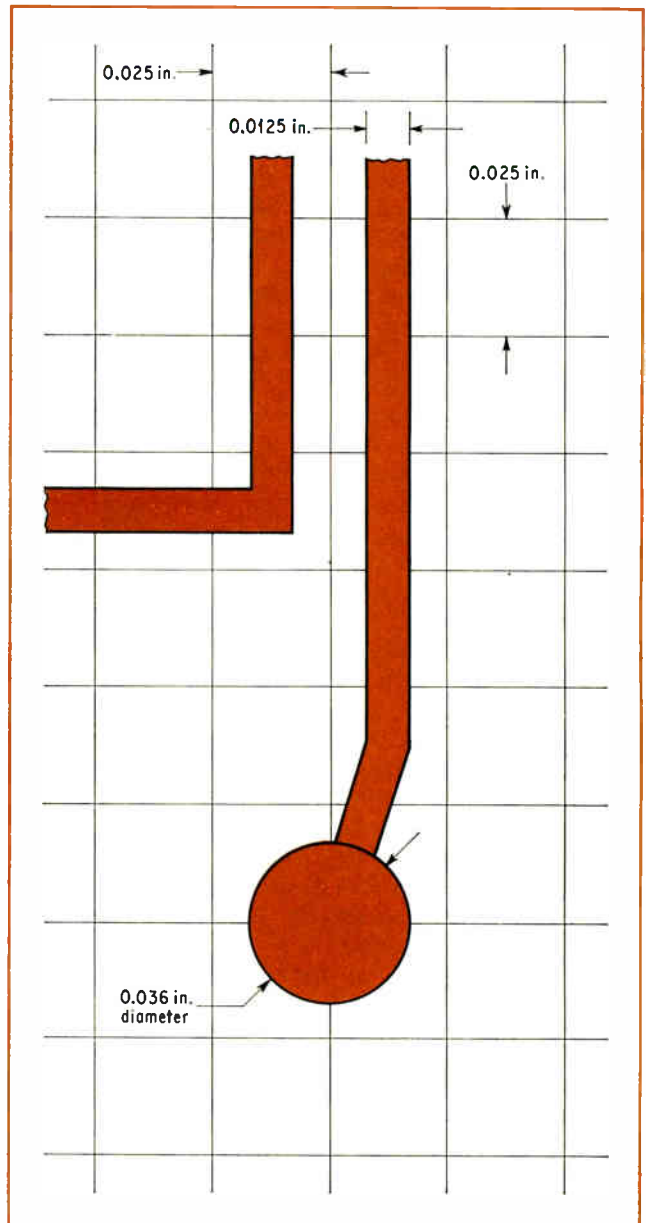

1. Grid paths. Board is laid out as grid of square, 25-mil cells. Traces 12.5 mils wide run down cell centers. Pads and holes, the latter 36 mils in diameter, are placed at junction of four cell corners. Grid could also be set up with cells of variable width.

connection points on the board then are organized into an order that will give minimum wire lengths when the paths are routed. For economy, the program was designed to proceed continuously and not to return and revise previously made traces. Therefore it starts with the connections between a few points that are close together and then moves on to the common lines serving many points widely spaced on the board. The last two nets that the program attacks usually are the ground and power lines. If these were laid out first, they would tend to give less freedom of choice to the shorter paths and would also tend to isolate areas of the board from later connections.

The board area then is defined as a matrix of

2. Making connections. Connections on same side of board are called A-type, connections between sides are B-type, and those that pass back and forth are stitches, which are needed to generate extra floods.

3. Runaround. Traces shun connector pin because of weighting factor, w_1 , assigned to adjacent cells. When trace passes through nearby cells, extra weights, w_2 , are added alongside to keep subsequent traces at least one cell away. Later the w_1 cells will be used for traces only as last resort.

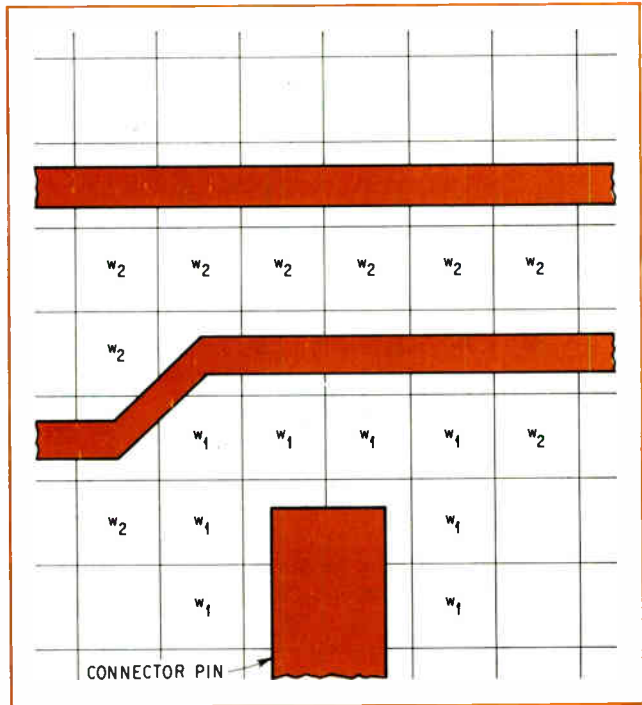

cells, the routing program, operating from the connection list, makes the connections, and the computer delivers a magnetic tape that describes the completed board. If the computer finds it cannot complete certain connections without violating the spacing tolerance, it makes out a failure report so that the designer can subsequently complete the layout. The tape then is processed by a set of programs that organize the data into hole locations and straight line segments, resulting in paper tapes for numerically controlled drafting and drilling machines.

The magnetic tape can be altered with an adjustment program, either to add a missed connection or to make an engineering change. A man can add a connection in 10 to 15 minutes, using an overlay on a printout of the board layout. The routing program can also be restarted from the tape to add connections.

The routing program is based on Lee's algorithm,¹ the first practical automatic method for plotting connections between several points on a surface. However, it does not allow for holes, weighting, or directions other than horizontal and vertical. The main improvements added in the new program are: stitching, in which conductive patterns are passed freely from one side of the board to the other through holes or vias; dynamic weighting, by which space is allowed for additional conductors and efficient use of diagonal lines; and the ability to examine many possible interconnections and paths to choose the one that allows the most freedom in making subse-

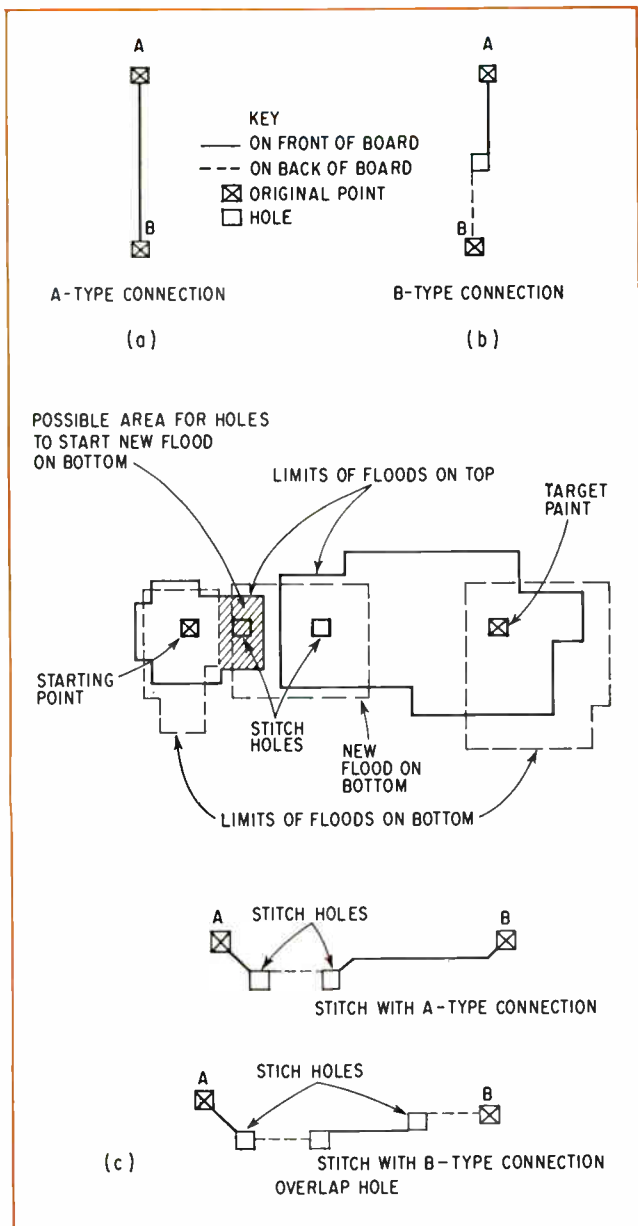

MOS and multilayers, too

Although the GTE-Sylvania program described in the article was designed for two-layer boards, its use is not restricted to them. Author Campagna points out that it can be adapted for a variety of board types and also for laying out metal-oxide semiconductor integrated circuits.

Densely packed two-layer boards have much in common with MOS ICs. MOS circuits have only a limited area available for conductor paths; they also often contain two metalization layers, which makes placement of through holes wherever needed a useful feature. It's also often desirable to place conductors of different widths on the two layers in the MOS circuit, and the GTE-Sylvania program is well suited to such cases; the grid in the program can have variable spacing, since it's defined in terms of incremental steps and rows of wide cells can be inserted between rows of narrow cells.

Weighting also can result in lines that run straight and narrow, a necessity in many MOS circuits. Other layout programs, Campagna notes, often work on a bumper effect—the conductor is continued until it meets an obstacle and then it is turned away. In his program, however, the conductor avoids obstacles because a buffer zone established by a weighting system surrounds each obstacle, thus forcing wiring into channels. In addition, by assigning a weight of large value to any direction other than vertical, Campagna points out, he can set the program to run mostly vertical lines, without actually eliminating the possibility of diagonal or horizontal lines, if they are really needed.

On some straightforward printed circuit boards where there is a good deal of space, this program may not be necessary. A simpler, faster running method such as the Manhattan geometry, in which all horizontal lines are on one side of the board and all vertical lines are on the other, may be more desirable. The method gets its name from the X-Y layout of Manhattan streets.

quent interconnections on the board surface.

Horizontal and vertical conductors are centered in cells measuring 0.025 inch per side (Fig. 1). This allows for the 12.5-mil conductor width and also the 10-mil minimum spacing. (Diagonal conductors require different treatment, which is discussed later.)

Holes are specified as 36 mils in diameter, or larger than any one cell. They are therefore always located at the center of an area formed by four cells, i.e. a square 50 mils on a side.

When a pair of points is to be interconnected, the computer notes each of the groups of cells bordering on either point and includes them, if available, as possible elements in the path. It then continues, noting all the cells that border on the first group, thus creating an expanding "flood" around each of the points to be interconnected. If a cell contains a portion of a hole or a previously made conductor, it is excluded from forming part of the final conductor path. The floods around the two points are expanded alternately on both surfaces and from both points. When the two floods meet, on either side of the board, the computer stops them, notes where they have met, and then starts up again until another intersection

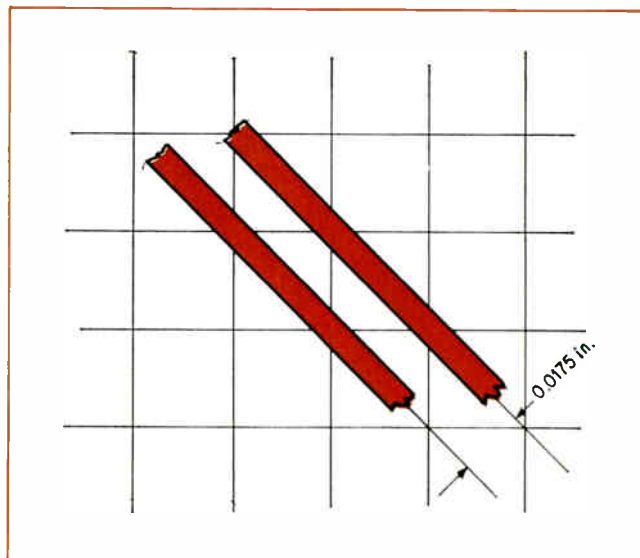

4. Diagonal cut. Diagonal lines through centers of adjacent cells are 17.5 mils apart, which violates 25-mil tolerance. But one-cell separation would be an excessive 35 mils. Program therefore allows lines to cross corners, one and a half cells or 52.5 mils apart, and a third trace fits easily between them.

occurs. It continues this process, until it has accumulated a number of possible points of interconnection to choose from.

To choose the most advantageous of the interconnections, the computer makes use of a weighting scheme which enables the program to select those cells in the flood that will leave most space for later runs. Each cell is first assigned a weight, which may change later as conductors are placed in neighboring cells. The computer records the weight of each cell in the two floods, sums those weights back to the starting points, and chooses the path that yields the minimum total weight.

To make a connection, the computer can choose between:

- the A-type, a conductor on one side of the board
- the B-type, a conductor which passes from one side of the board to the other through a via or hole
- the stitch-type, in which a conductor passes alternately from one side of the board to the other until the connection is made.

The A-type connection, though the easiest to make, need not result in the lowest weight total if it follows a circuitous path. The B-type is penalized because it must allocate a four-cell square to the hole, but still may result in a lower total. The stitch connection uses two or more holes and thus tends to produce high total weights, but is often the only method of completing the connection.

The stitch is necessary when opposing floods, including all possible cells, still neither touch nor overlap. The floods then are searched to find cells available for vias for starting a new flood on the other side of the board (there must be squares of four cells unused by traces or holes on the either side of the board). The flood then is restarted from this new

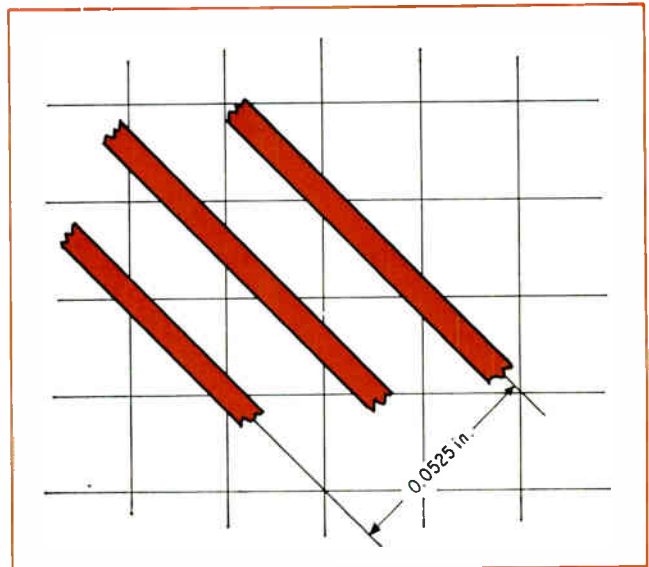
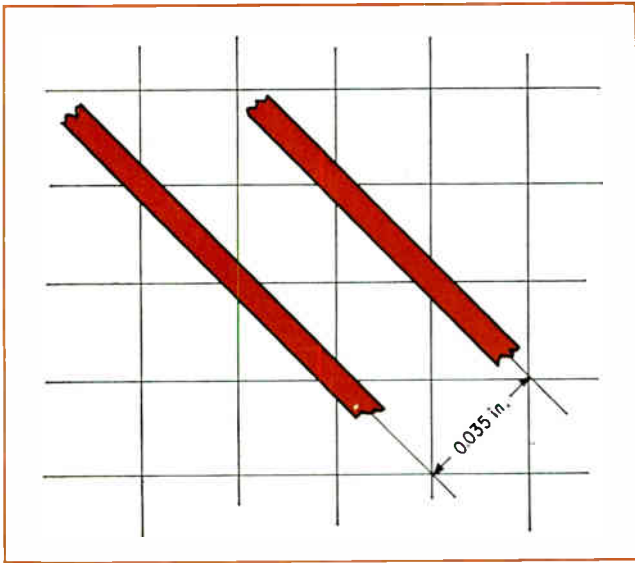

position until an A- or B-type connection can be made, or, if the floods still do not touch or overlap, another stitch has to be taken. This capacity for starting a new flood from any point on the board also allows a connection to be made to a previously established trace, at any point along its run.

At the start, the areas around the IC leads and other critical areas are assigned large weights to make them less desirable for use as a connection. Similarly, as traces are added, the neighboring cells are increased in weight to cause future traces to avoid those areas. The alleyways thus left between the traces are then used only if necessary.

In Fig. 3, for example, the initial weighting round a connector pin is designated by w_1 , and influences a line to avoid the pin and leave room for a later line to reach the pin. When the first line to be put in the adjoining area is traced on the board, weights are added to the cells that border it. These are shown as w_2 . When the program establishes a second line, it runs at least one cell removed from the first line.

In the case of parallel diagonal lines, however, the tolerance requirements would not normally permit the use of adjacent grid cells, since the diagonal distance from the center of a 25-mil-square cell to its corner is 17.5 mils—too small to contain both trace and space under the usual rules. However, it would waste space to require a separation of one cell between diagonal lines. Yet the obvious alternative, the use of stepwise lines, is also wasteful, since more lines can be run diagonally than stepwise.

To get out of the dilemma, it was necessary to relax the requirement that lines run only on cell centers, and this was done by developing a corner-cutting technique that permits diagonal lines instead to pass across the corners of a grid cell. With this arrangement, two traces and two spaces which require 50 mils all told, can fit into the 52.5-mil diagonal across one and a half cells. □

Reference

1. C.Y. Lee, "An algorithm for path connections and its applications," IRE Transactions on Electronic Computers, Sept. 1961, p. 346.

5. Results. Typical two-sided board made with the layout program shows how diagonal lines and vias are used.

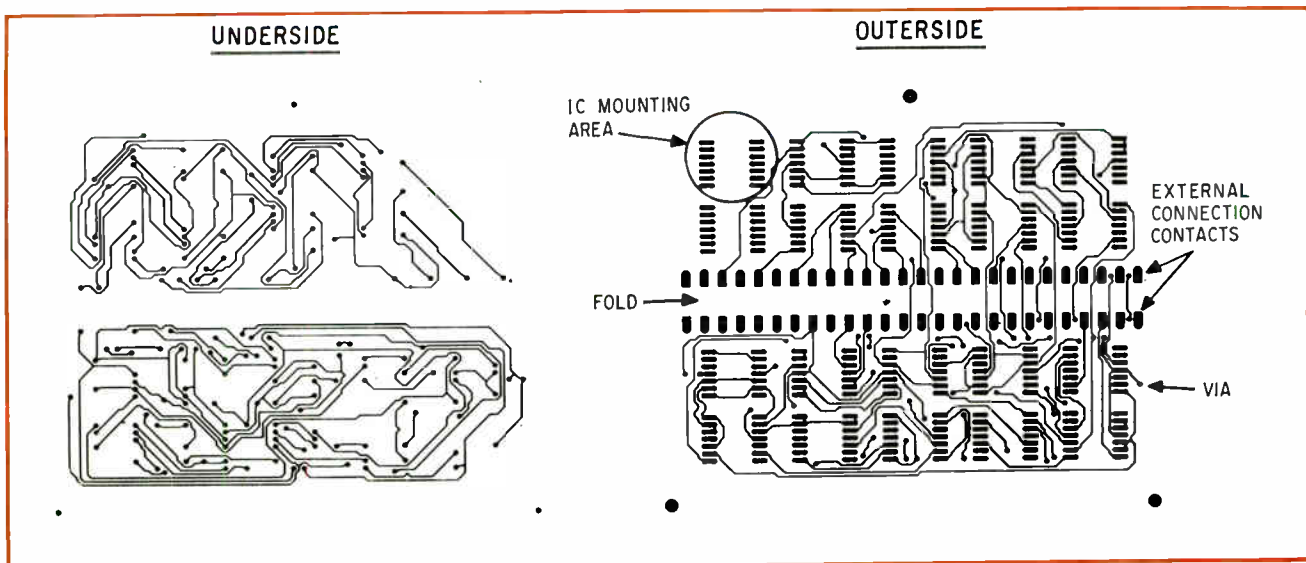

Designer's casebook

Probability table*

n	$-\log_{10}P$
5	6.542
6	9.005
7	11.892
8	15.206
9	18.947
10	23.118

* From M. Abramowitz and I.A. Stegun, "Handbook of Mathematical Functions," AMS-55, Table 26.2, p. 972, National Bureau of Standards, June 1964.

Probability analysis cuts power supply needs

by S. Gery and E. Drogin

AIL division, Cutler-Hammer Inc., Deer Park, N.Y.

The law of averages is on the side of the digital system designer who saves money on power supplies by not designing for the worst-case current requirement. That way, there's little chance that any large collection of digital devices will pull much more than the total of their average currents.

Risk can be limited to perhaps one blown fuse every few centuries by calculating a safety factor with probability statistics. The criteria are:

$$P = \text{probability that } I_s > I_{ave} + n\sigma$$

where

$$\sigma = \sqrt{K} \left[\frac{I_{max} - I_{min}}{2} \right]$$

and I_s is the supply current; I_{ave} is the average supply current; n is the probability factor (see table); σ is the standard deviation of current; K is the number of statistically independent devices; I_{max} is the maximum current of one device; and I_{min} is the minimum current of one device.

Once I_{ave} is found (it's simply $K(I_{max} + I_{min})/2$ for all similar devices), the safety factor can be reasonably approximated. A large K makes the statistical distribution of currents nearly normal, even in the "tails" of the $n\sigma$ curve. A conservative application of normal approximation is $K \cong -30(\log_{10}P)$.

The value of n depends on the acceptable risk. For instance, at $n = 9$, the probability of an insuffi-

cient I_s is less than once in $10^{18.9}$ trials. A trial in a digital system is a clock period; if the clock frequency is 10 megahertz, there are 3.2×10^{18} clock pulses in 100 years, so I_s is statistically safe for three centuries.

Even the most conservative engineer might settle for a lower value of n , particularly at lower clock rates. For example, assume a system contains 600 gates operating randomly and that each gate needs 1/30th of an ampere in the 0 state and 10 milliamperes in the 1 state. If it is equally probable that each gate will be in the 0 or 1 state at any given time, $I_{ave} = 13$ A and $\sigma = 285$ mA. For $n = 9$, $I_s = 15.6$ A, which is more than 20% less than the worst-case requirement that 20 A (600/30) be supplied.

In practice, designers of large systems should consider how many devices pull more than the average current specified by the device manufacturer, rather than calculate σ with worst-case I_{max} and I_{min} values. Moreover, the 1 and 0 probabilities for a system may not be equal.

Frequently, one set of gates will switch to 1 when another set switches to 0, or vice-versa. Paired off, such gates don't need more than an average current increment, reducing the magnitudes of K and $n\sigma$. Moreover, functional blocks, such as flip-flops, have current requirements that are independent of state, also reducing K .

On the other hand, a "master clear" or similar control may switch large numbers of gates into fixed states. The equations don't change if the gates are held in I_{min} states, but I_s must increase if more gates switch into I_{max} than I_{min} .

Designer's casebook is a regular feature in Electronics. Readers are invited to submit novel circuit ideas and solutions to design problems. Descriptions should be brief. We'll pay \$50 for each item published.

Stable FET clamp operates at 10 MHz

by Tom E. Polcyn
Center for Research in Engineering Sciences, Lawrence, Kan.

In addition to handling video signals, a clamping circuit also can serve well as a general-purpose dc level restorer. It locks the level of its output to a reference voltage, following the timing of randomly arriving inputs out to frequencies of 10 megahertz. And unlike conventional dc restorers, its input impedance is high, output impedance is low, and temperature stability is good.

The standard diode-capacitor restorer often distorts signals, especially if the signal frequencies are random or, like video signals, contain very narrow pulses. Moreover, the circuit's output impedance is relatively high and the diode makes it temperature-sensitive.

For the video clamp, the capacitor C_1 blocks off the original signal level. But the input pulse is replaced by one at V_{ref} for the duration of the pulse time.

A second FET, Q_2 , acts as a constant-current source

for Q_1 and R_1 through Q_3 , which is cascode-connected. The gate-to-source voltage of Q_1 and the voltage drop across R_1 also are constant while the circuit is quiescent.

When a pulse is ac-coupled through C_1 to the gate of Q_1 , the original dc component is lost. As a result, the signal reappears at point A with a different dc level. This level tries to go toward -12 volts but as soon as it is 0.6 v below V_{ref} , Q_4 turns fully on and C_2 begins to charge positively.

Because Q_3 has been maintaining a constant voltage at the source of Q_2 , the gate-to-source voltage of Q_2 now increases as C_2 charges. Q_2 must reduce the current it supplies to Q_1 and R_1 . The voltage now increases at point A, reducing the collector current of Q_4 and the charging of C_2 .

Resistor R_2 and capacitor C_2 are chosen so that C_2 discharges very slowly when Q_4 turns off. For a fraction of the time constant R_2C_2 , the current will remain nearly constant in Q_1 , Q_2 , Q_3 , and R_1 . Therefore, the most negative value of the signal at point A is clamped about 0.6 v below V_{ref} . The emitter-follower action of Q_5 shifts the signal back up about 0.6 v so that the output voltage is effectively clamped to V_{ref} . Temperature drift is negligible if Q_4 and Q_5 are well matched.

Clamping at 10 MHz. Current and voltage at point A are constant. Q_4 turns on and C_2 charges, making Q_2 reduce the current through Q_1 and R_1 . Then Q_4 cuts off and C_2 slowly discharges. This action clamps point A at 0.6 volt below V_{ref} . Q_5 then shifts the output level up by 0.6 v to V_{ref} .

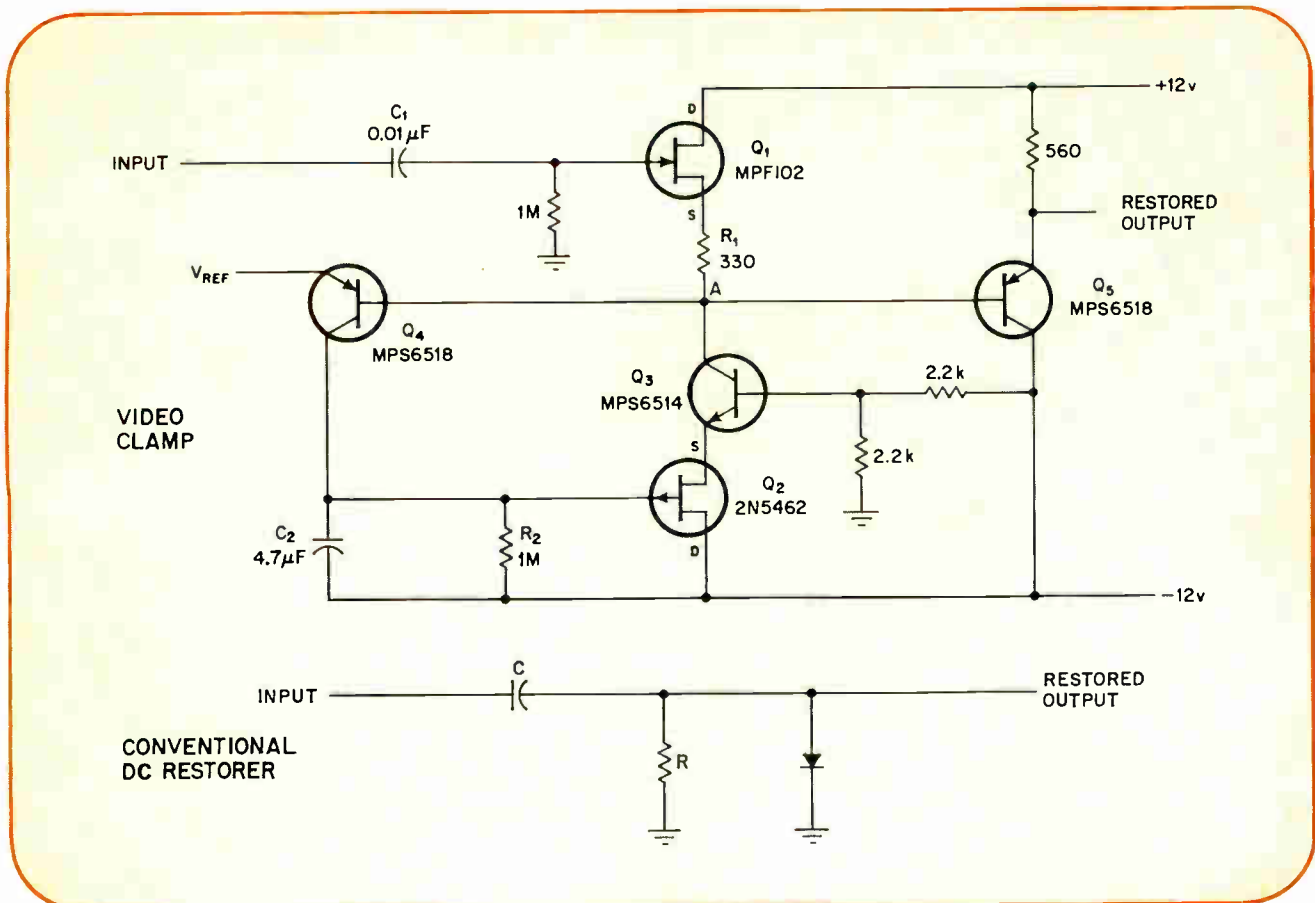

Impedance-lowering op amp speeds filter response

by Robert J. Battes

Delta-Pacific Electronics, Prospect Heights, Ill.

By minimizing ac impedance, an active filter will solve the problem of removing ripple from dc signals applied to digital voltmeters and other equipment with high input impedances.

Simple RC filters are not very practical in such applications because a large capacitor is needed to attenuate the ripple. Such a large capacitor can stretch out the response time, while its leakage current will heavily load the dc signal. But by lowering just the ac impedance, the necessary capacitance will be kept small while attenuation will improve over a wide range of ripple frequencies.

Ripple at point A is coupled through dc blocking capacitor C_1 to the operational amplifier, which in-

verts and greatly amplifies the ripple. Because the negative feedback, which is brought back to point A through C_2 , is large, the effective ac input impedance is reduced at point A by about X_{C_2}/A_V . This is the ratio of C_2 's reactance to the voltage gain from A to B when C_2 is disconnected.

As a result, the ripple at A drops by nearly $A_V R_1 / X_{C_2}$, or more than 100 decibels at 60 hertz. It is easily attenuated by small, low-leakage capacitors that also isolate the dc signal line from the amplifier bias currents.

Attenuation remains high well into the audio region. Both X_{C_2} and A_V drop rapidly as frequency rises. The fall in A_V is due to the amplifier's internal frequency-compensating components.

The active filter takes about 5 seconds to bring the output to within 1% of final value after a step change in the dc level. The passive network, which attenuates about 100 dB at 60 Hz, takes some 1,350 seconds.

In addition, the active filter maintains a good response speed as frequency increases into the line and audio regions.

Capacitance amplifier. Ability of small capacitors to attenuate ripple is multiplied by inverting, amplifying, and feeding back the ripple to the signal input. This reduces the effective ac impedance by the ratio of C_2 's reactance to the amplifier gain. A passive filter responds slowly because a large capacitor is needed to attenuate directly.

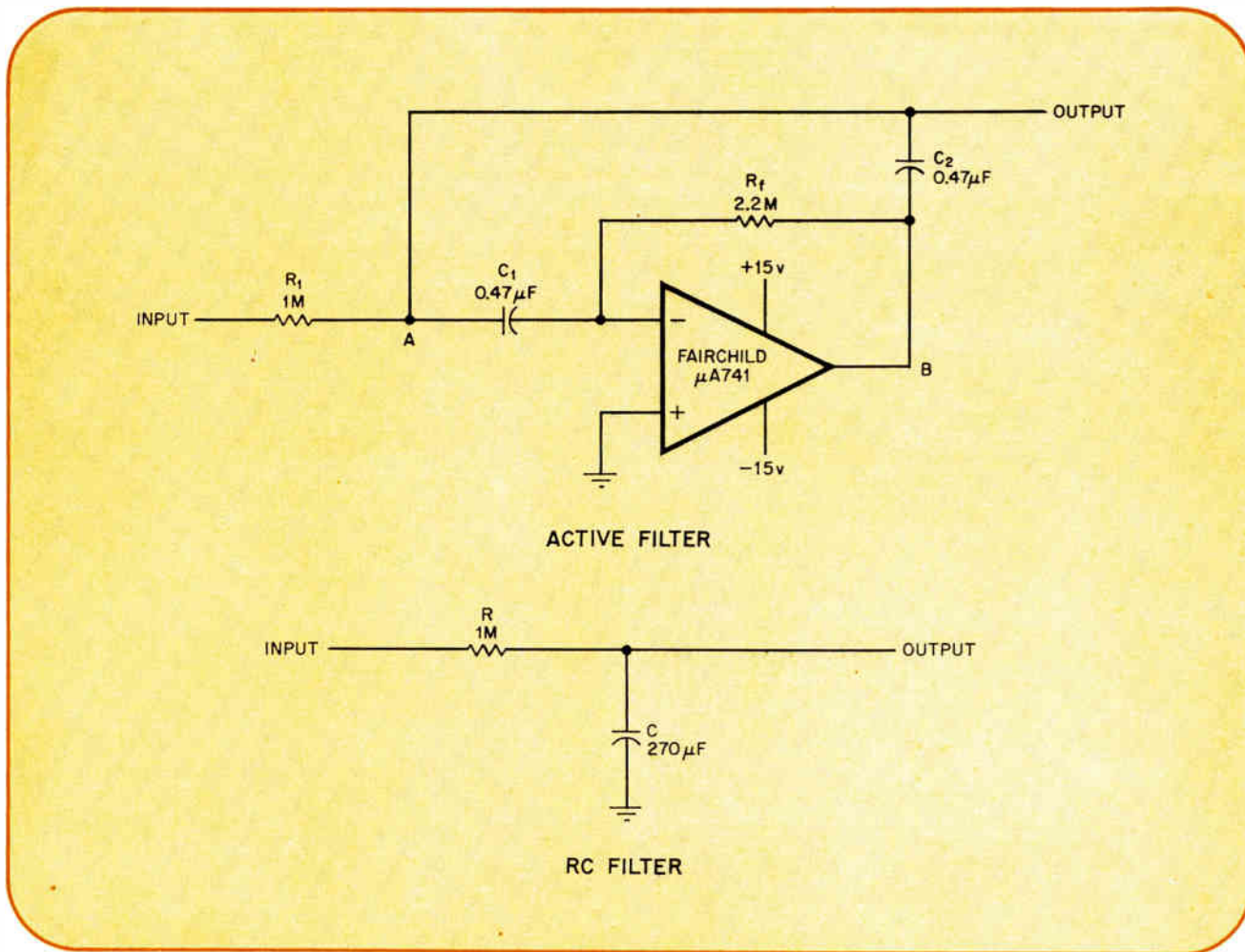

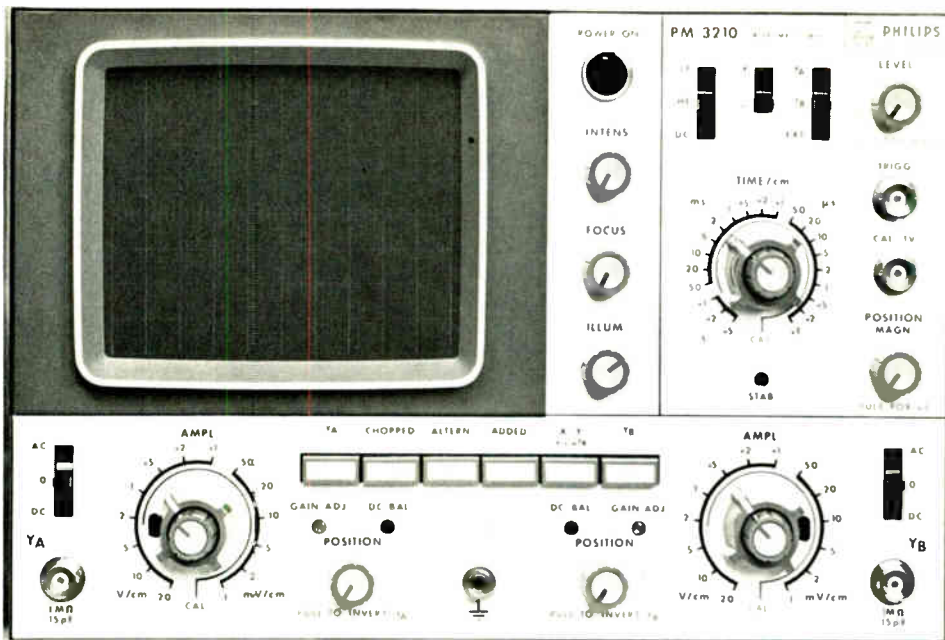

PM 3210
\$1350

easy

**Best
price/
performance
ratio**

25 MHz/1mV
15 pf input capacitance
No dc drift*

For service application in production testing, quality control, medical research and computer servicing, Philips' new PM 3210 easily gives you the best all around price/performance ratio of any scope in its field: dual trace 25 MHz at 1 mV sensitivity per channel ... dual delay lines ... input impedance 1M Ω /15pf ... X-Y displays with only 2° phase shift from 0 to 5 MHz ... 16 combinations of vertical display modes

Easy to use

*No correction needed for dc drift, self-correcting ... push button mode selection ... automatic triggering, 10 Hz to 25 MHz

Easy to read

10kV acceleration and 8 x 10 cm screen produce clear, unambiguous displays

Easy to service

Plug-in circuit boards throughout

Easy to buy

Call Dick Rude, Sales Manager, Test & Measuring Instruments today (914-664-4500). He's holding a demonstrator for you.



750 S. FULTON AVE., MT. VERNON, N.Y. 10550
A DIVISION OF PEPI, INC.

With a speech pattern classifier, computer listens to its master's voice

Vocal control unit analyzes speech to produce and process a digital code for computer command; though its vocabulary is small now, system is pointing toward aircraft control and computer-aided instruction

by James W. Glenn and Myron H. Hitchcock, *Scope Electronics Inc., Reston, Va.*



1. **Voice Command System.** This box recognizes up to 24 commands spoken into the microphone, and displays a corresponding number on the front panel, while a binary equivalent is available at a rear connector.

□ Communication with machines by voice already has made the transition from science fiction to practical reality. Today it permits a human to perform complex manual tasks without interruptions to punch a keyboard. Tomorrow it may be applied to computer-aided instruction systems, permitting vocal response by the student, and to airplane control and interrogation. And the list of specialized applications could be nearly limitless.

But even at the level of present equipment, many psychological and technical questions remain to be answered before the practicality of voice communication with machines can be definitely determined. Answers to these questions, and perhaps some new questions, will become evident as experience accumulates with the present machine, called the Voice Command System, the first of which is to be shipped this summer.

The Voice Command System (Fig. 1) is an acoustic pattern classifier that produces a digital code as an output in response to a spoken command. It consists of a spectrum analyzer, an analog-to-digital converter, a hard-wired digital processor, a core memory, and an output register, as shown in Fig. 2.

Speech begins with an excitation of air by the vocal cords. The oral, nasal, and pharyngeal cavities (Fig. 3) superimpose on the excited air a transfer function; the combination of both determines the spectrum of radiated acoustical energy. Thus, the spectrum analyzer obtains the spectrum of a word uttered into

a microphone, and generates samples of the spectrum for conversion to digital form for further processing. All pattern recognition functions are carried out by the digital processor.

The recognition process must handle two kinds of variations: changes in the rate of articulation, and physiological differences between speakers—or “who said it?” and “how fast did he say it?” To do these jobs, the processor includes a command detector, a coding compressor, an estimator, and a command classifier.

The classifier's functions include training the system to respond to a new vocabulary and classifying spoken commands to match the contents of a previously learned word store. The coding compressor compensates for changes in the rate of articulation, while the training process matches the system to individual voices.

The pattern memory stores digitized spectral data and the set of reference patterns that represent the current vocabulary; the basic memory's capacity is 1,024 eight-bit words. Classification decisions are placed by the processor in an eight-bit buffer, which holds them for acceptance by a data collection device to which the system is connected. The decisions are also displayed on front panel lights.

The system accepts 24 commands of up to one-second duration; its vocabulary can be expanded to 128 words. A pause of at least 250 milliseconds is required between commands, though shorter breaks

2. Voice input. Spectrum analyzer divides spoken command into 16 narrow frequency bands which are converted to digital form and compressed into a standard length for pattern recognition. In training, the average of five utterances of the same command is stored in the core memory. In classification, each spoken command is compared with all stored patterns and “recognized” by the one that correlates highest.

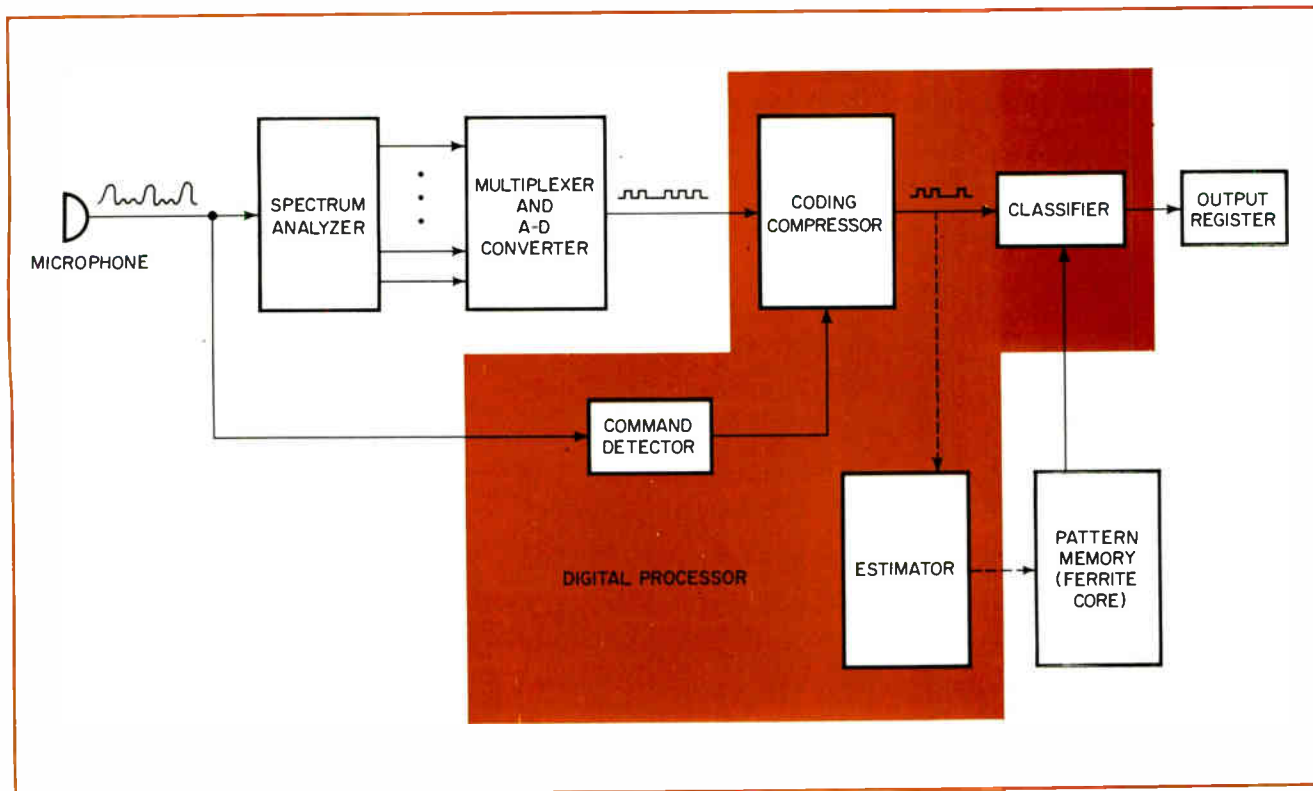

Theory of pattern recognition

To recognize and process patterns of speech for voice control of computers, the patterns must be converted into signals and be classified automatically. The signals to be classified are subsets of an infinite set of signals. The infinite set would be all possible sounds; progressively smaller subsets would be all speech sounds, all speech sounds in a particular language, and the sounds of a limited vocabulary in that language.

Although each subset itself is a finite part of the original infinite set, and although each signal has a finite duration, the signal potentially contains an infinite amount of data, because it is continuous in time. The classification process can't be expected to pull useful information out of all data available in each finite but continuous signal—it is intended only to identify which of the several signals in the subset is present. To perform this function, feature extraction is required.

Feature extraction involves finding a finite set of functions that spans, or represents, every part of the original infinite set. The coefficients of such a set of functions then can adequately specify each signal in the subset to be identified. If the original set is characterized as an infinite set of points in a space of an infinite number of dimensions, then the subset of finite but continuous signals represents a finite set of points in that space. The feature extraction function labels each point with a finite number of dimensions—a vector.

One way to obtain such a vector is to convert the continuous signals from analog to digital form. The digital representation is the desired vector, with the number of dimensions depending on the degree of resolution.

This number can be rather large. For example, in the Voice Command System, where the spectrum analyzer and multiplexer do the feature extraction, there are 16 bandpass filters, each sampled 60 times a second. The samples are quantized and expressed as four bits, so that each second, a new vector of $16 \times 60 \times 4 = 3,840$ dimensions is presented to the processor.

To deal with such a large number of dimensions, it's desirable to use a selection algorithm that will produce a vector of fewer dimensions. This vector should retain most of the significant information represented by the larger vector—although obviously, something is lost in this reduction, just as something is lost in transforming the original continuous signal into the large vector.

A requirement of feature selection is a criterion for evaluating feature effectiveness. An ideal criterion would permit prediction of a signal classifier's error rate, but it would be very difficult to achieve mathematically. Several criteria have been proposed that attempt to predict error rates by measuring the bit-by-bit difference between signal vectors—for example, Pruzansky's, cited in the bibliography—but they do not take advantage of the similarities between vectors as an aid to pattern recognition.

A more sophisticated criterion developed at Scope Electronics uses these similarities iteratively to minimize the number of dimensions in the vector while still classifying patterns on a maximum-likelihood basis. This approach has been developed as a computer algorithm, which has given highly satisfactory results in analyzing and classifying both seismic and radar data. Incorporated in the Voice Command System in hard-wired form, it cuts the 3,840-bit vector to 120 bits.

within words can be accommodated. (For example, in the word "six," as usually pronounced, the sounds of "i" and "x" are separated by nearly 100 ms.) Following any pause that signals the end of a command, a decision classifying the command is made within another 20 ms.

The spectrum analyzer divides the audio input into 16 frequency bands between 200 and 5,000 hertz; these bands compose a power spectrum that is the basis for speech classification. Samples of these 16 bands taken every 1/60 second are multiplexed onto a single channel and are converted to digital form. Thus, the original utterance arrives at the digital processor as a string of four-bit binary numbers, each representing the amplitude of one of the frequency bands at some instant of time.

Since the length of an utterance varies significantly—even when the same person repeats a single word—the system includes a coding compressor whose function is to reduce the spectral data generated by each command to a fixed-length code for the pattern classifier. This procedure preserves most of the desired information while eliminating redundant spectral data. Finally, during classification, the pattern produced by the coding compressor is correlated with each of the stored reference patterns to determine which one, if any, of the previously trained commands was spoken.

The coding compressor is the heart of the system.

3. **Speech source.** The energy of speech originates in the vocal cords; cavities of the head modulate it.

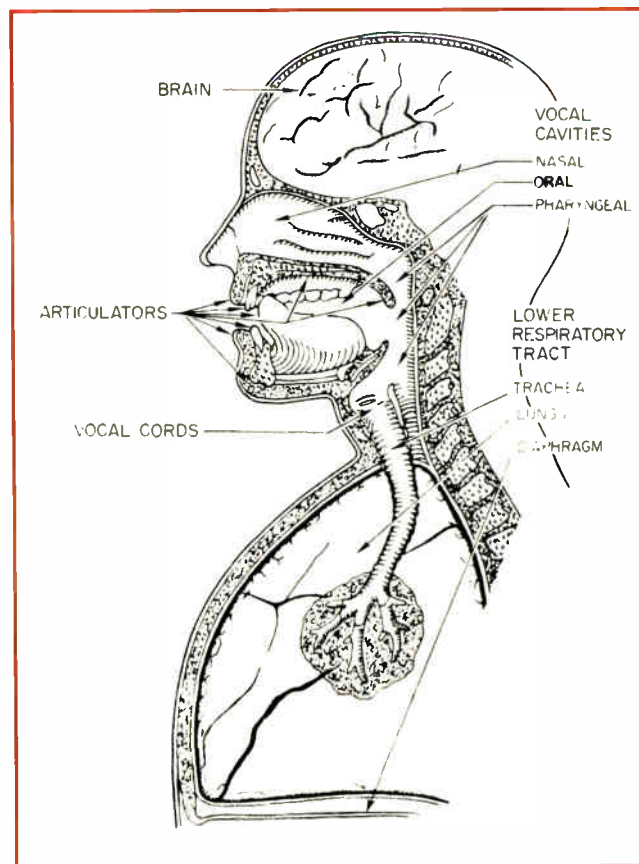

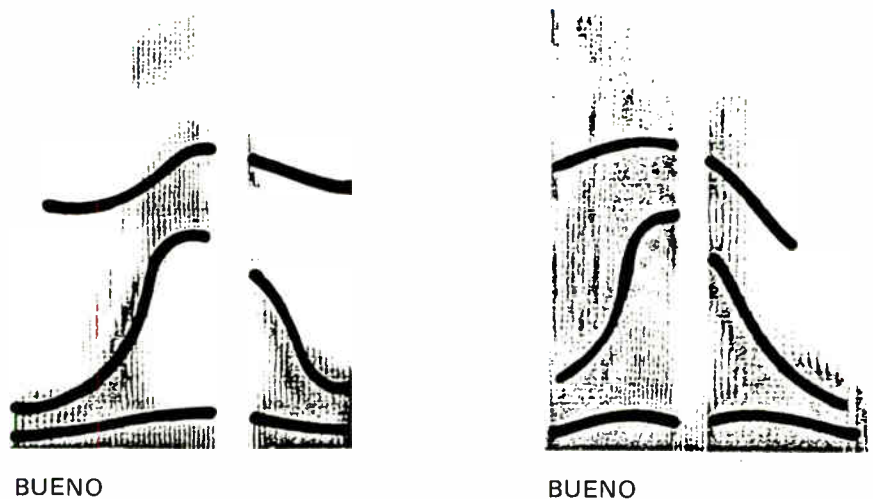

4. Spectrogram. Two voicings of the same word, spoken a few minutes apart by the same person, show obvious differences in frequency distribution and timing.

It reduces every command, regardless of length, to a 120-bit pattern; for a command lasting one full second, the data compression is greater than 30 to 1 relative to the analog-to-digital converter's output. The resulting fixed-length codes can be processed by the simplest pattern-recognition techniques.

To get into the compression process more deeply, consider two spectrograms of the Spanish word "bueno," shown in Fig. 4. In graphically representing the frequency content of each utterance, frequency is plotted along the vertical axis and time along the horizontal axis. Both utterances in these spectrograms were made by the same person, but a few minutes apart and in different contexts.

The heavy black lines emphasize the three major vocal-tract resonances, or formants. They are characterized at the input of the digital processor by three numbers of a group of 16; this group, in turn, represents the samples from a single sweep of the multiplexer across the frequency band. In general, but not invariably, the three numbers are relative maximums in the set of 16.

From the spectrogram it's clear that the two utterances show significant differences in duration that are not linearly distributed. For instance, the nasal stop consonant "n," which appears as a break in the energy pattern, occupies the same time duration in both, but the relative durations of the initial and final vowel sounds vary sharply.

The compression process is shown in Fig. 4. The upper and lower patterns on the left preserve the original time dimension of both utterances; the compression intervals defined by the coding compressor are indicated by the superimposed vertical divisions. These compression intervals vary in length: the more rapidly the spectral energy in the pattern changes, the

shorter the compression interval definition.

These intervals are determined by a process that distributes the total spectral change equally in all intervals over the duration of the utterance. Computed first are the vector differences of successive pairs of sample sets, then the scalar sum of all the vector differences. Finally this scalar sum is divided by the desired number of compression intervals. An utterance lasting one full second is sampled 60 times, so that 59 vector differences must be calculated. Although the diagram shows 10 compression intervals, the Voice Command System as presently designed uses only eight.

The two outputs from the coding compressor are shown on the right of Fig. 5. The details of the compression algorithm are proprietary; it is essentially an arithmetic process based on considerations from information theory, preserving all the things that change during an utterance and eliminating those that remain constant.

All the compression intervals shown on the right side of Fig. 5 are the same length, corresponding to time normalization. However, the slight curvature of the formant lines shows that small variations still persist in the frequency descriptions of the two utterances.

These residual variations are compensated for by the estimation process that forms the reference patterns stored in the system's memory. During training, five voicings of each command are compressed into patterns that, in turn, are combined into a single 120-bit pattern. These 120 bits represent both the tendencies that are common to the five utterances and the small variations that are almost inevitable from utterance to utterance.

After the system has been trained, and as it classi-

fies an utterance, as shown in Fig. 6, a new 120-bit pattern from the coding compressor is compared with each of the previously learned 120-bit reference patterns in the system's memory. Basically the comparison process matches the patterns bit by bit in inverting exclusive-OR circuits, which produce an output for each matching pair of bits. The total number of outputs is counted for each of the reference patterns; the one pattern that produces the highest output above a preset noise rejection threshold identifies the compressor output, and therefore the spoken command.

The most apparent applications for the Voice Command System are those that relate to operations in which a man's hands or eyes are busy with other tasks. The range of such applications goes from interrogation and control of cockpit functions in military aircraft to sorting parcel post packages. In the postal example, voice control can replace a second man on the job; in the cockpit, it can promote greater effectiveness in a complex environment.

One system has been installed at a large Government warehouse that's using a high-capacity automated conveyor. Before the Voice Command System was installed, destinations of packages put on the conveyor were called out to a woman, who entered them into a keyboard. Because the keyboard entry had to be made at the moment the package was placed on the conveyor, even though an empty carrier wasn't always immediately available, she had to remember as many as six destinations.

Now the Voice Command System hears the destination as it is called out and a small buffer memory operating in a first-in/first-out mode remembers the six destinations; a photoelectric sensor triggers the release of packages onto the conveyor when an empty carrier becomes available. Input to the system in this warehouse is through a wireless microphone, so that

employees are free to move about as they toss packages into the conveyor.

A large airline in a major metropolitan airport is planning a similar installation this summer for automatic baggage handling. And the U. S. Postal Service is interested in trying out one or two systems for sorting parcel post by zip code.

In another possible application, a manufacturer of television picture tubes is considering using the system in his quality-control operation. Now, one person measures each tube's characteristics and another person punches the information into cards. The system would be connected to an automatic paper-tape punch whose output would be fed into a computer, eliminating the need for two people to record the tube data.

A large chemical firm is seriously thinking about installing a Voice Command System in a laboratory where measurements are carried out on precision equipment in a controlled environment. The equipment and the necessary tools are kept inside sealed containers; to manipulate them, technicians insert their hands into rubber gloves that are attached to holes in the containers. The system could permit these technicians to enter data into a computer without removing their hands from the containers.

Perhaps the most interesting and significant application is control and interrogation of airplane systems. This configuration is still very much in the research stage, although it has been successfully implemented in mockup form. In an early version, the digital processor was implemented in a general-purpose computer through software, rather than the hard-wired processor used in the present commercial version. The system was trained to recognize 54 words in a vocabulary that would be used by a military pilot to check the status of his aircraft's weapons, to select and arm them, to check out his airplane at each of several

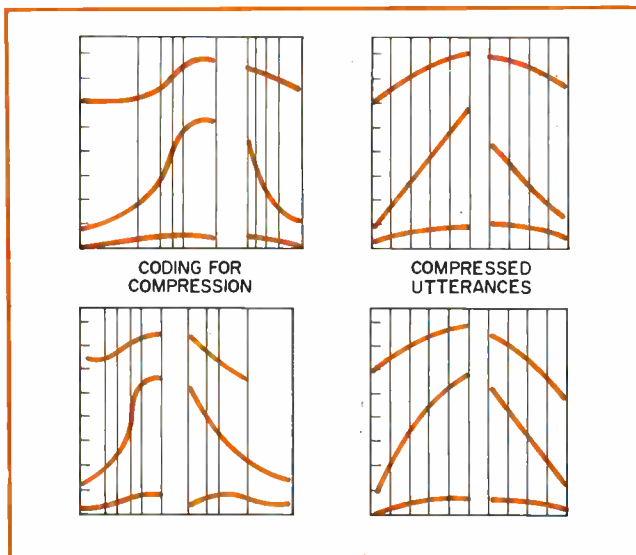

5. Compression. The two spectrograms in Fig. 3 are compressed to the same length to simplify their identification and to reduce the amount of storage space needed for correlation and recognition.

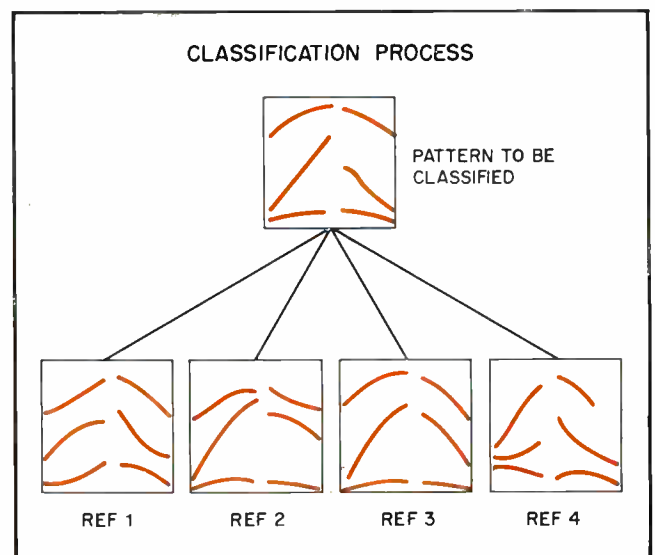

6. Comparison. Every compressed pattern is compared with all patterns that the system has been trained to recognize. Here the incoming pattern is the Spanish word "bueno"; matches the pattern marked "Ref. 3."

Other work in speech recognition

Although the speech recognition machine described in the article appears to be the only one being actively marketed, many other investigators have been experimenting with different approaches at varying levels of sophistication.

One of the old-timers is G.L. Clapper, of International Business Machines Corp., Raleigh, N.C., who described one of his earliest voice recognition machines in an article in *Electronics* [Oct. 30, 1967, p. 91]. Since then he's built more sophisticated models that store the recognized spoken words and forward them upon command to a computer. These models also incorporate automatic visual or aural feedback, permitting the user to check the machine's recognition of what he said and to correct it if necessary. The newer models also can be trained to recognize the accents of a particular speaker more rapidly than could the earlier versions, which required a series of repetitions. Clapper is working on recognition of continuous speech, and has built two prototype models, the second a substantial improvement over the first.

Considerably more sophisticated is the work at Culler-Harrison Co., Goleta, Calif., which is developing a system that will recognize an unlimited vocabulary in general American English. Significantly, it need not be trained to recognize new speakers or to acquire a new vocabulary. In Culler-Harrison's approach, the individual phonemes in the spoken message are massaged by the company's signal-processing computer; the software required for the operation is immense—but so are the prospects for the system.

At RCA Laboratories, Princeton, N.J., a research effort is under way to build a speaker-independent speech-recognition system that is limited to a relatively small vocabulary of isolated words coming in over a bandwidth-limited channel, such as a telephone line. Although investigators have succeeded in achieving a

degree of speaker independence, so far they haven't been able to make the system accept female voices. The analysis is carried out by software in a medium-sized computer, but the process is carefully kept within limits that could be implemented in hardware without too much additional effort, should an independent system ever be desired. Speaker independence is achieved by tracking the sequence of voiced and unvoiced sounds and pauses, and of certain easily identified voice sounds. Each of these segments is sampled at a sufficiently high rate so that the utterance can be time-normalized by discarding all but one or a few of the segments.

In 1969, Philco-Ford Corp., Blue Bell, Pa., under a contract from the Mitre Corp., designed a software system that could recognize 36 words once adapted to a particular speaker. The system was said to be 96% accurate—it either recognized a spoken word correctly, or didn't recognize it at all, and made no incorrect recognitions.

At about the same time, Philco-Ford built a speaker-identification system that could distinguish among one to five people based on their pronunciation of no more than five words. This work was done under a contract with the Department of Defense, and was later refined to identify a speaker on the basis of a single word. Philco-Ford has continued on similar Defense contracts, presumably for weapon control and secure communications; the work is classified.

Less than a year old, Threshold Technology Inc., of Cinnaminson, N.J., was established by a group of former employees of RCA's Advanced Technology in Camden, N.J., who had been working on voice recognition for several years. The company has announced no products so far, although it may before long; meanwhile, like Philco-Ford, it's busy with classified Government contracts.

—Wallace B. Riley

points in a mission, and to operate his identification-friend-or-foe control panel.

But beyond these immediate applications lie even stronger potentials for utilizing speech in designing man-machine interfaces. Eventually, voice could become the preferred mode of control—for example, in computer-aided instruction. And ultimately, the public could query specialized data banks by voice from home telephones.

Further developments will attempt to remove some of the constraints on the operation of the present system—the most serious of which is the requirement to train the system to each individual user, the obvious stumbling block in the path of general public acceptance. One approach could be a technique that trains the system quickly to each new user's vocal characteristics from his first few words.

Other less critical, but inconvenient, constraints are the requirement for short pauses between individual spoken commands and the need to avoid similar-sounding words in the recognition vocabulary. Continuous speech recognition probably will be achieved initially through recognition of short continuous sequences from a limited vocabulary.

But not even fairly sophisticated applications seem to require large vocabularies. Rather, a seemingly large vocabulary can actually be handled with a syntax structure imposed on a smaller vocabulary, with the necessary commands obtained through appropriate combinations. For example, the simulated aircraft control system achieved over 13,000 recognizable sequences from a command vocabulary of only 54 words.

A possible constraint that remains to be determined is the psychological impact of voice control—how well persons accustomed to button-pushing and knob-twisting can adapt to their new freedom. □

Bibliography

- S. Pruzansky and M. Mathews, "Talker Recognition Procedure Based on Analysis of Variance," *Journal of the Acoustical Society of America*, Vol. 36, 1964, p. 2,041.
- Nilo Lindgren, "Machine Recognition of Human Language, Part I—Automatic Speech Recognition," *IEEE Spectrum*, March 1965, p. 114.
- Wayne A. Lea, "Establishing the Value of Voice Communications with Computers," *IEEE Transactions on Audio and Electroacoustics*, June 1968, p. 184.
- J.R. Pierce, "Whither Speech Recognition?" *Journal of the Acoustical Society of America*, Vol. 46, 1969, p. 1,049.
- J.W. Bessman and J.W. Glenn, "Optimum Seeking Pattern Classifier," Scope Inc., Technical Memorandum No. TM-159, April 11, 1969.

now it's possible... one-step programming of any N/C drilling system at 1300 positions and functions/hour

Excellon's new OPIC II Optical Programming and Inspection Center makes short, accurate work of printed circuit board drilling programs ... no matter what N/C machine you use, no matter what its format. English or metric measurements. For one drill size, or sequentially selected drills. For automatic spindle offsets... and automatic grid programming... and making duplicate tapes *fast*. ■ OPIC II systems let you work directly from printed circuit art, negatives, or p.c. boards up to 25" X 25" (635 X 635 mm), optically, with a resolution of $\pm 0.0001"$ (± 0.01 mm). Fast. And it permits fast, accurate inspection of drilled boards, first articles and artwork. ■ If N/C drilling is in your present or your future, get the data on OPIC II programming.

Write for the OPIC II brochure.



Where variety is the problem, versatility is the answer.

Excellon

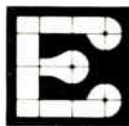

EXCELLON INDUSTRIES

23915 GARNIER / TORRANCE, CALIFORNIA 90505

Phone: (213) 325-8000

Telex: 674562 - Cable: EXCELLON Torrance

ENGLAND • Excellon International • Arkwright 18, Astmoor Industrial Estate, Runcorn • Cheshire, England • Phone: Runcorn 66545 • Telex: 627496

FRANCE/BELGIUM • Electro-Dutil • 31, Rue du Gouverneur-General-Eboue • Issy-Les-Moulineaux (Seine) • Paris, France • Phone: 736-16-50 • Telex: 25045

SCANDINAVIA • Edvard Schneider AB • Malmkillnadsgatan 54 • Stockholm 3, Sweden • Phone: 23 24 20 • Telex: 17434

THE NETHERLANDS • Excellon Europa N.V. • Vijfhuizerdijk 158, Vijfhuizen • Netherlands • Phone: 02508-456 • Telex: 41478

GERMANY/AUSTRIA • Excellon Europa GmbH • 6368 Bad Vilbel b. Frankfurt • Alte Strasse 37 • Deutschland • Phone: 06193-85794 • Telex: 416101

FAR EAST • Nippon S.T. Johnson Sales Co. • No. 3-5, Uchikanda-3 chome Chiyodaku • Tokyo, Japan • Phone: Tokyo (252)1251-65 • Telex: 02223367 • Cable: NPOHEATING Tokyo

ROM can be electrically programmed and reprogrammed and reprogrammed...

2,048-bit MOS read-only memory, which stores charge in floating gate element, not only dodges the expense and delays of mask making but also can be easily altered in the factory and in the field

by Dov Frohman-Bentchkowsky, *Intel Corp., Mountain View, Calif.*

□ The first read-only semiconductor memory to be completely or selectively alterable has been put into production. It uses MOS technology and is programmed electrically.

Unlike mechanically programmable ROMs, which are programmed with masks at the time of fabrication, the new device has the required memory pattern imprinted on it by electrical signals. And unlike other electrically programmable memories, which are programmed by large electrical pulses that permanently and irreversibly destroy selected metal interconnection lines, the new ROM can still be reprogrammed, in total or at any selected storage point, even after the device has been packaged. The process therefore not only eliminates the expense and delays encountered in generating a new custom mask for each program and for every modification of a program but also allows program changes and debugging to be implemented quickly even by the user.

The device in current production is a fully decoded 2,048-bit ROM. It is organized as 256 words of eight bits, is fully TTL compatible, and can be operated in both the static and dynamic decoding and sensing modes. Using silicon gate technology, it has access times below 800 nanoseconds in the static mode and below 500 ns in the dynamic mode. The chip is assembled in a 24-lead dual in-line package.

To give this ROM its electrically programmable features, a unique storage element was developed that's fundamentally a floating avalanche-injection MOS (Famos) structure. The gate of each of these Famos elements is kept floating, i.e. electrically isolated, and charge is transported from source or drain to the floating gate by avalanche injection. Being isolated, the gate traps the charge, and on conduction, the electrons flowing through the oxide cause negative charge to accumulate in the silicon under the gate. For p-channel devices, this negative charge inverts the silicon under the gate, that is, induces conduction in a layer connecting source and drain. Thus, the presence or absence of gate charge (the logic 1 or 0) is sensed by measuring the conductance of the layer. And since the gate is surrounded by silicon dioxide—a very low-conductivity dielectric—the storage condition of each element is permanent.

The detailed picture of the Famos storage structure in Fig. 1 shows one element along with its suggested

electrical symbol. It's seen to be essentially a p-channel silicon-gate MOS field effect transistor, in which no electrical contact is made to the polysilicon gate. A silicon dioxide layer approximately 1,000 angstroms thick isolates the polysilicon gate from the silicon substrate, and a 1.0-micron-thick layer of vapor-deposited oxide isolates it from the top surface. In this device, substrate resistivity is 5-8 ohms per cm.

In operation, a voltage of —30 volts or more is applied to the p-n junction avalanche region of such a p-channel device (Fig. 2) and injects electrons into the floating silicon gate, resulting in the accumulation of a negative charge on the gate. This negative charge induces a conductive inversion layer connecting source and drain. The amount of charge transferred to the floating gate is a function of the amplitude and duration of the applied junction voltage.

Once the applied junction voltage is removed, no discharge path is available for the accumulated electrons, since the gate is surrounded by SiO₂. A plot of charge decay at 300°C and 125°C is shown in Fig. 3; extrapolation of this plot indicates that 70% of the initially induced charge is retained for more than 10 years at 125°C.

Erasure, however, has to be accomplished by non-electrical methods, since the gate electrode is not accessible electrically. Shining ultraviolet light on any part of an unpackaged device causes a photocurrent to flow from the floating gate back to the silicon substrate, thereby discharging the gate to its initial, uncharged condition. This method of erasure allows complete testing and correction of a complex memory array before the package is finally sealed. Once the package is sealed, information can still be erased by exposing it to X radiation in excess of 5×10^4 rads, a dose which is easily attainable with commercial X-ray generators.

Built into an array, this Famos charge-storage element forms the basis for a family of electrically programmable, selectively erasable memories, such as the fully decoded 2,048-bit ROM. A circuit schematic of this memory's cell and its associated decoding circuitry is shown in Fig. 4. Programming (or writing) a memory bit is accomplished by applying coincident pulses to the appropriate X and Y select lines. These transfer the two applied programming pulses to the selected storage element, which traps the electron

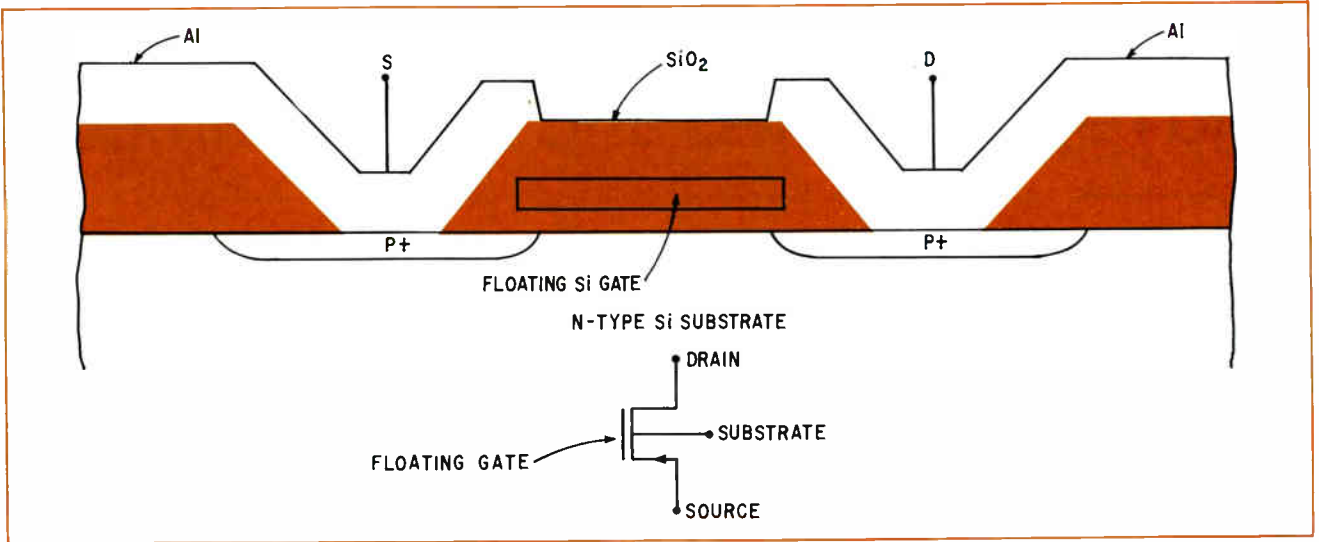

1. **Floating gate.** Essentially a p-channel silicon-gate MOSFET, the Famos structure has no electrical contact to the gate. Cell is programmed when charge is transported to the gate by avalanche injection of electrons from either source or drain.

charge on its floating gate and turns the cell on. No other memory bits are programmed since the elements lack a pulse on either their X or Y select line.

The programming signal V_P is a -50 -volt, 1.0 -ms pulse. The amount of charge stored in a memory cell in response to a programming pulse is typically 3.0×10^{-7} coulomb per square centimeter, the equivalent of 10 V on the gate of a conventional MOS transistor. The load current required to program a memory bit is approximately 5.0 mA.

Memory cell operation in the READ mode is similar to that of other ROMs: a memory bit is selected by coincident signals on the X and Y select lines. However, the voltages for reading are substantially lower than the programming voltages. This difference in operating voltages is important for reliable operation. A READ voltage, of, say, -15 V will not disturb information stored at above the programming threshold of -30 V.

In the READ mode, information in the selected memory cell is sampled by the output sense circuit. If a 0 is stored in the cell (i.e. there's charge on the

floating gate), the storage element is on and the level at the input on the sense circuit is approximately V_{CC} . A 1 corresponding to no charge stored in the cell is reflected by a more negative level, approximately V_{DD} , at the input of the sense circuit. Information can be decoded and sensed in either the dynamic (two clocks) or static (no clocks) mode. The latter mode of operation does without clocks but has higher power dissipation and lower speed.

The option of alternative modes of operation is made possible by parallel load transistors in the decode and sense circuitry, as shown in Fig. 4. One transistor is connected to the clock lines and the other to V_{GG} . To select the dynamic mode, the clocks are activated and V_{GG} is connected to V_{CC} , while in the static mode V_{GG} is activated and the clocks are connected to V_{CC} .

This cell design is organized into 256 words of 8 bits in the 2,048-bit ROM (Fig. 5). All circuit blocks are common to both PROGRAM and READ modes, with the exception of the program data input buffers, which are part of the program circuit only.

2. **All charged up.** Since gate in the Famos element structure is floating, electrons moving through the oxide result in negative gate charge. This current induces inversion layer between source and drain. Thus, presence or absence of charge on any gate can be sensed by measuring conductance between source and drain regions.

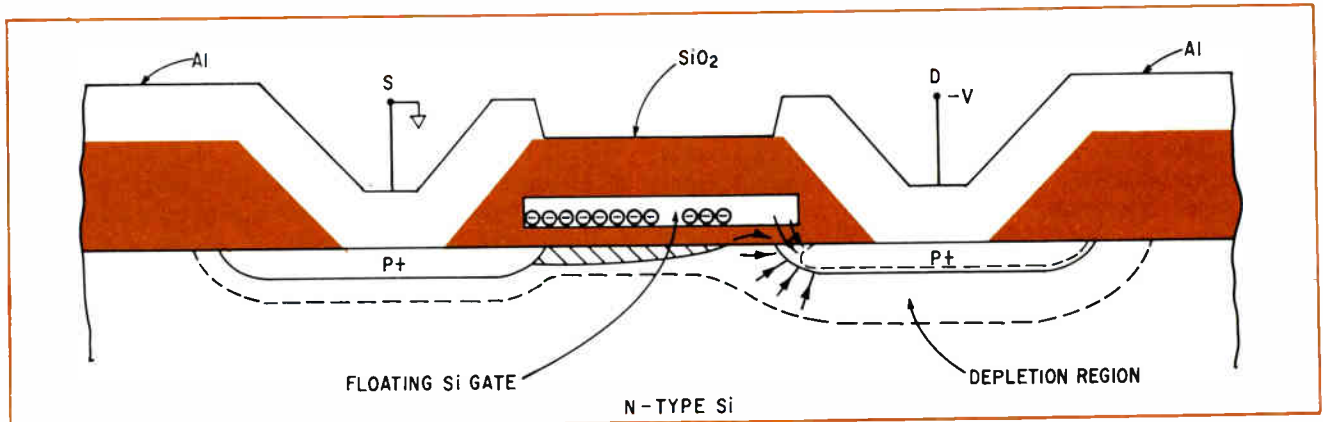

Why electrical programming?

Most semiconductor ROMs are programmed permanently at the fabrication stage by a custom mask, which defines the desired information pattern. But whenever there are program changes in microprogramming applications or pattern changes during the debugging phase of digital systems, a new mechanical mask must be used. Besides being expensive, this requirement delays production and hence sets limits to the number of pattern changes that is practical.

Enter the electrically programmable ROM. Here the permanent information pattern is recorded by an electrical signal, and the need for a mask is obviated.

Basically, there are two methods of programming a ROM with electrical pulses: permanent, irreversible change in the metal interconnection pattern of the memory, or reversible change in the active-memory characteristics.

Devices produced by the first method include fusible-type ROMs, which are mainly bipolar memories with capacities of up to 512 memory bits. Their disadvantage is that they cannot be reprogrammed. In addition, they cannot achieve high bit density.

Alterable ROMs, on the other hand, which depend on charge storage, should be capable of providing the density needed for low-cost, fully tested, field-programmable devices, and also offer the nonvolatile storage, i.e. the retention of information independently of an external power source, that makes magnetic memories attractive. But until the Famos storage element was designed, proposed alterable ROMs had relied on charge storage in a dielectric, which formed part of the gate of an insulated-gate field effect transistor. Examples are a MNOS (metal-nitride-oxide-silicon) memory, a MAS (metal-aluminum-oxide-silicon) memory, and a dual-gate MNOS memory. Difficulties in controlling the electrical characteristics of the storage dielectrics, and the extra fabrication steps required to achieve on-the-chip decoding, have to date limited the realization of these approaches to undecoded memory arrays in complexities no greater than 256 bits per chip.

As the block diagram shows, in the PROGRAM mode the eight output terminals are used as data inputs to determine the information pattern in the eight bits of each word; word address selection is performed by the X and Y decoders through the input drivers. Initially all 2,048 bits are in the 1 state, corresponding to normally OFF, or uncharged storage elements. By charging the storage elements from the program terminal, 0s are selectively entered in the proper bit locations. The supply (V_{DD} , V_{GG} , V_P), address (A_0 through A_7), and data input (D_{IN1} through D_{IN8}) voltages in the PROGRAM mode are detailed in Fig. 4.

In the READ mode, the program data input buffers are instructed by the chip select signal to cut off the feedback path from the output to the memory array established in the PROGRAM mode. From this point on, operation is the same as in conventional mask-programmable ROMs. The input and output buffers provide for full TTL compatibility, and addressing is accomplished by the X and Y decoders. A selected memory cell with charged storage element will show up as a low, or 0, TTL level at the output, while a

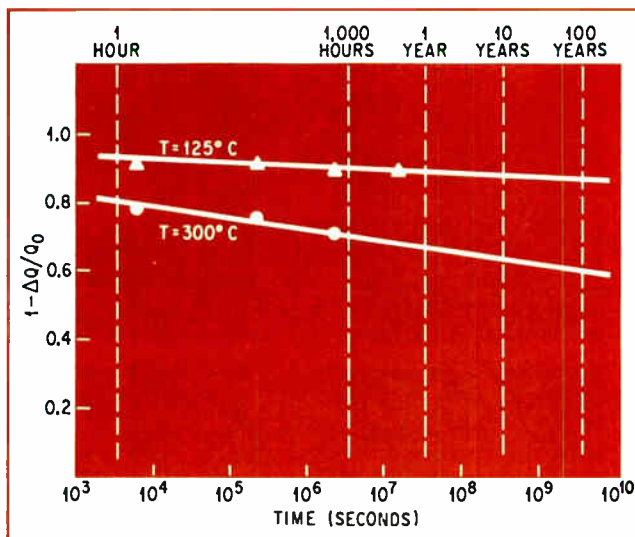

3. No decay. As a measure of reliability, charge decay is plotted against time for two temperatures. Retention of devices that survive 300°C for a few minutes is guaranteed for 10 years at 125°C.

memory bit not charged will result in a high, or 1, TTL level.

To choose between the static and dynamic modes of decoding and sensing that are available in a single package, a user activates the clock lines (ϕ_1 , ϕ_2) for the dynamic mode selection and the V_{GG} terminal for static mode. Typical access times are 400 ns in the dynamic mode and 700 ns in the static mode. A chip is shown in Fig. 6.

Conceptually, of course, the electrical programming of the memory is the same as operation in the READ mode, with the exception of the voltage levels. Hence, the memory can easily be programmed from punched paper tape or other data input devices through an electrical programming terminal. Such a terminal is shown in Fig. 7. Here, input data is entered through punched paper tape and translated to generate the proper electrical programming signals. The programmed device is checked in both the static and dynamic READ modes against the stored tape input pattern.

The ability to erase errors with ultraviolet radiation before packaging allows for complete checkout of the memory chip prior to shipment. In fact, erasure of information in packaged devices by placing them in a commercially available X-ray generator allows for correction of programming errors as well as unpredictable future pattern modifications.

However attractive this electrically programmable and selectively erasable memory is, it raises more complex questions of reliability than do mechanically programmed ROMs. Two major issues concern MOS technology itself and the permanence with which the Famos storage elements can retain information.

On the first issue, since the memory employs standard silicon-gate MOS technology, on which reliability data is well known, its record of many hours without failure is directly applicable.

On the second, the information stored in the elements decays slowly but predictably according to a

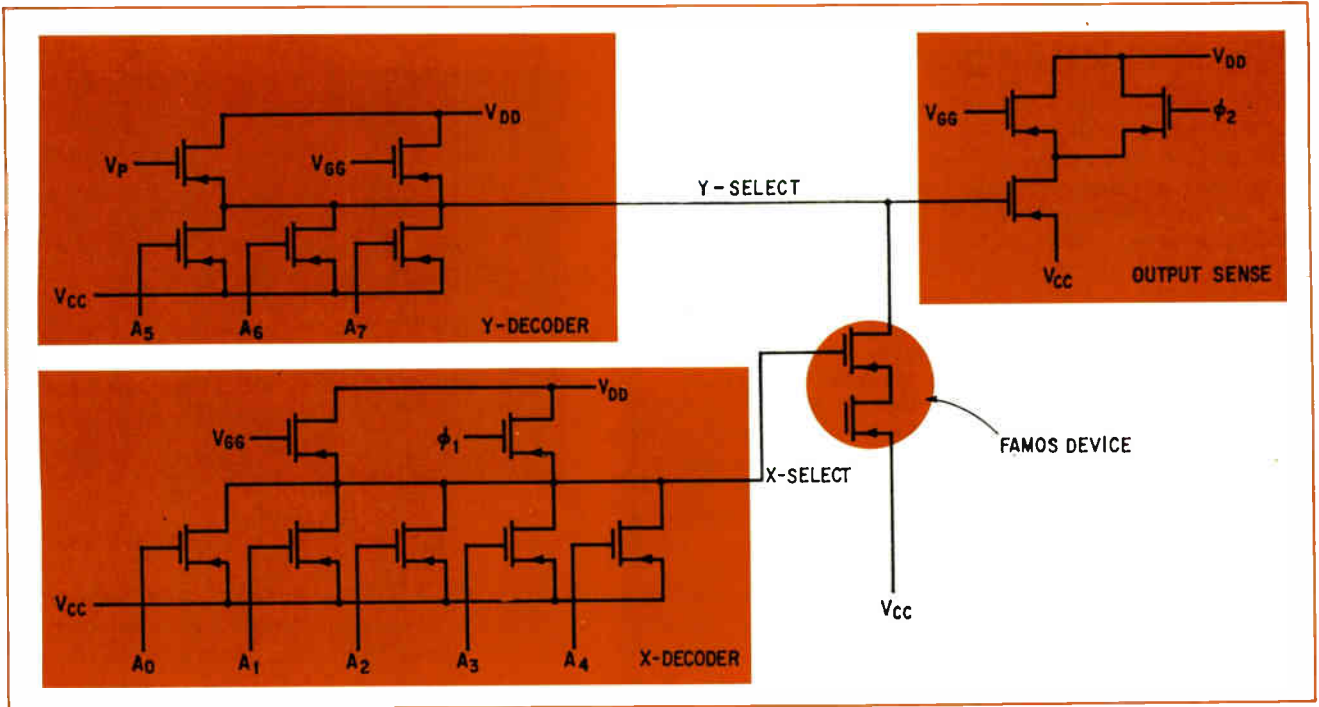

4. **The program.** To enter a bit in a Famos charge-storage device, X and Y select lines are simultaneously addressed with pulse of -30 volts. Cell is read by pulse of -15 V, well below the program threshold. A 0 is indicated at the sense circuit by voltage V_{CC} , a 1 by voltage V_{DD} .

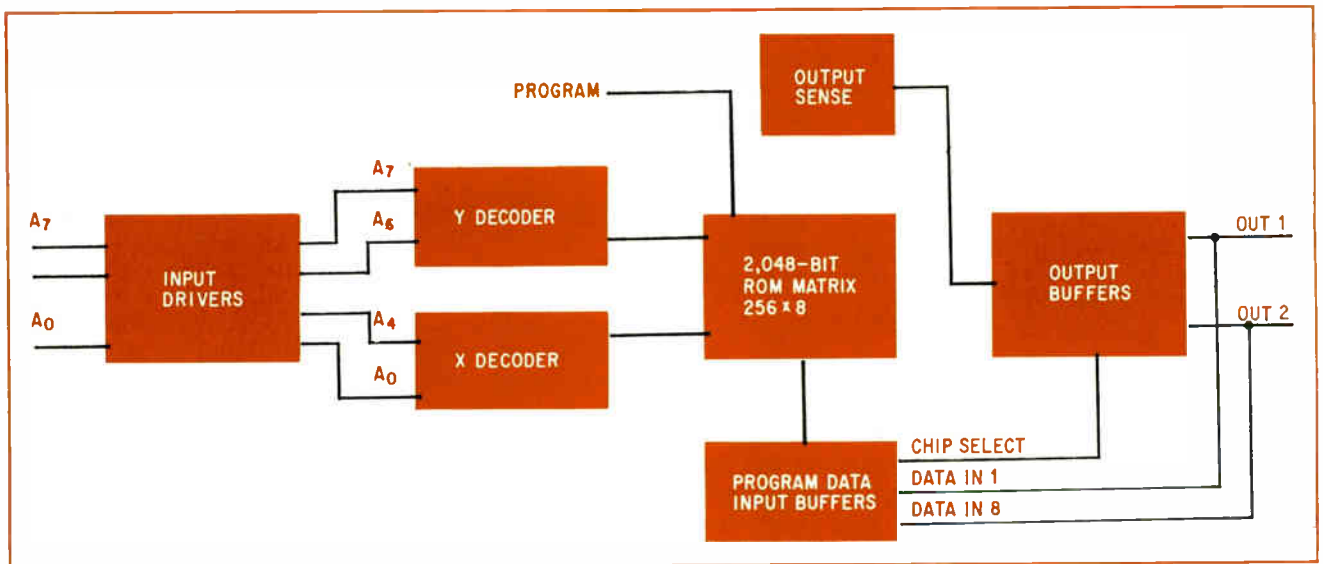

5. **The layout.** Eight terminals are used to input data. Word address is performed by the X and Y decoders. When reading, the program input buffers interrupt the feedback path from output to the program array.

particular time-temperature relationship. This long-term decay curve, which was shown in Fig. 3, has a logarithmic dependence on time, with a slope of approximately 1.0 volt per six decades of storage time, at 125°C . This rate of charge decay extrapolates to storage retention times greater than 10 years at 125°C . The predictable time-temperature behavior of stored charge, corresponding to an activation energy of 1.0 electron volt, allows for accelerated life testing of the electrically programmable ROM. To guarantee 10 years retention at 125°C , the device has to be subjected

to 300°C storage for a few minutes, a standard procedure similar to existing high-temperature stress testing performed on many MOS products to detect potential contamination in the dielectric.

A third important aspect of reliability is the extent of preshipment testing. Because of its reprogrammability, the memory array before shipment can be completely tested for functionality and programability. After the tests are performed, the information pattern can be erased and the programmable ROM shipped with a pattern of all 1s ready for programing.

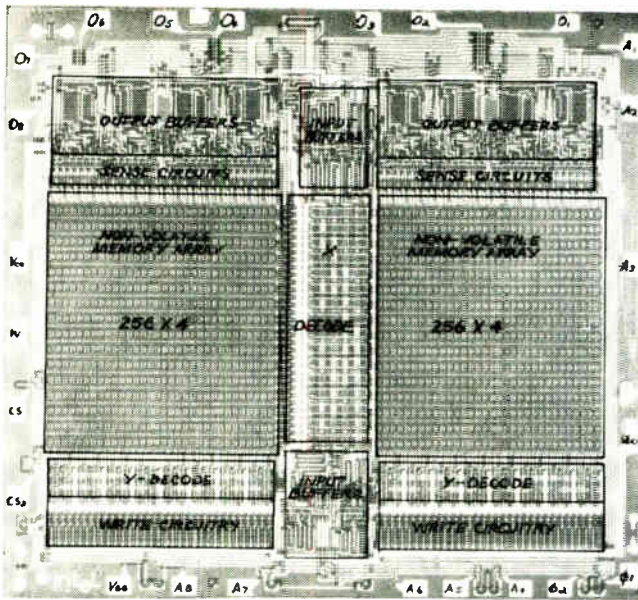

6. Chip shot. Photomicrograph of chip shows circuit components. Dynamic or static operation is available on each chip. The clock lines (ϕ_1, ϕ_2) selects the dynamic mode, activating the V_{GG} terminal selects the static mode.

Another aspect of memory design is cost—and its effects on applications. Despite the attempts of semiconductor manufacturers to lower mask charges and turnaround time for mask-programable ROMs, the economics involved have limited the versatility of semiconductor ROMs. The availability of a low-cost electrically field-programable ROM opens application areas which until now have not been economically feasible—those in which relatively small quantities of different ROM patterns are required. One example is computer look-up tables, which provide a hard-

wired means of performing certain routine computer calculations. The variety of possible patterns needed for this function could be easily and economically implemented with electrically field-programable ROMs. Other applications are binary sequence generators, microprogramming control in computer terminals, and programmed logic arrays.

Moreover, wherever large quantities of a few patterns are required, as in code converters and characters generators, the field-programable ROM augments the capability of mask-programable ROMs. In these applications, the initial custom mask cost is small in relation to the total cost of the high-volume standard ROM pattern. However, to finalize a decision on a given high-volume standard pattern, a method of debugging is needed that avoids the costly phase of correcting errors. In this initial pattern definition phase, the electrically programable ROM is most economical and flexible. Since this flexibility is generally achieved at the expense of chip area, once the pattern has been defined, the high-volume order is placed for mask-programable ROMs which are cheaper in high quantities. Hence the combination of programming methods offers flexibility and a cost incentive. □

Bibliography

- H.G. Dill and T.N. Toombs, "A New MNOS Charged-Storage Effect," *Solid State Electronics*, Vol. 12, pp. 981-987, 1969.
- L.L. Vadasz, A.S. Grove, T.A. Rowe, and G.E. Moore, "Silicon Gate Technology" *IEEE Spectrum*, Vol. 6, p. 28, 1969.
- D. Frohman-Bentchkowsky, "An Integrated Metal-Nitride-Oxide-Silicon (MNOS) Memory," *Proc. IEEE (Letters)*, Vol. 57, pp. 1,190-1,192, June 1969.
- S. Nakanuma, T. Tsujide, R. Igarachi, K. Onoda, T. Wada, and M. Makagiri, "A Read-Only Memory Using MAS Transistors," *ISSCC Digest of Technical Papers*, pp. 68-69, Feb. 1970.
- H.A. Wegener, "MNOS Memories," *Digest of the Intermag Conference*, p. 11, 5, April 1970.
- R.G. Neale, D.L. Nelson, and G.E. Moore, "Nonvolatile and reprogrammable, the read-mostly memory is here," *Electronics*, p. 56, Sept. 28, 1970.



7. Feeding. This 2,048-bit ROM can be electrically programmed from punched tape. Data from the tape is translated and made to generate programming signals. Information can be erased, even after packaging, by exposure to X rays.

Frequency standard hides in every color TV set

As part of color video transmission, the three major networks generate a highly stable subcarrier; this signal can easily be used as a reference for calibrating other signal sources

by D. D. Davis, *National Bureau of Standards, Boulder, Colo.*

□ Along with every color broadcast, the major TV networks provide a quick, inexpensive means for measuring frequency with a resolution of a few parts in 10^{11} . ABC, NBC, and CBS each generate a highly stable 3.58-megahertz signal for color video transmission. This signal can be taken from a color TV set and used as a reference for calibrating other signal sources.

In theory, resolution in the range of 1×10^{11} is presently attainable by phase-tracking low-frequency and very-low-frequency broadcasts from the National Bureau of Standards. But in practice it would take too long. To obtain resolution of this order from such broadcasts, it would be necessary to phase-track for as long as a week or more in order to average out the effects of such propagation anomalies as sun spots and changes in the height of the ionosphere. As a result, it would also be necessary to take into account the long-term drift of the oscillator being calibrated. In contrast, the excellent short-term stability of the color TV signal makes the calibration task quick and simple to perform.

The National Television System Committee (NTSC) system of compatible color television broadcasting obtains color information from the sum of two quadrature double-sideband suppressed carrier signals at 3.58 MHz. Phase comparison information for the locked subcarrier is supplied by an eight-cycle burst of a 3.58-MHz signal on the trailing edge of each horizontal sync pulse transmitted along with the picture information. The 3.58-MHz reference signal necessary for demodulating the chroma sidebands is supplied in the home television receiver by a phase-locked crystal-controlled oscillator.

If the viewer is not to see objectionable changes in color on his screen, this subcarrier oscillator must be capable of locking to within $\pm 5^\circ$ of the burst reference frequency. Most receiver designs have this capability and so provide a system that permits the measurement of the phase difference between the transmitted color subcarrier and a local reference standard with resolution of one part in 10^{11} .

Each of the major television networks derives its 3.58-MHz burst reference frequency from a rubidium-controlled oscillator/synthesizer whose output is stable to within one part in 10^{12} per day. By being phase-locked to this burst reference frequency, therefore, a color TV set's 3.58-MHz oscillator is essentially as

stable a source as the rubidium standard itself.

Figure 1 shows the measurement scheme. The local standard to be calibrated—in this case a 5-MHz signal—is converted into a 3.58-MHz signal which is fed to one input of a linear phase comparator. The comparator's other input comes from the color TV's crystal-controlled oscillator. Though it would be possible to build a receiver and crystal-controlled oscillator from scratch, it's usually more convenient just to buy a color TV set since they cost as little as \$200.

Included in Fig. 1 is a representative 1-hour strip chart record comparing a network subcarrier with the NBS frequency standard, which has been synthesized to 3.58 MHz. The local station breaks every half-hour appear as several cycles of phase change over a period of 1 or 2 minutes. The changes occur because the 3.58-MHz oscillators at local stations aren't as stable as the ones at network studios; the changes have no effect on the overall resolution of the measuring scheme.

The frequency offset is obtainable from the slope of the linear trace and is measured by extending the trace to a base line corresponding to a 0° shift and a top line corresponding to a 360° shift. The time difference between the two intercept points corresponds to the time required for a phase change of 360° , which for a 3.58-MHz signal is equivalent to 280 nanoseconds (one period at 3.58 MHz). In the case of Fig. 1, frequency offset, $\Delta f/f$, is given by

$$\frac{\Delta f}{f} = \frac{\Delta t}{t} = \frac{280 \times 10^{-9}\text{s}}{810\text{s}} = 3.3 \times 10^{-10}$$

where Δt is the period for the reference signal, and t is elapsed time between intercepts.

Several versions of the 5-MHz-to-3.58-MHz synthesizer were constructed for comparison and evaluation (the 5-MHz level was chosen because many installations use it as the frequency for their local reference). The synthesizer makes a negligible contribution to measurement error. All versions had less than 2-ns long-term (one day) phase instability and less than 1-ns short-term jitter. Parts cost for the unit shown in Fig. 2 is under \$50.

Commercial linear phase comparators that are able to perform satisfactorily at 3.58 MHz are relatively expensive. Less costly comparators are suitable for operation at low frequencies (around 100 kilohertz),

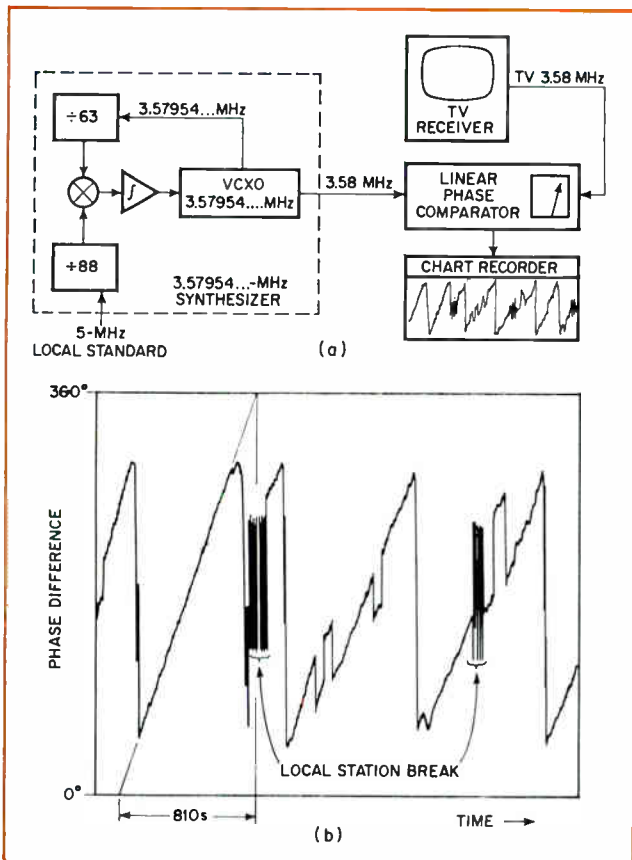

1. **Calibrating.** Synthesizer converts output of source being calibrated (5 MHz in this case) into 3.58-MHz signal which is then compared with color subcarrier from TV set. Chart recorder plots phase difference as function of time. In typical plot phase difference increases linearly (except when station breaks or other sources of distortion occur) until it approaches some value close to 360°, when it drops to some low value, and then begins increasing linearly again. Frequency offset ($\Delta f/f$, where f is frequency of reference) is found by extending linear portion of trace to 0° and 360° base lines and dividing time between intercepts (810s) into period of reference signal (280 ns).

but have excessive dead band at 3.58 MHz, i.e., when inputs to the comparator differ in phase by less than 0.1 microsecond, the comparator is unable to resolve the difference and its output is ambiguous.

Instead, the linear phase comparator shown in Fig. 3 was designed for this application. Its dead band is about 0.3 ns with better than 1% linearity. The unit, which uses four ICs and several discrete semiconductor components, costs about \$20.

The locations of the 0° base line and 360° top line are found by turning the circuit's switch to CALIBRATE and adjusting the CAL resistor until the recorder trace goes to a maximum value, which is the level of the 360° line. Next, the resistor is turned to just above the 360° position, causing the trace to fall to a minimum level—the 0° base line. Finally, the resistor is turned back to the 360° position, and the switch is turned to OPERATE.

Frequency stability measurements of the color subcarriers of all three major U.S. networks (all of which broadcast from New York) have been made at the NBS Laboratories in Boulder^{1,2}. These measurements indicated that it's possible to resolve the phase difference between the subcarrier and another 3.58-MHz signal to less than 10 nanoseconds. This, as the following equation shows, corresponds to a determination of frequency difference of about one part in 10^{11} in 1,000 seconds (approximately 17 minutes).

$$\frac{\Delta f}{f} = \frac{\Delta t}{t} = \frac{10\text{ns}}{1,000\text{s}} = \frac{10^{-8}}{10^3} = 10^{-11}$$

Resolution of frequency differences to one part in 10^{11} does not mean accuracy is that good. A local frequency source can be calibrated by this method with a network's rubidium source to within one part in 10^{11} but it won't necessarily agree with a national standard unless the rubidium standard itself has been adjusted to agree. In November 1970 the rubidium oscillators used by the major television networks in New York differed from the NBS frequency standard as follows:

- ABC: -1×10^{-11}
- CBS: $+20.7 \times 10^{-11}$
- NBC: -33.6×10^{-11}

But these figures change from month to month, and at present there's no convenient way of getting information on the precise amount of offset. However, if the adoption of this measurement scheme creates a demand for this information, ways of making the offset size known can be made available (see panel).

Absolute accuracy, however, isn't necessary in many applications. For example, a comparative scheme would prove valuable for synchronizing two frequencies, and would provide users of single sideband with a rapid means of presetting their operation frequencies. Similarly, long baseline interferometry requires

2. **Synthesizer.** Circuit for converting frequency to be calibrated into a 3.58-MHz signal can be relatively simple. One above is for 5-MHz local sources.

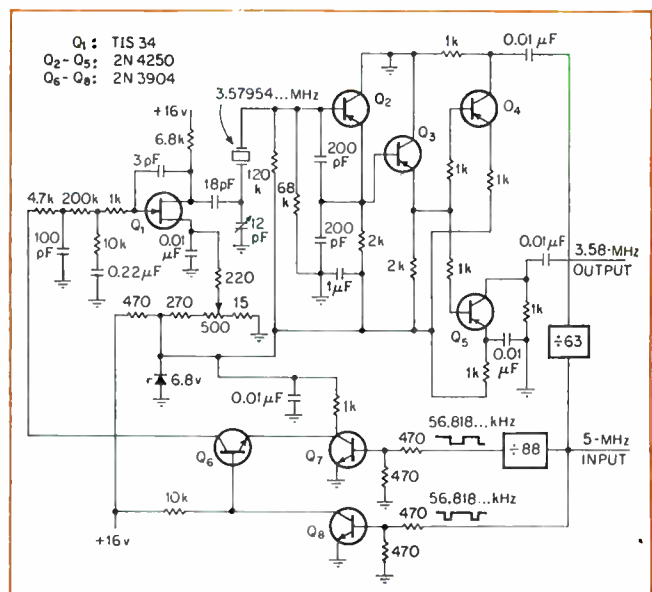

Absolute measurements

The accuracy of measurements made using the 3.58-MHz received TV color subcarrier as a stable frequency reference depends on how closely the frequency standards used by the networks agree with the national frequency standard at the National Bureau of Standards.

Two methods could be used to calibrate the subcarrier frequency in terms of a national standard. One would be to publish, but not change, the amount of frequency offset of the three networks on a regular monthly basis. This would be adequate since the rubidium oscillators used as standards by the major network change frequency very slowly—by parts in 10^{12} per day.

The other method would be to adjust the frequency of the rubidium oscillators whenever the offset exceeds some prescribed, arbitrary value. If, for instance, the limit were established at plus or minus two parts in 10^{11} , adjustments would be required only once a month. Even without any calibration, the accuracy of the network frequency standards is never worse than one part in 10^9 . This exceeds the accuracy of high-frequency broadcasts (WV and WVH) by approximately two orders of magnitude.

two widely spaced stations with precisely synchronized frequencies.

Obviously, before using the 3.58-MHz subcarrier as a frequency reference, it must be determined whether a particular program originates from a network's New York studio or from the local station, since the local station will use a relatively unstable crystal oscillator. There are a couple of ways to do this.

First, if the user has a copy of the television schedules for his own and an adjacent time zone, comparing the two will show which programs are being broadcast simultaneously and are probably "live" from the network. The most likely candidates are daytime serials and quiz shows. Second, it's possible to take

advantage of the fact that the local stations have relatively poor 3.58-MHz references—stable to at best 1 hertz in 5 minutes. A "suspected" network program can be tuned in and the user's oscillator adjusted to agree. The other two major network stations can then be tuned in successively to see if their 3.58-MHz subcarriers are drifting relative to the first. For two "live" network programs, the relative frequency offset will be less than 1 cycle per 10 minutes, while for local programs the offset will generally drift about 1 cycle every few seconds. This approach requires an oscillator with a drift rate of no more than a few parts in 10^8 per day, and short-term stability of plus or minus one part in 10^9 per hour.

There's another consideration involved in using the color subcarrier as a standard frequency source. The local network affiliate receives programming from New York over the American Telephone and Telegraph microwave relay system. Depending on the station's location, from one to 100 repeaters are included in the microwave system. Although the microwave relay system is phase-stable, problems arise when one of the microwave links fails and is replaced by a protection or "back-up" channel. The resulting change in path delay, or change in the distance traveled by the signal, will cause an abrupt shift in the phase of the color subcarrier as received. The color seen on the receiver screen is not affected because the composite video is delayed by the same amount as the burst. But since the phase measurement requires comparison with an independent standard, an instantaneous change of phase to another stable value occurs. □

References

1. D.D. Davis, J.L. Jespersen and G. Kamas, "The Use of Television Signals for Time and Frequency Dissemination," Proc. IEEE (Letter), Vol. 58, No. 6, pp. 931-933, June 1970.
2. D.D. Davis, "Transmission of Time/Frequency Signals in the Vertical Interval," Synopses of Papers (108th Tech. Conf. & Equip. Exhibit, Soc. Mot. Pict. & Tele. Eng., New York, N.Y., Oct. 4-9, 1970), Paper No. 43, Oct. 1970.

3. Phase comparator. In addition to comparing local signal with 3.58-MHz subcarrier, circuit provides built-in calibration. When switch is turned to CALIBRATE, resistor can be adjusted to determine position of 0° base line and 360° top line.

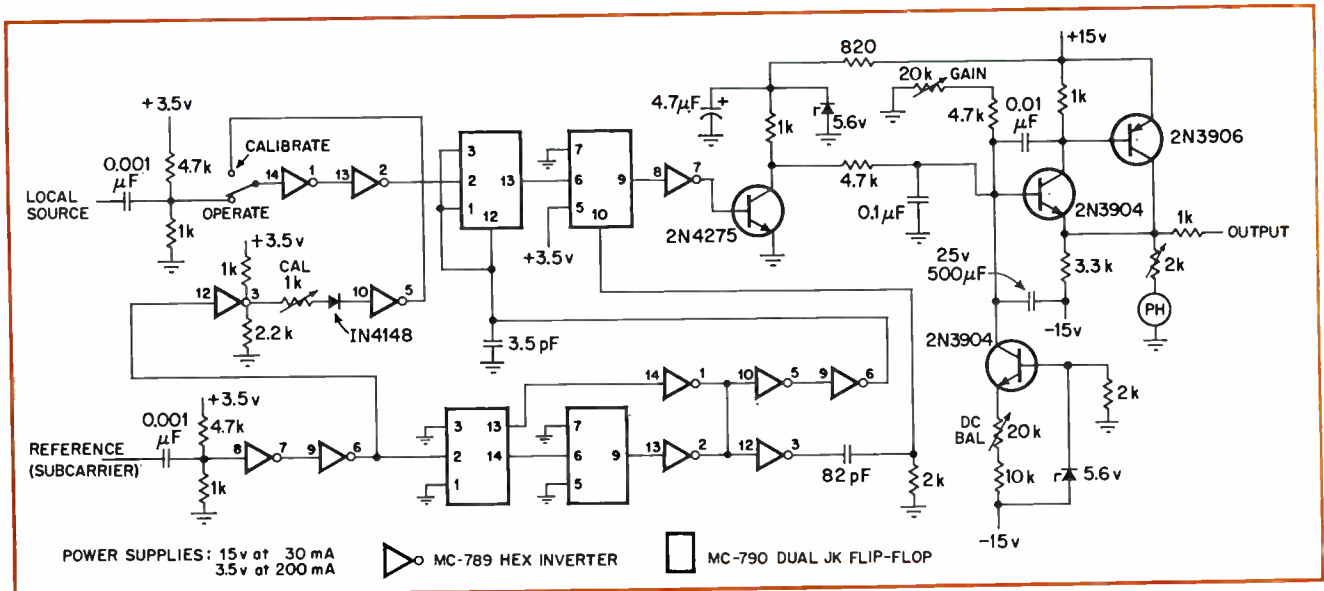

a thought about you...

Perplexed

And no wonder! With so many general-purpose minicomputers to choose from, how can you possibly decide which is the best for you?

It's easy! Let Cincinnati Milacron help you. Our sales staff is trained to analyze your needs and supply answers to all those questions that are vital to your decision-making. Answers in plain English, not jargon.

But we don't stop with answers. We realize that for your product to succeed in your market place, you demand much more. You must have things like reliability, competitive prices, and on-time deliveries. Beyond these, you want good service, thorough training, and a continuing information flow.

More and more OEM users are discovering that Cincinnati can solve their problems; meet their needs, and help them keep their customers coming back for more. All this is part of the package when you buy a CIP/2100. So don't feel perplexed any longer. Call Cincinnati Milacron today.



minicomputers

**CINCINNATI
MILACRON**

Lebanon, Ohio 45036

Cincinnati area (513) 494-5444 • Chicago area (312) 439-5726 • Los Angeles area (213) 582-8361 • Detroit area (313) 557-2700 • New York area (201) 687-4500

Your Helpmate of Any Month

THE GUARDIAN ANGEL

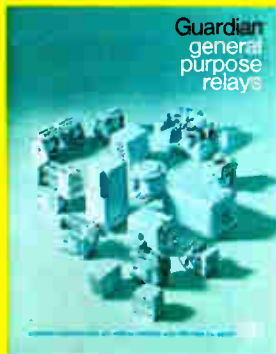

Guardian
general
purpose
relays

RELAYS

24 pages of facts, figures and dimensional drawings on all Guardian relays... from heavy-duty power types to the new miniature plug-in relays specifically engineered for PC board applications.

CIRCLE NO. 255 FOR YOUR COPY



GUARDIAN
MOLDED
SWITCHES

SWITCHES

Complete technical data on the comprehensive line of Guardian switches: Molded, stacked, push button banks and the miraculous lever switch with snap-in cam inserts so you change actuator functions instantly!

CIRCLE NO. 256 FOR DATA

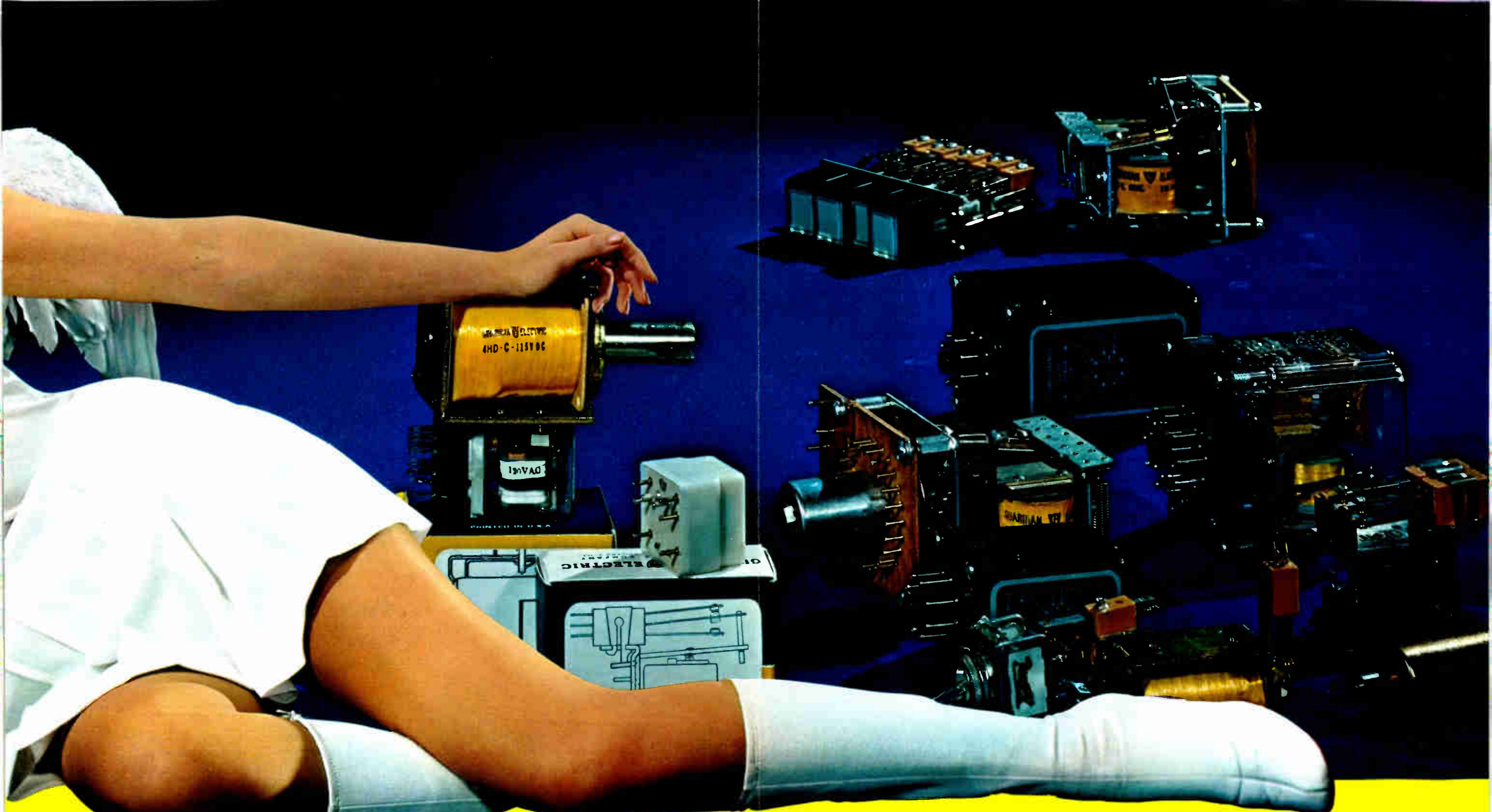

GUARDIAN[®]

GUARDIAN ELECTRIC MANUFACTURING COMPANY
 1566 West Carroll Avenue, Chicago, Illinois 60607

In a hurry? Call your Guardian Distributor.

GUARDIAN SOLENOIDS

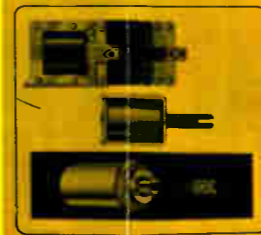

SOLENOIDS

44 page manual/catalog tells everything you need to know to spec a Guardian solenoid—frame, laminated or tubular types—pull or push action! Includes specs, pull/stroke graphs and dimensional drawings on 25 basic solenoids—with 61,034 variations.

CIRCLE NO. 257 FOR YOUR COPY

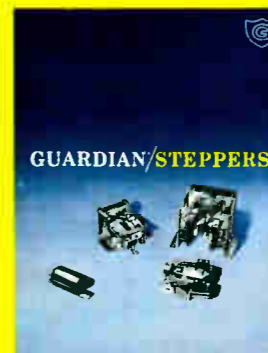

STEPPERS

Stepping relay fact book/catalog—32 pages of comprehensive application data on stepper types ranging from counting, sequence selecting and automatic resetting to pulse multiplying, slave and master and more.

CIRCLE NO. 258 FOR YOUR COPY

**A CENTERFOLD
FULL OF
MIRACLES**
from your Guardian Angel

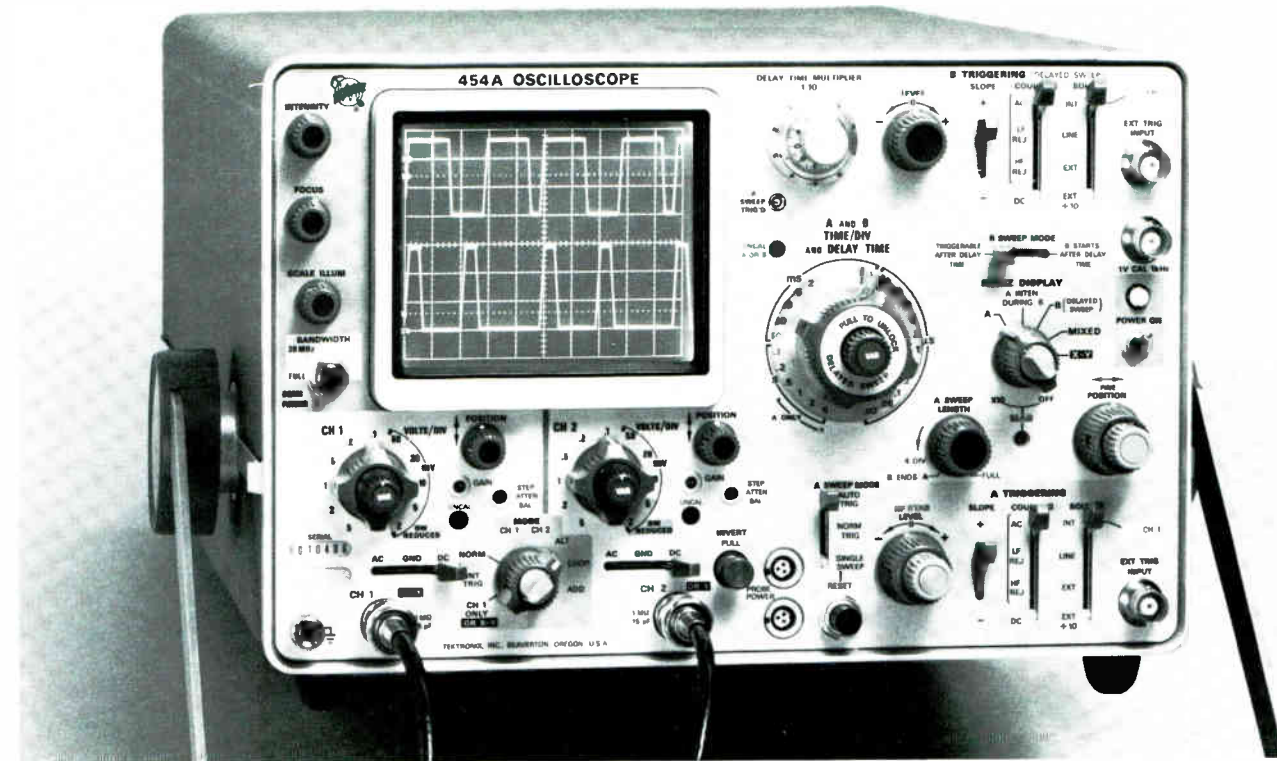
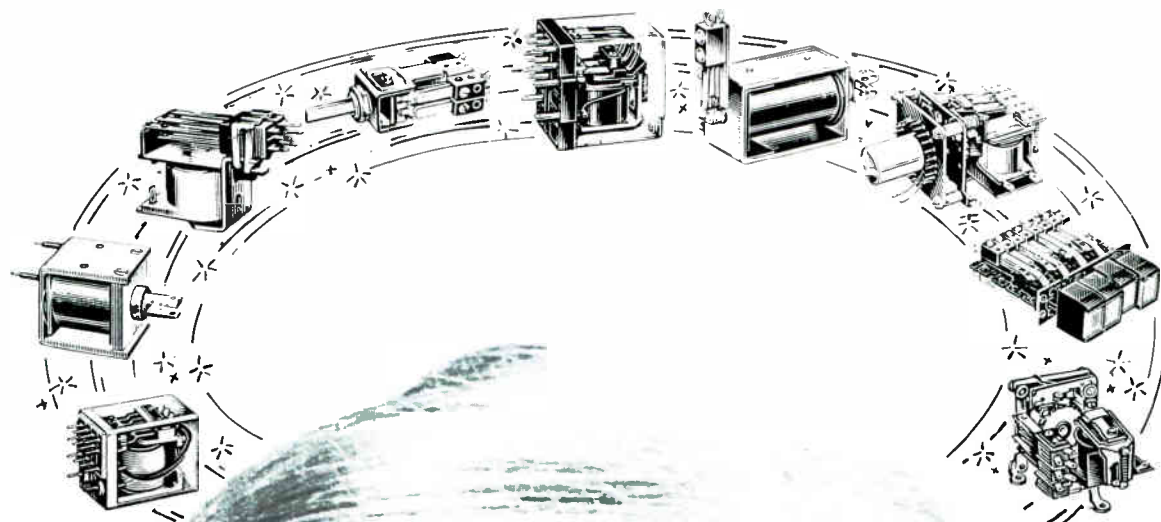

What's different about the NEW Tektronix 454A 150-MHz Oscilloscope?

There's plenty of difference in this NEW model of the field-proven 454 oscilloscope. The New 454A has even more built-in performance and measurement ease. Here are just a few of many examples:

MORE:

Display Area—over 33% more with an 8 x 10 div CRT (0.8 cm/div).

Sweep Rates—now, up to 2 ns/div (using the X10 mag) for quick, easy measurements of pulses with low nanosecond periods.

Stability and Reliability—with FET inputs which make the 454A completely solid-state.

Sensitivity at Higher Bandwidths—deflection factors are 10 mV/div at 150 MHz, 5 mV/div at 100 MHz and 2 mV/div at 50 MHz.

Display Modes—calibrated mixed sweep, new to portable oscilloscopes, expands delayed sweep measurement capability.

Measurement Ease—color coded panels reduce guesswork by clearly identifying related controls.

Maintenance Ease—circuit boards which remove quickly, faster access to components plus other factors decrease maintenance time and increase on-site operating time.

There's even MORE! For instance, the step response is improved and the standard accessories include new, smaller, easier-to-use probes.

AND—just like the 454, high impedance inputs are standard on every 454A.

It all adds up to a NEW model of a field-proven oscilloscope—an oscilloscope designed to measure with laboratory precision and to be carried with small-package ease.

454A Oscilloscope \$3050

U.S. Sales Price FOB Beaverton, Oregon



TEKTRONIX®

committed to
technical excellence

Your field engineer will gladly arrange a demonstration. See for yourself all that's NEW about the 454A.

Tektronix rental and lease programs are available in the U.S.

Solid state invades Detroit

Safety and pollution laws spur work on electronic fuel injection, ignition, and air-bag sensors; digital displays and central processors may follow

by Alfred Rosenblatt, New York bureau manager

The citadel of mechanical complexity—the automobile—for years has been besieged by electronics companies trying to push their technologies into new areas. This time around, though, the gates are opening fast—from the inside—as automobile companies, facing tough new Federal antipollution and safety statutes, are eager to put electronic devices and systems into production-line cars.

The pollution commotion is lead-

ing to development of new electronic ignition and fuel injection systems, operating in conjunction with redesigned engines and chemical catalytic converters. These systems will be essential to the efficient fuel combustion required to meet auto exhaust emission levels under the Federal Clean Air Act amendments of 1970. And safety regulations are spurring design of inflatable bag systems for passenger protection—and the sen-

sors and electronic trigger systems that go with them. The ignition and fuel injection units already are being installed on some cars, as are electronic anti-skid systems.

Further ahead, electronics designers are eyeing such high-electronics systems as central control computers, a single-wire multiplex network that ties together and controls individual subsystems, radar velocity and collision sensors, and a dozen detectors. These won't be

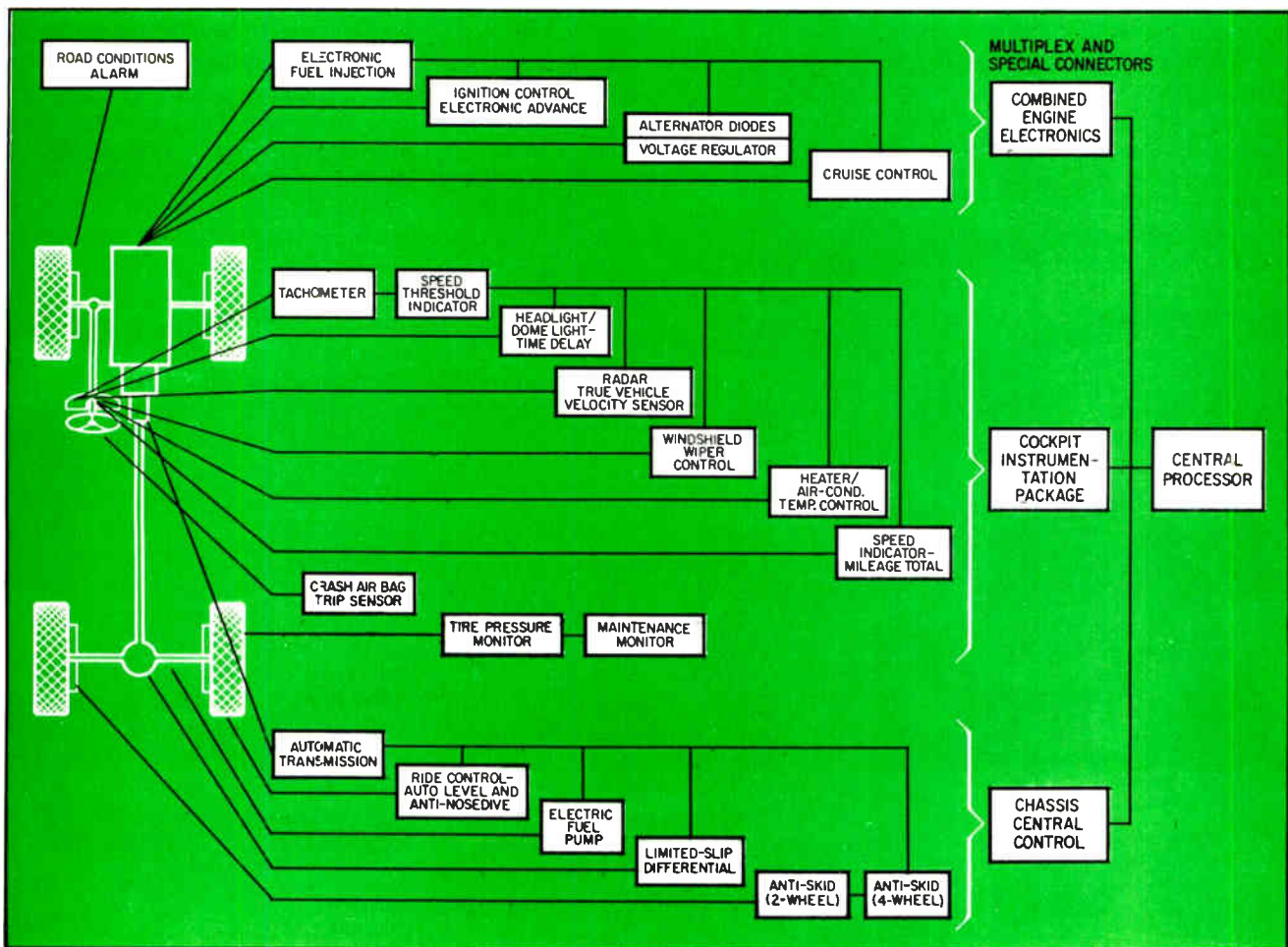

Probing the news

installed until the end of the decade. But electronics already is being used in cars for many functions. (See chart, prepared by Fairchild Semiconductor, p. 105.)

Chrysler Corp., for example, uses electronic devices in its voltage regulator, automatic temperature control unit, and headlamp system. The latter automatically turns lights on at dusk, dims them when a car approaches, and turns them off after the driver leaves the car.

Typical of other applications for electronics are those of Ford Motor Co. cars: electronic tachometer, sequential turn signals, speed control, heated rear window timer, intermittent windshield wiper control, engine speed governor for high-performance engines, transistorized clock, and a distributor modulator.

Perhaps the most highly electronics-laden cars are being turned out by Toyota Motor Co. in Japan. First to introduce an electrically controlled automatic transmission system [*Electronics*, Feb. 16, 1970, p. 69], Toyota in February added an optional electronic anti-skid system to go with its constant speed control. An electronic fuel injection system is expected later this year.

Sobering. GM device opens ignition only when driver punches random numbers displayed on digital readout.



Most of the automotive systems rely heavily on discrete power semiconductors. The market for power transistors alone is pegged at \$9 million, according to RCA's Solid State division, Somerville, N.J., most of them in low-cost plastic packages. This market will hit \$33 million by 1975. Altogether, power and small-signal devices, whose sales now are minimal, should make for combined totals of anywhere from \$100 million to \$300 million by 1975. And most of this increase should come in 1973 and 1974 as Federally mandated electronics hits the cars.

But all of this business isn't going to fall into electronics firms' laps without some tough design work, particularly in packaging and mounting. Automotive environmental conditions are rugged indeed, even tougher than military requirements, with under-hood temperatures ranging from -40°C during a cold start in an Alaskan blizzard to $+130^{\circ}\text{C}$ idling under the south Florida sun. Voltage levels can vary widely with battery charge. And ambient conditions, such as shock, vibration, salt, acid, and hundreds of volts of electrical noise on wiring harnesses, also add their stresses.

Right now, pollution statutes are making electronic ignition and fuel injection systems the top-priority items. The Federal standards call for a 90% reduction by 1975 from 1970 levels of carbon monoxide and hydrocarbon emissions, and by 1976 a similarly drastic reduction in oxides of nitrogen. Further, an automobile will have to conform to the standards for at least 50,000 miles, requiring virtually maintenance-free systems.

That's why all the major power semiconductor companies, as well as auto-company groups, are working on ignition and fuel injection systems. In electronic ignition, the usual rotating distributor shaft, with its mechanically operated contact points, is replaced by a rotating, but contactless, magnetic pickup. This configuration eliminates inefficiencies due to contact arcing and point bounce, as well as timing drift caused by contact and rubbing-block wear. A complete system also regulates spark ad-

vance by sensing signals from the pickup and adjusting timing based on the engine's speed and load.

Although they've been available as retrofits for several years, solid state ignition systems are only now being introduced on production cars. In Britain, Jaguar has them in its 12-cylinder V-12 engine, announced in March. And Chrysler uses an electronic distributor on some late 1971 models; it's likely to be available at least as an option on all Chrysler cars next year. The Chrysler system has a control unit that includes a regenerative input circuit to assure positive switching at all speeds, a variable univibrator to determine arc duration as a function of speed, and a high-voltage transistor to switch coil current.

Electronic fuel injection is more complicated. In addition to engine speed and load, such factors as engine temperature and intake manifold pressure also must be factored into a computer-like system to assure optimal combustion. For example, Delco Electronics, Milwaukee, is working on a nine-input system.

Volkswagen several years ago became the first auto maker to introduce an electronic fuel injection system on production passenger cars. The designer of the system, Robert Bosch, GmbH, Stuttgart, West Germany, concedes there were problems with the first systems, which used about 220 components [*Electronics*, March 17, 1969, p. 84]. But these problems involved interconnection, not parts, and "third-generation" units, which also use discrete components, have shown few interconnection difficulties, according to Bosch, largely because of improved soldering techniques and component mounting boards.

Bosch says it will introduce ICs in its fourth-generation system during the next two years.

Among the semiconductor companies, Fairchild, for example, is shooting for a fuel injection system with only 30 separate components, according to Robert B. Hood, systems and applications engineer for automotive controls at the Mountain View, Calif., division. And the approach will be through standard parts.

Another project under way at

Choose from 47 styles of film capacitors...

There's one to meet your exacting requirements

HERMETICALLY-SEALED METAL CASE TUBULAR CAPACITORS



BARE METAL CASE

Style LJ8, metalized polysulfone film
Style LP8, metalized polycarbonate film
Style LM8, metalized PETP-polyester film
Style LS8, metalized polystyrene film
Style AP8, polycarbonate film
Style AM8, PETP-polyester film
Style AS8, polystyrene film
Style AF8, PTFE-fluorocarbon film

METAL CASE WITH INSULATING SLEEVE

Style LP9, metalized polycarbonate film
Style LM9, metalized PETP-polyester film
Style LS9, metalized polystyrene film
Style AP9, polycarbonate film
Style AM9, PETP-polyester film
Style AS9, polystyrene film
Style AF9, PTFE-fluorocarbon film

EPOXY-CASE RECTANGULAR CAPACITORS



AXIAL-LEAD

Style LP7A, metalized polycarbonate film
Style LM7A, metalized PETP-polyester film
Style LS7A, metalized polystyrene film
Style AP7A, polycarbonate film
Style AM7A, PETP-polyester film
Style AS7A, polystyrene film

RADIAL-LEAD

Style LP7S, metalized polycarbonate film
Style LM7S, metalized PETP-polyester film
Style LS7S, metalized polystyrene film
Style AP7S, polycarbonate film
Style AM7S, PETP-polyester film
Style AS7S, polystyrene film



HERMETICALLY-SEALED METAL CASE RECTANGULAR CAPACITORS



Style CML, high voltage paper/PETP-polyester film, inserted tab construction.

HERMETICALLY-SEALED CERAMIC CASE TUBULAR CAPACITORS



Style SML, high voltage paper/PETP-polyester film, inserted tab construction.
Style SMLE, high voltage paper/PETP-polyester film, extended foil construction.

HERMETICALLY-SEALED GLASS CASE TUBULAR CAPACITORS



Style GML, high voltage paper/PETP-polyester film, 85 C
Style GTL, high voltage paper/PETP-polyester film, 125 C

WRAP-AND-FILL ROUND TUBULAR CAPACITORS



Style LJ66, metalized polysulfone film
Style LP66, metalized polycarbonate film
Style LP88, met. polycarb. film (Fuz-ion Sealed*)
Style LM66, metalized PETP-polyester film
Style LS66, metalized polystyrene film
Style AP66, polycarbonate film
Style AM66, PETP-polyester film
Style AS66, polystyrene film

WRAP-AND-FILL OVAL TUBULAR CAPACITORS



Style LP77, metalized polycarbonate film
Style LM77, metalized PETP-polyester film
Style LS77, metalized polystyrene film
Style AP77, polycarbonate film
Style AM77, PETP-polyester film
Style AS77, polystyrene film

EPOXY CASE RECTANGULAR CAPACITORS



Style EFX, high voltage paper/PETP-polyester film.

*Trademark

For engineering bulletins on the capacitor styles
in which you are interested, write to Dearborn
Electronics, Inc., Box 530, Orlando, Fla. 32802.

Dearborn Electronics, Inc.

(a subsidiary of the Sprague Electric Company)

FOREMOST IN FILM CAPACITORS

FINALLY!

A compact testing system that will make your accountant smile



The array of test equipment often used today not only costs a fortune, but is hard to maintain, takes experienced people to operate, and often fills a storeroom.

Now, AVCO can change all that . . . with AVMOTS, a new automatic testing system that reduces operating costs by as much as 75% and gives you the flexibility to test a wide variety of units.

AVMOTS uses a mini-computer programmed to do much of the work that current ATE requires of the operator. The operator does not have to be a computer expert to write or change his test procedures.

This highly flexible and easily operable system is the first of its kind available to the test community. It offers a series of benefits to the user, such as:

- 1) Full Use of Computer -- All measurement capabilities are synthesized by the computer, eliminating the need for costly instrumenta-

tion thus increasing test equipment availability. And, AVMOTS is automatically self-calibrated.

- 2) Simple to Operate -- Computer experts or programmers are not required for operating AVMOTS -- it writes, edits, and executes programs "on the spot" with straight English. AVMOTS knows how to perform all tests -- just tell it what you want it to do.
- 3) Customized Adaptation -- AVMOTS is customized to solve your test problems -- it can be changed from testing one unit to another in seconds -- it can rapidly test any number of equipment configurations.

There are 15 additional reasons why you should incorporate AVMOTS into your test environment. For example, it provides fast testing of analog, digital, and hybrid devices; the system never requires adjustment; and you can tie our system into your local or remote computer for data processing purposes. *FOR THE OTHER 12 REASONS, WRITE:*



AVMOTS/AVCO SYSTEMS DIVISION
201 LOWELL STREET, WILMINGTON, MASS. 01887

Probing the news

the auto companies is a crash sensor system for a protective air bag that would absorb shock in a crash and keep passengers inside the car. Delco's sensing unit, for example, includes two magnetically restrained g-force detectors connected in series with detonators that puncture air bottles to inflate the bags. An analog IC diagnostic circuit on a single chip monitors the entire system.

Somewhat further down the road are digital readout devices aimed at replacing analog instruments on dashboards. Two of the newest units have been developed by Pentron Electronics Corp., Vanderbilt, Pa. One, to be introduced by the end of the month, is a two-digit tachometer starting at \$80, for the auto aftermarket. The other is a two-digit speedometer, which also is being evaluated by "a major auto manufacturer," asserts Harry R. Sampey, director of research and development.

The hybrid circuitry for Pentron's speedometer is housed in a 30-pin ceramic package. Inside are 11 integrated circuits, and thick film resistors and interconnections. The package measures 0.9 by 0.9 inch and is 0.1-in. high. Pentron had to go to Japan to obtain the digital readouts. They're green, seven-segment, incandescent units operating from the car's 12-volt battery.

Sampey sees many auto applications for digital readouts, including speed-limiting devices and message displays. His company also has developed a performance-speed computer, shown above, with a four-digit display of either speed or elapsed time. Designed with hybrid ICs, it's intended for high-performance cars and racers.

One of the most complex electronic devices built for the automotive market is Delco Electronics' Phystester—an ignition lock incorporating a digital function generator and a memory on an LSI chip. Its function is to prevent drunk drivers from starting their cars.

A small hand-held unit, shown on page 106, has a set of telephone-like pushbuttons and a window displaying five numbers. To start his

car, the driver activates the control, which flashes five numbers at random for about one second. Then the driver has about three seconds to punch out the numbers he saw. He has three tries in which to do it. If the driver fails, the car won't start for 30 minutes.

As the move to electronic devices builds speed, semiconductor houses are developing units especially to satisfy automotive applications. RCA's Solid State division, for example, has generated a mechanically "more flexible" design for mounting a power semiconductor chip within its package, says Herbert B. Shannon, manager of linear power marketing. And Motorola is developing new monolithic circuits that are combined with discrete components on ce-

As the number of electronic tasks performed in a car increases, a central processor will begin to look more attractive. Adding everything on a one-for-one basis will "wind up costing \$10,000 per car," says Arthur Sidorsky, market manager for standard MOS products at General Instrument Corp.'s Semiconductor Products Group, Hicksville, N.Y. "But once you tie everything to a processor, you could share components and subsystems, and it would be relatively cheap to add extra features."

Many functions could be handled digitally, Sidorsky points out, including the ignition, anti-skid, and fuel-injection systems.

Bosch in Germany is working on such a centralized control system and so is Intel Systems, Mountain

Digital dash. Pentron computing unit replaces analog displays with digital.



ramic substrates. The initial monolithics are linear units to handle analog functions, but later they will be digital. To date, three such monolithic linears are being produced and used in "some of the premium models of a major auto manufacturer," says Robert Jenkins, operations manager for linear ICs. Later units will be digital.

The three circuits are a sensing device or tachometer circuit, a hex-quad operational amplifier that has four or six op amps on a chip, depending on a customer's needs, and a comparator circuit. Nine more products are being designed for this building-block family. When the volume justifies it, a particular function done with hybrids could probably be put on one LSI chip, says Jenkins.

View, Calif. The cost involved does not depend on the processor, says Intel president Robert Noyce, "It's the sensors and activators that cost money." Since many of the proposed systems use the same inputs, it would be simple and economical for the computer to be fed by a common set of sensors or even a new type of sensor that could do the job of several.

Fairchild, for example, is working on a true vehicle velocity sensor, a device based on a Gunn oscillator radar system. Information from such a unit could be used for anti-skid, cruise control, transmission control, and fuel injection systems, according to Fairchild. And in production quantities it might only cost \$25. In Japan, Mitsubishi Electric Corp. and Nippon

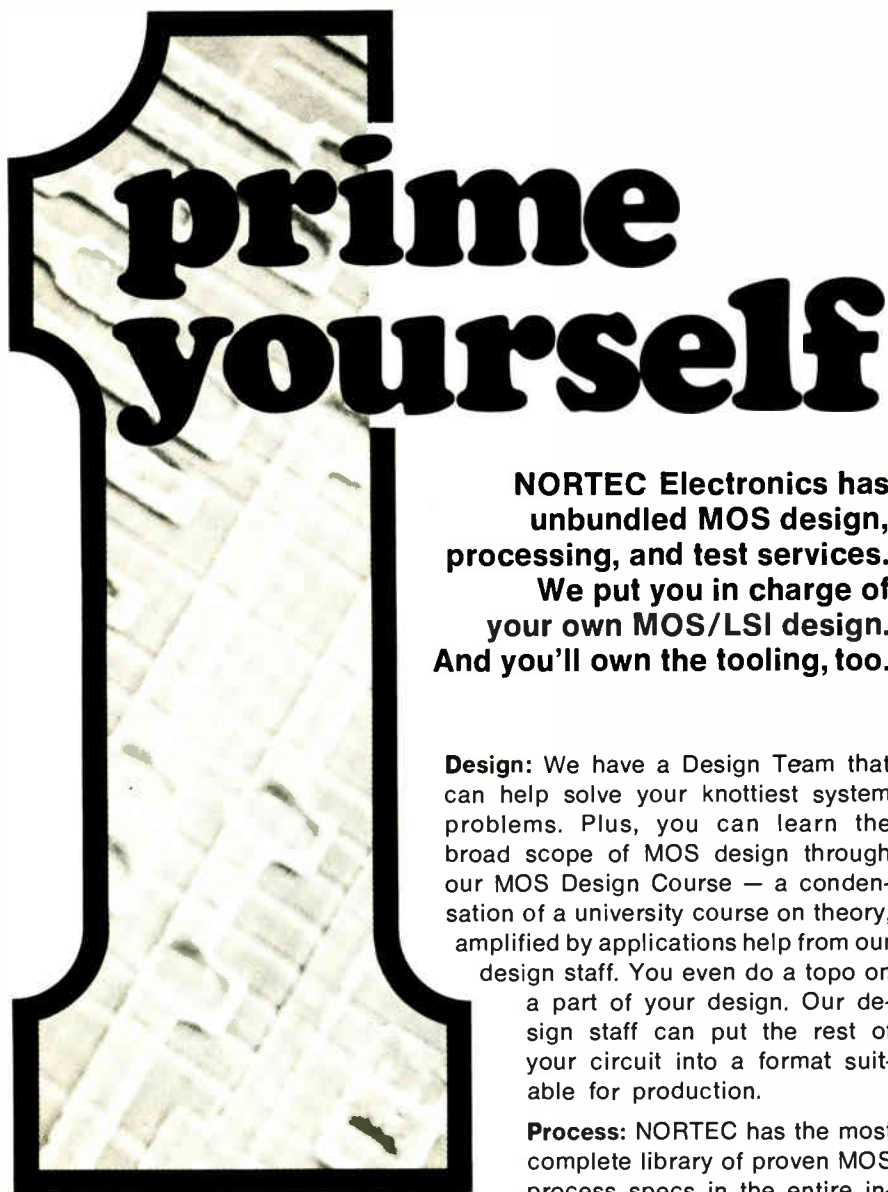

prime yourself

NORTEC Electronics has unbundled MOS design, processing, and test services. We put you in charge of your own MOS/LSI design. And you'll own the tooling, too.

Design: We have a Design Team that can help solve your knottiest system problems. Plus, you can learn the broad scope of MOS design through our MOS Design Course — a condensation of a university course on theory, amplified by applications help from our design staff. You even do a topo on a part of your design. Our design staff can put the rest of your circuit into a format suitable for production.

Process: NORTEC has the most complete library of proven MOS process specs in the entire industry: P-Channel, N-Channel,

Nitride, Silicon gate, and Complementary. One process will be most suitable for your specific application. We'll tell you which it is. And for \$3450 we will process and package 25 of your circuits from your artwork.

Assembly: Ceramic, metal, plastic . . . you name it.

Test: Our complete Sentry 400 LSI tester is also unbundled. You can rent time on it to test your circuits, even if you have elected to have someone else be your prime source.

Custom MOS is your key to higher profits. Call or write NORTEC for a brief summary of our test and design services, dates for our next MOS Design Course, and a complete listing of our available MOS processes. We'll also be glad to give you an estimate on customizing your circuits.

NORTEC 
ELECTRONICS CORPORATION

3697 Tahoe Way, Santa Clara, California 95051 • (408) 732-2204

Probing the news

Electric also are working on Gunn oscillators for anti-collision braking and air-bag control.

Intel's goal is to develop an LSI processor for a car featuring the complexity of a PDP-8 computer on a single chip. Noyce is confident the price of the single-chip processor could fall dramatically, starting out at \$50 and with volume, dropping to \$10.

Intel also is considering applying its read-only memories to such functions as fuel control. Such systems require a table look-up function—finding the proper amount of fuel for a given speed, air flow, temperature, vapor content of the air, and engine power requirement.

Hand in hand with the central processor concept is the plan for multiplexing electronic functions onto a single-wire, continuous-loop system. Present wiring harnesses are bulky and consume an unusually large amount of copper. But although multiplexing would certainly simplify the wiring problem, Ford believes the resulting electronics system would be complex and, right now, even more expensive: it would add at least \$50 to the cost of a Mercury.

But reduction of bulk won't be the only reason for going to multiplexing, points out Art Fury, linear product marketing manager at Signetics Corp., Sunnyvale, Calif. "It would not only save copper," notes Fury, "but it would simplify wiring changes," an important consideration if makers begin paying less attention to style and more to new features inside the car.

All in all, the automotive electronics sector is going to represent a very sizable market in the not-too-distant future. By 1980, estimates RCA's Solid State division, the electronics package inside every car will be worth \$100. And in a big production year, those packages will add up to a \$1 billion market. □

Contributing to this article were Lawrence Curran in Los Angeles, Stephen Wm. Fields in San Francisco, Paul Franson in Dallas, Michael Payne in London, John Gosch in Frankfurt, Charles Cohen in Tokyo, and McGraw-Hill World News staffers William Hampton in Detroit and Gerald Parkinson in Los Angeles.

Testing digital IC's?

8013A, \$625



8007A, \$1600

HP's new pulsers give you the most capability per dollar

If digital IC's are your big interest, HP's new 8000-Series pulse generators are for you. You not only get **versatile capability**, but you **save money** as well! These new pulsers offer you a choice of price/performance packages to meet your needs, within your budget—whether you're working with computers, communications, telemetry, or any other digital system.

The new 8007A gives you rep rates from 1 kHz to **100 MHz**, **variable transition times** (2.5 ns to 250 μ s), ± 5 V amplitude, and ± 2.5 V dc offset—all for **\$1600**. With the 8007A, you can design and test the fastest of today's digital devices—ECL IC's and bi-polar memories—and have "speed to spare" for tomorrow's advances.

If you don't need 100 MHz, you can save. For only **\$875**, you can get the new 8012A, which gives you rep rates from **1 Hz to 50 MHz**. Like the 8007A, it offers **variable transitions** from 5 ns to 0.5 s, with ± 5 V amplitude and ± 2.5 V dc offset.

If you don't need variable transitions, you can save even more. Our 8013A gives you rep rates from **1 Hz to 50 MHz** with a fixed transition time of **< 3.5 ns**, ± 5 V with dc offset, and dual outputs—all for **\$625**.

All three of these new pulsers give you pulse-shaping capabilities, allowing control of NRZ or RZ waveform parameters with the output width determined by the input waveform width. Normal external triggering and gating are also supplied.

The 8007A also gives you a double-

pulse mode, and all three models have square-wave capabilities. And the 8013A offers simultaneous positive and negative outputs, with ± 5 V amplitude across 50 Ω (± 10 V open-circuit or with high-impedance internal source).

Other HP pulse generators, listed in the catalog, begin as low as **\$225**.

For further information on any of these new 8000-Series pulsers, contact your local HP field engineer. Or write Hewlett-Packard, Palo Alto, California 94304. In Europe: 1217 Meyrin-Geneva, Switzerland.

081/11

HEWLETT  **PACKARD**

S I G N A L S O U R C E S

Communications

Western Union: still a live wire

If and when the FCC lets younger competitors into the data communications market, Western Union plans to keep them in their place

by Jim Hardcastle, Washington bureau

As FCC approval of specialized data communications carriers becomes more and more likely, brash young companies like Microwave Communications Inc. and Data Transmission Co. have captured the limelight. But the vast market potential of data communications has also attracted the nation's oldest common carrier, Western Union Corp., which is determined to upstage the newcomers and grab a big piece of the action.

According to a Booz-Allen-Hamilton study commissioned by Data Transmission Co. Vienna, Va., switched-data traffic will increase tenfold to 32 billion calls a year in 1980. And though leased-line studies are harder to come by, industry sources note that during the past five years voice-grade, leased-line service has grown an annual 25%. Sales of communications gear for both markets are also expected to grow from this year's \$1 billion to as much as \$2.5 billion by 1975, according to one estimate by Raytheon Data Systems Co., Norwood, Mass. [*Electronics*, Feb. 1, p. 71]. And Western Union, unlike AT&T, buys all equipment from suppliers.

"Our main business isn't in sending and receiving telegrams. It is in providing data communications services to all types of users," says Earl Hilburn, president of Western Union's Telegraph Co. subsidiary. And to meet these, he says, the company is ready to build a switched pulse-code modulation network, serving the eastern half of the country by 1974, and eventually the rest of the nation.

The proposed PCM network, Western Union's existing 7,900-mile analog microwave network and

the company's 78,500 Teleprinter Exchange (Telx) customers will be the platform for the company's bid to increase its share of the switched-data market, Hilburn states. And most market research studies agree that the under-300-bit-per-second services will grow most during the decade, largely because they're compatible with the teletypewriter.

Today's 75,000 teletypewriters, an Arthur D. Little study says, will grow to an estimated 250,000 to 300,000 by 1974. Most of these, the study notes, are currently tied as remote access terminals to computers by AT&T's direct-dial network.

Western Union's chances appear to be best in the switched low-speed data market, because of the head start it has in its existing computer-based message-switching capabilities and numerous teleprinter customers. And new markets for teleprinter service, such as the Postal Service's Mailgram, could easily swell revenue beyond current predictions, Wall Street sources say. Moreover, the company has acquired AT&T's Teletypewriter Exchange service, under a sales agreement by which AT&T gave up TWX and agreed not to furnish additional teletypewriters to its Data-Phone customers for five years.

Industry sources point out, however, that while switched low-speed services will probably show the greatest growth in numbers of users, they don't necessarily produce the largest amount of revenue. Customers for such services, one source points out, generally use a network infrequently and for short times only. He adds that equipment

costs are high, extra multiplex equipment being needed to break voice-band circuits down.

In addition, a competitor points out, "Western Union will have a tough time just digesting the TWX acquisition." He notes that to maximize the profits of the 40,000-customer TWX system, the company will have to install much more of its own cable, multiplex equipment, and switching gear in urban areas, instead of using Bell System facilities. It will also have to install computers to generate a common code for the five-level Baudot-coded Telex system and the ASCII-coded TWX system. All this is expensive.

While Western Union struggles to capitalize on the low-speed market, however, Datran and AT&T will be gaining a strong foothold in the promising switched medium- and

Overbuild. WU will add digital services onto existing microwave systems.



Send us your precious metal scrap...

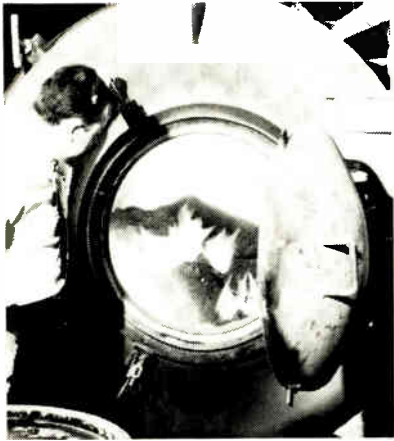

**we'll treat it
as if it were our own.**

At Handy & Harman we have been refining our own scrap for a century. We'll treat yours as we treat ours. Which means refining in big, modern electric furnaces—no frequent refilling . . . precise temperature control to minimize flue loss . . . streamlined removal without entrapment. And we have a lot of careful techniques for sampling your shipment, too.

Little things? Yes, little careful things that add up fast in today's precious metals market. We have a booklet that's concerned with where to find precious metal scrap, and how to get the last pennyweight out of it. Please send the coupon for your copy.

*Please send your booklet
about precious metal scrap.*

Name _____
Title _____
Company _____
Address _____
City _____
State _____ Zip _____

HANDY & HARMAN
850 Third Avenue, Dept. EL15,
New York, N.Y. 10022

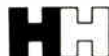

Probing the news

high-speed markets. After extensive market research Datran asked FCC permission to offer 4,800-, 9,600-, and 14,400-bit-per-second switched service, aiming at users of high-speed remote computing equipment. Industry sources generally agree that both MCI and Datran will be issued construction permits for their networks by year's end.

AT&T also, to keep its monopoly hold on the medium- and high-speed data markets, is proposing to build a leased-line PCM network with 2.4-, 4.8-, 9.6-, and 56-kilobit-



Priority. Our main business is data communications, says WU's Hilburn.

per-second speeds. These services, to be offered in 1973 or 1974, will be followed by the addition of switched service.

For Western Union's part, "we are prepared to offer high-speed services whenever we feel they are necessary," says Hilburn, eyeing the growing market for channels that will serve remote card readers, teleprinters and CRTs. He says that Western Union is currently preparing an application for a higher-speed switched service, which he declines to describe. Industry sources predict, however, a 4,800-bits-per-second rate.

However, the company's bid to capture a large share of the private-line market is already under way. Its present Datacom is a leased-line service that permits 2,400-kHz circuits to be split into 24 telegraph channels at rates as much as 75% below earlier tariffs, and application for a higher-speed Datacom is to be made soon. This, in turn, will be followed by an asymmetrical service, which would permit a

remote user to query a computer over a low-speed circuit and get fast answers back to a teleprinter or CRT without paying for high-speed service in both directions.

Hilburn claims Western Union will be able to offer digital services at a fraction of the cost of MCI or Datran because his company can add digital beams to its analog facilities—it calls this digital overbuild—using existing towers, antennas, feeders, buildings and power. (Datran officials, however, maintain that microwave transmission facilities will account at most for 15% of the cost of their system.)

For the 1,000 engineers and programmers at Western Union's Mahwah, N.J. development center, the highest priority is the development of a multiplexer for use with high-speed Datacom service, says John E. Cox, assistant vice president for transmission.

Next comes the digital beam. Western Union plans to install along analog routes between New York and Chicago, beginning with a leg between New York and Washington. The firm has received FCC permission to add such a beam between Atlanta and Cincinnati and has filed for permits to build the New York-to-Washington route. And shortly after 1975, Western Union foresees the need for satellite circuits, which could be afforded by the company's satellite proposal now before the FCC.

Yet another development needed by the firm is a reliable high-speed switching system that will interface Telex, TWX, and a host of related services. West Germany's Siemens AG is to deliver a prototype system this fall.

With its plans backed up by the capital to carry them out, Western Union's chances in the data marketplace are rated high by industry observers. "Western Union is by far the strongest competitor Bell has," states one data services expert. "They have a strong dynamic management, and they have modern equipment—a fine computer-based communications system. If they have a weakness, it's their present size. To compete in the data market, they'll have to be as ubiquitous as the telephone network." □

Clad metal parts reduce production costs.

Can you save on silver...or labor?

There are still ways to cut the costs of fabrication.

The technology of cladding is expanding rapidly, saving money where two or more metals must work closely together.

Handy & Harman has adapted the technology to producing clad metals which reduce the amount of precious metal needed in many components. Our Bimets put the precious metal only where it's needed—base metal supplies the beef.

Now, thanks to the addition of American Clad Metals, Inc., Pawtucket, Rhode Island, to the Handy and Harman group, we are able to provide a greater variety of clad metals that reduce costs by reducing labor.

We have attacked the costs of making a connection. Fabrication of a finished assembly often calls for soldering. This involves placing of the solder, or a preform. This expensive operation can be eliminated by using a clad metal that consists of the part to be soldered, clad with

the solder.

We are manufacturing a variety of these solder-clad bimets, cladding solder (of various tin/lead ratios) to such base metals as steel, copper, copper-clad aluminum and nickel-clad moly.

This may sound like small potatoes. But we prepared solder-clad metals for a company that makes electrical components, and the elimination of solder preforms will save them \$150,000 per year in the production of just one of their components. The company is now working with us in investigating clad metals of various materials for five other assemblies.

You may be using more silver or gold than necessary. You may be using too much labor for joining functions.

Handy & Harman would like to discuss the possibilities of our rolling a clad metal strip or drawing a Bimet wire, to reduce your manufacturing costs. Just ask us.

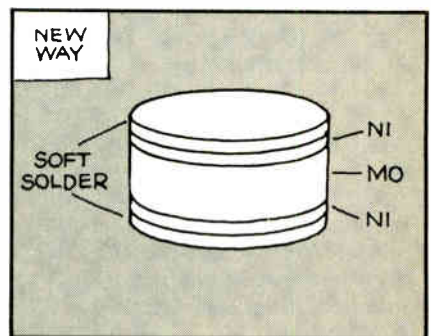
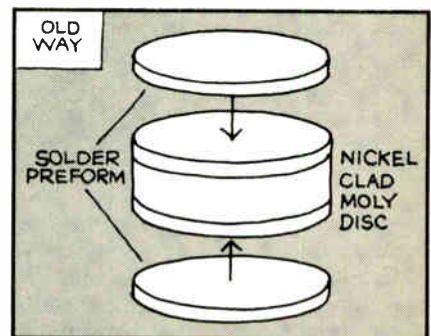

Naturally, you'll ask Handy & Harman

how Bimets could be used for

Application: _____
Name _____ Title _____
Company _____
Address _____
City _____
State _____ Zip _____

Send to: Handy & Harman, 850 Third Avenue, Den^t FL60, New York, New York 10022



The bear who was an optimist.

ONCE UPON a time, there was a big brown bear who invented a bear-made, vitamin-enriched substitute for the acorn. It was made out of a special material that required whole new production and processing technologies, and his investment in the first few units was absolutely astronomical. Especially for a bear. He called it the Mighty Oak Substitute — MOS, for short.

Theoretically, the bear said, each MOS should only cost a penny or two. Right now, however, they were costing much more because only about one out of ten came out right. Besides, he was still producing them in very small quantities. And as the quantities increased and the yield improved, he felt sure that he could turn out his MOS's at a lower price than the *real* acorns.

So the bear turned from development and processing problems to where he felt it was really at: Marketing.

To be a good marketeer, the bear felt, you have to be something of an optimist. After all, he'd never met a salesman in the forest who said that his product was going to *decrease* in volume over the next three years. Onward and upward, the bear said. That's the way to think in marketing.

So he made a market study. He counted all the squirrels in the two trees in front of him. And he multiplied that number by all the trees he'd ever seen. And he asked a few squirrels about how many acorns they stored for the winter. And he multiplied by that number. And he finally got a number that was absolutely tremendous.

Well, he said proudly, I'm the only one making MOS. And it's going to be better than acorns. So this number represents my total market. And if I can look forward to making this many of them, then I can drop the price to half a penny each. And I'll still make enough money to buy all the honey in the world.

So then he went out to call on all the squirrels and he explained the advantages of the Mighty Oak Substitute. And they were impressed. And when they asked him about cost, he showed them his projection and he explained:

"If you buy them from me right now at three pennies each, by next year I'll have enough

quantities to drop the price to one penny. And in two years, I'll be able to supply you with MOS at well under a penny each. Much cheaper than acorns. And look at all the other advantages."

Well, the squirrels were really interested. MOS looked a little expensive right now, but they had to agree that the forecasts certainly looked promising.

But then a few of the older and wiser squirrels took the bear's market study and started to make their own forecast. They figured on a percentage of more conservative squirrels that would always stay with acorns, no matter what. They figured on the new squirrel diet program that had been cutting down acorn consumption. And, being pragmatists, they even took into consideration the general statistics on — sad as it may seem — squirrel attrition. Not to speak of those gourmet squirrels who would always prefer the more expensive walnuts.

By the time they were finished, they came up with a total that was about one tenth of what the bear had projected.

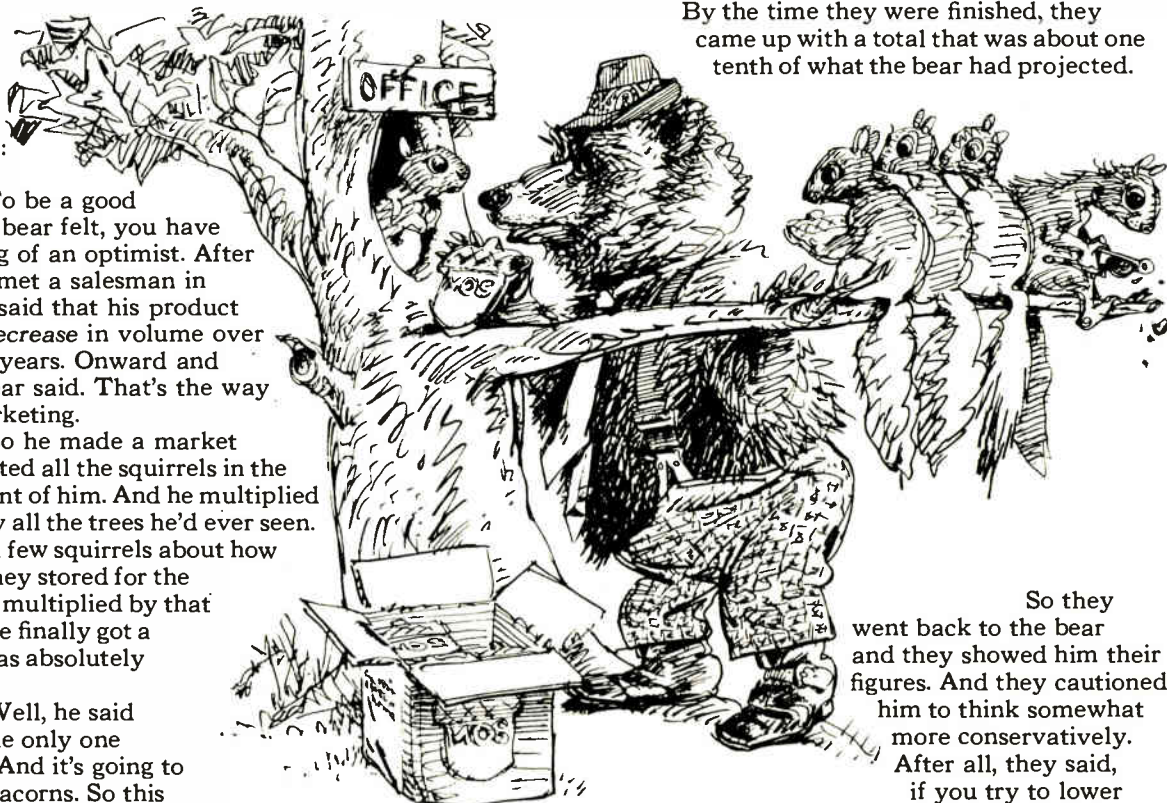

So they went back to the bear and they showed him their figures. And they cautioned him to think somewhat more conservatively. After all, they said, if you try to lower your MOS prices as per your projections,

you're going to find yourself operating at a loss. And you are in this for the honey, aren't you?

The bear finally agreed. Sadder but wiser, he dampened his optimistic forecast. He still found a goodly number of squirrel customers. But he had to admit a need to co-exist with acorns and walnuts. And still make a profit.

Moral: Before you go nuts over a projected price, it sometimes pays to take a bearish look at the total market.

An affiliate of Electronic Memories & Magnetics Corporation
3883 No. 28th Ave., Phoenix, Ariz. 85017. Phone (602) 263-0202

SEMI
semiconductor electronic memories, inc.

Military

Plracta spells digital avionics

Air Force pushes low-cost communications, navigation, identification approach as first step toward lashing together all airborne electronics

by James Brinton, Boston bureau manager

For years, the Air Force has been trying to find a way to reduce the proliferation of avionics gear aboard tactical aircraft. Though the technology became available to combine communications, navigation and identification in one black box [*Electronics*, July 21, 1969, p. 115], the Air Force couldn't sell its hardware unification concept, largely because of the amounts of money needed. However, a far less costly program to upgrade tactical communications, navigation and identification is under way now that may just bring the elusive single black box a step closer to reality.

Known as Plracta—for position, location, reporting, and control of tactical aircraft—the \$6 million program uses specially formatted digital signals to speedily transmit large amounts of information. As envisioned, the system would greatly enhance the efficiency of command and control operations between air and ground, thwart jamming, permit planes to respond much more quickly to changing tactical situations, and provide superior navigation.

Perhaps even more significantly, Plracta wouldn't require the costly mass removal and replacement of avionics gear that might have been dictated under the defunct Unified Communications, Navigation and Identification (U/CNI) effort. "If we went operational, we probably wouldn't remove on-board avionics gear. That would cost money," says Eric Ellingson, Plracta project leader at the Mitre Corp., Bedford, Mass. Thus, Plracta-equipped planes could communicate outside the Plracta system; the demise of U/CNI as a concept was at least

partly due to fears that military aircraft would have been unable to navigate or communicate outside U/CNI-controlled airspace.

Plracta is an outgrowth of the 407L Tactical Air Control System (TACS) developed jointly by the company and the Air Force's Electronic Systems division. "We might adapt a small part of the aircraft's communications system to digital transmission, and add computer and clock capabilities," adds Ellingson. "Depending on the plane, the change could be as small as the addition of some memory for its computer, some software, and perhaps a 9- to 11-gigahertz transmitter."

With Plracta as a first step, truly unified communications, navigation,

and identification equipment—probably with a strong Plracta flavor—could be developed later and phased in as new aircraft were added to inventory, says Ellingson. And if Plracta also were made operational, retrofit penalties would be small, he adds.

Although funded through fiscal 1973, Plracta's team is working as if it were running out of time—and money, too. "Senator Proxmire should see this," says an Electronic Systems division staffer. For the phase-one tests under way, the team borrowed a 1954 Reo truck from a Navy depot, and installed on it an FAA-supplied distance-measuring-equipment antenna. The program's transmitter-receivers have been surplus Air Force APX-25

Unification lives on

Though the Air Staff last autumn ordered abandonment of the U/CNI effort, the aim of reducing the 400-500 black boxes that fly aboard various Air Force craft still has strong backing. In fact, after U/CNI fell out of bed, the Air Force Systems Command directed the Electronic Systems division to coordinate all communications, navigation and identification (CNI) efforts. The task: search out and identify all activities fringing on CNI, and integrate their data into an eventual concept for a CNI approach in the 1980s.

The last gasp for the unified hardware approach seems to have been the "thin thread" demonstration. Despite an effort to mount a low-cost demonstration of concepts, signal structures, and some hardware, the demonstration was cancelled in December 1969 at the Air Staff level because the program was said to lack solid objectives and a firm list of users. Systems Command subsequently requested a proof-of-concept effort comparable to Plracta's, but one that would have involved more ground stations than the present Plracta effort and up to two squadrons of fighter aircraft, reports Lt. Col. Kenneth H. Kronlund, Plracta/CNI program manager. This was turned down because of cost.

"We stepped back from the demonstration phase in order to be able to return in one to three years a firmly formulated concept based on studies, experiments, and operation requirements. Thus, data from Plracta, the Army's automated battlefield work, and the Navy's efforts all will be grist for our mill," Kronlund relates.

NOW THE SMALLEST IS ALSO THE LARGEST.

The world's smallest power supplies for micro-electronics are now available in the world's largest line of high power density, high efficiency supplies: 54 off-the-shelf models.

From 100W to 500W; from 3VDC to 30VDC; single, dual, triple outputs; commercial, military, and export models.

Now in use by such leaders as Burroughs, Control Data, Honeywell, IBM, Litton, NCR, RCA, Univac, and many Government installations. We also custom develop/produce to specific needs.

Write for complete literature.

Trio Laboratories, Inc., 80 Dupont St., Plainview, L.I., N.Y. 11803. Tel.: (516) 681-0400.
TWX: 510-221-1861.

triolab
POWER SUPPLIES

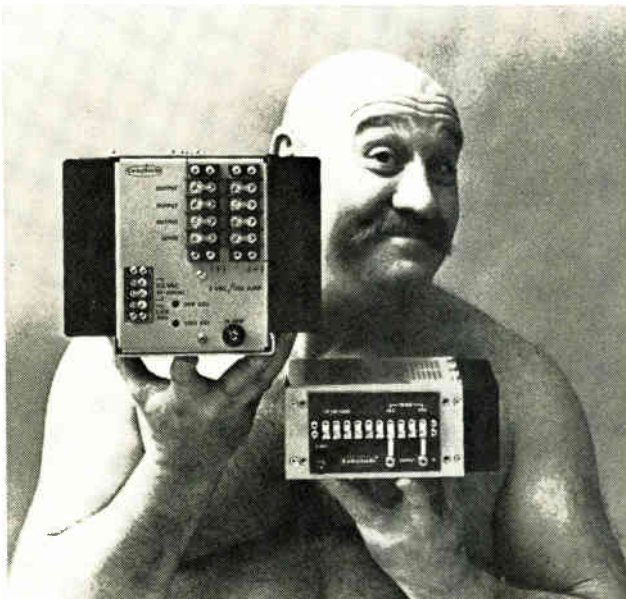

Model SP631
5VDC/100A
Typical efficiency 70%
8.50" x 6.81" x 8.75"
21.5 lbs.
\$695.

Model SP601
5VDC/20A
Typical efficiency 65%
3.25" x 6.50" x 7.50"
6 lbs.
\$400.

See us at SJCC Booth 2238 and AFCEA Booth 411

Probing the news

IFF units. And for computer gear, Ellingson's team raided the F-111 program and came away with eight IBM 4-Pi computers that had been used for acceptance tests; though unflyable in F-111s, they work well in Plracta's test program.

The real money is being saved for EDP gear and software for phase two. Two C-11-C Link trainers on loan from an Air Force warehouse in Ogden, Utah, will be connected to a Digital Equipment Corp. PDP-15 computer; the computer will enable them to simulate tactical operations of a wide range of aircraft—F-111, F-14, F-15, A7D, etc.—in a Plracta environment. Some live aircraft tests already are under way using a C-131 from the Rome (N.Y.) Air Development Center. About eight tests have been flown in aid of propagation and navigation experiments.

Plracta is based on two key concepts. The first is a time-shared radio data bus containing in digital form all the information needed to exercise command and control. The second is a common geographical frame of reference used for navigation and target location by both aircraft and control centers.

The data bus grew out of the 407L studies aimed at improving communications among air and ground elements in a tactical environment, says Ellingson. It was largely the work of Mitre's Gordon Welchman, a member of the technical staff.

Though the results of the study aren't public, they probably parallel those of a similar effort made for the Navy by Technical Communications Corp., Lexington, Mass. [*Electronics*, June 9, 1969, p. 51]. The Navy study showed that just establishing a voice link could take from 50 seconds to three minutes—a lifetime in battle. There also was a 20% chance, according to the study, that the process would have to be started all over again if security procedures were botched.

After much thought, the Mitre team decided on a switch to digital messages, a time-division multiplex data bus, and the near-total elim-

ination of voice communication. However, Plracta would retain the standard ulif voice communications frequencies between 225 and 400 megahertz, and voice communications still would be available if the pilot wanted it. The digital data bus operates in the Tacan/IFF band of 9-11 GHz.

As envisioned, Plracta's digital message forms could carry considerable data. A position/status report, for example, though allotted 300 bits, needs only 198 to give up to 29 detailed parameters about a mission, including position, altitude, heading, fuel on board, and many others. So it's no surprise that a study by Bunker-Ramo Corp., Oak Brook, Ill., estimates that an 80-message Plracta system could eliminate more than 95% of normal tactical chatter, while even a 20-message repertoire could cut traffic by up to 84%.

Assuming 1,000 users on the Plracta bus, each would be able to transmit or receive messages an average of every five seconds, or 10 seconds at worst. Each user would transmit whether he had been queried or not—the appearance of his message and position in the proper bus time slot would serve as identification and perhaps aid in collision avoidance.

The experimental system has 8-millisecond message time slots followed by 2 milliseconds of silence. Ellingson points out that radio waves propagate about 310 miles in these silent periods, and that for tactical area operations, this is enough to prevent overlap between one message and the next in a 600-mile-diameter tactical theater.

Whether or not a user receives a message depends on his position in the chain of command. Theater commanders would have access to all messages in all time slots; individual pilots would receive and acknowledge orders or initiate communications by punching a message-designator button on a keyboard. Spotting a target of opportunity, for example, would be a quick pushbutton job: the outgoing message would give the grid location of the aircraft passing over the target, and thus of the target itself. This is a far cry. Ellingson points out, from loitering over a target,

dropping flares, firing smoke rockets, and other techniques now used. "They're not only slow, they tip off the enemy," he notes.

Navigation would be by trilateration. An aircraft would measure radio propagation delay between it and, say, three ground stations to generate a three-way navigational fix with an onboard computer.

This will require tight control of Plracta bus timing. Ellingson and his team are using crystal clocks, backed up with a computer algorithm allowing an aircraft with a drifting clock to iterate its way to a precise location.

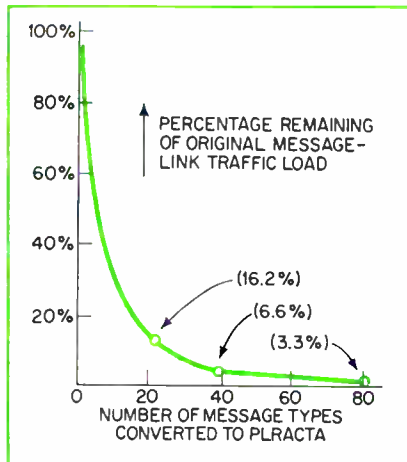

Efficiency. Bunker-Ramo study shows dramatic decrease in traffic load for Plracta-transmitted messages.

The same algorithm works for ground stations, too. These could use aircraft transmissions to locate themselves more tightly within the common grid structure. Thus it would seem that while Plracta's common grid is closely related to true latitude and longitude, it is more a relative than an absolute system of location.

"Use of trilateration doesn't mean that an aircraft can't try Loran, Tacan, inertial, or other aids to navigation," says Ellingson. These techniques could prove useful if part of the Plracta system were disabled, and also could be added to the total of available navigational data, providing even tighter fixes. And computer routines have been proposed that would plug this data into the Plracta system. □

Now the famous 829 has a "G" for good measure!

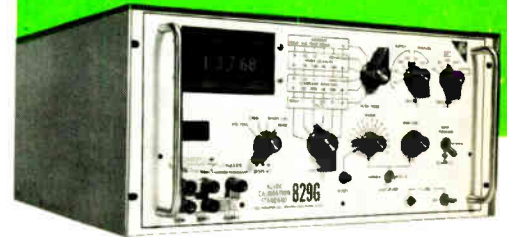

Calibrate or Measure with the

RFL Model 829G

RFL's famous 829, for 15 years the industry calibration standard, now gives way to the new 829G — still the industry calibration standard, but now it's twice as useful. The 829G provides a precision source of AC and DC volts, amps and ohms — plus precision measurements of these parameters from external sources. It offers four-terminal sensing in both source and measurement modes, and high accuracy, resolution and regulation, with 5-digit readout. 5 ranges of AC or DC, 0.1 to 1000V. 6 ranges of current, 100 uA to 10A. 50, 60, 400, 1000 Hz AC plus EXT. And many other features — all for just \$3,350. □ Write for complete data today. RFL Industries, Inc., Instrumentation Div., Boonton, New Jersey 07005. Tel: (201) 334-3100 / TWX: 710-987-8352 / CABLE RADAIRCO, N. J.



RFL Industries, Inc.

Circle 119 on reader service card

In these days of brownouts, blackouts and poop-outs— every motor and transformer needs a little failure insurance. It's called **NOMEX®**



NOMEX* nylon,
to be specific.
A high-temperature
(UL-rated at 220°C.) insulation
that doesn't support combustion,
won't melt, has great resistance to
chemicals and moisture, and is
exceptionally tough and flexible. It has
many other advantages, too.

So does NOMEX M,
its corona-resistant
counterpart. We'll tell
you all about them and
send you some samples,
if you write to: Du Pont
Company, Room CRB 3156, Wilmington,
Delaware 19898. Do it today, a little failure
insurance can go a long way.

*Du Pont registered trademark.



Minicomputer expands terminal processing power

Intelligent display to be shown at Spring Computer Conference seen as thrust toward multiprocessor jobs

Its first product as an independent company will be introduced at the Spring Joint Computer Conference, and Raytheon Data Systems Co. promises that there's going to be more to it than meets the eye—even though it looks like just another cathode ray tube display.

Actually, it's designed around a minicomputer, and the modular character of the design hints at multiprocessor systems to come.

Called the RDS programable display terminal, the modular system will allow input, output, and display of 512, 1,024, or 2,048 alphanumeric characters on either a 14- or 9-inch (diagonal) screen. The characters are said to be sharper than those usually found on alphanumeric displays using dot matrix writing because the Raytheon Data display uses raster scan with a one-half-position jitter imposed on the writing beam to flesh out the letters, and also uses slightly different character shapes. "The display will use letters looking more like ordinary block letters," says Charles Hesner, marketing director. Graphics and TV also are available.

But getting down beneath the cover—past the MOS-encoded, plug-in keyboard, the straightforward-looking display, and the refresh electronics in the pedestal—there's a surprisingly capable 16-bit, 1-

microsecond, byte-manipulative minicomputer running the show from within the pedestal. It's already running eight displays or keyboards in satellite fashion.

Thus, setting its price well below \$7,500, including keyboard, display, and processor, Raytheon Data system appears to be coming into the market with capabilities that could exceed those promised by several companies during the past year. Why Raytheon has decided to nail what's really a minicomputer with the term microprocessor isn't known, though it's true that some routines are microprogramed. But, in fact, the processor, rather than

the display, deserves the most attention.

Within the mini are three separate memory sets: 1,024-by-one MOS ROMs (with bipolar drive circuitry) to store characters, perhaps two of these chips depending on the character set ordered by the customer; 1,024-bit chips, also used in RAM storage for display refreshment; finally, 2,048 to 4,096 bytes of read-write memory, also built up from 1,024-bit ram chips, remain for user programing. This RAM storage is expandable to 65,536 bytes.

This all solid state memory capacity, combined with 16 autoin-

Programable. Display terminal controlled by a minicomputer can predigest data for mainframe used in distributed-processing information systems.

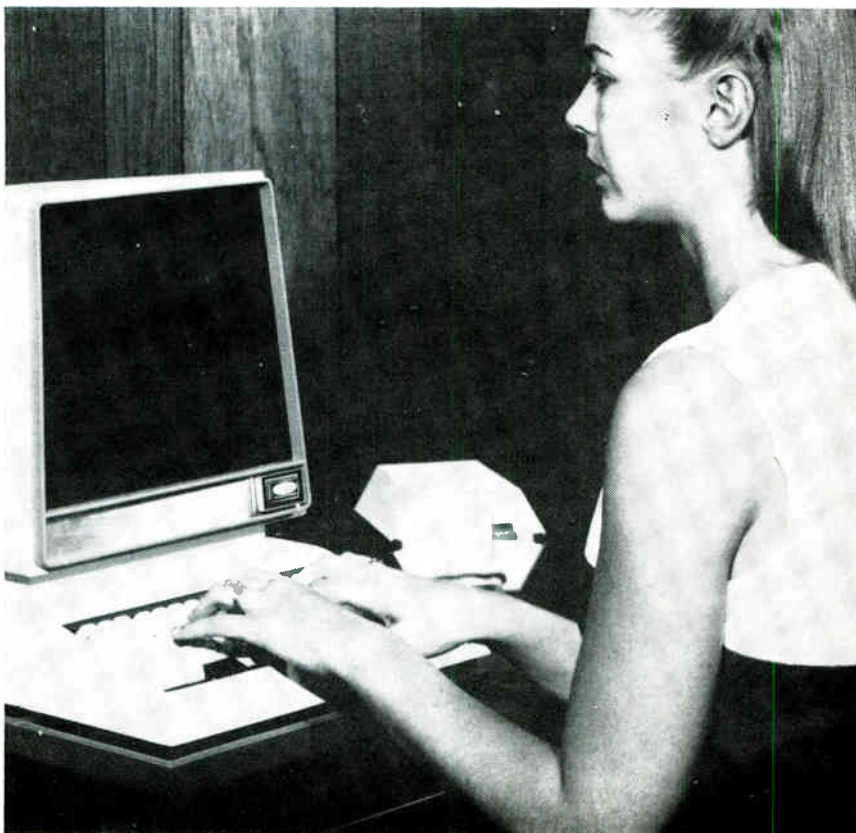

New products

dexing and 16 autodecrementing registers per page of memory (2,048 bytes), byte manipulation, indirect addressing, push-pop storage for work in progress during interrupt, and a 20-unit instruction set, make the processor under the display a powerful minicomputer. Planners are looking forward to beefing up the instruction set with multi-operand instructions and other niceties.

Initially, Raytheon Data spokesmen expect the system to be used to predigest data for larger mainframes—say in the airline and hospital information system markets where the company already is entrenched. But looking ahead a year or so, advance planners admit that this introduction is just a peek at much larger modular systems for a variety of applications.

"We think it's possible, and probable, that you'll find our processors linked together in task-sharing systems jobs formerly reserved for larger machines," says a spokesman. "For example, one display-processor could perform standard terminal duties while another processor would handle polling and supervision of the minicomputer network, and other mainframes would task-share large jobs."

There are other indications of big things in store for the processor in the pedestal. A standard computer control panel, which would plug into the jacks for the keyboard, is being designed and may mean a new and separate minicomputer thrust by Raytheon Data. Tape storage systems also are in development. Cassettes and paper tape would be used initially, but since the processor already includes control logic for a high-speed modem, perhaps high-speed tape could be part of the company's thinking.

Finally, in the lab are the beginnings of more capable versions of the processor itself (at least one with a longer word length) and another capable of operating at higher speed. Engineers admit that the MOS/LSI they are using in the present RAM setup has an 800-nanosecond cycle time, and 500-

nanosecond access capability.

Though Raytheon marketers are aiming for a price in the \$5,000-to-\$7,500 class for a display, processor, and keyboard combination, they haven't named a figure yet, probably because of the difficulty often encountered in pricing modular systems. Delivery hasn't been firmly decided either, but Raytheon will have the system in operation at Spring Joint—one running a television display, one unit running its own, and two slave CRT alphanumeric displays. Raytheon will be in Booth 2403.

Raytheon Data Systems Co., a subsidiary of the Raytheon Co., Norwood, Mass. 02082 [338]

Low-cost digital tape drive provides automatic threading

Medium- to high-speed digital tape drivers with sophisticated features like automatic tape threading are hefty five-foot-high units that carry equally hefty price tags of more than \$10,000, and often up to \$22,000. But the Computer Products division of Ampex Corp., Culver City, Calif., has packed many of the features of these drives into a unit that will sell for less than \$5,000 in quantities of 25. It is only 24 inches high, 18 in. deep, and fits into a 19-in.-wide rack space. It will be shown at the SJCC.

Edward S. Kinney, tape product manager, believes users will be interested primarily in the TMA's automatic threading feature, though they can order straight-line (manual) tape threading at a slightly lower cost if they want. Kinney thinks the automatic threading model will appeal to users concerned about contamination from the environment and from handling.

He's not playing down other TMA features, however, such as medium to high speeds and small size at a low price. Tape speeds range from 45 to 112.5 inches per second. The small size derives in part from the use of a linear reel servo system, which allows a smaller vacuum chamber. In con-



Type 75 price, less cabinet: \$1575.

OMATIC
NDICATOR

5

3 Laboratory
HAMMER INC
NEW YORK

AGC

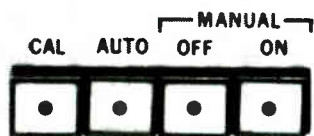
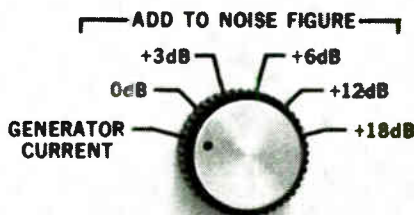
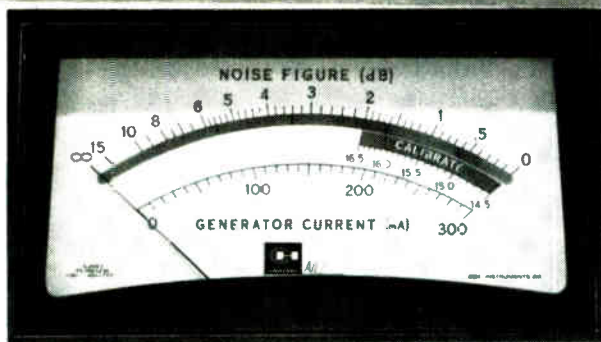

A.C.
POWER
ON

Unmatched accuracy and operating speed.

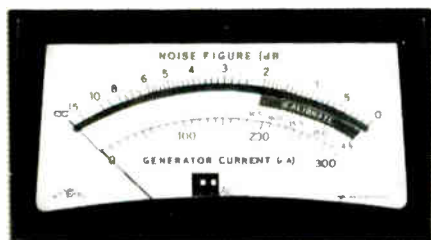

Here is the most precise **automatic noise figure indicator** you can buy. A unique tool for the microwave engineer that quickly pays for itself in the time it saves through simplicity of operation. □ Its expanded readout provides **accuracy to ± 0.15 dB**, with a resolution of a few hundredths of a dB over the lower half of the meter scale. And a flip of the range switch puts *any* noise figure from 0 to 33 dB into an expanded portion of the scale. □ One of the many ways the AIL 75

saves costly engineering time is that you can calibrate to the exact excess noise ratio of the noise source, then read actual noise figure directly over the RF range from 10 MHz to 40 GHz. IF ranges from 10 to 1000 MHz are available. □ 100% solid-state design, of course. Front panel indicator confirms adequate signal level. Manual and remote operation too. □ And now, AIL offers new **solid-state noise sources** from 0.01 to 18.0 GHz. As well as conventional wave-guide and coaxial types. And with AIL's **noise-source calibration service**, you can trace noise-figure readouts directly to NBS. □ Here's one investment it will pay not to delay. Phone (516-595-6471) or write today for a demonstration.

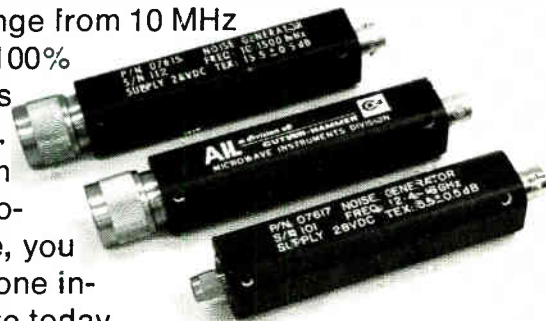

AIL a division of
CUTLER-HAMMER



FARMINGDALE, LONG ISLAND, NEW YORK 11735

Circle 123 on reader service card

New products

ventional drives, tape position is detected by several sensors and tachometers in the vacuum chamber. Elimination of the tachometers allows substantial reduction in the size of vacuum chamber, thereby cutting the TMA's overall size.

The Ampex linear reel servo system senses tape position all along the tape's length, not just when the tape passes the sensors. The linear reel servo system is a feature of one of Ampex's militarized airborne tape recorders.

Kinney says the TMA's price is "40% less for comparable performance, including twice the speed and automatic threading" of one competitor's tape drive. It's the only machine of its size with automatic threading, he adds.

A nine-track model has a packing density of 1,600 characters per inch for phase-encoding read and write; a seven-track model offers 200, 556, or 800 characters/in. for NRZI read and write.

In off-line data-capture applications, the TMA is suited for lower-cost units that don't require data manipulation, and which operate at rates as low as in a cash register or as high as in an instrumentation controller.

Computer Products Division, Ampex Corp., 9937 West Jefferson Blvd., Culver City, Calif. 90231 [339]

Low-cost printer handles 165 characters per second

What may be the least costly self-contained printer available will be introduced at the SJCC by Centronics Data Computer Corp., Hudson, N.H. The price tag on the model 101 medium-speed, alphanumeric impact printer will be \$2,400 in lots of one to 25 units, \$2,280 for 26 to 50, and \$2,190 for 51 to 100.

The model 101 is Centronics' first off-the-shelf product—the company was working on a custom data-collection system for a gambling casino when it realized the need for an inexpensive printer and decided to develop its own. Dennis Buckley, chief engineer, feels that "even in a tight money situation a low-cost item like the printer will still sell."

With a print rate of 165 characters per second, the model 101 can print 60 lines of 132 characters per minute, or up to 150 shorter lines per minute. Data input can be serial or parallel; serial transmission rate is 3,000 bits per second (10 bits per character) and parallel transmission rate is 75,000 characters per second.

The 5 x 7 dot-matrix characters are printed in the standard ASCII code by a seven-pin print head driven by seven solenoids. The print head moves across the platen, generating five-column characters column by column. Characters are generated by an MOS read-only memory with 2,240 bits capacity. The unit contains an MOS 132-character buffer.

Centronics Data Computer Corp., 1 Wall St., Hudson, N.H. 03051 [340]

new

BIPOLAR KEYBOARD ENCODER

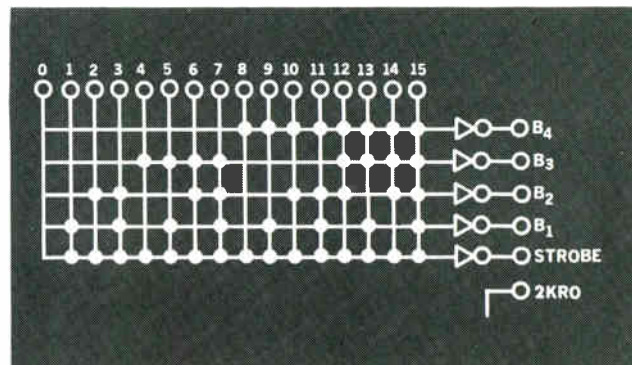

OFF-THE-SHELF DELIVERY

Easy configuration to any binary code, including ASCII and EBCDIC, without time-consuming keyboard modification.

- 16 x 5 Matrix — Adaptable in Parallel Operation for 256 keys
- Self-contained strobe compatible with DTL and TTL levels
- Detects two or more keys depressed at the same time
- Propagation Delay — 115ns
- Power Supply — 5V, 52mA
- Temperature Range — 0°C to +75°C

The HD-0165 is available in a 24-lead dual in-line package at: \$4.60^{ea}.

*100 to 999 unit price.

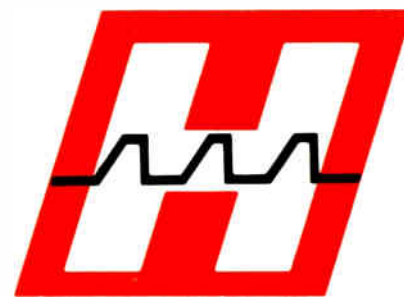

HARRIS SEMICONDUCTOR

A DIVISION OF HARRIS-INTERTYPE CORPORATION

P. O. Box 883, Melbourne, Florida 32901 (305) 727-5430
DISTRIBUTORS: SCHWEBER ELECTRONICS—Metropolitan N.Y. & Connecticut (516) 334-7474, Upstate New York (800) 632-1226, New Jersey (800) 645-7377, Washington/Rockville (301) 881-2970, E. Pennsylvania (800) 645-7377/
HARVEY/R & D ELECTRONICS—Lexington, Mass. (617) 861-9200/SEMICONDUCTOR SPECIALISTS, INC.—Chicago (312) 279-1000, Detroit (313) 255-0300, Minneapolis (612) 884-8132, Kansas City (816) 452-3900, St. Louis (314) 428-6100, Dallas (214) 358-5211, Indianapolis (317) 243-8271, Pittsburgh (412) 781-8120, Dayton (513) 278-9455/
R. V. WEATHERFORD CO.—Albuquerque (505) 265-6112, Anaheim (714) 547-0891, Dallas (214) 231-6051, Denver (303) Enterprise 165, Glendale (213) 849-3451, Palo Alto (415) 321-5373, Phoenix (602) 272-7144, Pomona (714) 623-1261, San Diego (714) 278-7400, Seattle (206) 762-4200.

IC's

IN STOCK RELIABLE LOW COST

The Harris family is designed to solve your problems

When you need to — convert to binary or decimal codes, convert voltage to current pulses, interface with modems, transmit and receive over a party line, encode a keyboard or restore current pulses to voltage pulses — Call Harris.

DIGITAL I.C.'s

Keyboard Encoder

Adapt to any Binary code
HD-0165

Line Driver/Receiver

Meets EIA RS-232-C
Interface specification
HD-1488, HD-1489

Party Line Transmitter/Receiver

Compatible with DTL
and TTL Logic
HA-245, HA-246

Diode Matrix

Easily customized to
specific pattern
7 configurations

When you need to — amplify, buffer, compare, multiplex, convert D to A or anything else in analog signal processing — Call Harris.

LINEAR I.C.'s

Op Amp

General Purpose/
Low Power
HA-2700
Wide Band
HA-2620, HA-2625
High Slew Rate
HA-2500, HA-2510, HA-2520
Low Noise
HA-2909
High Impedance
HA-2600

8-Bit D/A Converter

Monolithic/Guaranteed Accuracy
HI-1080

10-Bit Ladder Network

Low Cost, High Accuracy
HI-0910, HI-1010

16-Channel Multiplexer

J-FET/Bipolar
HS-1000

When you need to — convert a code, microprogram a computer, store information and recover it quickly — Call Harris.

MEMORY I.C.'s

64 x 8 PRØM™

Field Programmable
HROM-0512

256 x 1 PRØM™

Field Programmable
Very high speed
HROM-1256

16-Bit RAM

High speed
HHRAM-0016

64-Bit RAM

High speed, fully decoded
HHRAM-0064



HARRIS SEMICONDUCTOR

A DIVISION OF HARRIS-INTERTYPE CORPORATION

P. O. Box 883, Melbourne, Florida 32901
Please send me more information on the
Harris Off-the-shelf I.C.'s checked below.

- Memories
 Linear Circuits
 Digital Circuits

NAME _____ TITLE _____

ADDRESS _____

CITY _____ STATE _____ ZIP _____

PHONE _____

DISTRIBUTORS: HARVEY R & D ELECTRONICS—Lexington, Mass. (617) 861-9200. R. V. WEATHERFORD CO.—Albuquerque (505) 265-6112. Anaheim (714) 547-0891. Dallas (214) 231-6051. Denver (303) Enterprise 165. Glendale (213) 849-3451. Palo Alto (415) 321-5373. Phoenix (602) 272-7144. Pomona (714) 623-1261. San Diego (714) 278-7400. Seattle (206) 762-4200. SEMICONDUCTOR SPECIALISTS INC.—Chicago (312) 279-1000. Detroit (313) 255-0300. Minneapolis (612) 884-8132. Kansas City (816) 452-3900. St. Louis (314) 428-6100. Dallas (214) 358-5211. Indianapolis (317) 243-8271. Pittsburgh (412) 781-8120. Dayton (513) 278-9455.

SALES OFFICES: P. O. Box 883, Melbourne, Florida 32901 (305) 727-5430. Lexington, Massachusetts (617) 237-5430. Frederick, Maryland (301) 662-5400. Palos Heights, Illinois (312) 448-9110. Albuquerque, New Mexico (505) 268-3549. Palo Alto, California (415) 321-2280. Dallas, Texas (214) 231-9031. Long Beach, California (213) 426-7687. Norwalk, Connecticut (203) 853-3646. EXPORT SALES, DAGE CORPORATION, STAMFORD, CONNECTICUT.

RADIATION MICROELECTRONICS HAS CHANGED ITS NAME TO HARRIS SEMICONDUCTOR

THE QUALITY AND PERFORMANCE COUNTER LINE



Featuring the Model 120A
AUTORANGING/
PROGRAMMABLE
COUNTER-TIMER

All around excellence, plus:

- dc to 512 MHz
- 100 ns time interval resolution
- 3 independent input channels
- Time base autoranging – hands off operation
- Solid State numeric display (LEN)
- Full complement of C/T functions including "Burst Mode"
- External programming
- BCD output

120A 512 MHz \$2,195

120A 150 MHz \$1,775

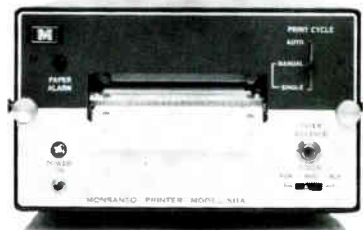

PRINT OUT

with the Model 511A digital printer, compatible with most counters. Compact (only 4½ inches high), 21 columns at up to 3 lines per second, auto zero suppression, BCD input and a price of only \$1195.

For more information on any of these priced-to-fit instruments, call or write:

Monsanto
Electronic Instruments
620 Passaic Avenue
West Caldwell, New Jersey 07006
(201) 228-3800

Select the Counter that suits your needs.

- 100B, 40 MHz Counter-Timer \$575
- 101B, 50 MHz Counter-Timer \$695
- 103A, 20 MHz Counter-Timer \$420
- 104A, Variable Time Base C/T \$795
- 105A, 512 MHz Counter-Timer \$1550
- 106A, Up Down Counter-Timer \$775
- 107A, Computing Counter \$1250
- 109A, Dual Limit Counter \$975
- 110B, 150 MHz Counter-Timer \$1585
- 114A, 150 MHz Freq. Counter \$995
- 120A, 512 MHz Auto/Programmable C/T \$2195
- More coming.

Monsanto

New products

Data handling

\$650 printer has 16 columns

Datos 307 can turn out
one line per second and
comes mounted, ready to go

One way to lower production costs per unit is to increase volume. While that's often hard to do in the instrument field, with its limited

market, Data Graphics Corp. of San Antonio, Texas, has found a way to take advantage of some of the economies of scale. The company is marketing a digital printer using a mechanism developed by the SCM Corp. for its Marchant 1016PR Cogito electronic printing calculator, which has a broad industrial market.

John G. Peddie, Data Graphic president, says that engineers at SCM asked him to develop the logic required to use the printing mechanism in other applications. Data Graphics then discovered that it could sell the product, which it calls the Datos 307, for \$650—less than other comparable printers.

Data Graphics' logic makes the parallel-to-serial conversion, and the company also makes the power supply and bottom plate, and mounts the mechanism; the final product is a printer that's ready to use. It prints 16 digits to the line at approximately one line per second using standard 3-inch-wide adding machine paper. All digits, plus a decimal and space, are available, and other characters can be ordered as options.

The 307 accepts standard transistor-transistor logic levels. Control is either remote or from the front panel. Characters are 0.12-in. high by 0.075-in. wide. Peddie says that the reservoir-fed con-



Family of Teletype 38 terminals with their own modems include automatic send-recv, keyboard send-recv, and receive-only terminals. Modems are optional. Terminals employ same concepts as 33 line plus upper- and lower-case printout and a wide platen. Teletype Corp., 5555 Touhy Ave., Skokie, Ill. [401]



Drum plotter model 462 is designed for verification of IC masters, other uses where computer output lends itself to graphic representation. Drawing speed is 1600 in./min. and it can accelerate from 0 to 1600 in./min in 30 ms. Prices start at \$35,000. Gerber Scientific Instrument Co., 83 Gerber Rd., S. Windsor, Conn. [402]

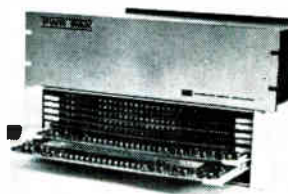

Add-on core memory system CorPac 11 provides PDP-11 users with up to 24k words of additional core memory in 10½ in. of rack space. Unit is available in 4k x 16f bit increments, can replace or add to the original 4k. Price is \$18,500. Information Control Corp., 9610 Bellanca Ave., Los Angeles, Calif. [403]

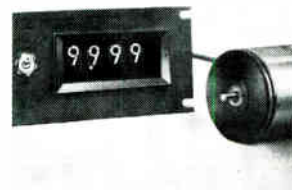

Shaft encoder and display system model EDS-170 is a position measuring system requiring no additional equipment. Power supplies and circuitry are built in, with auxiliary BCD outputs available for driving optional equipment. Price is \$995. LEM Instruments Corp., 20 Sarah Dr., Farmingdale, N.Y. [404]

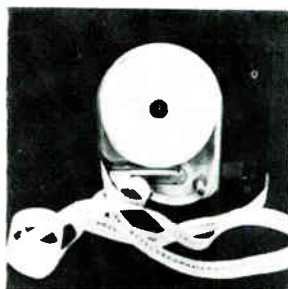

Non-impact strip printer MC-100 prints silently at 10-65 c/s and uses throw-away cassettes loaded with 350 ft. of ¼-in.-wide paper. It can be interfaced with computer or communications line. Price is less than \$200 in OEM quantities. Datalog Div., Litton Industries, Walt Whitman Rd., Melville, N.Y. [405]



Acoustic adapter VA100 couples VA300 series of data sets to phone lines, expanding modem capability. Transmitted signals directly drive coupler microphone after passing through VA300 bandpass filter. Price is \$80 to \$100, depending on quantity. Vadac Corp., 405 Alberto Way, Los Gatos, Calif. 95030 [406]

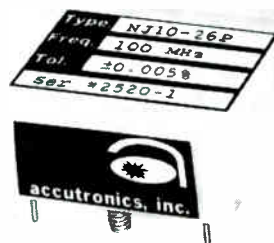

Computer clock series 90 is compatible with all variations of IC logic. Frequency ranges are 1 Hz to 250 MHz with stabilities of ±0.001% from 0-60°C. Supply voltage range is 3.6 v dc for RTL to -20 v dc for c/mos. Price is \$12 to \$68 depending on frequency, application. Accutronics, 628 North St., Geneva, Ill. [407]

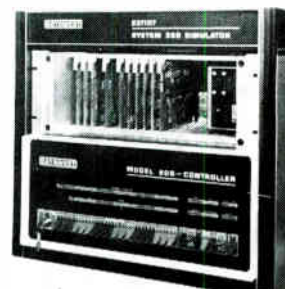

IBM-system-360 simulator model 531107 enables makers of 360-compatible equipment to decrease testing cost. Unit provides responses, timing, and control for bidirectional communications. Price is \$22,500. Quantity discounts are available. Datalog Corp., P.O. Box 1208, 7503 E. Osborn Rd., Scottsdale, Ariz. [408]

Tron Rectifier Fuses



Available in sizes from 1/2 to 1000 amps for voltages up to 1500, TRON Rectifier Fuses are ideal for protecting variable speed drives, inverters, battery chargers, plating power supplies, power controls, and any other application where fast opening and great current limitation are required.



Write for BUSS Form TRFS

Bussmann Mfg. Division, McGraw-Edison Co., St. Louis, Mo. 63107
Circle 165 on reader service card

FUSES

for protection of Electronic Devices

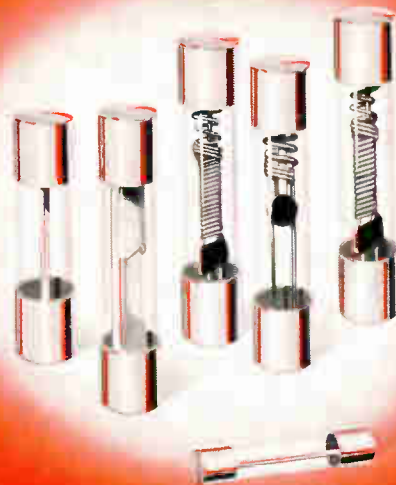

There is a complete line of BUSS Quality fuses in 1/4 x 1 inch, 1/4 x 1 1/4 inch, and miniature sizes, with standard and pigtail types available in quick-acting or dual-element slow blowing varieties.



Write for BUSS Form SFB

Bussmann Mfg. Division, McGraw-Edison Co., St. Louis, Mo. 63107
Circle 207 on reader service card

BUSS: The Complete Line of Fuses and . . .

ELECTRONICS OUT OF STONE



Primitive Art? Magic? No. We use the most modern and advanced equipment to produce electronic components from quartz. Tadiran manufactures CR-type crystals (as well as crystals in TO-5 cases), crystal filters and crystal discriminators. Our quartz crystal products are manufactured to meet U.S. Military Specifications — proof of their high quality and reliability.

TADIRAN
ISRAEL ELECTRONICS INDUSTRIES LTD
3, HASHALOM ROAD, TEL AVIV ISRAEL

The power supply you plan to build is built!



Low Cost—Reliable

\$125 each

It's on the shelf, ready for immediate delivery from Electrostatics. With specs proven in service. Low cost. Brief specs on our Model 503:

- 3 DC Voltages
- All in one DC power supply
- + or - 4.5 to 6.5 at 5A
- +12 to 20V at 0.5A
- -12 to 20V at 0.5A
- Input 105-125V, 47-420 Hz
- Regulation: Line 0.01%
Load 0.1%
- Ripple: 500 μVmax.
- Temp: -20 to +71°C operating
- Foldback current limiting
- Size: 8" W x 4" H x 8" L

(S150 with overvoltage protection)
For full information call Robert McCartney, Manager of Application Engineering, (714) 279-1414. Or circle the number below for our latest data sheet.

Electrostatics, inc.

7718 Clairemont Mesa Blvd., San Diego, California 92111

DEPT. 121

New products



Ready-made. Digital printer includes logic, mounting for applications in data handling and instrumentation.

tinuous nylon belt prints 150,000 cycles per inking, and lasts about 900,000 cycles.

He feels that the unit will find use in production applications and

in research, where it provides a convenient direct replacement for digital panel meters in instruments such as blood analyzers.

The Datos 307 is 6.5 in. high by 13 in. wide by 12 in. deep, and weighs 10 lbs. It operates from 115 volts ac, 60 hertz.

Data Graphics Corp., 8402 Speedway Drive, San Antonio, Texas 78230 [409]

8,192-bit bipolar ROM has access time of 55 ns

The state of the read-only memory art has risen to the 4,000-bit-per-chip range. The next jump, say most memory-watchers, will be to the 8,000-bit area and the route will be MOS because of the higher density afforded by MOS and also because of the power dissipation problems associated with bipolar technology.

But those memory watchers will

be in for a surprise at the SJCC. That's where Monolithic Memories Inc. of Sunnyvale, Calif., will introduce an 8,192-bit bipolar ROM with an access time of 55 nanoseconds and power dissipation of only 60 microwatts per bit. This is roughly the same total power dissipation as currently available in 1,024-bit ROMs.

The memory is organized as 1,024 words by eight bits, and comes in a 24-pin package. Address-input-current requirements are only 250 microamperes maximum, so "you can drive more memories without buffering," says Zeev Drori, company president. "Four chip-enable lines are provided and so the memory can be expanded to 8K, eight-bit words in the word direction with no additional circuitry," he notes. "And because of the very low address-input-current spec, up to 60 packages can be driven in the word direction. This

Fuseholders of Unquestioned High Quality

Quick-connect Fuseholders and Fuseblocks

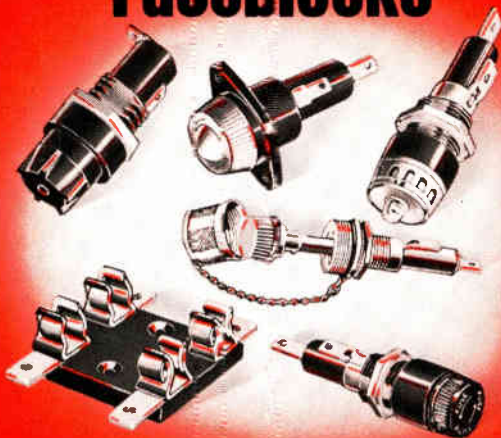

The complete line of BUSS fuseholders and fuseblocks is available with quick-connect terminals to save assembly time and cut costs.

Bussmann Mfg. Division, McGraw-Edison Co., St. Louis, Mo. 63107



Write for BUSS Form SFB

Subminiature Fuses and Fuseholders



BUSS has the fuses and fuseholders for space-tight applications, in a wide range of ampere ratings from 1/100 to 15. Allow visual inspection of element. Tiny but tough, they're built to withstand severe environments.



Write for BUSS Form SFB

Bussmann Mfg. Division, McGraw-Edison Co., St. Louis, Mo. 63107

There Is a Difference In Quartz Crystals

I Space age communication equipment demands a crystal that meets all standards of technical advancement. Crystals that were acceptable some years ago do not meet present day specifications. As a general rule, your crystal must be selected from the best quartz . . . (no throw off cuts). Tight tolerances demand selected angles of cut. The x-ray is important in making this selection. The crystal should be preaged with stress cycling. It should be checked for frequency change vs temperature change. It must be checked for optimum spurious response. It should be calibrated to frequency with the correct oscillator. International Crystals are manufactured to meet today's high accuracy requirements. That's why we **guarantee** all International crystals against defective materials and workmanship for an unlimited time when used in equipment for which they were specifically made.



WRITE FOR CATALOG



CRYSTAL MFG. CO., INC.
10 NO LEE • OKLA. CITY, OKLA. 73102

New products

yields a memory that is 8K words by 480 bits without any additional decoding circuits."

In microprogramming applications, the memory offers both high density (it's equivalent to 256 bipolar TTL packages or about 1,000 gates) and the high speed essential in microprogramming, according to Drori. "And in calculators, one ROM can store all of the data for sine, cosine, tangent, and cotangent." Moreover, says Drori, "It will sell for below MOS prices." In quantities of 100, the price is half a cent per bit—\$40. Delivery is from stock.

Monolithic Memories Inc., 1165 East Arques Ave., Sunnyvale, Calif. 94086 [410]

Interactive graphics terminal offers gray-scale video image

Designed to operate on-line or over telephone lines as a remote, time-shared unit, an interactive graphics terminal developed by Princeton Electronic Products Inc. can display a stored or non-stored gray scale video image obtained from a video cable or other source.

The terminal, called the PEP-801, will be exhibited at the Spring Joint Computer Conference. Its gray-scale capability results from use of the Lithicon silicon storage tube developed by the company and incorporated in its PEP-400 storage terminal (*Electronics*, June 8, 1970, p. 137). The earlier terminal is the refresh memory for the 801.

The new unit provides high-density alphanumeric at 4,000 characters on a 14-inch screen, high-resolution vectors, and selective editing of characters. A TV raster readout allows multiple monitors or cluster displays with additional costs for the TV monitors only.

Besides operating as a remote terminal via 2,400-baud links, the 801 can be modified to run at on-line speeds and to interface with specific computers.

Alphanumeric characters are formed by a 5-by-7 dot matrix. Character writing time is 50 micro-

lev-er-wheel



... so new
you can't look it up
in your Funk & Wagnalls

LEVERWHEEL SWITCH ... Thumbwheel Lever-Action by CHERRY ... new larger numbers

FASTER SETTING: A single movement of the Leverwheel setting lever through its 90° arc is all that's necessary for a complete 10-Position cycle. (Compare *that* to plunking through the 360° rotation on conventional thumbwheel!)

Instant reset at no extra cost: A simple sweep with the hand and all levers return to home position with every switch in the bank returned to "zero."

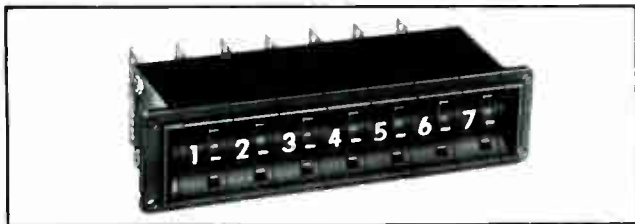

Cherry has new standard thumbwheel switches, too! Like the unique new Leverwheel, Cherry thumbwheel switches are available in miniature and subminiature sizes, totally-interchangeable with other leading thumbwheels.

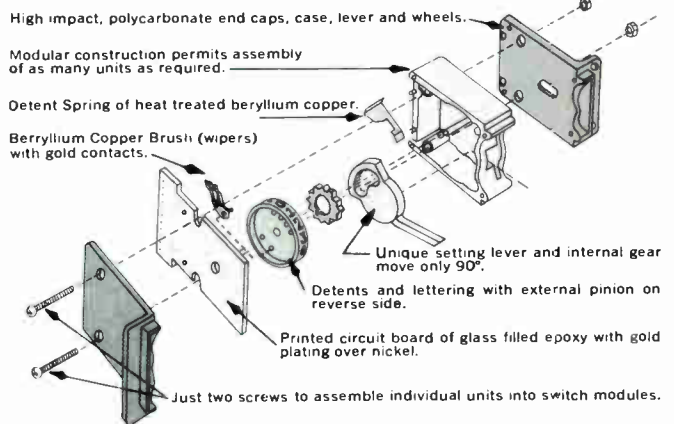

SEND TODAY for our new 44-page full line catalog ... which includes complete data on Cherry Leverwheel and Thumbwheel Switches. For immediate action phone 312/689-7600.

CHERRY



CHERRY ELECTRICAL PRODUCTS CORPORATION

3608 Sunset Avenue • Waukegan Illinois 60085

Makers of patented Leverwheel/Thumbwheel Switches, Matrix Selector Switches, Snap-Action Switches and Keyboards.

Circle 131 on reader service card

Now you can
make a sales
trip to Japan
for \$400....
... and talk to
15,000 buyers
in their
native tongue!

The vehicle? Nikkei Electronics — the Japanese version of Electronics Magazine published in Japanese for consumption in Japan only.

Joint Venture

Nikkei Electronics will be published bi-weekly by NIKKEI/McGRAW-HILL INC. — a joint venture of NIHON KEIZAI SHINBUN and McGRAW-HILL INC. Nikkei Electronics will be published entirely in the Japanese language including advertisements. For your convenience in placing advertising in Nikkei Electronics, the sales staff of Electronics Magazine has been designated as your liaison.

Editorial

The editorial staff of Nikkei Electronics consists of ten full-time editors plus contributions from Electronics editors, the McGraw-Hill World News staff and the news services of NIHON KEIZAI SHINBUN—the world's largest publisher of financial newspapers.

Every two weeks, these editors will produce a news and technology Japanese language magazine for electronics engineers in Japan.

Circulation

- Nikkei Electronics will begin publication with a paid Japan circulation of 15,000 in April and with a guaranteed paid Japan circulation of 20,000 within the first year of publication.
- Nikkei Electronics circulation is restricted to: engineers and management in companies manufacturing electronics products; users of electronics products; and managers of governmental and independent R&D; educational and electronics studies associations.
- The subscriber universe for Nikkei Electronics is 120,000 electronics engineers plus 18,000 new engineers graduating annually.
- Nikkei Electronics is the only Japanese Electronics magazine going ABC. All others are not audited.

Advertising in Nikkei Electronics

- If you sell, or want to sell your products in Japan, you can talk to 20,000 buying influences in their native tongue for just \$400 a page.
- If you are already advertising in any of the unaudited lesser media in Japan, here is your opportunity to consolidate your schedule in the one strong medium, make a dominant impression and save advertising dollars.

If you are interested in advertising in Nikkei Electronics contact your local Electronics salesman or any of the Electronics sales offices in the U.S. and Western Europe.

Nikkei Electronics



A Nikkei /McGraw-Hill Publication.

New products

seconds. Characters and vectors are drawn on the Lithicon during the CRT retrace time to eliminate any flicker that would occur because of switching among read, write, and erase in a single electron gun storage tube.

Characters are both upper and lower case, and standard size is consistent with a 4,000-character display—80 characters per line and 50 lines. Other sizes can be selected, the largest one providing a 32-character-per line density.

An incremental technique is used to draw vectors, with each vector word made up of four 8-bit ASCII words.

Princeton Electronic Products Inc., P.O. Box 101, North Brunswick, N.J. 08902 [411]

Lightweight terminal prints at 30 characters per second

A mobile—though not portable—printer terminal using a thermal printhead will be introduced at the Spring Joint Computer Conference by Anderson Jacobson Inc.

Designated the AJ-YEP, it weighs 36 pounds. Although not available in a briefcase, it has a carrying case that allows it to be moved from desk to desk. Aimed at the data communications and computer time-sharing market, the terminal has a solid state keyboard and a thermal non-impact printer for quiet operation in office environments.

Operating at speeds up to 30 characters per second, the AJ-YEP has a 14-inch-wide carriage that permits 140 characters per line. It has a full ASCII character set. The printer accommodates a roll of commercially available heat-sensitive paper that is 450 feet long and 4½ inches in diameter.

The printer terminal will be available in late summer, and the company says it will sell for “under \$4,000.” An acoustic adapter for telephone lines is available from Anderson Jacobson for \$100, and an acoustic coupler at \$375.

Anderson Jacobson Inc., 1065 Morse Ave., Sunnyvale, Calif. 94086 [412]

Computer malfunctions cause incalculable chaos in split seconds. That's why you need multi-layer laminates made by the finicky folks at Norplex Division of UOP.

They're such sticklers for high standards they had to design much of their own quality-control equipment. That's how they can guarantee to meet or exceed NEMA, MIL-P and customer specifications.

And their clean rooms with precisely controlled temperature and humidity provide an extra measure of inclusion-free dependability. Norplex multi-layer laminates are without equal for stress-free uniform quality and dimensional stability.

Your Norplex representative is unique, too. He's a laminate engineer, a problem-solving consultant, offering you the widest line of laminates in the business. And he's backed by a

customer-service team assigned to each account for complete follow-through.

For process predictability in computer laminates, call on the Lint-Pickers. Norplex Division, UOP (Universal Oil Products Company).

Main Office and Plant
Norplex Drive
LaCrosse, Wisconsin
54601
608/784-6070

Franklin Office and Plant
P.O. Box 186—
Route 31 North
Franklin, Indiana 46131
317/736-6106

How the Lint-Pickers keep the numbers game clean.

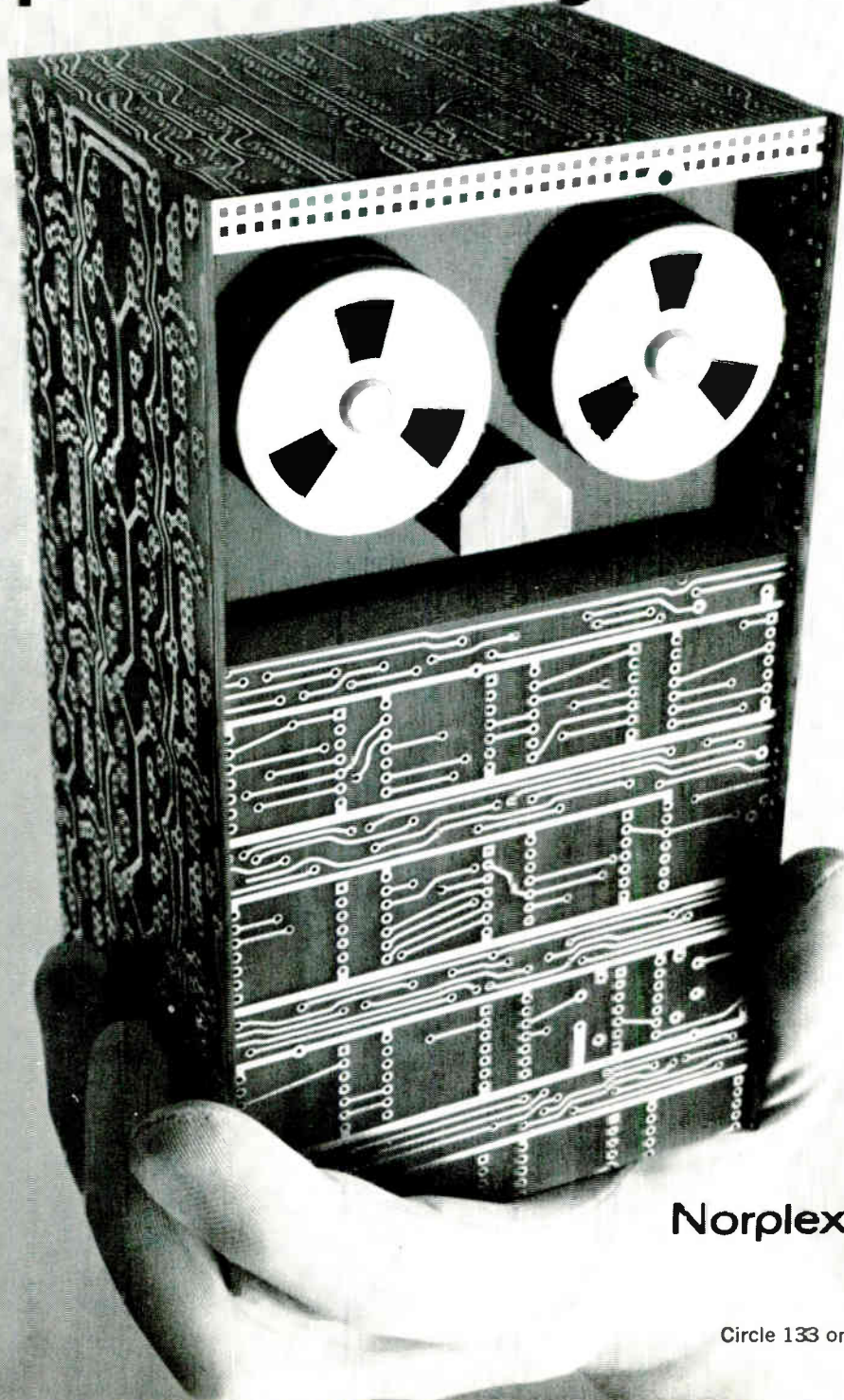

Norplex® laminates
by UOP

Circle 133 on reader service card

A new exciting concept in RF instrumentation

**An RF generator,
frequency stabilizer,
and counter--all in one**

925 SIGNAL GENERATOR

with Signalock™

Signalock is a new, patented technique that automatically corrects for frequency drift. When you set the Tune-Lock switch to the Lock position, the generator's fundamental RF oscillator is locked to the built-in frequency counter's crystal time base. Signalock continuously compares the actual frequency output to the selected frequency data which has been stored, and produces an error voltage to correct oscillator drift. The result is an unprecedented frequency stability of $\pm 10^{-7}$.

The 925 Signal Generator covers the frequency spectrum from 50 kHz to 80 MHz. It provides leveled calibrated RF power from 11 μ v to 3 volts. The integral 3-digit frequency counter, incidentally, can be used to measure external frequencies while the generator is operating.

Contemplating a synthesizer or synchronized RF generator? Take a look at the exciting new Signalock 925 by LogiMetrics. It brings a higher level of sophistication to RF instrumentation while reducing equipment costs.

**all for
\$2975**



LogiMetrics INC.

A Subsidiary of Slant/Fin Corp. ■ 100 Forest Drive, Greenvale, New York 11548 ■ Phone: (516) 484-2222 Telex 96-1371
Circle 134 on reader service card

New products

Instruments

Fairchild's into bench testers

Transistor checker with 96-word memory handles up to 62 tests per second

Fairchild Systems Technology is taking three skips and a jump into the IC and transistor tester business, benchtop division. To skip

much design and development work, the firm is buying three types of testers from Microdyne Instruments of Waltham, Mass., and selling them with Fairchild labels. The 301 and 321 both test linear and digital integrated circuits, with the 321 able to run automatically. The 335 is for linear ICs.

For the transistor checker, Fairchild opted to jump in and design and develop the instrument itself. The result is PATT (programmable automatic transistor tester). It's a go/no-go unit that checks leakage current, breakdown voltage, dc gain, saturation voltage, and base turn-on voltage. Able to run 62 tests per second, PATT can deliver

10 amperes of collector current and 600 volts for breakdown tests.

The most important feature, states William Root, director of engineering, is the "simple-minded computer" which can be programmed to run a sequence of up to 96 tests. This allows one program to perform several classification routines.

Root's "computer" is an MOS memory and some digital control circuitry. With a 10-word memory (56 bits per word), PATT sells for \$12,900. Larger memories are available, with the 96-word PATT selling for \$20,000.

With its high test rate, the instrument can be multiplexed, simultaneously running tests at up to



Keyboard test set checks logic output of encoded keyboards by plugging them into the set. Proper voltages are given with no external supply or circuitry needed. Code is selected by panel switch, and bit 8 is enabled if parity checking is desired. Maxi-Switch Co., 3121 Washington Ave., North, Minneapolis, Minn. [361]



Digital volt-ohm-milliammeter model 460 combines high accuracy, multiple range testing with non-blinking digital numeric display and front panel analog meter readout in a portable instrument. Twenty-six switch-selectable ranges are available. Price is \$395. Simpson Electric Co., 5200 W. Kinzie St., Chicago, Ill. [362]

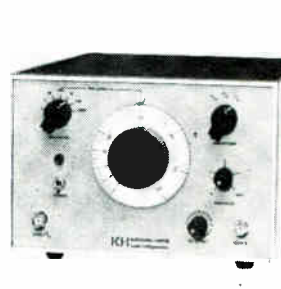

Function generator model 5000 provides sine, square and triangular waveforms over frequency range of 0.2 kHz to 3 MHz. Maximum output for all functions is 20 v peak-to-peak with an additional 5 v peak-to-peak square wave output available. Price is \$295. Krohn-Hite Corp., 580 Mass. Ave., Cambridge, Mass. [363]

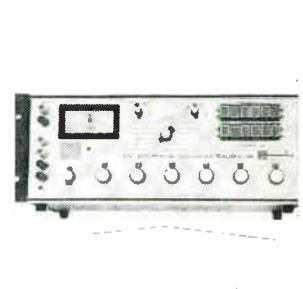

Differential voltmeter/calibrator model 2901 has chopper design with feedback from wire-wound resistors in output selection circuits. This means constant input/output impedances independent of output setting. Price is \$1,350. Electronic Development Corp., 11 Hamlin St., Boston, Mass. 02127 [364]



Digital test oscillator model 101A fills most sine wave source requirements from 10 Hz to 12 MHz. Unit has amplitude and frequency modulation, BCD remote programming over wide range. Price is \$495 for basic model and \$580 for programmable model. Progress Electronics Co., 5160 N. Lagoon Ave., Portland, Ore. [365]



Tension monitor model M-100 measures dynamic tape tension between drive capstan and two tape packs within digital and audio cassette decks. Monitor uses special cassette, instrumented internally with a strain gage containing 150 ft of tape. Information Terminals Inc., Terra Bella Ave., Mt. View, Calif. [366]

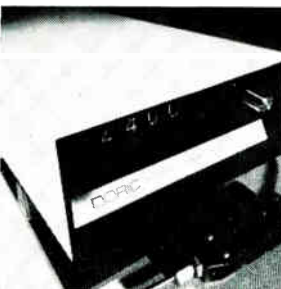

Digital thermocouple thermometer replaces analog horizontal, vertical scale indicators. Device offers automatic zero correction circuitry and differential inputs which allow use with grounded or ungrounded thermocouples, without loss of noise rejection. Doric Scientific Corp., 7601 Convoy Ct., San Diego, Calif. [367]



Displacement measuring system acts as radiometer, providing system accuracy to $\pm 0.1\%$ + one digit. Other types of dc-dc linear variable differential transformers with displacement ranges of ± 0.02 ft to ± 5.0 ft are available. Price starts at \$510. Pickering and Co., 101 Sunnyside Blvd., Plainview, N.Y. [368]



**OUTSTANDING
THERMAL ENDURANCE
RUNS IN THIS FAMILY:**

**ELECTRICAL
TEMP-R-TAPE
OF KAPTON.**

Temp-R-Tape® of Kapton* is now available in a complete "family" of tapes—all offering outstanding thermal endurance, retaining their excellent mechanical and electrical properties over an operating range from -100F to +500F. Available in thicknesses from .001 to .0045" with electric strengths up to 10,000 volts . . . with a choice of pressure-sensitive silicone adhesive on one or both sides, or thermosetting acrylic adhesive, or a flame retardant adhesive . . . and in ¼", ½", ¾", 1", 1½", and 2" widths, with special widths slit to order.

Find your CHR distributor in the Yellow Pages under "Tapes, Industrial" or in industrial directories. Or write for details and sample. The Connecticut Hard Rubber Company, New Haven, Connecticut 06509.



a HITCO company



*T.M. of DuPont

New products



High current. Since PATT delivers up to 10 A of collector current, it can test high-power transistors.

three stations with each station running the same or different programs as the others. In fact, one station can be testing npn transistors and another pnp.

PATT has four operating modes. In automatic, all tests in a sequence are run and the results are displayed. In repeat, the system runs the same test over and over. In manual, it stops after each test. The fourth mode is stop on failure.

In the basic instrument, programming is via keyboard. Optionally, it can be done with a cassette, digital switches, modems, or an external computer.

Interface circuits can be provided to allow PATT to work in an automatic system—controller, tester, and handler. In fact, Fairchild is making a handler—the 100. Its advantage, says manager Root, is "that you don't have to be a mechanical engineer to fix it if it jams." The entire path a transistor travels through the handler is easily accessible. Delivery time for PATT is 30 days.

Fairchild Systems Technology, 974 East Arques, Sunnyvale, Calif. 94086 [369]

**Digital multimeter
measures ac and decibels**

The "multi" in multimeter used to mean simply "able to measure resistance, dc voltage, and dc current." No more. The latest digital multimeters also have an ac capability. The 3310 of Hickok Electrical Instrument Co., for one, measures the rms value inputs over a frequency range that goes to 50 kilohertz.

That's not the end of the instru-

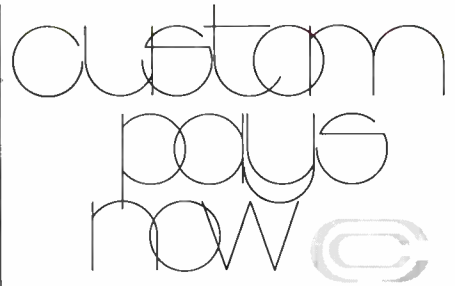

So you won't have to pay later.

The design looks perfect . . . but then, somewhere something goes wrong. A defective part, an improper assembly, or maybe it was the installation in the field. It's impossible to avoid all imperfections.

As experts in the field of reconstituted mica capacitors, our experience shows that the greatest single cause for capacitor failure is a short in the dielectric material. Consequently, we precisely inspect and grade all of our dielectric material **before** production. Because of our meticulous quality control, Custom Mica Capacitors are absolutely the finest quality capacitors of their kind available on the market today.

We pay now so you won't have to pay later.

Another major reason why you should join our client list of Who's Who in high voltage electronics. Write for our Facility Folder and Product Sheets, or call today for our rapid reaction quote to your specific requirements.



CMR, wrap and fill



CER, epoxy housed



CEM, epoxy molded



CUSTOM ELECTRONICS, Inc.
Browne St., Oneonta, N. Y. 13820
PH: 607-432-3880 TWX 510-241-8292

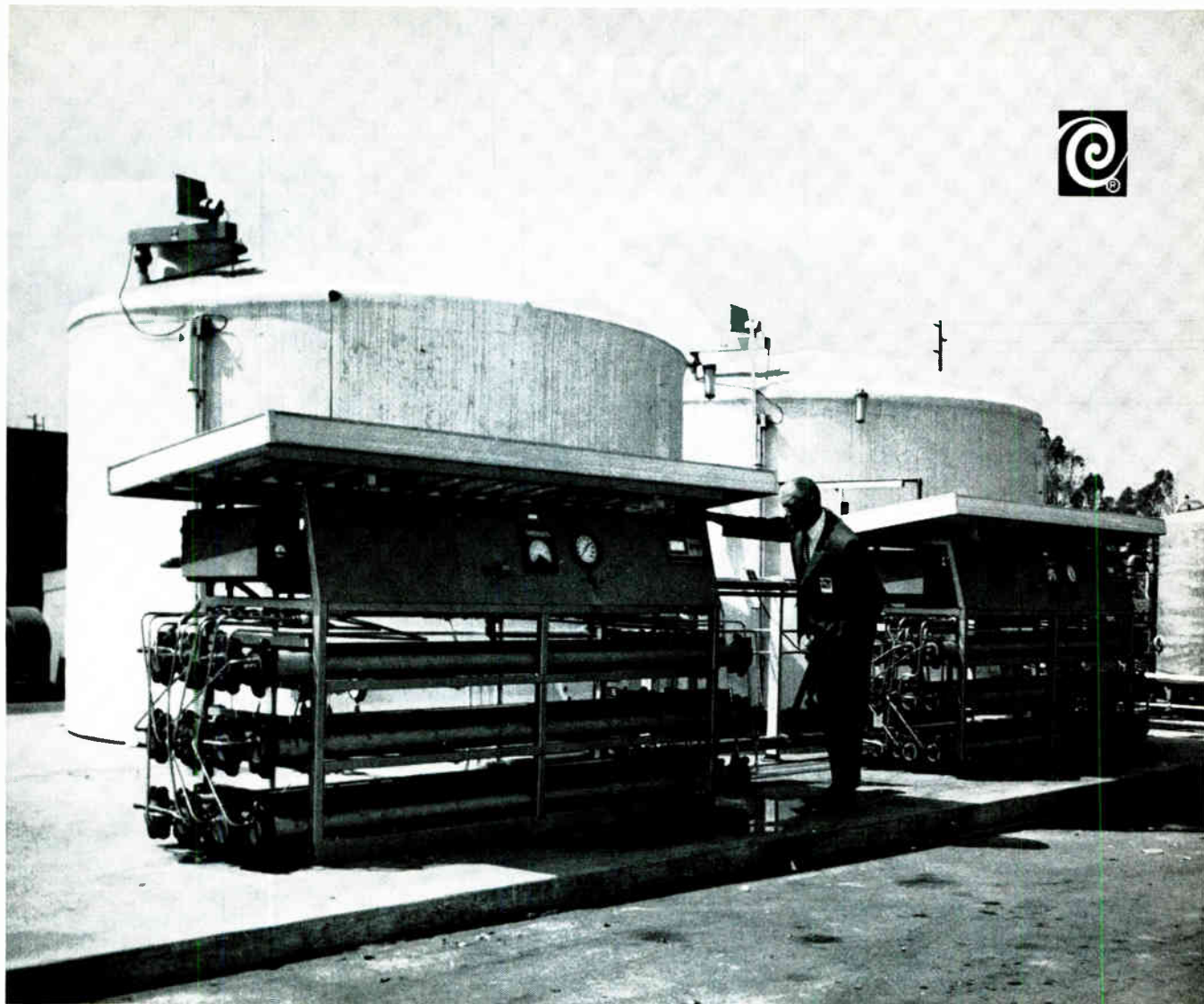

Twenty thousand times purer water is a lot purer water.

Water twenty thousand times purer than average drinking water is produced for the North American Rockwell Microelectronics Company (NRMEC) starting with the Culligan system shown above.

The final product water is zero in hardness, has zero total dissolved solids, 18 megohm resistivity, and a bacteria count less than 10 ppm.

This water is produced by our new Reverse Osmosis units and subsequent ion exchanges. Its high purity is vital to the efficient manufacture of the microscopically-small electronic devices made by NRMEC.

NRMEC devices incorporate circuit lines as narrow as .0002 inch. Thus, the most minute impurity could immediately short circuit adjacent circuits and ruin the entire device. To prevent this, NRMEC bathes the microelectronics devices with this very high purity water several times during processing to assure maximum

cleanliness. The water does not permit precipitation of impurities to the wafer surfaces.

Our Reverse Osmosis system has achieved two main objectives for NRMEC. First, water ready for deionizing is now dependable and consistent in quality. It is not affected by fluctuations in the local municipal water supply. And second, water costs have been substantially reduced from the previous method of starting with distilled water which was delivered daily by truck.

In addition to conditioning process and production water, Culligan capability includes equipment for softening, filtration, boiler water, cooling towers, and waste water treatment.

Call your local Culligan Man today for a consultation. He will evaluate your water needs as to flow, quality, application, and treatment equipment requirements.

Culligan®

THE WORLD-WIDE WATER CONDITIONING PEOPLE WHO SERVE YOU BETTER LOCALLY

Franchised Dealers in the U.S. and 85 countries. Culligan International Headquarters, Northbrook, Illinois 60062. Franchises available.

STRESS RELIEVED AND WEATHERPROOFED

BNC Cable Assemblies

These new cable assemblies feature polyethylene collars which are injection molded directly onto cable jacket and connector body. The resulting encapsulation offers two outstanding advantages:

STRESS PROTECTION
against failure from excessive bending, flexing, twisting;

WEATHERPROOF SEAL
between cable and connector. Available in various lengths and RG58C/U, RG59B/U, or RB62A/U. Connectors have non-tarnish finish and conform to MIL-C-39012. Write for specifications, prices, and delivery.

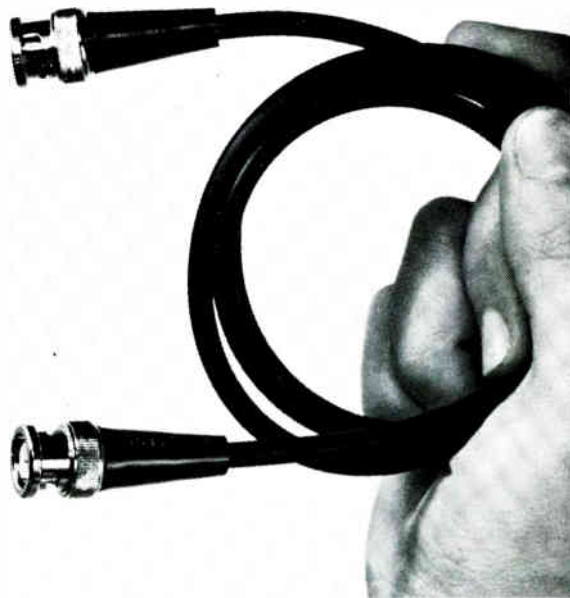

PE POMONA ELECTRONICS CO., INC.
1500 East Ninth Street, Pomona, California 91766 • (714) 623-3463

Circle 167 on reader service card

MICO

WIDE-RANGE ENGRAVER

NEW FEATURES FOR
HANDLING PANELS UP
TO 23 x 25 INCHES

NO. 885

FOR LONG AND
MULTI-LINE WORK

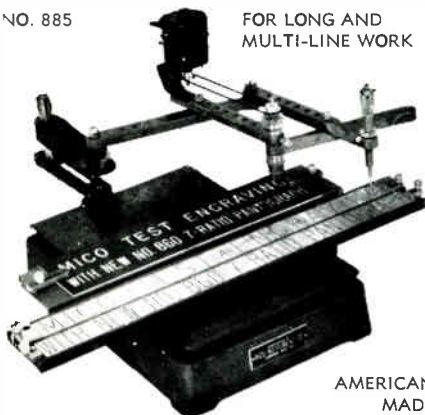

AMERICAN
MADE

- A time-saver for large plate work.
- Engraver letters 1/32" to 3" high using standard masters.
- Seven pantograph ratios—from 1:5:1 to 6:1.
- Choice of 3 ball-bearing spindle assemblies for 1/8" 3/16" or taper-shank cutters.
- HSS, Cobalt and Solid Carbide Cutters.
- Single and multi-line copy carriers for holding blanks 3/4" to 3 1/2" high.
- Accommodates Mico standard accessories.

Send for bulletins and prices

MICO INSTRUMENT CO.

77 Trowbridge St. Cambridge, Mass. 02138

138 Circle 138 on reader service card

New Micro-Miniature Form C Reed Relays

Only
.290 00!

- The First FORM C Micro-Min. Relay Available!
- Measures .435 x .290 00, only 0.03 cu. in.!
- Min. Overall Length with Bent Leads .600
- High Speed 100 microsec. Operate Time (ex. Bounce)
- Stock Voltages 3, 6, 12 and 24
- Leads or Pins. Also Available with Form A.

Special voltages, resistances, electrostatic and/or magnetic shields available. Write for new Bulletin MR-9.2.



COTO-COIL COMPANY, INC.
61 Pavilion Avenue, Providence, R. I. 02905
Tel: (401) 941-3355

Circle 168 on reader service card

New products



Broad application. Multimeter has range of dc to 50 kilohertz for both ac and dBm measurements.

ment's versatility; it also makes decibels-above-1-milliwatt readings. An optional probe permits voltage measurements up to 30 kilovolts at dc and from 50 hertz to 70 Hz. A second probe—this one a clamp-on—extends current range for both ac and dc to 100 amperes.

For dc and rms voltage readings, the 3310 has five ranges from 100 millivolts full scale to 20 kv. Resolution runs from 100 microvolts to 1 volt. Accuracy is 0.1% of reading for dc and as good as 0.5% of reading ± 1 count for ac.

For current readings—dc and rms—the five ranges go from 100 microamperes to 1 A, and resolution from 100 nanoamperes to 100 μ A. Accuracy is 0.2% of reading ± 1 count, and as good as 0.5% of reading ± 1 count for rms.

The instrument's seven resistance ranges go from 100 ohms to 100 megohms, with accuracy being 0.5% ± 1 count; the dBm range is -40 to +60 dBm; resolution is 0.1 dBm; and accuracy is ± 0.2 dB. Frequency range for dBm measurements also goes to 50 kHz, and a front panel switch allows selection of a 600-ohm or 900-ohm reference.

The 3310 automatically changes polarity and it also automatically zeroes itself.

The instrument measures 3.5 by 8.37 by 13 inches and weighs 12 pounds.

Base price for the 3310 is \$845. A binary-coded-decimal output adds \$90, and a battery pack \$75. Delivery time is 60 to 90 days.

Hickok Electrical Instrument Co., 10514 Dupont Ave., Cleveland, Ohio 44108 [370]

Electronics | May 10, 1971

Stay where you are.

We'll bring the 39 best office and industrial sites in New Jersey to you.



Free.

Here is a great way to handle the research and details that can slow down preliminary site selection: Our latest Industrial Parks Kit. New Jersey's 39 finest plant sites *come to you* with complete information on each. You get a full-color aerial photo of each site, its exact location, distance from the New York City and Philadelphia marketing centers, transportation facts, utilities available, lease or purchase requirements, zoning, and a lot more.

Send for your free kit today. After you've made your preliminary choices, call us. Without charge or obligation, we'll assign a highly qualified Sitefinder to you who will make arrangements for your close-up inspection of the sites and provide additional help or information. And he can even arrange a tour by helicopter.

After all, you can't stay at home forever.

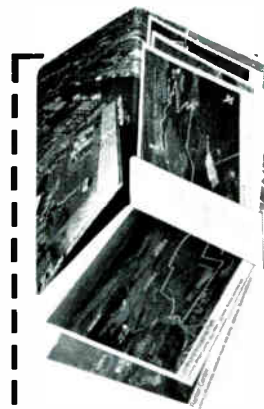

Fill in this coupon and mail today!

Public Service Electric and Gas Company
Box CE
80 Park Pl., Newark, N.J. 07101

Gentlemen:

Send the new Industrial Parks Kit to me at the address below:

Name _____

Company _____

Street _____

City _____ State _____ Zip _____

Public Service Electric and Gas Company

**Buy the performance
you need at the
right price.**



Sorensen DCR's.

Today every budget dollar has to go as far as possible for both new and replacement equipment. And Sorensen's DCR line saves you money because it offers you regulated dc power at the lowest cost per watt in the industry. Not only that, you select from the broadest line available anywhere. Pick the exact unit you need from 37 models covering power levels from 400 W to 20 KW . . . voltage ranges from 20 V to 30 KV. Remote programming and sensing, too. The cost? Consider the typical comparisons below.*

For complete information on our DCR's, contact Raytheon Company, Sorensen Power Supplies, 676 Island Pond Road, Manchester, N.H. 03103. Telephone 603-668-1600.

Sorensen
POWER SUPPLIES

Output	Power Supply	Cost/Watt
400 Watts	DCR 40-10A	\$0.78
	Mfr A	1.02
	Mfr B	1.18
2400 Watts	DCR 300-8A	0.36
	Mfr C	0.47
5000 Watts	DCR 20-250A	0.31
	Mfr C	0.60

*Specific competitive model numbers available on request.

New products

Packaging & production

IC package is leadless

LID technique, first used with discretes, is aimed at high-density LSI applications

The lead frame is at the root of many packaging problems in large-scale integrated circuits. The cost of gold plating and the difficulties

of maintaining lead alignment are causing package manufacturers to take a new look at the package's function and how it can be simplified. The latest move in that direction is a square ceramic, leadless, inverted device carrier from Frenchtown/CFI Inc., a subsidiary of Plessey Inc.

Frenchtown has been making LIDs for use with discrete transistors for several years—the new IC LIDs are an extension of the concept. The chip rests in a cavity in the package and is connected to the contact posts with wire bonds to a step inside the cavity. A dot of epoxy is applied to give mechanical protection; the package then is in-

verted and is soldered to contact pads on the substrate. The latter carries metalized interconnection paths for the circuit.

John D. Fredericks, Frenchtown vice president for sales and marketing, says that the IC LIDs will compete with nonhermetic plastic IC packages. Fredericks readily agrees that the LID's nonhermeticity is a drawback, but says that Frenchtown is developing a way to seal the package with a flat Kovar lid.

In its present form, however, it can be made with 40 or more contact pads. A 32-contact package, for example, measures about 345 mils square in outside dimensions and will handle a chip more than 200

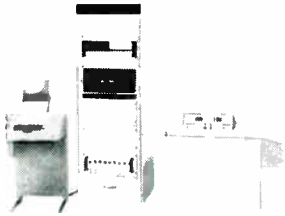

SF-PIES 6000 Automatic Test System

Computer-controlled automatic test system series 6000 can test digital, linear and passive circuits. Because of versatility and cost (generally under \$40,000), it is suited for incoming inspection and quality control functions as well as production testing. Optimized Devices Inc., Pleasantville, N.Y. 10570 [421]

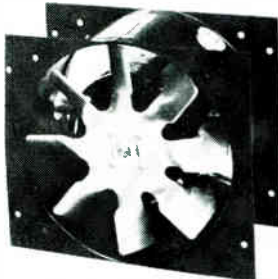

All-metal tube axial module fan features low noise levels, multi-bladed aluminum impeller, and permanently lubricated precision-bearing motor. Unit can replace existing module fans without alteration of plastic mounts, and withstands shock and vibration. Kooltronic Inc., P.O. Box 504, Princeton, N.J. 08540 [422]

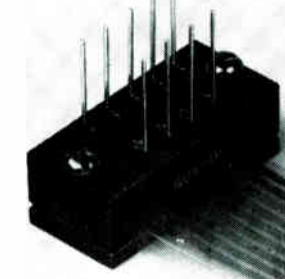

Connector called Tapecon terminates and taps flat flexible cable with a screwdriver, eliminating need for prepared cable or installation tooling. Connection is made by placing cable between connector halves. Tightening two screws brings halves together to make electrical contact. Burndy Corp., Norwalk, Conn. [423]

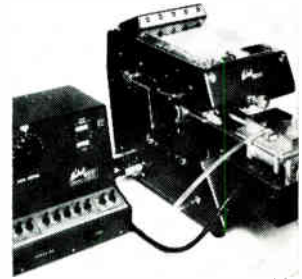

Thick film screen printer model 1200-rs is semi-automatic. features print repeatability to ± 0.0005 in., ease of setup, a print area of 4 x 4 in., and low-cost conversion to automatic operation. Optional attachment allows "on-contact" printing. Price starts at \$6,450. Wells Electronics, So. Bend, Ind. [424]



Memory exerciser model 4602 is a simulator for testing computer-controlled systems. The exerciser is capable of 65,536 addresses of 40-bit words at cycle time of 300 ns, with selection of 192 data patterns in six test modes. Automated Measurements Div., Technitrol Inc., 1952 Allegheny Ave., Philadelphia, Pa. [425]

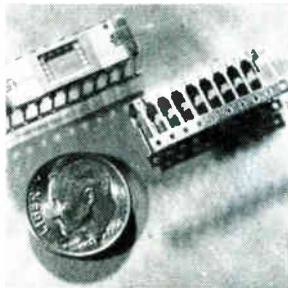

Large-cavity, dual in-line ceramic package has side-brazed leads. Multilayer 16-lead package is formed from 96% alumina tape, metalized in the green state, then high-temperature-fired. Projected price is 45 cents in very large quantities. Metalized Ceramics Corp., W. River Industrial Pk., Providence, R.I. [426]

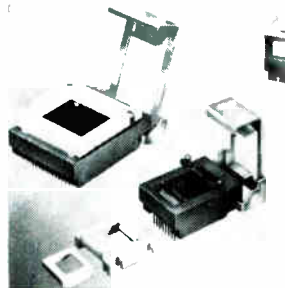

Carriers and test contactors for 30- and 50-lead flatpacs have .050-in. lead centers and standard geometries. Contactor insulator is polysulfone -55°C to $+150^{\circ}\text{C}$. Contacts are wiping type, made of beryllium-copper-plated gold over nickel, in conformity with Mil-G-45204. Barnes Corp., Lansdowne, Pa. 19050 [427]

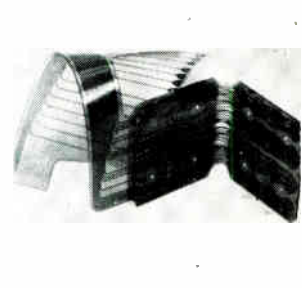

Packaging technique lets design engineer create circuit boards to fit any shape. Called Multiflex, it combines multilayer and flexible circuit construction, resulting in printed circuits that bend or twist, allowing design of a wrap-around package. Data Products Div., Lockheed Electronics Co., Los Angeles, Calif. [428]

UNIVERSAL IC PACKAGING PANEL

INCREASES FLEXIBILITY
IN PROTOTYPING
PRODUCTION AND
FIELD SERVICE

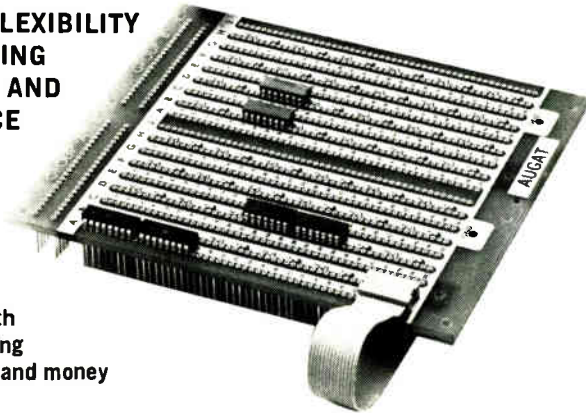

U Series panel with
point to point wiring
saves time, space and money

- Available in multiples of 9 row sections up to 54 rows.
- Each 9 row section accepts 3 plugs for interfacing or input-output connections.
- Accepts 14, 16, 24 and 36 lead Dual-in-Line integrated circuits.
- Double sided board with power and ground planes connected to additional wire wrap terminations outside of contact row.
- Wire wrap terminations with tri-level connection length.

Request complete I. C. folder.

AUGAT
INC.

Tel: 617-222-2202
Perry Ave., Attleboro, Mass. 02703

Circle 169 on reader service card

Perfect mate for Integrations— Micro-Vectorbord® Tenth-Tenth Pattern "P"

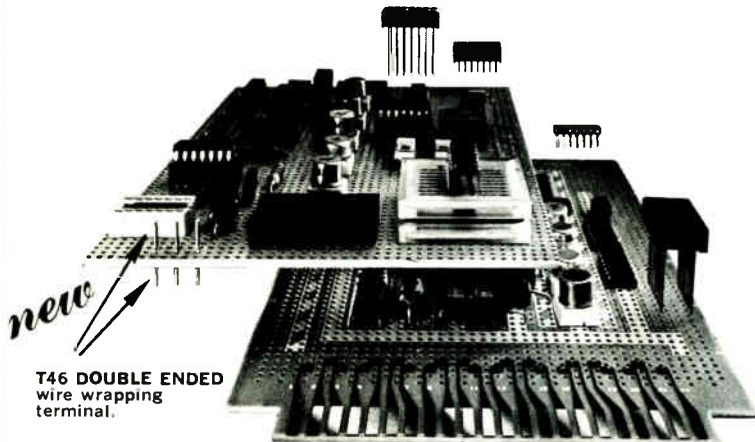

T46 DOUBLE ENDED
wire wrapping
terminal.

Precision punched .042" holes spaced .1" x .1" available in sheets of various sizes up to 8½" wide by 35" long, ¼" thick Epoxy Glass, Epoxy Paper, Phenolic. Now all flame retardant. Copper Clad and Non-Clad. Also available in Plugboards with etched or Elco Varicon contacts, buses, ground planes.

MINIATURE PUSH IN TERMINALS FOR .042" HOLES.



T44 MINIWRAP .025" Square, for wire-wrapping.



K27 .042" Diameter



T42-1 Micro-Klip

Vector

ELECTRONIC CO., INC.

12460 Gladstone Ave., Sylmar, California 91342

NEW ► Phone (213) 768-6080 • TWX (910) 496-1539

Earthquake? We resumed shipping Feb. 11 and production the 16 th.



New products

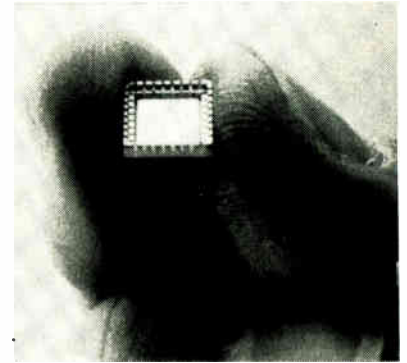

New job. LID carrier for ICs uses wire bonds from chip to step. Posts are soldered to contact pads.

mils square. Contact pads are about 25 mils wide on approximately 20-mil centers.

The packages are made by pressing the cavity into the ceramic blank, metalizing the die attach pad and contact areas, and then plating with 75 microinches of nickel and 75 microinches of gold. The contact pads then are isolated with an 8-mil diamond wheel. However, Fredericks says that the isolation cuts could be made before plating, since the devices are small enough to pick up enough gold in a barrel plating solution.

The material can be white 96% alumina or opaque black or brown high alumina for protection of light-sensitive devices. In addition the LID's flat top surface can also be plated to prevent parasitics. A notch also can be provided for automatic indexing and soldering.

Price of a typical unit, a 32-lead LID, ranges from \$1.35 for quantities up to 1,000 and \$1.00 for quantities of 5,000, to 49 cents for 100,000 quantities and 24 cents for 1-million quantities. Price of 24-lead device would be about 10% less, according to Fredericks, because of the lower labor involved in making the isolation cuts, while price of a 40-lead device would increase by 8% to 10%.

The height of the carrier is about 65 mils; the chip cavity is 45 mils deep, with a 20-mil step for uphill bonding.

Frenchtown/CFI Inc., subsidiary of Plessey Inc., 8th and Harrison Streets, Frenchtown, N.J. 08825 [429]

GE Announces 10 New Lamps To Help You With Your Design Needs.

Here are ten "little" ideas in lighting fresh from the engineers at
General Electric's Miniature Lamp Department.

New SSL Red Heads

(gallium phosphide solid state lamps, sometimes called light emitting diodes)



SSL-212

Our tiniest SSL, only .08" diameter, .125" high. Light output, 1 mc. Both leads out of one end for easy mounting.



SSL-12

Same small diameter as the SSL-212 but with square base collar, .095" wide for modular application.



SSL-22L

The 1/8" longer barrel permits mounting in panels up to 1/8" thick with full 180° visibility. Easily seen across a lighted room. Rated at 10 mA and $V_f = 2.15$ volts.

New Red Numeric Displays

SSL-140

SSL-190

Red, easy-to-read seven segment solid state read-outs with character heights of .140" and .190". Wide segments for easy viewing.

New Neon Glow Lamp



#3AG-F New circuit component lamp with tinned leads, and a special silicone Dri-Film[®] coating that increases leakage resistance to 1,000 megohms minimum. Use with MOSFET, matrix or time delays.

New Wedge Base Incandescent Lamps

(low-cost, all-glass construction)



#74

New smaller size wedge base lamp for automotive and aircraft indicator and electronic applications, where space is at a premium. T-1 3/4 bulb size, 14V, 0.1A, .75 cp.

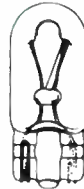

#557

First wedge base *flasher* lamp. For attention-getting warning lights on instrument panel. 14V, .42A, 2.5 cp.



#558

Lens end wedge base lamp beams light for fiber optics illumination, instrument panels, and warning lights. 14V, .27A.



#657

New 28-volt wedge base lamp for indicator applications. It completes GE's line of 6.3-, 14- and 28-volt ratings.

© Trademark of General Electric Co.

All products shown actual size.

SEND THIS COUPON TODAY

Mail to:

General Electric Company, Miniature Lamp Department, #382E-1, Nela Park, Cleveland, Ohio 44112.

Gentlemen: Please send me complete information on the items checked.

New SSL
Red Heads

New Neon
Glow Lamp

Name _____

New
Red Numeric
Displays

New Wedge Base
Incandescent
Lamps

Title _____

Company _____

P.S. Also, please send () copies of General Electric SSL 2-part manuals on theory, characteristics and applications—106 pages in all. I have enclosed \$1.00 for each set of manuals.

Address _____

City _____ State _____ Zip Code _____

SEND THIS COUPON TODAY

CIRCLE READER SERVICE NO. 250 SSL, 251 RED NUMERIC, 252 WEDGE BASE, 253 NEON GLOW

GENERAL  ELECTRIC

Let's say you're in charge of ordering oxygen or nitrogen or argon. And maybe every other Tuesday (except in the summer when consumption is down at your place and then it's every third Tuesday) you have to check your gas supply. It's not low enough to order right then. But low enough so that two

Tuesdays from then (when you check it again) you'll run out before the truck gets there. Now let's say you did business with Airco. Our computer keeps a detailed, running record of what you use, when you use it, how much, how often. It tells us what to deliver and when. Automatically. You never have to

worry about ordering again. That's all. Details? Call Steve Varga at (201) 464-8100 or write to him at 575 Mountain Avenue, Murray Hill, New Jersey 07974.

AIRCO
Industrial Gases

Our brain saves your brain.

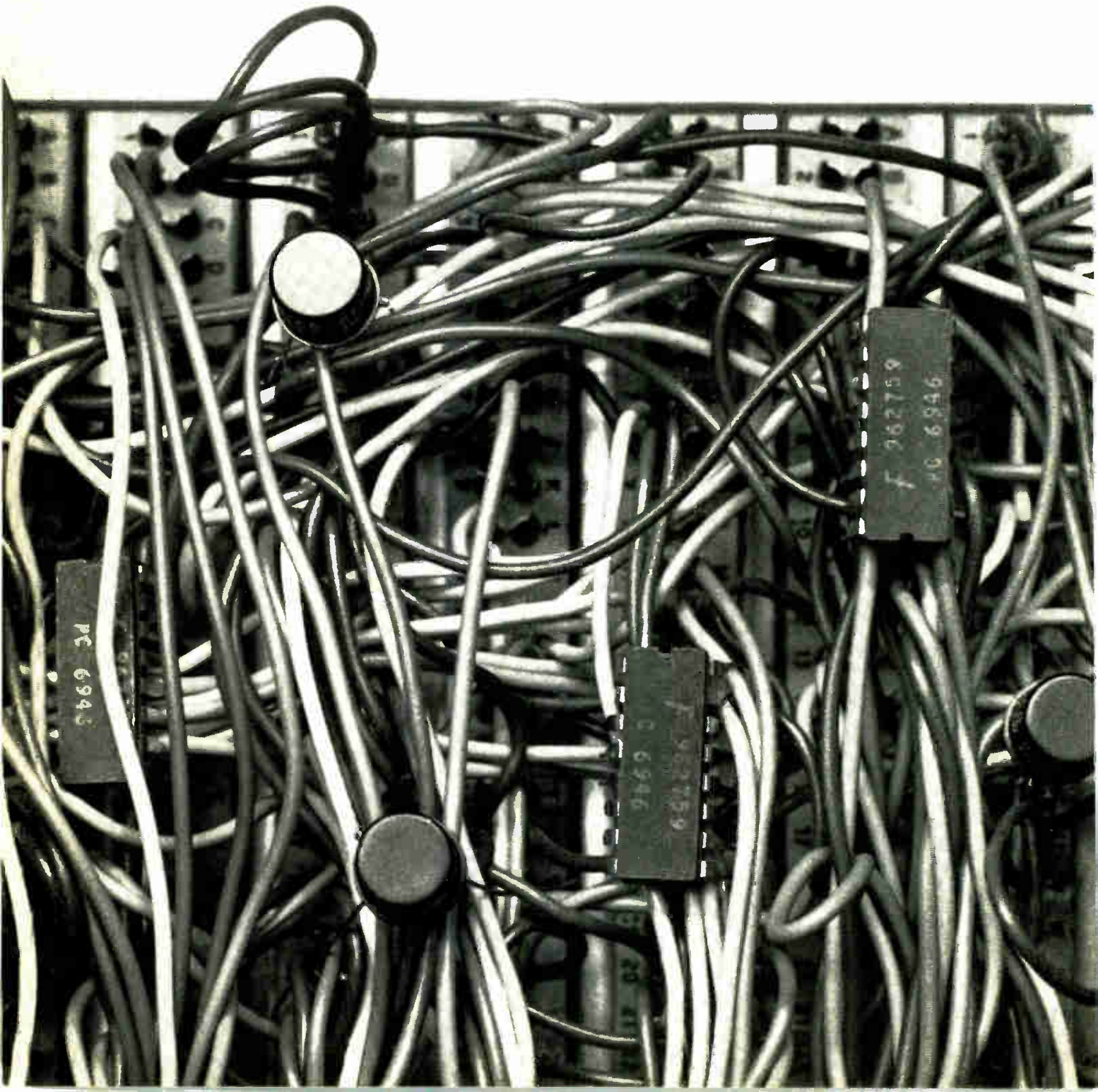

New products

Semiconductors

Drivers set for displays

Motorola offers character generator while Sperry readies decoder/driver

When a new gas-discharge numeric display was announced by Sperry Information Displays Division [*Electronics*, April 12, p. 124], there

was no monolithic decoder-driver designed for the high-voltage, seven-segment readout. But now the other shoe has been dropped by Sperry and two semiconductor houses—ICs tailored for the SP-730 displays.

Conversely, Motorola Semiconductor is introducing an MOS character generator to drive a light-emitting-diode five-by-seven array, but the company doesn't yet have the dot-matrix display to go with it. However, Motorola probably will introduce a readout this fall, and other display makers already are marketing them or planning to introduce them.

The character generator—called

the MCM1131L in a 24-pin package and MCM1132L in a 28-pin package—is built around a 64 x 35 read-only memory. Stored in this ROM are the commands needed to generate any of 64 ASCII characters, including all numerals and letters.

In addition to the ROM, the IC contains an address-decode circuit, a column-select circuit, and a row of buffers. It can be driven directly from transistor-transistor logic, and delivers a minimum of 2 milliamperes per dot.

The memory itself has an access time of 500 nanoseconds, and can be expanded with external circuitry.

The 24-pin version has seven address inputs for selecting a particu-

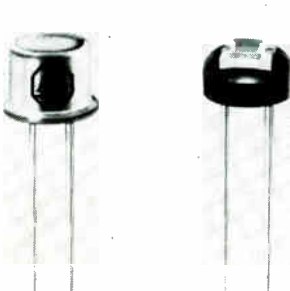

Cadmium sulfide and cadmium sulfo-selenide photo-detectors called Photochips are available as individual units or in arrays up to 20 cells, and with several peak spectral responses. Power dissipation is 75 mw. Prices start at 43 cents each in quantity. Allen-Bradley Co., 1201 S. 2d St., Milwaukee, Wis. 53204 [436]

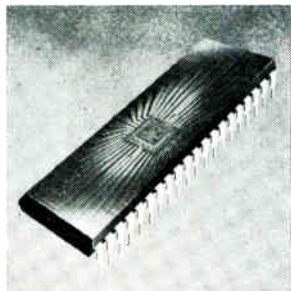

MOS ICs in plastic dual in-line packages can operate in range from -25 to 85°C . Packages include 40-, 28-, 24-, 18-, 16- and 14-lead units with 100-mil pin spacing, 300- or 600-mil row spacing. Prices range from \$4.40 to \$18.50. Texas Instruments Inc., P.O. Box 5012, M/S 308, Dallas, Tex. [437]

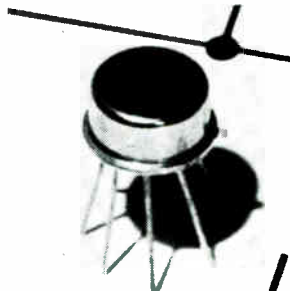

c/MOS switch G150 handles up to $\pm 10\text{-v}$ analog signals with $\pm 10\text{-v}$ supply level. Switching speed is 50 to 80 ns. Circuit has p- and n-channel MOSFETS on the same silicon substrate, and microwatt standby power. Price is \$3.50 for industrial type, \$5.10 for military. Siliconix, Laurelwood Rd., Santa Clara, Calif. [438]



Rectifier bridge GEB100 is hermetically sealed in epoxy package, includes four glassivated, cavity-less A14 rectifier cells. The 1-A, single-phase, full-wave bridge is compatible with standard pc board layouts, and available up to 1000 v. General Electric Co., Electronics Pk., Bldg. 7, Mail Box 49, Syracuse, N.Y. [439]

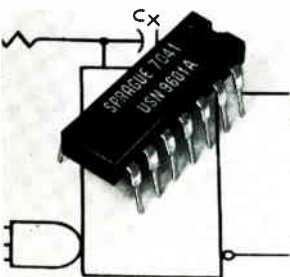

Monostable multivibrator type USN9601A has a 50-ns-to-infinity pulsewidth range with selection of an external RC network. The IC is compatible with TTL and DTL, uses leading- or trailing-edge triggering, which is insensitive to transition times. It has complementary outputs. Sprague Electric Co., North Adams, Mass. [440]

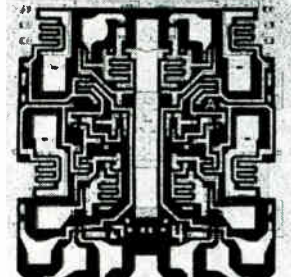

Quad single-ended line driver (Am2614) and line receiver (Am2515) are part of five-circuit family. Driver is inverting device with two pairs and common strobe input. Receiver has common mode rejection, can receive differential or single-ended data. Prices start at \$4.20. Advanced Micro Devices Inc., Sunnyvale, Calif. [441]

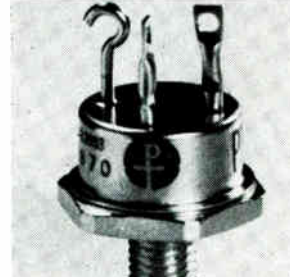

Silicon power transistors series PT-5501 offer turn-off times of less than 700 ns at 50 A, collector-emitter saturation voltage of less than 0.5 v at 50 A, and current gain at 100 A. Units are rated at 200 w at 100°C in TO-63 package. Prices start at \$48.25. Power Tech Inc., 9 Baker Ct., Clifton, N.J. [442]



FET voltage follower model 9746 couples low input bias current with high output current capability and fast, wideband operation. Device is in 8-pin epoxy package, 0.75 in. diameter x 0.43 in. high. Prices range from \$29 to \$36, depending on quantity. Optical Electronics Inc., P.O. Box 11140, Tucson, Ariz. [443]

3A Sensitive Gate

TRIAC's

for IC Drivers
50-600V, 3mA
all quadrant gating

6, 10, 15, 25, 30 & 40A

TRIAC's

4A to 35A

SCR's

200 μ A to 25mA gates

**For motor, heating,
cooling and lighting
controls and
special applications**

A complete line of oxide-glass passivated devices. Triacs, 6 to 40A., 50 to 800V. 3A sensitive gate Triacs, 3mA and 10mA(I_{GT}). SCR's, 4A, 200 μ A (I_{GT}) to 35A, 25mA(I_{GT}). Compatible 32V Diacs available in DO-7 package.

Triac's and SCR's interchangeable with other industry types. Write for cross-reference and data sheets.

IMMEDIATE DELIVERY

IN GLASS-PASSIVATED CHIP OR, IN STANDARD PACKAGES



HUTSON INDUSTRIES

2019 W. VALLEY VIEW LANE
DALLAS, TEXAS 75234 (214) 241-3511
TWX 910-860-5537

Distributed by:

BODELLE COMPANY, Chicago, Ill.
312/468-1016 ■ INTERMARK ELECTRONICS,
Newport Beach, Cal., 714/540-1322 ■
THOR ELECTRONICS, Elizabeth, N.J.,
201/354-2420

European Representative:

10 Rue F. D'Orbay, Draveil 91 France
Tel: Paris 921-7640

New products

lar character, five column-select inputs, and a chip-enable input. The 28-pin model has only six address inputs. Price for the circuit is \$14.60 in 1,000-unit lots, and delivery is from stock.

Unlike the Motorola circuit, which is MOS, the Sperry decoder/driver will be a bipolar IC, and it will deliver the 170 volts dc demanded by the Sperry display. An unusual feature is that the circuit will generate not only all 10 digits and the seven-segment display, but also the letters A through F. Price for the unit will be \$1.55 in 1,000-unit lots. Deliveries in product quantities are expected to start in September.

Besides Sperry itself, Motorola and National Semiconductor Inc. will be offering the decoder/driver.

Motorola Semiconductor Products Inc., Box 20912, Phoenix, Ariz. 85036 [444] Sperry Information Displays Division, P.O. Box 3579, Scottsdale, Ariz. 85257 [445]

128-bit bipolar memory has access time of 15 ns

Although the semiconductor memory market, as a whole, hasn't taken off as expected, certain segments are doing well. One of these is the very high speed—under 50 nanoseconds—buffer memory. And the state of this art has just been doubled.

Advanced Memory Systems Inc., Sunnyvale, Calif., has developed a 128-bit bipolar random access memory that, in the ECL-compatible version, has an access time of 15 nanoseconds. The TTL-compatible unit has an access time of 25 ns.

According to Jerold Larkin, vice president and director of marketing at AMS, "the memory is a fully decoded, high-speed, random access device that's designed for use in scratch-pad, buffer, and control memory applications in data processing, and also in test equipment and digital communications systems." Existing high-speed TTL RAMs have access times of about 50 ns, and the only existing ECL RAM is a 64-bit device with an ac-

AE 21 NOCHAR

**Try a
really new
Rosin-Core
Solder...on us!**

We are so positive that our new AE 21 Nochar (TM) is superior, that we are asking you to be our guest and try a sample . . . free!

AE 21 NOCHAR IS . . .

- Absolutely non-corrosive
- Totally inactive below soldering temperature
- Resistant to charring & burning
- The unique behavior of AE 21 NOCHAR is most advantageous when used in conjunction with alloys that have higher melting points.
- Conforms to all military specifications

Write for literature, prices and your free sample today.



**BOW SOLDER
PRODUCTS, INC.**

25 Amsterdam Avenue
Newark, New Jersey 07105

PIONEERS IN SOLDER PRODUCTS

Circle 170 on reader service card

THIS SPACE CONTRIBUTED BY THE PUBLISHER

LISTEN TO YOUR BODY.



**If something's going wrong,
it'll tell you.**

1. Change in bowel or bladder habits.
2. A sore that does not heal.
3. Unusual bleeding or discharge.
4. Thickening or lump in breast or elsewhere.
5. Indigestion or difficulty in swallowing.
6. Obvious change in weight or mole.
7. Nagging cough or hoarseness.

If you have a warning signal, see your doctor. If it's a false alarm, he'll tell you. If it isn't, you can give him time to help. Don't be afraid. It's what you don't know that can hurt you.

 American Cancer Society

Now...phototransistors from Clairex!

right
performance
...right
price

DESIGN FEATURES

High current at low illumination
Hermetically sealed
Fast switching
High breakdown voltages

PURCHASING ADVANTAGES

Competitive pricing
Fast, stock delivery
Quality controlled
Established vendor

Our 18 years of leadership in electro-optics can help you select the *right* phototransistor from our *growing* Clairex product line.

Let us help you balance the price/performance factors that are important to you!

For full data about our CLT 2000 series and CLT 2100 series call 914-664-6602 or write Clairex®, 560 South Third Avenue, Mount Vernon, N. Y. 10550.

CLAIREX ELECTRONICS

A DIVISION OF CLAIREX CORPORATION

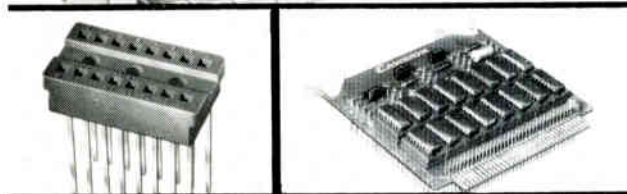
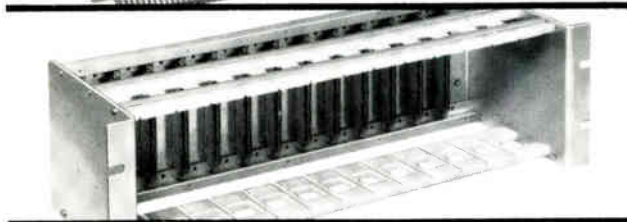
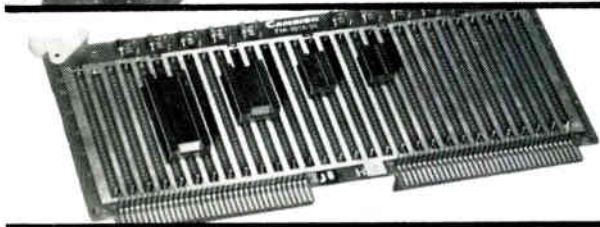
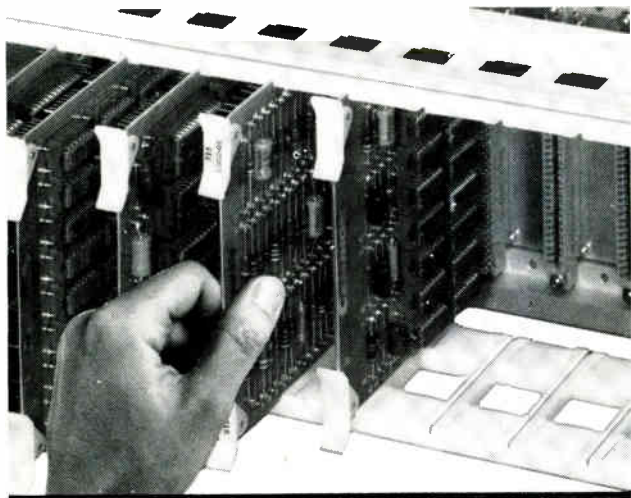

if you design with ic's Cambion has the "works" for your work

If your digital system is a packaging puzzle, CAMBION can provide the solution.

We have the high density sockets, wire-wrappable Cambi-Cards®, PC logic cards, general purpose and discrete component cards for your functional requirements.

And to complete the picture: card files, power planes, card connectors and extenders, plus a complete numerically controlled Wire-Wrap* service.

Result: Tightly integrated packaging systems. The "works" for your work.

For details, call us or write for the latest word on IC accessories and wire-wrapping. Cambridge Thermionic Corporation, 445EA Concord Avenue, Cambridge, Mass. 02138. Phone: (617) 491-5400. In Los Angeles, 8703 La Tijera Boulevard 90045. Phone: (213) 776-0472.

*Registered Trade Mark Gardner-Denver Co.

Standardize on

CAMBION®

The Guaranteed Electronic Components

For the Computer Industry

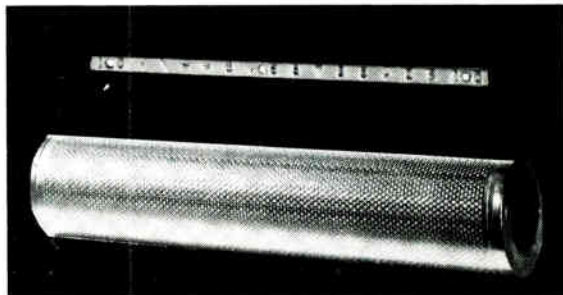

Print Bars and Drums

At Buckbee-Mears we etch the entire drum in one operation. Costly assembly problems are eliminated because there are no segments to line up. We are also geared to etch print bars faster at lower costs. Our print drums and bars are made of hardened tool steel for extra long life.

For more information, see your nearest Buckbee-Mears representative, or forward your print for prompt quotation. You'll be glad you did!

bmc

**BUCKBEE - MEARS
COMPANY**

245 E. 6th St., St. Paul, Minn. 55101 / (612) 227-6371

Circle 171 on reader service card

To pinpoint a cosmopolitan Texas location convenient to R & D capabilities, brainpower and productive labor:

ASK INSTA-SITE

The answers to specific Texas plant location questions and impartial site selections are instantly available from the nation's most comprehensive industrial computer program. Write or call for detailed Insta-Site information and your free copy of the Texas Fact Book.



TEXAS INDUSTRIAL COMMISSION

Capitol Station — Box 12728-E

Austin, Texas 78711 — 512/475-4331

The Material
of Unlimited Uses...

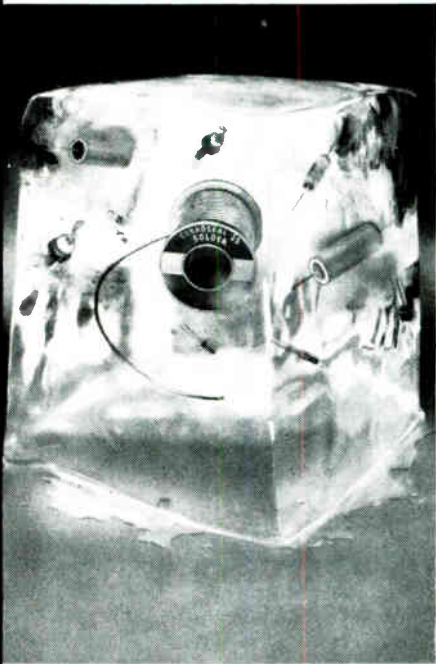

SOLDERING "UNSOLDERABLES"

...is but one of the thousands of uses for advanced low-melting-temperature alloys such as Cerroalloy® 35. Cerroalloy 35 melts between 238° and 260° F., and can be used with ordinary soldering techniques. When soldered with this versatile alloy, "toughies" such as glass-to-metal, ceramic-to-metal and metal-to-metal seals stay tight even in a deep vacuum. Other Cerro® Alloys, including specials made to your individual specs, are perfect for joining ultra-delicate parts like integrated circuits which cannot be heat-sunk during soldering. Low-temperature soldering as cool as 117° F. can also be accomplished with certain Cerro Alloys.

For detailed information contact Cerro Alloy Dept., Cerro Copper & Brass Company, Bellefonte, Pa. 16823 . . . (814) 355-4712.

In Europe, contact Mining & Chemical Products Ltd., Alperton, Wembley, Middlesex, England.

CERRO®

New products

cess time of 15 ns. It also is made by AMS.

On both memories, power dissipation is 3.2 milliwatts per bit and organization is 128 words by one bit. Larkin says that memory expansion is simplified "because the chip is fully decoded and two chip-select inputs are provided. And the ECL memory can be wire-OR'ed at its outputs."

Larkin says that two chip-select lines are provided "for more efficient systems utilization of the device. Either input can be used to select a particular row or column of packages on a pc card. The output is high when either select input is high."

In addressing the memory, the appropriate binary code is applied to the address inputs 0 through 6. To read the contents of an address, the select inputs must be held low and the read-write input must be high while the bit location is addressed. With the TTL memory, the output data in the complement of the input data—the memory inverts data. Writing is accomplished by addressing the desired bit location, while holding both select lines low, and bringing the read-write line low while the data-in line is valid. In the ECL memory, high is -0.8 volt and low is -1.6 v. In the TTL memory, high is +3 v and low is +0.4 v.

Larkin points out that in data processing applications the new memory "means you can get 2-3 times the speed available with TTL units, with the same power dissipation." He says that digital communications systems need these high-speed units as buffers in satellite ground stations, and Comsat is testing them.

The bipolar memory is also aimed at pulse code modulation systems in telephone switching centers. Here, compact size is important as well as high speed, for handling a heavy volume of calls in a minimum of floor space.

The memories cost \$87.50 each in quantities of 100.

Advanced Memory Systems Inc., 1276 Hammerwood Ave., Sunnyvale, Calif. 94086 [446]

98.6°F. Maximum Body Temperature

From No Load To Full Load



PM568

Dual Output $\pm 15V$, 25mA DC Power Supply

- Series Regulated
- 0.02% Temp. Coeff.,
Line and Load 0.1%
- Highest Efficiency —
1½ Watts Input/
¾ Watt Output
- 115 VAC, 50 to 400 Hz
(230 VAC Model Available)
- Compact PC Mount
(3.50"x2.50"x.875")
- 2 Year Warranty
- Same Day Shipment
- Unit Qty. Price \$23⁰⁰

Call or write for bulletins
on our Complete Line
from 3.6V to 180VDC.



COMPUTER PRODUCTS®

Post Office Box 23849
Ft. Lauderdale, Fla. 33307
Telephone (305) 974-5500

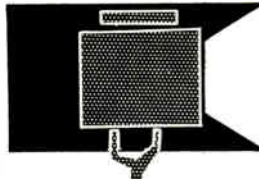

SEARCHLIGHT SECTION

• CLASSIFIED ADVERTISING • BUSINESS OPPORTUNITIES
• USED OR SURPLUS EQUIPMENT

AUTOTRACK MOUNT

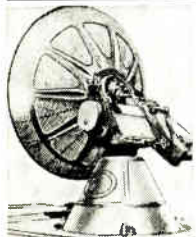

360 degree azimuth, 210 degree elevation sweep with better than 1 mil. accuracy. Missile velocity acceleration and slewing rates. Ampidyne and servo control. Will handle up to 20 ft. dish. Supplied complete with control chassis. In stock—immediate delivery. Used world over by NASA, USAF, MP-61-B. Type SCR-584.

Ideal satellite tracking. Large spare parts inventory for back-up.

ANTI-AIRCRAFT GUN MOUNT

Will handle 6,000 lbs. rapid slew through 360° azimuth, 180° elevation. Mobile.

COUNTERMEASURES SYSTEM

Covers L-band, S-band, X-band, all radars. Tacan, UHF drone control, VHF drone control, Communications band. All housed in shelter.

FIBERGLASS RADOME Will handle 20 foot antenna. Easily erected & shipped.

B-58 BOMBER ELECTRONICS

Ku band search radar, Ku doppler radar, Ku altimeter, all jamming countermeasures.

PULSE MODULATORS

MIT MODEL 9 PULSER 1 MW—HARD TUBE
Output 25kv 40 amp., 30kv 40 amp. max. Duty cy. .002, .25 to 2 microsec. Also 5 to 5 microsec. and 1 to 5 microsec. Uses 6C21. Input 115v 60 cycle A.C. Mfr. GE. Complete with driver and high voltage power supply. Ref: MIT Rad. Lab. Series, Vol. 5, p. 152.

2 MEGAWATT PULSER

Output 30 kv at 70 amp. Duty cycle .001. Rep. rates. 1 microsec. 600 pps. 1 or 2 msec. 300 pps. Uses 5948 hydrogen thyratron. Input 120/208 VAC 60 cycle. Mfr. GE. Complete with high voltage power supply.

SCR 584 AUTOTRACK RADARS

Our 584s in like new condition ready to go, and in stock for immediate delivery. Ideal for telemetry research and development, missile tracking, satellite tracking. Fully Desc. MIT Rad. Lab. Series, Vol. 1, pps. 207-210, 228, 284-286. Comp. Inst. Br available \$25.00 each.

AUTOMATIC TRACKING SYSTEM

Sci. Atl. Mod. 3101-J70 Antenna Pedestal. AZ-EL 15 deg. per second rated speed. 23 inch dia. bearing. Complete w/control console & mag. amplifiers. Also in stock complete Glo-track receiving system for 200-400 MHz telemetry band including 12' square quad. Helix. All part of Atlas missile instrumentation system.

MICROWAVE SYSTEMS

SPARE PARTS IN STOCK

Nike Ajax, Nike Hercules, M-33, MPFS-19, TPS-ID, TPS-10D, FPS-6 SPS8, SCB-584, MPQ-18. From Largest Inventory in World

KU BAND RF HEAD

18.5 GHz, 50 KW, .001 duty cycle, 45 Watts avg. compl. w/5C22 modulator compl. recv. Mfr. Emerson Electric.

L BAND RF PKG

20 KW peak 990 to 1040 MC. Pulse width .7 to 1.2 micro sec. Rep. rate 180 to 420 pps. Input 115 vac

MICROWAVE LINKS

C BAND Phico CLR6, CLR7, CLR9. Radar video link. Motorola MBR-4.

X BAND FIRE CONTROL SYSTEM

MD-4, A5, A1'G, 32 system. 50 KW Autotrack, complete system, all cables etc., incl. gun turret if desired.

AN/MPQ-29 3CM AUTOTRACK SYSTEM

Complete with plotting boards in van. Capable of skin or beacon track. Ideal for recon drone, etc. Airborne beacons also in stock.

500 KW L BAND RADAR

500 kw 1220-1359 msc. 160 nautical mile search range P.R.I. and A scope. MTI. thyratron mod 5328 magnetron. Complete system.

C BAND AUTOTRACK

1 Megawatt 10 ft. Parabola. Sperry.

AN/GPG-1 SKYSWEEP TRACKER

3 cm. auto. tracking radar system. Comp. pkg. w/indicator sys. Full target acquisition & auto. tracking. Input 115v 60 cy. new. In stock for immed. del. Entire sys. 6' x 3' x 10'. Ideal for infrared tracker, drone tracker, missile tracker, R & D

INDICATOR CONSOLES

AN/SPA-4A, PPI 10", range to 300 mi. VJ-1 PPI 12". Range to 200 mi. VL-1 RHI 12" to 200 mi. 60K ft. FPS-6 RHI. FPS-8 PRI. CPS-6B PPI. plus many more.

HUNDREDS MORE IN STOCK
LARGEST RADAR
INVENTORY
IN WORLD.
WRITE
FOR
CATALOG
ON YOUR
LETTERHEAD

Radio-Research Instrument Co.

45 W. 45th St., New York, N.Y. 10036 • 212-586-4691

CIRCLE 966 ON READER SERVICE CARD

Your Used, Surplus and Rebuilt Equipment

Advertising here in the

SEARCHLIGHT SECTION

will impress key buyers . . .

Buyers regularly turn to these pages for their used equipment needs. . . .

You can reach these buyers quickly and economically with your advertising in this "meeting place" of used equipment buyers and sellers.

FOR RATES, PLEASE WRITE:

Electronics

A McGraw-Hill Publication

Classified Advertising Dept., P. O. Box 12, New York 10036

New literature

High temperature materials. Aremco Products, Inc., P.O. Box 145, Briarcliff Manor, N.Y. 10510. A two-page bulletin describes 33 high temperature materials and special materials such as inks and encapsulants. Bulletin includes listing of trial kits and a wall chart. Circle 446 on reader service card

Focus coils. Syntronic Instruments, Inc., 100 Industrial Rd., Addison, Ill., 60101, offers a two-page technical bulletin on type F50 and F55 shielded static/dynamic focus coils. [447]

Counters. Veeder-Root, 70 Sargent St., Hartford, Conn. 06102 has available technical literature describing its totalizing counter used in high speed printers, copiers, folders, collators and key-punches. [448]

Dielectric capacitors. Gudeman Co., 340 W. Huron St., Chicago, Ill. 60610. An engineering bulletin for series PCG miniature tubular polycarbonate dielectric capacitors contains specifications and engineering data including voltage rating and typical performance curves. [449]

Infrared crystals. Barnes Engineering Co., 30 Commerce Rd., Stamford, Conn. 06902. A four-page folder offers step by step instructions on how to cleave, grind and polish NaCl, KBr and CsBr crystals. Both the alcohol/felt method and aqueous solution/glass method are shown. [450]

Controllers. Hamlin Electronics, Inc., 3066 W. Clarendon Ave., Phoenix, Ariz. 85017 has available a 12-page brochure with electrical specifications, dimensional drawings, and price information on its line of solid state ac controllers. [451]

Delay lines. McGraw Edison Co., Grenier Field, Municipal Airport, Manchester, N.H. 03103 has published a buyer's guide to assist system and circuit designers in specifying delay lines. The brochure has a glossary of terms and formulas. [452]

Dielectric encapsulants. National Beryllia Corp., Greenwood Ave., Haskell, N.J. 07420. Three beryllia-filled thermally conductive rigid encapsulants are described in a technical bulletin. General features, mixing and curing procedures, properties and handling characteristics are covered. Evaluation samples are offered. [453]

Instrument drive motors. A.W. Haydon Co., 232 North Elm St., Waterbury, Conn. 06720. A two-page brochure describes 8600 series of high torque, synchronous instrument drive motors that are adaptable for computer peripherals, business machines and environmental control equipment. [454]

NEW FLIP-LOC HINGED CLAMP MANUAL

Shows how
to save
up to 80%
on installation
and maintenance.

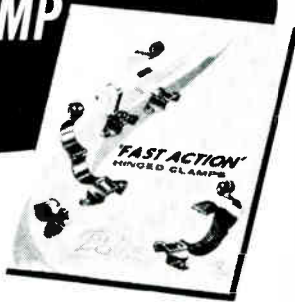

SEND FOR YOUR **FREE** COPY!

Whatever the need, there is a TA Flip-Loc fast action hinged clamp at your fingertips... for permanent or temporary installations, it's just as simple and fast to install or detach.

When your particular job requires a clamp of unusual design, TA's new FREE manual has the answer. A silent consultant that turns your clamp problems into simple solutions. This manual is easy to read and easier to understand with full illustrations. The manual covers all phases of requirements, pointing up why it is simpler and less expensive to use which clamp where. It covers the design, dimensions and varieties of application... the why and wherefore.

TA MFG CORP A VIKING INDUSTRIES COMPANY

4607 Alger Street, Los Angeles, California 90039 ■ Phone 213-245-3748/
TWX 910-497-2065 L. A./WUX CAT L. A., Calif.

Circle 174 on reader service card

Now solve
scientific/financial
problems with one
calculator
simultaneously

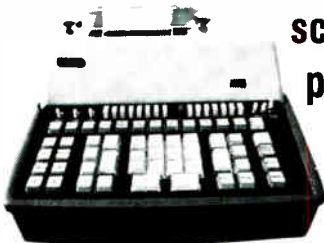

The NEW WANG Series 100

Two complete adding and calculating machines plus four or twelve additional storage registers are but a few of the extras that are "built-in" to make the Wang Series 100 more than just a calculator, in either printing or display versions

For engineers and scientists, the lowest cost calculator with e^x, Log, X, trig. and statistical keys. For budgets, cost analysis and all financial work, the essential roundoff keys and standard 10-key keyboard with implied two decimal entry.

Our demonstrations are something to see. Phone Mr. Courtney today (collect 617-851-7211) for one in your office, or clip the coupon and let us know where and when.

WANG Laboratories, Inc. Dept. E-5
836 North Street, Tewksbury, Mass. 01876
I'd like a 100 demonstration in my office. Call me at _____ for a date.
(phone number) _____
Name _____
Company _____
Street _____
City _____ State _____ Zip _____

Circle 176 on reader service card

Introducing TECH FAB CARBON BOATS

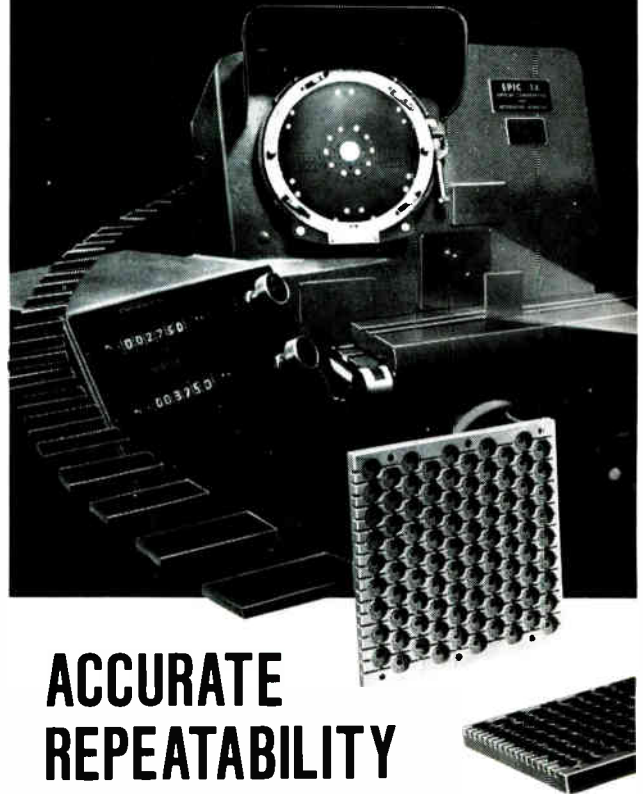

ACCURATE REPEATABILITY

TECH FAB, specialists in the precision manufacturing of carbon, metal and plastic products for the electronics industry, now offers you a new source for carbon boats. Our completely automated N/C production facility can manufacture carbon fixtures to your specifications, *any line, hole or shape to tolerances of .001", in quantities from one to one million or more.*

Made from the carbon of your choice, TECH FAB fixtures are especially suited for use with high-volume automatic loading equipment. Precision TECH FAB carbon boats will reduce downtime and production costs, and will increase end product quality and output.

TECH FAB's custom carbon line includes fixtures for alloying, soldering and brazing, thin-film masks, molds for flat glass and diode packages, fixtures for header and connector molds, evaporation crucibles and boats for crystal growing or zone refining.

TECH FAB
Mid-America
Industrial Park
P.O. Box 129
Pryor, Okla. 74361

SEND FOR FULL
DETAILS AND FREE
SAMPLE ON YOUR
COMPANY
LETTERHEAD.

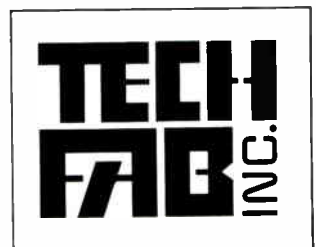

Circle 151 on reader service card

151

copy cat



Puts what your calculator says on the record.

The growing list of peripherals for Cintra calculators now includes a modestly-priced printer with a special virtue: it can think as well as print.

The basic function of Printer 941, of course, is to dutifully duplicate data displayed on either the Cintra Scientist or Cintra Statistician calculators. That it does, all of it, as you can see.

12	+0479001600	
13	+6227020800	
14	+8717829120	+10
15	+1307674368	+12
16	+2092278989	+13
17	+3556874281	+14

The printer operates at a good clip—150 lines/minute. But it thinks twice if it gets too busy to print fast-flowing data. And it signals the calculator to paws until it catches up, so there's no data lost.

If an illegal answer comes up, such as the square root of a negative number, the printer turns red. (Actually, the printout turns from black to red.)

The printer, calculator and the Cintra Programmer 926 make a compatible threesome. You get fast listings of programs, showing all information needed for debugging.

Prices: Printer \$995; Scientist or Statistician Calculators, \$3,780 each; Programmer, \$1,495. (Slightly higher outside the U.S. and Canada.)

Let's make tracks. For more details or a demo, contact Cintra, Inc., 1089 Morse Ave., Sunnyvale, CA 94086. Phone (408) 734-3630. In Europe, contact Cintra at Rue Léon Frédéric, 30, 1040 Brussels. Tel 33 62 63. Canada: Allan Crawford Associates, Ltd.

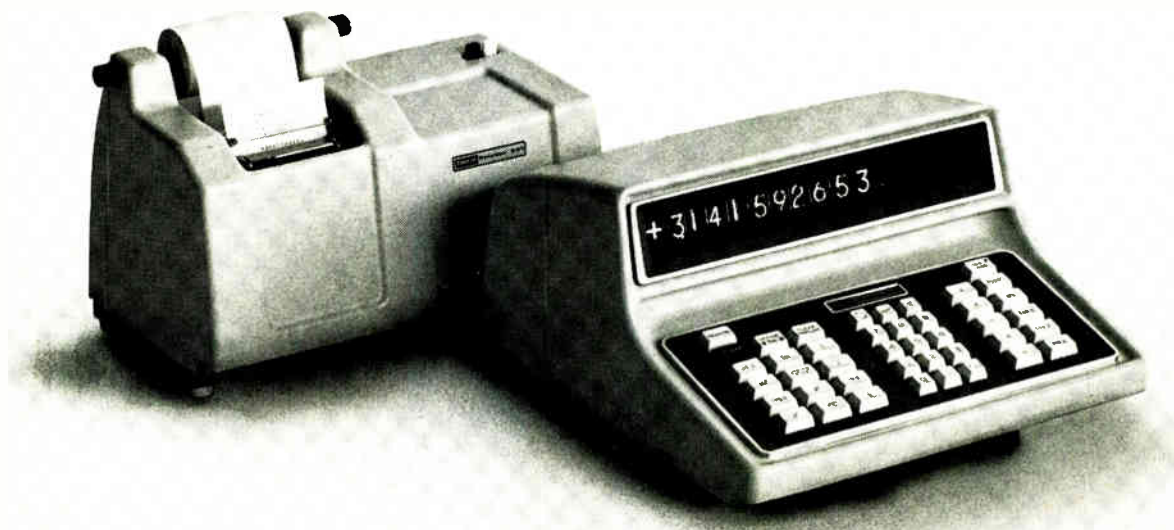



Dick Wolters

MAY 1971

DOLLARS

A look at "convertibles"
REITs for land buys

HIGHWAYS

Accidents: picking
up the pieces

THE GOOD LIFE

The look in men's
summer styles
California's varieties:

SPORTS

Backpacking is sheer joy

TAXES

Cash for mobile managers

HEALTHY, WEALTHY AND WISE

Giving cash, getting it
back; electronics, travel

Summer sports: getting into shape for the season

By now, a weekend sportsman has prepared for the season by polishing up his fishing gear, golf clubs, tennis rackets, and the rest. The question might be, though—what about his own personal preparation for the full pace of summer sports? What about a plan for training and working out?

A deskbound businessman who's been inactive through the winter is foolish to bypass the routine. It's a case of better health, and a steadier game, as well. The medics sound this warning: Some sedentary men who skip warming-up risk anything from a severe sprain to a coronary. It depends on your age, and your fitness.

A man over 35—or 50—needn't cut down on sports, say doctors. "But, says Dr. Warren Guild of Harvard, a top specialist in sports medicine, "—you must

follow some simple rules to get your best performance, if nothing else."

The warmup. A deskbound type should avoid eating and tipping for about two hours before a heavy workout. Alcohol blunts the reflexes, makes a man more accident-prone—and tempts him to try himself at mid-season pitch. The last can be a danger for the flabby type who might be, says Guild, "just a bit coronary-prone." It's also wise to avoid coffee for about three hours before a rugged game: It brings on a mid-way letdown.

An hour before starting play, take extra water and salt to prevent possible sunstroke and too much dehydration. But skip salt tablets at this point—they aren't absorbed into the bloodstream fast enough. Get salt another way, such as taking bouillon cubes in water. Note: To sharpen the game, drink some orange juice after the bouillon. It gives quick, extra energy.

Personal Business, exclusive with McGraw-Hill, takes a few moments to review the purely personal interests you share with others: investments, health, housing, books, travel, fashions, are a few.

Like the rest of this magazine, Personal Business hopes to be enjoyable, helpful.

A physical warmup is a must if you expect best performance. Walking a little and flexing muscles—but not to the point of straining—is the best idea. Too much pre-game straining will tighten muscles and may put a man off his game instead of on it.

The medics stress this idea: At the start of the season, it takes four to seven sessions with a sport before the body can readily take the extra heat generated by the game and the sun. Start slowly, they insist, and you'll do better and last longer at any game.

In play. If the sport is fast, like tennis, stop every 30 minutes or so for a 10 minute rest, especially in hot, humid weather. If a player suddenly feels light-headed, he should take a long rest or quit—but should walk around slowly for a few minutes before he does. A pain of obscure origin, such as a sharp stitch in the abdomen, also signals a rest. But play can be started again safely when the pain goes away. If a player gets extremely thirsty or tired during play, he should drink 2 oz. or 3 oz. of water.

Smokers: The cigarette smoker, say the doctors, should skip the habit between sets of tennis or during pauses on the golf course, or such. This type of smoking will slow a man at his sport, and tax the heart, as well.



Will your insurance replace your house at today's prices?

Probably not, unless you've increased the value of your Homeowners insurance recently.

Because, inflation has increased the value of the average home by 43% over the past ten years. That means the house you paid \$25,000 for ten years ago could cost \$35,000 or more to replace today.

Don't gamble with insurance based on yesterday's prices. Let

your State Farm agent insure your home and your possessions for what they're worth today. With no worry about tomorrow, because a special inflation-coverage feature automatically increases the amount your policy pays, as inflation boosts the cost of things. Just one more reason to see a State Farm agent when your policy comes up for renewal.

A State Farm policy protects you from loss by fire, tornado, burglary, vandalism and more... at surprisingly low rates. It's the kind of coverage that has made us the world's largest home insurer.

State Farm Fire and Casualty Company. Home Office: Bloomington, Illinois.

State Farm is all you need to know about insurance.

**State Farm
inflation-coverage
Homeowners
Insurance**

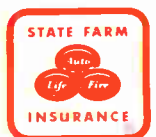

Repair job. It's best not to jump under a cold shower or into a swimming pool right after a heavy workout. Wiser idea is to walk around slowly for a few minutes to cool down, then take a tepid shower. Note: A hot shower—despite what many think—will keep a man hot and sweating. And a cold shower will tighten muscles, sometimes severely.

A sharp muscle pull after a game should be treated with respect. You don't "walk it off." What's more, it shouldn't be used again in play until it no longer needs to be favored. It may take a few days, or even a few weeks.

After a hard, sweaty workout, it's important to take on some extra salt, especially in hot weather. Now tablets are practical to use—or some shakes of salt into a couple of beers.

DOLLARS

Playing it both ways with convertibles

Anybody who's still leery of common stocks—and why not, after the 1969-70 debacle?—might want to look into convertible debentures. These bonds that are supposed to act like stocks have some built-in features that let you "play it safe"—up to a point.

The converts, so called because they can be converted into common stock, have been enjoying good fortune for two reasons: Declining interest rates have pushed up their value as bonds; and rising stock prices have pushed up their value as stocks. "You get a kind of double play here," says a top Wall Street analyst. "There's unlimited upside potential coupled with limited downside risk. And note: A man with limited funds can buy in. Converts can be bought indirectly via specialized mutual funds, with monthly payments at \$50 or less."

The theory is simple: When the commons go up, the converts usually rise

along with them. When the stocks decline in price, the converts revert to their bond nature but usually drop no lower than their original investment value. The converts have two added advantages: Their yields are generally better than stock dividends. And—and this is important—they can be bought on 50% margin, for greater leverage.

Leverage. Say that you buy a \$1,000 debenture that is convertible into 100 shares of XYZ stock at \$10 each. You put up only \$500, and borrow the other \$500 from your broker. This lets you double your money if the stock rises just 50%, to 15 a share. Had you bought the 100 shares directly, you would have needed 65% margin, or \$650—and the price would need to rise 65% (to 16½) for you to double your money.

The debenture gives the buyer leverage of 2-to-1, as the Wall Streeters say, while a share of stock provides just 3-to-2 (or 1½-to-1).

Say that the same debenture (convertible into 100 shares of common at \$10 each) carries a 7% coupon and the price of the common is now up to \$12. Adding a small premium, you pay, say, \$1,250 for the debenture. Now your yield is down from 7% to 5.6% while the common stock dividend is, say, 3%. The question: Is 5.6% high enough?

But take the downside and say that the stock drops from \$12 to \$8 a share. In this case, the convertible will probably fall to the \$1,000 level, and not even approach \$800. It might even stay a bit higher than \$1,000 if interest rates are low enough. Note: For the yield of a 7% debenture to remain at 6%, its price cannot fall below \$1,150.

Tips. It's seldom necessary to convert to benefit from a rise in the price of the common because the debenture will rarely lag behind for long. It might be smart to convert, though, if the company raises its stock dividend above the yield on the debenture, or—and it happens—if the company calls the debenture and converting becomes a way to maintain an equity position in the company. Note, though, that converting means putting up more margin—to meet the common stock 65% requirement.

In shopping for converts, it's wise, of course, to first figure the basic investment value without the conversion feature. A broker can compare the debenture with bonds of the same corporation and others. The idea: to know the risk—that is, what the "floor" is.

Also, the common stock's prospects should be checked out. If the stock has already been run up, or if the debenture is selling at a sizable premium above stock market value, it might be smart to look elsewhere.

In any case, debenture yield must be checked out carefully, and should be sufficiently greater than the common stock dividend.

REITs: real estate investment trusts

Real estate comes to mind, too, when unvarnished common stocks seem too chancy. To some, the Real Estate Investment Trust (REIT) has its place in the spectrum of chances to take. In their newest form, the REITs have matured. Some have, anyway, partly due to smart management.

The REIT got a good push in the early 1960s when Congress passed a law permitting the trusts to avoid corporate taxes if they distributed 90% or more of their earnings to shareholders (though, of course, the shareholders still pay regular income tax on the payouts). For several years, most REITs invested strictly in shopping centers, office buildings and other income-earners. Another form, called the Mortgage Investment Trust, became popular in the tight money markets of 1966 and 1969-70. These trusts centered in on mortgage and construction loans, and made their profits in the spread between interest rates: They would borrow from a bank at, say, 7%—and lend at 12%.

Combinations. What makes REIT shares more attractive today is that after nearly 10 years of seasoning in different markets, they have finally learned to combine both basic types of investment. In easy money periods, when the spread in interest rates is narrow, they invest heavily in properties that will keep producing income during recessions. When tight money comes, they shift over to making high-yield loans—and get the best of both bargains.

One sign of the growing maturity of the REITs: Insurance companies and banks have both begun moving into the field as portfolio managers.

Some 80 REITs now exist; nine are listed on the New York Stock Exchange and about two dozen on the American. A broker should help in evaluating an REIT prospect.

Caution: REIT shares trade like those of any corporation. So it's a case of knowing how high other investors have driven shares above their book value. Mortgage investment shares collapsed in 1969 after speculators chased them. You don't buy high—and sell low.

108	75 3/4	76	75 3/4	75 3/4	- 1/8	65	56 1/2
118	28 3/4	28 3/4	27 1/2	27 1/2	- 1/8	17	14 1/2
1	36	36	36	36	- 3/4	24	19 3/4
197	35 1/2	36 3/4	35 3/4	36 1/2	+ 3/4	34 1/4	27 3/4
346	34 1/4	34 1/4	33 3/4	33 3/4	- 1/4	19 1/4	15
21	67 1/2	67 1/2	67	67	- 1/2	23 3/4	20 3/4
52	15 3/4	15 3/4	15 1/2	15 1/2	...	58 1/2	51 1/2
66	37 3/4	37 3/4	37 1/2	37 3/4	...	17 1/2	15 1/4
150	60 1/4	61 1/2	60	61 1/2	+ 1	33	25 3/4
26	11 3/4	11 3/4	11 3/4	11 3/4	+ 1/8	20	14 3/4
95	37 3/4	38 1/2	37 3/4	38 1/2	+ 3/4	50 1/2	44 1/2
46	34 1/2	34 3/4	34	34	- 3/4	49 3/4	40
141	21 1/2	21 3/4	21	21 1/4	...	24 3/4	17 1/2
9	43 3/4	43 3/4	43 1/2	43 3/4	+ 1/4	7 3/4	7 3/4
153	56	56	56	56	...		
23	55	55	54 1/2	54 1/2	...		
68	11 1/4	11 1/4	10 3/4	10 3/4	...		
5	10 3/4	10 3/4	10 3/4	10 3/4	...		

Light and fancy: the look in men's summer styles

Peacock is the word if you take a look at the new summer styles for men. The accent is on lighter colors and fancier patterns than ever before—and on new "easy-living" fabrics that make comfort and coolness as automatic as a lawn sprinkler. Shopping note: A rundown of what the top-name city shops are showing reveals prices holding as firm as the colors. But as usual, every place you go there are quite good but less fancy stores carrying virtually the same fashions—at prices as much as 20% less. Shop around.

The easy-living fabrics? Knits of 100% polyester are the newsmakers. This is particularly the case in summer slacks, but holds true, too, in hot weather suits and sports jackets. The new knits offer easiness and stretchability, and will hold creases and resist wrinkles. Traveling tip: A few tailored knits are almost a must for the man who'll live in suitcases a lot this summer.

Summer suits and even tuxedos are made in polyester-and-wool combinations and are washable and permanent press. And wash-and-wear denim is another big fashion note this year. The added weight of denim and canvas-like fabrics works well with today's "unstructured" tailoring—meaning that there are no linings or padding and less sewing-on inside. The result: clothing that's free and easy to wear and as simple to care for as you can get.

By Palm Beach, a jacket in polyester knit (\$75); cotton knit shirt is by Strobe (\$15).



Suits. Two- and three-button suit coats with 4-in. lapels are now standard, and this season the pocket flaps and vents are deeper and many jackets have "biswing" belted backs. Double-breasted suit coats are out for this summer, unless in six-button style (with one to be buttoned). Lighter, softer colors made into stripes, herringbones and worsteds have replaced the dark browns and olive shades of last year. A practical, stylish buy is the blazer suit—it has a country look, with patch pockets and a jacket that can be worn with various slacks (\$110 to \$160).

Botany and Hammonton Park have some new variations: off-white and light tan suits in polyester blends (\$110 to \$140), three-piece white linen suits with vests (\$175), and seersuckers in both solids and stripes, with denim-blue the dominant color (\$65 to \$90). A summer-weight worsted dacron suit in brown, bamboo and light blue has a smart look about it, by Clubman (\$110).

Jackets and slacks. Sports jackets have taken off higher than ever this season in fancy patterns and bright colors. Combination ice cream colors, raspberry, and light blues and greens are showing up in small geometric and jacquard designs. Two-button jackets in bright, splashy flower prints come in polished cotton and add snap and pizzazz to anybody's patio party outfit (\$90). And note: Madras jackets are back—in every color you can think of (\$50).

There are some impressive variations. Stanley Blacker, for instance, is making solids and patterns in several off-beat shades: camel, sand, wheat. But they note, too, that the navy blue blazer has by no means left the scene. A smart-

looking polyester double-knit jacket, by Clubman, is single-breasted, two-button, and has a belted back and scalloped flapped pockets. Here the colors range is red, tan, brown, and navy (\$70).

In slacks for summer, both Esquire and Asher, among leading makers, are talking knits and more knits. Most are straight-legged or slightly flared and have big belt loops and pockets in all styles. They come in polyester blends which are washable—a plus for any hot weather wear. But the big story in slacks this season is patterns of all shapes and sizes. Multi-stripes and geometrics come in such shades as mint, kelly green, coral, and peacock blue.

Anyone who wants to get ultra-casual can find flower-print slacks (\$25 to \$40)—most stylishly worn with solid-colored blazers, especially egg-shell.

Accessories. Shirts are wild, of course, but with stripes seeming to outdo other designs. Most have long, pointed collars, and two-button cuffs. But note: Despite the big peacock trend, all-white shirts are making a comeback in some circles—though the button-down collar remains as dead as the 5¢ cigar. Summer hats are big-brimmed (a la Panamas), in tan or off-white straw and with very colorful bands, frequently of madras (\$15 up). Shoes for summer? This time around, you'll notice many in two shades of the same basic color.

Formal side. Space-odyssey should replace the term "formal." People such as After Six and Lord West have taken the staid country club dance and put it up on a bright, full moon. After Six even has a "jump suit"—a one-piece slacks-and-top combination worn with shirt and jacket. If you get too hot, you can remove the jacket and relax (jump suit \$90). Tip: Formal-wear rental shops are now up to date, and have the newest styles. Tab: \$15 to \$35 a night.



MFA

A Dobbs white straw (\$15), worn with Clubman's polyester-wool jacket (\$75).

Gant's polyester-cotton shirt blazes on anybody (\$12). Tie by Gant, too.



How to be \$650 ahead of the President of IBM.*

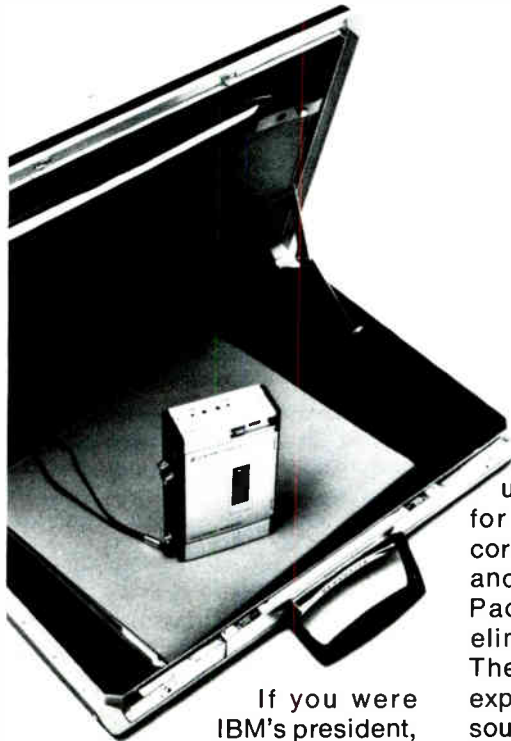

If you were IBM's president, you'd probably be using their Executory dictating equipment that retails for close to \$950.

Now you can own a complete Craig office dictation set-up for under \$300. The complete package—Electronic Notebook for dictation, Rechargeable Battery Pack, and Steno Unit for transcribing—sells for about \$650 less than IBM. And that puts you way ahead of the head of IBM.

The Electronic Notebook (model 2605, \$119.95**) is the smallest standard cassette player/recorder made. Small enough to hold and operate easily

with one hand. But don't be misled by its miniature size. This is a precision instrument with a built-in microphone for personal use, and a remote microphone for conferences and group recording. It is completely portable, and the Rechargeable Battery Pack (model 9215) practically eliminates changing batteries. The Electronic Notebook looks expensive. It feels expensive. It sounds expensive. And for all that... it's not that expensive.

The Steno Unit (model 2702, \$154.95**) is the companion piece to the Electronic Notebook. It has a digital counter that is synchronized with the 2605, for easy indexing of cassettes. And a two-stage footswitch for controlled backspacing. It is the only unit of its kind for anywhere near the price.

There's a lot more we could tell you about both the Electronic Notebook and the Steno Unit. But if you're not interested by now, it would be meaningless. And if you are interested, you'll call

(800) 851-3360; in Illinois, (800) 642-3372, for the name of your nearest Craig Office Equipment dealer or send your business card to Craig Corporation, Attention: Office Equipment Dept., 921 W. Artesia Boulevard, Compton, California 90220, and we will send you more information on Craig products and the location of your nearest dealer where you can see and try them.

* Assuming he'd have to pay the retail price for IBM Executory dictating equipment, Models 271 & 272 around \$950 (but chances are someone can get it for him wholesale).

** Manufacturer's suggested retail price.



The great dictators
under \$300
by **CRAIG**

Putting on a pack to get 'neath blue and starry skies

Backpacking is sheer joy and fun for anybody who is weary of too many people, too many parties, too much pressurized neon living, and so damned much action at the office that the emotional seams feel like they're going to split wide open any minute. Backpacking is putting your belongings on your back—enough for magical survival in the outdoors—and making an enchanting rediscovery of nature at its basic level. A packer lives in a world of trees, leaves, wind, rain, snakes, deer, sweat, hurt muscles, and blue-black skies.

And if this reads corny to a man—he needs backpacking. At least, he needs the kind of emotional refueling that a good session in the outdoors can produce. The question is: How do you do it in style and with a reasonable amount of comfort packed in? A modern packer needs this, or else his junket into the wilds will fall into a state of utter disaster. Despite all the sweet elixir, there's nothing so weary as a man sitting out a long night—with wet feet, in a wet tent.

Basic gear. Whether a packer is a deep-woods hiker or a mountain climber or an angler, he needs the right basic gear to stay out of trouble. He should first make a visit to the nearest top-rate camping specialist where he'll find improvements in equipment that he wouldn't have dreamed of in his teenage scouting days. Today's gear is lighter, smaller, stronger—it really packs.

Every city has its top outfitter, but

there are some exceptional shops specializing in backpacking equipment: Leon R. Greenman, Inc., and Camp & Trail Outfitters in New York; Eastern Mountain Sports in Boston; Ptarmigan in Denver; Holubar, Ltd., in Boulder, Colo.; Westridge Sports in Los Angeles; and Recreational Equipment Co., and Eddie Bauer in Seattle. And note: Many outfitters supply illustrated catalogues—it's a way to buy all sorts of specialized equipment, or possibly some items overlooked at the outfitter's shop.

Basic gear includes a pack-and-frame for carrying, a tent, sleeping bag, stove (SVEA's 9 oz. model at \$13 is good), mountaineering type cooking utensils, extra clothing, boots, freeze-dried and dehydrated foods, and a medical and survival kit (\$10). A good outfit runs about \$250 a person, maybe 25% less if the whole family packs. Lightness is the key word, especially at high altitudes. This means 28 up to 35 lbs. for a man, and 22 for a woman.

Pack-and-frame must be light and tough at the same time. Gerry's Traveler Sack with K-frame has vertical compartments to distribute weight (\$45). Kelty's B-4 pack has extra outside pockets, rugged frame (\$50). Camp Trails makes a heavy-duty frame for game hunters (\$30). A pack must be comfortable, well constructed, and have rustproof zippers and seams that will take heavy stress. A broken pack when you're miles in the woods can be disaster. Many packs come in children's sizes, and there are horse and dog packs (\$15 to \$28 by Gerry).

Sleeping out. There's an art to tent-buying. Gerry makes a rainproof tent for two, three or four, of lightweight nylon (\$95 to \$190). It has a wetproof nylon floor to keep sleeping bags dry, and netting over all openings. Coleman has a new two-man tent especially designed

for packers (\$70), and Alp-Sport and Sierra Designs also make top-grade lightweight packer's models.

Tips: In buying a tent, rub the fabric briskly with your hand; if sizing comes off, it's a second-grade piece of material. Get a tightly woven cloth—for example, pima cotton (250 threads per in.). Don't let the salesman sell you on the idea of a double-stitched tent; what you want is lap-fell seams with stitching through four layers of fabric instead of just two. Don't buy a white tent—unless you want your fellow campers to see your night-time activities when it is dark outside. Olive drab is best for privacy. And note: It is vitally important that the tent have good cross-ventilation (or you'll smother).

A backpacking sleeping bag must be down-filled for warmth, lightness and compactness. Get either eider-down or goose down. It should be the mummy type with about 2 lbs. of down and a total weight of roughly 3 lbs. It should not be waterproof; in dampness or rain, you use a tent. Top makers include Alp-Sport, Sierra Designs, Eddie Bauer, and Gerry. A quality with protection good for anyplace in the U.S. in summertime costs \$60 to \$80.

Special clothing isn't needed—a warm, rugged outfit will do. The exception is boots. For rough terrain, over-the-ankle hiking boots give support plus protection. Voyageur makes an A-1 boot with lug Vibram sole (\$30). Also get a waterproof nylon poncho—a general protector against rain and wind. Bauer's model weighs 18 oz. (\$17.50), and rain pants are useful (\$8.50).

Beginners find out later on. Here are some items that are forgotten 90% of the time until a man has been on the trail a few years: a Silva Huntsman compass (\$6), a 20 ft. length of ¼-in. nylon rope, quality heavy-framed sun-glasses for glare and physical protection of the face, lightweight leather gloves, a Swiss Army knife with wood saw, for 100 uses—folds up to pocket-size (\$15), a Flashomatic distress lamp that flashes 14 hours and can be seen 15 miles away (\$30), knee-high Gokey boots for snake country (\$60), and Trak soap to wash face and hands, pots and pans, clothes (\$2.95 a tube).

Reading up. Top-rate guides to the sport are *Handbook of Wilderness Travel*, by George Wells (Johnson, \$3.75), and *Freedom of the Hills* (Seattle Mountaineers, \$7.95), both sold at outfitting shops. Don't take your house key along. You may like backpacking so much—you might throw the key away.



Bruce McAllister



THE AMBASSADOR

**IS PURELY AND SIMPLY THE ONLY
1971 STATION WAGON IN THE WORLD WITH
AIR-CONDITIONING, AUTOMATIC TRANSMISSION AND
A V-8 ENGINE AS STANDARD EQUIPMENT.**

And that's not all. The Ambassador's impressive list of standard equipment also includes a roof rack, a dual hinged tailgate and full wheel covers.

And that's not all. You get something usually found on only the most expensive cars: coil spring seats for couch-like comfort.

Also, to carry your comfort close to the extreme, you ride on a 4-wheel coil spring suspension.

And that should be enough for anybody.

American Motors 

MOVING

How to Talk to a Gorilla for Fun and Profit.

A lot of people worry when they use a moving company. They think the moving man is a gorilla who drives a truck. So anything he has to say just naturally sounds like jungle gibberish. It's full of strange, legal terms like "tare weight" and "bill of lading." Which somehow always creep into the final bill. And make it add up to a lot more than they originally expected to pay.

Well, now you can speak to the moving man in his own terms. There are new government regulations that carefully translate all of the gibberish into easy, everyday language. And help you to save time and money by explaining your rights when you use a moving company's services.



Lyon, one of the big, national moving companies, is offering to send you a free copy of these regulations under no obligation.

By reading these new regulations, you'll learn what to do when you think the bill is too high. What the mover's liability is for lost or damaged household goods. How to avoid delays in delivery. Where to file a claim. And how generally to protect yourself and your possessions on moving day.

Every state has its own regulations. And these are often difficult to learn. Because many states don't print them for general distribution to the public. However, your local Lyon Moving and Storage agent will be happy to provide you with the rules that apply within your state.

For a free copy of the regulations governing your move within or out of state, call (800) 553-9950 for your nearest Lyon agent. In Iowa call collect (319) 242-1867. The calls are toll free, and there's no obligation.

You're probably wondering why Lyon, a moving company, would want you to know about these new regulations. For a very simple reason. Lyon feels the more you know about the new rules that protect you, the more you'll want to let Lyon guard your goods.

LYON MOVING • STORAGE
LYON VAN LINES, INC.

California's varietals: bouquet of success

The corks are popping in all directions, and today California's fine varietal wines are enriching the tables of all manner of VIPs. The high-quality "varietals"—named for the grapes from which they are produced and made by numerous wineries—are "in," at \$2.25 to \$4.25.

"You are making a mistake if you forever compare Europe's vintages with those of California," says leading wine expert Robert Misch. "It's foolish. The varietals stand on their own and have their own unique character." Here is a capsule review for a possible buyer:

Star ratings. Two of the varietals are "distinguished" and merit a four-star rating. Cabernet Sauvignon is red, rich, full-bodied; it's made from the same grape used in the great French clarets including the outstanding Chateau Lafite-Rothschild. A five-year-old Cabernet is excellent. The other four-star is Pinot Chardonnay (or simply Chardonnay), a dry, crisp white; the same grape is used for the finest of the French white Burgundies. Four varietals merit "excellent" or three-star rating: Pinot Blanc (white, dry, slightly fruity aroma); Pinot Noir (red, smooth); Sauvignon Blanc (white, rich, aromatic, from dry to sweet), and White or Johannisberg Riesling (dry, white, from the grape that produces the finest Rhines and Moselles of Germany).

Two-star or "good" varietals include Barbera, Gamay Beaujolais, and Zinfandel (reds), the latter uniquely American, not grown abroad. And Chenin Blanc, Green Hungarian, Semillon, and Traminer (whites), and Grenache Rose. One-star or "ordinary": Charbono, Gamay.

A dozen of California's varietals—the top of the crop, at \$1.47 to \$5.25.



Baccarat's crystal wine glass is \$12.50.

Dick Wolters

The labels. Top-rated wineries with reasonably wide U.S. distribution and specializing in varietals include Beaulieu, Buena Vista, Inglenook, Korbel, Krug, Louis Martini, Sebastiani, and Wente Brothers. Three big producers make varietals along with a full range of other wines: Almaden, Christian Brothers, and Paul Masson.

With all wineries, it is a case of experimenting and discovering personal favorites. It should be noted, too, that the big-volume producers of non-varietal wines often give excellent buys for the money—and a good wine of this group costs just 99¢ to about \$1.49 a bottle.

Vintage. A date if it appears on a California wine bottle is useful. It lets you know the age, of course—and generally, the rule for reds is the older the better (five years or older, if possible). Whites, though, should be quite young—about one to three years is best. The best quality in California sparkling wine will be found by picking one labeled "fermented in this bottle."

Says expert Robert Misch: "If you'll be buying ahead for summertime, the whites—cool and light—are fine for patio entertaining." For a review that is concise, practical, see Misch's *Quick Guide to Wine* (Doubleday, \$2.95).

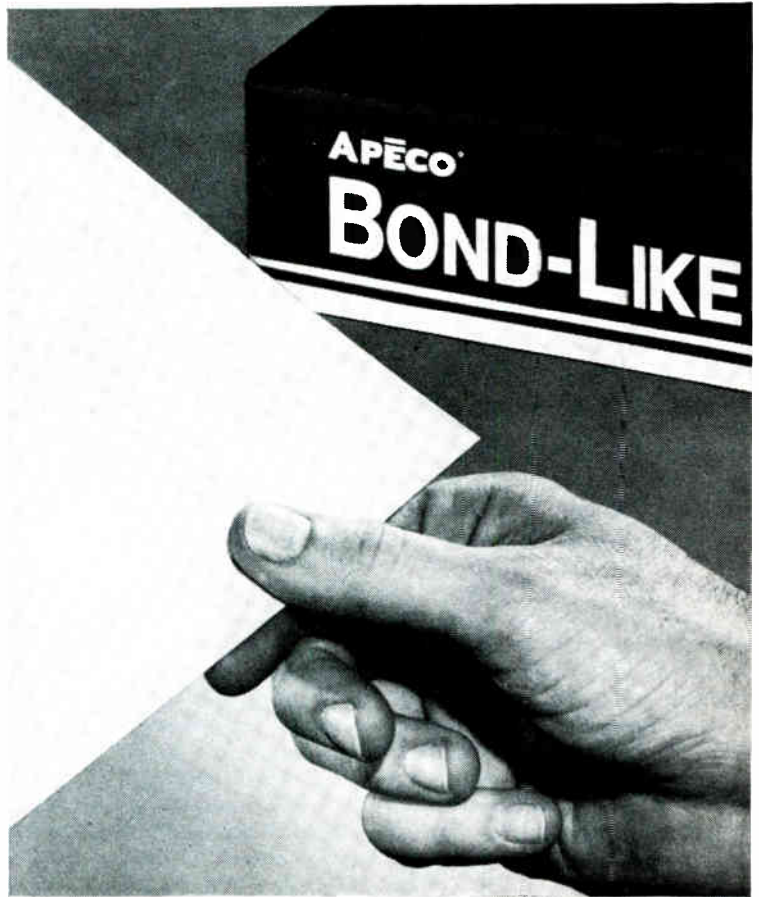

Now a new
electrostatic copy paper
for all electrostatic
copiers that looks
and feels like your
office stationery

Apēco® Bond-Like copy paper is here

Brings a whole new image to electrostatic copiers

Whatever you thought about Electrostatic Copy Paper until now . . . forget it! With new Apeco Bond-Like Copy Paper you will get blacker black . . . whiter white . . . lighter weight, and the overall look and feel of quality office stationery . . . the copies you always wanted.

More than a Promise—Here's Proof!

Apeco will give you a free sample of new Bond-Like Copy Paper to test on your present electrostatic Copymaker. Compare the results with the copies you are now getting . . . and get set for a happy surprise.

For your test sample of Apeco Bond-Like Copy Paper check Apeco's Free sample offer on the attached Reply Card.

**RUSH ME
APECO BOND-LIKE
PLUS FREE EXECUTIVE
CREDIT CARD COPY**

Company _____
Name _____
Title _____
Address _____
City _____ State _____ Zip _____

I want to test FREE Apeco Bond-Like Copy Paper on my _____
(Fill in Name of Your Present Copy Maker)

FILL OUT AND MAIL THIS CARD TODAY.

APĒCO®

AMERICAN PHOTOCOPY EQUIPMENT CO. / 2100 W. DEMPSTER ST. / EVANSTON, ILL. 60204

What to do and not to do after a crash

Heading off auto crashes gets a lot of press space. But hard-core advice on what to do after an accident is mostly bypassed. With the heavy summer driving season ahead, it's smart to review some pros and cons. One point is sure: Just "keeping calm" is no real answer, and it could amount to underacting to the point of death. Safety experts as well as negligence lawyers who've seen the courtroom side of hundreds of highway mishaps sum up these pointers:

The beginning. Freezing in the middle of the highway after an accident can be a dire blunder. Too many drivers do this—and get killed when they step out of their cars to inspect the damage. The alert move is to drive to the shoulder of the road, if possible, then immediately turn on the emergency flasher. Next, if there are any injured, they should be given emergency aid. Then if there are any on hand, warning flares should be put out, about 300 yds. from the scene.



Dick Walters

At this point, the police should be called or flagged down.

Says a top Manhattan negligence lawyer: "Carrying some flares and a red flag can save a life. It might also help secure your legal position, if and when you end up in a courtroom."

At this point, the police should be called or flagged down.

Less apparent is how the facts should be established. First, the license-plate numbers of all cars in the wreck should be taken down. And if it's a multiple-car, chain collision—the big menace today on superhighways—it is especially important to get the number of the last driver in the pile-up. He's the one most likely to be found legally responsible for failing to avoid a rear-end crash. Having this number tucked away can save courtroom hassling later on.

Three or four witnesses should be quickly found, if at all possible. One can help, though, if he has even a vague understanding of what happened. Note, however, that unlike the police, a citizen has no legal right to make any demands of witnesses, but their names and addresses should be written down if they're willing.

Blunder: It's a mistake to talk with witnesses about details of the accident. Screening them and sifting their stories is a lawyer's job. "You're apt to scare off a good witness if you try to quiz him," says a Cincinnati negligence lawyer. "It happens—and kills good cases."

The evidence. The names and addresses of the other driver and his passengers, plus the driver's personal license number and car registration number, are points to be written down. And the precise carseat locations of each individual in the other car should be noted—even if none claims to be injured or appears to be. They may claim serious injury later, and the information could support your position if and when you get to the lawsuit stage.

Also, an attempt should be made to get the other driver's insurance identification. But again, unlike the police, a citizen has no right to insist on this. Conversely, of course, the other man lacks this right, too.

As a safeguard, the badge number of the policeman who appears should be taken down. Negligence lawyers note that sometimes police reports aren't filed. Highway police, especially, are confronted by too many accidents—and too many courtroom appearances. But your own lawyer may be greatly helped if the identity of the policeman at the scene can be fixed without doubt. Also, no matter how much the police write down, anybody involved as a driver should make his own notes of the details: place, time, position of cars, directions, highway conditions, weather—and as much detail as possible on passenger seat locations as well as apparent injuries or lack of injuries.

Giving notice. Next phone the nearest office of your insurance company, or the agent back home. And as soon as possible—apart from contacting your own agent—a letter should be written directly to the insurance company, using certified mail, return-receipt. The company should be given a clear and reasonably detailed account of the accident, but without speculation as to "blame" on the part of any driver.

If the accident has taken place far from home, in another state, the wise move is to phone your own lawyer at home—or another lawyer in his firm. The point: A driver involved in an accident should not try to set up a contact with a local attorney in a distant place. It should be done by his own lawyer. Ignoring this can prove to be a costly mistake. The fact that the lawyer back home ordinarily doesn't handle accident cases makes no difference.

If there is personal injury or property damage over a fixed minimum (usually \$100 to \$200), an accident report must be filed with the state motor vehicle bureau, generally within 48 to 72 hours. The fact that a police report is filed usually doesn't remove the obligation. It's a good idea—partly because of the chance of later injury claims—to file an accident report even if property damage is below the minimum and nobody appears to have been injured. But note: In filing the report, keep all statements as clear-cut as possible. Says a Connecticut negligence lawyer: "You want to protect yourself—but at the same time, the less said, the better. This way you're in less danger of making a risky admission."

Rentals. A driver gets \$100,000/\$300,000/\$25,000 liability coverage in a rental car; and \$100 deductible collision coverage for \$2 a day. But despite this, it's always smart for a driver to notify his own insurance company and agent after a rental car crack-up. In some cases, the private insurance gives extra protection.

Let's put the O back in Sonoco.

There's one thing we at Sonoco want to be remembered by: our name.

But people keep spelling it with a U instead of an O. Which is not just another way to spell Sonoco. It's another company.

So to help you remember who we are, we'd like for you to remember, one: we don't pump gas for a living. And, two: our business is making things out of paper and plastics.

Things like cones, cores and spools for textiles. Cores and tubes for paper manufacturers and converters. Cans, containers and folding cartons for packaging. Column forming tubes and underground pipe for construction. And underground vaults for the utility industry.

What's more, each of the thousands of products we make is developed in some of the largest and most complete laboratories in the paper, cone and tube industry: our own. And none of them go to consumers. Because all our products are made to solve specialized industrial problems.

We'd like to tell you more about all the things we do. If you'll write Sonoco Products Company, Department SL, Hartsville, S.C. 29550, we'll

send you a copy of our capabilities booklet.

Because other than our name, there's at least one product we want to be remembered by.

The one we can make for you.

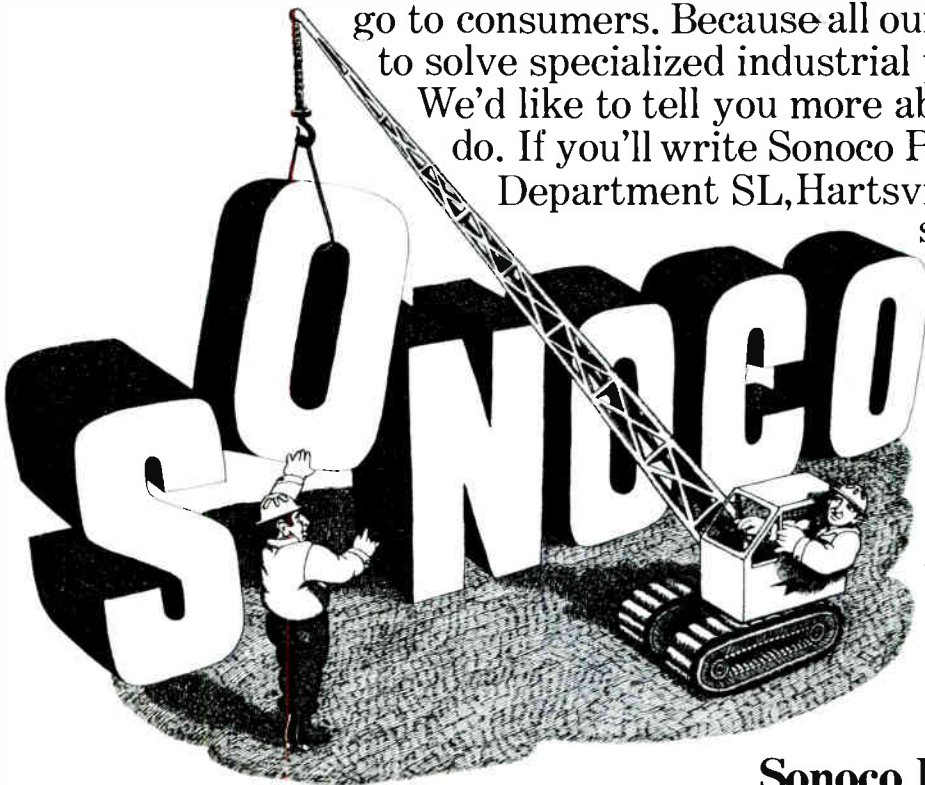

Sonoco Products Company.
Innovators in paper
and plastics.



Mobile managers: a tax break

THE REVISED LAW PUTS CASH INTO POCKETS OF MEN ON THE MOVE

A businessman moving to a new city this spring—for his old company or a new one—may save a tidy sum in the form of tax deductions, assuming that he pays part or all of the moving bills himself. Under the old tax law, only "direct" moving expenses—cost of the van, packing, transporting the family—could be deducted. This year, three additional kinds of business-related moving expenses can be written off:

Costs related to the sale of the old house and the purchase of the new; travel expenses for pre-move house-hunting trips; and temporary living costs covering up to 30 days before the day the family actually moves into the new house. These three items may be deducted up to \$2,500, with \$1,000 of this allowed for the temporary living costs and househunting trips. But there is one string attached: The rule now is that the deductions can be made only if the move is over 50 miles. Old limit was 20.

House sale. If a man is transferred by his company and makes a fast sale of his house at a loss—what's his tax position if the company makes up the difference between his sales price and the reasonable market value? The Tax Court is saying that this is taxable compensation.

The point for the transferred man is, of course, to try to get the company to pay not only the house-sale loss, but the extra tax as well. Today, formalized "transfer plans" are in motion in many companies. In effect, they become a fringe benefit for the middle manager who is moving up the line and changing cities every three or four years. In some cases, the company buys the old house, helps find a new one, sets up the mortgage deal, and makes the whole proposition easier to live with.

A man who's with a company that is slow on this approach, but fast on the idea of city-to-city moves, might do some pushing for the extra benefits.

Vans: On a COD furniture move, you pay 110% of the "estimate" upon delivery. If the bill is more, you have 15 days to pay the excess, or protest.

Desk set
in classic jet crystal
with clock - \$80.00.
Others, \$3.95
to \$175.00

SHEAFFER
the proud craftsmen

W. A. SHEAFFER PEN COMPANY, A **Extron** COMPANY, FORT MADISON, IOWA 52627

Planning to Build or Remodel?

The windows and doors of your home are a basic factor in determining its beauty and character.

That's why you should check first with Andersen before you make any final decisions.

We offer the finest materials and the widest selection of sizes and styles available.

Beauty and Practicality

Andersen Windows and Gliding Doors are made of warm, natural wood. They go beautifully with any style of home; and because they're made of wood, they act as natural insulators

against both summer heat and winter cold. They'll keep your family in comfort the year around.

If you choose Andersen's Perma-Shield® Windows, you won't have to bother with painting and scraping. Perma-Shield is available with welded insulating glass, too, so there's no need for storing, cleaning and changing storm windows.

For more information on how Andersen Windows and Gliding Doors can bring more beauty, comfort and lasting economy to your home, send for our free booklet.

Please send me your free booklet, "How to get good windows."

Mail to: Andersen Corporation, Bayport, Minnesota 55003

I plan to build. I plan to remodel a _____

Name _____

Address _____

City _____ State _____ Zip _____

How to
get good
windows



Andersen WindowsTM
Window beauty is Andersen.



PB-51

Andersen Corp., Bayport, Minnesota 55003



Mighty squawks from little scratches grow.

If you or a friend happen to scratch your furniture it's forgive and forget.

But if it happens when we move it, it isn't a little scratch anymore.

It's a big mistake.

Because our job is to be as careful as we can. And our people know and understand how you feel. And why you'd squawk.

That's why at northAmerican we spend more time and money than any other moving company to train our people to think of your furniture as something very fragile.

Like eggs.

So we don't pack a crystal chandelier the same way we pack pots and pans.

In fact, we use 16 different kinds of cartons for packing different things. That's just one example of the special kind of care you can expect from northAmerican.

Why?

Because we know squawking is strictly for the birds.

northAmerican
VAN LINES



**Dollar parade:
giving it away,
getting it back**

The "custodian account" for youngsters is booming. You can give a sizable amount to a child annually, without gift tax (\$6,000 to each child if you and your wife join in the gift). Over the years, a meaningful sum can be cut from a man's taxable estate. But more than this, state laws allowing the accounts have been eased. In the past, most states let you give only stocks and bonds. Today you can usually give life insurance policies—or cash. . . . Idea is, of course, to give income-producing property to a child and split off some of your own taxable income, letting it fall into the child's low tax bracket. This year, a child can get over \$1,800 without paying any tax at all. Drawback: The youngster gets the property, without any strings attached—at 21.

Tax-deductible medical costs continue to display a liberal trend. A new Internal Revenue case okayed a special phone-teletype system for deaf people. In another case, a wheelchair patient deducted \$1,500 for especially rigging his car. Everything from air purifiers to whirlpools has been allowed. Rule of thumb: If your MD prescribed it, deduct it. If you missed a sizable item, file an amended return (1040X). . . . Audits: If IRS beckons and the amount in dispute is under \$1,000, note the Tax Court's new and cheap "small case" procedure—worth checking with your tax man. Some people have let smaller amounts go, rather than face a costly Tax Court case. . . . Careers and compensation: If you are moving into a higher executive spot, check out the "dual" option as a fringe benefit. You choose between a qualified stock option (with capital gains) and a non-qualified plan (where option price can be below market value). It's a case of paper, pencil, and adviser—to figure tax breaks. The new 1972 50%-of-earned-income maximum rate enters in.

**Summer living:
cars, electronics,
and travel**

If you need an extra car for the summer, try long-term rental. A sedan is \$75 a week plus 15¢ a mile at most agencies; tab includes gas, oil, insurance. Avis, Hertz, and others, have special \$99 weekly deals. Avis, for instance, lets you return the car anyplace, and gives you the first 1,000 miles at no extra charge; then it's 7¢ a mile. . . . Monthly, a sedan runs \$250 to \$300 (New York City \$360), depending on where you live. You get unlimited mileage, but pay for gas and oil. A three-month lease is \$200 to \$235 (New York higher). . . . Wagons and convertibles: \$85 plus 16¢; monthly, \$275-up. Sports cars: not rentable.

Time and place: Longines' "ultrasonic" tuning fork watch is out; it's battery-powered, comes in stainless steel or 14K gold filled cases, will take a lot of shock.



Longines

Skindiver model gives water protection to 20 atmospheres, or over 500 feet, (\$150 to \$195).

. . . A world of tours: New York's Theater Guild (producer of over 200 Broadway plays) is offering theatrical tours of Europe. You travel with a small group of fellow theater buffs to London's West End, Vienna, Spoleto, Edinburgh. (Theater Guild Abroad, 226 W. 47th, New York 10036).

. . . The Foreign Policy Assn. has some unusual travel programs, too; for people who share an interest in foreign policy and want to meet with U. S. and foreign officials abroad, attend group discussions of international problems, and such; requires ample advance planning (FPA, Dept. FORUM, 345 E. 46th, New York 10017). . . . The Eurailpass

people now have a new Student-Railpass, good for two months of unlimited second-class rail travel on the Continent (\$125). Ages: 14 to 26.

The Food-Lover's Garden, by Angelo Pellegrini, tells you in good clear style how to grow all the fresh stuff that you see in the market after it's slightly wilted; first-rate garden instruction for a man who's weary of raising flowers (Knopf, \$6.95).

**After we get you there...
we promise not to leave you alone.**

We got a call from a man who said he appreciated Econo-Car's fast service and low rates and he was amazed that we could rent Fords for less than Hertz, but he wished we could figure out a way to make those after hours on business trips less miserable.

Well, first of all, we supplied him with a toothbrush because he'd forgotten his, and there's nothing more miserable on a business trip.

Then we got down to finding him a place to go that night . . . with the help of our Night Owl Directory. In his case, it was a fine restaurant, but we also locate good nightclubs or just a good hotel to fall asleep in. We recommend only the best. And we'll make the reservations for you. **1-800-874-5000*** Give us a call and let us help you.

**What does a 5th place car rental company do?
Anything you want us to!**

ECONO-CAR[®]
INTERNATIONAL



*We put the Ford
in affordable.*

*from Florida 1-800-342-5628

For more information and list of locations write to: Econo-Car International, Box 5765, Daytona Beach, Fla. 32020. Some franchises still available.

The Mitsubishi MU-2 prop-jets offer you these jet-age advantages the competition doesn't have.



SPEED — Both the MU-2F at 340mph and the MU-2G at 325mph are faster than other prop-jets in their category. This means more miles at lower operating cost and less time enroute.

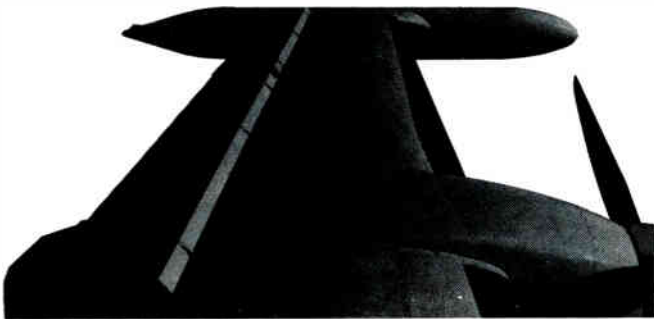

SPOILERS vs AILERONS — By utilizing spoilers instead of ailerons the entire trailing edge of the wing is available for full span flaps. The MU-2 uses jet-type spoilers for better lateral control.



2 YEAR WARRANTY —

The MU-2 has proven itself in the field. MU-2F and G owners now have a full two year warranty on the airframe—the best in its category.

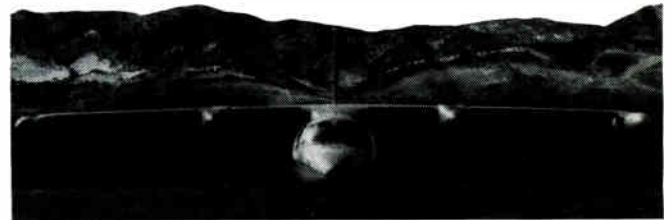

LOW DRAG WING — The MU-2 wing is designed for true prop-jet performance. The low drag air foil takes full advantage of turbine power for maximum speed.

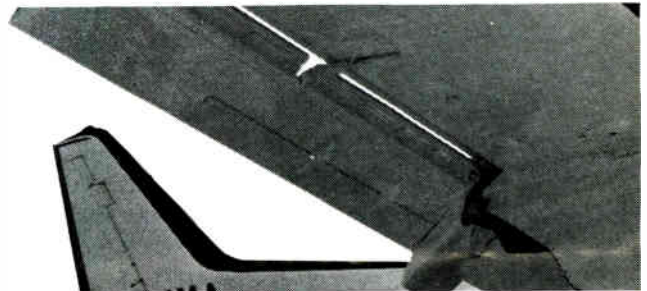

FULL SPAN FLAPS — Our modified fowler-type flaps plus this extra large flap area provide excellent short field capability and maximum control at low speeds.



50 YEAR AIRFRAME — The structural integrity of the MU-2 is second to none. The airframe on this rugged reliable aircraft is certified for 25,000 flight hours. (50 years based on 500 hours/year).

These are just a few of the outstanding advantages of flying the MU-2. Write: Mitsubishi Aircraft International, P. O. Box 3848, San Angelo, Texas 76901, or call 915-944-1511.

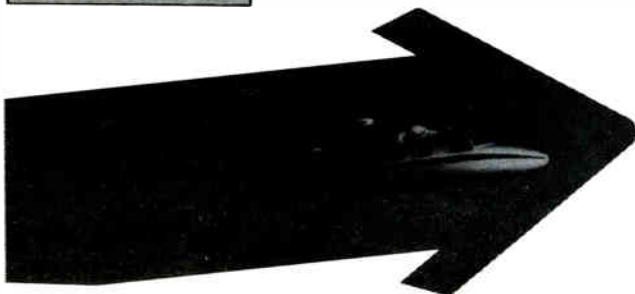

MU-2 MITSUBISHI AIRCRAFT INTERNATIONAL
P.O. Box 3848 San Angelo, Texas 76901

International Newsletter

May 10, 1971

Japanese firms set up minicomputer unit

Seven Japanese firms have joined in a venture to set up that nation's first company to make minicomputers only. The new organization, Nihon Minicomputer Corp., will specialize in OEM applications and is awaiting government approval to use technology supplied by the Data General Corp. of Southboro, Mass. The new company initially will import kits of components for Data General's Nova 1200, Nova 800, and Super Nova SC machines, but by the year-end, Nihon expects to be using 50% Japanese-made components, and close to 100% native parts by the middle of 1972.

The venture was set up with the guidance of the Ministry of International Trade and Industry, which feels that Japan's minicomputer requirements will increase sharply, and that the country's needs will be best served by a native company specializing in the machines. The Digital Equipment Corp. of Maynard, Mass., has been trying to enter Japan to manufacture minicomputers, but since the government favors technology-sharing license agreements, DEC's chances for approval are considered slim.

Siemens develops new ceramic capacitor material

Researchers at West Germany's Siemens AG have made an improvement in dielectric materials that promises to yield smaller and more stable ceramic capacitors. A proprietary titanate-ceramic process gives a material with a dielectric constant of 50,000—said to be five times higher than the best achieved with existing combinations thus far. Siemens components experts say this will permit ceramic capacitors of the same value to be made five times smaller. The new capacitors will hit the market shortly.

French to extend satellite experiment

French space officials will extend the solar-ray experiments based on Tournesol, the second-generation satellite launched in mid-April from the space center in French Guiana. The satellite, officially dubbed D2A, was designed for a six-month active life. But its gas-jet stabilization system, first for a French satellite, worked so well that the craft still has enough gas to keep its antennas pointed properly for several years. With considerably more than six months of use assured, space agency scientists are stretching out the schedule of experiments and are expanding the scope of some.

Along with the gas-jet stabilization, Tournesol differs from the first-generation D1 satellites in its real-time telemetry for both control and experimental data. A second D2A is slated for launching—this time in a polar orbit—next November.

SGS ships MOS ICs for German calculator

Italy's SGS has begun mass deliveries of a series of MOS integrated circuits designed for a desktop calculator made by Olympia Werke AG, a large West German office machines producer. The SGS deliveries will reach a volume of \$1 million during the next 12 months—the biggest shipment of custom-designed MOS devices ever handled by a European semiconductor maker. Two U.S. firms, Texas Instruments and General Instrument, each are delivering the same dollar volume of custom MOS ICs to Olympia.

International Newsletter

MOS tetrode provides gain at 900 MHz

An MOS tetrode with useful small-signal performance to nearly 1 gigahertz has been developed by Hirst Research Center, a part of Britain's General Electric Co. Ltd. The device shows a gain of 10 decibels and a noise figure of 8 dB at 900 megahertz; gain and noise figures at 500 MHz are 17 dB and 4 dB, respectively. Researchers say that with the tetrode, it will be easier than with bipolar transistors to eliminate cross-modulation in high-selectivity uhf communications receivers. Furthermore, the tetrode's construction is said to eradicate oscillation.

The tetrodes are n-channel, depletion-mode devices with the two gates running between interdigitated source and drain fingers. Total active chip area is 200 microns square. Channel length is 2.5 microns, achieved by ion implantation, and mutual transconductance is 12 millimhos. Gate protection from voltage surges, difficult to obtain in depletion-mode devices, has been provided by integrating into the chip a pair of back-to-back diodes between the gates and the source.

New 110° tube yoke said to give better color at lower voltage

Valvo GmbH, the Philips component-making subsidiary in Germany, says its new design for 110° color TV tube deflection yokes permits it to achieve high color fidelity while reducing deflection-voltage requirements. Instead of using a toroid yoke and a thin-neck tube, as does RCA in its recently introduced 110° color receiver [*Electronics*, April 26, p. 60], the Valvo design employs a new saddle-type yoke and the existing thick-neck tube. Valvo says this combination reduces deflection voltage and eliminates the need for a corner convergence generator, as does RCA's design, but the German firm claims it obtains better color fidelity than does RCA because the thick-neck tube permits greater shadow-mask transparency. Moreover, no changes are required in the deflection circuitry.

Swedish systems venture seeks jobs in industrial control

Swedish heavy electrical equipment maker ASEA and communications giant L M Ericsson have formed a joint company, AB ASEA LME Automation, that will develop and market computer-based systems for process and production control and other industrial applications. Both firms previously had worked in similar areas, with ASEA generally using Control Data Corp. computers and Ericsson employing its own machines. The new company will take over computer-based contracts held by both and will offer CDC and Ericsson computers.

Addenda

American Express Co. and Europe's Citel, a multinational company based in Paris, are setting up an IBM 360-based reservation system linking 500,000 hotel rooms and 4,500 car rental counters in 56 countries in Europe, North America, Asia, Australia, and the Caribbean . . . The Royal Navy will fit eight frigate-sized warships with twin-dish satellite communications terminals under development by Marconi Space and Defense Systems Ltd. . . . India's telecommunications facilities will be updated with the help of a \$78 million loan from the International Development Association, a World Bank affiliate. Two-thirds of the amount will be used to import materials and components for local manufacture of switching and transmission gear, phones, printers, and cable; the remainder will finance imported microwave equipment, cable, and local exchange systems.

Japanese companies push work on plated-wire memories

2.5-million-bit store, from the Electrical Communications Laboratory of NTT, challenges core-type memories . . .

Following a four-year development effort, Nippon Telegraph and Telephone Public Corp.'s Electrical Communications Laboratory has revealed ambitious plans for a plated-wire memory with a nominal capacity of up to 2.5 million bits. The read-write unit, with a cycle time of 2 microseconds, will be aimed at the commercial versions of the DIPS (Dendenkoshu Information Processing System) standard computers for time-sharing installations scheduled to go into production by 1974.

The memory was developed by the same group, headed by Sachinobu Shimizu, that brought out an earlier plated-wire read-only memory [*Electronics*, Jan. 19, 1970, p. 65]. This store has been formally adopted for use in electronic telephone exchanges, and Nippon Telegraph and Telephone is hoping its read-write unit will enjoy the same widespread deployment.

One big advantage of the new memory is that it can be fabricated in convenient size planes, while large core memories often are made in awkward sizes and shapes to keep prices down. But the module containing all the passive components for the 2.5-million-bit wire memory measures only 24 by 24.8 by 11.2 inches.

The fabrication technique also

accounts for the memory's low cost and good performance. It's literally glued together with three sheets of Mylar, each with an adhesive coating on one side. On two of these sheets, 700-micron-wide word lines are attached, with a center-to-center spacing of 0.04 in. On the third tape, groups of three glass fibers, 110 microns in diameter, are attached with group-center-to-center spacing of 0.02 in. Then 100-micron-diameter plated-wire digit lines are attached between the groups of glass fibers.

During assembly, epoxy cement is applied to both sides of a six-micron-thick sheet of Mylar and one word and one digit line preassembly are pressed against opposite sides. When the cement has hardened the adhesive Mylar is peeled off. Then the memory is completed by cementing on the second Mylar sheet and the second preassembly of word lines. The

larger diameter of the glass fibers leaves a gap between the Mylar sheet and digit lines that prevents assembly damage to the latter by excessive pressure.

Each plane is designed to have 256 word lines and 288 digit lines, though some have been fabricated with 280 digit lines and 332 word lines to provide spares. Word lines are terminated on the support for each plane, but digit lines extend beyond the plane and are terminated in connectors for testing. After testing, the connectors are cut off and digit lines on separate planes are interconnected by infrared soldering. Two groups of 16 planes each are used in each module, yielding a digit line length of 4,096 words.

The word lines have keepers of plated permalloy film with directional magnetic characteristics on three sides and toward the outside edges of the fourth side. This gives

In place. Fabrication methods used by NTT relies on adhesive-backed Mylar sheets to hold the word and digit lines together during assembly.

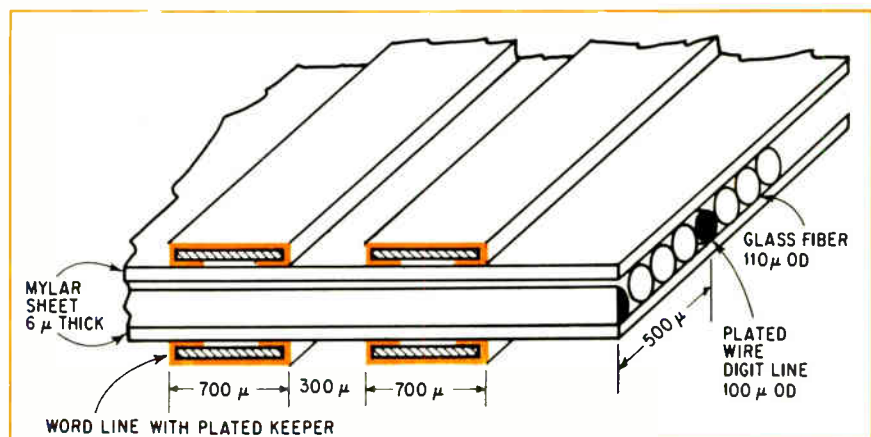

a horseshoe shape, with the portion on the fourth side serving as a polepiece. The result is an essentially closed magnetic circuit with nearly all of the flux coupled to the crosspoints of the digit lines under the word line, and none coupled to adjacent crosspoints. Digit lines are made of beryllium copper with an improved version of the five-layer plating developed for the ROM. This results in a nondestructive readout capability while retaining a large margin for writing currents and freedom from the effects of creep during readout.

This relative freedom from creep permits unipolar, rather than the more complex bipolar, pulses to be used, leading to important cost reductions in peripheral circuits. Elimination of the reverse current phase of the bipolar pulse also tends to speed up operation, so that the basic memory plane can be operated with cycle times as short as 200 nanoseconds. (The 2-microsecond cycle time was selected to keep down peripheral circuit costs.) Word driving current range is 550 milliamperes to 1 ampere, while the digit driving current range is 40 to 90 mA. The standard output voltage to the sense amplifiers has a rise time of 50 nanoseconds and an amplitude of 6.3 millivolts.

Also serving to keep peripheral circuit cost down is a matrix of metal film cores used for word line selection. These metal film cores provide about three times the switching speed and about an order of magnitude higher selection/half-selection output-current ratio than ferrite cores. They consist of a chrome permalloy film about three microns thick with an insulating coating rolled up like a jelly roll—except that cores have about 50 turns. The roll is then cut to the proper length.

... while smaller one is geared to compete with IC storage

Meanwhile, Toko Inc. has developed its own plated-wire memory and is calling it a direct competitor

for fast bipolar semiconductor memories in small- and medium-sized computers.

Toko, one of the early Japanese proponents of the plated-wire approach, claims its plated-wire store yields higher speeds at lower power dissipation than equivalent bipolar IC memories, and adds that availability will be better—deliveries are scheduled for September.

Since the new memory operates in the nondestructive readout mode, says Toko, part of it can be used as a read-write store and part as a random access, read-only memory. This permits a new type of architecture in which microprogramming can be set into the hardware by the user, eliminating the need for working with any complex software.

The new memory is designed to have 16 kilobytes per unit, with each byte having nine bits so that one may be used for parity if desired. The actual configuration is 2,048 words of 72 bits each. Read access time is 125 nanoseconds, read cycle time is 150 nanoseconds, and write cycle time is 300 nanoseconds.

These memory speeds are maintained throughout by using high-speed transistor-transistor logic for decoding and other peripheral functions. Cost has been kept low by using a diode matrix for selection. Thus, Toko expects to sell the memory to volume users for 5.5 cents per bit this year, with price sliding down to between 2.7 and 3.9 cents by 1973.

The plated-wire unit achieves improved nondestructive readout characteristics by using digit lines with multilayer magnetic plating and magnetic keepers. Word lines and spacers of copper wire and keepers of magnetic wire are insulated wire about 0.03-inch in diameter woven at right angles to the plated digit lines. The word lines are connected to form two turns and the keepers and spacers are left unconnected. Although two turns are used, only one digit line suffices for each bit, so the memory is considered to have one intersection per bit.

Drawing a bead on infrared radiation

If you want high sensitivity to infrared radiation you ordinarily have to play it very cool indeed and use a cryostat detector. The deep freeze may no longer be necessary, says Alexis Agramakoff, head of Applied Infrared Laboratory, located near Cannes.

Agramakoff has come up with an ambient-temperature i-r detector that stands up favorably against cooled indium antimonide and lead selenide detectors. The peak detectivity (D^*) of his detectors is 10^9 centimeter-hertz^{1/2} watt⁻¹. That is from 10 to 100 times better than some conventional uncooled thermistor bolometers, maintains Agramakoff. What's more, the package sizes—down to 1.5 millimeter diameter—are minute for bolometers and the bias voltages very low—3 to 4 volts. As for prices, Agramakoff says they can be as low as \$400 to \$500.

What makes for all these remarkable characteristics is the way Agramakoff's Micristors are made. The usual active element in a bolometer is a sintered flake of manganese, nickel, and cobalt oxides. With a sintering process, about as small as you can go is 10 microns thickness and edge dimensions of 0.1 mm. In the Micristor, the sensing element is a globule of a proprietary material that can range from 3 to 15 microns in diameter.

Agramakoff understandably won't reveal the exact composition of his thermistor material. The ingredients all have melting points between 2,300° and 3,000°C. Mixed together, though, the melting point is about one quarter that of the individual ingredients, making it possible to melt a speck of the material between two 1-micron platinum wires.

Expensive optics, obviously, would have to be paired with a 3-micron globule to focus incoming infrared rays upon it. Instead, Agramakoff cements black-

ened goldleaf foil onto the globule to expand the active area. The foil most often measures 0.5 by 0.5 mm. The globule-cum-foil assemblies are mounted in housings with optically matched reflectors and membrane windows. The spectral response depends on the windows: the active element responds well at wavelengths up to about 26 microns.

Agramakoff, a one-time physics professor at Berlin's Polytechnic Institute, doesn't plan to go into mass production. Big orders, he says, will be handled by Celduc, a French company best known for relays. The first applications for the device will be in some classified equipment for the French army. Next should come an i-r microscope for checking hot spots on integrated circuits. It has a resolution of 3 microns and is accurate to 0.1°C. The prototype has been built and three microscope makers are negotiating for production rights.

Japan

Fujitsu glows over plasma displays

Backed by a healthy government subsidy, Japan's Fujitsu is going into plasma displays in a big way. It is already well along in display panels, with the 10-centimeter square display well in hand—and a 30-cm square panel scheduled by year end—and a 14-digit numerical panel. It has also shown a prototype of a plasma display/light pen combination console.

The 10-by-10-cm panel, of which Fujitsu has built several models, is 1.5 cm thick and can be selectively written on and erased. The display has a matrix of 128 by 128 gold electrodes, spaced 0.6 millimeters apart, to give a total of 16,384 addressable points. Firing voltage is only 150 volts, compared with 800 V for some earlier versions. The 30-cm square panel will have a 512-by-512-line matrix, for a total of 262,144 crosspoints.

Fujitsu will start using both the 10-cm panel and the 14-digit numerical display inside the com-

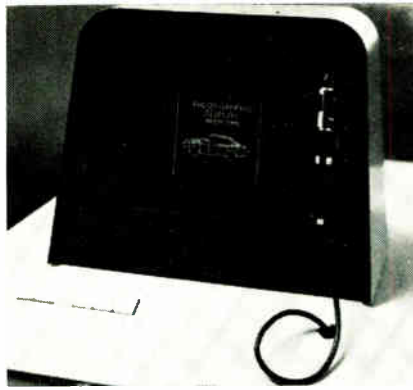

Flat screen. One of Fujitsu's plasma displays sports a light pen.

pany to give engineers a chance to design equipment and to field test the panels. So far, the timetable for outside sales has not been set.

The company feels that it has made two important contributions to the art of building plasma displays. One has been in materials and fabrication research, which has enabled it to tailor the glass to fit the insulating needs, including the desired charge storage on the surface, and to select the proper neon/rare-gas mixture for each glass.

The other has been the development of an improved voltage waveform for driving the display. Instead of using a sine-wave approach, in which operating margin proved poor, Fujitsu uses a return-to-zero square-wave signal. The company says that kind of driving pulse gives a much larger margin between selected and nonselected crosspoints and a tighter control on which crosspoints light up.

Canada

Satellite will push technology to open up northern areas

Well aware that the high-frequency radio links used to serve Northern Canada leave much to be desired, the Canadian Department of Communications plans to turn to satellites to improve its communications services. But since it will be five to seven years before Canada begins to build second-generation domestic satellites, Canada plans to

launch an experimental spacecraft to refine the techniques it will have in operational use in the late 1970s.

John Chapman, DOC's assistant deputy minister for research, says that Canada is banking on the use of high-powered satellites using the uncluttered 10- to 15-gigahertz bands to extend low-cost communications to its northern regions. "Somewhere around 1975, we'll have to be making some system decision," he says. "We therefore have time to do what experimenting is necessary."

Canada's main vehicle for the experiments will be a spacecraft dubbed Cooperative Applications Satellite C (CAS-C) that DOC is building for launch by the U.S. National Aeronautics and Space Administration in 1974. The 1,000-watt power of the craft "should permit us to make the best trade-offs between costs in the sky and on the ground," Chapman says.

Chapman says that awards for the preliminary design of the spacecraft should be made this summer. Meanwhile, he adds, the department is drafting bid solicitations for a wide variety of terminals that should be out to industry within six months.

Canada plans to build as much of the spacecraft as it can within its borders but will probably have to turn to U.S. manufacturers for control and orientation systems for the three-axis stabilized craft and for apogee motors. As part of the joint NASA agreement, NASA will provide a 200-watt travelling-wave tube with greater than 50% efficiency. Current tubes range up to 40 watts and 40 to 50% efficiency, NASA officials say. In addition, NASA will provide launch and integration services.

Samuel E. Fordyce, NASA's CAS-C program manager, says that the Canadians plan to develop liquid-metal slip rings to transfer power from the tracking solar arrays to the three-axis stabilized spacecraft. Other technical developments required are unfurlable solar arrays and electric propulsion gear.

In the long run, however, the low-cost ground terminals that

Canada hopes to develop may prove to be the most significant spin-off of the program, Fordyce says. "After this program, they will no longer be a development item."

Canada's Chapman agrees but adds that Canada has set tough goals for the ground station equipment. In order to maximize the number of users, "we would like to have a receive-only TV terminal no costlier than a color TV set. Maybe we won't get there, but it's a target." Current 4- and 6-GHz receive-only stations cost around \$100,000.

Great Britain

**ICL breathes new life
into its 1900 computers**

When most of the major business computer makers announced new lines last year, International Computers Ltd. was not among them. Because ICL's basic product range—the 1900 series computers—dates back to 1964, with an IC facelift in 1968, pundits have been predicting that ICL would not survive against the American giants. Now ICL has unveiled four updated 1900 models, confounding the critics who said it had nothing new to offer but at the same time acknowledging their argument that sustained sales will depend on new models.

ICL's updating bears some resemblance to IBM's switch from the 360 to the 370. The two biggest new machines—the 1906S and the 1904S—are largely the existing A-model machines boosted by slotting in much faster stores and enhanced peripheral handling facilities. In place of 750-nanosecond 2½-D cores used in the stores of the 1906A and 1904A, the 1906S uses a Plessey plated-wire store with 300-nanosecond cycle time.

This big machine uses extensive interleaving and instruction overlap for which access time is more important than cycle time. The plated-wire access time of 130 nanoseconds compares with 375 nanoseconds for the 2½-D cores.

The new memory, plus some rearrangement of the cabinets to reduce interconnection delay times, and a new peripheral controller with 43 channels has boosted throughput of the controller from 5 million six-bit characters a second on the 1906A to 11 million characters a second on the 1906S.

In the 1904S, the 2½-D cores are replaced by a semiconductor mainframe memory in n-channel MOS technology supplied by Cogar Corp., of Wappingers Falls, N.Y. Donald Marsh, deputy computer equipment manager at ICL's West Gorton plant where the 1900 series is built, says the chips are the fastest Cogar can make using proved technology. Cogar will make first volume deliveries early next year. Store cycle time is 300 nanoseconds, access time 175 nanoseconds. Maximum data throughput through an autonomous peripheral controller of 38 channels is 6 million characters a second, compared with 3 million for the 1904A.

These two new stores mean that ICL is now using all three mainframe technologies in production computers. Marsh says the justification is cost at the speed level required. He says plated wire had to be used in the biggest machine because "there is no semiconductor store which is fast enough at a reasonable price at present". The bipolar store is fast enough, "but even if it was cheap enough it would probably require too much power." The MOS store can get the cycle time, but it's just not fast enough on the all-important access time. On the other hand, in the smaller machine interleaving is not used, cycle time is relatively more important, and on cycle time alone the MOS store is cheaper.

West Germany

**Focusing on
water pollution**

The growing arsenal of pollution monitoring tools now sports an optoelectronic instrument that can determine water turbidity and do it

right on the spot. Thus, there's no need for water sampling, which is time consuming and unsuitable for continuous testing of large bodies of water.

The new instrument, called Variosens, can also be used to determine the direction of water is flowing at various levels by detecting the presence of fluorescent materials added to the water.

Variosens was developed by Impulsphysik GmbH, a 100-man Hamburg-based firm specializing in high-speed photographic and in optoelectronic equipment. Partly funded by West Germany's Ministry for Science and Education, the instrument will hit the market soon and sell for about \$6,000.

Two basic units, a light projector and a receiver, are housed in separate brass cylinders about 16 inches long and 3 in. in diameter. Mounted on a common support, the cylinders are dragged by a ship at depths of up to 15,000 feet. Near-white light pulses from a xenon spark lamp in the projector are aimed at a photosensor in the receiver. The amount of light actually received measures the water's turbidity or fluorescence.

By changing optical filters in both the receiver and projector, Variosens can be used in several ways. Without filters it measures turbidity—for example, the impurity level in industrial waste waters. For fluorescence measurements, on the other hand, a filter in the projector passes only the narrow band of wavelengths that will excite fluorescence; the receiver's filter passes the narrow band of emitted fluorescent wavelengths.

The receiver uses a wide-aperture lens for focusing onto a photosensor, a silicon guard-ring photodiode. Moving the photodiode adjusts the focus to suit the incoming radiation. Photodiode output is fed to a dc-coupled logarithmic amplifier which delivers a current between 0 and 1 milliamperes. That current range covers about five orders of magnitude of the incoming signal. After conversion in an dc/ac converter, the output signal is sent through the probe's supply cable.

Advertising Sales Staff

Pierre J. Braudé [212] 971-3485
Advertising Sales Manager

Atlanta, Ga. 30309: Charlton H. Calhoun, III
1375 Peachtree St., N.E.
[404] 892-2868

Boston, Mass. 02116: William S. Hodgkinson,
James R. Pierce, 607 Boylston St.
[617] 262-1160

Chicago, Ill. 60611: Ralph Hanning,
Kenneth E. Nicklas, 645 North Michigan
Avenue, [312] MO 4-5800

Cleveland, Ohio 44113: William J. Boyle,
[716] 586-5040

Dallas, Texas 75201: Richard P. Poole,
1800 Republic National Bank Tower,
[214] RI 7-9721

Denver, Colo. 80202: Richard W. Carpenter
Tower Bldg., 1700 Broadway
[303] 266-3863

Detroit, Michigan 48226: Ralph Hanning,
2600 Penobscot Building
[313] 962-1793

Houston, Texas 77002: Richard P. Poole,
2270 Humble Bldg. [713] CA 4-8381

Los Angeles, Calif. 90017: Robert J. Rielly,
Bradley K. Jones, 1125 W. 6th St.,
[213] HU 2-5450

Minneapolis, Minn. 55402: Kenneth E. Nicklas,
1104 Northstar Center [612] 332-7425

New York, N.Y. 10036
500 Fifth Avenue
Warren H. Gardner [212] 971-3617
Michael J. Stoller [212] 971-3616

Philadelphia, Pa. 19103:
Jeffrey M. Preston
6 Penn Center Plaza,
[215] LO 8-6161

Pittsburgh, Pa. 15222: Jeffrey M. Preston,
4 Gateway Center, [412] 391-1314

Rochester, N.Y. 14534: William J. Boyle,
9 Greylock Ridge, Pittsford, N.Y.
[716] 586-5040

St. Louis, Mo. 63105: Kenneth E. Nicklas,
The Clayton Tower, 7751 Carondelet Ave.
[314] PA 5-7285

San Francisco, Calif. 94111: Don Farris,
Richard R. Butera, 425 Battery Street,
[415] 362-4600

Paris: Alain Offergeld
17 Rue-Georges Bizet, 75 Paris 16, France
Tel 727 33 42, 727 33 60

Geneva: Alain Offergeld
1 rue du Temple

United Kingdom and Scandinavia
London: Keith Mantle, Brian Bowes
Tel: Hyde Park 1451
34 Dover Street, London W1

Milan: Robert Saidel, Roberto Laureri
1 via Baracchini Phone 86-90-656

Brussels: Alain Offergeld
22 Chaussee de Wavre
Brussels 1040, Belgium

European Special Project Manager: Oliver Ball
Tel: Hyde Park, 1451, London: 34 Dover Street

Frankfurt/Main: Fritz Krusebecker
Elsa-Brandstroem Str. 2
Phone 72 01 81

Tokyo: Masaru Wakeshima, McGraw-Hill
Publications Overseas Corporation,
Kasumigaseki Building 2-5, 3-chome,
Kasumigaseki, Chiyoda-Ku, Tokyo, Japan
[581] 9811

Osaka: Akihiko Kamesaka, McGraw-Hill
Publications Overseas Corporation, Kondo
Bldg., 163, Umegae-cho Kita-ku [362] 8771

Australasia: Warren E. Ball, IPO Box 5106,
Tokyo, Japan

Business Department

Stephen R. Weiss, Manager
[212] 971-2044

Thomas M. Egan,
Production Manager [212] 971-3140

Dorothy Carter, Contracts and Billings
[212] 971-2908

Frances Vallone, Reader Service Manager
[212] 971-6057

Electronics Buyers' Guide

George F. Werner, Associate Publisher
[212] 971-3139

Regina Hera, Directory Manager
[212] 971-2544

Service...Engineering...Experience

MAKE THE **BIG** DIFFERENCE
BETWEEN A YOKE SPECIALIST
AND A YOKE SUPPLIER

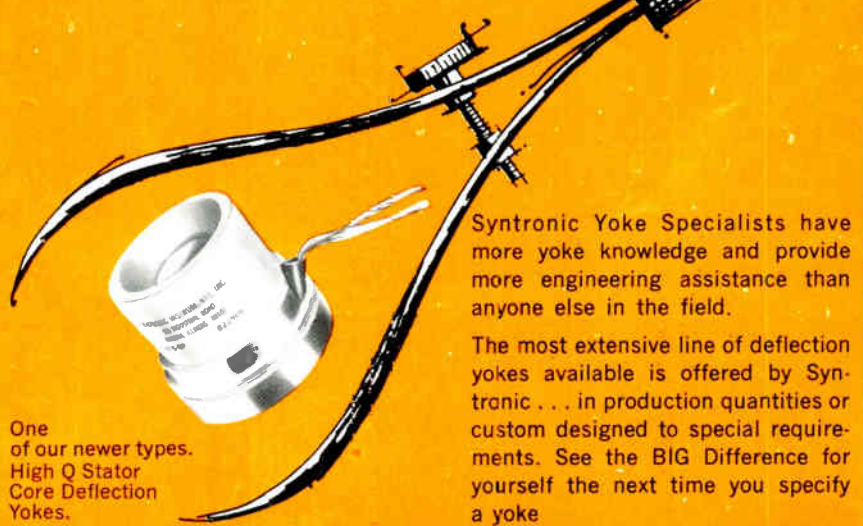

One
of our newer types.
High Q Stator
Core Deflection
Yokes.

Syntronic Yoke Specialists have more yoke knowledge and provide more engineering assistance than anyone else in the field.

The most extensive line of deflection yokes available is offered by Syntronic... in production quantities or custom designed to special requirements. See the BIG Difference for yourself the next time you specify a yoke

syntronic INSTRUMENTS, INC.
100 Industrial Road, Addison, Illinois 60101 Phone 312, 543-6444

Circle 175 on reader service card

The 1971 Digilin.

3 ways better... full price \$375⁰⁰

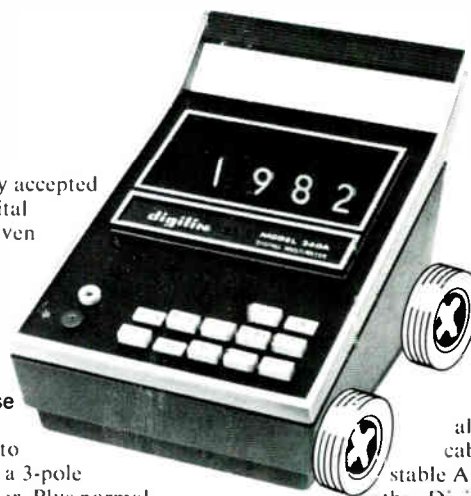

Digilin's widely accepted Model 340 digital multimeter is even better as the Model 340A.

Three ways better. Check these new features:

- **Fast response** of less than 1 second from 0 to full scale using a 3-pole active input filter. Plus normal mode rejection of 60 db at 60 Hz and low noise.
- **Best AC stability**, better on low input frequencies than you'd ever

expect in a low-cost meter. New averaging circuit does a better job on nonsinusoidals, too. • **Utmost quality** — best components operated at conservative levels, extensive use of TTL IC's, optimized circuit layout on all-plug-in boards, new extra-stable A/D converter. Plus all the other Digilin innovations that made the 340 so great. *And it is priced at \$375.00.* Digilin, Inc., 1007 Air Way, Glendale, Calif. 91201 (213) 240-1200.

digilin
DIGITAL INSTRUMENTS

SLIDE SWITCHES

Miniature series offers multiple circuit switching in limited P. C. space. Choice of upright mounting or right-angle mounting. Compact size for P. C. cards. Economically priced.

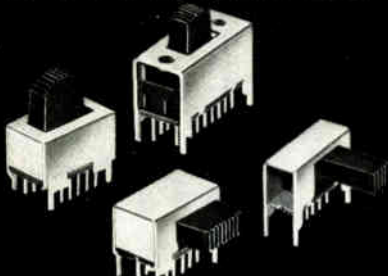

ALCOSWITCH®

DIV. OF ALCO ELECTRONIC PRODUCTS, INC., LAWRENCE, MASS.

IDEAL SIZE FOR
PRINTED CIRCUITS

Telephone: HENRY O'CONNOR (617) 686-3887

MAGNET REED MINIATURES

Super miniature proximity switch & magnet assembly includes an encased Alnico-5 magnet that actuates the reed switch within .39". Rating @ 50 VDC: 150ma break, 500ma carry.

NORMALLY OPEN or



NORMALLY CLOSED

ALCOSWITCH®

DIV. OF ALCO ELECTRONIC PRODUCTS, INC., LAWRENCE, MASS.

Circle 162 on reader service card

TOGGLE SWITCH MINIATURES

Higher ratings, longer life 250,000 operations. Metal construction, high impact insulation allows use under wide range of environmental conditions. U/L approved. SPDT, DPDT. 1/4" or 1/2" bushings.

10A @ 125 VAC



MCT
Series

ALCOSWITCH®

CYLINDRICAL CASE

DIV. OF ALCO ELECTRONIC PRODUCTS, INC., LAWRENCE, MASS.

Telephone: TED LAMBERT (617) 686-3887

PUSH BUTTON MINIATURES

Lighted snap-action DPDT models handle 6A @ 125 VAC & features separate connections to T-1 1/4 lamp. 1/2", 5/8", 3/4" round or square buttons; transparent or translucent colors. P.C. side terminals.

MSPN SERIES



ALCOSWITCH®

ILLUMINATED

DIV. OF ALCO ELECTRONIC PRODUCTS, INC., LAWRENCE, MASS.

Circle 163 on reader service card

How much free time do you have available for reading?



Add up the number of magazines that come across your desk.

Multiply them by an average reading time — minutes to scan, an hour or more to dig in.

Most people can only spend six hours each week on all sources of occupational information.

So how do you fill your professional needs and still keep your reading within reason?

Leaf through this issue again.

Notice how much of its editorial is designed to keep you aware of trends, show you how new technologies are being applied, and give you information on new products.

If you want to keep yourself up to date and cut down on your reading time, do the same thing with every issue of Electronics.

When you make Electronics your regular habit, you'll find you have only occasional need for other electronics magazines.

More information, in less reading time, is one reason it pays you to have your own subscription to Electronics.

Electronics.

It's all you need to read.

with what we know
about capacitors
we could write
a book...

so we did!



If you specify or buy capacitors you'll find the Aerovox Product Specifier for Electrical and Electronic Components the handiest thing that's come off the press since money. Between the covers we've included basic technical data, application data, Mil Spec and industry data along with detailed product information on multi-layer ceramic, paper, film, mica, oil filled, high voltage, SCR, EDC, feed-thru, disc and high voltage multiplier capacitors. In addition we have included technical information on our capabilities in thick and thin film microcircuits, RFI/EMI filters, and active and passive wave filters.

It's brand new, it's up-to-date and best of all... it's FREE for the asking. So if you specify and buy capacitors, filters, or microcircuits, you'll want your own personal copy of this all important Aerovox catalog. Your copy is waiting for you; write for one today or call your local Aerovox representative.



AVX Aerovox®

AEROVOX CORPORATION, NEW BEDFORD, MASSACHUSETTS 02741 • TEL. 617-994-9661
PLANTS IN: NEW BEDFORD, MA., OLEAN & FRANKLINVILLE, N.Y., MYRTLE BEACH, S.C. AND HAMILTON, ONT., CANADA

Circle 901 on reader service card

RCA's five new IC arrays give you the design flexibility and cost-effectiveness of discrete devices

RCA linear IC arrays offer cost-conscious design engineers an ideal way to achieve new economies—they are priced as low as 10¢ per transistor (8¢ in high volume).

Here are five new monolithic, active-device arrays that combine the performance and versatility of discrete devices, with the inherent reliability and match of integrated circuits to provide a new approach to design problem solving.

Check into the:

- CA3081 and CA3082—for 7-segment incandescent and LED display drivers

and other current switching applications including relay control and thyristor triggering.

- CA3083—for high current signal processing, thyristor triggering, and driver applications from DC to 120 MHz.
- CA3084—p-n-p type for dynamic loads, level shifting, bias circuitry, and small-signal amplification (including complementary configurations).
- CA3086—5-transistor array for maximum economy and performance in signal processing systems operating in the DC to 120 MHz range.

For further information on these devices and RCA's complete line of linear IC arrays, see your local RCA Representative or RCA Distributor. For a copy of RCA's Integrated Circuit Product Guide (or a specific technical bulletin by File No.) write RCA, Commercial Engineering, Section 70E-10/CA61, Harrison, N.J. 07029. International: RCA, Sunbury-on-Thames, U. K., or 2-4 rue du Lièvre, 1227 Geneva, Switzerland, or P.O. Box 112, Hong Kong.

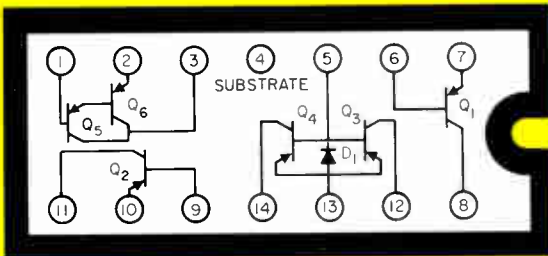

CA3084

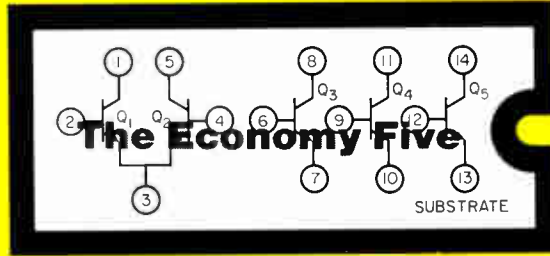

CA3086

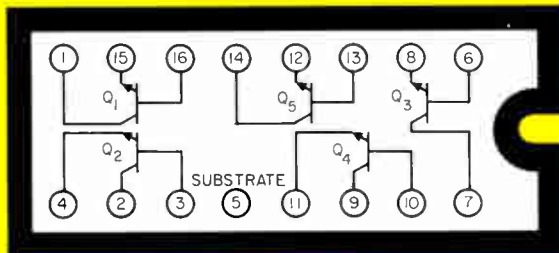

CA3083

CA3082

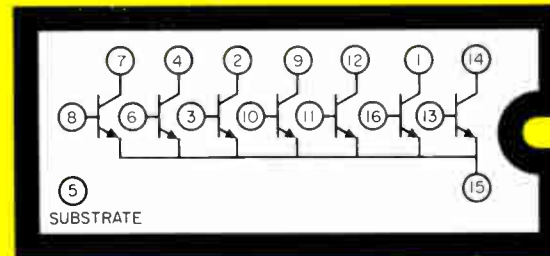
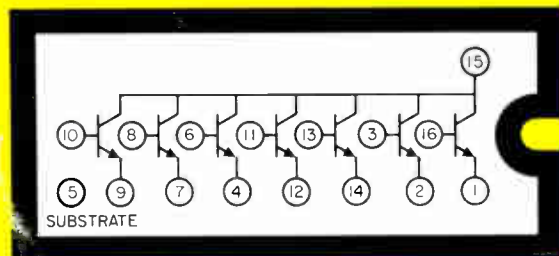

CA3081

Type	Package	Description	Technical Bulletin File No.	Price (1000-unit level)
CA3086	14-lead DIP	The economy five	483	.49
CA3084	14-lead DIP	P-n-p array	482	1.79
CA3083	16-lead DIP	Five independent 100-mA n-p-n transistors, with $V_{CE0} = 15\text{ V}$ (Q_1 and Q_2 are matched at low currents, i.e. 1 mA)	481	1.69
CA3082	14-lead DIP	Seven 100-mA transistors with $V_{CE0} = 16\text{ V}$ (common-collector array)	480	1.89
CA3081	16-lead DIP	Seven 100-mA transistors with $V_{CE0} = 16\text{ V}$ (common-emitter array)	480	1.89

RCA Solid State

Circle 902 on reader service card