

Ferroelectric display is selectively erasable 34

Current generators find wider use 40

Hospitals are unhealthy for electronic gear 54

# Electronics®

**Film plays  
supporting role  
in automating  
IC assembly**



1420 KSS954 44RA7 FEB71  
R KISSLER  
BASIC COMM ELEC  
BOX 956  
MOSES LAKE WA 98837

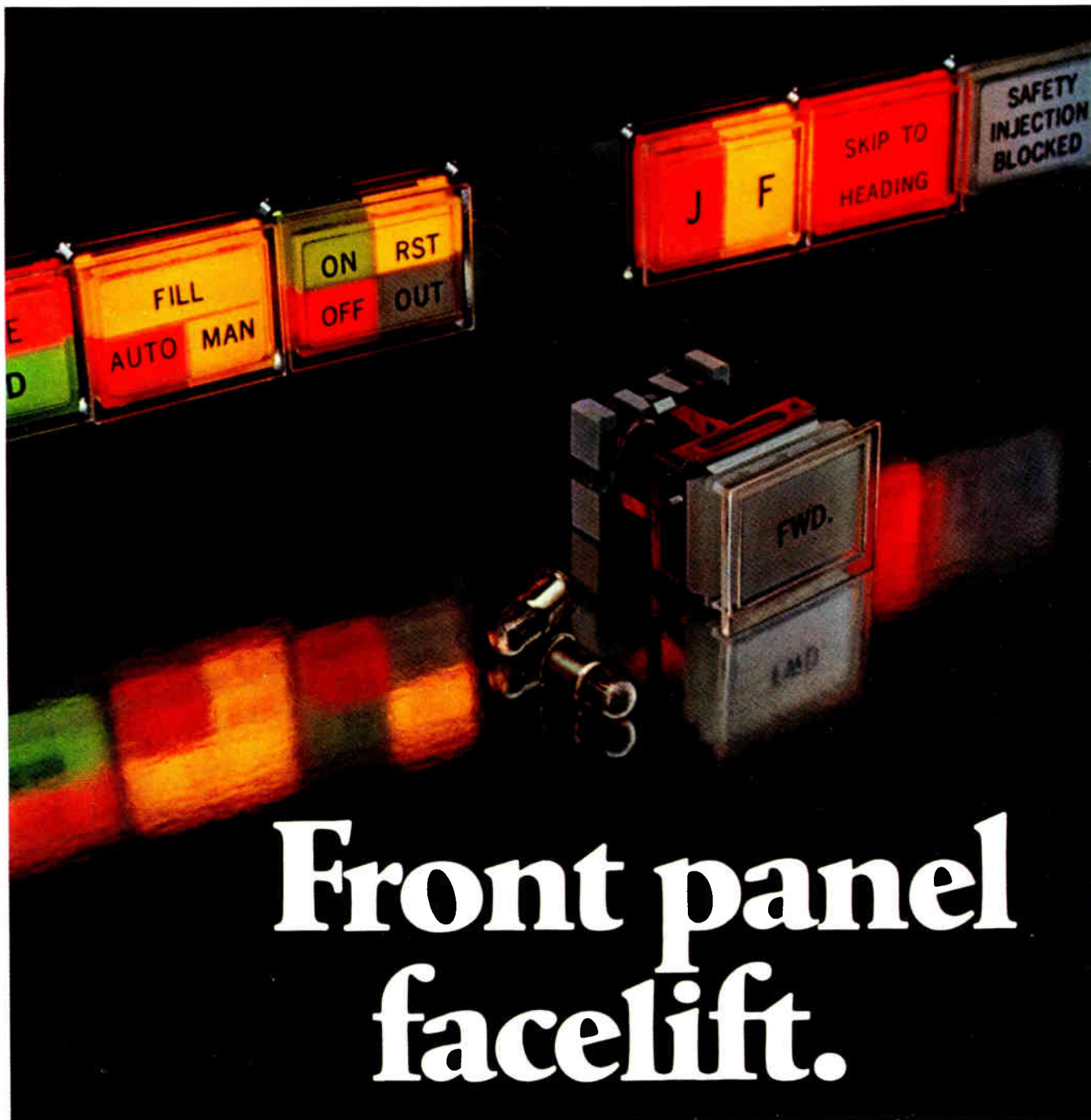

# Front panel facelift.

When one of our Series 2 lighted pushbuttons needs a change of color filters, legends, or lamps—the change is simple. Because the switch stays mounted in the panel. Just one straight, gentle pull and the change is ready to be made.

Accessible . . . as well as available. The Series 2 can be had with a wide variety of display screens, color filters and switch modules.

So, more than likely, our switch is perfect for the

application you're now working on. Even if it's military/aerospace. Because we have Series 2 versions that meet the requirements of MIL-S-22885.

For more information, call your MICRO SWITCH Branch Office or Authorized Distributor (Yellow Pages under "Switches, Electric"). Or write for Catalog 51.

**MICRO SWITCH**

FREERPORT, ILLINOIS 61032  
A DIVISION OF HONEYWELL

MICRO SWITCH products are manufactured, sold and serviced worldwide through Honeywell International.

Circle 900 on reader service card



# The Incredible Dodecameter...



**Adds twelve programmable measurement functions to your system.** You start with the basic dc unit and add options to fit your systems needs. You can use the new HP 3450A Multi-Function Meter for dc, ac and ohms measurements — ratio, limit tests, and ratio limit tests. The 3450A has autoranging on all functions — and all functions are fully programmable. This broad capability is contained in a 3½" high rack mount — ideal for systems.

The basic dc unit is integrating and fully guarded for excellent noise immunity. You can make 15 readings per second with a sensitivity of 1  $\mu$ V. Add the AC Voltage and AC Ratio Option to your basic dc unit and you can make true RMS ac measure-

ments from 45 Hz to 1 MHz—without the errors due to harmonic distortion.

Add the Ohms and Ohms Ratio Option for ohms measurements with 1 m $\Omega$  sensitivity. The four-wire ohms input provides sense and signal leads to reduce errors due to lead resistance.

Put in the Limit Test Option and you can preset two four-digit limits. Your system then can make simple comparisons without using a computer or digital comparator. Use the Digital Output Option with the Limit Test Option for nine columns of information including HI, GO, LO limit test decisions.

The Rear Input Terminal Option provides a set of guarded rear input terminals and a FRONT/REAR INPUT selector switch on the front panel.

If your requirements change, any of the options are field-installable (except rear input terminals). Call your nearest HP field engineer to learn how easily "the incredible dodecameter" adapts to your measurement system. For full specifications, write to Hewlett-Packard, Palo Alto, California 94304. Europe: 1217 Meyrin-Geneva, Switzerland.

Prices: Basic 3450A, \$3300; AC Option 001, \$1250; Ohms Option 002, \$425; Limit Test Option 003, \$375; Digital Output Option 004, \$225; Remote Control Option 005, \$260; Rear Input Terminal Option 006, \$70.

099/4A

**HEWLETT  PACKARD**

**DIGITAL VOLTMETERS**

Circle 1 on reader service card



# To celebrate our 40% price reduction, we're offering this special diode kit.

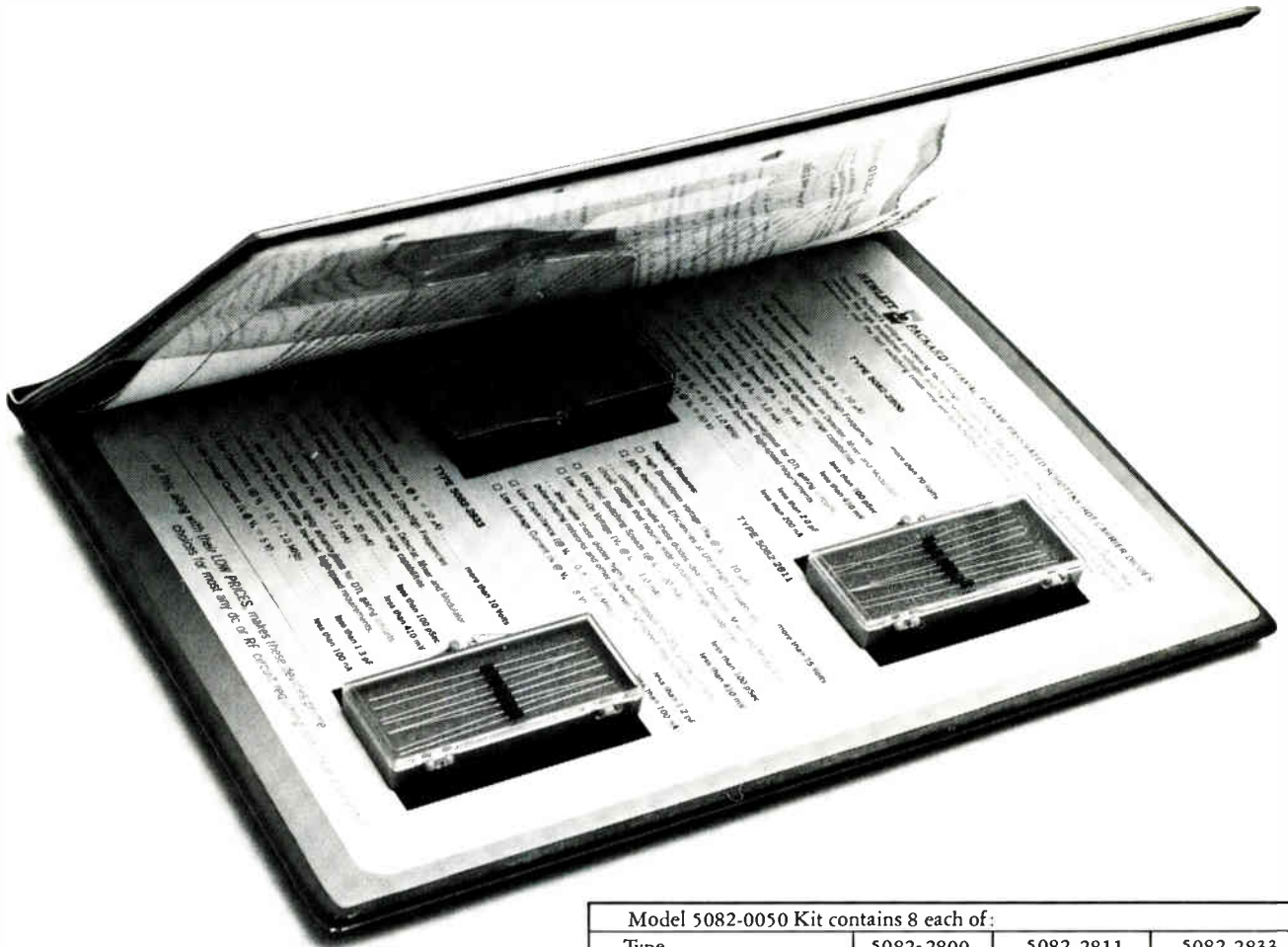

Model 5082-0050 Kit contains 8 each of:			
Type	5082-2800	5082-2811	5082-2833
Breakdown Voltage	70 v	15 v	10 v
Forward Current at 1v	15 ma	20 ma	100 ma
Capacitance	2 pf	1.2 pf	1.5 pf

If you've never designed around universal Schottky barrier diodes, here's your chance to upgrade circuit performance for pennies. HP will send you \$32 worth of these diodes for only \$8.40. That's right—only \$8.40 for 24 of the best diodes you ever got your hands on (see chart for specs). And they're packed in a handy leatherette folio along with complete data.

The big kit giveaway celebrates HP's across-the-board 35 to 40% price reductions on these great diodes—reductions that bring prices down to 35¢ each in 10K quantities, even less if you order more.

These general-purpose hot carrier diodes deliver better overall performance than P/N junction silicon or germanium diodes. Complementing the 0.4 volt turn-on is low series resistance, 100 picosecond switching speed and 1 mV/°C temperature coefficient. So now you can simplify circuit design and improve performance at the lowest possible cost.

Send for your HP diode bargain and find out for yourself.

## \$32.00 value only \$8.40!

(Offer expires May 1, 1971)

Clip this coupon and mail with check, money order, or P.O. to: Hewlett-Packard Associates, 620 Page Mill Road, Palo Alto, California 94304. Your nearby sales office can also handle this offer.

Name \_\_\_\_\_ Application \_\_\_\_\_

Company \_\_\_\_\_

City \_\_\_\_\_ State \_\_\_\_\_ Zip \_\_\_\_\_

HEWLETT  PACKARD  
COMPONENTS

01102



## 19 Electronics Review

---

INTEGRATED ELECTRONICS: Mostek puts calculator on single chip, 19  
INTEGRATED ELECTRONICS: AMS sticks to two-chip design, TI to three, 20  
SATELLITES: TI has leg up on surveillance system work for aerosat, 20  
COMMUNICATIONS: Pushbutton-phone credit verification pushed by AT&T, 21  
ELECTRONICS INDEX OF ACTIVITY, 21  
MILITARY ELECTRONICS: Infrared termed best for "electronic battlefield," 22  
MANUFACTURING: Electron-beam IC masker is ready for market, 22  
MANUFACTURING: Computerized diagnostic system can be used by production workers, 23  
DISPLAYS: Inexpensive graphic printout for data-compressed photos, 23  
MEMORIES: Silicon-on-sapphire to debut in ROM, 24  
COMPONENTS: Capacitor makers complain about Japanese practices, 26  
FOR THE RECORD, 28

## 34 Articles

---

ADVANCED TECHNOLOGY: Ferroelectric display's big bonus: selective erase/write capability, 34  
CIRCUIT DESIGN: The uncommon versatility of the common current generator, 40  
PACKAGING & PRODUCTION: ICs on film strip lend themselves to automated handling, 44  
CIRCUIT DESIGN: Designer's casebook, 50  
MEDICAL ELECTRONICS: Electronic gear in hospitals is often defective and sometimes dangerous, 54  
OPINION: A critique of MOS/LSI testers, 62

## 69 Probing the News

---

AEROSPACE: Aerosat: is anybody happy? 69  
COMMUNICATIONS: Data firms count their chickens, 71  
MEDICAL ELECTRONICS: Isolation transformer—friend or foe? 73  
INTERNATIONAL: Tito's growing boy: electronics, 75  
PRODUCTION: New resist baker: microwave ovens, 78

## 81 New Products

---

IN THE SPOTLIGHT: Software speeds pc board production, 81  
DATA HANDLING: C/MOS shift register has own clock, 83  
INSTRUMENTS: Pulse generator offers double-pulse output, 85; Two voltmeters complete new line, 86  
SEMICONDUCTORS: Triac handles 80 amperes, 89; Monolithic op amp, draws only 2.5 milliwatts, 91  
COMPONENTS: Light-emitting diode is 0.6 inch high, 93  
SUBASSEMBLIES: Plastic ICs help cut converter prices, 95

## 103 Electronics International

---

WEST GERMANY: Deflector steers laser beam into million-spot matrix, 103  
JAPAN: How to cut a calculator in half, 104  
BELGIUM: ITT homes in on switching, process control, 104  
FRANCE: Putting more speed in a small oscilloscope, 105  
SWEDEN: Isotopes foil forgers of secure credit card, 105  
GREAT BRITAIN: Gunn diodes work as high-speed shift register, 106

## Departments

---

Publisher's letter, 4  
Readers comment, 6  
People, 14  
Meetings, 15  
Electronics Newsletter, 17  
Washington Newsletter, 21  
New literature, 98  
International Newsletter, 101

---

Title R registered U.S. Patent Office; © copyright 1971 by McGraw-Hill Inc.  
All rights reserved, including the right to reproduce the contents of this publication in whole or in part.

EDITOR-IN-CHIEF: Kemp Anderson

EXECUTIVE EDITOR: Samuel Weber

MANAGING EDITORS: Robert Henkel, News;  
Arthur Erikson, International

SENIOR EDITORS: John Johnsrud, H. Thomas  
Maguire, Stephen E. Scrupski

ASSOCIATE EDITORS: William Bucci, Richard  
Gundlach, Howard Wolff

### DEPARTMENT EDITORS

Communications & Microwave: Leon M. Magill;  
Computers: Wallace B. Riley; Consumer:  
Gerald M. Walker; Industrial Electronics:  
Alfred Rosenblatt; Instrumentation: Owen Doyle;  
Military/Aerospace: Herman Lowenhar;  
New Products: H. Thomas Maguire (Mgr.),  
William P. O'Brien; Packaging  
& Production: Stephen E. Scrupski;  
Solid State: Laurence Altman

COPY EDITORS: William S. Weiss,  
Margaret Eastman

ART: Fred Sklenar, Director  
Charles D. Ciatto, Associate Director

PRODUCTION EDITORS: Susan Hurlburt,  
Arthur C. Miller

EDITORIAL SECRETARIES: Claire Goodlin,  
Vickie Green, Terri O'Neil,  
Bernice Pawlak

### FIELD EDITORS

Boston: James Brinton (Mgr.), Gail Farrell;  
Dallas: Paul Franson (Mgr.);  
Los Angeles: Lawrence Curran (Mgr.);  
San Francisco: Stephen Wm. Fields (Mgr.),  
Marilyn Howey; Washington: Ray Connolly  
(Mgr.), Jim Hardcastle, Larry Armstrong;  
Frankfurt: John Gosch; London: Michael  
Payne; Paris: Arthur Erikson; Tokyo:  
Charles Cohen

### McGraw-Hill WORLD NEWS

Director: Walter A. Stanbury; Atlanta: Stan  
Fisher; Chicago: Mike Sheldrick; Cleveland:  
Arthur Zimmerman; Dallas: Marvin Reid;  
Detroit: James Wargo; Los Angeles: Michael  
Murphy; San Francisco: Margaret Drossel,  
Tyler Marshall; Seattle: Ray Bloomberg;  
Washington: Charles Gardner, James Canan,  
Herbert W. Cheshire, Seth Payne, Warren  
Burkett, William D. Hickman; Bonn: Robert F.  
Ingersoll; Brussels: James Smith; London:  
Marvin Petal; Milan: Jack Star; Moscow:  
Axel Krause; Paris: Robert E. Farrell, Stewart  
Toy; Tokyo: Mike Mealey

PUBLISHER: Dan McMillan

ASSISTANT TO THE PUBLISHER: Wallace C.  
Carmichael

PLANNING & DEVELOPMENT MANAGER:  
Donald Christiansen

ADVERTISING SALES MANAGER: Pierre Braudé

CIRCULATION MANAGER: George F. Werner

RESEARCH MANAGER: David Strassler

PROMOTION MANAGER: Tomlinson Howland

ADVERTISING SALES SERVICE MANAGER:  
Wallis Clarke

**O**ur man in Germany, John Gosch, recently was our man in Yugoslavia. Gosch flew from his home base, Frankfurt, to Zagreb. Then for a week he toured the electronics plants in Slovenia and Croatia, the country's two most industrialized republics. The result: an in-depth report on Yugoslavia's growth as an electronics supplier to the West (see Probing the news, p. 75).

Gosch, an electronics engineer turned writer, is used to far-ranging forays away from Frankfurt. During the 1967 Six-Day War, he was sent to Tel Aviv by *Electronics* to get the details about all the Russian electronic gear that the Israelis had captured from the Egyptians. Closer to home in miles, but not in time needed to get clearance for the trip, East Germany has been often visited by Gosch in his search for what's new in electronics. He has also helped cover developments in the field in Switzerland, France and England in his nearly 6 years on the job for *Electronics* in Europe.

Remembering the secretiveness of some East Bloc officials, Gosch was agreeably surprised by the Yugoslavians. "At first glance," he says, "Yugoslavia doesn't strike you as a Communist country at all. Although relatively poor by Western standards; the country has none of that grimness that's typical elsewhere in the East. There are no queues in front of butcher shops, no streamers and banners on public buildings that tell of the glories and accomplishments of Socialism. It's only when you engage in conversations that you become aware of

Yugoslavia's different social and political order. But unlike their counterparts in other Communist countries, Yugoslav industry managers will not hit you over the head with anti-Capitalist diatribe.

"Western influences, good and bad, are very much in evidence in Yugoslavia's cities: rock music emanating from bars and night clubs, the latest fashions—the maxi look is "in"—and even a dab of anti-establishment rebellion on the part of younger people.

"Company officials were quite candid, even about their finances, business troubles, or marketing policies. Such frankness is in sharp contrast to other Communist countries, where you can't help feeling that industry managers and planners are out to put one over on you. The one recurring question asked by plant managers was: 'How's the electronics industry doing in western countries?' Their concern is understandable, for setbacks elsewhere will affect their industry.

"All travel in Yugoslavia—1,000 miles of it—was by car, which proved the best means for getting to all those factories, some of them hidden deep in the heavily wooded gorges of northern Yugoslavia's rugged mountains. But no matter how remote a factory, well-thumbed copies of *Electronics* magazine were very much in evidence in plant libraries."



February 1, 1971 Volume 44, Number 3  
91,137 copies of this issue printed

Published every other Monday by McGraw-Hill, Inc. Founder: James H. McGraw 1860-1948. Publication office 330 West 42nd, N.Y., N.Y. 10036; second class postage paid at New York, N.Y. and additional mailing offices. Executive, editorial, circulation and advertising addresses: Electronics, McGraw-Hill Building, 330 W. 42nd Street, New York, N.Y. 10036. Telephone (212) 971-3333. Teletype TWX N.Y. 710-581-4235. Cable address: MCGRAWHILL N.Y.

Subscriptions limited to persons with active, professional, functional responsibility in electronics technology. Publisher reserves the right to reject non-qualified requests. No subscriptions accepted without complete identification of subscriber name, title, or job function, company or organization, including product manufactured or services performed. Subscription rates: qualified subscribers in the United States and possessions and Canada, \$8.00 one year, \$12.00 two years, \$16.00 three years; all other countries \$25.00 one year. Limited quota of subscriptions available at higher-than-basic rate for persons outside of field served, as follows: U.S. and possessions and Canada, \$25.00 one year; all other countries \$50.00. Air freight service to Japan \$60.00 one year, including prepaid postage. Single copies: United States and possessions and Canada, \$1.00; all other countries, \$1.75

Officers of the McGraw-Hill Publications Company: John R. Emery, President; J. Elton Tuohis, Senior Vice President—Services; Donald B. Gridley, Group Vice President; Vice Presidents: Ralph Blackburn, Circulation; John R. Callahan, Editorial; William P. Giglio, Administration; David G. Jensen, Manufacturing; Jerome D. Luntz, Planning & Development; Joseph C. Page, Marketing; Robert M. Wilhelm, Finance. Officers of the Corporation: Shelton Fisher, President; Joseph H. Allen, Group Vice President—Publications and Business Services; John J. Cooke, Senior Vice President and Secretary; Gordon W. McKinley, Vice President and Treasurer.

Title © registered in U.S. Patent Office. © Copyright 1971 by McGraw-Hill, Inc. All rights reserved. The contents of this publication may not be reproduced either in whole or in part without the consent of copyright owner. Subscribers: The publisher, upon written request to our New York office from any subscriber, agrees to refund that part of the subscription price applying to copies not yet mailed. Please send change of address notices or complaints to Fulfillment Manager; subscription orders to Circulation Manager, *Electronics* at address below. Change of address notices should provide old as well as new address, including postal zip code number, if possible, attach address label from recent issue. Allow one month for change to become effective.

Postmaster: Please send form 3579 to Fulfillment Manager, *Electronics*, P.O. Box 430, Hightstown, N.J. 08520.



# URGENTLY NEEDED: RELIABILITY

## Accidental Electrocutions Claim 1200 Patients a Year

**Fairchild News Service**  
At least three patients in United States hospitals are accidentally electrocuted each day.

The total number of electrocutions annually is about 1200.

According to Dr. Paul W. Wight, a surgeon at Holy Spirit Memorial Hospital, Boston, who supplied the figures, most of the patients were undergoing "routine diagnostic tests," or "routine treatment."

Dr. Wight's figure on accidental electrocutions was quoted last week at a Symposium held in Boston at a session of the Medical Instrument Manufacturers Association.

search Council, Canada, said: "Internal electric shock is a subtle hazard that has often escaped recognition. As a result, many patients were attributed to a computer study

patients a year are electrocuted during hospital treatment in the U.S.A."

In a telephone interview last week, Dr. Wight said he received the figures from an actuary for a national United States insurance company's computer study.

NEWS

## The tiny flaws in medical design can kill

Errant currents from faulty electronic equipment are reported imperiling patients in certain cases

Ronald Gochman  
West Coast Editor

aware that small electrical currents applied to the human body can be fatal.

Reproduced from: Electronic News

Reproduced from: Electronic Design

# FROM SPRAGUE: RELIABLE CAPACITORS

Sprague Electric has long been aware of the crucial importance of reliability . . . particularly in medical electronics, where failure can be fatal. The capacitors shown on this page are designed for utmost reliability . . . not merely to meet existing standards, but to be as failure-free as the present state of the art will permit.

### HYREL® Capacitors



Manufactured under climate- and dust-controlled conditions in factory space used solely for high reliability production. 100% tested for optimum quality control. Exceed military and industrial standards for shock, vibration, moisture resistance, life. Reliability documented by extensive test data. Applications now include cardiac pacers and coronary care units. One 4-year user reports no failures. Available in following types:

- Type 350D HYREL® ST Solid Tantalum  
6 to 75 WVDC, .0047 to 330  $\mu$ F
- Type 351D Non-Polar HYREL® ST Solid Tantalum  
6 to 50 WVDC, .0023 to 160  $\mu$ F
- Type 309D HYREL® GT Sintered-Anode Tantalum  
6 to 150 WVDC, 1.7 to 1200  $\mu$ F
- Type 330D HYREL® GT Sintered-Anode Tantalum  
4 to 100 WVDC, 1.7 to 1200  $\mu$ F
- Type 195P HYREL® Q Subminiature Paper  
200 to 600 WVDC, .001 to 1.0  $\mu$ F
- Type 168P HYREL® PQ Subminiature Paper  
50 WVDC, .001 to 1.0  $\mu$ F

### Type 118P Subminiature DIFILM® Metallized Capacitors



Unmatched for reliability at 125C by any other metallized paper capacitor. Higher insulation resistance than that of any other metallized paper design. Unique dielectric combines metallized paper and polyester film impregnated with special high temperature mineral wax. Hermetically sealed.

200 to 1000 WVDC, .001 to 12.0  $\mu$ F

### Heart Defibrillator Capacitors

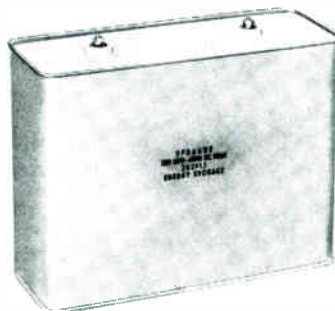

True energy-storage capacitors expressly developed for heart defibrillators. Charged in milliseconds and discharged in a fraction of a millisecond.

Three case sizes available.  
Each rated 16  $\mu$ F, 7500 WVDC.

### Type 260P METFILM® 'K' Film Capacitors



Exceptional versatility and superior electrical characteristics in small physical size. Metallized polycarbonate-film dielectric provides high insulation resistance, high capacitance stability, low dielectric absorption, low dissipation factor. Hermetically sealed.

200 to 600 WVDC, .01 to 10.0  $\mu$ F

### COMPULYTIC® Aluminum Electrolytic Capacitors



Power supply filter capacitors with low leakage currents, low ESR, long shelf life. Feature the most reliable seal yet developed for aluminum electrolytics.

Type 32D—Cylindrical with tapped terminal inserts or solder lug terminals

2.5 to 450 WVDC, 35 to 200,000  $\mu$ F

Type 34D—Tubular with axial leads

2.5 to 450 WVDC, 1 to 13,000  $\mu$ F

For technical literature on any of these capacitors, or engineering assistance without obligation, write or call Mr. John Moynihan, Sprague Electric Company, 35 Marshall Street, North Adams, Mass. 01247. Telephone (413) 664-4411

**THE BROAD-LINE PRODUCER OF ELECTRONIC PARTS**



45C-0119  
Sprague® and Ⓢ are registered trademarks of the Sprague Electric Co.

Our passive components can be obtained from a well-stocked industrial distributor right near you, for even faster delivery. Isn't it time you investigated our innovative people and products? Write Airco Speer Electronics, Bradford, Pennsylvania 16701.

**We do.**



The  
passive  
innovators  
at  
**AIRCO Speer Electronics**

## Readers comment

### The real world

To the Editor: In response to the article on "EE students' new thing: relevance" [Dec. 7, 1970, p. 101], I did not mean to imply that I find it difficult to retain my original enthusiasm on the job. I tried to establish the concept that, when I got out of school, I thought I would have the world at my feet. As is usually the case, the real world is different from the ideal. I found that my goals had changed due to the fact that I knew what one segment of engineering was like. I did not mean that I was oppressed or that I lacked authority or freedom. I merely stated that I am still going to school to attain my personal goals.

The statement made in the article that I feel that I am in no position to press for more socially relevant goals is completely wrong. In relation to the questions I was asked concerning social problems, I said that the semiconductor industry was not the industry to implement direct engineering solutions for such ecological problems as air pollution, but that computer and systems houses are in a better position to solve social problems with hardware. I did not advocate that these organizations should divert their efforts to supporting social groups, but rather should provide workable systems which could be used as tools for solving such problems as noise pollution.

Darryl Koivisto  
Signetics Corp.  
Sunnyvale, Calif.

### Standards stance

To the Editor: Wallace B. Riley's article on the problems of developing interface standards for computer peripherals [Oct. 26, 1970, p. 115] was both accurate and complete. However, aside from a few gentle hints like "glacially slow" and "very elastic," it rather glossed over the resistance from the central processor manufacturers.

Each of the remaining six dwarfs knows that a channel interface standard can hardly be achieved

by consensus and indeed can be sabotaged at the American National Standards Institute conference table. On the other hand, a device interface standard, say for tape drives, is so straightforward that Uncle Sam could even work one out unilaterally and use it for procurement. Rep. Jack Brooks (D., Tex.) and the peripherals-only manufacturers are all for it, and the Bureau of Standards was set to go last spring.

IBM already is losing business to the "plug-to-plug" boys, and could have been expected to support the device interface idea, thereby exposing its competitors to the same challenge. Instead, Snow White buried the channel interface down inside the 370/145 ("Try plugging into *that*, fellas!") and promised more bang for a buck with the newest tape drives.

Your readers probably think EDP standards are dull. Believe me, they aren't.

H.R.J. Grosch  
Director  
Center for Computer Sciences  
and Technology  
National Bureau of Standards  
Potomac, Md.

### Pollution and polymers

To the Editor: We are grateful that *Electronics* noted our efforts in studying the effects of air pollution on electronic components [Dec. 7, 1970, p. 42]. However, we are quoted as saying that SO<sub>2</sub> causes polymer film buildup on electrical contacts. We did not say this. We doubt that it is even true. Perhaps you were referring to some work by Hermance and Egan in which they showed that polymer formation on electrical contacts may be attributed to the catalytic action of platinum and palladium on hydrocarbon and other organic vapors.

We believe that the article reflects quite well the trends that we have been observing even at this stage.

W.A. Vail  
ITT Electro-Physics Labs Inc.  
Hyattsville, Md.



# Electronic Arrays will build any circuit that your little calculator desires

We have in production a set of standard MOS/LSI calculator circuits that perform the functions of add, subtract, multiply and divide. But many of our customers want more. So we modify, expand, and design new circuits that provide the functions and organization our customers want.

The EA S-100 calculator circuit set was designed with a high degree of modularity.

By adding new circuits, and special microprogramming of the Read Only Memory, many additional features are possible.

You can add in square and square root, additional memory, grand total, fixed and floating decimal point, trigono-



metric functions, character generators for graphic displays, and also a printout capability. Electronic Arrays will design the circuit functions you want.

Buy an EA S-100 set for only \$158.46 at your favorite EA distributor. Evaluate it. Then let's talk about your production needs or custom requirements.

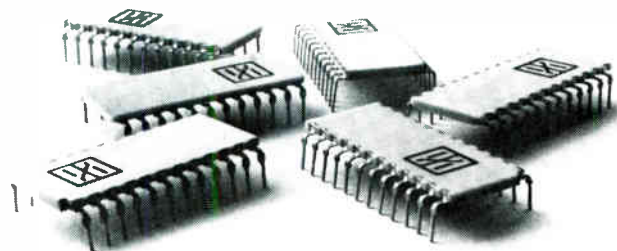

Write for a free copy of Guidelines For Custom Calculators and a data sheet on the EA S-100.

**electronic arrays, inc.** 

ELECTRONIC ARRAYS, INC., 501 Ellis Street, Mountain View, California 94040 Telephone (415) 964-4321  
TWX: 910-379-6985

Stocking Distributors: Computer Components Corp., Cramer, Intermark, K-tronics/Wesco, Schweber Electronics

The Fairchild TTL family offers the freedom-loving designer the broadest range of speed/power trade-offs and an extraordinary variety of memory, interface and logic functions, including TTL/MSI Counters for every possible application in both old and new digital systems.

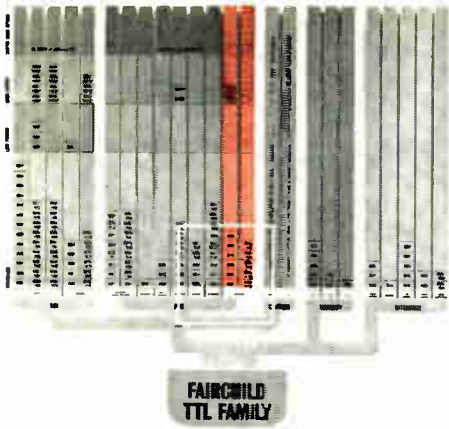

Shift Register		Full Adder		
7495 Left/Right Shift Register		9348 12 Bit Parity Generator/Checker	9356 Binary Counter	
7494 Shift Register	9377/7477 Quad Latch	9342/74182* Carry Lookahead	9350 Decade Counter	9393/7493 Binary Counter
7491 Shift Register	9375/7475 Quad Latch	9341/74181* 4 Bit Arithmetic Logic Unit	9316 Binary Counter	9392/7492 Divide by 12 Counter
8 Bit Shift Register	9334* 8 Bit Addressable Latch	9340 4 Bit Arithmetic Logic Unit	9310 Decade Counter	9390/7490 Decade Counter
8 Bit Shift Register	9314 4 Bit Latch	9324 5 Bit Comparator	9306 Up/Down Decade Counter	9366/74193 Up/Down Binary Counter
Dual 4 Bit Shift Register	9308 Dual 4 Bit Latch	9304 Dual Full Adder	9305 Variable Modulo Counter	9360/74192 Up/Down Decade Counter

REGISTERS

LATCHES

OPERATORS

COUNTERS

**MSI**



More TTL freedom you can count on: our new MSI

# SUPER COUNTER

The new Fairchild 9305 Variable Modulo Counter actually covers more counting applications than the combined capability of the 7490, 7492 and 7493. With no additional logic, it can count or divide in ten binary modes: 2, 4, 5, 6, 7, 8, 10, 12, 14 and 16. And with the simple addition of two gates, it can divide in three additional modes: 11, 13 and 15. What's more, this most versatile counter provides 50% duty cycle outputs for division by 8, 10, 12, 14 and 16.

To further the flexibility of the 9305, all of the counting modes are programmable by logic, rather than hard wiring. And, of course, an asynchronous Master Set and Reset are provided.

Best of all, you can get this high speed counter for

lower cost than any *one* of the competitive counters it replaces. So now you can design in and inventory just one device instead of several, saving the kind of time and money that adds up to real design freedom. It's Fairchild's counter revolution.

A TTL/MSI Counter for every application.

The 9305 is just one of a complete line of proprietary and second source counters. Want to count up? Down? In serial? Parallel? Synchronously or asynchronously? Fixed modulo or variable? You name it, our TTL family has an MSI counter you can count on.

Call your local Fairchild distributor. He has the complete line. Right over the counter.

#### FUNDAMENTAL MODULOS

THE FAIRCHILD COUNTER FAMILY		2	3	4	5	6	7	8	9	10	11	12	13	14	15	16
FIXED MODULO RIPPLE COUNTERS	9350†	•			•					•						
	9356†	•		•				•								•
	9390/7490	•			•					•						
	9392/7492	•	•				•					•				
	9393/7493	•		•					•							
SEMI-SYNCHRONOUS VARIABLE MODULO COUNTER	9305	•		•	•	•	•	•		•	○	•	○	•	○	•
SYNCHRONOUS UP COUNTERS WITH PARALLEL LOAD*	9310									•						
	9316															•
SYNCHRONOUS UP/DOWN COUNTERS WITH PARALLEL LOAD*	9306									•						
	9360/74192									•						
	9366/74193															•

†Available with center or corner power supply pins.

\*All Parallel Load Counters can be pre-set so the counter can be made to count in any modulo.

○ With 2 external gates.

**FAIRCHILD**  
SEMICONDUCTOR

# We'll give you our no strings attached.

We'll give you a Cogar System 4™. The data-entry system with a heart. And a heart-shaped cartridge of magnetic tape. That snaps into the Cogar 4 tape deck. And programs the system at the touch of a key. So that the Cogar 4 becomes an advanced replacement for your present data-conversion equipment.

In your keypunch room, the Cogar 4 is the best of both worlds. It has all the automatic features of modern key-to-tape equipment. And all the advanced operator functions of sophisticated key-processor systems. But it comes with no strings. It doesn't have to be tied to a processor because it has its own processor built into each data-entry station. So there's no risk of a single failure shutting down your whole data-entry operation.

No strings means even more. It means, when you're ready, you can move your Cogar 4 out of the keypunch room. Back to remote locations where the source documents originate.

Now, at the touch of a key, you can program Cogar 4 for interactive operator instructions. And for fill-in-the-blanks data-entry. So that it can be used by shipping clerks, purchasing agents, secretaries. People

who don't know computers. But do know what the source document is all about.

And finally, the Cogar 4 can become an on-line communications terminal. So that you can send data from a Cogar 4 in the field to a Cogar 4 at headquarters. That means instant access to data originating at remote locations.

Keypunch replacement. Remote data-collection system. Communications terminal. Plus countless other business functions you can program into the system.

That's quite a lot for one desktop unit.

With no strings attached.

## **Cogar System 4: The data-entry system with a heart.**

Cogar Corp., Information Systems Div.  
Cosby Manor Road, Schuylar, N.Y. 13502  
(315) 797-5750

Please send me additional information on the Cogar 4 data-entry system.

Name \_\_\_\_\_

Title \_\_\_\_\_

Company \_\_\_\_\_

Address \_\_\_\_\_

\_\_\_\_\_ Zip \_\_\_\_\_

Phone \_\_\_\_\_

- I am interested in remote data entry
- I am interested in keypunch replacement
- I am interested in key-to-tape replacement

# heart with





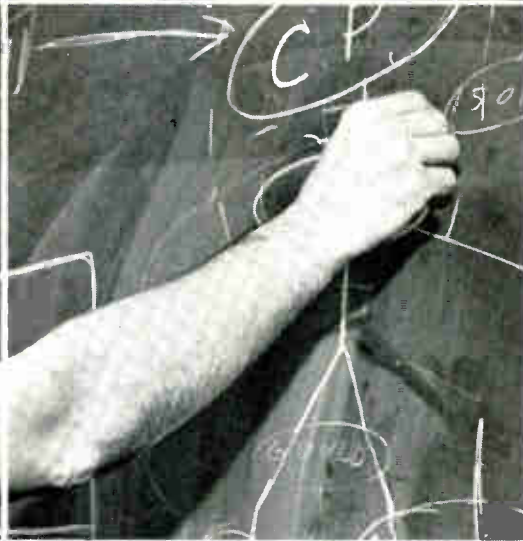
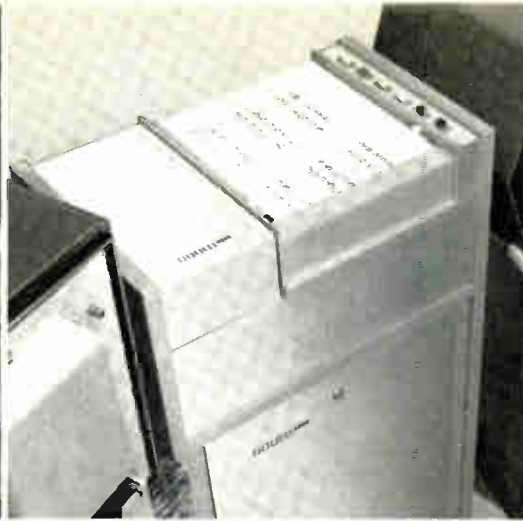

# Software systems firm slashes printout costs, compresses production schedules with Gould 4800.

Automation Technology Inc. is a specialty software systems house in Champaign, Illinois. One of their many capabilities is the design and production of the precision artwork used for making printed circuit boards. To help meet the rapidly growing demand for increasingly complex and compact circuitry, ATI uses a Gould 4800 electrostatic printer/plotter.

Art Carroll, ATI's President, provides the details:

"One of the key steps in our operation is the validation of our circuitry designs. This is done with our design automation system and requires several iterations to arrive at the optimum combination of component placement, circuit paths, interconnections and drilling patterns. Before we had the Gould 4800, we had to go to our photoplotter for these iterations. This was both costly and slow as photoplotter time runs about \$75 an hour and one iteration may take hours to produce.

"The Gould 4800 gives us both alphanumerics and graphics for pennies per page. And lets us pinpoint defective inputs and make corrections as we go.

This way, we don't have to use the photoplotter until we're ready for the production master.

"As our circuit designs grow more complex, the Gould 4800 becomes even more valuable. At the rate of 100 sq. in. per sec., it furnishes a graphic printout that superimposes the wiring patterns for several layers of a multi-layer circuit. It also provides our alphanumeric "fail" list that gives us complete details on connections not successfully completed. This permits early manual intervention.

"This sort of speed, combined with its versatility, quietness and reliability, makes the Gould 4800 ideal for our operation. Without question, it's our key piece of peripheral equipment."

All kinds of companies with all kinds of hardcopy requirements have found the Gould 4800 to be an optimum solution. This smooth, quiet electrostatic printer delivers up to 4800 lines per minute on an 8½" or 11" format. It has an optional character generator. Software and interfaces for major computers are available. And while the Gould 4800 has relatively few moving parts and little need for maintenance, there are service facilities nationwide.

**Find out what the Gould 4800 can do for you.** Give us a call. Or write: Graphics Division, Gould Inc., 3631 Perkins Avenue, Cleveland, Ohio 44114.





## People



Wiles

**H**ow do you manage an electronic components company that has grown by acquisition to include 15 divisions producing anything from rf power transistors to connectors? Q. T. Wiles' answer to that question hasn't changed substantially since he was president of Good-All Electric Manufacturing Co. of Ogallala, Neb., when the company was acquired by TRW Inc. in 1960.

Wiles has just become group executive and vice president and general manager of TRW Electronic Components divisions in the TRW Electronics group. Essentially he still believes that managing a diversified organization means he has to motivate and direct people toward profits but let them make their own decisions. In this manner, the brighter young people will move up, Wiles believes, in what he likes to call his "cream to the top" philosophy.

**Within weeks** after taking over the former Pacific Semiconductors Inc. (now TRW Semiconductors) in 1964, Wiles had changed the organization so that individual "plant managers" or product line managers were running their own operations with individual profit and loss statements.

The approach worked. The former PSI went from what Wiles terms an unsatisfactory profit margin to good profitability within six months. And it's still working. TRW's Electronic Components divisions were profitable in every reporting period in 1970—no mean feat. "In fact," says Wiles, "we came very near meeting the profit forecast we made in November

1969, on quite a bit less sales. [But] we don't usually miss forecasts, and from that standpoint our performance wasn't satisfactory to us."

**Wiles can't spend** as much time in direct communication with his plant managers—there could be as many as 10 of them in a given division—as he'd like to. But he still wants them to learn good management techniques, both through the discipline of a profit and loss statement and in making sure that they continue to "go to school" during business meetings.

"We've also had the patience to wait for company growth and business opportunities, and that's not easy to do. We've learned a system that filters out the too eager guy who wants to pursue an opportunity when he thinks he can get 2% of the world market for a certain product."

**It's rare that** a man is able to parlay a profitable and enjoyable sideline into a full-time job. But that's what happened to Donald T. Valentine. For the past 11 years, Valentine has been affiliated with the semiconductor industry in sales or marketing jobs—most recently as marketing director at National Semiconductor, Santa Clara, Calif. Recently, however, Valentine was named president of Capital Management Services Inc., a firm that will be heavily involved in venture capital arrangements. And as almost anyone who has dealt with Valentine over the past 11 years knows, he is intensely interested in capital investments.

"Being in the semiconductor business," says Valentine, "I've been in a position to see many startups and I've been able to get in early with some money." He says that his involvement "helped both me and National. By picking the winners, I not only made some money for myself, but I also picked companies that would be good customers for National."

Valentine also has been involved in nonelectronics-related investments. In 1964, he and Tom Bay,

an ex-general manager of Fairchild Semiconductor and now president of Tenet Inc., joined two professional restaurant men and started L'Auberge, one of the more successful and posh Peninsula eating establishments. Bay and Valentine have since sold their interests. Other Valentine ventures include undeveloped recreational land, apartment houses, fruit orchards, and, of course, the stock market.

This background in finance, combined with the fact that most venture capital in the past few years



Valentine

has gone into electronics-based companies, made Valentine a prime candidate for the presidency of Capital Management Services. The firm is a wholly owned subsidiary of the Capital Group Inc., a holding company with subsidiaries in the financial services field.

With Valentine coming aboard, Capital Management's basic financial management and counseling activities will be restructured so that the company will be more involved in financing new ventures, mergers, and acquisitions.

Valentine is looking to the Capital Group's various backers to come up with some money for his use; the Capital Group is looking to Valentine to put the money in the right places. "It's a small group right now," says Valentine, "and we will work very closely together—we've all got a lot to learn."



## Meetings

### Calendar

International Solid State Circuits Conference, IEEE; Sheraton Hotel, University of Pennsylvania, Feb. 17-19.

International Convention & Exhibition, IEEE; Coliseum and New York Hilton Hotel, New York, March 22-25.

European Semiconductor Device Research Conference, IEEE, DPG (German physical society), NTG (German communications society); Munich, March 30-April 2.

Reliability Physics Symposium, IEEE; Stardust Hotel, Las Vegas, March 31-April 2.

USNC/URSI IEEE Spring Meeting, Statler Hilton Hotel, Washington, April 8-10.

National Telemetry Conference, IEEE; Washington Hilton Hotel, April 12-15.

International Magnetics Conference (Intermag), IEEE; Denver Hilton, Denver, Colo., April 13-16.

Conference & Exposition on Electronics in Medicine, Electronics/Management Center, Medical World News, Modern Hospital, Postgraduate Medicine; Sheraton-Boston Hotel and the John B. Hynes Civic Auditorium, April 13-15.

Offshore Technology Conference, IEEE, Houston, April 18-21.

International Geoscience Electronics Symposium, IEEE; Marriott Twin Bridges Motor Hotel, Washington, April 18-23.

Frequency Control Symposium, U.S. Army Electronics Command; Shelburne Hotel, Atlantic City, N.J., April 26-28.

Relay Conference, College of Engineering, Oklahoma State University Extension, National Association of Relay Manufacturers; Stillwater, Okla., April 27-28.

Southwestern IEEE Conference and Exhibition, Houston, Texas, April 25-May 2.

### Call for papers

Switching and Automata Theory Symposium, IEEE, Michigan State University, East Lansing, Mich., Oct. 13-15. May 3 is deadline for submission of abstracts to Frederick C. Hennie, Project MAC, M.I.T., 545 Technology Square, Rm 420A, Cambridge, Mass. 02139.

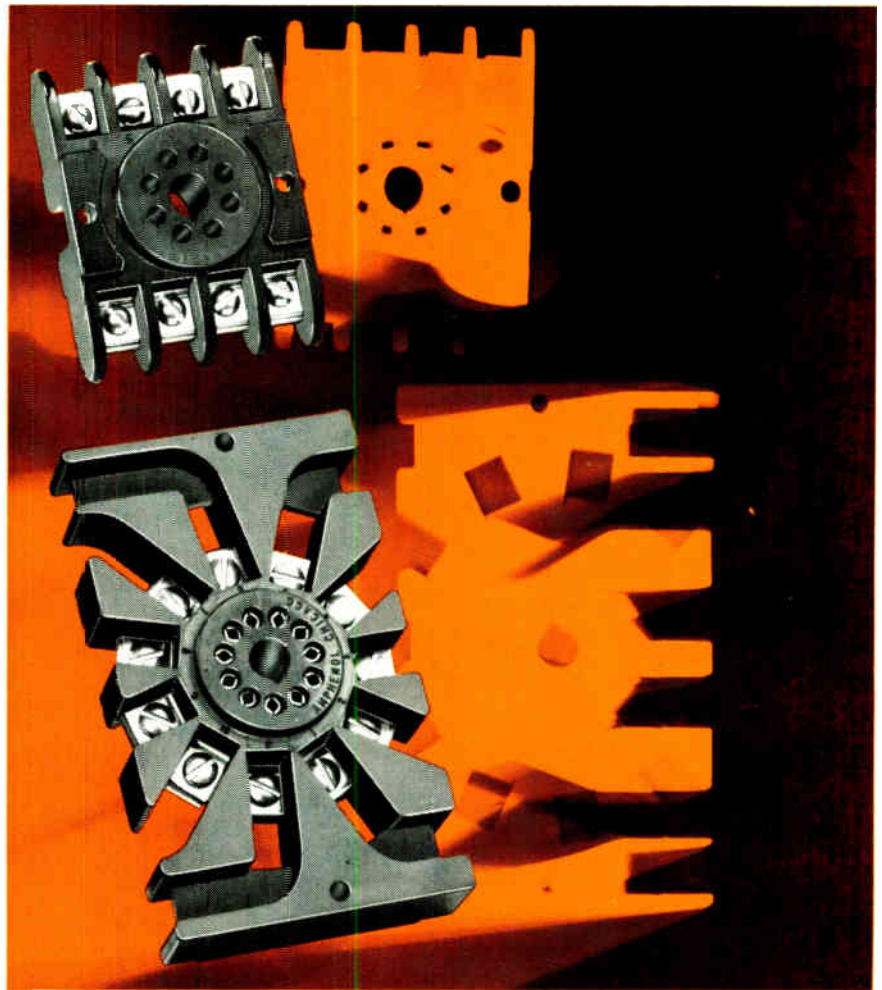

**These precision designed, multi-contact Amphenol Industrial Relay Sockets are used in**

motor controls for elevators, air conditioning, vending and dispensing machines, and in plug-in modules for photo-electric controls, as well as electronic resistance sensing amplifiers.

**The sockets, molded of Plenco 714 Melamine-Phenolic,**

are produced by Amphenol Industrial Division, The Bunker-Ramo Corporation, Chicago. 714 is one of our series of Plenco flame-retardant, arc-resistant

thermoset molding compounds formulated to provide an extra factor of product safety in electronic and electrical applications.

**Plenco 714 was selected, says this user, for its**

excellent electrical insulation and arc-resistant properties. Its ability to withstand rough handling. And its low cost.

Could anyone ask more of a molding compound? Clearly not in this application. Can we show similar user-satisfaction with Plenco products and Plenco service in other applications? You bet we can. Countless others. We hope that we can soon include yours.

**PLENCO**  
THERMOSET PLASTICS

PLASTICS ENGINEERING COMPANY  
Sheboygan, Wisconsin 53081

Through Plenco research... a wide range of ready-made or custom-formulated phenolic, melamine, epoxy and alkyd thermoset molding compounds, and industrial resins.



# Don't take any chip from anybody... for more than a "spec" of difference specify Aerovox

If other manufacturers could supply chips of "CERALAM" construction, then and only then would you be getting the ultimate in chip capacitors. The fact remains however, that only AEROVOX manufactures chip capacitors using the superior "CERALAM"® construction . . . rugged chips combining ceramic dielectric layers and noble metal electrodes, all fired into a dense, monolithic block.

Along with state-of-the-art chips to meet micro-miniature size configurations, Aerovox offers you chips in any one of the three standard cera-

mic formulations including "NPO", the most stable capacitor dielectric available. TC materials are also available on order, as are chip capacitors with leads and thin epoxy coating for protection during handling. Take advantage of our capability to put more capacity into any size package.

If you're tired of waiting for your "chips" to come in and are more interested in deliveries and not promises, and you want the best chip capacitor available today and tomorrow, call Aerovox.

**AVX** AEROVOX®

AEROVOX CORPORATION, NEW BEDFORD, MASSACHUSETTS 02741 • TEL. 617-994-9661  
PLANTS IN: NEW BEDFORD, MA., OLEAN & FRANKLINVILLE, N.Y., MYRTLE BEACH, S.C. AND HAMILTON, ONT., CANADA

---

# Electronics Newsletter

---

February 1, 1971

## Federal budget boosts opportunities

The Nixon Administration's "full employment" budget offers substantial continuing applications for electronics in defense and opportunities for beginning new ones in such peacetime markets as medicine, transportation, law enforcement, and environmental control. But, says one capital economist, it's "admirably conceived but likely to be bent out of shape" by the 92nd Congress.

Congress is expected to hack this request down to size just as it stripped \$6 billion from the current budget last year. Also, the budget request always runs larger than actual outlays, and this—coupled with the fact that a good share of the increase is budgeted for military aid to allies—is likely to raise electronics outlays only marginally, if at all. But defense technologists will have new programs, with new Navy starts in onboard and ship-to-shore communications near the top as the service seeks to expand the fleet. Sensors, communications, and weapons for antisubmarine warfare also are likely to expand.

## MCI, Lockheed to file for domestic satellite

A proposal for a 48-transponder domestic-communications satellite, with four times the capacity of Intelsat 4, will be filed about Feb. 25 with the FCC by MCI Lockheed Satellite Corp. The new company, a 50-50 joint venture of Microwave Communications of America Inc. and Lockheed Missiles & Space Co., will bow with the filing and propose ownership of its own earth stations. Micom administrative vice president Alexander Buchan is heading the effort for the special-service carrier company.

MCI Lockheed Satellite Corp. expects to disclose in mid-March results of a contract study with Stanford Research Institute and Stanford University to employ the system secondarily to build a vast nationwide public education net, using the domestic satellite with receive-only earth stations at schools to build tape libraries for computer-assisted instruction and computer-assisted management. Lockheed proposes to build two of the stationary three-axis satellites; one for 1975 launch and one for backup in orbit.

## Electronic Arrays in calculator race

With the apparent intention of taking dead aim at the low-priced end of the market, Electronic Arrays Inc. has formed a wholly owned subsidiary to manufacture electronic calculators. The name is International Calculating Machines Inc., and it shares Electronic Arrays Systems division's 50,000-square-foot facility at Woodland Hills, Calif. Al Kovalsky, director of marketing for the new subsidiary, says the firm will be a supplier to original equipment manufacturers. The first customer is Caltype Corp., a Los Angeles-based wholesaler of office machines, and the first calculator produced bears the Caltype name of Senator Mini-Calc. Its price is \$395.

## NRMEC developing chips for Victor

North American Rockwell Microelectronics Co. is developing calculator chips under contract to Victor Comptometer Corp.—but a Victor spokesman will say only that the MOS/LSI arrays being made in Anaheim, Calif., by NRMEC are for "new equipment." He won't divulge either the value of the contract or when a calculator using the chips



---

# Electronics Newsletter

---

could be introduced. He says Victor has "done some work" with Fairchild Semiconductor in the past, but adds that NRMEC is the only MOS supplier currently under contract.

NRMEC would like to broaden its customer base for calculator chips to include more than Japan's Sharp Corp. and Victor would undoubtedly like to get back into the thick of the calculator business after pioneering in MOS calculators—but failing to deliver—back in 1967 when the then General Micro-electronics Inc. couldn't turn out chips in sufficient volume.

## **Motorola to offer Schottky-clamped TTL**

Motorola's Semiconductor Products division is about to join other makers in tooling up to meet the growing demand for Schottky-clamped transistor-transistor logic. While officials at Motorola, which pioneered emitter-coupled logic, are convinced that the faster variety of TTL won't threaten ECL's domination of the super-fast computer field, they are loathe to turn their backs on a potentially lucrative market.

As a result, Motorola's first Schottky TTL component, a 64-bit memory circuit, is expected to be introduced as a product during the first quarter of 1971.

## **16-bit machine joins GE line**

General Electric will strengthen its process computer line with a low-cost, 16-bit processor aimed at machine and process control applications. Though GE merged its large computer interests with Honeywell last year, it held onto its industrial automation equipment and now is extending its reach downward into lower cost markets. The new machine, tentatively designated the MCS-2 for miniaturized control system-2, should be ready early in 1972, and the initial user probably will be a GE Virginia manufacturing plant. The MCS-2 will join the GE/PAC 30-1 and 30-2, both eight-bit machines, and the GE/PAC 4000 series of 24-bit processors in GE-supplied systems.

## **Mars program to pick up steam**

Work will begin in earnest on NASA's Viking-Mars orbiter/lander this year when the agency's fiscal 1972 money becomes available. Officials at Martin Marietta, the prime contractor, say that work has already begun on such long-lead-time items as the data recorder and the biology experiment for the \$750-million program. Sometime before summer, NASA sources add, a request for proposals will be issued for the data-processing subsystems for the two spacecraft, scheduled for launch in August or September of 1975.

Martin Marietta is advising NASA to put a second, redundant, computer aboard the Viking orbiter. If NASA follows the recommendation, the lack of power aboard the craft may force the use of dense p-channel MOS devices or a 2-mil plated-wire memory.

## **FCC probing Western Electric**

As part of a comprehensive rate investigation, the FCC is taking a hard look at AT&T's rate of return on Western Electric. The FCC Common Carrier Bureau contends that the return on Western Electric equipment—between 10% and 11%—should be kept in line with AT&T's interstate traffic, which usually returns between 7% and 8%. AT&T disagrees.

# Single-chip calculator hits the finish line

Mostek's device for Japanese company contains all the logic and is cheaper; machine could hit consumer market

**The apparent winner** in the race to produce a calculator on a chip has hit the wire. Mostek Corp. of Carrollton, Texas, is now producing such a chip for Japan's Basicom Corp., formerly Nippon Calculating Machine Corp. The 180-mil-square chip contains the logic for a four-function, 12-digit calculator—more than 2,100 transistors in 360 gates plus 160 flip-flops. Its promise of lower labor costs means a giant step toward a calculator for the consumer market.

The chip contains all the logic for the calculator. It doesn't include some passive parts dependent on the keyboard used, the clock generator, or the display drivers—though small drivers are on the chip, external transistors are used to drive the display tubes. This makes the chip more versatile, permitting it to be used with other types of displays besides hot-cathode, low-voltage tubes, and also keeps its size down, since a larger chip would be required if the output drivers had to handle the display tubes. Likewise, the clock oscillator needs only a few parts and could have been included, but having it separate simplifies tests.

Basicom's initial use of the chip will be as a direct replacement in its junior model calculator now be-

ing distributed in the U.S. by National Cash Register. In this application, the chip in its 40-pin package permits one simple circuit board to replace two complex ones with no changes in keyboard, display, case, or power supply. The machine as available at present uses a combination of discrete and IC logic; Mostek's device, according to Berry Cash, Mostek's marketing vice president, is being sold to Basicom for less than the electronic components it replaces.

Basicom is expected to introduce other calculators using the chip. It's likely that two pocket-size units will be among them. One would be 5 by 2.5 by 0.75 inches; one would use a light-emitting diode display, the other a liquid-crystal. One or

both will be in production later in the year.

Though Mostek is perhaps best known for its ion-implanted MOS products, this circuit is made with conventional, high-threshold, p-channel MOS operating from -12 and -24 volts because it's compatible with the power supply in the calculator. However, Robert H. Crawford, Mostek's engineering manager, points out that the same masks could be used with an ion-implanted process to produce a low-threshold chip more suitable for battery operation.

**Less than six months** elapsed between the time Basicom first started talking to Mostek and receipt of the first parts. Late last May, when Cash was in Japan,

Inner space. Mostek chip in Nippon calculator replaces two circuit boards full of components.

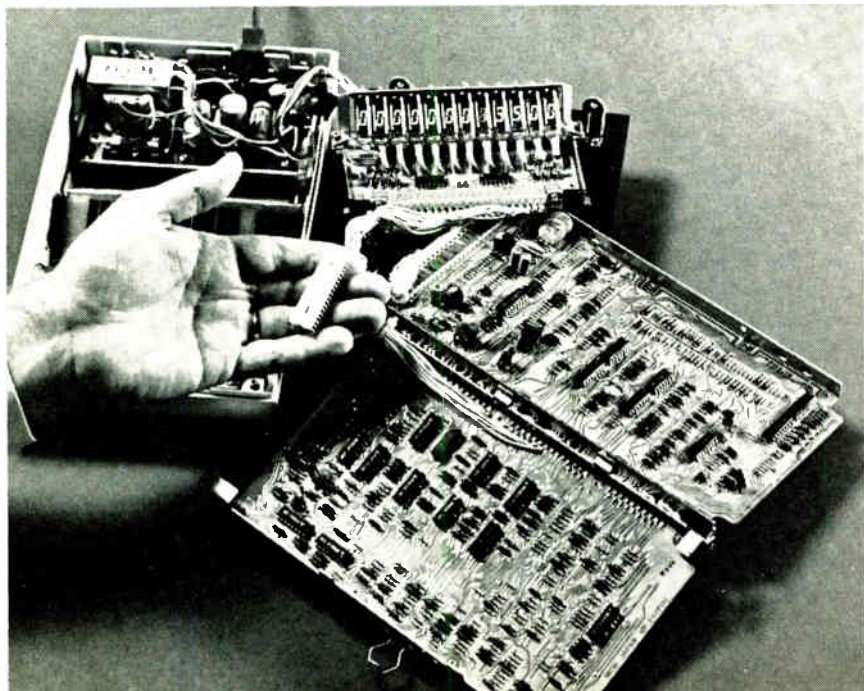

Basicom asked if Mostek could put a whole calculator on a chip. Cash says he balked at that but felt sure Mostek could put the logic on two or three chips even though the company had no previous experience in calculators. A month later the contract was signed, and Mostek was committed to delivering calculator chip prototypes by the middle of November. It decided to try for one chip, and consequently allotted six weeks for its layout. It took three months—and made meeting the rest of the schedule very difficult. An earlier report [*Electronics*, Jan. 18, p. 26] indicated that American Micro-systems Inc. would second-source the chip. Actually, AMI will second-source a Mostek random-access memory unrelated to the one-chip design.

The original calculator's discrete diode-resistor and IC logic was a very clever design, says Mostek, developed over many years and requiring nearly the minimum logic necessary for a four-function machine. In fact, Cash says, the minimized logic contributed greatly to Mostek's success in putting the calculator on a single chip.

---

### ... as AMI uses two and TI three

American Micro-systems Inc. of Santa Clara, Calif., considered the largest MOS producer, also has been looking at one-chip calculator designs. AMI has decided that, though such a machine is possible and feasible, it's not economical now. "The cost effectiveness of an MOS calculator is no longer dependent on the MOS circuits; it's the display [that counts]," says one executive. "But if a customer really wanted one, we could do it and deliver it in 20 weeks."

For example, when SCM asked AMI to make the MOS circuits for its Marchant 1 machine, the original goal was a single chip. According to Fred Jenkinson, director of engineering at the New York-based Smith-Corona-Marchant division of SCM, "we had considered a one-chip machine, but AMI showed us

that the best cost situation would be achieved with a two-chip design."

And while AMI is manufacturing the chips for the machine, SCM wanted a second source. Jenkinson says that it's difficult to get one MOS manufacturer to second-source someone else's chips, "so we went through the whole design procedure again with TI." The Dallas firm is providing the same functions—add, subtract, multiply, and divide with eight-digit display and a register that allows chain calculations—on three chips. So although the machines may look and function the same, they are different inside.

Alan E. Pound, an AMI technical staffer and one of the SCM chip designers, says that no technical breakthrough was required to get all of the electronics (except for the display driving circuitry, which most companies prefer to leave out) on the chips. "We can get three times as much logic on an equivalent size chip as we did two years ago. We're smarter in laying out the chip—they are laid out by hand, which is the best way to lay out general logic." However, AMI did employ some computer-aided design in calculating individual device geometry.

The circuit-packing capability of the AMI design is very apparent when the three TI chips are compared to the two AMI units—each of the AMI devices is smaller than any of TI's.

Says a TI spokesman regarding the comparative chip density: "SCM requested a design that was already partitioned into three chips and TI furnished it per the specifications."

---

### Satellites

---

#### Aerosat surveillance looks to Dallas

Texas Instruments appears to have a jackrabbit start in the race to provide the independent air surveillance system for the aeronautical services satellites. Since it has finally been decided that the aero-

sats will operate in L band and be managed by the Federal Aviation Administration [see p. 69], attention is turning to hardware.

A government source close to the program says that since TI is one of the few firms that has tested such a system, chances are good that it will be courted by several of the consortiums that probably will be formed to offer aeronautical satellite services packages, which will include ground stations, satellites, aircraft equipment, and independent surveillance systems. The packages will be bid in response to an FAA performance specification, which will ask for complete satellite services, the source says.

While the airlines were primarily interested in voice and digital communications, the TI approach provides location information and navigational data at little added cost.

In TI's system concept, planes entering an air traffic control area are assigned a time slot in which to relay transponder signals via the satellite to a remote ground station. The time at which the coded signal is received at the ground station is used to determine aircraft location, which is displayed on a scope.

TI says that in tests planes were located within a mile. To date, tests have been carried out using vhf frequencies, but the system is frequency independent. In fact, TI says, L-band transponders and satellites would provide greater resolution.

If such a system is put into operation, the firm says, as many as 50,000 aircraft could be controlled from a single location. Airline engineers say that a satellite surveillance system conceivably could permit all air traffic over vast global areas to be controlled from one remote location.

TI not only wants its scheme accepted by the FAA and airlines, but it's also seeking to handle the system, including the ground stations, aircraft transponders, displays, and receive-only stations. TI feels that its experience with the system, plus its background in developing L-band transponders



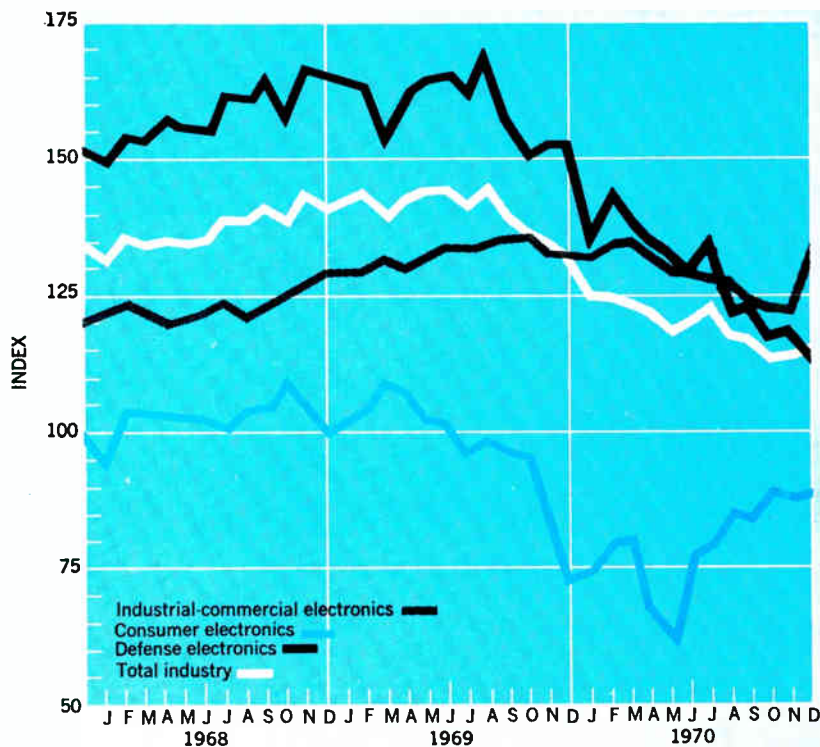

Segment of Industry	Dec. '70	Nov. '70*	Dec. '69
Consumer electronics	89.0	88.4	73.7
Defense electronics	114.4	118.3	149.8
Industrial-commercial electronics	133.8	123.0	131.9
Total industry	115.4	114.3	131.4

## Electronics Index of Activity

Feb. 1, 1971

The index of total industry output in December inched up to 115.4 from November's downward revised 114.3. The 1% increase left the index 12.2% below the December 1969 figure.

The industrial-commercial sector was the big gainer, showing its best month-to-month increase in the index's history—10.8 points, an 8.8% jump to 113.8. The rise from its year-ago total was 1.4%, the first time since April 1970 that industrial-commercial topped its year-ago figure. Consumer electronics rose just 0.6 point.

The only loser was defense—at 114.4 it was off 3.9 points from November's revised figure.

Indexes chart pace of production volume for total industry and each segment. The base period, equal to 100, is the average of 1965 monthly output for each of the three parts of the industry. Index numbers are expressed as a percentage of the base period. Data is seasonally adjusted. \* Revised.

and phased-array radar, gives it a good edge over competitors even though TI doesn't have much experience in communications.

### Communications

#### Automatic dial system accepts credit cards

After letting the potentially huge cable television market slip through its fingers, AT&T isn't going to be left out of another potential money maker: credit card verification. The communications giant has redesigned its automatic dial system to accept a dial card, with an array of holes like those on an IBM punched card, that's the same size as a standard credit card.

While there hasn't been much publicity about the new system, the orders are coming in. For instance, American Express, which tested it in Miami in 1969, has ordered 30 units to start, to be followed by 300, and then several thousand by

the year's end. AT&T expects to have more than 5,000 new automatic dialers by the end of 1971.

To verify a charge purchase, a store first uses its dial card to call the central computer. Then, a special store card is used to identify the merchant and the customer's card is inserted into the dialer to let the computer know who's making the purchase. Finally, if the purchase exceeds a certain amount, the store owner punches in the purchase amount on the pushbuttons. If the transaction is verified, a vocoder at the computer gives the merchant the go-ahead. The entire operation can take less than a minute, doing away with the paperwork of manual verification.

Two of the system features Bell feels users will find attractive are the dialer's low cost and availability. All that's required is a push-button telephone fitted with the automatic dialer. And if the user's central office isn't equipped to handle pushbuttons, Bell will provide a rotary dial phone and a pushbut-

ton pad fitted with the automatic dialer. The pad is used to transmit the data after the rotary dial phone places the call. One thing lacking: a built-in method to prevent use of a card by unauthorized persons. Bell says this is not its concern.

The new dial system differs from Bell's older version in several ways: it uses reed relays rather than wire spring fingers to read the card, its mechanism is encapsulated, and the new dial cards have one set of drive holes—the old card had two. Also, the new card is smaller: while there are still eight columns with 14 holes each, the holes are now rectangular and closely spaced. This permits two blank spaces, one for the credit card number and the other for a piece of magnetic tape—even though the new phones can't read the tape right now. Finally, the new dial system can dial a 10-digit number in less than 1 second, three times as fast as the old automatic dial system.

What's more, says Bell, the cost totals an average of \$3.50 per month



Credit where due. AT&T's new credit verification system uses pushbutton phone.

for the dial system plus the \$1.50 monthly charge for pushbutton service. It's also cheaper at the computer end. For example, if the credit card company uses an incoming wide area telecommunications service (WATS), then charges are for exact on-line time.

---

### Military electronics

---

#### Infrared seen best bet for 'electronic battlefield'

A special Senate armed services investigations subcommittee, which has been probing past outlays on the development of an "electronic battlefield" system, is expected to report in about a month that programs to improve surveillance, target acquisition, and night operations (Stano) are worth every cent of the more than \$2.68 billion they cost. Likely, too, is a rebuke for military managers who ran the programs well, if a bit deceptively.

Sensing systems are one of the few technological success stories of the Vietnam war. Under the Defense Communications Planning Group, the battlefield sensor system went into operation in less than two years at about 75% of expected cost. Now the military says electronic surveillance devices along the Ho Chi Minh Trail in Laos practically guarantee the U.S. can unilaterally police any enemy movement in the case of a standstill

cease-fire. They also believe that with the same devices, and associated air and ground munitions, only a third to half the troops formerly used will be needed to protect U.S. and South Vietnam installations in Southeast Asia. In the Army's view, the most promising area for future development of image intensification lies in infrared technology, the investigators were told. Low-light-level television and light-amplification systems appear to have reached the limits of their development.

Success of the laser-guided and electro-optical guided bombs are now leading Air Force officers to promise the Senate Armed Services Committee circular-error probabilities of a few feet.

After examining the hearing record, the investigating subcommittee decided that all the money committed had not yet been reported to Congress and asked the Air Force and Navy to show how much of their own funds had been used on the new Stano development.

- Since 1966 the U.S. Armed Forces and the super-secret DCPG have committed more than \$3 billion to developing and producing ground and airborne systems, including mines and bombs, for all-weather night fighting.

- The 200-man DCPG managed its part of the program so well it returned more than 25% of its money, \$667 million, to the Department of Defense; DCPG spent \$1.68 billion over the five-year fiscal period, and the U.S. Army spent a billion dollars more of its own funds in addition to money from DCPG.

- The armed services and defense industry managers are discussing a three- to five-year development program whose total costs cannot yet be estimated. Army and Air Force witnesses talk in terms of \$100 million yearly, the Navy has reached no firm conclusions, and DCPG witnesses forecast a considerable drop from its \$310-million level for 1971. However, part of the DCPG decline will be accounted for in service budgets as the group turns production management over to the using services.

---

### Manufacturing

---

#### Electron-beam masker ready for market

Eighteen months ago, William Hogle, then president of Hogle Industries in Sunnyvale, Calif., promised a revolution in semiconductor masking operations. His approach: substitute Westinghouse's electron-beam image projection system for contact printing in IC image exposure [*Electronics*, Aug. 4, 1969, p. 50]. Hogle has moved up to chairman of the firm he founded, and the subsidiary established to build the electron-beam-projection machine appears ready to deliver on that promise.

Radiant Energy Systems Inc., Newbury Park, Calif., is building two versions of the new masker and is right on its timetable for getting the research machine prototype up and running. Kevin Kilcoyne, Radiant Energy Systems president, says his firm could deliver a research machine by April or May if an order were placed now. The research unit will process one 2-inch wafer at a time in three to four minutes and cost about \$86,000.

Radiant Energy Systems will quote six-month delivery on the production version of the machine. Dubbed the EPS-1000, it will cost approximately \$150,000 and process a wafer in 15 seconds. Hogle Indus-

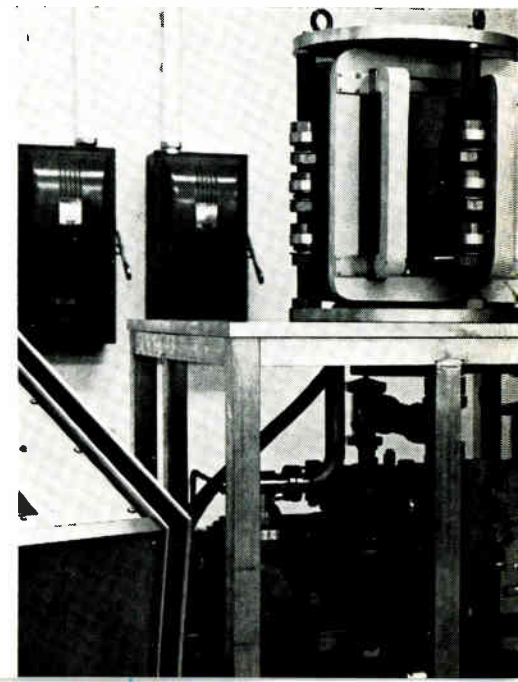



tries landed an exclusive license to manufacture and sell the machine from Westinghouse Research Laboratories, which pioneered the concept but built only rudimentary hardware to demonstrate it.

In operation, the IC pattern to be exposed on a wafer is applied to the photocathode portion of an image tube, using either conventional contact printing or electron-beam scanning. The specially coated photocathode and the wafer, which acts as the anode, are placed in a vacuum, and ultraviolet light is passed through the cathode, or mask, causing electrons to be emitted from the palladium coating. The electrons reach an energy of 10,000 electron volts, and are focused at a point on the wafer directly opposite the point from which they were emitted from the cathode. This leaves a 1:1 projection of the entire cathode or mask image on the wafer, which is coated with a resist (polymethyl methacrylate) that is sensitive only to electron bombardment. Then the resist is developed; the rest of the wafer processing steps are as in conventional systems.

But there's no need for step-and-repeat cameras and mask aligners. The electron-beam-projection ma-

---

**Loading up.** Wafer is loaded into electron-beam projector. System will use PDP-8E computer, though PDP-12 is being used to check more sophisticated programs.

chines can deliver alignment accuracy as good as 0.5 micron, with line resolutions as fine as 0.5 micron. Kilcoyne says this compares with 4 microns, the best resolution possible with optical processing. Another advantage: there's virtually no cathode (mask) wear; conventional contact masks often have to be replaced after about 10 exposures.

A Digital Equipment Corp. PDP-8E computer will be included with both the research and production machines. In the research version, the computer controls cathode and anode alignment. Alignment marks are transferred from the cathode to the anode, and a special sensing system triggers signals that are fed to the computer, which automatically aligns the two marks to within 0.5 micron.

The production machine will accommodate up to 40 different cathode (masks) and 80 wafers up to 3 inches in diameter. All operations except loading and unloading will be computer controlled.

---

### A hand for the troubleshooter

A computer-controlled system is turning production personnel into experts at diagnosing networks that don't work. Developed at the Electronics Laboratory division of Lockheed-Georgia Co. in Marietta, Ga., the system guides an operator to the bad component. It can quickly find the malfunctioning integrated circuit in a network containing as many as 50 ICs.

Lockheed is keeping details about the system to itself until patents and copyrights are obtained. Plans haven't been settled, but it's likely that the firm will turn its troubleshooter into a commercial product.

Lockheed already has put one system to work troubleshooting certain digital modules bound for the C5-A and a station-keeping radar. Chief circuit design engineer Joseph Mehaffey, who helped design the system, credits it with tripling the production rate for

these modules. Basically, the system tells an operator where to place a test probe and then interprets data from the probe. "The operator has a schematic diagram of the network under test with numbers on it," explains Mehaffey, "and he will be directed to go to a certain test point and put a probe on it, and tell the computer by carriage return on the Teletype that he has done so. Then the computer will say: OK, now let's go to so and so."

The computer then "may refer to another plug point or it may simply say that that particular test point is good," says Mehaffey. "If it's good, the operator must decide where to put his test point next. So there is an interaction. But the decisions that get the operator to the bad point are principally made by the computer."

A MAC-12 minicomputer from Lockheed controls the system. The only other parts are the teletypewriter, tape drives, interface circuits, and the troubleshooting software.

The present system works only with digital networks, but under development is a program for analog testing. Mehaffey says it's about 75% finished.

---

### Displays

---

#### Data-compression study yields graphic technique

The Mitre Corp., Bedford, Mass., has evolved a new method for displaying computer graphics. The display innovation was achieved with a CalComp plotter that converted restored digital images to a visual format after they had undergone data compression to eliminate redundant features. The Mitre research team, using an IBM system 360 model 50 to compress and restore the images, was evaluating four data-compression algorithms for Air Force use in transmitting aerial reconnaissance photos.

According to Ernest A. Duquet, an associate department head in Mitre's Communications Systems





Planning department, the plotter's big advantage is low cost. While highest resolution is possible with a digital-to-photo converter, these are expensive devices. And since most fairly large computer installations already are likely to have a CalComp machine on hand, for no added expense such facilities as a teaching hospital or a large university library could have graphic display of photos with redundant data eliminated. The technique also might be applied to low-cost transmission of data-compressed weather maps or copies of X radiographs.

One of the Mitre team members, Mrs. Janice Hartman, had worked on Bell Labs' early efforts to produce pictures with apparent gray shades from computer output devices that displayed only black and white images. She tackled the problem of obtaining an inexpensive display that could produce 16 shades of gray.

She found that a line printer would have been the least expensive approach, but would have provided only 10 shades of gray by typing and overtyping. Also, white space between letters would have produced a distinct line-column effect, only 132 characters could be plotted per line, and images looked stretched because the printed characters were taller than they were wide.

The plotter, on the other hand, is quite flexible. It's a paper-and-pen-type display that draws each character while electrical signals raise and lower the pen and move the paper. A 16-character set was developed in which each had a different gray level. That capability was accomplished by giving each character a set of radii of varying density—the more radii, the darker the character. And to avoid the appearance of lines, each character with its radii was rotated at random.

Patterns. The CalComp plotter that prints out Mitre's data-compressed photo uses radii patterns, rotated randomly, to obtain shades of gray. An enlarged sample is shown at left.

## Memories

### SOS to bow in as 5,120-diode ROM

Silicon on sapphire (SOS) appears ready to live up to its promise of high-speed circuits. Last year, James Luisi of the then Autonetics Products division of North American Rockwell Corp. said the division had redirected its SOS efforts toward a high-speed array of 5,120 diodes [*Electronics*, June 8, 1970, p. 88]. Now the unit is in customers' hands, in "developmental production quantities," Luisi says [*Electronics*, Jan. 18, p. 26].

Luisi is a member of the technical staff at North American Rockwell Microelectronics Co. (NRMEC), which inherited the development from Autonetics. NRMEC's data sheet describes the unit as a 40-by-128-diode read-only memory, but Luisi says it can be used in logic applications, too. "Its charm and power is that it's so simple to build that it offers the potential for high-volume production," Luisi asserts, "and it gives the circuit design engineer a good alternative to conventional memory and logic circuits."

The unit "operates conveniently" at 20 megahertz, Luisi says, compared to about 3 or 4 MHz for the fastest MOS read-only memory components on the market. Its speed allows typical cycle times of 50 nanoseconds with 30 ns minimum, and access times as fast as 20 ns. Luisi points out that one semiconductor manufacturer has introduced a Schottky-clamped bipolar ROM with speed comparable to that of the NRMEC SOS device but only one-fifth the storage capability. "So we have a product that's as dense as MOS parts and as fast as bipolars."

He believes it's the first truly commercially available SOS part anywhere but emphasizes that it's still in the prototype stage. NRMEC estimates an array could be custom encoded for less than \$100 for a single part, but Luisi is anxious to

find out if there's enough interest in the unit to justify volume production. "We'd have to be able to slug it out right now at a cent a bit if we committed to production," he says, but adds that the price probably will drop to a tenth of a cent within a year or two. Another company pursuing SOS technology, RCA, which showed a 50-bit SOS shift register at last March's IEEE show, hasn't a product yet.

The former Autonetics SOS work resulted in more complex circuits than the present one at NRMEC. "We've changed our circuit philosophy toward simplification," Luisi explains. The prototype unit is organized as 128 rows of diodes connected through a series resistor to a common power supply. With 40 columns of these rows, any word length from 1 to 32 bits at a time can be retrieved.

The arrays are now stored as blanks with aluminum links connecting all the diodes. For small quantities, the customer's program will be encoded by removing the aluminum links or selected diodes with a laser micromachining tool [*Electronics*, Dec. 23, 1968, p. 37], creating the desired patterns of 1 and 0. For larger production runs, NRMEC will create a custom metalization mask to encode the customer's data pattern.

The array can be customized in three ways, Luisi says. Custom row decoding will allow row selection via a code applied to the row leads. Then another set of rows may be selected and committed to the output function. This usually leaves 3,328 bits for custom data storage. The unit is in a 42-lead ceramic dual in-line package.

## Air traffic control

### Microwave landing system has a 5-year plan

With the microwave Landing Guidance System officially proposed by the Radio Technical Commission for Aeronautics as the international successor to today's Instrument Landing System [*Elec-*

# push in the two center plug-ins and...



have an oscilloscope that digitally measures: frequency, resistance, current, voltage, and temperature. You still retain all normal scope features such as delaying sweep and dual trace. The CRT display at right is just one of many measurements possible with a scope/DMM/counter combination.

The 7D13 Digital Multimeter has 3 1/2-digit readout. It measures DC voltages to 1000 V with an accuracy of  $\pm 0.1\%$ ,  $\pm 1$  count; DC current to 2 A; resistance to 2 M $\Omega$ ; and temperature from  $-55^{\circ}\text{C}$  to  $+150^{\circ}\text{C}$ .

The 7D13 input can be floated up to 1.5 kV above chassis potential. This allows considerable flexibility in measuring parameters that have a high common-mode voltage. A unique probe is supplied for measuring both voltage and temperature.

The 7D14 Digital Counter is *directly gated* to 500 MHz and has 8-digit readout. Both 50- $\Omega$  and 1-M $\Omega$  inputs are provided. Sensitivity is 100 mV P-P (35 mV RMS), about three times better than most counters. The signal connected to the vertical ampli-

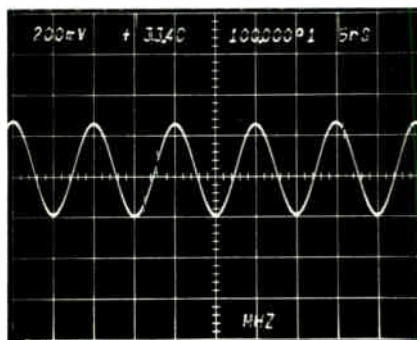

The output of an oscillator is displayed and its frequency is simultaneously correlated against changes in temperature.

fier can also be routed to the 7D14 through the oscilloscope's trigger source switches. All eight 7000-Series vertical amplifier plug-ins (differential comparator, 10- $\mu\text{V}$  differential, current amplifier, etc.) are available as signal conditioners for the counter.

The counter's Schmitt trigger circuit output can be displayed directly on the CRT. This gives a picture of the actual triggering point, thus, many signals that are difficult to trigger on with other counters are now measured with greater reliability.

The 7D14 will determine ratios from 0 to  $10^5$  and totalize from 0 to  $10^8$ . The delayed sweep from the oscilloscope can drive the counter gate. By doing this, signals are displayed on the CRT with the ones being counted intensified.

For complete information on these exciting plug-ins, contact your nearby Tektronix field engineer or write: Tektronix, Inc., P.O. Box 500, Beaverton, Oregon 97005.

Prices of instruments shown: 7504 90-MHz Oscilloscope \$2000, 7A12 Dual-Trace Amplifier \$700, 7B52 Dual Time Base \$900, 7D13 Digital Multimeter \$560, 7D14 Digital Counter \$1400. The 7D13 and 7D14 are compatible with all five 7000-Series mainframes.

U.S. Sales Prices FOB Beaverton, Oregon

**Tektronix lease and rental programs are available in the U.S.**



**TEKTRONIX®**

committed to  
technical excellence

tronics, Dec. 21, 1970, p. 32], the Federal Aviation Administration wants to launch a vigorous hardware-building program. The commission report on the LGS provisional signal format includes recommendations for worldwide follow-on work to prove the system concepts, develop ground and airborne gear of both microwave-scanning and Doppler types, and to perform operational tests of prototype equipment. An evaluation of the results would be followed by selection of the best system for manufacture and installation at airports around the world.

That program might take eight years, but the FAA hopes to cut it to five years by letting comprehensive competitive contracts that eventually will encompass all phases of the program: analysis, development, tests, and evaluation. Alexander B. Winick, chief of the FAA's Navigation Development division, believes that the aerospace and electronics industries can deliver prototypes within five years and hopes to commit \$30 million to the intensive development effort.

**His plan calls for** a one-year contract definition and concept validation phase, with five or six competitive awards. Three or four of those contractors would receive follow-on awards to demonstrate the feasibility of the proposed system by actually building several categories of microwave-scanning and Doppler gear. This phase would take from 18 months to two years. The resultant feasibility models then would be evaluated in flight tests and the best system would be selected for further development. At this point, two finalists would be chosen from among the contractors, and each would receive a contract to build preproduction prototypes of the selected equipment.

The winning designs, complete with their production specifications, then would form the basis for a full-scale procurement.

Although the FAA plan does not include specific arrangements for foreign participation, the international cooperation that characterized the three-year effort to draft

the LGS report is expected to continue, perhaps through foreign-domestic teaming. French participation in one way or another is likely since Thomson-CSF has been closely associated with the work. And Britain's Standard Telecommunication Labs originated the Doppler-scanning concept, so British participation is a virtual certainty.

---

### Components

---

#### Capacitor makers claim injury from Japan

Sprague Electric Co. of North Adams, Mass., and five other U.S. makers of aluminum electrolytic and ceramic capacitors are pressing the Tariff Commission to find injury to U.S. industry from Japanese imports dumped—or sold at less than fair value—to original equipment manufacturers. And if past Tariff Commission rulings are any indication, the six U.S. companies, which account for roughly half the nation's \$155 million electrolytic and aluminum capacitor output, stand a good chance of winning. In adjudicating the last 13 dumping decisions by the Treasury Department, the commission found injury to U.S. manufacturers in all but one of the cases.

In the capacitor action, Treasury transmitted its finding of less-than-fair-value sales on Dec. 8, giving the commission until March 8 to determine if industry had been injured. If injury is found, Treasury will assess duties against Japanese imports on a case-by-case basis, retroactive to last fall's withholding of appraisal by the Customs Bureau.

**Sprague sought** to demonstrate as much as a fivefold price difference between U.S. and Japanese capacitors with a confidential exhibit to the commission late in January. Witnesses argued that competition was based both on price and on a delivery factor, and that in 1967 and 1968 U.S. manufacturers held a clear advantage of up to 10 weeks in comparative

delivery times. But in late 1969 and 1970, Japanese manufacturers established warehouse inventories in the U.S. for certain major classes of capacitors, eliminating the competitive advantage.

Domestic manufacturers pointed out they had established offshore facilities in the late 1960s to manufacture the components for export to the home market. This represented an effort to compete with the lower priced Japanese capacitors, but even then aluminum electrolytic capacitors cost as much as three times more. The aluminum foil is usually etched and oxidized in the U.S. for quality control, the witnesses explained, and then shipped to an offshore plant for the labor-intensive assembly operations. The only reason OEM's will pay the higher U.S. prices is to maintain a domestic supply source for backup protection, witnesses claimed.

Japanese capacitor manufacturers and exporters said that major injury to U.S. manufacturers stems from overly optimistic predictions of monochrome and color TV sales made early in 1967. U.S. manufacturers geared up for the anticipated increasing demands for capacitors, and were seriously hurt by the decline in the TV market. Also, relaxed tariffs contributed to the increase in TV imports, which in turn resulted in declining capacitor demand.

**Matsushita Electric Industrial Co.** testified that even though the Treasury found dumping in only two of five companies examined, its less-than-fair-value judgment was levied on a nationwide basis. Matsushita claimed that this determination had hurt its capacitor sales, even though the company had not dumped capacitors on the U.S. market, and even though no retroactive tariffs could be assessed.

---

### For the record

---

**Inventory control.** One of the top ten Wall Street brokerage houses went on line this week with



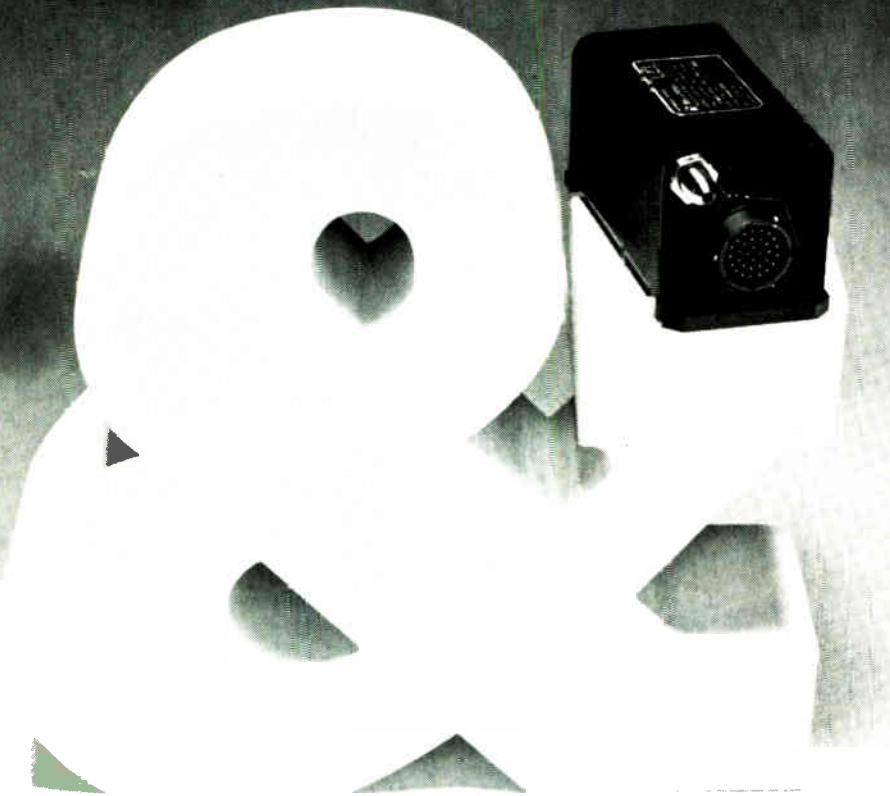

## **Bell & Howell & The 4-460 Digital Pressure Transducer.**

We've developed a unique little black box. The Bell & Howell 4-460 digital pressure transducer. It's an awfully big name for a little black box.

It measures pressure with electrical output in digital formats. Available from 10 up to 16 bits. Perhaps we should call it the little bitty black box.

But consider its accuracy at .05% or better. And a high speed readout with an update period of 160 microseconds for a 10-bit word rate. 8 milliseconds for a 16-bit word rate. Maybe we ought to name it the little better black box.

There are two models. One for industrial use—process control, secondary pressure standards, long line data transmission. Another for extreme environments—jet engine test stands, airborne instrumentation and space vehicles.

You can split the digital electronics from the sensor. Multiplex the sensor outputs and interrogate multiple channels, sequentially. We could call it the little black box box.

We'll leave it up to you. Consider the 4-460. It eliminates A-D conversion problems. Gives you rapid readout and cuts costs by multiplexing transducers. It's unique. You ought to get to know it. And you can call it anything you want. Get all the specs now. Write Bell & Howell, Instruments Division, 360 Sierra Madre Villa, Pasadena, California 91109.

**INSTRUMENTS DIVISION**



**BELL & HOWELL**

Circle 27 on reader service card

© Copyright 1973 Bell & Howell

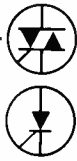

3A Sensitive Gate

## TRIAC's

for IC Drivers  
50-600V, 3mA  
all quadrant gating

6, 10, 15, 25, 30 & 40A

## TRIAC's

4A to 35A

## SCR's

200 $\mu$ A to 25mA gates

**For motor, heating,  
cooling and lighting  
controls and  
special applications**

A complete line of oxide-glass passivated devices. Triacs, 6 to 40A., 50 to 800V. 3A sensitive gate Triacs, 3mA and 10mA(I<sub>GT</sub>). SCR's, 4A, 200 $\mu$ A (I<sub>GT</sub>) to 35A, 25mA(I<sub>GT</sub>). Compatible 32V Diacs available in DO-7 package.

Triac's and SCR's interchangeable with other industry types. Write for cross-reference and data sheets.

## IMMEDIATE DELIVERY

IN GLASS-PASSIVATED CHIP  
OR IN STANDARD PACKAGES



### HUTSON INDUSTRIES

2019 W. VALLEY VIEW LANE  
DALLAS, TEXAS 75234 (214) 241-3511

Also Available From:

BODELLE COMPANY, Chicago, Ill.,  
312/468-1017 ■ INTERMARK ELECTRONICS,  
Newport Beach, Cal., 714/540-1322 ■  
THOR ELECTRONICS, Elizabeth, N.J.,  
201/354-2420

## Electronics review

a new computerized system to track the movement of securities into, through, and out of the order-handling departments. Called Vista (for viewing instantly security transactions automatically), the program is designed to eliminate the staggering and costly task of accounting for stocks.

E.F. Hutton is the first brokerage firm to use Vista under an agreement with Brokerage Transaction Services Inc., a financial district joint venture recently set up by Control Data Corp. and GTE Ultronic Systems Corp. to provide both hardware and software. Vista will be run on Hutton's IBM 360/40 computer using Sanders 720 display terminals at key locations.

**Shakeup.** RCA has reorganized its Computer Systems group under L. Edward Donegan Jr., vice president and general manager. There are five divisions within the group: Data Processing, under Joseph W. Rooney; Systems Development, under V. Orville Wright; Systems Manufacturing, under John R. Lenox; a Computer Systems staff group, under W. William Acker; and Magnetic Products, under H.H. Jones. Also included in the group and reporting to Donegan is the Memory Products division under Steven P. Marcy. Donegan, Rooney, Wright, and Acker, all of whom have been with RCA for two years or less, are from IBM; Lenox, Jones, and Marcy are old RCA hands.

**Boeing's relief.** A \$148-million Air Force production award to Boeing Co. for the controversial Short-Range Attack Missile (SRAM) is expected to help stabilize employment in the Seattle area for the company's Aerospace group. SRAM jobs in Seattle should peak at about 3,600 in September from the present 2,700, the company says. The strategic, supersonic air-to-ground missile will arm the FB-111 and late-model B-52s, and is being considered for the B-1 bombers.

**Old Green.** Dartmouth alumnus James H. Wakelin Jr., better known as consultant and adviser to Tele-

dyne Ryan Aeronautical, has been named by President Nixon to succeed former Dartmouth engineering dean Myron Tribus as Assistant Secretary of Commerce for Science and Technology.

**Scan.** Reliability—always important in space circles—is becoming even more important as NASA draws up plans for 10-year missions to Mars and beyond. As a result, NASA's Goddard Space Flight Center is urging NASA field installations to require the scanning-beam electron microscope inspection of the metalization on transistors and integrated circuits. Similar inspection standards are under consideration by the Air Force Systems Command.

The recommendation is contained in Goddard Specification S-311-P-12, which is gaining increasing acceptance even though it is not mandatory. Briefly, it requires that a number of chips from each device wafer be inspected after scribing and dicing for anomalies in metalization.

**Do it yourself.** Perkin-Elmer has designed and built its own computer processor for the data system it introduced to analyze gas chromatograph outputs. Price of the basic system—including a teletypewriter, 4,000 words of core memory, and an interface for a single chromatograph—is \$16,000. However, it can be expanded to accept data from eight chromatographs at a time at a cost of \$40,000.

**Link.** The IEEE has reached an agreement that will allow its members to receive the services and publications offered by the National Society of Professional Engineers. These benefits, available for \$15 to \$30, include the NSPE's employment referral service and retirement program. In addition, NSPE lobbies from its headquarters in Washington.

Also, three new societies have been created within the IEEE framework: the Control Systems Society, the Computer Society, and the Power Engineering Society.



# when you need high voltage switching transistors...

## we'll deliver more than promises.

We offer you faster, more efficient power switching at prices that won't make your temperature rise. And we can deliver off-the-shelf.

Our 2N5660-67 series high voltage switching transistors, operating to 2 and 5 amps, will sustain up to 400 volts with a saturation voltage of 0.4 volts maximum.

And they're fast enough to operate in 20kHz inverters. Standard packages are compact 15 watt Thermoslug TO-5's and TO-66's, or others such as TO-3, TO-59, and TO-61. Use them for more efficient and simplified circuit design in power supplies, inverters, converters, switching regulators and motor drives. Wherever you need high reliability at reasonable cost.

We think they offer the best combination of specs and prices anywhere. (400 volt types are as low as \$15.00 in 100 lot quantities.)

With promises like these, shouldn't you make us prove it?

For fast action, call Sales Engineering collect at (517) 926-0404  
Unitrode Corporation, Dept. 2B 580 Pleasant Street,  
Watertown, Mass 02172, or contact your local Unitrode distributor.

Data sheets and prices on request.

 UNITRODE

FIRST CLASS  
SPECIAL DELIVERY  
FIRST CLASS





# Monolithic Memories puts the bite on core



It took core 20 years to reach its present cost per bit level. Monolithic memories are available today that match core penny for penny and have a five times performance advantage.

You can buy a monolithic memory system of 16K by 16 bits at core prices—today, with access and cycle times less than 200 nsec. But that's only half the story. Let's take a look at some specific cost/per-

formance advantages of monolithic memories.

*Cycle time better than or equal to access time.* Core requires a read/restore cycle. Monolithic memories use storage cells where the state of the memory does not change with read-out. This Non-Destruct Readout (NDRO) cuts cycle time by a factor of 2.

*Hardware savings and field-replacement ease.* Monolithic memories require much less support electronics than core. Only one +5 volt power supply is needed. Decoding and sensing is done on the chip. And they are fully TTL/DTL compatible with no special interfacing or

multiphase clocks required. Field replacement is accomplished in minutes. Add this feature to semiconductor memory's high reliability and long life and you can cut your system downtime to near zero.

*No design time lag.* Monolithic Memories' Series 4/3 RAM planes are ready for delivery now — in volume. The standard planes come in complexity from 512 to 1024 words with up to 9 bits. If you prefer larger systems, semiconductor memory card files with up to 5 million bits can be yours in a matter of weeks.

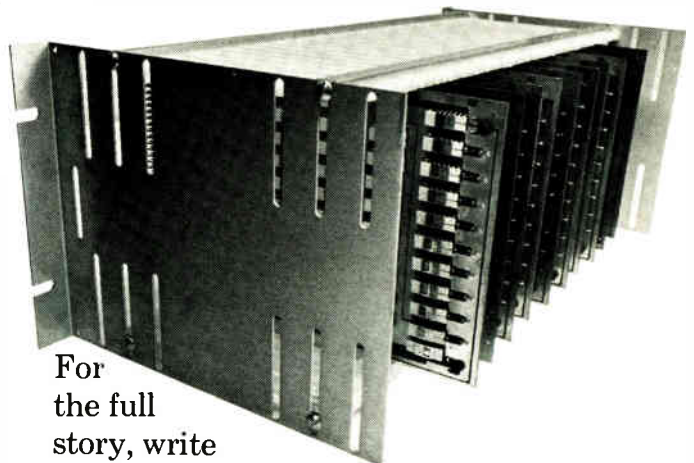
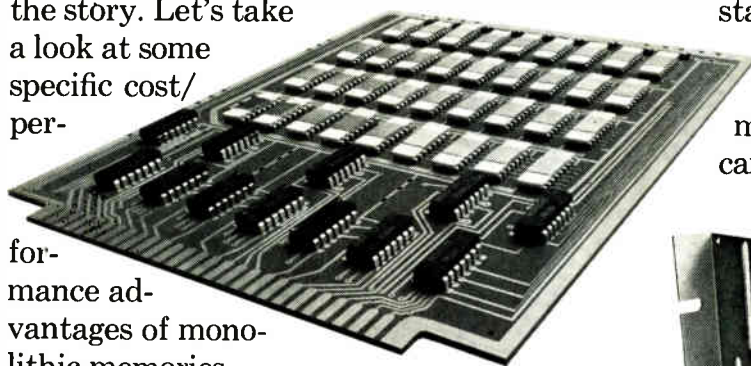

For the full story, write or call for the Series 4/3 data sheet and copy of our Monolithic Memories vs. Core Check List.

## Monolithic Memories

Monolithic Memories, Inc., 1165 E. Arques Avenue, Sunnyvale, Ca. 94086  
Telephone (408) 739-3535 TWX 910-339-9229 Telex: 34-6301

---

# Washington Newsletter

---

February 1, 1971

## Louisiana: new frontier for defense spending?

Military and Defense Department fears that spending programs would get tougher scrutiny from the powerful Senate Appropriations Committee under new chairman Allen J. Ellender (D., La.) are easing somewhat. In the past, the 80-year-old Ellender, successor to the late Richard B. Russell of Georgia, has been sharply critical of spending programs, cost overruns, and technological failures. Now, however, he's demonstrating new adroitness at the defense spending game by suggesting that Defense Secretary Laird and Navy Secretary Chafee take over the NASA Michoud Test Facility in Ellender's home state and use it as headquarters for the Navy's Undersea Long-range Missile System (ULMS)—potentially the largest project in Navy history. "He's just a country boy taking a leaf from the book of Mendel," says one Capitol Hill staffer, referring to the success of the late Rep. L. Mendel Rivers in employing his chairmanship of the House Armed Services Committee to build his South Carolina district into an economic bastion of military and defense industry installations.

## Garwin to call for ATC satellites

A report recommending the use of satellites in air traffic control over the continental U.S. will be on President Nixon's desk by the end of the month, White House sources say. Prepared by a President's Scientific Advisory Committee panel headed by Richard Garwin [*Electronics*, Aug. 31, 1970, p. 39], it comes on the heels of another report, from the Office of Telecommunications Policy, that calls for the pre-operational use of satellite aircraft surveillance after 1975 (see p. 69).

One White House source says that the Garwin panel will recommend the use of the same L-band frequencies OTP directed the FAA to use in the Pacific and Atlantic aeronautical services satellites. It is also expected to argue that satellites offer the best means of cutting down on the operational costs of the labor-intensive air traffic control system.

## FCC, OTP ready spectrum study plans

In about three weeks the Federal Communications Commission and the White House Office of Telecommunications Policy will disclose detailed plans for a study of the use of the radio spectrum. In preparation for the study, OTP has already asked the Interdepartment Radio Advisory Committee to prepare a statement on the nature and extent of the Government's use of the spectrum. At present, large blocks of frequencies are set aside for exclusive Government use, and the committee's statement could lead to provisions for non-defense agencies to share their frequencies with private users. George Mansur, deputy OTP director, says that the study is part of a long-term program that he hopes will lead to a more rational use of the frequency spectrum.

## Navy accepts S-3A computer with Mated Film memory

On-time completion of Navy acceptance tests of the first of nine Univac 1832 computers for the S-3A antisubmarine warfare aircraft's avionics represents the first success for the company's Mated Film memory concept [*Electronics*, Apr. 1, 1968, p. 31]. The 32,768-word memory units, produced by depositing vaporized metal on glass substrates, have a 750-nanosecond cycle time and are capable of 2 million operations per

---

# Washington Newsletter

---

second, with performance much improved over ferrite cores even under extreme temperatures, Univac says. The \$40-million S-3A computer development program calls for nine of the 380-pound machines to be delivered by July, together with the complete software package. The S-3A will carry two of the 1832 central processors, input/output controller and interface units, memories, and one power supply, besides allowing space for a third 32-kiloword memory.

## **FCC to reaffirm decision on EDP services, carriers**

In a final, slightly expanded decision expected shortly, the Federal Communications Commission will reaffirm its last year's tentative decision prohibiting the communications common carriers from directly entering the data processing services field. The commission basically holds that communications firms will have to maintain strict separation between their computer and communications operations if they offer data services.

## **MCI pins down Chicago-St. Louis microwave route**

The Federal Communications Commission has rejected petitions of American Telephone & Telegraph and other carriers to reexamine the FCC decision approving Microwave Communications Inc.'s plan for a point-to-point public microwave service between Chicago and St. Louis. General Telephone Co. of Illinois had said that if MCI's application to the FCC for permission to relocate some towers on its route were approved, the result would be harmful interference with one of its installations. The FCC rejected the interference claim, dropping the final barrier to MCI's completion of its construction by early spring. Commercial operation is expected to begin by June 1.

## **Lockheed to study possibility of nuclear-powered C-5**

Piling one controversy atop another, the Naval Air Systems Command is asking Lockheed-Georgia Co. "to develop viable concepts" for modifying its C-5 supertransport into "a nuclear-powered seaplane." The classified \$95,900 state-of-the-art study represents the Navy's first look at nuclear-powered aircraft since the late 1950s when it ran feasibility studies on the Saunders-Roe Princess. That project was part of a controversial overall military look at nuclear aircraft that expended upwards of half a billion dollars. However, military sources agree that the C-5 is the first aircraft large enough to accommodate a nuclear power plant. Should the feasibility be proved, massive new avionics instrumentation programs for command, control and power plant monitoring could stem from the project. The Air Force is conducting its own studies for C-5 modification to nuclear power.

## **Addenda**

The microwave Landing Guidance System, international successor to today's instrument landing system, has been assigned the 5- to 5.25-gigahertz and 15.4- to 15.7-GHz bands. The assignment, by the Office of Telecommunications Policy, came as the FAA prepared a five-year procurement plan (see p. 24). . . . Plans for a joint Department of Transportation and National Academy of Sciences research study conference on crime in transportation will be disclosed shortly. The meeting, to be held near Washington, D.C., will emphasize new engineering applications to cut cargo theft and related crime.



# Technical articles

---

## **A new contender in the display competition, page 34**

Ferpics, the snappy name bestowed on a display technology by its developers at Bell Labs, offers an important bonus along with the basic imaging and storage capabilities required by modern display devices. Based on some novel properties of a ceramic ferroelectric material, the display, which can store images indefinitely, can be electrically altered by selectively erasing and rewriting portions of the stored image.

## **An uncommonly versatile circuit, page 40**

The current generator is more than just a symbol in an illustration of Thevenin's theorem. It really does exist and in fact can be useful in a wide variety of circuit applications. Authors J.P. Keene and D.W. Hayden have applied current generators to ramp generators, regulated power supplies, and amplifiers.

## **ICs strip for automated action, page 44 (cover)**

A promising new packaging and bonding method, developed by General Electric, is said to produce increased IC packaging yield and higher reliability, while offering automatic processing for both manufacturer and user. The new production technique features lead frames etched out of a copper strip laminated to rolls of polyimide film; chips are bonded directly to the rolls and are encapsulated in plastic.

## **Prognosis for hospital electronics: abuse, misuse, failure, page 54**

Sophisticated medical electronics gear is expensive, and if it does the job of prolonging human life, it's worth the price. But a recent survey shows that too often manufacturers of such equipment don't take into account the hostile environment in which it will be expected to operate. To realize the great potential of medical electronics, hospital personnel and manufacturers will have to work together to establish appropriate standards of quality and maintenance.

## **Wanted: an MOS/LSI tester that really works, page 62**

Commercial testers leave a lot to be desired, says author Michael A. Robinton, who did his own highly critical survey of what's available today. Among his controversial findings were that many machines are just adaptations, and limited ones at that, of systems designed to handle the vastly different problems of bipolar MSI testing.

## **And in the next issue . . .**

Associative processors face first operational test in air traffic control . . .  
Double diffusion speeds up MOS arrays . . . Subminiature connectors for high-speed digital equipment . . . Ion implantation produces fast random access memory . . . New materials quell fires in consumer electronics.

# Ferroelectric display's big bonus: selective erase/write capability

Using PLZT ceramic, new system allows selected portions of an image to be electrically erased and altered without changing entire picture; nonvolatile storage lasts indefinitely and requires no power

By A. H. Meitzler and J. R. Maldonado, *Bell Laboratories, Murray Hill, N. J.*

□ There's a new runner in the display race—and this one covers a lot of ground. Satisfying the basic requirement of imaging, storing, and displaying high-quality pictures, an imaging device called the fepic (after ferroelectric picture device) has an important plus: the capability of selective electrical erasure of part or all of the picture. This capability, a result of the combined ferroelectric and photoconductive properties of the material, promises to make the fepic competitive with the other solid state devices as well as with cathode ray tubes.

With the fepic, selected portions of the picture, or the entire image, if desired, can be electrically erased by illuminating the active area with a light source. Selective erasure is accomplished with only milliwatts of power. Storage, which is nonvolatile and lasts indefinitely, requires no power at all. CRT storage, on the other hand, requires watts of power. In addition

only that part of the image that must be updated is changed—the entire image is not reconstructed.

What's more, with the fepic system's intrinsic memory and its selective erase/write property, the stored image can be broken up into individual lines or elements, so that only the upgraded elements would have to be transmitted over data lines, not the entire image. This would require only a fraction of the bandwidth usually needed.

The ferroelectric properties of the fepic material (lead-zirconate titanate, doped with lanthanum, or PLZT) are the key elements in its imaging and storage capabilities. These properties are strongly dependent on the microscopic structure of the material. The PLZT material used in the fepic is polycrystalline, with grain sizes of a few microns. Within each grain there may be as many as 10 domains, or regions in which the polarization vectors of the unit cells of the lattice

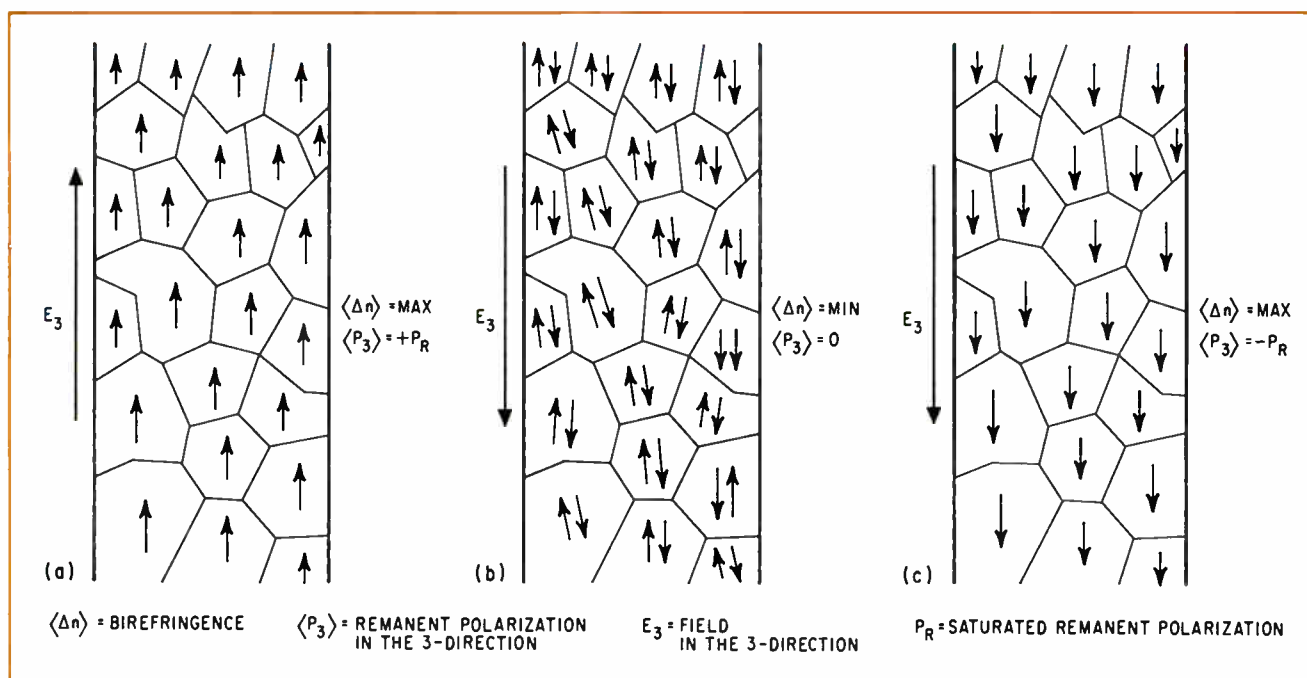

1. Light valve. In 180° domain reversal, some domains aligned in the same direction (a) are switched by reversing the field as shown in (b). Birefringence is minimal and the intensity of polarized light is changed. With fully reversed field (c) material again is saturated and is optically equivalent to (a).

are essentially pointing in the same direction.

How these domains behave (switch) under the influence of an applied poling electric field determines the material's optoelectric properties. The simplest type of switching is called 180° domain reversal. In this mode, the domains, shown in Fig. 1(a) in a state of saturated remanent polarization, are all substantially aligned in the same direction. As the field is reversed (Fig. 1(b)), some of the domains within each of the grains reverse their polarization, yielding a net polarization of zero. Finally, when the field is fully reversed (Fig. 1(c)), the material again saturates but in the opposite direction.

Although the two fully saturated states of remanent polarization are optically equivalent, the antiparallel domain configuration of condition (b) has less birefringence associated with it for normally incident-polarized light than the states of saturated polarization. In other words, by switching from state (a) to state (b), the material's optical transmission properties can be changed, and then returned to the initial condition by switching to state (c).

Though this form of switching is attractively simple, arranging the electrodes and connecting leads for an array of such devices for image or digital information storage would be a formidable problem, since each element of the array would require separate leads. To make the devices practical, another form of ferroelectric domain switching must be used.

In this approach, the PLZT ceramics are switched in a 90° domain-rotation mode, illustrated in Fig. 2. As before, a plate is poled by an electric field applied in the plane of the ceramic plate. Both major faces of the plate, covered with transparent electrodes,

are connected to a dc voltage. The resulting field is transverse to the applied poling field, and this causes a 90° rotation of the domain polarization vectors instead of the full 180° rotation. Figure 2(a) shows the initial state of the domain vectors in the plane of the plate; Fig. 2(b) shows the final state.

This configuration offers maximum change in birefringence to normally incident polarized light. However, there is a disadvantage: two sets of electrodes, instead of one, are required to obtain two fields at right angles to one another.

**The 90° domain-rotation mode** has been used in a simple version of the fepic. A thin, transparent plate of PLZT ceramic is poled, as shown in Fig. 3(a), by applying a voltage to the electrodes on its edges. The remanent polarization lies unidirectionally in the plane of the plate. In this condition (called the L-state), the plate exhibits uniform birefringence for incident polarized light that's normal to the plane of the plate. An image is stored by rotating some of the polarization vectors through 90° (called the T-state) in the areas where the plate is illuminated.

The required transverse switching field can be obtained via the arrangement shown in Fig. 3(b). The ceramic plate is coated on both sides with a photoconductive film and is sandwiched between transparent electrodes. A high-contrast transparency, illuminated by a beam of collimated incident light, is put in front of the fepic. When voltage is applied to the transparent electrodes, the high impedance of the unilluminated photoconductive regions prevents the field inside the ceramic from reaching a value high enough to produce significant domain switching.

In the illuminated regions, however, the photocon-

## The basic fepic

A fepic acts as a complex light valve that allows an image to be stored and displayed. Operation is based on birefringence, a property of many transparent materials and of the PLZT ceramics. A birefringent material has different indices of refraction for polarized light oriented in different directions. Said another way, the intensity of polarized light that's transmitted through the material at some angle relative to the symmetry axes depends on the magnitude of the birefringence at that point when that transmitted light is passed through an analyzer. Thus, if an image can be sorted as a spatial variation of the material's birefringence, it can be reproduced by shining light through the material, passing it through an analyzer, and on to a screen.

One way to obtain the necessary birefringent condition for storing an image is to provide the PLZT ceramic plate with two pairs of electrodes. One is a poling electrode pair, put on the ends of the ceramic plate. When connected to a dc voltage, it creates a uniform electric field in the material that gives the ceramic plate a uniform birefringence. A second set of electrodes is transparent and parallel to the face of the ceramic plate. Working in combination with a photosensitive layer, this set of electrodes is used to supply a second electric field, at right angles to the poling field, with its strength

capable of being varied in a spatial manner corresponding to the visual details of the image to be stored. This electric field locally changes (or modulates) the birefringence in accordance with the image.

To achieve this modulating electric field pattern, the ceramic plate is coated on both sides with a photoconductive film and then given a pair of vapor-deposited transparent electrodes. A high-contrast transparency of the picture to be stored then is placed in front of the sandwich structure and is illuminated by a light beam. The resulting light intensity pattern falls on the photoconductive film and at each point sets up a value of impedance—high intensity, low impedance; low intensity, high impedance. Since the photoconductive film is on the surface of the crystal, the electric field intensity in the ceramic directly under the photoconductor will depend on the particular impedance value at that point.

This resulting field pattern changes the previously uniform birefringent pattern to correspond in magnitude to the electric field pattern. This, in turn, corresponds to the light intensity emanating from the image on the transparency. Thus the image is reproduced as a spatial modulation of the birefringence of the ceramic plate. The picture is obtained by passing the image through an analyzer and displaying it on a screen.



## Ceramic properties

The changes produced in polarized light transmitted through a ferroelectric ceramic depend on the birefringent properties of the ceramic. An experimental arrangement to determine these properties is shown in figure (a), below. In this setup, the state of polarization of a thin ceramic plate can be changed electrically via a dc voltage supply, which charges the ceramic sample through the current limiting resistor, R. The shorting switch, S, allows all optical measurement to be made at zero applied field.

As shown in the figure, the arrangement of the electrodes is such that the applied electric field is along the  $X_3$ -axis, and thus the only nonzero component of remanent polarization is  $P_3$ . However, the thin ceramic acts optically like a slice of uniaxial crystalline material, with the optic axis along the polarization direction and with a birefringence,  $\Delta n$ , that is a function of polarization. Therefore, a normally incident polarized light wave, with an electric field vector at  $45^\circ$  to the  $X_3$ -axis, is resolved into two components along the plate's principal optic axes. If the plate has thickness,  $t$ , one of these components experiences a phase retardation relative to the other, given in absolute units of length by  $\Gamma = \Delta n \cdot t$ .

The variation of  $\Gamma$  with  $\langle P_3 \rangle / P_R$  is shown in figure (b) below. For this configuration, a plate with a thickness of about 75 microns will produce a  $\lambda/2$  change in retardation, where  $\lambda$  is the wavelength of the measuring light. The light was obtained from a helium-neon laser ( $\lambda = 633 \mu\text{m}$ ). Also shown is the variation  $\langle P_3 \rangle / P_R$

as a function of the applied field  $E_3$ , where  $P_r$  is the saturated remanent polarization. This graph shows that the ceramic has a dc switching characteristic that makes it possible to traverse the full hysteresis loop a step at a time by changing the voltage applied to the electrodes. It is also possible to traverse a path shown by the partial hysteresis loop  $A'AB'BA'$ , in which the sample is taken back and forth between points of maximum and minimum phase retardation. This is done by first applying a positive field, corresponding to point A', and then shorting the sample to obtain point A. Then a negative field is applied, corresponding to point B', and the sample is shorted to obtain point B.

The optoelectric and ferroelectric characteristics shown in this figure make this simple structure useful as a latching optical light gate or polarization switch. For example, if the ceramic plate is between crossed polarizer and analyzer, as shown in the figure of the test setup, the intensity of the light at the photomultiplier is given by

$$I_{\text{out}} = I_0 + I_1 \sin^2\left(\frac{\pi L}{\lambda}\right)$$

where  $I_0$  is the intensity of light depolarized by scattering in the ceramic and  $I_1$  is the intensity of polarized light incident on the ceramic. When the ceramic plate is in state A, minimum light arrives at the photomultiplier tube; when it is in state B, maximum light arrives at the tube.

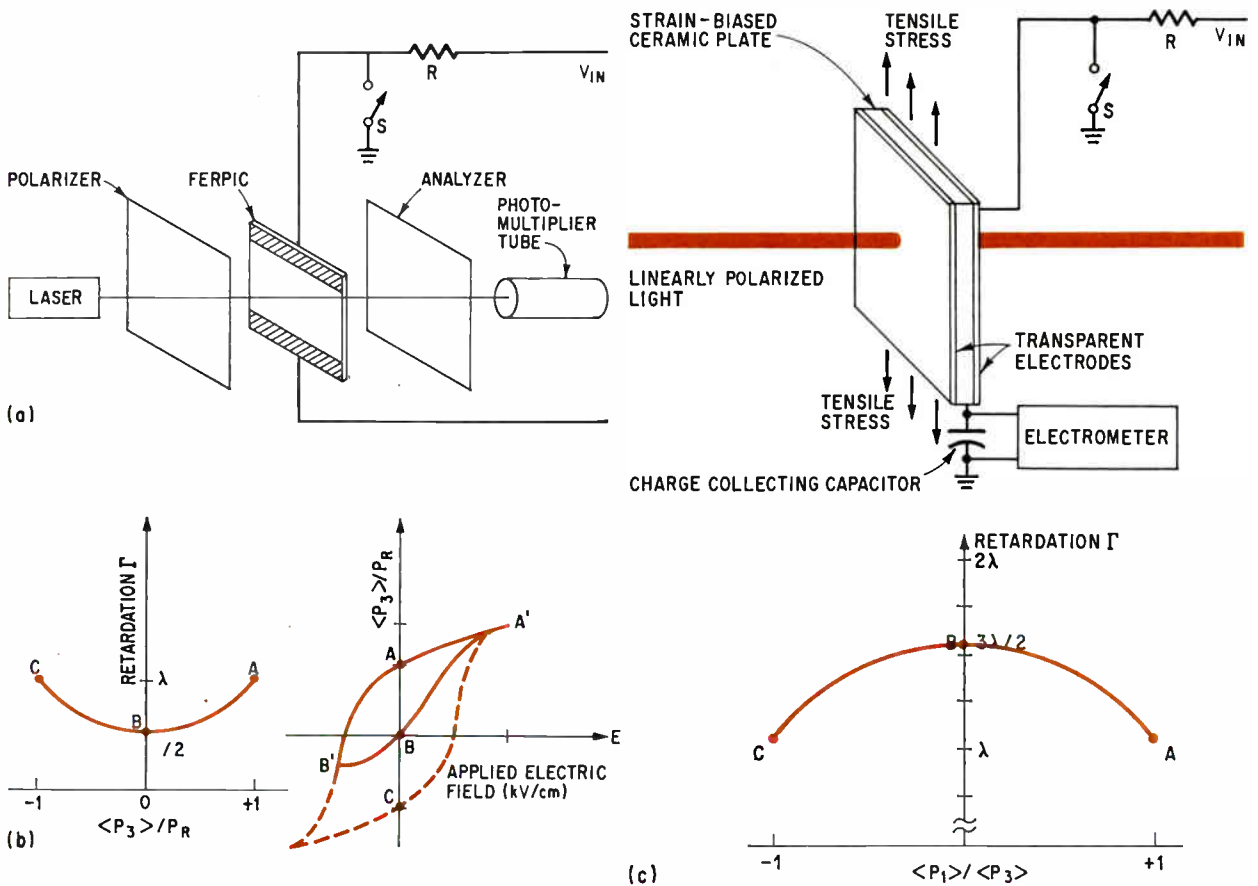
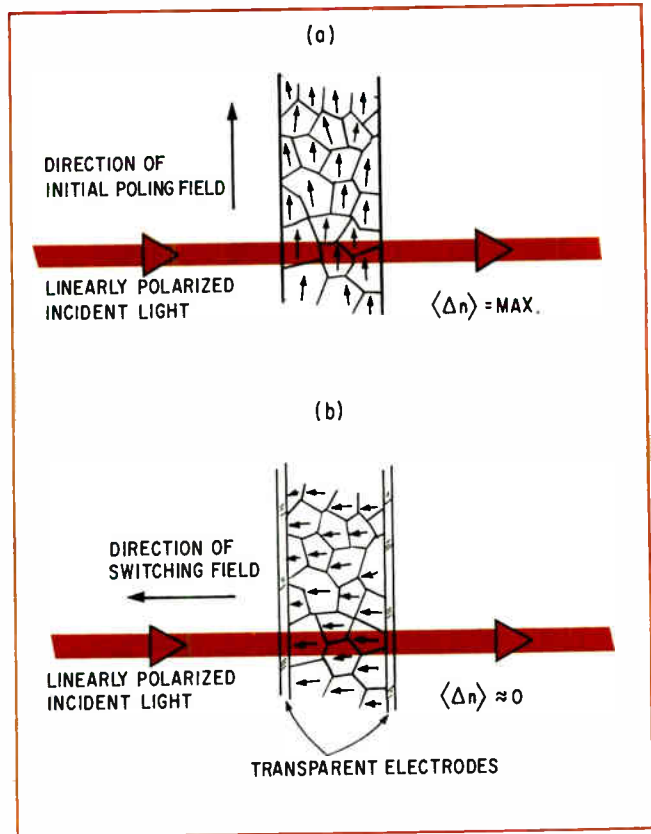
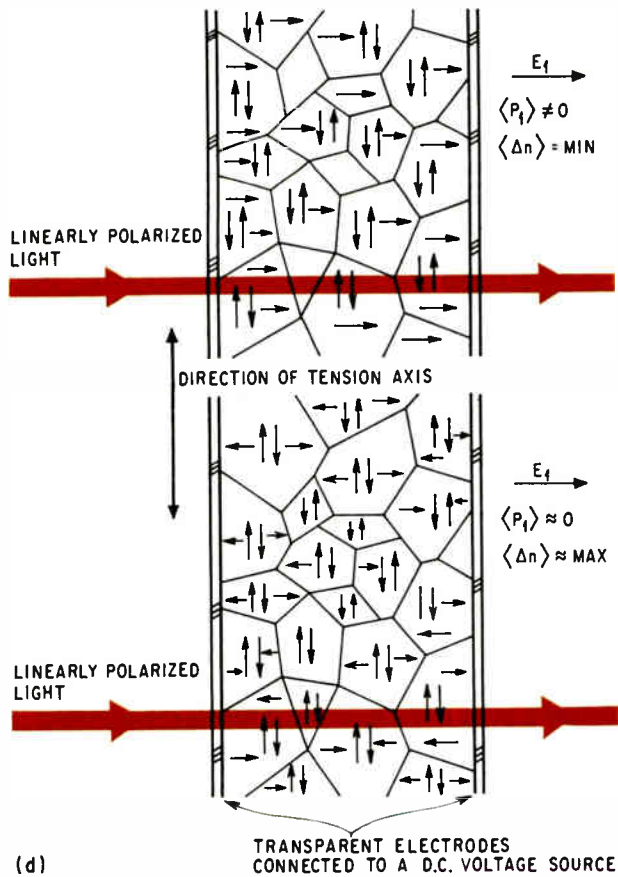

Figure (c), left, illustrates the optoelectric and ferroelectric properties of a strain-biased plate of PLZT ceramic switched under the influence of a field in the thickness direction. Although a large number of domains have polarization vectors aligned along the tension direction parallel to the  $X_3$ -axis, domains still are free to switch under an electric field  $E_1$  in the  $X_1$  direction. Experimentally, a normalized retardation vs a normalized polarization curve is also shown in the figure. One obvious difference from the unstrained case is that the normalized retardation vs normalized polarization curve is now a downward-turned parabola. The hysteresis loop is the same shape as before; it is possible to switch the ceramic to intermediate states of polarization, as well as the points A, B, and C.

Figure (d), below, is a pictorial interpretation of the behavior of the polarization vectors in the grains of a plate or strain-biased ceramic. The upper figure shows the condition of the ceramic when it is first switched to the point A, and the lower figure the condition of the ceramic when it is switched to point B. Maximum birefringence is now obtained at zero polarization because this condition has the maximum number of domain polarization vectors aligned parallel to the tension axis.

As in the case of the simpler  $180^\circ$  domain switching, the ceramic can be switched to intermediate points. This is important because it enables the ceramic to form an image storage medium with the capability of showing a gray scale.



2. Fully switched. To obtain level of domain switching necessary for practical devices,  $90^\circ$  switching is used. In the simple fepic, this requires an electrical field transverse to the poling field as shown in (b).

ductor's impedance is reduced and the field in the ferroelectric increases sufficiently to produce appreciable domain switching, so that the ceramic underlying the illuminated areas is switched to the T-state. This spatial modulation of the birefringence of the ceramic writes or stores the image. To view the stored image, the fepic is inserted between a polarizer and an analyzer (Fig. 3c), then it's illuminated with a collimated light source. The image can be erased either by removing the voltage on the transparent electrodes and again electrically poling the sample in the plane (L-state), or by thermally depoling the material.

But this simple device configuration requires two sets of electrodes to obtain the  $90^\circ$  domain-rotation mode of operation. To remove this disadvantage, a strain-biasing technique was developed. As illustrated in Fig. 4, this technique establishes a preferred direction for domain alignment within the ceramic plate. The random orientation of polarization vectors in a plate that has never been poled is shown in Fig. 4(a); Fig. 4(b) shows how the polarization vectors tend to align in antiparallel pairs along the direction of a tension axis when the plate is strained.

With strain biasing, a plate can be conditioned so that it has a nonzero remanent birefringence, even when a zero electric polarization exists at the same time. This desirable condition results from the fact that either direction along a tension axis becomes

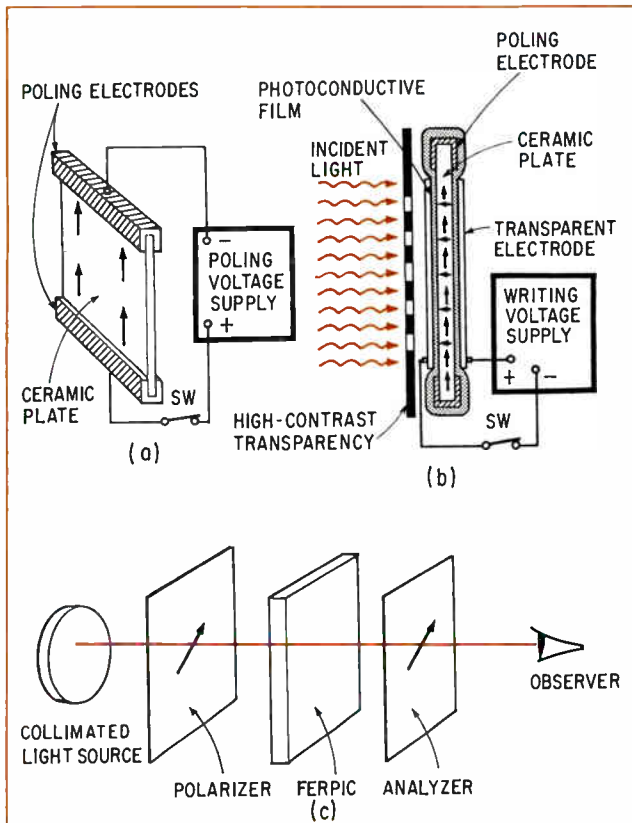

**3. Basic ferpic.** Simplest device is a dc-poled plate of PLZT (a). Storage is achieved by switching domains at points corresponding to image's high-intensity regions. To switch domains, high-contrast transparency, placed in front of the ferpic, is illuminated (b), setting up low-impedance regions in the photoconductive film. Writing voltage supply switches in these regions only. Viewing (c) is accomplished by passing transmitted light through analyzer.

### PLZT's evolution

Until a few years ago, lead zirconate, lead titanate (PZT) ceramics were largely used for electromechanical transducers. Then C.E. Land of Sandia Laboratories observed that when PZT was lapped into thin plates, these ceramics would be fairly transparent and uniaxially birefringent but with the birefringence electrically controllable. In particular, Land and his associates discovered that of several rare earth additives commonly used to dope PZT ceramics, lanthanum was particularly effective in improving optical transparency.

Following this line, G.H. Haertling, a ceramist working with Land, developed techniques of hot-pressing ceramic compositions with higher concentrations of La (more than 20 atomic percent in some cases) than had been possible heretofore. From this came a new family of ceramics, designated PLZT, with a wide range of electrical and optical properties. Although relatively new, these ceramic materials will be useful in a variety of optoelectric device applications, such as modulators, polarization switches, digital light deflectors, optical memories, and for image storage and display devices.

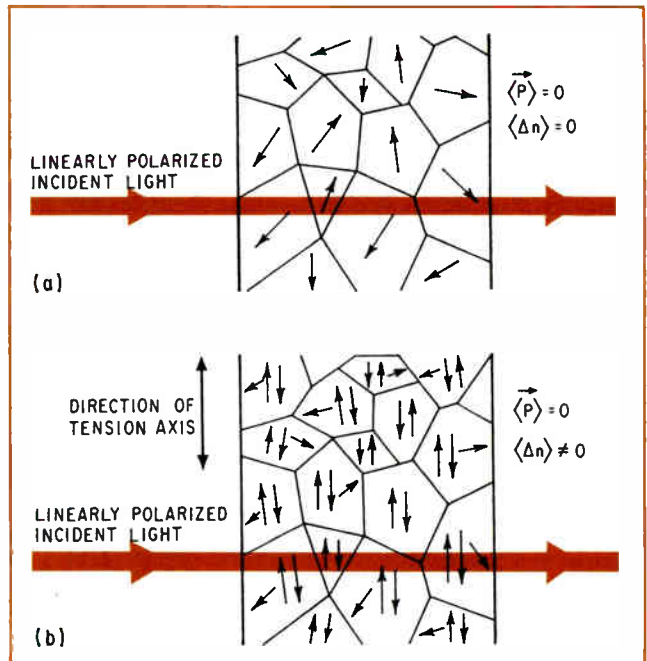

**4. Straining.** Strain-biased ceramic plate achieves 90° domain rotation without a transverse field. Randomly aligned domains (a) align in the direction of the tension axis (b).

an equally preferred direction of domain alignment. Thus, the position of the domain required for the 90° rotation mode operation is now available without requiring a second external field.

Applied to image storage and display devices, the strain-biased technique can continuously store high-quality images and alter them electronically. As in the more elementary configuration, a photoconductive layer (Fig. 5) also serves to spatially modulate the strength of the ceramic's transverse electric field.

A raster-scanned laser beam provides one method of writing in the device. During the write operation a voltage of +70 v is connected across the ceramic plate. The resistance of the photoconductive layer decreases when the beam strikes it, and the electric field in the ceramic becomes large enough to produce 90° domain switching. The polarization is switched from a direction parallel to the tension axis to one more nearly normal to the plate, causing a decrease in birefringence. Thus, where the beam strikes a region originally in a birefringent state, it is switched to a new birefringent state; the material not illuminated remains in the initial state. And when the scan is completed, the image is stored in the ceramic.

The switch then is moved to the view position, which short-circuits the device's electrodes. The device then is illuminated with polarized light and the stored image can be viewed indefinitely. To erase, the switch is placed in the erase position by applying -35 v across the ceramic material and flooding the whole active area with light. This eradicates the stored image and returns the entire ceramic plate to its original birefringent state.

Selective erasing and writing can be accomplished using the scanning light beam where only the desired



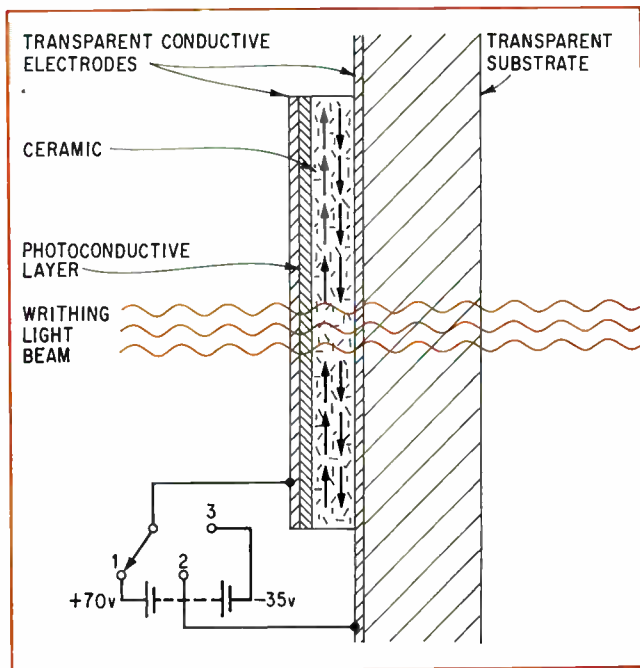

5. Write on. Raster-scanned laser beam used with a +70-V supply can be used for writing. Photoconductor, offering low resistance at bright spots, permits switching at those points.

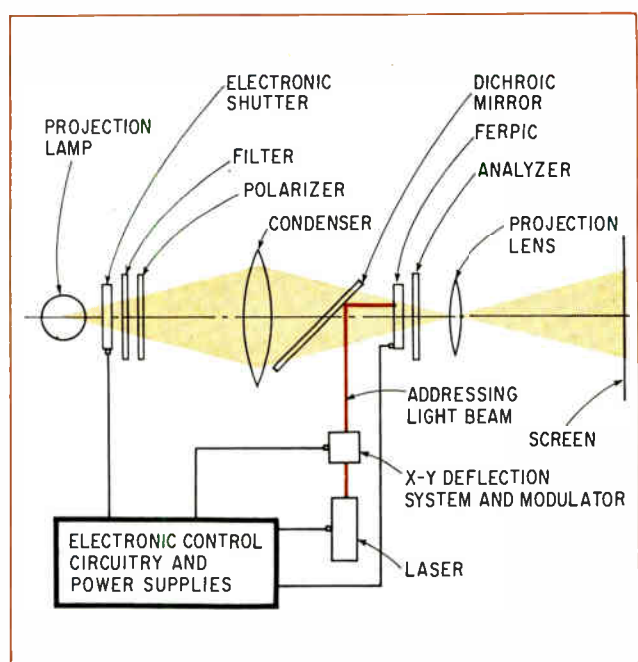

6. On display. System has reset, write, and view cycles. To write, laser scans the image, writing an element at a time. Projection lamp goes on for viewing.

point accessed by the beam is to be written or erased. The method also makes it possible to achieve gray scale variations. This is done by controlling the amount of charge passed through the ceramic switching area to obtain the required intermediate states.

Figure 6 shows the essentials of an electronically alterable projection display system using a ferpic in combination with a laser-beam-addressing module and viewing light source. In this display system, three stages make up a complete cycle: RESET, WRITE, and VIEW. A mirror that transmits at the wavelength of the light from the projection lamp, and reflects at the wavelength of the laser light used to write, allows the laser subsystem to be positioned off axis.

**During the RESET stage**, the projection light is off and the laser beam sweeps the entire ferpic so that the ceramic can be switched to an initial state. During the WRITE stage, the projection light remains off while the picture is formed on the ferpic one element at a time by successively scanning the laser beam. The electric field applied to the ceramic is modulated by the laser beam's intensity. The beam is steered by an X-Y deflection system, which can be an ultrasonic light deflection or a mechanical scanning system. Once the picture has been formed, it can be viewed by turning on the projection lamp.

In such a display system, the image is formed one picture element at a time by a scanned laser beam. The entire picture, however, is viewed or projected as a whole, using incoherent light as in a conventional projection system. With the scanning and viewing functions separated, a relatively low-power laser can be used for the scan, while a powerful, more efficient incoherent source provides the light for viewing.

For real-time animated display systems, such as those used in TV, the elements that form the picture must switch in microseconds. To assure a practical lifetime of several years, the material must perform adequately over  $10^{10}$  cycles of operation. These are severe requirements for a ferpic material, but it's felt that such ceramic materials can be developed. In fact, even with the present material, it's possible to realize projection display ferpics that could compete with tubes like the Titus and Eidophor.

Besides fast-scan TV displays, the ferpic can fit other applications with less stringent requirement. One is slow-scanned, high-resolution image storage systems requiring arbitrarily long storage times that either continuously display the information by optical projection or project it onto some form of hard-copy printout. Such a task would not require the high cycling rate or long lifetime and could be met with present materials and techniques. □

#### Bibliography

- G.H. Haertling and C.E. Land, "Hot-Pressed (Pb,Lu) (Zr,Ti)  $O_3$  Ferroelectric Ceramics for Electrooptic Applications," Jour. Amer. Ceramic Soc. (to be published).
- J.R. Maldonado and A.H. Meitzler, "Strain-Biased Ferroelectric Picture Devices," Proc. IEEE (to be published).
- A.H. Meitzler, J.R. Maldonado, and D.B. Fraser, "Image Storage and Display Devices Using Fine-Grain Ferroelectric Ceramics," Bell Syst. Tech. Journal, p. 953, July-August 1970.
- J.R. Maldonado and A.H. Meitzler, "Ferroelectric Ceramic Light Gates Operated in a Voltage-/Controlled Mode," IEEE Trans. on Electron Devices, Vol. ED-17, p. 148, February 1970.
- P.D. Thacher and C.E. Land, "Ferroelectric Electrooptic Ceramics with Reduced Scattering," IEEE Trans. on Electron Devices, Vol. ED-16, p. 515, June 1969.
- C.E. Land and P.D. Thacher, "Ferroelectric Ceramic Electrooptic Materials and Devices," Proc. IEEE, Vol. 57, p. 751, May, 1969.
- G. Marie, "Un Nouveau Dispositif de Restitution d'Images Utilisant un Effet Electrooptique: Le Tube Titus," Philips Res. Repts. 22, No. 2, p. 110, April 1967.
- E. Labin, "The Eidophor Method for Theater Television," Jour. Soc. Motion Picture and Television Eng., Vol. 54, p. 393, April 1950.

# The uncommon versatility of the common current generator

The imaginative use of the current generator's chief merit, its stability of current output, will often provide a handy solution to routine circuit design problems

By J. P. Keene and D. W. Hayden, *Westinghouse Electric Corp., Aerospace and Electronic Systems division, Baltimore, Md.*

□ Though current generators have been around for some time, it's only just becoming obvious how versatile they are and how many common circuit design problems they can help solve.

For instance, a current generator provides a simple way to linearize ramp generators. It can fill several roles in regulated power supplies and eliminates the difficulties over pulse stretchout that may occur with emitter followers and capacitive cable. It's also useful in fast-pulse amplifiers, high-gain FET amplifiers and dc level shift amplifiers, to name only the applications discussed in this article.

Moreover, the ease with which the several configurations of this simple circuit can be temperature-compensated makes it attractive whenever either a severe thermal environment or wide variation in the ambient temperature is anticipated.

A simple yet extremely linear ramp generator can be made by using a current generator to charge a capacitor. The rate of voltage change across a capacitor is:

$$\frac{dV}{dt} = \frac{i(t)}{C}$$

And since a current generator supplies a constant  $i(t)$ ,

the above derivative will be constant and the voltage waveform itself will be a linear ramp.

Figure 1 illustrates the approach. The current generator,  $Q_1$ , charges capacitor  $C$ , generating a linear ramp for as long as gate  $Q_2$  is cut off. When  $Q_2$  is switched on, the capacitor's stored charge and  $Q_1$ 's current flow to ground through  $Q_2$ . A compound output stage comprising  $Q_3$  and  $Q_4$  is used instead of a single stage to minimize loading on  $Q_1$ . That load, the base-to-emitter current of  $Q_3$ , is also made essentially independent of the voltage across the capacitor by using a second current generator,  $Q_5$ , in place of an emitter resistor for  $Q_3$ .

In applications where the ramp signal drives the deflection yoke of a cathode ray tube, the steep trailing edge of the sweep may cause undesirable transients. As a remedy, a current generator may be used to establish the discharge rate of the sweep network. In the circuit in Fig. 2, which generates a negative-going ramp with a controlled positive-going discharge,  $Q_1$  is the current generator. It draws current through  $R_1$  to charge the capacitor when gate transistor  $Q_4$  is switched on, establishing a path to ground. When  $Q_4$  is shut off,  $C$  discharges through  $R_2$ . However,  $Q_4$ 's shutdown also turns  $Q_2$  and  $Q_3$  on, and they act as the

1. **Smooth ramp.** Of the two current generators in this linear ramp generator,  $Q_1$  charges the capacitor at a constant rate, and  $Q_5$  limits load-induced nonlinearity. When gate transistor  $Q_2$  is switched on, it provides a discharge path, terminating the ramp.

2. **Controlled discharge.** A transient-suppressing, controlled discharge is featured in this negative-going ramp generator intended to drive a magnetically deflected CRT. The linear, positive-going discharge starts when gate transistor  $Q_4$  is turned on.

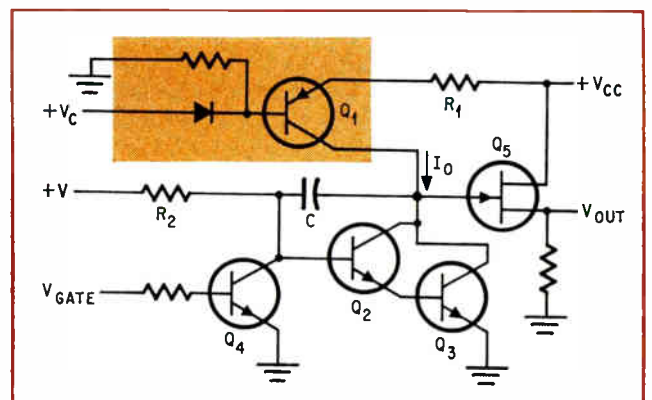
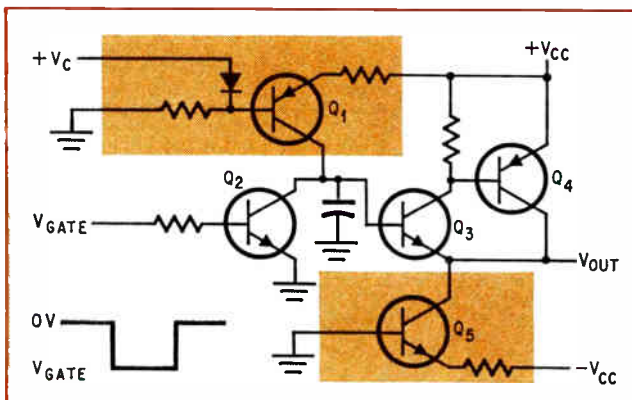





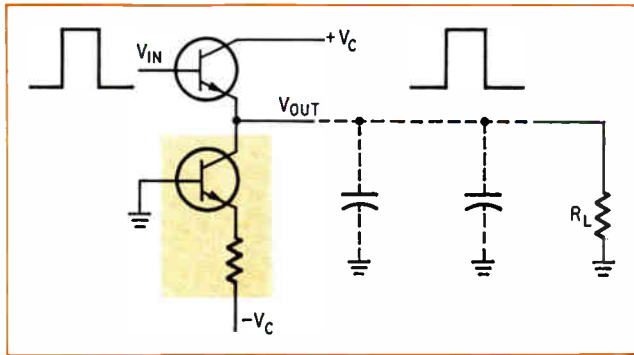

4. **Tail chopper.** If a current generator is used in place of the emitter resistor in an emitter follower used to drive a coaxial line, it eliminates the asymptotic, trailing-edge stretchout that normally occurs as the line's stored charge discharges into the load.

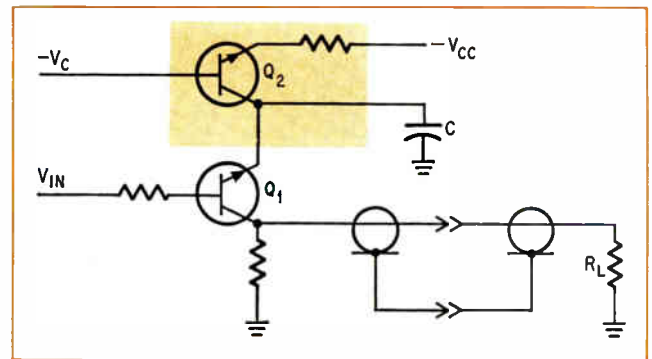

5. **Short proof.** Current generator  $Q_2$  protects fast-pulse amplifier  $Q_1$  against short circuits. The capacitor provides  $Q_1$ 's signal current until a short occurs, discharging  $C$  and thus cutting the stage output to the trickle of capacitor-charging current from  $Q_2$ .

will be needed for longer pulses.

When very high gain at low frequencies must be obtained from a minimum number of stages, a current generator will present a very large dynamic load to a FET single-stage amplifier and boost its open-loop gain as high as 2,000. In the circuit shown in Fig. 6,  $Q_1$  provides the high dynamic load in the following manner: as  $Q_2$  is driven by an input signal, the voltage across it changes, varying the collector voltage on current generator  $Q_1$ . Despite this variation, however,  $Q_1$  supplies a virtually constant current, in effect acting as a load on the order of several megohms but without limiting the FET to the microamp currents implied by such a load. Instead, the FET operates at several milliamps, in a stable noise-free region, while still providing the extremely high gain of the virtually

6. **High gain.** A current generator is here used as a high-impedance dynamic load for a FET amplifier. It provides a stable, noise-free operating point and a virtually flat load line so that the FET operates as a very high gain stage.

flat load line presented by the current generator. The addition of the negative feedback loop sets a gain of 1,000 (the ratio of the 10-kilohm and the 10-ohm resistors), while the use of  $Q_3$  as an output stage allows a low impedance load to be driven.

Because temperature stability is critical in this application, a bipolar transistor configuration rather than another FET, is used for the current generator.

For signal level shift without distortion, Fig. 7 illustrates a very simple solution. The current generator,  $Q_1$ , supplies emitter current through the level shifting resistor,  $R_s$ , to emitter follower  $Q_2$ . When an input signal is applied to  $Q_2$ , it appears at the output shifted by  $I_s R_s$  volts in the positive direction. The output current of  $Q_1$  divides into two parts,  $I_L$  and  $I_s$ . Since  $I_s R_s$  is the voltage by which the output signal is shifted,  $I_L$  must be either constant or smaller than  $I_s$  by at least two orders of magnitude. If not,  $I_L$  could vary enough in response to input signal level changes to cause signal distortion. When the dc level is critical and the anticipated ambient temperature range is wide, the emitter follower also must be temperature-compensated. □

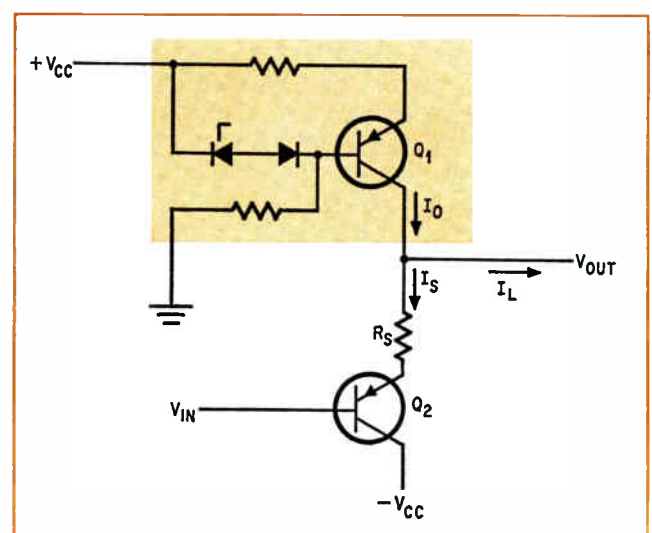
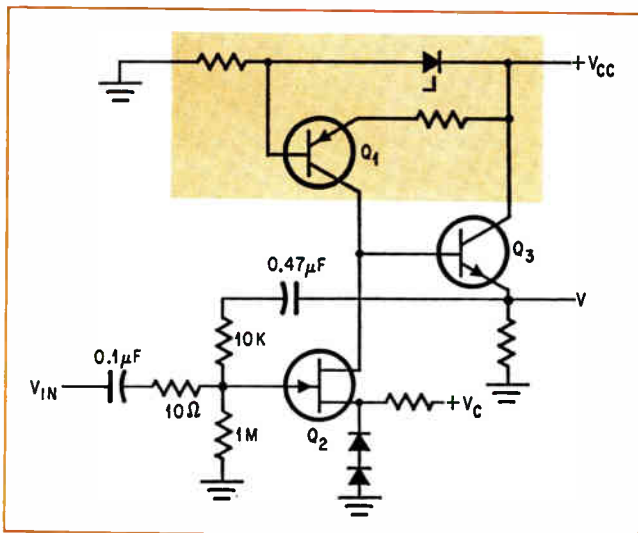

## The current generator: theme and variations

A current generator is basically a common-base stage whose output current is largely independent of the voltage between its collector and emitter. That voltage can vary from a value just short of what would result in saturating the stage to a value just short of the collector-to-emitter breakdown voltage, yet it won't change the collector current appreciably.

Shown below is a basic current generator. The cur-

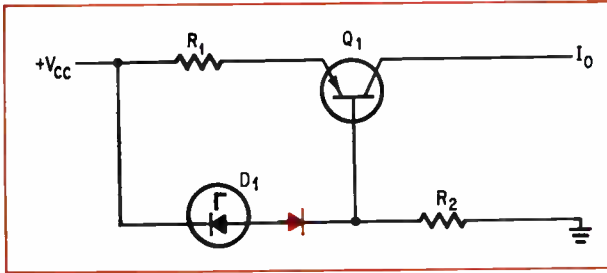

rent through  $R_2$  consists of the base current of  $Q_1$  and the zener current through  $D_1$ .  $R_2$  should be selected to draw sufficient current to keep  $D_1$  conducting beyond the knee in the zener region and over the full operating temperature range. The voltage appearing across  $R_1$  then equals:  $(V_Z - V_{BE})$ , where  $V_Z$  is the actual zener voltage of  $D_1$  obtained at the zener current established by  $R_2$ , and  $V_{BE}$  is the base-emitter voltage established by  $R_1$  and  $V_Z$ . The output current can be expressed as:

$$I_o = \frac{V_Z - V_{BE}}{R_1} - I_B$$

Using a high current-gain transistor considerably reduces the effect of base current on  $I_o$ .

Temperature effects can be limited with a temperature-compensated zener diode. Moreover, using a wire-wound or metal film resistor for  $R_1$  further reduces variations in output current caused by temperature. The change in emitter-base voltage,  $\Delta V_{BE}$ , which is about  $-2.2 \text{ mv}/^\circ\text{C}$ , is the major remaining temperature-dependent variable. But it can easily be controlled by adding a small-signal diode with temperature characteristics similar to those of the emitter-base junction of silicon transistor  $Q_1$ , in series with the zener diode.

$V_{R1}$ , the voltage across  $R_1$ , now equals  $V_Z + V_F - V_{BE}$ , where  $V_F$  is the forward voltage drop of the added diode at the forward current established by  $R_2$ . If the zener is temperature-compensated,  $V_{R1}$  will remain virtually constant over a wide temperature range. Of course, even if  $R_1$  is a wire-wound or metal film resistor, that component will still produce a variation in  $V_{R1}$  on the order of 20 to 50 parts per million per degree centigrade.

Where an additional regulated supply voltage is available that's negative with respect to  $V_{CC}$ , the current generator may be further simplified by eliminating the zener and connecting the base directly to that voltage,  $V_C$ . The output current is now:

$$I_o = \frac{V_{CC} - (V_C + V_{BE})}{R_1}$$

The greater the difference between  $V_{CC}$  and  $V_C$ , the less effect will  $V_{BE}$  have on the generator's output current

as the ambient temperature changes.

As before, temperature compensation can be accomplished by introducing a properly chosen diode in series with the base of  $Q_1$ .

Still closer compensation for any change in voltage over temperature can be achieved with the circuit illustrated below. If the emitter-base junction of transistor  $Q_2$ , similar to  $Q_1$ , replaces the diode, the variation

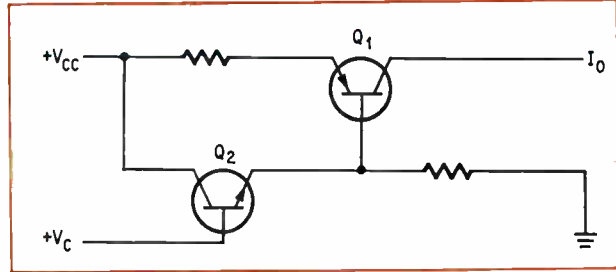

with temperature of the voltage between the base of  $Q_2$  and the emitter of  $Q_1$  will be close to zero. And if  $Q_1$  and  $Q_2$  are in a single package, tracking will improve dramatically because of the common thermal environment of the two chips.

For higher current applications, that configuration may be further modified, as shown next.  $Q_1$  operates

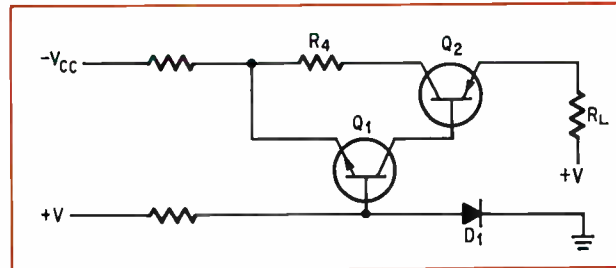

in the same manner as before, but its collector current now drives the base of  $Q_2$ . This configuration allows the use of a small geometry transistor for  $Q_1$ , with resultant low power dissipation. With reduced internal heating,  $V_{BE1}$  and the forward drop in  $D_1$  will track more closely over a wide temperature range.  $Q_1$  should be a high-gain type so that any change in base current with temperature represents a small portion of the collector current. Resistor  $R_4$ , while not generally used, may be added to reduce the power dissipation in  $Q_2$  if that stage's  $V_{CE}$  is high.

The configurations shown employ pnp transistors as current sinks. If the load must be returned to a positive voltage, npn transistors may be used and the entire circuit inverted, as shown below.

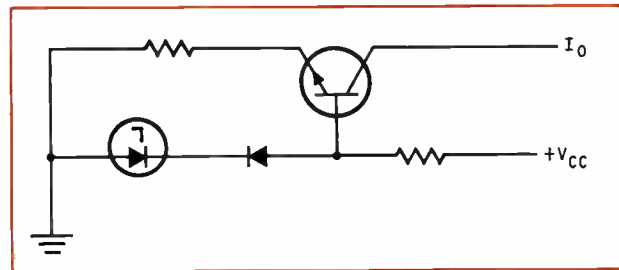

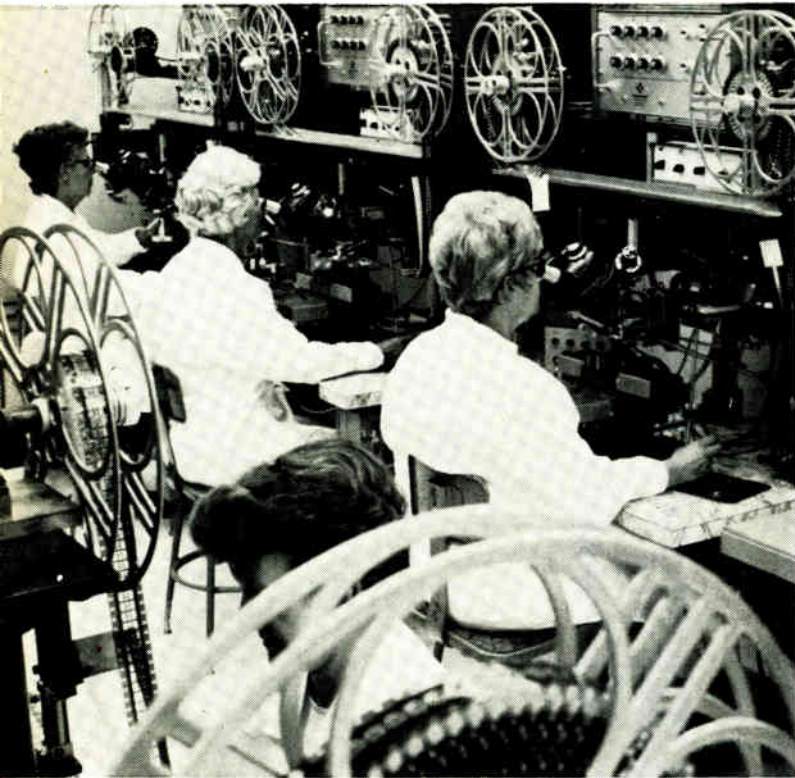

## ICs on film strip lend themselves to automatic handling by manufacturer and user, too

---

Chips mounted on reels of plastic film also can be processed as DIPs and beam-leaded devices; one-step bonding method promises to increase yields and reliability

---

By Stephen E. Scrupski, *Packaging & Production editor*

□ A highly automated assembly and packaging process developed for integrated circuits promises to substantially increase IC reliability and keep bonding costs competitive with the lowest-priced approach available now. What's more, the process can be readily adapted by users to their own automated handling and insertion procedures.

Dubbed the Minimod package by its developer, General Electric Co.'s Integrated Circuit Products department, Syracuse, N.Y., the new process's key elements are a lead frame etched from a copper strip and a sprocketed 35-mm polyimide film onto which the copper strip is laminated. The lead frame is bonded directly to the chip, eliminating the costly and error-prone wire bonding process (see panel, p. 46). To perform this important step, GE developed a new, automated gang-bonding process, called Multibond, which can make as many as 100 bonds simultaneously to a complex chip. The film serves as a support for the chip leads, and as a holding and indexing medium during automated assembly. After encapsulation, the completed packages are shipped on 25-foot reels of film. The customer then can use this sprocketed film setup for his own automated testing, handling and mounting operations.

The Multibond process is not restricted to the

Production set. Reel-to-reel handling is used throughout the GE process. Above, operators are bonding chips to the lead frames. Only minor adjustments are necessary to position the wafer under the lead frame for each bond; operator's primary purpose is to select unmarked (good) chips. GE says selection could be automated via optoelectronic sensors.

Minimod package format. In fact, it can be used for standard dual in-line packages. The Multibond process also can be adapted to form a type of beam lead device using unencapsulated chips—but still using the filmstrip carrier. And the process isn't just designed for large-scale automated procedures. The company says the Minimod format can be just as useful to the small-quantity user for prototypes and short runs: circuits can be snipped off the reels as needed with a pair of scissors, and soldered directly to appropriate pads on a pc board.

GE's scheme, which was developed under the leadership of James M. Smith, manager of assembly technology development, also allows a metal or metalized ceramic heat sink to be mounted directly on the back of every chip to improve heat dissipation. Up to 20 watts have been dissipated with a copper-sunked Minimod package.

In developing the package, a basic decision was required on materials for the lead frame and the chip contact pads. The process had to be adaptable for soldering to such materials as copper, Kovar, nickel, nickel-iron, and others. Because aluminum is difficult to solder and tends to electrolyze in the presence of humidity, copper, and some plastics, copper was selected as the lead frame material. And since aluminum contact pads aren't suitable for a copper lead frame, GE chose gold bumps for the contact pads.

The wafer is prepared by standard processing methods, including aluminum for the contacts and interconnect patterns on top of the chip. Then the wafer is tested.

The wafers then get a glass coating to cover the aluminum conductors. The glass offers extra dielectric protection and also reduces the danger of surface



inversion of the chip due to ionic contamination. Holes then are etched through the glass to the aluminum contacts, and gold bumps are put on the contacts. An intermediate metallic layer prevents gold-aluminum contact, thereby eliminating "purple plague." Since all the aluminum contacts and connectors are covered with glass, and the aluminum pads are covered with gold, the danger of corrosion in the aluminum is effectively eliminated.

The wafer is bonded to a wax-covered support plate that maintains chip orientation for the bonding step. The chips then are separated through the wire saw-and-slurry method.

The saw-and-slurry approach offers a significant advantage over scribing in accommodating automated bonding. The wax holder used in the former method maintains chip orientation even after the chips have been separated. In the scribing approach, however, the chips aren't cut completely through; the wafer must be rolled to be separated, and this disrupts chip orientation.

In GE's approach, the chips are lifted off the wax holder via the lead frame motion. To prevent the wax from exerting too much grip on the chip, a wax compound was chosen that melts from the heat of bonding. What's more, the sawing of chips cuts down into the wax, providing a thermal path that keeps the heat applied to one chip from melting the wax holding another (see Fig. 1).

The lead frame is prepared by first punching sprocket holes along the edges of a polyimide plastic strip and holes in the center at each chip location. (Polyimide film was chosen because it is a high temperature material that is mechanically stable.) The punching is critical: the sprocket holes maintain indexing accuracy during the automatic handling procedures to a few mils.

Then a copper foil strip, 1.4 mils thick, is laminated to the polyimide, and the copper-filmstrip sandwich is coated with positive-acting liquid photoresist. Twenty-five-foot lengths of the laminated film are wrapped around a 12-inch drum and the photoresist is sprayed on by a lead-screw-actuated spray head that moves linearly as the drum rotates beneath it. With the positive photoresist, pinhole problems caused by dust particles are eliminated; in fact, dust particles on the masked parts (which remain after etching) actually reinforce the masking. Dust on the etched portions present few difficulties: the material will be etched away all around them.

After the photoresist dries, the film is placed back on a reel and then is masked with the lead-frame pattern. It's exposed in a stepping arrangement similar to a movie projector—the film steps past the lens as the mask pattern is projected onto the copper.

After exposure, the film is etched, leaving the lead frame, which then is tinned by electroless plating for easy soldering. The lead frame, already formed in the copper, then is ready to be bonded to the chips.

The device wafer is placed on an X-Y table under the bonding tip. Looking through a microscope, the operator first checks for a dot on the die that would indicate failure of an earlier test. If the device is

## Early work

A concept of automated chip packaging based on etching lead frames out of copper foil laminated on a plastic strip was advanced more than three years ago [*Electronics*, July 24, 1967, p. 36]. A patent for the process (number 3,440,027) was granted to the late Frances Hogle in April 1969. Mrs. Hogle was the wife of William Hogle, chairman of Hogle Industries, a manufacturer of semiconductor chip processing and handling equipment.

The process as envisioned in 1967 appears similar to GE's Minimod system, although GE, when queried, said, "We are aware of Hogle's patent and do not believe it is relevant." Hogle's approach started with a strip of copper laminated to a strip of Mylar. The copper was etched to form lead frames, upon which IC chips were bonded face down. The chips were plastic encapsulated by running the film strip through an injection molding machine and then onto a reel. This reel then was put through an automatic testing machine.

The user, receiving his reel of encapsulated ICs, would put it through his testing machine, then through automatic insertion equipment, which would punch the Mylar from between the leads, cut the circuits apart, and put them on circuit boards.

Of course, there are some differences between GE's and Hogle's schemes. For example, GE uses a polyimide film, rather than a polyester like Mylar (polyimide film was not available to Hogle in 1967). In GE's approach, chips are automatically bonded from wafer to lead frame through holes in the polyimide, rather than face down as separate chips. And Hogle apparently intended the copper to serve as the actual dual in-line package; GE, when using its process for DIPs, employs the copper as just an intermediate vehicle for a separately formed dual in-line lead frame.

Since the original announcement, Hogle says it has proposed its system to several semiconductor manufacturers, but so far, the system is not believed to be in production.

On top. Etched copper lead frame can be designed to match any layout of chip contact pads simply by changing the photomask. Note the asymmetry of contact layout.

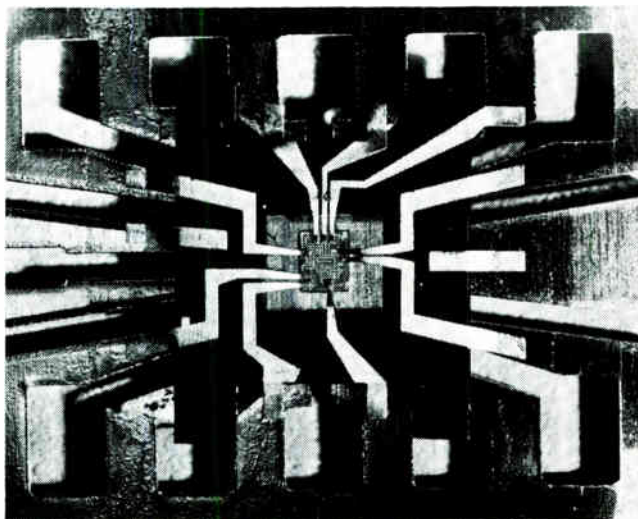

1. Heat not thy neighbor. Saw cuts in the wafer separating the chip extend through a wax adhesive, into the support plate. This produces thermal isolation between chips so that when one is heated and released, the adjacent chip remains fixed to the wax.

## A penny saved . . .

The GE Multibond process, like other multiple-lead approaches such as Motorola Semiconductor's spider bonding and Fairchild Semiconductor's Unibond, was developed as a more reliable, low-cost alternative to the standard wire technique. Wire bonding, when done in the Orient, may still be cheaper than any of the three multiple-lead methods in the U.S.; but the companies could take further advantage of the lower labor rates and reduce bonding costs to a level below that of wire bonding if they moved their multiple-lead machinery to the Orient.

Spider bonding [*Electronics*, Sept. 16, 1968, p. 58] now costs only a little more than wire bonding in the Orient, according to a report on semiconductor packaging and materials recently completed by Quantum Sciences Corp., New York. The study shows that a wire-bonded, 14-lead plastic-encapsulated package, including materials, costs about 5.4 cents when assembled in the Orient and about 20 cents if put together in the U.S. Labor costs, of course, account for the difference: U.S. labor is rated about \$9.50 an hour, including overhead, while in the Orient, the corresponding figure is about \$1.30 an hour. Thus, wire bonding costs are about 12 cents here and less than 2 cents there. And the 0.7-cent duty that a company typically pays to bring the device back to the U.S. under present section 807 tariff provisions doesn't raise the cost much.

A package that's spider-bonded in the U.S., however, runs to about 5.7 to 7.7 cents, according to the report. Though Motorola isn't doing any spider bonding in the Far East, it's possible that any of the three companies could install the automated multiple bonding machines overseas and drop their costs still further.

In spider bonding, a lead frame is stamped out of a strip of aluminum one to three mils thick. The usual configuration is 14 or 16 leads.

Guide holes then are stamped in the edges of the aluminum strip. The chips are separated by scribing, and an optical and servo system lines up a chip with the spider lead frame; the leads then are simultaneously bonded ultrasonically. The chip then moves on to the next station, where a ceramic disk is epoxied at its base for mechanical strength. The bonded chips then are cut from the aluminum lead frame and bonded to the dual in-line lead frame.

Fairchild's Unibond [*Electronics*, Jan. 4, p. 21] uses a stamped, gold-plated, copper-alloy lead frame that's attached to the chip with controlled-collapse solder bumps. The solder bumps consist of two layers of different metals that melt by a predetermined amount when they're soldered to the lead frame. The frames are soldered to the chip in a conveyORIZED furnace, soldered to a standard dual in-line lead frame, and finally encapsulated.

Neither Fairchild's nor Motorola's bonding process, of course, features the continuous handling advantages of GE's Minimod-package reel format.

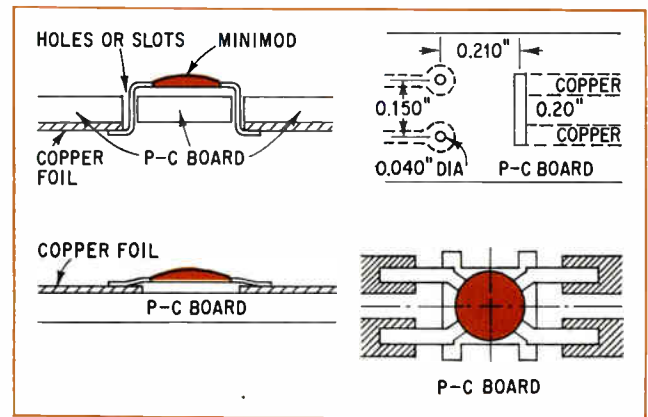
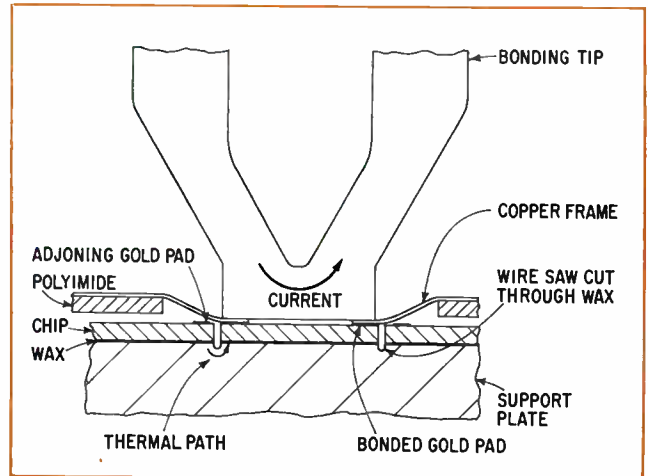

2. On board. Printed circuit board connections to Minimod package can be made in two ways: by dropping the leads through holes or a slot on the board and wave soldering to the copper, or by placing the package on the copper side of the board and reflow soldering. Either method is applicable to automation.

good, she checks alignment of the lead frame over the bonding pads, and then pushes the bond button. The bonding tip comes down and the tip applies heat (caused by passing a short pulse of current through the tip) to all the leads simultaneously.

The table then indexes to the next position on the wafer and the film indexes to the next position on the strip, bringing in a new lead frame. Finally, the bonded chips are wrapped on the takeup reel. This cycle takes about 3 seconds. Though an operator is involved for decision-making at present, the process could be automated by adding an optoelectronic sensor to spot dotted (bad) chips.

For power applications, a copper-plate heat sink can be applied automatically by preparing the copper plates on an adhesive strip and rolling them over a knife edge to lift one edge up for removal. It then can be picked up, coated with epoxy cement, and applied on the back of the film strip, behind the chip.

Spacers are used between the strips to separate one layer of film from another on the reel. With this spacer the whole reel (which is made of a nylon-type plastic)



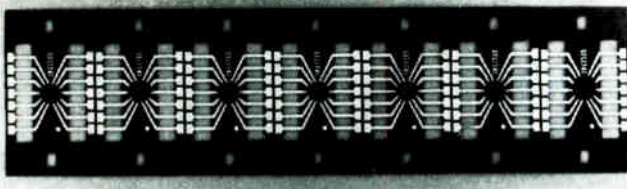

Ready for the camera. Devices in this 35-mm film strip are GE's version of the 741 operational amplifier. The lead frame is set up with standard dual in-line spacings for ready replacement of existing devices without changing printed circuit board layouts.

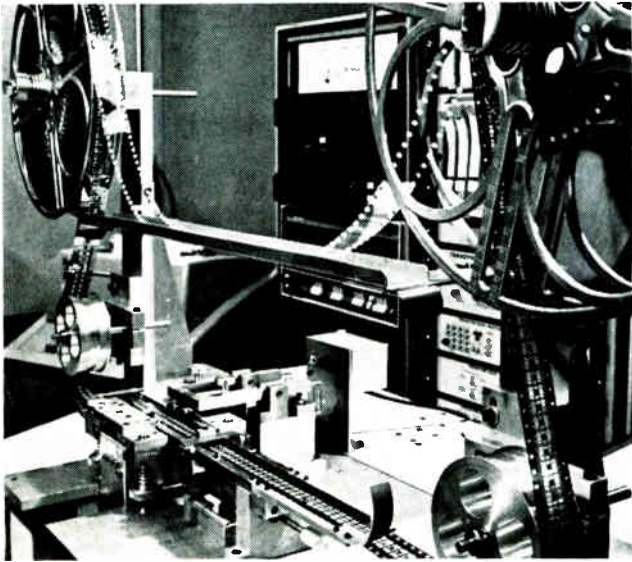

Step and test. Testing of completed devices can be automated with reel-to-reel handling. Bad devices can be sheared out of the film strip before shipping to the customer.

can be dipped into a cleaning solution, so that all the chips can be cleansed at one time.

The devices are unreeled to be encapsulated with a dot of epoxy. If a heat sink is used, the epoxy simply covers the chip, but without a heat sink, the epoxy spreads beneath the chip to cover its underside. After heat treating the epoxy, the strip of packaged devices is reeled again for shipping.

Once shipped, the Minimod package can be mounted in the user's circuit in several ways; two methods are shown in Fig. 2. The leads can be bent and inserted in holes in the pc board and then wave- or dip-soldered on the circuit-pattern side of the board along with the other components. Or the leads can be laid down on top of the copper pattern and reflow soldered on the same side of the board, thus eliminating the need for drilling holes. In the latter approach, a simple flat-faced soldering tip, normally sold for extracting dual in-line packages from circuits, can solder all leads simultaneously.

As a further example of the versatility, the devices can even be functionally tested in the final circuit

## Poly-usage for polyimides

Polyimide is a mechanically tough, high-temperature plastic that has found its way into various electronics applications. Kapton, the most well-known polyimide film (produced by E.I. du Pont de Nemours & Co., Wilmington, Del.) behaves similarly to Mylar at room temperature, but it holds its properties much better than Mylar at extremely low and high temperatures. In fact, says du Pont, Kapton has performed at liquid helium temperatures,  $-269^{\circ}\text{C}$ , and as high as  $400^{\circ}\text{C}$ . It also holds its dimensions well during wide temperature changes.

Kapton, because of its toughness in thin sheets, has been used extensively for flexible printed circuits, for insulation in transformer and motor windings, and as a dielectric in high-temperature capacitors. It also has been employed, in schemes somewhat similar to CE's, as a substrate for lead frames bonded to integrated circuit chips. Such work has been done at MIT's Lincoln Laboratory by Robert McMahon, and at Hughes Aircraft Co. by K.C. Hu [*Electronics*, March 30, 1970, p. 126].

McMahon developed what he called a "beam-lead substrate" in which the conductor pattern is extended to overhang holes in the substrate, forming beams that bond to chips inserted in the holes. He has used both ceramic and Kapton as substrate materials. In his latest work, McMahon puts aluminum conductor patterns and beams on Kapton.

Hu used similar beam lead concepts to build a multichip memory. Individual chip carriers are made by etching both the copper laminate and the Kapton. The copper beams then overhang the outside edges of the Kapton; when the chip is bonded face-down in the center of the carrier, the combination becomes, in effect, a beam lead device. These carriers, in turn, are bonded to Kapton-based circuitry to form a single, multichip substrate which can be placed on a printed circuit board or thick film substrate.

simply by pressing the leads down on the bonding pads and checking circuit operation. If operation is acceptable, the device then can be bonded down permanently.

GE's process for attaching Multibond chips to standard dual in-line lead frames is similar to the procedure a Minimod package user would follow for automatically mounting the devices on pc boards. A metal strip of dual in-line lead frames is aligned, via the indexing holes, with the film strip holding the Multibonded chips. When a chip is in position above a lead frame, a temporary support moves out horizontally between the two strips and a head comes down to shear the leads out of the film. The support then moves back; the head holds the chip with vacuum and then moves all the way down to the lead frame. A quick tack of the leads then is made and the lead frame strip moves on to the next station for reflow soldering.

In addition to producing the basic Minimod package and the dual in-line adaptation, GE, by stamping the chip and the lead frame out of the film, can make



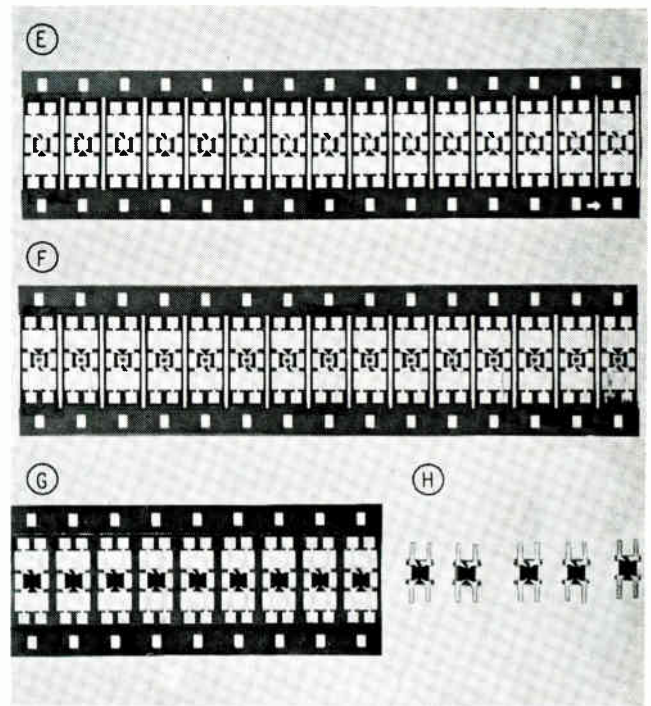
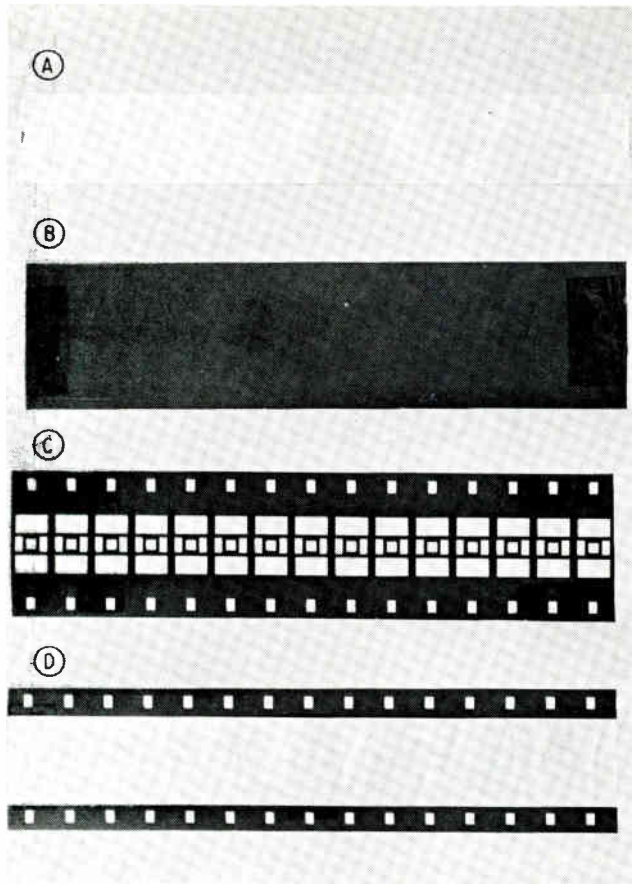

Step at a time. These are the steps involved in producing the Minimod package. Copper, A, and polyimide, B, are laminated, D, after punching the polyimide, C. Copper is photoetched and plated, E, chips are bonded, F, and then encapsulated, G, and sheared apart, H.

## Needed: equipment support

If the Minimod package is to establish itself, automatic insertion machinery will have to become available. GE, therefore, is encouraging equipment manufacturers to develop the necessary gear.

One company talking with GE is Industrial Modular Systems Inc., Cupertino, Calif. IMS president Arthur Lasch says he's considering producing automatic insertion equipment and a line of hand tools for the Minimod packages. IMS' experience with photoresist processing equipment will be the basis of similar equipment specially designed to handle the 35-mm film in the Minimod package, says Lasch.

Although the automatic insertion machine has not yet been designed, Lasch envisions a device with X-Y positioning capability for placing the Minimod packages at any point on the printed circuit board. He also foresees a four-quadrant positioning head that could rotate the Minimod package to any of four orientations on the board. Lasch sees the work table performing the X-positioning function while the head would take over Y positioning and rotation. It's too early to estimate cost, but Lasch feels the machine could sell for less than \$20,000.

Computervision Inc., Burlington, Mass., manufacturers of mask-making and mask-aligning machinery, will be a source for the die- and lead-bonding machines, as well as automatic mounting equipment for the Minimod packages, says Michael Cronin, Computervision's vice president for marketing. Cronin says there's a good chance that equipment will be ready in the spring.

devices similar to conventional beam-leaded chips. This configuration offers significant advantages over the standard beam-leaded IC. For example, the copper leads in the GE device can be longer and thus easier to bond than their gold counterparts.

In addition, the copper's flexibility permits the chip to be mounted backside down on a heat sink, while the conventional beam-leaded chip must be placed face down, with a space between its face and the substrate, considerably limiting its heat dissipation potential.

Copper leads also are easier to remove from a circuit than the gold beams. With copper, the circuit around a bad device can be masked with a resist and the exposed copper leads then can be etched away. With gold, which can't be etched, the beams have to be cut free mechanically.

The technology also can be easily adapted to MSI and LSI circuits having up to 100 leads. Because the leads are formed by etching rather than stamping, lead widths down to 2 or 3 mils have been achieved regularly. And, since only the mask must be changed to redesign the leads, the same equipment can be used for both simple and complex packages for fast changes during processing.

Prices of Minimod circuits initially will not be lower than corresponding devices in plastic dual in-line packages. The first two circuits introduced are a threshold detector, PA 1494, for \$2.30 and a 741-type operational amplifier, GEL 1741, for \$1.36, both in quantities of 1,000 or more. □

**The 5600 magnetic tape recorder:  
more performance per dollar than any  
other recorder available!**

# **IT'S A MOVER!**

Our 5600 magnetic tape recorder is a 75-pound, lab-quality portable. Which means it goes where you go. Easily.

But the 5600 does more than just go where you want it to. It gives you more value per dollar than any other magnetic tape recorder. Because it does everything you'd expect it to. And more.

The 5600 is the most versatile portable in its price category. It gives you a choice of FM, direct and digital electronics. Recording bandwidths available DC to 40kHz FM, 50Hz to 300kHz direct, and 600 BPI serial digital. It converts between tape widths of 1/4", 1/2" and 1" on all

standard reels up to 10 1/2" diameter. It offers seven electrically switched speeds. And can be powered from virtually any commercial source as well as two different battery voltages: 12 volts and 28 volts.

The 5600 also has features previously found only in laboratory-size systems. Like full 14-channel, 16-track recording capability. And low-mass, high-performance phase lock capstan servo drive which provides a faster response than other drive systems. It also features a complete line of accessory devices, including

differential input wideband amplifiers. The 5600 is available in either horizontal or vertical rack mount configurations.

If you need a lab-quality recorder that flies, rides or even walks along with you, you need the 5600. For additional information, simply complete and mail the coupon, call your local Honeywell office or contact C. S. Corbin, 303-771-4700, X692, Honeywell, Test Instruments Division, P. O. Box 5227, Denver, Colorado 80217.

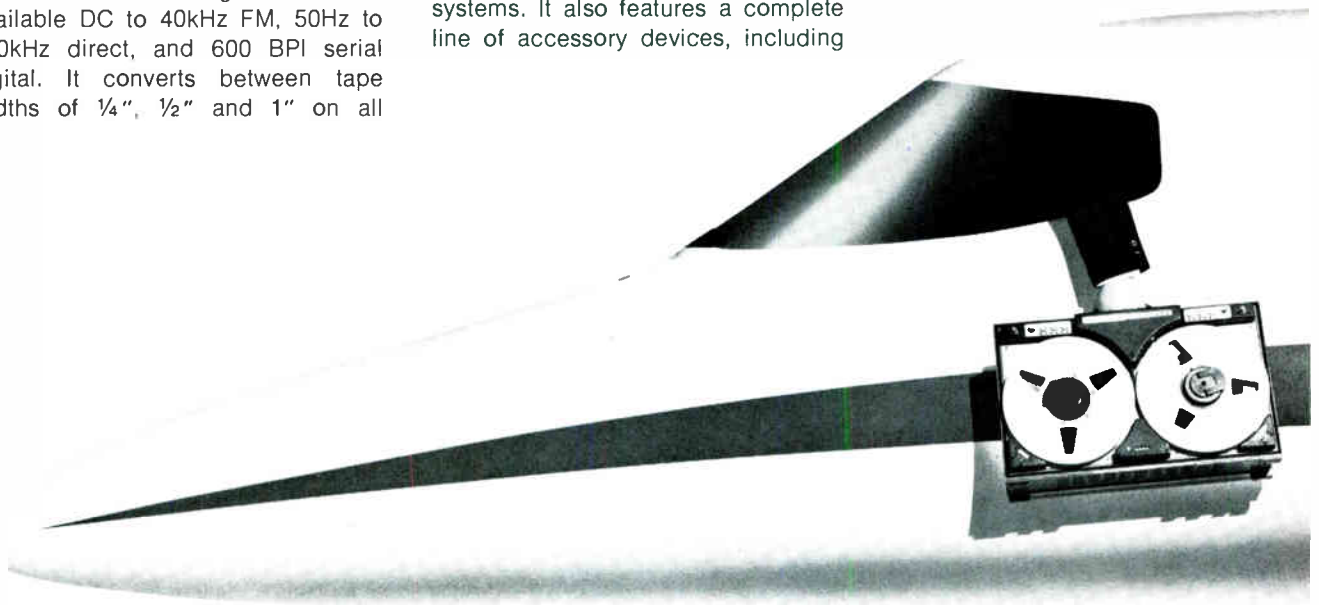

**Honeywell**  
The Automation Company

Yes! Please have someone contact me with more information on the Honeywell 5600 magnetic tape recorder.

NAME \_\_\_\_\_

FIRM \_\_\_\_\_ POSITION \_\_\_\_\_

ADDRESS \_\_\_\_\_

CITY/STATE/ZIP \_\_\_\_\_

# Designer's casebook

## Amplifiers let voltmeter measure op amp noise

By Richard C. Gerdes,  
Optical Electronics Inc., Tucson, Ariz.

Special instruments aren't needed to measure the noise generated by an operational amplifier. Peak-to-peak, root-mean-square, and even spectral-density noise characteristics can be measured with an ordinary panel meter or digital voltmeter.

The test circuit makes the amplifier under test (AUT) generate highly amplified noise peaks. These are detected and then simply scaled down to find the noise values. Measuring errors are less than 1%, small enough to test op amps for critical applications such as low-level jobs, instrumentation, and video circuits.

One part of the noise meter is a test board with ground inputs for the amplifier under test, a feedback resistor chosen to give the amplifier a gain of 100, and an isolation network to minimize power supply

noise, which could, if large enough, cause inaccuracy.

The test board plugs into a detector circuit with a gain of 1,000, (preamplifier A<sub>1</sub>). A<sub>1</sub> is an operational amplifier with field effect transistor inputs. Noise bandwidth is 10 hertz to 10 kilohertz.

A<sub>1</sub> drives A<sub>2</sub>, an absolute-value circuit that detects or rectifies the ac noise voltage to a dc voltage with positive polarity. The unipolar noise signal drives A<sub>3</sub>, a module that senses and holds the peak noise value.

Together, A<sub>2</sub> and A<sub>3</sub> ensure that the largest noise peak is captured and presented to a voltmeter connected to the dc output, regardless of that noise peak's polarity. After the amplifier under test is plugged in and the power supplies turned on, the reset switch is closed for 10 seconds. This sampling period permits capture of low-frequency noise transients.

Since the total gain in the test board and in the preamplifier is 100,000, a 1-volt reading on the voltmeter represents a peak noise voltage of 10 microvolts, 20-microvolts peak-to-peak noise or 3.3- $\mu$ V rms noise. If the amplifier under test has a gain-bandwidth product of at least 1 megahertz, it is fairly safe to assume that the spectral noise density in  $\mu$ V/Hz is the meter reading in millivolts divided by 30.

**Noise detector.** Noise generated in the amplifier under test is amplified by 100 on the test board and by 1,000 in preamplifier A<sub>1</sub>. Amplifier A<sub>2</sub> detects or rectifies the noise peaks as a positive voltage that is stored in A<sub>3</sub>. The output of A<sub>3</sub> is a smooth, dc voltage 100,000 times the peak noise level; it is easily measured and scaled.

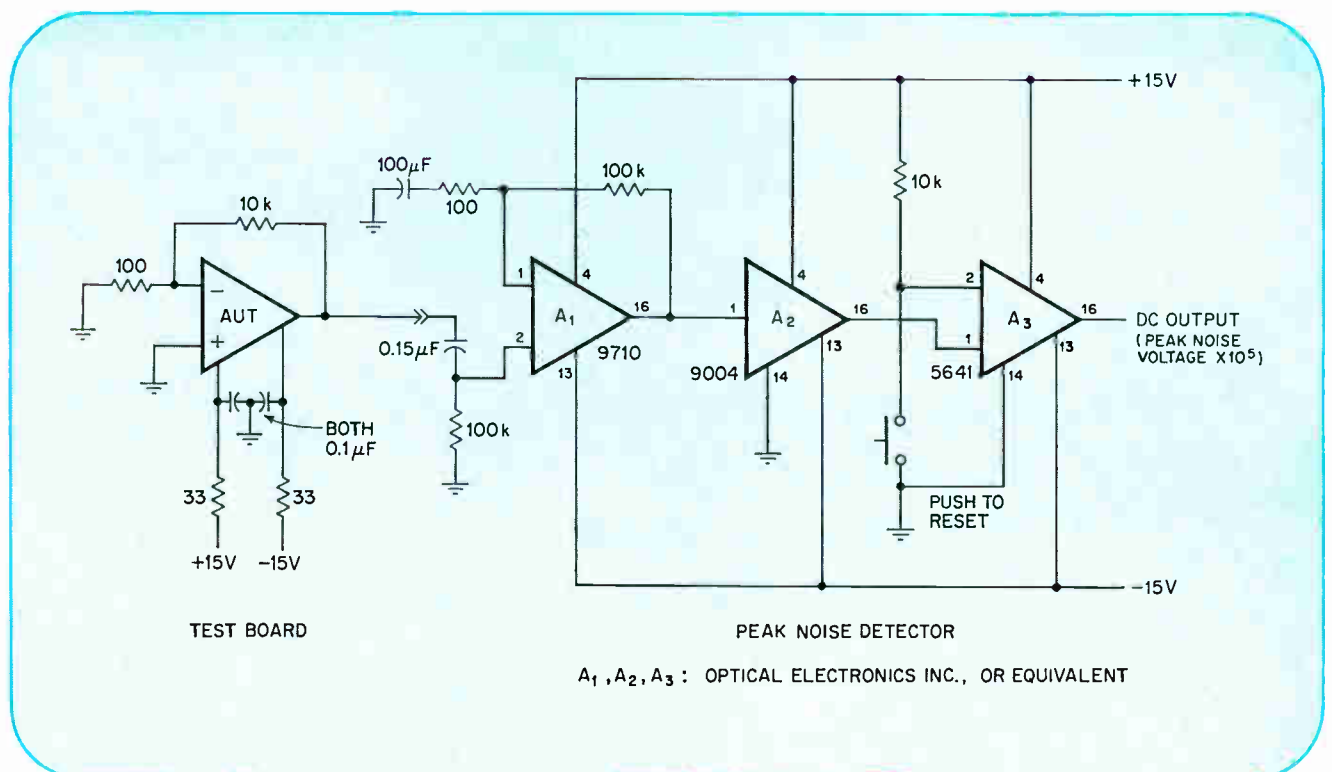



# FET pair bridges meter impedance gap

By Jack Theodore,  
Tri-Electronics, Hammond, Ind.

Operating as a differential pair, two monolithic junction field effect transistors can increase the sensitivity of a high-resistance bridge's galvanometer null detector. Accuracy of zero-balancing thus is increased. The small, inexpensive FET circuit can be battery powered, and fits easily into bench or portable instruments. In fact, with carefully selected range resistors, the detector can serve as a good general-purpose voltmeter.

An unaided galvanometer will lose sensitivity as the bridge resistance values are increased. But with the J-FETs the detector's terminal resistance can be very high. For best sensitivity, the terminal resistance should equal the series-parallel resistance of the bridge arms (a galvanometer usually has a low, fixed resistance).

Also, because both transistors are on the same substrate, differential drifts due to temperature changes

are limited to the low-microvolt range.

The circuit is built around a galvanometer with a coil resistance of about 350 ohms and a current sensitivity of 0.15 microampere per scale division. There are 30 scale divisions on each side of the zero point.

Input resistance at terminals A-A is established at 100 megohms by voltage-divider resistors  $R_1$ ,  $R_2$  and  $R_3$  through  $R_8$ . Only 30% of the input voltage appears across the gate-load resistors,  $R_9$  and  $R_{10}$ . The gates are biased from the junction of voltage divider  $R_{11}$  and  $R_{12}$ . Source resistors  $R_{13}$  and  $R_{14}$  drive the galvanometer. Small differences in the currents through the two sides are balanced out via potentiometer  $R_{15}$ .

Sensitivities ranging from 1 volt per scale division to 1 millivolt per division can be selected with the switch. Zero adjustment is made on the most sensitive range after the detector is connected to the de-energized bridge circuit.

The FET detector is more sensitive than the galvanometer alone at bridge values above 10 kilohms. The unaided meter's sensitivity is better at lower bridge resistances.

Sensitivity may be improved by using terminals B-B, which reduce input resistance. But care must be taken that the transistors' gate breakdown voltage is not exceeded.

FET null detector. Transistors  $Q_1$  and  $Q_2$  improve the galvanometer's sensitivity when nulling a bridge with high-resistance values. Input resistance is raised to 100 megohms by resistors  $R_1$  through  $R_8$ . The transistors operate as a differential pair, biased with a dc supply. Switch ranges are 1 volt to 1 millivolt per meter division.

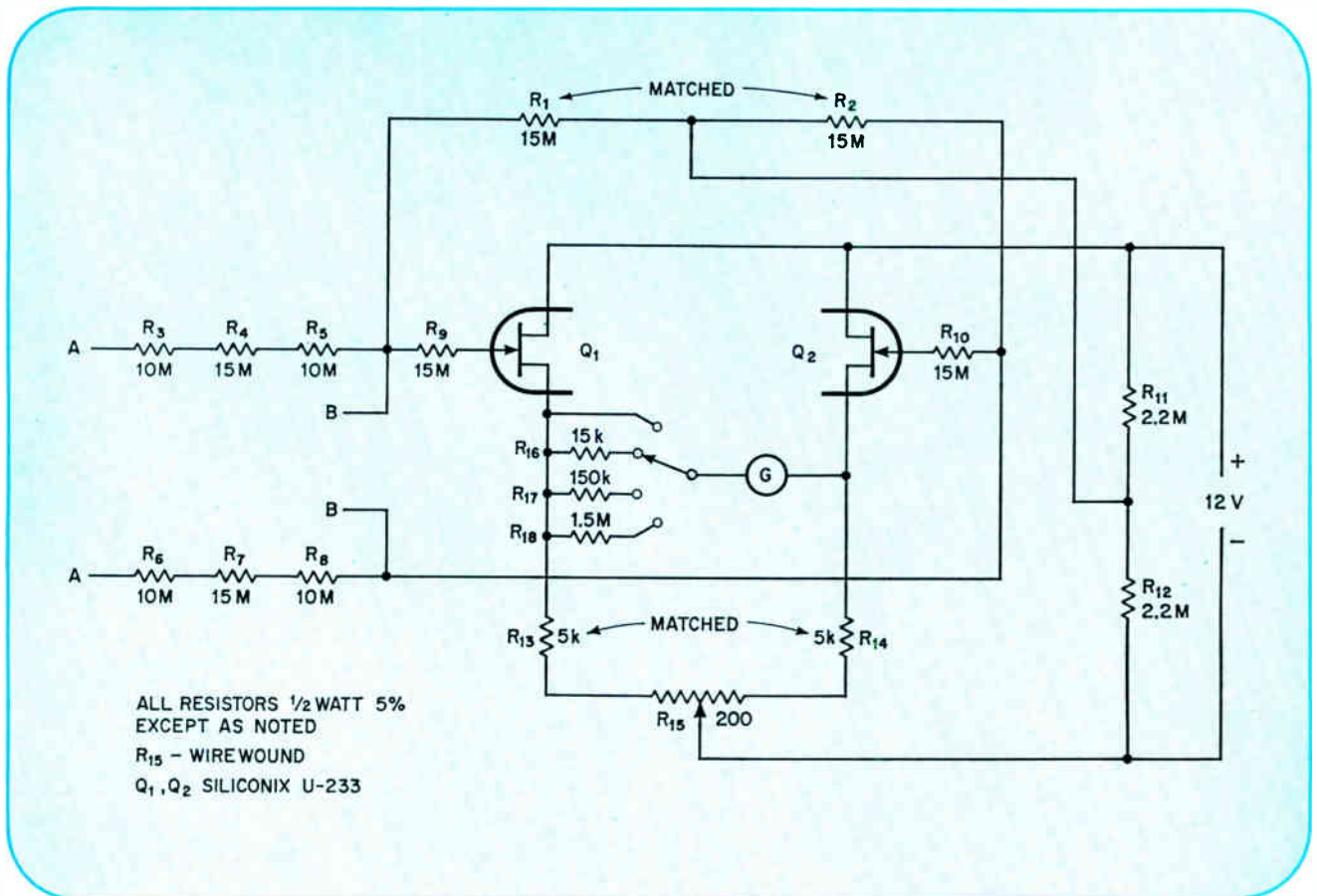

# 1-volt cell powers mini audio amplifier

By Don G. Jackson,  
Resalab Inc., Garland, Texas

An audio amplifier designed specifically for micro-power applications features automatic gain control, a large dynamic range, and high efficiency from a low-voltage supply.

Maximum output level is about 1 volt peak-to-peak across a 5-kilohm load. Typical gain is 65 decibels. The amplifier draws only 50 microamperes of current from a 1.35-v mercury cell and has an overall efficiency of about 40%. Tradeoffs among current drain, efficiency, output impedance, and crossover distortion may be made by changing component values.

Automatic gain control is accomplished by detecting the output signal and feeding back the resulting dc signal to the gate of the series field effect transistor, Q<sub>1</sub>. This varies the channel resistance of the junction

field effect transistor. Transistor Q<sub>6</sub> is the AGC detector. Although the FET type is not critical, it should be selected for a  $V_{GS(off)}$  of 1 V or less since the output signal is limited to 1 V pk-pk. Output voltage in the AGC range depends on resistors R<sub>1</sub> and R<sub>2</sub>; both are 1 megohm for 1 V pk-pk.

Transistors Q<sub>2</sub> through Q<sub>5</sub> form a complementary output, current-driven amplifier. Output level is limited by the  $V_{CE(sat)}$  of Q<sub>4</sub> and Q<sub>5</sub>. Bias is stabilized by dc feedback. Resistor R<sub>3</sub> and the  $\beta_{FE}$  of Q<sub>4</sub> essentially set the current drain (50  $\mu A$ ). Currents in the other portions of the circuit remain low because they are clamped by the feedback, base-emitter voltages, and the supply voltage.

Low-frequency response is controlled largely by bypass capacitor C<sub>1</sub> in the dc feedback loop. A 1-microfarad capacitor sets the 3-decibel low-frequency cutoff at about 270 hertz. The 3-dB high-frequency point is about 4.5 kilohertz. Depending mainly on the signal-source impedance, the low-frequency rolloff can exceed 6 dB per octave.

Designer's casebook is a regular feature in Electronics. Readers are invited to submit novel circuit ideas and solutions to design problems. Descriptions should be brief. We'll pay \$50 for each item published.

Micropower microamplifier. Powered by a 1.35-volt mercury cell, audio amplifier is basically a current-driven device with complementary outputs at Q<sub>4</sub> and Q<sub>5</sub>. Gain is controlled by detecting the output with Q<sub>6</sub> and feeding back the dc signal to control series FET Q<sub>1</sub>. The components shown limit the output to 1 V peak-to-peak.

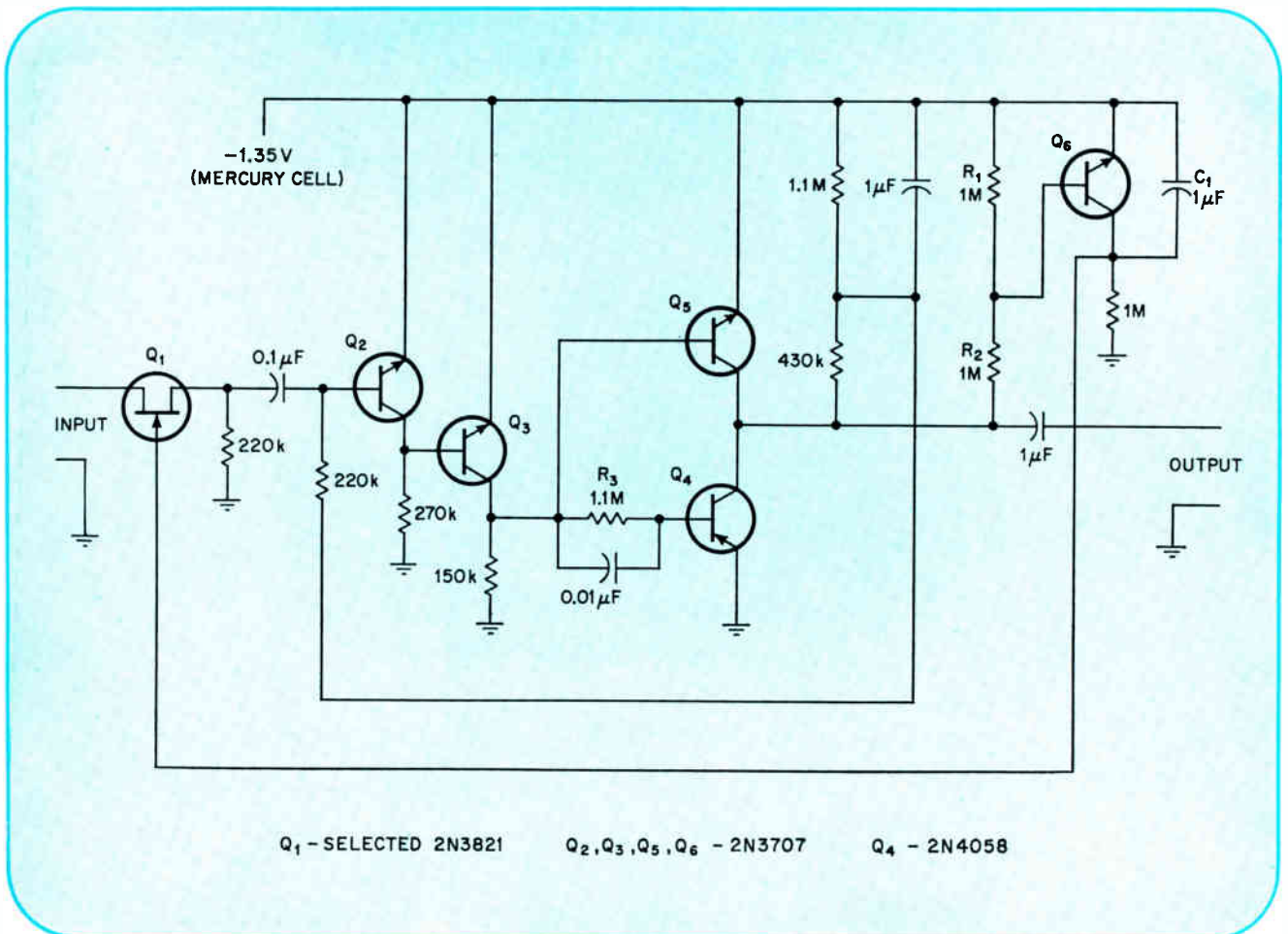

# Computer Microtechnology has the ideal TTL memory

1024 words x 4 bits.  
Also available 2k x 2 (2401)  
and 4k x 1 (2402).  
The 2400 series expands easily  
to match your word and bit  
requirement. Access: 400 nsec.  
Cycle: 600 nsec.

Our coding tells us the  
complete history of each of the  
16 MOS/LSI storage chips  
and 6 bipolar decoding and  
sensing chips that make  
the 2400 work.

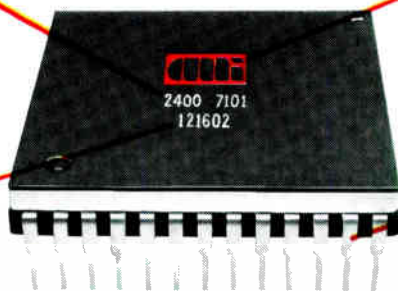

You're going to see this logo  
on a lot of parts.  
Computer Microtechnology  
has ROMS, RAMS, and  
REGISTERS.

These 26 pins plug 4096 bits  
of fully decoded read/write  
memory into your circuit board.  
A real savings in pc board  
and system assembly costs!

The CM 2400 is a simple static read/write memory. No timing signals to refresh. Power required is very low — .4 mW/bit. It needs only two power supplies, +5V and +10V, for compatibility with all DTL and TTL systems. It features complete TTL interface, in and out, and has standard TTL noise immunity on all pins.

**It's easy to use:** Plug it in and get on the air. No hairy design problems. No big assembly and subsystem test problems. No waste of circuit board real estate.

And no delivery problems. We've built your TTL memory for you.

Get details from us at (408) 736-0300, (617) 891-0002, or (714) 835-8323.

Get parts from stock at Kierulff, K-Tronics, F-J-R Electronics or Schley Electronics.



Computer Microtechnology Inc., P. O. Box 7050, Sunnyvale, Calif. 94086





1. Poor parts. Some manufacturers sell hospitals less than top-flight equipment. Above, leaking electrolyte from faulty capacitor shorts resistor in a monitor. Below is board that failed but is in ECG machine anyway.

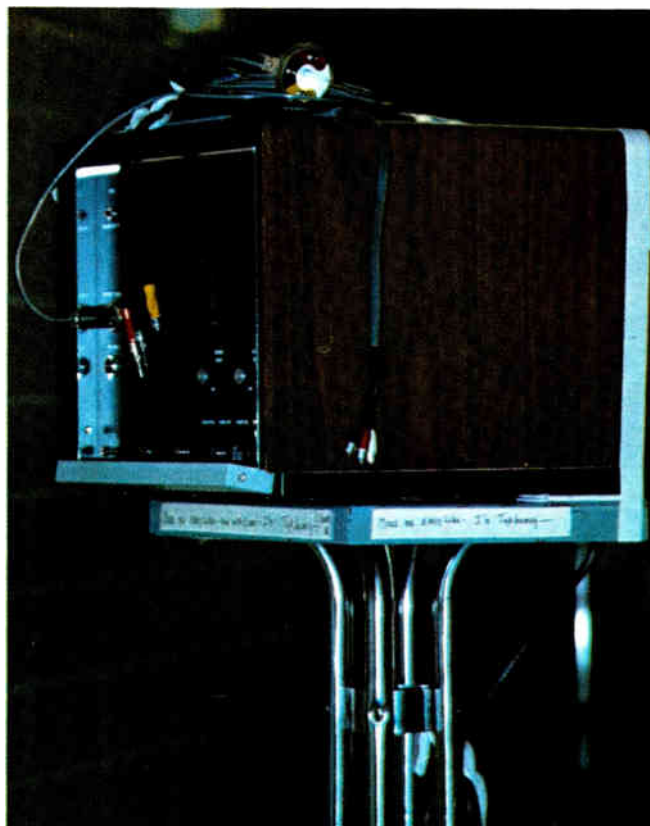

2. Poor planning. Thoughtless placement of equipment creates dangers. Above heart monitor sits precariously on stand. Taped-on message warns: "Move me easy like I'm Topheavy—". At right, web of cables surrounds operating table, limiting doctors in their movements.

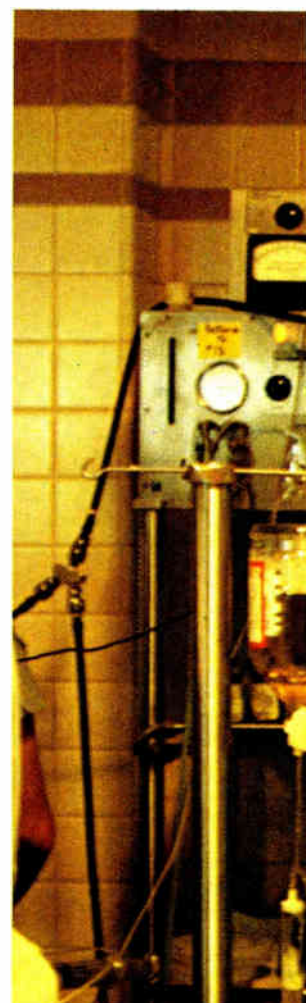

## For medical electronic gear, hospitals are not very healthy places

Survey faults both makers and users of biomedical equipment; military reliability standards, preventive maintenance, and regional service groups could be remedies

By Gregory E. Hieb and Henry L. Green, M.D.,  
*Cardiac Care Unit Surveillance Project, Southfield, Mich.*

□ The hospital has just admitted a patient suffering from a possible heart attack. Suddenly he gasps and falls back. There's no pulse, and a monitor shows ventricular fibrillation—uncoordinated twitching of the heart. Normal rhythm must be restored quickly, or he'll die. The nurse applies a defibrillator, and presses its discharge button. Nothing happens. Another is rushed to the scene. This one works; the delay isn't fatal; and the patient lives.

But the fact remains—vital hospital equipment failed without warning. It happens a lot. All too often biomedical instruments either work improperly or don't work at all. This startling conclusion is drawn from a recent survey of medical electronic gear in 12 Detroit-area hospitals. Among its findings are:

- Few pieces of equipment are properly maintained.
- Simple calibrations, like adjusting a potentiometer, and simple adjustments, like focusing an oscilloscope, are not made.
- Dust is allowed to build up inside chassis, causing components to overheat.
- Few defibrillators accurately produce the amount of energy they're supposed to.
- Most monitoring scopes and electrocardiographs have substandard frequency response.

Blame for these conditions can't be placed exclusively on the shoulders of any one group. Doctors

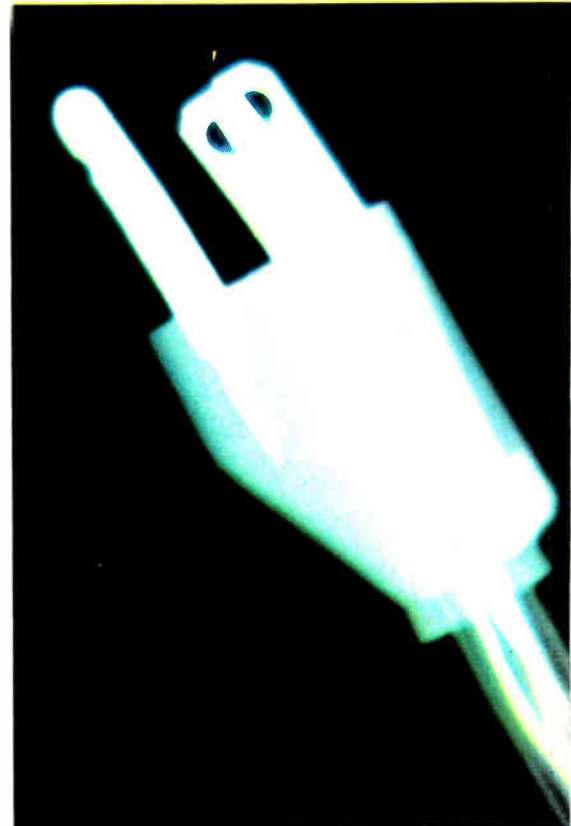
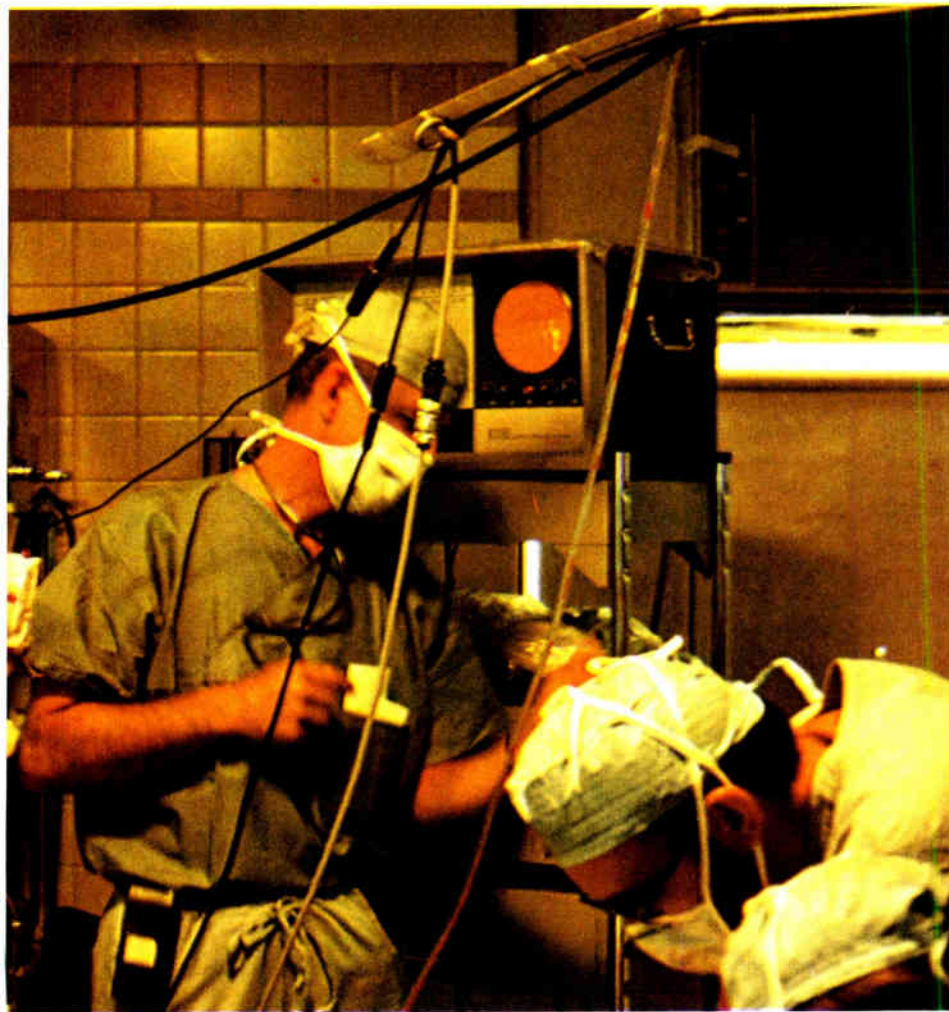

3. Poor ground. X-ray reveals broken ground wire in electrocardiograph's molded plug. Since this unsafe condition can't be detected visually, molded plugs shouldn't be used.

tend to have blind faith in the reliability of their instruments, and they're not trained to think in terms of calibration and preventive maintenance.

However the survey does show that equipment manufacturers can do a lot by themselves to improve the situation. Certain modifications can be made on existing equipment, and different approaches can be taken in designing new gear. More importantly, manufacturers can take into account what the survey clearly demonstrates—hospitals are a "hostile" environment. Some equipment is moved frequently, so there's always the chance that it will be dropped or banged against a wall. Gear may be splashed with conductive or corrosive fluids like water, blood or urine. Most physicians and nurses aren't skilled at maintaining electronic devices. Once installed, devices are assumed to be reliable diagnostic or therapeutic tools. Unexpected results are usually attributed to the patient's illness and not to equipment malfunction or misuse. Equipment is rarely tested to specific performance criteria before each use, and it's seldom recalibrated on a routine basis. Periodic maintenance is rare. Defects are recognized only when a device obviously fails.

Much has been said and written recently about the safety of medical electronic equipment. Certainly concern about shock hazards is justified. But un-

fortunately device safety has overshadowed a far more important topic—device effectiveness. How many people receive a faulty diagnosis because an electrocardiograph isn't calibrated? How many die because defibrillators don't deliver the energy their control dials say they deliver? In general, how many patients receive improper medical treatment because of poorly designed or maintained biomedical gear?

**The survey started out to answer** this question, as well as to respond to the safety issue. In 1961 the British journal *Lancet* reported two cases of micro-electrocution caused by electrocardiographs. Since then, case reports and reviews dealing with the possibility of patients being endangered by minute leakage currents have been appearing frequently.

These papers have usually been concerned with the special problems of monitoring critically ill patients in cardiac care units. Here, the techniques used work by defeating the natural insulation of intact skin: conducting paste is placed between skin and flat electrodes; needle electrodes pierce the skin; or catheters wind through a blood vessel into the heart itself. But, flowing through low-resistance paths between an electrode or catheter and the heart, currents as small as 20 microamperes can trigger the rapid, uncoordinated contraction of cardiac muscle fibers called ventricular fibrillation.



Fibrillation caused by minute currents is commonly referred to as microelectrocution. It is indistinguishable from naturally caused cardiac arrest, and therefore difficult to detect. For this reason estimates of the number of hospital microelectrocutions recorded in the literature are unsupported by hard data.

In an attempt to determine the extent of microelectrocution and related hazards, the authors, through the Michigan Association for Regional Medical Programs, proposed to the Department of Health, Education, and Welfare that a detailed survey be made of medical electronic instruments in hospitals.

The survey concentrated on four types of equipment—cardiac monitors, electrocardiographs, pace-makers, and defibrillators—and covered 12 major hospitals, ranging in size from 100 to 700 beds and including both teaching and non-teaching institutions. However, the results reflect on the condition of all biomedical equipment in the typical hospital.

Devices were compared both with specifications written by various independent sources, such as the Veteran's Administration and the American Heart Association's Committee on Electrocardiography, and with manufacturers' specifications when available. Most manufacturers were cooperative and supplied electrical specifications and calibration protocols upon request, although some seemed reluctant to participate.

A standard procedure was followed in investigating each hospital. An initial "walk-through" was undertaken to note any instances of equipment misuse. Electronic testing of each device then followed within the hospital itself. Here, equipment was taken to a central test location, where it was disassembled and inspected for mechanical failures (broken connectors, loose wires, cold solder joints) and electrical performance. Dummy test signals or appropriate resistive loads were used to simulate a patient.

**Disturbances in the heart's rhythm** cause half of all coronary deaths. They're reversible if detected early enough. Thus the cardiac monitor is a critical bit of equipment. It's an oscilloscope designed to display the electrical rhythm of the heart from two electrodes placed on the chest and forming a differential input. A third lead, usually placed on the chest, acts as a reference terminal. The recorded electrical pattern—the electrocardiogram—has a nominal period of 800 milliseconds and a range of 0.1 to 5 millivolts. Important information is contained within a bandwidth of near dc to 50 hertz.

The Veterans Administration specification states that CRT monitors with their electronic amplifiers should have a bandwidth of 0.15 to 50 Hz. Of 95 monitors tested, representing 10 manufacturers, 55% had responses with upper 3-dB points below 50 Hz. In over 5%, the 3-dB point was below 20 Hz.

All monitors have calibration markers to allow recorded waveforms to be referenced to a 1-mV signal. In 25% of the monitors checked, the 1-mV reference was off by 10% or more.

Inadequate vertical gain was found in 51% of the 79 monitors checked for gain. Such a defect has the effect of making it hard to determine precisely when

an ECG pattern begins—an important piece of diagnostic information.

Thirty percent of the monitors exhibited some malfunction in the CRT spot-deflection circuits. Observable defects included: nonuniform sweep speeds; a prolonged blanking interval at the end of the trace; defocussing of the spot to the point where it became two individual spots; and a shift in the dc base line as the sweep traced across the tube. If an ECG pattern is superimposed on a nonhorizontal or fuzzy baseline—or is distorted in some other way by the monitor—the observer may be unable to recognize important rhythm disturbances.

**Leakage current** was as often as not found to be in excess of the 10- $\mu$ A level recommended by the Veterans Administration and most other independent sources. Leakage was measured by disconnecting the ground lead in a monitor's power line and connecting a 1-kilohm resistor—simulating a patient—between a patient lead and the ground terminal in the wall socket. In 47% of the monitors leakage exceeded 10  $\mu$ A, and in over 10% of the units it exceeded 50  $\mu$ A.

One might underrate the danger from this current since it was confined to the ground wire in the power cord, and that's the purpose of the ground. Unfortunately, in some of the monitors tested, the ground wire in the power cord was broken. Furthermore, a few hospitals still have only two-wire power line outlets; in these cases, 3- to 2-prong wire adaptors were commonly used.

Nor is there any assurance that the sockets themselves are in good shape. Twenty-three outlets in the special care wards of the 12 hospitals were found to be defective. Five were completely dead. Three had no ground connection to the grounding pin. And three more had reversed polarity.

Lack of a common ground potential from socket to socket is a source of leakage current. However the condition doesn't appear to be as widespread as some observers have suggested. Out of the large number of sockets checked for continuity (resistance between ground pins of less than 3 ohms), only seven failed. Two of these cases, however, were of special significance since they were found in a catheterization laboratory. This facility is used by physicians for the insertion of catheters into the heart.

**Another leakage hazard** is transient current spikes that may appear when a monitor is turned on. They showed up in 6% of the monitors tested. The spikes, measured between the patient cable and chassis ground, ranged from 80  $\mu$ A to greater than 400  $\mu$ A. They could cause ventricular fibrillation if they occurred during the repolarization (or resetting) phase of the heart cycle.

Internal inspection showed defective components or wiring in 21% of the monitors surveyed. Leaking electrolyte from high-voltage dc capacitors was found in the majority of the 25 monitors used in one hospital (all were of the same make and model).

One monitor had been internally miswired by the manufacturer. The right-leg reference (chassis ground lead) had been interchanged with the left-arm lead, presumably because the internal wires had not been



color-coded; the interchanged leads were both black. As a result of this slipup, the monitoring of the cardiac activity of all patients ever attached to this instrument had been improperly displayed.

**Examples of hospital misuse** of monitors ranged from improperly set control switches to conductive fluids being spilled near the air circulation vents of the equipment.

Misuse was particularly evident in the case of those monitors with built-in cardiometers for measuring heart rate. These meters trigger alarms that alert the nurse or doctor if a patient's heart rate goes above or falls below predetermined limits. Two sliding pointers above the meter's face are used to set these limits. The indicating needle moving past a pointer trips a switch, which turns on the alarm.

To avoid annoying alarms triggered by stray signals, the rate meter alarms are often defeated by the hospital staff, who set the alarm limits to extremes (e.g. 0 and 200 beats per minute). This cheating occurs so often that manufacturers should call out the appropriate limits (50 and 130 beats per minute) with colored bands on the meter face. This would at least have the psychological effect of telling doctors and nurses that they're using the instrument incorrectly.

In six monitors, serious cardiometer defects were found. In one, for example, the meter wouldn't work unless the ECG pattern was centered vertically on the CRT—but the meter should work independently of the display. In another monitor, the indicating needle was bent so much that it ran into the pointers instead of moving freely past them. With the needle frozen in this way, the alarm could never sound.

**The electrocardiograph** is a strip-chart recorder that gives an accurate printout of a patient's heart rhythms. Such a graph, which permits precise measurements of amplitudes and time intervals, becomes a permanent part of a patient's record. The survey covered 51 ECG machines from seven manufacturers.

The American Heart Association recommends 100 Hz as the upper cutoff frequency for electrocardiographs. Of the units tested, none met this standard. In 75% of the units the 3-dB point was under 50 Hz. Two machines cut off below 20 Hz.

The Association also stipulates that the 1-mV calibrating pulse should be accurate to within  $\pm 2\%$ . The inaccuracy was greater than 10% in seven of the 51 units checked.

Six percent of the electrocardiographs had broken ground wires in the line cord. This percentage is significant because leakage current of over 10  $\mu\text{A}$  was measured in the ground wires of 55% of the machines. In fact, 43% had leakage currents in excess of 50  $\mu\text{A}$ .

Most of the ECG machines had line-polarity reversal switches for minimizing power line noise. Invariably, these switches doubled the leakage current through the ground wire. Some machines, fortunately, don't have these switches. When found, they should be removed.

Another problem with electrocardiographs in hospitals is that the response may vary from machine

to machine. When daily electrocardiograms from the same patient are recorded on different machines at different times, resulting variations in patterns are often interpreted as pathological change when they may really represent differences in the recording capabilities of the machines. One brand deliberately introduces a possible recording variation. It has a high-low switch which removes a filter controlling the instrument's upper cutoff point. In one hospital the switch was found randomly set from machine to machine. Apparently no one appreciated that this switch could affect the shape of an ECG pattern.

In one ECG machine, internal inspection turned up a printed circuit board that had evidently been rejected by a quality control inspector at the manufacturing plant. Written on the board was the word "defective". In another machine, a board was found with the words "poor gain" written on it.

External examination of ECG gear frequently turned up cases of equipment misuse. Electrodes were found corroded or still sticky with partially dried electrode paste. Power cords were twisted and bent.

**Pacemakers are pulse generators** designed to drive the heart at a safe rate when its regulatory mechanism fails. From the generator run a pair of pacing leads, which are usually connected directly to the heart, allowing precise control and the use of low-current pacing pulses. Bypassing the skin resistance in this way, however, also provides a path to the heart for minute stray currents.

Fifty-seven external pacemakers (not to be confused with implanted pacemakers) were investigated, the products of six manufacturers. They included both line- and battery-operated models. In 56% of the units, the output amplitude was found to be non-linear. Increasing the stimulus setting from two to four, for example, did not necessarily double the strength of the stimulus.

A linear output is extremely important. The pacing threshold—the minimum voltage level needed to pace the heart—can change from hour to hour. When using a pacemaker, a physician will slowly increase the amplitude until he "captures" the heart, i.e. reaches threshold. Then, as a safety factor, he'll increase the amplitude—experience tells him by how much. How-

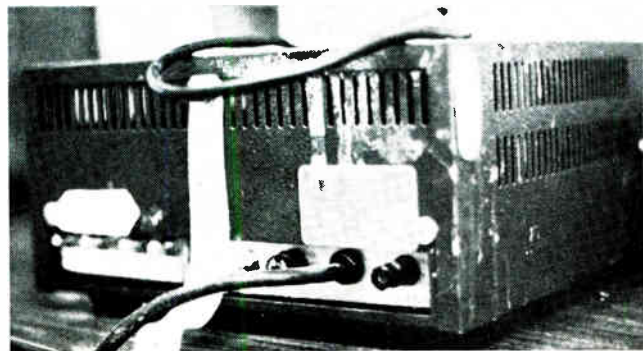

4. Harsh environment. In a typical hospital accident, saline solution has been spilled onto monitor. This fluid can corrode components and cause short circuits.

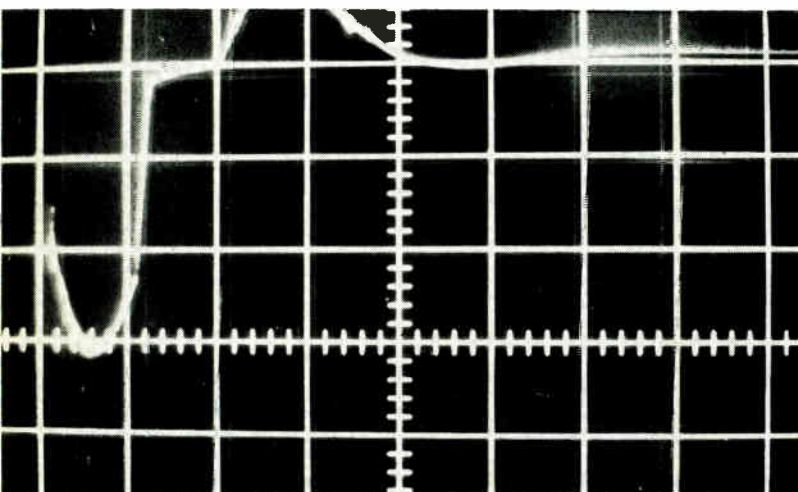
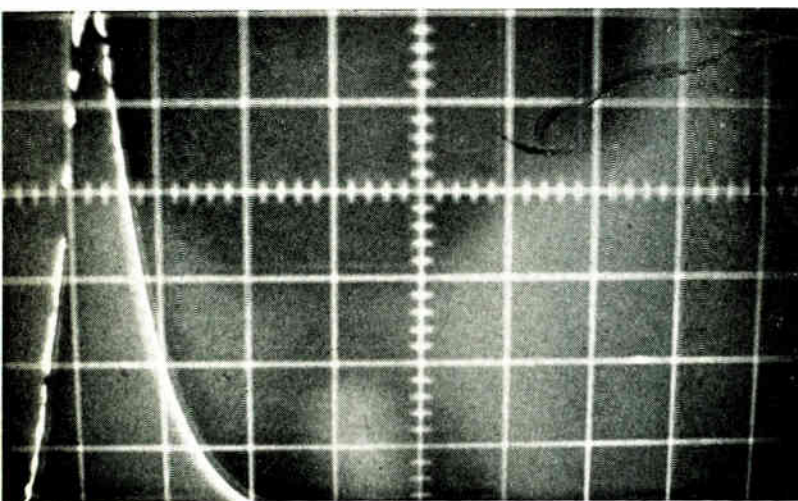
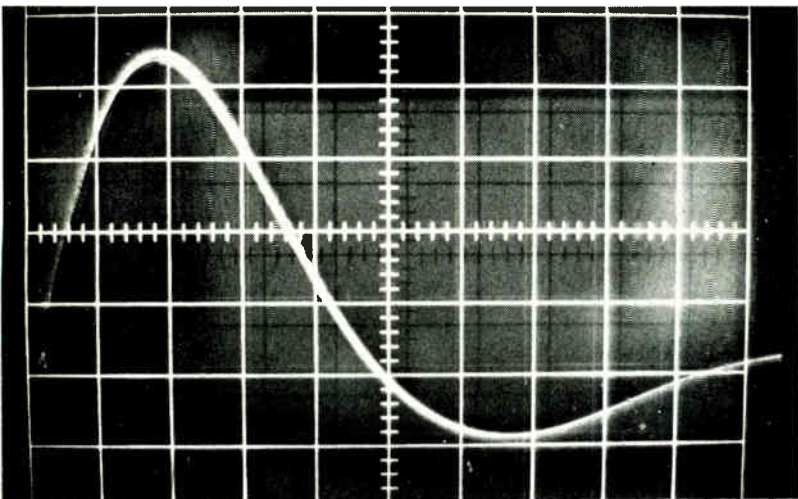

5. Changing output. Most defibrillators are designed to put out pulses like one in top photograph. However, as defibrillators age, waveshapes can change, and it's not uncommon to find older units delivering deformed pulses like two lower traces. Since such outputs can injure cardiac muscle, hospitals should periodically check defibrillators for output waveshape. But they can't. No manufacturer has developed an instrument that'll perform this test.

ever, if increasing the setting of the pacemaker's control a certain amount doesn't result in a proportional increase in output power, the risk increases that the threshold may rise above the pacemaker's output amplitude. If this happens, the pacemaker fails to drive the patient's heart.

Fifty percent of the pacemakers inspected delivered a pulse amplitude that varied at least 10% from the amplitude setting. In two cases, the delivered waveform resembled a differentiated square wave, instead of the intended square wave. In addition, 40% of the pacemakers exhibited pulse rates that deviated from the setting by more than  $\pm 2$  beats per minute.

Leakage current through the pacing leads in line-operated pacemakers (pacemakers not grounded by a third wire) was negligible in all cases except two. These had a five-wire—not a two-wire—patient cable, in which three wires were used as the input for a CRT monitor, while the other two carried the pacemaker stimulus. When the unit was first switched on or off, a 400- $\mu$ A transient current passed between the right-arm lead and one of the pacing leads.

There was some interaction between the rate and amplitude controls in 10% of the pacemakers. In two units, as the rate was slowed to just below 80 beats per minute, the pulse amplitude abruptly dropped to zero. In others, as the rate was changed from one setting to another, the pulse height varied by as much as 1 mV across 500 ohms. Such interaction cannot be tolerated since it is frequently necessary to change the pacing rate.

In all brands observed, the terminals that connect the pacing leads to the pulse generator showed exposed metal. Most pacemakers had only simple binding posts. With their terminals exposed, all of these pacemakers are susceptible to stray current. For instance, terminals may be touched by nurses, or come in contact with a metal bed rail. Since any voltage on the terminals will drive a current directly to the heart, the terminals should be insulated.

In addition, batteries should be easy to replace. But in one model examined, a screwdriver was needed to open the battery compartment.

A battery log book should come with a pacemaker. Furthermore the nickel-cadmium batteries should be replaced at fixed intervals. Otherwise the batteries may fail suddenly while the pacemaker is being used. During the survey several pacemakers with dead batteries were found.

**Defibrillators** are high-voltage, high-energy instruments that shock the heart when the ventricles are fibrillating. The shock action temporarily arrests all cardiac activity, allowing normal heart rhythm to supervene. The defibrillating pulse should last about 10 milliseconds and have an energy content adjustable to 400 joules. It's delivered through two paddles placed across the chest, which is smeared with electrode jelly to insure good electrical contact. For the survey, 41 defibrillators were tested, representing nine manufacturers.

The defibrillating paddles were, in a few cases, poorly designed. Some paddle surfaces were so malleable that they became deformed. Contact area



between a bent paddle and a patient's chest is small, so skin burns may result. Other paddles were designed with a friction-fitted rubber rim between the paddle surface and the handle. Electrode jelly can seep through the seal and cause the operator to receive the defibrillating shock. Still other paddles with a low-profile design make it possible for the operator to touch the paddle surface and the paddle discharge button simultaneously. Although such a possibility may seem remote, the circumstances surrounding a resuscitation are highly unpredictable.

Some defibrillators are designed to have one paddle electrically connected to their chassis, and therefore to ground. In the event of a poor ground, such a design introduces a shock hazard for personnel coming in contact with the chassis. In addition, if the patient is grounded through a second connection, such as a ground lead of a monitor, an alternate path, away from the heart, exists for the defibrillating pulse. Then the small contact area offered by a monitor electrode increases current density at the point where the current leaves the body, causing patient burns. Examples of such occurrences can readily be found in medical literature.

In the case of recurring ventricular fibrillation, the delivery of high-energy pulses in rapid succession may be necessary. One particular defibrillator, however, has a thermal circuit breaker that overheats when shocks are delivered rapidly. The machine is then useless until the breaker can be reset. Worse still, if additional shocks are delivered, the breaker opens again, generally within four shocks—and this time the breaker can't be reset for about three minutes.

**When a defibrillator's dial** is set to a particular energy level, a capacitor is charged to deliver that energy. If subsequently the defibrillator isn't used, the energy should be dissipated internally when the device is turned off. Otherwise, the defibrillator could discharge accidentally. This safety feature, called automatic discharge, was not included in 50% of the defibrillators tested. Some makers offer it only as an option; it should be a standard feature.

Of all the types of devices tested during this survey, defibrillators exhibited the worst disparities in electrical performance. For example, when they were set to deliver 400 joules, the actual output of the different defibrillators ranged from 20 J to over 650 J. In fact, only one brand had acceptable agreement between the energy indicated on its watt-second meter and the energy delivered into the test load.

To test the output of a defibrillator, a resistive load of 50 ohms was placed across the patient paddles. The delivered pulse was attenuated and displayed on a storage oscilloscope, photographed, and later segmented into 20 data points. A computer calculated the energy delivered.

The variety in output energy from brand to brand indicates that a uniform standard of calibration must be adopted by all manufacturers. Unpredictability in therapeutic devices is intolerable in critical patient care. At the very least, all defibrillators should be tested regularly for energy output and pulse wave-shape. Degradation of either can mean loss of life or

severe injury to the heart. There's an immediate need for an adequate defibrillator tester for hospital use. Some of those on the market are no better than threshold detectors. Others actually integrate a signal, but still do not give any indication of pulse shape. And none has the capability of supplying the percent error between the indicated and delivered energy.

**What can be done** about improving medical electronic equipment? The survey surely indicates that manufacturers, hospitals and the Government must each take steps to safeguard patients from faulty equipment and equipment abuse.

Manufacturers would do well to incorporate some of the design and production techniques of the military contractors, including printed circuit boards and modularity for easy replacement and maintenance. Those medical instruments that have already been produced to military-type construction specifications are very reliable and rugged, and much easier to repair and calibrate.

Steps have to be taken to make medical instruments easier to service even on the local level. Front panels should be simple to remove; it's not uncommon now for a panel to have 20 or more screws holding it in place. Test points and key components, such as potentiometers, should be clearly labeled and accessible. Equipment should be designed with interchangeable functional units, such as plug-in power supplies and plug-in CRT deflection circuits. Hospitals cannot afford duplicate instrumentation, but can afford to keep a small stock of the functional units most likely to fail.

Industry-wide standardization of connectors for patient cables, pacemakers, defibrillators, monitors, and electrocardiographs must be mandatory. Standardizing switches, instrument cables, and other non-proprietary accessories should be encouraged; it would be an immense help in day-to-day maintenance.

Self-check features should be designed into medical devices. A passive circuit involving seven resistors, one capacitor and a battery was suggested by the American Heart Association<sup>1</sup> in 1967 as a test circuit to determine high and low frequency response, input impedance, common mode rejection, and linearity of electrocardiographs. Something like this should be incorporated into monitors and ECG machines for simple in-house testing. A self-contained, momentary, ground-line checker should be used to provide a means of testing ground integrity just before a patient is connected to any line-operated device. The use of molded line plugs should be abandoned because they can't be inspected for broken ground connections.

Patients, particularly those being monitored with electrodes or catheters, must be protected from leakage currents. This means, first, that instruments should be made to generate as little leakage as possible. Furthermore, the patient should be isolated from any monitoring instrument by high impedance devices, such as current limiters or optoelectric couplers, inserted in the patient leads.

Manufacturers must also get more involved in maintenance. Some do offer service contracts which



require them to inspect and calibrate their products periodically. But in most hospitals there's no one qualified to judge how well the equipment is being maintained. As a result, most manufacturers don't do a good job in this area.

Although manufacturers can begin the job of improving medical electronic devices, the hospitals themselves must also take action. One approach that has been suggested is the formation of regional service groups. Organized by the hospitals in a given area, each group would have the job of keeping all their biomedical equipment up to standard. It wouldn't be a maintenance arm made up of technicians, but a supervisory and educational organization made up of biomedical engineers and physicians familiar with instrumentation. Such groups would advise hospitals on equipment purchases, and see that manufacturers lived up to service contracts and warranties.

These groups could also help hospitals develop preventive maintenance programs. Hospitals often have individuals who can perform routine checks, such as measurements of leakage current, cable continuity, and ground wire integrity. These people can also be trained to recognize the early symptoms of

impending equipment failure and to make minor repairs of broken patient cables, frayed line cords, and so on.

Further, electricity and electronics must lose their mystery for the health profession. Service groups could design educational programs that would provide an easy introduction to these topics and relate them to special medical applications.

Finally, it has been suggested that manufacturers and service groups need a Federal "watchdog agency" to evaluate their products or services. Such an organization could stem the influx of inadequate devices, and could also license service groups. In addition, it could draw up mandatory testing protocols that would define both the types of tests to be performed on particular types of equipment and the allowable interval between such tests. □

#### Reference:

1. I.C. Kossman et al., "Recommendations for Standardization of Leads and Specifications for Instruments in Electrocardiography and Vectorcardiography," *Circulation*, 1967, vol. 35, p. 58.

The views expressed in this article do not necessarily represent those of the Department of Health, Education, and Welfare, or the Michigan Association for Regional Medical Programs.

## Federal procrastination

The doubtful state of electronic gear in hospitals is only part of the long battle over Federal regulation of the medical electronics industry. And with health care high on the list of Nixon Administration priorities, the outlook for medical device legislation is better now than it ever was. But Capitol Hill sources say to expect no definitive legislation this year.

Nevertheless, device bills will be considered this year. Most are likely to incorporate the recommendations of the Department of Health, Education, and Welfare's Special Committee on Medical Devices, chaired by Dr. Theodore Cooper, Director of the National Heart and Lung Institute. The Cooper committee report calls for a review of existing standards and premarket clearance for certain types of devices, and it recommends that all devices be classified into three categories: those which require scientific review by a peer panel of multi-disciplined experts prior to clinical application and marketing; those for which existing standards are adequate, or for which sufficient data exist for the establishment of new safety and performance standards; and those which should be exempt from pre-clearance.

Championing medical device legislation to date has been Rep. Paul Rogers (D., Fla.), whose 1970 bill was in sympathy with the Cooper report. HEW apparently feels the Rogers legislative package is unsatisfactory, and is working on its own bill, which it may or may not transmit to Congress this session. But if hearings are scheduled for Rogers' bill, they will almost certainly force HEW to show its cards.

Meanwhile, though the Administration has made no official comment on the Cooper report, Food and Drug Administration Commissioner Dr. Charles C. Edwards, a member of Cooper's committee, last December appointed David Link to begin device classification. Link, formerly at Hewlett-Packard Co., is using

questionnaires sent to industry to compile the inventory, which can be done independently of legislation. But later this year, as the replies come in and FDA nears the classification stage, it will need more money, requiring legislative appropriation. Barring that appropriation, the only source of funds is FDA itself. Link's office speculates that enough money to contract a scientific panel to categorize devices can be found in contingency funds.

To prepare the questionnaires, Link is working closely with an informal group of representatives from associations interested in medical devices. The group includes spokesmen for the National Electrical Manufacturers Association, the American Medical Association, the Medical-Surgical Manufacturers Association, and the Association for the Advancement of Medical Instrumentation. Absent is the Electronics Industries Association. A spokesman explains that EIA wants to be free to differ with Link's group.

FDA's regulation of medical devices in the past has extended only to the misbranding and adulteration clauses of the 1938 Food, Drug, and Cosmetic Act. In fact, the staff that Link inherited had dealt mainly with quack-type devices, and FDA's device money largely has been spent for after-the-fact litigation. Recent court decisions now allow FDA to extend pre-market clearance to certain types of medical devices. But most sources say that FDA won't use this power because of the complex litigation involved.

Besides FDA efforts, device regulation and control is limited to those few devices covered by the Atomic Energy Act of 1954 and the Radiation Control for Health and Safety Act of 1968. And several governmental organizations exert some control through standards such as Veterans Administration and Department of Defense purchasing specifications.

Larry Armstrong



Store  
a new term  
in your memory  
data bank:

OVONIC  
**RMM**

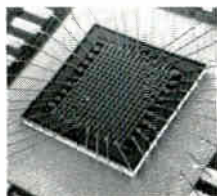

RMM. It stands for "Read-Mostly Memory"—which aptly describes the unique capabilities of our new 256-bit silicon/amorphous semiconductor memories.

Unique because they're the only memory elements being made that combine the *non volatility* offered by ROMs (and one-shot field programmable PROMs, FROMs, SCROMs and the like) with the *electrical alterability* featured by RAMs.

Which means you can use 'em just like any other hard-wired memories. But with no loss of data in the event of power failure. And with complete freedom to change, up-date and

re-alter stored information on the spot. Quickly, easily, selectively. *And repeatedly*—by simple electrical means. Other characteristics of these LSI arrays include: Rapid random access. Fast read speed. Non-destructive readout.

Applications? You name 'em! Microprogramming, emulation, table look-up. Special character generation. Code conversion. Sequencing and logic control—just to mention a few. And they can also be used to good advantage for simulation of logic or fixed program ROMs in prototype development.

Availability? Here *and now!* From stock in evaluation quantities: a couple months for delivery of production orders. George Landers is your man. Call him: 313/549-7300.

Energy Conversion Devices, Inc.

1675 WEST MAPLE ROAD • TROY, MICHIGAN 48064





# A critique of MOS/LSI testing

Building a successful, commercial MOS/LSI test system requires radical rethinking of test concepts plus acute awareness of the evolving needs of the market; today's systems fall short of these criteria

By Michael A. Robinton, *National Semiconductor Corp., Santa Clara, Calif.*

□ Semiconductor manufacturers and users appear fed up with footing the developmental bill for MOS/LSI tester manufacturers whose equipment is unsuited for the test problem or doesn't work properly or is doomed to quick obsolescence, and they will increasingly require the vendor to exhibit completed working hardware before committing themselves to a purchase agreement [ see "LSI testers: still a hard sell?," *Electronics*, Dec. 7, 1970, p. 107].

Since LSI is basically the technology of producing digital subsystems on semiconductor chips, the ability to test digital subsystems economically is a fundamental requirement for the application of LSI technology. And test requirements for digital subsystems are qualitatively different from test requirements for small- and medium-scale integrated circuits. In addition, LSI is most easily implemented through MOS technology, and MOS requires a totally different test concept from earlier bipolar technology. Some of the types of MOS parts that must be tested are random access memories, serial shift registers, random combinatorial logic, and sequential logic with buried states. As a result, to be effective, the LSI test system must address the twin requirements of digital subsystem test and MOS test.

**Digital subsystem test** in its most general terms requires the ability to store and present to the subsystem under test a very large number of arbitrary input-output patterns and the ability to make good-bad decisions based on the subsystem's response to these patterns. Further, the economics of testing requires that these patterns must be presented very rapidly, so that total test time is short.

To bring home the necessity of high-speed testing, an example is in order. A simple walking-one walking-zero pattern (i.e. write a one in a field of zeros and a zero in a field of ones) to test a  $1,024 \times 1$  read-write memory, such as the Intel 1103, requires slightly over two million read-write operations. If we assume the pattern itself is generated by algorithm, the test speed is the only parameter which is of importance. At a 1-MHz test rate this would be 2 seconds. Since it would take 20 s at a test rate of 100 kHz, and 200 s at 10 kHz, it can be easily seen that slower test rates and/or more complex parts cannot be economically handled on a slow component-oriented tester.

MOS testing requires that the amplitude and timing of the patterns presented to the subsystem under test must be controlled very precisely and that the test system must have negligible effect on the subsystems under test. MOS/LSI testers must be able to exercise any MOS component fully over its entire design range from a few hundred hertz up to 5 MHz, while providing worst-case clock and data pattern timing as well as worst-case voltage levels. In addition, it must be capable of testing input/output bus structured devices with commutation times of a clock cycle or less. The full range of parametric testing must be provided, including breakdown, leakage, and supply current. In short, an MOS/LSI test system must provide complete parametric, functional and dynamic testing to the device under test.

**But the successful system**, besides providing answers to all of the preceding requirements, must be priced to encompass the maximum possible area of the test system market. However, these requirements of capability and cost are somewhat opposed to one another, and a solution to the price-capability dilemma does not seem to have been found by either of the two distinct classes of manufacturers presently supplying the MOS/LSI test market.

The first of these, the established supplier of test systems for semiconductor components, who is intent on adapting his product to cope with the shifting market emphasis, usually has little or no direct knowledge of the MOS/LSI test market and has a development staff attuned to component test rather than to systems test requirements. In addition, because these suppliers have a large investment in their existing product lines, they are faced with the problem of forcing a return on existing equipment designed to test components and MSI. As a result, offerings from these vendors are merely adaptations of existing equipment. Since this market is actually a digital subsystems test market, adapted component testers are at best inadequate and expensive compromises. Teradyne and Fairchild are the principal examples of this class. Another is Adar, which is attempting to expand its market coverage from memory testing to the general MOS/LSI test market.

The second class of equipment vendors is the new company start-up, typified by the group of semiconductor industry instrumentation engineers intent on



January 8, 1971  
National Semiconductor Corporation  
2900 Semiconductor Drive  
Santa Clara, California 95051  
Phone: (408) 732-5000

Kemp Anderson, Editor-in-Chief  
Electronics  
McGraw-Hill Building  
330 West 42nd Street  
New York, New York 10036

Re: "LSI testers: still a hard sell?"

Dear Mr. Anderson:

After reading Mr. Curran's article in *Electronics* (December 7th, page 107) "LSI testers: still a hard sell?", I felt that many questions were left unanswered. I called Mr. Lawrence Curran, in an effort to provide answers to some of those questions. He suggested that I write a "letter to the editor" and send it to you. I have included a great deal of information which I am sure many of your readers will find very interesting and enlightening.

Sincerely,



Michael A. Robinton

as a result it is capable of handling the storage and manipulation of large data patterns. In addition, it has a very effective high-level software package. Its data manipulation and software capabilities make the Sentry 400 the most effective system for testing standard bipolar and bipolar MSI; however, the system has only limited capability for testing static MOS circuits and none for testing dynamic MOS/LSI.

A proposed MOS adapter for Sentry would provide a multiphase clock system with a resolution of 10 nanoseconds, but it would also push the price to the \$300,000 region. However, the basic system's comparators remain a slow 350 ns. Even with the addition of a clock system, the total overall data speed of 286 kHz is still inadequate for testing 1-MHz MOS circuits, let alone 5 MHz.

**Other shortcomings of the system** are the lack of high-speed data generation, the lack of the necessary data and clock timing, and the lack of a low-capacitance high-speed comparator. These shortcomings are shared by the Teradyne J-283 and the Datatron 4400.

The Teradyne J-283 is similar conceptually to the Fairchild Sentry 400, but it does not have the massive data storage and manipulation capabilities of the Fairchild system. Even with a MOS adapter, the maximum data limit of 50 to 100 kHz on the J-283 makes it even less suitable for the MOS/LSI test market.

The Datatron 4400 is more suitable for testing bipolar MSI than the Teradyne J-283 in terms of overall test speed and systems cost; however, it suffers from more severe data handling and data manipulation problems than the Teradyne system. These limitations make the Datatron 4400 even less suitable for the MOS/LSI test market.

The CDC Scat 68 is similar in systems structure to the Fairchild Sentry 400 except in the area of functional test speed. In this area it is more like the Teradyne J-283. For this reason it is judged to be less suitable for the MOS/LSI test market than the Sentry 400. An additional difficulty with the CDC system and vendor is that only one system was completed over a year ago, and there is no indication that the product line will be pursued.

**Systems capable of performing Type 3 testing** include models from Adar, Macrodata, Redcor and LSI Testing, and a proposed system from Xintel. The primary difference between this class of system and the systems previously discussed is its ability to provide adequate data and clock timing. The other activities necessary for MOS/LSI, such as high-speed algorithm generation, memory recycling, and I/O bus testing, may or may not be present in a particular machine. The only system which may embody all necessary attributes is the Xintel Spectrum 1. The Xintel Spectrum 1 is a proposed system for MOS/LSI testing, scheduled to be available by spring of this year.

The Spectrum 1 system architecture embodies a microprogramable random access high-speed local memory. This appears to be the most acceptable memory structure; however, the Spectrum 1 system organization requires that a data cycle be sacrificed for each microinstruction processed. This is a severe drawback when performing random bit-masking and I/O bus

capitalizing on their specific knowledge of a limited segment of the test systems market by forming a company to build a particular test system. Companies in this class suffer from two problems. Their in-house designs have been slanted toward the test philosophy of the semiconductor manufacturer with whom they were affiliated, and they have given little or no thought to a continuing product line for the full test systems market. Redcor, LSI Testing and Macrodata, for instance, have all manufactured systems which work—more or less—but they have neither perfected them nor given evidence of a continued product line development.

**It would be impractical** at best to discuss all of the test equipment manufacturers in the MOS/LSI area. However, a brief representative analysis of those who hold or have potential to capture a significant portion of the MOS/LSI and complex array tester market is in order.

Of the scant amount of equipment available to test MOS/LSI, LSI Testing and Redcor have delivered the majority of installed systems. These two suppliers provide duplication of equipment developed to the specifications of General Instrument and AMI respectively. However, these specifications are not generally applicable for MOS testing requirements.

The testers described have one or more of the following capabilities—

1. parametric testing: the ability to make precise voltage and current measurements while forcing exact current or voltage levels.
2. dc functional testing: the ability to provide voltage level patterns of arbitrary sequence but without regard to precise timing.
3. dynamic functional testing: the ability to provide precise timing and phase information while providing arbitrary data patterns to the device under test.

To fully address the market place, an MOS/LSI tester must have all three types of capability. It must be noted that Type 2 is inherent in Type 3.

The Fairchild Sentry 400 is an example of a system with Types 1 and 2 test capability. This system was designed to accomplish testing of complex bipolar arrays both functionally and parametrically, and

testing. In the extreme case, cycle stealing can reduce test speed from the advertised 5 MHz rate to 2.5 MHz. An additional problem with the proposed memory structure is that there does not appear to be a provision for a "keep alive" pattern for the device under test during memory reload.

The proposed Spectrum 1 system uses the driven-shield technique to allow separation between interface electronics and the device test as an integral part of the system architecture. This technique is acceptable at lower operating frequencies such as 1 MHz; however, it is very unlikely that system specifications can be met at 5 MHz. An additional problem is the effect of cable inductance on system overshoot. Pulse rise time will have to be degraded to avoid overshoot, and it is very unlikely that the required 50-ns rise times will be possible without cable termination and performance boards. Since wafer-sorter and parts-handler interfaces are based on the assumption of an acceptable driven-shield system, the system will probably be derated to 2 MHz from the proposed 5 MHz.

**The author has completed the design** and construction of a test system which uses drive-shield techniques, is conceptually similar to the Xintel system, and is currently operating at National Semiconductor's Santa Clara facility. It is clear from conversations with Xintel engineers and examination of their breadboards that they are not yet aware of all of the problems arising from use of driven-shield techniques. While these techniques are effective up to 2 MHz, the cable delays and inductances are such that rise times and input capacitance are not adequate for 5-MHz testing. This is borne out by their system capacitance specification of 25 picofarads and rise-time specification of more than 100 ns with capacitive loading. Neither of these specifications is adequate for 5-MHz testing nor accurate for testing at 2 MHz.

If these and other problems are addressed, the Xintel system could be very effective. However, if these problems are not realized until late in the development cycle, a redesign delay will result. Though this system is advertised for delivery in the first quarter of 1971, the present state of system hardware indicates that a more realistic date is late in the second or third quarter at the earliest.

In addition, Xintel's price schedule seems unrealistically low. Many start-up operations have found out all too late that building a piece of equipment for X dollars as an in-house instrumentation group and selling it for X dollars as an equipment manufacturer are two entirely different things. It is still necessary to pay the cost of overhead (e.g. sales, marketing, and manufacturing).

The second system meeting Type 3 requirements is the Adar Doctor 64. This system also uses a high-speed random access memory, but is not as flexible as the proposed Spectrum 1 system. The system is an outgrowth of Adar's Doctor 100 memory tester, and many of its characteristics reflect this specific origin, with the result that the system does not provide the flexibility required for MOS/LSI test.

A catalog of the Doctor 64 shortcomings would include a lack of I/O bus capability, a lack of long-term

timing accuracy, a lack of wafer-sorter interface capability, a lack of random-bit-masking capability, and a lack of data manipulation software. These deficiencies limit the system's capability and make it much less desirable than the proposed Xintel Spectrum 1.

The Macrodata MD 200 is another Type 3 system. It is structured with a shift register high-speed local memory. Of all high-speed memories, this is the least versatile in that it is a serial access memory with an access time of 256 microseconds, and the system presently has no ability to provide a "keep alive" pattern while reloading memory or to generate data at high speed via algorithm. Additional problems include the lack of I/O bus capability and the lack of random bit-masking. The MD 200 is basically a 2-MHz test system with no capability of expansion to higher frequencies. As such, it can have only a limited market life.

Macrodata has shipped only two systems during 1970, one to Varadyne Inc., and the other to MOS Technology Inc. At least one of these systems is said not to perform to the satisfaction of the purchaser (Varadyne) and may even be returned to Macrodata. A third system, originally scheduled for delivery to National Semiconductor in the fall of 1970, has repeatedly failed to meet National's acceptance specifications and is still at the Macrodata plant.

The Redcor Paft 2 and LSI Testing Inc. 4024 test systems are similar conceptually to the Macrodata MD 200. Each of these systems is limited to 2-MHz operation and is less capable than the Macrodata system.

**From the preceding analysis,** several things become clear. To test MOS/LSI effectively, a test system must be able to cope with shift registers, read-only memories, random combinatorial logic, sequential logic, and read-write memories. The systems designed by Redcor, LSI Testing and Macrodata are structured primarily to cope with shift registers, read-only memories, and random combinatorial logic, with no provision for effective testing of sequential logic and read-write memories. Since the highest growth rates for MOS/LSI are projected in the areas of read-write memories and digital subsystems, an effective method of dealing with sequential logic and large regular test patterns is mandatory. In addition, provision must be made for I/O bus tests and for tester synchronization to digital subsystems with buried logic states.

It is interesting to note that the various test systems currently available are designed for a maximum data rate of 2 MHz in a market where 5 MHz is already required. These systems seem to have no provision for growth without complete redesign. Moreover, of the systems proposed or currently available, only one, Xintel's, appears to show an awareness of the applications problems; however, their awareness is tenuous at best. □

*Controversial subjects like this one are nothing new to Electronics, and we realize that many different opinions exist. We encourage readers, both users and makers of LSI testers, to submit their views. Write to The Editor.*

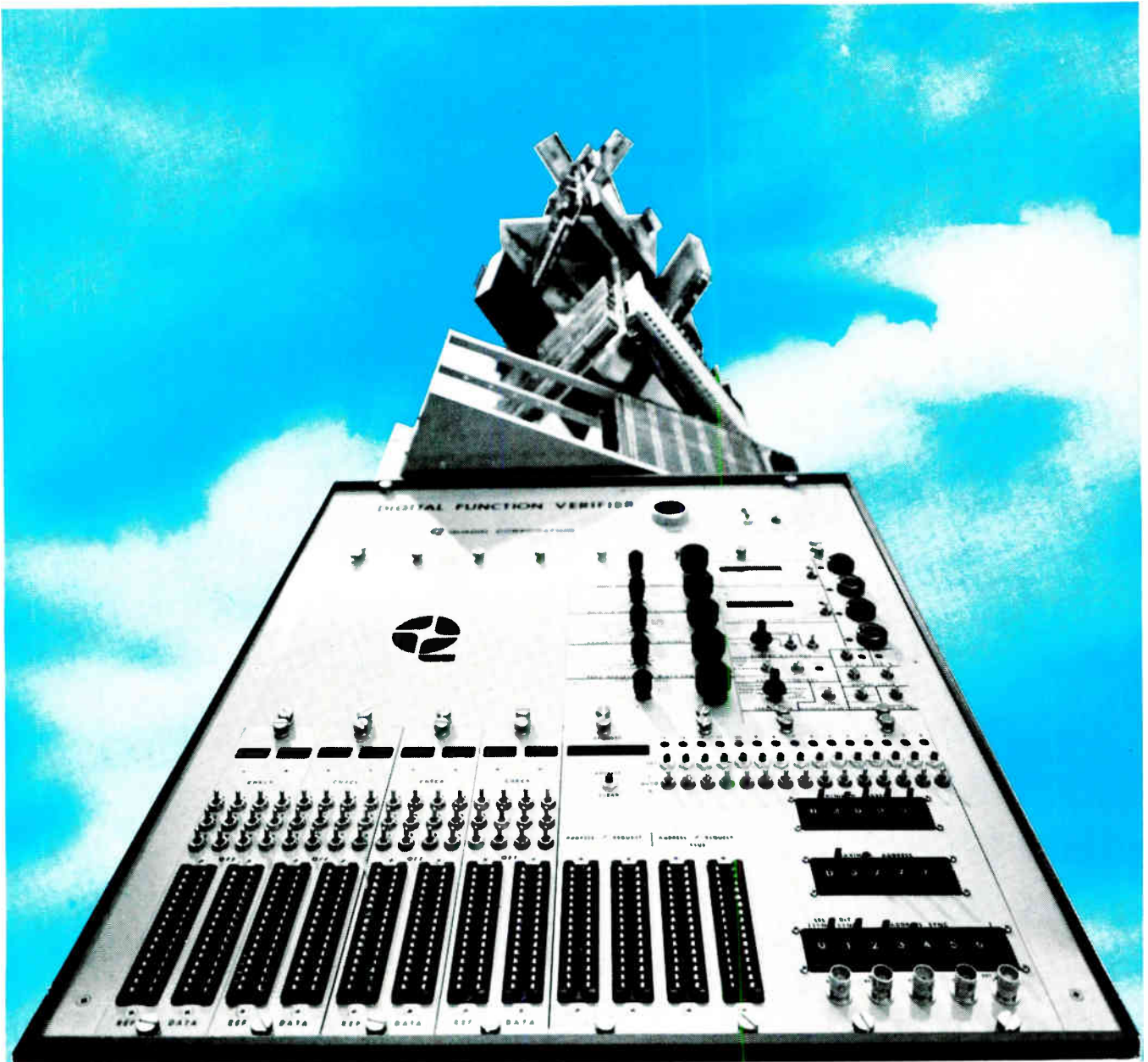

# QUADRI...ON THE MOVE!

**MEMORIES?** ... At Quadri you'll find the most complete line of field-proven memories available.

Quality, technology, and production "as you need it" in large or small quantities. More than 23 basic models have kept us *M-O-V-I-N-G!*

**1970 Developments** ... to name a few:

*Field Alterable PROM • Hi-Speed Bipolar Read/Write • Military Magnetic Read/Only • Dynamic MOS Read/Write • Magnetic Read/Only • Military Read/Write Stacks & Systems • Digital Function Verifier and associated test equipment PLUS—special order "toughies" to meet specific customer requirements.*

QUADRI can and will help you with your memory requirements.

Call or write today:

**COMPUTER DISPLAY EQUIPMENT SHOW**  
**U. S. TRADE CENTER, FRANKFURT, GERMANY**  
**FEB. 15-19, 1971**

**QUADRI**  
**CORPORATION**  
 2950 WEST FAIRMONT  
 PHOENIX, ARIZONA 85017  
 (602) 263-9555



RETROFITS MOST MINIATURE  
THUMBWHEEL SWITCH  
PANEL OPENINGS.

# MINI- THUMBWHEEL SWITCH

FOR COMPUTERS. NUMERIC  
CONTROLS. IN-FLIGHT GEAR.  
MANY OTHER SMALL-SPACE  
INPUT SWITCHING OPERATIONS.

CDI Series TSM mini-thumbwheel switches mount on  $\frac{1}{2}$ -inch centers . . . can be furnished with decimal, binary, or binary with complement output—or with specified code characters. Available with extended PC boards for mounting additional components if desired. Large, easily-read numerals . . . positive detent . . . 8, 10 and 12 positions. Completely O-ring sealed against hostile operating environments.



.900" x .980"  
FRONT PANEL SIZE  
FOR SINGLE  
MODULE ASSEMBLY:

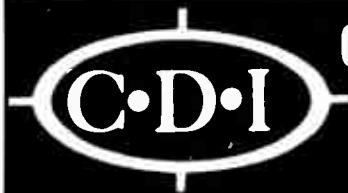
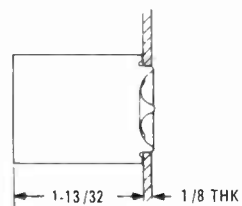
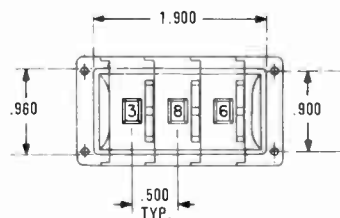

**CHICAGO DYNAMIC INDUSTRIES, INC.**

PRECISION PRODUCTS DIVISION

1725 Diversey Blvd., Chicago, Illinois 60614

Phone (312) 935-4600

# Sorensen's new SRL power supply has a great thing going for it.

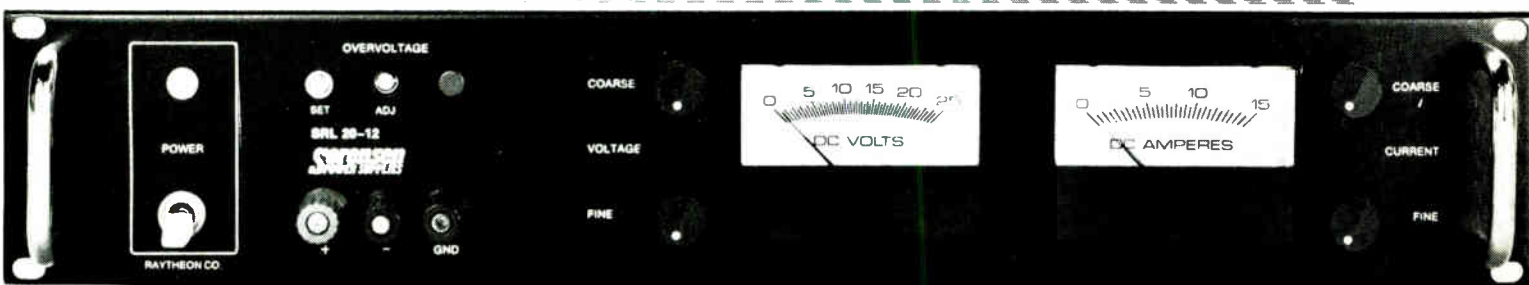

## Built-in overvoltage protection that can be quickly set and instantly checked even under full load.

SRL is a new low voltage, regulated DC power supply for systems and laboratory applications. We designed it by asking power supply users what they liked and didn't like, the features they wanted or needed. Features like exclusive front panel monitoring and adjustment of overvoltage setpoint without removing the load.

SRL comes in 14 models: 4 voltage ranges to 60 VDC, 4 power levels to 2000 watts. It offers higher power density, low ripple and noise, fast response time over full load range, operation to 71°C, IC reliability.

Check out SRL. Or any of the hundreds of other Sorensen power supplies with output voltages from 3 to 150,000 VDC, output currents from 1.5mA to 1000 A. They are all listed, with prices, in the Sorensen catalog. Write for your free copy to Raytheon Company, Sorensen Power Supplies, 676 Island Pond Road, Manchester, New Hampshire 03103. Tel: 603-668-1600.

Model	Output Power			
	Voltage (VDC)	Current (ADC)		
		55°C	60°C	71°C
SRL 10-25	0-10	25	22	16.7
50		50	44	33.5
100		100	88	67
SRL 20-12	0-20	12	10.5	8
25		25	22	16.7
50		50	44	33.5
SRL 40- 6	0-40	6	5.3	4
12		12	10.5	8
25		25	22	16.7
50		50	44	33.5
SRL 60- 4	0-60	4	3.5	2.68
8		8	7	5.36
17		17	14.9	11.4
35		35	31	23.4

**Sorensen**  
POWER SUPPLIES

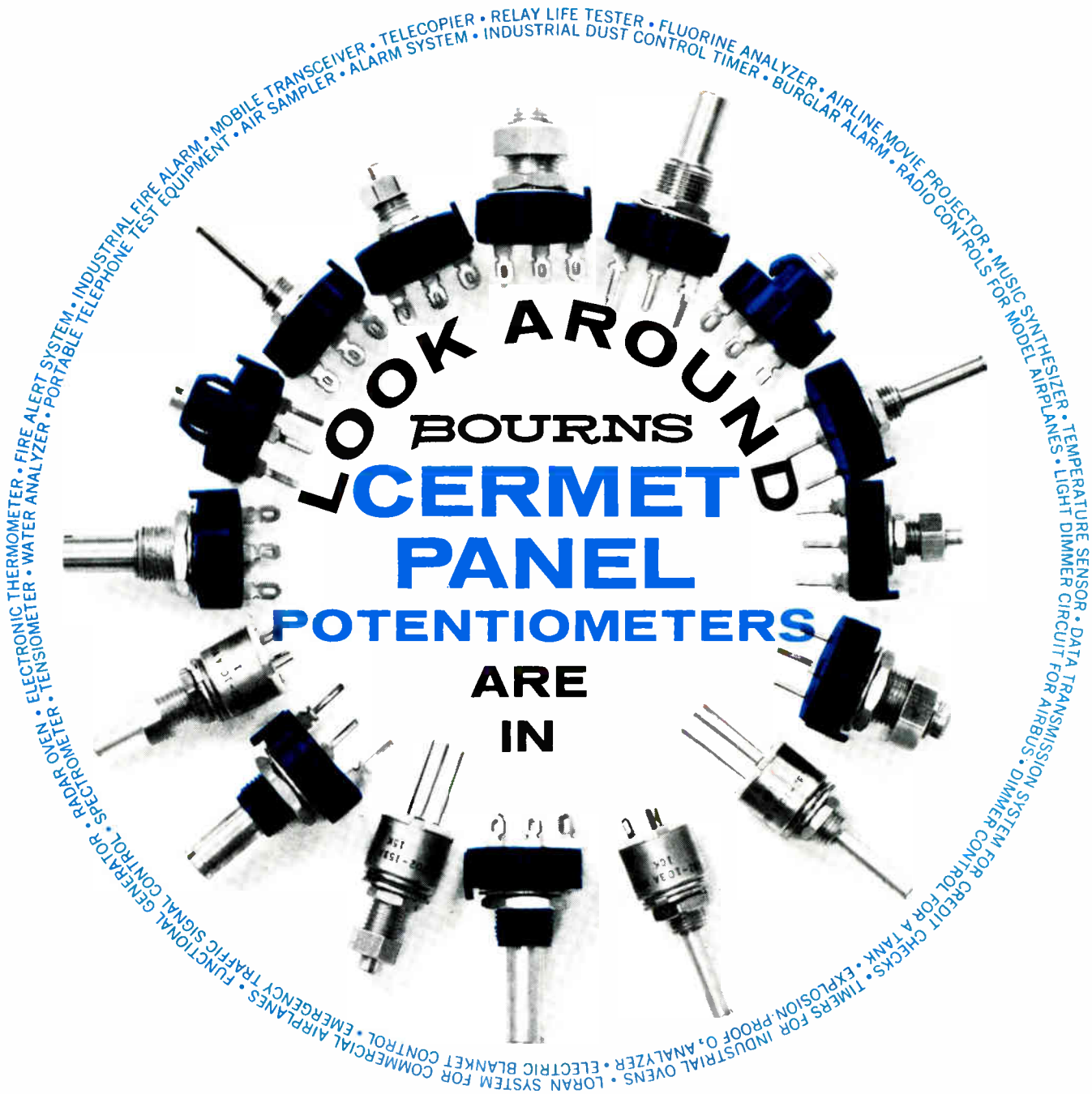

Take an idea . . . or do your own thing. Applications for Bourns Cermet Panel Controls turn up everywhere.

Cermet resistance elements offer you a wide advantage in performance over their old-fashioned carbon counterparts. Look for:

- BETTER STABILITY
- HIGHER POWER RATING
- SUPERIOR TEMPCO ( $\pm 150$  ppm/ $^{\circ}$ C)

Bourns Panel Controls **save space**, too. The  $\frac{3}{4}$ " diameter models extend only  $\frac{1}{4}$ " behind the panel — that's not far out.

Take a look at our new brochure on Panel Control Potentiometers — 16 pages of cutaways, photos, specifications and prices. Ask for it anywhere Bourns products are sold, or direct from the factory.

#### HIGH PERFORMANCE

Series 3852:  $\frac{3}{4}$ " dia.; metal bushing, locking or non-locking; 2 watts at 70 $^{\circ}$ C; res. to 5 meg.; tol. to  $\pm 5\%$ . Typical price per piece \$2.40; (2M) \$0.81.

Series 3862:  $\frac{1}{2}$ " dia.; 1 watt at 125 $^{\circ}$ C; res. to 5 meg.; tol. to  $\pm 5\%$ . Typical price per piece \$4.20; (2M) \$1.18.

#### COMMERCIAL

Series 3859:  $\frac{3}{4}$ " dia.; plastic bushing or quickly installed snap-in version; 2 watts at 70 $^{\circ}$ C; res. to 5 meg.; tol. to  $\pm 5\%$ . Typical price per piece \$1.95; (2M) \$0.66.

Now look at the Controls. **Stocked in depth by Bourns distributors all over. 24-hour delivery on standards.**



TRIMPOT PRODUCTS DIVISION • 1200 COLUMBIA AVE., RIVERSIDE, CALIF. 92507



## Aerosat: is anybody happy?

Airlines bemoan L-band decision, Europeans and NASA resent being left out of the action, but electronics firms see healthy contracts

by Jim Hardcastle, Washington bureau

**The five-year wrangle** over who will manage the first aeronautical services satellites over the Atlantic and Pacific and what frequency they will operate on has been decided [*Electronics*, Jan. 18, p. 52]. But NASA is bitter, and the Europeans and the airlines are still grumbling.

Two pre-operational satellite systems, both using the 1,535-to-1,670-megahertz segment of the L-band spectrum, will be launched, the White House Office of Telecommunications Policy declares in its first major policy statement. And the Federal Aviation Administration, not NASA and the European Space Research Organization, will manage the systems. OTP also proposes that private firms should build the satellites, while the users, the FAA and the airlines should share system costs.

The first system will get off the ground in 1973 with two satellites to be launched over the Pacific. There they will provide voice communications services and demonstrate satellite techniques for locating aircraft over the sea. Two years later, a second system will be boosted over the North Atlantic, starting up services for pre-operational digital data links and automatic position reporting over both oceans, says OTP. The policy statement also urges development of an operational international system for the 1980s.

**But it remains to be seen** whether one company would both build and operate the satellite. "We think the policy statement implies the development of a total air traffic control system that would be designer-coordinated, and operated by a sin-

gle contractor," says an engineer at one of the aerospace giants. "Therefore, we see it as a major area of new business."

But a White House source replies, "We haven't made any such decision. The firm that is best at developing hardware isn't necessarily the one that is best at operating it."

Work is expected to begin on the Pacific satellite systems once the FAA issues its request for proposals, expected momentarily. When bids are received, the FAA will award a contract and issue a system definition to the airlines to let them get started. Time is an important consideration. OTP decided to scrap the vhf radio specification for the system after seven major electronics firms told it they could build uhf sets in time for the 1973 launch over the Pacific. How-

ever, these firms stipulated that orders would have to be placed this year if the sets are to be ready for the pre-operational launch.

The list of prospective bidders reads like a who's who in aerospace work. Hughes Aircraft, Lockheed Aircraft, GE, RCA, Comsat, The Boeing Co., Philco-Ford, Fairchild Hiller, TRW, and North American Rockwell all are mentioned as likely bidders.

**Meanwhile the airlines** are less than enthusiastic about the decision to go to L band. "It's a perfect political solution, everybody loses," quips one airline engineer—and he's right, to a degree. Since pre-operational systems don't require international approval, and the U.S. will in all likelihood build the systems, Europe lost the chance to gain an edge in spacecraft engineering and production. It had hoped to do

### A hollow victory for Europe?

European communications engineers are jubilant over part of the White House decision—the selection of L-band frequencies for the transoceanic aeronautical services satellites the U.S. says it will launch. In fact, one top European space official already is calling the decision a "total technical victory for Europe." However, he notes that there is more to European participation than just the selection of frequencies. And in his opinion, the part of the White House's unilateral decision that cuts Europe out of satellite development is "an attempt to swindle Europe by trying to use commercial sources for satellite construction."

As spelled out in the Office of Telecommunications Policy statement, private development of an aeronautical services satellite rules out European participation because American industry "has more experience and funding power," the European source says. He notes, however, that in the past, government has taken the lead in developing space technology, and it seems reasonable to let government—along with the European Space Research Organization—develop this one. One advantage would be that the airlines would not have to finance the development phase, he says. As for system use, the official says the U.S. might be able to go it alone with the Pacific satellites, but "it is inconceivable to do anything over the Atlantic without European participation." —Stewart Toy

## There is a difference in Heath Dynamics' Quartz Crystal Filters!

Heath Dynamics specializes in the design and manufacture of the highest quality Quartz Crystal Filters and Discriminators for the Communications Industry.

Our facility is completely new, inside and out, fully staffed and equipped with the most modern mechanical and electronic test measuring devices.

We employ the assistance of one of the largest time sharing computers available.

Heath Dynamics' area of specialization includes the manufacture of miniature and sub-miniature filters in the range of 10 thru 32 Mhz. Bandwidths may be from .025% thru .35% in the smallest packages and may range up to 2.0% in the larger ones.

*We manufacture direct replacement filters for all the current monolithic designs using our half lattice configuration which yield lower insertion loss, lower ripple and greater ultimate rejection. Yet our filters cost less and faster delivery is guaranteed!*

All Heath Dynamics' crystal filters designed and manufactured to your particular specifications meet Mil F. 18327.

In short, we want your business and we'll act like it. Do us both a favor and send us your print or specification for a quote. If you have any questions just write or call us... we're here to serve you.



so under the now-dead NASA European Space Research Organization plan for an L-band system. The Europeans, however, may attempt to pressure the U.S. into making some provisions for European participation in the Atlantic system by not installing aerosat ground stations and requiring the use of high-frequency radios in their air traffic control sectors.

For their part, the airlines, which have spent five years developing a specification for vhf satellite systems, now must develop an L-band spec. This leaves them facing the prospect of radio racks crammed with domestic vhf equipment and oceanic L-band gear.

NASA is bitter because the decision has relegated it to a supporting research and development role in a fast-growing area. And even the FAA loses in the sense that it must use a frequency its operational people did not want.

**With L band**, an OTP source points out, the vhf congestion problem, which is growing worse in the U.S. and is impossible in parts of Europe, is circumvented. What's more, many European governments fly nationalized airlines. Since they must use the system to make it viable, and since most Europeans expressed preference for L band, the choice of that frequency is again a reasonable move. Thirdly, L band offers superior propagation characteristics and can provide an order-of-magnitude better position fixing in an independent air surveillance system. Finally, he says, the major argument for a vhf system was that it could be implemented immediately. But since the airlines' grim profit picture rules out fitting transoceanic fleets for even vhf satellite communications in the next few years, why not go with L band, which all concede is ultimately superior?

When the FAA releases the winning design in the satellite competition, expected in about six months, the Airline Electronics Engineering Committee, a group consisting of 32 airlines communications experts, will begin working on requirements for airline satellite communications sets. Airline sources say that the committee has never completed work on a major requirement in

less than one year, and because of its complexity, this system may require two years of work.

Only when the requirements are drawn can avionics manufacturers begin building the sets.

Because of the need for quick and reliable service, the established airline communications firms are expected to nail down the bulk of the orders. But another two years may be required to get production lines rolling after initial orders are received, airline sources say.

Meanwhile, the FAA will have to ask industry to begin work on an independent air surveillance system if it is to meet the schedule for the Pacific demonstration. The mechanics of this demonstration have not yet been worked out, but the FAA either could ask the prime satellite contractor to include the demonstration in his proposal or it could turn to qualified contractors to begin work on their own.

Whatever system is used, industry will have its toughest job with the antenna design, airline sources say. Because of the difference in antenna sizes in L-band and vhf frequencies, there is a 22-decibel loss that must be made up by more power or more gain aboard either the satellites or the aircraft. R.W. Sutton, a Boeing engineer who heads up a team conducting FAA aerosat research, says that much of the loss can be picked up in the spacecraft if a non-spinning type of satellite is used, because the solar cells would then always face towards the sun and would be more efficient.

**Other airline equipment** problems are weight, power and cost, airline sources say. They note that the best efficiency achieved in an L-band set to date is about 25%. With an expenditure of about \$500,000, that figure probably goes up to 35% to 37%. But 50% efficiency is some time away, they say.

Designing a spacecraft with four voice channels small enough to be packaged in a 650- to 680-pound satellite that can be launched by a Thor-Delta will require elegant engineering. "You have to have enough power to get through the noise level and that's a problem when you're trying to cover the Pacific," says an airline source. □

Communications

# Data firms count their chickens

Companies in data communications are right to expect a boom—  
but which of them will it benefit and how big will it be?

by James Brinton, Boston bureau manager

**The boom** in data communications has sold many a share of stock and lured many a company into joining the gold rush. Latest to do so is Raytheon Co., which has formed Raytheon Data Systems to go after business it expects will double from this year's \$1 billion to \$2 billion or \$2.5 billion in 1975. Included in this figure for communications gear sales is income from equipment ranging from minicomputers and data entry consoles to modems, multiplexers, and carrier systems.

Some market researchers, including Quantum Science Corp. in New York, agree with Raytheon's estimates, but others do not. A marketing director of one data communications company, for instance, comments that the many market studies he subscribes to not only differ from one another but are overly optimistic.

The disagreement stems from many unanswered questions. Will the new independent carriers survive? How will the large carriers counterattack? Will data processing operations be centralized or decentralized? Will old-fashioned technology keep prices up or will LSI push them down?

"Making data communications market estimates, is like making mudpies with dust," says one marketing analyst. "But at least there's a lot of dust around."

But whatever the uncertainties, data communications is big business and everybody agrees it's growing rapidly. To corner as much of the market as possible, Raytheon's Norwood, Mass., subsidiary aims to supply nearly the total teleprocessing needs of companies,

plus plant equipment and servicing to the new breed of independent common carriers. These include Data Transmission Co., in Vienna, Va., the University Computing Co. subsidiary known as Datran, and Microwave Communications Inc., Joliet, Ill.

"Of the 17 or so applications for independent common carriers now before the FCC," says D. Brainerd Holmes, Raytheon corporate executive vice president, "we expect to sell hardware into at least half the resulting systems." Raytheon already has a \$3.5-million contract with MCI for the carrier's initial 1800-channel link between Chicago and St. Louis [*Electronics*, Apr. 27, 1970, p. 52] and, along with the Martin-Marietta Corp., New York, and others, is doing time division multiplexing work for Datran.

**The breadth of products** from Raytheon is matched by only a few competitors, among them Collins Radio Co., Dallas, General Telephone and Electronics Corp., New York, and International Telephone and Telegraph Corp., New York. According to New York researchers Frost and Sullivan Inc., these firms will be able to tap a market of more than \$1 billion for long-haul systems alone in the next five years, selling to the new independents.

Datran divides the data communications business into seven economic sectors: securities, insurance, banking and finance, manufacturing, retailing, information services, and health care. Of these, "two major retailing applications, sales and inventory, will account for about half of total transaction volume," says the company.

Remote data terminals will represent the major hardware market, Datran predicts, as the massive initial investment in transmission equipment tapers off with the establishment of national systems. Excluding government and "terminal-in-the-home" units, by the end of 1974 there will be 800,000 terminals in use compared with 1970's total of 185,000, it says. Of these, "the use of high-speed input/output devices—line printers, magnetic tape terminals, card and optical readers—will grow dramatically as remote batch processing becomes more relevant."

Video displays also will enjoy major growth, forecasts Andreas H. Kruse, general manager of ITT's Data Equipment and Systems division in East Rutherford, N.J. He expects a 300% rise by 1973 from 65,000 or so units now in use, and he sees significant price cuts coming late this year or by 1972 in both color and graphic displays, broadening the market for these bandwidth hungry units.

One of the most promising submarkets—modems—should reach \$421 million by 1975, with most of the growth in units transmitting below 4,800 baud, says Paul Seckendorf, a senior staff scientist at Quantum Science Corp. He feels this market was worth about \$81 million in 1970.

However, modem market growth estimates vary widely, and industry and market consultants don't even agree on the number of units now in use. For example, perhaps 50,000 Bell System-type 202, 1,200-baud modems are in use, or perhaps again it's 75,000. One company



# Want high Q and low cost too?

Take a look at Delevan's Toroidal Inductors, Series 2770



Inductance Range Available: 1mH thru 3H.  
Inductance Tolerance: 1mH thru 8.5mH  $\pm 2\%$   
8.6mH thru 3H  $\pm 1\%$   
Construction: Epoxy encapsulated

These coils have been designed to exceed industrial application requirements and meet the specifications of MIL-T-27C for enclosed and open-type toroidal inductors.

**CUSTOM DESIGN.** In addition to the values listed above, Delevan offers the design engineer a variety of special custom inductors. Write for literature and our quotation request form.

**Delevan**  
Division



**AMERICAN  
PRECISION  
INDUSTRIES INC.**

270 QUAKER RD. / EAST AURORA, N. Y. 14052 / TEL. (716) 652-3600 / TELEX 081-293

OTHER DIVISIONS OF AMERICAN PRECISION INDUSTRIES INC.: BASCO • DURTEX •  
MOELLER INSTRUMENT CO. • OXFORD CORP. • TRUCK EQUIPMENT CO.

president says 30,000 units of the 201-type, 2,400-baud set have been sold, while another expert puts the total at only 16,000. And according to Robert Carroll, director of industrial accounts at Collins' Newport Beach, Calif., facility, the Bell System will hold 70% of all modem business over the next five years.

Another important growth segment, multiplexers, should reach about \$300 million by 1975, according to Quantum Science's Barry J. Keagy, director of computer technology. This market includes concentrators and pre-processors.

Despite these bullish predictions, however, more sober voices are starting to be heard. For instance, one comes from Arthur D. Little Inc., Cambridge, Mass., which is doing a market study for 17 clients. "This time we are going to spend a lot of effort pointing out the uncertainties that plague this market," a spokesman notes.

"First is the question of the survival of the new independent carriers," he says. "All the FCC licenses in the world won't keep a company solvent;" and Datran already needs about \$275 million [*Electronics*, Dec. 21, 1970, p. 39].

Then comes the large carriers' response to the independents' threat. "AT&T could push faster into digital carrier equipment, reserving it for data while retaining, and thus amortizing, its analog system with voice traffic," he says.

**Third in line** is the quick but varying rate of growth in the remote terminal business. "There will be growth here, but it will have to be swift to stress existing carriers so much that customers can be coaxed to the independents."

Next come many individual corporate decisions for either centralized or decentralized EDP operations. "There's no estimating the mix," says the Little spokesman.

There's the question, too, of how fast new technology will come. MOS and LSI could drive prices down, especially those of modems, and thus boost the market.

Finally, there are imponderables like the point-of-sale market. "Point-of-sale has been on the verge of taking off for two years," says the team member; "I don't see any sure signs of growth here yet." □

Medical electronics

# Isolation transformer—friend or foe?

Proponents say devices are essential for protecting patients from shocks; critics feel they're too expensive—and introduce dangers of their own

by Owen Doyle, Instrumentation editor

A battle is raging over the use of isolation transformers in hospitals. One side holds that the devices, which isolate hospital power lines from ground, are essential to protect patients against potentially lethal shock hazards in medical electronics gear. The other side claims that the transformers not only are too expensive but also create hazards themselves.

Part and parcel of the growing concern over the safety of medical electronics equipment [see p. 54], the isolation transformer controversy centers around current leakage in bedside electrical equipment. Everyone agrees that no more than 10 to 20 microamperes should flow into a patient [*Electronics*, Feb. 17, 1969, p. 92], but today's isolation transformers themselves cause as much as 1 milliampere of leakage current. And while a ground close to the patient can dissipate most of this current, transformer foes maintain it's foolhardy to base a safety program on a device that can introduce such a large leakage.

A key battle is being waged as several committees and subcommittees of the National Fire Protection Association (NFPA) wrangle over the wording of article 517 of the National Electrical Code of 1971. A section of that article, which deals with hospital wiring, recommends the use of an "isolated power center" for equipment near an "electrically susceptible patient." If the general membership approves this section at NFPA's annual meeting this May, the recommendation will become part of the 1971 National Electrical Code. The code has the force of law in many parts of the U.S. where states

and municipalities use it as the basis for their writing regulations.

Right now, it seems likely that the NFPA's general membership will vote to recommend—but not require—the isolation transformers with a 2-mA leakage limit. But if the transformers become standard, a \$20 million market will open up for several companies. Right now, the market stands at well below \$10 million.

The Veteran's Administration, in anticipation of the 1971 code, already is equipping 2,200 of its hospital beds with isolation transformers at a cost of \$2,000 per bed, including installation. "We've got \$50 million worth of equipment in the field with such high leakages that we need something to protect the patient," explains James A. King, chief of the technical services division at the VA in Washington.

One of the severest critics of the devices is David Kilpatrick, a consulting biomedical engineer and head of Kilpatrick Associates Inc. in Bala-Cynwyd, Pa. "Not only does an isolation transformer provide very limited protection," Kilpatrick maintains, "but it injects a new hazard of its own." He refers to the fact that the monitor used in the transformer to detect current leakage itself constitutes a leakage path because it is connected between the building ground and the transformer's secondaries.

The transformers are designed both to prevent electrocution from current surges and to sound an alarm if leakage currents are present. Connected to the primary are hot and neutral leads from the hospital's main power line. The secondary connects to a wall out-

let, and a third lead from the main lines—the ground wire—bypasses the transformer and goes directly to the outlet's ground connector. Any instrument plugged into this outlet is isolated from building ground: even if a hot lead in the device's power cord were to short to the device's chassis, no current surge would occur.

A detector—called a line isolation monitor—measures the leakage current flowing from the isolated lines to ground. One of its terminals connects to the ground wire while the other is switched between the transformer's secondary terminals. Whenever a device's leakage current exceeds a predetermined threshold, an alarm sounds. In setting the threshold, the leakage path of the monitor itself must be considered. This can account for as much as 1 mA. As a result, the proposed NFPA recommendation sets the threshold at 2 mA.

And though critics say this is

Alarm. Monitor warns when currents flow from secondary to ground.

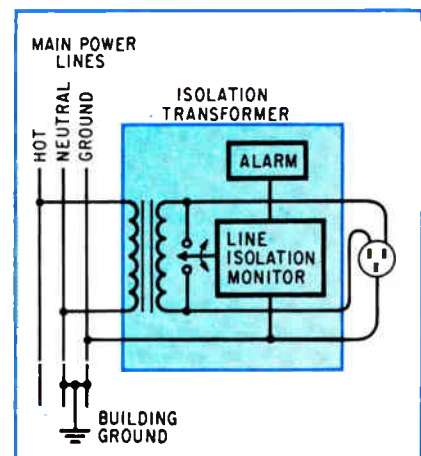

# INTERNATIONAL frequency meter

- Tests Predetermined Frequencies 25 to 1000 MHz
- Extended Range Covers 950 MHz Band
- Pin Diode Attenuator for Full Range Coverage as Signal Generator
- Measures FM Deviation

MOBILE

FM-2400CH



WRITE FOR CATALOG!

The **FM-2400CH** provides an accurate frequency standard for testing and adjustment of mobile transmitters and receivers at predetermined frequencies.

The **FM-2400CH** with its extended range covers 25 to 1000 MHz. The frequencies can be those of the radio frequency channels of operation and/or the intermediate frequencies of the receiver between 5 MHz and 40 MHz.

Frequency Stability:  $\pm .0005\%$  from  $+50^\circ$  to  $+104^\circ\text{F}$ .

Frequency stability with built-in thermometer and temperature corrected charts:  $\pm .00025\%$  from  $+25^\circ$  to  $+125^\circ$  (.000125% special 450 MHz crystals available).

Self-contained in small portable case. Complete solid state circuitry. Rechargeable batteries.

FM-2400CH (meter only).....	\$595.00
RF crystals (with temper- ature correction).....	24.00 ea.
RF crystals (less temper- ature correction).....	18.00 ea.
IF crystals.....	catalog price

**INTERNATIONAL**  
CRYSTAL MFG. CO., INC.  
10 NO. LEE • OKLA. CITY, OKLA. 73102

far too much leakage, Dr. Carl Walter, clinical professor of surgery at Harvard Medical School and chairman of NFPA's hospital committee, contends, "Nobody ever said isolation transformers did anything by themselves. They have to be interlocked with a grounding system."

Critics answer that another method—localized grounding alone—can protect just as well for far less money. In this approach, a bus bar is installed in the wall near a patient's bed, and all nearby electrical equipment and conducting surfaces are grounded to it. Advocates say cost shouldn't exceed \$1,000.

The only advantage isolation transformers offer over localized grounding is that they "permit you to use a smaller wire in your equalizing ground bus," says Robert Mosenkis, senior project engineer at Philadelphia's Emergency Care Research Institute, an independent laboratory specializing in equipment evaluation [*Electronics*, Sept. 14, 1970, p. 121].

Walter answers, "You just can't put in good equipotential grounding systems by themselves without such a volume of copper that it almost drives you bankrupt." Others say that a patient's bed can be safely wired for about \$750, the cost of installing 50 feet of 0.5-inch copper wire.

**But it's risky** to rely solely on ground, says Robert Cassidy, marketing supervisor at Federal Pacific Electric Co., Newark, N.J., a transformer maker. "If you were absolutely sure you could get a good ground and you had some device that could measure the fact, you'd have a good system," he points out. Others, however, note that there are a number of inexpensive commercially available devices for checking ground continuity.

One way to resolve the conflict would be to lower the monitor threshold in the isolation transformers to a level within the micro-ampere region. But as Federal Pacific's Cassidy argues, "We can make detectors down to 400  $\mu\text{A}$ —even to 100  $\mu\text{A}$ —but they'd constantly be in alarm because nobody makes equipment any better than that." □



International

# Tito's growing boy: electronics

Yugoslavian components find growing market in the West; industry officials hope licensing agreements with capitalist firms will spur advances

by John Gosch, Frankfurt bureau

Known primarily as the most independent of the Communist nations, Yugoslavia also is familiar as an Alpine vacation resort, and as the home of slivovitz brandy. But less well known is the fact that the Wyoming-sized Balkan state boasts an electronics effort that is bigger and more vibrant than any in southeastern Europe. Yugoslavia's electronics production isn't large by U.S. standards but it is growing at a fast clip. Output in 1969 climbed 25% to reach \$108 million; \$21.6 million of electronics goods were exported. Production should grow another 25% in 1970 and 1971.

Unlike other Communist countries, Yugoslavia directs the bulk of its electronics exports, valued at 60% of the total, to the U.S. and Western Europe. Moreover, striving to catch up with Western

technology, the nation has become East Europe's number one licensee for Western products and engineering knowhow and is trying to lure foreign plants.

The nucleus of the country's exports to the West is passive components—mostly resistors, capacitors, and relays. Yugoslavia electronics officials are particularly proud of their high-quality carbon film resistors, made by a special manufacturing process pioneered by ZP Iskra, a native company. This process, Iskra says is being emulated in some European plants.

But the country is also mounting a major effort to increase its semiconductor production. Already exporting diodes, triacs, transistors, and power devices to Western Europe, Yugoslavia expects to offer integrated circuits soon.

"To compete in Western markets isn't easy," says Metod Rotar, commerce director of Iskra, Yugoslavia's largest electronics producer. "But it forces us to produce to the quality standards common in the West," he notes. "And that benefits our own industry." While production capacity in some areas is still limited, Rotar says lower wages (assembly line workers average about \$100 a month after taxes) balance out this disadvantage, allowing Yugoslavia to compete on even terms with the West.

One practice that's avoided, officials emphasize, is softening up Western markets through price dumping. "That we can't afford," says Ivo Banic, Iskra's chief representative in Western Germany. "If we lower prices beyond a minimum, we lose, and the state won't make up for any losses."

Yugoslavia's electronics firms also have licensing agreements with some of the biggest companies in the West. Iskra, for example, has a long-term cooperative arrangement with General Electric Co. for semiconductors, with West Germany's Siemens AG, and with various European members of the International Telephone and Telegraph group for railway signaling equipment and telephone switching gear.

Yugoslavia also maintains electronics plants abroad. Iskra has put up a components factory near Bombay, is a co-founder of a reed relay factory in Denmark, and is building a telephone equipment plant in Turkey.

To help speed up industrialization at home, Yugoslavia is attempting to increase foreign investment in its plants. Until now, except for automobile and chemical operations, few Western industries have set up shop in the country. But the climate for investments is improving now that the Belgrade government is permitting 49% foreign ownership in Yugoslavian companies. And the profit transfer problem—until a few years ago the biggest deterrent to foreign investment—has been eased, making industry officials confident that Western electronics firms will take a second look at setting up Yugoslavian operations. In fact, negotiations are under way with a German electronics producer. "But we don't want to become another Taiwan or Hong Kong," states Iskra's Banic. "We must benefit from plant investments and from the technology that comes along."

Almost 90% of the country's elec-



# Best Buy

in 1% Tolerance  
1-Watt Zeners  
**SCHAUER**

Immediate Shipment

No fragile  
nail heads

All welded and  
brazed assembly

Gold plated  
leads

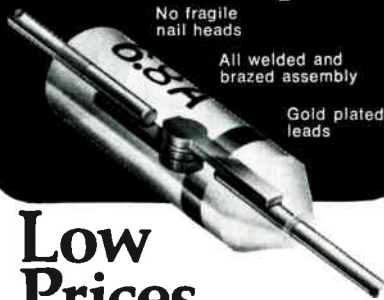

## Low Prices

ANY voltage from 2.0  
to 18.0

Quantity	Price each
1-99	\$1.07
100-499	.97
500-999	.91
1000-4999	.86
5000 up	.82

Write for complete rating data and other tolerance prices.

## Buy The Kit!



A  
\$54.57  
value  
for  
only

## \$24<sup>50</sup>

Kit contains a 51-piece assortment of SCHAUER 1% 1-watt zeners covering the voltage range of 2.7 to 16.0. Three diodes of each voltage in reusable poly bags. Stored in a handy file box. Contact your distributor or order direct.

Semiconductor Division

## SCHAUER

Manufacturing Corp.

4514 Alpine Ave. Cincinnati, Ohio 45242

Telephone: 513/791-3030

## Probing the news

tronics production is accounted for by Iskra, which is located in Kranj in northern Yugoslavia, and at Elektronska Industrija in Nis near the Bulgarian border. The remaining 10% is split up among a handful of firms; the best-known are Nicola Tesla, a telephone equipment maker in Zagreb, and Gorenje in Velenje, a household goods producer with strong consumer electronic activities.

As the biggest electronics firm in southeastern Europe, Iskra has a near monopoly on the potentially vast Balkan markets. In fact, one of the prime reasons for Iskra's strong commercial leanings toward the West is to be prepared for the time when those markets open up. Says commerce director Rotar, "These ties help us to catch up with Western Europe, and that, in turn, will make us a better company for our own markets."

The efforts to catch up are starting to pay off. For example, assessing Yugoslavia's semiconductor industry, Holger Rothe, Eastern European sales manager at West Germany's Intermetall GmbH, says: "Right now I'd put it about halfway between East and West Europe's technology. In terms of time, this would mean a lag of only two years behind the West." One reason for the lag, Rothe says, is slow approval of funds to buy production equipment from Western suppliers. "By the time the money question is solved that equipment is considered old in the West."

The bulk of Yugoslavia's discrete and monolithic devices are produced at the semiconductor division of Radioindustrija Zagreb (RIZ), a member of the Iskra group. The division, housed in a multi-story building at the outskirts of Zagreb, Croatia's capital, employs about 160 people, including 50 engineers. Most of the division's capability stems from its four-year-old licensing agreement with GE, which "has worked well so far," says Josip Jukic, head of the division.

Competitive edge. Assembly line workers, such as these in components plant, average \$100 a month.

Helped by GE knowhow and by a largely American array of production, measuring, and test equipment, RIZ' current production program includes between 130 and 150 different types of transistors. Production runs, though quite small, are proportioned to the small Yugoslav transistor market and to the relatively limited demand from abroad.

But one benefit is short delivery times—generally less than four weeks and in some cases less than two, says Ivan Smalcelj, who heads the division's new technology group. "Besides, having a wide range allows us to be flexible in satisfying customers' demands and to get good prices for our products."

Prominent in RIZ's future plans is a four-story, IC plant with a total floor space of nearly 50,000 square feet and 340 new workers. Production equipment will be installed early this year, and manufacturing will be in full swing by the year-end. Once the facility is operating, RIZ expects to be able to cover Yugoslavia's IC needs with enough left for exports.

RIZ's current digital IC output is for the Yugoslav market only. The devices are used in in-house equipment and also are being sold to outside customers, including a small Zagreb manufacturer of desk calculators. Jukic puts his country's 1970 IC market at about \$1 million and 1971's at twice that figure. The total Yugoslavian semiconductor market for 1970 is estimated at between \$3 million and \$4 million.

In production are 26 different ICs of the transistor-transistor logic and diode-transistor logic





types, similar to Texas Instruments' 7400 and 1500 series housed in ceramic packages. Next year RIZ also will add linear devices in plastic packages for use in radios and television sets. They will include i-f amplifiers and two- and five-watt amplifiers.

Smaleclj, the new-technology group leader, is typical of the new breed of electronics engineers emerging in industrial Yugoslavia. He is well versed in both theory and application, and he frequently visits the U.S. and countries in western Europe.

**Like most of his men,** Smaleclj is a graduate of Zagreb University, with whose electronics faculty RIZ' semiconductor division cooperates closely in research and development. One example is computer-aided design: the division's design equipment is linked to the university's IBM 1630 computer.

Another advanced facility in Smaleclj's area is a new electron beam exposure system used in IC mask fabrication. Built around a Japanese-made electron microscope with a 30,000-volt electron gun, the system can produce geometries on metalized masks with line widths as narrow as one micron. It is controlled by a PDP-8 computer supplied by the Digital Equipment Corp., Maynard, Mass. Smaleclj says it's the second such system operating in Europe.

While Iskra and its RIZ subsidiary are preparing to sell more semiconductors abroad, exports of passive devices already are in full swing. For some specialized products like carbon film resistors, exports represent 80% of total production. Output at Iskra's Sentijer-

nej resistor plant has doubled annually for the past few years and is approaching the \$5 million mark.

Iskra isn't underselling its competitors abroad; in fact, the carbon film resistors are about 10% more expensive than others. Plant officials attribute the resistors' export success to their quality, achieved through a special design pioneered by Iskra several years ago. The resistors, capless and with leads coming out of recessed holes, have better heat conduction properties, feature lower noise, and take up less space than carbon film resistors with caps at the ends, the company says.

Equally dependent on exports is Iskra's semiconductor products plant at Trbovlje. With a staff of 330, it produces over \$1.5 million worth of selenium rectifiers, fast-switching diodes, and triacs every year; 70% of the devices are exported.

Iskra's biggest facility is the electromechanical products plant at Kranj, which employs 5,000 people. About 45% of the plant's production capacity is set aside for building telephone equipment—from simple handsets to complete exchange systems designed for 50,000 subscribers and more. These systems use crossbar switching techniques, but research aimed at electronic switching systems is under way, says Alojz Grear, technical director of the Kranj facility.

**Most of the plant's output** is intended for the Yugoslavia market. So great is the nation's need for telephone equipment—Yugoslavia ranks third-last among European countries in phone density—that production capacity is being expanded by 20% to 25% a year. About 18% of the plant's output goes abroad. Slated for shipment to a U.S. customer are 1,000 facsimile systems.

Iskra also is heavily involved in R&D. At the company's "Institute for Automation" at Ljubljana, over 800 specialists are supporting the R&D activities of all Iskra plants. In addition, the institute is studying computerized process optimization for the oil industry, electric power plants, and for other industrial sectors. Extensive work is also being done in lasers. □

custom  
pays  
now

### So you won't have to pay later.

The design looks perfect . . . but then, somewhere something goes wrong. A defective part, an improper assembly, or maybe it was the installation in the field. It's impossible to avoid all imperfections.

As experts in the field of reconstituted mica capacitors, our experience shows that the greatest single cause for capacitor failure is a short in the dielectric material.

Consequently, we precisely inspect and grade all of our dielectric material **before** production. Because of our meticulous quality control, Custom Mica Capacitors are absolutely the finest quality capacitors of their kind available on the market today.

**We pay now so you won't have to pay later.**

Another major reason why you should join our client list of Who's Who in high voltage electronics. Write for our Facility Folder and Product Sheets, or call today for our rapid reaction quote to your specific requirements.



CMR, wrap and fill



CER, epoxy housed



CEM, epoxy molded

**CUSTOM**  
The QC Fanatics

**CUSTOM ELECTRONICS, Inc.**  
Browne St., Oneonta, N. Y. 13820  
PH: 607-432-3880 TWX 510-241-8292



# BUG KILLER

**FACT® (Flexible Automatic Circuit Tester)**, Hughes' random access system hunts down electronic "bugs:" shorts, opens, defective insulation, poor solder connections.

In any type system: spaceborne, airborne, underwater communication, control, computer, support, telephonic switching. In any type assembly. And to insure the results are always accurate, FACT "de-bugs" itself.

FACT. Quick delivery. Order now. Lease/rental plans available. Contact:

L. W. Risner  
FACT Systems  
Hughes Aircraft Company  
P. O. Box 92904  
Los Angeles, California 90009  
(213) 670-9040



## Probing the news

### Production

# New resist baker: microwave ovens

Experiments with microwave drying of ICs, pc boards show faster processing and could bring higher yields

by James Brinton, Boston bureau manager

A valuable kitchen aid that can prepare food in record time, the microwave oven, is taking on another baking chore, and the results could prove appetizing to companies making integrated circuits and printed circuit boards. Experiments with microwave ovens for drying liquid photoresist during IC and pc board fabrication, have indicated some important advantages over conventional hot air units. The microwave ovens can cut drying times from upwards of 20 minutes to seconds, reduce exposure and development times, make it possible to use thicker resists, permit tighter control of mask and device geometry, and thus may improve circuit characteristics.

These results were attained by several Northeastern companies in preliminary experiments using a process and ovens developed by Sage Laboratories Inc., Natick, Mass. A small microwave components firm with a line of microwave ovens for the fast food market, Sage began its photoresist-drying project a year ago when Jay C. Karp, its manager of microwave IC operations, tried one of the ovens on MICs.

In mid 1970, experimental ovens went to independent researchers—all of them in the Northeast, where Sage is known, and also because Karp wanted to facilitate data exchanges. Now, after about seven months of research, information and opinions are flowing in from a list of firms including Alpha Industries Inc., Newton, Mass; Bell Telephone Laboratories, Murray

Hill, N.J. and Allentown, Pa.; Crystalonics Inc., Cambridge, Mass.; EG&G Inc., Bedford, Mass.; Eastman Kodak, Rochester, N.Y.; Shipley Co., Newton, Mass.; and even Sylvania's Semiconductor division, which got an oven before its shut-down began.

Of course, most of the firms haven't had enough time to thoroughly evaluate their investigations, so they're unlikely to start scrapping their hot air ovens for microwave replacements. Then too, questions remain about absolute resolution and edge sharpness, and nobody has yet had time to make a pinhole count in microwave-dried circuits. Pinholes in photoresists can cause short circuits, unwanted etchings, or prevent etchings, thus cutting yield.

Moreover, most companies in other parts of the country haven't heard of the Sage process and are understandably skeptical about changing over.

If the process lives up to the promise of the preliminary experiments, though, it could find acceptance throughout the semiconductor industry, where photoresists are used on nearly everything from discrete semiconductor and IC photo-masks and wafers, through hybrid and microwave ICs and pc boards.

Based on the favorable response so far, Karp has convinced Sage to produce about 20 new ovens with selectable power outputs of 200 or 400 watts at 2.45 gigahertz, versus the 500 W of the prototypes. Sage also is adding a timer capable of working within fractions of a second. Both these features make it

easier to control the drying process.

Karp claims that his ovens perform pre-exposure drying of chrome-coated glass masks in only 0.6 to 0.8 second; the 2-micron resist layer formerly took 15, 20, or even 30 minutes to dry completely. In some cases, he says, he has eliminated a similarly long post-exposure bake.

And when Sylvania Semiconductor tried the oven on microwave ICs, "resist drying times shrank from 15 to 20 minutes to a few seconds," reports Arthur Solomon, head of the solid state components section. "For high-volume production of MICs, this system would be very useful—maybe essential for cost reasons," he asserts. "There was no degradation of the MICs made using the oven, and it was many times faster than hot air drying."

In fact, the system was so fast that Crystalonics was able to double the thickness of the resist coatings on discrete semiconductor devices, thereby increasing resistance to mechanical damage and corrosive etchants. Also, "for the first time, I have been able to get repeatable 0.2-to-0.3-mil-wide lines—even through double my normal resist thickness and without the usual fuzziness and scalloping along the edges," says John W. Morey, research and development engineer.

**Microwave mesa devices** also were dried in the Sage oven. "I had to use 0.1-to-0.2-mil-thick resist coatings since the resist had to last through lengthy etching," reports Gustav Voit, research scientist at Alpha. "Using KMER, a Kodak resist, it formerly took 40 minutes at 110° to 115° C to dry these coatings," he notes. "The microwave oven dried them in about four seconds."

Voit compared four wafers of Schottky barrier X-band diodes and found that the two dried with microwaves "showed better and more consistent dc and rf characteristics" than the hot-air-dried diodes, he says. But he cautions that the statistical sample was too small to make a case for microwaves as a performance booster.

However, the researchers all found exposure and development

# the Giant Killer strikes again...



## New Heath SM-105A

**\$350.00\***

**ASSEMBLED  
& TESTED**

- 10 Hz to over 80 MHz range
  - Advanced design — new Texas Instruments 74S Series superspeed Schottky TTL
  - 5-digit LED readout
  - Wide range input without adjustment
  - 1 megohm input
  - Crystal clock
- *Send for free SM-105A spec sheet... and watch the giants fall!*

**SM-105A SPECIFICATIONS** — Sensitivity: 100 mV RMS to 50 MHz; 250 mV RMS, 50 MHz to 80 MHz. Frequency Range: 10 Hz to 80 MHz. Input Impedance: 1 Megohm shunted by less than 15 pF. Overload: 50 V RMS from 10 Hz to 15 MHz; from 15 MHz to 80 MHz derate linearly at 0.8 V RMS/MHz from 50 V RMS. Maximum DC input is  $\pm 50$  V. Time Base: 1 MHz  $\pm 2$  Hz. 0° C to 40° C ambient,  $\pm 10$  ppm. Readout: Five 7-segment light-emitting-diode displays. One single light-emitting-diode for overrange. Overrange: Flashing, 40 ms on, 60 ms off. Power Requirements: 120/240 VAC, 12 watts. Dimensions: 9 $\frac{1}{8}$ " D x 6 $\frac{3}{4}$ " W x 2 $\frac{1}{4}$ " H. Net Weight: 3 $\frac{1}{2}$  lbs. Shipping Weight: 6 lbs.

### FREE HEATH SCIENTIFIC INSTRUMENTATION CATALOG

Investigate these and other new ideas in Spectroscopy, Digital Instrumentation, Lab Equipment and Test Equipment. Send for your FREE catalog now.

HEATH COMPANY, Dept. 520-28  
Benton Harbor, Michigan 49022

 **HEATHKIT**  
a Schlumberger company

Please send free Heath Scientific Instrumentation Catalog

Name \_\_\_\_\_

Address \_\_\_\_\_

City \_\_\_\_\_ State \_\_\_\_\_ Zip \_\_\_\_\_

\*Mail order prices; FOB factory.

Prices & specifications subject to change without notice. EK-296



# You Can't Afford Late Deliveries!

and Allied Electronics is Doing Something About It!

We're First in the Field to **GUARANTEE SHIPMENT**

—Or We Allow You a 20% Discount from the Face of Your Invoice.

For every order of \$100 or more, we will ship on time per our promise, or we will allow you a 20% discount from the face of your invoice. *Offer good only during month of February, 1971.*

... Now Make Us Put Our Money Where Our Mouth Is!



**Request Your FREE Catalog on Your Next Order**

*It's like having a 450,000 sq. ft. electronics supply house right in your hands!*

**ALLIED ELECTRONICS** A Subsidiary of Tandy Corporation  
 2400 W. Washington Blvd., Chicago, Ill. 60612 — Phone: (312) 421-2400

## Probing the news

times shortened by microwave drying. Bell Labs cut exposure times about in half, for example. Development time was reduced less dramatically, but with positive resists, the latent image appears almost the instant development begins, instead of taking the usual 15 seconds.

As yet, there's no proven explanation for this phenomenon, but Shipley's David J. Elliott, photoresist product line manager, feels that thermal drying could be desensitizing resists. "Heat-dried resists often are overcooked," he says, "making them harder to expose."

What's more, faster exposures mean less time for light to diffuse around mask line edges and into the resist. This probably is the reason Crystalonics' Morey reports cleaner line edges and narrower lines.

But semiconductor makers won't be the only beneficiaries of the process; Bell Labs' Donald Engling, associate member of the Allentown technical staff, used the oven on multichip hybrid substrates of glass, high-grade alumina, and even sapphire as well as pc board laminates. "The oven seems to dry thick resists more thoroughly than heat, perhaps because it works throughout the volume of the layer," he notes, "so there's no 'skin' formed at the surface. And certainly, it's faster," he adds.

Kodak reported that standing waves in the oven's cavity caused hot spots in the oven. Unlike the other companies, Kodak "never achieved results as good as with our recommended thermal bake-out procedures," says Richard W. Nubert, an engineer at Kodak's photofabrication center.

Karp and Nubert believe that the Kodak microwave oven had a defective "mode stirrer"—a rotating device similar to an electric fan designed to continually change the energy distribution within the oven. Karp notes that an EG&G experimenter had results as good as the others' until he accidentally turned off the stirrer. Then his results duplicated Kodak's. □



# Software speeds manufacture of pc boards

by Stephen E. Scrupski, Packaging & Production editor

Multi-program package reduces errors at each stage from artwork generation to component insertion

In an effort to shorten the design and manufacturing cycle of printed circuit boards, many companies have called on computers for automatic layout of conductor patterns. But good artwork isn't the whole story in pc production. The other parts of the process—drilling, laminating, testing, and component insertion—are just as significant. Photocircuits Corp. is therefore offering off the shelf a software package that delivers numerical control tapes, or the signals for direct numerical control of machinery, for each of these steps, as well as for artwork production.

"Anyone who buys an artwork plotter can use the package," says Page Burr, Photocircuits' vice president for corporate development, "because the first thing he asks himself when the plotter is delivered is, 'That's nice, now what do I do with it?'" But a company doesn't have to have its own plotter to be able to use this software, as long as it can ship its tapes to someone who does have a plotter and other numerically controlled pc board production equipment. It will get better results, Photocircuits points out, than by shipping masks to a pc board maker and having him manually take data off the masks in order to generate numerical control data.

The software package accepts inputs from any one of, or a combination of, three sources: digitized data taken from a rough pencil sketch, manual input from a description of the circuit, which is then card punched, and numerical data from a computer layout of the board.

The Institute of Printed Circuits hasn't yet settled upon a standard format for describing printed circuit boards for use with design automation systems, but Photocircuits says its package will include the format as soon as it's available.

The software, which is designed to run on an IBM 1130, a widely used engineering computer, consists of several component blocks, covering input-output formats, digitizer programs, and optional features that are occasionally important in printed circuit design.

Since the computer manufacturer doesn't include routines that are directly applicable to artwork generation, the basic block includes core partitioning and bit manipulation procedures that are tailored to the specialized tasks involved. The

Photocircuits package, for example, includes a routine to drive a high-speed paper tape output system and drivers for the Teletype BRPE punch, which runs at 100 characters a second. This is important since one of the primary outputs of the software package is a paper tape for numerically controlled drilling and artwork production equipment.

Input data need not be in a rigid format, but inputs are set up so they may be used by any of the pc production personnel—from drilling to photo department foremen.

Output routines are set up to drive a high-speed CalComp plotter for data verification or a cathode ray tube display before committing the data to mask production. They also can drive a Gerber photoplotter and line printer, and similar equipment from other companies could be programed.

Programs for accepting data from digitizers allow the computer to capture graphical data. The software package has several subroutines to ease the task of the digitizer operator. For example, if

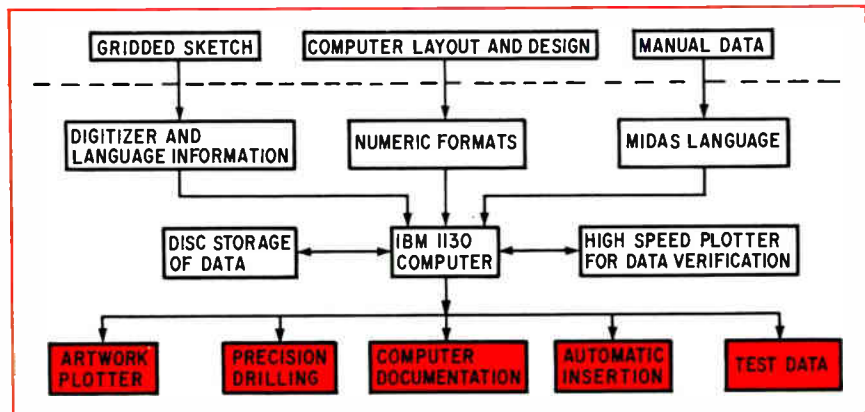

get close  
to a  
good  
thing in...  
**indianapolis**

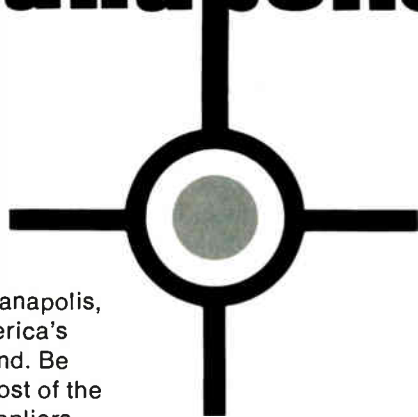

Get close to a good thing in Indianapolis, the middle of America's economic heartland. Be within hours of most of the nation's major suppliers and markets and minutes from our own highly diversified industrial and commercial facilities. Over 100 available site locations give your company access to an outstanding transportation system that includes . . .

- 7 Interstate Highways
- Complete City-circling Interstate
- Inner-city Interstate Loop Under Construction
- 18 U.S. and State Highways
- More than 100 Major Truck Lines
- 5 Major Rail Carriers
- Inner-City Rail Belt—100 Miles of Inner-city Track
- Air Facilities For Major Passenger and Cargo Jets

Get close to 81 of the top 100 U.S. markets today. For information on Indianapolis, for assistance on sites and building and for computerized site selection data, write *John Hardy, Area Development Director, Dept. 705* or call 317-635-6868 collect.

### **Indianapolis Power & Light Company**

25 Monument Circle • Indianapolis Indiana 46204

there is a large ground plane on the board, he need only trace the outline and the computer will store data to block out the area on the final mask. Or if there is a repetitive pattern on the board, such as lead holes for a dual in-line package, the computer will automatically generate the pattern when given only the location.

Many times a printed circuit board is described in shorthand in terms of coordinates on a grid. The software package will accept such inputs, using its Midas language. The language has the same repetitive pattern and area fill-in features as the digitizer programs, and it allows entering textual material for part numbers that are added to the mask. It also permits the input of curves, describing them as arcs of circles by giving circle center, radius, and degrees of arc.

Some features of the package may not be needed often but are "darned nice to have when you need them," says Burr. One, for instance, adds fillets to conductors where they meet pads. On tightly packed boards with small pads, the drilling tolerances can be relaxed a little if the conductor widens where it meets the pad. The software can have the computer scan the data and add fillet instructions to each location of this kind.

Also, the software can make sure that the drilling tape follows the most economical paths—the shortest distances between successive drilling steps. The package uses a relaxation technique, where it tries several alternate drilling paths and picks the one that is best. It can also add non-uniform grids in tightly packed boards to allow for extra conductor lines.

Any block of the package, or the total package, is available at a price of \$10,000 to \$20,000, depending on the components chosen. Photocircuits says it will also train personnel, provide an operations manual, and make arrangement for continuous updating and maintenance of the programs for an extra fee.

Photocircuits Corp., a division of Kollmorgen Corp., Glen Cove, N.Y. 11542 [338]

## New products

Data handling

# C/MOS register has own clock

Storage length of unit is variable up to 96 bits; buffer applications seen

The catalogs are filling up with MOS static shift registers, but few, if any, are complementary MOS types capable of storing up to

96 bits, with electrically variable lengths, and with an internal clock rate that's independent of the input and output clocks.

All these are features of a shift register developed by Ragen Semiconductor Inc. and designated the MS-618. Because of its variable length, it is one of the most versatile registers on the market. Since its information flow is controlled by its own clock, the MS-618 can serve as a buffer between two systems whose clocks are not synchronized.

In addition, the company points out, the device offers the benefits typical of C/MOS: low power dissipation at a fairly good speed. The

MS-618 consumes less than 25 nanoamperes of total static current, and it has a 2.5-megahertz input and output shift rate. And since the mechanism to control length is built into the register, there is no need for the control logic that other variable-length registers require.

In the case of the MS-618, "variable length" means that while the register has a capacity of 96 bits—24 four-bit words—it can operate as a one-bit or a one-word or a three-word storage unit, or any other size up to the full 24-word capacity. In fact, as information comes in, it goes immediately through the register to the last available cells. Whereas in a conventional 64-bit



Punched-card data entry and program assembly capability is available in a new peripheral designated the Comfile 88-130. It is a vacuum feed, optical card reader with a speed of 300 cards per minute. It permits the user to assemble programs written for the Comfile 88-23's powerful 4K x 16 computer. Monthly rental is \$95. Compat Corp., Cantiague Rock Rd., Westbury, N.Y. [401]

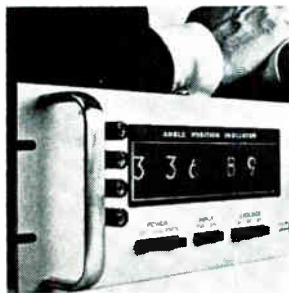

High-speed resolver/synchro-to-digital converter model 545/100 provides high-accuracy visual display of shaft angle. It develops digital BCD output for data acquisition, checkout, and computer interfacing. Size is 5 1/4 in. high by 19 in. wide. Price is \$3,500 to \$3,800, depending on options; delivery, 5 weeks. North Atlantic Industries Inc., Terminal Dr., Plainview, N.Y. [402]



Optical character recognition system designated model 170 can scan pages of variable size at a rate of 100 characters per second. Output can be on punched cards, punched paper tape or magnetic tape. The scanner utilizes fiber optics, eliminating use of conventional lenses. Deliveries begin this month. CompuScan Inc., 900 Huyler St., Teterboro, N.J. 07608 [403]



Computer terminal CT-100 is for use in digital data and management acquisition networks. It can be plugged in directly to existing computer systems servicing teletypewriters, and requires no special modems or voice response equipment. Fixed and variable alphanumeric information can be entered and printed out simultaneously. Electronic Arrays Inc., Woodland Hills, Calif. [404]

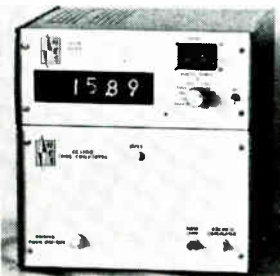

Data logging system model CC1200-SP4 offers efficient data interchange between balance outputs and computer inputs. It reads out and logs any analog voltage from 20 mV to 1kV. It affords automatic logging of most scientific instrument outputs. The unit converts voltage or resistance for teletypewriter tape recording. Nationwide Electronic Systems Inc., Route 53, Itasca, Ill. [405]

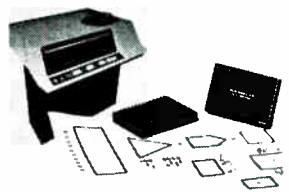

Programable gain data amplifier model 3600K operates on low-level signals under computer control. Voltage drive and noise are  $\pm 1 \mu\text{V}/^\circ\text{C}$  and  $2 \mu\text{V}$  rms, respectively. Common mode rejection is in excess of 100 dB. Gain accuracy and linearity are  $\pm 0.1\%$  and  $0.01\%$ , respectively. Small quantity price is \$245. Burr-Brown Research Corp., Int'l Airport Park, Tucson. [406]

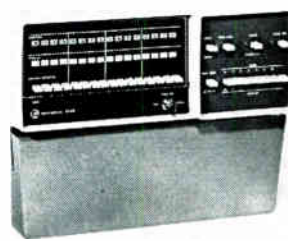

High-speed, general purpose computer model 2500 has a 16-bit word length and a memory speed of 850 nanoseconds. It measures 19 inches wide, 14 inches high and 21 inches deep. The table model handles up to 16,384 words of magnetic core memory; and the rack-mounted model, up to 65,536 words. Westinghouse Electric Corp., W. Colonial Dr., Orlando, Fla. [407]



System 1500 performs comprehensive off-line data editing and validation to reduce the number of steps necessary to prepare data for computer input. It comprises a small processor, an operator's console (with CRT display) and up to four magnetic tape units for production of computer-ready output tape. Data Action Corp., 4445 W. 77th St., Minneapolis, Minn. 55435 [408]



## Have circuits to switch ?

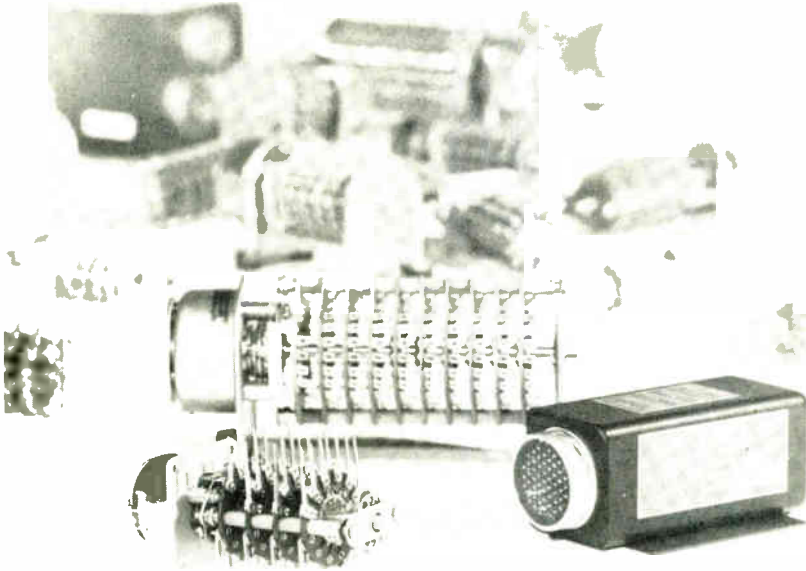

### ... one of these 47 Ledex stock stepping switches can help you get a quick start on your prototype.

**Ledex switches do a lot of work in a small space.** They are used as programmers, circuit selectors, sequencers, scanners, intervalometers, memory pulse decoders, converters . . . features like a rugged solenoid drive and corrosion resistant, self cleaning double grip contacts assure dependable switching.

**Exceptional variety, too**—open switches, hermetically sealed packaged switches and special designs. New PC leg terminals (optional) eliminate hand wiring and permit quick installation.

**Ledex also manufactures solid state switches** functionally interchangeable with other Ledex stepping switches. Check them when long life and speed are more important than price.

If one of these stock models doesn't meet your exact requirements, we'll custom design for you . . . whether it's an open circuit selector, a packaged switching network, a solid state selector or some combination of these. We've the people, facilities and capability to get the job done—fast and right.

Write or call today for our new stepping switch/circuit selector catalog or the new packaged switch catalog.

Stepping Switches & Circuit Selectors



#### Specialists in remote switching



LEDEX DIVISION, LEDEX INC.

123 Webster Street, Dayton, Ohio 45402 • phone (513) 224-9891

static register one bit goes in and 63 bits are needed to shift it down and out, the MS-618 shifts the bit automatically and internally at 200 nanoseconds per bit, without reference to any external clock. It operates on a first-in, first-out basis, so its length varies according to the number of bits initially introduced.

For example, if it is to operate as an eight-bit register, it is loaded with eight bits, and these ripple down to occupy the last eight stages. As additional bits of information are stored, they unload bit by bit in the normal fashion.

One application to which the MS-618, with its internal clock rate, is particularly suited, is as a buffer between airborne instruments and ground equipment operating at different clock rates. The register receives information at the airborne input rate, stores it at its own internal clock rate, and feeds it to the ground instrument at that instrument's rate, thus eliminating the need for synchronized clocks between ground and airborne equipment. This application is being explored by the Naval Research Laboratory.

NASA is considering the MS-618 for use aboard spacecraft as part of the launch-phase telemetry. On-board tape recorders vary slightly in speed, especially during launch, causing jitters that trouble ground equipment and degrade the received signals. An onboard shift register with its own internal clock could receive the signals, store them, and transmit them without jitter, thus eliminating the need for synchronization.

The MS-618 is priced at \$145 each in quantities of 1 to 24, or \$60 each for 100-999 quantities.

#### Specifications

Power supply	5-16 V
Input capacitance	5 pF
Input current, any input	< 1.0 nA
Power supply current	< 20 nA
Output impedance	600 $\Omega$
Output voltage	high > 9.99 V low < 0.01 V
Temperature range	-55°C to +125°C

Ragen Semiconductor Inc., a subsidiary of Ragen Precision Industries Inc., 53 South Jefferson Road, Whippany, N.J. 07981 [409]

## New products

### Instruments

# Pulser stresses test versatility

50-MHz unit offers variable rise time, double-pulse output

The odds were long. There was EL Instruments Inc. bidding on a General Services Administration contract for 20 pulse generators. Com-

peting with the small Connecticut firm, which had never made a pulser, were most of the major pulse-generator makers.

Nevertheless, EL got the nod. Now the company hopes that the same generator that won the contract can prove a winner in the industrial market. A 50-megahertz instrument, the unit will sell for between \$1,000 and \$1,100.

Asked why EL won that GSA contract in the first place—and why the company expects to be able to hold its own against entrenched firms—president R.J. Portugal points to his pulser's versatility. Among its most important features, he says, are variable rise time (6 nanoseconds

to 0.5 millisecond), a 10-ns synch pulse, high output (10 volts peak into 50 ohms), single-pulse operation, external and internal triggering, and double-pulse output.

"Double-pulse" means that the spacing between adjacent pulses can be adjusted. The first pulse in an output pair is fixed in time relative to the triggering signal. But the time between the end of that first pulse and the beginning of the second is variable up to 10 ms.

The pulser has dual output, each with the double-pulse feature. Output polarity is set with a front-panel switch, and offset is variable over a range of  $-2$  to  $+2$  volts.

Any of these features—from vari-

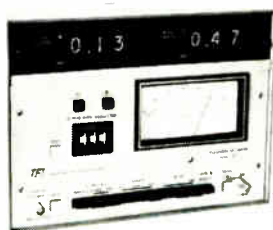

Frequency and modulation monitor 701 measures audio and visual frequency, and percent audio modulation, up to 30 miles away and operates up to 18 months between calibrations. It covers all uhf and vhf channels and provides digital readout of frequency errors. Operating temperature is  $0^{\circ}$  to  $50^{\circ}$  C. Time and Frequency Technology, Box 2072, Sunnyvale, Calif. [361]



Counter/frequency meter, designated cf 350, features six digits of memorized display. It can be used as a counter, frequency meter, period meter, timer, or ratio meter. It is equipped with coded outputs, allowing easy interface with measuring systems. Suitable for bench use or rack mounting, the unit is priced at \$595. Dixon Inc., Box 1449, Grand Junction, Colo. [362]



Pushbutton calibrator model 305B measures rf power ranging from  $-45$  dBm to  $+35$  dBm over a frequency range from 10 MHz to 40 GHz. It utilizes long-life mercury cells in conjunction with a temperature-stabilized zener diode to provide a standard voltage reference level. This reference is scaled to 8 discrete values in 5-dB steps. General Microwave Corp., Farmingdale, N.Y. [363]



Battery-operated rf millivoltmeter is for use in the field or where complete isolation from the line is required. The range-programmable instrument offers a basic accuracy of 1% of reading plus 1% of full scale. It measures  $100 \mu\text{V}$  to 3V from 10 kHz to 1.2 GHz in 8 ranges by push-button selection. Price is \$900. Boonton Electronics Corp., Parsippany, N.J. 07054 [364]



Digital panel meter 8440 fits a panel cutout  $2\frac{1}{2} \times 3\frac{3}{8}$  in. and is  $5\frac{1}{4}$  in. deep. It features TTL logic with full-scale count of 15,000. Three full-scale ranges are: 0 to 1,500.0, 0 to 15,000, and 0 to 150.0. Basic accuracy is 0.001% of reading  $\pm 1$  digit, or 0.02% of reading  $\pm 1$  digit for 30 days at  $15^{\circ}$  to  $35^{\circ}$  C. California Instruments Corp., Midway Dr., San Diego, Calif. [365]



Frequency meter, offering BCD output, remote programming, and internal crystal oscillator, is a 20-MHz unit. Four or five digits of stored display are available. Gate times from 1 ms to 10 s are programmable from the rear connector with automatic selection of reading rate. Also featured is sensitive preset triggering. Digital Displays Inc., 22 Drake Rd., Mendham, N.J. [366]



Portable 3-digit multimeter model 3300 has 26 ranges, operates 24 hours on nickel-cadmium battery, floats 1,500 volts off ground, and is priced at \$395. It measures dc volts (1  $\mu\text{V}$  to 15 kV); ac volts ( $\mu\text{V}$  to 1.5 kV); ac/dc currents (1  $\mu\text{A}$  to 2A); and resistance (100 milliohms to 200  $\mu\text{ohms}$ ). Hickok Electrical Instrument Co., 10514 Dupont Ave., Cleveland, Ohio 44108 [367]

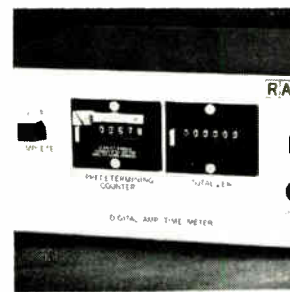

Linearity and calibration accuracy of  $\pm 1\%$  of rated capacity  $\pm 1$  digit is one of the features in this ampere-time (minutes or hour readout) meter. It is designed for standard 50 and 100 mV external shunts. Input impedance is 100 ohms, fuse protected. Isolation to ground is 500 V dc. Raven Industries Inc., Electronic Systems Division, P.O. Box 1007, Sioux Falls, S.D. 57101 [368]

# In the United States there are two more possibilities how to make the coming decades your most successful ones.

## 1st possibility

**To record measured values by means of Kienzle\* Digital Printers**

Kienzle\* Digital Printers offer considerable advantages. Parallel input, incorporated read-out unit for BCD outputs or 1-out-of-10 information. Kienzle\* Digital Printers are available as tape printers or with motor-returned carriage and, upon request, also with card and tape punching units.

## 2nd possibility

**To represent Kienzle\* Digital Printers in the United States**

Kienzle\* Digital Printers are a novelty on the U. S. market. For the distribution of our instruments we are looking for representatives who are well introduced, who know the market and who can provide technical service.

**Come to see us at the IEEE-show Stand 3737/3838**

You can see the Kienzle\* Digital Printers on our stand at the IEEE-show and we can also discuss with you the possibility of cooperation. In any case you should write to us and ask for detailed information.

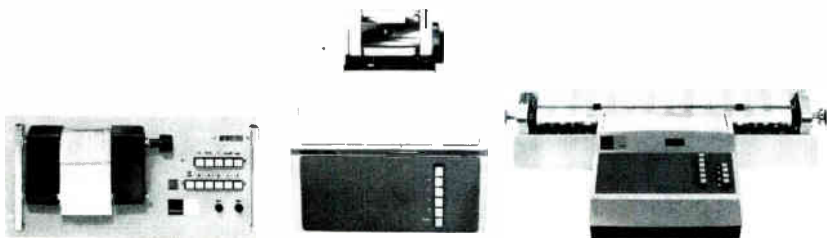

\* pronounced Kinsler by the way

**Kienzle Apparate GmbH · 7730 Villingen/West Germany  
Postfach 1640 · Telex 07-92 838**

## New products



Width change. Generator puts out double pulses. Each has its own width control, providing a range of 10 ns to 5 ms.

able rise time to adjustable offset—can be found in a competitive pulser, admits Portugal. But no one box has all of them, he says.

“The only unique thing here,” says Portugal, “is this extra control for the pulse width of the second pulse in double-pulse operation.” This allows the width of each pulse in a pair to be adjusted independently of the width of the other. Range for both pulses is 10 ns to 5 ms, and either or both can have up to a 100% duty cycle.

A warning light comes on to tell the operator that he has dialed the impossible—pulse widths and delay time totaling more than the inverse of the selected frequency.

The instrument comes in either a benchtop or rack-mount package. It weighs approximately 15 pounds, and is 17 inches wide, 3½ inches high, and 10 inches deep.

Delivery time will be 30 days by the end of March, says Portugal. Till then, EL will be tied up making the generators for GSA.

EL Instruments Inc., 61 First Street, Derby, Conn. 06418 [369]

## Two digital voltmeters —the plain and the fancy

Where size is not critical, the principal reason for going to integrated circuits in a new line of instruments is improved performance at the same price as earlier models, or similar performance at a substantially lower price.

Engineers at Dana Laboratories



Inc. had both these goals in mind when developing two new digital voltmeters. Four-digit units with automatic ranging, they are the last of four products, introduced since August of 1970, that represent an almost complete turnover in the Dana line of DVMs.

The model 4800, which replaces the Dana 5400, offers improved performance at a slightly lower price. A top-of-the-line model, it costs from \$1,295 to \$2,495, depending on options. Dana describes it as a premium DVM, having the wide versatility required in laboratory applications, plus the speed and programability needed in systems jobs.

It is directed at the same market that Hewlett-Packard had in mind when it introduced its model 3480 several months ago.

The standard version of model 4800 has ac-dc, dc-dc, ohms-dc, and millivolts-dc ratios, plus isolated binary coded decimal output, analog output, and automatic ranging from 10 microvolts to 1,000 volts or, with a preamplifier, from  $1\mu\text{V}$  to 1,000 V. Its dc accuracy is 0.01% over 90 days with 10- $\mu\text{V}$  resolution. The instrument has a dual-slope integrating filter which provides 20 milliseconds integration time, making it possible to take a dc reading in a little more than 50 ms with more than 48-decibel noise rejection at 60 hertz. Other speeds are 400 ms for ac, 70 ms for ohms.

Options include the preamplifier, an ohms converter, and an ac converter. The ohms converter is a true four-wire converter, two wires being used to put an exact, standard current through a resistor, and two going around the resistor to detect the voltage generated. An added feature is the use of a single zener reference for both current and voltage, so that errors are cancelled out. Dana calls the unit a ratiometric ohms converter. Accuracy is 0.01% of reading, plus 0.01% of range, over 90 days with a temperature span of 10° C. Speed is 18 readings per second. In addition to the six standard ohm ranges, the converter has ranges of 1 ohm,

## He's intelligent, well-educated, and takes a midwestern pride in his work. He's an Iowan.

He's the kind of person who doesn't have to be told what to do . . . or watched while he's doing it. He's good with his hands . . . many like him have an agricultural background and are used to working with machinery.

And for the past twenty-five years he and thousands like him have moved into industrial work. They have made Iowa plants among the most efficient in the nation . . . so efficient that 127 of America's top 500 companies now operate 516 plants in Iowa.  **Iowa**  
For information on Iowa's quality work force—**workers who work**—write or phone 515-281-3251. **a place to grow**

Jerry Ceaser, Marshalltown, Iowa



Iowa Development Commission  
250 Jewett Bldg., Dept. E2  
Des Moines, Iowa 50309

Please send me information on industrial opportunities in Iowa.

NAME .....

FIRM .....

ADDRESS .....

CITY ..... STATE ..... ZIP .....

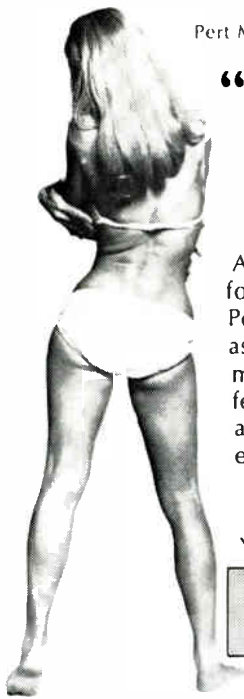

Pert Mag, the PERMAG girl, says:

## “Handling is chore-less with Magnets!”

And Perm Mag has just the right magnet for your material handling problem. Perm Mag offers permanent magnets, assemblies, electrical alloys, flexible magnets, soft magnetic materials and ferrites. Also, special precision grinding and cutting. And full magnetizing and engineering facilities.

YOUR NO. 1 SOURCE FOR ALL MAGNETIC MATERIALS

# PERMAG

ALL ACROSS THE COUNTRY

PERMAG SIERRA CORP. 3721 HAVEN AVENUE, MENLO PARK, CALIF. 94025 • (415) 369-0303  
PERMAG PACIFIC CORP. 5441 WEST 104th ST., LOS ANGELES, CALIF. 90045 • (213) 776-5656 • TWX [910] 328-6547  
PERMAG SOUTHWEST CORP. 2720 TAYLOR STREET, DALLAS, TEXAS 75226 • (214) 748-6909 • TWX [910] 861-4154  
PERMAG CENTRAL CORP. 1213 ESTES AVENUE, ELK GROVE VILLAGE, ILLINOIS 60007 • (312) 956-1140  
PERMAG MAGNETICS CORP. 2960 SOUTH AVE., TOLEDO, OHIO 43609 • (419) 385-4621  
PERMAG NORTHEAST CORP. 50 THAYER ROAD, WALTHAM, MASS. 02154 • (617) 484-0550  
PERMAG CORP. 88-06 VAN WYCK EXPWY., JAMAICA, N.Y. 11418 • (212) 657-1818 • TWX [710] 582-2952

Circle 113 on reader service card

## MODULAR TYPE

MULTIPLES OF 30 PATTERN SECTIONS UP TO 180 PATTERNS, STANDARD CATALOG ITEMS

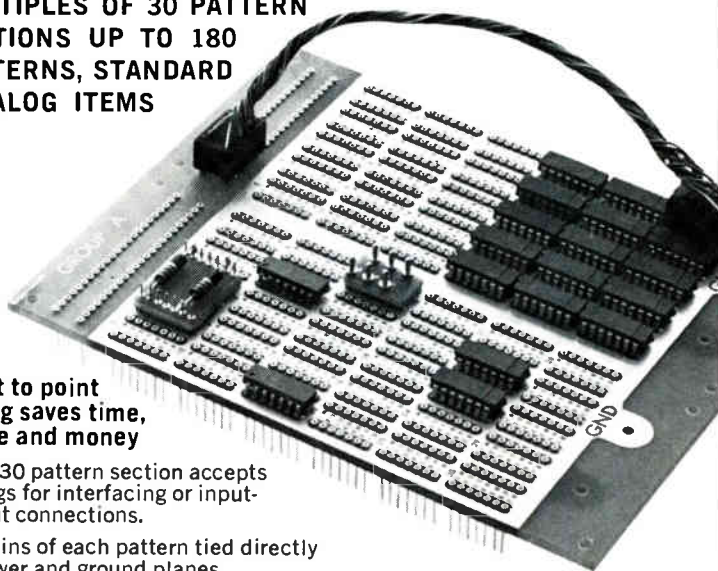

Point to point wiring saves time, space and money

Each 30 pattern section accepts 3 plugs for interfacing or input-output connections.

Two pins of each pattern tied directly to power and ground planes.

Changes and replacement made at component level.

Complete wire wrap service.

IC PACKAGING PANELS

Request Catalog 266

# AUGAT

INC. TEL: 617-222-2202  
30 PERRY AVE., ATTLEBORO, MASS. 02703



No accessories. Model 4700 offers all modes and ranges in basic instrument.

10 ohms, and 100 megohms full scale.

The ac converter has a 1-megahertz bandwidth and five ranges, including a 100-millivolt range. Accuracy is 0.02% of reading, plus 0.04% of range, over 90 days and a 10° C temperature span. Speed is three readings per second. The converter is distortion-insensitive, allowing a root-mean-square reading even when the wave is not a sine wave.

The second new DVM, the model 4700, replaces the Dana 4500 and offers similar performance at a substantially lower price. It has five dc ranges, four ac ranges, and six ohm ranges, and includes isolated BCD output and isolated remote programming, all in the basic instrument. Priced at \$985, the 4700 has only one configuration, with no options. It is fully programmable, has 100% overrange, and maintains 100-dB common mode rejection. The meter's dc accuracy is 0.01% for 24 hours and 0.03% over 90 days.

“It's more expensive to build a modular instrument,” explains a company spokesman, “and for the buyer it's cheaper to buy a better instrument with more capability than to buy a lower-priced model and then buy a lot of options. We found in studying this that many people pay a little more to get everything in one instrument because they actually save money. Modular construction is worthwhile when the options are worth a lot of money, because it costs a lot to make them.”

Dana Laboratories Inc., 2401 Campus Drive, Irvine, Calif. 92664 [370]



## New products

### Semiconductors

# Triac handles 80 amperes

Industrial control device requires only 80 mA of gate current

Aiming at the industrial control market, RCA's Solid State division has developed what it calls "the first real industrial triac." The

device can handle 80 amperes—twice the current of the division's previous triacs—and can accommodate power loads as high as 22 kilowatts at ac line voltages of up to 277 volts. The triac is expected to find control applications in infrared heating banks for paint drying, industrial ovens and furnaces, central heating and air conditioning systems, high-intensity lamps, and welding gear.

The new triac requires a gate current of only 80 milliamperes. "A competitor is offering a 110-A triac, but it requires 250 mA of gate current," says Reinhard Rist, RCA's marketing manager of thyristors and rectifiers. Rist adds that the

RCA triac can be triggered by positive or negative half-cycles of the ac voltage, regardless of phase, or by positive or negative pulses, regardless of line voltage. Other triacs, says Rist, can't be positively triggered by negative line voltages.

The 80-A triac can be used in power control systems that require zero voltage switching, phase control, or replacement of a static relay. With the power level controlled at zero ac voltage, there's no radio-frequency interference problem, and power remains either on or off for an integral number of cycles. If the application can tolerate rfi, phase can be controlled from zero to full power by varying the triac's

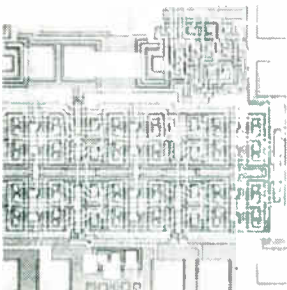

Bipolar, monolithic random access memory, designated HRAM-0016, is a 16-bit unit featuring 25 ns propagation delay and incorporating Schottky-clamped transistor technology. The device contains 16 RS flip-flops, each addressable in a 4 x 4 matrix and fully compatible with DTL and TTL logic. It comes in a 14-pin dual in-line package. Harris Semiconductor, Melbourne, Fla. [436]

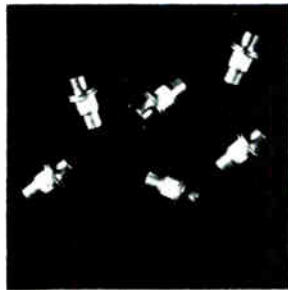

Self-pulsing oscillator diode MD632 uses the Trapatt mode of oscillation. With a dc bias of 1-2 ma applied in the reverse direction, the device puts out 50-100 W of pulsed power. Due to its low power input requirement no special heat sinking is required. Typical PIV is 250 V. Range of oscillations is 200 MHz to 6 GHz. Microwave Diode Corp., Newburyport, Mass. [437]

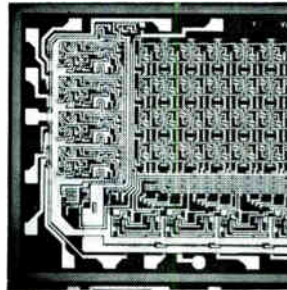

Random access memory MM5500 is a 64-bit unit. It is organized as a 16 by 4 bit memory, and is for high speed scratch pad, accumulators and small buffer memories requiring fast access time. It has an access time of 40 ns and a power dissipation of 6 mW per bit, with Vcc of 4.5 to 5.5 V over full temperature range. Monolithic Memories Inc., E. Arques, Sunnyvale, Calif. [438]

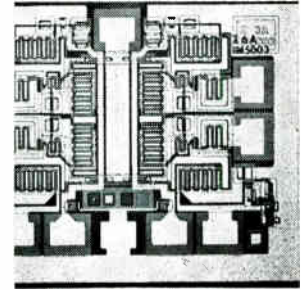

Monolithic IC MOS clock driver is designated IM5003. Each chip contains four independent driver circuits capable of sourcing and sinking 500 mA. Supply voltage differential can be as high as 30 V with resultant output swings of approximately 2 V less than supply differential. Unit comes in 14-pin DIP and TO-8 packages. Intersil Memory Corp., N. Tantau Ave., Cupertino, Calif. [439]

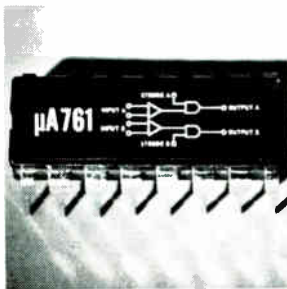

Linear IC  $\mu$ A761 is a two-channel core memory sense amplifier that provides a 25 ns response time and a typical threshold accuracy of  $\pm 2$  mV. The design features two independent channels, each of which can sense up to 4,000 bits of information. These channels share common reference and supply voltages. Fairchild Semiconductor, 464 Ellis St., Mountain View, Calif. [440]

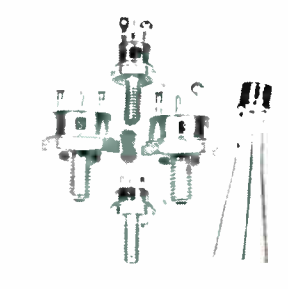

Radiation-resistant, npn silicon power transistors are identified as the SRD 2710-13, 2720-23, and 2730-33 series as well as the JEDEC 2N5527-5538 series. Typical capabilities include breakdown voltages to 90 volts and peak currents to 90 amperes. Units are immediately available from factory stock. Solitron Devices Inc., 1177 Blue Heron Blvd., Riviera Beach, Fla. [441]



Fast-firing Hockey-Puk SCRs, types 420PM60 through 420PM120, feature di/dt capability of 800 amperes per microsecond. Devices can be turned on with 150 mA gate drive at 25° C, thereby eliminating firing circuit complexity and cost. Voltage range is from 600 to 1,200 V. International Rectifier, 233 Kansas St., El Segundo, Calif. 40245 [442]



Pnp/npn complementary signal transistors, JEDEC numbers 2N5998-99 and 2N6008-09 are encapsulated in an epoxy TO-98 package. Intended for use in pre-amplifiers and/or instrumentation requiring ultra low-noise performance, the units feature a specified noise figure of 1.5 dB max, typically 0.5 dB, and are free of burst noise. General Electric Co., N. Syracuse, N.Y. 13212 [443]



# Tron Rectifier Fuses



Available in sizes from 1/2 to 1000 amps for voltages up to 1500, TRON Rectifier Fuses are ideal for protecting variable speed drives, inverters, battery chargers, plating power supplies, power controls, and any other application where fast opening and great current limitation are required.



Write for BUSS Form TRFS

Bussmann Mfg. Division, McGraw-Edison Co., St. Louis, Mo. 63107  
Circle 114 on reader service card

# FUSES

for protection of Electronic Devices

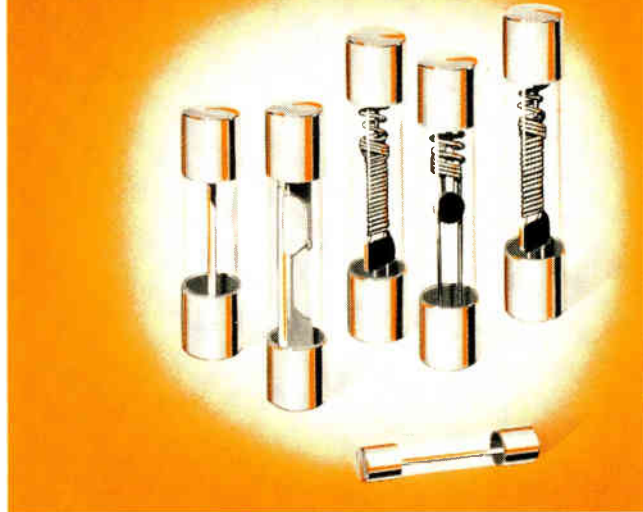

There is a complete line of BUSS Quality fuses in 1/4 x 1 inch, 1/4 x 1 1/4 inch, and miniature sizes, with standard and pigtail types available in quick-acting or dual-element slow blowing varieties.



Write for BUSS Form SFB

Bussmann Mfg. Division, McGraw-Edison Co., St. Louis, Mo. 63107  
Circle 141 on reader service card

## BUSS: The Complete Line of Fuses and . . .

### The power supply you plan to build is built!

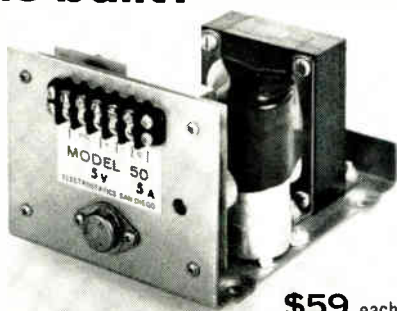

\$59 each

OTHER MODELS 3 to 50 V available

It's on the shelf, ready for immediate delivery from Electrostatics. With specs proven in service. Low cost. Brief specs on our Model 50:

- 5V 5A Power Supply
- Input 105-125V, 47-420 Hz
- Regulation: Line 0.01%  
Load 0.1%
- Ripple: 500  $\mu$ V max.
- Temp: -20 to +70°C
- Foldback current limiting
- Size: 5" W x 4.13" H x 7" L

(\$69 with overvoltage protection)

For full information call Robert McCartney, Manager of Application Engineering, (714) 279-1414. Or circle the number below for our latest data sheet.

**Electrostatics, inc.**  
7718 Clairemont Mesa Blvd., San Diego, California 92111 DEPT 101

Circle 90 on reader service card

To pinpoint a cosmopolitan Texas location convenient to R & D capabilities, brainpower and productive labor:

## ASK INSTA-SITE

The answers to specific Texas plant location questions and impartial site selections are instantly available from the nation's most comprehensive industrial computer program. Write or call for detailed Insta-Site information and your free copy of the Texas Fact Book.



**TEXAS INDUSTRIAL COMMISSION**  
Capitol Station — Box 12728-E  
Austin, Texas 78711 — 512/475-4331

Circle 115 on reader service card

## New products

angle of conduction. Finally, as a replacement for a static relay, the high-current triac eliminates voltage spikes common in relays.

The triac was developed in three package styles—press fit, stud, and isolated stud—each capable of handling peak off-state voltages of 200, 400, and 600 v. The press-fit models are 0.75 inch in diameter and are designated TA 7752, 3, and 4 for 200, 400, and 600 v, respectively. The stud models are called the TA 7755, 6, and 7, while the isolated-stud versions are TA 7937, 8, and 9. Operating ac voltages are 120 v for the 200-v peak off-state models, 240 v for the 400-v units, and 277 v for the 600-v triacs.

All nine triacs are specified as follows: average gate power dissipation is 1.5 W; operating temperature is 110° C, and instantaneous on-state voltage at 25° C is 2.5 v. While the new triacs operate at frequencies up to 60 hertz, RCA is readying another series of 80-A triacs to operate at 400 Hz, specifi-

cally for aircraft applications.

Prices range from \$25 for the 200-v press-fit model to \$45 for the 600-v isolated-stud unit. The triacs are available now in small quantities. Production volumes will be ready in September.

RCA Solid State Division, Somerville, N.J. [444]

### Monolithic op amp draws 2.5 mW at 15 V

Dielectric isolation is combined with a novel input circuit design in a monolithic operational amplifier from Harris Semiconductor. The result is extremely low power dissipation without any compromise of response characteristics or output drive capability. The device is intended for aircraft and space applications, as well as other instrumentation and control functions where a premium is placed on low power consumption with low offset voltage and current drift, large

voltage gain, and high common mode rejection.

The IIA-2700 features an open loop gain of 2,000,000, a slew rate of 20 volts per microsecond, input bias current of 5 nanoamperes, and input offset voltage of 2 millivolts with offset null capability. Power dissipation is only 2.5 milliwatts at  $\pm 15$  volts. It operates over a power supply range of  $\pm 5.5$  v to  $\pm 22$  v.

The circuit is fully frequency-compensated internally and is protected against a short circuit across the output. Only one stage of voltage amplification is used; this assures stability without external compensating networks, even when the op amp is operated in the non-inverting unity-gain follower mode. The bias network maintains a fixed operating point over a wide range of power supply voltages.

Price of the IIA-2700 is \$24 in the military version and \$10.20 in the commercial version.

Harris Semiconductor, Melbourne, Fla., 32901 [445]

## .. Fuseholders of Unquestioned High Quality

### FUSEBLOCKS

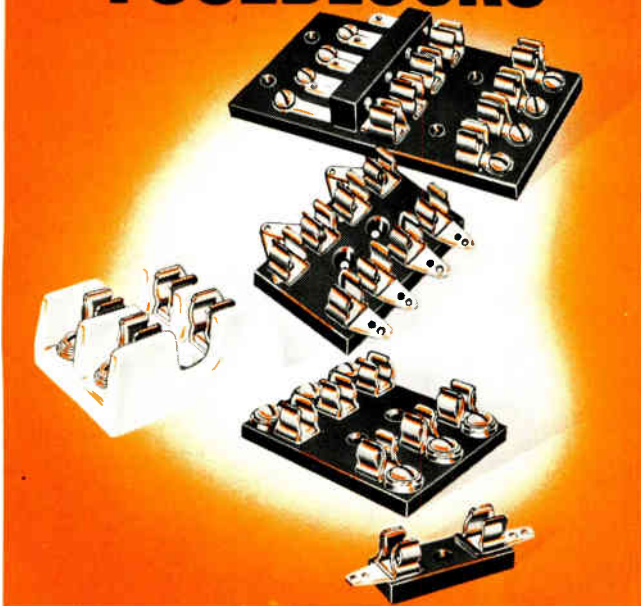

There is a full line of BUSS Quality fuseblocks in bakelite, phenolic, and porcelain, with solder, screw-type, or quick-connect terminals.



Write for BUSS Form SFB

Bussmann Mfg. Division, McGraw-Edison Co., St. Louis, Mo. 63107

Circle 142 on reader service card

### FUSEHOLDERS



BUSS has a complete line of fuseholders to cover every application. It includes lamp indicating and alarm activating types, space-saving panel mounted types, in-line holders, RFI-shielded types, and a full line of military types. Most are available with quick-connect terminals.



Write for BUSS Form SFB

Bussmann Mfg. Division, McGraw-Edison Co., St. Louis, Mo. 63107

Circle 91 on reader service card

# It took us years to develop the best stereo microscope.

## Now give us a few minutes to prove it.

Let us compare our StereoStar/ZOOM to any stereoscopic microscope in your lab.

Our microscope offers high resolution, larger fields of view, greater working distance. We have as wide a magnification range as you're likely to need: a full 6 to 1 zoom range with magnifications from 3.5 X through 210 X. The zoom control knob is coupled—so that it's conveniently located on both sides, for either left or right-hand operation. And the entire head is easily rotatable through 360°.

135 years of optical excellence went into the AO StereoStar/ZOOM. Let us compare it to any stereo microscope in your lab. After all, if it's worth your money, it's worth your time.

Call your AO Representative. Or write for our convincing 24-page brochure.



**AMERICAN OPTICAL  
CORPORATION**

SCIENTIFIC INSTRUMENT DIVISION • BUFFALO, N.Y. 14215

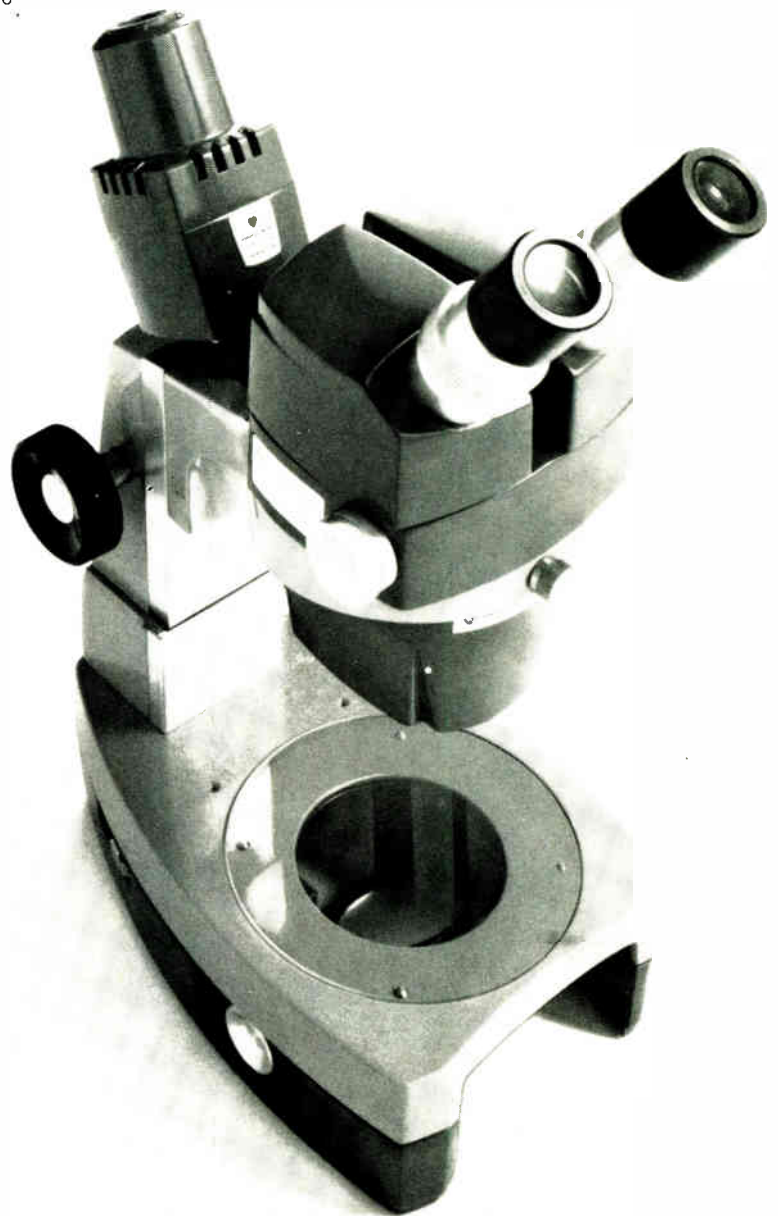



Components

# LED readout is 0.6-in. high

Big numeric display using two bars per segment is aimed at control board jobs

For industrial control board displays, relatively big numerical readouts are required. These have to be larger than the 0.25- or 0.3-

inch-high numbers that are typical of today's light-emitting diode arrays [*Electronics*, Jan. 18, p. 35].

The biggest LED so far—0.6-inch high—has been developed for control board applications by the newest and smallest of the companies in the business, Litronix Inc., a Cupertino, Calif. firm organized last April by former employees of Monsanto, Hewlett-Packard, Signetics, and other Bay-area firms.

The gallium-arsenide-phosphide device, called the DATA-LIT 6, is intended as a replacement for a filament-type or a projection-type display in control boards. Priced at \$19 each in quantities of 100, the devices are about four or five

times more costly than filament types. But Litronix points out that the GaAsP units offer better wide-angle, front-plane viewing than filament characters, and that maintenance and driving costs are lower than for projection-type indicators.

George Smith, manager of applications engineering at Litronix, says the design criteria for the DATA-LIT 6 were readability at 25 feet, standard socket mounting, 5-volt logic operation at less than 1 watt, and sufficient luminance to be clearly legible in ambient light. The final design yielded two long chips per segment, series-connected, with a large gap between them. A chip size of 80 by 20 mils was selected

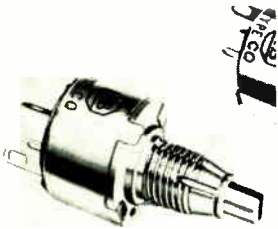

Cermet 1/2-in.-diameter variable resistors type CQ are designed for operation in severe environments as rheostats or potentiometers in military or industrial equipment. Temperature range is -65° to +175°C. Power dissipation is 1/2 watt at 125°C. Resistance range is 100 ohms to 5 megohms. Allen-Bradley Co., Electronics Division, 1201 S. Second St., Milwaukee, Wis. 53204 [341]



Thick film resistor networks in 14, 16 and 18-pin DIP configurations conform to TO-116 dimensions and can be obtained with special design features. Ratings are typically 1/4 W maximum per resistor with 3/4 W total package rating. Standard resistive tolerance is ±2% with a temperature coefficient of 250 ppm/°C. Dale Electronics Inc., P.O. Box 609, Columbus, Neb. 68601 [342]



High-frequency, precision tuning capacitors feature the ability to adjust capacitance with linearities as low as 0.3%. The series incorporates a contacting mechanism designed to provide long life with greater than 100,000 tuning cycles. Average size is 1/4 in. diameter by 2 1/4 in. long with bulk-head mounting. Johanson Mfg. Corp., 400 Rockaway Valley Rd., Boonton, N.J. 07005 [343]

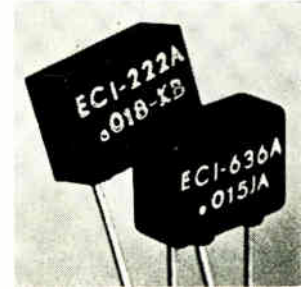

Metalized foil capacitors in epoxy cases as thin as 0.18 in. are for dense stacking on pc boards. Series 636A metalized polycarbonate units come in capacitance values 0.001 to 0.15 µF and are rated at 50 V dc. Series 222A, using a metalized Mylar dielectric, have values from 0.001 to 0.047 µF and 100 V dc ratings. Electro Cube Inc., 1710 S. Del Mar Ave., San Gabriel, Calif. [344]

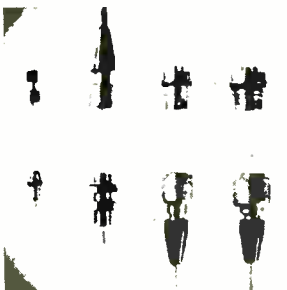

Ultraminiature coaxial connectors and multicontact 4- and 7-pin connectors are designed to meet the needs of high density packaging in space, aircraft, integrated circuits, servo systems, transducers and medical applications. Prices are as low as 95 cents each in quantities of over 1,000. Delivery is from stock. Microtech Inc., 777 Henderson Blvd., Folcroft, Pa. 19032 [345]



Filter pin connectors come in both miniature and subminiature configurations. They feature a one-piece filter pin that is permanently mounted in a metal and plastic insert. Since the crimp terminated contacts eliminate soldering, there is no possibility of damaging the filter by overheating. The Deutsch Co., Electronic Components Division, Municipal Airport, Banning, Calif. [346]

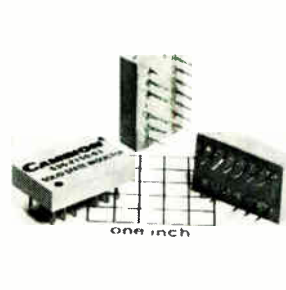

Solid state inductor 536-2051-01 weighs less than 3 grams and is designed in the 14-pin DIP configuration. It has no external magnetic field, contains no magnetic material and has no windings. Ranges from 1 H to greater than 100 H may be obtained. Q values in the order of 15 are obtainable at 1 Hz or less. Cambridge Thermionic Corp., 445 Concord Ave., Cambridge, Mass. [347]



Ultraminiature plug and receptacle pc connectors are qualified to Mil-C-55302. The plugs accommodate 0.062 in. nominal thickness boards and the receptacles, 0.094 in. Both are terminated by dip solder with molded-in hollow rivets used for the mechanical attachments. The series ranges from 13 to 92 contacts in 14 different pin patterns. Burndy Corp., Norwalk, Conn. 06850 [348]

# re.li.a.bil.i.ty (ri-li'a-bil'a-ti)n.

**1.** Dependable. Trustworthy. **2.** Capable of being counted upon to fulfill all assigned and implied responsibilities dealing with the design, development, manufacture and service of sophisticated instrumentation and control systems. **3.** The aviation/aerospace-proven reputation enjoyed by AERONETICS throughout the world.

*AERONETICS can solve your electronic measuring and metering needs with proven engineering imagination and manufacturing flexibility. Make us prove it. Send your requirements and specifications today!*

**AERONETICS**   
A DIVISION OF AAR CORP

2100 Touhy Avenue  
Elk Grove Village, Illinois 60007  
PHONE: (312) 593-6700  
TELEX: 253594 / CABLE: AIRNAVCOM

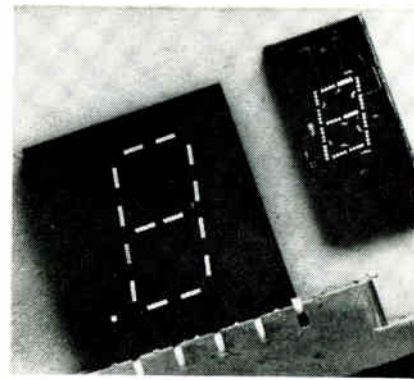

The big one. New 0.6-inch-high numeric is shown with 0.25-inch type.

as the best compromise between reasonable material costs and an aesthetically pleasing display.

Then a suitable chip, 80 mils long, had to be designed, with sufficient active area to provide about 500 foot-lamberts luminance at normal operating current of 20 milliamperes per segment and 3.4 volts. "We wanted to make the bar of light look as wide as possible and also wanted to raise the luminous intensity at the ends of the chip to help in closing up the gaps," says Smith. The eventual design was a double row of nine 3-mil spots spaced to put the spots at the ends of the chip closer than were the center spots.

Packaging also was a problem. The 0.6-inch character height, says Smith, was too large to mount on a conventional 0.3-inch dual in-line package, and a 0.6-inch DIP configuration was ruled out because of the high cost of the substrate and the 0.6-inch sockets. The best package configuration seemed to be the vertically mounted card-edge type.

By using a 1/16-inch substrate and a 0.156-inch pad center, a vertical mounting package that plugs into a standard pc card edge connector was developed. These connectors are widely available at low cost, says Smith, and in various sizes permitting multidigit arrangements. What's more, he notes, "this package configuration offers considerable cost savings over a multi-pinned package."

Litronix Inc., 10440 North Tantau Ave., Cupertino, Calif. 95014 [349]

Circle 116 on reader service card

**NEW**

## VECTOR-PAK SYSTEM SOLVES PACKAGING PROBLEMS

- CAGES NOW AVAILABLE FULLY OR PARTIALLY ASSEMBLED.
- NEW EASY-TO-ORDER NUMBERING SYSTEM.
- BUILT IN ADJUSTABILITY AND FLEXIBILITY TO SOLVE YOUR PACKAGING PROBLEMS.



- ① New "NIM" Bins and Modules for cost saving interchangeability — exclusive Vector Card Mounting System.
- ② Rugged all aluminum Vector-Pak Card Cages with extruded guides located at .50" or .750" spacing — easily adjusted.
- ③ Dozens of new Plugboards for building Plug-In Cards — IC and discrete types.
- ④ Multi-Mod Cases — sleek functional aluminum cases for instruments and other circuitry. 4 slotted interior surfaces for cards, mounting plates.
- ⑤ Front Panel Card Mount Plates supplied ready for cards, "pots" and switches—Mount plates in Vector-Pak Cages.

Send for new specification sheets.

**VECTOR ELECTRONIC CO., INC.**  
12460 Gladstone Ave., Sylmar, California 91342  
Phone: (213) 365-9661 ■ TWX (910) 496-1539





## New products

Subassemblies

# Plastic ICs cut converter price

A-d and d-a line starts at \$19; in-house thick film capability also helps keep costs down

Price is the make-or-break factor in conversion products, and with the introduction of a new family of analog-to-digital and digital-to-

analog converters by Zeltex Inc., prices reach a new low. An eight-bit, hybrid d-a module, for example, that includes op amp and reference, sells for only \$19, and the eight-bit a-d unit is priced at \$49.

Donald Peinetti, development engineering manager, says costs are cut by using standard plastic monolithic ICs and transistors, "and by having a well-controlled thick film screening facility in house."

The d-a family consists of the 430 M11, the eight-bit unit that is priced at \$19 and has a settling time of 25 microseconds; the 430 M1 (\$29), an eight-bit unit with a settling time of 1.5 microseconds; the 431 M1 (\$39), a 10-bit, 2.5-

microsecond converter; the 432 M1 (\$49), a 12-bit 5-microsecond d-a device; and the 433 M1 (\$49), a three-digit, binary coded decimal unit that settles in 5 microseconds. All except the BCD unit will operate on 0-10 volt,  $\pm 10$ -V or  $\pm 5$ -V supplies. The BCD device requires 0-10 V only. Peinetti says that all of the inputs are "truly TTL compatible and all are buffered." They are accurate to within one-half the least significant bit. Stability is specified at 50 parts per million/ $^{\circ}$ C.

The a-d family includes the 460 M11 (\$49), an eight-bit unit with a conversion time of 100 microseconds; the 460 M1 (\$79), eight bits, 10 microseconds; the 461 M1 (\$89),

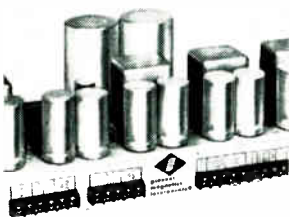

Lightweight power supply meets the requirements of small to medium computer systems and computer peripheral equipment. Features include automatic voltage sequencing and extended power storage for protection in the event of loss of line. Unit operates over an input voltage range of 105-135 V ac, 47 to 2,000 Hz. Pioneer Magnetics Inc., Santa Monica, Calif. [381]

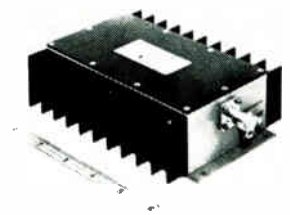

Pulse-optimized transistor amplifier model AV-9 offers the system designer high bipolar output power and 30 dB gain with fast rise-time, low over-shoot, and minimum pulse droop. A minimum of  $\pm 9$  V peak output power into a 50-ohm circuit is guaranteed. Typical small signal pulse risetime is 0.9 ns. Price is approximately \$900. Avanteck Inc., 2981 Copper Rd., Santa Clara, Calif. [385]

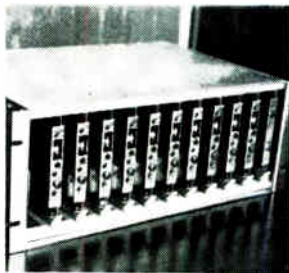

Differential dc amplifier 614M80 offers a max gain of 1,000,000 for thermal gradient detection. Noise is less than 0.1  $\mu$ V peak with bandwidth greater than 10 Hz. Rfi suppression is used to protect the sensitive input lines from stray fields. An input suppression circuit permits input offsets up to 25 mV to be balanced to zero. Ectron Corp., Engineer Rd., San Diego, Calif. [382]



Differential operational amplifiers models 2117, 2118, and 2119 are FET input units that feature a settling time to 0.01% in 0.5  $\mu$ s. Other features include a high common mode rejection of 10,000 to 1, a slew rate of 150 V/ $\mu$ s, and a unity gain crossover frequency of 20 MHz. Price is under \$40 in production lots. Melcor Electronics Corp., Farmingdale, N.Y. [386]

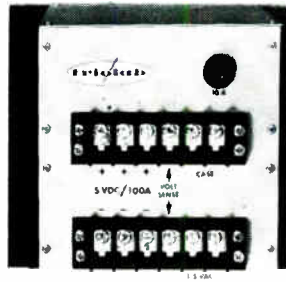

Power supply, designated model 630, is a 5V dc/100A unit that measures 8 $\frac{1}{2}$  x 6 $\frac{3}{4}$  x 8 $\frac{1}{2}$  inches and weighs 16 pounds. Efficiency is high (65% for all load conditions), and operation is cool (no forced air or external cooling needed for full-rated output to 55 $^{\circ}$ C). Price is \$695 and delivery is off-the-shelf. Trio Laboratories Inc., 80 Dupont St., Plainview, N.Y. 11803 [383]

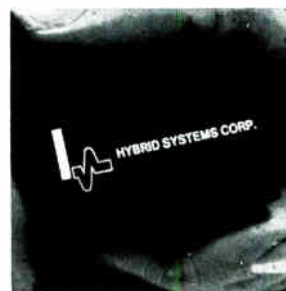

D-A converter model 325 has 10 bits of resolution. It contains a complete set of switches, a resistance ladder, an internal reference and an output amplifier. Full scale output is from 0 to  $\pm 10$  V. The unit operates from  $\pm 15$  V dc. It will operate over a temperature range of 0 $^{\circ}$  to  $\pm 70^{\circ}$ C and with a TC of 50 ppm/ $^{\circ}$ C. Hybrid Systems Corp., Burlington, Mass. [387]

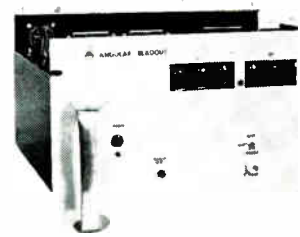

Inductosyn angle readout system model 391 is for field installation to test tables. It provides 0.0001 $^{\circ}$  (0.36 arc second) resolution position readout up to speeds of 200 $^{\circ}$  per second and also generates high resolution pulses for use in timing. It operates from 10 kHz reference frequency. Goerz Optical Co., subsidiary of Kollmorgen Corp., 301 Alpha Dr., Pittsburgh, Pa. 15238 [384]



Power video amplifier model PVA-200 was developed to help systems designers overcome limitations imposed by the capacitance of electro-optical modulators. It can drive a 150-pF transducer over a 200-V range from 10 Hz to 10 MHz with less than 1 dB ripple within the bandpass. Unit measures 5 x 17 x 12 in. Instruments For Industry Inc., Toledo St., Farmingdale, N.Y. [388]



# STRESS RELIEVED AND WEATHERPROOFED

## BNC Cable Assemblies

These new cable assemblies feature polyethylene collars which are injection molded directly onto cable jacket and connector body. The resulting encapsulation offers two outstanding advantages:

### STRESS PROTECTION

against failure from excessive bending, flexing, twisting;

### WEATHERPROOF SEAL

between cable and connector. Available in various lengths and RG58C/U, RG59B/U, or RB62A/U. Connectors have non-tarnish finish and conform to MIL-C-39012. Write for specifications, prices, and delivery.



**POMONA ELECTRONICS CO., INC.**

1500 East Ninth Street, Pomona, California 91766 • (714) 623-3463

Circle 117 on reader service card

## New products

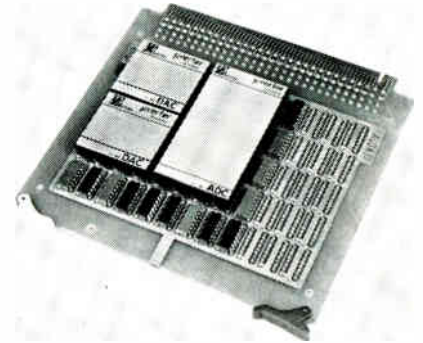

Board mates. D-a and a-d converters have terminal pins on same spacing as DIPs and fit on same plug-in board.

10 bits, 15 microseconds; 462 M1 (\$119), 12 bits, 20 microseconds, and the 463 M1 (\$119), a three-digit BCD unit with a conversion time of 20 microseconds. All a-d units employ a successive approximation technique, and require  $\pm 15$ -V and  $\pm 5$ -V supplies.

All of the converters are packaged in standard-sized modules: the d-a packages measure 1.9 by 1.7 by 0.4 inches, while the a-d modules are double sized—1.9 by 3.5 by 0.4 in. Peinetti says most systems manufacturers are moving to standard circuit boards, including dual in-line package matrixes with wire-wrap formats. "Pin spacing on these is either 0.5 or 0.6 in.," he says, "and we designed our modules so that they can plug right in."

"Even the power supply pins are in the correct position for the standard transistor-transistor logic layout," Peinetti adds.

The family also is compatible within itself. If a designer puts together an eight-bit system for example, he can later change to 10 or 12 bits without any redesign. All he has to do is plug in another unit. The same is true if he needs more speed.

The company is also developing a new line of sample-and-hold and multiplexing circuits.

Zeltex Inc., 1000 Chalomar Road, Concord, Calif. 94520 [389]

# new!

FROM

## BABCOCK HALF-SIZE COAXIAL RF CRYSTAL CAN RELAY...

...WELDED HEADER PIN/COAX CONNECTION  
ELIMINATES LEAD PROBLEMS

The new Model BR25 is offered in DPDT (RF), or SPDT (RF) with auxiliary SPDT contacts for dc to 2 amp. operation. Other features include:

- 6, 12 and 26 VDC
- Three mounting styles, with plug-in or versions solder hook terminals
- Meets shock, vibration and salt spray requirements.

A new data sheet provides complete product information and includes basic RF reference charts. Write Babcock Electronics Corp., Subsidiary of Esterline Corp., 3501 No. Harbor Blvd., Costa Mesa, Calif. 92626; or call (714) 540-1234.

Available from your local Babcock Distributor: Powell Electronics or Hamilton-Avnet.



ESTERLINE



MIL-R-6106



MIL-R-5757

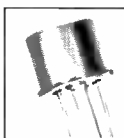

TO-5



Mercury Wetted

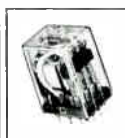

3A Industrial



10A Industrial

INDIANA GENERAL  
ELECTRONIC PRODUCTS

# Ferrite Components for

## Digital Circuits

Pulse Transformers  
Recording Head Ferrites  
Keyboards  
Read-Only Memories  
Modems  
Displays

### Get the inside free.

Ferrite components used in digital circuits often require specialized materials, shapes, and testing procedures. Indiana General engineers have pioneered the development of ferrites for digital applications and we have prepared this twelve page publication to assist you in applying ferrite technology to your digital circuit requirements.

If your design problems concern data in pulse form, this survey of the latest ferrite components and their application will give you a quick look at the state of the art in ferrite technology. And our engineers are always ready to work with you in finding solutions to your specific design needs.

**indiana general**



ELECTRONIC PRODUCTS • Crowa Mill Road • Keasbey, N.J. 08832  
Gentlemen: Please send me Ferrite Components for Digital Circuits

Name \_\_\_\_\_

Title \_\_\_\_\_

Company \_\_\_\_\_

Address \_\_\_\_\_

City \_\_\_\_\_

State \_\_\_\_\_

Zip \_\_\_\_\_

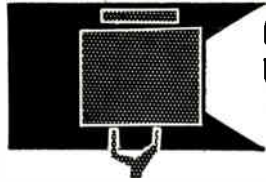

# SEARCHLIGHT SECTION

- CLASSIFIED ADVERTISING • BUSINESS OPPORTUNITIES
- USED OR SURPLUS EQUIPMENT

## AUTOTRACK MOUNT

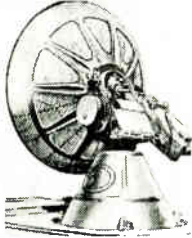

360 degree azimuth, 210 degree elevation sweep with better than 1 mil. accuracy. Missile velocity acceleration and slowing rates. Amplidyne and servo control. Will handle up to 20 ft. dish. Supplied complete with control chassis. In stock—immediate delivery. Used world over by NASA, USAF, MP-61-B. Type SC1-584. Ideal satellite tracking. Large spare parts inventory for back-up.

### ANTI-AIRCRAFT GUN MOUNT

Will handle 6,000 lbs. rapid slew through 360° azimuth, 180° elevation. Mobile.

### COUNTERMEASURES SYSTEM

Covers L-band, S-band, X-band, all radars. Tacan, UHF drone control, VHF drone control, Communications band. All housed in shelter.

### FIBERGLASS RADOME

Will handle 20 foot antenna. Easily erected & shipped.

### B-58 BOMBER ELECTRONICS

Ku band search radar, Ku doppler radar, Ku altimeter, all jamming countermeasures.

## PULSE MODULATORS

**MIT MODEL 9 PULSER 1 MW—HARD TUBE**  
Output 25kv 40 amp. 30kv 40 amp. max. Duty cy. .002. .25 to 2 microsec. Also 5 to 5 microsec. and .1 to .5 microsec. Uses 6C21. Input 115v 60 cycle AC. Mfg. GE. Complete with driver and high voltage power supply. Ref: MIT Rad. Lab. Series, Vol. 5, p. 152.

### 2 MEGAWATT PULSER

Output 30 kv at 70 amp. Duty cycle .001. Rep. rates. 1 microsec. 600 pps. 1 or 2 msec. 300 pps. Uses 5948 hydrogen thyratron. Input 120/208 VAC 60 cycle. Mfr. GE. Complete with high voltage power supply.

### SCR 584 AUTOTRACK RADARS

Our 584s in like new condition ready to go, and in stock for immediate delivery. Ideal for telemetry research and development, missile tracking, satellite tracking. Fully Desc. MIT Rad. Lab. Series, Vol. 1, pps. 207-210, 228, 284-286. Comp. Inst. 1/4 available \$25.00 each.

HUNDREDS MORE IN STOCK  
LARGEST RADAR  
INVENTORY  
IN WORLD.  
WRITE  
FOR  
CATALOG  
ON YOUR  
LETTERHEAD

## AUTOMATIC TRACKING SYSTEM

Sci. Atl. Mod. 3101-J70 Antenna Pedestal, AZ-EL 15 deg. per second rated speed. 23 inch dia. bearing. Complete w/control console & mag. amplifier. Also in stock complete Glo-track resolving system for 200-400 MHz telemetry band including 12' square quad. Helix. All part of Atlas missile instrumentation system

## MICROWAVE SYSTEMS

### SPARE PARTS IN STOCK

Niko Ajax, Niko Hercules, M-33, MPS-19, TFS-ID, TFS-10D, FPS-6 SPSS, SCH-584, MPQ-18. From Largest Inventory in World

### KU BAND RF HEAD

16.5 GHz, 50 KW, .001 duty cycle, 45 Watts avg. compl. w/5C22 modulator compl. recv. Mfr. Emerson Electric.

### L BAND RF PKG

20 KW peak 990 to 1040 MC. Pulse width .7 to 1.2 micro sec. Rep. rate 180 to 420 pps. Input 115 vac

### MICROWAVE LINKS

C BAND Public CLR6, CLR7, CLR9.  
Radar video link. Motorola MRR-4.

### X BAND FIRE CONTROL SYSTEM

MD-4, A5, A1PG, 32 system, 50 KW Autotrack, complete system, all cables etc., incl. gun turret if desired.

### AN/MPQ-29 3CM AUTOTRACK SYSTEM

Complete with plotting boards in van. Capable of skin or beacon track. Ideal for recon drone, etc. Airborne beacons also in stock.

### 500 KW L BAND RADAR

500 kw 1220-1359 msc. 160 nautical mile search range P.R.I. and A scopes. MTI. thyratron mod 5J26 magnetron. Complete system.

### C BAND AUTOTRACK

1 Megawatt 10 ft. Parabola. Sperry.

### AN/GPG-1 SKYSWEEP TRACKER

3 cm. auto. tracking radar system. Comp. pkg. w/indicator sys. Full target acquisition & auto. tracking. Input 115v 60 cy. new. In stock for immed. del. Entire sys. 6' x 3' x 10". Ideal for infrared tracker, drone tracker, missile tracker, R & D

### INDICATOR CONSOLES

AN/SPA-4A, PPI 10", range to 300 mi. VJ-1 PPI 12". Range to 200 mi. VJ-1 RHI 12" to 200 mi. 60K ft. FPS-6 RHI. FPS-8 PRI. CFS-6B PPI. plus many more.

# Radio-Research Instrument Co.

45 W. 45th St., New York, N.Y. 10036 ■ 212-586-4691

CIRCLE 966 ON READER SERVICE CARD

## New literature

**Water purification.** Witco Chemical Corp., 277 Park Ave., New York, N.Y. 10017. Two-page technical bulletin 4-3 describes the characteristics of activated carbon grade 718 used to purify water required in electrochemical processes such as the manufacture of printed circuit boards.

Circle 446 on reader service card

**Lighted pushbutton switches.** Marco-Oak Industries, 207 S. Helena St., Anaheim, Calif. 92803. An eight-page catalog describes 19 new additions to the company's extensive line of lighted pushbutton switches and indicator lights. [447]

**Relays.** Hart/Advance Relay division, Oak Electro/Netics Corp., Crystal Lake, Ill. 60014. A diverse line of more than 30 signal power and rf relay design types with many exclusive operational features is described in eight-page catalog DSC-5. [448]

**Data sets.** General Electric Telecommunications Products Dept., Box 4197, Lynchburg, Va. 24502. A 20-page publication covers the entire DigiNet family of data sets. [449]

**Power converters.** Arnold Magnetics Corp., P.O. Box K, Culver City, Calif. 90230. An eight-page condensed catalog describes the features, specifications, modifications, and mounting dimensions for a line of miniature and sub-miniature power conversion equipment. [450]

**Analog recorder.** Beckman Instruments Inc., 3900 River Rd., Schiller Park, Ill. 60176. Bulletin 666A describes the type IC-1 single-channel analog recorder. [451]

**Frequency multipliers.** Applied Research Inc., 76 S. Bayles Ave., Port Washington, N.Y. 11050. A catalog of broadband varactor frequency multipliers covers a wide range of active and passive devices for operation from 30 MHz through 16 GHz. [452]

**Wideband op amps.** Intronic Inc., 57 Chapel St., Newton, Mass. 02158. The practical and theoretical considerations necessary in applying wideband amplifiers to high-speed analog circuitry are outlined in a 12-page brochure. [453]

**Microwave absorbers.** Emerson & Cuming Inc., Canton, Mass. 02021, has released a colorful folder on high-loss dielectrics and electromagnetic absorbing materials. [454]

**Power supplies.** Texas Electronic Instruments Inc., 5619 Etheridge St., Houston, Texas 77017, has released a 12-page catalog describing the T series of low-voltage power supplies. [455]

# "SEARCHLIGHT"

IS

## OPPORTUNITY ADVERTISING

- to help you get what you want.
- to help you sell what you no longer need.

Take Advantage of it—For Every Business Want

"Think SEARCHLIGHT First"





**(PLUG-INS  
GO HERE)**

Choose the single chassis lock-in amplifier configuration you need:

- Dual channel
- Simultaneous in-phase and quadrature measurements
- Ratiometric measurements
- Filter, oscillator and log amplifier plug-in modules

Accessories

- Single and dual light beam chopper systems
- Low noise preamplifiers (current and voltage)

**“Lock-in amplifier customers tell us we’re the best buy on the market.”**

Since the majority of lock-in amplifier applications call for a basic instrument, we designed ours to be general purpose. And easy to use.

Some researchers, though, have applications that demand more specialized operation. For these people we provide specialized modules. Just plug them into our basic instrument, and voilà, it’s no longer basic. But it’s still easy to use.

Everyone gets what they pay for. And want. No wasted capability, no inflated prices.

So it really doesn’t surprise us to hear that we’re the best buy on the market. We know. We planned it that way.

If you’d like to hear more about our products and how they can help solve your application problem, give us a call. 607-272-7640. Ask for Mr. Ed Mitchell.

**ITHACO INC.**

735 WEST CLINTON STREET, ITHACA, N.Y. 14850

Circle 118 on reader service card



**YOU’RE WHISTLING IN THE DARK...**

if you think that heart disease and stroke hit only the other fellow’s family.

**GIVE ... so more will live  
HEART FUND**



Contributed by the Publisher

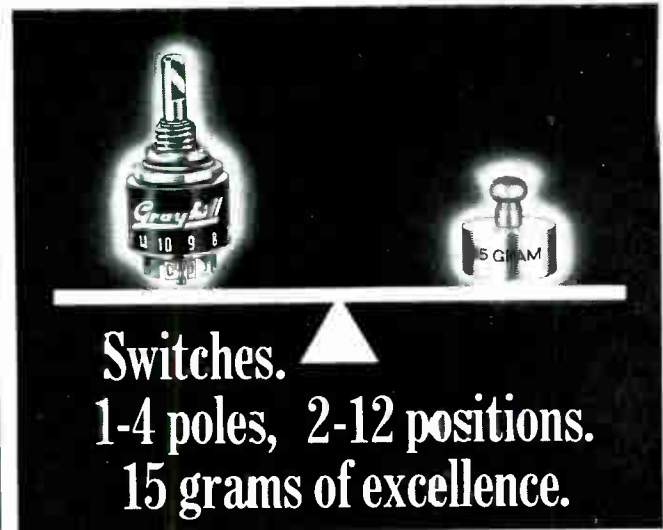

This 15 gram Series 51 switch from Grayhill offers you an unprecedented choice of poles and positions.

The mini rotary also gives you a choice of adjustable, or fixed stops. Solder, or PC terminals.

The flexible Series 51 is only one of a number of Grayhill miniature rotaries. All have been proved for reliability, by a length-

ening list of customers in many different applications.

Like to know more? Write or phone for our latest general engineering catalog. Grayhill, Inc., 523 Hillgrove Ave., La Grange, Ill. 60525. (312) 354-1040.

**Grayhill**

... the Difference Between  
Excellent and Adequate

Circle 99 on reader service card

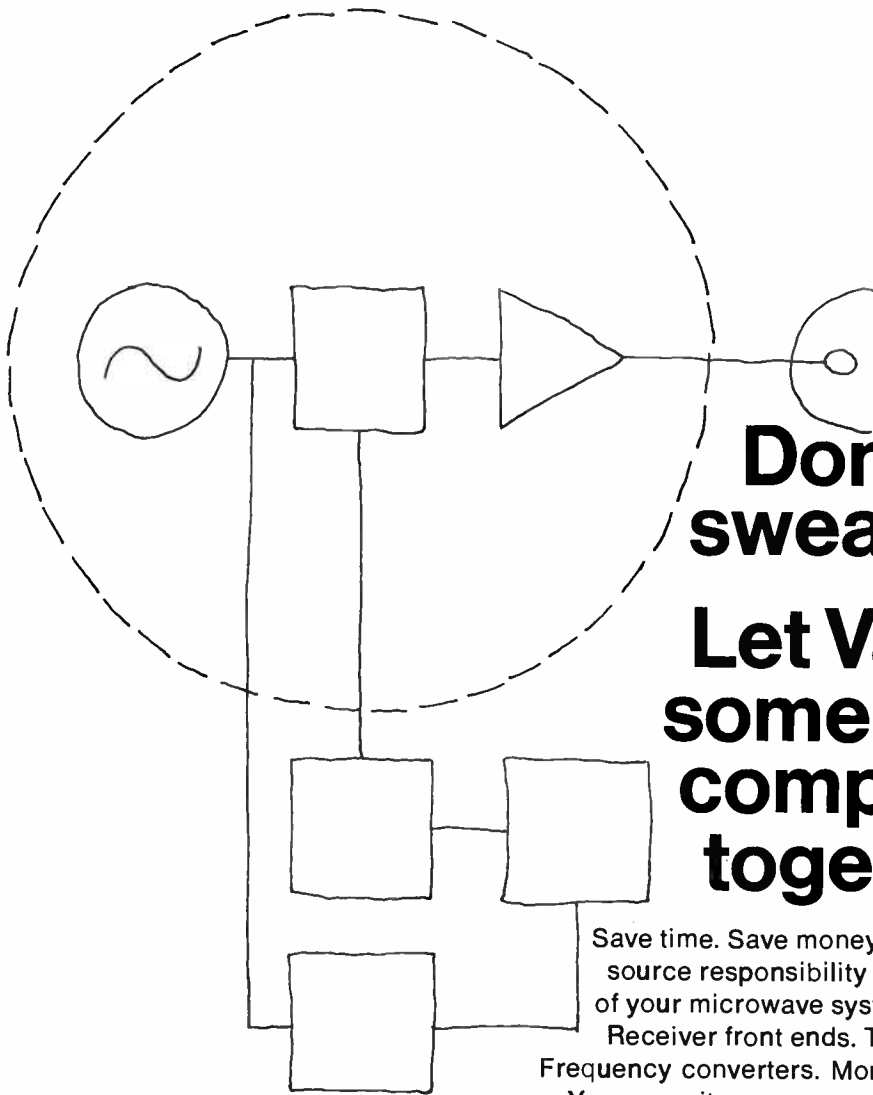

**Don't  
sweat the details.**

**Let Varian put  
some of those  
components  
together.**

Save time. Save money. Let Varian take single source responsibility on complete sections of your microwave system. IF subsystems.

Receiver front ends. Transmitter assemblies.

Frequency converters. Monopulse receivers.

You name it.

Who knows more about microwave components than Varian. And this experience gives Varian special skill in designing and assembling subsystems using the broad range of Varian components. Plus flexibility enough to select parts from other suppliers when necessary.

We've established our credentials by building CW, pulse and monopulse radar front ends. Saving thousands of dollars and weeks of time in the process. We're developing and testing a complete dither transmitter subsystem with AFC to increase range and reduce clutter in airborne radar.

Find out what we can save for you. Get in touch with the Solid State Division, 1365 Akron Street, Copiague, Long Island, New York 11726.



**varian**

solid state division

1365 Akron Street, Copiague,  
Long Island, New York 11726.

Or contact one of our more than 30 Varian Electron Tube and Device Group Sales Offices around the world.

FEBRUARY 1971

**Investments**

Real estate syndication is gaining ground  
New perils facing the art buyer

**Estates**

The sober side: Dusting off a man's will

**Travel**

Avoiding the tourist crowds in Hawaii

**Healthy, Wealthy and Wise**

## Home Buying Ahead of the Season May Be Smart

It's still no field day for the man buying a home in the \$40,000-plus range. But it's a more promising day. Prices are softer than a few months ago—in some places much softer. And mortgage money is easier to come by, and a shade less expensive.

If you're in the market for a new house, a pre-season purchase now may be a smarter move than waiting until spring or early summer.

You might just find a bargain. You'll beat the rush of seasonal house shoppers, and this can easily make a 3% to 5% difference. You'll see the house when the defects show up—before blooming springtime covers such blights as chipped paint and cracks. And if nothing more, you'll get plenty of time and attention from the local real estate agents.

In the New York City tri-state area, there are many more houses on the market than six months ago, and they're moving slowly. Asking prices are often down a bit, and selling prices have slipped even more.

Example: In Ridgewood, N. J., a top commuting town, realtors advised a seller to ask \$57,000. In-

stead he held out for \$63,000, waited four months—and last month sold for \$52,000. "That's the way a lot of deals have been going in the past few weeks," says a top New Jersey agent. Westchester County and southern Con-

**Personal Business** is an exclusive McGraw-Hill feature that you will see periodically in this magazine.

Personal Business takes a few moments to discuss the personal interests you share with other successful people. Investments, health, housing, taxes, travel, books and fashion are a few of the subjects.

Like the rest of this magazine, Personal Business' purpose is to be helpful and we hope you enjoy it and look to it for valuable information.

necticut realtors and bankers agree.

As elsewhere in the country, mortgage money in the New York area has been leaning more and more in the buyer's favor. In suburban Connecticut, 8½% with 25% down can be managed rather eas-

ily by a man who is qualified to buy, say, a \$50,000 house. Westchester County is at a legal 7½% with a third down, with very few deals involving lender's "points", as in the past. Suburban New Jersey: about 8%, with 30% down.

**National scene.** Coast to coast, the outlook for the \$40,000-plus house buyer follows pretty much the New York pattern. Prices of homes are generally softer and mortgage money easier—at least now, ahead of the springtime selling season.

As a rule of thumb, you can usually get at least 1.5 times your annual income in mortgage money, with some banks leaning to 1.7. Given the right house, it's sometimes possible to get 2 times—if you have good corporate or professional connections.

**Wintertime tip:** If you can locate a "spec" house—one that a builder has put up as a speculation in hopes of finding a willing buyer—you might get a good deal by buying fast. Such a house, still empty and now being held for a springtime sale, is often quite a costly proposition for a builder who's in a cash bind.

**Seller's side.** Reliable profes-



## The hard way to find out you're underinsured.



*Inflation has increased the value of the average home by 43% over the past ten years. Unless you've recently increased the value of your Homeowners insurance, your home is probably one of the two out of three homes that are underinsured.*

*Don't take the chance of having to come up with thousands of*

*dollars to make up the difference between what your insurance would pay and what it would cost to replace your home today.*

*Your State Farm Agent has a policy that not only covers your home and your possessions now, but automatically increases in value as inflation continues to boost the cost of things.*

*We're the world's largest home insurer. We protect you from loss by fire, tornado, burglary, vandalism and more. At surprisingly low rates.*

*State Farm Fire and Casualty Company. Home office: Bloomington, Illinois.*

*State Farm is all you need to know about insurance.*

**State Farm  
inflation-coverage  
Homeowners  
Insurance**



sionals, from Boston to San Francisco, appear to feel that the day of the sky-high house sales price has come to an end. Too many people were scared and hurt by the bear market in Wall Street in 1970, and too many were hurt by the business downturn.

Says one seasoned pro: "The kind of high-ticket sale that worked like a charm a year or two ago just won't jell." Price it within reason.

## INVESTMENTS

### Real Estate Syndication is Gaining Ground

The real estate syndication—where you buy a "unit" share in a big property—is making a widespread comeback. If you want to take a shot at realty investment, you might land yourself a comfortable proposition.

Today, apartment house deals are cropping up everywhere. And with the aid of tax shelters, an annual return of 15%-plus is quite possible.

But it's also possible to be led up the garden path in syndications that are complex, full of fine-print paperwork, and managed by fast-buck novices. "There's a wide range of quality," says James L. Keating, of Los Angeles-based Property Research Corp. "Just be sure you don't wind up with a marginal operator."

Today's good returns are possible largely because of a comfortable tax break built into the 1969 tax reform law. Aimed at encouraging a flow of money into "multiple-dwelling" housing, the rule lets you take advantage of "accelerated depreciation" (double the "straight-line" allowance)—a tax item that's no longer available in commercial or industrial property deals.

Take a simplified example. Jones is in the 50% tax bracket and puts \$20,000 in cash into XYZ apartments. In a fairly typical syndicate deal he will have tax losses of, say, \$10,000 a year for the first four years. So in his 50% bracket, he saves \$20,000 in taxes—a return of his investment.

He gets the annual tax loss because

the total deduction for depreciation, mortgage interest, and building operation exceeds the apartment rental income. During the following 10 to 12 years in such a deal, Jones will continue to get some tax loss and at least a modest cash income.

**The long-term.** Potential is good. Over a span of about 15 years, a 50%-bracket man should end up with roughly a 16% to 19% annual return on his money—if all goes well.

Rates of return go even higher, and some fall a lot lower. In checking the tax side of such a deal, note that a heavy tax could be due in the year of eventual sale because of the possibility of having to pick up excess depreciation as income. "It's a point that many investors overlook," says Harry Simon of Alexander Grant & Co. In any case, syndication units today are selling mostly at \$10,000 and up, though some are moving to the public in the \$2,500-to-\$3,000 per-unit range.

Finding a unit for investment is no problem. A CPA, tax lawyer, or bank real estate officer should be able to steer a client to syndicates of all shapes and sizes. Some well established real estate outfits are solid in the business, and a number of leading brokers have set up syndication subsidiaries. Some of the national CPA firms are actively involved. But before you go into any such deal, take stock of the drawbacks:

**The law.** Experts warn that the tax law on liberal depreciation rules could be changed. Present deals wouldn't be hurt, but future ones would.

**Front end.** You stand to lose heavily if forced to sell out in the first few years. "Some deals, in effect, have a front end load," says one pro.

**The rents.** Too many unknown circumstances can put dents into rental income figures, and building expenses are uncertain even in gold-plated deals.

**Paperwork.** This can get to the point where even a lawyer has hard going. "Lack of full disclosure is part of the problem," says Jerome Halperin, partner in the accounting firm of Lybrand, Ross Bros. & Montgomery.

So even the most promising syndication should be sifted carefully—by

## Here's how Beech Aircraft saved 30%



### by using Samsonite<sup>®</sup> MODULEX<sup>®</sup> charting systems

Beech Aircraft switched their daily program scheduling from reams of paper charts to Samsonite's Modulex charting system, and realized savings of 30% in man hours.

Beech found that Modulex' unique third dimension gives them masses of highly readable information in a small space. And they also discovered that Modulex operating expenses are negligible because all of the rugged plastic components are reusable and last indefinitely.

**MODULEX applications include:** Sales and stock control • Production planning • Purchasing schedules • Organizational charts • Work scheduling • Transportation timetables • Programming charts • Construction scheduling • Computer timetables • Job planning • Personnel training • Specialized charting (banks, hospitals, auto dealers, schools, architects, etc.)

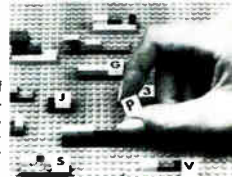

Modulex consists of multi-colored, precision-made components that easily snap together and to a studied baseboard.

For a free, full color demonstration booklet and the name of the Modulex dealer in your area, write today:

Mr. Dale Kincannon  
International Management Systems  
Division of Samsonite Corporation  
11200 East 45th Avenue  
Denver, Colorado 80217  
Telephone (303) 344-6393

Name \_\_\_\_\_  
Title \_\_\_\_\_  
Company \_\_\_\_\_  
Address \_\_\_\_\_  
City \_\_\_\_\_ State \_\_\_\_\_ Zip \_\_\_\_\_  
Telephone \_\_\_\_\_  
I read this ad in (Magazine) \_\_\_\_\_





**KENWOOD KR-6160**  
 220-Watt • FET • IC • FM/AM  
 STEREO RECEIVER

...with step-type tone controls for Bass, Treble, and Mid-range to provide a continuously variable presence control...plus its own Dynamic Microphone for "mike-mixing" in any mode. \$379.95 at your nearest KENWOOD Dealer.

**KENWOOD**  
 15711 S. Broadway,  
 Gardena, Calif. 90247



a tax attorney or a CPA and by an impartial real-estate man, as well.

**New Perils Facing the Art Buyer**

Investing in paintings? Now there's even more reason to know your way about the galleries and auction houses.

Hand forgers, already firmly established, may yet be outclassed by mechanical reproduction methods. True, the big-name sellers of mechanical masterpieces are above suspicion: Brentano's in New York, some top department stores around the country, and New York's Whitney Museum, among others. Their copies of works by such artists as Andrew Wyeth and Picasso look so authentic that they are reduced 10% in size and are stamped "reproduction" (\$50 to \$250).

But the art experts are worried. They fear that clever mechanical forgery may be added to the palette of the forger's technique. They offer some safeguards:

If you're buying original art, go to an established, reputable dealer after first checking him out through a local art museum. For further checking, contact the Art Dealers Assn. (575 Madison Ave., New York).

If it's a sizable purchase get a provenance ("pedigree") from the seller. This lists previous owners, and you can check with them. If you are refused a provenance, you might be smart not to buy.

**Authentication.** Getting a painting authenticated is often difficult, sometimes impossible. Museums generally won't authenticate, though there are exceptions. The Boston Museum of Fine Arts will tell you if it's an obvious fake, or may perform tests for a fee. Washington's National Gallery will authenticate a painting free (by appointment). The Smithsonian performs a similar service for American art.

Major private galleries in New York and Chicago will sometimes authenticate a work for a long-established customer, or for a small fee (1% of purchase price). The art history departments of some universities (Columbia, Harvard, Michigan)

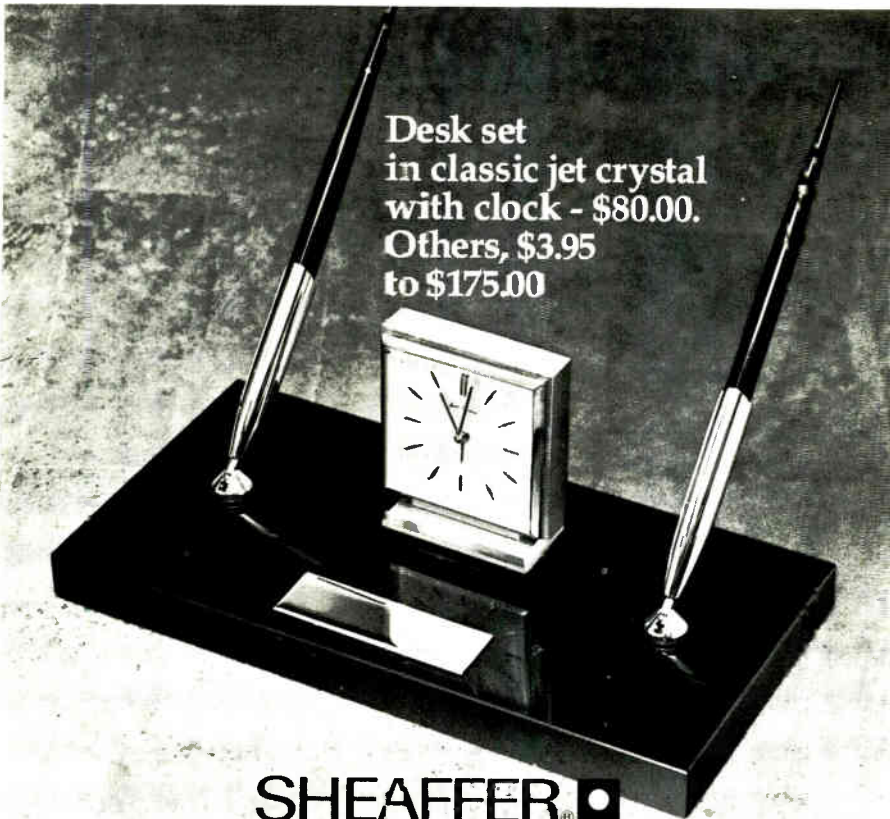

Desk set  
 in classic jet crystal  
 with clock - \$80.00.  
 Others, \$3.95  
 to \$175.00

**SHEAFFER**   
 the proud craftsmen

W.A. SHEAFFER PEN COMPANY, A  COMPANY, FORT MADISON, IOWA 52627



might also be willing to help. You might check with a professor of art at your local university.

In most states, laws against fraud are your sole protection if you're cheated. But such laws are often difficult to enforce. In New York, though, a new law says that your invoice is, in effect, a warranty if it names the artist. Check state law if you are spending big money.

In any case, be wary of fuzzy wording on dealers' invoices and in art catalogues. A statement that a painting carries an artist's name is no legal guarantee that he actually painted it. But a special rule covers New York auction houses. They are legally responsible if the listing incorrectly attributes a painting to an artist, despite any disclaimer. Parke-Bernet has special house rules to protect clients against fraud—whether the art piece costs \$1,000 or \$100,000.

**Speaking of cost.** Good quality original art runs in price roughly \$500-and-up, even for the work of a young unknown. If his work shows promise in the opinion of the dealer who represents him, the new artist's work may be pegged higher in price say, \$2,500 for a sizable painting.

## ESTATES

### The Sober Side: Dusting Off a Man's Will

Have you blown the dust off your will in recent months—or years? A will is the true starting point in an "estate plan." And however tedious the chore, updating it periodically can mean much more to your family than many months of chipping away at smaller savings.

The laws change. Family needs change. And your own ideas do, too—or maybe they should.

A lot of states have lately revised laws on such things as trusts, treatment of life insurance payoffs, adoption and guardians—the items add up. And on the federal scene, you can find at least two prime reasons for updating a will early in 1971:

First, federal income tax reforms—now effective—might have short-cir-



# bread winners

**Breadwinners are responsible people who hustle to make sure they work full-time. We know.**

**We meet them every day and place them in jobs, according to their capabilities. Sales.**

**Secretarial. Clerical. Technical. Administrative.**

**You name it.**

**Thus, if you have need for eager, active, capable people for your job openings, let's talk.**

**Look us up in the White Pages. Now.**



# Snelling AND Snelling

World's Largest Professional Employment Service

## Pennsylvania Grade motor oils:

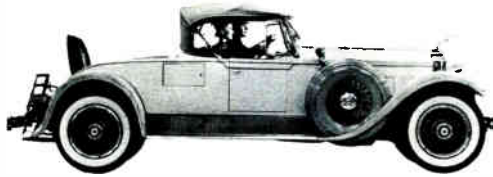

important when interstate travel  
was two lanes slow



## (Vital on high-speed freeways)

Sustained high-speed freeway driving causes ordinary motor oils to thin out. To break down. To stop protecting.

But Pennsylvania Grade motor oils aren't ordinary! They provide the greatest stability under high compression and high temperatures. The greatest protection for modern engines.

Any wonder Pennsylvania Grade motor

oils are the most asked-for brands in America? They're refined from crude oil unique to the Pennsylvania region... the finest crude in the world.

Our free booklet explains the difference in motor oil and what it means to your engine. Send for your copy today; write Dept. PB12.

"Pride of  
Performance."

**PENNSYLVANIA GRADE CRUDE OIL ASSOCIATION**  
P.O. Box 250, Oil City, Pennsylvania 16301

# HOW MANY TIMES HAVE YOU THOUGHT...

## "Why don't I live in Florida...?"

"Get away from the blasted Winters. Crowds. Air pollution.  
"How much of life is left, anyway? I can do business there.  
"Open an office. A distribution center. Great for Research.  
"Maybe move the whole Plant. Take an afternoon and go fishing.  
"Play golf. The key people would love it. Labor would be no problem.  
"Less, from all I've heard..."

If you'd like to pursue your thoughts we suggest you learn what SEMINOLE COUNTY in Central Florida has to offer. We're an hour from gulf or ocean. Fresh lakes and streams for your pleasure. Disney World, Daytona Beach, Kennedy Space Center are in our "backyard." Two main highways, a railroad, an inland waterway. What more do you need?

Write: Seminole County, P. O. Drawer C, Dept. PB, Sanford, Fla. 32771, and we'll send you everything you want to know about this rich and still "undiscovered" SEMINOLE COUNTY, Florida. It could be the best investment of a postage stamp you ever made.

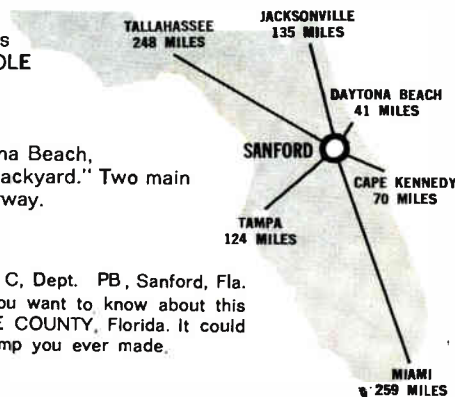

culated a will provision that was "safe" for years. "Make a check," says a New York estate lawyer, "—for instance, a bequest to a charity may need rewriting."

Also, federal estate and gift tax rules are in line for reform. Even estate lawyers agree that some new law is needed. You can't walk into an estate planner's office today and get pat answers—but you can hedge your bets. "For example, you might take advantage of some present liberal rules on family gifts and trusts," says Robert Ferguson, a top estate authority and executive vice president of Pittsburgh National Bank.

**Family and assets.** There are, of course, more reasons to recheck a will. A birth, death, divorce, or legal separation may call for changes. Or, say that despite the 1969-70 bear market, your property is up in value. You might fix a trust so that your wife has more freedom to use principal. Or maybe add a nephew to the list. Or—if you have lost money—the nephew might be dropped.

A shift in the type of assets you hold may demand a change in a bequest from, say, stocks to real estate. Other reasons for revamping a will: a wife's sizable inheritance from her side of the family, or a change in the health of your executor—or his death, or moving to a new state. "Changing states causes all sorts of mixups," notes a Washington lawyer. **Executors.** In sifting through your will, don't forget to consider your executor—whom you have and why. The prime rule: Don't name your wife just for sentimental reasons. The job of executor is no sinecure. It takes some doing, and this holds true even if you have a skilled professional trustee named to oversee your assets.

A trustee must wait until the estate is settled before taking over. And what with the courthouse routine, even a moderately involved estate can take a year or two, or longer. Meantime, the executor is in full charge, even though an attorney for the estate is on hand. A lot can happen to the property in a man's estate in two years' time.

During the settlement period, the executor is responsible for collecting and distributing the assets of the es-



# The Prop·Jet Edge

## faster than pistons - more economical than jets

Today's heavy demand for key executive time calls for fast, versatile transportation. Your corporate personnel simply cannot afford to wait for airline schedules, layovers and delays trying to reach "off line" destinations.

Some companies have tried million-dollar jets and found them expensive to operate and impractical for most non-metropolitan airports.

The 325mph and 340mph MU-2 prop-jets are the practical answer for air travel in today's tight money econ-

omy. The MU-2 fills the gap between the expensive jets and the piston type aircraft. On trips of 300-700 miles, the MU-2 will take only minutes more than the fastest jet. Your cost for getting there will be less than half.

1970 was a tough year for everyone but if you are looking for the practical answer to company air travel, look to us. Our MU-2F and MU-2G are the only prop-jets whose percentage of the market during this "tough year" increased substantially. Advantages in

speed, performance and cost of operation will provide a competitive edge in the tough world of business this year.

For further information or if you would like us to arrange a "proof of performance" demonstration flight, call (915) 944-1511 or write Bill Stinson, Director of Marketing, Mitsubishi Aircraft International, P. O. Box 3848, San Angelo, Texas.

 **MU-2** MITSUBISHI AIRCRAFT INTERNATIONAL  
P.O. Box 3848 San Angelo, Texas 76901





CSC,  
the Big One in  
total computer sciences,  
presents

# Infonet



# Timesharing / Plus

**INFONET puts people who don't have computers in competition with people who do. INFONET gives people who have computers maximum plus / capability — economically, too.**

INFONET was created by Computer Sciences Corporation, the largest independent producer of software in the world. CSC's customer list reads like a "Who's Who" of business, industry and government. To name a few, General Electric, General Motors, General Mills, NASA, A.E.C., D.O.D., even IBM and Univac... the list could go on and on. What makes INFONET so different is that we start from a different point of view. Not ours. Yours!

**We study the business you're in.** How you use information. What kind of information you need. How to get it to you in usable, manageable form.

**Now, a total data processing capability through your own terminal.** INFONET goes beyond being responsive to your needs. We built a system to give you the information you want when you want it. Only INFONET offers you so many computer-use options. There's BASIC — with direct "conversation" to the computer. Then there's high-speed batch processing called Remote Job Entry. And INFONET has added a third option. A happy marriage between the two called Conversational Remote Job Entry. The exclusive combination of all three lets you do a total data processing job from your own high and/or low speed terminal — without owning your own computer, or adding to the one you have.

Only INFONET has it.

**INFONET offers total "packages."** You'll get information "packages" based on your business. Premium packages. All the way from basic engineering data to total nuclear packages. From basic business management information to instant actuarial information for insurance men. Hundreds of proven programs jointly developed by INFONET and top companies in their fields.

**You are not alone with INFONET.** INFONET has the people. Your first INFONET contact is far more than a salesman. He's an expert, schooled in translating your information needs into

computer-based, manageable, decision-directed packages. And he's backed by Applied Science representatives (most of them PhDs) who study and solve problems. And systems experts to translate these solutions on our computers. And Operations people who know the system. Equally important, we train your own people... quickly and easily... to work with our system. You don't have to bring a stranger in and teach him your business.

**INFONET is worldwide.** Boston, Chicago, Cleveland, Dallas, Denver, Detroit, Los Angeles, New York, Philadelphia, Portland, Richland, Wash., Richmond, San Diego, San Francisco, Seattle, Washington, D.C., Calgary, Montreal, Toronto, Vancouver and a growing international network.

INFONET can be a useful supplement to your operation. We'll complement what you have... saving you costly, additional personnel and capital expenditure.

That's Timesharing / Plus. Your point of view. The total capability system. The packages. The people. The network. INFONET.

CSC has made a commitment to the future. We're putting our technology, time and money into INFONET... to put you money and time ahead today. And tomorrow.

May we send you some interesting information? Send your business card to:

**John W. Luke, President**  
**INFONET**  
650 North Sepulveda  
Los Angeles, California 90245

**INFONET**  
THE INFORMATION NETWORK DIVISION OF

# CSC

COMPUTER SCIENCES CORPORATION

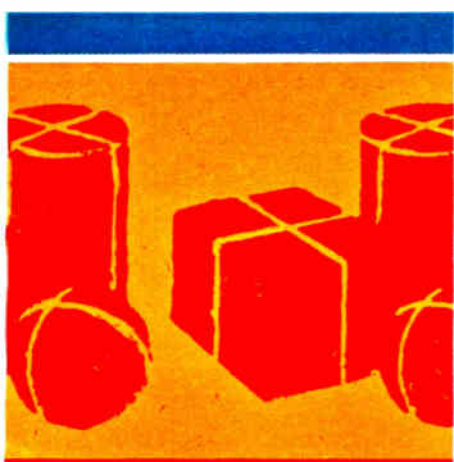

# MONONGAHELALAND\* IS THE LAND OF OPPORTUNITY.



Consider a 10% tax credit for plant construction or expansion. Couple it with 100 per cent financing, a productive labor force, a new Interstate highway system, and an improved business climate. That's opportunity.

So if you're looking for a new plant site or an expansion site, an extremely difficult and complicated process, we can be of service. We've been through it before.

Our professionals will give you the opportunity to save a lot of time and money.

Use the coupon for a copy of our free, new booklet, "Monongahela Power Plant Location Service." Or phone collect, M.W. Forsythe, Manager of Area Development, 304/366-3000.

\*Mid-Ohio Valley, West Virginia, western Maryland, western Virginia

## Monongahela Power



Part of the Allegheny Power System

To: Area Development Services  
Dept. A21  
Monongahela Power Company  
Fairmont, West Virginia 26554

Check here for free information on:

- Manpower       Taxes  
 Training         Transportation

Plus our new brochure on Plant Location Services.

NAME \_\_\_\_\_

TITLE \_\_\_\_\_

FIRM \_\_\_\_\_ PHONE \_\_\_\_\_

ADDRESS \_\_\_\_\_

CITY \_\_\_\_\_ STATE \_\_\_\_\_ ZIP \_\_\_\_\_

tate, and this means, among other things, paying debts and taxes. It can come down to picking the proper stocks out of a portfolio to be sold—no job for a novice.

Alternatives: You can name your family lawyer as co-executor to serve with your wife. This puts him in a strong position to protect the family's best interests until the trusteeship comes into full operation. It also gives him an executors' fee (2% to 4% of gross value).

Or you can name a bank or trust company as executor as well as eventual trustee, and your attorney co-executor. But it means two fees.

## TRAVEL

### Avoiding the Tourist Crowds in Hawaii

If you have Hawaii on your list for this winter or spring, the message is clear: Go to the outer islands if you want a relaxing vacation.

The Honolulu area (on Oahu) has become the San Juan of the Pacific. It's more crowded than Miami Beach. But the outer islands—Hawaii, Maui, Kauai—remain more or less clear of crowds.

The island of Hawaii has become popular, and 10 airlines now fly to Hilo, the county seat. There the top name on the resort list is the 256-room Mauna Kea Beach hotel, a 45-minute ride by plane or about 3½ hours by car from the town. It has everything—at \$50 or more per person per day.

Other names to check on are the new Kona Hilton, near the town of Kailua on the west coast of Hawaii, and the Kona Inn. A hideaway: Kona Village Resort, a cottage colony with a true South Seas flavor. This island, you'll find, has the full range of water sports, plus camping, hiking, riding, hunting. An outrigger canoe picnic is a must. Or for a thrill, take a glider plane ride (contact Hawaii Trails, Kamuela).

Maui has a rain forest as well as cactus and desert, and some of the

This unique book helps you manage your personal affairs with the same skill you bring to your business:

## Business Week's Guide to Personal Business

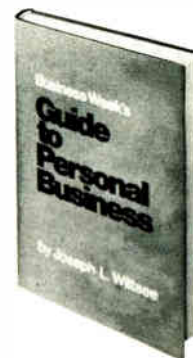

\$9.95.

"Many a man who should know better—whose business or professional income is, say, \$25,000 to \$50,000 or more—treats his own personal business like a third cousin who turns up in town in search of a loan. He brushes them off," says Editor Joseph L. Wiltsee.

If that describes your situation in any way, here's help. This unique book, distilled from the popular "Personal Business" section of *Business Week*, offers you a wealth of *new* ideas on planning and managing your personal finances. Real estate, investments, insurance, school costs, taxes, estate planning—even advice on how to choose and evaluate an advisor! The money you can save—or make—from just *one* of the ideas in this 320-page guide should more than pay for its modest cost.

Get it now from your favorite book store for \$9.95. Or send your order (enclose payment please) to the address below. **Note:** a special deluxe edition, bound in buckram, gold stamped, slipcased is available at \$2.50 more per copy, by mail only.

Business Week Guide  
Book Service Office  
330 Broadway  
Marion, Ohio 43302



least crowded beaches in the islands. The new luxury hotels are in the Kaanapali beach area just north of Lahaina, an old whaling port. The Sheraton Maui, a hillside hotel in which you go from the lobby down to your rooms, and the Royal Lahaina, are top names. Others are the Maui Hilton, a comfortable oasis, and the Kaanapali Beach.

No matter where you stay in this area, for a day or week, have at least one breakfast in the garden of the Pioneer Inn in Lahaina. It's a colorful gathering place for townspeople and yachtsmen.

**Hideaway islands.** Kauai is the favorite hideaway island of the Hawaiians. At the Hanalei Plantation hotel, across the island from the town of Lihue, a guest rides a funicular to the Hanalei River, then takes a boat to the ocean beach. Another favorite: the Coco Palms hotel.

Poipu beach, at the southern tip of Kauai, is ideal for swimming, with the Sheraton Kauai and quaint Waiohai Cottages to provide the amenities. Near Lihue, your teenager can put up at the Kauai Beach Boy, where he can stay with friends four-in-a-room (\$15 a day).

If you want a remote retreat, seek out Lanai or Molokai, small islands between Oahu and Maui. Lanai is mostly for exploring: mountains (highest 3,370 ft.), desert, beaches, and a mile-long shipwreck coast. Here, stay at the Lanai Inn, an old plantation house. Molokai offers more of the same plus exceptionally good hunting and camping. On the south shore there's the comfortable hotel Molokai.

Sign of the times: Even these remote havens have air service.

If you're in Honolulu for a few nights, you can still sidestep the crowds. The top-rate Kahala Hilton, for instance, is located around Diamond Head at Kahala Beach, away from the Waikiki hubbub. The hotel adjoins the Waiālae Country Club, site of the top-ranking Hawaiian Open Golf Tournament (February). Another new escapist's spot is the Makaha Inn, 90-minutes drive from Waikiki on the west coast of Oahu at Makaha Beach. Try it for cocktails and dinner.

# Here's where you start saving money.

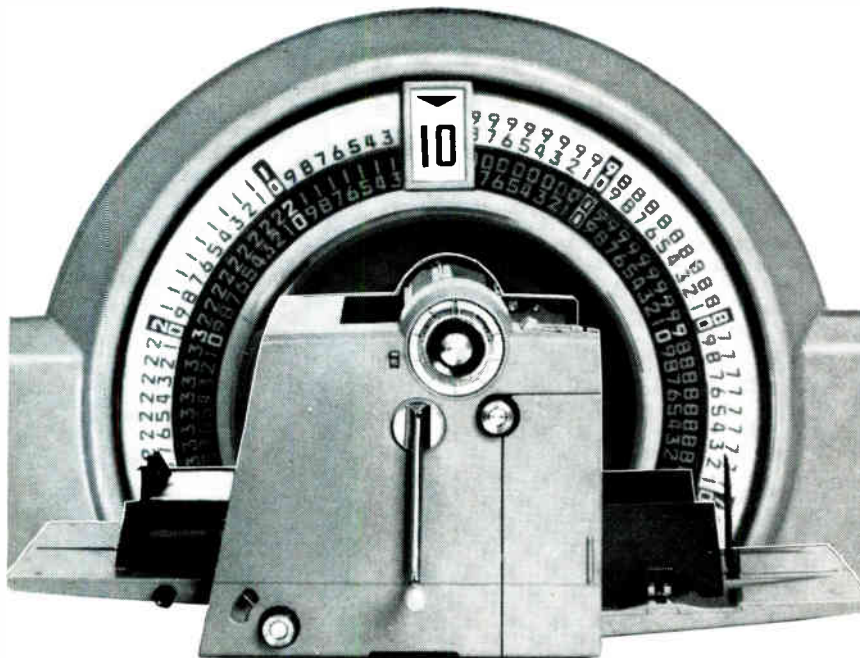

## For 10 copies or more, no copier can duplicate the economy of Gestetner duplicating.

If your office uses a copier to make multiple copies, they are wasting your money.

With Gestetner duplicating, one copy is inexpensive, but set the automatic counter for anywhere from 10 to 10,000 and the savings really start piling up.

Even on jobs that you would normally give to outside printers.

No one has to type or draw anything on a stencil. Our electronic Gestefax cuts them automatically. From the stencil, the Gestetner duplicator produces duplicates of photographs, charts, clippings, office forms, letterheads and direct mail pieces.

Crisp clear copies (in any of 19 colors or any combination) with a sparkling printed look that only your printer knows he didn't print.

And it's as easy as pushing that money-eating copier button.

### Call toll free—(800) 553-9550

For your nearest Gestetner office or dealer.  
In Iowa call collect: (319) 242-1867

## Gestetner

Dept. PEB-2  
216 Lake Avenue  
Yonkers, N.Y. 10703

Name \_\_\_\_\_

Organization \_\_\_\_\_

Address \_\_\_\_\_

City \_\_\_\_\_

State \_\_\_\_\_ Zip \_\_\_\_\_

Please tell me more.



# We just cut the electronic calculator down to size. Again.

## Introducing the new Sharp ELSI-8. It's down to 3½ x 5½ inches 26 ounces 345 dollars.

If you do more than simple adding and subtracting, you know it's rough getting by these days without some electronic calculator help.

Our new ELSI-8—the \$345 electronic "Math Machine"—helps you do much better than just get by.

Given half a chance, it returns as much as \$3200 a year in time savings.

In many cases it pays for itself every 74 working days—four times a year, year after year.

You see, this 3½" x 5½" calculator has both the capability and efficiency to match machines three times its size and cost.

Like them, the Sharp ELSI-8 divides and multiplies, subtracts and adds.

It also does mixed and exponent calculations.

It gives you credit balances in milliseconds instantly.

Its special underflow system has built-in calculation logic.

And it makes sure you never make a mistake. Its floating decimal sets automatically.

Unlike many calculators, ours is a sight for sore ears. Figure on it for absolute silence on rechargeable battery or A.C.

What makes our smallest electronic calculator so big a performer?

The answer is right in its name. The ELSI (Extra Large Scale Inte-

grated) circuits the ELSI-8 employs are incredibly dependable. They're the most advanced, most miniaturized circuits in and out of this world. NASA harnesses them to send men to the moon. We harness them to send calculator problems packing.

Compact and complete with battery, recharger and case, our \$345 electronic "Math Machine" is probably all the electronic calculator any modest-size business or professional office will ever need.

For large companies, it makes a fine auxiliary that minimizes costly waits for the big office calculators.

By all means, see our small electronic wonder. For fast action mail the coupon. Or call us toll-free at (800) 553-9550. In Iowa: (319) 242-1867.

**The ELSI-8 cuts math problems down to size so fast, it pays for itself 4 times a year. Year after year.**



Sharp Electronics Corporation Dept. PB-3  
10 Keystone Place, Paramus, New Jersey 07652

The Sharp ELSI-8 sounds like what we need.  
Please send full information promptly.

Name \_\_\_\_\_

Company \_\_\_\_\_

Street \_\_\_\_\_

City \_\_\_\_\_ State \_\_\_\_\_ Zip \_\_\_\_\_







### Who puts a college drop-out on the street?

*Why College Students Fail*, by Robert Pitcher, Ph.D., and Babette Blaushild, goes right to the point in a sharp, honest effort to clear away the nonsense and the fuzzy psychological jargon. Parents aren't castigated—but they aren't in the least placed beyond blame, either. Clear case examples are used to examine such questions as how families contribute to failure, and how high schools contribute to college troubles later on. . . . "What is the 'right way' to rear children? In terms of this discussion the answer is that there isn't any." (Funk & Wagnalls, \$6.95).

Meantime, a parent who is concerned about a teenager's college chances may want to take another look at the idea of the private college prep school—particularly if progress in the local high school is slow and hard. Lately the boarding schools, especially those in rural locales, have had a hard time in filling rosters. "Even the 'name' schools have been available," says Mansfield Lyon, of Bunting & Lyon, the Wallingford, Conn., school consultants. For parents, it's a point to ponder. . . . An application now, for 1971-72 might make sense; and a number of the preps have summer programs.

### The tax scene: save a dollar—lose a dollar

Early warning on tax audits: Your chances of an audit—or partial examination—by Internal Revenue are obviously higher if your 1040 shows unusual items, say, high contributions to charity that go way past what most people in your bracket give, or income-averaging, or a fuzzy real estate transaction, or such. The point is that now—well ahead of April 15—you're wise to carefully gather all needed paperwork to support any unusual claims. Shore up any weak spots in the paperwork with added evidence: bills, cancelled checks, business or professional travel and entertainment records, photos and police reports showing casualty losses. . . . Note: Figure that if you're over \$25,000, you've a good 25% chance of a full audit by IRS. But don't feel scot-free if you're in the \$15,000 to \$25,000 range. There is this solace, though: If you file your 1040, then discover a serious error, you can always file an amended return (1040X). What's more, even if you are audited, you have a 7% chance—of a refund.

Deductions in the news: In a new Tax Court case involving investment expenses, a taxpayer hired both a lawyer and an accountant to help handle a real estate deal. The lawyer was to work the usual contract closing, and the accountant was to make sure that taxes were kept to a minimum. Says the Tax Court: The lawyer's fee is a non-deductible capital investment. But the accountant's fee—for tax-saving services—is a fully deductible current expense. . . . For the businessman or professional, the office-at-home deduction is getting easier all the time. IRS's old idea was to let you deduct only if the homework was actually a required part of your routine. Now the courts are saying, in effect, that you can choose to work at home and still get the deduction. . . . IRS has some new standard deduction allowances for autos. If you use your car for business, you can now take 12¢ a mile for the first 15,000, then 9¢ (up from 10¢ and 7¢). If you use it to get medical care or for a charity, the new rate is 6¢ (up from 5¢).

### Easy life

James Ullman and Al Dinhofer's *Caribbean Here & Now*, 1971-72, is a good island or two ahead of the competition; it's detailed and up-to-the-minute travel material, written by people who actually live there (Macmillan, \$8.95). . . . At Home Abroad, Inc., has a new cost-conscious list of villas for rent in Europe; example: two-bedroom cottages in Spain with cook at \$400 a month (136 E. 57th St., New York 10022). . . . *How to Eat Better for Less Money*, by gourmet James Beard and wine expert Sam Aaron, is a good buy. Beard's comments on kitchen stuff are fine, covering meats to pasta, and Aaron explains such items as vintage years, prices, and how to deal with a wine merchant (Simon & Schuster, \$6.95).

Health side: *The Executive Diet*, by Austin Schoen, M.D., and William Kaufman, tells you some very serious things such as how over-eating can kill you—sometimes faster than you think. ("More and more coronary heart attacks are occurring in people in their 30s.") At the same time, the authors list over 80 top restaurants, coast to coast, where you can dine delightfully—on a low-calorie budget (Corinthian, \$1.95).

If we can pack up and move  
\$2,000,000,000 in hard, cold cash, then we  
can pack up and move your new  
treasurer because he's  
worth a fortune!

Actually, it was only a short move.



But still, moving two billion dollars required a lot of planning and maximum security. It also required three of our

biggest vans! Mayflower is called upon frequently to make unusual moves. So when an Indianapolis bank wanted two billion in cash and negotiable securities moved to their new headquarters, we sent our people over to pack it. And move it. Whomever or whatever you have to have moved, remember the Mayflower! Some of the most particular people still come over on it!





We know that when you get plenty of help in the planning stages, better workmanship and on-time delivery, you're not likely to try other sources. So we put more manpower in the field; operate three strategically located plants and provide the largest dealer network. That way, you can

always count on timely personal help from a Lyon Dealer salesman, a factory representative, or both. You have a lot more going for you when you take full advantage of Lyon leadership. Proven quality. The best selection—more than 1500 stock items. The easiest

ordering system. The best packaging. All of our products are unit packaged and shipped as shown in the catalog. And most orders are rolling in 24 to 72 hours. Next time, spare yourself: enjoy the kind of service that made us No. 1. Call your Lyon Dealer.

## We know what it takes to stay Number 1: more personal service

LYON METAL PRODUCTS, Inc.  
75 Monroe Avenue, Aurora, Illinois 60507

Please send me a copy of catalog No. 20

Name \_\_\_\_\_

Firm \_\_\_\_\_

Address \_\_\_\_\_

City \_\_\_\_\_ State \_\_\_\_\_ Zip \_\_\_\_\_

Look for us in the Yellow Pages under LYON  
"STEEL SHELVING," "LOCKERS" or "SHOP EQUIPMENT"



LYON METAL PRODUCTS, INC.  
General Offices: 75 Monroe Ave., Aurora, Ill. 60507  
Plants in Aurora, Ill., York, Pa., Los Angeles  
Dealers and Branches in All Principal Cities





---

# International Newsletter

---

February 1, 1971

## Color TV makers cut prices in Japan

Under heavy government pressure, three Japanese companies have reduced color television list prices by about 20% and the rest of the industry will probably follow. Initial driving force came from consumers' organizations, which began complaining about "dual prices" last summer. Then in September, they declared a boycott because of the wide spread between list and actual retail selling prices. The consumers' organizations were encouraged by the Fair Trade Commission, which said that an excessive spread between advertised list and actual selling prices would be considered deceptive advertising.

In mid-January, the Ministry of International Trade and Industry, in an unprecedented administrative guidance move, requested Matsushita Electric Industrial Co. to reduce prices of new color sets to be put on the market by at least 15%. Matsushita was picked because it is Japan's largest consumer electronics manufacturer.

The first company to pick up the challenge was Sharp Corp., which introduced two new color TVs with prices about 20% below those of former models. Then came Matsushita, and a few days later Sanyo Electric.

## French mount U.S. exports drive

With a kickoff at the IEEE Show in New York next month, the French government and the country's electronics trade association—FNIE—are launching a year-long campaign to increase sales in the U.S. For the first time in IEEE Show history, the French will man a joint exhibit, selling the products of 23 companies. That same week, a chartered jet will bring 150 executives of electronics companies to New York and Washington. The third part of the program will come April 2 in Paris—a seminar on selling electronics in the U.S.

The emphasis is on computer peripherals, so the FNIE also is planning a major effort at the Spring Joint Computer Conference in Atlantic City. Meanwhile, French consular officials are studiously examining the distributorship structure in the U.S. to help provide sales outlets.

## Banks in Sweden merge EDP services

Sweden has taken another big step toward creating nationwide computer operations. Three of the nation's largest banks—Svenska Handelsbanken, Skandinaviska Banken, and Goeteborgs Bank—have formed a jointly owned data service subsidiary, to be known as Data-Service-EDB.

The new company will coordinate the running of the three banks' data processing service subsidiaries, through which they offered a range of computer services—for financial and some administration work—to small and medium-sized companies. With Handelsbanken and Skandinaviska Banken installing nationwide networks, it will eventually be possible for data service customers to be linked to the system through the local offices of all the banks.

## East Bloc looks at cooperative know-how exchange pacts

Worried about the self-interest some individual East Bloc countries display in their dealings with the West, a group of Communist trade and industry officials is recommending that license and know-how exchange agreements be put on a new basis. Specifically, they are proposing that the technological know-how any Comecon country

---

# International Newsletter

---

acquires from a Western firm be shared by any other interested Comecon member. Comecon is the seven-nation trade and economic assistance pact that is East Europe's equivalent of the Common Market. Although contrary to Comecon's stated goals, many of the countries are quite secretive about their know-how deals, a practice that partly explains the big disparities that exist between Communist countries in the electronics sector.

To right the situation, the officials are urging Comecon members to discuss licensing deals before they are made and then to conclude multilateral agreements with a Western firm. Such a policy will also help prevent duplicate arrangements from being made and cut down on the outflow of hard currencies.

## ITT eyes growing LED market

After two years of indecision, ITT Components Group Europe is moving toward commercial production of light-emitting diode displays. Its entry will be the 35-diode, red-light, alphanumeric displays, using planar diffused gallium arsenide phosphide, developed at Standard Telecommunication Laboratories, ITT's British research labs [*Electronics*, March 3, 1969, p. 249]. By spring the group's plant at Paignton, Devon, expects to offer samples of six-letter modules, packaged complete with all drive circuitry. Fabrication by planar diffusion enables arrays to be quite small: the samples will pack five-by-seven matrices into 0.12-by-0.85-inch and possibly 0.169-by-0.117-inch packages. The primary marketing targets are data processing—particularly single letters in keyboard keys—and in instruments and electrical tools. Single-array drive voltage is 1.7 volts, and each diode takes 4 milliamps.

## Swedish computer exchanged for tires

Sweden's Saab-Scania is bartering its way into the role of leading computer supplier to Czechoslovakia. In its latest deal, Saab-Scania is trading its top-of-the-line Saab D-22 computer for about \$1.5 million in tires and plastics. The order, the fourth from Czechoslovakia to Saab-Scania in about a year, is the largest ever given by the Czechs for a Western computer. The Saab D-22, which uses some American-made parts, has a memory cycle time of 1.6 microseconds and a main memory capacity of 16,384 24-bit words, expandable to 262,144 words.

The computer will be used for administrative purposes at the Barum chemical plant in Gottwaldov, which makes tires and plastic products. Saab-Scania could use the tires on its own cars or trucks, or sell them on the Swedish market—either to the other Swedish auto maker, Volvo, or to wholesale dealers. Saab may end up putting them on the cars and trucks it sells to the Eastern Bloc nations.

## ESRO orders TWTs for 12-GHz link

West Germany's AEG-Telefunken has won a preliminary design and study contract for a traveling-wave-tube amplifier that will be used in satellite communications in the 12-gigahertz range. The contract, coming from the European Space Research Organization, could result in a quarter-million-dollar order for a series of such TWTs, AEG-Telefunken says. They are intended as power stages in satellites ESRO is planning for telephone communications and for TV signal transmissions to ground stations. The TWTs will have an output power of 10 watts and a bandwidth of around 500 megahertz. Italy's Selenia will furnish the power supply equipment for the TWTs.

# Deflector steers laser beam into million-spot matrix

Kerr cells and birefringent prisms switch beam direction in less than 1 microsecond under digital control

The state of the art of light deflection by electronic means has moved a step ahead now that researchers at Philips Central Laboratories in Hamburg have built a digitally controlled electro-optical deflector capable of steering a laser beam into a matrix of more than a million different positions.

Developed by physicists Uwe J. Schmidt and Walter Thust, the experimental deflector can switch beam directions in less than 1 microsecond. That, as far as the two researchers know, is the highest number of beam deflection positions and the fastest direction switching rate yet achieved with any light deflector. Thust will report on the new deflector at the Electro-optical Systems Design Conference to be held March 23 to 25 in Brighton, England.

The deflector's key elements are Kerr cells and birefringent prisms, which have two refraction indices. When linearly polarized light from a laser enters one side of a prism, it will leave the other side in one of two directions. The exit direction depends on how the beam's plane of polarization is oriented with respect to the prism's optical axis. If the plane and axis are parallel, the light beam will encounter one refraction index and

leave the prism in one specific direction. If the two are at right angles, the other index will become effective, causing the beam to take the other exit direction.

The Kerr cells alternately change the polarization of the light beam from one plane to the other before it hits a prism. Each cell, also called a polarization switch, consists of two electrodes with an electro-optically active liquid between them. With no voltage applied across the cell the liquid is isotropic and has no effect upon the polarization. But when a voltage is applied, the liquid becomes optically anisotropic, and the light's plane of polarization turns 90° at a certain voltage.

One cell/prism deflection unit gives two exit directions. Two such units installed one behind the other give four possible deflection direc-

tions, and n units would yield 2<sup>n</sup> directions. A requirement is that the beam deflection angles of each prism be twice as large as those of the prism preceding it.

The actual Philips light deflector incorporates 20 deflection units, giving 1,048,576 different directions. With the 20 prisms all mounted the same way, the image points would all be arranged in either a vertical column or a horizontal row across a display screen. But to obtain a useful matrix with image points arranged both horizontally and vertically, half the prisms are turned on their side, producing a 1,024-by-1,024 matrix.

The deflection units in the Philips device are installed in a glass tube about 1.5 feet long and 1.5 inches in diameter. The tube is filled with nitrobenzene, which acts as the electro-optically active liquid for

On the beam. Researchers at Philips Central Laboratory in West Germany set up a row of 20 Kerr cell/prism pairs to generate a 1,024-by-1,024 array.

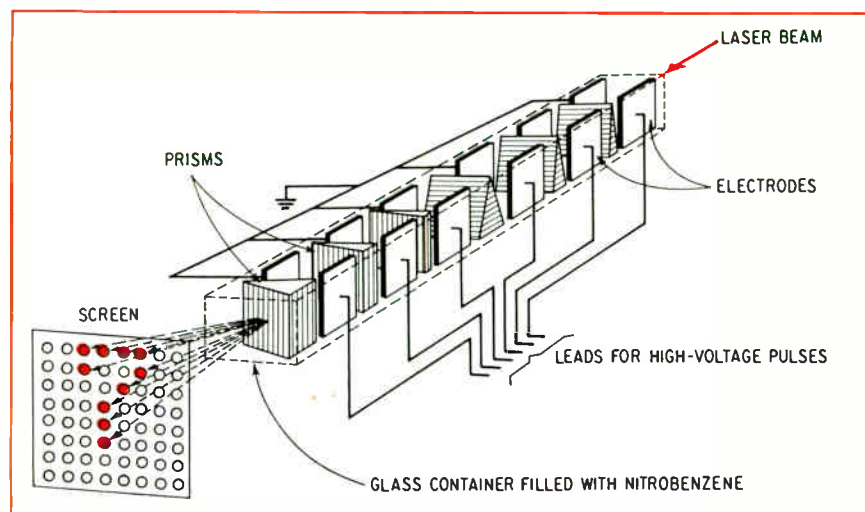



the Kerr cells. Beam deflection is controlled by applying discrete voltage steps, up to 8.5 kilovolts in amplitude, across the Kerr cells. These voltages are sufficient to move the beam at a rate of 250 kilohertz. The time it takes to switch the beam from one position to another in the 1,024-by-1,024 raster is 0.8 microsecond. This does not include the dwell time of 4 microseconds for the laser beam on a particular spot. Switching is digitally controlled by a computer but can also be handled by conventional digital circuitry.

### Japan

#### How to cut a pocket calculator in half

Limited battery power was the biggest problem faced by Sharp Corp. engineers when they were told to repack the company's Micro-compet electronic desk calculator into a case with about half the volume of that formerly used [*Electronics*, Jan. 15, p. 142 or 4E]. The new case has only enough room for six penlight-size rechargeable nickel cadmium cells, giving a total of 450 milliampere-hours compared with the 1,200 milliampere-hours available in the earlier model. Even the smaller cells are a tight fit: the case measures 2.76 inches high by 4.02 inches wide by 6.46 inches long. Weight including cells is only 1.59 pounds.

Redesign was quite successful—display drain was reduced to 460 milliwatts from 1,480 mW and logic circuit drain was reduced to 100 mW from 375 mW. As a bonus, the redesign eliminated the separate high-voltage power supply for the display.

The redesigned calculator, called ELSI-8 around the Sharp plant, uses the same four large-scale-integration arrays made by North American Rockwell Electronics. These arrays feature a 4-phase logic scheme in which there is no steady-state dc power drain. Only the small current—1 to 2 mW—needed to charge the small gate capaci-

tances of the driver transistors flows in the logic circuits.

The lion's share of the power charged to the logic circuit is actually dissipated in the clock generator. The new clock generator reduces drain by three quarters and has better frequency stability. It consists of a static cross-coupled reset-set multivibrator circuit operating at twice the 50-kilohertz clock frequency, followed by logic circuits for generating the clock signals. An external resistor and an external capacitor set the frequency. The former arrangement was less stable because it used circuit resistance and stray capacitance. The double frequency arrangement cuts the number of logic inverters needed from 250 to 50.

Display circuit power drain was reduced, and the need for a separate power supply eliminated, by a circuit change that at first glance appears to be a step backward. Instead of using the time division mode pioneered by Sharp several years ago, the new calculator drives each segment of each display tube separately in a static mode. The big virtue of time division is large reduction in driving circuits, but the big disadvantage is that the rapid switching dissipates large amounts of power in load resistors.

**Today, the saving** in components is far less important than when the time division mode was adopted. In the new calculator, segment drive is by MOS FETs with nine driving circuits per package. Nine packages are sufficient to drive all eight digits and decimal points. Load resistors are completely eliminated because the display tubes' segments serve as loads on the driving circuits.

What's more, because the display tubes are operated in a static mode, the power supply voltage can be reduced from the 55 volts used in the time division mode to 25 V, the same voltage used for the logic circuits. With time division operation, a high supply voltage is needed for high instantaneous brightness to obtain high average brightness because of the short duty cycle.

### Belgium

#### ITT homes in on switching, process control

After many years of varied computer experience, ITT-Europe is staking its future in computers on two markets: electronic switching and process control. Last fall the first commercial ITT 1600 process control computers rolled off the lines at its Bell Telephone Manufacturing Co. in Belgium. They will be followed in the next few months by the more powerful ITT 3200 series, made at both Bell and at Le Matériel Téléphonique in France.

Both lines are third-generation, high-speed digital computers primarily intended for on-line digital control applications. Besides a complete set of general-purpose instructions for solving all logical and arithmetical problems, special instructions are included to facilitate bit and slice manipulation of data by the bus, thereby increasing memory and real-time efficiency.

M. H. Nothman, assistant technical director for digital systems at ITT-Europe in Brussels, calls the two "perhaps the first and only third-generation computers for this type of application at this power."

**The coordination** of ITT-Europe's computer effort actually began several years ago. Back in 1967 the firm found itself building equipment for a variety of process-control applications. As far back as 1956 Standard Telephones and Cables, its British subsidiary, had developed a cumbersome, wired-logic system that was used in one of the British national air traffic control centers. Later, joint development work between U.S. and European affiliates produced the 654L for the U.S. Strategic Air Command and the ADX 7300, said to be the first message-switching system in Europe.

By 1967 ITT operating companies were offering systems design and software services on a turnkey basis—but usually using someone else's computer. The main target

was message switching for air traffic control, telecommunications authorities and defense. Clients included Reuters, the British Post Office's giro banking service, Pan Am, the BBC, and a hospital in Sweden.

The diversity of these applications led to ITT's design rationale. As Nothman puts it: "We knew pretty well what markets we were in and what we wanted to serve. We set our priorities with a strong bias toward telephone switching—but not so as to obviate other uses."

**The two new computers** were designed to fit that formula. The ITT 1600, which has a modular structure that can be varied according to type of application, has a random access core memory with a word length of 16 bits plus parity and a maximum size of 65,536 words. It has a cycle time of 0.9 to 1 microsecond and access time of 0.4 microsecond.

The ITT 3200 is a 32-bit design for larger exchanges. It has the same general characteristics as the 1600 but provides variations for the larger capacity required to handle calls in the biggest exchanges. The memory may reach 512,000 words.

---

## France

---

### Putting more speed in a small oscilloscope

Oscilloscope users who want increasingly compact units that also have the capability to work at higher frequencies should be pleased with a new French scope. France's Thomson-CSF has borrowed a principle from the linear accelerator to come up with a family of electrostatic cathode ray tubes that combine high frequency with small size.

A high-frequency CRT must have a high deflection factor to make up for low sensitivity of associated components. Up until now achieving high deflection has meant placing a series of deflection lenses in the tube's neck, increasing tube length. However, Thomson-CSF's new 150-megahertz model is only 11.5 inches long, compared with

around 20 inches for existing 150-MHz tubes. And an ultrafast 350-MHz model measures only 13.8 inches long.

Thomson-CSF designers found a way to amplify electron deflection by using a quadrupole lens borrowed from linear accelerator technology. Four hyperbola-shaped electrodes surround the electron beam's path after it has passed through a standard deflection lens. Seen from the front of the tube, the right and left electrodes are positive, and the top and bottom ones are negative. Voltage on all electrodes is constant, so the potential in the center is zero.

If the beam already has been deflected to the right, it is pulled still further in that direction by the right positive electrode. If the beam goes toward the top of the lens, the negative electrode placed there reverses its deflection more sharply downward. A vertically reversed image is avoided by reversing the electron gun input connections.

To prevent the electrons' path from being straightened by the high voltages in the tube's post-acceleration zone, a final electrode, in the shape of a curved shield with a 0.12-inch-wide, 0.8-inch-long slit, is placed ahead of the deflection amplification lens.

The 150-MHz tube, already ordered by several U.S. and European companies, has a flat, rectangular screen measuring 4 by 2.4 inches. The deflection factor is 4 volts per centimeter. The 350-MHz model, to be made available in about three months, has a 4-by-3.2-inch screen with a deflection factor of 1.5 v per cm.

---

## Sweden

---

### Isotopes foil forgers of secure credit card

When is a forger not a forger? When he's working for the Swedish state testing agency. The Swedes some years ago set out to make a credit card that would be virtually impossible to alter or counterfeit

and that would feature a variety of electronic or mechanical reading devices. In the process, they hired a man to obtain samples of every kind of card extant—and test their suitability by trying to forge them.

Now, based on that testing, a new credit card has been launched in Sweden and the company behind it, AB ID-kort, is eyeing the huge American market. The card has at least a half-dozen security measures built into it. Topping these is an isotope trace element that cannot be altered and that can be verified by a desk-top Geiger measuring unit.

**It's easier to counterfeit** money than falsify one of our cards," says Karl-Erik Svensson, managing director of AB ID-kort. He points out that the card was tested by the West German national police, who reported it was "quite impossible" to forge.

The Swedish card, having a standard credit card format, is aimed at foiling the growing number of credit card thieves. The Swedish firm, eyeing the richness of the American market, has had discussions with some U.S. firms but will give no details.

AB ID-kort is 50% owned by the Swedish state (the post office; AB Ceaverken, maker of X-ray film and photo paper; and AB Atomenergi, the state nuclear research company) and 50% by private commercial and savings bank groups.

The card is a single piece of photographic paper, with a special double watermark. Banknote-type fine printing (in colors that cannot be photographed) covers the front of the card. On top is a special thin plastic that is applied to become part of the film emulsion and the paper, and thus cannot be peeled off. On the back is more printing and a thicker plastic for stiffening.

Trace beta isotopes are placed into the paper, in a well controlled quantity and location. Isotope life is five years but can be reduced or expanded if the card customer—such as a driving license agency—wants it.

A customer must submit a mug

shot and fill out an application form when applying. The photo and form are sent to the AB ID-kort laboratory, where they are photographed. The negative is destroyed, but the mug shot and application form are kept on file.

AB Atomenergi developed a simple Geiger reader for checking the card. The card is placed face up in the reader. If it has been tampered with in any way—even if a piece of transparent tape is placed on the face—the reader flashes a red light. A green light is flashed if the card is legitimate. The card also can be fitted with a variety of reading devices: magnetic strips, punched holes, optical configurations, and embossed alphanumeric.

The reader unit costs between \$80 and \$140 depending on production quantities. The cards sell in Sweden for about \$1.50, but could get down, in large quantities, to "less than \$1," says Svensson.

So far, about 200,000 cards have been sold in Sweden by the banks and post offices. In addition, some 25,000 have been sold through Danish banks. It appears likely that the card will become the standard Swedish driver's license and will be used for state agencies and companies.

---

### Great Britain

---

#### Gunn diodes work as high-speed shift register

If future high-speed digital transmission rates reach 1 gigabit per second or more—a requirement for digitized video services, which need wide bandwidth—something faster than conventional junction devices will have to be used for analog-to-digital conversion, pulse generation and regeneration, and decoding. One possible source of high-speed pulses is Gunn-effect devices. Workers at Japan's Nippon Electric Co. and the Electrotechnical Laboratory, and in the U.S. at Bell Laboratories are looking into that concept. In Britain a team led by Hans Hartnagel, lately at Sheffield University but now a professor at

Newcastle University, is building some experimental systems based on Gunn diodes.

Hartnagel has devised a shift register configuration using three Gunn diode circuits per stage: a free-running pulse generator, a memory, and an output gate. To get it working as soon as possible, Hartnagel has built a two-stage, 1-gigabit-per-second register by omitting the output gate in each stage, and simulating the connection between the stages with synchronized external pulsing. Eventually, a full register will be built. It's essentially a research project to find out what can be done with Gunn diodes—Hartnagel doesn't expect to see similar commercial devices for three to five years.

**The free-running generator** is a Gunn diode that is positively biased slightly above threshold so that it puts out a continuous stream of current pulses at 1 GHz. A series resistor converts the current to voltage and inverts the polarity, and the negative pulse stream is fed to the back of the memory diode. This diode is positively biased below threshold and does not rise above it until a positive input pulse from the previous stage of the register hits the front of the diode at the same time that a negative pulse from the generator hits the back.

When this happens, the resulting domain pulse is inverted, routed to the delay line, and reflected back to the rear of the memory diode to arrive simultaneously with a generator pulse. Together, they nucleate another domain and the process repeats indefinitely until interrupted. This is how the memory stores a digital 1.

At the same time, part of the memory output is directed as a positive pulse stream to one input of the output AND-gate diode. Like the memory, this diode is positively biased below threshold and does not nucleate a domain, and hence does not produce an output, until a pulse from the previous register stage arrives at the other input to supplement the memory's input.

The AND-gate output is negative,

and part of the pulse is fed to the generator diode input to reduce the positive bias below threshold and temporarily break the pulse flow to the memory, which is thus emptied. When the next pulse from the previous register stage arrives, the process is repeated.

Applications in communications systems probably will require as much power as possible from the diodes. This is a difficult task, considering the extensive resistor loading necessary for operation in the pulse output mode, as distinct from the ordinary oscillation mode. Hartnagel says he needs high-quality GaAs diodes—with a carrier density times domain trajectory product of  $10^{13}$  per square centimeter—so that the domain grows to full size as quickly as possible. Using this sort of material, he says he gets peak-to-valley ratios in the current pulses of 50%, indicating that cw output powers of 1 watt are possible. The breadboard gives only 1 milliwatt.

The diode terminals are side by side and the domain travels between them. The 10-micron-thick active GaAs layer is grown epitaxially on semi-insulating GaAs substrate material. Photoetching defines the 100-micron-long GaAs channel between the evaporated alloy terminals. The semi-insulating substrate wafer is polished down to about 80 microns, gold-germanium is evaporated onto the back face, and chips, cut to various widths, are soldered to gold-plated, finned-copper heat sinks. Width was varied to check the effects of different low-field resistances in the GaAs channel and to see how wide a domain could be and still remain coherent. At 2,500 microns, the limit was not in sight.

**Hartnagel foresees** one particular snag in a full operating system: unavoidable reflection effects may lead to spurious domain formations because the two-terminal diodes are direction insensitive. He plans to cure this by developing a three-terminal diode. He also thinks that Gunn-type electronic generators should make good triggers for GaAs-laser optical pulse generators and regenerators.



# Electronics advertisers

February 1, 1971

<b>Aero Mayflower</b> Caldwell Van Riper	PB15	<b>Iowa Development Commission</b> Creswell, Munsell, Schubert & Zirbet Inc.	87
<b>Aeronetics Div. of AAR Corp</b> Robert L. Cohn, Inc. Adv.	94	<b>Ithaco, Inc.</b> Hart Conway Co. Inc.	99
<b>Aerovox Corporation</b> Lescarboura Adv., Inc.	16	<b>Kenwood</b>	PB4
<b>Airco Speer Electronic Components</b> Hazard Adv. Co., Inc.	6	Albert Frank-Guenther Law, Inc.	86
■ <b>Allied Electronics</b> Ontario Adv.	80	<b>Kienzle Apparate GMBH</b> Fahrenson & Fehse	
<b>American Optical Corp., Scientific Instrument Div.</b> Fuller & Smith & Ross, Inc.	92	■ <b>Ledex Inc.</b> Yeck & Yeck Incorporated	84
■ <b>Augat, Inc.</b> Horton Church & Goff, Inc.	88	<b>Lyon Metal Products, Inc.</b> Reincke, Meyer & Finn	PB16
<b>Babcock Control Products</b> Babcock Electronics Corp.	96	■ <b>Micro Switch Division of Honeywell</b>	2nd cover
Jansen Associates Inc.		N.W. Ayer and Son Inc.	PB7
■ <b>Bell &amp; Howell—Electronics &amp; Instruments Group</b> Coordinated Communications, Inc.	27	<b>Mitsubishi Aircraft Int.</b> Womack/Claypoole	18E-19E
<b>Bourns, Inc.</b> Marlborough Assoc., Inc.	68	<b>Mo'lex Products Inc.</b> Fensholt Advertising	PB10
<b>Business Week Guide</b> Benson, Stagg & Association	PB10	<b>Monongahela Power</b> Fahlgren & Assoc.	D4
■ <b>Bussmann Mfg. Division of McGraw Edison Co.</b> Henderson Advertising Company	90-91	■ <b>MM Electronic Enclosures Inc.</b> Berin Pecor Inc.	30
<b>By-Buk Company</b> J.R. Bloome Company	D2	<b>Monolithic Memories</b> Regis McKenna Inc.	
■ <b>Cambridge Thermionic Corporation</b> Chirura & Cairns, Inc.	D1	<b>Pennsylvania Grade Crude Oil Association</b>	PB6
■ <b>Chicago Dynamic Industries, Inc.</b> Burton Browne Advertising	66	■ <b>Permag Corporation</b> Scheider, Allen, Walsh, Inc.	88
<b>Circuit-Stik, Inc.</b> Haaga Advertising	D2	□ <b>Phillips GAD ELCOMA</b> Media International	10E-11E
<b>Coqar Corp. Information Systems Division</b> Davi-Callihan Inc.	10-11	□ <b>Phillips N.V. Pit/TMI Division</b> Marsteller International S.A.	2E
■ <b>Colorado Video, Inc.</b> Tallant/Yates Adv., Inc.	D4	□ <b>Plastics Engineering Company</b> Kuttner & Kuttner, Inc.	15
<b>Computer Microtechnology, Inc.</b> Paul Pease Advertising	53	□ <b>Plessey Electronic Components</b> Rumill Hoyt Inc.	17E
■ <b>Comouter Sciences Corp.</b> N.W. Ayer/Joraensen/MacDonald, Inc.	PB8-9	<b>Pomona Electronics Company</b> Buxton Advertising Agency	96
■ <b>Cosmicar Optical Co., Ltd.</b> Matsushita, Inc.	D3	<b>Quadri Corporation</b> MB Advertising Agency	65
<b>Custom Electronics, Inc.</b> Laux Advertising, Inc.	77	<b>RCA Electronic Components</b> Al Paul Lefton Co.	4th cover
■ <b>Delevan Electronics Corp.</b> Stahlka, Faller & Klenk, Inc.	72	□ <b>Reliance Controls</b> Bond Publicity Services Ltd.	20E
<b>Dia'ight Corporation</b> Michel Cather, Inc.	D2	<b>Samsonite Corporation</b> Frye-Sills, Inc.	PB3
<b>Electrostatics</b> The Phillips Agency of California, Inc.	90	<b>Schauer Manufacturing Corp.</b> Nolan, Keelor & Stites	76
<b>Electronic Arrays, Inc.</b> Regis McKenna, Inc.	7	<b>Seminole County</b> Anderson/Bourne Inc.	PB6
<b>Electronics in Medicine Conference</b> Enerv Conversion Devices Inc.	D3	<b>Sharp Electronics Corp.</b> Wisser & Sanchez, Inc.	PB12-13
Watkins Rogers Incorporated	61	<b>Snelling &amp; Snelling Inc.</b> Evo & Mattern	PB5
<b>Fairchild Semiconductor, Inc.</b> Carson/Roberts, Inc. Adv.	8-9	<b>Sorensen Operation Raytheon Company</b> Provandie Eastwood & Lombardi Inc.	67
□ <b>G &amp; E Bradley Ltd.</b> Hyde and Partners Ltd.	9E	<b>Sprague Electric Company</b> Harry P. Bridge Company	5
□ <b>General Instruments Microelectronics Ltd.</b> J.E. May Limited	12E	<b>State Farm Insurance</b> Needham, Harper & Steers	PB2
<b>Gestetner Corp.</b> Savitt/Tobias/Balk, Inc.	PB11	■ <b>Tektronix Inc.</b> Dawson Inc.	25
□ <b>Goerz Electro Gmbh</b> Werbemittlung	15E	<b>Tenney Engineering Inc.</b> Keyes Martin & Company	D4
<b>Gould, Inc./Graphics</b> Carr Liggett Advertising	12-13	<b>Texas Industrial Commission</b> The Pitluk Group Advertising	90
■ <b>Grayhill Incorporated</b> Carr Liggett Advertising, Inc.	99	<b>Unitrode Corporation</b> Impact Advertising Inc.	29
■ <b>Heath Company, Sub. of Schlumberger Ltd.</b> Advance Advertising Services	79	<b>Varian Associates, Electron Tube and Device Group</b> Jack Herrick Adv., Inc.	100
<b>Heath Dynamics, Inc.</b> Ira Morton Advertising	70	<b>Vector Electronic Co., Inc.</b> Buck Advertising	94
<b>Hewlett Packard</b> Lennen & Newell, Inc.	2	<b>W.A. Sheaffer Pen Company</b> A Textron Company	PB4
<b>Hewlett Packard, Colorado Springs Division</b>	3rd Cover	<b>William Wahl Corp.</b> Enyart & Rose Advertising Inc.	D1
Tallant/Yates Adv., Inc.			
<b>Hewlett Packard, Loveland Division</b> Tallant/Yates Adv., Inc.	1		
<b>Honeywell, Test Instruments Division</b> Campbell Mithun, Inc.	49		
<b>Hughes Aircraft Company</b> Foote, Cone & Belding	78		
<b>Hutson Industries</b> Warren Associates	28		
■ <b>Indiana General Corporation Electronics Div.</b> The Griswold & Eshleman Company	97		
<b>Indianapolis Power &amp; Light</b> Ruben, Montgomery & Associates Inc.	82		
■ <b>International Crystal Mfg. Co.</b> Robert V. Freeland & Associates	74		

## FREE SAMPLE

### The World's Smallest Temperature Recorder

Temp-Plate, the world's smallest temperature recorder, records surface temperatures within  $\pm 1\%$  accuracy. Heat-sensitive indicator turns permanently black upon exposure to critical temperatures for economical and irreversible record. 85 standard sizes from  $\frac{1}{16}$ " diameter to  $\frac{3}{4}$ " x  $1\frac{1}{2}$ " with 1 to 8 different calibrated temperature indicators per recorder. Self-adhesive installation. Max. thickness .006". Ranges from 100°F to 1100°F. As low as \$1.10 each. Qualified on Gemini, Apollo, F-111, DC-8. Specified by more than 1200 companies.

ACTUAL SIZE



Before After



Write for Free Brochure with 101 Actual Uses and Free Temp-Plate® Sample!

Temp-Plate® Division • William Wahl Corp.  
12908 Panama St., Los Angeles, Ca. 90066

Circle 120 on reader service card

## a Cambion "quickie"

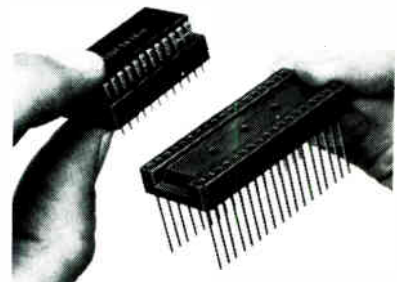

### IC sockets for MSI

High density IC sockets for 24 and 36 pin Integrated Circuits have been added to the basic CAMBION line of 14 and 16 pin sockets. Same top quality throughout, these sockets are of molded one piece dially construction. Available with wire-wrap\* or solder tab terminations, they accept round or flat leads up to .024". In stock!

Want to try a sample? 24 or 36? Send us your name and address.

Standardize on

**CAMBION®**

The Guaranteed Logic Accessories

Cambridge Thermionic Corporation,  
445E Concord Ave., Cambridge, Mass. 02138.

\*REG. MARK GARDNER-DENVER CO.

## Classified & Employment Advertising

F.J. Eberle, Manager 212-971-2557

**EQUIPMENT (Used or Surplus New) For Sale**  
Radio Research Instrument Co. . . . . 98

■ For more information on complete product line see advertisement in the latest Electronics Buyer's Guide  
□ Advertisers in Electronics International

# DIALCO SUBMINIATURE INDICATOR LIGHTS

Here are 4  
out of 4000

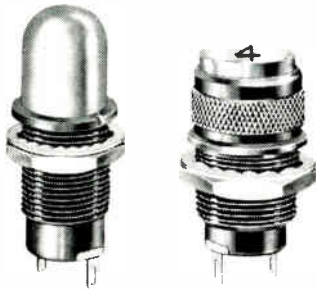

SHOWN ACTUAL SIZE

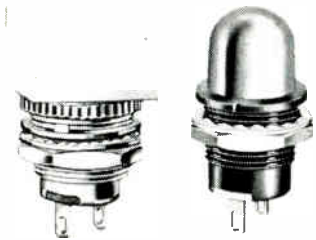

Designed to meet requirements of MIL-L-3661B and MIL-L-6723.

Sizes for mounting in  $1\frac{1}{32}$ ",  $\frac{1}{2}$ " or  $1\frac{1}{32}$ " clearance hole.

Incandescent for 1.35 to 28V and neon for 105-125V AC-DC or 110-125V AC.

Patented built-in current limiting resistor (U.S. Patent No. 2,421,321).

Wide selection of lens shapes and colors.

Both hot-stamped or engraved legends.

Available off-the-shelf for prompt delivery.

**Send for free catalog**



SAMPLES ON REQUEST—AT ONCE  
NO CHARGE

Dialight Corporation, 60 Stewart Ave.,  
Brooklyn, N.Y. 11237. (212) 497-7600



D 2 Circle 108 on reader service card

## Advertising Sales Staff

Pierre J. Braude [212] 971-3485  
Advertising Sales Manager

Atlanta, Ga. 30309: Charlton H. Calhoun, III  
1375 Peachtree St., N.E.  
[404] 892-2868

Boston, Mass. 02116: William S. Hodgkinson,  
James R. Pierce, 607 Boylston St.  
[617] 262-1160

Chicago, Ill. 60611: Ralph Hanning,  
Kenneth E. Nicklas, 645 North Michigan  
Avenue, [312] MO 4-5800

Cleveland, Ohio 44113: William J. Boyle,  
[716] 586-5040

Dallas, Texas 75201: Richard P. Poole,  
1800 Republic National Bank Tower,  
[214] RI 7-9721

Denver, Colo. 80202: Richard W. Carpenter  
Tower Bldg., 1700 Broadway  
[303] 266-3863

Detroit, Michigan 48226: Ralph Hanning,  
2600 Penobscot Building  
[313] 962-1793

Houston, Texas 77002: Richard P. Poole,  
2270 Humble Bldg. [713] CA 4-8381

Los Angeles, Calif. 90017: Robert J. Rielly,  
Bradley K. Jones, 1125 W. 6th St.,  
[213] HU 2-5450

Minneapolis, Minn. 55402: Kenneth E. Nicklas,  
1104 Northstar Center [612] 332-7425

New York, N.Y. 10036  
500 Fifth Avenue  
Warren H. Gardner [212] 971-3617  
Michael J. Stoller [212] 971-3616

Philadelphia, Pa. 19103:  
Jeffrey M. Preston  
6 Penn Center Plaza,  
[215] LO 8-6161

Pittsburgh, Pa. 15222: Jeffrey M. Preston,  
4 Gateway Center, [412] 391-1314

Rochester, N.Y. 14534: William J. Boyle,  
9 Graylock Ridge, Pittsford, N.Y.  
[716] 586-5040

St. Louis, Mo. 63105: Kenneth E. Nicklas,  
The Clayton Tower, 7751 Carondelet Ave.  
[314] PA 5-7285

San Francisco, Calif. 94111: Don Farris,  
Richard R. Butera, 425 Battery Street,  
[415] 362-4600

Paris: Alain Offergeld  
17 Rue Georges Bizet, 75 Paris 16, France  
Tel 727 33 42, 727 33 60

Geneva: Alain Offergeld  
1 rue du Temple

United Kingdom and Scandinavia  
London: Keith Mantle, Tel: Hyde Park 1451  
34 Dover Street, London W1

Milan: Robert Saidel, Roberto Laureri Jr.  
1 via Baracchini Phone 86-90-656

Brussels: Alain Offergeld  
22 Chaussee de Wavre  
Brussels 1040, Belgium

Frankfurt/Main: Fritz Krusebecker  
Elsa-Brandstroem Str. 2  
Phone 72 01 81

Tokyo: Masaru Wakeshima, McGraw-Hill  
Publications Overseas Corporation,  
Kasumigaseki Building 2-5, 3-chome,  
Kasumigaseki, Chiyoda-Ku, Tokyo, Japan  
[581] 9811

Osaka: Akihiko Kamesaka, McGraw-Hill  
Publications Overseas Corporation, Kondo  
Bldg., 163, Umegae-cho Kita-ku [362] 8771

Australasia: Warren E. Ball, IPO Box 5106,  
Tokyo, Japan

## Business Department

Stephen R. Weiss, Manager  
[212] 971-2044

Thomas M. Egan,  
Production Manager [212] 971-3140

Dorothy Carter, Contracts and Billings  
[212] 971-2908

Frances Vallone, Reader Service Manager  
[212] 971-6057

## Electronics Buyers' Guide

George F. Warner, Associate Publisher  
[212] 971-3139

Regina Hera, Directory Manager  
[212] 971-2544



**NEW**

*Catalog of  
pressure  
sensitive  
electronic*

*component drafting aids*

**T**ime saving electronic component shapes, patterns and conductor line tapes are listed by the thousands in By-Buk's new P-50 catalog. This easy to use, cost-saver index of pressure sensitive printed circuit drafting aids is the source book of ideas for engineers, designers and draftsmen interested in faster, more accurate artwork layouts. Find new ways to reduce the tedium of repetitive artwork with individually die cut artwork patterns in opaque black, transparent red and transparent blue materials.



**FREE CATALOG** Send today for a free copy  
**FREE SAMPLES** of the new P-50 catalog and  
a selection of samples.



**BY-BUK COMPANY**

4326 W. Pico Blvd.  
Los Angeles, Calif. 90019  
(213) 937-3511

Circle 121 on reader service card

## NEW PRODUCT: AN INSTANT CIRCUIT BOARD™ SYSTEM!



**CIRCUIT-STIK'S** system of component sub-elements and materials produce circuit boards that are as durable and reliable as conventional printed circuit boards.

**CIRCUIT-STIK ELIMINATES:** design • drilling • art work • photo work • etching

CIRCUIT-STIK sub-elements are pressure sensitive and offer exceptionally good adhesion strength, withstand soldering temperatures and yet may be removed for easy circuit design modifications.

All types of circuit-element configurations may be mixed and combined.

U.S. PATENT 3,538,389 & other Patents Pending

**SEND FOR FREE SAMPLES—CATALOG.**

**circuit-stik®**

1518 W. 132nd St., GARDENA, CALIFORNIA 90249

IEEE SHOW • MARCH 22-23-24-25 • BOOTH #1219

Circle 122 on reader service card

# Learn new applications for electronics in medicine

- Attend technical sessions
- See exhibits and demonstrations
- Participate in workshops

The 3rd National Conference and Exposition on Electronics in Medicine, presented by McGraw-Hill publications—ELECTRONICS, MEDICAL WORLD NEWS, MODERN HOSPITAL, and POSTGRADUATE MEDICINE—will be held April 13-14-15, 1971, at the Sheraton-Boston Hotel, Boston. The technical program will feature experts in the field of hospital equipment and automation, computers in medicine, patient monitoring, prosthetic devices, thermography, plethysmography, cardiac screening, multiphasic screening, and other pertinent applications. Six workshop sessions will be lead by specialists who will invite active participation by conference attendees. New medical electronics instrumentation and support equipment will be featured in the exposition that accompanies the technical program. Pre-registrants may use the following form to avail themselves of the special advance registration rate.

**REGISTER NOW — SAVE \$35!**  
**Advance registration fee: \$165**  
**Registration at conference: \$200**  
 (includes all sessions, exhibits, two luncheons, reception and a digest of technical papers when published). Mail this form along with your check to:  
**Donald Christiansen**  
**Conference Chairman**  
**Electronics in Medicine**  
**330 West 42nd St., New York, New York 10036**  
**A block of rooms is being held at the Sheraton-Boston Hotel for registrants. Make your reservations directly with the hotel, identifying yourself as a Conference attendee.**

Advance Registration Form  
 3rd National Conference & Exposition  
 on Electronics in Medicine  
 April 13-14-15, 1971

EL

- Please pre-register me for meetings, work sessions, and exhibits. My check for \$165 is enclosed.
- I cannot attend the full conference but plan to visit the exhibits. Fee: none for qualified registrants. Please pre-register me for
- first day                       third day   
 second day                       all three days

Name \_\_\_\_\_ Title \_\_\_\_\_

Company or Hospital \_\_\_\_\_

Address \_\_\_\_\_

City \_\_\_\_\_ State \_\_\_\_\_ Zip \_\_\_\_\_

## Perfect your CCTV system with **COSMICAR®** lenses



TV-COSMICAR-EE 25mm F/1.4

The TV-COSMICAR-EE 25mm f/1.4 is a high-speed EE lens specially designed for 1" vidicon cameras. It maintains image luminance 100 lx against subject brightness between LV11 ~ 17 (280 ~ 18,000 cd/m<sup>2</sup>), about 1,500 ~ 96,000 lx. The automatic electric-eye diaphragm closes down completely when subject brightness exceeds approx. LV20 (144,000 cd/m<sup>2</sup>), 768,000 lx. When the camera is switch off and not in operation, the automatic diaphragm closes down, completely shutting off the light for protection of the vidicon camera. The "EE-OPEN" switch on the lens controls the operation of the diaphragm. When it is turned to "EE," the diaphragm operates as fully automatic electric-eye; when it is turned to "OPEN," the diaphragm stays fully open.

**Be sure to get the finest image recording results with quality Cosmicar lenses.**



## **COSMICAR OPTICAL CO., LTD.**

424, Higashi-Oizumi, Nerima-ku, Tokyo, Japan  
 Cable Address: "MOVIEKINO TOKYO"



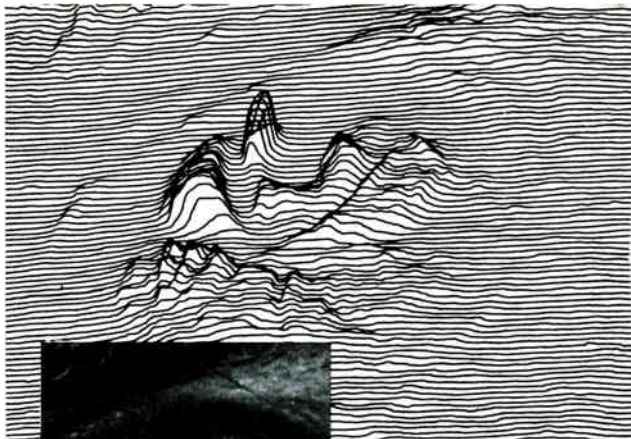

## How Can You Sort Useful Information from 100 Million Bits Per Second?

Today the television camera is an extremely versatile data acquisition tool. It can give you around 100 million bits of information per second — spatial dimensions, brightness, color, time — with a wide range of sensitivities. Not all of what the camera sees is usable, however.

How can you extract the exact, useful data you need from this source?

Colorado Video has the Model 321 Video Analyser specifically designed to help you pinpoint the data you want and eliminate the redundant or useless bits.

The 321 can be used on a "stand-alone" basis as a laboratory instrument for such applications as image analysis and camera-to-hard-copy interfacing. Or, the 321 can provide input to your computer for a variety of analysis functions. It can also be controlled by the computer.

The 321 now is being used for such diverse operations as automatic instrument calibration via computer, cancer cell analysis and measuring changes in the diameter of human veins.

Find out what the Colorado Video Model 321 Video Analyser can do for you. Write or call for information. Price: \$2500.



COLORADO VIDEO,  
INCORPORATED

# cv*i*

P.O. Box 928, Boulder, Colorado 80302. Phone (303) 444-3972  
Video Data Acquisition • Processing • Display • Transmission

OVER  
**1,000,000 SIZES**

**MILITARY CASES**  
COMBINATION • TRANSIT • INSTRUMENT

MIL-T-945A, T-4734, T-21200, STD-108, C-4150



Choose from over 1,000,000 variations in dimensions, proportions, metals, finishes, and custom accessories. Whatever your need, the MM (multi-measure) method gives you high production savings even on custom runs as low as 25 units. Send your print or requirements. Manufacturers representatives in all major cities.

SEND FOR FREE CATALOG & DIMENSION SPECIFICATION SHEETS.

•• **mm ELECTRONIC ENCLOSURES, Inc.**

111 Bloomingdale Rd., Hicksville, N.Y. 11801 • 516-935-9400

Circle 123 on reader service card

## ON THE MOST WANTED LIST

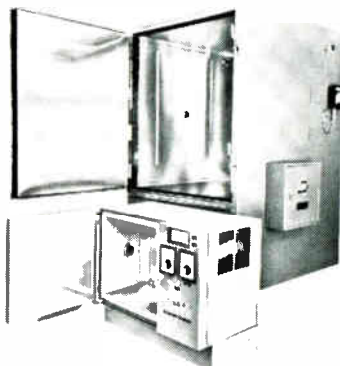

### ALIAS MINI & MAXI

Real names: TH-Jr. and TH-65. Smallest and largest members of the "Tenney Gang" of reach-in, temperature-humidity chambers. Easily identified by the Tenney Vapor-Flo® humidity generation system and the fully hermetic, all-welded Hermeticool® refrigeration system.

Known to cover a temperature range of 0 F to 200 F and a humidity range of 20% to 95% RH. Noted for responsive performance. Praised for ease of operation and high reliability.

Can be found serving in evaluation or manufacturing of products sensitive to temperature and humidity environments. For details on Mini, Maxi and all the Gang in-between, call or write today:

**Tenney**  
ENGINEERING, INC.

1090 Springfield Rd., Union, New Jersey 07083 • (201) 686-7870

Western Division: 15721 Texaco St., Paramount, Calif. 90723



Cut this out and tape it on the front of your present scope.

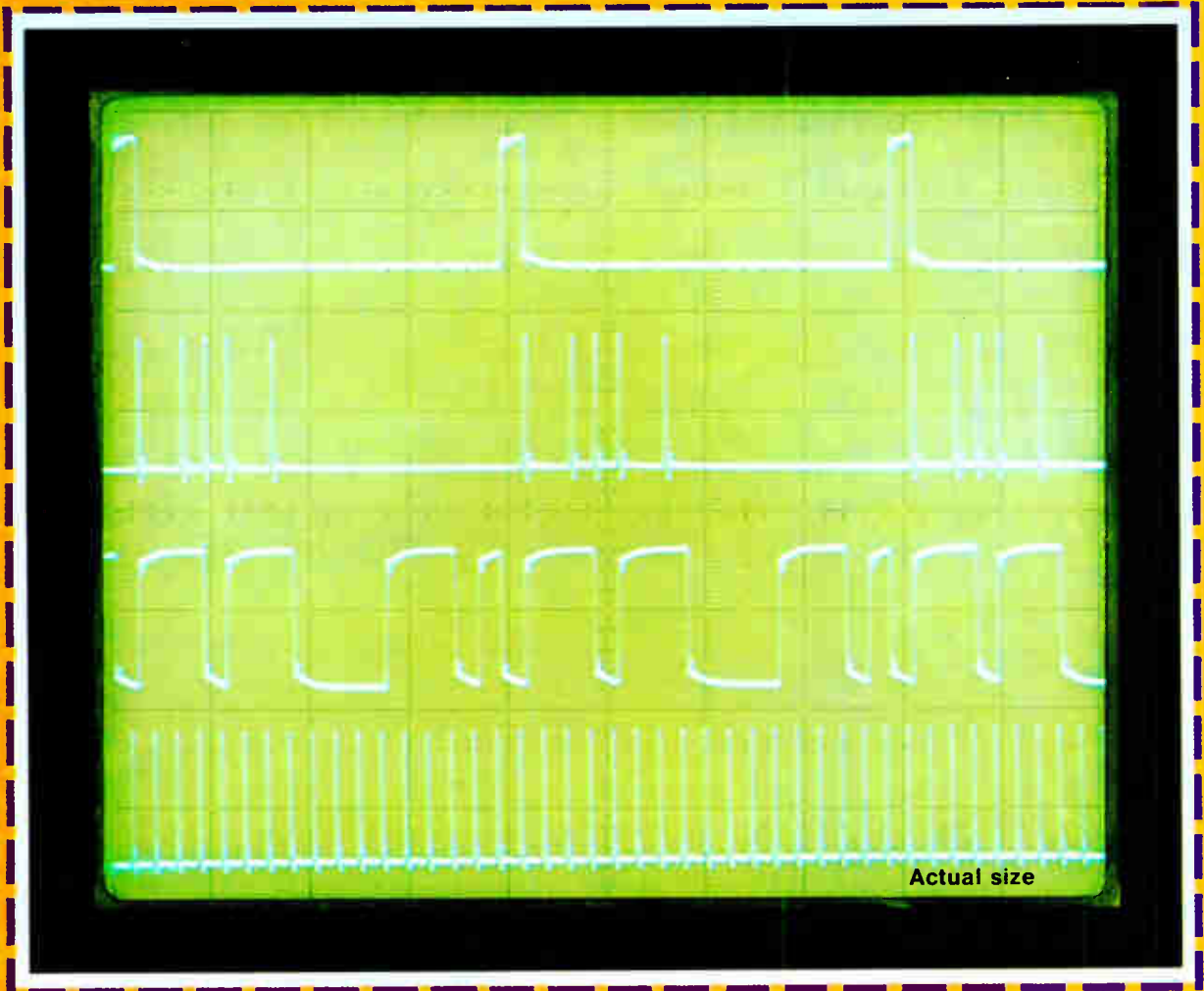

## See how much easier you could measure high-frequency waveforms on HP's new scope?

Get the big picture! The 180-Series oscilloscope family now has a "big brother"—the 182A—a scope with a viewing area 66% larger than any other high-frequency scope, and three times larger than some. Yet, despite its larger viewing area, the 182A takes up no more bench space than the 180A, and maintains full bandwidth of 180 System plug-ins to 100 MHz.

The result is easy viewing for you—even at a distance. The 182A's 8-div x 10-div CRT is marked off in big 1.3-cm x 1.3-cm squares. And internal grati-cules allow accurate readings from any angle—a real plus in systems-testing work.

This new big-screen CRT is possible because of HP's pioneering advances in CRT technology. Improved HP expansion-mesh magnification techniques used in the 182A CRT make it possible to have a big-screen scope with 100 MHz capabilities, while still



**HEWLETT *hp* PACKARD**

**OSCILLOSCOPE SYSTEMS**

retaining the sensitivity required for compatibility with solid-state vertical amplifiers. Thus, you get easy-to-interpret displays, even in 4-channel or TDR work.

Because the 182A is part of the 180 "family," it will take ten different 180 System plug-ins—up to and including the 100 MHz 1802A dual-channel vertical amplifier—without degradation. This means you can upgrade your existing system without having to replace any of your present HP plug-ins. It also assures compatibility in the future.

Price of the 182A mainframe is only \$1100; plug-ins start at \$525. For further information on the new 182A, or any element of the HP 180-System "family," contact your local HP field engineer, or write to Hewlett-Packard, Palo Alto, California 94304. In Europe: 1217 Meyrin-Geneva, Switzerland.

Circle 901 on reader service card

# RCA Announces the Industry's First Power Transistor Thermal-Cycling Ratings.

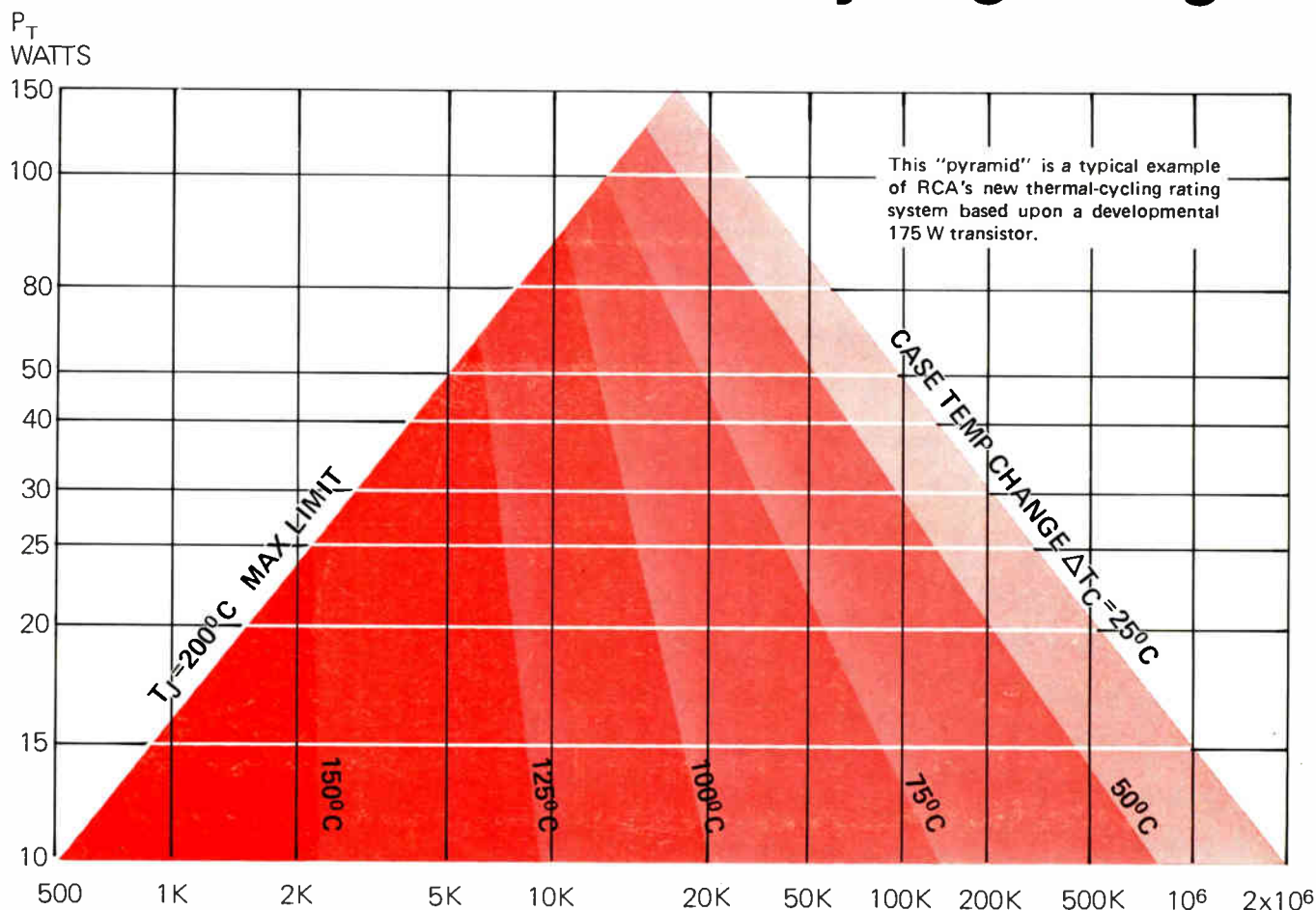

## The Rating "Pyramid" – built with the help of RCA's Controlled Solder Process.

RCA, the industry leader in over-all silicon resources, introduces a totally new concept in thermal-cycling ratings to help you establish and extend equipment life.

Using these new thermal-cycling ratings, you can tell at a glance the life expectancy of any given RCA power transistor in terms of number of cycles, power dissipation, and case temperature change. A rating chart is being developed for each family of RCA power transistors, and will be included in data sheets as they are completed. RCA's Controlled Solder Process (CSP) has made possible these ratings – the only such ratings in the industry.

Controlled Solder Process is an RCA development. With it, RCA can control the effects of thermal stress between the pellet and mounting base, and thereby extend the number of times a transistor can be cycled thermally. CSP increases the device thermal-cycling capability from five to 20 times. The RCA "pyramid" is the only rating chart yet devised to help you avoid thermal-fatigue failure in the field.

This announcement of thermal-cycling ratings on power transistors is made in the same spirit as RCA's pioneering disclosure in 1964 on Second Breakdown capability. The philosophy, simply, is to continue to provide power transistor users with the best possible tools to achieve the optimum interface between the capabilities of RCA devices and the needs of their applications.

For more information on RCA's new thermal-cycling ratings, consult your local RCA Representative or your RCA Distributor or write:  
RCA, Commercial Engineering, Section 70B-1 /UT 16, Harrison, N.J. 07029.  
International: RCA, 2-4 rue du Lièvre, 1227 Geneva, Switzerland, or P.O. Box 112, Hong Kong.

**RCA**