

Contactless keyboard with simplified encoding 68

Light-gated CRTs for large displays 78

The young engineer: is a new breed coming? 101

# Electronics®



**S-parameter  
measurements  
check out  
fast IC logic**

1420 K55956 44RA7 FEB71  
R KISSLER  
BASIC CGMM ELEC

# ok, what is a real-time analyzer?

A Real-Time Analyzer (RTA for short) is simply a system that makes on-the-spot analyses from random and irregular electrical signals such as radar echoes or nerve impulses. In fact, signals from any electrical, mechanical, or biological source, detected by the appropriate transducers, can be examined by an RTA. Moreover, the 'smartest' RTA (like T/D's 1923 Analyzer) can aid in the identification of the source of a signal (or any element in the signal) and, because of its speed, can direct almost instantaneous corrective measures.

## What does an RTA offer beyond conventional analysis equipment?

In a word – speed! Data from the usual system (a swept spectrum analyzer, for example) often must be examined away from the equipment before any reaction can occur – much too slow a process in critical situations! Consider: The **immediate** detection of an abnormal electrocardiogram can direct emergency medical action to save the life of a cardiac patient. Or, the **immediate** detection of a potential oil source can save as much as six months' delay in drilling and drastically reduce the cost of exploration in remote parts of the world. Many other less dramatic instances exist, of course, but the **immediacy** of reaction is still the forte of the RTA alone.

## What kind of information can I get – and use – from an RTA?

An RTA, by internally performing any of several mathematical operations, can provide useful information – in the form of a scope trace, a printout, or an unseen control signal – about:

- Coherent signals buried in noise. The process of extracting the desired signal is so sensitive that the magnitude of the noise can be up to 100 times that of the hidden signal. Examples include examinations of communications channels and radar ranging.
- The similarity and common characteristics of two apparently dissimilar signals. In the cross-correlation of two such signals, one could be a standard of comparison representing a known normal condition. Geophysical explora-



tions and airframe testing illustrate this kind of data search.

- The identity of acoustic sources and paths, plus data about the transmissibility of materials. Radar, sonar, loudspeakers, and auto-chassis development are fields that come to mind.

The ability of the RTA to keep pace in situations where large quantities of data are generated can effect a substantial cost savings. Using the RTA to test mass-produced items permits 100% testing rather than occasional spot-checks and assures you of the best quality products. It would take many men to equal this level of quality control.

At the other extreme are the limited-data situations you may encounter. An RTA has no difficulty producing accurate data during missile launches, aircraft flyovers, test explosions, or chassis vibrations during engine start-up. Whereas other spectral analyzers are at best cumbersome in analyzing short-term signals (by using tape loops for repeated playbacks of segmented data, for instance), the RTA samples the data at precisely the right instant and includes the proper sample length. Vibrations during engine start-up can be very different from those generated by an idling engine; primary explosion effects can be different from the effects of secondary explosions, etc. At either data extreme, only an RTA can keep up with long-term events or avoid averaging long-term information into short events.

## What kinds of RTA's are available?

General Radio and its subsidiary, Time/Data, produce several different Real-Time Analyzers that cover every performance need. The GR 1921 Analyzer, with its hard-wired processor, provides amplitude-vs-frequency breakdowns of acoustic signals in thirty 1/3-octave bands up to 80 kHz. Custom versions with up to 45 bands, in either 1/10-, 1/3-, or full-octave bandwidths (or mixtures of the three), are available, too.

The T/D 1922, with a digital processor, measures the spectrum density of signals from dc to 20 kHz in bandwidths from 0.05 to 800 Hz. By means of simple pushbutton operations, the 1922's scope displays time-domain data, spectral data, and all measurement parameters.

For the broadest capability in real-time signal analysis, you will want one of the T/D 1923 Analyzers. The three models in this series all utilize the flexibility of a digital computer to give you analyses in the time and frequency domains. In addition to basic spectrum analyses, the 1923's perform operations such as auto correlation, cross correlation, complex multiply, transfer function, convolution, coordinate conversion, coherence function, amplitude histograms, and cepstrum. The 1923A is the fastest and most versatile of the three. The 1923B is only slightly slower, but proportionately less expensive. The 1923C is the lowest-priced analyzer that gives you real-time performance.

With a price range from less than \$10,000 up to \$85,000, there is a GR analyzer for any purpose you have in mind.

## Where can I learn more about Real-Time Analyzers?

The best way to get the exact analyzer you need is by talking to an RTA expert from GR. To get the full story on all the RTA's, the options, and the possible custom variations available, just call one of the telephone numbers listed below or write to: General Radio, 300 Baker Ave., Concord, Massachusetts 01742; Time/Data, 490 San Antonio Rd., Palo Alto, California 94306; or GR/Europe, Postfach 124, CH 8034, Zurich, Switzerland.



**General Radio**

Circle 900 on reader service card



**These are the  
solid-state displays  
you'll be  
hearing about.**

**Starting now!**

HP's new solid-state monolithic numeric indicators are ready for you right now. They give solid-state reliability and long operating life to your information display. Their small size (5 digits in 0.750 inch width), low power requirements (200 fL at 5mA per segment) and low cost (\$7.05/digit in 1 K quantities) open up many new applications in the display of numeric data.

All characters are brilliant, easy-to-use, 7-segment figures, available in a standard DIP or flat-pack package. And lead connections are truly minimal — only 13 connections for 5 characters.

For more information on these 5082-7200 series of displays as well as our other numerics, alphanumerics and LED's, call your local HP field engineer. Or write: Hewlett-Packard, Palo Alto, California 94304; Europe: 1217 Meyrin-Geneva, Switzerland.

**HEWLETT  PACKARD**

COMPONENTS

Circle 1 on reader service card

01012

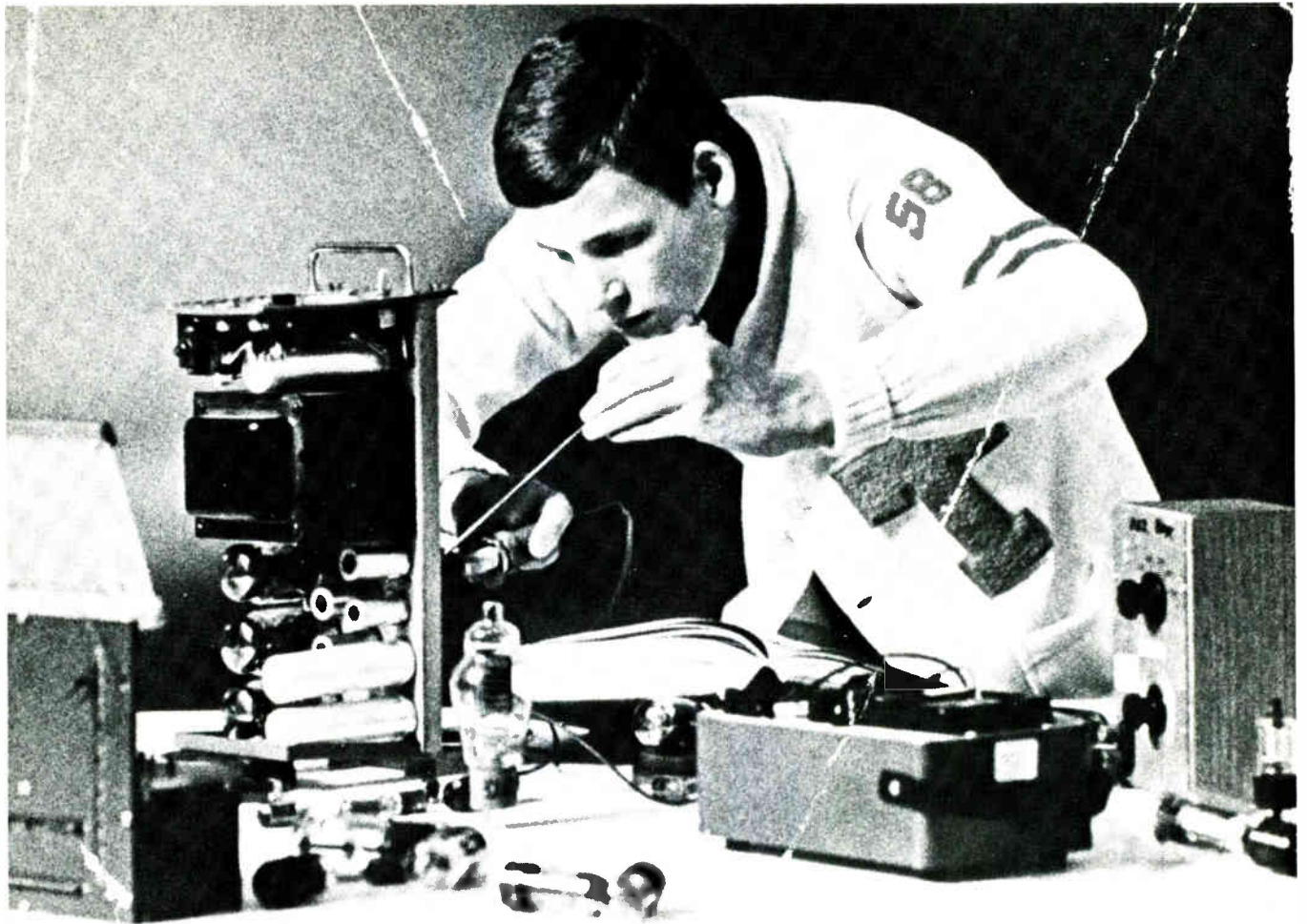

## Are you still using the same scope you used in college?

If so, you've been missing out on the greatest achievements in scope technology. During the last five years, Hewlett-Packard has quietly but firmly assumed technological leadership in the oscilloscope industry with the revolutionary HP 180 Scope System.

HP's innovations in general-purpose lab scopes include: the first scope with a real-time bandwidth of 250 MHz; the first 18 GHz sampling scope; the first 100 MHz variable-persistence storage scope; the first calibrated TDR scope with 35 ps rise time; and the first and only high-frequency (100 MHz) scope with a "big picture" CRT (8 x 10 div, 1.3 cm/div). And all these have a broad range of compatible plug-ins.

And, as these "for instances" illustrate, HP's innovations are *functional* improvements that increase your scope's usefulness. No "bells and

whistles" that add little to performance and a lot to the price.

This functional approach has been applied to our lower-priced field-service scopes, too. No frills. Just function. With HP, you get the most favorable price/performance ratio of any scopes on the market. And all HP scopes are backed by comprehensive training and service organizations to optimize your scope investment.

It's amazing how many engineers have clung to the "old school traditions" while scope technology has progressed in quantum leaps. Call an HP Field Engineer and find out what the state-of-the-art is today. He'll be glad to give you a side-by-side demonstration with your "old school scope." Or write Hewlett-Packard, Palo Alto, California 94304. In Europe: 1217 Meyrin-Geneva, Switzerland.

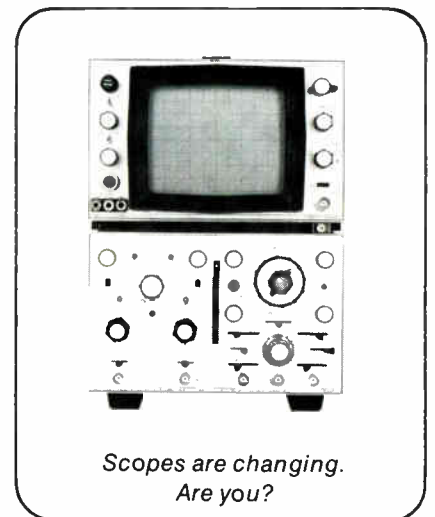

Scopes are changing.  
Are you?

081/3

HEWLETT  PACKARD

## 33 Electronics Review

---

MEMORIES: 2,048-bit MOS ROM operates faster than bipolars  
INTEGRATED ELECTRONICS: GE hush-hush Integrated Circuits Project comes up with first two products  
INDUSTRIAL ELECTRONICS: Correlator may be answer to railroads' hunt for hotbox spotter  
COMMUNICATIONS: Does Picturephone mean spots before your eyes?  
COMPUTERS: Minicomputer activity is oasis at Fall Joint  
COMMERCIAL ELECTRONICS: Slow-scan TV starts to pick up speed  
AIR TRAFFIC CONTROL: FAA trying out system to spot over-water planes beyond range of radar  
CONSUMER ELECTRONICS: Antihijack device for trucks utilizes oscillators  
SOLID STATE: Can smog cause short circuits?  
FOR THE RECORD

## 61 Articles

---

INSTRUMENTATION: Fast logic extends range of high-frequency counters  
COMMUNICATIONS: Capacitive keys, simpler circuits add up to reliable keyboard  
CIRCUIT DESIGN: Designer's casebook  
COMPONENTS: Light gating brightens CRT image for large projection displays  
SOLID STATE: FET input reduces IC op amp's bias and offset

## 101 Probing the News

---

MANPOWER: EE students' new thing: 'relevance'  
INSTRUMENTS: LSI testers: still a hard sell?  
INTERNATIONAL: Fairchild sets sights on Europe  
COMMERCIAL ELECTRONICS: Next, computer-aided firemen  
INTERNATIONAL: Hong Kong outlook; sweet and sour

## 121 New Products

---

IN THE SPOTLIGHT: Solid state amplifier bows; Computer runs analyzer; Ion implants speed memory  
COMPONENTS: Relay rejects plant noise  
INSTRUMENTS: Texscan moves into analyzer field; Hybrid buffer amplifier sharpens pulses  
SUBASSEMBLIES: Digital transducer detects 5 minutes of arc  
PACKAGING AND PRODUCTION: Wafer rinser reduces breakage  
MATERIALS: Epoxy resin for coating, bonding

## 159 Electronics International

---

ITALY: U.S. companies dominate Milan automation show  
JAPAN: Ringing a change on discretionary wiring; MOS process offers high speed or low power  
NORWAY: Kongsberg's latest weapon is a ship-to-ship missile  
GREAT BRITAIN: Plessey develops MOS read-mostly memory  
WEST GERMANY: Photochromic layer holds data in laser-based optical store

## Departments

---

4 About this issue  
6 Readers comment  
12 Who's who in electronics  
18 Meetings  
25 Electronics Newsletter  
35 Index of activity  
51 Washington Newsletter  
152 Technical abstracts  
154 New literature  
157 International Newsletter

EDITOR-IN-CHIEF: Kemp Anderson

EXECUTIVE EDITOR: Samuel Weber

MANAGING EDITORS: Robert Henkel, News;  
Arthur Erikson, International

SENIOR EDITORS: H. Thomas Maguire,  
Stephen E. Scrupski

ASSOCIATE EDITORS: William Bucci, Richard  
Gundlach, John Johnsrud, Howard Wolff

#### DEPARTMENT EDITORS

Communications & Microwave: Leon M. Magill;  
Components: George F. Watson; Computers:  
Wallace B. Riley; Consumer: Gerald M. Walker;  
Industrial Electronics: Alfred Rosenblatt;  
Instrumentation: Owen Doyle; Military/  
Aerospace: Herman Lowenhar; New  
Products: H. Thomas Maguire (Mgr.),  
William P. O'Brien, George Weiss; Packaging  
& Production: Stephen E. Scrupski;  
Solid State: Laurence Altman

COPY EDITORS: William S. Weiss, Chief;  
Margaret Eastman

ART: Fred Sklenar, Director  
Charles D. Ciatto, Assistant Director

PRODUCTION EDITORS: Susan Hurlbut,  
Arthur C. Miller

EDITORIAL SECRETARIES: Claire Goodlin,  
Vickie Green, Terri O'Neil,  
Bernice Pawlak

#### FIELD EDITORS

Boston: James Brinton (Mgr.), Gail Farrell;  
Los Angeles: Lawrence Curran (Mgr.);  
New York: Peter Schuyten (Mgr.); San  
Francisco: Stephen Wm. Fields (Mgr.),  
Marilyn Howey; Washington: Ray Connolly  
(Mgr.), Jim Hardcastle, Lois Vermillion;  
Frankfurt: John Gosch; London: Michael  
Payne; Paris: Arthur Erikson; Tokyo:  
Charles Cohen

#### McGraw-Hill World News

Director: Walter A. Stanbury; Atlanta: Stan  
Fisher; Chicago: Robert E. Lee; Cleveland:  
Arthur Zimmerman; Dallas: Marvin Reid;  
Detroit: James Wargo; Los Angeles: Michael  
Murphy; San Francisco: Margaret Drossel,  
Tyler Marshall; Seattle: Ray Bloomberg;  
Washington: Charles Gardner, James Canan,  
Herbert W. Cheshire, Seth Payne, Warren  
Burkett, William D. Hickman; Bonn: Robert F.  
Ingersoll; Brussels: James Smith; London:  
Marvin Petal; Milan: Jack Star; Moscow:  
Axel Krause; Paris: Robert E. Farrell, Stewart  
Toy; Tokyo: Mike Mealey

PUBLISHER: Dan McMillan

ASSISTANT TO THE PUBLISHER: Wallace C.  
Carmichael

PLANNING & DEVELOPMENT MANAGER:  
Donald Christiansen

ADVERTISING SALES MANAGER: Pierre Braudet

CIRCULATION MANAGER: George F. Werner

RESEARCH MANAGER: David Strassler

PROMOTION MANAGER: Tomlinson Howland

ADVERTISING SALES SERVICE MANAGER:  
Wallis Clarke

Our reporters touched a nerve when they began interviewing young engineers and faculty members about social awareness. They discovered that opinions were strongly held and vigorously presented. Thus, what started out as a short study of the new breed of electrical engineer soon mushroomed into three full magazine pages (see p. 101). Interviews were held both individually and in groups after classes by Gail Farrell in Boston, Carol Harris in Los Angeles, Marilyn Howey in San Francisco, Jane Shaw in Chicago, and trainee Larry Armstrong in New York. The mountains of material were sorted out by New York bureau manager Peter Schuyten, who, not that many years out of school himself, was perhaps the staff member most in tune with the subject.

Ham station WØNFO was a critical design tool in the development of the capacitive-key data-input keyboard described in the article starting on page 68. Richard C. Webb, president and technical director of Colorado Instruments Inc., was holding down the shop in Broomfield, Colo., while his son, James R., one of the chief contributors to the keyboard's design, was in Antarctica putting in a stint with the Environmental Science Services Administration. It's not only a long way from the green slopes of the Rockies to the white wastes of Antarctica, but it takes mail a while to go the distance and return. So short-wave radio was a priceless

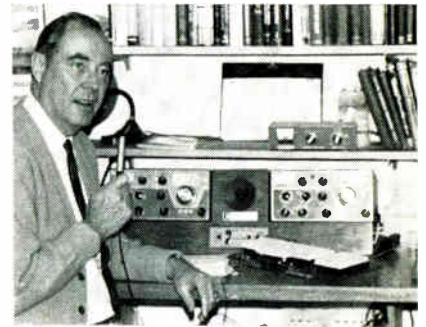

short cut to ironing out snags in the design.

A veteran contributor to Electronics, Richard Webb has a long string of achievements to his credit. Holder of a score of patents, he has organized two companies to develop electronic gear. He also has taught at the University of Denver, Iowa State, and Purdue. Before joining the University of Denver, where he was also associated with the allied Denver Research Institute, Webb was for seven years research engineer at RCA Laboratories.

*Jim Hauptli, Electronics' Western advertising sales manager, died Nov. 24 after a long illness. He was 45. Known and respected throughout our industries, Jim started with McGraw-Hill Publications as a direct mail trainee in 1950 following graduation from Illinois Institute of Technology. He joined Electronics in 1952 and, except for two years at Business Week, played a vital role in the growth of Electronics. He is survived by his wife Ann and four children.*

December 7, 1970 Volume 43, Number  
25—91,442 copies of this issue printed

Published every other Monday by McGraw-Hill, Inc.  
Founder: James H. McGraw 1860-1948. Publication office  
330 West 42nd, N.Y., N.Y. 10036; second class postage  
paid at New York, N.Y., and additional mailing offices.  
Executive, editorial, circulation and advertising ad-  
dresses: Electronics, McGraw-Hill Building, 330 W. 42nd  
Street, New York, N.Y. 10036. Telephone (212) 971-3333.  
Teletype TWX N. Y., 710-581-4235. Cable address:  
M C G R A W H I L L N Y.  
Subscriptions limited to persons with active, profes-  
sional, functional responsibility in electronics technol-  
ogy. Publisher reserves the right to reject non-qualified  
requests. No subscriptions accepted without complete  
identification of subscriber name, title, or job function,  
company or organization, including product manufac-  
tured or services performed. Subscription rates: quali-  
fied subscribers in the United States and possessions  
and Canada, \$8.00 one year, \$12.00 two years, \$16.00  
three years; all other countries \$25.00 one year. Lim-  
ited quota of subscriptions available at higher-than-  
basic rate for persons outside of field served, as fol-  
lows: U.S., and possessions and Canada, \$25.00 one  
year; all other countries \$50.00. Air freight service to  
Japan \$60.00 one year, including prepaid postage. Single  
copies: United States and possessions and Canada,  
\$1.00; all other countries, \$1.75

Officers of the McGraw-Hill Publications Company:  
John R. Emery, President; J. Elton Tuohis, Senior Vice  
President—Services; Donald B. Gridley, Group Vice  
President; Vice Presidents: Ralph Blackburn, Circula-  
tion; John R. Callahan, Editorial; William P. Gislio,  
Administration; David G. Jensen, Manufacturing; Jerome  
D. Luntz, Planning & Development; Joseph C. Page,  
Marketing; Robert M. Wilhelm, Finance.  
Officers of the Corporation: Shelton Fisher, President;  
Joseph H. Allen, Group Vice President—Publications  
and Business Services; John J. Cooke, Senior Vice Presi-  
dent and Secretary; Gordon W. McKinley, Vice President  
and Treasurer.

Title © registered in U.S. Patent Office: © Copyright  
1970 by McGraw-Hill, Inc. All rights reserved. The con-  
tents of this publication may not be reproduced either in  
whole or in part without the consent of copyright owner.  
Subscribers: The publisher, upon written request to  
our New York office from any subscriber, agrees to re-  
fund that part of the subscription price applying to copies  
not yet mailed. Please send change of address notices or  
complaints to Fulfillment Manager; subscription orders  
to Circulation Manager, Electronics at address below.  
Change of address notices should provide old as well as  
new address, including postal zip code number. If pos-  
sible, attach address label from recent issue. Allow one  
month for change to become effective.  
Postmaster: Please send form 3579 to Fulfillment Man-  
ager, Electronics, P.O. Box 430, Hightstown, N.J. 08520.

NEW!

# QUAD POWER DRIVERS REDUCE PACKAGE COUNT

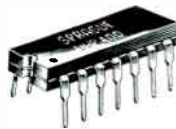
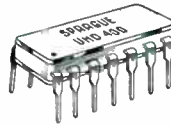

FIFTEEN NEW  
DRIVERS INCORPORATE  
MONOLITHIC LOGIC GATES  
DRIVING HIGH-CURRENT  
SWITCHING TRANSISTORS

Extremely versatile power devices designed for lamp driver, relay driver, level shifter, and a wide variety of similar applications. Operating at a standard  $V_{CC}$  voltage of 5 volts, each driver output transistor is capable of sustaining 40 volts in the OFF state while sinking 150 mA in the ON state. Special selection can guarantee even higher breakdown voltages and sink currents. Other features include inputs

Cat. No.	Description	Package	Temp. Range
UHC-400 UHC-402 UHC-420 UHC-451 UHC-459	Quad 2-input AND Quad 2-input OR Dual 4-input AND 2-wide, 2-input AND-OR 2-wide, 2-3-input AND-OR	14-lead flat pack	-55 C to +125 C
UHD-400 UHD-402 UHD-420 UHD-451 UHD-459	Quad 2-input AND Quad 2-input OR Dual 4-input AND 2-wide, 2-input AND-OR 2-wide, 2-3-input AND-OR	14-lead ceramic dual in-line	-55 C to +125 C
UHP-400 UHP-402 UHP-420 UHP-451 UHP-459	Quad 2-input AND Quad 2-input OR Dual 4-input AND 2-wide, 2-input AND-OR 2-wide, 2-3-input AND-OR	14-lead plastic dual in-line	0 C to +70 C

that are compatible with DTL/TTL logic devices, and pinning compatible with Series 54/74 networks.

For the name of your nearest stocking distributor, call or write to Bill Campbell or Bill O'Connor, Functional Electronic Circuits Operations, Sprague Electric Co., 115 Northeast Cutoff, Worcester, Mass. 01606. Telephone 617-853-5000, Ext. 314, 270, or 313.

For Engineering Bulletin 29300, write to Technical Literature Service, Sprague Electric Co., 509 Marshall St., North Adams, Mass. 01247.

**THE BROAD-LINE PRODUCER OF ELECTRONIC PARTS**



# HICKOK

## Portable Multimeter

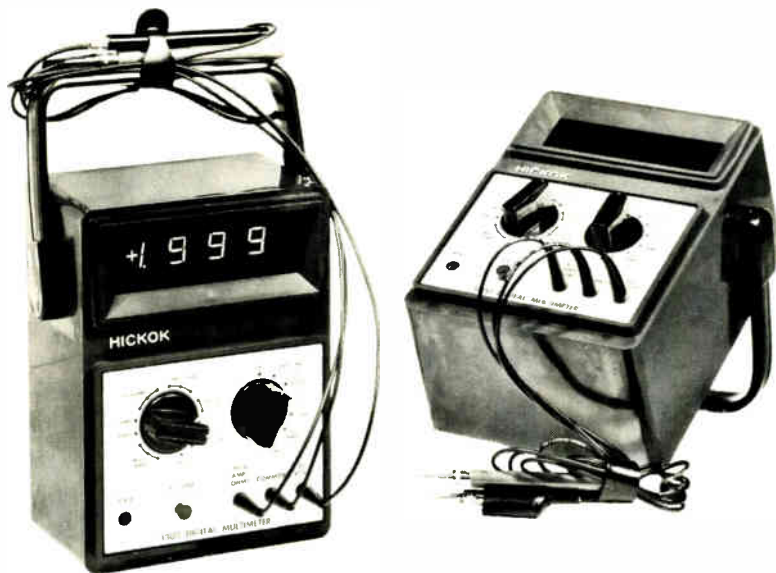

- Hickok's new Model 3300 3 1/2 digit multimeter has 26 ranges of ac-dc voltage and current, and ohms.
- Ranges are 100.0 millivolts to 15.00 kilovolts, 1.000 milliamp to 1.999 amps, 100.0 ohms to 199.9 megohms.
- Measurement conveniences—automatic zeroing and polarity, constant input Z, LSI reliability.
- Operates 24 hours off internal battery pack (more than anyone else's). And the battery pack is standard.
- Recharges overnight (faster than others).
- Or, operates off the ac line, even during the recharge cycle.
- Goof-proof, even in less experienced hands—solid state circuitry is overload protected.
- Rugged case is impact-resistant and shockproof.
- Price: **\$395**, including nicad battery pack.

Really, should you pay more?  
And maybe get less?

# HICKOK

INSTRUMENTATION &  
CONTROLS DIVISION

10514 Dupont Ave.  
Cleveland, Ohio 44108  
Phone 216-541-8060

## Readers comment

### Programmable ROMs

To the Editor: In the article on fusible programmed read-only memories [Oct. 12, p. 52], it's stated: "The process of producing a fusible link must be tightly controlled and requires steps that aren't needed in an ordinary IC process. When a link is fused, material is released inside the hermetically sealed package and this can cause long-term reliability problems. Worst of all, sometimes the fused links flow back together after extended operation, changing the memory's truth table."

We at Harris Semiconductor can claim results quite to the contrary with our 0512 dielectric isolated field programmable ROM. Our nichrome thin film process was chosen for the deposition material for the PROM as a result of many years of stable and reliable field experience achieved through several successful defense programs. The 0512 PROM therefore was simply built using an existing process which has proven to be extremely reliable and of high yield capability. No unusual "tight controls and processing steps" have been invoked. We would suggest that such technical complexities as "avalanche-induced migration" are in themselves unproven from a reliability standpoint and would require unique tight controls.

Material released inside the package during the fusing operation is certainly no problem for us. Special nichrome test elements were designed and stressed. We found that upon fusing (during programming in order to open a fuse), the nichrome thin film material, in the order of 100-150 Å thickness, approaches the liquid meltback phase near the constriction of the fuse geometry due to the passage of current when using a controlled ramp-voltage source. Video-monitored scanning electron microscope studies have shown this phenomenon of Harris' process to be highly orderly, resulting in reliable gap separation. This is further enhanced by the presence of the glass overcoat, which also passivates the unopened (unprogrammed)





# a fan for all reasons

270 CFM at Free Delivery  7" Diameter by 2.44 Axial Depth  Reversible Air Flow  Maintenance Free  Draws Only 22 Watts — Less Than Several 100 CFM Fans  115 VAC, 50-60 Hz, 1 Phase  Strong, High Impact Plastic  Recognized Under U.L. Components Program  In Stock for Immediate Delivery

## the Rotron Feather Fan



For complete technical details  
call 914-679-2401 or write

Rotron Incorporated, Woodstock, N. Y. 12498

# AIRPAX makes

- THE HIGHEST QUALITY
  - MOST RELIABLE
  - BEST PERFORMING
- magnetic  
circuit breakers  
—in the world



250  
VOLTS

5000  
AMPS

Quality, reliability, performance, and service. The circuit breakers you use *must* have these essential characteristics. Your equipment and your reputation will depend on it. Airpax has a reputation to uphold, too. That's why they will never sacrifice the quality of their circuit breakers for *any* reason — manufacturing economies, lower selling price, or whatever. Want to know more? Call or write Airpax Electronics, Cambridge Division, Cambridge, Maryland 21613. Phone (301) 228-4600. Telex: 8-7715. TWX: (710) 865-9655.

**AIRPAX** ... components of confidence.

## Readers comment

fuses. The overcoat has proven to be a very stable process in Harris' radiation-hardened devices and again in our PROM.

Flowback of fused links after extended operation has not been observed. We have accumulated 72 million fuse-hours utilizing numerous fuse test elements over an extended life test and the resulting leakage across the gap typically measures 0.1 picoampere with no trend toward increase. Additional life tests using partially and fully programmed ROMs with and without bias have not shown any tendency to self-healing opened fuses.

J.G. Steele  
Harris Semiconductor  
Melbourne, Fla.

### Atomic clocks

To the Editor: Hewlett-Packard congratulates Thomson-CSF for building its rubidium-gas clock [Oct. 26, p. 160]. A note of correction, however: H-P is not going the rubidium route. After careful consideration, and after having made both rubidium and cesium clocks in considerable quantities, H-P's proposal as the best approach is a cesium-beam frequency standard.

We're proud that our cesium clocks repeatedly have been flown around the world, most recently by the U.S. Government, to carry time worldwide, and with millionths-of-a-second accuracy.

By international agreement, the second (of time) is defined in terms of cesium atom characteristics. Therefore, absolute accuracy is an inherent advantage of cesium clocks. The cesium-type collision avoidance clock provides very high inherent accuracy— $2 \times 10^{-11}$ . What's more, warmup takes only 15 minutes, an important factor in aviation applications where the clock may be required to operate suddenly. And this U.S. product excels the European unit in operating temperature specifications: you show the French clock at  $-20^{\circ}\text{C}$  to  $+70^{\circ}\text{C}$ , while the H-P spec is  $-54^{\circ}\text{C}$  to  $+74^{\circ}\text{C}$ .

Joe Bourdet  
Hewlett-Packard Co.  
Santa Clara, Calif.

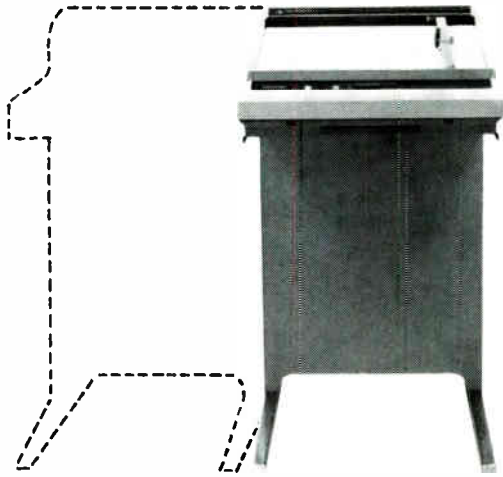

# Picture your terminal (even if it's IBM) with our \$3,300 graphic plotter.

At last, everybody can see their time-share data plotted in smooth, clear graphs. Hewlett-Packard's Model 7200 Graphic Plotter will add a new visual dimension to any terminal in the business. Now, even if you're partial to IBM's 2741, you can have instant graphic solutions to every type of engineering or mathematical problem.

There's no special operation or programming knowledge needed. You control the program. Plot numerical data in points, lines, curves, circles, ellipses, bar graphs or pie charts. Or, manipulate and expand computer data

and plot in finished graphic form. You get smooth lines—not the staircase drawn by the incremental recorder.

Use the HP 7200 simultaneously with your time-share terminal or silence the terminal and use the plotter alone. Because it goes to work when the data comes in, there's no time lag.

Simple manual controls allow you to set the graph limits to fit any pre-printed grid. HP's Autogrip electrostatic holddown firmly grips any graph paper up to 11x17 inches.

You can arrange to add a graphic plotter to your existing time-share

terminal by contacting Hewlett-Packard. Buy it at \$3,300. Rent it. Lease it. Or lease to buy.

We can match a 7200 with any EIA ASCII terminal in the business... or even IBM's 2741. So now, everybody can be the arty type. For details, contact Hewlett-Packard, Palo Alto, California 94304; Europe: 1217 Meyrin-Geneva, Switzerland.

**HEWLETT**  **PACKARD**

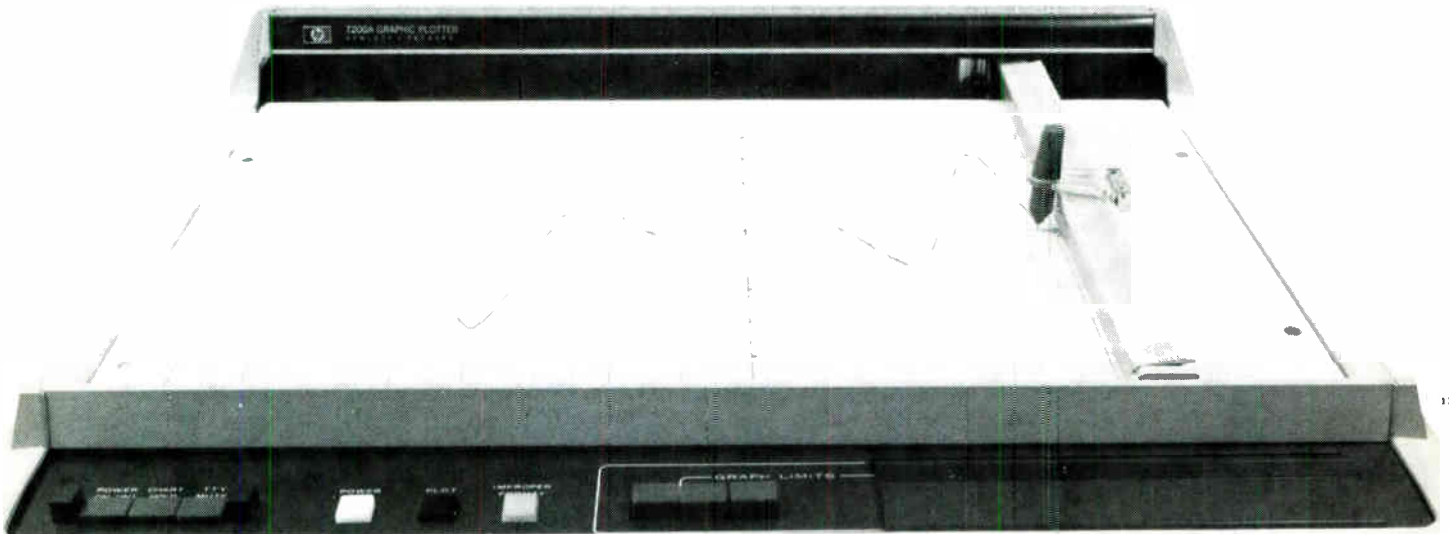

# Enroll now in the Magnetics Technology Center

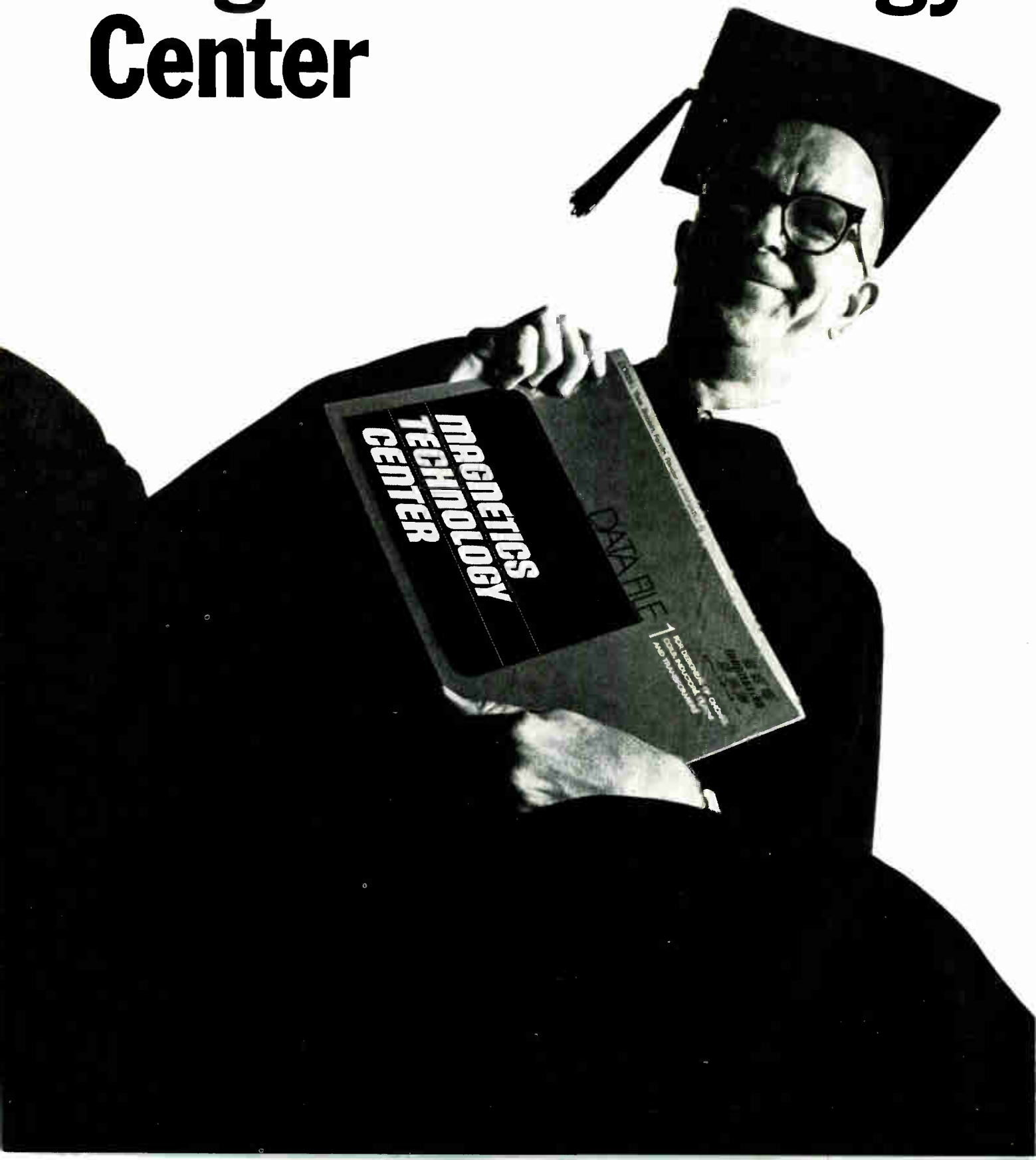

# Magnetics introduces a post-grad center that keeps you up to date on the state of the art in magnetic materials. No campus; no fee; texts free. You learn on your own time.

We don't pretend to be scholars behind ivy-covered walls. We are a group of inquisitive specialists with interests in electronics, electrical engineering, physics, metallurgy and related fields. We work with low and high permeability magnetics, ferrites and photo-chemically machined metals. Some of us have spent over 20 years here at Magnetics developing theories and putting them to practical use.

Now we'd like to share with you what we've learned—through a curriculum that no undergraduate school to our knowledge now offers. (Sure, we have another purpose. We believe that as people learn what our products can do, the more these products will be used in future commercial applications. If today we give you the kind of information that will help you do a better job, it seems reasonable to assume you may give us an order someday.)

So we invite you to enroll now in our newly created Magnetics Technology Center. It exists as a repository of what is known about magnetic materials. It intends to spread this knowledge freely—and broadly. It seeks engineers interested in learning more about this field. It welcomes both recent graduates and those who have been involved in design and application for some time. We intend to gear

our programs to your needs.

As an enrollee in the Magnetics Technology Center you will receive without obligation a continuing flow of printed material. You may have received some of this in previous years, but the bulk will be new material developed especially for our Center. Among the items:

1) Magnetics Technology Center Study Courses on such subjects as:

- Ferrites versus magnetic materials
- Photo-chemically machined parts
- Reducing magnetic circuit size and response time
- Ferrites in transformer design
- Proper selection of cores for saturating transformers

2) Magnetics Technology Center Data Bank Files for designers of chokes, coils, inductors, filters, magnetic amplifiers, converter-inverter transformers and electronic transformers

3) Magnetics Technology Center news, at regular intervals, on advances in magnetic materials, applications, etc.

4) Magnetics Technology Center Annual Bibliography of important papers and articles on magnetic science technology

Enroll now. No tuition. No tests.

No campus. Merely fill out and mail the coupon.

MAGNETICS, Magnetics Technology Center, Dept. EL-106, Box 391, Butler, Pennsylvania 16001

## How do we qualify to institute this Center?

- We developed the 550 Mu Flake Core, an industry first, that allows miniaturization without excessive circuit losses
- We tightened up industry inductance tolerances for powder cores. Twelve years ago the accepted tolerance was as high as  $\pm 22\%$ . We went to  $\pm 8\%$  and others followed
- We established ourselves as the only approved source of bobbin cores for the Apollo program
- We patented a one-piece powder core die to increase production and help make a more uniform product
- We developed linear inductance-temperature characteristics in powder cores
- We stabilized miniature cores for inductance changes with temperature
- We developed a guaranteed voltage breakdown finish for tape and bobbin cores, eliminating the need for taping
- We developed our own powder metallurgy techniques and producing facilities to gain stricter control of magnetic core properties
- We tightened limits or standards on tape wound cores and set limits on other cores where no industrial standards were in place

To enroll, clip this and mail today.

**MAGNETICS, Magnetics Technology Center, Dept. EL-106, Box 391, Butler, Pennsylvania 16001**

Please enroll me in the Magnetics Technology Center and forward all curriculum materials, free of charge, to:

Name \_\_\_\_\_

Title or Function \_\_\_\_\_

Field of Interest and/or Product Now Working On \_\_\_\_\_

Specific Subjects You Would Like Us to Include in the Curriculum \_\_\_\_\_

Degree \_\_\_\_\_ School \_\_\_\_\_ Year \_\_\_\_\_

Firm Name \_\_\_\_\_

Address \_\_\_\_\_

City \_\_\_\_\_ State \_\_\_\_\_ Zip \_\_\_\_\_

Your associates may wish to enroll also. Have them furnish the above information on their company letterhead and send it to us. We need this data to assist us in selecting your curriculum.



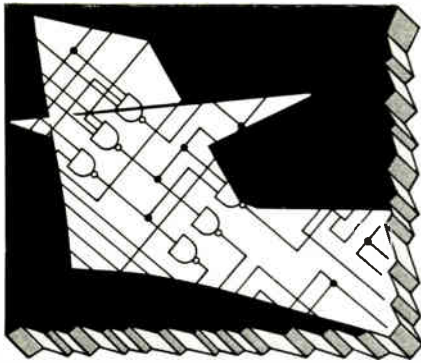

# 28 VOLT LOGIC

for aircraft and industrial control.

Siliconix H100 series 28V gates offer immunity from 80V line transients.

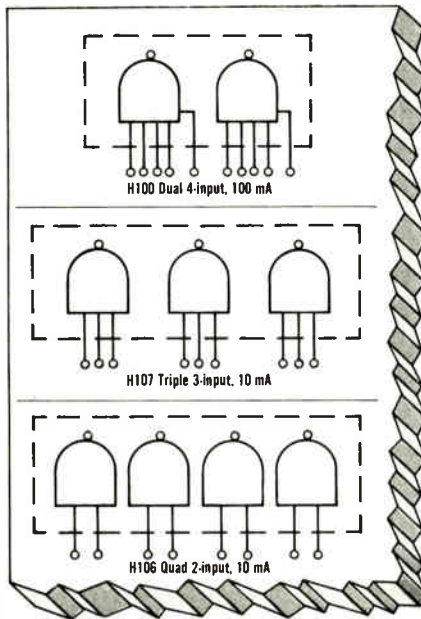

These gates, specifically designed for noisy aircraft and industrial supplies, are available in TO-86 or TO-116 packages. Write or call us for the complete story!

**Siliconix**  
incorporated

2201 Laurelwood Rd. • Santa Clara, Calif. 95054  
(408) 246-8000 Ext. 201 • TWX: 910-338-0227  
In Europe: Siliconix Limited, Saunders Way, Sketty, Swansea, Great Britain

## Who's who in electronics



Mansur

**When the White House** reorganized and upgraded the Office of Telecommunications Policy, the nature of the change was obvious. Policy will be the prime concern of the new group, with management left to telecommunications users. OTP's new deputy director, George F. Mansur Jr., spells this out with his observation that the office will devote more of its limited resources to forecasting Federal telecommunications needs and industry's potential. At the same time, it will participate less in government and industry committees dealing with such things as communications standards. Of that role, the former Collins Radio Co. executive says, "I doubt that this is an appropriate one for the office, although we may make occasional recommendations as to where standards are necessary."

Until recently the head of Collins' Microwave and Space Systems division in Dallas, Mansur's electrical engineering expertise blends nicely with that of his new boss, Clay T. Whitehead. Among other common characteristics, both men are alumni of Bell Laboratories.

Though Mansur has been on the job less than three months, the slim

and soft-spoken Missourian already is grappling with major policy issues that will shape OTP's image. Domestic satellites, of course, represent one, but there are others such as "the evolution of specialized common carriers;" "wideband cable communications and distribution systems," of which cable television is but a small part; and "the whole field of teleprocessing—the interaction of computers and communications—which is going to expand very rapidly in the next five to 10 years." All of these, he points out, will help compound the growing problem of further congestion of the crowded spectrum, "so I think we will be taking some new looks at radio spectrum resource allocation."

The biggest problem facing OTP right now is money. Though Whitehead and Mansur's areas of interest are expanding, their bankroll is not. Plans for staff expansion were deferred along with a proposed 50% budget increase to more than \$3 million [*Electronics*, Sept. 28, p. 51]. And the fiscal squeeze appears to have compounded the challenge Mansur faces in adapting to a new job. "I'm not sure I have a nonprofessional life, quite frankly," he says of his experience since moving to the capital. But when he finds that time for a bit of relaxation Mansur expects to divide it between camping with his family, a bit of fishing, and an occasional "white-hat novel where the good guys and bad guys are clearly defined."

**After spending** four years as deputy director of defense research and engineering at the Pentagon, and being installed as a new Raytheon vice president, Charles A. Fowler is obviously well qualified to be concerned about R&D. "The last thing I would trim in next year's defense budget is R&D," he says. "I hope Congress will be shrewd enough to at least leave funding at present levels during fiscal 1971, but frankly I'd be less worried if I saw a nice round \$8

# Introducing... A New Modular Concept in RCA Hybrid Power Circuits

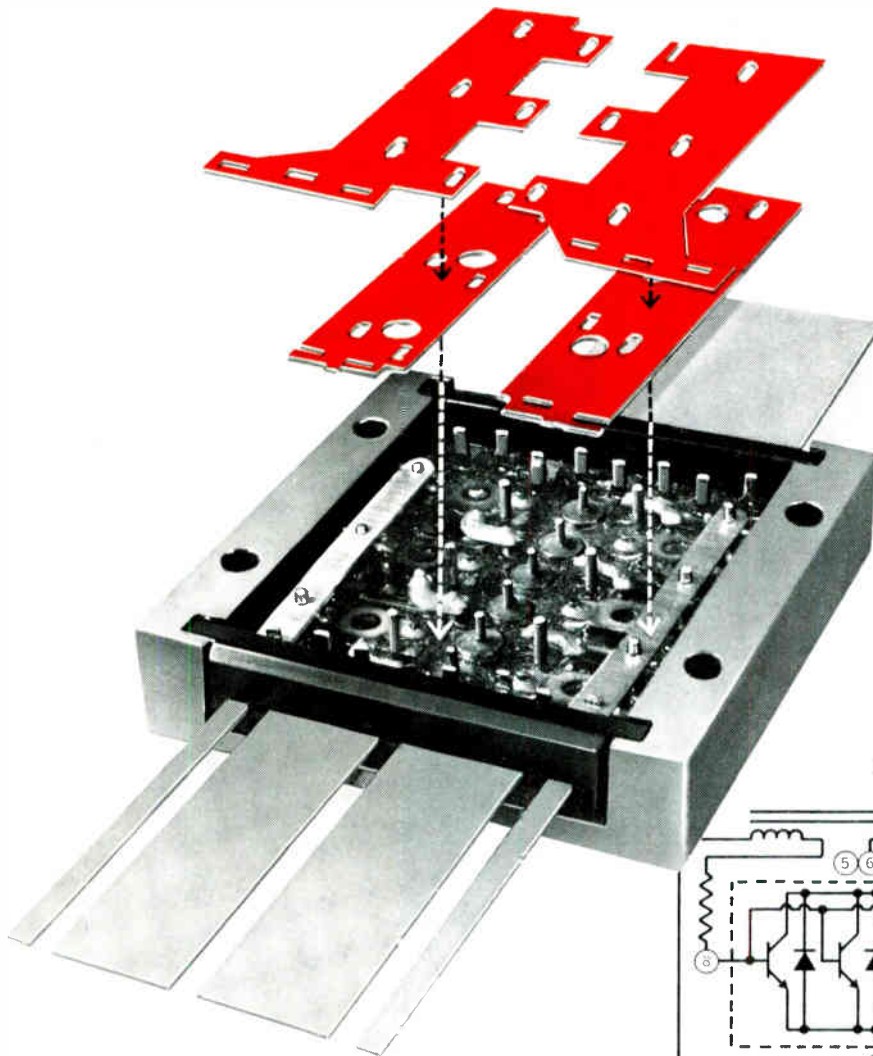

Exploded view shows one of the standard interconnections of the RCA hybrid power module as used in a common-emitter inverter. That portion within the dotted lines in the circuit schematic represents the RCA module.

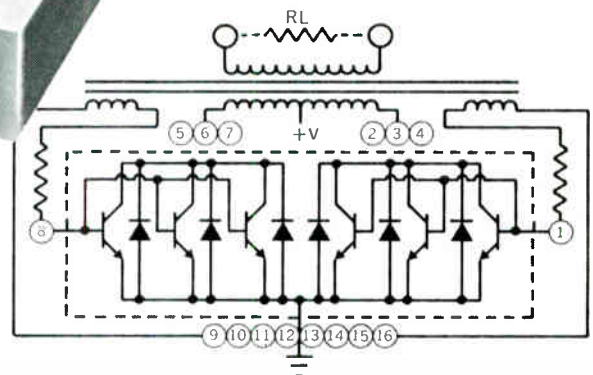

Module shown actual size

Take RCA transistor chips with current capabilities up to 80 A, rectifiers with peak currents to 80 A, and resistors to 10 watts. Interconnect them — in any number of ways. What do you get? A power capability up to 800 W, current capability up to 300 A!

Right now, RCA is mass-assembling a variety of thick-film hybrid high-power arrays that are ideal for switching and amplifier applications in military and industrial equipment. Modules are also available in unconnected versions, if you prefer to create your own design. These hybrid power circuits offer obvious power circuit advantages, including: compact-

ness, light weight, fewer parts, minimum assembly costs, factory-selected and matched components, and efficient built-in heat dissipation.

Look over the inverter example illustrated. Then call your local RCA Representative or your RCA Distributor for more information on the modular concept. For RCA's new, detailed brochure, "High-Power Arrays" (HPA-100), write: RCA, Commercial Engineering, Section 70L7/UC2R, Harrison, N. J. 07029. International, RCA, 2-4 rue du Lièvre, 1227 Geneva, Switzerland, or P.O. Box 112, Hong Kong.

# RCA

# It took a new generation to bridge the gap

## Delevan's Micro-i® Series 155

A new generation of low-cost, miniaturized inductors that is the long-sought transition between discrete and monolithic IC circuits.

### HIGH RELIABILITY AND VERSATILITY

Originally designed to meet the rigorous standards of DOD and NASA specifications, Micro-i Series 155 inductors are perfect for communications applications and the computer field where performance is critical and ownership costs are a consideration. Proven successful for choke and filter applications.

### SUPERIOR FEATURES

Ruggedly constructed with internal connections, thermo-compression bonded for high temperature processing.

RF Inductor Epoxy-molded to meet MIL-C-15305, Rev. D, Grade 1, Class A.

Miniaturization and low profile give improved compatibility with hybrid ICs.

Four separate leads are readily adaptable for solder reflow connections. Eliminates costly body tie-down, reduces lead fatigue caused by vibration and is easily adaptable to tuned circuits by means of outboard chip capacitor.

Write for complete technical data

**Delevan**  
Division



**AMERICAN  
PRECISION  
INDUSTRIES INC.**

270 QUAKER RD. / EAST AURORA, N. Y. 14052  
TELEPHONE 716/652-3600 TELEEX 091-293

OTHER DIVISIONS OF AMERICAN PRECISION INDUSTRIES INC.: BASCO • DUSTEX •  
MOELLER INSTRUMENT CO. • OXFORD CORP. • TRUCK EQUIPMENT CO.

## Who's who in electronics

billion or so in the President's 1972 Budget Message."

Fowler feels that, like all budget outlays, R&D needs pruning from time to time, but he adds that further cuts in 1971 could damage the nation's defense posture.

Fowler qualifies as an expert witness. He has worked on military hardware since World War 2, when he helped develop the ground-controlled approach system. "We initially called it ground-controlled landing, but after we nearly crashed the first test plane we figured that GCA was a more appropriate name."

Now, after his stint with the Defense Department, Fowler will be manager of Raytheon's development laboratories in Wayland and Sudbury, Mass. But while he will watch over programs from air traffic control radar to missile guidance system, Fowler is not grinding his company's ax when he worries about R&D.

"Defense funding now is reaching the point where one must choose to spend on either technological development or hardware," he asserts. "And because the services must maintain given hardware and manpower levels, we are witnessing disproportionate cuts in R&D funding."

Fowler feels these reductions have "reached the point where it is possible to foresee several other countries taking technology leads over the United States. And if this happens, the repercussions will be felt not only in our strategic posture, but in balance of payments, the stability of our currency, and other areas."

Fowler's answer? Restore tightly controlled R&D funding, "with more emphasis on low-cost design and less on sheer elaboration. It should be the lean, tightly defined systems that are funded, and it will be these that will sell."

Fowler hopes to bring to Raytheon "a sort of objectivity that's hard to get from within a corporation—my emphasis is going to be on less costly solutions to technological problems, reduced engineering costs, and less expensive production."



# Saves Man Hour with Harness System\*

NEW PRODUCT  
ANNOUNCEMENT



**1** Quickly locate termination point by touching connector pin

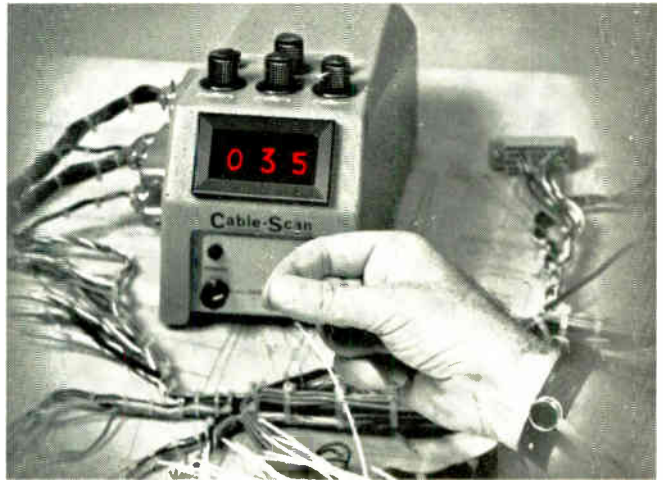

**2** Instantly identify any wire by touch

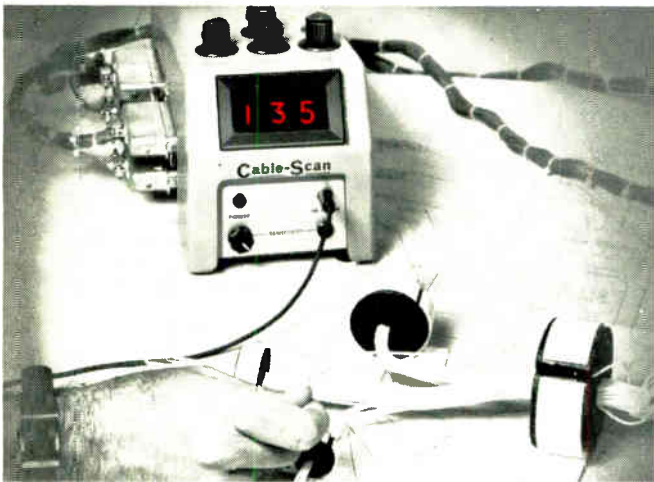

**3** Route wire to proper destination



**4** Complete installation and get immediate verification of proper termination

Until 15 months ago the only way wires could be selected and routed to make harnesses and cable assemblies was by traditional methods such as color coding, wire tagging, preprinted wire or some other equally slow tedious and expensive method of identification. Now Thomas & Betts Corporation offers a totally new system which combines instant identification and testing at the point of fabrication in 1/5th the time of any present method. Since everything is verified while the job is in process costly rework is eliminated. By touching the end of any wire the operator introduces a low level signal through the finger tips to each circuit. This causes the numerical readout of the wire identity. Cable-Scan Inc., 1320 Miller Street, Anaheim, California 92806.

\*Documented Case Histories

**Cable-Scan Inc.**  
Subsidiary of Thomas & Betts Corporation



# When you build a product last, you better build it better.

Now, that may sound like sour grapes. So we'll just give you the facts:

All our competitors beat us to market with their industrial/lab supplies. They became entrenched. (Sure, we've pioneered most of the major innovations in the power supply industry—such as our DCR series—but we're not always first.) So before we began our design, we talked with the people who were using these kinds of power supplies. What did they like? What didn't they like? Any changes they'd like to see made? Any features added?

Here are the results:

1. Our new SRL line has a special circuit which allows you to check overvoltage setpoint instantly, and easily change settings without removing the load from the supply.
2. Complete line features new small-sized SRL units available in 14 models in voltage ranges from 0-10 Vdc to 0-60 Vdc and current ranges up to 100 amps.
3. High stability and reliability through use of integrated circuitry.
4. These supplies all feature an adjustable built-in SCR crowbar and adjustable current limiting circuitry as standard.
5. We have the fastest response time over full load range.
6. These supplies give you less than 1 millivolt RMS ripple.

Now, those are just a few of the reasons you may want to consider Sorensen the next time you consider buying industrial/lab power supplies. For more reasons and complete information on these or any of our power supplies (we manufacture and inventory more power supplies than any one else in the world), please contact Raytheon Company, 676 Island Pond Road, Manchester, New Hampshire 03103. We'll also send you our 124 page Power Supply Handbook and Catalogue. Or circle 200 on the inquiry card.

**Sorensen**  
**POWER SUPPLIES**

AN OPERATION OF RAYTHEON CO.





## Arc/Corrosion Resistant Marine Wiring Devices by HUBBELL.

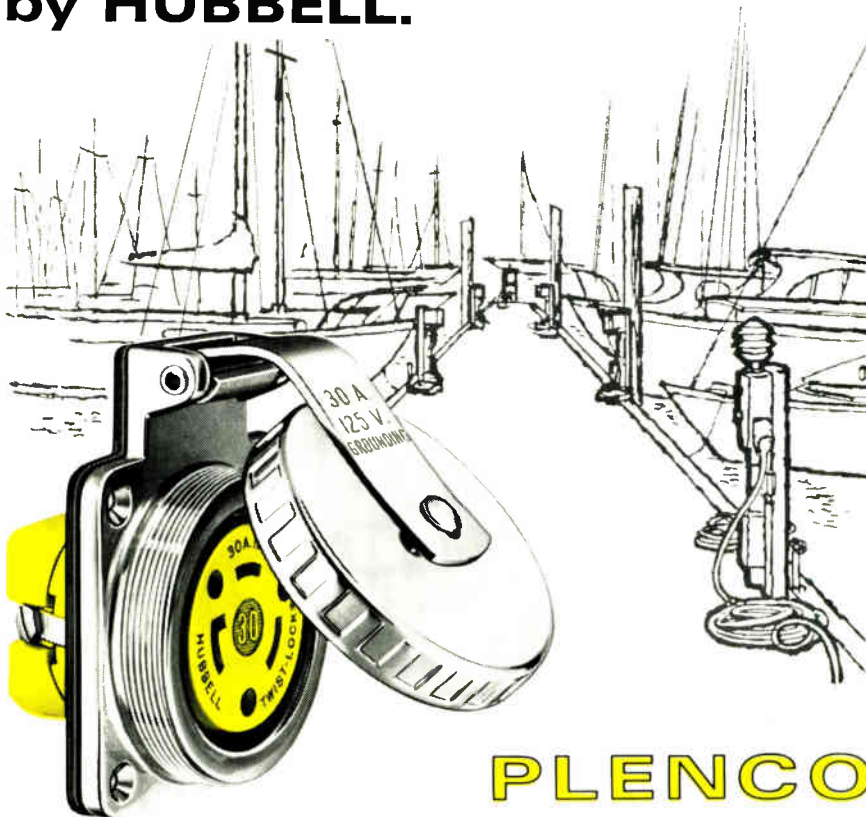

### PLENCO

Melamine-Phenolic Yellow helps keep them that way.

Moisture, acids, alkalis, oils, grease, solvents, salt spray make a mean mix. They can eat up conventional wiring devices.

To provide peak performance and protection for ship-to-shore electrical power systems, the Plastics Division of Harvey Hubbell Incorporated, Newtown, Conn., molds rugged and attractive corrosion-resistant marine wiring devices. And chose Plenco 705 Yellow to help.

Our Plenco Melamine-Phenolic 705 is a special-purpose thermoset with excellent electrical insulation characteristics. It resists arcing and tracking. It resists corrosive materials. It resists impact. And it offers the added plus of its "safety yellow" coloration.

For advice and service on the most effective use of thermosetting molding compounds in your own particular application—invite Plenco on board.

PLASTICS ENGINEERING COMPANY  
Sheboygan, Wisconsin 53081

Through Plenco research . . . a wide range of ready-made or custom-formulated phenolic, melamine, epoxy and alkyd thermoset molding compounds, and industrial resins.



## Meetings

### Calendar

International Symposium on Circuit Theory, IEEE; Sheraton Biltmore Hotel, Atlanta, Ga., Dec. 14-16.

Reliability Symposium, IEEE; Sheraton Park Hotel, Washington, Jan. 12-14.

Optics in Microelectronics, Optical Society of America, Stardust Hotel, Las Vegas, Jan. 25-26.

Winter Convention on Aerospace and Electronic Systems (WINCON), IEEE; Biltmore Hotel, Los Angeles, Feb. 9-11.

International Solid State Circuit Conference, IEEE; Sheraton Hotel, University of Pennsylvania, Feb. 17-19.

International Convention & Exhibition, IEEE; Coliseum and New York Hilton Hotel, New York, March 22-25.

Reliability Physics Symposium, IEEE; Stardust Hotel, Las Vegas, March 31-April 2.

European Semiconductor Device Research Conference, IEEE, DPG (German physical society), NTG (German communications society); Munich, March 30-April 2.

National Telemetry Conference, IEEE; Washington Hilton Hotel, April 12-15.

Southwestern IEEE Conference and Exhibition, Houston, Texas, April 25-May 2.

### Call for papers

Design Automation Workshop, Association for Computing Machinery; Shelburne Hotel, Atlantic City, N.J., June 28-30. Jan. 4 is deadline for submission of abstracts to R.B. Hitchcock Sr., IBM Watson Research Center, P.O. Box 218, Yorktown Heights, N.Y. 10598.

Nuclear and Space Radiation Effects, IEEE; The New England Center for Continuing Education, University of New Hampshire, Durham, July 20-23. Feb. 15 is deadline for submission of summaries to T.M. Flanagan, Gulf Radiation Technology, P.O. Box 608, San Diego, Calif. 92112.

Consumer Electronics Symposium, IEEE; McCormick Place-on-the-Lake, Chicago, Oct. 18-20. April 1 is deadline for submission of abstracts to Wayne Luplow, consumer papers chairman-NEC, Zenith Radio Corp., 1851 Arthur Ave., Elk Grove Village, Ill. 60007.



**Behind this counter are 40 million hours of reliability data.**

**That's only one reason it's the world's best seller.**

Only the 5245's have over 40 million hours of operating data behind them — data which is computerized so HP can keep track of the performance of the 20,000 5245's now in use around the world. In addition, they all get torture-tested up to 160° F to make sure they'll operate under the most severe conditions.

The 5245's adapt easily to your needs. 14 plug-ins go from dc to 18 GHz and perform a great variety of functions. You can even order a long-term time-base stability of  $<5 \times 10^{-10}$  — good enough to use as a precision frequency standard.

That's why, in the long run, buying the best all-around counter on the market

— the 5245 — will save you money. Downtime and servicing are minimal. But you can get parts and service around the world. No wonder these counters are the only choice for many leasing companies.

Prove it to yourself. Call your local HP field engineer and find out why these are the most accurate, flexible and economical counters you can get. Anywhere.

Or write Hewlett-Packard, Palo Alto, California 94304; Europe: 1217 Meyrin-Geneva, Switzerland.

HEWLETT  PACKARD  
ELECTRONIC COUNTERS

# Custom(er) Cable Constructions by Chester

Proof of Chester's ability to produce plastic coated multi-conductor cable construction to customer requirements is reflected in part by the production samples shown on these pages. Though only representative of the thousands of "specials" made for our many customers they graphically prove Chester's ability to translate a wide range of special multi-conductor needs into dependable and practical cable constructions.

When standard cable constructions will not suffice, Chester's vast resources, technical skills and manufacturing facilities are placed at your disposal to manufacture conductors, insulations and jackets to meet your most exacting requirements.

Whatever your multi-conductor cable needs, check first with Chester. We know you'll be more than pleased with the expeditious and thorough handling of your request.



- A. RECORDING STUDIO:** Audio scunc cable: 25 shielded pairs, stranded copper conductors, low loss insulation, twisted with uninsulated drain wire, isolated aluminum tape shields, cabled, PVC jacket
- B. TV CAMERA MFR.:** Camera control cable for Audio and Video signals: a composite of PVC and polyethylene insulated conductors, cabled, overall braid shield PVC jacket.
- C. AIRCRAFT SIMULATOR MFR.:** Control cable: 12 triples shielded jacketed, stranded copper conductors PVC insulated, individual shield jacket color coded cabled overall PVC jacket.
- D. ELEVATOR MFR.:** Control cable: 35 conductors, stranded copper, PVC insulated conductors coded by colors and printed numbers, cabled with open braid; individual conductors U/L listed.
- E. INTERCOM EQUIPMENT MFR.:** 25C conductor inter-office communication and signaling cable: solid bare copper, PVC insulation, paired, cabled, PVC jacket U/L listed.
- F. ELECTRIC UTILITY CO.:** Station control cable for general use: 37 conductors, stranded, polyethylene and PVC insulated, color coded, cabled, overall tough PVC jacket; per NEMA, IPEA Specifications.
- G. LARGE CITY:** Communication cable: 50 pairs, polyethylene insulated, cabled, continuous layer of copper shielding tape, PVC jacket; per spec. IMSA-19-2, 630 volts.
- H. LEADING SHIPBUILDER:** shipboard cable: stranded conductors, nylon-jacketed PVC insulation, pairs shielded and jacketed, cabled, PVC jacket, and aluminum braid armor overall; per spec. MIL-C-915.
- I. U. S. GOVERNMENT:** Coaxial cable: type RG-218; U, solid copper conductor, polyethylene insulated, copper braid shield, PVC jacket; per spec. MIL-C-17/79.
- J. BROADCASTING COMPANY:** Remote control broadcasting cable: stranded conductors, polyethylene insulation, pairs & triples shielded and jacketed, cabled, PVC jacket overall.
- K. COMPUTER MFR.:** Computer control cable: 55 conductors, stranded copper conductors, PVC insulated, formed into 7 groups of 7 conductors, cabled, PVC jacket; U/L listed.
- L. MACHINERY MFR.:** Bus drop cable: 3 PVC insulated stranded conductors, with split uninsulated grounding conductor, cabled, overall PVC jacket; U, L listed; per NEC.



**CHESTER CABLE**

OPERATIONS

CITIES SERVICE COMPANY

CHESTER, NEW YORK • 10918

PHONE: (914) 469-2141 TWX (914) 469-9801

Circle 21 on reader service card

# Reliability is staggered steps and a hunk of DAP.

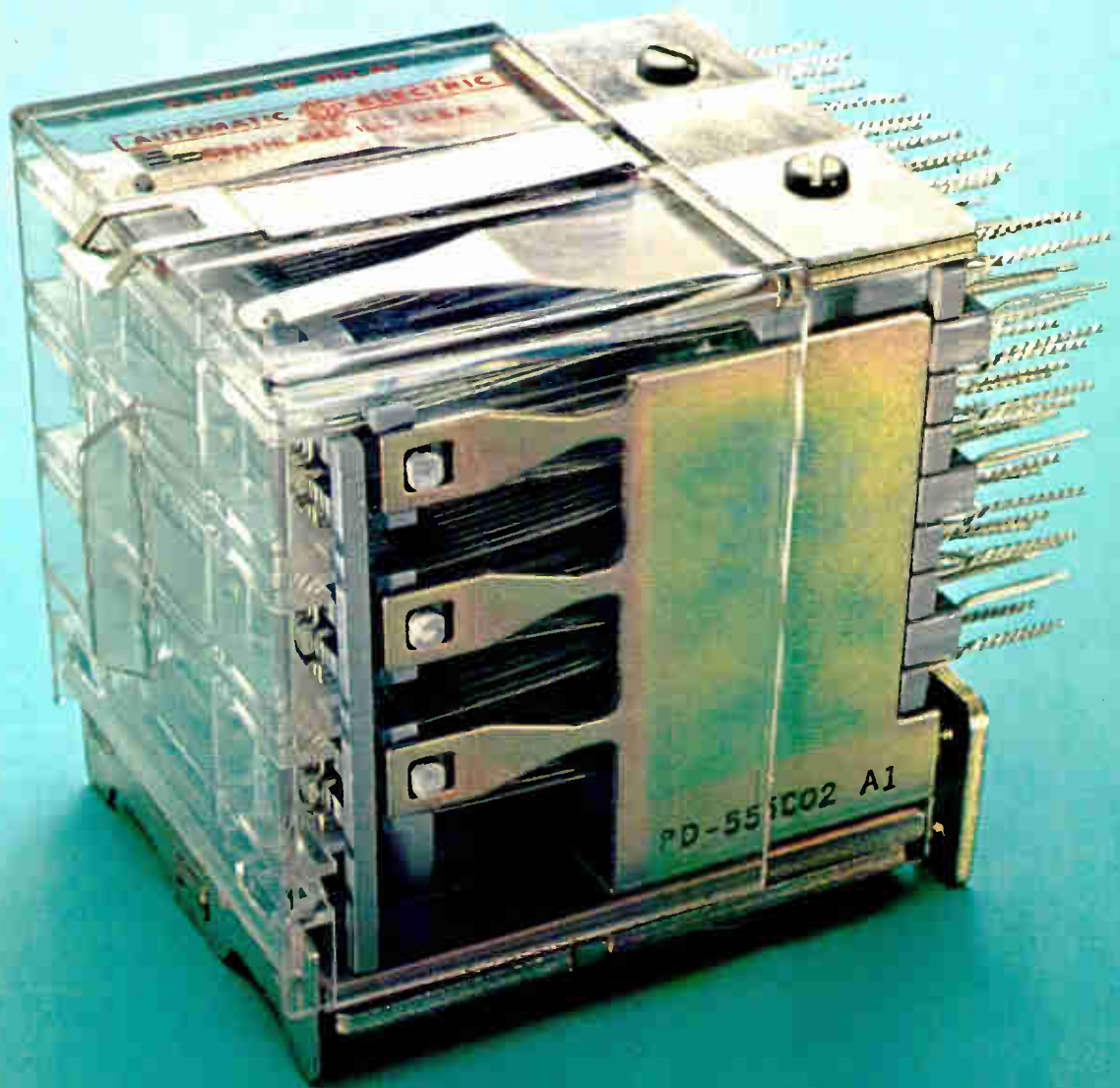



### Expect over a billion operations.

Our Class W wire-spring relay is different. In fact, there's nothing like it in the entire industry. Where else can you find a relay with lots of contacts and a mechanical life of more than a billion operations! That's about two and a half times the life of the best conventional relay around.

Another nice thing about our Class W is that it takes up a lot less space and costs less than using a bunch of other relays. That's because we build our Class W relay with one, two or three levels of contact assemblies, with 17 form C combinations per level. By the way, they're available with gold contacts for low-level switching.

### Making it tough on creepage.

All those staggered steps you see on the side were put in to raise the breakdown voltage between terminals. These molded steps add extra creepage distance between the terminals. This really counts for high voltage testing, or when using our Class W in unfavorable ambient conditions.

These steps, and all the molding compound used for insulating the contact springs, are made from

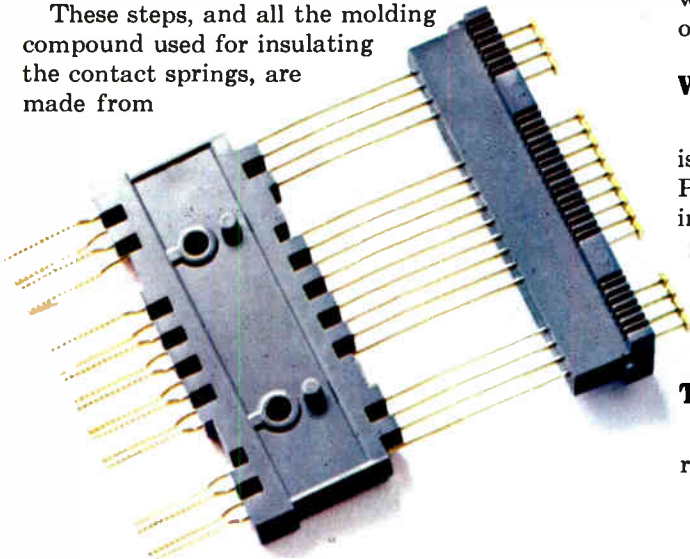

diallyl phthalate. (They call it DAP for short.) It has great insulating properties and it wears like iron. Even if the humidity is high, you have excellent protection.

### Redundancy—two springs are better than one.

Each of our long wire-spring contacts has an independent twin with the same function. One tiny particle of dust could prevent contact on other relays. Not with our Class W. You can be sure one of the twins will function. That's back-up reliability.

The twin contacts are twisted together at the terminal end. Then we give them a spanking (you might call it swedging) to provide solderless wrap.

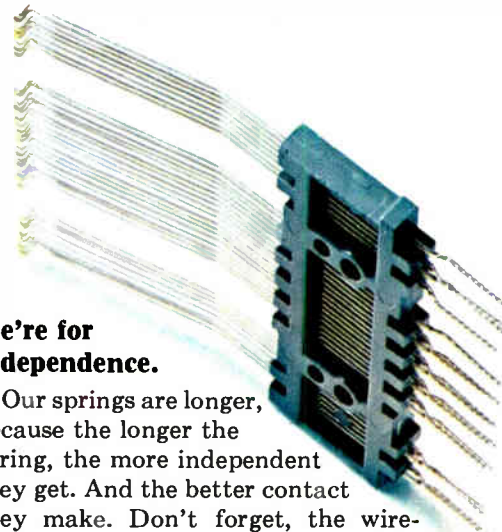

### We're for independence.

Our springs are longer, because the longer the spring, the more independent they get. And the better contact they make. Don't forget, the wire-spring relay is the most reliable way to get a permissive make or break contact. You can rely on it.

The middle contact springs have to be stationary. To make sure they stay that way forever, we actually mold them between two thick pieces of DAP on both ends. Just try to move one.

### When we say flat, it's flat.

Each frame, banged out by a gigantic machine is extra thick and extra flat. Then they're planished. Planishing is another step we go through in forming the frame to add strength and stability by relieving surface strain.

We've made our spring-loaded pile-up clamp extra thick, too. Once it's tightened down, the whole pile-up is nice and tight, and stays tight.

### There's more.

We could tell you a lot more about our Class W relays. Like how the tough high-temp molded

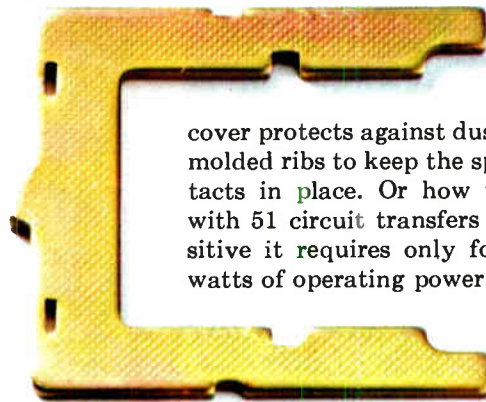

cover protects against dust and has molded ribs to keep the spring contacts in place. Or how this relay with 51 circuit transfers is so sensitive it requires only four to six watts of operating power.

But why don't you let us prove how much reliability we put into our Class W? We'll be waiting to hear from you. Industrial Sales Division, Automatic Electric Company, Northlake, Ill. 60164.

**AUTOMATIC ELECTRIC**  
GENERAL TELEPHONE & ELECTRONICS

Circle 23 on reader service card

# No drag. No lag.



Our new High Performance DC Motors get to full speed 100 times faster than conventional permanent magnet motors. Because the drag caused by excessive inertia has been practically eliminated by our unique hollow rotor design. And with low drag, you have little lag.

This can mean accelerations up to 900,000 radians/second<sup>2</sup>.

These features make our motors ideal for such applications as tape capstan drives, line printer drives and machine tool positioning.

There are 5 sizes available and options include: Integral low ripple tachometers, special shaft lengths and shapes and forced air cooling adaptations.

For more information on our low-inertia, High-Performance DC Motors, contact your MICRO SWITCH Branch Office (in the Yellow Pages under "Switches, Electric"). Or write for our special literature.

## MICRO SWITCH

FREEPORT, ILLINOIS 61032

A DIVISION OF HONEYWELL

HONEYWELL INTERNATIONAL—Sales and Service offices in all principal cities of the world. Manufacturing in Australia, Canada, Finland, France, Germany, Japan, Mexico, Netherlands, Spain, Taiwan, U.K. and U.S.A.

---

# Electronics Newsletter

---

December 7, 1970

## DEC planning faster PDP-11s

Faster computers will be added to the Digital Equipment Corp.'s PDP-11 line "within the next few months," says a company official. The firm is shooting for an ultrahigh-speed processor module for its PDP-11 and is looking at several technologies, including emitter-coupled logic. "We want a processor faster than foreseeable semiconductor memories," says the official.

The high-speed processor could form the heart of the rumored PDP-11/40, and if TTL or ECL memory is selected, it could be the first all-bipolar minicomputer, and certainly one of the fastest. Although DEC says that memory technology is secondary, it is moving to deliver a semiconductor memory for the PDP-11 within the next six or seven months. DEC has looked not only at MOS, but also at hybrids using MOS storage with bipolar drive and decode chips, as well as at pure bipolar chips.

## Signetics offers speedy 'D/MOS' ...

While the experts argue about which MOS process is the best—(111), (100), p channel, n channel, nitride, ion implant, C/MOS, or silicon gate—researchers at Signetics have added another. Theirs is called D/MOS, for double-diffused metal oxide semiconductor. These n-channel D/MOS devices can be depletion or enhancement mode, and can be used for both logic circuits and high-frequency microwave devices.

A major difference between D/MOS and standard MOS devices is that with D/MOS the channel is much narrower—1.5 microns vs. 5 microns—so the devices are five times faster than standard n-channel and 10 times faster than p-channel devices. Typical rise time for a digital device is said to be on the order of 0.2 nanosecond (210 picoseconds), and an  $f_{max}$  of 10 gigahertz has been achieved with discrete microwave devices. Such a device may be available late next year.

## ... as AMI readies Si gate, ion implant

Even as new MOS processes are developed, more firms are entering the market or expanding already existing capabilities. For example, American Micro-Systems Inc. of Santa Clara, Calif., the largest MOS supplier in the country, will have two new processes—silicon gate and ion implantation—on line by spring to add to its high-threshold, p-channel process.

And Siliconix, also of Santa Clara, is about to enter the growing custom MOS LSI custom market. The company acquired some experienced MOS men when Computer Modules Inc. closed.

## Aegis to use semiconductor memory ...

The Aegis surface-to-air missile system appears to be the first major military system with a designed-in semiconductor memory. The high-speed bipolar memory will have a 500,000-bit capacity and will have a 200-nanosecond access time.

RCA is prime contractor on the Navy fleet defense system. The Navy has picked Semiconductor Electronic Memories Inc. in Phoenix to build the memory. Neither RCA nor SEMI is talking, but it's understood that the first prototype system will be completed in early 1971. Production will begin in the second half of next year and probably continue for three to four years. Value of the semiconductor memory work over the life of the program is expected to amount to between \$6 million and \$10 million.

---

# Electronics Newsletter

---

Competition to design and build the memory attracted dozens of companies; the final competition was narrowed down to Texas Instruments, Motorola, and SEMI, which bid its hybrid bipolar memory [*Electronics*, Feb. 2, 1969, p. 40].

## ... as Navy okays design of missile system

There seems to be no truth to recurring rumors that the Navy is stretching out the Aegis program. **RCA already has had its first milestone meeting with the Navy and system design was approved.** The Navy also was briefed on results of successful testing of a new RCA-developed power tube for the Aegis radar. So far, both the contractor and the customer appear to be happy.

The rumors apparently started when the Navy continued to fund an improvement program for the old, short-range Terrier and Tartar surface-to-air missiles. The Navy has been forced to fund several weapon systems simultaneously because of the increasing vulnerability of its attack carrier forces to standoff missile attack. **The improvement program is aimed at upgrading the older missiles for some antimissile capability.**

## GaAs diode display measures up

A California company has developed an 0.6-inch light-emitting-diode display—the same height as the most popular cold-cathode readout version—that has the same power equipment as 0.25-inch GaAs displays. The company is Litronix Inc. of Cupertino, and the seven-segment display is called Data Lit 6. **It's slated for high-reliability military use, but will be offered commercially when production warrants lower prices.**

## IEEE faces cash pinch, layoffs

At a time when members and local chapters are screaming for more, not less, support, the IEEE is tightening its belt. Facing higher costs and lower revenues, **the IEEE's overall budget cut for next year is expected to amount to \$500,000.** Although institute spokesmen say plans are not yet final, nearly 40 "administrative support" people may be laid off at New York headquarters. Furthermore, plans are afoot to chop the budgets of both Spectrum and the Proceedings, while the IEEE student quarterly may be suspended. Finally, the IEEE is considering cutting back funds normally allocated to section activities by nearly \$150,000.

## Addenda

Working with a major oil company, General Electric's Process Measurement and Control division may announce early next year an information-collection system typing regional gasoline distribution terminals to individual gas stations to cut on the paperwork now required for fuel and materials deliveries. **There are 225,000 gas stations in the U.S.; 10% could use a data system. . . . RCA will most likely introduce another computer in its new line with an all-semiconductor memory, or a computer with a high-speed semiconductor buffer or "cache."** Another possibility is incorporation of a cache into one or more of the previously announced machines before initial shipment, scheduled for the summer of 1971 . . . **Watch for Motorola to establish regional computer-aided design centers in this country and Europe to bring its capabilities closer to customers now that the CAD facility built around the polycell LSI approach to custom MOS and bipolar arrays is on line at the company's Semiconductor Products division [*Electronics*, Aug. 3, p. 26].**

# OUR ANGLE: four frequency phase angle voltmeters

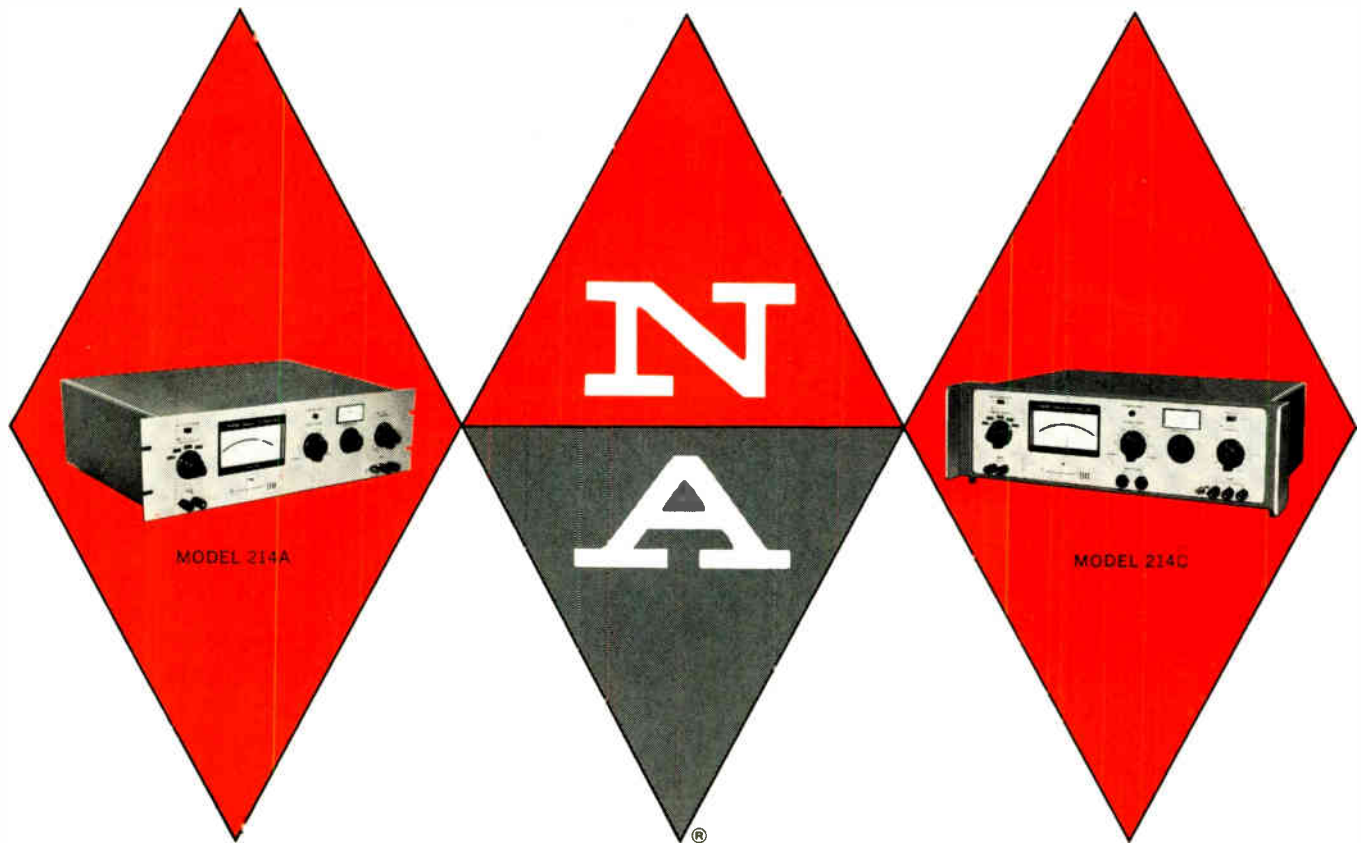

## CAN YOU THINK OF A BETTER ANGLE TO AVOID OBSOLESCENCE?

North Atlantic's 214 FOUR-FREQUENCY PHASE ANGLE VOLTMETER introduces a new flexibility in AC voltage measurements. It enables direct reading of null balance, total voltage, fundamental voltage, in-phase voltage, quadrature voltage, and phase angle.

It's also pre-wired to handle four operating frequencies from 30Hz to 20kHz, which means extended longevity and broader application. Even if you only need one frequency, there are three extra spots to add other frequencies later. Frequency changes can be made rapidly and conveniently in the field with plug-in modules. The 214 can be completely recalibrated at the installation site by a single rear-panel adjustment.

Harmonic rejection and high signal overload design of the unit screens out conventional distortion and errors in measurement and calibration. The all solid-state Model 214 offers full accuracy over  $\pm 5\%$  bandwidth,  $1^\circ$  phase measurement, adjustable meter scaling for go/no-go testing, and  $300 \mu\text{V}$  full-scale sensitivity. Priced from \$1215.00.

Options? Other models offer  $0.25^\circ$  phase accuracy, lower-cost single frequency operation, broadband phase-sensitive performance from 10Hz to 100kHz.

Whether your AC measurements are large or small, contact your North Atlantic sales engineering representative today. He'll show you a new angle to your AC voltage measurements.

**NORTH ATLANTIC**  
*industries, inc.*

200 TERMINAL DRIVE, PLAINVIEW, NEW YORK 11803  
cable: noatlantic / twx. 510-221-1879 / phone: (516) 681-8600

# What makes ours the world's best MOS?

## Unique features. Like PSG passivation, cerdip, MOSAB.

Things that make Philco® MOS the most reliable on the market.

First, our PSG passivation. We apply a unique phosphosilicate glass over the entire surface of the chip—not just over the metallization. This produces the most trouble-free MOS you can buy.

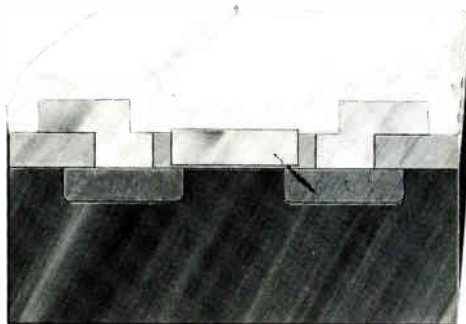

All-over PSG passivation

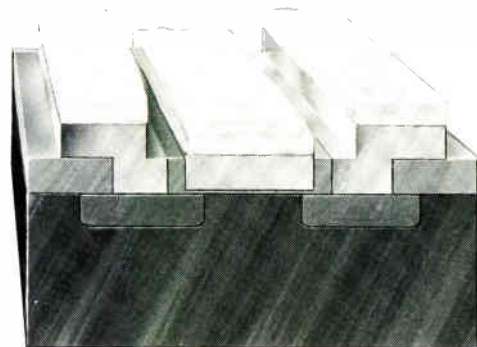

Passivation over metal only

Our special PSG process ends surface ion migration and eliminates field inversion voltage effects—the “Fahrenheit freakout” that can cause all sorts of logic errors when chip temperatures rise. It also prevents corrosion, scratched metallization, and bridging of metal lines by stray conductive particles.

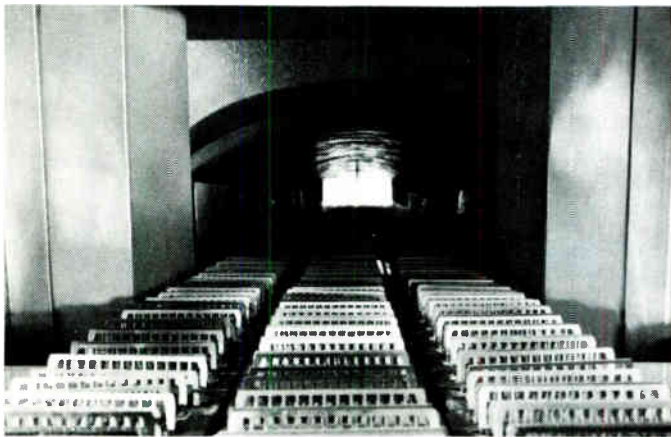
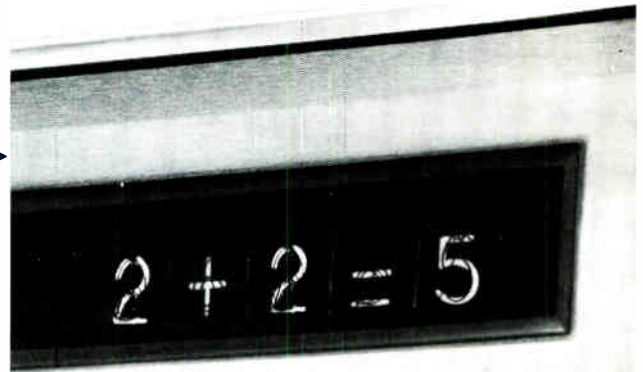

Sealing cerdip at 550° C

And PSG's high-temperature capability lets us give you MOS in cerdip—the low-cost hermetic packaging that meets all the environmental requirements of MIL Standard 883.

Then there's our patented MOSAB input device. It ensures permanent over-voltage protection at every input on every circuit. In conventional MOS circuits the voltage limit increases each time there's a transient surge, as shown on the curve tracer. Until eventually there's no over-voltage protection left.

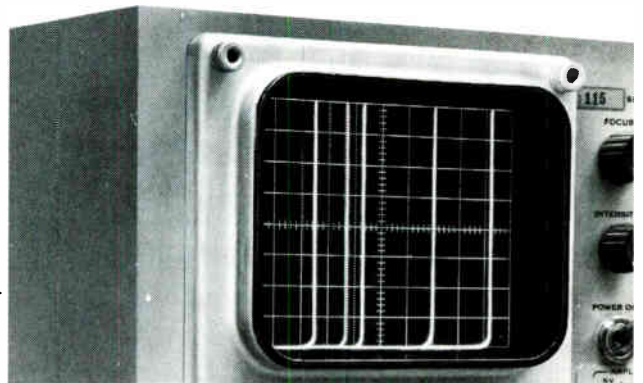

These all add up to yields that are double the industry average . . . from a plant that can make up to a million perfect chips a week. And that means top reliability at attractive prices. See for yourself. Write Philco-Ford Corporation, Microelectronics Division, MOS Marketing, Blue Bell, Pa. 19422. (215) 646-9100.

Or call our nearest sales office: Los Angeles, Calif., (213) 641-8105 • Palo Alto, Calif., (415) 321-8740 • Melrose Park, Ill., (312) 345-1000 • Burlington, Mass., (617) 272-1600 • Dearborn, Mich., (313) 323-3797 • Union, N.J., (201) 686-7512 • Syracuse, N.Y., (315) 422-3154 • Dayton, Ohio, (513) 223-1832 • Don Mills, Ontario, (416) 444-2541.

**PHILCO**   
The better idea people in MOS.

# You may be buying semiconductor memories at a distinct disadvantage.

## You never heard of us.

Selection of the type and size of semiconductor memory has been a choice between a “not-always-there-when-you-need-it” component or a card designed for some other computer. When you’re trying to build a computer with advanced semiconductor memories while maintaining economical development and engineering costs, any choice became a chance. Until now.

Our business is to provide the computer systems and peripheral equipment manufacturers a flexible, reliable choice of semiconductor memories.

We are building advanced bipolar ROM’s and RAM’s that are available to you now. But we haven’t stopped there. We’ve put together standard subsystems with up to 9000 bits capacity on a fully tested card. We have the capability to provide a memory component or a complete memory system — you tell us which one you want.

You see, we’re not only semiconductor experts, nor are we only computer experts, we are both. Our circuit designers were developing semiconductor memories as long as

five years ago. Our systems people developed memories for the most advanced computers. And we back this all up with manufacturing people who produced TTL products for the largest suppliers in the industry.

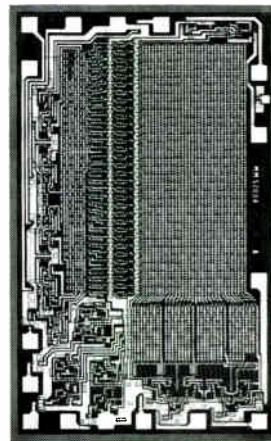

By bringing together people from both sides of the fence, we’ve been able to combine highly reliable semiconductor processes with advanced computer memory organization techniques.

To demonstrate this capability, let’s look at some of the products we are introducing this month. Our first is the fastest 1024 ROM on the market with the lowest power dissipation around. We can program it to your requirements with only a three week turn-around time.

Next is a 256-Bit Read/Write RAM with associated decoder driver. It is loaded with good features — fast cycle time, low



power and DTL/TTL compatability. If you prefer memory subsystems, we have a standard Read/Write 1024 words by 9 bit memory for your buffer or main memory applications. Our memory subsystems are on standard 5 by 7 inch PC cards, organized to the memory size you require. Four different configurations are available now.

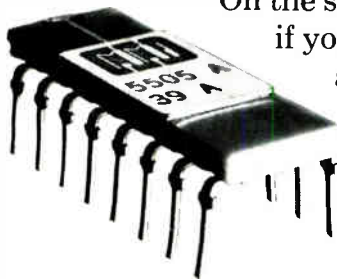

On the subject of costs—  
if you're using up to  
a quarter million bits

per system,  
Monolithic  
Memories can  
provide you a  
product with ten

times the performance of cores at a competitive price. And, we are building larger systems at even lower cost per bit.

A final word about our testing capability. We've developed a sophisticated, high speed test system for both components and subsystems. There's none like it. Our 256-Bit RAM, for example, goes through

62,000 individual measurements before shipment. This test system is also used for

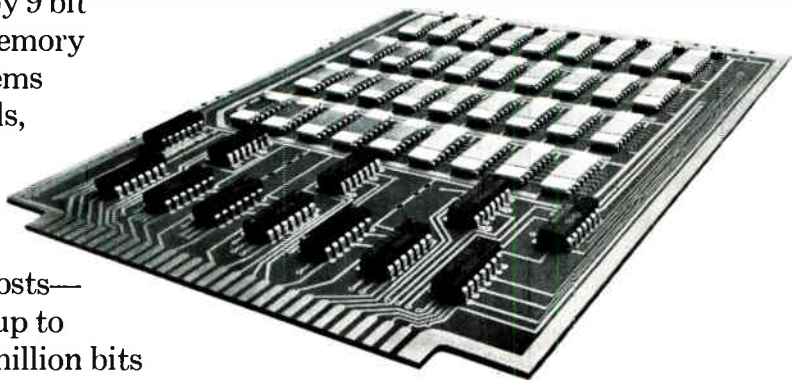

testing our complete memory systems.

We've taken a lot of words to tell you about our capability. We would prefer to let our products speak for us — they're available to you now.

Write or call for data sheets and prices, or see us at the Fall Joint Computer Conference — we'll demonstrate everything we've said.

## Monolithic Memories

Monolithic Memories, Inc., 1165 East Arques Avenue  
Sunnyvale, California 94086 Telephone: (408) 739-3535 TWX: 910 339-9229

Circle 31 on reader service card

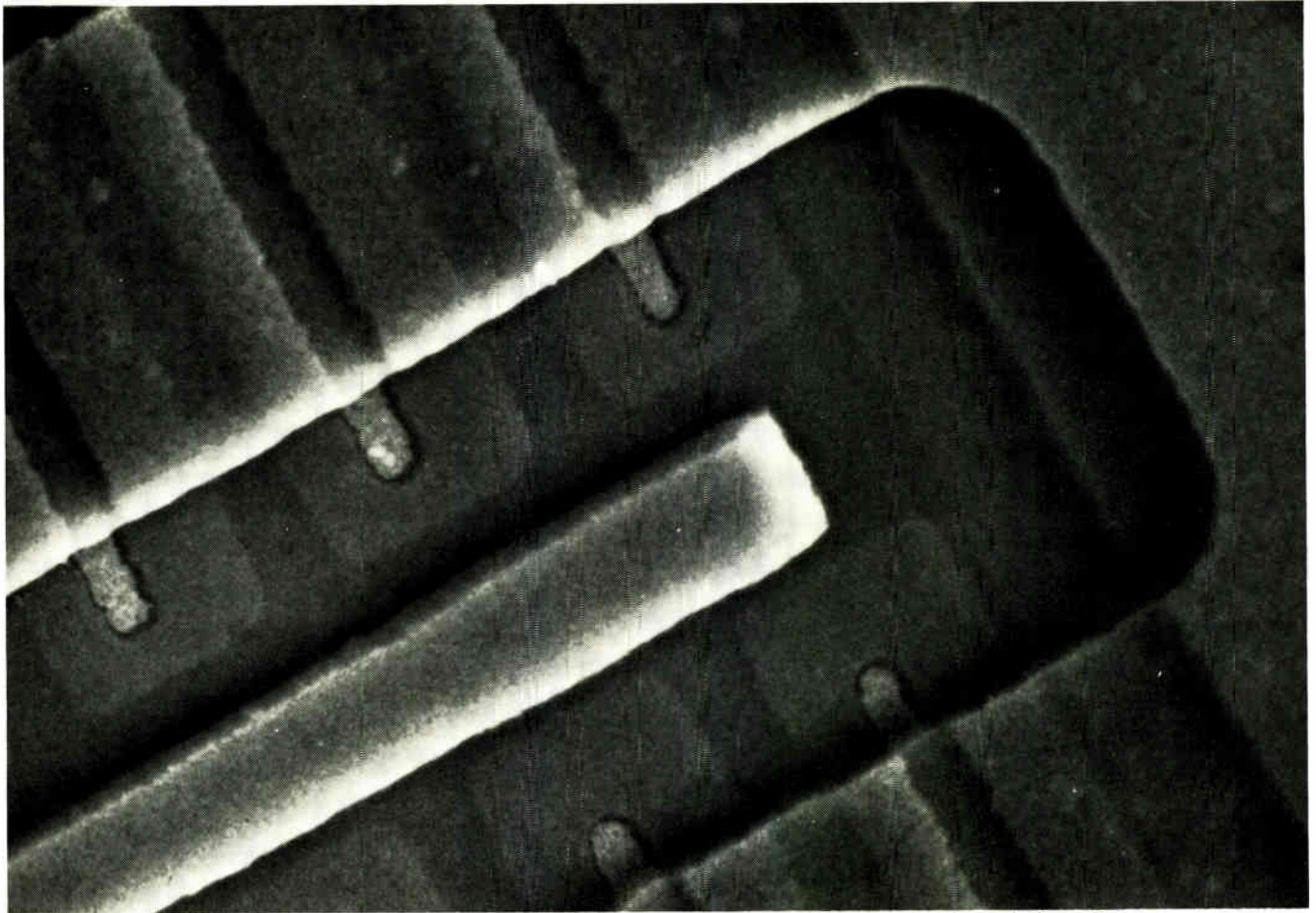

1600x scanning electron photomicrograph of an interdigitated RF power transistor, enlarged about 2x.

## These emitter fingers are 2 to 2.5 microns wide. To clean them you need a FREON® cleaning agent.

FREON fluorocarbon cleaning agents wet and penetrate to clean thoroughly at the sub-micron level. Their high density combined with low surface tension lifts soils and floats away trapped contaminants other solvents miss.

In fact, using FREON solvents has increased production acceptance dramatically for many microcircuit manufacturers.

And there are five more reasons why you should be using FREON solvents:

**1. Chemically Pure and Stable.**

No need for acid acceptance and scratch tests. No inhibitors needed. Parts dry residue-free.

**2. Compatibility.** No damage to widely used materials of construction.

**3. Low Boiling Point (under 120°F).** Ideal for low temperature vapor degreasing. Cooling time eliminated. No damage to heat-sensitive parts. Low heat passage to work environment.

**4. Lower Overall Cleaning Costs.** FREON is recoverable for reuse indefinitely: Power requirements are low in vapor degreasing. Fewer production rejects. Save labor by cleaning complete assembly instead of separate parts.

**5. Safe.** Nonflammable, nonexplosive, low in toxicity.

If you have a cleaning problem or are looking for an improved cleaning system, write today to Du Pont Company, Room 8902-G, Wilmington, Delaware 19898.



# Ion implantation gives MOS ROM bipolar speed

2,048-bit Hughes device boasts 100-ns access time, order of magnitude better than p-channel versions

An MOS read-only memory with speeds approaching those of bipolar circuits—but with a density surpassing any yet attained by bipolar devices—has been developed by the MOS division of Hughes Aircraft. The 2,048-bit ion-implanted ROM has an access time of 100 nanoseconds, a 10 megahertz bit rate, full on-chip decoding, and direct TTL input and output compatibility.

The 100-ns cycle time makes the memory an order of magnitude faster than p-channel MOS read-only memories with comparable features, while its 2,048-bit capacity is twice as large as the biggest of the faster bipolar circuits. The device was developed by Hughes engineers for use as a microprogrammer in their I14400 general-purpose computer.

Ion-implantation techniques [*Electronics*, May 25, p. 125] are responsible for the high speeds. I/MOS ROMs are characterized by a self-aligned gate structure that reduces both Miller feedback capacitance and stray capacitances at a node, increasing circuit speed by a minimum factor of three. The large memory and on-the-chip decoding are achieved using p-channel MOS large-scale integration techniques.

The other leader in I/MOS, Mos-

tek Corp. of Dallas, plans to market a 1,024-bit ion-implanted random-access memory with an access time of 400 ns [see p. 128]. However, Hughes is waiting for customer response and marketing forecasts before deciding whether to go with its device. Samples haven't yet gone to commercial customers.

## Integrated electronics

### GE's secret project yields two devices

This week, General Electric Co. will announce the first two fruits of its closely guarded integrated circuits project; but industry insiders have learned some of the details. First will be a new IC packaging

concept in which the conventional metal lead frame is replaced by a high-temperature polyimide plastic film. Second will be a random-access hybrid memory.

Processing of the package is accomplished on long rolls of 35-mm film. A series of metalization, etching, and stamping steps produces the lead pattern directly on the film, and chips then are bonded into place and encapsulated. Sprocket holes along the sides of the film facilitate automation in the production process, which culminates in a reel of ICs shipped to the customer. The concept also lends itself to automation on the customer's production line: the circuits can be cut off and bonded to pc boards or ceramic substrates automatically.

First products in the new line are

Bit by bit. This is the input stage of the Hughes, 2,048-bit ion-implanted MOS ROM that features a 100-nanosecond access time.

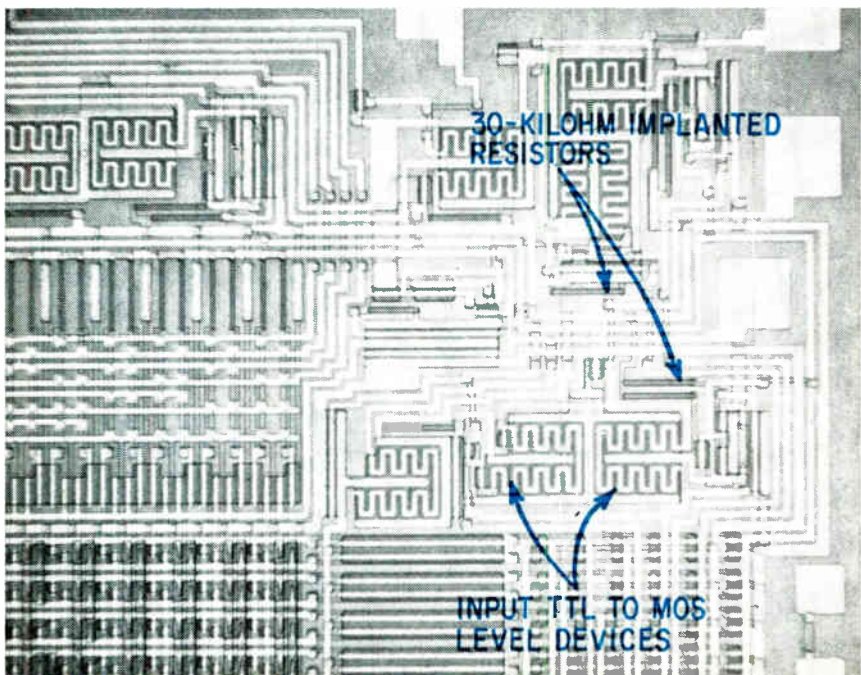

## Electronics review

linear ICs aimed at the industrial market. However, the company plans to follow up with a series of consumer-oriented products and digital ICs as well.

The second GE disclosure will be a 4,096-bit random-access hybrid memory (RAHM), utilizing the company's recently announced refractory MOS (RMOS) technology [*Electronics*, Nov. 9, p. 33]. The memory comprises 16 RMOS and four bipolar chips, and has an access time of 100 nanoseconds, cycle time of 125 ns, and power dissipation of 2 watts. Sample quantities will be available for delivery in the second quarter of 1971, initially priced at \$1 per bit with projected dips to 10 cents in volume.

### Industrial electronics

#### Correlator cools hotbox problems

For the nation's railroads, burnt-out wheel bearings and the breakdowns and derailments they cause are recurring headaches. A variety of techniques for spotting these "hotboxes" has been tried. Placing a thermal sensor near the track is most popular. But at best these systems only narrow hotbox detection to a single wheel assembly.

**Finding the heat.** Railroad wheel hotbox detection is usually done with thermal sensor. But correlation technique promises more accuracy.

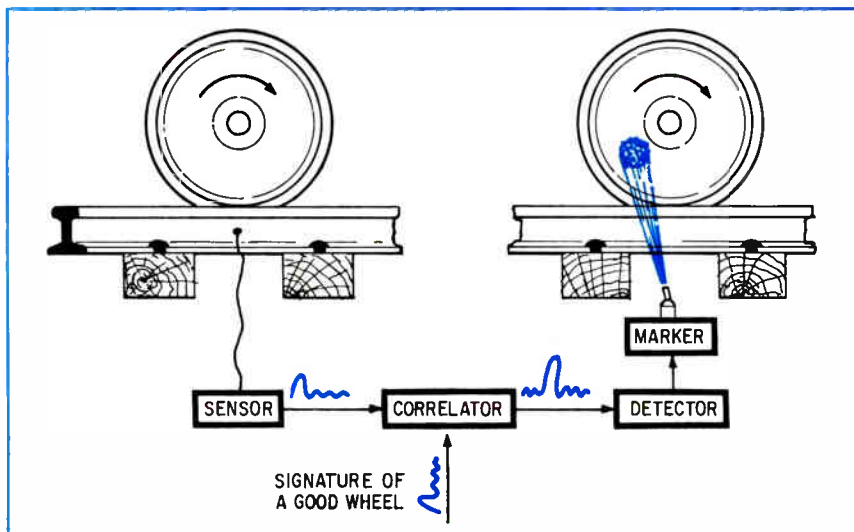

Correlation techniques, says Real Time Geophysics of Norwood, Mass., conceivably could not only detect a hotbox, but also tell exactly what wheel it's in.

Company chairman Warren Moon says his firm is proposing to more than one railroad a system that pinpoints potential hotboxes while a train is still in the yard. A car would be run over a section of track that is connected to a strain gage, a microphone, or some other type of transducer. A wheel would generate an electrical signal to be correlated with one standardized from a wheel known to be in good condition passing over the same section of track. By analyzing the resulting correlation function, a potential hotbox could be detected.

**Moon says** that railroads stand to gain other advantages from correlation. Out-of-round wheels could be spotted by a setup similar to the hotbox detector, or the tables could be turned by having the system mounted in a train where it would monitor track conditions.

Real Time makes the correlator—the MW-10—which generates a 2,000-point curve and has a sampling period as short as 10 microseconds [*Electronics*, Nov. 24, 1969, p. 147]. A complete system will run about \$30,000.

## Communications

#### Spot problems plague Picturephone

White spots on Picturephone screens, caused by imperfections in the silicon target camera tube, still are causing problems for the Bell System. And both Western Electric and Bell Laboratories are trying different approaches to solve the problem.

Bell Labs engineers feel that the problem is due to variations in the growth of the silicon crystal lattice. "One bad diode in an array of more than 500,000 can become visible as a white spot," says L. H. Von Ohlsen, head of electron device and applied mechanics at Bell Labs in Reading, Pa.

But while they're investigating basic silicon technology, Bell Labs personnel also are attempting to eliminate white spots by using special circuitry. For example, during the scanning process, a current spike produced by a bad diode can be canceled by appropriate circuitry. But this increases cost and reduces resolution in the video signal. Besides, Von Ohlsen says Bell Labs is making headway in silicon processing techniques.

**Western Electric**, on the other hand, thinks the problem is dirt particles, both airborne and carried in processing liquids, that degrade diodes within the array. And so Western Electric engineers hope to minimize white spots when they install a Class 1 clean room in Reading early in 1971 [*Electronics*, Jan. 19, p. 131]. Installation had been slated for last month.

### Computers

#### Maxi activity marks Minis at Fall Joint

Just about everyone concedes that sales of EDP hardware this year are going to be down 7% to 20% from 1969 shipments. The resulting belt-tightening by the industry was evi-

## Electronics Index of Activity

Dec. 7, 1970

After climbing for three consecutive months, the index dropped 3.8 points to 113.3 in October from September's revised 117.1 to settle at its lowest level since February 1966. What's more, the total is off 24.5 points from the year-ago figure.

Defense electronics was the big loser in October, down 7.5 in the month to 116.2, its lowest since April 1966. The drop from October 1969 is 36.2 points. Industrial-commercial activity decreased 2 points for the month to 122.9, some 13.5 index points below the year-ago level.

The only October winner was consumer electronics, up 5 points to 89.7.

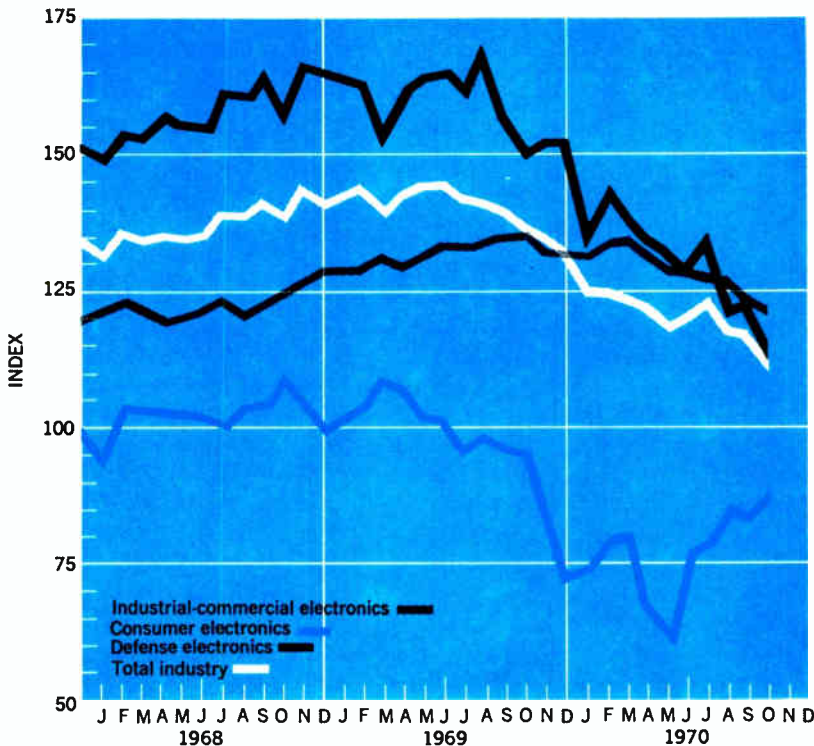

Segment of Industry	Oct. '70	Sept. '70	Oct. '69
Consumer electronics	89.7	84.7	95.0
Defense electronics	116.2	123.7	152.4
Industrial-commercial electronics	122.9	124.9	136.4
Total industry	113.3	117.1	137.8

Indexes chart pace of production volume for total industry and each segment. The base period, equal to 100, is the average of 1965 monthly output for each of the three parts of the industry. Index numbers are expressed as a percentage of the base period. Data is seasonally adjusted. \*Revised.

dent at the Fall Joint Computer Conference in Houston last month as both the number of exhibitors and attendance slipped badly. But the activity in the minicomputer arena bucked the trend.

Not only were there more new companies introducing new machines, but major trends surfaced. One was low-cost peripheral equipment designed specifically for use with minicomputers.

"There are lots of peripherals available now to match the prices of minicomputers, but most of them are just cheap versions of large-system peripherals," says Allen Z. Kluchman, marketing director at Data General. "Nothing has been available with a price-performance ratio approaching those offered by minicomputers themselves," he says. Data General is working on such a line, but Digital Equipment Corp. created a stir at the conference by showing the first of its new line of minicomputer peripherals—a character printer

and a line printer.

The character printer, called DECwriter [*Electronics*, Nov. 23, p. 26], spits out 30 characters per second—three times faster than a model 33 Teletype, but for only \$1,000 more than the \$1,500 Teletype terminal. Seven solenoid-driven wires print the characters in a 5-by-7 dot matrix as stepping motors drives the mechanism along the print line. An LSI read-only memory translates incoming data into the code for the solenoids.

With DEC's new peripherals and a fast-growing software library, vice president Nick Mazzaresse figures he has "all the ingredients to rattle [IBM's] cage."

Even though DEC has delivered "well over 11,000" small computers—in the past 60 days alone it shipped more than 700—the company has never competed in the classic business EDP market. But now DEC is making a "big investment commitment" to get into this end-user market, Mazzaresse says.

DEC's decision to butt heads with IBM—and it won't be the only minicomputer maker to try—signals another significant trend: the expansion of minicomputers from their present applications such as a peripheral or part of another system into a full-fledged stand-alone system for business applications.

Despite the overwhelming number of companies that are now selling minicomputers and the increasing requirements for makers to provide services and software in addition to the processor, there were no signs of a shakeout at the show. "I thought some of these companies would be gone by now," says one official of a large computer maker. "But companies die slowly," he notes. He maintains that even if recent studies are correct in saying there are 100 companies in the minicomputer market, "most of these companies are not for real." Even so, minicomputers were exhibited in dozens of systems.

One company getting into the

business was Ferroxcube Corp. When it found that many of its customers were buying components and adding about the same modifications, the company decided to do the job itself. So Ferroxcube introduced a digital controller made with its standard memory systems, plus a handful of logic cards, together with software to make the controller useful in such applications as process control and communication-line concentration. The FDC-300 controller is priced at \$3,220 in small quantities for 2.5-microsecond cycle time and \$3,620 for a 1- $\mu$ s.

Another new minicomputer exhibited for the first time was Digital Scientific Corp.'s META 4. The machine provides user-alterable microcode capability with read-only memories and has a cycle time of 90 nanoseconds.

### Thinned out

No one really gave the Fall Joint Computer Conference much of a chance to hit its 1970 goals of 310 exhibitors in 1,000 booths and 30,000 total attendance—but it didn't even come close. Exhibitors were canceling space right up to the last minute and the show in Houston's giant Astrodome was marred by gaping holes left by many empty booths scattered throughout the hall.

Some 253 companies did show up and filled 815 exhibit spaces. An estimated 20,500 people registered for the conference, down from 23,000 at the 1969 show in Las Vegas. The drop in attendance was compensated, at least in many exhibitors' minds, by an increase in the quality of the attendance—summed up by one exhibitor as "5,000 less programmers."

The conference is continuing to move toward a stance as an exhibit for the computer industry rather than for end users. More and more booths, including even IBM's, were oriented toward the original equipment manufacturers. This fall's exhibit was right down the alley of the computer system designer, with much of the OEM activity in semiconductor memories.

---

### Commercial electronics

---

#### Quicker pace for slow-scan tv?

No longer confined to military work, narrow-band, slow-scan television is finding its niche between closed-circuit television and facsimile. It can thank new equipment for interconnection with telephone company services and for split-screen or color reception. It has broken into medicine, education, and banking, and may also get into traffic surveillance, Weather Bureau communications, and industrial record transmission.

Despite gradual acceptance of the technique and two recent drop-outs among manufacturers, slow scan's time may have come, says Glen Southworth, president of tiny Colorado Video Inc. (CVI) of Boulder, Colo. And it's all because this technique can now use a wide range of circuits—telephone line, fm subcarrier, satellite, and cable multiplex—while the broadcast spectrum has become more and more crowded. This gives slow scan a longer and more practical range than CCTV and more flexibility than facsimile, he adds.

But the cost of equipment is high—about \$10,000 for a complete one-way system, including standard CCTV cameras and monitors. Another drawback is limited experience in applications other than military, says Richard Schathorst, manager of visual communications for the Communications and Technical Services division of Philco-Ford. Even the installation solely for education at the University of Wisconsin, which launched Westinghouse Learning Corp. into slow-scan broadcast, has not yet attracted other schools.

On the other hand, Southworth anticipates that prices will come down when production requirements increase enough to justify solid state transmitters and receivers. And Schathorst expects the arrival of the Picturephone to make potential users sharply aware of digital video communications.

Among the nonmilitary users is a hospital in Fresno, Calif., which uses CVI equipment to transmit X rays 300 miles to radiologists at the UCLA Health Center. A bank in Denver employs a four-segment split-screen display system for signature verification over a leased phone line; the 3,000-foot hookup costs \$4 a month.

In the planning stage is a slow-scan satellite transmission of instructional programming from Stanford University to Lima, Peru. Also under study are communications links from the U.S. Weather Bureau to television studios, over which weather maps with overlays may be transmitted for copying and rebroadcast. Philco-Ford is looking at the possibility of installing portable slow-scan equipment on the mobile health vans that provide medical care in ghetto neighborhoods. It would transmit color pictures of patients transmitted on police and emergency voice bands to a nearby hospital for consultations.

"Sixty pictures per second is highly wasteful for most television transmission," Colorado Video's Southworth maintains. "Movement is for emotion, still images for learning."

---

### Memories

---

#### Death of 8K stack boosts MOS backers

Potential customers for the 8,192-word hybrid MOS/bipolar memory module introduced by Motorola's Semiconductor Products division at last year's Fall Joint Computer Conference may not be pleased that the firm has changed horses to an all-MOS approach in mid-stream. But one company that couldn't be happier about the move is Advance Memory Systems of Sunnyvale, Calif. AMS happens to be the prime source for the monolithic MOS chip Motorola will use to go after the mainframe memory market. The 1,024-bit-by-1-word dynamic random access memory is the California company's AMS 6001,

# New oscilloscopes from TELEEQUIPMENT



The 54 Series represents a new standard of performance for low priced oscilloscopes.



Telequipment products are backed by a one year warranty, parts support and 26 Tektronix service centers; marketed through 58 Tektronix Field Offices.

For a demonstration or more information call your local Tektronix Field Engineer or write Tektronix, Inc., P.O. Box 500, Beaverton, Oregon 97005.

- **10 mV/cm DEFLECTION FACTOR and 10 MHz BANDWIDTH** permit viewing of low level high frequency signals with good vertical resolution.
- **FET INPUTS** minimize vertical trace drift.
- **TRIGGERED SWEEP**, including TV field or line, so that signals remain stationary with changes in sweep speed.
- **22 CALIBRATED SWEEP SPEEDS** from 0.2  $\mu$ s/cm to 2 s/cm permit analysis of a wide range of frequencies.
- **4-kV CRT HIGH VOLTAGE** which means that the trace is bright.
- **VOLTAGE CALIBRATOR** for verification of the vertical gain.
- **SOLID STATE** for reliability.

The 54 Series are only three of the low-cost Telequipment Oscilloscopes. Many other models are available (priced from \$245), designed by Telequipment specifically for applications where price is a prime consideration.

U.S. Sales Prices FOB Beaverton, Oregon



..... a subsidiary of **Tektronix, Inc.**

which Motorola has designated the MCM 1173L.

Motorola's move has significant implications. Richard Abraham, Motorola's director of integrated circuits, says the hybrid approach was abandoned simply because the monolithic MOS chip is cheaper to produce. That's a strong vote of confidence for all-MOS memories, and a blow to those still espousing hybrid combinations of MOS storage and bipolar drivers.

"MOS was far slower than it is today when the hybrid was undertaken," says another Motorola spokesman, "and we felt the hybrid would be faster. Now we can see that MOS will be at least as fast as what we'd projected [150-nanosecond access time] for the hybrid." Initially, however, Motorola will go with a chip that has an access time between 300 and 400 ns, and a maximum cycle time of 800 ns; indications are that speed will be boosted by follow-on developments.

The 8K stack, as the hybrid unit was called, wasn't without its problems [*Electronics*, Aug. 17, p. 75], but they're typical of new prototype system difficulties "that had not all been solved from a production point of view when the approach was abandoned," say Motorola officials. The beam-lead laminate with face-down bonding to the interconnect pattern has not been retained for the all-MOS RAM, which will use conventional lead bonding in a 24-pin ceramic dual in-line package. "We don't know if we'll ever use the beam-lead laminate or not," says a Motorola source.

**Abraham says** the hybrid effort "was carried through to the prototype stage on the premise that the combined MOS/bipolar hybrid would provide highest speed at lowest cost. Indeed, it was anticipated that speeds approaching those of bipolar memories could be achieved at costs competitive with high-quality core structures. Recent technical developments, however, have altered this evaluation," he notes.

The all-MOS unit is now in prototype production, with sample quantities available. High-volume pro-

duction is expected by February.

The new memory is said to be easily paralleled to increase storage capacity to any desired level by interconnecting the required number of packages on a circuit board. Abraham estimates that the monolithic MOS approach represents a price-per-bit reduction factor of two to three compared to the hybrid unit, whose initial price had been projected at about 10 cents a bit.

Motorola hasn't fixed prices for the MCM 1173L, a p-channel enhancement mode device. AMS, however, sells its unit for \$21 in quantities of 1,000, \$15 in 5,000 lots, \$10 each for the next 10,000 and \$7 each for the next 25,000. That last price works out to less than one cent per bit.

---

### Medical electronics

---

#### Mental ward adapts space age sensor

An exotic electronic sensor and an ordinary stereo receiver appear to have answered the long-standing mental health problem of diagnosing a wildly agitated patient.

The usual procedure in these cases was for doctors to sedate the patient and wait until he settled down before diagnosis began. But in many cases, the powerful drugs turned out to be unnecessary or even to be harmful.

Today, in Agnews State Hospital in San Jose, Calif., schizophrenic patients can be tested immediately via a headset that telemeters brain wave patterns to a computer that can pinpoint disturbances. Once the diagnosis is made, doctors can decide whether to use drugs or some other form of therapy. Previously, says Kenneth Hopkins, a bio-engineer at Agnews, obtaining brain wave patterns entailed shaving the head for electrode contact or inserting EEG needles in the scalp, frequently impossible for a highly agitated patient. For these reasons, plus the fact that the electrode leads also present problems, EEGs often are not taken.

Developed at NASA's Ames Research Center for centrifuge tests, the headset consists of a wire clip fitted with two small electrodes that sense brain waves with no scalp preparation. The headset also contains a 5/8-by-1/2-by-1/4-inch transmitter built out of transistors.

**Brain wave** patterns relayed by a 1-milliwatt dc input transmitter are picked up by a standard fm stereo receiver. A black box built at Ames then discriminates the sub-carrier which carries the data. Brainwave data is received in a tape unit that feeds a computer programmed to distinguish schizophrenic patterns in the mass of brain wave data stimulated by flashing lights in varying patterns in front of the patient.

Richard Westbrook, the headset's developer, says that the headset and discriminator box can be built for around \$450, or even less if the unit were produced in quantity. And if the three-year tests of the device—now nearly half complete—prove successful, Hopkins predicts that the unit will find wide applications. Among the most promising of these, he says, is in long-term monitoring of brain patterns. It may also find use in checking out the degree of disturbance in manic depression and other psychotic disorders. Some members of the hospital research team even predict that it can be used as a research tool with normal people to measure varying degrees of introversion and extroversion.

---

### Air traffic control

---

#### FAA testing farsighted system

Groundwork for an air traffic control system that keeps track of transoceanic aircraft flying far beyond the range of radar is now being laid down in tests at the FAA's Oakland, Calif., Air Route Traffic Control Center. The system, which could maintain surveillance over 40 transoceanic flights from San Francisco to Hawaii once the hybrid aeronautical services satel-



# BUSS

THE COMPLETE LINE OF SIGNAL-INDICATING,  
ALARM-ACTIVATING FUSES AND FUSEHOLDERS

FOR USE ON COMPUTERS, MICROWAVE UNITS, COMMUNICATION EQUIPMENT, ALL ELECTRONIC CIRCUITRY



BUSS Grasshopper Fuse, Visual-Indicating, Alarm-Activating.

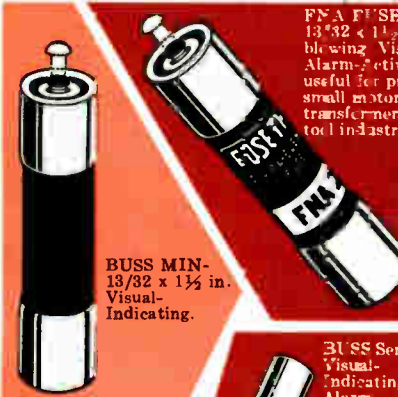

BUSS MIN-13/32 x 1 1/2 in. Visual-Indicating.



FNA FUSETRON Fuse 13/32 x 1 1/2 in. slow-blowing Visual-Indicating, Alarm-Activating. (Also useful for protection of small motors, solenoids, transformers in machine tool industry.)



HPC-C panel mounted holder, visual-indicating, for 13/32 x 1 1/2 in. fuses.



BUSS ACH Aircraft Limiter, Visual-Indicating.



BUSS Series 70. Visual-Indicating, Alarm-Activating. (Used in telephone and similar applications.) Ask for Bulletin 705-C



HLD panel mounted holder, visual-indicating, for 1/4 x 1 1/4 in. BUSS GBA fuses (or GLD fuses) 1/4 to 5 amp.



BUSS GBA-1/4 x 1 1/4 in. Visual-Indicating.

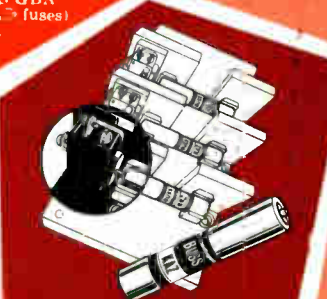

HGC panel mounted holder lamp indicating Military type FHL 12U Single pole for 13/32 x 1 1/2 in. fuses.

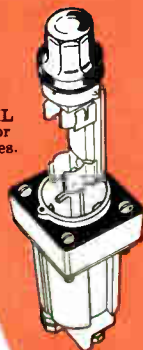

BUSS KAZ Actuator 13/32 x 2 in. Signal-Indicating, Alarm-Activating Device. Use to call attention to the opening of a fuse of 50 amp or larger. Can be mounted "piggy-back" on large fuse or in special block with micro-switch. Ask for Bulletin KAFS.



Signal fuse block No. 3835 for 13/32 x 1 1/2 in. indicating fuse.



HGA-C panel mounted holder lamp indicating Military type FHL10U Two pole for 1/4 x 1 1/4 in. fuses.

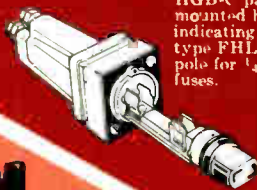

HGB-C panel mounted holder lamp indicating Military type FHL11U Single pole for 1/4 x 1 1/4 in. fuses.

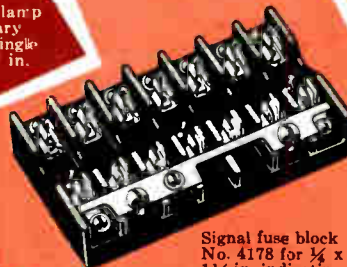

Signal fuse block No. 4178 for 1/4 x 1 1/4 in. indicating fuse.

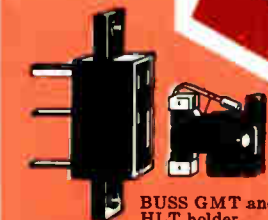

BUSS GMT and HLT holder, Visual-Indicating, Alarm-Activating.



HKA panel mounted holder, lamp indicating, signal activating, for 1/4 x 1 1/4 in. BUSS GLD fuse. 1/4 to 5 amp.



HKL panel mounted holder, lamp indicating, for 1/4 x 1 1/4 in. fuses.

WRITE FOR BUSS BULLETIN SFB

SUPPLIED THE ECONOMICAL WAY  
THRU DISTRIBUTORS  
**BUSS QUALITY**  
FUSES

BUSSMANN MFG. DIVISION,  
McGraw-Edison Co., St. Louis, Mo. 63107

lite is available [*Electronics*, Sept. 28, p. 52], uses readouts from the inertial navigation systems carried aboard some Pan American World Airlines Boeing 747s to maintain fixes on the planes.

Locations of the aircraft are displayed as diamonds on a 21-inch CRT leased from American Data Systems Inc. Altitude, air speed, and identity are shown alongside the diamonds. And superimposed on the display are all the boundaries, aircraft routes, and other background data.

Until the Pacific satellite is launched in 1973, the range of the system will be limited to about 350 to 400 nautical miles—the range of Aeronautical Radio Inc.'s extended range vhf station in San Francisco. This station interrogates transponders aboard the planes. The transponders transmit messages containing location, altitude, air speed and identity data back to the center through the plane's standard vhf set, Arinc says.

**Transponder messages** are transmitted to a tropospheric scatter antenna in Palo Alto, Calif., and are relayed to the San Francisco center. They are processed there by a Honeywell 316 computer and are switched to a Varian 620/I mini-computer that tracks the planes and feeds the data to the display in San Francisco.

When the flight controller wants more information about one of the diamonds representing an aircraft on his display, he initiates a priority interrupt signal via a light pen and function keyboard. The 620/I computer then displays pertinent information about the aircraft.

---

### Consumer electronics

---

#### Antihijack system built around oscillators

How do you thief-proof a truck, especially when it's so easy to jump ignition wires or obtain master keys that unlock almost any vehicle's electrical system?

One way is to put a lock in the transmission as well, which opens

only when it receives electronic signals from the driver's own virtually unreproducible ignition key. This is the system developed by Guardian Electronic Systems, a small Atlanta company that has developed a key with a built-in crystal oscillator. There's a similar crystal, with its center frequency matched to the first to within .005%, down in the transmission. In the same electronics package is a sweep circuit, an instantaneous voltage comparator, and a solenoid tied to a metal pin that sits between the transmission gears to hold them in place. The transmission package is connected to the ignition key by a coaxial cable.

When the ignition key is inserted in the lock, both crystals are swept across their bands by power from the truck's battery. If the two bands match in frequency and amplitude, a signal from the comparator activates the solenoid; the pin is pulled from its position and the truck is free to move.

**But if a key** with the wrong crystal, or without a crystal, is used, or if someone jumps the ignition wires, the pin stays put; the truck cannot move.

The idea for the Frequency Lock System, as it's called, was conceived about four years ago, says Guardian's president Ted M. Margeson. But it was only last year that the system was developed far enough for a trial—in 25 trucks belonging to an Atlanta trucking company. It has been working "even better than expected," says Margeson, who anticipates that his system could be used by approximately 3 million trucks hauling expensive cargoes across the country. Cost of each system, which truck companies could retrofit in their trucks in about 2 hours, is \$200.

As first conceived, the system used a crystal oscillator only in the key, with its output sensed by a filter in the transmission. But it would have been vulnerable to a sophisticated thief with a frequency oscillator, says P.T. Spence of Raftec Inc. of Atlanta, a consulting firm that handled the engineering for Margeson. In the present ver-

sion, only Guardian Electronics knows the frequencies—anywhere from 10 to 100 magahertz—of each ignition key, an oversize device about 0.5 inch wide and 2.5 inches long. Two keys are supplied with each system; if one is lost it can be replaced only by Guardian.

**Guardian assembles** the printed circuit board containing the electronics package. It buys the keys, special ignition housings, and coaxial cables from outside suppliers. The electronics includes off-the-shelf silicon integrated circuit operational amplifiers for the comparison and decision-making functions, and discrete components for the sweep circuit. The encapsulated package will operate in temperatures ranging from  $-40^{\circ}\text{F}$  to  $+180^{\circ}\text{F}$ .

Next applications Guardian has in mind are for locking the doors on those huge cargo-carrying truck trailers, and for locking the trailers so they cannot be moved.

---

#### Paddle wheel design ends switcher problems

When engineers at the Ampex Corp.'s Video Products division set out to design a new video switcher for commercial television stations, they had to contend with a packaging problem. The switcher, basically a matrix of inputs and outputs, enables any camera to connect with any tape recorder in any studio—in effect, it's a switchboard for television signals.

In past designs, all the video lines were on parallel paths. A signal would come in through the back of the unit, go up, down, around, and out again through the back. This created many parallel paths that caused crosstalk interference and the long paths affected system gain.

But by going to a paddle wheel design, most of the problems were eliminated. The basic switcher characteristics are determined by a summing bus—the line that ties all the signals together. In the old version, the summing bus was about 10 feet long. In the paddle

# New, Rugged 5kW Magnetron for Microwave Heating

This F 1123 Magnetron tube is a microwave source specially designed for industrial heating. It delivers a typical CW power of 5 kW at a fixed frequency between 2430 and 2470 MHz. The output connector doesn't require cooling and allows easy coupling to the wave guide RG 112/U or coaxial 1½". The tube, which features an impregnated-type cathode, utilizes only a small amount of filament power. It is usually built with an integral magnet, but may be fitted with an electromagnet for particular requirements.

Magnetron tubes used in microwave heating offer the advantages of speed, even heating, con-

trollability and efficiency. Today they are being increasingly used for moisture removal, chemical changes, and biological changes in a growing number of industrial processes. For information, use Reader Service Card or contact us directly.

#### TYPICAL OPERATION

Heater voltage (V) .....	0
Cathode voltage (kV) .....	5.2
Cathode current	
—Average current (A) .....	1.5
—Peak current (A) .....	3.2
Power output (kW) .....	5.0
Efficiency (%) .....	65
VSWR .....	1.1

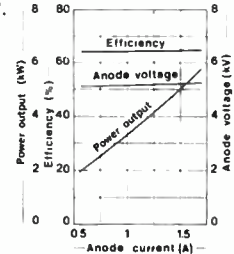

**THOMSON-CSF**

Thomson-CSF Electron Tubes, Inc./50 Rockefeller Plaza/New York, N.Y. 10020/(212) 489-0400

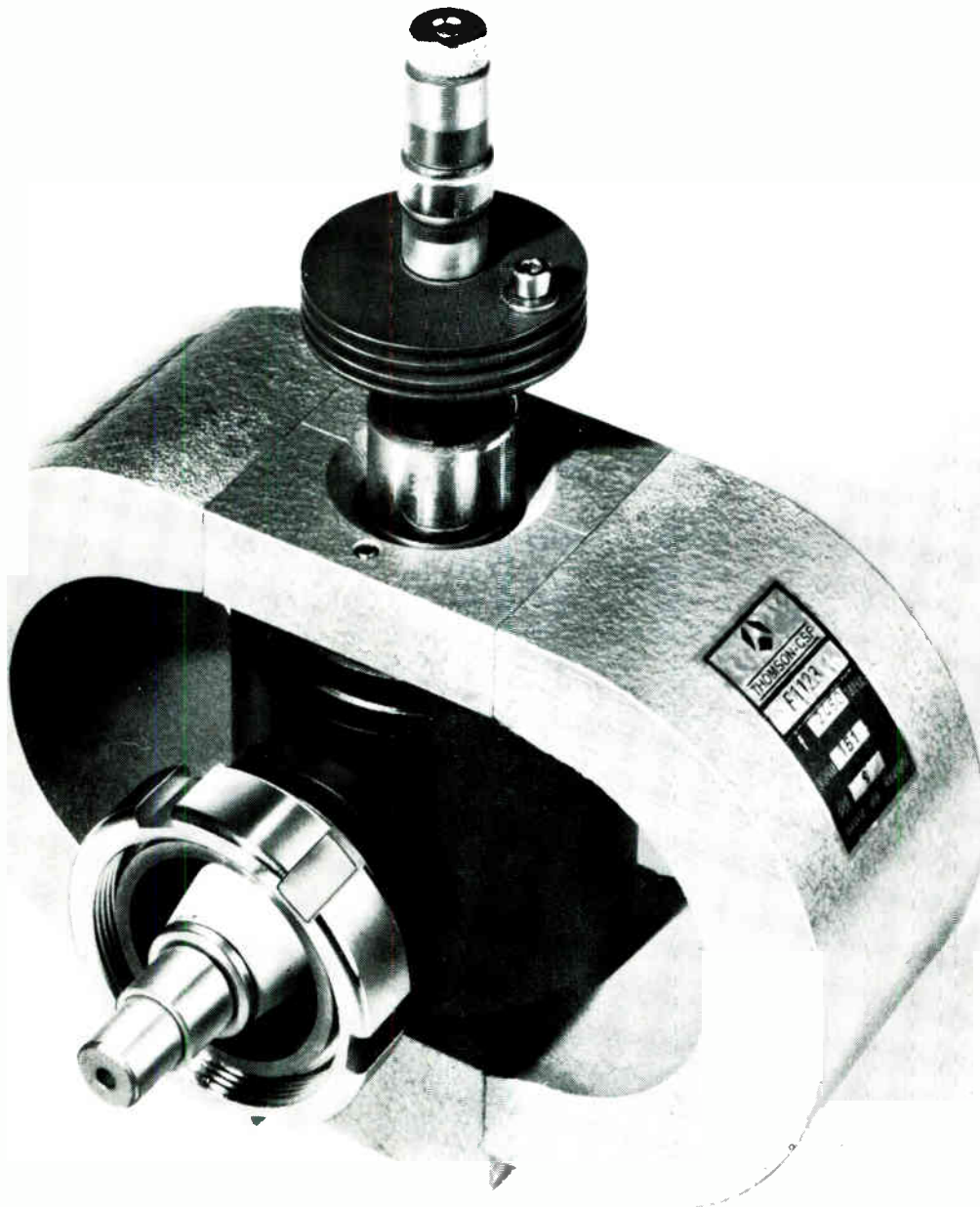

wheel, it's down to only 10 inches. All the switching amplifiers are on pc cards that plug into a central core that serves as the summing bus. Signals come in from the outside edge of a card, go into the bus, and emerge on the outside edge of another card. This way, parallel paths are eliminated and almost all the video paths are the same length, eliminating any timing problems that may have been caused by varying path lengths.

As an example of the improved specifications, Ken Lauth, the paddle wheel's designer, says crosstalk has been reduced from 60 decibels to 66 dB. Differential gain has been cut from 1% to 0.15%, and differential phase has been pared from 0.5% to 0.05%. "And it's all due to the central core," says Lauth.

---

### Solid state

---

#### Can smog cause shorts?

#### ITT seeks the answer

The National Air Pollution Control Administration, as part of its mandate to determine how air pollution affects the U.S. economy, is trying to determine what, if any, effects smog has on electronic components. Under a \$32,210 contract, the International Telephone and Telegraph Co. is surveying component makers and users, including the Federal Government, to assess air pollution costs and damage to electronic components, and to determine which devices are most affected.

The award to ITT's Electro Physics Laboratory, Bladensburg, Md., though small, could turn up the reasons for high failure rates in some components. Also, by pinpointing the areas most susceptible, it may induce manufacturers to make changes in design and packaging.

As one example of what can happen to electronic gear after being exposed to smog, ITT cites an example involving a printed circuit board. The board is supposedly isolated from contact with dirty air, but sulfur dioxide—one of the most

noxious pollutants—can reach it, oxidize to form sulfur trioxide, then form sulfuric acid—an electrolyte. The electrolyte conductor can form a new current path, which would very likely cause the mother board to short out. Though the odds against this chain of events probably are quite high—ITT is still compiling statistics—it takes only one SO<sub>2</sub> particle to start the process.

SO<sub>2</sub> also can cause corrosion in relays, switches, and contacts. It causes contact pitting, wear, and polymer film buildup, ITT says. Ironically, in one case cited, the film buildup caused by SO<sub>2</sub> reduced contact pitting.

**Smog effects** are not limited to relays, switches, contacts, and other relatively exposed devices, but can also affect hermetically sealed components. ITT says particles that can ionize and produce electrolytes can affect any component, especially those which use surface properties. These are especially vulnerable to ash and carbon deposits. Semiconductors of germanium and silicon, for example, could be affected by deposits when their surfaces are disturbed, and the proper bond for operation is not created.

---

### For the record

---

**Northrop threat?** Selection of Northrop Corp.'s F-5-21 twin-engine fighter by the Pentagon as the international fighter aircraft, America's \$2 million-plus competitor in the Western world's air defense market, is viewed by some ranking Air Force officials as an indirect threat to its F-15 air superiority fighter contracted to McDonnell Douglas. Should the Nixon Doctrine—limiting future aid to friendly nations to military hardware—be rigidly applied, the Air Force need for F-15s—roughly five times more expensive than Northrop's GE-powered jet—could decline in proportion to increased F-5-21 production, say sources. This Air Force concern reportedly was a major factor in the months-long delay in selecting an IFA contractor.

With its initial \$21 million award,

Northrop defeated LTV's modified F-8 entry as well as McDonnell Douglas' stripped F-4 and Lockheed's F-104. While USAF staff chief Gen. John Ryan made a point of noting he preferred another competitor's entry to Northrop, sources say he was not referring to LTV's V-1000 Voodoo, as reported, but rather to the F-4—a plane on which USAF presumably could recoup some of its investment later with foreign sales from inventory as the F-15 is deployed.

Avionics for the F-5-21 remain to be selected, but competition is expected from original suppliers to the builder, including Martin Marietta for communications transmitter (AN/ARW-77); Magnavox for the radio and command uhf (AN/ARC-34B); Hoffman Electronics for the tactical air navigation system (AN/ARN-65), and Hazeltine for the IFF system (AN/ARX-46). Garrett-AiResearch built the central air data computer in the Canadian version of the original, although other competitors have surfaced for this system.

**Changing signals.** Rule changes that would permit nonvoice systems to operate on land mobile frequencies are under serious consideration by the Federal Communications Commission. In a rule-making notice, the FCC says nonvoice signaling techniques appear to be quicker and less repetitious than voice communications in certain specialized uses. Thus, nonvoice uses could be used to cut down increasing congestion in the land mobile frequencies. The suggested rule changes would limit nonvoice transmission to no more than two seconds and require that licensees have a primary voice requirement.

In other action, the FCC is giving CBS, NBC, and ABC affiliate associations until Jan. 5 to file an application for a prototype receiver-only earth station using the 4- and 6-gigahertz bands. The decision also gives the affiliates an additional month past the deadline to work up their proposals. The commission says any other applicants that can prove they are faced with



# RADIATION RESISTANT NPN SILICON POWER TRANSISTORS!

Solitron offers a complete line of Radiation Resistant NPN Silicon power devices with capabilities to 90 Volts and peak current to 25 Amps. Standard hi-rel types are clearly indicated on the specification chart. Additional hi-rel versions of these types and specialized designs to customer requirements are also available.

Contact us today for engineering and application assistance and a free copy of Solitron's Radiation Hardened Silicon Power Transistor Manual.

SOLITRON TYPE NUMBER	CASE TYPE	V <sub>CBO</sub> V	V <sub>CEO</sub> V	I <sub>C</sub> A	P <sub>T</sub> 25°C CASE W	PRE RADIATION			POST RADIATION			J-C °C-W
						I <sub>C</sub> A	h <sub>FE</sub> ⊖ — (min)	V <sub>CE(s)</sub> Δ V(max)	I <sub>C</sub> A	h <sub>FE</sub> ⊖ — (min)	V <sub>CE(s)</sub> Δ V(max)	
2N5527	TO-5	60	40	5	5	3	40	1	3	15 ⊖	2 ⊖	15
SDR2710	MT-27	60	40	5	7.5	3	40	1	3	15 ⊖	2 ⊖	15
2N5528	TO-59	60	40	10	35	3	40	1	3	15 ⊖	2 ⊖	3.5
SDR2711	TO-60	60	40	10	35	3	40	1	3	15 ⊖	2 ⊖	4
2N5529	TO-61	60	40	10	35	3	40	1	3	15 ⊖	2 ⊖	2.5
2N5530	TO-61*	60	40	10	35	3	40	1	3	15 ⊖	2 ⊖	3
2N5531	TO-5	90	75	5	5	3	30	1	3	7 ⊖	3 ⊖	15
SDR2712	MT-27	90	75	5	7.5	3	30	1	3	7 ⊖	3 ⊖	15
2N5532	TO-59	90	75	10	35	3	30	1	3	7 ⊖	3 ⊖	3.5
SDR2713	TO-60	90	75	10	35	3	30	1	3	7 ⊖	3 ⊖	4
2N5533	TO-61	90	75	10	35	3	30	1	3	7 ⊖	3 ⊖	2.5
2N5534	TO-61*	90	75	10	35	3	30	1	3	7 ⊖	3 ⊖	3
2N5535	TO-61	60	50	25	50	5	50	1	5	15 ⊖	2 ⊖	2.5
2N5536	TO-61*	60	50	25	50	5	50	1	5	15 ⊖	2 ⊖	3
2N5537	TO-61	90	75	25	50	5	40	1	5	10 ⊖	2.5 ⊖	2.5
2N5538	TO-61*	90	75	25	50	5	40	1	5	10 ⊖	2.5 ⊖	3
SDR2720	TO-61	60	50	25	50†	10	40	1	10	10 ⊖	2 ⊖	2
SDR2721	TO-61*	60	50	25	50†	10	40	1	10	10 ⊖	2 ⊖	2
SDR2722	TO-61	90	75	25	50†	10	40	1	10	10 ⊖	3 ⊖	2
SDR2723	TO-61*	90	75	25	50†	10	40	1	10	10 ⊖	3 ⊖	2
SDR2730	TO-61	60	50	25	50†	5	60	0.5	5	12 ⊖	2.0 ⊖	2
SDR2731	TO-61*	60	50	25	50†	5	60	0.5	5	12 ⊖	2.0 ⊖	2
SDR2732	TO-61	90	75	25	50†	5	60	0.5	5	7 ⊖	2.5 ⊖	2
SDR2733	TO-61*	90	75	25	50†	5	60	0.5	5	7 ⊖	2.5 ⊖	2

Base Width ≈ 0.6 microns. \*With isolated collector. All other TO-61 packages with collector connected to case. ⊖ VCE = 5V.

Δ IC/IB = 5. ⊖ ⊖ = 1 x 10<sup>14</sup> n/cm<sup>2</sup>. ⊖ ⊖ = 3 x 10<sup>14</sup> n/cm<sup>2</sup>. P<sub>T</sub> (i 100°C case).

Dial 1-800-327-3243 for a "No Charge"  
telephone call and further information



## Solitron

### DEVICES, INC.

1177 BLUE HERON BLVD. / RIVIERA BEACH, FLORIDA (305) 848-4311 / TWX: (510) 952-6676

Solitron is next door to you . . . in Baltimore (301-243-0060) • Canoga Park, Calif. (213-833-3822)  
Chicago (312-824-8127) • Dallas (214-341-1180) • Needham, Mass (617-444-1152) • and Tappan, N.Y. (914-359-5050)

• EUROPE: Solidev Ltd., Tubbs Hill House North Entrance, London Road, Sevenoaks, Kent, England, TEL: (0732) 57541-2-3

• ISRAEL: A.E.L. Israel Ltd., 51 Hayarkon Street, Bene Baraq, TEL: 78-21-41

• JAPAN: Matsushita Electric Trading, 5 Chrome Kawamachi, Higashi-Ku, Osaka

TEL: (06) 202-1221 or World Trade Centre Bldg., No. 5, 3-Chrome, Shibahamamatsu-cho, Minato-Ku, Tokyo, TEL: (03) 435-4501

# SCIENCE / SCOPE

The first Intelsat IV communications satellite has been readied for delivery to Comsat by Hughes, prime contractor to the International Telecommunications Satellite Consortium (Intelsat) and is scheduled for launch this winter. The 17½-foot-high satellite will be capable of relaying 3,000 to 9,000 two-way telephone calls, depending on the mode used, or 12 color television programs, or any combination of communications including data and facsimile, from its synchronous orbit 22,300 miles above Earth. Intelsat recently contracted with Hughes for four additional satellites, making a total of eight.

Los Angeles' overburdened communications system is under the scrutiny of aerospace technology. A team of Hughes scientists is at work on a special study aimed at giving the city's emergency services -- police, fire, and ambulance -- a modern command-and-control system. They are evaluating the efficacy of equipping all police vehicles and control centers with electronic devices that would make it possible to determine every vehicle's location almost instantaneously in order to speed the nearest patrol car or cars to respond to a specific situation.

A temperature/humidity infrared radiometer (THIR) for the next two versions of NASA's Nimbus weather satellite is being built by Santa Barbara Research Center, a Hughes subsidiary. The THIR is a two-channel, high-resolution scanning radiometer which measures the earth's terrestrial, cloud, and atmospheric radiation to provide day-night cloud maps and moisture distribution on a global basis. The timely information it will provide on storm buildups and movements is expected to aid in weather forecasting.

A new insulation to shield wiring from high heat has been developed by Hughes research chemists for the U.S. Air Force Materials Laboratory. Electrical wiring coated with the polymeric material can withstand temperatures of 600°F. indefinitely -- or 700°F. for short periods -- without degradation or danger of fire. The new material, in development for nearly two years, also seals wire against the effects of moisture and air and maintains its flexibility down to -100°F.

Needed at Hughes: analog and digital circuit designers experienced in the design of digital-to-synchro and synchro-to-digital converters, feedback amplifiers and active filters, and high-speed digital equipment using LSI/MSI techniques for radar signal processing. Also: logic designers for display applications; microelectronic applications engineers with thick- and thin-film hybrid circuit design experience. EE degree and U.S. citizenship required. Please write: Mr. R. S. Roth, Hughes Aircraft Company, P. O. Box 3310, Fullerton, Calif. 92634. Hughes is an equal opportunity employer.

A supersensitive level sensor invented by a Hughes scientist is so accurate that it could level an imaginary beam 100 miles long to within 1/32-inch of true level. It is now being used by various government and private agencies in tilt measuring instruments, leveling systems, and level reference bases. At Hughes, for example, the sensor holds a 3600-pound granite block level for 15 hours during the final testing of accelerometers for the inertial guidance system of the U.S. Navy's Poseidon missile -- despite vibrations, temperature variations, tides and earth tremors.

Creating a new world with electronics



## Electronics review

a hardship situation can get an extension to prepare a filing for satellite use of the bands.

**Bendix buys.** Logitron Inc., the Cambridge, Mass., maker of portable CRT computer terminals [*Electronics*, Nov. 24, 1969, p. 123], was acquired by Bendix "for an undisclosed amount of cash" only after the 18-month old company was virtually folding up and unable to deliver on a Bendix order. As a Bendix subsidiary, Logitron will be revitalized under the direction of C.B. Sung, Bendix vice president in charge of the Advanced Technology group.

**Johnson declines.** Controversial FCC commissioner Nicholas Johnson has rejected, as predicted, the AT&T petition that he disqualify himself from all commission actions affecting the carrier because of an alleged bias against the company [*Electronics*, Nov. 23, p. 91]. Johnson's 34-page brief rejecting the bias charge contends that public officials should be free to comment on issue that come before them, provided such comments don't prejudice specific cases still pending. FCC counsel Richard Wiley sided with Johnson, saying in effect that AT&T's charge was too broad to permit "determination on the merits." Nevertheless, the full commission still may review the petition. And in any event, AT&T still has the option to appeal to the courts any unfavorable future decisions in which Johnson takes part.

**Getting ready.** General Electric is going ahead with its fourth South Carolina plant—a \$25 million, 340,000 square-foot operation—which will produce mobile communications equipment. Output of the Florence plant, part of Richard P. Gifford's Communication Systems division, is planned to meet a mobile radio market which GE forecasts will double in the next decade from the present 3 million units now licensed in the U.S.

**Bright touch.** Low-light-level television is shortening the test cycle

for the imaging X-ray telescope scheduled to fly aboard NASA's Skylab satellite in 1972. The camera, which uses a Westinghouse secondary electron conduction (SEC) tube, compensates for the weakness of laboratory X-ray sources used in testing the telescope. In operation, the telescope will image soft X rays from the sun onto photographic film.

**Courtin'.** Massachusetts should more actively court IBM and RCA in a move to create 25,000 new jobs for unemployed aerospace workers, says Arthur D. Little Inc. in a report to that state's Department of Commerce. Little also suggests that the state use legislative tactics to encourage the growth of the biomedical instrumentation and pollution monitoring and control industries.

Makers of computer peripherals now employ 5% of the state's labor force. Little figures that by 1975 the industry could double that percentage by getting at least one key IBM facility and more of RCA's computer plant investment.

**Medical economics.** The Department of Defense could shave at least 10% from its hospital operating costs by increasing automation in laboratories and radiology departments and using computer-assisted planning in the design of facilities, two study contractors say. Initial research indicates cuts could be achieved if computerized planning and diagnostic automation were coupled with self-help beds and convenience food systems, report Westinghouse Electric Corp. and Arthur D. Little Inc. in studies prepared under Pentagon contracts. Final reports are due in January.

**Home movies for EVR.** CBS Laboratories has developed a camera that will permit home movies and stills to be made on standard Super 8 film that can be processed for EVR television viewing. Users can shoot on inexpensive black-and-white film and get color coding in the finished prints thanks to an optical element in the camera.

# How did Hughes get a reputation for innovation?

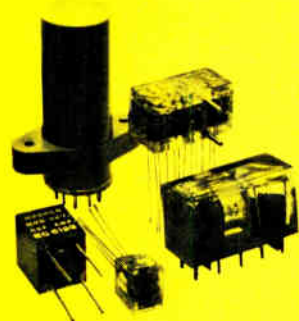
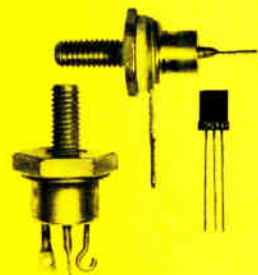
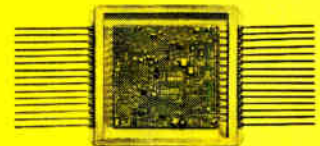

## That's how

A reputation from technical know-how in developing better MOS devices (RS 283), bipolar and hybrid circuits (RS 284), discrete devices and monolithic circuits (RS 282), frequency control devices (RS 285), and special assemblies (RS 286).

### HUGHES

HUGHES AIRCRAFT COMPANY  
INDUSTRIAL ELECTRONICS GROUP

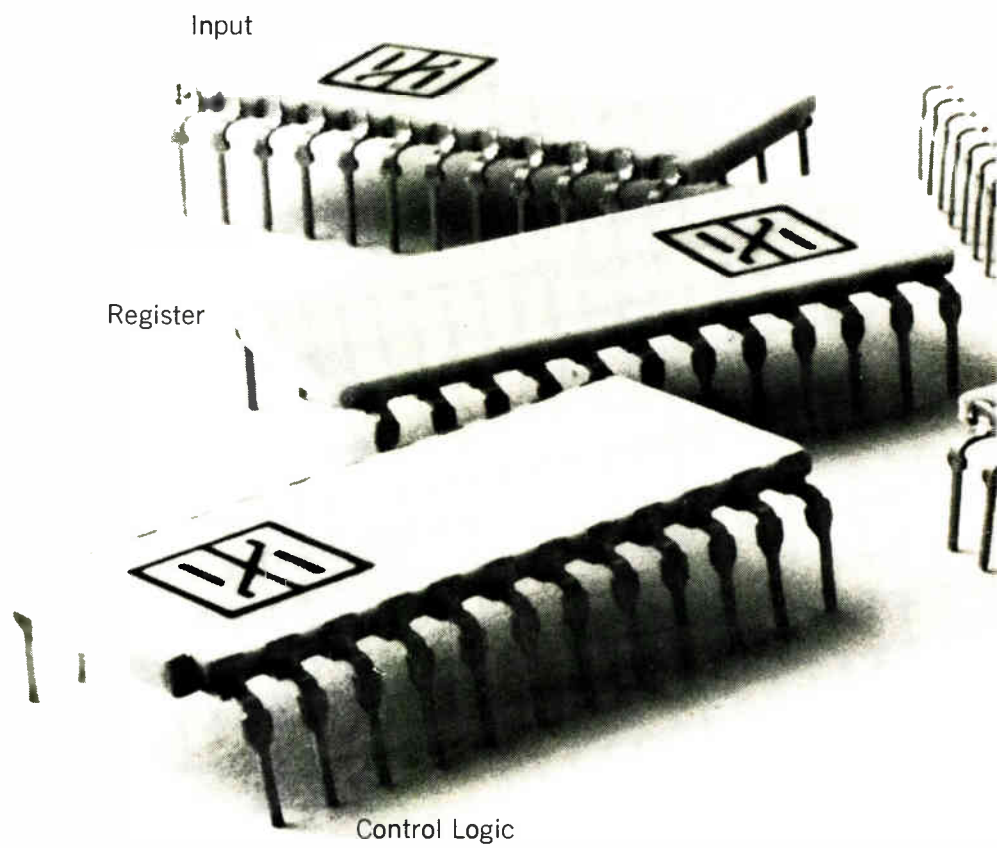

Input

Register

Control Logic



# \$119.04\* buys you a quarter of a million dollars in calculator circuit development.



While you're trying to one-up the competition on the drawing board or in the lab, he may already be on the market establishing a position with a low cost, available calculator. Electronic

Arrays can save you a bucket of money, one year in development time, and put you ahead in the calculator ballgame with an MOS/LSI calculator circuit set.

The set consists of six MOS/LSI circuits in 24 pin dual-in-line hermetic packages providing the functions to add, subtract, multiply and divide.

The circuits are in volume production, yet offer the user flexibility in design.

Your proprietary advantages can be maintained through selection of the display system, case design and unique microprogramming to implement additional functions such as square, square root, trigonometric functions and additional memory.

Character generators are also available in ROM form for graphic displays. And this is just the beginning; many other features are possible.

The circuits are not limited to calculator application—they can be utilized in many digital systems requiring real-time data reduction.

They are on the shelf—now.

Available in volume—now.

Rapid turn-around on custom adaptations.

Write or call your EA representative for a copy of our 12 page brochure describing the set in detail.

## electronic arrays, inc.

501 Ellis Street, Mountain View, California 94040  
Telephone: (415) 964-4321 TWX: 910-379-6985



\*100 set price

Microprogrammed ROM



Output

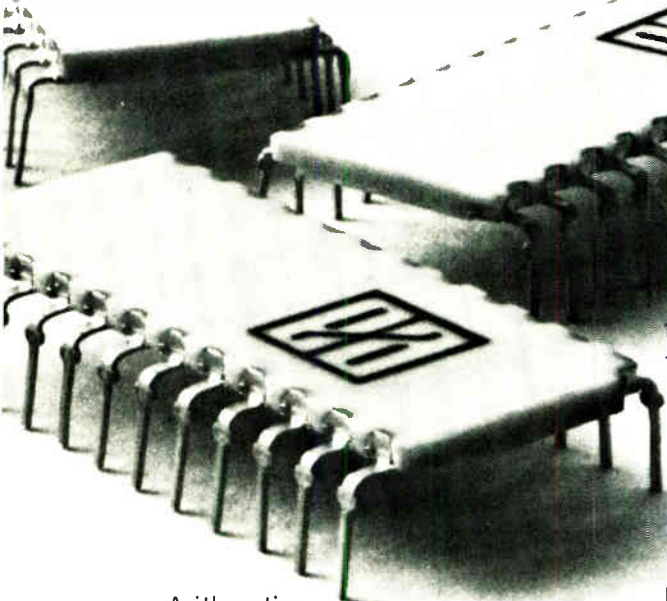

Arithmetic

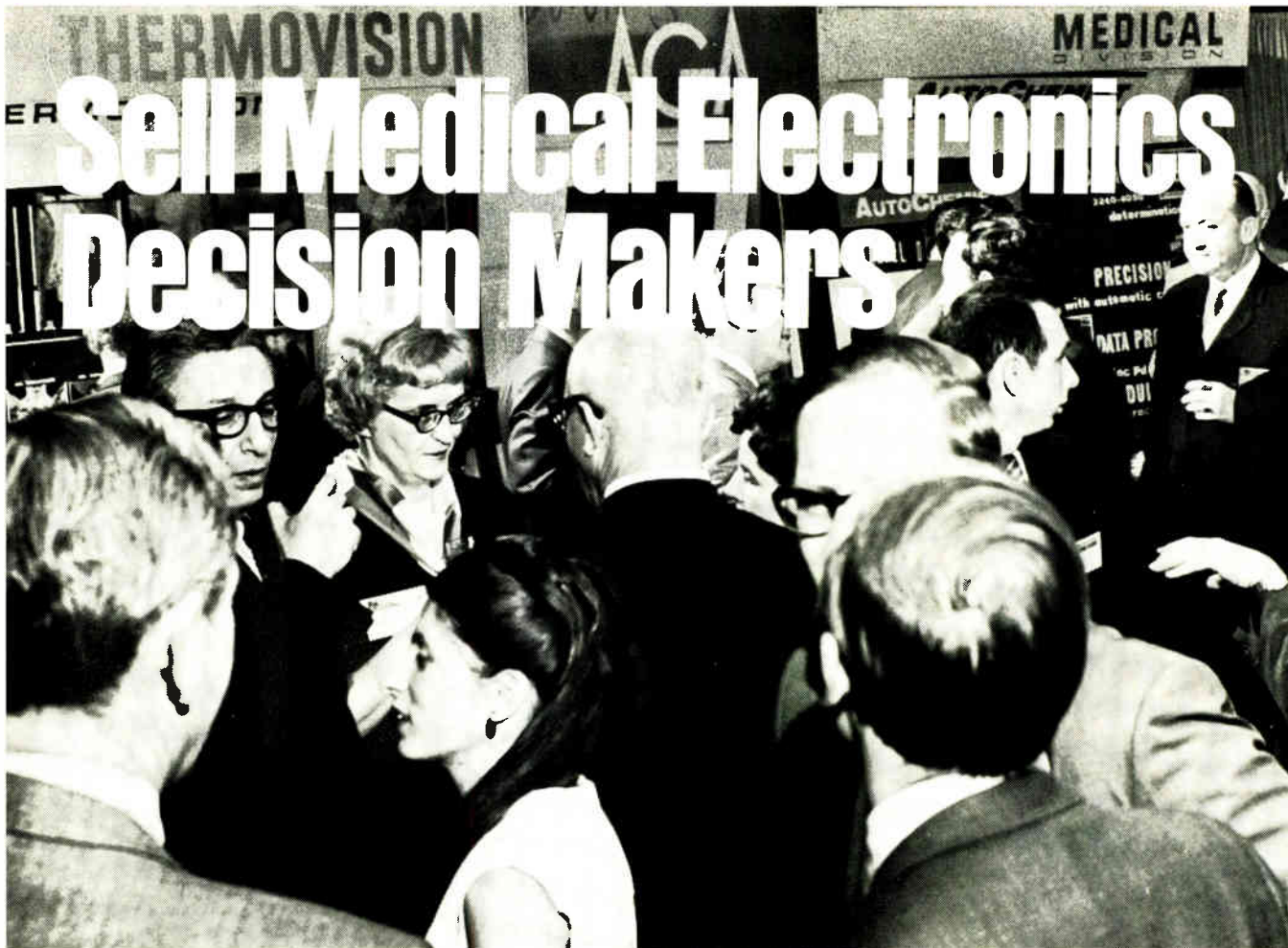

# Sell Medical Electronics Decision Makers

The ELECTRONICS IN MEDICINE Conference & Exposition is different. Unlike every other medical show, it concentrates solely on medical electronics. It brings together only the manufacturers of medical electronics gear and the buyers and specifiers of such equipment—physicians, hospital administrators, biomedical engineers, educators, researchers and system design engineers.

## Effective Sponsorship

ELECTRONICS IN MEDICINE is co-sponsored by Medical World News, Modern Hospital, Postgraduate Medicine and Electronics. The combined know-how and circulation of these major publications assure exhibitors of a highly qualified national audience.

## On-Target Conference

A carefully crafted series of sessions, designed to attract only buyers and specifiers of medical electronics equipment and services, will be created by the editors of the co-sponsoring publications in conjunction with Dr. John Truxal, Institute Professor, Polytechnic Institute of Brooklyn. Dr. Truxal has long been concerned with the inter-play of engineering with biology and medicine and chaired a committee of the National Academy of Engineering on that topic.

## Aggressive Promotion

The conference and show will be broadly promoted by the co-sponsoring publications, which have a combined

circulation of 400,000. A massive direct mail campaign and public relations campaign will be undertaken. Full page ads, well in advance of the event, will appear in all magazines. Direct mailers will repeatedly find buyers and specifiers wherever they work—hospital, private or group practice, clinic, research lab, and university.

## Exhibitors Sell

The 3rd National Conference & Exposition on ELECTRONICS IN MEDICINE will enable you to find and sell new customers, expose current customers to your new products, create impressive lists of new, valuable contacts and create significant penetration of this burgeoning multi \$million market.

## Reserve Your Booths Today

There is no premium on corner or upfront booths. Excellent locations, at no extra cost, will go to those firms which act promptly.



## 3rd National Conference & Exposition on Electronics in Medicine

Sheraton Boston Hotel / John B. Hynes Civic Auditorium  
April 13-15, 1971

For space reservations, information:

Steve Miller, Exhibit Manager, National Expositions Company, Inc., 14 West 40th Street, New York, N. Y. 10018 • 212/564-8714.



MOS TECHNOLOGY, INC.

washes cleaner.  
travels safer.  
traps burglars.  
tests drunkards.  
takes inventory faster.  
and makes beautiful music.

Some baby, this infant technology, with its rugged, durable offspring that weighs next to nothing, needs so little space and costs so little money! Every day it's doing something new . . . finding its way into automatic washers, audio synthesizers, burglar alarm systems, drunkometers, inventory control systems . . . even juke boxes! MOS TECHNOLOGY has found a way to mate its infinite possibilities with complete photomask operations, computer-aided design and test techniques, continuous calibrated process, in an environmental and dust-controlled facility to produce a mature, quality product! MOS — the powerful, versatile, highly adaptable and economical brainchild of MOS TECHNOLOGY, INC.

WE'VE TURNED  
A TECHNOLOGY  
INTO A COMPANY



VALLEY FORGE INDUSTRIAL PARK, VALLEY FORGE, PA. 19481 (215) 666-7950

*A Proud Affiliate of Alcoa-Bradley Co.*

**EASTERN REGION**

Mr. Bill Whitehead, Sales Director, MOS Technology Inc., 88 Sunnyside Blvd., Suite 307, Plainview, N. Y. 11803 • 516-822-4240 • REPRESENTATIVES — Michael Scott Co. Inc., 20 Walnut St., Wellesley Hills, Mass. 02181 • 617-235-0102 • Ossmann Component Sales Corp., 280 Metro Park, Rochester, N. Y. 14623 • 716-422-3290 • Bob Jackson, Mfr.'s Rep., P.O. Box 17484, Charlotte N. C. 28211 • 704-366-6678 • Falk-Baker Associates, 382 Franklin Ave., Nutley, N. J. 07110 • 201-661-2430 • Atlantic Component Corp., 1331 Harbor Lane Dr. Largo, Fla. 33540 • 813-584-8257 • C. H. Newson & Associates, Inc., 711 Bethlehem Pike, Philadelphia, Pa. 19118 • 215-248-3377.

**CENTRAL REGION**

Mr. Al Mattal, Sales Director, MOS Technology Inc., 10400 W. Higgins Rd., Suite 631, Rosemont, Ill. 60018 • 312-298-2035 • REPRESENTATIVES — Norvell Associates, P.O. Box 20279, Dallas, Texas 75220 • 214-357-6451 • John Grey Associates, 3957 Denley Ave., Suite 206, Schiller Park, Ill. 60176 • 312-671-3258 • Hastings Inc., 249 Winding Way, Dayton, Ohio 45429 • 513-771-5674 • Special Electronic Sales, 8053 Bloomington Freeway, Bloomington, Minn. 55420 • 612-884-4317 • Harlan J. Weisler & Associates, Inc., 2050 Woodson Rd., St. Louis, Mo. 63114 • 314-428-3934 • R. C. Merchant & Co., Inc., 18411 W. McNichols, Detroit, Mich. 48219 • 313-535-6000.

**WESTERN REGION**

Mr. Jack Turk, Sales Director, MOS Technology Inc., 2172 Dupont Dr. (Patio Bldg.) Suite 221, Newport Beach, Calif. 92660 • 714-833-1600 • REPRESENTATIVES — Hunter Associates, 1208 Fox Plaza, San Francisco, Calif. 94102 • 415-626-8576 • W. B. Knight Co., Inc., P.O. Box 400, 112 Glasgow Ave., Inglewood, Calif. 90301 • 213-678-4711 • J. A. Tudor & Associates, Inc., 2605 Western Ave., Seattle Wash. 98121 • 206-682-7444 • Checkmate Sales, P.O. Box 22411, Denver, Colo. 80222 • 303-771-4920 • Toward Engineering Associates, Inc., P.O. Box 15268, Arcadia Station, Phoenix, Ariz. 85018 • 602-955-3193.





## No. 1: The 24-Second Q Meter

Think back to the last time you used a Q Meter. It was probably an ancient-looking monster that you couldn't operate without studying a manual. A lot of cumbersome controls took strength and patience to manipulate. Once you got the hang of it, you still had to spend about a minute to get a reading... and then, you had to multiply that reading by another to get the answer you were looking for.

No more. Now, there's HP's 4342A—the Q Meter that lets you take readings in 24 seconds or less, start-to-finish. A single indicator gives you Q directly, over a

range from 5 to 1000; there's no Q-multiplier to contend with. Fingertip controls let you choose any frequency from 22 kHz to 70 MHz—a wider range than ever before. Likewise, you can select L, C, or  $\Delta C$  scales effortlessly, in seconds.

The 4342A is just one of HP's family of "Useables"—easy-to-use instruments for testing components. For further information on the 4342A, or on any of the "Useables," contact your local HP field engineer. Or write Hewlett-Packard, Palo Alto, California 94304. In Europe: 1217 Meyrin-Geneva, Switzerland.

HEWLETT  PACKARD

091/8

COMPONENT-TESTING INSTRUMENTS YOU CAN USE

# The Useables:



No. 1: 4342A Q Meter. No. 2: 4270A Automatic Capacitance Bridge. No. 3: 4328A Milliohmmer. No. 4: 4329A High Resistance Meter. No. 5: 4260A Universal Bridge. No. 6: 4470A Transistor Noise Analyzer.

Circle 50 on reader service card

---

# Washington Newsletter

---

December 7, 1970

## Nixon 1972 budget delayed . . .

The new Congress is not likely to convene before the third week in January, perhaps later, giving embattled Nixon Administration economists two or three extra weeks to pull together the fiscal 1972 budget. By law, the President must submit his budget within 15 working days after Congress convenes, usually the first week in January. But the outgoing lame duck session expects to work until nearly Christmas, with the new Congress postponed. One Office of Management and Budget staffer says the extra time will be required to put finishing touches on a budget that will bolster the national economy enough to enhance President's Nixon's 1972 re-election chances without "booming the economy so we get into another inflationary spiral."

## . . . but DOD buys unchanged

The OMB considers that, in the words of one official, "defense is our biggest spending problem" because the high-technology aerospace and electronics companies are "among the hardest hit by unemployment, but big defense spending increases are politically unpopular." Procurement, he believes, will remain essentially unchanged at \$19 billion-plus with most military spending increases going for previously ordered civilian and military pay increases. But program priorities will be altered, with new strategic systems getting top priority.

## Sikorsky challenges Army's revival of Cheyenne gunship

Sikorsky Aircraft, never very subtle about promoting its privately developed twin-turbine S-67 Blackhawk as a substitute for the canceled Lockheed AH-56 Cheyenne helicopter gunship, is now very nervous about Army plans to revive the Cheyenne for ground support, primarily in an antitank role. In reaction, Sikorsky flew an S-67 to the Pentagon's helipad for first-hand DOD evaluation and a high-level management marketing pitch. Of significance to avionics makers is that, unlike the Cheyenne's rich load of electronics, the S-67's avionics can be tailored to fit budget needs.

Sikorsky claims its craft set an unofficial helicopter speed record of 225.4 miles per hour in a routine flight test last month. And, says Wesley A. Kuhrt, president of the United Aircraft division, the Blackhawk can save "more than \$1 million per unit over equivalent systems"—a thinly veiled allusion to Cheyenne—and can "ultimately save the taxpayer half a billion dollars" on a production buy of 400.

Though the Army Materiel Command still wants to salvage its investment in Cheyenne, Sikorsky is counting on convincing top DOD management that its bird is superior with its "combination of proven technology . . . and without much of the sophisticated equipment which has been driving costs up and out of sight."

## Defense critic seen leaving Treasury

Murray L. Weidenbaum, the Treasury Department's Assistant Secretary for Economic Policy who has been a long-time critic of the defense electronics and aerospace industries, reportedly will leave the Administration on the heels of his boss, Secretary David Kennedy. Reports of Weidenbaum's personal plans to depart are said to be unrelated to his latest blast at industry's inability to convert from defense to environmental systems contracting. Emphasizing that he spoke for himself and

---

# Washington Newsletter

---

not the Administration, Weidenbaum told a House subcommittee that he rejects the concept that "industry can convert in a very short time to environmental needs, so let's not spoon feed them contracts." Weidenbaum says his "most basic criticisms relate to the naivete of industry personnel which led them to think they could blithely apply the so-called systems approach as readily to social, political and economic questions as they had to military problems."

## **Navy studying mini-tube plan of SRI spinoff**

Vacuum tubes no bigger than bipolar monolithic transistors are being studied by Navy engineers. The microminiature tubes, proposed by a small group recently spun off from the Stanford Research Institute, are expected to find use in airborne environments where temperature or radiation levels would be too high for semiconductors and conventional vacuum tubes would be too big. Navy sources say the tubes, which operate at extremely high temperatures, resemble conventional units only in that they boil off electrons from a hot cathode and operate using a vacuum.

## **Slipping morale may endanger Apollo shots**

Concern is growing among manned space officials that declining morale of Apollo ground crews could jeopardize the safety of coming moon shots. As a result, some third- and fourth-tier space officials are even suggesting that the Apollo 16 and 17 shots be cancelled. They fear that layoffs and the grim outlook for the workers still employed have led to such severe demoralization that sloppy launch preparations are bound to result. And any scientific gain that could be achieved by Apollo 16 and 17 is outweighed by the political damage that would result from a space tragedy, the space officials say. Another round of layoffs expected to send about 1,000 NASA employees out on the streets soon will aggravate the situation even further.

## **There's IR imaging in STANO's future**

Infrared imaging systems rate highly in development plans of the Army's Surveillance, Target Acquisition and Night Operations project office. Short-term gains in the image intensification systems area over the past five years have peaked, in STANO's view. And the Army is abandoning plans for further work on night binoculars using the technique, as well as the Textron Bell Helicopter division's stabilized night sight for the Huey Cobra, but favors the Hughes system called Infant—acronym for Iroquois Night Fighter and Night Tracker.

## **Addenda**

Industry's first look at defense satellite spread-spectrum requirements since the creation of the Secretary of Defense's telecommunications office will come Jan. 13, at a one-day secret briefing at the Institute for Defense Analyses. Short- and long-term procurement plans, spread-spectrum system descriptions, and technical objectives for antijam systems and related special problems will be reviewed at the meeting sponsored by the Defense Communications Agency and the Electronic Industries Association . . . First operational airborne tactical satellite terminals will be installed in EC-135 transports for the Air Force by Electronics Communications Inc. The AN/ARC-64 uhf terminals produced by ECI will be used with the LES-6 and Tacsat-I satellites.

All necessary electronics are located at the test station, modularized, with upward design compatibility for 5MHz operation.

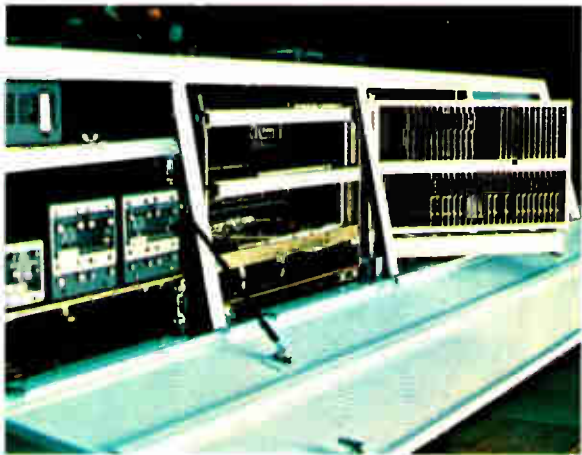

Total systems integration includes prober handlers, remote testing and push button production control.



Data logging and Binning. Disc operating systems control. On-line test program generation. Off-line production testing.



# MACRODATA



Pin electronics (with cover removed). 2MHz speed is possible because analysis is performed within inches of chip, not in a compute, 30-50 feet away

## MOS TESTING

The MD200 series of MOS/LSI test systems are fully automated, modularized and computer controlled... the most efficient test systems available. All possible functions are under software control. The test system can be installed and in operation within 24 hours after delivery. Complete test programs can be generated in a matter of hours with the use of TOIL (test oriented interactive language). The MD200 conducts on-wafer and final package tests, both digital functional and parameter, at speeds of 2MHz... on as many as 8 stations per single computer. MD200's are operating in the field now. We can arrange a demonstration at your convenience. Or write for our 16 page brochure describing Macrodata's MD200 Diagnostic Test System in detail. Macrodata Company, Test Systems Division / 20440 Corisco Street, Chatsworth, California 91311 • Telephone (213) 882-8880.



Circle 53 on reader service card

# Our TTL family gives you freedom where it counts.



## FAIRCHILD TTL FAMILY

The Fairchild TTL family offers the freedom-loving designer the broadest range of speed/power trade-offs and an extraordinary variety of logic and memory and interface support functions.

\*Available January, 1971.



# Now you can design with Low Power TTL/MSI at even less cost than with Standard!

93L21 Dual 1 of 4 Decoder		93L22 Quad 2 Input Multiplexer				
93L11 1 of 16 Decoder		93L12 8 Input Multiplexer	93L28 Dual 8 Bit Shift Register	93L14 4 Bit Latch	93L40 4 Bit Arithmetic Logic Unit	93L16 Binary Counter
93L01 1 of 10 Decoder	93L18 8 Input Priority Encoder	93L09 Dual 4 Input Multiplexer	93L00 4 Bit Shift Register	93L08 Dual 4 Bit Latch	93L24 5 Bit Comparator	93L10 Decade Counter
<b>DECODERS/ DEMULTIPLEXERS</b>	<b>ENCODERS</b>	<b>MULTI- PLEXERS</b>	<b>REGISTERS</b>	<b>LATCHES</b>	<b>OPERATORS</b>	<b>COUNTERS</b>

## Our Low Power TTL now sells for the same price as Standard TTL and costs even less to use.

If you don't need the speed of Standard, why pay the freight? In our TTL Family you'll find 15 low cost Low Power MSI devices to choose from. All compatible. All off the shelf.

It's the largest, most complete, most versatile selection in the business. Designed to give the cost-conscious designer freedom now. And freedom where it really counts:

- No board redesign (pin-for-pin equivalent to and compatible with Standard TTL/MSI devices).
- Smaller power supply.
- Less noise (fewer decoupling elements required).
- Less heat.
- High fanout (fewer buffers needed).
- Largest Low Power MSI/TTL family around.

Typical performance:

Gate Tpd = 20ns Gate Pd = 2mW  
Binary Toggle Rate = 10MHz  
MSI Clock Rate = 10MHz

You might re-examine your current design. If speed is not a critical factor, then look at our 93L Low Power series. If you care about costs, they have a lot to give. Our new catalog tells the whole story. Send for it.

**FAIRCHILD**  
SEMICONDUCTOR

# AMP IC receptacles difference in panels

## A different kind of IC receptacle.

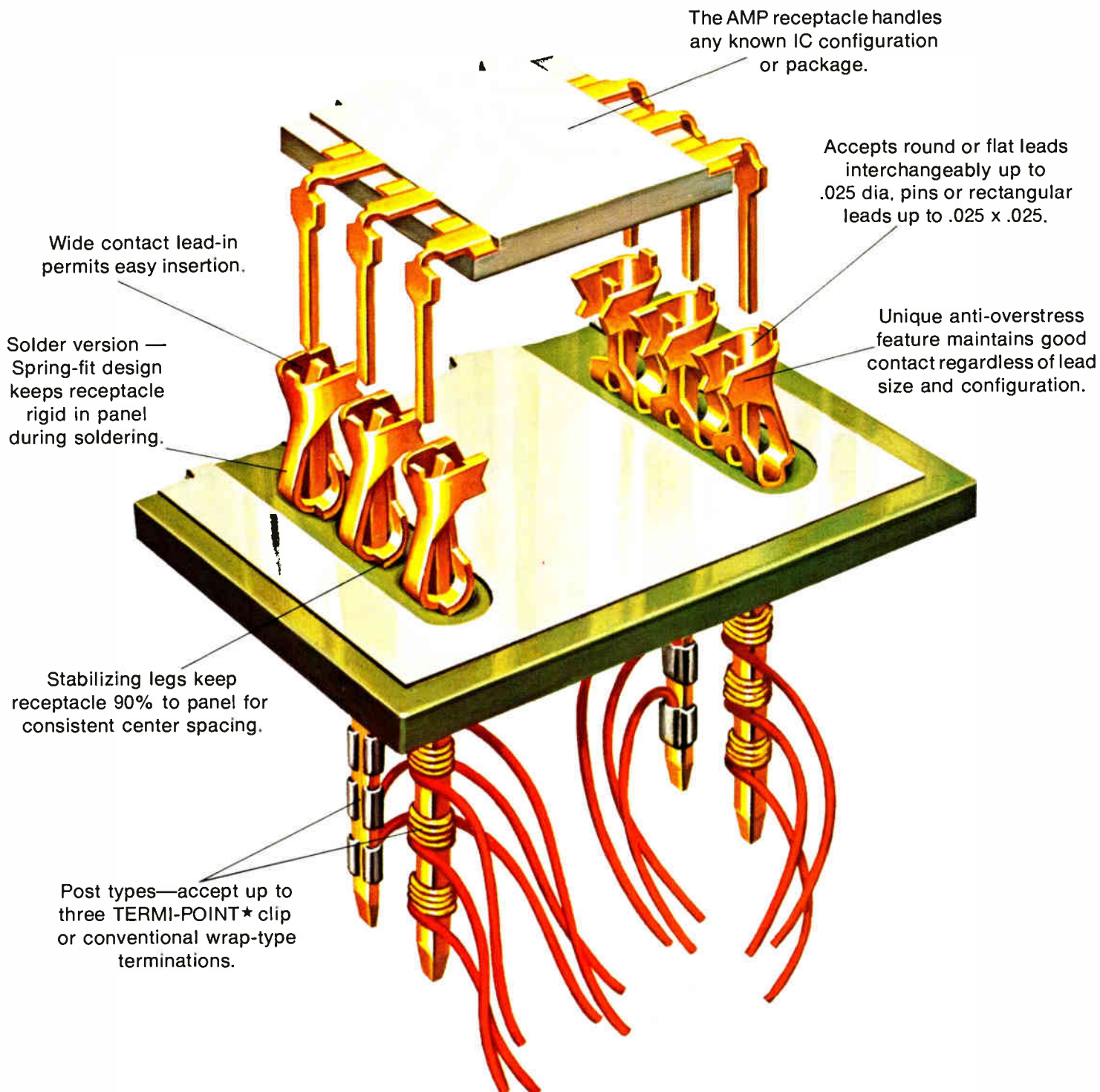

# are where the starts.

## We don't stop there.

We've designed greater reliability into the critical receptacle portion of your panel designs, but that's only *part* of the difference in AMP's complete packaging panel capabilities. No other company offers the flexibility that AMP does in panels. We offer a tried and tested panel building technique and AMP's one-house responsibility to back it up.

### Tell us what you want.

#### 1. You build the panel.

If your requirements dictate that you build the panels, we don't just supply you with loose receptacles and let you tackle your production problems alone. The AMP IC receptacles are supplied with a carrier strip and special insertion tooling for high speed assembly to the board or panel. We've lived with panel production problems and we'll share the resulting know-how with you.



★Trademark of AMP Incorporated

#### 2. We build the panel.

Obviously, the same time tested know-how can be put to work in our plant to build standard or custom panels for you. The placing of the IC receptacles can be as random or uniform as you need. Remember, our receptacle can handle any IC configuration or package. Pictured below are several of the panels produced for our customers.

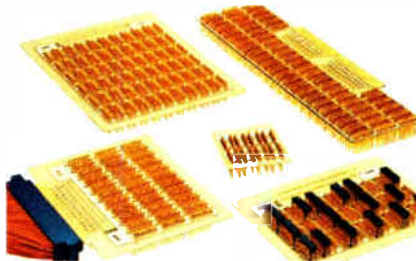

#### 3. Either of us wire the panel.

For point-to-point wiring, AMP offers two basic types of panels. One for use with the versatile termi-point wiring technique and another for use with the conventional wrap-type techniques, for use in your plant or ours.



## And the price is right.

Forget the usual claim that something better always costs more. The advantages of the AMP IC receptacle are available at a competitive, low per-unit cost, *plus* there are additional savings in our assembly technique.

For more information on the difference in AMP IC receptacles or our panel capability in general, write:

**AMP Incorporated, Industrial Division, Harrisburg, Pa. 17105.**

**AMP**  
INCORPORATED

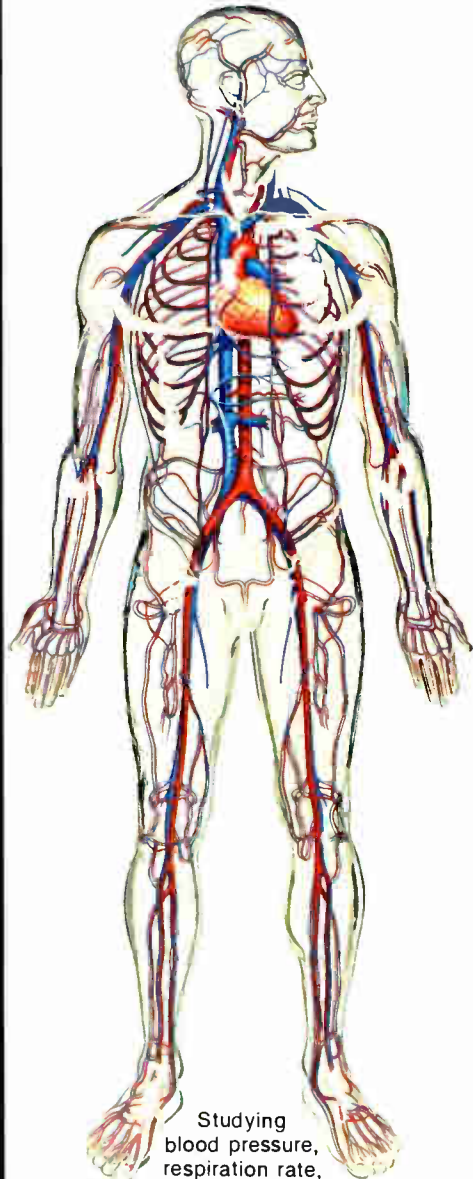
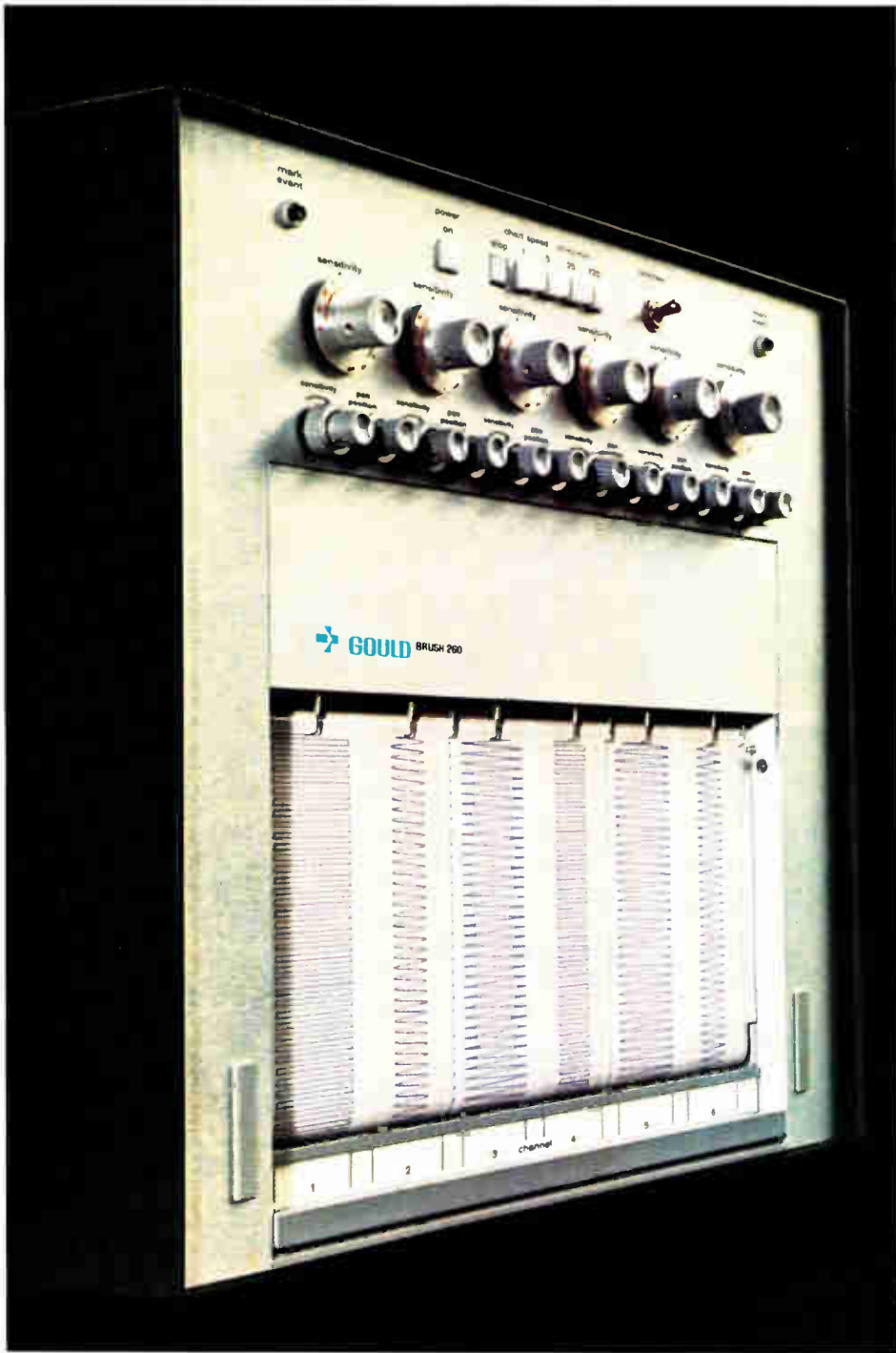

Studying blood pressure, respiration rate, heart sounds, temperature, EKG traces.

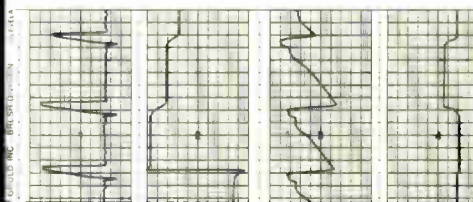

## We can't solve your problem. But we can help you get a better look at it.

Take the situations you see above.

In each, there's a need to simultaneously measure and monitor several dynamic variables. And that's a job that's tailor-made for Gould's line of Brush Recorders.

Brush Recorders can record up to 8 variables against a common time base, side

by side, on the same piece of chart paper. Instantaneously. Continuously. With a system accuracy of 99-1/2%.

Most Brush Recorders feature patented pressurized ink-writing. This means traces of uniform width and exceptional clarity. It also means no puddling or smearing.



Measuring current, voltage and roll forces to control product uniformity.

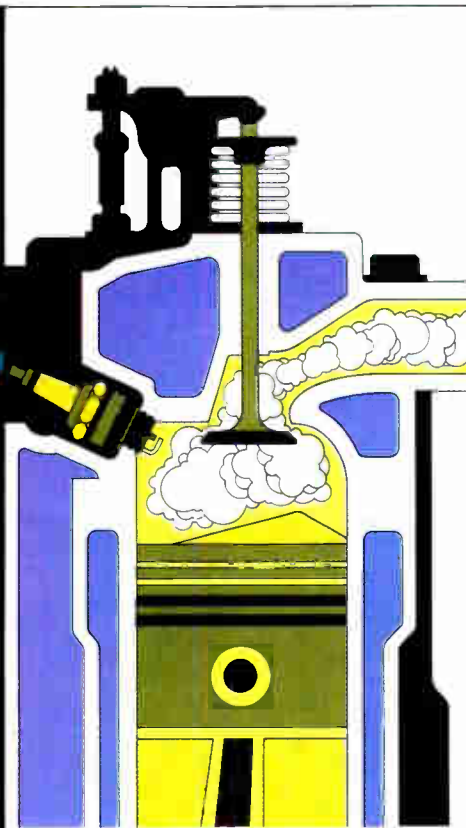

Monitoring engine emissions for air pollution.

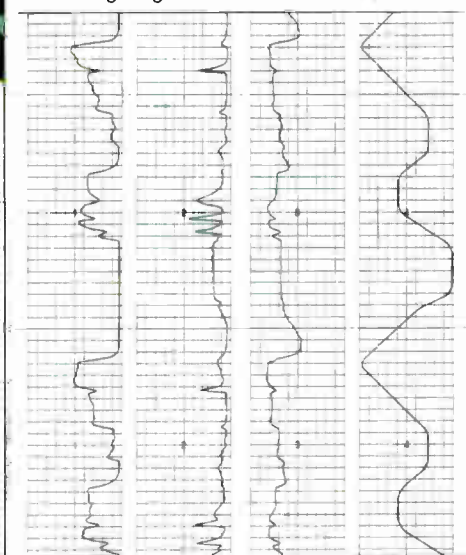

Measuring stress, strain and torque on aircraft assemblies.

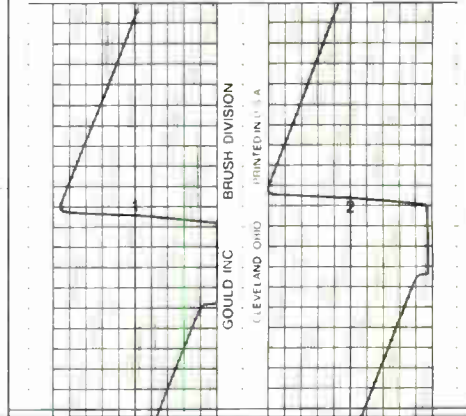

As a result, charts generated by Brush Recorders can be studied or reproduced or referred to for years to come. With little chance of the data being misread or misunderstood.

So if you have questions, take a look at Gould's line of Brush Recorders. They have

a way of coming up with the answer. In the lab, in the shop, and in the field.

Brush Recorders. They're one more example of how Gould's Instrumentation Group puts hard-to-get information into easy-to-use form. Gould Inc., 8550 West Bryn Mawr Avenue, Chicago, Illinois 60631.

# Your new RF power choice: the first of the new geometry

The Unisem RH3787 RF power transistor.

First working example of tomorrow's RF device geometry.

Broadband.

Broadest broadband you can get.

Plug it in and it plays—from 100 MHz to a GHz.

Insiders see it as the RF power transistor of the future. As soon as RH3787 is joined by some more powerful brothers, we'll all be able to cut RF power inventory down to a handful of broadbands.

Nice. And we're working on it.

Until it happens, though, you're still going to have to solve your RF power transistor problems by the numbers. Lots of numbers.

Which brings us to us.

Unisem.

We're not the biggest people in the RF power business. You know that. But we are the broadest—that. you might not have known.



Unisem distributors can give you just about any RF power transistor you need.

Some people use us as a second source for all three of the big three, because we're the only company that can fill that spot. And an increasing number of people are using us as first source in applications ranging from handy-talkies to high-rel military. Either way, as first source or as number one second source, we'll be glad to help.

For full information on the broadest broadband RF power transistor (our RH3787) or on the broadest RF power transistor supplier (us), drop a line to:

Unisem Corporation

P.O. Box 11569

Philadelphia, Pennsylvania 19116

Att: Marty Kiouis

Or phone him at (215) 355-5000 and ask him for our RF Power application chart; it makes selection easy.

## or the most of the old math.

VHF Communications / Beacons / Avionics / Mobile

Mobile / CATV / Sonobuoy / ECM

UHF Communications / Military / Commercial / CATV

DME / Telemetry / Radiosondes / ECM

**Unisem**

SUBSIDIARY OF UNITED AIRCRAFT CORPORATION

**U  
A  
C**

Circle 60 on reader service card

# Article Highlights

---

**Fast logic  
extends range of  
high-frequency counters  
page 62**



Counters that perform high-frequency measurements themselves must be built with high-frequency circuits. Thanks to a high-speed variation of emitter-coupled logic, a family of shift registers, counters, and other circuits has been developed that allows these instruments to measure frequencies as high as 550 megahertz. And there's a special test procedure for these new circuits: a test element laid down on one corner of the wafer during fabrication allows chips to be checked out during several processing steps using s-parameter measurements.

**Key design simplifies  
keyboard circuitry  
page 68**

In a new keyboard, the design of an electrostatic impulse key is directly related to the simplification of encoding circuitry. In fact, only 13 field effect transistors mounted on one printed circuit board are required to service a 90-key ASCII keyboard, instead of the hundreds of diodes or the expensive MOS chip used in other approaches. And with no mechanical closure, the key itself is inherently reliable.

**Light gating brightens  
CRT projection displays  
page 78**

Variations of the familiar cathode ray tube have the best potential for large-area projection displays, providing the required speed, information density, and flexibility at moderate cost. A checklist of 15 ideal criteria is provided to help the designer decide which of the many approaches to light-gated display CRTs offers the best choice for this application.

**J-FETs reduce  
IC op amp  
bias and offset  
page 85**

Thanks to improvements in planar processing techniques, junction field effect transistor inputs can be integrated into monolithic operational amplifiers. The amplifiers feature much lower bias currents and higher slew rates than those with discrete inputs, making them ideal for such applications as sample-and-hold circuits, long-term integrators, and logarithmic amplifiers.

---

## Coming

**European markets  
in 1971**

With U.S. electronics markets in a slump, increased attention is being focused on the performance of the Western European markets. In the next issue, *Electronics* examines the outlook for 1971 in 11 European nations.

# Fast logic extends range of high-frequency counters

---

A high-speed variation of emitter-coupled logic and a novel test procedure that checks out chips during production yield reliable ICs that boosts counter capability to 550 megahertz

---

By Merrill Brooksby, Rick Pering, and Roger Smith, *Hewlett-Packard Co., Santa Clara, Calif.*

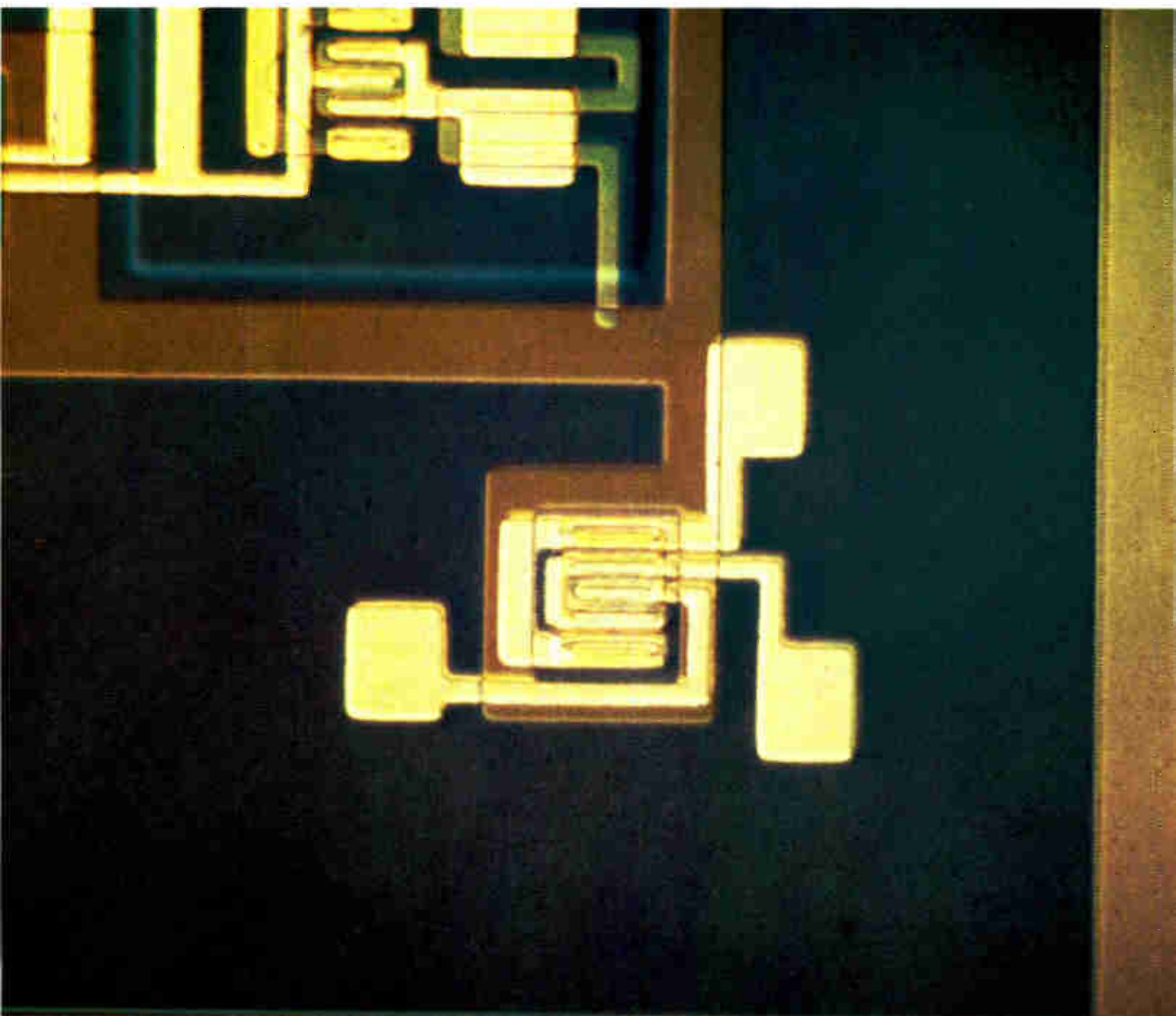



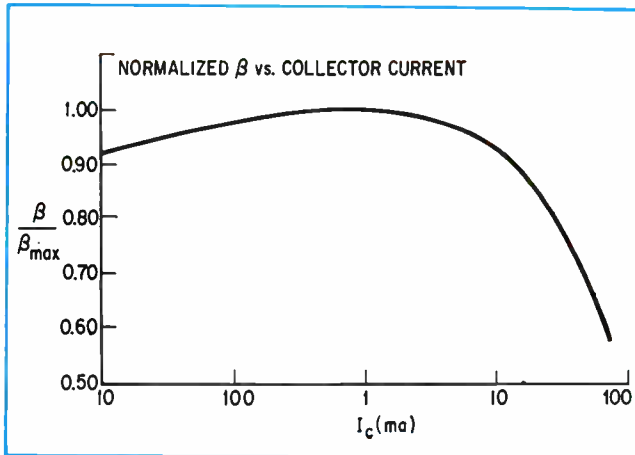

**1b. Flat out.** Advantages in high-speed switching circuits result from constant  $\beta$  over a large current range, in this case from 10  $\mu$ A to approximately 20 mA. Overdrive is reduced because circuit no longer must be pushed in the 1-2  $\mu$ A region to actuate device.

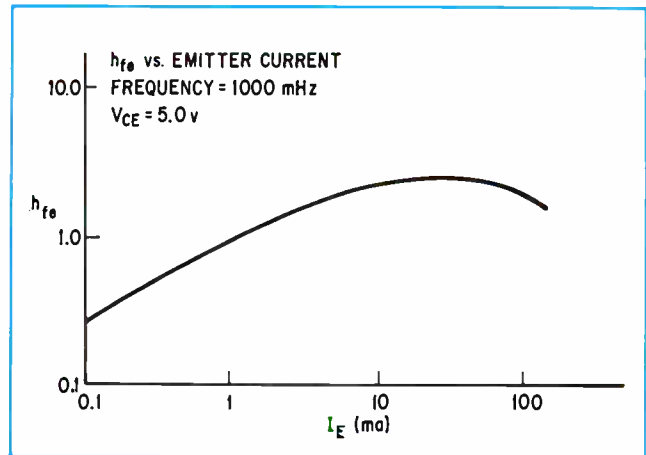

**1c. Checkout.** Since the parameter  $h_{fe}$  is related to operating frequency of the device, it is a good indication of the transistor's performance at high frequency. These measurements can be taken automatically during the production cycle and made available to user.

□ Testing high-speed digital circuits demands measurement instruments that operate at least as fast, if not faster than, the devices they're intended to be used on. To meet this challenge, a family of input gates, logic switches, binary and decade counters, shift registers, and dividers has been developed and is in production for such instruments as time and frequency counters. The family is based on emitter-to-emitter-coupled logic, a high-speed variation of the emitter-coupled logic technique, yielding instruments with switching rates as high as 550 megahertz.

The development of this logic family brought with it improved chip test procedures that could become industry standards. Using these procedures, the high-frequency operation of individual elements and the entire circuit array of a chip are measured at several steps in the production cycle before the wafer is diced. The measurement standard is a typical test device laid down on one corner of each wafer during fabrication, yielding small- and large-signal s-parameter checks of transistor elements operating up to 2.5 gigahertz.

It's important to note the differences between the emitter-to-emitter-coupled ( $E^2L$ ) logic technique and the older, more familiar emitter-coupled logic (ECL) made available by both Motorola and Texas Instruments, and at one time by Westinghouse. Although in the same family,  $E^2L$  has a different input-output structure than conventional ECL:  $E^2L$  has an input emitter-follower and an output current switch, while

**1a. Fast transistor.** Key to the new high-frequency instrumentation circuits are these 2.5-GHz transistors, which make up the new emitter-coupled logic. Shown here is a test device fabricated during wafer production which is used to derive statistical data on circuit performance. Typical devices have an  $F_t$  of greater than 2 GHz and an isolation capacitance of less than 0.2 pF.

ECL uses an input current switch and an output emitter-follower.

This structural difference can be seen from the schematics of  $E^2L$  and conventional ECL circuits. In  $E^2L$ , the input emitter-followers are formed by three transistors whose emitters are tied together and connected to the base of an output transistor. Switching is done in this output transistor, called the output current switch. Although an ECL circuit also has a three-transistor input and an output transistor, the three input transistors take care of switching, while the output is the emitter follower.

**This switching arrangement** makes  $E^2L$  output levels immune to base-emitter voltage drift, yielding very stable devices. Moreover, in  $E^2L$ , the capacitance of only one inverting transistor is in parallel with the lowest impedance of the system, yielding lower isolation capacitance values than in conventional ECL, where all transistors are in parallel. And there's no Miller capacitance in  $E^2L$ . All in all, the reduced capacitance—as low as 0.2 picofarad—is responsible for  $E^2L$ 's subnanosecond propagation delays and rise-fall times, resulting in counting speeds of over 550 MHz across a temperature range of  $-25^\circ\text{C}$  to  $75^\circ\text{C}$ .

The  $E^2L$  circuits also offers improved isolation of the switching element: the current switch is a single output transistor instead of three parallel input transistors, allowing the switching elements to be more readily isolated from the other chip functions. Said another way, an  $E^2L$  circuit has a small isolation tub while an ECL device has a large one. And better isolation means minimum frequency-limiting parasitics.

A typical transistor and a few of its characteristics are shown in Fig. 1a, b, and c. As indicated in Fig. 1b, dc characteristics remain relatively flat over a very large current range—they stay within 90% of their maximum value over the current range from 10 microamperes to approximately 20 milliamperes. This stability offers significant advantages over other high-speed switching circuits, linear amplifiers, and

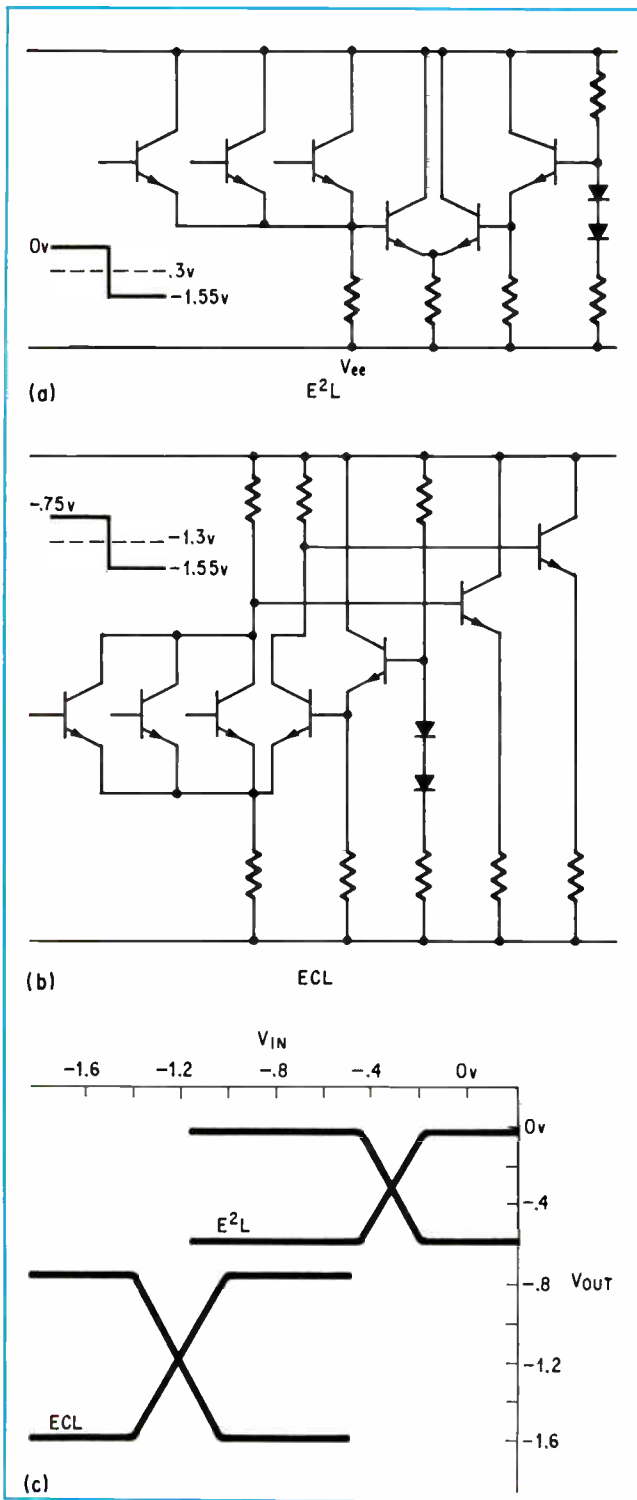

2. Logical switch. Instead of switching between two negative logical levels, E<sup>2</sup>L circuits switch from ground to -0.6 volt, giving a typical swing of 600 mV, against ECL's 800 mV, permitting E<sup>2</sup>L to provide same functions at lower power levels. In addition, because of better isolation, E<sup>2</sup>L series exhibit subnanosecond propagation delays and rise/fall times, and counting speeds of over 550 MHz, specified over a temperature range of -25°C to 75°C. Typical  $V_{in}$ ,  $-V_{out}$  and OR-NOR characteristics are shown for both logic schemes.

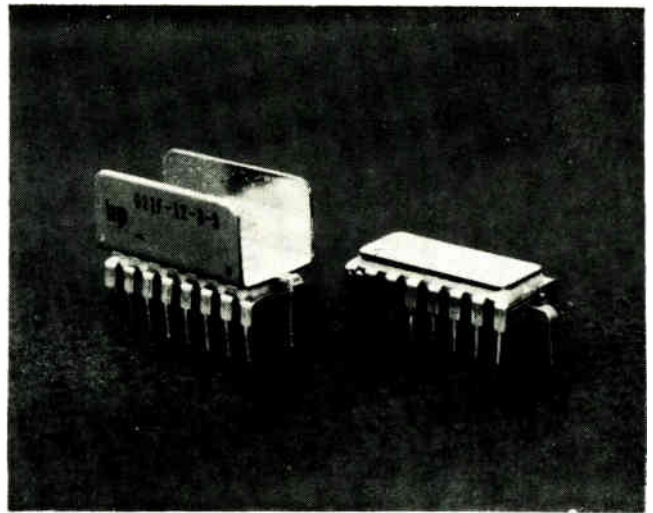

3. New packs. The standard 16-pin DIP package is adapted to receive an oversized heat fin to provide cool operation at high frequencies. Shown is a 550 Mhz binary and a 400 Mhz divide-by-five quinary.

low-level oscillators marketed for instrument applications. For example, high-speed switching generally requires driving the logic into current saturation. But with E<sup>2</sup>L, a flat beta curve means that this overdrive is greatly reduced; in fact, the circuit can operate below the 1- or 2- $\mu$ A current region and still yield satisfactory switching.

The switching waveforms of the E<sup>2</sup>L circuits are shown in Fig. 2, along with those of conventional ECL devices on the market. In general, the input and output voltages of E<sup>2</sup>L have the same shape as those for comparable ECL circuits; their typical OR-NOR characteristic also are similar. But in E<sup>2</sup>L circuits, the logic levels are ground and -0.6 volt, giving a typical logic swing of 600 millivolts, against 800 mV for conventional ECL. Thus, in addition to providing the benefits of working at ground voltage levels, E<sup>2</sup>L can perform the same switching functions as ECL at lower voltage swings, resulting in lower power consumption and cooler operation.

Although E<sup>2</sup>L is faster than standard ECL, it's unlikely to swiftly dominate all IC designs. Subnanosecond speeds are not required for standard computer and logic applications; fan-out, fan-in, and circuit design and servicing by personnel unskilled in high-frequency techniques often are a more important consideration. However, E<sup>2</sup>L is expected to shine in instrumentation applications where speed is the prime design consideration. Here, though, a typical E<sup>2</sup>L element is not as compact as a corresponding ECL element, so it's fortunate that circuits for instrumentation applications normally are not too complex, allowing the required logic to be included on one chip. For example, a high-speed decade counter requires feedback around only three binary stages; this is handled easily by chips which are only approximately 0.1 inch on a side.

The E<sup>2</sup>L family of monolithic circuits soon will be found in production-line instruments as dual three-

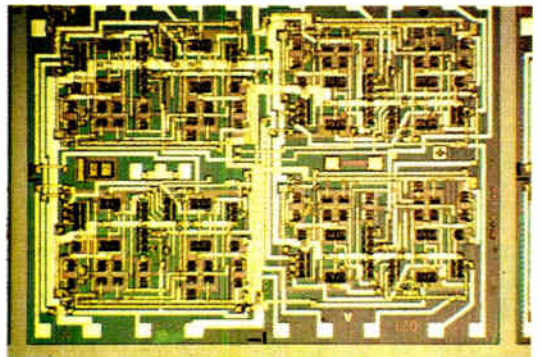
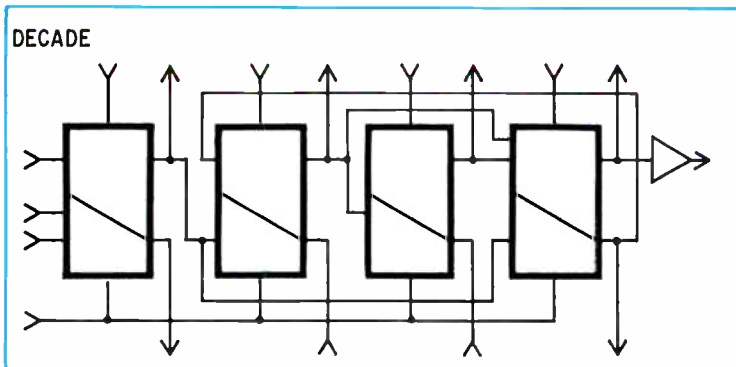
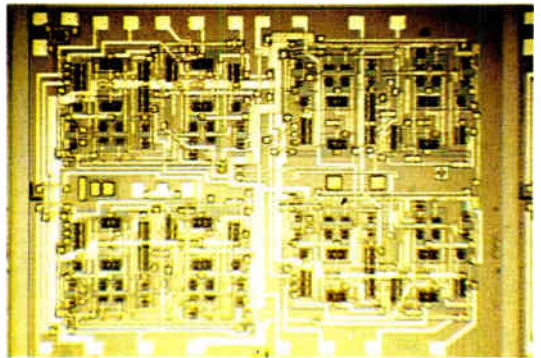
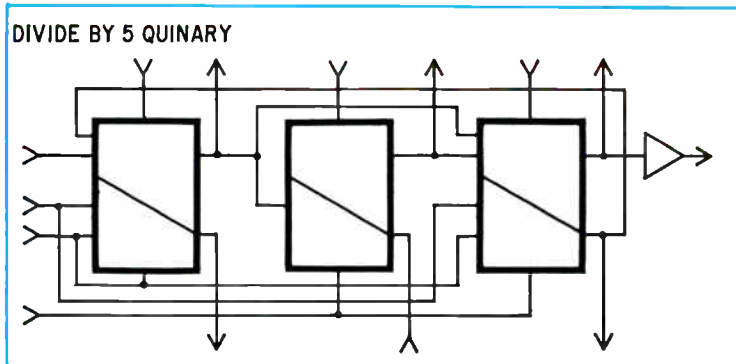
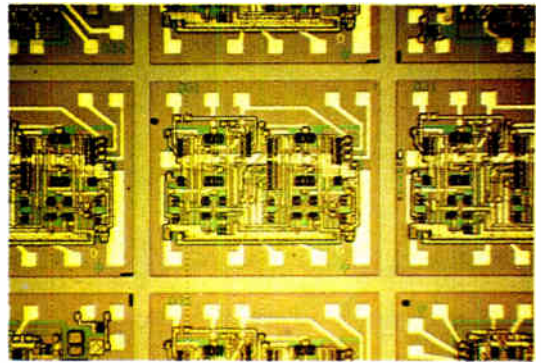
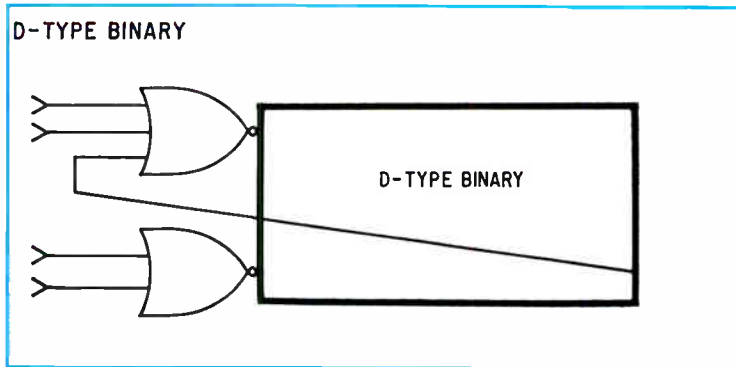

4. Counting off. New family of high-speed ICs includes: a binary and decade with a 550-MHz counting speed and a divide-by-five quinary with operating speed of 400-MHz. Both 550-MHz circuits have 50-ohm output impedance, while the quinary has 100-ohm impedance. All feature master-slave operation, low power dissipation (300 mW, 400 mW and 750 mW, respectively), and all are packaged in 16-pin DIP's.

and four-input gates, logic switches, 550-MHz d-type binary counters and shift registers, as well as 500-MHz divide-by-16 counters.

Schematics and photographs of circuits boards for the binary, quinary, and decade units are shown in Fig. 4. As an indication of the capabilities available from these components, the decade counter is built on a monolithic chip and uses standard 1,224-bit logic configuration. Each binary within the decade is a complete dual rank (master-slave operation) unit, which offers improved reliability as well as greater flexibility from incoming driving signals. The input information can be held until decisions are made on how to use it, at which time it's fed into the cycle.

The development of these high-frequency devices required new packaging techniques. For example, to adapt the standard dual in-line package to the circuits it was necessary to minimize the capacitance

losses between pins, which become very large as the frequency increases. This was accomplished by increasing the capacitance to ground, thus forming a high-frequency pin-to-pin capacitance block, permitting better pin isolation.

After the dual in-line package was made suitable for E<sup>2</sup>L circuits, it became apparent that new heat dissipating methods also were needed. High-speed logic always is power hungry, resulting in large heat dissipation; the decade counter itself for example, dissipates more than 700 mW. This necessitated development of a heat-sinking package with an oversized fin; one is shown in the package of Fig. 3. In addition, new fabrication methods have been devised that allow the chips to be bonded directly to the heat sink just inside the package, permitting maximum chip contact with the finned area.

But the heat sink does more than just cool the

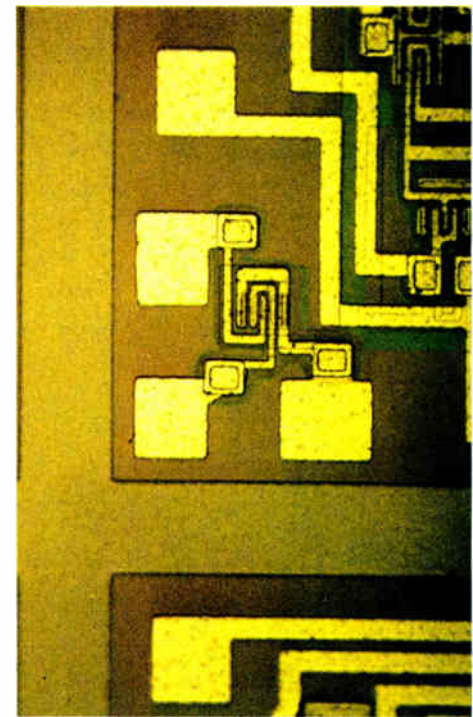
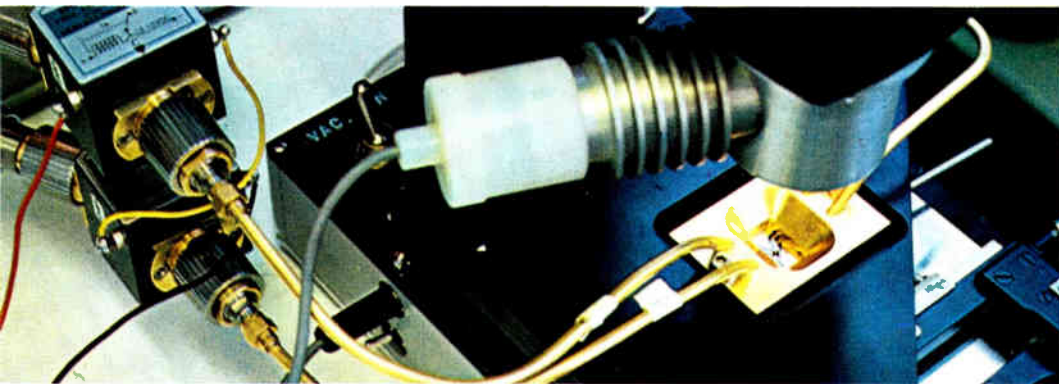
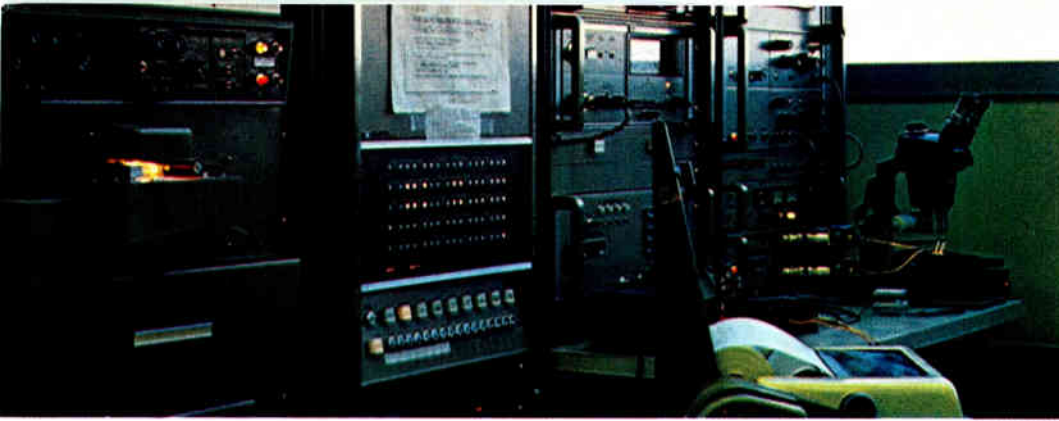

5. Tight control. Instruments in Hewlett-Packard's production facility (upper left) allow measurement of individual device as well as complete circuits. The setup consists of a graphic readout of the XY recorder which gives a bar graph of the system parameters; the 16-kHz computer which runs the analyzer and controls the current, voltage, and frequency applied to the device under measurement; the magnetic tape cassette which records raw s-parameters from which all other parameters are obtained, and the network analyzer itself. In the wafer probing station (lower left) a rigid co-ax runs from the network analyzer to the

chip. For example, device operation at 550 MHz requires a very solid ground for the supply voltage in the vicinity of the chip. With the heat sink itself firmly connected to ac ground, pin-to-pin isolation is improved. This ground connection is also important in controlling high-frequency signals transmitted inside the dual in-line package: it prevents lead and pin radiation, so troublesome in high-density, high-frequency circuits.

Special instrumentation is needed to measure and characterize these circuits for an expanded production-line test procedure. For example, rapid feedback of data during wafer processing is essential to maintain desired reliability levels. Moreover, this data must be statistical in nature to accommodate local chip variation, and must be traceable to a specific wafer number, run number, or process sheet. To accomplish this, the location of a typical test device on the chip always must be accurately known, the measurements must be made quickly, and they must be reproducible.

To meet these requirements, a technique has been developed that characterizes the individual transistor elements that comprise the high-speed logic of each chip, as well as performance of the array as a whole before individual circuit chips are diced and scribed. On each wafer, an isolated test transistor element is fabricated on an accessible corner of the substrate during the normal production cycle. It is fabricated with the same diffusion and processing steps as all

other elements in the array, differing in no way from the other elements except for its accessibility. Thus, performance measurements made on the test element can be used to characterize all the elements fabricated during a particular run.

Using this test element, small- and large-signal device parameters (such as  $\beta$ ,  $h_{FE}$ , etc.) can be made at frequencies in excess of 2.5 GHz. From these, the necessary statistical information to characterize the elements is derived. Within minutes after the wafer processing is completed, the performance of the units can be evaluated and a decision can be made on the acceptability of the wafer.

**In addition**, this technique has been interfaced with a computer system to measure the small-signal s-parameters at frequencies ranging from 100 MHz to greater than 2 GHz. The system has been programed to first step the frequency, current, and voltage applied to a device and then to measure a complete set of s-parameters at each point. Statistical data is tabulated and analyzed by the system, and feedback is made available immediately in the form of a bar graph plot of the probability density function and the distribution function of the wafer for any specified parameter. In addition, mean and standard deviation are indicated on each plot.

The probing system also can be used for checking large-signal dynamic characteristics and functional operation in complete circuits. In fact, digital circuits tested at frequencies greater than 700 MHz have given

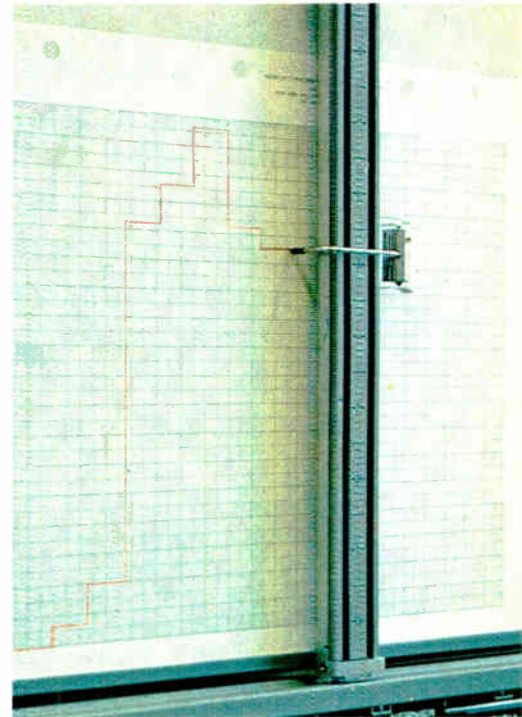
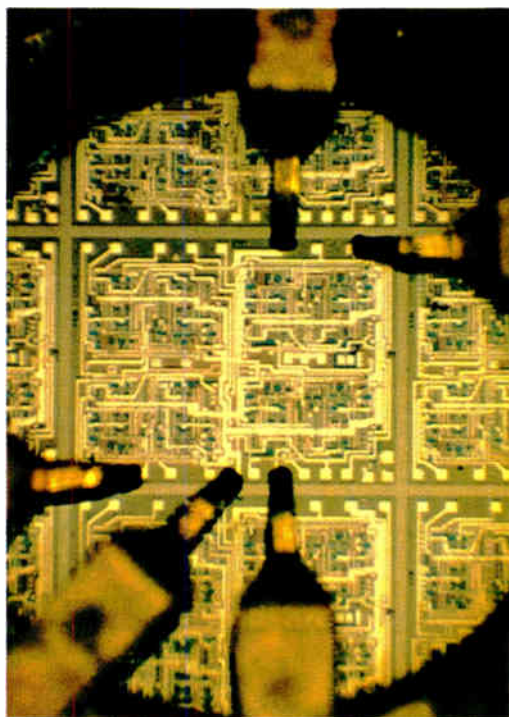
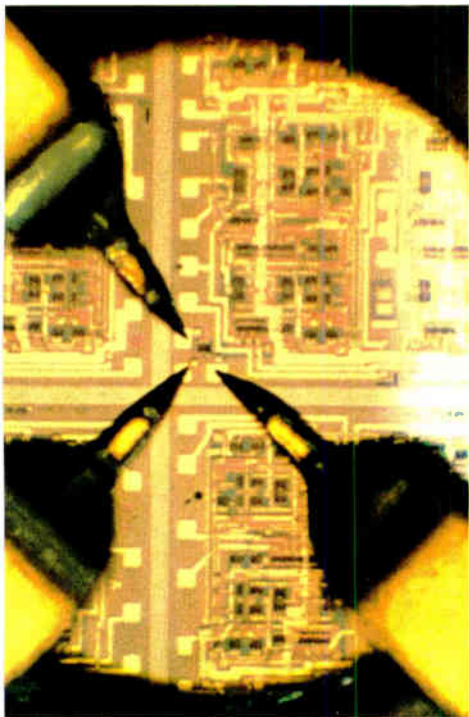

microscope. A typical test device (shown opposite page, right) is checked out for small-signal s-parameters (above left). A 50-ohm transmission line transforms into the probe, which has three measurement heads: one each for base, emitter and collector. Circuits, such as this 550-Mhz decade counter (above, center) receive large-signal dynamic characteristic and functional operation tests. Tests also include output data (above, right) in the form of a bar graph plot of probability density function and distribution function of the wafer for any specified parameter.

results that show they are more reliable than commercially available circuits.

In addition to providing important advances in IC technology, the fast logic and quick-turnaround test procedures are paying off in improved instrument performance. For example, consider a typical product-line timer/counter, which combines the measurement capabilities of frequency, period, and time interval in one basic instrument. Using a standard 50-MHz decade counter, this instrument has a basic frequency range of 50 MHz and a time interval range from 0.1 microsecond to  $10^9$  seconds. In addition, its time-interval averaging function provides an increased resolution of 1 nanosecond or better, or repetitive signals.

But instrumentation requirements in such fields as communications have been pushing frequency measurements to even higher ranges. This is where the E<sup>2</sup>L family comes in. Although the high-frequency requirement has been partially satisfied in some electronic instruments through the use of discrete components, this approach is expensive and inherently unreliable.

The first electronic counters to use the E<sup>2</sup>L technology will be the Hewlett-Packard 5327A timer/counter, and the H-P 5327C frequency counter. The 5327A is essentially an upgraded version of the lower-speed H-P 5326A, the range of which is 0-50 MHz. The 5327C is a new instrument which has the multifunction capabilities ( $10^{10}$  time interval ranges, time averaging) plus the 500-MHz frequency capability. □

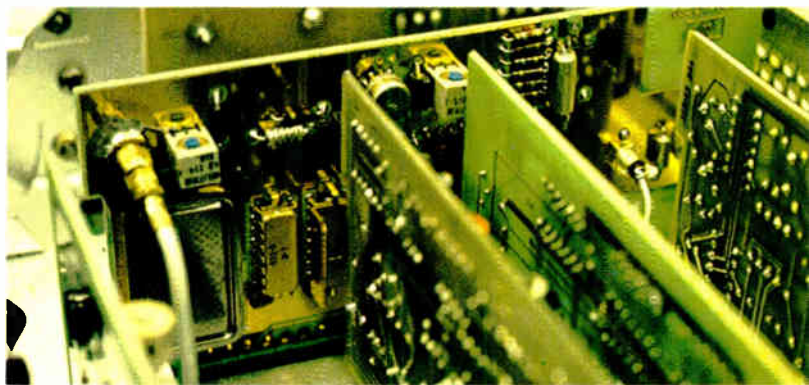

6. At work. Above, a 550-MHz binary and 400 MHz divide-by-5 quinary mounted in printed circuits to perform a decade function. Below, the packaged instrument, with frequency ranges of 0-50 MHz and 0-550 MHz.



# Capacitive keys, simpler circuits add up to reliable keyboard

A 90-key ASCII-coded keyboard has been built at low cost from novel, contactless keys and circuitry that needs only 13 transistors for the job of producing a seven-bit code

By Richard C. Webb and James R. Webb,\* *Colorado Instruments Inc., Broomfield, Colorado*

□ In the race to develop more reliable and economical electronic keyboard assemblies, designers are focusing on improving the keying mechanism and simplifying encoding circuitry. A new keyboard where the design of a novel electrostatic impulse key is directly related to the simplification of the circuitry has been constructed.

The capacitive key needs no mechanical closure and therefore can claim long life and reliability. The circuitry requires only 13 field effect transistors on a printed circuit board, a distinct departure from designs that required either hundreds of diodes or an expensive metal oxide semiconductor chip.

The feature of the key's design that makes it possible to use so few FETs is its ability to send a three part signal to three transistors at once. Each key transmits to a different combination of FETs. These combinations form a subcode which is translated by some logic circuitry into a seven-bit code that is adequate to service the 90-key American Standard Code for Information Interchange (ASCII) keyboard.

The element basic to the key's construction is a thin, dome-shaped metal spring about the size of a dime and arching to a height of about 0.025 inch. (Fig. 3). Three edges are clipped from its base so it sits on three equilaterally spaced points above a conducting target disk electrically insulated from the spring by a film coating. These two elements make a capacitor, which increases in capacitance whenever pressure applied to the dome causes it to buckle with a crisp audible snap, like the sound of a toy "cricket." The target disks are protected by a solder mask material that is silkscreened over the entire pc board. Only the ring upon which the dome spring rests is uncoated.

**When a key is struck**, the capacitance between the dome and the target doubles its static value of 4 or 5 picofarads in about 100 microseconds. When the key is released, the dome spring quickly recovers its arched position and the capacitance reverts to its static value.

The concept is the same as the one behind a capacitor microphone, in which sound waves cause a diaphragm to vibrate and produce capacitance variations that an amplifier promptly converts into audio frequency signals. But the signal voltage available from the key is much larger than a microphone's

because of the large increase in capacitance. For example, a 150-volt bias and a suitable target load resistance will produce a signal pulse of 15 to 20 volts that lasts about 0.5 millisecond.

The instantaneous relationship between the time-variant capacitance,  $C$ , voltage,  $V$ , and charge,  $Q$ , is

$$Q = CV$$

From this it might be inferred that, when  $Q$  is constant,  $C$  and  $V$  will vary reciprocally, a change in  $C$  producing an immediate offsetting change in  $V$ . In reality, however,  $Q$  continually readjusts as a time-variant function of the circuit parameters, since  $C$  is not lossless and current leakage paths exist. Thus, a more accurate expression for the signal voltage,  $V_s$ , is

$$V_s = V_b \left( \frac{1}{1 + \frac{1}{nR}} \right) \left[ 1 - \left( \frac{C_0}{C_0 + nt} \right)^{\left(1 + \frac{1}{nR}\right)} \right]$$

where  $V_b$  = the dc bias voltage,  $R$  = the target load resistance,  $C_0$  = the total static capacitance of the key,  $n$  = the rate of change of capacitance in farads per second (assumed constant while the key is in motion), and  $nt = C_v$  is the incremental snap capacitance of the key.

**The signal voltage**,  $V_s$ , appears while the moving dome spring is varying the capacitance; when the spring becomes stationary,  $V_s$  falls off exponentially. Some temporary ringing motion of the spring persists, but is damped by the polyurethane pressure pad that rests on top of the spring. To obtain the required 15-volt pulse, the dome spring must generate a rate of change of capacitance of about 0.1 pF/ $\mu$ s.

The key is in effect an electrostatic impulse transducer, and matching its high impedance of 2.4 megohms to the associated logic circuitry is a necessity. A practical impedance converter (Fig. 1) is an n-channel junction field effect transistor biased well into cutoff. When an impulse key is depressed, its positive going pulse is arranged to drive the gate/source junction of the J-FET into conduction thereby clipping the positive excursion of the pulse at about +0.5 V. Simultaneously with gate conduction, the drain circuit of the J-FET is turned fully on, allowing the

\* Now with the Environmental Science Services Administration, Boulder, Colo.

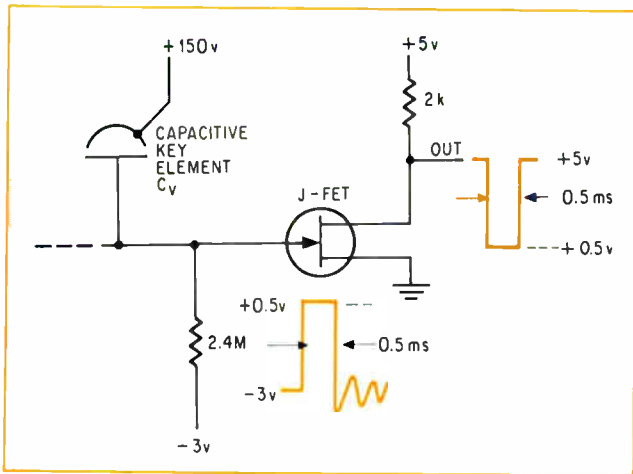

**1. Pulse forming.** With key at rest, transistor is biased into cutoff. Depressing key abruptly increases key capacitance, driving the field effect transistor into conduction. When the FET is fully on, clipping occurs, limiting pulse's amplitude to +0.5 volt. Prescribed change in capacitance restricts pulse width to 0.5 millisecond.

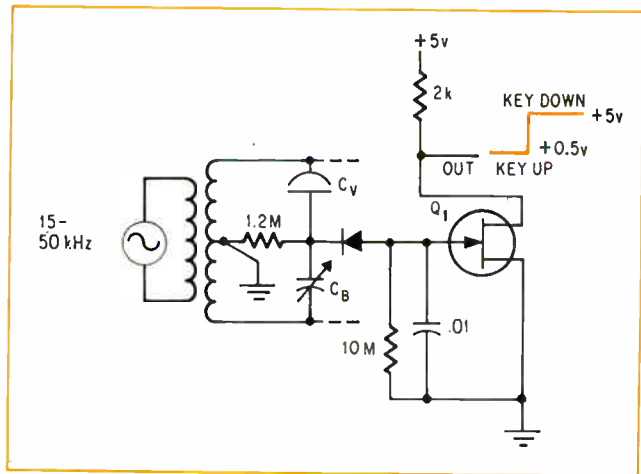

**2. Steady output.** Control and shift functions require steady output. Key capacitance  $C_V$  is balanced in bridge by  $C_B$ . When key is depressed,  $C_V$  increases, unbalancing bridge, and  $Q_1$  is biased off; result is +5 V out until key is released. Frequencies from 15 to 50 kHz usually are available from the dc-to-dc converter that biases the impulse key.

transistor to sink a 2- or 3-mA load, sufficient to drive diode-transistor or transistor-transistor integrated circuit logic loads.

But, the impulse transducer must be able to perform static action as well as impulse action. For, though impulse action is desirable for most of the keys in a keyboard, the output signals of some keys must follow the finger pressure function exactly, just as a dry reed switch stays closed as long as the magnet is held depressed about the reed. Such keys place a keyboard in the shifted mode or generate external control functions.

**Static action** is achieved by means of an ac capacitance bridge (Fig. 2). The key element acts as one side of the bridge and, when not being operated, has the same capacitance value as the capacitor that forms the other side of the bridge. A 10-volt peak-to-peak signal at a frequency in the 15- to 50-kilohertz range excites the bridge. Such a signal is readily available from the dc-to-dc converter used to bias the impulse keys with +150 v.

When the static action key is at rest, the bridge is balanced and generates no output voltage, while the FET is biased at zero voltage and conducts. But for as long as the key is depressed, the bridge is unbalanced and the FET's gate is biased with sufficiently negative voltage to cut off current flow in the drain circuit. Voltage from the depressed shift/control key is about -5 V, from the undepressed key about  $\pm 0.2$  V.

Since it provides adequate signal voltage—15 v—the target element of the impulse key transducer can be subdivided into three sectors without too great a loss of signal amplitude. It's this sectored target that makes it possible to subcode the several independent signal sources available at each key.

The subcoding arrangement used in this keyboard defines each key of an alphanumeric set in terms of

X, Y, and Z coordinates. These coordinates represent portions of the outgoing bit pattern generated by a typical key—Z represents the first three bits, Y the next two, and X the last two of a 7-bit code. Each of the three target sectors is assigned to one X, one Y, and one Z coordinate line. (Assignment is made during the printed circuit artwork layout of the keyboard and depends on the selected code format.) Each coordinate line is then provided with an impedance transforming FET. This method allows the seven active bits of the ASCII code to be encoded with only 13 transistors, four each for the X and Y axes and five for the Z axis.

The method of subdividing the 7 active bits is shown in Fig. 4. Each X, Y, and Z coordinate line

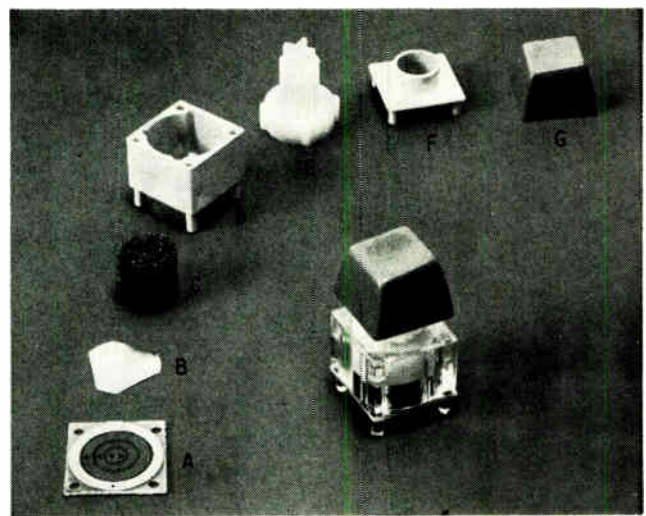

**3. Impulse key.** Component parts of key are target disk (A), dome spring (B), foam pad (C), key body (D), plunger (E), key lid (F), and key cap (G).

## 7 BIT ASCII CODE 128 CHARACTERS

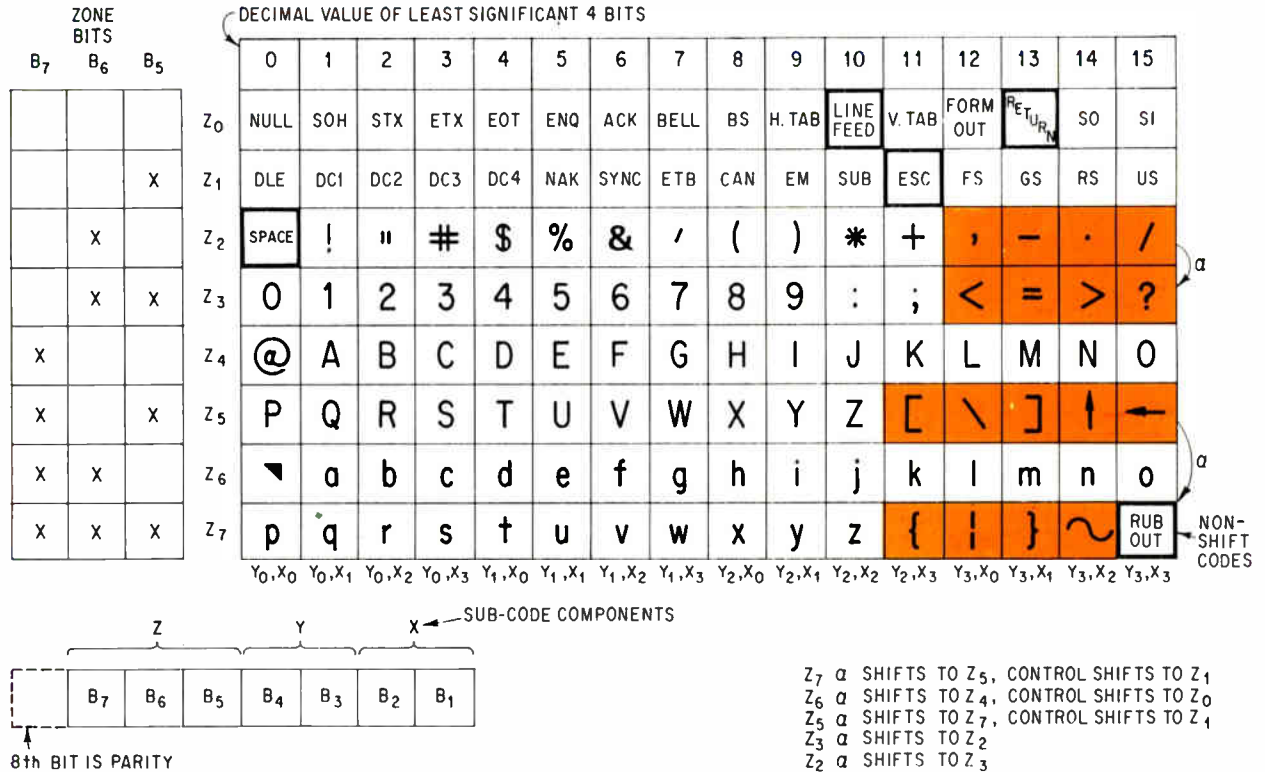

4. Approach to ASCII. Three part subcode defines ASCII characters: Z coordinate includes 3 most significant bits, X and Y each contain 2 less significant bits. Anomaly in ASCII code requires shifting certain keys (in color) in direction opposite to that of major group shift—lower case to upper case. Result requires two additional Z-coordinate lines, Z<sub>2</sub> and Z<sub>5</sub>. Special non-shift codes are required for LINE FEED, RETURN, ESCAPE, SPACE, and RUB OUT keys.

with its impedance-transforming FET generates its own assigned portion of the bit pattern. For example, the lower-case characters *a* to *o* lie on the Z<sub>6</sub> coordinate line and are represented by the bit pattern 110, the most significant bits. The latter half of the lower case alphabet, *p* to *z*, lies on the Z<sub>7</sub> line and has a 111 bit pattern. In the horizontal direction across the chart, the X and Y coordinates advance in simple binary form.

Selection of a particular character requires a combination of the two least significant bit patterns, determined by the X and Y coordinate lines, and the Z bit pattern. For example, the letter *g* is represented by coordinate line X<sub>3</sub>, whose bit pattern is 11, Y<sub>1</sub>, whose bit pattern is 01, and Z<sub>6</sub>. Therefore, when the *g* key is depressed, it is identified by the bit pattern 1100111-Z<sub>6</sub>Y<sub>1</sub>X<sub>3</sub>.

Ideally, such an arrangement should require only three Z-coordinate lines—Z<sub>3</sub>, Z<sub>6</sub> and Z<sub>7</sub>—in the non-shift mode. But when the ASCII code was developed, certain lower-case symbols were placed on upper-case lines, requiring an inverted shift function to accommodate them. One such inconsistency is the equal-sign

which appears as upper case on the key and lower case in the code format. These anomalies require shifting certain punctuation symbols (shown in color in Fig. 4) in a direction opposite to that for the group shift. Hence, two additional Z-coordinate lines, Z<sub>2</sub> and Z<sub>5</sub>, were introduced, making the logic shift function more elaborate than strictly necessary.

The keyboard is organized to use the fewest possible FETs and logic circuitry. Each coordinate line may have from 11 to 16 key targets attached to it. The drain of each FET impedance converter is connected to a set-reset flip-flop—the entry point to external integrated circuit control logic. Whenever a key is depressed, the FETs attached to the excited coordinate lines execute a momentary closure between the drain and source terminals, placing the associated flip-flop in the SET condition. A timer circuit subsequently clears this flip-flop, but so long as it is set it serves as the source of the output signals. The interface between the keyboard and the control logic is at the drain of the FET, which is a low impedance point capable of driving several feet of wire. Each FET is thus associated with a



## In key with computers

The keyboard industry, clearly recognizing where its fortune lies, has striven to keep pace with the rapid growth of the digital computer. Contactless keying mechanisms, such as Hall effect, and electromechanical keys, like the dry reed switch, are competing for a place in today's computer input terminal. Encoding circuits are equally diverse, running the gamut from exotic MOS chips to simple diode matrices.

The competition between keyboard manufacturers, if anything, has increased over the past year [*Electronics*, Nov. 10, 1969, p. 145]. Several new comers are off and running in the keyboard derby.

A keyboard designed around a second-order Hall-effect device is being built by Nucleonic Products of Canoga Park, Calif. The active device is a magnetoresistive chip. A magnet moved near the chip changes the chip's resistance from 40 to 200 ohms, causing a transistor in the key to conduct. An integrated circuit trigger built into the key then shapes the output signal and sends it to a diode matrix encoding circuit.

**A ferrite toroidal core** is the basis of a design by the Licon division of Illinois Tool Works, Chicago. The core is wound with three wires—drive, sense, and interlock—and is permanently mounted in a plastic housing. Two magnets, mounted on the key plunger, saturate the core, preventing the sense wire from responding to an ac signal on the drive wire. When the key is depressed, the magnets move away from the core, which then acts as a transformer, coupling the ac signal. The signal is converted to dc by an external IC and is transmitted to TTL circuitry for encoding.

Unimax Switch of Wallingford, Conn., offers a keyboard with a "flying magnet" key. The key contains two magnets with their poles in opposition. Each opposed pole resets against a metal strip, with a third strip between them. When the key is depressed, the upper magnet's strip is pushed in contact with the center strip, repelling the lower magnet. The lower strip snaps up to contact the middle strip momentarily. When the three strips touch, a signal is transmitted in two parts—a three-bit and a four-bit segment—to flip-flop circuitry for encoding. The lower magnet returns to its original position in 2 milliseconds, drawing the lower

strip away and breaking the electrical contact.

A keyboard that looks like a fat plastic card is built by Flex-Key Corp. of Waltham, Mass. Inside the plastic is a printed circuit board covered by a conductive elastomeric membrane. When the key is pushed down, the membrane is deformed, and it contacts the printed wire line beneath it. The key is compatible with DTL, TTL, and MOS logic interfaces.

In other new keyboards, the emphasis is on encoding. One approach that uses MOS technology is featured in a Hall-effect keyboard built by the Micro Switch division of Honeywell Inc. of Freeport, Ill. A large-scale integrated MOS chip containing the equivalent of 5,000 transistors, resistors, diodes, and gates performs all signal coding tasks. The MOS encoding package has an added feature—n-key rollover. The key's pulsed output is set into the encoding chip's memory, allowing keys to be depressed sequentially so data are entered in the proper sequence, regardless of the order of key release.

Another keyboard that features a single-chip LSI/MOS encoding circuit is made by Clare-Pendar of Post Falls, Idaho. Here, a scanning technique searches for a closure of a dry reed switch key. Clock circuitry contained in the chip operates at 50 kilohertz, permitting a scan rate of 20 microseconds. A 2,000 bit read-only memory, also in the chip, generates an output code that is compatible with DTL, TTL, and MOS circuitry.

**A different encoding approach** is taken by Cherry Electrical Products of Waukegan, Ill. Its scheme includes an eight-stage clocked, ripple-through counter; two 16-channel multiplexers; a 1-of-16 decoder; a monostable multivibrator; and assorted gates. The 1-megahertz clock scans all possible bit combinations every 256  $\mu$ s. When a coded signal corresponding to a depressed dry reed switch key is sensed, the clock is inhibited, stopping the counter at a particular eight-bit code. The four most significant bits are fed to the multiplexer, where a strobe activates the circuit, while the four least significant bits go into the 1-of-16 decoder. A matrix connection between the multiplexer and the 1-of-16 decoder is established and a one-shot is triggered generating the encoded signal to the logic.

—Leon M. Magill

set-reset flip-flop which deals with the remaining control circuitry at standard IC logic levels—0 V for a binary 0 and +5 V for a binary 1.

While many logic schemes are possible with the electrostatic impulse key, the one shown in Fig. 5 is a good choice. The logic control section ensures that the individual members of the X, Y, and Z groups produce the output bit patterns assigned to them, and adjusts the three most significant bits for alpha and control shifts. The basic key coding is provided by the layout of the printed circuit board which incorporates coordinate assignments made for the individual key targets.

Fundamental to the keyboard is the timing arrangement which clears any one or all of the X, Y, Z flip-flops after an interval of about 3 ms from the moment that one of the flip-flops has been keyed into

the SET condition. During this interval, information is available on the 7 outgoing signal lines, and about midway in the interval a 100-microsecond strobe pulse is issued to propagate it from the key flip-flops into the downstream equipment, such as a cathode ray tube display, the input buffer to a computer, or a printer.

Since a valid 7-bit signal from one of the impulse keys is composed of an X component, a Y component, and a Z component, all three must be present before a strobe signal is transmitted from the circuit. To check that this is so, the strobe pulse is logically ANDed with the X, Y, and Z signal components.

If two or more keys are depressed simultaneously, it's easy to detect with the subcode because at least two Xs, or Ys, or Zs are generated. Sensors, in the form of current summing resistors, are wired to the flip-

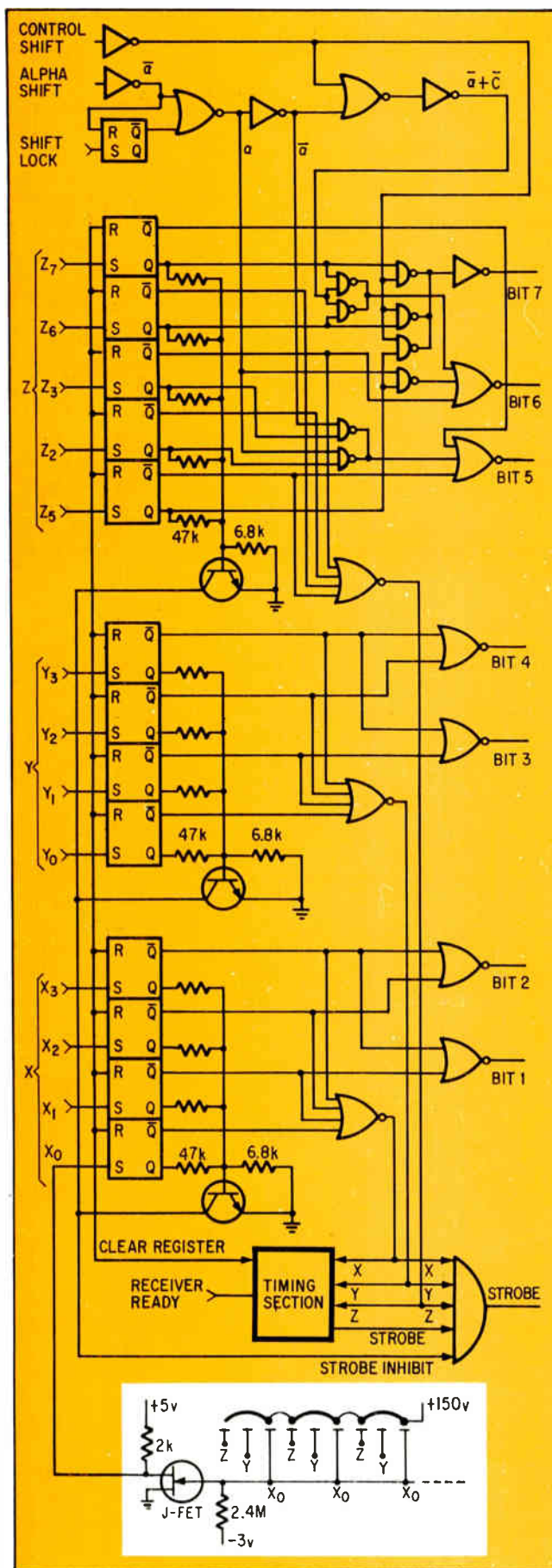

**5. Logical approach.** Logic scheme utilizes the signals of the impulse keys. Subdivided keys feed into set-reset flip-flops. As an example, keys corresponding to  $X_0$  bits are shown at bottom. When key is struck, an X, Y, and Z flip-flop is set and the proper arrangement of 7 bits is generated. Erroneous data resulting from simultaneous depression of keys are prevented by current summing analog sensors (47 kilohm resistors). If two or more keys are depressed, current developed through resistors turns on transistor, pulling strobe inhibit AND gate input to ground. With strobe inhibited, data stream is blocked.

flops. If more than one key is hit at a time, the current furnished by the affected sensors is sufficient to turn on a transistor which pulls the strobe inhibit line to ground. Since a logic 1 is required on this line for a strobe pulse, no output is generated.

The sensor circuitry is a necessity when the keyboard is transmitting signals to downstream equipment incapable of accepting data at a rate of 200-300 characters per second. In such cases, a receiver-ready signal may be invoked to inhibit the timer cycle until the data can be used. Naturally, the longer the receiver is not ready, the greater the likelihood of multiple key depressions. In such cases, more than one signal will rest in the keyboard register, inhibiting the strobe signal when the receiver ultimately does become ready to accept data.

Of particular importance to keyboard users is the "feel" of the keys. The impulse keyboard, for example, can be made to respond to a light but positive touch because the spring dome feeds back a small impulse to the finger. Furthermore, since the dome spring acts as a snap-action mechanism, such a key can't be teased into producing a partial signal. The polyurethane foam pressure pad has a desirable compression characteristic—it starts out at a low pressure which increases nonlinearly as the key is depressed. Starting pressure is between 50 and 60 grams, and the key operates at a displacement of 0.150 inch and 75 grams; it bottoms at 0.187 inch with a pressure of 80 to 90 grams. The spring recovers its arched position when the applied pressure is reduced to about 65 grams.

An asset of the impulse key is that it need not be raised before a subsequent key is depressed. This increases the reliability of output during burst typing of familiar character groups. Typing speed is therefore limited only by the ability of the operator and the capacity of downstream equipment to accept data.

While the keys in this keyboard require a bias voltage, impulse keys that are completely self-generating, requiring no external bias, could be built with electrets—permanently charged dielectric films—over the target elements. Such electrets are now widely used for biasing condenser microphones.<sup>1</sup> However, the cost of an electret key is more than five times that of a biased key and electret life is not yet established. □

#### Reference

1. P. Murphy and F. Fraim, "Electret Condenser Microphones of High Quality and Reliability," J. Audio Eng. Society, No. 16, p. 450, 1968.

# Now You Need All This To Build A Power Supply:

**1.**  
Darlington  
Power  
Transistor  
**\$1.57**

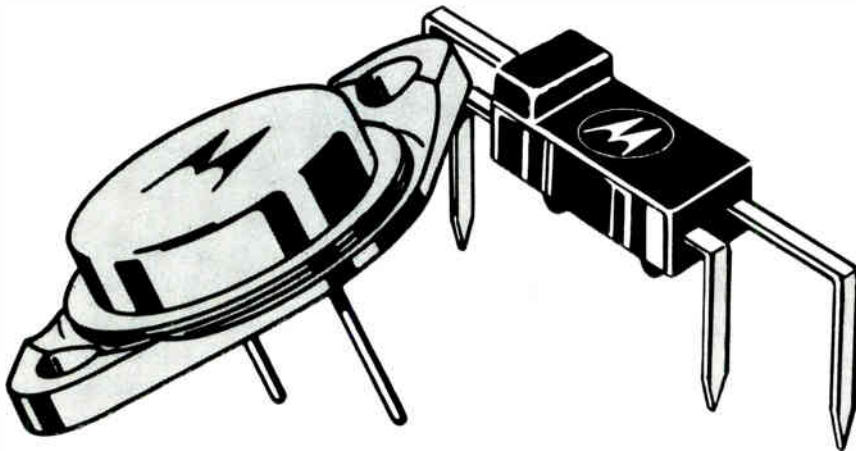

**2.**  
Functional  
Circuit  
**90¢**

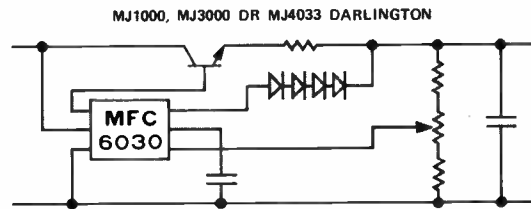
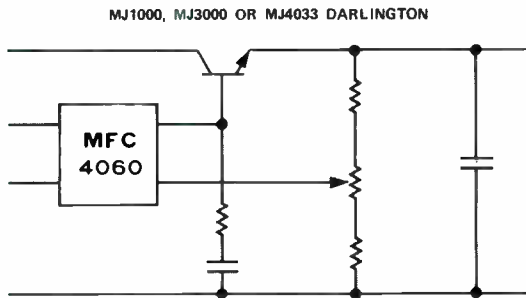

Economical "Darlington + Functional" circuit performs as 3, 5, or 10 A, 5 V regulator. An MJ1000 (I<sub>OUT</sub> = 3 A) affords load regulation of 0.02% @ 0°C, 0.2% @ 25°C and 0.04% @ 75°C. An MJ3000 (I<sub>OUT</sub> = 5 A) furnishes 0.04% load regulation for each temperature. An MJ4030 (I<sub>OUT</sub> = 10 A) yields load regulation of 0.04% @ 0°C and 25°C and 0.06% @ 75°C. MFC4060 is the same as MFC6030 except for current limiting 30 V outputs possible for both circuits.

A short-circuit protected supply with 3, 5, and 10 A outputs obtained with MJ1000, MJ3000 or MJ4030 Darlington and an MFC6030 regulator. For each output, load regulation is 0.08% when used as 5 V regulator. Short-circuit characteristics indicate limiting performance with each Darlington. MFC6030 Functional Circuit has 38 V maximum input voltage, 200 mW maximum load current and 3 V minimum voltage differential.

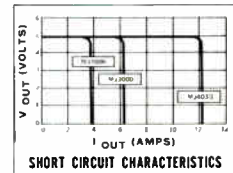

## Just 2 Active Components!

... that's all it takes now to build reliable, regulated power supplies for your commercial / light industrial / computer peripheral equipment.

One Darlington and one "functional" eliminates a dozen or more resistors, diodes and discrete devices ... PLUS their associated wiring ... PLUS the cost involved in their assembly!

Power Darlington's furnish state-of-the-art performance and design simplicity in most any relay and solenoid drivers, audio amplifiers, servo amplifiers and series pass regulators by forever obsoleting conventional, "one-for-one" driver and output transistors and associated base-emitter resistors. Complementary in polarity, the metal and plastic series

offers many "firsts" — 2,500 typical h<sub>FE</sub>, up-to-100 V sustaining voltage, 5 A @ 30 V safe operating area and 100-up prices low as \$1.35.

MFC4060/6030 functional circuits afford industrial-quality performance through precision voltage regulation. Load regulation is 0.2% and line regulation is 0.03%/V maximum at 30 V. T<sub>C</sub> = ± 3.0 mV/°C and output voltage is adjustable from 4.8 to 35 V. The MFC-6030 can be externally programmed to current-limit from 100 to 200 μA. 90¢ buys you an MFC4060 in 100-up quantities!

Both are new, both offer unique advantages individually, both are available now from your Motorola distributor for team evaluation on your prototype power

supply workbench. Your inquiry will bring you a complete package of product data and how-to-do-it power supply circuits. Write for it today ... it's all you'll need. Box 20912, Phoenix, Arizona 85036.

### POWER DARLINGTONS

PNP/NPN Series	I <sub>C</sub> Range (CONT.) A	V <sub>CEO</sub> (V <sub>CE</sub> ) V	h <sub>FE</sub> (Q) I <sub>C</sub> (min)	P <sub>D</sub> W	SOA	Price Range 100-up
MJ1000 to MJ4033	4-16	60-300	750-1000 @ 1.5, 3, 4.5 & 10 A	75-150	3 A @ 25 V to 5 A @ 30 V	\$1.35-5.35

### FUNCTIONAL VOLTAGE REGULATORS

Type	Outstanding Characteristics	Price 100-up
MFC4060	Ultra-low cost, precision, series pass regulator in 4-lead plastic	\$ .90
MFC6030	Short circuit protected, 6-lead version programmed to current limit from 100 to 200 μA	\$1.78



**MOTOROLA POWER**  
—where the priceless ingredient is care!

# Designer's casebook

## Operational preamps help balance big sound system

By George R. Latham IV  
Hewlett-Packard Co., Loveland, Colo.

Balancing a big, multi-input audio system in a large area such as an auditorium can be made easier, especially for stereo reproduction, if VU meters are built into each microphone preamplifier.

In one such system, the preamps, really operational amplifiers, operate at a signal gain of 30 decibels. Each VU meter bridge is placed in the open-loop gain path of its op amp, nearly eliminating the diode offset voltages from the output signal. Diode-switching distortion is negligible, signal gain is stable, and signal noise is low.

Good signal-to-noise ratio can be achieved with a closed-loop gain of 10 or more. Low distortion and good linearity require a closed-loop gain of 5,000 to 10,000. However, dc operating voltages, bandwidths, and amplifier drift are not critical, so inexpensive transistor or integrated op amps may be used.

Resistor  $R_1$  is selected on the basis of microphone signal range and meter sensitivity. The low-impedance microphones used in this system have a strong signal output of 10 millivolts peak to peak; the meters' full-scale current is 0.25 milliamperes. The meters read 0 dB at 6.3 mV pk-pk; the potentiometer controls larger signals. At 6.3 mV input, meter current averages 0.2 mA. Then,

$$R_1 = (E_{\text{peak}} \times 0.636) / I_{\text{DC}} \\ = (3.15 \text{ mV} \times 0.636) / 0.2 \text{ mA} = 10 \text{ ohms}$$

$R_2$  is chosen to set the voltage gain, which equals  $(R_1/R_2)/R_1$ . The low-frequency cutoff is determined by  $R_1C_1$ . Shunting feedback resistor  $R_2$  with a bypass capacitor  $C_2$  will roll off the high frequencies (as much as 30 dB in the design shown).

If loading is not too high,  $R_1$  determines meter current by establishing the current through  $R_2$ . The meter is calibrated with low fixed loads.

The amplifiers were built with a differential input pair of 2N3391 transistors, and the bridges with germanium diodes. Five summed preamplifiers have a combined noise output of 2.5 microvolts rms, referred to the input, with a noise-equivalent bandwidth of 15 kilohertz. Signal-to-noise ratio is 60 dB at a medium-strong signal input.

Two amps in one. Microphone preamplifier with built-in VU meter provides a linear drive current for the meter and allows the sound-system operator to balance the system at a glance. The operational amplifier's feedback network determines audio signal gain, cutoff, and rolloff.

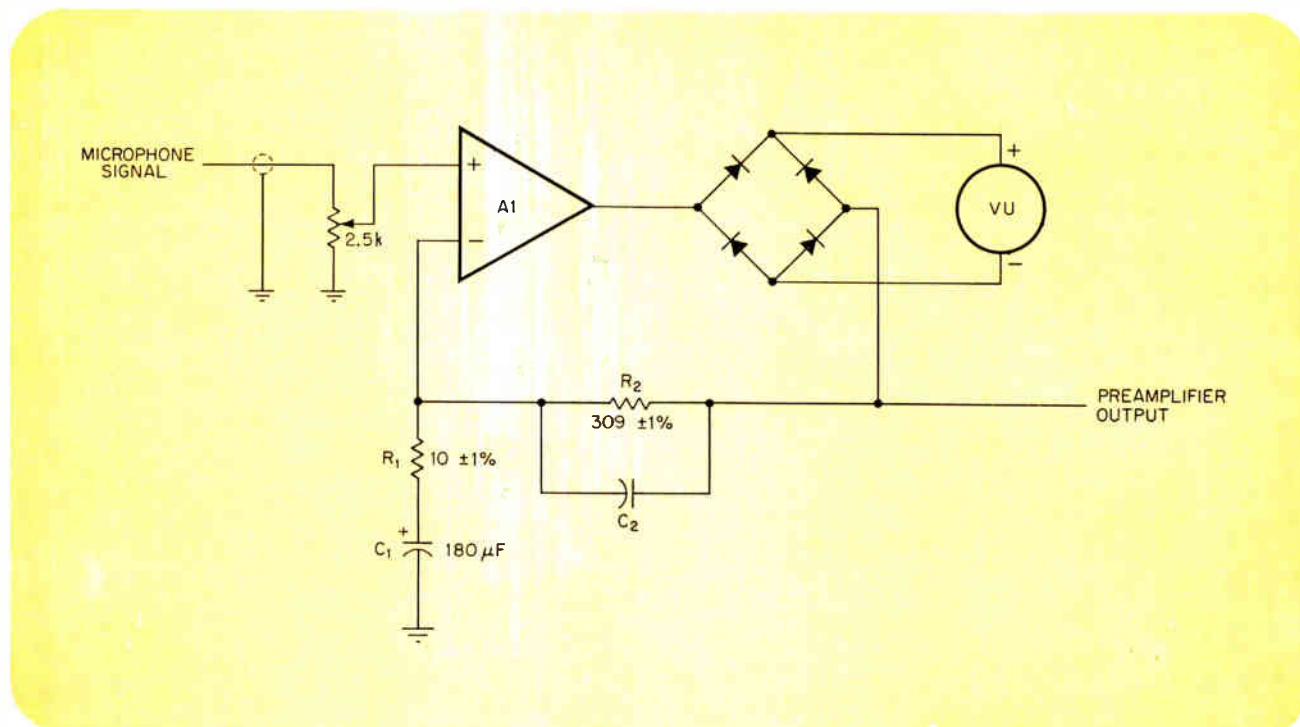

# Five bits and five ICs switch 32 analog signals

By Leonard Accardi  
Kollsman Instrument Corp., Elmhurst, N.Y.

Bipolar-compatible MOS (metal-oxide-semiconductor) analog switches can largely free multiplexer and commutator design from dependence on level shifters, switch drivers and complex channel-selection logic. The reason is that their lower threshold voltages are well within the driving capability of bipolar logic, which until recently was not true of MOS switches.

Moreover, MOS field-effect transistors are bilateral: signal current can flow in either direction when one is switched on by the control logic. Therefore a multiplexer becomes a commutator when its analog output is relabeled as the input and its channel inputs relabeled as outputs.

The designs shown below use one such multiplexer/commutator building block—the Fairchild 3705, which comes in a 16-pin dual in-line package, has eight channels selected by a 3-bit address decoder, and an output-enable control.

A 4-bit binary address will control 16 channels in two packages, as in the first diagram. If the fourth address bit's complement is available, the inverter is not needed.

A control switch at the bipolar logic "1" level (MOS "0") enables the common output of the eight switches. But only one package output may be enabled at a time. Otherwise, channels would be selected in parallel and the inputs shorted at the multiplexer summing node, while in a commutator a parallel enable would switch the input to two outputs.

A simple way of selecting 32 channels in four packages is shown by the second diagram and truth table. The TTL quad NOR gate decodes the output-enable signal from the higher-order address bits. (The same technique can be used to control more higher-order bits and more gates.)

Switching performance sets the practical limit on the number of channels with a common output, since signal errors due to MOS leakage currents and crosstalk increase with the number of channels. The combined output leakage current of the 32-channel multiplexer is 40 nanoamperes maximum at a temperature of about 25°C.

Channel ON resistance is 400 ohms maximum, signal voltage range -5 to +5 volts and nominal switching time is 1 microsecond.

**In the chips.** Thanks to bipolar-compatible address decoders and output-enable controls in the MOS analog switches, one TTL IC controls a 32-channel multiplexer. The NOR gates select package outputs, while the first three address bits select one of eight channels in each package. The assembly can also behave as a commutator.

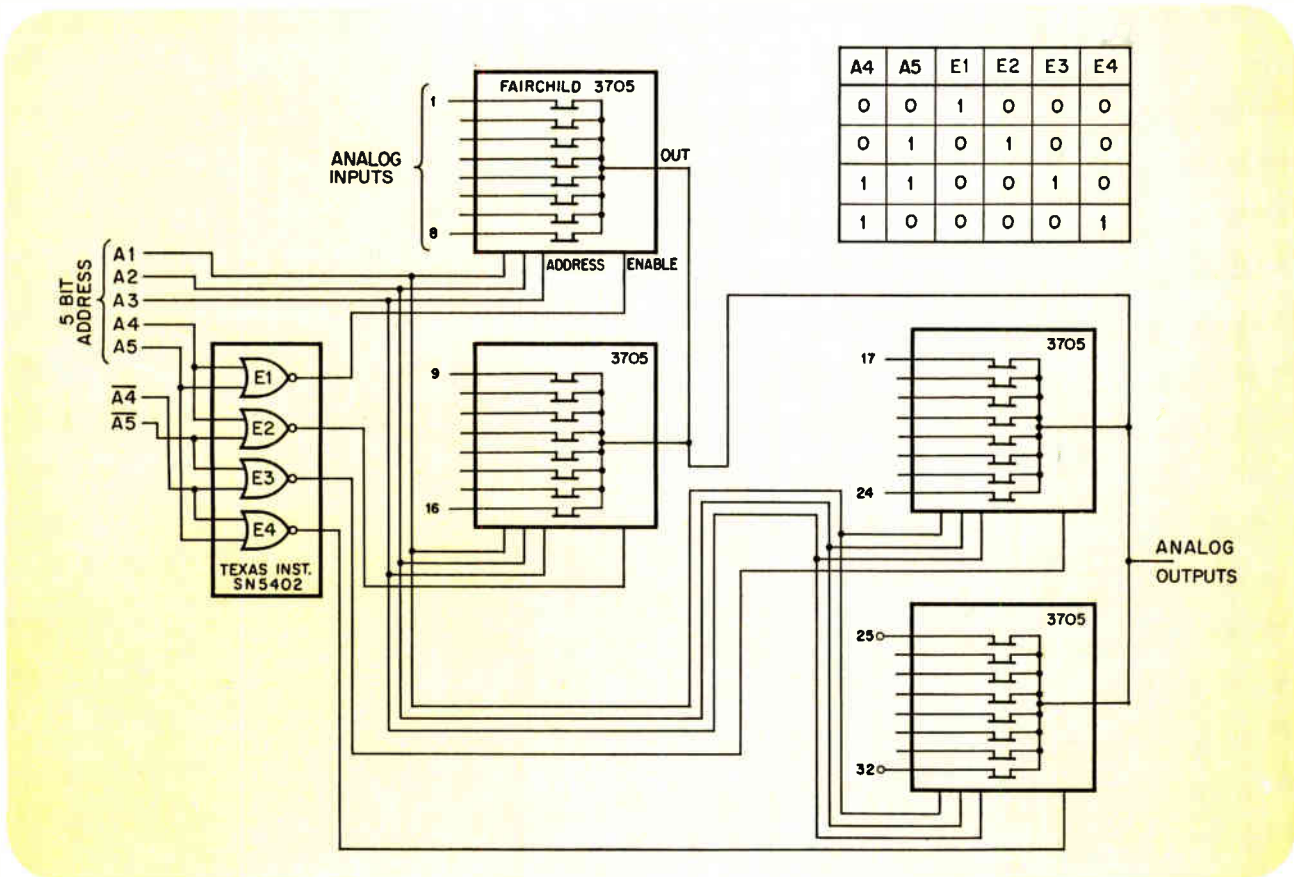

# FETs in RC network tune active filter

By Arthur D. Delagrange  
White Oak, Silver Spring, Md.

If the resistors of a conventional bridged-tee RC network are replaced by the ON resistances of two field-effect transistors, the FETs can be made to convert a standard active bandpass filter circuit into an electronically tunable narrow-band filter.

Since  $R_{on}$  is inversely proportional to the gate voltage, a change in gate voltage linearly varies the center frequency. The center frequency is

$$f = \frac{1}{2\pi \sqrt{R_1 R_2 C_1 C_2}}$$

Furthermore,  $Q$  depends primarily on the size of the large shunt capacitor  $C_1$ , rather than the ON resistances  $R_1$  and  $R_2$ .  $Q$  is approximately

$$Q = \frac{1}{2} \sqrt{\frac{C_1}{C_2}}$$

The performance curves show that  $Q$  varies little over the tuning range; gain which is a function of  $Q$ , is also quite stable. Over a 1-volt tuning range, the gain increased 2dB and the  $Q$  increased from 7 to 8.5.

Gain at center frequency is kept about unity by resistor  $R_3$  at the operational amplifier's inverting input. To avoid distortion, the FETs must be kept in their resistive region by limiting the output amplitude to below 1 volt, peak-to-peak. FET matching is not critical, but it is convenient to use a matched pair in a single package.

Designer's casebook is a regular feature in Electronics. Readers are invited to submit novel circuit ideas and solutions to design problems. Descriptions should be brief. We'll pay \$50 for each item published.

**Active R.** Field effect transistors act as voltage-controlled variable resistors in this filter. Small change in gate voltage of the dual FETs varies their ON resistances, changing the network's RC value, and hence the filter center frequency. Control range of 0 to -1 V varies frequency over an octave.

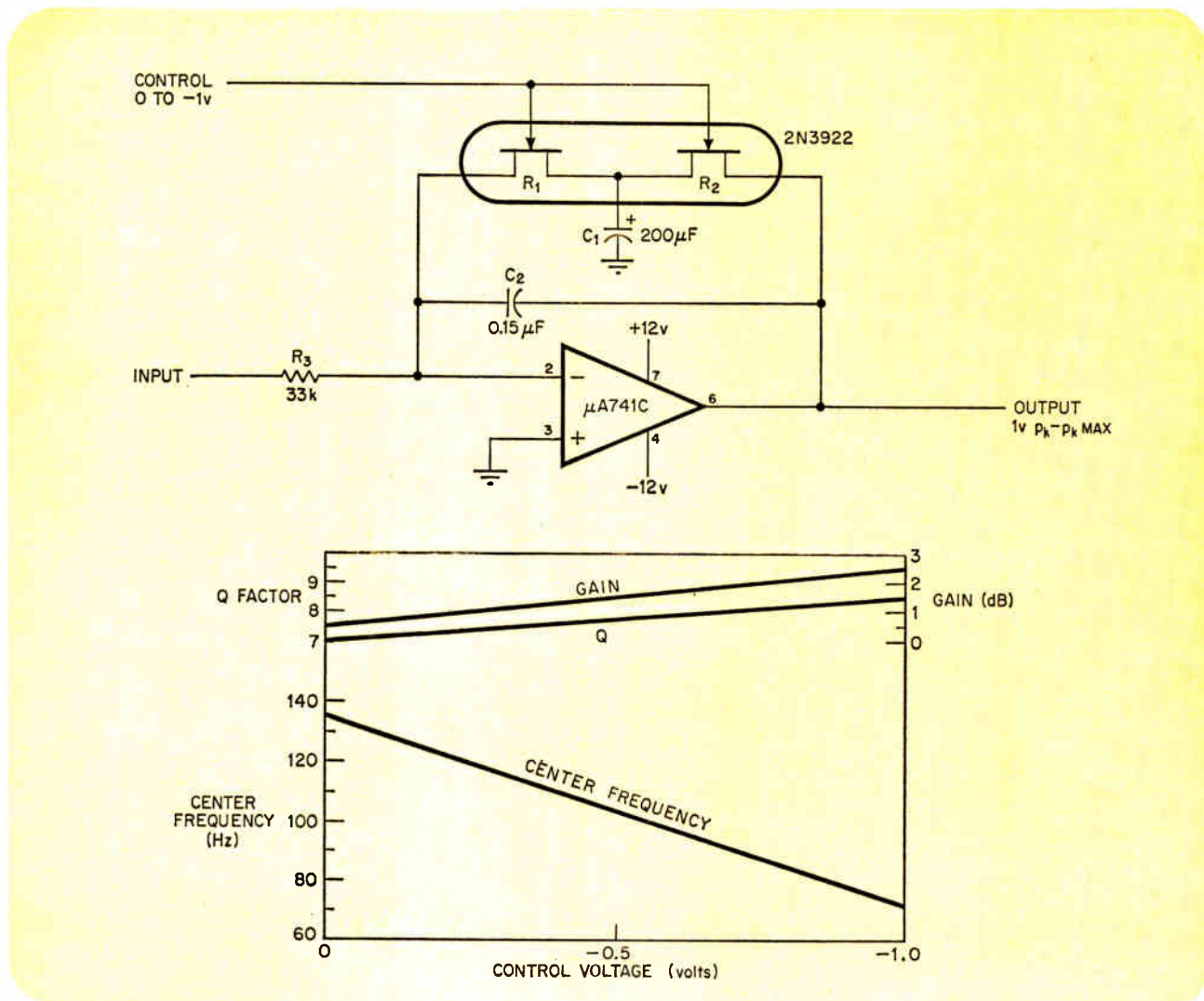

# yours free

—when you tear out coupon  
and mail to one of these  
A-B distributors

#### **Baltimore**

Cramer/Baltimore  
922-24 Patapsco Avenue  
Baltimore, Maryland 21230

#### **Boston**

Cramer Electronics, Incorporated  
85 Wells Street  
Newton, Massachusetts 02159

#### **Chicago**

Newark Electronics Corporation  
500 North Pulaski Road  
Chicago, Illinois 60624

#### **Cleveland**

Schweber Electronics Corporation  
23880 Commerce Park Drive  
Cleveland, Ohio 44122

#### **Denver**

Cramer/Denver, Incorporated  
5465 East Evans Place at Hudson  
Denver, Colorado 80222

#### **Detroit**

Newark-Detroit Electronics, Incorporated  
20700 Hubbell Avenue  
Oak Park, Michigan 48237

#### **Los Angeles**

Kierulff Electronics, Incorporated  
2585 Commerce Way  
Los Angeles, California 90022

#### **New York**

Schweber Electronics  
Jericho Turnpike  
Westbury, New York 11590

#### **Philadelphia**

Almo Electronics Corporation  
Roosevelt Blvd. at Blue Grass Rd.  
Philadelphia, Pa. 19114

#### **Phoenix**

Kierulff Electronics Corporation  
2633 East Buckeye Road  
Phoenix, Arizona 85034

#### **San Diego**

Kierulff Electronics  
8797 Balboa Avenue  
San Diego, California 92133

#### **San Francisco**

Elmar Electronics, Incorporated  
2288 Charleston Road  
Mountain View, California 94040

#### **Seattle**

Kierulff Electronics, Incorporated  
5940 Sixth Avenue, South  
Seattle, Washington 98134

#### **Washington, D. C.**

Cramer/Washington  
692 Lofstrand Lane  
Rockville, Maryland 20850

#### **IN CANADA:**

##### **Montreal**

Cesco Electronics Ltd.  
4050 Jean Talon  
Montreal, Quebec

##### **Ottawa**

Cesco Electronics Ltd.  
1300 Carling Avenue  
Ottawa, Ontario

##### **Quebec**

Cesco Electronics Ltd.  
98 Rue St. Vallier, Ouest  
Quebec P. Q.

##### **Toronto**

Cesco Electronics Ltd.  
24 Martin Ross Avenue  
Downsview, Ontario

Allen-Bradley  
electronic components

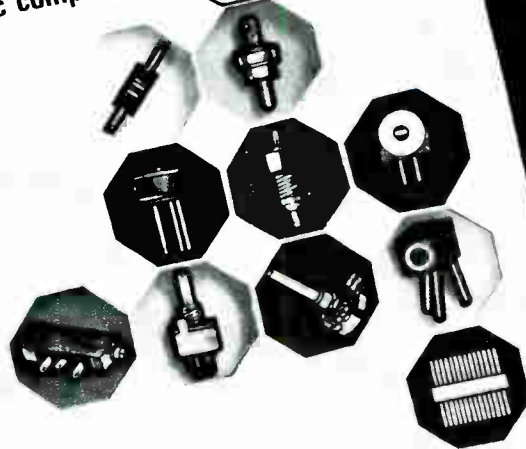

## 40 pages of specs and operating characteristics to supplement A-B distributors' catalog listings

Comprehensive reference manual. Provides in-depth information on Allen-Bradley precision resistor networks, trimmers, variable resistors, feed-thru and stand-off capacitors, feed-thru filters, composition fixed resistors. All are available off the shelf from your appointed Allen-Bradley distributor.

#### MAIL TO THE A-B DISTRIBUTOR NEAREST YOU

Send me free catalog RD.

Name \_\_\_\_\_

Company \_\_\_\_\_

Address \_\_\_\_\_

City \_\_\_\_\_

State \_\_\_\_\_ Zip \_\_\_\_\_

# Light gating brightens CRT image for large projection displays

Light-gated CRTs may incorporate a variety of technologies, with very different performance characteristics; fifteen criteria help the system designer to decide which tube type best suits his purpose

By Guenther O. Langner, *International Business Machines Corp., Systems Development division, Kingston, N. Y.*

□ For large displays of changing data, graphics, and pictures, nothing rivals the cathode ray tube in speed, information density, and flexibility. Though schemes for projection displays involving other technologies abound, they are relatively expensive and unlikely to offer the CRT much competition for at least the next decade.

However, the CRTs being developed for display work are very different from the familiar television tube, in which the energy of the electron beam changes into visible light upon impact on a phosphor screen. Phosphor CRTs aren't bright enough for projection, nor can they be easily made brighter. Increasing electron beam energy would increase brightness, but at the expense of phosphor life. And enlarging screen size for the same purpose requires expensive, large-diameter optics.

Instead of the phosphor screen, therefore, CRTs for large displays use another kind of target—one that changes its optical properties when the electron beam strikes it, so that the tube modulates, or gates light from an external source. The advantage is that the brightness of the projected image is largely determined by the light source.

Many diverse technologies have been proposed, and some implemented, for such light-gating CRTs. In one approach, the electron beam causes the target to scatter or absorb light from the external source and thus appear opaque. Another approach is to use a target with reflection properties that are changed by electron-beam-induced deformation. Still another is to have the electron beam change the index of refraction of the target. At present, the more feasible technologies are in a state of fierce competition, but within a year or so, one or two of the contenders will have gained an edge and be entering the production stage.

With this embarrassment of riches, how can the most eligible candidates be identified? It's easy with the aid of the criteria and table in "How to score light-gating CRTs," page 80. The 15 criteria pinpoint ideal characteristics, and the table quantizes the degree to which the various light-gating technologies approach the ideal. No one system can meet all 15 criteria—but only rarely would an application require all 15 to be met. Nevertheless, the list is a valuable starting point for evaluation and comparison.

The lower the score in the table, the more closely the system approaches the ideal. A multipurpose system with a score of up to 30 should be considered for further development, but if the score is greater than 40, the technology should be disregarded. A high (unfavorable) score does not necessarily mean that the system is unsuited to certain limited applications, however. If, for example, a system gets an unfavorable rating of 4 or 5 in categories 5 through 9, it may still be feasible for application in TV projection.

Perhaps the best known of the approaches listed in the table is the dark-trace tube, in which ionic crystals such as potassium chloride are used as the target. When the electron beam strikes a crystal, it induces so-called color centers that absorb light and therefore appear dark to the viewer. The image is erased when the crystal is heated. This need to use heat for erasure is one disadvantage of the dark-trace tube for large screen displays, since it makes selec-

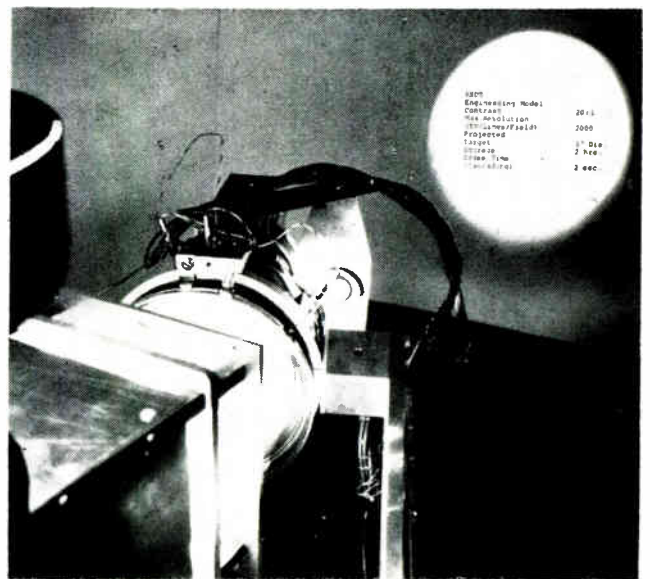

1. One technique. Electrostatic storage and display tube (ESDT) is one of many approaches to light-gating CRTs for large-screen displays. To gate light, ESDT uses a xerographic toner controlled by the electron beam.



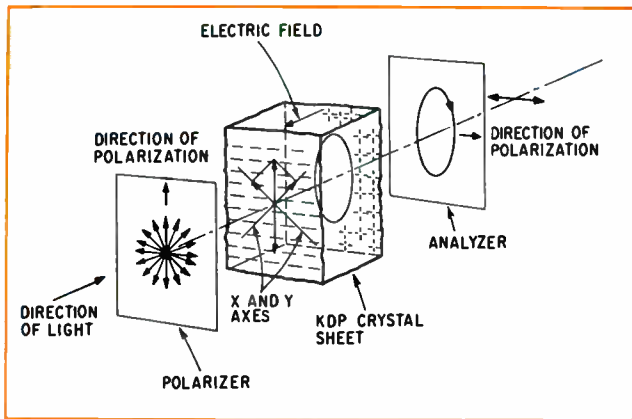

tive erasure difficult and updating speeds relatively slow. A second disadvantage is the high beam-current densities required for adequate contrast.

Further, although the dark-trace tube is compatible with a fairly simple optical projection system, of the type used in opaque projectors, the target's sensitivity to heat limits the light flux. Even so, cooling must be provided for the brightness needed for projection.

The dark-trace tube is representative of a class of CRT display devices that change the optical properties of a target by the direct effect of the electrons. Most other light-gating CRTs use some effect generated by the electric field associated with the deposited charge. For example, certain birefringent crystals such as potassium dihydrogen phosphate (KDP) change their refractive index under the influence of an electric field parallel to the path of light passing through them (Fig. 2). As a target in a Pockels effect tube, a single-crystal sheet of KDP can therefore change linearly polarized light into elliptically polarized light, and a polarization analyzer can be used to convert the pattern written on the crystal into a visible pattern of dark (linearly polarized) and light (elliptically polarized) areas. Interference of the electron beam path with the light path can be avoided by using reflected light from the birefringent crystal for projection, rather than transmitted light.<sup>1</sup>

The brightness and contrast of the image on the tube is determined primarily by the combination of electrical field strength and crystal thickness. A KDP crystal sheet typically requires a potential difference of several kilovolts to yield a 50-to-1 contrast ratio.

Checking the Pockels-effect tube against the ideal standards in the table reveals that large-screen black-and-white TV projection is this CRT's strong point. Some of the standards cannot be met. Selective erase and cursor overlay, for example, would have to be handled in the same way as in any constantly refreshed CRT—with memory buffers.

Actually, electro-optical gated CRTs are not in the mainstream of CRT display technology. Most of the proposed and demonstrated light-gated CRTs are based on an entirely different principle: the deformation or reorientation of particles by an electric field.

The principle is implemented by having the electron beam write on some insulating deformable material, a liquid film, for example. Figure 3 shows how this

2. **Changed polarization.** Electron beam in Pockels-effect tube alters refractive index of potassium dihydrogen phosphate sheet, changing polarization of light passing through Polarization analyzer makes change visible.

3. **Deformable film.** Electron beam can create electrostatic forces in a film of insulating material. This causes localized deformation of film (top), altering the light beam path. If a thin membrane separates the deformable film from the electron gun (bottom), cathode poisoning is prevented.

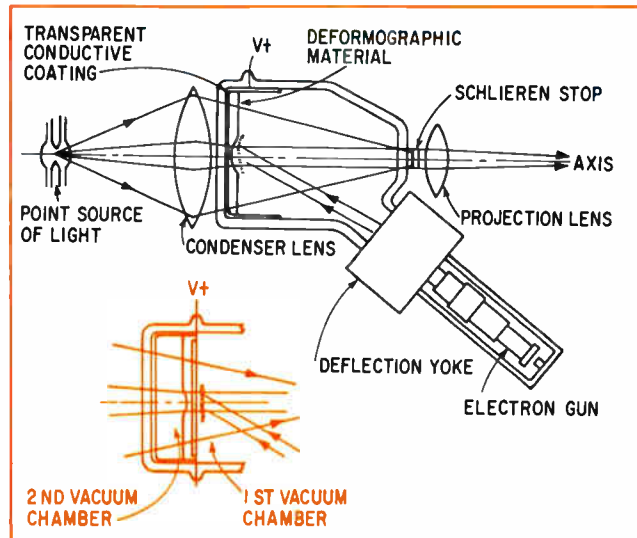

can be done. The electron beam directly charges the target material, deforming it locally because of the electrostatic forces associated with the charge. The optical imaging system consists of a point source, a condenser that focuses the point source on a schlieren stop, and a projection lens. If, during the write cycle, the electron beam charges an image point, the resultant deformation will refract light so that it passes the schlieren stop and reaches the screen.

The Eidophor tube is one attempt to use the deformation principle. It was invented by F. Fischer and H. Thieman and later refined by E. Bauman of the Zurich Institute of Technology in the early 1950s. Though the deformation principle is simple enough, the developers of the Eidophor projector, which uses a reflective, schlieren system and a rectangular image spot, found its implementation not so simple. The main complication was poisoning of the electron gun cathode by gases generated by electrons impacting the target. This made it necessary to evacuate the tube continuously with an external vacuum pump. Many other problems had to be solved, too. One was the temperature of the deformographic liquid, which had to be kept constant to maintain the critical viscosity. Another was the necessity for constantly cleaning the deformable liquid, which is slowly decomposed by the electron beam and hence contaminated.

A light-valve tube proposed by W.E. Glenn and developed by W.E. Good and coworkers at General Electric solved these problems with a proprietary combination of cathode material and deformable liquid.

## How to score light-gating CRTs

To insure high performance, versatility, economy, and reliability, the ideal cathode ray tube for large-area projection display should have certain characteristics:

- **Gray scale.** It should display shades of gray as well as outlines. Ten shades of gray, or a minimum contrast ratio of 20:1, are desirable.
- **Color.** It should have a color version.
- **Brightness.** The tube system should be capable of a projected light intensity of 5,000 lumens for black-and-white and 2,000 lumens for color. Versions with more moderate brightness, down to about 200 lumens, should also be available.
- **Resolution.** In black-and-white, the CRT should resolve 1,000 tv lines, or 1 million image points. For color alphanumerics and graphics, the resolution should be the same; for color pictorial displays, it should be about 500 lines.
- **Variable persistence.** The duration of continuous light emission should be adjustable between several seconds and approximately 20 milliseconds. At the tv refresh rate of 30 times per second, there should be no charge build up.
- **Storage time.** The CRT should be able to store an image—without necessarily displaying it—for at least 10 minutes without significant degradation.
- **Selective erase.** It should be possible to selectively erase and replace a part of the image.
- **Cursor display.** An overlay of image elements requiring short persistence (like a cursor, for example) with stored image elements should be possible.
- **Tube life.** Life expectancy should be comparable to that of conventional CRTs, which last for several thousand hours.

▪ **Standard optics.** The projection optics and light source should be simple and straightforward. If possible, schlieren optical systems, which essentially make visible inhomogeneities in a material, or reflection-polarized light systems should be avoided, since they are relatively complex and costly.

▪ **Standard CRT technology.** The CRT, from its cathode and gun to its high voltage and deflection circuitry, should employ standard, well understood technology to maximize reliability and facilitate manufacture.

▪ **Target technology.** The underlying principles of target structure and operation should not be unique, but also be employed in applications other than the light-gating CRT, to cut cost and development time.

▪ **Optical axis.** The light-optics path should not interfere with the electron-optics portion of the tube. Usually this means using either an off-axis light-optics system or an off-axis electron beam with the unsymmetrical deflection necessary for keystone-distortion correction.

▪ **Adjustments.** Installation of the light-gating CRT package in a system should not require supernatural skill at making optical adjustments.

▪ **Special equipment.** The CRT should not require special—and expensive—auxiliary equipment like heaters or vacuum pumps.

The accompanying table is the author's estimate of the degree to which the various light-gating projection systems approach these ideal criteria. For each criterion, a system is rated as: 1—if it meets it unconditionally; 2—if it does so with reservations; 3—if it has only a 50-50 chance of meeting the criterion; 4—if it's unlikely to meet the criterion; 5—if it won't meet the criterion without a major, unforeseen breakthrough.

CLASS	CATEGORY OF IDEAL TUBE STANOAROS ↓ TECHNOLOGY	1	2	3	4	5	6	7	8	9	10	11	12	13	14	15	REMARKS	
		GREY SCALE	COLOR VERSION	IMAGE BRIGHTNESS	RESOLUTION	VARIABLE PERSISTENCE	STORAGE	SELECTIVE ERASE	CURSOR OVERLAY	TUBE LIFE	OPTICAL SYSTEM	STANDARD CRT TECHNOLOGY	TARGET TECHNOLOGY	OPTICAL AXIS	ADJUSTMENTS	SPECIAL EQUIPMENT		
ELECTRO-OPTICAL	DARK TRACE TUBE	2	5	3	3	5	1	4	5	1	2	1	2	1	1	2	Demonstrated feasibility for limited application (direct view storage tube); 38 Points	
	POCKELS EFFECT TUBE	1	4	2	3	5	5	5	5	2	3	1	3	1	2	1	Limited application in B&W displays at TV rate; 43 Points	
DEFORMATION OR REORIENTATION	EIDOPHOR PROJECTOR	1	1	1	1	5	5	5	5	2	4	5	3	1	4	5	Demonstrated feasibility for limited application (large screen TV projection, B&W and color); 49 Points	
	LIGHT VALVE TUBE	1	1	2	1	5	5	5	5	2	4	4	3	1	2	2	Demonstrated feasibility for limited application (large screen TV projection, B&W and color); 43 Points	
	ELECTROSTATIC DISPLAY AND STORAGE TUBE (ESDT)	3	5	2	1	5	1	5	5	1	2	2	2	5	1	2	4	Limited application (projection storage of display graphics); transmission 45 points, reflection 41 points
	ORIENTED PARTICLE TUBE	1	5	2	2	1	1	1	1	1	2	1	4	5	1	1	1	Multipurpose tube; transmission 29 points, reflection 25 points
	DEFORMOGRAPHIC STORAGE AND DISPLAY TUBE (DSDT)	1	4	1	1	1	1	1	1	1	4	3	4	5	1	3	1	Multipurpose tube; transmission 32 points, reflection 28 points
	ARRAY-TARGET TUBE	1	1	1	1	1	1	1	2	1	3	2	3	1	2	1	1	Multipurpose tube; 22 points

This tube, although it's permanently sealed, has a longer lifetime even than that of conventional phosphor tubes used for projection. In addition, its optics are better than the Eidophor's: an ingenious schlieren optical system works without interfering with the electron beam system—neither the light beam nor the electron beam is off-axis. Another improvement is the combination of the electrostatic deflection system with a focusing lens. This combination produces a rectangular spot on the target that creates a ripple pattern in the electron beam's sweep so that every image becomes a diffraction grating. This opens up possibilities for use of optical diffraction schemes for color.

The Eidophor and GE light-valve tubes, like any of the deformation or particle-reorientation tubes, depend critically on the time constants of the electric field and the particle deformation or reorientation. In general, the latter must be the shorter, so that the optical action responds rapidly to the field, and is therefore controlled by the electron beam. And this is true of both the Eidophor and the light-valve tubes, in which the time constant of the deformable liquid is the controlling factor and is chosen to handle standard TV frame rates. As a result, neither tube has storage capability. They are designed primarily for black-and-white and color projection of TV images, as the ratings in the table indicate.

Aside from the proprietary approach used in the GE light-valve tube, the problem of cathode poisoning can be solved by dividing the tube into two vacuum chambers by means of a thin dielectric membrane, as shown in Fig. 3. This solution allows ordinary oxide cathodes to be used, and has been employed successfully in a variety of light-gating CRTs.

A double-chamber tube can also be used to advantage with targets other than the deformographic type. Figure 4 illustrates the use of a xerographic toner in the front chamber, mechanically cascaded over the dielectric membrane. The toner sticks to the membrane wherever the electron beam has deposited a charge-projected image. This type of tube, called the electrostatic storage and display tube, or ESDT (Fig. 1), was invented by C.K. Clauer and J.D. Kuehler of the IBM Corp.<sup>2</sup> and its feasibility has been demonstrated by J.M. Engel.

The ESDT tube has several advantages. Instead of complex schlieren optics, a simple, conventional projection system can be used. Resolution exceeds 2,000 TV lines, and storage time can be in weeks.

Operation in the transmission mode requires the tube to have two light ports and forces either the projection optics or the electron-optical system (electron gun and deflection yoke) to go off-axis. A reflective dielectric coating on the target would permit operation in the reflection mode, which would permit simpler optical and electron-optical systems. Two ratings are given for the ESDT in the table under "Optical axis"—one for transmission mode and one for reflection mode.

The chief disadvantage of the ESDT is the need to cascade the toner powder mechanically over the target both after the charge pattern has been written by the electron beam (a development process) and after the charge pattern has been erased. The ESDT therefore

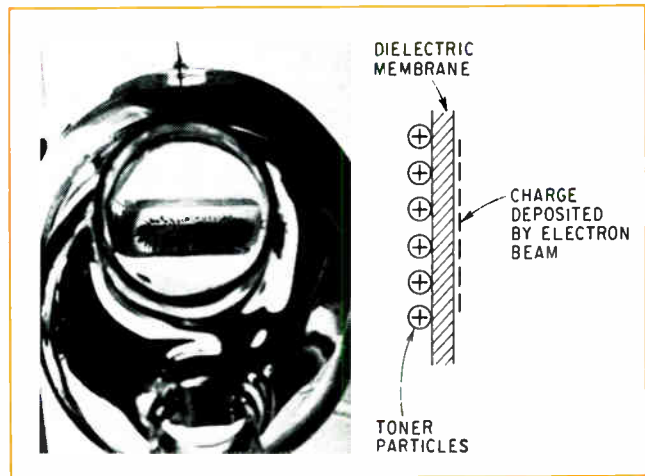

4. Xerography. In electrostatic storage and display tubes, the electron beam creates an opaque image by attracting toner particles to dielectric membrane. Photograph shows magnetic brush collecting particles to erase image.

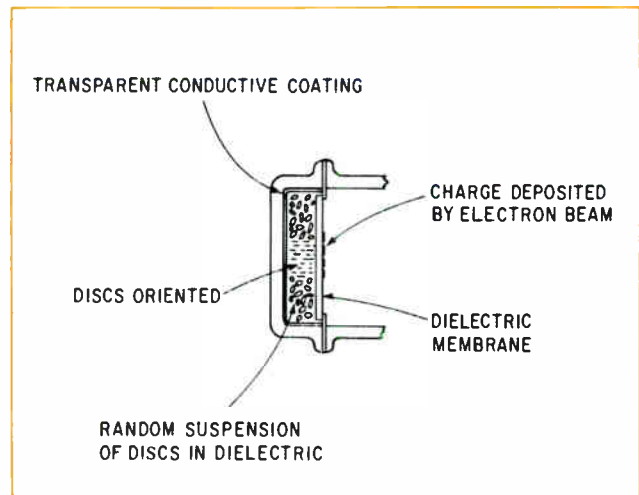

5. Particle orientation. Electron beam orients particles so that they are perpendicular to dielectric membrane and allow light to pass through in a straight line.

has an unfavorable rating in column 15 of the table, the special equipment category. Also, selective erasure and updating are not possible and the attainment of gray levels is difficult. Moreover, there is no known way to extend the principle to color. This results in poor ratings in categories 1, 2, 5, 7, and 8.

A rather simpler two-chamber tube is the deformographic storage and display tube (DSDT). Like the Eidophor tube, the DSDT uses a deformable material for the target, which, however, is separated from the electron gun chamber by a membrane to prevent cathode poisoning. This tube has been developed at IBM by Robert J. Wohl and his coworkers to the point where it can already be termed a multipurpose tube.

The DSDT can be operated in transmission mode or reflection mode. In addition, it is capable of selective erasure and overlaying of short-persistence and long-

## Target and electron-beam interaction

There are two basic ways to gate light in a cathode ray tube. In one, the electron beam directly changes the optical properties of the target material. For instance, electrons with a low-kilovolt energy can change the refractive index of some materials and, since the angle of total reflection is dependent on the index of refraction, this property can be used to change the path of an external light source so that the information written by the electron beam becomes visible. An example is the "dark trace" that an electron beam generates in a layer of potassium chloride and which absorbs light until erased by heat.

In the other basic method, the electric charge that the electron beam has deposited in a spot on the target indirectly controls the optical properties of the target by generating an electric field.

For a charge to be deposited by the beam, the target must be insulated, or, more precisely, the time constant of the small capacitors formed by the beam on the insulated target must exceed a certain value, given by

$$t_{\min} = 9 \times 10^{-14} \epsilon \zeta \text{ seconds}$$

where  $\epsilon$  is the dielectric constant of the target and  $\zeta$  is the resistivity of the target in ohm centimeters.

Another factor that affects charge deposition is secondary emission, the tendency of an electron beam to knock loose other electrons in the target material. There are two opposing effects at work here: the number of secondary electrons knocked loose increases with the energy of the primary electron—yet the greater the energy of the primary electron, the deeper it penetrates into the target, and the less chance it gives loose electrons to escape.

The net result is summed up in the emission curve of the target material. It contains two regions in which the secondary emission ratio is less than one, indicating that the number of electrons leaving the target is less than the number of electrons in the primary beam, so that there's a net gain of charge on the target. Between the regions is a range in which the *secondary emission ratio* is greater than one, indicating a net loss of charge at the target.

If the target is an insulator, charge will accumulate at a target spot being hit by the electron beam. If the beam energy is below (to the left of) the first crossover, the target spot becomes negatively charged and the

potential of this charge becomes more and more negative until it finally reaches cathode potential. If the beam energy is initially between the crossover points, a positive charge accumulates, becoming increasingly positive until it reaches either the potential of the second crossover or the potential of some surface in the tube which is below that of the second crossover but above the acceleration potential of the electron beam.

If the beam energy (expressed as the acceleration potential) is greater than the second-crossover energy, a negative charge accumulates at the target spot. The spot becomes increasingly negative until it has dropped to the potential of the second crossover, where there is a balance between hitting and escaping electrons. In order to collect the secondary electrons, a surface must be provided in the tube which has a potential at least equal to the beam potential; otherwise, the secondary electrons will return to the target at some point other than the spot irradiated by the beam.

These mechanisms offer a means of controlling storage time because they can be used to erase a charge pattern at will. Erasure simply means returning the entire target to a uniform potential. Thus, simultaneous operation of two beams—one a continuous beam for erasure and the other a pulsed beam for writing—can produce the short time constant necessary for rapidly changing images. For longer storage, successive write-erase cycles can be used.

In some insulators, resistivity can be varied as a function of the electron beam energy. The effect, electron-bombardment-induced conductivity (EBIC), can be used for controlling the time constant and for erasure.

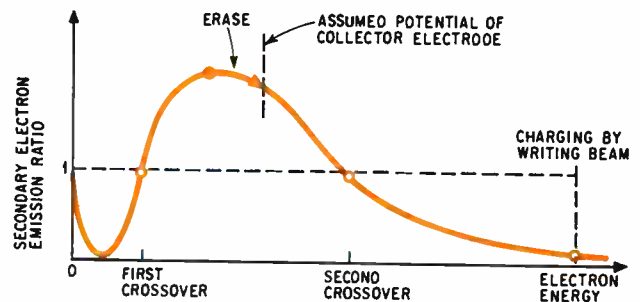

persistence image details. Selective erasure is accomplished by shifting the potential between target and gun, so that the target operates between the crossover points in the secondary-emission characteristic (see "Target and electron-beam interaction," above). Under this condition, the electron beam erases. Overlaying short persistence images, such as a cursor or other points that are constantly changing, is done by allowing the electron beam to write, erase, and rewrite only on those points where the image is changing.

The circuitry for control of overlaying and selective erase presents some challenges to the designer. Both require high voltage switching (up to 7 kilovolts) at frequencies up to several hundred hertz, and the synchronous switching of the deflection sensitivity. However, it is not necessary to change the deflection

sensitivity if a mesh lens is used to reduce unwanted deflection as the beam is accelerated after deflection.

For the 1,000-line resolution required by the ideal standard at high switching rates and voltages, the ancillary circuits for overlay and selective erasure don't come cheaply. Nevertheless, it's possible to assign an excellent rating to the DSDT in categories 7 and 8 in the table.

Two other highly promising applications of the deformographic or particle reorientation concept are possible, but are not yet completely proven. The first is a proposal, made many years ago by W.J. Donal and D.B. Langmuir of RCA,<sup>3</sup> to include a suspension of dielectric disks in the space between the membrane and the faceplate of a tube, as shown in Fig. 5. A working model of the tube was recently built.<sup>4</sup>

When there's no charge on the target, the disks are randomly oriented, and scatter or absorb light that passes through them. When a charge pattern is written on the dielectric membrane, the disks adjacent to the charged areas become perpendicular to the membrane and permit light to pass through in that region. After erasure, the disks are again randomly oriented. As usual, an optical projection system makes the light pattern, as defined by the charge trace and oriented particles, visible on the projection screen.

Target technology is the main problem with this kind of oriented-particle tube. A suspension material must be found which responds rapidly enough to the write and erase patterns traced by the electron beam (the time-constant problem again). And a way must be found to prevent clogging and sedimentation of the suspension—embedding the disks in a rubber-like matrix might be an answer, except that it restricts the angular motion of the disks and results in poor contrast. If these target problems can be solved, the oriented-particle approach will have a real chance of meeting the ideal criteria.

In the form shown in Fig. 5, the oriented-particle tube is a transmission-mode display device. It could, however, be converted to the reflection mode by placing a reflective dielectric coating on one side of the suspension, to prevent interference between the light path and the electron optics and allow use of a simple opaque projection system. The tube probably could be made in a direct-view version also.

In any of these dual-chamber tubes, fabrication cost is rather high because of processing complications. Both chambers, for example, must be evacuated at the same time to prevent a pressure differential across the thin membrane. Moreover, formidable demands are imposed on the materials in both the deformographic and electrostatic (xerographic) approaches.

The second promising, but as yet unproven, application of the deformographic concept—the array-target tube, proposed by the author—is an effort to circumvent these disadvantages.<sup>5</sup> In this tube, the deformable dielectric material is replaced by an array of tongues or flaps, as shown in Fig. 6. Because this target is made of inorganic materials, the impact of electrons from the beam does not cause outgassing. There is no need, therefore, for a double chamber.

Without a charge on the target—or with a uniform charge on the electron-beam side of the target—all flaps are in the same plane. Light from this spot is then reflected in such a way that it can pass the schlieren stop and appear on the projection screen. The angle to which the flaps can be bent by the electrostatic forces, without exceeding the elastic deformation range, is large enough for relatively simple schlieren optics to be used. This justifies a rating of 3 in the table under the optical system category.

Color projection is possible with the array-target tube if a shadow mask is placed in front of the target and the flaps are arranged in groups of three, with each flap bending in a direction 120° away from each of the other flaps in the group. The optical system for color projection would be only slightly more complex.

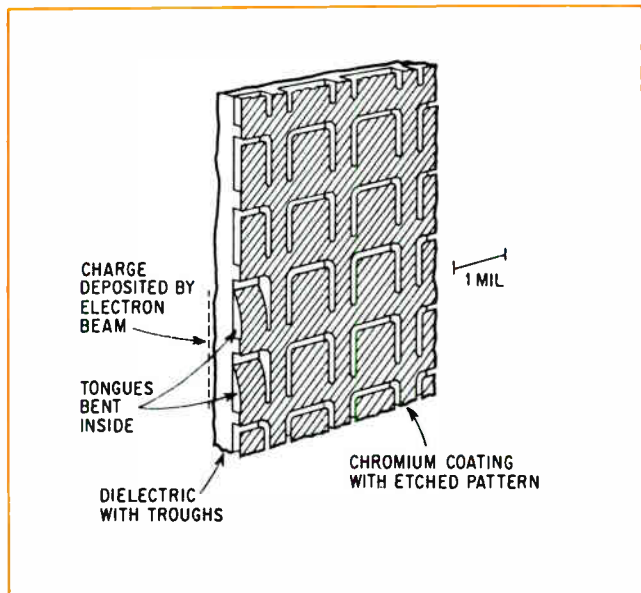

6. Electrostatic bending. In array-target tube, electron beam impinges on dielectric material and generates electrostatic forces that deflect flaps.

Like the oriented-particle tube, the array-target tube shares with the DSDT the capacity for storage, selective erasure, and cursor overlay. All this gives the array-target approach a favorable rating in the first eight categories in the table. (The rating of 2 for the cursor simply indicates that it is not yet known which of the several methods available would be the most appropriate.)

Controlling short persistence images—those of TV frame duration—is more of a problem, but can be accomplished by utilizing electron-bombardment-induced conductivity (EBIC), by alternating write and erase cycles, or by one or more wide-angle flood guns. The last technique has been employed successfully in many CRT designs; the flood gun operates continuously and begins to erase a spot as soon as it has been written by the image gun.

The big question concerning the array-target tube is the target itself: fatigue of the flaps may limit tube life. However, the manufacturing technology used to form the flaps for the target—electrochemical “machining”—is widely used in integrated circuit manufacturing. Enough experience has been accumulated with this technology to forecast that the problems can be solved, and to warrant a rating of 3 or better in the target technology category. □

#### References

1. D.H. Pritchard, "A Reflex Electro-Optic Light Valve Television Display," *RCA Review*, Vol. 30, Nov.-Dec. 1969, pp. 567-593.
2. C.K. Clauer and J.D. Kuehler, U.S. Patent No. 3,109,062, issued Oct. 29, 1963.
3. W.J. Donal and D.B. Langmuir, "A Type of Light Valve for Television Reproduction," *Proc. IRE*, Vol. 31, p. 208, 1943.
4. B. Kazan, D.P. Foot, and D.G. Marlow, "Image Recording by Particle Orientation," *Proc. IEEE*, Vol. 56, p. 338, 1968.
5. G.O. Langner, "CRT-Display Target," *IBM Technical Disclosure Bulletin*, Vol. 13, No. 3, p. 603, Aug. 1970.

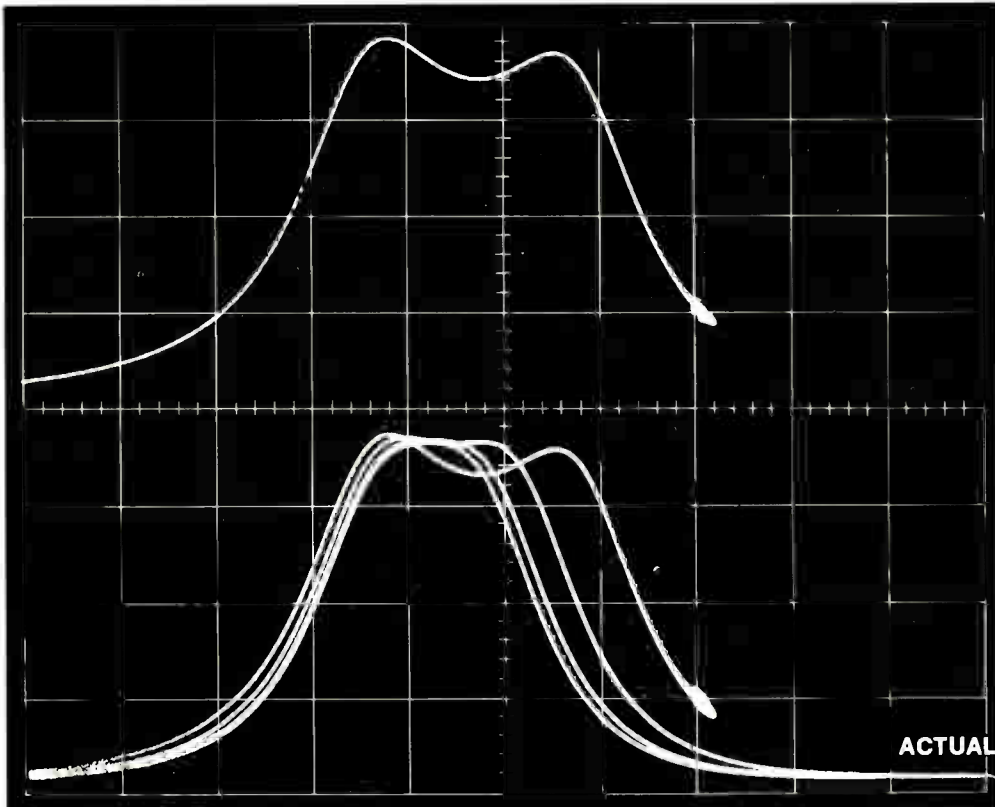

CH1  
> 100  
mV

CH2  
> 100  
mV

HORIZ  
200  
mS

ACTUAL SCREEN SIZE

# A DUAL-BEAM FAMILY

Performance in a Configuration to fit YOUR individual application

Big performance . . . in a compact size! Performance characteristics of this dual-beam oscilloscope family include high-gain, wide-bandwidth amplifiers with 19 calibrated deflection factors from  $10 \mu\text{V}/\text{div}$  to  $10 \text{V}/\text{div}$ . The voltage inputs (differential or single ended) have a bandwidth of DC to 1 MHz at all deflection factors. Current probe inputs are also provided for each beam with 10 Hz to 1 MHz bandwidth and eight calibrated deflection factors ranging from 1 mA to 200 mA/div. A wide sweep range is provided in 21 steps from  $1 \mu\text{s}/\text{div}$  to 5 s/div. The convenient direct reading magnifier provides sweep magnification ratios of up to 50 times. Bright fiber-optics automatically read out scale-factors adjacent to the extra large 8 x 10 div (1.27 cm/div) CRT.

This big display area is available in a 6½" conventional or rugged bistable storage CRT; both have internal graticules. Three instrument configurations are available, each at the same price. They are: a 5¼" high rackmount, a 6" high x 17¾" wide low-profile cabinet and a 10" wide upright cabinet. Save space without compromising your measurements!

Ask your Tektronix Field Engineer for a demonstration. For complete specifications consult your 1970 Tektronix Catalog or write: P.O. Box 500, Beaverton, Oregon 97005.

5031 (Storage) . . . . . \$2500 5030 (Conventional) . . . . . \$1850

These oscilloscopes are available through our new Leasing Plan.  
U.S. Sales Prices FOB Beaverton, Oregon



**Tektronix, Inc.**



committed to progress  
in waveform measurement

# FET input reduces IC op amp's bias and offset

With junction FETs processed on the same chip, monolithic operational amplifier maintains the high impedance of discrete input devices, and features sharply lower bias and offset currents, as well as significantly higher slew rates

By Terrance McCaffrey and Randy Brandt,  
Fairchild Semiconductor division,  
Mountain View, Calif.

Recent improvements in planar processing for the first time have allowed field effect transistor inputs to be integrated into monolithic operational amplifiers. These J-FET amplifiers offer lower input bias and offset currents than the conventional bipolar inputs they replace, with the added bonus of higher input impedance. These features are particularly useful in sample-and-hold circuits, long-term integrators, and logarithmic amplifiers.

The new monolithic J-FET amplifiers achieve input impedances in the 100,000-megohm range, higher than those obtainable from bipolar-input units. And bias current, at about 100 picoamperes, is about 10 times lower than the best offered by amplifiers using bipolars as inputs, while offset current is more than five times lower. Moreover, the monolithic amps' slew rate is greater than 6 volts per microsecond, against 0.1 to 2.5 V/ $\mu$ s for conventional amplifiers.

These specifications are attractive in many applications. In a sample-and-hold circuit, for example, a

1. **Good input.** The input stage of the operational amplifier consists of a differential amplifier that uses clamped, low-voltage J-FETs as source followers in each half. This arrangement, providing common-mode rejection, keeps the voltage below 2 volts. High-voltage lateral pnp transistors  $Q_3$  and  $Q_4$  protect the J-FETs against large differential voltages.

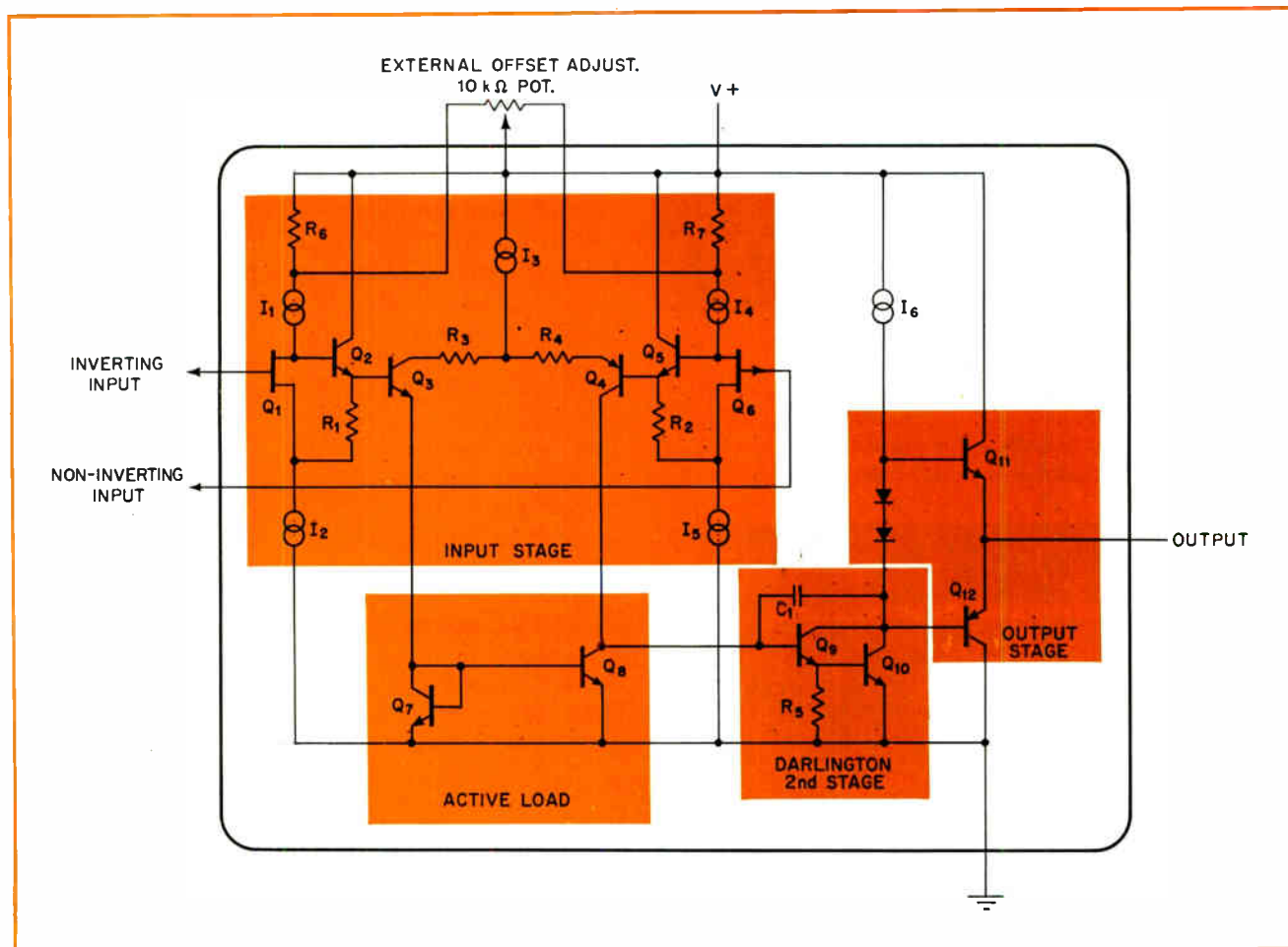

low bias current is needed to prevent signal loss during the hold cycle, while a high slew rate insures good accuracy during signal acquisition—greater portions of the signal can be sampled in a given interval. For long-term integrator applications, the monolithic amplifier's low bias current results in low capacitor leakages, allowing long charging time. And in log amp designs, where the device should be able to handle widely separated current values, the J-FET op amp's ability to receive currents from 1 nanoampere to 0.1 milliamperes extends the range of log amps into very low current regions, thus enabling them to operate over five decades, against only one to two decades for conventional units.

In fabricating J-FETs, very low input bias currents can be achieved only if the gate-to-source leakage caused by reverse-biasing the FET is kept very low. Precise control of FET channel thickness is a must—anything above a few tenths of micron inconsis-

**2. Fast riser.** The  $6\text{ V}/\mu\text{s}$  slew rate (slope of output rise time) is greater than conventional op amps using bipolar inputs. Each vertical line corresponds to 2 V, each horizontal line 1  $\mu\text{s}$ .

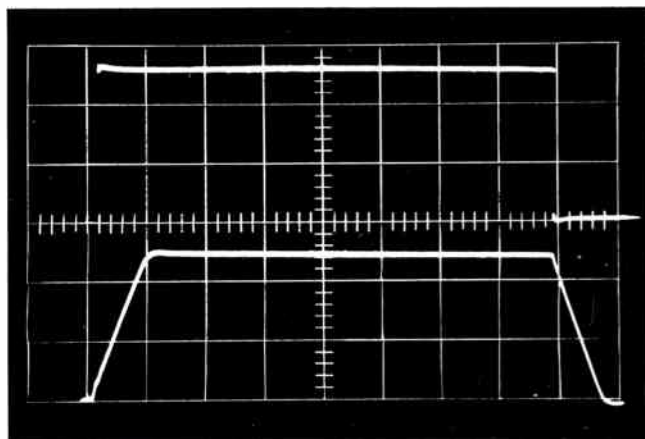

**3. Stable.** Overshoot on the output trace is less than 5%, which allows the op amp to drive into highly reactive loads. Each vertical division is 20 mV; each horizontal division is 0.5  $\mu\text{s}$ .

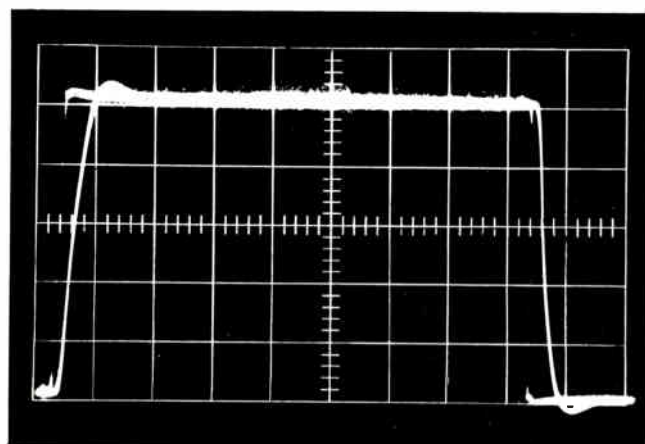

encies results in undesirably large junction leakages.

Until now, channels could not be controlled precisely enough to allow J-FETs to be built into integrated circuits. In fact, designers found that the processing step for making J-FET monolithic inputs were even more severe than those used for making linear ICs. But improved techniques developed for linear circuit fabrication were applied to the J-FET junction. Techniques to purify the oxide during FET fabrication and remove impurities in the bulk starting materials are instrumental in J-FET fabrication.

**These techniques** have been so successful that input bias currents an order of magnitude lower than that obtainable by the best input transistor technology (for example, super beta transistors) can be realized. Low bias currents are available with MOS transistors, but J-FETs are the better choice for inputs to op amps. Although MOS devices have an even lower gate leakage than J-FETs, they are vulnerable to transient spikes and must be protected by large-area diodes. This added diode leakage nullifies their advantage.

An amplifier, designated the  $\mu\text{A}740$ , has been built that is similar to present high-gain internally compensated monolithic operational amplifiers, except that it has a pair of matched J-FETs in the input stage. A simplified circuit diagram of the device is shown in Fig. 1. The input stage comprises a differential amplifier, which uses matched J-FET source followers, an active circuit source load, a Darlington second stage, and an output stage. Both sides of the input stage are identical: a p-channel J-FET, an npn transistor, and a pnp transistor make up the active elements of each.

This input construction differentiates the new design from conventional op amps. The input provides a common-mode clamp on the FETs that suppresses the large differential voltages that cause FET breakdown. The clamp protects the J-FET against forward bias operation which is instrumental in causing FET failure. (With p-channel J-FETs, forward biasing is caused by common-mode gate voltages exceeding those on the channels.)

CMR is accomplished by clamping the source-to-drain voltage of the J-FET in each half of the input, keeping the voltage below the FET breakdown level but above pinch-off. Source,  $I_1$ , supplies a current of 200 microamperes through FET  $Q_1$ . But since current source  $I_2$  is set to draw off 400  $\mu\text{A}$  from  $Q_1$ , 200  $\mu\text{A}$  must be supplied by the combination of  $Q_2$  and  $Q_3$ . This current flows through resistor  $R_1$ , which is selected to give a voltage drop of about 1.5 volts. The sum of the voltage drop across  $R_1$  and the voltage drop across the base-emitter of  $Q_2$  effectively clamps the source-to-drain voltage of  $Q_1$  to this voltage. Since the same procedure is followed for  $Q_6$ , the drain-to-source voltages of both input FETs always are approximately 2 V.

Because the input stage also is protected against large differential voltages which could cause breakdown, up to 30 V can be put across the input without allowing more than 6 V across the FETs' gate-to-source junction. This differential voltage suppression is accomplished by placing pnp transistors  $Q_3$  and



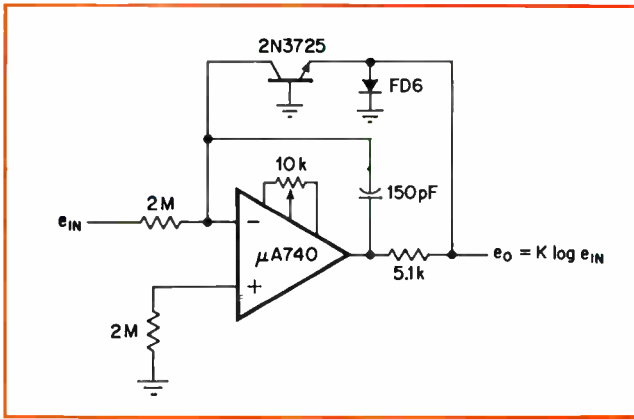

4. **Simple.** Because of its low bias and offset current, using the J-FET amplifier in log amp designs eliminates complex nulling circuitry.

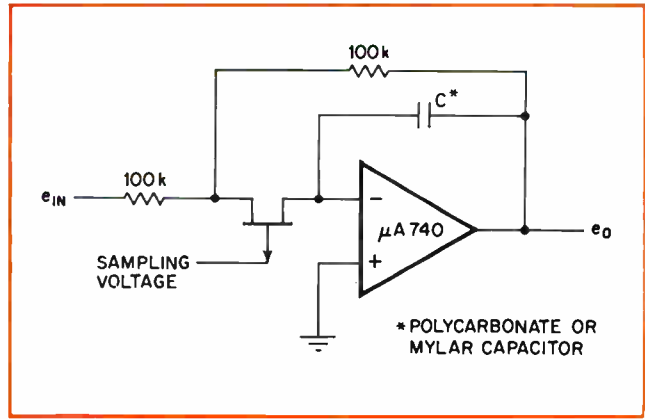

6. **Low leakage.** Because of low bias current, J-FET amplifier reduces the capacitance leakage, extending the holding time of circuits.

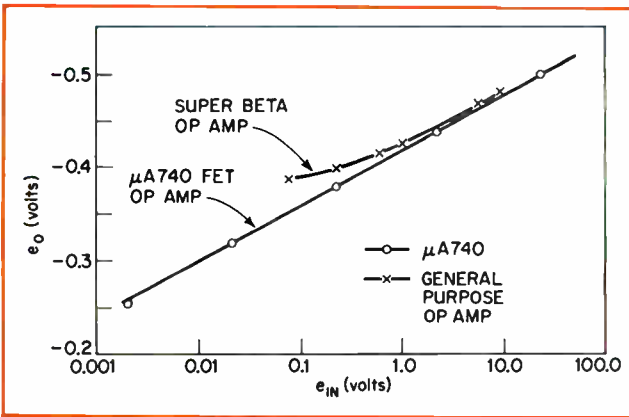

5. **Extended range.** Five-decades range is achieved compared to three decades with some conventional op amps.

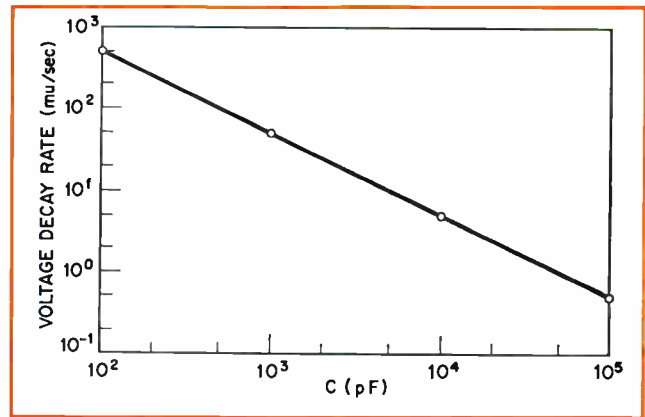

7. **Sample and hold.** Low voltage decay rates, such as these shown, are due to J-FETs low input bias current.

## How it's done

A monolithic junction FET begins with an n+ buried layer diffused into a p substrate to form the bottom gate. Next, an n-type epitaxial layer is deposited, followed by a p+ diffusion, giving isolating n pockets. A p-type diffusion then is made into the epitaxial layer, resulting in a p region which forms the channel. The top gate is formed by diffusing an n dopant into the p region. Ability to control channel width is key factor that allows integration of J-FET into op amp designs: it allows low leakage currents from source-to-drain.

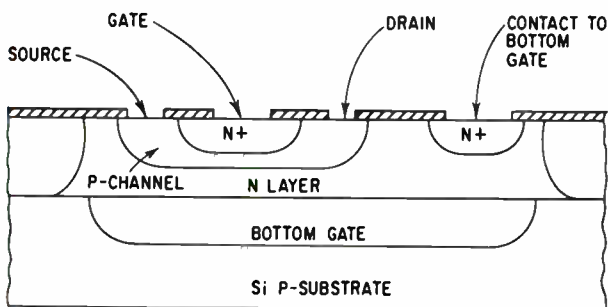

$Q_4$  in series with the two input FETs. The base-emitter junctions of the pnp transistors have very high breakdown voltages—in some cases as high as 60 V. They provide the high-voltage protection on the gate of the FETs, guarding them against large differential voltages.

Since the transconductance  $g_m$  of J-FETs is relatively low, a high-impedance active load must be included in the input stage to minimize any loss in gain and maintain high input impedance. This is accomplished by using a common-emitter differential loop as the load resistance for the J-FET.

Following the input stage is an active load stage,  $Q_7$  and  $Q_8$ , which not only provides full differential gain to the Darlington amplifier, but also provides a CMR feedback effect to compensate for inconsistencies in the current sources. This active load eliminates the need for a CMR feedback loop.

The second and output stage are standard designs. The Darlington stage, along with the MOS capacitor,  $C_1$ , comprise a Miller integrator and is used to roll off amplifier gain with frequency to insure stability. The output stage's low driving source impedance enable the op amp to drive high reactive loads while minimizing standby current and crossover distortions.

Figure 2 shows the slew rate of a typical J-FET input operational amplifier. The slew rate, the slope of the rising edge of the output trace, is  $6 \text{ V}/\mu\text{s}$ , allowing the amplifier to be used for high-speed circuit applications in which a large portion of the signal must be detected in a short time.

The overshoot characteristics of the J-FET amplifier are shown in Fig. 3.; the trace is the small-signal transient response for a typical amplifier. Again, the input is a square wave, while the output trace, which is superimposed on the square wave, almost duplicates the shape of the input, except for the small overshoot and slightly degraded rise-time. The small overshoot—less than 5%—insures stable amplifier operation under heavy reactive loads. This is an attraction in buffer amplifiers for digital-to-analog converters.

**The performance** of the J-FET amplifier is shown in the table, compared with two typical conventional amplifiers that use standard super-beta input transistors. One of the comparison amplifiers features low differential voltage swing, while the other shows high differential voltage swing. In either case the J-FET op amp exhibits generally superior performance. The key parameter, bias current  $I_b$ , is lower by almost an order of magnitude than the best value given for the standard input amplifier. Offset current—the differential current between the matched input transistors—is lower by a factor of five and slew rate is much higher, in one case by a factor of 60, in the other by almost 3. Although  $V_{os}$ , the offset voltage, is higher for J-FET amp, it can be adjusted to zero easily with a  $10 \text{ k}\Omega$  potentiometer that's connected across the nulling terminal.

PARAMETER	OPERATIONAL AMPLIFIER TYPE		
	FET INPUT	SUPER BETA AMPLIFIER WITH LOW DMV	SUPER BETA AMPLIFIER WITH HIGH DMV
$I_b$ BIAS CURRENT	100 pA	800 pA	8000 pA
$I_{os}$ OFFSET CURRENT	10 pA	50 pA	1000 pA
$\rho$ SLEW RATE	$6 \text{ V}/\mu\text{s}$ .	$0.1 \text{ V}/\mu\text{s}$ .	$2.5 \text{ V}/\mu\text{s}$ .
DIFFERENTIAL DMV VOLTAGE SWING	30 V	0.5 V	30 V
$V_{os}$ OFFSET VOLTAGE	10 mV	0.7 mV	2 mV
PSR POWER SUPPLY REJECTION	80 db	96 db	86 db
CMR COMMON MODE REJECTION	70 db	80 db	80 db
$A_v$ VOLTAGE GAIN	120 db	106 db	106 db

\*Adj to zero with  $10 \text{ K}\Omega$  potentiometer

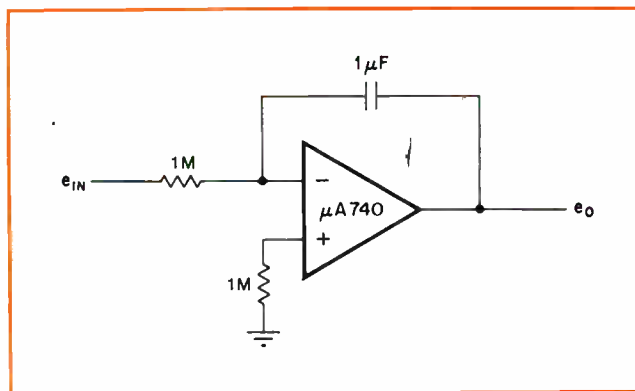

8. Long time. J-FET operational amplifiers allow large source resistance (1 megohm in this case) to be used in long-term integrator circuits. This means smaller values of capacitance can be used with lower leakages to provide increased integration times.

Logarithmic amplifiers will be one of the major applications of this op amp. When using conventional op amps, numerous resistors and potentiometers generally are required to compensate for high bias and offset currents. The J-FET op amplifier, however, is ideal; its low bias current and ease of offset adjustment keep nulling circuits to a minimum.

The circuit shown in Fig. 4 was built to demonstrate the capabilities of the J-FET amplifier when used in a basic log amp configuration. The op amp used in this circuit had a bias current of  $100 \text{ pA}$ , which kept the error voltage due to amplifier bias current to only  $0.2 \text{ mV}$  for a 2-megohm source resistance, allowing the circuit to handle a large range of input currents. The results of the circuit are shown in Fig. 5, compared with the super beta operational amplifiers with high differential voltage using the same source impedance and input voltage range. The J-FET amplifier operates over a full five decades of current values, while the super beta amplifier is seen to operate over approximately only one decade.

Performance of the J-FET op amp also has been built into a sample-and-hold circuit. The schematic of this circuit is shown in Fig. 6, while in Fig. 7 the decay rate is plotted as a function of capacitance for an amplifier with a  $100\text{-pA}$  input bias current. For an amplifier operating in the hold mode using a charging capacitor of  $0.1 \mu\text{F}$ , for example, the error due to bias current is only  $0.1\%$  per microsecond. This indicates that very little charge leaks off from the capacitor; for a  $5\text{-V}$  input about  $5\text{-mV}/\text{second}$  will leak off. The voltage holding times can be made long using smaller values of capacitors with lower leakage voltage than would be required for conventional bipolar transistor-input op amps where the bias current is considerably larger.

For long-term integrator application (Fig. 8) the J-FET amplifier's high input impedance allows the source resistance to be increased. Thus smaller-value capacitors with lower leakage can provide fairly long integration times. □

# Signetics makes interface IC's to meet the toughest standards.

## COMPUTER PERIPHERALS EQUIPMENT

8T13 Dual Line Driver and 8T14 Triple Line Receiver. Interface with the IBM system I/O interface channel-to-control-unit.

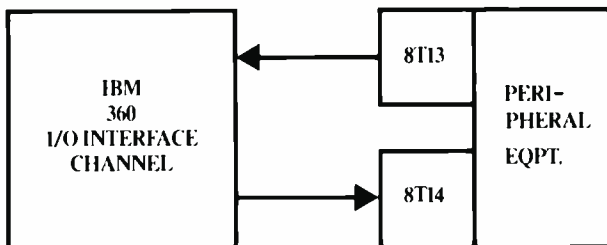

The 8T13 Driver/8T14 Receiver features:

1. Party-Line Multiplexing Operation.
2. Short Circuit Protection.
3. 8T13 High-Power Drive Capability:  $-75 \text{ mA}$  at  $2.8\text{V}$  ("1" level).
4. 8T14 Receiver Input Hysteresis of  $0.5 \text{ Volt (typ)}$  provides High Noise Immunity.

## COMMUNICATIONS EQUIPMENT

The 8T15 Dual Line Driver and 8T16 Dual Line Receiver. For data transmission and reception between Data Communication and Terminal Equipment.

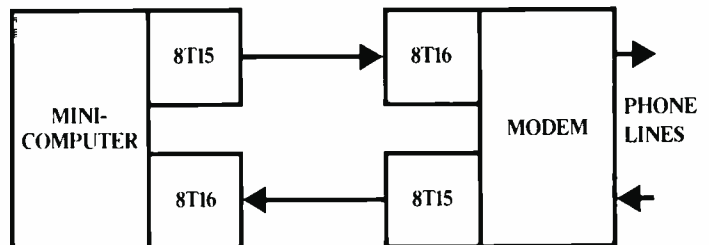

The 8T15 Driver/8T16 Receiver features:

1. Meet EIA Standard RS-232C and MIL-STD-188B and CCITT V24.
2.  $\pm 25 \text{ Volt}$  Output Short Circuit Protection.
3. 8T16 Dual Receiver accepts single (EIA) or double-ended (MIL) inputs and provides output strobing control.
4. 8T16 Dual Receiver Hysteresis:  
EIA Hysteresis  $\sim 4\text{V}$   
MIL Hysteresis  $\sim 1.2\text{V}$

Detailed data sheets, comprehensive application notes available.

Sample parts too—we've got the devices on the shelves ready to go. Contact your Signetics salesman, local distributor or Signetics Corporation, 811 E. Arques Avenue, Sunnyvale, California 94086. (408) 739-7700. A subsidiary of Corning Glass Works.

# Signetics

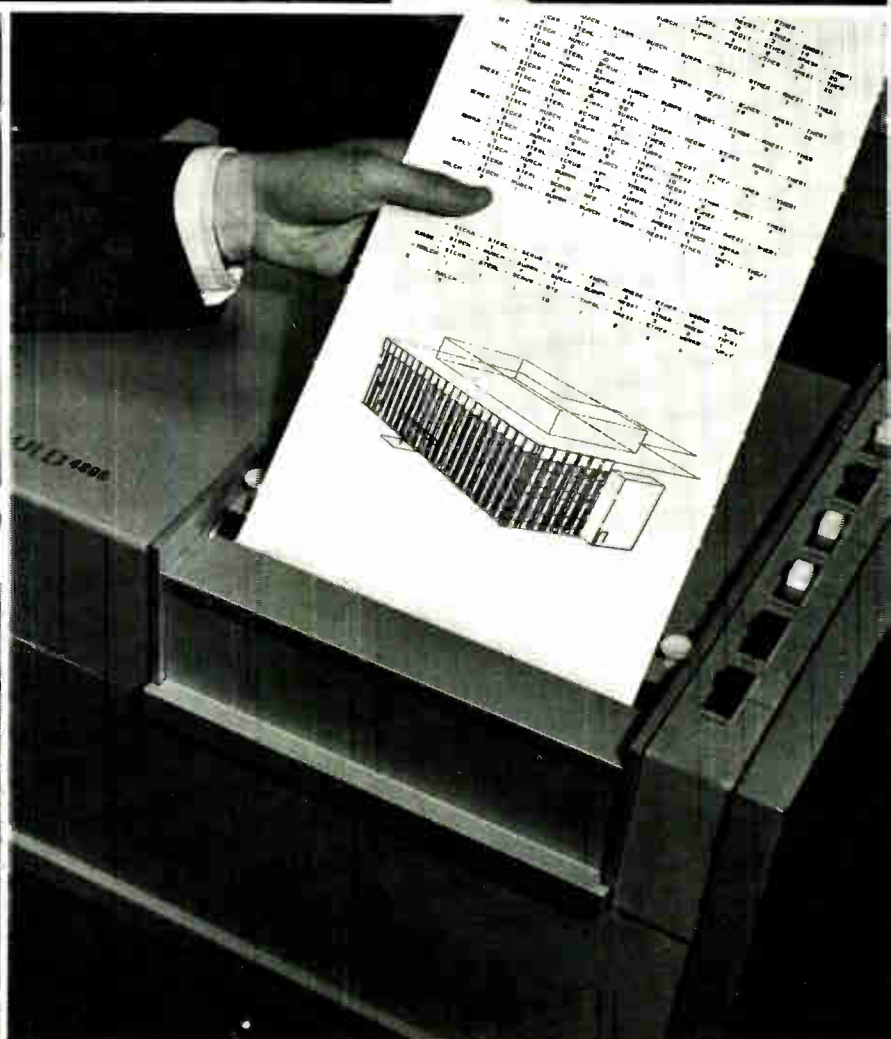
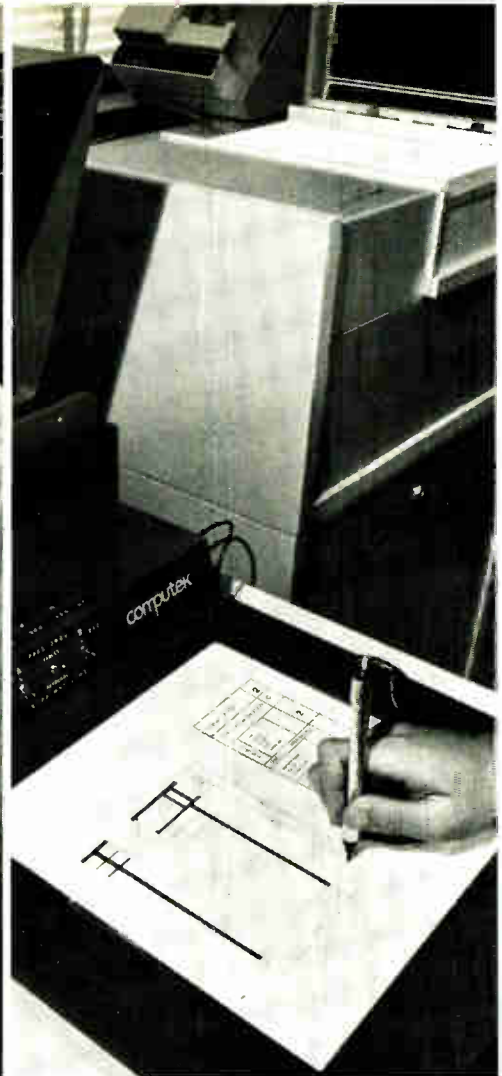

# Gould 4800 meets architects' demanding requirements for hardcopy alphanumerics and graphics.

A Boston-based architectural firm, specializing in institutional projects, has made a high speed interactive computer system an integral part of their architectural design process. And to take full advantage of this capability, they use a Gould 4800 electrostatic printer to provide hardcopy alphanumerics and graphics.

The Gould 4800 provides printout for feasibility studies, area diagrams, alternate plans, perspectives, detail drawings, specifications and managerial reports. Where a plotter would take up to 30 minutes to produce a drawing, the Gould 4800 delivers one in seconds.

And where a dry-silver photographic process would produce muddy copies that can't be traced or used directly, Gould 4800 copy is sharp, clean and fully acceptable for client presentations.

The computer system, called the ARK/TWO was developed by Perry, Dean and Stewart Architects and Planners and programmed by Design Systems, Inc.

It includes an Autrotrol digitizer, a DEC PDP 15/20 (16K), 500K Disk, two Computek CRT's with a keyboard and tablet. Ultimately, it's felt this advanced system will reduce the critical path in large construction projects by 4 to 6 months.

All kinds of companies are using the Gould 4800 to meet all kinds of hardcopy requirements. This smooth, quiet unit delivers up to 4800 lines per minute on an 8½" or 11" format. It has an optional character generator. Software and interfaces for major computers are available. And while the Gould 4800 has relatively few moving parts and little need for maintenance, there are service facilities nationwide.

**Find out what the Gould 4800 can do for you.**

**Give us a call. Or write:** Graphics Division,  
Gould Inc., 3631 Perkins Avenue,  
Cleveland, Ohio 44114.



 **GOULD**

**Nobody-but nobody is a source  
for more T<sup>2</sup>L types than Motorola**

MSI/Complex-function:	Series 5400/7400	Series 4300/4000	Series 9300/8300	Series 8200/7200	TOTAL
<b>COUNTERS:</b>					11
Divide by 10	1	1			
Divide by 12	1	1			
Divide by 16	1				
Programmable Modulo-N		2			
Presetable			2	2*	

# ...including these most-used, Complex-function/MSI types:

Motorola made a commitment . . . one year ago . . . to become "one of the World's leading suppliers of series 54/74 T<sup>2</sup>L integrated circuits in 1970." The above lineup of complex-function/MSI circuits indicates that we've done that . . . and, then some! Here's the rest of the story:

In all, Motorola offers you the industry's most complete, interchangeable selection of T<sup>2</sup>L, for all of your design requirements. Seven (7) families, *plus* . . . Check the lineup:

- MTTL I — MC500/400 series (SUHL I)
- MTTL II — MC2100/2000 series (SUHL II)
- MTTL III — MC3100/3000 series (SN54H/74H)
- MC4300/4000 series complex functions
- MC5400/7400 series (SN54/74)
- MC8200/7200 series complex functions
- MC9300/8300 series complex functions

*Plus*, these additional capabilities:

- MTTL Beam Lead ICs and Chips.
- MDTL & MTTL Dielectrically-Isolated Circuits.
- The World's broadest line of system-compatible MDTL circuits.

For complete data, including high-light specifications and selection guides, write: P.O. Box 20912, Phoenix, Arizona 85036.

*The Logical T<sup>2</sup>L Choice is yours.*

<b>DATA SELECTORS:</b>					3
Dual 4-input		1	1		
8-input			1		
<b>DECODERS/DATA DISTRIBUTORS:</b>					20
BCD to Decimal	1		1		
Excess-3 to Decimal	1				
Excess-3 Gray to Decimal	1				
BCD to 7-segment	4	1			
Binary to 1-of-16	1**		1		
Binary to 2-of-8		1			
Binary to 1-of-8		1			
Binary to 1-of-8					
Invert/non-invert			1		
Dual Binary to 1-of-4 line			1		
BCD to Decimal/Driver	3				
Dual 1-of-4 line		1			
Dual 1-of-2 line		1			
<b>ENCODERS:</b>					2
Binary to BCD		1			
BCD to Binary		1			
<b>ARITHMETIC FUNCTIONS:</b>					12
Adders	1	6			
Dual Adders	2		1		
4-bit Adders	1				
Look-ahead-carry-lock		1			
<b>SHIFT REGISTERS:</b>					7
4-bit Universal	1	1	1	2*	
8-bit Serial	1				
Dual 8-bit Serial			1		
<b>LATCHES and FLIP FLOPS:</b>					6
4-bit Latch	2	2			
Dual 4-bit Latch			1		
Quad D Flip Flop		1			
<b>MEMORIES:</b>					4
16-bit RAM		1			
64-bit RAM		1*			
128-bit ROM		1			
256-bit ROM		1			
<b>MULTIVIBRATORS:</b>					3
One-shot	1				
Retriggerable 1-shot			1		
Voltage-controlled		1			
<b>PARITY TREES:</b>					3
8-bit		1			
Dual 4-bit		1			
Single-error Hamming-Code					
Detector and Generator		1			
<b>COUNTER/LATCH, 7-SEGMENT DECODER/DRIVER</b>					1
		1*			
<b>FREQUENCY PHASE DETECTOR</b>					1
		1			
	23	35	11	4	73

\*To be introduced within 30-days.

\*\*Functionally-replaceable by 9300 series type.



**MOTOROLA TTL**  
— total capability . . . of course!



**“When Mohawk decided to build a family of tape drives, I went out and hired the sharpest tape men in the business.”**

*Dave Hemphill, VP, General Manager, MDS-King of Prussia, talks engineering.*



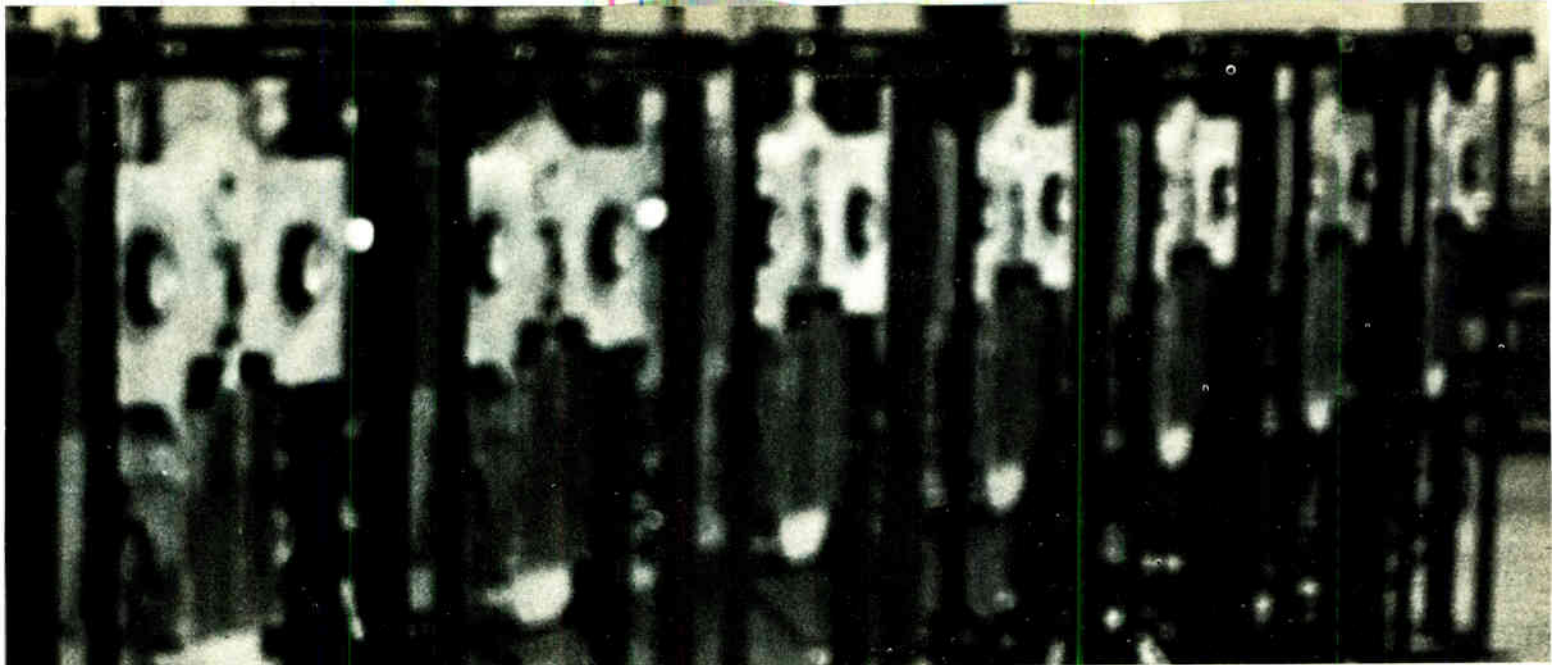

“With our reputation for reliability and performance, we couldn’t afford to make our early mistakes in public. So we budgeted enough time, money, manpower that we could build a whole pilot run, work it to the ground and scrap it before we shipped a drive to a customer.

“We were building a new drive from the casters up; so we could take advantage of the latest techniques.

“Knowing that, we went one step further. We put together a team of men who had grown up designing tape drives.

“With time, money and that kind of talent, we didn’t set out to build just another state-of-the-art tape drive. We wanted to build a drive that would be flexible, mobile, maintainable, reliable, rugged, compatible and economical. Every drive has some of those characteristics. The 2000 series has all of them.

“Our new transports are built to operate at computer drive speeds. They’re not low-speed decks stretched past their design limits to reach a richer market.

“We’ve reached some kind of pinnacle of maintainability with these drives, too. The side panels open up. The library swings out. The single-capstan drive mechanism is a model of simplicity.

“Naturally, the drives are IBM-compatible. And naturally they’re economical.

“What’s most unusual about them, though, is the flexibility. We designed three transport mechanisms. And we built seven electronics packages. That’s a lot of combinations. I figure we can satisfy just about any specifications you have without designing a new machine.

“Right now, we’re introducing five models. We’re particularly proud of the model 2000. It reads both 7-track (200, 556, or 800 bpi) and 9-track tapes at up to 45 ips. And it’s the least expensive model in the 2000 series. That even surprised me.”

Mohawk Data Sciences Corp.  
Herkimer, New York



# National TTL/MSI tha

# Delivery isn't the only rea

Say good-bye to slow bus systems. National is introducing Tri-State logic. A first-of-its kind family of TTL devices specifically designed to speed up bus-organized digital systems.

Tri-State logic allows you to work with fewer packages and without external open collector gates.

Our first off-the-shelf product in this new family is the DM8551 bus or-able quad D flip-flop. A unique device that lets you connect outputs of many circuits to a common bus line.

The DM8551 is organized as four D-type flip-flops operating from a common clock. The outputs are normal low-impedance, high-drive TTL types. Up to 128 can be tied together because, unlike other TTLs, the DM8551 can be gated into a state where both the

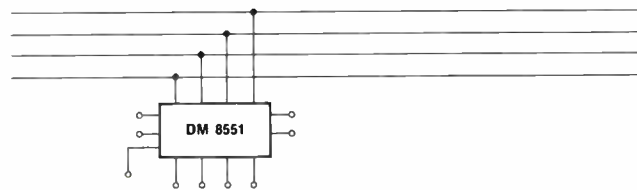

TRI-STATE BUS SYSTEM

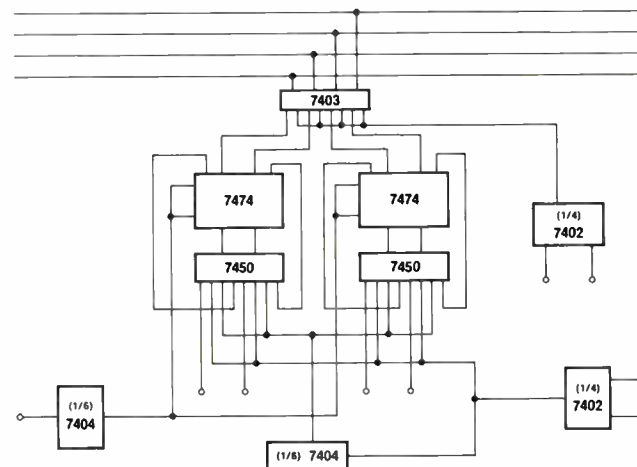

STANDARD BUS SYSTEM

# **sells more n Fairchild.**

## **t son:**

upper and lower output transistors are OFF. The output, therefore, appears as a high impedance. It neither delivers current nor demands significant current from the outputs to which it is connected. You get the economy of bus connection without losing output waveform integrity.

The DM8551 design eliminates the false clock-signal problem usually associated with D-type flip-flops. Internal data input disable lines feed the Q output back into the D input so there's no change of state during clocking.

Output disable lines are used for gating into the OFF state. NOR gate logic was chosen for this function since it is possible to select up to 128 DM8551s with only two BCD-to-Decimal decoders (DM8842s). You get

maximum decoding capability at minimum cost.

In addition to the DM8551, we're also introducing the DM8230 Tri-State Data Flow Gate for signal routing and the DM8831 Tri-State Party Line Driver for multiple signal driving. (They're also available off-the-shelf.)

Of course, Tri-State logic is only one reason National sells so many TTL/MSI circuits. Call any National distributor for prices and specs on twenty-seven other reasons.

National Semiconductor Corporation  
2900 Semiconductor Drive, Santa Clara,  
California 95051 / Phone (408) 732-5000  
TWX (910) 339-9240

## **National**

# What's the prognosis for Medical Electronics?

## DOCTORS, HOSPITAL ADMINISTRATORS, AND ENGINEERS CAN FIND OUT BY ATTENDING THE

3rd National Conference & Exposition on Electronics in Medicine  
April 13-14-15, 1971/Sheraton-Boston/Boston, Massachusetts

Presented by Electronics/Management Center  
in association with McGraw-Hill Publications

Electronics/Medical World News  
Modern Hospital/Postgraduate Medicine

- What's available in patient-monitoring equipment and what's needed?
- What can computers do in medical record keeping and data analyses that they couldn't do before?
- How safe is medical electronics equipment – from the standpoints of both patient and operator?
- How stringent are major test equipment requirements of the clinical laboratory?
- What are the most effective techniques now in use in multiphasic screening?
- What are the key problems in hospital electronic equipment buying and maintenance?
- How will the Cooper Committee report affect new device control legislation?

These questions will be fully explored at a series of unique workshop sessions during the three-day 3rd National Conference on Electronics in Medicine to be held in Boston next April.

The 1971 meeting will include 50 per cent more topics and speakers than the previous conference. Morning sessions will feature speakers who have been selected for their expertise as well as for the articulate manner in which they convey their knowledge to a professional gathering such as this.

The enthusiasm of the '70 conferees for the afternoon panel/workshops has won a repeat performance – this time with topical discussions and specialists who will lead the workshops. They'll attack problems from all sides, then invite attendees to become active participants in the sessions. Conferees will have a chance to join at least two of the six workshop sessions.

An important adjunct to the technical program will be an exposition of new hardware (and software) in the medical electronics field.

### SPEAKERS:

Dr. John Knowles, General Director  
The Massachusetts General Hospital  
Boston, Mass.: Feature address

Dr. Donald M. MacArthur, former  
Deputy Director (Research & Technology)  
Department of Defense  
Topic: Hospital of the future

Dr. H. Fernandez-Moran  
The University of Chicago  
Topic: Information storage

Dr. Charles Edwards, Commissioner  
Food and Drug Administration  
Topic: FDA's role in medical device legislation

William Goodrich, General Counsel, FDA  
Topic: Evaluating present and proposed regulatory practices

Professor Oliver Schroeder, Director  
Law-Medicine Center  
Case Western Reserve University  
Topic: Medicolegal aspects of electronics in medicine

Dr. Arthur C. Beall, Jr.  
Baylor University, College of Medicine  
Topic: Device legislation: Another look

Dr. Cesar A. Caceres  
Professor and Chairman  
Department of Clinical Engineering  
The George Washington University Medical Center  
Topic: Cardiac screening

Dr. Octo Barnett  
Director, Laboratory of Computer Science  
The Massachusetts General Hospital  
Topic: Hospital automation

Dr. John B. Henry, Professor and Director,  
Dept. of Pathology  
State University of New York  
Upstate Medical Center  
Topic: Multiphasic screening

Dr. Julius Korein  
Dept. of Neurology  
New York University Medical Center  
Topic: The computer and the medical record

Dr. Max Harry Weil  
Associate Professor of Medicine  
Presbyterian Hospital, Los Angeles  
Topic: Patient monitoring

Dr. Joel Nobel, Director of Research  
Emergency Care Research Institute  
Philadelphia  
Topic: Evaluating equipment

Dr. Dwight E. Harken  
Chief, Thoracic Surgery  
Peter Bent Brigham Hospital  
Topic: Periontogenic diseases

Dr. William A. Spencer, Director  
Texas Institute for Rehabilitation and Research  
Topic: Electronic prosthetic devices

Dr. Allen Wolfe  
Barnes Engineering Company  
Stamford, Conn.  
Topic: Thermography

Dr. Aida S. Khalafalla  
Senior Principal Research Scientist  
Honeywell  
Topic: Plethysmography

Mr. Roger S. Powell  
National Heart & Lung Institute, NIH  
Topic: Electrical energy systems for  
artificial hearts

#### EXHIBITS:

New medical electronics instrumentation and support equipment will be featured in the exposition that accompanies the technical program. Many manufacturers will display equipment that can be demonstrated or operated on site in the exhibit hall (John B. Hynes Civic Auditorium, adjacent to the Sheraton-Boston).

Among those companies which plan to display their most advanced equipment are American Tele-

phone and Telegraph Co., Bio-Optronics, Biotronics, Birtcher Corp., Civil Systems, Coulter Electronics, DeVilbiss, Dyonics, Goodman Brothers, Graphic Controls, Honeywell Inc., Humetrics, Intec, Isotopes (Teledyne), Macro Service, Mechanics for Electronics, Mediquip Corp., Medical Information Technology Inc., Motorola, Raytheon, Sanders Associates, Sloan Technology Corp., Princeton Fluidics, T & T Technical, and Technicon.

Exhibits will provide an important opportunity for attendees to see first hand (and in some cases even operate) the latest equipment and instrumentation designed specifically for medical applications.

#### WORK SESSIONS:

*Patient monitoring:* Leader, Dr. Howard Hochberg; Roche Medical Electronics; A discussion of routine and critical problems in patient monitoring, including available instrumentation and equipment needed to provide improved monitoring.

*Computers in medicine:* Leader, Dr. William E. Chapman, Palo Alto Medical Research Foundation. What the computer can and can't do in medical record-keeping, data analysis, and medical history taking.

*Safety clinic:* Leader, Allan F. Pacela, chief research scientist, Beckman Instruments. A forum at which doctors and engineers will be able to exchange views on what is available and what is needed to improve the safety of medical electronic equipment from the standpoint of both patients and operators.

*Laboratory automation:* Leader, Dr. Hugo C. Pribor, Director, Institute of Laboratory Medicine, Perth Amboy. A discussion of the major test equipment requirements of the clinical laboratory, with a critical evaluation of present and future needs.

*Multiphasic screening:* Leader, Dr. Allen Pryor, Latter Day Saints Hospital. What are the most efficient techniques now in use and how can they be improved? This session will probe the question.

*Impact of electronics instrumentation in hospitals:*

Leader, A. Allen Weintraub, Administrator,

St. Vincent Infirmiry, Little Rock. Key problems center on selecting and organizing electronics equipment in the hospital to get maximum immediate benefit.

#### REGISTER NOW—SAVE \$35!

Advance registration fee: \$165  
Registration at conference: \$200  
(includes all sessions, exhibits,  
luncheons, reception and a digest  
of technical papers when published).  
Mail registration form and make  
checks payable to:

Donald Christiansen  
Conference Chairman  
Electronics in Medicine P-30  
330 West 42nd St.,  
New York, New York 10036

A block of rooms is being held at  
the Sheraton-Boston Hotel for  
registrants. Make your reservations directly  
with the hotel, identifying yourself  
as a Conference attendee.



Advance Registration Form  
3rd National Conference & Exposition  
on Electronics in Medicine  
April 13-14-15, 1971

Name \_\_\_\_\_ Title \_\_\_\_\_

Address \_\_\_\_\_

City \_\_\_\_\_ State \_\_\_\_\_ Zip \_\_\_\_\_

Hospital or Company affiliation \_\_\_\_\_

Please be sure check is enclosed

01—Electronics

# 500-MHz Direct Counter

with  
Trigger Point Indication

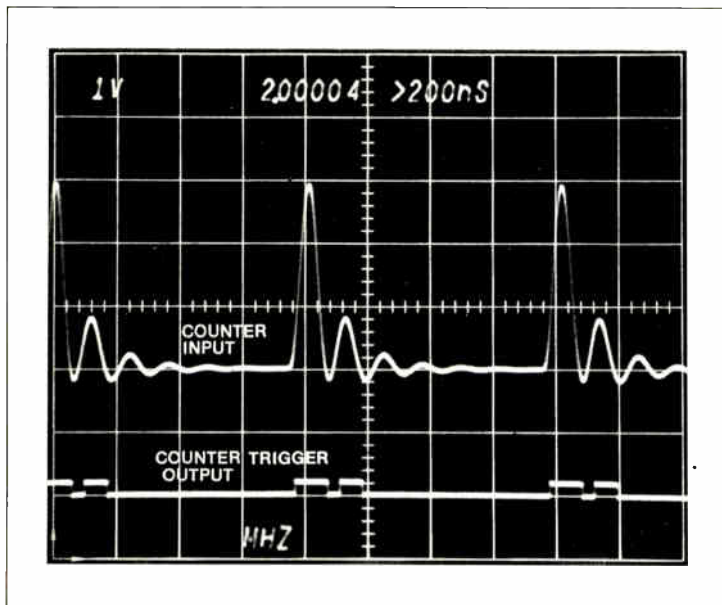

and  
Signal Conditioning

- 10  $\mu$ V sensitivity at 1 MHz
- 5 mV at 150 MHz
- Current from 1 mA
- DC to 500 MHz, 50- $\Omega$  and 1-M $\Omega$  inputs
- Differential with 20,000:1 (86 dB) CMRR

The 7D14 Digital Counter Plug-In is compatible with all five 7000-Series Oscilloscope mainframes. For a demonstration or more information, contact your nearby Tektronix field engineer or write: Tektronix, Inc., P.O. Box 500, Beaverton, Oregon 97005. Price of the 7D14 is \$1400, 7000-Series Oscilloscopes start at \$1775.

U.S. Sales Prices FOB Beaverton, Oregon  
Available in the U.S. through the Tektronix lease plan

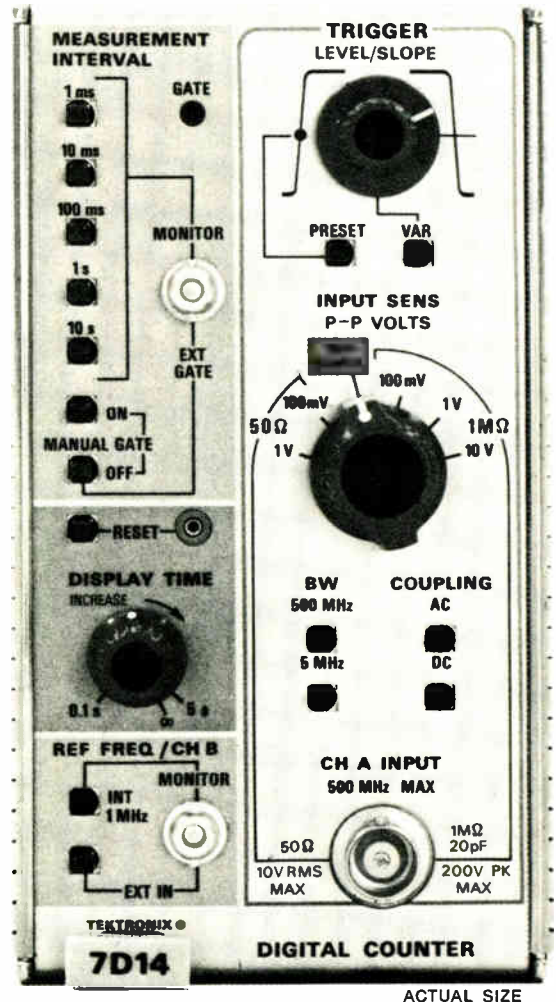

ACTUAL SIZE



**TEKTRONIX®**

committed to  
technical excellence

## EE students' new thing: 'relevance'

More socially aware than predecessors, young engineers say they'll shun defense jobs for 'human-oriented' work; college curricula broaden, too

Though terms like "social relevance," "environmental pollution," and "military-industrial complex" won't be found in any college engineering text, they are increasingly finding their way into engineering students' vocabularies. And significantly, most of today's EE candidates eschew defense work, which supplies a great many engineering career opportunities. In sum, though he still is not as activist as his liberal arts counterpart and generally looks less hip and better groomed, this year's student is a far cry from his career-oriented, engineering-only predecessor of five years ago.

With an increasing number of students doing graduate work in non-engineering disciplines and planning to use their EE degrees toward social goals in other fields, such as medicine and law, engineering schools are beginning to loosen up their curricula, providing greater flexibility in selecting courses and offering others that adapt technology to solving social problems. And campus administrators aren't the only people watching which way the wind is blowing; many company recruiters are being asked searching questions about the "relevance" of the jobs they offer.

This "different breed" of student, says Carver A. Mead, professor of electrical engineering at California Institute of Technology in Pasadena, "is having a kind of identity crisis in terms of how he fits into the world as an engineer. There's a great deal more interest on his part in doing something meaningful." EE candidates, he says, are finally picking up the familiar re-

frain about how a nation that can land men on the moon should be able to solve other problems closer to home. "You didn't hear this type of question too many years ago from engineering students," Mead says.

Echoing and expanding on these sentiments is UCLA senior Jerry Dahlin, who notes: "Today the engineer not only has to assume responsibility for the technical side of what he does, but also the social implications." Toward this end, he says, UCLA is opening up "many, many options" for EE candidates. "Today's engineering students are very conscious of current events—they have to be in order to understand what is happening in the university and in today's world," says Dahlin. "Since our whole society today revolves around the engineer—through new products and new discoveries—he must be involved whether he likes it or not. I think we are on the verge of seeing a new engineer."

"I can't think of another field that can make such contributions to help the world," concurs Arthur Uhlir Jr., chairman of Tufts University's Department of Electrical Engineering. "Student engineers are seeing what a mess is being made now and they know they can do better," asserts Uhlir. "We're now witnessing a move out of strict disciplinary studies into a decidedly different phase of technology. By 1980, it might be hard to define exactly what is an engineer."

This move away from a strict diet of electrical engineering courses to a broader approach is manifest on more than just a few campuses as faculty and administrators try to

accommodate the new drive toward social commitment and relevance. A case in point is George Bugliarello, dean of the College of Engineering at the University of Illinois' Circle Campus. Under Bugliarello's direction, the college has attempted to move away from strictly electrical engineering courses, offering classes in such applications-oriented areas as materials, energy, communications, and systems to encourage flexibility. In addition, the Circle Campus' engineering school is conducting an interdis-

Aware. That's the word for today's student EE, says UCLA's Jerry Dahlin.



## Probing the news

disciplinary study of urban mass transportation and a beginning course in systems engineering that trains students to work in groups on projects ranging from politics to birth control. Longer-range plans include a systems study of the instructional process (what is best done by the teacher versus what can be done by machine).

Stanford's engineering curriculum also is bending with the breeze. Beginning this year, undergraduate engineering students at the Palo Alto, Calif., campus are required to take two courses in the relationship between technology and society. "The program," says faculty adviser Ralph Smith, "was initiated partly at the students' request." Further, the EE department has loosened up its curriculum to allow for more student electives. However, Smith notes that EE students haven't made demands for new or restructured courses; "they still need and want a strong math and technical background," he says.

At Tufts, as at many other schools, a Bachelor of Science in Engineering degree is offered in which students take fewer engineering courses and more liberal arts classes than do other engineering candidates. Also offered are courses that attempt to help the young engineer apply technology to emerging problems. These courses include urban planning, taught by the head of Boston's Model Cities program; maternal, infant, and child care, designed for the budding public health engineer, and an untitled course which gives "a technical viewpoint for the non-technical person on the difficulties in solving problems of pollution."

**Career goals are changing, too.** "The EE student is moving toward social relevance in his job thinking just as fast as any other student—maybe faster," contends John G. Truxal, academic vice president of Polytechnic Institute of Brooklyn. "They realize they have the tools to solve some of society's problems—tools that the liberal arts students don't have."

Barbara Mickevics, a candidate for Homecoming Queen at Illinois

Institute of Technology, and a major in bio-engineering, believes that the engineer today has "the responsibility to apply technological advances to help man in general. Since the engineer has the tools, he must use them" she declares. Barbara will pursue her goal next summer by working on a National Science Foundation program that will study the application of technology to pollution.

Another factor bearing on changing career attitude, says Brooklyn Poly provost James J. Conti, is the crimp in the economy, which he feels is opening up more, not less, job ideas for the students. "Because there are not as many jobs available under defense contracts, students are having to look further

Involved. IIT Homecoming Queen candidate Barbara Mickevics feels engineers must work for man's benefit.



afeld for engineering jobs," he says. "It's forcing them to consider working in the community."

Confirming this view is Arnon Garonzik, an EE senior at the University of Pennsylvania. "Now is the best time to make yourself unique," claims Garonzik. "There's a vacuum out there, and it's the perfect time to do something besides work." Garonzik is making himself unique by going to law school. But instead of studying patent law, as have many engineers, Garonzik wants to work for the Government. "The Commerce Department eventually will have to pick up on the type of thing Ralph Nader is doing, and they'll need someone schooled in both engineering and law to prosecute," he says.

One engineer who's found a niche for himself in a "socially relevant" job is John Berenyi, who graduated from Columbia last June. Berenyi, who is working on policy-level studies of automobile pollution as a member of New York Mayor John V. Lindsay's staff, feels that "engineering students are becoming more and more socially concerned, and I don't mean that they're just going to be taking courses in urban affairs or the environment. They are really starting to question whether engineering is going to be a subservient field to other disciplines, like political science or law. They're coming to the point where they're now asking how can they make the policy decisions that were, up to now, made by bureaucrats, lawyers, etc. To do this, many are turning away from engineering."

Berenyi estimates that more than 10% of his engineering class at Columbia went on to law school, while another 10% went to medical school. Others, he says, explored urban planning, or enrolled in graduate business or pure science courses. "A very small percentage, in comparison to the classes of '68 and '69, continued straight on in engineering," he claims.

Louis D. Smullin, chairman of the electrical engineering department at Massachusetts Institute of Technology, says that while some MIT EEs have always done graduate work outside strict electrical engineering, their number is on the increase. Last year a total of 78 EEs applied to medical school while another group is going into law, he says. In the graduate department itself, nearly 20% of the students are working in an area loosely defined as engineering and living systems.

With most universities now offering biomedical engineering courses, this field offers a bright opportunity for EEs who want to do "human-oriented" work. "When the biomedical engineer goes into a research group, the diversity of his background puts him in the leading position," says John E. Jacobs, professor of electrical engineering at Northwestern and director of the biomed program.

The quest for human-oriented



These are  
reference  
standards.



This is  
the new Fluke  
working standard.

The new Fluke 730A DC Transfer Standard, a rugged 20 pound, battery powered instrument, takes the fuss out of calibration.

Of course you'll continue to use your standard cell bank as a basic reference. But you'll be time and money ahead if you use the Fluke 730A as your "working standard" and avoid standard cell problems such as temperature sensitivity, length of settling time, and overload. The truly portable Fluke 730A features low temperature coefficient, full accuracy in minutes, overload protection, and quick and easy calibration to your reference standard.

The Fluke 730A consists of four identical independent reference supplies. Output terminals provide individual outputs, the mean output of up to four references and the series output of up to four references. Specific reference voltage outputs available are 1.020, (1.018 +  $\Delta V$ ), (1.019 +  $\Delta V$ ), 10.000 and  $\Delta V$  Volts. The Model 730A may be used as a 1 volt or 10 volt standard, or as an "electronic standard cell."

Transfer accuracy is 2 ppm. Stability is 10 ppm/month for individual references. Only 3½" high, the 730A can be used on the bench or in a rack. Guarded outputs give you freedom from noise in high accuracy floating measurements.

Price is \$1995.

For the full story, see your Fluke sales engineer or contact us directly.



Fluke, Box 7428, Seattle, Washington 98133. Phone (206) 774-2211. TWX: 910-449-2850/  
In Europe, address Fluke Nederland (N.V.), P.O. Box 5063, Tilburg, Holland.  
Phone: (04250) 70130. Telex: 884-50237. In the U.K., address Fluke International Corp.,  
Carnett Close, Watford, WD2 4TT. Phone: Watford, 27769. Telex: 934563.

## Probing the news

jobs isn't confined to bio-engineering. For example, engineering students at Northwestern who felt it was "fashionable but not practical" to look for socially relevant jobs decided to take things into their own hands. They organized "Concerned Careers Day" and invited companies whose product lines or services are directed toward improving the quality of life. "We were especially looking for small companies that can't afford to recruit," explains Charles W. N. Thompson, faculty advisor to the project.

Despite Chicago's first snowfall of the season and a bomb threat at the university, 16 company and government representatives showed up to meet with more than 50 students. "Everyone I talked with was enthusiastic," says Larry Kozimor, the Northwestern senior who organized the program. "In fact, most of the companies indicated they would be back for the next concerned careers day, slated for April."

One factor that hasn't undergone radical change is the EE student's desire for job security. "Security is still a surprisingly large factor in the engineering graduate's approach to jobs," says Sidney S. Shamis, professor of electrical engineering at New York University. "One reason that students are moving away from the so-called military-industrial complex as a source of jobs is that it no longer offers job security," he asserts.

**Many others agree** with Shamis that while most graduate and undergraduate EEs profess strong feelings against defense work, their reasons are based as much on security as moral conviction. For example, Richard Garrett, a first-year graduate student at Tufts, says, "Because of layoffs, not many students are favorably disposed to work in defense industries; they're afraid to look in that direction now." Garrett doesn't think moral scruples enter into decisions against working for defense. "If people had moral reasons against defense work, they would have quit long ago," he asserts.

At Northeastern University, EE seniors Timothy Moore, Jonathan S. Radovsky, and Randall G. Wagner all state they would prefer not to work for defense, but mainly for practical reasons: "I understand it's transient," explains Wagner.

Furthermore, some students and administrators feel this new "social relevance" attitude may be only skin deep. Alfred Poe, an upperclassman at Brooklyn Poly, admits that he's in the EE curriculum for the money and the job security, and he says his attitude is typical of engineering students. A lot of social relevance is social rhetoric, claims Poe.

Like Poe, Kenneth Armstrong, an EE senior at Kansas State University, agrees that "most engineering students want to get where the money is. K-State students are acutely aware of the aerospace cutbacks in nearby Wichita, but aren't against working for the military-industrial complex. The only changes in engineering students here are in appearances—some

beards and long but neat hair."

Some of the more idealistic EE students are headed for cruel confrontation with reality, says the chairman of a large northeastern university's EE department. "In electronics in particular, a large percentage of the jobs have traditionally been provided by DOD and NASA. Now military R&D is cut drastically, supposedly in favor of 'socially relevant' programs. The gimmick here is that there just isn't any money for that sort of thing," he asserts. "All the talk about anti-pollution work, transportation, and urban help is mainly that—just talk. The kids are talking about dreams based on false promises. EEs are getting very little of what money there is. They're being duped into thinking there's opportunity in these areas, and the politics of the whole thing disgusts me." □

Contributing to this report were Larry Armstrong in New York, Gail Farrell in Boston, Carol Harris in Los Angeles, Marilyn Howey in San Francisco, and Jane Shaw in Chicago. It was written in New York by Peter Schuyten.

## On the job: disappointment

The new social consciousness of engineering students hasn't gone unnoticed at the corporate level. But results so far have been inconclusive. Daniel E. Serieka, a personnel representative at Sanders Associates, says he notes "quite a significant change in the young engineers, both materially and idealistically. They want to contribute not only to the company but to society in general. They want to get into systems: oceanic, data, communications. It's part of a general attitude change in society; it's more politically oriented."

However, this view is far from universal. While admitting that young engineers are better and more broadly educated, one personnel manager at a large Midwest electronics firm says, "They are not asking any more demanding questions of industry. No one is saying, 'What are you doing about ecology or urban problems.'" Other recruiters and personnel managers hold out little hope for effective action from the new EEs. Says one, "They devote an inordinate amount of time to study. I mean, how much social action are you going to get out of higher calculus? Besides, all the activists go into other fields."

Many idealistic young engineers are finding it difficult to retain their original enthusiasm on the job. For example, a young electrical engineer at Signetics Corp., finds that after a year and a half on the job, "there is not as much freedom or authority to do what I want." Koivisto handles production problems for several products at Signetics, and as such feels he's in no position to press for more socially relevant goals. However, he does think "the systems houses and computer companies should go into social action programs."

Hal Feeney, a 27-year-old MOS circuit design engineer for the Intel Corp., is basically pessimistic about the future of social action programs at electronics companies. "We certainly have the talent for it," he says, but "who is going to force electronics firms to reallocate money?" Only a significant reordering of Government funding priorities, as well as corporate spending, will get the companies moving on these programs, Feeney believes, and he's not sure when or if that will happen.

# Isolate with light...

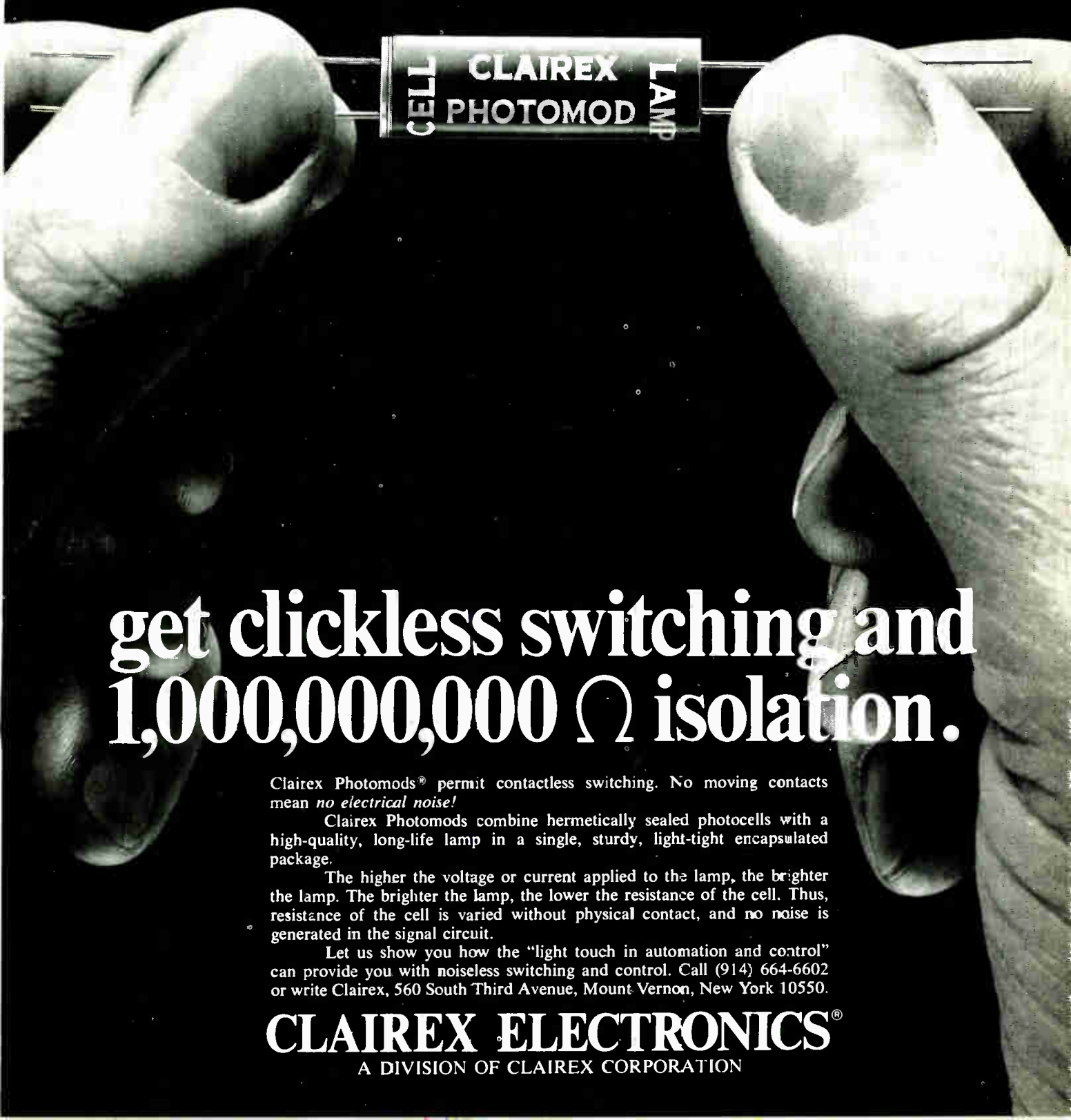

## get clickless switching and 1,000,000,000 $\Omega$ isolation.

Clairex Photomods<sup>®</sup> permit contactless switching. No moving contacts mean *no electrical noise!*

Clairex Photomods combine hermetically sealed photocells with a high-quality, long-life lamp in a single, sturdy, light-tight encapsulated package.

The higher the voltage or current applied to the lamp, the brighter the lamp. The brighter the lamp, the lower the resistance of the cell. Thus, resistance of the cell is varied without physical contact, and *no noise* is generated in the signal circuit.

Let us show you how the "light touch in automation and control" can provide you with noiseless switching and control. Call (914) 664-6602 or write Clairex, 560 South Third Avenue, Mount Vernon, New York 10550.

### CLAIREX ELECTRONICS<sup>®</sup>

A DIVISION OF CLAIREX CORPORATION

# QUICK

One of these dependable,

# OPERATING

easy-to-install Simmons fasteners

# FASTENERS

may be exactly what you need

# FOR

to solve your fastening problem.

# ELECTRONICS

Standard Simmons panel fasteners, latches, pressure hinges, hole plugs and other devices have proved themselves in thousands of varied electronics applications. Most are immediately available from stock in various sizes and capacities, and all can be adapted to your special needs. Quickly. Economically.



Write for this 36-page catalog. Complete data on Simmons' quality quick-operating fasteners.

# SIMMONS

**FASTENER CORPORATION**

1745 North Broadway, Albany, New York 12201

**MIN-Q-LOCK** — quick-operating fastener for miniaturized electronics applications where space and weight limitations are important. ▼

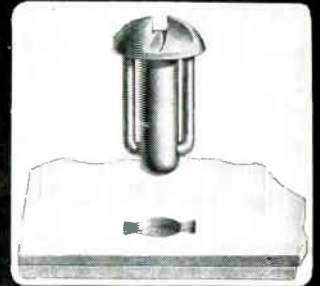
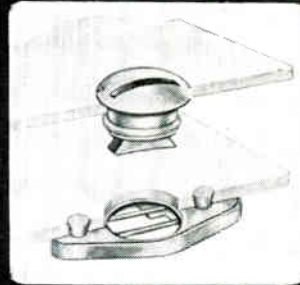

**SPRING-LOCK** — one-piece blind rivet for removable panels and control covers; self-adjusts to various panel thicknesses. Locks, unlocks with a 1/4-turn.

**QUICK-LOCK** — for removable panels and access doors; locks or opens with a 90° turn. Works with curved sheets or slightly misaligned holes. ▼

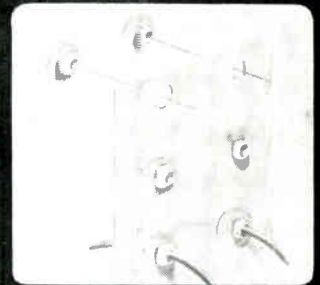

**HOLE PLUGS** (plastic) permit fast, secure, snap-in installation in round, square or unusual-shaped holes. Not affected by climate or temperature.

**LINK-LOCK** — ideal for latching where heavy locking pressure is required. High impact resistance. Available in medium and heavy duty. ▼

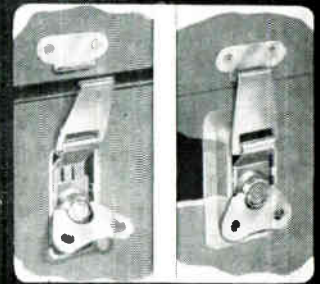
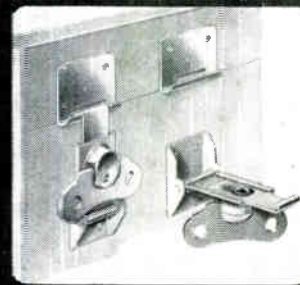

**RECESSED LINK-LOCK** — minimum protrusion, pressure-tight seal. Can be bonded with adhesive or riveted to any sheet, sandwich material or plywood.

**HINGE-LOCK** — rugged pressure hinge provides strong seal on hinge line of gasketed cases. (Matched hardware with Link-Lock fasteners.) ▼

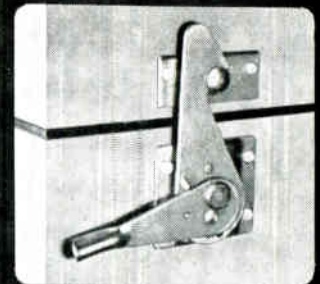
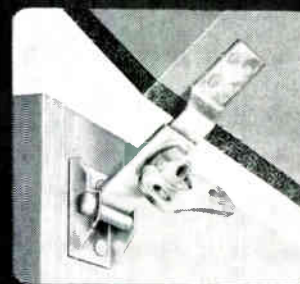

**HOCK-LOCK** — springless, positive-locking latch lies flat on mounting surface; high closing pressure and load-carrying capacity. Impact and shock-proof.

Instruments

# LSI testers: still a hard sell?

More companies are manufacturing more, and more versatile, LSI testers than ever before; many IC makers still hesitate

By Lawrence Curran, Los Angeles bureau manager

A year ago, LSI makers were complaining they couldn't find any commercial systems to test large arrays. So they built them in house. Today, at least eight companies have introduced LSI testers, and sales over the next year could range as high as \$12 million.

And all this is in the face of continued resistance from many IC manufacturers, who complain that the versatility they need costs more than they want to pay and who are therefore still building their own testers. Eventually this problem may evaporate—it's largely because no one has yet decided which of the many possible tests are indispensable, so equipment manufacturers are forced into designing highly versatile and highly priced units. But in the meantime, the entry of several newcomers into the field is increasing the range of options open to the customer.

Teradyne Inc., for example, which once had a virtual corner on the bipolar test market, is being challenged by Fairchild's Systems Technology division, Datatron Inc., and Tau-Tron Inc. And where Redcor Corp. made about the only commercially available MOS/LSI tester a year or so ago, some newcomers are now competing, among them Macrodata Co., Adar Associates, and Xintel Corp.

**Today's test equipment** checks out LSI logic and memories with three types of measurements. Though engineers don't always agree on definitions, parametric tests essentially refer to dc measurements of power and efficiency; functional tests measure the digital output characteristics of circuits either at low frequencies, around

50 kilohertz, or at high frequencies starting around 2 megahertz; and dynamic testing measures a circuit's high speed response, checking such parameters as rise time. The last type of test requires equipment to be capable of responding over a bandwidth of several hundred MHz. Lately, there's also been a trend towards high-speed functional testing, which dictates taking the computer off line and adding a buffer memory to hold the test data pattern.

**Equipment makers** are now designing units that either do all tests themselves or interface with other testers to do so. "Although nobody really knows yet just what's wanted in a production LSI tester, no one wants to get caught with a bad one when he does find out," says Adar president Ramon Alonso. "The accent is on machines that are as flexible as practicable—and very costly. A finer estimate of what's really needed would make many costly performance hedges unnecessary."

Prices range from about \$55,000 for relatively simple systems to around \$300,000 for sophisticated computer-controlled units with plenty of peripherals. And there's not much chance of prices dropping in the near future because volume isn't great enough to win equipment makers discounts on such "components" as minicomputers, says Macrodat president William Mow.

Among the new units that offer the desired flexibility is Teradyne's dynamic test station, which can do all tests when coupled with the company's J259 and J283 machines [*Electronics*, Aug. 31, p. 119]. But

Donald Merlino, supervisor of test engineering at Harris Semiconductor division, points out that dynamic test heads are "very expensive—and the more pin terminals you add, the more expensive the unit becomes." The test head costs \$100,000.

Datatron's Clyde Davis Jr., vice president for marketing, adds that dynamic testing, particularly with MOS devices, is tricky. "It's pretty difficult to live with both the bipolar and dynamic MOS worlds," he asserts. "For bipolar you need high current capability, while for MOS you need high speed and low current, as well as higher voltages at present than for bipolar." His company now markets their model 4400 for parametric and functional testing of bipolars and plans to add a test station early next year to handle MOS/LSI at 2 MHz.

**Another example** of a versatile tester is Xintel's Spectrum 1, which the company says is the first machine capable of testing any of today's devices—whether they're bipolar or MOS/LSI (p-channel, n-channel or complementary) and whether they're logic or memory arrays. Xintel also claims its machine is the first with a 5-MHz functional testing speed, made possible by using a 1,024-word-by-8-bit bipolar random-access memory system as the data pattern memory. The unit performs simultaneous functional and parametric testing of devices with eight to 64 pins. The price for a machine to test 40 pins is \$150,000, which causes another tester maker to call the system a breakthrough—he compares Xintel's accomplishment to "building a Cadillac for \$2,000." Tera-

## Probing the news

dyme, on the other hand, is counting on add-ons like its upcoming clock tester and the s-257 dynamic tester to put its system in the same ballpark as Xintel's.

But Xintel isn't alone in the race for higher speeds. Macrodata has already delivered three of its MD200 machines [*Electronics*, Feb. 2, p. 155]. This model, Mow says, was the first to achieve functional testing speeds of 2 MHz at the wafer level. Although it's getting to be known as an MOS tester, it will perform functional and parametric tests of both MOS and bipolar LSI. Another speedster is Adar's model 32, which hums along at 8 MHz, but is primarily a function memory tester.

Then there's Tau-Tron Inc., Lowell, Mass., which will unveil its DFE-7P and DFE-3P systems early next year [*Electronics*, Nov. 23, p. 26], both of which will run at an eye-popping 100 MHz to test both bipolar and MOS/LSI functionally and dynamically. Neither does parametric tests. The DFE-7P will handle devices with 36 to 72 pins, and includes a computer; the DFE-

3P will be for standard ICs or MSI devices, and doesn't include computer control. The machine will probably find use in dynamic testing of high-speed bipolar logic devices.

Tau-Tron is running into the teeth of Teradyne, however, which makes its s-257 dynamic test station for the J-259 and J-283 testers. The dynamic test station has a 350-MHz bandwidth, which Teradyne Dynamic Systems officials in Chatsworth, Calif., feel is necessary to measure 1-nanosecond rise times. The big difference between the Tau-Tron and Teradyne units, it would appear, is that Tau-Tron will offer its 100-MHz rate for \$80,000 to \$100,000 in the DFE-7P, while the addition of the dynamic test station to the Teradyne units kicks the price up to about \$200,000.

**Fairchild Semiconductor**, which uses its sister division's Sentry 400, maintains, however, that the system is fast enough at 286 kilohertz. However, early next year Fairchild will introduce a 5-MHz test head that will provide precision timing measurements and a precision strobe.

Pricing of today's LSI testers is highly controversial because most

device makers and tester manufacturers are still feeling their way. "List prices don't mean anything, because you can't test LSI if you take a list-price machine," asserts Macrodata's Mow. Extensive software, mainframe computer memory and data patterns memory are required, he says.

The three MD200s installed to date range in price from \$160,000 to \$270,000. The customers were Varadyne Inc., National Semiconductor and MOS Technology Inc. Another system will be shipped to an unnamed Japanese firm this year, and three more will be delivered in the first quarter of 1971.

Intermediate in price is Adar's Model 32 memory tester, which costs \$65,000 and tests 32 pins. (A new model for testing 64 pins on logic or memory devices is expected early next year, but its price isn't yet available.) In the same price range is the Datatron model 4400, an \$80,000 to \$90,000 machine for testing bipolar LSI devices with 40 pins. Datatron's unit comes in either a console (100-pin capability) or stand-up rack (256-pin capability) version. Eight 4400s have been delivered, four are on order.

Next in the range comes Tau-Tron's still-to-be-introduced DFE-7P. The price will range from \$80,000 to \$100,000. Teradyne's J-283 SLOT machine costs slightly more—\$130,000 for a unit capable of testing 48-pin LSI devices.

Like many others in this sampling, the SLOT (for sequential logic tester) machine can handle both more and less than 48 pins. But something around 40 pins seems to cover most of today's MSI. Thus Xintel's Spectrum handles 40 pins and costs \$150,000, Redcor Corp.'s PAFT 2 MOS/LSI tester, also for 40 pins, is about \$160,000, and then the price tag jumps to about \$180,000 for Fairchild Systems' Sentry 400, again for 40 pins.

**Of the machines introduced** within the last year, there are still some that store the test data pattern in computer memory and pull it directly from there to exercise the device. But the speed merchants use various kinds of buffer memory to store test patterns, because these can make testing significantly faster. □

## The do-it-yourselfers

Many semiconductor manufacturers aren't satisfied with the performance of commercially available testers on MOS/LSI and are making their own as a result. Among these do-it-yourselfers are Motorola, National Semiconductor, and American Micro-Systems Inc.

Commercial testers are well suited for bipolar MSI and LSI devices, believes Donald Dean, manager of integrated circuit equipment engineering at Motorola's Semiconductor Products division. But "we don't see an MOS tester on the market that does all the things we need," he says. "We need to generate lengthy test patterns, but MOS testers capable of this lack the ability to clock at different frequencies," while machines that do ac and functional testing can't run checks at MOS device speeds, he adds.

Motorola builds its own MOS/LSI testers that clock at up to 4 MHz. Dean estimates their minimum cost

for testing devices with 40 to 60 pins at \$60,000.

National is working with Macrodata Co., feeding it design inputs for a new tester that the IC maker will buy. But it's also developing its own tester, a high-speed functional unit for 24-pin packages. For bipolars, National uses Teradyne's J-259 and is now phasing in the J-283 for MSI bipolar testing.

Robert B. Billner, manager of instrumentation at National, maintains there isn't a machine available today that can test 200-gate-and-up MOS arrays. The Fairchild Sentry 400, for example, "isn't suitable for MOS because it doesn't have precision strobes and you can't monitor rise times," Billner points out.

AMI, the earliest user of Redcor's PAFT machines, is designing a tester of its own for MOS/LSI and has already built a custom unit to test MOS read-only and random access memories, plus shift registers.

You've probably known Kearfott for our digital computer capability in navigation, guidance and control. But we're also the leading designer and producer of analog-to-digital and digital-to-analog converters. So you'll probably want to convert your thinking.

In fact, you'll find Kearfott converters in the P3C, A7D/E and F-111. We're in navigation and control computers. Weapons delivery. Missile guidance and control. Data annotation and data processing. As well as flight management.

Kearfott converters include all solid-state electronic A/D

(ac, synchro, or resolver to digital), D/A (digital to ac, synchro or resolver), single channel or multi-channel—from individual conversion cards to complete conversion or digital systems.

There are too many to adequately describe here, but you'll find them all detailed in the 24-page catalog below. It's yours for the asking. Send for it today and it may convert your thinking about converters.

Kearfott Division, Singer-General Precision, Inc., 1150 McBride Avenue, Little Falls, N.J. 07424.

**SINGER**  
KEARFOTT DIVISION

# The Persuader.



Circle 109 on reader service card

All the known, tested, thoroughly proven qualities of Foamflex, are now available in Cuflex, a foam dielectric coaxial cable with the copper corrugated outer conductor. Perfect for long run transmission line application. Ideal for feeding high frequency transmitting and receiving antennas. The copper corrugated sheath adds to flexibility as well as to strength and corrosion resistance. New Cuflex is available in ½",

¾" and 1½" sizes, 50 ohm impedance.

Interested in high power, low attenuation, good frequency response, high phase temperature stability and low radiation? You'll be interested in Cuflex.

May we send you all the details? Just write: Phelps Dodge Communications Company, 60 Dodge Avenue, North Haven, Connecticut 06473.

**phelps  
dodge**  
*Communications Company*

Circle 110 on reader service card



**Cuflex.™**  
**Our new copper  
corrugated  
Foamflex  
coaxial cable.**



International

## Fairchild sets sights on Europe

A heavily automated plant at Wiesbaden, Germany, will spearhead the company's drive to double its share of the European semiconductor market

By John Gosch, *Frankfurt bureau*

A major force in the domestic semiconductor market, Fairchild Camera and Instrument Corp. doesn't hold a comparable position overseas because of a false start. But in the two years since its semiconductor division and Italy's Societa Generale Semiconduttori broke up their eight-year venture, Fairchild says it's won 5% of the European market. And now it is going all out to double its share by 1973.

As a first step, Fairchild is spending \$5.5 million on building a heavily automated plant in Wiesbaden, Germany, that's scheduled to be fully operative by the end of next year. The company says it will be the most modern semiconductor manufacturing operation in Europe

and will churn out integrated circuits three times faster than competing facilities. Later, three more factories will be built in England, France, and Italy.

"These are steps toward our goal of becoming a truly multinational organization, in which each plant will eventually be run by nationals and will turn out products that satisfy local market demands," says Sven A. Behrendt, head of Fairchild's European market research.

However, Fairchild faces strong competition from both other American and European firms. Many former SGS-Fairchild customers are still sticking with the Italian firm, for instance. And Fairchild's present share of the semiconductor

market overseas is still small, compared with those of such heavyweights as Philips or Texas Instruments. As a counter, Fairchild points out that its sales rose faster than those of any other semiconductor firm in Europe during a comparable time.

Meanwhile, at the 100,000-square-foot Wiesbaden facility, girls have already begun turning out limited quantities of integrated circuits and discrete components while the construction workers are still busy at the other end of the building. The work force will increase from the present 260 to 500 by next spring, to 1,500 when Fairchild Halbleiter GmbH, as the German subsidiary is called, is fully on-stream.

Fairchild chose the site primarily "because Germany is the biggest semiconductor market in Europe, despite the large captive portion held by companies like Philips and Siemens," says Behrendt. "On top of that, it's expanding faster than anywhere else in Europe."

In Germany, Fairchild plans to emphasize both discrete devices and integrated circuits. First in the line-up of transistors will be standard TO-92 plastic devices for low and high-frequency applications as well as custom devices. Added later will be metal can TO-5 and TO-18 transistors. The product mix will eventually also include diodes and power devices in plastic packages.

To speed the design of complex ICs, the new German facility will tie up with the company's IBM 360/67 computer at Mountain View, Calif., by way of a 4,800-bit-per-second transmission link. In this way, Fairchild will provide

Modern look: Fairchild's new Wiesbaden semiconductor plant will be heavily automated with equipment such as this cutting and loading machine.



# The Sky's the Limit for your own Lightning

1,000,000  
VOLTS  
OR  
MORE

WITH  
SILICON  
OR SELENIUM  
HI-VOLTAGE  
RECTIFIERS  
FOR MULTIPLIERS,  
PRECIPITATORS,  
RADAR,  
X-RAY,  
Etc.

IN  
THESE  
AND  
OTHER

PHYSICAL  
AND  
ELECTRICAL  
STYLES

WRITE  
FOR  
KILOPOTENTIAL  
BULLETIN OR  
CONDENSED  
CATALOG

AND  
SEND US  
YOUR REQUIREMENTS

ALSO AVAILABLE  
BRIDGES TO 1,000 PRV 1.5A TO 25A



GENERAL INSTRUMENT CORPORATION  
SEMICONDUCTOR ASSEMBLY DIVISION,  
65 GOUVERNEUR STREET,  
NEWARK, NEW JERSEY 07104

complete service in Wiesbaden to its European customers, taking their logic function diagrams and translating them into hardware. The computer will also be used for fault-finding and for checking out complex circuits.

"We plan to mount a double-barreled drive, with the accent on both standard and custom-designed ICs," Behrendt reports. Fairchild will concentrate on TTL/MSI circuits of the standard series 9300 and the low-power series 9200. While the company believes in second sourcing, Behrendt says, "first priority will be given to new designs using our own technologies."

The company also plans to go after linear IC sales because it feels that both domestic houses and other U.S. firms have to date aimed linears only at specific customers and in so doing have neglected a sizeable portion of the market.

"In Germany, linear ICs are accepted as solutions to circuit problems much more readily than anywhere else in Europe or even in Japan," observes Fairchild's general manager for Europe, Douglas O'Connor. He sees the automobile industry developing into a volume linear IC market by 1975. "That's when we'll see them in antiskid systems and in many other units on the car," he predicts.

The other product area to get top attention will be MOS devices. The Wiesbaden engineers plan to capitalize on the Mountain View MOS capability and use the computer link to take advantage of the Fairchild-developed computer-aided design concept called the "Fairsim" method.

The company hopes to get at least 25% of European MOS business, a market that is expected to soar to \$25 million by 1973, though it's presently put at less than \$5 million. Right now, 85% of the MOS market is accounted for by custom devices, but Rudolf Leibbrand, advanced production engineering manager at the Wiesbaden plant, expects the percentage to shift more and more towards standard circuits.

The dampening factors on the present MOS market in Germany are the sharp drop in TTL prices

this year, the small number of semiconductor houses producing these circuits, and customers' belief that MOS is expensive. Leibbrand maintains that although MOS/LSI devices are still expensive, once in production they have a significant cost advantage over conventional bipolar ICs on a "per gate" basis.

To keep its production costs low at the new facility, Fairchild is employing several of the processes it uses in the U.S. For example, the so-called "die-attach" automatic process pioneered at the company's Mountain View facility [*Electronics*, September 28, p. 37] will be used for producing TO-92 plastic transistors. The TO-92 "fast tester" will check more than two million transistor parameters per hour, and since it is computer-controlled can be used for any type of transistor.

Another Mountain View development, the automatic-frame-and-die attach process, will produce ceramic ICs at three times the rate of conventional processes, according to Fairchild. Wiesbaden already has two such production lines, each with a cutting and loading machine, in operation, and two more are scheduled for next year. All lines are set up for producing devices such as DTL, TTL, RTL, CTL and TTL/MSI, and a computer-controlled tester for checking out IC parameters will be in use within the next few weeks. Most of the other equipment at the Wiesbaden plant was also designed and developed by Fairchild in the U.S.

Presently, the parts that go into IC production—the glass-coated, gold-dotted ceramic base materials and the lead frames—are supplied by the Mountain View plant. But they will later be bought from German firms because of the cost advantages this provides.

Although it is making every effort to pare costs, Fairchild is not contemplating doing away with the Mountain View-Wiesbaden computer link. The monthly rental is costly—\$1,000 for a data terminal and \$15,000 for the direct-line, 24-hour-a-day transmission link—but is estimated to cost less than installing an IBM 360/67 locally. And there's no other IBM 360/67 in Europe that presently has spare capacity available. □

Commercial electronics

# Next, computer-aided firemen

Los Angeles and San Diego are pioneering the introduction of city-wide command and control systems for police, fire and ambulance services

By Gerald Parkinson, *McGraw-Hill world news*

**Alarm signals** are sounding pleasantly in the ears of systems manufacturers. By early next year San Diego will have part of its fire department under an electronic command and control system, and a year later Los Angeles will have done the same for its entire fire department.

For both cities, this is just their first step to implementing the largest command and control systems for city services to date, at a total expected cost of \$15 million to Los Angeles and \$4.8 million to San Diego. Their plans mark the emergence of such systems from the study stage into an important market commodity.

Included in the two Californian systems will be large central processors, minicomputers, wall and cathode ray tube displays, vehicle locators, and communications systems. These will provide automatic dispatching of police, fire and ambulance vehicles to emergencies, direct access to state and Federal computer files on criminals and stolen vehicles, and local storage of data for use by various city departments.

**The master plan** for Los Angeles' systems is to be ready in December, when Hughes Aircraft Co.'s Ground Systems group of Fullerton, Calif., is expected to present the results of its one-year, \$240,000 study contract. It will incorporate the city fire department's system, which was designed by Public Safety Systems, Inc., a subsidiary of General Research Corp., Santa Barbara, Calif. The fire department system will cost about \$2.5 million. Hardware procurement will start early in 1971, and the system

will be operational by January 1972.

Late in 1971, pending approval of funding by the City Council, there will be a request for bids for detailed design and implementation for Hughes' master plan, with hardware to be bought in 1972 and 1973.

Similarly, San Diego expects to complete the rest of its over-all system during the next three years. Its study contract went to Arinc Research Corp.'s Western division, Santa Ana, Calif., but National Cash Register is responsible for its detailed design and implementation. An NCR 200 will be the basic computer, with software provided

by Automated Systems Corp., Houston, Texas. Other equipment, including two minicomputers that will be used for such functions as driving dispatcher consoles and wall displays, is being bought through separate bids. All this is to be installed in an underground command center with a central data processing room and separate control rooms around it for the police, fire and other departments, overlooked by a mezzanine floor with a special control room for use during emergencies involving several departments. This room will have windows all around, looking

## Bottlenecks

Probably the biggest single problem for designers of city command and control systems is the lack of a reliable, economical, off-the-shelf vehicle location system. Los Angeles is studying several approaches, including sign post, Loran, phase ranging, and pulse ranging. But San Diego is awaiting the evaluation of various systems by the Federal Department of Transportation, though it may participate by evaluating a system itself.

However, all the approaches tried so far are expensive and have other drawbacks, notes William C. Hanna, chairman of Public Safety Systems, which is working on the Los Angeles fire department system. He estimates it will be about five years before economical, off-the-shelf equipment is generally available.

Other hardware needs, according to Hanna, are large displays other than electromechanical ones—for example, a good CRT projection system; graphics displays that are both rapid and inexpensive to update; and economical computer input-output devices for mobile units like police cars.

Formed more than two years ago and controlled by General Research Corp., Public Safety Systems doesn't build hardware and normally doesn't design it. "We think it's important to stay out of the hardware business and concentrate on the design of systems and software based on available hardware," Hanna says. The company has won more than a dozen contracts so far for command and control systems studies in several Western cities and states.

One thing the company learned was that very little military technology on command and control could be transferred to civil systems. "Municipalities need a much stronger interaction between the system and people, and data processing tasks are different," says Hanna.

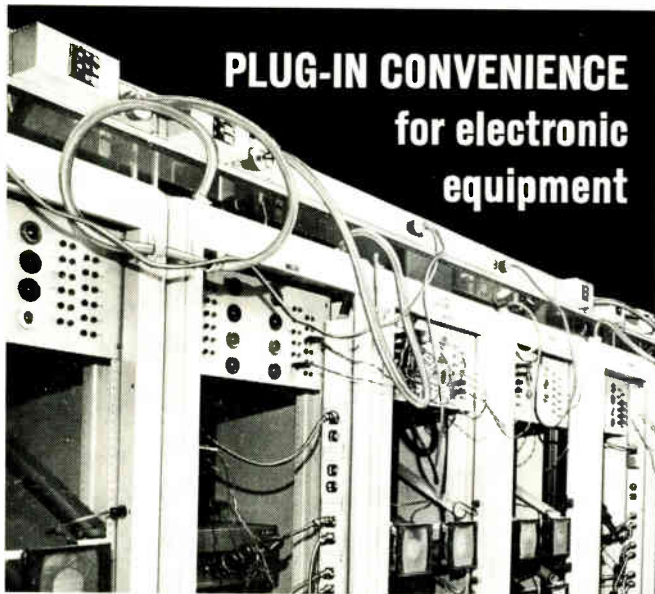

This test rack has power outlets right where they're needed — the last word in plug-in convenience! Easy-to-mount Plugmold® Multioutlet Systems are highly useful behind or inside cabinets, panels, consoles . . . in all types of complex electronic gear. If you make, test or use electronic equipment, write today for wiring systems literature.



THE WIREMOLD COMPANY / HARTFORD, CONNECTICUT 06110

Circle 169 on reader service card



it's HELPED A LOT OF PEOPLE GLUE THINGS THEY THOUGHT COULDN'T BE GLUED.

For example, how do you bond neoprene to fluoroelastomer? (Eastman 910® Adhesive does a great job if you etch the fluoroelastomer with sodium before you apply the adhesive.) Or rubber to polyacetal? (Pretreating the polyacetal with chromic acid increases bond strength 500%.)

Questions like these come from a lot of big companies. And from a lot of smaller ones. The answers come from our technical service laboratory. And from our more than ten years of experience with cyanoacrylate adhesives. (We invented them.)

And we have more answers. Like how to make Eastman 910 set faster, or slower. How to make

your bonds stronger, or more heat-resistant, or more impact-resistant, or whatever.

So if you're trying to glue something, and you're having a problem, we may be able to help. Contact your Eastman 910 distributor, or call Dick Blair at (615) 246-2111 at Eastman Chemical Products, Inc. in Kingsport, Tennessee.

He and our lab people are pretty good at finding what's wrong and setting it right.

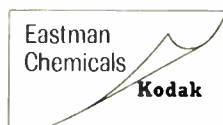

## Probing the news

out over department control rooms.

As an illustration of how these systems will operate, the Los Angeles fire department computer will store data on the locations of approximately 110 fire stations, the equipment available at each station, and department personnel. The system will use two medium-sized computers, plus three or four mini-computers controlling wall displays and other control functions.

When a dispatcher in the central control room gets a telephone report of a fire, he will key the information into the computer, which will check the address in its memory and display it on the CRT along with the name of the nearest cross street and a code of identification number. Simultaneously, a map of that district will appear on the console's microfilm display. The computer next decides what equipment is needed for the job, the name of the station closest to the fire, and whether there are any unusual situations, such as blocked streets in the area. Finally, the dispatcher keys the computer to send a Teletype message to the fire station and sound an alarm there.

**The all-services system** planned by Los Angeles is much more complex and will include a central data processor, probably about the size of an IBM 360/50; a vehicle locator subsystem to keep track of patrol cars; display consoles for dispatchers and possibly a wall display; and a subsystem of communications between the computer and printers in patrol cars.

Police dispatchers will operate like fire department dispatchers, except they'll be dealing with some 600 cars. The patrolmen will have direct access to computer files, and by typing in an access code plus a name or vehicle license number, will learn immediately if a suspect has a criminal record or a car is stolen. Also planned are at least two mobile command centers for "unusual occurrences," such as demonstrations. These vehicles will have CRT displays and other communications devices, and be directly linked with the central processing unit. □

International

## Hong Kong outlook: sweet and sour

Rising costs and dependence on the U.S. market hurt growth rate of the British colony's electronics exports—but it's still healthy

By Lorna Strauss, *McGraw-Hill World News*

After a decade of turning out millions of transistor radios and other electronic products for an increasingly eager foreign market, Hong Kong is feeling the sobering effects of its prosperity and heavy dependence on a declining U.S. market. And though the British colony expects a 40% growth in electronics exports this year, skyrocketing labor and factory costs and the fact that 77% of these products now go to the U.S. make future prospects far less certain. A rapidly diminishing labor pool and siren songs from other Asian countries aren't helping matters either.

Yet, industry observers in Hong Kong expect electronics exports to grow in 1971, though not as much as this year's 40%, and feel new foreign investments will be made. Nor does the government seem unduly disturbed. It hasn't changed its policy of not offering tax advantages to foreign firms and restricts itself to giving advice to new companies and helping them to find suitable factory space and local business partners if they want them.

For Hong Kong, electronics companies are an exceedingly valuable national resource. They are the colony's third largest employer, after the textile and plastics firms; as of June, their 170 factories were manned by nearly 37,000 employees. Last year their exports brought in \$146 million, and increased at a faster rate than overall exports, which grew only 25%. Almost half the output are transistor radios ranging from simple a-m units through a-m/fm/lw to a-m/fm police/aircraft units. Other hot items include memory cores,

planes, arrays and stacks; transistors; diodes; capacitors; and television parts and subassemblies.

Twenty-five percent of the electronics factories are U.S. owned; and the importance of the U.S. companies' welfare to Hong Kong is attested to by a report compiled by the United States Consulate-General in the colony. It says, "U.S. firms, together with those operating under joint ventures with American partners, represent 70 percent of all companies" in the colony.

Among the largest of the colony's electronics manufacturers are such familiar names as Centralab Hong Kong Ltd. and Oak Electro-Optics Corp. Hong Kong Ltd. Other leading firms include Arvin Hong Kong Ltd., Atlas Electronic Corp., Carter Semiconductor Ltd., Coronet Industries Ltd., Electra Instruments Ltd., and Micro Electronic Ltd.

So far no firms have left the colony, but the big question is whether new ones will locate there or established firms expand there. Many argue that, so long as inflation there stays lower than in major developed nations and manual labor continues to be available, the colony will prosper.

However, there are danger signs. The consumer price index shows that the rise in the cost of living over the last twelve months was 8%, or more than double the average yearly increase for the past five years. Industrial wages also climbed 16% instead of the usual 8% in the year ending March 1970.

And Hong Kong's labor force is steadily being absorbed. The Labor Department says it is lacking 2,500 technicians and 8,500 craftsmen needed to staff the colony's various

industries. In March 1970 there were 2,000 jobs unfilled in electronics companies, and, if the U.S. economy picks up, the situation could get worse.

Fortunately for the colony, other Asian countries are also having their problems. American managers in Hong Kong point out that Singapore has a similarly diminishing labor pool and allows less freedom to foreign companies. They criticize Taiwan for its red tape and "pay off system" and claim that Korea's apparently lower labor costs are deceptive and actually exceed Hong Kong's when legislated fringe benefits and bonuses are counted in.

Hong Kong also has the edge over Singapore and Taiwan since it doesn't need to import as much

Exports. Booming Hong Kong electronics has been slowed up by U.S. recession.

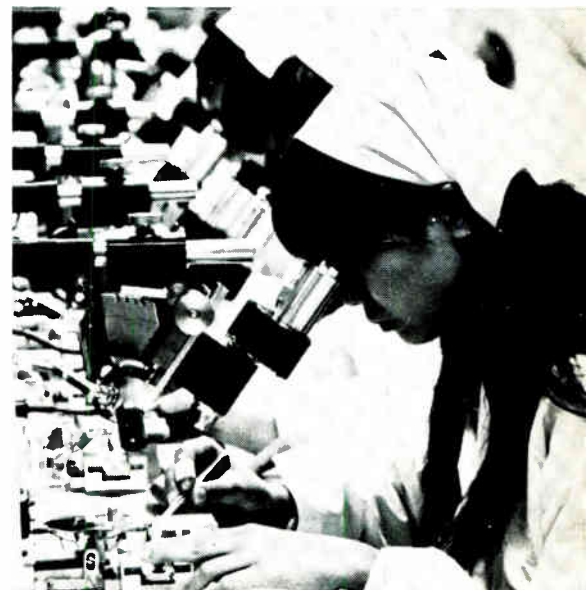

# New! Zenith's colorful two gun CRT

Where precise, high resolution color displays are essential, Zenith Dual Neck, Flat-Face Two Color CRTs offer the best answer. Independent operation of two guns allows different scan formats and rates without the need of complex switching circuits . . . assuring excellent color purity from edge to edge. Details are easily separated by variations of vivid color. For specifications, write for Zenith's new Dual Neck product file.



ZENITH RADIO CORPORATION  
THE RAULAND DIVISION  
5614 W. JARVIS AVE. • CHICAGO, ILL. 60648 • 312-647-8000

Circle 170 on reader service card

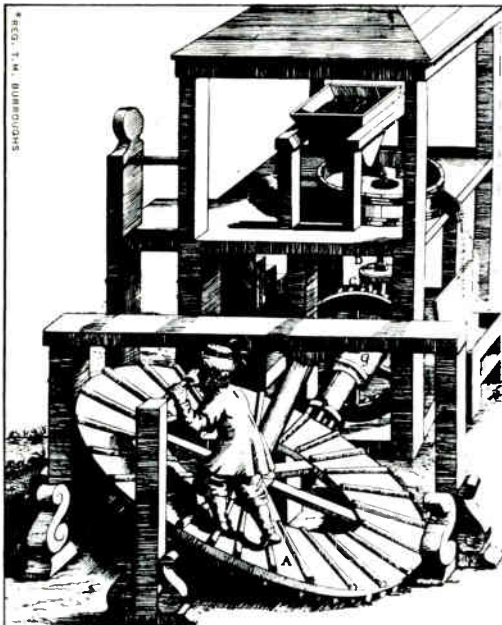

## There's an easier way to solve your problems

Problems in engineering, mechanics, research, finance, education, medicine, statistics, and almost everything else in the world can be solved more easily by Mathatronics.

- 4K core memory • up to 16 terminals • natural language • 2816 program steps and 128 storage registers of internal storage • 176 addressable program locations • conditional branching • conditional decisions • subroutines • printed record of problems or self-scan\* available
- exterior program storage available

Write for complete details:

**MATHATRONICS**

1619 Hanford Street, Levittown, Pennsylvania 19057, U.S.A.



## Probing the news

in the way of materials for assembly, say some American managers. "The people in Singapore can't buy locally and are importing more than we are," reports Frank G. Cole of General Electric's subsidiary, Electronic Industry Ltd. "We buy 60 percent of our parts in Hong Kong," he adds. However, earlier this year GE opened a sister radio plant in Singapore, to replace one in Taiwan.

American companies generally operate with a minimum of expatriates, finding that the colony's skilled and engineering manpower is first rate. Because of the available expertise, more of these companies have lately been branching out into sophisticated products, such as television circuits and computer components. Fairchild, for example, now builds diodes, metal and plastic encapsulated transistors, phototransistors, and integrated circuits in Hong Kong. "We build nearly every product Fairchild sells," says Charles Smith, director of Far Eastern Operations.

The company is one of those that's felt the effect of the U.S. business slowdown. Its 100,000-square-foot factory dropped from a high of 5,800 employees to 3,000 in the last few months though "business is beginning to pick up some," according to Smith.

While the radio segment of the industry has held up well, most other American semiconductor companies have found their volume down in recent months. Harold Lipschultz of Sprague World Trade Corp. says, "We are tied in pretty closely to stateside operations," and the Hong Kong production of electrolytic capacitors as a result "has leveled off."

Obviously, the future of the colony's electronics companies depends largely on the U.S. economy, and nobody's making detailed predictions about sales in 1971. Meanwhile, the colony's foreign companies continue to praise its excellent worldwide communication links, freedom from customs and foreign exchange problems, industrious laborers, lack of union problems—and its moderate climate. □

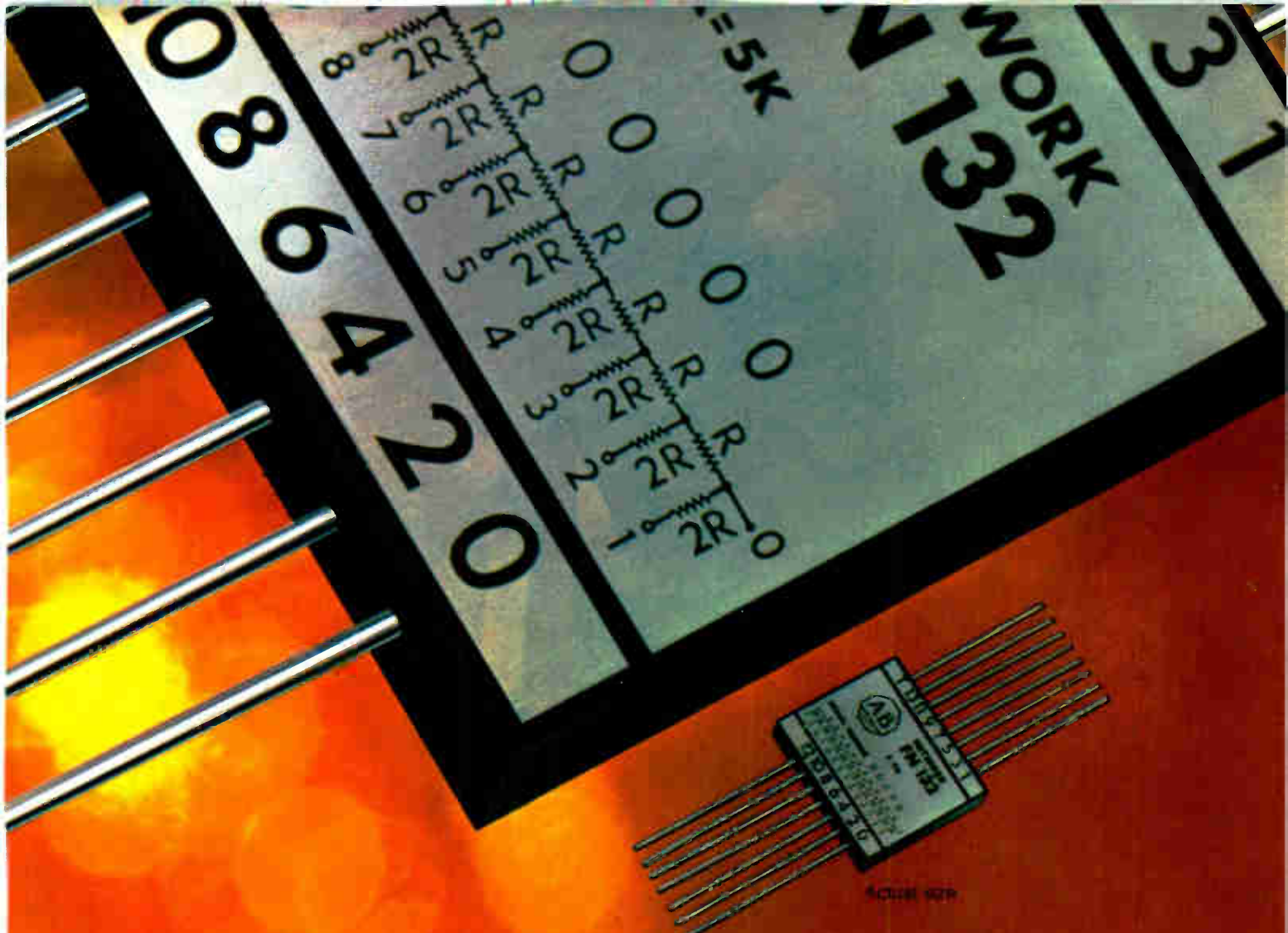

# Now true precision in Allen-Bradley thin film networks.

Resistance networks for A/D and D/A conversion, digital volt meters and numerical control systems demand extreme precision. Allen-Bradley can deliver. Precision that starts with a patented chromium-cobalt resistive material vacuum deposited on a substrate made to Allen-Bradley specifications. Precision based on exclusive computer drawn grids. Precision backed by extensive design and testing facilities. Precision on a continuing basis assured by Allen-Bradley's 14 solid years of experience.

Add the reliability of a single substrate, uniform temperature characteristics, much lower attachment costs and you see why Allen-

Bradley thin film networks are the logical replacement for discrete precision resistors.

#### SELECTED SPECIFICATIONS

RESISTANCE RANGE	1K ohms to 2 megs, standard 25 ohms to 50 megs, special (Single substrate range— 10,000 to 1)
TCR LEVELS -55°C to +125°C	± 25 ppm/°C ± 10 ppm/°C ± 5 ppm/°C
TCR TRACKING	± 5 ppm/°C standard to ± 1 ppm/°C special
TOLERANCES	Absolute to ± .01% @ +25°C Matching to ± .005% @ +25°C
RESOLUTION	Line width and spacing to .0001 inch
ENDURANCE	Exceeds MIL-R-10509F Characteristic E Procedure: MIL-STD-202D

Investigate the superiority of Allen-Bradley thin film networks. Write: Marketing Department, Electronics Division, Allen-Bradley Co., 1201 South Second Street, Milwaukee, Wisconsin 53204. Export office: 1293 Broad St., Bloomfield, N. J. 07003, U.S.A. In Canada: Allen-Bradley Canada Ltd., 135 Dundas Street, Galt, Ontario. Several standard networks are available through your appointed A-B industrial electronic distributors.



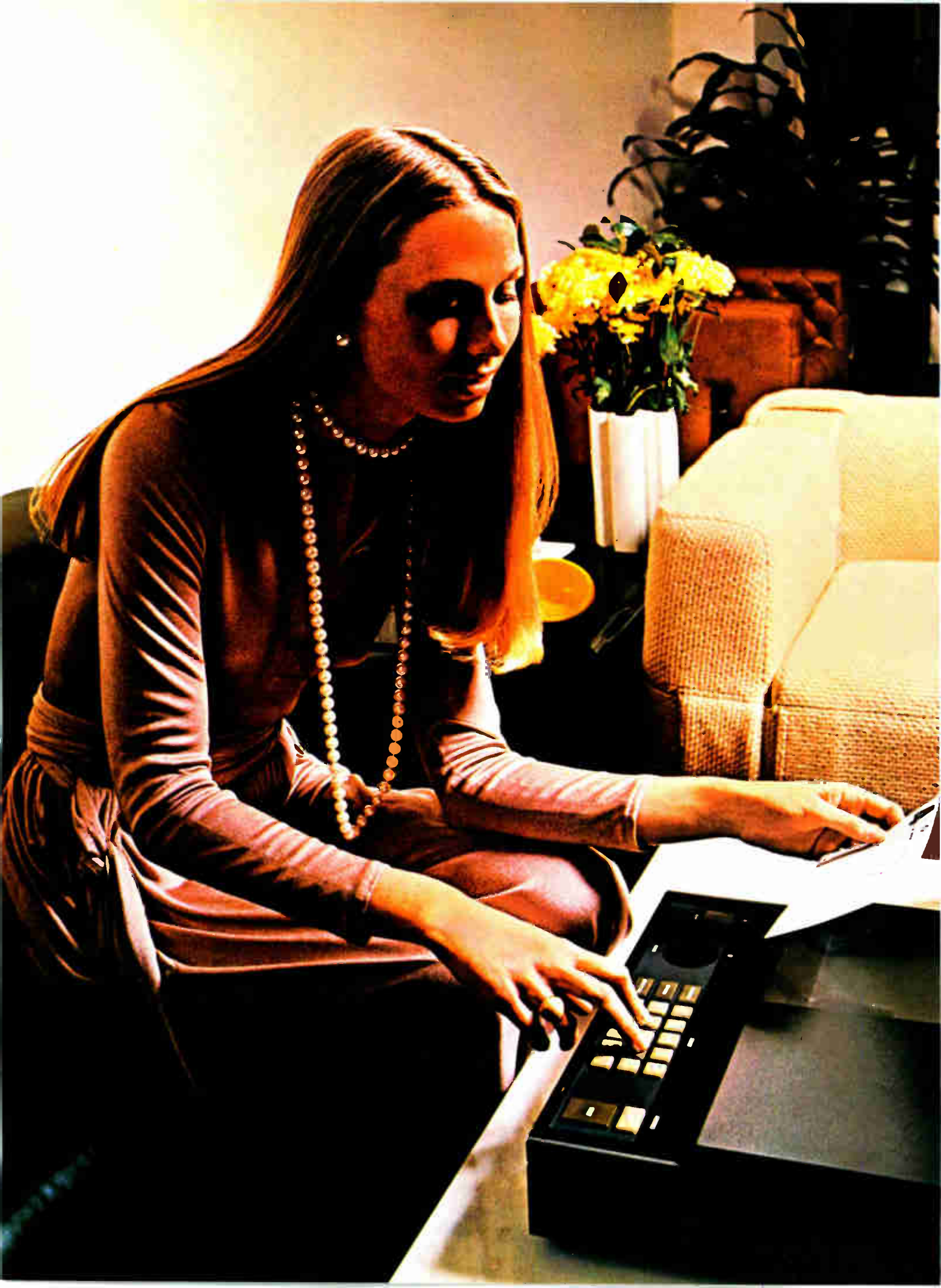



# By 1979, newspapers will be printed in your living room.

You won't have to roll up the carpet. Or even cover up the furniture.

Because all it will take is a compact print-out unit attached to an ordinary tv set.

When you're ready for the stock market closings, ball game scores or movies listings, you'll simply push a button.

Instant newspaper. And you'll be able to get any part of it, or all of it, any hour of the day or night.

The fact is, the products of electronics technology will be doing more for our lives tomorrow than electricity does for us today.

Automated highways will drive our cars. Home computers will cook the food and wash the clothes. Electronic health maintenance programs will even help us avoid illness.

Who are the master minds masterminding these changes?

Our readers. Engineers and technical managers who must keep abreast of all fast-changing developments. Industry-wide and world-wide. Which is why they come to us.

Every two weeks, Electronics magazine presents them with a complete, up-to-the-minute picture of the state of the technology.

Last year alone, Electronics presented six times as much information on consumer electronics as any other publication in the field. And twice as much on communications.

If you expect to be part of the future, speak to the men who are working on it today.

Electronics, a McGraw-Hill market-directed publication.



**Our readers are changing the world.**

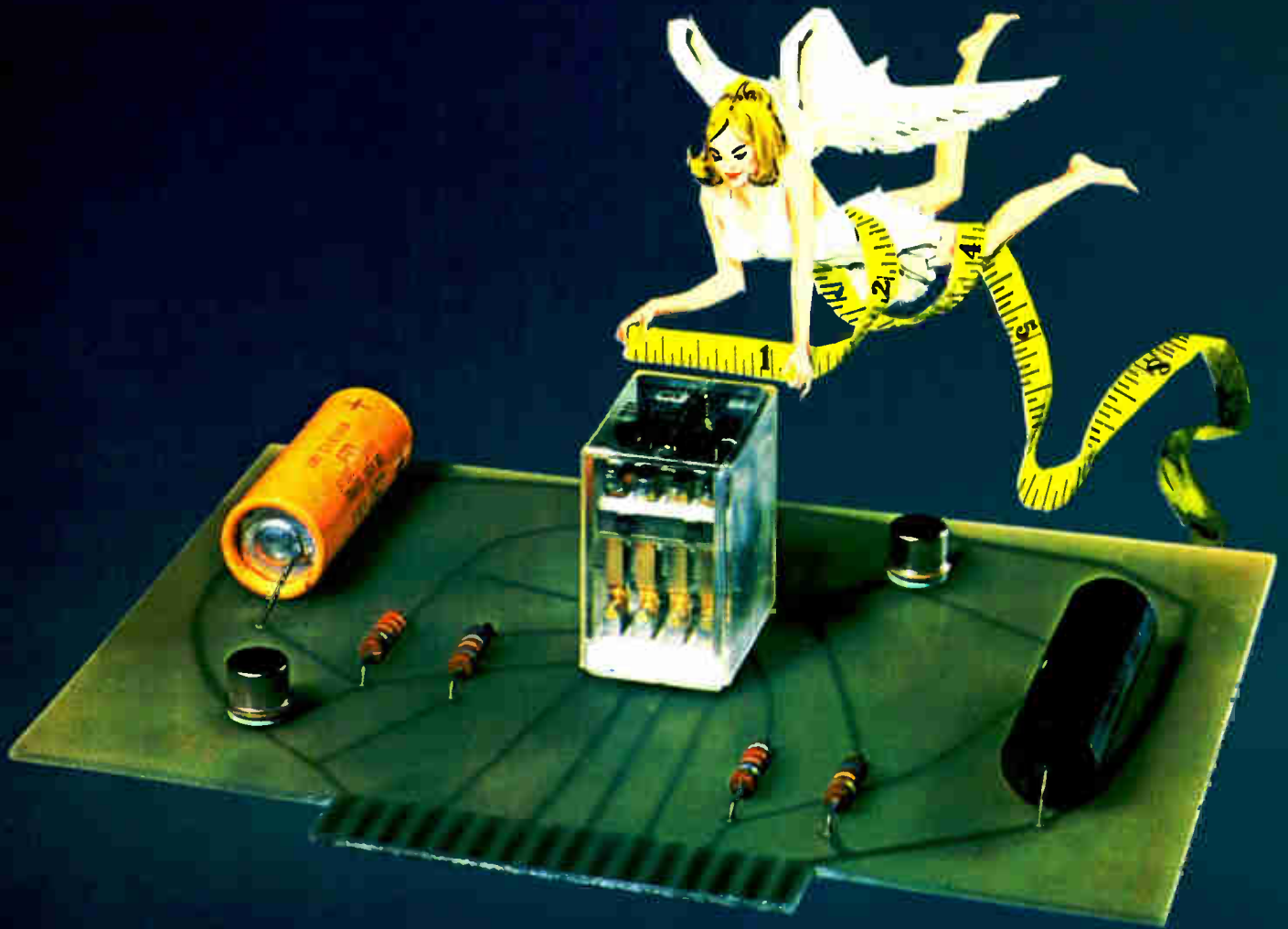

# Trust your Guardian Angel

for the newest 4PDT—5amp miniature relay

Give us a cubic inch on your printed circuit board . . . and we'll fill it with a plug-in relay. The logical relay for logic systems, computers, business machines—any application requiring maximum endurance and reliability in minimum space. Our new 1310, 4PDT-5 amp miniature relay is just a little more than one cubic inch in size, with inductive load contact rating of  $\frac{1}{8}$  hp @ 120V 60 Hz. But the small size doesn't limit its mechanical life of 100 million operations DC, 50 million AC. Minimum!



The miniature size doesn't limit its versatility, either. It's available with a choice of solder lug, quick connect .110, or printed circuit terminals—sockets for "plug-in" installation available with PC or solder lug. Other features like AC and DC versions, the Lexan dust enclosure that's standard, plus U/L and CSA recognition make this relay the answer to an engineer's prayers. (And all this time you didn't really believe you had a Guardian Angel!)



**GUARDIAN<sup>®</sup>  
ELECTRIC**

MANUFACTURING COMPANY · 1550 West Carroll Avenue, Chicago, Illinois 60607

Circle 120 on reader service card



COMPLETE APPLICATION DATA is yours for the asking, on this and other Guardian relays. Send for Bulletin B9.

# Solid state amplifiers challenge TWTs

By Laurence Altman, *Solid state editor*

Gunn-type gallium arsenide devices achieve stable negative resistance operation over large bandwidths

Replacing the venerable traveling-wave-tube amplifier with reliable solid state devices has been no easy task. Gunn—or transferred-electron—oscillators using gallium-arsenide chips have been on the market for some time and are steadily replacing TWTs. But development of Gunn-type amplifiers has been retarded by the difficulty of getting the required negative real impedances in stable configurations, and over bandwidths large enough to be useful for systems applications.

RCA, long a leader in developing transferred-electron oscillators, is the first to go to market with a TEA—a transferred-electron amplifier. The new line is aimed at specific TWT markets—microwave and millimeter wave communications links, ground and airborne stationary and phased-array radar, electronic countermeasures, satellite relays—and wherever medium- and high-power microwave signals are used.

The TEAs are continuous wave linear amplifiers that operate in C, X or Ku band (4-18 gigahertz) with bandwidths of 4 GHz or larger. Each can achieve a small-signal gain of from 6 to 12 decibels at its center frequency. Since their 1-dB-gain power output is 250 milliwatts, with a saturated power output exceeding 500 mW for both C

and X bands, they are compatible with many systems that already contain TWT amplifiers. A noise figure of 15 dB gives the devices a dynamic range of nearly 100 dB, while their amplitude and phase linearity also are as good as those

of traveling wave tubes.

The TEAs are GaAs epitaxial sandwich structures, grown by vapor epitaxial processes. The thickness of the n-layer is chosen so that the transit-time frequency lies within the amplifier pass band; the

System-ready. Single-stage X-band TEA uses a gallium arsenide chip (far right) and a circulator network. Table summarizes TEA performance.

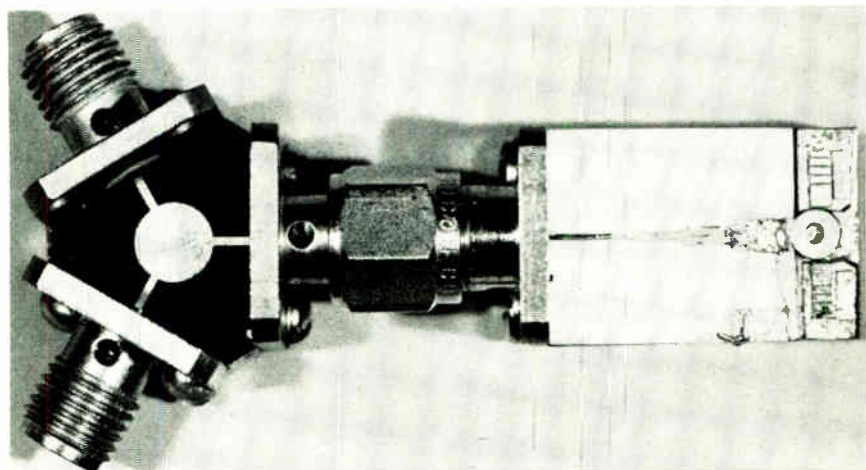

Frequency Band	Small Signal Gain (dB)	3 dB Bandwidth (GHz)	P <sub>o</sub> (watts) (—1 dB) Gain Compression	P <sub>o</sub> (watts) Gain = 3 dB
C	8 (22)*	4.5-8.0 (5.0-7.5)	.250	1
XL	12 (24)*	7.5-10.75 (7.65-10.25)	.200	.55
X	6	8.0-12.0	.250	.5
KU	6	12.0-16.0	.250	.5
*Two Stages				

# DIGITAL TV



CVI video sampling instruments allow your computer to "look" at practically anything. High accuracy bandwidth compression of conventional television signals opens new doors to data processing in research and industrial applications. Let us tell you about some of our unique video devices.

COLORADO VIDEO, INCORPORATED  
P.O. Box 928 • Boulder, Colo. 80302 • Phone (303) 444-3972

# CVI

Video Data Acquisition • Processing • Display • Transmission

Circle 171 on reader service card

## Don't depend on the fickle finger of fate

Wouldn't it be nice if you could eliminate human operator limitations and manual switching errors during dynamic data acquisition? And reduce costs.

Now you can.

ITHACO's AUTOGAIN® data acquisition systems leave nothing to chance. They automatically record and recover 120 db dynamic range signals by auto-ranging in 6 or 10 db steps. Gain status of up to 32 channels is multiplexed on a single tape-track. During data recovery, gain status is demultiplexed and presented to analysis equipment.

Alternatively, our universal logarithmic amplifier can continuously compress 100 db of dynamic range to 20 db, record on a single tape track, and recover gain status during playback.

Both systems may be operated under computer control, or with one or more channels slaved to a selected master.

No matter what the application is, there's never a chance of operator error. Never a chance of data loss.

We believe you'd like dynamic data acquisition to be a sure thing. To find out more, write or call collect. 607-272-7640. Ask for Mr. Ed Mitchell.

 **ITHACO INC.** 735 WEST CLINTON STREET, ITHACA, N.Y. 14850

## New products

X-band unit, for example, requires a layer 10 microns thick.

Development of the TEA into a product line was a direct result of RCA's ability to obtain stable negative resistance operation from Gunn diode structures. Researcher Barry S. Perlman, a member of the technical staff at the company's Advanced Technology Laboratory, found that instabilities stop abruptly when the bias voltage is three or more times larger than the threshold values. The voltage level where stability is achieved—approximately 20 volts dc—is a function of the physical characteristics and temperature of the device, as well as of the circuit impedance.

The phase response of the TEAs is linear over the bandpass. Phase deviation from linearity for a typical device is less than  $\pm 5^\circ$  over a 2-GHz bandpass, RCA says. Since the devices will operate from simple dc power supplies of 20 volts or less, they provide a significant advantage over TWT amplifiers. Also, the new devices can be directly integrated into the new solid state systems. And RCA engineers are predicting that multi-octave instantaneous bandwidths will be achievable with a single amplifier of the new line.

The TEA packaged circuit uses filter and circulator networks for widebanding, and with multiple stage design, both high gain and large bandwidth can be achieved.

Forrest Gehrke, marketing manager for microwave devices at RCA, says that prices have not been determined but they will be competitive with those of traveling wave tubes with similar power levels. "Because of the inherent simplicity of the TEAs," says Gehrke, "they will be much lower in price—a few hundred dollars—when volume production is realized."

At present, delivery time is dependent on the gain, bandwidth, and frequency desired. For relatively narrowband devices, delivery of prototypes can be made in 90 days.

RCA Solid State Microwave, Commercial Engineering section, 415 South 5th St., Harrison, N.J. 07029 [338]

# If you want to have better hybrid modules,

## you better have this.

We don't just make hybrid modules. We make them better. Matter of fact, we wrote a book on it. And we'll send it to you today.

You'll read how Raytheon is your best single-source selection for high reliability hybrid modules. How our expert module designers and process engineers can develop the best approach for you. How our modules meet MIL-Q-9858A and MIL-STD-883. How we'll even supply you with a permanent record of test results from our automatic tester T.I. 553.

Find out for yourself why Raytheon is the reliable way to meet your requirements, proprietary or disclosed. Send for the brochure. Then you can send us your specs.



RAYTHEON COMPANY, INDUSTRIAL COMPONENTS OPERATION, 465 CENTRE ST., QUINCY, MASS. 02169

Raytheon Company  
Industrial Components  
Operation  
465 Centre Street, Quincy, Mass. 02169  
(617) 479-5300

**RAYTHEON**

Gentlemen: I want better hybrid modules.  
I better have your brochure.

- Send it today.  
 Send a Raytheon sales representative.

Name \_\_\_\_\_

Title \_\_\_\_\_

Company \_\_\_\_\_

Address \_\_\_\_\_

City \_\_\_\_\_ State \_\_\_\_\_ Zip \_\_\_\_\_

Telephone \_\_\_\_\_

## ELECTRONIC COMPONENT DESIGNERS:

### **PUT YOUR MINIATURIZATION REQUIREMENTS IN THE RIGHT HANDS!**

When you're designing small . . . materials selection becomes a bigger consideration. Uniformity of magnetic behavior, for example, becomes an extremely critical factor in miniaturized applications. In such instances, the smallest change in a material's response to a given current can be enough to upset the operation of an entire electronic system.

Many other considerations, equally as critical, must be made in selection of materials for miniaturized, high-precision and ultrasensitive equipment.

Carpenter specialization brings you a full range of electronic alloys, all made to meet exacting quality standards. Among them: Magnetic Core Irons, High-Permeability Alloys, Temperature-Compensator Alloys, Glass-Sealing Alloys, Controlled-Expansion Alloys, Electrical-Resistance Alloys, Magnetostrictive and High-Saturation Alloys, plus others. Each of these materials is made to consistent standards of uniformity for dependable, long-lasting performance. Your Carpenter representative can give you full details. Steel Division, Carpenter Technology Corporation, Reading, Pa. 19603.

European Office: Emmastraat 39, Amsterdam-Z, The Netherlands

The logo for Carpenter Technology, featuring the word "CARTeCH" in a stylized, bold, sans-serif font. The letters are black with a white outline, and the "e" is lowercase.

CARPENTER  
TECHNOLOGY

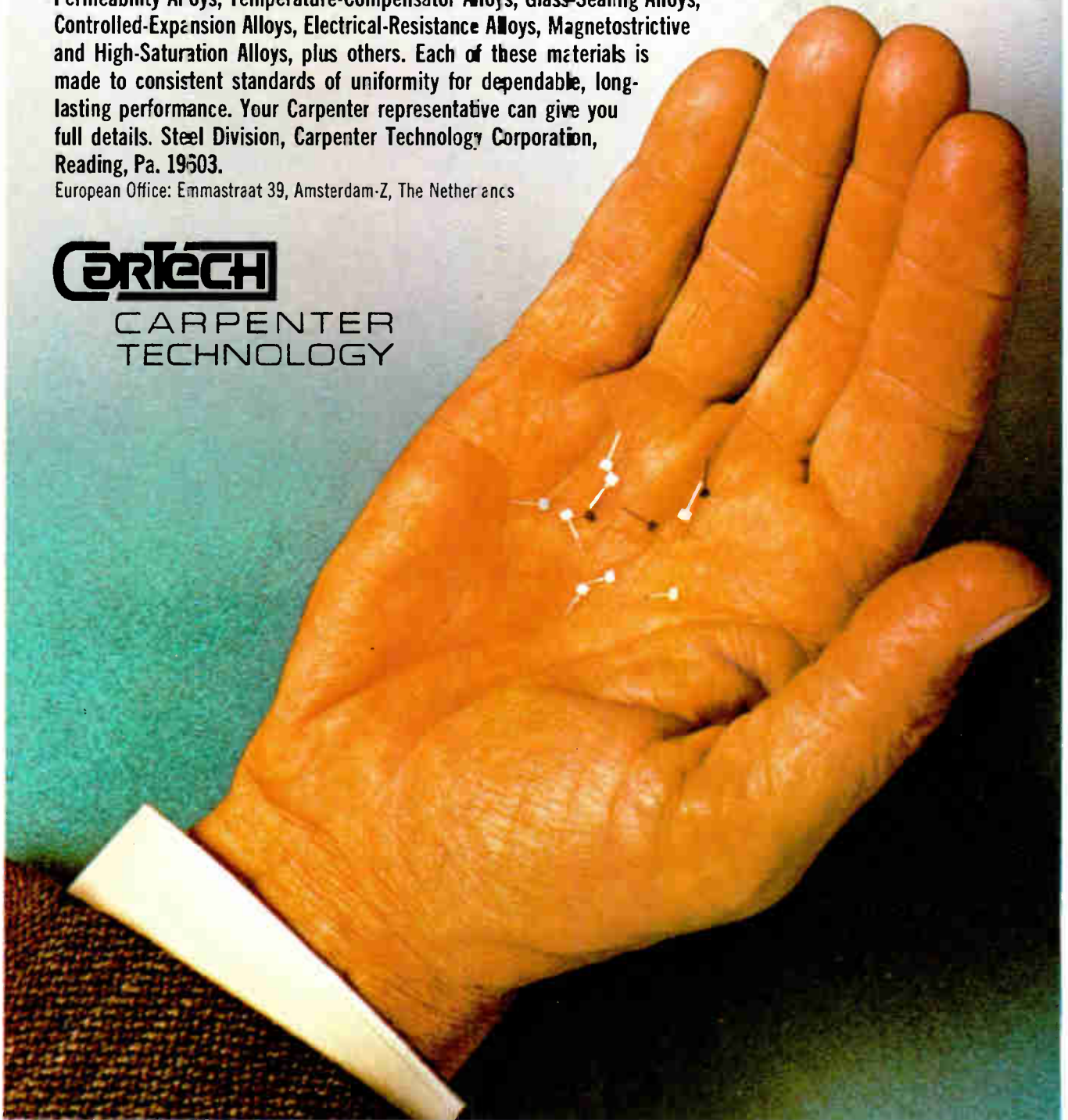

## New products

Instruments

# Computer runs spectrum analyzer

Fully automatic system designed for communications monitoring, rfi surveillance, air traffic control jobs

Twiddling a knob on an r-f signal generator and seeing what happens to a waveform on a scope is hardly the most accurate or quickest way of undertaking spectrum analysis. And some of the r-f signal generators that are used this way can be traced back to World War II equipment. Subsequent models were broader band units, then more accurately calibrated units, and then automatic systems that would sweep across a set of frequencies so the engineer could see what was happening in a dynamic mode.

"Now," says Michael Cunningham, product manager for automatic systems at Hewlett-Packard Co.'s Microwave division, "we've made a fully automatic system for unattended operation. Older systems used CRTs and needed an operator to interpret and record the data, but in our new 8580A automatic spectrum analyzer a computer does this. We call it a programmable receiver, because we can tell it to go a frequency and decide what is happening there."

H-P's more formal name for the 8580A is a general purpose, frequency domain, measurement system operating under the control of a small, stored-program, digital processor. It can be used for characterizing components and subsystems for their transfer characteristics (gain, attenuation, and distortion) and input/output characteristics (reflection coefficients). "And," says Cunningham, "it's well suited for surveillance application

in electromagnetic compatibility work, communications system monitoring, and signal analysis."

One of the prime expected uses for the 8580A is site surveillance. The FCC, for example, could use the analyzer to collect channel usage data, Cunningham points out. There would be an unattended station that would record the frequency, number of calls and the lengths of the calls. In areas with heavy traffic, it could detect unauthorized usage.

Another application is in air traffic control. The 8580A could be set up to scan both the tower frequencies, and those not covered by a particular tower. The system would alert the controllers if an aircraft were trying to reach the tower on an off frequency and also tell them what the off frequency was.

"The 8580A is of course a natural for Comsat," adds Cunningham. "A communications satellite will turn around any small signal you send up to it, so Comsat could use the 8580A to detect unauthorized use. It could also be employed to measure the traffic and then make frequency and channel allocation changes to provide optimum operation."

A more down-to-earth application is antenna characterization. "In measuring antennas," Cunningham points out, "you have to look in three dimensions and you can't do this with normal setups." Because the 8580A is computer controlled, untrained operators can quickly learn how to run the system. This is why it's ideal for the production lines of television or radio, for example, where you have to "tune on the fly"; "the 8580A is fast and accurate," Cunningham claims.

The 8580A breaks down into three major subsystems: a spectrum

## This Christmas Give Security



Gift selection can be a problem. This year give a gift that will be truly appreciated . . . **Security.** DeltAlert ultrasonic intrusion detection security.

Burglary and vandalism are constant threats to your home, office or shop. With DeltAlert on the job, you have dependable and economical security. A silent ultrasonic blanket guards 150 to 300 square feet of critical space in the home or business.

When the ultrasonic blanket is disturbed by motion the system is activated, lights go on, and the separate DeltaHorn emits an ear-splitting noise . . . frightening off even the boldest intruder.

These sturdy units, finished in handsome walnut veneer, are maintenance free and plug right into the wall socket. The DeltaHorn plugs directly into the DeltAlert. Small, the DeltAlert is only 10<sup>3</sup>/<sub>8</sub>" w x 3<sup>1</sup>/<sub>4</sub>" d x 3<sup>1</sup>/<sub>4</sub>" h and the DeltaHorn, 3<sup>1</sup>/<sub>4</sub>" square, the units blend inconspicuously into your decor.

This Christmas, give a lasting gift of security . . . security for your friends, your family and yourself.

Order your DeltAlert Security today!

DeltAlert Only **\$69<sup>95</sup>** ppd.

DeltaHorn Only **\$24<sup>95</sup>** ppd.

"Delta Products, One Of America's Finest Names In Electronics"

	DP 70-21
<b>DELTA PRODUCTS, INC.</b>	
P.O. Box 1147 E / Grand Junction, Colo. 81501 (303) 242-9000	
Please send me literature immediately: <input type="checkbox"/>	
Enclosed is \$ ____ <input type="checkbox"/> Ship ppd. <input type="checkbox"/> Ship C.O.D.	
Please send: _____ DeltAlert(s) @ \$69.95 ppd.	
Please send: _____ DeltaHorn(s) @ \$24.95 ppd.	
Name _____	
Address _____	
City/State _____ Zip _____	

## Varo Epoxy Bridge Rectifiers are mounting successes

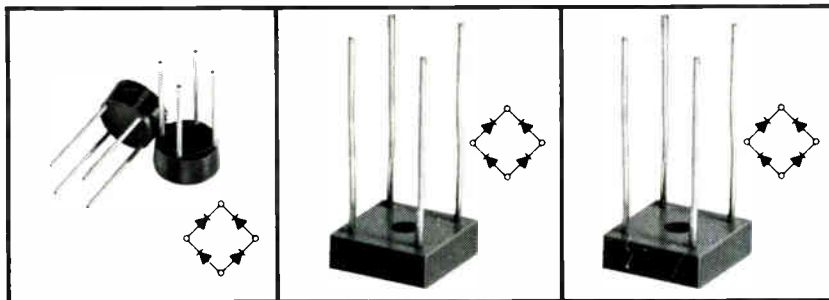

### 1 Amp EBR

Circuit board mounting.

**ONLY 91¢**

In 200V rating and quantity of 1,000. Available in 200V, 400V and 600V ratings, full-wave bridge and controlled avalanche.

### 2 Amp EBR

Circuit board mounting.

**ONLY 95¢**

In 200V rating and quantity of 1,000. Available in 200V, 400V and 600V ratings, full-wave bridge and controlled avalanche.

### 6 Amp EBR

For chassis mounting.

**ONLY \$1.59**

In 200V rating and quantity of 1,000. Available in 200V, 400V and 600V ratings, full-wave bridge and controlled avalanche.

Write for complete information on Varo rectifier products.



SEMICONDUCTOR DIVISION, 1000 N. SHILOH ROAD, GARLAND, TEXAS 75040 (214) 272-4551

Circle 172 on reader service card

## What Memory-System Maker Is Speeding Up the Cycle Time—But Holding Down the Price?

### Toko. Of course!

Beef up your technology with Toko's 500 nanoseconds Memory System without raising your costs.

Now rolling off the production line, Toko's HS500R Memory System offers the following key features:

- \* Access time of 250ns.
- \* Memory capacity of 4K words by 18 bits expandable to 16K words by 18 bits, rearrangeable to multiples of 36 and 72 bits.
- \* Compact, space-saving advantages—measuring 10" x 19" x 13-1/3".

Toko's advanced electronic technology also enables it to provide computer components, such as memory stacks. Contact Toko today for details.

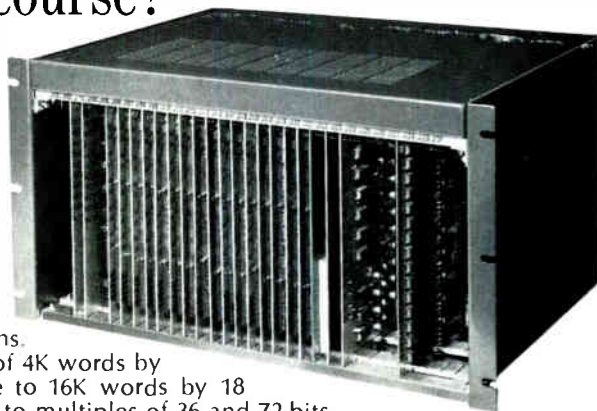

HS500R



**TOKO, INC.**

Head Office: 1-17, 2-chome, Higashi-Yukigaya, Ohta-ku, Tokyo, Japan  
TOKO N.Y., INC. 350 Fifth Avenue, New York, New York 10001 Tel: 212-565-3767

## New products

analysis subsystem, a signal source subsystem, and a digital processor subsystem.

The instruments in the spectrum analysis subsystem are a Model 85801A rf signal processor, the Model 85803A programable rf section, the Model 85802A programable i-f section, and an optional Model 85811A programable power meter.

The rf signal processor allows multiple inputs to be scanned either manually or under program control. It operates from 10 kilohertz to 18 gigahertz. In its basic configuration, four 50-ohm inputs are provided. The selected input is routed either directly to an output port designed for absolute calibration with a broadband power meter, or through a 0-70 decibel attenuator (10-dB steps) to a second output port. The three unselected ports are terminated in 50 ohms. Isolation between inputs exceeds 100 dB, and maximum safe input is +30 dBm.

In the signal source subsystem, the components include a Model 85810A output/level selector and a Model 85807A programable tracking generator counter, plus programable oscillators and a synthesizer that will be available early in 1971. The selector selects one of the signal sources available with the 8580, attenuates it over a 70-dB range in 10-dB steps, and routes it to the desired front panel output; frequency range is 10 kHz to 18 GHz. The tracking generator counter contains an oscillator that frequency-tracks the tuned frequency of the 85803A/85802A programable rf i-f section.

The third configuration, the digital processor subsystem, contains a Model 2114B controller (an H-P minicomputer), a Model 2752A teleprinter, a Model 2748A photo-reader, and a Model 1215B oscilloscope.

Cunningham says a typical system will start at \$60,000, "including some software and peripherals." First deliveries are expected in March.

Hewlett-Packard Co., 1501 Page Mill Road, Palo Alto, Calif. 94304 [339]



# The cable that won't hold you back

To move ahead in today's complex technology, the wire and cable you specify must be as sophisticated as the equipment it connects. Being unable to repair themselves, connections have to be more dependable than the humans they replace.

The wire and cable you put in today should have the most contemporary construction and electronic capabilities available . . . to minimize rewiring as you expand.

It should be equal to the unfamiliar equipment and interfacing systems that you're going to be living with soon.

This is the kind of wire and cable that Brand-Rex can bring you because we've been in on the development of these systems for years.

Are you the push-forward type? Send for our "all-products brochure". It covers contemporary wire and cable for telephone/communications . . . computer/peripheral . . . commercial/appliance . . . municipal . . . industrial/utility . . . and military applications. Tubing and sleeving, too. Brand-Rex Division, American Enka Corp., Willimantic, Conn. 06226. Phone 203 423-7771.

**Connect for tomorrow  
BRAND-REX**

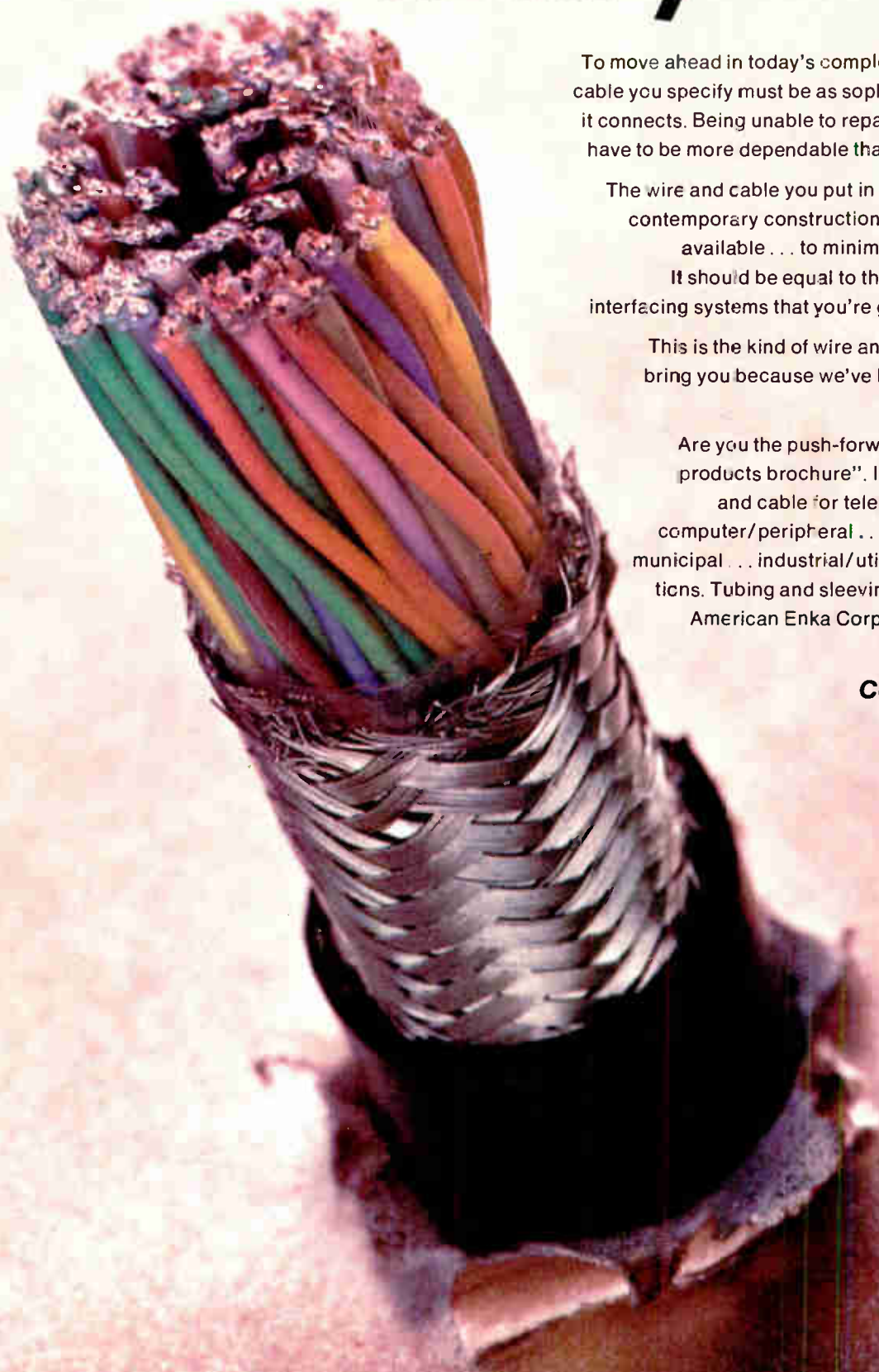

Semiconductors

# Ion implants speed memory

Depletion load transistors used in peripheral circuits of RAM; chip includes buffer, decode, drive logic

As competition sharpens in the semiconductor memory field, Mostek Corp. of Dallas lays claim to the first IC random-access memory made with ion implantation, depletion load techniques. Among other advantages, the company says, ion-implanted depletion load transistors help boost speed and save on chip real estate [*Electronics*, Nov. 23, p. 25].

The 1,024-bit RAM, designated the MK4006P, is compatible with transistor-transistor logic and includes the buffer, decode, and drive logic on its chip. Most comparable devices require external address latches, level shifters, clock drivers and multiplexers. While these may be individually small, the peripheral electronics needed to make them operate may take up a printed circuit board holding 50

Complete. Chip has address and drive circuits besides storage matrix.

to 80 components.

The MK4006P has the equivalent of an internal clock—at least it doesn't need the external clock signals required in some memories to control precharging. This precharging is required in other MOS RAMs that use enhancement mode transistors. These must be forward biased before adequate channel conductance—and speed—is attained. But the depletion load devices in Mostek's circuitry have relatively high channel conductance even at zero gate bias—a feature that not only saves precharging circuitry but can be used to boost speed or decrease component size.

The MK4006P's designers didn't try for the smallest possible size in laying out the chip. They used standard enhancement mode transistors in the memory storage matrix, but gained speed by applying the depletion load technique to the chip's peripheral circuits.

Read access time is 300 nanoseconds for the Intel 1103 RAM, chief competitor of the 400-ns MK4006P. But in considering this apparent 25% disadvantage, the company notes that it is possible to change the address of data requested about every 200 ns. Since this kind of interleaved addressing is becoming more common, a read access time between 250-300 ns probably is a more realistic specification, Mostek says. It still takes 400 ns for each batch of requested data to reach the output, but the next batch can follow more closely.

Intel, at 580 ns, outspeeds Mostek's 650-ns worst-case write cycle time. But the Intel chip's read cycle time is 540 ns, versus Mostek's worst-case 400 ns. Thus, neither chip wins a speed competition hands down, says Mostek.

But that's not what Mostek's engineers feel will make the differ-

ence to customers. One of the chip's designers cites the MK4006P's simplicity as a prime feature. Substrate bias supplies, noise suppression circuitry, sense-enable circuitry, and precharge power requirements all are either simplified or done away with, he says. Thus the MK4006P comes in a standard 16-pin package—other 1,024s need 18 to 24 pins.

Supply voltage is said to be less of a problem with the new memory than with other MOS devices. "We specify supplies of +5 and -15 volts  $\pm 5\%$ ," says a designer, "but the depletion load transistors' high gate conductance allows us to work with voltages lower than 15. I've seen this chip work anywhere between 10 and 20 V, and there's no data loss even if the 15-V line falls almost to zero."

Power hunger may be one of the chip's apparent disadvantages, but according to H.B. Cash, Mostek vice president, it's not a real one. Using a 4,096 by nine memory as an example, "Intel's 1103s dissipate about 4.9 watts versus our 19.9 watts," he says. "But because of our low input capacitance we need only a 0.1 W drive power versus 2.3 for Intel; Intel also needs another 9 to 17 W for its input level shifters—something we have included on the chip." In sum, he notes the speed power products of the two systems "come out about even, with Intel's using anything from 16 to 24-25 W and ours dissipating about 20 W even."

Mostek has priced the MK4006P at \$65 in lots of one to 24, but in lots of 500 to 999 the cost drops to \$39.25. In very large quantities, Cash estimates prices could be in the vicinity of one to two cents a bit.

The Mostek Corp., 4403 North Central Expy., Dallas, Texas 75205 [340]

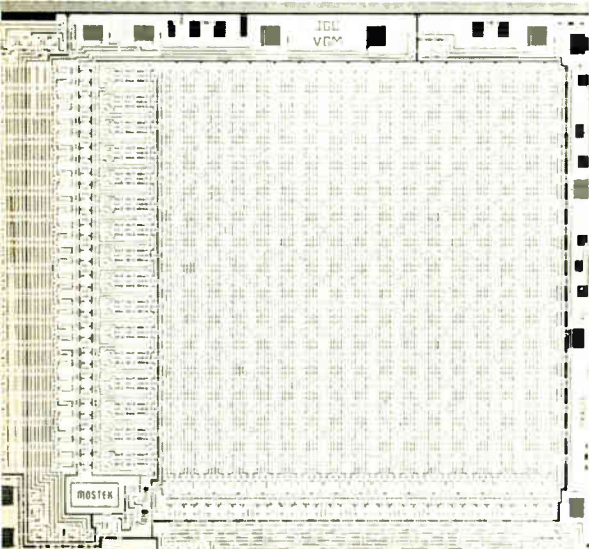

# You've met Skinny Mini II...

# Now meet Skinny Mini IV.

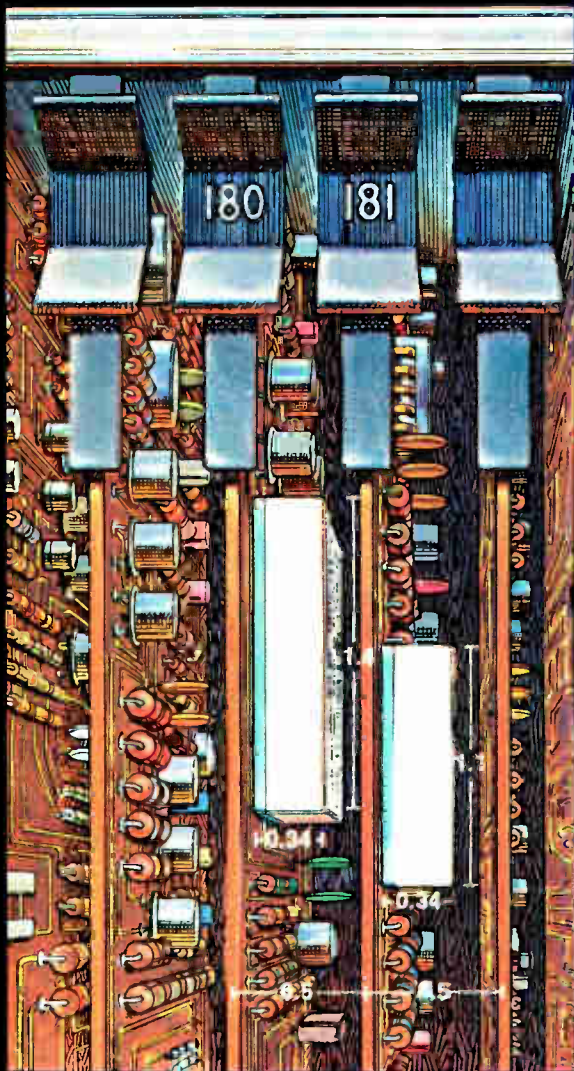

MIDTEX/AEMCO  
181-12C1C0  
24V DC



**SKINNY MINI II**, the first 2 amp 2PDT relay skinny enough to mount on 0.5 PCB centers has an off the board height of just 0.340 inches. Cheaper than a crystal can, handles more power than a TO-5 relay, and provides true Form C switching which micro-reeds do not provide. Call her Midtex/AEMCO Type 181, if you wish.

MIDTEX/AEMCO  
180-10SOA1  
6 VDC  
325274



**SKINNY MINI IV**, the first 2 amp 4PDT relay skinny enough to mount on 0.5 PCB centers, has all the features of her sister, plus 2 more poles and a silly .3 inch increase in length. Affectionately called Midtex/AEMCO Type 180, Skinny Mini IV, like II, provides 1/16" clearance through air and 1/8" over surface. Terminals are 0.025" pins. The relay mounts on four raised pads to permit proper PCB cleaning and soldering. Both Skinny Minis are smaller than any other 2 amp industrial relay, and they come with low-level gold, fine silver, or silver cadmium oxide contacts. For more information about either Skinny Mini II or Skinny Mini IV, write or call Midtex/AEMCO, 507 388-6286, or see a Midtex/AEMCO representative.

**AEMCO DIVISION**

**MIDTEX**   
INCORPORATED

10 STATE STREET  
MANKATO, MINNESOTA 56001

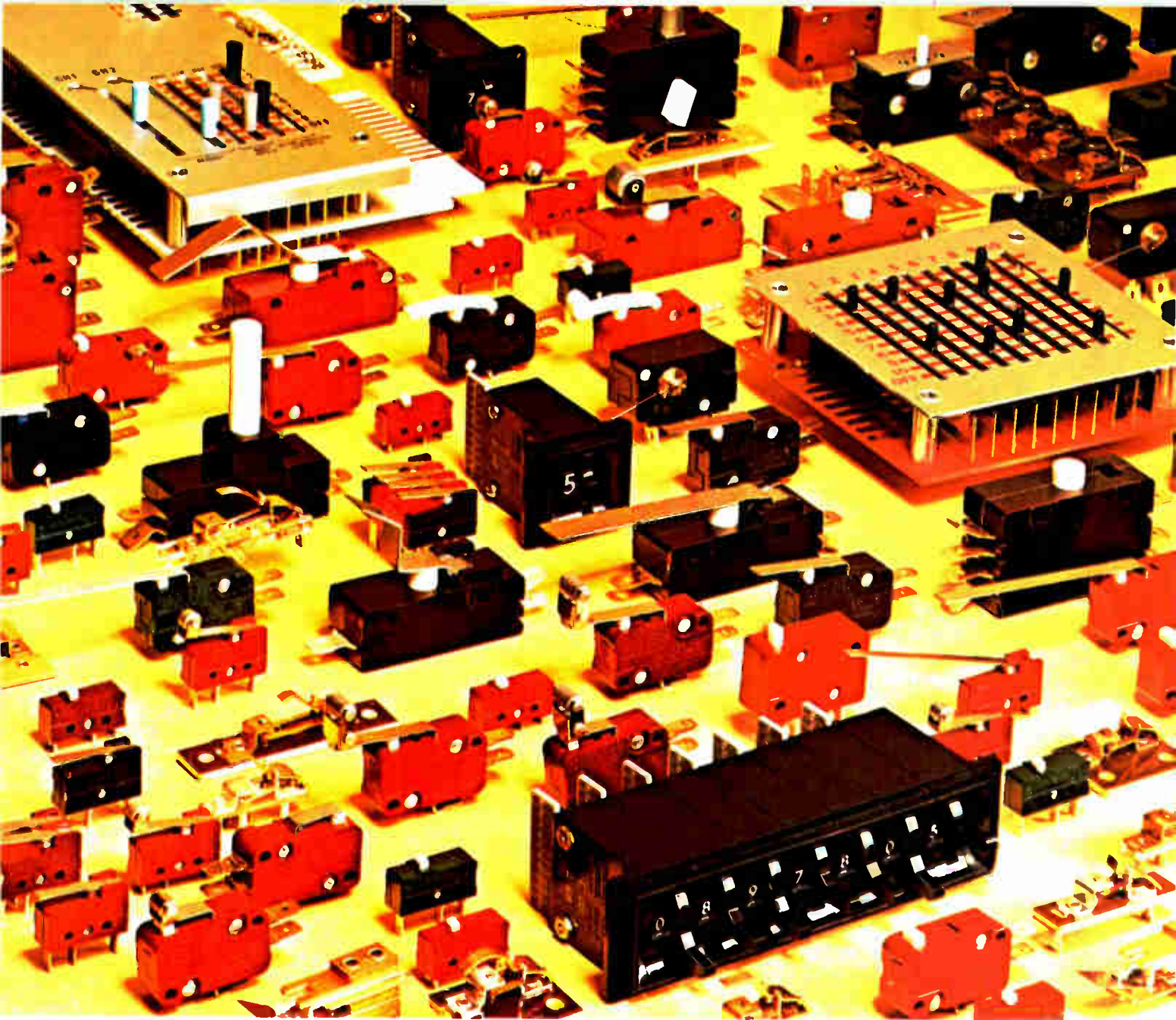

# If 97,650 aren't enough

...we'll propose one just for you

**Switching problem? Bring it to Cherry.** We'll make the switch search FOR you. From among the nearly 100,000 different switches made possible by our highly specialized switch design and manufacturing facilities.

With so many switches from which to choose, there's sure to be one that's perfect for your application . . . and to solve your switching problems.

Whether it's a simple adaptation of something we've already produced or a standard catalog type switch available from stock, you'll get fast action from Cherry. And, if your application requires tooling, we'll propose an entirely new switch . . . just for you.

SEND FOR OUR NEW 44-PAGE FULL LINE CATALOG. It contains complete design information on Cherry long life precision switches.

# CHERRY



**CHERRY ELECTRICAL PRODUCTS CORP.**  
3608 Sunset Ave., Waukegan, Ill. 60085

Makers of patented Leverwheel/Thumbwheel Switches, Matrix Selector Switches, Snap-Action Switches and Keyboards.

Circle 130 on reader service card

## New products

### Components

# Relay rejects plant noise

Solid state device accepts IC logic levels, can drive 240 volts ac

For a while, solid state relays will be too expensive to take over applications in which electromechanical relays are doing an adequate

job. But when extra sensitivity, noise immunity, or durability is needed, the solid state types are worth the two to four times greater price they command. Ohmite's SSB solid state relay is a case in point: this device accepts directly the control signals from a computer at the usual integrated circuit logic level of 5 volts, and from this it drives power devices like solenoids at currents of up to 13 amperes and voltages of 120 or 240 volts ac.

The SSB, moreover, is virtually immune to false actuation; it can't be triggered by the 1.5 to 2 V of noise that is typical of the industrial environment. An SSB with a threshold voltage of 3.5 V, for ex-

ample, will turn on or off within 60 or 70 millivolts typically and within 200 mV at worst. This noise immunity is especially important in industrial systems, where reaction to a spurious signal could cause injury to personnel or damage to the process. Another important feature is high isolation—500 gigohms from "coil" to "contacts," "contacts" to mounting plate, and mounting plate to "coil". (A solid state relay, of course, doesn't have coil or contacts but the terms are used analogously to represent the input and output portions of the device.)

SSB relays operate on any input voltage within the range of 2.5 to 32 V dc; input current is typically

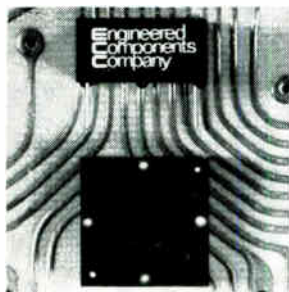

Low-silhouette toroidal inductors come in 89 ratings from 0.10  $\mu$ H to 10mH. They are designed to provide minimum distributed capacity, maximum Q, and the highest self-resonant frequency possible commensurate with minimum size. They come in sizes ranging from 0.200 x 0.200 x 0.125 in. to 0.550 x 0.550 x 0.300 in. Engineered Components Co., Gardena, Calif. [341]

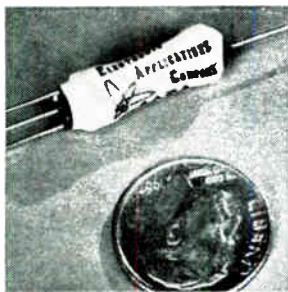

Reed relays measure 0.275 in. diameter by 0.950 in. long and are available for coil voltages of 1, 3, 5, 6, 12, and 24 volts. The coil bobbins are molded directly on the reed capsule allowing greater flux densities and reducing costs through automation. Contacts are rated up to 1A at 20 W. Electronic Applications Co., 2213 Edwards Ave., S. El Monte, Calif. [342]

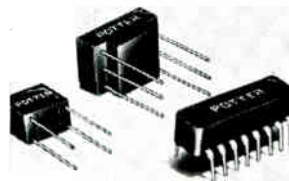

Pulse transformers, in both conventional and dual in-line packages, are designed for application with core memory systems. Ranging in inductance from 10  $\mu$ H to 100 mH, units have turns ratios from 1:1 to 10:1, with up to four windings. Price is from 50 cents to \$1 in production quantities, depending on type. The Potter Co., 500 W. Florence Ave., Inglewood, Calif. [343]

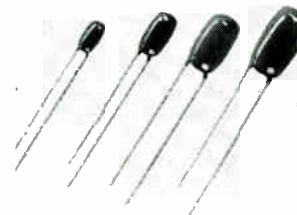

Dipped tantalum capacitors series GS feature rugged plug-in lead construction, and operate at full-rated voltage from  $-55^{\circ}$  to  $+85^{\circ}$ C. Capacitance/voltage range is 0.47  $\mu$ F at 50 V through 330  $\mu$ F at 6 V. Four cylindrical cases are available, ranging from 0.175 to 0.400 in. in diameter by 0.350 to 0.750 in. in height. Dickson Electronics Corp., Scottsdale, Ariz. [344]



Solid state relay type 12 is essentially a full wave power switch for controlling ac loads. It operates as a relay when terminal pins 2 and 7 are shorted, and as a proportional controller when resistance is substituted for the short. Operating frequency range is 50-500 Hz. The device has built-in transient protection. Profile Electronics Inc., S. Main St., Concord, N.H. [345]

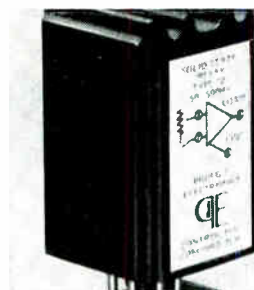

Low-level, dry-reed, signal switching relays series CR300 achieve a differential thermal offset of less than 0.1  $\mu$ V for 5% coil duty cycle and less than 1  $\mu$ V for 100% coil duty cycle. Units feature speed of up to 20C samples/s when used in multiplexing. Single quantity prices start at \$10.40. Computer Products Inc., Box 23849, Ft. Lauderdale, Fla. [346]

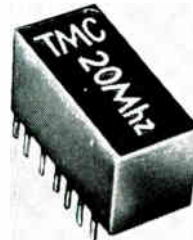

IC crystal oscillator XO-2007 comes in a card-compatible, 14-pin, dual in-line configuration. It covers the frequency range of 18 MHz to 25 MHz providing stability of  $\pm 50$  ppm over  $0^{\circ}$  to  $+50^{\circ}$ C. Input power is +5 V dc  $\pm 10\%$  at 22 to 30 mA and provides a squarewave output. Price in lots of 500 is \$18.45 each. TMC Systems (Arizona) Inc., Tempe, Ariz. [347]

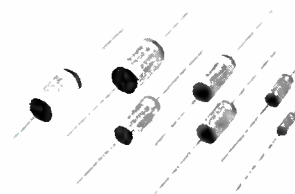

Deltafilm LP polycarbonate capacitors style LP88 are available in Fuz-ion Sealed tubular construction. They include a 75-volt dc rating in capacitance values as high as 27  $\mu$ F. The upper capacitance limit for 50 V designs is increased from 5.6 to 50  $\mu$ F; for 100 V units, to 22  $\mu$ F; for 200 V designs, to 8.2  $\mu$ F. Dearborn Electronics Inc., P.O. Box 530, Orlando, Fla. 32802 [348]

# USING ACTIVE FILTERS OR PASSIVE FILTERS ?

**Are size, shape or weight considerations important? Special mechanical configurations offered—Hermetically sealed or encapsulations for pcb installations**

**Low, high, band pass and reject designs—Butterworth, Chebishev, Bessel or elliptic response characteristics—wide range of source and load impedances**

**Low frequency actives, stable toroidal LC's, RC twin-T's**

**No EXTERNAL components required**

**Unbiased recommendations on active or passive filter selections for maximum economy**



**instruments, incorporated**

PHONE AREA 512/892-0752 • P.O. Box 698 AUSTIN TEXAS 78767

Circle 173 on reader service card

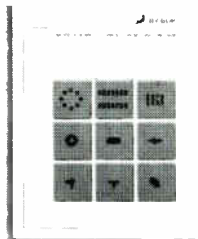

**NEW**

*Catalog of  
pressure  
sensitive  
electronic*

*component drafting aids*

**T**ime saving electronic component shapes, patterns and conductor line tapes are listed by the thousands in By-Buk's new P-50 catalog. This easy to use, cost-saver index of pressure sensitive printed circuit drafting aids is the source book of ideas for engineers, designers and draftsmen interested in faster, more accurate artwork layouts. Find new ways to reduce the tedium of repetitive artwork with individually die cut artwork patterns in opaque black, transparent red and transparent blue materials.



**FREE CATALOG  
FREE SAMPLES**

Send today for a free copy of the new P-50 catalog and a selection of samples.



**BY-BUK COMPANY**

4326 W. Pico Blvd.  
Los Angeles, Calif. 90019  
(213) 937-3511

## 3 AMP SENSITIVE GATE TRIAC



Now there's a source with first-class capability. Hutson triacs are rated from 50-600V. Standard TO-5 packages. Immediate delivery.

3 ma FIRES		PRICE PER
RATING	ALL QUADRANTS	1K UP
200V	HI 2:SS	\$1.19 ea.
400V	HI 4:SS	\$1.49 ea.
10 ma FIRES		PRICE PER
RATING	ALL QUADRANTS	1K UP
200V	HI 2:SG	95c ea.
400V	HI 4:SG	\$1.19 ea.

**HUTSON  
INDUSTRIES**  
P. O. Box 34235 • Dallas, Texas 75234  
214-241-3511

## New products

1.7 milliamperes. The 13-amp output rating at 25°C requires a heat sink; the unmounted maximum rating is 3 A. For greater compatibility with the IC logic input, response time is fast: pull-in time is less than 1 millisecond and drop-out time is one half cycle of load current. All standard SSB units are single pole, double throw, normally open. There are several lead configurations available for the package: quick connect, screw terminals, printed-circuit pins, or octal base with or without heat sink. Price in lots of 100 is \$21 each.

For applications in which intermediate sensitivity is required—less than that of the solid state SSB but more than that of an electromechanical relay—Ohmite offers a hybrid relay. The SSH model has a reed switch on the input end and a solid state device at the output end; it operates on a somewhat larger driving current than the SSB, but costs half as much. Three versions are available, turning on with 6 V and 33 mA, 10 V and 10 mA, and 24 V and 10 mA. Pin configurations are similar to those of the solid state relay.

Maximum load current at 40°C is 8 to 15 amperes, depending on type, at 120 volts ac. Pull-in and drop-out times are identical to those of the SSB.

Ohmite Manufacturing Co., 3601 West Howard St., Skokie, Ill. 60076 [349]

Choice. Lead configurations include quick connect, pc pins, octal base.

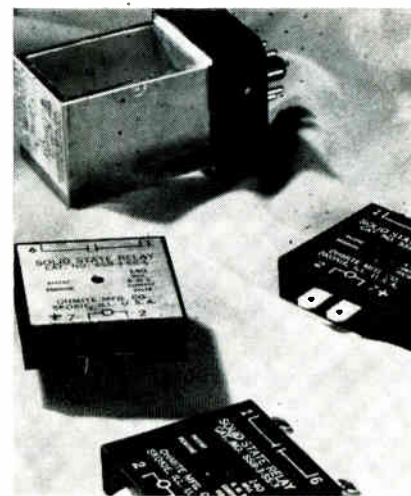

ANOTHER BOX OF QUALITY  
**Magnecraft Relays**  
Magnecraft ELECTRIC CO.  
5575 NO. LYNCH AVE. CHICAGO, ILL. 60630

ANOTHER BOX OF QUALITY  
**Magnecraft Relays**  
Magnecraft ELECTRIC CO.  
5575 NO. LYNCH AVE. CHICAGO, ILL. 60630

**Magnecraft Relays**  
Magnecraft ELECTRIC CO.  
5575 NO. LYNCH AVE. CHICAGO, ILL. 60630

**Magnecraft Relays**  
Magnecraft ELECTRIC CO.  
5575 NO. LYNCH AVE. CHICAGO, ILL. 60630

HANDLE WITH CARE -  
ANOTHER BOX OF QUALITY  
**Magnecraft Relays**  
Magnecraft ELECTRIC CO.  
5575 NO. LYNCH AVE. CHICAGO, ILL. 60630

HANDLE WITH CARE -  
ANOTHER BOX OF QUALITY  
**Magnecraft Relays**  
Magnecraft ELECTRIC CO.  
5575 NO. LYNCH AVE. CHICAGO, ILL. 60630

HANDLE WITH CARE -  
ANOTHER BOX OF QUALITY  
**Magnecraft Relays**  
Magnecraft ELECTRIC CO.  
5575 NO. LYNCH AVE. CHICAGO, ILL. 60630

HANDLE WITH CARE -  
ANOTHER BOX OF QUALITY  
**Magnecraft Relays**  
Magnecraft ELECTRIC CO.  
5575 NO. LYNCH AVE. CHICAGO, ILL. 60630

HANDLE WITH CARE -  
ANOTHER BOX OF QUALITY  
**Magnecraft Relays**  
Magnecraft ELECTRIC CO.  
5575 NO. LYNCH AVE. CHICAGO, ILL. 60630

HANDLE WITH CARE -  
ANOTHER BOX OF QUALITY  
**Magnecraft Relays**  
Magnecraft ELECTRIC CO.  
5575 NO. LYNCH AVE. CHICAGO, ILL. 60630

HANDLE WITH CARE -  
ANOTHER BOX OF QUALITY  
**Magnecraft Relays**  
Magnecraft ELECTRIC CO.  
5575 NO. LYNCH AVE. CHICAGO, ILL. 60630

HANDLE WITH CARE -

Shown actual size — Available for off-the-shelf delivery.

## **Magnecraft achieves a breakthrough in reed relay technology... NOW...20,000 VOLT SWITCHING!**

The Class 102HV, 10,000 volt relay and the Class 102UHV, 20,000 volt relay are natural additions to the growing line of Magnecraft's high voltage reed relays.

To assure 1 million operations at rated load and longer life at reduced loads, these relays incorporate contacts of a special material plus the inherent reliability of a reed relay. Standard operating coil voltages are 6, 12 and 24 VDC.

Safety for the user and maximum dielectric strength are provided through the uniquely designed insulation system, offering insulation resistance in the range of  $10^{10}$  megohms.

For immediate off-the-shelf delivery, these relays are stocked in depth by Magnecraft and its nationwide network of distributors. The 10,000 volt, Class 102HV is priced as low as \$19.88 in single quantity and even lower in larger quantities.

To get all the facts on these relays and our full line of 512 stock relays, contact your local Magnecraft distributor or send for Stock Catalog No. 272.

© Magnecraft Electric Co., 1970

See our product data in EEM

# **Magnecraft**<sup>®</sup> ELECTRIC CO.

5575 NORTH LYNCH AVENUE • CHICAGO, ILLINOIS 60630 • 312 282-5500 • TWX-910-221-5221

## New products

### Instruments

# Texscan enters analyzer field

Marker technique provides accuracy of 0.005% in three low-priced units

It was a logical step for Texscan Corp., long a builder of sweep generators, to move into the spectrum analyzer market. Following a two-

year engineering effort, the Indiana company has introduced a trio of analyzers that offer a marker system enabling the instruments to pick out a frequency with an accuracy of 0.005%—and at low prices, too.

The new units are called the AL-70, the AL-60, and the AL-40. The first two sell for \$4,950 each and are after the high-frequency business, where many of the analyzers cost \$10,000 or more. The AL-40, priced at \$2,500, is intended primarily for commercial and industrial applications.

The AL-70 has a range of 0.5 megahertz to 5 gigahertz, split into three bands. With an additional

mixer, the instrument goes to 12.6 GHz. The dispersion is continuously variable between 500 hertz and 2 GHz. Input range is -95 decibels below 1 milliwatt to +40 dBm.

The instrument is built around the swept-front-end, triple-heterodyne technique.

The AL-60's range is 1 MHz to 3 GHz, and, like the AL-70, dispersions are 500 Hz to 2 GHz. But the AL-60 uses a double-balanced mixer which improves sensitivity. The instrument's input range is -105 dBm to +40 dBm.

Both instruments have an automatic phase lock, which the company says is needed to make the narrow dispersions "usable." Turn-



Multiple, discrete, frequency synchronizer/stabilizer series 250A can phase or sweep-lock any type of rf or microwave voltage tunable source. Covering the range of 1 to 18 GHz for phase locking and 100 MHz to 18 GHz for sweep locking, the unit can be used conveniently for imparting crystal stability to an oscillator. Sage Laboratories Inc., 3 Huron Dr., Natick, Mass. 01760 [361]

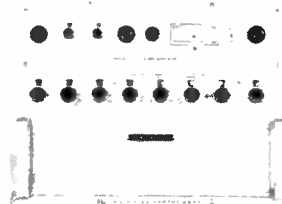

Megohm bridge 515A consists of a solid state, guarded, electrometer null detector; an ultra-stable, highly regulated dc voltage source; and a Wheatstone bridge. It measures from  $10^5$  to  $10^{15}$  ohms with a 7-dial in-line readout. Standard deviation of the resistance measured ranges from 0.012% at  $10^5$  to 0.5% at  $10^{15}$  ohms. Keithley Instruments Inc., Aurora Rd., Cleveland [362]



Pulse generator 3103, for time domain testing on the production line or in the lab, offers continuously variable manual control of pulse rate, delay, width and amplitude. It generates single or double pulse trains at any rep rate from 1 Hz to 25 MHz, or a single cycle output may be initiated from the "manual" pushbutton. Lear Siegler Inc., Morena Blvd., San Diego, Calif. [363]



Digital multimeter model 1800 can measure ac and dc volts, ohms and current. Extensive use of LSI circuitry and high-impact plastic cases bring about significant cost savings. The 10-megohm input impedance, along with the slope measurement method, allows accurate 5 readings/s measurements. Eldorado Electrodata Corp., 601 Chalomar Rd., Concord, Calif. [364]

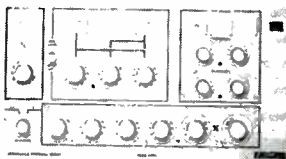

Resistance bridge model 126 DA automatically controls trimming of hybrid IC resistors. It features selectable single and dual "stop" limits, internal and external standards, remote input facilities for control operation and across-the-board outputs in computer styled indicators, contact closures, and logic level. Boonton Electronics Corp., 1279 Route 46, Parsippany, N.J. 07054 [365]



Function generator model 5400 covers the frequency range of 0.002 Hz to 5 MHz and provides multiple waveforms including sine, square, triangle, positive and negative ramp. The 30 volt peak-to-peak output is controlled by a pushbutton attenuator that permits selection from 0 dB to -70 dB in 10-dB steps. Krohn-Hite Corp., 580 Massachusetts Ave., Cambridge, Mass. [367]



Sweep-frequency reflectometer 1641 is available in a 1- to 18-GHz version. A wide-range directional coupler makes directivity as good as 39 dB across the band. Insertion loss can be measured with an accuracy of 0.6 dB. A storage scope permits the simultaneous measurement of SWR and loss. Price is \$5,035 (rack). General Radio Co., West Concord, Mass. [368]



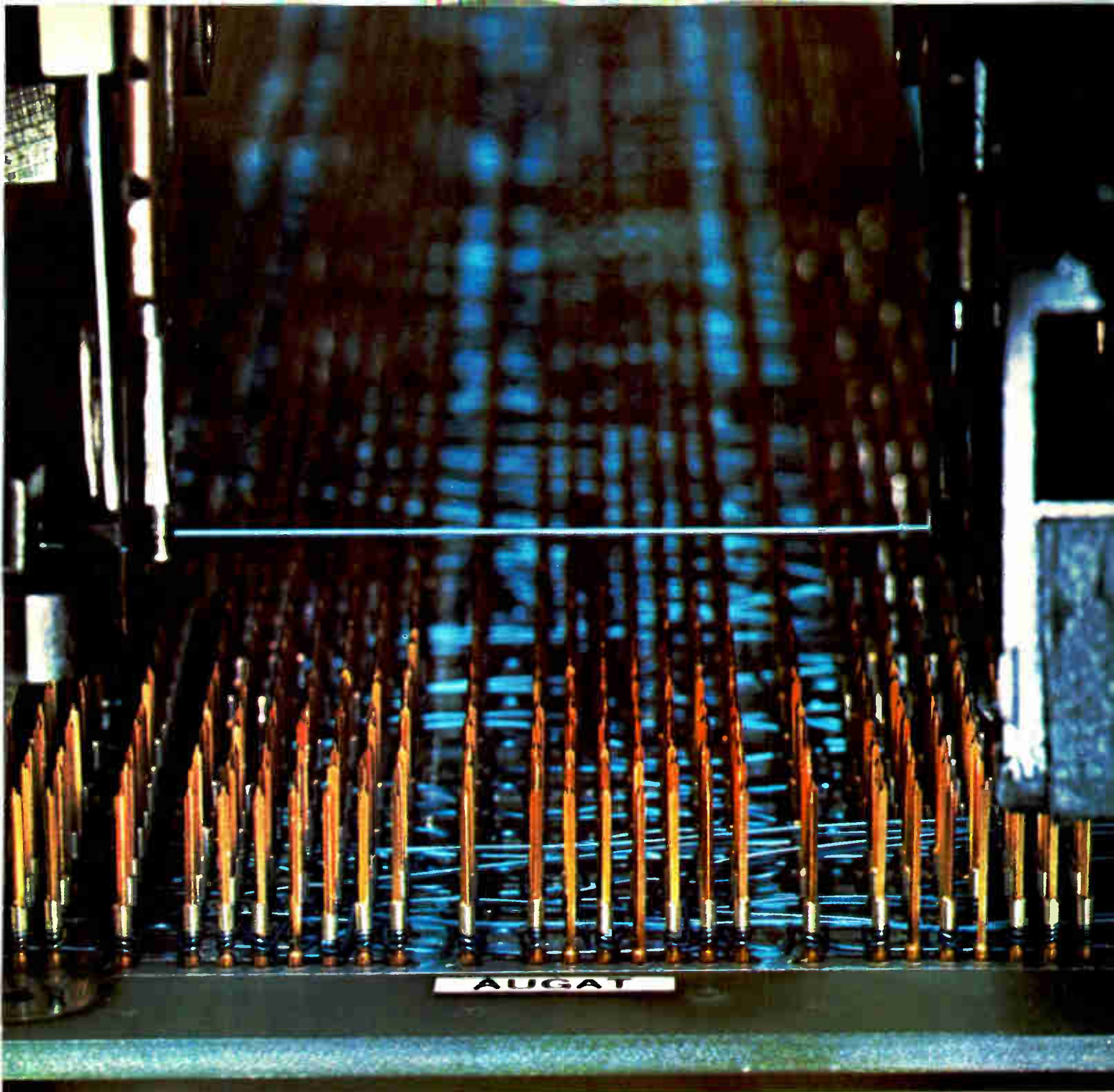

## Teamwork pays off

Complete Wire Wrapped IC Panels . . . One Source Responsibility

**Augat** and **Raytheon** are working together to cut your costs and turnaround time.

Augat . . . pacesetter in top quality IC packaging panels. Raytheon . . . most experienced and largest in wire wrapping service facilities. This unbeatable team is now delivering complete wire wrapped packaging panels, unmatched in versatility and quality. And Augat wraps it all up with single source responsibility.

Saves you time and money.

No setup charge for tooling or computer programming on any cataloged panels. Nominal charge, one time per card, to produce drive deck from wire list.

Simply furnish wire list with panel order.

Contact: Augat Inc., 33 Perry Ave.,  
Attleboro, Mass. 02703.  
Tel: (617) 222-2202

**AUGAT**<sub>INC.</sub>

Circle 135 on reader service card

# “We came to fish, and got hooked.”

“Eight years ago, I decided to combine business and pleasure. I was seeking a site for a new manufacturing facility for our electronic instruments company. So, on a trip to Colorado I brought Louise and the boys along to do some fishing and sight seeing as well as site seeking.

“Our whole family was fascinated by western Colorado.

“Well, one year later, we located our new plant in a city of about 40,000 people, nestled in a scenic valley of the Colorado River. It's strategically located on an excellent

air, rail and all-weather highway transportation network which provides efficient distribution to all our national markets.

“Now we employ over 300. And, the people here are great. Our local employees are reliable, stable and trainable. Our local college organized a vocational training program for our new employees and provides a continuing educational service for industry throughout the area.

“It's a great place for a family and a business to grow. And incidentally, the fishing *is* great.”

For further details on Colorado site seeking, write William C. Hacker, 1121 State Capitol Annex, Denver, Colorado 80203.

Mr. Bruce Dixon,  
President of Dixon, Inc.,  
Grand Junction, with son.



**COLORADO...** *where there's room to live and breathe.*

## New products

ing on the phase lock involves pressing a couple of buttons, adjusting the trace to the desired position on the analyzer's display, and releasing a button.

The AL-40, as can be expected, has a much smaller range—3 MHz to 300 MHz—than its two brothers. However, this instrument does have the high sensitivity of the AL-60. Input range is  $-110$  dBm to  $+10$  dBm. Dispersion ranges from 200 kilohertz to 300 MHz.

The 0.005% results from a "birdy-bypass" marker system which Texscan developed for its sweepers. In this technique, a sample from the first local oscillator in the sweeper is mixed with harmonics from a crystal-controlled oscillator. The output beats, or "birdies," then are fed directly to the analyzer's cathode ray tube, bypassing the whole mixer chain. Thus there's no interaction between the markers and the signal being analyzed.

For the two high-frequency units, worst-case flatness is  $\pm 2$  dB. For the AL-40, the figure is  $\pm 1$  dB.

Texscan Corp., 2446 N Shadeland Ave., Indianapolis, Ind. 46219 [369]

## Hybrid buffer amp sharpens pulses

Though the Datapulse division of Systron-Donner Corp. is known primarily as a maker of pulse and function generators, it started a thin-film laboratory early this year. Now the lab's first commercial circuit—the 930 Picopulser—is available. This thin-film hybrid IC is a buffer amplifier that takes input pulses with rise times in the 1.5 nanosecond region and turns the rise time into 500-picoseconds.

The 930 will be offered in conjunction with the 330 controller whose job is to take almost any pulse and convert it into a form the 930 can handle. Working together, the two devices can turn any signal generator into a source suitable for testing high-megahertz and gigahertz communications systems and high-speed digital circuits.

The hybrid IC has two cascaded

the new Bausch & Lomb StereoZoom 7 Coaxial Illuminator <sup>(Patented)</sup>

# You're looking at a **major** advancement in microelectronics cost reduction and quality assurance

Now—speedily, surely—you can examine reflective micro-objects for the first time *as they really are*. Full-color definition. Without flare, glare, shadowy ambiguity. With image quality comparable to the best monobjective microscope . . . and in 3-D.

One-step visual quality control is now possible, for example, in assembling microelectronics. And quality assurance checking of multi-layer elements is swift and conclusive. Results: significant time and cost reductions.

New, unique, vertical illumination is the reason. The Bausch & Lomb StereoZoom 7 Coaxial Illuminator supplies uniform-intensity, full-aperture, on-axis illumination to both sides of the optical system. Better than ring lighting. Better than ordinary vertical and incident light systems.

But words can only hint. See it for yourself. Ask for Catalog 31-2368 and a demonstration of the Bausch & Lomb StereoZoom 7 Microscope with Coaxial Illumination . . . now.

**BAUSCH & LOMB**   
SCIENTIFIC INSTRUMENT DIVISION

99736 Bausch St., Rochester, N. Y. 14602



# Minnesota is moving to a better state!

We were rated second best in a recent study of the Quality of Life in the 50 states and we think we should be better. So we're on the move to improve. We want the best for our people—the best education, the best living conditions, the best opportunity, the best of everything. They're about the most productive people anywhere. Which means the best business climate for industry, too.

If you're ready to move your business to a better state, come join us.

Send for the facts that will help you decide.

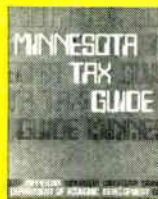
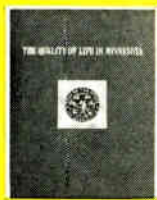

## mMinnesota

Department of Economic Development  
Industrial Development Division Suite: L-11  
57 West Seventh St., St. Paul, Minn. 55102

Please send your free literature on:

*Quality of Life*—Why Minnesota ranks second among the 50 states.

*Towns Alive*—What Minnesota towns are doing to attract industry.

*Minnesota's Instant Manpower*—How Minnesota's 26 Vo-Tech schools provide trained labor for your needs.

*Minnesota Tax Guide*—How Minnesota collects and allocates the tax dollar.

NAME \_\_\_\_\_

FIRM \_\_\_\_\_

POSITION \_\_\_\_\_

ADDRESS \_\_\_\_\_

CITY \_\_\_\_\_

STATE \_\_\_\_\_

ZIP \_\_\_\_\_

## New products

stages of differential amplifiers. Each stage is overdriven to attain the high-frequency operation. Repetition rate is one-shot to 0.5 GHz for pulses, and 0.25 GHz to 0.5 GHz for sine waves. Its input amplitude is 3 volts. The unit is on a 1-square-inch substrate, which is attached to a copper base. The sides and top of the package are brass.

The controller, besides clamping its input to improve its rise time, also delivers supply voltages to the Picopulser. The controller and Picopulser sell for \$750 each.

Datapulse Division, Systron-Donner Corp., 10150 W. Jefferson Blvd., Culver City, Calif. [370]

And now a meter  
with 2¾ digits

It's a misnomer, but the overrange digit in a numerical display is usually referred to as a half digit. Hence the 2½-digit meters, 3½-digit meters, and so on.

Now there's a 2¾-digit meter—which is how engineers at Triplett Company describes their new panel meter, the 4228-N. The extra quarter refers to two small digits—a "0" and "5" on the right side of the instrument's face. What the little numbers do is double the resolution expected of a 2½-digit unit. For example, suppose the meter had a full-scale range of 1.99 volts. By lighting either the "0" or the "5", the meter resolves the input to within 0.005 v, rather than to within 0.01 v.

Triplett makes the unit available in five voltage ranges, from 0-199 millivolts to 0-1,000 V, and five current ranges, from 0-199 microamperes to 0-1.99 amperes.

Input resistance varies according to range. On the millivolt unit, it's 1 kilohm, and on the 1,000-v version, 10 megohms. The resistance of the  $\mu$ A model is 1 k $\Omega$ ; of the 1.99-A version, 0.1 $\Omega$ . The meter has an accuracy of 0.25% of reading  $\pm$  ½ digit, draws 2 watts, and responds in 16 milliseconds.

The price is \$140.

Triplett Electrical Instrument Co., Bluffton, Ohio [371]

# Under-drafting.

**Draw less.  
Let photography  
handle your repeat  
drafting chores.**

If you're retracing design elements that are repeated again and again in a drawing, you're overdrafting. Same thing applies if you're retracing a design that's part of another drawing.

Save time. Underdraft with KODAGRAPH Films and Papers for a welcome change. Let them do the repetitive work—photographically.

Talk it over with your local Kodak Technical Service Representative. Or write Eastman Kodak Company, Business Systems Markets Division, Department DP 840, Rochester, New York 14650.

**DRAWING REPRODUCTION  
SYSTEMS BY KODAK**

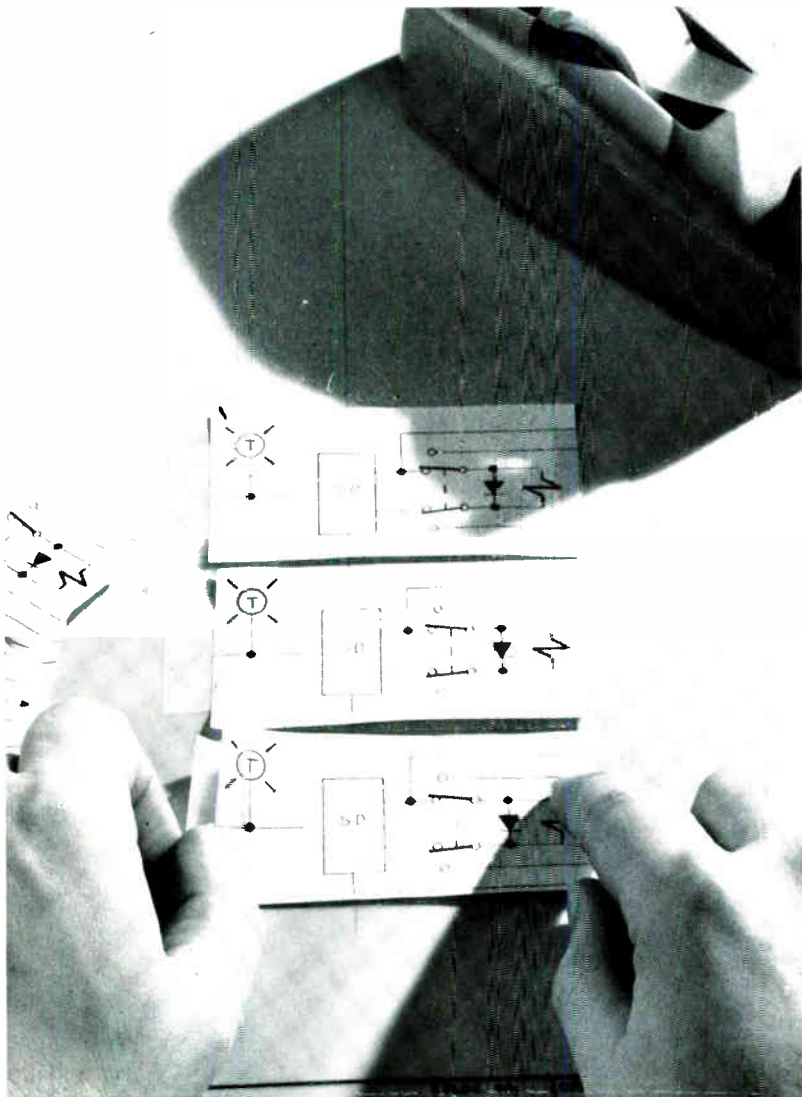

Kodak

# “look ma, no cavities”

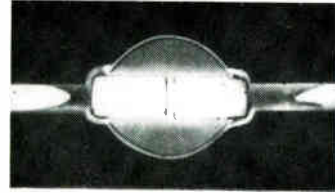

## Glass-Amp III™

After 1/2 billion Glass-Amps... General Instrument announces  
Glass-Amp III—the rectifier offering the best combination of reliability,  
performance and price available in the industry today

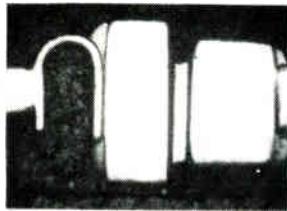

Magnified (unretouched) photo of cross section  
of Glass-Amp soldered joint

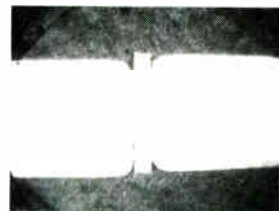

Magnified (unretouched) photo of cross section  
of Glass-Amp II brazed joint

### FEATURES

Cavity-free unitized construction  
High temperature joints—brazed instead of soldered  
Glass passivated junction—low leakage  
Avalanche operation

Matched thermal expansion of glass to metal  
Low thermal resistance  
High mechanical strength  
Hermetically sealed

Glass-Amp II promises to surpass the unmatched performance of its predecessor, Glass-Amp™, the most successful and most imitated rectifier in the history of the industry with sales of over 1/2 billion units. A major General Instrument engineering development, Glass-Amp II features cavity-free construction with a specially developed, extremely pure glass in direct contact with the silicon junction. The carefully matched expansion characteristics of the glass and metal, plus the double heat sink design obviate the need for solder joints and compression contact parts. No organic materials are required for passivation, and no voids are present to interfere with long term stability. Glass-Amp II is, in fact, a solid unit as reliable and long lived as silicon, glass and metal of which it is made. Furthermore, only high temperature brazing operations are used to withstand the 800°C required to melt and fuse the glass. This technique tremendously enhances mechanical strength, temperature cycling capability and reduces thermal resistance.

These characteristics of void-free double heat sink brazed construction together with General Instrument's expertise in silicon rectifier junction design provide Glass-Amp II with unsurpassed operating characteristics at high temperatures. High temperature performance over extended periods of time is superior. Moreover, the unit is designed to withstand repetitive reverse avalanche power surges up to 1000 Watts.

Glass-Amp II rectifiers available for immediate delivery are:

MIL/JEDEC types 1N4245 thru 1N4249 (200 PIV to 1000 PIV @ 1A @ 55°C) to meet MIL-S-19500/286C

JEDEC types 1N5059 thru 1N5062 (200 PIV to 800 PIV @ 1A @ 75°C)

G1 Series (50 PIV to 1200 PIV @ 1A @ 100°C)

G2 Series (50 PIV to 1200 PIV @ 2A @ 75°C)

General Instrument technology is making possible large scale production of high voltage (greater than 1000 Volts) versions of Glass-Amp II for highly reliable high temperature operation.

For full information write General Instrument Corporation, Dept. G, 600 West John St., Hicksville, N.Y. 11802, or call in New York: 516-733-3333; in Chicago: 312-774-7800; in Los Angeles: 213-873-6500. In Canada, call or write to General Instrument Canada, Ltd., 61 Industry St., Toronto 337, Ontario, Canada, Tel: 416-763-4133. (In Europe, write to General Instrument Europe S.P.A., Piazza Amendola 9, 20149 Milano, Italy; in the U.K., to General Instrument U.K. Ltd., Stonefield Way, Victoria Road, South Ruislip, Middlesex, England.)



GENERAL INSTRUMENT CORPORATION • 600 WEST JOHN STREET, HICKSVILLE, L. I., NEW YORK

## New products

### Subassemblies

# Encoder senses 5 min of arc

## Film pot and ratiometer combined in low-priced digital transducer

If you need to know how far or how fast a shaft turns, you use an encoder—either an expensive but ultra accurate optical encoder, or

a brush encoder which is relatively expensive but accurate, or a synchro. The synchro may cost as little as \$50, but to wring out accuracies of 6-12 minutes of arc requires thoughtful application and usually about \$1,000 worth of digital converter circuitry.

However, the New England Instrument Company has combined a precision film potentiometer, laser-trimmed to  $\pm 0.025\%$  linearity, with a ratiometer/analog-to-digital converter in a single package. NEI claims that the 300 DT (digital transducer) provides the reliability, accuracy, and resolution of a digital synchro at a price beneath that of brush devices: at about \$500 in

single unit quantities, it falls between brush encoders and analog-output synchros.

Instead of using the absolute resistance of its potentiometer to measure rotational change, the 300 DT senses the ratio between one resistance position and the next one by means of its ratiometer. Thus, temperature coefficient and absolute accuracy—problem areas with pot-type transducers—have been avoided. The 100-megohm input impedance of the ratiometer tends to minimize the effects of contact resistance and loading, which also can degrade measurement quality. Further, the reference supplied to the ratiometer and the signal sup-



Two hf amplifiers provide wide dynamic ranges. Model WBHF-10G-30 is a 0.5-60 MHz unit with an 11-dB gain and an output of up to 1 W. Typical noise figure is 6 dB at 60 MHz. Model WBHV-30G-27 is a 0.5-100 MHz unit with a 30-dB gain and an output of up to +24 dBm. Anzac Electronics Div. of Adams-Russell, 39 Green St. Waltham, Mass. 02154 [381]

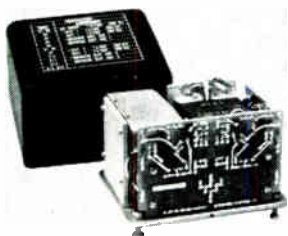

Dual-output power supply model 23077 has line, load, and temperature stability of 0.1% for 30 days. Regulation is  $\pm 0.002\%$ , no load to full load. Ripple is 1 mV maximum, peak-to-peak. Transient response is 25  $\mu$ s to within 1.5 mV, 0-100% of rated load. Dynamic impedance is 0.1 ohm maximum, dc to 1kHz. Glentronics Inc., 748 E. Alosta Ave., Glendora, Calif. [382]

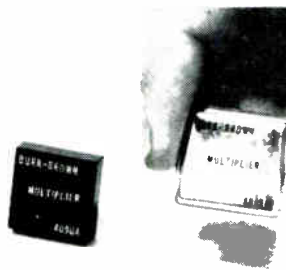

Hybrid IC analog multiplier comes in two versions: the 4090 epoxy encapsulated unit for operation from  $-25^\circ$  to  $+85^\circ\text{C}$ , and the 4091 cold-welded, hermetically sealed flatpack for operation from  $-55^\circ$  to  $+125^\circ\text{C}$ . Units are scaled for compatibility with commonly available IC operational amplifiers. Burr-Brown Research Corp., International Airport Industrial Park, Tucson [383]



Encapsulated dc power supplies, models 906, 903 and 905, provide 15 V output at 250 mA, 500 mA, and 1,000 mA, respectively, for operating monolithic IC logic circuits. They are priced at \$38, \$47, and \$66 respectively, and operate from a nominal 115 V ac at 50 Hz to 400 Hz. Analog Devices Inc., 221 Fifth St., Cambridge, Mass. [384]



Potted module PM559 is a regulated dual 15 V at 200 mA power supply that provides a total of 6 watts of power output. Primary application is powering operational amplifiers. Line regulation is  $\pm 0.01\%$ ; ripple and noise, 1 mV rms; temperature coefficient, 0.02%/°C; output impedance, 0.2 ohm at 10 kHz. Computer Products, Box 23849, Ft. Lauderdale, Fla. [385]



Op amps with differential inputs are designated P/N 6.851 and 6.852. Specifications include 4 MHz full signal bandwidth, 154 dB dc gain, 200 V/ $\mu$ s slew rate, and 50 mA min output current. Units are plug-in types and operate from  $0^\circ$  to  $+70^\circ\text{C}$ . The 6.851 measures 1.5 x 1 in.; the 6.852, 1.9 x 1.12 in. Electronic Associates Inc., West Long Branch, N.J. [386]



Instrumentation amplifier model 1100, with automatic zero suppression, adds a dc potential, automatically, to the amplified input signal keeping the data trace well within the channel boundaries. Design permits recording of dc through 10-kHz data accurately regardless of the dc bias or offset present. Diginetics Inc., P.O. Box 777, Bridgeton, Mo. 63044 [387]



Dc/dc inverter model 2050 provides an isolated dual 15-volt output at load currents of up to 50 mA when operating from a single 28 V dc power source. Line regulation is 0.5% and load regulation is 1.5%. Output ripple is less than 1%. The unit is designed to operate over military environmental conditions. Melcor Electronics Corp., 1750 New Highway, Farmingdale, N.Y. [388]

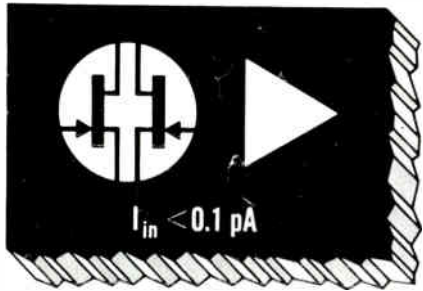

# MEASURE LOW CURRENT

**Problem:** Design a sub-picoamp electrometer circuit.

**Solution:** Use a Siliconix 2N5909 with an op amp.

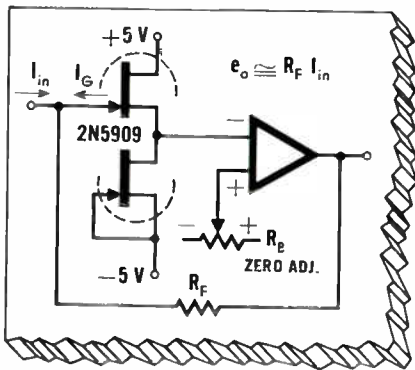

The circuit above, using a 2N5909 and an op amp will provide accurate current measurements in the picoamp and sub-picoamp ranges. When  $V_D = +5\text{ V}$  and  $V_{CS} = 0$ ,  $I_G$  is typically less than 0.05 picoamp, hence output error voltage is minimized. You can use the 2N5909 with the op amp of your choice or get the complete circuit (less  $R_F$  and  $R_E$ ) in a TO-99 package (Siliconix L137).

Write for further information on the 2N5909 and the L137 op amp.

**Siliconix**  
incorporated

2201 Laurelwood Rd. • Santa Clara, Calif. 95054  
(408) 246-8000 Ext. 201 • TWX: 910-338-0227

In Europe: Siliconix Limited, Saunders Way, Saesby, Swansea, Great Britain

## New products

plied to the pot come from the same 12- to 15-volt dc supply, obviating a potential source of error.

The ratiometer feeds a 12-bit a-d converter, which in effect, divides the  $360^\circ$  of pot rotation into 4,096 binary words—equivalent to a resolution of about 5 minutes of arc. This is the kind of resolution claimed for \$1,000 brush encoders, and exceeds the 6-12 minutes of arc of industrial/military grade servos. Accuracy of the 300 DT is specified at  $\pm 10.6$  minutes of arc.

Though the company considered dual slope and successive approximation converters, it picked a tracking type with continuous parallel digital output on the grounds that it combined speed with simple data transfer control. The converter tracks shafts at up to 730 rpm and is monotonic, generating all 4,096 position words in order as the shaft rotates through  $360^\circ$ .

Finally, NEI spokesmen point out that there are some things a pot can do that other transducers cannot: for example, pot transfer function can be matched to most non-linear sensors to provide an output scaled directly to engineering units; expanded scale operation can be achieved just by increasing the applied dc excitation voltage; sine cosine, and exponential tapers are already stock items in pot inventories; and pots adapt as easily to linear as to rotary operation.

The New England Instrument Company,  
Kendall Lane, Natick, Mass. 01760  
[389]

Either way. Digital transducer comes in rotary or linear version.

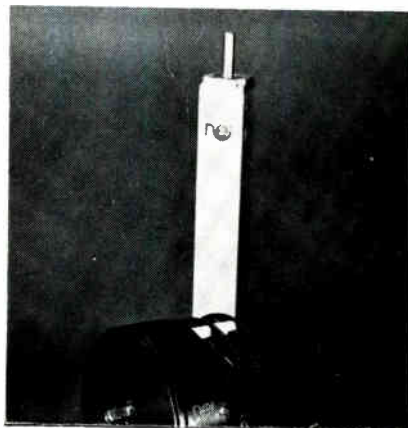

## The Material of Unlimited Uses...

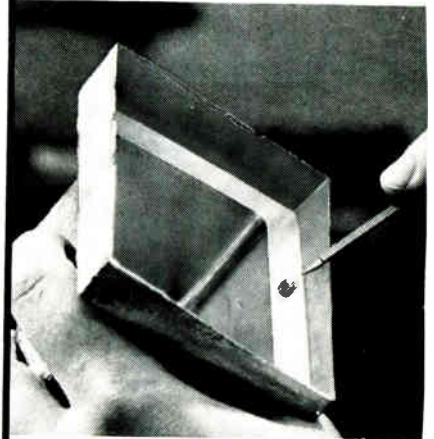

## INSTANT DIP-A-MOLD

In seconds, you can make perfect molds, like this one, for potting any encapsulation, and make them economically, with low-melting CERRO® Alloys. Just dip the master in molten alloy. A thin coating of alloy clings to the pattern. Withdraw the pattern, and you have a perfect high fidelity mold. When the encapsulating plastic cures, simply remove the CERRO Alloy. Use it over and over again, almost without limit.

This particular alloy—CERROTRU®—does not shrink, slips easily from the pattern without parting or contaminating compounds or coatings. Because of its low melting point, it is safe and easy to handle.

You can reproduce such unusual details as positioning lugs for transformer cases, as shown above, without the use of cores, inserts or secondary operations.

Instant molding is just one of the many uses for CERRO Alloys. To find out more, contact Cerro Copper & Brass Co., Alloy Dept., Bellefonte, Pa. 16823. Telephone (814) 355-4712. In Europe, contact Mining & Chemical Products Ltd., Alperton, Wembley, Middlesex, England.

**CERRO®**



# We've upped the line to 7 pin spacings without upping the price.

CTS cermet industrial trimmers  
still **50¢** each.\*



Stability of  $\pm .03\%$   
and environmental  
performance requirements  
of characteristic  
C of MIL-R-22097D plus:

- 1.5% average equivalent noise resistance
- 0.5% average CRV
- $\frac{1}{2}$  watt @ 70°C
- TC  $\pm 150$  ppm/°C

Now you can choose from an expanded line of compact CTS Series 36C single-turn cermet trimmers. Seven pin spacings: .150"-.125"-.100" in both top and side adjust, plus TO-5 arrangement in side adjust only. (TO-5 style at extra cost.) All available from your CTS Distributor still at the lowest cost in the industry **just 50¢ each**: CTS of Berne, Inc., Berne, Indiana 46711. Phone: (219) 539-3111.

\*In 50,000 quantity for  $\pm 20\%$  tolerance. Add 4¢ for 10% tolerance. Comparably low prices for smaller quantities.

Circle 143 on reader service card

**CTS CORPORATION**  
Eixhart, Indiana



Your CTS Answer Man stands ready to fit our expanded trimmer line into your application.

## New products

Packaging and production

# Wafer rinser cuts breakage

Boat design, slower spinning rate offer added production for 2-3 inch diameter slices

In many of today's machines for rinsing and drying semiconductor wafers, flower-type baskets hold the wafers in a vertical position. In

the rinsing cycle, they're spun around under a vertical spray of water, and in the drying cycle they may revolve as fast as 5,000 rpm. But when wafers 2 inches or more in diameter are spun that fast in flower-type baskets, says Raymon F. Thompson, chief engineer at the Fluorocarbon Co., breakage of one wafer can trigger a chain reaction as the pieces smash into the wafers behind it.

Important features, therefore, of the company's Fluoroflo RD70A rinser/dryer are the redesigned wafer holders or boats, said to reduce breakage, a machine design that permits drying to occur at lower speeds, and the horizontal distribu-

tion of fluids over horizontally held wafers.

The boats, which accept wafers between 2 in. and 3 in. in diameter, are inserted into the spinner at a slightly less than vertical angle, to prevent spillage. When the spinner motor starts, the centrifugal force slides the boats into a vertical position, with the wafers then horizontally positioned in the chamber. Wide slots in the boat bottoms permit free flow of water and drying gas across the wafer out toward the chamber walls. With this arrangement, Thompson says there's much less likelihood of breakage, but even if a wafer breaks, the fragments will be spun

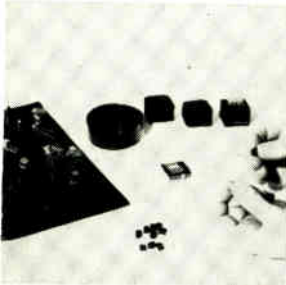

Electrically conductive Velofoam is a flexible lightweight material used to short out leads of static-sensitive electronic devices during their shipping, handling, and assembly. It can easily be adapted for packaging protection of all electronic devices. It comes in varying degrees of hardness and thicknesses from 1/8 in. to 1 in. Custom Materials Inc., Chelmsford, Mass. [421]

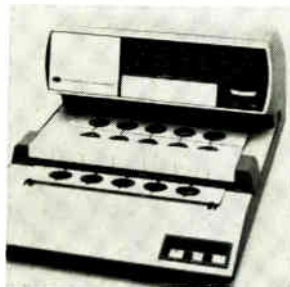

Wafer photoresist spinner A5S can process between 400 and 800 wafers per hour. It operates by automatically moving a loaded boat with five wafers into a five station coating/spinner area, then delivering the coated wafers to a separate unloading station while loading a new boat into the coating station. International Instruments Inc., 1293 Forgewood Ave., Sunnyvale, Calif. [422]



Tape-controlled laser resistor trimming system can trim both thin and thick film resistors at a rate of 3,000 per hour. It utilizes a Q-switched YAG laser with average output power of 0.75 W and minimum peak power of 2,000 W. It is designed for trimming all types of resistor compositions including nichrome gold, and tantalum films. Hughes Aircraft Co., Box 92904, Los Angeles [423]

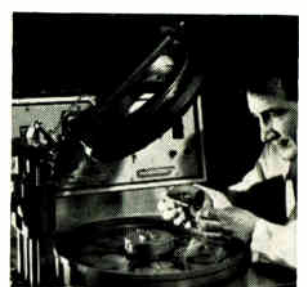

Silicon wafer lapping machine 7136 finishes wafers within tolerances of a few millionths of an inch, both in thickness and parallelism. Fifteen 2-inch-diameter wafers are lapped in one operation with 66% more production capacity than the company's earlier model. Four-way action gives high yields with less wear on parts. Norton Co., 160 Charlemont St., Newton, Mass. [424]

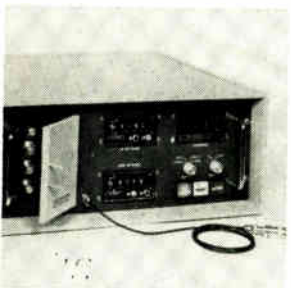

Ultrasonic gage, designated Caliper model 105, makes possible non-destructive thickness measurements from 0.010 in. to 2 in. at production line speeds. It provides instantaneous and continuous thickness measurements with accuracies up to  $\pm 0.0001$  in. A digital readout display of thickness simplifies calibration. Branson Instruments Co., Progress Dr., Stamford, Conn. 06904 [425]

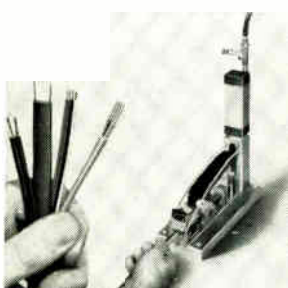

Self-adjusting bench tool ABMK-300 will cleanly strip insulation from single or multiple wires from No. 22 to No. 10 AWG aluminum or copper without nicking the conductor. Designed for production wire stripping, the unit's multiple cutting blades are mounted in a wide jaw that eliminates critical wire positioning. The Thomas & Betts Co., 36 Butler St., Elizabeth, N. J. 07207 [426]



Infrared back-side wafer alignment system is for semiconductor processing. An IR light is used to look through silicon. This light is sensed by an image converter that turns the image around. The wafer is processed upside down, but it looks rightside up to the operator. Beam-lead applications are expected. Kasper Instruments Inc., 983 Shulman Ave., Santa Clara, Calif. [427]

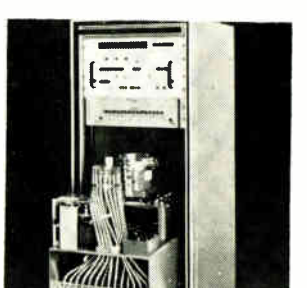

Ceramic chip capacitor test system model 7201 is designed for continuous high speed operation providing fully automatic handling and testing of a wide variety of capacitor chip sizes. As many as 10,000 chips per hour can be tested and graded for capacitance and dissipation factor and sorted into 15 different categories. Micro Instrument Co., Crenshaw Blvd., Hawthorne, Calif. [428]

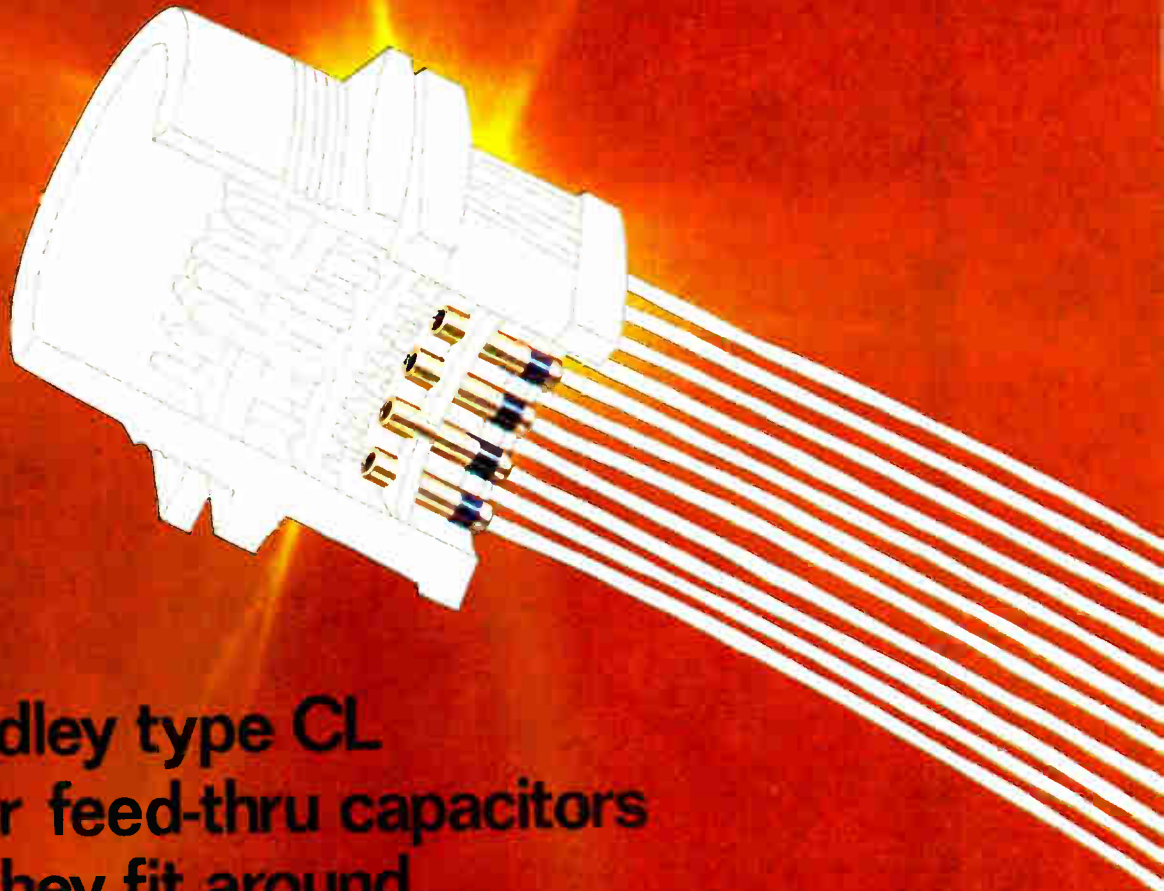

## Allen-Bradley type CL multi-layer feed-thru capacitors so small they fit around the head of a pin.

**VOLUMETRIC EFFICIENCY.** Big words that explain why Allen-Bradley type CL feed-thru capacitors are so small. Our unique multi-layer concept shaves size to a minimum, without affecting performance. It took Allen-Bradley to get filter capacitors down to their fighting weight. Now rolled capacitors are no longer a design alternative.

Concentric layers of proprietary Allen-Bradley ceramic and noble metal electrodes are fired together for unmatched protection against moisture and contamination. Rugged. Non-polar. With lower inductance and far less noise.

Voltages to 200 WVDC. Temperatures to 125°C. Capacities to 1.0  $\mu$ F. High dielectric strength and reliability.

Several styles and sizes are available through your appointed A-B industrial electronic distributors. For further information write: Marketing Department, Electronics Division, Allen-Bradley Co., 1201 South Second Street, Milwaukee,

Wisconsin 53204. Export office: 1293 Broad Street, Bloomfield, N.J. 07003 U.S.A. In Canada: Allen-Bradley Canada Ltd., 135 Dundas St., Galt, Ontario.

### **ALLEN-BRADLEY**



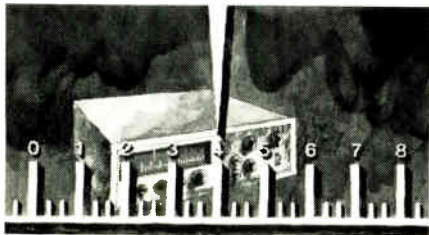

# Rent- a Test

Are the instruments in your lab the latest and most accurate available? Do you have all the equipment necessary to handle peak work loads? Does it provide enough versatility to take care of special requirements? Are you able to keep it in use during a respectable portion of the 8-hour day?

If you hesitated before answering yes, maybe you should think about putting RENTAL to the test. R.E.I. gives you a wide choice of the latest equipment, precision-calibrated and in perfect working condition. You can have as much as you need, when you need it, and you can keep it only as long as you need it.

R.E.I. can give you the fastest service, the widest selection and the lowest rates of any rental firm in the country. One of our inventory centers is located near you, wherever you are, for instant delivery. Let us tell you more about the many advantages of renting vs. buying. Send today for your free copy of the new R.E.I. Instrument Rental Handbook.

Amplifiers	Filters	Power Supplies
Analyzers	Generators	Recorders
Attenuators	Meters	Sources
Bridges	Oscillators	Stroboscopes
Cameras	Oscilloscopes	Synthesizers
Counters	Plug-In Units	Test Chambers
Detectors	Generator/Synchronizer	

## INSTANT INSTRUMENTS FROM THESE INVENTORY CENTERS:

### Waltham, Mass. 02154

69 Hickory Drive  
(617) 891-7610—Telex 923472

### Anaheim, Calif. 92801

159 East Freedom Ave.  
(714) 879-0561—Telex 655473

### Gaithersburg, Md. 20760

16600 Oakmont Ave.  
(301) 948-0620—Telex 898446

### Rosemont, Ill. 60018

5607 Pearl St.  
(312) 671-2464—Telex 726488

### Fl. Lauderdale, Fla. 33308

4808 N.E. 10th Ave.  
(305) 771-3500—Telex 51-4467

RENTAL ELECTRONICS, INC.  
AN INSTRUMENT RENTAL COMPANY

INSTRUMENT  
RENTAL  
CATALOG  
1970

### Dallas, Texas 75207

1341 Crampton St.  
(214) 638-4180  
Telex 732617

MORE INVENTORY CENTERS COMING SOON

# Rental Electronics inc.

A PEPSICO LEASING COMPANY

## New products

out toward the walls instead of striking other wafers.

Four jet spray nozzles are mounted at 90° to each other and stacked vertically on a column that extends down from the spinner's lid. This configuration ensures the even distribution through the nozzles of, first, deionized water and then nitrogen for drying. Thompson adds that it also promotes more thorough fluid runoff, because the fluid flow is in the same direction as the centrifugal force.

The wafers are located at a greater distance from the nozzles than in the conventional machines, so that the spin rate can be slower (200 to 500 rpm for rinsing and up to 2,100 rpm for drying) and still give as high a g rate. This again, says Thompson, reduces breakage.

The rinse and dry cycles each take 1 minute. A heater at the nozzles brings the dry nitrogen up to 200°F for drying, and another in the spinner's lid heats the lid to 180°F, so that droplets won't form on the lid and splash down on wafers, leaving a residue.

The RD70A will hold two or four boats (the initial units will probably have two), and each boat holds up to 25 wafers. This contrasts with the flower-type basket, which may hold a maximum of about 24 wafers, but only one boat can be spun at a time. The RD70A requires 18 inches of counter space and will fit on laminar-flow benches.

The price is \$1,400, plus \$200 for the spindle or boatholding rack.

The Fluorocarbon Co., 1754 S. Clementine St., Anaheim, Calif., 92803 [429]

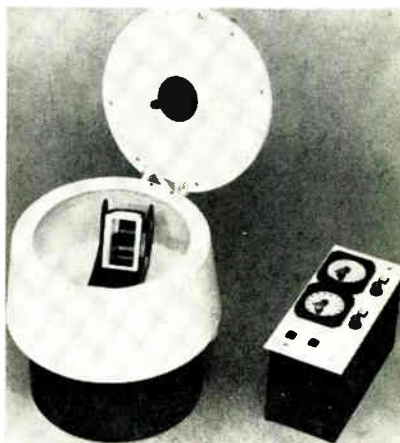

# TROUBLE- FREE TROUBLE- SHOOTER

**FACT® (Flexible Automatic Circuit Tester)**, Hughes' random access test system simplifies and shortens the trouble-shooting procedures required for today's circuit technology.

The systems engineer has wide latitude in his checkout procedures: test or retest at any point, adapt to changes by simply adding or deleting new test information, use computer control or computer-generated data. FACT detects any possible trouble in any type wiring circuit. Without any trouble. FACT. Quick delivery. Order now. Lease/Rental plans available. Contact

L. W. Risner  
FACT Systems  
Hughes Aircraft Company  
P. O. Box 92904  
Los Angeles, California 90009  
(213) 670-9040



**HUGHES**

HUGHES AIRCRAFT COMPANY  
FACT SYSTEMS

# MARKEL EXCELLENCE

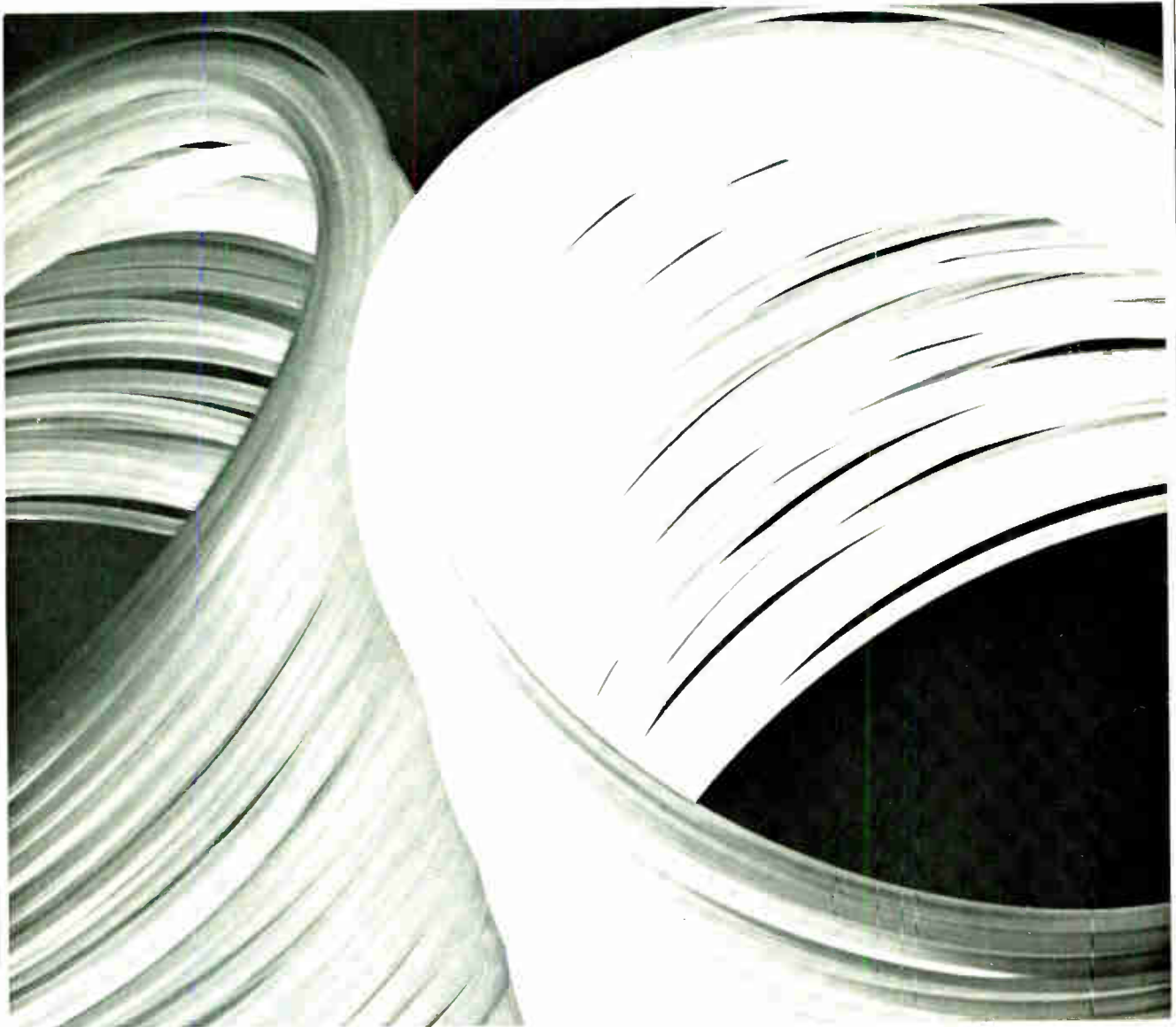

## *it's worth more than it costs*

For nearly half a century, Markel insulations have been engineered and manufactured with one overriding objective: to produce a line of products built up to the highest standard, not down to the lowest price. As a result, Markel products have earned a solid reputation as the *line of excellence*.

Buyers too often shop for the lowest price, failing to consider *value*. You cannot pay a little and get a lot. When you specify Markel, you get the extra value that goes with excellence: superb quality, outstanding engineering capability, complete and dependable customer service. We invite you to inspect the Markel line. Ask for a free copy of our new Materials Selector and Sample File, containing data and actual sample lengths of 18 Markel tubings and sleeveings.

**ONE SOURCE FOR EXCELLENCE**  
in Insulating Tubings and Sleeveings  
High Temperature Wire and Cable



L. FRANK MARKEL & SONS, INC., NORRISTOWN, PA. 19404 • PHONE: 215/272-8960



A single pair of wires, or a leased telephone line, can carry the audio signals for a complete control system.

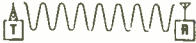

For inaccessible areas or mobile installations, a radio transmitter and receiver system can carry the signals.

## REMOTE CONTROL SWITCHING WITH AUDIO SIGNALS

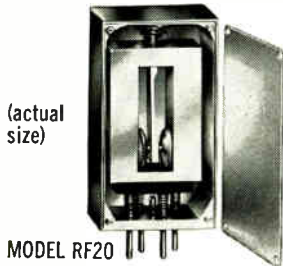

(actual size)

MODEL RF20  
contactless resonant reed encoder/decoder  
.395 x .620 x 1.100

An audio tone can be generated by an electronic oscillator or resonant reed encoder circuit, then transmitted by wire or radio. The tone activates a resonant reed relay to perform a control function.

Bramco reeds permit over 100 selective control frequencies within the 67 to 3000 Hz. spectrum. This is assured by: (1) the narrow response band-width of about 1% for decoders and (2) the high accuracy of Bramco reed encoders (1/10 of 1% of design frequency).

A big advantage of reeds in control switching is that they are ideally suited for simultaneous and sequential coded tone systems. The actual number of control functions possible in such a system is virtually unlimited. For example, over 3300 individual control functions are possible with only 16 frequencies coded sequentially in groups of three.

Compared to other types of tone filters, resonant reeds are small and inexpensive. They give more control functions per spectrum, per size, per dollar.

If you work with controls that select, command, regulate, or indicate, you should know how it can be done with audio signals. We custom design and stock a broad line of encoder/decoder components and modules. Bramco also custom designs LC filters from 0 to 200 KHz.

For literature write Bramco Controls Division, Ledex Inc., College and South Streets, Piqua, Ohio, or call 513-773-8271.



BRAMCO CONTROLS DIVISION  
LEDEX INC.

College and South Streets, Piqua, Ohio 45356

## New products—Materials

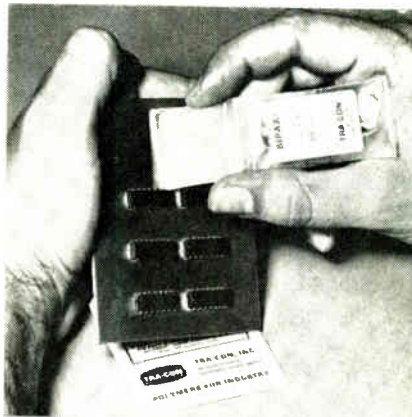

Epoxy resin adhesive Tra-Bond 2101 is suited for countless bonding, laminating, coating and maintenance applications. It is particularly effective for coating resistors, capacitors and diodes. Fully cured Tra-Bond 2101 is a good electrical insulator, has excellent weatherability, and is impervious to corrosive salts and salt solutions, mild acids and alkalis, petroleum products and solvents, jet fuel, alcohol, and numerous other organic and inorganic compounds. It has a 30-minute pot life after thorough mixing in the accurately proportioned Bipax package, and a low exotherm during the cure cycle. Tra-Con Inc., 55 North St., Medford, Mass. 02155 [470]

Blendalloy 25-8005, an 80% nickel 5% molybdenum alloy available in rod and wire forms, is suitable for applications in magnetometers, memory stores, inductors, sensor probes, sensitive relays and dc magnetic circuits. Magnetics, Specialty Metals Division, Butler, Pa. 16001 [471]

Eccocoat No Burn is a mineral filled, conformal coat and potting compound that does not burn in 100% oxygen. It is a two-part system with one-hour pot life and cure time at room temperature of 4 to 5 hours. It can be applied by brush, dip, trowel or pouring into a cavity or mold. It has a use temperature capability to 300°F. Dielectric strength is 400 V/mil. Emerson & Cuming Inc., Canton, Mass. 02021 [472]

One-part, copper-filled conductive resin system called Con-Cu-Bind has a volume resistivity of 0.01 ohm-cm or less. It has a shelf life of six months or more and exhibits excellent adhesion to a wide variety of substrates, including glass, metals, ceramics, and plastics. Rheology of the epoxy-based materials can be regulated for application by syringe dispensing, silk screening, dipping, or troweling. A 2-oz kit of Con-Cu-Bind costs \$5. Conshohocken Chemicals Inc., 8 Rodney Rd., Rosemont, Pa. 19010 [473]

# START

WITH A LENS-END LAMP



# TEST

FOR SPOT SIZE AND CANDLEPOWER

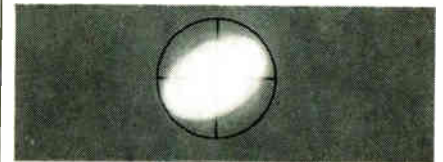

# WELD

PINS TO END OF LEAD WIRES

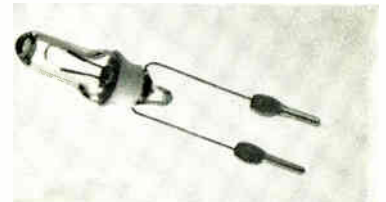

# MOLD

TO MAKE A PLUG-IN LIGHT MODULE THAT WILL ACTIVATE PHOTO ELECTRIC SENSOR IN A HIGH SPEED CHECK SORTER

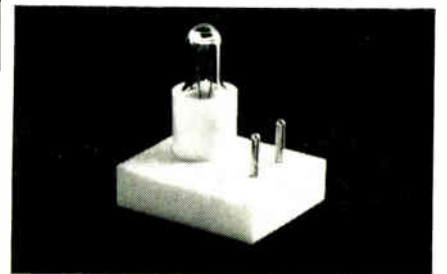

We specialize in finding practical solutions to small applications where cataloged items won't do. Write, describing your requirement. Tung-Sol Division, Wagner Electric Corporation, 630 W. Mt. Pleasant Avenue, Livingston, N.J. 07039. TWX: 710-994-4865. Phone: (201) 992-1100.

# TUNG-SOL®

WHERE BIG THINGS ARE DONE WITH SMALL LAMPS

® Reg. T.M. Wagner Electric Corporation

Circle 175 on reader service card



**You'll get  
the direct print paper  
on the right faster.**

There's no need for "hurry" stamps on Astroprint oscillographic papers. Easy ordering and direct delivery are part of the package.

You also get a direct print, orthochromatic paper unsurpassed for

trace density, instant pop-up (less than 1 second), excellent image stability and sharp contrast. On mercury vapor, Xenon, and cathode ray light sources.

Astroprint DP 90 (for open magazine applications) and DP 80 (for closed magazines).

As a starter, test us for delivery and cost. Just call your local Xerox Product Specialist or write to Xerox Corporation, Dept. HL, Rochester, New York 14603.

The paper will prove itself.

**XEROX**

Xerox and Astroprint are registered trademarks of Xerox Corporation.

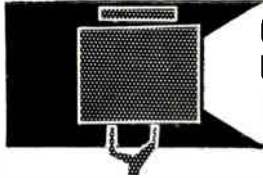

# SEARCHLIGHT SECTION

- CLASSIFIED ADVERTISING • BUSINESS OPPORTUNITIES
- USED OR SURPLUS EQUIPMENT

## New Books

### Down to basics

Physical Design of Electronic Systems, Volume 1: Design Technology Staff, Bell Telephone Laboratories Prentice-Hall Inc., 626 pp., \$19.95

In the preface, the authors say, "The material in the four volumes of this series has been chosen to emphasize the importance of drawing on fundamental technology in the physical sciences in achieving the physical realization of these systems." And they proceed to do just that—draw on fundamental technology. They use stress tensors to show how printed wiring boards warp, and shock wave propagation equations to show the effects of a solenoid armature striking a stop. Similar basic thermal equations are used to investigate cooling in electronic systems and electromagnetic equations for interference effects. The book thus is well-grounded in theory, but the average engineer may find it tough going even if he's determined to bone up on the basics of physical system design.

A four-semester graduate course for Bell Labs engineers provided the basis for the book, which explains the heavy slant toward communications systems design. However, it begins with such fundamental equations that anyone can use it, if he's willing to invest the energy.

Divided into four parts—statics and dynamics of structures, thermal design, electrical interactions, and human factors in design—the book is the first of a four-volume series. Later volumes will cover materials, integrated circuits, and the design process.

### Recently Published

Space Age Acronyms, Abbreviations, and Designations, Reta C. Moser IFI/Plenum, 534 pp., \$17.50

Geared to meet the needs of those who must deal with and identify the myriad of acronyms and definitions that are solidly entrenched in terminology. This latest edition boasts a 45% increase in its completely up-to-date compilation of official Army, Air Force, NASA, FAA, and foreign acronyms. Also included under separate listings are missile, rocket, aircraft, ship, and communications equipment designations.

### AUTOTRACK MOUNT



360 degree azimuth, 210 degree elevation 1 sweep with better than 1 mil. accuracy. Missile velocity acceleration and slowing rates. Amplidyne and servo control. Will handle up to 20 ft. dish. Supplied complete with control chassis. In stock—immediate delivery. Used world over by NASA, USAF, MP-61-B. Type SCR-584. Ideal satellite tracking. Large spare parts inventory for back-up.

### ANTI-AIRCRAFT GUN MOUNT

Will handle 5,000 lbs. rapid slew through 360° azimuth, 180° elevation. Mobile.

### COUNTERMEASURES SYSTEM

Covers L-band, S-band, X-band, all radars. Tacan, UHF drone control, VHF drone control. Communications band. All housed in shelter.

**FIBERGLASS RADOME** Will handle 20 foot antenna. Easily erected & shipped. \$4800.

### B-58 BOMBER ELECTRONICS

Ku band search radar, Ku doppler radar, Ku altimeter, all jamming countermeasures.

### PULSE MODULATORS

**MIT MODEL 9 PULSER 1 MW—HARD TUBE**  
Output 25kv 40 amp., 30kv 40 amp. max. Duty cy. .002. 25 to 2 microsec. Also 5 to 5 microsec. and 1 to .5 microsec. Uses 6C21. Input 115v 60 cycle AC. Mfg. GE. Complete with driver and high voltage power supply. Ref: MIT Rad. Lab. Series, Vol. 5, p. 152.

### 2 MEGAWATT PULSER

Output 30 kv at 70 amp. Duty cycle .001. Rep. rates. 1 microsec. 600 pps. 1 or 2 msec. 300 pps. Uses 5948 hydrogen thyratron. Input 120/208 VAC 60 cycle. Mfr. GE. Complete with high voltage power supply.

### SCR 584 AUTOTRACK RADARS

Our 584s in like new condition ready to go, and in stock for immediate delivery. Ideal for telemetry research and development, missile tracking, satellite tracking. Fully Desc. MIT Rad. Lab. Series, Vol. 1, pps. 207-210, 228, 284-286. Comp. Inst. Bk available \$25.00 each.

### AUTOMATIC TRACKING SYSTEM

Sci. Atl. Mod. 3101-J70 Antenna Pedestal. AZ-EL 15 deg. per second rated speed. 23 inch dia. bearing. Complete w/control console & mag. amplifiers. Also in stock complete Glo-track receiving system for 200-400 MHz telemetry band including 12' square quad. Italx. All part of Atlas missile instrumentation system.

### MICROWAVE SYSTEMS

#### SPARE PARTS IN STOCK

Niko Ajax, Nike Hercules, M-33, MPS-19, TPS-ID, TPS-10D, FPS-6 SPSS, SCR-584, MPQ-18. From Largest Inventory in World

#### KU BAND RF HEAD

16.5 GHz, 50 KW, .001 duty cycle, 45 Watts avg. compl. w/5C22 modulator compl. recr. Mfr. Emerson Electric.

#### L BAND RF PKG

20 KW peak 990 to 1040 MC. Pulse width .7 to 1.2 micro sec. Rep. rate 180 to 420 pps. Input 115 vac

#### MICROWAVE LINKS

C BAND Phileo CLR6, CLR7, CLR9. Radar video link. Motorola MRH-4.

#### X BAND FIRE CONTROL SYSTEM

MD-4, A5, APG, 32 system, 50 KW Autotrack, complete system, all cables etc., incl. gun turret if desired.

#### AN/GMD-1B RAWIN RADAR

L-Band Radiosonde Tracking System. Complete, new cond. in stock for immed. del. AN/GMD-2 computer mfg. Gen'l Mills also in stock.

#### 500 KW L BAND RADAR

500 kw 1220-1359 msc. 160 nautical mile search range P-R.I. and A scopes. MIT. thyratron mod 5J26 magnetron. Complete system.

#### C BAND AUTOTRACK

1 Megawatt 10 ft. Parabola. Sperry.

#### AN/GPG-1 SKYSWEEP TRACKER

3 cm. auto. tracking radar system. Comp. pkg. w/indicator sys. Full target acquisition & auto. tracking. Input 115v 60 cy. now. In stock for immed. del. Entire sys. 6' x 3' x 10'. Ideal for infrared tracker, drone tracker, missile tracker, R & D

#### INDICATOR CONSOLES

AN/SPA-4A, PPI 10", range to 200 mi. VI-1 PPI 12", Range to 200 mi. VI-1 IIII 12" to 200 mi, 60K ft. PPS-6 IIII, FPS-8 PRI. CPS-6B PPI. plus many more.

HUNDREDS MORE IN STOCK  
LARGEST RADAR  
INVENTORY  
IN WORLD.  
WRITE  
FOR  
CATALOG  
ON YOUR  
LETTERHEAD

## Radio-Research Instrument Co.

45 W. 45th St., New York, N.Y. 10036 • 212-586-4691

CIRCLE 966 ON READER SERVICE CARD

### free catalog

POTTING APPLICATORS  
MANUAL AND DISPOSABLE

6cc 12cc 30cc

FOR POTTING, ENCAPSULATING, AND  
SEALING OF MINIATURE COMPONENTS

PHILIP FISHMAN COMPANY

7 CAMERON ST., WELLESLEY 81, MASSACHUSETTS

CIRCLE 967 ON READER SERVICE CARD

### Sold!

"Please discontinue our ad in 'Searchlight' as we have sold the equipment through this advertising."

Can "Searchlight" Serve You?

## "SEARCHLIGHT"

IS

## OPPORTUNITY ADVERTISING

—to help you get what you want.

—to help you sell what you no longer need.

Take Advantage of it—For Every Business Want

"Think SEARCHLIGHT First"



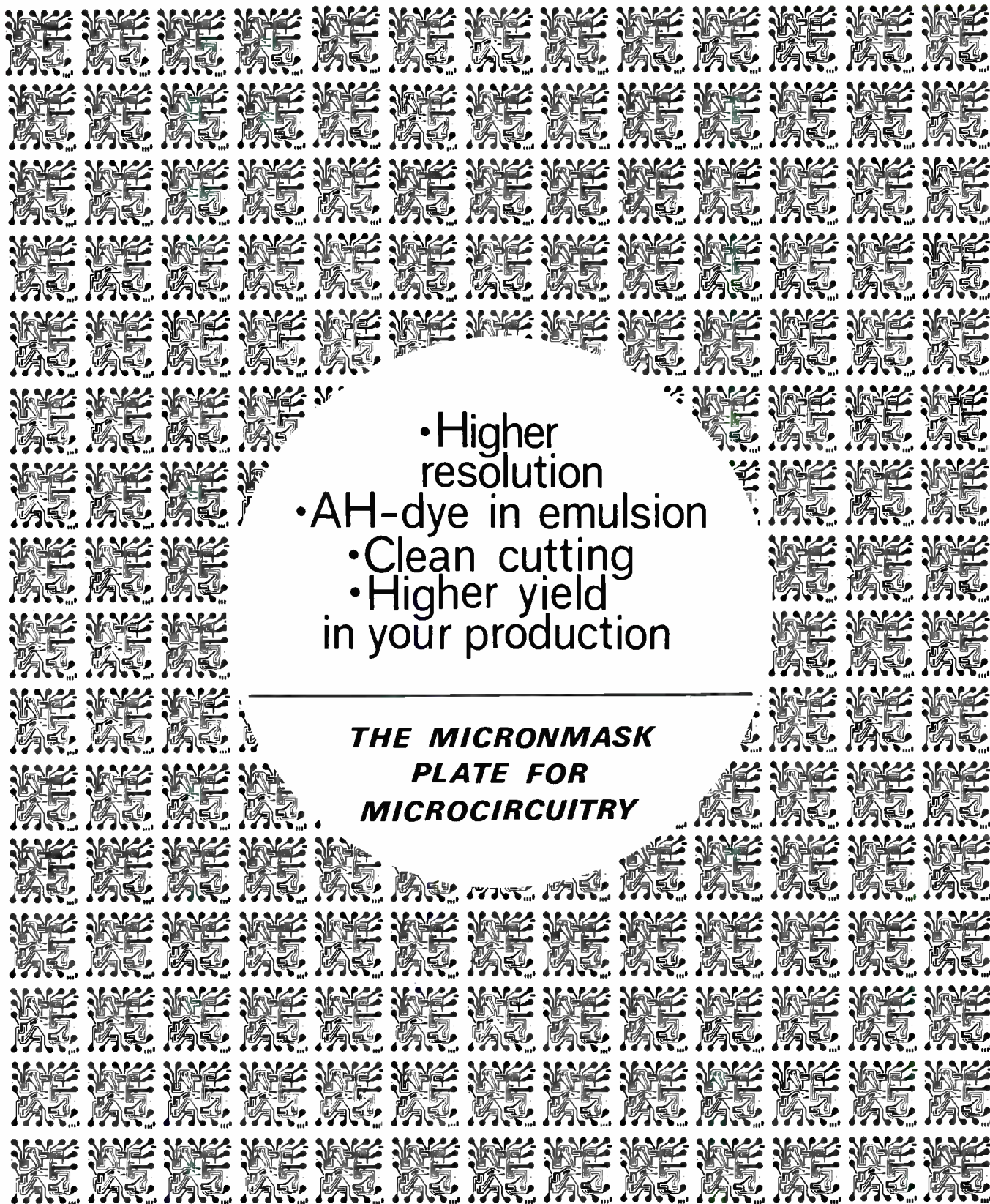

- Higher resolution
- AH-dye in emulsion
- Clean cutting
- Higher yield in your production

**THE MICRONMASK  
PLATE FOR  
MICROCIRCUITRY**

Write for full information to :

AGFA-GEVAERT INC. - 275 NORTH STREET - TETERBORO - NEW JERSEY  
GEVAERT-AGFA N.V. - MORTSEL - BELGIUM

**MICRONMASK**



**AGFA-GEVAERT**



WORDS OF WISDOM  
ON  
**blanketing  
atmospheres**

Sir Francis Bacon never heard of a "dry" box. But when he said, "A wise man will make more opportunities than he finds," he could well have been stimulating the use of blanketing atmospheres.

And, in electronics, your uses are legion. From IC production to behind-closed-doors research. Wherever there's a need for pure, strictly-controlled atmospheres of argon, nitrogen, helium, or hydrogen.

Here's where NCG comes in. We supply all of these gases. When you need them. Where you need them. In the quantities you want—from cylinders to tank cars to a complete, on-site air-separation plant, operated by NCG personnel.

Opportunity knocks. Write to us today for complete details on industrial gases for blanketing atmospheres.

**NCG**<sup>®</sup>

**CHEMETRON CORPORATION**  
NATIONAL CYLINDER GAS DIVISION  
840 North Michigan Avenue • Chicago, Illinois 60611

**CHEMETRON**  
TRADEMARK

© 1970, Chemetron Corporation

152 Circle 152 on reader service card

## Technical Abstracts

### Hybrid tripler needs no tuning

Hybrid integrated frequency multipliers, M.V. Schneider and W.W. Snell Jr.  
Bell Telephone Laboratories Inc.  
Holmdel, N.J.

By scaling down an optimized, low-frequency multiplier, a hybrid high-frequency version can be designed that won't need final tuning adjustments. The procedure yields harmonic generators with power levels and efficiencies useful for many microwave and millimeter-wave purposes.

One such device, multiplying 10 to 30 gigahertz, has been built, starting from a 270- to 810-megahertz tripler and scaling down all the dimensions of every passive circuit element as well as the junction capacitance of its varactor diode.

The tripler's optimized microstrip conductor pattern, made of 0.25-mm-wide brass strips, comprised a lowpass input filter, an idler section and a bandpass output filter. The lowpass filter was a five-element semilumped structure consisting of three capacitive and two inductive sections, while the bandpass filter consisted of two parallel coupled microstrip resonators. Mounted between the conductor and a tab in contact with a side wall of the channel was a silicon varactor diode. Output power was 2.5 watts and overall efficiency was 80%.

The hybrid device is scaled down in size by a factor of 37.5. Its substrate is synthetic fused silica, with a relative dielectric constant of 3.82 and a dielectric Q-factor of at least 3,000 measured at 8.5 and 24 GHz. Its diode is a planar, diffused gallium arsenide varactor with a 20-micron junction diameter, a zero-bias capacitance of 0.15 picofarads and a breakdown voltage of 15 volts. Input is an SMA connector and output is measured in RG-96/U rectangular waveguides. It has a cw output power of 50 mW and an overall efficiency of 29% at 30 GHz.

Presented at Northeast Electronics Research and Engineering Meeting, IEEE, Boston, Mass. Nov. 4-6.

THIS SPACE CONTRIBUTED BY THE PUBLISHER



Photo: O'Neill

Miss Raquel Welch

Learn the seven warning signals of cancer. You'll be in good company.

1. Unusual bleeding or discharge.
2. A lump or thickening in the breast or elsewhere.
3. A sore that does not heal.
4. Change in bowel or bladder habits.
5. Hoarseness or cough.
6. Indigestion or difficulty in swallowing.
7. Change in size or color of a wart or mole.

If a signal lasts longer than two weeks, see your doctor without delay.

And be sure to have a health checkup once a year, no matter how well you may feel.

**Fight Cancer with a checkup and a check**

American Cancer Society

**Open up  
closed-circuit  
markets...**

**...with this new  
one-inch-diameter  
Plumbicon\***

\*Registered trade-mark of  
N.V. Philips'Gloeilampenfabrieken  
Eindhoven, the Netherlands

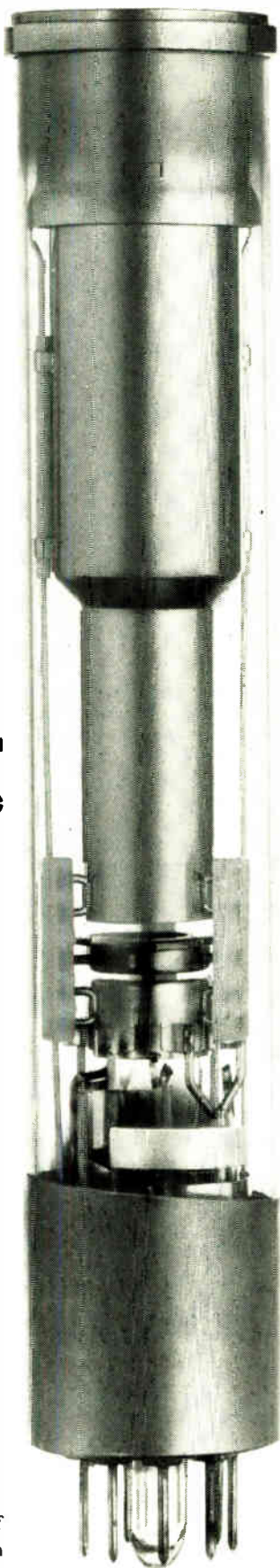

What a boost the entire CCTV industry would enjoy if existing cameras could operate well at significantly lower light levels and higher response speeds. That's exactly what this new Philips **Plumbicon** camera tube has to offer. Its one-inch-diameter makes it **retrofitable into existing cameras now using vidicons**. Developed originally to meet the exacting needs of live broadcast television, the **Plumbicon** won the industry's "Emmy" in 1967, as the year's most significant technological advance. Since then it has dominated its field-today it's in 9 out of 10 colour cameras in use throughout the world. When used in CCTV applications - in medicine, industry, education or commerce - this superb tube makes practical many applications hitherto only theoretical. The very high sensitivity, low dark current and fast response mean greatly improved picture quality - even when the subject is poorly illuminated or moving rapidly. All of which means the **Plumbicon** can make existing CCTV equipment work better, can make CCTV colour a practical proposition... can open up vast new markets, not only for cameras, but for related equipment as well! Let's help you open up new opportunities!

**Philips Electronic Components  
and Materials Division,  
Eindhoven, the Netherlands.**

Manufactured, distributed and sold  
in the U.S. by  
Amperex Electronic Corporation,  
Electro-Optical Devices Division,  
Slatersville R.I.

**PHILIPS**



**LABOR**  
SKILLED

**RESOURCES**  
WATER-FUEL-POWER

**ROOM**  
FOR  
EXPANSION

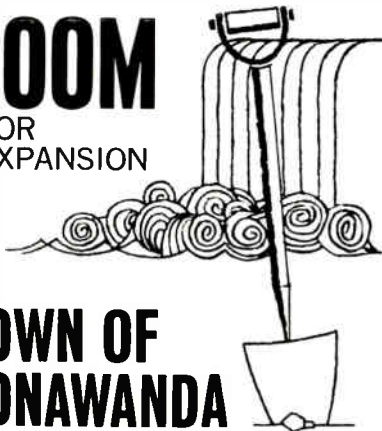

**TOWN OF  
TONAWANDA**

has all these and more for  
your plant development.

Western New York's skilled labor force; natural gas, cool water for power, processing, and deep port facilities; industrial zoned areas separate from spacious residential districts. Write for complete 36 page brochure with details on these and all the extras Town of Tonawanda has to offer.

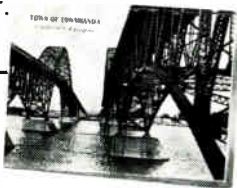

Town of Tonawanda Development Corp.  
2919 Delaware Ave., Kenmore, N.Y. 14217

Please send my free copy of "Town of  
Tonawanda . . . A Panorama of Progress".

name \_\_\_\_\_  
title \_\_\_\_\_  
company \_\_\_\_\_  
address \_\_\_\_\_  
city \_\_\_\_\_ state \_\_\_\_\_ zip \_\_\_\_\_

## New Literature

**Converters and testers.** Astrosystems Inc., 6 Nevada Dr., Lake Success, N.Y. 11040, offers an eight-page short-form catalog covering a line of analog-to-digital, digital-to-analog, transducer-to-digital, and special purpose converters, as well as manual and automatic test instrumentation.

Circle 446 on reader service card.

**Precision microphones.** B & K Instruments Inc., 5111 W. 164th St., Cleveland 44142. A 12-page brochure describes a full line of precision measuring microphones and supporting accessories. [447]

**Encoded switch array.** Chomerics Inc., 77 Dragon Court, Woburn, Mass. 01801. A product bulletin describes how conductive plastic technology combined with a totally integrated keyboard design enables the company to provide encoded keyboards with volume prices approaching 25 cents per key. [448]

**Gunn diodes and oscillators.** Microwave Associates, Burlington, Mass., has released a comprehensive brochure containing general information and applications for Gunn diodes and oscillators. [449]

**Connectors.** AMP Inc., Harrisburg, Pa. 17105. An expanded series of pin and socket connectors for rack and panel/cable applications is fully described in catalog 908. [450]

**Rf switches.** Relcom, 2329 Charleston Rd., Mountain View, Calif. 94040. A six-page catalog contains detailed specifications and application material for a line of solid state rf switches. [451]

**Digital plotting systems.** Houston Instrument, division of Bausch & Lomb Inc., 4950 Terminal Ave., Bellaire, Texas 77401, has available a four-page short form catalog on its line of digital plotting systems. [452]

**Variable attenuators.** Hyletronics Corp., Newtown Rd., Littleton, Mass. 01460. A six-page brochure details a complete line of reflective solid state variable attenuators and nanosecond switches. [453]

**IC interconnect assemblies.** Component Manufacturing Service Inc., 1 Component Park, West Bridgewater, Mass. 02379. Bulletin 1-70 describes a line of low-cost molded-on IC interconnect assemblies for interfacing and I/O connections in dual in-line packaging systems. [454]

**Recording spectrophotometer.** Cary Instruments, 2724 S. Peck Rd., Monrovia, Calif. 91016, has published a 16-page brochure on the model 14 automatic recording spectrophotometer. [455]

**Capacitance bridges.** Teradyne Inc., 183 Essex St., Boston, Mass. 02111. A 12-page brochure discusses capacitance measurement, including guidelines to choosing capacitance measuring equipment. It also describes automatic capacitance bridges and classifiers. [456]

**Dc-to-dc signal isolator.** Solid State Electronics Corp., 15321 Rayen St., Sepulveda, Calif. 91343, offers a bulletin covering the model DC1-178 dc-to-dc signal isolator, which is intended specifically for the isolation of low-level dc signals. [457]

**Remote switching systems.** Rust Corp., 168 Tremont St., Everett, Mass. 01929. Video/audio remote switching systems are described in a four-page brochure. [458]

**Key-to-cassette terminal.** Data Input Devices Inc., Tinkham Industrial Center, Derry, N.H. 03038. An eight-page brochure introduces Term-mite, a 20-pound, key-to-cassette terminal for source data entry. [459]

**Calculators.** Wang Laboratories Inc., 836 North St., Tewksbury, Mass. 01876. An eight-page technical brochure describes the series 100 scientific and engineering calculators. [450]

**Optical character recognition.** Cognitronics Corp., 41 E. 28th St., New York 10016. System/70, a compact optical character recognition system, is described in a recent brochure. [461]

**Bidirectional counters.** Theta Instrument Corp., Fairfield, N.J. 07006. Bulletin 67-16B covers a line of low-price, solid state counters for use with shaft encoders and photoelectric sensors. [462]

**Semiconductor catalog.** Unitrode Corp., 63 Atlantic Ave., Boston, Mass. 02110, has published a 34-page design guide and short-form catalog describing its total semiconductor product line capability. [463]

**Analog multiplier.** Analog Devices Inc., 221 Fifth St., Cambridge, Mass. 02142. A fold-out application note describes models 424/5 high accuracy wideband multipliers, which are based on the pulse height/width modulation principle. [464]

**Phototransistors.** Clairex Corp., 560 S. Third Ave., Mt. Vernon, N.Y. 10550. Three new narrow-tolerance phototransistors are described in a data sheet. [465]

**Tantalum capacitors.** Components Inc., Biddeford, Maine 04005, has available a data sheet on hermetically sealed, gelled electrolyte, tantalum capacitors. [466]

# SANKEN Packs 50 Watts into A Hybrid Audio Amplifier!



SI-1020A (25W)



SI-1050A (50W)

SI-1000 Series Hybrid Power Amplifiers are designed and manufactured for a Hi-Fi stereophonic system and other kinds of sound systems. With the simple addition of power supply and a coupling capacitor to a speaker one has an IC audio amplifier of the highest quality.

#### OUTSTANDING FEATURES:

- \*Single-ended push-pull circuit
- \*Provided with temperature compensating element
- \*Can withstand a 5-second short-circuit in the output terminals due to special single-diffused power transistors
- \*Harmonic distortion of less than 0.5% at full power level

U. S. Agent:

**AIRPAX ELECTRONICS** incorporated

P. O. Box 8488, Fort Lauderdale, Florida 33310

Phone : 305-587-1100 Twx : 510-955-9866 Telex : 051-4448

	SI-1020A	SI-1050A
Power supply voltage	48V	62V
Max. continuous output power (distortion < 0.5%)	25W	50W
Voltage gain	30dB typ.	
Frequency range (output 1W)	20Hz~100kHz	
Input impedance	70kΩ typ.	
Output impedance	0.2Ω typ.	
S/N ratio	90dB typ.	
Idling current	30mA typ.	

10W and 20W types also available



Write for further information to:

**SANKEN ELECTRIC CO., LTD.**

1-22-8, Nishi-Ikebukuro, Toshima-ku, Tokyo

Cable: SANKELE TOKYO Phone: 986-6151

Telex: 0272-2323 SANKELE TOK

Circle 176 on reader service card

## E=2(C+EDP)X

Last year, Electronics magazine contained twice as much information on computers and electronic data processing as the next leading electronic publication.

If the cover of this magazine has your name and address on it, there is no better formula for keeping yourself abreast of the industry's technology.

## A SMALL ROTARY SWITCH



### with TREMENDOUS features

- 30° Angle of Throw (12 Positions)
- 0.7" Behind Panel, 0.562 Diameter
- One, Two or Four Poles
- Shorting or Non-Shorting
- PC or Solder Lug Terminals
- Sealed or Unsealed
- Adjustable or Preset Stops
- Commercial or Military Styles

To Make and Break 50 MA for 25,000 cycles,  
200 MA for 10,000 cycles (rated at 115 VAC resistive)

**REQUEST YOUR ENGINEERING DATA SHEET 157**



523 Hillgrove Avenue  
LaGrange, Illinois 60525  
Area Code 312, Phone 354-1040

... the Difference Between Excellent and Adequate

# Brush announces a new X-Y plotter. It's everything you've done without.

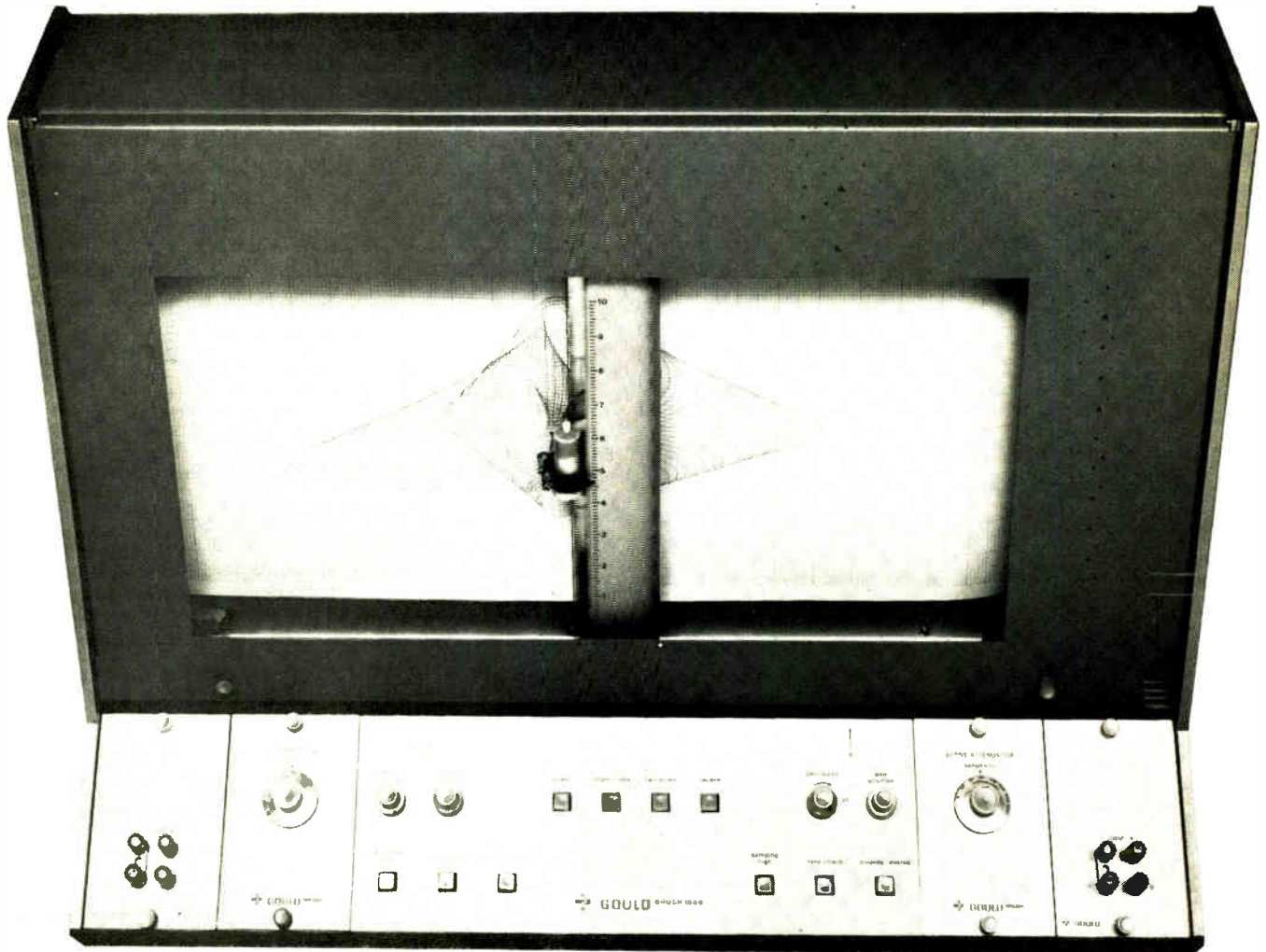

The new Brush 1000 X-Y plotter is all the things that other plotters aren't.

Let's start with the trace.

It's sharp and crisp and uniform. There's no jitter, no skips, no puddles, no smears. All because our patented pressurized ink-writing system forces ink into the paper. And pulls it back from the pen point the instant the pen is lifted.

Another thing: we've put the ink supply in a disposable cartridge. It's good for 41 miles of trace. And then, in seconds, you can pop in a new one. It's fussless, mussless.

Our new plotter is very fast, too. High-torque servo-motors produce writing speeds up to 100 inches per second while acceleration is 1750 in/sec<sup>2</sup> in the X direction, 2750 in the Y. Our non-contact servo-loop feedback system controls pen movement continuously. It enforces linearity

of 99%, eliminates slewing, and assures repeatability at any speed. It also gets rid of slide wires, electrical noise and all the pot problems of potentiometric-type feedback systems.

About signal conditioning. Interchangeable pre-amps plug right into the front panel. So that particular problem is no problem at all.

Paper's no problem, either. The built-in supply roll carries 100 feet of it. And you advance a fresh 10" x 15" area by simply pushing a button.

Velvet-smooth. Quiet. Quick. Neat. And accurate. The new Brush 1000 X-Y plotter is all these things. And more.

Get the whole picture. Talk to your Brush representative. Or write: Brush Division, Gould Inc., 3631 Perkins Avenue, Cleveland, Ohio 44114.

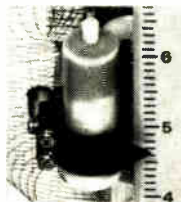

**GOULD BRUSH**

---

# International Newsletter

---

December 7, 1970

## Color TV slumps in Japan . . .

Japanese color TV makers all are cutting production by 20% to 40% because they have too many sets in their warehouses. Inventory at the end of October was 25% higher than the previous month and 167% higher than the same time last year for a total of more than one million sets, an all-time record for Japan, according to the Ministry of International Trade and Industry. Dealers' stocks probably hold another 600,000 to 800,000 sets, bringing the total to about three months' production.

Dull market conditions in the U.S. and antidumping charges by the U.S. Government contributed to a falloff in export orders. The antidumping charges contributed to the domestic slump because consumer groups complained about the large difference between the export price and domestic retail price.

## . . . and in West Germany

In West Germany, color TV sales are experiencing their first big slump since color broadcasting was started three years ago. The demand has become so sluggish that some firms will curtail production by cutting working hours during the next two months. Between 850,000 to 900,000 sets were expected to be sold but it appears that the 1970 goal will be missed by about 15%. Industry and retailers alike are beginning to doubt whether the customary Christmas buying spree will change the situation.

Ironically, the slackening demand coincides with a drop in prices, amounting to an average of \$40 or 6% per set. Market watchers credit that to a wait-and-see attitude; customers are putting off set purchases in hopes of more price cuts. The 6% drop was anything but a wholehearted action taken by the industry. It came when a big Westphalian discount house offered German-made color sets, reimported from the Netherlands, at considerably less than the going rate, a maneuver legal in price-controlled Germany.

## British imports of computer gear hurt trade balance

Booming imports of computer parts and peripherals are great for business but bad for Britain's balance of trade. The year-end computer deficit looks to be at least \$200 million, double last year's \$98 million. Exports of complete computer systems take up some of the slack, and shipments of parts and peripherals are up on last year, but the quantities involved are too small to really dent the import boom.

As a result, it looks as though Britain's overall balance of trade on electronics capital equipment will run into the red for the first time, to the tune of at least \$20 or \$30 million, compared with a surplus of \$30 million last year. One industry view is that many different types of peripheral and peripheral parts are being sold, and the market for each is too small to make fabrication in the U.K. economically viable.

## Japanese follow Bell with room temperature laser

A double heterodyne junction laser operated continually at room temperature in mid-October at the Nippon Electric Co. Central Research Lab, the company has just revealed. The company's researchers were less than two months behind Bell scientists, and claim their success did not come from copying Bell's results, but was based on work begun long before. Because of the physical constraints, others setting out to build a room temperature lasers are going to wind up with a similar structure, they say,

---

# International Newsletter

---

but years of experience in semiconductor fabrication are essential.

Output power is presently several tens of milliwatts, but in the future is expected to reach 100 mW. Efficiency is in the 1% to 2% range, but it should be possible to increase this by an order of magnitude. Response time is less than 1 nanosecond. Output radiation is in the 8,400-to-9,200-angstrom range.

## French gear up for rf transistors

Philips' Gloeilampenfabrieken has ordered its French components subsidiary to prepare for the fast-growing radio frequency transistor market in Europe. The subsidiary, **RTC-la Radiotechnique-Compelec**, expects to be turning out 2N3866 and 2N4427 overlay transistors at a rate of 500,000 yearly by 1972. The 3866 puts out 1 watt at 400 megahertz, the 4427 gives 1 W at 175 MHz.

Company officials say they'll continue their upward trek in frequency and power. In the works for 1971 are 1-W and 2-W transistors for 2.1-gigahertz operation. RTC also has to have ready by the end of next year a 6-W, 1.7-GHz unit for the French space agency. The company's researchers already have worked up to 5 W at 1.5 GHz with a transistor design that tucks eight bases into a chip measuring 0.8 by 1.2 millimeters.

## More companies join EVR bandwagon

Mitsubishi Electric Corp. has followed Hitachi in concluding an agreement with EVR Partnership Ltd., London, to manufacture electronic video recording players in Japan and sell them internationally outside the U.S. and Canada. They join Motorola in the U.S., Rank Bush Murphy Ltd. in England, Thomson-Brandt in France, Robert Bosch GmbH in West Germany, and Industria Zanussi SA in Italy as EVR licensees. EVR Partnership is owned jointly by CBS of America, Imperial Chemical Industries Ltd. of Britain and Ciba of Switzerland. Rank Bush Murphy almost certainly will be first with a player on the market outside the U.S. It expects to start volume production next April. EVR Partnership's software plant will have programs available at the same time. Equipment initially will be aimed at educational and training markets, because of the players' high \$860 price tag.

## Britain's Phantoms get detachable reconnaissance pod

The RAF has just put into service an underbelly reconnaissance pod built for its McDonnell-Douglas Phantom Mark 2 aircraft. First planes to be fit with the EMI Electronics Ltd. unit are operational conversion trainers. The RAF wanted a detachable pod so that aircraft function can be quickly changed; USAF Phantoms have recon equipment built in. The pod uses an American infrared mapping receiver, CRT display and film recorder. The rest is British equipment, including a Q-band side-looking radar, using slotted waveguide antennas in the pod walls, supplied by Mel Equipment Co., a Mullard subsidiary. The radar mapping recorder, radar data converter and all power supplies are EMI units.

The recorder uses two CRTs, which can show terrain on each side of the aircraft in large scale, or all terrain in smaller scale on one CRT and moving targets on the other. Displays are filmed, along with corresponding navigational data dot-marked onto the film in binary code by a 64-bit gallium phosphide diode matrix. Navigation data from the Ferranti inertial system and the STC radio altimeter is integrated with the radar displays by the data converter unit.



## U. S. firms out in force at Milan show

Exhibiting companies see reluctance to buy automation, instrumentation gear coming to an end

**Non-Italian firms** led the field at Milan's Eleventh International Automation and Instrumentation Conference and Exhibition, proving both that the Italians have still a long way to go to catch up in process control and that the Italian market, growing steadily over the past few years, is still a hot one.

As Gabriele Galanti, of Battaglia-Rangoni SpA, Bologna, explains it, "many industrialists still do not realize that they can really save money by putting in automation and instrumentation. You have to fight your way into the plant and install a piece of equipment on trial. Then, when they see it working, they finally come around."

A pickup in industrial investment in up-to-date equipment has been expected in Italy since the first of the year, when healthy wage increases went into effect as a result of new, three-year labor contracts. But with unsettled political and labor situation continuing, many companies, especially the middle- and smaller-sized ones, were reluctant to invest in new equipment.

Apparently, convinced that this reluctance could not continue much longer, non-Italian companies arrived in force, with 441 companies exhibiting from 18 countries, compared with 383 from 14 countries at the last show two years ago. Only

318 Italian companies showed their wares this year.

American firms were especially prominent among the familiar big names—some showing off their major Italian subsidiaries. Honeywell was there, as were Foxboro, Hewlett-Packard, and other international giants, like Philips and Siemens. Participation by American firms was emphasized as, for the first time, American companies were featured in their own special exhibit, with 31 firms demonstrating computer terminals and peripheral equipment. At the adjoining U.S. Trade Center another 40 firms held a show of the latest in electro-optical and laser devices.

Digital Equipment Corp., out to make a dent in the original equipment market, had one of the larger computer control displays, with Control Data and Varian also highly visible.

**While most of the Italian** companies tended to be small, many of them working under license, the number of Italian firms showing highly sophisticated equipment was impressive. Battaglia-Rangoni introduced an automatic time and amplitude reader of polygraphic tracings, which featured closed circuit television magnification of graph tracings, coupled with digital readout of time to 0.01 second and amplitude to three decimal places.

Pignone Sud, SpA, a company formed as a joint venture by two large Italian state-owned groups—ENI and EFIM—paraded updated models of its control panels featuring miniaturized pneumatic devices

introduced at the last show. Pignone Sud recently signed a licensing and sales agreement with General Electric under which it will manufacture and sell the GE-MAC 7000 series of electronic instruments. With its growing emphasis on electronics, Pignone Sud displayed its own interface, which ties the analog readings from its pneumatics with a GE process computer.

Carlo Gavazzi, former Honeywell licensee now on its own, introduced the Sybbrik, a series of compatible modular panel elements for control or integrated automation of boilers, petrochemical plants, and paper manufacturing. Sybbrik uses the same signal both for regular controls and for safety, thus reducing the number of control panels.

A major Italian company better known for its telecommunications equipment, Telettra SpA, featured its multiplex data transmission systems, particularly its TIC 100, which can control up to 100 peripheral stations. The central unit has a 6,000-command capacity. Its modular units feature printed circuit boards and silicon transistors.

### Japan

#### Ringin a change on discretionary wiring

Discretionary wiring can boost IC yields by working around faulty elements, saving whole circuits from the scrap bin. But it can also be time-consuming and expensive. Now being developed at the Central Research Laboratory of Hitachi

is a simplified chip selection approach to LSI that combines computer aided design, projection exposure of photoresist, and numerical control.

**Hitachi claims yield** is greatly increased over fixed-pattern wiring because actual circuit layout is selected only after probing of unit cells arranged in a matrix. This enables circuits to be laid out to make optimum use of good cells. Yet the use of standard masks together with projection exposure and numerical control eliminates the custom mask-making process for individual circuits needed in the pioneering Texas Instruments discretionary wiring approach.

For example, in a circuit that uses six cells, Hitachi uses a fixed pattern that includes only six cells in a specified orientation. Then, after each wafer is probed, a computer run can determine the optimum layout of groups of six contiguous cells in the specified configuration. Because the system need only expose a section of the chip rather than an entire wafer, it was designed to have a maximum working area of only 10 square millimeters. The optical system has a four-to-one reduction ratio, reducing costs and erasing mask fabrication and maintenance.

The final link is numerical control of the printer. The computer punches a tape at the same time that it selects the positions for circuits on the chip. In operation, the wafer is aligned in the printer through a microscope in the usual manner. Then the numerical control steps the table. Positioning accuracy at any point on the wafer is 2.5 microns.

Hitachi added several innovations to this basic system to increase flexibility and yield. In general a customer will want several types of LSI circuits fabricated from the same basic matrix. If, say, only nine-cell circuits are being selected, the yield might be distressingly low. But by selecting the required number of nine-cell circuits first, then six-cell circuits, and then four-cell circuits, yield can be far higher than for the basic six-cell

circuit. The computer also can lay out the wafers to obtain circuits in the approximate ratio in which they are needed.

Hitachi's approach also eliminates the need for a third wiring layer and allows for cutting the metalization in the first layer. The transistors initially are connected in a two-stage arrangement with dual two-input AND gates in the first stage. After testing, cuts may be made in the first-layer wiring for connection into other configurations by second-stage wiring.

To eliminate the third-layer wiring, each basic cell has blank areas along two perpendicular sides. These regions, which are continuous between cells, are metalized but not etched during fabrication of the first-layer wiring. After cell testing, these areas are masked, then etched along with the first layer cuts, providing a type of perpendicular bus.

---

### MOS FET process offers high speed or low power

Self-aligned structures for diffused MOS ICs are not new, but characteristics of devices produced with this structure sometimes suffer because of design tradeoffs or complex fabrication. Now researchers at Japan's Electrotechnical Laboratory have made significant simplifications of an approach developed a year ago [*Electronics*, Oct. 13, 1969, p. 207].

The improved diffusion self-aligned structure facilitates fabrication of ICs with MOS FETs having submicron channel lengths. The structure also combines an enhancement-type driver FET and a depletion-type load FET, which are considered to give the most advantageous configuration. Submicron channel lengths and the enhancement-depletion combination allow designing for either extremely high-speed or very low-power operation.

The effective channel length of the driver FET is determined by the difference in depth between two diffusions, a process used with bipolar transistors to achieve sub-

micron base widths. This process is well understood and gives good yields. Used with the new structure, the process requires only one more mask than for fabrication of ordinary MOS ICs. What's more, neither epitaxial growth nor isolation diffusion is required.

**The design team**, led by Yasuo Tarui, starts with a wafer of high resistivity p-type silicon, usually referred to as pi-type. The p diffusion for the driver FET enhancement channel is made through a window in the oxide coating. Other windows, which have been previously marked, eliminate loss of precision caused by poor mask alignment, then are opened at the region that will become the driver drain and load source, and also at the region that will become the load drain. Together with the driver source, these two regions are simultaneously diffused into n<sup>+</sup> regions.

Depth of the n diffusion is controlled to give the desired narrow p channel in the driver, typically about 0.6 micron. The impurity concentration just inside the p region on the side closest to the n source has a large effect on most of the characteristics of the FET, especially the threshold voltage. The pi wafer channel regions, which have an impurity concentration of about 10<sup>14</sup> atoms per square centimeter, give depletion-type characteristics because the presence of gate oxides and gates produce n-type inversion layers near the surface. As impurities in the diffused channel region are increased, inversion no longer takes place, and more impurities increase the threshold voltage, giving an enhancement-type FET. Thus the threshold voltage of the enhancement channel can be tailored to the desired value.

The load depletion FET has a much shorter channel length than the commonly used enhancement FET, which results in a significant saving in semiconductor real estate. It also permits circuit operation at low voltages. Although the FET works at constant current when operated in the depletion region, the channel resistance with low

terminal voltage is proportional to channel length. The ability to set the threshold at a low, predetermined value is a necessary condition for low voltage operation.

---

### Norway

---

## Kongsberg's latest weapon: ship-to-ship missile

When a handful of Norwegian gunners sunk the German heavy cruiser *Blucher* in April 1940 with a few rounds from two 50-year-old artillery pieces, the nation's reputation for handling attacking vessels was pretty well established. Today, however, Norway is relying on much more modern equipment for filling defense needs.

Without much fanfare, Norway has put into production a ship-to-ship missile system named the Penguin, which is primarily designed to operate from small, fast patrol boats—the kind that make up the backbone of the Norwegian navy. With modification it can also be used as a mobile or fixed coast artillery system. And it can even be carried by helicopter.

Penguin development was started in the early 1960s by the Norwegian Defense Research Establishment, with some funding coming from the United States and West Germany through bilateral agreements. The U.S. navy also contributed the use of test facilities.

Production is now in hands of A/S Kongsberg Vaapenfabrikk, which has been producing arms for 150 years. Kongsberg, among the most experienced missile makers

in NATO, built the all-Norwegian Terne anti-submarine weapon system in the late 1950s, and produced the servo steering units for the Sidewinder air-to-air missile under a NATO program. It was also prime contractor and a major supplier for the NATO production of the Bullpup air-to-surface missile.

The Penguin missile is mounted in a launcher box for protection after leaving the factory. The entire unit, tested before installation on the ship, needs only mounting to a base on the deck and a quick hook-up of an "umbilical cord." Range is listed as 13 miles-plus, with speed given as high subsonic. The missile itself weighs 725 pounds and its length is about 10 feet.

**When a target is acquired**, a ship-board fire control computer calculates the predicted point of hit, and the missile's inertial guidance is automatically slaved to the computer data. The missile is fired, as the Norwegians say officially, "in the general direction of the target." After takeoff, the missile follows a programmed trajectory to the target area, where a heat-sensitive target seeker searches a strip of the sea in the direction of the flight. When a target is detected, the seeker locks onto it and guides the missile to the strike.

The shipboard computer, designed and made by Kongsberg, was initially designed for field artillery fire control. It was recently selected for the NATO Sea Sparrow ship-to-air missile system. The SM-3 computer weighs about 220 pounds and measures about 3 by 3 by 2 feet. Its main memory is expandable up to 64 kilowords of 16

bits each. Memory cycle time is 0.8 microsecond. A civilian version is used in Kongsberg machine tool and drawing machine controls.

---

### Great Britain

---

## Plessey develops MNOS read-mostly memory

Semiconductor memories are volatile. If their power supply fails, the stored information is lost. Therefore, either duplicate power supplies are needed or vital data is stored somewhere else. Metal-nitride-oxide-semiconductor transistors offer a way around the volatility problem, at least for certain memory types.

While RCA and Fairchild are investigating the storage possibilities of MNOS transistors in America, in Britain the Ministry of Defence (Navy) is supporting work at Plessey's Caswell Research Laboratories. And the team there has made a batch of six-by-six integrated MNOS storage arrays, half of which have all 36 transistors showing good non-volatility characteristics.

In MNOS transistors, the gate lies on top of a silicon nitride layer on top of the silicon dioxide layer over the channel. The charge is stored at the interface between the dielectrics, in deep traps that form when the nitride is deposited on the oxide. To induce it, a voltage above a certain critical level has to be applied to the gate, and to discharge it, a similar voltage of opposite polarity is used.

The charge stored can be preset by gate voltage and duration of

Coastal defense. Norway's Penguin ship-to-ship missile travels in its own weatherproof launching box. It homes in on target by heat-seeking sensors.

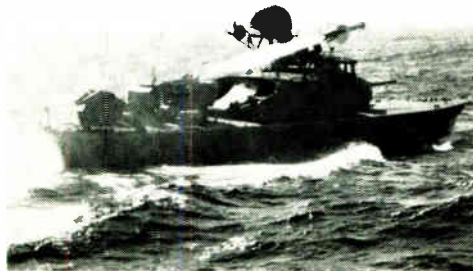
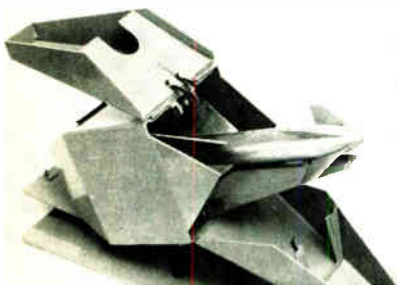

application and it determines the threshold voltage at which the transistor turns on—which may be at any voltage over a wide spread. And, the transistor will retain the selected threshold when the gate voltage is removed.

The use of two voltage levels a few volts apart creates a two-state storage device, which can be read by applying a gate voltage between the two thresholds to detect whether the transistor is on or off, cleared by applying an opposite voltage, and written into with gate voltages above the critical level. Transistors made by the Plessey team show that the charge storage level remains much the same over several months at least.

**The snag is** that the switching speed is not constant over the range of possible threshold levels, so that the choice of logic levels is dependent on speed considerations, and vice versa. In a read/write application the two thresholds must have a switching time equal in both directions. But Ray Oakley, leader of the team developing the devices, says that at present his transistors can only permit a switching time of 10 microseconds or more, which is totally uncompetitive with established read/write stores.

However, a read-mostly store is read many times during an operation, cleared at the end when time is not pressing, and held ready for fast re-writing during the following operation. The switching times need not be equal, so suitable logic levels can be found that take advantage of the fastest section of the switching curve for the write operation, and the corresponding slow clear time in the reverse direction does not matter.

Oakley says a switching pulse amplitude and duration can be found that writes from the low to the high threshold in 1  $\mu$ s or less, and clears from the high to the low threshold in up to 100  $\mu$ s. Oakley's team is developing this type of device for calculators and main-frame sub-routine stores. Eventually, he reckons, between 1,000 and 10,000 bits will be put on a chip, at a price of \$1.

Apart from the amplitude and duration of the switching pulse, the performance of the transistor is critically affected by the thickness of the oxide and nitride. Since the stored charge affects the threshold voltage by influencing the state of the silicon surface under the oxide, the oxide has to be as thin as possible so as to get the fastest response out of the minimum charge and lowest applied gate voltage.

Oakley's integrated devices have an oxide thickness of between 10 and 20 angstroms, controlled to  $\pm 1$  angstrom, he claims. Nitride thickness is 500 to 600 angstroms. Devices with 12-angstrom oxide switch from the low threshold of 4 volts or so to the high threshold of 8 V, using a switching pulse of 1  $\mu$ s and  $-40$  V. The clear time is 30 to 40  $\mu$ s. The read voltage used is about 6 V.

---

### West Germany

---

#### Photochromic layer holds data in laser-based store

Like researchers around the world, engineers at West Germany's AEG-Telefunken have turned to optical recording techniques as one solution to the growing problem of computer speed vs. low memory capacity. The work at the company's Ulm laboratories promises a relatively inexpensive way of recording and storing digital data at high bit densities.

The AEG-Telefunken method is unusual in that a special photochromic layer deposited on plastic tape holds laser-recorded data in the form of tiny color dots. The storage density attained so far is 3 million bits per square centimeter. But, says Stephan Maslowski, head of the laboratory for laser applications, that's far from being the limit of the technique's capabilities. The data transfer rate for which the researchers are trying is 10 million bits per second.

The photochromic layer is an AEG-Telefunken development. Between 10 and 20 microns thick, it's made of an organic compound

called spiropyrane. Unexposed, this layer is colorless, fully transparent and stable, so far as visible light is concerned. But once exposed to ultraviolet radiation, it takes on a bluish color and is opaque to visible light.

In contrast to photographic film, the coloration sets in the instant the layer is exposed to UV light; no developing and fixing are needed. What's more, the spiropyrane layer is free of grains, which could limit definition. While spiropyrane has been known to chemists for some time, the Telefunken people say they are the first to have made it stable against visible light, which they do by mixing it with certain acids and other chemicals.

The ultraviolet laser beam penetrates the spiropyrane layer for several microns, producing a blue dot about 30 microns in diameter. These dots are arranged in lines running at an angle across the width of the tape, consisting of 30,000 dots, and spaced 10 microns apart.

Having proved that the dots can easily be packed at such density on the new storage medium, the Ulm researchers are now concentrating their efforts on laser equipment that can write the dots at the rate of 10 million per second. That isn't too difficult in principle, Maslowski says. By next spring he expects to have a functional version of such a laser write system ready. And toward the end of next year a suitable read system should follow.

**Part of the lab's** current efforts is developing a laser with an output power of 100 milliwatts or so—the power required for high write speeds. Experiments are being made with a gas laser that emits green light. In a frequency-doubling process, the green wavelength is cut in half to give ultraviolet light. The UV beam is then modulated by the digital data to be written, and its focal point deflected across the layer's surface.

In the functional version to be shown in the spring, a mirror rotating at about 10,000 rpm will deflect the beam. Data read-out will be by means of visible light.



**SCHAUER**

**1%**

**tolerance**

**1 WATT ZENERS  
ARE A REAL BUY!**

**IMMEDIATE SHIPMENT**

ANY voltage from 2.0 to 16.0  
at the industry's **LOWEST  
PRICES!**

Quantity	Price each
1-99	\$1.07
100-499	.97
500-999	.91
1000-4999	.86
5000 up	.82



**THE  
HI-RELIABLE!**

No fragile nail heads.  
Silicon junction aligned between two, parallel, offset tantalum heat sinks . . . great lead tension strength.

All welded and brazed assembly.

High pressure molded package.

Gold plated nickel-clad copper leads.

Write or phone for Form 68-4 for complete rating data and other tolerance prices.

**Semiconductor Division**

**SCHAUER  
MANUFACTURING  
CORP.** 4514 Alpine Avenue  
Cincinnati, O. 45242  
Ph. (513) 791-3030

- TA Manufacturing Corp. D4
- Bear Advertising Inc.
- Tektronix Inc. 37, 84, 100
- Dawson Inc.
- Thomas & Betts Company Inc. 15
- McCarthy Scelba, DeBiasi Advertising Agency Inc.
- Thomson CSF Electron Tubes, Inc. 41
- Mohr & Company Inc.
- Toko Inc. 126
- Hakuhodo Inc.
- Town of Tonawanda Development Corporation 154
- Melvin F. Hall Advertising Agency
- Tung-Sol Division, Wagner Electric Corp. 148
- Winius-Brandon Company

Unisem Subsidiary of  
United Aircraft Corporation  
Schaefer Advertising Inc. 60

■ Varo Inc. 126  
Tracy-Locke Inc.

□ Wayne Kerr Ltd. 26E  
W. S. Crawford Ltd.

■ White Instruments Inc. 132  
Wilson & Associates The Art Studio  
A Division of Graphic Studios

Wiremold Company, The 114  
Charles Brunelle Company

Xerox Corporation 149  
Hutchins Advertising Company Inc.

Zenith Radio Corporation 116  
Mills, Fife & MacDonald Inc.

**Classified & Employment Advertising**

F.J. Eberle, Manager 212-971-2557

**EQUIPMENT (Used or Surplus New) For Sale**

Phillip Fishman Co. . . . . 150

Radio Research Instrument Co. . . . . 150

- For more information on complete product line see advertisement in the latest **Electronics Buyer's Guide**
- Advertisers in **Electronics International**

**Advertising Sales Staff**

Pierre J. Braude [212] 971-3485  
Advertising Sales Manager

Atlanta, Ga. 30309: Charlton H. Calhoun, III  
1375 Peachtree St., N.E.  
[404] 892-2868

Boston, Mass. 02116: William S. Hodgkinson  
607 Boylston St.  
[617] 262-1160

Chicago, Ill. 60611: Ralph Hanning,  
Kenneth E. Nicklas, 645 North Michigan  
Avenue, [312] MO 4-5800

Cleveland, Ohio 44113: William J. Boyle,  
[716] 586-5040

Dallas, Texas 75201: Richard P. Poole,  
1800 Republic National Bank Tower,  
[214] RI 7-9721

Detroit, Michigan 48226: Ralph Hanning,  
2600 Penobscot Building  
[313] 962-1793

Houston, Texas 77002: Richard P. Poole,  
2270 Humble Bldg. [713] CA 4-8381

Minneapolis, Minn. 55402: Kenneth E. Nicklas,  
1104 Northstar Center [612] 332-7425

New York, N.Y. 10036  
500 Fifth Avenue  
James R. Pierce [212] 971-3615  
Warren H. Gardner [212] 971-3617  
Michael J. Stoiler [212] 971-3616

Philadelphia, Pa. 19103:  
Jeffrey M. Preston  
6 Penn Center Plaza,  
[215] LO 8-6161

Pittsburgh, Pa. 15222: Jeffrey M. Preston,  
4 Gateway Center, [412] 391-1314

Rochester, N.Y. 14534: William J. Boyle,  
9 Greylock Ridge, Pittsford, N.Y.  
[716] 586-5040

St. Louis, Mo. 63105: Kenneth E. Nicklas,  
The Clayton Tower, 7751 Carondelet Ave.  
[314] PA 5-7285

James T. Hauptli [415] DO 2-4600  
Western Advertising Sales Manager

Denver, Colo. 80202: Richard W. Carpenter  
Tower Bldg., 1700 Broadway  
[303] 266-3863

Los Angeles, Calif. 90017: Robert J. Rielly,  
Bradley K. Jones, 1125 W. 6th St.,  
[213] HU 2-5450

San Francisco, Calif. 94111: Don Farris,  
James T. Hauptli, 425 Battery Street,  
[415] 362-4600

Paris: Denis Jacob  
17 Rue-Georges Bizet, 75 Paris 16, France  
Tel 727 33 42, 727 33 60

Geneva: Denis Jacob  
1 rue du Temple

United Kingdom and Scandinavia  
London: Keith Mantle, Tel: Hyde Park 1451  
34 Dover Street, London W1

Milan: Robert Saidel, Roberto Laureri Jr.  
1 via Baracchini Phone 86-90-656

Brussels: Denis Jacob  
22 Chaussee de Wavre  
Brussels 1040, Belgium

Frankfurt/Main: Fritz Krusebecker  
Elsa-Brandstroem Str. 2  
Phone 72 01 81

Tokyo: Masaru Wakeshima, McGraw-Hill  
Publications Overseas Corporation,  
Kasumigaseki Building 2-5, 3-chome,  
Kasumigaseki, Chiyoda-Ku, Tokyo, Japan  
[581] 9811

Osaka: Akihiko Kamesaka, McGraw-Hill  
Publications Overseas Corporation, Kondo  
Bldg., 163, Umegae-cho Kita-ku [362] 8771

Australasia: Warren E. Ball, IPO Box 5106,  
Tokyo, Japan

**Business Department**

Stephen R. Weiss, Manager  
[212] 971-2044

Thomas M. Egan,  
Production Manager [212] 971-3140

Dorothy Carmesin, Contracts and Billings  
[212] 971-2908

Frances Vallone, Reader Service Manager  
[212] 971-6057

**Electronics Buyers' Guide**

George F. Werner, Associate Publisher  
[212] 971-3139

Regina Hera, Directory Manager  
[212] 971-2544

# C/MOS 64 BIT STATIC SHIFT REGISTER

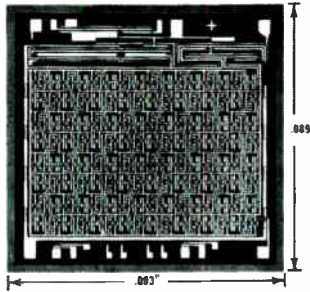

**10 NANOAMPERES STATIC CURRENT DRAIN  
25 MEGAHERTZ CLOCK RATE**

• Single clock and single power supply

Now available from stock—our unique shift register array offers design advantages and ultra-low power dissipation unparalleled in the industry. Available off-the-shelf in a 24-lead dual-in-line, hermetically welded, ceramic package. Pellets are stocked and can be supplied in a variety of DIP and flat packs. Two isolated chips in the same package are also available. Ultra-low power and high speed performance derive from Ragen's latest advances in C/MOS technology. Special low voltage versions, operating from (2 to 10 volts) or (1.5 to 5 volts) are available on custom-order basis. Write or call today 201-887-4141.

**RS RAGEN SEMICONDUCTOR INC.**  
A SUBSIDIARY OF RAGEN PRECISION INDUSTRIES  
53 SOUTH JEFFERSON ROAD WHIPPANY, NEW JERSEY 07981

Circle 178 on reader service card

## The power supply you plan to build is built!

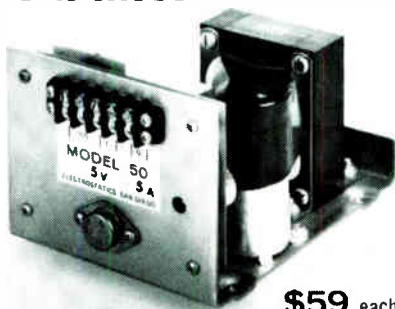

**\$59** each

OTHER MODELS 3 to 50 V available

It's on the shelf, ready for immediate delivery from Electrostatics. With specs proven in service. Low cost. Brief specs on our Model 50:

- 5V 5A Power Supply
- Input 105-125V, 47-420 Hz
- Regulation: Line 0.01%  
Load 0.1%
- Ripple: 500  $\mu$ V max.
- Temp: -20 to +70°C
- Foldback current limiting
- Size: 5" W x 4.13" H x 7" L

(\$69 with overvoltage protection)

For full information call Robert McCartney, Manager of Application Engineering, (714) 279-1414. Or circle the number below for our latest data sheet.

**Electrostatics, inc.**

7718 Clairemont Mesa Blvd., San Diego, California 92111 DEPT 101

Circle 179 on reader service card

## NEW AND NOTABLE



**HANDBOOK OF MATERIALS AND PROCESSES FOR ELECTRONICS**  
CHARLES A. HARPER, EDITOR.

Compiles in a single source extensive data, basic principles, and application guidelines for the whole range of materials and processes used in the electronic and electrical field. Broad in scope, but thorough and detailed with full coverage of new advances. 1,344 pages, 803 illustrations, \$33.50.



**PLASTIC COATINGS FOR ELECTRONICS**  
JAMES J. LICARI.

Primarily for electronic and electrical design engineers, chemists needing knowledge of organic coatings, and industrial engineers who require process data. Correlates the properties and applications of coatings with chemical structure. 318 pages, 130 illustrations, \$21.50.

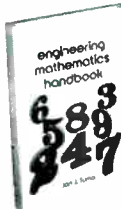

**ENGINEERING MATHEMATICS HANDBOOK**  
JAN J. TUMA

Designed like a modern cookbook for easiest possible reference and use. All pages laid out in facing spreads to constitute complete conceptual and visual units. Two-color printing emphasizes significant features. Easy to grasp, advancing from the simple to the difficult concepts. 228 pages, 297 illustrations, \$9.95



**INDUSTRIAL ELECTRONICS: For Engineers and Technicians**  
NOEL M. MORRIS.

Written for those in electrical engineering, and containing many worked examples and problems. First five chapters deal with basic devices and characteristics, and final eight are devoted to circuits and applications. 372 pages, 201 illustrations, \$12.50

AND COMING IN JANUARY...

**RELIABILITY MATHEMATICS: Fundamentals, Practices, Procedures**  
BERTRAM L. AMSTADTER.

Designed to fill the requirements of engineers and managers needing practical approaches to the mathematical aspects of probability. Includes all required reliability equations, formulas, methods, and tables. 320 pages, 128 illustrations, \$17.50

**PROBABILITY STATISTICS**  
L. DANIEL MASSEY.

For the practicing engineer who wishes to renew his familiarity with elementary probability and statistics. Sound working knowledge assured in an easy-to-understand style, with emphasis throughout on applications to your problems. 256 pages, 47 illustrations, \$11.50

At bookstores, or direct from publisher for a 10-day examination

McGraw-Hill Book Co. • 330 West 42nd St., New York, N.Y. 10036  
Send me the book(s) checked for 10 days on approval. In 10 days I will remit for those I keep, plus local tax, postage, and handling, and return the others postpaid. I understand that if I remit with this coupon, McGraw-Hill pays all postage and handling costs, and that full refund privileges still apply.

- Handbook of Materials and Processes for Electronics (266735)
- Plastic Coatings for Electronics (37712X)
- Engineering Mathematics Handbook (654301)
- Industrial Electronics (942609)
- Reliability Mathematics (015988)
- Probability Statistics (407207)

Name \_\_\_\_\_

Address \_\_\_\_\_

City \_\_\_\_\_

State \_\_\_\_\_ Zip \_\_\_\_\_

This offer good only in U.S. and Canada

23-E-127

*You say you want a*

low-profile snap-in-mounting push button switch or matching indicator that is interchangeable with most 4-lamp displays... available in a full range of cap colors... with a choice of bezels with or without barriers in black, gray, dark gray or white.

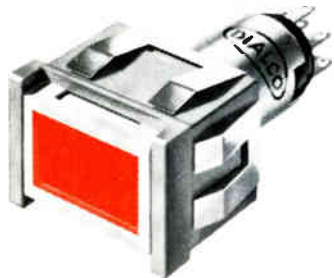

*and a*

legend presentation that's positive (like this one) or negative (like the one below) or just plain (like the one above)... one that's white when "off" and red, green, yellow (amber), blue or light yellow when "on"... or colored both "on" and "off."



*and a*

highly reliable switch proven in thousands of installations... available in momentary or alternate action... N.O., N.C. or two circuit (one N.O., one N.C.)... that accommodates a T-1 3/4 bulb with midget flanged base, incandescent, in a range of voltages from 6-28V.



*etc.  
etc.  
etc.*

*Now, for the first time Dialight gives you custom panel designing with a standard line of push-button switches and matching indicators*

Dialight offers a broader range of switch and indicator possibilities than you'll find anywhere in a standard single-lamp line. Sizes: 3/4" x 1", 5/8" and 3/4" square and round. Send today for our new catalog.

**DIALIGHT**

Dialight Corporation, 60 Stewart Ave., Brooklyn, N.Y. 11237

DT-125

D 4 Circle 165 on reader service card

# FREE!

## CLAMP Design Manual

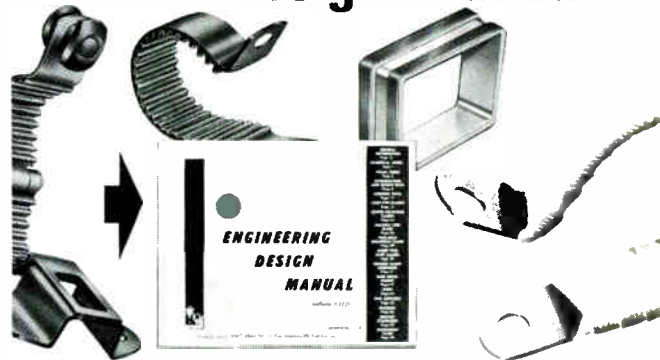

### 72 pages of engineering data!

The most complete work of its kind, this manual features 72 pages of prints, illustrations, tables, specifications and installation tips for any clamp situation. Whether of aluminum, titanium or stainless steel, from 1/8" to 6" diameter, for hot or cold temperature insulation... for any situation, you'll find the best way to "clamp down" clearly shown in this booklet. ■ Over 41,000 clamp designs at your fingertips, ready for shipments now, at big off-the-shelf savings. Also shows blocks, brackets, line supports and related items. **BEFORE YOU DESIGN OR BUY, CHECK WITH TA FIRST!** Write or phone today for a quotation. ■ Send for your free clamp manual today!

**TA MFG CORP** A VIKING INDUSTRIES COMPANY

4607 Alger Street, Los Angeles, California 90039 ■ Phone 213-245-3748/TWX 910-497-2065 L. A./WUX CAT L. A., Calif.

Circle 210 on reader service card



**YOU'RE WHISTLING IN THE DARK...**

if you think that heart disease and stroke hit only the other fellow's family.

**GIVE... so more will live  
HEART FUND**



Contributed by the Publisher

Electronics | December 7, 1970





## Exotic — Yet Simple Functional & Reliable

AMI/MOS devices made in the Orient are just like the custom parts produced in great volume by AMI in California, Mexico and Idaho. AMI means MOS, and MOS means metal oxide semi-conductors — the remarkable “new” parts that lower your product cost while raising reliability. At the same time, AMI/

MOS parts reduce your capital investment requirement, and simplify your manufacturing process. Sound exotic? Not really. It is sensible, practical and profitable. Hop a jet and visit our Santa Clara headquarters for the whole story — or if you need a long trip, we can talk business at our Seoul

plant — not too far from an exotic Korean temple.

**American Micro-systems, Inc.**  
3800 Homestead Road, Santa Clara,  
Calif. 95051 Phone: (408) 246-0330



THE LEADING  
MOS COMPANY,  
WITH FACILITIES IN  
CALIFORNIA, MEXICO  
IDAHO & KOREA

# Introducing RCA's new superswitch: light sensor and power amplifier on one IC chip!

Choose a medium-speed application that uses a light sensor. You'll find the circuitry easier to design when you use the RCA-CA3062—because there's less to design.

The CA3062 consists of two parallel-connected photosensitive Darlington pairs which drive a differential power amplifier to provide a normally-off and normally-on output in response to a light input.

Available in a compact, window-ended TO-5 style package, the CA3062 has 100 mA output current capability, and can be operated at supply voltages in the range of 5 to 15 volts dc. It is compatible with RCA's 40736R infrared emitter. Use it for counter and position sensors, optical tachometers, limit detectors, level scanners, paper web sensors, wheel balancers, and similar devices.

For further details, see your local RCA Representative or your RCA Distributor. For technical bulletin, File No. 421, write: RCA, Commercial Engineering, Section 70L-7/CA41, Harrison, New Jersey 07029. International: RCA, 2-4 rue du Lièvre, 1227 Geneva, Switzerland, or P. O. Box 112, Hong Kong.

## CA3062 Photo Detector and Power Amplifier

- FOR:
- counters
  - sorters
  - level controls
  - intrusion alarms
  - edge monitoring
  - position sensor
  - isolators
  - inspection

- FEATURES:
- Darlington-connected photosensitive pairs
  - 100 mA output current capability (drives a relay or thyristor directly)
  - 5 to 15 Vdc supply voltage range
  - compatible with RCA= 40736R IR emitter

(5x actual size)

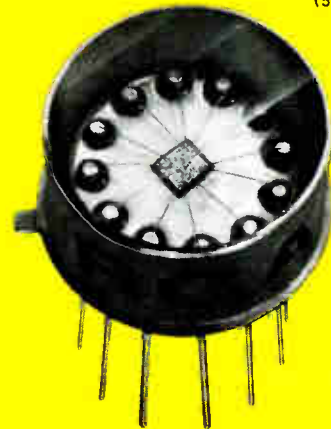

CA3062 \$2.95 (1000-unit level)

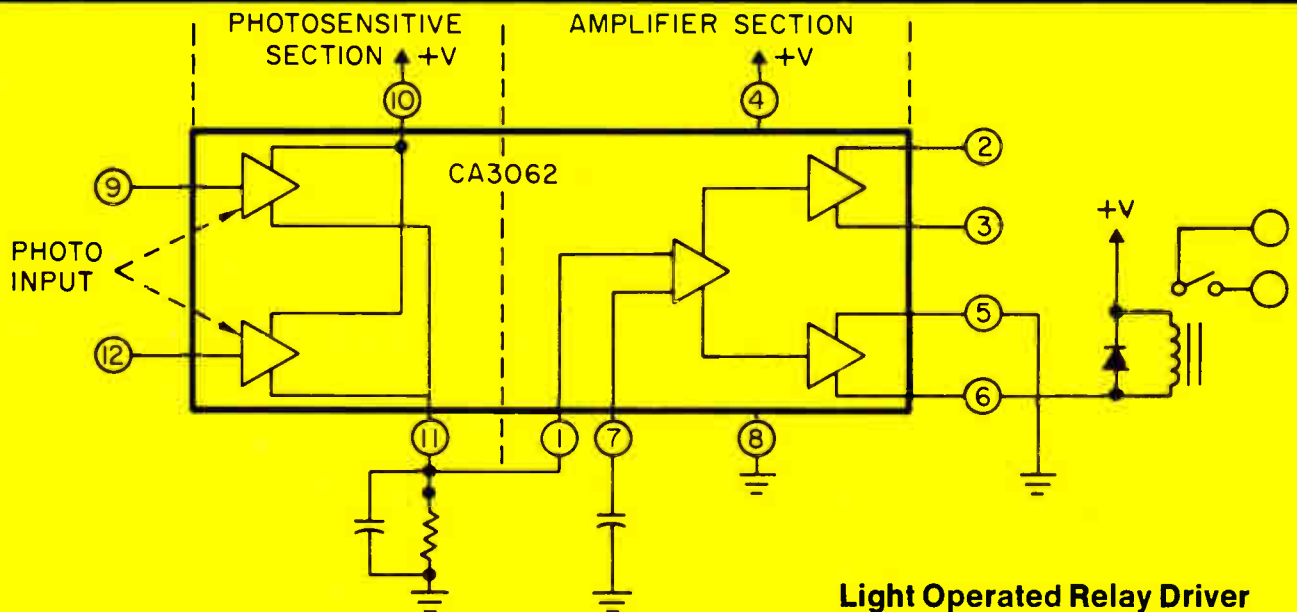

Light Operated Relay Driver

**RCA**  
Integrated Circuits