

Three-state logic brings wired-OR to TTL 78

\$1.00 A McGraw-Hill Publication

Logarithmic compression with saturated op amps 103 September 14, 1970

Wide-ranging capacitor in small package 108

# Electronics®

The bold  
Japanese and  
their surging  
market



41K865116

Toshiba

東芝

FUJITSU LIMITED

SHARP

SANYO

HITACHI  
Hitach, Ltd. Tokyo Japan

NIVICO

MITSUBISHI

SONY

TTL

1420 KSS996 44RA7 FEB71  
R KISSLER  
BASIC COMM ELEC  
BOX 956  
MOSE... MA

Nippon Electric Company, Ltd.

Sounds incredibly easy, but it's possible with the new T/D 1922 Real-Time Analyzer. These seven buttons let you control an entire sequence of analysis processes from signal capture to final displayed spectrum. The scope shows you where you are during the analysis and can guide you to a perfect measurement the first time.

There's no guesswork or calculation necessary when you use a T/D 1922. Designed for simple, straightforward operation, the T/D 1922 handles both sophisticated research investigations and on-line production tests equally well. And, versatility has not been sacrificed for simplicity.

*With a T/D 1922*

*You can* check input conditions and bandwidth adequacy *before* you analyze.

*You can* observe the analysis window or "time slice" *before* you analyze.

*You can* actually see where the measurement trigger point is.

*You can* capture a transient and analyze it at the touch of a button.

*You can* observe data convergence during spectral-averaging operations.

*You can* obtain level-versus-time information about a single frequency component or a band of components.

*You can* go from a constant, narrow-bandwidth analysis to a constant-percentage, one-third-octave analysis without rebuilding your measurement system.

To learn more about the T/D 1922 • Call your nearest GR District Office • Write to Time/Data, 490 San Antonio Rd., Palo Alto, Calif. 94306; or • Write to General Radio, 300 Baker Ave., Concord, Mass. 01742 • In Europe write to GR at Postfach 124, CH 8034, Zurich, Switzerland.

**Frequency Coverage:** DC to 20 kHz in fourteen ranges.

**Analysis Bandwidth (Constant):** 0.05 Hz to 100 Hz, depending on range in use (25, 50, 100, or 200 frequency points may be selected on any range). Constant-percentage, one-third-octave analysis characteristic also available.

**Accuracy:**  $\pm 1$  dB in level;  $\pm 1\%$  in frequency. **Dynamic Range:** 54 dB.

**Presentation:** Built-in storage scope displays input signal, measurement trigger point, analysis "window," recorded signal, frequency spectrum, rms-ensemble-averaged spectrum, frequency components versus time, and measurement parameters (instrument control settings). Hard-copy records also possible.

**Price:** \$32,000 F.O.B. Palo Alto, Calif.

# easy spectrum analysis

just push these seven buttons  
and watch the scope



Time/Data



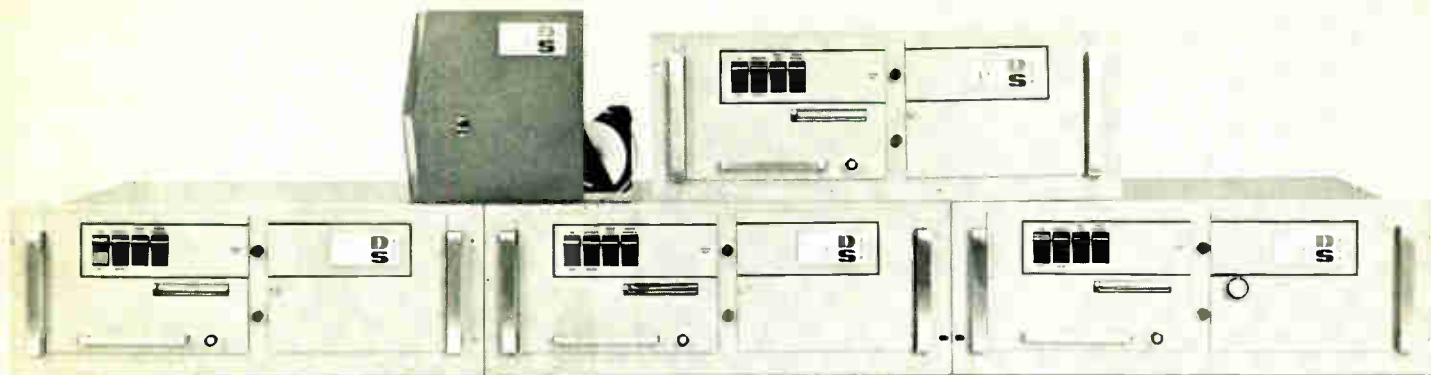

## Five new printers from Mohawk.

These 5 new printers plus the 6 original Franklin printers give MDS a product line of strip and lister printers that can fill any requirement.

Our five new printers are the 2015 through the 2019. They're all fully buffered, asynchronous, have ultra-reliable TTL integrated circuits, and can operate on either 50 or 60 cycles. The lister printers range from 8 columns to 20 columns with printing rates from 10 to 20 lines per second. While the 2016 and the 2018 are numeric, the 2017 and 2019 are alpha-numeric. All four have programmable zero suppress and format control. And two of them, the 2018 and 2019, are character-serial. The 2015 strip printer features first character readability and a full 96 character ASCII font.

Our six original Franklin printers, the 800, 1200, 1600, 2200,

and 3200, add more capabilities to our line. Such as speeds up to 40 lines per second, a range of positive and negative interfaces, synchronous operation, and capacities up to 32 columns.

And, of course, all these printers are in production and are available for immediate delivery.

For more information about these MDS/Franklin digital printers, or about special printers like airline ticket printers, boarding pass printers, and card serial printers, call your nearest MDS salesman.

Mohawk Data Sciences Corp.  
King of Prussia, Pa.



# MAKING THE BEST OVEN MADE EVEN BETTER WASN'T EASY

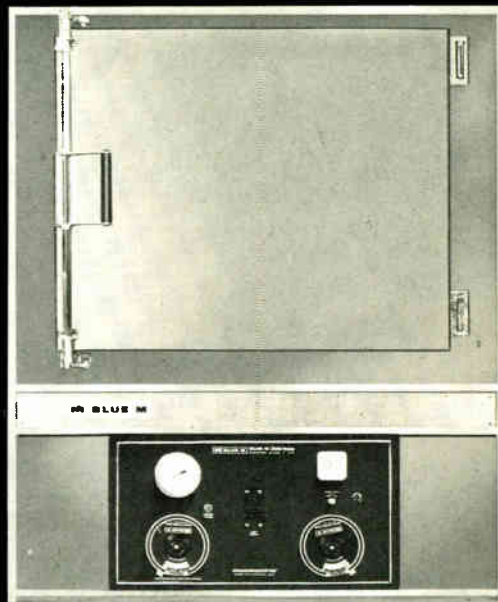

## (BUT WE DID)

We began by taking our most popular reactor-controlled mechanical convection ovens — already accepted as *the* standard for quality and performance — and scrapping them. Then using their best features and starting from the ground up, we took proven design concepts and re-engineered them into radically superior ovens we call the Incomparables. For performance, reliability and appearance they out-class any other oven of their kind on the market. Here's why:

They feature the patented POWER-O-MATIC 60® Saturable Reactor Proportioning Control. Acknowledged as the ultimate in simplicity and reliability, it provides true straight-line, infinitely proportional performance. Control accuracy is  $\pm 0.5^\circ\text{C}$ . . . . setability is  $\pm 1.0^\circ\text{C}$ . . . . repeatability is  $\pm 0.5^\circ\text{C}$ .

We simplified operation and service, too. The control

panel and vital control components are mounted on a special sliding drawer. A gentle pull, and you have immediate and complete access to any part that may require inspection. New panel design features large, easy-to-read instruments to avoid operator confusion. And, of course, we kept Blue M's traditional quality construction.

Finally, we re-styled these ovens completely. Beauty doesn't improve performance, we admit, but these units now complement any modern laboratory or production department.

They come with choice of  $+204^\circ\text{C}$ . or  $+343^\circ\text{C}$ . ranges . . . in 15 models . . . 5 sizes . . . bench (illustrated) and floor styles. We have a new brochure describing them in detail. Why not write: *Blue M Electric Company, Corporate Headquarters: Blue Island, Illinois 60406.*



## Features

### Probing the News

- 121 **Medical electronics:** Biomedical gear gets a watchdog
- 125 **Government electronics:** Postal automation outlook brightens
- 129 **Manpower:** Women in engineering
- 133 **Environmental electronics:** Fumes don't faze New York network
- 136 **Communications:** Low-cost voice digitizer push is on

### U.S. Reports

- 45 **Communications:** U.S. to seek world spectrum compromise
- 46 **Communications:** Technology seen solution to political snarls
- 46 **Communications:** AT&T digital net draws caustic comments
- 47 **Integrated electronics:** Hybrid circuit packs power
- 48 **Military electronics:** Foreign sales sought for Tacfire
- 50 **Management:** Power struggle at Fairchild
- 52 **Management:** Riley feels Signetics is too big
- 52 **Computers:** Designing in-house means compact machine
- 55 **Companies:** What's ahead for Honeywell
- 56 **Avionics:** Time, money pinch means end of AIM-82
- 60 **For the record**

### Electronics International

- 203 **Great Britain:** Avionics in flight at Farnborough
- 204 **Canada:** Airborne digital computer
- 204 **Italy:** Artificial leg controlled by electronics
- 205 **Japan:** Varying radar bandwidth
- 206 **Great Britain:** Thin silicon makes diode encoder

### New Products

- 145 **In the spotlight**
- 145 A 2,000-word voice-response system
- 149 Probe station troubleshoots ICs
- 155 **Subassemblies review**
- 155 Color video recorder is portable
- 160 D-a converter fits in flat pack
- 162 High-gain silicon-target tube
- 167 **Data handling review**
- 167 Memory is medium fast
- 171 **Packaging and production review**
- 171 Modules simplify IC testing
- 174 Computer directs core checkouts
- 178 Backplane handles 101 IC sockets
- 180 **Semiconductor review**
- 180 25 MHz C/MOS shift register
- 184 Multiplexer also counts, decodes
- 188 **New Materials**

Title R registered U.S. Patent Office: © copyright 1970 by McGraw-Hill Inc. All rights reserved, including the right to reproduce the contents of this publication in whole or in part.

## Articles

- Computers 78** **Three-state switching brings wired OR to TTL**  
Switch that removes base drive from both transistors in push-pull output permits wired-OR configuration, thus bringing TTL advantages to bus-organized computers  
John Sheets, National Semiconductor Corp.

- Special report 85** **Electronics views the spectacular Japanese market**  
Four-page gatefold lists Japanese equipment and components markets and production estimates

- 89 **Consumer electronics market still the strongest in Japan**  
Defense, space take back seat; desk calculators and other new products, as well as computers, communications and industrial sales fuel fast growth  
Arthur Erikson  
Managing editor, international  
Charles Cohen, Tokyo bureau

- Circuit design 101** **Designer's casebook**
  - Control voltage resets logic at power turn-on
  - Shared one-shot simplifies pulse width converter
  - Diodes prevent power loss and burnout in converters

- Instrumentation 105** **Saturating operational amplifiers add up to simple way to compress ac signals over many decades**  
Melvyn G. Morris  
National Semiconductor Corp.

- Components 108** **Sequential contacting extends range of variable capacitor**  
Dielectric problems in earlier approaches are circumvented by rotor linking many fixed metal islands in compact thick film device with capacitance range of 3,000:1  
John Fabricius and John Maher  
Sprague Electric Co.

## Departments

- |    |                          |     |                          |
|----|--------------------------|-----|--------------------------|
| 4  | Readers Comments         | 47  | Index of Activity        |
| 9  | Who's Who in this issue  | 67  | Washington Newsletter    |
| 12 | Who's Who in electronics | 192 | New Books                |
| 22 | Meetings                 | 194 | Technical Abstracts      |
| 33 | Electronics Newsletter   | 199 | New Literature           |
|    |                          | 201 | International Newsletter |

# Electronics

EDITOR-IN-CHIEF: Kemp Anderson

EXECUTIVE EDITOR: Samuel Weber

MANAGING EDITORS: Robert Henkel, News;  
Arthur Erikson, International

SENIOR EDITORS: H. Thomas Maguire,  
Stephen E. Scrupski

ASSOCIATE EDITORS: William Bucci, Richard  
Gundlach, John Johnsrud, Howard Wolff

## DEPARTMENT EDITORS

*Advanced Technology:* Laurence Altman;  
*Communications & Microwave:* Leon M. Magill;  
*Components:* Joseph Mittleman; *Computers:*  
Wallace B. Riley; *Consumer:* Gerald M. Walker;  
*Industrial Electronics:* Alfred Rosenblatt;  
*Instrumentation:* Owen Doyle; *Military/  
Aerospace:* Herman Lowenhar; *New  
Products:* H. Thomas Maguire (Mgr.),  
William P. O'Brien, George Weiss; *Packaging  
& Production:* Stephen E. Scrupski;  
*Solid State:* George F. Watson

COPY EDITORS: William S. Weiss, Chief;  
Margaret Eastman, Edward Flinn

ART: Fred Sklenar, Director  
Charles D. Ciatto, Assistant Director

PRODUCTION EDITORS: Susan Hurlburt,  
Arthur C. Miller

EDITORIAL SECRETARIES: Barbara  
DiBenedetto, Claire Goodlin, Vickie Green,  
Terri O'Neill, Bernice Pawlak, Patricia Ritter

## FIELD EDITORS

*Boston:* James Brinton (Mgr.), Gail Farrell;  
*Los Angeles:* Lawrence Curran (Mgr.);  
*New York:* Peter Schuyten (Mgr.); *San  
Francisco:* Stephen Wm. Fields (Mgr.);  
*Marilyn Howey;* *Washington:* Ray Connolly  
(Mgr.), Jim Hardcastle, Lois Vermillion;  
*Frankfurt:* John Gosch; *London:* Michael  
Payne; *Paris:* Arthur Erikson; *Tokyo:*  
Charles Cohen

## McGRAW-HILL WORLD NEWS

*Director:* Walter A. Stanbury; *Atlanta:* Fran  
Ridgway; *Chicago:* Robert E. Lee; *Cleveland:*  
Arthur Zimmerman; *Dallas:* Marvin Reid;  
*Detroit:* James Wargo; *Los Angeles:* Michael  
Murphy; *San Francisco:* Margaret Drossel,  
Tyler Marshall; *Seattle:* Ray Bloomberg;  
*Washington:* Charles Gardner, James Canan,  
Herbert W. Cheshire, Seth Payne, Warren  
Burkett, William D. Hickman; *Bonn:* Robert F.  
Ingersoll; *Brussels:* James Smith; *London:*  
Marvin Petal; *Milan:* Jack Star; *Moscow:*  
Axel Krause; *Paris:* Robert E. Farrell, Stewart  
Toy; *Tokyo:* Mike Mealey

PUBLISHER: Dan McMillan

ASSISTANT TO THE PUBLISHER: Wallace  
Carmichael

PLANNING & DEVELOPMENT MANAGER:  
Donald Christiansen

ADVERTISING SALES MANAGER: Pierre Braudé

CIRCULATION MANAGER: John D. Drummond

RESEARCH MANAGER: David Strassler

PROMOTION MANAGER: Tomlinson Howland

ADVERTISING SALES SERVICE MANAGER:  
Wallis Clarke

## Readers Comment

### Working prototype

To the Editor:

I would like to correct your comment that Hughes has yet to develop a working H4400 prototype computer [Aug. 3, p. 25]. A prototype does exist consisting of two arithmetic and control processors, two input-output processors, and 64 kilobits of memory. It has been functional for several months, and it is now undergoing software testing of the operating system, Meta assembler, and diagnostics.

E.S. Richards

Hughes Aircraft Co.  
Fullerton, Calif.

### Solid state triplers

To the Editor:

In your special report on consumer hazards [Aug. 3, p. 62], the portion dealing with the solid state tripler-rectifier-regulator is not complete. Without taking away any credit due Sylvania and Varo, the implication that the solid state approach to the problem has been their's alone is not correct. Among the U.S. manufacturers of TV sets, RCA, Zenith, and Warwick are producing chassis equipped with solid state triplers, and we are certain others are experimenting with, if not already using, these triplers. In Europe practically all color sets produced there have a solid state high voltage supply. This is not surprising because the solid state approach is the logical one, besides being "somewhat more elegant."

Although most of the initial work on developing a tripler for the high voltage supply in color TV sets has

been done in Europe using selenium devices, a number of domestic producers, besides Varo, have developed and marketed these devices: Electronic Devices Inc., General Instrument, and Scientific Components Inc., among others.

Among the foreign suppliers, AEG Telefunken, Siemens, and ITT's subsidiary SEL have available either ready-built selenium triplers or building blocks for these units.

Igor Yurevitch  
Interman Industrial Products Ltd.  
Garden City, N.Y.

### In figures

To the Editor:

I have a couple of corrections to add to my article [Aug. 17, p. 92]. In the figure on page 95, upper left,  $R_x$  should be 8.3 k $\Omega$  instead of 9.3 k $\Omega$  to let  $I_1 = 1$  mA. Also in the figure on page 95, lower left, upper portion, the pnp transistor which has  $R_x$  connected to it should have a collector-base short.

Michael J. Callahan Jr.  
Semiconductor division  
Texas Instruments  
Dallas

### Wrong connection

To the Editor:

In the schematic which appeared in Designer's casebook [Aug. 17, p. 90], the 25  $\mu$ F capacitor that was shown connected between pin 7 and 8 of the comparator should have been connected from pin 8 to ground. Also the maximum frequency of operation is approximately 4 MHz.

Eric C. Breeze  
Fairchild Semiconductor  
Mountain View, Calif.

September 14, 1970 Volume No. 43, Number 19—89,487 copies of this issue printed

Published every other Monday by McGraw-Hill, Inc. Founder: James H. McGraw 1860-1948. Publication office 330 West 42nd N.Y., N.Y. 10036; second class postage paid at New York, N.Y. and additional mailing offices.

Executive, editorial, circulation and advertising addresses: Electronics, McGraw-Hill Building, 330 W. 42nd Street, New York, N.Y. 10036. Telephone (212) 971-3333. Teletype TWX N. Y. 710-581-4235. Cable address: MCGRAW HILL N. Y.

Subscriptions limited to persons with active, professional, functional responsibility in electronics technology. Publisher reserves the right to reject non-qualified requests. No subscriptions accepted without complete identification of subscriber name, title or job function, company or organization, including product manufactured or services performed. Subscription rates: qualified subscribers in the United States and possessions and Canada, \$8.00 one year, \$12.00 two years, \$16.00 three years; all other countries \$25.00 one year. Limited quota of subscriptions available at higher-than-basic rate for persons outside of field served, as follows: U.S. and possessions and Canada, \$25.00 one year; all other countries \$50.00. Air freight service to Japan \$60.00 one year, including prepaid postage. Single copies: United States and possessions and Canada, \$1.00; all other countries, \$1.75.

Officers of McGraw-Hill Publications Company: Joseph H. Allen, President; John R. Emery, J. Elton

Tuohig, Senior Vice Presidents; Donald B. Gridley, Group Vice President; Vice Presidents: Ralph Blackburn, Circulation; John R. Callahan, Editorial; William P. Giglio, Administration; David G. Jensen, Manufacturing; Jerome D. Luntz, Planning & Development; Joseph C. Page, Marketing; Robert M. Wilhelm, Finance.

Officers of the Corporation: Shelton Fisher, President and Chief Executive Officer; John J. Cooke, Senior Vice President and Secretary; Gordon W. McKinley, Vice President and Treasurer.

Title  $\text{\textcircled{c}}$  registered in U.S. Patent Office:  $\text{\textcircled{c}}$  Copyright 1970 by McGraw-Hill Inc. All rights reserved. The contents of this publication may not be reproduced either in whole or in part without the consent of copyright owner.

Subscribers: The publisher, upon written request to our New York office from any subscriber, agrees to refund that part of the subscription price applying to copies not yet mailed. Please send change of address notices or complaints to Fulfillment Manager; subscription orders to Circulation Manager. Electronics at address below. Change of address notices should provide old as well as new addresses, including postal zip code number. If possible, attach address label from recent issue. Allow one month for change to become effective.

Postmaster: Please send form 3579 to Fulfillment Manager, Electronics, P.O. Box 430, Hightstown, N.J. 08520.

# PETP FILM CAPACITORS



# SIZE & COST:

# NO BIG THING.

EASIER THAN EVER TO FIT  
YOUR BOARD & BUDGET.

BROAD LINE GETS BROADER.  
8 LOWER CAPACITANCE VALUES  
(100 pF thru 390 pF @ 200 V).

Type 192P Pacer® Polyester Film Capacitors are mass-produced to beat the space/cost squeeze in commercial and industrial applications. Extended-foil PETP film sections with metal end caps provide best possible non-inductive construction. End caps also act as moisture barriers. Ideal for automatic insertion on printed wiring boards. Expanded line includes capacitance values from 100 pF to .47  $\mu$ F. Voltage range, 80 to 600vdc. Write for Bulletin 2066C.

Technical Literature Service  
Sprague Electric Company  
35 Marshall Street  
North Adams, Mass. 01247

**SPRAGUE®**  
THE MARK OF RELIABILITY

45M-0143

**THE BROAD-LINE PRODUCER OF ELECTRONIC PARTS**



**4 A Power** — 1,000 Minimum Gain at 1.5 A  
Now In Economizing,  
Simplifying TO-3 Complements!

- MJ4000/4010 Series
- 60, 80 V Sustaining Voltage
- 75 W Power-Handling
- The Pair For \$3.20



**5 A Power** — 1,000 Minimum Gain at 3 A  
Now In 5 A,  
High-Gain Metal Complements!

- MJ900/1000 Series
- 60, 80 V Sustaining Voltage
- 3 A-at-30 V Safe Operating Area
- The Pair For \$3.85

# Power Darlington

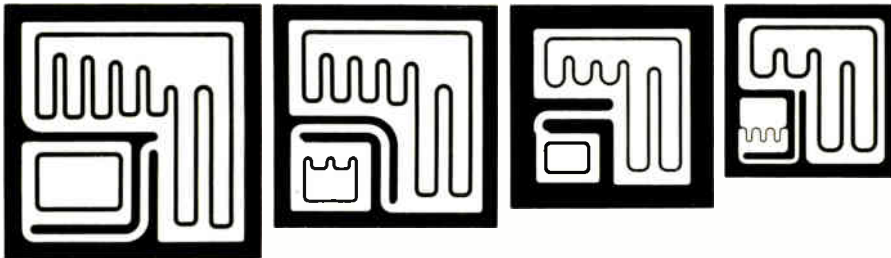

NOW there's more new power darlington transistors that promise to forever eliminate conventional, silicon power circuits requiring separate, "one-for-one" driver and output transistors and associated emitter-base resistors... NOW there's five new, first-of-their-kind, series from 5 A to 16 A that let you design revolutionary new levels of efficiency, simplicity and cost-savings into most any of your relay and solenoid drivers, audio amplifiers, power supply regulators, servo amplifiers and series pass regulators!

NOW you can:

**Up op amp power** — no separate, dis-

crete drivers needed... it's all there on one monolithic, EpiBase\* power chip: driver transistor, output device and base-emitter resistors.

**Compress your costs** — Cut space and heat sinking needs, assembly time and components because the driver is now on the same heat sink as the output unit. Reliability rises, too.

**Innovate with IC's** — Drive the darlings with power levels derived from integrated circuit logic gates. Go from milliamperes to amperes directly, compatibly, easily.

**Obtain 1,000 dc gain** — Design min-

imums of 1,000—and typicals of 2,500... into your state-of-the-art commercial/ industrial equipment!

**Put in either polarity** — they're all complementary! You can positive or ground-connect and use them as direct-coupled pairs in audio amps.

**Perform with package variety** — Metal or plastic... you have your choice of two optimized, standard packages for the exact degree of cost/performance you need.

NOW there's every reason to take another look at new and existing designs that demand unequalled power device performance and a minimum of components and costs.

Break with the past — contact your franchised Motorola distributor about evaluating any of these 28 revolutionary new devices or the factory for production quantities.

Tomorrow's new world of silicon power darlington is here for you today!

\*Trademark Motorola Inc.

All prices shown are 100-up for 60 V, NPN/ PNP complementary pairs; individual darlings are substantially less in 100-up quantities.



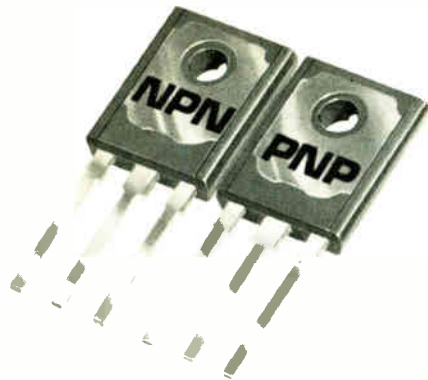

**5 A Power** — 750 Minimum Gain at 3 or 4 A  
Now In Cost-Cutting,  
70 W Plastic Complements!

- MJE1090/1100 Series
- 60, 80 V Sustaining Voltage
- 2 A-at-30 V Safe Operating Area
- The Pair For \$3.45



**10 A Power** — 1,000 Minimum Gain at 5 A  
Now In Time-Saving,  
Medium-Power Complements!

- MJ2500/3000 Series
- 60, 80 V Sustaining Voltage
- 5 A-at-30 V Safe Operating Area
- The Pair For \$6.70



**16 A Power** — 1,000 Minimum Gain at 10 A  
Now In High-Performing,  
100 V Complements!

- MJ4030/4033 Series
- 60, 80 & 100 V Sustaining Voltage
- 150 W Power-Handling
- The Pair For \$8.50

# Revolution Goes On

**How To Revolutionize With Complementary Power...** Circuit and performance information are provided in a fresh new application note to help you on the way to designing 15 to 60 W amplifiers using the power darlington devices. Write Motorola Semiconductor Products, Inc., Box 20912, Phoenix 85036 for your copy of AN483A and data sheets on these state-of-the-art silicon power innovations today!

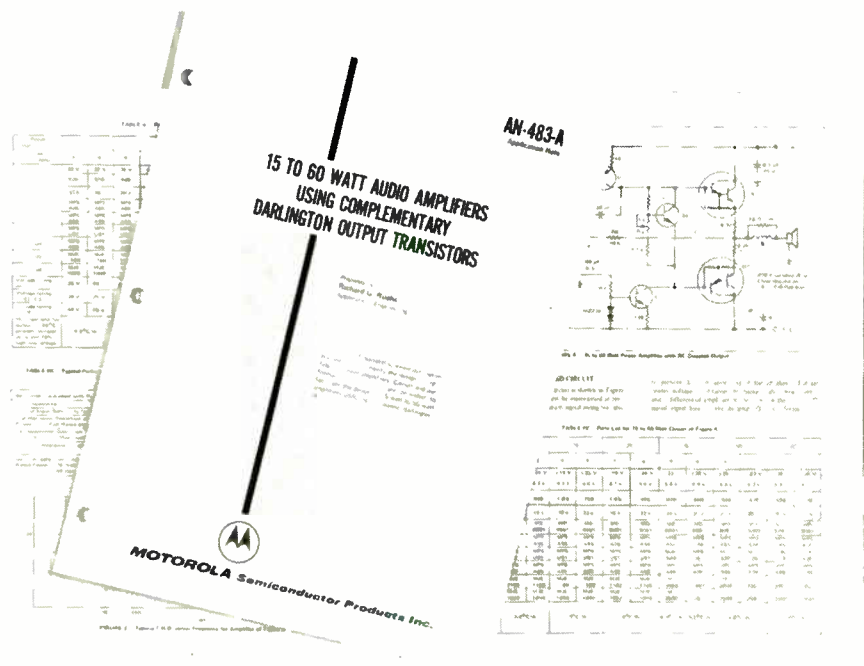

**MOTOROLA POWER**  
—where the priceless ingredient is care!

We deliberately designed the new Wang 100 electronic printing calculator to have a dual personality. And for good reason. The simple fact is your work is getting more complex. These days, in addition to your own discipline, you have to be disciplined with dollars and cents figures. Bidding, budgeting, funding and estimating are just some of the business things you may have to do.

The Wang 100 is both a scientific calculator and a business machine in one unit. So when you want to turn businessman, all it takes is a key stroke instead of a trip to a separate adding machine or calculator. And the 100 has enough capacity so you don't have to leave it when you want to do side calculations. You can get up to 14 registers . . . 14 calculators in this one unit!

The Wang 100 has some other interesting facets. Like programming ability and the

neat little trick of being able to drop decimal places from the right so you always have the 12 most significant digits.

As you can see, we gave the 100 a split personality so you wouldn't have to have one.

For a demonstration of the Wang 100 at your desk, call any one of our factory sales/service offices from coast to coast. Wang Laboratories, Inc., Dept. E-9, 836 North Street, Tewksbury, Mass. 01876. Tel. (617) 851-7311.

# The schizoid calculator



# Who's Who in this issue



Cohen



Erikson

The inscrutable East becomes scrutable in the hands of Arthur Erikson and Charles Cohen, authors of the article on Japan that starts on page 85. Paris-based Erikson, international managing editor, recently

toured the U.S., Vietnam, and Japan, where he joined Cohen to gather inputs. Cohen, Tokyo bureau chief, is fluent in Japanese and holds an MA from the University of Tokyo.

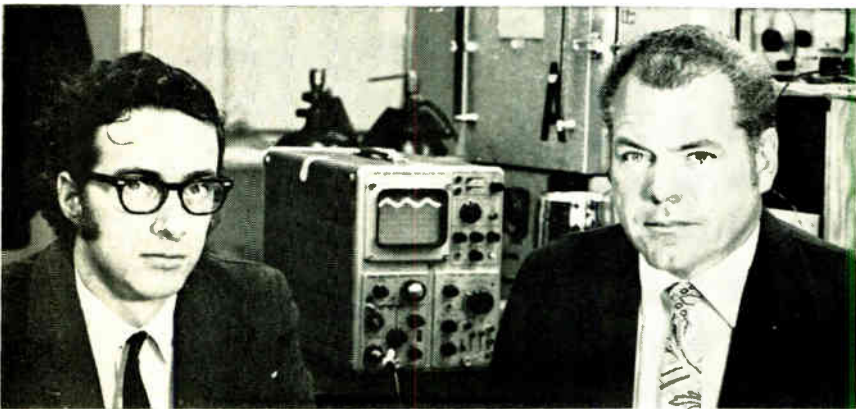

Maher

Fabricius

Experts in ceramic technology and thick and thin film electronics were behind the variable capacitor described in the article starting on page 108. Authors John H. Fab-

ricius and John P. Maher both work for Sprague Electric Co., where Fabricius heads ceramic product development and Maher is with the new ceramic products group.



Morris

Not all valuable circuit designs are developed by laboratory staffs. A man on the road, Melvyn G. Morris, designed the logarithmic amplifier described in the article that starts on page 105. Morris holds a BSEE degree from Northeastern University. At National Semiconductor Corp. he works as a field applications engineer, covering the New England area.

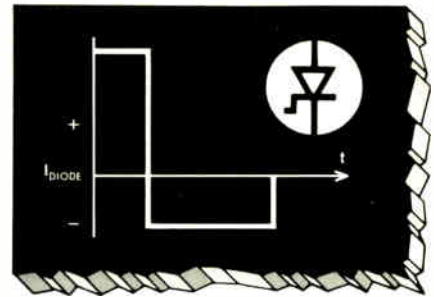

# PULSE SNAP DIODE

**Problem:** You need to sharpen a high amplitude pulse to picosecond speeds.

**Solution:** The Siliconix PSD. Here's a typical application, a pulse sharpener:

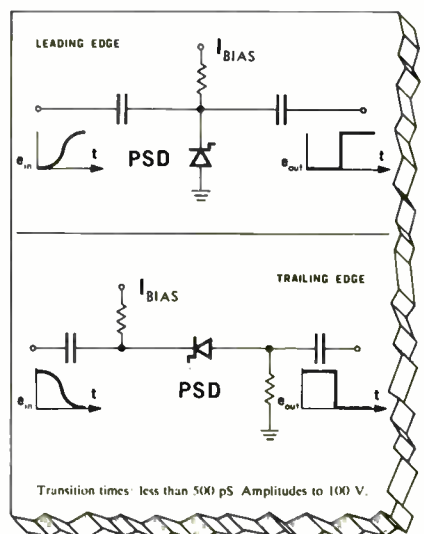

Use the PSD for pulse squaring, delaying, area limiting and other applications, too.

Write for instant data and applications information.

**Siliconix**  
incorporated

2201 Laurelwood Rd. • Santa Clara, Calif. 95054  
(408) 246-8000 Ext. 201 • TWX: 910-338-0227  
In Europe: Siliconix Limited, Saunders Way, Sketty, Swansea, Great Britain

**ON SEPTEMBER 1, THE FOLLOWING LETTER WAS RECEIVED  
BY MR. JOE VAN POPPELEN, DIVISION GENERAL MANAGER  
OF FAIRCHILD SEMICONDUCTOR:**



MOLLY SINCERE, PRESIDENT AND FOUNDRRESS, SINCERE TRANSISTOR & DIODE CO, 2113 Fairchild Dr., Mountain View, Calif. 94040

Dear Joe,  
I've done my job. I've reminded your people at Fairchild how to treat every customer -- big or small, IC or discrete -- like a big shot. (What more can a person do?)  
Now it's time you should get the credit. Now, Fairchild should be as well liked as Sincere.  
So, take it away, Fairchild.  
Good luck and don't forget to write home once in a while.

Molly

P.S. Take good care of my boys!



FAIRCHILD SEMICONDUCTOR, 313 Fairchild Drive, Mountain View, California 94040

# This digital L-C Meter pays for itself!



Priced at only \$550, Systron-Donner's unique digital L-C meter can pay for itself in 60 days. That's because its automatic digital readout saves hours of measuring time. Model 9400 measures inductance from 0.1  $\mu$ H to 100 mH and capacitance from 0.1 pF to 100  $\mu$ F with an accuracy of  $\pm 1\%$ . BCD systems interface is standard.

Applications? Incoming inspection, production testing, component identification, general lab use—to name a few.

Once you use this digital L-C meter you'll swear by it. **So take us up on this offer:**

Yes, I'd like to try your L-C meter for 10 days at no cost or obligation.

Name \_\_\_\_\_

Company \_\_\_\_\_

Street \_\_\_\_\_

City \_\_\_\_\_

State \_\_\_\_\_

Zip \_\_\_\_\_

Phone \_\_\_\_\_

For literature, contact Concord Instruments Division, 888 Galindo St., Concord, CA 94520. Phone (415) 682-6161.



**SYSTRON-DONNER**

## Who's Who in this issue



Minor

The view of life that "most of us take it too seriously" is one you might expect from a native son of Kentucky, home of fleet thoroughbreds, smooth bourbon, and blue grass. It is clearly a view that has served John W. Minor well in his 17-year progression through the ranks of Honeywell's engineering management to become director of the Aerospace division's guidance and navigation products.

"Bad decisions are made when people are under stress," contends the stocky, 44-year-old in the soft accents of his native state. Thus he defines part of his management role as protecting his staff from unnecessary stress in order to preclude bad decisions. It is a function he believes he can perform and still remain "comfortable in my job." Without that satisfaction, he says earnestly, "I'd just as soon become a beachcomber."

Even though Minor's assignment at Honeywell's St. Petersburg, Fla., operation is a choice location for beachcombing, it is unlikely that the man will ever exercise the option. His involvement in guidance and navigation is deep. A recognized authority in the field, he is a

strong proponent of strapdown inertial guidance for military and space systems. Compared with conventional inertial systems, which can cost in the vicinity of \$100,000, Minor says strapdown guidance can achieve comparable performance at costs as low as \$15,000 to \$20,000 each.

With Honeywell he has managed development of a family of strapdown systems, including the H-404, which guided the Air Force Prime reentry vehicle in 1966; the H-408, first system to undergo a high-speed sled test, and the H-429, first system to complete successfully an aircraft flight test. Other assignments include roles as senior system and project engineer on the Air Force's Dyna-Soar system before its cancellation.

For the future, Honeywell's effort as supplier of inertial guidance components for the Navy's sub-launched Poseidon missile bodes well for John Minor's men should the service proceed with development of either the Underseas Long-Range Missile System (ULMS) or the seaborne variation of the Army's Antiballistic Missile System, known as Sabmis.

"I'm an eternal optimist; I know this place is going to go like crazy." So says Leo J. Chamberlain, recently appointed executive vice president of Time/Data Corp. in Palo Alto, Calif., a manufacturer of real time systems. Chamberlain came to Time/Data when it was acquired by General Radio last March, and much of his present optimism derives from what he sees as an ideal marriage for the two companies.

"GR had been in the analog signal processing business for 50 years," he notes, "and wanted to develop a digital signal processing capability. Time/Data was working on its second-generation digital signal processor, but had run into financial problems due to the time lapse between its first and second-generation products." As a result of the acquisition agreement, "General Radio now has a product to

Our new line of amplifiers and oscillators are as small as, or smaller than the competition's. But they're a big thing to us because this is the first time we've ever offered them to you. After years of making them for our own use, we decided to make them generally available. And we've formed a new Microwave Products Division just to handle them.

What does this mean to you? It means that you can now buy sub-assemblies from the people who are famous for high quality transistors and diodes. And it means that you're assured of the same high quality, because KMC transistors and diodes are used throughout.

For example. Our RF, IF and wide band amplifiers are ultra-low-noise and cover a frequency range from 2 to 1200 MHz. And our oscillators cover a frequency range from 100 MHz to 18 GHz.

The selection, as you can see, is quite complete, and KMC will further assemble these components into sub-systems (such as receiver front ends).

Of course, there are some of you who'd rather buy our transistors and diodes for in-house assembly. Fine. We have Applications Notes that tell you, in detail, how to fabricate these components.

If you'd like more information — on either the sub-assemblies or the Application Notes — write:



KMC Semiconductor Corporation,  
a subsidiary of Harvard Industries, Inc.  
Parker Rd., Long Valley, N.J. 07853.  
Telephone number, (201) 876-3811.

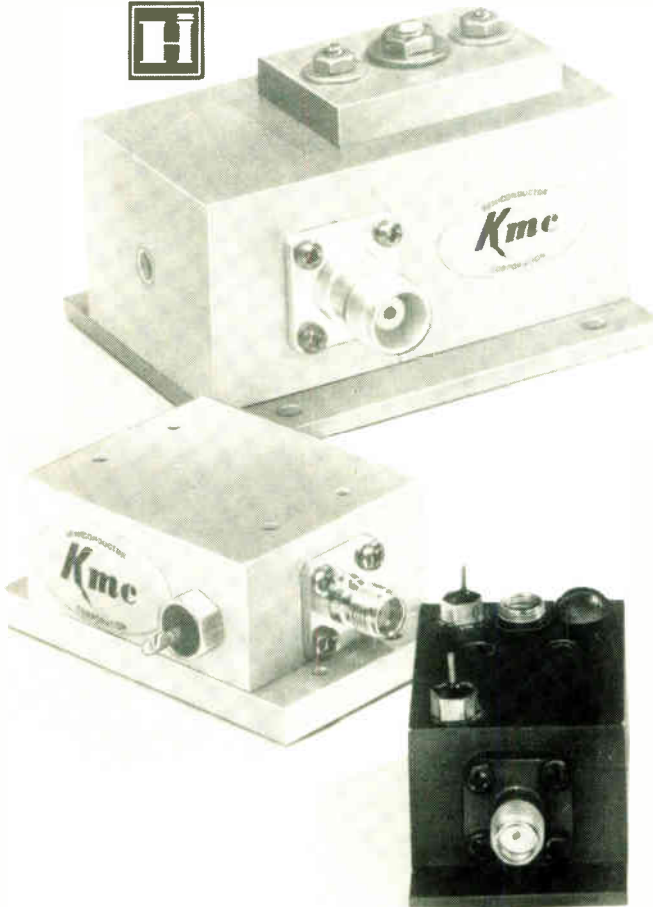

**UNTIL NOW,  
WE'VE NEVER MADE  
A BIG THING  
OUT OF  
KMC TRANSISTORS  
AND DIODES.**

**INTRODUCING  
SOME BIG THINGS.**

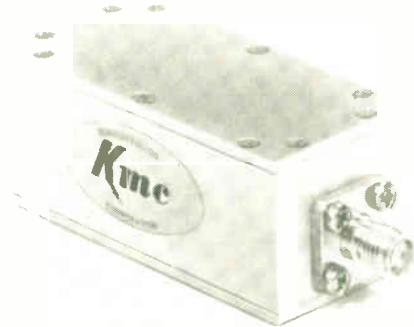

## Who's Who in electronics

market that would have taken another two or three years to develop in-house."

As Chamberlain sees it, there were three areas where Time/Data needed help that General Radio could provide: financial resources, marketing force, and "help in management." The company pumped enough money into Time/Data to move six products onto the market; four months ago Time/Data had only one, the TD 90 data processor. According to Chamberlain, "Time/Data now has the widest line of signal processors in the world." This includes three different versions of the TD 90 and three PDP 11 turnkey signal analysis systems.

Chamberlain, 40, was graduated from Cornell University in 1952 with a BSEE, spent 35 months on a Navy destroyer, and joined General Radio in 1955 as a sales trainee; in 1957 he became a member of the company's New York sales staff. He was sent to Syracuse, N.Y., in 1961 as a general manager to open a new office. In 1964 he became the company's assistant sales manager, moving up to sales manager in 1965. From 1969 to his appointment at Time/Data, Chamberlain served as General Radio's assistant U.S. marketing manager.

In assessing Time/Data's problems, Chamberlain says, "Time/Data never has had sufficient resources to sell a product." To solve that problem, the company now uses General Radio's marketing operation both domestically and abroad. But Chamberlain has more extensive plans for Time/Data's products than just selling them; "We would like to become the IBM of signal processing."

Such ambitions will be fulfilled, Chamberlain predicts, as Time/Data increases its software capabilities. "We are looking for custom software solutions to customer problems," he says. Immediate plans call for processing and consulting services. Already Bay Area companies are coming to Time/Data to make use of existing processing systems. Eventually, says Chamberlain, "We hope to run a mail-order service."

## Get your FREE rectifiers from your authorized GE semiconductor distributor

<p><b>ALABAMA</b></p> <p>Birmingham Forbes Distributing Co. (205) 251-4104</p> <p>Huntsville Cramer/Huntsville, Inc. (205) 536-4493 Electronic Wholesalers, Inc. (205) 534-2461</p> <p><b>ARIZONA</b></p> <p>Phoenix Hamilton/Avnet Electronics (602) 272-2601 Kierulff Electronics, Inc. (602) 273-7331</p> <p><b>ARKANSAS</b></p> <p>Little Rock Carlson-Bates Co. (501) 375-5375</p> <p><b>CALIFORNIA</b></p> <p>Culver City Hamilton Electro Sales (213) 870-3301</p> <p>El Monte C. S. Marshall Company (213) 686-1500</p> <p>Los Angeles Kierulff Electronics, Inc. (213) 685-5511</p> <p>Mountain View Elmar Electronics (415) 961-3611 Hamilton/Avnet Electronics (415) 961-7000</p> <p>Oakland Brii Electronics (415) 834-5888</p> <p>Palo Alto Kierulff Electronics, Inc. (415) 968-6292</p> <p>Riverside Electronic Supply (714) 683-8110</p> <p>San Diego Hamilton/Avnet Electronics (714) 279-2421 Kierulff Electronics, Inc. (714) 278-2122 C. S. Marshall Company (213) 686-1500 Western Radio &amp; TV Supply (714) 239-0361</p> <p><b>COLORADO</b></p> <p>Denver Electronic Parts Co. (303) 266-3755 Hamilton/Avnet Electronics (303) 443-8551 L. B. Walker Radio Co. (303) 935-2401</p> <p><b>CONNECTICUT</b></p> <p>North Haven Cramer/Connecticut (203) 239-5641</p> <p>Norwalk Arrow Electronics (203) 838-4851</p> <p>Waterbury Bond Radio Electronics, Inc. (203) 753-1184</p> <p><b>DELAWARE</b></p> <p>Wilmington Almo Industrial Electronics (302) 656-9467</p> <p><b>FLORIDA</b></p> <p> Ft. Lauderdale Cramer/Florida, Inc. (305) 566-7511</p> <p>Hollywood Schweber Electronics (305) 927-0511</p> <p>Miami Electronic Wholesalers, Inc. (305) 696-1620</p> <p>Orlando Electronic Wholesalers, Inc. (305) 841-1550 Hammond Electronics (305) 241-6601</p> <p><b>GEORGIA</b></p> <p>Atlanta Jackson Electronics Co. (404) 355-2223</p> <p><b>ILLINOIS</b></p> <p>Addison Hamilton/Avnet Electronics (312) 543-8500</p> <p>Chicago Electronic Distributors, Inc. (312) 283-4800 Newark Electronics Corp. (312) 638-4411 Semiconductor Specialists, Inc. (312) 279-1000</p> <p><b>INDIANA</b></p> <p>Evansville Ohio Valley Sound (812) 425-6173</p> <p>Indianapolis Graham Electronics, Inc. (317) 634-8486 Semiconductor Specialists, Inc. (317) 243-8271</p> <p><b>IOWA</b></p> <p>Cedar Rapids Dreco, Inc. (319) 365-7551</p> <p><b>KANSAS</b></p> <p>Wichita Inferstate Electronics Supply Corp. (316) 264-6318</p> <p><b>KENTUCKY</b></p> <p>Louisville P. I. Burks Co. (502) 583-2871</p> <p><b>LOUISIANA</b></p> <p>Lafayette Ralph's of Lafayette (318) 234-4507</p> <p>New Orleans EPCOR (504) 486-7441 Sterling Electronics, Inc. (504) 522-8726</p> <p><b>MAINE</b></p> <p>Portland Holmes Distributors, Inc. (207) 774-5901</p>	<p><b>MARYLAND</b></p> <p>Baltimore Kann-Eliert Electronics, Inc. (301) 889-4242</p> <p>Hanover Hamilton/Avnet Electronics (301) 796-5000</p> <p>Rockville Cramer/Washington, Inc. (301) 424-2700 Schweber Electronics (301) 427-4977</p> <p>Salisbury Almo Industrial Electronics (301) 742-1393</p> <p><b>MASSACHUSETTS</b></p> <p>Dedham Gerber Electronics (617) 329-2400</p> <p>Newton Cramer Electronics, Inc. (617) 969-7700</p> <p>Springfield T. F. Cushing, Inc. (413) 788-7341</p> <p>Waltham Schweber Electronics (617) 891-8484</p> <p><b>MICHIGAN</b></p> <p>Detroit Radio Specialties Co. (313) 491-1012</p> <p>Grand Rapids Newark Industrial Electronics (616) 452-1411</p> <p>Redford Semiconductor Specialists, Inc. (313) 255-0300</p> <p><b>MINNESOTA</b></p> <p>Edina Lew Bonn Company (612) 941-2770</p> <p>Minneapolis Semiconductor Specialists, Inc. (612) 866-3434</p> <p>St. Paul Gopher Electronics Co. (612) 645-0241</p> <p><b>MISSISSIPPI</b></p> <p>Jackson Ellington Electronic Supply, Inc. (601) 355-0561</p> <p><b>MISSOURI</b></p> <p>Kansas City Radio Lab, Inc. (816) 421-0171</p> <p>North Kansas City ECJ Semiconductors, Inc. (816) 421-8400</p> <p>St. Louis Olve Industrial Electronics (314) 863-7800</p> <p><b>NEBRASKA</b></p> <p>Lincoln Scott Electronic Supply Corp. (402) 434-8308</p> <p>Omaha Radio Equipment Co. (402) 341 7700</p> <p><b>NEW JERSEY</b></p> <p>Camden General Radio Supply Co., Inc. (609) 964-8560</p> <p>Cedar Grove Hamilton/Avnet Electronics (201) 239-0800</p> <p>Cherry Hill Hamilton/Avnet Electronics (609) 662-9337</p> <p>Mt. Ephraim Almo Industrial Electronics (609) 933-3800</p> <p>Pensacola Cramer/Pennsylvania, Inc. (215) 923-5950</p> <p>Totowa Arrow Electronics, Inc. (201) 256-7331</p> <p><b>NEW MEXICO</b></p> <p>Albuquerque Newark Electronics, Inc. (505) 268-3901 Sterling Electronics, Inc. (505) 247-2486</p> <p><b>NEW YORK</b></p> <p>Buffalo Standard Electronics, Inc. (716) 685-4320</p> <p>Endicott Standard Electronics, Inc. (607) 754-3102</p> <p>Farmingdale, L. I. Arrow Electronics, Inc. (516) 694-6800</p> <p>Hempstead Cramer-Long Island (516) 231-5600</p> <p>Rochester Cramer/Rochester (716) 275-0300 Rochester Radio Supply Co. (716) 454-7800</p> <p>Rome Rome Electronics, Inc. (315) 337-5400</p> <p>Syracuse Cramer/Syracuse (315) 437-6671</p> <p>Westbury, L. I. Schweber Electronics (516) 334-7474</p> <p>Yorkville Valley Industrial Electronics, Inc. (315) 736-3393</p> <p><b>NORTH CAROLINA</b></p> <p>Charlotte Oxie Radio Supply Co. (704) 377-5413</p> <p>Raleigh Southeastern Radio Supply Co., Inc. (919) 828-2311</p> <p>Winston-Salem Electronic Wholesalers, Inc. (919) 725-8711</p>	<p><b>OHIO</b></p> <p>Akron Sun Radio Co., Inc. (216) 434-2171</p> <p>Cincinnati Hughes-Peters, Inc. (513) 351-2000</p> <p>Cleveland Pioneer-Standard Electronics, Inc. (216) 432-0010</p> <p>Columbus Electronics Marketing Corp. (614) 299-4161 Hughes-Peters, Inc. (614) 294-5351</p> <p>Dayton Pioneer-Dayton (513) 236-9900</p> <p>Toledo Warren Radio Co. (419) 248-3364</p> <p><b>OKLAHOMA</b></p> <p>Oklahoma City Trice Wholesale Electronics (405) 524-4415</p> <p>Tulsa Oil Capitol Electronics Corp. (918) 836-2541</p> <p><b>PENNSYLVANIA</b></p> <p>Philadelphia Almo Electronics Corp. (215) 676-6000</p> <p>Pittsburgh R.P.C. Electronics (412) 782-3770 Semiconductor Specialists, Inc. (412) 781-8120</p> <p>York Rosen Electronics Co. (717) 843-3875</p> <p><b>RHODE ISLAND</b></p> <p>Providence W. H. Edwards Co. (401) 781-8000</p> <p><b>SOUTH CAROLINA</b></p> <p>Columbia Drisie Radio Supply Co., Inc. (803) 253-5333</p> <p>Greenville Dixie Radio Supply Co., Inc. (803) 239-1328</p> <p><b>TENNESSEE</b></p> <p>Chattanooga Harpe Electronic Distributors, Inc. (615) 267-2381</p> <p>Kingsport Radio Electric Supply Co. (615) 247-8111</p> <p>Memphis Bluff City Distributing Co. (901) 276-4501</p> <p>Nashville Electra Distributing Co. (615) 255-8444</p> <p><b>TEXAS</b></p> <p>Dallas Aro Electronics (214) 239-9122 Hamilton/Avnet Electronics (214) 638-0900 Sterling Electronics (214) 357-9131</p> <p>El Paso McNicol, Inc. (915) 566-2936 Midland Specialty Co. (915) 533-9555</p> <p>Houston Hamilton/Avnet Electronics (713) 526-4661 Sterling Electronics (713) 623-6600</p> <p><b>UTAH</b></p> <p>Salt Lake City Kimball Electronics (801) 328-2075</p> <p><b>VIRGINIA</b></p> <p>Charlottesville Virginia Radio Supply Co. (703) 296-4184</p> <p>Richmond Meridian Electronics, Inc. (703) 353-6648</p> <p>Roanoke Peoples Radio &amp; TV Supply Co. (703) 342-8933</p> <p><b>WASHINGTON</b></p> <p>Seattle Almac/Stroum Electronics (206) 763-2300 Hamilton/Avnet Electronics (206) 824-5930 Kierulff Electronics, Inc. (206) 763-1550</p> <p>Tacoma C&amp;G Electronics Co. (206) 627-3185</p> <p><b>WEST VIRGINIA</b></p> <p>Charleston Mountain Electronics (304) 342-8151</p> <p><b>WISCONSIN</b></p> <p>Milwaukee Electronic Expeditors, Inc. (414) 374-6666</p> <p>West Allis Marsh Radio Supply Co. (414) 545-6500</p> <p><b>CANADA</b></p> <p>Toronto Canadian General Electric Co., Ltd. 537-4481</p> <p><b>EXPORT</b></p> <p>IGE Export Division 159 Madison Ave. New York, N. Y. 10016</p>
--	---	--

# GENERAL ELECTRIC

221-29

### FREE RECTIFIER SAMPLES

Present (or mail) this coupon to your authorized GE semiconductor distributor.  
ATTN: INDUSTRIAL SALES MGR. Please furnish up to four free rectifiers shown below.

Circle cat. no. and insert qty. (max. 4)	50V	100V	200V	400V	600V	800V
A14 1-amp	A14F	A14A	1N5059	1N5060	1N5061	1N5062
A15 3-amp	A15F	A15A	1N5624	1N5625	1N5626	
A114 1-amp fast recovery	A114F	A114A	A114B	A114D	A114M	

NAME \_\_\_\_\_ FIRM \_\_\_\_\_  
 POSITION \_\_\_\_\_ STREET \_\_\_\_\_ CITY \_\_\_\_\_  
 STATE \_\_\_\_\_ ZIP \_\_\_\_\_ Distributor Name \_\_\_\_\_

Offer expires October 31, 1970



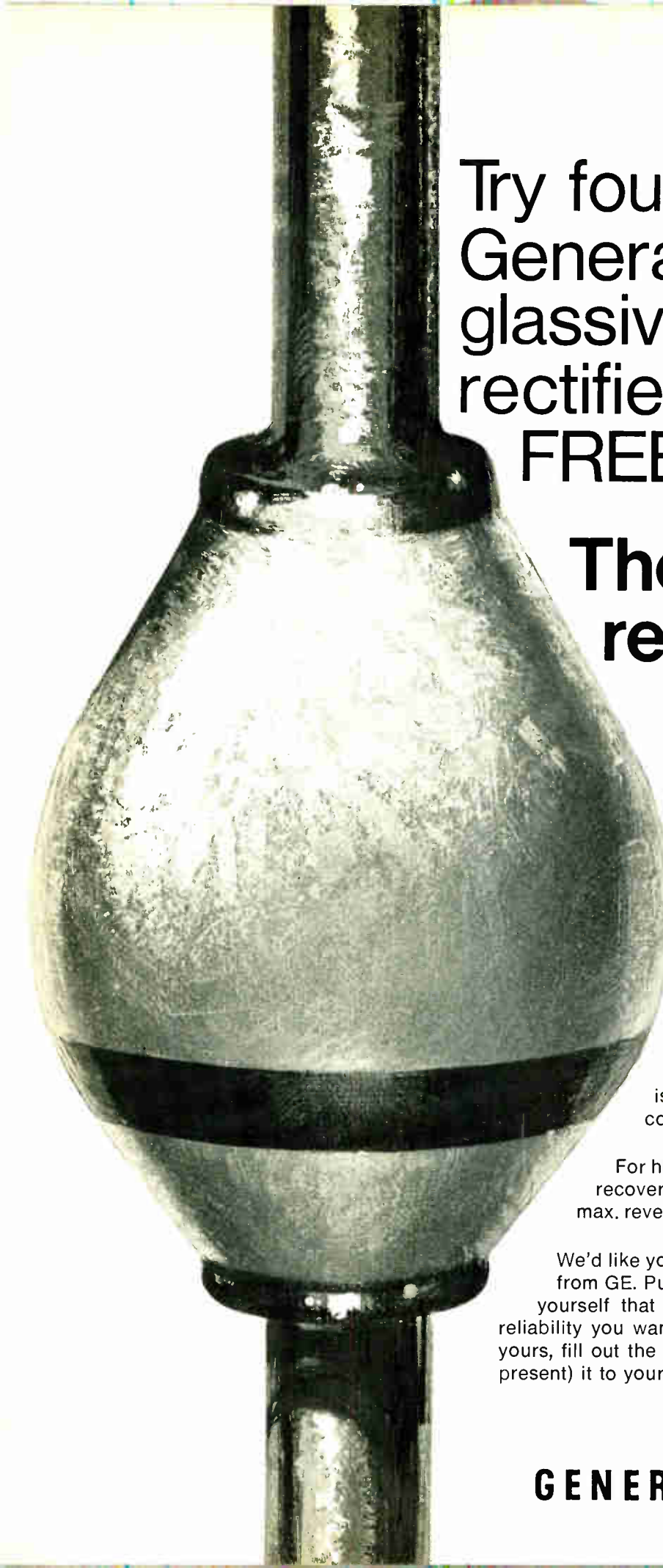

Try four  
General Electric  
glassivated  
rectifiers  
**FREE**

**The reliable  
rectifier**

The best way to assure reliability in a low-current rectifier pellet is to put it in a package that really protects it. Protects it from shock, humidity, vibration and temperature.

And that's just what we do with General Electric's glassivated 1-amp (A14) and 3-amp (A15) rectifiers. Solid glass provides passivation and protection of the silicon pellet's P-N junction—no organic material is present within the hermetically sealed package. In addition, rigid mechanical support and excellent thermal characteristics are provided by the dual heat sink construction.

For high-frequency applications, GE offers a fast-recovery rectifier, the 1-amp A114, with a 200 nsec. max. reverse recovery.

We'd like you to try up to four free glassivated rectifiers from GE. Put them to any test you can think of. See for yourself that GE's A14/A15/A114 rectifiers deliver the reliability you want for your low current application. To get yours, fill out the coupon on the opposite page and mail (or present) it to your authorized GE semiconductor distributor.

220-85

**GENERAL**  **ELECTRIC**

Circle 15 on reader service card

# When you build a product last, you better build it better.

Now, that may sound like sour grapes. So we'll just give you the facts:

All our competitors beat us to market with their industrial/lab supplies. They became entrenched. (Sure, we've pioneered most of the major innovations in the power supply industry—such as our DCR series—but we're not always first.) So before we began our design, we talked with the people who were using these kinds of power supplies. What did they like? What didn't they like? Any changes they'd like to see made? Any features added?

Here are the results:

1. Our new SRL line has a special circuit which allows you to check overvoltage setpoint instantly, and easily change settings without removing the load from the supply.
2. Complete line features new small-sized SRL units available in 14 models in voltage ranges from 0-10 Vdc to 0-60 Vdc and current ranges up to 100 amps.
3. High stability and reliability through use of integrated circuitry.
4. These supplies all feature an adjustable built-in SCR crowbar and adjustable current limiting circuitry as standard.
5. We have the fastest response time over full load range.
6. These supplies give you less than 1 millivolt RMS ripple.

Now, those are just a few of the reasons you may want to consider Sorensen the next time you consider buying industrial/lab power supplies. For more reasons and complete information on these or any of our power supplies (we manufacture and inventory more power supplies than any one else in the world), please call our Applications Engineering Manager, Norbert Laengrich (collect) at (203) 838-6571, or write him at Sorensen, Richards Avenue, Norwalk, Connecticut 06856. He will also send you our 124 page Power Supply Handbook and Catalogue. Or circle 200 on the inquiry card.

**Sorensen**  
**POWER SUPPLIES**

AN OPERATION OF RAYTHEON CO.



Over-Volt. Guard

DIAL NO. 23

**SCEPTOR**

ALL VACUUM TUBE SET

10 AMP. TAP

VOLTAGE

DC AMPERES

DC AMPERES

DC AMPERES

COARSE

ADJUSTMENT

FINE



# Insisting on one brand or the right product?

Most big-name producers have their devout followers. Buyers for whom one particular brand holds a magic personal identification. And we happily confess to having our share of partisan clients.

But chances are you are not familiar with our components. Despite the fact that you're almost certainly within arm's reach of them every day.

This is because our work is carefully concealed. Carefully and precisely concealed inside Japan's record breaking products. From the latest super-tanker to the finest new photographic equipment.

Computers and business machines, automotive products and original equipment.

All being produced with a quality and economy hitherto undreamed of. Due, in strictly small way, to the concealed originality of Japan's largest electrical and electronic components producer. OMRON.

Remember the name, should your present faith ever be shaken.

Components, Control Devices, Systems. An original world of electronics

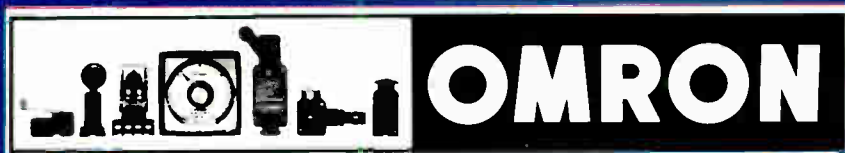

**OMRON TATEISI ELECTRONICS CO.**

**Overseas Dept.**

Toa Bldg., 5, Yonban-cho, Chiyoda-ku, Tokyo, Japan.  
Cable Address: OMRONELCO TOKYO Telex: 232-2179

**U.S. Distributor: SIGMA INSTRUMENTS INC.**

170 Pearl Street, South Braintree Massachusetts 02185 U.S.A.  
Phone: 671-843-5000 Telex: 094-6577



CANADIAN  
MARCONI  
COMPANY

Circle 21 on reader service card

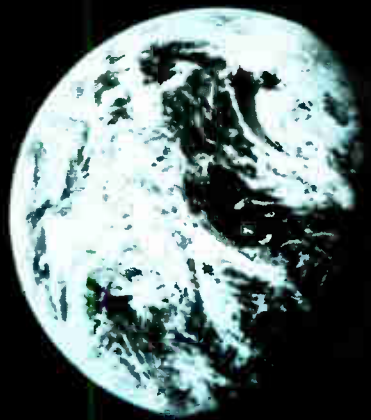

Since 1902,  
we've been reshaping  
the world's  
communications.

We've given the world two-way transatlantic and trans-continental radio broadcasting. We've pioneered the design of wide-band tropospheric scatter communications systems. We've put together the microwave communications and telemetry for Canada's "Mid-Canada Defense Line".

We've spanned Venezuelan jungles with the world's longest line-of-sight radio relay communications path.

We've provided the world's most versatile tactical PCM-on-radio microwave relay system. Canadian Marconi Company has come a long way since introducing wireless in 1902 and...

Now our MCS 6900  
is the shape of  
microwave  
communication systems  
for the future.

MCS 6900 is a complete PCM communications system, capable of voice, data and computer-to-computer transmissions. It costs less than any comparable system — FDM or PCM. Yet it provides communication flexibility never before possible by combining common and line-interface equipment into each channel module. Consequently you can expand your system channel-by-channel to keep pace with expansion needs. You get 100% solid state reliability in a 120 voice-channel system with 5 years MTBF for each channel. Meet all your present and future requirements with MCS 6900... Write now for complete information: Canadian Marconi Company, Telecommunications Division, 2442 Trenton Avenue, Montreal 301, P. O., Canada.

**CANADIAN MARCONI COMPANY**  
TELECOMMUNICATIONS DIVISION



# If you'd like to make your FM radio 20 times smaller, we've got just the filter for you.

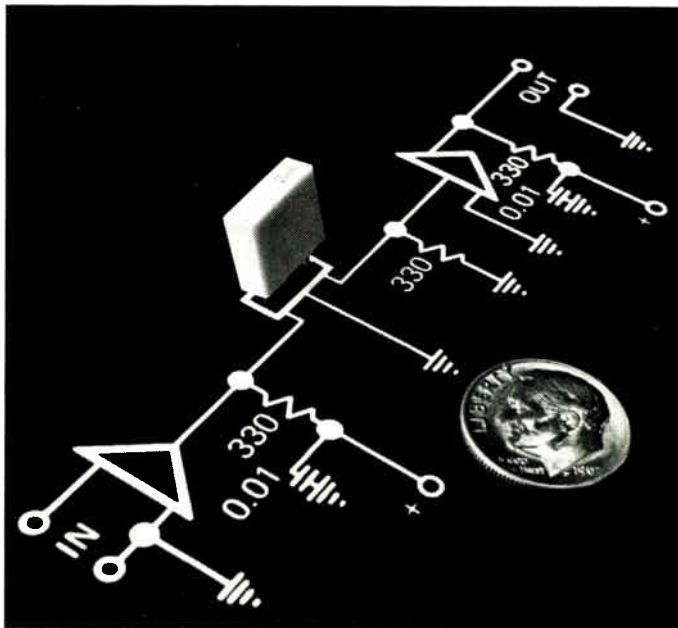

Our new 10.7 megahertz FM filter — the FM-4 — measures only 0.016 cubic inches in volume. But it replaces four tuned circuits more than twenty times its size. Price is competitive with IF cans, and it saves additional dollars by reducing the number of components and interconnections in your IF strip. It's just a sample of what Vernitron can do in piezoelectric filters — in which we've done the lion's share of development.

The FM-4 is based on the coupled-mode monolithic technique developed for our quartz filters. Result is a new level of performance — higher adjacent channel rejection, distortion less than ½ percent, bandwidths characteristically 235 kHz at 3 dB and 825 kHz at 40 dB. Insertion loss about 3.5 dB. It's just a sample of what we can do in piezoelectric filters — in which we've done the lion's share of development.

So, if you're on a size-reduction kick — or a cost reduction kick — our neat little FM-4 is a good place to start. In fact, for high-quality filters for almost any kind of communication equipment — military, commercial or consumer — get in touch.

Vernitron Piezoelectric Division, 232 Forbes Road, Bedford, Ohio 44146. Or: Vernitron (U.K.) Limited, Southampton, England.

 **Vernitron Piezoelectric Division**  
232 Forbes Road / Bedford, Ohio 44146 / (216) 232-8600

## Meetings

### Two for one

Sponsors of this year's International Telemetry Conference believe they've taken a firm step toward eliminating the possible duplication that now exists because there are two telemetry conferences each year. The upcoming international gathering, to be held Oct. 13-15 at the International Hotel, Los Angeles, previously has been sponsored solely by the International Foundation for Telemetry.

This year, however, the Instrument Society of America and the Electronic Industries Association's instrumentation magnetic recording section are cosponsoring the technical conference and exhibit. "It's the first time we've had technical society backing," says general chairman Thomas Eccles, "and we hope to have IEEE backing soon." The IEEE sponsors the "rival" National Telemetry Conference, but Eccles says that one of the foundation's objectives is "to continue to strive for a single, well-organized telemetry conference to serve the telemetry community."

The October gathering will include for the first time a session on magnetic recorders and reproducers, a portion of telemetry that's getting considerable attention because of a desire for instrumentation standardization on the part of the military services and the Interrange Instrumentation Group (IRIG).

Four of 10 sessions have been designated as special because of their timeliness or special nature: "Biomedical Telemetry," "Feedback Communications," "Telemetry in a High-G Environment," and "Apollo Information Systems."

The medical session includes a paper on studies of life before birth by R. Stuart Mackay of the department of surgery at Boston University Medical School. He'll discuss the use of transmitters in fetal animals to relay vector cardiograms and intrauterine pressure. I.S. Scott, a research engineer at the University of Michigan School of



# Allen-Bradley cuts space requirements with new sealed type Z cermet trimmers

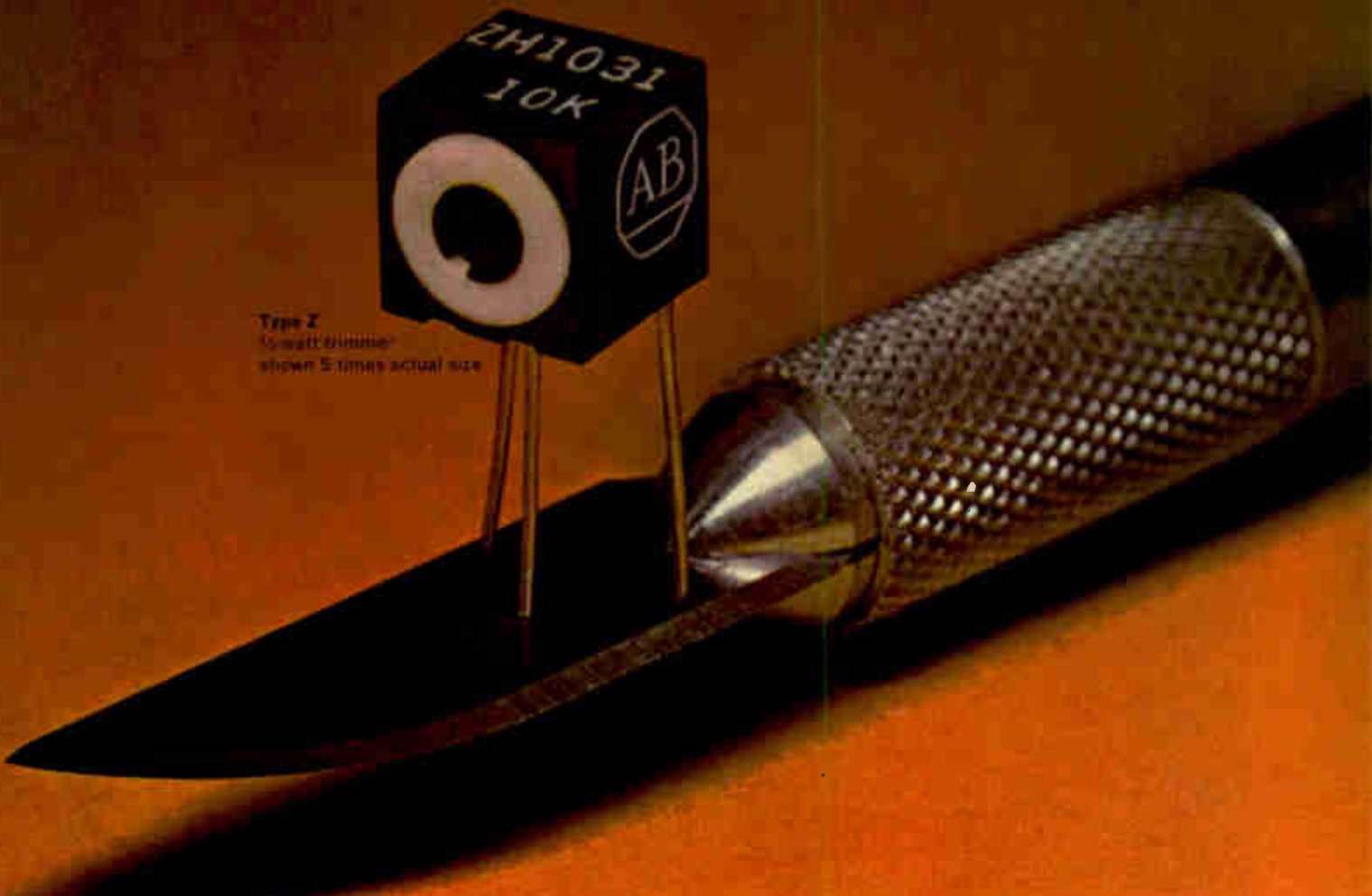

this latest addition to the Allen-Bradley line of cermet trimmers...the type Z...affords high performance in an especially compact package

The cermet material — an exclusive formulation developed by Allen-Bradley — provides superior load life, operating life, and electrical performance. For example, the full load operation ( $\frac{1}{2}$  watt) for 1000 hours at  $70^{\circ}\text{C}$  produces less than 3% total resistance change. And the temperature coefficient is less than  $\pm 250$  PPM/ $^{\circ}\text{C}$  for all resistance values and throughout the complete temperature range ( $-55^{\circ}\text{C}$  to  $+125^{\circ}\text{C}$ ).

The Type Z is ruggedly constructed to withstand shock and vibration. The unique rotor design ensures smooth adjustment and complete stability under severe environments. The leads are permanently anchored and bonded. The connection exceeds the lead strength — opens cannot occur. Leads are weldable.

The enclosure is *SEALED*. It is both dust-tight as well as watertight and can be potted. Mounting pads prevent moisture migration and also post-solder washout. You can get immediate delivery at factory prices from your authorized A-B industrial electronics distributor. Or write: Marketing Dept., Electronics Div., Allen-Bradley Co., 1201 S. Second St., Milwaukee, Wis. 53204. Export Office: 1293 Broad St., Bloomfield, N. J., U. S. A. 07003. In Canada: Allen-Bradley Canada Limited.

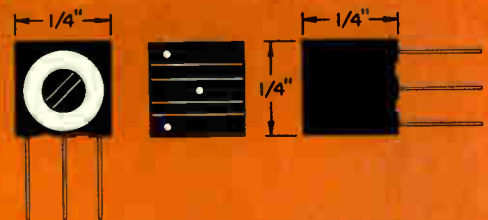

## SPECIFICATIONS SUMMARY

- Adjustment:** Horizontal or vertical.
- Temperature Range:**  $-55^{\circ}\text{C}$  to  $+125^{\circ}\text{C}$ .
- Resistances:** 50 ohms through 1 megohm. Lower resistances available.
- Tolerances:**  $\pm 20\%$  standard,  $\pm 10\%$  available.
- Resolution:** Essentially infinite.
- Rotational Life:** Less than 2% total resistance change after 200 cycles.
- Rotation:**  $300^{\circ}$  single turn.
- End Resistance:** Less than 3 ohms.



**ALLEN-BRADLEY**

QUALITY ELECTRONIC COMPONENTS

# It took a new generation to bridge the gap

## Delevan's Micro-i® Series 155

A new generation of low-cost, miniaturized inductors that is the long-sought transition between discrete and monolithic IC circuits.

### HIGH RELIABILITY AND VERSATILITY

Originally designed to meet the rigorous standards of DOD and NASA specifications, Micro-i Series 155 inductors are perfect for communications applications and the computer field where performance is critical and ownership costs are a consideration. Proven successful for choke and filter applications.

### SUPERIOR FEATURES

Ruggedly constructed with internal connections, thermo-compression bonded for high temperature processing.

RF Inductor Epoxy-molded to meet MIL-C-15305, Rev. D, Grade 1, Class A.

Miniaturization and low profile give improved compatibility with hybrid ICs.

Four separate leads are readily adaptable for solder reflow connections. Eliminates costly body tie-down, reduces lead fatigue caused by vibration and is easily adaptable to tuned circuits by means of outboard chip capacitor.

Write for complete technical data.

**Delevan**  
Division



**AMERICAN  
PRECISION  
INDUSTRIES INC.**

270 QUAKER RD. / EAST AURORA, N. Y. 14052  
TELEPHONE 716/652-3600 TELEEX 091-293

OTHER DIVISIONS OF AMERICAN PRECISION INDUSTRIES INC.: BASCO • DUSTEX •  
MOELLER INSTRUMENT CO. • OXFORD CORP. • TRUCK EQUIPMENT CO.

## Meetings

(Continued from p. 22)

Dentistry, Ann Arbor, will detail intraoral telemetry using a small transmitter to monitor eight physiological parameters that give insight into dental problems.

Two papers in the Apollo information systems session will treat the manned spaceflight network. R.E. Spearing of the Goddard Space Flight Center will show how the unified S-band system has been modified to meet 1970 requirements, and T.C. Underwood, also from Goddard, will cover modifications and procedural changes in the manned spaceflight network telemetry systems to support existing and anticipated requirements.

For further information, contact Thomas Eccles, Microdot Inc., 220 Pasadena Ave., South Pasadena, Calif. 91030.

## Calendar

**Intersociety Energy Conversion Engineering Conference, IEEE;** Frontier Hotel, Las Vegas, Sept. 20-25.

**Conference on Engineering in the Ocean Environment, IEEE;** City Marina Auditorium, Panama City, Fla., Sept. 21-24.

**Conference on Electron Device Techniques, IEEE;** United Engineering Center Auditorium, New York, Sept. 23-24.

**Fall Broadcast Technical Symposium, IEEE,** Washington Hilton, Sept. 23-26.

**Industry & General Application Group Annual Meeting, IEEE;** La Salle Hotel, Chicago, Oct. 5-8.

**Government Microcircuit Applications Conference: GOMAC,** Department of Defense, Army, Navy, Air Force, NASA, Department of Commerce, National Bureau of Standards, Post Office Department; U.S. Electronics Command, Fort Monmouth, N.J., Oct. 6-8.

**Symposium on Microwave Energy,** International Microwave Power Institute, Scheveningen, Holland, Oct. 7-10.

**American Society for Information Science Meeting,** Sheraton Hotel, Philadelphia, Oct. 11-15.

**International Telemetry Conference,** Electronic Industries Association, Instrument Society of America;

(Continued on p. 26)

# Would you believe a 50 MHz pulser from E-H for only \$395?



Here are the facts about GENERATION 70™, a revolutionary new series of test instruments from E-H Research Laboratories, which will offer maximum performance at minimum cost to the user.

The first instrument in the Generation 70 Series is E-H Model G710, a 50 MHz pulse generator for only \$395! That boils down to \$7.90 per MHz! Where else could you get such high performance at such a price? Other features of the Model G710 include dual outputs with amplitudes to 5V into 50 ohms, rise and fall times of 5 ns, duty factor greater than 50%, external triggering and waveform distortion less than

5% peak-to-peak. It weighs 7 lbs. and measures only 3½" x 8½" x 12" in size.

Like all other Generation 70 instruments to come, the Model G710 will also feature no internal adjustments, no special parts (which means replacement parts are available from shelves of local distributors), and no recalibration procedures. Add to all this a One-Year Guarantee of Performance, One-Year Free Service and a price tag of \$395. Unbelievable? E-H believes their new Generation 70 instruments to be so superior that they're offering you a 5-Day Free Trial. So what can you lose? Clip out the coupon below or call your E-H Representative today and order one—or three or four.

## Try us!



## G70 GENERATION

515 11th Street • Box 1289, Oakland, California 94664 • (415) 834-3030

Dear Sir:

- Here is a purchase order. Please ship me \_\_\_\_\_ \$395 Model G710 pulsers for a 5-day free trial.
- Sounds interesting. Please have an E-H Representative contact me.
- I'm still not convinced. Please mail me more information.

Name \_\_\_\_\_ Title \_\_\_\_\_

Company \_\_\_\_\_

Address \_\_\_\_\_ Telephone \_\_\_\_\_

City \_\_\_\_\_ State \_\_\_\_\_ Zip \_\_\_\_\_



## When Captor promises fast delivery, you get the filters on time

RFI/EMC filters from Captor *always* arrive when you need them. No miserable production delays waiting for the missing parts to show. If you've been buying filters somewhere else, chances are you know the feeling. Captor's prices are competitive, their designs match your specs to a "T", and nobody builds in more quality. Their engineers are actually eager to work with you on unique solutions to difficult problems; that's a refreshing change, too. So, if you must have just the right filter design... at a good price... in a precise quantity... on a given day, call on Captor and stop worrying.

 **CAPTOR**  
CORPORATION

Electronics Division

5040 Dixie Highway, Tipp City, Ohio 45371, Phone: (513) 667-8484

## Meetings

(Continued from p. 24)

International Hotel, Los Angeles, Oct. 13-15.

Systems Science and Cybernetics Conference, IEEE; Pittsburgh, Oct. 14-16.

Digital Computer Applications in Engineering Sciences in Turkey, IEEE; Istanbul Technical University, Oct. 14-17.

CAMAC Instrumentation, European Organization for Nuclear Research; Geneva, Switzerland, Oct. 14-16.

## Short courses

Modeling of Industrial Processes for Computer Control, Purdue Laboratory for Applied Industrial Control, Schools of Engineering; Purdue University, Lafayette, Indiana, Oct. 5-14; \$300 fee.

Electro-Optical System Analysis, University of California at Los Angeles; Boelter Hall, Room 4442, Oct. 26-30; \$310 fee.

Process Control, Purdue Laboratory for Applied Industrial Control, Schools of Engineering; Purdue University, Lafayette, Ind., Oct. 26-31; \$175 fee.

## Call for papers

International Symposium on Antennas and Propagation, IEEE; Tohoku University, Sendai, Japan, Sept. 1-3, 1971. Papers should be sent as soon as possible to Dr. K. Nagai, Secretary of the Executive Committee of the Symposium, Denshi-Tsushin-Gakkai, Kikai-Shinko-Kaikan Bldg., Shiba Park 21-1-5, Minatoku, Tokyo, Japan.

International Symposium on Fault-Tolerant Computing, IEEE, Jet Propulsion Laboratory, California Institute of Technology; Huntington-Sheraton Hotel, Pasadena, Calif., March 1-3, 1971. Letters of intent should be sent as soon as possible. Nov. 1 is deadline for submission of papers to Dr. W. C. Carter, IBM T. J. Watson Research Center, P.O. Box 218, Yorktown Heights, N.Y. 10598.

Electronics Components Conference, IEEE, Electronic Industries Association; Statler-Hilton Hotel, Washington, May 10-12, 1971. Nov. 15 is deadline for submission of abstracts to Edward M. Moss, program chairman, Electronic Components Conference, P. R. Mallory and Co., 3029 East Washington St., Indianapolis, Ind. 46206.

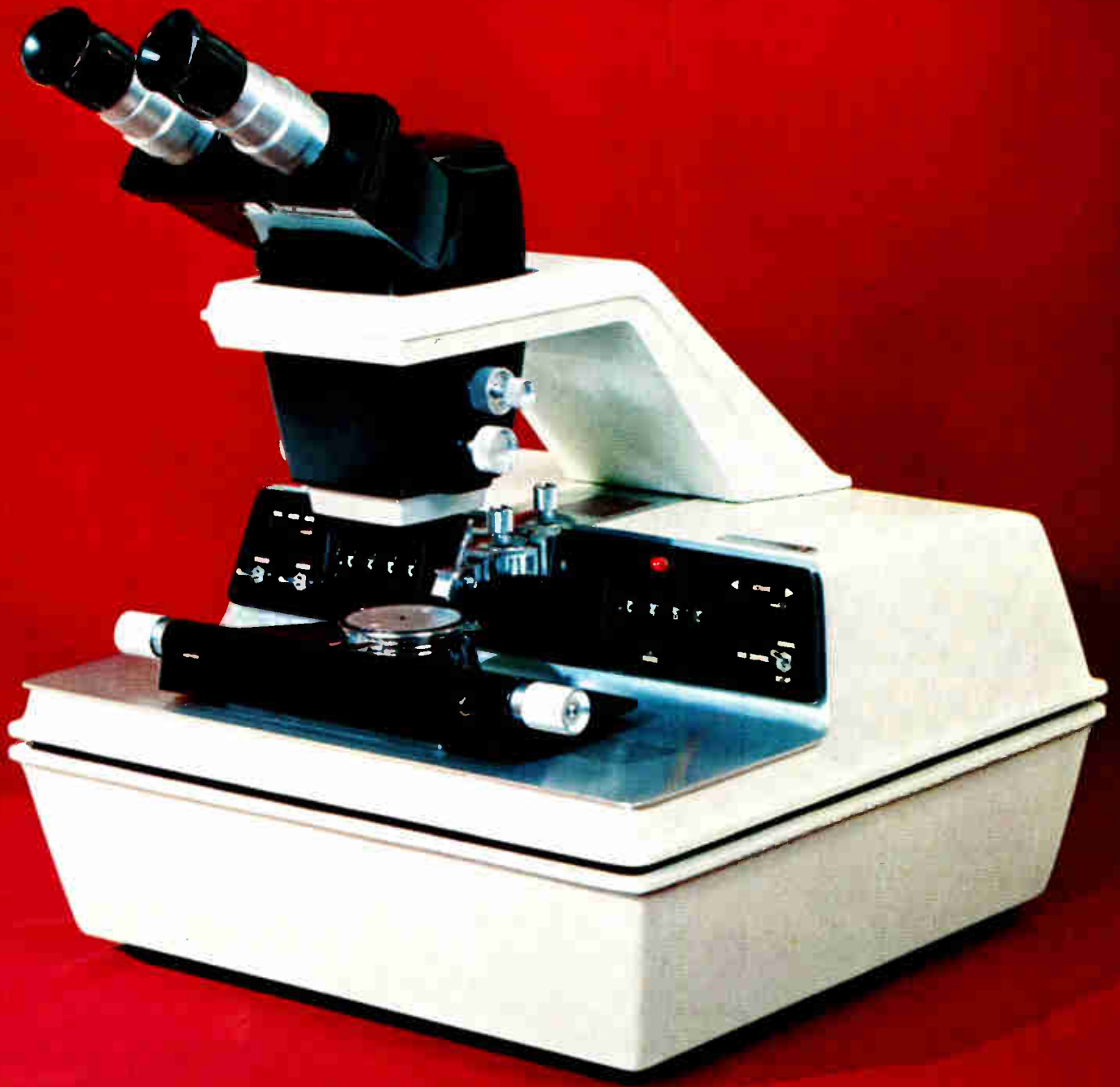

## Improving the leader...Split Field Optics

A new high-accuracy alignment system on the Tempress Model D Automatic Scribing Machine dramatically increases scribing efficiency. The unique Tempress split-field alignment microscope reduces set-up time by 90%. Fast, repeatable alignment, to 50 millionths of an inch accuracy, allows narrower scribe streets, resulting in more devices per wafer. This superb instrument, although compact in size, incorporates the finest advanced optical design features. It provides 75 $\times$  magnification, built-in high-intensity illumination, built-in focusing mechanism, built-in movable reticle, and wide-field high-eyepoint binocular viewing. Adjustable objective

spacing permits optimum accuracy, regardless of wafer size. The MODEL D Automatic Scribing Machine with split-field optics reflects the world renowned Tempress Standard of Excellence in the manufacture of miniature assembly tools and production machines for the semiconductor and microelectronics industries.



**TEMPRESS**  
TEMPRESS INDUSTRIES INC. 980 UNIVERSITY AVENUE,  
LOS GATOS, CALIFORNIA 95030, USA TEL: 408 356 8151

**MOTOROLA'S**  
**"CHECKMATE"**

**...THE**  
**ULTIMATE**  
**HIGH**  
**RELIABILITY**  
**PROGRAM**

**...designed**  
**to meet**  
**the intent of**  
**MIL-STD-883**





Motorola's vast experience in high-reliability military and manned spacecraft programs such as Apollo, coupled with an investment of millions of dollars for research and development, has resulted in the ultimate quality assurance program for Integrated Circuits: "CHECKMATE" . . . designed to meet the intent of MIL-STD-883.

"CHECKMATE" is structured to provide an environment in which proven methods of manufacturing, quality assurance, monitoring, screening and testing can thrive — to give you *the most reliable product on the market today.*

The "CHECKMATE" specification is designed to support a broad base of test and evaluation programs for microelectronic devices: materials, workmanship, performance capabilities, identification and processing — applied to linear and digital circuits with appropriate levels of reliability.

Reliability levels of Integrated Circuits needed for your application are outlined by Motorola in a comprehensive "CHECKMATE" / MIL-STD-883 brochure. This brochure covers your most demanding application requirements.

Motorola's "CHECKMATE" program was designed to facilitate delivery and minimize specification preparation time. Beginning with a nucleus of popular IC types, from our high volume lines, the "CHECKMATE" program is continually adding more devices to the list of qualified products — available from bonded stock. All Integrated Circuits can be ordered to any of four reliability levels, whether or not they are currently stocked.

Other semiconductor manufacturers have had their say, regarding their approach to MIL-STD-883 testing for ICs. Now Motorola has the optimum program: "CHECKMATE." *It is a functional, operating program, which began with Motorola's own long-range objective: to improve and demonstrate Integrated Circuit reliability . . . designed to benefit YOU.*

Write for the "CHECKMATE" / MIL-STD-883 program, on your company letterhead, to: MOTOROLA Semiconductor Products Inc., P. O. Box 20912, Phoenix, Arizona 85036. Or call your Motorola Sales Representative!



 **MOTOROLA** CHECKmate  
*the ultimate high-reliability program!*

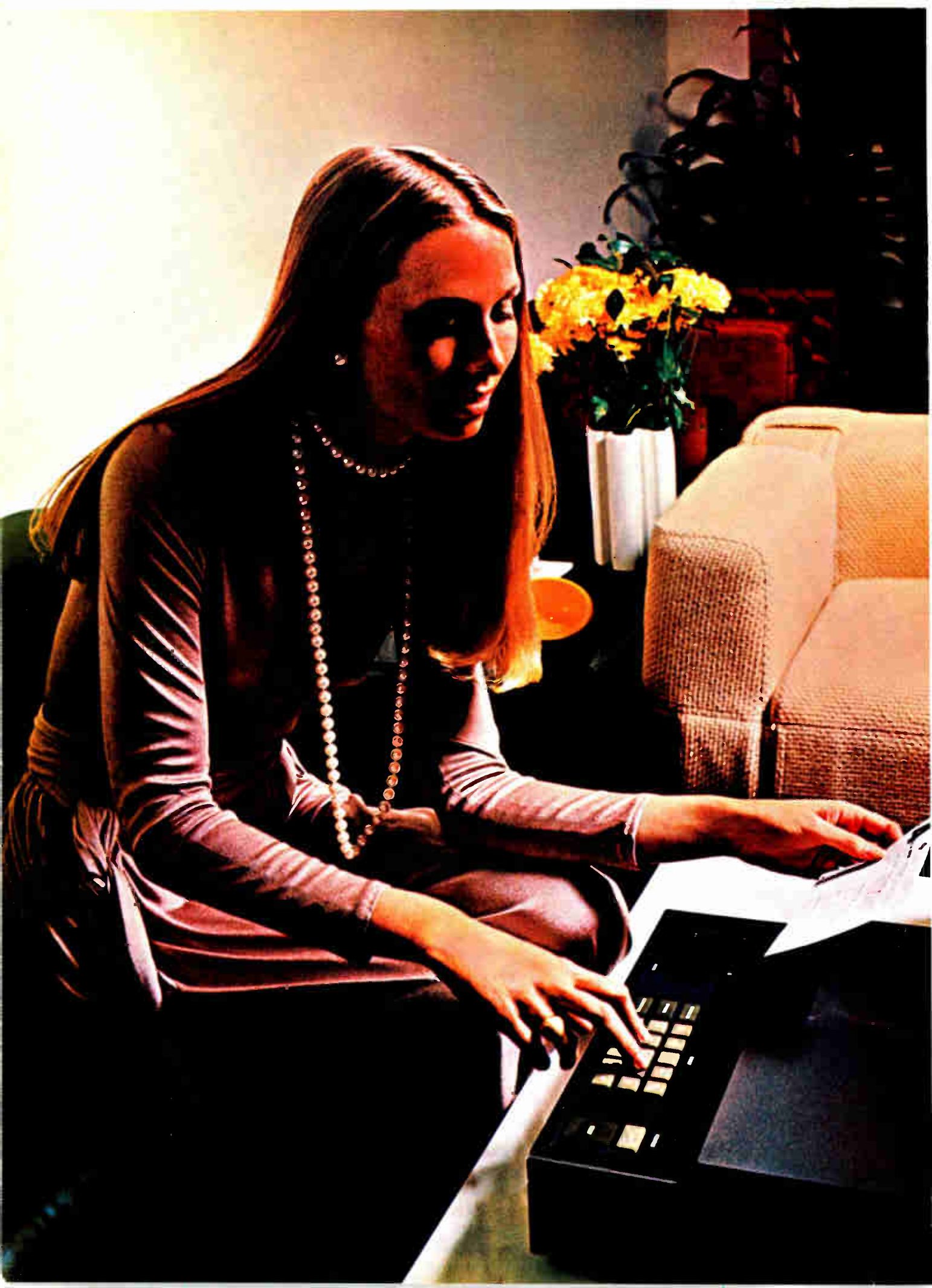



# By 1979, newspapers will be printed in your living room.

You won't have to roll up the carpet. Or even cover up the furniture.

Because all it will take is a compact print-out unit attached to an ordinary tv set.

When you're ready for the stock market closings, ball game scores or movies listings, you'll simply push a button.

Instant newspaper. And you'll be able to get any part of it, or all of it, any hour of the day or night.

The fact is, the products of electronics technology will be doing more for our lives tomorrow than electricity does for us today.

Automated highways will drive our cars. Home computers will cook the food and wash the clothes. Electronic health maintenance programs will even help us avoid illness.

Who are the master minds masterminding these changes?

Our readers. Engineers and technical managers who must keep abreast of all fast-changing developments. Industry-wide and world-wide. Which is why they come to us.

Every two weeks, Electronics magazine presents them with a complete, up-to-the-minute picture of the state of the technology.

Last year alone, Electronics presented six times as much information on consumer electronics as any other publication in the field. And twice as much on communications.

If you expect to be part of the future, speak to the men who are working on it today.

Electronics, a McGraw-Hill market-directed publication.

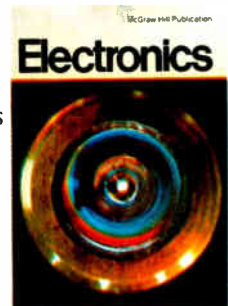

**Our readers are changing the world.**

# Air Controller.

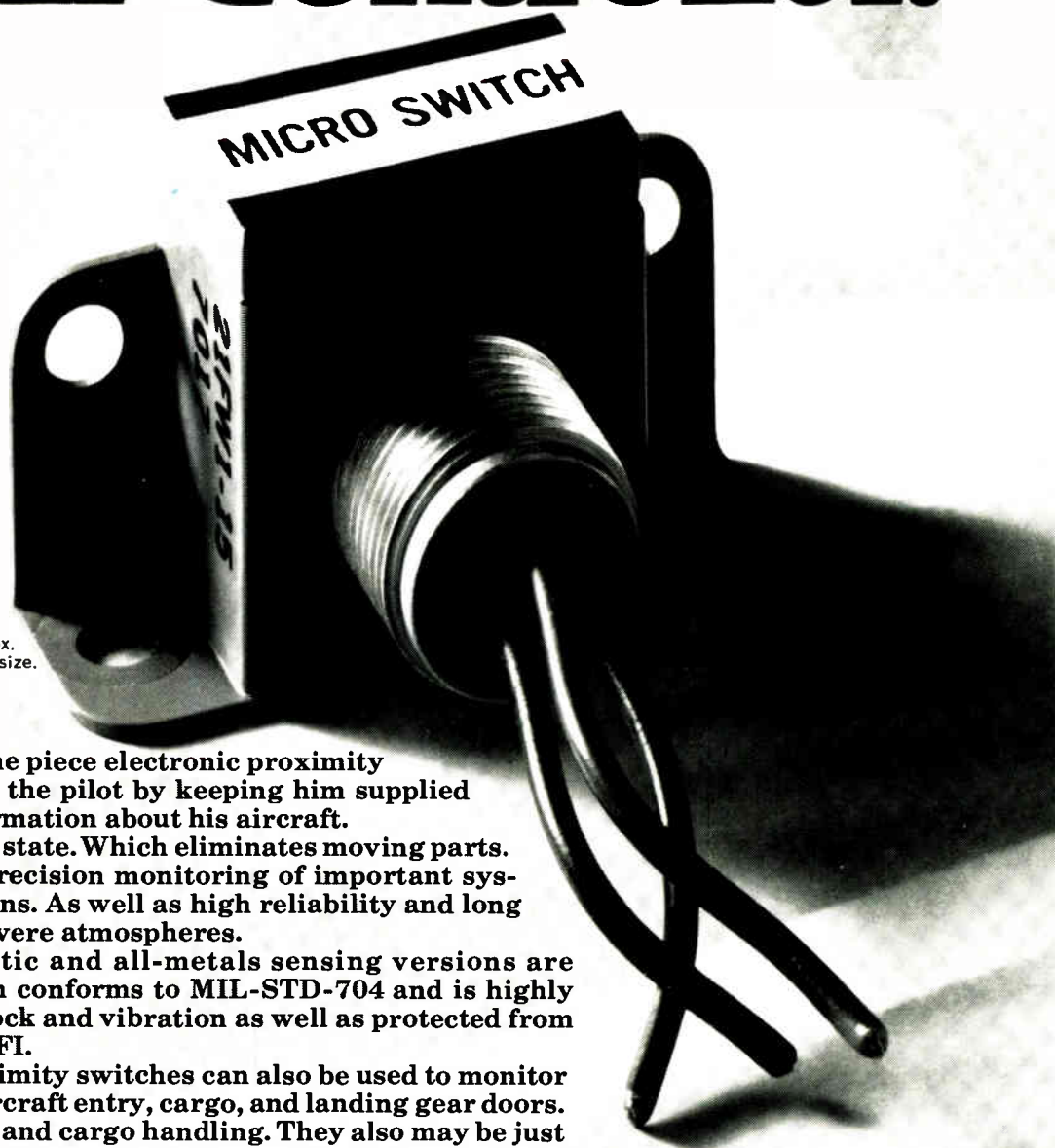

Shown approx.  
twice actual size.

Our new FW one piece electronic proximity switches guide the pilot by keeping him supplied with vital information about his aircraft.

They're solid state. Which eliminates moving parts. The result is precision monitoring of important systems or functions. As well as high reliability and long life. Even in severe atmospheres.

Ferromagnetic and all-metals sensing versions are available. Each conforms to MIL-STD-704 and is highly resistant to shock and vibration as well as protected from the effects of RFI.

Our FW proximity switches can also be used to monitor the status of aircraft entry, cargo, and landing gear doors. Or for baggage and cargo handling. They also may be just what is needed in most any tough ship, tank, missile or artillery application you have.

For more information, call your MICRO SWITCH Branch Office (in the Yellow Pages under "Switches, Electric"). Or write for Product Sheet FW.

**MICRO SWITCH**

FREEPORT, ILLINOIS 61032  
A DIVISION OF HONEYWELL

HONEYWELL INTERNATIONAL—Sales and Service offices in all principal cities of the world. Manufacturing in Australia, Canada, Finland, France, Germany, Japan, Mexico, Netherlands, Spain, Taiwan, U.K. and U.S.A.

---

# Electronics Newsletter

---

September 14, 1970

## Litton building post-and-film LSI computer

An all-LSI computer using Litton's post-and-film memory [*Electronics*, Jan. 6, 1969, p. 53] is under development at the firm's Data Systems division in Van Nuys, Calif. A breadboard version of the L-3070, which will do a full 32-bit add in 2 microseconds and handle 500,000 to 600,000 instructions per second, is expected to be ready next July, to be followed by an engineering prototype in the second quarter of 1972. Cycle time is expected to be no greater than 500 nanoseconds, with projected costs of two to three cents a bit.

Litton officials believe that without such an LSI computer, they won't be able to compete in the military market by 1972. L-3070 software will be compatible with the L-3050 used in the Army's Tacfire system. The computer's capacity will roughly equal that of an IBM 360/44, but speed will be two to three times greater. It will use a 112-gate TTL array as its basic logic block.

The machine originally was sized to meet the onboard data-processing requirements of the Awacs program, which it could do with 96,000 words of memory. The Litton division was teamed with McDonnell Douglas in the losing fight against Boeing.

## RCA's Secant CAS wins Navy contract

RCA appears to have won a round in its bout with the Air Transport Association over which road to take toward a collision avoidance system. The boost for RCA's Secant system came in the form of a contract from the Naval Air Development Center at Johnsville, Pa. The contract calls for three proximity warning indicators (the most basic Secant equipment), a correlator and tracking channel (which are the core of the business aircraft, airliner, and military versions of Secant), and a synthetic dense-traffic generator. The PWIs are to be delivered for flight tests by next summer.

The ATA favors time/frequency systems, while Secant is an acronym for separation and control of aircraft by nonsynchronous techniques.

While the contract is only for \$50,000, it appears to be the kickoff for a program of cooperative development, with RCA supplying the test units and the Navy supplying the test beds. The Navy's dissatisfaction with time/frequency CAS dates at least from 1968 when two Eros-equipped F-4s collided over St. Louis. It has never quite bought McDonnell Douglas' explications on the cause of the collision. For the record, McDonnell Douglas will say only that the matter is still in litigation.

## Ovonic to debut as nonvolatile memory device

The much sought after nonvolatile semiconductor memory is about to make its debut—as the first commercial Ovonic device. The controversial brainchildren of Stanford Ovshinsky and his Energy Conversion Devices Inc., Ovonic devices are amorphous semiconductors [*Electronics*, Nov. 25, 1968, p. 49].

The memory itself will be a 256-bit IC that's a cross between a random access and a read only memory: although the circuit is nonvolatile, it can be reprogramed at will. To be called a "read-mostly memory," the device is the result of a collaboration between the Intel Corp. and Energy Conversion Devices.

---

# Electronics Newsletter

---

## New RCA machines feature virtual memory

After several months' delay, RCA's Information Systems group is finally announcing its new line of computers. The machines, four in all, will be in "the medium range," and two of the four will have "extended" virtual memories, suggesting a time-sharing application. With virtual memory, the physical memory can be loaded with whatever the programmer needs when he needs it, on a moment-to-moment basis. This, in effect, gives him as much memory as he can address, regardless of the capacity of the machine's physical memory.

The new machines will not be called Spectra. Instead they will have simple single-digit designations like RCA 2, RCA 6, RCA 7, and so forth. Along with the computers, the company is announcing a new front-end communications peripheral (which would also be applicable to time sharing).

Meanwhile, IBM is still keeping quiet about other models in its new 370 line. Latest speculation, according to industry sources, is that the company will take the wraps off its third machine, the 370/145, some time later this month, a prediction IBM will neither confirm nor deny. More System/3 equipment is said to be in the works, too.

## Electronic Arrays adds bipolar firm . . .

Electronic Arrays, which manufactures MOS memory and logic components, has decided to protect its flanks by becoming one of the chief backers of Monolithic Memories Inc. of Sunnyvale, Calif. The new firm will make fast bipolar semiconductor memories. At the same time, says Electronic Arrays president Samuel Nissim, the company expects to market silicon gate products by the year-end. Nissim says they'll be slower than more conventional silicon gate devices, adding that the process is different from that of the Intel Corp. and others.

## . . . as it prepares calculator line

Electronic Arrays' announcement this summer that it was making a set of six MOS chips for a small calculator [*Electronics*, July 20, p. 122] was only part of the story. In fact, Electronic Arrays will build the complete calculator and sell it worldwide through its Systems division in Northridge, Calif., where the chips and most of the rest of the unit were designed. Philips of Eindhoven has granted Electronic Arrays marketing rights to the calculator. The Dutch firm is the parent of the North American Philips Corp., which, in turn, owns the Amperex Electronic Corp., which will market the MOS chips in Europe. The calculator is the first of an entire family to be marketed next year. The line will use the six chips in the first unit as common devices with additional read-only memories or other customer-proprietary devices.

## Fairchild Hiller victory presages other challenges

The Fairchild Hiller Corp. won't have to close parts of its Germantown, Md., plant as rumored now that it has won its battle to take the ATS MOS satellite contracts away from General Electric [*Electronics*, April 27, p. 42]. Fairchild Hiller will now be hiring in preparation for the experimental communications satellite's launch in 1973.

Unless GE recovers the contracts in court, Fairchild will also have a leg up in further contests for future third-generation satellites. The battle for the satellite award, which ended with a NASA panel recommendation that Fairchild get the award, is expected to lead to similar challenges.

# IDEAS

FROM  
SYLVANIA

Component and  
Circuit Design

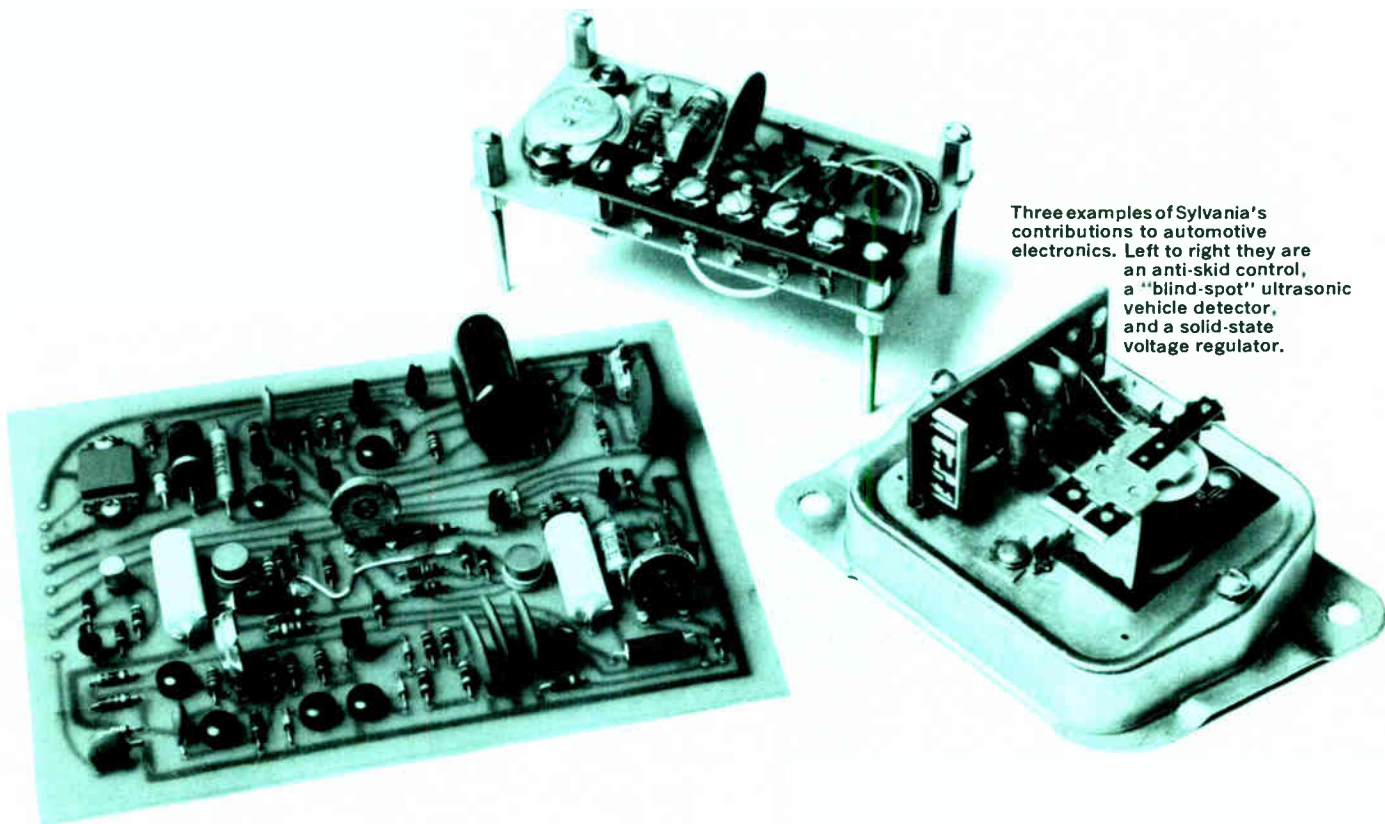

Three examples of Sylvania's contributions to automotive electronics. Left to right they are an anti-skid control, a "blind-spot" ultrasonic vehicle detector, and a solid-state voltage regulator.

## CIRCUIT MODULES

### Zeroing in on transportation electronics.

Our new development laboratory, geared specifically to transportation electronics, is closely tied in to our high-volume production facilities.

One area of great potential for the electronics industry is the transportation systems field. Trucks, subway trains and passenger vehicles are foremost in this area.

Our new Wakefield Development Laboratory facility has been set up with the specific charter of meeting these needs from system concept to volume production.

Today's automobiles are using more and more electronics, and over 100 potential electronics applications have been identified. As of now, more than twenty functional systems are either in use or are undergoing field testing. These range from clocks, turn signals, voltage regulators and automatic temperature controls to electronic fuel injection and anti-skid braking systems.

Other potential applications include electronic monitoring units for oil, water and fuel levels, electronic ignition, electronic speedometers and, eventually, total electronic control by a small on-board computer.

So far, in its short existence, the Wakefield Laboratory has come up with a number of interesting practical systems for cars, including an ultrasonic "vehicle" detector, an anti-skid control system and an electronic voltage regulator.

The ultrasonic "vehicle" detector was designed to meet the requirements of a large automobile manufacturer. System requirements were tough. Wanted was a system that would detect vehicles in the blind zones within 30 feet of the rear of the car and would cover an area

## This issue in capsule

### CRTs

Silicon target storage tube gives high resolution.

### Integrated Circuits

How to design a character generator for ASCII address decoding.

### CATV

Our cable communications equipment spans a wide spectrum.

### Hybrid Microcircuits

Interface circuits solve TTL-MOS matching problems.

### Microwaves

We're bringing beamleads to microwaves.

### Manager's Corner

A philosophy for the future of cable communications.

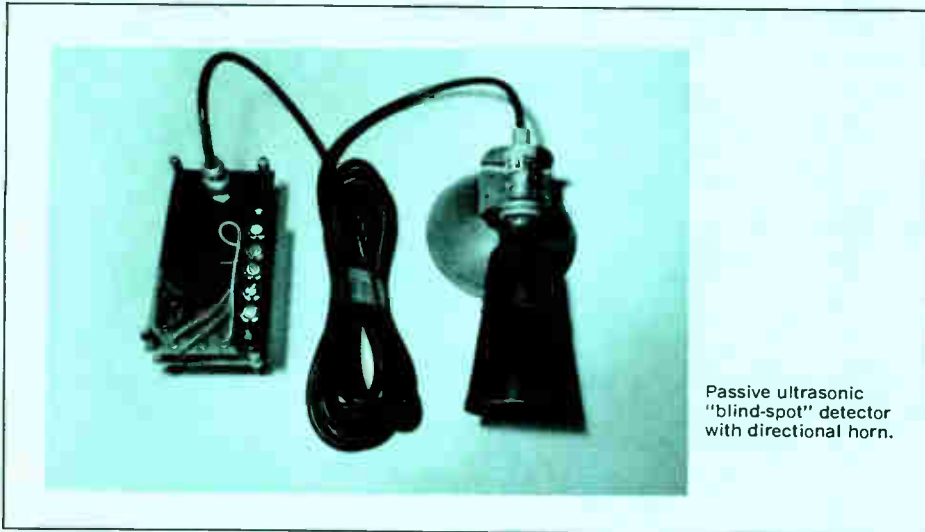

Passive ultrasonic "blind-spot" detector with directional horn.

only slightly larger than a single lane. The system had to ignore such things as tunnels, fences, signposts and billboards while also being impervious to rain, snow, dust, salt, shock and vibration over a broad temperature range. On top of that, the system had to be inexpensive.

Our Wakefield engineers investigated radar, active ultrasonic and infrared approaches and discarded them because of their inability to discriminate. A simple active system cannot distinguish between a real target vehicle and a stationary object.

Needed was a system that could respond to a characteristic inherent in the operation of a moving vehicle. The characteristic we picked was noise. We decided on a passive ultrasonic detection system to give us control over range and directivity as well as discrimination. The system, illustrated in the diagram and photograph, responds only to those sounds generated by a moving vehicle, such as its engine and tire noise.

With a detector horn mounted in each rear taillight assembly, a vehicle approaching from either side will cause a small bulb to light on the appropriate side of the rearview mirror.

To avoid nuisance display in bumper-to-bumper traffic, the system is designed to respond only at speeds above 35 mph, which makes it especially useful in high-speed traffic on multiple-lane expressways.

We can't claim original design for the anti-skid systems we've made, but we can claim fast delivery and drastic system improvement. One customer brought us a six-card, 600-component, hand-wired, prototype of his anti-skid system. He needed the six cards in printed circuit form within three months. Our elapsed time, from receipt of schematics to delivery of hardware, was only two months.

Now this same customer has asked us to redesign and cost-engineer his original system. With this effort nearing completion, it appears that we will have reduced the component population by

30% and the system cost by 50%.

Another customer requested redesign and cost engineering of their anti-skid module. Within three months, component population was halved and cost was cut by two-thirds. This same customer has now requested assistance in the basic design and engineering of a more advanced system.

These examples highlight the technical competence and fast response this group offers to serve our customers.

Although electronic voltage regulators are not new, most existing ones have drawbacks. The electromechanical regulator has proved unreliable and just can't carry the higher field currents of the newer, more powerful alternators. Regulators using germanium transistors require extensive finned packages for heat sinking and still won't take present underhood temperatures. Microcircuits have not been able to meet the severe automotive environment and be cost competitive.

In addition, all previous solid-state regulator designs were subject to catastrophic failure if the battery was disconnected while the engine was running. This could happen during routine servicing or as the result of a loose battery cable.

Our design is able to withstand the transients caused by battery disconnect. In addition it has passed severe testing in the field and is going into volume production.

These are only a few of the new developments that are coming out of our Wakefield Lab and entering production at our custom module facility. If you need an electronic system for anything that moves on tracks, road, water, or in the air, we've got the people who can design and produce your system at the lowest cost and with the shortest lead time.

CIRCLE NUMBER 300

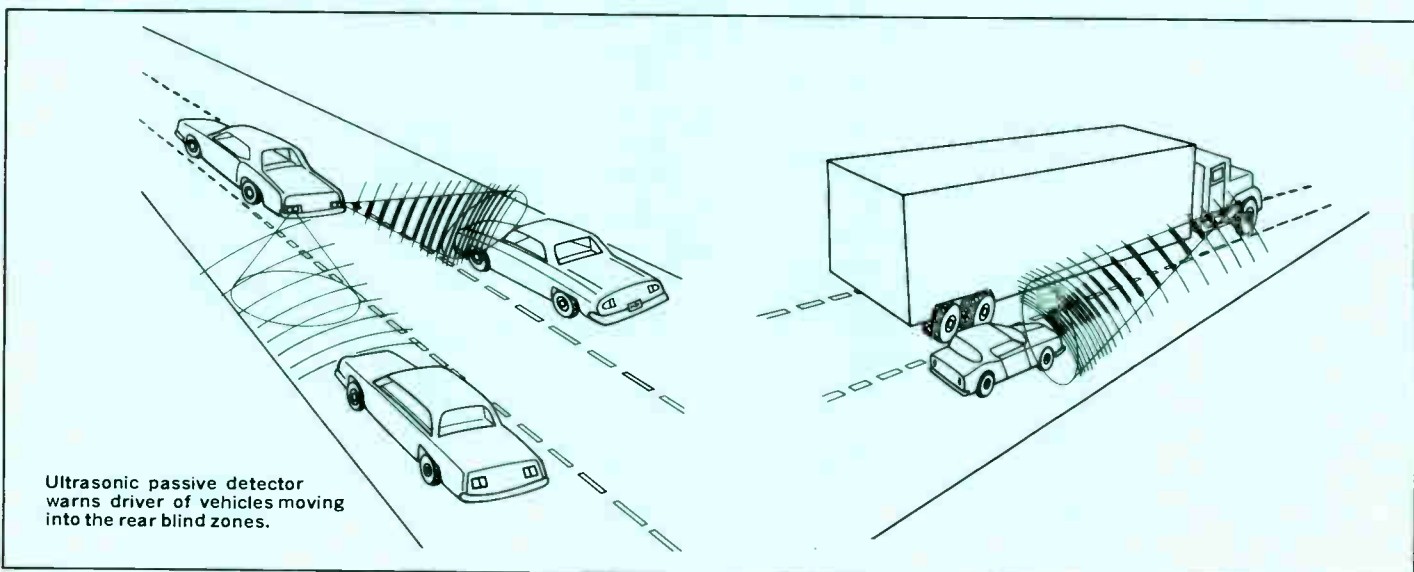

Ultrasonic passive detector warns driver of vehicles moving into the rear blind zones.



## CRTs

### Silicon target storage tube gives high resolution.

Mosaic target of silicon oxide storage islands provides resolution better than 1,000 TV lines/diameter with high writing speed and long retention times.

A new 1½" silicon mosaic target storage tube, developed by our Advanced Technology Laboratory, is ideally suited for scan conversion, video frame storage, computer output buffers and display refreshing. It may be selectively updated, thus requiring only that changes in information be transmitted from the source. Low speed transmission systems, such as those for facsimile printers, can advantageously use this device. The tube will find applications in many information processing and data display systems.

Advantages of the new 1½" silicon storage tube include: resolution of better than 1,000 TV lines/diameter, retention times of over 15 minutes with gray scale capability, high writing speeds, and low cost. Images can be held for several days or longer with the beam turned off.

The structure of the tube is shown in the diagram. It is similar to a magnetically focused and deflected vidicon. The storage target is a mosaic of insulating SiO<sub>2</sub> islands, as shown in the photograph. In operation, a charge pattern established on the islands during writing is used to control the landing of the primary beam current at local areas dur-

ing reading.

During the erase cycle the target is held at +15V and scanned. The beam charges the insulating islands to cathode potential (0 V), since the secondary emission ratio is less than one. The charge storing islands are now at -15V with respect to the n-type substrate.

For writing, the target is held at +250V, and the beam current is modulated by applying the signal to control grid G<sub>1</sub>. Where the beam strikes, the high-energy incident electron beam creates a secondary emission ratio greater than unity. Thus, the islands become less negative in proportion to the beam current striking them. Islands not struck by the beam remain at -15V with respect to the substrate.

In the readout mode, target voltage is reduced to +5V. With respect to the beam potential of 0V, the oxide islands will range from -10V (if not written upon) and will approach 0 V (if maximum "white" signal was applied to G<sub>1</sub>).

The reading beam is split into two components: i<sub>r</sub>, current "reflected" to the collector mesh, and i<sub>i</sub>, the current landing on the substrate. The landing current, i<sub>i</sub>, through the output resistor, provides the required output signal.

Since the reading beam is prevented from landing on the islands because of their negative potential relative to the cathode, the target can be scanned repeatedly without appreciable deterioration of the stored information. Operation is possible with both conventional raster scanning, or random X-Y addressing.

Our 1½" silicon mosaic storage tube is now available in prototype form. We are presently designing complete storage modules to meet specific customer applications. These will be self-contained units requiring only an input signal and line power.

CIRCLE NUMBER 301

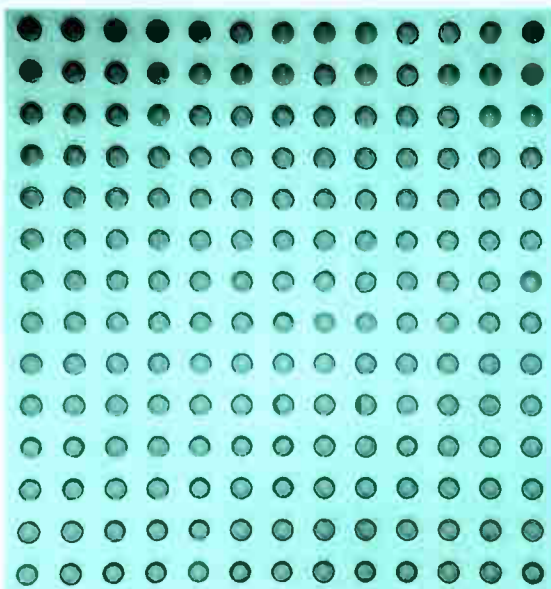

Enlarged section of silicon mosaic island pattern.

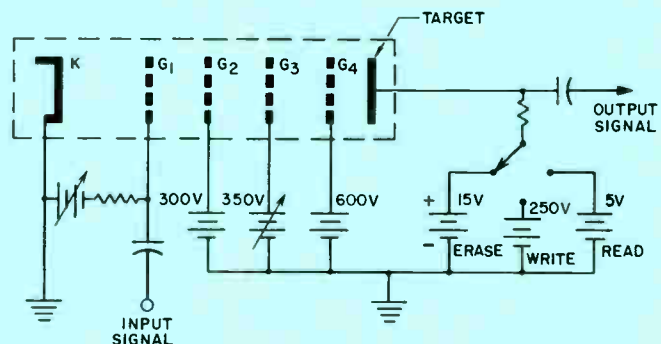

Circuit diagram of silicon mosaic target storage tube.

## INTEGRATED CIRCUITS

### How to design a character generator for ASCII address decoding.

Here's how to use read-only memories as code converters for addressing a memory containing the 64 characters of the popular ASCII code.

In a typical character display using a 5 x 7 pattern, as shown in Fig. 1, each character is made up of 5, 7 or 8-bit words. There are available so-called character generators with bit patterns for storing the alphabet, numerals and other characters. Actually they use 256-bit read-only memories (ROM) containing 32 eight-bit words with binary addresses from 0 to 32. Numeral 1 would be stored in locations 0 to 4 and numeral 2 would be stored in locations 5 to 9, etc. Thus, to generate the numeral 2, a binary 5 is used as the starting address and is positively incremented four times by one until the value reaches nine.

These ROM's would be very easy to use if the code for 1 is 0 and the code for 2 is 5. However, most codes do not follow this pattern. In fact, there is an unlimited number of address codes that can be used for character generation.

One of the simplest ways to over-

come this problem is to use additional ROM's as code converters. Here is a simple method for applying this technique to the popular ASCII code.

Figure 2 shows the ASCII code with its associated characters arranged in ascending numerical order without regard to the most significant character of the code. Also, for this discussion each character will be stored in five adjacent locations in a memory which must be large enough to handle the full 64 characters. Thus,  $64 \times 5 = 320$  storage locations must be available which can be provided by ten 32 x 8 ROM's.

The ASCII code is converted to binary numbers which incremented by five for each unit change in the ASCII code. This conversion can be done in two ROM's where the five lower order bits of ASCII are used as the address and the sixth bit is used to select which ROM's are used.

For example, the six-bit value in ASCII for the letter A is 000001 which will decode to 00000101, or five, while the letter B, 000010, will decode to 00001010 etc. The eight bits from the decoder ROM's are then preset into a counter whose output is used to select the locations in the 320 x 8 bit memory. Four clock pulses can then be added to the counter to advance the character generator through the five desired locations. Figure 3 shows the logic to do this.

This technique makes optimum use of the character generator for all locations that are used. That is, although each ROM contains 32 locations or can store 6-2/5 characters, the 2/5 of a character can be used. This means that some characters are split between ROM's but only 10 ROM's are required instead of 11 for the character generator.

This method is very straightforward but a reduction in logic can be achieved by putting some constraints on the character locations in the character generator.

An examination of the least significant bit of the ASCII code shows that one-half of the characters have an even-number code and the other half have an odd-number code. This would imply that it is only necessary to decode

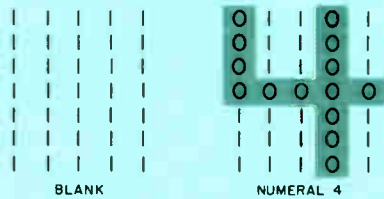

Fig. 1. Typical ASCII address for numeral four.

300	@	320	P	240	SPACE	260	Ø
301	A	321	Q	241	!	261	1
302	B	322	R	242	"	262	2
303	C	323	S	243	#	263	3
304	D	324	T	244	\$	264	4
305	E	325	U	245	%	265	5
306	F	326	V	246		266	6
307	G	327	W	247	'	267	7
310	H	330	X	250	(	270	8
311	I	331	Y	251	)	271	9
312	J	332	Z	252	*	272	:
313	K	333	[	253	+	273	;
314	L	334	1	254	,	274	<
315	M	335	]	255	-	275	=
316	N	336	↑	256	.	276	>
317	O	337	←	257	/	277	?

Fig. 2. ASCII code and its numerical equivalents.

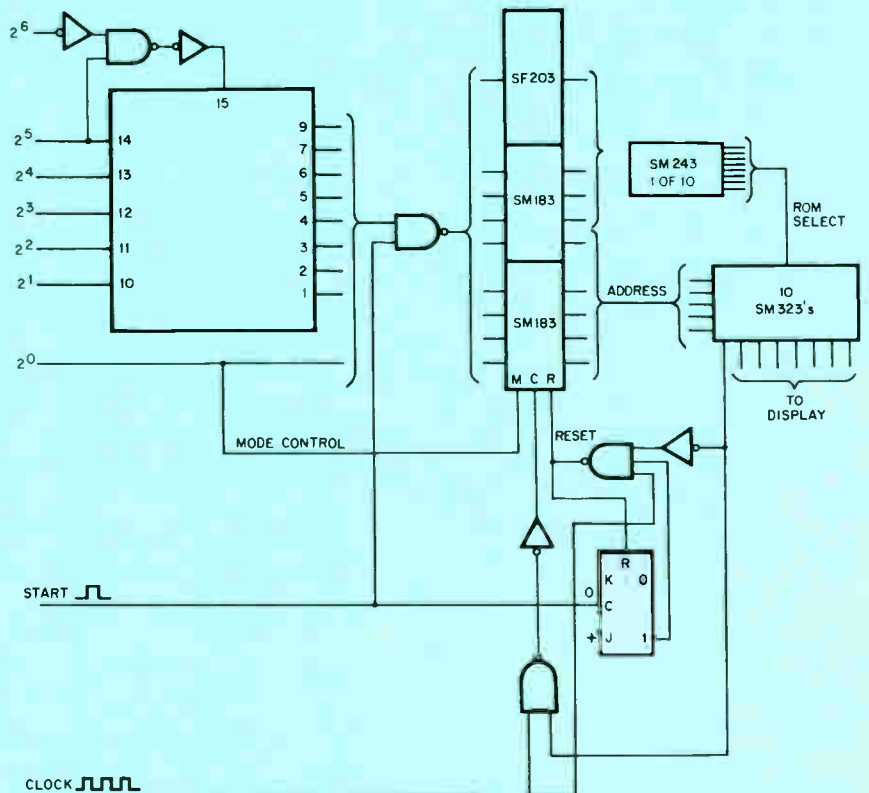

Fig. 3. Logic system for decoding ASCII code using ROM's.



32 values of the ASCII code if in each pair of characters one will start in an odd location and the other will start in an even location. Since each ASCII character requires five locations in memory, adjacent characters will always have one even and one odd address.

For example, B has an ASCII code 02 and C has a code of 03. If B has a starting address of ten and C has a starting address of fifteen, then one is even and one is odd. However, the remaining bits of the address are not the same. This problem is easily overcome if B has a starting address of fourteen, 1110, and the address counter counts down to ten on four count pulses, and if C has a starting address of fifteen, 1111, and the address counter counts up to nineteen on the four count pulses.

Figure 3 also shows the logic to do this where bit 2<sup>0</sup> controls the mode of the up/down counter. In addition if a 5 x 7 format is used for each ASCII character, then the eighth level or line can be used to control the count pulses. This is also shown in Fig. 3 where, for the letter B with a starting address of 14, there will be a one stored in the 8th line for locations 14, 13, 12, and 11 which will enable clock pulses to the up/down address counter. The eighth line for location 10 will have a zero stored in it which, when inverted and NANDed with the clock, will reset the address counter to zero and reset flip-flop A. Since the zero location in memory will contain a zero in the 8th line, it is necessary to inhibit additional reset pulses to the address counter to avoid a race condition. Flip-flop A does this function and holds the character generator in the "off" condition until the next start pulse. The gating to the chip enable for the address decoder is to inhibit the character generator for commands such as tab, line feed, return, etc.

This technique of address decoding for ROM's and also for random access memories can be used where more than one word out of a memory is required for a given address. If, for example, one address is to call out four successive words, the first address could call location four in the memory and then count down to one while the next address could call out location five and count up to eight. In this case the zero location of the memory would not be used but the simplified decoding would more than justify this method. It is not necessary that each address call out the same numbers of words, or sets, to use this method. However, the starting address for each set in a pair must only differ by one.

CIRCLE NUMBER 302

## CATV

### Our cable communications equipment spans a wide spectrum.

Family of amplifiers, power supplies and ancillary equipment features sub-VHF, bi-directional, and other special transmission capabilities.

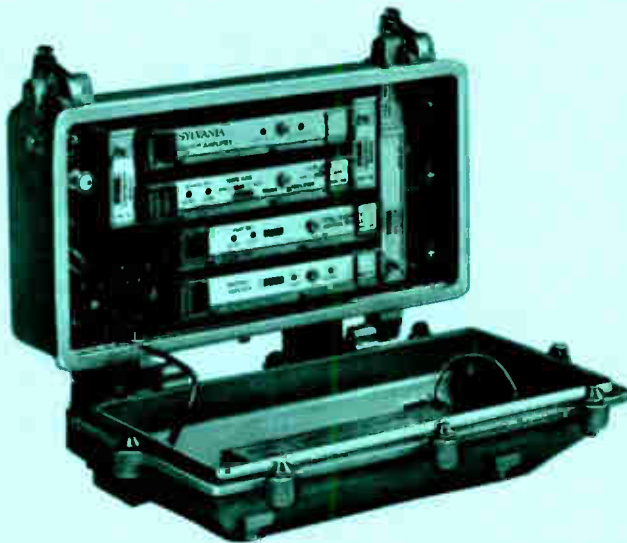

Our new, growing line of rugged equipment for cable television has the design flexibility to solve many systems applications problems and assure long operating life with minimum downtime.

Take, for example, our fully modularized trunk amplifier station. It has a wide bandwidth from 50 to 270 MHz. A dual-pilot feature gives totally automatic 16-dB level control, and 16-dB slope control ranges over wide temperature excursions. High overload-to-noise capability of the Sylvania equipment enables cascading up to 80 amplifiers satisfactorily. The amplifier is available with manual or automatic control and with or without a bridging amplifier. An optional feature designs you into the future—permitting addition of an extra-service module that can provide a number of other functions, including bi-directional operations in the 6 to 30 MHz band. You can also have sub-VHF for long-haul forward transmission or split-band trunking (54 to 110 MHz and 140 to 270 MHz) for multiplexing of octave bandwidths.

Our line extender amplifier comes in two different models. One provides for manual control of gain and slope; the other is totally automatic. Both units are otherwise identical. They complement our trunk amplifier with their wide 50 to 270 MHz bandwidths. High overload-to-noise capability and superior VSWR allow these units to be used as economy trunk amplifiers.

The dual pilot control feature of the fully automatic model allows higher operating levels in distribution and tighter control of these levels at the subscriber drop. The level and slope control functions are achieved through use of current-sensitive solid-state control elements to minimize distortion products.

Both amplifier models use plug-in attenuation pads and equalizers. The high-signal level stages employ stud-mounted transistors with stable current bias for reliable operation over a wide temperature range.

Like the trunk amplifier, the line extenders are housed in rugged, cast housings for EMI shielding and protection against weather.

Our outdoor multi-tap/directional coupler allows up to 8-way distribution. Provision is made for use of a variable 8-dB cable-equivalent equalizer. Various splitter combinations and plug-in couplers may be inserted after installation of the multi-tap housing.

Also included in the cable television equipment family are a balun for 75 to 300-ohm transformation, an outdoor directional coupler with high directivity and power passing capability, an outdoor splitter and a power coupler. All Sylvania passive devices provide the same wide bandwidth as our amplifiers. An AC power supply package provides a well regulated output for 30 or 60 V AC operations.

CIRCLE NUMBER 303

## HYBRID MICROCIRCUITS

### Interface circuits solve TTL-to-MOS matching problems.

Translating current-oriented TTL outputs to voltage-sensitive MOS inputs is a job that hybrid circuits can easily handle.

One of the main advantages of hybrid microcircuits is design flexibility, and one of the major places where this flexibility is of value is in interfacing between two different types of logic systems. Translating between TTL and MOS circuitry is one important place this flexibility can be used.

For example, our MS-303 interface driver, shown in Fig. 1, will accept a TTL input and translate it to a signal capable of driving MOS circuitry with output currents of +500 mA with voltage swings of up to 30 V.

Figure 2 shows the MS-303 with the external circuitry required to give two typical rates of  $t_{on}$  and  $t_{off}$ . If these don't meet your needs, we'll be glad to help you design a circuit that will.

And that is one of the advantages that we offer in hybrid

circuit design. If you can't meet your requirements with our off-the-shelf devices, we'll be glad to give you a custom design that will do the job. Don't let the phrase "custom design" turn you off. Because we know these circuits inside out, we can make a custom design at a cost comparable to off-the-shelf designs.

Another hybrid microcircuit that can solve interface problems is our MS-302 dual-phase clock driver shown in Fig. 3. By connecting external capacitors, you can control clock pulse widths over a wide range. Figure 4 shows two typical configurations and the table shows the circuit characteristics operating at two different frequencies using different values of capacitance.

Like all Sylvania hybrid microcircuits, these units are available to meet both industrial and military specifications. They use thick film and hybrid techniques and are packaged in hermetically sealed enclosures for high reliability.

Of course, neither of these circuits may solve your interface problems, but don't let that worry you. We have off-the-shelf designs, but we know how to customize them at minimum cost. If you have an interface problem, we're willing to face it.

CIRCLE NUMBER 304

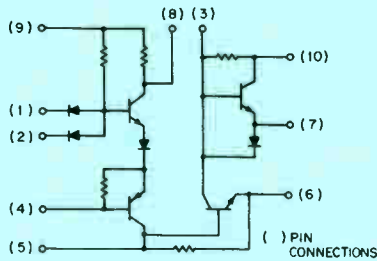

Fig. 1. Basic circuit of MS-303 interface driver.

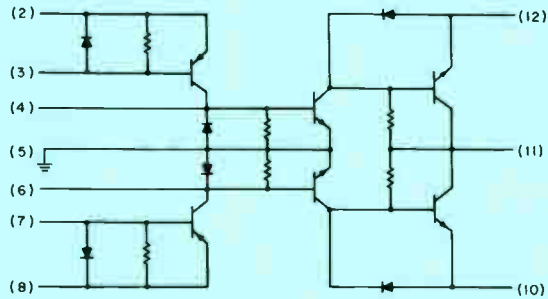
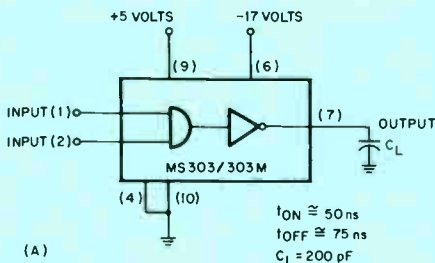
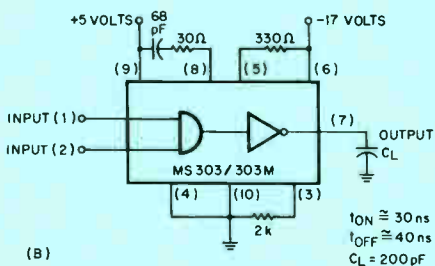

Fig. 3. Circuit of MS-302 dual-phase driver.



(A)



(B)

Fig. 2. External circuitry for MS-303 for different operating speeds.

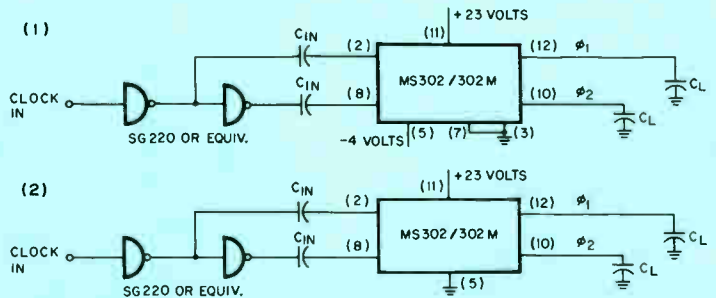

Fig. 4. Two configurations for using MS-302 dual-phase driver. Table shows typical characteristics for both configurations using specific values for frequency and capacitance.

	Configuration 1		Configuration 2	
	Condition 1	Condition 2	Condition 1	Condition 2
$t_r$ (ns)	77	30	59	23
$t_f$ (ns)	55	21	41	17
$t_d$ (ns)	50	27	41	22
$t_{pw}$ (ns)	440	134	363	125
Power (Mw)	815	495	680	444

Condition 1,  $f=0.5$  MHz,  $C_L=1000$  pF,  $C_{in}=2200$  pF

Condition 2,  $f=1.0$  MHz,  $C_L=200$  pF,  $C_{in}=600$  pF

## MICROWAVES

### We're bringing beamleads to microwaves.

Our full family of beamlead devices offers a lot of advantages to designers of microstrip circuits.

Capacitors, tunnel diodes, PIN diodes and Schottky diodes are now available from Sylvania in both beamlead and chip form.

The SC-9001 beamlead capacitors are high-temperature thermally grown, silicon devices. Their very high Q and small size makes these devices ideal for microwave applications. Units are available in a capacitance range from 0.5 to 100 pF at 1 MHz.

The beamlead tunnel diode family, DTB-5724, 5725, is designed for use as low-level amplifiers and oscillators in microstrip systems. They are also used in satellite and phased-array antenna systems. The tunnel diode, itself, consists of a circular, passivated, germanium substrate with two metal leads. The lengths of the leads are different to allow identification of the cathode as the shorter lead. Overall length is 30 mils and the substrate is 8 mils in diameter. The cathode beamlead contributes less than 0.1 pf to the total capacitance.

Our beamlead microwave PIN diodes are essentially voltage-dependent variable resistances, which makes them valuable for switching, limiting and controlling microwave

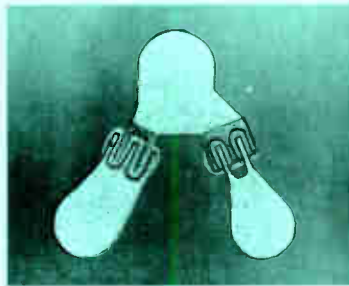

Photomicrograph of dual Schottky diode.

power. The D5840 PIN diodes are surface-oriented beamlead silicon devices consisting of a p+ type and an n+ type separated by an intrinsic layer. Breakdown voltage is 60V, and forced minority carrier lifetime is typically 15 ns. The graph shows change of resistance with forward current for a typical PIN diode.

Beamlead Schottky diodes are available in three frequency ranges: S-band, X-band, and Ku-band. Although used primarily as mixers, Schottky diodes can also be used as detectors, modulators, low-power limiters and high-speed switches.

Our beamlead Schottky diodes are made by depositing a suitable metal on an epitaxial silicon substrate to form a junction. The process and choice of materials results in low series resistance, and a narrow spread of capacitance values for close impedance control. These devices also feature a low forward-voltage knee which makes possible efficient operation at low local-oscillator drive levels, or for low-level detection.

All of these beamlead microwave devices are also available in mounted or unmounted chip form. We have the most complete line of microwave beamlead and chip device diodes in the industry. So why look further? Just talk to us.

CIRCLE NUMBER 305

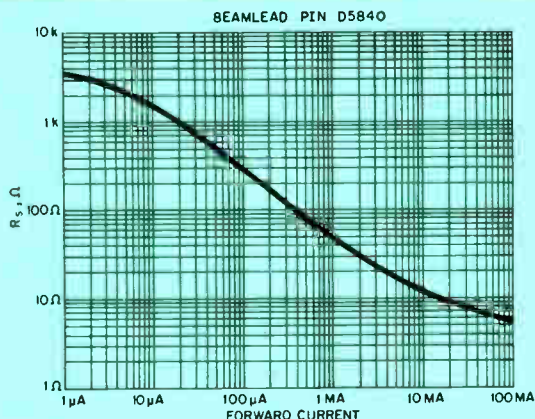

Typical curve of  $R_s$  plotted against forward current in PIN diode.

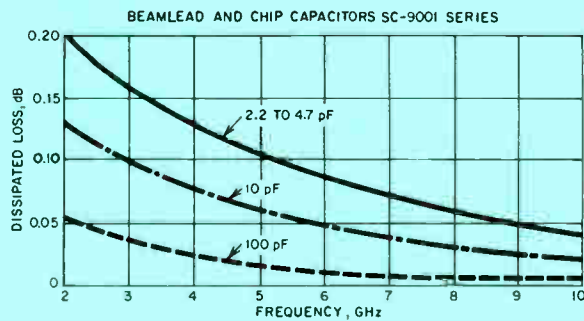

Plot of dissipation loss versus frequency for beamlead capacitors.



Use Sylvania's "Hot Line" inquiry service, especially if you require full particulars on any item in a hurry. It's easy and it's free. Circle the reader service number(s) you're most interested in; then fill in your name, title, company and address. We'll do the rest and see you get further information by return mail.

### BUSINESS REPLY CARD

No Postage Stamp Necessary if Mailed in the United States

FIRST CLASS  
Permit No. 2833  
Buffalo, N.Y.

POSTAGE WILL BE PAID BY

Sylvania Electric Products Inc.  
Advertising Services Center  
70 Empire Drive  
West Seneca, New York 14224

Dept. E 555

---



---



---



---



---



---



---

## MANAGER'S CORNER

### A philosophy for the future of cable communications.

Cable television is a booming industry. At the present time there are over 2,000 systems in operation and an equal number under construction. In addition, there are over 2,300 applications under consideration in various cities throughout the United States.

All of this means big business for cable equipment suppliers, but it poses problems for the equipment buyers. The problem is not what type of equipment to buy for operation today, but what type of equipment to buy that will be usable in the future.

And the future of cable television is as exciting as it is unpredictable. Visionaries of the industry predict completely wired cities with all television programming coming over cable. They see the next logical step as interconnection of the wired cities to form a network throughout the nation. With this growth they predict an expansion of the use of cable television beyond the usual entertainment programming. Data transmission, facsimile transmission, educational and special interest programming (such as courses for doctors) are among the exciting possibilities of the future.

For the CATV operator, all of this means that the future will demand greater channel capacity. And that is where the Sylvania design philosophy comes in. We have designed our complete line of cable TV electronics, amplifiers, directional couplers and baluns, to meet the needs of the

future. All of these units are broad spectrum equipment, covering the entire range from 50 to 270 MHz with "hands off" total automatic control. For bi-directional service, the Sylvania equipment also covers the sub-VHF 6 to 30 MHz band.

This broad spectrum capability means that Sylvania equipment won't have to be replaced to meet the changing needs of the future. Regardless of the future direction cable television may take, you can be sure our equipment won't become obsolete.

Our Components Group is applying this same advanced engineering philosophy in the design of other equipment for cable television. You can get the cable system of tomorrow from Sylvania, today.

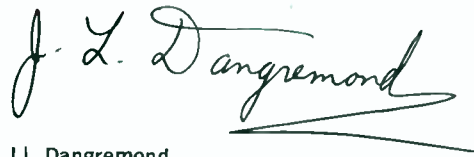

J.L. Dangremond  
Product Marketing Manager, CATV-Special Products.

This information in Sylvania ideas is furnished without assuming any obligations.

# SYLVANIA

## GENERAL TELEPHONE & ELECTRONICS

NEW CAPABILITIES IN: ELECTRONIC TUBES • SEMICONDUCTORS • MICROWAVE DEVICES • SPECIAL COMPONENTS • DISPLAY DEVICES

E5

NAME \_\_\_\_\_

TITLE \_\_\_\_\_ PLEASE PRINT

COMPANY \_\_\_\_\_

ADDRESS \_\_\_\_\_

CITY \_\_\_\_\_ STATE \_\_\_\_\_ ZIP \_\_\_\_\_

#### Circle Numbers Corresponding to Product Item

300    301    302    303    304    305

Please have a Sales Engineer contact me.

Visit    Phone . . . Phone No. \_\_\_\_\_ Area Code \_\_\_\_\_



#### HOT LINE INQUIRY SERVICE

Need information in a hurry? Clip the card and mail it. Be sure to fill in all information requested. We'll rush you full particulars on any item indicated.

You can also get information using the publication's card elsewhere in this issue. Use of the card shown here will simplify handling and save time.

# JAPAN 1970-1971 Components Markets

(millions of dollars)

	1969	1970	1971
Antennas, tv	33.9	42.5	43.5
Capacitors, fixed and variable	230.0	274.0	337.0
Connectors, plugs, and sockets	4.5	53.5	63.7
Crystals and crystal filters (including ovens)	8.6	10.0	12.8
Loudspeakers (OEM type)	48.5	56.0	62.7
Magnetic tape	30.5	41.6	54.4
Microphones (OEM type)	17.8	22.8	29.4
Potentiometers	63.8	82.0	106.1
Printed circuits	30.5	36.0	41.6
Relays	83.3	98.5	125.0
Resistors	133.5	175.0	203.0
Semiconductors, hybrid ICs	13.3	26.7	38.6
Semiconductors, monolithic digital ICs	57.8	114.8	150.0
Semiconductors, monolithic linear ICs	10.9	32.8	64.8
Semiconductors, rectifiers (rated over 100 ma)	54.3	74.1	100.0
Semiconductors, signal diodes (rated 100 ma or less)	45.8	66.6	80.5
Semiconductors, transistors	185.5	260.0	372.0
Semiconductors, other (optoelectronic devices, thermistors, SCRs, etc.)	32.2	42.8	55.5
Switches	45.8	60.0	71.7
Transformers, chokes, and coils (including tv yokes and flybacks)	218.0	254.0	309.0
Tubes, picture	56.7	54.2	39.4
Tubes, power	32.2	38.9	47.2
Tubes, receiving	349.3	418.8	476.1

*Note: Estimates are based on market data supplied by some 60 companies, trade associations, and government agencies. The estimates include components used to manufacture equipment both for domestic and export markets.*

# Electronic equipment markets in Japan 1970-1971

(factory prices in millions of dollars)

		1969	1970	1971
<b>CONSUMER PRODUCTS</b>	Phonographs, record players, combinations, hi-fi sets	269.0	329.0	394.0
	Radios (includes car radios)	116.8	136.5	145.0
	Tape recorders (for home use)	125.5	153.0	184.0
	Television sets, black and white	305.0	244.5	217.0
	Television sets, color	1,140.0	1,415.0	1,500.0
	Other consumer products	111.2	178.5	311.0
	<b>TOTAL</b>	<b>2,067.5</b>	<b>2,456.5</b>	<b>2,751.0</b>
<b>COMPUTERS AND RELATED HARDWARE</b>	Analog and hybrid computers	5.4	5.9	7.3
	Digital computer central processors (except process control)	243.0	353.0	447.0
	Mass memories, external	152.5	253.0	370.0
	Read-in and read-out equipment	146.5	237.5	303.0
	Remote terminal equipment	22.2	41.7	52.8
	Electronic desk calculators	71.0	142.0	251.0
	<b>TOTAL</b>	<b>640.6</b>	<b>1,033.1</b>	<b>1,431.1</b>
<b>COMMUNICATIONS EQUIPMENT</b>	Broadcast equipment	62.5	69.8	77.6
	Closed-circuit television	13.0	16.9	21.9
	Intercoms and intercom systems	11.9	13.3	14.7
	Microwave relay systems	39.0	47.3	60.5
	Navigational aids, air and marine, except radar	42.2	49.2	62.5
	Radar, airborne, ground, and marine	32.5	37.2	47.2
	Radio communications (except public broadcast)	100.0	117.0	136.0
	Telephone switching, electronic or semielectronic	5.5	9.2	10.0
	Wire message equipment (except telephone)	77.8	91.5	108.5
	Other electronic communications equipment	63.9	89.0	125.0
<b>TOTAL</b>	<b>448.3</b>	<b>540.4</b>	<b>663.9</b>	
<b>INDUSTRIAL EQUIPMENT</b>	Industrial X-ray inspection and gauging equipment	26.4	27.8	30.6
	Infrared inspection and gauging equipment	22.8	26.5	30.0
	Machine tool controls	30.6	41.6	55.5
	Process controls and related equipment (including computers)	264.0	289.0	346.0
	Simulators, trainers and teaching aids	6.4	7.8	11.4
	Ultrasonic cleaning and inspection equipment	16.7	22.2	27.8
	Welding equipment (with electronic controls)	9.7	10.9	11.9
	<b>TOTAL</b>	<b>376.6</b>	<b>425.8</b>	<b>512.2</b>
<b>TEST AND MEASURING INSTRUMENTS</b>	Amplifiers and power supplies, laboratory types	9.7	11.1	12.5
	Calibrators and standards	16.6	18.0	19.7
	Components testers	5.5	6.5	7.8
	Counters and timers	5.5	7.0	8.6
	Electronic ammeters, voltmeters, and multimeters (analog)	3.7	4.4	5.0
	Electronic ammeters, voltmeters, and multimeters (digital)	3.3	4.2	5.3
	Microwave test and measuring equipment	6.8	8.4	10.0
	Oscillators	7.3	9.1	10.6
	Oscilloscopes and accessories	18.5	22.5	26.6
	Recorders	11.1	12.5	14.0
	Signal generators	7.0	9.1	10.8
	<b>TOTAL</b>	<b>95.0</b>	<b>112.8</b>	<b>130.9</b>
	<b>MEDICAL EQUIPMENT</b>	Diagnostic equipment, except X-ray	16.9	18.3
Patient monitoring equipment		3.9	4.6	5.1
Therapeutic equipment, except X-ray		4.7	5.2	5.9
X-ray equipment		18.4	20.8	22.2
<b>TOTAL</b>	<b>43.9</b>	<b>48.9</b>	<b>53.6</b>	
<b>TOTAL EQUIPMENT CONSUMPTION</b>		<b>3,671.9</b>	<b>4,617.5</b>	<b>5,542.7</b>

## Japanese electronic equipment production

	1967	1968	1969	(est.) 1970
<b>Consumer products</b>	<b>1,713</b>	<b>2,302</b>	<b>3,507</b>	<b>4,321</b>
Radio receivers	326	370	416	548
Black-and-white tv receivers	495	495	533	578
Color tv receivers	371	773	1,399	1,710
Tape recorders	251	328	399	558
Other consumer products	270	336	710	927
<b>Computers and peripherals</b>	<b>295</b>	<b>453</b>	<b>535</b>	<b>750</b>
<b>Desk calculators and office machines</b>	<b>37</b>	<b>82</b>	<b>167</b>	<b>358</b>
<b>Communications equipment (except telephones)</b>	<b>295</b>	<b>394</b>	<b>509</b>	<b>596</b>
<b>Industrial equipment (includes instruments)</b>	<b>211</b>	<b>263</b>	<b>336</b>	<b>423</b>
<b>Test and measuring instruments</b>	<b>72</b>	<b>84</b>	<b>124</b>	<b>138</b>
<b>Total (millions of dollars)</b>	<b>2,623</b>	<b>3,578</b>	<b>5,178</b>	<b>6,586</b>

Source: MITI

## Japanese electronic components production

	1967	1968	1969	1970
<b>Passive components (except parts for telephones)</b>	<b>600</b>	<b>755</b>	<b>1,100</b>	<b>1,390</b>
<b>Electron tubes</b>	<b>254</b>	<b>338</b>	<b>485</b>	<b>575</b>
Cathode ray tubes	153	224	340	413
Receiving and power tubes	101	114	145	162
<b>Semiconductors</b>	<b>204</b>	<b>252</b>	<b>348</b>	<b>472</b>

## Japan's ten largest electronics companies

	electronics sales	total sales
1. Matsushita Electric Industrial Co.	1,160	2,140
2. Tokyo Shibaura Electric Co. (Toshiba)	740	1,600
3. Hitachi Ltd.	690	2,030
4. Nippon Electric Co.	500	620
5. Sanyo Electric Co.	370	690
6. Sony Corp.	340	340
7. Sharp Corp.	310	380
8. Fujitsu Ltd.	310	370
9. Mitsubishi Electric Corp.	270	1,130
10. Victor Co. of Japan	260	320

Note: Figures are *Electronics'* estimates of 1970 sales in millions of dollars. Figures are not consolidated for companies that have wholly or partly owned subsidiaries.



**Electronics  
views the  
spectacular  
JAPANESE  
market**



*For a limited time only!*

# Special Trial Offer on a New Low-Cost State-of-the-Art Counter--the Model 904!

Compare these main-frame features with those of any other counter. Compare the price tags. Then choose!

- 8-decade readout
- Direct counting to 200 MHz
- Universal functions in main-frame — TIM, Period, Multiple Period Average, Signal Scaling, Frequency Ratio, Multiple Frequency Ratio, Totalizing

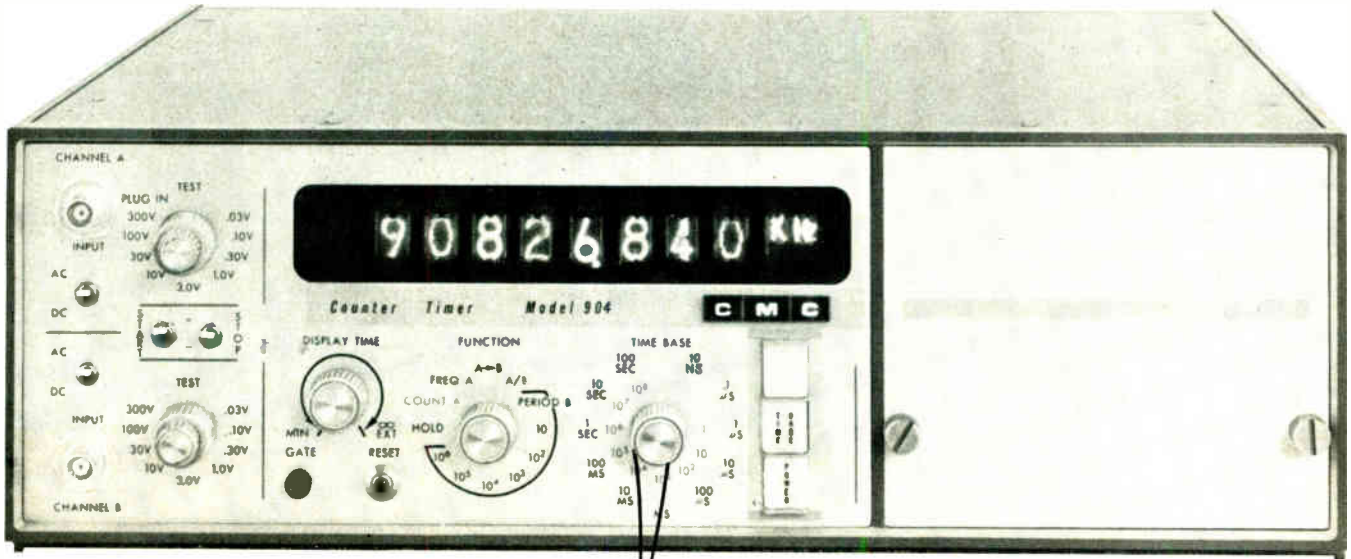

- Accepts all 901 plug-ins — heterodyning to 3 GHz

**\$1975**

*For a limited time only!*

CMC's 200-MHz Model 901 is still the best universal counter-timer available for only \$2475. But now—for a limited time only—we are market testing our brand new Model 904 Universal Counter-timer which boasts many of the same features as the Model 901 and sells for \$500 less! Compare it with competitive units that sell for \$1000 more, and you will see what a bargain the 904 truly is.

But, to take advantage of the special trial price, you must act now. Since we are market testing this low-cost high-quality instrument—we will not be able to hold the price at \$1975 for very long unless there is a high-volume response to our trial offer. So get yours now while the price is right. Why wait and pay more?

For more information, use the reader service card. And for immediate action at the price quoted, take advantage of our Special Trial Offer by mailing the coupon now.

COMPUTER MEASUREMENTS COMPANY



A DIVISION OF NEWELL INDUSTRIES

12970 Bradley / San Fernando, Calif. 91342 / (213) 367-2161

## SPECIAL TRIAL OFFER New CMC Model 904 Universal Counter-Timer

If it's as good as you say, send me a Model 904 for the Special Trial Offer price of \$1975. (Purchase order is enclosed, but I reserve the right to return the instrument within 10 days—without obligation—if not fully satisfied.)

Reserve a Model 904 for me at the Special Trial Offer price of \$1975, but I want to see a demonstration before I buy.

Name \_\_\_\_\_ Title \_\_\_\_\_  
Company \_\_\_\_\_  
Address \_\_\_\_\_  
City \_\_\_\_\_ State \_\_\_\_\_ Zip \_\_\_\_\_

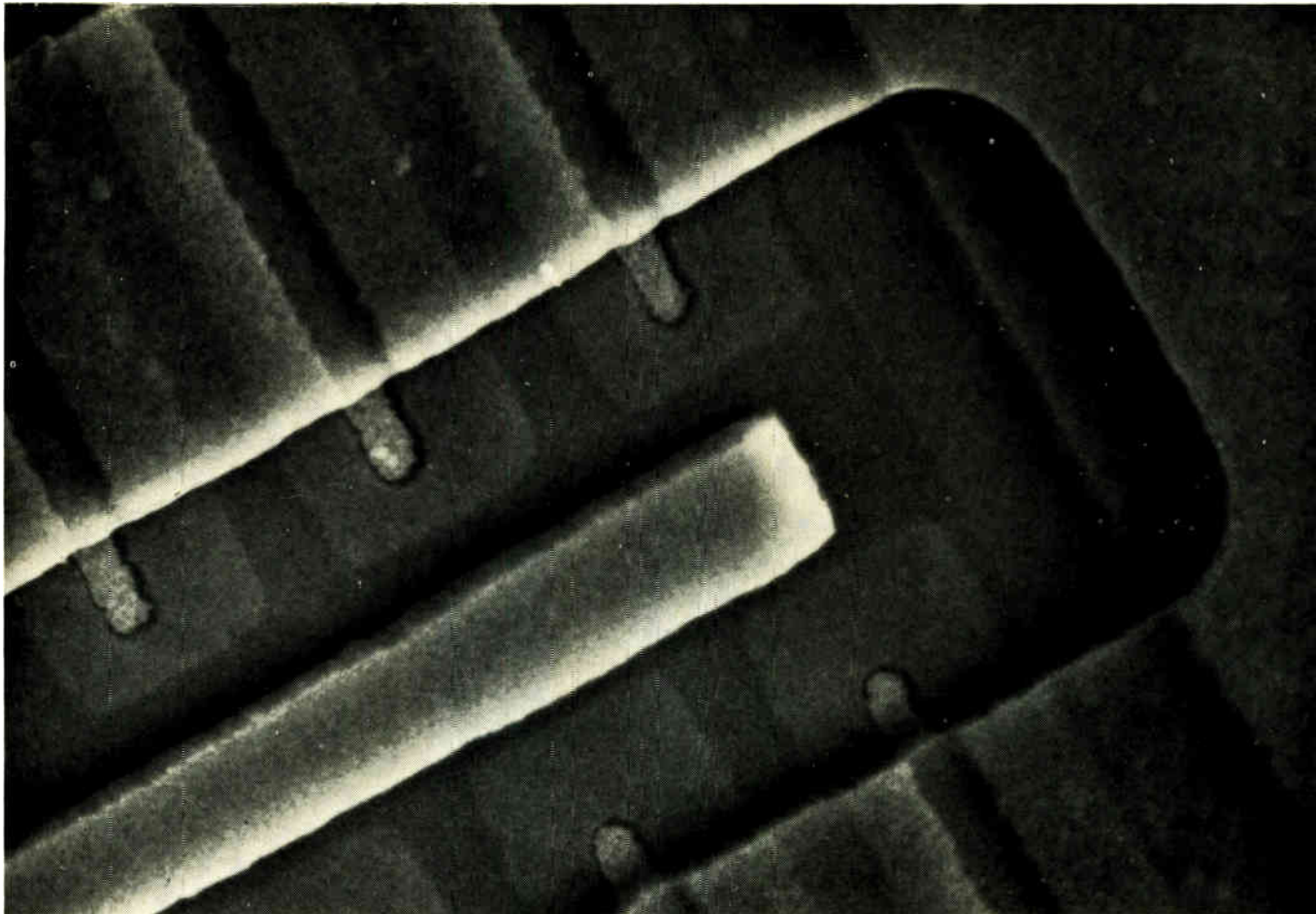

1600x scanning electron photomicrograph of an interdigitated RF power transistor, enlarged about 2x.

## These emitter fingers are 2 to 2.5 microns wide. To clean them you need a FREON® cleaning agent.

FREON fluorocarbon cleaning agents wet and penetrate to clean thoroughly at the sub-micron level. Their high density combined with low surface tension lifts soils and floats away trapped contaminants other solvents miss.

In fact, using FREON solvents has increased production acceptance dramatically for many microcircuit manufacturers.

And there are five more reasons why you should be using FREON solvents:

- 1. Chemically Pure and Stable.** No need for acid acceptance and scratch tests. No inhibitors needed. Parts dry residue-free.
- 2. Compatibility.** No damage to widely used materials of construction.
- 3. Low Boiling Point (under 120°F).** Ideal for low temperature vapor degreasing. Cooling time eliminated. No damage to heat-sensitive parts. Low heat passage to work environment.

- 4. Lower Overall Cleaning Costs.** FREON is recoverable for reuse indefinitely: Power requirements are low in vapor degreasing. Fewer production rejects. Save labor by cleaning complete assembly instead of separate parts.
- 5. Safe.** Nonflammable, nonexplosive, low in toxicity.

If you have a cleaning problem or are looking for an improved cleaning system, write today to Du Pont Company, Room 8902-F, Wilmington, Delaware 19898.



# U.S. to seek compromise on spectrum allocation at 1971 world parley

Opposition to main plan expected from nations fearful of propaganda broadcasts from satellites

Negotiating meaningful treaties between Communist bloc and free world countries is tricky business—and the World Administrative Radio Conference at Geneva next June will be no exception. It will be the first such conference in which Communist bloc nations have actively participated, and the first to make spectrum allocations for broadcasting from international satellites.

American officials are now working to complete the details of their set of proposals. The Federal Communications Commission has held seven inquiries on the U.S. position and there will be an eighth. The position isn't firm, though it probably will stand with minor changes.

The most controversial U.S. proposal would allow direct reception of satellite transmission by individual members of the public in the 11.7-to-12.2 gigahertz band. The Federal Communications Commission says it sees the broadcast satellite service evolving from one served to conventional earth stations for distribution, to one rendered to smaller earth stations for local distribution, and eventually—in 15 to 20 years—to a direct-to-the-home service.

The FCC says it worked with European and some Latin American countries on its proposal, but

a private report of an 11-agency panel set up by the Office of Telecommunications Policy forecasts heavy opposition from Russia, France, and several Latin American countries. These nations, the report indicates, probably will not sign a treaty which allows the possibility of unwanted political broadcasts from satellites to areas within their boundaries. Despite U.S. policy supporting freedom of information on a worldwide basis, the panel advocates community reception systems for protection from propaganda broadcasting since, it says, such systems would be essentially "closed"—and easily regulated by government.

Technology for community broadcasting satellites will be ready in the late 1970s, according to a NASA estimate, and satellites to supply individual reception in the late 1980s. However, the development of ground systems will lag about five years behind satellite capability.

Originally, the U.S. proposed to allocate the 6,625-to-7,125 megahertz band to nongovernment satellite services, but because of European opposition on the grounds that this band is used to feed earth stations, FCC sources say, the U.S. switched to the 10.95-to-13.25 GHz band. The band will accommodate domestic and international broadcast communication, including up and down links—"Admittedly tailored to European requirements," the FCC says. This kind of shuffling, sources say, could prove costly to U.S. companies now preparing applications for domestic communi-

cations satellites. There are no guarantees that a frequency assignment agreed on at Geneva will coincide with U.S. domestic systems—which may be flying before the treaty is ratified by the Senate. Changes would, of course, entail expensive modification of equipment. In addition, the few broadcast receivers that can service these frequencies are more complex and expensive than uhf or vhf receivers.

Commercial airline satellite communicators have been put on notice that the FCC and the White House Office of Telecommunications Policy expect development of a uhf aeronautical services satellite. Aeronautical Research Inc. (Arinc), the Air Transport Association, and the Communications Satellite Corp. have been working on an air traffic satellite to operate over the Pacific in the 118-to-136 MHz band. The FCC inquiry notice says the three groups should aim for a more appropriate band, such as 1,535 to 1,660 MHz.

Though Arinc lost this round—as expected—it convinced the FCC to scrap a proposed primary/secondary sharing arrangement in the 1,535-to-1,660 MHz band, to be jointly occupied by aeronautical and maritime mobile services. The FCC has substituted a provision for common translation frequency, exclusive space for each service, and—in two 5-MHz bands to be shared—expansion room for the first service that overflows its allocation.

The commission and OTP are still working on a proposal to allocate bands near 400 MHz for the collection of oceanographic and en-

vironmental data from remote platforms and sensors. This probably will not be resolved until the next treaty conference—about 1980.

### Technology may be used to solve policy problems

Can technology solve purely political problems? The White House Office of Telecommunications Policy suggests it can in the case of broadcast satellites. Though shaping of satellite antenna beams to conform to political boundaries represents "an extreme, if not impossible, technical problem," the OTP says multiple-shaped beams should be available by the late 1970s for broadcast transmissions to subdivided areas with different channel requirements within a geographical boundary.

The conclusion is one of several on the future of broadcast satellites contained in an OTP survey of U.S. agencies. The survey is for Federal Communications Commission use in drafting an American position for the World Administrative Radio Conference. Satellite-antenna beam shaping is conceived as one possible answer to fears of France, the Soviet Union, and other WARC participants that satellites could be employed to broadcast political propaganda within their boundaries.

**Community antenna** systems for the late 1970s, the report says, could employ 10-foot dishes, with receivers providing program output to video displays or audio transducers via cable systems, or the receiver could drive one large display for community viewing. Satellite transmitter power would reach kilowatt levels, requiring multi-kilowatt subsystems relying on specially designed signals, such as wideband fm.

Though community systems can solve the propaganda broadcast problem, they also are intended to service developing areas where little or no broadcast coverage exists. By extension, the OTP panel says, the systems can provide specialized service to widely dispersed

groups in developed areas.

The feasibility of broadcast satellite systems depends on four major technological requirements: the generation and handling of high dc and radio frequency power, the deployment and orientation of large flexible structures, adequate dissipation and control of heat generated as losses, and long operating life.

With the exception of rf transmitter, high-power amplifiers, the OTP report says that communications subsystems for community-reception tv broadcast satellites can be built with current technology. Output of current spaceborne rf devices is a few hundred watts; they must have kilowatt output.

**Solar arrays** of 400 W have been deployed on past space programs, the OTP panel study notes, but the large power requirements of broadcast satellites will probably require a 3-kw array design with a 1.5-kw capability. OTP says this development is under way and will be tested in space late next year. By the 1980s, nuclear power sources will be available, according to the OTP report, and will replace conventional systems.

Parabolic-reflector spacecraft antennas—like the 30-foot Applications Technology Satellite parabola, already ground tested—capable of operation from uhf to 10 GHz, can be used in broadcast systems. But the OTP sees the need for more development work on antenna feed systems with respect to feed interaction, control of sidelobes, and high-power operation. Development is required for illumination patterns for low sidelobe levels and pattern shaping to avoid spillover and promote efficient spectrum usage, and for power handling capability up to 10 kW. The OTP recommends research on shaped-beam, power reflector antennas, so they can be available by 1975.

Enhancement of efficiency in rf output devices and transmitter circuits could simplify the design of thermal control systems and large solar arrays. However, the OTP report says thermal control systems must be developed beyond AT&T's

technology to maintain the structural integrity of large spacecraft antennas and for dissipation of heat losses in high-power transmitters. This is not, OTP points out, within the current state of the art.

### AT&T's digital net has them talking

"AT&T is being dragged by the events of time into the 20th century, and, as usual, they're announcing that the 20th century is their idea." That's the caustic comment of William McGowan, chairman of Microwave Communications of America, one of the companies bound to feel the effects of the private-line digital data network that AT&T plans to have operating by 1974. AT&T says that the net will link 60 cities and account for \$2 billion of its revenue by the middle of the decade.

In other quarters, the Bell announcement was met with calm. For example, David Foster, vice president for administration at the

### Cox joins Micom

Prior to AT&T's announcement of its digital network, Micom moved to gain a political advantage of uncertain value by bringing former FCC Commissioner Kenneth Cox into the corporate fold a few days after his term at the commission expired. Cox, acknowledged to be in sympathy with special service carriers and land mobile equipment makers during his FCC term, will become a senior vice president of Micom (Microwave Communications of America) as well as a partner in the Washington law firm of Haley, Bader & Potts, specialists in communications litigation and attorneys for Micom and its affiliates. Cox reportedly was offered a comparable post with the Data Transmission Co., the Washington-based subsidiary of the University Computing Co. commonly referred to as Datran. Until AT&T's announcement, Datran and Micom were considered the top contenders for the special service communications market.

## Electronics Index of Activity

Sept. 14, 1970

After experiencing its first upturn in 15 months in June, the index fell 1.4% to 118.8 in July. Further, it was down 16% from July of 1969. The only bright spot in the picture was consumer electronics, which gained 2.6 points to 80.2 from June's upward revised figure of 77.6.

The same cannot be said for defense and industrial-commercial electronics. Defense's 2.8% drop in July left it 21.3% below last year's level. The other unhealthy sector of the electronics industry, industrial-commercial, was off for the fourth month in a row. It declined 0.6% from June.

Indexes chart pace of production volume for total industry and each segment. The base period, equal to 100, is the average of 1965 monthly output for each of the three parts of the industry. Index numbers are expressed as a percentage of the base period. Data is seasonally adjusted. \*Revised.

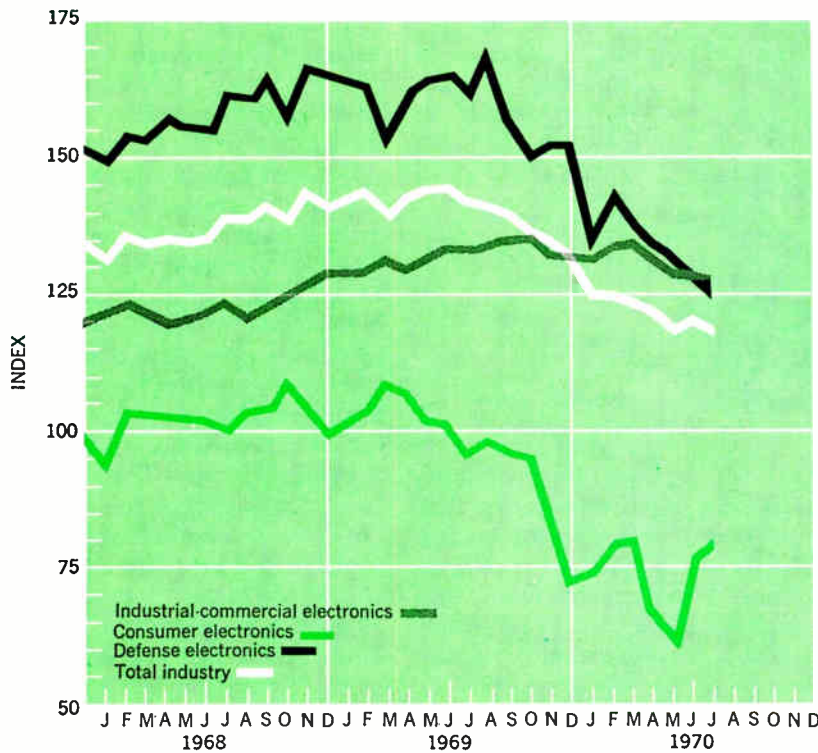

Segment of Industry	July '70	June '70*	July '69
Consumer electronics	80.2	77.6	96.4
Defense electronics	126.2	129.8	160.4
Industrial-commercial electronics	128.4	129.2	133.3
Total industry	118.8	120.5	141.5

Data Transmission Corp. (Datran) says, "This confirms Datran's approach to serving mature markets in selected cities. It also shows that competition does get a response from the carrier community."

Former AT&T vice president, W.M. Ellinghaus, who is now president of New York Telephone, says that the Bell System is completing "the most extensive, most detailed study of the data market ever made." He adds, "It is a massive effort to discern what the market will require in the next decade and what we want to do to meet these needs." But Foster points out that Datran has spent close to \$1 million on market research to find out what the users want and how much they will spend for it. While agreeing with the statements of Ellinghaus on market size and revenues, Foster says they should be based on Datran's rates, which are 50% to 60% lower than Bell's for comparable service.

McGowan of Micom—who hopes to interconnect 20 or more affiliates, such as Microwave Communications Inc. (MCI), into a digital net like Bell's voice network—acknowledges that AT&T will have only to file routinely with the FCC for construction of new facilities to begin its network. And Foster feels that "AT&T's entry into switched digital communications doesn't threaten Datran's position since users will turn to us because we are 100% in data transmission rather than 5%."

Technically, the new Bell digital network should be better than its present system. The new data net will have error performance better than  $10^{-7}$  and will have call-completion times cut to only a few seconds, with Bell's goal set at less than a second, adds Ellinghaus.

By operating long-haul carrier systems over both microwave channels and coaxial cable, the new Bell digital network will provide

a variety of data speeds. When queried about the network's technical capabilities, a highly placed spokesman at AT&T refused to comment until the market study was complete. Datran plans to release the results of its market survey along with its Oct. 1 filing with the FCC. Foster adds that he foresees the greatest growth in the 14.4-kilobit-per-second data rate area. Datran will serve four categories: up to 150 bits per second, 4.8 kb/s, 9.6 kb/s, and 14.4 kb/s.

### Integrated electronics

#### Hybrid circuit packs power in

Hybrid integrated circuits consisting of bare transistor or IC chips mounted on a substrate typically operate at power levels of a few tenths of a watt. If any significant

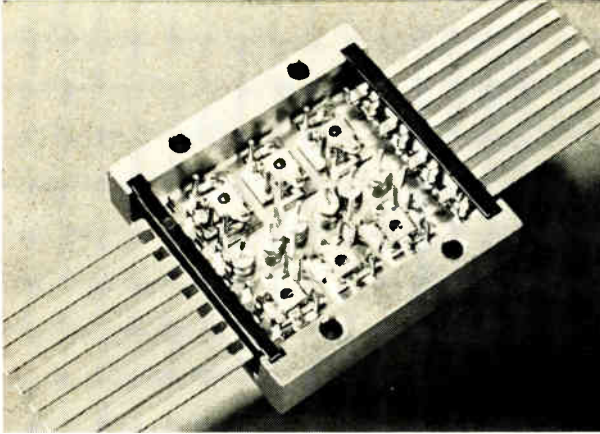

**Hybrid power.** Array contains 12 transistors—npn and pnp—and 12 thick-film resistors in a three-inch-long package. It's an RCA development.

power output is required, an external power transistor is needed. But hybrid circuits developed at RCA's Electronic Components division may change all that—a single hybrid package can deliver 300 amperes of current and dissipate 1 kilowatt in steady state operation, or more than 2kW in pulsed operation.

Basically, the hybrid circuit is an array of power transistor chips, diode chips, and thick-film power resistors. The key to the high power capability is the way the chips are attached to the hybrid substrate: each chip is mounted on a ceramic block of high thermal conductivity which provides electrical isolation and, at the same time, removes heat efficiently. The transistor-diode-resistor array is interconnected according to the user's wishes simply by placing a plastic sheet containing the appropriate metalization pattern over the array. Alternatively, leads for all the devices may be brought outside the package and interconnected externally.

**A typical array** consists of six 15-ampere and three 3-A pnp transistors, three 3-A pnp transistors, and 12 thick-film resistors. The transistors are low- to medium-frequency devices, with gain-bandwidth products of 5 to 60 megahertz. Another array consists of six 50-A transistors and six 50-A diodes. By combining these two arrays, it's possible to switch 300 A from a monolithic IC input.

Warren Totten, manager of market planning for circuit modules, believes that the power hybrid cir-

cuits will appeal to customers chiefly because of the economy that prepackaging affords. An added dividend is that transistor matching is done by the manufacturer. RCA is supplying the arrays in small quantities for evaluation, and expects to be in full production in six to 12 months.

### Military electronics

#### Tacfire has Litton looking overseas

The Army's acceptance of the first Tacfire (tactical fire-direction system) for artillery has officials at the Data Systems division of Litton Industries happily eyeing foreign markets for their baby. And even though the military delayed its acceptance for two to three months, Litton people maintain that there are no technological problems.

Under a \$122-million total package procurement contract, the division will develop the system and equip 16 Army divisions with the gear. Tacfire will automate a range of battalion and division fire-direction center functions from tactical fire control to target intelligence.

On July 31 the Army accepted the first system—a programming support system without all the elements of an operational unit. A second system, a training support unit, will probably go to the Army this fall, and the first engineering service test model—including all the hardware elements to equip a full

division—should be in Army hands early next year. The service test model will be tested in pieces at different Army facilities before it's all put together at Fort Sill, Okla., the Army's artillery center.

Delayed acceptance of the training support system stemmed partly from a strike by the International Union of Electrical Workers against RCA, which supplies drums for Tacfire's mass memory, and partly from unspecified development problems at Litton. "But there's no technology problem with the system as far as we're concerned, and the Army agrees," says Thomas O'Donnell, vice president for marketing. "And we're delighted with the total package procurement status as it stands," he adds. "Both RDT&E and advanced production engineering funds have been released," he notes. Production funds are to begin flowing eight months after the Army accepts the engineering service test model.

O'Donnell's chief concern is that the Army's option to buy enough Tacfire hardware to equip an additional 16 divisions would suffer from possible reductions in force, which could cut off some part of another estimated \$75 million or more in sales beyond the initial \$122 million contract.

**But on the brighter side,** Litton officials are looking to the U.S. Marine Corps and to overseas sales—which, they say, can equal those in the U.S.—to take up any slack that is caused by an Army manpower cut. George Romano, vice president for advanced programs at the Data Systems division, says the Marines are watching the program and have stated a requirement for a system such as Tacfire. There are three Marine divisions.

And the Data Systems division has completed a design study for a Tacfire system for Switzerland. Romano expects the Swiss to fund two competitive development contractors next spring from among the five firms that did similar studies. Besides Litton, they are IBM in France, with help from the Federal Systems division; Univac/Switzerland; Elliot Space and Weapons

# Why DEC uses the Teradyne J133 to inspect incoming ICs

Digital Equipment Corporation, as the world's leading maker of small computers, knows the economics of incoming inspection as well as anybody. It knows that even with garden-variety ICs, defectives can easily run to 2 or 3 percent. Assuming 25 to 50 dollars to find and replace a bad IC in a logic module, you don't need a computer to figure out that even *one*-percent defectives can do a job on a balance sheet. So DEC subjects *all* its incoming ICs to



thorough testing. Lots are first sample-tested dynamically. Once a lot passes these tests, DEC puts every IC in that lot through a full battery of functional and dc parametric tests. And it manages these dc and functional tests with an instrument that isn't much bigger than a breadbox and that costs less than a Cadillac. The instrument is a Teradyne J133.

Why did DEC choose the J133 from among the many IC test instruments available?

First, because it is so easy to use and program. Plug-in PC cards do the job, and DEC doesn't have to worry about getting stuck for a program: Teradyne offers cards for over 1000 different ICs.

Second, it is economical. At only about \$5000 apiece, DEC's pair of J133s paid for themselves in a few weeks.

Third, it is handler-compatible. One of DEC's J133s works with a 4800-unit/hour Daymarc handler, taking bowl-fed ICs and putting the bad ones where they belong — in reject bins.



Fourth, it is protected against obsolescence by a strong applications-engineering program at Teradyne and by the continuing development of new program cards to test new devices.

Fifth, it is backed up by a 10-year warranty from a service-conscious manufacturer. If trouble does occur, Teradyne moves fast to keep downtime down.

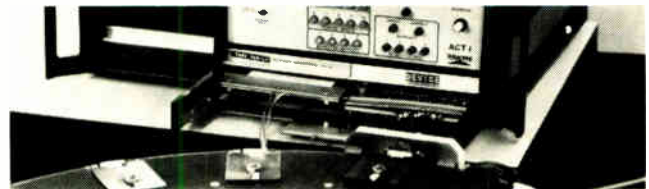

If you would like to know reasons six, seven, eight, etc., your local Teradyne sales engineer would be delighted to take up the count with you. And if you want a closer, faster, more economical look at your incoming ICs (or transistors or diodes or capacitors or resistors), Teradyne has the answer.

Teradyne, 183 Essex St., Boston, Mass. 02111.

## Teradyne makes sense.

## NANOPULSER

the fast rise time,  
large amplitude, variable  
delay pulse generator



Rise/fall time less than 1ns  
Amplitude variable up to  $\pm 50v$

The Series 2306 NANOPULSER combines extremely fast rise/fall time and large amplitude with other important performance features:

- REP RATES UP TO 1 MHz
- BIPOLAR OUTPUTS
- GATING CAPABILITY
- SINGLE SHOT OPERATION
- LOW JITTER
- PRE-TRIGGER PULSE
- PROGRAMMING CAPABILITY

**TYPICAL APPLICATIONS:** Testing high speed switching devices such as semiconductors, IC's, memory elements, etc.; Reflectometer pulse source for discontinuity testing of long or lossy cables via time domain reflectometry. **PRICE:** From \$650

## VARIABLE CALIBRATED DELAY UNIT



0 to 60.75ns in  
0.25ns increments

Bandpass > 1000 MHz

Series 1200 Delay Units provide discrete values of calibrated delay for applications in RF, pulse and digital systems. Delay steps as small as 0.25ns, continuously variable up to a total of 60.75ns with a built-in 0.3ns vernier. Delay accuracy is better than  $\pm 1\%$ . Ideal for use with Series 2306 NANOPULSERS to provide calibrated pulse widths. Both manual and remotely programmable models available. **PRICE:** From \$340

## GRALEX

INDUSTRIES  
155 MARINE ST., FARMINGDALE, N.Y.  
516-694-3607  
A DIVISION OF  
GENERAL MICROWAVE CORPORATION

## Electronics review

of England; and Contraves of Switzerland. Litton officials believe they are in a good position because Elliot is the only other firm that has hardware to offer, and it's not as advanced as Litton's, they contend.

Litton won't divulge the amount of the design study contract for the Swiss government; O'Donnell says only that it was small. But the total Swiss Tacfire potential comes to about half the U.S. potential, Litton figures, which means possibly \$60 million or more.

## Management

### Does smoke at Fairchild mean there's a fire?

The executive shakeup at Fairchild Camera & Instrument has industry observers wondering if a power struggle has begun between president C. Lester Hogan and chairman Sherman Fairchild.

The move followed a loss of nearly \$5 million in the last quarter, cuts in capital equipment expenditures of 30%, and the week-long closing of plants in the Semiconductor division. F. Joseph Van Poppelen Jr., hired by Hogan

Moved out. F. Joseph Van Poppelen Jr. (below) has been shifted from his post as semiconductor division head.



as vice president and general manager of the Semiconductor division, has been moved aside. The division has been split four ways, with each leader reporting to Hogan.

The reason, insiders believe, is that Sherman Fairchild wants to find out if the problem is at the top, middle, or bottom of the executive ladder. Even before Van Poppelen was moved, the chairman had moved Richard Osborne into the company. Osborne's new post of vice president of corporate development enables him to check Hogan's balance sheets.

In the Semiconductor division, Wilfred J. Corrigan, who was vice president in charge of high-volume products, has been promoted to vice president and general manager of domestic operations. Leo E. Dwork, who was a vice president and chief technology officer of the corporation, is now vice president and general manager of memory



President. C. Lester Hogan finds himself back atop the Fairchild Semiconductor operation.

systems—a newly formed group within the Semiconductor division. George M. Scalise remains vice president and general manager for international operations (Far East) and Douglas J. O'Connor is still European general manager.

Van Poppelen has been named a



# new tektronix 7514 with write thru...

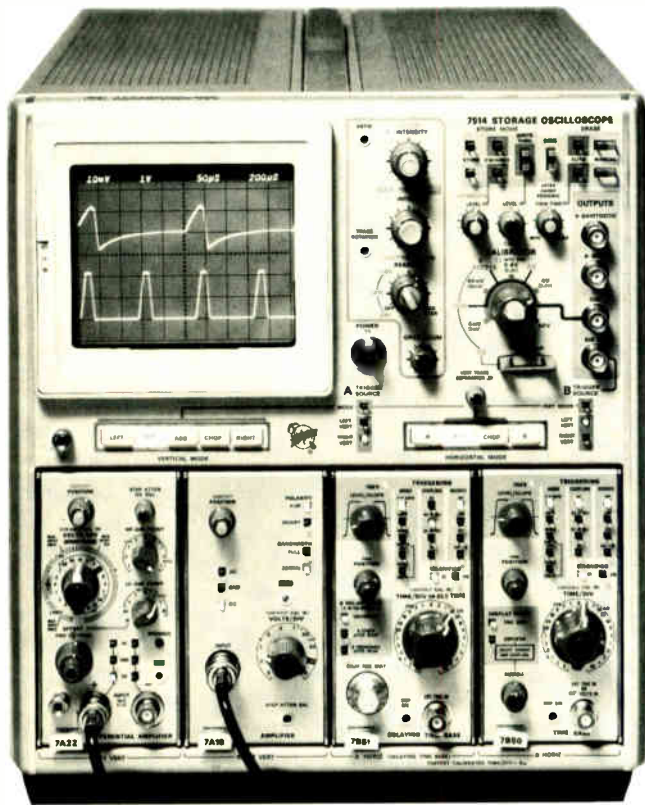

## a significant advancement in storage oscilloscopes

**WRITE THRU** is the most significant advancement in storage scopes in several years. **WRITE THRU** allows simultaneous stored and conventional displays in the same area of the CRT . . . ideal for precise comparison of waveforms. Store a waveform, switch to **WRITE THRU** and the stored waveform then becomes a reference for all subsequent ones. Storage oscilloscopes are frequently used in the non-store mode, but until now, their usefulness has been limited due to a lack of trace brightness. Not so with the 90-MHz 7514! The 7514 has a conventional writing speed of  $450 \text{ cm}/\mu\text{s}$  . . . faster than any other storage oscilloscope. Set the focus control only once, and a new **auto-focus** circuit will take over, so that additional manual focusing is not required with changes in intensity.

The NEW 7514 uses rugged, bistable, split-screen storage which has a **high-burn resistance**. An auto-erase system with variable viewing time allows automatic erasure of either half of the screen after pre-selected view time. The extensive use of push-button controls make the 7514 very **easy to use**.

Seventeen plug-ins covering a wide performance spectrum are currently available, including the NEW 7D13 DIGITAL MULTIMETER, which measures voltage, current, resistance and temperature; and the NEW 7D14 500-MHz DIGITAL COUNTER. With vertical and horizontal mode switching in the mainframe, simultaneous measurements can be made by up to four plug-ins having widely different features.

For measurement ease, Auto Scale-Factor Readout, which is exclusive to Tektronix, labels the CRT with time and frequency; volts, ohms, C (temperature), and amps; invert and uncal symbols.

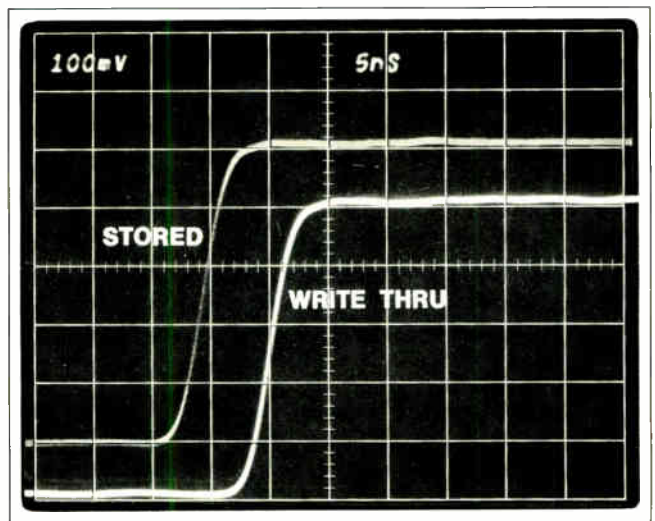

See your 1970 Catalog Supplement for complete specifications. Prices of instruments shown: 7514 Storage Oscilloscope \$3200, 7A16 Amplifier \$600, 7A22 Differential \$500, 7B50 Time Base \$450, 7B51 Delaying Time Base \$510.

U.S. Sales Prices FOB Beaverton, Oregon  
**Available in U.S. through the Tektronix lease plan**



**TEKTRONIX®**

committed to progress  
in waveform measurement

# Being



# st

is what you'd expect  
of **BALLANTINE**

After all . . . over the past  
three decades we've  
developed the



**Systems Compatible  
AC DVM with 10 MHz  
Response**



**True RMS Voltmeter  
with 20 MHz Response**



**Sensitive Wideband  
True RMS Voltmeter**



**Sensitive Ultra-Low  
Frequency Voltmeter**



**Sensitive  
AC Voltmeter**



**AC Voltmeter Utilizing  
Logarithmic Indicating  
Meter**

and during 1970  
we will introduce



**7 more**



**Watch for them!**

In the meantime, request  
a copy of our latest catalog.

Contact us at:

The Singer Company  
Ballantine Operation  
Boonton, N.J. 07005  
201-334-1432

# SINGER

INSTRUMENTATION

## Electronics review

group vice president, responsible for all of the company's divisions except Semiconductor and MOD (Microwave and Optoelectronics division). M.M. Atalla, formerly vice president and general manager of MOD, has been named a group vice president and will also head the company's R&D activity.

### Riley's departure:

#### Signetics too big

Problems faced by large companies differ from those of small ones. James Riley, who until two weeks ago was president of the Signetics Corp., prefers the problems of the small ones. Riley left to become president of Intersil in Cupertino, Calif., and the semiconductor industry is speculating that Intersil and Intersil Memories—which is now headed by Marshall Cox—will be merged under Riley's stewardship. Cox would then become marketing vice president of the combined firm.

Riley's reason for moving on is simply that he wants to work in the environment of a small operation; Signetics had grown too big in his six years there.

His successor at Signetics, Charles C. Harwood, is from the Electronic Products division of the Corning Glass Co., parent firm of Signetics. Ironically, Harwood originally hired Riley.

Other Signetics changes include moving Richard Kruger, a vice president and director, back to Corning. He will, however, remain a Signetics director. Timothy da Silva, corporate products manager, will take over Kruger's duties.

## Computers

### In-house design

#### yields compact machine

When the System IV/70 was announced [*Electronics*, Aug. 31, p. 34], its maker demonstrated an unusual but effective approach to system design. Unlike most other

technical organizations, Four-Phase Systems has done all its design in-house, farming out only the actual diffusion of its large-scale integrated circuit wafers. The result is a computer system unlike anything else currently available.

The machine is a large-scale general-purpose computer processing three full bytes—24 bits—in parallel. It's not to be confused with mini-computers that take four or eight bits at a time and whose word lengths are not more than 16 bits. Yet it sells for only \$7,500 and sits on a desk. Its secret: a complete processing unit in 12 LSI circuits that fit on one card, and a very dense semiconductor memory.

Four-Phase was able to pull this king-sized rabbit out of its hat partly because its principals were willing to plunge ahead on such a radical idea, and partly because among them they had plenty of experience in both semiconductor technology and in system design. They would have done their own diffusion, too, but decided instead to spare the capital investment for the necessary equipment.

Another thing that they haven't done is generate a lot of software for the system—a task often considered essential. Eventually, they say, the software will be available; but for now they're taking advantage of the particular capabilities of the IV/70 to lean on somebody else's software.

The company is shooting for the remote display terminal market, now largely the province of IBM and its 2260 display units and 2848 display controllers. Four-Phase says it can match the performance of one 2848 running a string of 2260s at half the IBM price, and still use only 15% of its computer's capacity. This is achieved with a couple of small software packages that make the IV/70 simulate the other equipment. Or for an investment approximately equal to what the customer is paying for his 2848/2260 setup, he can add other peripheral equipment to his IV/70 and have capability equivalent to an IBM System 360 model 30, which

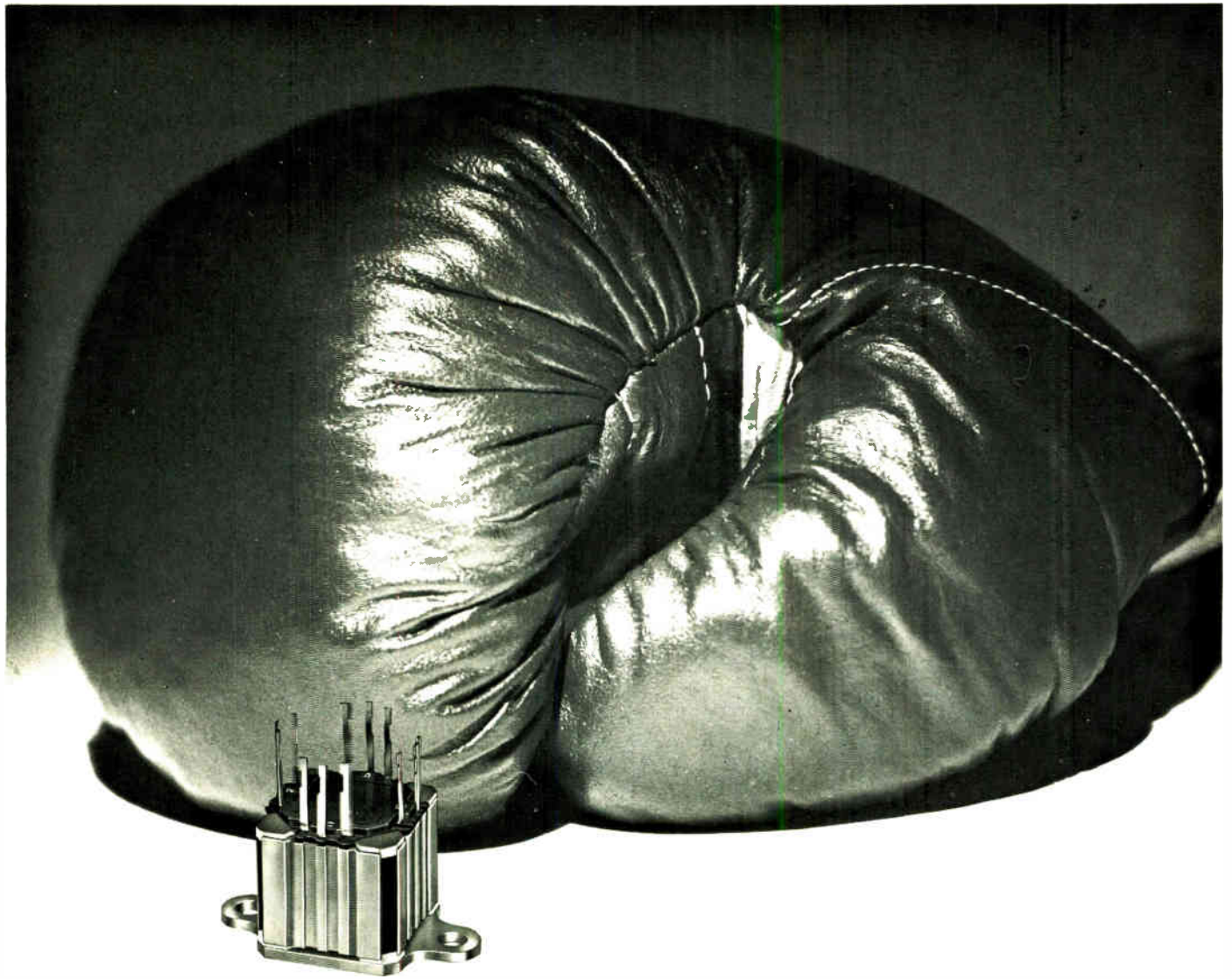

# This Featherweight Champion

## HAS MORE POWER THAN MOST HEAVYWEIGHTS

If you design power supplies, Powercube "flight proven" modules provide many times the power handling capabilities of conventional "black boxes" at a fraction of the size and weight (0.8 ounce, 0.5 cubic inch). Powercube modules allow high efficiency conversion and low thermal rise, as well as proven high-reliability.

Power circuits to fit your most unique requirements are available off the shelf. All modules are identical in appearance and are easily soldered or welded together to form sub-miniature power supplies. Send for our 28-page design guide.

And make your designs the best in their class.



**POWERCUBE CORPORATION**

214 CALVARY STREET, WALTHAM, MASS. 02154 (617) 891-1830

SUBSIDIARY OF UNITRODE CORPORATION

A 512 CHARACTER ARGUMENT  
FOR NOT BUILDING  
YOUR OWN DATA DISPLAY:

OURS IS LESS EXPENSIVE.  
IT'S COMPACT.  
AND IT HAS EVERYTHING AN  
O. E. M. NEEDS FOR OPTIMUM KEY  
ENTRY AND OTHER JOBS. DISPLAYS  
ASCII ALPHANUMERIC CHARACTERS IN  
1.3 MICROSECONDS. TTY/DATA SET  
INTERFACE OR KEYBOARD. SOLID  
STATE MEMORY. TV OUTPUT.

AND USE UP TO 512 CHARACTERS  
FOR DATA AND INSTRUCTIONS: LIKE  
WE JUST DID.

IT'S FROM HUGHES AIRCRAFT  
COMPANY, INDUSTRIAL PRODUCTS  
DIVISION, 2020 OCEANSIDE BLVD.,  
OCEANSIDE, CALIFORNIA 92054. \_

HUGHES IHOM D(9)S



# Are you thinking Hughes is big in electronics?

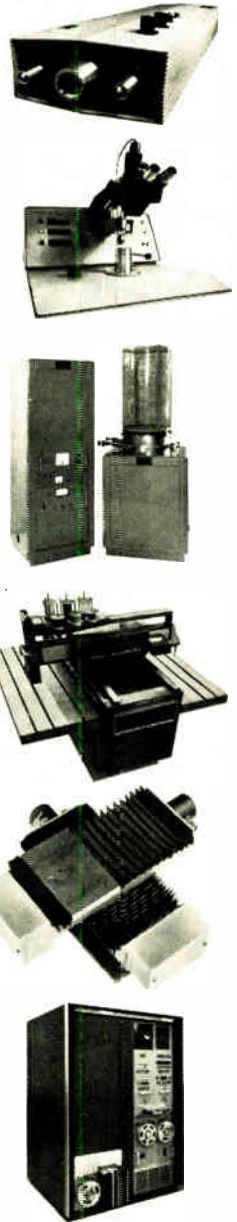

## Electronics review

would cost him three times as much. And he still has his display system, which he couldn't have with the 360/30. All this leans, of course, on the software that IBM makes available with its 360 and 370 line.

In the early days of Four-Phase Systems it was interesting to contrast the company's approach with that of Viatron Computer Systems [*Electronics*, Aug. 18, 1969, p. 50]. It's even more interesting now, because Four-Phase seems to be about to go into orbit, while Viatron is stumbling badly.

### Companies

#### GE and Honeywell: they'll have to try harder

Now that the merger between Honeywell's Computer and Communications group and General Electric's Information Systems Equipment division looks assured, the question is: how long will Honeywell's proud proclamation to its stockholders, "Now we're number two," remain true?

In product lines and geographical strengths, the Honeywell and GE operations are undoubtedly complementary. But, says one industry insider, the new Honeywell Information Systems is in urgent need of a line of computers compatible with Honeywell's Series 200 and GE's 400 and 600.

The reason is simple. Would-be customers looking for replacements for their present computers are likely to reject Honeywell unless the salesmen can promise them compatibility. Traditionally, Honeywell has been reluctant to announce computer products before it was ready to sell them. But if it doesn't make an announcement soon, it runs the risk of at once dissipating two of the four assets it expects to realize from the GE deal—GE's customer base and salesmen. The latter, a mobile group when it comes to company hopping, are likely as not to become demoralized when they have little to sell.

As for the other two components in the merger—GE's manufacturing capabilities and its European operations—only the latter appears to be in strong shape. On the other hand, integrating GE and Honeywell manufacturing operations may be the trickiest problem that the new management and its head, C.W. (Clancy) Spangler, find staring them in the face.

Comments one industry observer: "If I were Clancy Spangler, I'd be scared to death. Just where would I start? It's one thing to go into towns where there are both GE and Honeywell sales forces and combine them; that's microintegration. It's a whole different ball game, though, when it comes to the Phoenix operation [GE's manufacturing base]." For, as many in the industry are quick to point out, saying two organizational charts are to be merged is a far cry from actually merging them.

The answer has to be: put Honeywell people in the top spots (most top GE-Phoenix executives such as Hilliard Page and Thomas Vanderslice have already been reassigned to other GE corporate positions). But this could produce friction with middle management.

## Consumer electronics

#### Phone lines concentrated to save copper

Rising copper costs have spurred telephone companies to try to squeeze more lines to the central office out of less metal. One method that's getting wide attention: the line concentrator that electronically switches a large number of subscriber lines between a few trunks via a multiplexer situated between the subscribers and the central office. Two systems, a subscription loop multiplexer built by the Bell System and a subscriber line system developed by Digital Telephone Systems of San Rafael, Calif., will undergo field trials before the end of the year.

Digital Telephone's system con-

## Good thinking.

Because Hughes put a lot of innovative thought into making better gas and solid state lasers (RS 293), micro-circuit production equipment (RS 294), high vacuum equipment (RS 295), semi-automatic wire terminating and harness laying equipment (RS 296), N/C positioning tables and systems (RS 297), and FACT Flexible Automatic Circuit Testers (RS 298).

# HUGHES

HUGHES AIRCRAFT COMPANY  
INDUSTRIAL ELECTRONICS GROUP

concentrates 96 lines into 24 trunks and uses pulse-code modulation. It must be used in conjunction with a T-1 carrier, the same as the Bell System's concentrator. Bell says only that its decision to concentrate 80 lines in 24 trunks makes for better control of the traffic pattern, and that its system uses delta modulation.

While initial system cost is high, a run of several miles to the central office means considerable saving for the line concentrator over a copper line. Donald Green, president of Digital Telephone, puts it this way: "The cost of laying four miles of copper cable is \$450 and is rapidly rising as the distance increases. On the other hand, the cost of the subscriber line system is also \$450 per line—but varies only slightly with increasing distance."

Other advantages cited by Green include the ability to provide 96 loops with two or four parties on each loop; very low-noise operation thanks to pcm; the capability to carry data—40 kilobits per second over low-speed channels or a 50 k/b/s channel using three trunks at the expense of voice transmission; any sequence of telephone numbers can be used; remote stations can be pole or pedestal mounted, and battery operation for eight hours is possible in a power failure.

Here's how the Digital Telephone system works. Scanning circuits search both ends of the 96 lines at 1.5 milliseconds per line. When a demand for service appears at the remote end, the scanner relays the information to a control unit in the central office. The control unit searches the system's memory on a random basis for a free trunk. When the selection is made, an instruction is sent to a matrix control circuit at each end of the line for connection to a trunk. A loop is extended into the central office, providing the subscriber with a dial tone.

To indicate an incoming call, a ringing voltage is received from the central office. The scanning circuit sees this as a demand for

service and sends the information to the control unit, which searches for an available trunk. The trunk found, ringing is regenerated at the remote end, and a loop is presented in the central office to actuate the telephone's ringing circuit.

When two local subscribers wish to talk to each other, an outgoing call is set up and then returned as an incoming one. When the subscriber answers, a coded tone is injected into the trunk and is sought at the other end. When it's located, the control unit disconnects both trunks looping the local calls together within the system. The scanner continuously monitors the call's status, and when it observes a disconnect, it uncouples the link circuit. The central office maintains a busy signal for the duration of the call on both occupied lines.

The Digital Telephone line concentrator uses ICs and medium-scale integration through the logic and control portions of the system. The read-only memory that stores information is MOS type, while the logic is the transistor-transistor variety.

**Avionics**

**Lack of time and money shoots down AIM-82**

Poor timing on the Air Force's AIM-82 Dogfighter and economies within the Department of Defense proved the Navy's best weapon in getting an advanced version of its AIM-9H Sidewinder missile substituted for the AIM-82. It will be used as a common, short-range weapon for the McDonnell Douglas F-15 and Grumman F-14.

The cancellation left Philco-Ford's Aeronutronics division, a competitor for both weapons, still in the running with Raytheon, also a Sidewinder contractor. But it wiped out the efforts of General Dynamics and Hughes Aircraft. Predictably, the new version has been dubbed Supersidewinder by the military.

Most government and industry

**The Signetics Challenge.**

Here are the distributors who back it up:

<b>ALABAMA</b>	
Huntsville: Compar Corp.	(205) 539-8476
<b>ARIZONA</b>	
Scottsdale: Compar Corp.	(602) 947-4336
<b>CALIFORNIA</b>	
Burbank: Compar Corp.	(213) 843-1772
Burlingame: Compar Corp., (National)	(415) 347-9501
Culver City: Hamilton Electro Sales	(213) 870-7171
El Monte: G. S. Marshall	(213) 686-1500
Los Angeles: Wesco Electronics, Inc.	(213) 685-9525
Palo Alto: Wesco Electronics, Inc.	(415) 968-3475
San Diego: G. S. Marshall	(714) 278-6350
San Diego: Wesco Electronics	(714) 279-3471
<b>CANADA</b>	
Downsview, Ontario: Cescio Electronics, Ltd.	(416) 638-5250
Montreal, Quebec: Cescio Electronics, Ltd.	(514) 735-5511
Ottawa, Ontario: Cescio Electronics, Ltd.	(613) 729-5118
Quebec: Cescio Electronics, Ltd.	(418) 524-3518
<b>COLORADO</b>	
Englewood: Compar Corp.	(303) 781-0912
Denver: Hamilton/Avnet Electronics	(303) 433-8551
<b>CONNECTICUT</b>	
Hamden: Compar Corp.	(203) 288-9276
<b>FLORIDA</b>	
Orlando: Hammond Electronics	(305) 241-6601
<b>ILLINOIS</b>	
Elmhurst: Semiconductor Specialists, Inc.	(312) 279-1000
Des Plaines: Compar Corp.	(312) 775-0170
Schiller Park: Hamilton/Avnet Electronics	(312) 678-6310
<b>MARYLAND</b>	
Baltimore: Compar Corp.	(301) 484-5400
Hanover: Hamilton/Avnet Electronics	(201) 796-5000
Rockville: Pioneer Washington Electronics, Inc.	(301) 427-3300
<b>MASSACHUSETTS</b>	
Burlington: Hamilton/Avnet Electronics, Corp. of Mass.	(617) 272-3060
Newton Highlands: Compar Corp.	(617) 969-7140
Watertown: Schley Electronics, Corp.	(617) 924-1500
<b>MICHIGAN</b>	
Detroit: Semiconductor Specialists, Inc.	(313) 255-0300
Southfield: Compar Corp.	(313) 357-5369
<b>MINNESOTA</b>	
Minneapolis: Compar Corp.	(612) 922-7011
Minneapolis: Semiconductor Specialists, Inc.	(612) 866-3434
<b>MISSOURI</b>	
St. Louis: Compar Corp.	(314) 542-3399
<b>NEW JERSEY</b>	
Cherry Hill: Hamilton/Avnet Electronics	(609) 662-9337
Cedar Grove: Hamilton/Avnet Electronics	(201) 239-0800
Haddonfield: Compar Corp.	(609) 429-1526
<b>NEW MEXICO</b>	
Albuquerque: Compar Corp.	(505) 265-1020
<b>NEW YORK</b>	
Albany: Compar Corp.	(518) 489-7408
Buffalo: Summit Distributors, Inc.	(716) 884-3450
Deerpark: CIE Northeast, Inc.	(516) 586-7800
New York: Terminal-Hudson Electronics	(212) 243-5700
Woodbury: Compar Corp.	(516) 921-93
<b>NORTH CAROLINA</b>	
Winston-Salem: Compar Corp.	(919) 723-1002
<b>OHIO</b>	
Cleveland: Pioneer Standard Electronics	(216) 432-0010
Fairborn: Compar Corp.	(513) 878-2631
<b>PENNSYLVANIA</b>	
Philadelphia: Milgray-Delaware Valley, Inc.	(215) 278-2000
<b>TEXAS</b>	
Dallas: Hamilton/Avnet Electronics	(214) 638-2850
Dallas: Compar Corp.	(214) 363-1526
Houston: Hamilton/Avnet Electronics	(713) 526-4661
Houston: Universal Electronics	(713) 781-0421
<b>WASHINGTON</b>	
Kirkland: Compar Corp.	(206) 882-4191
Seattle: Hamilton/Avnet Electronics	(206) 624-5930



**“If I told you Signetics really delivers MSI, you’d tell me to prove it.**

**“So-effective Sept. 15 to Oct. 15—Signetics makes this challenge:**

**“If you order MSI from stock—and we don’t ship them to you within ten working days—you get up to 100 units free.**

**“I guarantee it. Personally.”**

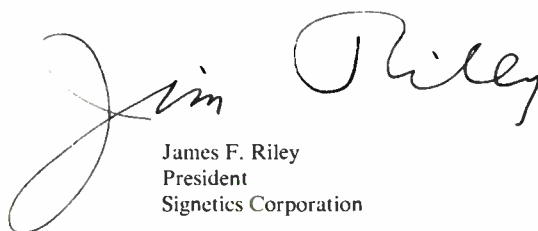
  
James F. Riley  
President  
Signetics Corporation

The Signetics Guarantee. We guarantee shipment of MSI from stock within ten (10) working days ARO, or customer will receive, without charge, the first 100 units or the quantity ordered, whichever is less, of each delinquent device type. This guarantee applies to all new single orders placed between September 15 and October 15, 1970 with Signetics' distributors for immediate shipment of quantities up to 4,999 of N8200 and N8T00 products in silicone DIP. Void if order is cancelled or reduced. Signetics Corporation, 811 East Arques Avenue, Sunnyvale, California 94086 / A subsidiary of Corning Glass Works

**ACL****ASTRO COMMUNICATION LABORATORY**

# Introduces the Most Versatile HF-LF RECEIVER

# SR-502

## Now Available



**SYNTHESIZED  
HF RECEIVER**

**Rugged Design  
Easy to Operate**



**SPECTRUM  
DISPLAY**

**RF TUNER  
10-500 KHz  
SINGLE BAND**



**BATTERY  
OPERATION**



**FREQUENCY  
READ OUT**



**RF TUNER  
0.5-30MHz  
SINGLE BAND**

### AM - FM - CW - USB - LSB - SEARCH

*Versatility in a small package!*

- PORTABILITY—AC DC Battery operation
- 2 PLUG-IN TUNERS: 10-500KHz—0.5-30MHz

*Other plug-in accessories available:*

- SPECTRUM DISPLAY • HF SYNTHESIZER • BATTERY PACK
- FREQUENCY READOUT with digital AFC can be used as 0-100MHz counter
- Rugged design • Simple to operate • Easy to maintain

**ACL****ASTRO COMMUNICATION LABORATORY**

A DIVISION OF AIKEN INDUSTRIES, INC.

9125 GAITHER ROAD, GAITHERSBURG, MD. 20760

TELEPHONE (301) 948-5210 TWX 710-828-9706

## Electronics review

sources in the capital agreed that there is evidence of a renewed tendency in the Defense Department toward development of common weapons wherever feasible, mostly at the subsystem level. This trend, coupled with the fact that AIM-82 slippage ruled out its completion in time for use with the Navy's F-14, was a key factor in the Dogfighter's demise.

A second consideration was high-level belief that the development of Dogfighter would require reinvention of the wheel at too great a cost of time and money. Further, the tough preliminary specifications for Dogfighter performance were regarded "as somewhat unrealistic by the people at the top," says an Air Force man. For instance, the Air Force was challenged on its need for a minimum 1,000-foot performance range with AIM-82 since the F-15's nose cannon will be capable of coping with targets as close as that.

The Dogfighter's death will terminate contract definition studies at Philco-Ford, Hughes, and General Dynamics costing from \$1.2 million to \$1.5 million. However, the Air Force indicates it may be able to apply some of the technology explored for the missile—partly in the area of target acquisition and homing—to the development of the Supersidewinder. For the new competition between Philco-Ford and Raytheon and its \$500 million potential prize, both companies will get development contracts leading to a missile flyoff.

**Supersidewinder** specifications are likely to be looser than those sought for the AIM-82. The Navy, however, is said still to want a weapon capable of executing a 10° turn, with a minimum turn angle of 15°, in 0.3 second or less.

An almost certain characteristic will be a guidance package different from the infrared system of the AIM-9 production model, which homes on jet exhaust. In close-in combat such a system would make it too easy for pilots to shoot down friendly aircraft inadvertently.

With the guidance package ac-





And Mallory TCG computer grade capacitors are small. A few of them together can give you the same capacitance as a bulky "can" . . . at a fraction of the volume. They mount directly on printed circuit boards and can be grouped in series or parallel for optimum space utilization.

All-welded construction and PVC sleeves are standard. High-purity aluminum foil assures low dc leakage current. And, an operating range of  $-40$  to  $+35^{\circ}\text{C}$  plus a pressure sensitive vent\* assure safe, effective service in variety of high C/V applications.

Available in diameters from  $\frac{3}{16}$  to 1 inch, case lengths from  $\frac{5}{8}$  to 3  $\frac{5}{8}$  inch, and voltages from 3 to 450 WVDC. Ratings from 22,000 mfd at 3 WVDC to 100 mfd at 450 WVDC.

\*Not on  $\frac{3}{16}$ -inch diameter capacitors.

**Small is beautiful.**

**MALLORY**

**MALLORY CAPACITOR COMPANY**

a division of P. R. MALLORY & CO. INC.  
3029 E. Washington St., Indianapolis, Indiana 46206; Telephone: 317-636-5353

Electrical and electronic components • sequence timers • metallurgical products • batteries

# RMC

## TEMPERATURE COMPENSATING SOLDER-INS

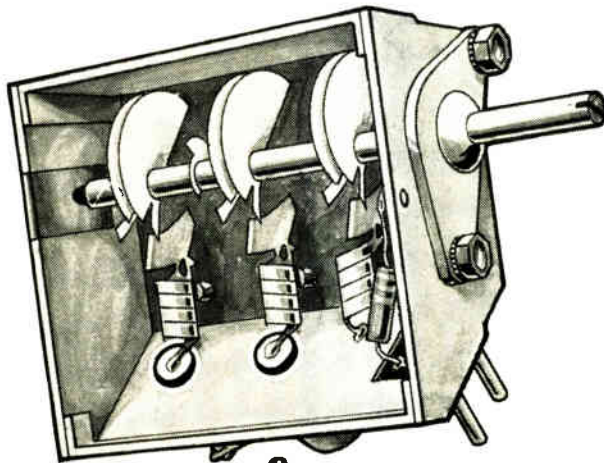

### for

## UHF APPLICATIONS

#### SPECIFICATIONS

**CAPACITANCE:** Within tolerance @ 1 MC and 25°C

**CAPACITANCE TOLERANCES:** ±5%, ±10% or ±20% (but not less than ±.25 pf)

**WORKING VOLTAGE:** 500 VDC

**INSULATION RESISTANCE:** Greater than 7500 Megohms @ 500 VDC

**FLASH TEST:** 1000 VDC for 1 second

**ELECTRODE:** Pretinned for assured solderability

These new solder-in capacitors are designed for use in UHF applications requiring the absolute minimum in lead inductance effects. Solder-ins are available in a wide range of temperature coefficients in capacities from 1.5 to 105 pfd.

If your application requires special physical or electrical characteristics, contact RMC's Engineering Department.

*Write today on your company letterhead for your copy of the RMC Catalog.*

counting for roughly half the missile's unit cost, the decision is a major one and the all-weather advantages of a radar system seem certain to get preference. With its advanced Sparrow, Raytheon has expertise in this area. But Motorola, as a Sidewinder subcontractor, is also on top of radar homing technology: its dual-mode for the AIM-9C version homes on either radar jamming signals from the target or the echoes of radar pulses transmitted from the launch plane.

#### For the record

**Navy pays.** An "amicable settlement" has ended a disagreement between Sanders Associates of Nashua, N.H., and the Navy over the price of a contract, Sanders has announced. The contract, for ALQ-100 electronics countermeasure equipment used on aircraft, has been in litigation since February 1969 [*Electronics*, June 8, p. 44]. The settlement includes related items not in dispute, and increases the total contract price to \$149 million, of which \$7.3 million is to be paid in cash to Sanders in August. Sanders had sued for \$5 million more than the \$140 million the Navy wanted to pay, plus \$10 million for units that Sanders said the Navy had ordered.

**Graybar, Western split.** The marriage between Western Electric, the manufacturing arm of the Bell System, and Graybar Electric is on the rocks; the divorce will be final on Jan 1, 1971. Graybar has been serving as Western Electric's agent for sales of equipment, such as terminals and modems, to operating telephone companies. The recent 2.8% price rise by Western Electric could be the prelude to Western Electric's announcement that it will act as its own agent.

**MOS in the East.** Electronics Arrays Inc. will begin shipping MOS products from its 20,000-square-foot Singapore facility to the Asian market in November.

DISCAP  
CERAMIC  
CAPACITORS

RMC

**RADIO MATERIALS COMPANY**

A DIVISION OF P. R. MALLORY & CO., INC.  
GENERAL OFFICE: 4242 W. Bryn Mawr Ave., Chicago 46, Ill.  
Two RMC Plants Devoted Exclusively to Ceramic Capacitors  
FACTORIES AT CHICAGO, ILL. AND ATTICA, IND.

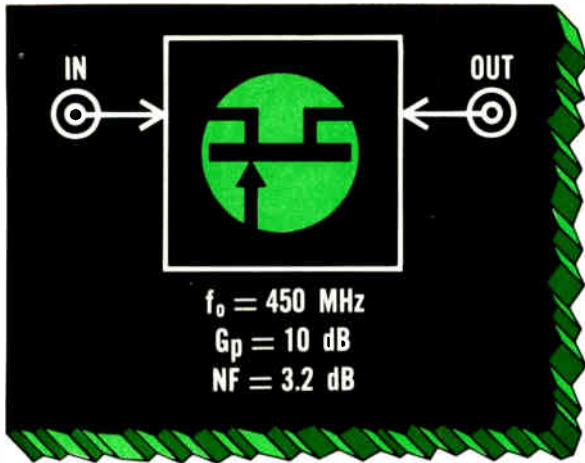

# A NEW UHF FET from SILICONIX

If you're a high frequency freak, going for 600 MHz, want large dynamic range (60 dB-plus) and want low IM (-50 dB and better), think FETs, namely the Siliconix 2N5397. Here's one way:

## 450 MHz COMMON GATE AMPLIFIER

With this setup you'll realize a power gain of 10 dB and a noise figure approaching 3.2 dB. Reverse isolation is typically >20 dB. It can be reasonably tweaked to a power gain of 15.5 dB and  $C_{RSS}$  is typically 1 pF.

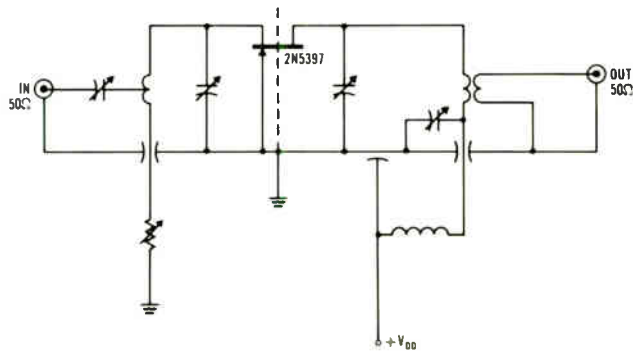

The Siliconix 2N5397 is the best HF FET around, and you can also think it into  Mixers  Oscillators  Video Amps  Switches  Etc.

For complete data, write or call any of the people listed below.

New York: Sy Levine (516) 796-4680  
 New England: Al La Croix (617) 769-3780  
 Ft. Worth/Dallas: Charlie Williams (214) 231-8151  
 St. Louis: Jim Spicer (314) 291-3616  
 Minneapolis: Ed Koelgen (612) 920-4483  
 Southern California: Dave Ferran (213) 420-1307  
 Northern California: Chuck Brush (408) 246-8000



**Siliconix incorporated**

2201 Laurelwood Road • Santa Clara • California 95054  
 Telephone (408) 246-8000 Extension 201 • TWX: 910-338-0227  
 In Europe: Siliconix Limited, Saunders Way, Sketty, Swansea, Great Britain

# Straight answers to common questions about MOS/LSI

The pace of change in MOS technology is bewildering. New products, new processes, new companies are being announced with almost each new issue of industry trade journals. If you're considering MOS, these answers will give you a quick understanding of how TI can help you make the most of this dynamic, complex technology.

**Q: First, where does TI stand in the MOS/LSI business?**

**A:** To meet the industry's burgeoning demand for MOS, we have committed heavily in resources, facilities and talent to develop a broad-spectrum MOS capability. TI can offer you the most complete *custom* capability in the industry plus a broad range of *standard* catalog products from which to choose. A large portion of our newest facility is fully dedicated to MOS, and expansion capability is virtually unlimited. So, we are ready to meet your *volume production* requirements now and are committed to the kind of growth you can depend on for your future needs. We are confident this kind of capability is the key to clear-cut leadership in this growth industry. That is our publicly stated goal.

**Q: But why should I consider TI rather than a "specialty" MOS supplier?**

**A:** The answer lies in your range of options. Today, there are a number of advanced MOS processes offering many advantages and trade-offs which should be tailored

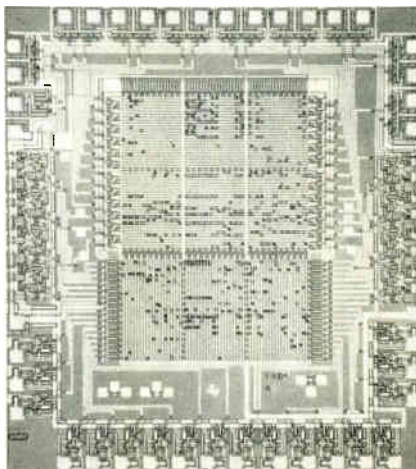

5040-Bit Programmable Logic Array

carefully to your specific requirements for speed, power consumption, circuit density, function, volume, economy and the like. Competence in circuit design is no longer enough; the industry has passed through the era when most MOS improvements were achieved by means of circuit design modification. The major advantages to you today are being brought about by innovations in process technologies and manufacturing capability. This requires resources, engineering talent, volume manufacturing know-how, computer-aided-design strength, and technological depth—in short, *real* commitment.

By coming to TI, you gain the flexibility that allows you to best adapt the optimum MOS approach to your requirements rather than vice versa. You can engage at any level and any stage; you can choose from several high-yield MOS production processes; you can draw on an extensive custom capability and a large selection of standard catalog products to best meet your cost/performance requirements—and you can get the circuits you need in whatever volume you need.

**Q: From exactly what processes can I choose at TI?**

**A:** Virtually any MOS/LSI process available in the industry. Depending on your requirements, we can employ (111) high threshold and (100) low threshold, or (111) nitride low threshold and (self-aligned gate). In addition, we are actively pursuing ion implantation and CMOS, though we feel these are not yet fully mature. We are also evaluating a variety of newer technologies and production techniques that hold considerable promise. To ensure the earliest advantage from these new technologies, TI will stay at the forefront of the MOS state-of-the-art.

**Q: What about my custom requirements?**

**A:** You can engage at any stage you desire for almost any circuit you require. As an example, we have produced volume-quantity circuits which can add, subtract, multiply and divide up to 12 digits for an electronic calculator which uses only three MOS/LSI chips. And we have designed and produced custom circuits for many different calculators and a variety of other types of systems.

**Q: In going custom, what kind of help can I expect from TI?**

**A:** TI will work with you at any phase of design and production. If you have a logic function in mind, but desire help with the logic implementation, we'll supply that help. We'll advise you in choosing the best MOS technology. We'll aid in the preparation of your logic and artwork, or work directly

from the artwork you've prepared. We'll partition the system, produce the prototype and supply a computer-generated performance simulation for your check and verification. We have the capacity to produce and deliver whatever quantities you need, and if you like, we will second-source present MOS/LSI designs from existing photomasks.

**Q: What standard catalog MOS circuits can I get from TI?**

**A:** Today, we offer you 22 off-the-shelf circuits, and there are a number of others in development for announcement later this year.

**TI's CATALOG MOS CIRCUITS**

**Shift Registers**

- TMS 3000 Dual 25-Bit Static
- TMS 3001 Dual 32-Bit Static
- TMS 3002 Dual 50-Bit Static
- TMS 3003 Dual 100-Bit Static
- TMS 3012 Dual 128-Bit Static Accumulator
- TMS 3016 Dual 16-Bit Static
- TMS 3021 21-Bit Static
- TMS 3028 Dual 128-Bit Static
- TMS 3304 3 x 66-Bit Dynamic
- TMS 3305 3 x 64-Bit Dynamic
- TMS 3406 Dual 100-Bit Dynamic

**Character Generators**

- TMS 2403 USACII (5 x 7) Row Output
- TMS 2404 EBCDIC (5 x 7) Row Output
- TMS 4103 USACII (5 x 7) Column Output
- TMS 4177 Combined, USACII (10 x 7)
- TMS 4178 Row Output
- TMS 4179 EBCDIC (5 x 7) Column Output
- TMS 4886 USACII Parallel Output

**Random Access Memories**

- TMS 4003 256-Bit
- TMS 4006 13 word x 6-Bit Digital Storage Buffer

**Analog Switches**

- TMS 6005 6-Channel
- TMS 6009 6-Channel, Common Drain

**Read Only Memories**

Each of the read only memories in our programmable circuits line (see list at right) is available off-the-shelf as a pre-programmed sample to assist you in evaluating the electrical characteristics of these memories.

**Q: What advantages are offered by programmable circuits?**

**A:** While these are essentially standard circuits, they can be pro-

grammed to your specifications by simply changing one mask in the production cycle—providing an economical, quick turn-around approach to custom requirements.

Your choices here include three static read only memories of 1024, 2048, and 4096 bits with full decode. Also, there are three fast (200 ns) partial decode ROMs of 2048 bits for 4, 8 and 16 output bits. A full line of programmable character generators is available for all types of alpha/numeric displays.

Further, there are two programmable logic arrays of up to 6000 devices which perform sequential and combinational logic. These are combinations of master-slave J-K flip-flops and static read only memories on a single chip that permit easy implementation of random logic with the same turn-around time and low cost as a read only memory. They feature bipolar buffers on the same chip.

**TI's PROGRAMMABLE MOS/LSI CIRCUITS**

**Static Read Only Memories**

- TMS 2800 Series 1024-Bit
- TMS 2600 Series 2048-Bit
- TMS 4300 Series 4096-Bit
- TMS 4500 Series 2048-Bit (128 x 16) High Speed
- TMS 4600 Series 2048-Bit (256 x 8) High Speed
- TMS 4700 Series 2048-Bit (512 x 4) High Speed

**Character Generators**

- TMS 2400 Series 5 x 7 Row Output
- TMS 4100 Series 5 x 7 Column Output
- TMS 4880 Series 5 x 7 Parallel Output

**Programmable Logic Arrays**

- TMS 2000 5040-Bit, 60 product terms
- TMS 2200 5472-Bit, 72 product terms

**Q: How are TI's programmable devices programmed to fit my requirements?**

**A:** We provide a software package which you use to prepare the coding information on punched cards. Your punched-card instructions then tell our computers how to program your circuit. This results in fast turn-around time and elimi-

nates human coding errors. Computer print-out of the circuit patterns can be returned to you for verification of coding accuracy before prototype production.

**Q: Is the cost of programming expensive?**

**A:** It's free on orders of 1000 or more pieces. For smaller quantities, there is a nominal charge depending on the type of devices and quantity you desire.

**Q: How about price and delivery?**

**A:** On catalog products, we can offer you immediate delivery at very competitive prices. The programmable circuit costs are comparable with standard catalog circuit prices. For example, the TMS 4300, a 4096-bit ROM, is priced at \$25.00 each in quantities over 1000 units. It is available as a pre-programmed catalog device, or the same device can be custom programmed to your needs with no additional coding charge in these quantities.

Now about delivery: working from your photomasks, we can usually deliver dedicated-design custom products in two months or less. If you have MOS logic, but no photomasks, turn-around time is usually three to six months. If you prefer, we will work from your system specifications and deliver within four to eight months.

**Q: How can I get more answers?**



**A:** A good place to start is with our brand new technical brochure on MOS/LSI, Bulletin CB-126. For your copy, circle 315 on the

Reader Service Card or write Texas Instruments Incorporated, P.O. Box 5012, M.S. 308, Dallas, Texas 75222. If you need more immediate help, call your local TI sales office or authorized distributor.



**TEXAS INSTRUMENTS  
INCORPORATED**

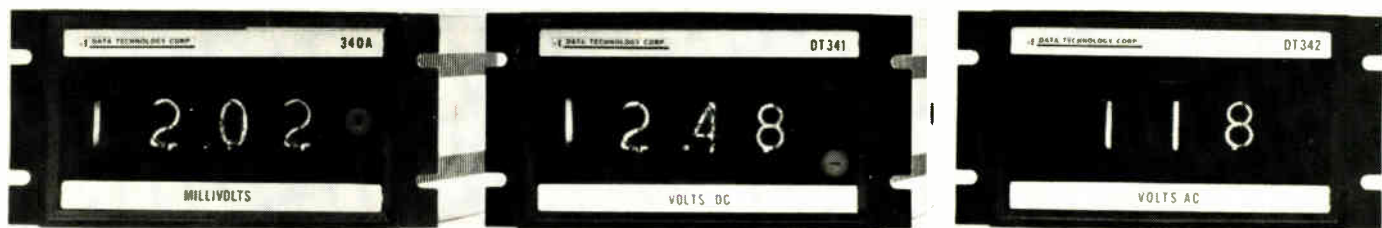

**Safety in**

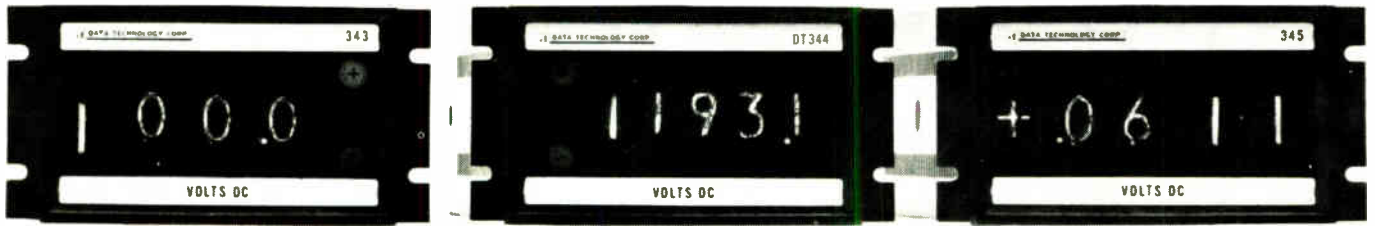

## Data Technology

In digital panel meters, long term stability is a chopper stabilized front end. That's our series 340. Full range, low cost digital panel meters that do away with interface problems. Across the board. With a temperature range of  $+10^{\circ}$  to  $+40^{\circ}\text{C}$ , zero stays put.

The indications are clear. Non-blinking displays you expect only in the most expensive meters, five readings per second with accuracy to 0.01%. And at low, low cost.

Volts, ohms, current and ratio. In three or four digit panel meters with output and accuracy assured by dual slope integration—the most accurate conversion technique ever developed.

The systems people play on our low input current, less than 100pA, for driving from a high impedance source. Get a load of our numbers:

- 340A 3 Digit Single Polarity Meter
- 341 3 Digit Auto Polarity/Systems Meter  
(isolated output)
- 342 3 Digit AC Meter
- 343 3 Digit Auto Polarity Meter
- 344 4 Digit/Systems Meter (isolated output)
- 345 4 Digit Low Cost Meter

Data Technology Corporation, 1050 East Meadow Circle, Palo Alto, California 94303, (415) 321-0551, TWX 910-373-1186.

# numbers.

# Fame is fleeting, but high quality lingers on.

CML-MACARR is a prime factor in the development and production of power supplies, with ratings to hundreds of Kilowatts for systems and laboratory applications. We don't care that our name isn't exactly a "household word".

What we do care about is that those who do business with us know that our products are computer designed . . .

that input factors are interpreted, analyzed and evaluated by electronic data processing equipment and that the final product is the ultimate in efficiency and operational capability.

We care, too, that our customers know of our evergrowing list of solid state power and conversion control equipment for commercial, industrial and military use, such as:

AC Power Supplies  
Wide Band Sonar Amplifiers  
Frequency Converters  
DC Power Rectifiers  
Precision Plating Power Equipment  
Battery Chargers/Analyzers  
Uninterruptible Power Systems  
Power Inverters and Converters  
Helicopter Starters  
Variable Speed Motor Controls  
Motor-Generator Controls



If you require power equipment, get the highest quality at a reasonable price . . . from CML-MACARR. For fast response, call collect!

**CML  
MACARR, INC.**  
subsidiary of *Lenney* Engineering, Inc.

166 National Road, Edison, N.J. 08817 • (201) 287-2830  
TWX 710-998-0560



---

# Washington Newsletter

---

September 14, 1970

**DOD in 1972:  
\$73 billion, but  
less to spend . . .**

First clues to the fiscal 1972 defense budget being put together by the Administration suggest a figure of about \$73 billion—up from the current \$71.8 billion. Pentagon comptroller Robert Moot points out that maintenance of the defense establishment at its present level would cost some \$78 billion in fiscal 1972, but DOD officials believe economies amounting to \$5 billion can be made—a significant portion in Vietnam war costs.

Despite the probable increase in the budget request—sure to be cut by Congress if it follows recent practice—Pentagon sources point out that procurement spending is likely to continue its downward curve since much of the rise comes from internal operating expenses such as pay increases and some price inflation.

**. . . While defense  
job cutbacks  
may top 1 million**

The worst is yet to come for the defense industry's labor force. That's the sad word from Moot, an assistant secretary of defense. Over 400,000 defense-oriented personnel already have lost jobs. Moot forecasts that "based on the funds we are currently requesting from Congress, we will see an additional reduction of some 600,000 to 700,000." The 1 million to 1.1 million contractor job loss is far above DOD's estimate of 640,000 earlier this year [*Electronics*, Feb. 16, p. 142].

On the in-house side, Moot says 562,000 military and civilian jobs have been eliminated by the Pentagon as of June 30. "We will still have to let go over 200,000 additional personnel by June 30, 1971," he adds. Moot's figures could be even more dismal if Congress doesn't appropriate all the \$71.8 billion sought by the Pentagon. DOD's final bankroll for fiscal 1971 is likely to require an additional \$1 billion spending reduction.

**HEW warns industry  
of deadline for  
radiation reports**

Many apparently unaware electronics companies face high penalties if they miss the Sept. 25 deadline for filing radiation reports with the Health, Education and Welfare Department. Failure to list radiation-emitting products, safety design specifications, and test methods could result in individual company penalties as high as \$300,000. A sampling of manufacturers indicates many executives are ignorant of the requirements spelled out in the Radiation Control for Health and Safety Act and HEW has responses from only 25 of some 600 companies affected.

Products covered include tv receivers, shunt regulator and cathode ray tubes, microwave ovens, high-voltage vacuum switches, lasers, X-ray machines and tubes, and ultrasonic devices, among others. Lasers, unlike the other products, are designed to emit radiation. The Electronic Industries Association says it has prepared special instructions and forms, approved by HEW, for laser manufacturers. Fines of \$1,000 can be levied for each element of a product description and for each product covered if HEW believes a firm deliberately failed to report on time.

**Adm. Moorer's role  
as Joint Chiefs head  
aids Sabmis, ULMS**

Watch for increasing military support—and fiscal 1972 money—for Navy development of its Sea-based Anti-Ballistic Missile Intercept System (Sabmis) and Undersea Launched Missile System (ULMS), the follow-on program to Poseidon. The two programs, ranked in order of Navy missile priority, are being advanced in the military-political arena following the succession of former Chief of Naval Operations, Adm. Thomas

---

# Washington Newsletter

---

Moorer, to the chairmanship of the Joint Chiefs of Staff. Both are part of a larger Navy strategic program known as the Advanced Sea-Based Deterrent (ASBD), which is getting an increased data flow from the Army's Safeguard program for Sabmis planning.

Though placement of an ABM system at sea has technological and political advantages—Sabmis is more readily adaptable for midcourse ICBM intercepts, obviates the need for warhead identification on re-entry, and eliminates most citizen panic on placement of ABM target sites—the Navy suffered a setback when Congress refused to reject Safeguard. Moorer, in selling ULMS—or its surface-launched missile system alternative—also must overcome Deputy Defense Secretary David Packard's penchant for using existing systems instead of starting new ones.

## Police radio specs available Oct. 1

After running the gauntlet in the Air Force chain of command, the specifications and requests for proposals for the Law Enforcement Assistance Administration's police transceiver will reach industry bidders by Oct. 1. Ironically, it was LEAA's decision to widen the range of possible bidders by going through military procurement channels that delayed the rfp, which was originally expected last March [*Electronics*, Mar. 15, p. 45].

The hangup is blamed by officials of the Justice Dept. agency on a variety of routine bureaucratic problems within the military including the requirement that projects for other agencies must be approved at multiple command levels all the way up to the service secretary. LEAA officials say the agency plans to set up its own procurement organization to cut the red tape in future development programs.

## Federal computers: Are benchmarks on the way out?

Government computer suppliers could see an end to the costly benchmark evaluation process in large competitive procurements, according to an internal Office of Management and Budget document. A summary of a closed summer conference of Federal computer users at Myrtle Beach, S.C., the document reiterates complaints by vendors that the expense of benchmarking tends to eliminate competition. More significant, however, is the first mention of a Government view that "benchmarks do not always reflect the work that is actually performed when the system becomes operational, and, therefore, the wrong system may, in fact, be selected."

## Addenda

Collins Radio Co.'s George Mansur is likely to have wide-ranging responsibilities as new deputy of the Office of Telecommunications Policy since director Clay T. Whitehead's expertise is in policy rather than technology. . . . Defense research centers may be moved off campus if attacks against them continue, says Defense Secretary Melvin Laird. The warning comes after bombs ripped the University of Wisconsin's Army Mathematics Center, a center that Laird brought to Wisconsin when he was in the House. . . . Transmitting equipment operating in the aviation frequency bands must be compatible with the Federal Aviation Administration's National Airspace System or the equipment won't get type acceptance by the Federal Communications Commission under a new FCC rule.

# THE BEST RINGS IN LIFE ARE FREE.

And trouble free.

You'll never have trouble with these ground sheathing connectors. For terminating, grounding or tapping shielded or coax cable, both the one-piece Uniring® and the two-piece Hyring® insure a crimped connection that is mechanically and electrically stable.

No solder, no heat . . . no danger of overheating cable. Only a few mils larger than cable diameter, the "rings" are corrosion resistant and color-coded. Immediately available insulated with nylon, or uninsulated.

Samples of the best rings in life are free . . . catalog, too. Send now.

 **BURNDY**  
Electronic Products/Norwalk, Connecticut

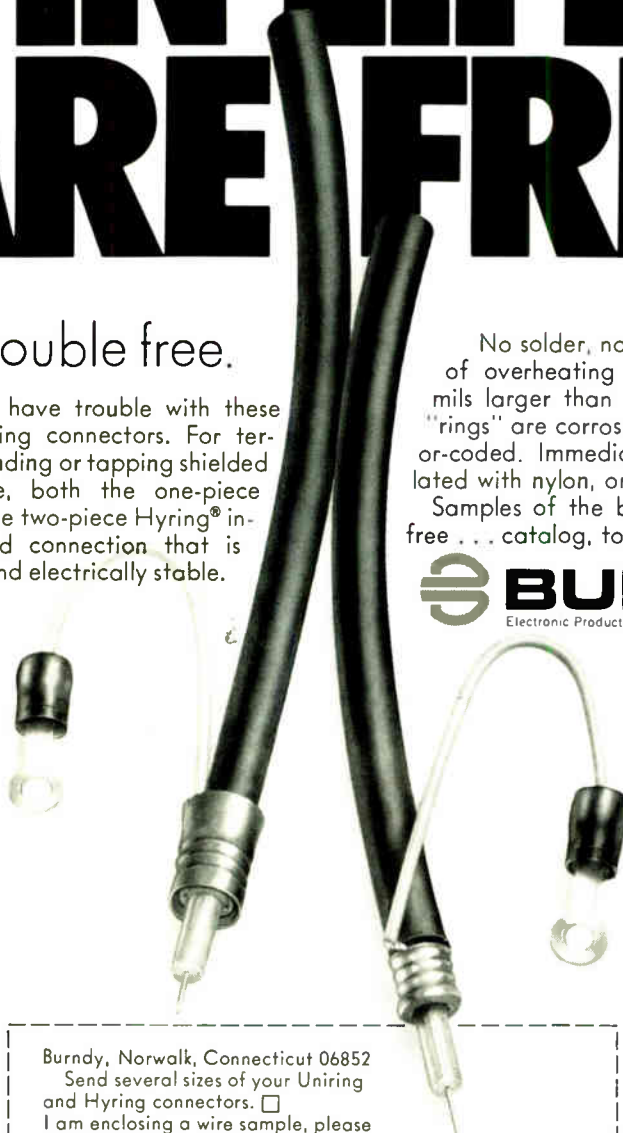

Burndy, Norwalk, Connecticut 06852

Send several sizes of your Uniring and Hyring connectors.

I am enclosing a wire sample, please install a Uniring or Hyring on it, and return to me.

Name \_\_\_\_\_ Title \_\_\_\_\_

Company \_\_\_\_\_

Address \_\_\_\_\_

\_\_\_\_\_

70-27

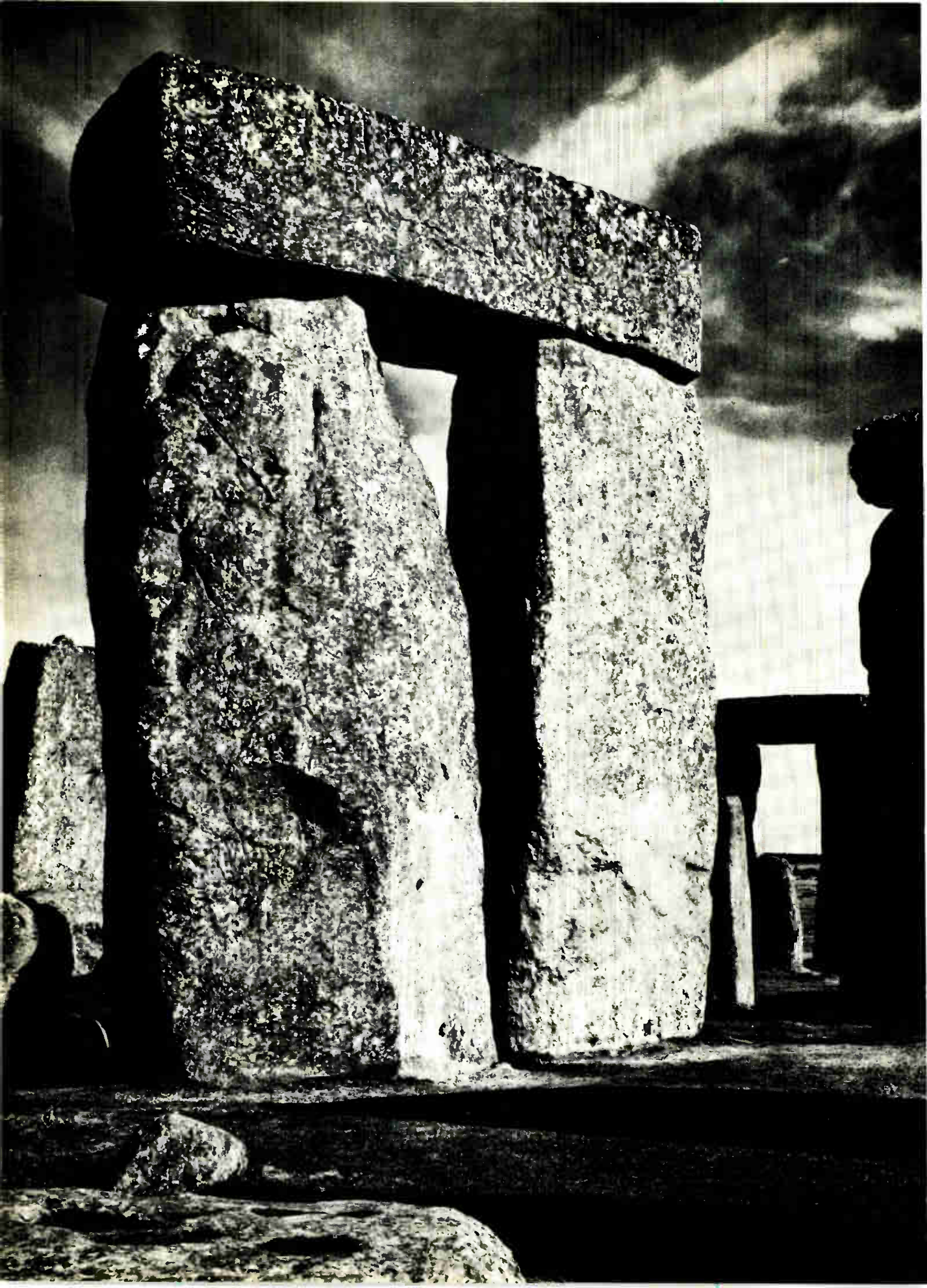

# Prototype.

Stonehenge.

Grey megalithic fingers of rock grappling with a leaden sky on the Salisbury Plain. Stonehenge. A monument to the inquiring mind of man, structured precisely toward that point on the horizon where the sun of the midsummer solstice rose on some prehistoric dawn. Was it only a sun temple? Or was it the first memory system for astronomic observation? Its mystique has traversed the ages from 1600 B.C. And it may survive to the end of time. Because once you have seen Stonehenge, you know why it can never be forgotten.

From the Bronze Age to the Computer Age

may be a giant step in history, but the need for man-made memory systems remains a constant. Then they were used for a sight of the sun. Now they are more likely to be used on a moon site. And the system of sarsen stones has been replaced by a system of ferrite core. But resistance to hostile environments and precise functioning under adverse conditions are still basic to the specifications.

And building data storage memories for severe environments is our business. We cut our teeth on Mil spec memory systems. Our Military Systems Division continues to be a

major contributor to both defense and space programs. And our leadership in severe environment memories has a long string of "firsts" to go with it.

For example, our development of the ISODRIVE wide-temperature core in 1962 introduced core memories in space applications. We were also the first to develop core memory systems for military aircraft. EM-developed memory units are operating aboard virtually every U.S. solar and lunar orbit spacecraft, on the lunar surface and in earth satellite systems. More recently we were the first to develop memories for

"inner space" applications to withstand deep undersea environments.

Our long record of accomplishments in severe environment military memories (SEMS™) is backed by our worldwide facilities for the production of core, stacks and systems. We deliver volume quantities when you need them. We work with you to solve special problems. And we offer a full spectrum of support services. That's how we built our reputation. That's how we're going to keep it. We, too, would like to last forever.



## Electronic Memories. Worth Remembering.

Electronic Memories is a division of Electronic Memories & Magnetism Corporation, 12621 Chadron Avenue, Hawthorne, California 90250. Telephone (213) 772-5201

Circle 71 on reader service card

**For the first time, we'll see how well sonar works where it's supposed to work.**

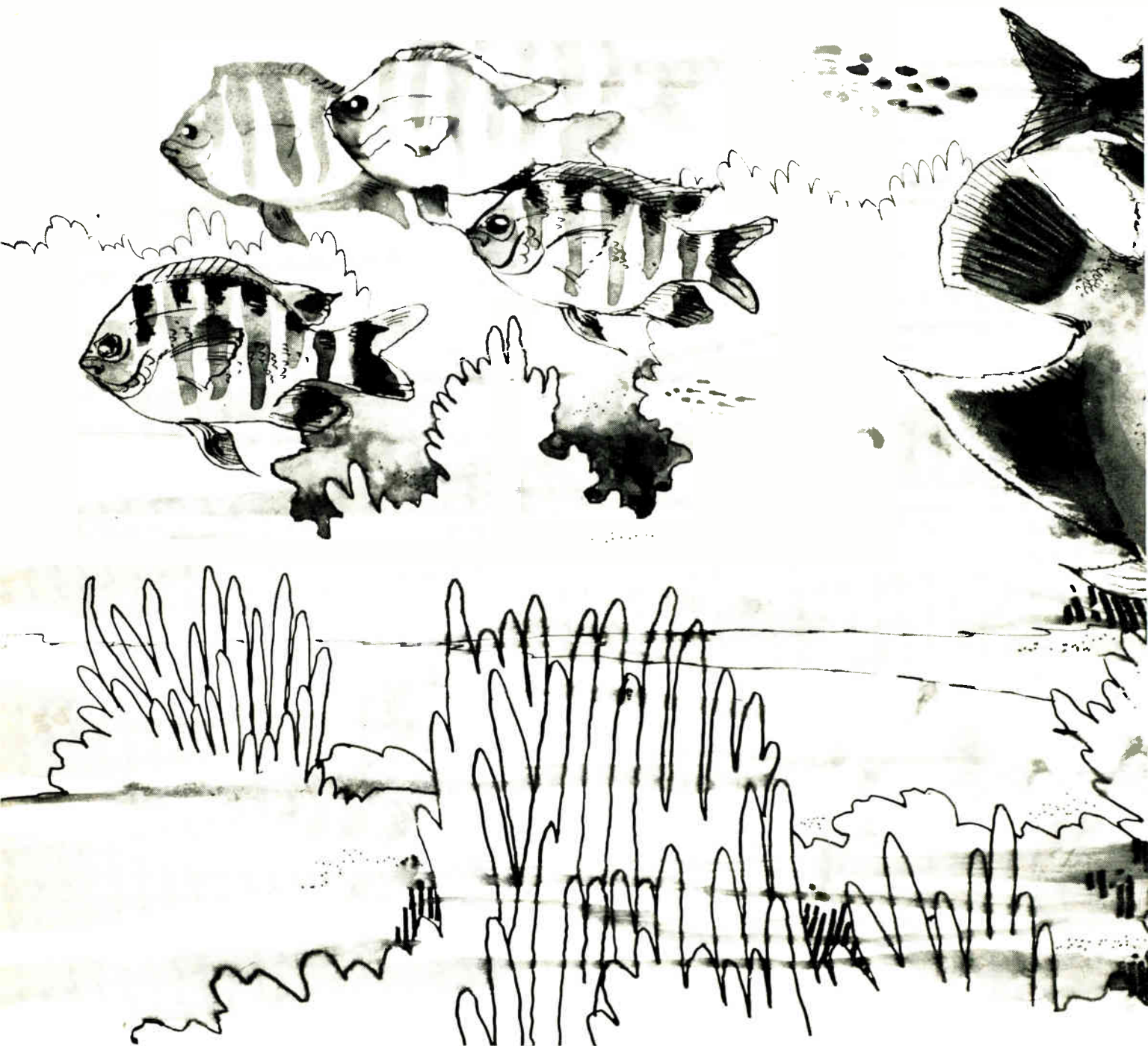

Think of sonar as a pair of eyes. The only trouble with the eyes is that no one has been able to precisely check them under working conditions.

Basically, that's the concept behind the sonar range of AUTECH, the United States Navy's Atlantic Undersea Test and Evaluation Center.

General Dynamics' Electronics division is building and will install the entire complex of shore-based, shipboard and underwater systems for this sonar range for the Navy. AUTECH is located off Andros Island in the Bahamas.

When it's completed, AUTECH will have the first system able to check all the performance characteristics of sonars in a working ocean laboratory.

The AUTECH sonar range will measure the three-dimensional beam patterns and source levels of various sonar devices and analyze signal content and performance levels of advanced sonar systems.

Both active and passive sonar performance will be tested. So, for the first time, the accuracy of underwater

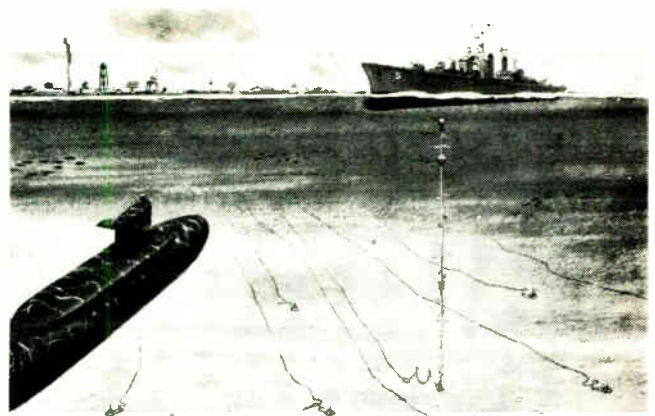

weapon systems installed on submarines and destroyers will be assured.

AUTECH is the first and only of its kind, and it requires the highest degree of technology.

But we like it that way. At General Dynamics, we put technology to work solving problems from the bottom of the sea to outer space ...and a good bit in between.

## **GENERAL DYNAMICS**

1 Rockefeller Plaza, New York, N. Y. 10020



# Emancipate your time



When You Are Faced With A Tough Design Problem  
The System 9100 Allows You  
To Pick It Apart, Analyze It, Modify It,  
And Solve It  
Right At Your Desk.



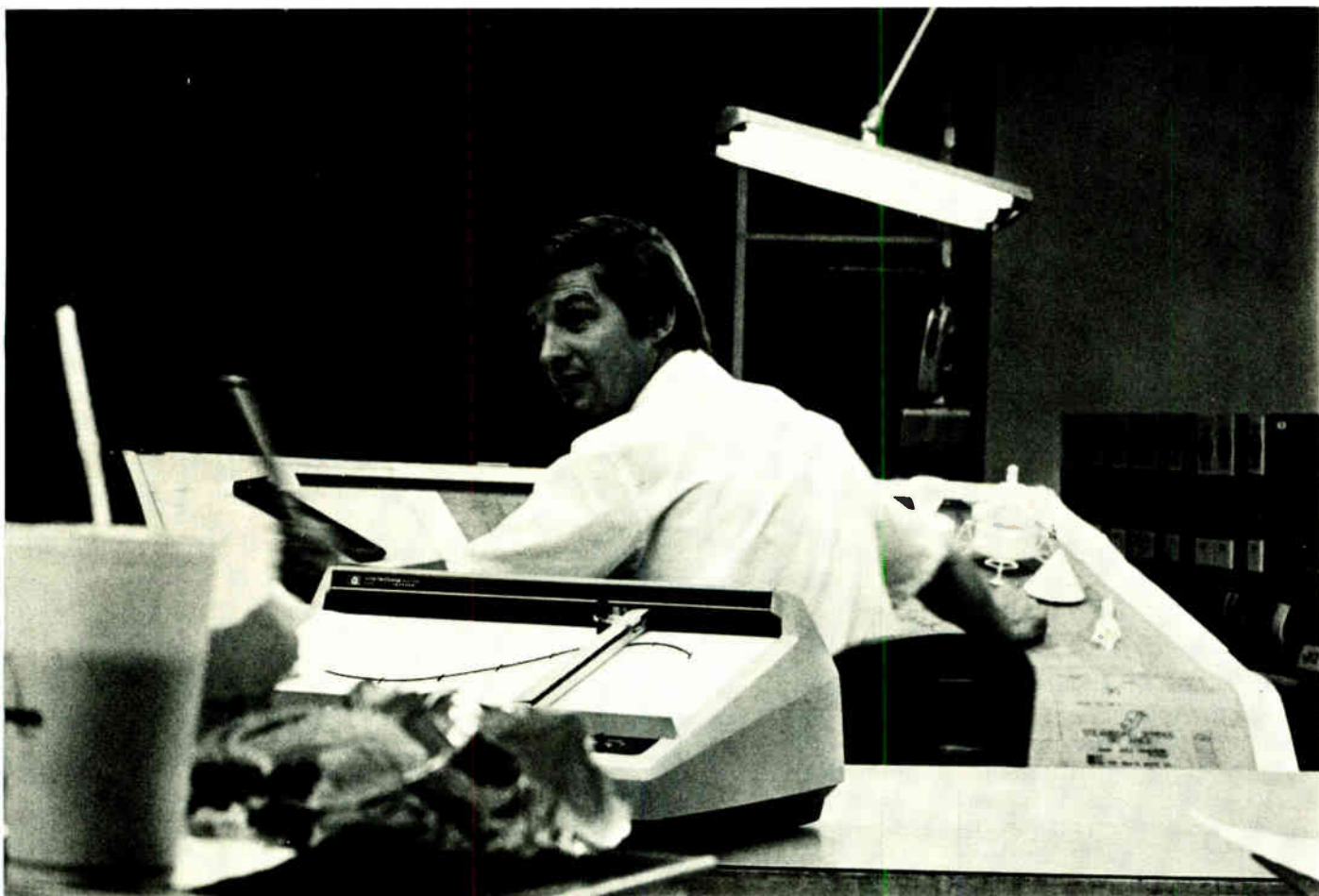

You are an engineer on the move—you see a problem and a host of possible solutions fill your mind. Complex combinations of components and parameters—any one of which may be a major breakthrough—demand careful analysis. You write up four or five of your better ideas and take them to the programmer to run on the computer. "Tomorrow if you're lucky," he says, "the next day if you're not." Back to your desk. Pencil, paper, slide rule—if you stay a little late tonight you might be able

to work through one possibility yourself.

There is a better way. The HP System 9100. We call it the Emancipator because it frees your time for innovative engineering. No need to wait for a programmer or wait in line to get on the big computer. The System 9100 will compute your problems, build your models, and plot your graphs—at your desk— instantaneously. With full programming capabilities, including looping and branching and sub-routines—and the

most extensive program library available anywhere, the System 9100 starts solving your problems as soon as you open the box.

Arrange a "hands-on" demonstration at your desk. Lease, rental and purchase options available, write: Hewlett-Packard, P.O. Box 301, Loveland, Colorado 80537.

090/31

**HEWLETT  PACKARD**

HP CALCULATOR SYSTEM 9100

Circle 75 on reader service card

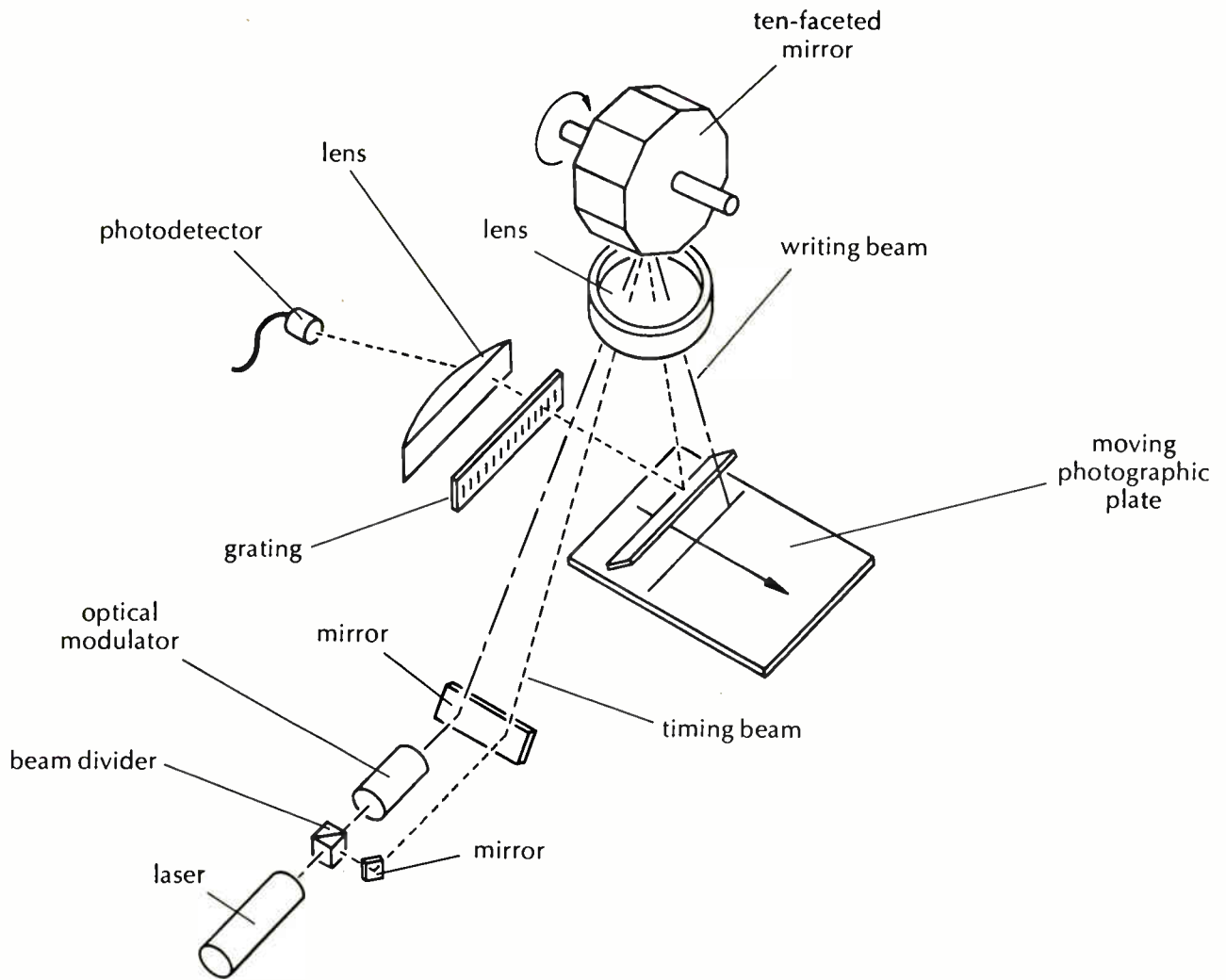

### Better circuit masks exposed

Making integrated semiconductor and thin-film circuits requires a set of photographic masks to outline the application or removal of materials during processing. The demand for these masks has increased as integrated electronics has come of age and it will continue to grow with the technology.

Mask-making has long been automated. The engineer feeds a geometric description into a standard program and a computer generates a tape. The tape controls a machine which moves a light beam or a knife along coordinate axes to draw the mask. This takes many hours.

Now, Bell Labs has developed a machine which can produce complex masks in under 10 minutes. The machine contains an argon-ion laser.

The laser beam is scanned across an 8 by 10 inch photographic plate and switched on and off to expose the emulsion on the plate according to the mask pattern. As each scan is completed, the plate is shifted one linewidth. Scanning time—20 milliseconds per line—is independent of the number of times the beam is switched on and off.

Each facet of a ten-faceted rotating mirror (above) sweeps the beam once across the plate. At the same time, each facet sweeps an auxiliary laser beam across a grating, generating 26,000 timing pulses for each scan. A digital computer processes the pulses to determine the position of the scanning beam and to generate control signals for an acousto-optic modulator

which switches the beam on and off.

The laser beam can be directed with an accuracy better than 2 arc-seconds, the equivalent of a mile-long straight line with less than  $\frac{5}{8}$  inch deviation. For such precision, the machine is operated in a special controlled-environment chamber where temperature is maintained within  $1/7^\circ\text{C}$  and a cubic meter of air contains fewer than 3500 dust particles larger than one micron.

These high-speed, precise machines will supply the Bell System's mask needs for several years. As integrated circuits gain wider telephone use, this will keep costs down.

From the Research and Development Unit of the Bell System:



**Bell Labs**

# Article Highlights

---

**Three-state switching  
brings wired OR  
to TTL  
page 78**

TTL circuits can't take advantage of a common bus system, along which every major subassembly of a computer communicates with every other, without modifications to the circuits that nullify their speed advantage. Now there's a new form of TTL that can be electronically disconnected from the bus, eliminating the short circuit problems that confronted other approaches.

**Electronics views  
the spectacular  
Japanese market  
page 78**



A comprehensive survey of the Japanese electronics industry, a first for *Electronics*, reveals that the nation's output of goods and services, which rose spectacularly over the last decade to stand third in the world, will continue its blistering pace. What's more, some observers predict that the output of Japan's booming electronics industry may catch up with U.S. production well

before the end of the century. The consumer sector continues to supply most of the fuel for the Japanese electronics industry, and new products and the growing computer, communications, and industrial markets will provide the push for the future.

**Saturating op amps  
compress ac signals  
over many decades  
page 105**

A few operational amplifiers are about all it takes to compress an ac signal whose amplitude varies over several decades. Connected in cascade, the amplifiers saturate one after the other as the amplitude increases. As the outputs are summed, a logarithmic version of the original ac signal is produced, with an uncalibrated accuracy of about 3%.

**Two-part electrode  
extends range of  
variable capacitor  
page 108**

The goal of achieving a large capacitance range in a small variable capacitor has been realized in a new approach that uses a two-part electrode consisting of a moving contact element and numerous electrode islands deposited over the dielectric surface. The contact interconnects the islands sequentially, and they form capacitors with the continuous conductor layer beneath the dielectric.

---

## Coming

**Read-mostly memory**

At last there's an Ovonic amorphous semiconductor device, in the form of a 256-bit memory circuit that's a cross between a random access and a read-only unit. The new circuit is non-volatile and can be reprogramed at will, promising great flexibility for computer memory systems.

# Three-state switching brings wired OR to TTL

A switch that removes base drive from both transistors in an otherwise conventional push-pull output permits a wired-OR configuration, thus combining TTL's advantages with those of bus-organized computers

By John Sheets, *National Semiconductor Corp., Sherman Oaks, Calif.*

□ A form of transistor-transistor logic has been developed that permits use of the wired OR and restores harmony between the data-bus concept of system design and TTL. Featuring the same speed but better drive capability than standard TTL the new logic has an output configuration that allows any circuit to be connected or disconnected internally from the output pin, so that a control signal can select which circuit on the line is to transmit data at any given time.

Therefore, large numbers of TTL circuits can be hard-wired to a bus line. This configuration is the equivalent of a logical OR function, and is known as a wired OR, or sometimes as a dot OR or a solder OR. It is the basis of the bus-organized concept of system design, an organization that improves system modularity and reduces wiring, assembly, design, and testing costs. Standard TTL's lack of wired-OR capability hinders economical use of bus organization.

The first of a family of such circuits is a quad-D flip-flop—four flip-flops and associated gating on a single chip. Its obvious application is as a building block for data-storage and data-transfer registers in computers and other data-processing systems. Its logic design enhances system modularity because it requires no special clock formats, so that any number of modules can be added to a system without modifying the clocking network.

The new design's most important feature, particularly for small systems, is its capability to serve as a combination storage, multiplexing, and line-driving element. This multifunctionality opens up a new range of bus-organization techniques, including time-shared operation of display drivers and sequential operation of large-scale integrated memory arrays that are unusually fast. Other expectations are simplified bus structures and a drastic reduction in the number of subsystem interface circuits required in a system.

In one move in this direction, additional medium-scale IC functions are being developed with the new output configurations. As presently planned, several of these will be monolithic equivalents of functions that now require the quad-D flip-flop plus external logic devices, such as bus-interchange functions and multiplexers.

The development of the new circuit stems from

the fact that, except for its lack of a wired-OR capability, TTL is ideal for bus-organized systems. A basic TTL gate enhances modularity because it requires much less area on the silicon chip than a DTL gate does. Consequently, TTL circuits in the MSI class of complexity—that is, complete logic functions in a single package—have been put into mass production, while DTL—in spite of the ease of connecting it in a wired OR—is still at the level of individual gates and other simple circuits that must be assembled to build a complete function. The available MSI functions make TTL useful in bus-organized systems, because the advantages of the bus organization offset the cost of doing without the wired OR or modifying the circuit to make it possible.

Wiring an OR function at the output of a TTL circuit presents difficulties that can be seen by inspecting the output design of the typical TTL NAND gate, shown in black on page 79, lower left. Multiple-emitter transistor  $Q_1$  performs the AND function, replacing the input diodes required in DTL; the other diodes prevent the circuit from switching falsely when the input rings, as it may at the end of a long line. Transistor  $Q_2$  and its two resistors form a phase splitter;  $Q_3$  and  $Q_4$  form a push-pull output driver.  $Q_3$  is on and  $Q_4$  is off in the logic 1 condition;  $Q_3$  is off and  $Q_4$  is on for a logic 0 output. [See "DTL and the wired OR," p. 79.]

Although the push-pull output improves line-drive capability and noise immunity, two or more such outputs can't be connected together in this configuration. In such a connection, with one output in the 1 state and another in the 0 state, a low-impedance path would exist between  $V_{cc}$  and ground; the resulting high current would destroy the IC.

Nevertheless, several TTL circuits can be connected to a bus line by employing a modified configuration known as the uncommitted-, bare-, or open-collector output. This configuration omits  $Q_3$  and its internal connection to  $V_{cc}$ , as shown on page 79, lower right. The output stage, in fact, resembles that of DTL. Lacking active pullup, these gates have a typical propagation delay of 30 nanoseconds, compared with 13 ns for standard TTL gates. In addition, many external resistors must be added to a typical bus-organized system using this modified circuit.

What is needed, then, is a push-pull output that

## DTL and the wired OR

In a simple two-input circuit using an npn transistor, the transistor conducts only when both voltages at the diode inputs are at their more positive levels. This back-biases the diodes, forces their junction to climb nearly to the supply voltage level, and forward-biases the emitter-base junction of the transistor.

When the transistor is on, its impedance is much lower than that of its collector resistance, so that the circuit's output voltage is near ground. Furthermore, when the transistor first turns on, the distributed capacitance along the output line discharges quickly through this low impedance, so that the turn-on transition of the output is fast. But when the transistor turns off, as one or both of the inputs switch to their more negative level, this capacitance recharges slowly through the relatively large collector resistance. Thus, turn-on is fast, turn-off is slow.

If two or more of these circuits have their collectors connected together, and share a single collector resistance of the same value as that of a single circuit, any one of the transistors in turning on pulls the output to ground level. Only when all the transistors are off can the output become positive. Thus, the simple wiring together of several circuits effectively implements a logic OR.

Several factors, however, limit the number of circuits that can be wired together in this way: for example, current leaks through the transistors when they are turned off. Many transistors in parallel present a lower leakage impedance to ground than does a single transistor, so that the positive output level of a wired OR isn't as high as that of a single circuit. If too many transistors are wired together, the output level falls to some indeterminate level which doesn't clearly define either a binary 1 or a 0.

The wired-OR circuit also suffers from the fast turn-on, slow turn-off of the single circuit. The desire to overcome this difficulty is one reason for the push-pull output of TTL circuits, which consists of two transistors in series between the voltage supply and ground, with the circuit's output between them. Unfortunately, before National Semiconductor's innovation, the push-pull output made the TTL wired OR impractical.

The DTL enjoys one advantage that the tri-state circuit can't match—any number of circuits can be on at one time without any external switching operation. With the tri-state circuit the system must choose one particular circuit among those connected to a wired OR, switch it on, and keep all the others switched off. For this reason, the output is more precisely referred to as a bused configuration rather than a true logic OR.—W.B.R.

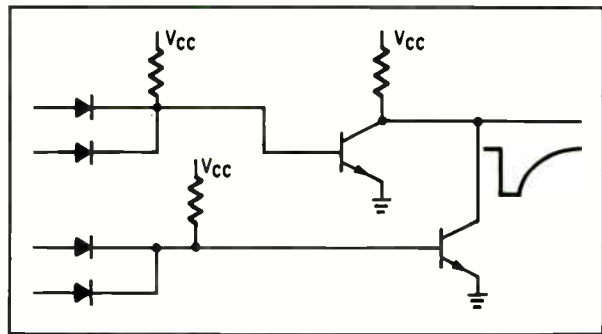

Obsolete. Old DTL circuit permitted wired-OR connection directly. But DTL takes up more chip real estate, so is now largely eclipsed by TTL.

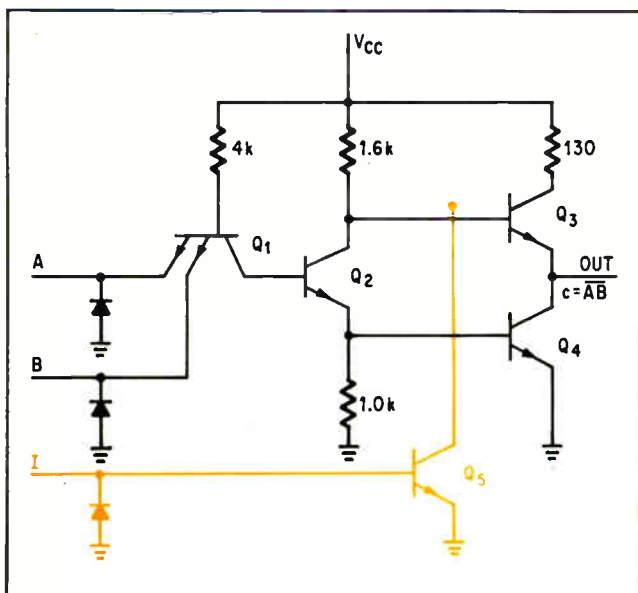

That's a switch. Push-pull output of conventional TTL circuit (black) can be clamped off with added switch (color), permitting a wired-OR connection at the output.

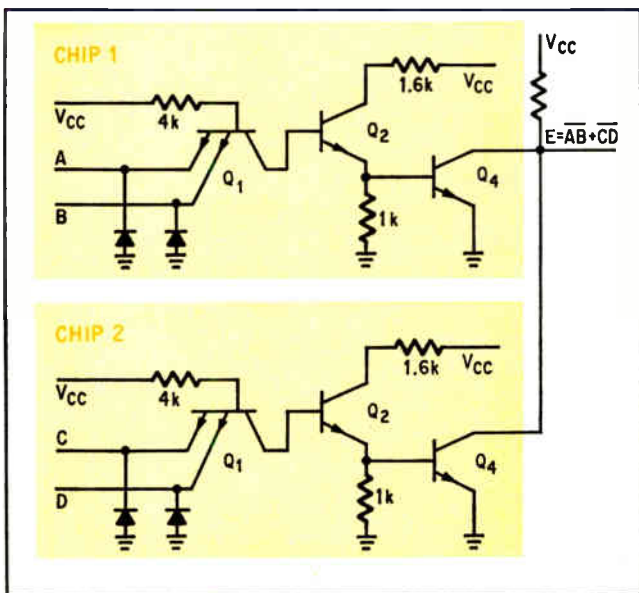

The old way. Without the added switch, TTL circuits must dispense with the push-pull circuit if they are to be connected in a wired OR. This costs them the speed advantage of TTL.

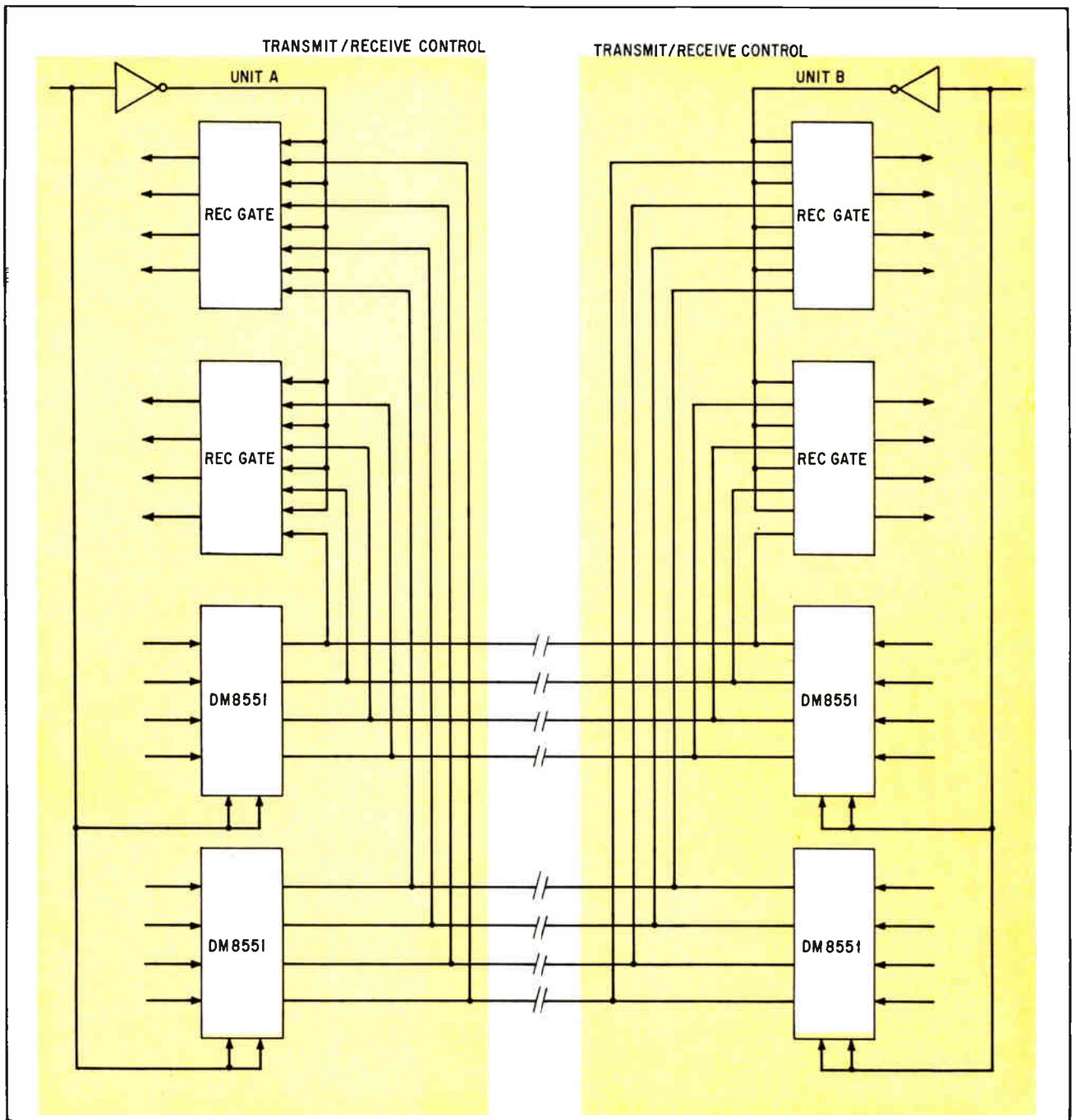

**Quad-D flip-flop.** This is the logic diagram of the first integrated circuit using the bus-connectable output gate. All circuits on the chip are conventional TTL except at the output (color), which can be bused with other similar circuits.

permits wired OR connections to be made. This has been accomplished with another input and a switch that disconnects the standard push-pull output, as shown in color on page 79, lower left. When this inhibit input I is at the logic 0 voltage level, the gate operates as if it were a standard TTL gate. When the inhibit input is at the logic 1 level,  $Q_5$  turns on, holding the base of  $Q_3$  and the collector of  $Q_2$  close to ground level. Thus  $Q_3$  removes the base drive current directly from  $Q_3$  and indirectly from  $Q_4$ , and neither one can turn on. Regardless of the input levels, no data is transmitted through the cir-

cuit. Furthermore, the output is electrically disconnected from the rest of the circuit, so that any number of outputs can be connected controllably and safely to a bus line.

How this tri-state output principle was implemented in the new DM8551 quad-D flip-flop can be seen in the logic diagram of the circuit, shown above. Each flip-flop also has an inverted output—0 when the flip-flop is on, 1 when it is off—connected to a one-input NAND gate. This NAND gate is a TTL circuit with a connection to the new inhibiting switch that permits a wired OR at its output. All the other circuits

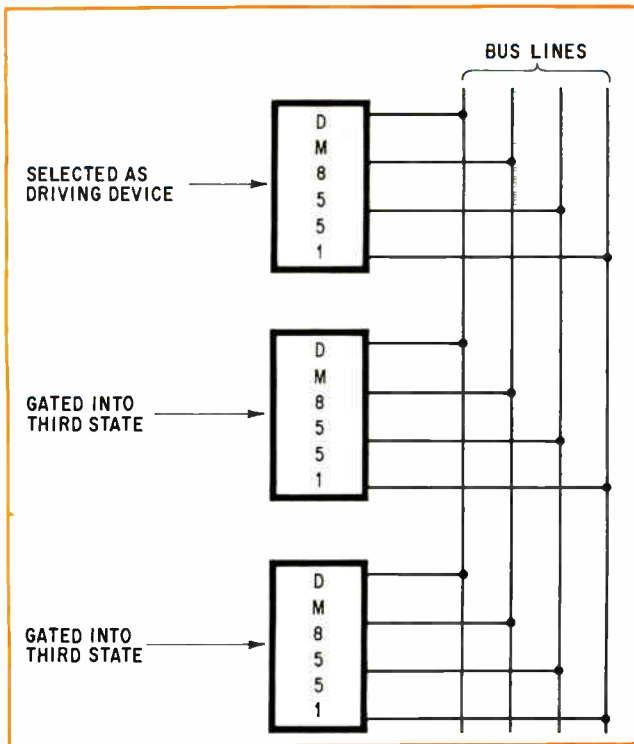

**Common control.** Quad-D circuit normally stores four bits of a data word, which enter or exit in parallel. Therefore the four flip-flops in the circuit need only one set of controls. DM8551 is National Semiconductor Corp.'s catalog number for the quad-D.

on the quad-D chip are standard TTL.

This arrangement permits all modules on a bus line to operate synchronously from a single free-running clock. Conventional quad-D's normally cannot operate in this mode, because the data changes state as the flip-flops are clocked; gating to retain the data in a conventional quad-D renders the clocking system complex and increases the danger of false switching of the circuitry.

Aside from being more compatible with bus organization than conventional quad-D's, this arrangement makes the new circuit the practical equivalent of four J-K flip-flops. The J-K is a much more complex type of binary, and a quad J-K would be expensive.

In the quad-D, the four inhibit connections to the output NAND gates are connected internally to a two-input NOR block on the chip. When both inputs to the NOR are 0, the NOR output is 1, which goes directly to all four gates and activates their output. But if either NOR input is 1, the gate's output is 0, which disables all four outputs. Transistor Q<sub>5</sub>, in the diagram on page 79, corresponds to the transistor in the NOR gate, which is shared by all four NAND gates. When packages are to be enabled at random, one of the NOR inputs is connected to ground. The second input is normally high and drops to 0 when an output is desired.

But the major advantage of this NOR function is that it allows selection of a particular package by a two-dimensional coincident-select technique, some-

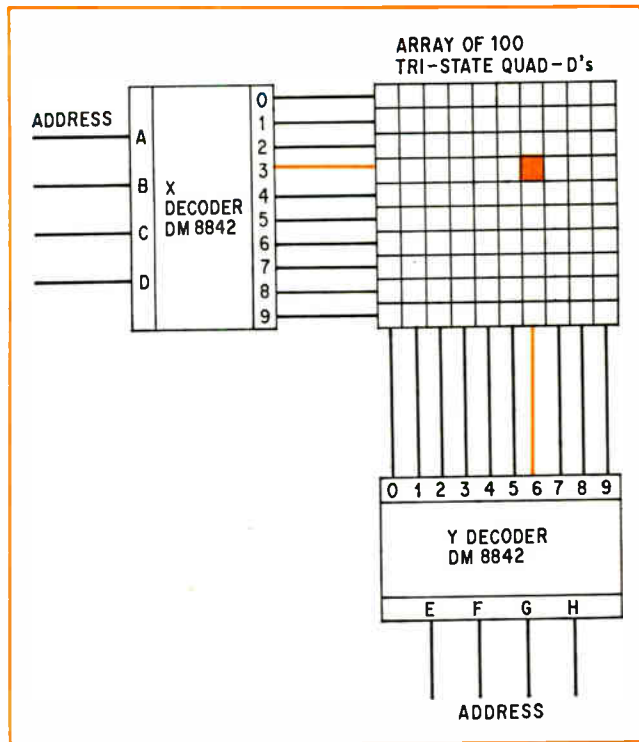

**Coincidence.** Two output-disable inputs in the quad-D flip-flop package make an array of packages addressable with two BCD-to-decimal decoders. In effect, one level of address decoding is performed right on the chip.

times called 0-0 coincidence, as described below. This arrangement takes advantage of the fact that the outputs of most TTL decoders remain at their more positive or 1 level except when an encoded address appears at the input of the decoder; this causes the output corresponding to the particular address to drop to its more negative or 0 level. When two such decoders together address one of an array of other circuits, the two 0 outputs coincide at the addressed location, hence the name.

**The outputs** of the quad-D flip-flop were designed to provide slightly more than 5 milliamperes of drive current in the low impedance TTL configuration, about 13 times higher than standard TTL devices. In all other respects, the characteristics are essentially the same as standard TTL, and the tri-state and bi-state devices are wholly compatible.

A standard TTL input requires 40 microamperes; thus the usual TTL fanout of 10 requires 400  $\mu$ A. Almost the entire 5 mA output remains available for leakage current into the high impedance outputs of other similar packages on the same bus line. In low speed systems—under 3 megahertz—this full drive capability can be realized, allowing as many as 128 outputs in a single wired-OR connection. Or, for fewer than 40 circuits wired together, speeds of up to 10 MHz are possible, with a fanout of 10 plus leakage.

The propagation delay through any of the four stages is less than that through many other TTL circuits. The nominal propagation delay from clock

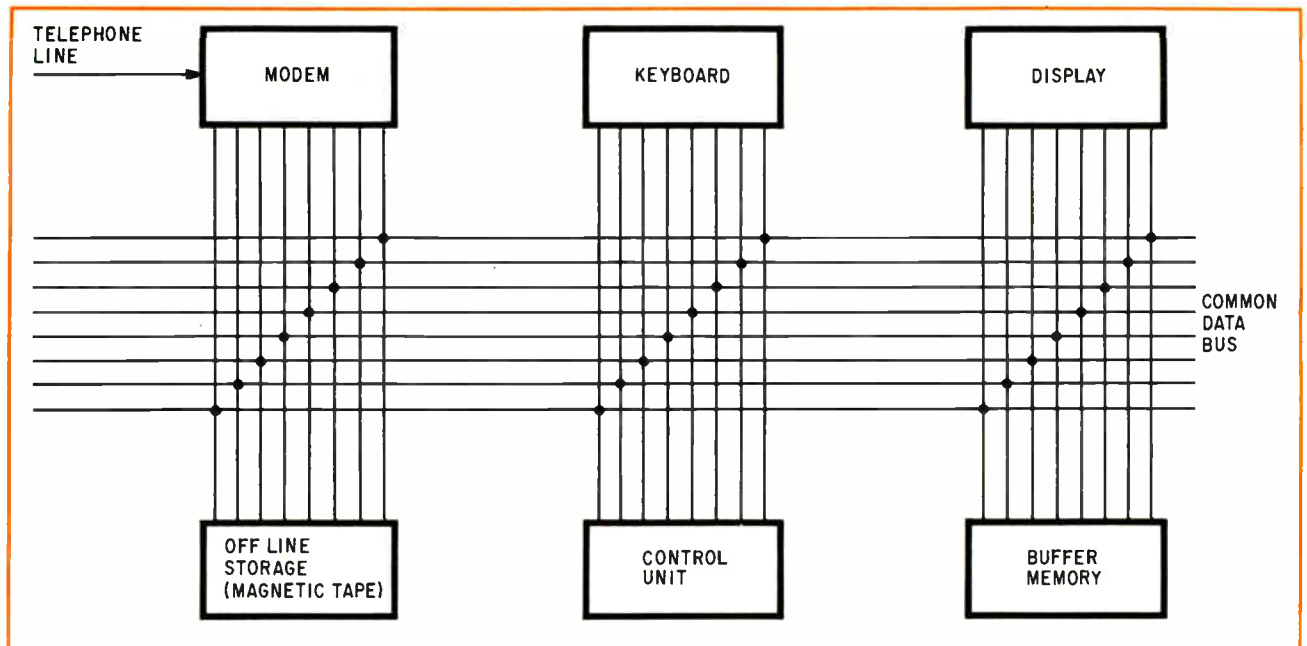

**Bus-organized.** An example of a powerful system organized around a common data bus is this interactive computer terminal. Almost any number of subsystems can be added to the bus to build anything from a small terminal to a large interactive network.

to logic 0 output is 26 ns; to logic 1 output it is 32 ns. Switching the output in or out of the high impedance state takes 19 ns.

The quad-D flip-flop's logic structure facilitates its use on bus lines, and minimizes system control logic. All four flip-flops on the chip have common control and clock inputs because a quad normally stores four bits of a data word. Separate controls are not needed to enter or transmit four bits in parallel along bus lines, as shown on page 81, left.

When the quad-D is used in systems with longer word lengths, such as 16 or 32 bits, the clock, clear, and input and output disable lines of four or eight DM8551 packages would all be brought to the same pins on the circuit card.

Selections from large numbers of packages can be made with 0-0 coincidences from TTL decoders such as National's DM8842 or Texas Instruments' SN7442 BCD-to-decimal decoder. Two of these decoders can select up to 100 DM8551's or word modules, as shown on page 81, right.

The data input-disable, like the output disable, is a two-input NOR function on the chip. This permits the flip-flop inputs to be wired to a data bus. A similar decoding technique controls data entry so that the entry and output sequences are identical. As a result, the control logic has only to monitor the storage or transfer subsystem and doesn't have to generate discrete control signals, except when a random selection of modules is needed for data entry or retrieval.

**In one application,** an interactive computer terminal can be organized around a common bus, as shown above. Data, entering through the modem, keyboard or off-line storage, is transmitted to any of the other subsystems as directed by the control unit. The system can be enlarged readily to permit several key-

board operators to share the same modem, the same display, or several displays, or to add more storage units. Thus small systems as well as very large interactive networks can be made with similar basic modules, all connected to the bus through wired-OR outputs of TTL circuits.

The flexibility of this approach permits savings in design time, assembly cost, and testing; and the regularity of the wiring structure reduces packaging cost. Printed circuits, connectors, packaging hardware and the like can easily amount to a bigger investment than the ICs in systems if the wiring structure is unique for each equipment model.

**Transmission between two computers,** between a computer and its peripherals, or between other subsystems can also be controlled by the quad-D flip-flop. Two quad-D's and two quad two-input gates can readily transmit and receive eight-bit bytes at each end of the bus.

In this application, the tri-state output stage of the quad-D makes a much better line driver than the standard TTL circuit. Although standard TTL has excellent drive characteristics for a digital IC, it can't drive a capacitance of more than 10 inches of wire with good signal integrity. A ground plane is mandatory if the interconnections are longer than 10 inches, and twisted-pair or coaxial cabling is recommended for runs longer than 20 inches, with standard TTL—but not with the new quad-D.

However, the tri-state output is designed to have a drive capability 13 times that of standard TTL. Of course, not all applications need such capability, but it's there if leakage into a large number of high-impedance outputs is present. In particular, as a line driver, the output that is driving sees only a gate input and one wired-OR output in the high impedance



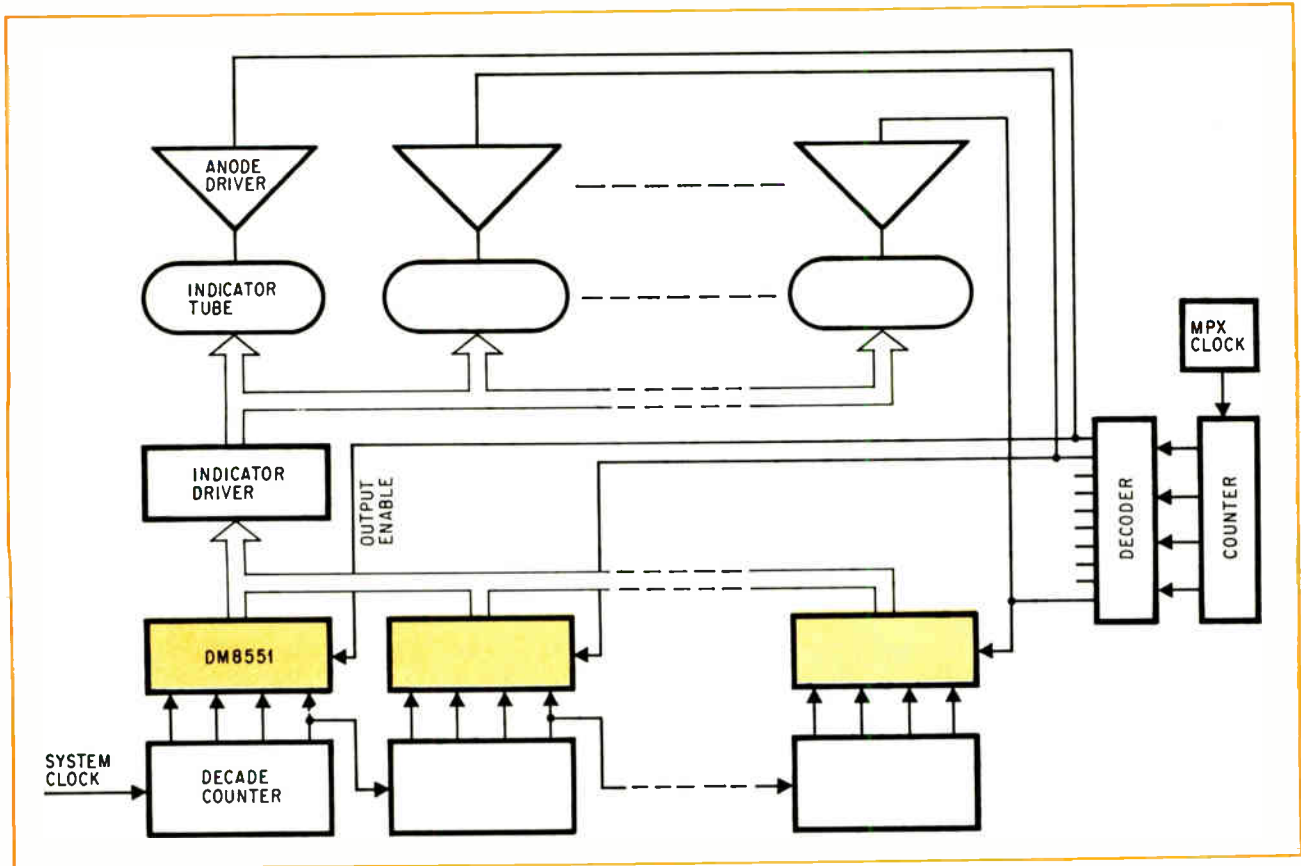
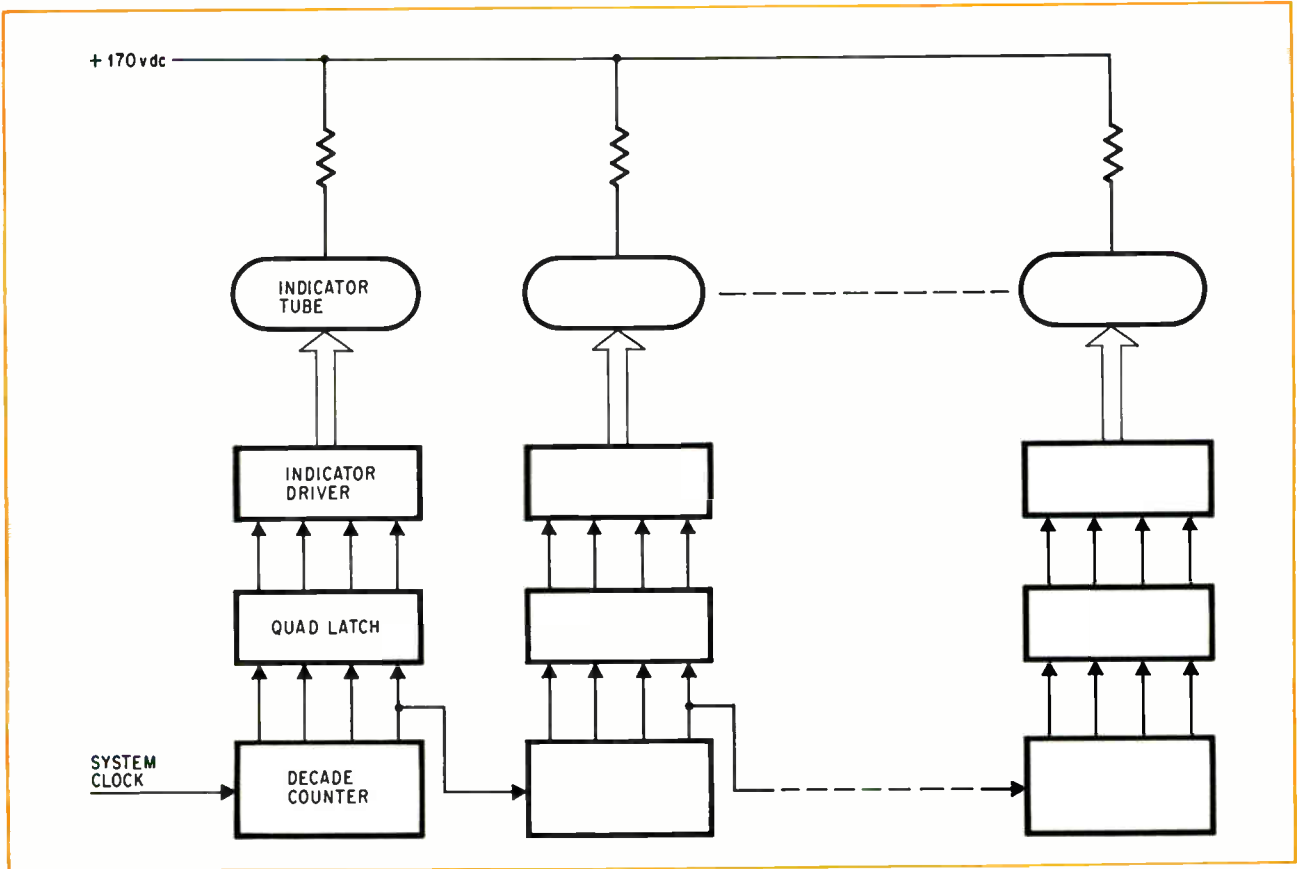

One is cheaper than 10. The simple way to drive cold-cathode indicator tubes requires a high voltage driver for each tube (top), a design that consumes space, time, and money. But multiplexing the displayed data onto a bus from quad-D flip-flops (bottom) displays all the data with only one driver circuit.

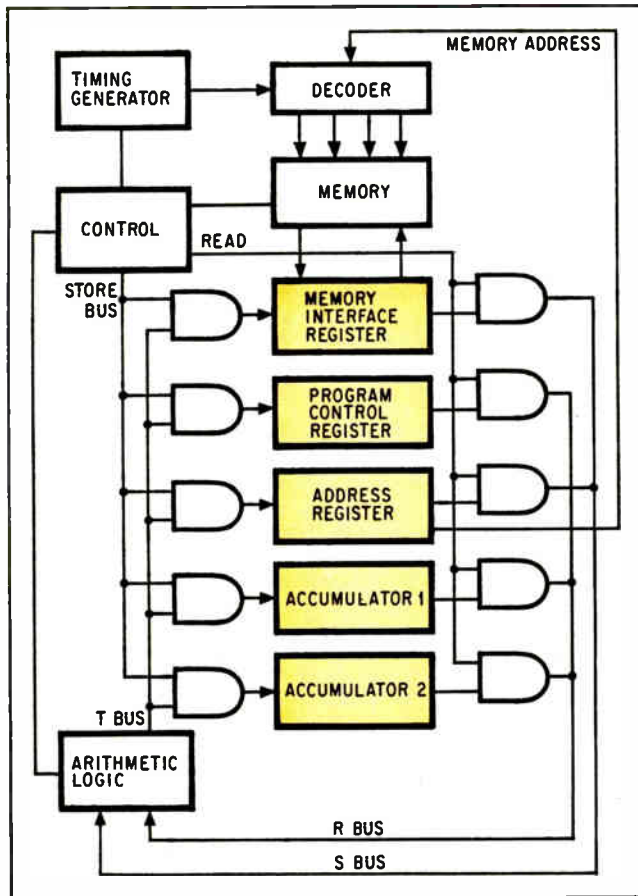

**Small computer.** Combining the quad-D packages into registers permits the business end of a computer to be implemented. Similar techniques can be used in the design of other computer-oriented equipment.

state at any one time. In other words, about 4.92 mA, or 98% of the approximately 5-mA drive capability is available for driving—that is, for charging and discharging the line capacitance without seriously affecting the signal.

Therefore, the outputs can drive longer lines at higher speed than standard TTL. Alternatively, the designer can hard-wire many more subsystems to the data bus, without using special line drivers. In most cases, he can get both higher speed and longer bus length with the extra drive available. These are very important advantages because twisted-pair driver circuits are rather expensive.

If more than two units are connected to the same bus line, the transmit-receive control lines at each end can select one unit as the transmitter and the other unit or units as the receivers. Thus, the multiplexing takes place on the bus, and the channels are selected by the same logic devices that control the transmit-receive select signals. Signals multiplexed this way experience less delay than in conventional multiplexing circuits, and the technique costs less, too.

Along with its multiplex function this design's memory function offers an advantage that increases with the number of inputs to be multiplexed on the bus line. This is especially true if the conversion is

not eight lines to one line as is the case with most of TTL MSI digital switches.

**Other opportunities** to reduce package counts drastically in small systems by multiplexing have been discovered. An example is the numeric displays of calculators and digital instruments.

The conventional display takes three MSI TTL circuits per digit position, as shown on page 83, top: a decade counter to convert the data to a BCD code, a latch to keep the display on while the data is changing, and a decoder/driver with high-voltage outputs. Thus 10 positions would require 30 circuits.

But the multiplexed arrangement, at the bottom of page 83, does the same job with only one decoder/driver. The other nine drivers are replaced with anode buffers and decoder, counter, and a clock. Quad-D flip-flops replace the latches, for a saving of about five MSI devices and corollary savings in space and assembly costs. The added decoder enables the quad-D flip-flops and simultaneously turns on the corresponding anode buffer, making data available to the indicator tube just as the tube is selected.

As long as the clock frequency remains high enough to scan the quad-D's and the anode buffers at a rate that turns on each tube at least 24 times per second, the display appears continuous to the human eye. TTL logic can scan many times 10 tubes at this rate—more than can be visualized in any practical display. And the more tubes, the greater the savings, because the same decoder-driver unit is still time-shared.

A major portion of a small computer could be built with the modules as general purpose registers, as shown at left. The five registers in the diagram are representative of a typical minicomputer's needs, but they could easily be replicated for a larger system. Each register block can be an identical subassembly of, for example, 16 flip flops—four quad-D packages. Data can be entered into any of the registers through the store and T buses by selecting the desired register with its input control. Control signals and processed data are gated onto the R bus by the output controls of the quad-D's.

This entire computer might be one of several similar processors in a multiprocessor. Furthermore, peripheral equipment such as memories, printers, and displays can use identical register modules for temporary storage, resulting in better system modularity.

Overlapping the operation of metal oxide semiconductor memories is one way to multiply their limited speed that can be implemented conveniently with the assistance of the quad-D flip-flop. Several small memories can be addressed sequentially at intervals corresponding to their normal access times; their outputs are stored in the flip-flops and then multiplexed onto an output bus to achieve high speed readout.

Such a system can be extended vertically to any desired word length, or horizontally to almost any degree of multiplexing. Even very small memory systems made with static MOS circuits could be synchronized with little difficulty. And it takes only a little imagination to visualize other kinds of data sources similarly sharing a digital-to-analog converter or a very high speed data-transfer channel. □

# Consumer electronics market still the strongest in Japan

Defense, space take back seat; desk calculators and other new products, as well as computers, communication and industrial sales, fuel fast growth

By Arthur Erikson, *managing editor, international*  
Charles Cohen, *Tokyo bureau*

□ There's much to shout banzai about this year in Japan. The strongly nationalistic country has seen its industrial image projected favorably and far through the wide lens of Expo 70. Suddenly, people all over the world have become aware that Japan has leaped upward during the past decade to become the world's third industrial power after the U. S. and Russia.

And the agile hard-working Japanese are set to continue upward. The country's output of goods and services this year should top \$200 billion, scoring a real growth of better than 11% for the year, and it's expected to continue in the years ahead. Unless there's a change of pace, Japan seems on its way to catching up with the U. S. as an affluent society, perhaps by the end of the century.

The catch-up in electronics may come well before then. Though Japan's \$9 billion electronics output (see

chart) is now far behind the U. S., electronics production in both countries will hit \$45 billion by 1986, predicts Ernest H. Shrenzel, an old Tokyo hand who is vice president, Far East, for Motorola Semiconductor Products Inc. "You hear a lot of talk that the curve has to flatten out, but I don't think it will happen," he says.

To Westerners not caught up in the flurry of Japan's economic miracle, this curve does indeed seem too fantastic to endure. After sounding out its members early this year, the Electronics Industry Association of Japan (EIA-J) forecast that hardware production would hit \$15.6 billion by 1973. That works out an amazing annual growth rate of 24% a year over the five years from 1968 to 1973 when color tv blossomed.

To be sure, there's concern as to what will come along to brighten the market when color tv starts to lose its bloom in the next two or three years. But by



1973, EIA-J figures, 15% of Japanese electronic output will come from "new products", including hardware that was just at the beginning of mass production last year, such as like desk calculators, electronic ovens, and video tape recorders. Noboru Yoshii, managing director of Sony Corp., is so confident about long-term prospects that he predicts electronics will represent 10% of Japan's gross national product by 1980. This year's figure will run slightly under 4%.

It was in consumer markets, of course, that Japan's electronics industry built its rock-ribbed foundations. And consumer markets are still the industry's strongest sector. This year's production of electronics hardware—not counting components—should run about \$6.5 billion, according to the Ministry of International Trade and Industry (MITI). Consumer goods add up to \$4.3 billion, nearly two thirds of the total.

But it's misleading to interpret MITI's figures as an indication that Japan intends to remain a nation of set makers. Military and space spending, which generate a lot of new technology in the U.S. and Western Europe, do not amount to much in Japan. Still, Japanese electronics producers have managed to stay at the forefront of technology by importing technological advances and often improving on them. For example, aided and abetted by MITI, the country's six native computer makers each year nibble a small percentage off the market shares of IBM, Sperry Rand, and other U.S. manufacturers of data processing equipment. In communications hardware, Nippon Electric Co. can hold its own against any other company in the world, particularly in microwave equipment. There's growing strength, too, among Japan's instrument makers.

It's misleading, too, to conclude from a local appliance dealer's window that the strength of Japan's electronics industry lies in export markets. Trade names like Panasonic, Sharp, and Sony are familiar around the world; but they're a way of life in Japan. Of the \$9 billion output of electronic components and equipment this year, including electronic telephone hardware, home consumption, according to *Electronics'* survey, will add up to \$6.9 billion. What's more, the forecast for 1971 is a whopping \$8.3 billion.

Nothing excites U.S. and European electronics producers like a huge, fast-growing market. For them, though, this particular one is largely off limits.

For one thing, the home competition is tough. For another, Japan's economy is founded on a tradition of government-business collaboration that keeps outsiders at arm's length. MITI's mission is to maintain the tradition. The maze of regulations set up to protect Japanese industry while it was rebuilding after the war still must be negotiated by any outsider who wants to do business in Japan. To set up an electronics plant, for example, a foreign company needs a MITI-approved Japanese partner—except if he plans to produce nothing but goods for the strong consumer market. Japan is under heavy pressure from other countries to open up, but change comes slowly.

**For consumer electronics,** prospects over the next year or two seem as bright as the gaudy neon signs that light up the Ginza at night. Along with the soaring economy, Japanese set makers are serving some of

the world's most avid electronics consumers—their increasingly affluent countrymen. This year's market, according to *Electronics'* survey, will hit \$2.46 billion; for 1971 the forecast is a 12% rise to \$2.75 billion.

There's plenty of money around to support this pace. Twice a year, workers, from production line to executive suite, get bonuses of about three months' pay; the last payout, in July, came to roughly \$6.1 billion. Unlike his western counterpart, the Japanese consumer most often can't translate his bonus into more prestige on wheels. In Japan, anyone owning a car with an engine larger than 360 cm<sup>3</sup>—a smallest Volkswagen, by contrast, checks in at 1,300 cm<sup>3</sup>—must have an off-street parking place for it, go through inspection red-tape every two years, and pay a high tax rate. And these keep many a city-dweller out of the auto market.

So almost anyone who wants a color tv set can have it, and most people do. This year, the country's 11 major set makers will turn out about 6 million color receivers, a 25% increase over the 4.8 million units produced last year. With only about 1 million going abroad, the domestic market will run to \$1,415 billion compared to 1969's \$1,140 billion. This year's spurt will carry the market close to its cruise level. The consensus forecast for 1971 is a \$1.5 billion year for color tv.

Like all market forecasts, even one by the keenest market watchers in a country, the color tv figure for 1971 may turn out to be off the mark. The technological forecast, however, is a sure thing. "Color set producers will all have all-transistor models for the home market before next year," says an executive of a components house privy to major set makers' plans.

Hitachi Ltd., Japan's third-ranking electronics company, made the change from hybrid receivers to all-solid state sets last year and other makers have been forced to follow. In Japan, the much lower power consumption of solid state sets is a strong sales point. With cramped living quarters the rule, a hybrid set that dissipates 300 watts or so acts as a heater in the summer, when the climate in parts of the country becomes tropical. What's more, anything that cuts power is a boon; householders most often have only 10 amperes at their disposal. In the U.S. 30 to 60 amperes is common.

"The only real problem facing the tv set industry now is the changeover from tubes to transistors," says Tadayuki Takei, an executive managing director at Hitachi. The stumbling block: power transistors with the high-voltage ratings needed for horizontal deflection circuits are in short supply. This shortage, plus the fact that hybrid sets are generally cheaper to make in the larger-screen sizes, will keep producers turning out hybrid color sets for export markets. There's also a tax break for all-solid state sets in the home market that doesn't apply to exports.

Integrated circuits, too, have started turning up in color sets. "Almost every major maker has an IC design in the works," says Jerry Coan, marketing manager for Texas Instruments Asia Ltd. Coan, from his position in the supplier's seat, sees the set makers using IC packages as "board-for-board" replacements

of discrete transistor circuits. There's no attempt to edge up performance with the shift to ICs. Like other semiconductor houses, TI rates sound i-f strips, video i-f strips, color demodulators, and audio output circuits as the packages that will be used first by set makers. They'll be followed by regulator circuits for tuning diodes and by the "jungle circuits" following the video detector. All major Japanese semiconductor producers are supplying ICs for tvs.

Tv manufacturers are using the ICs to shave set costs. In radios, however, makers have turned to ICs as much for advertising impact as anything else. Matsushita Electric Industrial Corp., for example, uses a 20-element monolithic i-f circuit in its top-of-the-line receivers. But Mitsuo Nakai, manager of radio product engineering at Matsushita, frankly admits it's not

because of a healthy surge in stereo radio receivers.

Takeoka is considerably more optimistic than the consensus forecast, which shows a strong climb from \$117 million last year to \$136 million this year and then a lesser spurt in 1971 that would carry the market to \$145 million.

Radios, though, are one of the few products where exports are considerably more important than home consumption. Matsushita the industry export leader, in fact sells abroad four out of every five radios it makes. The other major set producers—like Hitachi, Sony, Sanyo Electric Co., Sharp Corp., and Tokyo Shibaura Electric Co. (Toshiba)—export heavily, too. All told, radios worth \$466.5 million were turned out last year; \$360 million were exported.

Since exports are so essential to radio producers, one of their main concerns is keeping competitive with other Asian producers who enjoy low wage rates. It's a problem that U.S. producers faced, but that few solved, when the Japanese themselves had a large edge in labor costs.

Braced for a whopping 20% rise in wage rates this year, Matsushita is counting on a major production-line improvement to cover its increased wage bill. The improvement: automatic alignment of i-f strips. "It's the life blood of our production line," says Takeoka. The line, with 3,500 workers, turns out 600,000 radios monthly and according to Matsushita it's the world's largest radio plant. Matsushita won't bare details, but it's a reasonable guess that the system, at the portable radio plant at Matsushita's vast headquarters installation at Osaka, has much in common with the automatic alignment technique used in a sister company's auto radio factory in Yokohama. However, the headquarters system is digital and the system at Yokohama is analog.

There, tuning slugs are adjusted by screwdrivers powered by stepping motors. The output voltage of the i-f section is fed to a core memory in the stepping motor drive circuit. When the output reaches the optimum point, the voltage starts to drop. The system then steps the screwdriver backward, based on the core memory's content, to the maximum voltage position. An untrained aligner can adjust a strip to within 1 decibel of the optimum: Matsushita gets within 0.5dB with its automatic alignment.

All is going well this year, by and large, in Japan's traditional consumer electronics goods like color tv, radios and tape recorders. There's one "new" market, however—microwave ovens—that hasn't burgeoned as most Japanese producers thought it would: To be sure, output last year soared from nowhere to \$62 million, moving oven-makers to ecstatic predictions that the market would double or even triple this year.

But it won't happen. A radiation scare swept the country in the spring when MITI reported that ovens were showing radiation as high as 20 milliwatts per square centimeter at distances of 5 cm from the oven when the doors were opened. That's twice the level that MITI considers acceptable. The scare brought out a set of radiation standards from MITI and touched off a flurry of redesigning among the 13 oven producers. The solution most likely to be adopted by the



Affluent. Japanese flock to Sony's show building in the Ginza to try out radios, tape recorders, and tv sets.

economic. Most competitors, he says, have integrated the audio driver, one of the least demanding functions in a receiver, just so they can advertise an IC set.

Following i-f strips, Nakai figures, monolithic low-frequency stages will begin to show up next year even though it will be two or three years before the packages can compete on a head-to-head cost basis with the discrete transistor circuits they'll replace. The last section to be integrated in receivers, he expects, will be the radio-frequency front end. Here, noise problems require sophisticated chip technology. It will be another five or six years, Matsushita feels, before an all-IC radio could be justified strictly by cost. "But there will likely be loss-leaders on the market before then," says Kei-Ichi Takeoka, director of Matsushita's radio and stereo division.

Meanwhile, Takeoka is convinced, good times are ahead for radio set producers in Japan. Largely because of pressure by the public service network Nippon Hoso Kyokai (NHK) and by private-enterprise networks to blanket Japan with fm stations, set sales will shoot up "faster than you'd think," says Takeoka. His estimate is a 40% rise in value this year, largely

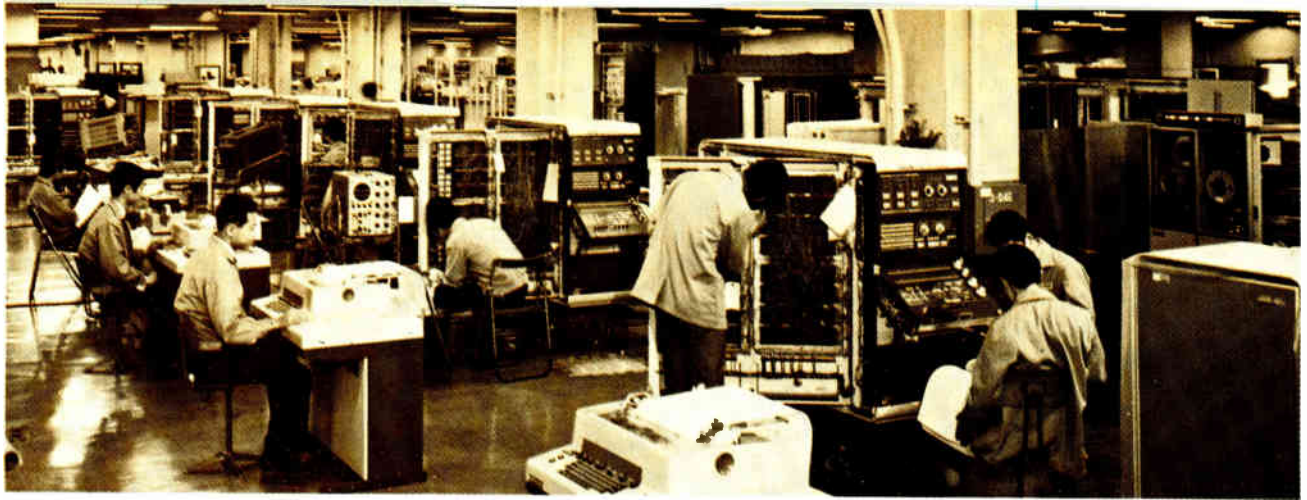

Assembly line. Fujitsu's home-grown line of computers, including the Facom 230/25, takes shape at its Kawasaki plant.

bulk of makers: a latch interlock that cuts the power supply to the oven's magnetron before the door is opened. In current designs the cutoff switch is actuated by the door itself, allowing a burst of energy that lasts about 0.1 second to escape before the power goes off.

Says Tsuyoshi Hamano, a senior managing director at Toshiba Shoji Ltd. Toshiba's sales company, "When we conquer radiation leakage, the market will take off." No one in the industry will quarrel with that assessment. At about \$280, the ovens are selling for about the same price as a 13-inch color tv, putting them within range of a worker who's just stuffed his semiannual bonus in his pocket.

Microwave ovens, then, should be selling well by the time saturation slows sales of color tv sets. Video tape recorders and pocket electronic calculators, too, could turn into market mainstays in the next few years. But consumer electronics makers, taking no chances that they'll lack a "post color tv" product, are turning to new realms. Matsushita, Hitachi, Sharp and other home appliance makers are eyeing the housing market. This year some 1.6 million new housing units will be built in Japan, and an additional 9.5 million units will be built over the next five years.

The electronics producers have made their first move into this market with kitchen modules. So far, they've been bare-bone affairs with a small sink, stove, hood, and light fixture. But as the market evolves, predicts Sanai Mito, director of Sharp's advanced development and planning center, the modules will get decked out with options like built-in radios, color sets, door intercoms, and eventually household "controls" systems. Sharp already has on the market a unit it calls "Home-keeper." It's a combination radio, clock intercom, burglar alarm, and bath-temperature monitor. Sharp started selling the units early this year and by mid year was selling 5,000 monthly, mostly to apartment-house builders.

Still another promising sector is educational electronics. There'll be plenty of customers when there's an "educational" terminal on the market for something like \$280, Mito is convinced. So intense is the competition to nail down a place in the country's universities that there are thousands of what Mito calls "education mamas" in Japan. They're paying monthly fees ranging from \$14 to \$28 to have their youngsters

tutored. So the wherewithal is there wherever electronics producers can turn out a reasonably priced terminal.

And there's a good chance that schools themselves will become mass buyers of teaching terminals. Already the Nippon Telegraph & Telephone Public Corp., the state telecommunications monopoly, has started trials on a two-way CATV setup that could be the forerunner of an educational network.

**A battery of computers** whirring under fluorescent lights makes as apt a symbol for industrial Japan as did cherry blossoms reflected in still pools in past times. Indeed, the high-stepping computer industry reflects much of what's behind Japan's ability to keep her economy booming upward.

For one thing, an informal alliance between government and industry—one that U. S. businessmen would brand unholy—has been crucial to Japan's economic miracle. And no sector of the economy has come in for more of MITI's "administrative guidance" than has the computer industry.

For another thing, the computer makers have leapt to the forefront of the state of the data processing art by importing U. S. technology. Fujitsu Ltd. excepted, the half-dozen major domestic computer makers adopted American designs for their third-generation machines. The tie-ups: Nippon Electric and Honeywell Inc., Oki Electric Industry Co. and Sperry Rand, Hitachi and RCA, Toshiba and General Electric, Mitsubishi Electric Corp. and Xerox Data Systems. But as has so often happened in their recent industrial history, the Japanese are making significant advances on their borrowings. Fourth-generation Japanese computers will be largely Japanese designs.

What's more, industrial history may repeat itself a second way in computers. The Japanese producers appear to be about ready to burst into export markets, following their consumer-electronics counterparts who've already scored heavily with desk calculators. "Their next export wave will be very small computers," says a U. S. official in Tokyo who keeps tabs on the data processing market.

For that market, MITI's "guidance" ranges from the royalty rates computer makers pay for technology on up to setting ambitious (for less aggressive lands they'd be unreasonable) national goals for computer installa-

tions. Last March, Japan wound up its fiscal year with some 6,700 computers operating, according to a count made by the Japan Electronic Computer Co., the government-backed firm which finances rentals of computers made by the six major native producers. At the same time, JECC reported, there were 48,000 installations in the U.S. (minicomputers don't figure in JECC's counts.)

Japan's computer population, then, is sparse when matched against its gross national product but MITI is determined to match the U.S. in computer/GNP ratio by 1985. To do that, the market will have to grow 33% to 36% annually for the next 15 years. "We don't agree with MITI on the absolute figures, but we do agree on the long-term growth rate," says Takeo Shiina, vice president, operations, for IBM Japan.

For 1970, in fact, most computer market watchers expect a rise of about 40%. *Electronics'* survey puts the market, desk calculators included, at \$1,033 billion this year. That compares with \$641 billion logged last year. Next year, the consensus outlook is for a 36% rise to \$1.431 billion.

As the explosion continues, look for the "average" computer to edge upward in size and for the market shares of U.S. producers to edge downward. The government's guidance is firm here. MITI has digital computers on its "import allocation" list and scrutinizes each import application, sometimes pointing out that a domestic computer could do the job. The computer utility market also is likely to be a preserve of domestic producers. As it stands, only the Nippon Telegraph and Telephone Public Corp. can set up time-shared computer networks open to all comers—and NTT buys Japanese. And to make sure the country's computer makers will have big machines for time sharing, MITI is well along with a \$35 million project to develop a computer by early 1972 that's in the same class as IBMs 360/85 or the Control Data Corp.'s CDC 6600.

MITI's specifications for the large-scale computer call for 50-nanosecond add time, 200-ns average instruction execution time, and a cycle time of 700 ns for a main memory with capacity up to 8 million bytes. Hardware is slated to be finished by the end of the year and all six major Japanese computer makers have a hand in it. Hitachi Ltd., for example, is building the main-frame. The company has worked out a hybrid

LSI package with propagation of 1.5 ns per gate. The package has 10 chips with up to 39 gates per chip.

The software is slated to be ready by the end of 1971. The job is being handled by Japan Software Co., a joint venture of Hitachi, NEC, and Fujitsu. The trio will produce commercial versions of the high-performance computer and chances are their first customer will be NTT. The telecommunications utility already has the beginnings of what will surely become the world's largest collection of time-sharing networks. "We'll be spending \$83 million for computers this year," says Hiroji Kurokawa, a general manager and chief engineer at NTT. "Next year's figure is double that and we'll keep a high rate of computer spending over the next few years," he adds. Most of the money is earmarked for expansion of time-sharing services.

IBM, as expected, has to its credit some landmark computer applications. One is the Nippon Hoso Kyokai's on-line program control, which musters four big computers to automate production of 640 television programs and 1,200 radio programs for NHK's five networks. Another is the "raw materials to shipping order" automation of Nippon Steel's Kimitzu works, a 5-million-ton-a-year integrated plant.

IBM has further orders for extensive automation of Japanese steel plants. Nonetheless, IBM's share of the market, which competitors put at about 34%, seems destined to dwindle as domestic computer makers add muscle under MITI's guidance. IBM now produces System 3, 360/20 and 360/40 machines in Japan, but an agreement with the government limits the types of machine that the wholly foreign-owned company is allowed to produce.

As they pick up more of their home market, Japanese computer makers will move into export markets. To be sure, five out of the top six can't export freely because of their technology ties with U.S. firms. But they're "sniffing," says a U.S. official.

Fujitsu, with no ties to bind it, has started sizing up its chances in the U.S. In June, Automation Sciences Inc. opened a computer service bureau in Manhattan equipped with a Facom 230/25, a machine in the same class as the IBM 360/30. "The bureau is a demonstration for our computer," says Taiyu Kobayashi, vice-manager of Fujitsu's information processing department.

The main Japanese impact on export markets is

Connecting link. Nippon Electric spans the communications field from broadcast gear to postal automation machines.



likely to be in small computers. Almost every important electronics producer—set makers excepted—has something in the way of a minicomputer in mind, if not actually in production. And the set makers are already into the low end of the data-processing market with desk calculators, about half of which go for export. Last year the 20-odd companies knocking out desk calculators more than doubled their collective output to produce \$152 million worth. This year should see another doubling in value even though prices will generally be lower.

And that's just the beginning. Market researchers at Sharp Corp. estimate that desk calculator output will hit \$830 million by 1973, and Motorola's Shrenzel predicts that "by 1980, every college student and possibly every high school student will have an electronic abacus." Tadashi Sasaki, general manager of Sharp's industrial instrument division and the man most responsible for the company's top rank among desk calculator makers, freely admits there's a cigarette-pack-size calculator in his company's future. Such is the impact of the desk calculator that The Japan Times last spring editorialized about the decline of the abacus. "There was a time," the editorial went, "when the annual abacus (soroban in Japanese) contest made big news . . . But this is no longer so . . . The Tokyo abacus championship contest was held recently and rated only two paragraphs."

At the same time there's a move downward to "consumer" calculators, there's a trend toward more sophisticated machines, too. Sony's Noboru Yoshii sees the desk calculator as a springboard to computer terminals. And Sharp, the pioneer in the field, this summer started selling in Japan a desk-top programmed billing machine for \$1,383.

**Communications hardware** makers can't be faulted for feeling that what's good for Japan is good for them. The economic boom in the country has triggered an information explosion and that means heavy spending for telecommunications. There's fallout, too, in the color tv spree: transmitters to get programs out to all those receivers. Even what's bad for Japan can turn out to the good of communications equipment producers. The riot police are setting up a vhf network to teleguide their van drivers, and local prefecture governments have "disaster networks" in the works to direct rescue operations should earthquakes or the like strike.

All told, the communications market in Japan next year should rise a smart 23% to \$664 million, according to *Electronics'* forecast. The figure does not include conventional handsets, electromechanical switchboards, and similar nonelectronic hardware. And prospects are that the growth rate will pick up in the early 1970's. Each year NTT, the best customer for telecommunications, not only ups its investment budget but also spends a bigger proportion of that amount on electronics. The utility's total investment budget for fiscal 1970 is \$1.9 billion and some 29% of that is going for equipment, not counting cable.

To be sure, electromechanical switchboards and carbon-granule handsets still predominate in NTT's backbone business: telephones. But electronics is

starting to gain a niche all the same. Push-button dialing, for example, was inaugurated on a limited basis last year in Tokyo, Osaka, and Nagoya. NTT bought 10,000 handsets to start and this year will buy 50,000. The push-button equipment is based on a ferrite-core oscillator paired with an IC.

Eventually, handsets will be a mass market for IC makers. Japan currently produces 3 million handsets a year and NTT is developing versions with electret microphones and IC amplifiers. Picture phones are coming up, too, being slated for commercial trials between Osaka and Tokyo in 1972. NEC, Fujitsu, Hitachi, Toshiba, and Matsushita Communications are ready when the time comes.

And like with-it telephone utilities everywhere, NTT has electronic exchanges in its immediate future. Two preproduction versions of a stored program exchange are dubbed DEX-2, are undergoing field trials, and will be followed late next year by the first production exchange, the DEX-21, which has a capacity of 40,000 lines. Seven more DEX-21's will go into exchanges in Tokyo, Osaka and Nagoya during 1972 and 1973. Then a massive effort will start. "We'll have 360 large electronic exchanges in service by 1977," says NTT chief engineer Kurokawa.

By that time, presumably, NTT will also have a small, 10,000-line electronic exchange ready. Its commercialization depends largely on the availability of a low-cost memory. But already NTT has developed a promising candidate: a plated-wire read-only memory that's electrically alterable and may cost as little as 1.4 cents per bit. It may find its way, too, into the larger DEX-21 exchange, which currently has a core memory.

NTT also has Japan lined up to reach new heights in frequency, sophistication, and, incidentally, exports for microwave links. It has been nearly a decade since the country first was covered by 4-GHz and 6-GHz trunk systems. Since then, secondary links operating at 2 GHz, 11 GHz and 15 GHz have been added. And even though a microwave route map of Japan is as heavily veined as a sheet of seaweed, NTT continues to spend some \$27.8 million a year to expand and strengthen its microwave links.

All this is much to the advantage of NEC, far and away the major microwave supplier to NTT. Between them, the two have put Japan at the forefront of telecommunications technology and helped make the country a major exporter of microwave systems. Apart from the final output stages in transmitters, NEC's current microwave hardware is fully transistorized. And where the transmitter output is less than 2 watts, the final stage is a solid state device.

Latest commercial fruit of the technical collaboration between the two is a 2,700-channel system designed for operation in the upper 6-GHz band. NEC is also developing microwave pulse code modulation systems, and has in its catalog 2-GHz pcm equipment with 240-channel capacity.

Although NTT's microwave dishes predominate in Japan, they do not stand alone on the country's hill-tops. The self-defense forces have a microwave net that covers most of the country. So do government





In control. Japan's government-run broadcaster, NHK, is the big domestic buyer of on-the-air transmission equipment.

agencies and Japan National Railways. One of the most extensive is that of the Construction Ministry. It runs a 7-GHz, 240-channel system that stayed on the air when other links went out during the 1968 Tokachioki earthquake. Over the next two or three years, the net's capacity will be doubled so that it will be able to handle data transmission as well as voice and facsimile. According to Takao Tsumura, a director of Japan Radio Co., government agencies and power utilities together will spend \$16.5 million for microwave equipment this year.

On top of that there will be heavy spending for vhf and uhf communications. *Electronics'* consensus forecast puts the market at \$117 million this year and \$136 million next. The increased business is coming in by land, sea, and air.

NTT, for example, is building a 150-MHz emergency communications system and has ordered 3,000 sets from Japan Radio, NEC, Matsushita Communications, Toyo Tshushinki, and Kokusai Denki. In addition, the prefectural governments have started to build local disaster networks, each comprising anywhere from 90 to 120 stations.

Another substantial chunk of vhf business is in the offing from Japan National Railways, which is rushing to fit out its trains with triple-purpose radios that will let the engineer up front talk to the trainmen at the back, to the nearest station, or to the emergency net. JNR will buy 10,000 of these \$4,200 train sets over the next five years.

Broadcast equipment producers are doing well also out of a reshuffling in frequency allocations. There are seven years left to run in the government's 10-year plan to liberate vhf channels for mobile services by shifting tv stations to uhf. That means good transmitter sales over the next few years. What's more, the government has granted a batch of licenses for new, privately owned tv stations as part of its fuel for the color tv boom. Then, the nonprofit network, NHK, continues doggedly but asymptotically toward its goal of getting a good signal out to every corner of the country. This spring, its 2,000th tv station went on the air and boosted coverage to 96.5%. To reach 98.1% coverage by 1973, the network plans to add 607 new stations and 3,000 community antenna systems. It's also making a massive effort to add fm stations, with

plans to get 300 more translator-repeater stations on the air during the fiscal year that ends next March 31.

As for the private-enterprise broadcasters that share the airwaves with NHK, their transmitter business splits up fairly evenly among the half-dozen major broadcast equipment producers. Most have ties with set makers and all the set makers have heavy advertising budgets.

**Industrial electronics** makers can do little wrong in an economy that's stepping out as fast as Japan's. The country's businessmen will pour more than \$40 billion into new facilities this year. With labor harder and harder to come by, a sizeable chunk of new plant investment is going for automation. The major customers are chemical companies, steel producers and oil refiners.

Nasahiro Shinizu, president of Hokushin Electric Corp., which is the third biggest controls producer in Japan, figures that the industrial controls market including process-control computers, ran about \$280 million in 1969. "The growth is about 20% a year," Shimizu says.

That figure will look high to C. B. Meech, who this spring wound up a five-year stint as vice president, Far East, for Honeywell, Inc. But on growth rates, he concurs. "Unless there's a worldwide recession," says Meech, "the controls market in Japan is good for 25% growth a year." Honeywell's joint venture, Yamatake-Honeywell, ranks second among makers of controls, behind Yokogawa Electric Co.

Like other controls makers, Yokogawa sees very good long-term growth, but expects a minor pause to develop in instrument sales late this year. "The cycle is a strong four-year rise and then a two-year decline," says Masaaki Toyama, chief of the company's industrial sales engineering department. Then he ticks off half a dozen big petrochemical plants that went on stream early this year. "The current cycle will end with four 1,000-ton-a-day ammonia plants that are about finished and the next generation will start in 1972," he says.

Toyama is convinced the generation to come will see a further advance in computer control. And since Yokogawa has put a lot of chips on direct digital control (DDC), the company is counting on a rise in strictly-by-the-numbers control. Yokogawa has sold 30

sets of DDC hardware during the past three years. Not coincidentally, Yokogawa introduced a special computer, the Yodic 500, for DDC systems three years ago.

The most elaborate system the company has so far installed is a \$220,000 affair that handles cracking distillation and vacuum topping at a refinery, and that has some 500 control loops. Reliability has been sensational in refinery DDC systems. Toyama proudly reports; instancing a case of 99.98% availability over a two-year span. As a result, analog backups are on the wane, and only 10% to 20% of the DDC loops have them.

The list of operations under DDC will be extended to conclude desulphurization and perhaps other functions in the next generation of automatic refineries. And when the generation's time comes, Yokogawa will have ready a new all-IC version of its Yodic computer. Like all new computers, it will be both faster and larger. Multiply time, for example, will drop from 51  $\mu$ s for the Yodic-500 to 100  $\mu$ s in the new version. At 32 kilowords, the new memory will be double that of the Yodic 500. At the same time, Yokogawa will improve the accuracy of the sensors that feed the computer, to 0.2% from the present 0.5%.

Like Yokogawa, Honeywell sees a faster pace toward DDC in Japan than in the U.S. "A lot of people got burned and backed off from DDC back home," is how one Honeywell man explains it. And some companies are going to DDC as a toy to attract engineers.

Hokushin's Shimizu, on the other hand, isn't nearly as high on DDC, although he agrees it was considered the coming thing a few years ago. Then, people thought in terms of "one plant at a time", but now he's convinced the trend is toward integrated groups of plants. One major textile company already has tied the process control computers in its plants throughout Japan into a master data processing system based on a large IBM 360 computer. Steel producers are doing the same thing on a smaller scale at their integrated plants.

Although views differ on DDC, there's general agreement that the chemical, steel, oil, textile and like industries will be forced to continue automating their plants if they want to keep headed upward at home and abroad. Although liberalization of plant investment is still quite distant, the chemical companies already have begun to gird themselves for the time when the U.S. and West German giants get an open crack at the Japanese market.

Then, too, the cradle-to-grave job situation in Japan adds its thrust. The shortage of labor makes automation a must when adding new plants. At the same time, shutting down of old, inefficient plants is almost impossible in a land where management can't fire unneeded workers. New plants, then, have to be superefficient to offset the old ones. It's not uncommon, Shimizu says, to find a company has 2,000 workers in an old plant that turns out no more than a new automated plant with 150 workers.

The trend to automation is so strong and apparently so permanent that Hokoshin's Shimizu thinks that



Flow gates. Computer-linked traffic sensors in Matsushita Communications system speed up Yokohama's traffic.

the controls makers' big problem may be an invasion in their sector by computer makers out for more of the automation market than just the process control machines. Fujitsu, indeed, has already staked out for itself an imposing claim to superiority in numerical control, with an overwhelming 90% of the NC business in Japan. Its sales of NC hardware doubled last year. This year Fujitsu has taken another bound by turning out between 2,200 and 2,700 control systems and thereby taking over the world leadership in NC from General Electric Co.

Fujitsu's position results largely from its long-ago decision to go for open-loop control instead of the more common, although more complex and more costly, closed-loop system. Fujitsu's open-loop system is based on pulse motors that step an increment each time the control system feeds them an input pulse. In addition to a regular rotary motor, Fujitsu now has a linear stepper.

Producers of traffic control equipment have a long string of green lights ahead, for the government plans to spend \$1 billion over the next five years on automating the flow of traffic in every city more than 50,000 people.

The first contract in the program went to Matsushita Communications. It's for a system to cover Kanagawa Prefecture, in which Yokohama is located. The sensors are sonic units, radars, and induction loops, all tied to a MACC-7 process control computer. Besides regulating traffic lights, the system turns on indicators that divert traffic around jammed intersections. It went into partial operation this spring and will cover about 150 intersections when it's finished by 1972.

Test instrument manufacturers, expectedly, are flourishing along with the electronics industry. Anywhere anyone is producing or servicing electronics hardware there has to be at least one and perhaps several hundred oscilloscopes. As a result, some oscilloscope makers say the market will surge 35% this year, repeating the performance of each of the past three

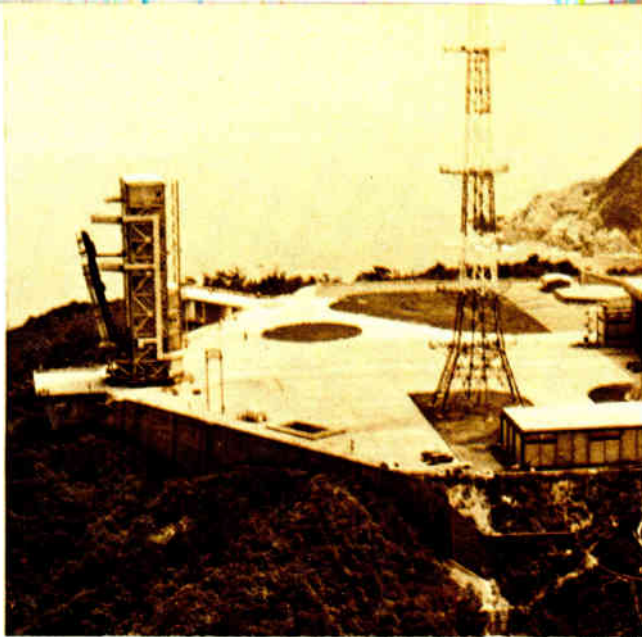

Countdown. Run by the University of Tokyo, space center is site for launching of the school's solid-fueled rockets.

years. The consensus forecast, though, shows a gain of "only" 22%, from \$18.5 million last year to \$22.5 million this.

There's nothing mysterious about the reasons for the rise. First, there's the color tv boom. Then, there's the onrush of the computer industry. Finally, there's the great leap forward in semiconductors.

Color tv and computer producers, in fact, are having two-fold impact on the oscilloscope market. Set makers need more scopes on their production lines to turn out solid-state color tv, explains Yozo Kanakubo, instruments sales manager for Iwatsu Electric Co. At the same time, the solid state set is harder to service, he continues. "There are 20,000 service shops in Japan and my guess is that half of them will buy scopes over the next three years," says Kanakubo.

Along with adding to the demand for oscilloscopes, computer makers are lifting the level of performance. Two years ago, the bulk of oscilloscope sales came from units rated from 15 MHz to 30 MHz. Now, largely because of the strength of 150-MHz units or computer work, the range has become 50 MHz to 200 MHz, and there's a "mine's the faster" skirmish under way. Iwatsu put a 300-MHz scope on the market this spring. Matsushita Communications, too, has a 300-MHz oscilloscope ready for market as does Yokogawa-Hewlett-Packard.

Still another young and lusty market for instrument makers is IC testers. Takashi Sakamoto, deputy sales manager of the measuring instruments division of Anritsu Electric Co., pegs the tester growth rate at 20% a year.

As with other sorts of complex testers, IC checkers are increasingly becoming computer-based systems with digital instruments tacked on. The trend has even caught up with such instruments as oscillators and distortion meters. "We found our car-radio designers were spending about 35% of their time making measurements," says Hajime Karatsu, manager

of the systems engineering division of Matsushita Communications, "so we built a digital test system to handle this." The system, shepherded by a MACC-7 computer, includes an oscillator, distortion meter, signal generator, voltmeter and a power supply.

**Japan's space effort** at first glance, looks to an outsider as confusing as the traffic patterns in downtown Tokyo. Fourteen agencies spread out among six government ministries have budgets for space research and development. Altogether, they'll spend some \$42 million during the current fiscal year. On top of that, Kokusai Denshin Denwa Co., the private company that has the monopoly on international telecommunications, has under construction a \$4.2 million third terminal for its ground-station facilities.

Despite all this, there's the embryo of a one-agency space program in Japan. Last fall, the government's space activities commission blocked out a six-year national effort and then the government set up the National Space Development Agency of Japan (NASDA), to see the program through. NASDA's mission covers both satellites and launchers, but the agency has not bodily taken over the existing programs of the other agencies. Thus it was the University of Tokyo, and not NASDA, that was slated to put the country's first working satellite into orbit in late summer this year. And the university will continue launching its current series of five scientific satellites through fiscal 1973. The launch vehicle is Tokyo university's own "M" rocket, which is a solid-fuel type.

The NASDA label, though, already turns up on key projects in the six-year plan, which runs until fiscal 1974. The main goal: an ionosphere sounding satellite (ISS), which will be used to help forecast the best frequencies for radio transmission around the world. Mitsubishi Electric Corp. has the prime contract for the \$8.4 million project, but the list of subcontractors comprises the major "advanced electronics:" Melco itself, NEC, Toshiba, Matsushita Communications, Hitachi, Fujitsu, and Oki Electric.

To get this bird up, NASDA will develop a four-stage rocket that's been dubbed "Q". It will have two solid-fuel stages topped by a liquid-fuel third stage and a solid-fuel fourth stage. With the "Q" rocket, NASDA expects to put an 185-pound payload into a circular orbit.

After "Q" will come the "N" rocket. Its purpose is to get a 550-pound experimental communications satellite into stationary orbit. The schedule calls for the first bird to fly in 1974 and the Japanese will use it to test millimeter-wave and quasimillimeter-wave propagation. NASDA will start the conceptual study for the satellite itself this year.

While work goes on for the satellites and launchers, NASDA will build up its launching center at Tanegashima, a small island of Japan. The University of Tokyo's launching site at Uchinoura near the southern tip of Kyushu, will be expanded, too. Then there's a tracking network on tap that will link Okinawa, Uchinoura and Katsuura, located on the coast near Tokyo.

As the program builds up, so will government

spending for space. Within two or three years, people close to the space program expect that annual outlays will be double the current \$42 million. It will be five years or more though, before Japan has an "industrial" space program, thinks Kiyoshi Nishikori, head of NASDA's satellite development group. When the industrial program does come, Nishikori guesses that NASDA might well be transformed into a public corporation, rather like Nippon Hoso Kyokai (NHK), the public-service broadcasting network. The corporation would take under its wing the disparate, space research activities scattered among half a dozen ministries today.

Although the national space program still is in a research phase, Japanese producers of telecommunications gear have been doing well in the international ground station market. The industry leader, Nippon Electric Co. will do \$62.5 million worth of satellite communications business this year with two-thirds of this business coming from overseas, for example, it is building ground stations in Singapore, in Jordan, and in New Zealand.

But such company officials as Takeshi Kawahashi, general manager of the company's microwave and satellite communications division, like to point out that they've won contracts in the U.S. as well as in countries that have no domestic space electronics capability. NEC's latest coup is a \$313,000 contract with the Communications Satellite Corp. for pulse-code-modulation equipment that will go into Comsat's Etam, West Virginia, ground station.

The Japanese equipment is called Spade (for single-channel-per-carrier PCM multiple-access demand-assignment equipment) and will put Intelsat a notch above its predecessors in operating efficiency. Until now, blocks of channels have been shared out among ground stations according to expected traffic, so that the assigned channels on lightly loaded links may be doing nothing when there's traffic backed up on other circuits. Spade ends all that by assigning free channels on demand from a pool shared by a group of stations. Though it can handle up to 49 stations, at the outset it will control a pool of channels from about a dozen stations in South America and Southeast Asia working through Intelsat.

A second Japanese trademark that's blazoned on satellite ground terminals around the world is that of Mitsubishi. It has supplied antennas for stations in Japan, Mexico, Australia, Columbia, and Malaysia. And like NEC, Mitsubishi intends to compete in America. The company bid on, but lost, the antenna Comsat will build at its Andover, Maine, station. Since its forte is the antennas themselves and since NEC has all sorts of expertise and experience in satellite transmitters and receivers, the two look like natural partners. Mitsubishi executives admit they've talked with NEC on the subject; but they're quick to add that nothing has come of the talks so far.

**Defense electronics** has had little part in the charge that carried Japanese companies collectively from nowhere to number two ranking among "Free World" electronics producers. For her armed forces, officially called the ground, maritime, and air self-defense

forces, Japan has budgeted just \$1.5 billion for the 1970 fiscal year, which ends March 1971. That works out to about 0.8% of the country's GNP not much of a bite out of the national output of goods and services. To support its far-flung military establishment, by contrast, the United States antes up 7.5 cents out of every dollar's worth of GNP while in most European countries the figure runs about 4% of GNP.

And there's no chance of any massive rise in military spending in Japan. So devastated was the national psyche by the crushing defeat of World War II that antimilitarism has since become a Japanese trait. Companies involved in defense business keep a very low profile lest their consumer business suffer. "Japanese companies are not a threat in military markets abroad," says Ernest H. Beverly, a retired general who is vice president, Far East area, for Hughes Aircraft International Service Co. "There has been too much public opposition at home," he explains.

All the same, there has been an upward drift in Japan's defense budget in recent years. For fiscal 1968, spending ran \$1.1 billion. It climbed to \$1.3 in fiscal 1969 and then on to the current year's \$1.5 billion. The rise, maintains an official of the Self-Defense Agency, "mainly covers inflation".

To a man, executives of Japanese electronic companies see defense as a slow growth market. And budget analysts at defense headquarters in Roppongi, a Tokyo district better known for its steak houses and cabarets, agree. The latest breakdown available—for fiscal 1968—shows an outlay of \$58 million for electronics and communications equipment. That works out to little more than 0.1% of the year's electronics production.

The feeling is that electronics' share of the defense dollar is on the rise. But hard figures to back up this general impression aren't yet available. What's sure, though, is that there'll be more and more Japanese-made black boxes going into military hardware, albeit most of them may be researched and developed in the U. S.

A case in point is a batch of F-4 Phantom fighters. So far, \$192 million has been earmarked for 34 planes that will be assembled from kits by Mitsubishi Heavy Industries. They are part of Japan's third five-year defense buildup plan that runs through fiscal 1971. The number of F-4's is quite likely to be upped to 100 or so during the fourth defense plan.

Whatever the F-4 total, about 25% of the cost will go for avionics. A Mitsubishi-group company, Mitsubishi Electric, will manufacture the fire control system, the communications gear, and the Tacan (for tactical air navigation) receiver. Other major avionics systems will be farmed out to five non-Mitsubishi companies, among them Toshiba and Hitachi. This airborne gear will be made under license with as little actual hardware imported as possible. "At the worst," says an official at Roppongi, "we'll assemble a kit of parts."

Also tagged to go into Japanese F-4's is a special radar of native design. Except that the radar warns the pilot when his plane has been picked up on an enemy radar, no details are forthcoming on this equip-

ment. The contractor is Tokyo Keiki, which is partly owned by the Sperry Rand Corp.

The Phantom program is the major procurement in the offing, and all told defense business is so sparse that even the largest companies lay out little of their own money for research that might lead to military contracts.

Nor is there much in the government's coffers for developing new arms. The defense agency's development section has to get by on an annual budget of \$28 million, some \$8.9 million of which goes for hardware. Since the hardware list includes prototypes of a jet trainer and a twin-jet transport, there's little more than \$1 million to spend in electronics hardware. "Compared to Germany, France, and England, our defense-research budget is zero" says Mitsugi Kofukuda, a defense-sales executive of Japan Radio Co.

Nonetheless, defense agency officials maintain that Japan has managed to stay up with the heavy-spending pack in infrared detectors. And Mitsubishi Electric insists it has come up with a "different" search radar for warships. The company won't say how, though; nor will company officials talk in detail about their "precision, long range" three dimensional radar. Eight sets, they say, will cover Japan's air perimeter.

**Components makers** have to hustle to keep up with the country's fast-stepping equipment makers, who figure to bounce up the national output of electronics gear, not counting telephone equipment, to \$6.58 billion this year. That means a 1970 components market of \$2.33 billion, according to *Electronics'* survey. This year's strong rise of 28% won't quite be matched next year, most people in the industry think. But in any other country it would be considered extremely good: the consensus forecast for 1971 components consumption is \$2.88 billion, or 24% better than this year.

Although there's much in the workings of Japanese electronics industry that puzzles outsiders, the patterns in the components business stand out like the stepping stones in garden pools. And most have familiar outlines—like, semiconductors are out-stripping other major sectors of the market and there's a population explosion in ICs. Receiving tubes are in a decline, their demise accelerated by the switch to all solid state color tv sets. Power tubes, though, figure to join the high-rise ranks mainly because magnetrons have picked up a mass market in ovens.

As in the U.S. and Western Europe, it's the IC market that's generating the most excitement. IC makers, as a matter of fact, have something very good going for them in every important equipment market. In computers, where ICs have long been entrenched, there's the arrival of mass production for desk calculators. In consumer electronics it's the start this year for ICs in mass-produced color sets and the advent of new consumer markets like IC watches and IC camera flash controls. In industrial electronics, it's the accelerating trend toward digital instrumentation.

With boosts like these, it's little wonder that semiconductor makers are predicting their IC market will double this year. *Electronics* forecasts \$174 million

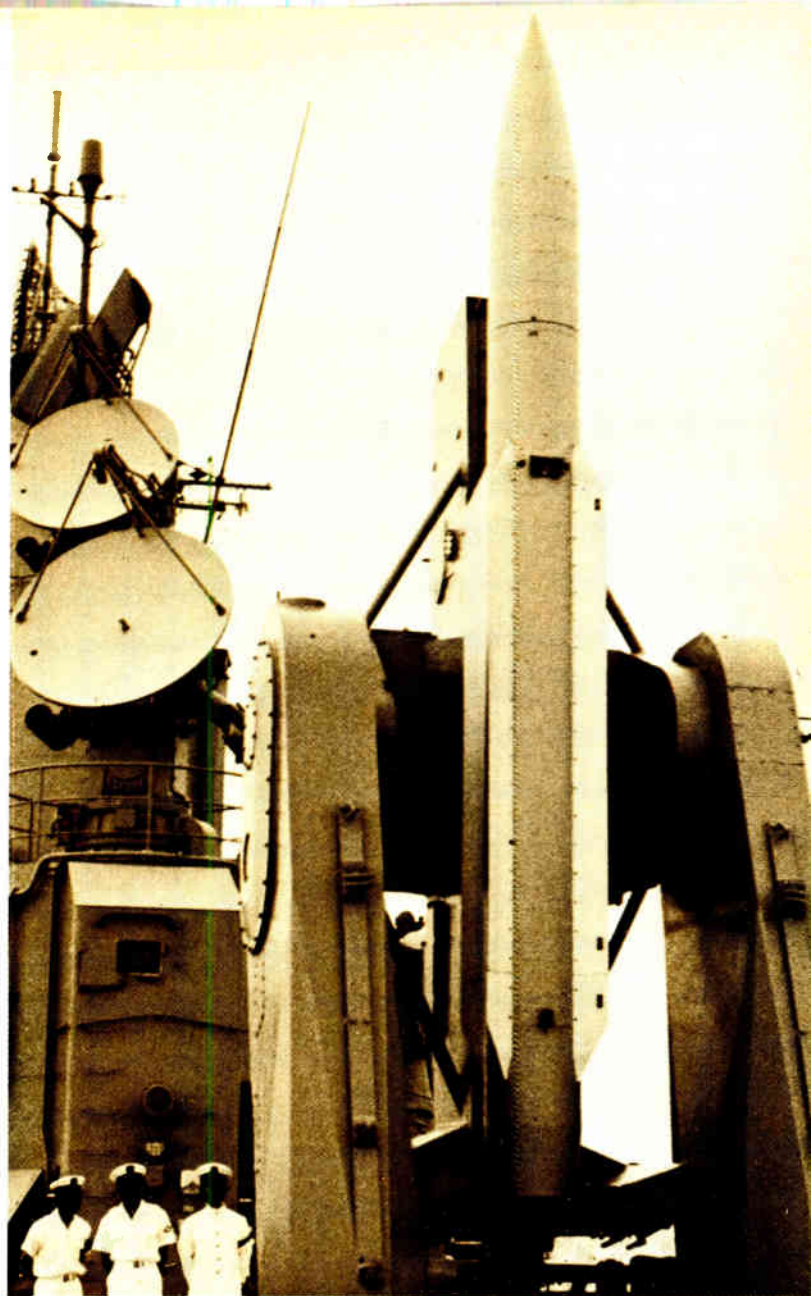

On the defensive. Destroyer-borne rocket and control system symbolize electronics' rising share of static defense budget.

for 1970 up from \$82 million for 1969. Next year's outlook is for a market of \$253 million. As for 1971 production, MITI surveyed the 10 major producers this year and got responses from everyone but Matsushita and Sony-TI. The package count for the eight: 120 million bipolar standard ICs, 75 million MOS, 16 million medium scale ICs (between 20 and 100 gates), and 4 million large scale ICs.

"By 1973," predicts Michael Jablow, marketing manager for Motorola in Japan, "ICs will match discretely in value." Last year, sales of discretely topped IC sales four to one.

As ICs catch on, their content will change: "There's a phenomenal growth in sight for MOS," says TI's Coan. Already, MOS/MSI predominates in desk calculators, and by 1971 MOS/LSI probably will. U.S. producers who got off to a big lead in MOS can look for hard local competition. For example, Hitachi, currently

the semiconductor sales leader in Japan, has developed a set of eight MOS/LSI circuits for a 16-digit calculator it plans to market next spring. The company's semiconductor division will also sell five of the packages, including a 2,048-bit read-only memory, to outside calculator makers. Computer peripherals should add a fillip to MOS sales, but won't become a major MOS market in Japan until 1972. Another relatively untapped market for MOS is in data terminals, especially when NTT builds up its public data communication networks.

The semiconductor producers all see glittering prospects for optoelectronics. The first to make solid state calculator display that can undercut the ubiquitous Nixie tube will be deluged by customers. Hitachi, Mitsubishi, and Sharp seem furthest along here.

**U.S. producers** trying to enter or stay in the Japanese market have to face both the formidable array of Japanese companies and the government's all-pervasive Ministry of International Trade and Industry. MITI's charged with, among other things, nurturing the electronics and computer industries to a point where they are invulnerable to foreign competition. While keeping its home market largely a preserve for Japanese companies, MITI has also been urging them on to higher export levels.

Last year, for example, Japan sold the U.S. \$1.1 billion worth of components and electronics equipment, mainly consumer goods. Trade the other way came to \$275 million, over half of it computers and semiconductors. There's no doubt the U.S. deficit would have been significantly smaller had U.S. computer and semiconductor companies been less restricted by MITI.

Digital computers, for example, turn up on MITI's "import allocation" list. There's no set quota, but the agency scrutinizes each application for an import license for a digital computer. Though MITI officials insist that they grant a "high percentage" of the requests, companies are often "guided" to Japanese

machines when they can do the job. Partly as a result of this guidance, Japanese computer makers now have more than half their home market, which in the early 1960s was dominated by U.S. makers.

True, the American companies do more business in Japan each year because the total market is bounding up so rapidly. But their shares in the market are destined to dwindle in the years ahead. Big machines, worth \$700,000 or more, have been the U.S. suppliers' main strength, but Japanese producers have added steadily to the top of their computer lines, and by the mid-1970s will begin marketing commercial versions of the national large-scale computer.

As a result of all this, U.S. officials have started a dialogue with their Japanese counterparts on relaxing computer-market restrictions, but with little success so far. "All this talk about liberalization is a lot of malarkey," says a U.S. official.

Semiconductor producers, too, have MITI to contend with. As far as discrete semiconductors go, Japanese makers are so competitive that there are no special barriers (there's a tariff, of course). ICs, on the other hand, turn up on the import allocation list if they have more than 100 elements per chip.

Domestic production, however, is building up fast. Mitsubishi is adding two new IC plants this year, NEC and Toshiba are each adding one. In addition, older plants in the Tokyo area are being shifted from producing discretely to producing ICs.

Should MITI set up more barriers to IC imports, U.S. producers will find it hard to counter the action as they've done in Europe—by setting up producing units inside the protective walls. As part of the dogged effort to keep the electronics industry in the country truly Japanese, there's a ban against foreigners setting up wholly-owned ventures in any key electronics sector. Although off and on there's much governmental trumpeting about liberalizing plant investment, it's a safe bet that sensitive sectors of electronics are likely to be opened to outsiders only when MITI is convinced it's for the national good. □

Up in the air. Some sophisticated military electronics gear flies over Mount Fuji in F-104J jets with rising sun insignia.



# Designer's casebook

*Designer's casebook is a regular feature in Electronics. Readers are invited to submit novel circuit ideas and unusual solutions to design problems. Descriptions should be brief. We'll pay \$50 for each item published.*

## Control voltage resets logic at power turn-on

By Richard L. Wiker

*Electronic Communications Inc., St. Petersburg, Fla.*

Resetting a logic system at power turn-on takes a pulse of known minimum length. To make sure that the pulse is long enough, regardless of how fast the logic supply rises, another supply voltage in the system can operate a time-delay switch.

As the logic supply rises toward 5 volts, it switches on the first buffer inverter. Then, after a time determined by resistor  $R_1$  and capacitor  $C_1$ , the 12 V supply reaches a level that's sufficient to turn on transistor  $Q_1$ , which switches the inverter

off. The  $R_1C_1$  combination ensures a sufficient delay between the rise of the +5 V logic supply and the turn-on state of the transistor stage to produce at least a 1-millisecond reset pulse.

If the power comes on fast,  $R_1C_1$  mainly determines the pulse width. If the power comes on slowly, the logic supply will reach the logic "1" level well before the 12 V supply exceeds the zener voltage. In either case, after  $Q_1$  turns on, the reset output goes high and stays there. A power interruption long enough to overcome the circuit capacity also causes a reset pulse to be generated.

Both inverters could be eliminated and only a positive reset pulse taken at the collector of  $Q_1$ . However, the inverters do sharpen the positive pulse and improve drive. TTL or DTL NAND gates could be used instead of buffer inverters to provide the reset pulses.

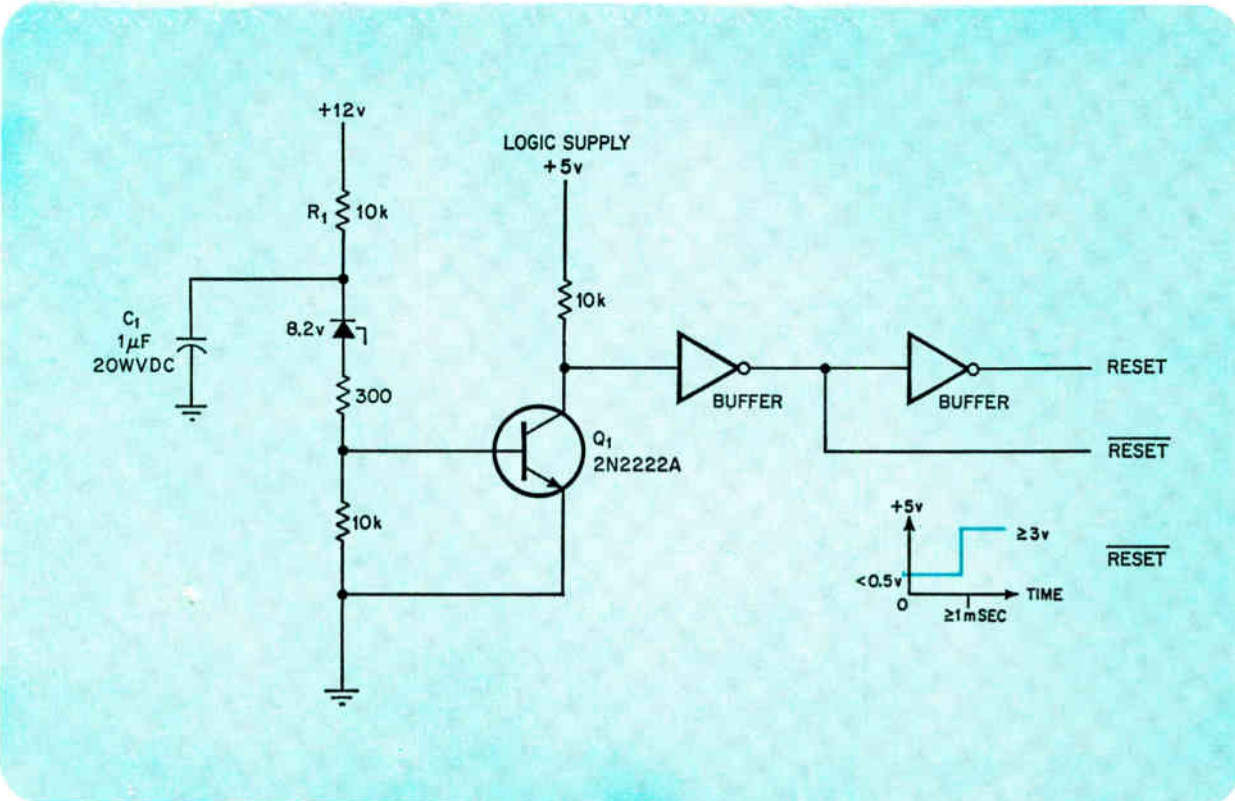

Slow turn-on. At power turn-on, the rise in the 5V logic supply generates a reset pulse, and the rise in the 12V supply switches  $Q_1$  and cuts off the pulse. The zener sets the turn-on voltage for  $Q_1$ . Using inverters as buffers provides better drive sources to the system logic that's being reset.

# Shared one-shot simplifies pulse width converter

By Ken Erickson

*Interstate Electronics Corp., Anaheim, Calif.*

Most of the one-shots that shorten or stretch pulses in data transfer channels are superfluous. In a digital system many components can be saved by using a single one-shot to control latches that hold the pulse level high for the one-shot's period.

Multichannel pulse width converters can be built with just a four-bit latch for each four channels, a shared one-shot, one resistor, and one capacitor. By contrast, the conventional technique takes three components in each channel—a one-shot and its RC network.

Since the one-shot controls all channels simultaneously, the channels must be synchronous. Buses carrying bit-parallel words or bytes meet

this requirement. A typical application is widening pulses to eliminate timing problems when data is clocked into a register.

In the data transfer format, a pulse represents a logical 1 bit and the absence of a pulse a 0 bit. Pulses on any or all input lines switch NOR gate  $G_1$ ,  $G_2$ , or both, to a 0 output, triggering the one-shot, which removes the reset from the latches.

Now the pulses (when inverted) on the input lines enable the set inputs ( $S_1$ , etc.) of the latches, causing all to set the corresponding Q outputs to go high. Those outputs remain high until the one-shot times out and restores the reset condition in the latches, dropping the Q outputs. Not including delay in the latches, the output pulse width is about  $0.693 RC$ .

The NOR gates can be omitted if the data bus carries a clock line. The clock is connected to the one-shot so that the triggering clock edge corresponds to the leading edges of the data pulses (the SN74121 has two inputs, one for a negative-going trigger edge and the other for a positive-going one). And the inverters are not needed if the complements of the data pulses are available.

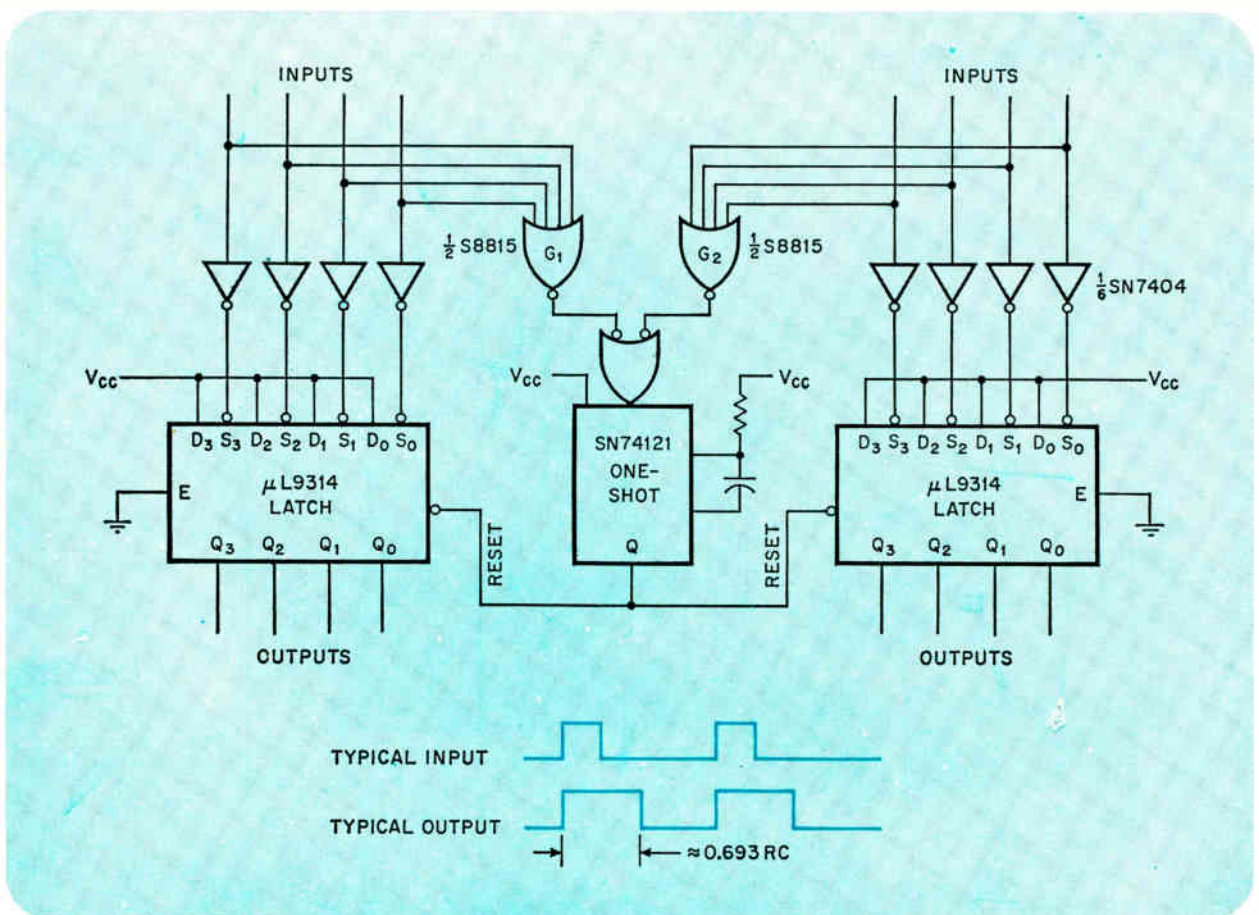

**Pulse stretcher.** Data pulses on the input lines trigger the one-shot through the NOR gates. The one-shot removes the reset signal from the four-bit latches, allowing the data pulses to set the latch outputs high ( $V_{cc}$ ). When the one-shot times out, it restores the latch reset condition and the data outputs all return to low.



# Diodes prevent power loss and burnout in converters

By Roy Hartkopf

Melbourne, Australia

High-power switching transistors in a dc-to-dc converter won't burn out if they're protected by just two low-voltage diodes. Inexpensive silicon power transistors like the 2N3055 with  $BV_{EBO}$  ratings of only 5 volts or less can be used with safety. In addition, the new design saves the price of a transformer winding and provides improved performance.

In the conventional circuit, the reverse base-emitter voltage of the transistor that is cut off can easily exceed breakdown levels. The bias winding that supplies the transistor is unloaded and undamped, and its voltage is in series with the reverse voltage that's developed across resistor  $R_1$

by the base current of the saturated transistor.

At best, the design is inefficient.  $R_1$  and  $R_2$  provide the starting forward bias. The resistance of  $R_1$  should be large for good starting with minimum current, yet should be small to minimize any voltage drop across it caused by the peak base-emitter current of the saturated transistor. The compromise results in wasted power. The base current is limited by adjusting  $R_3$  and  $R_4$ .

But in the improved design, diodes  $D_1$  and  $D_2$  limit the reverse bias across the cutoff transistor to the forward voltage drop of the diodes on that side, usually about 1 volt. With the single bias winding loaded evenly on both halves of the cycle no transients are developed. Operation is symmetrical because the bias winding and  $R_3$  are in series with each base alternately. And the need for  $R_1$ , with all its conflicting requirements, is eliminated.

The circuit starts easier and wastes little power. Starting bias favors  $Q_1$  since  $R_3$  is in the series with the base of  $Q_2$  at startup. Also, with  $R_1$  eliminated, only a few milliamps of bias current need flow to the transistors. Both resistors can be adjusted to increase power output and efficiency.

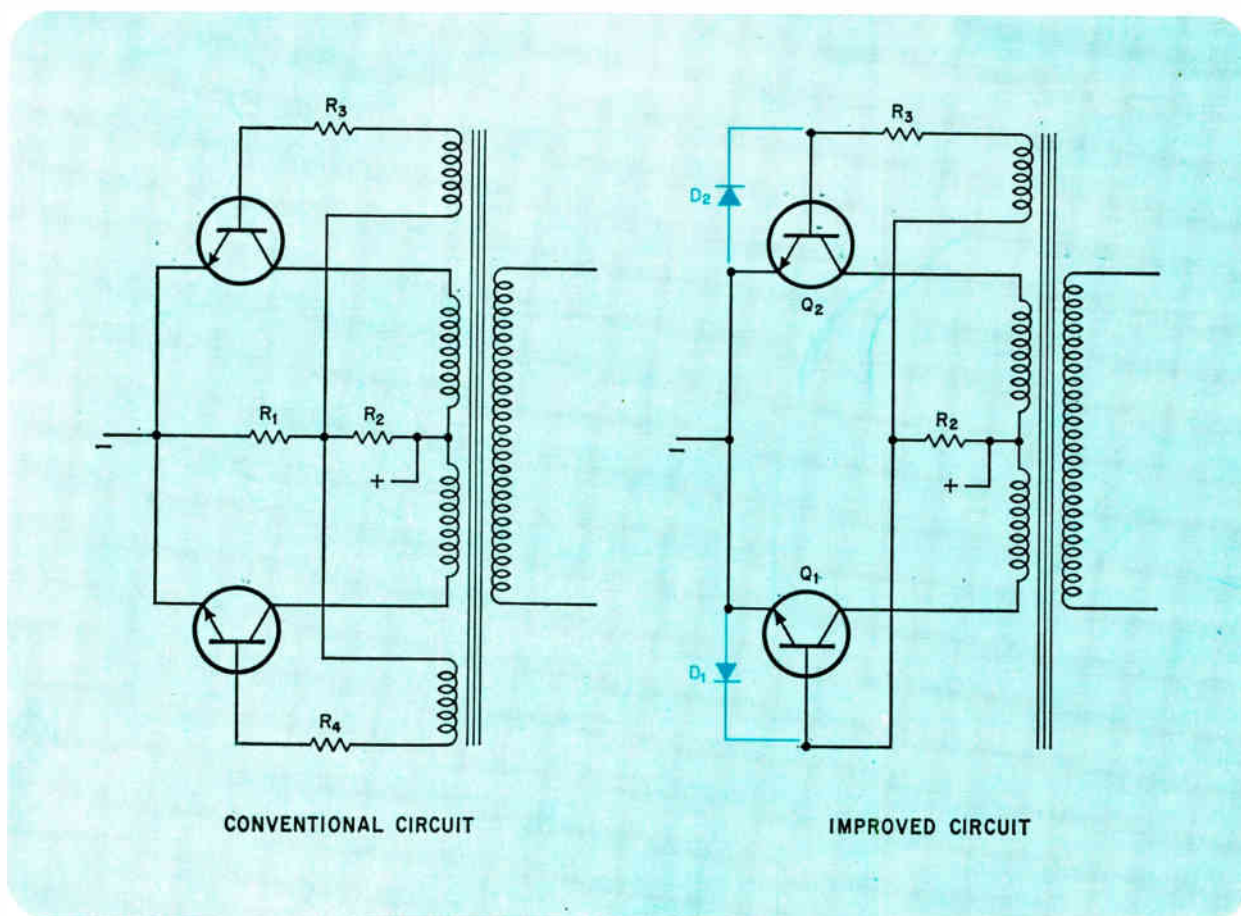

Quick change. Converter's old-style chopper circuit is updated by adding two diodes with PIVs of 50 volts, snipping out resistor  $R_1$  and using only one bias winding. The diodes prevent breakdown of the transistor base-emitter junction during reverse bias and elimination of  $R_1$  reduces the needed transistor bias current.

# New 15 MHz scope: two guns, two delay lines.

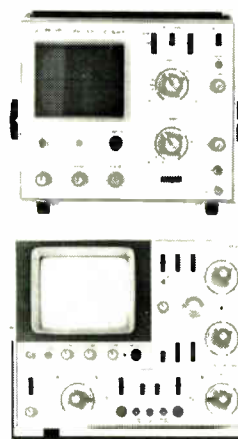
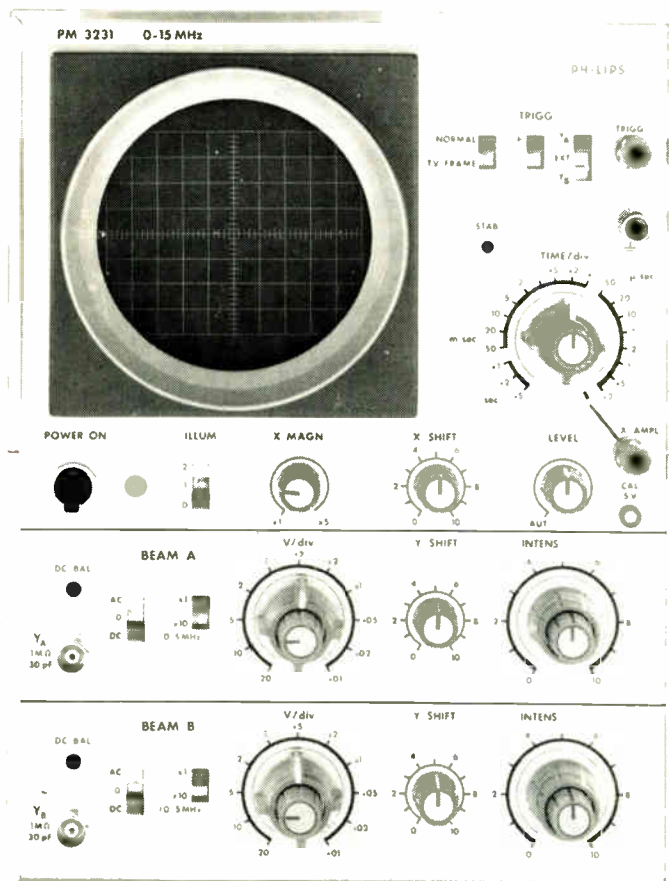

More of the Unbeatable  
Philips Scopes

PM 3200  
10 MHz, 2mV/div  
\$495

PM 3250  
50 MHz: 1mV  
Dual Trace  
\$1995

## Compare specs. Compare prices.

**PM 3231 costs only \$1,050.** PM 3231 is a new general-purpose scope incorporating all the features needed for accurate pulse measurement.

PM 3231 is a new scope, a new design. It uses delay lines and advanced components like FET's. It has two guns which are essential if you want to know where and when you're triggering. Time-shared beam switching can lead to misleading results.

For example, feed this same signal to



both channels on a time-shared scope and you might see this, a fact we'd gladly demonstrate.

PM 3231 uses delay lines which are essential if you want to see leading edges properly.

Other features include triggering from either channel. And drift is feedback and virtually eliminated. (at max. sensitivity less than 1/4 div/24 hours).

So, if bandwidth permits, and 15 MHz does, you should think real two-gun, not dual trace.

For information, contact:  
Philips Electronic Instruments, 750 S.  
Fulton Avenue, Mt. Vernon, N.Y. 10550.

**PHILIPS  
ELECTRONIC  
INSTRUMENTS**

750 S FULTON AVE., MT. VERNON, N.Y. 10550  
A DIVISION OF PEPI, INC

# Saturating operational amplifiers add up to a simple way to compress ac signals over many decades

Summing up the output currents from a series of amplifiers saturating at different input levels produces a log output

By Melvyn G. Morris, *National Semiconductor Corp., Waltham, Mass.*

□ A string of operational amplifiers, each saturating at a different input level, offers a simple, inexpensive way to bag a wide range of ac signals. It takes just a few components other than the operational amplifiers to compress several decades; such things as autoranging networks and diode-biasing circuits can be dispensed with. Adding the output currents from the operational amplifiers produces an ac signal that's the logarithm of the input. A conventional detector can then turn this signal into dc. If, instead, a synchronous detector is used, the polarity of the dc voltage tells whether the input to the amplifier is in phase or 180° out of phase with some reference signal.

Log amplifiers, built using this compression technique, have enough accuracy for many applications. Uncalibrated accuracies reach  $\pm 3\%$  referred to a best-straight-line approximation of the log function.

Adding a preamplifier and an output dc amplifier increases the log amplifier's versatility by allowing the accommodation of different input ranges and various readout devices, without any redesign or any change in the power supply level.

A typical outgrowth of this approach is the log amplifier at the top of page 106. It has a dynamic range of four decades—one for each stage. Further stages can be added until internal noise from the input amplifier is sufficient to saturate the last stage. With inexpensive commercial amplifiers, such as the LM 301A, the maximum number of stages is about six.

Although this log amplifier operates from 80 hertz to 250 Hz, the saturation technique itself can be applied at almost any frequency. A practical lower limit is 10 Hz. To go below that would require very large coupling capacitors and detector transformers. The upper limit is about 10 kilohertz with inexpensive operational amplifiers. To surpass this level, amplifiers specifically designed for high frequency operation must be used.

The  $\pm 3\%$  accuracy of the log amplifier can be refined by calibration to better than  $\pm 1\%$  at room temperature. Over a range of  $-20^\circ\text{C}$  to  $+70^\circ\text{C}$ , the maximum variation from the room-temperature response curve is  $\pm 4\%$ . Using Mil-type operational amplifiers extends the temperature range of the log amplifier to between  $-55^\circ\text{C}$  and  $+125^\circ\text{C}$ .

Each operational amplifier in the circuit has a gain of 10 and is connected in the inverting mode. As the amplitude of the input signal increases, the operational amplifiers start saturating from right to left. The output from each stage goes through a current summing resistor to the primary of the detector's transformer. The in-phase summing of these outputs by the transformer produces an ac signal whose amplitude is a piecewise logarithmic function of the amplitude of the input signal.

When the positive and negative swings of a stage's input equal some value slightly less than the supply voltage going to the operational amplifiers, the stage saturates. Stage four does so when the peak-to-peak input to the log amplifier is about  $10^{-4}$  times the supply voltage; stage one when the input is about  $10^{-1}$  times. When the input is too small to saturate stage four, the amplifier's summed output is a linear function of the input. When the pk-pk input exceeds the voltage needed to saturate the input stage, the summed output remains constant with an amplitude equal to some value slightly less than the supply voltage. The dynamic range of the four-decade amplifier in the figure is then 1.4 millivolts to 1.4 volts pk-pk when the supply voltage is 15V.

**Connecting** the operational amplifiers in the inverting mode proves to be the most economical way to build the log amplifier. Each stage needs only one inexpensive operational amplifier and no special isolation circuits. Each stage shifts the input signal 180°; so to obtain in-phase summing, the outputs of stages one and three are connected to one side of the detector transformer, and those of two and four to the other side. Hooking up the alternate outputs this way limits the possibility of oscillation to the closed loops around stages two and three, and stages three and four. Each loop with its two amplifiers has a forward gain of 100 and will oscillate unless the ratio of amplifier output resistance to feedback resistance is less than 1/100. Devices like the LM301A have an output resistance of less than 100 ohms. Therefore, the current summing resistor in each loop can be as low as 10 kilohms and still hold the loop gain under unity.

When there are more than two amplifiers in a loop,

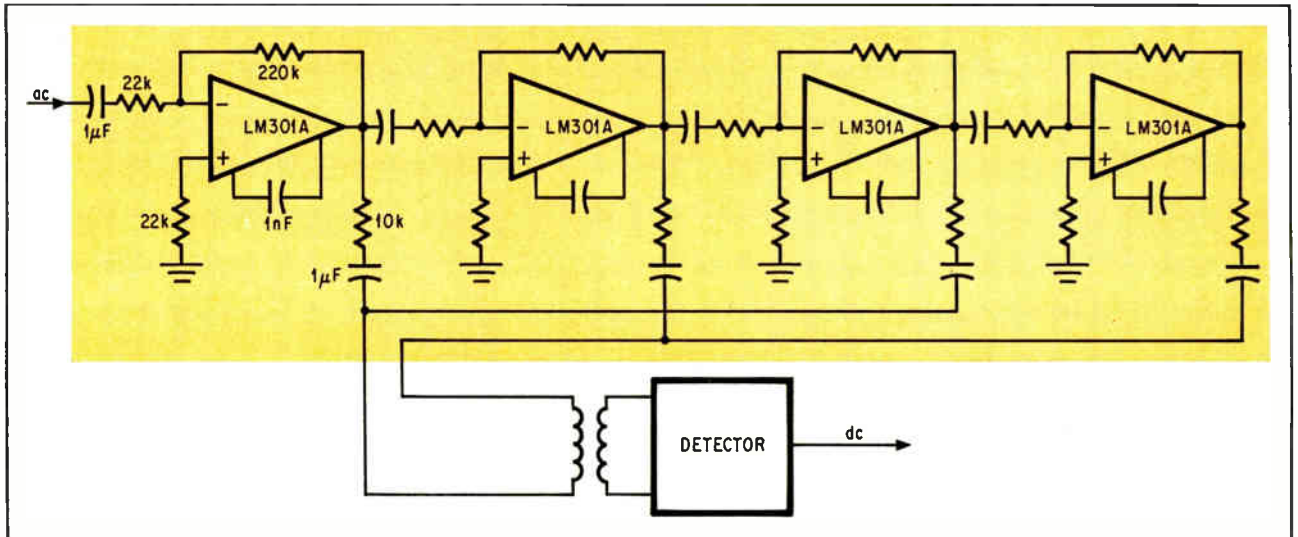

**Squeeze play.** This amplifier compresses its input down to an ac signal whose amplitude is a logarithmic function of the input's amplitude. The detector then converts this ac signal into dc.

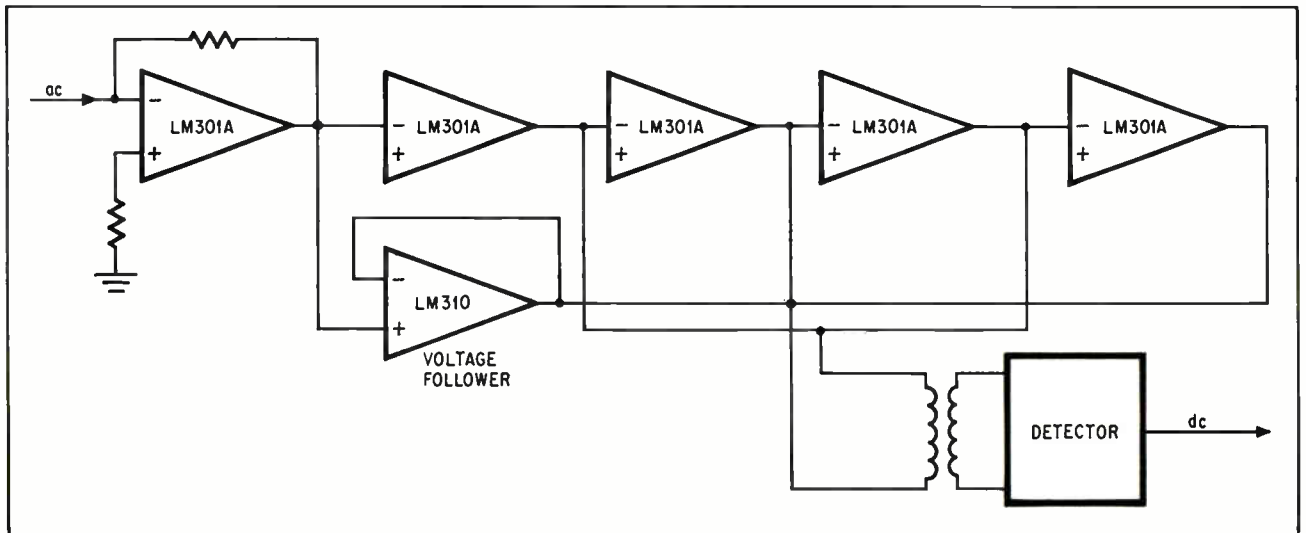

**Wider range.** A fifth stage adds a decade to the log amplifier's dynamic range, but requires a voltage follower to prevent oscillation.

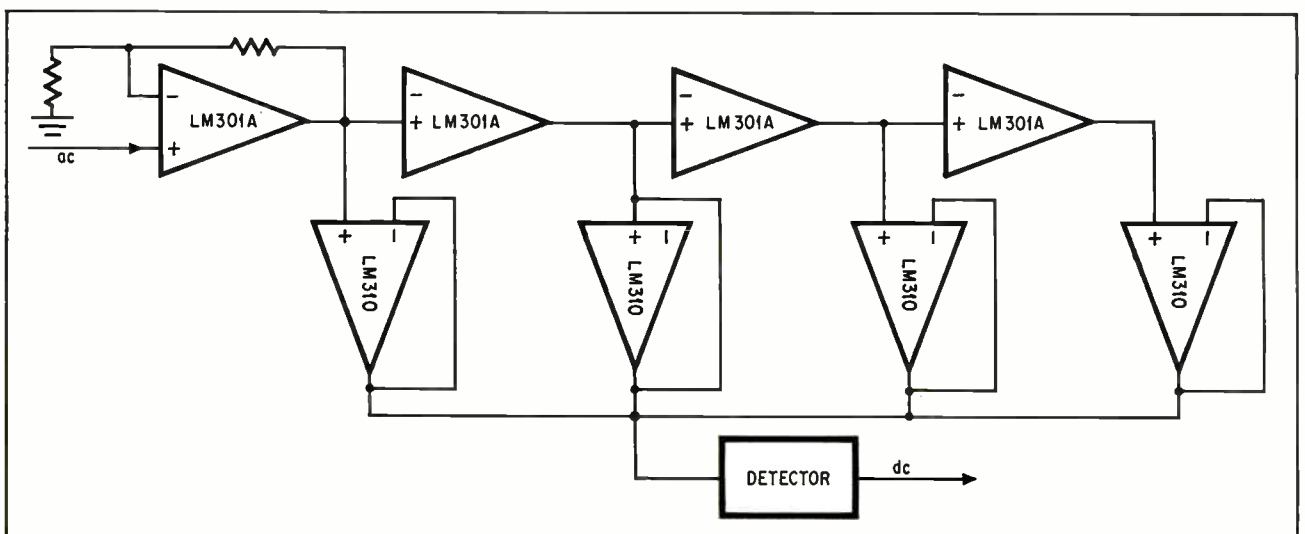

**To the point.** The outputs of the log amplifier's stages can be summed at a single point if the operational amplifiers are connected in the noninverting mode. However, for stability each stage needs a voltage follower.

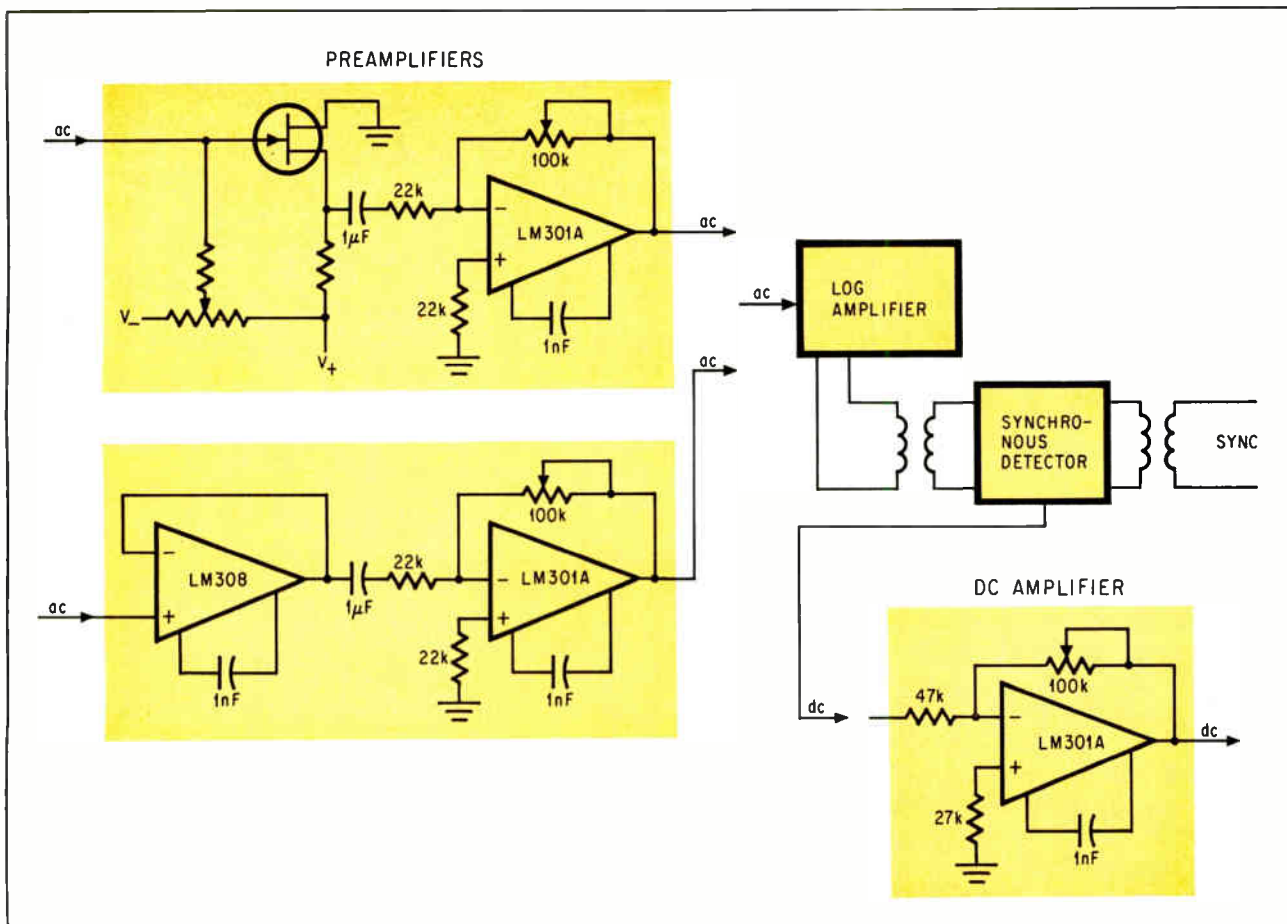

**All together.** With a preamplifier and dc amplifier, the log amplifier can handle almost any input and output range. A further bonus—phase information—results from detecting the log amplifier's output synchronously. For example, if the amplifier's input and the sync originate at the same source, a positive output from the detector indicates that the input and the sync are in phase. A negative output means a 180° phase difference.

either the resistor must have a much lower value, or a buffer must be placed in the loop. The buffer certainly would add to the cost of the network. Lowering the resistance would do the same since higher-priced operational amplifiers would be needed to handle the higher output currents that would be generated if the dynamic range were to remain unchanged. Unnecessary, and even unrealistic, power supply demands would also result from the lower-resistance approach. In practice, this technique is never even considered since in-phase summing can be done without buffers.

**If modifications** of the basic design are necessary, some sort of buffering is usually needed to keep closed-loop gains below unity. For example, adding a fifth stage to the log amplifier calls for a voltage follower inserted as shown on page 106. Without the follower, the closed-loop gain around the last four stages would be well over unity.

Voltage followers must also be included when the outputs of the operational amplifiers are to be summed at a single point. To do this requires using the amplifiers in a noninverting mode, with the followers isolating each amplifier from the common summing point, as shown by the circuit on the left. Single-point summing is useful when the compressed ac is to be transmitted over a single wire, or when it's not desirable

to use a detector with a transformer.

Once the log amplifier has been built, its versatility can be enhanced by a preamplifier and a dc output amplifier. Either preamplifier in the figure above can provide an input range control for the log amplifier. The field effect transistor unit is less expensive, but the operational amplifier circuit has better input impedance characteristics above 50°C.

In each preamplifier the input is adjusted with a 100-kilohm potentiometer. For example, to scale an ac range of 10 mV to 10 V pk-pk for compression by the log amplifier, the potentiometer would be adjusted to bring the preamplifier output to 1.4 V when the input is 10 V.

The dc amplifier tailors the log amplifier's output to drive such devices as voltmeters, analog-to-digital converters, and strip-chart recorders.

Suppose that the readout device is a meter whose range is 2.5 V dc. If the input to the log amplifier can be as high as 1.4 V, the output to the meter can be as high as 14 V. To scale this value down, the dc amplifier's feedback resistor is adjusted until the meter deflects full scale when the input to the log amplifier is 1.4 V. If the log amplifier's minimum input is 1.4 mV, the meter will be reading logarithmically for deflections from full scale down to 2.5 mV. □

# Sequential contacting extends range of variable capacitor

Dielectric problems in earlier approaches are circumvented by a rotor that links many fixed metal islands in compact thick film device with a capacitance range of 3,000:1

By John Fabricius and John Maher, *Sprague Electric Co., North Adams, Mass.*

□ Thick film and ceramic technologies have helped solve a long-standing problem: how to pack a large capacitance range into a small variable capacitor. This new device enables an engineer to design circuits in which the ac transfer characteristics can be varied manually over a 3,000:1 range while dc bias levels remain undisturbed.

Achieving these circuit features with only a potentiometer is usually difficult and sometimes impossible. In sophisticated audio equipment, for example, where performance preempts size and cost, multiple-position switches select the appropriate discrete values in RC networks. Many other applications, which do have the usual potentiometer, need a variable reactance to complement it. But until now variable capacitors that were small enough in size were too small in range.

To obtain a wider capacitance range while maintaining the desired impedance levels, the permittivity (dielectric constant) of the dielectric layer must be increased and its thickness must be reduced. Fluid dielectrics can't be used; they have very low values of permittivity (less than 5) and so cannot achieve capacitances higher than a few hundred picofarads without requiring electrodes to be placed impossibly close together. However, other dielectrics cannot be made smooth enough to eliminate all gaps between them and the moving electrode. These gaps act like capacitors in series with the dielectric, so they reduce the terminal capacitance of the device, and their maximum tolerable width is very small indeed.

For example, calculations show that a 0.03 microfarad variable capacitor, three-quarters of an inch in diameter that had a ceramic dielectric film 1 mil thick with a permittivity of 1,000, would require a gap between dielectric and electrode on the order of 2 angstroms—or less than the interatomic spacing of most solid materials.

Moreover, since the nominally flat dielectric and electrode touch only at asperities, which are a small percentage of the total area, the result is a very unstable situation. Temperature changes or mechanical stresses can induce fluctuations in system equilibrium that cause the area of contact to vary significantly. This problem is further intensified when the dielectric as well as the electrode must move

easily in relation to one another.

The solution, embodied in the new variable capacitor, is to replace the single moving electrode with a two-part electrode, composed of a moving element—the ohmic contact—and a fixed element—numerous electrode islands arranged over the dielectric surface. As the ohmic contact moves across the islands, it interconnects them sequentially and they act as capacitors with the continuous conductor layer beneath the dielectric. Once they are all interconnected, maximum capacitance is attained.

Intimacy of contact is ensured by molecularly bonding the conductor layers to either side of the dielectric. The discontinuous layer is formed by silk screening a metal conductor onto the dielectric surface, so as to deposit islets 5 to 10 mils square and 1 to 2 mils apart. About 1,600 islands fit into a semicircle three-quarters of an inch in diameter, yielding adequate resolution for most applications. The end result is a device that's manually variable from 10 picofarads to 0.03 microfarad—a range of 3,000:1.

The ohmic contact that interconnects the islands is made of specially prepared, woven metal mesh backed by a soft silicone rubber. The mesh is fine enough and flexible enough to touch each island at

**Variable capacitor.** By dividing the upper conductor into a movable ohmic contact and 1,600 unmoving islands, the designer obtains a capacitor that can be varied between 10 picofarads and 0.03 microfarad. The sliding contactor sequentially connects the islands to the collecting electrode.

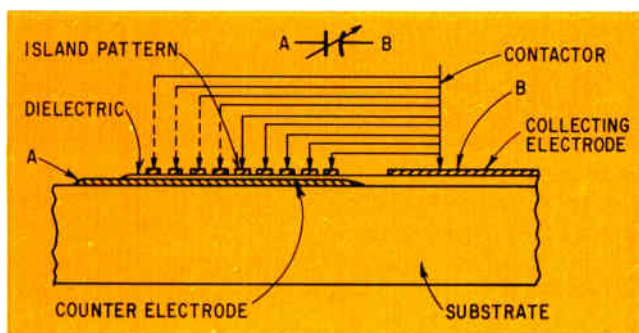

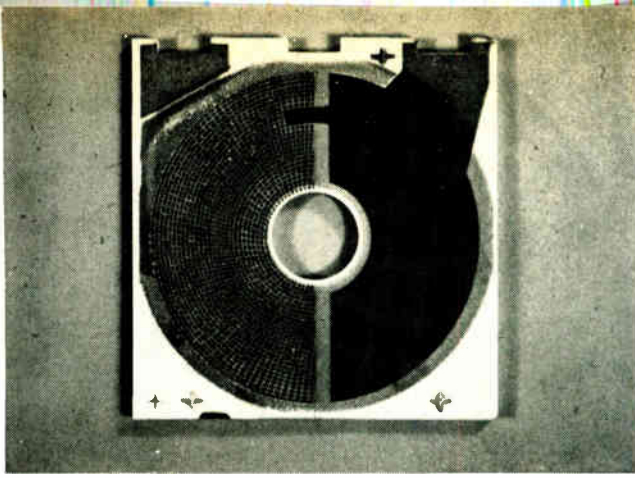

Choosing a value. All 1,600 islands on the right half of the substrate are interconnected by a sliding contactor made of woven wire mesh.

several points. Unstable capacitance generated between mesh and dielectric is kept to a minimum by the thickness of the islands and the tiny distance between them.

Foreign particles, a major cause of ohmic contact failure, are swept aside and collect in the mesh voids. The silicone rubber allows the mesh to conform to the island's surfaces and does not take a permanent set. It is backed by a flat washer, and the combination is forced against the electrode surface by a helical coil spring.

In this configuration, angular rotation causes capacitance change. The contacting mesh occupies about 180° of a circular plane, an insulating layer of Teflon occupies the other 180°, and the whole forms the movable part of the capacitor's top electrode, mounted adjacent to, and in contact with, the island pattern. The fixed part of the top electrode, the island pattern, is formed on the dielectric over the bottom electrode, which is a solid semicircle, and is concentric with the contacting rotor's axis of rotation.

Rotating the contactor changes the number of islands interconnected and hence the terminal capacitance of the device. Since the radial lines in the pattern are offset from true radii, the contactor intercon-

Making contact. Composite photo indicates how the conducting mesh makes several contacts with each island.

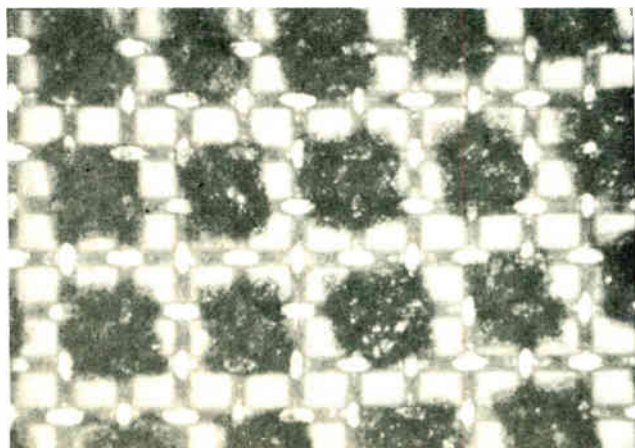

nects each island sequentially. The position of the individual parts can be seen more clearly in the cut-away view of the completed device.

**Electrically**, the device behaves like a conventional ferroelectric ceramic capacitor, as is shown in the plot (at bottom right) of how its capacitance and dissipation factor vary with frequency. Life tests established that the dielectric materials perform acceptably at 85°C and 50 volts. Throughout the tests, the dissipation factor for all units stayed constant at about 0.9% and leakage currents were consistently less than  $10^{-10}$  amperes at 50 volts dc. The capacitance drift was about 2% per decade of time, typical for ceramic capacitors with this dielectric constant.

From these data and previous experience with ceramic-film capacitors, a rating of 30 Vdc, 10 Vac, 85°C is reasonable.

Although a force of several pounds is needed for reliable contact between rotor and stator in a 3/4-in. diameter unit, the materials' low coefficients of static and dynamic friction keep the torque at 3 to 4 inch-ounces and let the device rotate smoothly. The devices resist wear, performing well after 100,000 cycles of rotation from minimum to maximum and return.

To meet special requirements, the basic capacitor

Measurements. Plot indicates how the capacitance and dissipation factor vary with frequency.

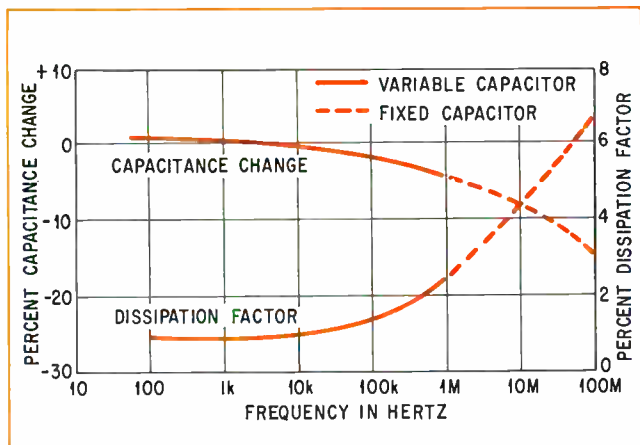

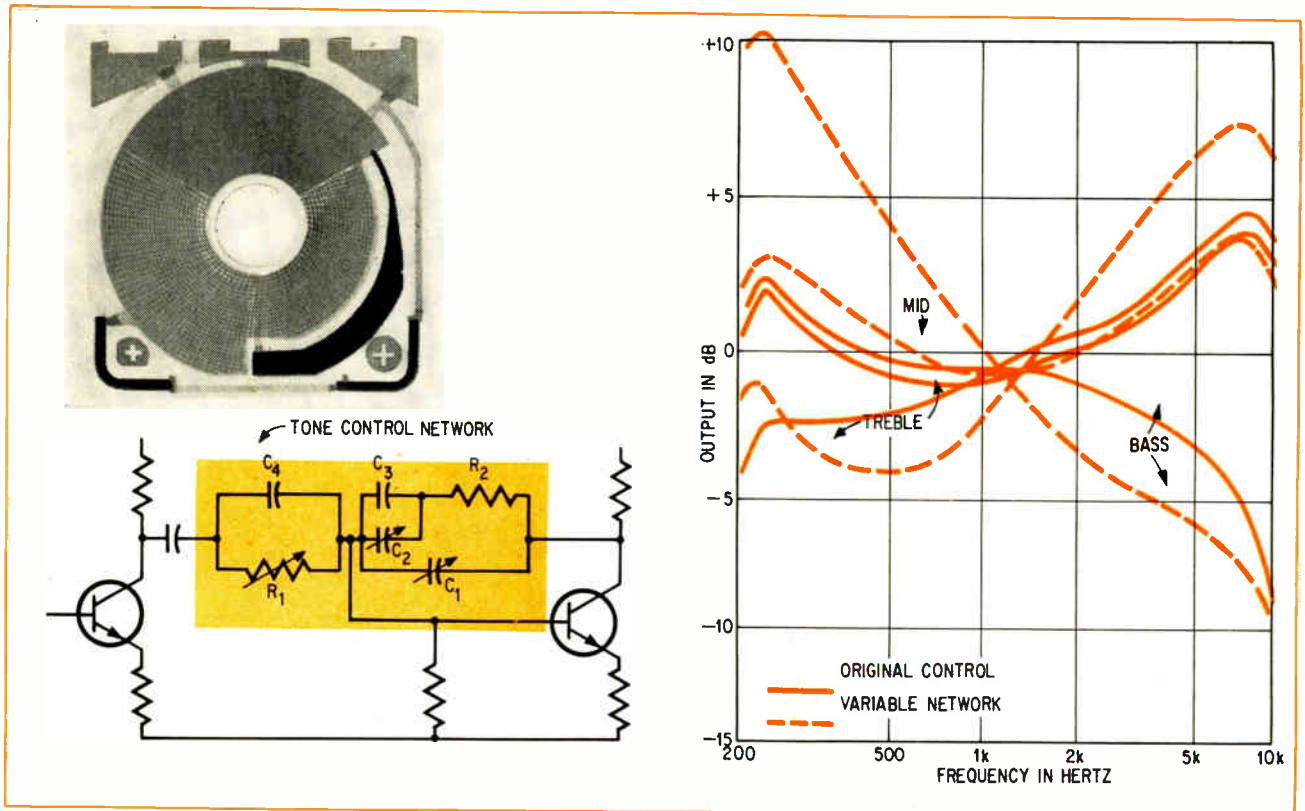

Tone control. Components  $C_1$  and  $R_1$  are tapered configurations used in this variable network tone control. Resistor  $R_1$  is the series combination of the two resistors at the top, and fixed capacitors  $C_3$  and  $C_4$  are formed with the solid electrode at the bottom. The contact mesh is a sector that may be rotated  $120^\circ$  in either direction to achieve the results in the plot.

can be easily modified, in a great variety of ways, thanks to the high degree of flexibility inherent in thick film technology. In one such modification, a second variable capacitor is deposited in place of the collecting electrode and the rotor connection is brought out to the center land area. Since each capacitor has a range of 1,000:1, this device is effectively an ac potentiometer that can be varied over a range of 1,000,000:1.

Additional versatility can be achieved by: arranging the interconnection pattern of the islands so that the sums or differences of their capacitances follow prescribed functions; eliminating the rotor stop to permit continuous rotation; and designing the island pattern so as to produce a function generator for a desired waveform.

To obtain tapered capacitors, it is only necessary to change the configuration of the bottom electrode. Tapered patterns, however, waste space unless special contacting schemes are devised. One such scheme uses the remainder of the substrate as an active area. Here, the surface of one electrode is split into two sections with only one half of its surface providing capacitance at any given time. Rotation past the  $180^\circ$  point causes a decrease in the

capacitance on one side, accompanied by a larger increase in capacitance on the second side. The final capacitance is nearly as great as that of a linearly tapered device. This construction has the added advantage, if resettability is important, of nearly doubling the angular displacement.

Thick film technology also permits the capacitor to be combined with other fixed and variable devices so as to yield functions that are otherwise technically or economically impractical. For example, cermet resistor materials have been combined with the capacitor technique to produce complex variable RC networks on a single substrate. These are especially handy for shaping all types of frequency response curves.

A simple illustration is an adjustable series RC network. To keep the impedance constant at a particular frequency requires both R and C to be variable. For if the potentiometer alone is varied, the impedance of the network increases as the crossover frequency decreases, which increases the transmission losses. Adding a variable capacitor enables the designer to provide a frequency adjustment without the increased transmission loss.

Tone controls are good examples of the way in



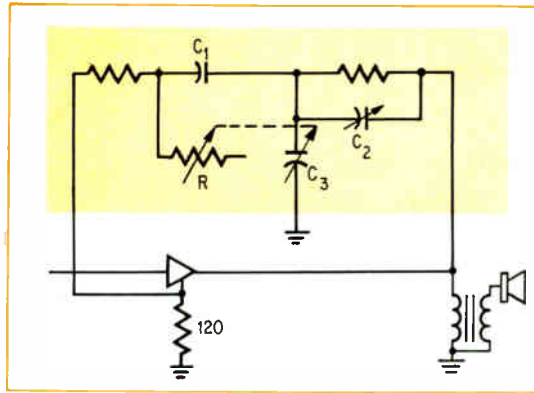
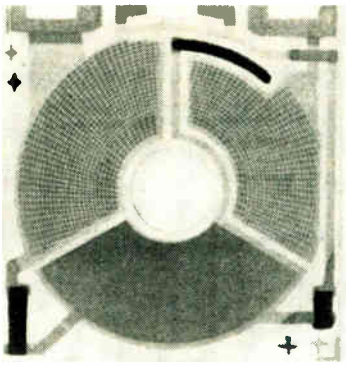

**Variation.** As in the tone-control network, a 120° sector is used to modify the parameters of this circuit, which features a switchable resistor.

**Simplifying.** Variable capacitor is added to this tone-control circuit to provide the network with a wide-range bass and treble adjustment.

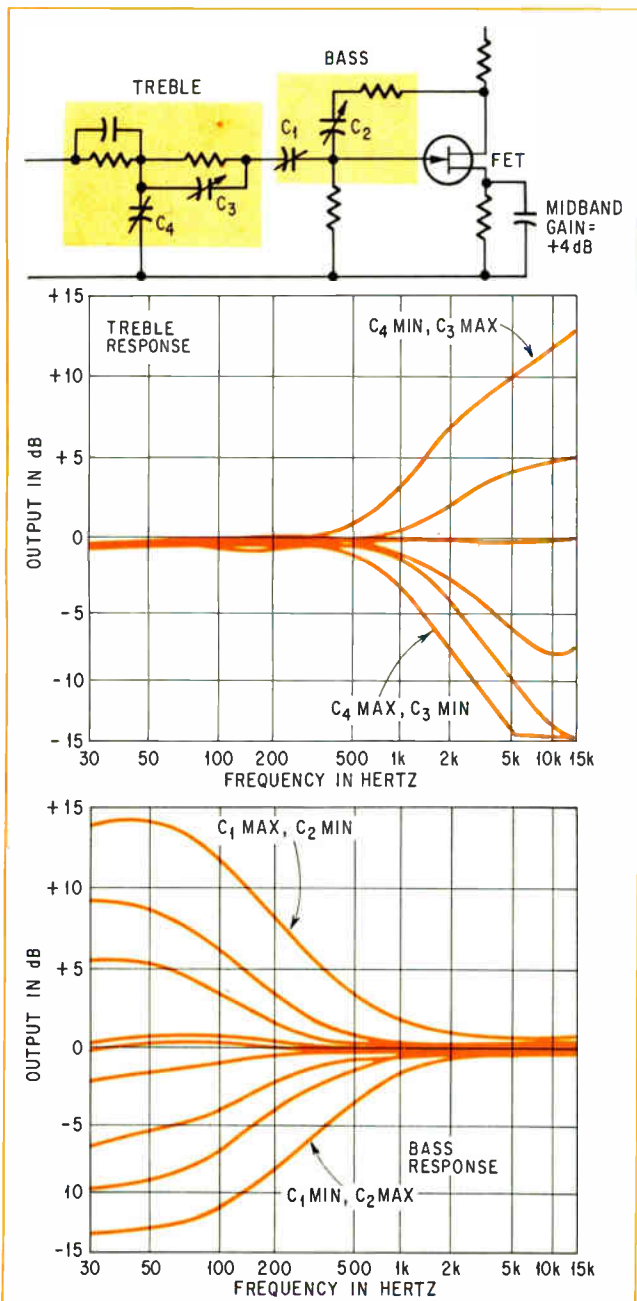

which tapered resistors and capacitors can be combined to yield both the desired function and its preferred rate of change with angular displacement. One such device, designed for a low-cost radio and shown on the page opposite, replaces a network of seven components, including the potentiometer. It achieves a wide control range while maintaining the subjective loudness at a constant level. Both variable capacitors have minimum values and the resistor is at maximum when the control is at its mid-position. The remaining components are selected to equalize the amplifier for flat response.

When the control is rotated toward the bass position, the capacitance of the tapered  $C$  increases, and cuts out the higher audio frequencies. As capacitance approaches the point where the mid-frequency gain begins to drop, the tapered  $R_1$  decreases its resistance level to maintain midband gain at a fixed level. The combined effect is a high-frequency cut followed by a boost in bass frequencies. If the control is rotated from midpoint toward the treble position, the capacitance of  $C_2$  is increased, lowering the crossover frequency and causing the bass-frequency reduction.

Another approach is a single-element tone control, tuned for high-frequency response, which is shown above. This device operates entirely in a negative feedback loop from the loudspeaker terminal to the emitter of the first audio amplifier.

When the control is at midposition, both variable capacitors are at minimum value, and the other components equalize the amplifier for flat response. Rotation to the bass position adds to the capacitance of  $C_2$ , causing increased high-frequency feedback and hence a treble cut. Rotation from midrange toward the treble position adds to the capacitance of  $C_3$ , removing highs from the feedback and producing a treble boost. After approximately 60° of rotation, the end of  $R$  is contacted. Further rotation decreases bass by shunting  $C_1$  while  $C_3$  continues to increase the treble response.

An application of an ac potentiometer in a tone-control network with individual bass and treble controls is pictured on the left, together with its frequency response curve. This circuit relies on a field effect transistor for its high input impedance. A bi-

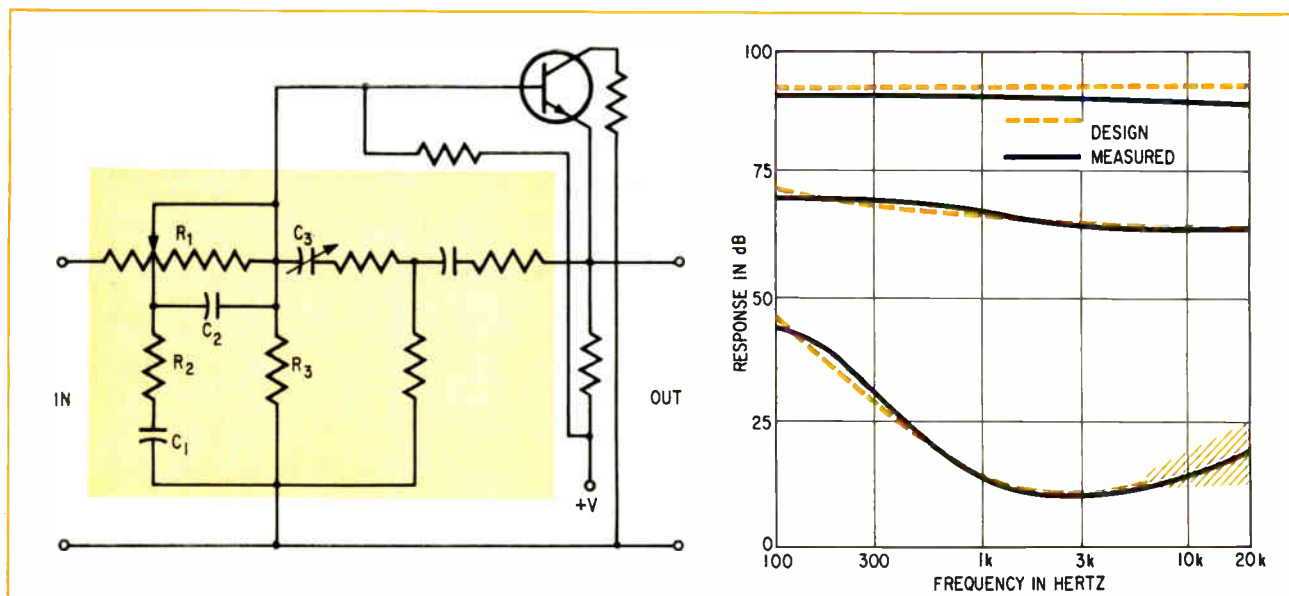

**Matching.** Loudness control contains a variable RC network that closely approximates the Fletcher-Munson curves.

polar transistor could be substituted, but with some loss of gain.

With both controls in their midrange position, the bass cut produced by series capacitor  $C_1$  is balanced by the bass boost from feedback capacitor  $C_2$ . Similarly, the high-frequency cut from shunt capacitor  $C_4$  is balanced by the boost from  $C_3$ . Clockwise rotation of the bass control simultaneously increases  $C_1$  and decreases  $C_2$ , yielding a considerable increase in bass response. Counterclockwise rotation produces the opposite effect. In a like manner, the treble control simultaneously varies  $C_3$  and  $C_4$  to obtain treble cut and boost.

Loudness controls have also been investigated, as a function readily embodied in variable networks incorporating the new capacitor.

One method for achieving loudness compensation is depicted above left. In the maximum gain position, series resistor  $R_1$  and feedback capacitor  $C_3$  are at minimum value and the response is flat. As the gain is reduced by increasing the series resistor (beginning at the left), the  $R_2C_1$  combination causes the mid- and high-frequency signals to be attenuated

more rapidly than those of low frequency, producing a bass boost. As the gain is further reduced, the wiper passes the tap on  $R_1$ , and  $C_2$  becomes increasingly effective in shaping the treble response. To shape the bass response properly at the lower loudness levels, more compensation is required than can be produced by  $R_2$  and  $C_1$ . Increasing  $C_3$  does the job by causing closer coupling of the feedback circuit.

A loudness control circuit, built using a given set of component values, yielded the curves shown above right. The gain at 1 kHz was varied over a range of 80 dB with a bass boost (100 Hz) of 30 dB and a treble boost of 3 dB (10 kHz). With different component values, these figures can be changed considerably—for example, by selecting values and tapers to compensate for over-all amplifier gain and loudspeaker efficiency, or by shunting  $R_3$  to ground to produce complete attenuation.

**Where it is desirable** to employ dual devices rotated by the same shaft, as in stereo amplifiers, both sides of the substrate can be used—an uncased assembly of this type appears below left. This approach yields the advantages of a reduction in size and friction, and limitation of the number of cases and substrates to one each per assembly. Moreover, this configuration can be modified further to accommodate concentric shafts or an external switch. □

**Boxing.** If frequent adjustment is not necessary, networks may be packaged as trimmers.

#### Bibliography

- H. Fletcher, and W.A. Munson, "Loudness, Its Definition, Measurement, and Calculation," *Journal of the Acoustical Society of America*, Vol. 5.2, Oct. 1933, p. 82.
- F. Langford-Smith, "Radiotron Designer's Handbook," fourth edition, RCA, Harrison, N.J., 1953.
- D.W. Robinson, and R.S. Dadson, *Journal of the Acoustical Society of America*, Vol. 29, 1957, p. 1,284.
- J.H. Fabricius, and J.P. Maher, "0.01 $\mu$ F Variable Capacitor," *Electronic Components Conference*, Washington, D.C., May 1970. Sprague Electric Technical Paper TP 70-4.
- J.H. Fabricius, and J.P. Maher, "Thick Film Variable Resistance-Capacitance Networks," *Chicago Spring Conf. on Broadcast and Television Receivers*, June, 1970. Sprague Electric, TP 70-6.

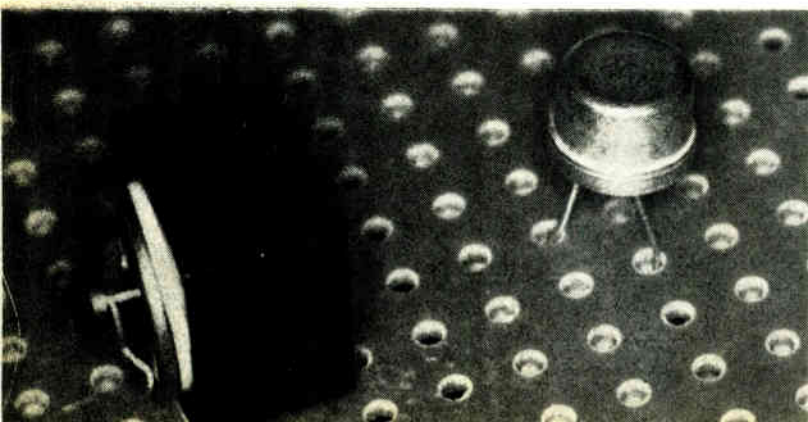

# Motorola's new age of FET pricing is here...

## N-Channel JFETs

2N4091	\$ 2.10
2N4092	1.23
2N4093	1.45

## Dual Gate MOSFET

3N140	\$ 1.10
-------	---------

## N-Channel MOSFET

2N4351	\$ 1.90
--------	---------

## P-Channel MOSFET

2N4352	\$ 1.80
--------	---------

## Plastic JFETs

MPF111	\$ .25
MPF112	.25



## For a new generation of FET designs.

Now — in one bold stroke — you can add new performance and practicality to those new and existing designs you may have hesitated to take off the shelf because of FET prices ... more than 125 top Motorola MOSFET and JFET prices have been cut as much as 69%!

FET's have long been desirable as choppers and in RF-VHF designs but cost factors minimize their usefulness. No longer. Full maturity of manufacturing and testing technologies has led to very high yields and total production which no longer justifies previous price levels. The additional reliability of Motorola's

exclusive silicon-nitride passivated MOS-FET's has generated such market acceptance that even many of these types are included in the action.

Our calculator shows just a few representative, reduced 100-up prices . . . for details on how you can join the new age of FET pricing, write Motorola Semiconductor Products, Inc., Box 20912, Phoenix 85036 or contact your nearest Motorola distributor.

We'll send along a price list and a FET Selector/Cross-Reference Guide that will show you the best in FET's at the newest in economy!

 **MOTOROLA FET**  
— where the priceless ingredient is care!

# NEC covers the world

**It's a small world.**

Japan's largest electronics/telecommunications manufacturer makes it smaller. Daily.

NEC products and projects—from satellite communications to computers and IC components—are covering the world.

Examples:

**Trailer trucks transport NEC NC-23 Switching Systems.** In Canada, the USA—with complete compatibility. Other crossbar customers include Brazil, Korea, India and more. Proofs that NEC crossbars the world.

**First of its kind: NEC's 240-channel 2GHz Radio PCM.** Just one of NEC's innovative firsts in Pulse Code Modulation technology. Customers in Mexico, Australia, Thailand, Belgium prove that NEC PCM's the world.

**NEC's "Oh Nine" (NA4-09) PABX expands telephone capacity from 50 to 400 lines.** Start with 50. Add up to eight 50-line units as your business grows. Plug-in method, compact, light-weight design save money and floorspace. Proofs that NEC telephones the world.

**Largest contract awarded one firm: NEC's Iran microwave network: a 3,557-km, 83-station system.** NEC's 70% share of Brazil's 7,100-km network, plus Mexico's solid-state system prove NEC microwaves the world.

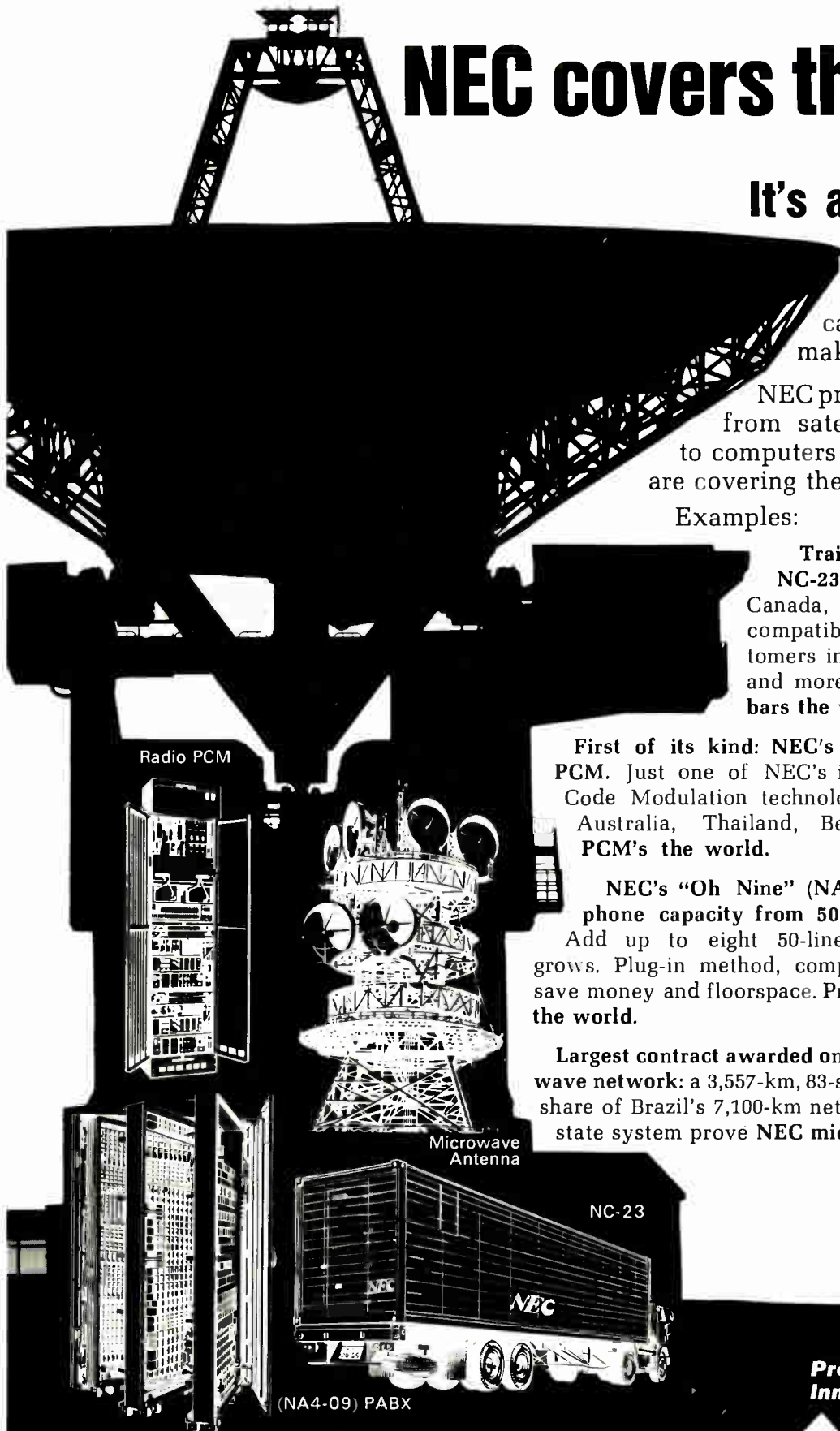

Radio PCM

Microwave Antenna

NC-23

(NA4-09) PABX

Overseas Offices: Taipei, Manila, Bangkok, Djakarta, Kuala Lumpur, New Delhi, Karachi, Teheran, Beirut, Melbourne, Düsseldorf, Mexico City, Rio de Janeiro, Bogotá, New York, Chicago, Los Angeles, Washington.

Main Products: electronic computers, data communication systems, telephone systems, carrier transmission, radio communication, radio & television broadcasting, satellite communications equipment, electrical household appliances, other applied electronic equipment, and electronic components.

**Products for today—  
Innovations for tomorrow**

# NEC

*Nippon Electric Co., Ltd.* Tokyo, Japan

# Now, with these 4 elements...

X trunk  
plate

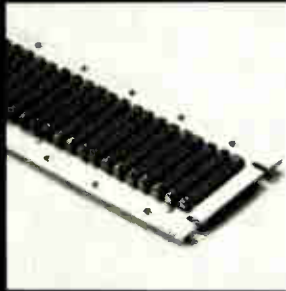

switching  
module



Y inter-  
connect  
cable



your  
conceptual  
need



... and any standard 50¢ screwdriver

## you can interswitch:

- ... computers
- ... test stands
- ... analog instrumentation
- ... broadcast studio switchers
- ... peripherals
- ... test instruments
- ... communications
- ... and many, many more!

The new Series 5800 T-Bar® Switching Module System offers you modular switching elements for creating any size interface switcher, matrix or scanner system ... at a fraction of usual cost, because each system contains ... pre-wired X and Y trunking lines ... plug-in switching modules ... fully documented assembly and engineering instructions ... and fits all standard cabinets.

- eliminates design
- eliminates selection
- eliminates packaging
- eliminates wiring
- eliminates sheet metal

Want more facts? Write or phone today for Bulletin #5800. We'll supply the facts, the 5800 Series and the engineering. All you need is the screwdriver.

**T-Bar**  
SWITCHING TECHNOLOGY DIV.  
electronic controls, inc.

Danbury Rd., Wilton, Connecticut 06897  
phone: 203 762-8351

# No stewardess. No movie. No steak.



# No fare.

And to top it off, you'll have to do a little homework to qualify for your free flight. It's a heck of a way to run an airline, but it's a great way to look over industrial real estate all over New Jersey.

Here's how you can fly:  
Write today for your free Public Service Electric and Gas Company Industrial Parks Kit. It will give you all the information you need to do preliminary site selection right in your office.



Choose from 39 of the best industrial sites anywhere.

After you've made your preliminary choices, call us for a flight and a closer look. An airline we're not, but it's a great way to do business... your business. Write

**ⓐ PUBLIC SERVICE ELECTRIC  
AND GAS COMPANY**

80 Park Place  
Box 8308  
Newark, N. J. 07101

# Plug in to big savings with GLASKYD®

alkyd molding compounds

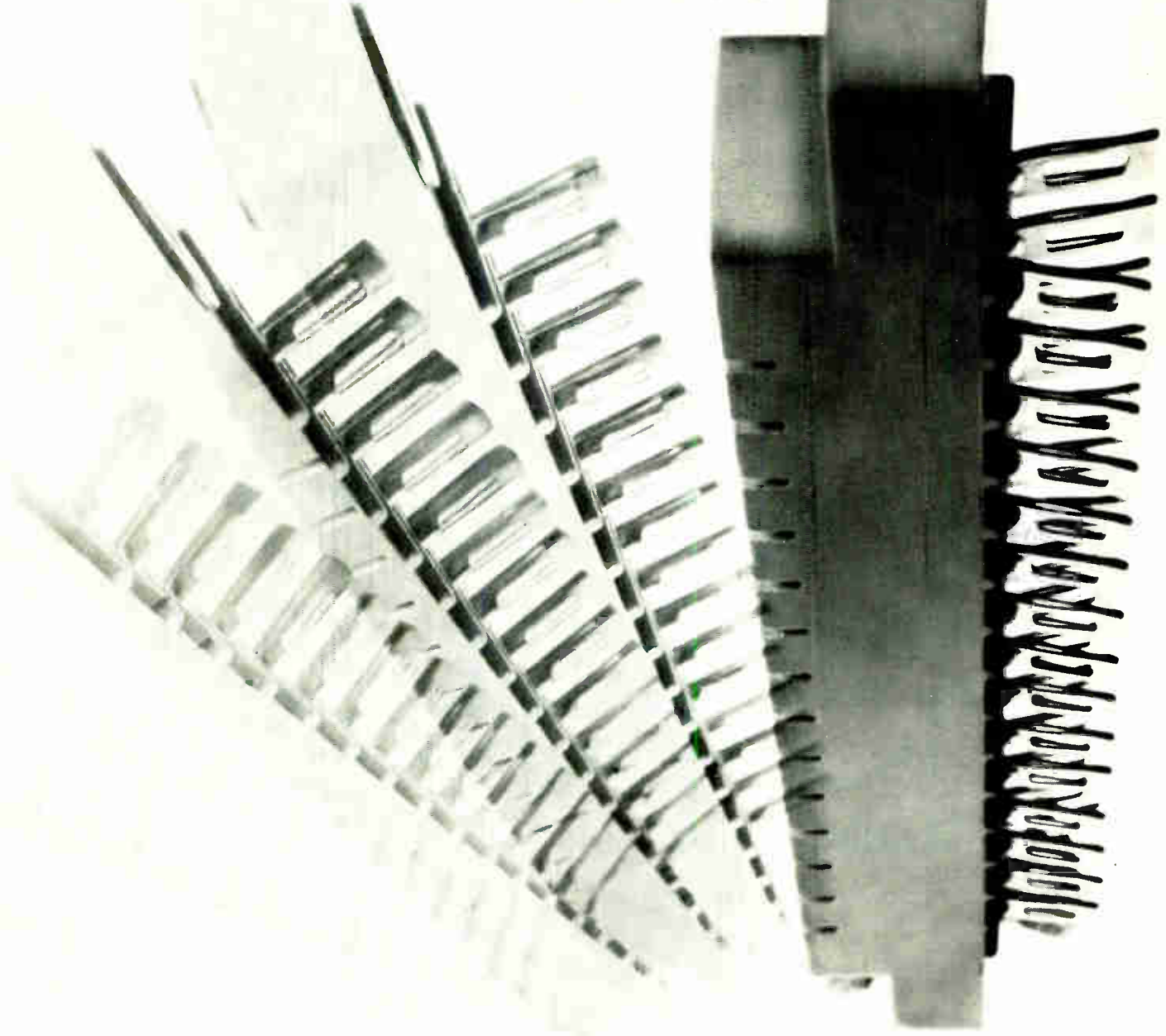

Viking Industries did. Viking insists on GLASKYD for its line of "Vikom" commercial printed circuit connectors, many of which are used in giant computers. The reason is simple. It costs only  $\frac{1}{4}$  as much as DAP.

But that's not the only reason Viking and many other manufacturers specify GLASKYD. It has superior moisture resistance, dielectric strength, arc and track resistance, dimensional stability and heat resistance. Non-burning properties, as deter-

mined by the most stringent military and commercial specifications, can also be obtained with a specialized formulation - Glaskyd 4000.

Smart designers using "value analysis" get optimum performance out of GLASKYD. Let us show you the advantages of a molding operation with GLASKYD molding compounds. Write American Cyanamid Company, Plastics Division, Wallingford, Connecticut 06492.

CYANAMID



**That's the Carnarvon,  
W. Australia satellite antenna  
there in the picture. It's by  
Mitsubishi Electric; so is its  
mate at Ceduna, S. Australia.  
We thought you'd be interested  
because—**

if you are reading this publication you're probably in communications.

Fact is, there are very few satellite communications centers in the world which don't have *some* Mitsubishi equipment. Which puts us pretty much in the front ranks of the industry.

Mitsubishi Electric is a good name to remember when you're in the market for communications equipment. ICs . . . transistors . . . thyristors . . . diodes—we make them all. We make computers. And we can build you an entire earth station. Let us know your needs. We'll reply with some interesting literature.



**MITSUBISHI ELECTRIC CORPORATION**  
**MITSUBISHI SHOJI KAISHA, LTD.** Marunouchi, Tokyo, Japan



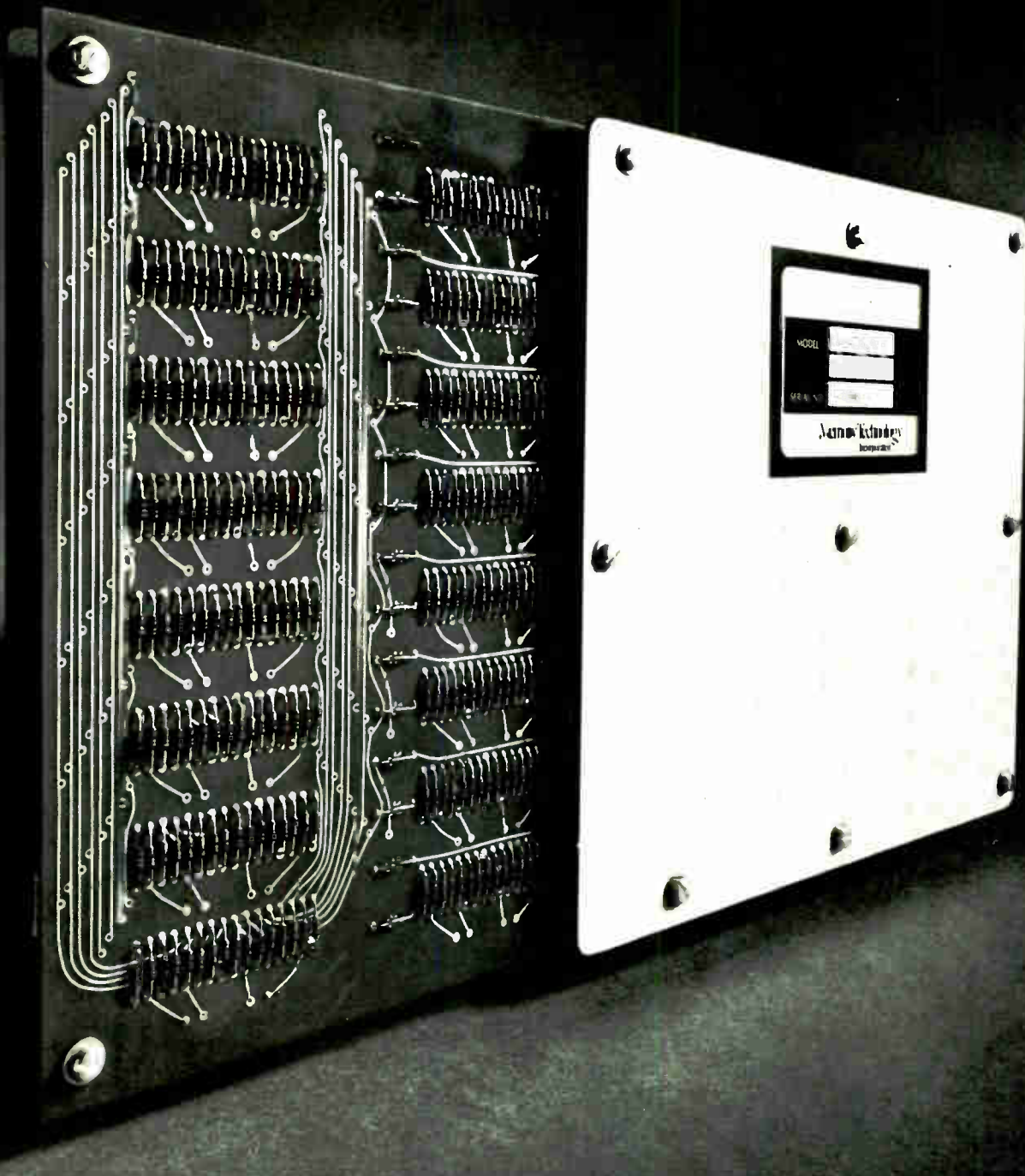

## New 90 Nanosecond READ-Only Memory

90 nsec access time. 190 nsec cycle time. 10,240 bits; up to 80 bits per word. Mechanically alterable memory contents — bits, words, or the entire memory may be mechanically modified. TTL compatible.

What's more, NANOROM 90 can be directly compatible — pin for pin, space for space, — with our other standard 300 and 500 nanosecond systems.

Get more details on the NANOROM 90. It's a natural addition to the new Engineering Guide to READ-Only Memory Systems. Ask for it. Write Paul Rosenbaum, Memory Technology, Inc., 83 Boston Post Road, Sudbury, Massachusetts 01776, (617) 443-9911.

**Memory Technology**  
Incorporated

# NEW . . . A PULSED HIGH-CURRENT FIXTURE FOR THE 576 CURVE TRACER

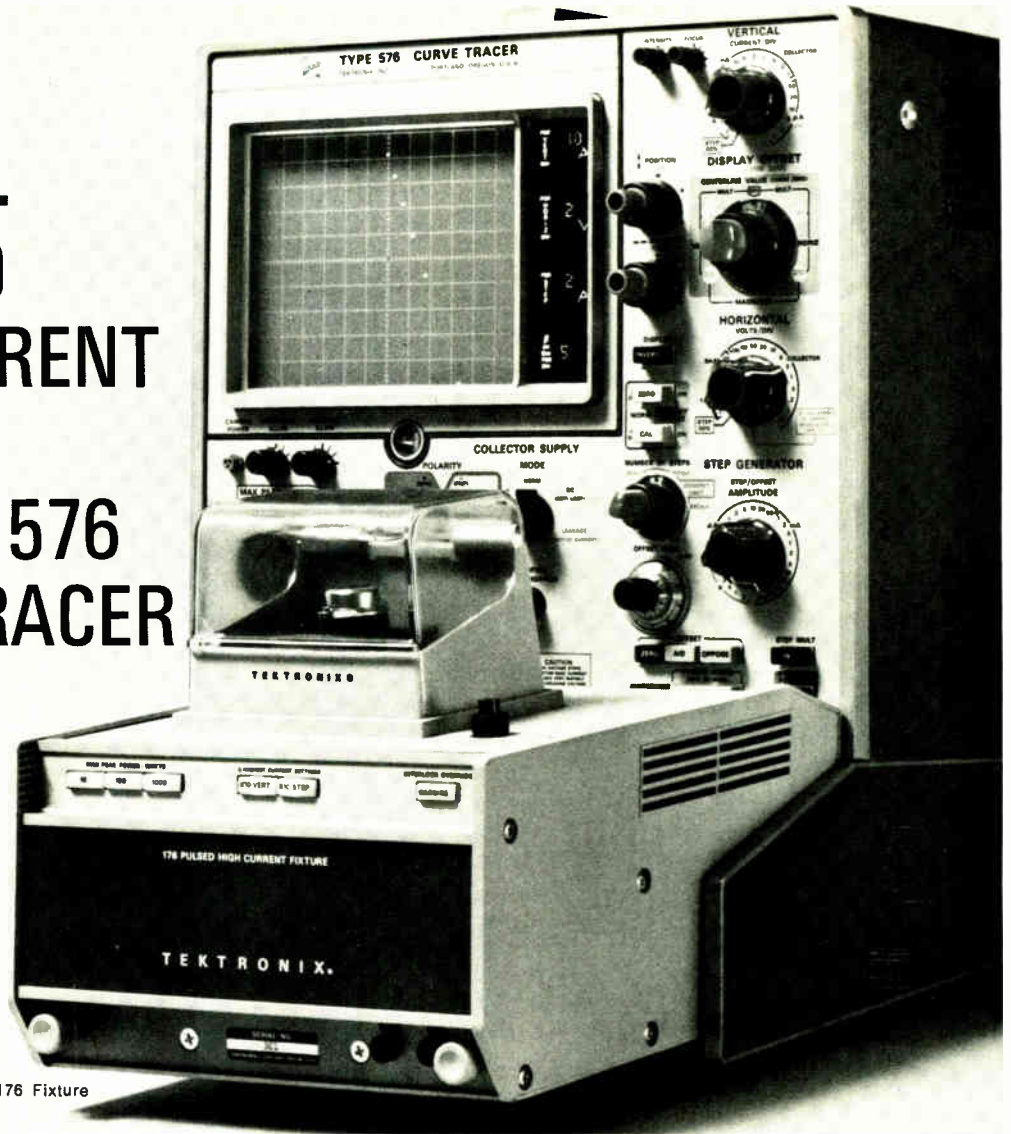

576 Curve Tracer with 176 Fixture

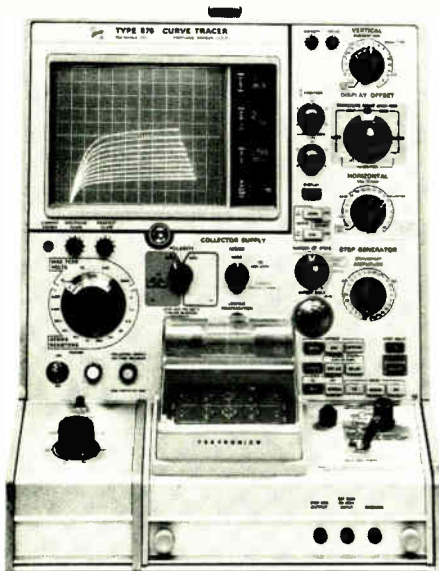

576 Curve Tracer with Standard Test Fixture

The 176 Pulsed High-Current Fixture increases the Step Generator and Collector Supply ranges of the 576 Curve Tracer by a factor of ten (to 20 A Peak and 200 A Peak respectively). Pulsing the collector and base steps permits checking diode characteristics, and collector emitter breakdown, at currents much higher than previously possible as dissipation limits are not exceeded. The need for heat sinks is also eliminated. The 176 is easily added to the 576 in place of the standard test fixture.

The 576 offers many advanced features for semiconductor testing:

- Expanded Viewing Area — combines a 10 cm x 12 cm graticule with fiber-optic readout of scale factors, step amplitude, and Beta/div or  $g_m$ /div
- Swept or DC Collector Supply to 1500 V
- Leakage Measurements to 1 nA/div
- Multi-function Switching — direct-reading power limits, polarity tracking, auto positioning, mode changes
- Calibrated Display Offset — improved accuracy ( $\pm 2\%$ ), increased resolution
- Step Generator Range to 2 A or 40 V
- Calibrated Step Offset — aid or oppose
- Pulsed Base Operation
- Interlock Operator Protection.

Your local Tektronix field engineer will be happy to demonstrate the 576 and 176 in your application. For additional information, please call him or write: Tektronix, Inc., P.O. Box 500, Beaverton, Oregon 97005.

**TEKTRONIX®**  
committed to technical excellence

576 Curve Tracer ..... \$2250  
176 Pulsed High-Current Fixture ..... \$1400

U.S. Sales Prices FOB Beaverton, Oregon

Available in U.S. through the Tektronix lease plan

## Medical electronics gets a watchdog

Consulting group, manned by physicians and engineers, intends to publish comparative studies on the safety and usefulness of biomedical gear

By Owen Doyle, *Instrumentation editor*

A small, nonprofit Philadelphia group, aiming to be a "Consumers Union" for doctors, could have a major impact on the design and acceptability of medical electronic equipment. The 14-man staff of the Emergency Care Research Institute is making brand-by-brand analyses of a wide variety of biomedical equipment.

While it may be hard to picture physicians as helpless consumers, doctors have to rely heavily on salesmen when buying medical electronics gear. No third-party expert counsels doctors who ask: "Is this thing safe and reliable? Will it really help me?" The institute wants to fill this role.

The group has consulted hospitals, designed equipment, and trained nurses and technicians, but the organization promises to make the biggest impact in the comparative studies of such equipment as

pacemakers, patient monitoring systems, and defibrillators. And Dr. Joel Nobel, scientific director and head of the institute, quickly points out that it receives no funds from equipment makers. Part of its budget comes from a pair of grants from the Public Health Service, with the remainder from contributions and fees.

A founder of the institute, Nobel draws on extensive experience in medical electronics. As a surgical resident at Pennsylvania Hospital, he developed a mobile emergency life support system. Later, as a medical officer on a U.S. Navy nuclear submarine, he worked with underwater physiological telemetry systems, physiological data acquisition systems for hyperbaric chambers and general laboratory use, and gas chromatography techniques for monitoring closed ecological environments.

Nobel isn't impressed with the overall quality and usefulness of much of today's biomedical equipment. "There are too many useless devices on the market," he complains. He also criticizes the large electronics companies and defense-oriented firms whose traditional markets are shrinking for "creating a new mythological industry called the health market," and then running after it. These companies apply their own standards to concepts and oversimplify many of the problems which are extraordinarily complex, he maintains.

**Equipment studies have** been going on at the institute throughout its five year history. Staff members have turned up many cases of hazardous or sloppy designs in instruments and have advised several hospitals on equipment purchases. Just about every piece of ultra-

Moment of truth. Monitoring a cart loaded with instruments and recorders, a team of staffers from the Emergency Care Research Institute evaluates the performance of commercial biomedical products under clinical conditions.

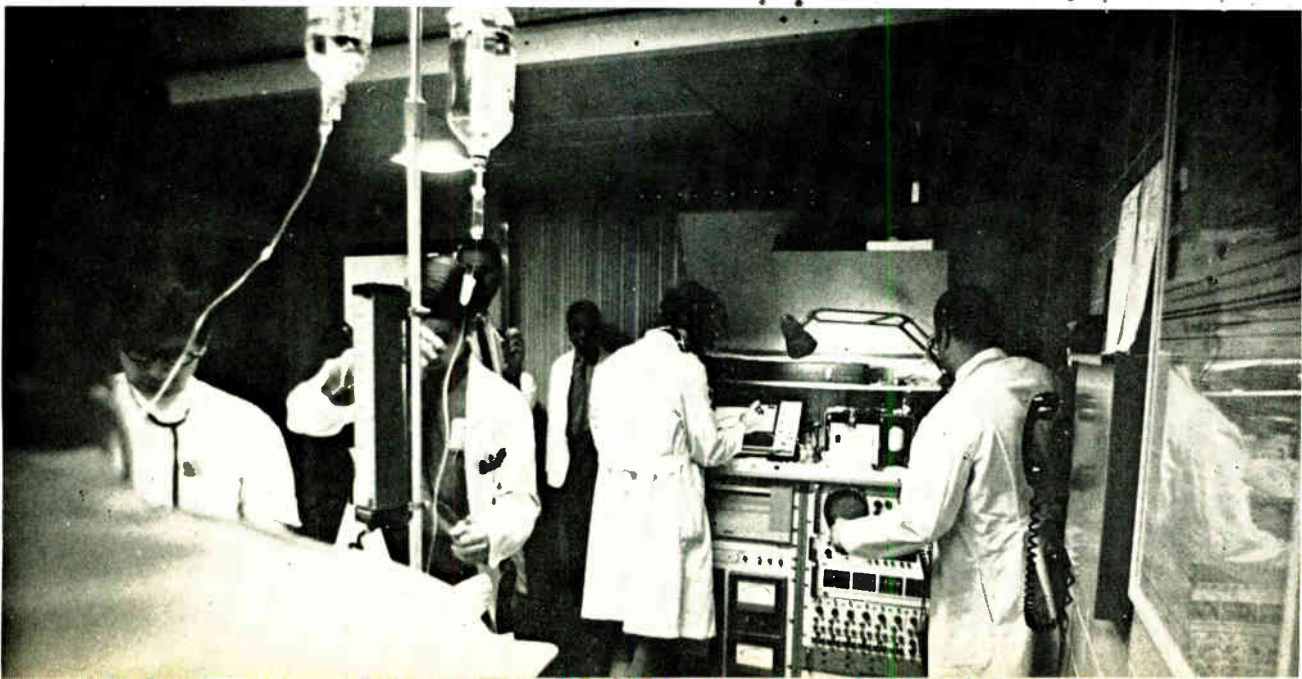

---

## Probing the news

---

sonic therapy equipment is hazardous, says Robert Mosenkis, senior project engineer. If not properly grounded, most of them can cause serious shock because their chassis are above ground potential.

Another problem that shows up is equipment that has no way of indicating it's malfunctioning. There's no way a user can tell when a ground lead in a power cord is broken unless he can make a continuity check, for example.

**Sloppy design** is another recurring problem. An electrocardiograph that the institute checked had solder terminals for its on/off switch close to the chassis. In one unit, the solder actually shorted the switch to the chassis. When advised of this, the manufacturer agreed to beef up the mylar barrier between the switch and the chassis.

In general, makers don't design ecg machines with hospital technicians in mind, Mosenkis says. Ecg's aren't rugged enough; it's difficult to change the chart paper in some models; and too many dials are accessible to the user."

Careless assembly work also crops up once in a while. Mosenkis recalls the case a year ago of a \$14,000 blood-gas analyzer. Transistors mounted in TO-5 cans had inch-long leads that were never trimmed, he notes, "sticking up like a spider doing a pushup. Any kind of shock or vibration is likely to cause leads to short out here." The same analyzer also "had a bunch of loose nuts and bolts rattling around the cabinet when it arrived," he adds.

Many instruments that appear on the market are designed for jobs that nobody really wants done, or else do something better than anyone requires, the institute feels.

The institute is about to begin a study of electronic thermometers. But Mosenkis already challenges the makers' claim that the fast responding devices will save any time. He says that they don't seem to realize that a nurse can take a dozen ordinary thermometers, give one to each patient and then go back to the beginning and start making the readings. Going to elec-

tronic thermometers wouldn't save any significant amount of time, he points out.

Mosenkis also questions the need for the Arteriasonde, an automatic blood pressure measuring device made by Roche Medical Electronics [*Electronics*, Dec. 8, 1969, p. 43]. Though acknowledging that the \$3,000 device does make measurements where the traditional cuff-and-column instrument won't, Mosenkis says, "We told them before they came out with it that it wouldn't sell, even for \$2,000." Most manufacturers who try to enter this sort of business don't realize there's not a mass market, he maintains. Makers predicate their design on sales in the thousands. Here there's just not that many that are going to be sold at that price, "because it doesn't do \$3,000 worth of functions," he says.

Walter Sharson, Roche marketing manager, disagrees with Mosenkis, insisting that initial acceptance and sales have lived up to expectations. But he does say that this his company faces "an educational problem" in getting hospitals to shift from an inexpensive manual device to a high-priced automatic one.

A nebulizer, or bedside atomizer, tested by the institute illustrates how the institute tries to work with a manufacturer. The nebulizer used a filter on the power-line side of its transformer to prevent noise from radiating back into the power line, as required by the Federal Communications Commission. However, if the unit weren't grounded, the chassis would be 55 volts above ground, and could send 1 milliamperes through a grounded patient, Dr. Nobel notes.

When the maker was told of this condition more than a year ago, it suggested half a dozen fixes. But each one created a bigger hazard than the one being corrected, says Mosenkis. Finally, the company made a satisfactory modification but is still awaiting FCC approval before implementing it.

**Getting the equipment** studies into the hands of physicians has been a major problem for the institute. Medical journals, in general, won't publish comparative studies, Dr. Nobel says. An editor at the

Journal of the American Medical Association told the institute that to do so would conflict with the journal's advertising policies and its concern over liability, Dr. Nobel says. And the eight months to two years that it takes to get a submitted paper published "is too long to wait," he says, "when design changes may be occurring from month to month."

To get the information out, the institute is planning late this year to publish a monthly newsletter that will include at least one comparative equipment study per issue.

A comparative analysis—on pocket paging systems—has been published. In it, the institute recommends fixed-antenna systems over loop-antenna systems where a wire antenna is strung through the buildings to be covered. The study provides a checklist for evaluating various makes and a comparison chart that points out the strengths and weaknesses of seven different systems.

One comparative study that the institute is working on right now will deal with patient monitoring systems—one of the fastest selling items in the biomedical market. Although it hasn't been completed, Dr. Nobel already has some opinions. He says, in general, that companies sacrifice simplicity for versatility.

While agreeing that monitoring is a valuable tool, he questions the way it's done today. "We're 250,000 nurses short in this country, and the concept of having nurses watch oscilloscopes to monitor patients flies in the face of all logic. The obvious way to do it," Dr. Nobel says, "is to translate the basic data by running it through a small dedicated computer or trend recording equipment."

Dr. Nobel would like to see hospitals use more minicomputers, but he feels the small machines have been elbowed out by salesmen with big machines. "In automating a clinical laboratory, for example, the cost-effective way to do it is to use a small dedicated computer, not a time-shared machine. But many of the time-sharing equipment producers with a foothold in the hospital market don't sell a small machine," he says.

When the institute decides to test a medical electronic product, it has three ways of obtaining the various brands for evaluation. It may buy the unit or borrow one from a hospital. Or it may go straight to the makers with form letters asking for the loan and explaining why the institute wants it. According to Dr. Nobel, manufacturers cooperate 95% of the time.

Even when makers do take special pains, the results can be mixed. Dr. Nobel cites one company that provided patient monitoring equipment to the institute. After the company double checked it, a company representative carried it in his lap on an airliner. He hand carried it all the way, putting it down gingerly on a test bench at the institute. "Whereupon, three out of five modules had catastrophic failures within 72 hours," Dr. Nobel recalls.

The institute runs both engineering and clinical tests. First the device is checked against its own specifications. It's also tested against additional specifications decided upon by the institute.

Many product failures don't occur nor do design inadequacies show up until the clinical evaluation stage, Dr. Nobel says. "This shows that MD's and nurses handle equipment in ways manufacturers don't anticipate."

Some clinical testing is done at the Thomas Jefferson University Hospital, which is across the street from the institute. Parked in the hospital's emergency ward is the institute's instrumentation cart—a 5½-foot high mainframe, which is as long as a standard hospital litter.

A 40-foot, 85-connector umbilical connects the instrumentation cart to one of the ward's emergency carts, which were designed by Nobel and the institute's director of engineering, Robert Rauch.

The \$100,000 worth of equipment on the instrumentation cart can measure and record 13 physiological parameters, including ecg's, the pH and the oxygen and carbon dioxide pressures of the blood, respiratory rate and volume, and various blood pressures. Once recorded, the data are taken back to the institute for use in evaluating devices that had been placed on the emergency cart.

# INTERNATIONAL frequency meter

- Tests Predetermined Frequencies 25 to 1000 MHz
- Extended Range Covers 950 MHz Band
- Pin Diode Attenuator for Full Range Coverage as Signal Generator
- Measures FM Deviation

MOBILE

FM-2400CH



WRITE FOR CATALOG!

The FM-2400CH provides an accurate frequency standard for testing and adjustment of mobile transmitters and receivers at predetermined frequencies.

The FM-2400CH with its extended range covers 25 to 1000 MHz. The frequencies can be those of the radio frequency channels of operation and/or the intermediate frequencies of the receiver between 5 MHz and 40 MHz.

Frequency Stability:  $\pm .0005\%$  from  $+50^\circ$  to  $+104^\circ\text{F}$ .

Frequency stability with built-in thermometer and temperature corrected charts:  $\pm .00025\%$  from  $+25^\circ$  to  $+125^\circ$  (.000125% special 450 MHz crystals available).

Self-contained in small portable case. Complete solid state circuitry. Rechargeable batteries.

FM-2400CH  
(meter only).....\$595.00  
RF crystals (with temperature correction)..... 24.00 ea.  
RF crystals (less temperature correction)..... 18.00 ea.  
IF crystals.....catalog price

**INTERNATIONAL**  
CRYSTAL MFG. CO., INC.  
10 NO. LEE • OKLA. CITY, OKLA. 73102

the

# GIANT™

GENERAL INSTRUMENT ADVANCED NITRIDE TECHNOLOGY

# HANDSHAKE

AY-5-1010 Terminal Transmitter

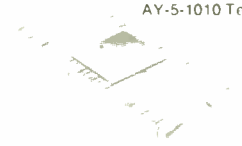

AY-5-1008 Terminal Receiver



**General Instrument announces  
the first and only LSI system for  
total serial data communications  
encoding and decoding  
in just 2 packages**

## FEATURES

Complete TTY Interface  
TTL/DTL and MOS Compatible  
Replaces at Least 126 Circuits  
Greatly Reduced Costs  
Variable Code Lengths and Formats  
Special Logic for Handling 5-bit Alphanumeric Codes

Low Power Consumption (150mW)  
Receiver Checks Parity  
Receiver Signals Data Ready  
Receiver Adapts to Bit Detecting Schemes  
Synchronous or Asynchronous Communication  
Internal Noise Discrimination

A giant breakthrough in peripheral communications. Now just two GIANT circuits in two 24-lead dual-in-line packages provide all necessary encoding, decoding and computer handshaking signals (functions previously requiring a minimum of 126 circuits) for serial data interface.

The transmitter accepts as inputs up to 9 bits of parallel information and adds the required Start and Stop bits to convert to serial data. Successive word entry is enabled by a locally generated access signal. Standard interface codes (ASCII, Baudot, EBCDIC, Selectric, etc.) are accommodated with or without parity. The circuit has the capability of transmitting data in synchronous and asynchronous mode and may be clocked at either the data rate or eight times that frequency. The transmitter is capable of shifting at data rates in excess of 9600 baud (i.e., clock frequencies of DC to 25 kHz).

The receiver accepts a serial word of programmed length, strips the Start and Stop bits and reorganizes the data into parallel form. Along with the data decoding, parity and computer handshaking signals are generated allowing ease of system interfacing.

Both GIANTS, the AY-5-1008 Terminal Receiver and the AY-5-1010 Terminal Transmitter are immediately available off-the-shelf from your authorized General Instrument distributors.

For full information write General Instrument Corporation, Dept. C, 600 West John Street, Hicksville, New York 11802, or call in New York: 516-733-3333; in Boston: 617-329-1480; in Chicago: 312-774-7800; in Los Angeles: 213-873-6500. (In Europe, write to General Instrument Europe S.P.A., Piazza Amendola 9, 20149 Milano, Italy; in the U.K., to General Instrument Microelectronics Ltd., Stonefield Way, Victoria Road, South Ruislip, Middlesex, England.)



GENERAL INSTRUMENT CORPORATION • 600 WEST JOHN STREET, HICKSVILLE, L. I., NEW YORK

Government electronics

# Postal automation outlook brightens

Reorganization act will free management and R&D funding from political interference, spurring outlays for implementation of new systems

By Jim Hardcastle, *Washington bureau*

**The struggle** to convert the Post Office Department into a public corporation took 12 years, and it will take at least as long again to change the deficit-ridden, \$8 billion giant into an efficient, self-sustaining operation, predict officials of the new U.S. Postal Service. The process will make the service a big market for electronics companies, since it will take a lot of money to develop and build the automated equipment necessary to handle the nation's mail. But it won't happen overnight.

A relatively limited research and development budget rules out a technological revolution in the Postal Service. But Harold Faught, the former Westinghouse Nuclear Rocket Program manager who heads the Bureau of Research and Engineering, believes the outlook for automating the system is bright. Outlays for Postal R&D in fiscal 1971 will remain essentially unchanged at \$63 million. But as the system becomes self-sustaining, he feels the percentage of R&D will more nearly resemble private industry's—about 3% of sales. Based on a total budget of \$8 billion, postal R&D could eventually reach \$240 million a year. The largest expenditures will go for optical character readers and computers.

Meanwhile, Faught says, the service will be able to use some of its \$10-billion borrowing authority to develop and acquire automation systems. And because the service has lagged in developing new machinery, opportunities for savings are plentiful. Programs already in the planning stages should save \$1.9 billion a year by 1975 by cut-

ting costs in major postal centers, Faught claims.

Broader R&D programs may well be launched following completion of major systems studies the Postal Service is awarding to industry. Faught warns, however, that the Postal Service right now is more interested in applying existing technological knowledge than in developing new technology.

**The program** with by far the most significance for the electronics industry is "code mail," which uses computers and optical character readers to sort letters. It began in Cincinnati in 1968 with a \$5 million effort to develop an advance letter handling testbed. Eventually, the techniques developed there are expected to be applied in the 110 largest post offices, which handle 70% of the nation's mail.

In the Cincinnati system, which was assembled by LTV Electrosystems Inc., letters are fed into a drum located at a coding station and rotated before a clerk at the rate of 60 a minute. The clerk extracts the portions of the addresses needed for the code, typing the code on a keyboard. A Xerox Data Systems Sigma 2 computer then searches a disk file, matches the code with addresses stored in memory, and automatically prints a series of bars on the back of the envelope. These identify the zip code, house number and street.

Next, the letter passes to a conveyor where the bars are read by a simple optical code reader. Then the code is fed to the computer, which runs a mechanical sorting machine that puts the letter in the appropriate bin. At present,

the machine breaks down the mail by carrier route, but the computer could be programed for sorting individual routes to match the order of delivery. Thus, Faught says, code mail may someday eliminate the 1.5 hours a day that the Postal Service's 200,000 letter carriers now spend sorting mail by route.

Code mail offers further advantages, he notes. Because the computer's memory allocates bar codes, the coding station operator needn't remember which of 150 to 200 bins a letter should be placed in.

Such a system should encourage large mailers, such as publishers and credit card companies to invest in equipment that could imprint

**Approved.** Supervisor authorizes employee overtime by inserting both the employee's badge and his own into transactor.



## Probing the news

bar codes on all their mail, Fought believes. For their investment, these mailers would get better service and probably a cost rebate.

In addition, the bar code system leaves room for the advances in optical character recognition equipment that are expected to revolutionize mail handling. Abraham Tersoff, an engineer who heads the Postal Service's OCR efforts, says that his goal within the next five years is to develop equipment capable of reading at least 50% of the mail. Such readers could scan all mail coming into the sorting system, and also assign bar codes.

To date, some \$20 million has been spent on OCR development, an amount Tersoff says is justified because of the demanding nature of the postal mail service.

Automation equipment, however, is not the postal service's only requirement. It also needs improved systems to keep track of the flow of the mail and keep tabs on its 750,000 employees. Thus, it has spent \$50 million to date for its Postal Source Data System.

In the system, more than 10,000 input devices—mostly employee badge readers and transactors which input payroll and labor distribution data, plus scales that monitor the flow of mail through postal facilities—feed data concentrators at each main post office. Leased voice-grade lines then lead to four dual Control Data Corp. 1700 computers that edit, format, and further compress the data for processing by dual CDC 3300 computers at data processing centers in Wilkes Barre, Pa. and St. Louis.

The system's critics charge that the setup is underused and overly expensive. Only 20% of the computer's capacity is employed, and 115,000 miles of leased lines cost \$2 million a year—facts expected to draw fire in a forthcoming General Accounting Office report.

Industry and labor also have their reservations, although their complaints follow entirely different lines. One industry source says the machine could do much more than payroll processing, which he says is its main task. For example, it

## Up the reorganization

No organization plan by itself can guarantee that the Postal Service can either develop or use automated equipment, but Harold F. Faught, the former Westinghouse Nuclear Rocket Manager who heads the Postal Service's Bureau of Research and Engineering, says that reorganization should step up the pace of electronics R&D for two reasons:

First, he says, the reorganization of the Post Office will end political interference in appointments of top postal research managers and will level out the cyclical nature of the postal research and development budget. With most top managers being replaced every two years and the R&D budget fluctuating wildly, he notes, there was a "very disruptive influence on engineering programs where you're trying to do things over a five-year period."

Equally important is the autonomy granted by the reorganization act. Congress will appropriate 10% or less of the budget through 1979; the remainder will come out of revenues and its \$10 billion bonding authorization. This new management freedom will permit the Postal Service to allocate research funds on the basis of projected benefits, rather than on what is left in the Federal budget, Faught says. The same autonomy will be used to upgrade salaries so that the Postal Service can hire the best engineering talent.

could be used for postal accounts payable and receivable and general ledger accounting.

Labor, on the other hand, fears the network's potential for monitoring an individual's efforts. "It's what we call a clock watching system," says David Silvergleid, president of the National Postal Union which represents about 80,000 postal clerks.

System manager Anderson, however, is not particularly worried about the criticisms of the data system. Already, he notes, the system has surpassed manual reporting in both accuracy and timeliness. And while he concedes that it is greatly under-utilized, he views the excess capacity as just another opportunity to put more applications on line.

Coded. After "code mail" system in Cincinnati removes mail that can't be sorted by machine, it sends other letters to computer-assisted stations where they get bar codes. Then mail goes to an optical card reader where the code is entered into a computer, telling the sorter where to put each letter.

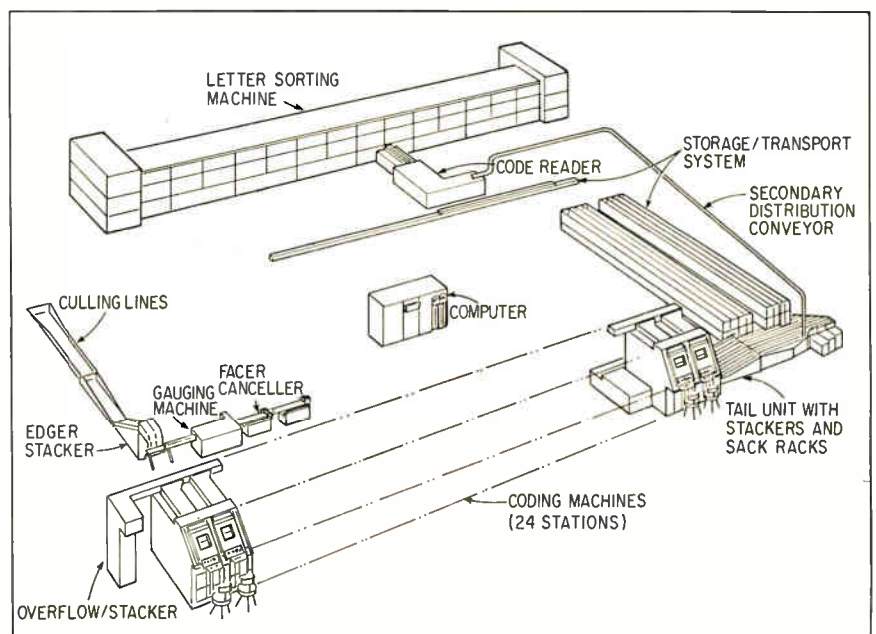



# THE ONLY 8-BIT GUARANTEED MONOLITHIC D/A

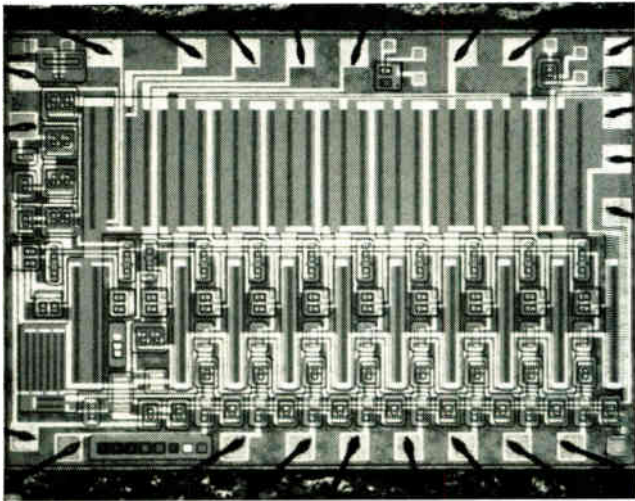

- Guaranteed performance from  $-55^{\circ}$  to  $+125^{\circ}$  C.
- Incorporates an internal resistor ladder network on the same chip.
- Operates in bipolar, unipolar positive or unipolar negative modes.
- 1  $\mu$ s typical settling time to  $\pm 1/2$  L.S.B.
- \$82.50 in quantities of 100 to 999.
- Available off-the-shelf in 24 lead dual in-line or flat-pack packaging.

Do we mean "guaranteed?" You bet we do. The RI-1080 has its own thin-film resistor ladder network built right on the same IC chip as the bipolar switches. Without that, any guarantee would be meaningless. With it, the RI-1080 is the only D/A converter that has a guaranteed 8-bit performance over the entire military range from  $-55^{\circ}$  to  $+125^{\circ}$  C. Not only that, but by using current-mode switching,

the converter ladder bus can be returned to voltages off-ground for high versatility. Current switching reduces ringing in output and reduces power-supply transients. The converter is capable of conversion rates in excess of  $10^6$  words/sec. Just check our specs with any other D/A — monolithic or hybrid — and we think you'll agree that the Radiation RI-1080 offers the *best price/performance on the market.*

Lexington, Massachusetts (617) 862-1055  
Norwalk, Connecticut (203) 853-3846  
Frederick, Maryland (301) 862-5400  
Oaklawn, Illinois (312) 423-6010  
Dallas, Texas (214) 231-9031  
Albuquerque, New Mexico (505) 268-3549  
Palo Alto, California (415) 321-2280  
Long Beach, California (213) 426-7687  
P. O. Box 37, Melbourne, Florida 32901 (305) 727-5430

EXPORT SALES, DAGE CORPORATION, STAMFORD, CONNECTICUT

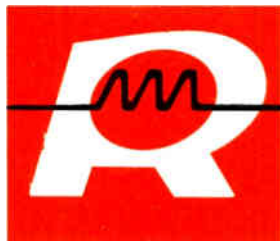

**RADIATION**  
INCORPORATED  
SUBSIDIARY OF HARRIS-INTERTYPE CORPORATION  
MICROELECTRONICS DIVISION

# OUR ANGLE: High Speed Accurate and Automatic Angle Position Indicators

## WHAT'S YOUR ANGLE?

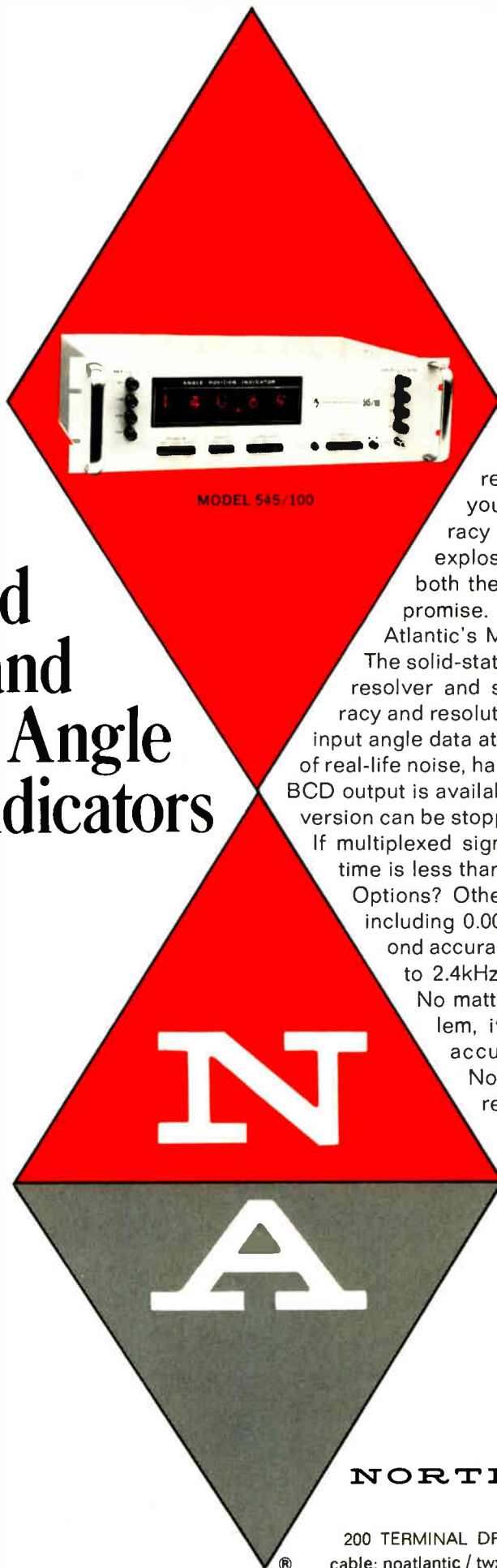

If you're converting synchro/resolver data to digital format, you need both speed *and* accuracy to keep pace with today's data explosion. Only one converter meets both these requirements without compromise. And for under \$4K. . . North Atlantic's Model 545/100.

The solid-state Model 545/100 converts both resolver and synchro data with 0.01° accuracy and resolution. And continuously digitizes input angle data at 20,000° per second in the face of real-life noise, harmonics and quadrature levels. BCD output is available at the rear connector. Conversion can be stopped by a data freeze command. If multiplexed signals are your bag, acquisition time is less than 30 ms.

Options? Other models offer many options, including 0.001° resolution with 10 arc-second accuracy; data frequencies from 60Hz to 2.4kHz, binary output, small size.

No matter what your conversion problem, if you require ultra-fast, ultra-accurate tracking, contact your North Atlantic sales engineering representative today. He'll show you a better angle.

**NORTH ATLANTIC**  
*industries, inc.*

200 TERMINAL DRIVE, PLAINVIEW, NEW YORK 11803  
cable: noatlantic / twx: 510-221-1879 / phone: (516) 681-8600

Manpower

## She's come a long way . . .

. . . but today's woman engineer still can't count on a promotion she's earned, particularly if it would make her a manager

By Gail Farrell, *Boston bureau*

**The more obvious** kinds of discrimination against women engineers are becoming history—pay is almost equal, and hiring practices are steadily improving.

But it's still tougher for a woman to get ahead. Women engineers charge the electronics industry is still reluctant to promote them as fast or as far as men.

Recent progress by women has its roots in the Equal Opportunity Act of 1964. Enforced by suits, backed up by Congressional passage of the women's equality constitutional amendment and publicized by women's liberation groups, the act has jolted management into action and aroused women themselves to a new, more aggressive career-mindedness.

Though only one in 100 engineers is a woman, girls are increasingly becoming aware of engineering as a career. Emily C. Wick, dean of women at the Massachusetts Institute of Technology, reports that the number of women enrolled in the Department of Electrical Engineering rose fourfold between 1965 and 1969. And Cornell has started an apparently successful program to recruit women engineers. Their numbers have risen from four in the class of 1972 to 28 applicants for the class of 1974.

But some schools, such as UCLA, have as few women engineering students as ever, and don't expect more of them in the future. The assistant dean of admissions at Northeastern University, Jack A. Curry, thinks that before colleges see many more female applicants "industry itself will have to go actively into secondary schools and

show its interest in women engineers."

When she graduates, today's woman engineer can expect fair pay. The average salary for the 1970 woman graduate is \$844 a month, for a man \$872 a month, according to a study conducted by

Dr. Frank S. Endicott of Northwestern University. And even this small difference apparently is growing smaller.

Some women still get lower salaries. Susan E. Schur, editor of the Society of Women Engineers newsletter, mentions the case of a friend

### The established woman

"A woman engineer is so rare she's completely visible—she's watched all the way up," says Amy C. Spear. "Good work is noticed, but so are goofs. And if goofs are made, there's a tendency to say, 'It's because she's a woman.'" By now a senior engineering scientist at RCA's Aerospace division, Burlington, Mass., Spear can't have goofed very often.

In her 22 years as an engineer, she has had time to observe industry's increasing tolerance of women. "Over the past 10 years there has been a lack of qualified EE's so companies were willing to let women try," she says. And, "there is a bit more wariness because of equal employment laws."

Apart from "a slight tendency always to pay women less," Spear feels her sex has not restricted her. When she complained to a company one time about being passed over for a promotion, "I found out that they hadn't even thought of a woman for the job." Next time around, she was promoted. She also feels she's sometimes "been thrown into a job where I wasn't given as much background or orientation as a man would have received, but I've always pulled it off."

Spear concludes that "a woman



has to be more voluble" than a man to succeed. Still, she's happy with her career, and says her experience hasn't deterred her two daughters from majoring in engineering at Cornell.

## Probing the news

"who knows she started a job last year at a salary \$1,000 less than that of a man in the same position." Nonetheless, Catherine W. Eiden, a supervising engineer at Illinois Bell Telephone Co., Chicago, Ill., believes that a talented woman "soon overcomes the salary difference" even if she was hired for less.

Actually landing the job with the almost fair pay is a little harder. Paul M. Sweeney of Paul M. Sweeney Assoc., Newton, Mass., a personnel agency specializing in electronics engineers, says, "A woman engineer was more of a freak a year ago. Now probably

5-10% of companies really emphasize women in engineering and 30-40% give equal opportunity although they don't seek out women. The rest are still reluctant to hire them." Similarly, John J. Begley of the engineering sciences personnel services agency in San Francisco thinks that "most employers will take the man first—women are flaky." But their numbers are growing smaller—in Chicago, for example, even over the last two months more companies have been hunting for women.

Everyone agrees, however, that women have a hard time getting promoted. Some managers aren't even aware that they discriminate.

There are managers who feel that only a man can function well

as a supervisor, says James L. Hackbush, personnel director, Analog Devices, Cambridge, Mass. "They say a supervisor has to be a hard-nosed type and judge fast," he says, something they think a woman can't do.

Most women, however, insist they are as capable as men, and some fight harder than others to prove it. One says, "This business is awfully competitive, and in some places a woman has to put her foot out" to get the promotions she wants. Many feel that their sex slows but does not stop their advancement. And others admit that what they see as discrimination may not be. "A mediocre woman can use her sex as a copout," one points out.

As men get used to the idea, more women will move up to the management ranks. Eiden already sees more women moving into management at Bell. They are also being transferred to different departments to broaden their experience—an educational tactic formerly reserved for men.

To improve their position, most women engineers work through professional societies and not women's liberation groups, although they recognize the groups have made industry aware of inequities. They want to stress the engineer, not the woman, but this can be difficult. So few engineers are women that they can't avoid being conspicuous. "They have to be not just good, but excellent. Both their talent and their femininity are on display, and the talent has to show through the femininity," says a New England woman engineer. "A mediocre man can stay in the profession and no one thinks of it. But a mediocre woman is conspicuously mediocre," says another.

That, however, is an obstacle that will dwindle as more women become engineers. For, as Harlyn Prouty, employment manager, AMP Corp., Redwood City, Calif., says, "This is an evolutionary process, and eventually we may have to open the doors all the way."

Women of Electronics and McGraw-Hill World News united to report, write, and edit this article. Reporting came from Jane Shaw in Chicago, Lois Vermillion in Washington, Carol Harris in Los Angeles, and Marilyn Howey in San Francisco. It was edited in New York by Margaret Eastman.

## The new generation

A childhood aptitude for mechanics, confirmed by tests in junior high, decided Linda D. Yurk, 21, on an engineering career. Since her parents objected, she started as a physics major at the University of Michigan, but gradually took more and more engineering courses, finally switching her major to electrical engineering. When her parents learned of the changeover through a letter from the engineering school announcing that "your son" had made the dean's list, they didn't object, and Linda graduated with a near A average and a BSEE in April, 1969.

After graduation, Linda was deluged with job offers. But though she found a woman with above average grades gets more offers than a man with the same grades, she thinks "it's a kind of tokenism." And not all the tokens offered were acceptable. Several firms wanted her as a systems analyst but not as an engineer, and one company wished to invent a job for her—"Our engineers often travel," the interviewer told her, "but we can't have you traveling."

Linda went on to receive an MSEE this spring at Cal Tech, where she was the school's second woman electronics engineer, and again ran into opposition. A faculty member who had said he would never teach another female gave her minimal instruction only. Her department head tried to talk her



out of Ph.D. work—unsuccessfully, for she plans to go to Stanford in 1971.

Now working on AT&T's electronic switching system at Bell Telephone Laboratories, Naperville, Ill., Linda is much happier. "If anything, the company is in my favor," she says. It paid for her year at Cal Tech, her supervisor is "fatherly", and if she is sent anywhere the company takes "special care" of her.—Jane Shaw

# New FET V-O-M features

## 8 Low-Power Ohms Ranges . . .

## 0.005 V AC Full Scale

Triplet's new Model 801 V-O-M offers 73 measurement ranges including 8 low-power resistance ranges that apply only 35 mV to the device under test. There are 22 voltage ranges—10 DC and 12 AC; 24 current ranges divided equally between DC and AC; 15 resistance ranges—including the 8 low-power ranges; and 12 ranges of output measurement.

As if such unsurpassed versatility were not enough, the Model 801 also offers 11 megohm DC and 10 megohm AC input resistances, 2% DC and 3% AC accuracy and a 25 uA suspension-type meter with a nearly 7½" long scale. There's no doubt that the new Triplet Model 801 has no equal among analog V-O-M's in terms of sensitivity and versatility.

See the remarkable new Model 801 V-O-M—priced at **\$200** suggested USA user net—at your Triplet distributor. For more information—or for a free, no-obligation demonstration—call him or your Triplet sales representative right away. Triplet Corporation, Bluffton, Ohio 45817.



The World's most complete line of V-O-M's . . .  
choose the one that's just right for you

Model 801

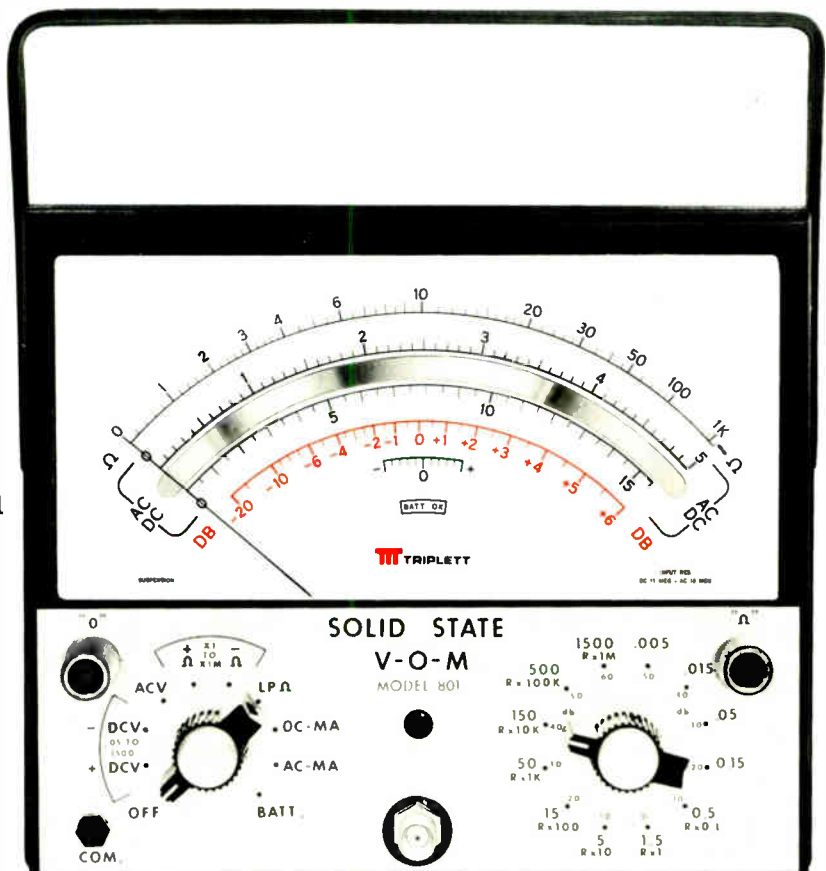

1. 8 ranges of low-power ohms at 35 mV with 1 ohm center scale.
2. High sensitivity (0.005 V AC full scale) at 10 megohm input resistance.
3. 8" meter has simplified scale with only 2 arcs for 46 AC/DC ranges.

# Your electronic needs can be met by just picking up the phone

Japan's biggest exporter of electronic components, communications equipment, test and measuring instruments and other electronic equipment



## Computer Equipment

Minicomputers  
Peripherals  
Disc Pack Drives  
Rotating Drums  
Card Punch Readers  
Others  
Traffic Control Systems

## Components

Computer Components  
Core Memories  
Wire Memories  
IC Memories

Pulse Transformers  
Delay Lines  
Connectors  
Light Emitting Diodes  
Sub-Miniature Lamps  
Key Board Switches  
Silicon Wafers  
Transducers  
Crystal Filters  
MOS ICs  
Video Tape  
Micro Motors

Metal Laminated Sheets  
Others

## Communications & Measuring Instruments

MM Wave Test Equipment  
CCTVs  
Marine Radars  
Mobile Telephones  
Oscilloscopes  
Others

## Other Electric and Electronic Equipment

Medical Electronic Apparatus

### Marubeni-lida (America), Inc.

42nd Floor, Pan American Bldg., 200 Park Ave., New York, N.Y. 10017 Tel. 212-973-5603 Machinery Dept. 1  
Los Angeles Branch: One Wilshire Bldg., 624 South Grand Ave., Los Angeles, Calif. 90017 Tel. 628-6271 Machinery Dept. 1  
Chicago Branch: 938 Merchandise Mart, Chicago, Ill. 60654 Tel. 527-3800 Machinery Dept.  
San Francisco Branch: Tel. 433-4550 Houston Branch: Tel. CA-4-6301 Seattle Branch: Tel. MA-4-5850  
Portland Office: Tel. 224-3760 Washington D.C. Office: Tel. 667-1900 New Orleans Office: Tel. 522-5569  
Detroit Office: Tel. 962-3250

### Marubeni-lida (Canada), Ltd.

Suite 2700, 401 Bay St., Toronto 1, Ontario Tel. 368-1171 Machinery Dept.  
Vancouver Branch: Tel. 685-3331 Montreal Office: Tel. 866-3667

WEST GERMANY: Marubeni-lida G.m.b.H., 4000 Duesseldorf, Immermann Str., 14-16 Tel. 353816 Machinery Dept. 2

BELGIUM: Societe Belge Marubeni-lida S.A., 26 Rue de la Loi, Brussels 4 Tel. 13-67-70

FRANCE: Marubeni-lida France S.A.R.L., 4, Rue Ventadour, Paris 1<sup>e</sup> Tel. 073-5960 Machinery Dept. 2

ITALY: Marubeni-lida (Italia) S.p.A., Via Vittor Pisani 28, 20124 Milano Tel. 63-58-14

UNITED KINGDOM: Marubeni-lida Co., Ltd.—London Branch, Machinery Division, 164 Clapham, Park Road, London, S.W.4  
Tel. 01-720-1911 Machinery Dept. 8



**Marubeni-lida Co., Ltd.**

Machinery Export Dept. II

C.P.O. Box 595, Tokyo, Japan Tel. 216-0111

## Probing the news

Environmental electronics

# Fumes don't faze New York network

City's pollution monitoring system passes crisis with only minor snags; more automation planned

By Alfred Rosenblatt, *Industrial electronics editor*

During the recent severe air pollution over the Northeast, New York's Mayor John V. Lindsay set in motion a pollution alert that eventually could have banned all vehicular traffic in the city. Guiding Lindsay through the alert were measurements from one of the largest and most automatic air quality monitoring systems in the nation. Ten remote stations throughout the city report every five minutes via a telemetry system to a central control station. And 28 more stations check in daily via data stored on strip chart recorders.

The system—particularly the automatic portion—"worked just fine during the entire air pollution episode," says telemetry specialist Peter Hiotis of New York City's Department of Air Resources. Six parameters—sulfur dioxide, carbon monoxide, particulate matter, wind speed, wind direction, and air temperature—were measured accurately and were quickly available.

More and more state and local governments are seeking such real-time information to act quickly against both air pollution and air polluters. In August, Los Angeles began installing a data telemetry system tying together 12 remote stations, and Detroit will start operating a 13-station linkup next month.

In Pittsburgh, IBM has a data collection network for the Allegheny County Health Department. Each of 30 continuous monitoring sensors in 15 remote stations, is directly linked to an IBM 1800 computer. Next year, when fully operational, the system will be ex-

panded to 103 sensors in 18 locations. IBM also has real-time collection systems in Hartford, Conn., State College, Pa., and Fort Wayne, Indiana.

Also installing automatic networks are Philadelphia and St. Louis, and the states of New York, Maryland, and Pennsylvania, as well as Dade County, Fla., Puget County Air Pollution District, Wash., and the Province of Ontario.

The Federal Government also is in the act. The Health, Education and Welfare Department's National Air Pollution Control Administration [*Electronics*, Dec. 8, 1969, p. 137] is setting up a computerized pollution reporting network. Napca plans to designate 85 metropolitan areas as air quality control regions, which will implement air quality standards and report on its plans.

With 18 months of operating experience behind it, New York City's Department of Air Resources has a strong grip on what makes an air pollution monitoring network work or not work.

New York's system was born during the dark days around Thanksgiving 1966, when a temperature inversion trapped polluted air over the city. "The episode brought out the need for fast information about what was happening to the air around the city," says Edward F. Ferrand, director of technical services for the department. Its system has allowed the city to implement a four-stage air pollution alert and warning system which, if the air over the city gets bad enough, allows for the ban on vehicular traffic, on pollution-caus-



## RESOURCES

WATER-FUEL-POWER

## ROOM

FOR EXPANSION

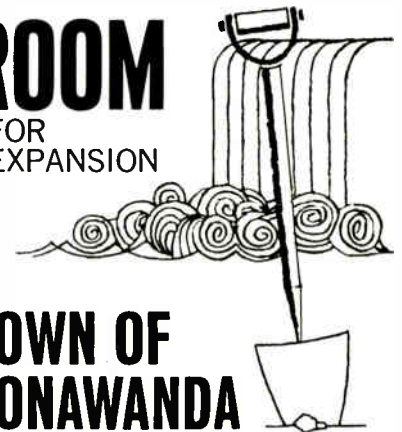

## TOWN OF TONAWANDA

has all these and more for your plant development.

Western New York's skilled labor force; natural gas, cool water for power, processing, and deep port facilities; industrial zoned areas separate from spacious residential districts. Write for complete 36 page brochure with details on these and all the extras Town of Tonawanda has to offer.



Town of Tonawanda Development Corp.  
2919 Delaware Ave., Kenmore, N.Y. 14217

Please send my free copy of "Town of Tonawanda . . . A Panorama of Progress".

name \_\_\_\_\_

title \_\_\_\_\_

company \_\_\_\_\_

address \_\_\_\_\_

city \_\_\_\_\_ state \_\_\_\_\_ zip \_\_\_\_\_

## Our Reconstituted Mica Capacitors Are Tested Harder



### You get higher capacitor reliability for less

Because Custom Electronics, Inc. is the reconstituted mica capacitor maker who precisely grades the dielectric material before it reaches production, other manufacturers' final mistakes are never started at Custom. The result is fewer production rejects, and lower job quotes for Custom Electronics' customers. Add this grading system to Custom Electronics' rather fanatical Quality Control efforts throughout the production process, and it becomes clear why our client list reads like the who's who of high voltage electronics.

If your high voltage capacitor needs are RELIABILITY and IMMEDIATE SERVICE write or call Custom Electronics, Inc., Browne St., Oneonta, N.Y. 13820. Phone 607-432-3880.



**CUSTOM ELECTRONICS, Inc.**

## Probing the news

ing incineration, and on burning of fossil fuels.

The instruments at the remote stations are interrogated every five minutes by a hard-wired control, or interface, unit in the central station. The station can send out as many as seven commands, made up of three frequency tones—at 730, 1,300, and 1,700 hertz. Data is returned as a pulse-width modulated 2,200-Hz tone. The commands also trigger signals for calibrating the telemetry system, the instruments, and the strip chart recorders that are tied to each instrument to capture data even if the telemetry system fails. Signals also warn if an instrument is malfunctioning.

Timing is generated by a 60-cycle clock in the interface. A PDP-8S computer is used mostly to compute pollutant averages. It also controls transmission of data to a teleprinter, a paper tape punch, and a large map that displays the location of the remote station being interrogated.

**Biggest bugaboo** has not been in the electronics but in the telephone lines tying the 10 remote stations to the central control, says Ferrand. Local repairmen have a habit of disconnecting the lines, which sometimes appear to be unused. What's more, noise and interference (the central station once was receiving police radio calls from a precinct in Queens) resulted in lost data before the system was adjusted.

However, especially in view of its performance during the pollution crisis, the city is quite satisfied with its system, Ferrand says. By the end of the year, instruments will be added to measure three more chemicals—nitrogen oxide, nitrogen dioxide, and ozone. Under the effects of sunlight, these chemicals are producing the famous Los Angeles type of smog. These new measurements can be handled readily by the telemetry system, which is expandable to 32 remote stations, each monitoring 16 parameters.

If the telemetry system were to be designed over again, however, it would probably be done differently. "We had nothing to base

the specs on," says Ferrand, a former chemistry professor at Cooper Union School of Engineering in New York. "We wrote them loosely in terms of what we wanted to do as air pollution experts, not electronics experts." The department's present electronics instrumentation group, led by Hiotis, was hired after the original contract for the system—\$182,000 to the now defunct Space and Systems division of Packard Bell Electronics—was awarded. As it turns out, they would have preferred that control be handled directly by the digital computer instead of by the interface.

The specifications written early in 1967 did not even call for a computer, points out Robert F. Ryder, manager of environmental sciences, Geotech-Teledyne, Dallas, Texas. Ryder directed the New York City job before Packard-Bell was acquired by Teledyne, which moved most of the Space and Systems division to Geotech in 1969.

New York's air pollution people were used to seeing data displayed on strip charts and were "spooky" about getting tied up in a digital computer, Ryder says. So the computer was added only to calculate data averages and the nonlinear scale factors of some of the instruments. With control invested in the sophisticated interface, the system can operate almost independently of the computer.

Now the city plans to upgrade its monitoring system, although it won't redesign it for more direct computer control, says Hiotis. A digital computer could handle the hard-wired interface's work with a software routine, he points out.

However, a new computer has been added—an \$18,000 PDP-8I with an 8,000-bit core memory. It will be used mostly for data manipulation, but eventually could back up the central control unit. Hiotis also wants to replace the strip-chart recorders, digitizing and storing the data on either paper or magnetic tape instead.

And to keep the phone company from disconnecting his lines, Hiotis will put isolation transformers at the remote stations so they'll appear to have an impedance of about 1,200 ohms, indicating usage.



The Brush 620 Data Logger converts multi-channel analog inputs to digital format, then records them on a ¼" endless-loop magnetic tape cartridge. The Brush Tape Reader (right) plays the cartridge for computer data reduction and presentation.

Thanks to the tape cartridge system you can put data loggers wherever you generate the analog input. The loggers are lightweight, portable, rugged, can be remotely- or intermittently-controlled, and are about as easy to operate as a car radio. Each logger accepts 18 channels of analog data and uses two additional channels for recording real time in hours, minutes and seconds at the start of each scan. The logger is expandable in increments of 10 channels to 118 channels. The continuous-loop

cartridge will provide 60 minutes of continuous recording. As much as 1860 hours of operation are possible on a single tape in the one hour intermittent-recording mode.

The Tape Reader offers two data reduction modes. In the computer mode, the reader takes the tape generated by the logger and through an interface card, transmits the data directly to the computer input bus. In the tape-to-tape mode, the data reader feeds a ½" incremental tape recorder to produce a computer-compatible tape.

This new analog-to-digital system is ideally suited for such applications as process data logging, pollution monitoring, weather and climatological studies, medical, geophysical and other types of research. And like we said, it

can chop hundreds of manhours from your analog data handling procedures.

We've described all the details in a new brochure. Brush Division, Gould Inc., 3631 Perkins Avenue, Cleveland, Ohio 44114.

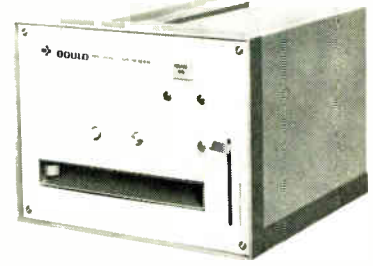

**GOULD BRUSH**

**This portable  
analog data gatherer can save you  
hundreds of manhours.**

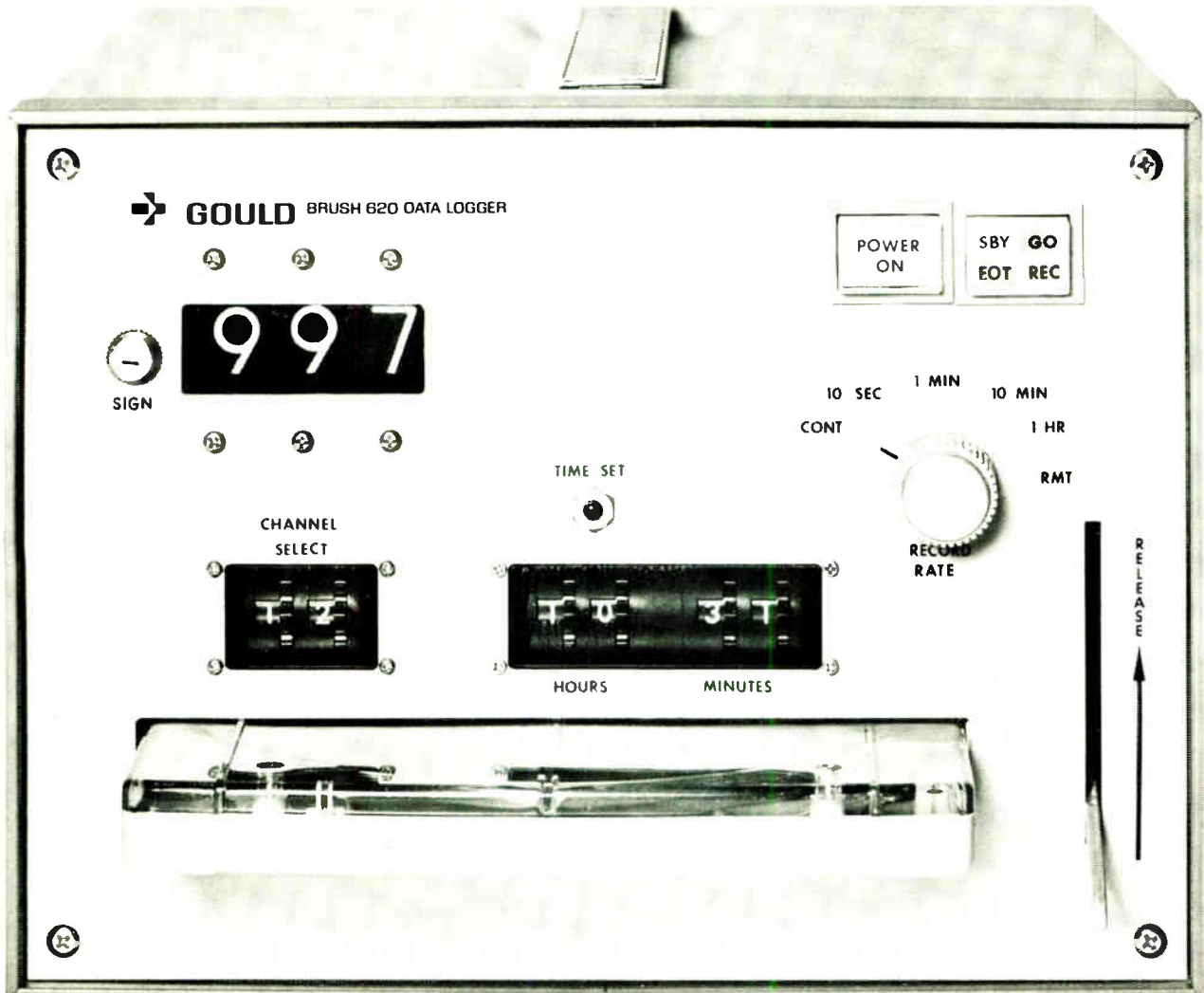

Communications

# Low-cost voice digitizer push is on

Military project taking advantage of advances in LSI and modem technology could hasten development of inexpensive commercial telephone security gear

By Herman Lowenhar, *Military/Aerospace editor*

A strong push from the military may provide the thrust needed by electronics firms to penetrate a major untapped market: commercial voice digitizers. Rome Air Development Center's recent request for letters of interest on a forthcoming low-cost voice digitizer development program envisions a 9,600 bit-per-second mil spec unit costing well below \$5,000, but the fallout generated by RADC's efforts could produce even lower-priced commercial devices.

An inexpensive digitizer would find a ready market in offices where concern for secure telephone conversations has become obsessive due to the proliferation of bugging equipment. While recent publicity has put many people on guard, and it's no longer easy to put a bug directly into a telephone, once the wires leave the office they're vulnerable to anyone with a pair of alligator clips or an induction pickup.

Laying the groundwork for low-cost voice digitizers are advances in large-scale integration and the recent development of modems that can process a 9,600 b/s stream for transmission over a standard telephone channel. This fourfold increase in capacity over older modems should make it far simpler to reliably encode voice communications, using such techniques as delta modulation. This technique involves rapid sampling of the speech signal waveform and transmission of negative pulses or positive pulses depending on whether the current sample is less than or greater than the preceding sample. At the receiving end, an integrator restores the original waveform.

Both Honeywell and Philips have put the relatively simple circuits needed for delta modulation at 19,200 b/s onto a few LSI wafers in brassboards. Now that engineering costs for custom LSI have dropped below \$10,000, even a small production run will quickly amortize these charges, slashing the parts cost for a digitizer. And LSI minimizes assembly costs.

The more difficult trick now is to develop the circuits needed for high-intelligibility delta modulation at 9,600 b/s. And all proposals to the Air Force are likely to be based on one or another of the many varieties of delta modulation.

A strong contender for the contract award will be Honeywell's Communication Center, which last year received two feasibility study contracts from the Naval Air Systems Command for research in 9,600 b/s modems and voice digitizers. RCA also has done work in this area, most recently under contract to the Defense Communications Agency. The company breadboarded a 19,200 b/s digitizer on LSI/MSI circuits using an analog processor to compress the voice

bandwidth by two to one and a delta modulator. Other expected competitors are General Electric, Northrop, and Philco-Ford.

Modems that can process the digitized voice signals for telephone-line transmission are made by Codex Corp., Honeywell's Aerospace division, and the International Communications division of Milgo Corp.

These modems use multilevel amplitude encoding, single sideband modulation, and adaptive equalization. In multilevel encoding, the 9,600 b/s digital data stream is usually sampled two bits at a time, and a 4,800 b/s stream coded in sign and amplitude is transmitted. The signal spectrum then is put through a low-pass filter, limiting the bandwidth to about 2,400 hertz, while passing 90% of the spectral energy. The pulse train is then modulated onto a 2,900-Hz carrier and is single-sideband filtered. Finally, it is passed through an equalizer, actually a self-adaptive digital filter that adjusts its phase and attenuation to compensate for channel characteristics.

## Watching your words

The selection of telephone security gear has been limited to two alternatives: a voice privacy device (a type of spectral scrambler with a limited number of codes) or a vocoder. The latter offers higher security because its digital output is readily encrypted. But vocoders are expensive because they sample the voice spectrum for subsequent reconstruction, rather than the actual signal waveform. Basically, they pass the signal through a filter bank, sample the energy in each filter at about 25 hertz, and transmit a digital stream describing the spectrum. Intelligibility can be as high as 98% if the user is willing to pay for the complex circuits.

# Ultrasonic cleaning power tailored to your exact needs.

Here's a new concept in ultrasonic cleaning — a whole family of Powerpack ultrasonic power supplies that (1) adjust automatically to any cleaning load and (2) always operate at optimum power without adjustment.

Powerpack is at the heart of every Branson cleaning system, providing efficient, consistent power under all conditions. Regardless of cleaning load or tank size. Regardless of ultrasonic frequency.

If you have a hard-to-solve cleaning problem, Branson can supply you with the *precise* cleaning system needed to solve your problem. Efficiently. Effectively. For good.

Call us today at (203) 324-6721, or write Branson Instruments Company, subsidiary of Smith Kline & French Laboratories, Progress Drive, Stamford, Connecticut 06904 or any one of our 34 sales offices.

## The Branson Powerpack.



# Panasonic Hi-ZNR stabilizing elements have an element of surprise. Stability at 30,000 volts.

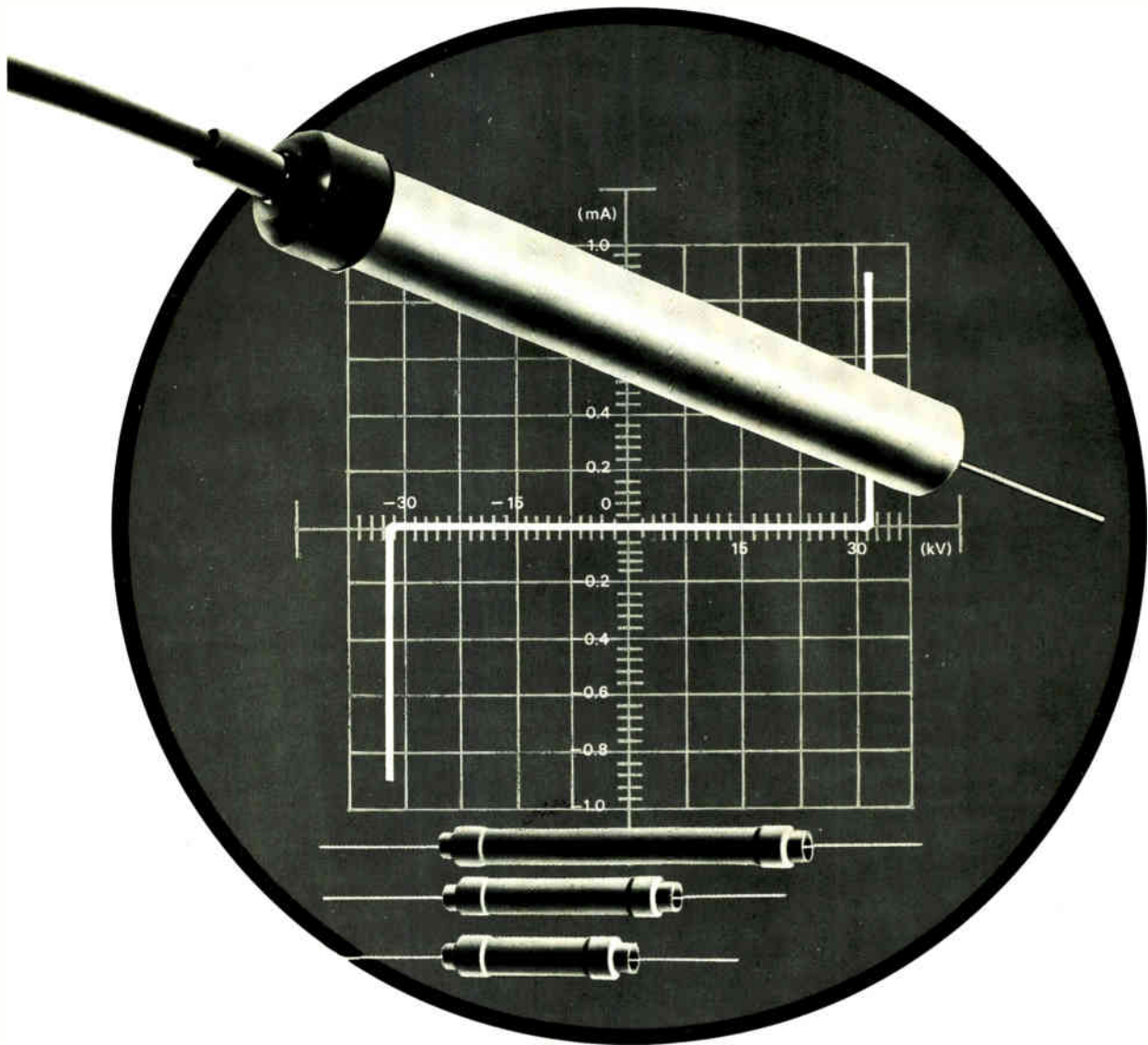

That's up in the neighborhood where conventional resistors refuse to cooperate. But things are different now. Panasonic has developed a Zinc Oxide Nonlinear Resistor—Hi-ZNR.

Hi-ZNRs simplify high voltage stabilization circuits with the capability to handle voltages ranging from 300 to 30,000. Their nonlinearity is unexcelled (over 10 times better than silicon carbide varistors), and stability against changes in ambient temperature,

humidity or electric load is high. Hi-ZNRs are also far superior in absorbing surge voltage.

Compare them with conventional stabilizers. You'll find they are better suited for applications like stabilization in color television and X-ray generators, or surge suppression and limitation in lightning arrestors and spark absorbers.

So what you buy is more than just stability, it's total peace of mind.

**PANASONIC**<sup>®</sup>  
just slightly ahead of our time

Industrial Division, Matsushita Electric Corp. of America 200 Park Ave., New York, N.Y. 10017 Phone: (212) 973-5710

Consider the GaAsLITE opto isolator.

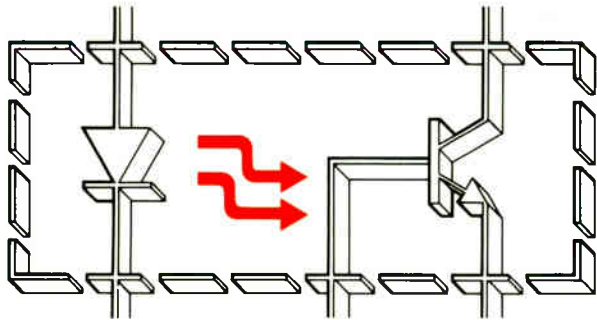

Couple a GaAsLITE to a silicon detector, and you get almost perfect isolation between input and output; 100,000,-000,000 ohms. Our opto isolators listed here do just that, and more. They give high performance at great speeds for very low cost. Scan the details. Each is packaged for mass production handling, and each is priced to suit quantity applications.

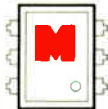

**MCT 2:**  
a GaAsLITE/phototransistor opto isolator compatible with semiconductors in digital or linear circuits.

High current transfer ratio (35%) and isolation characteristics make the MCT 2 an ideal isolation transformer, pulse transformer, or relay. It can transmit a complex signal between subsystems without noise feedback.

The MCT 2 is a planar GaAs diode optically coupled to an NPN silicon planar phototransistor. It delivers hundred-billion-ohm isolation resistance and voltage isolation in excess of 1500 V, with coupling capacitance of 1.3 pF. New ISO-DIP six-lead plastic dual-in-line package makes it easy to work with and gives maximum economy.

Characteristics:

Max. emitter forward voltage 1.5 V @  $I_F = 100$  mA

Detector  $H_{FE}$  typ. 150 @  $V_{ce} = 5$  V,  $I_c = 100$   $\mu$ A

Bandwidth 300 kHz @  $I_c = 2$  mA

Price: 1,000 quantities, \$3.55. (All prices quoted are suggested resale price.)

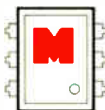

**MCD 2:**  
if you need a really fast GaAsLITE opto isolator, this is it.

In the MCD series, we've coupled a GaAsLITE to a diffused planar Si PIN photodiode. The new MCD 2 gives you a turn-on time of 5 nanoseconds, yet offers the high voltage (1500 V) and resistance ( $10^{11}$  ohms) isolation you need for amplifiers, isolation transformers, pulse transformers, relays, feedback circuits or logic switches. Its coupling capacitance is very low, too; 1.3 pF. It will perform beautifully in linear or digital circuits. And the ISO-DIP packaging makes pc board stuffing a snap.

Characteristics:

Max.  $V_F$  1.5 @  $I_F = 100$  mA

Typ. DC transfer ratio 0.2%

Bandwidth 8.5 MHz

Price: 1,000 quantities: \$3.95.

## GaAsLITE Update

How Monsanto GaAsLITEs, optically coupled to light detectors, become ideal switches for digital or linear circuits.

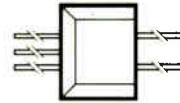

**MCS 1:**  
a new opto isolator — GaAsLITE/photo SCR — a SPST relay with no contact bounce, microsecond response and solid state reliability.

High input-output isolation ( $10^{11}$  ohms with 2500 V breakdown) and 3 pF coupling capacitance make the MCS 1 perfect for high speed switching or relay functions where an IC is looking at AC line voltages or any application that now uses an equivalent SCR. A bi-stable device, with a built-in memory, it can be used as a latching relay in DC circuits and carry 200 V across the anode.

Characteristics:

$V_{AX} \geq 200$  @  $R_{GK} = 27K$

$V_{AK} = .9$  V (typ.) @  $I_A = 200$  mA

$I_F = 4$  mA } @  $V_{ce} = 50$  V,  $R_{GK} = 27K$   
 $I_H = .1$  mA }

Price: \$11 ea., 1,000's.

### Coupled pairs are in stock world wide

You know that all of our products are available in the U.S. through Schweber (516) 334-7474; Semiconductor Specialists (312) 279-1000; K-Tronics (213) 685-5888; or Kierulff. You can get them overseas as easily:

United Kingdom: SEMICONDUCTOR SPECIALISTS, West Drayton 6415

France: YOUNG ELECTRONIC, 604-10-50

West Germany: Alfred Neye, ENATECHNIK, (04106) 4022

Denmark: SCANSUPPLY, AEGIR 5090

Belgium: TECHMATION, 384078

Netherlands: TECHMATION, 020-173727

Norway: ARTHUR F. ULRICHSEN A/S, 21 6510

Switzerland: OMNI RAY A.G., 051-478200

Italy: SILVERSTAR LTD., 46.96.551

Sweden: GP-INGENJOERSFIRMAN, 08/930280

Japan: NEW METALS AND CHEMICALS LTD. CORP., (201) 6585-7

Australia: HAWKER DE HAVILLAND AUSTRALIA PTY., LTD., 93-0221

Israel: MONSEL

# Monsanto

For additional technical information write Monsanto Electronic Special Products, 10131 Bubb Road, Cupertino, California 95014. (408) 257-2140.

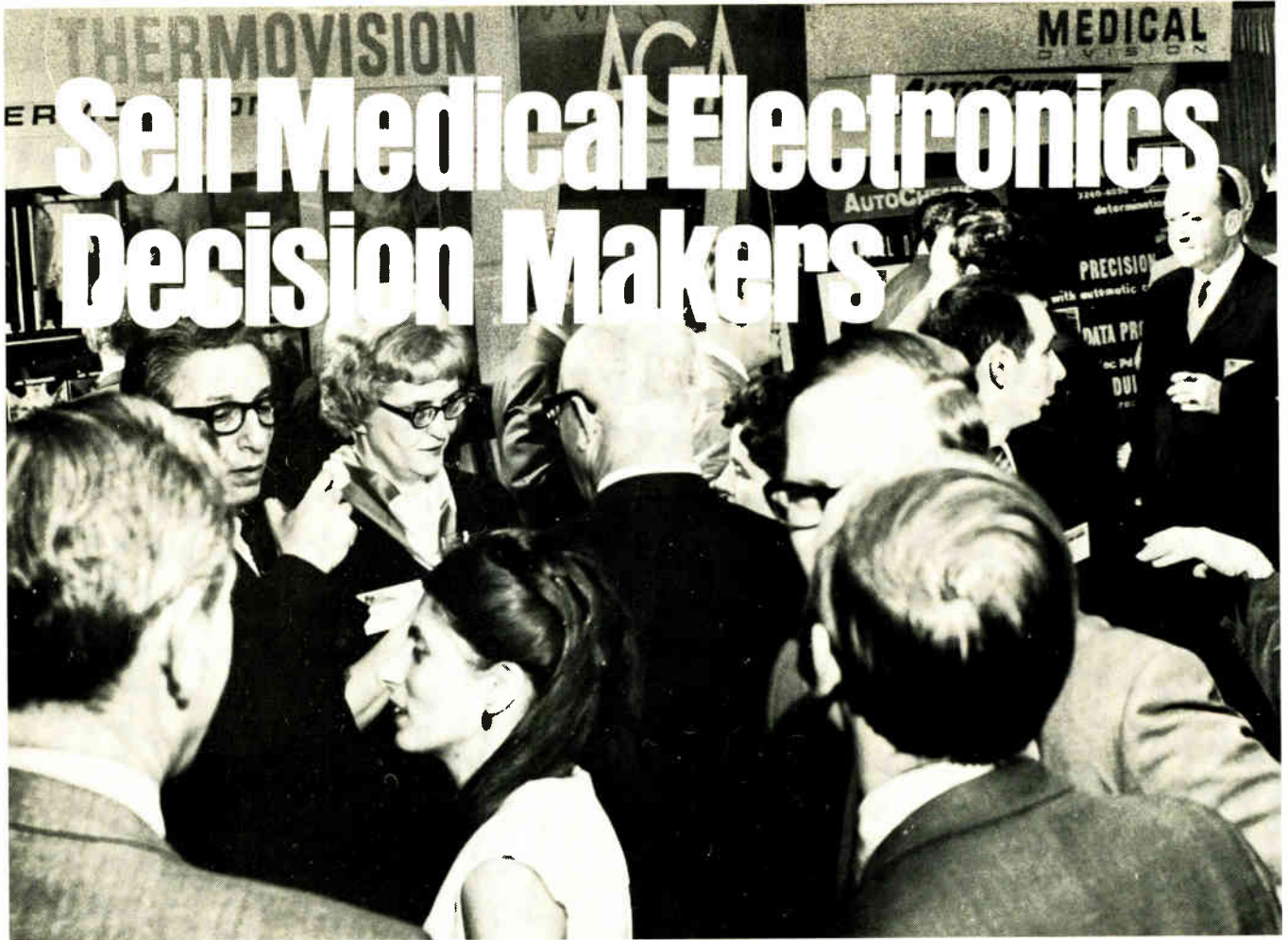

The ELECTRONICS IN MEDICINE Conference & Exposition is different. Unlike every other medical show, it concentrates solely on medical electronics. It brings together only the manufacturers of medical electronics gear and the buyers and specifiers of such equipment—physicians, hospital administrators, biomedical engineers, educators, researchers and system design engineers.

### Effective Sponsorship

ELECTRONICS IN MEDICINE is co-sponsored by Medical World News, Modern Hospital, Postgraduate Medicine and Electronics. The combined know-how and circulation of these major publications assure exhibitors of a highly qualified national audience.

### On-Target Conference

A carefully crafted series of sessions, designed to attract only buyers and specifiers of medical electronics equipment and services, will be created by the editors of the co-sponsoring publications in conjunction with Dr. John Truxal, Institute Professor, Polytechnic Institute of Brooklyn. Dr. Truxal has long been concerned with the inter-play of engineering with biology and medicine and chaired a committee of the National Academy of Engineering on that topic.

### Aggressive Promotion

The conference and show will be broadly promoted by the co-sponsoring publications, which have a combined

circulation of 400,000. A massive direct mail campaign and public relations campaign will be undertaken. Full page ads, well in advance of the event, will appear in all magazines. Direct mailers will repeatedly find buyers and specifiers wherever they work—hospital, private or group practice, clinic, research lab, and university.

### Exhibitors Sell

The 3rd National Conference & Exposition on ELECTRONICS IN MEDICINE will enable you to find and sell new customers, expose current customers to your new products, create impressive lists of new, valuable contacts and create significant penetration of this burgeoning multi \$million market.

### Reserve Your Booths Today

There is no premium on corner or upfront booths. Excellent locations, at no extra cost, will go to those firms which act promptly.



## 3rd National Conference & Exposition on Electronics in Medicine

Sheraton Boston Hotel / John B. Hynes Civic Auditorium  
April 13-15, 1971

For space reservations, information:

Steve Miller, Exhibit Manager, National Expositions Company, Inc., 14 West 40th Street, New York, N.Y. 10018 • 212/564-8714.

The "foremost-in-film-capacitors" people  
did it again...another first from Dearborn!

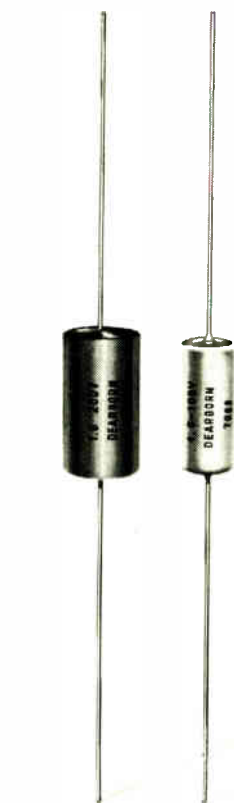

# -65 C to +150 C OPERATION WITHOUT VOLTAGE DERATING

NEW! DELTAFILM® 'LJ'  
METALIZED POLYSULFONE  
FILM CAPACITORS.  
OUTSTANDING.

Extended operating temperature range lets you use these new capacitors in applications where film capacitors could not previously qualify. Capacitance/voltage parameters equal to or better than those of metalized polycarbonate capacitors. Extended life expectancy. Improved electrical characteristics. Voltage range from 60 to 200 VDC. Available in hermetically-sealed metal cases as well as wrap-and-fill epoxy end seal construction.

For complete technical information write to:  
Dearborn Electronics, Inc.  
Box 530, Orlando, Fla. 32802

**Dearborn** Electronics, Inc.  
(a subsidiary of the Sprague Electric Company)

FOREMOST IN FILM CAPACITORS

# When Precision and Reliability Really Count... Count on Oki Electric Dry Reed Switches!

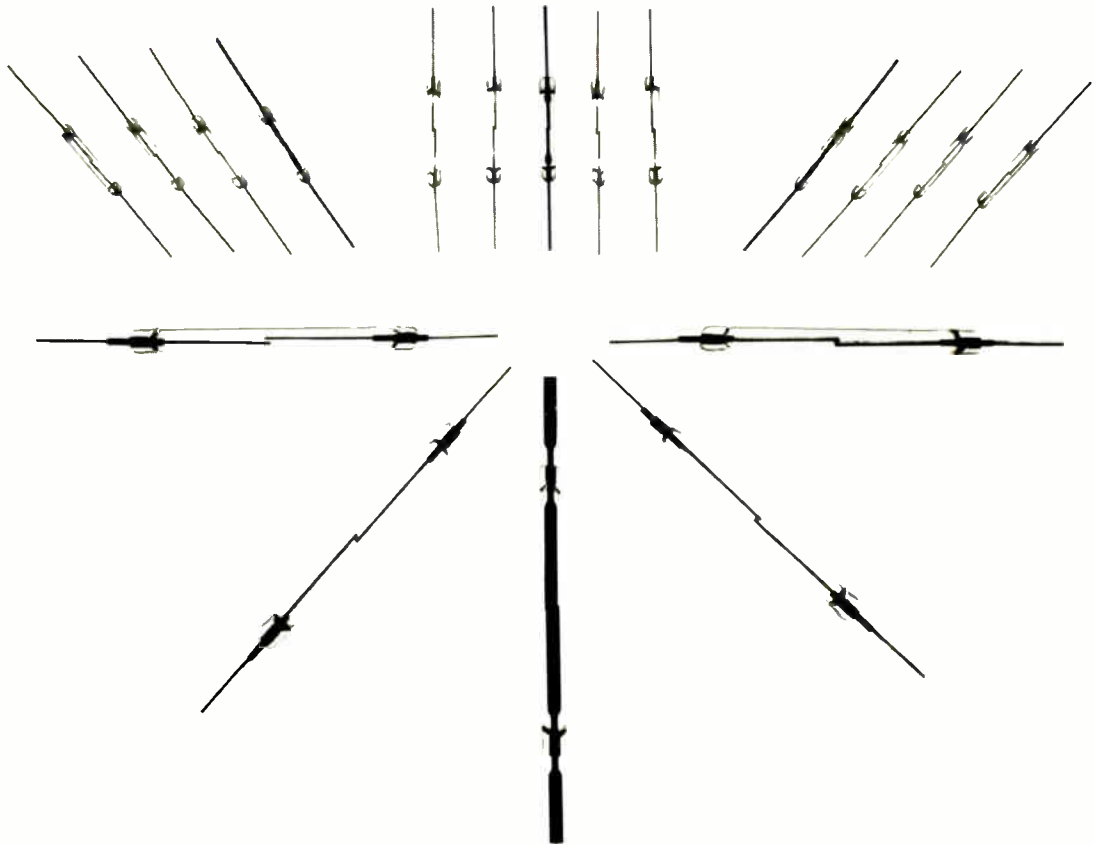

If your business is building better electronic products, give yourself a head start by starting with better electronic products—Oki Electric Dry Reed Switches.

Oki Electric is super-critical about quality, and that's why these special sealed switches are special in every way—beginning with a set of reeds (contact springs) sealed in an inert gas-filled glass capsule. This assures absolute protection

against pollution or contamination by internally effused organic matter. Just another quality idea that helps make Oki Electric a worldwide electronic leader.

Then too, Oki Dry Reed Switches are unlike conventional types because the reeds or springs are part of the magnetic circuit as well as the electrical circuit being controlled.

Another feature is gold or rhodium

plated contact points for higher reliability. Now add exceptional resistance to shock, vibration and extremes of temperature.

As one of the best high-speed switching devices available today, Oki Dry Reed Switches also provide excellent proximity switching and latching when used with bias magnets. So why not let our better products make your better products even better?



**OKI electric industry company, limited**

10, Shiba Kotohira-cho, Minato-ku, Tokyo 105, Japan Cable: OKIDENKI TOKYO TK2627  
Overseas Offices: New York, Mexico, Bogota, Tegucigalpa, La Paz, Taipei, Saigon, Beirut



# The new PDP-8/e: Its own mother wouldn't know it.



The PDP-8/e is a radical departure in computer design. There's no back panel wiring — everything plugs into the OMNIBUS™, even the CPU. In any order. It's completely flexible; you buy only what you need. And if you need more later, just buy it and plug it in. And the PDP-8/e is easier to interface and easier to maintain than old-style computers.

We've made a few other changes. Easier programming. 1.2  $\mu$  sec memory cycle time. 15 added instructions. 256 words of read-only memory. 256 words of read/write memory.

Yet there's no generation gap between the PDP-8/e and the rest of the PDP-8 family computers in 7500 world-wide installations. They all use the same peripherals (over 60 of them). They're all program and interface compatible, they all have extensive applications and documentation. PDP-8/e was born with a silver software package in its mouth.

The basic 4K machine sells for less than \$5000. With teletype, less than \$6500. Quantity discounts available.

**digital**  
COMPUTERS • MODULES

Digital Equipment Corporation  
Maynard, Mass 01754 (617) 897-5111

# FROM THE WAVE MAKERS:

## A NEW VARIABLE ELECTRONIC... "DIAL-A-FILTER"

...Krohn-Hite's new Model 3750 Multifunction Tunable Filter with selectable attenuation slopes represents a revolutionary approach to RC filter design work. It's the first "dial-a-filter" design tool of its kind. With it, you can set up virtually any type of variable electronic filter you require by simply setting dials. High pass, low pass, band pass or band reject with any kind of slope, and with or without gain. Best of all the cutoff frequency remains constant even though the slope is varied.

Check these specs. **Frequency Range:** 0.02 Hz to 20 KHz, **Attenuation Slopes:** 24, 18, 12, 6 db/octave, **Band Pass Gain:** 0 db or 20 db, **Frequency Response:** Butterworth or Low Q, **Frequency Accuracy:** 5%, **Hum and Noise (RMS):** 0.3 mv, **Optional Feature:** Battery Operation.



The Model 3750 Dial-tuned, low-priced variable electronic filter with selectable attenuation is the latest addition to the famous Krohn-Hite line of quality variable electronic filters. Price is \$850 (less batteries). Delivery from stock. For more information on the new Model 3750 that lets you "dial-a-filter", or the full line of filters write The Wavemakers: Krohn-Hite Corporation, 580 Massachusetts Avenue, Cambridge, Mass. 02139.

You'll soon be making signal success yourself.

**KH** KROHN-HITE  
CORPORATION

OSCILLATORS / FILTERS / AC POWER SOURCES / AMPLIFIERS

OVERSEAS SALES OFFICES: BELGIUM, C. N. Rood s. a.; DENMARK, SC Metric A/S; FRANCE, Antares; GERMANY, Nucletron Vertriebs-GMBH; HOLLAND, C. N. Rood n. v.; ITALY Dott. Ing. Mario Vianello; SWEDEN, Teletinstrument; ISRAEL, R. D. T. Elect. Eng. Ltd.; JAPAN, Shoshin Shoji Kaisha, Ltd.; AUSTRALIA, Sample Electronics (Vic.) Pty., Ltd.; G. B., B & K Inst. Ltd.

# Talking computers grow up; system uses 2,000-word vocabulary

Words stored in analog form on high-speed magnetic disk; market for audio response seen at 10,000 units by '75

**Voice-response** computers have a long way to go before they reach the capabilities of Hal, the talking computer in "2001: A Space Odyssey." But the technical limitations which plagued audio-response systems during the 1960's are being overcome, and interest is growing.

Some market managers predict that systems in operation may jump from today's 400 to more than 10,000 by 1975.

They see retail credit verification as a major opportunity, pointing out that direct audio response over a phone line from a computer center can speed the verification process and eliminate banks of video displays.

In its Voicepac 2000, Periphonics Corp. has devised a method of storing words on a high-speed, rotating magnetic disk that allows the user to program up to 2,000 words into the system and change the vocabulary at any time. Phonplex Corp., a subsidiary of Instrument Systems Corp., is readying a system in which words will be constructed from phonemes, the basic components of speech. Other companies active in the field are Dash Data Systems, Technitrend, Datatrol, IBM, Burroughs, Honeywell, RCA, and Cognitronics.

Audio response systems have

met slow acceptance because units marketed in the mid-1960's had limited vocabularies—under 200 words—and could handle only a restricted number of communication lines. More words could be incorporated into the system only at a tradeoff in the number of lines, and vice versa. The units also had to go back to the factory for vocabulary revisions—a procedure that took two or three months and cost \$2,000. Early models could only be tied in with large mainframes, such as an IBM 360/40, and had no stand-alone capability. The user thus was burdened with the heavy expense of the central processing unit managing the control functions. Furthermore, the proliferation of hard-copy and video terminals have convinced many managers that these are the best devices to handle their jobs in a batch environment. Others believe audio response is too slow for their needs.

A small group of physicists and

engineers at Periphonics set out to minimize these limitations in designing the Voicepac 2000. "We looked at the disk and decided that, if we were to store a thousand words digitally, we'd need all the megabits on the disk," says Julian Sandler, systems vice president. To reduce storage requirement and effectively increase packing density, Periphonics uses a novel method to store analog signals directly on the disk. This method, asserts Sandler, enables the system to deliver the same or different words simultaneously to hundreds of communication lines without buffers for output storage.

Periphonics also uses a high-speed disk, instrumental in reducing word access time to 1/30th of a second. In addition, disk space allocation is assigned according to word size—allowing more data to be compressed. Most systems still use drums, with typical revolution periods of 1.5 seconds. And in most cases only one to three words are

Phone queries. In a typical system, requests are received by data sets, then multiplexed and routed. Units in the color box are part of Voicepac.

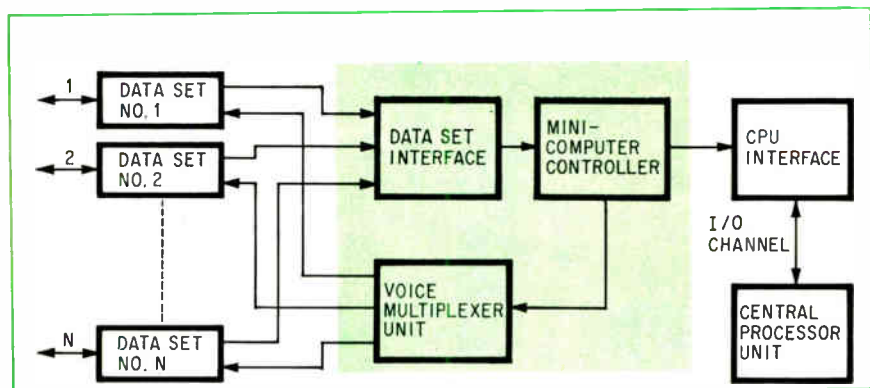

## New products

stored in one channel, a technique which uses excessive space and results in long access times.

One of the key features of the Voicepac system is its flexibility—it operates in either the time-shared mode or as a stand-alone unit. Says Donald B. Kaiserman, marketing vice president, "We're not saying that voice response is your only answer, but that it can complement your overall system concept." Kaiserman says the system can accommodate up to 120 terminals in the standard configuration and may use CRT displays, line printers and teletypewriters in addition to the pushbutton telephones. Kaiserman adds that voice response in conjunction with hard copy output may increase reliability and detect errors in transmission.

A minicomputer accounts for much of the system's versatility. Stored in the minicomputer's memory is a list of all the words located on the disk, each word's storage track, where the storage address

begins, and the length of the word. After the central processing unit (either the large computer's mainframe or the minicomputer's depending on the mode of operation) receives an interrogation, a coded reply is sent to the minicomputer's processor, which then commands the multiplex or audio response unit to generate the appropriate voice output. The minicomputer selects the particular word from the disk and decides which output line to deliver it to. Thus the minicomputer and its associated processor-interface act as a front-end communication device in the system.

Sandler explains that the words stored on the disk are in neither the conventional analog nor digital format, but are a version of pulse code modulation. "We still use a saturation concept of storage but with a special encoding technique," says Sandler.

Sandler says the complex technique allows efficient compression

of data and facilitates output. The Voicepac can store perhaps 15 words on the same track where other units store only one word. Since there is no analog-to-digital conversion, the system has no need for a synthesizer.

An important feature of the system is in-field modification of the stored vocabulary. Words can be revised or added to the vocabulary by an encoder module provided by the company. Redundant words and phrases can be eliminated under software control.

The Voicepac houses the supply, minicomputer, disk, and control logic in a 63-inch-high cabinet.

The standard unit will accommodate 40 to 2,000 words, and can be expanded to as many as 10,000 words. Deliveries are expected to begin in December, with prices ranging from \$27,000 for the basic 40-word system to \$62,000 for the 2,000-word unit.

The voice-response unit built by Phonplex Corporation uses an

# a good rule to follow...

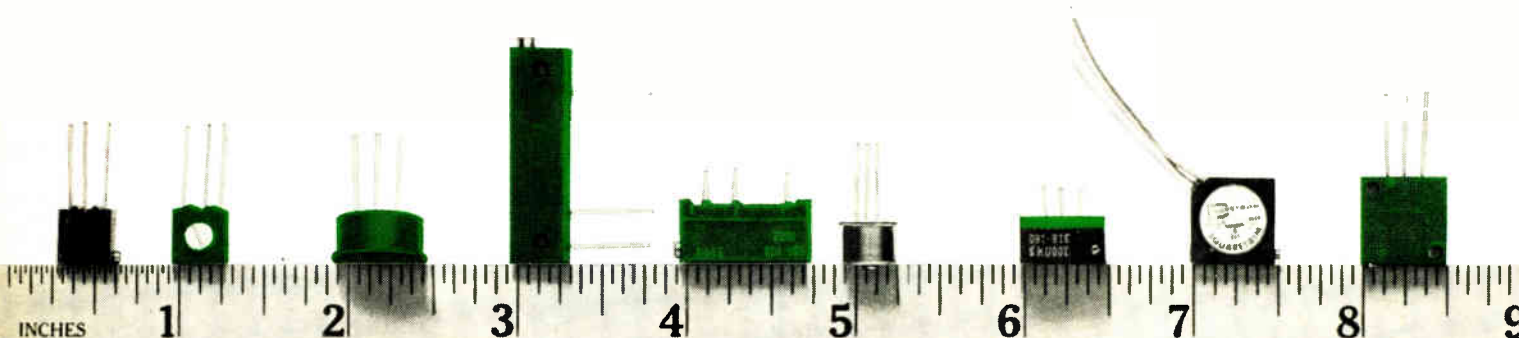

## New products

entirely different approach. Stemming from its development work on an audio-response warning system for aircraft pilots, Phonplex has designed a compact, rugged unit which digitally encodes and stores phonemes and coupling sounds in a metal oxide semiconductor read-only memory and contains a hard-wired subroutine that assembles the simpler parts of speech into a full word.

Looking beyond banking and credit card applications, Gordon Granert, marketing manager, feels such units could be widely used for industrial control where ruggedness and maintainability are essential. And when ears as well as eyes can be helpful in monitoring important process control functions, "you can't have tapes wearing out all the time, or running into mechanical problems with the storage device," says Granert. Furthermore, the phoneme concept uses solid state fabrication; to change the unit's vocabulary or add more lines

to the system, the user merely pulls or adds cards.

The MOS read-only memory also yields fast access time. Phonplex is manufacturing the basic units to handle 50 words and two telephone lines. However, Granert says

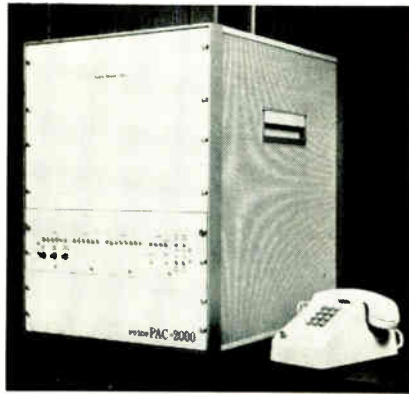

Talkbox. Minicomputer will be added to disk and logic in prototype shown.

that the system will be modularly expandable to include any size vocabulary with up to 256 lines.

The company started working on a word by word basis. But in analyzing the system, engineers found that storing many word sounds was redundant. Development progressed to the point where just the phonemes were stored; with words assembled from them, duplication was avoided. One of the problems encountered was that not all phonemes could be fit together in a logical manner for word composition. Certain additional sounds which Granert calls couplers had to be stored and then integrated with the phonemes to achieve a complete word. These phoneme-like parts make up an additional memory of 100 to 200 sounds.

The basic unit will be housed in a box about 2 by 1 by 1 feet and will cost \$19,500. Deliveries are expected to begin the first of next year.

Periphonics Corp., Route 25A, Rocky Point, N.Y. 11778 [338]  
Phonplex Corp., 789 Park Ave., Huntington, N.Y. 11743 [339]

# when ordering pots.

Weston Components, a Schlumberger company  
Archbald, Pennsylvania 18403

Gentlemen:

- Please send me a copy of your new catalog of Weston trimming potentiometers.
- Please have a salesman call to discuss samples and prices.

Name \_\_\_\_\_ Title \_\_\_\_\_  
Company Name \_\_\_\_\_ Mail Station \_\_\_\_\_  
Street Address \_\_\_\_\_ State \_\_\_\_\_  
City \_\_\_\_\_ Zip \_\_\_\_\_

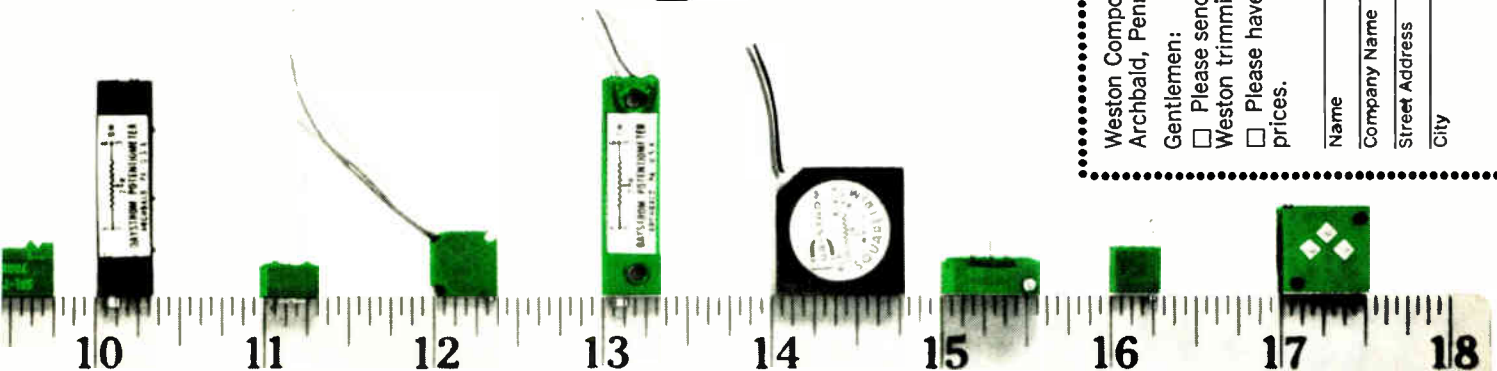

# WESTON®



## Bell & Howell & Jon Wells & The Simple Folk

Some people asked our guys how come we didn't turn out a recorder/reproducer that simple folk could use. At a simple price. Something that was production line oriented for a bunch of industries across the board.

We bounced that problem to Jon Wells who just recently came up with the remarkable, hi-rel VR3700B series.

Back Jon came with a little number called the VR3500. Although it's not as esoteric as the B model, it does have a lot of its features.

He used a modular concept with functions being grouped according to use. Linear IC's to get the bulk down. And large cards so any trouble shooting that needed to be done could be done fast.

Transport and electronics are set up so they can be easily repaired or modified. There's a closed loop tape path so you get real accuracy. Bi-directional speeds for versatility. A fail-safe phase lock DC capstan drive so you won't lose a smidgen of information. And very gentle tape handling.

As far as time base error and dynamic skew and flutter, they're fantastically low.

And so's the price.

Another thing. You don't have to be an engineer to run it. The how-to's are decal'd right on the equipment.

That's the VR3500. An industrial recorder/reproducer. Brand new. And ready.

For all the specs, write its father, Jon Wells, Bell & Howell, Instruments Division, 360 Sierra Madre Villa, Pasadena, California 91109.

**INSTRUMENTS DIVISION**

 **BELL & HOWELL**

Circle 148 on reader service card

© Copyright 1970 Bell & Howell

## New products

### Instruments

# Probe station troubleshoots ICs

Under-\$10,000 system does failure analysis, debugging; tester for chip designers will be offered with it

The engineer who can poke around a bad network with a voltmeter and an oscilloscope and tell exactly what's wrong is a member of an endangered species. With integrated circuits making equipment smaller and smaller, there isn't room enough to poke around, so troubleshooting is reduced to either running tests at input and output terminals or turning to a lot of expensive failure analysis gear.

But a three-month-old Long Island company—Comaltest Inc.—may help troubleshooters make a comeback. The firm's new probe station lets engineers check out an IC by applying and measuring signals anywhere inside the circuit, not just at its leads.

Comaltest engineers also are working on an IC tester to go with the station. Together, says company co-founder Peter Quinn, the two will perform just about any static, functional or dynamic test on just about any solid state device; do failure analysis work; and debug prototype ICs. The total price for the new gear will be under \$30,000.

The Mark X probe station—whose base price is \$9,700—comprises an optical system, a collection of microscope stages and device adapters, and three joystick-

manipulated probes. Having a tip diameter under 2 microns, each probe can be placed on a spot no wider than a metal interconnect.

With the probes, the user can feed test inputs to the circuit, measure responses at various points, and measure signals generated by the circuit's normal operating inputs.

In short, the probes let an engineer check out an IC in the same way he would examine a balky television or other piece of malfunctioning gear built with large, discrete components. Since the station's microscope magnifies by a factor of up to 750X, a user can easily trace through a microcircuit, looking for shorts, opens or other causes of failures.

If the user so desires, he can damage an IC with the probes. For

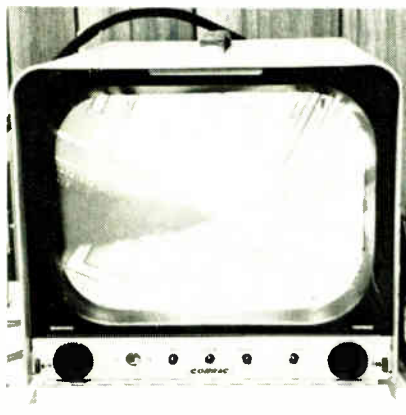

On the line. Inspecting an IC through the probe station's microscope, the user can place a needle-tipped probe right down on a metal interconnect, then apply or measure signals.

# Bell & Howell & Tape. & Tape?

Right. We're in the magnetic tape business. Very seriously.

No, we don't buy it out. We make it. And darn well, too. For instance, the way we formulate and lay down the oxide makes it a really superior performer. No joke. Its sensitivity is so good it'll give your recorder a 2-3 dB better SNR than is possible with any other tape commercially available.

It's also the smoothest tape going. Like .5 micro inches peak to valley. Which gives you a much longer head life.

Then there's the fantastic consistency of our runs. Not just from beginning to end of reel, but from one reel to another, so you don't have to run around adjusting recorders all the time.

For all that, you'd expect to pay a little more, right? Well, chances are, our tape costs less than the one you're buying now.

Types? A full range. Wide-band with a 2 MHz response. Mid-band with a 600 kHz response. Standard telemetry. And instrumentation audio.

Want to try it? You can—at an introductory 20% discount. Now. But for a limited time. Get full details by calling your local Bell & Howell office, or write Instruments Division, Bell & Howell, 360 Sierra Madre Villa, Pasadena, California 91109.

INSTRUMENTS DIVISION

 BELL & HOWELL



TINY....  
BUT—MVMs  
CAN TAKE IT!

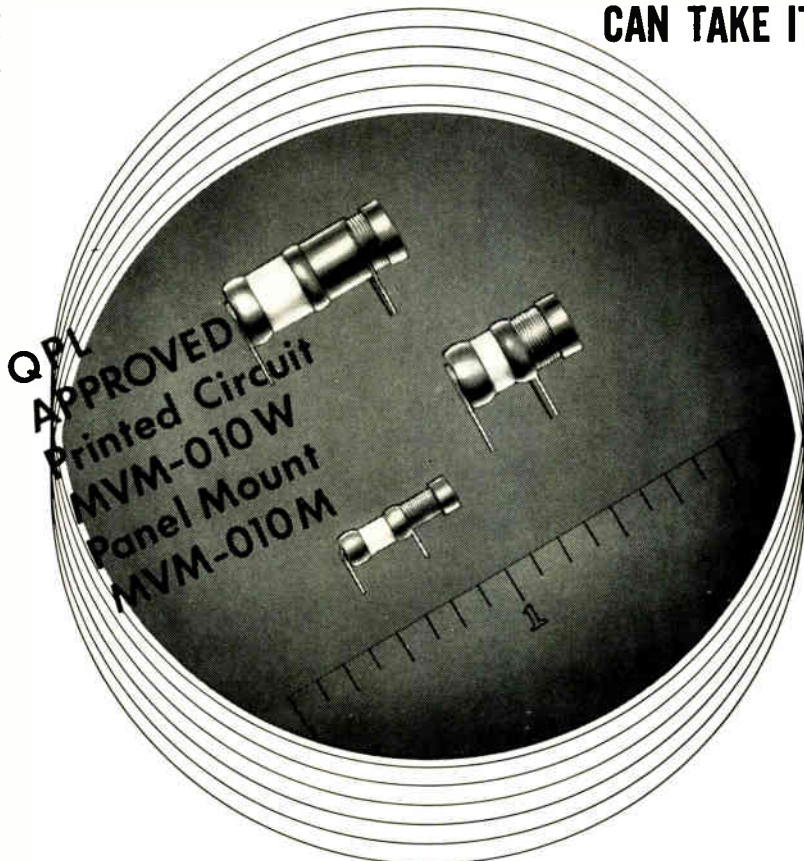

## THESE NEW HIGH Q AIR VARIABLES ARE RUGGED

JFD has developed three sizes of unusually rugged air variable capacitors. All three feature a unique internal guiding mechanism with a positive stop. The result: concentricity is constant and these capacitors can withstand conditions of extreme shock and vibration.

Further, newly developed metal biasing elements provide smoother, more constant torque during and beyond life cycling.

Other unique features of the series are:

- Engineered to withstand heat — during soldering.
- Internal air meshing shells are silver plated to provide best surface conductivity and long life.

All MVM's are completely interchangeable with competitive models.

Write for MVM catalogs.

**MVM-003** — Microminiature in size. Capacitance range is 0.35 pf to 3.5 pf. The Q factor measured at 3.5 pf and 100 MHz is 5,000. Available in 2 models.



**MVM-010** — Adjustable from 0.8 pf to 10 pf. Q greater than 3,000 measured at 10 pf and 100 MHz. Available in 4 models.



**MVM-020** — Adjustable from 1 to 20 pf. Q ranging from 3,000 at minimum capacitance, to 1200 at maximum capacitance. Available in 4 models.



Illustrations actual size.



"TODAY'S COMPONENTS BUILT FOR TOMORROW'S CHALLENGES"

**JFD ELECTRONICS CORP. / COMPONENTS DIVISION**

15th Avenue at 62nd Street / Brooklyn, New York 11219 / Phone 212-331-1000

SUBSIDIARY OF RIKER-MAXSON CORPORATION

## New products

example, the probes can scratch away the interconnections that join a suspect portion to the rest of a circuit. Then by applying the correct signals to the "good" portion, the troubleshooter can confirm or disprove that the problem lies in the severed section.

The Mark X's optical section is an arrangement of lenses and condensers bought from various manufacturers, rather than a single commercial microscope.

Comaltest engineers also build the station's microscope stages as well as the adapters that hold the device under the microscope and connect its leads to input sources and output loads.

The sharp-tipped probes are made by a special electrochemical process, which Comaltest explains to customers. "It just takes a little technique and a little patience," says Quinn.

Also available with the Mark X are a photographic setup which allows magnification up to 1,200X; a TV interface and monitor which lets the magnified view of an IC's surface be displayed; interferometric and phase-contrast attachments; and probe preamplifiers for MOS studies.

Delivery time for the probe station is 30 days. Getting the tester will take a little longer since it just came out of the prototype stage. Although intended to complement the probe station, the tester will also be offered separately, at a price of about \$18,000.

Mounted in a bench-type console, 5 feet wide and 4 feet high, the tester runs in either a static or dynamic mode. It's for IC development labs and, Quinn points out, there's no economical way to use it in high volume work.

A 50-pin connector joins the device under test to a switching network. In the static mode, the device is connected to a checkout network which feeds inputs to the device from constant-current supplies, and sends responses to a digital picoammeter, a digital voltmeter, and a curve-tracer port. The ammeter displays leakage currents, and the



**New from TRW**

**300 VOLTS**

**30 AMPS**

**$f_t > 100$  MHz**



**...a new concept in power supply design**

The high switching speed and high operating voltage of TRW's new PT6905 transistor provides a major forward step in power supply performance.

You can do away with the bulky 60 Hz transformer and work directly from rectified ac power lines. Switching above 20 kHz will assure your circuit is free from audio noise.

Consider these outstanding

PT6905 characteristics:

- $V_{CE0}$  300 V
- Sat. switching time  $< 900$  ns.
- Triple diffused double oxide construction for superior second breakdown characteristics.
- Hard-solder construction and welded interconnections

Available from stock in TO-63 or TO-3 non-isolated and TO-61 isolated collector packages.

For details and application as-

sistance contact TRW Semiconductors Inc., 14520 Aviation Blvd., Lawndale, Calif. 90260. Phone: (213) 679-4561, TWX: 910-325-6206, TRW Semiconductors Inc. is a subsidiary of TRW Inc.

**TRW**

# WE'VE GOT A BETTER WAY TO MAKE PRINTED CIRCUITS!

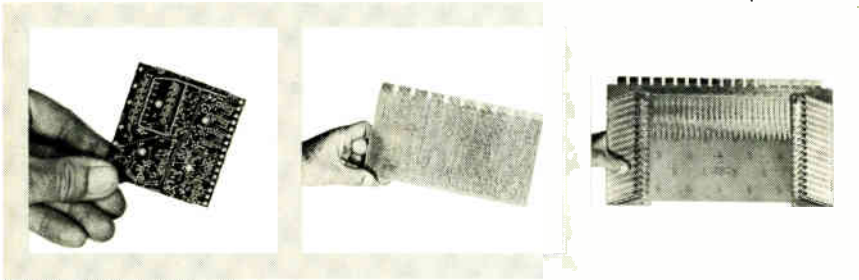

To avoid the necessity of a multi-layer circuit board for a process computer, we produced this high-density dual-inline double-sided board with a 6 mil line width and 8 mil line spacing. Ask us . . . we've got a better way to make printed circuits!

This 3-layer circuit board was designed to be as economical as most double-sided circuit boards . . . for the Control Data 7600 Computer. Ask us . . . we've got a better way to make printed circuits!

Not all multi-layer circuit boards are small. Although some of our circuits measure a fraction of an inch, double-sided circuit board produced for a memory system measures 18" x 22". Ask us . . . we've got a better way to make printed circuits!

## New products

voltmeter shows the breakdown voltages.

Rather than buy commercial meters, Comaltest engineers make their own. They're easy to build, points out Quinn, adding that it would take a lot of work just to repackage and modify off-the-shelf instruments.

**In the dynamic mode,** the tester joins the device to a 20-by-50 matrix. Shorting pins plugged into the matrix set up and sequence the desired tests. The matrix receives signals from a four-phase clock generator, a multichannel word generator, and three programable supplies, all of Comaltest design.

The clock generator has three modes—variable width/variable delay, variable width/fixed delay, and phase locked.

The ranges for width and delay are both 5% to 90% of cycle time. The outputs' amplitude can run between -30 volts and +12 V, and their frequency between 100 hertz and 10 megahertz.

The same ranges for voltage and frequency apply to the word generator. Word length for each channel can be specified as 8, 12, 16 or 32 bits, and channels can be tied together to produce up to 192-bit words.

In the first tester, the word generator will have 12 outputs, but only because the customer—MOS Technology Inc.—wants it that way. Quinn says any number can be specified.

For the first year or so the testers will have plenty of dials for adjusting the levels of various voltages and currents. But the face will eventually change since, as Quinn puts it, the tester "is being groomed for computer control." Tied to a minicomputer, the tester will be able to run quickly through many routine checkout and debugging programs. Comaltest will cover that part of the job, too. The company plans to write the software for these programs.

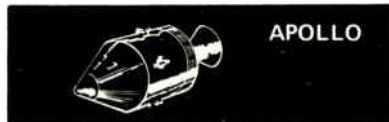

APOLLO

Our circuit boards were on Apollo, LEM, and seis, experiment. Sequential laminating, extra-fine line width and spacing, plated slots and edges.



GEMINI

Again, top reliability was required and delivery on-time was made to the customer.



F-104

Developed new technique to produce circuit boards with more reliable plated-thru holes.



C5

We introduced circuit boards that had the highest density circuitry ever used before on a production basis.

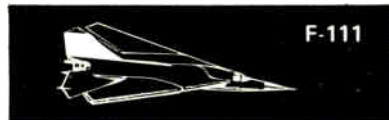

F-111

New industry technique was used to produce multilayer circuit boards with an internal heat sink.



PHOENIX

Required new techniques for manufacturing heat sinks and insulation by chemical milling.



707

Reliable circuit boards in high volume at low cost were produced for this project.



POSEIDON

Developed new technology for sequential laminating multi-layer circuit boards with aluminum backbone.



**This design and production experience can work for you . . . CALL US NOW.**

**CONTROL DATA  
CORPORATION**

CONTROL DATA CORPORATION  
CIRCUITS DIVISION  
7800 COMPUTER AVENUE  
MINNEAPOLIS, MINN. 55435  
PHONE: (612) 927-5681

Comaltest Inc. 124 S. 8th Street, New Hyde Park, N.Y., 11040 [339]

# Panel design ideas from Dialight

Many different push button cap and bezel options permit custom panel designing with standard switches and matching indicators. Designers and engineers are welcoming these low-profile, snap-in-mounting push button switches that are interchangeable with most 4-lamp and 2-lamp displays.

Units available in  $\frac{3}{4}$ " x 1" rectangular,  $\frac{3}{4}$ " square,  $\frac{5}{8}$ " round and  $\frac{5}{8}$ " square designs. Bezels with or without barriers in black, gray, dark gray or white. Legends are positive or negative—either visible or hidden when "off." Switches are momentary or alternate action and low level to 125V at 5A, resistive.

CIRCLE READER CARD NO. 250.



Snap-in bezel simplifies mounting. Fingertip grip permits easy cap removal. These switches and indicators are easily slipped into mounting cutout for a snug fit. No tools are needed.

Fingertip grip makes push button cap installation or removal an easy job. Caps come in a full range of colors or with underlying color filters. Each cap has a metal insert that receives T-1 $\frac{3}{4}$  bulb with

midget flanged base. Mounting cutouts may be made for individual units or for groupings of two or more units in horizontal or vertical panel configurations so that many different arrangements are possible.

CIRCLE READER CARD NO. 250.

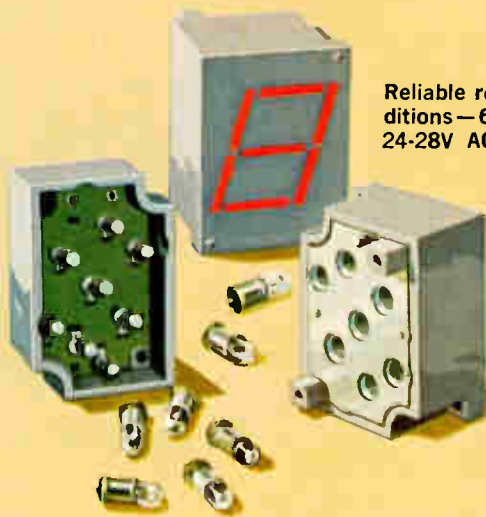

Reliable readouts for high ambient lighting conditions—6V AC-DC, 10V AC-DC, 14-16V AC-DC, 24-28V AC-DC, 150-160V DC or 110-125V AC.

You can read these readouts in a bright room from any viewing angle up to 30 feet away. Sharp seven segmented characters are formed by patented light-gathering cells (U.S. Pat. No. 3,210,876). They're designed for use with high-reliability neon or incandescent lamps to meet a variety of circuit voltage requirements. Separate BCD to 7-line translator driver. PC boards also available. Modules directly compatible with integrated circuit decoder drivers now universally available.

CIRCLE READER CARD NO. 251.

Wide selection of Datalites® and subminiature indicators are among 1,500,000 visual indicators available to designers. It's now easier than ever to select the units that meet your panel and circuit requirements from the many thousands of Datalites and subminiature indicator lights available from Dialight. Variety of lens shapes, colors and finishes. Many different positive or negative legends. Incandescent 1.35-120V; neon—high brightness at 110-125V AC and standard brightness at 105-125V AC-DC. For clearance holes from  $\frac{5}{32}$ " to  $1\frac{1}{32}$ ".

CIRCLE READER CARD NO. 252.

New 56-page Product Selector Guide provides data on 1,500,000 readouts, switches and indicator lights. Get your copy today.

CIRCLE READER CARD NO. 253.



## DIALIGHT DIALCO

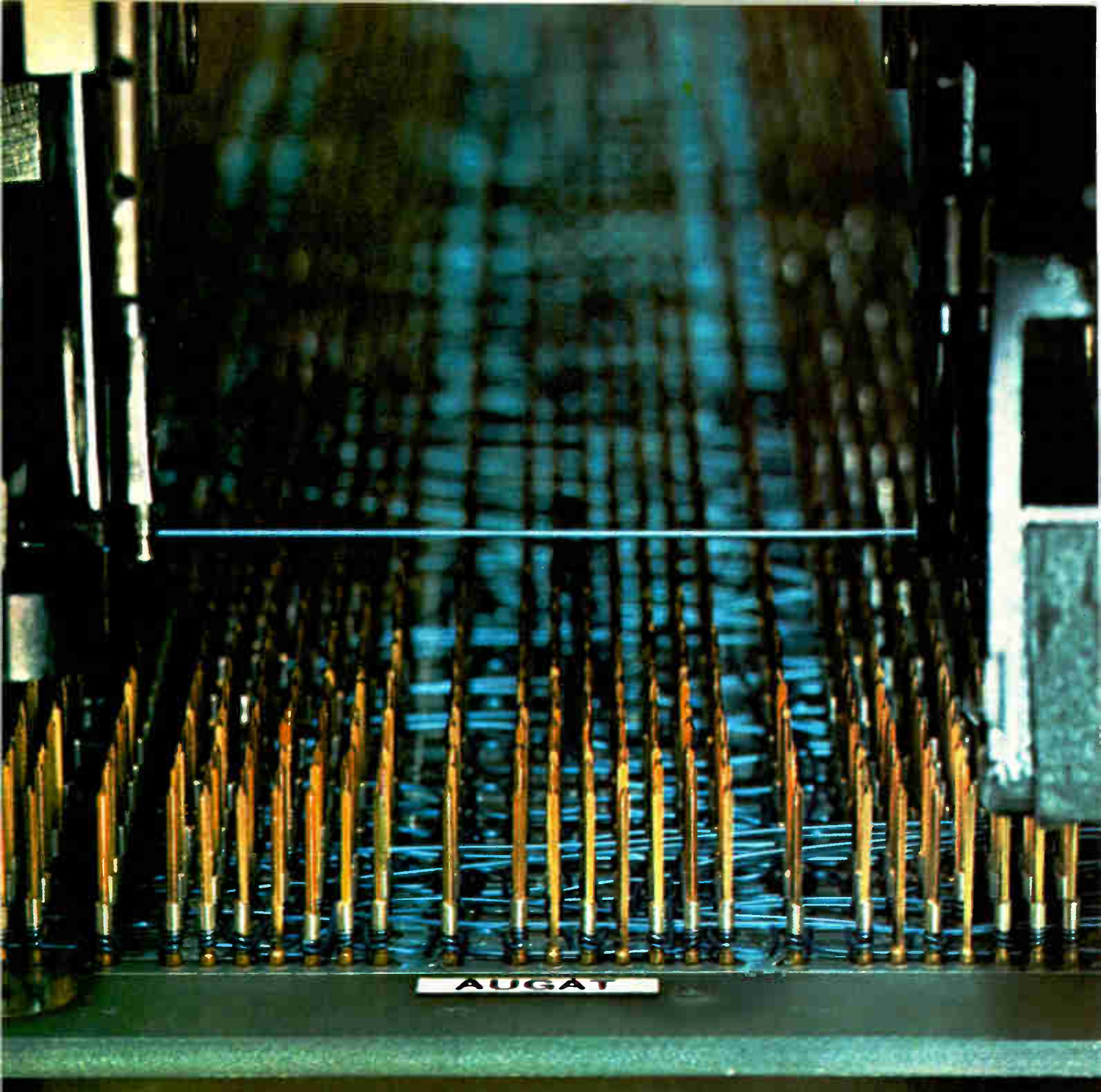

## Teamwork pays off

Complete Wire Wrapped IC Panels . . . One Source Responsibility

**Augat** and **Raytheon** are working together to cut your costs and turnaround time.

Augat . . . pacesetter in top quality IC packaging panels. Raytheon . . . most experienced and largest in wire wrapping service facilities. This unbeatable team is now delivering complete wire wrapped packaging panels, unmatched in versatility and quality. And Augat wraps it all up with single source responsibility.

Saves you time and money.

No setup charge for tooling or computer programming on any cataloged panels. Nominal charge, one time per card, to produce drive deck from wire list.

Simply furnish wire list with panel order.

Contact: Augat Inc., 33 Perry Ave.,

Attleboro, Mass. 02703.

Tel: (617) 222-2202

**AUGAT**  
INC.

## New products

### Subassemblies

# Portable VTR reproduces color

## Half-inch-tape cartridge aims recorder at huge industrial and home markets

In 1956, when the Ampex Corp. built the first practical video tape recorder, the company envisioned a huge industrial and entertainment market. Fourteen years later, they are carving themselves a piece of

this market, estimated by some to be as high as \$1 billion, with a new-generation VTR.

Called Instavision, the new machine will offer record and playback capabilities in either color or black and white, automatic cartridge loading, battery operation, and other features usually found only in studio equipment. While the first units will be geared for the growing educational, industrial, and medical markets, Ampex hopes to

penetrate the home entertainment sector when mass production gets under way. And the company is betting that the ability to record from tv will be the feature that the public wants—the CBS and RCA machines, EVR and SelectaVision, are for playback only.

Citing the lack of compatibility among home entertainment systems, Richard J. Elkus Jr., general manager of educational and industrial products, notes that Ampex



Bipolar input differential amplifier model ZA101D1 comes in a dual in-line package. It features maximum input voltage drift of  $15 \mu\text{V}/^\circ\text{C}$  ( $-25^\circ$  to  $85^\circ\text{C}$ ), common mode rejection of 50,000:1, and 4 MHz frequency response at unity gain. Maximum input bias current is 50 nA. Price (1 to 9) is \$20; delivery, from stock. Zel-tex Inc., 1000 Chalomar Rd., Concord, Calif. 94520 [381]

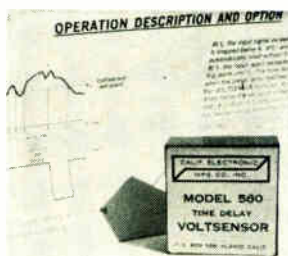

Model 560 Voltensor is a solid state voltage comparator with built-in time delay that allows for settling time or provides noise immunity. The time delay is adjustable from 5 to 100 ms with automatic reset, and the unit will sense a 1 mV change within 95% of full voltage range with no discontinuity through zero. California Electronic Mfg. Co., Box 555, Alamo, Calif. [382]

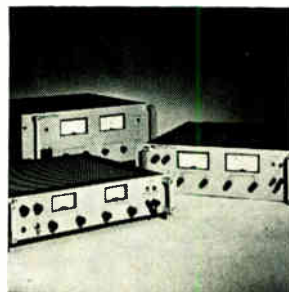

Low-voltage rack power supplies series LVR-B feature an internal overvoltage crowbar for protection of loads that are critical and expensive. The series of 13 models include the following outputs: 10 V at 20, 50, or 100 A; 20 V at 10, 20 or 50 A; 40 V at 3, 5, 10, 30 or 50 A; 60 V at 3 or 15 A. Hewlett-Packard, Berkeley Heights, N.J. 07922 [383]

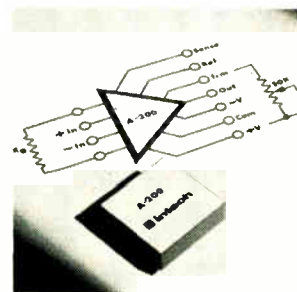

Fully differential FET-input instrumentation amplifier model A-200 has a gain range from 1 to 1,000. An internal feedback network allows true differential operation without degradation of the high input impedance (greater than 500 kilohms). Unit measures  $1.5 \times 1.5 \times 0.4$  in. Price in quantities of 1 to 9 is \$66 each. Intech Inc., 1220 Coleman Ave., Santa Clara, Calif. 95050 [384]



Laboratory power supply model 401 Digipower is a 4-in-1 unit. Its digital logic section furnishes 5 V dc at 3 A adjustable from 3-5 V with overvoltage protection. The linear section features dual-tracking dc outputs of 0.5 A, adjustable from 6-18 V. The MOS/relay section provides 0.5 A, adjustable from 15-28 V. Astro-Space Laboratories Inc., Huntsville, Ala. [385]

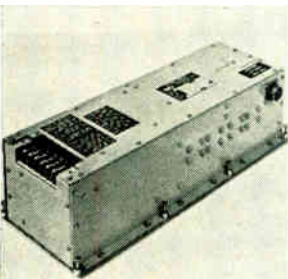

Multiple-output power supply model 23577 is for use in electronic fire control systems. Five outputs, ranging from 5 V dc to 28 V dc, are provided. Unit features plug-in circuit boards for each regulated output and ICs for space-saving reliability. It meets electromagnetic interference requirements of MIL-I-6181. Gentrionics Inc., 748 E. Alosta Ave., Glendora, Calif. [386]



Instrumentation amplifier model 603 uses FET circuitry for  $10^{12}$  ohms impedance. It combines 80 dB common mode rejection with 0.05% linearity. Unit is designed for amplifying signals from sources that impose severe common mode and impedance unbalance errors on the signal being measured. Price is \$54. Analog Devices, Inc., 221 Fifth St., Cambridge, Mass. [387]

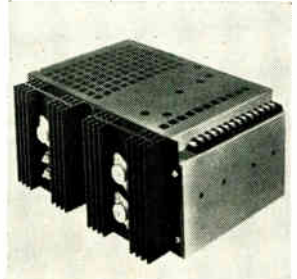

Power module TP3E provides three dc outputs and is designed for systems and OEM computer applications. Outputs are:  $\pm 3.2$  to  $\pm 5.5$  V dc, 0 to 6 A;  $\pm 10$  to  $\pm 26$  V dc, 0 to 1.8 A; and  $-5$  to  $-16$  V dc, 0 to 1.5 A. Prices vary with quantity but start at \$245 for unit quantities; delivery, stock to 4 weeks. Trygon Electronics Inc., Pleasant Ave., Roosevelt, L.I., N.Y. [388]

DISCRIMINATING  
ENGINEERS  
ARE  
AMAZED...

FIRST BY  
THEIR HIGH  
QUALITY  
&  
BROAD  
APPLICATION

...THEN BY  
THE  
LOW COST

**SWITCHCRAFT** *Preh*  
INC.

2 TO 7 CONTACT LOW-LEVEL AUDIO CONNECTORS

**FITS IN WITH TODAY'S TREND  
IN MINIATURIZATION**

Excellence throughout, low cost, wide variety of types and broad range of standard and optional features call-up practical and economical solutions to many design and cost-control problems in low level connections . . . particularly where miniaturization is a design consideration.

**OVER 90 CIRCUIT-TAILED TYPES**

Includes male and female plugs and receptacles from 2 to 7 contacts, in nickel-plated shells, or snap-on plastic shells. 13 different receptacles offer some form of internal switching (SPST, SPDT in addition to mating of contact circuits . . . in some instances eliminating need for external switches! Silver plated pins for low contact resistance. Exclusive "automatic" grounding and fool-proof polarization provisions. Contact friction coupling for minimal mechanical interference noise; locking coupling for reliability where vibration is a factor. Ingenious 8-

position right-angle plug enables you to position cable entry in any of 8 different angles. Etc., etc. Rugged and versatile . . . yet they cost surprisingly little.

**APPLICATIONS LIMITED ONLY BY  
YOUR IMAGINATION!**

Virtually unlimited commercial, industrial, consumer and military applications in any type of low level circuitry: audio and test equipment, instruments, computers, cameras, control devices, communications equipment and business machines. Receptacles for flush, extended, P.C. board, screw and rivet type mounting; straight cord, 90° angle; control and switching plugs: many others.

**SEND FOR THE NEW COMPREHENSIVE  
ENGINEERING SPECIFICATION**

CATALOG NO. C-503 or see your local Switchcraft Authorized Industrial Distributor . . . he has units for your inspection, and can make immediate delivery at factory prices.

**SWITCHCRAFT**®

5561 No. Elston Ave., Chicago, Ill. 60630

\* Preh is a trademark of Preh Electromechanical Works, Bavaria, Germany

**New products**



On scene. Battery operation, cartridge loading widen VTR's versatility.

has adopted the Type 1 standard of the Electronic Industries Association of Japan which applies to VTRs using 1/2-inch tape. Type 1 is responsible for compatibility among most Japanese VTRs.

The cartridge adopted by Ampex for Instavision is a small circular plastic package, 4.6 inches in diameter and 0.7 inch wide, enclosing a reel of 1/2-inch tape. Operation begins when the cartridge is inserted into the Instavision VTR and the record or play button is pressed. Automatic threading eliminates the need to touch the tape, but the cartridge also can be played on reel-type machines that conform to the Type 1 standard.

Instavision will be offered in several configurations—color record/playback; color playback only; black-and-white record/playback, and black-and-white playback only. Any model can be modified for color or record via plug-in modules. "The user therefore can build up from an inexpensive model to one that offers all modes of operation at any time," says Elkus.

A monochrome camera is available for recording. It contains a 4:1 zoom lens and an electronic viewfinder that is actually a miniature television receiver allowing the user to precisely frame his scene. While the camera is for black-and-white operation only, off-the-air recording can be done in color.

The basic recorder/player offers slow motion, stop action, automatic tape search, stereo audio record and playback, automatic threading, and

# the essential reference books from SAMS

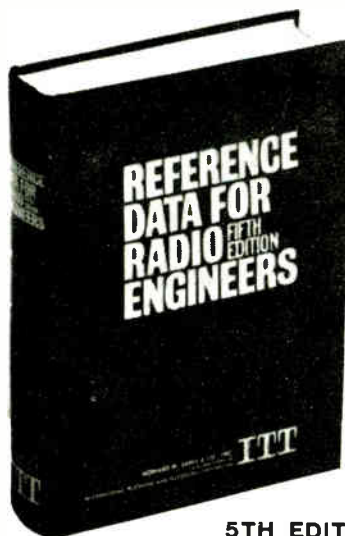

**5TH EDITION**  
of the world-famous electronics data source  
**REFERENCE DATA FOR  
RADIO ENGINEERS**

OVER 350,000 COPIES SOLD IN PRIOR EDITIONS

Now contains 50% MORE DATA to include major information developed over the past 12 years (includes all-new data on micro-miniature electronics, space communications, navigation aids, reliability and life testing, international telecommunication recommendations, switching networks and traffic concepts, and quantum electronics). Provides, in addition, comprehensive data on all basic phases of electronics, including tables, formulas, standards, and circuit information. Prepared by an outstanding group of practicing engineers, professors, and industry and government experts, under the direction of the International Telephone and Telegraph Corporation staff. 45 data-packed chapters; 1196 pages; over 1350 illustrations; plus 41 page index. Order 20678, only.....\$20.00

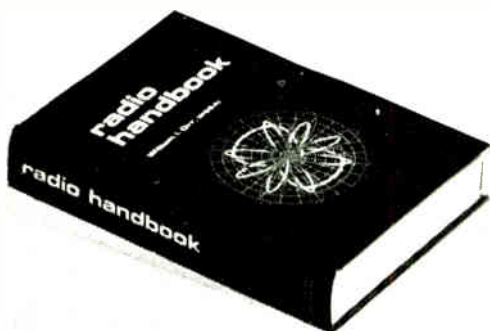

**NEW 18TH EDITION OF THE FAMOUS E & E  
RADIO HANDBOOK**

by WILLIAM I. ORR, W6SAI. Completely updated edition of the famous communications handbook which is the electronics industry standard for engineers, technicians and advanced amateurs. Explains in authoritative detail how to design and build all types of radiocommunications equipment. Includes SSB design and equipment, RTTY circuits, latest semiconductor circuits and IC's, as well as special-purpose and computer circuitry. Provides the broadest coverage in the field on how to build and operate a comprehensive variety of high-performance equipment. Order 24020, only.....\$13.50



**LATEST EDITION OF THE RENOWNED  
AUDIO CYCLOPEDIA**

by DR. HOWARD M. TREMAINE. This completely revised edition is the most comprehensive work on every phase of audio—virtually a complete reference library in a single volume. Includes the latest developments, right down to the newest solid-state and integrated circuits. Contains authoritative, concise explanations of thousands of topics in the fields of acoustics, recording, and reproduction. Covers basic principles, components and devices, film recording, studio techniques, motion picture equipment, audio installation techniques, audio measurements, etc. Over 1700 pages; 1600 illustrations. Truly the definitive reference work covering the entire audio art. Order 20675, only.....\$29.95

**MODERN DICTIONARY OF ELECTRONICS (3rd Edition)**

by RUDOLPH F. GRAF. This bestselling book now defines more than 16,500 terms directly associated with electronics. Includes special pronunciation guide. Also includes terminology often expressed in Greek alphabet symbols, abbreviated expressions for transistor parameters, and the most widely used electronic symbols and abbreviations. Covers terms used in the fields of microelectronics, space electronics, semiconductors, computers, data processing, etc. This famous work is the most complete and useful electronics dictionary available today. Over 400 illustrations. 608 pages. Order 20600, only.....\$9.95

**HANDBOOK OF ELECTRONIC  
TABLES & FORMULAS (3rd Edition)**

A convenient one-volume source for all charts, tables, formulas, laws, symbols, and standards used in electronics. Includes valuable data for technicians, as well as useful circuit design data for engineers. With 8-page full-color chart showing latest FCC frequency spectrum assignments. Order 20648, only.....\$5.50

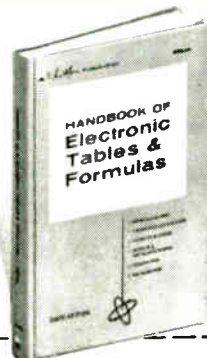

**HOWARD W. SAMS & CO., INC.**, Dept. EL-090  
4300 W. 62nd St., Indianapolis, Ind. 46268

Ship me the following books:

20678     20675     20600     20648     24020

\$\_\_\_\_\_ enclosed.

Name \_\_\_\_\_

Address \_\_\_\_\_

City \_\_\_\_\_ State \_\_\_\_\_ Zip \_\_\_\_\_

# How fast is GE's new helium leak detector?



## Let your fastest operator show you

Manufacturers of electronic components asked us to help cut down leak test time.

So General Electric engineers designed a new leak detector to do the job.

It's the LC-40 Mass Spectrometer Helium Leak Detector, which offers unmatched testing speed in a general purpose leak detector. The LC-40 achieves this by combining the highest net pumping speed of any leak detector on the market (for equivalent sensitivities), with fast recovery from leaks. This combination pays off in a time-to-test of only seconds.

Complementing this test-time capability is a new simplified control system, which permits the operator to complete a test merely by loading the test piece and flipping a single switch. Results are instantly displayed on a meter.

But the LC-40 detector isn't just fast. It includes such performance-proven features as all-solid-state circuitry for dependable service; burnout-resistant thoria-coated iridium filament, exclusive with GE; all-welded stainless steel high vacuum system; high sensitivity ( $5 \times 10^{-11}$  atmo. cc/sec He), a new source design to eliminate background signals, and many other significant advances.

Although ideally suited for high-speed production testing, the unit also can be used for general purpose applications. If you would like to learn more about General Electric's new LC-40 Mass Spectrometer Leak Detector, write General Electric Company, Analytical Measurement Business Section, 4MX, 25 Federal Street, West Lynn, Mass., 01905

268-41

GENERAL  ELECTRIC

## New products

elementary editing capabilities. Rewind or fast forward advances a complete tape in a minute. The user also can double the record time of a cartridge—a switch puts the unit in the extended play mode that is not compatible with the Type 1 standard but yields 60 minutes of recording time. Ampex hopes to offer up to two hours of recording time in subsequent units.

Included with each recorder or player is a separate power pack that houses an ac power converter for plug-in operation, a battery charger, and optional electronic circuitry for color playback. The power pack doubles as a base for the recorder during operation. It's detached from the VTR for portable operation—a set of rechargeable flashlight batteries provide the power in this mode.

When the Instavision recorders become available in mid-1971, they will be priced at less than \$1,500 for a color record/playback unit including a camera; about \$1,000 without the camera; and about \$900 for a black-and-white model. While Elkus sees broad applications for a portable unit, he indicates that Ampex eventually will offer an ac-only black-and-white machine for less than \$500.

Blank tape cartridges will cost about \$13 for either the 30-minute Type 1 standard or the 60-minute extended play. "While this might seem expensive at first, it's cheap compared to movie film," says Elkus. "The cost of color film with processing is about \$4 for three minutes or \$80 for 60 minutes—six times that of an Instavision cartridge."

The basic recorder/player weighs 15 pounds complete with rechargeable batteries and measures 11 by 13 by 4.5 inches. The power pack weighs 6.5 pounds and is 14 by 8 $\frac{3}{8}$  by 1 $\frac{1}{2}$  inches.

Instavision will be manufactured in Japan by Toamco, a joint venture between Ampex and Toshiba. Toshiba will market the line in Japan, Ampex elsewhere.

Ampex Corp., 2201 Estes Ave., Elk Grove Village, Ill. 60007 [389]



# circuit problems?



## ultra-high leakage resistance

Devices with leakage resistance in excess of  $10^{12}$  ohms are available for circuits requiring this property. Such applications would include sample and hold for A to D conversion, and capacitor memory systems. See Signalite Application News for typical applications.



## voltage regulators better than 1% accuracy

These subminiature voltage regulators are used in regulated power supplies, as reference sources, photomultiplier regulators, oscilloscopes, calibrators, etc. They are available in voltages from 82 to 143 V. They are used in multiples as regulators in KV ranges. See Signalite Application News for typical applications.



## photo-cell applications

The A074 and A083 have been designed for use with Cadmium Sulfide or Cadmium Selenide photo-cells. Applications include photo choppers, modulators, demodulators, low noise switching devices, isolated overload protector circuits, etc. Speed of operation is limited only by the photo-cells. See Signalite Application News for typical applications.



## neon timers

The bi-stable characteristics and high leakage resistance of Signalite's special glow lamps make them ideal as a component for timing circuits. The basic circuit resembles a relaxation oscillator network. See Signalite Application News for typical applications.

# Signalite

## glow lamps have solved problems in these areas:

- Voltage Regulation & References
- Photo-Cell Drivers
- SCR Triggering
- Timing
- Photo Choppers
- Oscillators
- Indicator Lights
- Counters
- Voltage Dividers
- Surge Protectors
- Logic Circuits
- Flip-Flops
- Memory
- Switching
- Digital Readouts

Signalite glow lamps combine long life, close tolerance and economy, and are manufactured with a broad range of characteristics to meet individual application requirements. For a creative approach to your design problem . . . contact Signalite's Application Engineering Department.

### SIGNALITE APPLICATION NEWS —



is used to communicate new and proven techniques and applications of Signalite's neon lamps and gas discharge tubes. Signalite Application News provides a forum for an exchange of ideas to keep the design engineer aware of the versatility of neon lamps and their many applications. Copies are available from your Signalite representative or contact Signalite.

# Signalite



A DIVISION OF  
GENERAL INSTRUMENT

1933 HECK AVE., NEPTUNE, N.J. 07753  
(201) 775-2490

319

# JAPAN ELECTRONICS SHOW

1971 OCTOBER 1-7 OSAKA  
1972 LATE IN SEPTEMBER TOKYO



Welcome your participation and your visit!

The SHOW gives you a great opportunity to go into the new market. Foreign manufacturers will account for over 1/3 of the exhibitors.

Sponsored by **ELECTRONIC INDUSTRIES ASSOCIATION OF JAPAN**

Conducted by **JAPAN ELECTRONICS SHOW ASSOCIATION**  
2-2, Marunouchi 3-chome, Chiyoda-ku, Tokyo, Japan

Circle 214 on reader service card

## Face up to the flat one!

The inherent advantages of Zenith Flat-Face CRTs assure the brightest, clearest display of alphanumeric and analog data. Parallax errors are minimized. Provides resolution as high as 2500 TV lines. Design variations include single and dual neck configurations. Optional rear projection ports and laminated implosion shields. For details, write or call (312) 674-8000.



**ZENITH RADIO CORPORATION**  
THE RAULAND DIVISION

5614 W. JARVIS AVE. • CHICAGO, ILL. 60648 • 312-647-8000

160 Circle 160 on reader service card

## New products

D-a converter fits  
in 1¼-inch flat pack

Depth saves area in a new line of hybrid digital-to-analog converters developed by Unisem. Depositing twice the usual number of metalization layers allows the components to be placed much closer together and produces a package 1¼ inches square, a size the firm claims is the smallest available for a 12-bit hybrid converter.

The H2200 series of 8, 10, and 12-bit converters house and interconnect 30 ICs through seven layers, including the storage logic, voltage switches, ladder network, output amplifiers, and reference supply. Only the chips and bonding pads can be seen on the surface—all interconnections are buried.

In the multilayer process, a metal pattern is screened onto the substrate. Then a glass pattern, which serves as an insulator, is screened and fired over this layer. The glass pattern consists of small windows, 20 mils square. A second metalization layer, screened over the glass, fills in the windows and interconnects the two metal layers. The process can be repeated up to a total of 10 metalization layers. The whole package is then hermetically sealed in a 44-lead flat pack.

The unit can deliver 12-bit d-a conversion with  $\pm\frac{1}{2}$  least significant bit resolution over the full MIL temperature range of  $-55^{\circ}\text{C}$  to  $125^{\circ}\text{C}$ .

Small and rugged, the converter

Surface look. Chip wiring runs through 7 metalization layers.

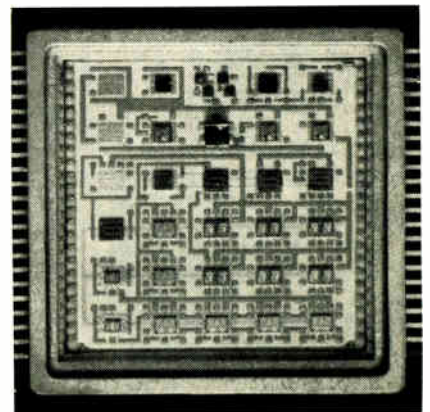

Electronics | September 14, 1970

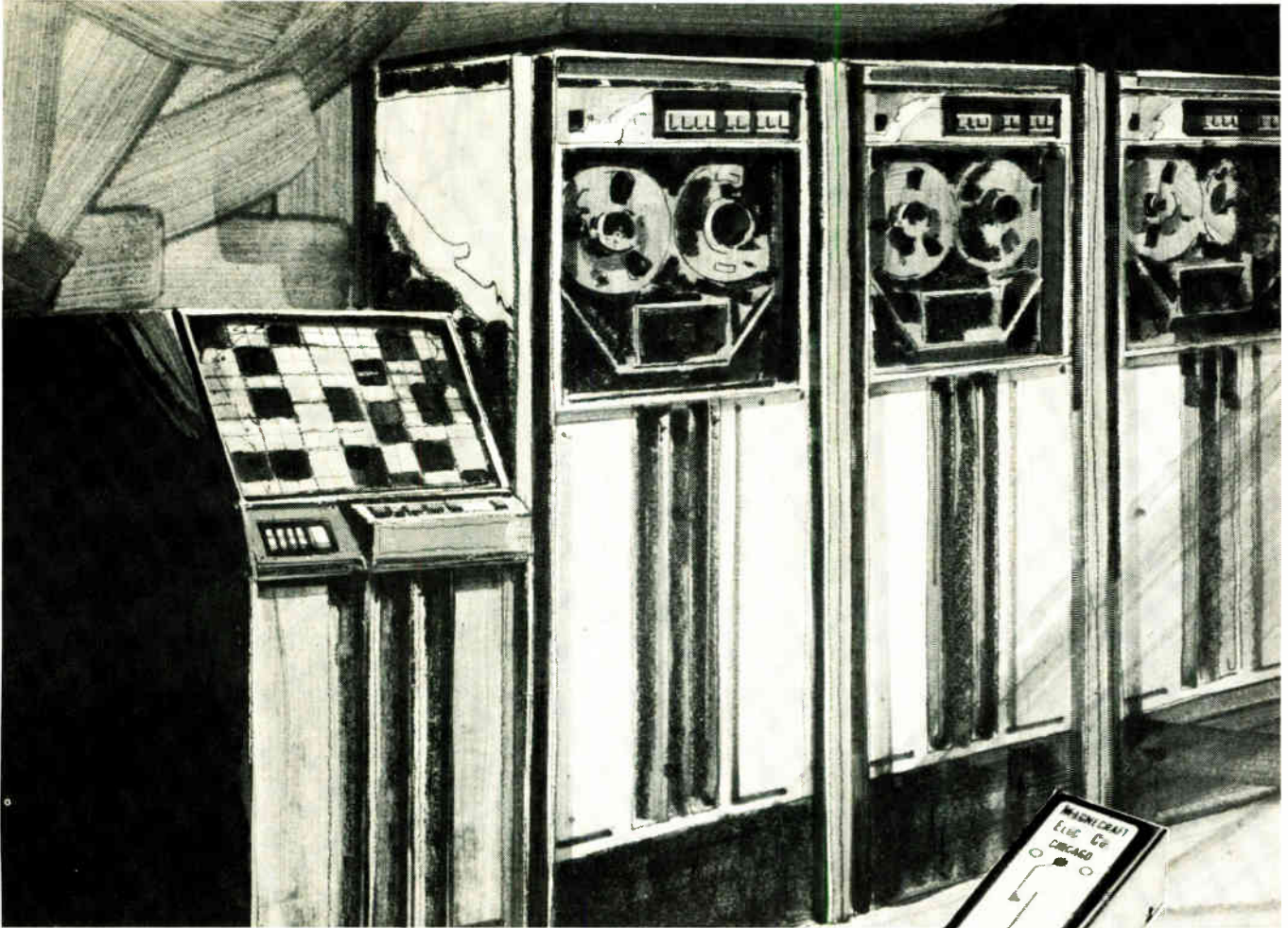

## **NEW! IC COMPATIBLE REED RELAYS**

***Let Magnecraft relays work, while  
your integrated circuits think...***

Our new IC compatible reed relays offer total isolation of the integrated circuit. These relays are capable of switching higher voltages, for example a neon lamp readout, while operating at the low input voltage of the IC, 2.5 volts or 5.0 volts.

Best of all, Magnecraft stocks the IC compatible reed relays for immediate delivery. They're priced right, too—as low as \$1.54 in 1000 quantities and even lower for larger quantities.

Contacts are rated 10 VA at 0.5 amp max. or 100 VDC max. resistive load with a configuration of SPST-NO (1 form A), and 3 VA at 0.25 amp or 28 VDC max. resistive load with a configuration of SPDT (1 form C). Two package designs for mounting are available: in-line axial leads; and low profile printed circuit type.

For all the facts on the new IC relays and Magnecraft's 512 other in-stock relays, send for our new Stock Catalog No. 271.

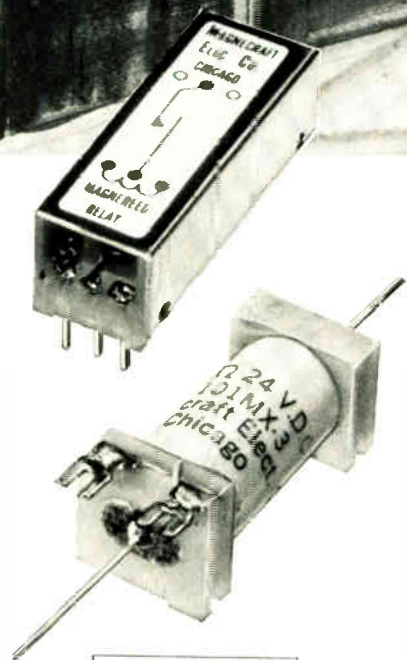

See our product data in EEM

# **Magnecraft<sup>®</sup> ELECTRIC CO.**

5575 NORTH LYNCH AVENUE • CHICAGO, ILLINOIS 60630 • 312 282-5500



## **GAS RADAR** GS-1

DX Gas Rader (Gas Detector) to safe guard you against Gas Danger which cost your life.

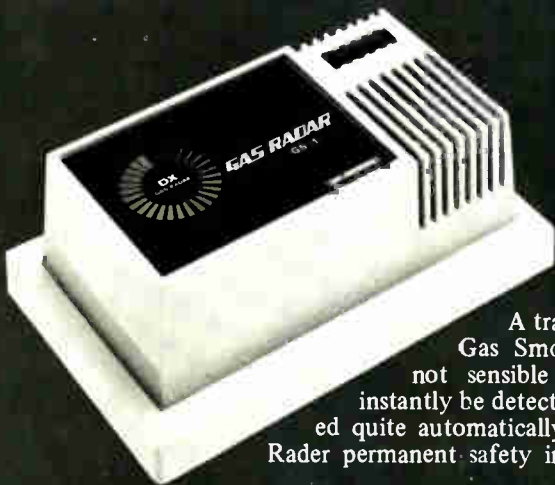

A trace of leakage Gas Smoke or Fume not sensible to you can instantly be detected and alarmed quite automatically by DX Gas Rader permanent safety in your home.

Highest sensitivity realized by DX Electronic level Gas Rader, Model GS-1. Negligibly Low Cost of Performance.\*

Quick response to present. The Growth of Danger to Uncontrollable magnitude. Extreme ease of Preparation.



**DX ANTENNA CO., LTD.**  
MANUFACTURERS, EXPORTERS  
CABLE DXANTENNA KOBE, JAPAN

**DX ANTENNA**

Circle 215 on reader service card

## *Introducing a cassette tape recorder for analog data collection*



Design features include four hours of simultaneous four-channel record time; PWM electronics with 33 dB dynamic range; standard C-120 cassette tapes; a self-contained battery power supply; and a three pound package.

Frequency response at the standard 15/32 ips tape speed is DC-100 Hz with PWM electronics and 200-2.5 KHz with interchangeable direct electronics. Optional

tape speeds of 15/16 and 1 7/8 ips provide the respective 2X and 4X frequency responses.

A companion dual-speed reproduce system provides playback in real time or with a time base contraction of 32 to one. Intermed, Dept. E, 2710 Forest Lane, Dallas, Texas 75234

**intermed**

162 Circle 162 on reader service card

## **New products**

has survived 20,000 G for 1.3 milliseconds in a shock tube. This toughness makes it especially useful for military and airborne applications, says John Zucker, marketing manager.

Inputs are DTL and TTL compatible, with provision for external strobing. The analog output provides up to  $\pm 10$  volts with built-in short-circuit protection, and the converter also features internal offset voltage nulling.

Unisem, Trevese, Pa. 19047 [390]

## **Subassemblies**

### **Silicon-target tube**

designed for high gain

**Ruggedness and sensitivity** are the main features of a new family of camera tubes from Westinghouse. Using a process called electron bombarded silicon, the tubes operate much like the company's secondary electron conduction line, but use a different target structure which is said to give 10 to 20 times greater sensitivity than SECs. The structure is similar to that of RCA's and TI's low-light-level tubes [*Electronics*, April 27, p. 155].

Westinghouse spokesmen say that the tube complements the existing line, including standard vidicons and image intensifiers, and is compatible as a direct socket replacement for the SEC tubes.

The new tube's target consists of an array of p-type silicon diodes diffused into one side of an n-type silicon wafer. The target's thickness is about 0.0005 inch with diode spacings of less than 0.001 inch. The complete camera tube consists of the EBS target, a fiber optic faceplate, photocathode, electrostatically focused image section, and a magnetically focused and deflected reading gun.

The high efficiency of the photocathode and high gain of the EBS target produce a typical sensitivity of 1,400 microamperes per foot-candle with a photocathode voltage of  $-10$  kilovolts. Using a standard 1/30th of a second frame

# SHARP FIGURES WITH MOS/LSI.

You're looking at a good customer's good product. The remarkable Sharp Micro Compet desk-top calculator that weighs just a little over 3 pounds. The world's best seller.

Our company, North American Rockwell Microelectronics, is producing more than 250,000 advanced MOS/LSI circuits a month. Five are employed in each machine, mounted on a 4" x 5" circuit board, as its calculating system.

## **Largest MOS/LSI order in history.**

North American Rockwell became the world's largest producer of advanced MOS/LSI circuits when the Sharp Corporation (formerly Hayakawa Electric Company of Japan) signed a \$30-million contract for these components.

Sharp now makes more than 30,000 of these calculators a month. Simple arithmetic shows we're well ahead of our

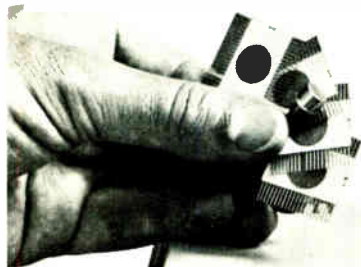
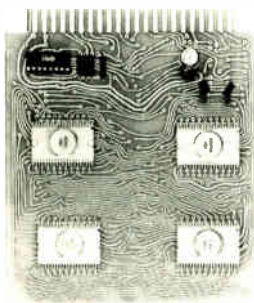

# OURS.

ing MOS/LSI systems or circuits for calculators, mini-computers, computer terminals and data transmission multiplexing systems, both airborne and ground.

## **Prices guaranteed, product guaranteed.**

NR - Microelectronics has developed innovations for making custom MOS logic and memory

devices at the lowest prices in the industry.

Cost effectiveness is just one of many customer appeals.

We're ready to protect our customers with guaranteed prices for the number of years required. And if we design the custom circuits you use, we're prepared to assure that they'll be yours exclusively.

Our telephone number is (714) 632-2231. Our zip code in Anaheim, California, is 92803.

customer's needs.

Since the initial contract, Sharp has signed an even larger follow-on contract.

## **The only house where everything's in-house.**

Today, NR-Microelectronics is the only company with total capability to transfer a multiplicity of circuit functions into a single MOS/LSI device and then mass-produce them. With our versatile computer equipment, we've designed more logic capability into a given circuit on a larger chip than other semiconductor manufacturers. Presently we're supplying or design-



**North American Rockwell  
Microelectronics Company**

# What Memory-System Maker Is Speeding Up the Cycle Time — But Holding Down the Price?

Toko. Of course!

Beef up your technology with Toko's 500 nanoseconds Memory System without raising your costs.

Now rolling off the production line, Toko's HS500R Memory System offers the following key features:

- \* Access time of 250ns.
- \* Memory capacity of 4K words by 18 bits expandable to 16K words by 18 bits, rearrangeable to multiples of 36 and 72 bits.
- \* Compact, space-saving advantages—measuring 10" x 19" x 13-1/3".

Toko's advanced electronic technology also enables it to provide computer components, such as memory stacks. Contact Toko today for details.

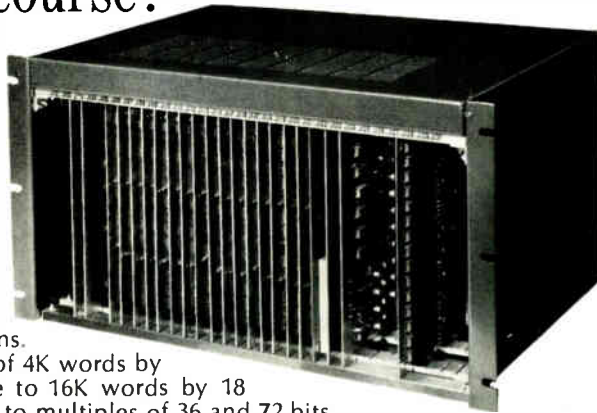

**TOKO, INC.**

Head Office: 1-17, 2-chome, Higashi-Yukigaya, Ohta-ku, Tokyo, Japan  
TOKO N.Y., INC. 350 Fifth Avenue, New York, New York 10001 Tel: 212-565-3767

Circle 216 on reader service card

## USING ACTIVE FILTERS OR PASSIVE FILTERS ?

**Are size, shape or weight considerations important? Special mechanical configurations offered—Hermetically sealed or encapsulations for pcb installations**

**Low, high, band pass and reject designs—Butterworth, Chebishev, Bessel or elliptic response characteristics—wide range of source and load impedances**

**Low frequency actives, stable toroidal LC's, RC twin-T's**

**No EXTERNAL components required**

**Unbiased recommendations on active or passive filter selections for maximum economy**



**instruments, incorporated**

PHONE AREA 512/892-0752 • P.O. Box 698 AUSTIN TEXAS 78767

164 Circle 164 on reader service card

## New products

time, the maximum signal current is typically 1  $\mu$ A.

Operation is similar to SEC tubes. An optical image focused onto the fiber optic faceplate is conveyed by many small light-transmitting fibers to the photocathode, which emits electrons in direct proportion to incident light. The electrons are accelerated by a high electrostatic potential from the photocathode toward the target and are focused by the diode image section to strike the target in a pattern that corresponds to the scene.

Typical limiting resolution for the EBS tube is 600 tv lines per picture height at the center, and 450 tv lines at the corner. Center square wave amplitude response at 200 and 400 tv lines typically are 60% and 20%, respectively.

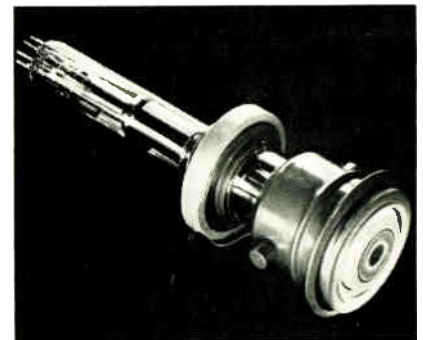

Compatible. New tube is a direct socket replacement for an SEC type.

Sensitivity is achieved at the expense of slightly higher lag and higher dark current. With 15 volts or less target voltage, lag in the third field (50 milliseconds after light is turned off) typically is 8% when compared to a starting signal current of 200 nanoamperes.

Even higher sensitivity can be obtained by fiberoptically coupling the tube to an image intensifier. This can provide 100 times greater sensitivity than for the EBS tube alone—and with no compromise in performance.

The base price is \$8,000. Delivery time is 30 days.

Westinghouse Electric Corp., Electronic Tube Division, P.O. Box 284, Elmira, N.Y. 14902 [391]

Circle 165 on reader service card →

# We've upped the line to 7 pin spacings without upping the price.

CTS cermet industrial trimmers  
still 50¢ each.\*



Stability of  $\pm .03\%$   
and environmental  
performance requirements  
of characteristic  
C of MIL-F-22C97D plus:

- 1.5% average equivalent  
noise resistance
- 0.5% average CRV
- $\frac{1}{2}$  watt @ 70°C
- TC  $\pm 150$  ppm/°C

Now you can choose from an  
expanded line of compact CTS  
Series 360 single-turn cermet  
trimmers. Seven pin spacings:  
.150" — .125" — .100" in both top  
and side adjust, plus TO-5  
arrangement in side adjust  
only. (TO-5 style at extra cost.)  
All available from your CTS  
Distributor, still at the lowest  
cost in the industry: **just 50¢  
each**: CTS of Berne, Inc.,  
Berne, Indiana 46711. Phone:  
(219) 589-3111.

\*in 50,000 quantity for  $\pm 20\%$   
tolerance. Add 4¢ for 10% tolerance.  
Comparably low prices for smaller  
quantities.

CTS CORPORATION  
Elkhart, Indiana



Your CTS Answer Man  
stands ready to fit our  
expanded trimmer line  
into your application.

Next time you spec a solenoid, odds are 61,034 to 1 that Guardian can provide the one that will do the job. Because we've got that many standards... solenoids in every imaginable shape and size to meet virtually any electro-mechanical requirement. AC or DC. Hefty 50 pound pull or a fraction of an ounce. Intermittent or continuous duty. Pull

or push. Laminated, C-frame, box-frame or tubular. In 25 basic designs and 61 thousand variations. Not enough? Then we'll custom engineer a solenoid to fit your specialized application. (And you didn't know there was a Guardian Angel watching over engineers!) **NEW 44-PAGE GUARDIAN SOLENOID CATALOG** is yours for the asking. Write for Bulletin G-3.

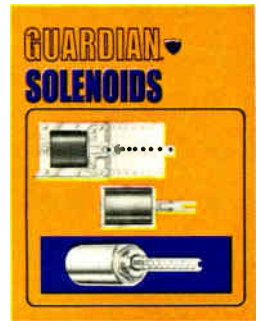

**GUARDIAN® ELECTRIC**

**MANUFACTURING COMPANY**  
1550 West Carroll Avenue, Chicago, Illinois 60607

***Your Guardian Angel stacks the odds in your favor  
(61,034 to 1)***





## New products

### Data handling

# Medium-sized memory fills market gap

Cycle time is traded for low cost per bit in 3-D, 3-wire system

When is a medium-sized, medium-fast memory as valuable as a big, fast one? When it's plugging a hole in a product line, says Richard Bravo, director of memory systems marketing at Electronic Mem-

ories and Magnetics Corp., Hawthorne, Calif. The firm's Electronic Memories division, which makes cores, core stacks, arrays, and systems, has introduced a new memory system that's slower than one it already is selling, but the company feels the new unit's capacities and low cost per bit will make it fit comfortably into its own market niche.

The Nanomemory 4850 has a cycle time of 850 nanoseconds and

an access time of 350 ns. Though cycle time is 350 ns slower than a smaller system Electronic Memories has been delivering for some time, Bravo explains, "our present systems line jumps from memories with 16,000 words by 18 bits to 32,000 by 40 bits. These are both fast 2½-D systems, but as we had nothing in between that was cost effective, we wanted to plug that hole. The big, fast memory is a good item for us, but there's a nar-



Portable data recorder model R-250 is an IRIG-standard unit for recording and reproducing analog signals from dc to 5 kHz on ½-inch-wide magnetic tape using a pulse fm system. It comprises eight tracks with seven independent record/reproduce channels and one voice channel, and a three-speed tape transport. Teac Corp. of America, 2000 Colorado Ave., Santa Monica, Calif. [341]

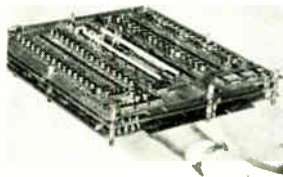

Random access core memory Comrac 30 is for minicomputers and terminals. It features 900 ns full cycle time. The entire basic memory (up to 8 K x 9 or 4 K x 18) is composed of three boards—a drive board, a data board and a core array which is the center board—all mechanically connected as a single plug-in assembly. Information Control Corp., 9610 Bellanca Ave., Los Angeles [342]

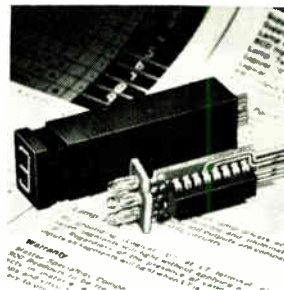

Fiber-optic readout 901 D2-D8, with a choice of five different built-in decoder/driver ICs, reduces mounting, wiring and pc board requirements as well as equipment size. The IC decoder and lamp drivers will accept 4 line 8-4-2-1 BCD inputs, translate them and then illuminate the proper fiber-optic readout segments. Master Specialties Co., Costa Mesa, Calif. [343]

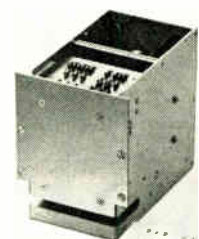

Numeric card printers for OEM applications accept serial count, time, 10 line or BCD, in any combination. Maximum complement is 20 columns. Each column can have up to 12 characters. Printing is ribbonless. Multiple copy printing is feasible, and optionally multicolored. Mounting may be behind panel or on table top. Practical Automation Inc., Trap Falls Rd., Shelton, Conn. [344]

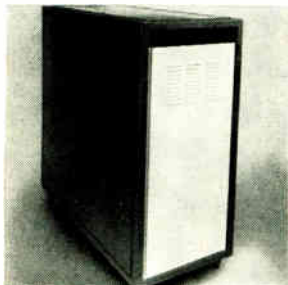

Disk memory systems series 10,000 offer storage capacities up to 10 million bits. They utilize fixed nonpositioning flying heads for fast access to all data. Included as standard equipment, each consists of complete TTL read/write logic and tuning system, disk cabinet, and power sequencing controls. Information Data Systems Inc., E. Eight Mile Rd., Detroit, Mich. [345]

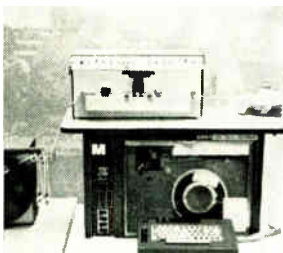

High speed perforated tape processor is for use with the NCR 735-501 encoder and MDS1105 paper tape reader. It consists of a high speed automatic electric winder, high speed center-feed unwinder with automatic braking, and a processor board. Both winder and unwinder operate at speeds up to 400 in/s. System costs \$485. Data-Link Corp, Box 5446, San Mateo, Calif. [346]



Digital cassette for computer applications features antistatic tape and liners, lubricated bearings, and a positive hub lock that eliminates tape slippage. Units are certified individually for absence of dropouts at 800 b/in. at 15 in./s. Cassettes contain 300 ft of computer grade tape. Price is \$2.50 in 100 lots. Computer Cassette Co., 4087 Glencoe Ave., Venice, Calif. [347]

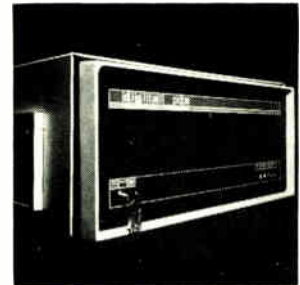

Minicomputer PDP-11/15 is for the OEM market. Price of \$6,200 for single units includes central processor; programmer's console; 4,096 sixteen-bit words of 1.2 µs cycle time core memory, expandable to 32,768 words; and Unibus data path for communications between computer components without going through central processor. Digital Equipment Corp., Maynard, Mass. [348]

# Quick-connect Fuseholders and Fuseblocks

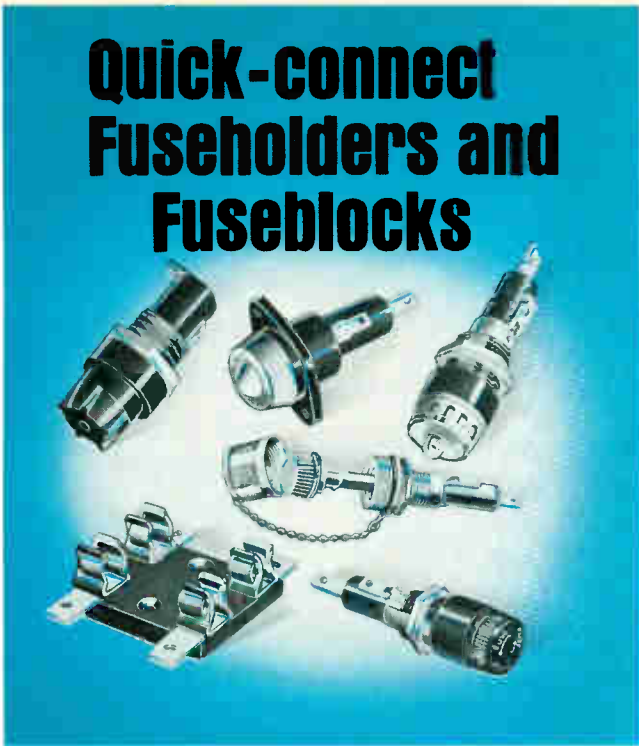

The complete line of BUSS fuseholders and fuseblocks is available with quick-connect terminals to save assembly time and cut costs.

Bussmann Mfg. Division, McGraw-Edison Co., St. Louis, Mo. 63107

Circle 217 on reader service card

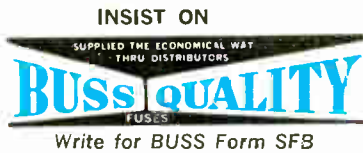

# Tron Rectifier Fuses

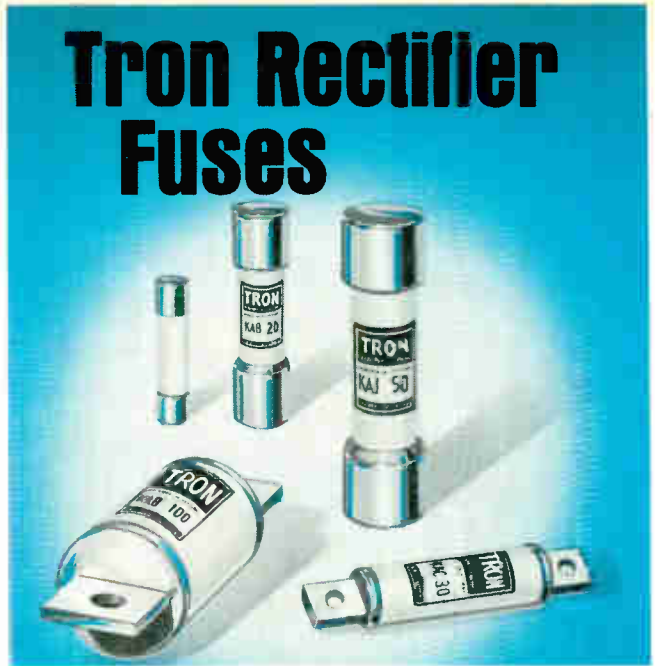

Available in sizes from 1/2 to 1000 amps for voltages up to 1500, TRON Rectifier Fuses are ideal for protecting variable speed drives, inverters, battery chargers, plating power supplies, power controls, and any other application where fast opening and great current limitation are required.

Bussmann Mfg. Division, McGraw-Edison Co., St. Louis, Mo. 63107

Circle 217 on reader service card

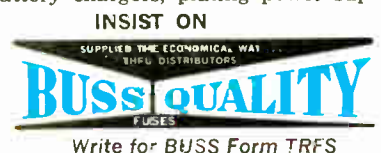

## BUSS: The Complete Line of Fuses and . . .

# PERFECT YOUR CCTV SYSTEM WITH COSMICAR<sup>®</sup> LENSES

Easy-to-operate, optically and mechanically superb lenses for CCTV and VTR cameras. That is exactly what Cosmicar is ceaselessly researching and endeavoring to make and is producing today.

A complete range from 8.5mm up to 1,000mm Cosmicar lenses. Plus zoom lenses. Including some motor-driven lenses. Noted for superb resolving power and edge-to-edge sharpness.

Be sure to get the finest image recording results with quality Cosmicar lenses.



### REMOTE CONTROLLED ZOOM

Article Number:	#RZ-5015
Lens description:	22.5~90mm 1:1.5
Number of lens element:	15, hard-coated
Focusing range:	5 feet or 1.5 meters to infinity
Maximum outside diameter:	12Cmm
Mounting type of the lens:	C-mount Focal distance=17.526mm (0.690")
Net weight:	2,500 grams
Motor are driven with 50V. A.C.	
Control Box and Control Cable attached.	



## COSMICAR OPTICAL CO., LTD.

568, Shimocroissai, 2-chome, Shinjuku-ku, Tokyo, Japan Cable Address: "MOVIEKINO TOKYO"

Circle 168 on reader service card

## New products

row customer base just now.

"When we asked what was the speed of most of the half-million bit memories being sold," he continues, "we found it was somewhere between 800 ns and 1.2 microseconds, and we concluded we couldn't serve that market with our small (16k by 18) or large (32k by 40) modules." Hence the Nanomemory 4850, which will be available in 4,096, 8,192, 16,384, and 32,768 words, and bit lengths from eight to 40 in five-bit increments.

The new unit is the first commercial three-wire, 3-D system marketed by Electronic Memories; the firm has relied extensively on the 2½-D organization it pioneered in the commercial market. "If you don't need to go blazing fast," Bravo notes, "you can go to 3-D and save money. A 2½-D system might be 25-30% faster, but it can be 20% more expensive, too."

"It's big enough to be the main-

frame memory for a medium-sized computer," Bravo says, mentioning the PDP-10 and Sigma 7 machines. The Nanomemory 4850 already is being sold; the largest customer to date, Bravo says, is a telephone company that's using it essentially as the mainframe memory in a central processor.

The price of the Nanomemory 4850 will be between 3 and 4 cents a bit in the 16,000-word-by-40-bit and 32,000-word-by-20-bit sizes, against 5-6 cents a bit for a comparably sized 2½-D unit. But Bravo isn't pushing the three-wire, 3-D organization as a major selling point. The core stack, which evolved from military designs, is particularly reliable, he says. It uses laminated finger contacts pressed together around the periphery of the stack, eliminating the need for half the usual riser wires. This means 50% fewer solder bonds—and solder-joint failures are the most common reliability prob-

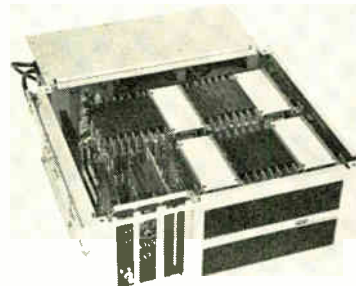

Median. Memory of medium size and speed features low cost per bit.

lem in core stacks, Bravo says.

The cores are bonded to aluminum frames that are interconnected by the molded fingers. The rigid metal substrate helps protect against shock.

The Nanomemory 4850 is housed in a 7-inch-high sliding drawer that's 2½ inches deep. It mounts into a standard 19-inch rack.

Electronic Memories, 12621 Chadron Ave., Hawthorne, Calif. 90250 [349]

## Fuseholders of Unquestioned High Quality

### FUSES

for protection of Electronic Devices



There is a complete line of BUSS Quality fuses in ¼ x 1 inch, ¼ x 1¼ inch, and miniature sizes, with standard and pigtail types available in quick-acting or dual-element slow blowing varieties.

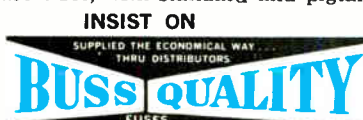

Write for BUSS Form SFB

Bussmann Mfg. Division, McGraw-Edison Co., St. Louis, Mo. 63107

Circle 169 on reader service card

### Subminiature Fuses and Fuseholders



BUSS has the fuses and fuseholders for space-tight applications, in a wide range of ampere ratings from 1/100 to 15. Allow visual inspection of element. Tiny but tough, they're built to withstand severe environments.



Write for BUSS Form SFB

Bussmann Mfg. Division, McGraw-Edison Co., St. Louis, Mo. 63107

Circle 169 on reader service card

# TRY TO MATCH THIS

for size and reliability

## you can't!

For their size, Type BB resistors pack a tremendous power dissipating ability. Rated 1/8 watt at 70°C in a 0.0004375 cu. in. volume.

And miniaturization has not reduced reliability. Tests prove it. They satisfy the highest level—the S level—of the latest MIL-R-39008 Established Reliability Specifications in all resistance values.

The key is hot molding—the Allen-Bradley way. A-B developed and built the machines. Only A-B uses them. They're fully automatic. Built-in precision control. A high degree of uniformity. Predictable performance from resistor to resistor—year after year.

For immediate delivery at factory prices call your authorized A-B industrial electronics distributor. Or write Marketing Dept., Electronics Division, Allen-Bradley Co., 1201 South Second St., Milwaukee, Wis. 53204. Export Office: 1293 Broad St., Bloomfield, N.J., U.S.A. 07003. In Canada: Allen-Bradley Canada Limited.

© Allen-Bradley Company 1969



**ALLEN-BRADLEY**  
QUALITY ELECTRONIC COMPONENTS

EC69-80



### Exclusive

Only A-B Type BB  
RCRO5 meets MIL-R-39008  
ER (established reliability)  
for 1/8-watt resistors  
at the S level.  
Shown actual size.

## New products

Packaging and production

# Modules simplify linear-IC testing

Interconnection of 2 to 7 subassemblies builds circuits for fast checkout

In the absence of standardized parameters and test methods for linear ICs, the user has little choice but to spend hours devising his own tests. To help him manage this task, I.C. Metrics Inc. has put

together seven modular test sets and a 175-page manual.

The modules are subassemblies of test circuits that provide bias, small signals for ac tests, floating bias, voltage division, attenuation, and other functions needed for linear-IC testing. To construct a test circuit for a particular parameter, a minimum of two to a maximum of seven modules are interconnected with laboratory instruments such as voltmeters,

power supplies and scopes.

"Since the engineer is not building test circuits from discrete components but from prefabricated circuit blocks, a considerable time-saving in circuit synthesis results," says Vice President Fred Gans. "And if only a certain number of parameters are of interest to the engineer," adds Gans, "he can choose from a selection chart those models which fulfill his needs."

But the greatest advantage the

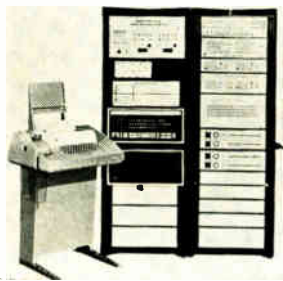

Computer-operated system W102 is for hot-tailoring film resistors in hybrid circuits. The dynamic adjust system controls x-y positioning optics and a trimming laser that adjusts up to 20 resistors on a single chip while simultaneously checking dc circuit operation. It can process 3,000 typical substrates per hour. Teradyne Applied Systems, 4034 N. Nashville Ave., Chicago [421]



Automatic handlers series 7000 provide high-frequency dynamic testing of ICs at temperature extremes. The controlled temperature is variable from  $-55^{\circ}$  to  $150^{\circ}\text{C}$ . Units are for testing in engineering evaluation departments, production quality control labs, and for incoming inspection. Price range is \$5,000 to \$6,000. Headway Research Inc., 3713 Forest Lane, Garland, Texas [422]

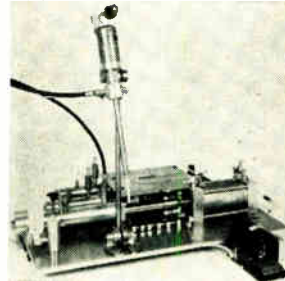

Mixer-dispenser measures shots of 2- and 3-component resins automatically. It permits accurate dispensing of very small shot sizes ( $1/10\text{th cc}$ ) and ranges upward to an accurately measured volume of 5 cubic inches. Accurate mixing and positive shut-off are provided by a principle in valving assuring complete synchronization. Otto Engineering Inc., Carpentersville, Ill. [423]

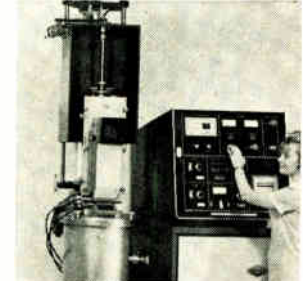

High capacity crystal growing furnace CG-700 produces single silicon crystal with diameters up to  $3\frac{1}{2}$  in. or lengths to 32 in. This reduces semiconductor device cost. For example, about 400 ICs on 50-mil squares are obtained from a wafer  $1\frac{1}{4}$  in. in diameter. A  $3\frac{1}{2}$ -in.-diameter wafer can provide 3,000 such ICs. Hamco, Div. of Kayex Corp., 1000 Millstead Way, Rochester, N.H. [424]

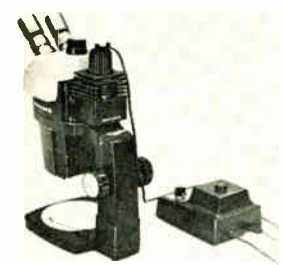

Coaxial illuminator with the StereoZoom 7 microscope offers greatly improved stereo microvision through superb incident (vertical) illumination of the specimen. It is useful on highly reflective subjects such as integrated circuits, pc boards, plated metals, metallurgical specimens and micro assembly work Bausch & Lomb, 635 St. Paul St., Rochester, N.Y. 14602 [425]

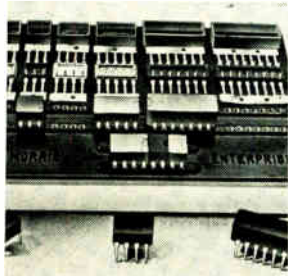

Molded epoxy DIP headers and cases are available for packaging reed relays, pulse transformers, delay lines, resistor networks, ICs and related items. They are available in standard 14- and 16-pin styles, plus 4, 6, 8, 10 and 12 pin packages that can be grouped on standard sockets for space saving. Morris Enterprises Inc., 16799 Schoenborn St., Sepulveda, Calif. 91343 [426]

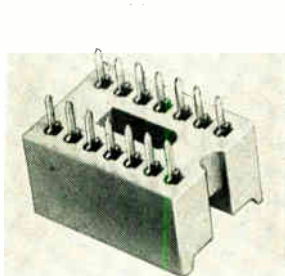

Socket type 561 fits 14-pin dual in-line ICs on 0.100 centers for adjacent terminals. Consistently reliable mating of the IC package is achieved by completely tapered pin entrance design. Solder tail centers of the socket are identical to those of the IC, permitting standard board layouts to be used with sockets as desired. Connector Corp., 6025 N. Keystone Ave., Chicago [427]

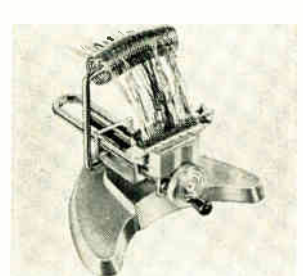

Connector work positioner LM204B holds electrical connectors and lead wires in position so solder flows down into the joint during wiring. The holder keeps the wires separated and positions them vertically for maximum assembly efficiency and accuracy. The vise has reversible jaw pads and a 0-to 2.5-in. grip range. Line-Master Products, Lawndale, Calif. [428]

# III-V semiconductors for electronic devices

## InSb

We're the first company in Japan to develop an extra-wide InSb crystal. With a diameter up to 2.36" (60mm). And that's the world's largest.

## GaAs

Sumitomo produces single crystals of high purity. Making possible accurate doping with various agents.

## GaP

Sumitomo utilizes the VG method to insure extra purity. Yours in large size poly-crystals.



## SUMITOMO ELECTRIC

Electronic Materials Section  
Research & Development Laboratories  
P.O. Box 1, Konohana, Osaka, Japan



Circle 218 on reader service card

## Varo Epoxy Bridge Rectifiers are mounting successes

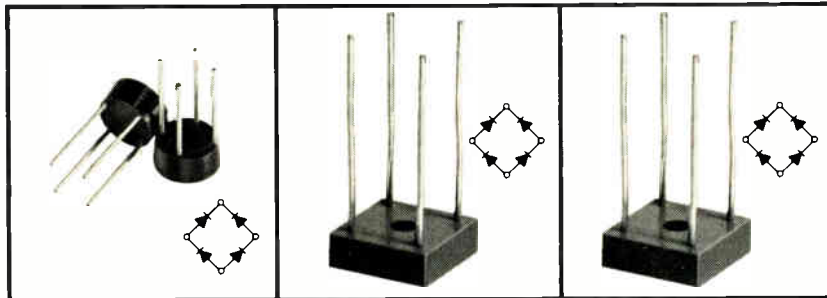

### 1 Amp EBR

Circuit board mounting.

**ONLY 91<sup>c</sup>**

In 200V rating and quantity of 1,000. Available in 200V, 400V and 600V ratings, full-wave bridge and controlled avalanche.

### 2 Amp EBR

Circuit board mounting.

**ONLY 95<sup>c</sup>**

In 200V rating and quantity of 1,000. Available in 200V, 400V and 600V ratings, full-wave bridge and controlled avalanche.

### 6 Amp EBR

For chassis mounting.

**ONLY \$1.59**

In 200V rating and quantity of 1,000. Available in 200V, 400V and 600V ratings, full-wave bridge and controlled avalanche.

Write for complete information on Varo rectifier products.



**VARO**

SEMICONDUCTOR DIVISION, 1000 N. SHILOH ROAD, GARLAND, TEXAS 75040 (214) 272-4551

## New products

modules offer, according to Gans, is stability: "Once stability is established, it persists through the measurement of several parameters, since the discrete components housed in the modules are never moved or disturbed." Changes in test parameters are effected simply by turning rotary switches located on the front panel.

Each module functions as follows:

- Model 411 amplifier plug-in: accepts the linear IC and makes the device terminals available through front panel jacks. A 14-pin programmable plug-in board is available to connect the linear IC with the plug-in module. The board has a universal mating connector that accepts dual in-line, flat pack, or TO-type packages.

- Model 412 bias supply: provides and controls the amplitude of the bias voltage, which is continuously variable through a range of positive

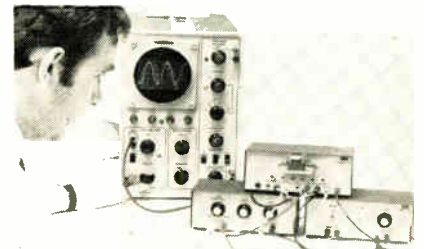

Building blocks. Modules shown are set up to measure differential voltage gain of a linear IC.

and negative values.

- Model 413 input continuity selector: makes it easy to select test components, voltages and signals by eliminating the need to resolder or reconnect wires while changing the test circuitry from the measurement of one parameter to another.

- Model 414 floating bias supply: provides a potential difference of positive or negative polarity, not referenced to ground, between two front panel jacks. The potential can be continuously varied by either a fine or a coarse adjustment. Another front panel jack allows a variable common-mode voltage to be applied to the inputs.

- Model 415 voltage divider: pro-

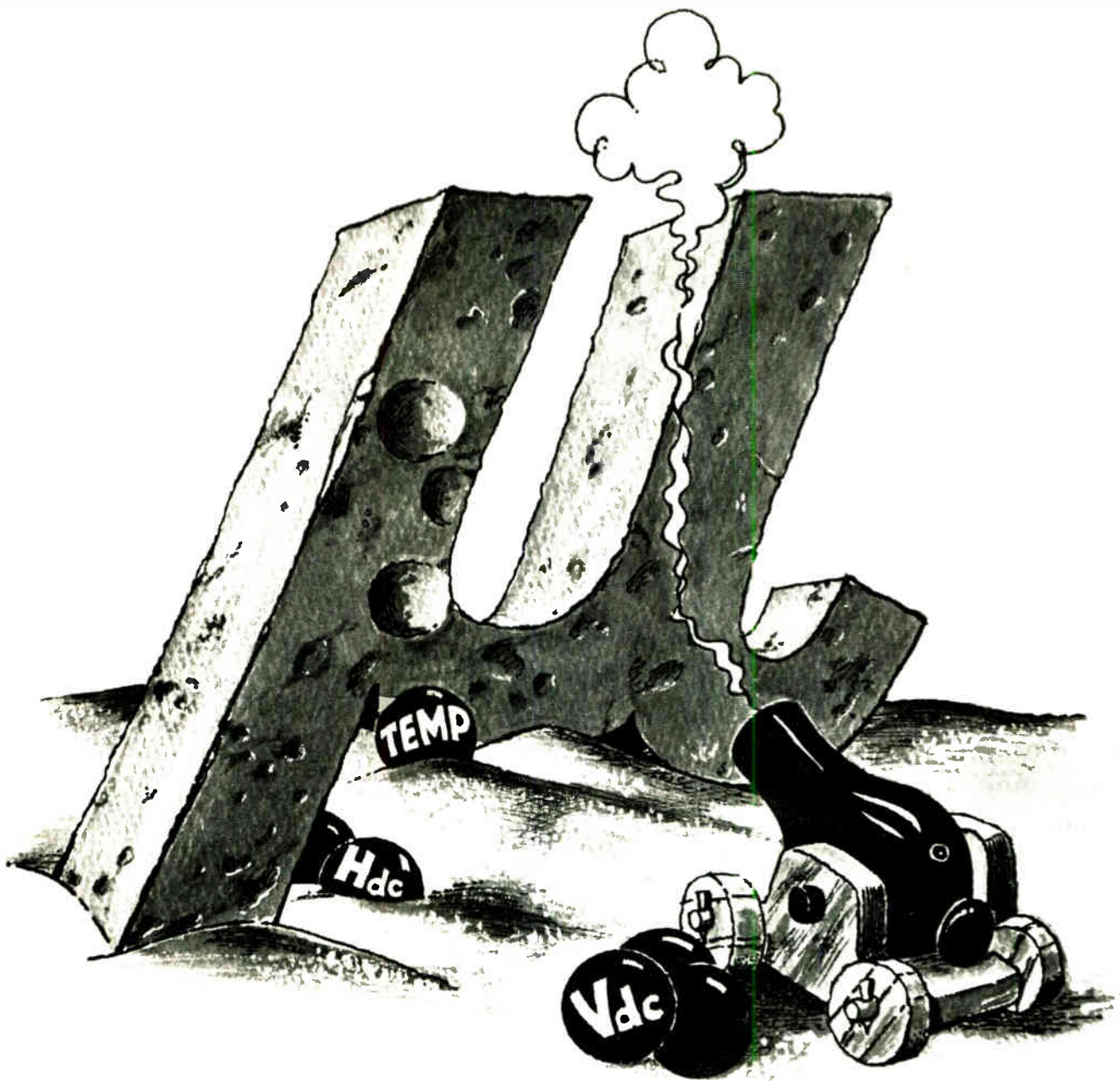

# Stability.

## Arnold MPP toroidal cores-high stability plus high Q.

No matter what sort of operating conditions our Molybdenum Permalloy Powder cores come up against, their permeabilities stay consistently stable. Through variations in temperature, DC magnetizing force, voltage, frequency, moisture. And our MPP cores also have high Q and high resistivity plus low hysteresis and eddy-current loss.

We produce MPP cores in O.D.'s from 0.140 in. to 5.2 in. With permeabilities from  $14 \mu$  to  $350 \mu$ . Think of what that means if you're working with telephone-loading coils, band-pass and band-reject filters, noise-suppression filters, decade inductors, transformers, and the like. You should have a copy of our new MPP Core catalog. Call or write.



The Arnold Engineering Co., Dept. C-2, Marengo, Illinois 60152 • Member Company of Allegheny Ludlum Industries • Branch Offices and Representatives in Principal Cities

# CIRCUIT-STIK IS FAST!

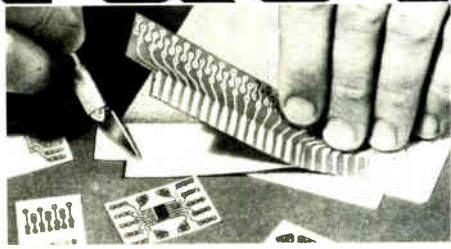

**CIRCUIT-STIK\* IS NOT AN EXPERIMENTER'S KIT! IT HAS UNLIMITED LARGE DIGITAL SYSTEMS CAPABILITIES.**

CIRCUIT-STIK is fast because it eliminates: design, etching, drilling, art work and photo work, in all prototype systems.

All types of circuit-element configurations may be mixed and combined on the same board. **SEND FOR YOUR FREE CATALOG AND SAMPLES.**

**circult-stik**  
1518 W. 132nd STREET, GARDENA, CALIFORNIA 90249

\*PATENT PENDING

Circle 219 on reader service card

## This digital multimeter takes a load off your mind about circuit loading.



Type 340

Digilin multimeters let you forget about transient noise creeping into the test circuit — a worry that always nags you when such input devices as dual slope integration and chopper stabilized amplifiers are used. Digilin's exclusive new input amplifier keeps meter impedance high throughout the measurement cycle. And with Digilin multimeters, you'll

never short another lead and adjust for zero again. Digilin meters zero adjust themselves, automatically, precisely, leaving no doubt in your mind about whether it was done right. Automatic decimal point and polarity sign, too. Write or phone today about the award-winning Type 340 or battery powered Type 341. You've got enough to think about. Digilin, Inc. 6533 San Fernando Rd., Glendale, Calif. 91201. 213/246-8161.

**digilin**  
DIGITAL INSTRUMENTS



Type 340  
3½-digit panel meter

## New products

vides a continuously variable dc voltage over positive or negative polarities for application to an amplifier's input terminals.

- Model 416 audio attenuator: receives the voltage output of a laboratory audio signal generator and supplies this voltage, properly attenuated, to various terminals of the device under test.

- Model 417 variable resistance: provides continuously variable resistance from 0 to 110 kilohms with resistor terminations going to dc ground, ac ground, or the supply.

The prices for the modules vary from \$99.50 for the voltage divider to \$167.50 for the variable resistance model.

I.C. Metrics, Inc., 607 Industrial Way West, Eatontown, N.J. 07724 [429]

## Packaging and production

Cores take orders from minicomputer

**What does a minicomputer mean to a core tester?** Plenty, if the goal is to speed testing, increase the types of tests, improve the process control in making the cores, sharpen test accuracy, and continually monitor the yields.

Computer Test Corp., which is using a minicomputer for the first time—in its Delta 400 core analysis system—says also that up to four core handlers can be multiplexed, so each one operates on line and tests a different core type.

"We can test 100 cores per minute and arrive at much more data using a computer-controlled system than we could before when it took nearly an hour to check about 20 cores," says Robert J. Merkert, project engineer. And increasing the number of cores in a sample batch improves control over the process, Merkert adds.

The system consists of the 5505 magnetics test terminal, 5510 stored program controller, and 5535 input/output console. The test terminal contains current drive, signal sensing, signal measuring, and data conversion instruments. In addition, it houses core handlers, as





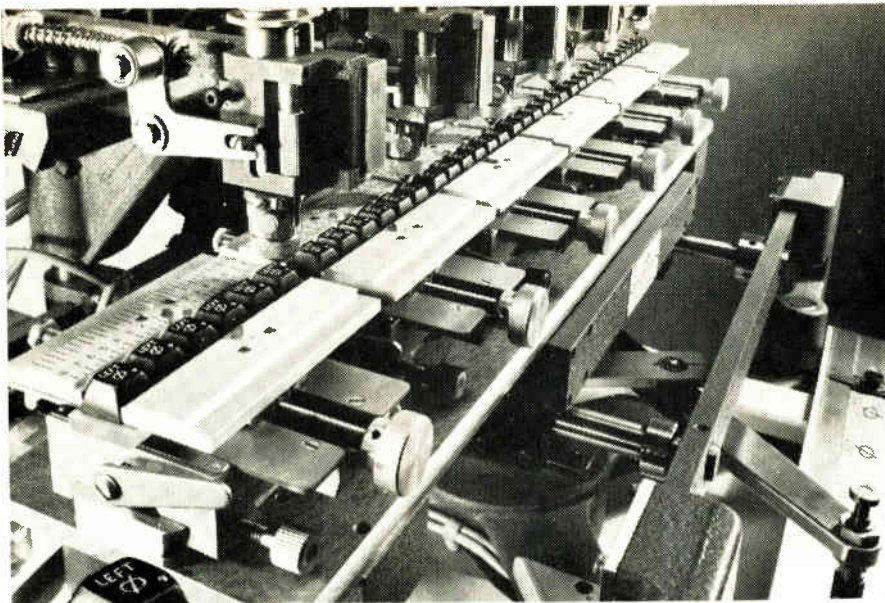

## 6 will get you 36

Now, new 6-spindle New Hermes engraves up to 36 machine keys with one set-up.

Any unskilled worker simply guides the pantographic tracer on this pneumatically-operated engraving

machine. Each spindle has an automatic depth-regulator, guaranteeing uniform depth and width of engraving over the complete contour of the key.

Write for detailed brochure No. 197.

*new hermes engraving machine corp.*



20 Cooper Square, New York, N. Y. 10003

Chicago, Atlanta, Los Angeles, Dallas, Montreal, Toronto, Mexico City

SEE US AT BOOTH 1138 IN CHICAGO

Circle 220 on reader service card

## WHOLESALE TO ALL

Breadboard Kits—"RF" Kits—"PC" Kits—Perf. Phenolic Board—Copper Clad board—Cowl Type Electronic Cabinets—Heat Sinks—Solid State Hobby Kits—Solderless Connectors—Hardware Kits—Transistor Sockets and many other items. (Products approved by the Defense Supply Agency—Federal Supply Code number furnished upon request.) Send for free catalog from:

**H. M. C. SALES**  
P.O. Box 276  
Santa Susana, Calif. 93063

## HEAT REACTIVE VINYL ZIPPERTUBING®

TYPE HRV



*best  
for  
skin-  
tight  
jacketing  
of cables  
and wire  
bundles  
in minutes!*

HRV is made from material that shrinks when heat is applied. (Also available to meet military specifications.)

for full information on specialized, high-performance jacketing, contact

**THE ZIPPERTUBING®**

13000 S. BROADWAY, LOS ANGELES, CALIF. 90061  
Los Angeles Phone: (213) 321-3901

BALTIMORE • BOSTON • CHICAGO • CLEVELAND  
DALLAS • NEW YORK • ORLANDO • PHOENIX  
SAN FRANCISCO • WEST GERMANY



## New products

well as the control logic for the handler multiplexing, the controller interface, and the pulse sequence generation. The stored program controller, a 16-bit digital computer, governs system operation by digital control and sequencing.

A waveform analyzer module in the system measures undisturbed voltage output when the core is in the binary 1 state, disturbed voltage output in either the 1 or 0 state, and peak amplitude. It also notes when the peak amplitude occurs, tells when the core switches state, and indicates the break or knee current in the hysteresis loop.

**Goes digital.** These measurements are read in analog form and converted to a digital format. The computer accepts and stores the digital data for analysis. Using a program to control the system eases changes in drive current conditions, says Merkert. Previously, time-consuming calibrations and adjustments were required for a different set of conditions, according to Merkert. Now, different parameters, core types, accept/reject criteria, and drive conditions can be handled by the same program.

The Delta 400 multiplexes four test stations. While one handler grades the core, retracts the probe, and drops the core into a bin, the computer sequences through the other three handlers, performing tests at each station. The core handler's 600-millisecond cycle time leaves plenty of time for tests on all four handlers, regardless of the core type in the handler.

Moreover, the computer-controlled system provides the user with a programmable yield monitor. "I can watch the yield of the cores being tested continually, and if it's not the yield I want, I can tell the operator to stop testing," Merkert points out. "No sense testing 500 cores when the yield is only 20%. And if all of a sudden you're getting 100% yields, which is nearly impossible, something's probably wrong in the system—so you have a safeguard feature."

Computer Test Corp., 3 Computer Dr., Cherry Hill, N.J. 08034 [430]

**Open up  
closed-circuit  
markets...**

**...with this new  
one-inch-diameter  
Plumbicon\***

\*Registered trade-mark of  
N.V. Philips'Gloeilampenfabrieken  
Eindhoven, the Netherlands

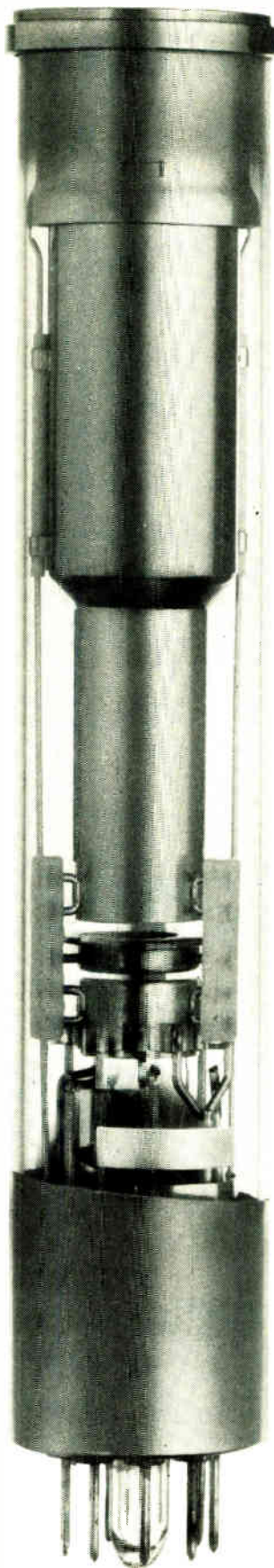

What a boost the entire CCTV industry would enjoy if existing cameras could operate well at significantly lower light levels and higher response speeds. That's exactly what this new Philips **Plumbicon** camera tube has to offer. Its one-inch-diameter makes it **retrofitable into existing cameras now using vidicons**. Developed originally to meet the exacting needs of live broadcast television, the **Plumbicon** won the industry's "Emmy" in 1967, as the year's most significant technological advance. Since then it has dominated its field - today it's in 9 out of 10 colour cameras in use throughout the world. When used in CCTV applications - in medicine, industry, education or commerce - this superb tube makes practical many applications hitherto only theoretical. The very high sensitivity, low dark current and fast response mean greatly improved picture quality - even when the subject is poorly illuminated or moving rapidly. All of which means the **Plumbicon** can make existing CCTV equipment work better, can make CCTV **colour** a practical proposition... can open up vast new markets, not only for cameras, but for related equipment as well! Let's help you open up new opportunities!

**Philips Electronic Components  
and Materials Division,  
Eindhoven, the Netherlands.**

Manufactured, distributed and sold  
in the U.S. by  
Amperex Electronic Corporation,  
Electro-Optical Devices Division,  
Slatersville R.I.

**PHILIPS**

# THE WORLD'S SMALLEST DIRECT RECORDING OSCILLOGRAPH

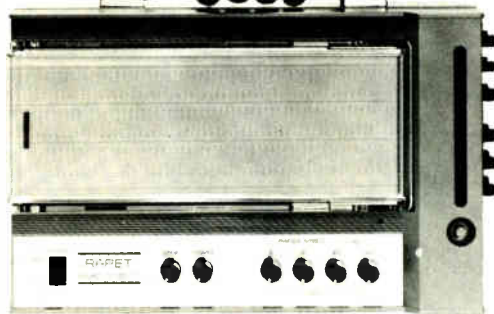

- Truly portable, only 12.8 lbs
- Unusually compact, 8" x 13" x 5"
- Tungsten light source with low power consumption, 25W
- 6 channels capability on 92mm (3-5/8") paper width
- Easy and simple pushbutton operation without elaborate spot adjustment
- 4 different basic models

- with 4 different recording speeds each, rack mounting versions available
- Galvanometer frequency response, 700 Hz
- Operation from AC mains or rechargeable Ni-Cd battery pack available optionally
- Competitively priced and economy of maintenance

Write today for more information to

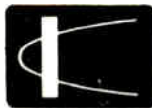

**KYOWA**  
ELECTRONIC INSTRUMENTS CO., LTD.  
1219, Shimofuda-cho, Chofu-shi, Tokyo, Japan

Circle 322 on reader service card

## MICO NEW MODEL 885 SEVEN RATIO WIDE-RANGE ENGRAVER

NO. 885

FOR LONG AND  
MULTI-LINE WORK

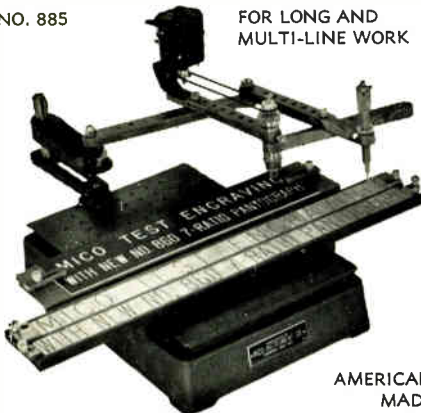

AMERICAN  
MADE

- A time-saver for large plate work
- Engravers letters 1/32" to 3" high using standard masters.
- Seven pantograph ratios—from 1:5:1 to 6:1.
- Choice of 3-ball-bearing spindle assemblies for 1/4", 3/16" or taper-shank cutters.
- HSS, COBALT and Solid Carbide Cutters.
- Single and multi-line copy carriers for holding, blanks 3/4" to 3 1/2" high.
- Accommodates Mico standard accessories.

Send for bulletins and prices

**MICO INSTRUMENT CO.**

77 Trowbridge St. Cambridge, Mass. 02138

178

Circle 178 on reader service card

## SAN-E

*MSP-4 full four track stereo  
R/P head for auto-reverse  
cassette system*



MSP-4 1/4 track full 4 heads R/P  
head for phillips cassette tape  
PE-M AC bias eraser for MSP-4 head

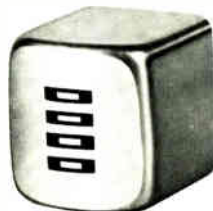

MS-84 head for  
8track 4 channels

\* write immediately  
for further details

**SAN-E DENKI COMPANY, LIMITED.**

110-1 Minami-Kawahori-cho, Tennoji-ku,  
Osaka, Japan  
phones: 779-1591  
cable: SANMAGNETICS

Circle 222 on reader service card

## New products

### Packaging and production

Backplane can handle  
101 wire-wrapped IC sockets

Designers looking for fast turn-around, both in their original layouts and in making engineering changes, are turning to wire-wrapped interconnections of socketed integrated circuits. A new high density IC backplane from Data Technology Corp. is tailor-made for the purpose.

The backplane, designated the model 4401, can handle up to 101 dual in-line packages—92 of the

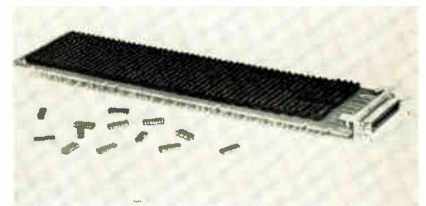

14-pin units and 9 of the 16-pin devices. Each socket has wire-wrapping posts extending from the bottom side of the board, which is made of 3/16-inch copper clad G-10 epoxy. The board has a ground plane on one side and carries  $V_{cc}$  voltage on the other, giving large low-resistance conductors and good decoupling between the power source and ground to minimize noise produced by high-speed switching transients.

All holes are plated through and drilled with numerically controlled machines for accurate location of the wrapping posts, a key factor in using automatic wrapping equipment.

Measuring 14.65 by 3.95 inches, the backplane can be mounted in a 1 3/4-inch deep frame. A 50-pin connector at one end handles input-output connections.

Price of the model 4401, including the wire-wrap sockets and the connector, is \$178. Delivery is from stock.

Data Technology Corp., 1050 East Meadow Circle, Palo Alto, Calif. 94303 [431]

Electronics | September 14, 1970

# Why call SIGMA for reed relays?

The acquisition of General Reed now gives us some unusual capabilities in the realm of reed relays. By manufacturing our own reed switches, we totally control the characteristics of this most important essential of any reed relay.



Form C Switch  
Actual size

In fact, we have total control over the entire relay manufacturing process, starting with the selection of vacuum-melt nickel/iron wire used to form the reeds, all the way through 37 subsequent steps. This includes our ability to change performance characteristics by varying contact plating materials as well as pickup and dropout levels. Such complete control gives you considerably more assurance that the final product will meet your special requirements.

In seven years of making many million reed switches, we've learned from experience how to achieve desired performance. This can be particularly useful when you need a non-standard

type. For example, consider our spec. no. 63024: Form C;  $250 \pm 50 \mu\text{sec}$  operate and release times; thermal drift less than  $6 \mu\text{V}$  max.; electrostatic shielding for microamp signal levels. In the realm of specials like this, we consider ourselves experts.

Where a standard reed relay will do the job, we offer five series: up to 4 Form C and 6 Form A . . . 42 QPL types qualified to MIL-R-5757/29 . . . ultra-miniature and dual in-line types (DIP) for IC compatibility. Sigma Distributors across the country are stocked.

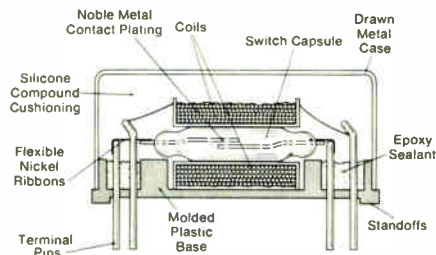

For application help, quotations on specials and technical bulletins, contact General Reed Division, 19 Walnut Avenue, Clark, N.J. 07066. Tel. (201) 382-7373.



Series 191  
Dual in-line (DIP)  
for IC compatibility

Series 200  
12 models,  
3 case sizes

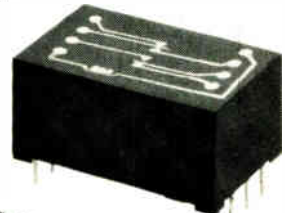

Series 300  
10 models,  
3 case sizes

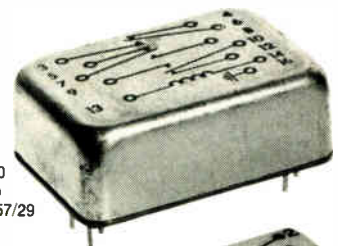

Series 400  
Quality to  
MIL-R-5757/29



Series 500  
Miniature:  
1 Form A Case Size  
.280" x .330" x .750"

**SIGMA**  
GENERAL REED DIVISION

## New products

### Semiconductors

# C/MOS shift register clocks at 25 MHz

Compact chip layout  
is key to high speed  
in 64-bit circuit

With a shift rate range from zero to 25 megahertz, a 64-bit shift register developed by Ragen Semiconductor is reported to be 2½ times faster than the fastest complementary MOS register available so

far. The extremely high speed of the new C/MOS circuit was made possible chiefly by compact chip layout, says company president Albert Medwin. This layout minimizes parasitic capacitance. The C/MOS shift register requires less area per function than an equivalent p-channel MOS IC.

This compactness runs counter to prevailing views which generally regards C/MOS as more wasteful of space than p-channel technology

because of the guard bands that are necessary to isolate the n-channel transistors from the p-channel ones. For proprietary reasons, Medwin won't reveal precisely what Ragen engineers have done to get the size down; the approach, however, permits Ragen to use tighter design rules, he says.

The MS612 operates with serial input and output over a single power supply voltage range of 5 to 16 volts. Lower voltage versions of

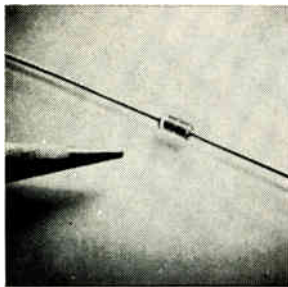

Ultraminiature diode type VC-2 is a high Q, variable capacity unit for automatic frequency control applications at uhf frequencies to 200 MHz. Characteristics include: 150 Q at 50 MHz, 9 pF capacitance at -4 V and 1 MHz, 250 mW dissipation at 25° C, and 15 V peak reverse voltage. Sarkes Tarzian Inc., Semiconductor Division, 415 N. College Ave., Bloomington, Ind. [436]

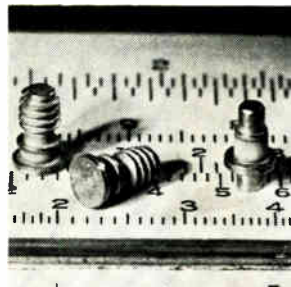

X-band GaAs Gunn diodes operate through bulk negative resistance and feature low fm/a-m noise characteristics. They are designed to accomplish a one-step conversion from d-c to microwave energy from a single low-voltage supply. Type MA-49107 operates over 8-12.4 GHz with output power of 100 mW, and 500 mA dc bias. Microwave Associates, Burlington, Mass. [437]

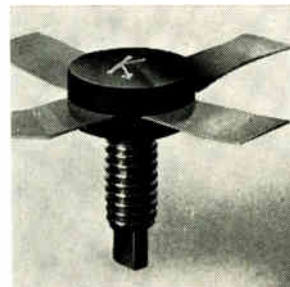

Communications transistor family is for operation at 28 V, 470 MHz with output power up to 5 W. Power gain is 8 dB for the 3TX630, 7 dB for the 3TX631, and 6 dB for the 3TX632. Units are offered in a molded ¼ inch stripline package with the leads isolated from the case. The 3TX830-2 comes in a ceramic package. Kertron Inc., Riviera Beach, Fla. [438]

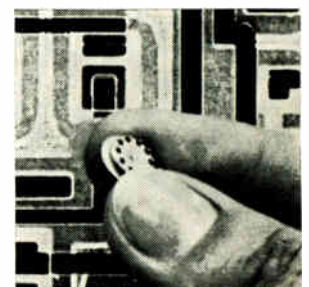

Two new phase-locked-loop linear ICs are for such applications as accurate multiplication and division of frequencies virtually in any ratio. Range of operation extends from subaudio frequencies to vhf. They can divide a fundamental frequency by 10/3, if desired, a process virtually impossible with digital devices. Signetics Corp., 811 E. Arques Ave., Sunnyvale, Calif. [439]

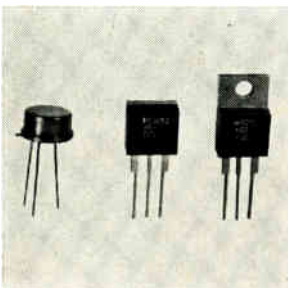

Pnpn silicon controlled rectifiers are gate-triggered bistable switching devices typed with gate sensitivities ranging from 50 µA maximum, 200 µA maximum, and 1.5 mA maximum. They may be used for low-level switching from 12 mA to 10 A. They are available in several packaging configurations in 30 to 800 V ratings. ECC Corp., 1010 Pamela Drive, Euless, Texas [440]

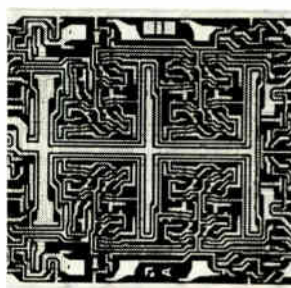

Dual 8-bit shift register 9328 features a 2-input multiplexer in front of each data input. It offers 25-MHz clock frequency operation as well as active pullup outputs. The circuit has an asynchronous master reset with a low logic level that allows clearing of the 16 stages independently of any other signal. Advanced Micro Devices Inc., 901 Thompson Place, Sunnyvale, Calif. [441]

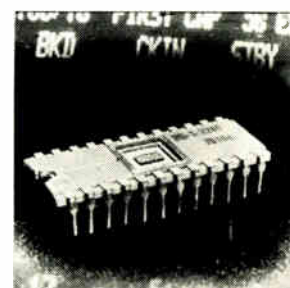

One-package character generator RO-1-2240 features a 2 MHz (500 ns) character access time, with horizontal output using ASCII coding. It is an MTOS 2240-bit read-only memory constructed on a single monolithic chip. It features asynchronous/synchronous operation and output buffers for TTL/DTL interfacing. General Instrument Corp., 600 W. John St., Hicksville, N.Y. [442]

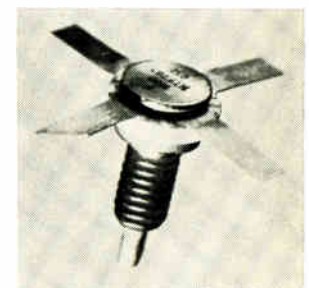

L-band power transistors are for use in class C amplifiers through 1.5 GHz and oscillators through 2 GHz. They have application in ecm systems, telemetry, radar and other microwave uses. Across L-band, power ranges from 1 to 20 watts. Pricing for the 5-watt devices is \$40.50 in lots of 100-249. Fairchild Microwave and Optoelectronics, 2513 Charleston Rd., Mtn. View, Calif. [443]

# SQUEEZE Time

## OUT OF YOUR CIRCUIT BOARD PRODUCTION

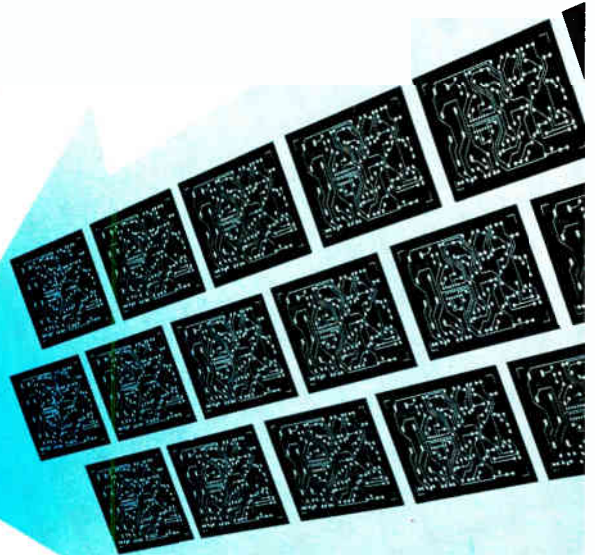
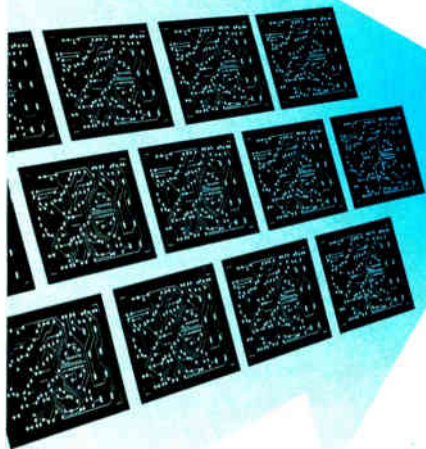

Do it with SLO-SYN® N/C Positioning Systems.

Everything is numerically controlled using information from one basic N/C tape. It starts with artwork generated from a rough, grid-paper sketch to precise 1:1 film master in 8 hours or less!

The SLO-SYN Photo Artwork Generator actually squeezes several days' work into one. Reduces lead time. Actually shrinks production time by two-thirds. When used with other systems in the line, you can do the whole job from design to finished product in many days less.

Your investment? We have managed to squeeze this down too! Leasing costs are as low as \$4.00 an hour. But first, write, wire or phone for full information.

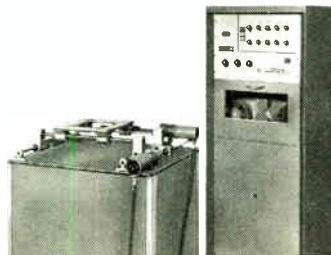
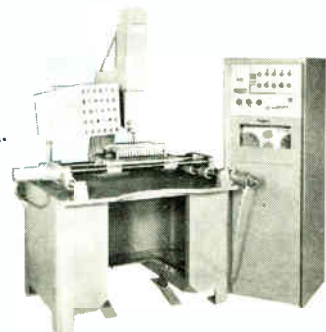
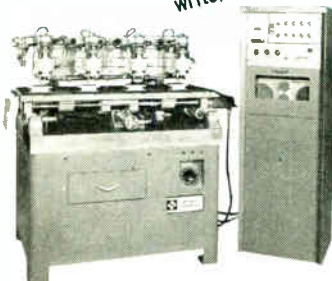

**THE  
SUPERIOR ELECTRIC  
COMPANY**

383 Middle Street, Bristol, Connecticut 06010  
Telephone 203/582-9561

YOU'LL ALSO RECEIVE COMPLETE INFORMATION ON ALL SLO-SYN N/C SYSTEMS —

# TACTICAL RADAR

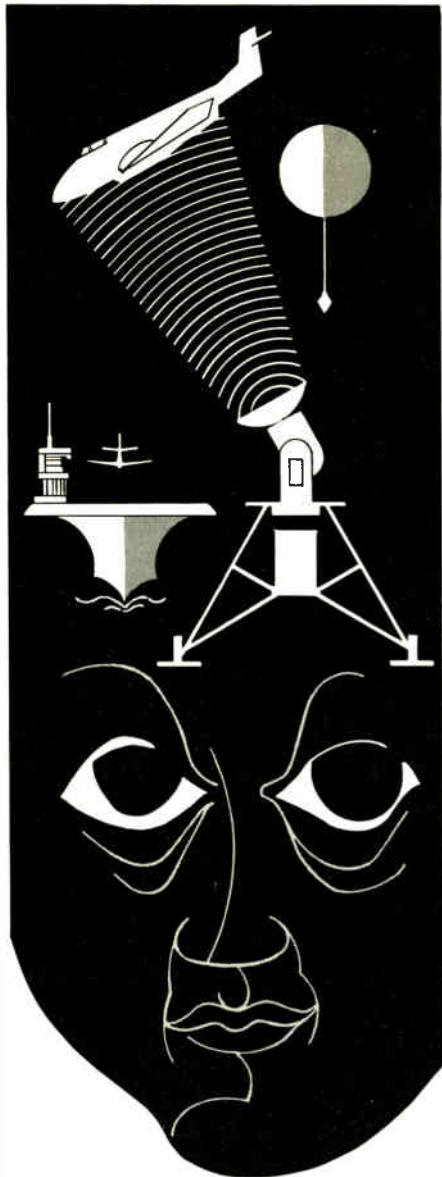

**TOTAL ELECTRONIC  
SYSTEMS CAPABILITY.  
SPECIALISTS IN  
TIME/FREQUENCY,  
RADAR AND  
DATA SYSTEMS  
OFFERING RAPID  
GROWTH.**



P.O. BOX 222, BUFFALO, N.Y. 14225

## New products

the register are also available: the MS615 operates at 2 to 10 V and the MS616 at 1.5 to 5 V.

Only one clock input is required in the register, and the clock input capacitance is a low 5 picofarads. Data input capacitance is 2.5 pF. Static current is less than 1 micro-ampere over the full supply voltage range, a low value characteristic of C/MOS circuits. The

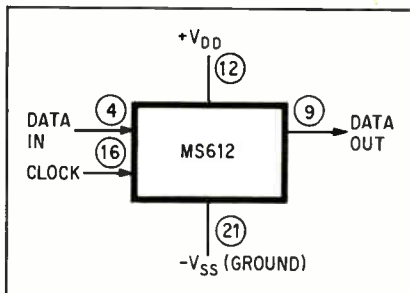
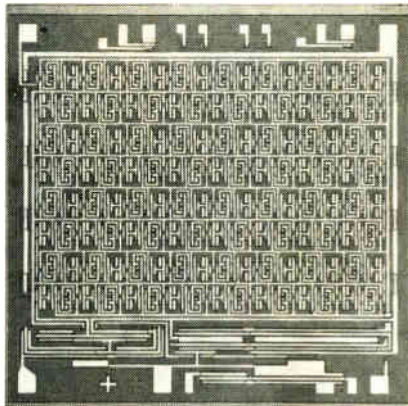

Tight. Extremely close spacing of C/MOS transistors accounts for high speed of shift register. Only one clock line is needed.

circuit is rated to operate over the full military temperature range,  $-55^{\circ}$  to  $+125^{\circ}$  C.

Input levels for clock and data signals are rated in terms of the drain voltage,  $V_{DD}$ . A high level is guaranteed to be within 80 to 100% of  $V_{DD}$ ; the low level is within zero to 20% of  $V_{DD}$ .

The register is available from stock in a 24-lead dual in-line hermetically welded ceramic package. In addition, two isolated shift register chips can be supplied in the same ceramic package. Price of the MS612 is \$28 in 1,000 quantities.

Ragen Semiconductor, 53 South Jefferson Rd., Whippany, N.J. 07981 [444]

## NEW FROM TAKEDA RIKEN 1000MHz WORD GENERATOR

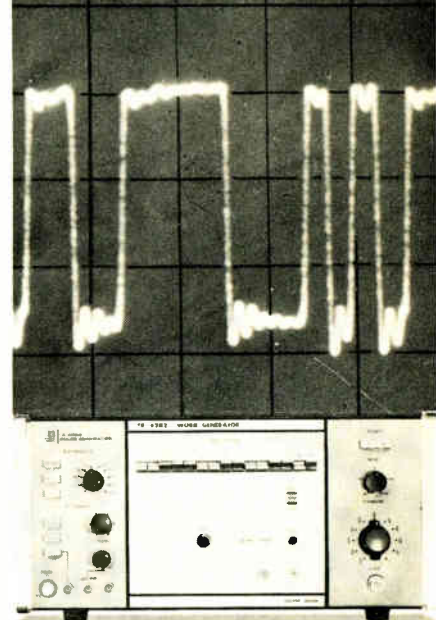

Plug-in for -TR-4200 Pulse System. Provides switchable 9- and 15-bit programmable word pattern at maximum clock rate of 1GHz, and NRZ format. Frequency range 100MHz to 1GHz. Complete pulse system consists of -TR-4202 Word Generator, -TR-4200 Main Frame, -TR-4201 Continuous pulse plug-in, and -TR-4203 Pseudo Random Noise Sequence Generator plug-in. For complete information on *Better Instrumentation for Better Systems* write:

**TR Takeda Riken  
Industry Co., Ltd.**

1-32-1, Asahi-cho, Nerima-ku, Tokyo 176, Japan  
Tel: Tokyo 930-4111 Cables: TRITRONICS TOKYO

### Agents:

LITTON PRECISION PRODUCTS INTERNATIONAL INC....  
...West Germany, Switzerland, Holland, Belgium, England  
INGENORSFIRMA CARL-ERIC LARSSON AB ..... Sweden  
ING. S & DR. GUIDO BELOTTI LTD. .... Italy  
SEMCO SEMLER & CO. .... Denmark  
NORES & CO OY ..... Finland



# Introducing RCA's new superswitch: light sensor and power amplifier on one IC chip!

Choose a medium-speed application that uses a light sensor. You'll find the circuitry easier to design when you use the RCA-CA3062—because there's less to design.

The CA3062 consists of two parallel-connected photosensitive Darlington pairs which drive a differential power amplifier to provide a normally-off and normally-on output in response to a light input.

Available in a compact, window-ended TO-5 style package, the CA3062 has 100 mA output current capability, and can be operated at supply voltages in the range of 5 to 15 volts dc. It is compatible with RCA's 40736R infrared emitter. Use it for counter and position sensors, optical tachometers, limit detectors, level scanners, paper web sensors, wheel balancers, and similar devices.

For further details, see your local RCA Representative or your RCA Distributor. For technical bulletin, File No. 421, write: RCA, Commercial Engineering, Section 701-14/CA41, Harrison, New Jersey 07029. International: RCA, 2-4 rue du Lièvre, 1227 Geneva, Switzerland, or P. O. Box 112, Hong Kong.

## CA3062 Photo Detector and Power Amplifier

- FOR:
- |   |  |
|---|--|
| <input type="checkbox"/> counters         | <input type="checkbox"/> edge monitoring |
| <input type="checkbox"/> sorters          | <input type="checkbox"/> position sensor |
| <input type="checkbox"/> level controls   | <input type="checkbox"/> isolators       |
| <input type="checkbox"/> intrusion alarms | <input type="checkbox"/> inspection      |

- FEATURES:
- Darlington-connected photosensitive pairs
  - 100 mA output current capability (drives a relay or thyristor directly)
  - 5 to 15 Vdc supply voltage range
  - compatible with RCA= 40736R IR emitter

(5 x actual size)

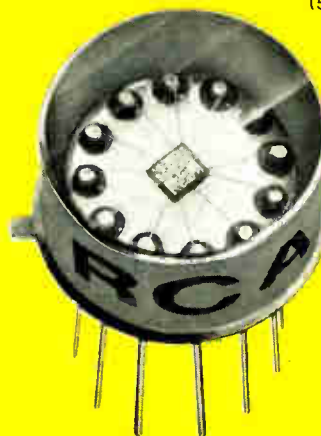

CA3062 \$2.95 (1000-unit level)

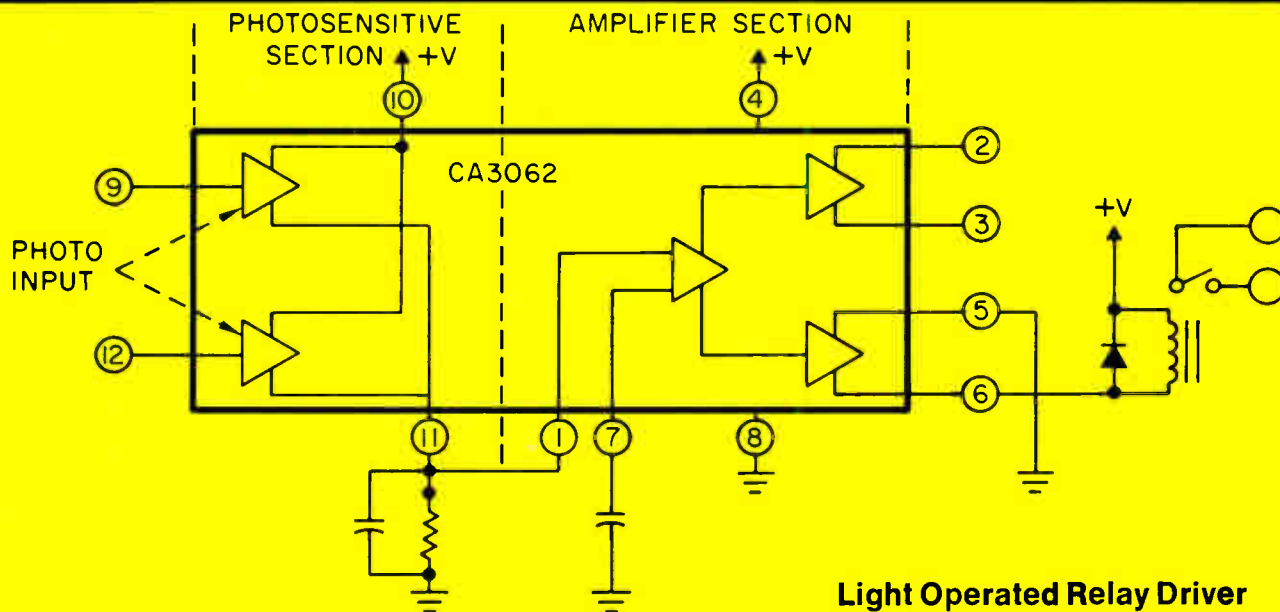

Light Operated Relay Driver

**RCA**  
Integrated Circuits

Circle 183 on reader service card

The Material  
of Unlimited Uses...

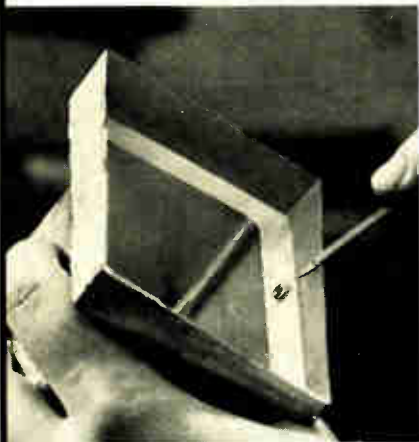

## INSTANT DIP-A-MOLD

In seconds, you can make perfect molds, like this one, for potting any encapsulation, and make them economically, with low-melting CERRO® Alloys. Just dip the master in molten alloy. A thin coating of alloy clings to the pattern. Withdraw the pattern, and you have a perfect high fidelity mold. When the encapsulating plastic cures, simply remove the CERRO Alloy. Use it over and over again, almost without limit.

This particular alloy—CERROTRU®—does not shrink, slips easily from the pattern without parting or contaminating compounds or coatings. Because of its low melting point, it is safe and easy to handle.

You can reproduce such unusual details as positioning lugs for transformer cases, as shown above, without the use of cores, inserts or secondary operations.

Instant molding is just one of the many uses for CERRO Alloys. To find out more, contact Cerro Copper & Brass Co., Alloy Dept., Bellefonte, Pa. 16823. Telephone (814) 355-4712. In Europe, contact Mining & Chemical Products Ltd., Alperton, Wembley, Middlesex, England.

# CERRO®

## New products

### Semiconductors

Multiplexer counts  
and decodes, too

A multiplexer does more than just multiplex if it's General Instrument Corp.'s AY-6-4016 16-channel random- or sequential-access unit. The new metal-nitride-oxide semiconductor integrated circuit contains a four-stage binary counter and a decoding matrix for channel control in addition to the multiplexer switches.

With this extra circuitry, the versatile unit can accept input channels either in sequence or at random, as determined by the address inputs, and operate with either single-ended or differential channel inputs. In the differential mode, the channel inputs consist of eight ganged pairs.

The extra circuitry also allows the multiplexer to be connected with other AY-6-4016s to form larger multiplexing arrays. Like the individual circuits, these expanded multiplexers can access the channels at random or in sequence.

They also can access, in the sequential mode, a predetermined number of channels—three, eight, or more—without going through the entire sequence of 16 channels, operate in the current or voltage mode, and accept either synchronous or asynchronous loading of address inputs.

This versatility is expected to bring applications in test instruments and peripheral equipment, as well as computers. The AY-6-4016 offers the economy of employing a single 40-lead dual in-line package instead of a multiplexer and separate logic ICs. The ceramic package is 1.97 inch long, 0.5 inch wide, and 0.070 inch high.

Because the AY-6-4016 is made with nitride passivation, it interfaces directly with bipolar circuits—TTL and DTL—as well as with other low-threshold voltage MOS ICs. The logic 0 level is +0.4 volt maximum; the logic 1 level is 1 volt minimum. Device power dis-

## SHIELDED BOXES

Take  
your  
pick.

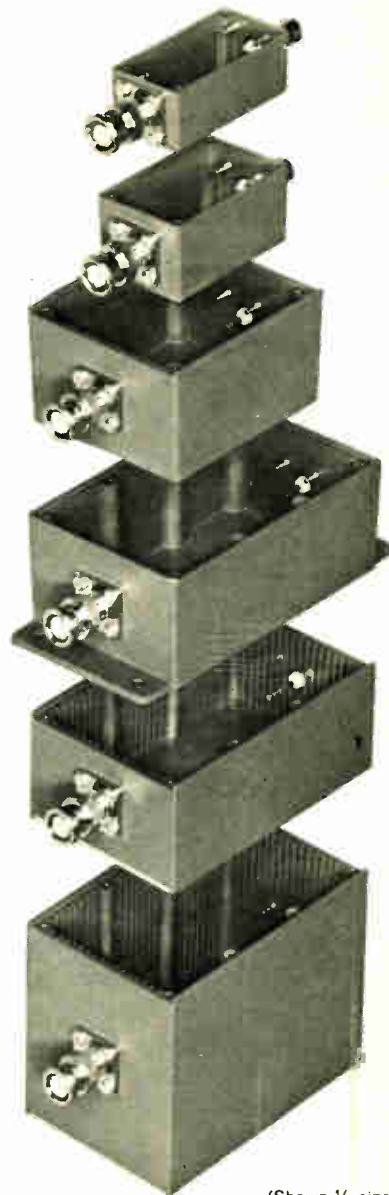

(Shown 1/3 size)

The newly expanded line of Pomona Shielded "Black Boxes" now comes in six different sizes; in cast or extruded aluminum; some slotted to accept circuit boards; in a broad choice of connector combinations or no connectors. There's bound to be one to meet your requirement. Write for complete information in our General Catalog.



**POMONA  
ELECTRONICS**

1500 E. Ninth Street • Pomona, California 91766

# TWO ENGINEERS WITH THE SAME PROGRAMMING PROBLEM



**USING ROTARY SWITCHES** requires 330 soldered joints . . . over 8 hours of labor . . . occupies 293 square inches of panel space . . . costs \$88.00 installed.  
(That's \$0.29 per switching point.)

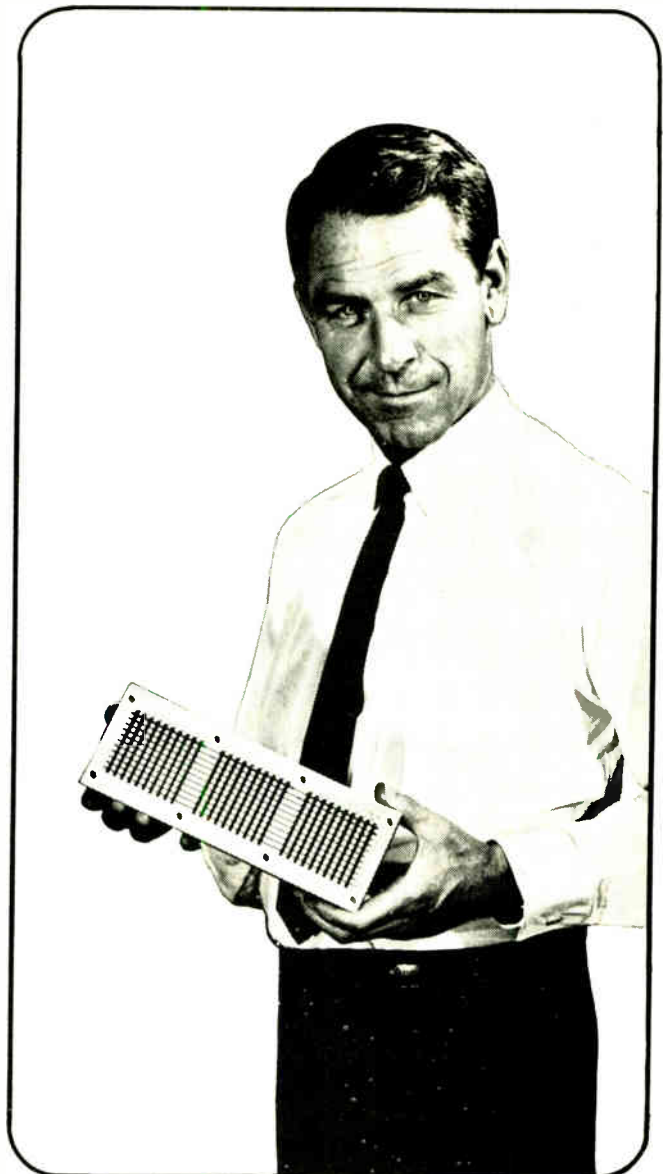

**USING CHERRY SELECTOR SWITCH** requires no soldering . . . less than 5 minutes of labor . . . occupies 41 square inches of panel space . . . costs \$32.95 installed.  
(That's \$0.11 per switching point.)

**WHICH ONE WOULD YOU LIKE TO  
CHECK FOR A MISTAKE IN WIRING?**

**WRITE TODAY** for full details on the totally new Cherry Selector Switch. It may change all your old ideas about programming devices.

*Makers of patented Leverwheel/Thumbwheel Switches, Matrix Selector Switches, Snap-Action Switches and Keyboards.*

**CHERRY** 

CHERRY ELECTRICAL PRODUCTS CORP. • 3608 Sunset Avenue • Waukegan, Illinois 60085

# MORIRICA

## PHOTOCELLS

HIGH QUALITY,  
REASONABLE PRICE,  
AND FAST DELIVERY



### MAIN PRODUCTS

#### CdS Photoconductive cell

- \* High sensitivity
- \* High fidelity for visibility of human eye.
- \* Large tolerable power dissipation
- \* Highly stabilized

#### CdSe Photoconductive cell

- \* Fast response time
- \* Remarkable high sensitivity
- \* Spectral response inclined more toward red than visibility

#### Photocell-Lamp

- \* Non-contact structure eliminates mechanical troubles
- \* Compact design
- \* Allows designing of most simple self-holding mechanism

#### Se Photovoltaic Cell

- \* Photovoltaic characteristics.
- \* While with lower output than solar cell, visible sensitivity is higher-fidelity than solar cell is
- \* Thin design
- \* Shape can be selected freely

\* For catalog, please write to:

**MORI PHYSICS & CHEMISTRY  
LABORATORY CO., LTD.**

205, Tozuka-machi, Tozuka-ku, Yokohama, Japan  
Tel: 045-881-2331 Cable Address: MORIRICA YOKOHAMA

### New products

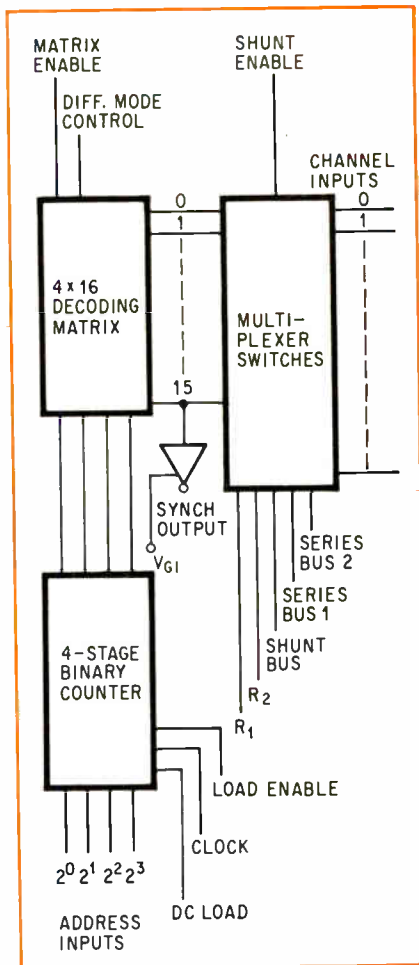

More than multiplexer. With logic included on chip, multiplexer becomes flexible and can easily be combined with additional channels.

sipation is 600 milliwatts, and 100 mW per channel. Clock repetition rate can be varied from dc to 2 megahertz. Off resistance of channels is extremely high, typically 5 gigohms.

The circuit is rated for operation over the military temperature range of  $-55^{\circ}\text{C}$  to  $+125^{\circ}\text{C}$ , and incorporates zener diode protection on all input leads.

Maximum rating range for  $V_{G1}$ , clock and logic inputs, bus voltages and matching resistor nodes, is  $-20$  volts to  $+0.3$  volt with respect to the substrate voltage  $V_{CC}$ . Storage temperature is  $-55$  to  $+150^{\circ}\text{C}$ .

Price of the YA-6-4016 is \$32.40 in quantities of 100.

General Instrument Corp., Microelectronics Div., 600 West John St., Hicksville, N.Y. [444]

### STABILITY & QUALITY

High quality capacitors unrivalled in the precision, dependability and compactness. Quality is recognized by ever wider use in measurement equipment, computers, and automatic controllers. "LEAF" the matter of capacitors to MATSUO ELECTRIC CO.



## MATSUO

### METALLIZED POLYESTER FILM CAPACITOR - "TYPE FNX-H".

#### Specifications:

Operating Temperature Range:  $-40^{\circ}\text{C}$  to  $+85^{\circ}\text{C}$   
Standard Voltage Rating: 100, 200, 400, 600 VDC  
Standard Capacitance Value: .1 MFD to 10 MFD.  
Standard Capacitance Tolerance:  $\pm 20\%$  (available  $\pm 10\%$ )

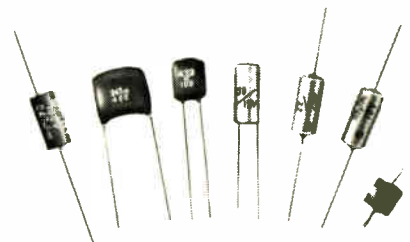

MATSUO'S other capacitors include:

**Solid Tantalum Capacitors:** MICRO-CAP for hybrid ICs, Type TAX hermetically sealed in metallic case, Type TSX encased in metallic case and sealed with epoxy resin, Type TSL encased in metallic case and sealed with epoxy resin. **Polyester Film Capacitors:** Type MFL epoxy dipped, Type MFK epoxy dipped, non inductive, Type MXT encased in plastic tube, non inductive.

For further information, Please write to  
Manufacturers and Exporters

**MATSUO ELECTRIC CO., LTD.**

Head Office: 3-5, 3-chome, Sennari-cho, Toyonaka-shi, Osaka, Japan  
Cable: "NCCMATSUO" OSAKA Telex: 523-4164 OSA  
Tokyo Office: 7, 3-chome, Nishi-Gotanda, Shinagawa-ku, Tokyo

Four interchangeable plug-in cavity drawers . . . convenient . . . practical. That's the MCL 10358 200 Watt CW amplifier. Flexibility that stretches all the way from 10 to 1000 MHz, yet is compactly designed and engineered to save space — save money. You get units customized to fit your exact needs, but with the engineering and reliability already proven.

The 10358 has the same sensible features as the 100 Watt CW amplifier . . . front panel tuning and calibrated frequency read-out. The four continuous tuning cavities are individually calibrated from 10-50 MHz; 50-200 MHz; 200-500 MHz; 500-1000 MHz, and all provide 200 watts of CW power. The high power makes it a valuable and versatile instru-



**10-50 MHz**

ment for antenna evaluation, calibration of power measuring equipment, amplifier drive source and many other applications.

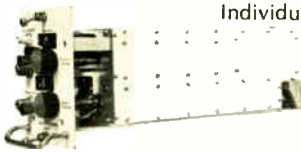

**50-200 MHz**

and power supply, protective circuitry and a ducted blower system, it is unmatched for efficiency and economy.

Whatever your amplifier or oscillator requirements for high power, broad band — whether CW or pulsed — contact Microwave Cavity Laboratories, 10 North Beach Avenue, La Grange, Illinois 60525 for a detailed catalog.



**200-500 MHz**

Individual cavity interchange and tuning operations can be completed in minutes.

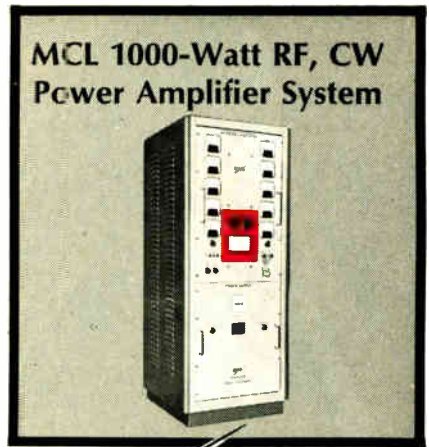

**MCL** DIVISION OF KMS INDUSTRIES, INC.

**MICROWAVE CAVITY LABORATORIES**

Phone (312) 354-4350 / TWX (910) 683-1899

# Plug-in 10 to 1,000 megahertz.

**500-1000 MHz**



**MCL 200-Watt RF, CW Amplifier Series**  
(UF, VHF, D, L Band Coverage)

- case or rack mounting
- weight 142 lbs
- front panel metering
- forward & reflected power
- RF sampling output



**unwanted**

noise or signals  
effectively reduced  
or eliminated  
with



**Rtron**



**Cylindrical Style Interference Filters**

that reduce or eliminate unwanted noise or signals. Small size, light weight, maximum attenuation. Voltage current or insertion loss characteristics required, determine physical size. Maximum isolation of terminals and high frequency performance are assured by threaded neck design for bulkhead mounting. Feed-thru capacitor circuitry conservatively rated for both military and commercial applications.

Send us your specifications.  
Ask for catalog and complete details.  
Dept. E-9

**Rtron** corporation  
P.O. Box 743 Skokie, Illinois 60076  
Phone 312 • 327-4020

**New products**

**Materials**

Teflon sheets provide  
substrate for stripline

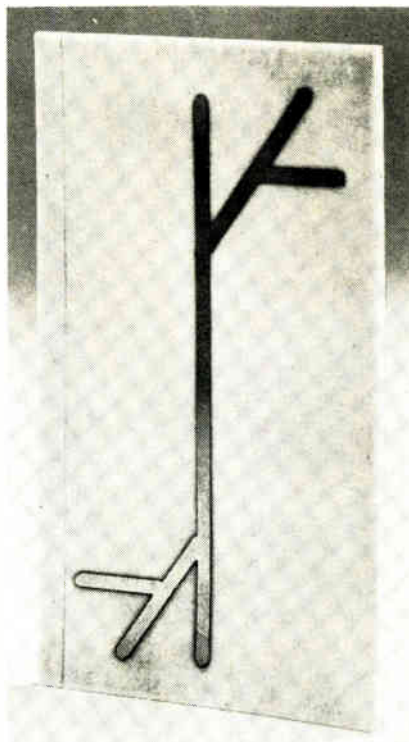

Electroplated Teflon sheet is suitable for use as a microwave substrate material for stripline circuitry. Advantages include low loss, high dielectric strength, and unchanging dielectric constant. It is extremely smooth and completely impervious to all etchants. The material can be supplied in special thicknesses of dielectric and/or metal plating, and as stiff or flexible plated sheets. Polyflon Corp., New Rochelle, N.Y. [446]

**Ceramacast 510** is a 3,000° F castable ceramic for encapsulating rf heating coils. The material comes in a powder form. The user mixes the powder with water in the proper ratio and pours the slurry around the coils in suitable mold. In three to four hours the mixture hardens, and then after a light bake-out at 200° F, it is ready for use at high temperatures. The material is available from stock in quart cans at \$25, or \$50 per gallon. Aremco Products Inc., P.O. Box 145, Briarcliff Manor, N.Y. 10510 [447]

**Eccotherm TC-4** is a white, thick grease-like compound highly filled with inert metal oxides to produce a material of

**SMK'S HIGHLY  
DEPENDABLE  
COMPONENTS  
SWITCHES**

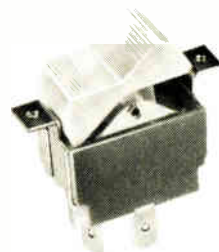

**SJ-1750** AC 125V 15A  
DPST



**SJ-1250** AC 125V 5A  
SPST

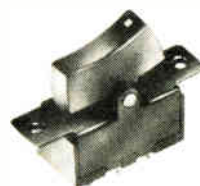

**XJ-0411** AC 125V 0.5A  
DPDT



**SJ-1261** AC 125V 0.3A  
DPDT



**SHOWA MUSEN KOGYO CO., LTD.**  
 Head Office: No. 6-21, 6-chome, Togoshi,  
 Shinagawa-ku, Tokyo, 141, Japan.  
 Cable: "SHOWAMUSEN TOK"  
 Phone: 785-1111  
 Telex: 246 6301 "SHOWAMUSEN TOK"

# Zehntel's Testpac™

## The Complete Checkout Station

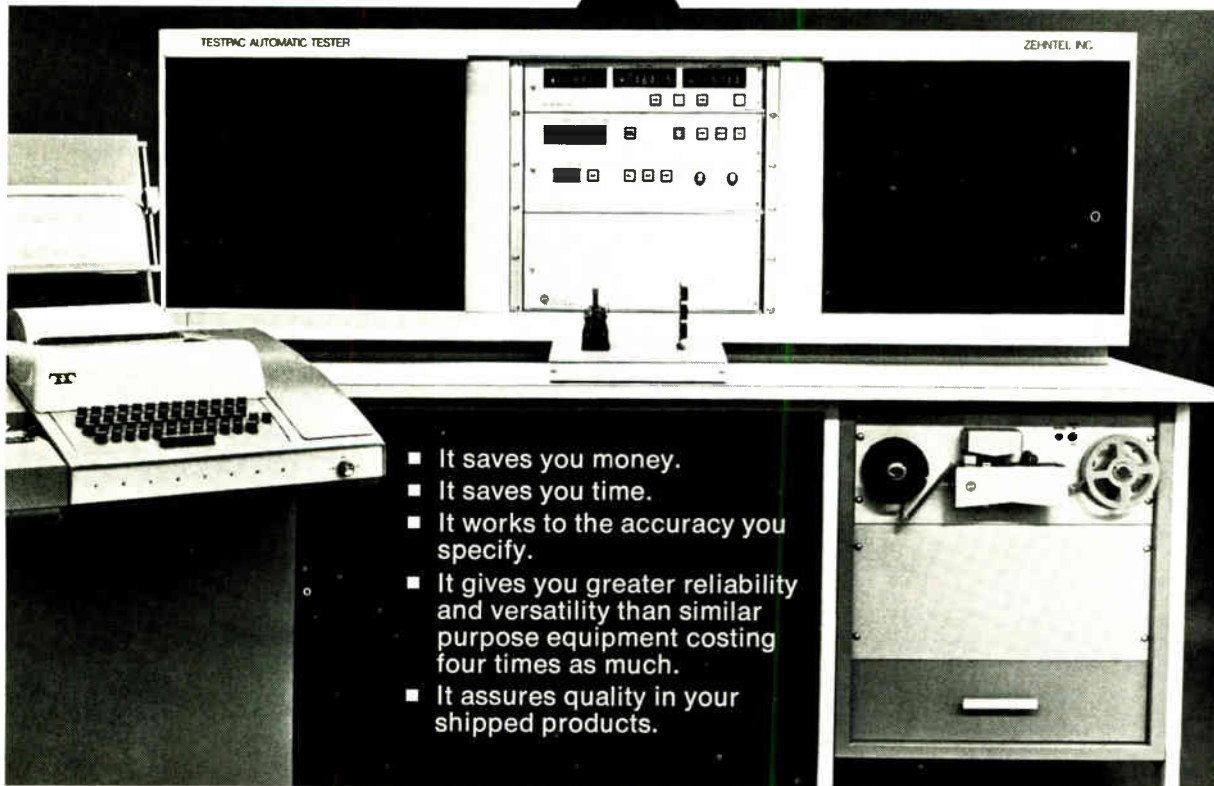
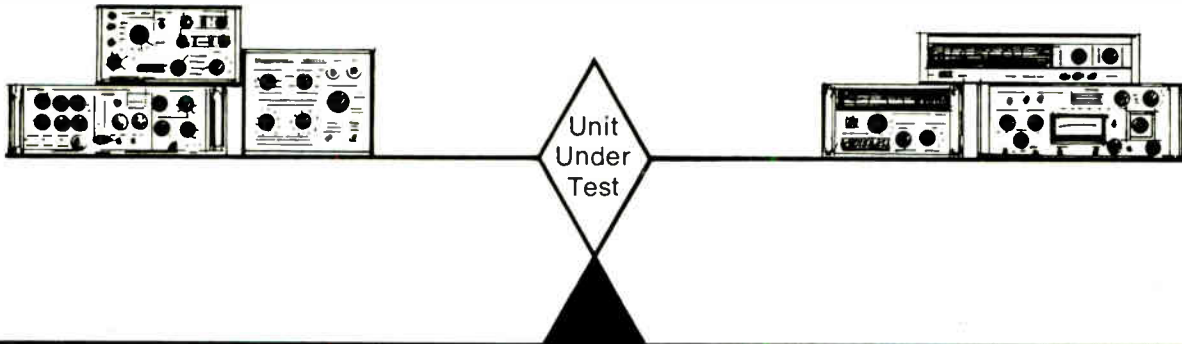

It is simple in the sense that it permits you to select the best balance of programmable stimulation and measuring instrumentation using TESTPAC's interface and control equipment.

Zehntel's TESTPAC is designed to accept simple instructions, while it is capable of precise and detailed readout. Ideally suited as a production checkout station, it is also capable of giving you a means of speedy calibration and detailed diagnostic readouts.

TESTPAC is simple enough to be operated by unskilled personnel, yet it is sophisticated enough to let you undertake the most complex, exacting test procedures.

And, while it costs a fraction of comparable equipment it gives you the versatility to eliminate the costly obsolescence of dedicated checkout stations.



For further information contact: Marketing Manager, Zehntel, Inc., 1450 Sixth Street, Berkeley, Ca. 94710 Telephone: (415) 527-5440 TWX 910-366-7047

An affiliate of Electronic Memories & Magnetics Corporation

# SCHAUER

# 1%

tolerance

## 1 WATT ZENERS ARE A REAL BUY!

ANY voltage from 2.0 to 16.0  
at the industry's **LOWEST  
PRICES!**

Quantity	Price each
1-99	\$1.07
100-499	.97
500-999	.91
1000-4999	.86
5000 up	.82



## THE HI-RELIABLE!

No fragile nail heads.  
Silicon junction aligned between two, parallel, offset tantalum heat sinks . . . great lead tension strength.  
All welded and brazed assembly.  
High pressure molded package.  
Gold plated nickel-clad copper leads.  
Write or phone for Form 68-4 for complete rating data and other tolerance prices.

*Semiconductor Division*

**SCHAUER  
MANUFACTURING  
CORP.** 4514 Alpine Avenue  
Cincinnati, O. 45242  
Ph. (513) 791-3030

## New products

much higher thermal conductivity than other silicones. It is useful for improving the contact between surfaces by eliminating air gaps which act as heat insulators. For example, the conduction of heat from a module to a heat sink is greatly improved by spreading a layer of Ecotherm TC-4 between the two. The material's volume resistivity is greater than  $10^{15}$  ohm-cm. Emerson & Cuming Inc., Canton, Mass. 02021 [448]

Cole-Flex solid shapes, extruded from pure Teflon to meet the most critical industrial and electronic applications, feature high and uniform density throughout, assuring not only consistent physical and electrical properties, but machinability and temperature constancy as well. Their fabrication from virgin Teflon resin makes them virtually contamination free, and close control of concentricity provides minimum scrap loss. Insulation resistance of Cole-Flex rods and sheets is above measurable range over the full span of operating temperatures, and remains so after 500 h at the rated temperatures of the resins. Volume sensitivity in ohm-cm of TFE is greater than  $10^{18}$  for measured temperatures from 40° to 440°F. Surface resistance in ohms/sq in. is greater than  $10^{10}$ . Dielectric strength, as measured by ASTM short-term test, is as high as 600 V/mil using 0.060-in.-thick specimens. Coleman Cable Electronic Products Division, West Babylon, N.Y. 11704 [449]

Four pure silver, conductive epoxy systems are for bonding, joining, and sealing. Formulated to produce a light, creamy paste, these systems may be applied with standard dispensing equipment. Volume resistivity at room temperature is  $2 \times 10^{-2}$ . Operating temperature range is from -80° to +300°F. Applications include making electrical connections to heat-sensitive components, ferrites, capacitor slugs, and integrated circuits. The epoxy is also used to bond waveguide flanges, repair printed circuits, and seal IC packages. Technical Wire Products Inc., 129 Dermody St., Cranford, N.J. 07016 [450]

Semi-organic polymer called FreKote 22 has been compounded to produce a thin film-forming release surface. It is easy to apply, requiring only a clean surface and room temperature cure. FreKote Inc., P.O. Box 825, Boca Raton, Fla. 33432 [451]

Beryllia microspheres known as grade G-6 Berlox are for plasma-sprayed, heat-conductive ceramic insulation of metallic substrates. The plasma powder consists of Berlox K-140, a 99% pure beryllium oxide. National Beryllia Corp., Haskell, N.J. 07420 [452]

## Wide range! MITSUMI COMPONENTS

Mitsumi components are produced in excellent combination of its unique electronics technology and superb equipment. Mitsumi elements carry our heartily wish to make all available best products to users. With 400 kinds of Mitsumi's reliable and highly qualitative components, we are all ready for you to help reduce costs and to increase quality of your machinery.



### PRODUCTION ITEMS

Thick Film ICs, UHF & VHF TV Tuners, Front-end FM Tuners, Push-button Tuners, IF Transformers, Various Coils, Polyethylene Variable Capacitors, Magnetic Heads, Micromotors, Synchronous Motors, CuS Photoconductive Cells, Trimmer Capacitors, Semi-fixed Resistors, Switches, Terminals, Fuse Holders, Small Mechanical Components.



# MITSUMI

MITSUMI ELECTRIC CO., LTD.

Main Office 1056 Koadachi, Komae-machi, Kitatama-gun, Tokyo,  
Japan Tel 489-5333

Europe office Marienstrasse 12, Dusseldorf, W. Germany,  
Tel 352701

MITSUMI ELECTRONICS CORPORATION

11 Broadway, New York 4, N.Y. 10004, U.S.A. Tel (212) 425-3085

MITSUMI COMPANY, LTD.

302, Cheong Hing Building, 72, Nathan Road, Kowloon, Hong Kong  
Tel 666925

Circle 227 on reader service card

## LOGIC TESTER

TYPE  
HL-1

Applicable to all logic systems, a completely new tester... capability exceeds other testers... much easier to operate than an oscilloscope.

Price  
\$87.00



KOKUYO ELECTRIC CO., LTD.

1-36-15 Ookayama Meguro-ku  
Tokyo Japan  
Cable: "INSTKOKUDEN TOKYO"  
Tel: TOKYO(717)3181

Circle 228 on reader service card



# SWITCHES THAT SAVE YOU SPACE • EFFORT • TIME • MONEY

## PUSHBUTTON SWITCHES

Miniature add/subtract units (left below) retrofit most minithumbwheel switch panel openings. Decades mount on 1/2-in. centers. Standard 10-position, 8- & 12-position on special order. Decimal, binary, and binary with complement outputs. Series PSB (at right in cut) binary and decimal rotary push-button switches are 10 & 12-position units; require but one inch panel space per module. All CDI push-button switches are fully sealed against hostile environments, impervious to dust and liquids.



## THUMBWHEEL SWITCHES

CDI turns off hostile environment, turns on total protection—sealing both switching area and panel. Positive, long, trouble-free service operation is characteristic. PS Series (center in cut above) is available in digital and binary, meets MIL-S-22710. E.E. style bezels have no screws visible when mounted.

New Series TSM (at extreme right in cut above) mounts on 1/2-inch centers and retrofits most panel openings for miniature thumbwheel switches. It can be furnished with decimal, binary, and binary with complement outputs, or specified code readout characters; is available with extended PC boards for additional component mountings; also features easily-read characters, positive detent, 10- & 12-position capability.

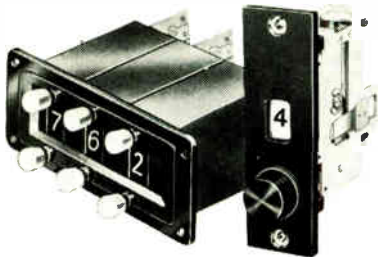

## ROTARY SWITCHES

Cut maintenance requirements to seconds—where it might otherwise take days. No unsoldering, no disassembly, no wire removal! RS series in lengths up to 36 wafers; manual, solenoid, or motor operation; up to 32-positions; sizes 2", 3", or 4" square. Change programs, configurations, circuits quickly. These units meet MIL-S-22710. Tabet Pat. 2,841,660 and others.

Snap-in, snap-out modules in seconds.

## RS SERIES



## CHICAGO DYNAMIC INDUSTRIES, Inc.

Precision Products Division

1725 Diversey Blvd., Chicago, Ill. 60614 • phone (312)543-4600

Circle 229 on reader service card

## OVER 1,000,000 SIZES MILITARY CASES COMBINATION • TRANSIT • INSTRUMENT

MIL-T-945A, T-4734, T-21200, STD-108, C-4150



Choose from over 1,000,000 variations in dimensions, proportions, metals, finishes, and custom accessories. Whatever your need, the MM (multi-measure) method gives you high production savings even on custom runs as low as 25 units. Send your print or requirements. Manufacturers representatives in all major cities.

SEND FOR FREE CATALOG & DIMENSION SPECIFICATION SHEETS.

**mm ELECTRONIC ENCLOSURES, Inc.**

111 Bloomingdale Rd., Hicksville, N.Y. 11801 • 516-935-9400

Circle 230 on reader service card

## MOST SUITABLE FOR COLOR TV SERVICE



MODEL 555G

TRIGGER OSCILLOSCOPE

Model 555G is used for the observation and measurement of signal waveforms on the cathode ray tube of 5-inch diameter. It provides two ranges of TV-H and TV-V in the time base for signal waveforms on horizontal and vertical circuits of TV receivers. The vertical axis provides bandwidth from DC to 7MHz, and Sensitivity of 0.02V/cm.



**kikusui**

KIKUSUI ELECTRONICS CORP.

3-1175, SHINMARUKO-HIGASHI, KAWASAKI-CITY, KANAGAWA-PREF. JAPAN  
TELEPHONE: (044) 41-0111. CABLE ADDRESS: "KIKUSUIDE" KAWASAKI

Circle 191 on reader service card

191

# Pulling down the cost of lighting up an instrument

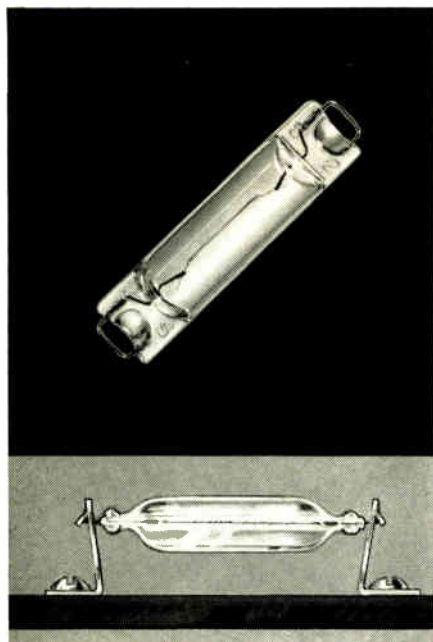

For a high-reliability light source, the Tung-Sol baseless cartridge lamp is about as simple as you can get. Elimination of cemented-on bases removes two potential failure sources while lowering cost. There are no anchors to generate noise and no soldered connections. Design permits use of an inexpensive clip-type mounting bracket which achieves low silhouette. Can be supplied in 6 v. and 12 v. types. Complete information and application assistance available. Write for catalog A-21. Tung-Sol Division, Wagner Electric Corporation, 630 W. Mt. Pleasant Avenue, Livingston, N.J. 07039; TWX: 710-994-4865, Phone: (201) 992-1100; (212) 732-5426.

## TUNG-SOL® BASELESS CARTRIDGE LAMP

TUNG-SOL—WHERE BIG THINGS ARE DONE WITH SMALL LAMPS

© Trademark TUNG-SOL Reg. U.S. Pat. Off. and Marcos Registradas

## New Books

### All about FET

Theory and Applications of Field Effect Transistors  
Richard S.C. Cobbold  
Wiley-Interscience  
534 pp., \$19.95

Clearly, only with an understanding of semiconductor physics, fabrication, and properties can the engineer get the best performance from the devices and his circuit. Cobbold goes far toward making an import semiconductor device, the field effect transistor, less of a black box and more an organic part of the circuit.

The author's underlying philosophy is that, in his own words, "a proper appreciation of the versatility and limitations of field effect transistors can best be achieved from a thorough understanding of the device physics and the restrictions imposed by fabrication technology." Accordingly, he treats at considerable length such topics as fabrication techniques, theory of junction-gate FETs at both low and high frequencies, properties of metal oxide semiconductor junctions, and static and high frequency theory of MOS device operation.

He then considers applications, but constantly relates device performance to the fundamentals. When explaining the use of the FET as a constant current source, for example, he notes that a low pinch-off voltage is desirable to maximize the range of drain-to-source voltage over which the device delivers constant current. He briefly explains the device-design factors that influence pinch-off voltage (channel thickness and doping), and refers back to chapter 3 for a fuller explanation. From this, interplay, the reader gains an insight into the reasons why a low pinch-off (0.6 volt is the value required in the example) is difficult to achieve. The reader may then decide to find a way to work with a higher voltage, or, depending on the system requirements, may insist on the low value.

A complete chapter is allotted to digital applications of MOS integrated circuits. Complementary MOS logic, multiphase logic, and memory systems are included.

**ZEBRA** performance is  
**TOP performance!**



**ZEBRA** audio transformer for every requirement. Every transformer bears the **ZEBRA** guarantee of stability and high quality performance with irresistible price. Give **ZEBRA** the hearing test.

Designs: Power and filament transformer  
Vertical deflection output transformer  
Filter inductors and reactors  
Audio and Hi-Fi output transformer  
Transformer for transistor applications  
Lamination for transformer

For further information, write to:  
**TABUCHI ELECTRIC CO., LTD.**  
Nisseifudosan-Utajimabashi Bldg. 1-18, Mitejima-naka, Nishi-Yodogawa-ku, Osaka, Japan  
Cable: ZEBRAELEC OSAKA Telex: 524-5657

Circle 231 on reader service card

## ECONOMICAL Thin Film!

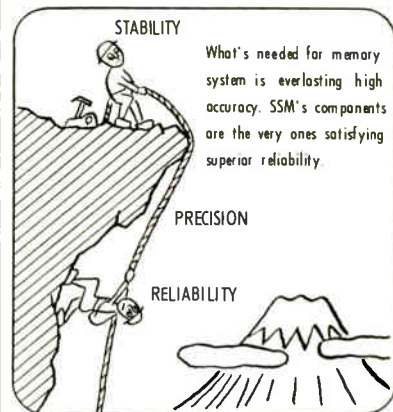

**SSM** **MAF-5**  
1 2 3 4 5 6 7 8 9 10 11 12  
Pla-module:  
thin film modulated  
C-R circuit.

**SSM**  
5.6K0  
Pla-ohm:  
evaporated metal film resistor.

**SSM**  
Pla-con:  
organic thin film capacitor by  
plasma reaction.

**SUSUMU INDUSTRIAL CO., LTD.**

Minami Bldg. 1-12 Ebisuminami  
Shibuya-ku, Tokyo, Japan.  
TEL: Tokyo (03) 712-5990  
TELEX: No. 246-6270

Circle 232 on reader service card

# TURNOVER TURN YOU OFF?

Funny thing about Mountain West people. They like to work. So they do. Usually for the same company, even in the same plant, year after year. Ten national electronics firms in Utah report 1.7% to 4% labor turnover.

In this age of unrest, wandering and searching, there are some who would scorn this. But Mountain West people simply like living in Utah. And, most of them have been raised with a pioneer virtue of employer loyalty. And that's valuable anywhere.

So, in some ways, we may be a little "old fashioned." Or is the word *steadfast*? These people also are better educated than most of the country, with a median of 12.2 years of schooling (highest in the nation), compared with the national average of 10.6 years. More stable? Of course.



If you'd like to cash in on low turnover, write:

Ask for our new 28 page Brochure

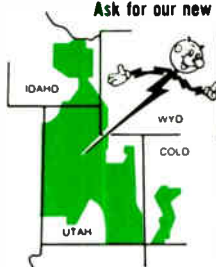

"A Treasure Chest in the Growing West"

Wayne F. Mulcock  
Director, Area Development  
P.O. Box 899, Dept. E-3ab  
Utah Power & Light Co.  
Salt Lake City, Utah 84110

## Utah Power & Light Co.

Circle 233 on reader service card

## New Subminiature VIBRASPONDER™ EMR's



(ACTUAL SIZE)

Just half the size and weight of other electro-magnetic resonators, Motorola's new K1026A is also the most rugged.

It provides maximum protection against shock and vibration, greatly exceeding EIA environmental and falsing standards. Special torsion design eliminates gravity effect and mounting sensitivity.

The K1026A's contactless design allows it to be used as the resonate element in either tone generators or decoders. Over 100 standard tone frequencies available from 67 Hz to 1320 Hz. Multiple resonators may be used to increase system capability and security.

Write for Bulletin TIC-3623 to Component Products Dept., Motorola Communications & Electronics Inc., 4501 W. Augusta Blvd., Chicago, Illinois 60651; or phone (312) 772-6500.



Circle 234 on reader service card

## NOBLE COMPONENTS

■ SLIDE VARIABLE RESISTOR  
Single & Tandem

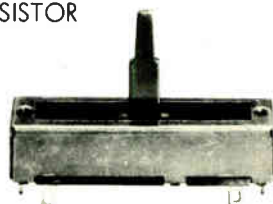

■ Polystyrene Capacitor  
Encapsulated with Special Resin



■ PRE-SELECTOR  
for AM/FM Amplifier



MAIN PRODUCTS  
VARIABLE RESISTOR  
ELECTRONIC SWITCH  
CAPACITOR  
FIXED RESISTOR



**TEIKOKU TSUSHIN KOGYO CO., LTD.**

335, NISHINAKA - MACHI, KARIYADO, KAWASAKI, JAPAN  
TEL: NAKAHARA (044) 42-3171 TELEX: 3842-155  
CABLE ADDRESS: TEITSU

Circle 193 on reader service card

193

# Low Cost Resonators?

Specify Murata's Microfork Model EFM Subminiature Piezoelectric Tuning Forks



If you are looking for low cost resonators for audio frequency specify Murata's Microfork Model EFM.

It has particular advantages of miniaturization, ruggedness and easy handling. Model EFM is not affected by magnetic field and not mutually coupled even in close layout.

Among its wide applications of Microfork are: page systems, selective call systems, mobile communication, security and fire alarm systems, remote controlled tone operated systems.

## SPECIFICATIONS

Frequency: 360 to 2,900 Hz  
 Freq. Accuracy:  
     below 1,000 Hz -  $\pm$  0.5Hz  
     1,000 Hz & over -  $\pm$  1.0Hz

Input/Output impedance: 300 K ohms  
 Insertion Loss: 10 dB max.  
 TC of frequency:  $3.5 \times 10^{-5}/C$  max.

## DELIVERY

Pilot run quantity - from our NY shelf  
 Production qty - 3 weeks

For further information call or write to:

**MURATA**

**MURATA CORP. OF AMERICA**  
 2 Westchester Plaza, Elmsford, New York 10523  
 Telex: MURATA EMFD 137332  
 Phone: 914-592-9180

## Technical Abstracts

### Up-conversion

Parametric up-converter for low noise broadband microwave receivers  
 W.J. Gemulla  
 Zeta Laboratories Inc.  
 Mountain View, California

The parametric up-converter provides low noise amplification by means of a time-varying reactive element, such as a variable capacitance diode. At microwave frequencies, pumping the varactor diode with a source higher in frequency than the input signal produces the time variation required. When the signal mixes with the pump in the nonlinear diode, the result is sum and difference frequencies, one of which must be supported in the up-converter, if amplification is required. The properties of the up-converter depend upon which signal is supported.

Supporting the sum frequencies produces an upper-sideband converter, which is stable because its power gain is limited to the ratio of input to output frequency. Its over-all conversion gain is below this ratio, while its noise figure is usually less than 1 decibel. As the noise of the following stage usually predominates in a microwave receiver, the gain of the up-converter is more important than its noise figure.

Supporting the difference frequency creates lower-sideband parametric up-converters, which can be used in place of the upper-sideband models and offer the possibility of regenerative gain plus up-conversion gain.

When the pump frequency of the upper-sideband up-converter is fixed, the received signal is simply translated upward. To avoid image response, it is usual to follow up-conversion with down-conversion—a mixer/i-f preamplifier circuit.

On the other hand, when a variable frequency pump source is used with the upper-sideband parametric up-converter, the device can serve as an electronically tunable preselector while also providing low noise preamplification and conversion to a fixed i-f.

Tuning ranges of several octaves have been demonstrated by tuning a 50 megahertz window from 500 MHz to 2 gigahertz with an elec-



**NORTON<sup>®</sup>**  
**MAGNETIC HEADS**

**MULTITRACK**  
**ERASE**  
**RECORD**  
**PLAY**

Send now for complete technical literature.

**NORTON**  
 ASSOCIATES, INC.  
 10 Di Tomas Court, Copiague, N.Y. 11726  
 Phone: 516 598-1600

Circle 235 on reader service card

**Apollo**  
 New Products!!  
**Atron DA-133D**  
**7 Segment Incandescent Digital Readout Tube**



### 12 Great Features:

1. Low Voltage - Low Current Operation
2. Compatible with IC Decoder/Driver
3. AC and DC operation
4. Brightest fully adjustable display
5. Unlimited filtered color selection
6. Best visibility
7. Excellent contrast to dark background
8. Produces numeric, alphabetic and symbol display
9. Single plane provides wide viewing angle
10. Unsurpassed reliability—rigid construction
11. Sub-miniature size
12. Long operating life

For more information, please write to:

**Apollo** CORPORATION  
 5-1, TOGOSHI 6-CHOME  
 SHINAGAWA, TOKYO 141, JAPAN  
 TELEPHONE: 786-2005  
 CABLES: APOLLOHAGITA TOKYO

# The power supply you plan to build is built!

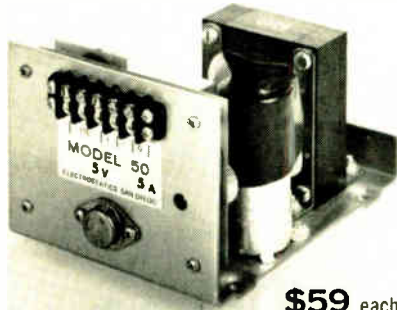

**\$59** each

OTHER MODELS 3 to 50 V available

It's on the shelf, ready for immediate delivery from Electrostatics. With specs proven in service. Low cost. Brief specs on our Model 50:

- 5V 5A Power Supply
- Input 105-125V, 47-420 Hz
- Regulation: Line 0.01%  
Load 0.1%
- Ripple: 500  $\mu$ V max.
- Temp: -20 to +70°C
- Foldback current limiting
- Size: 5" W x 4.13" H x 7" L

(\$69 with overvoltage protection)

For full information call Robert McCartney, Manager of Application Engineering, (714) 279-1414. Or circle the number below for our latest data sheet.

## Electrostatics, inc.

7718 Clairemont Mesa Blvd., San Diego, California 92111 DEPT 101

Circle 237 on reader service card

# new

slide-in mechanism  
for « Compact-Cassette »

- Automatic start by inserting the cassette
- Automatic stop at end of tape
- Available as playback only and as recorder/playback, monaural or stereo.
- Advanced design for assembly in automobile sets and in any portable cassette tape recorder.

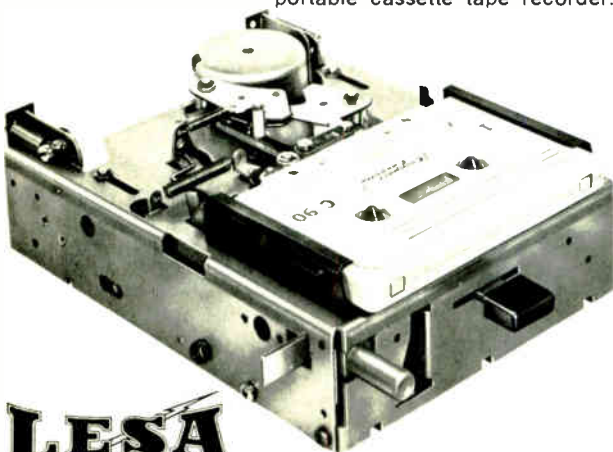

## LESA

For full information write to:  
LESA Costruzioni Elettromeccaniche S.p.A. - Via Bergamo 21 - 20135 MILANO

Circle 238 on reader service card

## Anritsu is comparatively better compare and see!

### coaxial & microwave measuring instruments

for 10,800 channel  
Coaxial System

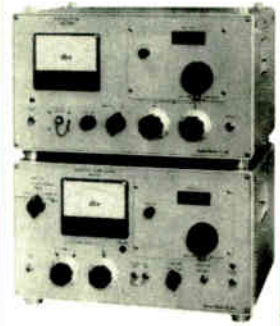

150 MHz Ultra wideband  
Measuring Equipment

Oscillator MG58A &  
Selective level Meter ML55A

for Microwave  
Relay System

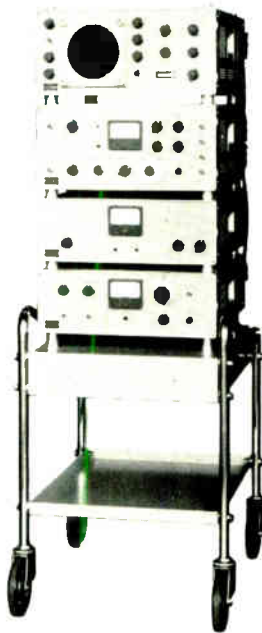

Measuring Equipment  
ME414A

IF group - delay  
differential gain  
linearity  
amp. characteristics  
mod / dem sensitivity

## Anritsu Electric Co., Ltd.

12-20 minamiazabu 4 chome minatoku Tokyo, 106 Japan

Telex: 0-242-2353 ANRITSU TOK

Circle 195 on reader service card

195

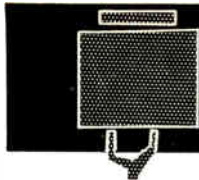

# SEARCHLIGHT SECTION

- CLASSIFIED ADVERTISING • BUSINESS OPPORTUNITIES
- USED OR SURPLUS EQUIPMENT

## AUTOTRACK MOUNT



360 degree azimuth, 210 degree elevation sweep with better than 1 mil. accuracy. Missile velocity acceleration and slewing rates. Amplidyne and servo control. Will handle up to 20 ft. dish. Supplied complete with control chassis. In stock—immediate delivery. Used world over by NASA, USAF, MP-61-B. Type SCR-584.

Ideal satellite tracking. Large spare parts inventory for back-up.

### ANTI-AIRCRAFT GUN MOUNT

Will handle 6,000 lbs. rapid slew through 360° azimuth, 180° elevation. Mobile.

### COUNTERMEASURES TRAINER

Covers L-band, S-band, X-band, all radars. Tacan, UHF drone control, VHF drone control, Communications band. All housed in shelter.

**FIBERGLASS RADOME** Will handle 20 foot antenna. Easily erected & shipped. \$4800.

## PULSE MODULATORS

### 250 KW HARD TUBE PULSER

Output 16 kv 16 amp. Duty cycle .002. Pulses can be coded. Uses 5D21, 715C or 4PR60A. Input 115 v 60 cy. AC \$1200 ea.

### MIT MODEL 9 PULSER 1 MW—HARD TUBE

Output 25kv 40 amp., 30kv 40 amp. max. Duty cy. .002. .25 to 2 microsec. Also 5 to 5 microsec. and .1 to .5 microsec. Uses 6C21. Input 115v 60 cycle AC. Mfg. GE. Complete with driver and high voltage power supply. Ref: MIT Rad. Lab. Series, Vol. 5, p. 152.

### 2 MEGAWATT PULSER

Output 30 kv at 70 amp. Duty cycle .001. Rep. rates. 1 microsec. 600 pps. 1 or 2 msec. 300 pps. Uses 5948 hydrogen thyratron. Input 120/208 VAC 60 cycle. Mfr. GE. Complete with high voltage power supply.

### SCR 584 AUTOTRACK RADARS

Our 584s in like new condition ready to go, and in stock for immediate delivery. Ideal for telemetry research and development, missile tracking, satellite tracking. Fully Desc. MIT Rad. Lab. Series, Vol. 1, pps. 207-210, 228, 284-286. Comp. Inst. BK available \$25.00 each.

HUNDREDS MORE IN STOCK  
LARGEST RADAR  
INVENTORY  
IN WORLD.  
WRITE  
FOR  
CATALOG  
ON YOUR  
LETTERHEAD

# Radio-Research Instrument Co.

45 W. 45th St., New York, N.Y. 10036 ■ 212-586-4691

CIRCLE 966 ON READER SERVICE CARD

## Collectors! Radio Historians!

### Six Original DeFOREST VACUUM TUBES

Known as 'ultraudion' with miniature lamp bases, and in original boxes. Best offer for one' or entire six to:

FS-1947

Electronics Classified Adv. Dept.  
P.O. Box 12, New York, N.Y. 10036

CIRCLE 967 ON READER SERVICE CARD

## WELDING HAND TOOL

TW 17 A

\$48.00



Replaceable Tips—Adjustable Pressure  
AC and Stored Energy Power Supplies

### EWALD Instruments Corporation

Route 7E, Kent, Conn. 06757

CIRCLE 968 ON READER SERVICE CARD

## AUTOMATIC TRACKING SYSTEM

Sci. Atl. Mod. 3101-J70 Antenna Pedestal. AZ-EL 15 deg. per second rated speed. 23 inch dia. bearing. Complete w/control console & mag. amplifiers.

Also in stock complete Glo-track receiving system for 200-400 MHz telemetry band including 12' square quad. Hallx. All part of Atlas missile instrumentation system.

### AN/GSS—1 PASSIVE TRACKER

10 cm passive automatic tracking system with 6 foot parabola. Complete, mounted on van. Supplied by GE for Atlas instrumentation system.

## MICROWAVE SYSTEMS

### SPARE PARTS IN STOCK

Nike Ajax, Nike Hercules, M-33, MFS-19, TFS-ID, TFS-10D, FPS-6 SFS8, SCR-584, MPQ-18. From Largest Inventory in World

### 200-2400 mc. RF PKG

Continuous coverage, 30 Watts Cw nominal output. Uses 2C39A. Price \$575.

### L BAND RF PKG

20 KW peak 990 to 1040 MC. Pulse width .7 to 1.2 micro sec. Rep. rate 180 to 420 pps. Input 115 vac incl. Receiver \$1200.

### 200-225 mc RADAR SYSTEM

1 Megawatt output, 200 nautical mile range for long range detection of medium and high altitude jet aircraft as well as general search. AN/TPS-28.

### AN/GMD-1B RAWIN RADAR

L-Band Radiosonde Tracking System. Complete, new cond. in stock for immed. del. AN/GMD-2 computer mfg. Gen'l Mills also in stock.

### 500 KW L BAND RADAR

500 kw 1220-1359 msc. 160 nautical mile search range P.R.I. and A scopes. MTI. thyratron mod 5J28 magnetron. Complete system.

### C BAND AUTOTRACK

1 Megawatt 10 ft. Parabola. Sperry.

### AN/GPG-1 SKYSWEEP TRACKER

3 cm. auto. tracking radar system. Comp. pkg. w/indicator sys. Full target acquisition & auto. tracking. Input 115v 60 cy. new. In stock for immed. del. Entire sys. 6' x 3' x 10'. Ideal for infrared tracker, drone tracker, missile tracker, R & D

### INDICATOR CONSOLES

AN/SPA-4A, PPT 10", range to 300 mi. VJ-1 PPT 12", Range to 200 mi. VL-1 RH1 12" to 200 mi. 60K ft.

## EMPLOYMENT SERVICES

Fee Paid Employment Service for all technical fields since 1959. Over 1,000 U.S. client cos. Send resume. Atomic Personnel, Inc., 1518 Walnut St., Box L, Phila., Pa., 19102.

## BUSINESS OPPORTUNITIES

Capital Contacts—Before you try Public or Private Placements to Underwriters, Investment Banking Houses, write for helpful information to Confidential Consultant, 817 51st St., Brooklyn, N.Y.

Wish To Represent Your Company, Instruments Service and Installation, computer installation, interface. Along the East Coast. P.O. Box 57 Jamaica, N.Y. 11435.

# Watch—

the Searchlight Section

for

Equipment Opportunities

tronically tuned pump—15.50 to 14.05 GHz—though a disadvantage of this approach is that a small error in pump frequency results in a large signal frequency error.

Presented at Wescon, Los Angeles, August 25-28.

## Lighted keys

An interactive keyboard for man-computer communication  
Larry L. Wear  
Hewlett-Packard Co.  
Mountain View, Cal.  
Richard C. Dorf  
Ohio University  
Athens, Ohio

In this age of time sharing and remote terminals, man-machine communication depends heavily on typing skill. If the operator of the standard teleprinter terminal is not a proficient typist, entering language statements can take a lot of time.

An interactive keyboard has three characteristics that make it suitable for use with interactive systems by operators who type slowly. First, multiple use of keys is eliminated; second, lights under the keys indicate which keys can be struck; and third, unlit keys are locked out electrically, preventing the typist from inserting statements of incorrect syntax. The feedback from the illuminated keys and the electrical lockout is quite unlike the standard keyboard's unidirectional information transfer.

The keyboard can be broken down into four elements: the lighted keys, the decoding matrix, the state storage registers, and the light and enable line drivers. Depressing an enable key sends a character to the processor—usually the central-processing unit of the computer—where the program stored in the memory begins to perform the actions indicated by the character. The character code is also sent to the decoding matrix which combines it with data kept in the storage registers on the existing state of the keyboard in order to determine the next state of the keyboard. This activates the correct line drivers, and the process starts over again when the next key is depressed.

Presented at SJCC, Atlantic City, N.J. May 5-7.

# SWITCHES for PRINTED CIRCUITS



## Grayhill Miniature Push Button or Rotary Switches with PC Terminals

Availability

### Push Button PC Switches

- Rated ¼ Amp. - 115 VAC Resistive
- 2 Circuits - One NC, One NO - Can Be Wired For SPDT
- Flush Or Stand-Off Mounting

### Rotary PC Switches

- 30°, 36°, 45° or 60° Angle Of Throw
- 2 to 12 Positions Per Pole
- 1 to 4 Poles Per Deck
- 1 to 12 Decks
- Totally Enclosed
- Shorting Or Non-shorting
- Commercial Or Military

For your  
Grayhill Engineering  
Catalog offering complete  
technical data—contact



523 Hillgrove Avenue  
LaGrange, Illinois 60525  
Area Code 312, Phone 354-1040

... the Difference Between Excellent and Adequate

Circle 239 on reader service card

## E=2(C+EDP)X

Last year, Electronics magazine contained twice as much information on computers and electronic data processing as the next leading electronic publication.

If the cover of this magazine has your name and address on it, there is no better formula for keeping yourself abreast of the industry's technology.

# Come down heavy on noise with Noise Filters by TOKIN



—the ferrite core people. TOKIN's new noise filters employ our special dust cores as inductance elements to give you high saturation magnetic flux density, and excellent DC superposing.

By placing priority on inductance elements rather than capacitor function, we minimize leakage to ground, doing away with disturbance to logic circuits from current leakage fluctuation. With TOKIN filters preventing noise leakage, you will also get better performance from apparatus connected to the same power line with thyristor (SCRs, triacs)—controlled devices.

Check out how TOKIN can improve your data processing—it's the logical thing to do.

## Tokin

Tohoku Metal Industries, Ltd.

Koei Bldg., 13-10, 7-chome, Ginza, Chuo-ku, Tokyo, Japan  
Telephone: Tokyo 542-6171 Cable Address: TOHOKUMETAL TOKYO

Main Products: Ferrite Cores, Memory Cores, Memory Matrices, Ferrite Magnetostrictive Vibrators, Pulse Transformers, Permanent Magnets (Cast, Ferrite), Tape Wound Cores, Bobbin Cores, Magnetic Laminations, Fe-Co Alloys, Sendust Cores

Pulling the nations  
of the world  
closer together...

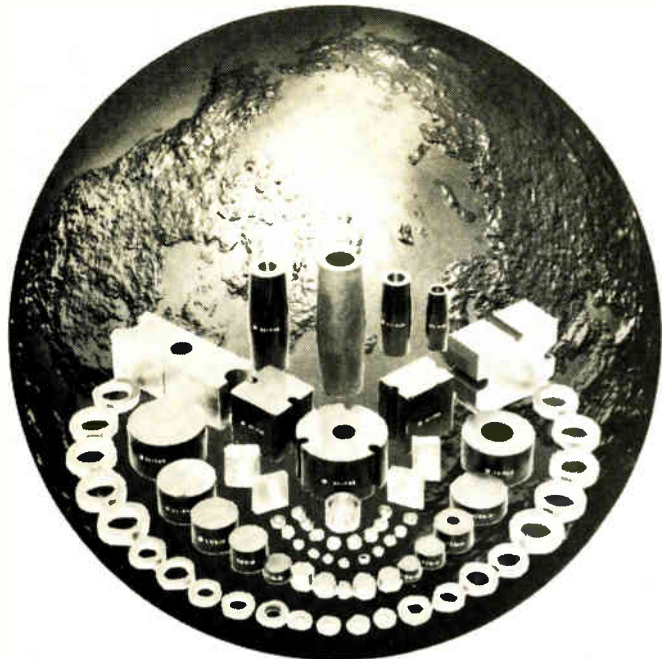

## Hitachi Cast Magnets

Today's communications systems could not exist without high-grade permanent magnets. Cast magnets in particular are becoming increasingly important. Hitachi Metals produces some of the best. Cast magnets for microwave communications. Compactly designed and finished to close tolerances. Featuring high coercive force and high energy product plus magnetic field uniformity and stability.

At Hitachi Metals, magnet production is integrated. Backed by decades of experience, and a tradition of quality workmanship. Hitachi Metals makes full use of technology as modern as tomorrow.

The results speak for themselves. In communications equipment around the world.

### Typical Hitachi Cast Magnets and Properties

Type	Residual Induction (Br) gauss	Coercive Force (Hc) oersteds	Energy Product (B x H) max. x 10 <sup>-6</sup>
HI-MAG (ALNICO-5-7)	13,000~14,500	700~750	6.8~8.2
YCM-8B (ALNICO-8)	8,800~9,600	1,380~1,500	4.8~5.5
YCM-9B (ALNICO-9)	10,000~11,500	1,400~1,700	9.0~11.0

Hitachi cast magnets are also used in meters, generators, motors, telephone equipment, magnetos and many other types of equipment. For further information, please contact:



**HITACHI**  
Hitachi Metals, Ltd.

Head Office  
Chiyoda Bldg., Marunouchi, Tokyo, Japan

**Hitachi Metals America, Ltd.**  
New York (Head Office) Magnet Materials  
Sect. 437 Madison Ave., New York, N.Y.  
10022, U.S.A. Tel. 212-758-5255  
Chicago 2200E, Devon Ave., Des Plaines,  
Ill. 60018, U.S.A. Tel. (312) 299-0031  
Detroit Suite 375, 24300 Southfield  
Road, Southfield, Michigan 48075, U.S.A.  
Tel. (313) 354-4425

Save  
Gold

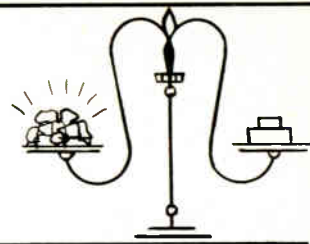

## Continuous Selective Plating

Economize  
on

**GOLD  
SILVER  
NICKEL  
RHODIUM**

### MORE UNIFORM DEPOSIT

Continuous Selective Plating is the product of precise engineering design and ingenuity. M-W LABORATORIES method is the result of many years experience by a leading firm in precious metal plating.

- Saves precious metals.
- Results in more uniform deposit.
- Application of the precious metal where specifically needed.

Continuous Selective Plating in many of its applications makes other methods of precious metal plating obsolete.

M-W Plating Service is offered to help show you just how Continuous Selective Plating can provide greater economy and efficiency.

Write or phone

**M-W LABORATORIES INC.**

1824 N. Milwaukee Ave., Chicago, Ill.  
60647

Phone: (312) DI 2-4020



Circle 335 on reader service card



ACTUAL SIZE

## GUARD AGAINST RFI/EMI with NEW LUNDY MINIATURES



Designed to incorporate the best features available in miniature RFI/EMI filters, Lundy miniatures meet or exceed the requirements of MIL-STD-202 and MIL-F-15733. Insertion loss exceeds 80 dB over most of the range from 10 KHz to 10 GHz.

- Series: Button,  $\pi$ , L or T
- Current: Full range from 0.060 thru 15 A
- Voltage: 50 or 100 VDC, 115 VAC (all series)
- Case dim.: 0.375" dia.  
L. - 0.225" thru 0.540" max.

For full technical data write:



**LUNDY ELECTRONICS  
& SYSTEMS, INC.**

Glen Head, New York 11545  
516 OR 6-1440 • TWX 510-223-0605



# ELFIN T. M.

## NEON INDICATORS

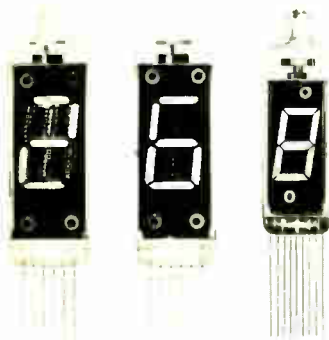

1. Single Plane
2. Brighter Display
3. Wide Viewing Angle
4. Smallest in Size
5. Low Power Consumption

**RODAN OKAYA ELECTRIC INDUSTRIES CO. LTD.**

Yasuda Bldg. 3-8-1-chome, Shibuya-ku,  
Tokyo, Japan  
Distributed by **ALCO ELECTRONIC PRODUCTS, INC.** Lawrence,  
Mass 01842 (617)686-3887  
Cable Address: Alltronics

Circle 241 on reader service card

MIL, UL, CSA, SAA, VDE, SEV, CES, JIS,

## TRANSFORMERS & THERMOSTATS

Excellent Quality!

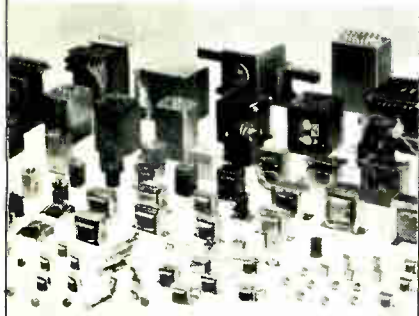

### MAIN PRODUCTS

- Transformer
- DC Magnetic Plunger
- Thermostat
- Converter, Inverter
- Power Supply
- Voltage Regulator

**SHIN-ON ELECTRIC CO., LTD.**

2-30, Kamihosoda-cho, Higashisumiyoshi-ku,  
Osaka, Japan  
CABLE "KAMISINON" OSAKA

Agents:

**TOHO SANGYO LIMITED**

4-25, Junkeimachi-dori, Minami-ku, Osaka,  
Japan TELEX 522-2260

J. E. G. G. M. B. H.

6 Frankfurt/M. Stegstra. /je 34, West Germany  
TEL: 613595

Circle 242 on reader service card

## New Literature

Digital thermometers. Doric Scientific Corp., 7601 Convoy Court, San Diego, Calif. 92111, has available a 16-page booklet describing in detail the pros and cons of various methods of digital thermocouple measurement.

Circle 464 on reader service card.

Flexible circuitry. Ansley West Corp., 4100 N. Figueroa St., Los Angeles 90065. Sixteen-page bulletin E-7 describes all types of flexible circuitry capabilities for computer, commercial electronics, aerospace and military applications. [465]

Function generator. Fischer & Porter Co., 222 Jacksonville Rd., Warminster, Pa. 18974. Specification 55FG3000 describes a solid state electronic function generator, which provides a characterized output from a given input signal. [466]

Engineering plastics. General Electric Co., One Plastics Ave., Pittsfield, Mass. 01201. A 12-page booklet provides descriptive information for each of the company's six engineering plastics. [467]

Electronic rental. Electro Rents, 4131 Vanowen Place, Burbank, Calif. 91504. A four-page brochure provides management, engineering and purchasing personnel with economic justifications for the rental of electronic equipment such as DVMs, scopes, counters, power supplies, recorders, and generators. [468]

Test equipment. Dynascan Corp., 1801 W. Belle Plaine Ave., Chicago 60613, has released a catalog of B&K professional test equipment for electronic servicing, school, laboratory, and industrial applications. [469]

Digital computers. Raytheon Computer, 2700 S. Fairview St., Santa Ana, Calif. 92704. Written for system designers, a 25-page brochure describes the features and characteristics of three different general-purpose digital computers. [470]

DIP socket board. Robinson-Nugent Inc., 800 East Eighth, New Albany, Ind. 47150. Data sheet RN90 covers a universal DIP socket board for wire wrap. [471]

Tunable bandpass filters. Premier Microwave Corp., 33 New Broad St., Port Chester, N.Y. 10573. Tunable bandpass filters that cover the microwave spectrum are described in short form catalog F-2. [472]

Repeat cycle timers. A. W. Haydon Co., 232 N. Elm St., Waterbury, Conn. 06720, has issued a bulletin providing information on hermetically sealed, ac and dc operated, subminiature repeat cycle timers. [473]

Circle 199 on reader service card →

# spec by spec

we're  
**Number 1**  
and  
we  
can  
prove  
it!



## LORLIN AUTOMATIC TRANSISTOR AND DIODE TESTERS

Go/no-go test results for high speed sorting and classifying

**Number 1**  
with full range capabilities

Transistor Models  
10 pa to 15 amps; 10 mv to 600 V  
Diode Models  
1 na to 100 amps; 1 mv to 2000 V

**Number 1**  
with accessory equipment  
Operator multiplex stations with all specifications and accuracies guaranteed at each station.

Auxiliary modules for matching devices and network testing.

**Number 1**  
with interfacing capability  
Interfaces are available to make the Lorlin testers compatible with any mechanical handler, classifying or probing equipment.

**Number 1**  
with consultation and technical assistance by Lorlin's highly skilled engineering staff.

Lorlin testers are designed especially for maximum reliability, ease of service, convenience of programming and simplicity of operation.

For further proof that we're Number 1  
Call Collect for Free Demonstration  
or write for spec-by-spec sheet.

**LORLIN industries inc.**

Precision Road, Danbury, Connecticut 06810

# How to sweep from 0.0005 Hz to 1.4 GHz in 2 easy steps:

**1.** Model 144 HF Sweep Generator: 0.0005 Hz to 10 MHz; sine, square and triangle waveforms, positive and negative pulses; 7 operational modes; may also be used as an oscillator, tone burst generator, pulse generator, and frequency shift keyer. \$845

**2.** Model 2001 Sweep/Signal Generator: 0.5 MHz to 1.4 GHz in 3 bands; can be used as a signal generator over the entire range; has start/stop,  $\Delta f$ , and calibrated output; frequency, attenuation and sweep width all may be remotely programmed. \$1695

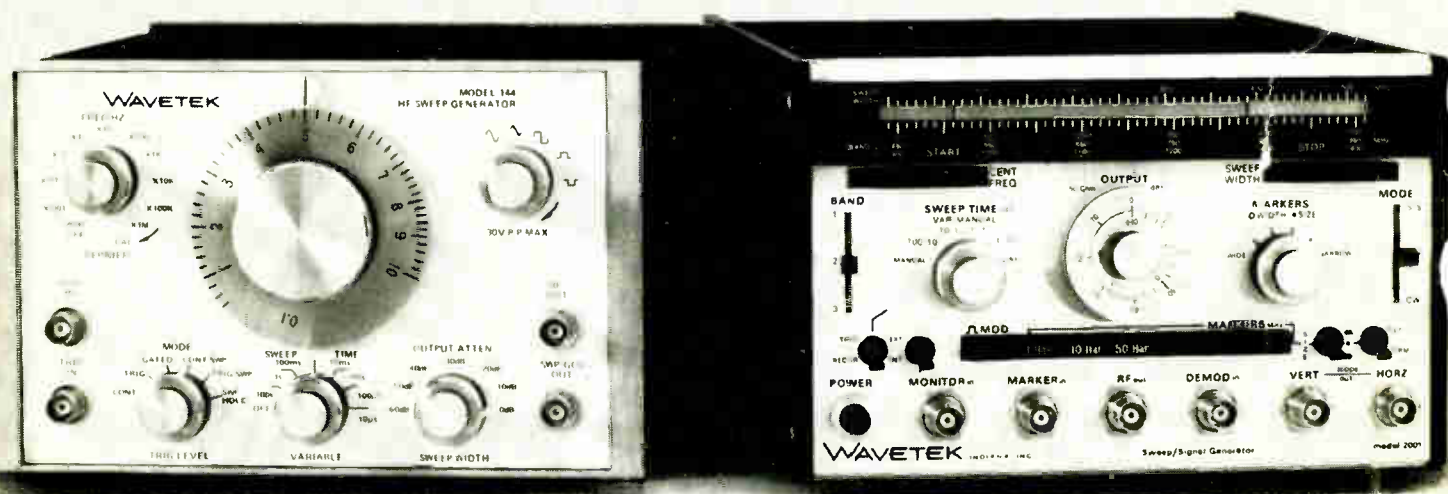

**WAVETEK®**

P.O. BOX 651, SAN DIEGO, CALIFORNIA 92112  
TELEPHONE (714) 279-2200, TWX 910-335-2007

---

# International Newsletter

---

September 14, 1970

## French market for desk calculators spurs domestic maker

European competition to Japanese calculators is growing. A 14-digit electronic desk unit selling for only \$530 will be unveiled by France's Schneider Electronique at the annual Sicob office equipment show opening in Paris on Sept. 26. The company claims its Exa 210 is priced 30% lower than any competing machine on the French market. Schneider launched France's first native-built calculator, priced at \$700, at last year's Sicob [*Electronics*, Sept. 29, 1969, p. 202]. It has since captured 15% of the French market, which is expected to total around 19,000 machines this year, up 30% from 1969.

The Exa 210 is similar to Schneider's previous model but cannot be coupled to a printer nor used with remote keyboards. These simplifications, coupled with production automation and price drops in the Exa 210's 82 TTL circuits explains the lower pricetag. Schneider has aggressive export plans for the new unit: marketing deals have been signed with Dictaphone in Britain and Ahrend in Holland, and others are being negotiated.

In addition, Schneider is putting finishing touches on a new generation of desk calculators using LSI circuits, which the company hopes to market early next year. The first machine will be a 12-digit unit with transfer memory and other features aimed for sale in retail shops. It will sell for less than the Exa 210, say Schneider officials.

## Japanese develop new fiber for use in lasers and links

Japanese researchers have devised low-loss glass fiber for use in laser transmission lines. What's more, using a 4% neodymium doping, workers at the Nippon Electric Co. and Nippon Sheet Glass Co. developed a continuous-wave glass fiber laser oscillator.

The glass fibers have a continuous variation in their index of refraction from the center to periphery, allowing low-loss guidance of a laser beam. Earlier fibers showed losses of about 600 decibels per kilometer, or about 14% per meter for 0.63 micron red light. The new 20-meter-long fibers reduce loss to between 2.3% and 7% per meter. Development of 250-meter fibers is under way.

The new laser uses doped glass fiber and a krypton arc lamp for excitation at the foci of an elliptical enclosure. The usual glass or ruby rods have a fairly large diameter to keep transmission losses low, but the lamp's high heat necessitates water cooling, which is hard to do evenly. And the thin fibers do not show the wall losses of small diameter rods. Typical power output is 3.5 watts at 0.6 microns.

## All-British satellite not slowed by rocket failure

The failure of the first all-British attempt to put a satellite—a simple tracking system test vehicle—into orbit is not likely to delay the next event in the British program. The launch of a much more expensive orbital-systems proving vehicle early next summer is still on schedule.

Faulty pressurization of a fuel tank was apparently the cause of the September 2 mishap over Australia. That's a well understood area of launch design. If, as is likely, it was a statistical reliability failure in a component, no redesign should be involved. As a result of the malfunction, the second stage of the Black Arrow rocket burned 13 seconds short of its full 135 seconds so that the third stage, which functioned correctly, had insufficient velocity to orbit the 30-inch diameter sphere,

---

# International Newsletter

---

which contained an L-band transponder. Because of Britain's restricted space investment, there is no spare launcher available to repeat the tracking system checkout before the orbital-systems checkout is due.

## Swedes to install separate network for data communications

The Swedes are pushing for a data-only network by 1975. The National Swedish Telecommunications Board has revealed plans for a separate data communications network to go on line much sooner than expected. The board had envisioned such a network "sometime between 1975 and 1980." However, the 1975 date is specified in its budget request for the coming fiscal year that was just presented to the Ministry of Communications.

No specific funding for the network was included in the coming year's budget, and sources say most work will be covered by general research and development funds. The need for the separate data communications network reflects the increasing pace of computer and terminal installation [*Electronics*, Aug. 17, p. 115].

Also in the budget request was a healthy bid for more electronic hardware, including \$6 million requested for 10 large uhf tv transmitters and 160 smaller uhf transmitters. These funds will enable uhf reception by 96.5% of the nation's population, compared with about 95% today.

## Britons order new space dish for Goonhilly

With transatlantic telecommunications traffic already increasing 25% each year, the British Post Office has decided it's time to order a third dish antenna for its satellite communications terminal at Goonhilly. Like the existing two the dish will be built by Marconi Co., but with a 97-foot diameter it will be slightly bigger. It will work with one of the mid-Atlantic Intelsat 4 satellites and will become operational in early 1972. Goonhilly 1 and Goonhilly 2 will continue to work with the Intelsat 3 satellites over the Indian and Atlantic Oceans respectively. Satellite communications gave the BPO a 25% return on capital in 1969, and telecommunications chiefs say it's one of the best investments they've ever made.

Improvements in the new dish include aluminum paneling instead of stainless steel, and extensive use of microstrip, instead of waveguides, for channel branching circuits and down converters in the receivers. It will use seven transmitter and 33 receiver carriers, and have a capacity of 1,800 4-kilohertz telephone channels and a television channel.

## Addenda

Motorola's Semiconductor Products division is shopping for a plant site in West Germany, and a decision is expected this year. Still open is whether the plant will assemble and test Phoenix-made devices only or have a full capability, including wafer fabrication. The firm's Toulouse, France, plant, has full capability after 24 diffusion furnaces were installed earlier this year . . . Communications Properties, Inc., will build the first phase of a 24-channel community antenna television system in Mexico City. Although it will work through subsidiaries, CPI claims to be the first large American CATV operator to enter the Mexican market. Two of the channels will handle cable origination of movies and special events. Two others will be reserved for the Mexican government's educational programs. A fifth channel will bring in American network programs via a microwave system.

# British avionics far from grounded by cloudy domestic future

On display at Farnborough was enough ingenuity to guarantee the industry a continuing world market

Though orders are no greater than last year, and even that steady level is precariously dependent on "iffy" aircraft projects, the British avionics industry has not allowed uncertainties to curb its inventiveness. As avionics talk at last week's Farnborough Aerospace Exhibition showed, the flow of new technical ideas is as good as it ever was.

However successful abroad, a country's avionics industry depends primarily on the domestic aviation industry. For Britons, however, there's no certainty about any of the projects that might provide a market for the generation of avionics equipment now in development. By far the most important project for the British avionics industry as a whole is British Aircraft Corp.'s projected 3-11 junior airbus, a 200-to-300 seat, short-to-medium haul, wide-bodied, twin-engined transport. British European Airways is known to favor it against the very similar A-300 French-German airbus. BAC thinks it could sell 200 or more and get the plane into airline service by 1975. But the British government has to put up most of the development money, and so far treasury officials haven't said yes.

Secondly, there are the European joint venture projects. The British-German-Italian multi-role combat aircraft, a two-seat fighter-bomber,

is very important to the military-oriented companies like Ferranti, Ltd., but less important overall to British avionics than the 3-11 because the work must be shared between the three countries. The MRCA is hardly on the drawing board and the partners have plenty of time to fall out. Then there is the French-German A-300 airbus itself. The British are certain they can win A-300 avionics contract in open competition—if there is open competition. And there's Concorde, potentially a big generator of avionics orders if the British and French governments give the production go-ahead, though in many respects Concorde avionics, as presently visualized, rely on 1970 technology.

Partly to counter the uncertainty and partly to go along with a growing dependence on international cooperative projects, the British are pushing harder to sell new avionics outside British air circles. Industry representatives are trying to persuade the government that avionics projects are viable in their own right and entitled to start-up aid in the same way as air frames and engines. So far, the government has tended to regard avionics as an appendage of a specific airframe, and hasn't granted the makers the same support given such major exporters as Rolls-Royce and BAC.

Elliott Flight Automation Ltd., whose success in selling advanced avionics to the U.S. Department of Defense helped avionics makers break their dependence on the British aircraft industry, showed some of its future thinking at Farnborough. Elliott's next autopilot, E-80

automatic flight control system, will incorporate a programable digital processor, based on one of its 900-series computers, to set up and control the 18 autopilot modes. In current autopilots, the aircraft control parameters—such as engine power or control surface movement—which maintain the aircraft in the selected mode are controlled largely by hardwired logic. As a rule, separate hardware has to be built for each aircraft type, which is not easy to modify once installed. Substituting a programable computer for the fixed hardware eases development of the autopilot, allows its use in different aircraft and permits modification of its action in any one aircraft if this should be necessary. Elliott says that on this project it is working with Boeing, which may use the autopilot in its projected 767 and updated 727 aircraft.

Another Elliott project is digital control of engine settings, both to keep the engine operating optimally for any desired objective and to improve the response of bypass engines. The latter respond much more slowly than straight jet engines to sudden throttle openings, but their response can be speeded up by continuously interrelating the various engine feeds during acceleration. Such control is beyond the capabilities of conventional hydro-mechanical controllers, but within those of a digital controller. Elliott's system has been shown to work on the ground and next year will probably be tried under airborne conditions.

Elliott favors several decentral-

ized airborne computers, rather than a single central unit. So far the company has half a dozen avionics systems incorporating small special-purpose digital computers, including a head-up display used in the LTV A-7 Corsair. A head-down display, a nav-attack system, and an air data computer are in development. Currently its special-purpose computers use rope-core read-only memories supplemented by small bipolar semiconductor read/write scratch-pad memories, and 12-bit parallel processors in DTL or TTL that use instruction overlap to get add times of 1 or 2 microseconds.

Ferranti also subscribes to the distributed computer approach, but will talk less about it. It has in development a digital inertial navigation system aimed directly at MRCA and obliquely at any interested civil aircraft operator. Company men say the advantage of a digital platform is compactness, not greater accuracy. The analog inertial platforms in the Harrier and British Phantom military planes are just as accurate, they say. Ferranti will also push a head-down display and an improvement on the pilot's moving-map display developed originally for the TSR-2 and used in the two Concorde prototypes. Ferranti men say one BOAC 747 will have a Ferranti moving map fitted for evaluation.

**Also in the moving map** business is the Marconi Co., which claims its unit has a film capacity four times that of other systems and sufficient for any airline's world air routes without refilling. Having put a lot of effort into television missile guidance and low-light tv, Marconi aims to develop these activities considerably, along with its associate company, Elliott Flight Automation. The company also sees ground avionics as one of the first fields to make use of solid state electro-luminescent alphanumeric displays. Its researchers have put together five seven-by-five gallium arsenide-phosphide modules to form a five-letter strip 1.25 inches long, complete with drive matrix.

Cossor Electronics Ltd., leading British maker of airborne ILS equipment, will offer for civil use its latest small and light airborne receiver developed for British military aircraft. It measures only 5.75 by 3 by 7 inches and weighs 5.5 pounds. Most of the bulk was saved by new and rather complex single-channel technique, about which the company won't talk, that replaces conventional L-C filter networks for demodulating the tone frequencies. It makes wide use of monolithic and thin and thick film integrated circuits. Military orders are worth \$1.7 million dollars so far to Cossor.

---

### Canada

---

#### Digital computer is fallout of airborne navigation work

**For its first flight** into general-purpose digital computers, the Canadian Marconi Co. is rolling out a compact 16-bit machine aimed at the growing avionics computer market. With a pricetag in the \$10,000-\$20,000 range, the new CMA-716 will be battling for airborne central computer contracts against such established systems as IBM's 4 pi, Ambac Industries Micro D 1808, and Rolm Corp.'s Ruggednova.

Marconi project engineer Paul Caden says that one of the computer's main virtues is its newness. By using the latest in off-the-shelf medium scale integrated circuits, Marconi engineers have been able to fit the entire central processor onto nine 4.5-by-6.5-inch printed circuit cards. Each card carries approximately 35 dual in-line MSI packs. The entire computer is 7 inches deep and weighs in at only 16 pounds.

The CMA-716 also takes advantage of some recent "software breakthroughs", says Caden. "Our 4,000-word version, which is the basic machine, can do Fortran and Algol, and also assemble and compile its own programs."

Marconi's in-house plans for the

CMA-716 predate the decision to sell the machine. The computer was originally designed to go into an Omega navigation receiver which the company hopes to be able to test fly later this year.

The computer's job is solving correlation problems and applying various geographic and diurnal corrections to incoming data. In its design, Marconi engineers took the unibus approach. All inputs travel on one set of 16 bus lines, outputs on another set, and address signals on a third. This accounts for 48 of the computer's 56 channels. The remainder are for timing and priority signals. The computer's cycle time is 2 microseconds, its add time is 4  $\mu$ s, and its multiply time is 187  $\mu$ s.

The 4,000-word memory in the basic machine is a core unit, as is the optional 8,000-word memory. Caden adds that Marconi designers made sure "provision was also made for the use of MOS read-only memories when they become available."

---

### Italy

---

#### Lockable knee is key to artificial leg control

**An artificial leg**, the motions of which are controlled by electronic signals and the wearer's muscular reflexes, has been developed by Italian researchers. Designed for persons with above-the-knee amputations, the leg is unusual because the knee locks on muscular command, enabling the wearer to put his weight on the leg with the force necessary to climb stairs.

The limb incorporates principles successful in artificial hand control [*Electronics*, Oct. 11, 1963, p. 34] and, says G.W. Horn, who developed it with the assistance of researchers at the Institute of General Physiology of Turin University, is the first lower-extremity prosthesis to use electronic control.

An electromagnet locks the knee. As long as the magnet isn't activated, the lower leg swings freely.

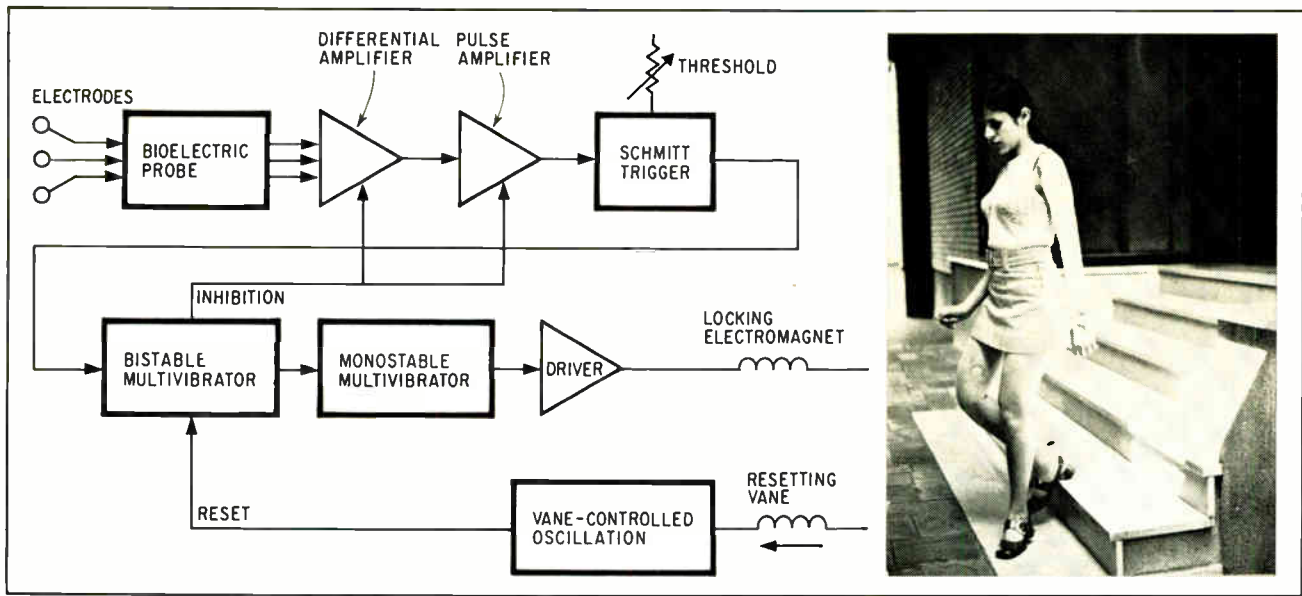

Out on a limb. Electronically controlled artificial leg, with a lockable joint, utilizes skin surface signals generated by muscles in the stump and allows the wearer to walk about and climb stairs in a near-natural fashion.

Once the magnet is pulsed, a clutch locks in and prevents the knee from bending any further, although it remains free to extend. Completely extending the knee turns off the magnet, allowing the lower leg to swing once more.

The wearer controls the magnet by flexing muscles in the stump of his amputated leg. The resulting myoelectric signals from the stump skin are picked up by a trio of electrodes in the artificial limb. They trigger a 50-millisecond pulse which turns on the magnet and also switches a bistable multivibrator that is in series between the electrodes and the magnet. This prevents more pulses from reaching the magnet and wasting battery power. When fully extended the knee triggers an oscillator that resets the multivibrator and turns off the magnet.

In climbing stairs the wearer lifts the leg, flexes the stump muscles when the knee is at the proper angle, and puts the leg's sole down on the next step. Then, applying the right force and leverage against the locked joint, he climbs the step, extending the knee fully and freeing it to bend. Horn says that a person can be trained to use the leg for climbing in a matter of hours. What's more, the first five experi-

mental wearers demonstrated quick learning in walking and bicycling.

Power comes from a 6-volt battery which fits into a compartment just above the knee. The battery is good for 20,000 flexes, or more than 24 hours of wear.

The leg and its controlling circuitry will be marketed by ENA SrL, a company based in Bologna. Horn expects it to cost around \$1,000, plus another \$200 for custom fitting. It has to make an airtight fit with the individual wearer's anatomy because it is attached in effect by suction, and the electrodes also must be correctly positioned.

### Japan

#### Bandwidth-time control varies radar's gain with distance

Intermediate frequency amplifiers for radar receivers have had to balance two contradictory demands. Short ranges require only moderate gain but need wide bandwidth for fine detail. Long ranges call for very high gain to compensate for the sharp decrease in the radar return with distance, but moderate bandwidth is acceptable because

mere detection of targets is good enough.

Now a group headed by Tsutomu Suzuki at the University of Electro-Communications has developed a simplified amplifier that varies bandwidth and gain as a function of time. This variation, synchronized with the trigger in the radar transmitter, makes bandwidth maximum and gain minimum for short ranges, and the reverse for the maximum range of the radar. What's more, the approach enabled a seven-stage i-f amplifier in a commercial marine radar to be replaced with an experimental four-stage amplifier. Amplifier performed excellently in experiments at the university, and further tests with the radar mounted on a ship are scheduled.

The new amplifier is the first step toward Suzuki's eventual goal of developing an adaptive radar in which bandwidth and gain of the i-f amplifier is adapted to the return pulse. This kind of radar would have the clutter suppression of logarithmic receivers without their sensitivity to deviation or degradation from optimum design characteristics. A simplified i-f amplifier along the lines of this experimental version may well find commercial applications, includ-

ing inexpensive radar for boats.

Maximum gain-bandwidth product of the experimental amplifier is about 20% to 25% that of an amplifier designed in the usual manner. Calculations show that this should make it possible to fabricate the amplifier with about half the number of components used in a standard amplifier. Design is also simpler. Suzuki prefers to trade gain for bandwidth in this manner rather than merely cut gain for short range returns.

**At close range**, resolution is critical for station keeping and navigation. Therefore, the bandpass characteristic at close ranges is made rectangular and wide to ensure crisp target definition. The time-bandwidth product is about 1.4, maximizing the signal-to-noise ratio yet at the cost of a 1.7-decibel receiver mismatch loss. At intermediate ranges, the bandpass is narrowed and the skirts flared out to approximate a gaussian characteristic with a time-bandwidth product of around 0.8. Here the mismatch loss reduces to about 1 dB. At maximum range the bandpass characteristic is changed to approximate that of a cascade of single-tuned stages, with an overall time-bandwidth product of around 0.6, the receiver mismatch loss reducing to about 0.6 dB. Thus,

Trade off. New amplifier (bottom) shows reduced close-in clutter, improved long range detection. Reduced resolution at maximum range (arrows) affects target separability, but not detectability.

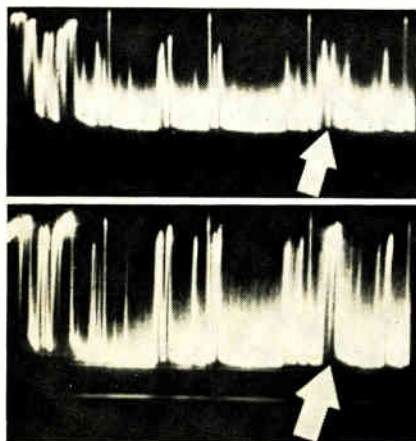

at close range where detection is not a problem, the technique maximizes resolution, while at distant ranges, where resolution is not critical, detectability is maximized.

### Great Britain

#### Thin silicon matrix addresses light-emitting diode array

**Researchers** at Standard Telecommunication Laboratories Ltd., the British ITT labs, by combining their work on very thin silicon slices [*Electronics*, Sept. 2, 1968, p. 170] and gallium arsenide-phosphide light-emitting diode arrays [*Electronics*, Mar. 3, 1969, p. 249] have produced a small, easily made encoder for addressing the diode arrays.

Two workers on thin silicon technology, Gordon Henshall and Bessie Hodgson, have so far made a simple encoder that will turn the lamps in a three-diode array on and off, both singly and in all the possible combinations. Now they are expanding the design, using the same technology, to make an encoder for addressing STL's alpha-numeric readout seven-by-five array modules. Henshall will describe the work at the Solid State Devices Conference at Exeter this week.

**The key to** the new technique, as applied in the three-lamp encoder, is the way the researchers create a matrix of diodes in a silicon chip 0.1-inch square. They diffuse boron to a depth of 10 microns in spots 0.005 inch in diameter on 0.01-in. centers and then thin the chip down from the other side till it's only 15 microns thick and the diode junctions are 5 microns from the surface. Output contacts mounted on the thinned surface are therefore very close to the junction, so that a given diode may pass current to its contact with no perceptible leakage to other diodes and without cross-talk in operation. The matrix is directly compatible with present gallium phosphide and gallium arsenide-phosphide lamps, and the input current will light any likely number of lamps

directly without intermediate amplification.

Henshall says that it would be possible to use the same operating principle in normal thick silicon, where the output contact and junction are much further apart, but the diode spacing necessary to avoid crosstalk would be so great that the matrix would have to be quite large. "The only practicable way to replace discrete diode-transistor switches or complex integrated circuit switching by a single simple matrix type switch is to use thin silicon technology," he says.

**For input** and output contacts, Henshall lays down seven parallel metal strips across each face of the wafer, along one axis on one face and the other axis on the other face, giving 49 crosspoints. Addressing of the lamps is determined by which crosspoints are provided with diodes and which are left empty so that no current can pass.

The full alpha-numeric encoder the researchers are developing will need 35 input and output leads: 26 letters and 9 numbers in the input, 35 diodes in the seven-to-five output array. In practice they will probably use 40-by-40 diode arrays, made in the same way as the seven-by-seven matrix.

In the larger arrays, the boron is diffused through oxide windows into silicon with relatively high resistivity, typically of 10 ohm-centimeters, to diminish the possibility of crosstalk. Titanium overlaid with gold is deposited on the slice and etched away to leave 0.005-inch wide contact strips. Holes are etched in the corners of each matrix square to ensure alignment of the mask for the contact strips on the other face. The slice is thinned to 20 microns by polishing and finished off to 15 microns by etching. The matrices are separated by etching through the slice. Contact strips are evaporated onto the thinned side through a mask made out of thin silicon, which is used to avoid contamination. These strips are of a gold-antimony alloy which is necessary to obtain a good ohmic contact to the high resistivity silicon.





RCA Electronic Components 4th Cover, 183  
 AI Paul Lefton Company  
 Resco 13E  
 G. Matthaes  
 Rhode & Schwarz 3E

San-E Denki Company Ltd. 178  
 Sanko Sha Advertising Agency Co. Ltd.  
 Schauer Manufacturing Corp. 190  
 Nolan, Keelor & Stiles  
 Schlumberger SIS 17E  
 T.B. Browne Ltd.  
 Scientific Radio Systems Inc. 18E  
 Jennings Advertising Co.  
 Sescosem 6E  
 Perez Publicite  
 Sharp Corporation 210  
 Grey-Daiko Adv. Inc.  
 Shin-On Electric Co., Ltd. 199  
 Daiyusha Inc.  
 Showa Musen Kogyo Co. Ltd. 188  
 General Advertising Agency Ltd.  
 Sierra Research Corporation 182  
 B.P. Myer Associates Inc.  
 Sigma Instruments Inc. 179  
 Culver Advertising Inc.  
 Signalite Inc. Sub. of General Instrument Corporation 159  
 McCarthy, Scelba, DeBiasi Adv. Inc.  
 Signetics Corp. Sub. of Corning Glass Works 56-57  
 Cunningham & Walsh Inc.  
 Siliconix Inc. 9, 61  
 Robertson West Inc.  
 Singer Ballantine Operation, The Technical, Industrial And Scientific, Marketing Inc. 52  
 Socapex S. P. I. 9E  
 Sodeco 26E  
 Dumesnil Publicite  
 Solartron Electronics Group Ltd. 19E  
 T.B. Browne Ltd.  
 Sorensen Operation Raytheon Company 16, 17  
 Fred Wittner Company  
 S.P. Electronica 7E  
 Studio Sergio Rosata  
 Sperry Rand-Sperry Tube Division Neals & Hickok Inc. 11E  
 The Sprague Electric Company Harry P. Bridge Company 5  
 Sprague Electric Company, The Harry P. Bridge Company 21E  
 Standard Condenser Corporation Rtron 188  
 R.N. Johnson Advertising  
 Sumitomo Electric 172  
 Dentsu Advertising Ltd.  
 Superior Electric Co. 181  
 K.C. Shenton Company  
 Susumu Industrial Co. Ltd. 192  
 Kyokuto Kikaku Co. Ltd.  
 Switchcraft Inc. 156  
 Buti-Roberts Advertising  
 Sylvania Electric Products Inc., Electronic Components Group Doyle Dane Burnbach Inc. 35 to 42  
 Systron Donner Corporation Bonfield Associates Inc. 12

Tabuchi Electric Co., Ltd. 192  
 Daiyusha, Inc. Adv.  
 Takeda Riken Industry Co., Ltd. 182  
 Shinwa Advertising Co., Ltd.  
 Teikoku Tsushin Kogyo Co. Ltd. 193  
 Diamond Agency Co., Ltd.  
 Tektronix Inc. 51, 120  
 Dawson Inc.  
 Tempress Industries Inc. 27  
 Hal Lawrence Inc.  
 Teradyne Inc. 49  
 Quinn & Johnson Advertising Inc.  
 Texas Instruments Incorporated Components Group 62, 63  
 Albert Frank Gunther Law Inc.  
 Tohoku Metal Industries Ltd. 197  
 Hakuodo Inc.  
 Toko Inc. 164  
 Hakuodo Inc.  
 Town of Tonawanda Development Corporation 133  
 Melvin F. Hall Advertising Agency  
 Triplett Electrical Instrument Company 131  
 Byer and Bowman Advertising  
 TRW Semiconductors Inc. 151  
 Fuller & Smith & Ross Inc.

Tung-Sol Division, Wagner Electric Corp. 192  
 Winius-Brandon Company  
 Utah Power & Light Company  
 Gillham Advertising Inc. 193

Varo Incorporated 172  
 Tracy-Locke Inc.  
 Vernitron Piezoelectric Division Deborah Advertising Inc. 22  
 V/O Techmashexport 12E  
 V/O Vneshtorgreklama

Wang Laboratories 8  
 Chirurg & Cairns Inc. Advertising  
 Wavetek 200  
 Chapman Michetti Adv.  
 Wayne Kerr Ltd. 10E  
 W.S. Crawford Ltd.  
 Weston Instruments Inc. Archbald Division 146, 147  
 Michel Cather Inc.  
 White Instruments Inc. 164  
 Wilson & Associates, The Art Studio, A Div. of Graphic Studios

Zehntel Incorporated 189  
 Markman Incorporated  
 Zenith Radio Corporation 160  
 Mills, Fife & MacDonald Inc.  
 Zippertubing Company  
 Edward S. Kellogg Company 176

### Classified & Employment Advertising

F.J. Eberle, Manager  
 212-971-2557

EQUIPMENT  
 (Used or Surplus New)  
 For Sale

Ewald Instruments Corp. 196  
 Radio Research Instrument Co. 190

For more information on complete product line see advertisement in the latest Electronics Buyer's Guide  
 Advertisers in Electronics International

### Electronics Buyers' Guide

George F. Werner, Associate Publisher [212] 971-2310  
 Regina Hera, Directory Manager [212] 971-2544  
 Mary Tully, Production Manager [212] 971-2046  
 Sales Offices:  
 Boston, Ben Briggs [617] CO2-1160  
 Detroit, Mac Heustis [313] 962-1793  
 New York, Cliff Montgomery [212] 971-3793  
 Jim Vick [212] 971-2661  
 Chicago, Bob Denmead [312] MO4-5800  
 Los Angeles, Kenneth Watts [213] HU2-5450  
 Philadelphia, Tim Bemis [215] LO8-6161

## Advertising Sales Staff

Pierre Braudé [212] 971-3845  
 Advertising Sales Manager

Atlanta, Ga. 30309: Charlton H. Calhoun, III  
 1375 Peachtree St., N.E.  
 [404] 892-2868

Boston, Mass. 02116: William S. Hodgkinson  
 McGraw-Hill Building, Copley Square  
 [617] CO 2-1160

Chicago, Ill. 60611: Ralph Hanning,  
 Kenneth E. Nicklas, 645 North Michigan  
 Avenue, [312] MO 4-5800

Cleveland, Ohio 44113: William J. Boyle,  
 55 Public Square, [216] SU 1-7000

Dallas, Texas 75201: Richard P. Poole,  
 1800 Republic National Bank Tower,  
 [214] RI 7-9721

Detroit, Michigan 48226: Ralph Hanning,  
 2600 Penobscot Building  
 [313] 962-1793

Houston, Texas 77002: Richard P. Poole,  
 2270 Humble Bldg. [713] CA 4-8381

Minneapolis, Minn. 55402: Kenneth E. Nicklas,  
 1104 Northstar Center [612] 332-7425

New York, N.Y. 10036  
 500 Fifth Avenue  
 James R. Pierce [212] 971-3615  
 Warren H. Gardner [212] 971-3617  
 Michael J. Stoller [212] 971-3616

Philadelphia, Pa. 19103:  
 Jeffrey M. Preston  
 6 Penn Center Plaza,  
 [215] LO 8-6161

Pittsburgh, Pa. 15222: Jeffrey M. Preston,  
 4 Gateway Center, [412] 391-1314

Rochester, N.Y. 14534: William J. Boyle,  
 9 Greylock Ridge, Pittsford, N.Y.  
 [716] 586-5040

St. Louis, Mo. 63105: Kenneth E. Nicklas,  
 The Clayton Tower, 7751 Carondelet Ave.  
 [314] PA 5-7285

James T. Hauptli [415] DO 2-4600  
 Western Advertising Sales Manager

Denver, Colo. 80202: David M. Watson,  
 Richard W. Carpenter  
 Tower Bldg., 1700 Broadway  
 [303] 266-3863

Los Angeles, Calif. 90017: Ian C. Hill,  
 Bradley K. Jones, 1125 W. 6th St.,  
 [213] HU 2-5450

San Francisco, Calif. 94111: Don Farris,  
 James T. Hauptli, 255 California Street,  
 [415] DO 2-4600

Paris: Denis Jacob  
 17 Rue-Georges Bizet, 75 Paris 16, France  
 Tel 72 33 42, 727 33 60

United Kingdom and Scandinavia  
 London: Oliver Ball, Tel: Hyde Park 1451  
 34 Dover Street, London W1

Milan: Robert Saldel, Roberto Laureri Jr.  
 1 via Baracchini Phone 86-90-656

Brussels: Denis Jacob  
 27 Rue Ducale Tel: 136503

Frankfurt/Main: Hans Haller  
 Elsa-Brandstroem Str. 2  
 Phone 72 01 81

Tokyo: Noboru Matsumoto, McGraw-Hill  
 Publications Overseas Corporation,  
 Kasumigaseki Building 2-5, 3-chome,  
 Kasumigaseki, Chiyoda-Ku, Tokyo, Japan  
 [581] 9811

Osaka: Akihiko Kamesaka, McGraw-Hill  
 Publications Overseas Corporation, Kondo  
 Bldg., 163, Umegae-cho Kita-ku [362] 8771  
 Australasia: Warren E. Ball, IPO Box 5106,  
 Tokyo, Japan

### Business Department

Stephen R. Weiss, Manager  
 [212] 971-2044

Thomas M. Egan,  
 Production Manager [212] 971-3140

Dorothy Carmesin, Contracts and Billings  
 [212] 971-2908

Frances Vallone, Reader Service Manager  
 [212] 971-2865

# Stable Mates.

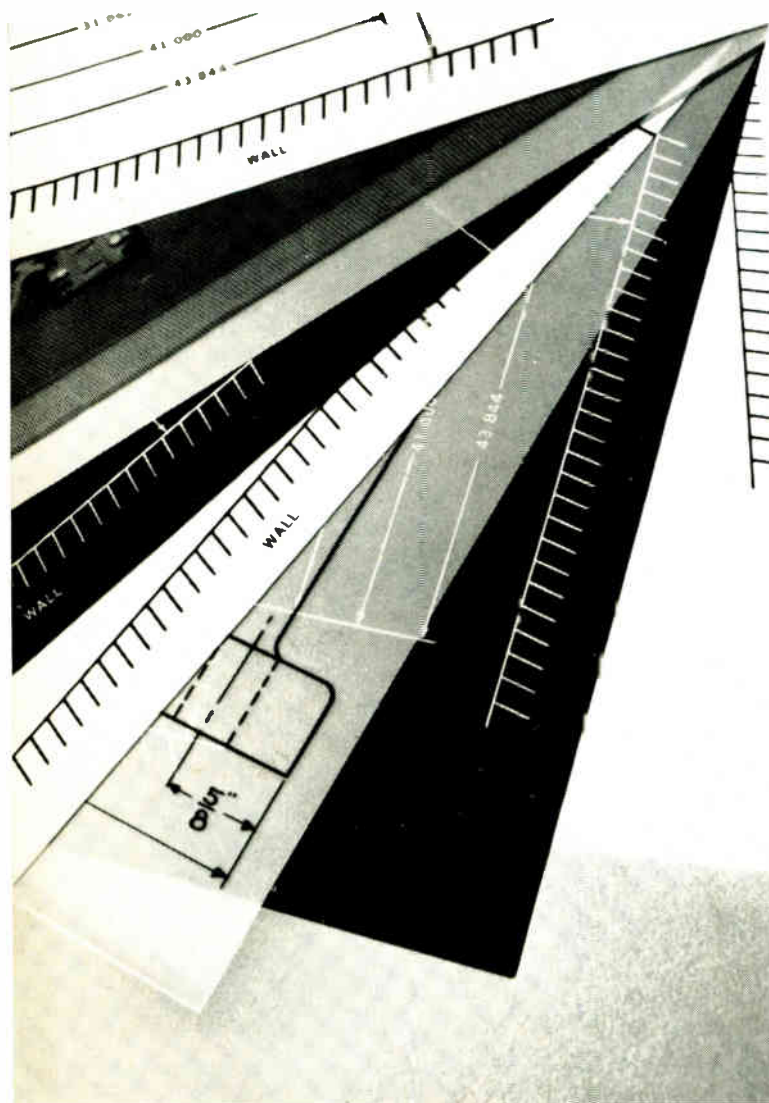

## New Kodagraph Super-K papers give you unusual dimensional stability.

Chances are you know how well Kodagraph Estar base films hold their size. Now Kodak introduces Super-K papers that give you better dimensional stability than conventional papers. And they lie flat and resist soiling, too.

Takes only two minutes to process them in the Kodak Supermatic processor, which also handles Estar base films. Or you can use conventional processing methods. You'll like the results either way.

For all the facts, contact your local Kodak Technical Sales Representative. Or write Eastman Kodak Company, Business Systems Markets Division, Dept. DP797, Rochester, N.Y. 14650.

**DRAWING REPRODUCTION  
SYSTEMS BY KODAK**

Kodak

## The smallest

QT-8B is a handy handful that your budget can hold.



## The quietest

Take it to the library.



## The lightest

3.63 lbs.  
including floating decimal.



## The PowerStructure

First use of ELSI cell other than  
space and military.



ELSI (Extra Large Scale In-  
tegration) shown approxi-  
mately 16 times actual size.  
Measures just 1/8" square.

## The portable

Use it anyplace because QT-8B  
operates on AC or battery power.  
Even in your car with  
an optional Car Adaptor QTA-3.



Executive Calculator  
**MicroCOMPET** by **SHARP**

SHARP CORPORATION, Japan

U.S. Subsidiary: SHARP ELECTRONICS CORPORATION 10 Keystone Place Paramus, New Jersey 07652 Phone: (201) 265-5600

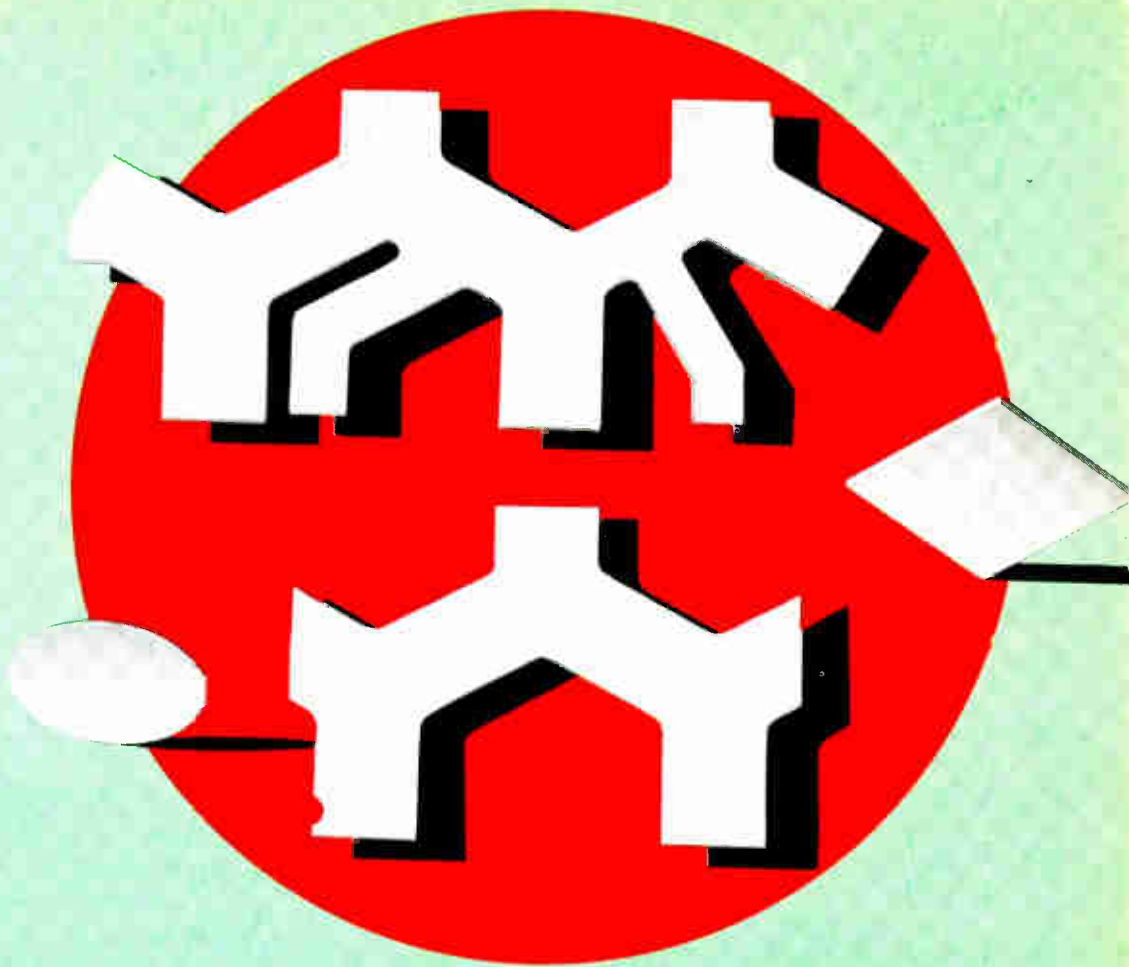

# Al Si Base<sup>®</sup>

## POLISHED SUBSTRATES

### *Better Surface, Better Control on Dielectric Constant*

AlSiBase<sup>®</sup> substrates with ground, polished surfaces are available in sizes to 5" x 5" with surface quality which sets new standards. Smaller sizes such as 1" x 1" are available with ground surfaces of less than one microinch, intermediate sizes as low as 2 microinches or better, and larger substrates 10 microinches or better.

The substrates are ground for thickness and flatness control with a remarkably uniform surface. The basic ceramic is a specially processed AlSiMag<sup>®</sup> 772 which is a 99.5% alumina ceramic

composition with superior strength and electrical characteristics. When required, the dielectric constant variation may be maintained at a level of  $\pm 1\%$  or less. Many of these substrates are being used in microwave technology.

This is the first time that volume deliveries of ceramics of this quality have been commercially available. Our technical staff with specialized experience will be glad to make suggestions if you will outline your requirements. Prototypes in many shapes can be supplied to your specification without tooling.

CODE IDENT. NO. 70371

PHONE 803/682-3215 • LAURENS, SOUTH CAROLINA 29360, U.S.A.  
PHONE 615/265-3411 • CHATTANOOGA, TENNESSEE 37405, U.S.A.

For service, contact American Lava representatives in Offices of Minnesota Mining and Manufacturing Company in these cities (see your local telephone directory): Boston: Needham Heights, Mass. • Chagrin Falls, C. • Chicago: Elmhurst, Ill. • Dallas, Tex. • Indianapolis, Ind. • Laurens, S. C. • Los Angeles, Calif. • Metropolitan New York: West Caldwell, N. J. • Up-State New York and Canada: Phoenix, N. Y. • Orange, Conn. • Philadelphia, Penn. • St. Louis: Lee's Summit, Mo. • Salem, Va. • S. San Francisco, Calif. • Tempe, Ariz. • International: c/o American Lava Corporation, Chattanooga, Tenn. 37405, U.S.A., TELEX 558432

**American Lava Corporation** **3M**  
A SUBSIDIARY OF **COMPANY**

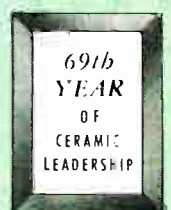

Circle 901 on reader service card

Here's important news for every cost-conscious designer—RCA's COS/MOS line in dual-in-line plastic packages, at prices you can't afford to overlook.

This new COS/MOS line, RCA's CD4000E series, offers a broad range of gate-level and MSI devices with the low-power, high-noise-immunity features of hermetically packaged COS/MOS devices. And this plastic package gives you a broad operating temperature range and built-in reliability for industrial, commercial, and consumer applications. Look into RCA's CD4000E series for automotive systems, appliances, avionics applications, alarm systems, communications equipment, computers, industrial controls, and instrumentation.

This new low-cost, high-performance COS/MOS line offers you wide design flexibility in 19 application-oriented devices in 14- or 16-

lead dual-in-line plastic packages. Check them now...and check our reliability report (listed below). Here are some important CD4000E series highlights:

- Wide operating-temperature range:  $-40^{\circ}\text{C}$  to  $+85^{\circ}\text{C}$  ( $-65^{\circ}\text{C}$  to  $+150^{\circ}\text{C}$  storage)
- Ultra-low quiescent-power dissipation—Gates— $P_T = 50 \text{ nW/pkg. (typ) @ } V_{DD} = 10 \text{ V}$   
MSI circuits— $P_T = 10 \mu\text{W/pkg. (typ) @ } V_{DD} = 10 \text{ V}$
- Operation from single unregulated voltage supply: 5 to 15 V range
- Excellent dc and dynamic noise immunity—gate level and MSI circuits—4.5 V (typ) @  $V_{DD} = 10 \text{ V}$  over full operating-temperature range
- Speed  
Gates—propagation delay ( $t_{pd}$ ) = 50 ns (typ) @  $V_{DD} = 10 \text{ V}, C_L = 15 \text{ pF}$

MSI circuits—clock pulse frequency ( $f_{CL}$ ) = 2.5 MHz (typ) @  $V_{DD} = 10 \text{ V}$

- Single phase clock
- Clock voltage equal to supply voltage
- Compatible gate level and MSI functions
- Protected inputs and outputs

For further information, see your local RCA Representative or RCA Distributor. Ask for technical bulletin File No. 445, and the following publications: "RCA CD4000E Series COS/MOS IC Reliability Data," RIC 103; "Counters and Registers," ST-4166; "Noise Immunity," ICAN-6176; "Astable and Monostable Oscillator Designs," ICAN-6267. Or write: RCA, Commercial Engineering, Section 701-14/CD47, Harrison, New Jersey 07029. International: RCA, 2-4 rue du Lièvre, 1227 Geneva, Switzerland, or P.O. Box 112, Hong Kong.

## Now! COS/MOS Goes Plastic for a Brand New Approach to Logic Circuits at Low Cost.

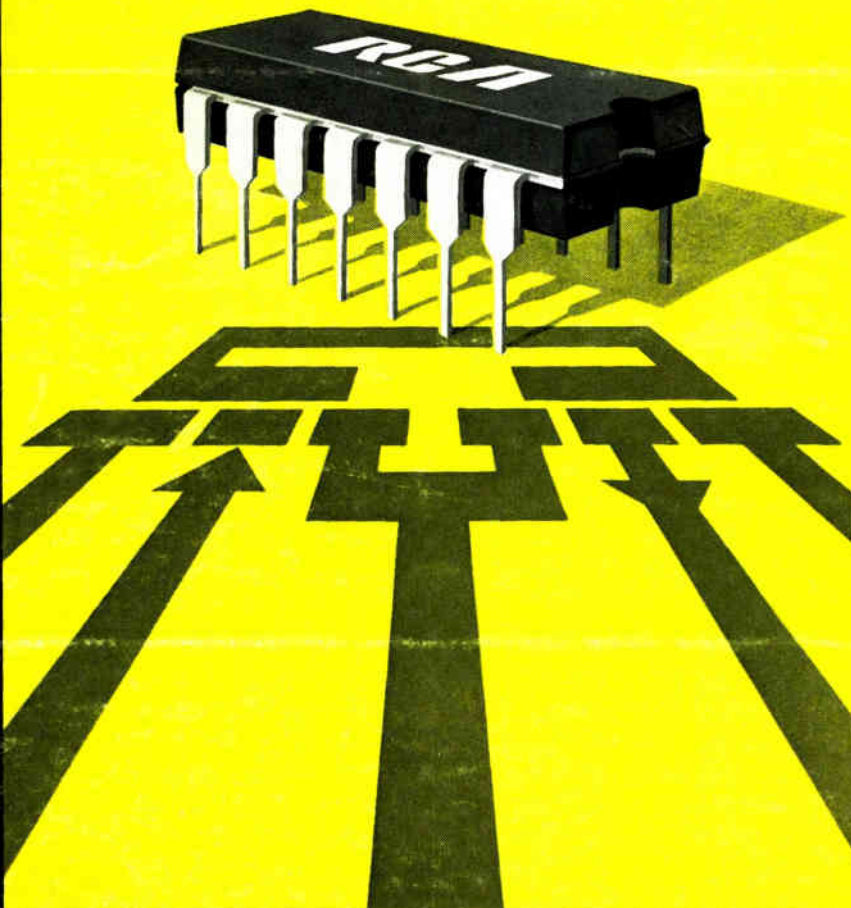

TYPE	DESCRIPTION	PRICE (1000 Unit level)
<b>Gates</b>		
CD4000E	Dual 3-input NOR plus inverter	\$2.20
CD4001E	Quad 2-input NOR	2.30
CD4002E	Dual 4-input NOR	2.50
CD4007E	Dual complementary pair plus inverter	2.30
CD4011E	Quad 2-input NAND	2.30
CD4012E	Dual 4-input NAND	2.50
CD4019E	Quad AND-OR select gate	3.70
<b>Flip-Flops</b>		
CD4013E	Dual "D" with set/reset capability	3.30
<b>Hex Buffers/Logic-Level Converters</b>		
CD4009E	Inverting	3.60
CD4010E	Non-inverting	3.60
<b>Multiplexer</b>		
CD4016E	Quad bilateral switch	3.30
<b>Static-Shift Registers—MSI</b>		
CD4006E	18-stage register	7.75
CD4014E	8-stage synchronous parallel or serial-input/serial-output	7.75
CD4015E	Dual 4-stage serial-input/parallel-output	7.75
<b>Counters—MSI</b>		
CD4004E	7-stage ripple counter/frequency divider	5.60
CD4017E	Decade counter/divider with 10 decoded outputs	8.00
CD4018E	Presetable divide-by "N" counter	7.00
CD4020E	14-stage ripple-carry binary counter/divider	9.50
<b>Adder—MSI</b>		
CD4008E	4-bit binary full-adder with parallel carry-out	7.50

# RCA

Integrated Circuits