

Dynamic memory cells 68

\$1.00 A McGraw-Hill Publication

Designer's choice: n- or p-channel MOS 79

August 3, 1970

Market trends off target at midyear 85

# Electronics®

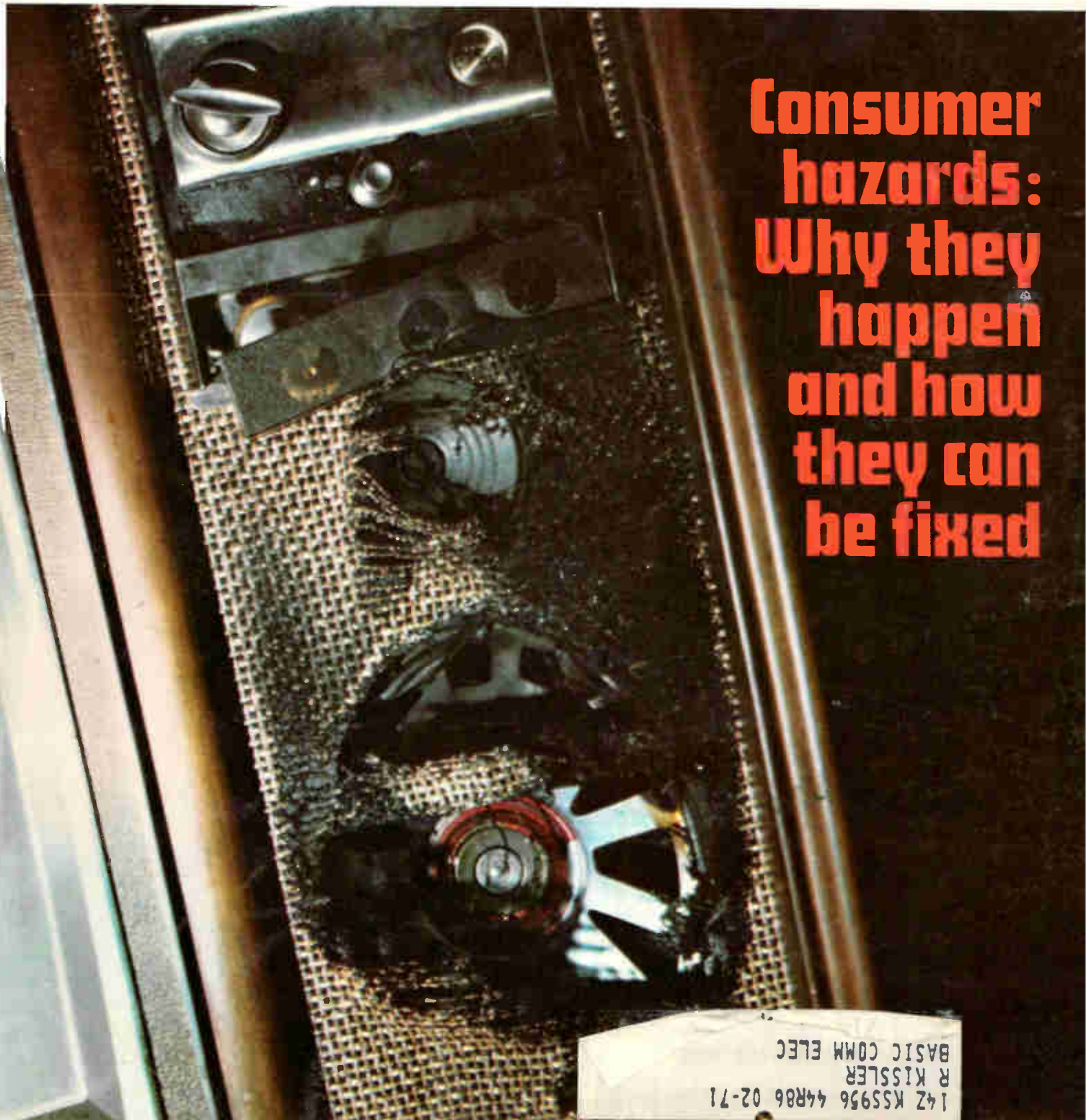

**Consumer hazards:  
Why they happen  
and how they can  
be fixed**

14Z KSS956 44R06 02-71  
R KISSLER  
BASIC COMM ELEC

# Why 24 firms have chosen GR's 1790 Logic-Circuit Analyzer this year:

"The 1790 has the best software of all the logic testers we surveyed."

"Our 1790 will pay for itself in the first few months of operation."

"GR's 1790 has significantly reduced the time required to debug engineering prototypes."

"LSI circuits are rapidly tested on our 1790."

Still other satisfied customers have told us how much they like the interactive mode of operation, which allows them to prepare and modify test programs on-line, and the tape-cassette memory for quick access to all existing test programs. Some have mentioned the programmable logic levels and power supplies that permit the testing of marginal conditions and boards with mixed logic families, the control panel and alpha-numeric display scope that simplify and speed test procedures, and the universal

device adaptors that allow all pins to be inputs or outputs and permit checking for shorted inputs.

We can stand behind these comments because we, too, have benefited from using the 1790 in our own development and production efforts. When we decided to build a logic-circuit analyzer, we did it because the system we needed just wasn't available commercially. So we built the best possible analyzer for ourselves, and we've used it for over two years to help manufacture our products with a resulting increase in quality and decrease in price. Now we want you to have the same advantages from your own 1790.

The basic 1790 includes a large I/O capacity (96 input pins and 144 outputs), a high-level test language that technicians can learn in only a few days, computer speed (up to 4000 tests per second), and a simplified GO/NO-GO test mode. The physical contents of the 1790 are a computer with 4096 12-bit words of 1.6- $\mu$ s-cycle core memory, teletypewriter, photoelectric tape reader, display scope, control panel, logic probe, and all the needed accessories. And the entire system is priced at only \$35,900 in the U.S.

Some great new options will increase the power of your 1790 many times: programmable logic levels for mixed-logic testing, expanded tape-cassette memory with 150,000 12-bit-word capacity, and universal device adaptors for testing a greater variety of devices.

Complete 1790 specifications and operating information are available from your nearest GR District Office or from 300 Baker Ave., West Concord, Mass. 01742. In Europe write Postfach 124, CH 8034, Zurich, Switzerland.



**General Radio**

ATLANTA 404 633-6183 / BOSTON 617 646-0550 / CHICAGO 312 992-0800 / CLEVELAND 216 886-0150  
DALLAS 214 637-2240 / LOS ANGELES 714 540-9830 / NEW YORK IN Y 1 212 964-2722 (IN J 1) 201 943-3140  
PHILADELPHIA 215 646-8030 / SAN FRANCISCO 415 948-8233 / SEATTLE 206 747-9190 / SYRACUSE 315 454-9323  
WASHINGTON, D C 301 881-5333 / TORONTO 416 252-3395 / ZURICH 10511 47 70 20

Circle 900 on reader service card



## Let our non-computer supervise your instruments. While you develop your next project.

Our new HP 2570A Coupler/Controller, with built-in programming, gives you a two-way link that lets your instruments run by themselves. At almost one-fourth the cost of a small computer.

The HP 2570A costs only \$1625. Plug-in interfaces cost \$450-600.

With it, you can mate measuring instruments such as DVMs and counters with a printer, teletypewriter or tape punch. You can simultaneously control power supplies, frequency synthesizers,

and other stimuli. There's also a plug-in analog scanner for data acquisition. And you program your system with the 2570's built-in pinboard, punched tape loop, or teletypewriter keyboard.

At any time, you can add data reduction and more sophisticated programming by mating with time-sharing terminals, mini-computers, or an HP calculator.

While your instruments are running themselves, you can do the things you

can't find time for now. For details, contact your local HP field engineer. Or write Hewlett-Packard, Palo Alto, California 94304; Europe: 1217 Meyrin-Geneva, Switzerland.

HEWLETT  PACKARD

DATA ACQUISITION SYSTEMS  
06006

# Time interval measurements like you've never seen before.

Plug the HP 5379A Time Interval Unit into the HP 5360A Computing Counter and things happen faster than they could ever happen before.

This unique combination resolves time intervals to 100 picoseconds. With absolute accuracy of 1 nanosecond. And you can measure zero, positive and negative intervals, which makes it ideal for checking coincidence.

By adding the HP 5375A Keyboard, you can enter programs to produce instantaneous answers about phenomena that you could never previously measure with a counter. Things like peak-to-peak jitter; rms jitter; phase measurements; duty cycle; and radar ranging in feet,

inches, meters or any other units you want.

Thanks to the 5379A, dozens of jobs can be handled easily and accurately. These include calibration of radar, lasers, and laboratory instruments; testing semi-conductors and computers; cable fault location; delay line adjustment; ballistic and nuclear measurements.

It does all this while saving you the cost of a computer, because the computer's built in. And you're not buying a counter that only measures time interval. You're getting the most advanced frequency measuring system available today, ideal for measuring pulses, pulse trains or any time-based events.

The cost is \$750 for the plug-in and

\$6500 for the mainframe. Your local HP field engineer will be glad to arrange a demonstration. Give him a call. Or write for complete information to Hewlett-Packard, Palo Alto, California 94304; Europe: 1217 Meyrin-Geneva, Switzerland.



**HEWLETT *hp* PACKARD**

**ELECTRONIC COUNTERS**  
02920

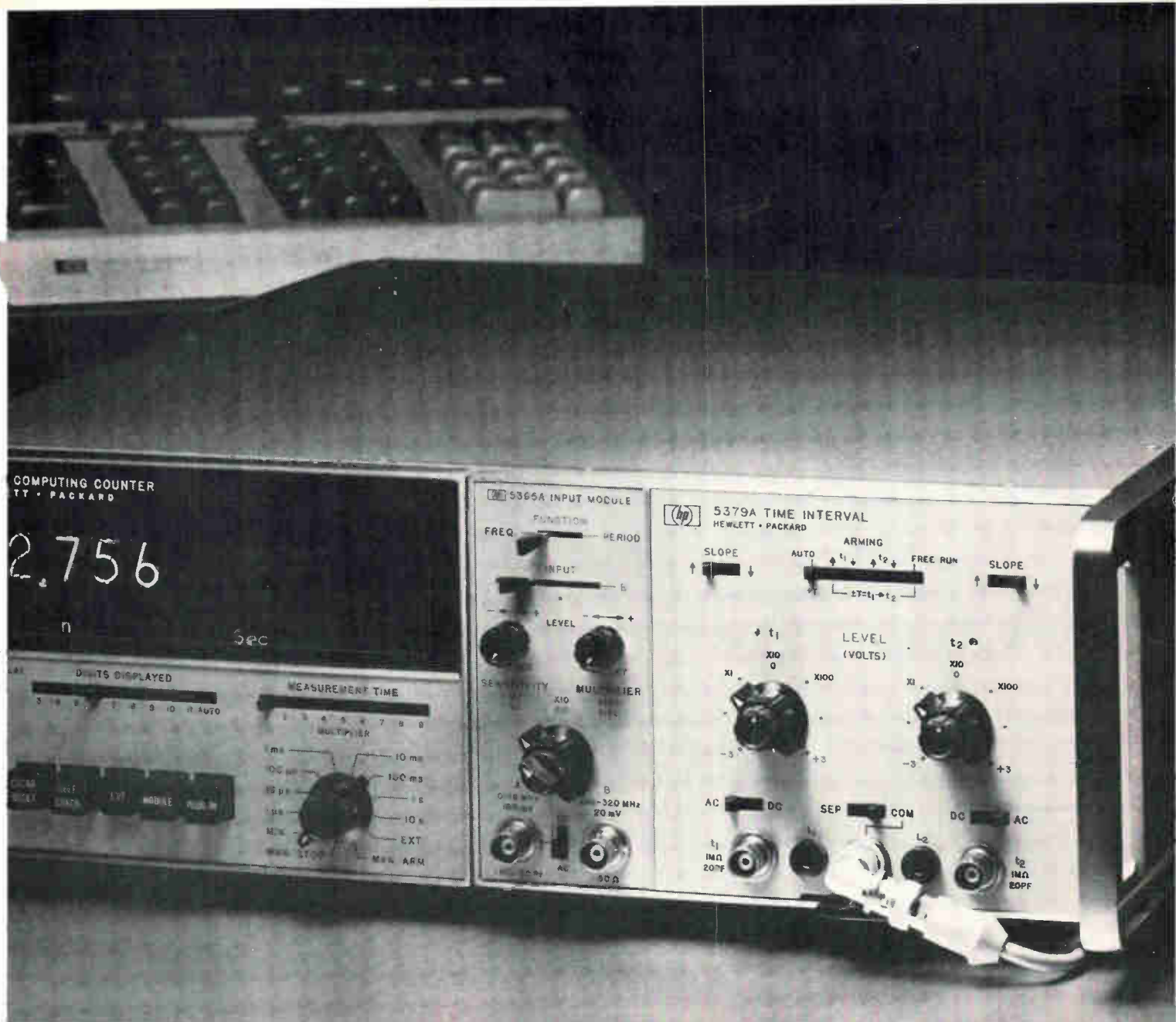

## Features

### Probing the News

- 85 **Market report:** 1970: a down year for the industry  
89 **Military electronics:** Navy engineers break the rules with radical EDP concept  
93 **Computers:** A new team takes over at Viatron

### U.S. Reports

- 29 **Avionics:** Radar to spot small pleasure craft  
30 **Electro-optics:** Process upconverts invisible i-r  
30 **Space electronics:** Laser may help dock space shuttle  
31 **Software:** Enabling computer to form abstract concepts  
32 **Industrial electronics:** Crt typesetter handles art  
34 **Solid state:** C/MOS means cheaper ROMs  
34 **Design theory:** How to specify safety by numbers  
36 **Advanced technology:** PLZT device stores images  
39 **Communications:** FCC bureau wants free competition  
39 **For the record**

### Electronics International

- 127 **West Germany:** Plastic disk for tv playback  
128 **International:** U.S. and Japan face tariff battle  
128 **Japan:** Low cost computer display  
129 **France:** 3D oscilloscope  
130 **Great Britain:** Antilock brakes

### New Products

- 101 **In the spotlight**  
101 Plug-ins expand oscilloscope into general-purpose test station  
105 Key-to-disk: \$100 million market  
109 **Components review**  
109 Differential amps speed data input  
110 Relay boasts low profile  
111 **Instruments review**  
111 Counter has thin figure  
113 **Packaging and production review**  
113 Carrier gets good grip on ICs  
115 **Semiconductor review**  
115 Op amp's bias current kept low  
116 IC provides parallel-serial link  
118 **New materials**

## Articles

- Special report** 54 **Consumer hazards: why they happen**  
Defective designs, haphazard regulation, and uncertain standards can combine to put potentially lethal fire, shock, and radiation hazards into consumer goods
- 62 **Consumer hazards: how they can be fixed**  
With improved materials and a systematic approach to quality control, manufacturers are building safer products and saving themselves money, too
- Computers** 68 **Silicon gate dynamic MOS crams 1,024 bits on a chip**  
M.E. Hoff Jr.,  
Intel Corp.
- Circuit design** 74 **Designer's casebook**
  - Storage coil cuts relay pull-in delay
  - Wave squarer shifts phase as much as 360°
  - Diode-switched FET's rectify the full wave
- Solid state** 79 **N- or p-channel MOS: take your pick . . .**  
. . . but not before you've carefully weighed such interrelated factors as chip area, threshold voltage, noise immunity, and power supplies  
David Maitland,  
Hewlett-Packard Calculator division

## Departments

- |    |                          |     |                          |
|----|--------------------------|-----|--------------------------|
| 4  | Readers Comment          | 51  | Washington Newsletter    |
| 9  | Who's Who in this issue  | 119 | New Books                |
| 14 | Who's Who in electronics | 120 | Technical Abstracts      |
| 20 | Meetings                 | 122 | New Literature           |
| 25 | Electronics Newsletter   | 125 | International Newsletter |

EDITOR-IN-CHIEF: Kemp Anderson

EXECUTIVE EDITOR: Samuel Weber

MANAGING EDITORS: Robert Henkel, *News*;  
Arthur Erikson, *International*

SENIOR EDITORS: H. Thomas Maguire,  
Stephen E. Scrupski

ASSOCIATE EDITORS: William Bucci, Richard  
Gundlach, John Johnsrud, Howard Wolff

## DEPARTMENT EDITORS

*Advanced Technology*: Laurence Altman;  
*Communications & Microwave*: Leon M. Magill;  
*Components*: Joseph Mittleman; *Computers*:  
Wallace B. Riley; *Consumer*: Roger Kenneth  
Field; *Industrial Electronics*: Alfred Rosenblatt;  
*Instrumentation*: Owen Doyle; *Military*/  
*Aerospace*: Herman Lowenhar; *New Products*:  
H. Thomas Maguire (Mgr.), William P. O'Brien,  
George Weiss; *Packaging & Production*:  
Stephen E. Scrupski; *Solid State*: George F.  
Watson

COPY EDITORS: William S. Weiss, *Chief*;  
Margaret Eastman, Edward Flinn

ART: Fred Sklenar, *Director*  
Charles D. Ciatto, *Assistant Director*

PRODUCTION EDITORS: Susan Hurlburt,  
Arthur C. Miller

EDITORIAL RESEARCH: Virginia Mundt

EDITORIAL SECRETARIES: Barbara  
DiBenedetto, Claire Goodlin, Vickie Green,  
Terri O'Neill, Bernice Pawlak, Patricia Ritter

## FIELD EDITORS

*Boston*: James Brinton (Mgr.), Gail Farrell;  
*Los Angeles*: Lawrence Curran (Mgr.), Ralph  
Selph; *New York*: Peter Schuyten; *San  
Francisco*: Stephen Wm. Fields (Mgr.), Marilyn  
Howey; *Washington*: Ray Connolly (Mgr.),  
James Hardcastle, Lois Vermillion; *Frankfurt*:  
John Gosch; *London*: Michael Payne; *Paris*:  
Arthur Erikson; *Tokyo*: Charles Cohen

## McGRAW-HILL WORLD NEWS

*Director*: Walter A. Stanbury; *Atlanta*: Fran  
Ridgway; *Chicago*: Robert E. Lee; *Cleveland*:  
Arthur Zimmerman; *Dallas*: Marvin Reid;  
*Detroit*: James Wargo; *Los Angeles*: Michael  
Murphy; *San Francisco*: Margaret Drossel,  
Tyler Marshall; *Seattle*: Ray Bloomberg;  
*Washington*: Charles Gardner, James Canan,  
Herbert W. Cheshire, Seth Payne, Warren  
Burkett, William D. Hickman; *Bonn*: Robert F.  
Ingersoll; *Brussels*: James Smith; *London*:  
Marvin Petal; *Milan*: Jack Star; *Moscow*:  
Axel Krause; *Paris*: Robert E. Farrell, Stewart  
Toy; *Tokyo*: Mike Mealey

PUBLISHER: Dan McMillan

ASSISTANT TO THE PUBLISHER: Wallace  
Carmichael

PLANNING & DEVELOPMENT MANAGER:  
Donald Christiansen

ADVERTISING SALES MANAGER: Pierre Braudé

CIRCULATION MANAGER: John D. Drummond

RESEARCH MANAGER: David Strassler

PROMOTION MANAGER: Tomlinson Howland

ADVERTISING SALES SERVICE MANAGER:  
Wallis Clarke

## Readers Comment

### A matter of bits

To the Editor:

In your article on read-only memories [Jan. 5, p. 88], it is claimed that a pair of cascaded ROMs allow two kilobits to define four independent functions of 12 variables each, a task that would normally require 16 kilobits. The four functions are far from being independent. The first eight variables (A through H) will define a given four bits to be input to the second ROM, but since there are only 16 possible combinations of these four bits, a number of other eight-bit addresses must produce the same output. The last four variables (I through L) will therefore produce the same variation of output functions ( $f_1$  to  $f_4$ ) for all common addresses.

Regrettably, I think that the only way to obtain four truly independent functions of 12 variables each is to use all 16,384 bits.

Christopher A. Brown  
Research Department  
British Post Office  
London

Mr. Brown is correct in pointing out that in the most general case to define four independent functions of 12 variables each, 16 kilobits would be required. What the cascaded ROM technique does do, however, is create secondary functions which are common to the output functions. Thus, a cascaded technique provides an avenue for simplifying the total ROM problem solution depending on the particular problem. The two examples of cascading shown were, in fact, solutions to two specific problems. The user of ROMs for logic simula-

tion is encouraged to attempt a ROM minimization by function factoring.

### Cell sensitivity

To the Editor:

Your article about cadmium sulfide photocells [April 13, p. 170] states that the devices made by the Matsushita Electric Corp. generate outputs 100 times greater than phototransistors and 50 times greater than other CdS cells. We must take exception and object to this type of gross inaccuracy. We have in our broad line many cells with sensitivities as great or greater than this and with significantly better linearity and response time.

Matsushita has apparently produced its device on a conductive glass substrate. This means that in going through the cell, light does not have to be limited by electrode spacing. This is not a new approach, and we can show that with our devices we can achieve similar sensitivities. We had discounted Matsushita's approach because we can obtain reliability and uniformity by means of an electrode deposition in vacuum and can control the spacing much more precisely.

M.D. Levy  
Vactec Inc.  
Maryland Heights, Mo.

*Electronics* should have said 50 times greater than other CdS cells "with the same sensitive area." The photocells are especially useful in building a card-reading sensor matrix with an aperture size of 0.055 inch diameter and spacing between centers of 0.087 inch. Some other cells that produce equivalent outputs are of larger diameter and are thus unsuited to this application.

August 3, 1970 Volume No. 43, Number 16  
89,882 copies of this issue printed

Published every other Monday by McGraw-Hill, Inc. Founder: James H. McGraw 1860-1948. Publication office 99 North Broadway, Albany, N.Y. 12202; second class postage paid at Albany, N.Y. and additional mailing offices.

Executive, editorial, circulation and advertising addresses: Electronics, McGraw-Hill Building, 330 W. 42nd Street, New York, N.Y. 10036. Telephone (212) 971-3333. Teletype TWX N.Y. 710-581-4235. Cable address: MCGRAWHILLN.Y.

Subscriptions solicited only from those professionally engaged in electronics technology. Subscription rates: qualified subscribers in the United States and possessions and Canada, \$8.00 one year, \$12.00 two years, \$16.00 three years; all other countries \$25.00 one year. Non-qualified subscribers in the U.S. and possessions and Canada, \$25.00 one year; all other countries \$50.00. Air freight service to Japan \$50.00 one year. Single copies: United States and possessions and Canada, \$1.00; all other countries, \$1.75.

Officers of McGraw-Hill Publications Company: Joseph

H. Allen, President; John R. Emery, J. Elton Tuhis, Senior Vice Presidents; Donald B. Gridley, Group Vice President; Vice Presidents: Ralph Blackburn, Circulation; John R. Callahan, Editorial; William P. Giglio, Administration; David G. Jensen, Manufacturing; Jerome D. Luntz, Planning & Development; Joseph C. Page, Marketing; Robert M. Wilhelm, Finance.  
Officers of the Corporation: Shelton Fisher, President and Chief Executive Officer; John J. Cooke, Senior Vice President and Secretary; Gordon W. McKinley, Vice President and Treasurer.

Title © registered in U.S. Patent Office; © Copyright 1970 by McGraw-Hill, Inc. All rights reserved. The contents of this publication may not be reproduced either in whole or in part without the consent of copyright owner. Subscribers: The publisher, upon written request to our New York office from any subscriber, agrees to refund that part of the subscription price applying to copies not yet mailed. Please send change of address notices or complaints to Fulfillment Manager; subscription orders to Circulation Manager, Electronics at address below. Change of address notices should provide old as well as new addresses including postal zip code number. If possible, attach address label from recent issue. Allow one month for change to become effective.  
Postmaster: Please send form 3579 to Fulfillment Manager, Electronics, P.O. Box 430, Hightstown, N.J. 08520.



SIZE & COST:  
NO BIG THING.

EASIER THAN EVER TO FIT  
YOUR BOARD & BUDGET.

BROAD LINE GETS BROADER.  
8 LOWER CAPACITANCE VALUES  
(100 pF thru 390 pF @ 200 V).

Type 192P Pacer® Polyester Film Capacitors are mass-produced to beat the space/cost squeeze in commercial and industrial applications. Extended-foil PETP film sections with metal end caps provide best possible non-inductive construction. End caps also act as moisture barriers. Ideal for automatic insertion on printed wiring boards. Expanded line includes capacitance values from 100 pF to .47  $\mu$ F. Voltage range, 80 to 600vdc. Write for Bulletin 2066C.

Technical Literature Service  
Sprague Electric Company  
35 Marshall Street  
North Adams, Mass. 01247



45M-0143

**THE BROAD-LINE PRODUCER OF ELECTRONIC PARTS**

# National TTL/MSI tha

# Delivery isn't the only rea

Say good-bye to slow bus systems. National is introducing Tri-State logic. A first-of-its kind family of TTL devices specifically designed to speed up bus-organized digital systems.

Tri-State logic allows you to work with fewer packages and without external open collector gates.

Our first off-the-shelf product in this new family is the DM8551 bus or-able quad D flip-flop. A unique device that lets you connect outputs of many circuits to a common bus line.

The DM8551 is organized as four D-type flip-flops operating from a common clock. The outputs are normal low-impedance, high-drive TTL types. Up to 128 can be tied together because, unlike other TTLs, the DM8551 can be gated into a state where both the

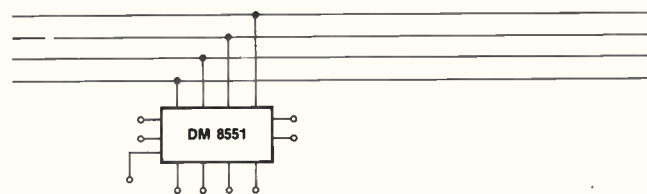

TRI-STATE BUS SYSTEM

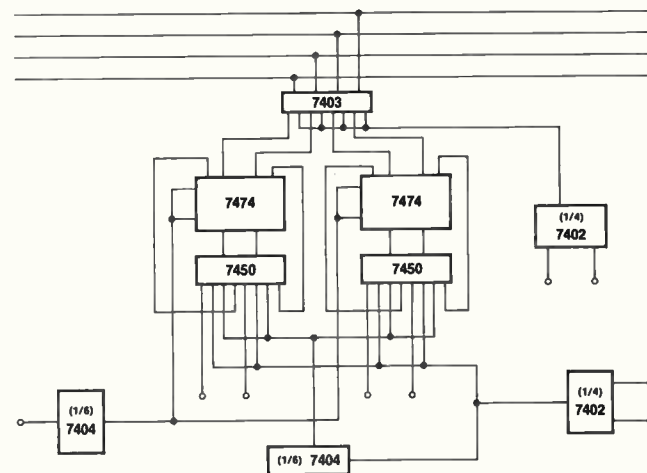

STANDARD BUS SYSTEM



# **sells more n Fairchild.**

**t  
son:**

upper and lower output transistors are OFF. The output, therefore, appears as a high impedance. It neither delivers current nor demands significant current from the outputs to which it is connected. You get the economy of bus connection without losing output waveform integrity.

The DM8551 design eliminates the false clock-signal problem usually associated with D-type flip-flops. Internal data input disable lines feed the Q output back into the D input so there's no change of state during clocking.

Output disable lines are used for gating into the OFF state. NOR gate logic was chosen for this function since it is possible to select up to 128 DM8551s with only two BCD-to-Decimal decoders (DM8842s). You get

maximum decoding capability at minimum cost.

In addition to the DM8551, we're also introducing the DM8230 Tri-State Data Flow Gate for signal routing and the DM8831 Tri-State Party Line Driver for multiple signal driving. (They're also available off-the-shelf.)

Of course, Tri-State logic is only one reason National sells so many TTL/MSI circuits. Call any National distributor for prices and specs on twenty-seven other reasons.

National Semiconductor Corporation  
2900 Semiconductor Drive, Santa Clara,  
California 95051 / Phone (408) 732-5000  
TWX (910) 339-9240

## **National**

# Now read this...



Actual Size

## 14 digits in 14 centimetres with the new Philips PANDICON\*!

Putting numbers into electronic calculators, computers and data terminals isn't so difficult these days. But getting numbers out — legibly and economically — can be another matter.

**Unless, of course, you've heard about Philips' new PANDICON fourteen-decade integrated readout tube, type ZM 1200.**

Its *legibility* you can see for yourself. No more unnatural spaces between digits. Decimal points and punctuation marks where you expect them to be. Coherent numbers instead of 14 separate digits — all in a space less than the width of this page.

But there are other advantages too. *Economy* for example. All 14 digits in one and the same tube. To provide this display with ordinary single tubes, somebody would have to make 168 external connections. The PANDICON needs only 27. Interconnections are inside — protected from damage. You save on drive components because only one decoder-driver is needed for the full 14-digits display. You save on power too — it consumes only 1.5 to 2 W.

Best of all is the *reliability*. We're not ready to quote Mean-Time-Between-Failure figures yet, because, after hundreds of thousands of life-test hours, we haven't had enough failures to make statistically significant conclusions. It may take some time yet, as we anticipate an MTBF of 500,000 hours.

Meanwhile, we've given you a full one-year guarantee on this tube — with the strong suspicion it will live 10 times as long! After all we have over 60 years experience in gas-discharge physics.

*If 14 digits are too much, we can offer you 8, 10 and 12-digit tubes soon.*

Our engineers have also developed a Dynamic Drive Module type DDM 14 to go along with the PANDICON. Everything is described in our new PANDICON data file, which is yours for the asking.

**Philips Electronic Components and Materials Division, Eindhoven, the Netherlands.**

Distributed and sold in the U.S. by: Amperex Electronic Corporation, Providence Pike, Slatersville, R. I. 02876.

\* Registered trade-mark of N. V. Philips' Gloeilampenfabrieken, Eindhoven, the Netherlands.

# PHILIPS

# Who's Who in this issue



Maitland

**Making comparisons** like those spelled out in the article that begins on page 79 are all in a day's work for author David Maitland. A research and development engineer with Hewlett-Packard's Calculator division, Maitland has had extensive experience with the article material in his capacity as an LSI/MOS designer. Maitland holds a BA from Rockford College, Rockford, Ill., and a BSEE from the University of Illinois.

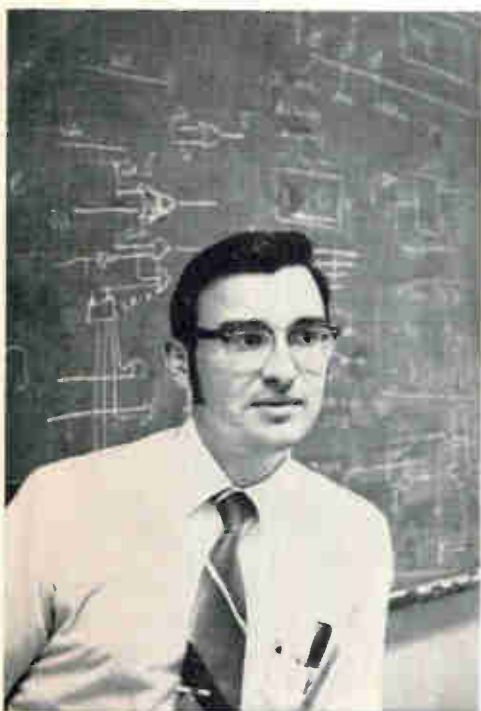

Hoff

**Research** has been the life's work of M.E. Hoff, author of the article on dynamic MOS memories that begins on page 68. Hoff holds a BEE from Rensselaer Polytechnic Institute and studied at Stanford for his MS and Ph.D. degrees. He stayed on at Stanford as a research associate, doing extensive work in adaptive systems and digital computer applications, including adaptive hardware, interfaces, and design of a-d and d-a converters. Hoff later joined the Intel Corp., where he's specialized in semiconductor memory applications, including design of memory systems and testers, and development of programs for simulation of MOS networks. He's now manager of applications research.

## KEPCO'S LOW-COST VOLTAGE SOURCE FOR IC'S

with  
**CROWBAR**

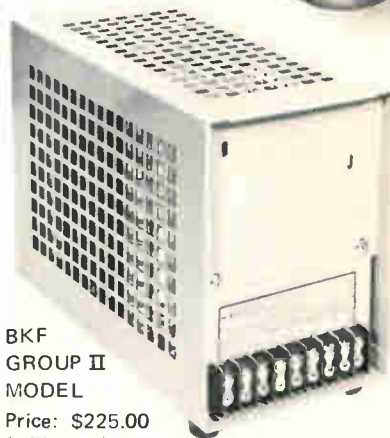

BKF  
GROUP II  
MODEL

Price: \$225.00  
(with case)

MODEL	VOLTS	AMPS	CROW- BAR TRIP
BKF 5-11	5 ±5%	0-11	6.5V
BKF 8-10	8 ±5%	0-10	11.1V
BKF 12-7	12 ±5%	0-7	15.3V
BKF 15-6	15 ±5%	0-6	19.5V
BKF 24-4	24 ±5%	0-4	30.0V
BKF 28-4	28 ±5%	0-4	35.3V
BKF 36-3	36 ±5%	0-3	45.7V
BKF 48-2.5	48 ±5%	0-2.5	59.5V

\* Adjustable crowbar option available.

The BKF Group II models offer up to 100 watts of 0.05% voltage regulated power for critical integrated circuits and other applications. The BKF Power Supply, itself, uses a plug-in linear IC for its regulator and protects itself and your load with a re-entrant overcurrent circuit and crowbar overvoltage circuit.



THE NEW  
KEPCO  
CATALOG  
B-703  
IS NOW  
AVAILABLE.

Write Dept.  
DA-14

# KEPCO®

131-38 SANFORD AVE. • FLUSHING, N.Y. 11352  
(212) 461-7000 • TWX # 710-582-2631

**Tektronix**

# PLUG-IN

*measurement flexibility*

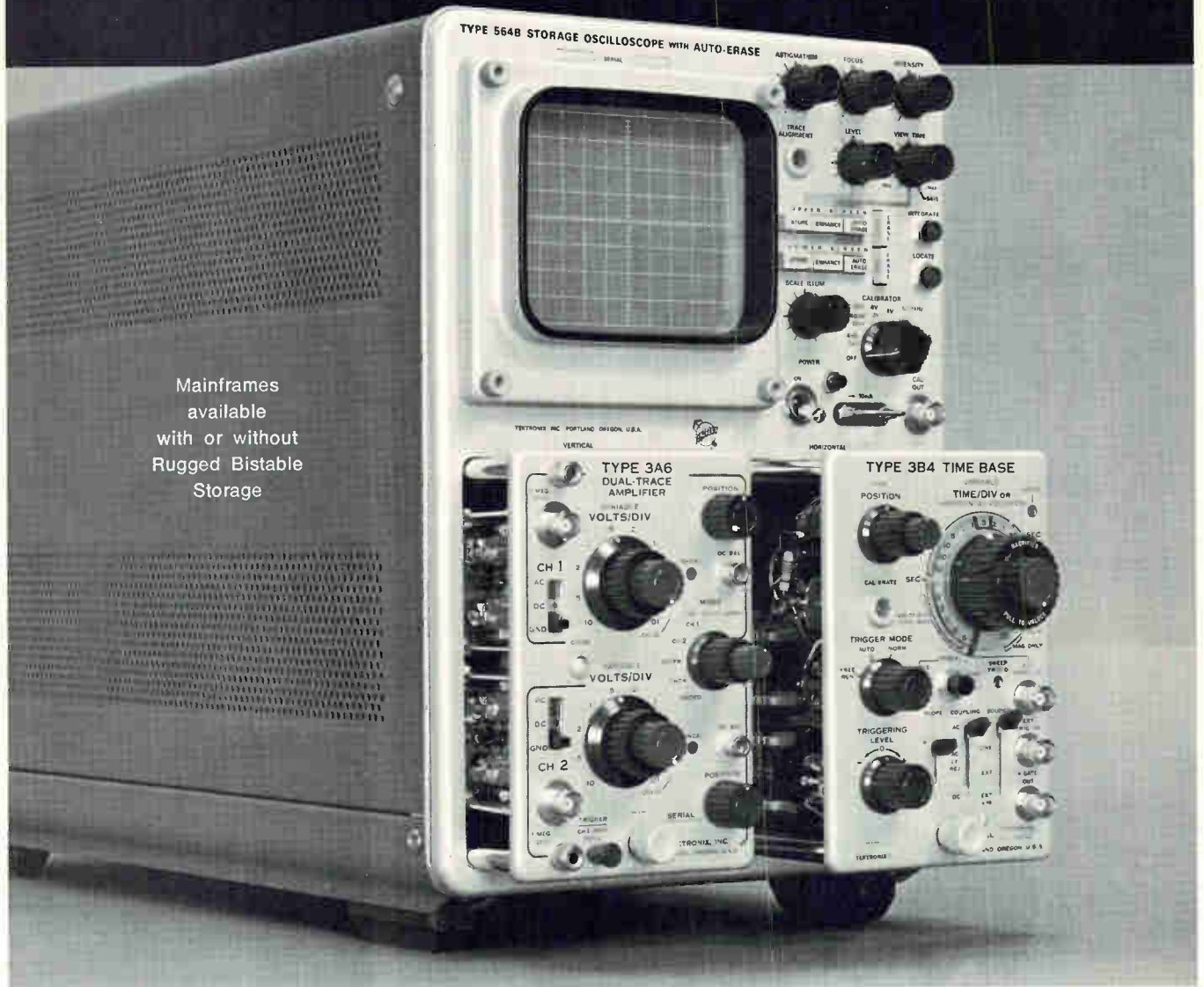

Mainframes  
available  
with or without  
Rugged Bistable  
Storage

**The Dual Plug-In Feature** of the 560-Series Oscilloscopes allows conventional Y-T or X-Y displays with either single-trace or multi-trace units. The 564B MOD 121N (pictured above) provides stored displays at constant brightness independent of signal repetition rates. Seven-inch rackmounts are available in this family of valued performers.

**561B** ..... \$595

**564B MOD 121N** ... \$1,250

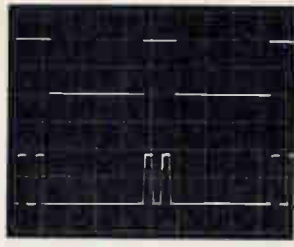

**MULTI-TRACE**

Compare time related pulse trains using this DC to 10 MHz, 35-ns risetime plug-in with deflection factors from 10 mV/div to 10 V/div.

**Type 3A6 . . . . . \$550**

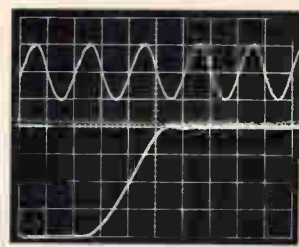
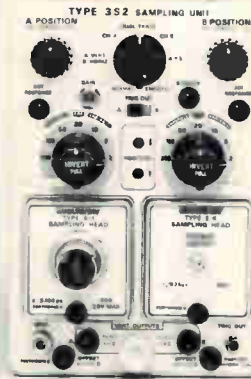

**SAMPLING**

Extend your measurement capabilities to 14 GHz with 25-ps risetime, internal triggering, dual-trace and interchangeable heads.

**Type 3S2 . . . . . \$950**

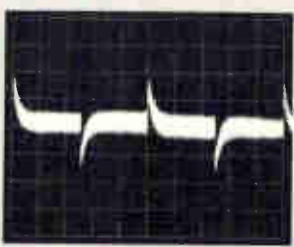

**DIFFERENTIAL**

Make differential measurements from DC to 1 MHz with 10- $\mu$ V/div deflection factor and 100,000:1 common-mode rejection ratio.

**Type 3A9 . . . . . \$525**

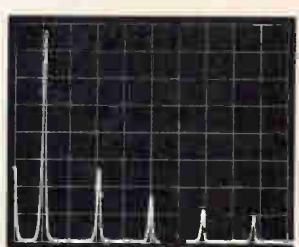

**SPECTRUM ANALYSIS**

Analyze the frequency spectrum from 50 Hz to 1 MHz with calibrated dispersion and calibrated deflection factors.

**Type 3L5 . . . . . \$1125**

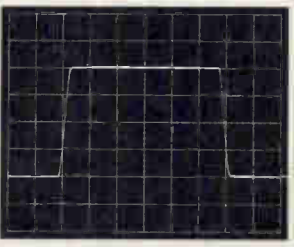

**SINGLE-TRACE**

Perform single-trace measurements from DC to 1 MHz at deflection factors from 50 mV to 50 V/div with this low-cost plug-in.

**Type 2A60 . . . . . \$140**

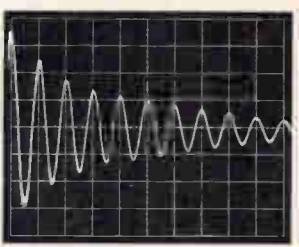
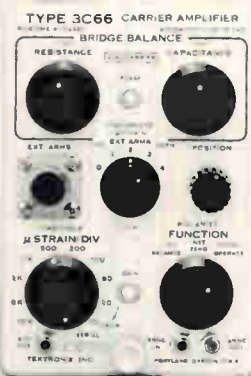

**CARRIER AMPLIFIER**

Measure force, acceleration, strain and displacement in applications such as stress analysis, vibration studies and fatigue tests.

**Type 3C66 . . . . . \$495**

The Tektronix 560-Series Oscilloscopes have a complete selection of plug-ins, permitting you to adapt your measurement capabilities to meet your changing measurement needs. More than 25 plug-in units are available covering single channel, multi-trace, differential, sampling, spectrum analysis and other special purpose applications. Adapting your measurement capability to meet your changing measurement needs is assured.

For detailed specifications contact your local Tektronix Field Engineer or write: Tektronix, Inc., P.O. Box 500, Beaverton, Oregon 97005.

These instruments are available through our new Leasing Plan.

U.S. Sales Prices FOB Beaverton, Oregon

**Tektronix, Inc.**  
committed to progress in waveform measurement

**See The Tektronix Display At WESCON**

Circle 11 on reader service card

# Now's The Time To Get

## Two Ways:

First, get a free evaluation unit of any of six different, popular Motorola unijunction transistors from now through December from your Motorola distributor . . . plus — and a BIG plus — purchase up to 999 of any Motorola UJT at 10% off his regular, published price!

Example: Send the July coupon to your favorite distributor — he'll furnish you a free MPU131, newest of our all-inclusive UJT line. It offers you "programmable" parameters ( $R_{BB}$ ,  $\tau$ ,  $I_V$  and  $I_P$ ) in your timing, sensing, pulsing and oscillator circuits simply by varying the external resistor values. You can make your own specs with it, so to speak.

And, during July, you can also buy up to 999 of any Motorola UJT currently offered from your distributor's inventory at 10% off his regular, 1-999 price.

Same thing in August, September, etc.

Sound like a good deal?

Then understand this: whenever you choose Motorola unijunction transistors you choose

preferred, state-of-the-art leadership in technology and performance.

. . . because the Annular process furnishes fast-response, long-time-delay advantages as well as superior reliability and stability in all applications.

. . . because there are over 20 different metal and plastic Motorola UJT's to meet your top-performance needs in most any design from consumer to military.

. . . because computerized testing ensures uniform results, faster deliveries and user confidence.

. . . because ready availability meets any demand.



. . . because applications assistance is yours for the asking, like AN294, "Unijunction Transistor Timers and Oscillators," a valuable application note we'll send you if you send to Box 20912, Phoenix 85036.

. . . because, almost always, they cost less. So you see, we do offer you a great deal in UJT's. Anytime.



GREAT UJT DEAL JULY	GREAT UJT DEAL AUGUST	GREAT UJT DEAL SEPTEMBER
FREE MPU131 The Programmable One!	FREE 2N2646 The Available Industry Standard!	FREE 2N4870 The 43¢ Plastic Performer!
Name _____ Title _____ Company _____ Div. _____ Address _____ City _____ State _____ Zip _____	Name _____ Title _____ Company _____ Div. _____ Address _____ City _____ State _____ Zip _____	Name _____ Title _____ Company _____ Div. _____ Address _____ City _____ State _____ Zip _____
My favorite Motorola distributor is: _____	My favorite Motorola distributor is: _____	My favorite Motorola distributor is: _____
Signature _____	Signature _____	Signature _____

# A Great Deal In UJT's

	Unijunction	Peak Point Current @ $V_{B2B1}$ uA(max)	Valley Point Current mA(min)	Intrinsic Standoff Ratio		Emitter Reverse Current (max)	Interbase Resistance kohms	
				Min	Max		Min	Max
	2N2646	5 @ 25V	4	56	75	12uA	4.7	9.1
	2N2647	2 @ 25V	8	68	82	200nA	4.7	9.1
	2N3980	2 @ 25V	1	68	82	10nA	4.0	8.0
	2N4851	2 @ 25V	2	56	75	100nA	4.7	9.1
	2N4852	2 @ 25V	4	70	85	100nA	4.7	9.1
	2N4853	0.4 @ 25V	6	70	85	50nA	4.7	9.1
	2N4948	2 @ 25V	2	55	82	10uA	4.0	12.0
	2N4949	1 @ 25V	2	74	86	10nA	4.0	12.0
	JAN2N4948**	2 @ 25V	2	55	82	10nA	4.0	12.0
	JAN2N4949**	1 @ 25V	2	74	86	10nA	4.0	12.0
	2N5431	0.4 @ 4V	2	72	80	10nA	6.0	8.5
		2N4870	5 @ 25V	2	56	78	1uA	4.0
2N4871		5 @ 25V	4	70	85	1uA	4.0	9.1
MU4891		5 @ 25V	2	55	82	10nA	4.0	9.1
MU4892		2 @ 25V	2	51	69	10nA	4.0	9.1
MU4893		2 @ 25V	2	55	82	10nA	4.0	12.0
MU4894		1 @ 25V	2	74	86	10nA	4.0	12.0
MPU131		2 @ 10V†		(Programmable)		5nA	(Programmable)	
MPU132		0.4 @ 10V†		(Programmable)		5nA	(Programmable)	
MPU133	0.15 @ 10V†		(Programmable)		5nA	(Programmable)		
	MU851	2 @ 25V	2	60	80	100nA	4.7	9.1
	MU852	2 @ 25V	4	70	85	100nA	4.7	9.1
	MU853	0.4 @ 25V	4	70	85	100nA	4.7	9.1

\*\* Conforms to Mil-S-19500/388

†R<sub>e</sub> = 1 MΩ

- where the priceless ingredient is care!

## MOTOROLA

Unijunction Transistors



GREAT UJT DEAL OCTOBER	GREAT UJT DEAL NOVEMBER	GREAT UJT DEAL DECEMBER
FREE 2N4852 The Minutes-TO-Microseconds Timer!	FREE MU851 The High-Frequency Micro-T!	FREE 2N5431 The Only Low-Voltage UJT!
Name _____	Name _____	Name _____
Title _____	Title _____	Title _____
Company _____	Company _____	Company _____
Div. _____	Div. _____	Div. _____
Address _____	Address _____	Address _____
City _____ State _____ Zip _____	City _____ State _____ Zip _____	City _____ State _____ Zip _____
My favorite Motorola distributor is: _____	My favorite Motorola distributor is: _____	My favorite Motorola distributor is: _____
Signature _____	Signature _____	Signature _____

**A new commercial version of our MINIATURE ROTARY "E" SWITCH at a MUCH LOWER PRICE**

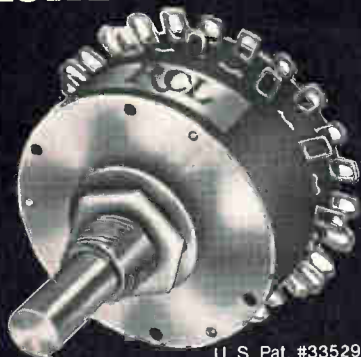

U. S. Pat. #3352979

Single deck 1 pole-24 position  
to 3 pole-8 position MBB or BBM

**\$196**  
each

as low as

in quantities of 1,000

For ordering purposes designate series "EC"

**DELIVERY FROM STOCK**

Completely automated facilities and mass production tooling now makes RCL highly competitive in commercial applications with "obsolete" wafer-type open frame switches!

Equivalent performance at much lower prices than "instrument type" switches.

- The smallest enclosed MINIATURE ROTARY SWITCH available with up to 24 positions shorting or non-shorting on each deck.
- Up to 12 poles per deck.
- As many as 9 decks may be specified.
- Life expectancy — 200,000 mechanical operations.
- Solder terminals will accept two .032 diam. (AWG #20) wires.

Write for complete technical information

**RCL**

RCL ELECTRONICS, Inc.  
700 South 21st Street,  
Irvington, New Jersey 07111

## Who's Who in electronics

When the first electronic computer was plugged in at the University of Pennsylvania in 1946, Ronald S. Entner was just one more three-year-old learning about life in Brooklyn. Today, however, Entner and a small group of colleagues are as immersed in electronic data processing as were the builders of that first machine. With the Advanced Airborne Digital Computer program, Entner and his group hope to expand the state of the computer art once more [see p. 89].

Entner, the AADC program manager, notes that his age of 27 makes him one of the oldest members of the program's team. But even though he's nearing the edge of the generation gap that begins at 30, Entner typifies the type of youth who is working on the program.

Like his colleagues, Entner delights in exploring the application of new technology. "It's kind of fun to think of things in new ways," he once said as he described a far-out plan to replace the pins on the bottom of large-scale integrated circuits with light-emitting diodes that would serve as optical data links. He also shares the widely held belief of those in the program that the Navy no longer can accept the data processing industry's latest hardware just because it is available. The Navy, he contends, must specify what it wants and then press for the product.

**Playwright.** Entner's interests and at least part of his background, however, set him apart from his colleagues on the program. After graduating from Brooklyn Polytechnic Institute in 1963 with a bachelor's degree in electrical engineering, he had serious qualms about engineering as a career. He spent four months writing plays and exploring different careers before deciding to stick with engineering. He took a job with the New York City Transit Authority designing control systems for new subway lines, "but I spent a lot of time walking the tracks," he recalls.

During his three years with the Transit Authority, Entner attended night classes—but not in engineer-



Entner

ing. As a result, he is probably the only Navy engineer who can say that he studied philosophy and drama at the New School for Social Research. He also is one of the few avionics engineers to have poetry published in Latin American journals.

After the job in New York, he worked with the Navy in advanced radar design. He then moved to a task force designing avionics for the Navy's A-7D and E attack planes. There, he first experienced the difficulties that arise when computers are fitted into aircraft. Entner adds that the problems encountered during the design of the A-7's avionics led to the advent of the AADC program and his latest job.

"The large computer manufacturers don't cater to the time-sharing business," says Helmut Sassenfeld, vice president and general manager of Tymshare's Technical division, so he plans to help them along. Sassenfeld, who helped design machines for GE and RCA (Spectra 70/46) and worked on Project MAC, plans to design hardware that will improve the time-sharing capacity of business and scientific machines.



# OUR ANGLE: four frequency phase angle voltmeters

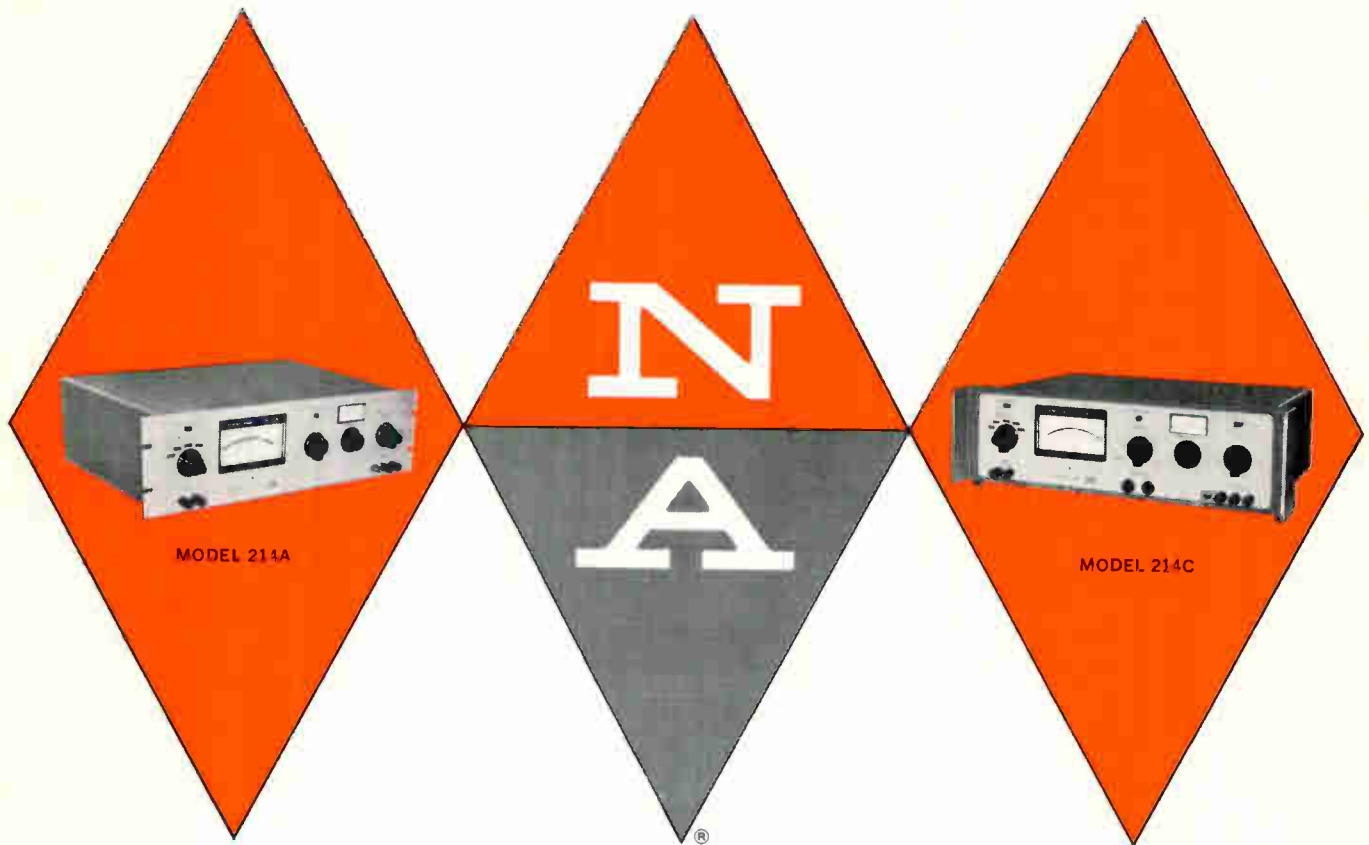

## CAN YOU THINK OF A BETTER ANGLE TO AVOID OBSOLESCENCE?

North Atlantic's 214 FOUR-FREQUENCY PHASE ANGLE VOLTMETER introduces a new flexibility in AC voltage measurements. It enables direct reading of null balance, total voltage, fundamental voltage, in-phase voltage, quadrature voltage, and phase angle.

It's also pre-wired to handle four operating frequencies from 30Hz to 20kHz, which means extended longevity and broader application. Even if you only need one frequency, there are three extra spots to add other frequencies later. Frequency changes can be made rapidly and conveniently in the field with plug-in modules. The 214 can be completely recalibrated at the installation site by a single rear-panel adjustment.

Harmonic rejection and high signal overload design of the unit screens out conventional distortion and errors in measurement and calibration. The all solid-state Model 214 offers full accuracy over  $\pm 5\%$  bandwidth,  $1^\circ$  phase measurement, adjustable meter scaling for go/no-go testing, and  $300 \mu\text{V}$  full-scale sensitivity. Priced from \$1215.00.

Options? Other models offer  $0.25^\circ$  phase accuracy, lower-cost single frequency operation, broadband phase-sensitive performance from 10Hz to 100kHz.

Whether your AC measurements are large or small, contact your North Atlantic sales engineering representative today. He'll show you a new angle to your AC voltage measurements.

**NORTH ATLANTIC**  
*industries, inc.*

200 TERMINAL DRIVE, PLAINVIEW, NEW YORK 11803  
cable: noatlantic / twx: 510-221-1879 / phone: (516) 681-8600

See Us at WESCON Booths 324-325

Circle 15 on reader service card

# filters...

To fit any requirement. Frequencies from 10MHz to 13GHz. Low insertion loss. Wide power range. Bandwidth from 1% to 120%. Choice of connectors. Fixed bandpass or lowpass, tunable, cavity.

You name it. Texscan can supply it. 48 hours for most models. Call us collect. We'll give you an immediate answer with model numbers to match your specs.

If your problems require a custom design, we'll build it. Whatever is necessary—folding, bending, connectors, mounting. You'll find nobody knows more about filters than Texscan. Call or write for catalog with specs, response diagrams and insertion loss curves. Texscan Microwave Products, subsidiary of Texscan Corporation, 7707 N. Records St., Indianapolis, Ind. 46226. AC 317/545-2101. Texscan Limited, Hemel Hempstead, Hertfordshire, England. Phone: 58558

## Fixed Frequency

Bandpass or lowpass. A wide selection of filters from 10MHz up. As small as 1/4" with choice of connectors.



## Tunable

Complete versatility for lab use. Each model covers more than an octave within the frequency range of 48MHz to 4GHz. Three or five section response with 3db bandwidth of 5%.



## Cavity

For low insertion loss, high selectivity applications. From 30MHz to 3000MHz. Two through six section Chebishev response. Low frequency operation with 1/4 wavelength or helical coil design.



# Texscan

## Who's Who in electronics

Why did he choose to do this at Tymshare? "Because time sharing is a business and you can't survive in business without a first-class selling and service organization. What attracted me to Tymshare is its selling and marketing group."

Sasensfeld says that the best setup for a time-sharing service is not a big super computer, but rather a network of smaller ones.

"One reason is the classic argument that if you have all of your customers on one machine and it goes down, you have a lot of unhappy customers. But there is another argument—a business argument. If you increase your business and you load your machine, you have to add to it in large chunks; and because you can't make complete use of the new added chunk for awhile, you can go broke almost before you start. The best way is to add in increments of 10% to 20%—too small is no good either."

**Kit bag.** But a working network of small machines needs communications and interface equipment, and this is where Sasensfeld comes in. He plans to build subsystems that will enable the machines to work together. "Today, because of IC's, you can do a lot of development in a hurry. You can go to an Allied Electronics catalog and pick out the parts; it's like putting a kit together. And it's a far cry from what was possible five years ago."

As an example, Sasensfeld points to a multiplexer that Tymshare makes. "It has more logic than the XDS 940 computer it works with," he says. But he is quick to say that Tymshare is not going into the terminal or peripheral business—although it does sell an acoustic coupler.

Sasensfeld believes that the ideal network would contain only about 10 computers interconnected to let the user access any processor. In Tymshare's present system, users can be switched from one machine to another, "but this is a patch-cord affair," says Sasensfeld. "The user can't dial in to a computer, but we're working on this. The next step is a fully automatic system where the front end is fully connected."

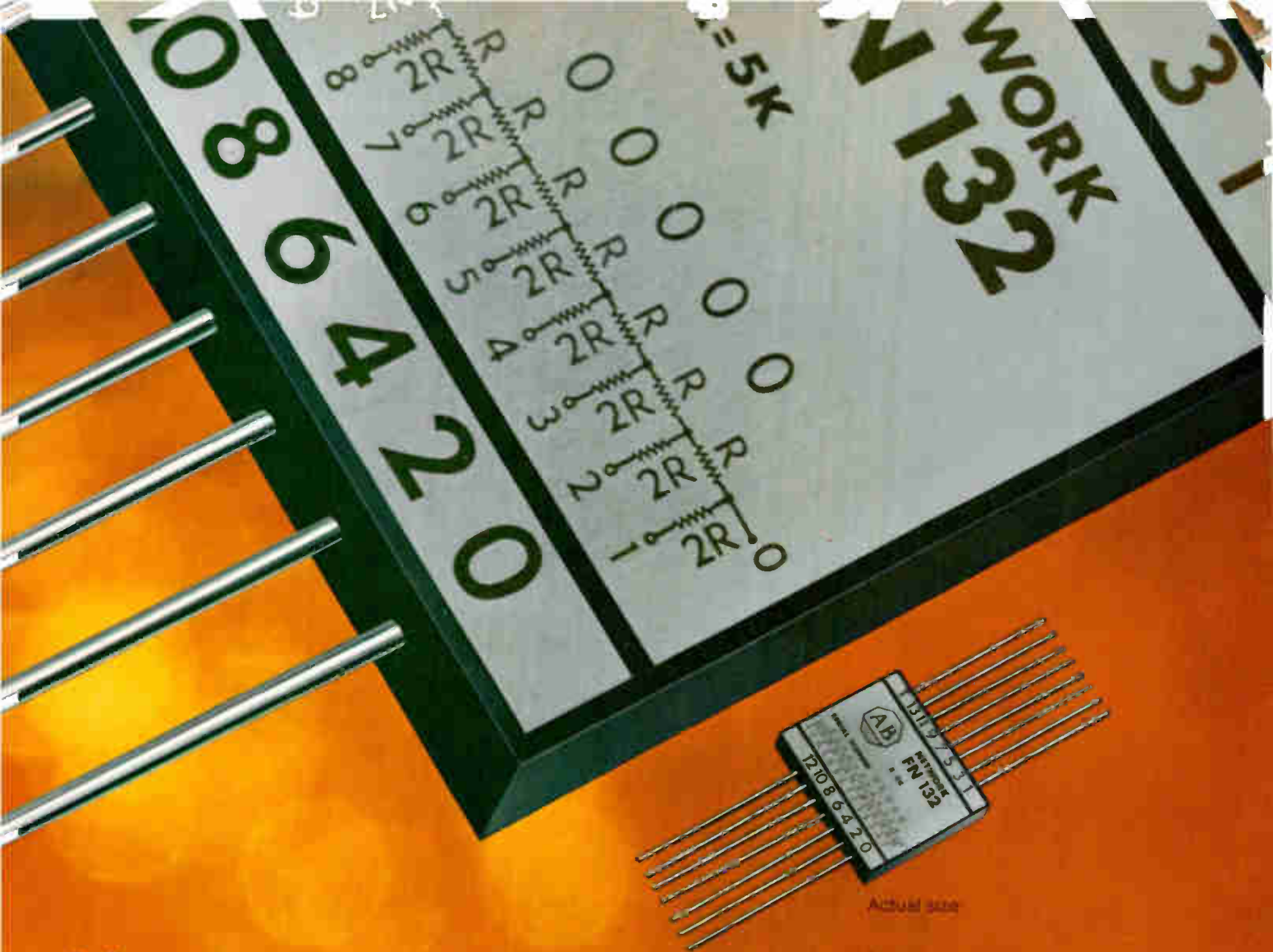

## Now true precision in Allen-Bradley thin film networks.

Resistance networks for A/D and D/A conversion, digital volt meters and numerical control systems demand extreme precision. Allen-Bradley can deliver. Precision that starts with a patented chromium-cobalt resistive material vacuum deposited on a substrate made to Allen-Bradley specifications. Precision based on exclusive computer drawn grids. Precision backed by extensive design and testing facilities. Precision on a continuing basis assured by Allen-Bradley's 14 solid years of experience.

Add the reliability of a single substrate, uniform temperature characteristics, much lower attachment costs and you see why Allen-

Bradley thin film networks are the logical replacement for discrete precision resistors.

### SELECTED SPECIFICATIONS

RESISTANCE RANGE	1K ohms to 2 megs, standard 25 ohms to 50 megs, special (Single substrate range— 10,000 to 1)
TCR LEVELS -55°C to +125°C	± 25 ppm/°C ± 10 ppm/°C ± 5 ppm/°C
TCR TRACKING	± 5 ppm/°C standard to ± 1 ppm/°C special
TOLERANCES	Absolute to ± .01% @ +25°C Matching to ± .005% @ +25°C
RESOLUTION	Line width and spacing to .0001 inch
ENDURANCE	Exceeds MIL-R-10509F Characteristic E Procedure: MIL-STD-202D

Investigate the superiority of Allen-Bradley thin film networks. Write: Marketing Department, Electronics Division, Allen-Bradley Co., 1201 South Second Street, Milwaukee, Wisconsin 53204. Export office: 1293 Broad St., Bloomfield, N. J. 07003, U.S.A. In Canada: Allen-Bradley Canada Ltd., 135 Dundas Street, Galt, Ontario. Several standard networks are available through your appointed A-B industrial electronic distributors.



# Economy class.

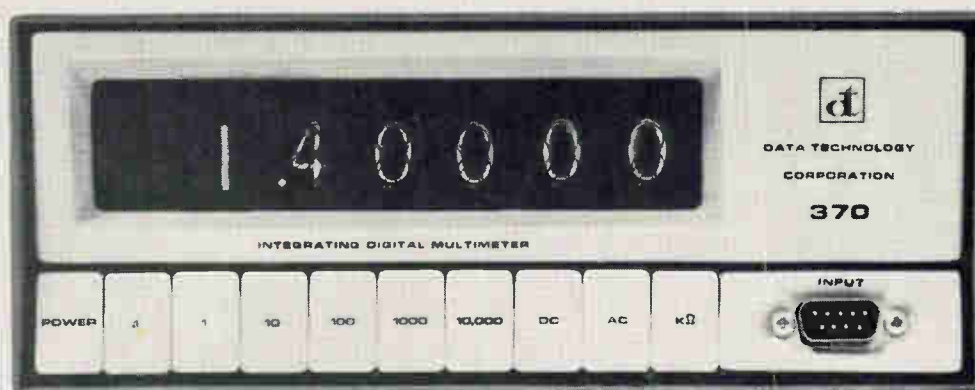

Save a grand (vs. Dana). Save two (vs. HP). We've got the lowest priced 5-digit DVM on the market with accuracy of .0025% of reading. Model 370, tagged at \$2400. About half the cost of comparable big boxes. And so stable we don't need a zero pot on the front panel.

We'll give you a sweep of  $1\mu\text{V}$  to 1000V, BCD output and remote programming, all standard. Five readings per second from dual slope integration — the most accurate conversion technique with the quietest ride in meters. Common mode rejection, in DC is 140 dB with a  $1\text{ k}\Omega$  imbalance; AC, 120 dB at 60 Hz.

Open up your options with our 370. All plug-ins. Like auto-range for all functions. Ohms option with 15V open Ckt. voltage, 1 milliohm resolution. Even ratio with any reference voltage you choose.

First-class warranty as well. Plus a team of specialists now in the field, scheduled to visit your area soon, with economy-minded innovations in digital measurement, and new briefs on applications.

Data Technology Corporation, 1050 East Meadow Circle, Palo Alto, California 94303, (415) 321-0551, TWX 910-373-1186.

Circle 19 on reader service card

# Data Technology



## Champagne quality RFI/EMC filters at beer prices

A toast! May you and your products benefit from finer, lower-cost filters from Captor Corporation. Captor combines knowledgeable application engineering with a quality assurance program that extends through every manufacturing step from order entry to final packaging. Costs are closely controlled because production is geared to a specific electronic components family: miniature RFI/EMC filters, communications and security filters, and custom designed filters and assemblies. Captor's new environmentally conditioned plant is designed expressly for fast, efficient manufacture of this integrated product line. Write for our capabilities brochure today and drink in the whole story.

 **CAPTOR**  
CORPORATION  
*Electronics Division*

5040 Dixie Highway, Tipp City, Ohio 45371, Phone: (513) 667-8484

## Meetings

### Seaside science

It would be a shame if engineers shied away from the IEEE's big oceanography meeting just because of its name. Set for remote Panama City, Fla., from Sept. 21 to 24, it's billed as the "first global meeting on technology progress" in oceanography. There should be enough material to interest even those engineers who aren't in technology's sunshine-and-scuba set.

For example, Singer-General Precision's R.A. Flower will describe a real-time unscrambler that corrects speech distortion caused by helium. While only deep divers have to contend with helium distortion, a real-time method to unscramble speech has applications in many parts of the communications industry.

**Coming ashore.** R.W. Sears and T.E. Tapley from Bell Labs will describe a data acquisition system built for underwater acoustic studies. Here, too, the system has potential uses on dry land.

Advanced technology also will play a big part in the Panama City papers. A Sandia scientist will discuss optical heterodyning techniques. W.R. Arndt of Perkin-Elmer intends to present a paper on holographic acoustic imaging. And Westinghouse engineers have gotten together a group presentation on low-light-level tv.

Those interested in oceanography as a market can benefit from tutorial sessions on the impact of integrated circuits and on oceanographic instruments.

For further information, write Calvin B. Cosey, Naval Ship Research and Development Laboratory, Panama City, Fla.

### Calendar

**Photovoltaic Specialists Conference,**  
IEEE; Seattle Center, Washington, Aug.  
11-13.

**International Conference on  
Microelectronics, Circuits, and Systems**

(Continued on p. 22)

# FETs



## 22 from the timber

TI cut down the confusion.

From the 903 different FETs now available\*, TI selected 22 that meet 85% of all FET applications.

TI's 22 FETs are popular, proven and readily available from factory and TI distributor stocks. They're all part of our *preferred semiconductor and components line*, selected after months of computer demand analysis.

Your choice is easier, faster. You'll save money, too. TI's volume production means you can get

all 22 at lower prices.

If one of the 22 doesn't meet your circuit requirements, remember TI makes over 100 standards, including N and P channel junction and MOS FETs. Many specials, too.

TI FETs offer exceptional cost and performance improvements in high impedance low noise amplifiers, RF amplifiers and mixers, differential amplifiers, chopper switches and instrumentation, to name a few.

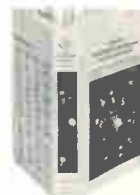

TI's Preferred FETs		
TIS58	2N3330	2N4416
TIS59	2N3819	2N4857
TIS73	2N3820	2N5045
TIS74	2N3822	2N5245
TIS75	2N3823	2N5246
3N160	2N3909	2N5247
2N2386	2N3993A	2N5248
2N2498		

Ask your distributor for TI's new *Preferred Semiconductors and Components* catalog. Or write : Texas Instruments Incorporated, PO Box 5012, M S 308, Dallas, Texas 75222.



\*1970 worldwide figure from D.A.T.A. Inc., publisher of *Electronic Data*.

**TEXAS INSTRUMENTS**  
INCORPORATED

**NOW**  
**HIGH-PERFORMANCE SCRs**  
**TO MEET THE**  
**CRITICAL NEEDS OF...**

- Power Inverters
- A.C. Motor Variable Speed Drives
- Induction Heaters
- Pulse Width Modulators

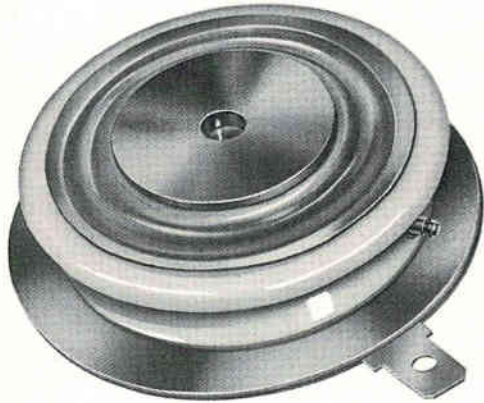

**NATIONAL®**  
**DISC PACKAGED**  
**REGENERATIVE GATE\* SCRs**  
 provide these plus factors...

- + Voltages to 1000 V
- +  $dv/dt$  to 500 V/ $\mu$  sec.
- + Turn-off time to 15  $\mu$  sec.
- +  $di/dt$  to 800 A/ $\mu$  sec.
- + Low power gate drive
- + Operation to 20 KHz, with low switching losses
- + 175 and 380 amperes RMS
- + Also available in stud packages to 470 amperes RMS

\* A NATIONAL® exclusive.  
 Patent No. 3,486,088

We welcome requests for detailed data and application assistance. Contact...

**NATIONAL ELECTRONICS, INC.**  
 a varian subsidiary

Geneva, Ill. 60134, phone 312-232-4300

## Meetings

(Continued from p. 20)

Theory, IEEE; University of New South Wales, Kensington, Sydney, Australia, Aug. 18-21.

AFMA National Conference, Armed Forces Management Association; International Hotel, Los Angeles, Aug. 20-21.

Radiation Effects in Semiconductors, Air Force Cambridge Research Labs; State University of New York at Albany, Aug. 24-26.

Western Electronic Show and Convention (WESCON), IEEE; Biltmore Hotel, Sports Arena, Los Angeles, Aug. 25-28.

Preparation and Properties of Electronic and Magnetic Materials for Computers, the Metallurgical Society, Statler-Hilton Hotel, New York, Aug. 30-Sept. 2.

Application of Computers to the Problem of Urban Society, Association for Computing Machinery; New York Hilton Hotel, Aug. 31.

### Short courses

Titanium Technology, University of California at Los Angeles; Boelter Hall, Room 4428, Aug. 24-28; \$310 fee.

Communicating Technical Information, Massachusetts Institute of Technology; Cambridge, Aug. 24-28; \$300 fee.

Aerodynamics of V/STOL Aircraft, Pennsylvania State University; University Park, Aug. 24-28; \$250 fee.

### Call for papers

Power Industry Computer Applications Conference (PICA), IEEE; Statler-Hilton Hotel, Boston, May 24-26, 1971. Oct. 15 is deadline for submission of abstracts to Paul L. Dandeno, Hydro Electric Power Commission of Ontario, 620 University Ave., Toronto, Ontario, Canada.

IFPI Congress 71, American Federation of Information Processing Societies; Ljubljana, Yugoslavia, Aug. 23-28, 1971. Nov. 30 is deadline for submission of papers to Academician V. M. Glushkov, Chairman, IFIP Congress 71 Program Committee, Institute of Cybernetics, Ukrainian Academy of Sciences, Kiev—28, U.S.S.R. or Prof. C. C. Gotlieb, Vice Chairman, IFIP Congress 71 Program Committee, Institute of Computer Science, University of Toronto, Toronto, Ontario, Canada, or Prof. H. Zemanek, Vice-Chairman, IFIR Congress 71 Program Committee, IBM Laboratory Vienna, Parkring 10, A-1010 Wien 1, Austria.



# Here's a quick plug for micro-systems.

The A-MP Chevron Shaped Connector plugs in, plugs out and interchanges to give you connection flexibility in your most mini-micro applications.

This connector has contacts on straight centers of .050". Or staggered centers of .025". Because of their special design, the contacts are very tolerant of misalignment and very redundant in their connection.

The receptacle contacts have an outside diameter of .030". Inside there are two spiral springs that redundantly grasp every pin.

The connector housings are dimensionally identical for both pin and receptacle contacts. (A foresight for versatility's sake.) They are available with contoured edges that correspond to the staggered pattern of the contacts. Which means you can fit the housings together and maintain even contact spacings.

For application versatility, the connectors can be mounted for either perpendicular or parallel card mating in addition to the standard in-line card-to-card applications. There's also a version for ribbon cable that opens many cable-to-card or cable-to-cable possibilities, or for transmission cable to match 75 ohm impedance.

That's our plug for micro-systems. But it's not all you'll need to know about it. For more information on the A-MP Chevron Connector write:

**Industrial Division,  
AMP Incorporated, Harrisburg, Pa. 17105.**

**AMP**  
INCORPORATED



ACTUAL SIZE



When you can't afford a "wrong number"...

Symbolic representation of the TV, voice, ranging data and biomedical telemetry signals from the moon. Photograph courtesy of NASA.

## bring ERIE in early.

Where are they? How are they? What do they see... and say? NASA and the world want to know. And, the only way to find out is over the special Motorola S-band equipment on both the Command and Lunar Modules. Once the Apollo Astronauts are over 30,000 miles out, it's their *only* communications link with Earth. It simply can't fail. That's why Motorola called on ERIE TECHNOLOGICAL to develop the EMI filters and Monobloc capacitors that would help this equipment perform flawlessly on every Apollo mission since Motorola has been involved. Proof, once again, that it pays to bring ERIE in early.

Circle 24 on reader service card

**ERIE TECHNOLOGICAL PRODUCTS, INC.**  
644 West 12th Street, Erie, Pennsylvania 16512  
(814) 453-5611

---

# Electronics Newsletter

---

August 3, 1970

## Fires in tv sets remain a problem

RCA, which already has one of the most active company programs for countering tv fires, has the whole subject under "very active consideration" and is trying to determine the best way to step up its retrofit program for color tv sets in use. **The firm's efforts come at a time when much of the publicity over tv-set fires has died down, but fires apparently relating to the problem continue.**

Three children were killed when a fire swept through a Yardville, N.J., home on July 11. An RCA color set, reportedly off at the time of the fire, was in the home. A detective in the Mercer County Prosecutor's office, Paul Woolverton, says the set contained RCA's CTC-15 chassis and **he speculates that the fire started in the on-off switch** (for related story, see page 58). Woolverton, who has a background in electronics, has dissected the burned-out set and says neither the flyback transformer nor the bypass capacitor appears to have triggered the fire.

RCA's general counsel, Robert Werner, has been in touch with detective Woolverton, offering him any help that RCA could provide. Werner points out though that "when a fire starts and a set is on the premises, it is often cited as the cause. We don't know that it was here."

## Proposals for changes at Pentagon would impact industry

There will be significant changes in the way the electronics industry does business with the Pentagon if recommendations of a Presidential panel are adopted. The 238-page report of the Blue Ribbon Defense Panel suggests that **more R&D on military subsystems should be allowed without the requirement that they be part of an approved program for production.**

The panel also would separate DOD responsibilities for research, development, test, and engineering into two organizations, with T&E becoming an independent function, and consolidate all military telecommunications into an expanded Defense Communications Agency responsible to a new Assistant Secretary for Telecommunications.

The modification in research, development, and procurement practices are likely to be implemented a lot more easily than other recommendations to restructure the Pentagon chain of command. **The panel would strip much of the responsibility from the Joint Chiefs of Staff and relegate them largely to a planning function.**

## Modular computer aimed at USAF and NATO projects

Watch for a series of air defense computer modules from Hughes Aircraft Co. Aimed for use in Air Force and NATO ground-based air defense systems during the 1970s, the Hughes family will consist of at least one and possibly two sets of modules. **Although Hughes has yet to develop a working prototype, it already has announced its H-4400 system made up of a modular arithmetic unit, an input/output processor, and a memory tied together by a switching module that provides parallel paths for processors to memory.** As many as eight processors and 16 memory modules can be tied together to produce a \$4-million-operations-per-second computer with 8.5 megabits of tightly-packed core memory. **Hughes denies it is developing a second set of modules, but industry sources say it will announce this fall an H-4700 machine with identical architecture but with faster processing speeds.**

---

# Electronics Newsletter

---

## **Ampex and others seeking to buy memory companies**

A shakeout appears imminent among San Francisco area semiconductor memory houses—ironically, even before the market begins its anticipated climb. At least two area manufacturers are reportedly in financial trouble, and the only way out may be to sell out.

Potential buyers—Ampex, Varian Associates, and DuPont—are standing by, and their interest isn't necessarily limited to equipment. Ampex already has started the nucleus of a semiconductor memory facility at Culver City, Calif. Says one company spokesman: "We are actively looking for people and the best way to get them seems to be by acquiring a small company that's having cash problems." Ampex sees the market by 1975 as 50% cores and 50% semiconductors and it doesn't want to be caught short.

## **New NAR firm to sell memory**

North American Rockwell Microelectronics Co., formerly the Autonetics Products division, will announce five new standard commercial MOS/LSI products before the end of the month, and one will be the company's first memory system. It's known that the firm wants to market standard chips that perform functions similar to those of the logic-and-memory arrays being delivered to the Sharp Corp. of Japan for its Micro-Compet calculator. Details about the memory system are skimpy, but it's believed to have about 10,000 bits storage capacity.

## **Motorola on line with CAD for MOS**

Motorola, a late entry in the MOS field, is catching up fast—its computer-aided design facility for custom MOS/LSI circuits is on line. The system, billed as a fast-turnaround design center, promises only 12 to 14 weeks between order and shipment. It employs a high-threshold p-channel MOS process; a low-threshold silicon gate process will be added next year.

Now that Motorola has a CAD facility, the Big Three are competing head-on for the custom, fast-turnaround MOS business. But Motorola thinks it has a price edge. Because its system, called polycell LSI, is built around small computers—CDC 1700s—instead of the large machines that TI and Fairchild use, Motorola feels that its overhead will be lower. Typical nonrecurring charges for a design run about \$10,000 to \$12,000.

## **Addenda**

Two companies see the numerical control market as a good place to diversify. For example, Tektronix plans to move into what is, for the scope maker, a completely unrelated market; the announcement could come as early as next month. Bryant Computer Products will enter the numerical control field with a system for running multiple machine tools. Bryant designed it for a machine-tool line made by its parent, the Ex-Cell-O Corp. . . . Honeywell's plans to announce a medium-scale computer in September may be delayed because of its consolidation of GE's computer operations. A Honeywell official says that GE marketing men are asking for the delay so that products developed by GE can be unveiled—computer firms like to release one product at a time. The Honeywell machine will be based on H-3200 concepts but will boast microprogramming and extensive use of integrated circuits. . . . Sperry Rand's Univac has kept on top of the antisubmarine warfare airborne computer market by grabbing a \$40 million contract from Lockheed to build nine machines for the S-3A carrier-based aircraft.

# General Electric parade of power control IC's

## Voltage, phase, temperature and threshold detector IC's for industrial control

General Electric—long a leader in power semiconductor devices—now offers a broad line of monolithic integrated circuits for power control tasks. Because they're monolithic, these devices provide better thermal coupling and stability. This means increased reliability which is essential to your industrial control applications.

### PHASE CONTROL

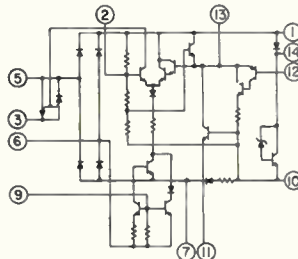

PA436—Phase-control

- controls loads up to 15A and 280V
- internal compensation for temperature and voltage changes
- induction motor speed control

### PRECISION THRESHOLD DETECTION

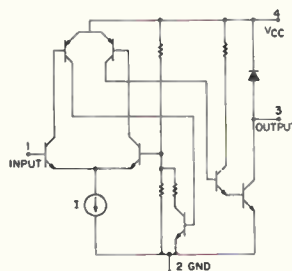

PA494—Threshold detector

- Schmitt trigger action
- 10% hysteresis
- low voltage operation (to 2.3V)
- high sensitivity (typ. 1nA)

### VOLTAGE REGULATION

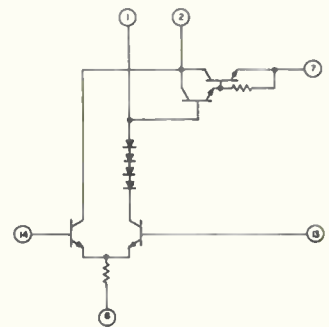

PA264/PA265—

Five-watt voltage regulators

- 25- and 37-volt ratings
- 5-watt dissipation for on-card regulation
- Up to 1.25 amperes

### TEMPERATURE CONTROL

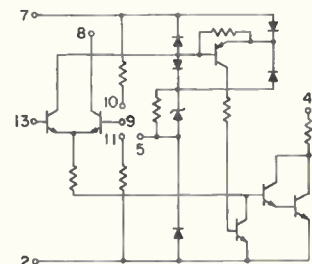

PA424—Zero-voltage switch

- a-c line operation
- eliminates RFI
- triggers power triacs/SCR's

For more information about General Electric integrated circuits, call or write your GE sales representative or authorized distributor, or write General Electric Company, Section 220-87, Room C-2, Northern Concourse Office Bldg., North Syracuse, N.Y. 13212. In Canada: Canadian General Electric, 189 Dufferin Street, Toronto, Ont. Export: Electronic Sales, IGE Export Division, 159 Madison Avenue, New York, N.Y. 10016.

GENERAL  ELECTRIC

Circle 27 on reader service card

# CENTIGRID\*

## The Low Profile .100 Grid Relay

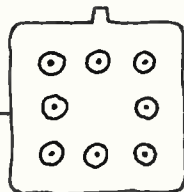

**Packaging and Production Engineers please note:**

CENTIGRID\* Series 112 Relay's 8 leads, spaced on 0.100 centers — all on the periphery of the header — permit direct plug-in convenience on all PC boards. This relay won't be the highest component on the board. It's only .225 high, thereby minimizing board spacing. It's only .370 per side.

Design and Circuit Engineers please note: The CENTIGRID\* has the same performance as our TO-5 relays. Coil voltages, in 6 choices, range from 5 to 26.5 VDC.

Using CENTIGRID\* Series 112 relays permits compliance to Mil Std. 275B and Mil-P-55110A circuit board specifications without complicated lead spreading.

Space-wise Engineers please note: Ease of installation and inspection makes CENTIGRID\* the perfect answer to any packaging density problem.

\*TM App.

We're not complacent. We're relay innovators. We built the first relay with single or double diodes for polarity reversal protection.

The first relay with coil transients suppression, and an internal transistor driver. We added internal diode chips for built-in arc suppression, combined it with the internal transistor driver, and made it double as a transapad. That's our TO-5 relay. We built it from the leads up!

And now: CENTIGRID\* . . . another big breakthrough from the "little relay people." All the problem-solving low-down is yours for the asking. Simply write or call:



**TELEDYNE RELAYS**

3155 West El Segundo Boulevard, Hawthorne, California 90250 • Telephone (213) 679-2205

# Airborne radar to spot small boats

Coast Guard spending \$1.46 million to develop unit that can pick out a 16-foot fiberglass craft in bad weather, 5-foot seas

The Coast Guard has given Airborne Instruments Laboratory a \$1.46-million contract to develop a new airborne radar, the AN/APS-119, for use in search and rescue operations for small craft. The contract calls for delivery of two flightworthy prototypes. The first is to be delivered in 12 months, while the second will include changes that may be necessary after flight tests on the first unit.

The projected instrument is intended to detect pleasure craft in stormy weather, when high seas, rain, and fog reduce the already limited detection range of standard radars for small targets. The new radar will use a variety of clutter rejection and target enhancement techniques originally developed for periscope detection, to achieve a range of ten miles when searching for 16-foot fiberglass craft (with a nominal backscattering cross section of about 1 square meter) in foul weather and five-foot seas. These are, except for narrow transmitted pulse widths and selectable polarization, signal processing techniques used in the receiver.

**Busy.** It will be designed for use in the Coast Guard's C-130 search aircraft, 15 of which are in service. This total may be expanded to 30 as the number of pleasure craft in the U.S. swells. Last year 70% of the Coast Guard's 48,000 search and rescue missions involved pleasure boats.

The receiver will be logarithmic to within  $\pm 2$  decibels over a full 100-db range, providing clutter discrimination against all but extremely close-in clutter. A sensitivity-time-control circuit setup will augment the log characteristic at close ranges when the sea return otherwise would exceed the receiver's dynamic range.

Logarithmic processing is effective in clutter suppression because at steep angles of incidence, sea clutter fits a Rayleigh distribution. The rms fluctuations are proportional to the local clutter level as wavelet backscatter builds up the local average sea return. A receiver that extracts the log of the instantaneous composite signal compresses the signal range, normalizing clutter fluctuations to the average clutter level. At this point the signal usually is passed through a fast-time-constant circuit to strip away the average clutter level and leave behind only the small fluctuations.

**New.** AIL will use a novel form of circuit, a type of tapped delay-line canceler. It will cut out the extended (average) clutter without significantly reducing the energy content of target returns as would an ordinary, differentiator type of fast-time-constant circuit. Since receiver effectiveness strongly depends on the accuracy of the logarithmic amplifier's characteristic, AIL already has built a breadboard of its proposed receiver, using ICs in series-parallel combinations to prove that it can achieve the large dynamic range.

One novel concept is the use of a scan converter as a combination of integrator and display driver. This takes advantage of the up to 300-rpm scan rate to integrate approximately 50 successive scans on the storage tube of the converter. It uses drift and ground-speed inputs from an AN/APN-147 doppler navigator to provide motion compensation in the form of a scan-to-scan-shifted writing point. The converter output will be in a standard tv raster format and will be used to drive several bright-screen displays. A direct readout of the

plan-position-indicator type also will be available.

**Fast and slow.** The scan rate, while high, nonetheless is slow enough to insure good decorrelation of sea clutter on a scan-to-scan basis. The clutter will appear as noise, insuring a good improvement in signal-to-clutter ratio as successive scans are integrated. The improvement may not be as great as with a frequency-agile radar, but this technique is regarded as less sensitive to aspect angle and will provide up to about an 8-db increase in the S/C ratio, depending on the integration interval, which can be selected in a range anywhere from 0.3 second to 10 seconds.

Major parameters of the APS-119 are as follows: frequency, 8.5 to 9 gigahertz; output power, 250 kilowatts peak, 180 watts average; pulse width, 0.1, 0.2, 0.4, or 0.8 microsecond; prf, 7.0, 3.5, 1.75, 0.875, or 0.44 kilohertz, antenna gain, 34 db; beamwidth, 2.4° azimuth, 4° elevation; polarization, horizontal, vertical, or circular.

The mixer is a balanced-diode imageless unit that uses Schottky diodes to provide high burnout protection, while achieving an 8-db noise figure. The receiver uses a 60-megahertz i-f preamplifier to precede its log amplifier. The preamplifier consists of a wideband (20 Mhz) gain section and a narrowband filter section which is switch-selected to match the transmitted pulse width. Rain clutter suppression will be enhanced by narrow pulse operation and by circular polarization. This also will reduce that component of sea clutter attributable to the wavelet patterns superimposed on the major wave structures.

The APS-119 will also be useful

## U.S. Reports

for weather avoidance and navigation, in its low-prf, wide pulse mode, and the displayed range is extended to 160 nautical miles for these purposes.

### Electro-optics

#### Making the scene

Now that powerful infrared lasers are on the scene, interest is focusing on their use as sources in imaging systems. But because the human eye is blind to i-r images, they are usually captured on film sensitive to those longer wavelengths. For, although there are techniques for converting i-r images to visible ones—such as the photoconductive detectors which extend the ability of the eye to detect i-r at wavelengths beyond 1.1 microns—all have major drawbacks that mean complex arrays with poor resolution.

To overcome these difficulties, RCA scientists at Princeton, N.J., have researched an entirely new approach that they call image upconversion. The process takes each photon from the i-r scene and, through the use of nonlinear media, raises its energy to produce a visible photon.

Tests with the upconverter are encouraging. Using a 1.2-centimeter cube of potassium dihydrogen phosphate (KDP), RCA has obtained upconversion images with more than 200 x 300 resolution elements and resolved more than 750 line pairs per inch.

There are powerful advantages to

the upconversion method. For one, it doesn't need cryogenic cooling, whereas some photoconductors now in use must be cooled to 77°K or less. For another, most i-r image converters require complex optical systems to focus the i-r scene onto the photosensitive surface. Not so the upconverter, which can be incorporated into a telescope-like arrangement that does away with this requirement.

More work needs to be done before the system can move from the laboratory to the world of real images. For one thing, the process is very weak. More powerful lasers are required, and so are more efficient, i.e. more nonlinear, upconversion materials. More important, the materials will have to work over large acceptance angles and spectral bandwidths.

### Space electronics

#### Saved by the laser

What kind of radar can be used to achieve the narrow beamwidths required for space docking without massive antennas? NASA, anxious to prevent its space shuttle from bending metal when docking with the first space station, is looking to lasers for the answer.

NASA sees no way to hang a 38-foot-diameter dish on the nose of the shuttle's orbiting stage. Yet an antenna of that size would be required if the agency decides to specify a 0.1° beamwidth system at centimeter wavelengths. So NASA is funding ITT's Aerospace

division for development of an ungimbaled laser radar that requires only an 0.0038-foot-diameter antenna for the narrow beamwidth. Terry Flom, an ITT engineer, says the micron-wavelength radar also would dramatically reduce side-lobes.

ITT achieves a 30° scan without gimbals—which are vulnerable in an environment where temperatures fluctuate by hundreds of degrees—by focusing a gallium arsenide laser beam on a beam deflector. The deflector is mounted on a piezoelectric crystal that bends in proportion to the applied voltage. A precision strain gage also is attached to monitor actual deflection, thus taking care of off-axis hysteresis.

**Spot.** A multi-electric lens assembly collects energy reflected from the target and focuses it into a small spot on an image dissector photocathode that's proportional to the radar's pitch and yaw angle. The angle can be determined by reading the current needed to direct the electronics emitted by the photocathode through an exit aperture.

Range is determined by measuring the GaAs laser pulse propagation time from the transmitter to the target and back to the receiver in increments of 0.67 nanoseconds (equivalent to about 9 cm or a single cycle at 1,500 megahertz). Time is resolved by using multiple tap delay lines and Motorola MECL 3 ultrahigh-speed logic modules for frequencies between 1,500 Mhz and 23 Mhz, and Texas Instruments' 54 series logic modules for frequencies below 23 Mhz.

Acquisition time for the unit is from 10 to 100 seconds depending on range, Flom says. The unit, which fits in a box 5 x 7½ x 18 inches, has a range of 75 miles. Angle resolution is said to be 0.02°, while ranging accuracy is ±10 cm. Power consumption of the system is 30 watts.

Flom says the unit could be readied for space use for \$10 million to \$20 million—a lot of money, he concedes, but only one-sixth the amount spent for development of the X-band radar aboard the Apollo lunar module. Additional units

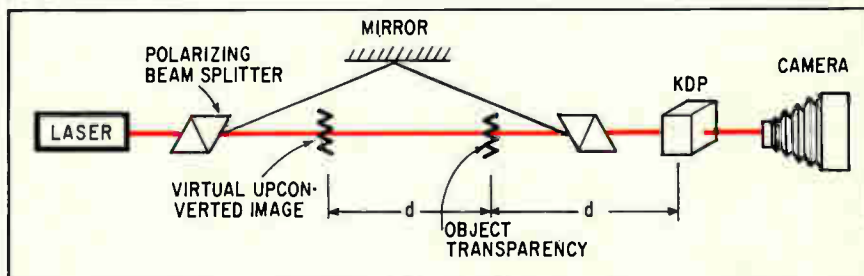

**Seeing is believing.** In this laboratory upconversion system, laser beam is split in two: one illuminates object, other passes to mirror where it's reflected back to plane of illuminating beam. Two radiations interact in KDP crystal to generate upconverted image.



## Electronics Index of Activity

Aug. 3, 1970

After 14 consecutive months of decline, the index rose 5.3 points in June from May's upward revised figure. While the increase lent a bit of a glow to a gloomy business year, the total index is still off 20 points from June '69.

The advance was led in the consumer sector, which soared 16.7 points to 80.2. That 26% rise may indicate the beginnings of a recovery in that segment of the industry after a year of depressed activity. At the same time, the 5.1-point defense increase to 137.1 may be a harbinger of a leveling off in this key component.

But to offset the good news, industrial-commercial activity was off 1.2 points, to 128.2.

Indexes chart pace of production volume for total industry and each segment. The base period, equal to 100, is the average of 1965 monthly output for each of the three parts of the industry. Index numbers are expressed as a percentage of the base period. Data is seasonally adjusted.  
\*Revised.

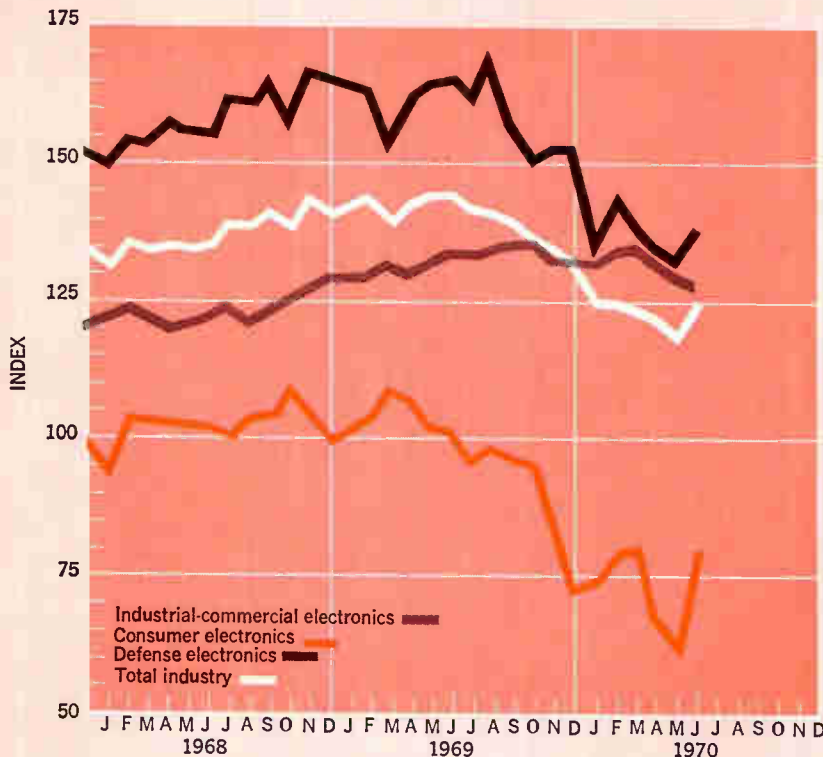

Segment of Industry	June '70	May '70*	June '69
Consumer electronics	80.2	63.2	101.5
Defense electronics	137.1	133.0	165.5
Industrial-commercial electronics	128.2	129.4	133.2
Total industry	125.2	119.9	145.2

could cost \$250,000 to \$500,000.

At least one space agency official, however, is not swayed by the laser radar's virtues. He is convinced that another \$120 million easily could be spent in going from laboratory to flight unit.

The space official also notes, and Flom concedes, that while the radar could be used to track cooperative targets equipped with corner cube reflectors, it hasn't enough power to track such targets as enemy satellites or tumbling communications satellites. And this, the NASA official states, is an objective of the shuttle radar.

### Software

#### Thinking it over

Science fiction writers for years have predicted that computers someday would be freed from the drudgery of grinding out bills and

inventory lists and will be able to be curious and examine the universe. That day has drawn a bit nearer thanks to an Air Force Office of Scientific Research project aimed at creating machine intelligence. It is about to bear fruit in software.

Inductive Inference Inc., a New York mathematical consulting firm, has a contract to complete a line of research begun at New York University by its president, David Rothenberg, and expanded by the New York Research Group. Inductive Inference, a group offshoot, appears to have resolved the theoretical hurdles and has begun to generate programs that will permit a computer to form abstract concepts to represent and reduce data fields, and to follow "hunches."

**Picture this.** The basic concept is to give the computer an "imagination." To imagine creatively is to hypothesize the results of a given set of circumstances; in effect to say, "Supposing that such-

and-such were fact, what could be inferred?"

The programs under development perform a comparable process by constructing formulas which describe potential attributes of a given data field, and then testing them for utility in reducing the information. The programs use a set of rules (syntax) to construct formulas from basic elements in much the same way that grammar is used to construct sentences from words. In essence, the elements consist of atomic predicates (less than, equal to, etc.); connectives (and, or, not, implies, etc.); quantifiers (there exists, for every, etc.); variables; and constants.

Formulas which define possible attributes of regions of the data fields are constructed in a pseudo-random manner. Then they're checked by standard rules of inference to insure that they are neither self-contradictory nor self-defining. Those that pass are applied to the data field to check

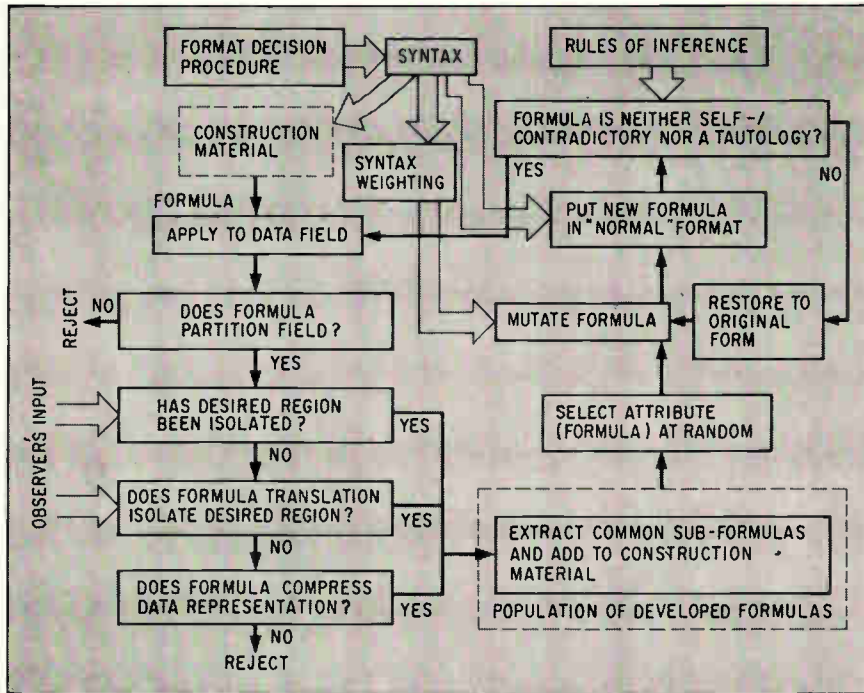

Thought process. Diagram shows software that will, it is hoped, enable a computer to form abstract concepts.

if they induce a partition of the field—to see if some, but not all, regions satisfy the postulated attributes. Formulas that succeed are added to the body of “construction material” and then are used to develop even more complex formulas. New ones are generated by altering (mutating) those already developed, so that, by a process that mimics evolution, a set of significant descriptors can be derived for the data field, whether a digitized representation of an aerial photo or an audio signal, a batch of number samples, etc.

**Sameness.** One major problem still to be worked out is the likelihood that, in mutating a formula, the program may simply construct a statement equivalent to a previous one—for example, “John is a good boy;” “A good boy is John.” This would waste valuable computer time without advancing the solution of the assigned task. Obviously, as the formulas become more complex, the risk increases that the computer may get locked in to futile recomputations. To prevent this, a sub-program is being developed to insure that essentially all formulas are generated in a single, “normal” form.

An equally important problem, and one that appears to have been solved, involves insuring that a mutating step results in modest, evolutionary changes, rather than major ones that may be too sweeping. Without this precaution even a small structural change could produce mutants functionally unrelated to their parent formulas.

The first programs will be directed to image processing. This technique has one uniquely relevant capability: the computer’s “concept” of the data field can be viewed by making use of the attributes that have been developed to generate and display an image of the data field as “seen” by the computer. An operator thus can see how well the program has adapted itself to the material to be analyzed, and where appropriate, can reinforce a trend by applying preferential weighting to a successful attribute, thereby steering the string of mutations. In this way, the system learns to learn. The program also is designed to display other possible attributes (translation) at the regions isolated by a partially successful analysis.

In fact, the ability to display results of the analysis allows check-

ing of complex cognitive processes which, in the past, have been simply classified as intuition or as an inborn talent. Suppose, for example, that a sonar operator is expert in detecting target echoes from a noise background, but can’t explain just how he does it. By using a self-organizing program to analyze the audio, and using an audio synthesizer to play back the results, the operator then can preferentially modify the program, training the computer to distinguish those subtle variations in audio content that spell “target” to him. When this process has been completed the program will consist of the detailed steps involved in extracting data; skill will be reduced to science.

## Industrial electronics

### Fast picture

High-speed electronic typesetters that compose complete pages by photographing characters generated on the face of a cathode-ray tube have been unable to deal with picture material. But both major competitors in the field, Harris-Intertype and RCA, have developed devices for handling drawings, opening the \$5 million crt typesetter market to more users.

The latest development—by Harris-Intertype—is an engineering model that uses a laser beam to convert line drawings to a digital code for processing and storage by the phototypesetter’s computer. And RCA’s Computer Systems division only last month delivered the first of the line-drawing digitizers announced last year for its Video-comp 70/800 machine.

**Tucked away.** While the RCA system operates on line—it interrupts the typesetting process because it digitizes a picture by using the crt as a flying-spot scanner—the Intertype device operates off line, storing the drawings on a magnetic tape, says Edwin R. Kolb, manager of Harris-Intertype’s Cleveland-based Fototronic-CRT division. This tape then is fed into the Fototronic’s computer system

# TRW Polycarbonates

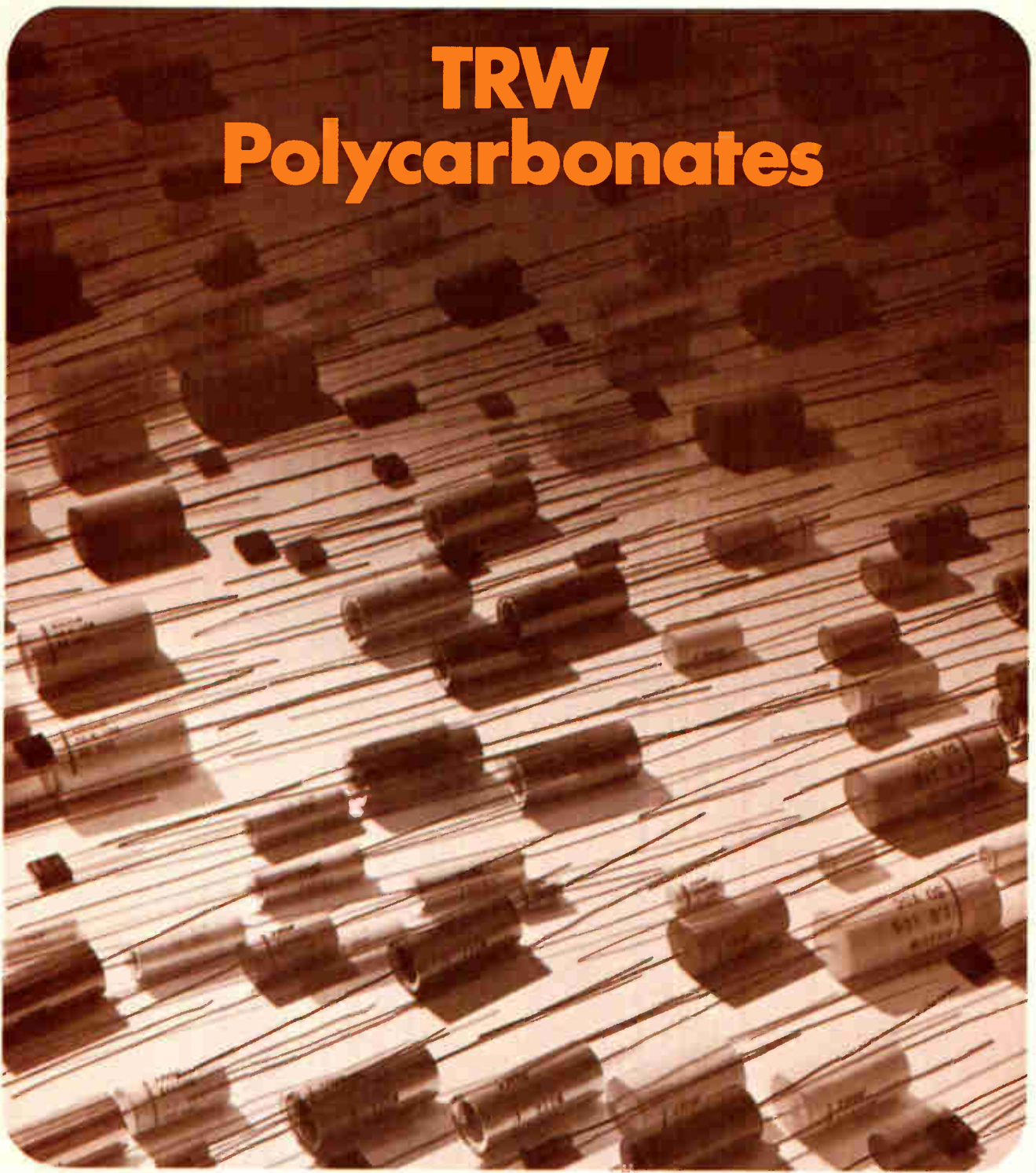

## ...small answers to big problems

Need capacitors with premium electrical and TC properties...and in the smallest possible package? Polycarbonate capacitors are your answer. And no one knows more about polycarbonates than TRW.

As the pioneer in polycarbonate capacitor development, TRW has the know-how to get that "extra

ounce of performance" out of this remarkable material. We can meet your design requirements with either metallized or foil wound polycarbonates in a wide range of capacitances, voltage ratings, shapes, and sizes. Standard types will solve most design problems...if not, let's talk about your special requirements.

For full information, contact TRW Capacitor Division, Box 1000, Ogallala, Nebraska. Phone: (308) 284-3611. TWX: 910-620-0321.

# TRW®

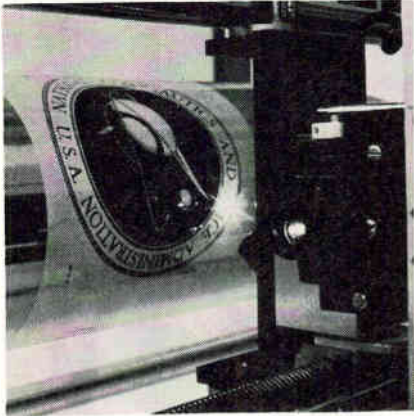

Bright spot. Harris-Intertype laser digitizer enables crt typesetters to handle certain art work.

where drawings and text are merged and located on the pages to be printed. Right now, both the RCA and Harris Intertype systems handle line drawings only: photographs still are off in the future.

In the Intertype system, a drawing is clamped to a drum rotating at 3,600 revolutions per minute. As the drum turns, the drawing is scanned by a laser beam, used because of its intensity from a commercial 1-milliwatt helium-neon unit. The laser light is reflected from the drawing's surface and sensed by a silicon photocell. Whether the light is reflected from black or white is determined by a Schmitt-trigger level detector which senses the photocell's output. The black-and-white signals then are converted to a run-length code which keys the information based on the length of each black-and-white run.

This information is further compressed—by 2.5 to 1, says Kolb—by converting and storing it in a Huffman code. A 960-bit read-only memory assists in this coding, and the information is stored in a buffer core memory before being put onto a medium-speed, nine-track tape deck.

Resolution of the laser digitizer, which will be available next spring, is as high as 720 lines per inch, says Kolb. Such resolution is needed for the drawings in many technical manuals which could now be set completely by this high-speed machine, Kolb points out.

Other new customers include printers of classified telephone directories and parts catalogs.

The digitizer costs \$65,000. All-electronic crt phototypesetters [*Electronics*, May 29, 1967, p. 137] can set as many as 1,000 characters per second, and cost upwards of \$300,000. Less expensive systems, using some kind of mechanical font for storing characters, can set only about 50 characters per second.

### Solid state

#### Another zapable ROM

Electrically programable read-only memories have enjoyed wide popularity since their introduction by Radiation Inc. five months ago [*Electronics*, March 2, p. 33], and more recently by Motorola Semiconductor. Users like the ease with which they can program these ROMs themselves, simply by applying a pulse to open the metalization in a memory cell where a logical zero is desired. Now a new IC from Solid State Scientific Corp., Montgomeryville, Pa., may make electrically programable ROMs even more attractive—by making them cheaper.

Solid State Scientific's ROM employs complementary MOS transistors, which are less expensive to make than the bipolar transistors used in the Radiation and Motorola devices. Another cost advantage: no dielectric isolation is needed in the Solid State Scientific version, whereas the other ROMs require the thin layer of silicon dioxide that separates one transistor from another in the dielectric isolation structure. The earlier units need the dielectric isolation because the voltage and current used to program the memory—to open the metal—otherwise would damage the circuit.

Solid State Scientific avoids this problem by substituting a proprietary material for the nichrome usually used for metalization, says Robert J. Lesniewski, program manager. The material can be fused with less energy—typically,

50 volts at 14 milliamperes is sufficient. Even though this value is above the breakdown rating of the n-channel transistors, they can withstand it because they are floated so that only 10 or 15 volts appear across the n channel.

So far the company has built 16-bit C/MOS ROMs. They've been on an operating life test to make sure that the opening in the metal won't close up again, and that no contamination is introduced by the fusing process. Lesniewski says that the metal has passed with flying colors, and has proven to be superior to nichrome in reliability.

The 16-bit electrically programable ROM sells for \$25 per unit to give designers a chance to try them out. On a per-bit basis, the price is still higher than the older larger capacity electrically programable ROMs. But when the company is in full-scale production, the low-cost advantage of MOS should become evident.

### Design theory

#### Safety in numbers

Kurt Greene, president of QRC Inc., a small consulting firm outside Washington, has a simple idea, and it's so simple that it just might work. The idea: specifying safety by numbers. Greene and associate Walter Cinibulk feel that an engineer ordering any size system can express in numbers just how safe he wants the system to be by allowing a designer to classify each part of a system on the basis of the likelihood of its failing and the severity of the hazard created by the failure.

The first step is deciding how many subsystems the system is to be broken into for the analysis. Next, the designer draws a block diagram for these subsystems. Each input arrow to an individual block carries both a label (e.g., voltage) and a specified range (e.g., 100 volts d-c  $\pm$  5%).

**List.** The designer then lists the things that could possibly go wrong with each subsystem, and

clip transients...



## with the New Uni-Imp "ZERO" Reaction Time Voltage Surge Protector

- Impulse Ratio ..... 1:1 to 1
- Trip Voltages ..... 550V to 15.0kV  
(constant up to 50 kV/microsec.)
- Life ..... greater than 5,000 shots  
@ max. rating
- Follow-on Current ..... Compatible with normal  
relay closure times

Now it is possible to protect sensitive components, even semi-conductor equipment, against voltage transients without concern for the rate of voltage rise. The "zero" reaction time of Signalite's new Uni-Imp is only one of the many unique features. Others include: bipolar, making them immune to di/dt restrictions; infinite high leakage resistance . . . plus more are described in a new data sheet.

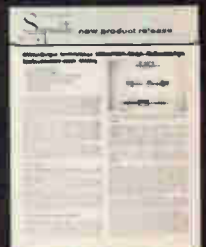
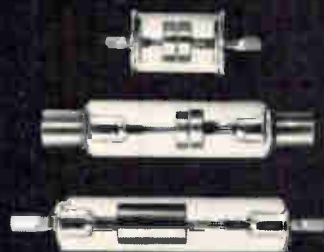

AVAILABLE UPON  
REQUEST Detailed  
Data Sheet . . . on  
Signalite's Uni-Imp  
Zero Reaction Time  
Voltage Surge Pro-  
tectors.

Signalite



Division of  
General Instrument

1933 HECK AVENUE, NEPTUNE - NEW JERSEY 07753  
(201) 775-2490

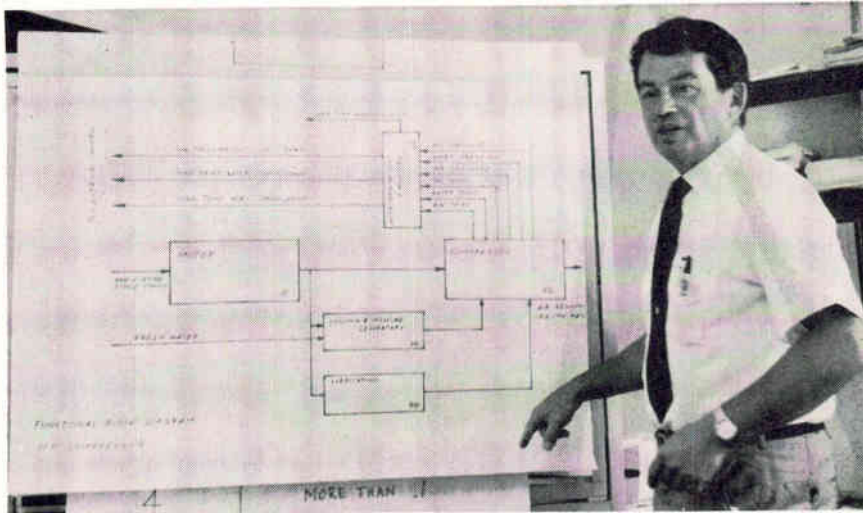

Parts of the process. QRC president Kurt Greene explains an approach that he says allows safety to be expressed as systems specifications.

the causes. For each failure mode the designer determines the probability of occurrence based on reliability tests, field histories, and his own experience. For simplicity, he assigns to each failure mode an integer whose value depends on the probability of that failure's occurrence. In Greene's work, for example, the numbers go from 1 for very low probability to 4.

Next the designer considers the effect of each failure on the safety of people around the system. This hazard level also gets an integer rating—1 for negligible risk to 4 for high-hazard condition that can't be prevented by operator.

Now the designer has two numbers for each failure mode, allowing the system's safety to be specified in terms of the product of these numbers. For example, specs could call for no modes whose level of severity is 4, no modes for which the product of hazard and probability levels is greater than 9, and no more than three modes for which the product is less than 9.

The technique, with little modification, also can be used for reliability studies. Instead of asking how each failure affects safety, the designer asks how it affects the system's operation.

**Pumped.** Greene says that the approach can be refined by breaking the hazard and probability levels into more classifications. The 4-4 ratings, however, are the ones

used in the technique's first test. Last year QRC landed a small Navy contract to try out the technique. The system selected for evaluation was a type of air compressor with years of service in nuclear submarines. The Navy, says Greene, insisted that the test not be run on electronic gear—it would make things too easy.

After 60 man hours Greene and Cinibulk concluded that the pump was very safe but unreliable, findings that Greene says are backed by the pump's history. Furthermore, Greene says that the reliability problems for the \$25,000 pump could have been solved by changing about \$150 worth of parts in the original design.

Greene says that making the safety evaluation isn't difficult and requires no special knowledge of the equipment being checked. You can learn all you need to know from the men who designed it, he points out. Furthermore, the evaluation takes little time: 40 to 60 man hours for equipment with 1,000 or less parts to as many as 500 man hours for gear with 15,000 parts. He estimates that the cost for the evaluation would run to 1% or 2% of the system's total engineering tab.

What's in it for QRC? Greene hopes the Navy and industry will adopt the approach and have him write manuals and set up training programs.

## Advanced technology

### New image

When the Sandia Corp. announced its improved transparency ferroelectric image storage and display crystals [*Electronics*, April 13, p. 33], Bell Laboratory was quick to pick it up. Using what Sandia calls its PLZT (fine-grained lanthanum-modified lead-zirconate titanate ferroelectrics) Bell scientists quickly showed the feasibility of a preliminary device structure that could store real images electrically.

But Bell knew these early devices were in an elementary stage and of limited usefulness. So even while they were describing their preliminary results at last spring's meeting of the American Ceramic Society, back at the lab Bell engineers were going full blast on more sophisticated devices. Now they've come up with a refined version of their ferroelectric. By keeping the crystal under tension, not only can they store and display a high-quality picture indefinitely, but they can erase electronically part or all of the picture, add new material, and store and display the revised picture again.

**Sandwiched.** The new device's operation is similar to the early version. A ferroelectric ceramic simply is coated on both sides with a photoconductive film and is sandwiched between transparent electrodes. To store a picture, a high-contrast transparency is placed in front of the ceramic sandwich and is illuminated with a laser beam. Since the crystal is birefringent—different indices of refraction for light polarized in different directions—the image is stored by electrically reducing the strength of the birefringence in selective regions—those that are heavily illuminated through the transparency.

This is effected by applying a voltage to the transparent electrodes. The high impedance of the dark photoconductive regions prevents the field inside the ceramic from reaching a switching value. But in the illuminated regions, the impedance of the photoconductor is reduced and the field in the

the performer

BY

PP PHYSICS  
POWER



Performs to your highest stability standards . . . backed by a total in-house manufacturing facility, plus many discerning customer approvals. Performs to your most rugged requirements . . . 100% in-house tested to JEDEC specs., plus power tested (117W/1sec.)  
 Performs to your Safe Energy Area Specifications . . . to avoid secondary breakdown risks.  
 Performs to proven single diffused mesa criteria . . . for superior power switching.  
 Power Physics offers a unique performance in price and delivery too . . . ask for a quote. Power Physics Corporation, Industrial Way West, P.O. Box 626, Eatontown, New Jersey 07724. Telephone (201) 542-1393.

PP PHYSICS  
CORPORATION

THE POWER PHYSICS FAMILY OF PERFORMERS . . .



**Single Diffused Mesa Power Transistors** . . . well known "standards" to you designers of power supplies, hammer drivers, regulators, control circuits. Immediate delivery offered on the 2N3055. Other types include 2N1487 through 2N1490; 2N3232, 33 and 35; 2N3771, 72, and 73; plus the popular modified mesa 2N3713 through 2N3716 series. Also ask us about the new power chip version of the 2N3055.



**Planar Epitaxial Power Transistors** . . . essential when your circuits demand more rapid switching, higher frequency performance and better efficiency. Ft: 150-200 MHz; useful hFE from 3A to 50A Ic: VCEO up to 140V.



**Radiation Hardened Power Transistors** . . . require a state-of-the-art capability well known to Power Physics. Through in-depth awareness of the device, physics and special environmental considerations, Power Physics offers significant and real product solutions.

Circle 37 on reader service card

## **SCIENCE/SCOPE**

When NASA's Synchronous Meteorological Satellite is launched in 1972 it will carry an instrument that can map the clouds over North America by night as well as by day. Called VISSR (for Visible Infrared Spin-Scan Radiometer), it is being built by Santa Barbara Research Center, a Hughes subsidiary. Earlier spin-scan cameras by SBRC, which are now taking daily cloud pictures from Applications Technology Satellites I and III, are limited to the visible spectrum. VISSR will also operate at infrared wavelengths to take nighttime pictures of "excellent" definition.

Automatic in-flight fault detection -- one of several advanced features Hughes has designed into the AWG-9 missile-control system for the U.S. Navy's F-14 -- enables the crew to check weapon system status before they commit the new fighter to an engagement. Four computer-controlled test sequences determine the status of AWG-9's weapon-delivery subsystems and a fifth checks the readiness of the Hughes-built Phoenix missiles. The results, shown on the missile control officer's tactical information display, tell him the F-14's mission capability at that instant.

A unique holographic technique for testing sandwich structures to detect flaws in the bonding of the honeycomb structure to the aircraft or spacecraft skin has been developed by Hughes research scientists. The new Hughes method uses a giant pulse ruby laser and thus does not require the massive table needed to hold helium-neon laser hologram systems rigid. Also, it is faster than present holographic testing techniques. A test specimen is stressed by being hit by a hammer, which also triggers the laser. Five to seven holograms are made on the same film in 1/1000 of a second. Areas where the honeycomb structure has failed to bond to the skin show up distinctly on the multiple-exposure hologram.

Opportunity for a senior-level electrical engineer with the proven capability to manage the design and development of microwave amplifiers. B.S. or M.S. in electrical engineering and U.S. citizenship required. High voltage and high reliability experience desirable. For immediate consideration, please forward your resume to: Mr. W. J. Walker, Hughes Aircraft Company, P.O. Box 338, Malibu, CA 90265. Hughes is an equal opportunity employer.

A quicker, less expensive way to expand CATV service into outlying suburban and rural areas than to extend trunk lines was introduced at the recent National Cable Television Assn. show in Chicago by Theta-Com, wholly owned subsidiary of Hughes Aircraft Company and TelePrompTer Corp. AML (Amplitude Modulated Link) is a multiple-channel microwave system that reradiates both off-the-air TV signals and CATV-originated programs from a single transmitter to multiple receivers, from which the signals are fed into cable distribution systems for final distribution into homes.

All existing CATV systems can use AML, which utilizes the same channels normally carried on cable. It can transmit four TV channels in the same spectrum space used by one FM channel.

*Creating a new world with electronics*





## U.S. Reports

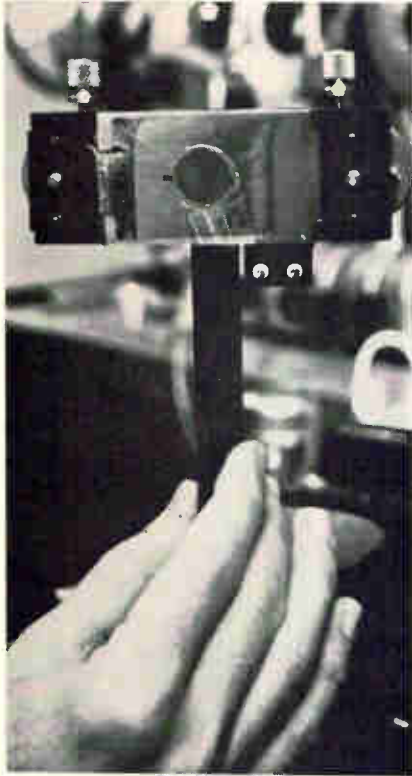

Crystal clear. Bell Lab's imaging and storage device transmits only parts of picture that change.

ferroelectric increased to the switching level; this in turn causes the ceramic in back of the illuminated regions, which becomes less birefringent, to transmit and diffract light different than in the dark regions. Thus the stored image is obtained as a spatial modulation of the birefringence of the ferroelectric ceramic.

The image is made visible by placing the structure between a standard polarizer and analyzer; it can be erased or reset by poling the crystal back to its full birefringent condition.

**Poling.** The problem, however, was that in the early structures the presence of the transparent electrodes inhibited the poling required for reset; the polarization vector under these electrodes simply could not be switched back to the fully birefringent state under application of the poling voltage. To erase, the ceramic had to be heat-cycled (depoled).

But the new device eliminates the need for separate sets of electrodes for switching. Instead, in its structure—called a strain-biased

ferroelectric by its inventors Allen Meizler, Juan Maldonado, and David Fraser—the device is bonded to a relatively thick transparent substrate which, when slightly flexed, applies crystal tension in one direction. And because of their electroelastic properties, the direction of the tension axis becomes the preferred direction along which the polarization vectors in individual domains tend to align. This allows the ceramic to be switched between states by applying a field in this direction.

Although, as in the preliminary version, only the illuminated regions can be switched to the partially birefringent state, the new structure allows localized switching to both the full and partial birefringent states, and thus permits electrical erasure of selective parts of the picture. Moreover, the device as a whole can be reset simply by illuminating the entire active area and applying reset voltage.

**The future.** Big things may be in store for Bell's new device. The selective erase and indefinite storage capabilities make it attractive for applications now being handled by cathode-ray tubes, which require large storage power. Even more important, because of its intrinsic memory and its local erase/write property, the device can be used to reduce the large bandwidth drain that will go with increased Picturephone use. It's possible to break up the stored picture into individual lines or elements, and by updating periodically, send just those elements of the picture that have changed. Since Picturephone images aren't expected to change greatly during a call, a tremendous saving in bandwidth could result.

## Communications

### Pressuring AT&T

Caricaturists frequently depict America's regulated monopolies as fat, dumb, and happy. But no one has ever successfully made a case that AT&T is dumb. And neither is it happy with increasing pressure

# Are you thinking Hughes is big in electronics?



## Good thinking.

Because Hughes put a lot of innovative thought into making better gas and solid state lasers (RS 293), micro-circuit production equipment (RS 294), high vacuum wire equipment (RS 295), semi-automatic wire terminating and harness laying equipment (RS 296), N/C positioning tables and systems (RS 297), and FACT Flexible Automatic Circuit Testers (RS 298).

# HUGHES

HUGHES AIRCRAFT COMPANY  
INDUSTRIAL ELECTRONICS GROUP

Circle appropriate Reader Service (RS) number.

## U.S. Reports

from the Federal Communications Commission to restructure rates and improve service.

"Bell isn't exactly a sleeping giant either," concedes one competitor's man in Washington, "although it has been known to nod off occasionally." But AT&T is nodding no longer following FCC's expected disclosure of an unprecedented staff paper calling for free competition among established common carriers, such as Bell, and special service microwave carriers, like Microwave Communications Inc. and Data Transmission Co., the University Computing Co. subsidiary commonly known as Datran [*Electronics*, July 6, p. 60].

**Predictions.** Though the seven FCC commissioners still must act on the call for free entry into the carrier marketplace recommended by FCC's Common Carrier Bureau, headed by Bernard Strassburg, they are not expected to oppose it. And while AT&T and other major carriers are expected to oppose the recommendation—in court, if necessary—the communications giants also can be expected to rise up in the marketplace.

"AT&T is a very efficient company and it can be very tough. Sometimes we tend to forget that," says an executive of one communications equipment maker. Of Western Electric, AT&T's manufacturing arm, he notes, "If we know they're bidding on a military job we won't bid unless we're convinced we can win. They know their costs better than anyone." Such observations, generally supported by most equipment manufacturers, raise questions. For example, will AT&T summon its vast resources and smite the smaller, less resourceful MCIs and Datran in competitive battle? Is this, in fact, what Strassburg's Common Carrier Bureau hopes to achieve with its recommendation?

"Established carriers would, of course, be free to compete on equal terms," the report says caustically, pointing to AT&T's probable competitive advantage over newcomers since it already provides communications services to potential customers, and is in a position to grab a substantial part of the market.

(Datran, for example, says it would serve only 10% of the data transmission market by 1980.)

Another AT&T advantage, the report says, is that while MCI, Datran, and others are waiting for construction permits to begin their new routes, AT&T need only file a tariff to begin providing microwave data service. However, the report does exhibit concern that attempts to adapt facilities designed primarily to meet voice requirements to data communications "may entail such compromises in service as to leave both types of users dissatisfied."

**Aid to users.** The FCC bureau says its position is based on the interest of users, who would benefit from flexibility in a wide range of choices in communications service. Datran is proposing a switched, all-digital nationwide network specifically designed and engineered for data transmission and would provide end-to-end service. MCI's network would accept both analog and digital data signals on a point-to-point basis, and the user could purchase the exact bandwidth required with rates based on transmission speed rather than bandwidth.

The Common Carrier Bureau's position probably will stand—it has had a good track record under Strassburg [*Electronics*, Sept. 15, 1969, p. 16], with such decisions as Carterfone (which permitted foreign attachments to the Bell System) and MCI (granting private voice data service between Chicago and St. Louis). FCC chairman Dean Burch probably will favor competition with minimum regulation, as he has in other areas—notably CATV.

If the position is accepted as FCC policy, new applicants will not have to face lengthy hearings in which they need to prove public need and economic and technical feasibility. Part of the package is avoiding hearings, with any future action taken through rulings or hearings at license renewal time.

Comments are due on the position Oct. 1 with reply comments by Nov. 2, although sources say there probably will be extensions granted, and possibly an oral argu-

ment before the commissioners. Action on the inquiry is expected two months after the inquiry is closed.

### For the record

**Cash.** Emerson Electric of St. Louis will be the major financial backer of the General Digital Corp., a new MOS/LSI firm founded by Alvin C. Philips, the former president of Autonetics. General Digital will begin immediately to build a 35,000-square-foot facility in Newport Beach, Calif. The company expects to be installed there by the first of the year with initial shipments expected in the second quarter. Emerson will provide cash through its new venture-capital subsidiary, Techno-Ventures.

**ERTS contract.** Speculation that declining business would cause GE's Valley Forge Space Center to be either shut down or absorbed by another GE division has cooled with the selection of GE as the prime contractor to develop hardware for the Earth Resources Technology Satellite system. The award of the \$50 million contract comes as a special selection panel led by Bruce Lundin, director of NASA's Lewis Research Center, reviews the award to GE of the applications technology ATS-F and C contract, which has drawn heavy fire from Fairchild Hiller and the General Accounting Office [*Electronics*, July 20, p. 56]. The panel has been instructed to decide whether to award the contract to GE or Fairchild Hiller by Aug. 3 on the basis of information known to be available April 7.

**Winner.** Philadelphia's General Atronics Corp., low bidder in the competition for 470 production models of the AN/SRN-12 shipboard receivers for the Navy's Omega communications system, was confirmed the winner with a \$1.94 million multiyear contract [*Electronics*, June 22, p. 33]. The Northrop Corp.'s Nortronics division developed and produced the 10-kilohertz receivers, but lost the work.

# GROUP SE-1 LAMINATES ARE GREAT!

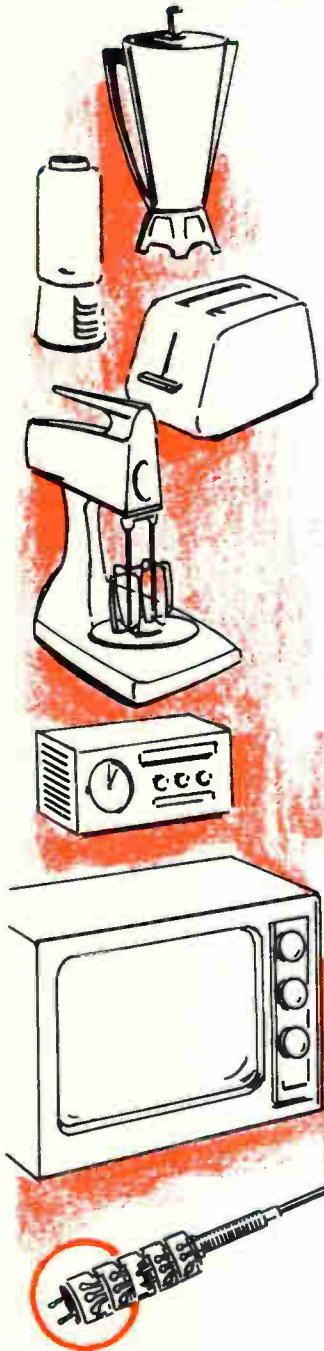

## but GLASTIC'S GROUP SE-0 LAMINATES are even GREATER!

To meet the ever increasing stringency for flame retardant and track resistant insulation material, Glastic is providing a unique flexibility of choice in reinforced polyester laminates. From Glastic you not only have the choice of Laminates in Group SE-1 you can now obtain an even higher reliability in arc, track and flame performance with GLASTIC'S GRADE 1560 Laminate . . . and without premium cost.

In addition to the outstanding values shown below you will also find excellent values in punchability, impact and compression strength, water absorption and flexural strength.

Write for data, prices and samples or call in your Glastic/Spaulding representative.

PROPERTY	GRADE 1560	GRADE 1478 (UTS)	GRADE 1582	GRADE 1631 (G-200 FR)
Flame Retardance UL Subject 94	SE-0	SE-0	SE-1	SE-1
Track Resistance Inclined Plane—Min.	>600	15	>600	70
I.E.C. 50 Drops-Volts	>900	>900	>500	>500
Arc Resistance Seconds	185	130	187	176
UL Recognition °C. Electrical/Mechanical	105/105	130/160	130/160	160/180



### The GLASTIC Corporation

A Subsidiary of Monogram Industries, Inc.

4325 Glenridge Road, Cleveland, Ohio 44121

Pioneer Developers and Producers of Electrical Grade Fiber Glass Reinforced Plastic Insulation Materials

Laminates / Standoff Insulators / Structural Shapes / Stator Wedges / Pultruded Glasrod Stock / Molding Materials / Molded Parts

© Reg. TM-  
U.S. Pat. Off.

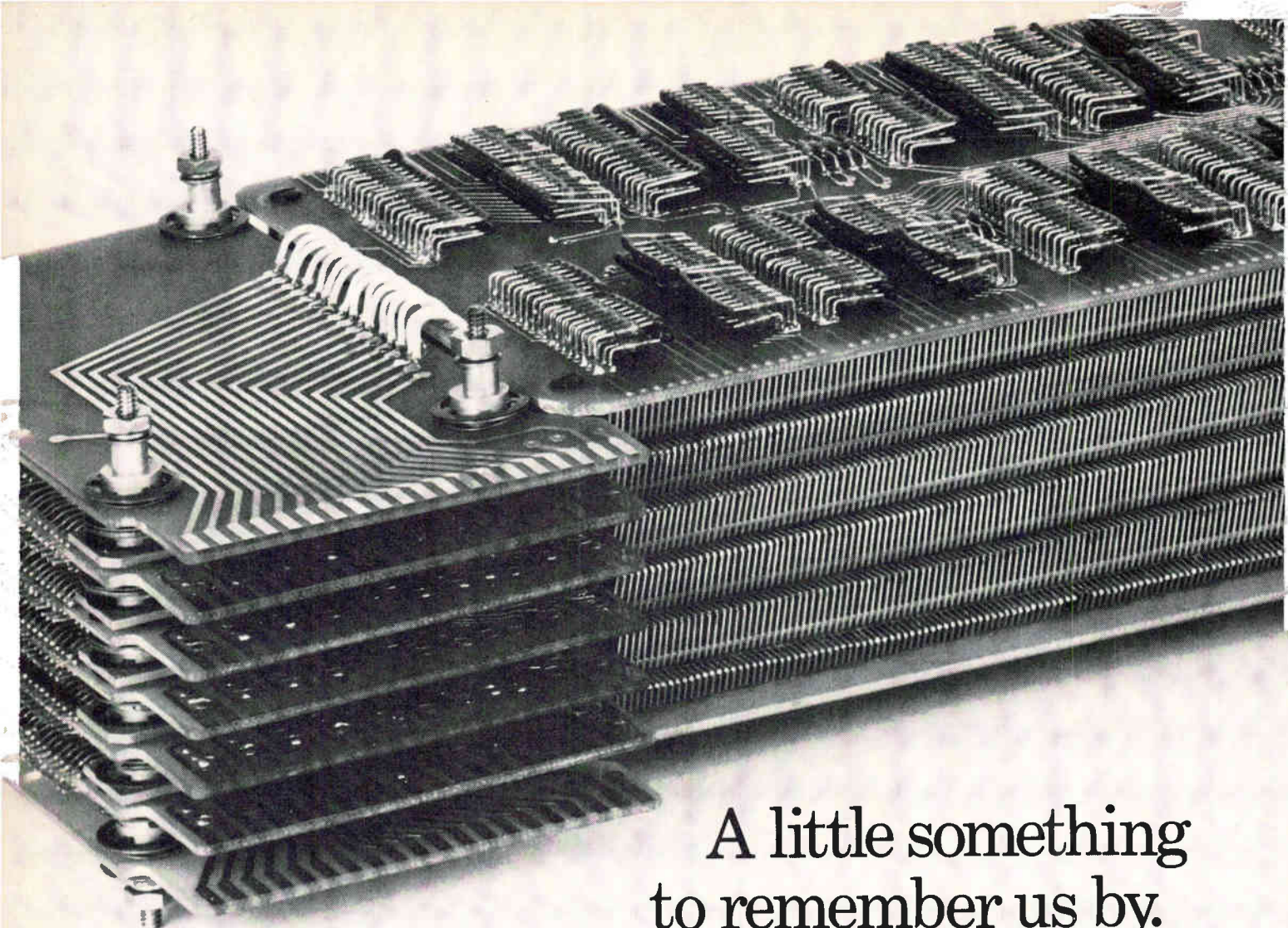

A little something  
to remember us by.

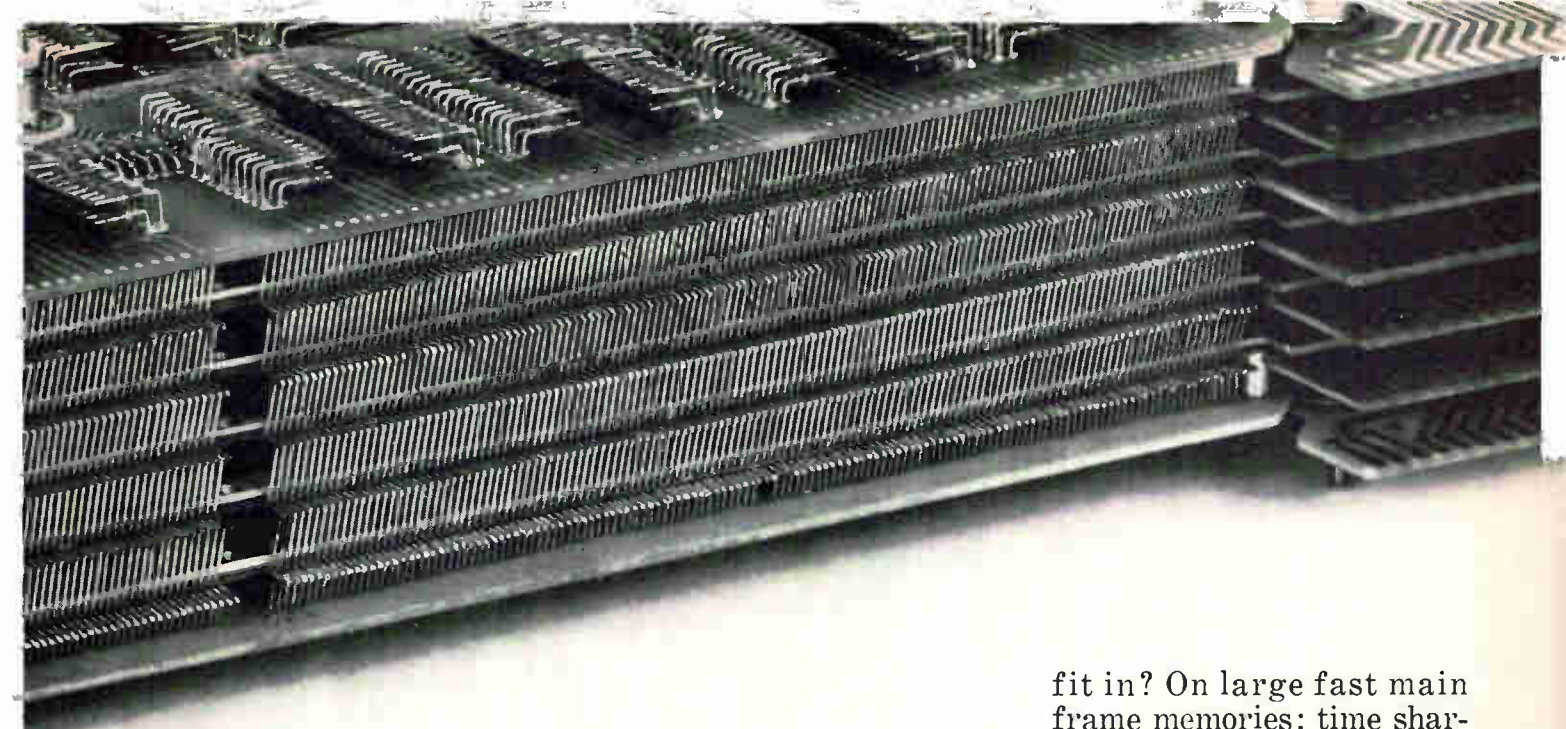

You're looking at an actual size photograph of the new Nanostak® NS-3020 commercial memory stack. Proof that big things come in small packages. This stack is so compact its volume is only 25% of competing planar designs.

But we didn't cut corners on performance.

Nanostak is a modular

2½D stack with full cycle times as fast as 700 nanoseconds. Its maximum capacities are 32,768 words by 20 bits, 16,384 words by 40 bits and 8,192 words by 40 bits.

And everything happens so easily.

We've designed Nanostak with printed circuit board edge connectors and mounting jack screws. Which gives you a simple plug-in unit for all NS-3020 configurations.

Just where does Nanostak

fit in? On large fast main frame memories; time sharing systems; electronic telephone exchanges and radar signal processors. We've built enough reliability into this stack for process control applications in the most severe industrial environments. Wide temperature range cores are even available as an option.

Nanostak. A little something you might want to talk over with us. Soon.



## Electronic Memories. Worth remembering.

# OUR PRIVATE LIFE IS OVER.

Now we're the North American Rockwell Microelectronics Company.

We emerged from our parent company's 15-year-old Autonetics Division, which is the largest of its aerospace activities.

We've a multimillion dollar MOS/LSI business of our own. A multimillion dollar facility of our own. A future of our own.

## **Fills largest MOS/LSI order in history.**

NR-Microelectronics became the world's largest producer of advanced MOS/LSI circuits when the Sharp Corporation (formerly Hayakawa Electric Company of Japan) signed a \$30-million contract for electronic components of its desk-top cal-

culator. Bearing the trade name Sharp Micro Compet, the calculator weighs just a little over 3 pounds.

Five MOS/LSIs are supplied by us for each Micro Compet: four logic memory circuits and one clock generator or synchronizing circuit, which are mounted by Sharp on a 4 x 5-inch circuit board as the calculating elements of the machine.

Sharp now makes more than 30,000 of these calculators monthly and we keep ahead of our customer's needs by producing some 200,000 plus MOS/LSIs a month. Since the initial contract, Sharp has signed an even larger follow-on contract.

## **Commercial success follows aerospace success.**

Our mentor—the NR Autonetics Division—nurtured us through successive generations of microelectronic products, built for a veritable Who's Who of Aerospace & Marine: Skate, Nautilus, X-15, XB-70, F-105, F-111, RA-5C, Saturn, Apollo, Polaris, Poseidon, Minuteman I, II, III.

The Minuteman Programs—perhaps more than anything else—led the way to widespread use and reduced costs of advanced microelectronics for industrial and consumer products.

Commercial markets were first penetrated in 1968, when NR signed a multimillion dollar contract to supply MOS/LSI devices for the passenger entertainment and service system for the Boeing 747



Superjets. And the contract with Sharp followed shortly after.

Presently we're supplying or designing MOS/LSIs for calculators, minicomputers, computer terminals, airborne instruments, data transmission multiplex systems — and, you'll be surprised to learn, for the musical tone generation system of a pipe organ without pipes.

**The only house where everything's in-house.**

Presently NR-Microelectronics is the only company with total capability to transfer a multiplicity of circuit functions into a single MOS/LSI device and then mass-produce them.

This embraces systems engineering, computer-aided custom circuit design and proofing, mask making, testing and development — as well as the high-volume production — all in our own facilities.

With our versatile computer equipment, we've



designed more logic capability into a given circuit on a larger chip than other semiconductor manufacturers.

While the LSI designation is usually reserved for circuits with a function density of 50,000 to 100,000 per square inch, development engineers ought to know that a 1024 bit MOS/LSI memory circuit — now in volume production here — contains 6244 transistors on a one-eighth-inch square chip. That's a function density of around 400,000 per square inch.

About the same as the nerve cells in the human brain.

**Prices guaranteed, product guaranteed.**

In turning the corner on high-volume production, NR-Microelectronics has developed innovations for making custom MOS devices at the lowest prices in the industry. For one thing, all MOS chips are home grown. Economies result from in-house control at every stage.

Cost effectiveness is just

one of many customer appeals.

We're ready to protect our customers with guaranteed prices for the number of years required. And if we design the custom circuits you use, we're prepared to guarantee that they'll be yours exclusively.

**Does anyone need 200,000 MOS/LSI devices a month?**

In our Anaheim plant are two custom processing lines: medium volume and high volume — the latter is now producing at a monthly rate of 200,000 plus. Firm commitments will more than double this production in 1971.

But we have substantially greater capacity

... which is being

increased daily by processing innovations.

So we're ready for more orders — both medium and high-volume

custom MOS/LSIs.

Our telephone number is (714) 632-2231. Our zip code in Anaheim, California, is 92803.

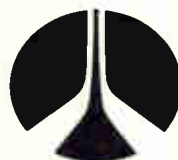
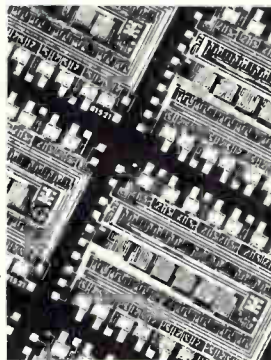

**North American Rockwell  
Microelectronics Company**

# Its \$395 price beats competition! But- that's only One reason to buy it! Look at the other reasons:



- Hickok's new Model 3300 3½ digit multimeter has 26 ranges of ac-dc voltage and current, and ohms.
- Ranges are 100.0 millivolts to 15.00 kilivolts, 1.000 milliamp to 1.999 amps, 100.0 ohms to 199.9 megohms.
- Measurement conveniences—automatic zeroing and polarity, constant input Z, LSI reliability.
- Operates 24 hours off internal battery pack (more than anyone else's). And the battery pack is standard.
- Recharges overnight (faster than others).
- Or, operates off the ac line, even during the recharge cycle.
- Goof-proof, even in less experienced hands—solid state circuitry is overload protected.
- Rugged case is impact-resistant and shockproof.

Really, should you pay more?  
And maybe get less?

Circle Reader Service Card # **(46)** for complete information. Or call your local Hickok man for a demonstration. See the Model 3300 in Booth 428-429 at WESCON.

# HICKOK

INSTRUMENTATION GROUP  
10514 Dupont Ave. • Cleveland, Ohio 44108  
Phone 216-541-8060



# It's fun to build with build-a-still.

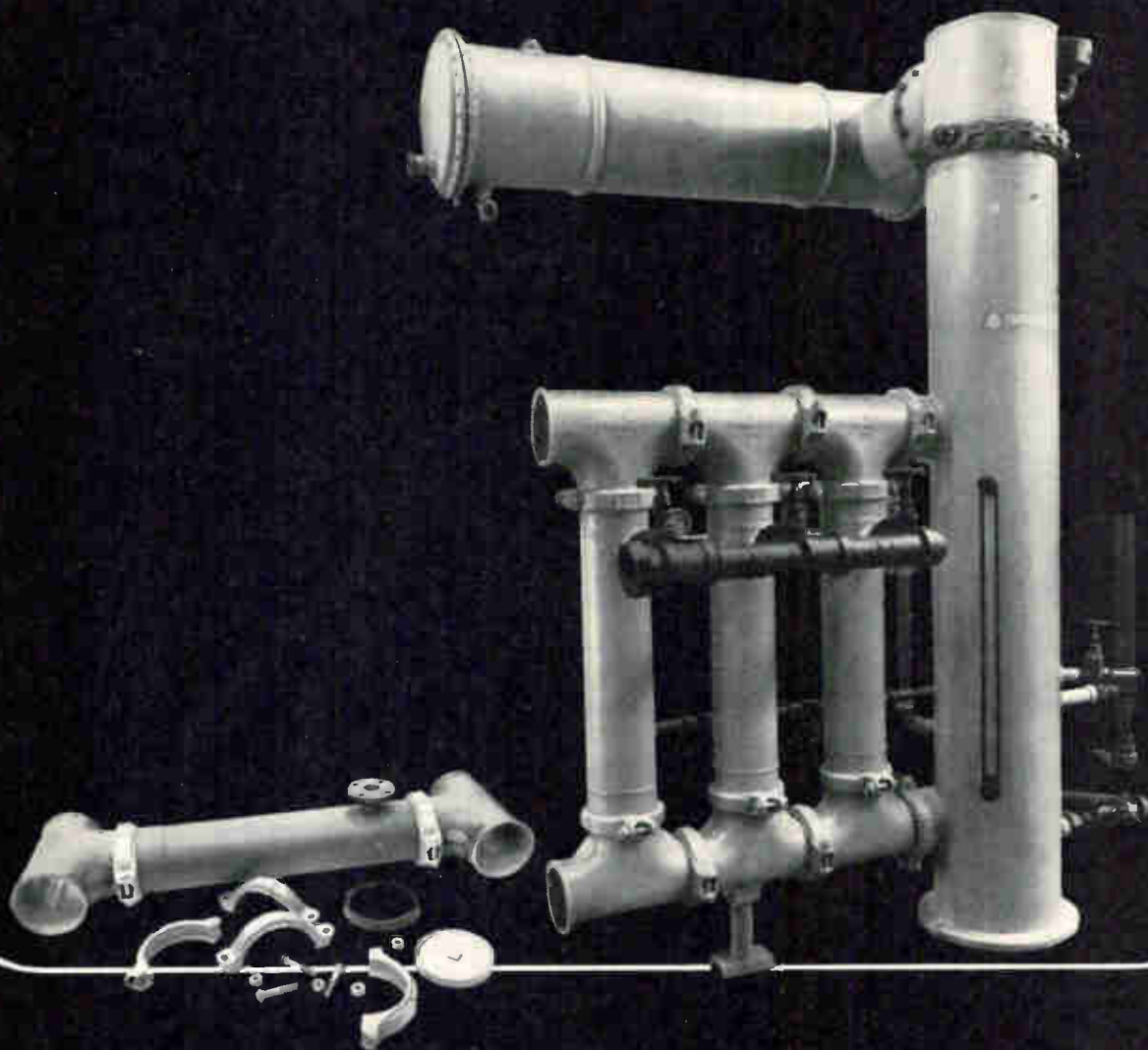

Our Thermodrive Distillation System® is a revolutionary advance in pure water technology.

We call it build-a-still.

You put it together with modules. Modules for evaporators and modules for condensers. Add them to our central unit, the Centri-Cyclone® whenever you need to expand.

Each addition will give you 50 gph of pure water. Start at a basic 50 and work all the way up to 300 gph. At any size, pyrogen-free water in the 1 to 1.5 megohm range

is delivered within seconds of start-up . . . faster than any still.

For higher purity add our Hi-Purity Chamber®. It produces water with an organic count below measurability. You might also want our air cooled condenser that eliminates the need for cooling water. It saves money and water where both are scarce.

If just money is scarce consider build-a-still anyway. At 300 gph it will cost 38% less than comparable systems. The modular design alone

means you don't have to junk an existing system, there's no reinvestment, and no costly delays in converting equipment to larger capacity.

And it's fun to build.

Just call or write for our comprehensive literature. Barnstead Company, 225 Rivermoor Street, Boston, Mass. 02132. (617) 327-1600.

 **BARNSTEAD**  
SYBRON CORPORATION

Circle 47 on reader service card

# SMI unbundles the \$11,134 ecom<sup>®</sup> F

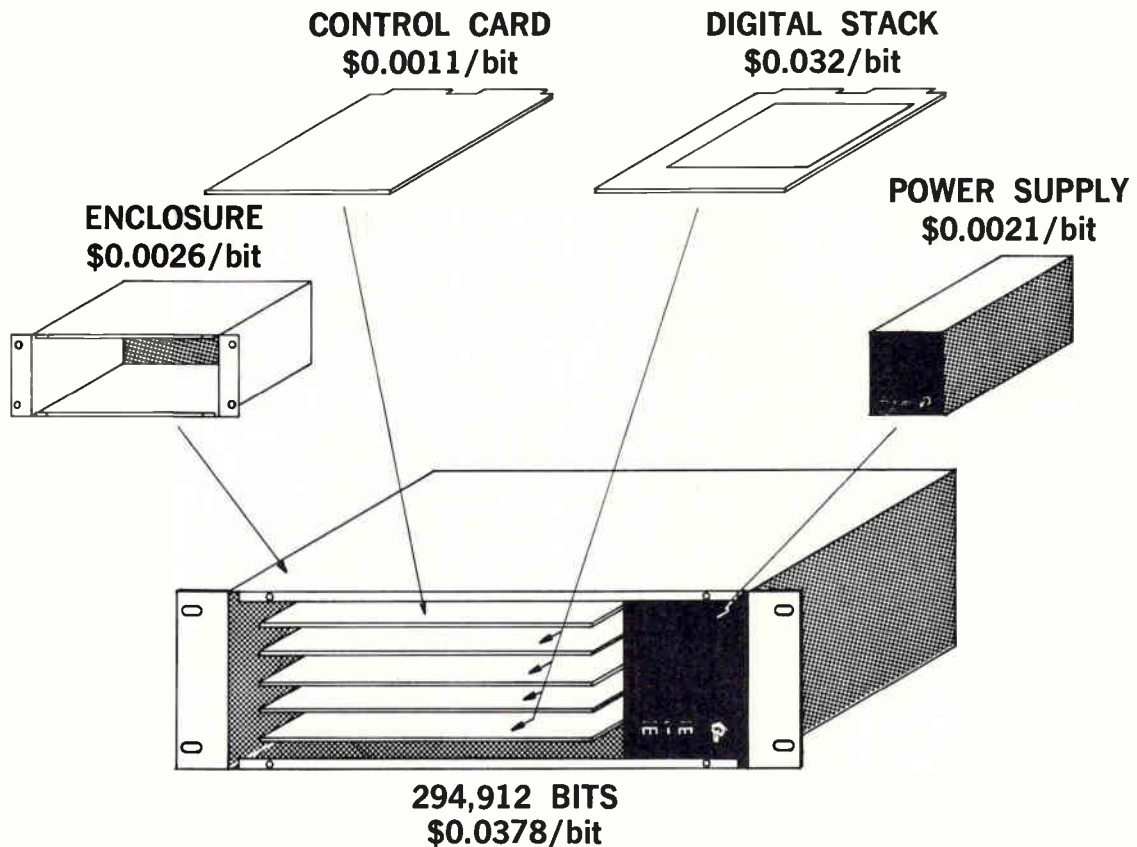

<b>SYSTEM SPECIFICATIONS</b>	Capacity: 16,384 words — 18 bits/words Modes: Full Cycle and Split Cycle Speed: 750 nanoseconds Access Time: 325 nanoseconds
<b>CONTROL CARD</b> \$0.0011/bit	Address Register, Data Register and Byte Control.
<b>POWER SUPPLY</b> \$0.0021/bit	117VAC-50-400 cycles. Drive capability to 16K x 18. Power Failure Detector.
<b>ENCLOSURE</b> \$0.0026/bit	Fully machine wired for 16K x 18 including all mating connectors. 5¼" Panel Height
<b>DIGITAL STACK</b> \$0.032/bit	4K x 18 Lithium Core Stack, Drivers Sense Amplifiers, Data Saver, and Temperature Tracking Circuits.

ATTENTION: Unbundlers ... \$11,134 is unit price!

Write or call  
the Memory People for  
Technical Bulletin TB 1001

ecom<sup>®</sup> registered trademark

## STANDARD MEMORIES

INCORPORATED  
A Subsidiary of Applied Magnetics Corporation  
15130 Ventura Boulevard  
Sherman Oaks, California 91403  
(213) 788-3010 TWX 910-495-1738

**Meet Datapoint.  
It's 20 times faster  
than other multipoint recorders.  
And infinitely more versatile.**

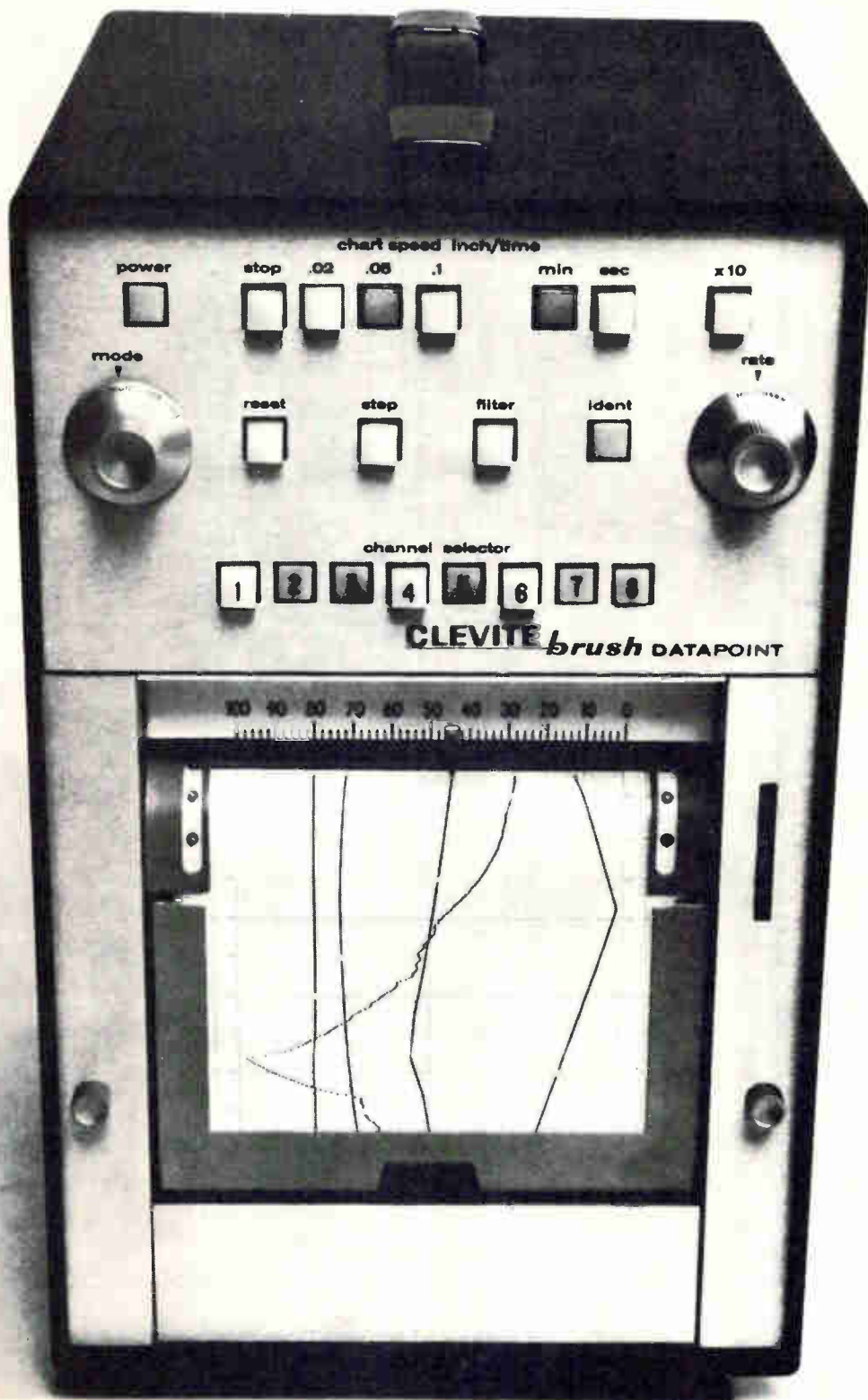

This new high-speed multipoint recorder by Brush runs off as many as 20 samples per second on 2 to 8 patients. So it's great for monitoring fast-changing variables in systemic and wound temperature, heart rate, ECG and the like.



Datapoint handles mixed inputs from high and low level inputs. All on one chart. Recordings come out clear, crisp, uncluttered. And Z-folded. You've got a choice of 12 chart speeds, pushbutton controlled.

About that versatility. Datapoint works in three modes: multipoint sampling, intensified sampling, for channels of high dynamic content, or continuous single channel recording. So you get much more than just a fast multipoint recorder. Without paying more to get it.

And Datapoint is accurate, too. A full 99.5%, enforced by a non-contact position-feedback system. It's a first in this type of recorder. (But a proven success in countless Brush direct writing oscillographs.)

Speed. Versatility. Accuracy. These make Datapoint a new concept in recording. There's never been anything like it. You'll find more proof in the Datapoint brochure. Send for your copy today. Brush Instruments Division, Gould Inc., 3631 Perkins Avenue, Cleveland, Ohio 44114.

**GOULD BRUSH**

# HELIAX ELLIPTICAL WAVEGUIDE

twelve  
ways  
to  
beat  
the  
clock...

by eliminating planning and installation complications of rigid waveguide . . .

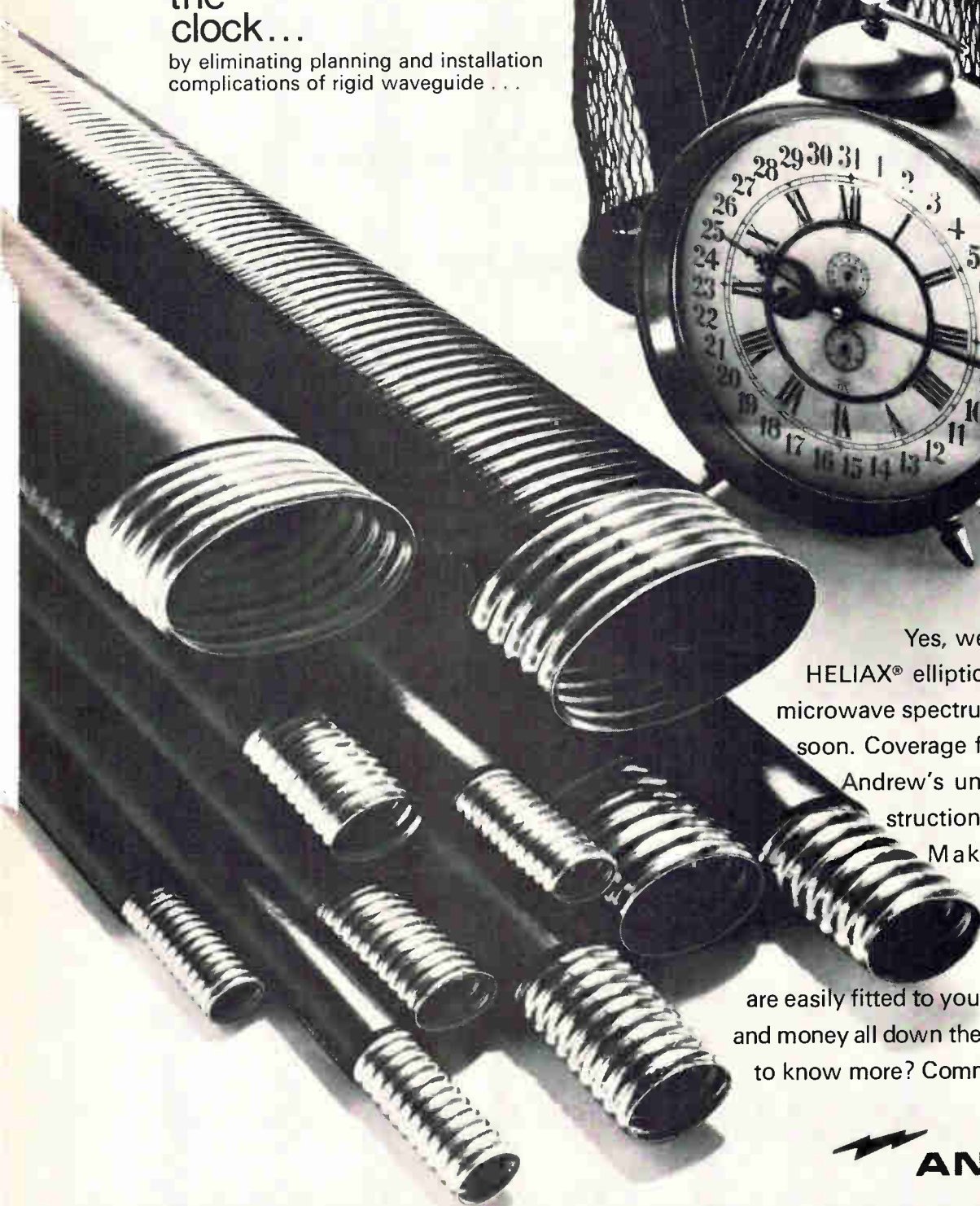
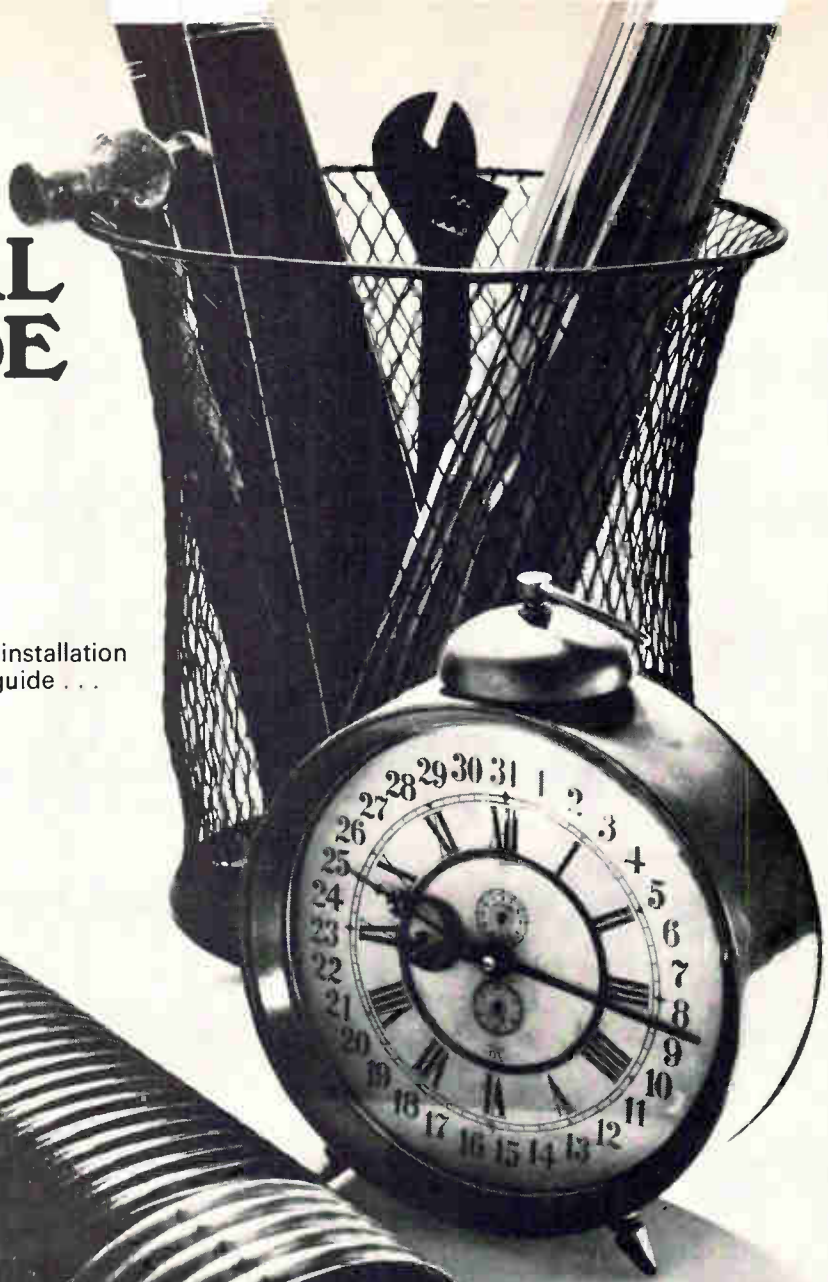

Yes, we have twelve sizes of HELIAX® elliptical waveguide for the microwave spectrum: 10 in stock, 2 more soon. Coverage from 1.7 to 15.2 GHz.

Andrew's unique corrugated construction makes the difference.

Makes HELIAX copper waveguide stronger, more flexible. Long continuous lengths are easily fitted to your layout. You save time and money all down the line. Wouldn't you like to know more? Communicate with Andrew.

10-68

 **ANDREW**

CONTACT THE NEAREST ANDREW OFFICE OR ANDREW CORPORATION, 10500 W. 153rd STREET, ORLAND PARK, ILLINOIS 60462

Circle 50 on reader service card

---

# Washington Newsletter

---

August 3, 1970

## Barium cloud tests aid missile radar, offensive programs

A new missile defense radar that will not be blacked out by nuclear blast effects is closer to development following successful blackout simulation by the Pentagon's Advanced Research Projects Agency. The effect was achieved in high-altitude explosions of warheads using barium, which dispersed in expanding clouds of free electrons and positive ions. Two successful tests—one over Puerto Rico in 1968 and another over Alaska last year—have caused ARPA to accelerate the program, called Secede, with another \$1 million in fiscal 1971, raising the annual outlay to nearly \$7 million.

An experiment in Florida this year using the Bendix AN/FPS-85 over-the-horizon radar will attempt to penetrate a barium cloud and track spheres, simulating re-entry vehicles, behind it. At the same time, the Directorate of Defense Research and Engineering has been sufficiently impressed with the barium cloud jamming effects to accelerate exploration of its use as a penetration aid for offensive missiles.

## Japanese seaplane may be next U.S. overseas arms buy

There's a sudden upsurge in U.S. purchases of foreign aircraft and electronics. John S. Foster Jr., the Pentagon's director of defense research and engineering, has confirmed Deputy Defense Secretary David Packard's interest in increasing foreign weapons purchases if they offer proven technology at a lower price than possible at home. In addition to Army procurement of the French-German artillery radar known as Ratac [*Electronics*, July 6, p. 60] and Marine Corps orders for the Hawker-Siddeley Harrier VTOL aircraft, the Navy is eyeing the Japanese PS-1 flying boat for antisubmarine patrol and air-sea missions under the designation SS-2.

Naval Air Systems Command's Vice Adm. Thomas F. Connolly says flyaway costs of the 15-plane, two-year program would average \$6 million per plane using Japanese-made airframes and engines and avionics installed by Grumman Aerospace Corp. Grumman has a company-to-company agreement with the plane's maker, Shin Meiwa Industry Co.

## Army, Navy suffer tactical air cuts; USAF's AX unhurt

The Air Force is winning its battle with the Army for close air support responsibility, getting all of the \$27.9 million it sought from Congress to develop the subsonic AX aircraft. The Senate, meanwhile, denied the Army \$17.6 million to continue the troubled Lockheed AH-56 Cheyenne helicopter gunship—competitor to the AX.

While the Army salvaged \$17 million of \$21 million for the Advanced Helicopter Development Program, the Senate made clear it expects termination of Lockheed's Cheyenne contract even though some of the AHDP money may be used for tests with the eight remaining helicopter prototypes. Best arguments for the AX were its estimated \$1.2 million price tag, compared with an escalated \$3.8 million for Cheyenne, and the promise that it will be "simple."

The quest for simplicity led the Senate to carve \$5.2 million from the Navy's \$982.2 million request for Grumman's F-14. All the money would have gone for a new avionics package for a "C" model. Told that total F-14C R&D would be \$337 million, the senators questioned "the wisdom of initiating a new avionics program to replace the AWG-9/Phoenix fire control system."

---

# Washington Newsletter

---

## **Electronics in AWACS core systems cut by half**

The Airborne Warning and Control System, which will be developed initially in stripped or "core" configuration [*Electronics*, July 20, p. 45], will carry only about half the electronics originally planned, say Air Force sources. What's more, it will require a crew of only 17 instead of the 29 initially slated. There will be no large display system for command and control, and the number of multipurpose crew consoles will be cut from 16 to 9. However, the Air Force characterizes AWACS as a modular system in the hope that increased capability can be added after initial flight tests are completed. AWACS communications using existing hardware is the only major segment of the system to suffer reduced capability, although electronic counter-countermeasures and a communications satellite terminal have been classified as "growth items" for inclusion at a later date.

## **Federal time-sharing experiment to get double scrutiny**

The Administration's powerful new Office of Management and Budget is going to take a hard look at the General Services Administration's computer time-sharing experiment. OMB officials plan to work closely with GSA in evaluating the test when results are available in mid-September.

The experiment, which interconnects about 10 Federal users in the Southeast to a General Electric 400 time-sharing machine in Atlanta, is expected to affect future Federal computer procurement policy. Its aim is to determine whether time sharing is a feasible alternative to the use of large GSA batch processing centers by smaller users and employment of in-house, large-scale machines for major Federal users. Top GSA officials say the tradeoffs between time-sharing communications costs and cost-effectiveness of large machines will be studied closely.

## **Western Union files for domestic satellites**

Western Union wants its own satellites, and has asked the Federal Communications Commission to approve an ambitious plan to put up a three-satellite domestic communications system linked to six send-receive ground stations. In an effort to capture some of the lucrative tv signal transmission business, Western Union says its system would be able to handle 10 tv signals simultaneously in addition to 4,800 two-way voice channels. The system is expected to be able to serve Alaskan as well as continental requirements.

## **Addenda**

The Justice Department is likely to be the first of several Federal agencies required to report regularly to Congress on computer-based data files. Justice will have to detail how its Law Enforcement Assistance Administration gets data for its files, how long it's kept, and how it's used. Sen. Sam Ervin (D., N.C.), who's sponsoring just such a rider to the LEAA appropriation, is set to schedule September hearings on government data banks in general before his Subcommittee on Constitutional Rights. . . . the President's latest nomination to the Federal Communications Commission, Sherman Unger, former general counsel for the Department of Housing and Urban Development, will give Republicans a 4-3 edge on the commission. Unger will serve out the unexpired term of Robert Wells, Nixon's first appointee, who will be named to a full seven-year term next June when the appointment of Democrat Robert Cox expires.

August 3, 1970

# Article Highlights

---

**Special report:  
Consumer hazards**  
page 54



Reports of fire, shock, and radiation hazards encountered in television and radio receivers, hi-fi's, and microwave ovens raise the fundamental question of just how safe consumer products really are. In the first section of this special report, *Electronics* assesses the magnitude of the problems and their causes. The second section takes a close look at how these hazards can be

prevented and concludes that with careful design, improved materials, and a systematic approach to quality control, hazardous failure can be minimized or eliminated while effecting considerable savings for manufacturers over the long run.

**Silicon-gate dynamic  
MOS crams 1,024 bits  
on a chip**  
page 68

A dynamic random access MOS memory that uses silicon gate technology enjoys the benefits of unusually high density and low cost thanks to a unique three-level selection technique which eliminates one selection line and thereby reduces the required chip area of the memory.

**N- or p-channel MOS:  
Take your pick**  
page 79

Choosing between n- and p-channel metal oxide semiconductor ICs isn't easy, but realistic comparisons are possible if key performance factors and device parameters are understood. The important criteria are chip area, threshold voltage, noise immunity, and power; with these factors evaluated, the designer can go on to select the right device for his application.

---

## Coming

**The industry's state  
in the West**

With the Western Electronics Show and Conference just around the corner, an attitude ranging from gloom to doom prevails. *Electronics'* staff is surveying the industry to find out just how deep the gloom and doom attitude runs, and whether or not it's justified.

# Consumer hazards: Why they happen

Defective designs, haphazard regulation, and uncertain standards can combine to put potentially lethal fire, shock, and radiation hazards into tv's, hi-fi's, and microwave ovens

● Last April, a jury in the 98th District Court in Austin, Tex., awarded \$212,000 to the family of Charles Partlow, an automobile dealer who died in a fire caused by a defective Magnavox color tv. The jury determined that a flyback transformer, evidently defective when the set left the factory, had caused the fatal fire.

The case clearly served notice on the electronics industry that a manufacturer can be held responsible for the consequences of hazardous failures attributable to fabrication or design defects.

Fire is the most prevalent hazard in consumer electronics, but it isn't the only one: shock, X-ray, and microwave leakages also have been cited as problem areas.

Last August, the Federal Government's National Commission on Product Safety, which was created to investigate consumer hazards, specifically those for which there was no corrective legislation, began to poke around in the embers of tv fires. Three months later it determined that there were "more than 10,000 fires annually."

The commission's estimate was based on data obtained from its own surveys of fire statistics around the nation. It set off an immediate, heated controversy within the industry. The Electronic Industries Association cited manufacturers' figures contained in one of the commission's reports and derived a much lower incidence of fires—2,600 over five years. And other sources used different data bases to arrive at fire occurrence figures that fell between both the EIA's and the commission's projections.

Then last December the commission published its findings in the first of two reports and followed up with another in January 1970. The first of these, the Tracor report—prepared by Tracor Inc., a Texas military-aerospace firm—is essentially an analysis of existing standards and an evaluation of critical components and materials used in television receivers. Its logic is straightforward and inarguable: in lieu of complete understanding of every possible mechanism underlying hazardous failure of tv components, fires can be eliminated by insuring that all fire-prone or flammable parts are, in fact, flameproof.

The only criticisms of the Tracor report center on its suggestion of specific materials to be used in certain applications (designers like to work with the broadest range of materials) and its timetable, which some manufacturers feel is impossible to meet.

Much more controversial was the commission's second report on tv fires—the Jitco report (again produced by Tracor and named for its John I. Thompson & Co. division). Basically, the Jitco report is a tabulation of data furnished by set manufacturers on fires reported for each model.

Criticism centered on the fact that the report related fire incidence to specific models when some felt that fires should have been related to chassis runs. Too, by making public each manufacturer's rate of total fire incidence as well as his total number of fires, it allowed any manufacturer to figure out his competitors' total sales. Finally, on the basis of dissimilar data generated by dissimilar reporting and bookkeeping systems, the public was presented with a list that purported to rank set manufacturers in order of decreasing incidence.

Understandably, the manufacturer with apparently the worst safety record, Lear Siegler Olympic, came forth with the most pointed criticism. Olympic's then president, Harry Kane, indignantly denounced data in the Jitco report as "obviously ill-conceived and patently incorrect . . . The approach you appear to be taking has all the earmarks of notoriety seeking, rather than that of safety improvements." He concluded that the survey was "misleading, incorrect, unsubstantiated and flagrantly deceptive. . . ."

"The Jitco report was intended to be a kind of bloodhound," contends Donald Berman, the product assurance expert who wrote the Tracor report. "It helped sniff out the handful of hazardous components in tv sets. It wasn't intended to grade manufacturers for safety, and it doesn't hold water when it's put to that purpose."

The Jitco report did isolate the causes of tv fires. It suggested that most were attributable to a small group of specific components—the horizontal output transformer or "flyback," the deflection yoke, on-off switches, and some types of capacitors.

But perhaps most significantly, the Jitco report ended quibbling over the extent of the problem. According to data submitted by the manufacturers themselves, color sets had 40 times the fire incidence of black-and-white receivers: the ratio pins the problem squarely on the color sets—their components and designs. Logically, fires induced externally (by doilies, lightning, voltage



This General Electric flyback transformer demonstrates one possible cause of failure—arcing between coils—which can sear the outer covering. In this case, the covering was made of a nonflammable silicone rubber; although the flyback failed, no fire resulted.



Such was not the case for another firm's transformer which ignited in a tv set fire. The white powder is the residue of fire extinguisher foam sprayed into the set's high-voltage enclosure.

At Underwriters' Laboratories, electronic components, such as these switches, repeatedly are cycled to meet qualifications. But divorced from overall equipment design, such tests don't always prevent hazardous situations.

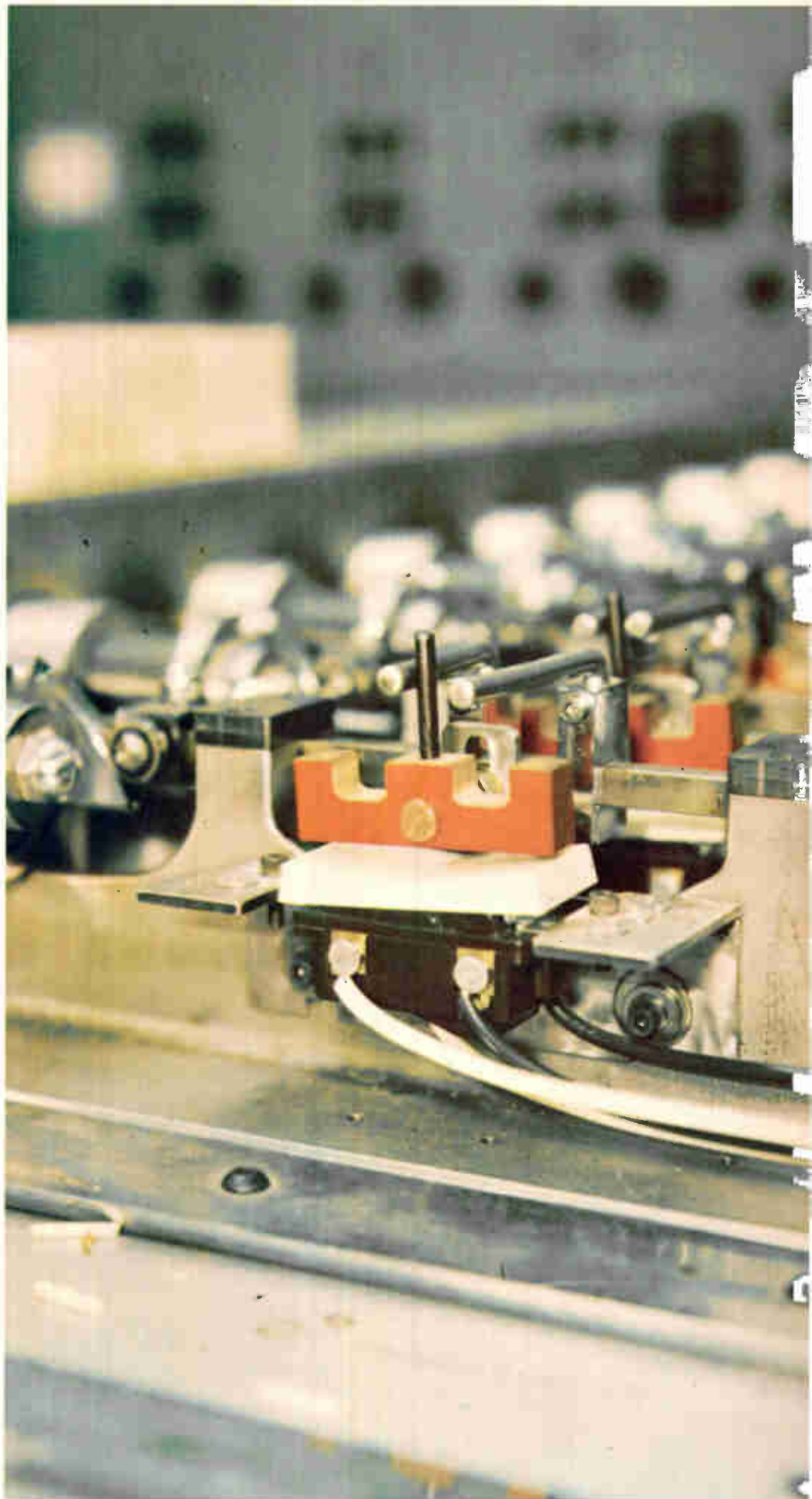

surges, faulty lamps) would have occurred with about equal frequency in both monochrome and color receivers. In short, color sets—most likely due to their higher voltage requirement and greater component density—were experiencing 40 times more fire incidents than black-and-white sets. If nothing else, the Jitco report settled the question of whether or not tv sets were as safe as they could be—except for Jack Wayman at EIA. His response to the Jitco report was stolidly negative: “Television sets are safe products,” he declared flatly. He characterized the commission’s talk about 10,000 tv fire and smoke incidents per year as “unsubstantiated and based largely on guesswork.” Furthermore, he insisted that the actual incidence of fires “is infinitesimally low.”

In the wake of the Jitco report another important fact emerged: overall design and the quality of supplier components can play an important part in preventing or promoting fire triggered by hazardous failure of components.

For example, manufacturers now admit that a high proportion of component fires occurred in what they refer to as “epidemics.” Fires in one RCA chassis, for example, were caused by switches. In another RCA chassis, some across-the-line capacitors deteriorated and failed, sometimes bursting into flame, according to an RCA engineer. The arrangement of leads on a batch of yokes posed a fire hazard in one Motorola color chassis, according to an engineer there: adjacent leads were subject to severe arcing. The problem was solved by specifying precise arrangement of leads and ordering a change in the cover material, he said. Several manufacturers, including Magnavox and Sylvania, have encountered some trouble with flyback transformers, and those two companies have instituted programs to replace such components.

The sequence of events that caused a fire in an RCA CTC-15 chassis, shown on page 58, provides an example of how design and component defects can combine hazardingly.

The fire evidently began in the switch—a push-pull variety that is commonly piggybacked on volume controls. Although the vendor, CTS Corp., had been selling the basic type TK switch for television applications since 1962, the company was first advised in late 1967

of field failures, some involving smoke and fire. CTS promptly made a very thorough analysis and early in 1968 increased contact pressure between the switch’s movable conductor and its stationary terminals, improved fatigue resistance of the operating spring, and removed excess lubricant to prevent recurrence of the problem.

Next, the company replaced the material used for the switch enclosure, a molded phenolic, with a nonflammable glass alkyd material.

The original switch had met RCA’s specifications and passed accelerated tests by Underwriters’ Laboratories, by CTS’s customers, and by the company’s own engineers. In fact, CTS’s in-house testing included a 25,000 cycle endurance test, then continued cycling until the switch failed—and after all this, none caught fire.

But in the RCA CTC-15 chassis, the on-off switch was mounted directly under the tuner, which contained a gear made of Delrin, a plastic. When the switch caught fire, the gear melted, giving off a flaming molten discharge that flowed on to the back of the speaker below; once the speaker cone caught fire, the rest went quickly. Outside, in front of the set, the burning speaker ignited the grille cloth. Flames melted the plastic ornamental pieces near the on-off control. Meanwhile, inside the set, it was possible for flaming tuner effluent to continue to leak on the inside of the set’s wooden cabinet. From there on, the extent of damage depended largely on a set of circumstances that had very little to do with design.

All RCA can do at this point, of course, is to try and turn up models with the CTC-15 chassis, and replace the phenolic TK switch with a metal-enclosed unit. In fact, RCA is one of two set manufacturers with a full-scale retrofit program to counter tv fires. Service technicians are encouraged to locate specific models, then are reimbursed for repairs. Magnavox, according to an executive there, now has a similar program for flybacks.

Beyond the immediate problem of retrofitting phenolic switches, the case of the CTS-15 raises a crucial point: the models containing the phenolic TK switch, like 95% of all tv sets sold in the U. S., were approved by Underwriters’ Laboratories.

However, the occurrence of fires and other hazards in UL-approved receivers raises serious questions about

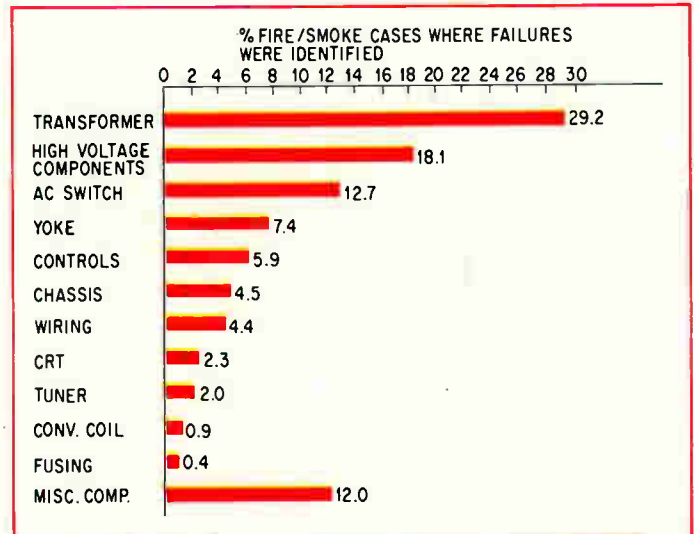
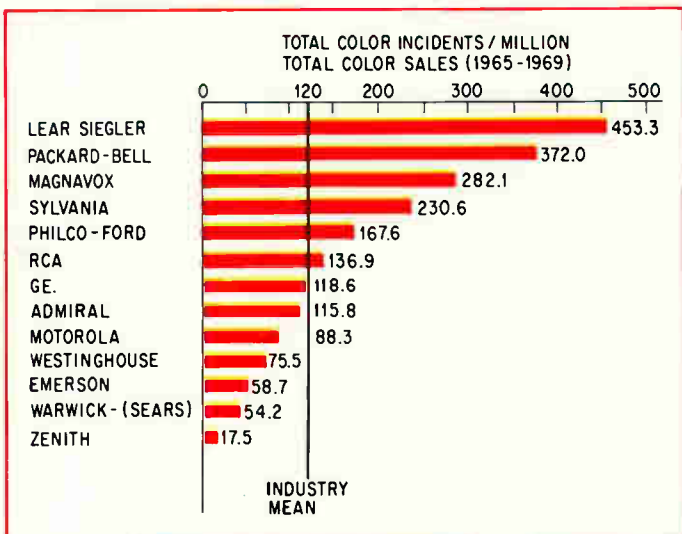



the effectiveness and relevancy of industry standards and tests.

The principal standard for radio and television receivers is Underwriters' Laboratories' UL 492. Since 1928, this standard has governed UL's testing of home receivers—procedures that aim to prevent fire, shock and X-ray leakage in receivers that bear the famous round UL seal. UL 492 covers virtually every aspect of the receiver, from the size of ventilation holes in the cabinet to the adequacy of insulation deep inside the chassis. This standard—with its 402 paragraphs, many of which cross-reference each other—is extremely complex despite its having gone through 12 editions since initial publication, including an extensive reworking program that began two years ago.

UL 492 represents a patchy historical record of haggles and compromises between UL's engineers, who tried to tighten and upgrade sections of the standard as the state of the art advanced, and manufacturers' engineers, who fought changes that increased costs. Says a UL engineer of this lengthy and challenging battle: "We've spent thousands of hours just fighting over the size of ventilation holes."

As another UL engineer sees it, compromise is essential to the improvement of safety: "We've been working for years on many of the changes that will finally go into effect this year," he says, "but manufacturers refused to change until the recent publicity about tv fires." But then he adds: "Remember, we're not policemen; we couldn't force them. We've always had to take the attitude that it's better to give a listing industry can live with, rather than to allow it to run rampant with no interlocks, no standards, no nothing."

One potentially high-hazard component in tv's is the flyback transformer, which the Jitco report suggests is responsible for roughly 40% of color tv fires. The Tracor report goes right to the heart of the flyback problem. It recommends specific materials to replace the usual beeswax covering—a coating of silicone rubber (already used by a number of manufacturers), or, much less desirable, anhydride-cured epoxy with a flame-retardant additive. In addition, Tracor recommends "that insulating materials . . . shall be subjected to dust and fog tracking and erosion resistance testing as specified in American Society for Testing and Materials D2136-67T and D495-61." And Tracor recommends either copper wire or copper-clad aluminum wire for transformer windings. Finally, during testing, a fire hazard is considered to exist and the component should be rejected if it glows or flames. Although EIA is willing to leave the date for conversion to flame-retardant covering for flybacks up to the manufacturers, Tracor urged specific dates.

Of course, fires originate in components other than flybacks. The problem for yokes is somewhat similar to flybacks, except that yokes operate at lower voltages and there is no enclosure to contain heat—or a possible fire. On-off switches and across-the-line capacitors also can provide an arc path of flammable material. For switch

Controversial Jitco report drew manufacturers' ire for implied safety "ratings" of color tv models (left) based on incomplete data. Report also analyzed failure histories of specific components. Asterisks indicate makers who didn't submit data on causes of fire.

Spokesman for the set manufacturers, EIA's Jack Wayman, disputes statistics on color television fires circulated by the National Commission on Product Safety. Wayman settles on the 2,600 incidents in five years reported to the commission by manufacturers; the commission cites surveys that indicate between 5,000 to 10,000 tv fires annually.

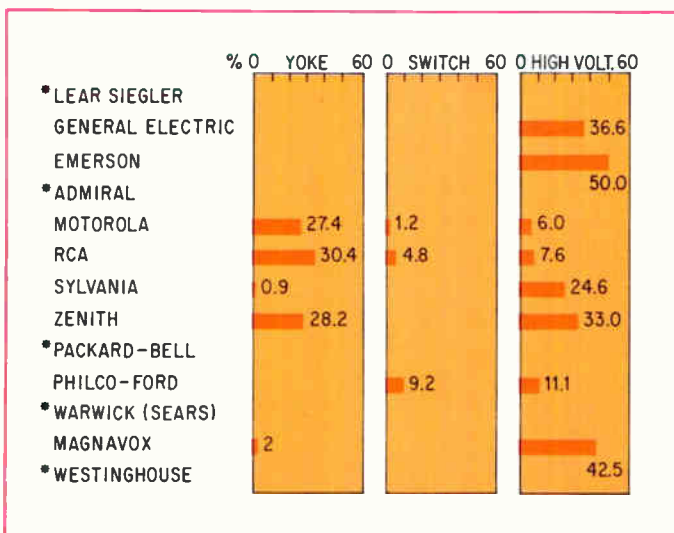

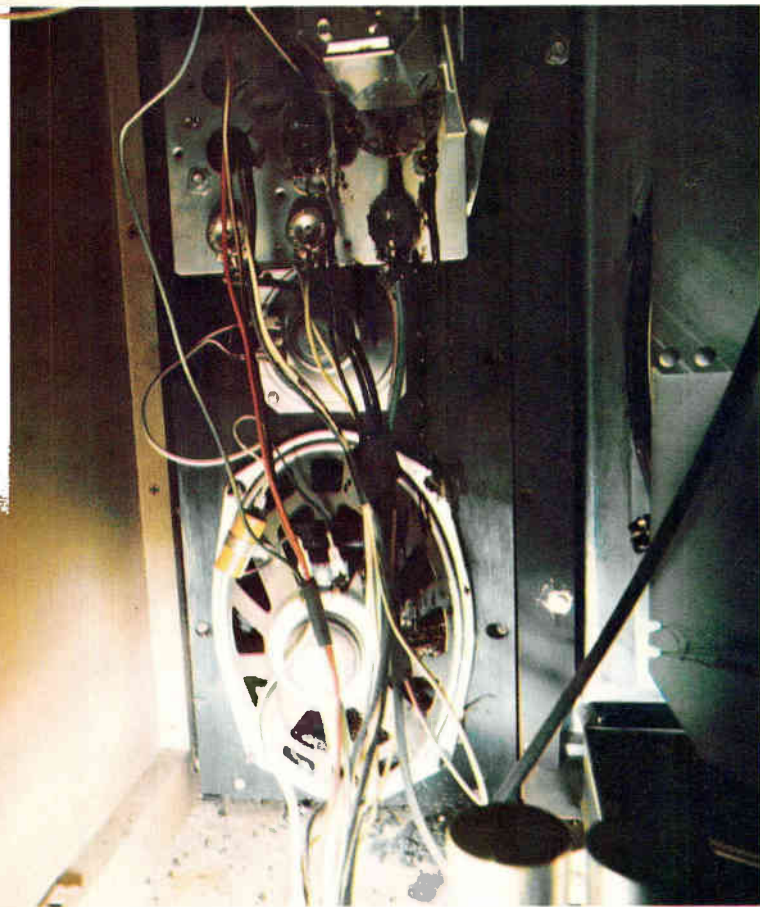

The complex interaction between a component and the set design in which it's used is exemplified by this burnt-out color set. According to the service technician, the fire began in the switch. Then a gear in the tuner above it caught, dripping flaming effluent on the speaker cone.

enclosures and other molded plastic parts, Tracor recommends glass-reinforced diallyl phthalamate compounded with diallyl chlorendates.

Across-the-line capacitors—included in every design as the last component across the interlock to satisfy FCC requirements for suppression of r-f interference—have been cited infrequently as a cause of fires. But the a-c capacitors' critical location makes them vulnerable to transient line voltage and permits a hazardous failure to ignite an unattended tv receiver. And across-the-line capacitors pose a double threat if they fail: if made improperly, they can burst into flame, and they can explode and spew conductive foil into other circuits.

The importance of strict control over the across-the-line capacitor prompted UL in 1958 to place this critical part in a separate category. UL 492, paragraph 86 unobtrusively indicates its special status this way: "A capacitor used for antenna blocking, line bypass, or metal cabinet isolation; or between live parts and exposed metal parts where the capacitor is continually stressed, shall be a recognized type."

By "recognized," UL means that the specified capacitor used must hold UL's yellow-card listing (UL accepts the capacitor for the application without further testing in the set). But according to a UL engineer, any capacitor was able to win a yellow card by passing two simple trials—a 900-volt dielectric strength test, which was performed on a single sample; and a flame test, which allowed up to 60 seconds of flaming in three samples. Again, UL says it's been holding lengthy and

## Tower of Babel

The fire problem in consumer electronics is complicated by the imprecise and confusing language of flammability testing.

For example, consider the terms "nonburning" and "self-extinguishing." Under its test for rigid plastics (D635-63), the American Society for Testing and Materials (ASTM) allows one of 20 material samples to burn completely and still be classified as "nonburning by this test." Some independent testing organizations consider a material "nonburning" if it burns for a while, with flames that fail to reach the one-inch mark—a rather different interpretation than that of UL. To pass UL standards, burning must cease when the test flame is removed.

If, however, one sample burns completely and the rest flame violently for an indefinite time but cease flaming before four running inches have been consumed, the material is termed "self-extinguishing by this test." Unfortunately, the terms "nonburning" and "self-extinguishing" often are used alone without further clarification. But without reference to specific tests, both are meaningless.

Further complicating matters, Underwriters' Laboratories considers ASTM D635-63 specification unwork-

able, and, since late 1959, has used a different test to define two additional classifications of "self-extinguishing." UL's SE-2 (self-extinguishing, group II) allows specimens to burn for an average of 25 seconds, and to drip flaming droplets or eject flaming particles. And UL's SE-1 also allows samples to flame vigorously for 25 seconds, but not to drip flaming droplets or particles. A new category, SE-0, formulated this March, restricts the permissible flaming period to a 5-second average (10-second maximum) and permits no flaming droplets.

Curiously, in tests for each of the three UL categories, "self-extinguishing" samples can burn longer than the specified ignition time. In SE-1, for example, the sample can burn for up to 30 seconds or an average of 25 seconds after application of two separate 10-second test flames. Theoretically, therefore, material that passes ASTM D635-63 and all the UL "self-extinguishing" tests conceivably could start fires in adjacent material that may have passed the same tests. And none of these four flammability tests specifies anything on smoke.

Even a "noncombustible" rating is no guarantee against flame. For example, the UL capacitor flame test (paragraph 280) says a capacitor is "enclosed in noncombustible material if it does not continue to flame

unsuccessful discussions with industry on tests that would simulate line surges of up to several thousand volts. Now, however, all "yellow-card" across-the-line capacitors must repeatedly withstand a "dump test" that drops 5,000 volts across their terminals while the capacitor is connected across the usual 120-volt line voltage. And, they have to pass the test without exploding. Tracor proposes that "no glowing or flaming of cheesecloth [used to drape test components] is to be permitted" (UL permits flaming in five out of 50 samples).

Clearly, the Tracor report suggests standards that are more stringent than anything yet proposed. But it can only recommend, not enforce. Would implementation of the Tracor report make sets absolutely fireproof? Says its author, Donald Berman: "*Absolutely* is quite a word, but you can sure come close to it."

Of the safety work being done before the furor started, Berman notes, wryly: "Generally, the manufacturers knew of these problems, but some were working on them harder than others. Our idea is to make safety independent of the unique characteristics of a particular component design, as supplied by a given source. Of course, parts will fail. You're always going to have parts fail. The purpose of our report is to help make sure that even a small amount of unreliability isn't hazardous unreliability."

#### Shocks and radiation, too

There's a considerable difference of opinion as to what constitutes a "safe" level for each of the other

three hazards, shock, X-ray and microwave leakage. Regulatory agencies usually try to set standards that are as stringent as possible, and manufacturers and their representatives usually have balked at them. So the standoff point is generally achieved, not on the basis of a level that's unquestionably safe for humans, but rather at a level that can be consistently met by manufacturers. Thus, 0.5 milliroentgen/hour at 5 centimeters is the present standard for X-ray emissions from tv sets, not because that level is optimally safe, but because manufacturers can easily make receivers that meet the standard's requirements.

But the X-ray standard is being tightened up. On Jan. 15, the Radiation Control for Health and Safety Act went into effect, requiring all television receivers to comply with the 0.5 mr/hr limit even if the user adjusts all external controls to maximize X-ray intensity. Sets manufactured after June 1 had to meet the 0.5 mr/hr standard even if all controls—including internal adjustments accessible only to service technicians—are set to maximize emission. Finally, sets made after Jan. 1, 1971 will have to meet the standard even if all controls are maladjusted and the failure of a circuit or component increases emission.

The mechanism for X-ray generation is straightforward. Any electrons that are accelerated through a voltage drop of 1 kilovolt or higher and allowed to strike metal cause X-ray emission. The higher the voltage gradient (as in color tv's) the harder the X rays; the higher the electron current, the more intense. A 1968

for more than 15 seconds after the first and second applications of a test flame, nor more than 60 seconds after the third flame application." Conceivably, such a "noncombustible" capacitor under the right condition could ignite "nonburning" insulation, which might then consume the rest of the tv set—even if it's made entirely of "self-extinguishing" materials that qualified under their own tests.

Unfortunately, it has been common industry practice to use SE-2 self-extinguishing materials in critical high-voltage, high-temperature, or across-the-line applications. Such materials can produce flaming droplets, or sustain combustion for a long enough time to initiate a roaring fire.

As a result of the confusion with the "nonburning" classification, ASTM's Flammability Committee is considering possible elimination of the term from its standards.

At Underwriters' Laboratories,  
"self-extinguishing"  
material drips flaming effluent,  
igniting a piece of cotton.

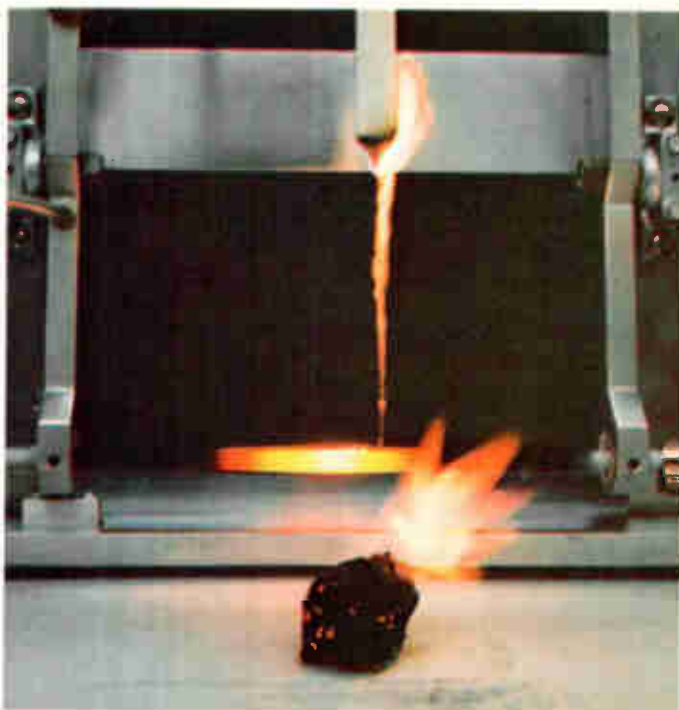

Department of Health, Education and Welfare survey indicated that all sets operating at voltage levels above 31 kv emitted X rays in excess of the 0.5 mr/hr standard. Generally, 25 kv is considered a safe level, but even that depends on set design. The shunt regulator and high-voltage rectifier tubes account for most X-ray emission produced by a color tv set. The remainder is generated by beam electrons that hit the metal shadow mask in the cathode ray tube. Good shielding can keep X-ray levels below 0.2 mr/hr and most sets made today would meet such a standard.

But there's some question about the acceptability of any measurable emission. Consumers Union, for example, unfavorably rated three sets—Lear Siegler's Olympic CC 5402, Packard-Bell's CRW-502, and Admiral's L 54111, although their emission was below the accepted standard when operated at normal power-line voltage. CU feels there should be no measurable X-ray emission: "Since many of the color tv sets we have tested in the past two years exhibited no X radiation, manufacturers should have no particular problem making their sets radiation-free," CU asserts, adding that "the 0.5 mr/hr level was picked, says HEW, because radiation levels under 0.5 mr/hr cannot be measured reliably. CU disagrees with that contention. In fact, according to published information from [EIA], manufacturers have been routinely measuring levels below that."

Although a widely circulated industry statement insists that the difference in background radiation between high-altitude Denver and low-altitude Baltimore exceeds

the 0.5 mr/hr level by 10 or 20 times, the truth is that ordinary background X radiation is on the order of 100 mr/year; which works out to almost exactly 0.01 mr/hr. And in fact, the portable meter used in HEW's Washington, D.C. survey could detect a minimum exposure rate of 0.04 mr/hr. Even with that sensitivity, no X radiation was evident in 856 receivers out of 1,124 tested.

**The microwave caper.** Until recently, in microwave exposure the only discernible problem was cataracts, which have shown up in both animals and humans. In scientific circles endless debate rages over the effects of microwave radiation: are microwave-induced cataracts due to purely thermal effects, or do microwaves have biologically significant properties associated with their portion of the spectrum? For the consumer, however, another question is far more important: how much microwave leakage can be considered harmless?

The culprit here is the home microwave oven, which operates at either 915 or 2,450 megahertz. The problem: there's no general scientific agreement on what levels of microwave leakage constitute a health hazard. This lack of agreement has been a constant source of friction between microwave oven manufacturers and HEW's Bureau of Radiological Health.

An HEW scientist, Dr. Russell Carpenter, working with rabbits, determined that a dose of 86 mw/cm<sup>2</sup> delivered an hour a day for 10 consecutive days consistently induces cataracts. When asked about acceptable levels for humans, he points out that he wouldn't like 10 mw/cm<sup>2</sup> on the eye itself. "If I had my druthers, I'd pick 1 mw/cm<sup>2</sup> on the eye," says Carpenter, "but I

## Weak link

Television and radio receivers that fail hazardously after receiving Underwriters' Laboratories approval raise a fundamental question: just how effective are UL test and clearance procedures? The case in point is UL's 492, which covers radio and tv sets. Some idea of the standard's complexity, as well as the opportunities it allows for hazardous failure, can be obtained from its sections dealing with flyback transformers—believed to have caused more fires than any other component.

To qualify flybacks under UL standards, the manufacturer can choose among four methods. The flyback itself must pass one of two tests, or it must be contained in an enclosure that complies with one of two sections.

Under one test—the noncombustible part flame test—chances of success are negligible. "I've never seen a flyback that can pass that test," says Steve Coen, one

of UL's managing engineers in charge of radio and television testing. "The only thing that could make it through would be a piece of clean, uncoated steel or ceramic, and UL requires anti-corrosion coating on steel." The difficulty is that it specifies that the part must not cause the size of an applied test flame to increase more than an inch. According to Coen, almost any flyback coating will do so.

If, however, the manufacturer is willing to place the flyback in an enclosure specified by UL down to the exact metal thickness, area of openings, bushing diameters and cover fastenings, then almost any flyback is acceptable, even if its coating is not especially flame resistant.

The two remaining possibilities—a flyback "high voltage arcing test" and a "high-voltage enclosure fire test"—present no obstacles, because the key requirement is the same for both tests.

In both cases, it specifies that the entire receiver is to be tested by "draping [it] loosely with a single layer of cheesecloth," after which the flyback is to be set on fire to simulate what might happen in operation. If the fire persists and even escapes the enclosure, the set still would pass the standard if the cheesecloth over the set itself remained unsmoked. Says a UL engineer: "We'd see fire and smoke in there, but if the cheesecloth didn't ignite, we'd have to pass the set."

UL engineers insist that the organization has tried for years to tighten this loophole, but manufacturers' engineers objected. However, under a current proposal, starting in January, the cheesecloth will cover only the flyback's enclosure inside the set. And for unenclosed flybacks, another proposed change would limit the size and duration of the flyback flame to one inch and no more than 10 seconds.

wouldn't go looking for even that."

Until recently, the industry's accepted standard for leakage from microwave ovens was 10 milliwatts/cm<sup>2</sup> at a distance of 5 cm. This 10 mw figure had been determined by experiments on the biological effects of "whole body" microwave radiation produced by military radar. But, again, state-of-the-art formulation of standards prevails: since manufacturers seem to be able to routinely make units that produce a fraction of a mw/cm<sup>2</sup> at a 5-cm distance, HEW has lowered the standard to 1 mw/cm<sup>2</sup> at the factory and 5 mw/cm<sup>2</sup> for the life of the oven as of July 1, 1971. Recently, however, a scientist reported to HEW that even the 1 mw/cm<sup>2</sup> level can cause death, in some circumstances. Certain electronic heart pacemakers could be stopped at distances up to 8 feet by the microwave leakage that is now permissible under the new standard.

The effects of microwave radiation may not be limited to the eyes or to the heart. According to Russian observers, low-level microwave radiation can cause headaches, irritability, lessened sexual activity, fear, asthma, hypochondria, and fatigue [*Electronics*, Oct. 13, 1969, p. 123].

**Shocking.** The shock problem, which was supposed to have been licked long ago, is still haunting the consumer. In high-fidelity stereo systems, current leakages in separate units hooked together by an unsuspecting audiophile can be cumulative. Tracor's Donald Berman reports instances where some listeners touched a grounded amplifier with one hand, then reached for a tone arm—only to get walloped by cumulative leakage currents.

Another source of hazard centers on the line-isolation transformer that is supposed to prevent shock. Some manufacturers have eliminated it, especially from the design of inexpensive portable television sets, which frequently have metal cases. Thus the set's filaments are connected in series and the chassis is hot. All that's needed to electrocute a user is a grounded hot-air register or floor lamp nearby, and a single ruptured bushing between the set's cabinet and its chassis, or a case screw that is tightened too far or replaced by a longer one. Some manufacturers are relying on the use and proper connection of a polarized plug and wall outlet. But most older buildings have outlets that allow plugs to be reversed. And electrician's helpers don't always connect the wires in proper sequence in a modern outlet. Some extension cords are nonpolarized, thus nullifying purpose of the polarized plug and outlet. These circumstances enhance the likelihood of hazard.

Standards for limiting current leakage are also subject to scrutiny and tightening. For example, UL's standard for current leakage between case and ground is 5 milliamperes. But a Consumers Union executive takes exception: "I'd like to subject a few corporate presidents to 5 ma, then see if they question the standard. It'll knock them on their fannies." Actually, the American National Standards Institute (a group of voluntary standards organizations) has already lowered the acceptable limit to 0.5 ma. And UL soon may decide to adopt the more stringent 0.5 ma standard, according to an inside source.

Unfortunately, mere tightening of standards—X-ray, microwave, shock or flammability—may not absolutely guarantee safety for consumers. The question of enforce-

ability lies at the bottom of most product hazards.

Though few people remember those days, there was a time when automobiles were UL-approved. Then Henry Ford insisted on putting the gas tank in the front of the car. UL believed that would be hazardous and refused to approve such an arrangement. Ford held to his position and the automobile manufacturers bolted UL. At that time the automotive industry was, in effect, UL's biggest customer.

Now the radio and television industry, with its annual model changes, is UL's biggest customer. And some manufacturers of consumer electronics—finding UL time-consuming to deal with, excessively bureaucratic and, some say, arrogant—are starting to ask themselves whether UL approval is worth the burden of obtaining it.

For example, Daniel von Recklinghausen, chief engineer, H.H. Scott, Inc., plainly admits that his company no longer submits every design to UL: "We do submit everything we make to the Canadian Standards Association—you must to sell in Canada—but only about half the total units we build have UL approval."

Additionally, lack of UL approval doesn't seem to impair a manufacturer's marketing efforts. UL approval or equivalent certification is required by only three cities—Portland, Ore.; Richmond, Va.; and Los Angeles, which is the only city that actually enforces a ban on non-approved merchandise. But a manufacturer can sell in Los Angeles if he submits his product to a municipal testing lab—the only one of its kind in the country—that functions as a miniature UL. Approval for a well-made product is a lot quicker and easier to come by than the Underwriters' Laboratories seal of approval, several manufacturers say.

Checking on television manufacturers' conformity to the recently tightened UL standard will be difficult, thanks in part to a recent change in the organization's method of listing approved equipment. In the past, UL listed all approved tv model numbers. But starting with the August 1969 listing, the model numbers have been omitted—leaving only the manufacturers' names. This was effected primarily to save space, UL insists. But in a 500-page document that lists 22 pages of model numbers for "air heaters," 12 pages of model numbers for "electric fans," and 22 pages of model numbers for "central air-conditioners," UL decided to save 22 pages in its listing of "household television receivers."

Thus, the consumer will have no way of checking if the specific model he is thinking of purchasing is approved other than by examining the set itself. But UL so far has resisted standardization of a conspicuous label, leaving the consumer to squint into crevices around the back of the receiver for what may be a tiny UL trademark molded into the case or stamped out of sight on the chassis. The National Commission on Product Safety in its final report has suggested one answer: that a special office be set up in the Executive Branch of the Federal Government to oversee standards and their implementation.

For its part, the electronics industry needs specific solutions to specific problems—safe components and safe designs. Also needed are general solutions—systems approaches to safety—that will prevent unanticipated problems and recurrences of old ones. The trick is to obtain all of this economically, since in consumer electronics every penny counts.

# Consumer hazards: How they can be fixed

With an abundance of improved coverings, seals, and devices, and a systematic quality control program, manufacturers are building safer products and saving themselves money, too

A modern systems approach to designing for safety, coupled with use of improved materials, can combine to minimize or even eliminate hazards in consumer electronics. And though some of these procedures entail immediate production cost increases, they'll pay off in the long run—in obviating litigation, expensive retrofit campaigns, and costly warranty fulfillment.

For example, Motorola makes its flyback transformer fire-safe for about 25 cents by substituting a silicone rubber “tire” covering for beeswax in its color receivers. In fact, Motorola is offering that formula, used by the company for nine years, free to any set manufacturer who wants it.

The silicone tire may not prevent flyback failures, but it can inhibit fire started by arc discharge between coils. Wax used to protect coils from moisture still may leak through a hole burned by arcing (right) but the silicone tire prevents air from reaching the wax, which then drops to the floor of the high-voltage cages and congeals without igniting.

A somewhat more elegant—and costly—way to eliminate flyback fires is to use a solid state voltage tripler-rectifier-regulator to reduce its high-voltage winding from 25,000 volts to 8,000 volts. Made by Sylvania and Varo, the units are priced at \$4.50 to \$10, but a good deal of this cost is made up in several ways. First, the flyback transformer cost is reduced by about \$1.50, since the lower voltage can be produced with one-third the turns, and the focus winding can be eliminated because the focus voltage can be tapped from an early stage in the multiplier. Next, the regulator and rectifier tubes are cut out, saving about \$1.40. With these components gone, much of the heat and X rays also disappears. Consequently, the high-voltage enclosure can be redesigned, with just enough of a guard to prevent shock. (This could save another 30 cents.) The tripler-rectifier-regulator may not be paying its way completely, but for a dollar or two the design of the high-voltage section has been freed from two major hazards.

Additional fire protection can be obtained at very low cost by placing a little thermal cutout near the horizontal driver tube (p. 64, left). The device should be located  $\frac{7}{8}$  inch from the tube. Should the tube's current rise to a value of 80% to 100% above normal, excessive heat triggers the cutout, opening the cathode circuit to the horizontal driver tube. GE patented the

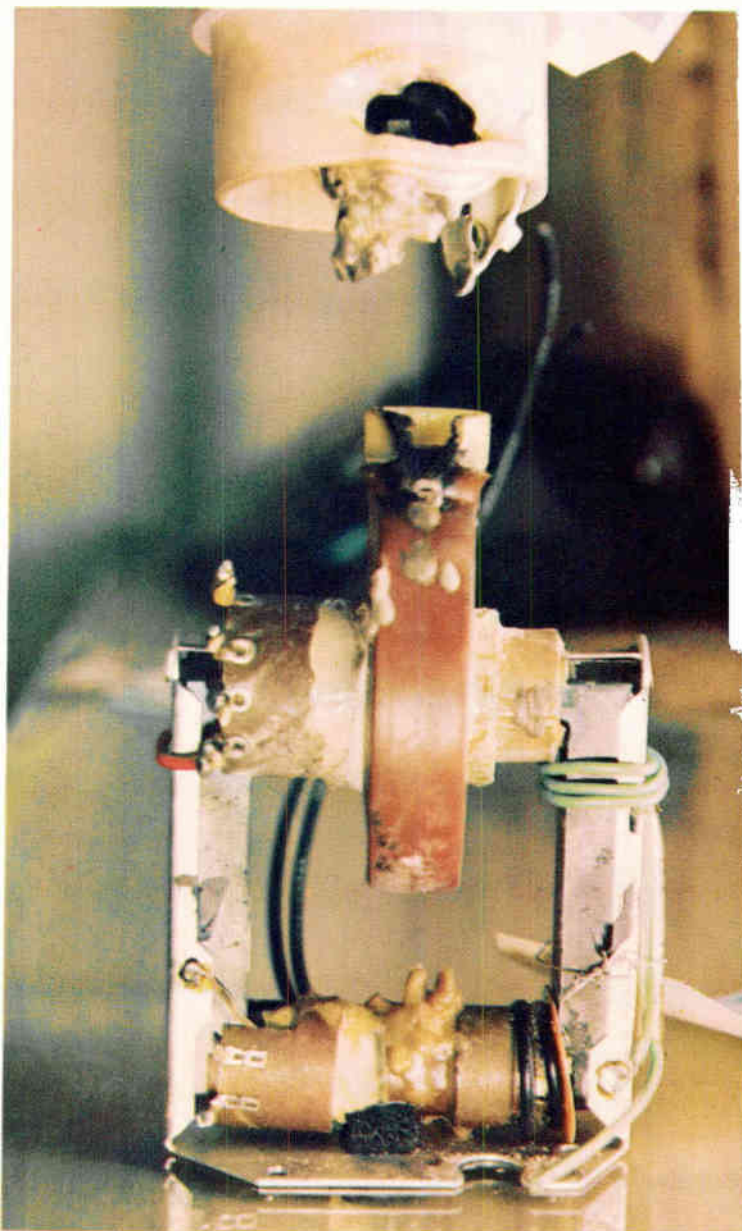

Protected by a silicone rubber covering, flyback fails, but is not hazardous. Wax inside drips out without flaming and congeals below. The wax's color indicates this flyback wasn't burning when it failed.



circuit, but will grant free use to any safety-seeking manufacturer. One source for the cutout is Bussmann Manufacturing Co. of St. Louis. In large quantities the cutout is available for nine cents as Bussmann's "type TFA heat limiter." Alternatively, a set manufacturer could design his own bimetallic device.

Another boon to safety-conscious designers is the flameproof resistor. Coated with a baby-blue blend of polymers and refractory oxides, a flameproof tin-oxide resistor made by Corning (seen intact in foreground, p. 64) handles up to 100 times its rated power without failing spectacularly like the Corning resistor above it, which is in parallel and is identical except for the coating. Corning sells the unit (designated FP) for the same price as tin-oxide resistors with an ordinary plastic coating.

As the Tracor report suggested, switches can be made fireproof by designing out "arc-track"—keeping the arc path from coinciding with the switch wall—and by making certain the switch's enclosure is either metal or laminated material of NEMA Grade FR-4 or FR-5. One manufacturer found that such a change—from a phenolic enclosure to one molded of a glass alkyd material that meets UL's SE-0—increased the price of the switch by five cents, to 35 cents.

For yokes, Tracor suggests that insulators, covers, housings, structural parts and terminal poles meet UL SE-1; and all plastic parts be nonburning according to ASTM D568-61, D635, and D1433.

For across-the-line capacitors, UL now requires that devices withstand a surge of 5,000 volts without expelling debris.

Unlike fire hazards, X-ray emissions cannot be completely eliminated. One source is the color picture tube, which produces X rays when the electron beam hits the metal shadow mask. But X-ray emissions can be reduced to well below the background level at the set. Some manufacturers are specifying glass with high lead content for the walls. And strontium is being substituted for barium in the front of the picture tube. Lead can't be used here; it darkens under exposure to electron beams. Strontium is estimated to absorb twice as much X radiation as barium.

In sets that exceed the 0.5 mr/hr limit, the X radiation largely originates in the high-voltage section. A quick and easy way to reduce this radiation is to combine a

solid state high-voltage rectifier with feedback regulation as an alternative to shunt regulation. In a recent Motorola design (p. 65, top), a plug-in rectifier contains a series string of 1-kv diodes in a cartridge sold by Varo. The solid state rectifier adds a cost increment of about \$1.25 over its vacuum tube counterpart, says a Motorola engineer. But the diode cartridge is much more reliable, he points out. Of course, the previously mentioned solid state tripler-rectifier-regulator also eradicates X rays in the high-voltage section.

In addition to the solid state route to reducing X rays, there is also a straightforward circuit design approach: basically, the horizontal drive voltage must be limited to around 27 kv, regardless of line voltage and load. A number of manufacturers—including GE, Magnavox, Andrea, RCA, Sylvania, Warwick, and Zenith—are employing such hold-down circuits, which reduce voltage in the horizontal drive circuitry should the shunt regulator fail or be pulled from its socket (p. 65). Furthermore, manufacturers are starting to specify high lead content in the glass envelopes of shunt regulator and high-voltage rectifier tubes, as in the funnel of the crt.

Shock hazards can be eliminated in a variety of ways. A line isolation transformer, of course, provides excellent protection as long as it doesn't leak current. Then there is a test procedure: the Canadian Standards Association requires a receiver under test to withstand 1,100 volts applied between plug contacts and chassis. One manufacturer, H.H. Scott, takes this test one step further in its high-fidelity audio units. Every unit made by Scott is tested individually with 1,100 volts just prior to being shipped, regardless of whether or not it goes to Canada, and no more than 6 ma leakage at 1,100 volts is allowed. Finally, a simple circuit can protect the user from shock by monitoring leakage directly and shutting down power quickly should any be detected. Basically, this technique uses a differential transformer to continuously compare the current going in one power-line conductor with that coming out the other. Should the algebraic sum add up to anything but zero, the transformer's output triggers a relay that opens the power line. Such a circuit is offered as a plug-in unit called "Safety Sentry," made by Rucker Electronics in Concord, Calif. In that design, the electronics allow leakage to persist for about 2 milliseconds to make sure current unbalance is not

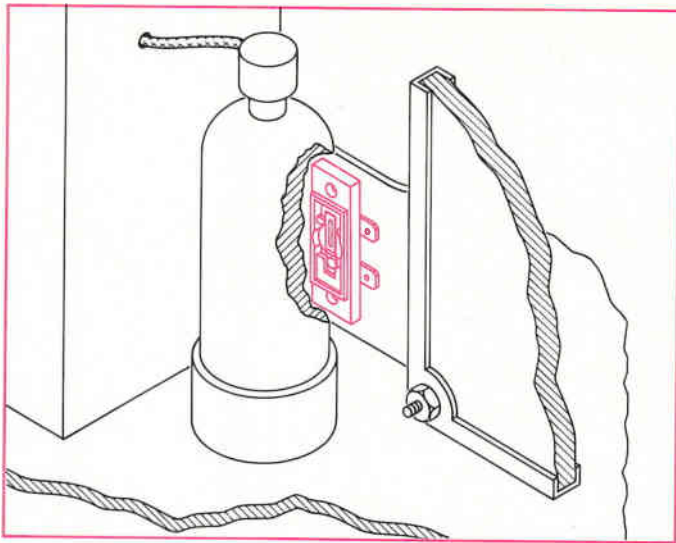

When current through the horizontal driver tube increases by 80% to 100%, radiated heat triggers a small thermal cutout, shutting down the circuit in a tv design by General Electric. The company allows any set manufacturer to use its circuit without charge.

A plastic-coated Corning resistor bursts into flame when driven by current 100 times higher than its rating, while an identical resistor connected in parallel doesn't. The secret: a coating that blends polymers with refractory oxides. Corning says the formula is proprietary, but supplies it at no extra cost.

due to a brief line-voltage spike. The mechanical interrupter adds a delay of 8 msec. And another 8 msec or so must be added for the arc plasma on its contacts to reach zero at the end of an a-c cycle or half-cycle. Within 25 msec—fast enough to protect a child from shock—power is completely shut down.

Microwave leakage from electronic ovens is due to nothing more complicated than imperfect door seals. But this seemingly simple problem has eluded effective solution because door hinges wear. And cooking residues accumulate in crevices, impairing an otherwise perfect seal. Oven manufacturers have devised three basic seals which may be used in combination or singly. The simplest is a sheet metal contact seal, which is inexpensive but only moderately effective and requires a good deal of closing force on the door to insure good contact. A wire-mesh roll around the door also is relatively inexpensive and provides a much better seal, but isn't easy to clean. A choke seal—which works by wave cancellation in a channel around the edge of the door—provides a good seal, requires only light closing pressure, stays clean, and looks attractive (p. 66, top). But it must meet close production tolerances to insure complete cancellation and it's more expensive to build. Some microwave ovens use a choke seal in combination with material designed to absorb residual leakage. One manufacturer uses a sliding door, or one with a horizontal hinge that permits the door to open down instead of to the side; he believes they're less prone to misalignment. UL, on the other hand, believes a horizontal door invites use as a shelf—a practice that may cause misalignment.

### It's all in the system

Specific solutions are appropriate for specific problems, but what each company needs is a systems approach to hazards—a carefully conceived program that makes safety a part of each product shipped out.

One such system was pieced together after a study of many product assurance activities, both commercial and military. The company: high-fidelity manufacturer H. H. Scott of Maynard, Mass.; the man behind the Scott system: Richard Powell now head of product assurance at Viatron Computer Systems Corp., Bedford, Mass.

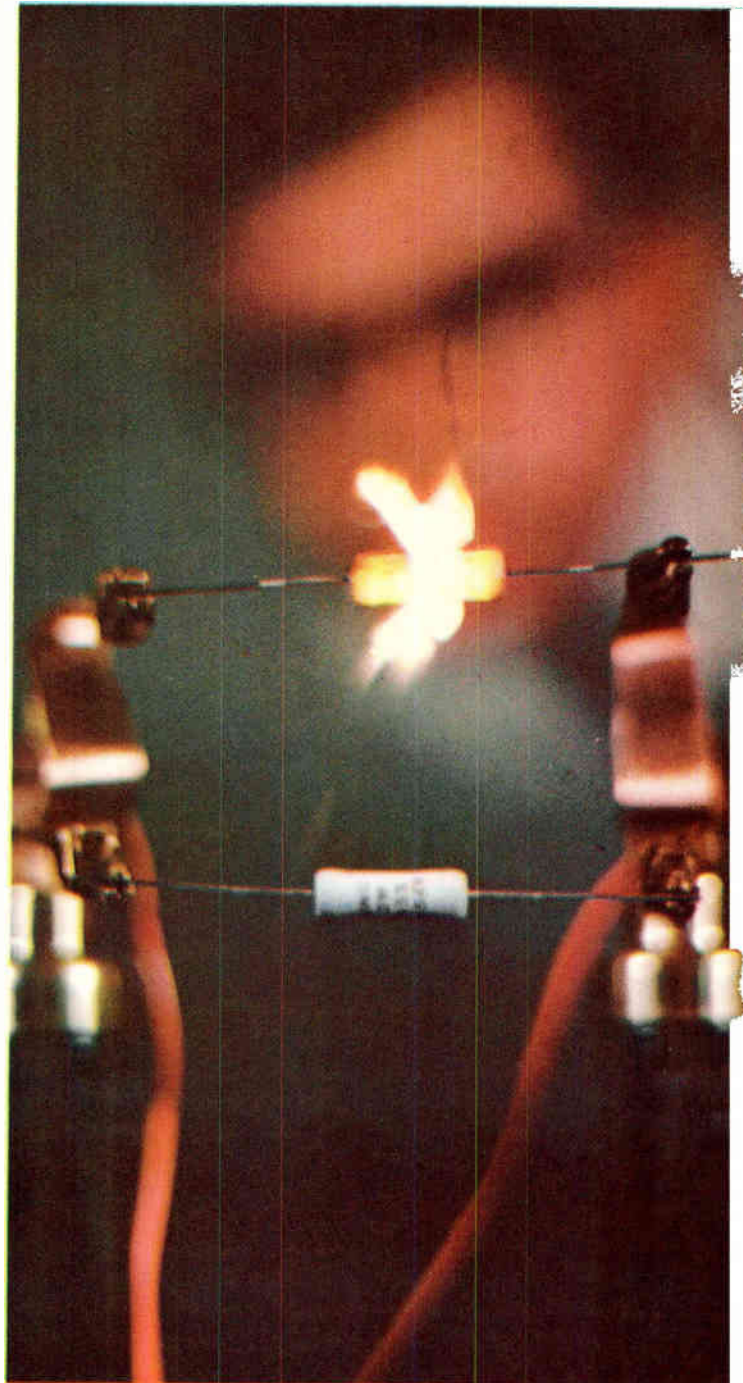

Powell believes that any viable product reliability system must prevent purchase of unsafe components; check prototypes of new products for potentially unsafe designs; use production techniques and tests that prevent the company from shipping any unsafe units, and secure feedback on field failures, to be used as a final check on the system and as input for comparison with lifetest data.

To accomplish these goals, says Powell, five elements are absolutely essential:

- ▶ Parts must be approved by the firm's engineering department; each vendor's individual part type requires separate approval.
- ▶ A long warranty (one to two years) must cover the product.
- ▶ The person actually performing the repair should relate the cause of failure to the factory.
- ▶ Every new product must be subjected to a test program designed to uncover failure mechanisms.
- ▶ Production must be regularly checked to insure that changes in a production technique haven't introduced potentially hazardous defects.

The most important items in Powell's system are a part data card filled out by the engineering department and checked by purchasing, and a "disapproved" stamp that cancels the part data card should engineering discover the part to be unsafe.

Once a mechanism for rejecting unsafe components is established, the next step is to determine the unsafe components. This, says Powell, is best done four ways:

- ▶ Before filling out the part data card, the engineer should examine the part carefully for possible hazards, lifetesting it if necessary and determining the composition and flammability of its materials.
- ▶ Lifetesting of preproduction units should be used to turn up signs of design defects that otherwise might lead to unsafe products.
- ▶ Occasional stock audits should be performed to determine whether or not failures are being caused by mishandling or inadequate packaging during shipment from factory to distributor, or distributor to dealer.
- ▶ A data base for field failure must be established to pick up causes that don't show up at the factory end and to ascertain whether or not corrective measures really work.

"This last point is absolutely crucial," says Powell, "and the best way to get data from the field is a long warranty. Practically nothing will stop a customer from bringing a failure to the company's attention if he believes his set is covered by warranty. Scott gives a two-year warranty and goes by serial numbers, allowing an additional 11 months under the assumption that the unit might sit around in a distributor's warehouse or on a dealer's shelf before it's sold. You can't go by warranty cards—they are a complete farce since only about one in five are ever returned—so you go by serial number, or a receipt if the customer presents one."

Once the validity of a warranty has been established, Powell believes the only way to obtain valid data is to require the repairman to report what went wrong. Here, symptom reports—especially those from customers—are of little value. "What a waste of time to sift through accounts like 'the unit started smoking,' or 'the receiver wouldn't light up,'" he says. Since the set manufacturer is picking up the tab for the repair,

A quick and easy way to cut X-ray emission is to replace the vacuum tube high-voltage rectifier with a solid state diode cartridge and a modified tube socket. Motorola buys the diode version from Varo; Motorola says it pays about \$1.25 more than for its vacuum tube equivalent.

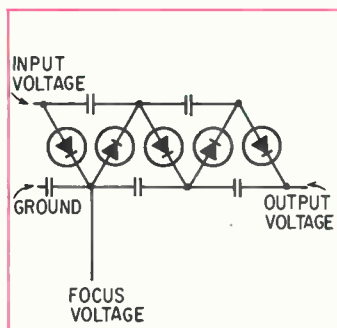
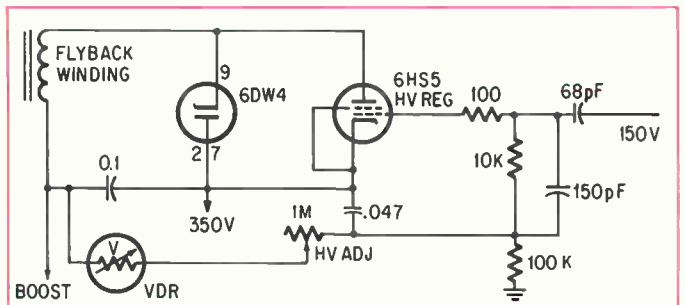
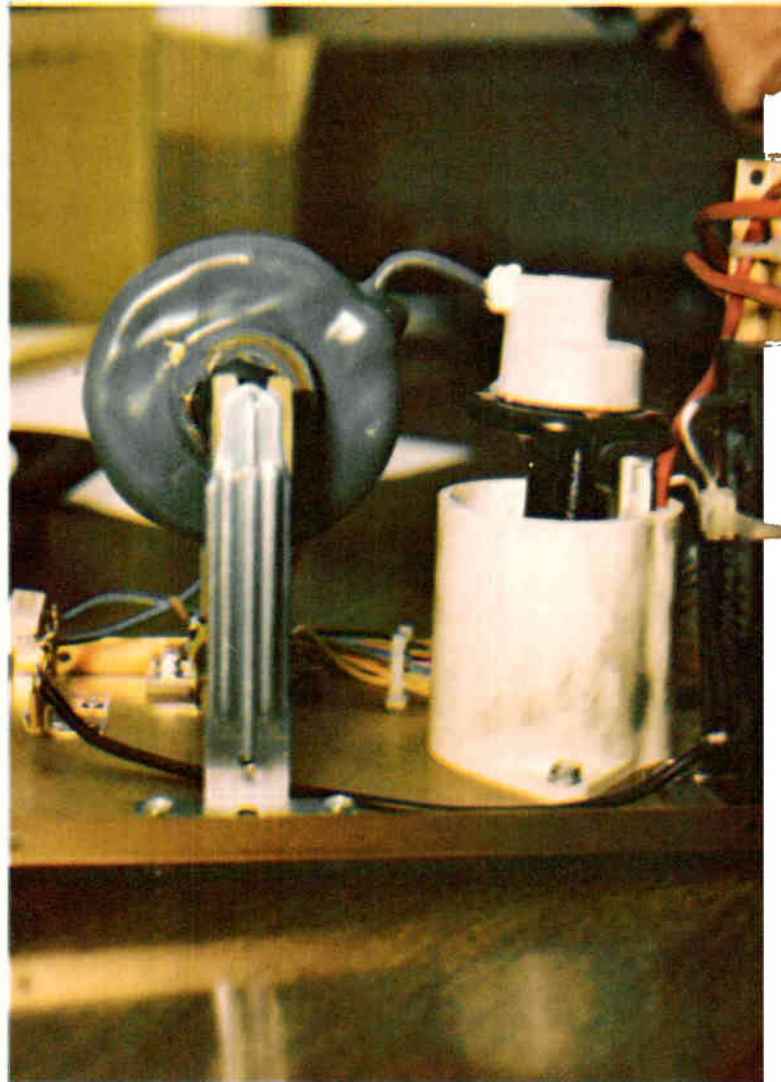

Many manufacturers prevent excessive X-ray emission with a straightforward hold-down circuit like Zenith's above. Another method (Sylvania's, left) substitutes a solid state tripler-rectifier-regulator for the X-ray-producing shunt regulator and high-voltage rectifier tubes.

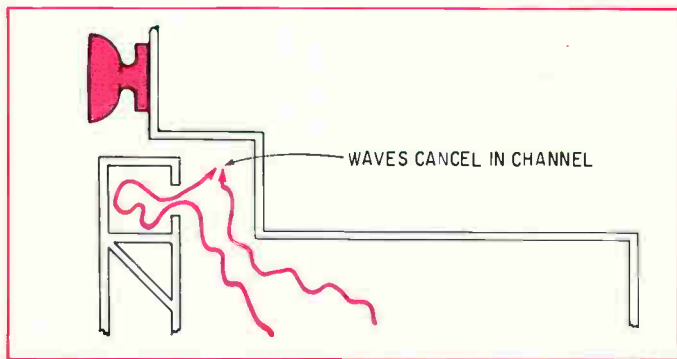

A "choke" seal is highly effective in preventing harmful leakage from microwave oven doors. Like the choke in a waveguide flange, it utilizes a carefully machined groove around the door edge which helps nullify escaping microwave energy.

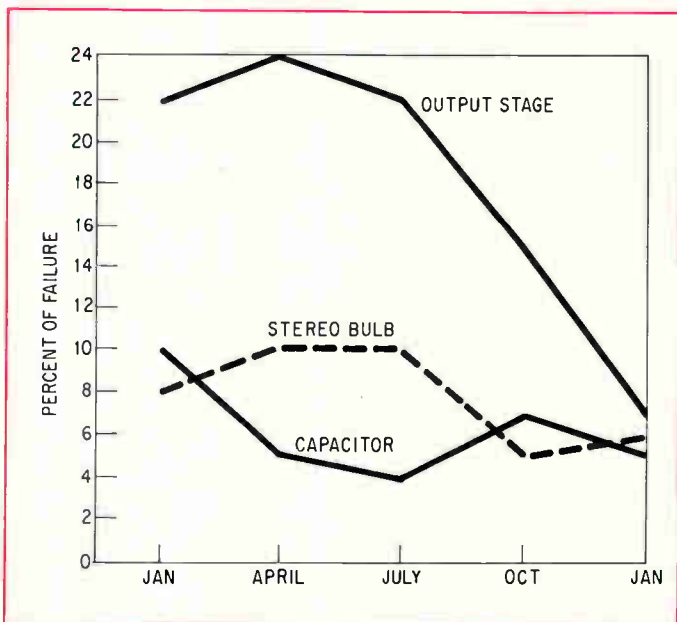

With a systems approach to product reliability, the effectiveness of corrective measures can be gauged by watching the field feedback. On this chart prepared from data at H. H. Scott a change in power-transistor vendors shows up as a dropping failure rate in the output stage.

asserts Powell, he's entitled to find out what went wrong—and to find out from the one person who's in a position to know—the service technician.

"Incredibly, some manufacturers let their distribution supply replacement parts and make the labor reimbursement—then throw away the data that describes the failure. That is valuable information," he adds.

The data, Powell suggests, should go to the factory as weekly reports from each authorized repair location. The manufacturer then can organize the data into a manageable form. The best way, according to Powell, is to break down the data into four-month production periods by serial number.

Next, a list of failure causes is prepared, with the highest incidence first. Before anything else, however, hazardous failure, even if infrequent, should be moved right to the top of the list, Powell advises. Then the product assurance engineer enters—looking for causes, determining which components or portions of the design are failing. After corrections are made, the results should start showing up in the field feedback, which, for this purpose, would be plotted as a running line graph with major causes of failure shown as a percent of total field failure by period of manufacture (below, left).

But Powell points out that many months usually pass before a problem is detected in the field data and is finally corrected. At Scott, for example, the average elapsed time between introduction of a product and the earliest opportunity to take corrective action was 11.4 months, then another two to eight months pass as the redesigned product flows through the distribution pipeline and the correction starts showing up in the field feedback. Preproduction lifetesting, usually at elevated temperatures and line voltages, often can hasten introduction of corrective measures. Lists of causes of failure assembled from lifetest data show striking similarity to their field data counterparts. For example, when a stereo amplifier was lifetesting at temperatures of 25°C, 40°C and 55°C and line voltage of 115, 120, 125, 130, and 135 volts, the same three causes of failure turned up at the top of the list, and in the same order, as a similar list compiled from field data.

Finally, Powell believes that a product assurance program should report its progress in dollars and cents. Assuming that resulting sales advantages justify a long



The product reliability system used at H. H. Scott was pieced together by Richard Powell from military and commercial systems. He believes his method minimizes safety hazards while paying its own way in cost savings.

warranty, field data figures can yield a direct calculation of savings effected by reduced failures. For example, say field failures on a product are running at 1,000 a month and the out-of-pocket cost of repair to the manufacturer is \$10 each, or \$10,000 a month. If a single change would reduce field failures by, say, 15% then the company can afford a change that costs up to \$1,500 a month in added production expenses. Thus, Scott discovered that a short burn-in of receivers at the factory was very worthwhile, since field failure rate goes down as the square root of operation time. Receivers that would otherwise fail early in service were caught in the burn-in and never left the factory. "The three-month warranty is another way of paying the customer to burn in equipment," says Powell. "But it may turn out to be cheaper doing the burn-in at the factory. The only way we know this, though, is by using our product assurance accounting technique. And to do that, you must have accurate field failure data."

If anything, Richard Powell's cost-effective approach to product assurance is conservative, especially when all the consequences of hazardous failure are added in. All Powell's calculations are predicated on two assumptions: the manufacturer only pays for actual failures in warranty, and the customer does no more than bring those failures to the attention of an authorized service operation.

For hazardous failure, however, the manufacturer may end up paying heavy legal fees and settlement verdicts. If, in the end, the manufacturer starts a retrofit program to replace potentially unsafe components, he's replacing parts that actually have not failed. He may well have to pay additional money to find affected sets. And unless he can figure out precisely what models and chassis contain the potential hazard, he may have to inspect sets that are not unsafe. In short, in a big retrofit program, costs go out the window. And that is definitely not the name of the game in consumer electronics. ●



Each receiver at Scott undergoes a short "burn-in" period. Here, the receivers are stacked on racks for on-off cycling.

Reprints of this special report are available at \$1.75 each. Write to Electronics Reprint Department, 330 West 42 St., New York, N. Y. 10036.  
© Copyright 1970, Electronics ® A McGraw-Hill Publication.



# Silicon- gate dynamic MOS crams 1,024 bits on a chip

By M. E. Hoff Jr.  
*Intel Corp., Mountain View, Calif.*

● Dynamic metal oxide semiconductor circuits can be used to build random access memories (RAMs) just as easily as shift registers. For either purpose, they are intrinsically better than MOS circuits—they form smaller storage units and have speeds of 100 to 150 nanoseconds, compared to 600 nsec—at best—using static-on-chip decoding.

Some innovative design changes, however, have resulted in a new dynamic 1,024-bit RAM on a single chip that improves on earlier random access arrays both in performance and in cost.

The chip's high performance is due chiefly to the use of silicon gate technology. Basically, silicon gate transistors differ from the conventional MOS types in that their gate electrode is made of polycrystalline silicon instead of aluminum. They begin to conduct at a much lower threshold voltage, and are capable of perhaps three times the aluminum gate MOS speeds. They also help lower cost by permitting circuits to be packed much more densely on the chip.

Other ways in which this chip achieves low cost include: the elimination of a select line, the avoidance of hybrid circuitry, and the use of chips about 130 mils square. While this chip size is fairly large as chips go, it's not so large that yield is a serious and expensive problem. The use of single-technology circuits, in which address decoding elements are put on the same chip as

the memory cells, is much less costly than hybrid technology. The latter, which combines MOS storage elements with bipolar decoding circuits, is often cited for its high performance—but never for its low cost.

The most interesting innovation is the simplification of the basic dynamic memory-cell design [see "Memory cell basics," p. 70]. Instead of having two select lines for the two operations of reading and writing, the cell has only one, as shown on page 70. This single select line permits more memory cells to be packed onto a single chip of a given size. It is charged to one voltage level,  $-3$  to  $-4$  volts, to read, and to another level,  $-20$  volts, to write. The result is much smaller and less expensive than the basic cell, but it is also significantly slower: some versions of the design have cycle times almost twice as long as that of the basic cell.

To read data from the new cell, the external precharge signal, which keeps both data lines at the precharge level, is removed from the read-data line. The voltage level on the select line is then set at its intermediate level,  $-3$  to  $-4$  volts, which is one and a half to two times the threshold voltage of transistor  $Q_2$ . If  $Q_1$  is off,  $Q_2$ 's source terminal is, in effect, floating,  $Q_2$  remains off, and the read-data line remains at its precharged level. But if  $Q_2$ 's source terminal is grounded through transistor  $Q_1$ , the select line's negative voltage level is enough to turn it on, since the gate needs be only about 2 volts more negative than the source to establish conduction. Then the precharged read-data line discharges through both transistors. After a time sufficient for the conditional discharge to occur, the logical complement of the charge on the capacitor  $C$  appears on the read-data line.

The small overdrive voltage on the gate of  $Q_2$  is the reason why the cycle time of this modified memory cell is longer than the basic cell's—any current passing through  $Q_2$  remains small and this makes the read-data discharge time relatively long.

**Note, too, that a select-line voltage** at this intermediate level, about  $-4$  volts, is not negative enough to turn  $Q_3$  on. For if the parasitic capacitance between  $Q_1$  and  $Q_3$  already carries a negative charge, it will be much more negative than the intermediate level on the select line. If, on the other hand, the parasitic capacitance is charged to between 0 and  $-2$  volts, or effectively not charged,  $Q_1$  is off. When the select line goes to somewhere between  $-3$  and  $-4$  volts,  $Q_3$  may turn on momentarily and admit some negative charge to  $C$ . But as soon as  $C$  charges to within 2 volts of the select line,  $Q_3$  cuts off. Thus, if the select voltage remains less negative than  $-4$  volts,  $C$  always remains above  $-2$  volts, hence  $Q_1$  never turns on.

To write data into the modified cell, the select line drops to an extreme negative level,  $-15$  volts or more. This is enough to turn  $Q_3$  on fully, so that the voltage on the capacitance approaches the level on the write-data line at that moment. If a 1 is being written, the write-data line still carries the  $-20$ -volt precharge level; for a 0, the line must be brought to ground before  $Q_3$  turns on. This select voltage, of course, turns  $Q_2$  on fully also; but the read operation is finished, so the condition of the read-data line is of no concern.

There are several ways of combining this new dynamic memory cell with decoders and various optional

features to build random-access memories. One comprises a 1,024-bit random-access memory on a chip that also fully decodes the input address and has a single dual-purpose lead along which data pass both into and out of the memory that appears on page 70. The single data lead requires the 1,024 memory cells to be individually addressable; the on-chip decoder requires 10 leads for the address ( $2^{10} = 1,024$ ). The array is square, 32 by 32 bits; five of the 10 address leads select one of the 32 rows and the other five select a particular bit in that row.

**The memory**, like the individual cell, is capable of three kinds of cycle: a refresh cycle, a read cycle, and a write cycle.

A refresh cycle transfers all the data contained in a particular row to the refresh amplifiers and then writes these data back again into the same cells they came from.

A read cycle transfers to the refresh amplifiers all the data from one row, as determined by the row-select bits, and then transfers to the input-output line the data from that one amplifier which is packed out by the five column-select bits.

A write cycle is the same as a refresh cycle, except that the datum being written replaces the previously stored bit during the rewrite half-cycle.

The timing for both read and write cycles is established by three signals, designated precharge, row-enable, and column-enable.

At the start of any cycle, precharge is on and the address inputs have stabilized. So first, the precharge signal is removed and row-enable is turned on. This causes the row-address decoder to turn on the select line for the one row, out of 32, specified by the row-address bits. Second, this line goes to its intermediate level, about  $-4$  volts, causing conditional discharge of the read-data lines; the lines from cells containing a logic 1 discharge and acquire a ground level, while the rest, whose cells contain a logic 0, retain the  $-20$ -volt precharge level and hold transistor  $Q_6$  on (refer to schematic on the right of page 70).

Third, once the read-data lines have all acquired their final values, the column-enable turns on. This has two effects: it conditionally discharges the write-data lines through the refresh amplifier and it drops the select line to its most negative level. To elaborate further, a write-data line discharges to ground through  $Q_6$  and  $Q_7$  only if both these refresh-amplifier transistors are on. Thus an original negative charge on the capacitance  $C$  is logically inverted—appears as a ground potential—on the read-data line, and is logically inverted again on the write-data line, which cannot discharge through the refresh amplifier if the read-data line is at ground. Conversely, if the capacitance  $C$  were originally discharged, the read-data line would have retained its precharge, and the write-data precharge would have discharged through the refresh amplifier. In every case, therefore, the write-data lines carry the same level that originally appeared on the capacitance.

The other consequence of turning on the column-enable—the select line's strongly negative level—precipitates the final event in any of the memory's cycles: it causes the voltage levels on the write-data line to be transferred back to the capacitance through  $Q_3$  refreshing the stored data.

## Memory cell basics

Any dynamic memory cell, whether used in a shift register or a random access array, basically derives from the design shown. Its key element is the parasitic capacitance  $C$ , which is associated with the gate of MOS transistor  $Q_1$  and the junction of the  $Q_2$  transistor. If  $C$  has enough charge to make  $Q_1$  conduct, the cell is said to contain a logic 1. Without such a charge,  $Q_1$  does not conduct, and the cell contains a logic 0. In most such designs, the transistors are p-channel enhancement mode devices, which require negative gate voltages to turn on.

To write data into the cell (to place charge on the capacitance  $C$ ), the write-select line is made negative, and the voltage corresponding to the data to be written—ground for 0 and a negative level for a 1—is placed on the write-data line. A negative write-select signal turns  $Q_3$  on, and the capacitance charges to the level of the write-data line. Returning the write-select line to ground turns  $Q_3$  off, but the capacitor retains the negative charge. (Eventually the charge will leak away, so well before that happens it is read out and written in again to refresh it.)

To read the data from the cell, the charge on  $C$  is nondestructively sensed by first precharging the read-data line to a negative voltage and then putting voltage on the read-select line that is negative enough to turn  $Q_2$  on. If the capacitance also is negatively charged,  $Q_1$  is on, and the precharge on the read-data line, maintained by its own parasitic capacitance, discharges to ground through these two transistors. If, on the other hand, the capacitance  $C$  carries no charge,  $Q_1$  is off,

and even though  $Q_2$  turns on, there is now discharge path to ground for the read-data line, which retains its precharged voltage. This is called a conditional discharge because its occurrence depends on the condition of the capacitance. Thus, the voltage on the read-data line, immediately after the read-select signal, is the logical complement of the charge on the capacitance.

Dynamic memory arrays consist of several rows and columns of cells like these, the rows sharing common select lines and the columns sharing common data lines. Activating one read- and write-select line pair addresses all cells in a row. Then the activation of a single data line reads or writes out a single cell in that row. Alternatively, all the read-data lines or all the write-data lines used simultaneously read out or write in an entire row at once.

During a refresh operation, the refresh amplifiers—one for each vertical column in this particular array—logically recompute the data. The row of amplifiers refreshes every cell in a given row simultaneously and successive rows in rotation. Since they also store data read from the cells for external use, they do the refreshing between external read and write cycles at a refresh interval that's fast enough to retain all the data in all the rows.

"Fast enough" depends on the time constant—the time it takes for the capacitor to discharge to 37% of its fully charged level. Typically, specifications for most of these memories call for refresh intervals that are small fractions of this time constant. In a well-

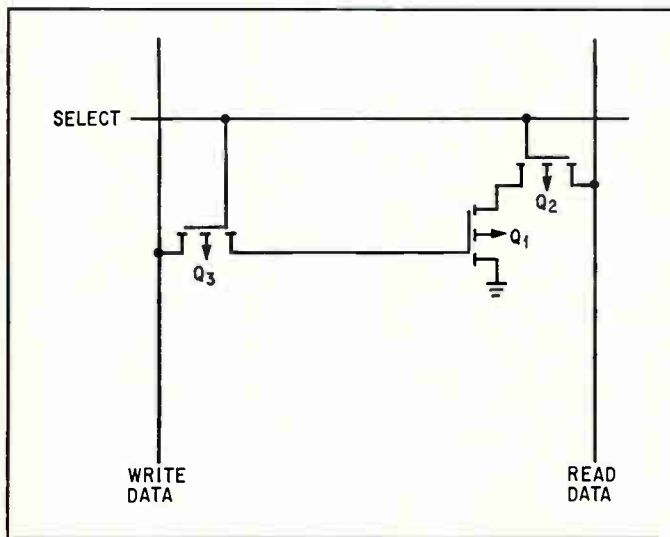

One will do. Intel's version of the dynamic cell controls both  $Q_2$  and  $Q_3$  with a single select line that has three voltage levels instead of two. Intermediate level turns on  $Q_2$ , bias established by storage capacitance holds  $Q_3$  off except when select line is strongly negative. The third level is at ground.

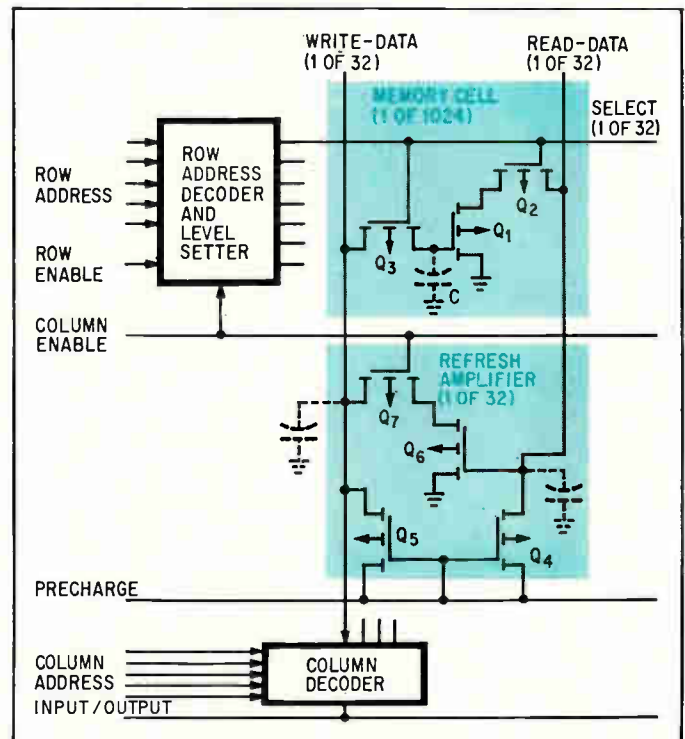

**Memory array.** Row and column decoders isolate one cell in an array of 1,024. Level setter in row decoder controls three-level signal on select line. One refresh amplifier per column of 32 memory cells stores data temporarily during refresh cycle or forwards it to sense amplifier during read cycle.



made device, the constant is 10 milliseconds or more, so to restore a capacitor's original voltage level every 2 msec requires a 500-hertz refresh rate. For example, in a 16-row array, an 8-kilohertz refresh cycle rate is used to refresh each of the rows in rotation. Doing so insures that the signal level in every cell in each of the rows will be maintained at a sufficient margin to permit no loss of data. In such a system one refresh cycle occurs every 200 microseconds, and takes as long to complete as a normal read or write cycle—about 500 nanoseconds. Thus, less than 1% of all the memory's cycles are devoted to refreshing.

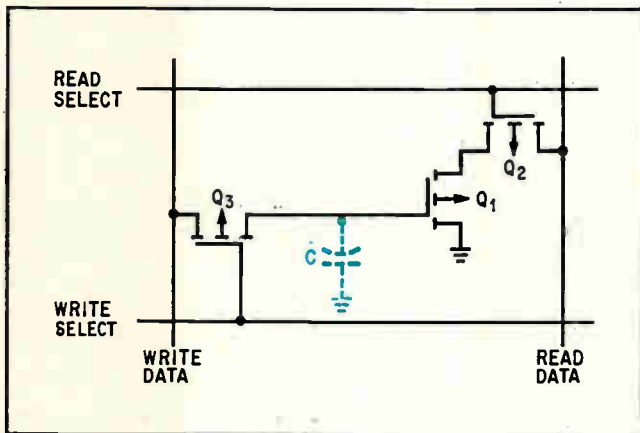

During the read cycle, when the column-enable signal turns  $Q_7$  on and so conditionally discharges the write-data line, it also opens a path from one of the write-data lines, as determined in the column decoder, through the decoder to the input-output data line. The act of discharging the write-data line creates a current from the ground in the refresh amplifier, through  $Q_6$  and  $Q_7$ , into the line's distributed capacitance. After this capacitance (which is in parallel with the decoder's relatively high resistance) has discharged, a relatively small current continues to flow to the output terminal. An external drive-sense circuit holds the output terminal at a potential more negative than that of the refresh amplifier. A transistor in the drive-sense circuit, together with the high resistance in the decoder, prevents the negative potential from significantly affecting the logic level of the write-data line. The drive-sense circuit also converts the signal to standard bipolar logic levels of 0 to 5 volts.

Within reasonable limits, the data remains available as long as the row-enable and the column-enable signals are present; when they turn off, the precharge voltage comes on again at least long enough to restore the precharge levels on the read-data and write-data lines, and the cycle is complete.

The writing cycle is different again. When writing, the column-enable line turns on only long enough to insure that the correct data is established on the write-data lines; then it turns off while the row-enable stays on. When it turns off, it breaks the connection to the write-data line in the refresh amplifier; but the select

line of the memory cell retains its strong negative level. Thus a direct path for changing capacitance  $C$  is established from the write-data line into the memory cell that's determined by the row and column addresses. After the capacitance  $C$  has achieved the proper charge for the bit it is to store, the row-enable is turned off and the precharge is turned on. Again, after a suitably long precharging interval, the cycle is complete.

When this memory chip is made with silicon-gate technology, all signal swings are nominally 20 volts. Such high levels permit very rapid access times. (Although lower input levels compatible with transistor-transistor logic could be designed with silicon gate technology, doing so would significantly increase access times.) The full memory cycle with this design takes about 500 nsec; read-access time, which includes the penalty incurred with the single select line, takes about 400 nsec. If, however, separate read and write select lines were used, the memory cycle time could be cut to 300 nsec and the access time to 200 nsec—but at the cost of fewer storage cells on a chip of a given size.

This design can be varied to suit the user's particular application and the tradeoffs the application may involve. One of the most obvious variations is to separate the input and output leads. The major advantage of a common input/output terminal is that it requires only one pin connection to the external circuits, with consequent improvement in maximum packaging density and interconnection reliability. But if, for example, the memory is to be used in a TTL system, the common output terminal suffers from the disadvantage of requiring an elaborate combination drive and sense circuit. For this purpose, separate input and output leads are better, since they permit integrated comparators to be used for sensing and simplify the conversion problem.

Another variation is a configuration with a larger ratio of refresh amplifiers to memory cells. This ratio would be increased, for example, if the 1,024-bit array were laid out as a 64-by-16 rectangle instead of a 32-by-32 square—logically, if not physically—with 64 refresh amplifiers instead of 32. With such an arrangement, a single refresh cycle would restore the data in more memory cells at once. This would reduce the percentage of cycles needed for refreshing and cut the amount of power dissipated in refreshing.

However, in applications where the addressing occurs in numerical sequence or in some other non-random sequence, the refresh control circuits may not be needed. Such applications would access each row of cells in the memory at least once in any 2-millisecond interval [see "No pause for refreshing," p. 72].

**Other factors**, of course, come into play when these variations are applied to memory products. For instance, TTL circuits operate at +5 volts to ground, so the conversion from TTL to MOS levels is usually simpler if the MOS circuits were operated with the nominal ground reference at +20 volts and the voltage supply at ground, instead of over the normal ground-to- -20 range.

Arrays such as this 1,024-bit chip and its variants are most useful as modules of larger memories. An example is a memory containing 4,096 eight-bit words, which can be made of 32 chips individually packaged and arranged as shown on page 72. To address a memory of this size, 12 address bits would be required. Ten of these bits, which would be connected to all 32 chips in par-

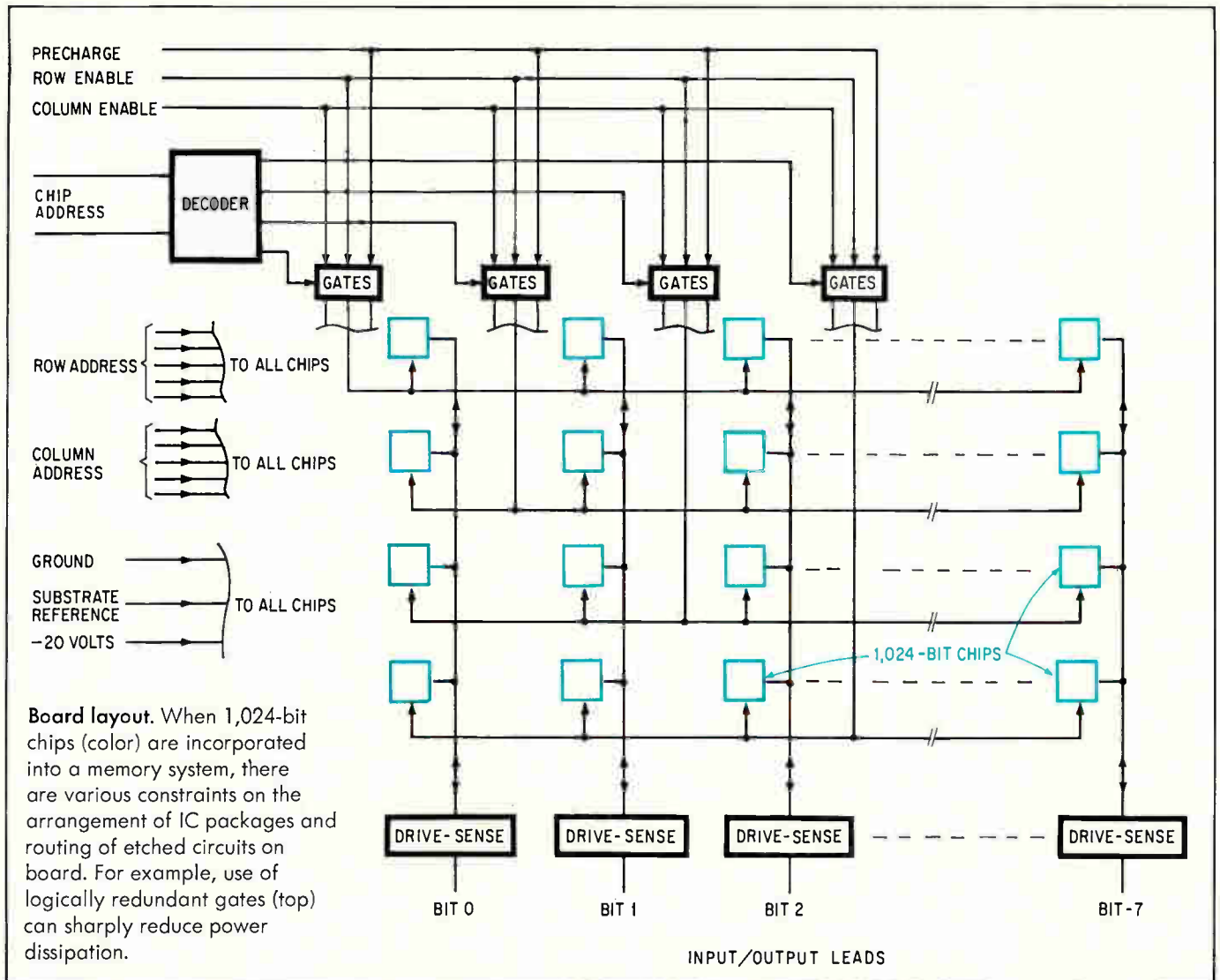

## No pause for refreshing

Although memories like those described by Dr. Hoff in the accompanying article are aimed primarily at the main frame memory market as substitutes for ferrite-core arrays, they have many other applications. For example, dynamic MOS random-access memories could be assembled into large-capacity storage units as backups for main frame memories; a serial shift-register memory of this magnitude already has been announced [*Electronics*, Feb. 16, p. 43]. Both mainframe and large-capacity units promise higher performance at lower costs than ferrite-core units.

But dynamic MOS circuits also have a unique suitability, adds Hoff, for "applications that involve addressing a memory either in numerical sequence or in some other nonrandom pattern, that accesses each row of cells at least once every refresh interval.

A memory for such an application might be able to dispense altogether with the refresh control circuits."

Consider those special-purpose computers that use the fast Fourier transform to analyze complex waveforms. This transform is based on a set of uniformly spaced samples of the waveform taken over a specified interval of time. A sequence of multiplications and additions is performed on these samples; the sums of the products represent the amplitudes of the waveform's various frequency components.

This procedure, when carried out directly, represents a computational effort that can nearly swamp even a large computer. However, the fast Fourier technique short-circuits the direct effort by combining the original samples into pairs, quadruples, octets, and so on, successively obtaining

Fourier coefficients that are better and better approximations of the original waveform.

This iterative procedure requires many fewer operations than does the straightforward approach; and it can, in fact, be hard-wired into a special-purpose computer that performs them in milliseconds. Several such computers have been built, for either experimental or commercial use, beginning with one at Bell Telephone Laboratories [*Electronics*, Sept. 4, 1967, p. 40; June 24, 1968, p. 92]. Characteristic of all such computers is the fact that each iteration is based on data that are obsolete as soon as the iteration is under way. Therefore the results of the iteration replace the original data in memory. But the iterations are completed in milliseconds, so that the data in a dynamic MOS memory need not be refreshed.

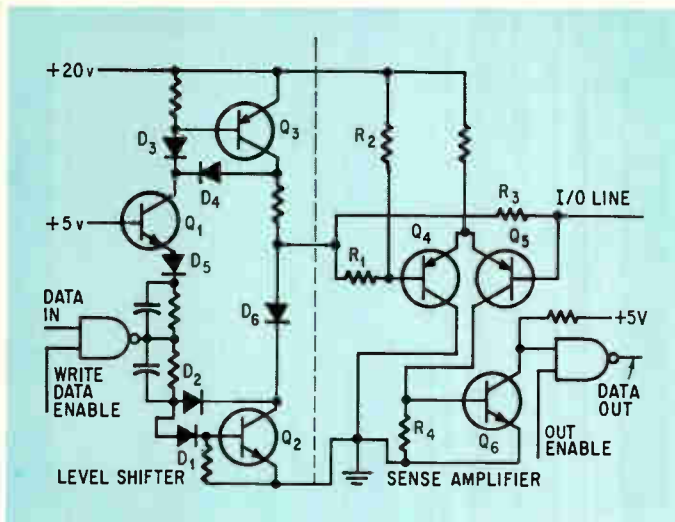

**Drive/sense circuit.**  
When a single input/output data line is used for a 1,024-bit array, this circuit translates from TTL to MOS levels when writing and senses the current output when reading.

allel, would address a specific row and column in every array to locate a specific memory cell in the same relative position on every chip. Thus these 10 bits would locate four eight-bit words made up of one bit on each chip. The other two address bits would select one of these four words.

In a system like the one shown on the preceding page, however, not only the 10 address leads but also three power leads—ground, substrate, and negative voltage—are common to all 32 chips. Each input/output lead is common to four chips of which only one is active at any given time, as determined by the two bits that address the chip.

Although the two enable lines and the precharge line are logically common to all 32 chips, they can be quadruplicated into four sets of three, each set common to only eight chips in a direction perpendicular to the input/output leads. Then each set can be gated with the two additional address bits, which have to be externally decoded anyway—there is no provision for them on the chip. Thus the row-enable line acquires a chip-select function in addition to its normal function, so that writing or reading can occur only on those chips whose row-enable lines have been activated. Consequently, a separate chip-select line is not needed. The additional gating costs little and, since most of the power is dissipated while charging capacitances during precharge and column-enable, it reduces the memory's total power dissipation.

Finally, if the memory is to interface with a TTL system, it needs some additional circuits. If the input and output lines are separated, only simple level shifts are necessary. However, if each chip has a common input/output line, a combination drive/sense amplifier would have to be used, incorporating the level-shifting function.

In a typical combination circuit, as shown above, transistors  $Q_1$ ,  $Q_2$ , and  $Q_3$  shift the lower voltage level of data signals coming in from bipolar TTL circuits to the +20-to-ground level that is required by the memory array. The diodes  $D_1$  through  $D_6$  provide two functions: they are used to prevent the transistors  $Q_2$  and  $Q_3$  from saturating and to properly bias the sense-amplifier portion of the circuit.

Transistors  $Q_4$  and  $Q_5$  form a difference amplifier. When resistor  $R_3$  carries no current, the base of  $Q_4$  is

biased slightly more positively than that of  $Q_5$ , so that  $Q_4$  is conducting and  $Q_5$  is cut off. But during a read operation, if the memory cell addressed contains a 0, there is a current coming into this circuit along the I/O line. This current then makes the base of  $Q_5$  more positive than  $Q_4$  so that  $Q_5$  turns on; the current through  $R_4$  causes  $Q_6$  to conduct and the input to the NAND gate to be low. If the memory cell contains a logic 1, there is no current; the base of transistor  $Q_5$  remains negative, transistor  $Q_6$  remains off, the NAND gate is conditioned, and the sampling pulse, output enable, emerges from it as a logic 1.

In this circuit the collector of  $Q_4$  is grounded, and it is toward this ground that the conditional-discharge current flows from the memory's refresh amplifier, which therefore must be biased to +20 volts. If the bias were not present, either the current would have to flow from ground to ground, which is obviously impossible; or a different drive/sense circuit would be necessary. Transistor  $Q_4$  keeps this ground from seriously affecting the level of the write-data line in the memory during this conditional discharge.

The juxtaposition of many chips in a single large memory creates another problem, fortunately easily solved. The data lines from the various chips to the sense circuits are likely to be rather long, because of unavoidable capacitive coupling, and may therefore pick up some unwanted transients. This makes it necessary to include a dummy sense line parallel to the data line; it would be connected to the base of  $Q_5$  in the combination drive/sense circuit shown, or similarly to a sense amplifier used with a chip that has separate input and output leads. Transients then appear on both lines, and the difference amplifier in the sense circuit rejects them because they are common-mode. Without this artifice, the transients may force a longer delay between the turning on of the column-enable and the output sampling. ●

#### Bibliography

- W.M. Regitz and J. Karp, "A Three-Transistor-Cell, 1,024-bit, 500-ns MOS RAM," Digest of Technical Papers, 1970 IEEE International Solid State Circuits Conference, p. 42.
- L.L. Vadasz, A.S. Grove, T.A. Rowe, and G.E. Moore, "Silicon Gate Technology," IEEE Spectrum, October, 1969, p. 28.
- Federico Faggin and Thomas Klein, "A faster generation of MOS devices with low thresholds is riding the crest of the new wave, silicon-gate IC's," Electronics, Sept. 29, 1969, p. 88.

# Designer's casebook

*Designer's casebook is a regular feature in Electronics. Readers are invited to submit novel circuit ideas and unusual solutions to design problems. Descriptions should be brief. We'll pay \$50 for each item published.*

## Storage coil cuts relay pull-in delay

By Joseph Gaon

JMR Electronics Corp., Bronx, N.Y.

Energy stored in a nearby coil will eliminate the electrical delay in the pull-in time of a magnetic relay or solenoid. The circuit operates an industrial control relay in only 5 milliseconds—the mechanical reaction time—compared with the normal 16 msec.

Opening the switch short circuits the relay. In this steady-state condition, transistor  $Q_1$  is off,  $Q_2$  is on, and current flows through inductor  $L_1$ .

Closing the switch turns  $Q_2$  off and  $Q_1$  on, causing the field in the inductor to collapse. The inductor generates a large voltage spike that is

integrated by the relay,  $L_2$ - $R_2$ . The current in the relay is a step function rather than an exponential buildup, as proven by the analysis of the equivalent circuit. So there is no electrical delay time required to build up the current through the relay coil.

Also, it can be seen that the applied voltage, 96 volts in this example, must be twice the nominal voltage of the relay. The inductor and the relay must have equal resistances and inductances, within normal tolerances.

Since the brunt is borne by the inductor, a relay identical to the operating relay may be used for  $L_1$  and  $R_1$ , if it can withstand twice the nominal coil voltage. The dummy relay's armature is jammed open so that  $L_1$  will equal  $L_2$  when the armature of the operating relay is unseated.

Optional diode  $D_1$  and resistor  $R_3$  may be added to guard against a collector-to-emitter breakdown of  $Q_1$ . However, adding the devices will cause a slight electrical delay.

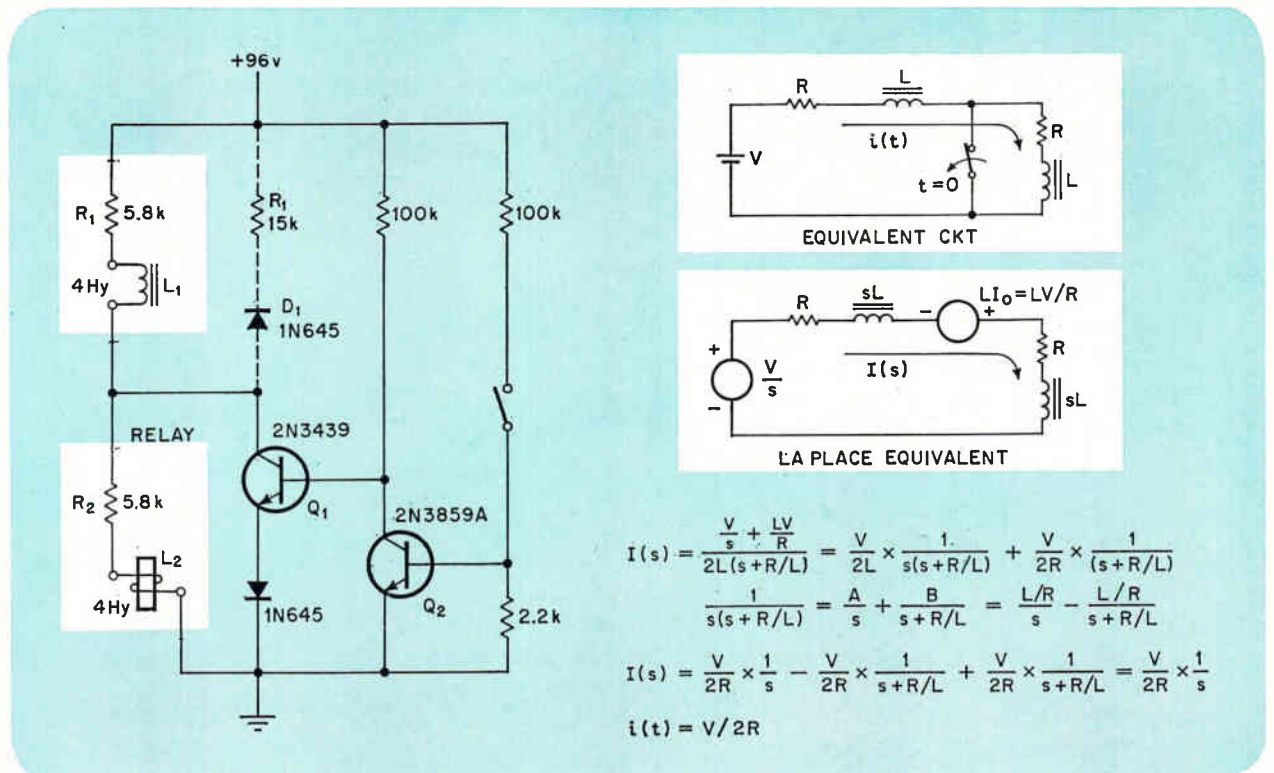

$$I(s) = \frac{\frac{V}{s} + \frac{LV}{R}}{2L(s+R/L)} = \frac{V}{2L} \times \frac{1}{s(s+R/L)} + \frac{V}{2R} \times \frac{1}{(s+R/L)}$$

$$\frac{1}{s(s+R/L)} = \frac{A}{s} + \frac{B}{s+R/L} = \frac{L/R}{s} - \frac{L/R}{s+R/L}$$

$$I(s) = \frac{V}{2R} \times \frac{1}{s} - \frac{V}{2R} \times \frac{1}{s+R/L} + \frac{V}{2R} \times \frac{1}{s+R/L} = \frac{V}{2R} \times \frac{1}{s}$$

$$i(t) = V/2R$$

**Big but fast.** Industrial control circuit gets set for fast relay operation by routing steady-state current through inductor  $L_1$  when relay is short-circuited by the switch. Closing the switch collapses the inductor field. The voltage impulse is rapidly integrated by the relay as a current step, eliminating the normal electrical delay.

# Wave squarer shifts phase as much as 360°

By Walter G. Jung

Forest Hill, Md.

A sine-wave to square-wave converter that's half linear and half digital produces pulse trains shifted in phase as much as 360° from the analog input. The circuit can't be saturated or overdriven, and the outputs remain at the integrated circuit logic levels of zero to 5 volts over a wide range of analog-signal amplitudes.

The input stage—a radio-frequency and intermediate-frequency amplifier (LM371)—operates as a comparator and level shifter and drives a Schmitt trigger built with half a quad NOR gate (LU380A). The trigger switching threshold is centered at 2 volts above ground.

Differential transistor pair, Q<sub>1</sub> and Q<sub>2</sub>, compare the analog signal with a d-c reference voltage. The amount of Q<sub>2</sub>'s collector voltage selected by the trigger bias potentiometer centers Q<sub>2</sub>'s output waveform in the trigger region. At small analog-signal amplitudes, the signal is amplified

linearly and the Schmitt trigger shapes the sine wave into complementary square waves.

If the input-signal amplitudes become large, Q<sub>1</sub> and Q<sub>2</sub> go into current-mode limiting. This results in a square pulse of current which provides an ideal drive for the Schmitt trigger. Furthermore, the differential pair limits the Schmitt input thus minimizing phase variations in the trigger level.

However, the good common-mode rejection of the differential amplifier allows the d-c reference level to Q<sub>2</sub> to be varied. Potentiometer R<sub>1</sub> varies the level, effectively moving the comparison point up and down the slope of the sine wave. The levels of the square-wave output can be made to correspond to the axis crossings of the sine wave or any other discrete point with this adjustment.

As a result, inputs to the Schmitt trigger are shifted in phase by ±90° with respect to the sine-wave input. As the trigger's outputs are complementary, one or the other will provide any amount of phase shift desired from 0° to 360°.

Pulses with fast rise times can be generated even at low frequencies thanks to the direct coupling and snap action of the digital Schmitt trigger. Its operation was described in applications memos published by the Signetics Corp.

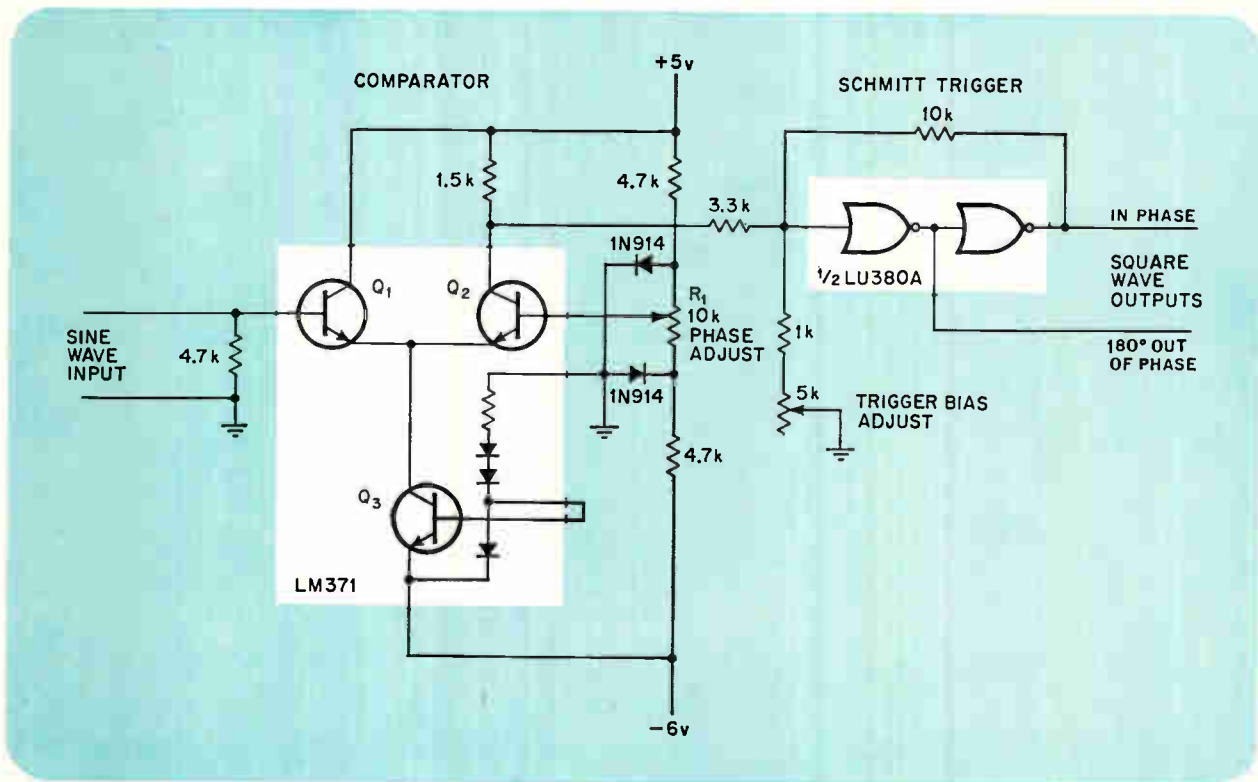

Shifty clipper. Besides limiting analog inputs to the trigger level, the comparator can be adjusted with R<sub>1</sub> to operate the trigger at any point on the sine-wave slope. Each complementary output can, in effect, be shifted ±90°, giving a total phase shift up to 360°. Output voltages are standard IC logic levels.

# Diode-switched FET's rectify the full wave

By Leonard Accardi,

Kollsman Instrument Corp., Elmhurst, N.Y.

Unlike diodes, field effect transistors won't distort a signal sent through a full-wave rectifier bridge. Also, the FET bridge is controlled by an integrated circuit comparator, eliminating the usual transformer.

A conventional diode full-wave rectifier distorts output at low voltage due to the diodes' cut-in voltages. But with the FET's zero offset voltage, output closely follows or inverts each half of the sine-wave input signal.

The four diodes in the complete circuit do not rectify the signal. Instead, depending on whether the signal voltage is positive or negative, they switch the pairs of n-channel and p-channel FET's. The resistors connected across the gate and source of each FET insure that the gate-to-source capacitance discharges when the comparator voltage switches. Comparator  $A_1$  is referenced to ground and biased such that the positive and negative switching voltages are always greater than the maximum signal voltage and the pinch-off voltage

of the field effect transistors.

When a positive signal is applied, the comparator's +15 volts output reverse-biases diodes  $D_1$  and  $D_3$ . This allows the n-channel FET's,  $Q_1$  and  $Q_3$ , to turn on because their gates now float. However, the p-channel FET's  $Q_2$  and  $Q_4$ , are held off because the forward-biased diodes  $D_2$  and  $D_4$  allow their gate voltage to go positive with respect to their sources. The positive portion of the input signal is conducted through  $Q_1$ , the load  $R_L$ , and  $Q_3$  to ground.

The process is simply reversed for a negative input signal. The n-channel FET's,  $Q_1$  and  $Q_3$ , are turned off and the current through the load  $R_L$  flows through  $Q_2$  and  $Q_4$ .

Since the load current,  $I_L$ , always flows in the same direction, full-wave rectification is provided. The input signal voltage is impressed across the load resistor and whichever pair of FET's are conducting. How much of the input signal appears across the load resistor depends on the ratio of  $R_L$  and the ON resistances of the FET's. Since the FET's are switched directly by a square wave at some large input voltage, spikes resulting from capacitance feedthrough in the FET's parasitic capacitance would be seen in the output, if the circuit weren't driven from a low-impedance source—less than several hundred ohms. Also, using FET's with very low input capacitance would reduce the amount of switching voltage coupled into the load.

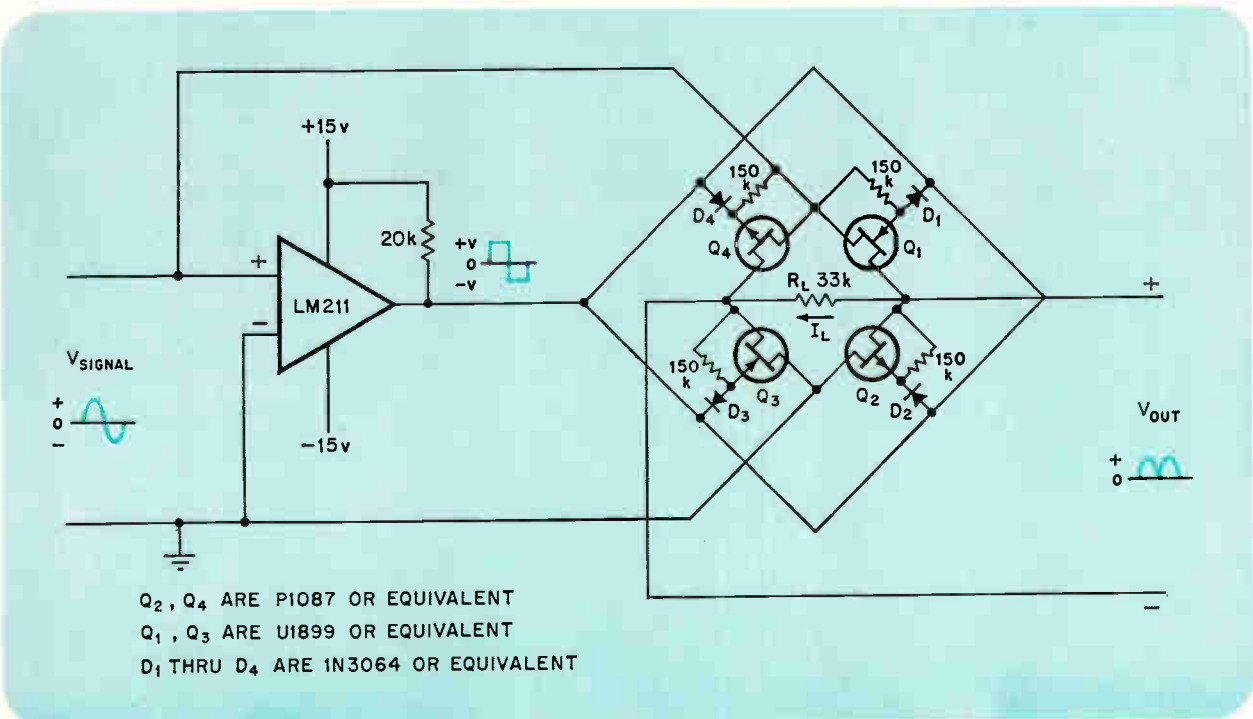

No distortion. Full-wave rectifier design demotes bridge diodes to secondary role of switching the field effect transistor. FET's  $Q_1$  and  $Q_3$  conduct the positive half of the input signal, and  $Q_2$  and  $Q_4$  conduct the negative half. Since the FET's have no offset voltage, they do not distort the output.

# 50 MHz/2mV. No drift. No DC balance.

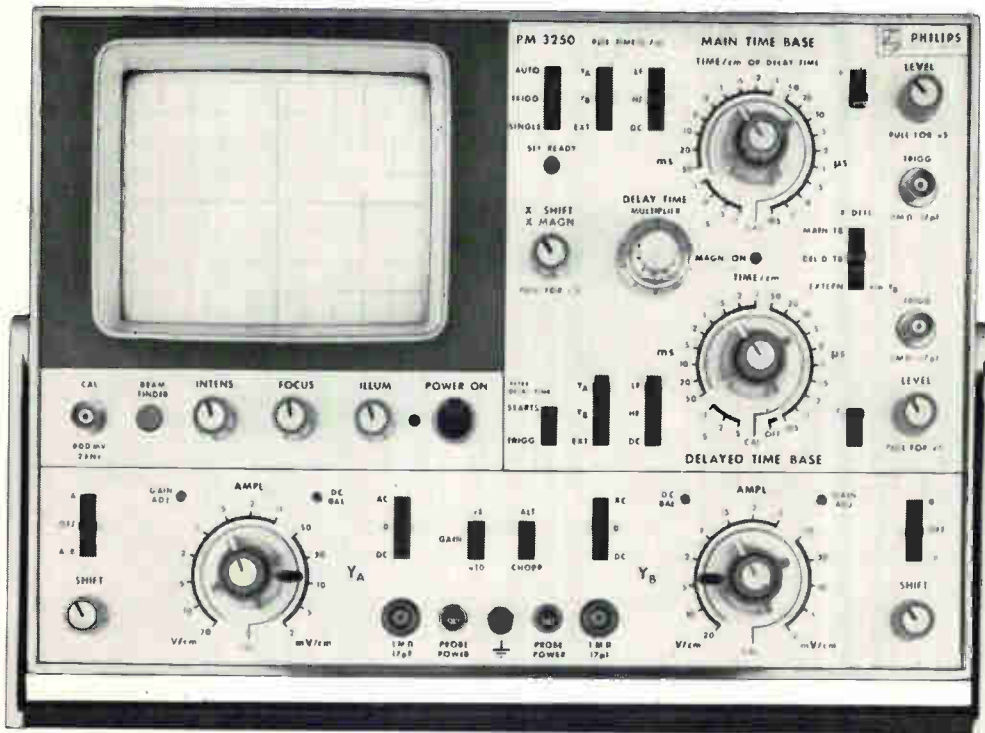

PM 3250  
50 MHz: 2mV  
Dual Trace  
\$1995

More of the Unbeatable  
Philips Scopes

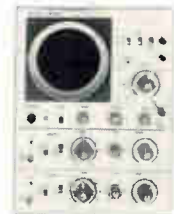

PM 3231  
15 MHz: 10mV  
Dual Beam  
Delay Lines  
\$975



PM 3200  
10MHz  
2mV/div  
\$480

Where wide bandwidth and/or high sensitivity are required, PM 3250 fits the bill. 50 MHz at 2mV/cm or 5 MHz at 200 $\mu$  V/cm.

No drift — We've eliminated it by a solid state chopper compensation network.

No dc balance — We've eliminated that too. As well as a number of formerly significant knobs.

Unique? How about PM 3250's ability to display a differential signal (A-B) and the original signal simultaneously. Or, how about a simple rearrangement of the conventional switching circuit so that

the dc positioning range is 160 divisions for x10 sensitivity gain.

Versatile? Other features include a delay line in the vertical channel which lets you see leading edges properly with high speed sweep circuitry. Only 35 ns is lost from a total delay of 65 ns which minimizes signal distortion.

Also, there's a specially designed front panel which simplifies complex operation.

So, if your requirement is for a wide bandwidth/high sensitivity scope, fill it with our PM 3250.

**PHILIPS  
ELECTRONIC  
INSTRUMENTS**

750 S. FULTON AVE., MT. VERNON, N.Y. 10550  
A DIVISION OF PEPI, INC.

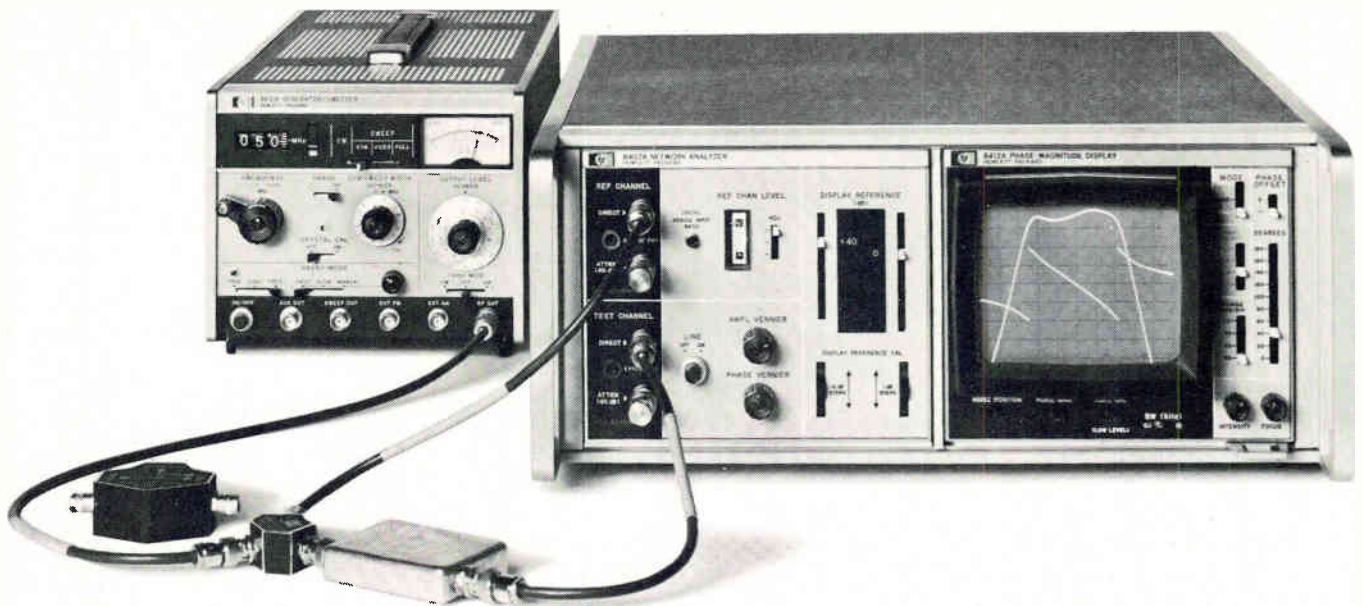

# For swept RF measurements of both magnitude and phase, try this test lab.

HP's 8407A Network Analyzer makes quick RF measurements, 100 kHz to 110 MHz with ease, accuracy and thoroughness. Inadequacies of alternate techniques have been eliminated and swept measurements over a wide dynamic range are now possible.

We're talking about full characterization — both magnitude and phase — of filters, amplifiers, attenuators, transistors, antennas, and any other RF component, device or network you can name. And you can check them at any stage of design, development or production.

The system consists of:

- 8601A Generator/Sweeper, a precision swept source, 0.1 to 110 MHz, with flat output, highly linear sweep and low residual FM.
- 8407A Network Analyzer mainframe with 8412A Phase-Magnitude Display unit for CRT presentation of test results.
- Accessory coax devices and probes to monitor the unknown's responses to the swept test signal.

For coaxial work: 11652A Reflection-Transmission Kit with all the accessories you'll need: precision power

splitter, high directivity flat coupler, termination and matched cables. Just hook up — make high accuracy swept measurements of complex transmission and reflection coefficients simply and quickly. For circuit work: 11654A Passive Probe Kit with high impedance voltage probes and dividers plus current probes. You can measure circuit and device performance without disturbing their behavior. And using voltage and current probes simultaneously, you can make swept impedance measurements with 10,000:1 dynamic range.

Dynamic measurement range is greater than 100 dB, and you can see 80 dB in one viewing of the 8412's CRT. And you can see phase response at the same time with 360° phase range. The system also provides 0.05 dB magnitude and 0.2° phase resolution.

The 8407A is a narrow-band detector that tracks the sweeping test signal; tracking provides these unique benefits:

1. Wide dynamic range *and* high sensitivity — make high-gain/high-loss measurements on sensitive networks and devices.
2. Accurate measurements — free from errors encountered in broadband detec-

tion methods resulting from harmonics and other spurious signals.

The 8407A RF mainframe costs \$2950; 8412A Display, \$1575; 11652A Reflection-Transmission kit (for coax), \$325; 11654A Passive Probe kit, \$325; 8601A Generator/Sweeper (general purpose precision swept source, useful for many applications), \$2250.

You can get the full story by phoning your local HP engineer and asking for a demonstration. He'll also be glad to give you Application Note 121-1, a comprehensive description of what this system can do for you; plus Application Note 121-2 which describes how to make wide dynamic range impedance measurements on a swept-frequency basis. Or write to Hewlett-Packard, Palo Alto, California 94304; Europe: 1217 Meyrin-Geneva, Switzerland.

04016R

**HEWLETT  PACKARD**  
NETWORK ANALYZERS



# N- or p-channel MOS: Take your pick...

...but not before you've carefully weighed such interrelated factors as chip area, threshold voltage, noise immunity, and power supplies

By David Maitland  
Hewlett-Packard Calculator division, Loveland, Colo.

● With n-channel metal oxide semiconductor IC's finally being produced in significant quantities, it's possible to make realistic comparisons between them and p-channel MOS devices. It's generally believed that n-channel units are faster than the p-channel devices, and are easier to interface with bipolar transistor-transistor-logic circuits. But any comparison of n-channel and p-channel MOS involves far more than just speed and interfacing. Other factors—threshold voltage, chip area, noise immunity, and power, for example—also merit consideration.

The major difference, from the designer's point of view, between n-channel and p-channel devices is the threshold voltage,  $V_T$ . Typically,  $V_T$  is between +0.25 volt and +1 volt for n-channel units, and between -2 volts and -4 volts for p-channel circuits.

Which is more advantageous to use? A good criterion is the chip area as a function of threshold voltage. This is important because the chip yield increases as more circuitry is packed into smaller chip areas. For comparison, a figure of merit,  $\beta_r$ , can be defined as the ratio of width/length of a driver transistor to the width/length ratio of a load transistor. Since the chip area is proportional to the W/L ratio of both driver and load transistor, the ratio  $\beta_r$ , is also proportional to the chip area. A typical inverter circuit shows how  $V_T$  is related to  $\beta_r$  with the gate of the driver of the inverter at logical 1,

$\beta_r$  must be selected so that the output of the inverter is at logical 0. The proper value of  $\beta_r$  insures that the voltage level corresponding to a logical 0 is below the threshold of the next stage.

If typical operating values are assigned to the inverter circuit, it can be shown that p channel has the edge in threshold voltage. As an example, let the gate supply voltage  $V_{GG}$  be +10 volts for the n channel device and -20 volts for the p channel, and let the respective values for the drain supply voltage  $V_{DD}$  be +5 volts and -10 volts. The output voltage for a logical 0 is  $V_T - 0.50$  volt and a 1 is  $0.80 V_{DD}$  in either case. Then  $\beta_r$  is a minimum at +2 volts in the n-channel FET, and at -3.75 volts in the p-channel, as shown below.

Unfortunately, for the n-channel transistor, the value of  $\beta_r$  required for a minimum chip area corresponds to a  $V_T$  outside the range that can be achieved conveniently by the n-channel fabrication process. However, the minimum chip area for a p-channel device is easily achieved, since the required  $V_T$  is easily obtained.

There are three ways to circumvent this problem in n-channel IC's: Reduce the  $V_{DD}$  supply voltage; increase oxide thickness to raise the threshold voltage, or use a so-called back gate bias. However, the first two techniques involve objectionable side effects.

Reducing  $V_{DD}$  will shift the n-channel curve in the graph that's plotted below, but it will also degrade

**Relative area.** For typical inverter circuit and logic levels, the relative areas of driver and load transistors,  $\beta_r$ , drop to a minimum within the usual range of threshold voltages of p-channel transistors. However, the minimum  $\beta_r$  is outside the usual n-channel threshold voltage range.

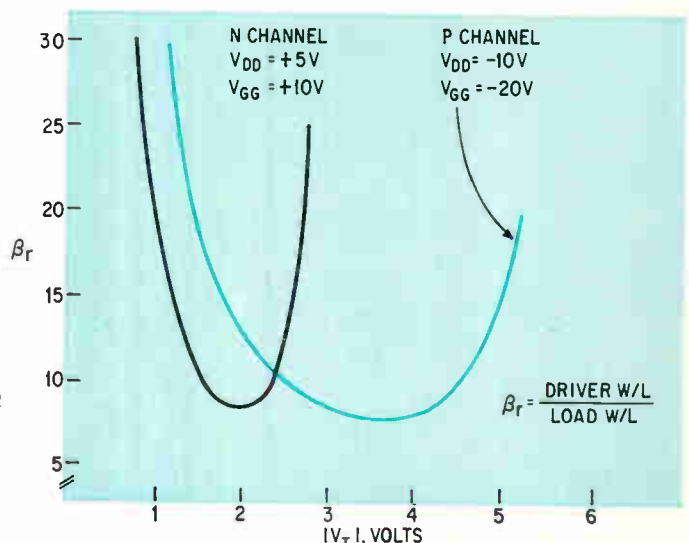
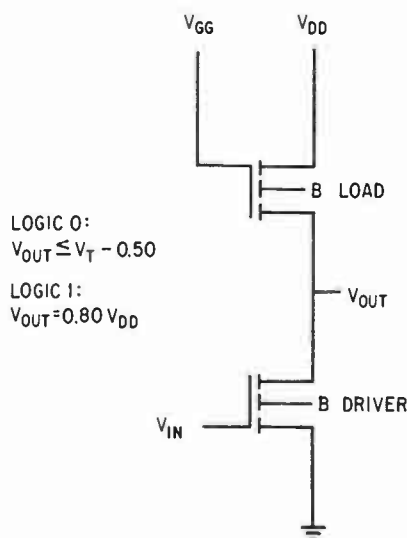

the circuit's noise immunity because the difference between the 0 and 1 levels is now less. Also, a less-than-5-volt  $V_{DD}$  is nonstandard, and therefore tends to make the system more complex.

A thicker gate oxide on the n-channel transistor would increase the threshold voltage, but it would also adversely affect the transconductance of the device,  $g_m$ . Transconductance is inversely proportional to the oxide thickness  $t_{ox}$  and directly proportional to carrier mobility  $\mu$ ; that is,  $g_m \propto \mu/t_{ox}$ . One of the major advantages of the n-channel MOS transistor is that its  $g_m$  is higher than that of an equivalent p-channel device because the mobility of electrons in an n-channel device is two to three times higher than that of holes in the p-channel device. But if the oxide were two to three times thicker to provide the correct threshold voltage for a minimum  $\beta_T$ , the higher mobility of the n channel would be offset by its higher  $g_m$ .

Furthermore, though a thicker oxide would provide a benefit in the form of reduced gate capacitance, it also increases the on resistance of the transistor sufficiently to offset any decrease in capacitance. Thus, the RC time constant remains nearly the same.

All in all, increasing threshold voltage via the back gate bias technique clearly is the most advantageous. The back gate bias voltage,  $V_{BG}$ , biases the silicon substrate of the IC more negatively than the source elec-

trodes on the transistors, which are connected to circuit ground.

For a given gate oxide thickness, the variation of threshold voltage with back gate bias largely depends on the dopant concentration of the substrate, as shown below. A lightly doped substrate in combination with a large value of  $V_{BG}$  yields the best circuit operation: light doping has the effect of making the threshold voltage change slowly with  $V_{BG}$ , and a high value of  $V_{BG}$  assures that the IC is operated on the portion of the curve where the already low rate of change is at its lowest. A large value of back gate bias voltage results in a lower depletion capacitance. This is because the operating levels that now correspond to a logic 0 and a logic 1 are much higher, even though the voltage difference between these levels remains the same.

Use of a lightly doped IC substrate also minimizes the effect of unintentional changes in the back gate bias on the load transistor in an inverter. Otherwise, these changes would tend to slow down load switching. To understand this effect, consider the circuit shown on page 79. In this circuit, as the voltage on the source of the load device pulls away from ground during switching, the back gate bias increases because the voltage between source and substrate increases. As a result, the  $V_{BG}$ -dependent threshold voltage increases, thus increasing the channel resistance of the load resistance. This causes the RC time constant to rise and thus impedes load charging. But with a lightly doped substrate, the effect is minimal; the threshold voltage changes only slightly with back gate bias and the load therefore behaves in more nearly linear fashion and imposes shorter rise time.

One of the biggest benefits of the back gate bias technique is flexibility: it allows threshold voltage to be controlled independently of other circuit parameters. For example, the lightly doped substrate can be combined with a thicker gate oxide to reduce both gate oxide capacitance and depletion capacitance of the source and drain. (This will change  $V_T$ , too, but the back gate bias can still be adjusted to give the desired  $V_T$  value.) Although the thicker gate oxide decreases the gate capacitance, the oxide also increases the on resistance of the transistor. However, the lighter doped substrate, because it requires a higher back gate bias voltage, offers a lower depletion capacitance without a

**Doping.** Rate of change of threshold voltage with back gate bias is considerably less for silicon substrates with low dopant concentration. Here,  $n$  represents the number of dopant atoms per cubic centimeter and  $n_1$  is greater than  $n_2$ .

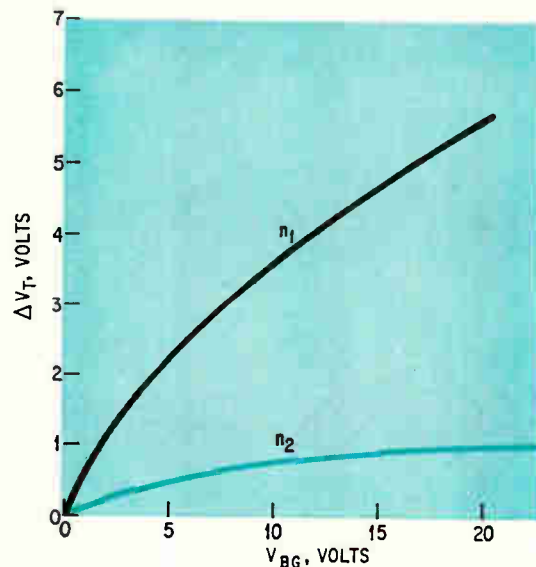

change in transconductance. It is this flexibility that makes it possible to decrease both the RC time constant and the device's power requirements. Thus the speed-power product of an n-channel unit can be lower than that of a p-channel IC.

To be sure, there are disadvantages to back gate biasing with which the circuit designer must contend. For one, the substrate no longer can be used as a ground bus. Additional metal interconnection must be deposited on the surface of the chip, using up valuable real estate. This disadvantage is not as great as it might seem—it's easier to assure a good ohmic contact between metal and substrate on the p-type material used for n-channel IC's than on the n-type material used for p-channel devices. In the latter, the material must be converted to  $n^+$  type by diffusion wherever metal is to be deposited.

Another disadvantage: an extra power supply is needed. A p-channel IC requires supplies for ground,  $V_{DD}$ , and  $V_{GG}$ , whereas a back gate biased n-channel circuit needs  $-1$  to  $-5$  volts for  $V_{BG}$ .

From the processing point of view there are also disadvantages: the source-to-drain breakdown voltage is less for a lightly doped substrate. Also, the threshold of the parasitic transistors now comes much closer to the threshold of the other MOS transistors.

For interfacing MOS IC's with bipolar circuits—usually TTL IC's—differences between p channel and n channel depend on whether the bipolar circuit is at the input or the output of the MOS IC. For input interface, both n-channel and p-channel circuits require a pull-up resistor with the typical supply voltages and logic levels, as shown above, and both have about the same  $\beta_r$  ratio for the input stage. So far, there's little to choose between n channel and p channel. However, the p-channel circuit pulls the output of the TTL circuit to a more positive level than the 5.5 volts at which TTL is rated. Depending on the manufacturer, some TTL IC's will break down under this condition and others won't. The problem doesn't arise in n channels.

With a TTL circuit at the output, as shown on page 82, the differences between p channel and n channel are more significant. The most obvious is power consumption. Because the n-channel output stage can sink the TTL current, no pull-up resistor is needed and power is dissipated only when the MOS output device is on.

### P channel vs. n channel: the score card

Performance characteristic	Figure of merit	
	p channel	n channel
Threshold:		
Static	3	1
Dynamic	1	4
Noise immunity	2	1
Speed	1	3
Ground bus	1	1
Power supplies	1.33	1
Input interface	1	2
Output interface:		
Power	1	50
Size	2	1
Speed power	1	3
Power	1	4

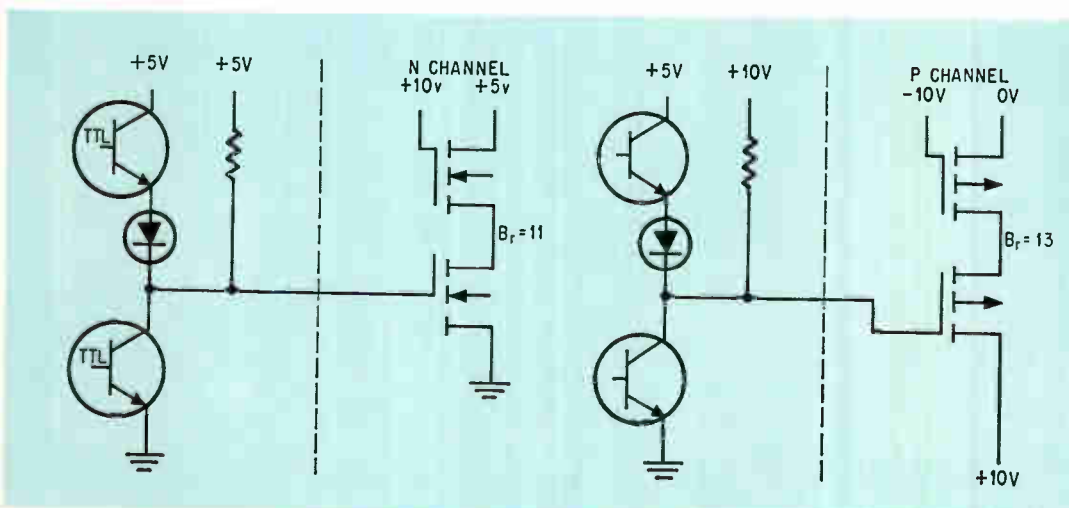

**Input interface.** When a TTL signal is applied to an MOS IC, the  $\beta_r$  ratio is about the same for both p channel and n channel. A pull-up resistor is needed in either case.

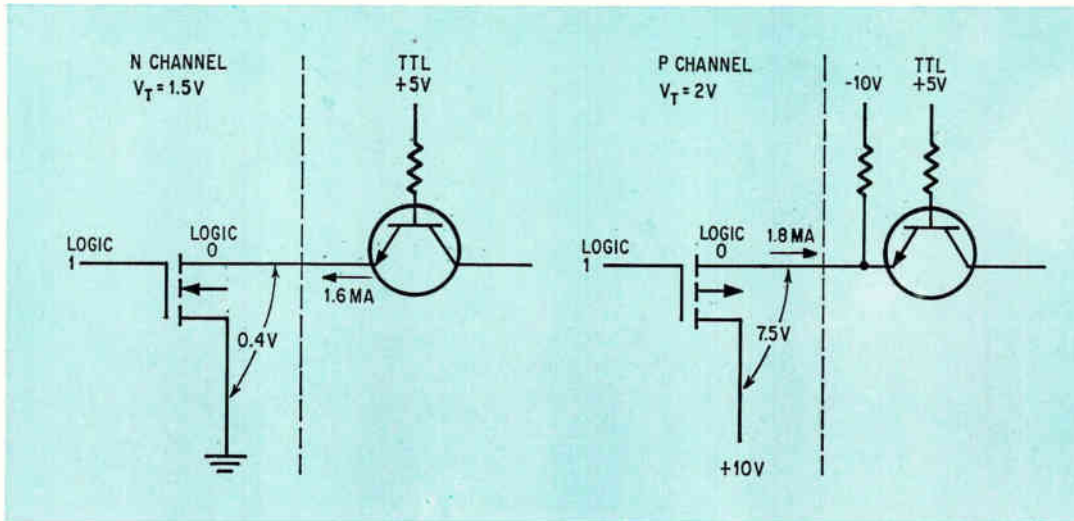

**Output interface.** When an MOS signal is applied to a TTL IC, the n-channel circuit doesn't need a pull-up resistor. Because of this, and because the voltage across the device is lower, it dissipates much less power than the p-channel output circuit.

But for the p channel, power is always dissipated—current, either in the pull-up resistor or in the MOS output device. The total power dissipation for the typical interfaces shown in the diagram is 50 times greater for p channel than for n channel.

P channel MOS has the edge, however, in the chip area—in fact, the area of the p-channel output driver is one-half that of the n-channel device. The reason: In the on state there is only 0.4 volt between drain and source of the n-channel output device; this means that the device to meet the worst case TTL requirements of 1.6 milliamperes sinking current must have a low on resistance of 250 ohms. The p-channel output transistor, on the other hand, has 7.5 volts across the drain to source while sinking 1.8 ma. This means its on resistance is about 4 kilohms. The higher on resistance of the p-channel output driver more than offsets the mobility advantage of the n-channel driver.

Aside from power consumption in output stages, power used in the inner portions of the circuit offers some interesting comparisons. For the basic inverter circuit shown on page 79, typical operating voltages are  $V_{GG} = -20$ ,  $V_{DD} = -10$ , and  $V_T = 2$  for p channel; and  $V_{GG} = 10$ ,  $V_{DD} = 5$ , and  $V_T = 1.5$  for n channel. For these voltages, and for identical rise times and equal capacitive loads, the power dissipated in the inverter is 4.75 times greater for p-channel devices than for n-channel units. It follows, because the p-channel power supply voltages are twice those of n channel.

All comparisons thus far apply to the widely used resistance-ratio type of MOS circuit. Here, ratio of the resistances of the driver and load transistors is selected to give the required binary 0 voltage level. But ratioless circuits are becoming increasingly popular, particularly in high-speed dynamic multiphase-clock MOS memories [*Electronics*, Feb. 17, 1969, p. 106] and some of the conclusions regarding the relative merits of p channel and n channel must be re-evaluated.

In a ratioless circuit, since the logic 0 level isn't a function of the relative resistance of load and driver, the  $\beta_r$  ratio no longer is significant. For n channel this means that threshold voltage can be in the 0.25-to-1-volt range where it naturally tends to fall. This lower  $V_T$  is particularly advantageous in ratioless circuits because the clock and logic voltages are functions of  $V_T$ . Thus, the lower the  $V_T$ , the lower the clock and power supply

voltages. In addition, ratioless n-channel circuits conserve chip area: for a given logic 1 level on the gate of an MOS output transistor, the width-to-length ratio of that transistor declines with smaller threshold voltages. Finally, a back gate bias voltage isn't needed to adjust the threshold voltage in ratioless n-channel IC's, so the substrate can be used as a ground bus and the extra  $V_{BG}$  power supply is eliminated.

It's evident that the many comparison points between n channel and p channel are closely interrelated. The table shown on page 81 gives figures of merit for the various factors that should help to put the relationships in perspective. The figures of merit are somewhat arbitrary, naturally, and depend on the particular system. The ratings were based on the following rationale:

- ▶ **Threshold.** In static (ratio) circuits,  $\beta_r$  is three times larger for n channel with 1-volt threshold than for p channel with 3-volt threshold. In dynamic (ratioless) circuits, low thresholds are easy to obtain in n channel without back gate biasing. This permits using lower-voltage supplies, and the substrate as a ground bus.
- ▶ **Noise immunity.** Since threshold is higher in p-channel circuits, they are less affected by a given noise level at both input and output.
- ▶ **Speed.** The 3-to-1 speed advantage of n channel is based solely on the theoretical 3-to-1 difference in mobility of n-channel and p-channel carriers.
- ▶ **Ground busing.** P channel has no extra advantage because it requires extra area for an  $n^+$  diffusion to ensure a good ohmic contact.
- ▶ **Power supplies.** The figure of merit corresponds to the number of power supplies needed for each type.
- ▶ **Interface.** The input interface favors n channel because it does not pull TTL beyond its rated 5.5 volts. The output interface is viewed from the standpoints of power and size. The size of the output driver favors p channel, but this should be weighed against total chip area. Moreover, interface power, which is 50 times less for n channel, should be weighed against total chip power.
- ▶ **Speed power.** The favorable status of n channel here is because the n-channel capacitance can be decreased at the expense of decreasing  $g_m$ . Thus, although the RC time constant stays the same, the power is less.
- ▶ **Power.** Since power dissipation varies with the square of the voltage, chips with 10-volt supplies dissipate considerably more than those with 5-volt supplies. ●

# Signetics throws design costs for a loop.

Again.

A short time back, we introduced the phase locked loop. Or, to be technical, the monolithic phase locked signal conditioner and demodulator.

Now we've gone ourselves two better.

First, with the PLL 562. This is our phase locked loop with the loop opened. It gives the designer access to the innards of the system. It also allows him to hook up the PLL to other standard parts like our 8200 series MSI. And this enables the PLL to do things like frequency multiplication and division. (If you ask us, the PLL 562's major uses will be in frequency synthesis and synchronizing data off tape and drum memories.)

Second, our low-cost PLL 565. This is a brand new design, again with the loop opened. It provides a reference on the output and operates from common power supply voltages. That's why the PLL 565 can drastically simplify modem designs.

Most important: you get the savings and benefits inherent in broader application of the PLL technique.

As we've said before, the PLL concept has many possibilities. It will be the universal building block that the op amp has become.

Our new phase locked loop devices are

available now from Signetics and Signetics distributors. Nowhere else.

In 100-up quantities, the PLL 562 goes for \$18; the PLL 565 for \$6.35.

Build yourself a better whatever. Cheaper. Write for a complete description of performance, applications and spec sheets. Be two up on everyone.

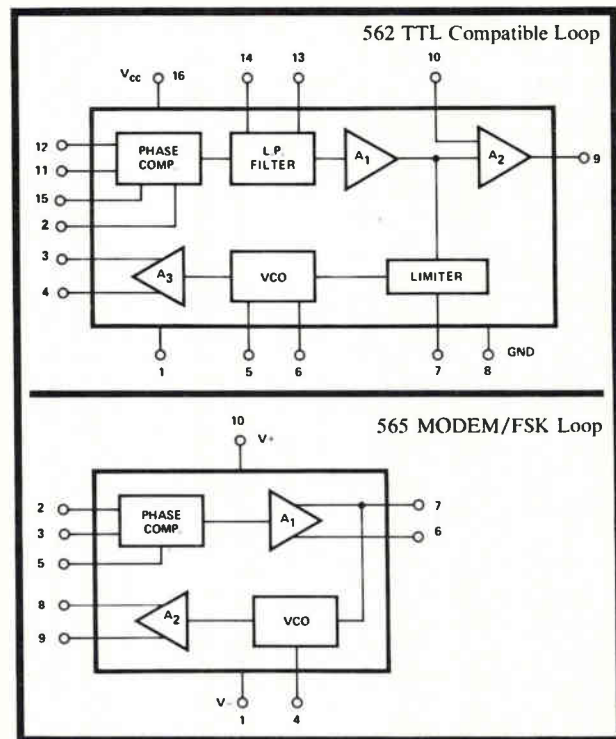

# Signetics

Signetics Corporation / 811 E. Arques Ave., Sunnyvale, California 94086 / A subsidiary of Corning Glass Works

# The new PDP-8/e: Its own mother wouldn't know it.



The PDP-8/e is a radical departure in computer design. There's no back panel wiring — everything plugs into the OMNIBUS™, even the CPU. In any order. It's completely flexible; you buy only what you need. And if you need more later, just buy it and plug it in. And the PDP-8/e is easier to interface and easier to maintain than old-style computers. We've made a few other changes. Easier programming. 1.2  $\mu$  sec memory cycle time. Added instructions. 256 words of read-only memory. 256 words of read/write memory.

Yet there's no generation gap between the PDP-8/e and the rest of the PDP-8 family computers in 7500 world-wide installations. They all use the same peripherals (over 60 of them). They're all program and interface compatible, they all have extensive applications and documentation. PDP-8/e was born with a silver software package in its mouth.

The basic 4K machine sells for less than \$5000. With teletype, less than \$6500. Quantity discounts available.

**digital**  
COMPUTERS • MODULES

Digital Equipment Corporation  
Maynard, Mass. 01754 (617) 897-5111

# 1970: a down year for the industry

Led by depressed military sector, electronics industry is trimming early projections for modest growth; overseas sales are bright spot

**A lean year is** upon the electronics industry despite earlier predictions that 1970 would see a modest sales increase. *Electronics'* annual market survey in January had projected a net gain of 3.4% for the year, but sales have been lagging, and prospects for a pickup are dim. However, the Electronics Index of Activity for June [see p. 31] shows an increase of 5.3 index points over May, including a 16.7-point rise for consumer electronics and a 5.1-point jump in the defense area.

Hardest hit is the defense electronics sector, which accounted for nearly \$10.5 billion in fiscal 1970, and is expected to slip to \$9.8 billion in fiscal 1971, according to Department of Defense figures. The last fat year was fiscal 1969's peak of \$11.1 billion.

On the consumer front, television sales are down even further from last year's low volume. However, manufacturers are eyeing declining dealer inventories and cautiously predicting a seasonal upturn during the fall.

And even the usually prosperous semiconductor industry expects little if any increase in sales. In fact, some companies are anticipating a small decrease.

In several sectors of the industry, the only hope for 1970 is that strong overseas sales will balance out the sagging domestic situation. At Hewlett-Packard, for example, overseas business jumped 31% during the first half of 1970 while domestic orders dropped 6%.

**Squeezed.** Complaining about defense cutbacks, a chief engineer at a major East Coast aerospace firm says, "I thought the widespread obsolescence of our weapons systems would force the Govern-

ment into a batch of major purchases. But funded programs, like AWACS, are being stretched out and stripped down to the bone. R&D money has all but dried up, inflation is hurting us, and we can barely afford the few internal programs we have."

At Philco-Ford's WDL division in Palo Alto, Calif., Edward Miller, director of the space system operation, notes that "the jobs are smaller and the time interval between them is longer—both time and money have increased for a job, so we are being more cautious about what we go into."

If the war ends before the next Presidential election, future defense budgets could slip to about \$50 billion a year. And for the fiscal year beginning July 1, 1971, Defense Secretary Melvin Laird already has indicated another \$5 billion spending slash.

Fighting for survival, several military-aerospace companies are setting up subsidiaries to focus on promising markets, such as environmental and atmospheric monitoring and telemetry systems, and law enforcement. Examples are General Dynamics' Dynatronics, Litton's Environmental Systems Group, Westinghouse's Security Systems subsidiary, Motorola's Applied Systems unit, and TRW's Resources Research Inc.

Also hit by the military-aerospace pinch—and by a declining auto market—are sales of numerically controlled machine tools. Norman Caban, manager of marketing and sales for Westinghouse's numerical control product line, says he "won't be a bit surprised" if an early forecast of \$120 million in sales is halved to an actual \$60 million.

But other industrial control areas

For comparison with earlier 1970 projections, see *Electronics*, Jan. 5, p. 101.

Selected components markets	In millions of dollars by halves		
	1st	2nd	Total
Resistors, fixed	104.0	106.0	210.0
Potentiometers	78.5	84.3	162.8
Capacitors, electrolytic	94.6	97.0	191.6
Capacitors, other	122.0	129.2	251.2
Tubes, receiving	76.0	82.4	158.4
Tubes, picture crt, b&w	32.7	47.0	79.7
Tubes, picture crt, color	342.0	410.0	752.0
Transistors, silicon	153.5	156.0	309.5
Transistors, germanium	34.7	31.0	65.7
Diodes, silicon	54.2	54.0	108.2
Diodes, germanium	10.3	9.0	19.3
Thyristors (SCRs, triacs)	32.8	34.7	67.5
Digital integrated circuits, monolithic	189.0	192.0	381.0
Linear integrated circuits, monolithic	44.2	47.5	91.7
ICs, thick film, hybrid	36.3	38.0	74.3

are coming up roses. Honeywell's Computer Control division, Framingham, Mass., finds itself "well ahead of the half-year plan" for sales of minicomputer-based data acquisition and control systems, asserts John Hoag, product manager for industrial control systems. Petrochemical and paper plants are continuing to buy their share of systems, Hoag notes. So are the electronic utilities, adds a General Electric spokesman.

At the instrument houses, the mood is bleak, with overseas sales the only cheery note. Edward Herman, president of Rental Electronics Inc., characterizes 1970 as "a miserable year" for instrument makers. From his vantage point as a big customer, Herman says "The second-quarter reports of some of the majors are going to be eye-openers. Sales are off anywhere from 10% to 40%." Another insider adds, "At some companies they think they shot the mailman—it's been that long since an order came in."

**Holding pattern.** In the semiconductor industry export sales and monolithic digital ICs, particularly MOS types, are compensating for discretes and linear market turndowns.

General Instrument reports MOS IC sales have more than doubled for the first half of the year. Random access memories, read-only units, and shift registers are the fastest movers, says Rein Narma, vice president and general manager of the semiconductor products group.

And at National Semiconductor Corp., Floyd Kvamme, microcircuits product manager, says the market for transistor-transistor logic ICs has dropped slightly, but diode-transistor logic is "right on target."

However, the overall outlook in semiconductors is gloomy. Says Stephen Levy, vice president and general manager of Motorola Semiconductor Products Inc., Phoenix, "We don't expect to see any growth now; instead we see a slight decline. I'd now guess sales will be off about 2% to 4% from 1969." He sees no indications that the market will start recovering this year.

Texas Instruments reports an expected 17% increase in monolithic IC sales over 1969 and sees

Selected consumer electronics markets	In millions of dollars by halves		
	1st	2nd	Total
Television receivers, b&w	185.0	260.0	445.0
Television receivers, color	850.0	1,050.0	1,900.0
Home & portable radios	90.0	115.0	205.0
Auto radios	144.0	160.0	304.0

gains in both digital and linear types with the largest percentage hikes in MOS.

Fairchild Semiconductor doesn't expect overall sales to grow in 1970; in fact, it says sales could even dip a bit.

Discretes are taking a beating throughout the industry, largely because of the depressed consumer market. Power transistors appear to be the only cause for mild rejoicing. The reason, says William C. Hittinger, vice president and general manager of RCA's solid state division, is a healthy market in Europe.

In the components market, biggest falloffs are in military and space products—high-reliability resistors, for example. But IC sockets, operational amplifiers, and analog-to-digital and digital-to-analog converters are growth areas, largely due to increased use of lower-cost ICs.

An additional lift could come from the consumer end if television sales do, in fact, pick up. Art Schnipper Jr., manager of the consumer products division of Motorola, feels the worst is over. "Dealers were cautious about increasing their inventories after the 1969 slumps and concentrated on getting rid of what they had. Now their inventories are in good shape and they're beginning to stock up." However, another source says tv makers might find themselves stuck with large inventories again in the fourth quarter if sales don't materialize.

**Capital investments.** In the computer industry, IBM reports a 2.2% increase in gross income for the first half, noting that "the small increase reflects the contribution of substantially lower levels of outright sales of data processing equipment." This increase suggests that an 18.8% growth in rentals may have helped compensate for depressed sales.

Sales of large computers have been particularly affected. Dan McGurk, president of Xerox Data Systems, reports the company's sales are below the 25% to 30% increase expected for 1970. "Although our salesmen are looking at more opportunities than they ever had before, people aren't taking that final step in committing to big computers," he notes.

Hard hit in the computers and peripherals area will be minicomputer firms: a third may be out of business by the year's end [*Electronics*, July 20, p. 105].

Analog Devices revised its 50% sales growth figure, predicted late last year, down to 35%. Domestic sales are off, but "a notable exception is export sales," says vice president Ray Stata. He expects overseas sales to increase 80%.

Original equipment maker sales have slowed, says Stata, "because customers are waiting until they absolutely must buy and then they're buying conservatively. There's no confidence in predictions as to what will happen in the next six to nine months."

**Others.** In the communications area, the recent FCC ruling requiring CATV stations to originate their own programming has given makers of broadcast cameras and other equipment a potentially lucrative outlet. And when the pending FCC decision on data transmission over independent microwave networks is made, the modem business also may get a lift. Datran, for example, has proposed a \$375 million switched network to tie 35 cities together from coast to coast.

Statistics for this report were provided in a midyear study conducted by David Strassler, research manager. Editorial inputs were supplied by field reporters from *Electronics* and McGraw-Hill World News, as well as New York editors.



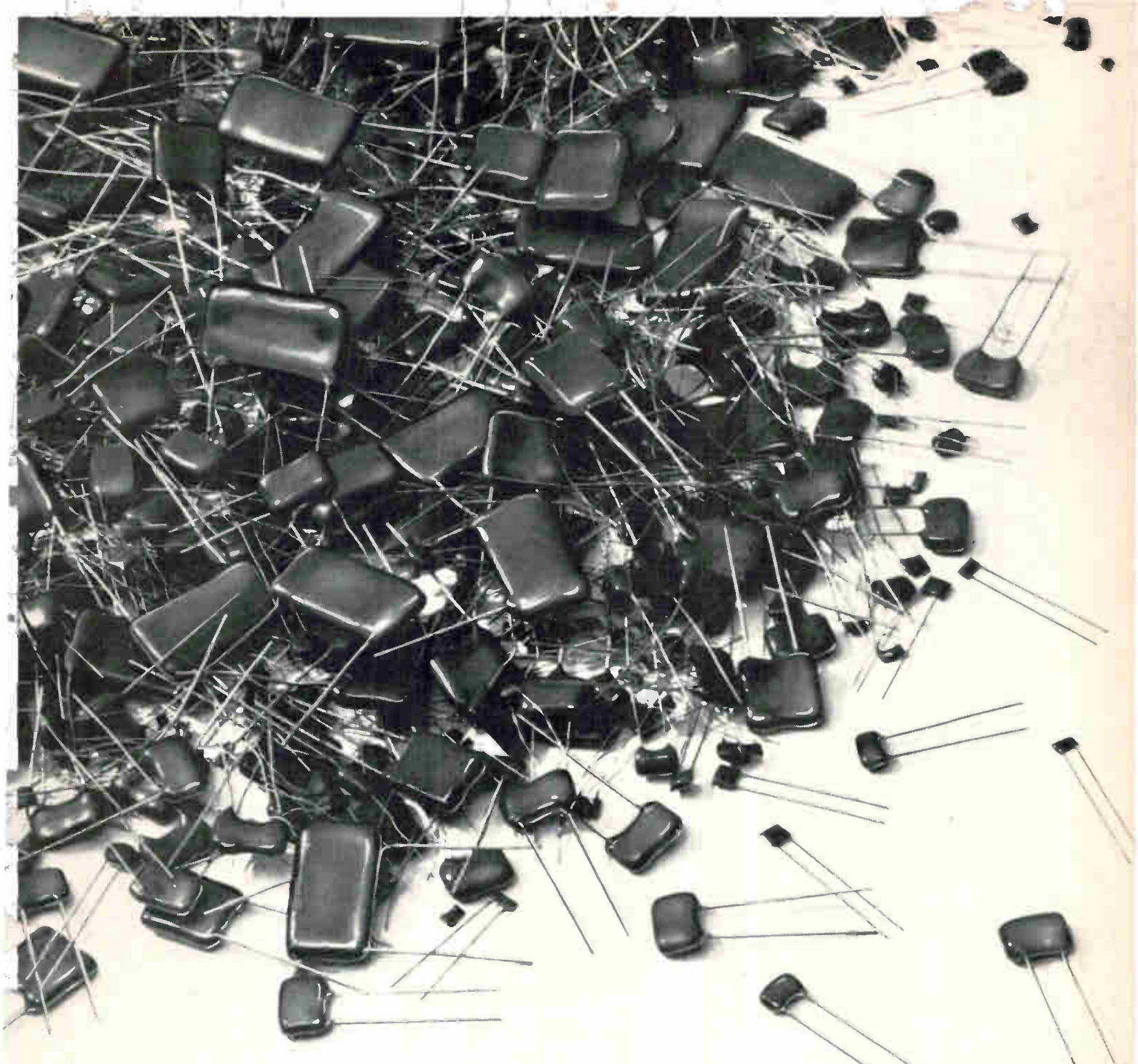

# Dipped Mica by the Millions!

The greatest selection of Dipped Mica Capacitors available—from the exclusive CD6 (the smallest dipped mica in existence) through the entire range of standard mica ratings.

From the inventor of the Mica Capacitor. **CDE** CORNELL-DUBILIER



# DON'T LET THIS LOW PRICE FOOL YOU

Triplett's new 3½-digit Model 5020 digital panel meter is a complete, self-contained instrument ready for panel-mounted or bench-top use.

Available in 6 ranges from 10.00 mV to 1000 V DC and 7 ranges from 1.000  $\mu$ A to 1.000 A DC, the bipolar Model 5020 features accuracies of 0.1% of reading  $\pm 1$  digit as a voltmeter and 0.15% of reading  $\pm 1$  digit as an ammeter through 100% over-range. Its seven-bar, fluorescent readout gives a single-plane display for accurate, wide-angle readability.

Priced at only **\$240** (\$265 with BCD output) suggested USA user net, this new Model 5020 allows even the budget-minded to enjoy the accuracy and easy reading of a digital display. For a free demonstration, see your Triplett distributor or call your Triplett sales representative right now. Triplett Corporation, Bluffton, Ohio 45817.

**TRIPLETT**  
Manufacturers of the World's  
most complete line of V-O-Ms



Shown actual size

1. Low-cost, bipolar 3½-digit instrument reads to 100% over-range.
2. Dual-slope analog/digital conversion gives high noise rejection, stability and accuracy.
3. Single-plane, seven-bar readout for accurate wide-angle readability.

# Navy engineers break the rules with radical airborne EDP concept

All-purpose system seen evolving from standard modules using advanced LSI to cut costs, raise performance

By James Hardcastle

Washington bureau

**Bucking** the doctrine that no single military system can effectively perform most functions, a team of young Navy engineers is promoting a new modular computer concept that could be tailored to meet all airborne requirements. The Naval Air Systems Command group, headed by Ronald Entner, believes an all-purpose machine based on 20 to 30 standard modules can be ready for use by 1975, bringing with it a tenfold reliability increase plus a pricetag 10 to 20 times lower than existing systems.

To get off the ground, the Advanced Airborne Digital Computer first will require several significant engineering breakthroughs, Entner and his colleagues concede, notably in the area of large-scale integrated circuits, their materials, packaging, and reliability. Some of these already have been achieved, Entner contends, including three-inch-diameter silicon chips that could eventually contain 5,000 or more gates. Components and computer manufacturers are tracking the program carefully with an eye toward its potential impact on areas far beyond airborne military systems.

**Timetable.** So far, \$12 million is expected to carry AADC through the feasibility stage; \$1.5 million is budgeted for fiscal 1971. The \$1.4 million spent so far has been divided among 19 contractors. AADC's feasibility must be established before the end of 1973; operating hardware is to be available for evaluation in 1974.

Should the program fly, the Navy no longer will expect to buy the five different airborne computers it now has in operation, some of

which include 20 different models. Nor will it be expected to continue advanced development on another 20 systems, much less pay software contractors up to \$150 a word to program the diverse machines.

Eventually, AADC's waves could be expected to ripple through the Pentagon where, by one count, as many as 287 different airborne computer efforts have been funded simultaneously.

## Doubting Thomases

Robert S. McNamara's misadventures with the F-111 aircraft convinced many in Washington that the concept of developing a single weapon to perform multiple missions was unsound. Ironically, the cry that "it can't be done" was loudest within the Navy, which now, in its Advanced Airborne Digital Computer program, is risking another shot at developing an all-purpose system, albeit on a much smaller scale.

Analogies between AADC and the F-111 are not only unpopular with the computer's proponents, they are also regarded as invalid. "If you want to compare AADC to something," says one industry observer, "compare it to an Erector set."

Though industry audiences at AADC briefings contain representatives from virtually every data processing company in the country, one marketing man is convinced that the machine will never fly. "Ron [Entner, AADC program manager] has done a fantastic job interesting industry in the program at its own expense," he concedes. But he also feels AADC—like the F-111—is doomed because its multiple application requirement will compromise the computer's ability to do any job well. Entner's group, asserts this critic, "talks primarily about processing elements, but that's the least significant part of the unit. Input-output is the monstrous part of the system in engineering terms, and memory is the most expensive. Here's where they are going to have problems."

Others are less critical, though some believe industry interest is likely to wane unless AADC's sponsors can find space on board an ongoing Navy airframe. But with AADC's feasibility still to be proved, this is unlikely before the advent of the C model of the F-14 fighter in the middle of the decade.

Entner replies by restating his belief that AADC will be specified for every Navy aircraft flying between 1975 and 1985. Furthermore, he notes that the number of chores to be performed by various AADC configurations is only a matter of identifying the number and types of interfaces required. Entner says his group is "working backwards from the interfaces before we develop components; we know what the interfaces are."

The program's industry critics, asserts Entner, are running scared before the revolutionary potential of a modular computer—one which could accelerate the entry of integrated circuit houses into the business of mainframe manufacturing, leaving less competitive computer makers out in the cold.

## ... 5,000-gate arrays on 3-inch chips are possible within five years ...

"We think we can build a simple, 2 million operations-per-second computer with 80,000 words of memory for about \$30,000," Entner asserts. "In quantity, the unit price should drop to about \$13,000." Additional associative fast-Fourier elements and arithmetic units would create a machine comparable to anything on the market priced at about \$100,000, he says.

Texas Instruments, Motorola, and Monsanto all have stated that they are able to grow the three-inch-diameter silicon needed for the ICs that will be the backbone of the program, says A. David Klein, program technology manager. But Klein is particularly intrigued by a process developed by Tyco Laboratories Inc. of Waltham, Mass., which would permit single crystals to be grown in virtually any shape or size.

Charles D. Caposell, one of Klein's staffers, says that besides offering potentially lower costs, Tyco's process enables crystals to be grown as sheets of varying thickness. Thus, Tyco's single-crystal semiconductors would not require subsequent slicing, which can destroy half the original stock. Because the sheets are seeded on polished surfaces, wafers can be grown that do not require polishing—a major source of semiconductor failures, he adds.

AADC program managers note that several technologies are being refined under Navy contract to cut costs and increase yields from the big chips. Westinghouse, for example, is under contract to adapt its electron-beam imaging system for masking the AADC chips, which cannot be processed by conventional lithographic techniques.

The process, soon to go commercial in machines built by Hugel Industries under a Westinghouse license, promises to greatly reduce costs. Klein says that the process also may provide submicron masking resolution compared with the 2.5 microns achievable with lithographic techniques.

**Laying it on.** Another breakthrough cited by Klein involves a

new means of interconnecting the thousands of transistors in the big chips through a selective anodization process developed by Texas Instruments. Designed to eliminate pinhole breaks in oxide layers, the process uses a conventional aluminum metalization layer over the chip. A photoresist then is used to protect the wiring pattern and the remaining metal is anodized, which converts it into an insulating layer.

More layers then can be added with far fewer breaks than would occur if oxide were laid over metal, permitting multiple metalization layers. Caposell notes that the process is very simple. He predicts it will be a major spur to development of a reliable 5,000- to 10,000-gate circuit.

Another boost is expected to result from pad relocation work done by Hughes Aircraft's Data Systems division [*Electronics*, Oct. 13, 1969, p. 44]. This technique eliminates the need for generating a unique interconnect mask to wire together good transistors on a chip. First, a master layer is applied as though the circuits were perfect. Then a dielectric layer is put down; a simple wiring pattern is applied on top to reroute the wiring for bad circuits to nearby good circuits. Finally, holes are etched through the dielectric layer and the pair of patterns then is interconnected.

Hughes so far has generated interconnection designs for logic arrays ranging in complexity from 207 to 700 gates. Caposell predicts the technique will permit reliable interconnection of 5,000 gates.

Using its LSI discretionary wiring technique, TI is producing 800- to 1,000-gate circuits on 1- and 1.5-inch wafers. According to Bill Wickes, TI's manager of the advanced integration program, 5,000 gate arrays on three-inch chips are possible by 1975. But he notes that: 5,000 bipolar gates create severe thermal problems; testing difficulties are "far from insignificant"; and industry has had little experience building standard IC's on three-inch chips, "yet alone inter-

connecting them discretely." He says, "We feel 5,000-gate arrays are more likely to be achieved using 1- and 1.5-inch or 2-inch chips."

**Memories.** With memories accounting for 70% of the cost of airborne computers, breakthroughs in that area are a must if the system is to meet its cost estimates. Entner is confident that they can be achieved largely because of progress made on Sylvania Electronic Systems division's magneto-acoustic memory [*Electronics*, July 6, p. 49]. Cheap (.1 to .2 cents a bit against the two to five cents a bit for core), and reliable (270,000 hours mean time between failures), the memory would store invariant data, which accounts for 80% of airborne computer data storage.

Because the Sylvania memory is block oriented and access time is in the microsecond range, a buffer memory will be used. Although Entner says conventional semiconductor memories could be employed in the buffer memory, he is carefully eyeing a closed-flux technique developed by Ampex Corp.

Initially developed for in-house use, the technique is now being refined under an AADC contract. Electrochemical plating is used to build a sandwich of two permalloy strips with a copper strip in between that performs bit and sense functions. A final layer is deposited to close the flux of the cell and a word strip is attached to the top of a cell array.

Although the memory is considered proprietary until the Navy and Ampex can determine who owns what, it is known that Ampex is shooting for a 50-nanosecond access time. Power consumption will be in the microwatt range. Ultimate packing densities will be in the range of 500 kilobits per square inch, Ampex says, allowing the buffer memory to be packed with the LSI chip.

Variable data will go into a random access memory that also will be tied directly to the processor as well as the buffer memory. Ampex's memory when perfected would be a likely candidate for the job, but right now, plated wire and a post-and-film memory by Litton are the leading contenders, Entner says. [*Electronics*, Jan. 6, 1969, p. 53].



**You'll get  
the direct print paper  
on the right faster.**

There's no need for "hurry" stamps on Astroprint oscillographic papers. Easy ordering and direct delivery are part of the package.

You also get a direct print, orthochromatic paper unsurpassed for

trace density, instant pop-up (less than 1 second), excellent image stability and sharp contrast. On mercury vapor, Xenon, and cathode ray light sources.

Astroprint DP 90 (for open magazine applications) and DP 80 (for closed magazines).

As a starter, test us for delivery and cost. Just call your local Xerox Product Specialist or write to Xerox Corporation, Dept. HL, Rochester, New York 14603.

The paper will prove itself.

**XEROX**

Xerox and Astroprint are registered trademarks of Xerox Corporation.

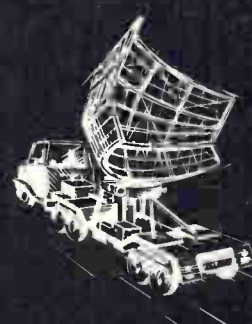
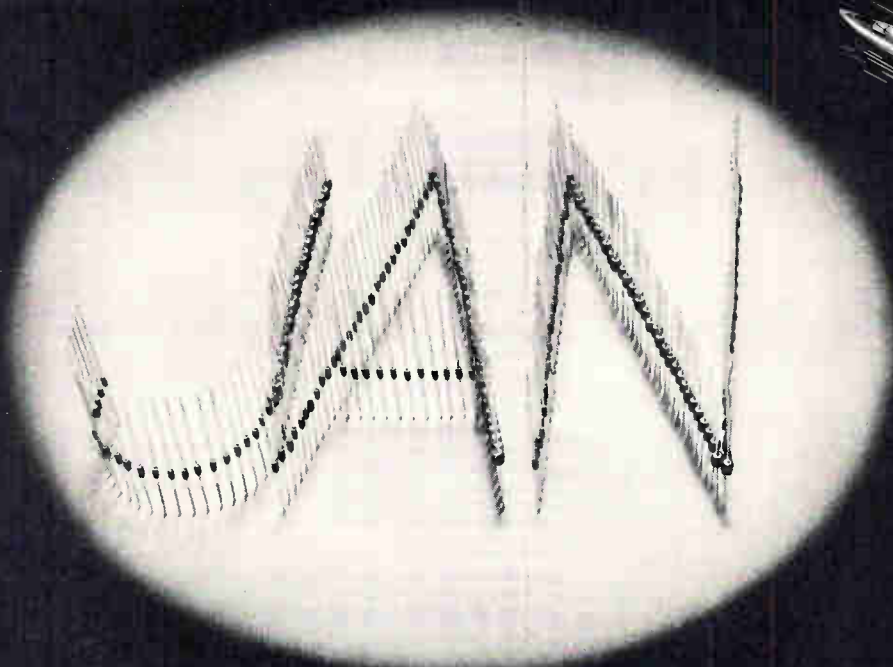

## “METOXILITE” RECTIFIERS MIL Qualified — Now Available

“METOXILITE,” Semtech’s new high-current axial lead monolithic silicon rectifier, is now MIL qualified. “METOXILITE,” a result of Semtech’s advanced manufacturing techniques, offers the ultimate in ruggedness and hermeticity. The metal oxides which form “METOXILITE’S” outer case material are fused directly to the high temperature metallurgically bonded assembly forming an impermeable subminiature package.

“METOXILITE” is available as JAN and JAN-TX devices.

### MIL-S-19500/427 (EL)

1 Amp General Purpose Rectifiers  
JAN & TX 1N5614, 16, 18, 20 & 22  
P.I.V. — 200, 400, 600, 800 & 1000 volts  
 $I_R$  @ P.I.V., 25°C — 500 nA  
 $T_{rr}$  — 2  $\mu$ sec

Chicago—140 N. La Grange Road, La Grange, Illinois 60525 / (312) 352-3227 / TWX: 910-683-1896  
Dallas—402 Irving Bank Tower, Irving, Texas 75060 (214) 253-7644  
New York—116-55 Queens Blvd., Forest Hills, New York 11375/(212) 263-3115/TWX: 710-582-2959  
Philadelphia—209 Chester Avenue, Room 5, Moorestown, N.J. 08057 / (609) 234-1244  
San Francisco—941 E. Charleston, Suite 10, Palo Alto, California 94303 / (415) 328-8025  
Washington—8654 Baltimore National Pike, Ellicott City, Maryland 21043 (301) 465-7363  
European Sales—Bourne A. G. Alpenstrasse 1, Zug, Switzerland / (042) 4 82 72/73

### MIL-S-19500/429 (EL)

1 Amp Fast Recovery Rectifiers  
JAN & TX 1N5615, 17, 19, 21 & 23  
P.I.V. — 200, 400, 600, 800 & 1000 volts  
 $I_R$  @ P.I.V., 25°C — 500 nA  
 $T_{rr}$  — 150, 250, 300 & 500 nsec

### MIL-S-19500/420 (USAF)

3 Amp General Purpose Rectifier  
JAN & TX 1N5550, 51, 52, 53 & 54  
P.I.V. — 200, 400, 600, 800 & 1000 volts  
 $I_R$  @ P.I.V., 25°C — 1  $\mu$ A  
 $T_{rr}$  — 2  $\mu$ sec

### MIL-S-19500/411 (EL)

3 Amp Fast Recovery Rectifiers  
JAN & TX 1N5415, 16, 17, 18 & 19  
P.I.V. — 50, 100, 200, 400 & 500 volts  
 $I_R$  @ P.I.V., 25°C — 1  $\mu$ A  
 $T_{rr}$  — 150 & 250 nsec

Immediate delivery on all advertised products.

 **SEMTECH**  
CORPORATION

652 Mitchell Road, Newbury Park, California 91320  
(805) 498-2111, (213) 628-5392 / TWX: 910-336-1264

# New team takes over at Viatron

Hurt by recession, stock slide, and overoptimistic delivery predictions, systems firm opts for new management to restore credibility and rethink goals

By James Brinton,

*Boston bureau manager*

**With its stock** now selling for about a tenth of its \$65 high, with backers hounding it for profits, and with a \$5.8 million loss so far this fiscal year, Viatron Computer Systems Corp., Bedford, Mass., has opted for a new management team.

Viatron made headlines two years ago with promises of a "Sears Roebuck line" of data processing gear renting for as little as \$39 monthly, and with predictions of a market measured in tens of thousands of units [*Electronics*, Sept. 30, 1968, p. 84]. Now the rental policy is history, and the sales strategy which replaced it, plus tight money, have severely squeezed Viatron's market potential. But right up to the end the predictions of Viatron's former management were as optimistic as ever, and its promotion was just as flamboyant.

As Viatron's stock and prospects dropped, morale fell and upper-management turnover rose. Finally, on July 20, in a board of directors' meeting at Edward M. Bennett's home, he was ousted as president and chairman, while Joseph Spiegel was removed as executive vice president. Bennett was taken by surprise, it is said, but after resigning from the board he offered to remain as technical adviser to the new president, Roger R. Phillips. Spiegel wasn't at the meeting, and apparently retains no corporate position.

Phillips is joined by Pearson Hunt as chairman. Hunt is professor of finance and banking at the Harvard Graduate School of Business Administration; Phillips formerly was president of Viatron's most successful subsidiary, Viatron

Computer Systems International Corp.

Both Phillips and Hunt radiate the image of financial sobriety and solidarity that Wall Street and Viatron's customers demand. "We hope to be recognized as a company that is both credible in its claims and responsible in its dealings," says Phillips. Both men have their work cut out for them, and it's largely a matter of dragging Viatron out of a hole the company dug for itself.

**Great expectations.** The powerful press-agentry that heralded the System 21 data processing line about two years ago, together with the charisma and glowing market predictions of Bennett and Spiegel, resulted in a flood of letters of intent which the company quickly cashed in for credit lines and a stock offering. Bennett confidently predicted monthly production of 5,000 to 6,000 terminals by mid-1970 [*Electronics*, June 23, 1969, p. 141]. But Viatron's first deliveries were almost a year late, and its production stands at a tenth of predicted levels. So far the company's best effort seems to have been the approximately 700 consoles produced in April, just before layoffs began.

Bennett was forced to revise his first delivery estimate several times. His initial prediction was that data entry consoles would be shipped in late 1968, then in spring 1969, then summer 1969. The first consoles actually were shipped in mid-September 1969, opening a credibility gap through 1969 which later was to hurt him with customers and backers.

But the real pinch came early

this year. As the economy cooled, Viatron's list of potential customers shrank, and its backers began pressing for profits that simply weren't part of the business plan until late this year.

One of the first consequences was a shift from rental of System 21 gear to outright sale, which further compressed Viatron's potential market. Though it is said that this marketing shift was forced on Viatron by its backers, it backfired, because Viatron's rental-gear production line suddenly was making more units than a new and smaller market could absorb. The sheer inertia of production forced Viatron into a manufacturing overshoot that resulted in a midyear inventory of about \$8.2 million. At the same time, conversion of letters of intent into sales fell below the level expected under the rental strategy, seriously hurting cash flow.

**Shocking.** In April and May, the atmosphere at Viatron became even more charged. A new vice president of finance, Paul F. Keating, arrived in mid-April to be shocked, it was said, by the accounting procedures he reviewed. For example, hardware outlays for the firm's manufacturing operations were being written off at purchase instead of being depreciated over several years, making Viatron's assets appear lower than they really were. It also is said that the firm's control of internal spending was poor and that accounts receivable weren't getting proper attention.

Keating also had to contend with Viatron's overhead position. Not only did Viatron occupy more plant space than it was using, but there

# HIGH SPEED CARD / TAPE READERS

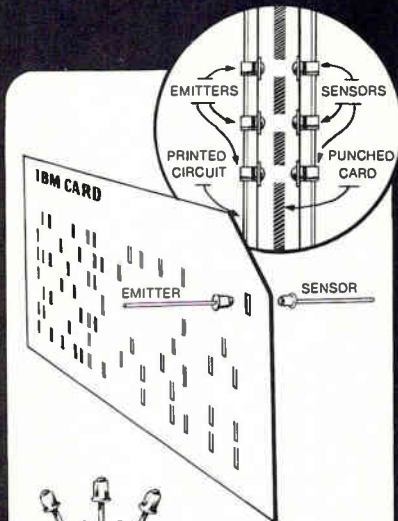

SE-2450 SE-1450  
EMITTERS  
SD-2440 SD-1440  
PHOTO TRANSISTORS  
PHOTO DIODES  
ACTUAL SIZE

- MATCHED PAIRS EMITTER/DETECTORS
- SOLID STATE RELIABILITY
- SPACE SAVING COMPACTNESS
- IDEAL FOR ALL PUNCHED MEDIUMS
- AVAILABLE FOR IMMEDIATE DELIVERY

Designed for mounting in printed circuit cards, these miniature emitters and detectors provide the perfect solution to designing extremely reliable, compact high speed reader assemblies for data processing and computer applications.

For more information and technical data, contact Spectronics, Inc.



## Spectronics

INCORPORATED

541 STERLING DRIVE  
RICHARDSON, TEXAS 75080  
AREA 214 231-9381

## ... as the former management's parting shot, 206 people got pink slips on July 17 ...

appeared to be no quick way to sell these buildings in Boston's depressed industrial economy. So Viatron laid off 294 people, mostly staff, marketing, and support personnel [*Electronics*, May 11, p. 33]. Further selective layoffs followed, and as the former management's parting shot, an additional 206 people—mostly production hands—got pink slips on July 17, as Bennett tried to use up inventory to make it into the black.

Manufacturing was to be sub-contracted, and still may be. The Hazeltine Corp. already makes circuit board subassemblies for Viatron, which was negotiating with the Martin-Marietta Corp. for production of whole systems. Bennett said that the contractual negotiations were ironed out and the pacts were about to be signed in mid-July. Bennett was confident he could slash overhead this way and live on Viatron's \$8.2 million inventory until Martin phased in with about 500 consoles per month in September, and as many as 1,000 by the end of the year if the market could support them.

But this idea now is on a list of many which Phillips must re-evaluate. Others include joint-venture manufacture of a digital wrist watch; a deal with an unspecified Japanese firm to manufacture electronics for a line of calculators, and the spinoff of Viatron's semiconductor operations as a separate profit center.

**Partners.** Bennett was looking for a partner on the wrist watch project when he was forced out. His engineering team designed a digital package which was to sell for about a tenth the price of other electronic timepieces. By mid-July no venture partner had been found, and insiders were grumbling about how much effort had been diverted from Viatron's primary lines.

The same grumbling accompanied the calculator project. Viatron would have designed and manufactured the electronics for machines the Japanese would have assembled in Asia and exported to the United States. It looked as if the scheme might yield some cash

flow for Viatron, but that the Japanese would be getting much the best of the deal. "They could mark their calculators up 300%," says a Viatron staffer, "but our profit wouldn't come anywhere near that"—and Viatron still would have had to amortize the engineering involved.

The latest action in what seems an anguished search for cash flow was formation of Viatron's Micro-electronic Systems division. Under Laurence C. Drew, vice president, the division was to act as the interface between buyers of custom metal oxide semiconductor arrays and their vendors. It also would have supplied custom design, both of circuit and systems, and development.

Phillips' position on these is flexible. There are an estimated 30 to 40 projects under way which will have to be evaluated, and either assigned a priority and funded, or dropped. Each will be judged, Phillips implies, on its ability to improve the firm's financial position—or on the resources it would divert from other efforts to improve cash flow.

**Survival.** As it stands, Drew's operation probably is likely to survive. Even if it loses a small amount of money during its start-up period, it will at least use plant and equipment that many within Viatron feel is far in excess of that needed for a simple bail-out operation.

Phillips says he already plans to augment production of the company's IBM-compatible tape recorder. Though peripheral to the firm's main line, it's felt the unit would trigger increased terminal sales. Its absence has delayed some bulk orders, and oddly, the tape recorder is one of the few Viatron devices to encounter MOS design troubles. "The mechanical portion was released for production six months ago," says one Viatron staffer, "but the logic problems have only recently been overcome."

Bennett and Speigel leave just as Viatron is about to release its 2140 and 2150 computers to production,



# Cut yourself in.

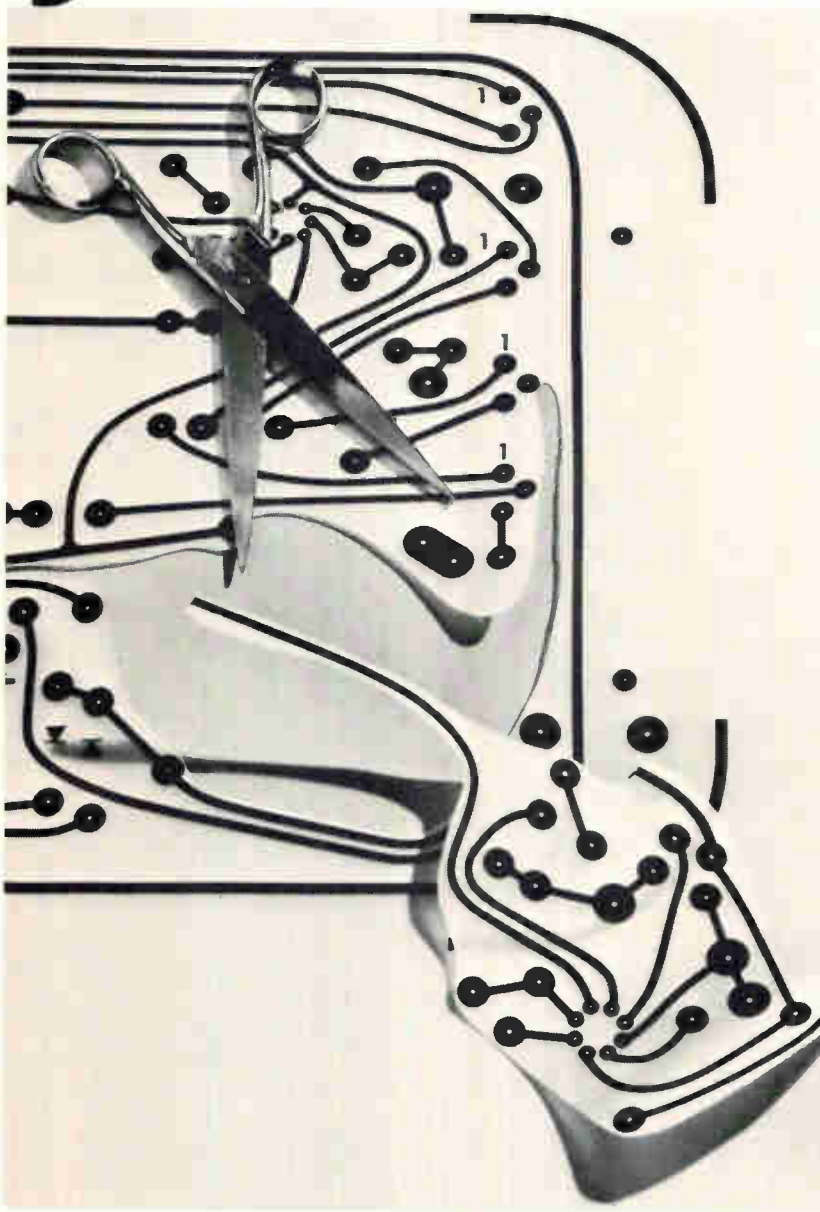

## **“Scissors draft” your way to increased production with KODAGRAPH Films and Papers.**

Why retrace an entire drawing needing only revision? Instead, copy your original photographically on KODAGRAPH Film or Paper. Cut out the unchanged portions (often much of your drawing), mount them on a new drawing form, have a second original made on KODAGRAPH Film, and make your revisions on that.

For more on “scissors drafting” and other time-saving techniques, contact your Kodak Technical Sales Representative, or write Eastman Kodak Company, Business Systems Markets Division, Dept. DP 784, Rochester, N.Y. 14650

**DRAWING REPRODUCTION SYSTEMS BY KODAK**

Kodak



**UNICERAM® CHIPS ...**

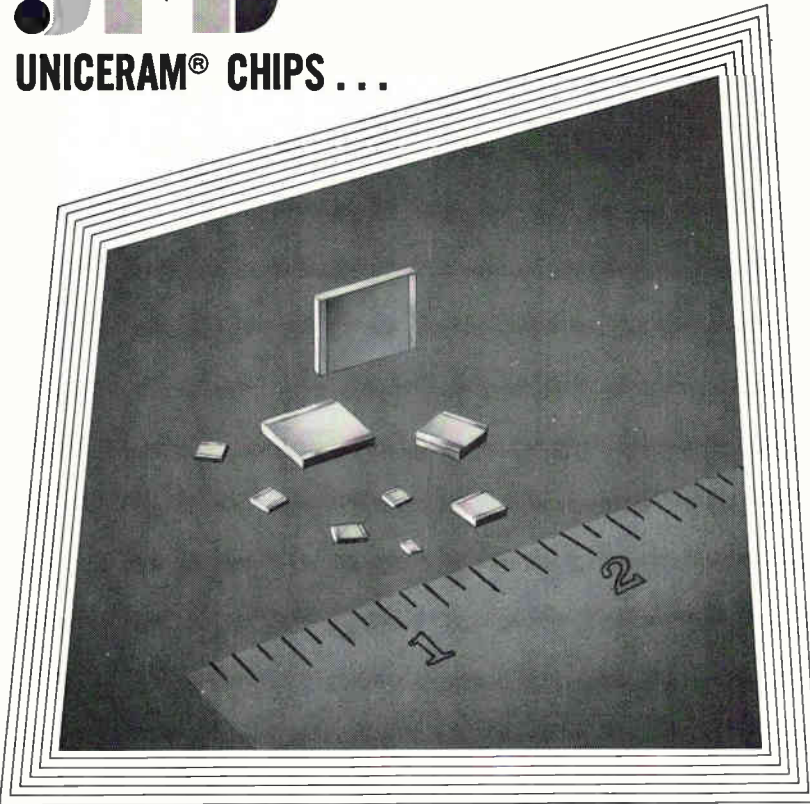

**HIGH FREQUENCY—USE HI Q  
HIGH CAPACITANCE—USE HI K**

JFD Hi Q monolithic Uniceram chips offer the ultimate in stability and small size for high frequency applications. Typical Q values of 10,000 and more, assure the highest ratio capacity per unit volume available. Stable and repeatable TC's plus the maximum in miniaturization are yours.

Available in 5 sizes from .109 to .406 in capacitance ranges of .5 pf to 3,000 pf. Tolerances as small as .25 pf. Meet or exceed applicable portions of MIL-C-11272B.

JFD Hi K chips are ideal for high density packaging in cordwood, hybrid and thick film circuits. They meet or exceed applicable portions of MIL-C-11015 and MIL-C-39014. Non polarized, Uniceram chips provide up to 1.5 mfd in volumes as small as .01 cubic inch.

Hi K Uniceram chips are available in 18 different sizes to fit every space problem. Voltage ratings 50 - 100 - 200 WVDC are standard with specials to 4,000 WVDC.

Hi Q and Hi K chips are available with silver leads and glass encapsulation for difficult applications.

Write for catalogs.



"TODAY'S COMPONENTS BUILT FOR TOMORROW'S CHALLENGES"

**JFD ELECTRONICS CORP. / COMPONENTS DIVISION**

15th Avenue at 62nd Street / Brooklyn, New York 11219 / Phone 212-331-1000

SUBSIDIARY OF RIKER-MAXSON CORPORATION

**... new computers should  
trigger more console sales ...**

and these also should trigger added data entry console sales. S.E. Greenfield, vice president for systems engineering, says that the 16-bit parallel processors now are ready for a 50-unit engineering preproduction run, "and after that has located any production bugs, we'll be ready to go quantity," he says. Viatron claims to have received about 45 orders already, 7 to 1 in favor of the 2150 model with its 8,192 words of core and \$9,552 price.

Also, Greenfield is almost ready to go with two other machines at both the higher and lower end of the price-performance scale. At the high end is the 2160 with more memory—16,384 words of core—and expanded input-output capabilities; no price for the machine has been set yet.

At the low end, priced for now at about \$2,000, is an OEM version of the Viatron computer. Architecture would be shared with the 2100 series, but the machine's memory capacity would consist of 256 words of read-write, and 256 words of read only.

The software is ready now, says Greenfield. "Not only is the IBM 1130 instruction set imbedded in our microprogramming," he says, "but our own software has been debugged on the transistor-transistor logic prototype, and was finished before the first processor." Next, spokesmen hint, will be Cobol and perhaps Basic software packages, and there are hints that the instruction set of the IBM 360-30 might follow that of the 1130 into the 2100 series soon.

To marketing vice president Charles A. Jortberg, the beauty of the computers is their effect on Viatron's other products. "The 2150 can operate with up to 24 consoles," he points out, "and peripheral to each one can be card reader/punches, optical character readers, and other devices." Thus, Jortberg foresees computer deliveries developing into a branching cascade of sales in other product lines, and perhaps creating the cash flow and thus the turning point Viatron wants.

"See JFD Electronics Corp. at the Wescon Show—Riker-Maxson Components Group Booths 1324 and 1325."

# FROM PLENCO: FLAME-RETARDANT, TRACK-RESISTANT MOLDING COMPOUNDS.

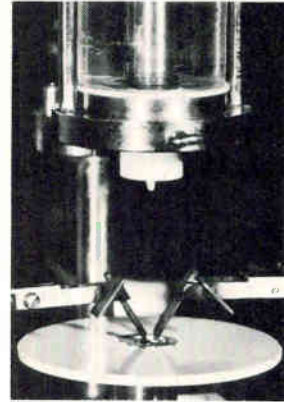

Melamine-phenolic and alkyd thermosets formulated to provide an extra factor of product safety in electronic and electrical applications. With greater range in choice of properties.

Available now, this Plenco flame-retardant series offers improved, consistent arc-resistance. More importantly, it offers excellent resistance to tracking under the influence of conductive contaminants. Offers compounds (all recognized under the Component Recognition Program of Underwriters' Laboratories) developed to help answer current concern for increased safety in electronic and electrical products. Where design and reliability requirements are being upgraded, the series gives the designer a wide range of properties and cost. Permits him to optimize the best approach to his problem.

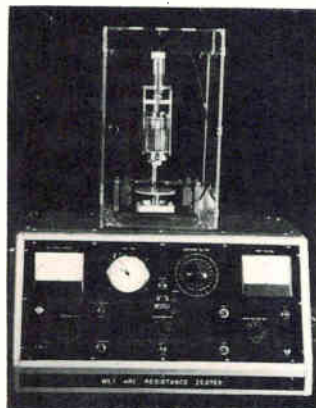

■ PLENCO 714, 744, & 757 MELAMINE-PHENOLICS. Priced close to electrical-grade phenolics, but with established capability to meet UL SE-0 flammability ratings, consistent D495 arc-resistance in excess of 180 sec, plus excellent track-resistance per IEC Publication No. 112.

Better dimensional stability is offered by 744, better mechanical strength by 757.

■ PLENCO 1502, 1506, & 1507 ALKYDS. Granular compounds with good molding latitudes and stable dimensional properties. Each meets UL SE-0 and other critical burning test ratings, and provides high arc- and tracking resistance and good dielectric characteristics at elevated temperatures.

Wide-ranging selectivity and experienced assistance is offered you by Plenco whatever your molding problem or process. Just part of our regular service, and yours whenever you call.

**PLENCO**  
THERMOSET PLASTICS

PLASTICS ENGINEERING COMPANY  
Sheboygan, Wisconsin 53081

Through Plenco research . . . a wide range of ready-made or custom-formulated phenolic, melamine, epoxy and alkyd thermoset molding compounds, and industrial resins.

**Charley Melton said he'd quit if anybody ever designed him another one-of-a-kind.**

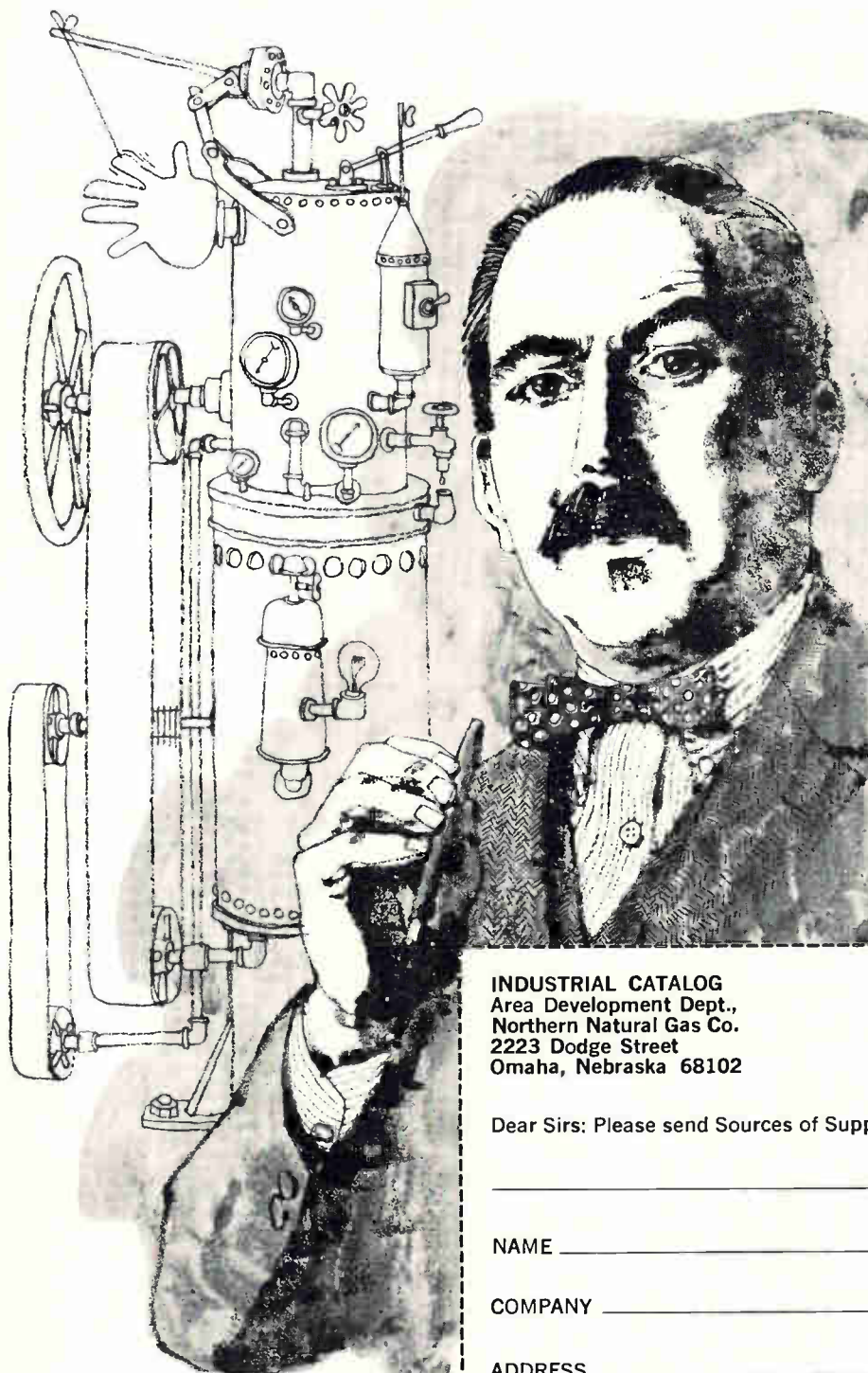

**Guess what, Charley?**

Charley's an engineer. He comes up with new ideas for new products. Then somebody else designs the parts that make up the new products. That's the problem. Because Charley inevitably ends up having to track down some creation the likes of which may never be equalled. Who makes 'em?

Keep your job, Chuck. Help's on the way in the form of the **NORTHERN PLAINS INDUSTRIAL CATALOG**. It's a complete, indexed, cross-referenced, multi-everything compilation of valuable information on creations like the one you're faced with. Tells you who makes them, where, how much, how to order. More, too. The Industrial Catalog's probably got a line on your — whatever it is, right now. So find out. Clip the coupon and return. It won't cost a penny. And it's better than quitting.

**INDUSTRIAL CATALOG**  
 Area Development Dept.,  
 Northern Natural Gas Co.  
 2223 Dodge Street  
 Omaha, Nebraska 68102

**Northern Natural Gas Company**  
Home Office: Omaha, Nebraska

E

Dear Sirs: Please send Sources of Supply information on:

\_\_\_\_\_  drawing enclosed.

NAME \_\_\_\_\_ TITLE \_\_\_\_\_

COMPANY \_\_\_\_\_

ADDRESS \_\_\_\_\_

CITY \_\_\_\_\_ STATE \_\_\_\_\_ ZIP \_\_\_\_\_

# 10 microvolt sensitivity with a lot of numbers.



## 40,000 to be precise.

Our latest bi-polar Model 1294 packs more numbers than any other into industry's smallest package! And it reads them with a sensitivity of *10 microvolts!* The 1294 is a true bi-polar 4½-digit instrument with a display capability of 19999 and out-of-range indication. Its state-of-the-art electronics utilizes T<sup>2</sup>L logic and unique time-sharing circuitry that cuts power consumption to less than six watts. BCD output is optional. Input impedance is high: 10 meg-

ohms on the 100 millivolt range. Reading rate is 5 per second. Response time is well under one second. Accuracy is .05% of reading, ±1 digit.

Housed in the same 7 sq. in. front-panel-mountable case as our five other DPM's, the 1294 offers all the features that have distinguished this line . . . Weston's patented dual slope\* integration, plug-in Nixie\*\* tubes, repairable (non-potted) circuit boards, and ten standard voltage and current ranges.

If you're sensitive about your numbers, Weston Model 1294 provides the ultimate at a reasonable price. See how the 1294 complements industry's broadest DPM line. Write for details from the DPM originators.

WESTON INSTRUMENTS DIVISION,  
Weston Instruments, Inc., Newark, N.J.  
07114

a Schlumberger company

**WESTON®**

\*U.S. Pat. #3,051,939

\*\*Registered trademark, Burroughs Corp.

# Our 5000 and 7500 permeability Ceramag<sup>®</sup> ferrite materials can pack a terrific amount of inductance into a small size.

And the higher the perm, the fewer turns required. Results. Lower distributed capacity. Material savings. Improved performance. Ceramag<sup>®</sup> 24H offers the designer a true 5000 permeability. New, Ceramag<sup>®</sup> 24K is also a true 7500 permeability. Both materials hold their permeability over a wide range of sizes.

Ceramag<sup>®</sup> 24H and 24K are production materials, ready for immediate use in your design. Stock available in some sizes.

Precisely engineered, Stackpole ferrite materials are produced by exact processing, density checks, rigid kiln controls and accurate sintering. You get more out of Stackpole Ceramag<sup>®</sup> materials simply because we put more into them.

Study the characteristics of 24H

	$\frac{L}{N^2}$ (nh) TOROID SIZE: 0.230" O.D. 0.120" I.D. 0.060" L.	MAXIMUM PERMEABILITY	SATURATION FLUX DENSITY @ 1.5 OERSTED	RESIDUAL MAGNETISM	COERCIVE FORCE	CURE POINT	TEMPERATURE COEFFICIENT OF $\mu_0$	
							-25° to 25° C.	25° C. to 75° C.
CERAMAG <sup>®</sup> 24K	1485	9700	4100	700	0.05	175	+1.000	-0.450
CERAMAG <sup>®</sup> 24H	990	6900	3800	850	0.1	175	+0.700	-0.450
2500 PERM REFERENCE	495							

and 24K, then consider how you might use these ferrites.

For more information, samples and applications, contact:

**Stackpole Carbon Company,**  
Electronic Components Division,  
St. Marys, Pa. 15857. Ph: 814-834-1521. TWX: 510-693-4511.

Disaccommodation factor for both materials is  $1.4 \times 10^{-6}$ , typical.



**STACKPOLE**  
Electronic Components Division

Producing high quality Ceramag<sup>®</sup> ferrite components for the home industrial electronics industries for over  ferrite entertainment, and computer twenty-two years.

# Plug-ins expand oscilloscope into general-purpose test station

Tektronix will show first units, digital multimeter and counter, at Wescon; computer-controlled mainframe under development will make system programmable

By Stephen Wm. Fields

*San Francisco bureau manager*

**The first steps** toward turning an oscilloscope into a complete computer-linked test station are being taken by Tektronix. At Wescon in Los Angeles, Aug. 25-28, the giant of the scope business will show two new plug-ins—a frequency counter and a digital multimeter. Both were built for the year-old 7000 series, and use that line's character generator to display results on the scope face.

This is the first time that a major manufacturer of scopes has made plug-ins that do more than just augment traditional scope capabilities. It comes as no surprise to industry observers that Tektronix is turning the 7000 into a general-purpose test system. And it's now predicted that the company will follow up with plug-ins that generate signals, calculate, and have a memory capability. Tektronix says only that more plug-ins are under development. Its engineers are also working on a mainframe that will interface with a computer and make the 7000 system a programmable one.

At Wescon 70, Tektronix will also introduce a split-screen storage oscilloscope with a new mode of operation that allows stored and conventional displays in the same area of the cathode-ray tube simultaneously.

**See as you go.** Because the alphanumeric readout for both of the new digital plug-ins is displayed on the mainframe's crt, the engineer can see what he is measuring with a combination scope-

multimeter or scope-counter. With one instrument, says Frank Elardo, assistant marketing manager, he can measure voltage levels, count pulses, and examine waveforms—all at the same time with one set of probes. He can even take the temperature of the component he is working on, using a temperature tip on the multimeter probe.

The multimeter plug-in, designated the 7D13, is described as very stable; it measures d-c voltage from zero to 1,000 volts; d-c current from zero to 2 amps; resistance from zero to 2 megohms; and temperature from  $-55^{\circ}\text{C}$  to  $+150^{\circ}\text{C}$ . The readout is three digits with a fourth for overrange (maximum reading is 1,999). The multimeter does not have a-c capa-

bility. Tektronix is planning a plug-in with that feature. The 7D13's input impedance on all voltage ranges is 10 megohms; the input circuit can be floated up to 1,000 volts above ground. The accuracy on the voltage scales is  $\pm 0.1\%$  of reading  $\pm 1$  count. Accuracy on the current and resistance ranges is  $\pm 0.5\%$  of reading  $\pm 1$  count, and on the temperature range, it's  $\pm 1^{\circ}\text{C}$ .

One of the features of the 7D13 is the way it measures temperature. Many types of probes were tried in an effort to find one that was accurate, and yet still be easily reproducible in the factory. Hiro Moriyasu, manager of advanced concept development, says the designers decided on a simple npn

**With the numbers.** Addition of plug-ins makes the 7000 scope a multimeter and a counter. Measured quantities are read out on scope face.

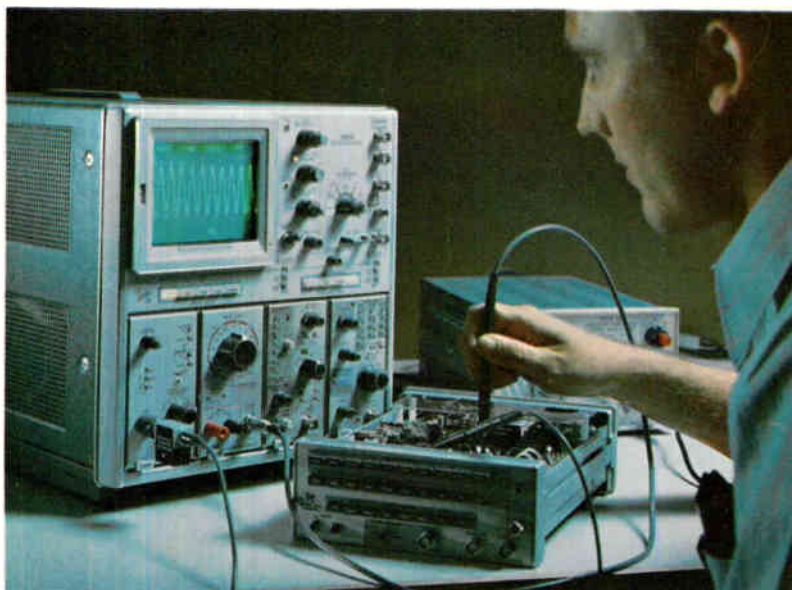

# low cost systems

\*Prices shown are 1000-lot.

## ELFIN Neon Display!

Latest 7-segment Elfin neon display and mating hi-volt BCD to 7 segment decoder-driver.

Combination Price **12.71\***

Circle 509



## Plug-in Display & Matrix

Segmented display operates on 5VDC and plugs into mating module with decimal input, easy mounting.

Package Price **11.58\***

Circle 510



## Plug-in Display w/BCD Input

Similar to above, except module has BCD input decoder-driver. Simply gang for multiple use.

Package Price **17.67\***

Circle 511



## ELFIN with Memory or Counter

Popular single plane neon display and BCD decoder-driver with memory or decade counter. Your choice.

Combination Price **16.19\***

Circle 512

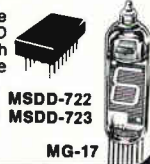

## Miniature Display!

Small incandescent single plane display play operates from 5V source. Decimal input. Compact size: 1/2" x 1".

Combination Price **13.71\***

Circle 513



## Display Has Wire Leads

Bright image, single plane display with 10" leads and BCD input decoder-driver.

Combination Price **13.94\***

Circle 514



Immediate Deliveries on Above Items

# ALCO®

ELECTRONIC PRODUCTS, INC.  
Lawrence, Massachusetts 01843

"SEE US AT WESCON BOOTH #1720."



transistor—one of the easiest devices to produce and one that has some property that changes with temperature. The npn transistor has a base emitter voltage ( $V_{BE}$ ) of about 2.6 millivolts per °C, which varies no more than 10% from device to device. But although the  $V_{BE}$  varies within 10%, the change in  $V_{BE}$ , or  $\Delta V_{BE}$ , is constant within 0.1%.

Measuring  $\Delta V_{BE}$  involves a technique that switches the collector current between two levels and detects the change in  $V_{BE}$  which is proportional to the junction temperature. The npn transistor is mounted on a small metal platform except for an encapsulated portion that protrudes and is actually the voltage-current-resistance probe. The probe has four leads: three for the transistor and one for the platform. A temperature output signal gives 10 millivolts/°C and can drive a separate analog chart recorder.

**Three modes.** The counter, called the 7D14, is an eight-digit unit and has three modes of operation: frequency from d-c to 500 megahertz; ratio from zero to  $10^5$ ; and totalize from zero to 10%. Two input impedances are provided, 50 ohms and 1 megohm, and the sensitivity on either is 100 millivolts peak-to-peak or 35 mv rms. Moriyasu points out that most counters have only the 50 ohm input and have to be reconditioned to interface prop-

erly with the circuits being measured. "And even with this arrangement," he says, "you still don't know if you are saturating the circuit; so we added the high Z input to eliminate conditioning."

Tektronix says its 7D14 is the first digital frequency counter that is directly gated to 500 Mhz, without a prescaler or other special technique. The gated approach makes possible single-event counting, sometimes desirable in rapid-burst measurements.

Another feature of the 7D14 is the externally gated mode of operation. By locating the counter in one of the vertical positions of the oscilloscope and operating the scope in the delaying time base mode, the B (delayed) sweep can drive the counter gate. Thus, the waveform can be displayed on the screen with A sweep while B sweep intensifies the trace and acts as the counter gate. Using a 7000-series vertical amplifier, a time-base unit, and a 7D14, a signal can be displayed on the oscilloscope screen while its frequency is simultaneously being measured to an accuracy of 0.00005%. When the 7D14 is used in a horizontal plug-in compartment, a signal connected to a vertical compartment can be internally routed to it.

The multimeter will sell for \$495, and the counter for \$1,400.

Tektronix Inc., P. O. Box 500, Beaverton, Ore. [338]



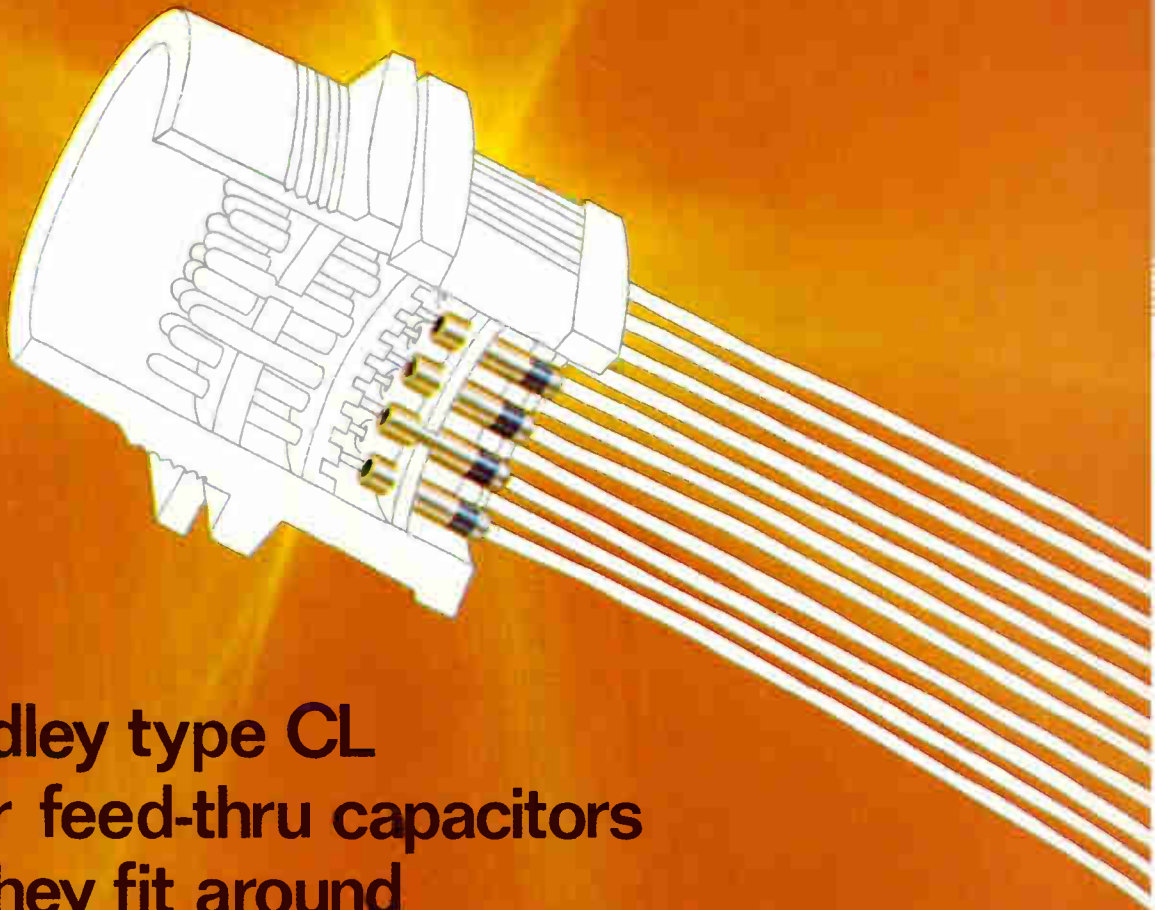

## Allen-Bradley type CL multi-layer feed-thru capacitors so small they fit around the head of a pin.

**VOLUMETRIC EFFICIENCY.** Big words that explain why Allen-Bradley type CL feed-thru capacitors are so small. Our unique multi-layer concept shaves size to a minimum, without affecting performance. It took Allen-Bradley to get filter capacitors down to their fighting weight. Now rolled capacitors are no longer a design alternative.

Concentric layers of proprietary Allen-Bradley ceramic and noble metal electrodes are fired together for unmatched protection against moisture and contamination. Rugged. Non-polar. With lower inductance and far less noise.

Voltages to 200 WVDC. Temperatures to 125°C. Capacities to 1.0  $\mu$ F. High dielectric strength and reliability.

Several styles and sizes are available through your appointed A-B industrial electronic distributors. For further information write: Marketing Department, Electronics Division, Allen-Bradley Co., 1201 South Second Street, Milwaukee,

Wisconsin 53204. Export office: 1293 Broad Street, Bloomfield, N.J. 07003 U.S.A. In Canada: Allen-Bradley Canada Ltd., 135 Dundas St., Galt, Ontario.

### **ALLEN-BRADLEY**



# OSM<sup>®</sup>

# miniature coaxial connectors



## dc-26GHz

OSM Miniature Coaxial Connectors offer the systems engineer ultimate performance for applications from dc to 26GHz. Recognized for their reliability, electrical performance and long life, OSM connectors have consistently been specified for an ever increasing number of space, airborne and ground installations. Stainless steel housings and beryllium copper center contacts provide the optimum combination of electrical and mechanical characteristics. Available from stock are

several hundred different connector designs for small and medium size semi-rigid and flexible cables, panel and bulkhead mount types, strip transmission, microstrip and integrated circuit types. Coaxial adapters to other popular connector series are also available from stock. For further information, phone, TWX or write your nearest Omni Spectra representative or Omni Spectra, Inc., 24600 Hallwood Ct., Farmington, Michigan 48024. TWX 810-242-1463. Tel. (313) 255-1400.



Send for NEW 82 page OSM Catalog of Components, Connectors, Adapters and Assemblies. Included are complete specifications, detailed outline drawings and applications and performance data.

**Omni**

**Spectra, Inc. MICHIGAN DIVISION**

# Key-to-disk: \$100 million market

By George Weiss

New products editor

**Almost an anachronism** amid today's superspeed machines, the punched card is still ubiquitous and a stalwart against new data entry methods for third-generation computers. With mainframes operating at nanosecond speeds, the preparation of punched cards is comparable to driving a horse-drawn carriage. But direct keying of data under the control of a time-shared processor onto magnetic disk for temporary storage, promises to come into its own in 1970. Some marketing managers predict \$100 million in sales by year-end and an annual growth of 30%.

The key-to-disk systems are leaping over key-to-tape technology, introduced in 1965 and hailed at that time as the successor of the punched card. But critics of key-to-tape say it has not fulfilled its promise. The operator must make too many decisions, and the programmer doesn't have enough control and editing capability.

Currently, key-to-disk systems are being introduced by Data Pathing and by Entrex. The first units from Systems Engineering Laboratories are now being installed, and Honeywell plans delivery of its first systems next year. Other companies with equipment in the field include the Computer Machinery Corp., Logic Corp., Inforex, Penta Computer Associates, Sanders Associates, and Consolidated Computer.

Key-to-disk systems can handle large volumes of randomly entered data in a variety of formats. The data can be checked, verified, and validated without the time-consuming process of tape pooling, necessary with key-to-tape units. A supervisor controls all operations and establishes a priority sequence. Unobtrusively the system monitors the operator's efficiency. Display

capability includes cathode ray tube; record format is flexible and many times greater than the 80-character limit of the punched card. Mass core or disk storage is available; remote data collection becomes practical; powerful applications-oriented programs control data entry and several programs can be stored in one processor. In addition, there is a savings in the number of personnel and a quicker learning period for the operators.

However, some may say the advantages are offset by the price. Depending on capability, quantity of terminals, software package, and options desired, monthly rentals can cost \$3,000 to \$4,000, while purchase prices can stretch from \$100,000 to over \$300,000. And even more costly, if the mainframe breaks down, the whole system shuts down.

Systems being delivered to customers have had as few as eight terminals and up to as many as 46 terminals in a cluster. One large broadcasting firm ordered three separate systems each with eight terminals rather than one system

containing 24. This way, at least one or two systems can act as backup if a failure occurs.

**Handles cluster.** The Entrex series 480 comprises a 16-bit Nova computer from Data General and can cluster up to 64 terminals, each with a keyboard and a 480-character crt. The 480 system handles one or two disk drives, available in disk capacities of 11, 22, or 44 megabits. Entrex relies on a special technique to compress character lengths on the disk. Eight-bit characters can be transferred from the disk to the processor at 80,000 characters per second.

One of the keys on the console keyboard, labeled HELP, assists the operator in getting out of difficult situations. For example, data being entered by keyboard may not be accepted as valid. Depressing the HELP button causes the crt to display a list of the possible alternatives to the dilemma. The operator corrects the entries prescribed by the instructions until the data is accepted.

Entrex rents the 480 with 16 stations for about \$2,400 a month

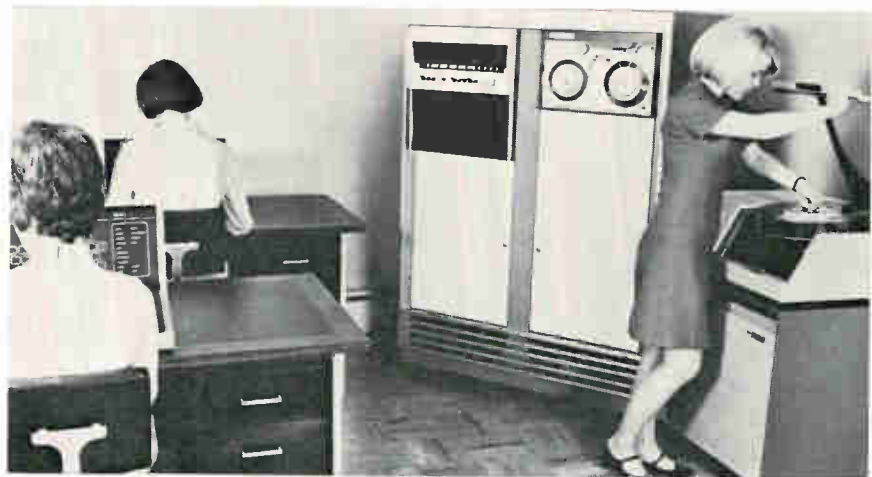

Keyed in. Data is entered by the operators at the Logic Corp.'s control consoles and recorded directly onto magnetic disk (right).

# more than a power supply

You get more than a power supply when you specify this or any Hewlett Packard power supply. An international network of 220 sales/service offices are at your disposal . . . the most comprehensive service manuals detailing every aspect of the supply from theory and operation to troubleshooting . . . protection circuitry including an internal overvoltage "crowbar" to safeguard delicate loads, standard on this Low Voltage Rack (LVR) Series. OUTPUTS: 10V @ 20, 50, or 100A; 20V @ 10, 20, or 50A; 40V @ 3, 5, 10, 30, or 50A; 60V @ 3 or 15A. RIPPLE AND NOISE: typically 200 $\mu$ V rms, 10mV p-p. Remote Programming and lots more. Prices start at \$350.

## and you can customize it with these options . . .

- 10-Turn Output Voltage and Current Controls
- Chassis Slides
- 3-Digit Graduated Decadal for Voltage or Current
- 115V, 208V, or 230Vac Inputs
- 50Hz Input



HEWLETT  PACKARD

POWER SUPPLIES

Over 100 power supplies are described in the 1970 HP Electronics Catalog. Write for your copy.

100 Locust Avenue, Berkeley Heights, New Jersey 07922 (201) 464-1234

# hp DC POWER

From 10 $\mu$ V to 4000V

From 1 $\mu$ A to 2000A

From \$90 to \$3,500

From manual to computer controlled.



## LOW COST SUPPLIES

Compact laboratory power supplies can be stacked or rack mounted. Choose from 6 well-regulated models: 10V @ 1A; 25V

@ .4A; 50V @ .2A. Three Constant Voltage/Current limiting models — \$90. Three Constant Voltage/Constant Current models — \$115.

**Constant Voltage/Constant Current with Automatic Crossover, Remote Programming, Remote Sensing, Auto-Series or Parallel, Optional Internal Overvoltage "Crowbar"**



## MEDIUM POWER / TRANSISTOR REGULATED

Precisely regulated. Programming speeds as fast as 500 $\mu$ s. 20 models: 7.5V @ 3 or 5A; 10V @ 10A; 20V @ 1.5, 3, 5, or 10A; 30V @ 1A; 40V @ .75, 1.5, 3, or 5A; 60V @ 1 or 3A; 100V @ .75A; 160V @ .2A; 320V @ .1A. \$144 to \$395.



## MEDIUM POWER / SCR REGULATED

8 models: 20V @ 15 or 45A, 40V @ 10 or 25A; 60V @ 5 or 15A, 120V @ 2.5A; 600V @ 1.5A. \$360 to \$550.

## HIGH POWER/SCR REGULATED

12 Models: 4V @ 2000A; 8V @ 1000A; 18V @ 500A; 36V @ 300A; 64V @ 150A; 110V @ 100A; 220V @ 50A; 300V @ 35A; 600V @ 15A. \$1275 to \$3500.



and sells it for about \$100,000.

Data Pathing's system will be available later this year and will consist of two models: one with eight terminals and the other with four.

The system will have four modes of operation: enter, verify, file maintenance, and supervisory control. The file maintenance mode includes search, insert, delete, corrections, output either to tape or mainframe, and a purge file.

The Inforex system links eight keyboards, each with a 125-character crt. A disk stores 5,400 records of 125 characters expandable to 500 characters.

Data can be verified either by key or by viewing the crt, or by a combination of both. And if data entry involves an arithmetic computation, a balance verify mode checks for inaccurate entries.

Options offered include a newly developed tele-processing capability, hard copy output, compatibility with an IBM 360, and tape inwards—a tape handling feature that searches, updates, blocks and unblocks tapes, and proofreads them. A standard eight-terminal system is rented for \$960 a month.

**Field backup.** Two companies that are emphasizing service support are Honeywell and Systems Engineering Laboratories.

Honeywell's system, known as Keyplex, is designed to serve large data processing centers of 30 to 60 stations. The system handles variable record sizes up to 400 characters with 400 available formats. Data verification takes place immediately after entry. If the disk becomes inoperative, the input data can be routed directly to the magnetic tape unit and later rerun through the processor and disk.

The basic system sells for \$67,200 and leases for \$1,400 a month. Each keystation costs an additional \$4,080 or leases for \$85 a month.

Keytran, SEL's data entry system, uses the firm's 810B processor with 750 nsec cycle time. The system links up to 48 terminals and offers such standard features as automatic batch transfer from disk to tape without interrupting data entry operations, dynamic allocation of disk storage space, batch balancing, check digit control, selective verification, and full supervisory control. Maximum record length is 399 characters with 1,000 formats.

As an option, the Keytran system includes a separate field position display holding 16 backlit windows for field identifications. An additional application-oriented removable sheet lets the user define each field block for each application. A typical system with 16 keyboard terminals rents for \$3,435 a month. The purchase price is \$116,500.

Computer Machinery Corp. and Logic Corp. could be viewed as the granddaddies of this fledgling industry. Already Computer Machinery claims sales of more than 60 systems.

Logic Corp. is installing what it claims is the largest system, at RCA headquarters in Cherry Hill, N.J. It has 46 terminals replacing 60 IBM keypunch machines at a price of \$304,000.

Henry M. Alken, Logic Corp.'s president, says that the company plans to add remote data entry by replacing the keyboard and display consoles with remote TouchTone phones.

BRAND-REX PRESENTS  
**BUCK ROGERS**  
 IN THE 25th CENTURY

WILMA, DR. HUER AND I WERE JUST LEAVING NEPTUNE WHERE WE'D HELPED TIE IN A NEW NETWORK OF PERIPHERAL EQUIPMENT WITH THE MASSIVE NEPTUNIAN COMPUTER CONTROL CENTER.

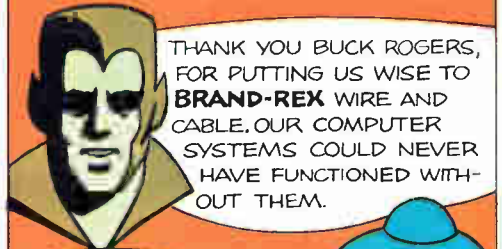

THANK YOU BUCK ROGERS, FOR PUTTING US WISE TO **BRAND-REX** WIRE AND CABLE. OUR COMPUTER SYSTEMS COULD NEVER HAVE FUNCTIONED WITHOUT THEM.

IF **BRAND-REX** IS ALREADY SUPPLYING THE 10 BIGGEST CENTRAL PROCESSING UNIT MANUFACTURERS IN THE UNIVERSE, IT STANDS TO REASON THEY'LL HAVE THE PRODUCTS COMPATIBLE WITH YOUR NEEDS. GOOD-BYE FOR NOW.



WE'RE OFF TO MERCURY TO DO ANOTHER CRITICAL HOOK-UP JOB WITH **BRAND-REX** WIRE AND CABLE.



SHORTLY AT THE PLANET MERCURY'S NEW COMPUTER CONTROL CENTER...

BUT DR. HUER, THIS MERCUREAN SYSTEM IS ENTIRELY DIFFERENT FROM THE ONE WE JUST WORKED ON FOR NEPTUNE.

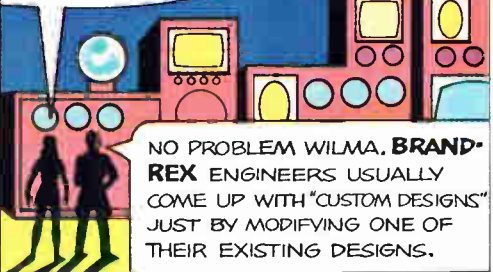

NO PROBLEM WILMA. **BRAND-REX** ENGINEERS USUALLY COME UP WITH "CUSTOM DESIGNS" JUST BY MODIFYING ONE OF THEIR EXISTING DESIGNS.

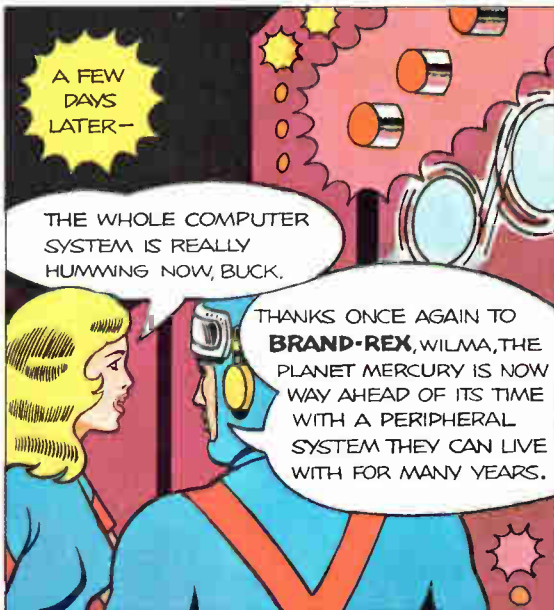

A FEW DAYS LATER—

THE WHOLE COMPUTER SYSTEM IS REALLY HUMMING NOW, BUCK.

THANKS ONCE AGAIN TO **BRAND-REX**, WILMA, THE PLANET MERCURY IS NOW WAY AHEAD OF ITS TIME WITH A PERIPHERAL SYSTEM THEY CAN LIVE WITH FOR MANY YEARS.

SAY EARTHFOLKS: DID YOU KNOW THAT **BRAND-REX** ENGINEERS TURN OUT AS MANY AS 3,000 NEW CABLE DESIGNS IN A YEAR? NO WONDER THEY HAVE MORE UL APPROVALS ON COMPUTER WIRE AND CABLE THAN ANYONE ELSE. THEY'RE USED TO WORKING HAND-IN-GLOVE WITH THE BIGGEST NAMES IN THE INDUSTRY SO THEY JUST NATURALLY OFFER THE MOST COMPATIBLE DESIGNS FOR PERIPHERALS AVAILABLE. TAKE MY ADVICE AND WRITE FOR THE **BRAND-REX** CATALOG ON BUSINESS MACHINE WIRE AND CABLE TODAY.

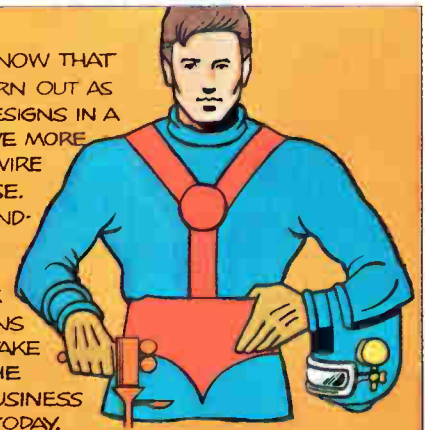

**BRAND-REX DIVISION** AMERICAN ENKA CORP.  
 WILLIMANTIC, CONN., 06226. PHONE 203 423-7771.

**BRAND-REX, WAY AHEAD IN WIRE AND CABLE**

# Differential amps speed computer input

Two discrete devices for use in a-d converters, pulse amplifiers are designed around fast settling time and slew rate

Computer engineers sneer about the slow peripherals their fast machines have to put up with: "If we only had faster analog-to-digital converters", new applications in fast process control, real time analysis, signal processing and display would open up.

A key component of fast a-to-d's is the input, a differential operational amplifier, since specifications

like slew rate, bandwidth, and settling time can limit the performance of the whole converter. Now Philbrick/Nexus Research, a Teledyne Co., has introduced two new differential amplifiers which have largely been optimized around settling time.

The faster one, the 1025, achieves 0.01% settling in a guaranteed 300 nanoseconds and a typical 150. It

needs only 75 nsec to reach 0.1%, and slews at 750 volts per  $\mu$ sec. But as a concession to its high speed, it has been made an "inverting-only" amplifier.

According to Alan R. Risley, marketing manager, an outboarded resistor or trimmer cuts the 1025's settling time further. Depending on demand, he'll offer this as an optional version, guaranteeing 150



Miniature storage tube TME1239 acts as an electronic buffer memory. It can store a full tv gray-scale image for 15 minutes with constant refreshing, and a black-and-white image for half an hour. If the power is turned off, storage capability is at least one month. It can erase an image in one tv frame. Thomson-CSF Electron Tubes Inc., 50 Rockefeller Plaza, N.Y. [341]



Half-inch-diameter, vernier adjustable variable resistor type VA-300, with a carbon ceramic resistance element, has a shaft to contactor turn ratio of 5 1/2 to 1. A wide resistance range from 100 ohms to 2.5 megohms (linear taper) is available with a tolerance of  $\pm 20\%$ . Power rating is 3/4 w at 70°C, derated to no load at 150°C. CTS Corp., Paso Robles, Calif. [342]



Miniature, 3pst, low thermal relay model 180 is designed for microvolt level switching in instrumentation systems. The less than 1  $\mu$ v thermal offset voltage suits it for multiplexers servicing large numbers of low level transducers. Coil-to-contact capacitance of 0.01 pf permits high common mode rejection. Computmet Inc., 21415 Wyandotte St., Canoga Park, Calif. 91303 [343]



Variable capacitors series 505 are for uhf, vhf, microwave and stripline uses, and are available with chip capacitors soldered in parallel to provide high Q with higher current and capacitance capabilities. The time-consuming and costly practice of trimming is eliminated by means of interchanging close-tolerance chips. Johanson Mfg. Corp., Rockaway Valley Rd., Boonton, N.J. [344]



Employing superior capacitive and inductive elements, the A.V. (Advanced Version) emi filters have ratings from 50 to 250 wvdc. One group, the 115 v a-c, 400 hz series, features no voltage deratings for temperatures up to 125° C and has standard ratings of from 50 ma to 10 amps. Price is \$12 each in small lots. Potter Co., 500 W. Florence Ave., Inglewood, Calif. [345]

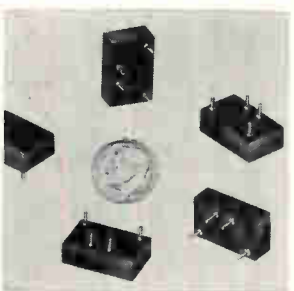

Mini-Spiradel delay line has a minimum time delay to rise time ratio of 5/1. The units, measuring 0.780 x 0.460 x 0.250 in., are for dual in-line mounting and are compatible with ICs. Standard delay tolerance is 10%. Operation is from -55° to +105° C. Time delays are from 10 to 100 nsec increments. Allen Avionics Inc., Mineola, N.Y. [346]

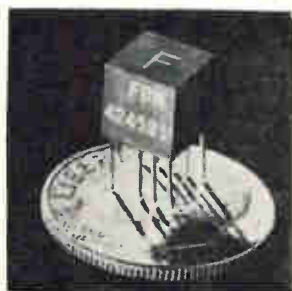

One-quarter-inch cube transformers and inductors series FMM are for computer, communication and instrument applications. Typical of the series is the FMM-7066 with primary and secondary impedance of 10,000 ohms each, primary d-c resistance of 600 ohms, secondary d-c resistance of 746 ohms. Ferrodyne Corp., 4240 Glencoe Ave., Venice, Calif. 90291 [347]



High-voltage, precision carbon film resistors offer resistance values from 20 ohms to 100 teraohms, with wattage capabilities up to 100 w and voltages to 125 kv. Resistors with higher voltage and wattage capabilities are also available on request. All are precision manufactured to tolerances of  $\pm 1\%$ . Berman Manufacturing Inc., Box 370, New Cumberland, Pa. [348]

# THE QUIET LAMP

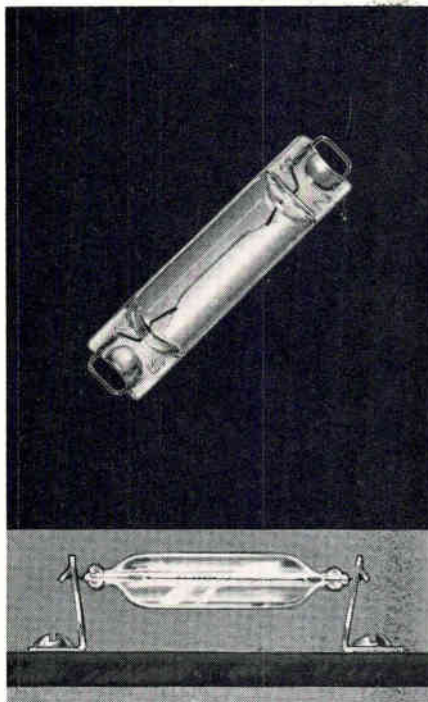

The design of this lamp makes it ideal for all audio-related applications where freedom from noise is desirable. There are no anchors, a principal source of noise. The lamp has no soldered connections and no soldered-on base. The clip-type mounting bracket is inexpensive and provides a low silhouette that conserves space. Can be supplied in 6 v. and 12 v. types. Write for catalog A-21. Tung-Sol Division, Wagner Electric Corporation, 630 W. Mt. Pleasant Avenue, Livingston, N.J. 07039; TWX: 710-994-4865, Phone: (201) 992-1100; (212) 732-5426.

## TUNG-SOL® BASELESS CARTRIDGE LAMP

TUNG-SOL—WHERE BIG THINGS  
ARE DONE WITH SMALL LAMPS

® Trademark TUNG-SOL Reg. U.S. Pat. Off.  
and Marcas Registradas

nsec even though 100 nsec settling times have been reached in laboratory tests.

The 1019, however, though slightly slower settling, is a full differential amplifier. Risley says its combination of characteristics is unique: it slews at 1000 volts per  $\mu$ sec, delivers its full  $\pm 10$  volts output at 15 Mhz, has a unity gain bandwidth of 100 Mhz, and settles to 0.01% accuracy in a guaranteed 500 nsec and typically in 300 nsec.

Peak output for either device is  $\pm 10$  volts, but the 1019 delivers 20 milliamps, while the 1025 delivers 50 ma.

Surprisingly, the faster settling amp, the 1025, has the lower price—\$75 each (1-9 units) compared to the 1019's \$125. The difference lies in the output sections of the two amps, in which the 1025 uses lower-cost transistors, trading some bandwidth and gain for price. Its open loop gain is 80,000, as against the 1019's 150,000, full output is available at 10 Mhz, and unity gain bandwidth is 50 Mhz.

For other parameters, specifications are identical: differential input impedance is  $10^{11}$  ohms paralleled with 5 picofarads, temperature coefficient is 25 mv per degree C, bias current is 50 picoamps maximum, temperature range is  $-25^{\circ}$  to  $+85^{\circ}$ C, initial offset is a maximum of  $\pm 1$  mv without trim.

Common mode rejection ratio holds up well with either unit; it's 50,000 minimum at frequencies as high as 1 khz. Usually this specification drops off quickly above 10-100 hertz.

Because of their combination of bandwidth, slew rate, and settling performance, the 1019 and 1025 are useful as pulse amplifiers, especially where complex waveshape signals are concerned. The broad bandwidths of the amps encompass more of the signals' Fourier components, making for less output distortion.

Thus, Risley expects the 1025 to make its way into the high speed analog to digital converters for data processing systems, and into display system pulse amplifiers. The 1019 also suits these applications, besides acting as a very fast follower amplifier.

Philbrick/Nexus Research, Allied Drive, Dedham, Mass. 02026 [349]

## New components

### Relay boasts low profile

Height of 0.225 inch,  
closer lead spacing allow  
high packaging densities

**Laying out components** on a printed circuit board and spacing the boards in a system are tasks where even tenths of an inch count. A reduction in the height of the largest component on a p-c board by a tenth of an inch multiplied by each card in the system saves many inches of needed space in packaging density, not only between connectors but also on the card itself. And shrinking the size of relays—often the largest components on the board—can be especially significant.

This is what engineers at Teledyne Relays had in mind when they designed their new relay, Centrigrid series 112. The unit is 0.225 inch high and has leads spaced on 0.100 inch centers, with all eight leads on the periphery of the can. By contrast, the conventional TO-5 is 0.265 inch high, and needs a 0.080-inch high pad to achieve the desired 0.1 inch lead spacing for p-c boards. The Centrigrid reduces height above the p-c board by 0.120 inch, or 35% over the TO-5, permitting substantially greater packaging densities in systems. The relay is 0.370 inch square.

Initial units offered are double-pole, double-throw and have six choices of coil voltage from 5 to 26.5 volts d-c.

In most applications, the series 112 relays plug directly into holes on the p-c board. Teledyne expects sockets for the new configuration to be available soon from suppliers. In large quantities, the new units should cost about the same as the TO-5 line. Initially, Centrigrids will be sold for \$29.95 in single quantities. Sample quantities will be available in September

Teledyne Relays, 3155 W. El Segundo Blvd., Hawthorne, Calif. 90250 [350]



# Counter counts on its thin figure

Just 1¾ inches high, 50-Mhz unit is for communications work; programed offsets allow direct reading of received frequencies

If a rack of communications gear has even a little spare space, a new frequency counter—the 71C 100—can squeeze in. Made by Orbit Controls Ltd., the 71C is but 1¾ inches high. It measures from 20 hertz to 50 megahertz.

“Equipment racks are often crowded,” says Craig Compton, Orbit’s chief engineer, and there wouldn’t be many sales for a thick

module. Also the operator wants the readout close to his controls: the thinner the module, the easier it is to arrange this.”

The 71C is for radio work. Instead of measuring input frequency, the counter adds or subtracts this unknown from an offset and then displays the sum or difference. In a communications setup the offset is the intermediate fre-

quency and the unknown is the output frequency of a receiver’s local oscillator. When the oscillator is tuned, the counter is measuring the setup’s received frequency.

This offset approach, says an Orbit spokesman, will solve the problem of putting a digital readout into communications systems. Digital frequency readouts, the company says, are usually designed

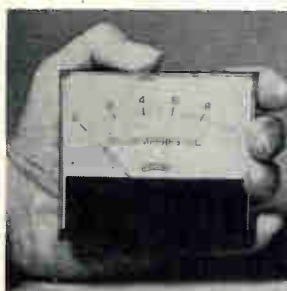

Panel meters series Stellar I come in sizes from 1½ to 4½ in. They offer a shielded permanent magnet moving coil mechanism; pivot and jewel or taut band for d-c, or rectified a-c measurements. A-c measurements utilize a moving iron van type repulsion mechanism. Phaostron Instrument & Electronic Co., 151 Pasadena Ave., S. Pasadena, Calif. [361]



Pulse generator model 8010A is actually two pulse generators with a common output. Each channel’s pulse shaping controls (width, amplitude, risetime, fall-time, offset) are controllable independently, giving an infinite variety of complex waveforms when the waveforms are combined in a common output. Hewlett-Packard Co., 1501 Page Mill Rd., Palo Alto, Calif. [362]

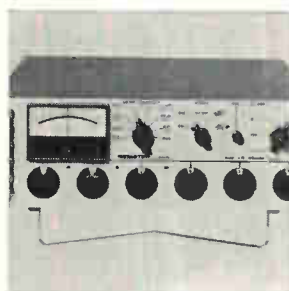

Differential voltmeter model A-72A features ±0.002% accuracy and 2 ppm/day stability. Short term stability is such that a 1/10 ppm or 0.1 μv voltage change can be detected. The instrument has six readout dials and five ranges from 110 mv to 1,100 v full scale. The smallest step is 1/10 μv. Medistor Instrument Co., 4503 8th Ave., NW, Seattle, Wash. [363]



Time interval meter model 536 provides a highly accurate measurement of time with a resolution and accuracy of 1 nsec, thus allowing resolution down to ½ foot at velocities equaling or approaching the speed of light. It is suited for use in high resolution radar ranging, radar altimeters, radar and laser measurements, etc. Nano Fast, 410 W. Erie St., Chicago 60610 [364]



Militarized phase angle voltmeter 215C measures the 4 basic components of an a-c signal: total, fundamental, in-phase, and quadrature voltage. It measures phase angle between fundamental and reference input to 1° accuracy on a precisely calibrated phase-shift dial. Unit spans 300 μv to 300 v full scale in 13 ranges. North Atlantic Industries Inc., Plainview, N.Y. [365]



Stroboscope-tachometer with position (phase) control is named Tachlite model 910. It consists of a solid state unit in a steel case with detachable strobe lamp. It can stop motion of moving objects, fans, shafts, printing webs, etc., and the built-in position control can inspect stamping machines. Price is \$375. Power Instruments Inc., N. Lawn-dale Ave., Skokie, Ill. [366]



Potentiometric recorder model 400, weighing less than 4 lbs, has a response time of less than 1 sec and a chart width of 2 5/16 in. Sensitivity is 100 mv with an accuracy of ±0.5% of full scale. Input resistance is 1 megohm min. Temperature stability is ±0.025 μv/°C, and maximum source resistance is 5 kil-ohms. Rustrak Instrument Div., Manchester, N.H. [367]



Digital panel meters IRV-300 have 100-meg input impedance BCD outputs, and are buffered for remote addressing, printer output, or computer input. Voltages are measured from 1 mv to 1,000 v; currents, from 1 μa to 1 amp; and resistance, from 10 ohms to 10 megohms. Prices start at \$183. Digital Instruments Inc., 13735 Victory Blvd., Van Nuys, Calif. [368]

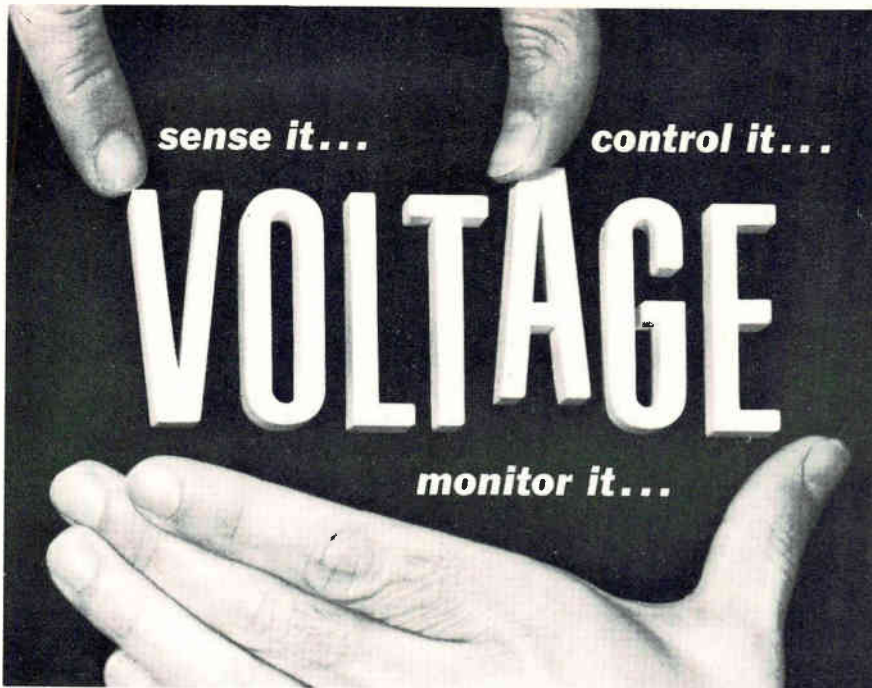

**...with Tempo's new voltage-sensitive relay, designed for maximum versatility in applications where voltage is critical.**

Here is a unique semiconductor device incorporating built-in signal sensing, conditioning and comparator circuits plus a relay or solid state output. It can be used for sensing and signaling an over or under-voltage condition, compared to a pre-set reference value — or, it can be utilized to operate within a pre-set voltage band, providing an output signal for alarm or load disconnection when the voltage varies from the band limits by as little as  $\pm 2\frac{1}{2}\%$ . Built-in hysteresis prevents output relay chatter. Models can be supplied with internal time delay to avoid false alarms caused by normal line voltage transients.

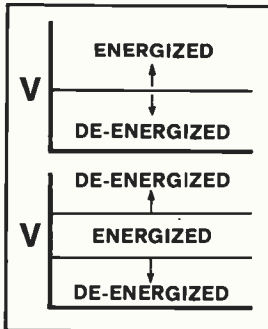

60Hz and 400Hz, 115-volt AC models are available in either 1 or 3-phase types, and are particularly suited for applications with MIL-STD-704 power systems and inverters. They meet or exceed all applicable requirements of MIL-R-5757 and MIL-R-6106. DC models are also available, for standard inputs of 28-volts or 5-volt IC supplies. The unit is packaged in a hermetically-sealed case, and is designed to operate under rugged environmental conditions, including temperatures up to 100°C. Complete tech data is yours for the asking. Send for it today, and start putting an end to your voltage problems.



Talk to Tempo When You Want to Time, Switch, Sense or Control

**TEMPO INSTRUMENT DIVISION**  
Allen Electric and Equipment Company  
PLAINVIEW, N. Y. 11803 • 516-694-4400  
Circle 112 on reader service card

**FIGHT THEM ALL...**

**Heart Attack  
Stroke  
High Blood Pressure  
Rheumatic Fever**



**GIVE ... SO MORE WILL LIVE HEART FUND**

**... one counter can have six selectable offsets ...**

as part of a system, limiting the user's options for making changes. When there is no display, an ordinary counter alone can't be used because the only frequency that can be conveniently measured is the local oscillator's, and not the receiver's. More processing is needed; and that's what the 71C does.

Orbit puts up to six offset frequencies into the counter. Any one can be selected via a rear panel connector. However, Orbit expects most customers will need just one offset. The British government already has bought several, each with a single offset.

The counter's price in the United Kingdom is \$1,200, and delivery time is 12 weeks. Each counter

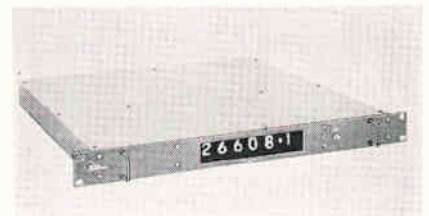

Here and there. The display can work in the instrument or remotely.

with its own offsets is, in a sense, a custom-made unit, so the chances of that delivery time coming down are as slim as the instrument.

All the controls and connectors are on the back panel, except for a button that switches a calibration signal across the instrument's input. Even the display doesn't necessarily stay in the front panel — it can be removed and set up remotely.

Display and gate time also can be programed. Display time settings are 0.02, 0.2, and 2 seconds. For the gate time, they're 0.01, 0.1, and 1 sec.

The counter is one member of a low-profile family. Already on the market is a bidirectional counter, also 1¾ inches high. And in the planning stage is a 10:1 frequency divider, which will push the 71C's range to 500 Mhz.

Orbit Controls Ltd., Alstone Lane Industrial Estate, Cheltenham, Glos. GL 51 8JQ, United Kingdom [369]

## Carrier gets a good grip on IC

Plastic molded unit is made for dual in-line packages with up to 40 leads; it locks chip in with three notched tabs that are built into inside walls

Even after an MSI or LSI chip receives its protective package, the circuit faces a hazardous road that leads through handling and testing routines both at the manufacturer's plant and at the customer's incoming inspection stations. Package leads aren't known for their ruggedness, but now some carriers are available that protect both the leads and the package itself.

A new dual in-line IC-package carrier, that offers lower cost and a firmer grip on the IC, adapts to a magazine for automatic feed to the test stations. The carrier is being offered by International Production Technology, a company formed about a year ago to manufacture and market the production and test equipment that had been developed at Siliconix.

According to company president Thomas S. (Stoney) Edwards, who had been vice president and one of the founders of Siliconix, the major economic advantage of the carrier is that its design requires less material, yet preserves the mechanical protection of the IC package. The carrier has three notched tabs that grip the IC by its body, between the leads. Carriers that depend on



Wyr-Guide is an automated method of furnishing clear, concise, audio instructions for production assemblers. It replaces cumbersome wiring procedures using wiring lists or other time-consuming visual aids. It speaks out wiring instructions to reduce errors and increase production, and has a repeat button if instructions are missed. Cognitronics Corp., Mt. Kisco, N.Y. 10549 [421]



Compact, ultrasonic vapor degreaser, using Freon TF, TMC, or other chlorinated solvents, provides quick, thorough cleaning of small contaminated parts such as electronic components, p-c boards, and silicon wafers. It measures 17 x 13 x 25 in. high. Price range is \$1,100 to \$1,325; delivery, from stock. Westinghouse Electric Corp., P.O. Box 868, Pittsburgh, Pa. 15230 [422]



Infrared tunnel oven is designed for use as a basic unit with optional accessories for diversified applications. It can cure epoxy resins in as little as three minutes, which is up to ten times faster than conventional air-dry methods. Other applications include drying inks, curing conformal coatings, etc. Rolenn Mfg. Co., 3131 Kansas Ave., Riverside, Calif. 92507 [423]



Infrared oven model 68-099, for p-c board drying and curing, has a production capacity of 216 sq ft per hour for curing solder resist coatings. Production would be approximately tripled for drying etch resist and seal coatings. Conveyor length is 11 ft 3 in.; belt, 24 in. wide. Belt speed is variable from 0 to 5 fpm. Fostoria-Fannon Inc., 1200 N. Main St., Fostoria, Ohio [424]

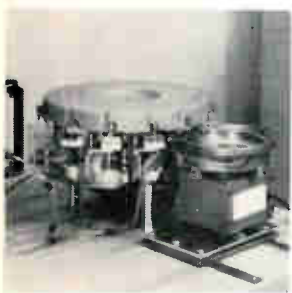

Automatic test and sorting system AT30 can process components such as chip capacitors and resistors. It can test chips in sizes from 0.060 to 0.600 in. long; 0.060 to 0.400 in. wide; and 0.020 to 0.070 in. thick. Rate is 6,000 chips per hour with one or two tests per chip. Rates may be adjusted from the control panel. K. Dixon Corp., Topham St., Tarzana, Calif. [425]



Spray-rinse unit model 1300, equipped with a 15-in.-wide horizontal conveyor, matches bench-type model 315 spray etcher. The new unit is mounted in-line with the etcher to allow post-etch treatments such as neutralizing, copper brightening or resist stripping by caustic solvent. All operations are automatic and continuous. Chemcut Corp., Science Park, State College, Pa. [426]

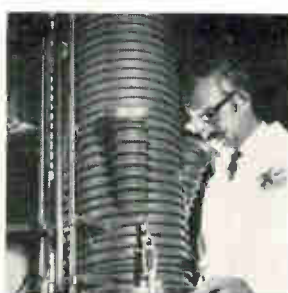

Resistance heated, vertical Czochralski-type furnace model NRC 2809 grows 3½-in.-diameter, 28-in.-long crystals in less time than normally taken to grow 2¼-in.-diameter crystals. The larger crystal will produce approximately ¼ million integrated circuit chips. Crucible capacity of the furnace is 75 grams. Norton Co., 160 Charlemont St., Newton, Mass. 02161 [427]

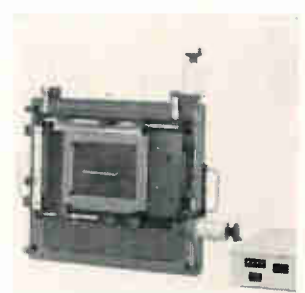

Automatic motorized step-and-repeat back, called SAR57, is for chemical micromilling and circuit photomask cameras. It permits digital programming of stepping motion in both X and Y axes in minimum increments of 0.001 in. It can position images up to 2 in. apart. Positioning accuracy is 0.0005 in. over the working area. HLC Mfg. Co., 738 Davisville Rd., Willow Grove, Pa. 19090 [428]

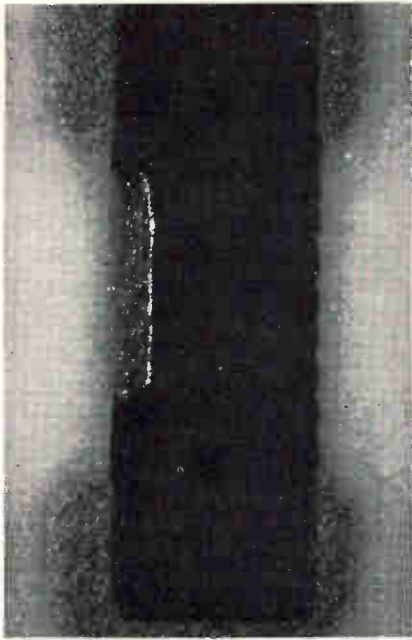

**Through  
thick  
and thin.**

**A better  
IC trim.**

Raytheon's SS-218 laser IC trimmer is a self-contained system that trims thick (as shown above) and thin film resistors, capacitors and other deposited materials. It is faster and provides better tolerances than abrasive trimmers. Accuracy is better than 0.1% from 1 ohm to 11 megohms.

The SS-218 operates manually and at pulse rep rates from 1-20 pps with output energy variable to 100 mj at 10 pps and to 50 mj at 20

The SS-218 comes with Yttrium-Aluminum-Garnet laser head, power supply, remote-control operating console, closed-cycle cooler, shielded viewing microscope, micrometer X-Y positioner, automatic resistance measuring bridge, and circuit probes.

For information and applications assistance, contact Raytheon Company, Laser Advanced Development Center, 130 Second Ave., Waltham, Mass. 02154. Tel. (617) 899-8080.

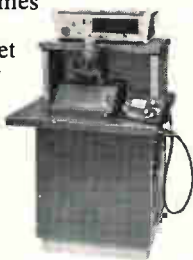

**. . . tabs prevent circuit package  
from moving more than 0.005 inch . . .**

the spring pressure between the IC leads and the carrier to hold the device in the package, according to Edwards, may work for the smaller dual in-line packages—14 and 16 leads, but for larger packages—up to 40 leads—such a scheme allows the package to twist inside the carrier. If twisted, the leads are not flush with the inside of the carrier wall and thus might not be accessible for testing or might even fall out of the carrier.

An IPT carrier handles packages of the same width and varying lengths. Tabs, molded into the carrier, form stops at the end of the package for the shorter 24-pin dual in-line types, but the larger 40-pin packages will also fit, since they will reach the end walls of the carrier.

The C-101 carrier handles dual in-line packages with lead-row spacing of 600 mils and 24, 28, 36, or 40 leads, while the C-102 carrier accommodates wider packages—1050-mil lead row spacing—that have up to 40 leads.

Simplicity of design accounts for the low price. The C-101, for example, sells for about 18 cents in quantities of 5,000, and for really high volume—several million or more—the unit price drops to less than 3 cents. Special carriers with individually designed molds would cost more.

The carriers are molded from ABS plastics, and polysulfone can be used—at a higher cost—for high-temperature applications. During temperature testing of a circuit, the thin walls of the carrier help to get the circuit up to the desired tem-

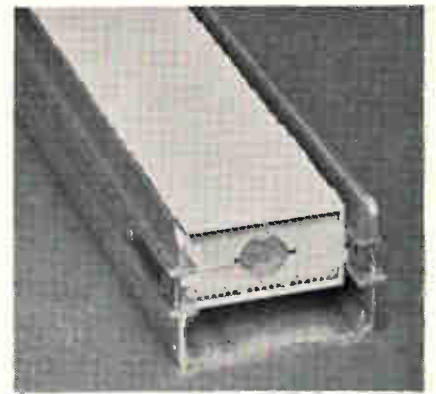

perature quickly; a carrier with thick walls would absorb much of the heat, lengthening the time it takes for the circuit to reach the required temperature.

The carrier is also well suited to automatic loading and unloading of the circuit packages since its molded tabs for gripping the circuit provide a positive action.

The tabs hold the package to within 0.005 inch of the true lead position—thus the package can move back and forth transversely in the carrier no more than 0.005 inch in either direction.

Other company products include photomask duplicators, high-speed testers for field effect transistors, wafer probing and die bonding equipment, and completely automatic handling equipment using the carriers and magazines.

International Production Technology, 185 Evelyn Ave., Mountain View, Calif. 94040 [429]

International Production Technology, 185 Evelyn Ave., Mountain View, Calif. 94040 [429]

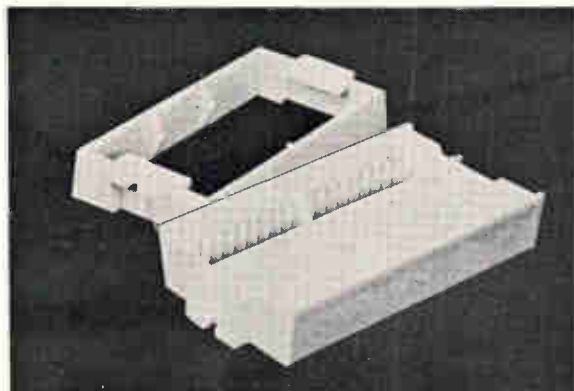

**Hold it.** The C-102 carrier handles LSI packages with 1050-mil spacing between the rows of leads. The notched tabs grip the package between the leads.

# Op amp's input bias current held to 10 na

Cancellation technique also helps reduce IC's thermal drift; unit can operate at power supply levels from  $\pm 3$  to  $\pm 20$  volts

High input bias currents to integrated circuit operational amplifiers are a source of error, particularly in sample-and-hold circuits, current amplification circuits, or circuits with high source impedances.

To reduce such currents, some manufacturers rely on the "super beta" process to develop transistor betas of several thousand. The

disadvantages are that the critical, narrow-base process results in lower yields, and the difficulty of matching the narrow base widths tends to cause higher input offset voltage and drift.

Burr-Brown Research Corp., however, in its model 3500 monolithic op amp, uses a cancellation technique to reduce input bias currents to 10 nanoamps and ther-

mal drift to 0.3 na per degree centigrade. Slew rate is 1.5 volts per microsecond. This is accomplished by a feedback loop that senses the instantaneous input and supplies it with the appropriate compensating current. The technique compensates both the quiescent levels and the signal variations of the bias and boosts the open loop differential input re-

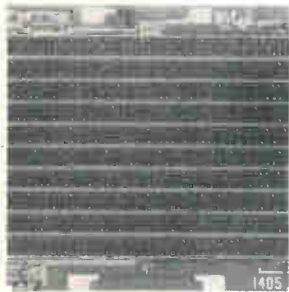

IC serial memory model 1405 is a 512-bit shift register complete with all necessary recirculating circuitry on one silicon-gate MOS chip. It is guaranteed to operate at data rates to 2 Mhz. Clock input capacitance is less than 80 pf. Capacitance at all other inputs is typically  $3\frac{1}{2}$  pf and guaranteed not to exceed 5 pf. Intel Corp., 365 Middlefield Rd., Mountain View, Calif. [436]



Silicon, single-phase bridges series BRE600 feature 6 amps average output at a temperature coefficient of  $55^{\circ}\text{C}$ . Peak reverse voltages are 50 to 800 v. Peak surge rating (1 cycle) is 50 amps. Packaging is accomplished with a  $0.6 \times 0.6 \times 0.25$  in. case, base mounted by either through bolt or a  $\frac{3}{8}$  in. 6-32 stud. Rectifier Components Corp., 124 Albany Ave., Freeport, N.Y. [437]



Microwave transistors types MS-173 and MS175 are priced at \$20 and \$14, respectively, in 100-piece quantities. They feature vhf (100 Mhz) to 4 Ghz microwave performance. Oscillator power output for the MS175 is to 100 mw at 4 Ghz and 300 mw at 2 Ghz; for the MS173 unit, 50 mw at 4 Ghz and 200 mw at 2 Ghz. Texas Instruments Inc., Box 5012, Dallas [438]

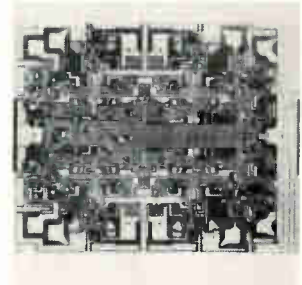

Two content addressable memory (CAM) elements, the 8220 for high-speed and the 8222 for low-power operation, are monolithic arrays. Both incorporate addressing and comparison logic and eight identical memory cells organized as four words, each two bits long. Each element can be conditioned to associate, read, or write. Signetics Corp., E. Arques Ave., Sunnyvale, Calif. [439]

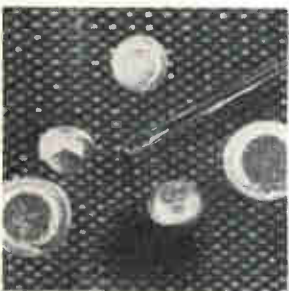

Gallium arsenide varactor diodes series GC-5400 are designed for tuning Gunn effect solid state oscillators in X and Ku band and as parametric amplifier diodes. They may be used for frequency multiplication as high as 60 Ghz. Cutoff frequency is typically 300 Ghz. Standard capacitance tolerance is  $\pm 10\%$ . GHZ Devices Inc., Kennedy Dr., North Chelmsford, Mass. 01863 [440]



Silicon npn transistor 2N5920 features the overlay multiple-emitter-site construction. It is intended for solid state equipment for microwave communications, S-band telemetry, microwave relay link, phased-array radar, and distance measuring equipment. It offers 2-w output with 10-db gain at 2 Ghz; 3-w with 12-db gain at 1 Ghz. RCA, Somerville, N.J. [441]



Silicon planar power transistor SDT9650 has usable  $h_{FE}$  at 200 amps,  $V_{CE0}$  up to 300 v, saturation voltage at 200 amps less than 1 v, and  $I_{CBO}$  less than 100  $\mu\text{a}$  at 150 v  $V_{0B}$ . Units are available in a TO-68 and TO-114 package. Typical applications include high current control circuits, converters and inverters. Solitron Devices Inc., Blue Heron Blvd., Riviera Beach, Fla. [442]



High-reliability 400 hz triacs in the BTN series come in the TO-64 package and feature hard-solder (eutectic) bonding for maximum protection against thermal fatigue. Units are suited for temperature and speed controllers, and a-c solenoid driving. They are rated to 10 amps in voltage categories to 400 v. Transiltron Electronic Corp., Albion St., Wakefield, Mass. [443]



WORDS OF WISDOM  
ON  
**blanketing  
atmospheres**

Sir Francis Bacon never heard of a "dry" box. But when he said, "A wise man will make more opportunities than he finds," he could well have been stimulating the use of blanketing atmospheres.

And, in electronics, your uses are legion. From IC production to behind-closed-doors research. Wherever there's a need for pure, strictly-controlled atmospheres of argon, nitrogen, helium, or hydrogen.

Here's where NCG comes in. We supply all of these gases. When you need them. Where you need them. In the quantities you want—from cylinders to tank cars to a complete, on-site air-separation plant, operated by NCG personnel.

Opportunity knocks. Write to us today for complete details on industrial gases for blanketing atmospheres.

**NCG**<sup>®</sup>

**CHEMETRON CORPORATION**  
NATIONAL CYLINDER GAS DIVISION  
840 North Michigan Avenue • Chicago, Illinois 60611

**CHEMETRON**

TRADEMARK

© 1970, Chemetron Corporation

Tailored to job.  
High input resistance of 10 megohms is obtained when IC op amp's quiescent level and signal variations are compensated.

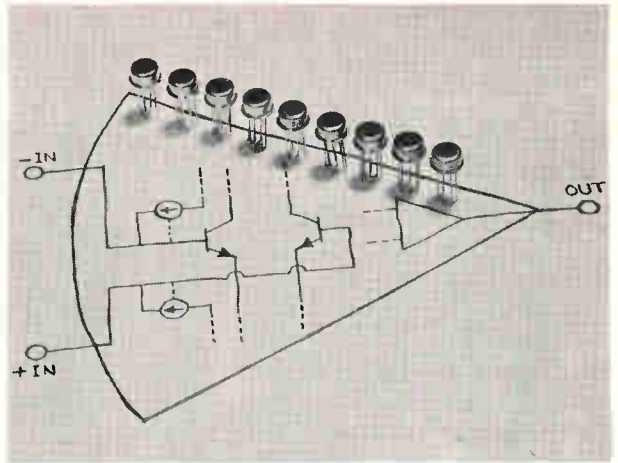

istance to 10 megohms. Common mode input resistance is  $10^9$  ohms. Common mode rejection is 90 db, and gain is 100 db. Settling time is 20 microseconds.

The device, which will be shown at Wescon, can operate at power supply levels from  $\pm 3$  to  $\pm 20$  volts without significant change in its performance because it employs a d-c biasing technique that is independent of power supply levels. In most monolithic op amps, the quiescent current levels vary directly with the supply voltages, causing extreme changes in gain, bandwidth, output current, slew rate, input offset voltage and input bias currents. In the model 3500, power supply sensitivities of 0.2 db per volt, 20 mv per volt and 0.1 na per volt are attained over its full operating range.

While most IC op amps also tend to be noisy, with low flicker noise of about 8 mv peak-to-peak, the model 3500 has 1 mv of noise peak-to-peak. This improves the signal-to-noise ratio and the sensitivity to low-level signals. With a 10-to-1 signal-to-noise ratio, it can handle a 10-microvolt signal.

Typical common mode rejection is 90 db, and open loop gain is 100 db. Unity gain bandwidth is 1 Mhz, input offset voltage 1.5 mv, full power response 20 khz, and quiescent current 2.5 ma. Input offset voltage drifts are limited to  $\pm 5 \mu\text{v}$  per degree C,  $\pm 10 \mu\text{v}$  per degree C, or  $\pm 30 \mu\text{v}$  per degree C. Maximum rated output of the device is 10 volts, 15 ma.

Burr-Brown Research Corporation, International Airport Industrial Park, Tucson, Arizona 85706 [444]

New semiconductors

**IC provides parallel-serial link**

Thanks to two monolithic ICs marketed by General Instrument Corp., low-threshold metal oxide semiconductors can function as parallel-serial and serial-parallel converters. They can be used to link teletype-writers, cathode ray tube terminals, recorders, and printers.

One circuit is designed for the transmitter end of the line and the other for the receiver. Each consists of a 10-bit shift register plus appropriate control logic and is mounted in a 24-lead dual in-line package. The company says that the combination replaces the equiv-

alent of about 35 transistor-transistor logic circuits, some multigate.

The transmitter type, AY-5-1010, is a 10-bit parallel-to-serial converter, and the receiver model, AY-5-1008, is a serial-in, 10-bit parallel-out shift register.

GI uses its silicon nitride process to manufacture the devices, described as metal thick oxide nitride (MTNS) semiconductors. The insulating layer is an oxide-nitride sandwich. The units generate threshold voltages compatible with conventional TTL circuits. "The nitride gives us an additional passivation

step which creates a better threshold stability," says Stanley Schiller, MOS applications manager. The circuits can operate up to 125°C.

The AY-5-1010 accepts parallel data input and can be programmed to accommodate five-, six-, seven-, or eight-bit code words plus one or two stop bits. In the asynchronous mode, the code word plus the stop bits are loaded into the register from the data input lines. Data is transferred out of the shift register serially at the clock rate. For better noise rejection, it also can be clocked at one-eighth the basic clock frequency by applying the appropriate logic level to the divide-by-eight terminal on the transmitter. In the synchronous mode, clock pulses are applied continuously and no start or stop bits are included.

At the receiver end, serial data enters the shift register through any one of four stages, depending on the code applied to the word-length decoder. If the receiver operates asynchronously, data is preceded by a start bit; data bits follow. The clock input controls the rate at which data is accepted into the register. If the divide-by-eight method is chosen, data is shifted on every eighth clock pulse. Data should be sampled at approximately half-bit time; it's accomplished by checking the first bit of data on the fifth count and continuing to sample on every succeeding eighth pulse.

During normal operation, data is shifted through the register until the first bit is transferred into the start bit stage. Then, two flip-flops in the control logic are reset, terminating the CLOCK ENABLE and DATA READY pulses. When the latter terminates, data has been stored and is ready to be read out in parallel. When a positive strobe pulse is applied to the receiver, data in the register and the parity flip-flop are gated out. Before receiving a new word, the register must be cleared by EXTERNAL CLEAR or the trailing edge of the strobe pulse.

The price in 1,000-quantity lots is \$16.80 for the transmitter and \$21.75 for the receiver.

General Instrument Corp., Microelectronics Division, 600 West John St., Hicksville, N.Y. 11802 [445]

## AN INSTANT CIRCUIT BOARD SYSTEM\* THAT WILL SAVE YOU MONTHS OF SCHEDULE TIME.

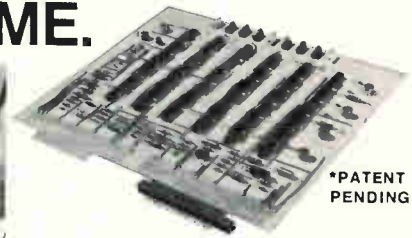
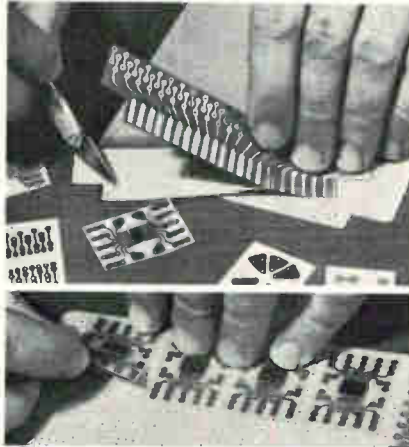

From schematic drawings to card cage systems — IN ONE STEP!

**ELIMINATES:**  
DESIGN • DRILLING • ART WORK • PHOTO WORK & ETCHING

All types of circuit-element configurations may be mixed and combined on the same board.

**SEND FOR YOUR FREE CATALOG AND SAMPLES**

# circut-stik<sup>INC.</sup>

1518 W. 132nd STREET, GARDENA, CALIFORNIA 90249

SEE THIS NEW PRODUCT AT THE WESCON SHOW, AUG. 25-28, BOOTH #3129

Circle 141 on reader service card

# FAILURE ANALYSIS

Why do failures occur in Electronic/Electro-Mechanical Components? Finding out why . . . and where . . . **that's our business.** We analyze the mode, cause and mechanism of the failure itself and provide practical working information to Engineering concerning the prevention of this problem in the future. Not only can we perform complete failure analysis on failed components, we can also predict possible device degradation before it happens, using our construction analysis methods.

As the acknowledged leader in the field of component screening and qualification, **Continental** is the **only** test laboratory of its kind in the U. S. offering impartial, unbiased **Failure Analysis** to both the manufacturer and the user.

We invite you to submit your problem. Send for descriptive brochure.



**CONTINENTAL TESTING LABORATORIES, INC.**

763 U. S. Highway 17-92  
Fern Park, Florida 32730  
Telephone (305) 831-2700

# DIGITAL TV



CVI video sampling instruments allow your computer to "look" at practically anything. High accuracy bandwidth compression of conventional television signals opens new doors to data processing in research and industrial applications. Let us tell you about some of our unique video devices.

COLORADO VIDEO, INCORPORATED

P.O. Box 928 • Boulder, Colo. 80302 • Phone (303) 444-3972

# cv*i*

Video Data Acquisition • Processing • Display • Transmission

Circle 142 on reader service card



# Printact®

**Plugs into your PC board... mates with plated conductors**

The design concept of the series G non-latching and series LD dual coil magnetic latching relays is to simply mate the encapsulated motor assembly and its associated swinger blade assembly with etched and plated conductors on your PC board which become the fixed contact section.

Encapsulated coil, bifurcated gold or palladium contacts, low thermal EMF, plug-in without sockets or soldering, low bounce and chatter, series-break switching eliminates pig-

tails, permanent magnet avoids return spring and mechanical linkage—all of which assures continuous performance for many millions of cycles.

Available with 6, 12 or 24 VDC coils (0.5 watt G series, 1.0 watt LD series) in 2, 3 and 4 pole configuration. Series break swingers permit each pair of fixed contacts to be etched with common (Form C) or isolated (Form A plus Form B) switching between make and break circuits.

For data write or call 212-EX 2-4800.

Printact Relay Division, Executone, Inc., Box 1430, Long Island City, N.Y. 11101

New materials

## Laminate takes solder dip, drilling



A family of non-measling laminates is available in NEMA grades G-10, G-11, FR-4, and FR-5. Two types are offered: Unilam NM and Unilam NMX. The NM can withstand solder dip for 150 seconds with no blistering. The NMX can withstand solder dip indefinitely, and also features excellent machinability. When it is drilled, it leaves virtually no hole smear and eliminates excessive drill wear. Universal Laminates Inc., Mohawk Drive, Leominster, Mass. 01453 [381]

Highly conductive, two-component epoxy adhesive AG-1 is applied and cured at room temperatures, but may be used on heated wires and components. It has excellent electrical and thermal conductivity, and will bond dissimilar materials together. It is a pure-silver filled resin/hardener mix with a resistivity of 0.01 ohm-cm and a tensile shear strength of better than 1,500 psi. It is mixed to paste consistency and applied with any appropriate tool in the quantity desired. The material is suited for rebuilding or repairing p-c boards where a strong bond to the board is desired; bonding thermocouples together; repairing the delicate wires in r-f coils; and soldering IC's where the heat of a soldering iron would damage the component. Thermoset Plastics Inc., 5101 E. 65th St., Indianapolis 46222 [382]

Extremely high purity (99.9%), beryllium oxide ceramic called Berlox K-160 has intrinsic chemical and mechanical properties approaching those of single-crystal BeO. The material is highly suitable for precision machining to high surface finishes, metalizing, and plating, and may also be used in production of high-strength consistent ceramic-to-metal hermetic seals. Electrical resistivity is  $10^{17}$  ohm/cm and thermal conductivity is 0.65-0.67 Cal/sec-cm<sup>2</sup> at 25°C. Applications for the material include tubes and components for laser systems, antenna coupler components and helix support rods. National Beryllia Corp., Haskell, N.J. 07420 [383]



## New Books

### Updating ferrites

Principles of microwave ferrite engineering

Joseph Helszajn  
Wiley-Interscience  
258 pp., \$12.50

Many new developments in the field of ferrite engineering have arisen, since the early books on the subject, quite concise at the time, were introduced in the early 1960's. This new book, which is devoted to bringing the reader up to date, handles the topic within an engineering framework rather than one of pure physics. Thus, experimental results are kept to a minimum, being drawn on only where they help to illustrate a fundamental point.

The physics of ferrites is not considered by the author, since his prime concern is the macroscopic behavior of the equation of motion of the magnetization vector and its interaction with the microwave magnetic field. The beginning of the book is devoted to the form of tensor permeability under various driving fields. The first five chapters are devoted to the theory of ferrite devices and the medium they use. The remaining six chapters are devoted to the devices themselves; among those described are the junction circulator, the Faraday-rotation isolator, the nonreciprocal ferrite phase shifter, the yttrium-iron-garnet filter, and the ferrite switch.

Probably the most important ferrite device known is the junction circulator, and an entire chapter is devoted to this device. The author develops the junction theory using several different approaches, all of which contribute to the general understanding of the device. The first description is in terms of the scattering matrix of the junction. This method relies on the adjustment of the eigenvalues of the scattering matrix, which in turn is related to the reflection and transmission coefficients of the junction. The second description is in terms of the electromagnetic properties, which allows the dependence of the disk diameter and magnetic field of frequency and magnetization to be determined. This method

assumes initially that the system is functioning as a circulator and then searches out the conditions to satisfy the assumption. Another method describes the theory of the junction circulator in terms of circuit theory by obtaining the normal modes of the equivalent shunt-resonator circuit of the junction. The chapter ends with a definition of the bandwidth of the junction and proposes external networks to improve the bandwidth.

The chapter on magnetically tunable yig filters covers various filter types, such as bandpass, bandstop, and directional. The author stresses the low losses of the polished single-crystal yig spheres when used in narrowband-tunable filters and coincidence limiters. A tunable circulator is developed, as is a tunable-filter limiter.

Two chapters are concerned with electromagnetic propagation in a ferrite-loaded waveguide. One covers cylindrical waveguides; the other rectangular waveguides. A lucid description is given to Faraday rotation in a circular waveguide containing a longitudinally magnetized ferrite rod. This is particularly important since this structure is the basis for the nonreciprocal ferrite phase shifter and the Faraday-rotating circulator and isolator, all of which depend on the nonreciprocal character of the Faraday-rotation effect.

The case of the transversely magnetized ferrite loaded in a rectangular waveguide is treated for the  $TE_{01}$  limit mode, which leads to the theory of the nonreciprocal ferrite phase shifter in rectangular waveguide. An application of this theory is in the construction of the differential phase-shifter circulator.

Coupled-wave theory of ferrite devices is developed in the chapter on infinite ferrite medium. A pair of coupled-wave equations are developed between x-y polarizations as an example of coupled-wave theory. This development is extended in a later chapter on ferrite devices to the Faraday-rotation phase shifter, the rectangular-waveguide amplitude modulator, and the elliptical-waveguide Faraday rotator.

# better switch



- **HIGHER RATINGS:**  
10 amps @ 125 VAC
- **LONGER LIFE:**  
250,000 operations
- **HIGHER IMPACT:**  
New metal case
- **MEETS IEC SPECS:**  
5A/250 VAC — 10A/115 VAC
- **LOWER PRICES (SPDT):**  
1.95 ea., 1.17 lots of 100
- **U/L OPTIONAL:**  
Write for details
- **SPDT AND DPDT TYPES:**  
With 1/4" or 15/32" bushings
- **IMMEDIATE DELIVERY**

A new series of miniature toggle switches with a cylindrical metal case where reliability is a prerequisite in the smallest size possible. All metal construction and high impact insulation allows use under all environmental conditions.

Alco-switch	Bush-ing	Type	One- 24	500- 999
MCT-110D	1/4	SPDT	1.95	.98
MCT-220N	15/32	DPDT	2.55	1.28
MCTG-110D	1/4	SPDT	1.95	.98
MCTG-220D	15/32	DPDT	2.55	1.28

Write for other quantity prices

# ALCO®

ELECTRONIC PRODUCTS, INC.

Lawrence, Massachusetts 01843

See us at WESCON Booth #1720

# SEARCHLIGHT SECTION

- CLASSIFIED ADVERTISING • BUSINESS OPPORTUNITIES
- USED OR SURPLUS EQUIPMENT

## AUTOTRACK MOUNT



360 degree azimuth, 210 degree elevation sweep with better than 1 mil. accuracy. Missile velocity acceleration and slewing rates. Amplidyne and servo control. Will handle up to 20 ft. dish. Supplied complete with control chassis. In stock—immediate delivery. Used world over by NASA, USAF, MP-61-B. Type SCR-584. Ideal satellite tracking. Large spare parts inventory for back-up.

### ANTI-AIRCRAFT GUN MOUNT

Will handle 6,000 lbs. rapid slow through 360° azimuth, 130° elevation. Mobile.

### COUNTERMEASURES TRAINER

Covers L-band, S-band, X-band, all radars. Tacan, UHF drone control, VHF drone control, Communications band. All housed in shelter.

**FIBERGLASS RADOME** Will handle 20 foot antenna. Easily erected & shipped. \$4800.

## PULSE MODULATORS

### 250 KW HARD TUBE PULSER

Output 16 kv 18 amp. Duty cycle .002. Pulses can be coded. Uses 5D21, 715C or 4PR60A. Input 115 v 60 cy. AC \$1200 ea.

### MIT MODEL 9 PULSER 1 MW—HARD TUBE

Output 25kv 40 amp., 30kv 40 amp. max. Duty cy. .002. 25 to 2 microsec. Also 5 to 5 microsec. and .1 to .5 microsec. Uses 6C21. Input 115v 60 cycle AC. Mfg. GE. Complete with driver and high voltage power supply. Ref: MIT Rad. Lab. Series, Vol. 5, p. 152.

### 2 MEGAWATT PULSER

Output 30 kv at 70 amp. Duty cycle .001. Rep. rates. 1 microsec. 600 pps. 1 or 2 msec. 300 pps. Uses 5948 hydrogen thyratron. Input 120/208 VAC 60 cycle. Mfr. GE. Complete with high voltage power supply.

### SCR 584 AUTOTRACK RADARS

Our 584s in like new condition ready to go, and in stock for immediate delivery. Ideal for telemetry research and development, missile tracking, satellite tracking. Fully Des. MIT Rad. Lab. Series, Vol. 1, pps. 207-210, 228, 284-286. Comp. Inst. Bk available \$25.00 each.

## AUTOMATIC TRACKING SYSTEM

Sci. Atl. Mod. 3101-J70 Arizona Tulestal. AZ-EL 15 deg. per second rated speed. 23 inch dia. bearing. Complete w/control console & mag. amplifiers. Also in stock complete Glo-track receiving system for 200-400 MHz telemetry band including 12' square quad. Holix. All part of Atlas missile instrumentation system.

### AN/GSS-1 PASSIVE TRACKER

10 cm passive automatic tracking system with 6 foot parabola. Complete, mounted on van. Supplied by GE for Atlas instrumentation system.

## MICROWAVE SYSTEMS

### SPARE PARTS IN STOCK

Nike Ajax, Nike Hercules, M-33, MPS-19, TPS-ID, TPS-10D, FPS-6 SFS8, SCR-584, MPQ-18. From Largest Inventory in World

### 200-2400 mc. RF PKG

Continuous coverage, 30 Watts Cw nominal output. Uses 2C39A. Price \$575.

### L BAND RF PKG

20 KW peak 990 to 1040 MC. Pulse width .7 to 1.2 micro sec. Rep. rate 180 to 420 pps. Input 115 vac incl. Receiver \$1200.

### 200-225 mc RADAR SYSTEM

1 Megawatt output, 200 nautical mile range for long range detection of medium and high altitude jet aircraft as well as general search. AN/TPS-28.

### AN/GMD-1B RAWIN RADAR

L-Band Radiosonde Tracking System. Complete, new cond. in stock for immed. del. AN/GMD-2 computer mfg. Gen'l Mills also in stock.

### 500 KW L BAND RADAR

500 kw 1220-1359 msc. 180 nautical mile search range P.R.I. and A scopes. MTI. thyratron mod 5J26 magnetron. Complete system.

### C BAND AUTOTRACK

1 Megawatt 10 ft. Parabola. Sperry.

### AN/GPG-1 SKYSWEEP TRACKER

3 cm. auto. tracking radar system. Comp. pkg. w/indicator sys. Full target acquisition & auto. tracking. Input 115v 60 cy. new. In stock for immed. del. Entire sys. 6' x 3' x 10'. Ideal for infrared tracker, drone tracker, missile tracker, R & D

### INDICATOR CONSOLES

AN/SPA-4A, PPT 10", range to 300 ml. VJ-1 PPI 12", Range to 200 ml. VL-1 RH 12" to 200 ml. 60K ft.

HUNDREDS MORE IN STOCK  
LARGEST RADAR  
INVENTORY  
IN WORLD.  
WRITE  
FOR  
CATALOG  
ON YOUR  
LETTERHEAD

# Radio-Research Instrument Co.

45 W. 45th St., New York, N.Y. 10036 • 212-586-4691

CIRCLE 966 ON READER SERVICE CARD

## EMHART CORP. GLASS TESTING LABORATORIES

Serving all Industries

Chemical Analysis (Gravimetric, X-Ray)  
Physical Measurements of Glass and Ceramics

HARTFORD DIVISION, BOX 1620

Hartford, Ct., 06102, Tel. (203) 242-8551, Ext. 514

CIRCLE 967 ON READER SERVICE CARD

## WELDING HAND TOOL

TW 17 A

\$ 48.00



Replaceable Tips—Adjustable Pressure  
AC and Stored Energy Power Supplies

### EWALD Instruments Corporation

Route 7E, Kent, Conn. 06757

CIRCLE 968 ON READER SERVICE CARD

ADDRESS BOX NO. REPLIES TO: Box No.

Classified Adv. Dept. of this publication.

Send to office nearest you.

NEW YORK, N. Y. 10036: P. O. Box 12

CHICAGO, Ill. 60611: 645 N. Michigan Ave.

SAN FRANCISCO, Cal. 94111: 255 California St.

## EMPLOYMENT SERVICES

**The Resume Game: An Insider's Guide How to write & use yours successfully.** Cover letter/resume samples. \$2. Plymouth Pubs, Box 318A Plymouth Mtg Pa. 19462.

## BUSINESS OPPORTUNITY

**Capital Contacts—Before you try Public or Private Placements to Underwriters, Investment Banking Houses, write for free helpful information to Confidential Consultant, 817 51st St., Brooklyn, N.Y.**

# DON'T FORGET

the box number when answering advertisements. It is the only way we can identify the advertiser to whom you are writing.

## Technical Abstracts

### Control's the word

Expandable contouring—tomorrow's N/C today  
John L. Patrick  
Manager, Industrial Systems division  
Westinghouse Electric Corp.  
Buffalo, N.Y.

The "most significant advance in numerical contouring control technology in 15 years" is how Westinghouse refers to a new control system that ties each machine tool directly to a computer, replacing the usual hard-wire control logic with a software package inside the computer's central processor. All positioning servo loops, functions on the operator's panel, and machine status information pass through the central processor of Westinghouse's Prodac 2000 mini-computer. The only function not in software is the emergency stop circuit.

The logic system can be adapted to meet any contouring, contouring positioning, or positioning application. The system offers all the benefits of conventional hard-wire controls and could be incorporated into the hierarchy of a computer-controlled manufacturing system.

For the system, Westinghouse has developed two special programs, called Sync and Main, which reside in the computer's memory. Sync is a synchronous program running once about every 10 milliseconds. Its job is to sample data from position information buffers and determine the positions of the machine tool slides. It then compares their active positions with the desired positions, and calculates new velocity commands for moving the tool slides.

Main performs such chores as controlling the tape reader that inputs the actual tool cutting pattern to the machine tool; making some of the calculations involved with the motion data, developing data for the digital displays, and keeping track of the various tool offsets. Only the start of the Sync program and the need for more data from the tape reader interrupt Main's cycle. Five thousand core memory locations are needed in the 16-bit Prodac 2000 to store information for five axes of contouring.

Presented at the 34th Annual Machine Tool Electrification Forum, Pittsburgh, May 26-27.

OVER  
**1,000,000 SIZES**

**MILITARY CASES**

**COMBINATION • TRANSIT • INSTRUMENT**

MIL-T-945A, T-4734, T-21200, STD-108, C-4150



Choose from over 1,000,000 variations in dimensions, proportions, metals, finishes, and custom accessories. Whatever your need, the MM (multi-measure) method gives you high production savings even on custom runs as low as 25 units. Send your print or requirements. Manufacturers representatives in all major cities.

SEND FOR FREE CATALOG & DIMENSION SPECIFICATION SHEETS.

**MM ELECTRONIC ENCLOSURES, Inc.**

111 Bloomingdale Rd., Hicksville, N.Y. 11801 • 516-935-9400

Circle 143 on reader service card



**PASS ME THE AVO!**

**SIL VOUS PLAIT • POR FAVOR**

Worldwide, "Pass the AVO" means someone wants the most accurate, most reliable multimeter... anywhere. Twenty four ranges for AC and DC current, voltage and resistance. Full meter protection includes fuse, velocity actuated mechanical cutout and diode protection for meter movement.



This internationally famous AVO Model 8 has for over 50 years set the highest standard in multimeters. Over a million in use today!

Calibration, parts and service by factory trained personnel are available at our Plainview, N.Y. facility and in most countries throughout the world.

**GENCOM DIVISION**  
varian/EMI

90 EXPRESS STREET PLAINVIEW N.Y. 11803  
TELEPHONE (516) 433 5900

Write for your copy of Catalog 958 describing the AVO Model 8 and many other AVO instruments.

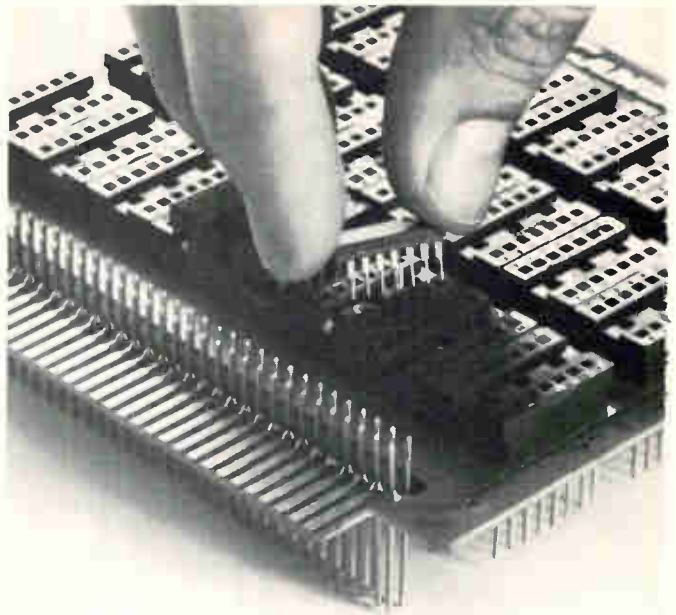

**use our wire-wrap\*  
cambi-cards to keep  
your ic's in line**

Matter of fact, we'll help you package whole IC sub-systems. Start with our 4.5 x 4.5 inch or 4.5 x 9.25 inch Cambi-Card® printed circuit boards with 70-pin input/output edge connectors, containing Wire-Wrap sockets for 14, 16 or 24-pin dual in-line IC's. Then our precision fabricated card files with 13 or 26 positions. Next our 13 or 26 position power planes.

And if you need 'em, our card extenders, Wire-Wrap card connectors, blank Cambi-Cards for discretes, pluggable/patchable breadboards for 16, 32 or 64 DIPS, patch cord kits... even our super fast, economical wire-wrapping service.

For details, call us or write for Catalog 92, the latest word on IC accessories and wire-wrapping. Cambridge Thermionic Corporation, 445 Concord Avenue, Cambridge, Mass. 02138. Phone: (617) 491-5400. In Los Angeles, 8703 La Tijera Boulevard 90045. Phone: (213) 776-0472.

\*Registered Mark of Gardner-Denver Co.

Standardize on

**CAMBION®**

The Guaranteed Electronic Components

Circle 144 on reader service card

Circle 121 on reader service card

121

## NEW from McGRAW-HILL

### INTEGRATED ELECTRONICS

By Rodney Sorkin 224 pages \$12.50  
Shows you how to design integrated circuits for a wide variety of uses. Covers all essential aspects of integrated electronics in logically progressive steps. Provides numerous worked-out design examples.

### BIOMEDICAL ENGINEERING SYSTEMS

By Manfred Clynes and J. H. Milsum 688 pages \$27.50  
Presents a collection of papers by leading specialists on modern electronic techniques in medical instrumentation, control of information and energy, analysis, and artificial devices. Covers topics of intrinsic importance and future significance.

### INTRODUCTION TO MATRIX ANALYSIS, 2 Ed.

By Richard Bellman 432 pages \$14.75  
The "father of dynamical programming" has updated his classic work to include all latest advances and make it the most thorough and completely current, as well as most original, book in the field.

### BATTERIES AND ENERGY SYSTEMS

By Charles L. Mantell 240 pages \$14.00  
A first-of-its-kind guide to primary and secondary batteries. Thoroughly and clearly explains major battery and energy systems. Details military and civilian uses and emphasizes engineering applications. Completely up to date.

#### Free 10 days' examination

McGraw-Hill Book Company  
330 West 42nd Street  
New York, N.Y. 10036

Send me the book(s) checked for 10 days on approval. In 10 days, I will remit for the book(s) I keep plus a few cents for local tax and delivery costs, and return the others postpaid.

- INTEGRATED ELECTRONICS  
 BIOMEDICAL ENGINEERING SYSTEMS  
 INTRODUCTION TO MATRIX ANALYSIS 2 Ed.  
 BATTERIES AND ENERGY SYSTEMS

Name \_\_\_\_\_

Address \_\_\_\_\_

City \_\_\_\_\_

State \_\_\_\_\_ Zip \_\_\_\_\_

23-83

## New Literature

THIS SPACE CONTRIBUTED BY THE PUBLISHER

**Operational amplifier.** Teledyne Semiconductor/Amelco, 1300 Terra Bella Ave., Mountain View, Calif. 94040. A four-page data sheet details complete electrical and physical parameters for the 809 linear operational amplifier. Circle 446 on reader service card.

**Instrumentation recorder.** Ampex Corp., M.S. 7-13, 401 Broadway, Redwood City, Calif. 94063, offers a four-page brochure describing the model AR-1700 instrumentation recorder for airborne and mobile data acquisition applications. [447]

**Infrared programable sealer.** GTI Corp., 1399 Logan Ave., Costa Mesa, Calif. 92626, announces an updated 14-page applications manual for the model DAP-700 infrared programable sealer. [448]

**Flying spot scanner.** General Time Corp., 599 S. Wheeling Rd., Wheeling, Ill. 60090, has issued a six-page brochure on the state of the art, current applications and capabilities of its flying spot scanner. [449]

**Bidirectional counter.** Anilam Electronics Corp., 25 W. 21st St., Hialeah, Fla. 33010. Product bulletin L90 describes an IC up-down digital counter/controller industrial and OEM requirements. [450]

**Power supply systems.** Lambda Electronics Corp., 515 Broad Hollow Rd., Melville, N.Y. 11746, offers a catalog featuring a complete line of standard power supply systems. [451]

**Wirewound devices.** Ward Leonard Electric Co., 31 South St., Mount Vernon, N.Y. 10550. A 20-page catalog covering a complete line of wirewound resistors and rheostats may be obtained by request on company letterhead.

**Fault isolation indicators.** A.W. Haydon Co., 232 N. Elm St., Waterbury, Conn. 06720. Bulletin M1607 covers the subject of fault isolation and performance monitoring. [452]

**Constant current sources.** Hewlett-Packard, New Jersey Division, 100 Locust Ave., Berkeley Heights, N.J. 07922, has available a bulletin containing detailed technical data on its line of d-c constant current sources. [453]

**Fungus resistance of plastics.** Electronic Properties Information Center, Hughes Aircraft Co., Culver City, Calif., has released interim report No. 70, prepared under U. S. Air Force contract. It covers microbial deterioration of insulation in jungle environments with 10 pages of text and tables and a 109-entry bibliography. Request on company letterhead.



Photo: O'Neill

Miss Raquel Welch

Learn the seven warning signals of cancer. You'll be in good company.

1. Unusual bleeding or discharge.
2. A lump or thickening in the breast or elsewhere.
3. A sore that does not heal.
4. Change in bowel or bladder habits.
5. Hoarseness or cough.
6. Indigestion or difficulty in swallowing.
7. Change in size or color of a wart or mole.

If a signal lasts longer than two weeks, see your doctor without delay.

And be sure to have a health checkup once a year, no matter how well you may feel.

**Fight Cancer with a checkup and a check**

American Cancer Society



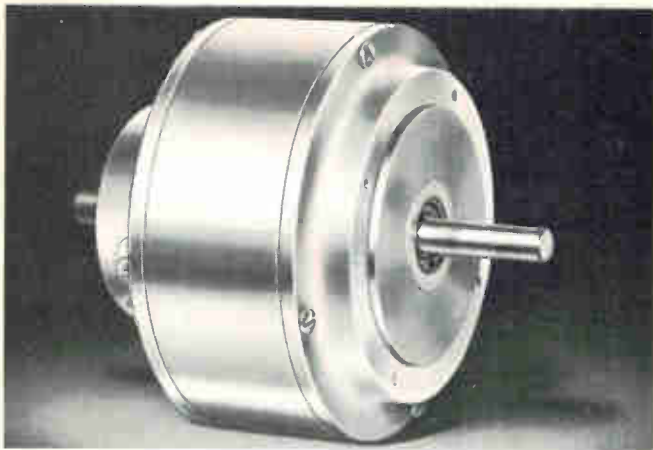

## Stops on a dime . . .

High Performance DC Motor jumps to full speed faster . . . stops quicker . . . than others its size because it has lower inertia. Produces pulse torques up to 10 times rated torque. For either open or closed loop systems.

Options: Tachometers, special shaft lengths and shapes, forced air cooling adaptations.

Get the complete story from your MICRO SWITCH Branch Office.

Or write: **MICRO SWITCH**

FREEPORT ILLINOIS 61032  
A DIVISION OF HONEYWELL

Circle 145 on reader service card

## Motorola temperature compensated crystal oscillators



**Come in small packages  
Do a big job**

Where low power, small size and instant warm-up are required, choose a Motorola TCXO. They're ideal for a wide variety of industrial applications.

**Small Size.** They come in packages as small as 1.5 cubic inch.

**Wide Frequency Range.** From 400 KHz to 40 MHz.

**Stability.**  $\pm 1$  ppm from 0° to + 55°C.

**Low Aging.** Less than  $1 \times 10^{-6}$  per year.

And if you need a non-standard TCXO, just let us know. Variations in input voltage, frequency, output level and wave shape are available on special order.

For complete information, send for your free copy of Bulletin TIC-3213 today. Write Component Products, Dept. 40F, Motorola Communications & Electronics, Inc., 4501 W. Augusta Blvd., Chicago, Illinois 60651; or call (312) 772-6500.



Circle 146 on reader service card

*we're  
BIG...*

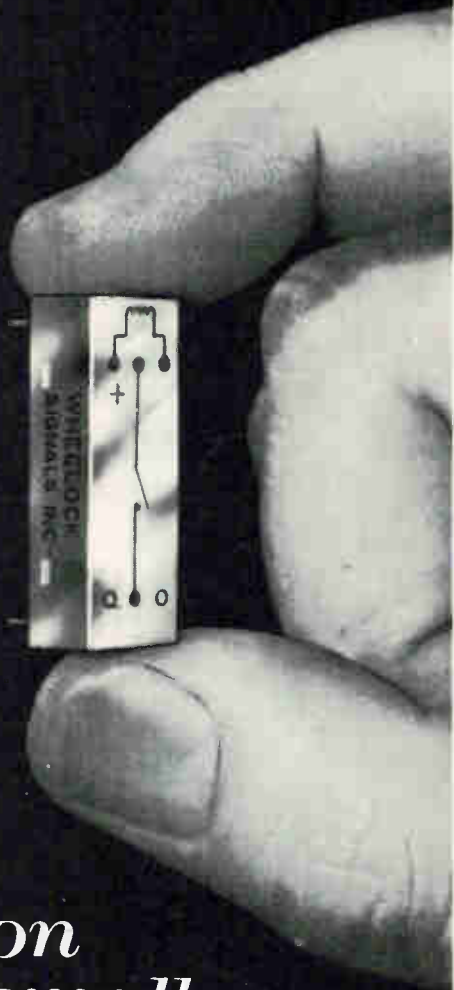

*on  
small*  
**REED  
RELAYS**

Wheelock probably has the reed relay you're looking for. Write for catalog describing the Wheelock Big Family of Small Relays

*Wheelock*

SIGNALS, INC.  
273 Branchport Ave.  
Long Branch, N. J. — 201-222-6880

Circle 123 on reader service card

123

# cure your logic testing headaches

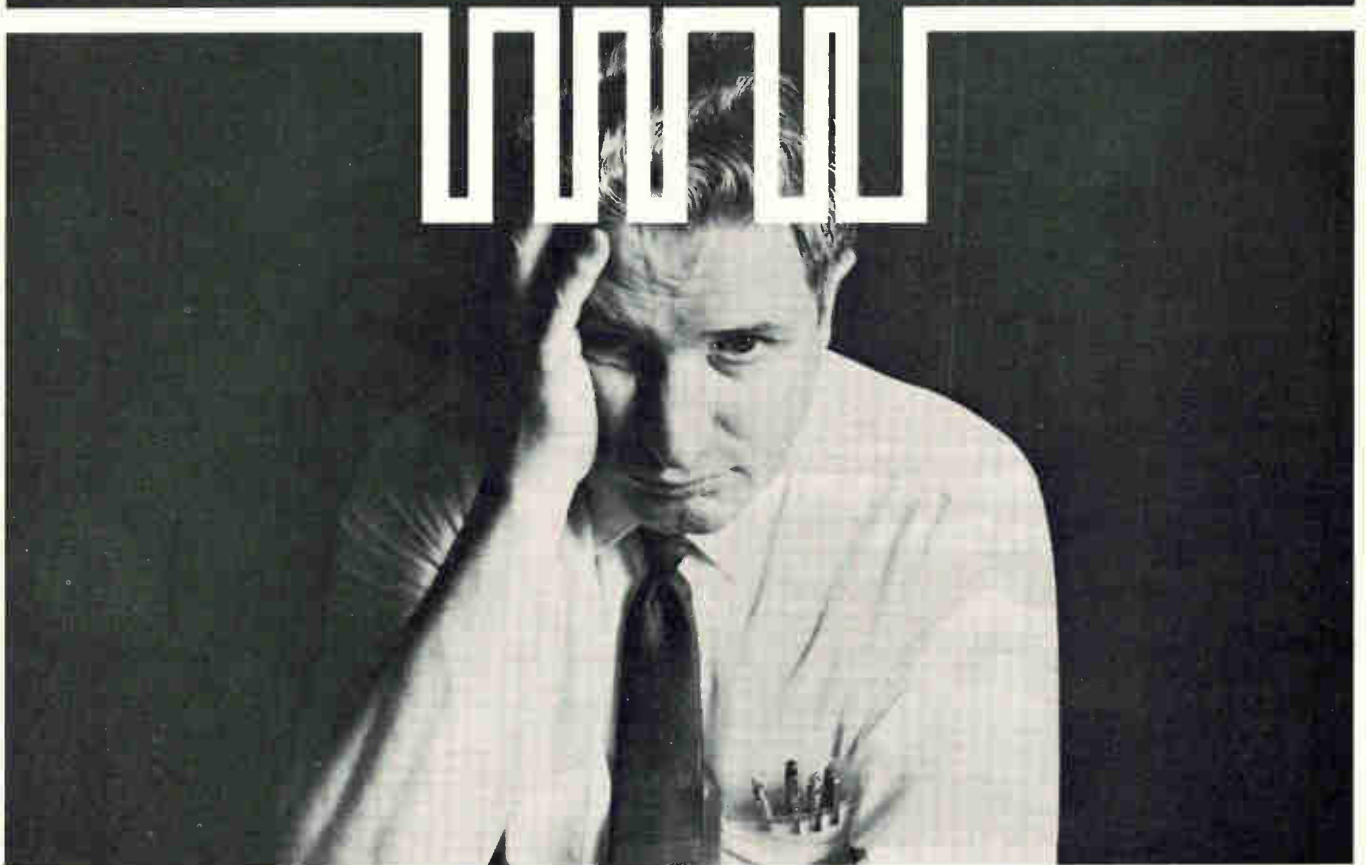

Mellonics offers new automated diagnostic tools for detecting functional logic faults in sequential digital circuits. These computer programs have already cured test headaches in dozens of circuits, some with more than 400 logic elements.

Specifically, we have programs for: **Logic Simulation** which certifies design correctness; **Test Sequence Validation** which verifies that all potential func-

tional faults in a logic design will be detected by your test procedure; **Automatic Test Sequence Generation** which produces a test procedure assuring that all testable functional faults in a logic design will be detected.

These services are economical and easy to use with guaranteed full data security. For more information contact Test Systems Marketing.

MELLONICS SYSTEMS DEVELOPMENT DIVISION  
LITTON INDUSTRIES

1001 WEST MAUDE AVE., SUNNYVALE, CALIFORNIA 94086 (408) 245-0795



---

# International Newsletter

---

August 3, 1970

## MRCA jockeying continues ...

Agreement between Britain and Germany to take approximately equal shares of the avionics work for the prototype multi-role combat aircraft has helped calm British fears that, because Rolls-Royce will make the engines, the Germans would get most of the avionics [*Electronics*, Sept. 15, 1969, p. 221].

However, Britons still have some fears. The biggest is that the Germans, short on military avionics know-how and under pressure from their government to buy from the U.S., will make many license agreements with U.S. companies. The worry here is that Panavia, the consortium formed to build the plane, will prefer bids based on these deals to those involving European-developed equipment, which Panavia may consider riskier. Thus, say some Britons, American avionics will get a boost in Europe which will extend far beyond MRCA, and Germany will be established as a major competitor to Britain in European avionics.

What's more, because the Germans have consistently cut down the number of aircraft they say they are likely to want, some Britons feel that Germany may end up buying far fewer than Britain, though still having done half the work. To minimize these hazards, many British companies are pairing off with German—and Italian—companies to make joint bids when Panavia starts requesting quotes next month.

## ... as prototype version takes shape

Because only two-seater aircraft will now be built, commonality in MRCA electronics will be high: among major systems, only radar requirements still have to be reconciled. But there's still a chance that a German-American radar system will be used on German aircraft and a British system on British planes. If the prototype aircraft works out, Germany and Britain are likely to take about 400 each and Italy 100. Prototype development is expected to cost \$600 million and each production aircraft about \$4 million, of which up to 40% will be avionics.

## European, Japanese firms discuss commercial jetliner

A Japanese-Dutch-German group soon may decide to go ahead with a 180-passenger commercial jetliner. The Dutch-German combine Fokker-VFW and Japan's Nihon Aeroplane Manufacturing Co. tentatively have agreed to jointly develop and sell the YX jetliner that is already on the drawing boards in Japan. They also have agreed to use some common parts on the YX and in the Japanese Defense Agency's projected PX-L flying boat. Namco, despite its name, does not build planes; if the YX is produced, manufacturing would be handled by Mitsubishi Heavy Industries and other airframe firms which make the YS-11 transport.

## Germany plans wide ATC coverage

West Germany is becoming a showcase for air traffic control. German flight control authorities are preparing to set up Europe's most modern ATC radar equipment. Designed by AEG-Telefunken, the new equipment can spot supersonic aircraft flying at up to 70,000 feet and at distances of more than 160 miles. And it's also capable of detecting slow-flying planes at low altitudes. Six such installations, totaling about \$40 million, will be in operation by 1975. A prototype is being installed at Bremen airport where trial operations probably will begin at the end of this year.

---

# International Newsletter

---

## Honeywell-GE deal may spur French computer growth

Though France has now quashed designs to draw Bull-GE into the government's Plan Calcul computer development effort, last week's official approval of Honeywell's bid to take over General Electric's French computer subsidiary nonetheless contains a few grains of cheer for the Plan Calcul-backed computer maker, Compagnie Internationale pour l'Informatique. To win approval, Honeywell has agreed to favor CII in farming out work for Bull-GE systems architecture, software, and other R&D needs—and has signed a general vow to be a “good neighbor” to CII; market-splitting or other cooperative arrangements could result.

Moreover, the Honeywell takeover bid has led the French government to re-examine its overall computer policy—it's now committed to carrying on Plan Calcul after 1971. Subsidies to CII might have ended under original planning. To combat the new Honeywell-GE competition in Europe, CII officials say they will step up efforts to negotiate a close tie with Britain's International Computers Ltd. CII executives say they hope shortly to launch joint hardware and software research with ICL, and eventually to market their machines in common. What's more, since both CII and ICL have licenses to make Control Data peripherals, they could design computers to use common peripherals.

## More Japanese communications gear head for Brazil

The largest single broadcast equipment order ever received by a Japanese firm has been awarded to Nippon Electric Co. by the Brazilian state of Pernambuco. NEC won the \$8.2 million order for tv transmitters, microwave transmission gear, and communications control equipment over stiff competition from U.S., British, Italian, Japanese, and Brazilian firms. Significantly, Nippon Electric was not the low bidder. Selection was based partly on technical assessment of equipment performance and partly on experience with NEC microwave equipment in Brazil's telephone network, 75% of which was supplied by the company.

## Commercial tv in France suffers setback

Backers of a proposed French commercial tv network [*Electronics*, June 22, p. 184] are glum, but electronics industry officials are happy about a new government report. The report supports the building of a third tv network, but recommends that it be state run like the present two. No matter what is finally decided about the network's operation, the electronics industry stands to gain. Indeed the report cites the “vulnerable” condition of the industry as a primary argument for launching a new channel. It would create new business for studio and relay equipment, as well as stimulate tv set sales.

## Millimeter waves near first trial in Britain

Long-distance millimeter-wavelength waveguides for future high-capacity digital communications links are nearing the practical test stage at the British Post Office. By the end of this year the BPO will be operating a five-eighths of a mile stretch of 50-millimeter-diameter guide, as a preliminary to a field trial over an 18-mile link scheduled for 1973. BPO work is centered on waveguides carrying digital signals at rates from 32 gigahertz to 90 Ghz. Structures under investigation include an insulated fine-wire helix that is resin bonded to the inside of a metal tubing support, and various types of thin dielectric films with similar mechanical support. Several structures have adequate electrical properties, and trials will be aimed at setting economic and operating guidelines.



# Video disks look good for tv playback

Using a high-speed record player, plastic disks are said to produce broadcast-quality pictures; color units to be marketed within two years

**A plastic disk** has joined the consumer tv playback competition. In a new tv signal storage system developed by AEG-Telefunken and Teldec, the disk, played back on a high-speed record player, shows prerecorded programs on television screens with quality comparable to ordinary tv broadcasts.

The first official demonstrations of the system were in black and white, but AEG-Telefunken says that basic research on the disk has been completed and that the step from monochrome to polychrome playback is a relatively minor one. In fact, when the video disk hits world markets from one and a half to two years from now, it will be designed for color reproduction.

The video disk—or the “Bildplatte” as AEG-Telefunken calls it—is a paper-and-thin-pvc-foil circle whose diameter is either 8 or 12 inches. The disk contains from 120 to 140 grooves per millimeter, 10

times more than an audio record. With such close groove spacing—a human hair would cover 10 grooves—the video disk features a density of 500,000 bits per square millimeter.

During playback the disk rides on an air cushion and spins at 1,500 revolutions per minute, producing one frame per revolution. In accordance with European tv standards, the disk stores 25 frames per second, or 1,500 frames per minute.

A new pickup principle has been developed for signal reproduction whereby a special sled-shaped needle and a piezoelectric transducer respond to variations of pressure exerted by the groove elevations, rather than to needle motion as is the case with a conventional record. Needle pressure is only 0.2 gram, so an auxiliary arm-tracking mechanism is needed. But because pressure is so low, the tracking mechanism can be disengaged for

stop-action playback—without any groove damage.

The 8-inch disk contains five minutes and the 12-inch disk 12 minutes worth of programs. AEG-Telefunken says by 1972 longer-playing disks are likely to be available. Further program extension will be possible with record changers. A 0.2-inch-high stack of video disks would suffice for a two-hour program.

AEG-Telefunken is cautious on disk price. It's pegged at “less than 20 marks” (about \$5.50), but one official says, “We would rather set a higher limit now and come down later than make too low an estimate and then find ourselves above that.”

Despite its present limited playback time, the new video storage and reproduction system spells stiff competition for units developed in the United States. At between \$140 and \$280 the playback

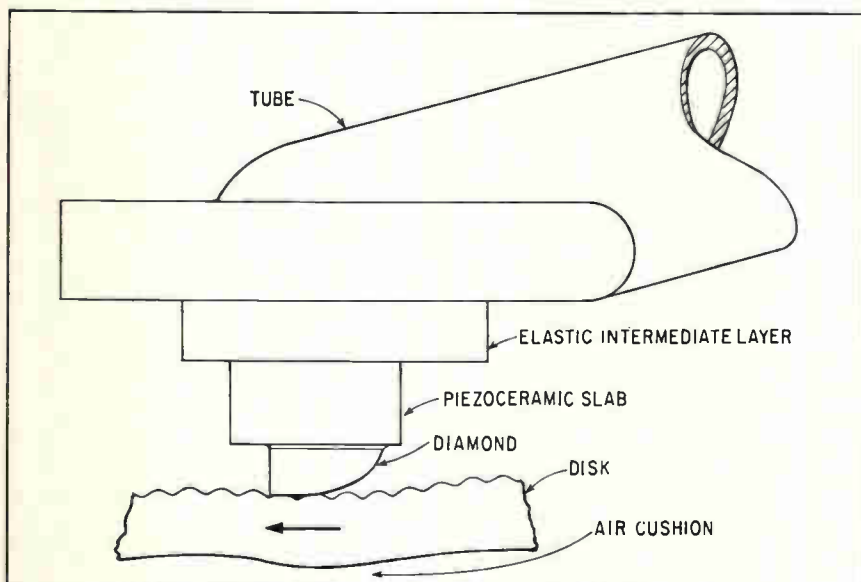

**Matched . . .** Specially shaped diamond stylus, although exerting only 0.2 gram force, gradually compresses ridges. Sudden change in pressure as a ridge pops out from under stylus is picked up for amplification.



**. . . set.** Flexible disk rotates at 1,500 rpm, riding an air cushion, and generates one frame per turn.

## Electronics International

unit is expected to be from a third to a sixth as expensive as the CBS Electronic Video Recording system and from a half to a quarter as expensive as RCA's SelectaVision, according to AEG-Telefunken information.

The storage costs for one hour of playing time will be less than \$2.80, thanks to use of an expensive pvc base material for the disks and to employment of well-established record fabrication techniques.

The playback time/copy time ratio, an indication of how inexpensively a signal store device can be made under mass production, is better than 1,000 to 1 for the video disk, meaning 1,000 12-inch disks can be made in less than 12 minutes. AEG-Telefunken says the video disk has a big future not only in the home entertainment field but also in the educational sector. What's more, the video disk can also be used as a data carrier in EDP equipment.

## International

### Tariffs and trade

With Japanese textile exports to the U.S. threatening to trigger an international trade war, both industry and U.S. Government sources suspect that electronics will become the next major battleground. Protectionist feelings are rising in Congress despite the strong Nixon Administration stand for free trade. And persistent charges by the Electronic Industries Association in Washington that Japan is dumping electronic components and parts on the U.S. market at low prices are getting sympathetic hearings from the Administration as well as Congress.

An adamant Japanese stand on textile exports, based on the contention that its shipments account for only about 1% of U.S. output, is making negotiations difficult for the President's men, who hear U.S. producers say that Japanese concentration in certain product areas—rayons, for instance—make its exports a far more serious threat.

In 1969, for example, Japanese

textile exports accounted for \$283.5 million of the nearly \$1.67 billion worth of manufactured goods shipped to the U.S. Electronic products accounted for nearly \$878 million in the same year exclusive of nearly \$171 million in precision instruments, largely electronic or electro-optical. The new figures were published by the U.S.-Japan Trade Council, an organization supported in great part by Japanese funds. Though the dollar value of electronics is more than three times that of textiles, it is reportedly a smaller percentage of the total U.S. market. Nevertheless, the data shows that telecommunications equipment alone accounted for \$646.5 million of the electronics import total.

**Action to come.** Responding to an EIA complaint, the Treasury Department recently ruled that Japanese tuners, other than stereo units, are being dumped on the U.S. market—a judgment now scheduled for evaluation by the Tariff Commission in a public hearing set for September 16. The commission will determine the extent of injury, if any, to U.S. industry by the tuner dumping to determine remedial action.

Whatever the outcome, the Treasury Department finding represents a clear warning to Japanese exporters that the U.S. will no longer let them off the hook as easily as it has in the past when written Japanese assurances sufficed that prices of the parts in question would be raised.

Though the tuner dumping rule represents a first by Treasury, sources say Customs Bureau investigators will recommend a similar finding to the department on a pending dumping charge against Japanese monochrome television receivers. The chairman of the EIA's parts division, Herbert J. Rowe, who calls the tuner action a "vindication" of the division's position, says the division now has no plans to refile dumping complaints against Japanese exporters of receiving tubes, loudspeakers, and transformers. "It's an expensive process," says one source. Complaints on these products were rejected by the department when the

Japanese wrote letters promising to raise prices.

Under the Treasury procedure, many more dumping cases are likely to get to the Tariff Commission which will determine injury. Customs duties can be assessed against importers of products, which are being dumped, retroactive to the date the Treasury Department finds dumping or, at the Secretary's discretion, to 120 days prior to filing of the original complaint. This clause of the anti-dumping laws, rarely used, is important not because of its monetary impact, but because of the psychological impact on importers who, when they discover antidumping proceedings are being taken against one of their foreign suppliers, will switch to a supplier against whom there are no dumping proceedings—and who is selling at prices which allow domestic industry to compete. If the importer continues to do business with the dumping exporter, the importer is subject to additional duties until the Treasury Department issues an order withdrawing its dumping finding.

## Japan

### Low-cost display

Consumer electronics products designers are masters at keeping costs low. So when the industrial arm of Matsushita decided to build a computer terminal with cathode ray tube display to complement its line of minicomputers, it turned for basic design to the group's laboratory specializing in consumer products.

The result is a low-cost unit that can display 16 lines of 38 characters. It also can show graphical information, and mixed alphanumeric and graphical data with only a few more circuits than needed for alphanumeric data.

As a first step in keeping costs low the Wireless Research Laboratory used standard television components as widely as possible, including the 12-inch tube and all associated circuits. However, the deflection coils are rotated 90° so

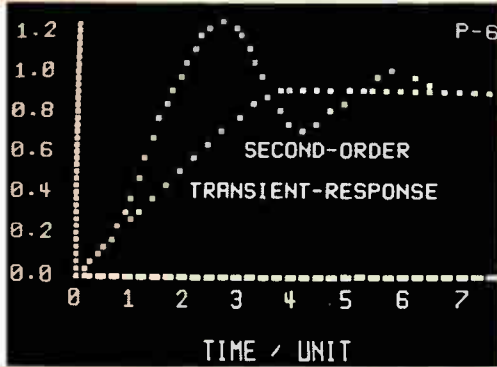

Mixed batch. Alphanumeric and graphic data share circuitry.

that raster lines go from bottom to top with successive lines proceeding from left to right. A simple air-wound coil is connected in series with the horizontal deflection yokes to cut vertical deflection.

The vertical scan keep costs down because it permits use of a smaller memory. What's more, a magnetostriction memory can be used, which further cuts costs because it is the least expensive type with the required 5,000-bit capacity. And by using a transformer-type character generator, the mask charge accompanying a semiconductor generator is eliminated.

**Storage.** The display is refreshed 50 times a second. Information is stored in a 5-millisecond delay line, which operates as a 1-megahertz clock frequency. This gives it a storage capacity of 5,000 bits of information. An auxiliary shift-register memory stores information in the single vertical column of characters being displayed. Since each character is represented by an 8-bit word, this memory has a capacity of 16 characters x 8 bits, or 128 bits. For alphanumeric display this information goes into a character generator, which drives the video amplifier. If normal horizontal scan had been used the shift register would have required a capacity of 38 x 8 bits.

The geometry used in this display provides good legibility for the alphanumeric characters and permits graphical display with very little additional circuitry or complication. Some other displays used in the graphic mode lose their normal alphanumeric character

capabilities. Thus, alphanumeric displays must be generated from individual graphic display dot elements rather than through built-in character generators. This complexity can cause a heavy burden on the computer.

The scheme used in Matsushita's display retains ordinary character generation ability even for the graphic mode, with graphic elements inserted either from an associated computer or from a keyboard. Once graphic display information has been generated it is stored in the delay-line memory in the same manner as ordinary alphanumeric information.

The alphanumeric characters are displayed as a six-by-nine-dot matrix—rather than the five-by-seven matrix usually used. Actually the space for each character is eight dots wide by 12 dots high, with the equivalent of two dots on the right-hand side and three dots below to provide spacing.

In both alphanumeric or graphical displays each eight-by-12 cell is represented by one eight-bit code word. Each alphanumeric character is represented by seven bits in the American Standard Code for Information Interchange. Basic elements of the graphic displays are a three-by-three square group of dots. Six groups can be independently displayed in each character position.

An extremely simple code represents the graphical elements. In each word, seven digits are used to represent alphanumeric characters; the eighth digit signifies a switch to graphical elements in that character cell. Six of the remaining dots have a one-to-one correspondence with the six possible graphical elements in that character cell.

## France

### 3D oscilloscope

Designers who want to test their ideas visually often program them into a computer and put the resulting geometric shapes through their paces on a tv screen. But that's

an expensive approach, requiring access to a lot of expensive equipment. Now a French inventor has come up with a \$250 black box that can transform almost any commercial oscilloscope into a three-dimensional design tool.

**Box.** Oscilloscopes having the same voltage values for both X and Y coordinates can be hooked to the new 3D box, developed by French inventor Maurice Pilato. It then can show any geometric shape in perfect design perspective—including the object's hidden lines. And the user can turn the object in any direction while the perspective changes accordingly.

The new device produces the world's only three-vector oscilloscope images, claims its inventor. It can thus produce 3D scenes in real time that even some computers shy away from.

In aircraft trajectory studies, for example, Pilato's oscilloscope can receive signals from a flying plane and instantly show not only its path but all positions of its wings during that trajectory as well. Other oscilloscopes can't do this, and a computer would require a lot of programming effort.

In medical electronics, vectocardiograms—which give a three-dimensional picture of the heart's electrical pulses—have been made up to now with two oscilloscopes and a system of prisms and glasses to combine images into one picture. Pilato says his black box will do the job with one oscilloscope and will let doctors "turn" a patient's heart to pinpoint visually where it may be defective.

**Channels.** The principles behind Pilato's scope are surprisingly simple. The first is that short-circuiting two perfectly symmetrical amplifiers produces three channels with the same performance. Since the X and Y signals of an oscilloscope each are composed of two half-channels, A and —A, Pilato joined together a half-channel from each, forming a new coordinate, Z. Thus X is the horizontal coordinate, Y the vertical, and Z a 45° oblique. This produces stationary 3D objects.

Moving these objects and keeping all lines in proper perspective

in the process was a tough problem that also was solved simply. Pilato applied an old draftsman's rule that turning lines circularly preserves perspective. His Z coordinate thus sweeps the screen circularly like a radar beam. Each oblique line hinges on its most central point—and cubes, spheres and other objects maintain their perspective automatically while they turn.

The black box that controls all this is a simple collection of switching mechanisms and resistors, containing no active electronic components, at least for now. A manual rotating switch is the signal distributor. Hooked to it is a selsyn-type turning transformer, motor controlled, that permits a 360° perspective rotation.

A mechanical perspective permutator switch lets the user shift an object on the screen in any direction. A relay switch allows the suppression of one or two parameters, or the pulling out of one plane of a design and showing it separately on any blank space in the screen.

Pilato, an independent designer who has licensed many electronic inventions to French manufacturers, is holding discussions with European firms interested in producing his attachment. He says production cost would be proportional to the price of the oscilloscope for which it is intended, due to the need to match component quality.

The inventor is working on a number of electronic refinements to his basic black box. He is developing an FET attenuator to provide an artistic perspective effect, with converging lines toward an imaginary horizon.

### Great Britain

#### Hub holds antilock brake

No car maker in Europe offers electronically controlled antilocking brakes, although some trucks are offered with such systems. But on trucks, cost and size are less critical and the solutions less difficult.



Braking in. Antilock brake actuator fits on wheel hub in test system.

However, the Research Laboratories of Mullard Ltd., the British Philips subsidiary, has spent \$250,000 and eight years developing an electronic braking system suitable for cars. Now fully developed at the laboratory level, the system, according to its originators, has some important advantages over other systems. It's currently on offer to the world's brake makers.

Mullard's system bears a resemblance in both mechanical and electronic principles to systems in the U.S., where some cars are already equipped with antilock brakes. However, there's an important exception. Novel mechanical developments let Mullard's system be mounted entirely on the wheel hub. U.S. systems employ large vacuum servos mounted under the hood. Mullard researchers believe that in production the electronics would most likely be made as a thick-film hybrid circuit, about 2 square inches in area, attached to the hub mechanism and connected by power leads to the engine compartment.

Furthermore, because each wheel unit is self-contained, it's easy to have antilock on two rear wheels only or on all four wheels. The major problem U.S. car makers encounter when offering four-wheel systems has been fitting two more vacuum servos under the hood, and arranging the balance between them, according to the Mullard

men. They also believe the effectiveness of a four-wheel system would lead any car maker to offer its system all around initially.

**Detection.** In any antilock system, the crucial cycle of events, repeated many times, is the detection during sudden deceleration of the moment when the wheel begins to lock, reduction of brake pressure to prevent locking, and—most difficult—quick reapplication of pressure to restore braking. For detection, Mullard uses a common method. A toothed ring around the hub spins past a stationary magnet, inducing pulses in a coil surrounding the magnet. A sudden drop in the pulse output rate denotes a wheel about to lock.

The pulse output is converted, by means which Mullard won't reveal, into a d-c voltage, which is compared with a standing reference voltage to determine when the wheel is about to lock. Derek Skoyles, the man in charge of the work, says the reference voltage depends primarily on the coefficient of friction of the tire, and as this is fairly standard on production cars there's no problem in determining proper references for any car. He justifies secrecy about detail on the grounds that digital-to-analog conversion could be done in a number of ways, and the best cost/performance compromise is a worthwhile secret.

**Lock.** If an incipient lock is detected, the electronic circuitry opens a solenoid valve to reduce the pressure. However, instead of relying on remote vacuum servos to reapply the brakes, as U.S. companies do, Mullard pumps the oil bled off back into the brake actuator—the caliper, on a disk system—using a piston driven by lobes 0.8-inch high on a ring around the hub inboard of the toothed ring. This is what makes Mullard's wheel units self-contained.

In the experimental setup, the circuitry for each wheel, in discrete component form, fits with space to spare on a board about 3 by 10 inches. There are 14 small transistors plus an output power transistor. In the test cars, these boards are mounted inside the car for access.

# Electronics advertisers

August 3, 1970

Alco Electronics Products, Inc. Marketronics Advertising	102, 119	■ JFD Electronics Corp., Components Div. Delphi Adv., Inc.	96	□ S.P. Elettronica Studio Sergio Rosata	9E
Allen-Bradley Co. Hoffman-York, Inc.	17, 103	■ Kepco, Inc. Weiss Advertising	9	Spectronics, Inc.	94
AMP, Inc.	23	■ Lambda Electronics Corp. Michael Cather, Inc.	3rd Cover	Sprague Electric Co. Harry P. Bridge Co.	5
Aitkin-Kynett Co., Inc. Andrew Corp.	50	□ LTT Publibel	12E, 13E	Sprague Electric Co. Harry P. Bridge Co.	10E
Fensholt Adv., Inc.		McGraw-Hill Professional & Reference Book Division		Stackpole Carbon Co., Electronic Components Div.	100
■ Barnstead Co., Div. of Sybron Corp. Creamer, Trowbridge, Case & Basford, Inc.	47	Mellonics		Thomas/Farragher and Associates, Inc.	48
Brand-Rex Creamer, Trowbridge, Case & Basford, Inc.	108	■ Diener & Dorskind, Inc.		M B Advertising Agency	
Cambridge Thermionic Corp. Chirurg & Cairns, Inc.	121	■ Micro Switch Division of Honeywell N.W. Ayer and Son, Inc.		Teledyne Relays Co.	28
■ Captor Corp.	20	■ MM Electronic Enclosures, Inc. Berin/Pecor, Inc.		S. Michelson Advertising	
Weber, Geiger & Kalat, Inc.		Motorola Communications and Electronics, Inc.		■ Tektronix, Inc. Dawson, Inc.	10, 11
Chemetron Corp.	116	Brand Advertising, Inc.		Tempo Instrument	112
Buchen Advertising, Inc.	117	Motorola Advertising, Inc.		Industrial Marketing Associates	
Circuit-Stik, Inc.	117	Motorola Semiconductor Products, Inc.	12, 13	Texas Instruments Incorporated, Components Group	21
Haaga Advertising		Lane & Wampler Advertising, Inc.		Albert Frank-Guenther Law, Inc.	
Colorado Video, Inc.	118	■ National Electronics, Inc. Subsidiary Varlan Associates		Texscan Corporation	16
Wolff, Weir & Schulz, Inc.		Connor-Sager Associates, Inc.		MacGill/Ross, Inc.	
Continental Testing Labs., Inc.	117	National Semiconductor Corp. Chiat/Day, Inc. Advertising		Triplet Electrical Instrument Co.	88
Anderson/Bourne Advertising		North American Rockwell, Autonetics Div.	44, 45	Byer and Bowman Advertising	
Cornell-Dubiller Electronics	87	Campbell-Ewald Co.		TRW Electronics, Capacitors Div.	33
Daniel & Charles, Inc.		■ North Atlantic Industries, Inc. Helme Associates, Inc.	15	Fuller & Smith & Ross, Inc.	
■ Data Technology	18, 19	Northern Natural Gas Co.	98	■ Tung-Sol Division, Wagner Electric Corp.	110
Hall Butler Blatherwick, Inc.		Bozell and Jacobs, Inc.		Winius-Brandon Co.	
Digital Equipment Corp. Kalb & Schneider, Inc.	84	Omni-Spectra, Inc., Michigan Div. Jack Karabees Associates	104	Weston Instruments, Inc., Newark Div.	99
Eastman Kodak Co., Business Systems Markets Div.	95	■ Permag Corp. Schneider, Allen, Walsh, Inc.	132	Arndt, Preston, Chapin, Lamb & Keen, Inc.	
J. Walter Thompson Co.		Philips GAD ELCOMA		■ Wheelock Signals, Inc. McCarthy, Scelba, Di/Biasi Adv. Agcy., Inc.	123
■ Elco Corporation	134	Media International		Xerox Corporation	
Schaefer Adv., Inc.		□ Philips N.V. Pit/TMI Div.	2E	Hutchins Adv. Co., Inc.	91
Electronic Memories, Inc.	42, 43	Marsteller International S.A.		Classified & Employment Advertising	
Gumpertz, Bentley & Dolan Adv.		Philips Electronic Instruments		F.J. Eberle, Manager	
Erie Technological Products Co., Inc.	24	Marsteller, Inc.		212-971-2557	
Walker, Schmidt & Mackall, Inc.		Plastics Engineering Co.		EMPLOYMENT OPPORTUNITIES	120
Executone, Inc., Printact Relay Div. J.A. Richards	118	Kuttner, & Kuttner, Inc.		EQUIPMENT (Used or Surplus New) For Sale	
Gencom Division—Varian/Emi A.D. Adams Adv., Inc.	121	Power Physics Corp. McCarthy, Scelba, Di/Biasi Adv. Agcy., Inc.	37	Emhart Corp.	120
General Electric Co., Semiconductor Products Div.	27	Raytheon Co., Microwave & Power Tube	114	Ewald Instruments	120
Robert S. Cragin, Inc.		Provandie Eastwood & Lombardi, Inc.		Radio Research Instrument Co.	120
General Radio Co.	2nd Cover	RCA Electronic Components	4th Cover	■ For more information on complete product line see advertisement in the latest Elec- tronics Buyer's Guide	
GRAD Associates		Al Paul Lefton Co.		□ Advertisers in Electronics International	
Glastic Corp., The, Sub. of Monogram Industries, Inc.	41	■ RCL Electronics, Inc. Morway Advertising Agency	14	Electronics Buyers' Guide	
Cross & Associates, Inc.		□ Rohde & Schwarz	15E	George F. Werner, Associate Publisher	
■ Gould, Inc./Brush Instruments Carr Liggett Adv., Inc.	49	Semtech Corp.	92	[212] 971-2310	
Burruss Advertising		■ Signallite, Inc., Sub. of General Instrument Corp.	35	Regina Hera, Directory Manager	
Hewlett Packard	78	McCarthy, Scelba, Di/Biasi Adv. Agcy., Inc.		[212] 971-2544	
Lennen & Newell, Inc.		Signetics Corp., Sub.		Mary Tully, Production Manager	
■ Hewlett Packard, New Jersey Div. McCarthy, Scelba, Di/Biasi Adv. Agcy., Inc.	106, 107	Corning Glass Works	83	[212] 971-2046	
■ Hewlett Packard, Palo Alto Div. Lennen & Newell, Inc.	1	Cunningham & Walsh, Inc.		Sales Offices:	
■ Hewlett Packard, Santa Clara Div. Lennen & Newell, Inc.	2	Chicago, Ben Briggs [617] CO2-1160		Boston, Ben Briggs [617] CO2-1160	
■ Hickok Instrumentation Group Frank Spiro & Associates, Inc.	46	Detroit, Mac Heustis [313] 962-1793		New York, Cliff Montgomery [212] 971-3793	
Houle Manufacturing Co.	132	Jim Vick [212] 971-2661		Chicago, Bob Denmead [312] MO4-5800	
■ Hughes Aircraft Co.	38, 39	Los Angeles, Kenneth Watts [213] HU2-5450		Philadelphia, Tim Bemis [215] LO8-6161	
Foote, Cone & Belding		Philadelphia, Tim Bemis [215] LO8-6161			
Hutson Industries	132				
The Hal Mayer Co.					
■ Indiana General Corp., Electronics Div. The Griswold & Eshleman Co.	133				



Pert Mag, the PERMAG girl, says:

## "Holding is a cinch with Magnets!"

And Permag has just the right magnet for your holding problem. Permag offers permanent magnets, assemblies, electrical alloys, flexible magnets, soft magnetic materials and ferrites. Also, special precision grinding and cutting. And full magnetizing and engineering facilities.

# Permag

PERMAG SIERRA CORP. 3721 HAVEN AVENUE, MENLO PARK, CALIF. 94025 • (415) 369-0303  
 PERMAG PACIFIC CORP. 5441 WEST 104th ST., LOS ANGELES, CALIF. 90045 • (213) 776-8656 • TWX [910] 328-6547  
 PERMAG SOUTHWEST CORP. 2720 TAYLOR STREET, DALLAS, TEXAS 75226 • (214) 748-6909 • TWX [910] 861-4154  
 PERMAG CENTRAL CORP. 1213 ESTES AVENUE, ELK GROVE VILLAGE, ILLINOIS 60007 • (312) 956-1140  
 PERMAG MAGNETICS CORP. (formerly EMPIRE MAGNETICS) 3130 SOUTH AVE., TOLEDO, OHIO 43609 • (419) 385-4621  
 PERMAG NORTHEAST CORP. 50 THAYER ROAD, WALTHAM, MASS. 02154 • (617) 484-0550  
 PERMAG CORP. 88-06 VAN WYCK EXPWY., JAMAICA, N.Y. 11418 • (212) 657-1818 • TWX [710] 582-2952

Circle 147 on reader service card

## 3 AMP SENSITIVE GATE TRIAC



Now there's a source with first-class capability. Hutson triacs are rated from 50-600V. Standard TO-5 packages. Immediate delivery.

RATING	3 ma FIRES ALL QUADRANTS	PRICE PER 1K UP
200V	HI 23SS	\$1.19 ea.
400V	HI 43SS	\$1.49 ea.
RATING	10 ma FIRES ALL QUADRANTS	PRICE PER 1K UP
200V	HI 23SG	95c ea.
400V	HI 43SG	\$1.19 ea.

**HUTSON INDUSTRIES**  
 P. O. Box 34235 • Dallas, Texas 75234  
 214-241-3511

Circle 132 on reader service card

## WHOLESALE TO ALL

Breadboard Kits—"RF" Kits—"PC" Kits—Perf. Phenolic Board—Copper Clad board—Cowl Type Electronic Cabinets—Heat Sinks—Solid State Hobby Kits—Solderless Connectors—Hardware Kits—Transistor Sockets and many other items. (Products approved by the Defense Supply Agency—Federal Supply Code number furnished upon request.) Send for free catalog from:

**H. M. C. SALES**  
 P.O. Box 276  
 Santa Susana, Calif. 93063

Circle 148 on reader service card

## Advertising Sales Staff

**Pierre Braudé** [212] 971-3845  
 Advertising Sales Manager

**Atlanta, Ga. 30309:** Chariton H. Calhoun, III  
 1375 Peachtree St., N.E.  
 [404] 892-2868

**Boston, Mass. 02116:** William S. Hodgkinson  
 McGraw-Hill Building, Copley Square  
 [617] CO 2-1160

**Chicago, Ill. 60611:** Ralph Hanning,  
 Kenneth E. Nicklas, 645 North Michigan  
 Avenue, [312] MO 4-5800

**Cleveland, Ohio 44113:** William J. Boyle,  
 55 Public Square, [216] SU 1-7000

**Dallas, Texas 75201:** Richard P. Poole,  
 1800 Republic National Bank Tower,  
 [214] RI 7-9721

**Detroit, Michigan 48226:** Ralph Hanning,  
 2600 Penobscot Building  
 [313] 962-1793

**Houston, Texas 77002:** Richard P. Poole,  
 2270 Humble Bldg. [713] CA 4-8381

**Minneapolis, Minn. 55402:** Kenneth E. Nicklas,  
 1104 Northstar Center [612] 332-7425

**New York, N.Y. 10036**  
 500 Fifth Avenue  
 James R. Pierce [212] 971-3615  
 Warren H. Gardner [212] 971-3617  
 Michael J. Stoller [212] 971-3616

**Philadelphia, Pa. 19103:**  
 Jeffrey M. Preston  
 6 Penn Center Plaza,  
 [215] LO 8-6161

**Pittsburgh, Pa. 15222:** Jeffrey M. Preston,  
 4 Gateway Center, [412] 391-1314

**Rochester, N.Y. 14534:** William J. Boyle,  
 9 Greylock Ridge, Pittsford, N.Y.  
 [716] 586-5040

**St. Louis, Mo. 63105:** Kenneth E. Nicklas,  
 The Clayton Tower, 7751 Carondelet Ave.  
 [314] PA 5-7285

**James T. Hauptli** [415] DO 2-4600  
 Western Advertising Sales Manager

**Denver, Colo. 80202:** David M. Watson,  
 Richard W. Carpenter  
 Tower Bldg., 1700 Broadway  
 [303] 266-3863

**Los Angeles, Calif. 90017:** Ian C. Hill,  
 Bradley K. Jones, 1125 W. 6th St.,  
 [213] HU 2-5450

**Portland, Ore. 97204:** Don Farris,  
 James T. Hauptli, 218 Mohawk Building,  
 222 S.W. Morrison Street,  
 Phone [503] 223-5118

**San Francisco, Calif. 94111:** Don Farris,  
 James T. Hauptli, 255 California Street,  
 [415] DO 2-4600

**Paris:** Denis Jacob  
 17 Rue-Georges Bizet, 75 Paris 16, France  
 Tel 727 33 42, 727 33 60

**United Kingdom and Scandinavia**  
 London: Oliver Ball, Tel: Hyde Park 1451  
 34 Dover Street, London W1

**Milan:** Robert Saidel, Roberto Laureri Jr.  
 1 via Baracchini Phone 86-90-656

**Brussels:** Denis Jacob  
 27 Rue Ducale Tel: 136503

**Frankfurt/Main:** Hans Haller  
 Elsa-Brandstroem Str. 2  
 Phone 72 01 81

**Tokyo:** Noboru Matsumoto, McGraw-Hill  
 Publications Overseas Corporation,  
 Kasumigaseki Building 2-5, 3-chome,  
 Kasumigaseki, Chiyoda-Ku, Tokyo, Japan  
 [581] 9811

**Osaka:** Akihiko Kamesaka, McGraw-Hill  
 Publications Overseas Corporation, Kondo  
 Bldg., 163, Umegae-cho Kita-ku [362] 8771  
**Australasia:** Warren E. Ball, IPO Box 5106,  
 Tokyo, Japan

### Business Department

**Stephen R. Welss, Manager**  
 [212] 971-2044

**Thomas M. Egan,**  
 Production Manager [212] 971-3140

**Dorothy Carmesin, Contracts and Billings**  
 [212] 971-2908

**Frances Vallone, Reader Service Manager**  
 [212] 971-2865

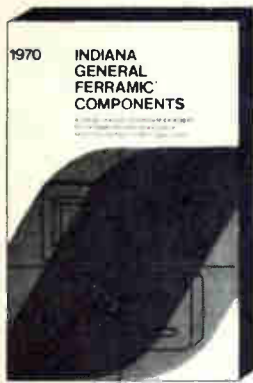

Even the best engineer can get lost on a hunt for Ferramic® components. That's why we wrote a new guide book.

The book combines two basic aids in one handy volume. In the locator section, you'll find the right component for most circuit design requirements. But when a circuit requirement doesn't fit the usual selection process, you can find additional information in section two. This part of the book is a basic text on ferrite design and technology. And it's all in the familiar terms of electronics, not magnetics.

Our new book can help you solve all but the most unusual ferrite circuit design problems. And when the book can't help, the people who wrote it can.

One way or the other, we'll help you survive the ferrite jungle.

For your free personal copy of *Ferramic Components*, write Indiana General, Electronic Products, Keasbey, N.J. 08832.

**indiana general**   
a division of Electronic Memories & Magnetics Corporation

## Don't venture into the ferrite jungle without our survival kit.

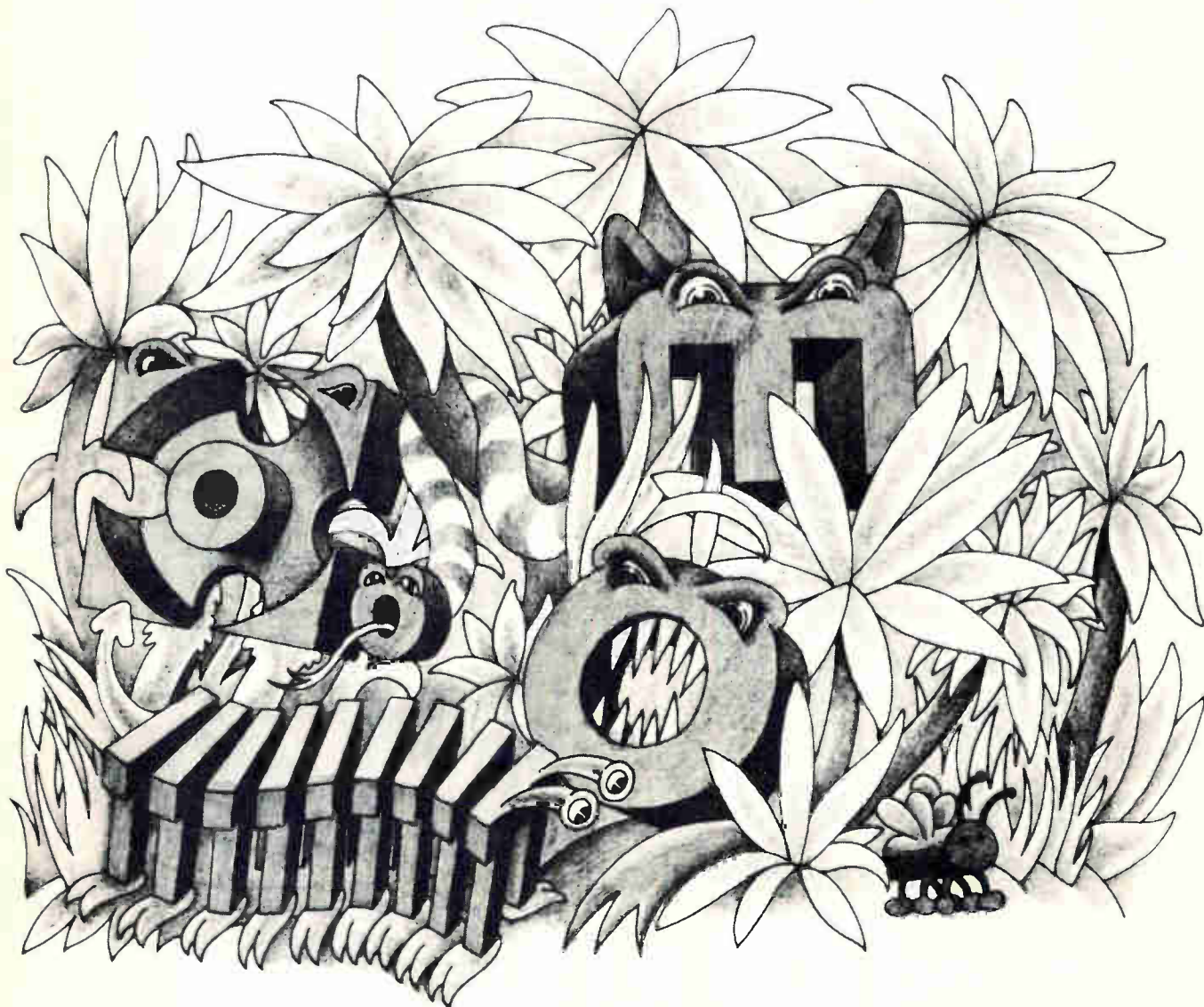

# Brazen Offer!

If you can come up with a PC fork and blade plate connector system that's more versatile than our 5420 system we'll make your "special" for the price of our "standard".

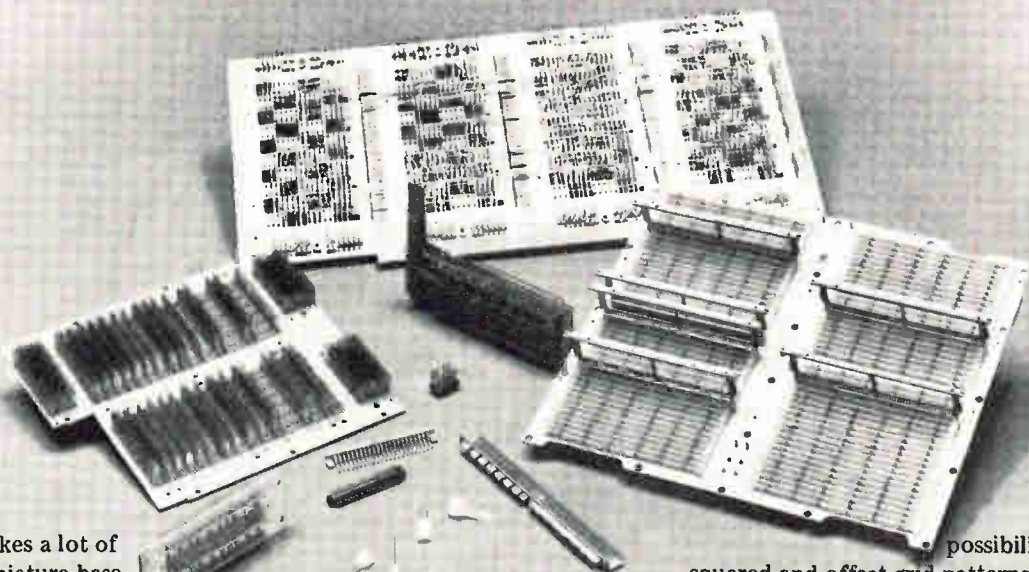

A bid like this takes a lot of guts and/or a miniature base plate connector system that's so versatile we're fairly sure we've got ourselves covered.

Our 5420 system has that kind of universality.

First off, consider the 5420's base plate components. Singles. Doubles. Males. Females. .025 square post. All of which can be spaced on .100", .125", or .150" centers. Okay?

Then there're the header components: 5420 has 50 contact headers for IC packages; heat sunked 40 contact headers standardized for SHP's; and modular headers for any other size.

And all the 5420's components provide the metal-to-metal contact required by MIL-E-5400. (No relation.)

If that's still not enough, multiply by the added

possibilities of both squared and offset grid patterns.

Now you're beginning to see what makes us so sure that our 5420 system will do the job even for the most cunning applications up with which you can come.

They're very much in step with NAFI's standard packaging concept, and versatile enough to take hundreds (make that thousands) of non-standard jobs neatly in their stride.

What we haven't said here we say in our catalog. Write for it. You'll find the 5420 specs on Page 14.

Elco Corporation, Willow Grove, Pennsylvania, 19090, (215) 659-7000, TWX 510-665-5573.

Or 2200 Park Place, El Segundo, California, 90245,

(213) 675-3311, TWX 910-325-6602.



**ELCO** Plate Connectors



# Electronics reader service

Use these handy post cards for more detailed information on: products advertised, new products, new literature.

Circle the number on the Reader Service post card that corresponds to the number at the bottom of the advertisement, new product item, or new literature in which you are interested.

Please print clearly. All written information must be legible to be efficiently processed.

If someone has beaten you to the post cards, you may obtain the needed information by writing directly to the manufacturer, or by sending your name and address, plus the Reader Service number, to Electronics Reader Service department.

All inquiries from outside the U.S. that cannot reach Electronics before the expiration dates noted on the Reader Service post card, must be mailed directly to the manufacturer. The manufacturer assumes all responsibilities for responding to inquiries. Electronics merely provides and clears requests for information from inquirer to manufacturer.

Correct amount of postage must be affixed for all mailings from outside the U.S.

### To subscribe to or to renew Electronics

Fill in the "For Subscriptions" area on the card if you desire to subscribe to or renew your present subscription to Electronics. Send no money. Electronics will bill you at the address indicated on the Reader Service post card.

### Multi-product advertisements

For information on specific items in multi-product advertisements which do not have a specific Reader Service number indicated write directly to manufacturer for information on precise product in which you are interested.

Warning: The Post Office now requires your ZIP CODE on all mail. Please include your ZIP CODE number when filling out your reply card.

16 For employment inquiries fill in home address. August 3, 1970 Card Expires October 3, 1970 14

Name \_\_\_\_\_ title \_\_\_\_\_

Company\* \_\_\_\_\_

Address \_\_\_\_\_

City \_\_\_\_\_ State \_\_\_\_\_ Zip Code \_\_\_\_\_

For Subscriptions  
 new  renewal  
 3 years \$16.00  
 1 year \$8.00

1	20	39	58	77	96	115	134	153	172	191	210	229	248	267	286	305	324	343	362	381	400	419	438	457	476	495	514	962
2	21	40	59	78	97	116	135	154	173	192	211	230	249	268	287	306	325	344	363	382	401	420	439	458	477	496	515	963
3	22	41	60	79	98	117	136	155	174	193	212	231	250	269	288	307	326	345	364	383	402	421	440	459	478	497	516	964
4	23	42	61	80	99	118	137	156	175	194	213	232	251	270	289	308	327	346	365	384	403	422	441	460	479	498	517	965
5	24	43	62	81	100	119	138	157	176	195	214	233	252	271	290	309	328	347	366	385	404	423	442	461	480	499	518	966
6	25	44	63	82	101	120	139	158	177	196	215	234	253	272	291	310	329	348	367	386	405	424	443	462	481	500	900	967
7	26	45	64	83	102	121	140	159	178	197	216	235	254	273	292	311	330	349	368	387	406	425	444	463	482	501	901	968
8	27	46	65	84	103	122	141	160	179	198	217	236	255	274	293	312	331	350	369	388	407	426	445	464	483	502	902	969
9	28	47	66	85	104	123	142	161	180	199	218	237	256	275	294	313	332	351	370	389	408	427	446	465	484	503	951	970
10	29	48	67	86	105	124	143	162	181	200	219	238	257	276	295	314	333	352	371	390	409	428	447	466	485	504	952	971
11	30	49	68	87	106	125	144	163	182	201	220	239	258	277	296	315	334	353	372	391	410	429	448	467	486	505	953	972
12	31	50	69	88	107	126	145	164	183	202	221	240	259	278	297	316	335	354	373	392	411	430	449	468	487	506	954	973
13	32	51	70	89	108	127	146	165	184	203	222	241	260	279	298	317	336	355	374	393	412	431	450	469	488	507	955	974
14	33	52	71	90	109	128	147	166	185	204	223	242	261	280	299	318	337	356	375	394	413	432	451	470	489	508	956	975
15	34	53	72	91	110	129	148	167	186	205	224	243	262	281	300	319	338	357	376	395	414	433	452	471	490	509	957	976
16	35	54	73	92	111	130	149	168	187	206	225	244	263	282	301	320	339	358	377	396	415	434	453	472	491	510	958	977
17	36	55	74	93	112	131	150	169	188	207	226	245	264	283	302	321	340	359	378	397	416	435	454	473	492	511	959	978
18	37	56	75	94	113	132	151	170	189	208	227	246	265	284	303	322	341	360	379	398	417	436	455	474	493	512	960	979
19	38	57	76	95	114	133	152	171	190	209	228	247	266	285	304	323	342	361	380	399	418	437	456	475	494	513	961	980

**Business reply mail**  
No postage stamp necessary if mailed in the United States

Postage will be paid by

**Electronics**  
**Reader service department**  
**Box 444**  
**Hightstown, N.J. 08520**

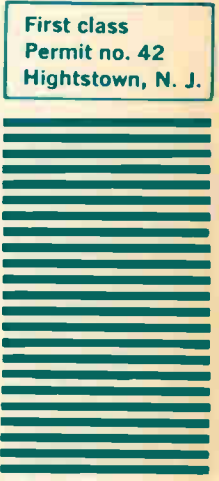

16 \*For employment inquiries fill in home address. August 3, 1970 Card Expires October 3, 1970 14

Name \_\_\_\_\_ title \_\_\_\_\_

Company\* \_\_\_\_\_

Address \_\_\_\_\_

City \_\_\_\_\_ State \_\_\_\_\_ Zip Code \_\_\_\_\_

For Subscriptions  
 new  renewal  
 3 years \$16.00  
 1 year \$8.00

1	20	39	58	77	96	115	134	153	172	191	210	229	248	267	286	305	324	343	362	381	400	419	438	457	476	495	514	962
2	21	40	59	78	97	116	135	154	173	192	211	230	249	268	287	306	325	344	363	382	401	420	439	458	477	496	515	963
3	22	41	60	79	98	117	136	155	174	193	212	231	250	269	288	307	326	345	364	383	402	421	440	459	478	497	516	964
4	23	42	61	80	99	118	137	156	175	194	213	232	251	270	289	308	327	346	365	384	403	422	441	460	479	498	517	965
5	24	43	62	81	100	119	138	157	176	195	214	233	252	271	290	309	328	347	366	385	404	423	442	461	480	499	518	966
6	25	44	63	82	101	120	139	158	177	196	215	234	253	272	291	310	329	348	367	386	405	424	443	462	481	500	900	967
7	26	45	64	83	102	121	140	159	178	197	216	235	254	273	292	311	330	349	368	387	406	425	444	463	482	501	901	968
8	27	46	65	84	103	122	141	160	179	198	217	236	255	274	293	312	331	350	369	388	407	426	445	464	483	502	902	969
9	28	47	66	85	104	123	142	161	180	199	218	237	256	275	294	313	332	351	370	389	408	427	446	465	484	503	951	970
10	29	48	67	86	105	124	143	162	181	200	219	238	257	276	295	314	333	352	371	390	409	428	447	466	485	504	952	971
11	30	49	68	87	106	125	144	163	182	201	220	239	258	277	296	315	334	353	372	391	410	429	448	467	486	505	953	972
12	31	50	69	88	107	126	145	164	183	202	221	240	259	278	297	316	335	354	373	392	411	430	449	468	487	506	954	973
13	32	51	70	89	108	127	146	165	184	203	222	241	260	279	298	317	336	355	374	393	412	431	450	469	488	507	955	974
14	33	52	71	90	109	128	147	166	185	204	223	242	261	280	299	318	337	356	375	394	413	432	451	470	489	508	956	975
15	34	53	72	91	110	129	148	167	186	205	224	243	262	281	300	319	338	357	376	395	414	433	452	471	490	509	957	976
16	35	54	73	92	111	130	149	168	187	206	225	244	263	282	301	320	339	358	377	396	415	434	453	472	491	510	958	977
17	36	55	74	93	112	131	150	169	188	207	226	245	264	283	302	321	340	359	378	397	416	435	454	473	492	511	959	978
18	37	56	75	94	113	132	151	170	189	208	227	246	265	284	303	322	341	360	379	398	417	436	455	474	493	512	960	979
19	38	57	76	95	114	133	152	171	190	209	228	247	266	285	304	323	342	361	380	399	418	437	456	475	494	513	961	980

# Reprint service

All Electronics editorial matter available in reprint form:

For reprints of special reports and feature articles see list on right side of this page. Send your order to Electronics Reprint Department at the address indicated. To expedite mailing of your order for single reprints please send cash, check or money order with your order. Allow 3-4 weeks for delivery.

Bulk reprints of editorial matter can be ordered from current or past issues. The minimum quantity is 100 copies. Prices quoted on request: call 212-971-6289, or write to address below.

Warning: The Post Office now requires your ZIP CODE on all mail. Please include your ZIP CODE number when filling out your reply card.

3

## Business reply mail

No postage stamp necessary if mailed in the United States

Postage will be paid by

**Electronics  
Reader service department  
Box 444  
Hightstown, N. J. 08520**

First class  
Permit no. 42  
Hightstown, N. J.



To order reprints or for further information, please write to: Electronics Reprint Department, 330 West 42nd Street, New York, N.Y. 10036.

To expedite mailing of your order for single reprints please enclose payment with your order.

You may order any of the below listed reprints by key number. Discounts on quantities over 10.

- Key no. R-01 Computer-aided Design: Part I, The Man-machine Merger. 16 pages. \$1.25.
- Key no. R-04 Multilayer Circuit Boards: Sharpening An Imperfect Art. 7 pages. 50¢.
- Key no. R-06 Report on Japanese Technology: Sony. 20 pages. 50¢.
- Key no. R-010 Special Report on Large Scale Integration. 54 pages. \$1.50.
- Key no. R-011 Medical Electronics (1967). 8 part series, 44 pages. \$1.25.
- Key no. R-012 Special Report on Gallium Arsenide 17 parts. 32 pages. \$2.00
- Key no. R-016 Special Report on The Transistor: Two Decades of Progress. 48 pages. \$1.50.
- Key no. R-017 Special Report on Ferrites. 16 pages. \$1.00.
- Key no. R-022 Active Filters: Part II, Varying the Approach. 8 pages \$1.00
- Key no. R-023 Special Report: Tomorrow's Communications. 32 pages \$1.75
- Key no. R-024 1969 Electronics Index to Technical Articles and Authors. Free
- Key no. R-025 Combined reprint of 1970 European and U.S. Markets Reports with two foldout charts. 62 pages \$1.75
- Key no. R-026 Consumer Hazards: Why they Happen, How they Can Be Fixed. 14 pages \$1.25

16 Please Print Clearly

August 3, 1970 Card Expires October 3, 1970 14

Name \_\_\_\_\_ title \_\_\_\_\_  
 Company \_\_\_\_\_  
 Address \_\_\_\_\_

For Subscriptions  
 new  renewal  
 3 years \$16.00  
 1 year \$8.00

1	20	39	58	77	96	115	134	153	172	191	210	229	248	267	286	305	324	343	362	381	400	419	438	457	476	495	514	533
2	21	40	59	78	97	116	135	154	173	192	211	230	249	268	287	306	325	344	363	382	401	420	439	458	477	496	515	534
3	22	41	60	79	98	117	136	155	174	193	212	231	250	269	288	307	326	345	364	383	402	421	440	459	478	497	516	535
4	23	42	61	80	99	118	137	156	175	194	213	232	251	270	289	308	327	346	365	384	403	422	441	460	479	498	517	536
5	24	43	62	81	100	119	138	157	176	195	214	233	252	271	290	309	328	347	366	385	404	423	442	461	480	499	518	537
6	25	44	63	82	101	120	139	158	177	196	215	234	253	272	291	310	329	348	367	386	405	424	443	462	481	500	519	538
7	26	45	64	83	102	121	140	159	178	197	216	235	254	273	292	311	330	349	368	387	406	425	444	463	482	501	520	539
8	27	46	65	84	103	122	141	160	179	198	217	236	255	274	293	312	331	350	369	388	407	426	445	464	483	502	521	540
9	28	47	66	85	104	123	142	161	180	199	218	237	256	275	294	313	332	351	370	389	408	427	446	465	484	503	522	541
10	29	48	67	86	105	124	143	162	181	200	219	238	257	276	295	314	333	352	371	390	409	428	447	466	485	504	523	542
11	30	49	68	87	106	125	144	163	182	201	220	239	258	277	296	315	334	353	372	391	410	429	448	467	486	505	524	543
12	31	50	69	88	107	126	145	164	183	202	221	240	259	278	297	316	335	354	373	392	411	430	449	468	487	506	525	544
13	32	51	70	89	108	127	146	165	184	203	222	241	260	279	298	317	336	355	374	393	412	431	450	469	488	507	526	545
14	33	52	71	90	109	128	147	166	185	204	223	242	261	280	299	318	337	356	375	394	413	432	451	470	489	508	527	546
15	34	53	72	91	110	129	148	167	186	205	224	243	262	281	300	319	338	357	376	395	414	433	452	471	490	509	528	547
16	35	54	73	92	111	130	149	168	187	206	225	244	263	282	301	320	339	358	377	396	415	434	453	472	491	510	529	548
17	36	55	74	93	112	131	150	169	188	207	226	245	264	283	302	321	340	359	378	397	416	435	454	473	492	511	530	549
18	37	56	75	94	113	132	151	170	189	208	227	246	265	284	303	322	341	360	379	398	417	436	455	474	493	512	531	550
19	38	57	76	95	114	133	152	171	190	209	228	247	266	285	304	323	342	361	380	399	418	437	456	475	494	513	532	551

1

## Business reply mail

No postage stamp necessary if mailed in the United States

Postage will be paid by

**Electronics  
Reader service department  
Box 444  
Hightstown, N.J. 08520**

First class  
Permit no. 42  
Hightstown, N. J.



SPECIAL REPRINT OFFER—75¢  
 Key no. R-026 The Seventies: super but seething. A 56-page business outlook prepared by McGraw-Hill's Business Week.

- Key no. R-79 MOS Integrated Circuits. 12 pages. 50¢.
- Key no. R-78 The Overlay Transistor. 15 pages. 50¢.
- Key no. R-64 Field Effect Transistors. Parts I, II, and III. 64 pages. \$1.00.

# New.

## high-current, high efficiency power supplies

Lambda's LB series high-current power supplies with up to 85% efficiency, up to 300 volts; up to 500 amps; less than 10 mV RMS ripple. Designed for main frames of computers, life-test equipment, aging racks and on-line testing.



**Up to 85% efficiency**  
**Low ripple**

10 mV rms max.

**Regulation**

line .05% + 6 mV

load 0.1% + 10 mV

**AC input**

208 ± 10% Vac; 57-63 Hz, 3 phase, 4 wire

**All silicon semiconductors**

for maximum reliability

**Convection cooled**

no blowers, no external heat sinks

**Overvoltage protection up to 70 Vdc**

standard on all models up to 60 Vdc

**Remotely programable**

**Remote sensing**

**Transformer**

designed to MIL-T-27C Grade 6

**Completely protected**

short circuit proof. Continuously adjustable automatic current limiting.

**Constant voltage/constant current**

by automatic crossover

**Temperature coefficient**

0.03% + 0.5 mV/°C

**Series/parallel operation**

LB SERIES, METERED, FULL-RACK SIZE: 7" x 19" x 20 1/16"

Model	Voltage Range	Max. Current (Amps) at Ambient of: (1)				Price(2)
		40°C	50°C	60°C	71°C	
LB-701-FM-OV	0-7.5	300	270	235	200	\$1,500
LB-702-FM-OV	0-15	180	170	160	150	1,500
LB-703-FM-OV	0-36	80	75	70	65	1,400
LB-704-FM-OV	0-60	50	47	44	40	1,400
LB-705-FM	0-125	25	22	19	16	1,400
LB-706-FM	0-300	10	9.5	9.0	8.0	1,400

LB SERIES, METERED, FULL-RACK SIZE: 12 1/4" x 19" x 22 1/16"

Model	Voltage Range	Max. Current (Amps) at Ambient of: (1)				Price(2)
		40°C	50°C	60°C	71°C	
LB-721-FM-OV	0-7.5	500	450	400	350	\$2,700
LB-722-FM-OV	0-15	300	265	225	180	2,700
LB-723-FM-OV	0-36	135	130	125	120	2,500
LB-724-FM-OV	0-60	80	75	70	65	2,500
LB-725-FM	0-125	40	36	32	28	2,500
LB-726-FM	0-300	16	15	14	13	2,500

NOTES:

1. Current rating applies over entire voltage range.
2. Prices include meters. LB Series models are not available without meters. Prices for all models up to and including 60 Vdc include built-in overvoltage protection. Prices are FOB Melville, New York. Prices and specifications are subject to change without notice.

 **LAMBDA**  
ELECTRONICS CORP.  
A  Company

515 Broad Hollow Road, Melville, L.I., New York 11746. Telephone: 516-694-4200. TWX: 510-224-6484. CABLE: LAMBDATRON, MELVILLE, N.Y.

Lambda has over 10,000 power supply units on-the-shelf for 1-day delivery. Every one fully guaranteed for 5 years . . . material and labor.

See us at WESCON Booth 1007

Circle 901 on reader service card

The same pricing advantage holds true for RCA's 2N5038—at \$6.25. (Prices of 2N5039 and its companion type are based on 1000-unit purchases. These prices go down as your volume requirements go up.) For the full story, call your local RCA Representa-

tive or your RCA Distributor. For technical data, write: RCA, Commercial Engineering, Section 70 H-3/UT10, Harrison, New Jersey 07029. International: RCA 2-4 rue du Lièvre, 1227 Geneva, Switzerland, or P. O. Box 112, Hong Kong.

# RCA

## 2N5039... switches off 15 A in less than 250 ns at \$4.90

